

Billboard 1979-1980

international buyer's guide



SECTION TWO
SEPTEMBER 29, 1979

All we asked you to do was listen...

Thanks,



Infinity Records

100 Universal Plaza
Universal City, Ca. 91608
(213) 763-8283

2450 Victoria Park Avenue
Willowdale, Ontario, Canada M2J4A2
(416) 491-7770

10 East 53rd St.
New York, N.Y. 10022
(212) 888-9700

1 Great Pultney St.
London W 1, England
01-439-9951

DISTRIBUTED BY MCA DISTRIBUTING CORPORATION

World Radio History

international buyer's guide

EDITORIAL

Publisher & Editor-in-Chief: Lee Zhitto (LA)

DIRECTORY STAFF

Editor: Earl Paige. Assistant Editor: Susan Peterson. Manager of Directory Services: Bob Hudoba. Assistant Manager of Directory Services: Jon Braude. Directory Associates: Roy Crosthwaite, Rand Rugeberg, Joan Elsener, Kathy Poff and Andrew Balterman. European Listings: Under Mike Hennessey, European Editorial Director, and Vera Madan, Assistant.

ART DIRECTION

J. Daniel Chapman: J.D.C. A.D.; Cheryl Sholund, production design; Ivo Gomez, metal sculpture; and Tim Carney.

EXECUTIVE EDITORIAL BOARD

Is Horowitz, Earl Paige, John Sippel, Eliot Tiegel, Stephen Traiman, Lee Zhitto

NEWS BUREAUS & REGIONAL OFFICES

Offices: **Chicago**—150 N. Wacker Dr., Ill. 60606, 312 236 9818. Editorial Staff: Alvin Penchansky, Bureau Chief & Classical Editor. **Cincinnati**—2160 Patterson St., 45214 Ohio, 513 381 6450. **Los Angeles**—9000 Sunset Blvd., Calif. 90069, 213 273-7040. Eliot Tiegel, Managing Editor; Editorial Staff: Dave Dexter, Copy Editor; Ed Harrison, Campus & Record Reviews Editor, Jim McCullough, Recording Studios Editor; John Sippel, Marketing Editor, Jean Williams, Talent Editor, Reporters, Paul Grein, Cary Darling. **London**—7 Carnaby St. W1V 1PG, 439-9411. Editorial Staff: Mike Hennessey, European Director, Peter Jones, U.K. News Editor. **Milan**—Piazzale Loreto 9, Italy, 28-29-158. Editorial Bureau Chief: Germano Ruscitto. **Nashville**—1509 Laurel St., Tenn. 37202, 615 748-8100. Editorial Staff: Gerry Wood, Bureau Chief & Country Editor. Reporters: Mike Hyland, Kip Kirby. **New York**—1515 Broadway, New York 10036, 212 714-7300. Editorial Staff: Is Horowitz, Bureau Chief & Commentary Editor; Doug Hall, Radio-TV Programming Editor; Radcliffe Joe, Disco Editor; Irv Lichtman, Publishing Editor, Dick Nusser, Assistant Disco Editor; Stephen Traiman, Tape/Audio/Video Editor; Adam White, International Editor. Reporters: Roman Kozak. **Washington**—733 15th St., N.W., D.C., 20005, 202 783-3282. Editorial Bureau Chief: Jean Callahan.

SPECIAL ISSUES

Earl Paige, Editor; Susan Peterson, Assistant Editor; Bob Hudoba, Directory Services Manager; Jon Braude, Assistant Directory Manager.

FOREIGN CORRESPONDENTS

Austria—Manfred Schreiber, 1180 Wien VIIH, Kreuzgasse 27 43-40-974
Australia—Glen Baker, P.O. Box 261, Baukham Hills, 2153 New South Wales
Belgium—Juil Anthonissen, 27A Oude Godstraat, 3100 Heist op den Berg 015 241953
Canada—David Farrell, 78 Mayfield Ave., Toronto, Ontario, 416-766-5978
Czechoslovakia—Dr. Lubomir Dourzka, 14 Zeleny Pruh 147 00 Prana 4 Brank 26 16-08
Denmark—Knud Orsted, 22 Tjornevej, DK 3070 Snekersten, Denmark 0062 01 31 30-76 01-31 30-76
Dominican Republic—Fran Jorge, PO Box 772, Santo Domingo
Finland—Kari Helopaltio, SF-01860 Perttula, Finland, 27-18-36
France—Henry Kahn, 16 Rue Clauzel, 75009 Paris, France 878-4290.
Greece—Lefty Kongalides, Hellinikos Vorras, Thessaloniki, Greece 416621. John Carr, Kan sanias 26 28, Athens 610
Holland—Willem Hoos, Bilderdijlhaan 28, Hilversum 035 43137
Hong Kong—Hans Ebert, 1701-2 Wah Kwong Bldg., Wanchan 5-226221.
Hungary—Paul Gyongy, Derektuca 6, 1016 Budapest, Hungary 859-710
Ireland—Ken Stewart, 56 Rathgar Road, Dublin 6, Ireland 97 14 72
Israel—Uri Alony, 3 Many Shochat St., Roshon le Zion, 997 532.
Italy—Daniele Caroli, Viale Marche 21, 20125 Milano 6083412 Paul Bompard, V.a Gramsci 54, 00197 Rome 360-0761
Malaysia—Christie Leo, No. 31 Jalan Riong, Kuala Lumpur, 209,049
Mexico—Marv Fisher, Apartado Postal 11-766, Mexico 11, D.F. 905 531 3907
New Zealand—Phil Gifford, 156 Upper Harbor Dr., Greenhithe, Auckland 413 9260
Norway—Randi Hultin, Norsk Hydro, Bygdoy Alle 2, Oslo 2, Norway 02 56 41-80
Poland—Roman Waschko, Magiera 9m 37, 01-873 Warszawa, 34-36-04.
Portugal—Fernando Tenente, R. Sta. Helena 122 R/c, Oporto.
Romania—Octavian Ursulescu, Str. Radu de la La Afumatini 57-B Sector 2, Bucharest D.P. 9 13 46-10, 16 20 80
Singapore—Peter Ong, 390 Kim Seng Road 374488.
South Africa—Don Albert, 21 5th Ave., Highlands N. 2192, Johanne-burg 011 40 6963.
Spain—Fernando Salaverri, San Bernardo 107, Madrid 15 446-20 04.
Sweden—Leif Schulman, Brantingsgatan 49, 4 tr. 115 35 Stockholm 08 629-873.
Switzerland—Pierre Haesler, Hasenweld 8, CH-4600 Olten, 062-215*09
Uruguay—Carlos A. Martins, Panama 1125 Ap 908, Montevideo
U.S.S.R.—Vadim D. Yurchenkov, 14 Rubinstein St., Ap. 15 Leningrad, 191025 15 33 41.
West Germany—Wolfgang Spahr, 236 Bed Segeberg, An der Trave 67 b, Postfach 1150 04551 81428.
Yugoslavia—Mitja Volcic, 61 351 Brezovica, Ljubljana 061 23-522

SALES

Sales Director: Tom Noonan (L.A.)

Natl Sales Manager: Ron Willman (N.Y.)
 U.K./European Sales Coordinator: Graham Lockart (London).
 European Sales Consultant: Andre De Vekey (London).
 Classified Advertising Manager: Murray Dorf (N.Y.)

REGIONAL OFFICES

Chicago—Jim Bender.
Los Angeles—Joe Fleischman, Harvey Geller, Jeri Logan
Nashville—John McCartney.
New York—Mickey Addy, Norm Berkowitz, Ron Carpenter, Michael Littleford.

INTERNATIONAL SALES

Australasia, Southeast Asia—Gary Day, Radel Consultants Ltd., 3 Downes Ave., Brighton, Victoria 3186, Australia 03 596-1251.
Austria, Benelux, France, Germany, Greece, Portugal, Scandinavia, So. Africa, Spain & Switzerland—contact U.K. office.
Great Britain—Charlene Burns, Colin Caffell, 7 Carnaby St., London W1V 1PG, 439-9411.
Italy—Germano Ruscitto, Piazzale Loreto 9, Milan 28-29-158.
Japan—Hugh Hishikawa, Billboard, 4th Floor, Utsunomiya Building, 19-16, Jingunae, 6-Chome, Shibuya-Ku, Tokyo, 150, Japan, (03) 498-4641.
Mexico—Marv Fisher, Apartado Postal 11 766, Mexico 11, D.F. 905 531-3907.

MARKETING SERVICES

Director of Marketing Services and Chart Director: Bill Wardlow (L.A.)

BILLBOARD PUBLICATIONS, INC.

Associate Publishers: Tom Noonan, Bill Wardlow.
 Business Affairs Director: Gary J. Rosenberg.
 Circulation: Jane Hoffman.
 Conference Director: Diane Kirkland.
 Chart Manager: Jim Muccione.
 Managing Director Billboard Ltd. U.K./European: Frederick C. Marks.
 Production Manager: John Halloran.
 Assistant Production Manager: John Wallace.
 Production Coordinators: Ron Frank, Tom Quilligan.
 Promotion Director: Joshua C. Simons.
 Chairman: W.D. Littleford. Executive Vice President: Jules Perel. Senior Vice President: Mort L. Nasatir. Broadcast Operations: Gerald S. Hobbs, Art/Design Group. Vice President, Treasurer: William H. Evans, Jr. Vice Presidents: Lee Zhitto, Billboard Operations; Walter J. Heaney, Amusement Business Group; Patrick Keleher, Music In The Air, Direct Marketing; William F. Fahy, Circulation; Mary C. McGoldrick, Personnel; Maxwell A. Biller, Cincinnati Operations. Secretary: Ernest Lorch. Corporate Managers: Charles Rueger, Publishing Services; Charles Buckwaller, Marketing Services. Controller: Donald C. O'Dell; Assistant Controller: Michael T. Dooley. Subscription rates payable in advance. One year, \$110 in U.S.A. (except Alaska, Hawaii, Puerto Rico, Canada). Other rates on request. Allow 3 to 6 weeks delivery first copy. Published weekly. Second class postage paid at New York, N.Y. and additional mailing offices. Postmaster send Form 3579 to Subscription Manager, Billboard, Box 2156, Radnor, Pa. 19089. © Copyright 1979 by Billboard Publications, Inc. The company also publishes in New York: American Art & Antiques, American Artist, Interiors, International Society of Artists, Painting Holidays, Photo Weekly, Residential Interiors, Watson-Guipill Publications, Amphoto, Whitney Library of Design, American Artist Book Club, Designers Book Club, Camera Arts Book Club, Music In The Air; Los Angeles: Billboard; Nashville: Amusement Business, Billboard Broadcasting Corp. (WLAC-AM, WKQB-FM); London: World Radio TV Handbook, The Artists Book Club.

Copyright 1979 Billboard Publications, Inc. All rights reserved. This work may not be copied or reproduced in any form (including but not limited to microfilm), stored in a retrieval system of transmitted in any form or by any means, electronic, mechanical, photocopying recording, or otherwise, without the prior permission of the publisher.

Billboard Publications, Inc., 9000 Sunset Blvd., Los Angeles, Calif. 90069 213 273-7040. Cable: Billboard LA; L.A. Telex: 698669; N.Y. Telex: 710581-6279.

Founded 1894



CONTENTS

U.S. LISTINGS 13

RECORD COMPANIES 13

MUSIC PUBLISHERS 46

SHEET MUSIC 86

WHOLESALE 88

Distributors One-Stops Rackjobbers Importers & Exporters

SERVICES 138

Associations & Professional Organizations	138
Design, Artwork, Printing & Lithographing	139
Licensing Organizations, Music	143
Licensors, Record & Tape	144
Plating, Processing & Pressing Plants	145

Record Promotion	151
Tape Custom Duplicators/Tape Packaging & Labeling.....	155
Tape Duplicator/Marketers	160
Entertainment Lawyers	161

SUPPLIES 164

Cartridge & Cassette Parts Manufacturers	164
Empty Cartridge, Cassette & Reel Manufacturers.....	166
Envelopes & Mailers	168
Jackets & Sleeves.....	169
Labels.....	171
Polyethylene Bags.....	172
Raw Materials Manufacturers/Importers	174

Record Processing Equipment Manufacturers/Importers	174
Tape, Blank Loaded, Manufacturers.....	175
Tape, Bulk Raw, Manufacturers.....	182
Tape Duplicating & Processing Equipment Manufacturers/Importers.....	188
Tape Packaging & Labeling Equipment Suppliers & Manufacturers	194
Tape, Professional Supplies, Manufacturers	197

ACCESSORIES 208

MERCHANDISING 219

JUKEBOX 221

INTERNATIONAL 222

Argentina.....	222	Egypt.....	262	Italy	308	Romania.....	367
Australia.....	224	El Salvador.....	263	Ivory Coast.....	327	Singapore.....	368
Austria.....	230	England,		Jamaica.....	328	South Africa, Republic Of	369
Bahamas.....	233	see United Kingdom		Japan	328	Spain.....	372
Belgium.....	233	Finland	263	Kenya	345	Sudan.....	376
Bermuda	237	France.....	265	Lebanon.....	345	Surinam.....	376
Bolivia	237	German Democratic		Malaysia.....	346	Sweden	376
Brazil	237	Republic (East)	276	Mexico	348	Switzerland.....	382
Bulgaria.....	240	German Federal		Netherlands.....	353	Taiwan, see China	
Canada	240	Republic (West)	276	New Zealand.....	359	(Republic Of)	
Chile.....	253	Greece	300	Nicaragua.....	360	Thailand	385
China, Republic Of	254	Guatemala	302	Nigeria.....	360	Trinidad & Tobago	386
Colombia	255	Holland, see Netherlands		Norway	360	Turkey.....	386
Costa Rica	256	Hong Kong.....	302	Pakistan.....	362	USSR.....	387
Cyprus.....	257	Hungary	303	Panama.....	362	United Kingdom	387
Czechoslovakia.....	257	Iceland.....	305	Peru	363	Uruguay.....	418
Denmark.....	257	India.....	305	Philippines.....	364	Venezuela.....	419
Dominican Republic.....	261	Ireland.....	305	Poland.....	366	Virgin Islands.....	420
Ecuador.....	262	Israel.....	307	Portugal	366	Yugoslavia.....	420

LOOKING FORWARD

TO
ANOTHER
GREAT
YEAR.

MCA RECORDS

SALES ANALYSIS

U.S. \$4 BILLION PACES WORLD SALES

The U.S. prerecorded music market continues to pace world sales though it reflects dramatic shifts during the 1978 study period, most noticeably in the rise of cassette sales.

U.S. manufacturers' sales of recordings in 1978 show an 18% upsurge in retail list value hitting \$4.131 billion compared to \$3.5 billion in 1977 reflecting in part the rise to \$8.98 pricing.

However, were it not for tape unit sales, the unit sales barometer would have not remained on the up side. U.S. unit sales are up only 4% and LP unit sales actually slipped 1%.

Cassette, coming on strong in recent years with a 70% unit sales burst in 1977, continued with 1978 up 66% in units to 61.3 million units from 36.9. Thus, cassette drew closer to 8-track where the U.S. now remains as the only significant market. U.S. 8-track sales were up 5% in units for 1978. Cassette to 8-track ratio in 1978 was 2:1 compared to 4:1 a year prior and 6:1 six years ago.

In other highlights of world market sales, reported elsewhere, Japan and West Germany continue a competitive pace. To offset currency fluctuations, these world sales charts are now expressed in unit sales primarily focusing on LPs. This barometer shows West Germany gaining 14 million units during 1978 and Japan slightly over one million. The U.K. is up four million in LP unit sales.

UNIT SALES ANALYSIS

	Dollar Volume	% Change From '77	Units Sales	% Change From '77
LPs	2,473.3	13%	341.3	-1%
Singles	260.3	6.2%	190	0 ¹
8-tr.	948	17%	133.6	5% ²
Cassettes	449.8	80%	61.3	66%

¹ Approximately 5% 12-inch singles

² 8-track/cassette ratio 2:1 vs. 4:1 in 1977

Source: RIAA (all figures in millions)

1978 SALES BY REPERTOIRE

TYPE OF PRODUCT	% OF DOLLAR VOLUME
Rock	41.7%
Pop	13.1%
Country	10.2%
Disco	9.0%
Soul	8.5%
Middle of the Road	5.0%
Jazz	3.8%
Classical	3.4%
Children's	2.6%
Comedy	1.3%
Other (includes spoken word, ethnic, language)	1.4%
Budget/Economy Priced Product	8.0% ¹

¹ Of total gross dollar volume Source: NARM

U.S. RECORDING SALES 1978-25

Year	Sales \$ Millions	% Change
1978	\$4131	18.00%
1977	3500	27.9%
1976	2737	16.0%
1975	2360	7.3%
1974	2200	9.1%
1973	1436	4.0%
1972	1383	10.6%
1971	1251	5.8%
1970	1182	1.0%
1969	1170	4.1%
1968	1124	6.9%
1967	1051	9.6%
1966	959	11.3%
1965	862	13.7%
1964	758	8.6%
1963	698	1.6%
1962	687	7.3%
1961	640	6.7%
1960	600	-0.5%
1959	603	18.0%
1958	511	11.1%
1957	460	22.0%
1956	377	36.1%
1955	277	30.0%
1954	213	-2.7%
1953	219	2.3%
1952	214	7.5%
1951	199	5.3%
1950	189	9.2%
1949	173	-8.5%
1948	189	-15.6%
1947	224	2.8%
1946	218	100%
1945	109	65.2%
1944	66	N.C.
1943	66	20%
1942	55	7.8%
1941	51	6.3%
1940	48	9.1%
1939	44	69.2%
1938	26	100%
1937	13	18.2%
1936	11	22.2%
1935	9	22.2%
1934	7	16.7%
1933	6	-45.5%
1932	11	-38.9%
1931	18	-60.9%
1930	46	-38.7%
1929	75	2.7%
1928	73	4.3%
1927	70	N.C.
1926	70	18.6%
1925	59	-13.2%

Source: Record Industry Association of America. Excise tax payments, estimates from other data.

sales by configuration

U.S. LP AND SINGLES SALES FOR 1970s

	1978	%	%	1977	%	%	1976	%	%	1975	%	%	1974	%	%	1973	%	%	1972	%	%	1971	%	%	1970	%	%
	\$	Change	Dist.	\$	Change	Dist.	\$	Change	Dist.	\$	Change	Dist.	\$	Change	Dist.	\$	Change	Dist.	\$	Change	Dist.	\$	Change	Dist.	\$	Change	Dist.
LPs	2,473.3	13.0	91	2,195.1	32	90	1,663	11.9	87.2	1,485	0.5	89.0	1,356	8.8	87.5	1,246	3.6	87.8	1,203	10.8	87.0	1,086	6.8	86.8	1,017	2.2	86.0
Singles	260.3	6.2	9	245.1	0	10	245	16.0	12.8	183	-5.7	11.0	194	2.1	12.5	190	5.6	13.2	180	9.1	13.0	165	0	13.2	165	-5.7	14.0
Total Sales	2,733.6	12.0	100	2,440.2	27.9	100	1,908	14.4	100.0	1,668	7.6	100.0	1,550	7.9	100.0	1,436	3.8	100.0	1,383	10.6	100.0	1,251	5.8	100.0	1,182	1.0	100.0

All figures in millions

SOURCE: RIAA

TAPE BY CONFIGURATION FOR 1970s

	1978	%	%	1977	%	%	1976	%	%	1975	%	%	1974	%	%	1973	%	%	1972	%	%	1971	%	%	1970	%	%
	\$	Change	Dist.	\$	Change	Dist.	\$	Change	Dist.	\$	Change	Dist.	\$	Change	Dist.	\$	Change	Dist.	\$	Change	Dist.	\$	Change	Dist.	\$	Change	Dist.
8-Track	948.0	17.0	68	811	19.6	76.5	678.0	16.3	81.8	583.0	6.2	84.2	549.2	12.3	84.5	489	15.1	84.1	425	10.4	78.6	385	1.8	78.4	378	26.0	79.1
Cassettes	449.8	80.0	32	249.6	71.3	23.5	145.7	47.5	17.6	98.8	13.3	14.3	87.2	14.7	13.4	76	25.5	13.1	102	6.3	18.9	96	24.7	19.5	77	2.7	16.1
Reel to Reel	-	-	-	-	-	-	-	-	-	2.0	-23.4	.3	2.6	-35.0	.4	4	-50.0	.7	8	-33.3	1.5	12	-33.3	2.4	18	-10.0	3.8
4" & Others	-	-	-	-	-	-	-	-	-	-	-	-	-	-	-	-	-	-	-	-	-	-	-	-	5	-76.2	1.0
Quad 8T & Reel	-	-	-	-	-	-	5.1	-37.8	.6	8.2	-27.4	1.2	11.3	-5.8	1.7	12	100.0	2.1	6	-	1.0	-	-	-	-	-	
Total Sales	1,397.8	32.0	100	1,060.6	15.9	100	828.8	19.8	100.0	692.0	6.4	100.0	650.3	11.9	100.0	581	7.4	100.0	541	9.7	100.0	493	9.7	100.0	478	14.9	100.0

All figures in millions

SOURCE: RIAA

PRERECORDED MUSIC SALES FOR 1970s

	1978	%	%	1977	%	%	1976	%	%	1975	%	%	1974	%	%	1973	%	%	1972	%	%	1971	%	%	1970	%	%
	\$	Change	Dist.	\$	Change	Dist.	\$	Change	Dist.	\$	Change	Dist.	\$	Change	Dist.	\$	Change	Dist.	\$	Change	Dist.	\$	Change	Dist.	\$	Change	Dist.
Records	2,733.6	12.0	66	2,440.2	27.9	69.7	1,908	14.4	69.7	1,668	7.6	70.7	1,550	7.9	70.5	1,436	3.8	71.2	1,383	10.6	71.9	1,251	5.8	71.7	1,182	1.0	71.2
Tapes	1,397.8	32.0	34	1,060.6	15	30.0	829	19.8	30.3	692	6.5	29.9	650	11.9	29.5	581	7.4	28.8	541	9.7	28.1	493	3.1	28.3	478	14.9	28.8
Total Sales	4,131.4	18.0	100	3,500.8	27.9	100	2,737	15.9	100.0	2,360	7.3	100.0	2,200	9.1	100.0	2,017	4.8	100.0	1,924	10.3	100.0	1,744	5.1	100.0	1,660	4.7	100.0

All figures in millions

SOURCE: RIAA

PLAYBACK

RADIO 1979-1971

YEAR	AM STATIONS	FM STATIONS
1979	4526	4016
1978	4510	3903
1977	4497	3676*
1976	4471	3511
1975	4445	3299
1974	4395	3135
1973	4382	2965
1972	4374	2775
1971	4343	2624

*1148 stereo

SOURCE: Television Factbook, F.C.C.

TOTAL U.S. MARKET OF SELECTED CONSUMER ELECTRONIC PRODUCTS

(Estimated in Millions of Dollars)

End Of Year	Auto Radios	Tape Equipment	Components	Radios			
1978							
\$9,303	582	1,975	1,143	485			
1977							
\$8,119	534	1,388	1,275	509			
1976							
\$6,849	497	1,120	1,027	398			
1975							
\$4,955	355	687	652	369			
1974							
\$6,274	370	886	704	559			
1973							
\$6,934	391	998	702	572			
		1973	1974	1975	1976	1977	1978
Monochrome TV Receivers	\$ 560	\$ 543	\$ 371	\$ 528	\$ 542	\$ 572	
Color TV Receivers	3,097	2,658	2,121	2,860	3,269	3,736	
Phonographs	614*	554*	400*	491*	602	810	

Totals above include television set sales

*Revised estimates.

†Data reflects products produced or purchased by U.S. manufacturers plus those products imported directly by distributors or dealers for resale.

SOURCE: Consumer Electronics 1978 Annual Review

U.S. PHONOGRAPH SALES

(Add 000 to figures)

YEAR	PORTABLE AND TABLE (Includes Compact and Component Systems)		CONSOLE		TOTAL	
	UNITS	DOLLARS	UNITS	DOLLARS	UNITS	DOLLARS
1978	4,116	650,000	682	160,000	4,798	810,000
1977	3,027	418,000	735	184,000	4,362	602,000
1976	3,021	145,000	654	172,000	3,855	491,000*
1975	2,641	133,000	523	132,000*	3,164	400,000*
1974	3,942	212,000	865	186,000	4,807	554,000*
1973	5,234	314,000	901	188,000	6,135	614,000*
1972	6,279	392,000	928	185,000	7,207	649,000*
1971 ²	4,972	216,000	1,062	209,000	6,034	425,000
1970 ¹	4,572	160,000	1,048	216,000	5,620	376,000
1969	4,958	200,000	1,362	190,000	6,320	490,000
1968	4,925	184,000	1,570	319,000	6,495	503,000
1967	5,134	173,000	1,492	307,000	6,626	480,000
1966	4,504	181,000	1,799	347,000	6,303	528,000
1965	4,363	175,000	1,767	330,000	6,130	505,000
1964	3,455	146,000	1,704	294,000	5,159	440,000
1963	3,474	143,000	1,668	278,000	5,142	421,000
1962	3,329	137,000	1,625	252,000	4,954	389,000
1961	2,538	109,000	1,451	195,000	3,989	304,000
1960	3,075		1,448		4,523	359,000
1959	2,917		1,387		4,304	339,000
1958	2,758		1,215		3,973	259,000
1957	3,402		1,256		4,658	240,000

*Revised

¹ Prior to 1971, data reflect factory sales by U.S. manufacturers plus those products imported directly by distributors or dealers for resale.

² 1971 and years following data reflect products produced or purchased by U.S. manufacturers plus those products imported directly by distributors or dealers for resale.

SOURCE: Consumer Electronics 1978 Annual Review

HISTORICAL REVIEW

RECORDED MUSIC REVIEW 1979-1877

1979	Label mergers and the energy/economy crunch rocked the industry just coming off an all-time 1978 sales surge that saw U.S. prerecorded volume shoot past \$4 billion. Major mergers: Paramount acquires 50% of EMI's music operations (earlier, Capitol Industries-EMI had acquired UA); Ariola-Eurodisc planned to acquire Arista; RCA acquired A&M distribution; and MCA acquired ABC.	Formation of Capitol Records.	1942
1978	As \$7.98 becomes the standard U.S. list price, sales leap past \$3.5 billion in a recording boom that taxes the nation's pressing facilities. Movie soundtracks enjoy renewed popularity, and combined with the continuing disco rage, boost "Saturday Night Fever" to record-breaking sales levels. Digital recording enters the scene and video gains wider acceptance despite format confusion.	Record industry charts bow in Billboard. In Germany superior magnetic tape recorders are produced.	1940
1977	New Revised Copyright Law passes, the first since 1909. Direct-to-disk recording is revived. Visually-pleasurable concept in retail arrives, and death of Elvis Presley rocks industry.	First experimental FM goes on air.	1939
1976	Disco breaks as potent promotion and sales source. Columbia Records hints of higher-priced super act releases.	Popularity of jukeboxes boosts industry.	1936
1975	Spiraling inflation raises singles prices from \$1 to \$1.29, LPs and tapes jump \$1. Budget lines disappear from majors, replaced by \$4.98 lines of steady catalog sellers. Record/tape retail chains proliferate.	American Decca is launched. A record-player-radio combination is marketed inexpensively by RCA Victor.	1934
1974	Continuing material shortages elevate production costs by 35% for singles and 60% for LPs.	EMI forms through Gramophone Co. and Columbia Graphophone merger. First 33 1/3 long-playing record demonstrated by RCA.	1931
1973	Surge of state antipiracy statutes cuts illicit tape flow.	Depression adds to record industry decline but radio turns more and more to recordings.	1930
1972	RCA, Japan Victor Co. and Panasonic debut 4-channel discrete disk system. Sound recordings afforded greater federal protection against piracy.	Victor purchased by RCA. Warner Bros. buys Brunswick Radio Corp.	1929
1971	CBS/Sony preview the "SQ" disk, a compatible 4-channel disk system. First international conference on video recording (VIDCA).	Brunswick's all-electric Panatropie bows. Columbia and Victor issue electrical recordings.	1925
1970	Compatible 4-channel 8-track cartridge system, Quad-8, introduced by RCA and Motorola.	Record boom shows due to radio. Electrical recording perfected by Bell Laboratories.	1924
1969	Trend toward bigness on all levels of the music business with all areas involved in the merger game.	First commercial radio broadcast over WEAf, N.Y..	1920
1967	Manufacturers raise monaural prices to stereo level as major step in creation of all-stereo industry.	Victor releases first jazz record by Original Dixieland Jass Band, and the first Leopold Stokowski/Philadelphia Orchestra recording.	1917
1966	Breakthrough of tape cartridge.	Cylinder abandoned, many new labels formed.	1912
1965	U.S. excise tax on records rescinded.	Odeon issues first large-scale orchestral recordings.	1909
1964	U.S. record sales hit all-time high with Beatles invasion and great gains in LP sales.	Victrola, first enclosed-horn phonograph, appears.	1906
1962	Summer season one of best in history for singles. Racks register 24% gain over 1961.	First double-sided records issued by Odeon. Caruso becomes exclusive Victor artist.	1904
1961	FM stereo gets FCC okay; racks show gains.	First royalty system for compensation of recording artists. In Berlin, formation of International Talking Machine Co. (Odeon).	1903
1960	Stereo booms to offset singles dip. ("Persuasive Percussion" scores big.)	Columbia and Victor share patent on disk recordings, and cylinder drops from favor. Enrico Caruso records opera for the Gramophone Co..	1902
1959	LP sales surge ("Flower Drum Song," "Peter Gunn," "Kingston Trio At Large").	Marketing of disk recordings moves ahead with formation of Victor Talking Machine Co.	1901
1958	First stereo LPs.	Columbia Phonograph Co. opens London office.	1900
1956	First appearance of high quality stereophonic tape recordings. Elvis craze booms.	Deutsche Grammophon Gesellschaft, oldest record manufacturing company, established in Hanover.	1899
1955	Columbia starts record club, while other companies cut LP prices.	International expansion starts with American Graphophone's London office.	1897
1954	"Sh-Boom" by Crew-Cuts heralds dawn of rock n' roll, "Rock Around The Clock" is out, but sleeps a year.	National Phonograph Co. formed by Edison, manufacturing and distributing spring-driven phonographs for homes.	1895
1952	RIAA founded.	Berliner manufactures gramophones and disks in Washington, D.C. while Pathe brothers in France manufacture phonographs and cylinders.	1894
1950	78 r.p.m. sales dwindle as RCA announces intention to produce LPs.	Columbia Phonograph Co. founded to market American Graphophone products. In Germany, first commercial gramophones and records are manufactured.	1889
1949	45 r.p.m. introduced by RCA sets off battle of speeds. Three-speed phonograph introduced.	Edison improves phonograph, using wax, forms Edison Phonograph Works. First celebrity recordings made in Edison's laboratory. North American Phonograph Co. formed.	1888
1948	Columbia issues 33 1/3 r.p.m. LP, with 23 minutes per side.	Flat phonograph disk patent application by Emile Berliner and formation of American Graphophone Co. launch recording industry.	1887
1947	Limited use of magnetic tape recording in America and Europe. MGM Records bows.	Bell & Tainter patent "graphophone," replacing tinfoil cylinder with wax-coated cardboard.	1885
1945	Mercury Record Corp. is born.	Chichester A. Bell and Charles Sumner Tainter work on phonograph improvements.	1881
1942	Nationwide recording ban by AFM, lasting until Nov. 11, 1944. High fidelity technique used by English Decca.	Edison Speaking Phonograph Co. and London Stereoscope Co. formed. Phonograph interest in limbo.	1878
		First reproduction of sound by Edison on tinfoil cylinders and device called "phonograph." Microphone invented by Emile Berliner. France's Charles Cros writes paper describing process of recording and reproducing sound.	1877

WORLD SALES

Configurations expressed in light face on second line are (1) singles, (2) tapes and (3) EPs. Where only two configurations appear, there are no EPs for that country. The broken bar for six nations indicates bar runs off page. The position of the bars indicate relative differences among the six nations.

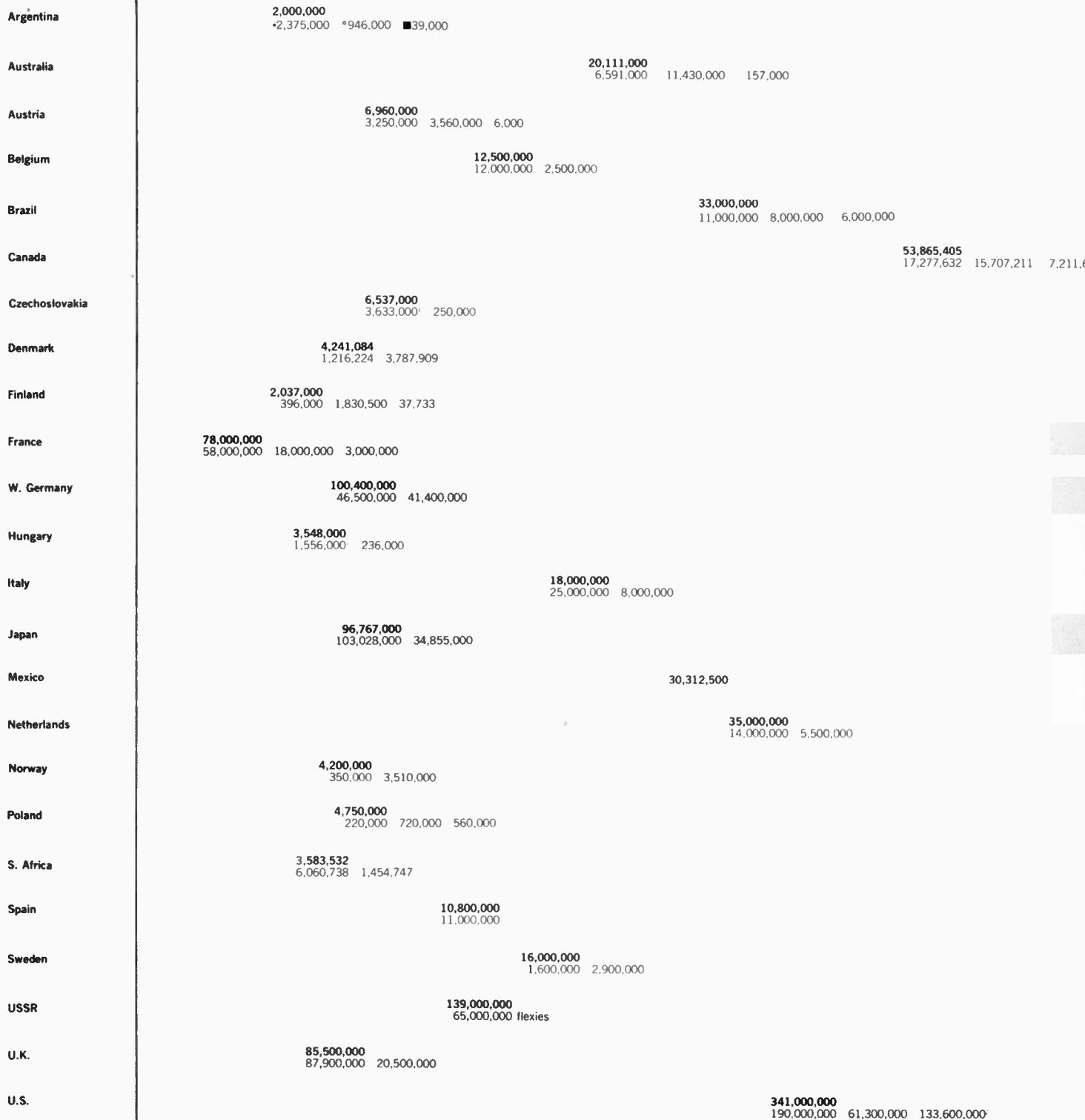

† also includes EPs
 ‡ 8-tracks

- = Singles
 * = Cassettes
 ■ = EPs

WORLD SALES

5 YEAR UNIT SALES PERSPECTIVE

Country	1977	1976	1975	1974	1973
Argentina	7,924,306	8,897,188	12,581,697 14,541,313	11,318,231	No Report
Australia	37,000,000 [†]	Imports** Exports	Imports* Exports	Imports* Exports	Imports* Exports
Austria	5,800,000 [†] 2,520,000	2,530,000 [†] 4,900,000	4,290,000 [†] 2,045,000	4,000,000 2,262,000	2,800,000 2,500,000
Belgium	8,000,000%	8,000,000	7,150,000 [†] 10,750,000	6,100,000	5,619,510 [†]
Brazil	30,000,000% 10,000,000	20,000,000% 9,000,000	15,000,000% 8,000,000	3,862,946 [†] 1,441,089	15,336,500
Canada	45,979,152 19,821,491	38,825,000 22,692,052	38,826,331 [†] 21,285,806	40,819,290 [†] 18,584,116	38,205,546 [†] 18,670,611
Czechoslovakia	5,696,000 [†] 3,477,000	5,378,000 [†] 2,522,000	5,964,000 [†] 4,075,000	5,571,000 [†] 4,347,000	4,454,000 [†] 5,862,000
Denmark	4,203,622 [†] 908,760	3,826,291 [†]	3,309,611 [†] 1,249,353	3,179,919 [†] 1,276,965 [†]	2,862,027 [†] 1,361,396 [†]
France	72,000,000 [†] 55,000,000 [†]	58,859,060	52,178,559 [†] 57,661,860	58,805,814 [†] 63,440,481	49,755,782 [†] 62,096,880
Finland	2,391,356 453,899	2,150,000 400,000	1,934,000 461,000	1,615,000 372,000	1,604,000 443,000
W. Germany	86,000,000 39,800,000	71,500,000 39,100,000	68,900,000 [†] 38,600,000	60,500,000 48,600,000	71,700,000 [†] 45,800,000
Italy	16,000,000 [†] 21,000,000	14,500,000 [†]	13,000,000 [†] 21,000,000	12,000,000 [†] 19,000,000	8,000,000 [†] 19,000,000
Japan	95,659,000 [†] 91,614,000	97,822,721 [†] 105,197,517	84,665,000 [†] 92,706,000	83,758,146 [†] 91,166,473	78,520,533 [†] 86,743,596
Mexico	30,312,500	22,917,000	25,065,000	17,284,000 19,013,964	14,195,000 17,978,381
Netherlands	25,000,000 [†]	23,000,000 [†]	7,000,000 21,000,000 [†]	7,000,000 18,000,000 [†]	16,000,000
Norway	3,600,000 [†] 370,000	3,500,000 [†] 500,000	2,779,113 [†] 507,513	2,000,000 [†]	1,775,000
Poland	2,162,070	3,430,000 420,000	2,560,000 140,000	3,757,054 145,192	6,000,000 260,000
S. Africa	4,305,000 [†] 6,091,659	3,385,380 [†] 2,734,837	3,142,888 [†] 2,943,546	2,685,467 2,956,178	2,463,681 3,182,059
Spain	11,600,000 [†] 13,000,000	10,000,000 [†]	5,200,000 [†] 14,700,000	4,650,000 15,150,000	4,908,000 14,000,000
Sweden	16,100,000 1,400,000	17,000,000	14,900,000 1,400,000	10,800,000 1,800,000	8,800,000 2,700,000
Switzerland	9,540,000 [†] 4,475,000	6,500,000 [†]	4,052,941 [†] 3,466,700	2,000,000 [†]	2,000,000
U.S.	344,000,000 245,100,000	273,000,000 245,000,000	282,000,000 183,000,000	276,000,000 194,000,000	208,000,000 190,000,000
U.S.S.R.	202,000,000 [†]	202,000,000 [†]	200,000,000 [†]	200,000,000 [†]	198,000,000 [†]
U.K.	81,500,000 59,000,000	85,000,000 55,000,000	107,140,000 [†] 58,400,000	117,116,000 [†] 60,530,000	100,000,000 [†] 60,700,000
Yugoslavia	3,500,000	3,500,000 [†]	3,500,000 [†]	4,500,000 [†]	1,800,000 [†]

domestic and export
domestic and import
LPs and tapes
all units
†Extrapolations from dollar sales
*All imports/exports
‡Estimated
†Import/Export U.S. only
‡EPs-singles

Because world currencies fluctuate continually, this chart now reflects unit sales. Spain's 1978 LP sales provide an excellent example: Whereas dollar value was up nearly \$4 million over 1977, unit sales were actually down 800,000. LPs are the top row and singles the bottom. In some cases, reports combine all units or combine some units. Consult individual notes. For an approximate dollar sales volume, consult the individual country by country listings where this figure is sometimes available. Also often available is the individual unit price for each configuration.

CONSUMER ELECTRONICS U.S. IMPORTS/EXPORTS

VIDEO TAPE EQUIPMENT IMPORTS

VIDEO RECORDERS AND PLAYERS			VIDEO PLAYERS			TOTAL VIDEO RECORDERS AND PLAYERS		
YEAR	UNITS	\$	YEAR	UNITS	\$	YEAR	UNITS	\$
1978	509	279,629	1978	77	19,422	1978	586	299,051
1977	250	140,947	1977	158	17,875	1977	408	158,822
1976	70	50,413	1976	221	14,109	1976	291	64,522
1975	40	26,532	1975	122	8,399	1975	162	34,931
1974	34	20,388	1974	104	4,889	1974	138	25,277
1973	76	23,960	1973	196	11,441	1973	272	35,401
1972	42	16,351	1972	na	na	1972	42	16,351
1971	29	8,138	1971	na	na	1971	29	8,138

(Add 000 to all figures)

AUDIO TAPE EQUIPMENT IMPORTS

AUDIO RECORDERS AND PLAYERS (Cassettes)			AUDIO PLAYERS (Cartridges)			AUTOMOTIVE PLAYERS			TOTAL AUDIO RECORDERS AND PLAYERS		
YEAR	UNITS	\$	YEAR	UNITS	\$	YEAR	UNITS	\$	YEAR	UNITS	\$
1978	15,996	706,523	1978	3,305	83,835	1978	10,507	471,595	1978	29,808	1,261,953
1977	13,473	519,893	1977	4,199	106,941	1977	8,249	316,746	1977	25,291	943,580
1976	12,664	437,218	1976	4,143	98,766	1976	9,136	286,472	1976	25,943	822,456
1975	7,653	272,669	1975	3,100	78,316	1975	4,903	150,168	1975	15,656	501,153
1974	9,087	310,653	1974	4,488	133,001	1974	4,983	146,655	1974	18,558	590,309
1973	10,470	318,691	1973	7,181	235,522	1973	4,687	102,327	1973	22,338	656,540
1972	9,873	266,698	1972	8,263	244,257	1972	3,641	69,615	1972	21,777	580,570
1971	8,390	212,920	1971	5,158	145,298	1971	2,739	51,136	1971	16,287	409,354

(Add 000 to all figures)

TOTAL U.S. IMPORTS

	Home Radios ²		Automobile Radios		Phonographs		Tape Recorders		Home Tape Players		Auto Tape Players		Video Tape Recorders	
	Units	\$*	Units	\$*	Units	\$*	Units	\$*	Units	\$*	Units	\$*	Units	\$
1978	37,935	627,749	5,439	184,471	4,312	231,883	15,997	706,523	3,305	83,835	10,507	471,595	509	279,629
1977	37,782	579,456	5,423	175,686	3,309	173,176	13,473	519,893	4,199	106,941	8,249	316,746	250	140,947
1976	35,394	498,010	5,970	148,643	2,455	103,726	12,664	437,631	4,364	112,875	9,136	286,472	70	50,413
1975	27,945	374,561	3,996	102,786	1,299	47,750	7,653	272,669	3,222	86,715	4,903	150,168	40	26,532
1974	34,433	474,716	4,848	110,994	1,934	92,657	9,087	310,653	4,592	137,890	4,983	146,654	34	20,388
1973	40,907	448,736	4,459	91,271	2,423	95,690	10,470	318,691	7,377	246,963	4,687	102,327	76	23,960
1972	40,159	404,499	2,924	53,358	2,451	92,997	9,873	266,698	8,263	244,257	3,641	69,615	42	16,351
1971	30,988	306,825	3,150	51,263	1,926	61,951	8,390	212,920	5,158	145,297	2,739	51,136	29	8,138
1970	31,150	305,227	2,232	38,535	2,040	52,456	8,076	202,251	3,655	113,213	2,779	60,351	24	8,779
1969	34,577	305,544	1,791	30,592	2,063	44,400	6,254	142,744	2,505	61,117	2,527	58,090	13	5,186
1968	28,346	225,118	1,814	29,650	2,129	37,456	4,914	110,262	1,254	26,863	1,224	28,017	9	4,045

(Add 000 to all figures)

¹ Includes receivers for compact and component systems and receivers other than broadcast band.

² Dollar value is defined generally as the market value in the foreign country (FOB) and excludes U.S. import duties, freight charges from the foreign country to the U.S. and insurance.

TOTAL U.S. EXPORTS

Year	Home Radios		Automobile Radios		Phonographs		Recorders ¹		Video Tape Recorders	
	Units	\$*	Units	\$*	Units	\$*	Units	\$*	Units	\$*
1978	836	21,891	795	55,827	336	55,049	278	36,962	4	51,693
1977	421	7,065	452	28,408	450	31,623	198	41,391	8	46,140
1976	328	4,607	472	24,648	333	28,863	171	33,163	15	51,513
1975	351	4,877	303	16,498	221	19,251	182	34,496	3	44,735
1974	405	5,516	333	14,742	196	17,353	209	31,711	3	49,510
1973	307	3,812	447	16,138	134	10,803	152	22,599	13	32,203
1972	248	3,644	566	15,644	112	7,966	92	16,343	2	27,083
1971	224	3,081	495	13,090	75	6,327	86	16,919	1	18,447
1970	245	4,007	432	9,399	55	4,926	98	22,679	3	16,651
1969	329	4,738	441	10,520	73	6,768	267	41,904	2	19,923
1968	385	4,960	258	6,637	59	6,006	320	31,586		13,806

(Add 000 to all figures)

¹ Excludes office type.

² Dollar value shown is defined generally as the value at the U.S. port of export, based on World Radio Helling price including inland freight insurance, and other charges to the U.S. port of export.

Source: U.S. Department of Commerce and EIA.

RECORD COMPANIES

Of The United States



A Record Co., 1608 Argyle, Hollywood, Calif. 90028. Tel. (213) 462-6608. Owner: George Jay.

A A Recs., 251 W. 57 St., New York, N.Y. 10019. Tel. (212) 765-3350. Pres.: A.I. Massler; Exec. VP: Robert L. Goemann, VP A&R: Ralph Stein.
Labels: (Owned) Wonderland; (distributed) Wonderland/Capitol.

A A T., see American Album & Tape.

A B (Street Level), see Sunrise.

A C I., see Daytwo.

A D & A Recs., PO Box 1412, Hollywood, Calif. 90028. Tel. (213) 462-3745. Pres.: Ardie Bryant, VP: Anne Bryant.

A & G., see Domino Ltd.

A G I., see Centurian.

A J., see Ala Ents.

A & M Recs. Inc., 1416 N. La Brea Ave., Hollywood, Calif. 90028. Tel. (213) 469-2411. Cable: ALPERMOSS. Chm.: Jerry Moss, Vice-Chm.: Herb Alpert, Pres.: Gil Friesen, Sr. Exec. VP: Promo: Harold Childs, VP A&R: David Kershbaum; VP Creative Servs. & Prod. Mgmt.: Jeff Ayeroff, VP Financial Affairs: Jolene Burton; VP Bus. Affairs: Ken Powell; VP Sales: Ernie Campagna; VP Promo.: Al Monnet, VP Quality Control/Quality Control Dir.: Marv Bornstein, VP Artist Development: Martin Kirkup, VP Horizon Recs.: Tommy LiPuma; VP Adv. & Mdsq.: Bob Reiman; Int'l Mng. Dir.: Jack Losmann; Sales Information & Analysis Dir.: Bob Elliott; Communications Dir.: Mike Gormley. (Distributed by RCA).
Branch: New York, N.Y., 595 Madison Ave., Zip 10022. Tel. (212) 826-0477. East Coast Opns. Dir.: Michael Leon; East Coast A&R Dir.: Mark Spector; East Coast Artist Development Dir.: Gail Davis; East Coast Pub. Dir.: Kathy Schenker.
Int'l branches: Canada, England, France.
Labels: (Owned) A&M, Horizon.
Int'l reps.: Argentina (EMI), Australia (Festival), Austria (CBS), Belgium (CBS), Bolivia (EMI), Brazil (EMI), Central America (Dideca in Guatemala), Chile (EMI), Colombia (TH), Costa Rica (Dideca), Denmark (CBS), Ecuador (Ruices), El Salvador (Dideca), Finland (CBS), France (CBS), Germany (CBS), Greece (CBS), Hong Kong (PolyGram), India (EMI), Israel (CBS), Italy (CBS), Japan (Alfa), Korea (PolyGram), Malaysia (PolyGram), Mexico (EMI), Netherlands (CBS), New Zealand (Festival), Norway (CBS), Panama (Dideca), Paraguay (EMI in Argentina), Peru (EMI), Philippines (Dyna Prods.), Portugal (Valentim de Carvalho), Singapore (PolyGram), South Africa (RPM), Spain (CBS), Sweden (CBS), Switzerland (CBS), Taiwan (PolyGram), Uruguay (EMI in Argentina), Venezuela (Ruices), West Indies (West Indies Recs.), Yugoslavia (Radio Television Belgrade).

A M C (Brazil), see Brasilia.

A M G., see Mutual Group.

A M J Int'l Recs., 9000 Sunset Blvd., West Hollywood, Calif. 90069. Tel. (213) 550-0397. Pres.: Alice M. Jackson; VP: K.H. Smith, Gen. Mgr.: Eddie Hersher; A&R Dir.: Horace Coleman, David N. Crawford.

A M P., see Ray Lawrence.

A N S A., see Ansap.

A P A., see TK.

A P I., see Atterram.

A R C (American Rec'g Co.), 9885 Charleville Ave., Beverly Hills, Calif. 90212. Tel. (213) 277-3111. (Distributed by CBS).

A R C Recs. (Artist's Rec'g Co.), 39199 Paseo Padre Pkwy., Fremont, Calif. 94538. Tel. (415) 656-8468. Pres.: Tom Sherrord, VP Nat'l Mktg. & Dist'n: Roy Segal, Nat'l Promo. Dir.: Bob Saporiti.

A R V Int'l., see House of Fun.

A/S., see Alshire.

A S A I Recs. Inc., PO Box 395, Oakwood, Va. 24631. Tel. (703) 498-3337/4566.
Labels: (Owned) ASAI, ASI, ASSI, Modoc.

A S I Recs., 711 W. Broadway, Minneapolis, Minn. 55411. Tel. (612) 521-7631. (Also see Nautilus Rec'gs).

A S I, Va., see ASAI.

A S I I., see ASAI.

A S R., see Grapevine Opry.

A T V Music Corp., 6255 Sunset Blvd., Hollywood, Calif. 90028. Tel. (213) 462-6933.
Branches: New York, N.Y., 115 E. 57 St. Zip: 10022. Tel. (212) 371-3810. Nashville, Tenn., 1217 16 Ave. S. Zip: 37212. Tel. (615) 327-2753.
Int'l branches: England, France.

A V I Recs. Inc., 7060 Hollywood Blvd., Suite 1212, Los Angeles, Calif. 90028. Tel. (213) 462-7151. Pres.: Treas.: Raymond Harris, VP & Sec'y: Ed Cobb; Gen. Mgr.: Nat'l Sales Mgr. & Disco Contact: John Jossey; Nat'l Promo. Dir.: George Sherlock; Eastern Sales Mgr.: Vito Samala.
Labels: (Owned) AVI; (distributed) In Town, Master 5, Out of Town.

A Z O Recs. & Publ'g, 6806 Lincoln Dr., Philadelphia, Pa. 19119. Tel. (215) 843-9723. Contact: William P. Lightfoot.

Abbey (UK), see Worldwide Music Servs.

Abet, see Nashboro.

Abkco Recs. Inc., 1700 Broadway, New York, N.Y. 10019. Tel. (212) 399-0300. Pres.: Allen Klein, VP: Joel Silver.
Int'l rep.: UK (Decca).

Above All, see Rainbow Room.

Accent Recs., 71906 Hwy. 111, Rancho Mirage, Calif. 92270. Tel. (714) 346-0075. Owner: Scott B. Seely; A&R: Buddy Merrill, Art Kempel, PR Dir.: Dolores Gulden.
Labels: (Owned) Accent (distributed by GNP Crescendo), New Sound; (distributed) In Sound.

Int'l reps.: Australia (Festival), Canada (CTI, MCA), France (Vogue), Germany (DG), Italy (CGD).

Accion, see Safari.

Acorn, Tex., see Freddie.

Acorn (UK), see Rounder.

AcousticGraphic Recs., 1 Simpson's Ln., Edgartown, Mass. 02539. Tel. (617) 627-4639. Owner: Benjamin L. Hall.
Labels: (Owned) AcousticGraphic, AcoustoQuad, Beau-Brian, Benjamin Lambert, Newzonophone.

AcoustoQuad, see AcousticGraphic.

Acropole Corp. of America, 1410 York Ave., Suite 2D, New York, N.Y. 10021. Tel. (212) 628-6315. Pres. & Gen. Dir.: Bruno George Ronty.
Labels: (Owned) Bruno, Colosseum.

Action Recs., PO Box 9470, Fort Worth, Tex. 76107. Tel. (817) 923-1111. Owner: Marvin Moore; Prods.: Lew Gillis, Bob Davis.

Action, Wash., D.C., see Warren.

Adam Prods. Inc., 2501 S. Ocean Dr., Hollywood, Fla. 33022. Tel. (305) 925-1799. Pres.: Robert S. Taran; A&R: Mike Lewis.

Adelia, see Creative Funk.

Adelphi Recs. Inc., Box 288, Silver Spring, Md. 20907. Wash., D.C. Tel. (202) 723-6958. Pres.: Gene Rosenthal; VP's: Gayle Moore, Jack Heyman; Promo.: Vicki Doyle.
Int'l reps.: Canada (Trebble Clef), Denmark (CSA), Germany (Moers Music, Taxim), Italy (Hi-Fi), Netherlands (Dutch Blues & Boogie), UK (Projection, Swift).

Ades (France), see Playette.

Advance, see Songs by Summers.

Adventure One Recs. Inc., 799 1/2 Martin Luther King Dr., Atlanta, Ga. 30314. Tel. (404) 523-3582. Pres.: Jesse J. Jones, VP: Michael Cohen.

Aerospace, see Ray Lawrence.

Aesthetic Artist Recs., PO Box 144, Mid City Sta., Dayton, Ohio 45402. Tel. (513) 252-9426. Owner: Paul Wayne Beach.

Aferton Recs., 2234 Watson Rd., Springfield, Ill. 62704. Tel. (217) 528-7355. Contact: Dave Hoffman. (Distributed by IRDA).

Afro Request, see Request.

Agon, see Dragon.

Aileron, see QCA in Calif.

Air, see Chrysalis.

Airborne, see Discout.

Akashic Recs., 3622-C Mt. Diablo Blvd., Lafayette, Calif. 94549. Tel. (415) 283-5151. Owner: Stephen Jarvis.

Ak Ba, see Black Fire & Mustevic.

Aladdin Rec. Co., 835 N. Federal Hwy., Fort Lauderdale, Fla. 33304. Tel. (305) 763-9196. Pres.: Alan Franklin; VP: Paul Hughes; A&R: Frank Lovchett; Sales & Mktg.: C. Franklin; Pub.: Alan Hunt; Promo.: Pam Bennett.
Labels: (Owned) Aladdin, Cassbah, China, China Doll, Dragon, Ecstasy, Genie, Head, Hong Kong, Horn, Kong, Penetration, Prayer Tower, Shiek.

Ala Ents. Inc., 4218 W. Jefferson Blvd., Los Angeles, Calif. 90016. Tel. (213) 737-1000. Pres.: Louis Droze; VP: David Droze; Exec. Admin'r.: Shelby Meadows Ashford.
Labels: (Owned) A.J. Ala, Blues Spectrum, Dingo, Hawk Sound, Laif.

Albatross Recs. Inc., PO Box 66558, Seattle, Wash. 98166. Tel. (206) 246-9400. Pres.: Ken Kinnear.

Albero, see Vintage.

Albert Int'l Music, 1790 Broadway, New York, N.Y. 10019. Tel. (212) 757-4840. Cable: MARKBRO. Telex: 620 960.
Label: (Owned) Albert Prod'ns.

Albert Prod'ns., see J. Albert.

Albradella, see Gwen.

Alear, see Sounds of Winchester.

Alhambra Dist'g Inc., 552 W. 27 St., Hialeah, Fla. 33010. Tel. (305) 885-4298. Pres.: Enrique Inurrieta Sr.; Exec. VP: Enrique Inurrieta Jr.; Gen. Mgr.: Miguel Estivil; Promos. Mgr.: Betty Diaz.
Branches: Los Angeles, Calif., 2720 W. Pico Blvd. Zip: 90006. Tel. (213) 733-0137. Gen. Mgr.: Antonio Estevez—San Juan, P.R., Alhambra Recs., GPO Box 2702, Zip: 00936. Tel. (809) 724-0465/7654. Mgr.: Ricardo Fabregues.
Labels: (Owned) Al Mex, Al Records, Alhambra, Libra, Aljean Recs., RD 4, Myerstown, Pa. 17067. Tel. (717) 866-5067. Owner & Pres.: Jean Shade. Sales & Mktg. & Country Mgr.: Al Shade.

Aljo, see Page.

All Ears Recs., 7033 Sunset Blvd., Suite 322, Hollywood, Calif. 90028. Tel. (213) 465-3990. Pres.: Antony Harrington.

Allegheny, see East Allegheny.

Allegre, see Fania & Mystic.

Allen-Martin Prod'ns Inc., 9701 Taylorsville Rd., Louisville, Ky. 40299. Tel. (502) 267-9658.

Alligator Recs., Box 60234, Chicago, Ill. 60660. Tel. (312) 973-7736. Pres.: Bruce Iglauer; Mktg. Dir.: Melinda Giles.

Int'l reps.: Europe & UK (Sonet in Sweden), Japan (Trio), Sweden (Smokesack, Sonet).

All Platinum Rec. Co. Inc., 96 West St., Englewood, N.J. 07631. Tel. (201) 569-5170.
Labels: (Owned) All Platinum, Cadet, Checker, Chess, MX, Stang, Turbo, Vibration; (distributed) Raticy.

Allstar, see National Music.

Almanac, N.Y., see American Themes.

Almanac Rec. Co., PO Box 13661, Houston, Tex. 77019. Dir.: Mack McCormick; Prod'r.: J.D. Horn.

Almeria, see Red Greg.

Al Mex, see Alhambra.

Al Recs., see Alhambra.

Alsan, see Dragon Int'l.

Aishire Int'l, PO Box 7107, Zip: 91510, 1015 Isabel St., Burbank, Calif. 91502. Tel. (213) 849-4671. Cable:

BUDSOUND TWX (910) 498-2759. Pres.: Al Sherman, Gen. Mgr.: Dick Ceja.

Labels: (Owned) A/S, Alshire, Aria Senza Voce, Audio Spectrum, Oscar, Peter Rabbit, Somerset, Stereo Fidelity, (distributed) Azteca, Gnt.

Int'l reps.: Argentina (Microfon), Australia (Astor), Brazil (Fermata), Canada (Rodyn), Colombia (Colombiana de Discos), Germany (Metronome), Greece (CBS), Israel (Hatakli), Japan (Trio-Kenwood), Mexico (Musart), New Zealand (New World), Philippines (Vicar), Portugal (Movieplay), Scandinavia (Montax), Singapore (Alshire), Spain (Movieplay), UK (Pye), Venezuela (Promus).

Alston, see TK.

Alternatives in American Music, 826 Kains Ave., Albany, Calif. 94706. Tel. (415) 524-0222, 647-9543.

Altone, see American Tape.

Alva Recs., 3929 Kentucky Dr., Los Angeles, Calif. 90068. Tel. (213) 980-7501. Owner & Pres.: Eddie Gurren; R&B Dir.: Barnett Williams; Promo. Co-ord.: Glorianna Monroe.

Alvorada, see Penco.

Amazon, see TK.

Amberlee, see Doric.

Ameraba, see West End.

Americana, see Sine Qua Non.

American Album & Tape Inc., 850 Seventh Ave., New York, N.Y. 10019. Tel. (212) 247-3188. Pres.: David King; VP: Hope King; VP Int'l: Warren Ashley; Gen. Mgr.: George Curtiss.
Labels: (Owned) AAT, American Album & Tape, American Entertainment, American Nostalgia, Hall of Fame Jazz.

American Entertainment, see American Album & Tape.

American Gramophone Int'l., see Centurian.

American Int'l., see Casablanca.

American Jazz, see Happy Jazz.

American Nostalgia, see American Album & Tape.

American Playboy, see Music Ents.

American Rhythm Music, see Rollin' Rock.

American Tape Corp., 1116 Edgewater Ave., Ridgefield, N.J. 07657. Tel. (201) 943-7860.
Labels: (Owned) Altone, Remington.

American Theme, see American Themes.

American Themes & Tape Inc., 240 W. 55 St., New York, N.Y. 10019. Tel. (212) 247-3690. Cable: BENANTIMUS.
Labels: (Owned) Almanac, American Theme, Fairland, Jazz Kings, Urania.

American Voices Rec. Co. Inc., 216 Applewood Ln., Virginia Beach, Va. 23452. Tel. (804) 340-4582. Pres.: Heath Webb; VP: Connie Webb; Adv. Mgr.: David Utt; Country Mgr.: Jean Webb.

American Way, see Glolite.

Amherst Recs., 355 Harlem Rd., Buffalo, N.Y. 14224. Tel. (716) 826-9560. WAITS (800) 828-7041. Pres.: Leonard Silver; A&R: David Parker. (Distributed by Infinity).

Am Rec. of America, Box 62263, Virginia Beach, Va. 23462. Tel. (804) 340-3366. Pres.: Alex Spencer; VP: George Crowling; Pub.: Nancy Strong.
Label: (Owned) Dimension.

Anahuac (Discos), 6331 Santa Monica Blvd., Hollywood, Calif. 90019. Tel. (213) 462-0088.
Int'l rep.: Mexico (Cisne).

Anamaze Recs., 1802 Ocean Pkwy., Suite 2A, Brooklyn, N.Y. 11223. Tel. (212) 627-8499. Pres.: Prod'r. & A&R: Cosmo Ohms; VP: Mktg. & Promo.: Dosa Tooner; Art & Graphics: Fae Ellen.
Branch: Chicago, Ill., 7518 N. Winchester. Zip: 60626. Tel. (312) 761-7005. Exec. Prod'r.: Michael Al-len Tubin.
Int'l rep.: UK (Rough Trade).

Lee Anderson Ents., PO Box 4141, North Hollywood, Calif. 91607. Tel. (213) 782-6915. Owner & Pres.: Lee Anderson; VP's: Betty & Bruce Dale Anderson.
Labels: (Owned) Belltone, Country Capers, Greenbush, Sports.

Andira Rec. Corp., Custom Servs. Div., 41 Central Ave., Newark, N.J. 07102. Tel. (201) 642-5991.

Angel, see Capitol.

Annuit Coeptis Music Recs. Tapes Ltd., 2933 River Rd., Croydon, Pa. 19020. Tel. (215) 785-1541.

Anomoly, see Jersey Coast.

Ansap Recs., PO Box 10612, Zip: 35202, 1005 Frank Nelson Bldg., 205 N. 20 St., Birmingham, Ala. 35203. Tel. (205) 252-8271. Pres.: Ann Scott; VP: Lee Burks; Pop A&R Dir.: Don Skipper; Sales & Mktg. Dir.: Bill Gowdy; Country Dir.: Rick Robbins.
Labels: (Owned) ANSA, Ansap, Faith.

Ansonia Recs. Inc., 802 Columbus Ave., New York, N.Y. 10025. Tel. (212) 865-2121. Cable: ANSORCORD. Pres.: Mercedes Glass; Exec. VP: Herman Glass.
Labels: (Owned) Ansonia, Superior.

Chuck Anthony Music Inc., PO Box 2000, Holbrook, N.Y. 11741. Tel. (516) 472-0900. Pres.: Chuck Anthony; A&R Dir.: Randy Irwin.
Label: (Owned) CVR, Rocky.

Antilles, see Island.

Apollo, see Hilding.

Apon Rec. Co. Inc., PO Box 3082, Steinway Sta., 44-16 Broadway, Long Island City, N.Y. 11103. Tel. (212) 721-5599. Pres.: Andrew M. Poncic; Prod'r.: Nick Kuznick; Mktg. Mgr.: Don N. Zemann; PR Mgr.: Dorian Michaels.
Labels: (Licensed) Amadeo (Austria), Harmonia Mundi (Germany), Hungaroton (Hungary), Supraphon (Czechoslovakia) (tape masters only).

Appalseed, see June Appal.

Applegate, see Fraternity.

April, see Dragon Int'l.

April Twenty-Two Prod'ns., 9000 Sunset Blvd., Suite 1119, Los Angeles, Calif. 90069. Tel. (213) 274-7877.

Aquila Rec. Corp., 6730 Tait St., Hollywood, Fla. 33024.

Tel: (305) 945-3738. Pres. & Exec. Dir.: J. Gilday; Disco Contact: M. K. Pancoast; VP A&R: Rufus Smith; Ass't A&R: Don C. Davis; Promo. Dir.: Dan Raymond. **Branch: North Miami Beach, Fla., PO Box 600516.** Zip: 33160; 9367 NE 168 St. Zip: 33161. **Labels: (Owned) Aquila, Gil's Funny Recs.** **Int'l reps.:** Canada (Laurel), UK (Today).
 Arbor, see Puritan.
 Arc Recs., 3100 Mowry Ave., Suite 304, Fremont, Calif. 94531. Tel: (415) 796-4444. Contact: Thomas Sherrod. (Distributed by IRDA)
 Arc, Hollywood, Calif., see Spina.
 Arcade, see Arzee.
 Arcano, see Caytronics.
 Arch, see Dragon Int'l.
 Archive of Folk & Jazz Music, see Everest.
 Archive of Piano Music, see Everest.
 Archiv Produktion, see Classics Int'l.
 Arctic, see Jamie/Guyden.
 Arctic (Norway), see SWS.
 Argo, see London.
 Argus Rec. Prod'n's (div. of Record Room), PO Box 58, Glenora, N.J. 08029. Tel: (609) 939-0034. Gen. Mgr.: Lem Harris; A&R Dir.: Eddie Jay Harris; Promo.: Patricia Cox. **Labels: (Owned) Argus, Merry Elf, Never Ending Music, Record Room; (distributed) Black & Blue, Now.**
 Argyle, see Spina.
 Arhoolie Recs. Inc., 10341 San Pablo Ave., El Cerrito, Calif. 94530. Tel: (415) 525-1495/4996. Pres.: Chris Strachwitz. **Labels: (Owned) Arhoolie, Folklyric; (distributed) Blues Classics, Old Timey.** **Int'l reps.:** Canada (Almada), Finland (Quality), France (Musidic-Europe), Germany (Bellaphon), Italy (Hi-Fi), Netherlands (Agram/Nuis), Sweden (Sonet), UK (Swift).
 Aria Senza Voce, see Alshire.
 Ariola Recs., 8671 Wilshire Blvd., Beverly Hills, Calif. 90211. Tel: (213) 659-6530. TWX: (910) 490-2569. Pres.: Jay Lasker; Exec. VP: Howard Stark; VP: Otis Smith; VP Promo.: Sales & Mktg.: B.J. McElwee; VP LP Promo.: Bill Bartlett; VP Int'l Finances: Edward Tawil; Nat'l A&R Dir.: Tim O'Brien; Nat'l Singles Promo. Dir.: Chuck Browning; Nat'l Pub. Dir.: Pamela Turbow; Nat'l Creative Servs. Dir.: Terry Barnes; Nat'l Mdsq. Co-ord.: Rich Fazekas; Nat'l Disco Promo. Dir.: Jack Witherby. (Distributed by Capitol) **Labels: (Owned) Ariola; (subsidiary) Ocean.** **Int'l reps.:** Argentina (Microfon), Australia (RCA), Austria (Ariola), Belgium (Ariola), Canada (Quality), Colombia (Sonolux), Denmark (AEG Dansk Elektricitets), Dominican Republic (Distribuidora Dominicana de Discos), Ecuador (Fadisa), El Salvador (Leo), Finland (Finlevy), France (Arabella), Germany (Ariola), Hong Kong (Studer-Revox), Italy (Dischi), Jamaica (Dynamic Sounds), Japan (King), Mexico (Discobol), Netherlands (Ariola), Norway (Disco), Peru (FTA), Philippines (Home), Spain (Ariola), Sweden (CBS), Switzerland (Ariola), UK (Ariola), Venezuela (Velvet).
 Arion, see Peters Int'l.
 Aris, see Peters Int'l.
 Arista Recs. Inc., 6 W. 57 St., New York, N.Y. 10019. Tel: (212) 489-7400. Pres.: Clive Davis; Ass't to Pres.: Michael Friedman; Exec. VP: Elliot Goldman; Sr. VP Finance: Aaron Levy; VP Sales & Dist'n: Leonard Scheer; VP A&R: Bob Feiden; VP Singles Promo.: Richard Palmese; VP LP Promo.: Scott Jackson; VP Nat'l R&B Prod.: Hank Talbert; VP Artist Development: Rick Dobbs; VP Pub. & Press Servs.: Dennis Fine; Nat'l Disco Promo. Dir.: Audrey Joseph. **Branch: Los Angeles, Calif., 1888 Century Park E., Suite 1510.** Zip: 90067. Tel: (213) 553-1777. Sr. VP: Larkin Arnold; VP West Coast Opns.: Michael Lippman. **Int'l branch: England.** **Labels: (Owned) Arista, Savoy; (distributed) Buddah.** **Int'l reps.:** Canada (Capitol), Japan (Toshiba), rest of world (EMI).
 Arlo Recs. Co., 7653 Telephone Rd., LeRoy, N.Y. 14482. Tel: (716) 584-3365. **Label: (Owned) BHR.**
 Armada Recs. Inc., 5825 N. 96 St., Milwaukee, Wis. 53225. Tel: (414) 462-5590. Pres.: Timothy Brophy; Sec'y Mgr.: Bob Ambos; A&R: Jim Spencer.
 Arrest Recs., 1420 K St. NW, Washington, D.C. 20005. Tel: (202) 347-1420. Mgr.: Sonia Karkenny; Prod'n Dir.: John Freeman; Chief Eng.: Tom McCarthy; Promo. Dir.: Cerphe Colwell.
 Arriba Recs., 2525 W. Pico Blvd., Los Angeles, Calif. 90006. Tel: (213) 487-2158. Pres. & Gen. Mgr.: Isaac Baly.
 Arrival, see Moonstone.
 Arrowhead, see Oakridge.
 Art Attack Recs. Inc., 964 W. Grant Rd., Tucson, Ariz. 85705. Tel: (602) 622-8012. Pres.: William Cashman.
 Artemis Recs. Ltd., PO Box 110, 157-52 96 St., Howard Beach, N.Y. 11414. Tel: (212) 738-4806. Pres.: John Giamundo; VP: Rocco Giamundo. **Int'l reps.:** Benelux (Supreme in Belgium), Japan (Polydor).
 Arth, see TK.
 Artic Recs. & Dist'g Co. Inc., 1806 Division St., Nashville, Tenn. 37203. Tel: (615) 329-3380. Pres.: Eddy Fox; Sales: Kaye Wells.
 Artists House Inc., 40 W. 37 St., New York, N.Y. 10018. Tel: (212) 594-9435. Creative Dir.: John Snyder; Prod'n & Mfg.: Jim Gicking; Sales & Promo.: Chuck Schwartz; Accounting & Foreign Affiliate Liaison: Janet Radtke. **Int'l rep.:** Japan (King).
 Art Recs. Mfg. Co., PO Box 15032, 991 SW 40 Ave., Fort Lauderdale, Fla. 33318. Tel: (305) 584-1904. Pres.: Harold E. Doane; Exec. Sr. VP: Vivian P. Doane; Pub. Dir.: David W. Dunn. **Labels: (Owned) Art, Citadelle, Cruise, Souvenir, Unity.** Arzee, see Everest.
 Arzee Music Co., PO Box 19518, Zip: 19124; 3010 N. Front St., Philadelphia, Pa. 19133. Tel: (215) 739-7501, 743-8549. Pres.: Rex Zario; Gen. Mgr.: Dave Wilson. **Labels: (Owned) Arcade, Arzee, Lisi, Regima; (distributed) Eastwood Sound.**

Asch, see Folkways.
 Asha, see Discount.
 Ashley Rec. Co., 249 Bluegrass Dr., Hendersonville, Tenn. 37075. Tel: (615) 824-3573. Co-Pres.: Leon Ashley, L. S. Walton; VP: F. Case Walton; Pub., Adv. & Promo.: Linda Denny.
 Aslan, see Consolidated Gospel.
 Associated Rec'g Cos. (div. of Associated Inds.), 2250 Bryn Mawr Ave., Philadelphia, Pa. 19131. Tel: (215) 477-7122. Pres.: George Guess; Exec. VP: Marcus Levy; VP Opns.: Ted Brown; VP Nat'l Sales & Promo.: Alonzo Brooks; VP Reg'l Sales: Leonard Spratley; Gen. Mgr.: Sales & Mktg.: Oscar Blalock; Promo. Mgr.: Ronald Williams; Promo.: Tom Goodman; James Boulding; James Wise. **Labels: (Owned) Jaguar, Jenges, Pearl Harbor.**
 Astro Recs., PO Box 30075, Eugene, Ore. 97403. Tel: (503) 485-0370. Pres.: James Egan.
 Asylum, see Elektra/Asylum/Nonesuch.
 Atco, see Atlantic.
 Atlanna, see McKinnon.
 Atlanta, see Trend Recs. in Ga.
 Atlantic Rec'g Corp., 75 Rockefeller Plaza, New York, N.Y. 10019. Tel: (212) 484-6000. Cable: ATCOMUSIC. TWX: (710) 581-6023. Bd. Chm.: Ahmet Ertegun; Pres.: Jerry Greenberg; Exec. VP: Sheldon Vogel; Sr. VP & Gen. Mgr.: Dave Glew; Sr. VP Atlantic & Pres. Cotillion: Henry Allen; VP's & Co-Dirs.: Nat'l Promo.: Tunc Erim, Vince Faraci; VP Special Markets: Eddie Holland; VP Jim Delehan; VP Int'l Mgr.: Bob Kornheiser; VP & Exec. Ass't to Bd. Chm.: Noreen Woods; Pres. Atco Recs. & Custom Labels: Doug Morris. **Branch: Los Angeles, Calif., 9229 Sunset Blvd.** Zip: 90069. Tel: (213) 278-9230. VP & Gen. Mgr.: Bob Greenberg. **Distribution branches:** Los Angeles, San Francisco, Calif.; Denver, Colo.; Hartford, Conn.; Miami, Fla.; Atlanta, Ga.; Chicago, Ill.; Greenbelt, Md.; Boston, Mass.; Detroit, Mich.; Minneapolis-St. Paul, Minn.; Kansas City, St. Louis, Mo.; Mount Laurel, N.J.; New York, N.Y.; Charlotte, N.C.; Cincinnati, Cleveland, Ohio; Dallas, Houston, Tex.; Seattle, Wash. (See Record & Tape Wholesalers section for complete listings for Warner/Elektra/Atlantic Corp.) **Int'l branches:** See WEA Int'l. **Labels: (Owned) Atco, Atlantic, Cotillion; (distributed) Big Tree, Finnadar, Hilltak, Little David, #1, Pacific, Rolling Stones, Scotti Bros., She, Swan Song, Virgin, Westbound, Zephyr.** **Int'l reps.:** See WEA Int'l.
 Atlantis Recs., 2460 Spring Lake Dr., Marietta, Ga. 30062. Tel: (404) 973-1170. **Labels: (Owned) Atlantis, Star Song.**
 Atlas, see Velvet de Puerto Rico.
 Atteiram Prod'n's Inc. (API), PO Box 606, Marietta, Ga. 30061. Tel: (404) 522-8106. Pres. & Prod'r: Carl Queen; VP: Bob Abel; Sales & Mktg. Mgr.: Lamont Crenshaw; Mgr.: Randall Collins; Promo. & Tape Mgr.: Shirley Queen. **Branch: Atlanta, Ga., 190 Boulevard S.E.** Zip: 30312. **Labels: (Owned) Atteiram, Lanta, Mars La Tour.**
 At the Copa, see SEI.
 Audax, see Discocorp.
 Audio Accessories Co., 38 W. 515 Deerpark Rd., Batavia, Ill. 60510. Tel: (312) 879-5998. Sales Mgr.: John S. Maloney. (Tape product)
 Audio Arts Inc., 5617 Melrose Ave., Los Angeles, Calif. 90038. Tel: (213) 461-3507. **Labels: (Owned) Audio Arts, Audio Gospel.**
 Audio Fidelity, see Audioidentity Ents.
 Audioidentity Ents. Inc., 221 W. 57 St., New York, N.Y. 10019. Tel: (212) 757-7111. Cable: AUDIOFIDEL. Bd. Chm.: Herman D. Gimbel; Pres.: Harold Drayson; VP: Classical A&R & Int'l: Carl Shaw; Treas.: John Freitag; Promo. Mgr.: Mary H. Welch; Prod'n Mgr.: Philip Goldschmidt; Art Dir.: Ron Warwell. **Labels: (Owned) Audio Fidelity, Audio Int'l, Audio Rarities, Chiaroscuro, First Component Series, Image, Karate, Mr. G., Thimble; (distributed) Harlequin, Improv, SMI.** **Int'l reps.:** Argentina (Microfon), Australia (Carinia), Austria (Bellaphon), Benelux (Dureco), Brazil (Gravacoes Electricas), Canada (Phonodisc), Central America (Indica in Costa Rica), Colombia (Philips), Costa Rica (Indica), Dominican Republic (La Guarachita), Finland (PSO), Germany (Bellaphon), Israel (Unatex), Italy (Font-Cetra), Japan (Teichiku), Mexico (Pren), New Zealand (Carinia in Australia), Philippines (Dyna), Scandinavia (Ad-Lib), South Africa (Gallo), Spain (Trova), Switzerland (Bellaphon), Thailand (Ching Thai), UK (Pye).
 Audio Gospel, see Audio Arts.
 Audio Int'l, see Audioidentity.
 Audiophile, Tex., see Happy Jazz.
 Audiophile, Ga., see Jazzology-GHB.
 Auditorama Recs. Corp., 658 10 Ave., New York, N.Y. 10036. Tel: (212) 246-9858. Pres.: Rafael Diaz Gutierrez; Gen. Mgr.: Hilda Diaz Gutierrez. **Labels: (Owned) Auditorama, Madely, Taurus.**
 Audio Rarities, see Audioidentity.
 Audio Spectrum, see Alshire.
 Audio-Technica US Inc., 33 Shawassee Ave., Fairlawn, Ohio 44313. Tel: (216) 836-0246. Pres.: Jon R. Kelly; VP Mktg.: Fred W. Nichols. **Labels: (Distributed) Gale Maximum Fidelity (UK), RCA/RVC (Japan), Telarc, Toshiba-EMI (Japan).**
 Aural Explorer, see MMO.
 Aurora Borealis, see Crimson Dynasty.
 Aurum Recs. (div. of RBR Communications Inc.), 43 W. 61 St., New York, N.Y. 10023. Tel: (212) 757-8805. Pres.: Richard Bradley; VP & Gen. Mgr.: Bill Radics; A&R Dir.: Ron Beigel.
 Aus-Tex, see Colonel Buster Doss.
 Authentic, see Sonic Arts.
 Autograph, see Sonic Arts.
 Autumn, Calif., see R. Dean Taylor.
 Autumn Hill Prod'n's, PO Box 844, Hendersonville, Tenn. 37075. Tel: (615) 824-4594. Pres.: Jim Voytek. **Labels: (Owned) Autumn Hill, Country Moods.**
 Autumn Int'l Recs., 3810 Cavalier St., Garland, Tex. 75042. Tel: (214) 494-3494. Pres.: Phil Otten Jr.; VP & Gen.

Mgr.: Glen Pace; Prod'rs: James Pritchett, Glen Pace. **Avalanche, see Crimson Dynasty.**
 Avant, see Crystal.
 Avante Recs., 8853 Sunset Blvd., Los Angeles, Calif. 90069.
 Avanti Garde Recs. Inc., 250 W. 57 St., New York, N.Y. 10019. Tel: (212) 246-1343. Pres.: Frank Siegfried; Gen. Mgr.: Bobby McFarland. **Int'l reps.:** Australia (Move), UK (Mayhew-McCrimmon).
 Avanti, see Reflection Sound.
 Avoca Recs. & Tapes, 1404 Sun Flower Ln., New Port Richey, Fla. 33553. Tel: (813) 868-5196. Owner: Francis X. Cashin; Prod'n Mgr.: Anna M. Cashin. **Branch: Deer Park, N.Y., 194 Gleeland St.** Zip: 11729. Tel: (516) 242-3539. Sales Mgr.: Nora M. O'Neill. **Labels: (Owned) Avoca, Blarney Castle, IMI.** **Int'l rep.:** Ireland (Dolphin).
 Aztec, see Dorn.
 Azteca Rec. Inc., 1015 Isabel St., Burbank, Calif. 91502. Tel: (213) 849-4671. Cable: BUDDSOUND. Pres.: Al Sherman; VP: Richard Ceja. (Distributed by Alshire Int'l)
B
 B-Atlas, see Jody.
 B B P, see Ray Lawrence.
 B C L Ents Inc., 1002 Hoefgen St., San Antonio, Tex. 78210. Tel: (512) 532-3216.
 B G O Recs. Inc., 3297 Northcrest Rd., Suite 203, Doraville, Ga. 30340. Tel: (404) 491-0950. Pres.: Arnie Geller; VP: Buddy Buie; VP/Bus. Affairs: Gloria Bue. (Also see polydor)
 B H R, see Arlo.
 B I, see Bollman.
 B I R C Recs., 601 E. Blackledge Dr., Tucson, Ariz. 85705. Tel: (602) 882-9016. Pres.: Joe Bidwell; Pop A&R: Erin Brooks; Country A&R: Joe Bidwell; Adv.: Joseph Ostrom; Sales & Mktg.: Bob Rollins.
 B L T Recs., PO Box 9830, 3507 W. Vickery, Fort Worth, Tex. 76107. Tel: (817) 737-9911. Pres.: J. P. Kimzey.
 B M A, see Jersey Coast & World Int'l.
 B M R, see Big Mack.
 B N A, see TK.
 B R C, see Brunswick.
 Baby Boy, see Old Dominion.
 Baby Girl, see Old Dominion.
 Bach Guild, see Vanguard.
 Back Door Recs., 909 Beacon St., Boston, Mass. 02215. Tel: (617) 136-8807. Pres.: Barry Glosky; VP Promo.: Joel Bernstein; Pop A&R: Andy Doherty; Sales & Mktg.: Fred Margolis; Pub.: Amy Glosky; Adv.: Nina Lanzillo; Promo.: Dawn De Angeles; Country Contact: Steve Morse. (Distributed by Rounder)
 Backlash, see Bomp.
 Backstreet, see MCA. (SEE ADVERTISEMENT)
 BaKim Rec. & Music Group, 18447 W. Eight Mile Rd., Detroit, Mich. 48219. Tel: (313) 862-5870. Pres.: Kenneth W. Baker; VP Promo. & Sales: William J. Davis. **Labels: (Owned) BaKim, Centaur, Odessa; (distributed) HouseTop.**
 Balboa Rec. Co., 16027 Sunburst St., Sepulveda, Calif. 91343. Tel: (213) 892-0044. Owner: Larry Fotine.
 Balkan Hi-Fi, see Balkan Music.
 Balkan Int'l, see Balkan Music.
 Balkan Music Co., 6917 W. Cermak Rd., Berwyn, Ill. 60402. Tel: (312) 484-6436. Owner: Slavko A. V. Hlad; Sales Mgr.: Louis J. Hlad. **Labels: (Owned) Balkan Hi-Fi, Balkan Int'l.**
 Balkanton (Bulgaria), see Worldtone.
 Bal Recs., Box 369, La Canada, Calif. 91011. Tel: (213) 790-1242. Pres.: Adrian P. Bal; Sec'y-Treas.: Berdella M. Bal.
 Bambuco, see Discolando.
 Banana, see Stacy-Lee.
 Bandolier, see Suncountry.
 Bang Recs., 4488 N. Shallowford Rd. NW, Suite 1000, Atlanta, Ga. 30338. Tel: (404) 394-2264. Pres.: Hlene Berns; Exec. Ass't: Lynn Carroll; Nat'l Pop Promo.: Rick Rockhill; Nat'l R&B Promo.: Chester Simmons; A&R: James Stroud. (Distributed by CBS) **Labels: Bang, Bullet, Shout, Solid Gold.**
 Banjar Recs. Inc., Box 32164, 7440 University Ave. NE, Minneapolis, Minn. 55432. Tel: (612) 633-7508. Pres.: LeRoy Larson; VP: Bert Woolfrey.
 Banner Recs., c/o ECU Inc., 6515 Sunset Blvd., Suite 300-A, Los Angeles, Calif. 90028. Tel: (213) 467-8172. Contacts: Don Gere, J. Clark Scott.
 Barenreiter (Germany), see Worldwide Music Servs.
 Barnaby Recs., 816 N. La Cienega Blvd., Los Angeles, Calif. 90069. Tel: (213) 657-6150.
 Barricade, see Sabre.
 Nelson Barry Recs. Ltd., 319 E. 44 St., New York, N.Y. 10017. Tel: (212) 679-7900.
 Bartone Studios, 1919 Tuolumne, Fresno, Calif. 93721. Tel: (209) 486-9082. Owner: Don Barton.
 Bass, see Warren.
 Bayou Blue, see Great Southern.
 Bayou Boogie Recs. Inc., 913 Birmingham Dr., Baton Rouge, La. 70815. Tel: (504) 272-1420. Pres.: James M. Rogers; Promo. & Dist. Mgr.: Ricky J. Viator.
 Bayou Classics, see Modern Sound.
 Bay Recs., 1516 Oak St., Suite 320, Alameda, Calif. 94501. Tel: (415) 865-2040. Contact: Michael Cogan. **Labels: (Owned) Bay, Silk Purse.** **Int'l reps.:** Australia (Folkways), Canada (Musimart), Japan (BOM), Sweden (SAM), UK (Free Reed, Swift).
 Beam Junction Recs., 360 E. 72 St., New York, N.Y. 10021. Tel: (212) 288-5149.
 Beantown Recs., 206 E. Jordan St., Pensacola, Fla. 32503. Tel: (904) 438-2763. Pres.: Gen. Mgr. & A&R: Earl Lett; Exec. Sec'y: Mattie Swain.
 Bear Family (Germany), see Rounder.
 Bearsville Recs. Inc., 8467 Beverly Blvd., Los Angeles, Calif. 90048. Tel: (213) 655-1177. Pres.: Albert Grossman; VP/Gen. Mgr.: Michael Pilot; Adm'n. Gen. Mgr.: Susan Lee. (Distributed by Warner Bros.)

Backstreet
MCA RECORDS

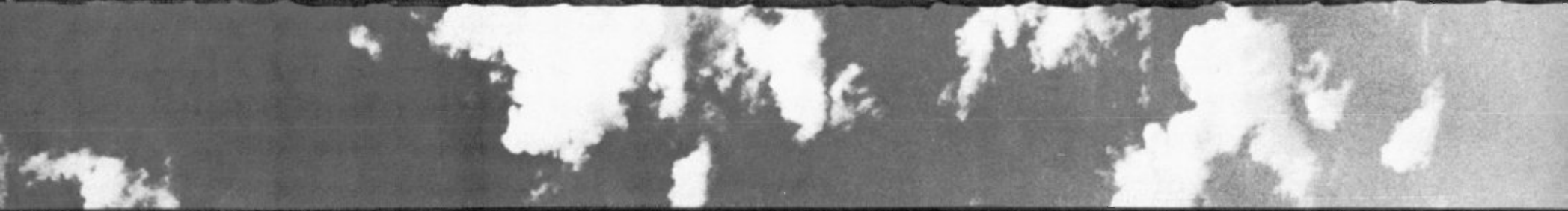

- Branches:** **Bearsville, N.Y.,** PO Box 135, Wittenberg Rd Zip 12409 Tel (914) 679-7303. **A&R/Artist Development Dir. Ian Kimmet—New York, N.Y.,** 75 E. 55 St. Zip 10022. Tel (212) 751-7030.
- Beau-Brian, see AcoustoGraphic**
- Beau Jim Agency Inc.,** PO Box 758, 301 Plantation Dr., Lake Jackson, Tex. 77566 Tel (713) 297-4030, 393-1703.
- Bee Hive Jazz Recs.,** 1130 Colfax St., Evanston, Ill. 60201. Tel (312) 328-5593. **Owners:** Susan L. & James R. Neumann.
- Int'l reps.:** Canada (Coda), Germany (Discofon), Italy (Hi-Fi), Sweden (Amigo), UK (Cadillac).
- Bee Jay Rec'g Studios,** 5000 Eggleston Ave., Orlando, Fla. 32810 Tel (305) 293-1781. **Pres. Eric T. Schabacker, Gen. Mgr. Jim Katt, A&R/Prod'r. Bill Vermilion, Prod'r/Arranger George Atwell, Technical Supervisor Andy de Ganahl.**
- Labels:** (Owned) Hype, Immunity, Tener.
- Tom Bee Prod'ns, PO Box 8207, Albuquerque, N.M. 87198 Tel (505) 268-6110. Gen. Mgr.: Tom Bee, Ass't Mgr. Mac Suazo, Sales & Mktg.: Dan Davis, Pub. Vicki Bee, Adv. Cheryl Walker, Tape Tom Krull.**
- Labels:** (Owned) Souled Out, Soul Roll, Tribal.
- Bego, see Music Ents**
- Bel-Ad Recs.,** 4307 S. Broadway, Los Angeles, Calif. 90037 Tel (213) 231-1416. (Distributed by Ray Lawrence)
- Bel Air, see Boot**
- Belkin Prod'ns Inc.,** 28001 Chagrin Blvd., Cleveland, Ohio 44122. Tel (216) 464-5990.
- Label:** (Owned) Sweet City.
- Belle, see La Louisianne**
- Belltone, see Lee Anderson**
- Belmont Recs. (div. of John Penny Ents. Inc.),** 259A Beech St., Belmont, Mass. 02178. Tel (617) 924-6722. **Pres.: John Penny.**
- Ben-La-Rose, see Heavy Sound**
- The Benson Co.,** 365 Grand Circle Rd., Nashville, Tenn. 37228. Tel (615) 259-9111. **WATS (800) 251-8984. Pres. Robert Benson Sr., Sr. VP/Gen. Circle Recs.: Robert Benson Jr., Sr. VP/Finance Mike Cowart, Sr. VP/Mktg. Eddy Messick, A&R Dir.: Phil Johnson, Promo Mgr. Matt Steinhauer.**
- Int'l branch:** England.
- Labels:** (Owned) CrossCountry, Greentree, Heart-Warming, Impact, (distributed) Jim.
- Int'l reps.:** Australia (Rhema), Belgium (Universal Songs in Netherlands), Canada (Lawson-Falle), Luxembourg (Universal Songs in Netherlands), Netherlands (Universal Songs), UK (Kingsway).
- Bente Recs.,** 382 Central Park W., New York, N.Y. 10025. Tel (212) 749-5613. **Co-Pres.: Karin Mann, John Blount, Disco Mgr. John Blount.**
- Ivan Berg Cassettes, see Communication Institute**
- Berlitz Publ'ns Inc.,** 866 Third Ave., New York, N.Y. 10022. Tel (212) 935-2000.
- Berry Hill, see Buzz Cason**
- Beserkley Recs.,** 1199-B, Spruce St., Berkeley, Calif. 94707. Tel (415) 527-7664. **Reigning Looney: Matthew Kaufman, Ass't Reigning Looney: Steve Levine, VP A&R Gary Phillips, VP Int'l Affairs: John Doukas, Pub. & Adv. Dir. Ken Baker.**
- Int'l branch:** England.
- Labels:** (Owned) Beserkley (distributed by Elektra/Asylum), Home of the Hits, Organ.
- Int'l reps.:** Australia (Festival), Austria (Teldec), Benelux (Ariola), France (Decca), Germany (Teldec), Japan (Teichiku), Sweden (Sonet), Switzerland (Teldec), UK (Polydor).
- Bethlehem, see Salsoul**
- Beverly (Brazil), see Brasilia**
- Bicycle Music,** 8756 Holloway Dr., Los Angeles, Calif. 90069. Tel (213) 659-6361. **Pres.: David Rosner.**
- Big Ben (UK), see Rounder**
- Big Boro Recs. Corp.,** 1700 Broadway, New York, N.Y. 10019. Tel (212) 757-4534. **Pres.: Jeff Lane, Pop A & R Shot Lee.**
- Big Ei, see Rob Lee**
- Big Fish, see California Sun**
- Big Mack Recs.,** 1300 Robin Rd., Muskegon, Mich. 49445. Tel (616) 744-0257. **Pres. Thomas E. Mack.**
- Labels:** (Owned) BMR, Big Mack.
- Big Rock Rec'g Inc.,** 121 S. Lincolnway, North Aurora, Ill. 60542. Tel (312) 859-3199. **Pres. & Gen. Mgr. John A. Montgomery, VP Promos & Sales: James C. Thompson, VP Studio Mgr. Kent Minor.**
- Big Sound Recs. Inc.,** Box 9, 10 George St., Wallingford, Conn. 06492. Tel (203) 269-4465. **Cable: BIGSOD-REC. Pres. & A&R Thomas Cavalier, Chief Eng. Richard Robinson, Mktg. Mdsjg & Promo Dir. Benjamin Gant, Promo Co-ord. Joel Webber.**
- Branch: New York, N.Y.,** Box 520, 175 Thompson St. Zip 10012. **Mng. Dir. Jon Tiven.**
- Label:** (Owned) Miracle.
- Int'l reps.:** Australia (EMI), Germany (Kuckuck), Japan (Decca), UK (Decca).
- Big Town, see Cadet**
- Big Tree Recs.,** 75 Rockefeller Plaza, New York, N.Y. 10019. Tel (212) 484-8061. **Pres. Dick Vanderbilt, Nat'l Promo Dir. Reen Nalli, (Distributed by Atlantic)**
- Big Wheel, see Long Neck**
- Big Willie, see Forrest Green**
- Bija, see Rounder**
- Biograph Recs. Inc.,** 16 River St., Chatham, N.Y. 12037. Tel (518) 392-3400. **Pres. Arnold S. Caplin, VP Barbara Caplin, A&R Dir. Joel Bernstein, Adv. Dir. Robert Biblo, Int'l Dir.: Robert Caplin.**
- Labels:** (Owned) Biograph Center, Melodeon.
- Int'l reps.:** Australia (Larrikin), Belgium (Parsifal), France (L'Oiseau Musicien), Japan (Shinsei), UK (EMI).
- Birch Recs.,** Box 92, Wilmette, Ill. 60091. Tel (312) 251-7037, 583-0129. **Pres. Dave Wylie, VP June Wylie, VP Promo: Terry L. Walker, VP Pub.: Ellen Ginden, VP PR: Barbara Allgaier.**
- Birdwing, see Sparrow**
- Birthing Recs.,** 3101 S. Western Ave., Los Angeles, Calif. 90018. Tel (213) 731-0907. **Pres. & Gen. Mgr.: Byron Spears Jr., VP Promo: Carl Spears.**
- Biscuit City Ents. Inc.,** 4027 E. 50 St., Minneapolis, Minn. 55417. Tel (612) 722-6720/7844. **Pres.: Laura Sunday.**
- Int'l reps.:** Italy (Hi-Fi), Japan (Black Hawk, Disc Center)
- Bitter Sweet Jazz, see Sine Qua Non**
- Blackbird, see Lakko**
- Blackbird (Ireland), see Rounder**
- Black & Blue, see Argus**
- Blackdisc, see Blackjack**
- Black Fire Recs.,** PO Box 38054, Zip 20020, 4409 Douglas St. NE, Washington, D.C. 20019. Tel (202) 396-0154. **Pres. James B. Gray, Exec. VP Plunkly Nkabinde, Sales Mgr. Jerome Gray, Bus. Mgr. Sylvia Potts, Promo: Jimmy Gray, Adv. & Graphics: Muzi Nkabinde, Layout & Graphics: Mary Greer.**
- Labels:** (Owned) Black Fire, Cosmic Fire, (distributed) Ak Ba, IPS, Tribe.
- Black Foot, see Startown**
- Black Fox, see Rolashed**
- Black Hawk, see Glenn**
- Blackjack Recs.,** PO Box 3367, Hollywood, Calif. 90028. Tel (213) 761-9679. **Mng. Dir.: Jeff Oxman, Dir.: Carl Todd, Mktg. Mgr. K. Dossat.**
- Labels:** (Owned) Blackjack, (distributed) Blackdisc
- Int'l reps.:** UK (Contempo, Sun-Pacific)
- Blackland Recs.,** PO Box 7349, Tulsa, Okla. 74105. Tel (918) 456-9541. **Pres. J.C. Garland, VP: Sec'y Jelinda De Vozen.**
- Black Saint (Italy), see Rounder**
- Black Treasure, see McKinnon**
- Black & White, see Wildwood**
- Eubie Blake Music Rec'g, 284-A Stuyvesant Ave., Brooklyn, N.Y. 11221. Tel (212) 574-8511.**
- Int'l reps.:** Canada (Coda), Japan (Shinsei).
- Blarney Castle, see Avoca**
- Blaze Rec. Co. (div. of Blaze Org.),** PO Box 1899, Little Rock, Ark. 72203. Tel (501) 375-2911. **Pres. James E. Handy II, Treas./Sec'y Betty Hansberry, VP Promo: Michael Bailey.**
- Labels:** (Owned) Blaze, GMC, Hot City.
- Blind Pig Recs.,** 208 S. First, Ann Arbor, Mich. 48103. Tel (313) 994-4780. **Prod'n Jerry Del Giudice.**
- Branches: Oakland, Calif.,** 4501 Reinhardt, Zip 94619. Tel (415) 530-2933. **Promo Dir. Edward Chmielewski—Chicago, Ill.,** 857 W. Wrightwood, Zip 60614. Tel (312) 528-0171. **Sales Rep.: Michael Del Giudice.**
- Bloodleaf, see Olivia**
- Blood Recs.,** 1152 Elm St., No. 203, Manchester, N.H. 03101.
- Blue Ash, see Kare**
- Bluebird, see RCA**
- Blue Bonnett, see Jim Hall**
- Blue Candle, see TK**
- Blue Canyon Recs.,** 1000 Granville Ave., Los Angeles, Calif. 90049. Tel (213) 826-0649. **Pres. Jim Terr.**
- Blue Diamond Co.,** Box 102C, Chubbuck Rd., Canonsburg, Pa. 15317. Tel (412) 746-2540. **Pres. Joe Diamond, VP: Cheryl Diamond, Gen. Mgr.: Jerry Walker, Sales & Mktg. Ron Walker.**
- Branch: Nashville, Tenn.,** 3410 Dickerson Rd. Zip 37207. Tel (615) 227-7843. **Mng. Bob McCracken.**
- Blue Flame, see CJ**
- Blue Goose, see Yellow Bee**
- Blue Horizon, see Sire**
- Blue Mark, see QCA in Ohio**
- Blue River Recs.,** 1741 N. Ivar, Suite 210, Hollywood, Calif. 90028. Tel (213) 463-7661.
- Labels:** (Owned) Musi-Que, Musi-Que Contemporary, Solo Plus.
- Blues Classics, see Arhoolie**
- Blue Sky Recs. Inc.,** 745 Fifth Ave., Suite 1803, New York, N.Y. 10022. Tel (212) 751-3400. (Distributed by CBS).
- Blues Spectrum, see Ala Ents**
- Blues Unlimited, see Modern Sound**
- Bob, see Surf City**
- Boblo Recs. & Sound Studio Inc.,** 3807 Norwich St., Brunswick, Ga. 31520. Tel (912) 265-1817.
- Boddie Rec. Mfg. & Rec'g Inc.,** 12202 Union Ave., Cleveland, Ohio 44105. Tel (216) 752-3440. **Pres. Thomas Boddie, VP Louise Boddie, A&R: Gerald Baxter, Sales Mgr.: Dennis Boddie.**
- Labels:** (Owned) Bounty, Caribl, Luau, Soul Mine
- Bold, see TK**
- Boliva, see Startown**
- Bollman Int'l Recs.,** PO Box 28553, Dallas, Tex. 75228. Tel (214) 328-7770.
- Branch: Lancaster, Calif.,** PO Box 4137, 42314 52 St. W. Zip 93534. Tel (805) 943-2384.
- Labels:** (Owned) BI, Gospel City
- Bomp Recs. Inc.,** 2702 San Fernando Rd., Los Angeles, Calif. 90065. Tel (213) 227-4141. **Pres. Greg Shaw, Gen. Mgr. Meryl Hauser, Dir. Wolfgang Spegg, Phil Lubman, Promo & Pub. Mgr. Paul Goldberg.**
- Labels:** (Owned) Bomp, (distributed) Backlash, Exhibit
- Int'l reps.:** Australia (Phantom), Canada (Bomb, PJ), Denmark (Stiff), France (Music Box), Germany (Sun, Teldec), UK (Rough Trade)
- Bonnet, see Country Stream**
- Booths, see Katie the Great**
- Boot Master Concert, see Boot**
- Boot Recs. Inc.,** PO Box 120478, Nashville, Tenn. 37212. **Pres. Jury Krytiuk, VP Tom C. Connors, Sales: Peter Krytiuk, Promo: Mitch LePage.**
- Home office:** Canada.
- Labels:** (Owned) Boot, Boot Master Concert, Cynda, Generation, (distributed) Bel Air.
- Boppin' Belle, see Rollin' Rock**
- Borinquen (Discos) Inc.,** GPO Box 4785, San Juan, P.R. 00936. Tel (809) 790-4286. **Pres. Darjo Gonzalez, VP Benito Valdes, Mgr. Miriam Gonzalez, Promo: Lidia Carrio, Sales: Victoria Fajardo, Eng.: Richard Stanley.**
- Branches: Miami, Fla.,** 1545 SW Eighth St. Zip 33135. Tel (305) 649-2110. **Pres. Jose Peniche—New York, N.Y.,** 200 W. 57 St., Suites 505-506. Zip 10019. Tel (212) 581-0655. **Mng.: Edward Cuervo.**
- Bounty, see Boddie**
- Bouquet-Orchid Ents.,** PO Box 4220, Shreveport, La. 71104. Tel (318) 686-7362. **Pres. Bill Bohannon.**
- Bourne Co.,** 1212 Ave. of the Americas, New York, N.Y. 10036. Tel (212) 575-1800. **Cable: BOURNEMUS.**
- Pres. Bonnie Bourne.**
- Label:** (Owned) Murbo. (SEE ADVERTISEMENT)
- Boyd Recs.,** 2609 NW 36 St., Oklahoma City, Okla. 73112. Tel (405) 942-0462. **Pres. Bobby Boyd.**
- Labels:** (Owned) Boyd, Saguaro.
- Boyzfriends, see Frank Evans**
- Branch Int'l Recs.,** PO Box 31819, Dallas, Tex. 75231. Tel (214) 690-8874. **Owner: Bart Barton, (Distributed by Sunshine Country)**
- Brand-X, see Sivatt**
- Brasilia Recs. & Tapes Corp.,** 29 W. 38 St., New York, N.Y. 10018. Tel (212) 354-5613. **Telex: 666794.**
- Pres. Herbert Cszasznik, Nat'l Sales Mgr. Jim Demay.**
- Labels:** (Owned) Brasilia, Brass, (distributed) AMC, Beverly, Building, Copacabana, Fontana, Discos Marcus Pereira, Philips, Phonogram, Polydor, Polygram, RCA, RGE/Fermata, Sabia, Som, Vision (all Brazil), Movieplay, Polygram (both Portugal), Emergency (SEE ADVERTISEMENT)
- Brass, see Brasilia**
- Brass Ring, see JEMKL**
- Briar, see Sierra**
- Briar-meade, see Ken Keene**
- Bridge, see Chapel/Bridge**
- Bridge the Gap Recs. & Tapes,** 909 W. Washington St., Petersburg, Va. 23803. Tel (804) 732-3333. **Pres. William Ford McGee, Exec. VP Francis Oliver, VP Mgmt. & Mgmt. Herman L. MacIn, VP Promo: Lynnwood Jones, A&R Dir. Ronald L. Smith, PR Dir. Larry O. Tynes, Adv. Dir. Michael Gray.**
- Bright Orange, see Cadet Recs**
- Bristol, see Moonstone**
- Broadsides, see Folkways**
- Broadway Baby, see Take Home Tunes!**
- Bronto Saurus, see Crimson Dynasty**
- Bronze, see Chrysalis**
- Brooklyn Country Recs.,** 6666 Brookmont Terr., Suite 712, Nashville, Tenn. 37205. Tel (615) 352-0138. **Promo & Gen. Mgr. Linda Snioris.**
- Brookville Mktg. Corp.,** 420 Lexington Ave., New York, N.Y. 10017. Tel (212) 687-3377.
- Labels:** (Owned) Brookville, TEJ.
- Brotherhood, see SIPRA**
- Brother Recs. Inc.,** 10880 Wilshire Blvd., Suite 306, Los Angeles, Calif. 90024. Tel (213) 475-0361. **Exec. VP Janet Lent-Koop.**
- Brownstone, Calif., see WILD**
- Brownstone, Fla., see TK**
- Brubson, see Gwen**
- Bruno, see Acropole**
- Brunswick Rec. Corp.,** 888 Seventh Ave., New York, N.Y. 10019. Tel (212) 541-9860.
- Branch: Chicago, Ill.,** 1449 S. Michigan Ave. Zip 60605. Tel (312) 427-0828.
- Labels:** (Owned) BRC, Brunswick, Dakar.
- Bryant Recs.,** 1 E 42 St., New York, N.Y. 10017. Tel (212) 682-2539.
- Buckboard, see Springboard**
- Buckshot, see Jere**
- Buddah Recs. Inc.,** 1350 Ave. of the Americas, New York, N.Y. 10019. Tel (212) 582-6900. **Pres. Arthur Kass, VP Chuck Walz, Controller: Mike Marone, (Distributed by Arista)**
- Int'l reps.:** Argentina (Interdisc), Australia (RCA), Belgium (Vogue), Brazil (Som), Canada (Quality), Colombia (Sonolux), Denmark (Teldec in Germany), Finland (Teldec in Germany), France (Vogue), Germany (Teldec), Greece (Phonogram), Italy (RCA), Jamaica (Sonic Sounds), Japan (Nippon Phonogram), Luxembourg (Vogue in Belgium), Mexico (Musart), Netherlands (VIP), Norway (Teldec in Germany), Philippines (Disc Corp.), South Africa (Teal), Spain (Teldec), Sweden (Teldec in Germany), Switzerland (Teldec in Germany), UK (Pye), Venezuela (Palacio de la Musica).
- Building (Brazil), see Brasilia**
- Bulldog, see Ember**
- Bullet, see Bang**
- Burchette Bros.,** PO Box 1363, Spring Valley, Calif. 92077. **Pres. Kenneth W. Burchette, VP Wilburn L. Burchette, Mktg. Ralph Roufus.**
- Burdette, see First American**
- Burlap, see Ken Keene**
- Busch Country Recs.,** 1002 W. Busch Blvd., Tampa, Fla. 33612. Tel (813) 935-6289. **Contact: Randall Bethencourt.**
- Butterfly Recs. Inc.,** 9000 Sunset Blvd., Suite 617, Los Angeles, Calif. 90069. Tel (213) 273-9600. **Pres. A.J. Cervantes, Exec. VP Nancy Sain, Int'l Dir.: Judy Sakawye, Disco Promo Dir.: Dee Joseph, (Distributed by MCA)**
- Int'l reps.:** Australia (Festival), Brazil (Tapecar), Canada (RCA), Colombia (Fuentes), El Salvador (Boni), France (EMI), Germany (EMI), Greece (Polygram), Israel (CBS), Italy (Baby, CGD), Japan (King), Mexico (Gamma), Netherlands (Basov), Peru (IEMPSA), South Africa (Gallo), Spain (Hisvavoc), Sweden (Sounds of Scandinavia), UK (Chrysalis, Ember), Venezuela (Velvet in USA). (SEE ADVERTISEMENT)
- Buttermilk Recs.,** 1310 Tulane, Houston, Tex. 77008. Tel (713) 869-0417. **Owner & Pres.: Charles Bickley, Promo Mgr. Suzanne Bickley, A&R: Trent Burns.**
- Labels:** (Owned) Buttermilk, Flatrock, (distributed) Fair Retail, Hamilton St.
- Buzz Recs. (div. of Brightside Inc.),** 50 Music Square W., Nashville, Tenn. 37203. Tel (615) 329-0776. **Contact: Lee Morgan.**



CBS Recs., 51 W. 52 St., New York, N.Y. 10019. Tel (212) 975-4321. **Cable: COLRECORD. CBS Recs. Group: Pres. Walter R. Yetnikoff, Sr. VP: Opns. Albert B. Earl, Sr. VP Finance & Admin. Seymour Gartenberg, VP Press & Public Affairs: Robert Altschuler, VP Admin.**

*Whenever
and
wherever
a song is
created...*

Si c'est un succès, nous avons notre doigt dessus Wenn es ein Schlager ist, können wir



ihnen bekommen Si es un éxito, no se nos escapa Als het een succes is, dan zijn we erop gevallen Se för successo, este



na mão Se e successo, siamo noi che l'abbiamo ヒットすれば、我々のもの

*if it's a hit we've
got our finger on it.*

RCA RECORDS/PUBLISHING
INTERNATIONAL

- & Personnel Frank Calamita; VP John J. Casey; VP/Gen Mgr. Masterworks Simon Schmidt **CBS Recs.** Div.: Pres. Bruce G. Lundvall, Exec. VP Walter L. Dean, Sr. VP & Gen Mgr. Mktg. Paul Smith, Sr. VP Opns. Mgt. Samuel Burger, Sr. VP Opns. Mktg. Calvin Roberts, VP Adv. Planning Linda Barton, VP Pkg. Art & Design John Berg, VP Bus. Affairs Marvin Cohn, VP Mktg./Southwest Jack Chase, VP Bus. Development Joe Dash, VP Nat'l Promo. Black Music Mktg. Paris Eley, VP Customer Financial Relations Eugene P. Friedman, VP Finance & Admin. William Fox, VP Mktg. Planning Joan Griewank, VP Planning & Diversification Stanley J. Kavan, VP Opns. Admin. Floyd Kershaw, VP Nat'l Accounts Mktg. John Kotecki; VP Adv. & Creative Servs. Arnold Levine; VP Mdsq. Mike Martinovich; VP Mktg./Northeastern Region; Ron Piccolo; VP Mfg. Admin. John F. Ryan; VP Mfg. Servs. Howard Schwartz; VP Jazz Progressive Mktg. Vernon Slaughter; VP Black Music Mktg.; LeBaron Taylor, VP Mktg./Midwestern Region; Don Van Gorp, VP Press & Public Information Black Music Mktg.; Win Wilford. **Columbia Recs.:** Sr. VP/Gen. Mgr. Jack R. Craig; VP Artist Development Arma Andon; VP Press & Public Information Hope Antman; VP Progressive & Jazz Music A&R George Butler; VP Talent Acquisition/East Coast Don DeVito; VP A&R/East Coast Michael H. Eichner; VP Contemporary Music A&R/East Coast Gregg Geller; VP Nat'l Promo. Ed Hynes; VP Mktg. Joe Mansfield; VP Columbia Rec. Prod'n. Thomas Van Gessel; VP Columbia Masterworks Marvin Saines; VP Columbia Special Prods. Albert E. Shulman **Epic/Portrait/Associated Labels:** Sr. VP & Gen. Mgr. Don Dempsey; VP Press & Public Information Susan Blond; VP Artist Development Al DeMarino; VP Promo. Al Gurewitz; VP Mktg. Ron McCarrell; VP Epic A&R Lennie Petze; VP Portrait A&R Lorne Saifer; VP/Gen. Mgr. CBS Assoc'd Labels Tony Martell
- Branches:** Los Angeles, Calif., 1801 Century Park W. Zip 90067. Tel (213) 556-4700. VP Bus. Affairs/West Coast Myron Roth; VP Mktg./Western Region Del Costello; VP Columbia Recs. A&R/West Coast Michael Dilbeck; VP Columbia Recs. Mdsq./West Coast Ron Oberman; VP Epic A&R/West Coast Frank Rand, VP E/P/A. Mktg./West Coast Stan Monteiro—**Nashville, Tenn.,** 49 Music Square W. Zip 37203. Tel (615) 259-4321 (rec. g. studio); 329-4321 (mktg.) VP Country Mktg. Rick Blackburn; VP Country A&R Billy N. Sherrill
- Distribution branches:** Los Angeles, San Francisco, Calif.; Denver, Colo.; Hartford, Conn.; Miami, Fla.; Atlanta, Ga.; Honolulu, Hawaii; Chicago, Ill.; Silver Spring, Md.; Boston, Mass.; Detroit, Mich.; Minneapolis, Minn.; St. Louis, Mo.; New York, N.Y.; Cincinnati, Cleveland, Ohio; Philadelphia, Pa.; Nashville, Memphis, Tenn.; Dallas, Houston, Tex.; Seattle, Wash. (See Record & Tape Wholesalers section for complete listings for CBS Recs.)
- Labels:** (Owned) CBS, Columbia, Columbia Masterworks, Epic, Odyssey, Portrait; (associated) ARC, Bang, Blue Sky, Caribou, Jet, Kirshner, Lorimar, Nemperor, Pavilion, Philadelphia Int'l, Sam, Starfile, Stiff/Columbia, Stiff/Epic, T-Neck, TSOP, Tabu, Tappan Zee, Unlimited Gold
- Int'l branches & reps.:** see CBS Recs. Int'l.
- CBS Recs.** Int'l (div. of CBS Inc.), 51 W. 52 St., New York, N.Y. 10019. Tel (212) 975-4321. Cable COLRECORD Telex 424567. Pres. Richard Asher; VP John Dolan, VP Admin. Bernard DiMatteo; VP Finance Farrell Bushing Jr.; VP Creative Opns. Bernice Freidus; VP Bus. Development Frank J. Welzer; VP Bus. Affairs Thomas Tyrell; VP Mfg./Eng. Servs. Michi Yoshimura; VP Int'l Artist Development & Promo.: Joe Senkiewicz
- Int'l opns. branches:** Australasia (CBS Int'l) in Australia, Europe (CBS Int'l in France), Latin America (CBS Int'l in Florida)
- Int'l branches:** Argentina (CBS), Australia (CBS), Austria (CBS), Belgium (CBS), Brazil (CBS), Canada (CBS), Central America (India in Costa Rica), Colombia (CBS), Costa Rica (India), Cyprus (CBS), Denmark (CBS), England (CBS), Finland (CBS), France (CBS), West Germany (CBS), Greece (CBS), Hong Kong (CBS/Sony), Ireland (CBS), Israel (CBS), Italy (CBS), Japan (CBS/Sony), Mexico (CBS/Columbia), Netherlands (CBS), New Zealand (CBS), Norway (CBS), South Africa (Gramophone), Spain (CBS), Sweden (CBS), Switzerland (CBS), Venezuela (CBS/Columbia)
- Int'l reps.:** Bolivia (Heriba), Chile (Odeon), Czechoslovakia (Supraphon), Dominican Republic (Continental de Discos), Ecuador (Emporio Musical), Jamaica (Federal), Kenya (Phonogram), Malaysia (EMI), Nigeria (Phonogram), Peru (Industrial Sono-Radio), Philippines (Blackgold), Portugal (Radio Triunfo), Singapore (EMI), Turkey (Grunberg Ticaret), Uruguay (Sondor), Yugoslavia (Suzy). (SEE ADVERTISEMENT)
- C C/Orion,** see Orion
- C D C,** see Commercial Dist'g Corp.
- C D E Recs & Tapes/Toll Free Recs & Tapes,** PO Box 41551, Atlanta, Ga. 30331. Tel (404) 344-2039. Pres. Charles D. Edwards
- C E I,** see Concepts Exchange
- C G M Recs./CGM Prod'n Co.,** 1725 W. Sixth St., No. 306, Los Angeles, Calif. 90017. Tel (213) 483-3911
- C G I Cassettes,** see Communication Institute.
- C I E,** see International Mktg. & Mgmt.
- C J Rec Co.,** 4827 S. Prairie Ave., Chicago, Ill. 60615. Tel (312) 285-1616. Pres. Carl Jones; Mgr. R. C. Hillsman. **Local branch:** 7855 S. Halsted. Zip 60621. Tel 224-5612, 787-8220
- Labels:** (Owned) Blue Flame, C.J. Colt, Firma
- C M H Recs Inc.,** PO Box 39439, Los Angeles, Calif. 90039. Tel (213) 663-8073. Pres. Martin Haerle, Exec. Ass't Paul F. Wells
- Branch:** Charlotte, N.C., 5457 Old Monroe Rd. Zip 28211. Tel (704) 536-0424. VP Arthur Smith
- Int'l reps.:** Austria (Ariola Schallplatten), Canada (Trend), Germany (Ariola-Eurodisc), Switzerland (Ariola-Eurodisc)
- C M S Recs. Inc.,** 14 Warren St., New York, N.Y. 10007. Tel (212) 964-3380. Telex 667138. Pres. Irving Tep-
- per, Sec'y-Treas. Leon Golovner; Sales Dir. Paul Backer
- Labels:** (Owned) CMS, Desto. (distributed) Oryx, Proms, Saga, Summit
- Int'l reps.:** Canada (Almada), UK (Peerless)
- C O R I,** see Continental Rec's
- C P Recs,** PO Box 7142, Berkeley, Calif. 94707. Tel (415) 524-6977. Pres. Tom White, VP Sales Bob Dean, VP A&R Jay Erokan
- C S A,** see Country Showcase
- C T I,** see Creed Taylor
- C V R,** see Chuck Anthony
- C V S,** see Don D. Sheets
- Cable Car,** see Grassroots
- Cactus,** see Jim Hall
- Cadet Polka Recs.,** Box 36, Burnett, Wis. 53922. Tel (414) 689-2211/2215/2320. Pres. Don Peachey
- Cadet Recs. Inc.,** 5810 S. Normandie Ave., Los Angeles, Calif. 90044. Tel (213) 753-5121. Telex 67-3572. Pres. Jules Bhari; Gen. Mgr.: James Takeda, A&R, George Matola; Sales & Mktg., Tape & Int'l Donald Macmillan
- Branch:** Park Ridge, N.J., 12 Maple Leaf Dr. Zip 07656. Tel (201) 391-3676. VP Sales Robert Herington
- Labels:** (Owned) Big Town, Bright Orange, Crown Custom, Kent, Modern, Mother Goose, Riviera, Robin Hood, Super-8, United, Vee-8
- Cadet, N. J.,** see All Platinum
- Caedmon,** 1995 Broadway, New York, N.Y. 10023. Tel (212) 580-3400. Pres. Carol Haubert, Exec. Prod'r Ward Botsford; Mktg. & Sales Dir. Robert D. Knox, Exec. Ass't Promo & Pub. Suesan L. Greenspan
- Labels:** (Owned) Caedmon, Soundbook
- Int'l reps.:** Australia (L&S, Phonogram), South Africa (Trutone), UK (Teakfield)
- Caelix,** see Triangle
- Cafe Juli,** see Daytwo
- Cajun Classics,** see Modern Sound
- Calabasas,** see Suncat
- Caliente,** see Caeyronics
- California,** see LA Recs.
- California Mud Slide,** see Crimson Dynasty
- California Sun Recs.,** 10811 Hesby St., North Hollywood, Calif. 91601. Tel (213) 766-7487. Co-Pres. Steve Goddard, Chuck Tennin; Exec. VP Prod'n Ray Thompson
- Labels:** (Owned) Big Fish, California Sun
- Calhoop,** see Festival
- Calumet,** see San-Lyn
- Calvary Recs. Inc.,** 1832 Van Ness, Fresno, Calif. 93721. Tel (209) 486-2170. Pres. Nelson S. Parkerson Jr., A&R Ronnie Drake
- Branch:** Nashville, Tenn., 142 Eighth Ave. N. Zip 37203. Tel (615) 244-8800
- Labels:** (Owned) Calvary, Clarion
- Cambridge Recs. Inc.,** 125 Irving St., Framingham, Mass. 01701. Tel (617) 879-2282
- Camden,** see RCA & Pickwick
- Camden Soul,** see Rob-Lee
- Camerata Tokyo (Japan),** see Outstanding
- Canaan,** see Word
- Canadian American,** see Dawn
- Canary-Yellow Bird Recs Co.,** 1119 Woodrow St., Redwood City, Calif. 94061. Tel (415) 368-5619. Owner Earl Miles
- Candide,** see Moss
- Candle,** see Soundwaves
- Candy Recs.,** 2716 Sprinkale Court, Irving, Tex. 75060. Tel (214) 259-4032. Owner & Gen. Mgr. Kenny Wayne Hagler
- Labels:** (Owned) Candy, Hollt, Lil' Possum, Sweet Tooth
- Candy, Pa.,** see Jeree
- Can Scor,** see R&R
- Canyon Recs. Inc.,** 4143 N. 16 St., Phoenix, Ariz. 85016. Tel (602) 266-4823
- Cap,** see Cha-Cha
- Capital City,** see Centurian
- Capital Star Artist Ent's Inc.,** 1458 Buffalo Rd., Rochester, N.Y. 14624. Tel (716) 328-5565. Pres. Don Bailes, VP & Sales & Mktg. Tony Powlowski; Mgr. Don Redanz
- Branch:** Williamsport, Pa., 836 Franklin St. Zip 17702. Tel (717) 323-6951. Mgr. Pat Craven
- Capitol Recs. Inds.-EMI,** 1750 N. Vine St., Hollywood, Calif. 90028. Tel (213) 462-6252. Cable CAPRECORDS Telex 674051. Bd. Chm. & Chief Exec. Officer Bhsark Menon; Exec. Pres. Don Zimmermann; VP Mktg. Dennis White, VP A&R Rupert Perry, VP A&R/R&B Dr. Cecil I. Hale, VP Creative Servs. Dan Davis, VP Promo. Bruce Wendell, VP Int'l. Helmut Fest; Bus. Affairs Dir. Arnold Holland, Mdsq. & Adv. Dir. Randall Davis, Talent Acquisition Dir.: Bruce E. Garfield
- Branches:** New York, N.Y., 1370 Ave. of the Americas. Zip 10019. Tel (212) 757-7470. Exec. Ira Derfler—**Nashville, Tenn.,** 38 Music Square E. Zip 37203. Tel (615) 244-1842. Div. VP: Lynn Shults; Talent Acquisition Dir. Chuck Flood
- Int'l branch:** Canada
- Distribution centers:** Los Angeles, San Francisco, Calif.; Denver, Colo.; Miami, Fla.; Atlanta, Ga.; Niles (Chicago Metropolitan Area), Ill.; Germantown, Md.; Westwood (Boston Metropolitan Area), Mass.; Madison Heights (Detroit Metropolitan Area), Mich.; Bloomington (Minneapolis-St. Paul Area), Minn.; New York, N.Y.; Cleveland, Ohio; Bala-Cynwyd (Philadelphia Metropolitan Area), Bethlehem, Pa.; Nashville, Tenn.; Dallas, Tex. (See Record & Tape Wholesalers section for complete listings)
- Labels:** (Owned) Angel, Capitol, EMI, Harvest, Seraphim, United Artists' group; (distributed) Ariola
- Int'l reps.:** Argentina (Capitol), Australia (EMI), Austria (EMI), Barbados (West Indies Recs.), Belgium (EMI), Bolivia (Discolandia), Brazil (Capitol), Chile (EMI), China (Four Seas), Colombia (CBS), Czechoslovakia (Artia), Denmark (EMI), Dominican Republic (Julio Tonos), East Germany (Deutsche Schallplatten), Ecuador (IFESA), Egypt (Sono Cairo), Finland (EMI), France (Pathe Marconi-EMI), Sonopresse), Germany (EMI Electrola), Greece (Columbia-EMI), Guatemala (Dideca), Hong Kong (EMI), Hungary (Hungarian Gramophone, Kultura), India (Gramophone), Ireland, (EMI), Israel (CBS), Italy (EMI), Jamaica (Record Specialties), Japan (Toshiba-EMI), Kenya (AIT), Korea (Oasis), Malaysia (EMI), Mexico (EMI-Capitol), Netherlands (EMI-Bovema), New Zealand (EMI), Nigeria (EMI), Norway (EMI), Pakistan (EMI), Peru (IEMPSA), Philippines (Dyna), Portugal (Valentim de Carvalho), Singapore (EMI), South Africa (EMI-Brigadiers), Spain (EMI-Odeon), Sweden (EMI), Switzerland (EMI), Thailand (EMI), Turkey (Grunberg Ticaret), UK (EMI), Uruguay (Ricardo & Rodolfo Gioscia), Venezuela (Los Ruices), Yugoslavia (Jugoton), Zambia (Teal)
- Cap-Orion,** see Cartoon
- Caprice Recs. Inc.,** 907 Main St., Nashville, Tenn. 37206. Tel (615) 226-0724. Pres. R. E. Don Lewis; Admin. Mgr. Barbara M. Lee; Exec. Prod'rs Joe H. Hunter, Roger LeBlanc; Sales Mgr. Catherine Charleton; Adv. Dir. Charlie Dick; Promo. Don H. Howser
- Labels:** (Owned) Caprice, Chariot, Checkmate, Palace, Relco, Soundmate
- Capricorn Recs. Inc.,** 535 Cotton Ave., Macon, Ga. 31201. Tel (912) 745-8511. Pres. Phil Walden, Exec. VP Frank Fenter; VP & Gen. Mgr. Don Schmitzler; VP Promo. Phil Rush; Treas. Ted Senters; Nat'l Pub. Dir. Mark Pucci; Nat'l LP Promo. Dir. Geary Tanner, A&R Dir. David Herscher; Artist Development Dir. Carole Kinzel
- Branch:** Hollywood, Calif., 6255 Sunset Blvd. Suite 814. Zip 90028. Tel (213) 462-7161. VP Special Projects John Scott; Adv./Creative Servs. Dir. Diana Kaylan
- Int'l rep.:** Worldwide excluding Japan & South Africa (Polydor Int'l)
- Captain,** see Sonic Arts
- Car Recs.,** 89 Bleeker St., New York, N.Y. 10012. Tel (212) 254-5315. Contacts Chris Stamey, Jamie Sims
- Cardinal, N.Y.,** see Vanguard
- Cardinal, Va.,** see Richtown
- Carib Recs.,** 1012 Ocean Ave., Brooklyn, N.Y. 11226. Tel (212) 434-5469
- Labels:** Carib, Cookhill
- Caribb,** see Boddie
- Caribou,** see CBS
- Carillon Recs. Inc.,** 521 Fifth Ave., New York, N.Y. 10017. Tel (212) 682-5844
- Carnio,** see Caeyronics
- Carolina Recs.,** 1605 Park Dr., Raleigh, N.C. 27605. Tel (919) 833-6694. Owner Ethel L. Casey; Mgr. Walker L. Casey
- Carol Rec. Co.,** 1076 River Rd., Hinckley, Ohio 44233. Tel (216) 278-4440. Pres. Thomas Gaines, VP/Sec'y Marilyn Gaines, A&R Steve Wasko
- Carousel Recs. Inc.,** 1273 1/2 N. Crescent Heights Blvd., Los Angeles, Calif. 90046. Tel (213) 650-6500. Pres. & A&R Stuart Lanis; VP Finance Adam Bank, VP Creative Servs. Colman Bank; VP Sales & Mktg. Nathan Bank, VP Pub. Mike Canyon, VP Adv. James Scott, VP Promo. Diann Joy
- Carrie,** see James Hendrix
- Carroll Recs., c/o Enchanted Door,** PO Box 1235, New Rochelle, N.Y. 10802. Tel (914) 961-7189. Gen. Mgr. & A&R Dir. Joe Messina; Artist Relations Dir. Ray Fernandez; Sales & Promo Mgr. Stan Lewinstone
- Labels:** (Owned) Cap-Orion, Cartoon
- Carwar,** see Warren
- Carwin Country Recs. & Tapes,** 13357 Lorain Ave., Cleveland, Ohio 44111. Tel (216) 476-2695. Pres. Carl French
- Casablanca Rec & FilmWorks,** 8255 Sunset Blvd., Los Angeles, Calif. 90046. Tel (213) 650-8300. TWX (910) 321-2937. Bd. Chm.: Peter Guber, Pres. Neil Bogart; Sr. VP Cecil Holmes; Exec. VP Bruce Bird; VP Sales Richard S. Sherman, VP Bus. Affairs Dick Etlinger; VP Int'l Mauri Lathower, VP Promo. Howard Rosen, VP Mktg. Peter Jones; VP/Press Roberta Skopp; VP Special Projects Marc Paul Simon
- Branch:** New York, N.Y., 137 W. 55 St. Zip 10019. Tel (212) 397-0660. VP/Gen. Mgr. East Coast Irv Biegall
- Labels:** (Owned) Casablanca, (distributed) American Int'l, Chocolate City, Ibis, Oasis, Tom'n Jerry
- Int'l reps.:** Argentina (Phonogram), Australia (Astor), Austria (Bellaphon), Belgium (Vogue), Brazil (Polygram), Canada (Polygram), Central America (Leo/Kismet), Chile (Quatro), Colombia (Fuentes), Denmark (EMI), Dominican Republic (Distribuidora Dominicana), Ecuador (Fediscos), Finland (EMI), France (Vogue), Germany (Bellaphon), Greece (Minos Matsas), Hong Kong (Shun Cheong), Israel (Litratone), Italy (Durium), Jamaica (Dynamic Sounds), Japan (Victor), Mexico (Polygram), Netherlands (VIP), New Zealand (Phonogram), Norway (EMI), Panama (Continental), Peru (El Virrey), Philippines (Disc Corp.), South Africa (Teal), Spain (Fonogram), Sweden (EMI), Switzerland (Bellaphon), UK (Pye), Venezuela (Polydor)
- Casa Frago Inc.,** PO Box 2774, San Juan, P.R. 00903. Tel (809) 725-8842
- Label:** (Owned) Frago
- Casa Grande Recs./Don-Mar Recs./Shawmut Recs.,** PO Box 113, Woburn, Mass. 01801. Tel (617) 933-1474
- Gen. Mgr.** Frank P. Pappalardo; A&R & Prod'n Mgr. Frank Paul; PR Joe Paul
- Label:** (Owned) Casa Grande
- Buzz Cason Prod'n.,** 2804 Azalea Pl., Nashville, Tenn. 37204. Tel (615) 383-8682. Pres. & Prod'r Buzz Cason
- Labels:** (Owned) Berry Hill, Palace
- Cassandra Recs.,** 2027 Parker St., Berkeley, Calif. 94704. Tel (415) 843-2365. Pres. Malvina Reynolds, Mgr. Ruth Burnstein
- Cassbah,** see Aladdin
- Casset Major,** see Steady
- Castalia Recs. (div. of Forever Ltd.),** PO Box 11516, Milwaukee, Wis. 53211. Pres. & A&R Jim Spencer; Sales & Promo. E.T. Caldwell
- Labels:** (Owned) Castalia, Fair Wind, Thoth
- Castle,** see Rob-Lee
- Cat,** see TK
- Catalyst,** see Vee Jay
- Cathedral (UK),** see Worldwide Music Servs.

WHICH NEW HIGH BIAS TAPE WINS WITH MAHLER'S FOURTH SYMPHONY?



Original manuscript sketch for the first movement of Gustav Mahler's Fourth Symphony. Courtesy of The Newberry Library, Chicago.

Choose eight measures of Mahler's Fourth that are really rich in the high frequencies. The type of passage that high bias tapes are designed for.

Record it on your favorite high bias cassette, using the Chrome/CrO₂ setting. Then again on new MEMOREX HIGH BIAS.

Now play back the tapes.

We're convinced you'll have a new favorite.

New MEMOREX HIGH BIAS is made with an exclusive ferrite crystal oxide formulation. No high bias tape delivers greater high frequency fidelity with less noise, plus truer response across the entire frequency range.

In short, you can't find a high bias cassette that gives you truer reproduction.

MEMOREX

Recording Tape and Accessories.
Is it live, or is it Memorex?



- Cayton Ent's., Box 367, Mayfield Rd., Orwell, Ohio 44076. Tel (216) 437-8422. Pres. Richard Rhodes; Bus. Mgr. Thomas Nordquist.
- Caytronics Rec. Corp., 240 Madison Ave., New York, N.Y. 10016. Tel (212) 889-7340. Pres. Joe Cayre; VP Stan Cayre, VP Latin Opns. & Sales Mgr. Lee Schapiro, VP Int'l Liaison Latin Div. Rinel Sousa.
- Distribution branches:** Los Angeles, Calif.: Cayre Inds. of California, Hialeah Gardens (Miami Metropolitan Area), Fla.; Cayre Dist's of Florida Inc., New York, N.Y.; Cayre Dist's.: Santurce, P.R.; SML Dist's., San Antonio, Tex.; Cayre Dist's of Texas Inc. (See Record & Tape Wholesalers section for complete listings).
- Labels:** Arcano, Caliente, Carino, Caytronics, Melody Mexico (Mexico), Movieplay (Spain), Pronto.
- Celebration, see Fisherfolk.
- Celeen Recs., 1540 Broadway, Suite 300, New York, N.Y. 10036. Tel (212) 757-3995. Exec. Prod'r & Gen. Mgr. Carl D. Potnick; Exec. Prod'r Vina Sattian; Assoc. Prod'rs Johnny Sullivan, Thad Darryl.
- Celestial Recs. Releasing Corp., 229 Las Vegas Blvd. S., Las Vegas, Nev. 89101. Pres. & Treas. Arthur H. Benson; Sec'y Leslie Sandhofer, A&H William "Hy" Seaman Jimmy Haskell, John Kraus, Dalton Priddy. Promo.: Howard Wormser.
- Nat'l sales office: Hollywood, Calif.** 1560 N. La Brea. Zip 90028. Tel (213) 467-7644.
- Labels:** (Owned) Celestial, Creative.
- Celluloid Fanfare, see Entracte.
- Cenpro, see Century Prod'ns.
- Centaur Recs., 82 Aldine St., Rochester, N.Y. 14619. Tel: (716) 328-4649. Pres. Martha B. Pitoni, A&R/Prod'r; Ven. Pitoni; Nat'l Sales Mgr. Marvin Steffey; Adv. & Promos. Dennis Majzak.
- Labels:** (Owned) Centaur, Jingles, Sea-King.
- Int'l reps.:** Canada (Quality) New Zealand (Peak).
- Centaur, Mich., see BaKam.
- Center, see Biograph.
- Center City, see McKinnon.
- Central Sounds, see Point Blank.
- Centurian Recs. Inc. & Assoc. d Labels (sub. of Graart Communications Corp.), PO Box 5747, Cleveland, Ohio 44101. Tel (216) 771-0501. Rec. Div. Admin'r Greg Beasley.
- Labels:** (Owned) Centurian, (distributed) American Gramophone Int'l (AGI), Capital City, Cleveland Unlimited.
- Century Artist, see Frank Evans.
- Century Prod'ns Inc., 171 Washington Rd., Sayreville, N.J. 08872. Tel (201) 238-5630. Owners: Mickey Yan-nich, Bob Ligotino.
- Label:** (Owned) Cenpro.
- Century Recs., 6550 Sunset Blvd., Hollywood, Calif. 90028. Tel (213) 464-3250. Telex: 67-7239. Pres.: Glen Giancy, Mktg. Dir. Don Grimes.
- Cetra (Italy), see Playette.
- Cezame (France), see Rounder.
- Cha-Cha Recs., 15041 Wabash Ave., South Holland, Ill. 60473. Tel (312) 339-0307. Pres. Donald L. DeLucia; VP's Don & Bob DeLucia.
- Labels:** (Owned) Cap, Cha-Cha.
- Challenge, see Four Star.
- Chamber Music Series, see Moss.
- Channel, see Music Resources.
- Chanterelle, see Mushroom.
- Chapel, see Chapel/Bridge.
- Chapel/Bridge Recs. (div. of Pacific Press Publ'g Ass'n) 1350 Villa St., Mountain View, Calif. 94042. Tel (415) 961-2323. Mgr. W. P. Turpel; Nat'l Sales Mgr. E. B. Johnson.
- Branch: Omaha, Neb.,** PO Box 37485, Zip 68137. Tel (402) 333-2820.
- Int'l branch: Canada**
- Labels:** (Owned) Chapel, Bridge.
- Chaplain, see World Int'l.
- Charade Recs., 1310 E. Kern St., Tulare, Calif. 93274. Tel (209) 286-2533. Pres. Raymond A. Baradat; Ass't to Pres. Pamela R. Baradat; VP Syl Grigsby; Sales & Mktg. Gary DeFoe; Pub. Bob Dennison; Adv. Bill Bowen; R&B Promo. Jimmy Garcia; Jazz Promo. Gene Short; Country Promo. Rod Gibson; Int'l Joe Luiz.
- Branch: Canoga Park, Calif.,** 22146 Lanark. Zip 91304. Tel (213) 887-6474. A&R Dir. Art Stewart.
- Labels:** (Owned) Charade, Tadarab.
- Charay, see Christ.
- Chariot, see Caprice.
- Charisma, see Polydor.
- Charity, see Richtown.
- Charma Recs. Inc., PO Box 2027, Chapel Hill 27514. 1419 Watts St., Durham, N.C. 27701. Tel (919) 489-8783. Cable EFFORTS. Pres. Charles M. Mann; Nat'l A&R Madonna Bentz; Sales & Mktg. Dale Kimberly; Mgr. Debra Collins.
- Labels:** (Owned) Cream of the Crop, Pied Piper.
- Charta Recs., 44 Music Square E., Nashville, Tenn. 37203. Tel (615) 255-2175. Pres. Charles Fields. (Distributed by Nationwide Sound).
- Labels:** (Owned) Charta, Time.
- Charter, see Gibson.
- Chase, see Chase Media.
- Chase Media Inc., Hotel Newhouse, Suite 1204, Salt Lake City, Utah 84101. Tel (801) 363-5858.
- Label:** (Owned) Chase.
- Chattahoochee Rec. Co., 16038 Ventura Blvd., Encino, Calif. 91436. Tel (213) 788-6863. VP John Yardum.
- Checker, see All Platinum.
- Checkmate, see Caprice.
- Chuck Chellman Co., 1201 16 Ave. S., Nashville, Tenn. 37212. Tel (615) 320-7287.
- Label:** (Owned) Renegade.
- Cherry Recs., 1201 Antoine Dr., Houston, Tex. 77055. Tel (713) 682-0941.
- Chess, see All Platinum.
- Chevere, see Discolando.
- Cheyenne Music Prod'ns, 1350 Irwin Dr., Pontiac, Mich. 48054. Tel (313) 673-6791. Pres. & Gen. Mgr. Anne Johnson; Exec. VP & PR Dir. Roger Johnson; Promo. Mgr./A&R Dir. Jack Breniser; Creative Servs. Tom Dennis; Diane Calvin.
- Chiaroscuro, see Audiofidelity.
- Chi-City, see Chi-Town.
- Chico, see Kubaney.
- Children's World, see JEMKL.
- Chimneyville, see Malaco & FK.
- China, see Aladdin.
- China Doll, see Aladdin.
- Chiron Cassettes, see Communication Institute.
- Chi-Town Recs. 2123 N. Seminary Ave., Chicago, Ill. 60614. Tel (312) 348-3730. Pres. Carl A. Bonafede; VP Frank Pizani.
- Labels:** (Owned) Chi-City, Chi-Town, Land of Lincoln Railroad Center.
- Chocolate City, see Casablanca.
- Choice Recs. Inc., 245 Tilley Pl., Sea Cliff, N.Y. 11579. Tel (516) 671-7299.
- Int'l reps.:** Japan (Trio) UK (This Rec. Co.)
- Choice, N.Y. City, see MMO.
- Chris, see 3 G's.
- Chrim, see Tempo.
- Christi Recs., PO Box 11152, Fort Worth, Tex. 76110. Tel (817) 738-8843. Pres. Major Bill Smith.
- Int'l branch:** England, Le Bill Music.
- Labels:** (Owned) Enaray, Le Cam.
- Christian Faith, see Skylyte-Sing.
- Christian Folk, see Skylyte-Sing.
- Chrysalis Recs., 9255 Sunset Blvd., Suite 212, Los Angeles, Calif. 90069. Tel (213) 550-0171. Pres. Terry Ellis; Sr. VP Sal Licata; VP & Controller Paul Hutchinson; VP Promo. & Creative Servs. Billy Bass; Artist Development Dir. Linda Steiner; A&R Dir. Roger Watson; Nat'l Sales Mgr. Chuck Melancon; Nat'l Promo. Dir. Scott Kranz; berg Nat'l Pub. Dir. Rick Ambrose; West Coast Pub. Mgr. Toby Lubov; Prod'n Mgr. Mick Bortnick.
- Branch: New York, N.Y.,** 115 E. 57 St. Zip 10022. Tel (212) 935-8750. East Coast A&R Jeff Aldrich; East Coast Pub. Mgr. Fred Salzberg.
- Labels:** (Owned) Chrysalis, (distributed) Air, Bronze, Takoma.
- Chuckie, see Little Richie Johnson.
- Churchill/Fona Recs., 2600 River Rd., Des Plaines, Ill. 60018. Tel (312) 298-1500. Chief Exccs. Tommy Martin; Herb Gronauer.
- Labels:** (Owned) Churchill, Fona.
- Chytowns, see JermA.
- Circle, see Jazzology-GHB.
- Ciadelle, see Art.
- Claddagh (Ireland), see Rounder & Shanachie.
- Claremont, see Lakco.
- Clanridge Recs., 6381 Hollywood Blvd., Hollywood, Calif. 90028. Tel (213) 469-8149. Pres. Frank C. Slay Jr.; Sales & Mktg. Victor G. Catala.
- Clarion, see Calvary.
- Classical Excellence, see Request.
- Classic Jazz, see MMO.
- Classics Int'l (div. of PolyGram Corp.), 810 Seventh Ave., New York, N.Y. 10019. Tel (212) 399-7000. VP & Gen. Mgr. James J. Frey; VP M. Scott Mampe.
- Labels:** Archiv Produktion, DG (Deutsche Grammophon), Festivo, Mercury, Golden Imports, Philips, Privilege.
- Clave, see IR & Penco.
- Claves, see Worldwide Music Servs.
- Clay Pigeon Recs. (div. of Clay Pigeon Int'l), PO Box 20346, Chicago, Ill. 60620. Tel (312) 476-2553. Pres. & A&R Vytautas Beleska; Sales Mgr. Rudy Markus; Promo. Dir. M. Bernes; Special Projects Mgr. D. Jaras.
- Labels:** (Owned) Clay Pigeon, Patofonas.
- Clear Gospel Recs., 146 Almondson Rd., Deptford, N.J. 08096. Contact: Ronald Butko.
- Cleo, see Mother Cleo.
- Cleveland Entertainment Co., PO Box 783, Willoughby, Ohio 44094. Tel (216) 951-0993. Pres. Steve Popovich; Nat'l Promo. Dir. Bill Catino; Marty Mooney; Nat'l Promo. Mgr. Dave Clemence.
- Branch: New York, N.Y.,** 538 Madison Ave. Zip 10022. Tel (212) 935-8630. VP Sales & Mktg. Stan Snyder; VP Bus. Affairs. Sam Lederman.
- Label:** (Owned) Cleveland Int'l.
- Cleveland Int'l, see Cleveland Entertainment.
- Cleveland Unlimited, see Centurian.
- Clock, see Mystic.
- Clouds, see TK.
- Clown, see Ray Lawrence.
- Cobra Recs., PO Box 2144, Winnetka, Calif. 91306. Tel (213) 347-2976. Owner & Pres. Don Bradley.
- Labels:** (Owned) Cobra, Knight.
- Cochise Rec. Co., PO Box 1415, Athens, Tex. 75751. Tel (214) 675-4170.
- Coco Recs. Inc., 1700 Broadway, New York, N.Y. 10019. Tel (212) 582-6886. Pres. Coco/Graffiti/Gala & Sec'y Treas. Novola Zafiro; Harvey Avenite; Pres. Novola Zafiro & Sec'y Treas. Coco/Graffiti/Gala; Sam Goff; Exec. VP Graffiti; Danny Rivera; VP Gala; Steve Lawrence; VP Novola Zafiro; Esteban Morencos.
- Labels:** (Owned) Coco, Gala, Graffiti, Novola-Zafiro.
- Int'l reps.:** (Coco) Ardeno Market (Indopesa), Colombia (Codiscos), Dominican Republic (Karen), El Salvador (Leo), France (Sonodisc), Japan (Nippon Phonogram), Mexico (Polydor), Netherlands (Fleet), Panama (Indica), Spain (Discophon), UK (RCA), Venezuela (Velvet), (Gala) Argentina (Microfon), Dominican Republic (Karen), Mexico (Discos & Cartuchos), (Graffiti & Novola Zafiro) Dominican Republic (Karen).
- Coda, see Spanish Music Center.
- Cognito Prod'ns, 4120 Excelsior Blvd., Minneapolis, Minn. 55416. Tel (612) 929-6727.
- Coherent Sound, see Nautilus.
- Coimbra, see Penco.
- Colibre, see Safari.
- Collectors Series, see Columbia Special Prods.
- Collegium Sound Inc., 35-41 72 St., Jackson Heights, N.Y. 11372. Tel (212) 426-8555. Pres. Donald Wade.
- Labels:** (Owned) Collegium, Minstrel.
- Colonel Redneck, see Colonel Buster Doss.
- Colonial, see Howard Knight.
- Colony-United, see Marc Gordon.
- Colony, N.Y., see Ottoo.
- Color, see IH.
- Colosseum Recs. Ltd., 134 S. 20 St., Philadelphia, Pa. 19103. Tel (215) 698-7710. Pres. Robert F. Morton.
- Colosseum, N.Y., see Acropole.
- Colt, see CJ.
- Columbia, see CBS.
- Columbia Masterworks, see CBS.
- Columbia Special Prods., 51 W. 52 St., New York, N.Y. 10019. Tel (212) 976-4126. VP A.E. Shulman; Gen. Mgr. John Franks; Sales Mgr. Dave Backer. (Also see CBS).
- Labels:** (Owned) Collectors' Series, Encore Series, (distributed) Commodore.
- Columb Ony Rec. Co., PO Box 4086, Springfield, Mo. 65804. Tel (417) 881-5015. Pres. James M. Martin.
- Combo, see Raco.
- Comedie France, La, see Everest.
- Comet, see Goldmont.
- Commercial Dist'g Corp. (CDC), PO Box 40212, 2535 Franklin Rd., Nashville, Tenn. 37204. Tel (615) 385-3674.
- Commodore Rec. Co. Inc., 3 Kensington Oval, New Rochelle, N.Y. 10805. Tel (914) 235-1229. Pres. Milt Gabler; Sec'y Treas. David Chase. (Distributed by Columbia Special Prods.).
- Int'l rep.:** Benelux, France, Germany, Italy, Japan & Scandinavia (Decca in UK).
- Communication Institute, 1008 N. Randolph St., Arlington, Va. 22210. Tel (703) 528-7931. Pres. Richard L. Spears; VP's E. B. Churchfield Jr., Nancy I. Spears.
- Labels:** (Owned) CI Cassettes, Chiron Cassettes, Ivan Berg Cassettes, London Times Cassettes.
- Communication Recs., 7212 S. Wabash Ave., Chicago, Ill. 60619. Tel (312) 783-3186. Pres. B. L. Dixon.
- Community, see SiPRA.
- Compas, see Godell.
- Compco Rec. Co., 105 Burk Dr., Oklahoma City, Okla. 73115. Tel (405) 677-6448. Pres. & Prof. Mgr.: Yvonne DeVaney, VP. Sonny Lane.
- Composers Recs. Inc., 170 W. 74 St., New York, N.Y. 10023. Tel (212) 873-1250. Pres. Blair Weille; Exec. VP Carter Harman; Nat'l Sales Rep. Larry Sockell.
- Label:** (Distributed) Louisville Orchestra First Edition.
- Con Bro Recs. Inc., PO Box 196, Nashville, Tenn. 37202. Tel (615) 329-1944. Pres. & A&R Dir. Bill Walker; VP Opns. Jeff Walker, Sales & Mktg. Bruce Davidson; Promos. Dir. Johnny Koval; Promos. Marty Midram; Special Projects Dir. Biff Collier.
- Labels:** (Owned) Con Bro, Concorde.
- Concepts Exchange Int'l (CEI), 1050 Plymouth Dr., Sunnyvale, Calif. 94087. Tel (408) 737-0565. Pres. Martin Espinosa; VP Craig Pedersen; Treas. Paul Giovanetti; Sec'y Bruce Marelich.
- Concert Co., PO Box 531, 3318 Platt Ave., Lynwood, Calif. 90262. Tel (213) 639-1341.
- Label:** (Owned) Concert Rec'g.
- Concert-Disc, see Everest.
- Concerto Live, see Moss.
- Concert Rec'g, see Concert Co.
- Concorde, see Con Bro.
- Concord Jazz Inc., PO Box 845, Concord, Calif. 94522. Tel (415) 682-6770. Pres. Carl E. Jefferson; VP & Admin. Mgr. Joan Kenston; Dist'n Mgr. Margaret Glasgow; Prod'r Frank Dorritte.
- Int'l reps.:** Germany (Bellaphon), Japan (Toshiba-EMI), Netherlands (Nuis Bedrijven), Sweden (Ad Lib), UK (Swift).
- Conestoga, see IRDA.
- Conn, see Johnson Rec. Co.
- Connoisseur Society Inc., 390B West End Ave., New York, N.Y. 10024. Tel (212) 873-6769. Cable CONNOSO-REC. Pres. A&R & Tape Dir. E. Alan Silver; VP Sales Rosana M. Silver; Promo. & Int'l Prod. Dir. Claudia Marx; Comptroller Elaine Barish.
- Labels:** (Owned) Connoisseur Society, (distributed) EMI Int'l (UK), EMIR (UK), Pathe Marconi-EMI (France).
- Int'l reps.:** Australia (Discuro), Canada (Almada), France (Pathe Marconi-EMI), Japan (Nippon Phonogram), UK (Rediffusion).
- Consolidated Gospel Inc., 1137 Grandview Dr., South San Francisco, Calif. 94080. Tel (415) 952-9750. Pres. Paul N. Lindner; VP Luke N. Lindner.
- Labels:** (Owned) Gospel Media, (distributed) Aslan, Eden Inwood, Star Song of California, Street Level, Trinity Sound.
- Constitution, see Paramount-West.
- Contemporary Recs. Inc., 8481 Melrose Pl., Los Angeles, Calif. 90069. Tel (213) 653-1560. Cable GOODREC. Pres. John Koenig; VP Victoria Koenig; Nat'l Sales Mgr. Richard Seidel.
- Labels:** (Owned) Contemporary, Good Time Jazz, SFM (Society for Forgotten Music).
- Continental Artist, see Frank Evans.
- Continental Rec's Inc., 210 South St., Boston, Mass. 02111. Tel (617) 426-3131. Pres. L. Daniel Flynn; VP John F. Flynn; Music Dir. Robert E. Rose; Treas.: John K. Chasson; Chief Exec. Sonny Du Fault.
- Label:** (Owned) CORI.
- Contrast Rec. Corp., 2404 E. Houston St., San Antonio, Tex. 78202. Pres. Larry C. Collins; Prod'n Dir. Edward L. Hill; Admin. Ass't Gene O. Collins; Sales & Mktg. Joan E. Green; Pub. & Promo. Joe Coole; Adv. Eddie V. Green.
- Contrast, Calif., see Ray Lawrence.
- Conversa-phone Institute Inc., 225 W. 34 St., New York, N.Y. 10001. Tel (212) 695-5386. Cable VERSAPHONE. Pres. Alfred Z. Owen; VP Edmund L. Owen; Sales Mgr. Larry Sockell.
- Cook, see Cook Labs.
- Cookhill, see Carib.
- Cookhouse Rec'g Studios, 2541 Niccollet Ave. S., Minneapolis, Minn. 55404. Tel (612) 827-5441.
- Labels:** (Owned) Cookhouse, Groove Soup.
- Cookin' Recs., c/o Jack Sager, 33 Harbor View Ave., Harwich Point, Mass. 02646. Tel (617) 432-9070.
- Cook Labs Inc., 375 Ely Ave., South Norwalk, Conn. 06854. Tel (203) 853-3641.
- Label:** (Owned) Cook.
- Cool Duck, see Jazzrel.
- Copacabana (Brazil), see Brasilia.
- Copperfield's Ent's Ltd., 2339 Jericho Tpke., Garden City Park, N.Y. 11040. Tel (516) 747-0666. Pres. Chuck Kimco's.
- Corol, see MCA.

THERE'S ONLY ONE SELECTION!

For UPC Film  Masters

1234-56789-0

Matthews



M

You're already beginning to see UPC Symbols on packaging for recorded products. It's a safe bet the film masters came from Matthews.

Go with the leader...

the *one* source that guarantees your symbols will scan accurately... the *experienced* leading producer and pioneer for UPC and other formats of bar code symbol film masters for the food, periodical and paper book industries, to name a few. For the recording industry, Matthews offers not only reliable film masters, but consultation testing and analysis of symbols for your different products with the only nationwide team of field representatives in the film master industry.

We'll even develop symbology to meet your special requirements. Call: 412/344-9433 or mail this coupon:

Matthews International Corp.
1910 Cochran Road, Manor Oak Two, Pittsburgh, PA 15220

Mail this coupon today.

- Please send sample, information and prices on Matthews UPC Film Masters.
- Have a salesman call.

NAME _____ TITLE _____

COMPANY _____

ADDRESS _____

CITY _____ STATE _____ ZIP _____

TELEPHONE _____

ATLANTA, GA
BOSTON, MA
CHICAGO, IL
CLIFTON, NJ
LOS ANGELES, CA
DALLAS, TX

PHILADELPHIA, PA
PITTSBURGH, PA
ROSELLE, NJ
ST. LOUIS, MO
HAMILTON, ONTARIO, CANADA

Worldwide distribution through
Matthews International Sales Corp.

Matthews

- Cord Recs., Box 7422, Shreveport, La. 71107. Tel: (318) 965-0781. Pres.: Carl Logan.
Labels: (Owned) Faces, 50%, Memorial, Pose, Summer.
- Cordak, see WILD.
Core, see Vintage.
Corey, see International Mktg. & Mgmt.
Corinthian, see Hanover.
Corito, see Safari.
Coro, see Safari.
Coronado Rec. Co., 897 Walker Ave., Oakland, Calif. 94610. Tel: (415) 763-5182. Pres.: Norman Hauge.
Cortina Language Recs., see R.D. Cortina.
Cortina Method, see R.D. Cortina.
R. D. Cortina Co., 136 W. 52 St., New York, N.Y. 10019. Tel: (212) 582-3845. Cable: ELCORTINA.
Labels: (Owned) Cortina Language Recs., Cortina Method, Master Linguist.
Cory, see NMI.
Cosmic Fire, see Black Fire.
Cosmos, see Peters Int'l.
Cotillion, see Atlantic.
Cotique, see Fania.
Counterpart, see Fraternity.
Counterpoint, see Everest.
Country Boy, see Vokes.
Country Capers, see Lee Anderson.
Country Gold, see Hal Southern.
Country Int'l Recs., 353 W. 57 St., New York, N.Y. 10019. Tel: (212) 581-5516.
Country-King, see Sid Kleiner.
Country Life, see McLain Family Band.
Country Moods, see Autumn Hill.
Country Pie Inc., 132 Spring St., Newton, N.J. 07860. Tel: (201) 383-9550. Pres.: Michael W. Carden; Sec'y/Treas.: Brian A. Sierra.
Country Road, see Scene Prod'ns.
Country Showcase America Recs., 11350 Baltimore Ave., Beltsville, Md. 20705. Tel: (301) 937-7200. Pres. & A&R: Francis Gosman.
Label: (Owned) CSA.
Country Star Inc., 439 Wiley Ave., Franklin, Pa. 16323. Tel: (814) 432-4633. Pres.: Norman Kelly; Sec'y-Treas.: June L. Kelly.
Labels: (Owned) Country Star, Mersy, Process.
Country Stream Music & Rec. Co., 5053 Tholoan, St. Louis, Mo. 63109. Tel: (314) 481-3916. Pres.: Tony Mazzola; VP: Virginia Mazzola; Gen. Mgr.: Sam Mazzola.
Labels: (Owned) Bonnet, Faith.
Countryway, see JEMKL.
Countrywide Tape & Rec. Dists. Inc., 200 Robbins Ln., Jericho, N.Y. 11753. Tel: (516) 433-9550. Pres.: Stanley Sirote; VP & Sec'y: Katherine Koury.
Label: (Owned) Kory.
County Recs., Main St., Floyd, Va. 24091. Tel: (703) 745-2001. Pres.: David Freeman; A&R: Barry Poss; Sales Mgr.: Chet Rhodes; Promo.: Wanda Dalton.
Labels: (Owned) County, Homestead; (distributed) Sugar Hill.
Int'l reps.: Canada (Almada), Japan (BOM).
Covenant Rec's Inc., 1345 S. Major St., Salt Lake City, Utah 84115. Tel: (801) 487-1096.
Coyote Recs., PO Box 6390, Corpus Christi, Tex. 78411. Tel: (512) 854-7376. Contact: Gary Beck.
Cozette, see Gwen.
Cracker Barrel, see Ray Lawrence.
Dave Crawford Prod'ns, see LA Recs.
Crazy Cajun, see Music Ents.
Crazy Meskin', 6703 W. Commerce, San Antonio, Tex. 78227. Tel: (512) 422-7893. (Distributed by Texas Record)
- Cream of the Crop, see Charna.
Cream Recs. Inc., 8025 Melrose Ave., Los Angeles, Calif. 90046. Tel: (213) 655-0944. Cable: BENNCO. Telex: 696182. Pres.: Alvin S. Bennett; Exec. VP: Phil Skaff; VP Mktg.: Paul Culberg; VP Promo.: Don Graham; VP/Int'l Div. Dir.: Robert B. Weiss; VP A&R: Hal Winn; Pub.: Laurie Hersch; Prod'n Mgr.: Al Ibarra.
Branch: Memphis, Tenn., 1320 S. Lauderdale. Zip: 38106. Tel: (901) 775-3790. Gen. Mgr.: Eddie Ray.
Labels: (Owned) Cream, Hi; (distributed) Xanadu.
Int'l reps.: Australia (Astor), Austria (Amadeo), Barbados/West Indies (West Indies Recs.), Belgium (Vogue), Brazil (Gravacoes Eletricas), Canada (GRT), China (Hong Kong Recs.), Colombia (Incolve), Denmark (Kleinerts), France (Vogue), Germany (Intercord), Greece (Minos Matsas), Hong Kong (Hong Kong Recs.), Ireland (Pye), Israel (Eastronics), Italy (CGD), Japan (Victor—except for Xanadu), Malaysia (Cosdel), Netherlands (VIP), New Zealand (Polygram), Norway (Skandinavisk Artist), Philippines (Home Inds.), Portugal (Trindade), Singapore (Cosdel), Sweden (Planet), Switzerland (Phonag), UK (Pye), Venezuela (Palacio de la Musica).
- Creative, see Celestial.
Creative Funk Music Inc., 122-21 Merrick Blvd., St. Albans, N.Y. 11434. Tel: (212) 978-6400, 525-9487.
Branches: Compton, Calif., 440 W. School. Zip: 90220—Cleveland, Ohio, 4480 Grand Blvd. Zip: 44121. Tel: (216) 581-8243—Memphis, Tenn., 4122 Westmont. Zip: 38109. Tel: (901) 785-0201.
Labels: (Owned) Adelia, Creative Funk.
Creative Sound, see Sonrise.
Creative World Inc., 1012 S. Robertson Blvd., Los Angeles, Calif. 90035. Tel: (213) 652-7280. Pres.: Stan Kenton; Mktg. Dir.: Earl Hodwin; Prod'n Mgr.: Bill Stillfield; Pub. & Adv. Dir.: Andrew Coke.
Credo, see Pathways of Sound.
Creed, see Nashboro.
Crescendo Rec. Co., 3203 36 Ave., Long Island City, N.Y. 11106. Tel: (212) 278-7832. Pres.: Guido Sgambellone; Prof. Mgr.: Louis Cerruti; Sales Mgr.: William Neal.
Crescent, see International Mktg. & Mgmt.
Crest, see Golden Crest.
Criket, see Sunny Day.
Crimson Dynasty Rec. Corp., PO Box 271, Cedar & West Ave., Jenkintown, Pa. 19046. Tel: (215) 757-8022. Pres.: Stan Peshota; Exec. VP: Alan Meier; VP: Frank Mulvenna; Sec'y-Treas.: Kathy Peshota; A&R Dir.: Destiny Knight.
- Labels: (Owned) Aurora Borealis, Avalanche, Bronco Saurus, California Mud Slide, Crimson Dynasty, Crystal Blue Flame, Debtors Prison, Dragon, Dungeon, Earth Quake, Earth Tremor, Enchanted Knight, Flame, Golden Hawk, Hologram, Hurricane, Knight, Lightning, Misty Blue, Operation Golden Hawk, Poltergeist, Sinbad, Thunder Lizard, Tornado, Typhoon, Zansabar.
- Criollo, see Latin Percussion.
Crissy, see Quinto.
Criterion Music Corp., 6124 Selma, Hollywood, Calif. 90028. Tel: (213) 469-2296. Pres.: M.H. Goldsen; A&R Mgr.: Bo Goldsen.
Labels: (Owned) Granite Music Corp., Palm, Reo Tahiti. Int'l rep.: Tahiti (ETS).
CrossCountry, see Benson.
Crossfire, see Oakridge.
Crossover Recs. Co. (div. of Ray Charles Ents), 2107 W. Washington Blvd., Los Angeles, Calif. 90018. Tel: (213) 737-8000.
Crossroad, see Voyager.
Crown, see Cadet Recs.
Crown Point Recs., 3308 Midway Dr., Suite 120, San Diego, Calif. 92110. Tel: (714) 223-5566 x 120. Pres.: Robert Racouillat.
Cruse, see Art.
Crystal Blue Flame, see Crimson Dynasty.
Crystal Clear Recs. Inc., 648 Mission St., San Francisco, Calif. 94105. Tel: (415) 543-4130. Pres.: Edward S. Wodenjak; VP: Charles R. Greene; A&R Dir., Promo. & Adv.: Thomas Wiggins.
Labels: (Owned) Crystal Clear, Ultragroove.
Crystal Rec. Co., PO Box 65661, Los Angeles, Calif. 90065. Tel: (213) 257-6787, 254-1234. Pres. & A&R: Peter Christ; Exec. Ass't: Carol Cunniff; Dist'n Mgr.: George Fowler; Adv. Mgr.: Sam Mundy.
Labels: (Owned) Avant, Crystal; (distributed) WIM. Int'l reps.: Canada (Almada), Netherlands (Inter-Music).
Cub, see Mother Cleo.
Cummings, see Dragon Int'l.
Cupid, see Sound Inc.
Mike Curb Recs., see MCA.
Cur-Non, see Rounder.
Curton Rec. Co. Inc., 5915 N. Lincoln Ave., Chicago, Ill. 60659. Tel: (312) 769-4676. Co-Pres.: Curtis Mayfield, Marv Stuart; VP: Clarice Polock; Promo. Co-ord.: Marilyn Atlas. (Distributed by RSO)
Branches: Atlanta, Ga., 2900 Camp Creek Pkwy. Zip: 30337. Tel: (404) 768-8243. Promo.: Charles Matthews—Dallas, Tex., 9119 High Plains Trail. Zip: 75236. Tel: (214) 296-1236. Promo.: Tony Price.
Custom Recs., PO Box 231, Tyler, Tex. 75710. Tel: (214) 597-2961. Mgr.: Curtis Kirk.
Custom, Calif., see Cadet Recs.
Cyclone Recs., 9000 Sunset Blvd., Suite 1010, Los Angeles, Calif. 90069. Tel: (213) 278-3397. Pres.: Larry Baunach.
Cynda, see Boot.
Cynthia, see Startown.
Czech, see MJ.
- D C, see Velvet de Puerto Rico.
D C Sound Country, see DC Sound Ents.
D C Sound Ents., 6505 Sheridan Rd., Fort Worth, Tex. 76134. Tel: (817) 293-5561, 738-1951. Co-Owner & A&R: Denwood Rowell; Co-Owner & Promo.: Stan Knowles; Sales Mgr.: Carolyn Rowell.
Labels: (Owned) DC Sound, DC Sound Country.
D G (Deutsche Grammophon), see Classics Int'l.
D G G-Label (Germany), see Playette Corp.
D G J Recs. Inc., PO Box 01072, Miami, Fla. 33101. Tel: (305) 576-6978. Cable: DGMJOMUS. Pres. & Sales & Mktg.: Donald G. Johnson; VP: Ronald C. Johnson; VP A&R: Donn Johnson; Pub., Adv. & Promo. Dir.: Pamela Johnson; Int'l Dir.: Armand Sava.
Labels: (Owned) DGJ, Doro, Sami; (distributed) Fonodisco, Guitarra, Oro.
Int'l reps.: Mexico (Discos de Guitarra), Venezuela (Fonodisco).
D G Recs., 301 Midland Ave., Port Chester, N.Y. 10573. Tel: (914) 967-4219, 937-2086.
D J M Recs., 119 W. 57 St., Suite 400, New York, N.Y. 10019. Tel: (212) 581-3420. Cable: DICKJAMES. TWX: (710) 581-4216. Gen. Mgr.: Carmen LaRosa. (Distributed by Phonogram)
D L V / U S A, see Musitrone.
D M C, see Dimitri.
D R C I, see Discostar.
D R G Archive, see DRG Recs.
D R G Recs. Inc., 200 W. 57 St., New York, N.Y. 10019. Tel: (212) 582-3040. TWX: (710) 581-4825. Pres.: Hugh Fordin; Mng. Dir.: Rick Winter; VP Sales & Mktg.: Lorna St. Hill; VP Finance: Stan Kugler.
Int'l branch: England.
Labels: (Owned) DRG, DRG Archive, Stet; (distributed) Decca Vintage Series (UK), Pema (France), United Artists (UK), World (UK).
Int'l reps.: Australia (Old Time), Canada (Trend), Finland (Polarvox), Germany (Lido), Germany (David Sternberg), Japan (Sumiya), Switzerland (Disc-Import), UK (EMI).
Daisy, see Waltner.
Dakar, see Brunswick.
Dana Publ'g Co., 824 83 St., Miami Beach, Fla. 33141. Tel: (305) 865-8960. Pres.: Walter Dana; VP: Gus Dana.
Label: (Owned) Echo.
Dana, N.Y., see Fiesta.
Dance-A-Thon Recs., 1957 Kilburn Dr., Atlanta, Ga. 30324. Tel: (404) 876-1073. Pres.: Aleck Janoulis; VP Pop A&R: Oliver Cooper; VP Classical A&R: Jean Lemonds; VP Sales: Scott Markhausen; VP Artist Relations: Sam Stewart.
Branch: Dallas, Tex., 3820 Spring Valley Rd., Suite 908. Zip: 75234. Tel: (214) 214-6235. Western Ops.: Hilton Dickerson.
Labels: (Owned) Dance-A-Thon, Hotlanta, Hottrax, Thevis; (distributed) Glamour & Grace, Revolver, Stereo Spectrum.
- Int'l reps.: Argentina (Calmex), Australia (Electric—Dance-A-Thon), Canada (Boot—Dance-A-Thon), Germany (Prom—Dance-A-Thon), UK (Emerald—Dance-A-Thon).
Dance Disk, see Red Greg.
Dani Recs. (div. of Hilton House Inc.), PO Box 315, Cleveland, Ohio 44127. Tel: (216) 429-1559. Pres.: Donald B. Catalano; VP & Gen. Mgr.: Danielle Catalano; Pop A&R Dir.: Samuel Magee; Classical A&R Dir.: Herbert Jugl; Sales & Mktg. Mgr.: Saul Telpitz; Pub. Dir.: Marian Driscoll; Adv. Dir.: Dan Kelly; Promo. Dir.: David Levy.
Dansk-Disk, see Lindberg.
Dark Horse, see Warner Bros.
Darva Recs. (div. of MBA Prod'ns), 8914 Georgian Dr., Austin, Tex. 78753. Tel: (512) 836-3201/3194. Pres.: Roy J. Montgomery; Gen. Mgr.: Marilyn Culp; A&R: Joe Montgomery; Promo. & Mktg.: Dick Culp.
Das Alte Werk, see London.
Dash, see TK.
Datone, see Met Richmond.
Dauphne, see Dellwood in N.J.
Davida Rec. & Publ'g Co., PO Box 24A, Detroit, Mich. 48232. Tel: (313) 491-7409. Pres.: David Futch.
Branch: Los Angeles, Calif., PO Box 77611. Zip: 90007. Tel: (213) 235-2835. Chm.: Dana V. Andrews.
Labels: (Owned), Davida, Final Connection.
Dawn Prod'ns, Cloud 40, Paradise, Pa. 17562. Tel: (717) 299-1600. Pres. & A&R Dir.: Joey Velz; VP Exec. Prod'r: Vernon Wray; Rock A&R: Jimmy Mack; Country A&R: Bill Rauck; Nat'l Sales Dir.: Jimmy Velvet.
Distribution center: Belair, Md., Box 535, Main St., Zip: 21014.
Labels: (Owned) Canadian American, Di-Gro, Graffiti; (distributed) Music City, Music Machine, Palmer.
DaySpring, see Word.
Daytwo Recs. Society, 416 E. Hugh, Suite 4A, Tampa, Fla. 33603. Tel: (813) 244-0001. Co-Pres.: G. Russell Smith, Trenton Lewis.
Labels: (Owned) Daytwo, Metro, Providence, Russell Street; (distributed) ACI, Cafe Juli.
Deadwood, see Jim Hall.
Death Recs., 125 Worth St., New York, N.Y. 10013. Tel: (212) 247-0130. Contact: Jimmy Antonucci.
Debtors Prison, see Crimson Dynasty.
Decca Vintage Series (UK), see DRG.
Dee-Bee Rec'g Serv., 704 Ninth Ave. S., Myrtle Beach, S.C. 29577. Tel: (803) 448-8091. Partners: Stan Deppen Jr., Patricia M. Deppen.
Labels: (Owned) Dee-Bee; (distributed) Eventide.
Deep River, see Olivia.
Dee Prod'ns of Philadelphia, 23 Darby Rd., Cherry Hill, N.J. 08002. Phila. Tel: (215) 473-3111. Pres.: Dick De Marco; VP: Martin Dipolito.
Labels: (Owned) Dee, Inside, Rugby.
Deep Roots, see Koala & Sonrise Mercantile.
Dejay "Gold & Platinum" Rec. Plaques, 3010 W. Burbank Blvd., Burbank, Calif. 91505. Tel: (213) 845-0744, 849-5347. Owners: Dave & Jackie Goldstein.
De-Lite Recs., 200 W. 57 St., New York, N.Y. 10019. Tel: (212) 757-6770. (Distributed by Phonogram)
Dellwood Music Co. Inc., 160 S. Lewing Ave., Saddle Brook, N.J. 07662. Tel: (201) 843-3239. Pres.: Woodrow C. Gardella; VP: Robert Gardella; Treas.: Sophie Gardella.
Labels: (Owned) Dauphne, Dellwood.
Int'l reps.: Canada (Quality), UK (EMI).
Dellwood Recs., 200 W. 57 St., New York, N.Y. 10019. Tel: (212) 586-4400.
Delmark Recs., 4243 N. Lincoln, Chicago, Ill. 60618. Tel: (312) 528-8834. Pres.: Robert G. Koester; VP: Susan Koester; Adv. & Promo. Dir.: Steve Tomashofsky.
Labels: (Owned) Delmark, Pearl.
Int'l reps.: France (Black & Blue; Free Bird—for Pearl), Germany (Ring), Italy (Hi-Fi), Japan (Trio), Sweden (Amigo), Switzerland (IRC), UK (Esquire).
Delmarti, see Don D. Sheets.
Del-Mar-Va, see Old Dominion.
Del Mundo Int'l, see TR.
Delos Recs. Inc., 855 Via de la Paz, Pacific Palisades, Calif. 90272. Tel: (213) 454-0524.
Labels: (Owned) Delos, Delos-Fy.
Delos-Fy, see Delos.
Del Rio, see Marsal.
Del Sol, see Musitrone.
Delta Int'l Recs. Inc., 1584 E. 31, Cleveland, Ohio 44114. Tel: (216) 861-7286. Pres.-Treas.: John R. Gaver; VP: Charles M. Gayer; Sec'y: Theresa Gayer.
Deluxe, see Gusto & Muse.
Richard Delvy Ents. Inc., 8127 Elrita Dr., Los Angeles, Calif. 90046. Tel: (213) 656-6509. Pres.: Richard Delvy; VP: Ed Fournier; VP A&R: Vic Gargano; Pub. & Adv.: Bob Markland.
Demand, Fla., see Request.
Demand, Tex., see Don Schafer.
Denbigh, see East Allegheny.
Denon, see Discwasher.
Denrich, see Wham Barn.
Deram, see London.
Derrick Recs., 322 N. Grand, Gainesville, Tex. 76240. Tel: (817) 665-0346.
Desert Morning Recs., c/o Robert B. Knox Ents., 41418 50 St. W., Quartz Hill, Calif. 93534. Tel: (805) 943-4183. Owner, Prod'r & A&R: Robert B. Knox; Adv., Publ. & Sales: Jennie Knox.
Desmar Music Inc., 155 Ave. of the Americas, New York, N.Y. 10013. Tel: (212) 741-1430. Pres.: Marcos Klorman; Gen. Mgr.: Frank Burton.
Labels: (Owned) Desmar; (distributed) IPA.
Destiny Recs., PO Box 2094, Sheffield Lake, Ohio 44054. Tel: (216) 949-6397. Owner: Robert Sellers.
Desto, see CMS.
Deutsche Grammophon, see Classics Int'l.
Deutsche Klassische, see Michele.
Deutschmark (Produktion), see Michele.
Dewdrop Recs., 1324 Old Yatesville Rd., Thomaston, Ga. 30286. Tel: (404) 674-8435, 647-7995. Owner: Don Buchanan.
Dharma Recs. (div. of Saturn Inds.), PO Box 615, 117 W. Rockland Rd., Libertyville, Ill. 60048. Tel: (312) 362-

4060 Telex 281051 Pres Perry Johnson, VP & Sales Dir Rick Johnson, Nat'l Promo Dir Alex Childs, College Promo Dir Ron Friedman, Reg'l Promo Mary Chris, PR Rep Tam Francis
Int'l reps.: France (Dave-Music), Italy (Hi-Fi), Netherlands (Dutch Blues & Boogie), Sweden (Scandinavian Blues), UK (Chris Wellard)

Diablo Rec Co., 3518 Champlain Ave., Youngstown, Ohio 44502 Tel (216) 755-7794 Owner, Pres & A&R Bill Schaffert

Dial Recs Inc., PO Box 1273, Zip 37202, 8 Music Square W., Nashville, Tenn. 37203 Tel (615) 327-3162 (Distributed by TK)

Different Drummer, see Salsoul

Dimension, see Am Rec

Dimension Six, see Sonic Arts

Dimin Music Co., 7859 Bastille Pl., Severn, Md 21144 Tel (301) 589-5192 Owner/Pres Robert H. Williams, Opns Mgr Chico Palomina, A&R Dir R. Jose Williams
Labels: (Owned) DMC Evergreen New Directions

Dimsa, see Orfeon

Dina, see Joey

Dingo, see Ala Ents

Dinsa, see Ottoo

Dion, see Jamie Guyden

Direct Disk, 16 Music Circle S., Nashville, Tenn. 37203 Tel (615) 256-1680

Direkt to Disk, see Sonic Arts

Disc Disk Joint Recs., 176-11 Jamaica Ave., Jamaica, N.Y. 11432 Tel (212) 523-0780 Owner Keith Hudson
Int'l branch: Jamaica

Disc-Go, see Dawn

Disco, see Discostar

Discocorp, PO Box 771, Berkeley 94701, 523 Coventry Rd., Kensington Calif 94707 Tel (415) 524-8079 Pres Frederick Maroth, VP George Marton, Sec'y-Treas Eric Miesel
Labels: (Distributed) Audax, I Grandi Interpreti, MORG, Rectal, SID, Bruno Walter Society, Western Sound Archive
Int'l reps.: Austria (Presser), France (Dave-Music), Germany (Helmut Marcuse), Italy (Stradivarius Club), Japan (Shinsei Serv.), UK (Music Discount)

Discolando Recs & Tapes Corp., 718-20 10 Ave., New York, N.Y. 10019 Tel (212) 581-0650 Pres Orlando Bru, Sales & Promo Mgr Louis Gargallo
Branch: Los Angeles, Calif., Box 20481 Zip 90006 Tel (213) 735-8197 Sales & Promo Robert Alvarez
Labels: (Owned) Discolando, (distributed) Bambuco, Chevere, Fri OB, Sonolux, Tikal Zeida

Discolor, see Kubaney

Discomex, see Mustiron

Disco Music Survey, see Disco Step by Step

Discos Fama, see Fama

Discos Fuego, see Fama

Discos Latin Int'l Inc., 1646 S. Vermont Ave., Los Angeles Calif 90006 Tel (213) 734-1527 Cable DISLATIN

Pres Jose A Garcia, Mgr Oscar Bolivar; West Coast Promo Felipe Arenas, Press/Promo Yanet Garcia
Branches: Hialeah Garden, Fla., 10100 NW 80 Ave. Zip 33016 Tel (305) 557-2135 Mgr Raul Lemes—Chicago, Ill., c/o Fernando Vian, 2151 N Humboldt Blvd Zip 60647 Tel (312) 278-7613
Labels: (Owned) Fono-Rex, Latin Int'l, No. 1, Pega, (distributed) Microlon, Parlophone

Discos Marcus Pereira (Brazil), see Brasilia

Discos Monica, see Peer-Southern

Discos Premier (Brazil), see Fermana

Discostar Inc., 10245 Collins Ave. Bal Harbour, Fla 33154 Tel (305) 861-6947 Pres Joseph C Martin, VP Jay Martin
Labels: (Owned) DRCL, Disco, Jayson, Marton

Disco Step by Step Recs Inc., 19 Slate Creek Dr., Buffalo, N.Y. 14227, Tel (716) 668-3161, 688-7511 Pres Martin Angelo, VP Promo Louis Mersola, VP Sales Hank Slipque, TV Sales Dir Roman Wheeler
Labels: (Owned) Disco Music Survey, Disco Step by Step, Discovery III, Go Disco

Discos Tropical, see Tropical Music

Disco Sur, see Velvet de Puerto Rico

Disco 3, see Red Diamond

Discount Recs & Books, 9093 Comprint Court, Gaithersburg, Md 20760 Tel (301) 977-2600 Pres Robert Bialek, VP & Treas Michael Bialek, Classical Buyer Matthew Prestone, Pop Buyer Jay Romasco, Adv. Mgr P. Allen Muller Jr., Gen Mgr John Croud
Labels: (Owned) Airborne, Asha

Discovery, see Trend in Calif

Discovery III, see Disco Step by Step

DiscReet Recs Inc., 5831 Sunset Blvd Hollywood, Calif 90028 Tel (213) 461-3267

Discus, see Stanyan

Discwasher Inc., 1407 N. Providence Rd., Columbia, Mo 65201 Tel (314) 449-0941 Nat'l Sales Mgr. Exec Prod'r James D. Hall, Prod'r Jeff Weber
Labels: (Owned) Discwasher, (distributed) Denon, Kiras Musical Works

Disko, see Hinstown-Disko

Disko-Mania, see TR

Disneyland/Vista Recs., 350 S Buena Vista St., Burbank, Calif 91521 Tel (213) 845-3141 Cable DISNEY VP & Gen Mgr Gary R. Krisel, Prod'n Mgr John Wood, Nat'l Sales Mgr. Steve Hoch
Int'l branch: Canada, Walt Disney
Labels: (Owned) Disneyland, Vista
Int'l reps.: Argentina (Phonogram), Australia (Summit), Belgium (Ades), Brazil (Abril), Chile (Industria de Radio & Television), China (Tang), Colombia (CBS), Denmark (Polygram), Dominican Republic (Distribuidores Musicales del Caribe), Ecuador (Fediscos), El Salvador (Discosa), Finland (Finnlevy), France (Ades), Germany (Ades), Greece (Phonogram), Iceland (SG), Israel (Hatak Int'l), Italy (CGD), Jamaica (CBS/Columbia), Japan (King), Korea (Han Jin), Mexico (CBS/Columbia), Netherlands (Bovema Negrum), New Zealand (EMI), Norway (PolyGram), Peru (El Virrey), Philippines (Victor) Portu-

gal (Radio Trunfo), Puerto Rico (Mena), Singapore (EMI), South Africa (Gallo), Spain (Hispanox), Sweden (Polydor), Switzerland (Ades), UK (EMI, Pickwick), Uruguay (Edisa), Venezuela (BASF), Yugoslavia (Vuk Karadzic)

Dixieland Jubilee, see GNP Crescendo

Dobre, see Ray Lawrence

Documentary Rec'gs., 10217 Scenario Ln., Los Angeles, Calif 90024, Tel (213) 474-8281

Dolejo, see Kare

Johnny Dollar Recs., 42-J Music Square W., Nashville, Tenn 37203 Tel (615) 254-3429

Dolphin (Ireland), see Shanachie

Domino Ltd., 222 Tulane St., Garland, Tex 75041 Tel (214) 278-3079 Owners David & Deanna Summers, A&R Dir. Dave Saxton
Labels: (Owned) Domino Ltd., Front Row, (distributed) A&G, Lake County (Switzerland)

Domino Recs., 37 Odell Ave., Yonkers, N.Y. 10701, Tel (914) 969-5673, VP & Gen. Mgr. Joe Bolton

Don, see Kubaney

Don-Mar Recs., see Casa Grande

Door Knob, see Gene Kennedy & World Int'l Group

Dore Recs., 1608 Argyle, Hollywood, Calif 90028, Tel (213) 462-6608. Owner Lew Bedell, Promo Mgr. George Jay

Doric Rec'g Group Inc., PO Box 282, Monterey, Calif 93940 Tel (408) 633-4219, 624-9556 Pres Frank R. Killinger, Gen. Mgr. Richard M. Penberthy
Labels: (Owned) Doric; (distributed) Amberlee
Int'l reps.: UK (Amberlee)

Dorn Recs., 20531 Plummer St., Chatsworth, Calif 91311, Tel (213) 998-0443. Pres. A. E. Sullivan, A&R Paul Martin, Sales & Mktg. D. Sullivan, Pub & Adv. Carol Ruskin
Labels: (Owned) Aztec, Dorn

Doro, see DGG

Doss, see Colonel Buster Doss

Colonel Buster Doss Presents, PO Box 927, Manchaca Sta., 78652, Tel (512) 282-4010 Pres. Col Buster Doss, VP Barbara Doss, Sec'y Kim Doss; Treas. Bo Doss
Labels: (Owned) Aus-Tex., Colonel Redneck, Doss, Kimbo, Range Buster, Six Shooter, Stardust, Wizard

Do-Tell Inc., 2940 E. Miraloma Ave., Anaheim Calif 92806, (714) 992-6820/6827 Telex 685553 Pres C E Whittington, Exec VP & Gen Mgr M.J. Graves; Mktg. Mgr. Michael Tell, VP Promo, Dottie McIlroy
Labels: (Distributed) Moonridge, Pacific Challenger.

Double A, see Sarg

Double Feature, see Talpro

Dove, see Startown

Down East, see Event

Down Home Recs., Box 10, Edna, Kan. 67342 Tel (316) 922-3322 Contact Vernon Sandusky (Distributed by IRDA)

Down South, see King Walk

Doylen Recs., 3610 Park Ave., Memphis, Tenn. 38111, Tel (901) 324-7147

How an executive finds a home near his new job while his new job is far away from home.

Coldwell Banker Residential Brokerage Company provides a very personal relocation service for executives transferring across the state, across the country, or from other countries. For complete information, call collect (213) 506-3100.

Coldwell Banker Relocation Services

4605 Lankershim Blvd., North Hollywood, CA 91606

Offices in Arizona, California, Washington, Oregon, Colorado, Texas, greater Chicago, suburban Washington, D.C., Kansas City and Atlanta



Coldwell Banker Relocation Services for transferring executives.

Dragon, Fla., see Aladdin.
 Dragon, Pa., see Crimson Dynasty.
 Dragon (Sweden), see Zim.
 Dragon Int'l Inc. of New Jersey, PO Box 8263, Haledon, N.J. 07508 Tel. (201) 942-6810. Pres. Samuel Cummings; VP Gauntlett Cummings; A&R; Jasseth Cummings.
Labels: (Owned) Alsamam, April, Arch, Cummings, Kela.
 Dragon Recs., 872 Morris Park Ave., Bronx, N.Y. 10462 Tel. (212) 792-2218 Pres. Vincent Gagliano
Labels: (Owned) Agon, Dragon
 Dream Machine, see Olivia
 Dreamstreet Recs., PO Box 193, Hohokus, N.J. 07423 Tel. (201) 825-1383 Pres. Howard Kenyon, Assoc. Prod'r Len Leone Jr.
Int'l reps.: Sweden (Disc), UK (Swift)
 Driftwood Recs., PO Box 22988, Nashville, Tenn. 37202 Pres. Margaret Yednak, VP & Gen. Mgr. Roland Dahhart, Promo. Howard Vokes, Sales & Mktg. John Valley
 Drive, see TK.
 Drum Recs. Inc., 909 Eighth Ave. N., Suite B, Fargo, N.D. 58102 Tel. (701) 235-8551.
 Duel, see Lee Dunne.
 Duke of Country Recs., 113 17 Ave. S., Nashville, Tenn. 37203 Tel. (615) 255-9366 Contact: Curtis Gordon.
 Dungeon, see Crimson Dynasty
 Lee Dunne Ents., PO Box 2270, Hollywood, Calif. 90028 Tel. (213) 874-9191 Pres. Lee Dunne, VP T.R. Eldridge, Sec'y L. Lane, A&R Dir. Chris Dunne, Pub. Thomas Randall
Labels: (Owned) Duel, LDE
 Dusk & Dawn Recs., 1810 Elton Rd., Adelphi, Md. 20783 Tel. (301) 445-1348 Contact: Andre Roman.
 Dyer-Bennet Recs., 792 Columbus Ave., New York, N.Y. 10025 Tel. (212) 866-3675 Mgr. Harvey Cort
 Dynamite, see Jim Hall
 Dynamo, see Talpro.
 Dynasty, see Vee Jay & West
 Dyno, see Gillette-Madison.

E

E, see West
 E B C, see NMI
 E C M, see Warner Bros.
 E C P Recs., PO Box 18320, Cleveland Heights, Ohio 44118 Tel. (216) 932-9033 Contact: Randy J. Wright
 E G, see Polydor
 E G C, see Rico.
 E & G Prod'ns, 2858 W. Pico Blvd., Los Angeles, Calif. 90006 Tel. (213) 733-2148
 E G Recs., 246 E. 62 St., New York, N.Y. 10021 Tel. (212) 355-5200 US Opns. Gen. Mgr. Ed Strait
Home office: England
 E K X, see Seven Hills
 E L J Rec. Co., 1344 Waldron Ave., St. Louis, Mo. 63130 Tel. (314) 863-3605 Pres. Edwin L. Johnson; Ass't VP W. Johnson; Sales Mgr. C. Primm.
 E M I, see Capitol
 E M I-America/United Artists Recs., 6920 Sunset Blvd., Los Angeles, Calif. 90028 Tel. (213) 461-9141 Telex 673271 Pres. & Chief Operating Officer: Jim Mazza, VP A&R Don Grierson; VP Promo. Charles Minor; VP Bus. Affairs: Mark Levinson; VP Mktg. Joe Petrone, Adv. Dir. Frenchy Gauthier; Pub. Mgr. David Budge, Artist Relations Mgr. David Bridger; R&B Mng. Dir. Varnell Johnson; Art. Dir. Bill Burks (Distributed by Capitol)
Branches: New York, N.Y., 1370 Ave. of the Americas Zip 10019 Tel. (212) 757-7470 Mktg. Mgr. Milton Allen, East Coast Pub. & Artist Relations Dir. Caroline Prutzman—Nashville, Tenn., 50 Music Square W. Zip 37203 Tel. (615) 329-9356 Nashville Div. Opns. & Nat'l Country Promo. Dir. Jerry Seabolt.
Int'l branch: England, Liberty-United.
Labels: (Owned) EMI-America, United Artists.
 E M I Int'l (UK), see Connoisseur Society.
 E M I R (UK), see Connoisseur Society.
 E S I (Entertainment Systems Int'l), 1628 W. 218 St., Torrance, Calif. 90501 Tel. (213) 328-5590 Pres.: Geoffrey Emery
 E S P-Disk Ltd., Acorn Hill Rd., Krumville, N.Y. 12447 Tel. (914) 657-6675 Pres. Bernard Stoffman
Int'l rep.: Japan (Nippon Phonogram).
 E T C III, see Katie the Great.
 E T S Rec. Co., PO Box 932, Honolulu, Hawaii 96808 Tel. (808) 623-9958 Owner: Richard R. Riccio
 Eagle Int'l Recs., PO Box 22312, Nashville, Tenn. 37202 Tel. (615) 255-8076.
 Eagle Rec. Co., PO Box 1102, Burbank, Calif. 91507 Tel. (213) 874-7656 Pres. & Gen. Mgr.: Peter Tevis, A&R Dir.: Scott Tevis
Int'l reps.: Colombia (Sonolux), Germany (EMI Electrola), Japan (EMI-Toshiba), Mexico (RCA), Netherlands (EMI-Bovema), South Africa (EMI-Brigadiers), Spain (EMI-Odeon), UK (WEA).
 Earl, see Ray Lawrence.
 Earth Quake, see Crimson Dynasty.
 Earth Sound Music/TAJ Ents. Inc., 469 Rockaway Pkwy., Brooklyn, N.Y. 11212 Tel. (212) 346-0397
 Earth Tremmor, see Crimson Dynasty.
 The East Allegheny Recs. Group, 335 Hidenwood Dr., Newport News, Va. 23606 Tel. (804) 595-9000 Cable: ALLEGROUP Chm & Pres. Elwood Evans Exec. VP: Mark Rosenberg, VP & Gen. Mgr. Darell Brookson; VP A&R Eric Sheppard; VP Artist Relations: Edie Rowe; Artist Relations: Paul Payne, Steve Owens; Sec'y: Carole Swenson, PR: Chuck Myerson; Dist'n: Bruce Shehan
Branches: North Hollywood, Calif., 6104 Cahuenga Blvd. Zip 90039 Tel. (213) 762-1001, West Coast Sales Dir. Craig Finch; PR: Tony Rosen—Chevy Chase, Md., 8815 Connecticut Ave. Zip 20015 Tel. (301) 657-0100, Mid-Atlantic Sales Dir. Marty Silver, PR: Kevin Coile.
Labels: (Owned) Allegheny, Denbigh, Marquee, Second Chance, Soul City, Southern Bell, Warwick.

East Wind, see JVC & Nautilus.
 Eastwood Sound, see Arzee
 Eb-Sko Prod'ns, 1726 1/2 Sherman Ave., Evanston, Ill. 60201 Tel. (312) 491-9155 Pres. Helen-Kay Eberley, Dist'n/Nat'l Sales: Vincent P. Skowronski.
 Echo, see Dana.
 Eckerworks, see Rounder
 Eclipse, see Galaxie III
 Ecstasy, see Aladdin
 Eden, see Consolidated Gospel
 Educational Film Systems Inc., 2716 Ocean Park Blvd., Suite 1050, Santa Monica, Calif. 90405 Tel. (213) 450-5752
Label: (Owned) Metric.
 Educational Media Assocs. of America Inc., PO Box 921, Zip 94701, 2034 Blake St., No. 7, Berkeley, Calif. 94704 Tel. (415) 525-4583 (Distributed by Discorp)
Labels: (Owned) I Grandi Interpreti, Recital, Bruno Walter Society, Western Sound Archive
Int'l reps.: Austria (Preiser), France (Dave-Music), Germany (Helmut Marcuse), Italy (Stradivarius Club), Japan (Nippon Columbia, Shinsei Serv.), UK (Music Disc)
 Educator Recs. Inc., 1921 Walnut St., Philadelphia, Pa. 19103 Tel. (215) 561-1283 Pres. Music Dir. & A&R Bart Arntz, VP Mktg./Adv. Cathy O'Dwyer
Labels: (Owned) Educator; (Distributed) Mira
 Elbejay Ents. Inc., PO Box 40544, Nashville, Tenn. 37204 Tel. (615) 297-3767 Pres. H. Raymond Ligon, Sec'y: Treas. Swall B. Jackson
Local branch: 1120 E. Dalmas Zip 37216 Tel. 228-8511 Mgr. R.M. Jackson
Int'l rep.: UK (Selectadisc)
 Electrecord (Romania), see Worldtone.
 Elektra/Asylum/Nonesuch Recs., 962 N. La Cienega, Los Angeles, Calif. 90069 Tel. (213) 655-8280 Bd. Chm. Joe Smith, Vice Chm. Mel Posner, Pres. Steve Wax, VP Finance: Jack Reinstein, VP Sales: Stan Marshall, VP Prod'n: Keith Holzman; VP Creative Servs.: Jerry Sharell, VP Promos: Ken Buttice, VP Int'l: George Steele, Artist Development Dir. Mark Hammerman, Pub. Dir. Bryn Bridenthal
Branches: New York, N.Y., 665 Fifth Ave. Zip 10022 Tel. (212) 355-7610 East Coast Mgr. Ralph Ebler—Nashville, Tenn., 1216 17 Ave. S. Zip 37212 Tel. (615) 320-7525 VP & Gen. Mgr. Jimmy Bowen, Nat'l Country Promo. Dir. Norm Osborne, Sales & Mktg. Dir. Ewell Russell, Pres. Mgr. Mike Hyland
Distribution branches: Los Angeles, San Francisco, Calif., Denver, Colo., Hartford, Conn., Miami, Fla., Atlanta, Ga., Chicago, Ill., Greenbelt, Md., Boston, Mass., Detroit, Mich., Minneapolis, Minn., Kansas City, St. Louis, Mo., Mount Laurel, N.J., New York, N.Y., Charlotte, N.C., Cincinnati, Cleveland, Ohio, Dallas, Houston, Tex., Seattle, Wash. (See Record & Tape Wholesalers section for complete listings for Warner/Elektra/Atlantic Corp.)
Int'l branches: See WEA Int'l.
Labels: (Owned) Asylum, Elektra, Nonesuch, (distributed) Beserkley, Planet.
Int'l reps.: See WEA Int'l.
 Elektra/Everest Legacy Series, see Everest.
 1108, see Point Blank
 Elm Recs. (div. of Edd L. McNeely Prod'ns), PO Box 1100, 14621 Allen, Westminster, Calif. 92683 Tel. (714) 898-7317
 Ember Recs. (div. of Ember Ents. Inc.), 747 Third Ave., 27th fl., New York, N.Y. 10017 Tel. (212) 688-8170 Pres. Jeffrey S. Kruger, VP Louis Zinman, VP Creative Affairs: Chris Denning, VP Int'l Sales & Artists Liaison: Leslie Lewis, VP Promos. Howard Kruger, VP PR: Angela Moritmore
Home office: England.
Labels: (Owned) Bulldog, Ember
Int'l reps.: Argentina (Siamecana), Australia (7 Recs.), Austria (Ariola), Belgium (Vogue), Brazil (Som, Companhia Ind'l de Discos), Canada (Almada, Quality), Costa Rica (Lyra), Czechoslovakia (Opus), Denmark (EMI), Finland (EMI), France (Ariola), Germany (Ariola-Eurodisc), Iceland (Hyjodfaerhus Reikjarkur), Israel (CBS), Italy (Durium), Kenya (EMI), Netherlands (VIP), New Zealand (Music World), Philippines (Disco), Singapore (Decca), South Africa (David Gresham), Spain (Disophon), Sweden (EMI), Switzerland (Phonogram), Venezuela (Palacio de la Musica).
 Emerald City Recs. Inc., 75 Rockefeller Plaza, New York, N.Y. 10021 Tel. (212) 484-6000 Owners: Charles Greene, Brian Stone.
 Emergency Rec. & Film Works Inc., 29 W. 38 St., New York, N.Y. 10018 Tel. (212) 921-9760 Pres. Sergio Cossa (Distributed by Brasilia)
 Emko, see Kool Kat.
 Empire Recs. & Tapes, PO Box 265, Deerfield Beach, Fla. 33441 Tel. (305) 428-2644 Pres. Josh Noland, VP: Jess Stansbury; Nat'l Promo. Richie Johnson
 Empress, see Express
 Enchanted Knight, see Crimson Dynasty
 Encore Recs., PO Box 343, Santa Monica, Calif. 90406 Tel. (213) 394-5110 Pres. Irvin A. Brock
 Encore Series, see Columbia Special Prods.
 Endeavor Recs., 30064 Annapolis Circle, Inkster, Mich. 48141 Tel. (313) 729-7836 Pres. & A&R: Hardie W. Daniel
 Enrica Recs. Inc., see Rae-Cox
 Enterprize, see Umpire
 Entertainment Systems Int'l, see ESI.
 Entr'act Rec'g Society Inc., 1220 N. State, No. 410, Chicago, Ill. 60610 Tel. (312) 649-5768 Pres. John Stevenson Lasher, Sec'y: Dennis Petersen
Labels: (Owned) Celluloid Fanfare, Entr'act
Int'l reps.: Australia (Janda), Canada (Trend), France (CWE), Japan (Sumiya), UK (Swift)
 Epic, see CBS.
 Epitaph, see Vee Jay
 Epitome, see Phono Rec. Dist'g.
 Epsilon, see Mustiron
 Erastus Recs., Box 737, Rt. 2, Lizella, Ga. 31052 Tel. (912) 935-2129
 Eric Dynamic Nitro Recs., PO Box 14755, Zip 45214, 921 William Howard Taft Rd., Office 2A, Cincinnati, Ohio

45206 Tel. (513) 281-8645 Pres. Eric Wilson Jr. VP Tom Coleman
Label: (Owned) Nitro
 Eric Recs. (div. of American Rec. Sales Inc.), 1120 Crown Point Rd., Westville, N.J. 08093 Tel. (609) 848-1900 Pres. Bill Buster, VP Anthony W. Colombet
 Erva Recs., 200 W. 57 St., Suite 1404, New York, N.Y. 10019 Tel. (212) 765-5722
 Esar, see Bill Rase.
 Esca, see Rounder.
 David Eskin Inc., 400 Riverside Dr., New York, N.Y. 10025 Tel. (212) 749-4257 (Exporter)
 Esoteric Inc., 26 Clark St., East Hartford, Conn. 16108 Tel. (203) 528-4126 Pres. Richard J. Godlewski, Classical A&R Prof. M. Colette.
Label: Haydn Society
 Esoteric, Calif., see Everest.
 Essar, see WILD
 Eterna, see Lyricord
 Eterna (East Germany) see Worldtone.
 Etowah Recs., 414 Fourth St., Attalla, Ala. 35903 Tel. (205) 538-7788 (Distributed by Orbit)
 Euclid, see Jam 79
 euphony Recs., PO Box 8037, Van Nuys, Calif. 91409 Tel. (213) 346-4505 Bd. Chm. James C. Smith; Pres. John Bossman
 Euphoria Recs. Inc., 99A Centennial Ave., Revere, Mass. 02151 Tel. (617) 522-1924, 284-5729 Mng. Dirs. Howard A. Cook, Curtis Naihershey, Moss Lynch, Art Dir. Donna Tessari.
 Euphoria, Fla., see Request.
 Europa Rec. Dist., 333 Seventh Ave., New York, N.Y. 10001 Tel. (212) 244-1442 Tel. 126207
Int'l branches: Canada, France, Canada, France, CADI.
Label: (Owned) Rockland
 Frank Evans Recs. Group, 335 Hidenwood Dr., Newport News, Va. 23606 Tel. (804) 595-9000 Cable: FRANKART Pres. & Chief Exec. Officer: Frank Evans, Exec. VP: Tom Gregory, VP & Gen. Mgr. Jon Michael Irey, Boyfriends Recs. A&R: Chris Newport, Century Artist Recs. A&R: Greg Cole; Continental Artist Recs. A&R: Ken Wheaton; GayArtist Recs. Craig London; Premiere Artist Recs. A&R: Marc Shevlin, PR Dir. Wayne Hampton, Dist'n Dir. Avery Kincaid
Branches: Hollywood, Calif., 9155 Sunset Blvd. Zip 90069 Tel. (213) 278-0400 Cable: FRANKART West Coast PR Dir. Timothy Norton, Dist./Sales Dir. Mark Hamilton—New York, N.Y., 919 Third Ave. Zip 10022 Tel. (212) 371-7100, N.Y. PR Dir. Bruce Shapiro, Int'l Sales Dir. Randy Coleman.
Labels: (Owned) Boyfriends, Century Artist, Continental Artist, GayArtist, Premier Artist
 Event Recs., Rt. 302, Westbrook, Me. 04092 Tel. (207) 854-2044 Owner & Gen. Mgr. Al Hawkes, Sales Dir. Darleen Boullie, Promo./Adv. Dir. Barbara Hawkes
Labels: (Owned) Down East, Event
 Event, N.Y., see Spring
 Eventide, see Dee-Bee.
 Everest Rec. Group, (2020 Ave. of the Stars, Century City, Calif. 90067 Tel. (213) 557-0309
Labels: (Owned) Archive of Folk & Jazz Music, Archive of Piano Music, Arvee, La Comedie Francaise, Concert-Disc, Counterpoint, Elektra/Everest Legacy Series, Esoteric, Everest, Hi-Fi, Hi-Fi/Life, Period, Renaissance, Scala, Stradivari, Tradition
Int'l reps.: Argentina (Microphon, Trova), Australia (Astor, W&G), Brazil (Fermata), Canada (Almada, Ampex, GRT, Keel), Chile (Goluboff), Denmark (Dansk), France (Barclay, Vogue), Germany (Baerenreiter, Bellaphon, Deutsche Vogue), Israel (Hataklti), Italy (Font-Cetra, Ricordi, Saar, Vedette), Japan (Nippon Columbia), Mexico (Gamma), Netherlands (Phillips, Supertone), Spain (Belter, Disophon, Hispavox, Movieplay, Vergara), Sweden (Harbor), UK (Peerless)
 Evergreen, see Dimitri.
 Everyman Classics, see Vanguard.
 Excello, see Nashboro.
 Exhibit "J", see Bomp.
 Experience Anonymes, see Lyricord.
 Express Recs., PO Box 3367, Hollywood, Calif. 90028 Tel. (213) 761-9679
Labels: (Owned) Empress, Express, Sweet Stuff
Int'l reps.: Greece (Seagull), UK (Gull, Sun-Pacific).
 Express, Tex., see Pantego

F

F E L Publ'ns Ltd., 1925 S. Pontius Ave., Los Angeles, Calif. 90025 Tel. (213) 478-0053 Pres.: Dennis J. Fitzpatrick Treas. James D. Boyd, Sec'y: Thomas L. Cook
 F F O Communications Inc., Box 313, Kingsbridge Sta., Bronx, N.Y. 10463 Tel. (212) 543-7770 Pres. Bruce Hest; VP Recs.: Neil Fredman; Mktg. Dir.: Steve LeBow, Pub. Dir.: Barry Stevens
 F J M, see Montilla
 F S R, see Fidelity Sound.
 F & W, see Rounder.
 F W P, see Fred Weinberg
 Facets, see Cord
 FaderKat, see Hilding.
 Fairmont Recs., PO Box 3392, Santa Monica, Calif. 90403 Tel. (213) 391-7833 Partners: Dave Caughren, Cecil Spiller
Int'l reps.: Denmark (CSA), UK (Great Jazz)
 Fair Retail, see Buttermilk.
 Fair Wind, see Castalia
 Fairyland, see American Themes.
 Faith, see Ansp & Country Stream
 Falcon, see House of Falcon
 Falconer Recs., PO Box 2217, Inglewood, Calif. 90205 Tel. (213) 644-8182 Pres. L.S. Falconer.
 Fama Recs., 1445 Knoll Circle, San Jose, Calif. 95112 Tel. (408) 289-1220
Labels: (Owned) Discos Fama, Discos Fuego
 Fame, see Vintage
 Famous Door Recs., PO Box 92, Sta. A, Flushing, N.Y. 11358 Tel. (212) 463-6281 Owner: Harry Lim
Int'l rep.: UK (Swift)

Fanfare Recs., PO Box 2501, 5311 SW Ninth, Des Moines, Iowa 50315. Tel: (515) 285-6564. Pres.: Art Stenstrom, Prod'r: Bob Parker.

Fania Recs. Inc., 888 Seventh Ave., New York, N.Y. 10019. Tel: (212) 397-6730. TWX (710) 581-6093. Pres.: Gerald Masucci, VP Johnny Pacheco, Comptroller: Victor Gallo; Int'l: Jose Florez; Press/Promo.: Sergio Rozenblat.

Branch: Condado, P.R., 1400 Magdalena Ave. Zip 00907. Tel (809) 723-9208.

Labels: (Owned) Allegre, Cotique, Fania, Inca, International, Tico, Vaya; (distributed) Karen.

Fantasy/Prestige/Milestone/Stax, 10 & Parker Sts., Berkeley, Calif. 94710. Tel. (415) 549-2500. TWX (910) 366-7246. Bd. Chm.: Saul Zaentz; Pres.: Ralph Kaffel; VP Jazz A&R: Orrin Keepnews; VP Bus. Affairs: Al Bendrich; VP Finance: Frank Noonan; VP Mktg.: Phil Jones; A&R Dir.: Hank Cosby, Bill Belmont; Sales & Adv. Mgr.: David Lucchesi; Nat'l Promo. Dir.: Quincy McCoy; Nat'l Promo. Dir.: Black Music: Bob Ursery; Secondary Nat'l Promo.: Nancy Levine; Art Dir.: Phil Carroll; Press & Public Information Dir.: Terri Hinte; Singles Sales Mgr.: Kirk Roberts; Chief Eng.: Jim Stern.

Branches: Los Angeles, Calif., 6363 Sunset Blvd. Zip: 90028. Tel. (213) 462-6409. West Coast Promo.: Bob Mercer; West Coast Sales: Bob Kirstein—**New York, N.Y.**, 1776 Broadway, Suite 617. Zip. 10019. Tel: (212) 757-2134. VP East Coast Opns.: Bernard Lieberman; East Coast Sales: Anthony Mascia; Eastern Promo.: Norm Gardner, Dennis Ganim—**Memphis, Tenn.**, Stax Recs., Mid Memphis Tower, Suite 600, 1407 Union. Zip. 38104. Tel. (901) 726-6360. VP A&R & Talent: David Porter.

Int'l reps: Australia (Festival), Austria (Bellaphon), Brazil (Top Tape), Canada (BSR, Emerson, Motown), Denmark (EMI), Finland (EMI), France (Musidisc-Europe), Germany (Bellaphon), Greece (Music-Box), Guatemala (Discos de Centroamerica), Hong Kong (HK), Israel (Hatak-lit), Italy (Fonti-Cetra), Japan (Victor), Mexico (Gamma), Netherlands (EMI), New Zealand (Festival), Norway (EMI), Philippines (Vicar), Portugal (Radio Triunfo), South Africa (Teal), Spain (Hisvox), Sweden (EMI), Switzerland (Bellaphon), UK (EMI)—Fantasy, Stax; RCA—Prestige, Milestone); Venezuela (Allstar), West Indies (Record Specialists in Jamaica), Yugoslavia (Jugoton).

Labels: (Owned) Fantasy, Galaxy, Milestone, Prestige, Riverside, Stax; (distributed) Fantasy/WMOT.

Fantasy/WMOT, see Fantasy/Prestige/Milestone/Stax.

Farr Recs. (Farr Music Inc.), Box 1098, 350 Grove St., Somerville, N.J. 08876. Tel: (201) 725-3850. Bd. Chm.: Asa Farr; Controller-Mgr.: Candace Campbell.

Fayette, see Parr-X.

Federal, see Gusto.

Fee Bee Rec. Co., 4517 Wainwright Ave., Pittsburgh, Pa. 15227. Tel (412) 884-4554. Pres.: Joe Averbach; A&R & Arranger: Butch Martin; Promo.: Carl Hirce.

Labels: (Owned) Fee Bee, Sceptre.

Fee-Line Recs. Ltd., 604 E. Madsion, Knoxville, Iowa 50318. Tel: (515) 842-3933/2135.

Fee Recs. Inc., 19025 Grand River, Detroit, Mich. 48223. Tel: (313) 838-8100. Pres.: Woodrow Wilson; VP Opns.: Jay Butler.

Femix, see Otsoo.

Maynard Ferguson Music Inc., PO Box 716, Ojai, Calif. 93023. Tel (805) 646-8715.

Label: (Owned) MFM.

Fermata Int'l Melodies Inc., Sunset-Vine Tower Bldg., Suite 916, 6290 Sunset Blvd., Hollywood, Calif. 90028. Tel (213) 462-7473. Cable: FERMATACAL TWX (910) 321-4063. Mgr.: Debora Frenkiel.

Home office: Brazil.

Labels: (Owned) Discos Premier, Fermata, Importa/Som, Peralta, Pick, RGE, Som/Maior, Young (all imported from Brazil).

Festival/Callope Recs., 17711 Margate, Encino, Calif. 91436. Tel (213) 344-4552. Gen. Mgr.: Chuck Edwards.

Festivo, see Classics Int'l.

Fiction Recs., PO Box 375, Wilmette, Ill. 60091. Contact: Cary Baker.

Label: (Owned) Fiction, Stranger Than Truth, (distributed) 20th Century Fox.

Fiddlededoo, see Rounder.

Fiddler, see Rounder.

Fidelo Recs., 120 Kingston Pl., No. 30, Bloomington, Ind. 47401. Tel (812) 339-2475.

Int'l rep.: UK (Henry Stave).

Fidelity Sound Recs., 23 Don Court, Redwood City, Calif. 94062. Tel (415) 366-3173. Owner & Mng. Dir.: Reginald McGovern; Promo. & Pub.: Jim Gallagher.

Int'l branch: New Zealand.

Labels: (Owned) Dana, Fiesta, Grecophon.

Int'l reps.: Canada (Fiesta, Holborne).

Fiesta Rec. Co. Inc., 1619 Broadway, New York, N.Y. 10019. Tel (212) 757-7760. Pres.: Jose Merand.

Sales Mgr.: Ed Kleinbaum.

Int'l branch: Canada.

Labels: (Owned) Dana, Fiesta, Grecophon.

Int'l reps.: Canada (Fiesta, Holborne).

Fifty-Fifty Prod's Inc., 11 E. 26 St., New York, N.Y. 10010. Tel (212) 686-7010. Pres.: Steve Martin.

50%, see Cord.

50 States Recs., 50 Music Square W., Suite 501, Nashville, Tenn. 37203. Tel (615) 327-1500. Pres.: Donald L. Riis; A&R Dir.: Johnny Howard; Pub. & Adv. Dir.: Georgia Rayhons; Promo. Mgr.: Richard P. Colanzi.

Filly Colt Recs. (div. of Pix-Russ Music), 49 Music Square W., Suite 513, Nashville, Tenn. 37203. Tel (615) 320-5796. Pres.: Bobby Russell; Prod'r & Affairs Dir.: Michael Snow.

Final Connection, see Davida.

Finer Arts Recs./Transworld Recs., 295 Monaco Pkwy., Denver, Colo. 80220. Tel (303) 355-4535. Contacts: Morris, Allan, Barry, Neil & Richard Bernstein.

Finnadar, see Atlantic.

Finnlevy (Finland), see Worldtone.

Fiorucci Inc., 127 E. 59 St., New York, N.Y. 10022. Tel.

(212) 751-1404. Telex 666768. Exec. VP: Gianfranco Rossi; Music Dir.: Cico Colacicco. PR: Peggy Fincher.

Fire Sign Recs. Ltd., 1650 Broadway, New York, N.Y. 10019. Tel (212) 765-4495. Telex: 237224. Pres.: Billy Arnell; VP: Steve Loeb; Ass't VP: Ezra Cook; VP Finance: Jerold Kanuk.

Labels: (Owned) Northern Light, Rock City.

Firma, see CJ.

First American Recs. Inc., 65 Marion St., Seattle, Wash. 98104. Tel (206) 625-9992. Bd. Chm.: Jerry Dennon; Pres.: Gil Bateman; VP: R.A. Harlan; Nat'l Accounts Mgr.: Stan Sulman; Nat'l Sales Mgr.: Linda Skore; Prod'n Co-ord.: Tanya Campana.

Labels: (Owned) First American, Great Northwest, Music Is Medicine, Piccadilly, (distributed) Burdette, Potato, Stony Plain.

First Artists Recs., 4000 Warner Blvd., Burbank, Calif. 91522. Tel (213) 843-6000. Telex: 698586. VP: Gary Le Mel; Ass't: Sandi Beach.

First Component Series, see Audiofidelity.

First Edition, see Louisville Orchestra.

Fisherfolk, PO Box FF, Woodland Park, Colo. 80863. Tel (313) 687-9237. Pres.: Grover T. Newman; VP: John P. Farra; Treas.: Lynn Hubbard; Sec'y: Margo Farra.

Int'l branch: England, Celebration Servs.

Labels: (Owned) Celebration, Fisherfolk, Fishermen, Net.

Fishermen, see Fisherfolk.

Fist-O-Funk Recs., 293 Richard Court, Pomona, N.Y. 10970. Tel (914) 634-2446, 354-7157. Pres.: Kevin Misevis; Prof. Mgr.: Ulla Misevis; A&R: T.C. James; Promo.: Lewis Calabro.

Branch: New City, N.Y., 90 Collyer Ave. Zip: 10956. Tel (914) 634-2446. Studio Mgr.: Robert Misevis.

Int'l reps.: Canada (Quality), Italy (EMI), UK (EMI).

Five Star, see Fidelity Sound.

Flama, see Gas.

Flambo, see King Walk.

Flame, see Crimson Dynasty.

Flamngans Recs., 16565 NW 15 Ave., Miami, Fla. 33169. Tel (305) 624-9881. Contact: Tony De Zago.

Flashlight, see Symposium.

Fiatrock, see Buttermilk.

Fiat Town Music Co., Floyd's Bldg., 434 E. Main, Ville Platte, La. 70586. Tel (318) 363-2139. Owner: J. Floyd Soileau; Pub. & Promo.: Benny Graeff.

Labels: (Owned) Jin, Maison de Soul, Swallow.

Int'l reps.: France (Le Chant du Monde), UK (Oval, Swit).

Fleurette Recs., PO Box 34, Claymont, Del. 19703. Pres.: Alex Czarenko.

Flin-Flon Country, Box 103, Mullen, Neb. 69152. Tel (308) 546-2293. Gen. Mgr.: L. E. Walker; Sales Mgr.: David L. Walker.

Label: (Owned) Garden of Eden.

Florida Independent Rec. Corp., PO Box 523790, Miami, Fla. 33152. Pres.: Joseph Stanzione.

Labels: (Owned) Magic Minstrel, Twelve O'Clock.

Flowers Rec'g Studio, Box 120A, Rt. 1, Swoope, Va.

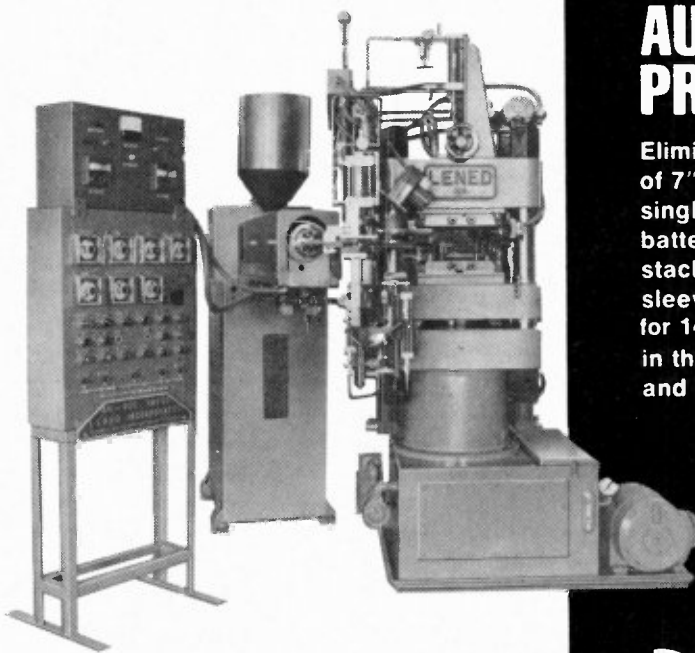

LENEDED AUTOMATED RECORD PRESSING SYSTEMS

Eliminate hand operations in the production of 7", 10" and 12" phonograph records. A single machine tender can operate a battery of these units, simply by providing stacks of labels and removing stacked and sleeved records at the delivery end. Proven for 14 years. In excess of 600 installations in the U.S., Canada, Europe, the Orient, and other areas.

Write, telex, or phone for information regarding Lened systems... or for information about Lened's other equipment for the industry including packaging, handling, counting, imprinting, and tape duplicating machinery.



LENEDED INTERNATIONAL CORP.
489 Henry Street, Elizabeth, New Jersey 07201
Telephone: 201-354-5205
Telex: 138767

- 24479 Tel (703) 885-3309. Owner Charles A. Flowers; Sec'y/Treas. Barbara R. Flowers.
Label: (Owned) Flowers
Flying Disc, see JVC
Flying Disco Disc, see Point Blank
Flying Fish Recs., 1304 W. Schubert, Chicago, Ill 60614
Tel (312) 528-5455. Pres.: Bruce Kaplan, VP Promo. Charles Gutfield; Ass't VP Promo Jennifer Berman, VP Opns. & Sales James Netter; Ass't VP Sales: Peter Crawford, Ass't VP Opns./Disco Promo. Donald Goldman
Labels: (Owned) Flying Fish, (distributed) Kaleidoscope, Mountain Railroad, Nessa.
Int'l reps.: Australia (Janda, Larrikin), Canada (Stony Plain, Trend), France (Free Bird), Italy (Hi-Fi), Japan (BOM, Disc Centre, G&G, Shinser, Trio), UK (Mike's Country Music Room, Projection, Sonet, Swift)
Flying Hawk, see Sirco.
Flying High, see Richey
Flyright (UK), see Rounder
Folk-Legacy Recs Inc., Sharon Mountain Rd., Sharon, Conn 06069. Tel (203) 364-5661. Pres.: Lee B. Haggerty; VP & Treas. Charles A. Paton; Sec'y Caroline A. Paton, Sales Mgr. John P. Holland.
Int'l reps.: Australia (Larrikin), UK (Free Reed)
Folklyric, see Arhoolie.
Folkraft Publ'g Co. Inc., 10 Fenwick St., Newark, N.J. 07114. Tel (201) 243-8700.
Folkways Recs. & Serv. Corp., 43 W. 61 St., New York, N.Y. 10023. Tel (212) 586-7260. Dir. Moses Asch; Controller Marilyn Conklin.
Labels: (Owned) Asch, Broadwaysides, Folkways, RBF
Int'l reps.: Australia (Carina), Belgium (Schott Freres), Canada (Almada), Denmark (Dansk), France (Chant du Monde), Germany (EMI-Electrola, Plane, Trikont), Italy (Editoriale Sciscia), Japan (Nippon Columbia), Norway (St. Olav), Sweden (Omega).
Fona, see Churchill.
Fonodisco, see DGJ.
Fono-Rex, see Discos Latin
Fontana (Brazil), see Brasilia
Foot, see Red Diamond
Forest Bay Rec Co., 703 Canham Rd., Santa Cruz, Calif 95060. Tel (408) 438-0729
For Singers Only, PO Box 10, North Hollywood, Calif 91603. Tel (213) 274-5863. Pres. Phil Moore, VP. Jack Tracy
Fortune & Hi-Q Recs., 3942 Third Ave., Detroit, Mich. 48201. Tel (313) 833-5383
Labels: (Owned) Fortune, Hi-Q, Strate-8.
415 Recs., 595 Castro St., San Francisco, Calif. 94114. Tel (415) 552-9828. Contacts: Howie Klein, Chris Knab, C.W. Bridges.
Four Leaf Clover, see Ozark Opry.
Four Star Recs Inc., 49 Music Square W., Nashville, Tenn 37203. Tel (615) 329-0444.
Labels: (Owned) Challenge, 4 Star
Fragoso, see Casa Fragoso
Frane Recs., PO Box 8135, Chicago, Ill 60680. Tel (312) 787-8220. Pres. Frank Howard Jr.; Exec VP R.C. Hillman, Nat'l Promo Mgr. Howard Pittman; Int'l Mktg. Mgr. Clayton Moore.
Fraternity Rec'g Corp., 3744 Applegate Ave., Cincinnati, Ohio 45211. Tel (513) 661-5451. Cable FRATREC
Pres. & A&R: Shad O'Shea; VP Pat Doran.
Labels: (Owned) Applegate, Counterpart, Fraternity
Freckle Recs., PO Box 31319, San Francisco, Calif 94131.
Branch: Seattle, Wash., Box 4005 Zip 98104. Tel (206) 329-4935. Sales Mgr.: Jack Burg
Freddie Recs., 6118 S. Padre Island Dr., Corpus Christi, Tex 78412. Tel (512) 992-8411. Owner Freddie Martinez, Gen Mgr. Lee Martinez, Sales & Promo Jessie Salcedo; Sales Rick Longoria; Engs. Ruben Peralta, Hector Gutierrez
Labels: (Owned) Acorn, Freddie, Johnny, Rosita
Freedom Recs Ltd., PO Box 888, Easley, S.C. 29640. Tel (803) 269-7012
Free Flight, see RCA
Free Spirit, see Salsoul.
Free Style, see Vanguard.
Frejo, see Fred Weinberg
Fretless, see Philo.
Fretone Recs Inc., 3114 Radford Rd., Memphis, Tenn. 38111. Tel (901) 327-8187.
Fri, see Discolando
Friends & Co., 108 Sherman Ave., New York, N.Y. 10034. Tel (212) 567-5110.
Frisco Prod'ns, 1218 Hollister Ave., San Francisco, Calif 94124. Tel (415) 467-5157. Owners James B. & William C. Taylor
Front Hall Recs., RD 1, Wormer Rd., Voorheesville, N.Y. 12186. Tel (518) 765-4193. Pres. Kay L. Spence.
Front Row, see Domino Ltd.
Fuego (Discos), see Fama
Fuentes (Colombia), see Mirosa
Full Moon Recs., 8380 Melrose Ave., Suite 307, Los Angeles, Calif. 90069. Tel (213) 658-6600. Pres. Irving L. Azoff
Full Sail Prod'ns, 1126 Boylston St., Boston, Mass 02215. Tel (617) 262-7880. Co-Pres. Fred Berk, Jeff Gilman.
Funnystone, see Horizon Publ'g.
Future Gold Recs Inc., 1834 W. Cheltenham Ave., Philadelphia, Pa 19126. Tel (215) 424-0800
Future Shock, see Red Diamond
- (Almada), France (Vogue), Germany (Bellaphoni), Italy (Font-Cetra), Japan (King), Mexico (Musari), Philippines (Home), Scandinavia (Sonet), South Africa (RPM), Spain (Discophon), Switzerland (Vogue), UK (Pye).
G O, see Grapevine Opry.
G P, see Glenn
G R A M, see Great American Music
G R I, see Gospel Recs.
G R S Music & Rec. Group Communications Co., 1236 E. India, Suite 223, Tampa, Fla. 33602.
G S I, see Progressive.
G T P, see Surf City
Gael-Linn (Ireland), see Rounder & Shanachie
Gala, see Cocco.
Gala Ball, see Jamie/Guyden
Galaxie Recs., 11 Music Circle S., Nashville, Tenn 37203. Tel (615) 244-3961. Contact Jim Lusk. (Distributed by IRDA)
Galaxie III Studios, 118 Fifth St., Taylorsville, N.C. 28681. Tel (704) 632-4735. Owner & Pres. Harry Deal
Label: (Owned) Eclipse
Galaxy, see Fantasy/Premiere/Milestone/Stax
Gale Maximum Fidelity (UK), see Audio-Technica
Gallup Recs., PO Box 56055, Los Angeles, Calif 90008. Tel (213) 731-4006.
Gamma Recs Inc., 10822 Overbrook, Houston Tex 77042. Tel (713) 721-3041, 781-2981. Pres. David Bromberg
Garden of Eden, see Flin-Flon
Garden Rec Co., 9000 Sunset Blvd., Los Angeles, Calif 90069. Tel (213) 274-0615
Garnet, see Michele
Martin Gary Prod'ns, Box 131, Rt. 4, Louisa, Va. 23093. Tel (804) 288-7288. Pres. Martin Gary, VP & Sec'y Kathleen Gary
Gasparo Recs., PO Box 90574, Nashville, Tenn 37209. Tel (615) 383-3168. Owner Roy Christensen
Gas Recs., 2716 W. Pico Blvd., Los Angeles, Calif. 90006. Tel (213) 731-7323
Home office: Mexico, Discos Gas SA
Labels: (Owned) Flama, Gas
Gateway, see Rite Rec. & Gillette-Madison
GayArtist, see Frank Evans
Gear, see Progressive.
Gem Recs., Box 9726, West Gate Sta., San Jose, Calif 95117. Tel (408) 353-3284. Pres. Dr. John E. Moran
Gem Toby, see RCA
General Music Corp., 3012 N. Main St., Houston, Tex 77009. Tel (713) 225-0450. Pres. Jay Collier, Sales Mgr. Bettye Aldis; VP A&R Tommy Melder, Nat'l Promo. Dir. Beau James
Label: (Owned) GMC.
Generation, see Boot
Genesis Rec'g Co., 1228 Reed St., Philadelphia, Pa 19147. Owner & Chief Operating Officer Grace Marchesa
Genesis Recs. Inc., 710 Wiltshire Blvd., Santa Monica, Calif. 90401. Tel (213) 393-9293
Genie, see Aladdin.
Genstation, see International Mod Recs.
Getaway Recs., 228 Normandy Professional Bldg., St. Louis, Mo 63120. Tel: (314) 382-2202. Contact Jim Logan.
Ghost Recs., 1905 Pesos Pl., Kalamazoo, Mich 49008. Tel (616) 375-2641. Pres. Don Jobe, VP Bill Grody.
Labels: (Owned) Ghost, Jobe
Gibson Ents., PO Box 2098, 4009 E. 18 St., Vancouver, Wash 98661. Tel: (206) 695-2112. Pres. Gene Breeden, VP Ellis Miller; Sales & Mktg. Blaine Allen; Pub. Adv. & Promo. Lorraine Walden
Labels: (Owned) Charter, Portland Ltd., Ripcord
Gillette-Madison Co., 600 Somerset St., North Plainfield, N.J. 07060. Tel. (201) 753-0777. Cable GILMADCO.
Pres. Robert W. Schachner, VP Sy Spiegelman
Branch: Studio City, Calif., 11375 Ventura Blvd. Zip 91604. Tel (213) 766-9419. Sales Rep. Michael Sasina
Labels: (Owned) Dyno, Gateway, Personal Choice, (distributed) Thunderbird, Who's Who
Gilleynan Recs., 4736 Volunteer Dr., Antioch, Tenn 37013. Tel: (615) 331-5379. Contact Doug Pierce (Distributed by IRDA)
Gil's Funny Recs., see Aquila.
Glades, see TK
Glad Hamp Recs Inc., 1995 Broadway, New York, N.Y. 10023. Tel (212) 787-1222.
Glamour & Grease, see Dance-A-Thon
Glenn Prod'ns & Promos., 157 W. 57 St., New York, N.Y. 10012. Tel (212) 265-6585. Pres. Ben J. Arrigo.
Labels: (Owned) GP; (distributed) Black Hawk, Juno, Rebecca.
Glo, see Jody.
Globe Ents., 827 Thomas, Memphis, Tenn. 38107. Tel (901) 525-0540. Pres. William E. Glore
Labels: (Owned) American Way, Glotte, Lunx, Memphis & It's Music, Prophesy, Tennessee Country, UFO
Glori Recs Inc., 246 Richmond Ave., Staten Island, N.Y. 10302. Tel (212) 720-6700. Pres. Steven Herman, VP Bruce Herman, Gen Mgr. Arnold McCloud; A&R Dir. Bill Green
Labels: (Owned) Glori, Reborn.
Int'l rep.: Europe & Africa (International Artist in Switzerland).
Godell Music Co Inc., 1545 SW Eighth St., Miami, Fla 33135. Tel (305) 649-2110
Labels: (Owned) Compas, Modiner, New-Mex
Go Disco, see Disco Step by Step
Goldband Rec'g Studio, 313 Church St., Lake Charles, La 70601. Tel (318) 439-8839. Owner Eddie Shuler.
Golden Crest Recs. Inc., 220 Broadway, Huntington Station, N.Y. 11746. Tel (516) 423-7090
Labels: (Owned) Crest, Golden Crest
Golden Cross, see Gusman.
Golden Hawk, see Crimson Dynasty
Golden Moon Recs., 136 Maple Ln., Mooresville, Ind 46158. Tel (317) 831-5207. Pres. William Haskett
Golden Shield, see Rite Rec.
Golden Soul, see Sonic Arts.
Goldhawk, see MCA
Goldisc, see Timeless
Gold Mind, see Salsoul.
- Goldmont Music Inc., 24 Music Square E., Nashville, Tenn 37203. Tel. (615) 254-3725.
Label: (Owned) Comet.
Gold Recs., 304 N. Point Dr., Stevens Point, Wis 54481. Tel (715) 344-8156. Pres. Norm Dombrowski, VP Lucille Dombrowski
Goldrush Recs., PO Box 7189, Burbank, Calif. 91510. Tel (213) 462-5993, 705-0892. Pres. Kathleen Williamson, VP Kellee Buchanan, VP Disco Promo. Eli Vincente, Exec Prod'r Major Lee Vincente
Gold Seal, see RCA.
Goldust Recs Co., 115 E. Idaho Ave., Las Cruces, N.M. 88001. Tel: (505) 524-1889. Owner & Gen Mgr. Emmit H. Brooks.
Good News, see Word.
The Good Sound Factory, 1415 N. Linc Dr., Minneapolis, Minn. 55422. Tel (612) 546-4343.
Labels: (Owned) Good Sound, (distributed) Hansen
Good Sounds Recs. Inc., (sub of Criteria Rec'g Studios), 1755 NE 149 St., Miami, Fla. 33181. Tel (305) 947-5611. Pres. Mack Eberman (Distributed by TK)
Good Time Jazz, see Contemporary
Marc Gordon Prod'ns, 1022 N. Palm Ave., Los Angeles, Calif 90069. Tel (213) 659-6034. Cable: ROCKYREC.
Owner & Pres. Marc Gordon; VP Maggie Monihan
Label: (Owned) Colon-United.
Gordy, see Motown.
Gospel, see Jim Hall.
Gospel City, see Bollman.
Gospel Media, see Consolidated Gospel
Gospel Recs. Inc., PO Box 90, Rugby Sta., 279 Buffalo Ave., Brooklyn, N.Y. 11213. Tel (212) 773-5910. Pres. John R. Lockley, Treas. Connie M. Lockley, Mgr. Julius R. Lockley Jr.; Promo Mgr. Bernice Reid
Label: (Owned) GRI
Gospel Roots, see TK
Gospel Time, see Ralph's Radio
Gotham Rec. Corp., 925 N. Third St., Philadelphia, Pa 19123. Tel (215) 627-2277
Gothic Recs Inc., PO Box 533, Murray Hill Sta., New York, N.Y. 10016
Graduation-Agreement, see Graduation Recs
Graduation Recs. Inc., 212 N. Kingshighway, St. Louis, Mo 63108. Tel (314) 361-4400. Pres. Julian H. Miller II, VP Lynn Schweizer.
Labels: (Owned) Graduation, Graduation-Agreement
Graffiti, see Coco.
Graffiti, see Dawn
Gramercy 5, see Grenadilla
Gramophone Recs (div. of Audio Int'l Inc.), Box 921, Beverly Hills, Calif 90213. Tel (213) 276-2726. Pres. Oliver Berliner, VP & Sec'y V. A. Dorsey, Pop A&R Dir. Bill Mundy
Labels: (Owned) Gramophone, Tropicana
Grandfalloon, see Jersey Coast
I Grandi Interpreti, see Educational Media & Discocorp
Grand Orgue, see Teleson-America
Grand Prix, see Sunshine Group
Granite Music Corp., see Criterion
Granny White, see World Int'l.
Grape Rec Co., PO Box 2466, Jackson, Miss 39205. Tel (601) 956-6014. Pres. R.A. Bridges. (Distributed by Howard Knight)
Grapevine, see Grenadilla
Grapevine Opry, 308 Main St., Grapevine, Tex. 76051. Tel (817) 481-3505. Owner Chisa Childs, Mgr. Johnnie High.
Labels: (Owned) ASR, GO
Grass Mountain, see Richey
Grassound, see Revonah
Grassroots Project Unlimited, PO Box 4689, San Francisco, Calif 94101. Tel (415) 922-3227. Owner James Heisterkamp.
Label: (Owned) Cable Car, Ragtime
Great American Music Machine Inc. (GRAM), 1130 W. Evans, Denver, Colo 80223. Tel (303) 922-3668
Label: (Owned) GRAM.
Great Circle Rec. Co., see Benson
Great Northwest, see First American
Great Southern Rec Co. Inc., PO Box 13977, New Orleans, La 70185. Tel (504) 482-4211. Pres. John Berthelot
Labels: (Owned) Bayou Blue, Great Southern, New Orleans Sound.
Grecophon, see Fiesta
Greenbush, see Lee Anderson
Green Dolphin, see Jerce
Forrest Green Ents. Inc., 5004 W. Francis Rd., Clio, Mich 48420. Tel (313) 686-0189. Pres. & Disco Contact Forrest Green; VP & Pub. Mgr. David O. Norris, A&R Forrest Green, Rob Carter, Sales, Mktg. & Adv. Mgr. Don F. Norris.
Labels: (Owned) Big Willie, Forrest Green, Ranger
Green Linnet, see Innisfree.
Green Menu Recs (div. of Green Menu Music Factory Inc.), 50 W. 57 St., New York, N.Y. 10019. Tel (212) 489-0859/0806. Pres. & A&R Henry Jerome; Ass't to Pres. Don Castaldi; Treas. Wallace Barneke, Sales & Mktg. Mgr. Bob Blume, Pub. Marty Hoffman; VP Eng. Ed Remusat
Int'l reps.: Australia (Festival), France (Barclay), Italy (Sugar), UK (London)
Green Tree, see Rounder.
Greentree, see Benson
Grenadilla Ents. Inc., 345 Park Ave. S., New York, N.Y. 10010. Tel (212) 679-6090. Pres. & A&R Dir. Richard Gilbert.
Labels: (Owned) Gramercy 5, Grapevine, Grenadilla, Rocking Horse.
David Gresham Prod'ns, 7033 Sunset Blvd., Suite 300, Los Angeles, Calif 90028. Tel (213) 462-0833. Pres. David Gresham, Exec VP & Mng. Dir. Patrick Boyle; VP Allan Goldswain
Label: (Distributed) Nitty Gritty (South Africa).
Grit, see Alshire.
Groove Sound, see Talpro.
Groove Soup, see Cookhouse
Groundhog, see Styletone
Grunt, see RCA.
Guild (UK), see Worldwide Music Servs



- G M C, Ark, see Blaze
G M C, Tex., see General Music
G M S-Disc, see Playtette
G M T Recs. Inc., PO Box 25141, Honolulu, Hawaii 96825. Tel (808) 521-0041. Pres. Gil M. Tanaka.
G N P Crescendo Recs., 8560 Sunset Blvd., Suite 603, Los Angeles, Calif. 90069. Tel (213) 659-7433. Cable CRESREC. Pres & Int'l. Gene Norman
Labels: (Owned) Dixieland Jubilee, GNP Crescendo, Largo; (distributed) Accent
Int'l reps.: Argentina (Ovation), Australia (Festival), Benelux (Vogue), Brazil (Gravacoes Eletricas), Canada

MCA RECORDS®

!NMOJNII
DISCO
THESE
THE



- Guitar Player Recs., 20605 Lazaneo Dr., Cupertino, Calif 95014 Tel (408) 446-1105.
- Guitarra, see GDJ
- Guitar World, see MMO
- Gule Recs., 7046 Hollywood Blvd., Hollywood, Calif 90028 Tel (213) 462-0502
- Gusman Co., PO Box 9202, 1216 E. Broad St., Savannah, Ga. 31401 Tel (912) 236-6733. Pres. Waymon A Jones; VP Hattie J. Graham.
- Labels: (Owned) Golden Cross, Gusman, Pitch, Specs
- Gusto Recs. Inc., 220 Boscobel St., Nashville, Tenn. 37213 Tel (615) 256-1656. Pres. Moe Lytle; Gen Mgr. Steve Kountzman; A&R/Studio Div., Tommy Hill, Nat'l Sales Mgr. Col. Jim Wilson; Nat'l Promo Mgr.: Peter Thomason
- Labels: (Owned) Deluxe, Federal, Gusto, Hollywood, King, Power Pak, Starday.
- Int'l rep.: Canada (Quality)
- Guyden, see Jamie/Guyden
- Gwen Rec. Serv., PO Box 3388, 319 Highland Ave., Albany, Ga. 31701 Tel (912) 436-6508. Pres. Jesse Boone, VP Bruce Jones, VP Promo. Jesse Boone Jr., Gen. Mgr.: Eric Boone; Sales, Mktg. & Pub. Regina Boone
- Labels: (Owned) Albradella, Bruboon, Cozette, Keith, Soul-Po-Tion.
- H**
- H C P, see January.
- H D M, see TK.
- H & L Recs. Corp., 532 Sylvan Ave., Englewood Cliffs, N.J. 07632 Tel (201) 567-8100 TWX (710) 991-9372
- Co-Pres. Luigi Creatore, Hugo Peretti; VP A&R Landy McNeal.
- Int'l reps.: Europe, excluding UK (Teldec), Japan (Victor), UK (Phonogram)
- H L J Inc., 5031 French Creek Rd., Lorain, Ohio 44054 Tel (216) 934-6189. Pres. Harry L. Jennings
- H M R Prod'ns Inc., 574 W. Court, Scotch Plains, N.J. 07076 Tel (201) 889-1767. Owner Harry M. Randel, Pres. Lillian M. Randel
- H N H Recs. Inc., 820 Davis St., Suite 222, Evanston, Ill 60201 Tel (312) 866-8300. Telex 289495 Owner Harvey Neil Hunt.
- Labels: (Owned) HNH; (distributed) Unicorn (UK).
- Int'l rep.: Canada (Trend).
- H R B Music, 919 Third Ave., New York, N.Y. 10022 Tel (212) 371-6040.
- H S E Recs. Inc., 1707 Church St., Nashville, Tenn. 37203. Tel (615) 320-1561.
- Labels: (Owned) HSE, JSJ, Ken-Tone, Sav-All, Su-Ann.
- Half Breed, see WILD
- Jim Hall-Gidget Starr Prod'ns, 5 Aldom Circle, West Caldwell, N.J. 07006 Tel (201) 226-0035 Owners Jim Hall, Gidget Starr.
- Branches: **Hollywood, Calif.**, 1680 N. Vine, Suite 1205 Zip 90028 Tel (213) 464-5875 Contact Dusty Rhodes—Fremont, N.C., Box 328 Zip 27830 Tel (919) 242-4793. Contacts: Ella Frances & Brenda Sullivan.
- Labels: (Owned) Blue Bonnett, Cactus, Deadwood, Dynamite, Gospel, Peek, Stardust, Tar Heel, True Love
- John Hall Recs. Inc., PO Box 18344, Fort Worth, Tex. 76118. Tel (817) 281-6605.
- Hall-Mark, see Vintage.
- Hall of Fame Jazz, see American Album & Tape
- Halo, see Mark Five
- Halpern Sounds, see SRI.
- Hamilton St., see Buttermilk.
- Hammar, see Sonar
- Hanna Barbera, see Promotions West
- Hanover Music Corp., PO Box 6296, Beverly Hills, Calif 90212. Pres. Paul Weston; VP Chester A. Kinzelberg, Sec'y-Treas. Marvin Freedman.
- Label: (Owned) Corinthian
- Hansen, see Good Sound Factory
- Happy Day Recs. Inc., 800 N. Ridgeland Ave., Oak Park, Ill 60302. Tel (312) 848-3322. Pres. Roger Paulzy; VP A&R: Vincent J. Ippolito; Nat'l Sales & Promo. Dennis J. Nowak
- Happy Fox Recs., 7188 Sunset Blvd., Suite 204, Los Angeles, Calif 90046. Tel (213) 876-2551. Prod'r: Ron Carson; Mgmt. Counselor: Mickey L. Carson; Contract Admin'r: Barbara Penney; Promo. Dir.: William Peele Jr.; A&R Dir./Mktg. Warren Sams Jr.; Eastern Promo Consultant: Valerie Stanley; Northwest Promo Consultant: Virginia Ford, Annie Meadows; Southern Promo Consultant: Ida Perine, Gwendolyn Lay, Southwest Promo Consultant: Linda Lonon.
- Happy Jazz Recs. Inc., PO Box 66, Zip 78291, 522 River Walk, San Antonio, Tex. 78205. Tel (512) 225-6841
- Labels: (Owned) American Jazz, Audiophile, Happy Jazz.
- Happy Tunes, see Springboard
- Hard Times, see Pharoah
- Hardy, see Jersey Coast
- Hardy Station Recs., Box 6A, Rt. 2, Grenada, Miss. 38901 Tel (601) 226-7299/7725. Contacts: W.C. Taylor Jr., Fancher Sargent. (Distributed by IRDA)
- Harem, see Polydor.
- Harlequin, see Audiofidelity.
- Harmony Club Recs., PO Box 925, Hollywood, Calif. 90068 Tel (213) 465-6043. Admin. Mgr. Sherry Barnett.
- Harvest, see Capitol.
- Haven Recs. Inc., 9220 Sunset Blvd., Suite 306, Los Angeles, Calif. 90069. Tel (213) 278-8970. Cable: M0S-SAC. Pres. Dennis Lambert; VP: Brian Potter.
- Hawk Sound, see Ala Ent's
- Haydn Society, see Esoteric
- Head, see Aladdin
- Headliner Stars, see Robbins.
- Heartsong, see IRDA.
- HeartWarming, see Benson
- Heavy Sound Prod'ns, PO Box 2875, Washington, D.C. 20013. Tel (202) 396-3009. Pres. & Prod'r: Ben Smalls; VP: Joe Holt; Prod'r & Arranger: Keith Holmes.
- Label: (Owned) Ben-La-Rose.
- Helicon, see Spoken Arts
- Heldon (Yugoslavia), see Worldtone.
- Hello, see Stark
- Hen Cackle, see Sonyatone
- James Hendrix Ents., PO Box 90639, 902 42 Ave. N., Nashville, Tenn. 37209. Tel (615) 297-4174. Pres. & Dir.: James Hendrix
- Label: (Owned) Carnie
- Henry Street Recs. Inc., 124 Montague St., Brooklyn, N.Y. 11201 Tel (212) 237-0250. Pres. Bob Motta; VP/Sec'y Vince Traina, Treas. Al Koppel.
- The Herald Ass'n Inc., Box 218, Wellman Heights, Johnsonville, S.C. 29555 Tel (803) 386-2600. Pres. & Treas. Erv Lewis; VP & Sec'y Frances B. Lewis.
- Labels: (Owned) Herald, Kleis, (distributed) Mark Five
- Lawrence Herbst Investment Trust Fund, c/o Antejo Corp., PO Box 1659, Beverly Hills 90213; 3815 Ocean View Blvd., Montrose, Calif 91020 Tel (213) 248-1084. Rec. Div. Admin. Lawrence Herbst; Pres. J. Tomlinson
- Labels: (Owned) Lawrence Herbst, Total Sound.
- Heritage, see Heritage Singers & MJ
- Heritage Singers Gospel Heritage Foundation, PO Box 1358, 3777 Newtown Rd., Placerville, Calif. 95667. Tel (916) 622-9369.
- Label: (Owned) Heritage.
- Herwin Recs. Inc., PO Box 306, Glen Cove, N.Y. 11542. Tel (516) 676-5523. Pres. Bernard Klatzko.
- Int'l reps.: Denmark (CSA), UK (CRD).
- Ht., see Cream
- Hickory Recs. Inc., 2510 Franklin Rd., Nashville, Tenn. 37204 Tel (615) 385-3031 Telex 55-4366. Pres. Wesley H. Rose, VP/Gen. Mgr. John R. Brown; VP/Dir. Mel Foree, A&R/Prod. Dept. Dir.: Ronnie Gant; Pop Div. Prof. Dept. David Kastle; Nat'l Promo. Dir.: Roy Accuff Jr.; Nat'l Promo. Dick Kiser, Ray McClain, Peggy Lamb, Jimmy Holland (Distributed by MCA)
- Ht Fr, see Everest
- HiFi/Life, see Everest.
- Hiding Int'l, PO Box 32111, San Jose, Calif. 95152 Tel (408) 258-6000. Pres. Eric R. Hiding, VP John P. Pecorino
- Labels: (Owned) Apollo, FaderKat, Hiding Int'l, Invader
- Hillside Recs., 948 Studer Ave., Columbus, Ohio 43206 Tel (614) 252-7116 Owner Larry McKenzie.
- Hillsdale, Tenn. see Nationwide Sound.
- Hilltak, see Atlantic.
- Hilltop, see Nationwide Sound.
- Hindsight Recs. Inc., PO Box 7114, Burbank, Calif. 91510 Tel (213) 841-3508. Pres.: Wally Heider.
- Ht-O, see Fortune
- Historical Anthology of Music, see Vanguard.
- Historical Recs. Inc., PO Box 4204, Jersey City, N.J. 07304. PO Box 109, Canaan, N.Y. 12029. Tel (518) 392-3400. Pres. Arnold Caplin.
- Historical Series, see Moss.
- His-Way, see Mitchell
- Hit Machine Recs. (div. of Diversified Mgmt. Group), PO Box 20692, San Diego, Calif. 92120. Tel (714) 277-3141. Pres. & Prod'r: Marty Kuritz; Prod'r's David Sanchez, David Compton, Clark Gault.
- Hit Recs. Inc., 576-B Goldsboro Rd. NE, Atlanta, Ga. 30307 Tel (404) 577-3709. 688-0799.
- Hitstown-Disko Rec. Corp., 327 Upshur St. NW, Washington, D.C. 20011. Tel (202) 882-7339. Pres.: Clifton Thomas; VP & Exec. Sec'y Charles Farmer.
- Labels: (Owned) Disko, Hitstown.
- Hob Recs. Inc., 1733 Broadway, New York, N.Y. 10019. Tel (212) 765-8840. Pres. Nick Albarano
- Label: (Owned) RS Int'l.
- Holl, see Candy
- Hollywood, see Gusto.
- Hologram, Pa., see Crimson Dynasty
- Hologram Recs., 888 Seventh Ave., 12th fl., New York, N.Y. 10019. Tel (212) 245-8170. (Distributed by RCA)
- Holy Cross, see McKinnon.
- Holy Spirit Recs., 27335 Penn St., Inkster, Mich. 48141. Tel (313) 274-5905. Pres. Otis G. Johnson.
- Home Comfort, see Ray Lawrence.
- Home of the Hits, see Beserkeley.
- Home Run, see Solid Smoke
- Homestead, see County
- Honeydew Recs. Inc., 950 Third Ave., Suite 3000, New York, N.Y. 10022. Tel (212) 752-3380. Cable: HOPRESSAM. Pres. Donald Ross; VP: Gayle Ross. (Distributed by Zim)
- Hong Kong, see Aladdin
- Hooks, see Styletone
- Hooks Bros., see Styletone
- Horizon, Calif., see A&M
- Horizon Publ'g Co., 13615 Victory Blvd., Suite 216, Van Nuys, Calif. 91401 Tel (213) 997-9100
- Labels: (Owned) Funnybone, Pedigree.
- Horn, see Aladdin
- Horo (Italy), see Rounder
- Robert Horwitz Org., PO Box 33073, Granada Hills, Calif. 91344. Tel (213) 363-5800. Pres.: Robbie Horwitz; VP Brad Kopenick; A&R Patrick Winningham; Pub.: Ray Rayner
- Hot City, see Blaze
- Hotland Recs., Box 13584, Sta. K, Atlanta, Ga. 30324. Tel: (404) 876-1073. Pres. George Aristotle Poulos; VP: A&R: Hamilton Underwood; Creative Servs. Dir.: Melanie Phillips; VP Mktg. & Sales: Alexander Smart; Disco Promo: Co-ord Vicki Crawley. (Also see Dance-A-Thon)
- Hot Lips, see RCA
- Hotrax, see Dance-A-Thon.
- House of Falcon Inc., 821 N. 23. McAllen, Tex. 78501. Tel (512) 687-7121. Cable: FALCON. Pres. A. Ramirez Sr. Sec'y & Gen. Mgr. A. Ramirez Jr., Rec'g Dir.: Mark A. Ramirez, Gen. Sales Mgr.: Ramiro Perez; Promo. Dir.: Jean Le Norman, Int'l. Rosario Grajales
- Branches: **Los Angeles, Calif.**, 2722 W. Pico Blvd. Zip 90006 Tel (213) 731-7247. Mgr.: Sara Segovia. Promo Mgr. Juan Vila—**San Antonio, Tex.**, 434 S. Main, Suite 207, Zip 78204. Tel (512) 225-3415. Mgr.: Elvia Casillas; Promo Mgr. Carlos Santa Cruz.
- Labels: (Owned) ARV Int'l, Falcon, RIC.
- Int'l reps.: Colombia (Corporacion Musical), Guatemala
- (Dideca), Sinaloa (Discos & Sinfonolas), Venezuela (Fonodisco)
- House of Guitars, see Mirror.
- HouseTop, see Bakim
- Hula Recs. Inc., Warehouse No. 3, 1020 Auahi St., Honolulu, Hawaii 96814 Tel (808) 524-8606.
- Labels: (Owned) Hula, Surfside.
- Hungaria Recs. Inc., PO Box 2073, Teaneck, N.J. 07866. Tel (201) 343-5240. Exec. Dir.: Kalman Magyar; Prod. Mgr.: Samuel Jackendoff.
- Hurricane, Pa., see Crimson Dynasty
- Hurricane Ent's., PO Box 3547, 1927 San Mateo NE, Albuquerque, N.M. 87110. Tel (505) 265-3049/4039, 255-8039. Pres.: Al Hurricane; VP: Tiny Morrie; Sec'y-Treas. Bennie L. Sanchez.
- Hype, see Bee Jay.
- I**
- I B C Recs., United Artists Tower, Penthouse Suite No. 902, 50 Music Square W., Nashville, Tenn. 37203. Tel (615) 329-0714. Chief Exec.: William Sorenson; Exec. Prod'r & A&R Dir.: Walter Haynes; Nat'l Promo. Dir.: Bobby Fischer; Gen. Mgr.: Stan Cornelius.
- I C A, see Independence Corp.
- I C M C, see Promotions West.
- I G L, see Iowa Great Lakes.
- I L S Institute, see Institute for Language Study.
- I M I, see Avoca
- I M M C O, see International Mktg. & Mgmt.
- I P A, see Desmar.
- I P S, see Black Fire
- I R C, see International Rec'g Co.
- I R D A (International Rec. Dist'g Assocs.), 260 W. Main St., Suite 107, Hendersonville, Tenn. 37075 Tel (615) 824-9100. Pres. Hank Levine; VP: Mike Shepherd; Nat'l Promo. Dir.: Keith Stewart
- Labels: (Represented) Alerton, Arc, Conestoga, Down Home, Galaxie, Gileyan, Hardy Station, Heartsong, Kard, Odo, Subbarao, Sure Fire, Tina, Triple III.
- I R M, see Sound Inc.
- Ibis Recs. Inc., 9701 Wilshire Blvd., Suite 1000, Beverly Hills, Calif. 90212. Tel (213) 550-8115. Pres.: Alec R. Costandinos; VP/Communications: Sheryl Feuerstein. (Distributed by Casablanca)
- Icepac, see WILD
- Ictus (Italy), see Rounder.
- Image, see Audiofidelity.
- Immunity, see Bee Jay.
- Impact, see Benson.
- Imports/Som (Brazil), see Fermata.
- Improvis, see Tobill & Audiofidelity.
- Improving Artists Inc., 26 Jane St., New York, N.Y. 10014. Tel (212) 243-2018. Cable: IMPROVART. Telex: 237166. Pres. & Int'l: Carol Goss; VP & A&R: Paul Biley; Sales & Mktg.: David Good; Artist Tour Dir.: Jim Silverman
- Int'l reps.: Canada (Trend), France (Free Bird), Germany (Phonogram), Italy (Hi-Fi), Japan (Nippon Phonogram), Sweden (Amigo), Switzerland (America Sound), UK (Projection).
- Inca, see Fania
- Incentive Prod'ns (div. of Jevent Music), 639 Buley Ave., Columbus, Ohio 43205. Tel (614) 258-7112. Pres.: Jeffrey V. Smith
- Inchecronin (Ireland), see Shanachie.
- Independence Corp. of America, 1511 Chester St., Little Rock, Ark. 72202. Tel (501) 376-4002.
- Label: (Owned) ICA
- India Navigation Co., 60 Hudson St., New York, N.Y. 10013. Tel (212) 962-3570. Owner: Bob Cummins.
- Int'l reps.: Canada (Trend), Germany (Moers), Italy (Hi-Fi), Japan (King), Netherlands (Hurleboth), Sweden (Forsyte), Switzerland (America Sound), UK (Cadillac, Jazz Servs.)
- Indian House, Box 472, Taos, N.M. 87571. Tel: (505) 776-2953. Mgr.: Ida Isaacs; Prod'n: Tony Isaacs.
- Int'l rep.: Canada (Prairie Crafts)
- Indi Corp. (a/k/a Florida Indi), 790 NE 45 St., Fort Lauderdale, Fla 33334 Tel: (305) 772-0013
- Labels: (Owned) Indi, Ministri, Soul Deep, Storyteller Series; (distributed) Magic Minstrel, Ondas, RE, 12 O'Clock
- Inergi Recs., 1300 Texas Ave., Houston, Tex. 77002 Tel (713) 222-8561
- Infinity Recs. Inc., 10 E. 53 St., New York, N.Y. 10022 Tel (212) 888-9700. Pres.: Ron Alexenburg; Sr. VP Bus. Affairs & Admin.: Barry Reiss; VP Mktg./Finance: Gary Mankoff; VP Promo: Terry Gidion; VP Field Promo: Rick Swig
- Branch: **Universal City, Calif.**, 100 Universal City Plaza, Bldg. 469, Rm. 263, Zip: 91608. Tel (213) 763-8283. VP & Gen. Mgr.: Bud O'Shea.
- Int'l branches: Canada, England.
- Labels: (Owned) Infinity; (distributed) Amherst. (SEE ADVERTISEMENT)
- Inner Circle, see Stacy-Lee
- Inner City, see MMO.
- Innisfree Recs. Inc., 70 Turner Hill Rd., New Canaan, Conn. 06840. Tel (203) 966-0864.
- Label: (Owned) Green Linnet.
- Int'l rep.: Shanachie Recs. in USA.
- Inphasion Recs., 449 S. Beverly Dr., Beverly Hills, Calif. 90212. Tel (213) 553-6360. Bd. Chm.: Clancy Grass; Pres.: Danny Kessler; Prof. Mgr.: Jay Kessler; A&R Dir.: Dick Monda; Exec. Ass't: Cathy Weissman; Pub.: Albeth Paris; PR: Lynn Shannon. (Distributed by TK)
- Int'l reps.: Australia (7 Recs.), Benelux (CNR), Brazil (K-tel), Japan (SMS), UK (Pye).
- Inside, see Dee Prod'ns.
- In Sound, see Accent.
- Institute for Language Study, 136 W. 52 St., New York, N.Y. 10019. Tel (212) 582-3845.
- Labels: ILS Institute, Nutshell, Seventh.
- Inter-Continental Music Corp., 816 Second Ave., Huntington, W. Va. 25701. Tel (304) 523-3951.
- International, see Fania.
- International Folklore, see Sound Inc.

International Mktg. & Mgmt. Corp., 3310 Lebanon Rd., Hermitage, Tenn. 37076. Tel. (615) 889-7100. Chm. & Pres.: Dallas Corey; Treas.: William H. Daniel.
Labels: (Owned) CIE, Corey; (distributed) Crescent, IMMCO, Monkey Joe.
 International Mod Recs., 2510 Tarrytown Mall, Houston, Tex. 77057. Tel. (713) 695-3648. Contact: Jim D. Johnson.
Labels: (Owned) Gestation, International Mod.
 International Rec. Dist'g Assocs., see IRDA.
 International Rec'g Co. Inc., 1649 W. Evergreen Ave., Chicago, Ill. 60622. Tel. (312) 227-2000. Pres.: Leonard March.
Label: (Owned) IRC.
 In Town, see AVI.
 Invader, see Hilding.
 Inwood, see Consolidated Gospel.
 Iowa Great Lakes Rec'g Co. Inc., 906 Ninth St., Milford, Iowa 51351. Tel. (712) 338-4482.
Labels: (Owned) IGL, Sonic.
 Irma, see Melody.
 Iron Horse, see Richey.
 Island Recs. Inc., 444 Madison Ave., New York, N.Y. 10022. Tel. (212) 355-6550. TWX (710) 581-5293. Pres.: Marshall Blonstein.
Home office: England.
Branch: Los Angeles, Calif., 7720 Sunset Blvd. Zip 90046. Tel. (213) 874-7760.
Labels: (Owned) Island (distributed by Warner Bros.), Antilles, Mango; (distributed) True North.
Int'l rep.: Canada (RCA).
 Isle City Recs., 411 Kempner, Galveston, Tex. 77550. Tel. (713) 763-8344.
 Ivan Berg Cassettes, see Communication Institute.
 Ivory, see Hal Southern.

J

J B Recs. Int'l Inc., PO Box 7221, Mobile, Ala. 36607. Tel. (205) 342-6202. Pres. John N. Blackburn; VP. Sara B. Smith; Sales & Mktg.: Lamar Walker, Promo. Mgr.: Mona Gill.
 J C O A, see Jazz Composer's Orchestra.
 J D C Recs., 610 S. Venice Blvd., No. 4284, Marina Del Rey, Calif. 90291. Tel. (213) 399-3984. Co-Admin's: Jim & Dale Callon.
Int'l reps.: Australia (K-tel), Benelux (Dureco), Brazil (K-tel), Canada (Attic), France (Flarensch), Germany (Jupiter), Israel (K-tel), Mexico (Gamma), Sweden (K-tel), UK (Gull/Miracle).
 J E M K L Ents. Inc., PO Box 680460, 1100 NE 125 St., Miami, Fla. 33168. Tel. (305) 891-0633. Pres. Emil Pettite; VP. Marlene Novak; A&R Prod'r. John Pettite; Adv. Mgr. Rosalie Pettite; Promo. Mgr. James Novak; Promo. Karen Thurman; Int'l Rep. Tiana Galanni.
Labels: (Owned) Brass Ring, Children's World, Country-way, JEMKL, Moonstone.

J & J, see Styletone.
 J S J, see HSE.
 J V C Cutting Center Inc., 6363 Sunset Blvd., Suite 500, Hollywood, Calif. 90028. Tel. (213) 467-1166. Pres. Saburo Watanabe; VP. Tom Nishida. (Also see Nautlius Rec'gs)
Labels: (Owned) JVC, (distributed) East Wind, Flying Disc.
 Jacksonville Gramophone Co., 4550 Attleboro St., Jacksonville, Fla. 32205. Tel. (904) 384-3878. Owner/Prod'r. Michael R. Fitzgerald; Talent Co-ord. Phillip Price.
 Jade, see Rob-Lee.
 Jaguar, see Associated Rec'g Cos.
 Jahrock, see PA.
 Jam-A-Ditty Recs., PO Box 21931, Greensboro, N.C. 27420. Tel. (919) 272-7336/6392. Contacts Edward Earl Gill, J. Cirt Gill III.
 Jamie, see Jamie/Guyden.
 Jamie/Guyden Dist'g Corp., 919 N. Broad St., Philadelphia, Pa. 19123. Tel. (215) 232-8383. Pres. Harold B. Lipinus; Sales & Mktg. Paul Fien.
Labels: (Owned) Arctic, Guyden, Jamie, Phil-L A. of Soul, (distributed) Dion, Gala Ball, Top & Bottom. (SEE ADVERTISEMENT)
 Jam Session, see Ray Lawrence.
 Jam 79 Recs. (div. of BRT Inds. Ltd.), 2501 S. Walter Reed Dr., No. 2, Arlington, Va. 22206. Tel. (703) 379-8761. Pres. A&R, Sales Robert Wardrick; Ass't to Pres. Janice Connor, Promo. Rep. Randy Austin.
Labels: (Owned) Euclid, Jam 79.
 Jane, see R. Dean Taylor.
 Jansco Recs., PO Box 807, Northridge, Calif. 91328. Tel. (213) 363-6000. Pres. Jan Scobey; VP. Promo. Gene Paleno.
Branch: Witter Springs, Calif., 10755 Bachelor Valley Rd. Zip: 95493. Tel. (707) 275-2766.
 January Recs., 5137 West Blvd., Los Angeles, Calif. 90043. Tel. (213) 296-4206. Pres. Jean Wilbourn Carbo (Distributed by WILD)
Labels: (Owned) HCP, January.
 Jay Bird Recs., PO Box 140, Parsons, Kan. 67357. Tel. (316) 421-1666.
 Jay Jay Rec. & Tape Co., 35 NE 62 St., Miami, Fla. 33138. Tel. (305) 758-0000. Owner & Pres. Walter Jagiello; Sec'y-Treas. J. Jagiello; Chief Eng. Larry Whittetk; Sales & Promo. Walter Jay.
Labels: (Owned) Jay Jay, Polka Tone.
Int'l rep.: Canada (Almada).
 Jayson, see Discostar.
 Jazz Ala Carte, see Ray Lawrence.
 Jazz Composer's Orchestra Ass'n Inc. (JCOA), 500 Broadway, New York, N.Y. 10012. Tel. (212) 749-6265. Pres. Timothy Marquand; VP. Jack Jeffers; Exec. Dir. Michael Mantler; A&R Dir. Carla Bley; Sales & Mktg. Dir. Jimmy Eigo; Sales & Mktg. Mgr. Ashton Richards; Promos. Dir.: Kip Hanrahan; Adv.: Taylor Storer; Creative Consultant. Paul Haines.
Label: (Owned) JCOA.

Int'l reps.: Canada (Trend), Europe, excluding UK (ECM in Germany), Japan (Trio), UK (Virgin).
 Jazz Connoisseur (Italy), see Zim.
 Jazzdance Recs., PO Box 5118, FDR Sta., New York, N.Y. 10022. Tel. (212) 758-8446. Contact: Robin Kenyatta.
 Jazz Kings, see American Themes.
 Jazzology-GHB Recs., 3008 Wadsworth Mill Pl., Decatur, Ga. 30032. Tel. (404) 288-1310.
Labels: (Owned) Audiophile, Circle, Southland.
Int'l reps.: Australia (Ron Gray), France (International Music Way), Japan (ANZ), Sweden (Ad Lib), UK (Swift).
 Jenero Rec. Co., PO Box 121, 300 Court St. Soda Springs, Idaho 83276. Tel. (208) 547-3715. Pres.: Ronald Watts.
 Jenges, see Associated Rec'g Cos.
 Jeree Recs., 1469 Third St., New Brighton, Pa. 15066. Tel. (412) 847-0111.
Labels: (Owned) Buckshot, Candy, Green Dolphin, Jeree.
 JermA Recs. Co., 1410 E. 72 St., Chicago, Ill. 60619. Tel. (312) 752-2755. Pres.: U. S. Warren.
Labels: (Owned) Chytowns, JermA.
 Jersey Coast Agents Ltd., 72 Thorne Pl., West Keansburg, N.J. 07734. Tel. (201) 787-3891. Cable: JERSEYCOAST. Chief Exec. Officer: Joe McHugh; VP & Gen. Mgr. Joshua Ericson; VP Contemporary A&R D.W. Griffiths; Bluegrass A&R Dir. John Conine; TV Prods. Mgr.: Larry Hanapole; Design & Graphics Mgr.: Babo Chamberlain; Design & Graphics Consulting Dir.: Lynn Lascaro; Video Prod'n Dir. Paul Savonen.
Labels: (Owned) Anomaly, Output, Recommended Viewing, World; (distributed) BMA, Grandfalloon, Hardy, Karass, Stonehedge.
 Jessup, see Michele.
 Jet Recs. Inc., 2049 Century Park East, Suite 414, Los Angeles, Calif. 90067. Tel. (213) 553-6801. Telex: 696170. Pres.: Don Arden; VP: Sharon Arden; Nat'l Pub. Dir.: Pat Siciliano; Assoc. Nat'l Publ. Dir.: Melissa Kojan; Nat'l Promo. Dir.: Kenny Ryback. (Distributed by CBS).
Int'l branch: England.
 Jet Stream, see Music Ents.
 Jewell Tone, see Pickin' Post.
 Jewel Rec. Corp., PO Box 1125, 728 Texas St., Shreveport, La. 71163. Tel. (318) 222-0673/0195. Pres. & Adv.: Stanley J. Lewis; Exec. VP: F. R. Lewis; VP Sales & Mktg.: Don Logan; Pub.: Peggy Mims; Nat'l Promo. Dir. Jo Wyatt.
Labels: (Owned) Jewel, Paula, Ronn.
 Jezreel Inc., 2058 First St., Highland Park, Ill. 60035. Tel. (312) 432-0116. Pres.: David J. Dahl.
Labels: (Owned) Cool Duck, Midway Prod'n's.
 Jim, see Benson.
 Jin, see Flat Town.
 Jingles, see Centaur in N.Y.
 Jobie, see Ghost.
 Jody, Miss., see Startown.
 Jody, Pa., see Vantage.
 Jody Recs. Inc., 2226 McDonald Ave., Brooklyn, N.Y.

OVATION RECORDS

one of the industry's leading independent labels

Looking forward to growth through independence in the 80's

- COUNTRY THE KENDALLS JOE SUN THE CATES SHEILA ANDREWS LOIS KAYE
 POP TANTRUM MARK GADDIS STEVE DAHL/TEENAGE RADIATION
 DISCO/R&B CLEVELAND EATON & THE GARDEN OF EATON
 OTHER "THE MAGICAL MUSIC OF WALT DISNEY" MIGHTY JOE YOUNG WILLIE DIXON

Recording, Publishing, TV & Film Production



Corporate Office
 Ovation Incorporated
 1249 Waukegan Road
 Glenview, Illinois 60025
 312.729.7300

Nashville Office
 Ovation Incorporated
 803 18th Avenue
 Nashville, Tennessee 37203
 615.327.4871

Los Angeles Office
 Ovation/Aurora
 9606 Santa Monica Blvd.
 Beverly Hills, California 90210
 213.275.4007

11223. Tel. (212) 373-4468. VP A&R: Vincent Vallis; VP's Tony Graye, Gloria Black; Sec'y-Treas & A&R Marty Pomerantz.
Labels: (Owned) B-Atlas, Glo, Jody, Romona.
 Joey Rec. Mfg. Co., 6703 W. Commerce, San Antonio, Tex. 78227. Tel. (512) 432-7893.
Labels: (Owned) Dina, Joey.
 Johnny, see Freddie
 Johnson Rec. Co., 1619 Broadway, New York, N.Y. 10019. Tel. (212) 757-2696. Pres.: Jim McCarthy; Prod'n Dir.: Henry Boys; Gen. Mgr.: Gil Miller
Labels: (Owned) Johnson, Jolie; (distributed) Conn, Virginia.
 Little Richie Johnson Agency, Box 3, Belen, N.M. 87002. Tel. (505) 864-7441. Pres.: Little Richie Johnson; Mgr.: John McHutchinson; Adv.: Keith Lukes.
Labels: (Owned) Chuckie, LRJ, Little Richie.
 Paul Johnson Music Prod'n Inc., PO Box 552, Woodland Hills, Calif. 91365. Tel. (213) 703-6707. Pres.: Paul Johnson; Gen. Mgr.: Jim Breeden; Prod'n: Paul Stilwell; Prod'n Ass't: Cheryl Wilks.
Label: (Owned) Petra.
 Joka Recs. Inc., 403 Summit St., Vineland, N.J. 08360. Tel. (609) 691-5240.
 Joker, see Lifetime.
 Jolie, see Johnson Rec. Co.
 Joy, see Stacy-Lee.
 Joyce Recs., 5500 W. Jefferson Blvd., Los Angeles, Calif. 90016. Tel. (213) 930-1722.
 Joy Song, see Paragon.
 Juana, see TK.
 Jucu, see Ray Lawrence.
 June Appal Rec's, Box 743, Whitesburg, Ky. 41858. Tel. (606) 633-9958.
Labels: (Owned) Appalseed, June Appal, Sourwood Mountain.
 Juno, see Glenn.
 Jupiter Jazz Inc., 1017 N. La Cienega, Los Angeles, Calif. 90069. Tel. (213) 657-8730. Pres. Juggy Murray Jones; VP: Robert Walkins; Sec'y: Paul Orland.
Branch: New York, N.Y., c/o A-1 Recs., 659 10 Ave Zip 10036. Tel. (212) 246-1236.
Label: (Owned) Sue Int'l.



K-tel Int'l Inc., 11311 K-tel Dr., Minnetonka, Minn. 55343. Tel. (612) 932-4000. Bd. Chm. & Pres.: Philip Kives; Exec. VP: Raymond Kives; Sr. VP: Mickey Elfenbein, VP & Gen. Mgr.: David Catlin; A&R Mgr. & Disco Contact David Milner.
 Kadia, see Old Dominion.
 Kajac, see Ozark Opry.
 Kajun, see Modern Sound.
 Kaleidoscope Recs., PO Box O, El Cerrito, Calif. 94530. Tel. (415) 527-6242. Pres. Jeff Alexson, A&R Dir.: Tom Diamant. (Distributed by Flying Fish)
 Kangaroo Recs., 302 E. Dewey, San Gabriel, Calif. 91776. Tel. (213) 288-5435. Pres.: Leslie W. Kangas, VP: Tom Kangas.
Label: (Owned) Koo-Koo.
 Karass, see Jersey Coast.
 Karate, see Audiofidelity.
 Kard Recs., PO Box 24, Chattanooga, Tenn. 37343. Tel. (615) 842-3312. Contact: Lewis Card Jr. (Distributed by IRDA).
 Karen, see Fania.
 Kare Recs. Inc., 1391 Oakland Park Ave., Columbus, Ohio 43224. Tel. (614) 263-4344.
Labels: (Owned) Dolejo, Kare; (distributed) Blue Ash.
 Kashmir, see Moonstone.
 Katie the Great, PO Box 19215A, Los Angeles, Calif. 90019. Tel. (213) 737-3496. Cable KATIEWEST. Pres.: Tommy Colbert; VP: Josie Strother.
Labels: (Owned) Booths, ETC III.
 Kayvette, see TK.
 Keene, see Ken Keene.
 Ken Keene Int'l, PO Box 515, St. Louis, Mo. 63166. Tel. (314) 776-2278, 464-1773. Pres.: Ken Keene, VP's Frankie Ford, Gene Miller; Adv. Mgr.: Wayne Keene.
Branches: New Orleans, La., PO Box 3763, Zip 70117. A&R: Wayne Kaye—Nashville, Tenn., PO Box 24561, Zip: 37203. Tel. (615) 776-5277. VP: Tom Pallardy.
Int'l branch: England.
Labels: (Owned) Briarmeade, Burlap, Keene, Keeta, Sea Cruise; (distributed) Primitive, Professional Artist.
 Keepsake, see Sound Inc.
 Keeta, see Ken Keene.
 Keith, see Gwen.
 Kela, see Dragon Int'l.
 Gene Kennedy Ent's., 2125 Eighth Ave. S., Nashville, Tenn. 37204. Tel. (615) 383-6002. Pres.: Gene Kennedy; VP: Linda Kennedy. (Distributed by World Int'l)
Label: (Owned) Door Knob.
Int'l rep.: Canada (London).
 Kent, see Cadet Recs.
 Ken-Tone, see HSE.
 Kenwood, see Nashboro.
 Kheba, see Trix.
 Kiamichi, see Richey.
 Kicking Mule Recs. Inc., PO Box 3233, Berkeley, Calif. 94703. Tel. (415) 452-1248. Head North American Opns.: Ed Denson; Head European Opns.: Stefan Grossman; VP Admin. Opns.: Noreen Nicholson.
Labels: (Owned) Kicking Mule, Sierra Wave, Sonet USA, Transatlantic USA.
 Kid Cuz'n Rec. Co., PO Box 182, Midwood Sta., Brooklyn, N.Y. 11230. Tel. (212) 339-3536. Mgr.: Jim Pelton; Sales: Dick Alexander.
 Kidd, see OK.
 Kiderian Recs. Prod'ns, 4926 W. Gunnison, Chicago, Ill. 60630. Tel. (312) 545-0861. Pres.: Raymond Peck; VP: George Peck.
 Kimbo, see Colonel Buster Doss.
 King, see Gusto.
 King Coal, see Nationwide Sound.
 King of Kings Rec. Co., 38603 Sage Tree St., Palmdale,

Calif. 93550. Tel. (805) 947-4657. Pres. & Gen. Mgr. LeRoy Pritchett.
Branches: Daytona Beach, Fla., 171 Pine Have. Zip 32014. Tel. (904) 252-4849. Exec. VP/Promos: Charles Vickers—Far Rockaway, N.Y., 423 Beach 47 St. Zip 11691. Tel. (212) 471-4319. Exec. Mgr./VP: Gladys Funchess.
 King Rec. Dist., 800 Gulf Breeze Ave., Gulf Breeze, Fla. 32561. Tel. (904) 932-2525. Contacts M Wax, S. Burke, F. Skecker
Labels: (Owned) King, Sky-High
 Kingsway, see Maranatha
 King Walk, Box 15094, 3531 Baronne St., New Orleans, La. 70115. Tel. (504) 486-1046. Pres.: Earl K. Johnson, VP: Tad Jones
Labels: (Owned) Down South, Flambo, King Walk, New Orleans Soul, Proud Cook, Seminar.
 Kiras Musical Works, see Discwasher.
 Don Kirshner Entertainment Corp., 1370 Ave. of the Americas, New York, N.Y. 10019. Tel. (212) 489-0440. Pres.: Don Kirshner; Exec. VP: Herb Moels; VP Music Div.: Wally Gold, Talent Development Dir.: Felix Di Palma; Nat'l Promo. Dir.: Allen LeWinter, Rec. Prod'n Dir.: Jay Siegel (Distributed by CBS).
 Klavier Rec. Co., 10520 Burbank Blvd., North Hollywood, Calif. 91601. Tel. (213) 980-8254. Pres.: Harold L. Powell; Prod'n Dir.: John Wolfe; Gen. Mgr. & Sales & Promo.: Pamela K. Harp, Promo.: Mildred Powell.
Int'l reps.: Canada (Almada), China (Hong Kong Recs.), France (Dave-Music), Germany (Phonogram), UK (EMI).
 Sid Kleiner Music Ent's., 3701 25 Ave. SW, Naples, Fla. 33999. Tel. (813) 455-2696. Mng. Dir.: Sid Kleiner, VP-Treas.: Trudy Kleiner; Sec'y: Sara Kleiner, Mgr.: Mark A. Kleiner
Labels: (Owned) Country-King, Musi-Poe, Top-Star, (distributed) This is It
 Klesis, see Herald Ass'n.
 Klub, see Mark Five.
 Knight, Calif., see Cobra.
 Howard Knight Ent's. Inc., SESAC Bldg., 11 Music Circle S., Nashville, Tenn. 37203. Tel. (615) 244-0461. Pres.: Howard A. Knight Jr., VP Promo. & Mktg.: Jerry W. Hayes, VP A&R: Dave W. Mathes, VP Adv. & Pub.: R. Eric Parton
Labels: (Owned) Colonial, Volunteer, (distributed) Grape.
 Knight, Pa., see Crimson Dynasty
 Koala Recs. Inc., 6253 Hollywood Blvd., Los Angeles, Calif. 90028. Tel. (213) 467-3203. Pres.: Irving Kessler; VP: Mary Kessler.
Labels: (Owned) Deep Roots, Koala, Lamb & Lion (selected titles), Lamb & Lion Country.
 Koko Recs., 888 Seventh Ave., New York, N.Y. 10019. Tel. (212) 541-6880.
 Konduko, see TK.
 Kong, see Aladdin.
 Koo-Koo, see Kangaroo.
 Kool Kat Prod'n Inc., PO Box 176, Monsey, N.Y. 10952. Tel. (914) 425-6040. Pres.: Edward M. Kaplan, VP & Gen. Mgr.: Sy Kaplan, A&R Dir.: Red Weed
Labels: (Owned) Ermo, Kool Kat, RRC, Recordland.
 Kory, see Countrywide.
 Kris, see SIPRA.
 Kronos, see Peters Int'l.
 Kubaney Recs., 170 W. 29 St., Hialeah, Fla. 33012. Tel. (305) 888-7411.
Labels: (Owned) Chico, Discolor, Don
Int'l rep.: France (Soul Posters).
 Kudu, see Creed Taylor.



L A Recs. & Tapes, PO Box 54021, Los Angeles, Calif. 90054. Tel. (213) 782-6226. Pres. Dave Crawford; Admin. Dir.: Pamela F. Jackson, VP & Gen. Mgr.: Chris Jozz; VP Promos.: Ted McQuiston; Secondary Promos.: Christian Super, Sales Mgr.: Andy Belvin, Gospel Dir.: Rick McGruder.
Labels: (Owned) California, Dave Crawford Prod'ns, Los Angeles.
 L A X, see MCA.
 L D E, see Lee Dunne.
 L I R S Classics, 72 Orange St., Brooklyn, N.Y. 11201. Tel. (212) 875-6193. Owner: Ernest W. Ucko.
 L J-N T S U, see Ray Lawrence.
 L J O Recs., 1466 Broadway, Suite 406, New York, N.Y. 10036. Tel. (212) 840-3670. Pres.: Lonnie Johnson.
 L M I, see Lee Magid.
 L P G, see Loypriquan.
 L R C, see Lester Radio Corp. & TK.
 L R J, see Little Richie Johnson.
 L S Recs., 120 Hickory St., Madison, Tenn. 37115. Tel. (615) 868-7172. Pres.: Adv., Tape & Int'l Mgr.: Lee Stoller; Pop A&R Mgr.: Charlie Black, Pub. Mgr.: Larry Vaughn; Promo. Mgr.: Jack Andrews; Country Dir.: Harold Hodges.
 Laboratory Series, see Sonic Arts.
 Lad, see TH.
 Laff, see Ala Ent's.
 Lakko Rec. Co., 3235 W. Fullerton Ave., Chicago, Ill. 60647. Tel. (312) 772-9444. Owner: Leon A. Kelert.
Labels: (Owned) Blackbird; (distributed) Claremont, Philips-Dutch Swing College Band, Red Onion, Sidewalk Hot Jazz Orch.
 Lake Country Music, PO Box 1073, Graham, Tex. 76046. Tel. (817) 549-5118. Owner & Pres.: Larry Wooldridge. Mgr.: Mark House.
 Lake Country (Switzerland), see Domino Ltd.
 La Louisianne Recs., PO Box 30072, Zip 70503; 711 Stevenson St., Lafayette, La. 70501. Tel. (318) 234-4118/5577. Pres.: Carol J. Rachou Sr.; Sec'y/Treas.: Noel Rachou; Studio Eng.: Carol J. Rachou Jr.
Labels: (Owned) Belle, La Louisianne, Tamm.
 Lamb, see Startown.
 Benjamin Lambert, see AcoustoGraphic.
 Lamb & Lion, see Koala & Sunrise.
 Lamb & Lion Country, see Koala.

Landers-Roberts Inc., 9255 Sunset Blvd., Los Angeles, Calif. 90048. Tel. (213) 550-8819.
Label: (Owned) Mums.
 Land of Lincoln, see Chi-Town.
 Land O' Jazz Recs., PO Box 26393, New Orleans, La. 70126. Tel. (504) 241-4246. Chief Exec.: Plato Smith Lane, see West.
 Lanor Recs., 329 N. Main, Church Point, La. 70525. Tel. (318) 684-2176. Owner & Mgr.: Lee Lavergne; Ass't: Linda Bellard.
Int'l rep.: UK (Swift).
 Lania, see Atteram.
 Largo, see GNP Crescendo.
 Lark, see Major Rec'g Co.
 Larrikin (Australia), see Rounder.
 Latin Int'l, see Discos Latin.
 Latin Movement, see TR.
 Latin Percussion Ventures Inc., 454 Commercial Ave., Palisades Park, N.J. 07650. Tel. (201) 947-8067. Pres.: Martin Cohen, VP: Marilyn Cohen, Sales & Promo.: Diane Seibert.
Labels: (Owned) Crollo, Latin Percussion Ventures, Turnstyle.
Int'l reps.: Australia (Billy Hyde), France (J. Capelle), Netherlands (World), Switzerland (Core).
 Laurel-Protone, see Protone.
 Laurie Recs. Inc., 20 F. Robert Pitt Dr., Monsey, N.Y. 10952. Tel. (914) 425-7000.
 La Val Rec. Co., 226 N. Burdick, Kalamazoo, Mich. 49006. Tel. (616) 342-5328. Pres.: Vic LaVal, Disco A&R: Tico Taylor, Nat'l Sales Mgr.: Vincent Taylor, Promo.: Val Taylor, Harry Whitted.
Branch: San Francisco, Calif., 1218 Hollister St. Zip 94124. Tel. (415) 467-5157.
Labels: (Owned) La Val, Smile, Vic; (distributed) Soul Set.
 Ray Lawrence Ltd., PO Box 1987, Studio City, Calif. 91604. Tel. (213) 552-1000. Cable: RAYLAW. Pres.: Ray Lawrence; VP: Jeff Lawrence; Artist Relations Dir.: Connie Lawrence.
Labels: (Owned) Dobre, Jam Session, LJ-NTSU, Milagro, (distributed) AMP, Aerospace, BBP, Bel-Ad, Clow, Contrast, Cracker Barrel, Earl, Home Comfort, Jazz Ala Carte, Jucu, Meridian, Roast, Royalty (Canada), Tablighi, Uncle Bear, Vegas, Vintage One, Wolf.
 Leader (UK), see Rounder.
 Le Cam, see Christ.
 Legacy, see Owl Rec. Co.
 Legrand, see Legrand-Norfolk.
 Legrand-Norfolk Int'l, 177 Rt. 304, New City, N.Y. 10956. Tel. (914) 634-5101. Cable: ROCKMASTAS. Pres.: Frank Guida; VP: Carmela Guida, Sec'y-Treas.: Pearl Frank.
Branch: Norfolk, Va., 317 Granby St. Zip 23510. Tel. (804) 625-3470.
Labels: (Owned) Legrand, Norfolk-Int'l, Peanut Country, SPQR.
 Lehua, see Surfside Hawaii & World Int'l.
 LeJoint, see London.
 LeMans Rec. Co., 331 Triangle Rd., Somerville, N.J. 08876. Tel. (201) 359-5520. Pres.: Chestelle Goydsh; VP: Bernard Goydsh.
 Lemon, see National Recs.
 LeRo, see Danny Luciano.
 Les-Ron Recs., PO Box 728, Sunland, Calif. 91040. Contacts: Leslie Michaels, Reuben Katz.
 Lester Radio Corp., 515 Madison Ave., New York, N.Y. 10022. Tel. (212) 688-1224. Partners: Sonny Lester, Bud Katzel (Distributed by TK).
Label: (Owned) LRC.
 Mark Levinson Acoustic Rec's Ltd., 131 Leederhill Rd., Hamden, Conn. 06517. Tel. (203) 281-6333.
 Libelula, see Safari.
 Liberty/United Recs., see EMI-America/United Artists.
 Libido, see Old Dominion.
 Libra, see Alhambra.
 Library of Congress, Motion Picture, Broadcasting & Recorded Sound Div., Rec'g Laboratory, Washington, D.C. 20540. Tel. (202) 426-5509. Chief: Erik Barnouw, Laboratory Servs. Head: Robert B. Carneal; Bus. Mgr.: Samuel Brylawski.
 Lifesong/Goldiggers, see Lifesong Recs.
 Lifesong Recs. Inc., 488 Madison Ave., New York, N.Y. 10022. Tel. (212) 752-3033. Pres.: Terry Cashman; Exec. VP: Philip S. Kunitz; VP: Tommy West; Gen. Mgr.: Stanley Nowak.
Labels: (Owned) Lifesong, Lifesong/Goldiggers.
Int'l reps.: Australia (RCA), Benelux (Aniolo-Eurodisc in Netherlands), Brazil (Top Tape), Canada (CBS), Germany (Aniolo-Eurodisc), New Zealand (RCA), UK (GTO).
 Lifetime Rec's, 314 S. Goodman St., Rochester, N.Y. 14607. Tel. (716) 244-7526. Owner: Lester W. Osband.
Labels: (Owned) Joker, Lifetime, Lyndell.
 Light, see Word.
 Lighthouse Prod'ns, 65 Lovel Ave., San Rafael, Calif. 94901. Tel. (415) 454-7548.
 Lightning, see Crimson Dynasty.
 Lil' Possum, see Candy.
 Lindberg Recs., 1445 Sunset Ridge Rd., Glenview, Ill. 60025. Tel. (312) 729-2047. Pres.: Sven Lindberg; VP: Bjorg Larsen; Pop A&R: Elizabeth Lisa, Sales Mgr.: Frank Three.
Labels: (Owned) Dansk-Disk, Lindberg, Norsk-Disk, Scandinavian, Svens-Disk.
 Lineman, see Nationwide Sound.
 Lions Den, see Stacy-Lee.
 Lisboa, see Penco.
 Lisi, see Arzee.
 Listening Library Inc., 1 Park Ave., Old Greenwich, Conn. 06870. Tel. (203) 637-3616.
Labels: (Owned) Listening Library, (distributed) Arca, Caedmon, Columbia, Everest, Folkways, London, RCA, Spoken Arts (all educational product).
 Little David Recs. Inc., 9200 Sunset Blvd., Suite 621, Los Angeles, Calif. 90069. Tel. (213) 278-7975. Pres.: Monte Kay, VP Mktg.: Ben Hurwitz (Distributed by Atlantic).
 Little Giant Recs., Box 205, White Lake, N.Y. 12786. Tel. (914) 583-4471. Pres.: Mickey Barnett.

Little Giant Rec. Co., 1014 16 Ave. S., Nashville, Tenn. 37212. Pres.: Roy Sinkovitch; VP: Mick Lloyd.

Little Nashville, see Don D. Sheets.

Little Richie, see Little Richie Johnson.

Little Star Recs. (div. of Barnum Entertainment), 723 N. Seward, Los Angeles, Calif. 90038. Tel: (213) 462-0723. Living Proof, see Mutual Group.

Loadstone & Open Rec. Co., 163 Orizaba Ave., San Francisco, Calif. 94132. Tel: (415) 334-2247. Pres. & Gen. Mgr.: Walter C. Stone; Sales & Promos.: Charlie Hines; Sales & Promos. Ass't: John E. Harris; Pub. & Assignment: Michael Moeller; Sec'y-Treas.: B.M. Stone.

Labels: (Owned) Loadstone, Open.

L'Oiseau-Lyre, see London.

London Pro Musica (UK), see Worldwide Music Servs.

London Recs. Inc., 539 W. 25 St., New York, N.Y. 10001. Tel: (212) 675-6060. Cable: FULLRANGE. Pres.: D.H. Toller-Bond; Exec. VP: Terry McEwen; VP Pop A&R: Walt Maguire; Controller/Treas.: Nick Cosmos; Nat'l Sales Mgr.: Stu Marlowe; Classical Prod. Mgr.: Richard Rolfeisen; Nat'l Classical Sales Mgr.: John Harper.

Home office: England, Decca.

Int'l branches: Canada (London), Germany (Teldec); Italy, Nigeria, Singapore (all Decca).

Labels: (Owned) Deram, London, Parrot, Phase 4, Treasury Series, (distributed) Argo, Das Alte Werk, LaJoint, L'Oiseau-Lyre, Telefunken, Threshold.

Int'l reps.: Argentina (EMI-Odeon), Australia (EMI), Austria (Musica Schallplatten), Barbados (West Indies Recs.), Belgium (Fonior), Bolivia (Discolandia Dueri), Brazil (EMI-Odeon), Chile (EMI-Odeon), China (Linfair), Colombia (Importaciones Daro), Costa Rica (Indica), Denmark (Nordisk Polyphon), Dominican Republic (La Guarachita), Ecuador (Emporio Musical), El Salvador (Indica), Finland (Finnlevy), France (Sofrason), Guatemala (Indica), Greece (Music Box), Honduras (Indica), Hungary (Kultura), India (Gramophone Co.), Ireland (Irish Rec. Factors), Israel (Symphonia), Jamaica (WIRL), Japan (King), Kenya (Phonogram), Korea (Sung Eum), Mexico (Peerless), Netherlands (Phonogram), New Zealand (EMI), Nicaragua (Indica), Norway (Phonogram), Pakistan (EMI), Panama (Indica), Peru (Industrias Electricas), Philippines (Super), Portugal (Valentim de Carvalho), South Africa (Gallo), Spain (Columbia), Sweden (Electra), Switzerland (Musikvertrieb), Turkey (Melodi), Uruguay (Clave), Venezuela (Palacio de la Musica), Yugoslavia (Jugoton).

London Times, see Communication Institute.

Longdivity, see Rounder.

Longhorn Ballroom Inc., 216 Corinth, Dallas, Tex. 75207. Tel: (214) 428-3128.

Long Neck Recs., 6004 Bull Creek Rd., Austin, Tex. 78757. Partner & Sales & Promo. Dir.: Bobby Earl Smith; Partner & A&R: Joe Gracey.

Labels: (Owned) Big Wheel, Long Neck.

Lorimar, see CBS.

Los Angeles, see LA Recs.

Lotus Music Corp., PO Box 2446, Toluca Lake, Calif. 91602. Tel: (213) 782-0988. Pres.: H. Lyman.

Branch: Nashville, Tenn., PO Box 2151. Zip: 37214. Mgr.: M. Michelle.

Lotus, N.J., see Stacy-Lee.

Louisiana Hayride Recs. Inc., 1708 Grand Ave., Nashville, Tenn. 37212. Tel: (615) 244-1322. Pres.: David Kent. (Distributed by World Int'l)

Louisville Orchestra First Edition Recs., 333 W. Broadway, Louisville, Ky. 40202. Tel: (502) 587-8681. (Distributed by Composers Rec'gs)

Label: (Owned) First Edition.

Love (Finland), see SWS.

Loyal, see OK.

Loypriguan Ltd., 39 W. 55 St., New York, N.Y. 10019. Tel: (212) 586-3350. Cable: LLOYDPRICE. Pres.: Lloyd Price; A&R Dir.: Nathaniel Adams; Promo. Dir.: Rudy Lucas; Controller: Debra Martinez Franqui.

Labels: (Owned) LPG, TPM, (distributed) Marina.

Luuau, see Boddie.

Danny Luciano Prod'ns, 1 Jeffro Plaza, Suite 206, 2655 Philmont Ave., Huntingdon Valley, Pa. 19006. Tel: (215) 947-7743. Pres.: Danny Luciano; VP: Ray Royal; Talent Co-ords.: Bill Mathias, Bob Castaldo, Barbara Super, A&R Dir.: Joe Fortunato.

Labels: (Owned) LeRoI, LuMar, Molly, Spiral.

Lucifer Recs. Inc., PO Box 263, 37 Woodside Ave., Hasbrouck Heights, N.J. 07604. Tel: (201) 288-8935. Pres.: Ron Luciano; VP: Ed Capone; A&R: Al Corri; Sales & Mktg.: Ron Michaels; Pub.: Tom Samuels; Adv. Arlene Patriano; Promo.: Joe Merlino.

Lucky Man Music, The Homeplace, Mount Juliet, Tenn. 37122. Tel: (615) 444-8431. Owner: Alfred H. LeDoux; Sec'y & Treas.: Bonnie J. LeDoux.

Int'l reps.: Denmark (Montax), Germany (Siegel), UK (Westwood).

Lucky's Kum-Ba-Ya Recs., Box 6, Broham, Mich. 49312. Tel: (616) 689-6886. Owner: Rosswell H. Fulton Sr.

LuMar, see Danny Luciano.

Luniz, see Glolite.

Lu-Tex, see Wagon Wheel.

Lybra, see Stacy-Lee.

Lyndell, see Lifetime.

Lynchord Discs Inc., 141 Perry St., New York, N.Y. 10014. Tel: (212) 929-8234. Pres.: Peter Fritsch.

Labels: (Owned) Eterna, Experience Anonymes, Lynchord.

Dir.: Larry White; Nat'l Secondary Promo.: Lorine Mendell; West Coast Pub. Dir.: Barbara Wyatt; Film & Video Serv. Dir.: Anne Lewis. **Backstreet Recs.**—Pres.: Danny Branson. **Songbird Recs.**—Exec. Dir.: Michael Ehrman, A&R Dir.: Chris Christian; Promo. & Prod. Development Dir.: Doug Corbin.

Branches: New York, N.Y., 445 Park Ave. Zip: 10022. Tel: (212) 759-7500. VP: East Coast Gen. Mgr.: Ray D'Arino; Artist Development & Pub.: Lynn Kellerman; East Coast Prod. Mgr.: Harold Fein; Nat'l Disco Co-ord.: Katherine McKilroy—Nashville, Tenn., 27 Music Square E. Zip: 37203. Tel: (615) 244-8944, 385-0840. Pres.: Jim Foglesong; VP Sales & Mktg.: Chic Doherty; VP A&R: Ron Chancey; Promo. Dir.: Erv Woolsey; Pub. Dir.: Jerry Bailey.

Int'l branches: Canada, England.

Distribution branches: Los Angeles, San Francisco, Calif.; Denver, Colo.; Miami, Fla.; Atlanta, Ga.; Chicago, Ill.; Baltimore, Md.; Boston, Springfield, Mass.; Detroit, Mich.; Minneapolis, Minn.; St. Louis, Mo.; Collingswood, N.J.; New York, N.Y.; Cincinnati, Cleveland, Ohio; Nashville, Tenn.; Dallas, Houston, Tex.; Seattle, Wash. (See Record & Tape Wholesalers section for complete listings).

Labels: (Owned) Backstreet, Coral, MCA, Songbird; (associated) Mike Curb Recs., Goldhawk, Hickory, LAX, Montage, (distributed) Butterfly, Source.

Int'l reps.: Argentina (Phonogram), Australia (Astor), Austria (Amadeo), Belgium (EMI), Bolivia (Discolandia), Brazil (PolyGram), Chile (Philips), China (Taiwan Kolin), Colombia (Philips), Denmark (Polydor), Dominican Republic (Velvet), Ecuador (Fediscos), El Salvador (LEO), Finland (Finnlevy), France (Barclay), Germany (Metrom), Greece (Emial), Hong Kong (Polydor), India (Polydor), Israel (CBS), Italy (Ricordi), Jamaica (Record Specialists), Japan (Victor), Korea (Sung Eum), Mexico (PolyGram), Netherlands (EMI), New Zealand (PolyGram), Norway (Polydor), Panama (Prom-Disko), Peru (El Virrey), Philippines (Home), Portugal (PolyGram), Singapore (PolyGram), South Africa (Gallo), Spain (Fonogram), Sweden (Polydor), Switzerland (Polydor), Turkey (Melodi), UK (EMI), Uruguay (EDISA), Venezuela (Polydor), West Indies (Record Specialists in Jamaica). (SEE ADVERTISEMENT)

M D J Recs. Inc., 601 Preston Tower, Dallas, Tex. 75225. Tel: (214) 691-7319. Pres.: Jerry J. Davis.

M F M I, see Maynard Ferguson.

M G M, see Thomas J.

M J Rec'g Inc., Dodge, Neb. 68633. Tel: (402) 693-2379. Pres.: Joe Spellerberg Jr.; Mgr. & Buyer: Jo Ann Sobczak.

Label: (Owned) Czech, Heritage.

M M G, see Moss.

M M I, see Music Mill.

M M O Music Group Inc., 423 W. 55 St., New York, N.Y. 10019. Tel: (212) 245-4861. Pres.: Irving Kratka; VP: Morton C. Hillman; Prod'n Mgr.: Kevin Yatarola; Promo. Dir.: Andrew Sussman.

Branch: North Hollywood, Calif., 13012 Satcoy St.

Zip: 91605. Tel: (213) 765-6600. Mgr.: David Kratka.

Labels: (Owned) Aural Explorer, Classic Jazz, Guitar World, Inner City, Music Minus One; (distributed) Choice.

Int'l rep.: Canada (Almada).

M O R G, see Discocorp.

M R I, see Music Resources.

M R C, see Major Rec'g Co.

M S K Prod'ns Inc., 8880 Hubbell Ave., Detroit, Mich. 48228. Tel: (313) 272-1484. A&R: Chet Kajeski.

M V P, see Polydor.

M X, see All Platinum.

Mable, see Startown.

Mace, see Springboard.

Made in USA Recs. & Tapes Inc., 185 West End Ave., New York, N.Y. 10023. Tel: (212) 580-0255. Cable: DAM-SOUND. Pres.: Marty Wilson.

Madely, see Auditorama.

Madison Music Ltd., see McKinnon.

Magda, see Marsal.

Magic Minstrel, see Florida Independent & Ind.

Lee Magid Inc., PO Box 532, Malibu, Calif. 90265. Tel: (213) 457-2056. Cable: LEEMAG. Pres.: Lee Magid.

Label: (Owned) LMI.

Magna-Glide Rec. Corp., 323 E. Shore Rd., Great Neck, N.Y. 11023. Tel: (516) 482-5930. Pres.: Jerrold Kasenetz; VP: Jeffrey Katz, A&R: Jerrold Kasenetz, Jeffrey Katz, Peter Kraft; Sales, Mktg. & Tape: Cynthia Vee.

Magnet, see Polydor.

Magnetic Video Corp., 23434 Industrial Park Court, Farmington Hills, Mich. 48024. Tel: (313) 477-6066.

Magneto, see Safari.

Maggie (UK), see Rounder.

Mahalo, see Surfside Hawaii.

Mainstream, see Roulette.

Maison de Soul, see Flat Town.

Majega Recs., 240 E. Radcliffe Dr., Claremont, Calif. 91711. Tel: (714) 624-0677. Pres. & A&R Dir.: Gary K. Buckley; VP Mktg.: Mark Aurelius; VP Sales: Jody Barry; Sales: Terry Anderson.

Major Label Recs., 6876 Alloway E., Worthington, Ohio 43085. Tel: (614) 846-2026. Pres.: Richard Deitch.

Major Rec'g Co., PO Box 2072, Waynesboro, Va. 22980. Tel: (703) 942-0106. Owner: John H. Major.

Labels: (Owned) Lark, MRC.

Major, Mass., see Rounder.

Major, Mich., see We Prod'ns.

Major, N.Y., see Thomas J.

Malaco Inc., 3023 W. Northside Dr., Jackson, Miss. 39213. Tel: (601) 982-4522. Pres.: Tom Couch; VP: Wolf Stephenson; A&R: James Stroud; Promo. Dir.: Joe Lewis. (Distributed by TK).

Labels: (Owned) Chimneyville, Malaco.

Mandala Int'l, 112 Maureen Dr., Hendersonville, Tenn. 37075. Tel: (615) 824-7144. Pres.: Louis Lofredo; VP: Jan Robin.

Mandy Kaye, see World Int'l.

Mango, see Island.

Manken, see Polydor.



THE GREAT CIRCLE RECORD COMPANY
A DIVISION OF THE BENSON COMPANY

365 Great Circle Road • Nashville, Tenn. 37228
1-800-251-8984 • In Tennessee (615) 259-9111

HeartWarming • Impact • Greentree • Jim • Cross Country

Lawson Falle Limited
Box 1144, 20 Parkhill Rd. E.
Cambridge, Ontario
Canada NIR 6C9
519-622-1941

Rhema Music
P.O. Box E 18
St. James NSW 2000
Australia
02-699-6957

Hanssler-Verlag
7303 Neuhausen-Stuttgart
Postfach 1220
West Germany
011-49-7158-5001

Kingsway
Publications Limited
Lottbridge Drive
Eastbourne, East Sussex
England BN236NT
011-44-1242-9609

Osborn Industries Ltd.
P.O. Box 212
Hastings, New Zealand
66-621

Bet-El Publishers
and Gospel Recordings
P.O. Box 30154
Pretoria 0038
Republic of South Africa
75-4287



M C A Recs. Inc., 100 Universal City Plaza, Universal City, Calif. 91608. Tel: (213) 985-4321. Cable: MUSICOR. Pres.: Bob Siner; VP Admin.: Arnold Stone; VP Bus. Affairs: David Jackson; VP A&R: Denny Rosencrantz; VP Int'l: Lou Cook; VP Mktg.: Stan Layton; VP Pub.: Joan Bullard; VP Creative Affairs: George Osaki; VP Artist Development: Russ Shaw; VP Prod. Development: Santo Russo; VP Promo: Larry King; VP R&B Promo.: John Smith; VP Rec'g Opns.: Brent Albright; Mktg. Dir.: Sam Passamano Jr.; Nat'l LP Promo. Dir.: Beth Rosengard; Nat'l Pop Promo. Dir.: Margo Knesz; Artist Development

- Mankind, see Nashboro
 Manna Recs., 2111 Kenmere, Burbank, Calif. 91504 Tel: (213) 843-8100.
 Mansion, see Sweetson
 Manton, see SIPRA
 Maranathal Music Inc., PO Box 1396, Costa Mesa 92626, 2902 W. Garry, Santa Ana, Calif. 92704. Tel (714) 979-8536 Gen. Mgr. Chuck Fromm; Mktg & Promo. Terry Shepard; Creative Servs. Dir. Dave Swaney, A&R & Publ'g Dir. Tom Coomes; Studio Opns Dir. Ted Bleyemyer. (Distributed by Word)
Labels: (Owned) Kingsway, Maranathal
 Marilu Recs., PO Box 6886, Loiza Sta., Santurce, P.R. 00914 Tel (809) 727-1348
 Marma, see Loypriquan
 Marjon Int'l Recs., 159 Easton Rd., Hermitage, Pa. 16146 Tel (412) 347-4726. Pres. John T. Krizancic. Mgr. Martha Krizancic
 Mark Five Rec'g., 10 Michael Dr., Greenville, S.C. 29610 Tel (803) 269-3961. (Distributed by Herald Ass'n)
Labels: (Owned) Halo, Klub, Mark Five, Mastertone.
 Marlin, see TK
 Mario Rec. Co., Box 49, RD 1, Utica, N.Y. 13502 Tel (315) 724-0895 Owner & Pres. Mario Ketchum, Music Coord.: Slim Piking; VP & Mgr. Floyd Ketchum
 Marquee, see East Allegheny
 Marsal Prod'n's Inc., 2015 Castroville Rd., San Antonio, Tex 78237 Tel (512) 433-9351 Pres. Antonio J. Mendendez; 1st VP Larry Ruess; 2nd VP Felix Elzondo; Sec'y-Treas. & Gen. Mgr. Pat Alvarado
Branch: Los Angeles, Calif., 2854 W. Pico Blvd Zip 90006 Tel (213) 737-3771 Mgr. Celia Camacho.
Labels: (Owned) Del Rio, Magda, Sondo Int'l
 Mars Hill Recs., 352 E 18 St. Erie, Pa 16503 Tel (814) 455-8124 Contact Angelo Natale
 Mars La Tour, see Atteram
 Glen Martin Prod'n's, PO Box 1318, Texarkana, Tex 75501 Tel (214) 793-0956 Contact Glen Martin
 Marton, see Discostar
 Marullo Prod'n's Inc., 1121 Market St., Galveston, Tex 77550 Tel (713) 762-4590 Pres. A.W. Marullo Sr., VP A.W. Marullo Jr., Pop & Country A&R Mark Allen, George Lee, Sales & Promo Mgr.: Russ Reeder
Labels: Red Dot, Ro Tab
 Marycords, Box 48, Powers Lake, N.D. 58773. Pres. Rev. J.J. Nelson, Sec'y-Treas. Mrs. James Smith
 Master Disc Recs. & Tapes, 711 E. Walnut St., Suite 209, Pasadena, Calif. 91101 Tel (213) 796-1600 Pres. Calvin M. Taylor
 Master 5, see AVI
 Master Linguist, see R.D. Cortina
 Masterpiece, see Sine Qua Non
 Masterscores, 1335 N. Detroit, Suite 103, Hollywood, Calif. 90046 Tel (213) 874-5766 Pres & Prod'r LaMont Johnson
 Mastertone, see Mark Five
 Masterworks, see CBS
 Max Recs., PO Box 7386, Beaumont, Tex 77706 Tel (713) 866-6726 Pres. Richard T. Bianco, A&R Mary Nell, Sales & Promo. Mgr.: Tim Meehan
 Max's Kansas City Recs., 213 Park Ave S., New York, N.Y. 10003 Tel (212) 777-7870 Pres. Tommy Dean, VP A&R & Prod'n Peter Crowley, Mktg & Promo Dir.: Macs McAree
 Maycon Recs. Co., 5306 W. Columbia Ave., Philadelphia, Pa 19131 Tel (215) 877-8760
 Mayhams Collegiate Recs., PO Box 46, Morning Side Sta., Zip: 10026; 135 Hamilton Pl., Suite 6B, New York, N.Y. 10031 Tel (212) 368-7275 Pres & Gen. Mgr.: N.B. Mayhams Sr., VP & Ass't Mgr. Shirley A. Mayhams, Ass't VP & Mgr. N. Smalls Mayhams Jr., Pub. Adv. & Promo. Norris Mayhams
 McKinnon Pictures/Rec. Co., PO Box 691, Reading, Pa. 19601 Tel (215) 372-7361 Pres. Leonard McKinnon, Ass't to Pres & Disco Prod. Mgr. Ann McLean, Latin Disco Dir. & Country Prod. Mgr. Phyllis Gray
Labels: (Owned) Atlanna, Black Treasure, Center City, Holy Cross, Madison Music Ltd., McKinnon, Movieland, Otsville, Reading, Slide, Tarheel; (distributed) Path
Int'l reps: Argentina (Microfon), Australia (Electric), Austria (Bellaphon), Bahamas (International House of Music), Belgium (Frankie), Bermuda (Music City), Bolivia (Discolandia Duen), Brazil (Odeon), Bulgaria (Balkanton), Canada (Musimari), Chile (RTI), Colombia (Incolve), Costa Rica (Indica), Denmark (Sonet/Dansk), Egypt (Sono Cairo), El Salvador (Dicesa), Finland (Finnlevy), France (Musidisc, Disc' AZ), Germany (DG), Greece (Music Box), Hong Kong (Cosdel), India (Gramophone), Ireland (Irish Recs.), Israel (Israel Recs.), Italy (Ri-Fi), Jamaica (Dynamic Sounds), Japan (King), Kenya (Sapra), Malaysia (Musico), Mexico (Guitarra), Netherlands (Dutch Rec. Co.), New Zealand (Hoghton Hughes), Nigeria (Senn-Sound), Norway (Arne Bendixsen), Philippines (Vic), Portugal (Radio Trunfo), Singapore (Kwang Sia), Spain (Movieplay), Sweden (Dollars), Switzerland (Metronome), Turkey (Melodi), UK (Black Wax)
 McLain Family Band, CPO 1322, Berea, Ky. 40404 Tel (606) 986-8111. Pres.: Raymond McLain.
Label: (Owned) Country Life
 Meat Man, see Posh Boy
 Meet the Classics, see Sine Qua Non
 Melodeon, see Biograph
 Melodia, see Polish Rec. Center
 Melodiya/Columbia, see CBS
 Melody Mexico (Mexico), see Caytronics
 Melody Rec'g Studio, 1912 St. Clair St., Hamilton, Ohio, 45011 Tel (513) 895-0719
Labels: (Owned) Irma, Melody, Pine Tree, Sunrise
 Melway, see Music of Polynesia
 Memorial, see Cord
 Memphis & It's Music, see Glolite
 Mercantile Recs., PO Box 2271, Palm Springs, Calif. 92262 Tel (714) 327-3271 Pres. Kent Fox
 Mercurio, see Velvet de Puerto Rico
 Mercury, see Phonogram
 Mercury Golden Imports, see Classics Int'l
 Mercana Rec Corp., 240 Madison Ave., New York, N.Y. 10016 Tel (212) 889-7340
Labels: (Owned) Mericana, Salsoul (Salsa).
 Meridian, see Ray Lawrence
 Merry Elf, see Argus
 Mersey, see Country Star
 Message, see Superior Sound
 Messenger Recs. (div. of Full House Inc.), PO Box 931, Zip 38101; 642 N. Second St., Memphis, Tenn. 38107. Pres.: William E. Taylor; VP Sales & Promo. Willie H. Bean; VP Mdsq. J. W. Crudginton.
 Metric, see Educational Film Systems & Opus
 Met Richmond Latin Rec. Sales, 1637 Utica Ave., Brooklyn, N.Y. 11234. Tel. (212) 253-4600. Cable SEECODISC N.Y. Pres. & Int'l: David Last. Sec'y Bea Last; Pub Mgr. S. Press, Promo Mgr. D. Erlichman, Tape Supervisor B. Cohen
Labels: (Owned) Datone, Seeco, Tropical
 Metro, see Daytwo
 Metrobeat Prod'n's Inc., PO Box 755, Minneapolis, Minn. 55440. Tel (612) 636-0841. Pres. Mike Jann.
Labels: (Owned) Metrobeat, Peak, (distributed) West Wind.
 Mexi-Rex Recs. Inc., 230 Peachtree NW, Atlanta, Ga. 30303 Tel (404) 688-1333 Pres. Ray Schoonmaker.
 Miami Recs. & Dist'g Corp., 2819 NW Seventh Ave., Miami, Fla. 33127 Tel (305) 635-7925. Pres. Caridad E. Moya; Sec'y-Treas. Carlos Diaz-Granados Jr.; Ass't Sec'y A. Sedenio; Promo./Sales Rolando Gonzalez
Labels: (Owned) Miami; (distributed) Fuentes (Colombia)
 Miami Valley Rec'gs, 2821 Oxford Dr., Springfield, Ohio 45506. Tel (513) 322-0516. Owner Patrick Suarez
 Michele Audio Corp., Andrews Street Rd., Massena, N.Y. 13662. Tel (315) 769-2448. Pres. Ginette Cormier.
Int'l branch: Canada
Labels: (Owned) Deutsche Klassische, Michele, Produktion Deutschmark, Windmill; (distributed) Garnet, Jes-sup
 Mickey Recs., 26 Mountain Ave., Dover, N.J. 07801 Tel: (201) 361-2084. Pres. Michael F. Matushin Sr.
 Microfon, see Discos Latin
 Microton America, 8155 NW 103, Hialeah Gardens, Fla. 33016. Tel (305) 558-1661.
Home office: Argentina
 Midsong Int'l Inc., 1650 Broadway, New York, N.Y. 10019. Tel (212) 541-5100 Cable MIDSONG. Pres.: Bob Reno, Exec. VP Louis DeBiase, VP Opns. Harry Spero; VP Sales & Mktg. Sy Warner; Nat'l Disco Promo.: Tony Gioe
 Midway Prod'n's, see Jezreel
 Mighty Wind, see Sunrise Mercantile
 Milagro, see Ray Lawrence
 Milestone, see Fantasy/Prestige/Milestone/Stax
 Milk & Honey, see Singpiration
 Mill City Recs., PO Box 3759, Minneapolis, Minn. 55403 Tel (612) 452-2105. Rec'g Head Alan L. Heigl.
 Millennium Recs., 3 W. 57 St., New York, N.Y. 10019. Tel (212) 759-3901. Pres. Jimmy Lerner.
 Miller-Brody Prod'n's Inc., see Newbery Award
 Miller & Kresel Sound Corp., 8719 Wilshire Blvd., Beverly Hills, Calif. 90211. Tel (213) 652-8318. Pres. Ken Kresel, VP Sales & A&R Jan Baskin; VP Jonas Miller.
Label: (Owned) RealTime
Int'l rep.: Europe (Audio Int'l in Germany)
 Mini Recs. Inc. (div. of Prosop Recs.), 736 Franklin Ave., Brooklyn, N.Y. 11238 Tel (212) 857-2324
 Ministri, see Indi
 Minstrel, see Collegium
 Mira, see Educator
 Miracle, see Big Sound
 Mirror Ball Discs, 958 W. Edgemont Dr., San Bernardino, Calif. 92405 Tel (714) 882-6796. Gen. Mgr. & A&R Dir. Bill Bellman, Admin. Myral Bellman
 Mirror Recs. Inc., 645 Titus Ave., Rochester, N.Y. 14617 Tel (716) 544-3500 Pres & Sec'y Bruce Schaubroeck, VP & Treas. Armand Schaubroeck, Promo. & Sales Jim Deignan; Promo. Brian Ormon
Labels: (Owned) House of Guitars, Mirror
Int'l reps.: Australia (Aleide), Canada (Opus 69), France (Music Box)
 Mr. G, see Audiofidelity
 Mr. Pickwick, see Pickwick
 Mistletoe, see Springboard
 Misty Blue, see Crimson Dynasty
 Mitchell Rec'g & Music Publ'g Co. Inc., Box 67, Rt. 7, Ridge Rd., Columbus, Miss 39701 Tel (601) 327-4932. Pres. W.B. Mitchell; Exec. VP & Bus. Mgr. M.A. Mitchell. VP & Artist Development Dir. A. Keith Mitchell, Creative Div. (A&R) Dir. Van T. Mitchell.
Labels: (Owned) His-Way, Mitchell, Vima
 Mobile Fidelity Sound Lab., PO Box 919, 9421 Winnetka Ave., Chatsworth, Calif. 91311 Tel (213) 993-4945. Pres. Brad S. Miller; VP Sales/Mktg. Gary Gorgi, Mgmt. Consultant Herbert A. Belkin; Mktg. Sales & Warehouse Mgr. L.R. Miller; Sales Mgr. Diane Giorgi; VP/Sec'y Patricia A. Miller; Comptroller: A.H. Reppel.
Branch: Olympic Valley, Calif., PO Box 2157 Zip 95730 Tel (916) 583-2664
 Mod-Art Recs. (div. of Mod-Art Prod'g Co. Inc.), 10358 S. Forest Ave., Chicago, Ill. 60628 Tel (312) 264-2463. Modern, see Cadet Recs.
 Modern Sound Studio Prod'n's Inc., 413 N. Parkerson Ave., Crowley, La. 70526 Tel (318) 783-1601
Labels: (Owned) Bayou Classics, Blues Unlimited, Cajun Classics, Kajun, Part T, Showtime, Soul Unlimited, Tribute
 Modiner, see Godell
 Modoc, see ASAI
 Molly, see Danny Luciano
 Monica (Discos), see Peer-Southern
 Monitor Recs. Inc., 156 Fifth Ave., New York, N.Y. 10010 Tel (212) 989-2323 Cable MONRECOIN
Int'l reps.: Argentina (Madrigal), Australia (Carinia), Belgium (Schoff Freres), Canada (Almada), France (Chant du Monde), Germany (Electrola), Hong Kong (Jones), Italy (Sciascia), Japan (Nippon Columbia), Netherlands (Pastor), Portugal (Mundusom), Switzerland (Musikverlag Zum Pelikan), UK (Conifer)
 Monkey Joey, see International Mktg. & Mgmt
 Monmouth/Evergreen, see Monmouth Recs.
 Monmouth Recs., 1697 Broadway, Suite 1201, New York, N.Y. 10019. Tel. (212) 757-5105. Pres.: William H. Borden, Sales Mgr. Claire R. Olivier.
Label: (Owned) Monmouth/Evergreen.
 Monta, see Warren
 Montage Recs. Inc., 2049 Century Park E., Suite 2240, Century City, Calif. 90067. Tel. (213) 552-0134. Pres.: David Chackler; VP & Gen. Mgr. Arnie Orleans; VP A&R Stuart Love. (Distributed by MCA)
 Montclair Recs., 13755 Bayliss Rd., West Los Angeles, Calif. 90049 Pres. Wallace Todd, A&R Dir.: Miriam Todd.
 Monterey Recs., PO Box 8497, Universal City, Calif. 91608. Tel (213) 243-3456. Owner Jack Daugherty
 Montilla Recs. of Puerto Rico Inc., Carrera 185, Km 0.7 Canovanas, P.R. 00629 Tel (809) 724-1434.
Labels: (Owned) FJM, Montilla, Montisa.
 Montisa, see Montilla
 Montuno Recs. Inc., 1470 Broadway, BMT Mezzanine, Times Square, New York, N.Y. 10036. Tel (212) 254-4024.
 Monument Rec. Corp., 21 Music Square E., Nashville, Tenn. 37203 Tel (615) 244-6565 Cable MONUWORLD. Pres. & A&R: Fred L. Foster; VP & Treas.: John Dorris; VP & Gen. Mgr.: Terry Fletcher; Nat'l C&W Promo. Dir.: Tex Davis; Int'l & Prod'n: Mary Brewer. (Distributed by Phonogram)
Labels: (Owned) Monument, Sound Stage 7.
Int'l rep.: Worldwide (CBS Int'l)
 Moogtown Prod'n's, 290 West End Ave., New York, N.Y. 10023 Tel (212) 580-7326. Pres. Mark Klingman; VP David Klingman; VP Artist Relations: Thomas Hamlin.
 Moonglow Recs., Box 317, 1610 N. Argyle Ave., Hollywood, Calif. 91403 Tel (213) 995-7611. Owner & Gen. Mgr. Ray Van Hogen; Promo. Mgr.: Connie Van Hogen.
Labels: (Owned) Moonglow. (distributed) Ronnex (Belgium)
 Moonridge, see Do-Tell
 Moonstone, Fla. see JEMKL
 Moonstone Int'l Recs., PO Box 946, Hollywood, Calif. 90028 Tel (213) 761-9679. Dirs. Jeff Oxman, Marko Perko; Mktg. Mgr. K. Dossat; Promo. Mgr.: Chuck Siler. Int'l Mgr.: J. Billingsley.
Labels: (Owned) Arrival, Moonstone Int'l; (distributed) Bristol, Kashmir
Int'l reps.: Greece (Seagull), UK (Contempo, Gull, Sun-Pacific)
 Morrhythm, see Outstanding
 The Moss Music Group Inc., 211 E. 43 St., New York, N.Y. 10017. Tel (212) 867-9360. TWX: (710) 581-5948. Pres.: Ira Moss; VP: S. Gordon Strenger; Sales Mgr.: Tom DiVita, A&R George H. de Mendelssohn-Bartholdy; A&R Dir./Creative Servs.: Carol Marunas; Promo. Patricia Willard.
Int'l branch: Canada
Labels: (Owned) Candide, Chamber Music Series, Concerto Live, Historical Series, MMG, Opera Live, Turnabout, Turn On, Vox, Vox Box; (distributed) Storyville Jazz
 Mother Cleo Prod'n's, PO Box 521, Sunset Blvd., Newberry, S.C. 29108. Tel (803) 276-0639 Studio Mgr. Polly Davis, Prod'r/Dir. Hayne Davis; Int'l: O.T. Hudson, Field Rep. Willard Brown.
Labels: (Owned) Cleo, Cub, Mother Cleo.
 Mother Goose, see Cadet Recs.
 Motivation Recs., 6605 Hollywood Blvd., Suite 209, Hollywood, Calif. 90028 Tel (213) 469-4631 Pres. Randolph Stewart; VP Bruce Stewart; VP & Nat'l Promo. & PR Head: Richard Bernstein
 Motown Rec. Corp., 6255 Sunset Blvd., Los Angeles, Calif. 90028 Tel (213) 468-3500 Chm. Berry Gordy, Vice-Chm. & Chief Operating Officer: Michael Roskind; Exec. VP Sales & Gen. Mgr. Mike Lushka, Sr. VP Promo. A. Skip Miller; VP Creative: Don Ellis; VP Artist Relations: Shelly Berger; Nat'l LP & Tape Sales Mgr.: Steve Jack; Nat'l Sales & Singles Sales Mgr.: Miller London Jr.; Nat'l Press & Pub. Dir.: Bob Jones; Nat'l Disco Promo. Dir.: Barry M. Bluestein.
Int'l branches: Canada, England.
Labels: (Owned) Gordy, Motown, Natural Resources, Prodigal, Rare Earth, Soul, Tamla.
Int'l reps.: Argentina (Microfon), Australia (Astor), Austria (EMI Columbia), Belgium (EMI), Brazil (Top Tape), Central America (Dideca in Guatemala), Colombia (Colombo-Venezalana), Czechoslovakia (Supraphon), Denmark (EMI), East Germany (Deutsche Schallplatten), Ecuador (Fedisco), Finland (EMI), France (Pathe Marconi-EMI), Germany (EMI Electrola), Ghana (Phonogram), Greece (Columbia-EMI), Guatemala (Dideca), Hong Kong (EMI), Hungary (Kultura), India (Gramophone), Israel (Eastronics), Italy (EMI), Japan (Victor), Malaysia (EMI), Mexico (EMI-Capitol), Netherlands (EMI-Bovema), New Zealand (EMI), Nigeria (EMI), Norway (EMI), Peru (Industrial Sono-Radio), Philippines (Victor), Singapore (EMI), South Africa (Teal), Spain (Ariola-Eurodisc), Sweden (EMI), Switzerland (EMI), Thailand (EMI), Turkey (Melodi), UK (EMI), Venezuela (Palacio de la Musica), Yugoslavia (Diskoton).
 Mount, see Outlet
 Mountain Railroad Recs. Inc., 2103 Pleasant Dr., Cambridge, Wis. 53523 Tel (608) 423-4358. Pres.: Stephen Powers; VP/Sales: Jeffrey C. Laramie; Promo. Dir.: Tom Van. (Distributed by Flying Fish)
 Movieland, see McKinnon
 Movieplay (Portugal), see Brasilia
 Movieplay (Spain), see Caytronics
 Mudies (Sweden), see SWS
 Mulberry Square Recs., 10300 N. Central Expwy., Dallas, Tex 75231 Tel (214) 369-2430
 Mulligan (Ireland), see Rounder & Shanachie
 Mums, see Landers-Roberts
 Murbo, see Bourne
 Muscle Shoals Sound Recs., 1000 Alabama Rd., Sheffield, Ala. 35660. Tel (205) 381-2060 Owners: Jimmy Johnson, Barry Beckett, Roger Hawkins, David Hood. (Distributed by TK)
 Muse Recs. (div. of Blanchris Inc.), 160 W. 71 St., New York, N.Y. 10023. Tel. (212) 873-2020. Pres.: Joe Fields.

Labels: (Owned) Deluxe Music (distributed) Timeless Music

Mushroom Recs Inc. 9000 Sunset Blvd Suite 710 Los Angeles Calif 90069 Tel (213) 550 4502 TWX (910) 490-2538 Creative Servs & Artist Development Dir Susie Gershon Nat'l Promo Dir Liam Mullen A&R Dir Marc Gilutin Bus Affairs Dir Rick Block Prod'n Mgr Paul Stofferahn Mktg Dir Mark Cope **Int'l branch:** Canada

Labels: (Owned) Chanterelle Mushroom

Music Adventures Recs Inc. 12501 Madison Ave Cleveland Ohio 44107 Tel (216) 521-1222 Int'l Pres Jon J Baruth USA Pres Dan Baruth Exec Ass't to Pres Terry Bruno VP Nat'l A&R David Baruth VP Nat'l Promo Denny Corder VP Artist Development Patrick Daley VP Finance Terry Stovering Midwest Promo Mgr Denny Conrad Nat'l Pub Dir Donna Nichols

Branch: Martinez, Calif., PO Box 967 Zip 94553 Tel (415) 228-1971 Western A&R Debbie Wolfe Western Mgr Jim Blake

Int'l branch: Italy

Label: (Owned) Ohio

Muscianza Corp. 2878 Bayview Ave Wantagh N.Y. 11793 Tel (516) 862-2735 Pres Al Rubin

Music City, see Dawn

Music Ents Inc. 5626 Brock Houston Tex 77023 Tel (713) 926-4431 Pres Huey P Meaux Treas Aaron Schechter Sec'y Mary E Thornton Studio Mgr Mickey Moody

Labels: American Playboy Bego Crazy Cajun Jet Stream Pacemaker Star Flite

Music Factory Inc. 567 NW 27 St Miami Fla 33127 Tel (305) 576 2600 Pres Robert Archibald

Label: (Owned) Platinum

Music Inn. 169 W Fourth St New York N.Y. 10014 Tel (212) 243-5715

Music Is Medicine, see First American

Music Machine, see Dawn

Music Mill Recs (div of Johnny Morris Prod'ns) 21 Music Circle E Nashville Tenn 37203 Tel (615) 256-0700 Pres Johnny Morris Mktg & Promo George W Cooper III

Label: (Owned) MMI

Music Minus One, see MMO

Music of Many Lands, see Request

Music of Polynesia Inc. Ala Moana Bldg Suite 1500 Honolulu Hawaii 96814 Tel (808) 946 1677

Labels: (Owned) Melway Music of Polynesia

Muscor, see Springboard

Musicrama Recs. 68 Box St Brooklyn N.Y. 11222 Tel (212) 389-2477 (Exporter)

Music Resources Int'l Corp. 161 W 54 St Suite 601 New York N.Y. 10019 Tel (212) 265-6420 Pres Andy Hussakowsky Gen Mgr Gene O'Brien Bus Affairs Dir Joseph Leist Controller Paul Kreindler

Branch: Los Angeles, Calif., 1100 N Alta Loma Rd Zip 90069 Tel (213) 657-5000 659-6692 Exec VP Steve Brodie

Labels: (Owned) MRI (distributed) Channel Sahara Thunderbird

Musimex, see Musitron

Musi-Poe, see Sid Kleiner

Musi-Que, see Blue River

Musique Circle Recs. PO Box 7991 Long Beach Calif 90807

Musi-Que Contemporary, see Blue River

Musitron Inc. 2534 1/2 W Pico Blvd Los Angeles Calif 90006 Tel (213) 380-6840 Pres Erasmo C Dominguez VP & Mktg Sales PR & Adv Dir Luis A Conte Gen Mgr Reginald Peacock A&R Edgar Galvis Quality Control Dir Nora Dominguez

Labels: (Owned) Discomex Epsilon Musimex Q-Key Sonotropic Tamborin Torres (distributed) DIV/USA Del Sol Novodisc Row

Int'l reps: Colombia (Discomoda) Mexico (Anola) Venezuela (Disco de Moda)

Mustevic Sound Inc. 193-18 120 Ave St Albans N.Y. 11412 Tel (212) 527-1586 Pres Brenda Reid Dir Steve Reid Promo Dir Ayanna Kai Sales Dir Kahero Masemela Pub Dir Edith Sheppard A&R Chief Phillip Paterson

Labels: (Owned) Mustevic Sound (distributed) Ak Ba

Int'l reps: Austria (International Jazz Federation) Belgium (Jazz Rec.) France (Musica) Germany (BFC Int'l Ring Vertrieb Jazz) Italy (Hi-Fi La Bella Bella) Japan (OM) Netherlands (Replicars) UK (Projection)

Mutual Group of Rec'g Cos. 130 E Sixth St Cincinnati Ohio 45202 Tel (513) 621-6233 Pres & Exec Prod'r Bill Stith Exec Prod'rs Bud Reneau Carl Edmondson Promo Tim Ferguson Diane Woahmeyer

Branch: Columbus, Ohio, 16 E Broad St Suite 410 Zip 43215 Tel (614) 221-0660

Labels: (Owned) AMG Living Proof Mutual Pilot Master

Muza, see Polish Rec. Center

My Rec Co. see Suncat

Myrrh, see Word

Mystic Recs (div of Mystic Music Centre Inc.) 6277 Selma Ave Hollywood Calif 90028 Tel (213) 464-9667 Pres Doug Moody A&R & Special Projects Keith Powe Adv Pub & Country Suzy Moore Promo & Sales Steve Saulter

Labels: (Owned) Allegre Clock Mystic Sassafras Solar

N M I Miss, see Startown

N M I Prod'ns Corp. 516 W 75 St Kansas City Mo 64114 Tel (816) 333-9617 Pres Eugene Gold VP Gilbert Roland Exec Dir Sales & Mktg Roy Boykins A&R Mike Green Country A&R Harold Stark Promo Dir C King Promo Charles Smith

Labels: (Owned) Cory FBC NMI

N S D, see Nationwide Sound

Nang Rec Co. PO Box 2069 Chapel Hill N.C. 27514

Nasco, see Nashboro

Nashboro Rec Co. 1011 Woodland St Nashville Tenn 37206 Tel (615) 227-5081 Pres Bud Howell VP Shannon Williams

Labels: (Owned) Abet Creed Excello Mankind Nasco Nashboro (distributed) Kinwood

Nashville Int'l Corp. 20 Music Square W Nashville Tenn 37203 Tel (615) 256-2885 Cable NICORP Pres Reggie M Churchwell VP Ronald L Bailey Sec'y Treas & Sales & Mktg Peggy J Churchwell Controller Donna Ancelet Adv & Pub James E Gray

Branch: Hollywood, Calif., 6255 Sunset Blvd Suite 1116 Zip 90028 Tel (213) 464-4260

Labels: (Owned) Nashville Int'l Phoenix

National Music Ents. PO Box 35855 Houston Tex 77035 Tel (713) 499-5943 Mgr Dan Mechura Sr Country A&R Danny James

Labels: (Owned) Allstar Star

National Recs. 3410 Ave R Lubbock Tex 79412 Tel (806) 744-5590 Pres Bud Andrews

Labels: (Owned) Lemon National

Nationwide Sound Dist. PO Box 23262 Nashville Tenn 37202 Tel (615) 385-2704 Pres Joe Gibson VP David Noel Gibson Nat'l Promo Dir & Sales Mgr Betty Gibson Ass't Promo Dir Debbie Gibson Promo Edie McCroskey Secondary Promo Jerry Duncan

Labels: (Represented) Charta Hillside Hilltop King Coal Lineman NSD Pantheon Desert Phono Prairie Dust Soundwaves Travel

Natural Resources, see Motown

Nature's Music, see RCA

Nautilus Recs 761 Shell Beach Rd Pismo Beach Calif 93449 Tel (805) 773-1771 Mgr Bob Jonte

Labels: (Owned) Nautilus (distributed) ASI Coherent Sound East Wind JVC Romar Sound 80 Trend

Naw, see OK

Neliz, see Rico

Nemperor, see CBS

Neostat Music Co. 425 Bryn Mawr Birmingham Mich 48009 Tel (313) 647-1662 538-4444 Pres Harvey Yates

Nessa Recs. 5404 N Kimball Ave Chicago Ill 60625 Tel (312) 588-1204 Owner Charles Nessa (distributed by Flying Fish)

Int'l reps: Germany (Ring) Italy (Hi-Fi) Netherlands (Replicars) Sweden (Amigo) Switzerland (America Sound) UK (Projection)

Net, see Fisherfolk

Network Recs. Fifth Ave Plaza Des Moines Iowa Tel (515) 243-3116

Never Ending Music, see Argus

Newbery Award Recs Inc. Miller-Brody Prod'ns Inc 342 Madison Ave New York N.Y. 10017 Tel (212) 661-7166 Newbery Award Pres Claire G Miller Miller Brody Pres Selma R Brody Promo Dir Barbara A Lowe

Labels: (Owned) Miller Brody Prod'ns Newbery Award New Day see OCA in Ohio & Word

New Dimension Recs Inc. 218 W Broad St Statesville N.C. 28677 Tel (704) 873-0706 872-7769 Pres H Cowles Bristol VP Parks Allen Gen Mgr Jim Barrow

Label: (Owned) NDR

New Directions, see Dimitri

New England Bay, see Seal

New England Rec Co. Drawer 520 Stafford Tex 77477 Contact Daniel Andrade

Int'l rep: France (Crypto)

New Horizon, see Owl Rec Co

New Mex, see Godell

Newworld Media Rt. 175 South Blue Hill Me 04615 Tel (207) 374-5539 Owner/Pres Noel Paul Stookey Studio Mgr/Eng Stu Davis Eng John Stuart Mktg Dir Louis Mitchell Sec'y/Treas Elaine Sutherland

Int'l reps: Australia (Spotlight) UK (Word)

New Orleans Recs. 915 Louisiana St New Orleans La 70117 Tel (504) 949-2911 Partner Clive Wilson

Branch: Chicago, Ill., 5259 W Dakin Zip 60641 Tel (312) 282-5111 Partner Paige Van Vorst

New Orleans Soul, see King Walk

New Orleans Sound, see Great Southern

NewPax, see Paragon & Word

Newport, see Old Dominion

New Sound, see Accent

New Spirit Prod'ns Inc. PO Box 10 Talking Rock Ga 30175 Tel (404) 337-2201 Pres Curtis L Smith VP Sec'y Jimmy Gunn VP/Treas David Jackson

Branches: Atlanta Ga., 3005 Look Out Place NE Zip 30305 Tel (404) 231-0337 Woodstock N.Y., PO Box 116 Zip 12498 Tel (914) 679-7998

New Wine Prod'ns PO Box 544 Lomita Calif 90717 Tel (213) 326-8466 Owner & Pres G Nelson Stringer

New World, Miss., see Startown

New World N.Y., see Recorded Anthology & Peters Int'l

New York Int'l, see RCA

Newzonophone, see AcoustoGraphic

Nicholodenn Rec Co Inc. 717 Washington Ave Miami Beach Fla 33139 Tel (305) 538-3513 Pres Stephen J Nicholas VP Dr Ronald Stander

Nine, see Westbound

Ninth Note Recs Inc. 4116 Meadowlark Ln Eagan Minn 55122 Tel (612) 452-4066 Contact Bobby Jackson

Nirvana Recs. 1145 Green St Manville N.J. 08835 Tel (201) 725-4366 Pres & Gen Mgr Marc Zydiac VP & A&R Mary Ellen Clark

Nitro, see Eric Dynamic

We create sound packages...



For those of you who may not be familiar with what we do, we have been designing ads, album covers, labels, catalogs, tape graphics, etc. for over 20 years. We also set the type, do color separations, do the printing, make the jackets. Part of the reason we are still around and growing is that our clients know they can count on us — we're honest, tell it like it is and de-

liver a commendable job, usually on time. Since most of our work (layout, art, typography, camera, printing, etc.) is done internally by our own people and our own equipment we can maintain control of all work and at the same time be very competitive.

Small run and/or low budget: see our full color "Instant Album Covers" free catalog available.



Lee-Myles Associates, Inc.
 160 East 56th Street, N.Y., N.Y. 10022 Tel: 758-3232
 Cable: LEEMYLES • Plant: 645 West 44 Street
 Serving the graphic needs of the record industry since 1952.

N A P Recs Inc. 3941 Don Juan Abilene Tex 79605 Tel (915) 673-4843. 677-8601 Pres Charles D. Grisom

N D R, see New Dimension

N F M, see Startown

N J Int'l Rec Co. 2337 Neshaminy Blvd Cornwall Heights Pa 19020 Contacts Nathaniel & J J Williams

N J P Recs Inc. 1108 17 Ave S Nashville Tenn 37212 Tel (615) 327-4571 Pres Dave Converse Mdsq Dir Jon Markus

PolyGram Tele

REF: O U R W O R

TO MARKET MUSIC IN
THE WORLD, JUST CA
POLYGRAM.

Program No. 056

WORLD OF MUSIC

145 COUNTRIES AROUND
THE GLOBE ALL ONE NAME:

Nitty Gritty (South Africa), see David Gresham.
 No Gap, see Zim.
 No Holds Barred, see Request.
 Nomad, see Vanguard.
 Nonesuch, see Elektra/Asylum/Nonesuch
 Noodle Recs. Corp., 39 W. 55 St., New York, N.Y. 10019.
 Tel (212) 246-0385. Cable VERSATILE
 Labels: (Represented) Disco Int'l, Greedy, Gull (UK),
 MCP, Playboy (all for Latin America); Springboard Int'l
 (for Argentina, Bolivia, Central America, Colombia, Do-
 minican Republic, Mexico, Panama, Peru, Uruguay, Ve-
 nezuela).
 Norfolk-Int'l, see Legrand-Norfolk
 Norsk-Disk, see Lindberg
 Northern Light, see Fire Sign
 Northstar Studios Inc., PO Box D, 1831 1/2 Pearl St., Boulder,
 Colo. 80302. Tel: (303) 442-2001 Owner Alex Major
 Nostalgia, see Sonic Arts
 Nostalgia Lane Inc., 211 W. 56 St., New York, N.Y. 10019
 Tel (212) 582-5390 Co-Owners Lee Halperin, Nina
 Mattikow, Comptroller Harry Ringler; Sales Mgr Paul
 Kahan; Customer Relations Supervisor Yvonne Sim-
 mons. Local branch: 221 W. 57 St. Zip 10019 (SEE
 ADVERTISEMENT)

Nova-Sol, see Suncat.
 Novodisc, see Mustron
 Novola-Zafiro, see Coco.
 Now, N.J., see Argus.
 Now, Calif., see Original Sound.
 Nucleus Recs., PO Box 111, Sea Bright, N.J. 07760 Pres
 Robert N. Bowden; Sec'y Jean Schweitzer.
 No. 1, see Discos Latin.
 = 1 Rec. Co.—distributed by Big Tree through Atlantic.
 Nu-Sound Recs., 4701 Trousdale Dr., Nashville, Tenn
 37220. Tel: (615) 385-3726 Pres.: R. Hayes.
 NuTop Rec. Inc., 2439 S. Dorsey, Tempe, Ariz. 85282 Tel
 (602) 277-2132.
 Nu-Trayl Rec. Co., 10015 W. Eight Mile Rd., Franksville,
 Wis. 53126. Tel. (414) 835-4622. Owner Mary Hri-
 bar; Pres. & Gen. Mgr. Tommy O'Day (Distributed by
 World Int'l)
 Nutshell, see Institute for Language Study.

O

O B, see Discolando
 O D C Recs., 122 Elleta Dr., Gallatin, Tenn 37066 Tel
 (615) 452-5487 Contact Don Carroll. (Distributed by
 IRDA)
 O H B Recs. Co., 224 Haddon Rd., Woodmere, N.Y. 11598.
 Tel (516) 295-2358 Owner & Pres Walt Sterling.
 Int'l branch: Bahamas.
 O K Recs., 137 E. Sixth St., Austin, Tex 78701 Tel (512)
 477-7100. Owners Charles D. Tullos Jr., Leon Vernon
 Eagleson
 Labels: (Owned) Kidd, Loyal, Naw.
 O M P, see Olinger Music.
 O R C, see Ottoo.
 Oakridge Music Rec'g Serv., 2001 Elton Rd., Fort Worth,
 Tex. 76117 Tel (817) 838-8001/7623 Pres Homer
 Lee Sewell.
 Labels: (Owned) Arrowhead, Crossfire, Oakridge.
 Oasis, Calif., see Casablanca.
 Oasis, Fla., see Request.
 Oats (Ireland), see Shanachie.
 Ocean, see Ariola & Seal
 Odessa, see BaKim.
 Odyssey, see CBS
 Odir, see Penco.
 Ogham (Ireland), see Rounder
 Ohio, Cleveland, Ohio, see Music Adventures
 Ohio Recs., PO Box 655, Hudson, Ohio 44236 Tel (216)
 653-8295. Pres. Ethel P. Delaney, A&R R.T. Delaney,
 Country Mgr. Russ Delaney; Pub., Adv & Promo
 Sandy Lambert.

L'Oiseau-Lyre, see London.
 Old Boston, see Rik Tmory
 Old Dominion Recs. Group, PO Box 6025, Newport News,
 Va. 23606 Tel (804) 595-9000 Cable DOMIREC
 Chm. & Pres. E.F. Evans, Exec VP Michael Collins,
 Gen. Mgr. Bruce Rader; Classical A/R Mgr Sunnie
 Wilcoxin, Pop A&R Mgr. Demain Sinclair, Country
 A&R Mgr. Brendon Hale; Artist Relations Olivia Rowe,
 Bron K. Hilton, Roxanna Cohen; PR Gwynne Mark-
 wood.
 Branches: Wheaton, Md., 11250 Georgia Ave Zip
 20902. Tel (301) 949-6900 Dist'n Keith Landisburg,
 PR Rondell Wynkovich—Nashville, Tenn., 649 16
 Ave S. Zip 37203. Tel (615) 244-4400 Dist'n
 Carlton Wainwright, PR. Kent Bishop.
 Labels: (Owned) Baby Boy, Baby Girl, Del-Mar-Va,
 Kadia, Libido, Newport, Old Dominion, Parquette, Pen-
 insula, Renoir, Stud Guy
 Old Hat Recs., PO Box 54, Mansfield, Tex. 76063. Tel.
 (817) 477-2897. Pres. James Michael Taylor
 Branch: Portland, Ore., 224 NE 92 Pl. Zip 97220.
 Tel (503) 253-9519. Rep John W Taylor.
 Labels: (Owned) Old Hat, T2 Topple
 Old Homestead Rec. Co., Box 100, Brighton, Mich 48116
 Tel (313) 227-1997. Pres John Morris, VP Norma
 Morris.
 Labels: (Owned) Old Homestead, Rutabaga
 Oldie Blues (Netherlands), see Shanachie
 Oldies 45, see Vee Jay
 Old Timey, see Arhoolie.
 Old Town Rec. Corp., 41-43 39 St., Long Island City, N Y
 11104. Tel: (212) 786-7667. Telex: 235976
 Olenik Recs., G-10282 N. Saginaw Rd., Clio, Mich. 48420.
 Tel (313) 686-9644. Owner Nicholas H. Olejnik
 Label: (Owned) Song Request Magazine
 Olinger Music Prod'n., 11110 Los Alamitos Blvd., Suite
 215, Los Alamitos, Calif 90720 Tel (213) 431-5013
 Label: (Owned) OMP.

Olivia Recs. Inc., 2662 Harrison St., Oakland, Calif., 94612
 Tel. (415) 835-9620. Pres. Judith Dlugacz; VP Kate
 Winters; Sec'y Jennifer Woodul, Treas. Ginny Berson,
 Promo Dir.: Liza Williams, Dist'n Mgr. Sandra Ramsey,
 Staff Prod'r: Linda Tillery; A&R Dir.: Meg Christian, Fi-

nancial Dir. Elizabeth Brown, A&R. Mary Watkins, Te-
 resa Trull

Labels: (Owned) Olivia, (distributed) Bloodleaf, Deep
 River, Dream Machine, Sister Sun, Thunderbird, Trish
 Nugent, Windbag.
 Ollie, see Rollin' Rock
 Omega Recs Inc., PO Drawer 20005, Westland Sta., Jack-
 son, Miss 39209. Tel (601) 969-3673, 852-2062
 Exec Pres Vernon S. Weakley, Exec VP Robert E
 Rosenthal
 Omnisound Inc., Delaware Water Gap, Pa 18327 Tel
 (717) 476-0550. Pres. Ernest R. Farmer; Gen. Mgr
 Yoshio Inomata
 Branch: Lawndale, Calif., PO Box 67. Zip 90260 Tel
 (213) 679-6681 Western States Mgr Jack Gittings
 Ondas, see Indi.
 Open, see Loadstone & Open
 Open Channel Sound Co., see SRI.
 Opera Live, see Moss
 Operation Golden Hawk, see Crimson Dynasty
 Opus Recs Inc., 2716 Ocean Park Blvd., Suite 1050,
 Santa Monica, Calif 90405. Tel (213) 450-9092.
 Pres. Ilyia Bond
 Label: Metric
 Orbit Recs., 100 Harvard Ave., Gadsden, Ala 35901 Tel
 (205) 546-6906 Pres Ray McGinnis, A&R Chuck
 McGinnis
 Labels: (Owned) Orbit, (distributed) Etowah.
 Oreo, see Vintage
 Orfeon Recs Inc., 2837 W. Pico Blvd., Los Angeles, Calif
 90006 Tel (213) 737-1223
 Home office: Mexico, Discos Mexicanos SA
 Branch: New York, N.Y., 689 10 Ave. Zip 10036 Tel
 (212) 581-4639
 Labels: (Owned) Dimsa, Orfeon.
 Orfeu, see Penco
 Organ, see Beserkley.
 Orient, see Rashid & Rounder
 Original Cast, see Take Home Tunes!
 Original Sound Recs., 7120 Sunset Blvd., Hollywood, Calif
 90046 Tel (213) 851-2500. Pres Art Laboe; Opns
 Mgr Joe Daigle
 Labels: (Owned) Now, Original Sound
 Orinda Rec'g Corp., 23 Altarinda Rd., Orinda, Calif 94563
 Tel. (415) 254-7600 Telex: 335448 Pres Michael R
 Phillips, VP's Robert Lundberg, John Hobberlin; Nat'l
 Sales Mgr. Grant Richards, PR Dir. C. Bennett.
 Orion Master Rec'gs Inc., PO Box 4087, 5840 Busch Dr.,
 Malibu, Calif. 90265. Tel (213) 457-3370. Pres. Giv-
 on Cornfield, Sec'y-Treas. Marion Cornfield, Mktg
 Consultants Earl Horwitz, Larry Sockell.
 Labels: (Owned) Orion, (distributed) CCC/Orion
 Int'l reps.: Italy (Sciascia), Spain (Dial), UK (Ember).
 Orlando Recs., 7513 Lake Dr., Orlando, Fla 32809. Tel
 (305) 855-8920. Contact: Carroll Fulmer.
 Oro, see DGJ
 Oryx (UK), see CMS.
 Oscar, see Alshire
 O'Sullivan's Inc. (div. of Yesterday's Inc.), PO Box 624, Tay-
 lors, S.C. 29687. Tel (803) 268-7743 Pres. James B.
 Rogers; Gen. Mgr. David Rowland; Promo Dir. Gary
 O'Sullivan, Music Reproductions Danny Lancianese
 Otisville, see McKinnon.
 Ottoo Recs Co. Int'l Ltd., 214 W. 96 St., New York, N.Y.
 10025 Tel (212) 866-2469 Cable OTOARECO.
 Pres L.R. Bernard, VP's B & M Bernard, Gen Mgr.
 Rafael Sanabia.
 Labels: (Owned) Colony, ORC, Sugar-Soul, Taino, (dis-
 tributed) Dinsa, Fenix.
 Outlet (Ireland), see Rounder
 Outlet Recs., Box 594, 118 Main St., Rocky Mount, Va
 24151. Tel (703) 483-0689. Owner & Pres. W. Rod
 Shively
 Labels: (Owned) Mount, Outlet
 Out of Town, see AVI.
 Output, see Jersey Coast
 Outrageous Recs. Inc., 186 Willow Ave., Somerville, Mass.
 02144. Tel (617) 354-0700 Co-Owner & Music Dir.
 Phil Wilson; Co-Owner & Promo Dir. Al Julian (Distrib-
 uted by Rounder)
 Outstanding Recs., PO Box 2111, Huntington Beach, Calif
 92647. Tel (714) 842-8635 Owner Earl S. Beecher
 Labels: (Owned) Morrhythm, Outstanding; (distributed)
 Camerata Tokyo (Japan)
 Intl reps.: Germany (Discofon), Japan (Camerata
 Tokyo), Sweden (Disc Music)
 Ovation Inc., 1249 Waukegan Rd., Glenview, Ill 60025.
 Tel (312) 729-7300. TWX (910) 651-4856. Pres
 Richard L. Schory; Nat'l Sales Margaret Schwegler;
 Nat'l Mktg Dir. David Webb, Pop/AOR Promo Dir
 Greg Dodd; Nat'l Pub. Dir.: Cary Baker
 Branches: Beverly Hills, Calif., 9606 Santa Monica
 Blvd Zip 90210. Tel (213) 275-4007—Nashville,
 Tenn., 803 18 Ave Zip 37203 Tel (615) 327-4871
 VP Nashville Opns. Bren Fisher, Gen Mgr.: Robert
 John Jones, Nat'l Country Promo Dir Michael Rad-
 ford, Ass't Nat'l Country Promo Dir Skipper Stevens
 Int'l reps.: Australia (RCA), Canada (RCA), UK (Poly-
 dor) (SEE ADVERTISEMENT)
 Overseas Wax, 1650 Broadway, New York, N.Y. 10019
 Tel (212) 541-9198 Pres., Sales & Adv. Mgr. David
 Franklin
 Owl Intermedia, see Owl Recs in Ohio
 Owl Rec. Co., PO Box 48, Lithia Springs, Ga 30057. Owner
 Jeff Brannon.
 Labels: (Owned) Legacy, New Horizon, Owl
 Owl Recs., 2551 Sunbury Rd., Columbus, Ohio 43219 Tel
 (614) 475-7309 Pres Ed Mikusa, A&R Mgr. Robin
 Jenney, Promo Dir Sterling Smith, West Coast A&R
 Dir Tom Smith
 Labels: Owl, Owl Intermedia
 Oyster, see Polydor
 Ozark Opry Inc., PO Box 242, Osage Beach, Mo 65065
 Tel (314) 348-2702/2270 Owner & Pres Lee Mace,
 Gen Mgr Harold Luck
 Labels: Kajac, Vision, (distributed) Four Leaf Clover, 2-
 J

P

P A Ents Inc., John Hancock Center, Suite 5404, 875 N.
 Michigan, Chicago, Ill 60611 Tel (312) 337-5643
 Pres.: Andy Pappas; VP Mktg. Bill Demis; Nat'l Promo-
 Les Davis; Int'l Promo Mario Contreras
 Labels: (Owned) Jahrock, Pa., Pygmy.
 P B R Int'l, 7033 Sunset Blvd., Los Angeles, Calif 90028
 Tel (213) 462-0833 Mng Dir Patrick Boyle; Gen.
 Mgr. Maritta Boyle; Sales Mgr Michael Russ
 Int'l reps.: Argentina (RCA), Austria (Ariola-Eurodisc),
 Canada (Trend), Germany (Ariola-Eurodisc), Mexico
 (Guitarra), Portugal (Radio Triunfo), Switzerland (Ariola-
 Eurodisc).
 P M Recs Inc., 20 Martha St., Woodcliff Lake, N.J. 07675
 Tel (201) 391-2486. Pres. Gene A. Perla; VP: Mary
 Perla
 Int'l branch: Canada, Post Meridien Prod'n's
 P R A S, see Rico
 P V C Recs., c/o Jem Recs., 3619 Kennedy Rd., South
 Plainfield, N.J. 07080 Tel (201) 753-6100 Pres.
 Marty Scott, VP Ed Grossi, Mktg. Servs. Mgr. Carol
 Green; Promo Phillip Page
 Pablo Live, see Pablo Recs. & RCA.
 Pablo Recs Inc., 451 N. Canon Dr., Beverly Hills, Calif.
 90210 Tel (213) 274-9831. Cable JAZPHIL Pres.
 Norman Granz, Exec. VP Mktg. & Promo. Albert Bramy,
 VP Eng'g Val Valentin. (Distributed by RCA)
 Labels: (Owned) Pablo, Pablo Live, Pablo Today
 Pablo Today, see Pablo Recs. & RCA
 Pacemaker, see Music Ents
 Pacific, see Atlantic.
 Pacific Challenger, see Do-Tell.
 The Pacific Arts Corp Inc., PO Box 5547, Carmel, Calif.
 93921 Tel (408) 624-4704 Telex 351455 Pres
 Michael Nesmith, VP Kathryn Nesmith; Mktg. Dir.: Rick
 Orr, Promo Dir. David Bean; Prod'n Mgr Ann New-
 hus-Schwarz.
 Pacific Recs., c/o Warner Bros Music, 9200 Sunset Blvd.,
 Hollywood, Calif 90069 Tel (213) 273-3323 Pres.
 Ed Silvers; Exec. VP Mel Bly. (Distributed by Atlantic)
 Page Rec'g Co., 604 Broad St., Johnstown, Pa 15906. Tel:
 (814) 539-8117 Owner & Pres. Al Page; Promos.: An-
 thony Page.
 Labels: (Owned) Aljo, Page, Ponderosa.
 Painted Smiles Recs (sub. of Battery Recs Inc.), 116 Nassau
 St., New York, N.Y. 10038 Tel. (212) 964-3140.
 Pres Ben Bagley
 Palace, see Caprice & Buzz Cason.
 Palladium Recs., 1650 Broadway, New York, N.Y. 10019.
 Tel (212) 581-6162. Contacts: Stephen Metz, Joseph
 Rapp
 Palm, see Criterion.
 Palmer, Pa., see Dawn
 Palmer, Tenn., see World Int'l.
 Palmetto Recs., 741 NW 137 St., North Miami, Fla 33168
 Tel (305) 681-5336. Chief Exec. Gene Roy.
 Pamlyn Recs., PO Box 6211, Cleveland, Ohio 44101 Pres
 Robert Wright, Gen. Mgr & Promo. Becky Strauss, Mu-
 sical Dir. Otto Mann.
 Labels: (Owned) Pamlyn, Tall Man
 Panama Recs., 831 W. 39, Kansas City, Mo. 64111. Tel
 (816) 531-6283. Pres Chris Fritz, VP Stan Koron
 Panama, N.Y., see Polydor
 Pan Americana, see Pan American.
 Pan American Recs. Inc., 3751 W. 26 St., Chicago, Ill.
 60623 Tel (312) 521-1100. Pres Gustavo Silva,
 Sec'y Isabel C Silva, Treas. J Manuel Calvo; Buyer J.
 Noel Munoz.
 Labels: (Owned) Pan Americana
 Panart Int'l Inc., 477 W. 27 St., Hialeah, Fla 33010 Tel
 (305) 887-1391 Cable PANARTREC.
 Int'l branch: Venezuela
 Panini Recs / Panini Prod'n's Inc., PO Box 15808, Honolulu,
 Hawaii 96815 Tel (808) 947-4985 Pres Steven O
 Siegfried, VP Witt H.P. Shingle, Sec'y-Treas. Law-
 rence N. Brown
 Panorama, see RCA.
 Pantego Sound Studios, 2210 Raper Blvd., Pantego, Tex
 75013. Tel (817) 461-8481 A&R Charles Stewart.
 Labels: (Owned) Express, Pantego, Plain.
 Pantheon Desert Recs., 6325 N. Invergardon Rd., Scotts-
 dale, Ariz 85253. Tel (602) 948-5883 Owner Den-
 nis R Alexander, Prod'r Brent Burns, Sales & Mktg.
 Cheri Alexander, Steve Moore (Distributed by Nation-
 wide Sound).
 Paradise Recs. Inc., 4720 W. Magnolia Blvd., Burbank,
 Calif 91505. Tel (213) 980-5644. Pres. Leon Rus-
 sell; Mgr.: Diane Sullivan. (Distributed by Warner Bros.)
 Paragon Assocs Inc., 19 & Hayes, Nashville, Tenn 37202.
 Tel (615) 327-2835 Pres. Robert R. MacKenzie, Gen
 Mgr Wayne Erickson, Promo & PR Larry Black, Mfg
 Greg Crouse (Distributed by Word)
 Labels: (Owned) Joy Song, NewPax, Paragon
 Paramount-West Ents., PO Box B, Mira Loma, Calif 91725
 Tel (714) 735-5845
 Labels: (Owned) Constitution, Para-West, Podium, Ro-
 deo, Soul Merchant.
 Parasound Inc., 680 Beach St., San Francisco, Calif 94109
 Tel (415) 673-4544 Cable DOOBYYODO Pres Bern-
 ard Krause, VP Sid Goldstein; Promo. Mgr.: Jayne
 Winter
 Para-West, see Paramount-West.
 Paredon Recs., 33 W. 17 St., New York, N.Y. 10011 Tel
 (212) 242-6001.
 Parlophone, see Discos Latin
 Parquette, see Old Dominion
 Parrot, see London
 Parr-X Corp., 8809-11 Rising Sun Ave., Philadelphia, Pa.
 19115 Tel (215) 676-8992 Pres Frank Virtue,
 Sec'y-Treas. Mary Bozzi; A&R Dir Mary Ann Virtue,
 R&B/Soul A&R Johnny Rites, Promos Linda Virtue,
 Melvin Wells
 Labels: (Owned) Fayette, Rising Star, Virtue
 Part T, see Modern Sound.
 Passport Recs Inc., 3619 Kennedy Rd., South Plainfield,
 N.J. 07080 Tel. (201) 753-6100. Telex 833438.

Pres. Marty Scott; VP Ed Grossi; Mktg. Servs. Mgr.: Carol Green; Int'l Co-ord. Phylis Pannone-Craig; Promo. Arnie Handwerker.
Labels: (Owned) Passport, Visa.
 Pastoral Music Co., 235 Sharon Dr., San Antonio, Tex. 78216. Tel: (512) 822-3593. Pres.: Carolyn Cunningham; Mgr.: W. Patrick Cunningham.
 Patefonas, see Clay Pigeon.
 Path, see McKinnon.
 Pathe Marconi-EMI (France), see Connoisseur Society.
 Pathways of Sound Inc., 102 Mt. Auburn St., Cambridge, Mass. 02138. Tel: (617) 354-6190. Pres.: Joe Berk; Mktg. Dir.: D. C. Littlefield.
Labels: (Owned) Cedro, Pathways of Sound.
 Paula, see Jewel.
 Pausa Inc., 9255 Sunset Blvd., Rm. 625, Los Angeles, Calif. 90069. Tel: (213) 274-6331.
 Pavillion, see CBS.
 Pax, see Tempo.
 Peaceable Music, 3525 Encinal Canyon Rd., Malibu, Calif. 90265. Tel: (213) 457-4405. Pres.: C. Randolph Nauert; Gen. Mgr.: Patricia Nauert; Mktg. & Art. Kathy Morphesis; Promo.: R. Nauert; Country A&R: Larry Groce.
 Peak, see Metrobeat.
 Peanut Country, see Legrand-Norfolk.
 Pearl, see Delmark.
 Pearl Harbor, see Associated Rec'g Cos.
 Pearly Gates, see Startown.
 Pedigree, see Horizon Publ'g.
 Peek, see Jim Hall.
 Peer-Southern Org., 1740 Broadway, New York, N.Y. 10019. Tel: (212) 265-3910. Cable: SOUTHMUSIC. Telex: 4243361. Pres.: Monique I. Peer; VP's: Ralph Peer II, Mario Conti.
Branches: Los Angeles, Calif., 6922 Hollywood Blvd. Zip 90028. Tel: (213) 469-1667. Mgr.: Roy Kohn—Miami, Fla., Northeast Airlines Bldg., Rm. 1409, 150 SE Second St. Zip 33131. Tel: (305) 358-1488. Mgr.: Omar Merchant—Nashville, Tenn., 7 Music Circle N. Zip 37203. Tel: (615) 244-6200. Prof. Assoc.: Debbie Cobb.
Int'l branches: Canada, England, Italy, Sweden.
Labels: (Owned) Discos Monica, Pic SOUND, Spark; (distributed) Southern Library of Rec'd Music.
 Pega, see Discos Latin.
 Pelican Recs Inc., 122 N. Kirkman Rd., Orlando, Fla. 32811. Tel: (305) 295-5079. Pres.: Glenn Hamman Jr.
 Pema (France), see DRG Recs.
 Penco Recs. Inc., 428 Wood St., New Bedford, Mass. 02745. Tel: (617) 995-0595. Cable: PENRECO. Pres.: Francisco M. Penha; VP: Francisco A. Penha.
Int'l branch: Canada.
Labels: (Owned) Coimbra; (distributed) Alvorada, Clave, Lisboa, Ofir, Orfeu, Rapsodia, Roda, Telectra, Vadeca.
 Peninsula, see Old Dominion.
 Pennant Releasing Group (a P. F. B & M Co.), PO Box 371, Beverly Hills, Calif. 90213. Tel: (213) 652-9627. Gen. Mgr.: F. Stuart Wilson.
Branch: Chicago, Ill., P. F. B & M (Phillips, Fountain, Bradshaw & Meade), 323 S. Franklin Ave., Suite 804, Zip 60606. Bd. Chm./Pres.: C. Ross Bradshaw.
Labels: (Owned) Pennant, Stripe 99.
 Pennetration, see Aladdin.
 Peralta (Brazil), see Fermata.
 Perceptive, see Sine Qua Non.
 Marcus Pereira (Discos) (Brazil), see Brasilia.
 Perfect, see Timeless.
 Period, see Everest.
 Periscope Rec. Co., 129 Bishop St., Brockton, Mass. 02402. Tel: (617) 588-6348. Pres.: Edward M. Hurvitz; Rec'g Dir.: Ed Michaels; Mktg. Mgr.: Linda Beraman.
Labels: (Owned) Periscope, Streke.
 Personal Choice, see Gillette-Madison.
 Pesante Rec. Co., 744 W. 28, Norfolk, Va. 23508. Tel: (804) 623-5710.
 Petco Int'l Inc., 88-20 Corona Ave., Elmhurst, N.Y. 11373. Tel: (212) 699-5258. Pres.: Robert Petrone.
Int'l reps.: Colombia (Fonobosa), Costa Rica (Indica), Ecuador (IFESA), Mexico (Musart), Peru (Petco), Puerto Rico (Rio Piedras).
 Pet Recs./Tapes, PO Box 1102, Burbank, Calif. 91507. Tel: (213) 874-7656. Pres.: Peter Tevis; Promo.: Gale Hawk; Sales Mgr.: Carol Haak.
 Peter Pan Inds., 145 Komorn St., Newark, N.J. 07105. Tel: (201) 344-4214. Pres.: Martin Kasen; VP: Donald Kasen; Nat'l Sales Mgr.: James Monaghan; Southern Reg'l Sales Mgr.: Perry Saltier; Mid-West Reg'l Sales Mgr.: David Wulfsohn; Eastern Reg'l Sales Mgr.: Irving Rosing; Sales Admin'r: Adele Breitbarth.
Branch: Paramount, Calif., 15714 Garfield Ave. Zip: 90723. Tel: (213) 663-1994. Pacific Reg'l Sales Mgr.: Robert Rice.
 Peter Rabbit, see Alshire.
 Peters Int'l Inc., 619 W. 54 St., New York, N.Y. 10019. Tel: (212) 246-2400. Cable: PETERSRECS. Telex: 666262. Pres.: Chris Peters Sr.; Exec. VP: James Bailey, VP: Chris Peters Jr.; Nat'l Sales Mgr.: Chris Spinosa; Licensing Dir.: Thomas Pappageorge; Mktg. Dir.: Pierre Bourdain; Mfg. & Purchasing Dir.: Mel Mager; Contemporary A&R Mgr.: Jim Kosloski.
Int'l branch: Canada.
Labels: (Owned) Aris, Cosmos, Kronos, Peters Int'l, West 54; (distributed) Anon, New World.
 Petra, see Paul Johnson & Tempo.
 Phantom, see Windfall.
 Pharoah Recs. Corp., 1260 E. Main St., Meriden, Conn. 06450. Tel: (203) 728-5639. Cable: BELHOP. Pres.: Bruce Lloyd; VP & A&R Dir.: John Michalek; VP: Sue Lloyd; Sales & Mktg.: Ted Berman.
Labels: (Owned) Hard Times, Pharoah.
 Phase 4, see London.
 Philadelphia Int'l Recs., 309 S. Broad St., Philadelphia, Pa. 19107. Tel: (215) 985-0900. Bd. Chm.: Kenneth Gamble; Vice Chm.: Leon Huff; Exec. VP: Harry J. Coombs; Ass't to Exec. VP: Parthena Graham; VP Finance: Larry Depte, Legal & Bus. Affairs Dir.: Philip Asbury; Pub./Adv./Mdsq./Promo./Artist Relations Mgr.: Becki Butler, A&R Co-ord.: Jean Scott; Ass't

Comptroller: Shirley Collins; Community Affairs Dir.: Harold Preston (Distributed by CBS).
Labels: (Owned) Philadelphia Int'l, TSOP.
 Philips, see Classics Int'l.
 Philips (Brazil), see Brasilia.
 Philips-Dutch Swing College Band, see Lakko.
 Phil-LA. of Soul, see Jamile/Guyden.
 Pili World, see So. Philly.
 Philo Recs. Inc., The Barn, North Ferrisburg, Vt. 05473. Tel: (802) 425-2111. Cable: PHILODISC. TWX: (510) 299-0029. Pres.: Michael Couture; VP A&R: William Schubart; Finance: Robert Crenshaw; Prod'n: Carol Ford; Promo.: Nova Stats; Eng'g Servs. Dir.: Charles Eller.
Labels: (Owned) Fretless, Philo.
Int'l reps.: Canada (Almada, London), France (SFPP), Germany (Bellaphon), Italy (Hi-Fi), Norway (Helgeland's Imports), UK (Projection).
 Phoenix, Tenn., see Nashville Int'l.
 Phoenix Jazz Recs. Inc., PO Box 3, Kingston, N.J. 08528. Pres.: Tom Curry; Sec'y-Treas.: Russ Chase.
 Phono, see Soundwaves & Nationwide Sound.
 Phonogram (Brazil), see Brasilia.
 Phonogram Inc./Mercury Recs. (sub of PolyGram Corp.), 1 IBM Plaza, Chicago, Ill. 60611. Tel: (312) 645-6300. Cable: PHONOGRAM. Bd. Chm. & Chief Exec. Officer: Irwin H. Steinberg; Pres. & Chief Operating Officer: Robert M. Sherwood; Sr. VP Mktg.: Lou Simon; VP/Finances: Dennis McCarthy; VP Sales: Mick Brown; VP R&B Prod.: Bill Hayward; VP Nat'l Promo.: Jim Jeffries; Controller: Jeannette Lindner; Nat'l Singles Promo.: Jay McDaniel; Nat'l LP Promo.: Jim Sotet; Midwest Publ.: George Kne Meyer.
Branches: Los Angeles, Calif., 6255 Sunset Blvd. Zip: 90028. Tel: (213) 466-9771. Nat'l Pub. Dir.: Eileen Bradley; Nat'l Promo./West Coast: Jimi Fox—New York, N.Y., 810 Seventh Ave. Zip: 10019. Tel: (212) 399-7485. VP East Coast A&R: Steve Katz; East Coast Pub. Sherrie Levy; Artist Tours/Press Liaison: Susan Scivoletti-Parks—Memphis, Tenn., 200 Madison Ave. Zip: 38104. Tel: (901) 726-6000. A&R: Judd Phillips—Nashville, Tenn., 10 Music Circle S. Zip: 37203. Tel: (615) 244-3776. VP Country A&R: Jerry Kennedy; Nat'l Country Promo.: Frank Leffel; Southern Pub. Mgr.: Janet Rickman.
Distribution branches: Los Angeles, San Francisco, Calif.; Miami, Fla.; Atlanta, Ga.; Chicago, Ill.; Greenbelt, Md.; Boston, Mass.; Detroit, Mich.; St. Louis, Mo.; Cherry Hill, N.J.; New York, N.Y.; Cleveland, Ohio; Dallas, Tex.; Seattle, Wash. (See Record & Tape Wholesale section for complete listings for Polygram Dist'n Inc.)
Labels: (Owned) Mercury; (distributed) DJM, De-Lite, Monument, Riva, Zappa.
Int'l reps.: Argentina (Phonogram), Australia (Phonogram), Austria (Phonogram), Belgium (Phonogram), Bolivia (Discolandia Dueri), Brazil (Companhia Brasileira de Discos), Canada (PolyGram), Chile (Philips), China (Four Seas), Colombia (Philips), Congo (Phonogram in Zaire), Denmark (Phonogram), Dominican Republic (Saion de Estudios), Ecuador (Fedisos), Finland (Finnlevy), France (Phonogram), Germany (Phonogram), Ghana (Phonogram), Greece (Phonogram), Guatemala (Dideca), Hong Kong (Polydor), India (Polydor), Iran (Ahang Rocz), Ireland (Polydor), Israel (Isralectra), Italy (Phonogram), Jamaica (Record Specialists), Japan (Nippon Phonogram), Kenya (Phonogram), Korea (Sung Eum), Lebanon (Philips), Mexico (Polydor), Morocco (Siemens), Netherlands (Phonogram), New Zealand (Phonogram), Nigeria (Phonogram), Norway (Norsk Phonogram), Panama (Sonomundi), Peru (El Virrey), Philippines (Home Inds.), Portugal (Phonogram), Singapore (Phonogram), South Africa (Trutone), Spain (Fonogram), Sweden (Phonogram), Switzerland (Phonogram), Trinidad (Record Specialists), Turkey (Gruenberg Ticaret), UK (Phonogram), Uruguay (Edisa), Venezuela (Polydor), West Indies (West Indies Recs.).
 Phono Rec. Dist'g Corp., 6425 Hollywood Blvd., Suite 208, Hollywood, Calif. 90028. Tel: (213) 464-4795.
Labels: (Owned) Hitbound Int'l, R'CADE, Super Star; (distributed) Epitome, Shaffer, Sky High, Swinger.
 Phonosonic, see Steady.
 Physical, see Rounder.
 Piccadilly, see First American.
 Pick (Brazil), see Fermata.
 Pick-A-Hit, see SIPRA.
 Pickin' Post Ent's., PO Box 51, Watertown Hwy., Lebanon, Tenn. 37087. Tel: (615) 449-1770, 444-3253. Owner & Pres.: Jewell W. Nave; VP: Joe W. Nave; Sec'y: Nancy Jewell Nave.
Labels: (Owned) Jewell Tone, Pickin' Post.
 Pickwick Recs. (div. of Pickwick Int'l), 7500 Excelsior Blvd., Minneapolis, Minn. 55426. Tel: (612) 932-7869. Gen. Mgr.: Richard Bibby; Mktg. Dir.: Ron Harvieux; A&R Mgr.: Steve Vining; Nat'l Sales Mgr.: Ken Yastic; Specialty Sales Mgr.: Dan Mounts; Opns. Dir.: Jim Tuller.
Branches: Sun Valley, Calif., 11350 Sherman Way, Zip 91352. Tel: (213) 764-5050. West Coast Div. Reg'l Sales Mgr.: Michael Mathewson—Atlanta, Ga., 365 Patton Dr. SW. Zip 30336. Tel: (404) 696-1850. East Coast Div. Reg'l Sales Mgr.: Larry Menatre—Arlington, Tex., 2200 E. Randol Mill Rd. Zip 76011. Tel: (817) 261-4281. Central Div. Reg'l Sales Mgr.: Tom Colley.
Labels: (Owned) Mr. Pickwick, Pickwick, Quintessence; (licensed—USA & Canada) Camden.
 Pic SOUND, see Peer-Southern.
 Pic-Vue, see Vantage.
 Pic Paper Recs., PO Box 5251, Evansville, Ind. 47715. Tel: (812) 477-8885. Pres.: Bob Alexander.
 Pied Piper, N.C., see Charma.
 Pilgrim, see Spiral.
 Pilot, see Stark.
 Pilot Master, see Mutual Group.
 Pina, see TR.
 Pine Tree, see Melody.
 Pioneer, see Sivatt.
 Pirate Recs. (div. of New Vista Music Corp.), PO Box 801, Williamsville Branch, Buffalo, N.Y. 14221. Pres.: David Coutts; Gen. Mgr.: John Watt.

Pitch, see Gusman.
 Plain, see Pantego.
 Planet Recs., 9120 Sunset Blvd., Los Angeles, Calif. 90069. Tel: (213) 275-4710. Pres.: Richard Perry; VP: David Urso. (Distributed by Elektra/Asylum)
 Plantation, see Shelby Singleton.
 Platinum, see Music Factory.
 Platinum Int'l Recs., 3256 Laurel Canyon Blvd., Studio City, Calif. 91604. Tel: (213) 766-1529. Contact: Laurance Hurwich.
 Platinum Sound Recs., 502 1/2 S. Berendo St., Los Angeles, Calif. 90026. Tel: (213) 387-6450. Pres.: K.H. Smith; VP: S.C. Scott.
 Playette Corp., 301 E. Shore Rd., Great Neck, N.Y. 11023. Tel: (516) 487-3064. Pres.: Sidney A. Evans.
Labels: (Owned) GMS-Disc, Wilmac; (distributed) Ades (France), Cetra (Italy), DGG-Green Label (Germany), Pleiade (France).
 Playground Recs., PO Box 133, Ojai, Calif. 93023. Pres.: Jim Pewter.
 Playhouse Recs., 126 S. Main St., Monroe, N.C. 28110. Tel: (704) 289-4459.
 Playme, see WILD.
 Pleason Recs., 1727 Roanoke Ave., Sacramento, Calif. 95838. Tel: (916) 925-4886. Owner: Jerry Parker.
 Pleiade (France), see Playette.
 Pliant, see Vantage.
 Podium, see Paramount-West.
 Poima Music, 8996 Fruitridge Rd., Sacramento, Calif. 95826. Tel: (916) 383-4387. Gen. Mgr./Adv. Dir.: Vladimir Sirota; Prod'n Mgr.: Thomas Conrad.
Label: (Owned) Rainbow.
 Point Blank Prod'n's, 2849 Granville, Los Angeles, Calif. 90064. Tel: (213) 478-8850. Pres.: Neil Avery; VP A&R/Opns. Dir.: Ronald L. Shaull; Promo. Co-ord.: Michael Davis; Sales/Dist'n Co-ord.: Michael Bennett; Artist Development: Michael Walthus.
Branch: Jackson, Mich., 1636 E. Michigan Ave. Zip 49202. Tel: (517) 782-3445. Int'l Opns. Dir.: Hans Fruechtenicht; Eastern Opns. Dir.: Leon Hemminger.
Labels: (Owned) 1108, Flying Disco Disc, Point Blank, Ultra-Audio; (distributed) Central Sounds, Polka-rama.
 Poki, see Tropical Music.
 Polish Rec. Center of America, 3055 Milwaukee Ave., Chicago, Ill. 60618. Tel: (312) 772-4044.
Labels: (Owned) Melodia. (distributed) Muza.
 Polka-rama, see Point Blank.
 Polka Tone, see Jay Jax.
 Polka Towne Music (div. of Polka Music Corp.), 211 Post Ave., Westbury, N.Y. 11590. Tel: (516) 334-6228.
 Poltergeist, see Crimson Dynasty.
 Polydor (Brazil), see Brasilia.
 Polydor Inc., 810 Seventh Ave., New York, N.Y. 10019. Tel: (212) 399-7075. Bd. Chm.: Irwin H. Steinberg; Pres.: Fred Haayen; Exec. VP: Dick Kline; Sr. VP Bus. Affairs: Dr. Ekke Schnabel; Sr. VP Mktg.: Harry Anger; VP Finance: Steve Salmonsohn; VP Sales: Mario DiFilippo; VP A&R: Rick Stevens; VP Artist Development: Jerry Jaffe; VP Special Projects: Sonny Taylor; VP Promo.:



Jamie/Guyden
DISTRIBUTING CORP.

JAMIE RECORDS

PHIL-LA. of SOUL RECORDS

WRITE FOR OUR GROWING LIST OF
SUPER OLDIES

... "where there's
always a hit"

919 N. BROAD ST., PHILA., PA. 19123
(215) CE 2-8383

Jim Collins; Nat'l Promo Dir /Special Markets Bob Frost; Bus. Affairs Dir. Chris Whent; Nat'l Singles Sales Mgr. Randy Roberts; Creative Servs. Dir. Bill Levy; Nat'l Pub. Dir. Carol McNichol; Nat'l AOR Radio Dir. Bill McGathy; East Coast A&R Dir. Stu Fine; East Coast Reg'l Mktg. Mgr. Tony Orr; Nat'l Disco Promo Mgr. David Steel; Int'l Exploitation Mgr. Jerry Voisin
Branch: Hollywood, Calif., 6255 Sunset Blvd. Zip 90028. Tel. (213) 466-9574. VP & West Coast Gen. Mgr. Marty Goldrod; West Coast Pub. Dir. Len Epanid; West Coast A&R Dir. Steve Duboff; West Coast Reg'l Mktg. Mgr. Robert Speiman
Distribution branches: Los Angeles, San Francisco, Calif.; Miami, Fla.; Atlanta, Ga.; Chicago, Ill.; Greenbelt, Md.; Boston, Mass.; Detroit, Mich.; St. Louis, Mo.; Cherry Hill, N.J.; New York, N.Y.; Cleveland, Ohio; Dallas, Tex.; Seattle, Wash. (See Record & Tape Wholesalers section for complete listings for Polygram Dist'n Inc.)

Home office: Germany
Labels: (Owned) MGM, Molyvd, Verve, (distributed) BGO, Charisma, EG, Harlem, PVP, Magnet, Manken, Oyster, Panama, Radar, Spring

Polygram (Brazil), see Brasilia
PolyGram Corp., 450 Park Ave., New York, N.Y. 10022. Tel. (212) 371-3000. Worldwide Pres. Coen Solleveld, Exec VP Irwin H. Steinberg; Sr. VP Finance Edward Forast; VP Law Arnold I. Rich; VP Taxes Peter Dordal
Operating companies: Capricorn Recs., Casablanca Rec. & FilmWorks, Chappell Music, Classics Int'l, Intersong Music, Phonogram Inc./Mercury Recs., Polydor Recs., Polygram Dist. Inc., Polymusic, RSO Recs. (SEE ADVERTISEMENT)

Polygram (Portugal), see Brasilia
Ponderosa, see Page
Portland Ltd., see Gibson
Portrait, see CBS
Pose, see Cord

Posh Boy Servs., 4205 W. Sixth St., Los Angeles, Calif. 90020. Tel. (213) 464-3001. Pres. & Sales Robbie Fields; A&R Brendan Mullen; Art Dir. Ginger Canzoneri; Artist Relations Jennie Stern; Mktg. Kendall Behnke

Int'l branch: England.
Labels: (Owned) Meat Man, Posh Boy
Positive Int'l Prod'n Inc., 4323 Bluffview Blvd., Dallas, Tex. 75209. Tel. (214) 352-4821. Pres. James Gribble III
Potato, see First American
Power Pak, see Gusto

Prairie Dust Recs., PO Box 40364, Nashville, Tenn. 37204. Tel. (615) 292-6677. Pres. Sam Kirkpatrick; A&R & Prod'r Larry Morton; Promos Mgr. Ann Morton; Promos /Sec'y Lynn Kirkpatrick (Distributed by Nationwide Sound)

Praise Recs., 1515 W. North St., Bellingham, Wash. 98225. Tel. (206) 671-9562
Home office: Canada

Prayer Tower, see Aladdin
Prelude Recs., 200 W. 57 St., New York, N.Y. 10019. Tel. (212) 581-4890. Pres. Marvin Schachter, Exec VP Stanley Hoffman, Sales Mgr. Joe Kolsky

Premier, see Steady
Premier Artist, see Frank Evans
Premier (Brazil), see Fermata
Prescription Co., 70 Murray Ave., Port Washington, N.Y. 11050. Tel. (516) 767-1929. Owner & Pres. David F. Gasman, Ass't Prod'r. Charles Fischer, Ass't Kirk Nordstrom

Prestige, see Fantasy/Prestige/Milestone/Stax
Prime Cut Recs., 439 Tute Hill, Lyndonville, Vt. 05851. Tel. (802) 626-3317. Pres. Bruce James

Primitive, see Ken Keene
Priority Recs., 2300 Lincoln Ave., Fort Worth, Tex. 76106. Owner John Case

Prism Recs., 1700 Broadway, 40th fl., New York, N.Y. 10019. Tel. (212) 582-6886

Private Stock Recs. Ltd., 40 W. 57 St., New York, N.Y. 10023. Tel. (212) 397-1600. Cable. PRIVATSTOX. Pres. Larry Uttal
Int'l branch: England.
Labels: (Owned) Private Stock, (distributed) Quality (Canada)

Privilege, see Classics Int'l
Pro-Arte, see Spanish Music Center
Process, see Country Star
Prodigal, see Motown

Produktion Deutschmark, see Michele
Professional Artist, see Ken Keene

Progressive Recs., Box 986, Rt. 4, Tifton, Ga. 31794. Tel. (912) 382-8192. Pres. Gus P. Statiras, VP's Genelle Perry G. & Glen Statiras
Branch: New York, N.Y., 95 Christopher St. Apt 7C. Zip 10014. Tel. (212) 929-0890
Labels: (Owned) GSI, Gear, Progressive, Statiras

Int'l rep.: Japan (Sunkyo)
Project 3, see Total Sound

Promotions West Inc., PO Box 10287, Eugene, Ore. 97440. Tel. (503) 484-5812. Pres. M.S. Briggs
Labels: (Distributed) Hanna Barbera, ICMC

Proms, see CMS
Pronto, see Caytronics
Prophecy, see Glotite

Protone Recs., 970 Bel Air Rd., Los Angeles, Calif. 90024. Tel. (213) 472-5344. Dir. Jane Courtland Welton; Exec Ass't: Laïla Padorn Nilles
Labels: Laurel-Protone, Protone

Proud Cock, see King Walk
Proud Earth, see Salt City
Providence, see Daytwo
Pulstrak, see Sceneville

Pumehana, see Tropical Music
Pumkins Recs., 6753 Hollywood Blvd., Suite 206, Hollywood, Calif. 90028. Tel. (213) 469-2008/5117. Contacts: Ralfi Pagan, Stephen Burke

Pure Gold, see SIPRA
Puritan Recs., Box 44, 512 Jewett St., Battle Ground, Ind. 47920. Tel. (317) 567-2273. Pres.: Dave Samuelson; Sales Mgr.: Jean McGroarty

Labels: (Owned) Arbor, Puritan
Int'l reps.: Japan (BOM, Towai), UK (Swift)

Pygmy, see PA
Pyramid Recs., 26177 Kinyon Dr., Taylor, Mich. 48180. Tel. (313) 292-5281. Pres.: Peggy LaSorda
Pyramid, N.Y., see Roulette
Pyramid, N.J., see Rob-Lee



Q, see QCA in Calif.
Q.C.A. PO Box 1127, Burbank, Calif. 91507. Tel. (213) 769-6582. Pres. Peter Skye
Labels: (Owned) Aileron, Q, QCA, Skye, Software, Studio Q

Q.C.A. Recs. Inc., 2832 Spring Grove Ave., Cincinnati, Ohio 45225. Tel. (513) 681-8400. Bd. Chm. Edward R. Bosken; Pres. Frank Ruhl; VP & Gen. Mgr.: Daryl Kalmus; VP A&R Chuck Seitz, Sec'y & Office Mgr. Betty Jennings; Radio Promo: Dennis Williams
Labels: (Owned) Blue Mark, New Day, QCA, Red Mark, Rejoice, Wildwood

Q-Key, see Musitron
Q.M.O. Sales Inc., 2300 W. Oakland Park Blvd., Fort Lauderdale, Fla. 33311. Tel. (305) 485-0020. Pres.: Margaret Goodman; VP/Treas. Everett Goodman; Sec'y: Ron Rosenberg

Quadrasonic Talent Inc., PO Box 630175, Miami, Fla. 33163. Tel. (305) 472-7757. Pres. Jack P. Bluestein; VP: Ethel Kanter, Sec'y Dorothy Leonard

Label: (Owned) Twister
Int'l rep.: Brazil (Firate)

Quality (Canada), see Private Stock
Quickway, see Revonah
Quintessence, see Pickwick

Quinto Recs., 4423 Ledge Ave., Toluca Lake, Calif. 91602. Tel. (213) 985-8284. Owner: Quint Benedetti
Labels: (Owned) Quinto; (distributed) Crissy



R B F, see Folkways
R.C.A. (Brazil), see Brasilia
R.C.A. Recs., 1133 Ave. of the Americas, New York, N.Y. 10036. Tel. (212) 598-5900. Pres. Robert Summer, Div. VP RCA Recs.-USA: Bob Fead; Div. VP Int'l Arthur Martinez; Div. VP Music Serv.: Rodney Starmer, Div. VP Finance: John Mangin; Div. VP Bus. Affairs: Mel Ibarman; Div. VP Int'l Creative Affairs: Kelli Ross; Div. VP Creative Servs.: Jack Chudnoff; Div. VP Int'l Relations: William O'Grady; Div. VP Public Affairs: Herb Helman; Div. VP Red Seal A&R: Thomas Z. Shepard; Div. VP Black Music Mktg.: Ray Harris; Div. VP Pop Promo: John Betancourt; Staff VP & Sr. Counsel: Jon Walton

Branches: Hollywood, Calif., 6363 Sunset Blvd., Zip 90028. Tel. (213) 468-4000. Div. VP Pop A&R: David Coast. Ed DeJoy; Div. VP Nat'l Field Promo: Chuck Thagard; Div. VP Prod. Mgmt. & Artist Tours: Don Burkheimer—Nashville, Tenn., 30 Music Square W., Zip 37203. Tel. (615) 244-9880. Div. VP Nashville Ops: Jerry Bradley; Div. VP Country Music: Chet Atkins; Div. VP Mktg.: Joe Galante

Distribution branches—RCA & A&M Assoc.'s Labels: Los Angeles, San Francisco, Calif.; Denver, Colo.; Miami, Fla.; Atlanta, Ga.; Honolulu, Hawaii; Chicago, Ill.; Silver Spring, Md.; Boston, Mass.; Detroit, Mich.; Edina (Minneapolis-St. Paul Area), Minn.; St. Louis, Mo.; Maple Shade, N.J.; New York, N.Y.; Cincinnati, Cleveland, Ohio; Dallas, Tex.; Seattle, Wash. (See Record & Tape Wholesalers section for complete listings)

Int'l affiliates: Argentina, Australia, Brazil, Canada, England, France, Germany, Italy, Japan, Mexico, Netherlands, Spain
Labels: (Owned) Bluebird, Camden, Free Flight, Gold Seal, RCA, Red Seal, Victor, Victrola; (associated) A&M group, Gem Toby, Grunt, Hologram, Hot Lips, Nature's Music, New York Int'l, Pablo, Pablo Live, Pablo Today, Panorama, Roadshow, Salsoul group, Solar, Tortoise, 20th Century-Fox, Windsong

Int'l reps.: Angola (Telectra), Austria (Musica), Belgium (Inelco), Bolivia (Lauro), Chile (Industria de Radio & Television), China (Taiwan Pony), Colombia (Sonolux), Denmark (Hede Nielsen), Dominican Republic (Distribuidores Musicales del Caribe), Ecuador (Fadisa), El Salvador (Dicesa), Fiji Islands (Kumar), Finland (Discophon), Greece (Minos Matsas), Hong Kong (Cosdel), India (Gramophone), Israel (Eastronics), Jamaica (Federal), Kenya (AIT), Korea (Jigu), New Zealand (Radio Corp. of New Zealand), Nigeria (Decca), Norway (Disco), Pakistan (EMIL), Panama (Padisco), Peru (FTA), Philippines (Victor), Portugal (Telectra), Puerto Rico (Kalmivator), Switzerland (Musikvertrieb), Thailand (Central Trading), Turkey (Melodi), Uruguay (APSA), Venezuela (Cordica), Yugoslavia (Jugoton). (SEE ADVERTISEMENT)

R.C.A./R.V.C. (Japan), see Audio-Technica
R.C.I. Recs., PO Box 126, Elmsford, N.Y. 10523. Tel. (914) 592-7983. VP: Ray Roberts

Labels: (Owned) RCI, Thomas

R.C.S., see Record Company of the South
R.E., see Indi

R.F.C. Recs., c/o Warner Bros. Recs. Inc., 3300 Warner Blvd., Burbank, Calif. 91510. Tel. (213) 846-9090. Pres.: Ray Caviano; VP A&R Vince Aletti; VP & Gen. Mgr.: Veronica Brice; Nat'l Disco Promo. Dir.: Craig Kostich (Distributed by Warner Bros.)

R.G.E. (Brazil), see Fermata
R.G.E./Fermata, see Brasilia

R.I.C., see House of Falcon
R & R Recs. Inc./Ren. Rome, 663 Fifth Ave., New York, N.Y. 10022. Tel. (212) 757-3638. Pres. Rena L. Feeney, VP Bill Feeney, Sec'y Jerald West, Treas. Winston Burse; Prod'r: Lenny J. Bailey, Billy Nichols; Promo: Al H. Willen Jr.

Labels: (Owned) Can Scor, Ren Rome

R.R.C., see Kool Kat
R.R.P., see Rite Rec

R.S. Int'l, see Hob
R.S.O. Recs. Inc., 8335 Sunset Blvd., Los Angeles, Calif. 90069. Tel. (213) 650-1234. Telex 69-8130. Pres. Al Coury, Exec. Ass't to Pres. Janis Lundy; VP Promo: Richard Fitzgerald; VP Sales: Mitch Huffman; Nat'l Promo. Dir.: Bob Smith; Nat'l Sales Mgr.: Mel DaKroob; Nat'l Pub. Dir.: Ronnie Lippin; Creative Servs. Dir.: Glenn Ross; Admin. Ass't: Larime Ward; Controller: Peter Fassler

Branch: New York, N.Y., 1775 Broadway, Zip 10019. Tel. (212) 975-0700. Telex 125779. Sr. VP & Gen. Mgr.: Bob Edson
Int'l branch: England
Labels: (Owned) RSO; (distributed) Curtom

R.T.P. Int'l, see Rik Timory
Radar, see Polydor

The Radiola Co., Box C, Sandy Hook, Conn. 06482. WATS Tel. (800) 243-0987. Pres. J. David Goldin; Gen. Mgr.: Eva Mester; Sales Mgr.: Larry Sockell

Radio & Television Commission of the Southern Baptist Convention, 6350 W. Freeway, Fort Worth, Tex. 76150. Tel. (817) 737-4011. Cable: BAPTCOM

Rae-Cox Recs. Inc./Enrica Recs. Inc., 1697 Broadway, Suite 702, M.O. Park, N.Y. 10019. Tel. (212) 586-9406. Pres.: Theodore McRae; VP: Fredia Staton; A&R: Williams Gray; Pub. Dir.: Tina Whitehead

Labels: (Owned) Enrica, Rae-Cox
Ragdoll Rec'g Studio, 205A Television Circle, Savannah, Ga. 31406. Tel. (912) 927-1761. Contact: David M. Evans

Ragtime, see Grassroots
Railroad Center, see Chi-Town

Rainbow Rec. Mfg. Corp., 1738 Berkeley St., Santa Monica, Calif. 90404. Tel. (213) 829-3476. Pres.: Jack G. Brown; VP: James Doyle; Prod'n Supervisor: Steve Sheldon

Rainbow, Calif., see Poema
Rainbow Room, 30 Rockefeller Plaza, New York, N.Y. 10020. Tel. (212) 757-9090

Label: (Owned) Above All
Rainbow Sound Inc., 1322 Inwood Rd., Dallas, Tex. 75247. Tel. (214) 638-7712. Pres.: Bob Cline; Exec. VP: Jim Greer; VP: Jack Whitt

Rally, see Ralph's Radio
Ralph's Radio Music, Demorest, Ga. 30535. Tel. (404) 778-9117

Labels: (Owned) Gospel Time, Rally, Zipcode

Ram (Ireland), see Rounder
Ram Recs., PO Box 2802, Corpus Christi, Tex. 78403. Tel. (512) 992-5126. Pres.: Bruce Taylor

Ram Recs., 4307 Saundersville Rd., Old Hickory, Tenn. 37138. Tel. (615) 847-4419. Pres.: Mira Ann Smith; VP's: Margaret Lewis, A. Alton Warwick

Int'l rep.: Canada (Mark-Lin)
Rambler, see Rounder

Ramex Recs. Inc., 202 S. Milby St., Houston, Tex. 77003. Tel. (713) 223-3591. Pres.: Emilio V. Garza; District Mgr.: Juan Mendoza

Rampart Recs. (div. of Gordo Ent's.), 255 N. New Hampshire, Los Angeles, Calif. 90004. Tel. (213) 384-9586. Owner & Nat'l Sales Mgr.: Edward L. Davis

Int'l reps.: Mexico (Cronos), UK (Croole)
Randall Recs., 29 Elaine Rd., Milford, Conn. 06460. Tel. (203) 878-7383. Pres.: Gerald Randall; VP: Howard Randall

Branches: Middletown, N.Y., 15 Randall Heights, Zip 10940. Tel. (914) 343-6918. A&R Samuel Randall—Syracuse, N.Y., 1900 W. Genesee St. Zip 13204. Tel. (315) 468-0161

Range Buster, see Colonel Buster Doss
Ranger, see Forrest Green
Rapsodia, see Penco

Rare Earth, see Motown
Bill Rase Prod'n Inc., 955 Venture Court, Sacramento, Calif. 95825. Tel. (916) 929-9181. Owner & Pres.: Bill Rase; VP: Lori Rase; Sec'y: Shirley Rase

Label: (Owned) Escar
Rashid Sales Co., 191 Atlantic Ave., Brooklyn, N.Y. 11201. Tel. (212) 852-3295. Cable: ALRASHID. Pres.: Albert Rashid; VP's: Raymond & Stanley Rashid

Label: (Owned) Orient

Rat Recs., 528 Commonwealth Ave., Boston, Mass. 02215. Tel. (617) 267-4156. Pres.: James G. Harold; Exec. Ass't: Judith A. Mintz; Staff Prod'r: John Kalishes

Ratcity, see All Platinum
Rattler, see Sarg

Raven Rec. Co., PO Box 20037, Zip: 95820; 5930 Vista Ave., Sacramento, Calif. 95824. Tel. (916) 422-5838. R'ade, see Phono Rec. Dist'g

Reader's Digest Ass'n Inc., Pleasantville, N.Y. 10570. Tel. (914) 769-7000; NYC (212) 972-4000

Reading, see McKinnon
RealTime, see Miller & Kreisel
Real, see Sire
Rebecca, see Glenn

Rebel Rec'g Co. Inc., Rt. 12, Asbury, W.Va. 24916. Tel. (304) 645-6650
Labels: (Owned) Rebel, Zap

Int'l reps.: Canada (Trend), France (Musimage), Japan (King), UK (Charmdale)

Reborn, see Glori
Recital Recs., 4640 E. Lewis, Phoenix, Ariz. 85008. Tel. (602) 959-2076. Owner: L. John Twiford

Recital, Calif., see Educational Media & Discocorp
Reco-Flex, see Vantage
Recommended Viewing, see Jersey Coast

Record Company of the South (RCS), 5220 Essen Ln., Baton Rouge, La. 70808. Tel. (504) 766-3233. Pres.: Cyril E. Vetter; VP/Gen. Mgr.: John Fred, Promo. & Sales: Ronnie Shaab

Record Dists. of America Inc., 780 W. 27 St., Hialeah, Fla. 33010. Tel. (305) 887-2638. Pres.: Eliseo C. Valdes; Sales Mgr. Angel Tamargo; Gen. Mgr. Lázaro Fernandez

Recorded Anthology of American Music (New World Recs.), 231 E. 51 St., New York, N.Y. 10022. Tel. (212) 753-9820. Cable: RECANTH. Pres. Herman E. Krawitz; A&R Dir.: Elizabeth Ostrow; Dist'n Mgr.: Jess Auerbach; Office & Promo. Mgr.: Christine McCarthy (Distributed by Peters Int'l)

Label: (Owned) New World.
 Recorded Treasures Inc., PO Box 1278, North Hollywood, Calif. 91604. Tel (213) 766-4693. Pres. Walter S. Heebner.
Label: (Owned) Welte Legacy of Piano Treasures
 Record Guild of America, 144 Milbar Blvd., Farmingdale, N.Y. 11735. Tel (516) 293-5858. Pres. David Shichman.
Label: (Owned) Simon Says
 Record Haven Int'l, 545 W 45 St., New York, N.Y. 10036. Tel (212) 247-5900 Telex 666 754 HAVEN. (Importer/Exporter)
 Recordland, see Kool Kat.
 Record & Music People Inc., 635 Elm St., Birmingham, Mich. 48011. Tel (313) 645-0750. Pres. Jim Elmsan. Exec VP Andre Williams.
Label: (Owned) Underground.
 Record Rendezvous Inc., 134 S 20 St., Philadelphia, Pa. 19103. Tel (215) 561-7340. Pres. Edward R. Marcus. VP Frances Marcus.
Label: (Owned) Rendezvous
 Record Room, see Argus
 Recordtime, see Institute for Language Study.
 Red (Italy), see Rounder
 Red Clay, see Sonyatone
 Red Diamond Rec. Co., 42 Chapman Ave., Auburn, N.Y. 13021. Tel (315) 253-4921
Labels: (Owned) Future Shock, Red Diamond, (distributed) Disco 3, Foot.
 Red Dot, see Marullo
 Red Greg Ents Inc., 1650 Broadway, New York, N.Y. 10019. Tel (212) 586-6543. Pres. Gregory Carmichael. VP & Gen Mgr.: Victor M. Carew
Labels: (Owned) Almaria, Dance Disk, Red Greg, Shylden
 Red Mark, see QCA in Ohio
 Red Onion, Ill., see Lakco
 Red Onion Recs., PO Box 366, Dayton, Ohio 45401. Tel (513) 222-2413. Owner & Pres. Sharon Rethman
 Red Rooster Recs., Box 300, Mount Marion, N.Y. 12456. Tel (914) 246-3266. Pres. Don Badgley. Sec'y Donn Adams. Pub & Promo. Phil Crandon
 Red Seal, see RCA
 Red Star Recs Inc., 200 W 57 St., New York, N.Y. 10019. Tel (212) 582-3585. Pres. Martin Thau. Information Minister: Roy Trakin, Press Officer: Miriam Linna
 Redwood Recs., 3384 21 St., San Francisco, Calif. 94110. Tel (415) 821-1170. Quality Control/A&R: Marsha Cummings, Dist'n Co-ord.: Trudy Fulton, Bus. Mgr. Carol Orshan, Promo Dir. Torie Osborn
 Reference Rec's, c/o Sumiko Inc., PO Box 5046, Berkeley, Calif. 94705. Tel (415) 843-4500
 Reflection Sound Prod's Inc., 1018 Central Ave., Charlotte, N.C. 28204. Tel (704) 377-4596. Pres. Wayne Jernigan, A&R Roger Branch, Duke Hall
Labels: (Owned) Avanti, Revelation, Southern Wing, Sugarbush
 Regency Recs., 9454 Wilshire Blvd., Suite 500, Beverly Hills, Calif. 90212. Tel (213) 274-5857. Cable: SEGALAW. Pres. Lloyd Segal, VP John Delgatto. (Distributed by Sierra/Briar)
 Regima, see Arzee.
 Rego Irish Recs & Tapes Inc., 84-48 62 Dr., Middle Village, N.Y. 11379. Tel (212) 476-1847. Pres. Paddy Noonan
 Reid's World, see TK
 Rejoice, see QCA in Ohio.
 Relco, see Caprice.
 Release (Ireland), see Shanachie.
 Release Recs., PO Box 234, St. Louis, Mo. 63166. Tel (314) 296-9526. Pres. & A&R Dir. B.J. Bax
 Remington, see American Tape.
 Renaissance, Calif., see Everest & Trend.
 Renaissance Recs. & Film Works, PO Box 3501, 1182 E. Russell, Flint, Mich. 48505. Tel. (313) 787-2694. Bd. Chm. M.D. Ruffin
Branches: Detroit, Mich., 384 City Nat'l Bank. Zip 48226. Tel. (313) 963-0559. New York, N.Y., 114 Liberty St. Zip 10006. Tel. (212) 227-5816
 Rena Recs Inc., PO Box 14743, Las Vegas, Nev. 89114. Tel (702) 870-8000. Pres.: Raymond Girard; VP Netta Rogers
 Rendezvous, see Record Rendezvous.
 Renegade, see Chuck Chellman.
 Renoire, see Old Dominion
 Ren Rome, see R&R
 Reo Tahiti, see Criterion.
 Repertoire, see Sonic Arts
 Reprise, see Warner Bros
 Republic Recs. Inc., 815 18 Ave S., Nashville, Tenn. 37203. Tel: (615) 329-9339. Pres. Dave Burgess. Nat'l Promo. Dir. Gary Branson, Nat'l Sales Mgr. Arnold Theis, Nat'l Country Promo. Barbara Kelly, Promo Co-ord. Nancy Hirth, Mktg. Ass't. Susie Hall.
Int'l reps.: Canada (RCA), UK (Decca).
 Request Recs., 3800 S Ocean Dr., Hollywood, Fla. 33019. Tel (305) 456-0847. TWX (510) 954-9798. Pres. Gene Settler; Exec VP John Pudwell, Gen. Mgr.: Ruth Gamba, Nat'l Promo Dir. Larry Barnes; Mktg. Joe Martin
Branch: Cos Cob, Conn., 28 Fado Ln. Zip: 06807. Tel (203) 869-1988. Eastern Reg'l Mgr. George Saydoh
Labels: (Owned) Afro Request, Classical Excellence, Demand, Euphoria, No Holds Barred, Music of Many Lands, Oasis, Request, Sounds of the Caribbean.
Int'l reps.: Canada (Almada), Germany (Phonogram), Netherlands (Basart), Switzerland (Evasion).
 Resco Recs., 2039 Antoine, Houston, Tex. 77055. Tel (713) 683-7171. Mgr. Russ Reeder, A&R Gene Watson
 Reuben Recs., 8537 Sunset Blvd., No. 2, Los Angeles, Calif. 90069. Tel (213) 657-8852
 Revelation, see Reflection Sound & Shiloh
 Review, see Starcrest
 Revolver, see Dance-A-Thon
 Revonah Recs., Box 217, Ferndale, N.Y. 12734. Tel (914) 292-5965. Owner & Chief Eng. Paul Gerry, Studio Mgr. & Promo. Patricia James
Labels: (Owned) Quickway, Revonah, Studio 17, Tel-E-Vue. (distributed) Grassound.

Int'l reps.: Canada (Almada), Japan (BOM, Pooh Yo-kocho), Netherlands (Only Yesterday), UK (Siring, Mike's Country Music)
 Reynolds Recs., 260 Kearny St., No. 402, San Francisco, Calif. 94108. Tel (415) 421-2216. Pres. Paul Reynolds. Exec. VP. William A. Parrish, Controller: Alma F. Lane. Sales Dir.: Jack Spinnato, A&R Dir.: Peggy J. Heath, Pub. Dir.: Marie Porche, Promo. Dir.: Albert Marshall
 Rhythms Prod's, Box 34485, Whitney Bldg., Los Angeles, Calif. 90034. Tel (213) 836-4678. Pres. R.S. White. Exec. Prod'r David O. White
Labels: (Owned) Rhythms Prod's, Tom Thumb
 Rice Recs. Inc., 49 Music Square W., Suite 303, Nashville, Tenn. 37203. Tel (615) 242-2461
 Richardson Recs., 1938 Old Annapolis Blvd. Annapolis, Md. 21401. Tel (301) 757-3733. Owner & Pres. Charles A. Richardson, VP Mary A. Richardson
Int'l reps.: Australia (MR Acoustics), Canada (Andre Ferrault), Germany (Audio Components)
 Richey Recs., 7121 W. Vickery, Unit 118, Fort Worth, Tex. 76116. Tel (817) 731-7375. Owner & Int'l Rep. Slim Richey, Sales James Yanaway; Adv & Promo. James Colegrove
Labels: (Owned) Flying High, Grass Mountain, Ridge Runner. (distributed) Iron Horse, Kiamichi
Int'l rep.: Japan (Trio)
 Richtown/Gospel Truth Recs. & Tapes & Film Works Inc., PO Box 7552, Richmond, Va. 23231. Tel (804) 226-0424. Bd. Chm. Reginald A. Charity Sr., Musical Minister Joseph N. Sire
Labels: (Owned) Cardinal, Charity Richtown/Sire
 Richtown/Sire, see Richtown
 Rico Recs. Prod's Inc., 748 10 Ave., New York, N.Y. 10019. Tel (212) 247-6330
Labels: (Owned) Combo, Neliz, Rico, Solo. (distributed) EGC, PRAS
 Ridge Runner, see Richey
 Right On! Recs. USA, 408 W 115 St., Suite 2-W, New York, N.Y. 10025. Tel (212) 222-8715. Cable RIGHTON. Pres. Bill Downs, A&R Carl Palmer; Mgr. Christopher Tchadje
Int'l reps.: Austria (Crystal), Belgium (Crystal), Canada (Quality), France (Crystal), Germany (Crystal), Netherlands (Crystal), Switzerland (Crystal)
 Rim Canyon Recs., 2616 Kendall Ave., Madison, Wis. 53705. Tel (608) 233-0347. Pres. V. Mordenti
 Riot, see Stacy-Lee.
 Ripcord, see Gibson.
 Ripsaw Rec. Co., 121 N. Fourth St., Easton, Pa. 18042. Tel (215) 258-5990. Pres. James Kirkhuff
Branch: New York, N.Y., 320 W 30 St. Zip 10001. Tel (212) 564-3246. VP. Jon Strong
 Rising Star, see Parr-X
 Rising Sun, see Scene Prod's
 Rite Rec. Prod's Inc., 9745 Lockland Rd., Cincinnati, Ohio 45215. Tel (513) 733-5533. Pres. Carl J. Burkhardt, VP Philip Burkhardt, Ass't Studio Mgr. Dan Burton
Labels: (Owned) Gateway, Golden Shield, RRP
 Riva Recs. Inc., Hotel Navarro on the Park, Suite 705, 112 Central Park S., New York, N.Y. 10019. (Distributed by Phonogram)
 Rivendell Recs./Star Song Recs., 2223 Strawberry, Pasadena, Tex. 77502. Tel (713) 472-5563. WATS (800) 231-3456. Texas WATS (800) 392-2088. Pres. Darrell Harris
 Riverside, see Fantasy/Prestige/Milestone/Stax
 Riviera, see Cadet Recs.
 Roadshow Recs. Corp., 1733 Broadway, New York, N.Y. 10019. Tel (212) 765-8840. Pres. Fred Frank, Co-Pres. Sid Maurer, Exec. VP Julie Lipsius. (Distributed by RCA)
 Roast, see Ray Lawrence.
 Robbins Recs., Box 277, Rt 3 Leesville, La. 71466. Pres. Sherree Scott; Nat'l Reps. Virginia Angel, Virginia, Darrell & David Scott; Int'l Promo. Leonard Scott
Branch: Magazine, Ark., PO Box 157. Zip 72943
Labels: (Owned) Headliner Stars, Robbins.
 Robin Hood, see Cadet Recs.
 Rob-Lee Music, PO Box 1385, Merchantville, N.J. 08109. Tel (609) 663-4540. Pres. Rob Russen, Exec. VP Bob Russen, VP A&R Rodney Russen; Sales Mgr.: Bob Harris, Pub. Mgr. Eric Russen, Adv. Mgr. Jeff Quig, Promo Mgr. Mark Porter, Tape Mgr. Gary Marlin, Country Mgr.: Marc Tomiselli, Accounts Mgr. Barbara Russen
Labels: (Owned) Big El, Camden Soul, Castle Jade, Pyramid, Rock Island, Silverbird, TCB
 Rockabilly Uprising, see Rollin' Rock.

Rock City, see Fire Sign.
 The Rocket Rec. Co., 489 Fifth Ave., 32nd fl., New York, N.Y. 10017. Tel (212) 682-8427. Telex 428013. Bd. Chm.: John Reid; Contact: Janet Weber.
Branch: Beverly Hills, Calif., 211 S. Beverly Dr. Zip 90212. Tel (213) 550-0144. TWX (910) 490-2586. Pres. Barney Ales; Nat'l Pub. Dir. Jane Ayer.
Int'l branch: England
 Rocking Horse, see Grenadilla
 Rockin' Ronny, see Rollin' Rock
 Rockin' Weiser, see Rollin' Rock
 Rock Island, see Rob-Lee.
 Rockland, see Europa.
 Rockland Road, see Superior Sound
 Rockmasters Inc., 177 Rt. 304, New City, N.Y. 10956. Tel. (914) 634-5101. Cable ROCKMASTAS. Pres. Frank J. Guida; Gen. Mgr. Perla Frank
 Rock's Greatest Hits, see Surf City.
 Rocky, see Chuck Anthony
 Roda, see Penco
 Rodeo, see Paramount-West
 Rodgers & Hammerstein, see Ziv
 Rogue Recs., 21315 Ibanez Ave., Woodland Hills, Calif. 91364. Tel (213) 992-4922. Pres. Ron Hitchcock
 Roi Recs., 4712 Elmwood Ave., Los Angeles, Calif. 90004. Tel (212) 467-1524. Pres. Joseph R. LeClair
 Rolashed Ents Inc., 1408 Taylor, Memphis, Tenn. 38106. Tel (901) 942-1937
Labels: (Owned) Black Fox, Rolashed, Silver Shadow, Rolling Stones Recs., 75 Rockefeller Plaza, New York, N.Y. 10019. Tel (212) 484-8760. (Distributed by Atlantic)
 Rollin' Rock Recs., 6918 Peach Ave., Van Nuys, Calif. 91406. Tel (213) 781-4805. Pres. Ronny Weiser, VP Patricia Weiser; Promo.: David Zalkus.
Labels: (Owned) American Rhythm Music, Boppin' Belle, Ollie, Rockabilly Uprising, Rockin' Ronny, Rockin' Weiser, Rollin' Rock, Tubby.
Int'l reps.: Canada (Don Park), France (Rollin' Rock), Italy (Rollin' Rock), Netherlands (Diwa), Norway (Scandinavian Rock 'N' Roll Society), UK (Radar, Rollin' Rock)
 Romar, see Nautilus.
 Romona, see Jody
 Ronn, see Jewel.
 Romnex (Belgium), see Moonglow
 Ron Service Prod's, N.Y. 12457, Nashville, Tenn. 37212. Tel (615) 297-0266.
 Roots, see TK
 Roper Recs. Inc., 45-15 21 St., Long Island City, N.Y. 11101. Tel (212) 786-2401. Pres. Franc Peri.
Int'l reps.: Canada (Trend), Germany (W. Glow)
 Rose Ents., PO Box 3443, Hollywood, Calif. 90028. Tel (213) 291-0539. Pres. & VP Rudy Aaron Rosales, Gen. Mgr. Willie E. Hoskins Jr.; Artist Development: Ester Rosales, PR Dianne Hoskins
 The Rose Hill Group Inc., 3929 New Seneca Tpk., Marcellus, N.Y. 13108. Tel (315) 673-1117. Pres. & A&R Dir. Vincent Taft, VP David R. Torrey
Label: (Owned) Star City
 Rose Recs. Co. Inc., 922 Canterbury Rd. NE, Atlanta, Ga. 30324. Tel (404) 237-1162. Pres. & A&R: Mano W. Peralta, VP & Int'l Mgr. Larry Marshall-Paul, VP. Frank P. Lappas, Controller, Rosalia P. Peralta.
 Rosita, see Freddie
 Ro Tab, see Marullo.
 Roulette Recs. Inc., 1790 Broadway, New York, N.Y. 10019. Tel (212) 757-9880. Pres. & Promo. Dir. Marian Leighton; A&R Ken Irwin; Sales Mgr. Bill Nowlin.
Labels: (Owned) Green Tree, Rambler, Rounder, (distributed) Acorn (UK), Back Door, Bear Family (Germany), Big Ben (UK), Bija, Blackbird (Ireland), Black Saint (Italy), Cezame (France), Claddagh (Ireland), Cur-Non, Eckenworks, Esca, F&W, Fiddledadoo, Fiddler, Flyright (UK), Gael-Linn (Ireland), Horo (Italy), Ictus (Italy), Larrikin (Australia), Leader (UK), Longdivity, Maggie (UK), Major, Mulligan (Ireland), Ogham (Ireland), Orient, Outlet (Ireland), Outrageous, Physical, Ram (Ireland), Red (Italy), Rubber (UK), Soulmate (Italy), Springwater (Canada), String (UK), Tangent (UK), Tara (Ireland), Topic (UK), Trailer (UK), Transatlantic (UK), Village Thing (UK), Xtra (UK).
Int'l reps.: Australia (Larrikin), Belgium (Parsifal), Canada (Almada), Denmark (CSA), France (Free Bird), Germany (Plane), Hong Kong (Studer-Revox), Ireland (Mul-

Sesame Street Records

1 Lincoln Plaza
 New York, N.Y. 10023
 Phone: 212 874-2700

Arthur Shimkin Art Denish Shy Raiken
 President Vice President

ligan), Italy (Hi-Fi), Japan (BOM, Disc Center, KYOA, Pooch Yokochi, Shimse), Netherlands (Pastor), Norway (Sinar), Spain (Compania Fonografica), Sweden (Sonet), Switzerland (Evasion), UK (Mike's Country Music Room, Projection, Swift). (SEE ADVERTISEMENT)

Rovi, see Musimex
 Royal Flush, see TK
 Royalty (Canada), see Ray Lawrence
 Rubber (UK), see Rounder
 Rugby, see Dee Prod's
 Rumble Recs., PO Box 84, Peoria, Ill. 61650 Contacts: Craig Moore, Gary Becka, Bill Knight
 Frank Russell Music & Recs. Group Inc., 170 Linwood Ave., Paterson, N.J. 07502, Tel. (201) 595-7557
 Russell Recs. Inc., 1403 Callens Rd., Ventura, Calif. 93003, Tel. (805) 642-3555
 Russell Street, see Daytwo
 Rutabaga, see Old Homestead



S A M, see Utopia.
 S C M Recs., PO Box 2096, Clearwater, Fla. 33517.
 S C R, see Sunshine Country.
 S E I Recs., 3610 McKinley St. NE, Minneapolis, Minn. 55418, Tel. (612) 781-0600 Pres. & Promo Dir.: Daniel G. Thompson; VP/PR/Artist Relations: Charles C. Osowski.
Labels: (Owned) At the Copa, SEI
 S F M (Society for Forgotten Music), see Contemporary.
 S I D, see Discocorp.
 S I P R A (Small Independent Prod'n & Rec. Assocs.), 247 N. Wester Ave., Suite 6, Los Angeles, Calif. 90004, Tel. (213) 462-9355 Pres. Bobby Sanders; VP: Ernie Freeman; A&R: Cardella DeMilo; Sales Mgr.: Marion Mitchell; Adv. Mgr.: Carolyn Wiggs. **Local branch:** 6255 Sunset Blvd., Suite 1903, Hollywood 90028 Tel. (213) 466-3261.
Labels: (Owned) Brotherhood, Community, Pick-A-Hit, Pure Gold, Soutdown, (distributed) Kris, Manton, Silver Sword, US, Velvet, Visconjon
 S & M Recs., 6777 Hollywood Blvd., 9th fl., Hollywood, Calif. 90028, Tel. (213) 466-4352 Pres. Charles Emmons; VP & A&R: John Condon.

S M C, see Spanish Music Center
 S M I, see Audiofidelity
 S P E B S Q S A (Society for the Preservation & Encouragement of Barber Shop Quartet Singing in America Inc.), 6315 Third Ave., Kenosha, Wis. 53141, Tel. (414) 654-9111
 S P O R, see Legrand-Norfolk
 S R I Recs. & Tapes/Halpern Sounds, PO Box 720, Zip 94302, 260 Sheridan Ave., Palo Alto, Calif. 94306, Tel. (415) 493-3344, Pres.: Steven Halpern; Admin. Ass't: Joyus Albright; PR: Joel Goldfus
Labels: (Owned) Halpern Sounds, Open Channel Sound Co., SRI
 S S S Int'l, see Shelby Singleton
 S W S Org. Inc., 1370 Ave. of the Americas, New York, N.Y. 10019, Tel. (212) 737-8106, 586-1451, Telex 224600. Pres.: Sverre O. Sundman.
Int'l branches: Sweden—Bastun Studio AB, Scandinavian Music Dist'n AB, Scandinavian SWS Music AB.
Labels: (Owned) SWS, (distributed) Arctic (Norway), Love (Finland), Mudist (Sweden), YTF (Sweden)
Int'l reps.: Denmark (Metronome), Finland (Love), Germany (Bellaphon, Orion), Sweden (Scandinavian Music Dist'n)

Sabia (Brazil), see Brasilia.
 Sabre Rec. Co., PO Box 90612, Nashville, Tenn. 37209, Tel. (615) 646-1974, Pres.: Ray Reeves.
Labels: (Owned) Barricade, Sabre
 Sacred, see Word
 Safari Recs. Co., 139 Maryland St., El Segundo, Calif. 90245, Tel. (213) 322-5460
Labels: (Owned) Accion, Corrito, Coro, Safari, (distributed) Colibre, Libelula, Magneto
 Saga, see CMS
 Sagittar, see Texas Sound
 Saguaro, see Boyd
 Sahara, see Music Resources
 Salsoul Recs., 240 Madison Ave., New York, N.Y. 10016, Tel. (212) 889-7340 Telex: 236464, Bd. Chm.: Stan Cayre; Pres.: Joe Cayre; Exec. VP A&R: Ken Cayre; Sr. VP Promo: Chuck Gregory; Nat'l Artist Development Dir.: Priscilla Chatman; Nat'l R&B Promo Dir.: Connie Johnson; Assoc. Nat'l Disco Promo: David Rodriguez; Ellen Galloway; Nat'l Disco Radio Promo: Chuck Rush; Nat'l Secondary Promo: Amy Rothlein (Distributed by RCA)
Labels: Bethlehem, Differant Drummer, Free Spirit, Gold Mind, Salsoul
Int'l reps.: Australia (RCA), Austria (Musica Schallplatten), Benelux (Phonogram), Brazil (Top Tape), Canada (RCA), Caribbean (Dynamic Sounds in Jamaica), Colombia (Codiscos), Denmark (Hede Nielsen), Dominican Republic (Dominica de Discos), Ecuador (IFESA), El Salvador (Leo), Finland (Discophon), Germany (Teldec), Greece (Minos Matsas), Guatemala (Leo), Hong Kong (Pro Grammy), India (EMI), Israel (K-tel), Italy (RCA), Jamaica (Dynamic Sounds), Japan (Nippon Phonogram), Malaysia (Pro Grammy in Hong Kong), Mexico (Sonida & Ritmo), Norway (Disco), Panama (Promo), Peru (IEMPSA), Philippines (Disc Corp.), Singapore (Pro Grammy in Hong Kong), South Africa (CCP), Spain (Ariola-Eurodisc), Sweden (Electra), Turkey (Gruenberg Ticaret), UK (EMI), Venezuela (CBS)

Salsoul (Salsa), see Mericana
 Salt City Recs. Inc., PO Box 162, 3697 N. 600 East, Provo, Utah 84601, Tel. (801) 224-1775, Pres.: Stan Bronson; VP: Steve Bronson; Sales Mgr.: Milt Fletcher
Labels: (Owned) Proud Earth, Salt City
 Salt of the Earth Recs., 3282 Catalina Ave., Santa Clara, Calif. 95051, Tel. (408) 243-0168 Pres.: Mark Aaron; VP A&R: Chris Aaron
 Salvation, see Creed Taylor
 Sam Prod'n's, 41-43 39 St., Long Island City, N.Y. 11104, Tel. (212) 786-7667, Telex: 235976, Owner: Sam

Weiss, Promo. & Mktg. Dir.: Daniel Glass (Distributed by CBS)
 Sami, see DGJ.
 Sandcastle Recs., 157 W. 57 St., New York, N.Y. 10019, Tel. (212) 582-6135 Owners: Mark Cosmedy, John Shoup; VP: Tom Morgan.
Branches: Studio City, Calif., 4045 1/4 Radford Ave. Zip 91604, Tel. (213) 985-7933—**New Orleans, La.,** 337 Rue Chartres, Zip 70130, Tel. (504) 529-4195.
 M R Sand & Co., PO Box 2255, 6211 Milan Rd., Sandusky, Ohio 44870, Tel. (419) 625-0028.
 San-Lyn Group, Box 46, 414 Cortland Ave., Syracuse, N.Y. 13205, Tel. (315) 476-2779
Labels: (Owned) Calumet, San-Lyn
 Sanskrit Recs., 4120 Excelsior Blvd., Minneapolis, Minn. 55416, Tel. (612) 920-9590 Pres.: Keith Christian-son
 Sarg (Rec'g Co.), 311 E. Davis St., Luling, Tex. 78648, Tel. (512) 875-3350, Owner: Charlie Fitch; Sales Mgr.: Sharon Mann; Promo: Denise Fitch; A&R: Ben W. Fitch; Ass't Mgr.: Celeste Fitch.
Labels: (Owned) Double A, Rattler, Sarg.
 Sassafrazz, see Mystic
 Sav-All, see HSE
 Savoy Recs. Inc., 342 Westminster Ave., Elizabeth, N.J. 07208, Tel. (201) 351-6800; NYC (212) 962-3354, VP & Gen. Mgr.: Fred Mendelsohn; Prod'r: Milton Bigg-ham; Jazz Prod'r: Robert Porter; Promo. Mgr.: Ben Mid-dleton; Exec. Ass't: Helen Gottesman. (Distributed by Arista)
 Scala, see Everest
 Scandinaviana, see Lindberg
 Scaramouche Recs., PO Drawer 1967, Warner Robins, Ga. 31093, Tel. (912) 922-1955 Pres.-Dir.: Robert R. Kovach; Sec'y: Judi L. Kovach.
 Scene Prod'n's, PO Box 1243, Beckley, W. Va. 25801, Tel. (304) 252-4836 Pres.: Richard L. Petry; Gen. Mgr.: William Gent.
Labels: (Owned) Country Road, Rising Sun.
Int'l reps.: Philippines (Empire), Switzerland (Metronome)

Sceneview Inds., 78-08 88 Ave., Woodhams, N.Y. 11421, Tel. (212) 296-1877 Pres. & Mng. Dir.: A. J. Kleinfield; VP & A&R: R. L. Knudsen; A&R Dir.: Jimi Knudsen.
Label: (Owned) Pulstrak
 Sceptre, see Fee Bee
 Don Schafer Promos., PO Box 57291, Dallas, Tex. 75207, Tel. (214) 339-5891/6166 Pres.: Don Schafer; VP: Becky Schafer
Labels: (Owned) Demand, Texas
 Scollar Recs., PO Box 441, Northridge, Calif. 91324, Tel. (213) 340-2752, Owner & Pres.: David M. Seiden
 Scorpione Recs. (div. of LJO Ent. Co.), 152 W. 42 St., Suite 406, New York, N.Y. 10036, Tel. (212) 840-3670, Pres.: L. Johnson
 Scorpio Ent's Inc., 38 Music Square E., Nashville, Tenn. 37203, Tel. (615) 256-3373, Pres. & A&R Dir.: B.L. (Slim) Williamson; VP: Randy Moore; Promo: Marty Williamson
Label: (Owned) Scorpion
 Scorpion, see Scorpio Ent's
 Scotti Bros., see Atlantic
 Scrimshaw Recs., 6943 Valjean Ave., Van Nuys, Calif. 91406, Tel. (213) 988-6746, Pres.: Robert P. Gentile
 Scripture in Song, see Tempo
 Sea Cruise, see Ken Keene
 Sea-King, see Centaur in N.Y.
 Seal Prod'n's, 19 1/2 Free St., Skowhegan, Me. 04976, Tel. (207) 474-2375, Pres.: Joel Ferris; Exec. Dir.: Lunis Or-cutt
Labels: (Owned) New England Bay, Ocean
 Sealsong, see Wormwood
 Second Chance, see East Allegheny
 Secco, see Met Richmond
 Ralph L. Seltzer Inc., 5243 Yarmouth Ave., Suite 26, Encino, Calif. 91316, Tel. (213) 705-1541, Pres.: Ralph L. Seltzer; Ass't to Pres.: Shosh Byron
Int'l branches: Australia, Germany, Spain, UK
Int'l firms represented: Dial (Spain), OctoArts (Philippines), Reville (South Africa), Mal Sondock (Germany), Tapcar (Brazil), Trindade (Portugal)

Semaphore, see Vantage
 Seminar, see King Walk
 Seminole, see Shiloh
 Sequel, see Rik Tinory
 Seraphim, see Capitol
 Serenus Corp., PO Box 267, Hastings-on-Hudson, N.Y. 10706, Tel. (914) 693-9321, Pres.: Paul Kapp
 Sesame Street Recs. (div. of Distinguished Prod'n's Inc.), 1 Lincoln Plaza, New York, N.Y. 10023, Tel. (212) 874-2700, Pres.: Arthur Shimkin; VP Sales: Shy Raiken; Mktg. Dir.: Arthur Denish. (SEE ADVERTISEMENT)
 Seven Hills Publ'g & Rec'g Co. Inc., 905 N. Main St., Evansville, Ind. 47711, Tel. (812) 423-1861, Pres.: Edward W. Kretemeyer; VP: M. Lottes; Sec'y-Treas.: Dorothy Pearce; Mgr.: P. J. Hayden.
Labels: (Owned) EKK, Seven Hills
 1750 Arch Inc., 1750 Arch St., Berkeley, Calif. 94709, Tel. (415) 841-0216, Pres.: Tom Buckner; Exec. Dir.: Phil Sawyer; Concert Mgr.: Eva Soltes; Rec'g Eng.: Bob Shumaker
Int'l rep.: Canada (Almada)
 Shadow Recs., 3346 Hennepin, Minneapolis, Minn. 55408, Tel. (612) 824-9491, Pres.: Charles F. Campbell
 Shadybrook Recs. Ltd., 8913 Sunset Blvd., Los Angeles, Calif. 90069, Tel. (213) 652-4782
 Shaffer, Hollywood, Calif., see Phono Rec. Dist'g
 Shaffer Recs., 13412 Gladstone Ave., Sylmar, Calif. 91342, Tel. (213) 367-0214, Co-Owner & Chm.: Frank J. Jacobs; Co-Owner & Pres.: Mrs. F. J. Jacobs; Sales & Promo: Deloris Ann
 Shakin Recs., PO Box 10530, Jackson, Miss. 39209, Tel. (601) 922-5242, 981-8061, Bd. Chm.: Joe Shamwell; Pres.: Lee King; Dist'n Dir.: Julian Davis
 Shanachie Recs., 1375 Crosby Ave., Bronx, N.Y. 10461, Tel. (212) 792-5388, Pres.: Daniel Michael Collins; Prod'n: Richard Nevins
Labels: (Owned) Shanachie, (distributed) Claddagh (Ire-

land), Dolphin (Ireland), Gael-Linn (Ireland), Inchechronn (Ireland), Innisfree, Mulligan (Ireland), Oats (Ireland), Oldie Blues (Netherlands), Release (Ireland), Sonet (Sweden), Tara (Ireland), Topic (UK), Transatlantic (UK)
Int'l reps.: Australia (Larrikin), Canada (Almada), France (DAM), Ireland (CBS, Tara), Netherlands (Munich), Sweden (Sonet), UK (Croislin, Spartan)
 Shawmut Recs., see Casa Grande
 She, see Atlantic
 Don D. Sheets Prod'n's, Box 212, Rt. 3, Nashville, Ind. 47448, Tel. (812) 988-2000, Co-Owners/Prod'rs: Don D. & Marti Mae Sheets.
Labels: (Owned) CVS, Delmarti, Little Nashville
 Sheffield Lab Inc., PO Box 5332, Santa Barbara, Calif. 93108, Tel. (805) 969-4744, WATS (800) 235-5737, Pres.: Douglas Sax; VP & Treas.: Lincoln Mayorga; Sec'y: Robert Louis
Int'l reps.: Australia (Megasound), Belgium (Blomhof), Canada (Gray), Denmark (SAC), France (Delta), Germany (Audio Int'l), Italy (Audio SNC), Japan (Marutani), Netherlands (Durob), Nigeria (Quintessence in UK), Norway (Mayco Agentur), Singapore (Singapore Audio), South Africa (Symphonia), Spain (Ataio), Sweden (Sven Eriksson), Switzerland (Young), Tahiti (Cida), UK (Regent). (SEE ADVERTISEMENT)
 Shelter Rec'g Co. Inc., 5112 Hollywood Blvd., Hollywood, Calif. 90027, Tel. (213) 660-1605, Telex: 674981, Pres.: Denny Cordell; Gen. Mgr.: Bernadette Gorman; A&R: Nick Basich
Int'l reps.: Australia (Festival), Austria (Ariola-Eurodisc in Germany), France (Arabella), Germany (Ariola-Eurodisc), Greece (CBS), Italy (Ariston), Japan (Nippon Phonogram), Netherlands (Ariola-Eurodisc), Scandinavia (Ariola-Eurodisc in Germany), South Africa (Gallo), South America (Phonogram in Netherlands), Spain (Ariola-Eurodisc), Switzerland (Ariola-Eurodisc in Germany), UK (Island)
 Sherri, see Startown
 Shiek, see Aladdin
 Shield, see TK
 Shih Shih Wu Ai Recs. Inc., 8120 Oakland Ave. S., Bloomington, Minn. 55420, Pres.: Milo Fine
 Shiloh Recs., 215 Ave. Del Mar, San Clemente, Calif. 92672, Tel. (714) 498-4330, VP Sales: Dale M. Davis; A&R Dir.: Gene A. Humphrey; Nat'l Music Dir.: Floyd "Gib" Gilbeau; Creative Arts Dir.: Pete Kleinow
Labels: Revelation, Seminole, Vantage
Int'l reps.: Finland (Quality), Italy (Hi-Fi), Japan (Disc Center, Pooch Yokochi), Norway (Norsk Musikforlag), UK (Mike's Country Music Room, Projection)
 Shire, see Wormwood
 Shooting Stars Recs. Co., PO Box 1294, Omaha, Neb. 68101, Tel. (402) 397-9052/7049, Pres.: Edward Thomas Weldon; Exec. VP & Gen. Mgr.: Clair Edward Weldon; VP Prod'n: James Monroe Walter; Treas.: Betty Lou Weldon; Mktg. Dir.: Gary Albert Weldon; Chief Eng. & A&R: Mike Mulaney
 Shout, see Bang
 Showcase, see World Int'l
 Showstoppers, see Ziv
 Showtime, PO Box 40074, Washington, D.C. 20016, Tel. (202) 397-6952, Exec. Pres.: C. Ables; Gen. Mgr.: B. Salles
 Showtime, La., see Modern Sound
 Shyriden, see Red Reg
 Shur-Tinga, see Styletone
 Sidewalk Hot Jazz Orch., see Lakko
 Sierra/Briar Recs., PO Box 5853, Pasadena 91107, 11312 Santa Monica Blvd., Suite 7, Los Angeles, Calif. 90025, Tel. (213) 477-1438, Exec. Dir.: John M. Delgatto; Mng. Dir.: Marsha Necheles; Sales & Promo Dir.: Roz Lerman; Art Dir.: Vicki Nadsady; Gen. Counsel: S. D. Ashley; Accounting Dir.: Steve Chapman; A&R Dir.: Gene Parsons
Labels: (Owned) Briar, Sierra, (distributed) Regency
Int'l reps.: Austria (Ariola), Belgium (Ariola-Eurodisc), France (Arabella Eurodisc), Germany (Ariola-Eurodisc), Italy (Caru, Hi-Fi, Millerecoms), Japan (BOM, Disc Center, Disc Union, Harmony House, Music Rec. Shop, Pooch Yokochi, Shinjuku, Tony's Recs.), Netherlands (Ariola-Eurodisc), Spain (Ariola-Eurodisc), Sweden (Country Music Center), Switzerland (Ariola-Eurodisc), UK (Mike's Country Music in Scotland, Swift)
 Sierra Wave, see Kicking Mule
 Signature Gramophone Co. Ltd., 1414 Ave. of the Americas, New York, N.Y. 10019, Tel. (212) 751-0322, Contact: Bob Thiele
 Silk Purse, see Bay
 Silverbird, see Rob-Lee
 Silver Blue Recs., 220 Central Park S., New York, N.Y. 10019, Tel. (212) 586-3535, Pres.: Joel Diamond, (Distributed by TK Prod'n's)
 Silver Cloud Recs., 65 W. 55 St., New York, N.Y. 10019, Tel. (212) 765-4410
 Silver Shadow, see Rolashed
 Silver Sword, see SIPRA
 Simon Says, see Record Guild
 Sinbad, see Crimson Dynasty
 Sine Qua Non Prod'n's Ltd., 25 Mill St., Providence, R.I. 02904, Tel. (401) 521-2010, Pres.: Samuel S. Attenberg; VP: Joan Grow
Branch: Los Angeles, Calif., 1362 Lucile Ave. Zip: 90026, Tel. (213) 666-6082, Sales Mgr.: John Ierardi
Labels: (Owned) Americana, Bitter Sweet Jazz, Masterpiece, Meet the Classics, Perceptive, Sine Qua Non, Superba
 Sinergia Inc., 46-003 Aialoa St., Kaneohe, Hawaii 96744, Tel. (808) 235-2940, Pres. & Treas.: Peter Coraggio; VP & Sec'y: Sheryl Coraggio
 Sing, see Skyline-Sing
 Singcord, see Singspiration
 Shelby Singleton Corp., 3106 Belmont Blvd., Nashville, Tenn. 37212, Tel. (615) 385-1960, Cable: SHELREC, Telex: 3711222, Pres.: Shelby S. Singleton Jr.; VP: John A. Singleton; VP Mktg.: Dick Bruce; Promo. Dir.: Tom McConnell
Labels: (Owned) Plantation, SSS Int'l
 Singspiration Rec'gs (div. of Zondervan Corp.), 1415 Lake Dr. SE, Grand Rapids, Mich. 49506, Tel. (616) 459-6900

land), Dolphin (Ireland), Gael-Linn (Ireland), Inchechronn (Ireland), Innisfree, Mulligan (Ireland), Oats (Ireland), Oldie Blues (Netherlands), Release (Ireland), Sonet (Sweden), Tara (Ireland), Topic (UK), Transatlantic (UK)
Int'l reps.: Australia (Larrikin), Canada (Almada), France (DAM), Ireland (CBS, Tara), Netherlands (Munich), Sweden (Sonet), UK (Croislin, Spartan)
 Shawmut Recs., see Casa Grande
 She, see Atlantic
 Don D. Sheets Prod'n's, Box 212, Rt. 3, Nashville, Ind. 47448, Tel. (812) 988-2000, Co-Owners/Prod'rs: Don D. & Marti Mae Sheets.
Labels: (Owned) CVS, Delmarti, Little Nashville
 Sheffield Lab Inc., PO Box 5332, Santa Barbara, Calif. 93108, Tel. (805) 969-4744, WATS (800) 235-5737, Pres.: Douglas Sax; VP & Treas.: Lincoln Mayorga; Sec'y: Robert Louis
Int'l reps.: Australia (Megasound), Belgium (Blomhof), Canada (Gray), Denmark (SAC), France (Delta), Germany (Audio Int'l), Italy (Audio SNC), Japan (Marutani), Netherlands (Durob), Nigeria (Quintessence in UK), Norway (Mayco Agentur), Singapore (Singapore Audio), South Africa (Symphonia), Spain (Ataio), Sweden (Sven Eriksson), Switzerland (Young), Tahiti (Cida), UK (Regent). (SEE ADVERTISEMENT)
 Shelter Rec'g Co. Inc., 5112 Hollywood Blvd., Hollywood, Calif. 90027, Tel. (213) 660-1605, Telex: 674981, Pres.: Denny Cordell; Gen. Mgr.: Bernadette Gorman; A&R: Nick Basich
Int'l reps.: Australia (Festival), Austria (Ariola-Eurodisc in Germany), France (Arabella), Germany (Ariola-Eurodisc), Greece (CBS), Italy (Ariston), Japan (Nippon Phonogram), Netherlands (Ariola-Eurodisc), Scandinavia (Ariola-Eurodisc in Germany), South Africa (Gallo), South America (Phonogram in Netherlands), Spain (Ariola-Eurodisc), Switzerland (Ariola-Eurodisc in Germany), UK (Island)
 Sherri, see Startown
 Shiek, see Aladdin
 Shield, see TK
 Shih Shih Wu Ai Recs. Inc., 8120 Oakland Ave. S., Bloomington, Minn. 55420, Pres.: Milo Fine
 Shiloh Recs., 215 Ave. Del Mar, San Clemente, Calif. 92672, Tel. (714) 498-4330, VP Sales: Dale M. Davis; A&R Dir.: Gene A. Humphrey; Nat'l Music Dir.: Floyd "Gib" Gilbeau; Creative Arts Dir.: Pete Kleinow
Labels: Revelation, Seminole, Vantage
Int'l reps.: Finland (Quality), Italy (Hi-Fi), Japan (Disc Center, Pooch Yokochi), Norway (Norsk Musikforlag), UK (Mike's Country Music Room, Projection)
 Shire, see Wormwood
 Shooting Stars Recs. Co., PO Box 1294, Omaha, Neb. 68101, Tel. (402) 397-9052/7049, Pres.: Edward Thomas Weldon; Exec. VP & Gen. Mgr.: Clair Edward Weldon; VP Prod'n: James Monroe Walter; Treas.: Betty Lou Weldon; Mktg. Dir.: Gary Albert Weldon; Chief Eng. & A&R: Mike Mulaney
 Shout, see Bang
 Showcase, see World Int'l
 Showstoppers, see Ziv
 Showtime, PO Box 40074, Washington, D.C. 20016, Tel. (202) 397-6952, Exec. Pres.: C. Ables; Gen. Mgr.: B. Salles
 Showtime, La., see Modern Sound
 Shyriden, see Red Reg
 Shur-Tinga, see Styletone
 Sidewalk Hot Jazz Orch., see Lakko
 Sierra/Briar Recs., PO Box 5853, Pasadena 91107, 11312 Santa Monica Blvd., Suite 7, Los Angeles, Calif. 90025, Tel. (213) 477-1438, Exec. Dir.: John M. Delgatto; Mng. Dir.: Marsha Necheles; Sales & Promo Dir.: Roz Lerman; Art Dir.: Vicki Nadsady; Gen. Counsel: S. D. Ashley; Accounting Dir.: Steve Chapman; A&R Dir.: Gene Parsons
Labels: (Owned) Briar, Sierra, (distributed) Regency
Int'l reps.: Austria (Ariola), Belgium (Ariola-Eurodisc), France (Arabella Eurodisc), Germany (Ariola-Eurodisc), Italy (Caru, Hi-Fi, Millerecoms), Japan (BOM, Disc Center, Disc Union, Harmony House, Music Rec. Shop, Pooch Yokochi, Shinjuku, Tony's Recs.), Netherlands (Ariola-Eurodisc), Spain (Ariola-Eurodisc), Sweden (Country Music Center), Switzerland (Ariola-Eurodisc), UK (Mike's Country Music in Scotland, Swift)
 Sierra Wave, see Kicking Mule
 Signature Gramophone Co. Ltd., 1414 Ave. of the Americas, New York, N.Y. 10019, Tel. (212) 751-0322, Contact: Bob Thiele
 Silk Purse, see Bay
 Silverbird, see Rob-Lee
 Silver Blue Recs., 220 Central Park S., New York, N.Y. 10019, Tel. (212) 586-3535, Pres.: Joel Diamond, (Distributed by TK Prod'n's)
 Silver Cloud Recs., 65 W. 55 St., New York, N.Y. 10019, Tel. (212) 765-4410
 Silver Shadow, see Rolashed
 Silver Sword, see SIPRA
 Simon Says, see Record Guild
 Sinbad, see Crimson Dynasty
 Sine Qua Non Prod'n's Ltd., 25 Mill St., Providence, R.I. 02904, Tel. (401) 521-2010, Pres.: Samuel S. Attenberg; VP: Joan Grow
Branch: Los Angeles, Calif., 1362 Lucile Ave. Zip: 90026, Tel. (213) 666-6082, Sales Mgr.: John Ierardi
Labels: (Owned) Americana, Bitter Sweet Jazz, Masterpiece, Meet the Classics, Perceptive, Sine Qua Non, Superba
 Sinergia Inc., 46-003 Aialoa St., Kaneohe, Hawaii 96744, Tel. (808) 235-2940, Pres. & Treas.: Peter Coraggio; VP & Sec'y: Sheryl Coraggio
 Sing, see Skyline-Sing
 Singcord, see Singspiration
 Shelby Singleton Corp., 3106 Belmont Blvd., Nashville, Tenn. 37212, Tel. (615) 385-1960, Cable: SHELREC, Telex: 3711222, Pres.: Shelby S. Singleton Jr.; VP: John A. Singleton; VP Mktg.: Dick Bruce; Promo. Dir.: Tom McConnell
Labels: (Owned) Plantation, SSS Int'l
 Singspiration Rec'gs (div. of Zondervan Corp.), 1415 Lake Dr. SE, Grand Rapids, Mich. 49506, Tel. (616) 459-6900

land), Dolphin (Ireland), Gael-Linn (Ireland), Inchechronn (Ireland), Innisfree, Mulligan (Ireland), Oats (Ireland), Oldie Blues (Netherlands), Release (Ireland), Sonet (Sweden), Tara (Ireland), Topic (UK), Transatlantic (UK)
Int'l reps.: Australia (Larrikin), Canada (Almada), France (DAM), Ireland (CBS, Tara), Netherlands (Munich), Sweden (Sonet), UK (Croislin, Spartan)
 Shawmut Recs., see Casa Grande
 She, see Atlantic
 Don D. Sheets Prod'n's, Box 212, Rt. 3, Nashville, Ind. 47448, Tel. (812) 988-2000, Co-Owners/Prod'rs: Don D. & Marti Mae Sheets.
Labels: (Owned) CVS, Delmarti, Little Nashville
 Sheffield Lab Inc., PO Box 5332, Santa Barbara, Calif. 93108, Tel. (805) 969-4744, WATS (800) 235-5737, Pres.: Douglas Sax; VP & Treas.: Lincoln Mayorga; Sec'y: Robert Louis
Int'l reps.: Australia (Megasound), Belgium (Blomhof), Canada (Gray), Denmark (SAC), France (Delta), Germany (Audio Int'l), Italy (Audio SNC), Japan (Marutani), Netherlands (Durob), Nigeria (Quintessence in UK), Norway (Mayco Agentur), Singapore (Singapore Audio), South Africa (Symphonia), Spain (Ataio), Sweden (Sven Eriksson), Switzerland (Young), Tahiti (Cida), UK (Regent). (SEE ADVERTISEMENT)
 Shelter Rec'g Co. Inc., 5112 Hollywood Blvd., Hollywood, Calif. 90027, Tel. (213) 660-1605, Telex: 674981, Pres.: Denny Cordell; Gen. Mgr.: Bernadette Gorman; A&R: Nick Basich
Int'l reps.: Australia (Festival), Austria (Ariola-Eurodisc in Germany), France (Arabella), Germany (Ariola-Eurodisc), Greece (CBS), Italy (Ariston), Japan (Nippon Phonogram), Netherlands (Ariola-Eurodisc), Scandinavia (Ariola-Eurodisc in Germany), South Africa (Gallo), South America (Phonogram in Netherlands), Spain (Ariola-Eurodisc), Switzerland (Ariola-Eurodisc in Germany), UK (Island)
 Sherri, see Startown
 Shiek, see Aladdin
 Shield, see TK
 Shih Shih Wu Ai Recs. Inc., 8120 Oakland Ave. S., Bloomington, Minn. 55420, Pres.: Milo Fine
 Shiloh Recs., 215 Ave. Del Mar, San Clemente, Calif. 92672, Tel. (714) 498-4330, VP Sales: Dale M. Davis; A&R Dir.: Gene A. Humphrey; Nat'l Music Dir.: Floyd "Gib" Gilbeau; Creative Arts Dir.: Pete Kleinow
Labels: Revelation, Seminole, Vantage
Int'l reps.: Finland (Quality), Italy (Hi-Fi), Japan (Disc Center, Pooch Yokochi), Norway (Norsk Musikforlag), UK (Mike's Country Music Room, Projection)
 Shire, see Wormwood
 Shooting Stars Recs. Co., PO Box 1294, Omaha, Neb. 68101, Tel. (402) 397-9052/7049, Pres.: Edward Thomas Weldon; Exec. VP & Gen. Mgr.: Clair Edward Weldon; VP Prod'n: James Monroe Walter; Treas.: Betty Lou Weldon; Mktg. Dir.: Gary Albert Weldon; Chief Eng. & A&R: Mike Mulaney
 Shout, see Bang
 Showcase, see World Int'l
 Showstoppers, see Ziv
 Showtime, PO Box 40074, Washington, D.C. 20016, Tel. (202) 397-6952, Exec. Pres.: C. Ables; Gen. Mgr.: B. Salles
 Showtime, La., see Modern Sound
 Shyriden, see Red Reg
 Shur-Tinga, see Styletone
 Sidewalk Hot Jazz Orch., see Lakko
 Sierra/Briar Recs., PO Box 5853, Pasadena 91107, 11312 Santa Monica Blvd., Suite 7, Los Angeles, Calif. 90025, Tel. (213) 477-1438, Exec. Dir.: John M. Delgatto; Mng. Dir.: Marsha Necheles; Sales & Promo Dir.: Roz Lerman; Art Dir.: Vicki Nadsady; Gen. Counsel: S. D. Ashley; Accounting Dir.: Steve Chapman; A&R Dir.: Gene Parsons
Labels: (Owned) Briar, Sierra, (distributed) Regency
Int'l reps.: Austria (Ariola), Belgium (Ariola-Eurodisc), France (Arabella Eurodisc), Germany (Ariola-Eurodisc), Italy (Caru, Hi-Fi, Millerecoms), Japan (BOM, Disc Center, Disc Union, Harmony House, Music Rec. Shop, Pooch Yokochi, Shinjuku, Tony's Recs.), Netherlands (Ariola-Eurodisc), Spain (Ariola-Eurodisc), Sweden (Country Music Center), Switzerland (Ariola-Eurodisc), UK (Mike's Country Music in Scotland, Swift)
 Sierra Wave, see Kicking Mule
 Signature Gramophone Co. Ltd., 1414 Ave. of the Americas, New York, N.Y. 10019, Tel. (212) 751-0322, Contact: Bob Thiele
 Silk Purse, see Bay
 Silverbird, see Rob-Lee
 Silver Blue Recs., 220 Central Park S., New York, N.Y. 10019, Tel. (212) 586-3535, Pres.: Joel Diamond, (Distributed by TK Prod'n's)
 Silver Cloud Recs., 65 W. 55 St., New York, N.Y. 10019, Tel. (212) 765-4410
 Silver Shadow, see Rolashed
 Silver Sword, see SIPRA
 Simon Says, see Record Guild
 Sinbad, see Crimson Dynasty
 Sine Qua Non Prod'n's Ltd., 25 Mill St., Providence, R.I. 02904, Tel. (401) 521-2010, Pres.: Samuel S. Attenberg; VP: Joan Grow
Branch: Los Angeles, Calif., 1362 Lucile Ave. Zip: 90026, Tel. (213) 666-6082, Sales Mgr.: John Ierardi
Labels: (Owned) Americana, Bitter Sweet Jazz, Masterpiece, Meet the Classics, Perceptive, Sine Qua Non, Superba
 Sinergia Inc., 46-003 Aialoa St., Kaneohe, Hawaii 96744, Tel. (808) 235-2940, Pres. & Treas.: Peter Coraggio; VP & Sec'y: Sheryl Coraggio
 Sing, see Skyline-Sing
 Singcord, see Singspiration
 Shelby Singleton Corp., 3106 Belmont Blvd., Nashville, Tenn. 37212, Tel. (615) 385-1960, Cable: SHELREC, Telex: 3711222, Pres.: Shelby S. Singleton Jr.; VP: John A. Singleton; VP Mktg.: Dick Bruce; Promo. Dir.: Tom McConnell
Labels: (Owned) Plantation, SSS Int'l
 Singspiration Rec'gs (div. of Zondervan Corp.), 1415 Lake Dr. SE, Grand Rapids, Mich. 49506, Tel. (616) 459-6900

Labels: (Owned) Milk & Honey, Singcord, Supreme.
Sirco Recs. Inc. (sub of Seabrook Int'l Corp.), 22 Pine St., Freeport, N.Y. 11520 Tel (516) 546-8008 Bd Chm: Anthony Ferrante Pres. Bill Seabrook VP Mark Seabrook VP Promo Yolanda Ayers
Labels: (Owned) Flying Hawk, Sirco
Int'l reps.: Argentina (Circle Line), Benelux (Money Tree in Netherlands), Brazil (Tapacar), Chile (Circle Line in Argentina), Germany (Decca), Greece (Greek Communications), UK (Decca), Uruguay (Circle Line in Argentina)
Sire Recs Co., 165 W 74 St., New York, N.Y. 10023 Tel (212) 595-5500 Cable BLUHORIZON Telex 62622 Pres. Seymour Stein Ass't to Pres. Michael Rosenblatt VP Bus Affairs Jonathan Brett VP Artist Development Ken Kushnick VP Sales & Mktg John Montgomery, Singles Promo Co-ord. Sue Emil Controller Nannette Rogoff Press Officer Audrey Strahl Creative Servs Co-ord. Gloria Robinson Int'l & Prod'n Dir John Gillespie (Distributed by Warner Bros.)
Branch: Burbank, Calif., 3300 Warner Blvd Zip 91510 Tel (213) 846-9090 VP Promo Mark Nathan Nat'l Promo Dir. Richard Sargent
Int'l branch: England
Labels: (Owned) Blue Horizon, Real, Sire
Int'l reps.: Australia (WEA), Benelux (WEA), Brazil (WEA), Denmark (Metronome), France (Pathe Marconi), Germany (Aniolo-Eurodisc), Greece (General Publ'g), Italy (RCA), Japan (Nippon Phonogram), New Zealand (WEA), Scandinavia (Phonogram), Spain (Hispanox), UK (WEA), Yugoslavia (Jugoton)
Sir Lion Recs. Co., 455 W Hanover St., Trenton, N.J. 08618 Tel (609) 989-9202 Pres. O. Weather.
Sister Sun., see Olivia
Sivatt Music Co. Inc., PO Box 7172, Greenville, S.C. 29610 Tel (803) 269-5529 Pres. Jesse B. Ewate
Labels: (Owned) Brand-X, Pioneer
Six Shooter., see Colonel Buster Doss
Skill Recs., 4154 NW 79 Ave., Miami, Fla. 33166 Tel (305) 591-2427 Pres. Laurence H. Shiller
Branch: New York, N.Y., 100 W 57 St. Zip 10019
Skye., see QCA in Calif.
Sky-High., see King Rec. Dist.
Skylite., see SkyLite-Sing
SkyLite Country., see SkyLite Sing
SkyLite-Sing Inc., 1008 17 Ave. S., Nashville, Tenn. 37212 Tel (615) 244-6116 Pres. Joel E. Gentry, VP Mktg. Carl L. Gentry
Labels: (Owned) Christian Faith, Christian Folk Sing, SkyLite Country, Stateswood, Temple
Slade Rec. Co., Box 536, Crookston, Minn. 56716 Tel (218) 281-3862 Owner Gary Emerson
Sleeping Giant Recs., PO Box 411, 847 Springfield Hwy., Goodlettsville, Tenn. 37072 Tel (615) 859-2820 Pres. Sidney Prosen, Treas. Florence Heitowitz, Music Co-ord. Stan Free
Branch: Jackson Heights, N.Y., 80-08 35 Ave. Zip 11372 Tel (212) 651-8213
Slide., see McKinnon
Small Independent Prod'n & Rec. Assocs., see SIPRA
Smile., see La Val
Smithsonian Collection., see Smithsonian Institution
Smithsonian Institution, Performing Arts Div., Washington, D.C. 20560 Tel (202) 381-6525
Label: (Owned) Smithsonian Collection
Snowdrop Recs., 400 First National Bank Tower, Garland, Tex. 75040 Tel (214) 272-8536 Contact Dick Roth
Soap Opera Recs., 9 E 46 St., New York, N.Y. 10017 Tel (212) 661-2106 Pres. Larry Levinson, Sec'y-Treas. Neil Warner VP A&R Phyllis Levinson, A&R Irvin Finiger
Society for Forgotten Music., see Contemporary Society for the Preservation & Encouragement of Barber Shop Quartet Singing in America Inc., see SPEBS/QSA
Software., see QCA in Calif.
Solar, Calif., see Mystic
Solar, N.Y., see RCA
Solid Gold., see Bang
Solid Recs., 6101 Ridgeview Ave., Baltimore, Md. 21206 Tel (301) 254-7354 Gen. Mgr. George Brigman
Solid Rock., see Word
Solid Smoke Recs., PO Box 22372, San Francisco, Calif. 94122 Tel (415) 731-0500 Contacts Marty Arbunch, Rick Tolmach
Label: (Owned) Home Run
Solo., see Rico
Solo Plus., see Blue River
Soma Recs., 5105A Golden Ln., Las Vegas, Nev. 89119 Tel (702) 739-9606 Pres. Phil Gitelman, VP Barry Goldsmith
Som (Brazil)., see Brasilia
Somerset., see Alshire
Som / Major (Brazil)., see Fermata
Sonar Recs. Corp., PO Box 455, Bronx, N.Y. 10463 Tel (212) 549-1770 Pres. Norman E. Mendenhall, VP Jack W. Garner, Promo Mgr. K. Marani
Labels: (Owned) Hammar, Sonar
Sonata Recs., 4304 Del Monte Ave., San Diego, Calif. 92107 Tel (714) 222-3346 Pres. A&R Paul DiLella VP Joseph DiLella, Sales Mgr. Melba Lee Newberry, Promo & Dist'n Helen DiLella
Sonet (Sweden)., see Shanachie
Sonet USA., see Kicking Mule
Songbird., see MCA
Song Request Magazine., see Olenik
Songs by Sommers., PO Box 322, Silver Spring, Md. 20907 Tel (301) 946-9039 Owner Henry J. Sommers
Labels: (Owned) Songs by Sommers, (distributed) Advance
Sonic., see Iowa Great Lakes
Sonicarts., see Sonic Arts
Sonic Arts Corp., 665 Harrison St., San Francisco, Calif. 94107 Tel (415) 781-6307 Pres. Leo de Gar Kulka, Exec. VP Herbert P. Haas, VP Artistic Development J.M. Speck, VP Direct Mail, Kenneth Kew, Gen. Mgr. Admin. Lydia Terry, Creative Servs. Leontine L. Kulka, Graphics Wayne Pope
Int'l branch: Germany
Labels: (Owned) Authentic, Autograph, Captain, Dimension Six, Direkt to Disk, Golden Soul, Laboratory Series,

Nostalgia, Repertoire, Sonicarts, Super Dimension Six, Washboard, (distributed) Star (Switzerland)
Sonido Int'l., see Marsal
Sonolux., see Discolando
Sonotropic., see Musitron
Sonrise Mercantile Corp., PO Box 607, 22802 Pacific Coast Hwy., Malibu, Calif. 90265 Tel (213) 456-2460 Pres. Bob Cotterell, Gen. Mgr. Dave Foster
Labels: (Owned) Creative Sound, Sonrise (distributed) AB (Street Level), Deep Roots, Lamb & Lion (selected), Mighty Wind
Sonyatone Recs., PO Box 567, Santa Barbara, Calif. 93102 Tel (805) 965-3784 Pres. Peter F. Feldman VP Toni Young
Labels: (Owned) Hen Cackle, Sonyatone (distributed) Red Clay
Int'l reps.: Australia (Folkways), Germany (Bear), Japan (BOM)
Soul., see Motown
Soul City., see East Allegheny
Soul City Recs., 10609 Budlong, Los Angeles, Calif. 90044 Tel (213) 779-7875
Soul Deep., see Indi
Souled Out., see Tom Bee
Soulin., see Warren
Soulmate (Italy)., see Rounder
Soul Merchant., see Paramount-West
Soul Mine., see Boddie
Soul-Po-Tion., see Gwen
Soul Roll., see Tom Bee
Soul Set., see La Val
Soul Sounds Unlimited Rec'g Co., PO Box 24230, Cincinnati, Ohio 45224 Tel (513) 681-1403 Co-Owner Alvin Don Chico Pettijohn
Soutlown., see SIPRA
Soultrack., see Startown
Soul Unlimited., see Modern Sound
Soundbook., see Caedmon
Sound 80 Inc., 2709 E 25 St., Minneapolis, Minn. 55812 Tel (612) 721-6341 (Distributed by Nautillus)
The Sound Environment Rec'g Series., 5421 S 84 St., Lincoln, Neb. 68516 Tel (402) 423-8736 TWX (910) 621-8240 Pres. Bob Bailey VP Bill Hendrix
Branch: St. Paul, Minnesota., 1236 Lincoln Ave. Zip 55105 Tel (612) 690-2707 Prod'n Eng G. Russ Borud
Sound Inc., 56880 North Ave., New Haven, Mich. 48048 Tel (313) 749-5182
Labels: (Owned) Cupid, IRM, International Folklore, Keepsake, Trash, Universal Sound
Soundmate., see Caprice
Sound-Off Recs., 200 N. Long Beach Blvd., Compton, Calif. 90221 Tel (213) 637-5845 A&R Johnny Cannon
Sound of Money., see Vantage
Sound Plus., see TK
Sounds of the Caribbean., see Request
Sounds of Winchester., 314 Lanny Dr., Winchester, Va. 22601 Tel (703) 667-9379 Pres. Jim McCoy, VP R. J. Alford Jr., Sec'y Bertha McCoy
Labels: (Owned) Alear, Winchester
Sounds Reasonable., 2000 P St. NW, Washington, D.C. 20036 Tel (202) 457-0852
Sounds South Recs. Inc., 203 Culver Ave., Charleston, S.C. 29407 Tel (803) 766-2500 Pres. Harold Thomas, VP A&R Michael Thomas
Labels: (Owned) Sounds South, Wahr
Int'l rep.: Belgium (Supreme)
Sound Stage 7., see Monument
Sound III., see Tempo
Soundwaves Recs., 1204 Elmwood, Nashville, Tenn. 37212 Tel (615) 385-0900 (Distributed by Nationwide Sound)
Labels: (Owned) Candle, Phono, Soundwaves
Soutrac., see Sunbeam
Source Recs. Inc., 1902 Fifth Ave., Los Angeles, Calif. 90018 Tel (213) 731-0693 Pres. Logan H. Westbrook (Distributed by MCA)
Sourwood Mountain., see June Appal.
South Breeze Recs., 1018 16 Ave. S., Nashville, Tenn. 37212 Tel (615) 255-8635
Southern Bell., see East Allegheny
Hal Southern Prod'ns., Box 4234, Panorama City, Calif. 91412 Tel (213) 786-6957 Pres. Hal Southern, VP Grace Dee
Labels: (Owned) Country Gold, Ivory
Southern Library of Rec'd Music., see Peer-Southern
Southern Wing., see Reflection Sound
Southland., see Jazzology-GHB
So Philly Prod'ns Inc., 1221 Bainbridge St., Philadelphia, Pa. 19147 Tel (215) 546-1808 Opns. Dir. John N. Anastasio, A&R Mike Forte, Bruce Weeden, Admin. Ass't Cheryl Solem
Label: (Owned) Philly World
Souvenir., see Art
Sovereign Rec. Corp., 1619 Broadway, Suite 411, New York, N.Y. 10019
Space Recs., 2037 Alvarado Dr. NE, Albuquerque, N.M. 87110 Tel (505) 268-8405
Spanish Music Center Inc., Belvedere Hotel, 319 W 48 St., New York, N.Y. 10036 Tel (212) 582-4280 Owner Gabriel Oller
Labels: (Owned) Coda, Pro-Ante, SMC
Spark., see Peer-Southern
Sparrow Recs. Inc., 8587 Canoga Ave., Canoga Park, Calif. 91304 Tel (213) 998-1733 Pres. Billy Ray Hearn, Ass't to Pres. Adeline Griffith, Nat'l Mktg. Dir. Steven Potratz
Labels: (Owned) Birdwing, Sparrow, (distributed) Spirit
Int'l reps.: Australia (Spotlight), Canada (Words), UK (Word)
Specialty Recs. Inc., 8300 Santa Monica Blvd., Los Angeles, Calif. 90069 Tel (213) 656-7711 Pres. Art Rupp, VP Sales & Mktg. Rosemary Patterson
Specs., see Gusman
Phil Spector Int'l., PO Box 69529, Los Angeles, Calif. 90069 Tel (213) 846-9900 Pres. Phil Spector, Admin. Dir. Donna Sekulidis, Bus. Admin. & Legal Counsel Martin Machat, Int'l Dir. Tony Bramwell, VP Pub. Dir. Avril Giacobbi

Spectrum Recs., PO Box 757, San Carlos, Calif. 94070 Tel (415) 593-9554 Pres. Paul Weaver
Spider Recs. Inc., 20780 Winchester, Southfield, Mich. 48076 Tel (313) 356-4989 Pres. Arnold E. Tencer, Exec. VP & Gen. Mgr. Joel H. Zuckerman
Spigot., see Spiral
Spina Music., 2232 Vista Del Mar Pl., Hollywood, Calif. 90068 Tel (213) 467-6018 Pres. Harold Spina, Sec'y-Treas. Edith Spina
Labels: (Owned) Arc, Argyle
Spindrift Recs., PO Box A, Trezevant, Tenn. 38258 Tel (901) 669-7087 Pres. Bill Stottlemeyer
Spinlet Recs., 3008 Belden Dr., Los Angeles, Calif. 90068 Tel (213) 469-2719 Pres. Nick Therry, VP Bud Mathis
Spinn Recs., Box 100-N, RFD 3, Stuart, Va. 24171 Tel (703) 694-6128 Owners Frank W. Singleton, John F. Williams
Spin-Out., see Wesley
Spiral Recs. Inc., 17 W. 60 St., Rm. 423, New York, N.Y. 10023 Tel (212) 581-6985 Pres. Harry Finfer
Labels: (Owned) Pilgrim, Spigot, Spiral
Spiral, Pa., see Danny Luciano
Spirit., see West End
Spirit, Calif., see Sparrow
Spoken Arts Inc., 310 North Ave., New Rochelle, N.Y. 10801 Tel (914) 636-5482 Pres. Dr. Arthur Luce Klein, VP Dr. Luce A. Klein, Admin. r. Harold Kaplowitz, Sales Promo Janice Mallin, Mktg. Servs. Dir. Daryl O'Rourke, Art Dir. Barbara Flynn, A&R Christopher King
Labels: (Owned) Helicon, Spoken Arts
Spoonfed Recs., 21544 Ramba Vista, Malibu, Calif. 90265 Tel (213) 456-8862
Sports., see Lee Anderson
Spring Recs. Inc., 161 W 54 St., New York, N.Y. 10019 Tel (212) 581-5398 Pres. Jules Rifkind, VP Bill Spitalisky, Sec'y-Treas. Roy Rifkind
Labels: (Owned) Spring (distributed by Polydor), Event
Springboard Int'l Recs. Inc., 947 US Hwy. 1, Rahway, N.J. 07065 Tel (201) 574-1400 Cable SPRINGMUS TWX (710) 996-5874, (510) 224-6043 (Int'l) Pres. Dante J. Pugliese, VP & Controller Sid Yallowitz, Int'l Mktg. Dir. Mrs. Winnie R. Pisano
Nat'l sales office: Los Angeles, Calif., 8295 Sunset Blvd. Zip 90046 Tel (213) 654-6240 VP Opns. John Salas
Labels: (Owned) Buckboard, Happy Tunes, Mace, Mistletoe, Musicor, (Springboard, Trip, Upfront)
Int'l reps.: Australia (Astor—Springboard, Festival—Musicor), Brazil (Som—Musicor & Springboard), France (Musidisc—Springboard), Japan (Nippon Phonogram—Springboard, Victor—Musicor), Mexico (Capitol), New Zealand (Allied—Springboard, Festival—Musicor), Panama (Onda Nueva—Springboard), South Africa (EMI), Spain (Palobal—Springboard), Switzerland (Musidisc in France—Springboard)
Springwater (Canada)., see Rounder
The Stacy-Lee Label., 425 Park St., Hackensack, N.J. 07601 Tel (201) 488-5211 Pres. Johnny Miracle, VP Frank Joy, Treas. Warren Payne, Sec'y Aileen Joy, A&R Kenny Luv
Labels: (Owned) Banana, Inner Circle, Joy, Lions Den, Lotus, Lybra, Riot, Stacy-Lee
Stage Prod'ns Recs. Ltd., 189 W. Madison, Chicago, Ill. 60602 Tel (312) 346-3173 Pres. Willie Nance
Standy Recs. Inc., 760 Blandina St., Utica, N.Y. 13501, Tel (315) 735-6187 Pres. Stanley Markowski, VP Andy Cittadino, Sales & Mktg. Joyce Markowski
Stang., see All Platinum
Stanyan Rec. Co., 8440 Santa Monica Blvd., Hollywood, Calif. 90069 Tel (213) 656-7311 Owner Rod McKuen, Pres. & Gen. Mgr. Wade Alexander, VP Promo Pamela Burns, Sales Mgr. Georgi Griffith
Labels: (Owned) Discus, Stanyan
Star., see National Music
Star City., see Rose Hill
Starcrest Rec. Co., 23200 Chagrin Blvd., Cleveland, Ohio 44122 Tel (814) 455-7729 A&R Dir. Frank J. Sonzala, Dist'n Co-ord. Janice Scheppner, Mktg. Dir. Mart Conn, Financial Mgr. Billy Lang
Branch: Erie, Pa., 2314 Peach St., Suite 1, Zip 16502 Tel (814) 455-7729
Labels: (Owned) Starcrest, (distributed) Wide World of Music
Starcrest Recs. Ltd., Box 23333, Nashville, Tenn. 37202 Tel (615) 244-7827
Labels: (Owned) Review, Starcrest
Starday., see Gusto

**THE GOLDEN AGE
OF
ENTERTAINMENT
ON
NOSTALGIA LANE
RECORDS & TAPES**

The Original Licensed
Radio Broadcasts
of Show Business
Legends

**CATALOG
AVAILABLE**

Dealer
Inquiries
Invited

NOSTALGIA LANE, INC.
200 West 57th Street, N.Y., N.Y. 10019





Stardust, N.J., see Jim Hall.
 Stardust, Tex., see Colonel Buster Doss.
 Starlite, see CBS.
 Star Flite, see Music Ents.
 Star Jazz Recs. Inc., 5220 SW Eighth St., Plantation, Fla. 33317. Tel: (305) 581-4310. Pres.: Will Connelly; Exec. VP: Tom Justice; VP Promo.: Jim Farrell; A&R Dir.: S.H.T. Nelson.
 Stark Recs. & Tape Co., 628 South St., Mount Airy, N.C. 27030. Tel: (919) 786-2865. Owner & Pres.: Paul E. Johnson.
 Labels: (Owned) Hello, Pilot, Stark, Sugarbear.
 Starline Recs. Inc., c/o Nicoletti Music, PO Box 2818, Newport Beach, Calif. 92663. Tel: (714) 497-3758; New York Tel: (212) 787-5400. Pres.: Joseph Nicoletti; VP & Gen. Mgr.: Cheryl Lee Gammon.
 Star Mountain Recs. RI Box 421, Rogers, Ark. 72756. Tel: (501) 636-6231. Contacts: Gladys M. & Guy Hunt.
 Starr Rec. Co., Box 1, Florida, N.Y. 10921. Tel: (914) 651-4266. Pres.: Jimmy Sturr; VP: Edward Kosior; Sec'y: Joe Dembeck.
 Star Song, Ga., see Atlantis.
 Star Song of California, see Consolidated Gospel.
 Star Song, Tex., see Rivendell.
 Star (Switzerland), see Sonic Arts.
 Startown Recs., Box 151-A, Rt. 3, Hwy. 82 W., Columbus, Miss. 39701. Tel: (601) 327-9977. Pres.: Allen White; Bus. Mgr.: Annie Mae White; Sales Rep.: Aldean Clemons; Promo.: Lantrhus Marshall.
 Branch: Louisville, Ky., 5341 Halsey Court, Washington Park. Zip: 40214. Tel: (502) 366-4882. Rep.: Ron Lewis.
 Labels: (Owned) Dove, NFM, Soultrack; (distributed) Black Foot, Boliva, Cynthia, Jody, Lamb, Mable, NMI, New World, Pearly Gates, Sherr.
 Starwest Recs., PO Box 21, Longview, Wash. 98632. Tel: (206) 423-9085. Gen. Mgr.: Mike Poo; Chief Eng.: Joe Gibson.
 Stash Recs. Inc., PO Box 390, 106 Prospect Park W., Brooklyn, N.Y. 11215. Tel: (212) 965-3407. Pres.: Bernard Brightman.
 Int'l reps.: Australia (Larrikin), UK (Jazz Horizons).
 Stateswood, see Skylite-Sing.
 Stairas, see Progressive.
 Stax, see Fantasy/Prestige/Milestone/Stax.
 Steady Recs., 846 Seventh Ave., New York, N.Y. 10019. Tel: (212) 757-3800. Pres.: Art Treferson.
 Labels: (Owned) Casset Major, Phonosonic, Premier, Steady.
 Stentorian Inc., 8525 Seminole St., Philadelphia, Pa. 19118. Tel: (215) 248-5380, 247-2994. Pres.: Keith R. Chapman; Sec'y-Treas.: Sally Ann Chapman.
 Stepping Stone, see Trend Recs. in Ga.
 Stereo Fidelity, see Alshire.
 Stereo Spectrum, see Dance-A-Thon.
 Steff, see DRG Recs.
 Stiff/Columbia, see CBS.
 Stiff/Epic, see CBS.
 Stinson Recs., PO Box 3415, Granada Hills, Calif. 91344. Tel: (213) 368-1612. Pres.: Jack M. Kall.
 Int'l reps.: Colombia (Ramirez), Mexico (Gomez), UK (Free Reed).
 Stone Gold Recs., PO Box 1302, 906 W. Queen St., Hampton, Va. 23661. Tel: (804) 380-9640. Pres.: Daniel Goldstone; VP: Quincy Lee; A&R/Promo. Dir.: Alex Goldstone; Sales Mgr.: Hugh Wilks.
 Stonehedge, see Jersey Coast.
 Stone Post Rec. Co., Box 1213, Emporia, Kan. 66801. Tel: (316) 343-2727. Pres. & A&R Dir.: Richard Bisterfeldt; VP: John Richard; VP Sales & Mktg.: Jacki Bisterfeldt; Mktg. & Disco Co-ord.: Jann Bisterfeldt.
 Stoneway Recs. Inc., 2817 Laura Koppe, Houston, Tex. 77093. Tel: (713) 697-7867.
 Stony Plain, see First American.
 Storyteller Series, see Indi.
 Straville Jazz, see Moss.
 Stradivari, see Everest.
 Stranger Than Truth, see Fiction.
 Strata-East Recs. Inc., 156 Fifth Ave., New York, N.Y. 10010. Tel: (212) 691-9294. Cable: SEFONIC. Telex: 234104. Chief Officers: Charles Tolliver, Stanley Cowell.
 Strate-8, see Fortune.
 Street Level, see Consolidated Gospel.
 Streke, see Periscope.
 String (UK), see Rounder.
 Stripe 99, see Pennant.
 Stud Guy, see Old Dominion.
 Studio Q, see QCA in Calif.
 Studio 7, see Vee Jay.
 Studio 17, see Revonah.
 Styletone Recs., 254 E. 29 St., Suite 7, Los Angeles, Calif. 90011. Tel: (213) 748-6074. Pres.: Jerry Hooks.
 Labels: (Owned) Groundhog, Hooks, Hooks Bros., J&J, Shur-Tinga, Styletone.
 Su-Ann, see HSE.
 Subbarao, see IRDA.
 Sue Int'l, see Jupiter Jazz.
 Sugarbear, see Stark.
 Sugarbush, see Reflection Sound.
 Sugar Hill Recs., PO Box 4040, Duke Sta., Durham, N.C. 27706. Tel: (919) 489-4349. Pres. Barry Poss; VP: David Freeman; Promo.: Chet Rhodes.
 Int'l reps.: Canada (Almada), Japan (BOM), UK (Mike Craig).
 Sugar Hill, Va., see County.
 Sugar-Soul, see Otao.
 SuiteWinds Prod'ns Inc., PO Box 27344, Los Angeles, Calif. 90027. Tel: (213) 665-6006.
 Summer, see Cord.
 Summit, see CMS.
 Sunbeam Recs. Inc., 13821 Calvert St., Van Nuys, Calif. 91401. Tel: (213) 994-7791.
 Labels: (Owned) Sountrak, Sunbeam.
 Sunbird, see Waltner.
 Suncat Recs. (div. of Suncat Entertainment), PO Box 66, Manhattan Beach, Calif. 90266. Tel: (213) 371-9578. Cable: SUNREC. Pres.: Gary Young; VP A&R: Larry Thatt; VP Promo.: James Morris; VP Sales: Ed Cardinali; VP Adv.: Mark McPhail; VP Country A&R: Ken Sat-

terlee; VP Special Prods.: Shaun Hicks; VP Disco A&R: Craig Moulton; Tape Sales Mgr.: Timothy Timm.
 Branch: Oklahoma City, Okla., 3313 NW 41 St. Zip 73112. Tel: (405) 947-5907. Pres.: Ron Hicks; VP: Gordon Johnson.
 Int'l branches: Canada, Venezuela.
 Labels: (Owned) Suncat, Windi, Windi-South (Venezuela); (distributed) Calabasas, My Rec. Co., Nova-Sol. Suncoast Recs., PO Box 5208, Clearwater, Fla. 33518. Tel: (813) 446-2914. Pres.: Earl Wagenseller.
 Suncountry Prod'ns Inc., 14 E. Second St., Tucson, Ariz. 85705. Tel: (602) 792-3194. Pres.: Fred Kriape; VP: Jim Bastin; A&R Dir.: Steve Chandler.
 Label: (Owned) Bandolier.
 Sundown Recs., Box 258, Rt. 1, Carriere, Miss. 39426. Tel: (601) 798-7099. Owner: Vern Pullens; Pub. Ed.: Bruce Dixon.
 Branch: Nashville, Tenn., 1204 Elmwood Ave. Zip 37202. Tel: (615) 385-2704. Owner: Joe Gibson.
 Sun Dyl Recs., 312 Sharon Ave., Marshalltown, Iowa 50158. Tel: (515) 752-3198. Dir.: Alan Lund, David Hofer, Jerry Carberry.
 Sun-Glo Recs. Inc., 12911 SW 82 Terr., Miami, Fla. 33183. Tel: (305) 279-2523. Pres.: Samuel Solomon Jr.; Exec. VP: Willie W. Harvey.
 Labels: (Owned) Sun-Glo, Tempus.
 Sun Int'l Corp., 3106 Belmont Blvd., Nashville, Tenn. 37212. Tel: (615) 385-1960. Cable: SHELREC. Telex 3711222. Pres.: Shelby S. Singleton Jr.; VP: John A. Singleton; VP Sales: Richard Bruce; Promo. Dir.: Tom McConnell.
 Sunny Day Prod'ns, 1931 SE Morrison, Portland, Ore. 97214. Tel: (503) 238-4525. Pres.: Russell E. Gorsline.
 Label: (Owned) Criket.
 Sunrise Recs., 1845 W. Empire Ave., Burbank, Calif. 91504. Tel: (213) 843-4444.
 Sunrise, Ohio, see Melody.
 Sun-Scape Recs., PO Box 42725, Tucson, Ariz. 85719. Tel: (602) 297-9422.
 Int'l branch: Canada.
 Sunshine Country Recs., PO Box 31351, Dallas, Tex. 75231. Tel: (214) 690-4155. Pres.: Bart Barton; VP's: B. C. Bramlett, Mike Anthony; Nat'l Sales: Rusti James. Labels: (Owned) SCR; (distributed) Branch Int'l, Vertex, Yatahey.
 The Sunshine Group Ltd., 800 S. Fourth St., Philadelphia, Pa. 19147. Tel: (215) 755-7000. Pres. & Gen. Mgr.: Walter B. Kahn; Legal & Bus. Affairs: Eric Lipman; Comptroller: Barry Schwartz; A&R: Rick Kunis; Pub. & Promo.: Jackie Stone.
 Label: (Owned) Grand Prix.
 Sunshine Sound, see TK.
 Superba, see Sine Qua Non.
 Super Bad Recs., 14001 Mont Ave., Cleveland, Ohio 44118. Tel: (216) 371-3965. Pres.: Roger Hatcher; VP: Janice Hatcher.
 Super Dimension Six, see Sonic Arts.
 Super-8, see Cadet Recs.
 Superior, see Ansonia.
 Superior Sound Studio, Rockland Rd., Hendersonville, Tenn. 37075. Tel: (615) 824-5141.
 Labels: (Owned) Message, Rockland Road, Superior.
 Super Star, see Phono Rec. Dist'g.
 Supreme Rec. Co., 110 21 Ave. S., Nashville, Tenn. 37203. Tel: (615) 327-1050. Owner: Thomas H. Walls; Promo. Mgr.: Allen B. Henson.
 Labels: (Owned) Supreme, Timberhill.
 Supreme, Mich., see Singpiration.
 Sure Fire Recs., RFD 100, Lowell, Vt. 05447. Tel: (802) 744-2710. Contact: W. Warner. (Distributed by IRDA)
 Sure Music & Rec. Co. Inc., PO Box 94, 39 N. Sprout Rd., Broomall, Pa. 19008. Tel: (215) 356-2996.
 Surf City Recs., Box 14, Hollywood, Calif. 90028. Tel: (213) 851-3161. Pres. Gary M. Theroux; VP: Robert L. Gilbert; Sales Mgr.: Michael Slick; A&R Dir.: Mark Changer; Opns. Mgr.: Joan Holpuch; Creative Servs.: Dusty Ann Smoke.
 Branch: Northbrook, Ill., 4 Court of Harbinger Falls. Zip: 60062. Tel: (312) 564-3673. Mgr. M.E. Theroux; Ass't Mgr.: B.D. France.
 Labels: (Owned) GTP, Rock's Greatest Hits, Surf City; (distributed) Bob.
 Surfside, see Hula.
 Surfside Hawaii Inc., 1365 Colburn St., Honolulu, Hawaii 96817. Tel: (808) 847-0855.
 Labels: (Owned) Lehua, Mahalo.
 Survivor Recs. Inc., 349 S. Lafayette Park Pl., No. 323, Los Angeles, Calif. 90057. Tel: (213) 383-0720. Exec. Dir.: Jason Schwartz; Gen. Mgr.: Richard Schulenberg.
 Susan, see Terock.
 Svensk-Disk, see Lindberg.
 Swallow, see Flat Town.
 Swallowtail Recs., Box 843, Ithaca, N.Y. 14850. Tel: (607) 844-4535. Owner & Pres.: Phil Shapiro.
 Swan Song, see Atlantic.
 Swedish Discophile (Sweden), see Worldtone.
 Sweet City, see Belkin.
 Sweetsong Recs., PO Box 2041, Parkersburg, W. Va. 26101. Tel: (304) 485-0525. Pres.: Roger L. Hoover.
 Labels: (Owned) Mansion, Sweetsong.
 Sweet Stuff, see Express.
 Sweet Tooth, see Candy.
 Swinger, see Phono Rec. Dist'g.
 Symposium Recs., 204 Fifth Ave. SE, Minneapolis, Minn. 55414. Tel: (612) 331-5750. Pres.: George Hanson.
 Labels: (Owned) Flashlight, Symposium.
 Syntonic Research Inc., 175 Fifth Ave., New York, N.Y. 10010. Tel: (212) 243-5434. Pres.: Irv S. Teibel; VP: Michael Kron; Prod. Mgr.: Kip Kaplan; Research & Development Mgr.: Russ Aarons; Adv. Mgr.: M. Berman.
 Int'l reps.: Australia (Modern Age), Canada (Treble Clef), Japan (Nippon Phonogram), Netherlands (Munich).
 Syrxin (UK), see Worldwide Music Servs.

T C B, see Rob-Lee.
 T E J, see Brookville.
 T H Rec. & Tapes Inc., 10124 NW 80 Ave., Hialeah Gardens, Fla. 33016. Tel: (305) 558-2722. Pres. Wilhelm Ricken; VP: Bernard Brecht; Gen. Mgr. & Sec'y: Antonio Moreno Jr.; Int'l Co-ord. & Dir.: Carlos Vidal; A&R Dir.: Antonio Moreno Sr.
 Branches: Puerta de Tierra, P.R., 304 Fernandez Junco Ave. Zip: 00906. Tel: (809) 722-1344. Mgr.: Frank Torres—San Antonio, Tex., 431 Linda Dr. Zip: 78216. Mgr.: Carlos Santa Cruz.
 Labels: (Owned) Color, Lad, TH.
 T K D, see TK.
 T K Prod'ns, 495 SE 10 Court, Hialeah, Fla. 33010. Tel: (305) 888-1685. Pres.: Henry Stone; VP: Steve Alaimo; VP Financial Affairs: Jack Kratish; Nat'l Sales Mgr.: Jim Solmson; Nat'l Mktg. & Mdsgr. Mgr.: Linda Fine; Prod. Affairs/Foreign & Domestic Dir.: Katie Kahrs; Pub. Dir.: Jae Zitzkin; Prod'n Mgr.: Ron Ransom; Gospel Dir.: Timmy Thomas; Nat'l R&B Promo.: George Chavous; R&B Promo. Co-ord.: Glynn Daniels; Nat'l Pop Promo.: Moe Preskell; Pop/AOR Promo.: Peggy Armstrong.
 Branches: Los Angeles, Calif., 6484 Sunset Blvd., Suite 780. Zip: 90028. Tel: (213) 462-6238. West Coast Mktg. Mdsgr. & Sales Dir.: Sandy Horn—New York, N.Y., 65 E. 55 St. Zip: 10022. Tel: (212) 752-0160. VP Special Projects & Nat'l Disco Promo. Dir.: Dan Joseph; Ass't to Nat'l Disco Promo. Dir.: Laurie Ingber; Mgr.: Norman Rubin; East Coast Mktg. Mdsgr. & Sales Dir.: Steve Stephens.
 Labels: (Owned) Alston, Amazon, Arth, Blue Candle, Bold, Brownstone, Cat, Clouds, Dash, Drive, Glades, Gospel Roots, Marlin, Reid's World, Roots, TK, TKD, Weird World, Wolf; (distributed) APA, BNA, Chimneyville, Dial, Good Sounds, HDM, Inphasion, Juana, Kayvette, Konkudo, LRC, Malaco, Musclic, Shoals, Royal Flush, Shield, Silver Blue, Sound Plus, Sunshine Sound.
 T M S Recs., 8833 Sunset Blvd., Penthouse, Los Angeles, Calif. 90069. Tel: (213) 855-0881. Chief Exec.: Thomas Schieno; Exec. VP: Barney Fields.
 T-Neck, see CBS.
 T P M, see Loypriquan.
 T R Recs. Inc., 747 10 Ave., New York, N.Y. 10019. Tel: (212) 582-5600.
 Labels: (Owned) Clave, Del Mundo Int'l, Disko-Mania, Latin Movement, Pina, TR.
 T R C Recs. (div. of TRC Corp.), TRC Mid-America Rec'g Center, 1330 N. Illinois St., Indianapolis, Ind. 46202. Tel: (317) 638-1491. Pres.: R. Gary Schatzlein; VP & Gen. Mgr.: K. Mark Clevenger; Prod'n Assoc.: George E. Wilson.
 T S K, see World Int'l.
 T S O P, see Philadelphia Int'l & CBS.
 T 2 Toppie, see Old Hat.
 T W C Entertainment Corp., GPO Box 2021, New York, N.Y. 10001. Tel: (212) 691-4565. Pres.: Thomas Schroeder; Sec'y & Rock Pop Promo. Mgr.: Jerome Haggart; Treas. & Country Div. Mgr.: Walter Balderson.
 Tabligh, see Ray Lawrence.
 Tabu, see CBS.
 Tadarab, see Charma.
 Taino, see Otao.
 Take Home Tunes! Rec. Co., Box 496, Georgetown, Conn. 06829. Tel: (203) 544-8288. Prod'rs: Bruce D. & Doris Chu Yeko.
 Branch: Fort Lee, N.J., Box 15. Zip 07024. Tel: (201) 224-5811.
 Labels: (Owned) Broadway Baby, Original Cast.
 Takoma Recs. Corp., 9255 Sunset Blvd., Los Angeles, Calif. 90069. Tel: (213) 550-0171. Pres.: Terry Ellis; A&R: Denny Bruce, John Fahey; Nat'l Sales Mgr.: Jon Monday. (Distributed by Chrysalis)
 Tall Man, see Pamlyn.
 Talpro Prod'ns Inc., 870 Seventh Ave., Suite 348, New York, N.Y. 10019. Tel: (212) 581-4680. Cable: ARTALMADGE. Pres.: Art Talmadge; Promo. & Sales & Disco Contact: Irwin Rawitz.
 Labels: (Owned) Double Feature, Dynamo, Groove Sound, Talpro.
 Tamborin, see Musitron.
 Taml, see Motown.
 Tamm, see La Louisianne.
 Tangent (UK), see Rounder.
 Tao Recs., PO Box 504, 4290 Acacia Ave., Bonita, Calif. 92002. Tel: (714) 421-0865. Pres. & Gen. Mgr.: Virginia Anderson; Exec. VP: Robert Anderson Sr.
 Tappan Zee Recs. Inc., 100 W. 57 St., No. 20G, New York, N.Y. 10019. Tel: (212) 765-0580. Pres.: Bob James; Gen. Mgr.: Peter Paul; Prod'r: Jay Chataway; Prod'r/Eng. Joe Jorgensen; Prod'n Co-ord. Marion Orr; Prod. Mgr.: J. Jaime Wilson. (Distributed by CBS)
 Tara (Ireland), see Rounder & Shanachie.
 Tar Heel, see Jim Hall.
 Tarheel, see McKinnon.
 Taurus, see Auditorama.
 Taxi Recs., 1740 Howard St., Chicago, Ill. 60626. Tel: (312) 274-5100. Owner: Alan Krookey.
 Creed Taylor Inc., 1 Rockefeller Plaza, New York, N.Y. 10020. Tel: (212) 489-6120. Bd. Chm.: Creed Taylor; Pres. Gerald Wagner; VP Sales & Mktg.: Tom Wolff; Nat'l Promo. Dir.: Bob Riley; Press: Arnold J. Smith.
 Labels: (Owned) CTI, Kudu, Salvation, Three Brothers.
 Int'l reps.: Argentina (Microfon), Australia (Phonogram), Austria (Metronome), Belgium (Dureco), Brazil (Gravacoas Eletlicas), Canada (RCA), Central America (Dideca), Colombia (Sonolux), Denmark (Metronome), Dominican Republic (Distribuidora Dominicana), Finland (Metronome), France (RCA), Germany (Metronome), Greece (Minos Matsas), Israel (Eastronics), Italy (CBS), Jamaica (Dynamic Sounds), Japan (King), Mexico (Gamma), Netherlands (Dureco), New Zealand (Phonogram), Norway (Metronome), Peru (Disco Casette), Philippines (Jem), Singapore (Phonogram), South Africa (Gallo), Spain (Hispanovox), Sweden (Metronome), Switzerland (Metronome), UK (Polydor), Venezuela (Velvet), West Indies (Dynamic Sounds).

R. Dean Taylor Prod'ns, c/o RDT Prod'ns Inc., 6515 Sunset Blvd., Suite 309, Hollywood, Calif. 90028. Tel. (213) 464-9903.
Labels: (Owned) Autumn, Jane.
 Tee Vee Recs. Inc., 1710 Grand Ave., Nashville, Tenn. 37212. Tel. (615) 327-4785. Gen. Mgr.: Stephen Hawkins.
Home office: Canada.
 Telarc Recs., 23293 Commerce Park Rd., Cleveland, Ohio 44122. Tel. (216) 464-2313. Pres. & Chief Eng. Jack Renner. Prod'r. Robert Woods. Mktg. & Promo. Dir.: Albert Petrak. (Distributed by Audio-Technica)
 Telectra, see Penco.
 Telefunken, see London.
 Telemark Dance Recs., 6845 Elm St., Suite 614, McLean, Va. 22101. Tel. (703) 356-9113. Pres.: Sheila M. Mason. VP Opns.: Richard S. Mason.
Int'l branch: England.
Labels: (Owned) Telemark; (distributed) Philips (UK), Al Pierson, Rediffusion, TM, Sydney Thompson (dance records only).
 Teleson America, 333 Beacon St., Boston, Mass. 02216. Tel. (617) 353-1664. Dirs.: Jacques Maigret, Kenneth Starr.
Home office: France, Teleson.
Label: Grand Orgue.
 Teleslar (Sweden), see Worldtone.
 Tel-E-Vue, see Revonah.
 Tell Int'l Rec'g Co., Box 368-A, Rt. 5, Yakima, Wash. 98903. Tel. (509) 966-6334. Pres.: Jerry Merritt. VP's: Hiram White, Lloyd Jones; Eng. Larry Merritt.
 Temple, see SkyLite-Sing.
 Tempo Inc., 1900 W. 47 Pl., Mission, Kan. 66205. Tel. (913) 384-1266. Pres.: Jesse Peterson; VP: Kent Barber, Adv. & Promo. Dir.: Bill Rayborn, Special Markets Dir. & Co-ord.: Don Klein.
Int'l branch: Denmark.
Labels: (Owned) Chrism, Sound III, Tempo; (distributed) Pax, Petra, Scripture in Song.
Int'l reps.: Australia (Sacred), Canada (Beacon), Netherlands (Universal Songs), New Zealand (Concorde), South Africa (Bet-El), UK (Pilgrim).
 Tempus, see Sun-Glo.
 Tener, see Bee Jay.
 Tennessee Country, see Glolite.
 Terock Recs., PO Box 4740, Nashville, Tenn. 37216. Tel. (615) 361-5356. Pres.: Wade Curtiss.
Label: (Owned) Susan.
 Texas, see Don Schaefer.
 Texas Re-Cord Co. (div. of Western Head Music Co.), Box 19, Bulverde, Tex. 78163. Tel. (512) 438-2465. Pres.: Augie Meyers; Mgr.: Carol Meyers; Dir.: Lucky Tomblin.
Branch: Austin, Tex., 2227 E. Ben White. Zip 78741. Tel. (512) 444-7699.
Labels: (Owned) Texas Re-Cord, Texas Roc Co., (distributed) Crazy Meskin.
 Texas Roc Co., see Texas Re-Cord.
 Texas Soul Recs., 3417 73 St., Suite F, Lubbock, Tex. 79423. Tel. (806) 795-1480, 747-7047. Contacts: Larry Corbin, Don Caldwell.
 Texas Sound Inc., 1311 Candlelight Ave., Dallas, Tex. 75115. Tel. (214) 298-9576.
Label: (Owned) Sagittar.
 The Record Co., 8535 Sunset Blvd., Los Angeles, Calif. 90069. Tel. (213) 652-4487. Pres.: Steve Angelica.
 Thevis, see Dance-A-Thon.
 Thimble, see Audiofidelity.
 Third Street Recs., 10 N. Third St., Philadelphia, Pa. 19106. Tel. (215) 627-3366. Pres.: Jerry Gordon.
 This is Country Music (div. of International Heritage Music Ass'n), 133 Walton Ferry Rd., Hendersonville, Tenn. 37075. Tel. (615) 822-4827. Pres.: Ralph H. Compton.
 This is It, see Sid Kleiner.
 Thomas, see RCI.
 Thoroughbred Recs., PO Drawer 2176, Zip 78767; 910 Post Oak St., Austin, Tex. 78704. Tel. (512) 442-3375. Owner: Rex T. Sherry.
 Thoth, see Castalia.
 Three Brothers, see Creed Taylor.
 3 G's Inds., 516 W. 75 St., Kansas City, Mo. 64114. Tel. (816) 333-9617. Pres.: Eugene Gold; VP Prod'n: Gilbert Roland; A&R Dir.: J. J. Gadsdon; A&R: Mike Green, Sales & Promos. Dir.: C. King.
Labels: (Owned) Chris, 3 G's.
 Threshold, see London.
 Thunderbird, see Olivia, Music Resources & Gillette-Madison.
 Thunder-Compute, 6362 Hollywood Blvd., Suite 218, Los Angeles, Calif. 90028. Tel. (213) 467-3619. Pres.: Damon Albert; VP: Sam Kleinman; Sec'y: Marz Frost.
 Thunder Lizzard, see Crimson Dynasty.
 Tico, see Fania.
 Tiger Lily, see Roulette.
 Tikal, see Discolando.
 Timberhill, see Supreme.
 Timberline Recs. Inc., 420 E. Frank St., Birmingham, Mich. 48009. Tel. (313) 646-1115. Contact: Paul Shubert.
 Time, see Charta.
 Timeless Entertainment Corp., 160 E. 56 St., New York, N.Y. 10022. Tel. (212) 233-5949. Pres.: Fred Bailin.
Labels: (Owned) Goldisc, Perfect.
Int'l reps.: Austria, Germany & Switzerland (Ariola-Eurodisc).
 Timeless-Muse, see Muse.
 Times Mgmt. Corp., 1216 Granby St., Norfolk, Va. 23510. Tel. (804) 625-0534. Pres. D.H. Burlage; VP: Guy A. Burlage; Sec'y-Treas.: Denis J. Burlage. **Local branch:** 107 E. 13 St. Zip 23510. Tel. 625-0534.
Label: (Owned) Waylon.
 Tina Recs., PO Box 189, Antioch, Tenn. 37013. Tel. (615) 833-1287. Contact: Dale Vast. (Distributed by IRDA).
 Rik Tinory Prod'ns, 622 Rt. 3A, Cohasset, Mass. 02025. Tel. (617) 383-9494. VP: Richard Tinory Jr., PR: Claire L. Tinory.
Labels: (Owned) Old Boston, RTP Int'l, Sequel, Venture.
 Tobill Entertainment Corp., c/o Audiofidelity Ents., 221 W. 57 St., New York, N.Y. 10019. Tel. (212) 757-7111. Owners: William D. Hassett Jr., Tony Bennett. (Distributed by Audiofidelity)

Label: (Owned) Improv.
 Toll Free Recs. & Tapes, see CDE.
 Tomato Music Co. Ltd., 611 Broadway, New York, N.Y. 10012. Tel. (212) 477-2800. Pres.: Kevin Eggers; VP: Mktg. & Sales: Mel Fuhrman; A&R Dir.: Heiner Stadler; Nat'l Promo. Dir.: Bob Gooding; Nat'l Pub. Dir.: Marion Sommerstein.
Int'l reps.: Canada (GRT), Japan (Victor).
 Tom 'n Jerry, see Casablanca.
 Tom Thumb, see Rhythms Prod'ns.
 Tool Room Recs., Box 118, Pewaukee, Wis. 53072.
 Top & Bottom, see Jamie/Guyden.
 Topic (UK), see Rounder & Shanachie.
 Top-Star, see Sid Kleiner.
 Tornado, see Crimson Dynasty.
 Torres, see Musimex.
 Tortoise, see RCA.
 Toshiba-EMI (Japan), see Audio-Technica.
 Total Sound Inc., 1133 Ave. of the Americas, New York, N.Y. 10036. Tel. (212) 869-8260.
Label: (Owned) Project 3.
Int'l reps.: Argentina (Jorge Esperon), Australia (Festival), Brazil (Som), Canada (London), Mexico (Guitarra), Netherlands (Barnart), Philippines (Dyna), Portugal (Radio Trunfo), South Africa (Teal), Spain (Hispanovox), Venezuela (BASF).
 Total Sound, Calif., see Lawrence Herbst.
 TownHall Recs., PO Box 5332, 1253 Coast Village Rd., Santa Barbara, Calif. 93108. Tel. (805) 969-3731. Pres.: Lincoln Mayorga; Mgr.: Linda Jones; A&R & Promo. Dir.: Patricia Meredith.
 Toy Recs., PO Box 219, Radio City Sta., Zip: 10019; 400 W. 43 St., Suite 19H, New York, N.Y. 10036. Tel. (212) 695-6995. Pres.: N.L. King; VP: Lawrence Lucie.
 Tradition, see Everest.
 Trailer (UK), see Rounder.
 Transatlantic (UK), see Rounder & Shanachie.
 Transatlantic USA, see Kicking Mule.
 Transworld Recs., see Finer Arts.
 Trash, see Sound Inc.
 Travel, see Nationwide Sound.
 Treasury Series, see London.
 Trend, Pismo Beach, Calif., see Nautilus.
 Trend Rec. Corp., 117 N. Las Palmas Ave., Los Angeles, Calif. 90004. Tel. (213) 938-5482. Pres.: Albert Marx; VP: Dennis Smith; Promo.: Pat Nickerson.
Labels: (Owned) Discovery, Renaissance, Trend, Very-disco.
 Trend Recs., PO Box 201, Smyrna, Ga. 30081. Tel. (404) 432-2454. Owner & Pres.: Thomas E. Hodges; VP: Frank D. Brannon; Assoc. VP: Jerry Burke.
Labels: (Owned) Atlanta, Stepping Stone, Trend, Trendsetter, Trendsides.
 Trendsetter, see Trend Recs. in Ga.
 Trendsides, see Trend Recs. in Ga.
 Triangle Recs. Inc., 824 19 Ave. S., Nashville, Tenn. 37203. Tel. (615) 329-1429. Pres.: Buryl Red; VP & Gen. Mgr.: Elwyn Raymer.
Labels: (Owned) Caelix, Triangle.
 Tribal, see Tom Bee.
 Tribe, see Black Fire.
 Tribute, see Modern Sound.
 Trinity Sound, see Consolidated Gospel.
 Trip, see Springboard.
 Triple Ill Recs., 2601 Hillsboro Rd., Nashville, Tenn. 37212. Tel. (615) 385-3058. (Distributed by IRDA).
 Trish Nugent, see Olivia.
 Trix Recs. Inc., Drawer AB, Rosendale, N.Y. 12472. Tel. (914) 687-9573. Pres.: Pete Lowry.
Labels: (Owned) Trix; (distributed) Kheba.
Int'l reps.: Canada (Almada), Sweden (Smokestack), UK (Swift).
 Tropical Music Inc., PO Box 1494, Honolulu, Hawaii 96806. Tel. (808) 521-6256. Pres.: Bill Murata.
Labels: (Owned) Discos Tropical, Poki, Pumehana.
 Tropical, N.Y., see Met Richmond.
 Tropicana, see Gramophone.
 True, see World Wide Music Inc.
 True Love, see Jim Hall.
 True North, see Island.
 Trutone Recs., 163 Terrace St., Haworth, N.J. 07641. Tel. (201) 385-0940. Pres.: Louis Rowatti; Sec'y-Treas.: Chief Eng. & Studio Mgr.: Carl Rowatti, Bus. Mgr. & Adv. Dir.: Adrienne Lyne Rowatti; Disk Mastering Engs.: Phil Austin, Steve Robb.
 Tubby, see Rollin' Rock.
 Tumbleweed Music Co. Inc., 200 Central Park S., New York, N.Y. 10019. Tel. (212) 586-8879. Pres.: Arie Fisher.
 Turbo, see All Platinum.
 Turnabout, see Moss.
 Turn On, see Moss.
 Turnstyle, see Latin Percussion.
 Twelve O'Clock, see Florida Independent & Indr.
 20th Century-Fox Rec. Corp., 8544 Sunset Blvd., Los Angeles, Calif. 90069. Tel. (213) 657-8210. Cable 20CENREC. Pres.: Alan Livingston, Sr. VP: Neil Portnow; VP Promo.: Dave Parks; VP Black Prod. Promo.: Bunky Sheppard; VP/Controller: Monty Houdeshell; VP Bus. Affairs: Frank Molloy; Int'l Dir.: Liz Gardener, Sales & Mktg. Dir.: Mort Weiner; Adm. Dir.: Caroline Molzan. (Distributed by RCA).
Int'l branch: England.
Int'l reps.: Argentina (Phonogram), Australia (RCA), Austria (Phonogram), Belgium (Phonogram), Brazil (Phonogram), Canada (RCA), Chile (Philips), Colombia (Philips), Denmark (Phonogram), Dominican Republic (Sonido), Ecuador (Fediscos), Ethiopia (Philips) Finland (Finnlevy), France (RCA), Germany (Phonogram), Ghana (Phonogram), Greece (Phonogram), Indonesia (Philips), Israel (Eastronics), Italy (Phonogram), Jamaica (Record Specialists), Japan (King), Lebanon (Philips), Mexico (Gamma), Netherlands (Phonogram), New Zealand (RCA), Nicaragua (Sonido), Norway (Phonogram), Panama (Discos Phonograficos), Peru (El Virrey), Philippines (Home Inds.), Portugal (RCA), Singapore (Phonogram), South Africa (Teal), Spain (RCA), Sweden (Phonogram), Switzerland (Phonogram), Turkey (Gruenberg Ticaret), UK (RCA), Venezuela (Polydor).
 20th Fontery Sex, see Fiction.
 Twister, see Quadraphonic.

2-J Recs. Inc., 1115 S. Lillian, Ottumwa, Iowa 52501. Tel. (515) 684-4195. Pres.: Jack Paris; Sec'y-Treas.: Ivan Tennyson. (Distributed by Ozark Opry).
 2-Mac Recs., 2097 Vistadale Court, Tucker, Ga. 30084. Tel. (404) 938-1210. Owners: Phil McDaniel, Joe McTamney.
 2001 Recs., Great Southern Center, Bridgeville, Pa. 15017. Tel. (412) 221-2001.
 Typhoon, see Crimson Dynasty.

U

U F O, see Glolite.
 U G R, see Unlimited Gold.
 U K Recs. Inc., 315 W. 57 St., Suite 3H, New York, N.Y. 10019. Tel. (212) 581-7577.
Home office: England.
 U S, see SIPRA.
 U U S, see Utopia.
 Ultra-Audio, see Point Blank.
 Ultragroove, see Crystal Clear.
 Umpire Enterprises, 1824 Laney Dr., Longview, Tex. 75601. Tel. (214) 758-9855. Owner-Pres.: Jerry Haymes; Mgr.: Betty Jacobs; Sec'y: Sandy Wilson; Assoc. Mgr. & A&R: Jeff Johnson.
Branches: Tucson, Ariz., 2806 N. Tucson Blvd. Zip 85716. Tel. (602) 795-7433—Springfield, Ill., 3036 N. Peoria Rd. Zip: 62702. Tel. (217) 523-5039.
Label: (Owned) Enterprize.
 Uncle Bear, see Ray Lawrence.
 Underground, see Record & Music.
 Unicorn (UK), see HNH.
 Unidisc (France), see Worldtone.
 Union Label, see United Rec'g.
 Unique Jazz (Italy), see Zim.
 United, see Cadet Recs.
 United Artists Recs., see EMI-America/United Artists & Capitol.
 United Artists (UK), see DRG.
 United Rec'g Group, Fourth & Race Tower, Suite 520, Cincinnati, Ohio 45202. Tel. (513) 621-1446. Pres. & Exec. Prod'r: Sanford S. Paris; VP & A&R & Artist Development Dir.: Tom Bass.
Labels: (Owned) Union Label, Urge.
 United States, see Van Winkle.
 Unity, Fla., see Art.
 Unity Recs., PO Box 63, Colona, Ill. 61241. Tel. (309) 796-0752. Contact: Wanda Hurry.
 Universal Sound, see Sound Inc.
 Unlimited Gold Recs. Inc. (UGR), 12403 Ventura Court, Studio City, Calif. 91604. Tel. (213) 760-1665, 877-0535. Cable: UNLIMGOLD. Pres.: Barry White; Exec. VP: Paul Politi; VP, Gen. Mgr. & Int'l: Ralph L. Seltzer; VP Promo.: Elmer Hill; VP Prod'n: Tony Sepe; Ass't to Pres.: Frank Wilson; Controller: Laurie Fernandez. (Distributed by CBS).
 Upront, see Springboard.
 Up With People, 3103 N. Campbell Ave., Tucson, Ariz. 85719. Tel. (602) 327-7351.
 Urania, see American Themes.
 Urge, see United Rec'g.
 Utopian Ents. Inc., PO Box 5314, Macon, Ga. 31208. Tel. (912) 477-0415. Pres. & Gen. Mgr.: Randy L. Howard.
 Utopia Ultra-Sound, PO Box 718, Newark, Ohio 43055. Tel. (614) 345-9426. Pres.: Robert H. Kirk Jr.
Labels: (Owned) SAM, UUS, Utopia.

Q: What one reference tool lists all key information for every major and talent market?

A: ITD: Billboard's International Talent Directory. Your #1 guide to the world's top talent.

V

Vadeca, see Penco
 Thomas J. Valentino Inc., 151 W. 46 St., New York, N.Y. 10036. Tel. (212) 246-4675. Pres. Robert Valentino, VP's Thomas & Francis Valentino.
Label: (Owned) Major (SEE ADVERTISEMENT)
 Vandalia Recs., Box 32, Rt. 2, Quaker St., Vandata, Mich. 49095. Tel. (616) 476-2110
 Vanguard Rec'g Society Inc., 71 W. 23 St., New York, N.Y. 10010. Tel. (212) 255-7722. Cable VANMUSICA. Pres. & Classical A&R Seymour Solomon; Sec'y-Treas. Maynard Solomon; Pop & Jazz A&R Danny Weiss; Nat'l Sales & Promo. Dir., Nat'l LaPatin; Pub. Dir.: Laurel Dann; Foreign & Licensing Opns. Dir. Jo Inguanti; Art Dir. Jules Halfant; Musicologist James Ringo
Labels: (Owned) Bach Guild, Cardinal, Everyman Classics, Free Style, Historical Anthology of Music, Nomad, Vanguard.
Int'l reps.: Argentina (Sicamericana), Australia (Astor), Austria (EMI), Belgium (EMI), Brazil (Som), Canada (London), Chile (Quatro), Denmark (Sonet/Dansk), Finland (Sonet in Sweden), France (Musidisc), Germany (EMI Electrola), Greece (CBS), Iran (CBS), Israel (CBS), Italy (Ricordi), Japan (King), Mexico (Discos & Cintas), Netherlands (Pye), New Zealand (Ode), Nigeria (CBS), Norway (Arne Bendiksen), Portugal (Radio Triunfo), South Africa (Teal), Spain (Hispanvox), Sweden (Sonet), Switzerland (Phonag), Turkey (Melodi), UK (Pye).
 Vantage, Calif., see Shiloh
 Vantage Rec'g Co., 915 Queen St., Pottstown, Pa. 19464. Tel. (215) 323-3336
Labels: (Owned) Jody, Pic-Vue, Piant, Reco-Flex, Semaphore, Sound of Money, Vantage, Zouvenir
 The Van Winkle Ent., 8533 Sunset Blvd., Suite 107, Hollywood, Calif. 90069. Tel. (213) 657-6026
Label: (Owned) United States
 Varese Sarabande Recs. Inc., 6404 Wilshire Blvd., Suite 1127, Los Angeles, Calif. 90048. Tel. (213) 653-3323
 Varulven Recs., Box 83, Tufts Univ. Branch, Medford, Mass. 02153. Tel. (617) 646-9490. Pres. Joseph Allen Vigione; VP Salvatore B. Niglione; VP A&R Paul Lovell; A&R Chief Joan McNulty; A&R Manuel Smith
Int'l rep.: France (Flammingo)
 Vaya, see Fania
 Vee-8, see Cadet Recs.
 Vee Jay Int'l Music, 131 E. Magnolia Blvd., Burbank, Calif. 91502. Tel. (213) 849-2469. Pres. Betty L. Chiappetta, Sec'y-Treas. Frank J. Chiappetta; A&R Dir. Patrick X. Britt; Special Prods. Dir.: Michael A. Ochs; Pub. & Promo. Dir. J.V. Barbieri II
Labels: (Owned) Dynasty, Epitaph, Oldies 45, Vee Jay, A World of Jazz; (distributed) Catalyst, Studio 7
Int'l reps.: Japan (Teichiku)
 Veevo Rec. Co., 54 W. 74 St., Suite 402, New York, N.Y. 10023. Tel. (212) 362-2259. Pres. Fredric Vonn.
 Vegas, Calif., see Ray Lawrence
 Vegas Encore, see Vintage
 Velvet, Calif., see SIPRA
 Velvet de Puerto Rico Inc., Calle Cerra 627, Santurce, P.R. 00907. Tel. (809) 722-3191, 723-4640. Pres. Roberto Page
Branches: Los Angeles, Calif., 2120 W. Eighth St., Suite 308. Zip: 90057. Tel. (213) 487-3596. Mgr. Tony Fernandez—Hialeah Gardens, Fla., 10128 NW 80 Ave. Zip: 33016. Tel. (305) 823-0812. Mgr. Ramon Castellanos—San Antonio, Tex., 1818 Fredencksburg Rd. Zip: 78201. Tel. (512) 735-5739. Mgr. Manuel Gonzalez
Labels: (Owned) Velvet, (distributed) Atlas, DC, Disco Sur, Mercurio
Int'l reps.: Germany (Polydor), Netherlands (Phonogram)
 Venture, see Rik Tinory
 Versatile Recs. Ltd., 39 W. 55 St., Penthouse North, New York, N.Y. 10019. Tel. (212) 582-5784, Telex 426942. Pres.: Michael S. Gusick, VP/Gen. Mgr. Vic Chirumbolo
 Vertex, see Sunshine Country
 Verve, see Polydor
 Verydisco, see Trend in Calif.
 Vetco Recs., 5825 Vine St., Cincinnati, Ohio 45216. Tel. (513) 242-8000. Pres. Lou Ukelson
 Vette Recs., 6290 Sunset Blvd., Suite 1809, Hollywood, Calif. 90028. Tel. (213) 462-5466. Pres. & A&R Dave Pell; VP. Larry Shayne
 Vibration, see All Platinum
 Vic, see La Val
 Victor, see RCA
 Victrola, see RCA
 Village Recs. Inc., 6325 Guilford Ave., Suite 4, Indianapolis, Ind. 46220. Tel. (317) 255-3116. Pres. Joe Halderman; VP & Gen. Mgr. Terry Barnes; Promo. Ron Townsend; Sales & Mktg. Gary Below; Pub. Debbie Rubush
 Village Thing (UK), see Rounder
 Vinla, see Mitchell
 Vintage Int'l Prods Ltd., 5441 Paradise Rd., Las Vegas, Nev. 89119. Tel. (702) 739-9266. Cable VIPENCO. Pres. & Exec. Prod'r. Leo A. Ciriano; VP & Gen. Mgr. Haven Dunn; Sec'y-Treas. & Admin. Kim Ciriano, PR Fiona Anderson; Prod'r/Eng.: Bill Shostak; A&R John Caccamo
Branch: Anaheim, Calif., 1631 N. Placentia Ave., No. D4. Zip: 92806. Tel. (714) 738-9026. Gen. Mgr. Parks Matthews
Labels: (Owned) Albergo, Core, Fame, Hall-Mark, Oreo, Vegas Encore
 Vintage One, Calif., see Ray Lawrence
 Vintage One Recs., Box 576, Libertyville, Ill. 60048. Tel. (312) 367-9390. Pres./Creative Dir. Dr. John B. DeVos; VP/Musical Dir. Ken Miller, Sec'y Marya H. DeVos
 Virgin Recs., Inc., 43 Perry St., New York, N.Y. 10014. Tel. (212) 243-6200. Telex. 666640. (Distributed by Atlantic)

Virginia Rec'g Co., 209 Main St., Fort Lee, N.J. 07024. Tel. (201) 947-3900. Owner: Al Thomas; A&R Tom Argro. Pub. & Promo. Jim McCarty (Distributed by Johnson Rec. Co.)
 Virgo, see Roulette
 Virtue, see Parr-X
 Visa, see Passport
 Visconjon, see SIPRA
 Vision, see Ozark Opry
 Vision (Brazil), see Brasilia
 Vista, see Disneyland/Vista
 Visual Recs. Inc., 1265 N. Grove St., Anaheim, Calif. 92806. Tel. (714) 632-8970. Contact Frank L. Touch
 Vocab Inc., 3071 S. Broad St., Chicago, Ill. 60608. Tel. (312) 254-8047
Labels: (Owned) Vocab, Wordcraft
 Vokes Rec. Co., PO Box 12, New Kensington, Pa. 15068. Tel. (412) 335-2775. Pres. Howard Vokes
Labels: (Owned) Country Boy, Vokes
 Volare Recs. Inc., PO Box 325, Englewood, N.J. 07631. Tel. (201) 567-7538. Pres. Clyde Otis, Prod'r David Wolford
 Volunteer, see Howard Knight
 Vox, see Moss
 Vox Box, see Moss
 Voyage Recs., 1700 Broadway, 40th Fl., New York, N.Y. 10019. Tel. (212) 541-7920
 Voyager Rec'gs, 3727 Seattle-First Nat'l Bank Bldg., Seattle, Wash. 98154. Tel. (206) 623-0110. Owners Philip L. & Vivian T. Williams, A&R Allen Yonge, Sales & Mktg. Vivian T. Williams
Labels: (Owned) Crossroad, Voyager

W

W A T T Works Inc., Willow, N.Y. 12495. Tel. (914) 688-5373. Owners Michael Mantler, Carla Bley.
Int'l reps.: Europe (ECM), Japan (Trio)
 W E A Int'l Inc., 75 Rockefeller Plaza, New York, N.Y. 10019. Tel. (212) 484-8100. Cable: ATCOMUSIC. Pres. Nesuhi Ertegun, Opns. Dir. Jim Caradine, Exec. A&R Dir. Dan Loggins, Int'l Projects Dir. Manfred Bormann, Press & Pub. Dir. Tracy Nicholas Bledsoe
Admin. office: Burbank, Calif., 3330 Warner Blvd. Zip: 91505. Tel. (213) 843-6311. Cable: WEAINTE
 W I L D (World Independent Label Dist.), PO Box 38391, Hollywood, Calif. 90038. Tel. (213) 733-7131. Pres. Steve Riggio, VP Sales Joan Austin, VP Promo Willy Hugron, Promo Co-ord. & Disco Mgr. Pat Va Byrd (Manufacturers' Rep.)
Labels: (Represented) Brownstone Cordat, Essar, Half Breed, Icecap, January, Playme
 W I M, see Crystal
 Wagon Wheel Recs., Box 266, Rt. 1, Georgetown, S.C. 29440. Tel. (803) 546-8835. Pres. Jack Redick
Labels: (Owned) Wagon Wheel, (distributed) Lu-Tex
 Wahr, see Sounds South
 Bruno Walter Society, see Educational Media & Discocorp
 Waltner Ent., 14702 Canterbury, Tustin, Calif. 92680. Tel. (714) 731-2981. Owner & Pres. Steve Waltner, Sales, Mktg. & Promo. Reggie South
Labels: (Owned) Daisy, Sunbird
 Warner Bros. Recs. Inc., 3300 Warner Blvd., Burbank, Calif. 91510. Tel. (213) 846-9090. Bd. Chm. & Pres. Mo. Ostin, Exec. VP Stan Cornyn; Sr. VP A&R Lenny Waronker, Sr. VP Sales & Promo. Ed Rosenblatt, Sr. VP/Treas. Murray Gitlin, VP Artist Development/Pub. Bob Regehr, VP Artist Relations Carl Scott, VP Bus Affairs David Berman, VP Nat'l Sales Lou Dennis, VP Int'l Tom Ruffino, VP & Exec. Prod'r Ted Templeman, VP Black Music Mktg. Tom Draper, VP/Talent Bob Krasnow, VP/Promo Dir. Russ Thyret; VP/Prod. Mgmt. Clyde Bakke; Creative Dir. Pete Johnson, Mdsgr. Dir. Adam Somers, Pub. Dir. Bob Merlis, Editorial Dir. Gene Sculatti, Exec. Art Dir. Peter Whorf; Prod. Mgrs. Robin Rothman, Benita Brazier, Barry Gross, Charlie Lourie, Adv. Mgr. Shelley Cooper, Nat'l Promo. Dirs. Bert Keane, Charlie Lake, Craig Kostich, Robert Richards, Nat'l LP Promo. Dirs. George Gerrity, Kim Anderson, Bonnie Simmons
Branches: New York, N.Y., 3 E. 54 St. Zip 10022. Tel. (212) 832-0600 (Pub.), 832-0950 (Admin.) Sr. VP Jerry Wexler, N.Y. Pub. Opns. Dir. Liz Beth Rosenberg—Nashville, Tenn., PO Box 121196, 1706 Grand Ave. Zip 37212. Tel. (615) 256-4282. VP/Country Music Dir. Andy Wickham; Promo. Dir. Stan Byrd, A&R Dir. Norro Wilson, Artist Relations & Pub. Dir. Bonnie Rasmussen
Distribution branches: Los Angeles, San Francisco, Calif., Denver, Colo., Hartford, Conn., Miami, Fla.; At-

lanta, Ga.; Chicago, Ill.; Greenbelt, Md.; Detroit, Mich.; Minneapolis-St. Paul, Minn.; Kansas City, St. Louis, Mo.; Mount Laurel, N.J.; New York, N.Y.; Charlotte, N.C.; Cincinnati, Cleveland, Ohio, Dallas, Tex.; Seattle, Wash. (See Record & Tape Wholesalers section for complete listings for Warner/Elektra/Atlantic Corp.)
Int'l branches: see WEA Int'l
Labels: (Owned) Reprise, Warner Bros., (distributed) Bearsville, Dark Horse, ECM, Island, Paradise, RFC, Sire, Warner Curb, Whitfield
Int'l reps.: see WEA Int'l
 Warner Curb, see Warner Bros.
 Warren Rec. Co., 1527 14 St. NW, Washington, D.C. 20005. Tel. (202) 332-1790. Pres. Dr. C.A. Warren, Exec. VP Charles H. Montague, VP Sales Angie M. Bell, Prod'n Mgr. Rodney Mason, Special Projects Dir. Betty Wilson, Mae Jackson, A&R Angus Warren; Promo. Bertha Rae, M.L. Ruffin, Disco Prod'n James Davis, Gospel Prod'n Robert Appletree
Labels: (Owned) Action, Carwar, Souln', Warren, (distributed) Bass, Monta, Wet
 Warwick, see East Allegheny
 Washboard, see Sonic Arts
 Waterhouse Recs., 100 N. Seventh St., Minneapolis, Minn. 55403. Tel. (612) 332-6575. Mktg. Dir. Gary Marx, A&R & Opns. Michael Sunday, Promo. Kathy Henkel
Int'l rep.: Canada (Attic)
 Waylon, see Times Mgmt
 Fred Weinberg Prod'n Inc., 16 Dundee Rd., Stamford, Conn. 06903. Tel. (203) 322-5778. Pres. & Chief A&R Fred Weinberg, VP J. R. Weinberg, Classical A&R David Carey Lehman, Bus Affairs M. Moller
Labels: (Owned) FWP, Frejo
 Weird World, see TK
 Wellsound Rec. Co., 11254 Blythe St., Sun Valley, Calif. 91352. Tel. (213) 765-7303. Pres. George Blackwell, Welte Legacy of Piano Treasures, see Recorded Treasures
 Wenra Rec. Co., 5729 Bayview Ave., Richmond, Calif. 94804. Tel. (415) 529-1610
 We Prod'n Inc., 14744 Puritan, Detroit, Mich. 48227. Tel. (313) 273-4635
Label: (Owned) Major
 Wesley Recs., PO Box 10044, Denver, Colo. 80210. Tel. (303) 777-9648. Owner & Mgr. W. L. Horning
Labels: (Owned) Spin-Out, Wesley
 Westbound Recs. Inc., 19631 W. Eight Mile Rd., Detroit, Mich. 48219. Tel. (313) 255-7640. Pres. Armen Bolidian, Admin. Ass't to Pres. Carole Ludeman, A&R Bernard Mendelson (Distributed by Atlantic)
Labels: (Owned) Nine, Westbound
 West End Music Inds. Inc., 254 W. 54 St., New York, N.Y. 10019. Tel. (212) 757-0695. Pres. Mel Cheren, VP Edward L. Kushins
Labels: (Owned) Ameraba, Spire, West End
 Western News Recs., 619-A Buck, Vacaville, Calif. 95688. Tel. (707) 446-1316
 Western Sound Archive, see Educational Media & Discocorp
 West 54, see Peters Int'l
 West Recs., PO Box 8875, Universal City, Calif. 91608. Tel. (213) 985-2539. Pres. Geroge E. Clements, Ass't to Pres. Silvia Fischer; VP Gary J. Kaye
Labels: (Owned) Dynasty, E. Lane, West
 West Wind, see Metrobeat
 Wet, see Warren
 Wham Bam Recs., 525 N. Broad St., Allentown, Pa. 18104. Tel. (215) 820-9090. Pres. Dennis Somach; VP Richard Somach
Labels: (Owned) Denrich, Wham Bam
 Whiplash Recs. Ltd., 150 Gorman St., Naugatuck, Conn. 06770. Tel. (203) 729-2508. Pres. George Fedorick, Treas./Sec'y Andrew C. Doback
Branches: San Diego, Calif., 8223 Calle Minas, Mira Mesa. Zip 92126. Tel. (714) 566-7142. VP George Csanka Jr.—Wantagh, N.Y., 1803 Interlake Dr. Zip 11793. Tel. (516) 826-3934
 White Fox/TR Studios, 404 N. Osprey, Sarasota, Fla. 33577. Tel. (813) 366-6765. Pres. Anthony Rasmus
 White Rock Recs. Inc., 401 Wintermaine Ave., Scranton, Pa. 18505. Tel. (717) 343-6718. Pres.: Phil Lad
 Whitfield Recs. Inc., 8719 Santa Monica Blvd., Los Angeles, Calif. 90069. Tel. (213) 652-5850. (Distributed by Warner Bros.)
 Who's Who, see Gillette-Madison
 Wide World of Music, see Starcenter
 Wildebeest Recs., c/o North Country Music, PO Box 311, Rt. 19 N., Wexford, Pa. 15090. Tel. (412) 935-1330. Owner C.W. Abbott
 Wildwood Entertainment, 114 W. Maiden Ln., Monroe, Conn. 06468. Tel. (203) 261-2979. Pres. Vincent Meyer II; VP David Roberts
Labels: (Owned) Black & White, Wildwood
 Wildwood, see QCA in Ohio & Wildwood Entertainment
 Wilmac, see Playette
 Wilwin Recs., PO Box 1669, Carlsbad, Calif. 92008. Tel. (714) 729-8406. Owner Dennis Tymer
 Winchester, see Sounds of Winchester
 Windbag, see Olivia
 Windfall Recs., 1790 Broadway, New York, N.Y. 10019. Tel. (212) 765-8450
Labels: (Owned) Phantom, Windfall
 Windi, see Suncat
 Windi-South (Venezuela), see Suncat
 Windmill, N.Y., see Michele
 Windmill Recs., 66 Highland Ave., Somerville, Mass. 02143. Tel. (617) 625-9805. Pres. James Murphy
 Windsong Recs., 1901 Ave. of the Stars, Los Angeles, Calif. 90067. Tel. (213) 557-2100. (Distributed by RCA)
Branch: New York, N.Y., 1345 Ave. of the Americas. Zip 10019. Tel. (212) 582-3923
 Wine Recs., 3307 Laurel Dr., Glenshaw, Pa. 15116. Tel. (412) 487-6156. Owner James Grime
 Wizard Prod'n Inc., 2501 S. Ocean Dr., Hollywood, Fla. 33019. Tel. (305) 921-6550. Pres. Robert S. Taran, Nat'l Sales Mgr. Evelyn Geldon, Promo. Burt Compton, A&R Mike Lewis
 Wizard Tex., see Colonel Buster Doss
 Wolf, Calif., see Ray Lawrence
 Wolf, Fla., see TK
 Wonderland, see AA
 Wonderland/Capitol, see AA

Wooden Nickel Recs. Inc., 9465 Wilshire Blvd., Suite 814, Beverly Hills, Calif. 90212. Tel: (213) 550-1010.
 Wordcraft, see Vocab.
 Word Inc., 4800 W. Waco Dr., Waco, Tex. 76703. Tel: (817) 772-7650.
 Int'l branches: Australia (Sacred), Canada (Word), England (Word), New Zealand (Sacred).
 Labels: (Owned) Canaan, DaySpring, Myrrh, Sacred, Word; (distributed) Good News, Light, Maranatha!, New Day, NewPax, Paragon, Solid Rock.
 World, see Jersey Coast.
 World Independent Label Dists., see WILD.
 World Int'l Group Inc., 2125 Eighth Ave. S., Nashville, Tenn. 37204. Tel: (615) 383-6540. Pres.: Gene Kennedy; VP: Linda Kennedy; Nat'l Promo. Dir.: Dave Allen.
 Labels: (Distributed) BMA, Chaplain, Door Knob, Granny White, Lehua, Louisiana Hayride, Mandy Kaye, Nu-Trayl, Palmer, Showcase, TSK.
 World Jazz Recs., 4350 E. Cambelback Rd., 190C, Phoenix, Ariz. 85018. Tel: (602) 959-3200. Pres.: Barker Hickox.
 A World of Jazz, see Vee Jay.
 Worldstar Recs., PO Box 2609, 119½ E. Main St., Lafayette, La. 70502. Tel: (318) 235-3587. Owner/Mgr.: J. Michael Fernandez.
 Worldtone Music Inc., 230 Seventh Ave., New York, N.Y. 10011. Tel: (212) 691-1934. Pres. & Gen. Mgr.: Kenneth Spear.
 Labels: (Owned) Worldtone; (distributed) Balkanton (Bulgaria), Electrecord (Romania), Eterna (East Germany), Finnlevy (Finland), Helidon (Yugoslavia), Swedish Discophile (Sweden), Telestar (Sweden), Unidisc (France).
 World (UK), see DRG Recs.
 World Wide Music Inc., 1300 Division St., Nashville, Tenn. 37203. Tel: (615) 256-7543. Pres.: Calvin H. Everhart; Sales: Debra S. Ward.
 Label: (Owned) True.
 Worldwide Music Servs., 1966 Broadway, New York, N.Y. 10023. Tel: (212) 724-4212.
 Labels: (Owned) Worldwide; (distributed) Abbey (UK), Barenreiter (Germany), Cathedral (UK), Claves, Guild (UK), London Pro Musica (UK), Syrinx (UK).
 Wormwood Projects, 1540 Lehigh St., Boulder, Colo. 80303. Tel: (303) 499-1108. Pres.: Michael D. Aisner.
 Labels: (Owned) Sealsong, Shire, Wormwood.
 Joseph Wyndell Prod'ns, PO Box 666, Madison, Tenn. 37115. Tel: (615) 868-7370. Exec. Prod'r: Neely Reynolds; Assoc. Prod'r/Dir.: Susan Reynolds.
 Branch: Bells, Tex., PO Box 194, Zip: 75414. Tel: (214) 965-4382. VP's: Joe & Ruby Reynolds.

X

Xanadu Recs. Ltd., 3242 Irwin Ave., Kingsbridge, N.Y. 10463. Tel: (212) 549-3655. Pres.: Don Schlitten. (Distributed by Cream)
 Int'l rep.: Japan (Teichiku).
 Xtra (UK), see Rounder.

Y

Y T F (Sweden), see SWS.
 Yatahey Recs., PO Box 31819, Dallas, Tex. 75231. Tel: (214) 690-8875. Owner: Pat McKool. (Distributed by Sunshine Country).
 Yazoo Recs. Inc., 245 Waverly Pl., New York, N.Y. 10014. Tel: (212) 255-3698. Pres.: Nick Perls; VP, Sales & Pub.: Scott Drury; Pop A&R: Steve Calt; Adv.: James Polk; Promo. Dir.: Felix Fernandez; Tape: Bob Hicks; Int'l Rep.: James Soli.
 Int'l reps.: Australia (Crest), Canada (Almada), France (International Rec. Imports), Japan (Shinsei), Sweden (Sonet), UK (CRD).
 Yellow Bee Prod'ns Inc., 245 Waverly Pl., New York, N.Y. 10014. Tel: (212) 255-3698. Pres., A&R & Disco Relations: Nick Perls; VP, Pub., Adv. & Promo.: Scott Drury; Sales & Mktg.: Roosevelt Graves; Adv.: Steve Calt; Tape: Lemon Jefferson; Int'l: Albert Ayler.
 Label: (Owned) Blue Goose.
 Int'l reps.: Australia (Crest), Canada (Almada), France (International Rec. Imports), Japan (Shinsei), Sweden (Sonet), UK (CRD).
 Yellow Bird, see Canary.
 Young (Brazil), see Fermata.
 Youngheart Music Education Serv., PO Box 27784, Los Angeles, Calif. 90027. Tel: (213) 663-3223. Dir.: Dan McTague; Ass't Dir.: Steve Millang; Children's Music A&R: Greg Scelsa; Pub.: Robin Baltic.

Z

Zansabar, see Crimson Dynasty.
 Zap, see Rebel.
 Zappa, see Phonogram.
 Zeida, see Discolando.
 Zephyr, see Atlantic.
 Zim Recs., PO Box 158, 18 Ivy Dr., Jericho, N.Y. 11753. Tel: (516) 681-7102. Owner: Arthur Zimmerman.
 Labels: (Owned) Zim; (distributed) Dragon (Sweden), Honeydew, Jazz Connoisseur (Italy), No Gap, Unique Jazz (Italy).
 Int'l reps.: Europe, excluding UK (Dragon in Sweden), Japan (Toshiba-EMI).
 Zipcode, see Ralph's Radio.
 Ziv Int'l Inc., 600 N. Sepulveda Blvd., Bel Air, Calif. 90049. Tel: (213) 476-7345, Cable: ZIVINC, Telex: 698619.
 Labels: (Owned) Rodgers & Hammerstein, Showstoppers, Ziv.
 Zouvenir, see Vantage.
 Zzyz Recs., 1155 N. Hyperion Ave., Hollywood, Calif. 90029. Tel: (213) 665-2807. Pres.: James H. Freedner; East Coast Promo.: William Oppenheimer.

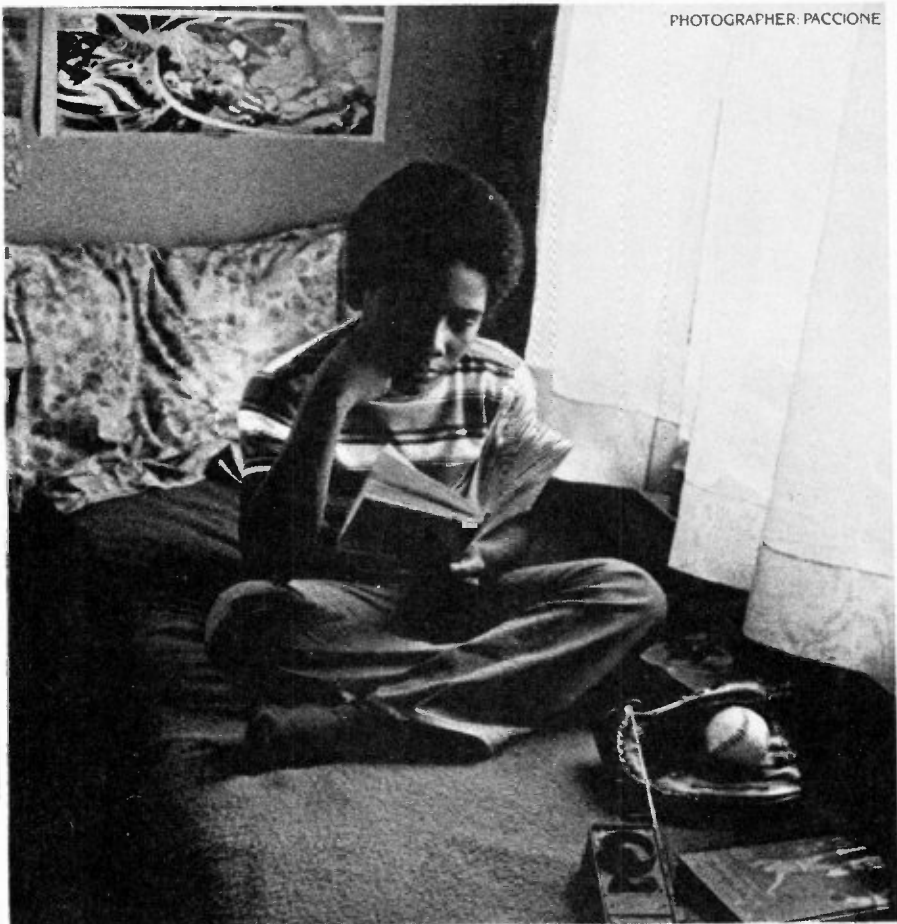

PHOTOGRAPHER: PACCIONE

**INVEST IN A MIND.
IT'S AS GOOD AS GOLD.**

Each year the United Negro College Fund pays off with thousands of black graduates with valuable training America's industry needs today. It's no wonder that UNCF member schools have become a natural resource for accountants, managers, engineers and technicians.

And that's only scratching the surface, because there is so much raw talent out there. Take this 11-year-old child, for example. Right now his mind is like raw material ready to be developed. But this can happen only if you are willing to invest in the United Negro College Fund.

Your contributions give our young people the opportunity to attend the 41 private, predominantly black, four-year colleges and universities sponsored by the UNCF. If we couldn't keep our tuitions low and grant financial aid, some 70% of our students couldn't attend college at all.

UNCF graduates have proven to be a precious commodity to the business community. And that's as good as gold.

Send your check to the United Negro College Fund, Box N, 500 East 62nd St., New York, N.Y. 10021. We're not asking for a handout, just a hand.

**GIVE TO THE
UNITED NEGRO COLLEGE FUND.**

A mind is a terrible thing to waste.

Ad

A Public Service of This Magazine & The Advertising Council

MUSIC PUBLISHERS

Of The United States



A A O Music (ASCAP), 7231 Franklin Ave., Suite 19, Hollywood, Calif. 90046 Tel. (213) 876-3588 Pres. Spike Jansen VP. O.K. Turner

A B C Dunhill Music Inc. (BMI), see American Broadcasting A M C Inc. (ASCAP), see BRS Inc.

A M E (American Metropolitan Ents. of New York Inc.) (BMI), see Copyright Serv. Bureau

A-M Music Corp. (ASCAP), see Chappell

A T M Music (ASCAP), see Schiffman

A T V Music Corp. (BMI), 6255 Sunset Blvd., Hollywood, Calif. 90028 Tel. (213) 462-6933

Branches: New York, N.Y., 888 Seventh Ave. Zip 10019 Tel. (212) 977-5680—Nashville, Tenn., 16 Ave. S. Zip 37203 Tel. (615) 327-2753

Int'l branches: England France

Int'l firms represented: ATV Ltd (UK), McCauley Music Ltd (Canada)

A V I R Music Inc. (BMI), see Riva

A Z O Recs & Publ'g, 6806 Lincoln Dr., Philadelphia Pa. 19119 Tel. (215) 843-9723 Contact William P. Lightfoot

Chris Aaron Music (BMI), 3282 Catalina Ave., Santa Clara, Calif. 95051 Tel. (408) 243-0168 Pres. Mark Aaron VP. Chris Aaron

Abado Music Co. (BMI), see Amigo

Abel Music Co. (BMI), see Spetzer

Abingdon Press, 201 Eighth Ave. S., Nashville, Tenn. 37202 Tel. (615) 749-6459/6396 Gen. Mgr. Charles O. McNish, Music Ed. Robert O. Hoffelt

Abkco Music Inc. (BMI), 1700 Broadway, New York, N.Y. 10019 Tel. (212) 399-0300 Pres. Allen Klein, VP. Joel Silver

Int'l rep.: UK (Essex)

Able Music Inc. (BMI), PO Box 395, Oakwood, Va. 24631 Tel. (703) 498-3337 Pres. Roy John Fuller, Gen. Mgr. Terry Arrington, Prof. Mgr. David Stevenson

Branch: Vansant, Va., PO Box 306, Zip 24656 Tel. (703) 498-3570 Gen. Mgr. J. Brown

Abnak Music Ents. Inc. (BMI), 825 Olive at Ross, Dallas, Tex. 75201 Tel. (214) 742-6111

Acadiana Music (ASCAP), see Flat Town

Accabonac Music (ASCAP), see Cherry Lane

Accadia Music Co. (ASCAP), 9962 1/2 Durant Dr., Beverly Hills, Calif. 90212 Tel. (213) 277-8383 Pres. Mary Herscher, Gen. Mgr. Selma Herscher, Prof. Mgr. Bobby Graham, (Affiliated with Eddie Weldon Music)

Int'l reps.: Australia (J. Albert) Japan (Toshiba), Sweden (Cupol), UK (Cyril Shane, Campbell Connelly)

Acclaim Music Inc. (BMI), see Jim Reeves

Accomplish Music (ASCAP), see Dwarf

Accretive Copyright Co. (ASCAP), see Solar Recs

Accumulative Copyrights Co. (BMI), see Solar Recs

Ace-Deuce-Trey Music (BMI), see Lori-Joy

Ace Music, see Copyright Serv. Bureau

Ace Spec Music (BMI), see Copyright Serv. Bureau

Achic (ASCAP), see Chicorel

Ackee Music Inc. (ASCAP), see Island

Acklen Music (BMI), see Southern Writers

Acme Music (ASCAP), see Royalty Control

Acorn Music Corp. (BMI), see TRO

Acorn Music Press (ASCAP), see Music Sales

Acoustic Music Inc. (BMI), 49 Music Square E., Nashville, Tenn. 37212 Tel. (615) 244-3450 Pres. Danny Davis, Prof. Mgr. Lamar Morris

Acropolis Publ'ns (BMI), see Cedarwood

Acuff-Rose Publ'ns Inc. (BMI), 2510 Franklin Rd., Nashville, Tenn. 37204 Tel. (615) 385-3031 Cable ACUF-ROSE Pres. Wesley H. Rose, VP & Gen. Mgr. John R. Brown, Prof. Mgr. Ronnie Gant

Int'l branches: Australia Belgium Denmark France Germany Italy Japan South Africa Switzerland UK

Int'l reps.: British Honduras (EMLASA), Colombia (EMLASA), Costa Rica (EMLASA), Dominican Republic (EMLASA), Israel (Subar), Japan (Shinko), Mexico (EMLASA), Nicaragua (EMLASA), San Salvador (EMLASA), Venezuela (EMLASA)

Adams-Ethridge Publ'g Co. (BMI), PO Box 434, 5028 Ave. N., Galveston, Tex. 77550 Tel. (713) 763-8344

Int'l reps.: Australia (J. Albert), UK (Francis Day & Hunter)

Adams, Vee & Abbott Inc. (BMI), 216 S. Wabash Ave., 4th fl., Chicago, Ill. 60604 Tel. (312) 922-9669

Addax Music Co. Inc. (ASCAP), see Famous

Addi Music (BMI), see Paragon Assocs

Addison Street (ASCAP, c/o Sterling Music Co.), 8907 Wilshire Blvd., Suite 102, Beverly Hills, Calif. 90211

A Dish-A Tunies Ltd (BMI), 1650 Beverly Hills, Calif. 90211

Adriatic Music Ltd (BMI), 1650 Broadway, No. 1107, New York, N.Y. 10019 Tel. (212) 245-9612 Pres. Ken Williams

Admiral Music Publ'g (BMI), see Brunswick

Adult Music (BMI), see Hilara

Adventure Music Co. (ASCAP), 1201 16 Ave. S., Nashville, Tenn. 37212 Tel. (615) 320-7287 Pres. Charles Chellman Gen. Mgr. Georgia Chellman

Aesthetic Artist Recs (ASCAP), PO Box 144, Mid City Sta., Dayton, Ohio 45402 Tel. (513) 252-9426 Owner Paul Wayne Beach

Affiliated Music Ents. Inc., PO Box 1929, Melbourne, Fla. 32901 Tel. (305) 727-2500

Affinity Music (BMI), see Beechwood

Agape (ASCAP), see Hope

Aguirre Music Publ'g Co. (SESAC), PO Box 1005, Englewood Cliffs, N.J. 07632 Tel. (201) 342-8875 Owner & Pres. Clancy Morales

Ahab Music Co. Inc. (BMI), 1707 Grand Ave., Nashville, Tenn. 37212 Tel. (615) 244-1348 Pres. Ray Stevens

Ahlert-Burke Corp. (ASCAP), see Fred Ahlert.

Fred Ahlert Music Corp. (ASCAP), 8907 Wilshire Blvd., Suite 102, Beverly Hills, Calif. 90211

Aimee Music Publ'g Co. (ASCAP), 100 W. Clarendon, Phoenix, Ariz. 85013 Tel. (602) 263-8067 Pres. Tommy Reed, Gen. & Prof. Mgr. Al Trace

Branch: Hollywood, Calif., 1680 N. Vine St. Zip 90028 Tel. (213) 465-8300

Air (BMI)—Pres. Theodore Daniel—see Deacon Daniel

Airefield Music (BMI), see Beechwood

Aisha Music (BMI), see Jondora Music—Prestige

Ajax Music Inc. (ASCAP), PO Box 10, North Hollywood, Calif. 91603 Tel. (213) 274-5863 Pres. Phil Moore

A-Kar Music (BMI), see A-Mark

Ala King Music (BMI), see Mietus

Alameda Music Inc. (BMI), see Edward B. Marks

Alamman Music Publ'g Co. (BMI), 551 Carroll, San Antonio, Tex. 78225 Tel. (512) 924-0037 Pres. Eddie Aleman

Alamo Village Music (BMI), 50 Music Square W., Suite 401, Nashville, Tenn. 37203 Tel. (615) 242-8774

J. Albert & Son Pty Ltd. 4 E. 52 St., New York, N.Y. 10022 Tel. (212) 755-0812

Home office: Australia

Albet Music Corp. (BMI), see Fourth Floor

Al-Bo Music Co. (ASCAP), 37 Odell Ave., Yonkers, N.Y. 10701 Tel. (914) 969-5673 VP & Gen. Mgr. Joe Bolton

Alchemical Music (ASCAP), see Doors

Alchemy Music Inc. (ASCAP), see Star Show

Aldi Music (ASCAP), see Notable

Aldrich Music Co. (BMI), see Copyright Serv. Bureau

Alear Music (BMI), see Jim McCoy

Aletha Jane Music (ASCAP), PO Box 4796, Nashville, Tenn. 37216 Pres. Wade Curtiss

Alexis Music Inc. (ASCAP), see Lee Magid

Alexscar Music (BMI), see Rondor & Chappell

Alfieri Music (BMI), 265 SW Seventh St., Boca Raton, Fla. 33432 Tel. (305) 392-4829 Pres. Louis Alfieri

Alfie Sound, see Sound Synccadate

Alford Music (ASCAP), see Copyright Serv. Bureau

Alfre, see Jasper

Alfred Publ'g Co. Inc. (ASCAP), 15335 Morrison St., Sherman Oaks, Calif. 91403 Tel. (213) 995-8811 Pres. Morton Manus, Exec. VP. Saul Feldstein, Mktg. Dir. Roberta Vaccaro Salerno

Algee Music Corp. (BMI), see Al Gallico

Aliben Music (BMI), see Skinny Zach

Aljion Music Co. (BMI), PO Box 18918, Los Angeles, Calif. 90018 Tel. (213) 930-1814 Owner Al Hall Jr.

Alkatraz Corner Music Co. (BMI), PO Box 3316, San Francisco, Calif. 94119 Mng. Dir. Bill Belmont, Dir. Joe McDonald

Int'l reps.: Australia (Festival), Austria (Rolf Budde), Benelux (EMI Songs), Brazil (ELAM), Central America (CBS), France (Bagatelle), Germany (Rolf Budde), Greece (EMI), Ireland (Chrysalis), Italy (Franton), Japan (Harry Fox), Mexico (CBS), New Zealand (Festival), Scandinavia (Sonnet), South America (CBS), Spain (EGO), Switzerland (Rolf Budde), UK & Commonwealth (Chrysalis)

Allanwood Music (BMI), see Glen Campbell

Joe Allen Music Inc. (BMI), Rt. 1, New Hope Rd., Hermitage, 37076 Tel. (615) 883-7226

Allied Artists Music Co. Inc. (ASCAP), 15 Columbus Circle, New York, N.Y. 10023 Tel. (212) 541-9200 Cable ALLARTINT Bd. Chm. & Pres. Emanuel L. Wolf

Allmusic Inc. (ASCAP), see Acoustic

All Night (BMI), c/o Odyssey Prod'ns Inc., PO Box 12384, Acklen Sta., Nashville, Tenn. 37212 Tel. (615) 327-9301

All of a Sudden Music Inc. (ASCAP), see Sudden Rush

Allroads Music (BMI), see Beechwood

All Sunrays Publ'g Co. (ASCAP), see 20th Century

Alysonne Publ'g Inc. (ASCAP), see 20th Century

Almanac Music Inc. (ASCAP), see TRO

Al-Mc Music (BMI), see Skinny Zach

Aimimo Music Inc., see T.B. Harms—Vogue

Almitra Music Co. Inc. (ASCAP), see Publishers' Licensing Corp.

Almo Music Corp. (ASCAP), see Rondor

Alotagoodmusic Inc. (ASCAP), see Buttermik Sky

Alouette Music Publ'g Co. (BMI), see Intercontinental Music

Alpane Music Inc. (ASCAP), see Copyright Serv. Bureau

Alpep Eds. (ASCAP), see C.F. Peters

Alpha Century Publ'g Corp. (ASCAP), see Alpha Omega

Alpha Film Music (BMI), see Alpha Music Inc.

Alpha Music Inc. (BMI), 40 E. 49 St., New York, N.Y. 10017 Tel. (212) 753-3234 Pres. Louis Nurko, VP. A. Vander Molen

Int'l firm represented: Bosworth & Co. Ltd. (UK), Jump Ed. Musicali (Italy)

Int'l rep.: UK (Bosworth)

Alpha-Omega Century Publ'g Group (div. of Centurian Recs.), PO Box 5747, Cleveland, Ohio 44101 Tel. (216) 771-0501 Cable CENTURION Admin. R. Lic. & Publ'g. Volney Games, Gen. Mgr. Gregory A. Beasley

Int'l rep.: Worldwide excluding Australia & Canada (Sparta-Florida in UK), Brazil (Gravacos Electricas), Japan (Shinko)

Alpha Phi Music (BMI), see Mietus

Alp Music Inc. (ASCAP), see Interval Music

Alrac Music (BMI), see Watt Works

Alrhond Music Inc. (BMI), see Roger Miller's Music

Alruby Music Inc. (ASCAP), 8515 Hollywood Blvd., Hollywood, Calif. 90069 Tel. (213) 654-3760 (Administered by Rondor)

Alshire Publ'g Co. Inc., PO Box 7107, Zip 91505, 1015 Isabel St., Burbank, Calif. 91502 Tel. (213) 849-4671, Telex (910) 498-2759 Cable BUDSOUND Pres. Al Sherman, Gen. Mgr. Freda Gross

Al's Written Music Publ'g (BMI), Parsons, Kan. 67357 Tel. (316) 421-1666 Pres. Albert H. Monday

Alta Mesa Music (BMI)—Pres. Jerry Styner—see Triple H

Altam Music Corp. (BMI), see Al Gallico

Alta Music Corp., see T.B. Harms—Harry Von Tilzer

Altaview Music Co. (BMI), PO Box 48, Lithia Springs, Ga. 30057 Pres. James F. Brannon Jr.

Altez Music, 119 Altez NE, Albuquerque, N.M. 87123 Tel. (505) 296-5578 Owner J.C. West

Alva Music (BMI), see E.J. Gurren

Alvera Publ'g Co. (BMI), PO Box 9304, Tulsa, Okla. 74107 Tel. (918) 242-3303 Pres. & Gen. Mgr. Al Clauser, Prof. Mgr. Vera Clauser

Alvert Music (BMI), see Independence

Amak Music Co. (ASCAP), see Chappell

Amalgamated Tulip Corp. (BMI) (div. of Saturn Inds. Inc.), 117 W. Rockland Rd., Libertyville, Ill. 60048 Tel. (312) 362-4060 Pres. Perry H. Johnson, Prof. Mgr. Mary Bortolotti

Amani Music Co. (ASCAP), see Copyright Serv. Bureau

A Mark Music Prod'ns (ASCAP), 7326 Biscayne Blvd., Miami, Fla. 33138 Tel. (305) 751-6296 Pres. Milton Schnapf Jr., Gen. Mgr. Robert Biddle, Prof. Mgr. Karen Wingert

Amberston Ent's Inc. (ASCAP), see G. Schirmer

Amberways Music (ASCAP)—VP. Ted Revell—see Americus

Ameb Music Co. (BMI)—Pres. Carl Maduri, Prof. Mgr. Gary Doberstyn—see Stone-Rap

American Academy of Music Inc. (ASCAP), see Belwin-Mills

American Broadcasting Music Inc. (ASCAP), 1313 Ave. of the Americas, New York, N.Y. 10019 Tel. (212) 887-4355 Dir. Ronald Schubert

Branch: Los Angeles, Calif., 4151 Prospect Ave. Zip 90027 Tel. (213) 663-3311 x 1389 Telex 673127 Cable AMBROCO Dir. Georgett Studnicka

Int'l reps.: Australia (Chappell), Austria (Schmolzi & Slezak), Belgium (Marouani), Brazil (Intersong), Central America (Edmusa), Czechoslovakia (Schmolzi & Slezak), France (Marouani), Germany (Schmolzi & Slezak), Greece (CBS), Hong Kong (Pathe), Hungary (Schmolzi & Slezak), Israel (CBS), Italy (Ricordi), Japan (Victor), Malaysia (Pathe), Mexico (Edmusa), Netherlands (Basari), New Zealand (Chappell), Scandinavia (April), South America (Intersong), Spain (Cuiraoga), Switzerland (Schmolzi & Slezak), UK (Cavalcade), Yugoslavia (Schmolzi & Slezak) (SEE ADVERTISEMENT)

American Composers Alliance (BMI), 170 W. 74 St., New York, N.Y. 10023 Tel. (212) 362-8900 Acting Exec. Dir. Frank Wigglesworth

American Composers Concerts Inc., see American Composers Alliance

American Composers Ed. (BMI), see American Composers Alliance

American Composers Orch., see American Composers Alliance

American Cowboy Music Co. (BMI), 11 Music Circle S., Nashville, Tenn. 37203 Tel. (615) 256-7648 Gen. & Prof. Mgr. William G. Hall

American Dream (ASCAP), c/o Yellow Dog Music Inc., 1619 Broadway, New York, N.Y. 10019

American Heritage Music Corp. (BMI), 1208 Everett St., Caldwell, Idaho 83605 Tel. (208) 459-7382 Pres. & Gen. Mgr. Loyd J. Wanzer

American Metropolitan Ents. of New York Inc. (AME) (BMI), see Copyright Serv. Bureau

American Music Awards Series—Sigma Alpha Iota (BMI), see C.F. Peters

American Music Ed. (ASCAP), see Carl Fischer

American Music Inc. (some copyrights), see T.B. Harms—Vogue

American Musicological Society, see Galaxy

American Mutual (SESAC), 130 E. Sixth St., Cincinnati, Ohio 45202 Tel. (513) 621-6233 Pres. Bill Smith, Gen. & Sales Mgr. Frank Moe

American Rainbird Music (ASCAP), see Morning

American Standard Music (ASCAP), see Rondor

American Wind Symphony Eds. (BMI), see C.F. Peters

Americus Music Publ'rs (ASCAP), 50 Music Square W., Suite 501, Nashville, Tenn. 37203 Tel. (615) 327-1500 Pres. Donald L. Rins, Gen. Mgr. Charles W. Fields, Prof. Mgr. Johnny Howard (Administered by Nashville Copyright)

Ameristar Music Publ'g Co. (BMI), see Four Star

Amestoy Music (BMI), 117 N. Las Palmas Ave., Los Angeles, Calif. 90004 Tel. (213) 938-5482 Pres. Albert Marx

Amigo Music & Rec. Co. (ASCAP), 6137 N. Sixth St., Philadelphia, Pa. 19120 Tel. (215) 548-4038 Pres. Ray Karol

Amiron Music (ASCAP), 20531 Plummer St., Chatsworth, Calif. 91311 Tel. (213) 998-0443 Pres. & Gen. Mgr. A.E. Sullivan, Prof. Mgr. Dale Sullivan

Amphora Music Corp. (BMI), 1727 Division St., Davenport, Iowa 52804 Pres. Frank L. Engel

Ample Prod'ns Ltd. (ASCAP), see Chappell

Amsco (SESAC), see Music Sales

Anacrusis Music Publ'g Co. (ASCAP), see Sun-Bear

Ananga Ranga Music (BMI), see Budd Music

Ancora Publ'g, 2439 S. Dorsey Temple, Ariz. 85282 Tel. (602) 277-2132 Owner & Mgr. V. Val Michael

Andalusian Music Co. Inc. (ASCAP), see T.B. Harms—Bibo

Alex Anderson Music Inc. (ASCAP), see T.B. Harms—Bibo

Andria Publ'g Co. (ASCAP), Park Pl., Newark, N.J. 07102 Tel. (201) 642-5991

And Music (BMI), see Copyright Serv. Bureau

Andorra Music (ASCAP), see Mushroom

Andrades Publ'g Co. (BMI), PO Drawer 520, Stafford, Tex. 77477 Pres. Daniel Andrade

Int'l rep.: France (Crypto)

Andrea Music Co. (SESAC), 925 N. Third St., Philadelphia, Pa. 19123 Tel. (215) 627-2277

Andredon Music Co. (BMI), see Mietus

Willie Andrew Publ'g Co. (BMI), 155 NW 28 Ave., Pompano Beach, Fla. 33060 Tel. (305) 972-0812 Pres. Willie A. Brown, Gen. Mgr. Earnestine James

Let us Pen a tune for you...

ask them...

George Benson
Edwin Birdsong

Jerry Butler
Jean Carn

Mary Clayton
Archie Bell & The Drets

The Force
The Futures

Frantique
Dee Dee Sharp Gamble

The Jones Girls
Bell & James

Ronnie James
O Jays

Elton John
Tom Jones

Andre Kostelanetz
LTD

POPULAR. R&B SOUL JAZZ DISCO COUNTRY

COMMERCIALS
Revlon, C. Schmidt & Sons, Polaroid

MOTION PICTURES
"The Fish That Saved Pittsburgh" (fall 79)

Johnny Mathis
Jackie McLean

Billy Paul
Michael Padelin

Teddy Pendergrass
Pockets

Helen Reddy
Cindy & Roy

Bobby Rush
Silk

Spinners
Amir Stewart

Stylistics
Dexter Wansel

Lou Rawls
Mc Fadden & Whitehead

MFSB
and Many More

Tunes for All Occasions by a Staff of Prolific Writers...

Mighty Three Music (East)
309 South Broad Street
Philadelphia, Pa. 19107
215-546-3510

Mighty Three Music (West)
117 South Main, Suite 200
Seattle, Washington 98104
206-682-5278

1344 Colver Place
Covina, California 91724
(213) 332-8383



"You'll never forget our tunes"
The Mighty Three Music Group

Android Music (BMI), see Bug.
 Andromeda Music Corp. (ASCAP), see Heavy Music.
 Andustin Music (ASCAP), PO Box 669, Woodstock, N.Y. 12498. Tel: (914) 679-6069. Dir.: Harris Goldberg, Tim Moore, Johanan Vigoda; Prof. Mgr.: Lionel Conway. (Administered in US & Canada by Ackee/Island Music).
 Int'l reps.: Australia (Festival), Germany (Seigel), France (Allo), Italy (Intersong), Japan (Intersong), Netherlands (WEA), South America (Intersong), UK (Sunbury-Dunbar), Sweden (Air).
 Andy's Candy (BMI), see PA Ents.
 Anfor Publ'ns, see Theodore Presser.
 Angelica, see Jasper.
 Angel Wing Music (ASCAP), see Southern Writers.
 Johnny Angle Publ'g (BMI), 1772 Hamilton Blvd., Jackson, Miss. 39213. Tel: (601) 373-4150. Owner & Pres.: Johnny Angle.
 Anje Music Co. (ASCAP), see Mietus.
 Anion Music Co. (ASCAP), see Pavanne.
 Annabelle Music (BMI), see Loring.
 AnnBen Music (BMI), PO Box 2388, Toluca Lake, Calif. 91602. Tel: (213) 985-8284. Owner: Quint Benedetti.
 Anne-Rachel Music Corp. (ASCAP), see Chappell.
 Annextra Music (BMI), see Me & Sam.
 Annie Over Music (ASCAP), see Cross Country.
 Annuit Music Ltd. (ASCAP), 2933 River Rd., Croydon, Pa. 19020. Tel: (215) 785-1541.
 Ant Hill (BMI), see Nashville Int'l.
 Chuck Anthony Inc. (BMI), PO Box 2000, Holbrook, N.Y. 11741. Tel: (516) 472-0900. Pres.: Chuck Anthony.
 Antique Music (ASCAP), see Chappell.
 Antisia Music Inc. (ASCAP), 1650 Broadway, Suite 1001, New York, N.Y. 10019. Tel: (212) 489-7555. Pres.: Ralph MacDonald; VP: William Salter; Gen. Mgr.: Diane Johnson; Prof. Mgr.: William Eaton.
 Antone Music Publ'rs (ASCAP), see Donna Music.
 Antra Music (ASCAP), see Mantra.
 Any Old Name Publ'g Co. (ASCAP), see Mietus.
 The Anyone Co. (ASCAP), see Chappell.
 Aopa Music Co. (ASCAP), see Curtom.
 Apex Music (BMI), Twig Ln., Cupertino, Calif. 95014. Tel: (408) 252-1580, 996-1722. Pres. & Gen. Mgr.: E.F. Moss; Prof. Mgr.: R. Richards.
 Branch: Melbourne, Fla., 4290 Sherwood Blvd. Zip: 32935. Tel: (305) 254-9286.
 Apis Music (ASCAP), see Segel & Goldman.
 Appalshop Inc. (BMI), PO Box 743, Whitesburg, Ky. 41858. Tel: (606) 633-9958. Pres.: Dee Davis; Gen. Mgr.: Marty Newell; Prof. Mgr.: Jack Wright; Promo & Dist'n Mgr.: Mary Flowers Starks.
 Appleberry Music, see Gopam.
 Apple Butter Music (ASCAP)—Owner: Danny Morgan—see Hal Bernard.
 Apple Cider Music Co. Inc. (ASCAP), see April/Blackwood.
 Apple-Glass Music (BMI), PO Box 168, Madison, Wis. 53701. Tel: (608) 251-2000. Pres.: Daniel W. Miller.
 Applesseed Music Inc. (ASCAP), see Sanga.
 Appleton Music Publ'ns (ASCAP), see Carl Fischer.
 April/Blackwood Music Inc., 1350 Ave. of the Americas, 23rd fl., New York, N.Y. 10019. Tel: (212) 975-7045. VP & Gen. Mgr.: Rick Smith; Admin. Ass't: Marsha Tannenbaum; Dir.: East Coast Prof. Opns.: Larry Fogel; Mktg. Dir.: Cinemusic Library; Bert Haber; Development & Opns. Admin. Dir.: Harvey Markovitz; Bus. Affairs Dir.: Wayne Rooks; Copyright Admin. Dir.: Lucy Coccia; Prof. Mgrs.: Helaina Brundo, Bert Haber, Marc Leber; Promo & Pub. Mgr.: Gina Blander; Financial Admin.: Irwin Griggs; Publ'ns Dir.: Al Kugler.
 Branches: Los Angeles, Calif., 1930 Century Park W. Zip: 90037. Tel: (213) 556-4790. Opns. Dir.: Irwin Mazur; Film & TV Dir.: Ulpio Minucci; Prof. Mgrs.: Irwin Pincus, Carol Cassano, Martin Kitcat—Nashville, Tenn., 31 Music Square W. Zip: 37203. Tel: (615) 320-2374. Nashville/Southern Opns. Dir.: Charles Monk; Prof. Mgr.: Judy Harris.
 Int'l branches: Argentina, Australia, Belgium, Brazil, Canada, Costa Rica, France, Germany, Greece, Israel, Italy, Japan, Mexico, Netherlands, South Africa, Spain, Sweden, UK, Venezuela, Yugoslavia. (SEE ADVERTISEMENTS)
 April Music Inc. (ASCAP), see April/Blackwood.
 April Twenty-Two Music Co. (ASCAP), 9000 Sunset Blvd., Suite 1119, Los Angeles, Calif. 90069. Tel: (213) 274-7877.
 Aqua Music Publ'g Co. (ASCAP), see Sure Music.
 Arandas Music (BMI), 7229 S. Janmar, Dallas, Tex. 75230. Tel: (214) 361-1427. Pres.: John Bryant; Gen. Mgr.: Gene Jacobson.
 Arat Music (BMI), see Music Music Music.
 Arcade Music Co. (ASCAP)—Pres.: Dave Wilson; Gen. Mgr.: Rex Zario—see Rex Zario.
 Arc Music Corp. (BMI), see Goodman Group.
 Arcola Music Inc. (BMI), see Cromia.
 Ardavan Music (ASCAP), PO Box 2512, Hollywood, Calif. 90028. Tel: (213) 462-3745. Pres. & Gen. Mgr.: Ardie Bryant; Prof. Mgr.: Anne Bryant.
 Ardesea Music (ASCAP), see Martin Cohen.
 Ardo Music Corp. (BMI), see Copyright Serv. Bureau.
 Arellia Music Co. (ASCAP), see Copyright Serv. Bureau.
 Argo Music Inc. (BMI), see BRS Inc.
 Argonaut Music (BMI), see ARGONAUT Music Group.
 Argonaut Music Group (div. of Hiding Int'l), PO Box 32044, San Jose, Calif. 95152. Tel: (408) 258-6000. Pres.: Eric R. Hilding; Gen. Mgr.: John P. Pecorino; Prof. Mgr.: Michael Drake.
 Argyle Music (ASCAP), see Spina.
 Arian Publ'ns (ASCAP), see OAS.
 Arie Publ'ns (ASCAP), see Music Sales.
 Ariola America Inc. (ASCAP), 8671 Wilshire Blvd., Beverly Hills, Calif. 90211. Tel: (213) 659-6530. Pres.: Jay Lasker; Exec VP: Howard Stark; Int'l Licensee Mgr.: Isaura Gutierrez. (Administered by Interworld)
 Arion Music (BMI), see Royalty Control Corp.
 Arista Music (ASCAP), see Arista Music Publ'g.
 Arista Music Publ'g Group, 6 W. 57 St., New York, N.Y. 10019. Tel: (212) 489-7400.
 Branch: Century City, Calif., 1855 Century Park E. Zip: 90067. Tel: (213) 553-1777.

Ark of Glens Publ'g Co., PO Box 19215A, Los Angeles, Calif. 90018. Tel: (213) 737-3496.
 Arko Music Corp. (ASCAP), see Edwin H. Morris.
 Arlo Publ'g/Bearce Publ'g, 7653 Telephone Rd., LeRoy, N.Y. 14482.
 Branch: Rochester, N.Y., 52 Belmont St. Zip: 14620.
 Ariou Music Inc. (ASCAP), see Chappell.
 Armstrong Music, see T.B. Harms—Harry Von Tilzer.
 Army Music Co., see Royalty Control.
 Arnakata Music Inc. (ASCAP), 65 E. 55 St., New York, N.Y. 10022. Tel: (212) 688-0888. Telex: 427284. Pres.: J.P. Dawson; Gen. Mgr.: Debra D. Shemesh.
 Home office: England.
 Arrex Music (BMI), see Empire.
 Arrowhead Publ'g Co. (BMI), see Copyright Serv. Bureau.
 Arrow Music Press (ASCAP), see Boosey & Hawkes.
 Ars Nova Music (ASCAP), see Rondor.
 Artal Music Inc. (ASCAP), see Catalogue.
 Art Audio Publ'g Co. (BMI), 9706 Cameron St., Detroit, Mich. 48212. Tel: (313) 893-3406. Pres.: Albert M. Leigh; Gen. & Prof. Mgr.: Dolores M. Leigh. Local branch: 12080 Moenart St. Zip: 48212.
 Artemis Music (ASCAP), see Arnold Mills.
 Artful Dodger Ents. Ltd. (ASCAP)—Pres.: Gary Kurfist—see Beldock Levine & Hoffman.
 Douglas Arthur Music (BMI), see Larry Spier.
 Edward Arthur Music Co. (BMI), see Copyright Serv. Bureau.
 Artisan Music Press (ASCAP)—Pres.: Robert O'Brien—see Envelope Music Group.
 Artrec Publ'rs (BMI), see Artsongs.
 Artref Publ'g (BMI), 846 Seventh Ave., New York, N.Y. 10019. Tel: (212) 757-3800. Pres.: Art Trefferson.
 Artrex Corp., 229 Las Vegas Blvd. S., Las Vegas, Nev. 89101.
 Artsongs Publ'g (ASCAP), PO Box 15032, Fort Lauderdale, Fla. 33318. Tel: (305) 584-1904. Pres.: Harold E. Doane; Exec. VP: Vivian P. Doane.
 Artwork Music Co. Inc. (ASCAP), see Ivan Moguil.
 Arzee Music Co. (ASCAP), see Rex Zario.
 Ascension Music (ASCAP), PO Box 2484, Trenton, N.J. 08607. Tel: (609) 921-6200. Pres.: Robin Garb.
 Int'l rep.: Canada (CMRRA).
 Ashley Hill Music (BMI), see Cape Ann.
 Ashley Publ'ns Inc. (BMI), 263 Veterans Blvd., Carlstadt, N.J. 07072. Tel: (201) 935-1113.
 Int'l reps.: UK (Ashley, Fields).
 Ash Valley Music Inc. (ASCAP), 25 Music Square E., Nashville, Tenn. 37203. Tel: (615) 244-1060. Pres.: Owen Bradley; Gen. Mgr.: Harold Bradley; Prof. Mgr.: Cecile Light.
 Asilomar Music (ASCAP) (div. of RBR Communications Inc.), 43 W. 61 St., New York, N.Y. 10023. Tel: (212) 757-8805. Pres.: Richard Bradley; VP & Gen. Mgr.: Bill Radics.
 Aslaug Publ'g Co. (BMI), see Sanskrit.
 Asleep At The Wheel Music (BMI), see Bug.
 A Song Music Inc. (ASCAP)—Pres.: Gayle Hill—see Shada.
 Assinborne Music Co. (BMI), see Copyright Serv. Bureau.
 Associated Music Publ'ns Inc. (sub. of G. Schirmer Inc.) (BMI), 866 Third Ave., New York, N.Y. 10022. Tel: (212) 935-5100.
 Int'l firms represented: Bote & Bock (Germany), Breitkopf & Haertel (Germany), Ludwig Doblinger (Austria), Enoch & Cie (France), Max Eschig (France), F.E.C. Leuckart (Germany), Nagels Verlag (Germany), D. Rahter (Germany), N. Sirop (Germany), Union Musical Espanola (Spain), VWAOP (USSR).
 Int'l reps.: Australia (Allen), Austria (Ludwig Doblinger), Denmark (Wilhelm Hansen), France (Max Eschig), Germany (Bote & Bock), Italy (G. Ricordi), Spain (Union Musical Espanola), UK (G. Schirmer).
 Assorted Music (BMI), see Mighty Three.
 Assurance Music (BMI), see Party-Time.
 Astral Gift Shoppe (ASCAP), see Prima-Donna.
 Astral 7 Publ'g (BMI) (div. of Herbe Smith Music Inc.), 1514 W. Dorothy Ln., Dayton, Ohio 45409. Tel: (513) 298-8640, 293-3535. Pres., Gen. & Prof. Mgr.: Herbert J. Smith.
 Astronette Publ'g Co. (BMI), 2037 Alvarado Dr. NE, Albuquerque, N.M. 87110. Tel: (505) 268-8405. Pres.: Gen. & Prof. Mgr.: A. Medley.
 Athenaise Music Ltd. (ASCAP), see JBP & Chappell.
 At Home Music (ASCAP), see Martin Cohen.
 Athon Music Co. (BMI), 26 W. Benton Ave., Naperville, Ill. 60540. Tel: (312) 355-8343. Owner: Conrad Haidu.
 Int'l rep.: Japan (Arrow).
 Atlantic Music Corp. (BMI), see Criterion.
 At Last Publ'g Co. (BMI), see Marzique.
 Atmosphere Music Co. (BMI), see Chappell.
 Atomic Music (ASCAP), see Fourth Floor.
 Atrium Music Corp. (ASCAP), see Big Seven.
 Attache Music (BMI), see ATV Music.
 Attearun Publ'g Co. (BMI), PO Box 606, Marietta 30061. 1672 Spring St. SE, Smyrna, Ga. 30081. Tel: (404) 522-8106.
 Atwater Music Co. (ASCAP), see Copyright Serv. Bureau.
 Atzal Music Inc. (BMI), see Chappell.
 Audigram Music (BMI) (div. of Audigram Inc.), PO Box 22635, Nashville, Tenn. 37202. Tel: (615) 383-8318. Pres.: A. Ashworth.
 Audio Architects Publ'g Co. (BMI), 790 NE 45 St., Fort Lauderdale, Fla. 33334. Tel: (305) 772-0013. Pres.: J. Michelle Scott.
 Audio Arts Publ'g Co. (ASCAP), 5617 Melrose Ave., Los Angeles, Calif. 90038. Tel: (213) 461-3507. Owner, Pres., Gen. & Prof. Mgr.: Madelon Baker; VP & Admin. Ass't: Robert G. Young.
 Int'l reps.: Australia (Essex), Germany (Global/Altus), Japan (Toshiba), South America (Odeon in Argentina), UK (Carlin).
 Aud-Lee (BMI), 806 16 Ave. S., Suite 300, Nashville, Tenn. 37203.
 Audophone Music Inc. (ASCAP), see Shelby Singleton.
 Audre Mae Music (BMI), see Royalty Control Corp.
 Audway Music (BMI) (div. of Howard Knight Ents.), 11 Music Circle S., SESAC Bldg., Nashville, Tenn. 37203. Tel: (615) 244-0461. Pres.: Dave W. Mathes.
 Augsburg Publ'g House (SESAC), 426 S. Fifth St., Minneapolis, Minn. 55415. Tel: (612) 332-4561. Pres. &

Gen. Mgr.: Albert E. Anderson; Music Sales Mgr.: William O. Bliss.
 Branches: Los Angeles, Calif., 3224 Beverly Blvd. Zip: 90057. Tel: (213) 386-3722—Columbus, Ohio, 57 E. Main St. Zip: 43215. Tel: (614) 221-7411—Seattle, Wash., 2001 Third Ave. Zip: 98121. Tel: (206) 624-0244.
 Int'l rep.: Australia & New Zealand (Lutheran Publ'g House).
 Aulos Music Publ'rs, PO Box 54, Montgomery, N.Y. 12549. Tel: (914) 692-6270. Ed.: Robert A. Carabia; Publ'ns Dir.: Howard M. Feldsher.
 Aunt Polly's Publ'g Co. (BMI), PO Box 120657, Nashville, Tenn. 37212. Tel: (615) 385-2555. Owner: Allen Reynolds; Gen. Mgr.: John Donegan.
 Int'l reps.: Worldwide (Morning Music).
 Aunt Susie Publ'g (BMI), 308 Main St., Grapevine, Tex. 70651. Tel: (817) 481-3616. Pres.: Chisai Chilos; Gen. Mgr.: Johnnie High. (Administered by Grapevine Opry).
 Aurelia Music (ASCAP), see Caribou—James William Guercio.
 Auspex Music (ASCAP), 12188 Laurel Terrace Dr., Studio City, Calif. 91604. Tel: (213) 877-1078. Owner & Pres.: Jules Chaikin.
 Autograph Music (BMI), 601 E. Blackledge Dr., Tucson, Ariz. 85705. Tel: (602) 882-9016. Pres.: Joe Bidwell; Artist Relations: Erin Brooks.
 Autumn Hill Music (BMI), PO Box 844, Hendersonville, Tenn. 37075. Tel: (615) 824-4594. Pres.: Jim Voytek.
 Branch: Bloomington, Ind., 3929 E. Third St. Zip: 47401. Tel: (812) 332-3616. VP: Linden Hepler.
 Autumn Leaves Music (ASCAP), 3810 Cavalier St., Garland, Tex. 75042. Tel: (214) 494-3494. Pres.: Glen Pace; Prof. Mgr.: James Pritchett. (Administered by United Artists Music Group).
 Avant Garde Music Inc. (ASCAP), see Rondor.
 Avellino Music (ASCAP)—Pres.: Dee Anthony—see Beldock Levine & Hoffman.
 Average (ASCAP), c/o John C. Mitchell, 315 S. Beverly Dr., No. 400, Beverly Hills, Calif. 90212.
 Avary Music (BMI), see Beldock Levine & Hoffman.
 Aviva Music Inc. (BMI), see Shapiro Bernstein.
 Axehandle Music Inc. (ASCAP), see Chappell.
 Roy Ayers (ASCAP), 390 Riverside Dr., Apt. 1C, New York, N.Y. 10025.
 Ayler Desiree Music (BMI), see United Int'l Copyright.
 Azmoro Music Co. (BMI), see Cetra.
 Azyo Publ'g (SESAC), see Inspirational Sounds.
 Azure Music Co. (ASCAP), see Memnon.



B A S Music Publ'g (ASCAP), 5925 Kirby Dr., Suite 226, Houston, Tex. 77005. Tel: (713) 522-2713. Pres., Gen. & Prof. Mgr.: Shelton Bissell.
 B B P Music (ASCAP), see Valgroup.
 B C Ents. of Memphis Inc. (BMI), 726 E. McLemore, Memphis, Tenn. 38106. Tel: (901) 947-2553. Pres.: Bob Catron Jr.; VP & Admin. Ass't: Byron Catron; VP: Claudette Catron; VP & Gen. Mgr.: Linda Hillard.
 B-Flat Music (BMI), see Copyright Serv. Bureau.
 B L & H Music Corp. (ASCAP), see H. B. Webman.
 B M G Publ'g (ASCAP), 517 N. Robertson Blvd., Los Angeles, Calif. 90048. Tel: (213) 273-9600. VP Publ'g: Don Sorkin.
 B N P Music Publ'g Co., see T.B. Harms—Bibo.
 B O Cuit Songs Inc. (ASCAP), 23 Green St., Huntington, N.Y. 11743. Tel: (516) 423-2227. Pres.: Samuel Pearlman; Treas. & Gen. Mgr.: Bruce Clayton.
 B R S Inc., 15010 Ventura Blvd., No. 306, Sherman Oaks, Calif. 91403. Tel: (213) 990-1004.
 B W Music, 114 W. Maiden Ln., Monroe, Conn. 06468. Tel: (203) 261-2979. Pres.: Vincent E. Meyer II; VP: David Roberts; Gen. Mgr.: James Lategano.
 Branch: Wyckoff, N.J., Dartmouth St. Zip: 07481—Rensselaer, N.Y., 223 Broadway. Zip: 12144. Tel: (518) 434-2014.
 Baby Chick (BMI), PO Box 12513, Nashville, Tenn. 37212. Tel: (615) 373-1255. Mgr.: Anne Waller.
 Baby Fingers (ASCAP), 1205 Koletta Dr., Harbor City, Calif. 90710. Tel: (213) 326-6140.
 Baby Foxx Music (ASCAP), see Fred Fox.
 Baby Powder Music (ASCAP), see Paul Leka & Mietus.
 Baby Tate Music Corp. (BMI), PO Drawer AB, Rosendale, N.Y. 12474. Tel: (914) 687-9573. Pres.: Peter B. Lowry.
 Bacchanalia Music Co. (BMI), PO Box 3201, Oak Ridge, Tenn. 37830. Tel: (615) 482-2752. Pres.: Kit Haaland.
 Bach-Trac Music Inc. (ASCAP), 315 E. 86 St., New York, N.Y. 10028. Tel: (212) 348-4450.
 Back Bay Music (BMI), see Mietus.
 Back Porch Music (BMI), see Copyright Serv. Bureau.
 Back to Mono Music Inc. (BMI), see Mother Bertha.
 Back Yard Music (ASCAP), see Front Lawn & April/Blackwood.
 Ba-Dake Music Inc. (BMI), see A. Schroeder.
 Badco Music Inc. (ASCAP), see Stevens H. Weiss.
 Bad Ju Ju Music (ASCAP), see Tintagel.
 Bagatelle Music Publ'g Co. (BMI), see Floyd Tillman.
 Bainbridge Music (BMI), see Jerden.
 Baked Alaska Music (BMI), see Beldock Levine & Hoffman.
 Baker's Lane (ASCAP)—Owner: Mike Reid—see Hal Bernard.
 Baker's Mule (BMI), see Kicking Mule.
 Bakim Music Div., Bakim Rec. & Music Group, 18447 W. 8 Mile Rd., Detroit, Mich. 48219. Tel: (313) 342-4881. Exec. Dir.: Kenneth W. Baker; Assoc. Dir.: Ronald L. Kimbrough.
 Bal & Bal Music Publ'g Co. (ASCAP), PO Box 369, La Canada, Calif. 91011. Tel: (213) 790-1242. Pres.: Adrian P. Bal.
 Bald Medusa Music (ASCAP), see Martin Cohen.
 Bald Mountain Music Corp. (ASCAP), 2984 Goodview Trail, Los Angeles, Calif. 90068. Tel: (213) 876-7086. Pres.: J.C. Phillips; VP: Daniel D. Fantz; Bus. Mgr.: V. Catala.
 Baldy Baldwin Music (BMI), see April/Blackwood.
 Russell Ballard Ltd. (ASCAP), see April/Blackwood.
 Balloon Head Music (ASCAP), see Chicago Music.
 Balloon Music (ASCAP), see Segel & Goldman.

THERE'S NO SHORTAGE OF HITS HERE

*The
Entertainment
Company*



THE ENTERTAINMENT COMPANY MUSIC GROUP

World Radio History

- Balmac Music, see Bug.
- Balthasar Publ'g (BMI), see Copyright Serv. Bureau.
- Bambar Music Corp. (ASCAP), see Pickwick.
- Bandito Music Inc. (BMI), see Big Seven.
- Bandora Music Publ'g (BMI), see Sun-Bear.
- Bandy Music (BMI), see Jondora.
- Banff (BMI), see Jasper.
- Banjar Publ'ns (ASCAP), Box 32164, 7440 University Ave. NE, Minneapolis, Minn. 55432. Tel: (612) 633-7508. Pres.: LeRoy Larson; VP: Bert Woolfrey.
- Bantu Music (ASCAP), see Martin Cohen.
- Baradat Music (BMI), 1310 E. Kern St., Tulare, Calif. 93274. Tel: (209) 686-2533. Owner & Pres.: Raymond A. Baradat; Gen. Mgr.: Pamela R. Baradat.
- Baray Music Inc. (BMI), 50 Music Square W., Suite 603, Nashville, Tenn. 37203. Tel: (615) 329-1323. Pres.: Ray Baker; Prof. Mgr.: Barbara Baker.
- Barbam (BMI), see Pickwick.
- Barbecue Bar Music (BMI) (div. of Jam '79 Recs.), 2501 S. Walter Reed Dr., No. 2, Arlington, Va. 22206. Tel: (703) 379-8761. Contact: Janice Connor.
- Barber-Picone Music Co. (BMI), see Copyright Serv. Bureau.
- Barberry Music (ASCAP), see Royalty Control Corp.
- Barclay Music Corp. (ASCAP), see Shapiro Bernstein.
- Barcone Music Co. Inc. (BMI), see Copyright Serv. Bureau.
- Peter Barden Songs (BMI), see Copyright Serv. Bureau.
- Bare Back Music (ASCAP), see Intercontinental Entertainment.
- Barenreiter Music Publ'ns—Gen. Mgr.: Eric Fletcher—see Worldwide Music Publ'rs & Dists.
- Bar Fox Sound (BMI), see April/Blackwood.
- Barking Spider Music (ASCAP)—Owners: Michael D. Aisner, Eric Holle—see Ferndock.
- Barmasus Music (BMI), see Mietus.
- Barmour Music Corp. (BMI), see Pickwick.
- Barmatopom Music (BMI), see Martin Cohen.
- Bar Music (ASCAP)—Contacts: Billy Fox, Souren Mozian—see MRI.
- Barney Music (BMI), see Blanchris.
- C. L. Barnhouse Co. (SESAC), 110 B Ave., Oskaloosa, Iowa 52577. Tel: (515) 673-8397. Pres.: C. L. Barnhouse III; Gen. Mgr.: Robert Barnhouse.
- Int'l reps.: Austria, Germany & Switzerland (Emil Ruh in Switzerland); Norway (Schlagerforlaget).
- Bar None Music, see Piccasso.
- Bar None Music, see Piccasso.
- M. Baron Co., PO Box 149, Oyster Bay, N.Y. 11771. Tel: (516) 922-3377. Mgr.: Virginia Baron.
- Baron Music Publ'g Co. (BMI), 1117 17 Ave. S., Nashville, Tenn. 37212.
- Barracks 9 Music Inc. (BMI), see Star Spangled.
- Barricade Music (ASCAP), see Rondor.
- Jeff Barry Music (ASCAP), see Broadside.
- Barstic Music (BMI), 1921 Walnut St., Philadelphia, Pa. 19103. Tel: (215) 561-1283.
- Earl Barton Music Inc. (BMI), 1121 S. Glenstone, Springfield, Mo. 65804. Tel: (417) 869-6379. Pres. & Gen. Mgr.: E. E. Siman Jr.; Prof. Mgr.: Scott F. Siman. (Licensed through Publishers' Licensing Corp.).
- Barton Music Corp. (ASCAP), 200 W. 57 St., New York, N.Y. 10019. Tel: (212) 541-6103.
- Branch: Los Angeles, Calif.: 9220 Sunset Blvd., Zip: 90069. Tel: (213) 273-3590.
- Baruth Music (ASCAP) (div. of Baruth Prod'ns Inc.), PO Box 07120, Cleveland, Ohio 44107. Tel: (216) 521-1222. Pres.: Jon J. B. Baruth; Gen. Mgr.: Dan Baruth; Prof. Mgr.: David Baruth.
- Branch: Martinez, Calif.: PO Box 967, Zip: 94553. Tel: (415) 228-1971. Chief Exec.: Debbie Wolfe.
- Barwin Music Co. Inc. (ASCAP), see Edwin H. Morris.
- Diane Basie Music Corp. (ASCAP), see Big Seven.
- Basitone Music Inc. (SESAC), see Midsong.
- Baskin Music (BMI), see Open End—Open End.
- Bates Music Publ'g Co. Inc. (BMI), see Van-Jak.
- Bathurst Music (BMI), see Morning Music.
- Robin Batteau Music (ASCAP), see April/Blackwood.
- Mel Bay Publ'ns, 4 Industrial Dr., Pacific, Mo. 63069. Tel: (314) 257-3970. Pres.: Mel Bay.
- Int'l reps.: Canada (Leeds), Europe (Belwin-Mills).
- Bayou Boogie Music Co. (BMI), 913 Birmingham Dr., Baton Rouge, La. 70815. Tel: (504) 272-1420. Pres.: James M. Rogers.
- Beachtime Music (BMI), see Argonaut Music Group.
- Beacon Hill Music (SESAC), see Lillenas.
- Beagle Publ'g Co. (ASCAP), Gettysburg, Pa. 17325. Tel: (717) 334-2434. Contact: Craig Dayton.
- Bealin Music Publ'g Co., see T. B. Harms—Harry Von Tilzer.
- Beam Junction Music (BMI), see Mietus.
- Beantown Publ'g Co. (BMI), 206 E. Jordan St., Pensacola, Fla. 32503. Tel: (904) 438-2763. Pres. & Gen. Mgr.: Earl Lett; Prof. Mgr.: Matty Swain.
- Bear Brown Publ'g Co. (BMI), see R.A. Hodge.
- Beau-Di Music Inc. (BMI)—Tel: (713) 393-1703. Pres. & Gen. Mgr.: Buddy Hooper—see Beau-Jim.
- Beau-Jim Agency Inc. (ASCAP), PO Box 758, Lake Jackson, Tex. 77566. Tel: (713) 297-4030. Pres.: James E. Hooper.
- Beautiful Things Unlimited (BMI), see 20th Century.
- Beaver Music Publ'g Corp. (ASCAP), see H.B. Webman.
- Beckenhorst Press (ASCAP), PO Box 14273, 3841 N. High St., Columbus, Ohio 43214. Tel: (614) 268-3010. Owner: John Ness Beck.
- Beckie Publ'g Co. Inc. (BMI), see Sounds of Memphis.
- Bedivere Music Ltd.—Pres. Brian Lane—see Beldock Levine & Hoffman.
- Bedrock Music Co. Inc. (BMI), see Chappell.
- Beechic (BMI), see Chicorel.
- Beechmont Music Corp. (BMI), see H. B. Webman & Co.
- Beechwood Music Corp. (BMI), 6255 Sunset Blvd., Hollywood, Calif. 90028. Tel: (213) 469-8371. VP & Prof. Activities Dir.: Paul Tannen; VP Creative Affairs: Iza Jaffe. (Administered by Screen Gems-EMI).
- Branch: Nashville, Tenn., 1014 17 Ave. S. Zip: 37212. Tel: (615) 244-2789. Gen. Prof. Mgr.: Richard Allen.
- Int'l branches: Canada, Beechwood Music of Canada.
- Bee Cool Publ'g Co. (BMI), see Jamie.
- Beeheart Music Co., see Martin Cohen.
- Beeff Baron Music Inc. (BMI), see Roger Talent.
- Beeff State Publ'g Co. (BMI), Box 14267, Omaha, Neb 68114. Tel: (402) 432-3498. Pres. & Gen. Mgr.: Fenton R. Isaacson; Prof. Mgr.: Chuck Penington.
- Jenny Bee Music (BMI), see Horse Creek.
- Bee Keeper (ASCAP), c/o Honey Recs., 4045 Bellevue Ave., No. 401, Oakland, Calif. 94610.
- Beekman Music Inc. (ASCAP), see Theodore Presser.
- Beelezebub Music (ASCAP), see Royalty Control Corp.
- Bee Ray Music (BMI), see Berry Lo.
- Beethoven Music Co. (ASCAP)—Pres.: Lincoln Myorga—see Harrison.
- Begonia Melodies Inc. (BMI), see Chappell.
- Bekson Music Publ'g Inc. (BMI), see Gene Kennedy.
- Beldock Levine & Hoffman, 565 Fifth Ave., New York, N.Y. 10017. Tel: (212) 490-0400. Cable: TELHOFFLAW. Telex: 422046. Gen. Mgr.: Elliot L. Hoffman; Prof. Mgr.: Peter S. Matorin.
- Int'l firm represented: William Tell Music Ltd. (UK).
- Belinda Music Inc. (BMI), see Chappell.
- Belkin Music (BMI), see Stone-Rap.
- Belladonna Music (ASCAP), see Rondor.
- Bellboy Music (BMI), see Mighty Three.
- Bell Holding Music (ASCAP), 1260 E. Main St., Meriden, Conn. 06450. Tel: (203) 728-5639. Cable: BELHOP.
- Bellis Music Publ'g Co. (ASCAP), see Brunswick.
- Bell Kat Music (BMI), see Chappell.
- Bello Music Ltd. (ASCAP), see Copyright Serv. Bureau.
- BelMar Music (BMI), see Copyright Serv. Bureau.
- Belmont Music (BMI), see M. M. Cole.
- Belmont Music Publ'rs (ASCAP), PO Box 49961, Los Angeles, Calif. 90049. Tel: (213) 472-2557. Cable: BELMUSIC. Pres.: Lawrence A. Schoenberg; Dir.: Reiko Bisey.
- Int'l firms represented: B. Schott Sohne (Germany), Universal (Austria).
- Int'l rep.: Austria (Universal).
- Belton Music Inc. (ASCAP), see Vector.
- Belwin-Mills Publ'g Corp. (ASCAP), 1776 Broadway, New York, N.Y. 10019. Tel: (212) 245-1100. Cable: BELMILPUB. Pres.: Martin Winkler; VP & Gen. Mgr.: Burton L. Litwin.
- Branch: Melville, N.Y., Printed Product Sales Div., 25 Doshon Dr. Zip: 11747. Tel: (516) 293-3400. Telex: 423665.
- Int'l branches: Australia, Brazil, Canada, England, France, Germany, Italy, Mexico, Netherlands, New Zealand, Spain, Sweden.
- Int'l firms represented: Associated Board of the Royal School of Music (UK), Bessel (France), Bornemann (France), Casa Musicale Sonzogno (Italy), Quiroga (Spain). (SEE ADVERTISEMENT)
- Belzam Music Co. of Canada, see Martin Cohen.
- Bema Music (ASCAP)—Pres.: Carl Maduri; Prof. Mgr.: Gary Doberstyn—see Stone-Rap.
- Bendig Music Corp. (BMI), see Fermata Int'l.
- Benfel Music (BMI), 10th & Parker Sts., Berkeley, Calif. 94710. Tel: (415) 549-2500. Mgr.: Jack L. Aho.
- Bengrad Ents. Inc. (BMI), see Mietus.
- Bennie Benjamin Music Inc. (ASCAP), see Chappell.
- Phil Bennett Music Co. (ASCAP), 1 E. 42 St., New York, N.Y. 10017. Tel: (212) 682-2539. Pres.: Phil Bennett; VP: Julia Lincoln.
- John T. Benson Publ'g Co. Inc. (ASCAP), 365 Great Circle Rd., Nashville, Tenn. 37228. Tel: (615) 259-9111. Pres.: Robert Benson Sr.; Gen. Mgr. & Music Publ'ns Dir.: Jim Van Hook; Catalog Admin.: Jackie Peters.
- Int'l branch: England, Benson Co. Publ'g Ltd.
- Int'l reps.: Australia (Rhema), Benelux (Universal Songs in Netherlands), Canada (Lawson-Falle), UK (Kingsway). (SEE ADVERTISEMENT)
- Berdoog Music (BMI), PO Box 8875, Universal City, Calif. 91608. Tel: (213) 985-2539. Pres.: Geroge Clements; Prof. Mgr.: Jim McGuckin.
- Beresford Music Inc. (BMI), see Damila.
- Norman Bergen Music (BMI), see Ceborg.
- Bergstrom Music Ltd. (ASCAP), see Publishers' Licensing Corp.
- Berkeley Cooperative Publ'rs, PO Box 3233, Berkeley, Calif. 94703. Tel: (415) 452-1248. Mgr.: Ed Denson.
- Int'l reps.: Scandinavia (Sonet), UK (SONAT).
- Berkshire Music Inc. (BMI), see Copyright Serv. Bureau.
- Irving Berlin Music Corp. (ASCAP), 1290 Ave. of the Americas, New York, N.Y. 10019. Tel: (212) 247-4200.
- Hal Bernard Ents. Inc., see listing under "H."
- Bern Doubt Music (BMI), see Richard Kaye.
- Berner Music (BMI), see DaAnn.
- Bernetia Music Co. (BMI), see Copyright Serv. Bureau.
- Bernice Music Inc. (ASCAP), see Copyright Serv. Bureau.
- Dave Bernie Music Co. (ASCAP), see Gordon.
- M. Bernstein Music Publ'g Co. (ASCAP), 295 Monaco Pkwy., Denver, Colo. 80220. Tel: (303) 355-4535. Pres.: Morris Bernstein; Gen. Mgr.: Allan Bernstein; Prof. Mgrs.: Barry, Neil & Richard Bernstein.
- Berry Hill Songs (BMI), see Southern Writers.
- Berry Lo Music (ASCAP), 7046 Hollywood Blvd., No. 410, Hollywood, Calif. 90028. Tel: (213) 462-0502. Owner, Pres. & Prof. Mgr.: Harry Gordon; Gen. Mgr.: Linda Gordon.
- Bertram (ASCAP), c/o William Robinson, 6255 Sunset Blvd., Hollywood, Calif. 90028.
- John Berthelot & Assocs. (ASCAP), PO Box 13977, New Orleans, La. 70185. Tel: (504) 482-4211. Pres.: John Berthelot.
- Besco Music (ASCAP), see Copyright Serv. Bureau.
- Beserkeley, 1199 Spruce St., Berkeley, Calif. 94707. Tel: (415) 527-7664. Chief Execs.: Mathew King Kaufman, Steve Beserkeley.
- Besson (ASCAP), see Boosey & Hawkes.
- Bestat Music (ASCAP), see Copyright Serv. Bureau.
- Best Bet Music (ASCAP), 106 W. Madison, Kirkwood, Mo. 63122. Tel: (314) 821-5537. Pres.: Russ Lewis.
- Int'l rep.: Canada (CMRRA).
- Betdolph Music (ASCAP), see Notable.
- Beth-Ann Music Co. (ASCAP), 615 Baldwin Ln., Wilmington, Del. 19803. Tel: (302) 762-2410. Pres.: Albert G. Teoli.
- Better-Half Music Co. (ASCAP), 1894 N. Stanley Ave., Hollywood, Calif. 90046. Tel: (213) 874-1707.
- Bett Lou Music (BMI), PO Box 2424, Muscle Shoals, Ala. 35660. Tel: (205) 381-4549. Pres.: Wayne Henderson.
- Beverly-Culver Music Inc. (ASCAP), see Shoestrung & Copyright Serv. Bureau.
- Beverly Hills Music (BMI), c/o Lawrence Herbst Investment Trust Fund, PO Box 1659, Beverly Hills, Calif. 90213. Tel: (213) 248-1084. Pres. & Admin'r: Lawrence Herbst.
- Bevill Music Co. (BMI), see Arnold Mills.
- Bewalk Music (BMI), see Copyright Serv. Bureau.
- Bibo Music Publ'rs Inc. (ASCAP), see T. B. Harms.
- Bi-Circle Music (BMI), see Gopam.
- Bicycle Music Co., 8756 Hollywood Dr., Los Angeles, Calif. 90069. Tel: (213) 659-6361.
- Johnny Bienstock Music (BMI), 1619 Broadway, New York, N.Y. 10019. Tel: (212) 489-8170. Comptroller: Lester Boles.
- Bifern Music Publ'g (BMI), 3361 S. Blue Ridge Court, Westlake Village, Calif. 91361. Tel: (805) 495-8765. Owner: Bill Doane.
- Big Apple Music Co. (BMI), see The Entertainment Co.
- Big B Music Inc., see T. B. Harms—Harry Von Tilzer.
- Big Baby Music Inc. (BMI), see Copyright Serv. Bureau.
- Big Bass Music (BMI), see April/Blackwood.
- Big Bopper Music Co., see T. B. Harms—Hall-Clement.
- Big Boro Publ'g Corp., 1700 Broadway, New York, N.Y. 10019. Tel: (212) 757-4534.
- Big C Music (ASCAP), see 20th Century.
- Big Diamond Publ'g (BMI), PO Box 15018, Tulsa, Okla. 74115. Tel: (918) 939-0641, 324-5553. Owner: Ken Holiday Garton.
- Big E Little e Music (BMI), see Segel & Goldman.
- Big Elk (ASCAP), c/o James William Guercio, PO Box 310, Nederland, Colo. 80465.
- Big Fish Music (BMI), 10811 Hesby St., North Hollywood, Calif. 91601. Tel: (213) 766-7487. Co-Owners: Chuck Tennin, Steve Goddard.
- Big Five Music Inc. (BMI), see Copyright Serv. Bureau.
- Big Fuss Music (BMI), see Chappell.
- Big Heart Music Inc. (BMI), 9454 Wilshire Blvd., Beverly Hills, Calif. 90212. Tel: (213) 278-7020. Pres.: Sherwin Bash; VP: Alan Mink; Gen. & Prof. Mgr.: Randy Bash.
- Big Hill (ASCAP), 41-A E. 74 St., New York, N.Y. 10021.
- Big Hurry Music Co. Inc. (ASCAP), 321 Commercial Ave., Palisades Park, N.J. 07650. Tel: (201) 224-8000. Telex: 135384. Pres.: Alfred Haber. (Represented by Mietus)
- Big Jim Music (SESAC), see Autumn Hill.
- Big Kitty Music (ASCAP), see Rondor.
- Big Mama Music (BMI), see Royalty Control Corp.
- Big Mike Music (BMI), 408 W. 115 St., New York, N.Y. 10025. Tel: (212) 222-8715. Cable: RIGHTON. Pres.: William H. Downs; Gen. Mgr.: Dolly Gilmore; Prof. Mgr.: Carl Palmer.
- Int'l firm represented: Minerva Music (Germany).
- Int'l rep.: France (Michel Meyer).
- Big Music (BMI), PO Box 9, 10 George St., Wallingford, Conn. 06492. Tel: (203) 269-4465. Cable: BIGSO-DREC. Pres.: Thomas Cavalier; Gen. & Publ'g Mgr.: Edyth L. Mercier.
- Branch: New York, N.Y., 2 Washington Square Village, Suite 7D, Zip: 10012. Tel: (212) 260-8645. Mgr. Dir.: John Tiven.
- Int'l rep.: Worldwide excluding USA & Canada (Celestial Harmonies in USA).
- Big Seven Music Corp. (BMI), 1790 Broadway, New York, N.Y. 10019. Tel: (212) 582-4267. Cable: ROULREC. Telex: 422573. Pres.: Morris Levy; VP, Gen. & Prof. Mgr.: Phil Kahl.
- Int'l branches: Australia (Planetary-Nom), Belgium (Caradam Eds.), France (Caradam Eds.), Germany (Musiwerk Verlag Planetary), Netherlands (Caradam Eds.), South Africa (Planetary-Nom), Switzerland (Caradam Eds.), UK (Planetary-Nom).
- Int'l reps.: Brazil (Victor), Colombia (Intersong), Denmark (Intersong), Finland (Intersong), Greece (Blackwood), Italy (Star), Japan (High Note), Mexico (EMLASA), Norway (Intersong), Portugal (Canciones del Mundo), Spain (Canciones del Mundo), Sweden (Intersong), West Indies (Record Specialists in Jamaica).
- Big Shoe Publ'g Co. (BMI), 1011 Fountain Rd., Jacksonville, Fla. 32205. Tel: (904) 781-4311. Pres.: Bruce Beard.
- Big Six Music Co. (BMI), see Chappell.
- Big Sky Music (ASCAP), PO Box 660, Cooper Sta., New York, N.Y. 10003. Tel: (212) 473-5900. Admin'r: Naomi Saltzman.
- Big Smoky Publ'g (BMI), PO Box 585, Central Sta., St. Louis, Mo. 63188. Pres.: George E. Patterson II.
- Big State Music Publ'g (BMI), 1311 Candlelight Ave., Dun-canville, Tex. 75137. Tel: (214) 298-9576. Pres.: Paul S. Ketter.
- Big Swing (BMI), c/o L.D. Allen, 3120 S. Robinson, Oklahoma City, Okla. 73109.
- The Big 3 Music Corp., see United Artists.
- Big Willie Music (BMI), 5004 W. Francis Rd., Clio, Mich. 48420. Tel: (313) 686-0189. Pres.: Forrest Green, VP: David O. Norris.
- Bijou Ridge Music, PO Box 476, First & Montana Sts., Wakkonda, S.D. 57073. Tel: (605) 267-2859. Owner: Douglas Sharples.
- Bikini Music Publ'g Corp. (ASCAP), see Jova.
- Bilt Publ'g (BMI), see Bug.
- Steve Binder Prod'ns, 1800 Century Park E., No. 418, Los Angeles, Calif. 90067. Tel: (213) 277-7855, 456-2777.
- Biograph Music Inc. (ASCAP), 16 River St., Chatham, N.Y. 12037. Tel: (518) 392-3400. Pres.: Arnold S. Caplin; Gen. Mgr.: Joel Bernstein.
- Birchfield Music, see Faron Young.
- Birch Island Music Press (ASCAP), see C.L. Barnhouse.
- Robert Fairfax Birch Publ'ns (ASCAP), see Theodore Presser.
- Benny Bird Co. (BMI), see Copyright Serv. Bureau.
- Birdes Music Corp. (ASCAP), see Cream.
- Birdseye Music (BMI), see United Int'l Copyright & Copyright Serv. Bureau.
- Birdsheet Music (BMI), 21350 Califa St., No. 224, Woodland Hills, Calif. 91367. Tel: (213) 884-9312. Pres.: Roger Jewell.

**WE'RE BUILDING
A WORLD
OF MUSIC
RIGHT IN
THE BUILDING.**



CBS

CBS SONGS INTERNATIONAL
51 W. 52 ST., NEW YORK, N.Y. 10019

"CBS" is a trademark of CBS Inc.

© 1979 CBS Inc.

Birdwalk Music Publ'g Co. Inc., see T.B. Harms—Hall-Clement.
 Birdwing Music (ASCAP), see Sparrow Recs.
 Birthday Music Inc. (BMI), see Music Music.
 Birthright Music (ASCAP), 3101 S. Western Ave., Los Angeles, Calif. 90018. Tel. (213) 731-2460.
 Bislar Music Publ'g (BMI), PO Box 23261, Nashville, Tenn. 37202. Tel. (615) 794-2949. Pres.: Ed Bislar III.
Branch: El Sobrante, Calif., 3449 San Pablo Dam Rd. Zip 94803. Tel. (415) 222-0385. Gen. Mgr.: D. De-Silva.
 Bitter Wind Music (BMI), see Copyright Serv. Bureau.
 Bizarre Music Inc. (BMI), see Martin Cohen.
 Bill Black Music Inc. (ASCAP), see Lyn-Lou.
 Black Board Music (BMI), see Faron Young.
 Black Caviar Music Inc. (ASCAP), 540 Madison Ave., New York, N.Y. 10022. Tel. (212) 838-6670. Pres.: Ronnie Lyons. Gen. Mgr.: Fred Biehl.
Int'l rep.: Worldwide excluding USA & Canada (Chappell Int'l).
 Black Coffee Music Inc. (BMI), see Prophecy.
 Black Ivy Music (BMI), see Mietus.
 Black Kat Rec. Co. Publ'g (BMI), 542 S. Dearborn, Suite 1102, Chicago, Ill. 60605. Tel. (312) 939-9066, 486-2989. Bd. Chm., Admin'r & Nat'l Dir.: Hank Williams; Ass't Mgr. & Project Dir.: Barbara McNeal.
Branch: Midfield, Ala., 544 Bessemer Super Hwy. Zip 35228.
 Blackland Music Co. (BMI), PO Box 7349, Tulsa, Okla. 74105. Tel. (918) 456-9541. Pres.: J.C. Garland. VP: Jelinda Devorzon.
 Black Magic Music (BMI), 1109 Brooks Ln., Indianapolis, Ind. 46202. Tel. (317) 637-9498. Pres.: George Khaliq. Creative Dir.: Michael Whittaker.
 Black Molasses (ASCAP), see Segel & Goldman.
 Black Sheep Music (BMI), PO Box 22635, Nashville, Tenn. 37202. Tel. (615) 383-8318. Pres.: Audie Ashworth.
 Black Stone Music (BMI), see Main Stone.
 Milton Blackstone Music Corp. (ASCAP), see Copyright Serv. Bureau.
 Black Tent Music (BMI), see Bug.
 Black & White Music Co. (BMI), see Copyright Serv. Bureau.
 Blackwood Music Inc. (BMI), see April/Blackwood.
 Eubie Blake Music (ASCAP), 284-A Stuyvesant Ave., Brooklyn, N.Y. 11221. Tel. (212) 574-8511. Pres.: Eubie Blake. (Administered by Beldock Levine & Hoffman).
 Blanchris Music (BMI), 160 W. 71 St., New York, N.Y. 10023. Tel. (212) 873-2020. Office Mgr.: Renee Steele.
 Blanding Publ'g Co. (BMI), PO Box 162, Provo, Utah 84601. Tel. (801) 224-1775. Pres.: Stan Bronson.
 Blat Music (BMI), see Copyright Serv. Bureau.
 Eric Blau Music Inc. (BMI), 251 W. 92 St., New York, N.Y. 10025. Pres.: Eric Blau.
 Blaze Music Co. (BMI), Box 1899, Little Rock, Ark. 72203. Tel. (501) 375-2911. VP: Kenneth Baker.
 Blecker Street Music (BMI), see Katch Nazar.
 Blendingwell Music Inc. (ASCAP), 488 Madison Ave., New York, N.Y. 10022. Tel. (212) 752-3033. Cable: PHILKURN. Telex: 234128. Co-Pres.: Terry Cashman, Tommy West, VP & Gen. Prof. Mgr.: Bob Esposito. Gen. Mgr.: Stan Nowak. (Administered by Publishers Licensing Corp.).
Branch: Nashville, Tenn., 812 19 Ave. S. Zip 37203. Tel. (615) 329-9282. Prof. Mgr.: Karen Scott-Conrad.
 Blind Baby Music (BMI), see Rondor.
 Blind Basement Music (BMI), PO Box 288, Silver Spring, Md. 20907. Wash. D.C. Tel. (202) 723-6958. Mgr.: Gene Rosenthal.
 Blockbuster Music Inc. (BMI), see Jamie.
 Blonde Lion Songs (BMI), see Martin Cohen.
 Blue Ace Music (ASCAP) (div. of Bass-Goldstein Inc.), PO Box 497, Yonkers, N.Y. 10702. Tel. (914) 423-8789. Pres.: Bruce Bass; VP: Jay Goldstein. (Administered by Copyright Serv. Bureau).
 Blue Band Music (BMI), see Ray Griff.
 Blue Book Music (BMI), 1225 N. Chester Ave., Bakersfield, Calif. 93308. Tel. (805) 393-1011. Owner: Buck Owens; Gen. Mgr.: Dorothy Owens; Prof. Mgr.: Jim Shaw.
 Blue Bottle Music (BMI), see Copyright Serv. Bureau.
 Blue Branch (BMI), see Eriction.
 Blue Bros. Music (BMI), see AlRuby.
 Blue Canyon Music (BMI), 1000 Granville Ave., Los Angeles, Calif. 90049. Tel. (213) 826-0649. Owner: Jim Terr.
 Blue Coast Music Inc. (ASCAP), see Fairlyland.
 Blue Dahlia / Paraflores Music, 1901 Ave. Of The Stars, Suite 740, Los Angeles, Calif. 90067. Tel. (213) 277-2224. Pres.: Lauren Caplan.
 Blue Echo Music (ASCAP), see Ray Griff.
 Blue Fin Music Co. (ASCAP), see Robin Hood.
 Blueford Music (ASCAP), see Mercantile.
 Blue Fox Music (ASCAP), see Skip Taylor.
 Blue Guitar Music Co. (ASCAP), see Chappell.
 Blue Island Music (BMI), see South Breeze.
 Blue Lick Music (BMI), see Bald Mountain.
 Blue Mace Music (BMI), PO Box 62263, 2716 Sandy Valley Rd., Virginia Beach, Va. 23462. Tel. (804) 340-3366. Pres.: Alex Spencer.
 Bluemark Music (ASCAP), see QCA.
 Blue Max Music (BMI), see Americus.
 Blue Melody Music (ASCAP), see Ray Griff.
 Blue Menu Music Co. (BMI), see Green Menu.
 Blue Monday Music (BMI), see Garrett.
 Blue Moon Music (ASCAP), see Nashville Copyright.
 Blue Rangers Music (ASCAP), see Greasy King.
 Blue River Music Inc. (BMI), 1741 N. Ivar, Suite 210, Hollywood, Calif. 90028. Tel. (213) 463-7661. Pres.: Harry Bluestone; Gen. Mgr.: Ross J. Bluestone; Prof. Mgr.: Michael Reynolds.
 Blue Rock Music (BMI), see Copyright Serv. Bureau.
 Blue Sable Publ'g (BMI), see Fairchild.
 Blueside Music (BMI), see April/Blackwood.
 Blues Man Music (BMI), see Copyright Serv. Bureau.
 Bluesome Lady Music (ASCAP), see Jondora Music—Delta R&E.
 Bluestocking (ASCAP)—Owner: Annie Dinerman—see Hal Bernard.
 Blue Umbrella Music Publ'g Co. (ASCAP), 3011 Beach 40

St., Sea Gate, Brooklyn, N.Y. 11224. Tel. (212) 372-6436, 449-5265. Owner: Nadish Millet.
 Bobbin & Weavin Music (ASCAP), see Martin Cohen.
 Bobby Anthony Music (ASCAP), see Chappell.
 Bobby's Beat Music (SESAC), see Cross Country.
 Bobcat Music (ASCAP), see PPX.
 Bobob Music Corp. (ASCAP), see Clardge.
 Bobrich Music Inc. (BMI), see Ashley.
 Boca Music Inc. (ASCAP), 532 Sylvan Ave., Englewood Cliffs, N.J. 07632. Tel. (201) 567-8100. TWX (710) 991-9372. Co-Pres.: Luigi Creatore, Hugo Peretti, Prof. Mgr.: Landy McNeal.
Int'l reps: Australia (Festival), Belgium (Intersong in Netherlands), France (Radio Music), Germany (Melodie der Welt), Italy (Sugar), Japan (Victor), Netherlands (Intersong), Philippines (Lustre), South Africa (Leeds), Sweden (Sweden Music), UK (Carlin).
 Bocephus Music Co. (BMI)—Pres.: J.R. Smith—see Single-tree.
 Fred Bock Music Co. (ASCAP), Box 333, Tarzana, Calif. 91356. Tel. (213) 996-6181.
 Bo-Gal Music (BMI), PO Box 6687, Wheeling, W. Va. 26003. Ohio Tel. (614) 758-5812. Pres. & Gen. Mgr.: Robert H. Gallion.
 Bohannon Phase II Music Publ'g Co. (ASCAP), see Chappell.
 Bokirk Music (ASCAP), 6255 Sunset Blvd., Suite 1005, Hollywood, Calif. 90028.
 Boldex Ent's. Inc. (BMI), see Copyright Serv. Bureau.
 Bomac Publ'g Inc. (BMI), see Copyright Serv. Bureau.
 Bomass (BMI), c/o Aucoin Mgmt., 645 Madison Ave., New York, N.Y. 10022.
 Bombs Away Music Inc. (ASCAP), see Castle Hill.
 Bomike Music Co. (ASCAP), see Mietus.
 Bonhomme Music (BMI), see Open End—New Times.
 Bonnyview Music Corp. (ASCAP), see Drive-In.
 Bonton Music (ASCAP), 10441 Santa Monica Blvd., Los Angeles, Calif. 90025. Tel. (213) 279-1659.
 Boogie Music (BMI), see Skip Taylor.
 Boogie Nite Music (SESAC), see Red Greg.
 Boomerang Music Co. (BMI), see S&R Music.
 Boossey & Co. (ASCAP), see Boossey & Hawkes.
 Boossey & Hawkes Inc. (ASCAP), 30 W. 57 St., New York, N.Y. 10019. Tel. (212) 757-3332. Cable: SO-NOROUS. Pres. & Mng. Dir.: W. Stuart Pope. Copyright & Royalty Dept. Mgr.: Sylvia Goldstein.
Home office: England.
Int'l branches: Australia, Canada, France, Germany, South Africa, Sweden.
Int'l firms represented: Amberson Ent's., Artia (Czechoslovakia), Edwin Ashdown Ltd. (UK), Barry (Argentina), Carisch (UK), Gehrmann (Sweden), IMI—Israel Music Institute (Israel), Kultura (Hungary), New Wind Music (UK), Norman Richardson Ltd. (UK), Suvini Zerboni (Italy), Josef Weinberger Ltd. (UK).
Int'l reps.: Argentina (Barry), Austria (Theater-Verlag Erich), Denmark (Wilhelm Hansen), Italy (Carisch), Japan (Academia Music, Nippon Gakki), Netherlands (Albersen), Norway (Norsk Musikforlag), Spain (Vidal Limona y Boceta), Sweden (Carl Gehrmann).
 The Boppers Music (BMI), see Martin Cohen.
 Border Brigands Music, 1101 E. Morehead St., No. 5, Charlotte, N.C. 28204. Owner: Ted Holt.
 Border Star Music Inc. (BMI), PO Box 0107, Los Angeles, Calif. 90048. Tel. (213) 655-6189. Pres. & Gen. Mgr.: Roger B. Perry; Prof. Mgr.: Richard Perry.
 Bornwin (BMI), see Beechwood.
 Bosken Music Inc. (BMI), see QCA.
 Boston Music Co. (ASCAP) (div. of Williamson Music Inc.), 116 Boylston St., Boston, Mass. 02116. Tel. (617) 426-5100. Gen. Mgr.: Warren W. Morris.
Int'l reps.: Australia (Allens), UK (Chappell).
 Botnk Music Co. (ASCAP), see SuLyn.
 Bottom Line Music Co. (ASCAP), see Chappell.
 Bouldin Music Publ'g Co. (BMI), PO Box 1375, Baltimore, Md. 21203. Tel. (301) 327-8236. Pres. & Prof. Mgr.: Ray Donahoe; Gen. Mgr.: Henry Donahoe.
 Bourne Co. (ASCAP), 1212 Ave. of the Americas, New York, N.Y. 10036. Tel. (212) 575-1800. Cable: BOURNEMUS. Pres.: Bonnie Bourne; Prof. Dept.: Dick Stone, Ken Brescia. (Sheet music distributed by G. Schirmer).
Branch: Los Angeles, Calif., 6381 Hollywood Blvd. Zip: 90028. Tel. (213) 469-5101.
Int'l branches: Canada (Bourne Music Canada), France (Bourne-France), UK (Bourne Music Ltd.).
Int'l reps.: Australia (Boossey & Hawkes), Germany (Melodie der Welt), Italy (Gallazzi), Japan (High Note), Mexico (Brambila), Netherlands (Basari), Portugal (Ivan Mogull), South America (Fermata in Brazil), Spain (Ivan Mogull), Switzerland (Melodie der Welt) (SEE ADVERTISEMENT).
 Bovina Music Inc. (ASCAP), 1650 Broadway, New York, N.Y. 10019.
 Bowling Green Music (BMI), see Trust Music.
 Bow Man Music Corp. (BMI), see Sagittarius.
 Bow Wow Music (BMI), see Stone-Rap.
 Box (BMI), see MacArthur.
 Boxcar Music Publ'g Co. (BMI), 13615 Pinerock Ln., Houston, Tex. 77079. Tel. (713) 468-6622. Pres.: Peter Breaz.
 Boxer Music (BMI), Box 120501, Nashville, Tenn. 37212. Tel. (615) 383-5073. Pres.: Curtis L. Allen.
Branch: North Hollywood, Calif., 10200 Riverside Dr., No. 202. Zip 91602. Tel. (213) 766-3818. Gen. Mgr.: Mickey Gross.
Int'l rep.: Worldwide excluding USA (Morning Music in Canada).
 Tommy Boyce & Melvin Powers Music Ent's (ASCAP), 12015 Sherman Rd., North Hollywood, Calif. 91605. Tel. (213) 875-1711. Pres.: Melvin Powers; Gen. Mgr.: Tommy Boyce; Prof. Mgr.: Karen Sweeney.
 Boy Wonder Music Co. (BMI), see Mietus.
 Bracknuc Music (BMI), see Chappell.
 Bradshaw Music (BMI), see Beechwood.
 Braintorm Music Co. (BMI), see Stoneway.
 Braintree Music (BMI), see Bug.
 Brantree Music (BMI), c/o Segel & Goldman, 9126 Sunset Blvd., Los Angeles, Calif. 90069. Tel. (213) 278-9200. Pres.: Richard Perry; Prof. Mgr.: Cathie Carey; Publ'g Admin'r.: Paul Giger. (Administered by Segel & Goldman).

Int'l reps.: Australia (Rondor), Austria (Altus in Germany), Belgium (Pathe Marconi in France), Central America (CBS), Denmark (Sweden Music in Sweden), Finland (Sweden Music in Sweden), France (Pathe Marconi), Germany (Altus), Hong Kong (Pathe), Iceland (Sweden Music in Sweden), Ireland (Rondor in UK), Italy (RCA), Japan (Pacific), Luxembourg (Pathe Marconi in France), Malaysia (Pathe in Hong Kong), Mexico (CBS), Netherlands (Universal Songs), New Zealand (Rondor in Australia), Norway (Sweden Music in Sweden), Portugal (Penta/Quiroga in Spain), Singapore (Pathe in Hong Kong), South Africa (Music Publ'g Co.), South America (CBS), Spain (Penta/Quiroga), Sweden (Sweden Music), Switzerland (Altus in Germany), UK (Rondor).
 Bramsdene Music Corp. (BMI), see Campbell Connelly.
 Brand X Music, see Beserkley.
 Branston Music Inc. (BMI), see Big Seven.
 Brass Music Ltd. (ASCAP), see Brass Press.
 Brass Press (BMI), 136 Eighth Ave. N., Nashville, Tenn. 37203. Tel. (615) 254-8969. Owner & Pres.: Stephen L. Glover. Sales Mgr.: James Vester.
Int'l firm represented: Musica Rara—Brass Eds. (UK).
Int'l reps: Australia (Brass & Reed), Norway (Norsk Brass), Switzerland (BMI).
 Braun Music Inc. (SESAC), see Music Sales.
 Brazos Valley Music Co. (BMI)—Pres.: Hank Thompson—see Jim Halsey.
 Break of Dawn (BMI), PO Box 490, Bogalusa, La. 70427.
 Breegh Music (BMI), see Yuggoth.
 Breeze Publ'g Co. (BMI), Box 1354A, Rt. 2, Cheyenne, Wyo. 82001. Tel. (307) 638-8733. Gen. Mgr.: Ray Alexander.
 Bregman Vocco & Conn Inc. (ASCAP), see 20th Century.
 Briar Music Co. (ASCAP), see The Entertainment Co.
 Brian Music (BMI), see BC Ent's.
 Briarhead Music Unlimited (ASCAP), PO Box 515, St. Louis, Mo. 63166. Tel. (314) 776-2278, 464-1773. Pres. & Prof. Mgr.: Ken Keene. VP: Frankie Ford.
Branches: New Orleans, La., PO Box 3763, Zip 70117. Prof. Mgr.: Wayne Keene—Nashville, Tenn., PO Box 24561, Zip 37203. VP: Tom Pallardy.
Int'l firms represented: Baby Snaker (UK), Southern Sound (UK).
Int'l reps.: UK (Baby Snaker, Southern Sound).
 Briarpatch Music (BMI)—Pres.: Edward T. Rabbit. Gen. Mgr.: Keni Wehrman—see DebDave.
 Brickbert Music (BMI), 6801 W. 76 St., Overland Park, Kan. 66205. Tel. (913) 642-9600. Owner & Gen. Mgr.: William E. Gilbert.
Branch: St. Louis, Mo., 1843 Kennett Pl. Zip 63104. Tel. (314) 772-2894. Gen. Mgr.: William J. Keyes.
 Bridge Music (BMI), see The Herald Ass'n.
 Bridge Music Publ'g Co. (BMI), (a div. of Pacific Press Publ'g Ass'n), 1350 Villa St., Mountain View, Calif. 94042. Tel. (415) 961-2323.
 Bridgeport Music Inc. (BMI), 19631 W. Eight Mile Rd., Detroit, Mich. 48219. Tel. (313) 255-6740. Pres.: Armen Boladian. Ass't to Pres.: Carole Luedeman.
 Brigantine Music (BMI), 23 Darby Rd., Cherry Hill, N.J. 08002. Pres.: Martin Dippolito. VP: Richard DeMarco. Treas.: Norman D. Cooper.
 Briggsville-Taylortown (BMI), see Copyright Serv. Bureau.
 Joani Brightharp (BMI), see Copyright Serv. Bureau.
 Bright Moments (BMI), 40 Bulkley Ave., Sausalito, Calif. 94965.
 Bright Tunes (ASCAP), c/o Howard Sheldon, 292 Madison Ave., New York, N.Y. 10017.
 Brim Music Inc. (SESAC), 38 Music Square E., Suite III, Nashville, Tenn. 37203. Tel. (615) 256-3373. Pres. & Prof. Mgr.: Marty Williamson. Gen. Mgr.: Dick Runyeon.
 British Rocket Music Publ'g Co. (ASCAP), see Rocket Publ'g.
 Broad River Press, see Brass Press.
 Broadside Music Inc. (BMI), see Segel & Goldman.
 Broadway/Hollywood Int'l Music Publ'rs, Box 496, Georgetown, Conn. 06829. Tel. (203) 544-8288. Contacts: Doris & Bruce Yeko.
Branch: Fort Lee, N.J., PO Box 15. Zip 07024.
 Broadway Music Corp. (ASCAP), see Copyright Serv. Bureau.
 Brodt Music Co. (ASCAP), PO Box 9345, Zip 28299, 1409 E. Independence Blvd., Charlotte, N.C. 28205. Tel. (704) 332-2177. Owner: Gladys F. Brodt.
Int'l firms represented: Ashdown (UK), Banks (UK), Forsyth (UK), Frederick Harris (Canada), Henle (Germany), Leduc (France), Leslie (Canada), Royal School of Church Music (UK).
Int'l rep.: Canada (Leslie).
 Broken Arrow Music Inc. (BMI), see Segel & Goldman.
 Broken Bird Music (ASCAP), see Segel & Goldman.
 Broken Soul Music Co. (BMI), see Copyright Serv. Bureau.
 Bronjo Music (BMI), 1637 Utica Ave., Brooklyn, N.Y. 11234. Tel. (212) 253-4600. Cable: SEECODISC.
Int'l rep.: UK (Sparta-Florida).
 Samuel Bronston Music Publ'g Inc. (ASCAP), see TRO.
 Bronze Music Co. Inc. (SESAC), see Sure-Fire.
 Brookdale Music Inc. (BMI), see Copyright Serv. Bureau.
 Brooklyn Heights Music Inc. (ASCAP), 124 Montague St., Brooklyn, N.Y. 11201. Tel. (212) 237-0250. Pres.: Bob W. Motta. VP & Sec'y: Vince Traina.
 Brooklyn Music (ASCAP), see 20th Century.
 Brooks Bros. Publ'rs (BMI), 311 Marga Ln., Nashville, Tenn. 37211. Tel. (615) 834-4124. Gen. Mgr.: Jake C. Brooks. (Affiliated with Enchantment Music).
 Brookside Music Corp. (ASCAP), 159 W. 53 St., New York, N.Y. 10019. Tel. (212) 541-7761. Pres.: Reid White-law.
 Brookville Music Inc. (BMI), see Mietus.
 Brother Publ'g Co. (BMI), 10880 Wilshire Blvd., Suite 306, Los Angeles, Calif. 90024. Tel. (213) 475-0361. Exec. VP: Janet Lent-Koof.
 Brothers Two Music (BMI), see Chappell.
 Alexander Broude Inc., 225 W. 57 St., New York, N.Y. 10019. Tel. (212) 586-1674. Cable: ALBRO. Pres.: Robert J. Bregman. VP: Dean Street. Sec'y-Treas.: Michael Lefferts.
Int'l firms represented: Breitkopf & Haertel, J&W Chester (Choral Works), Composers Library Eds., Continuo Music Press, J.B. Cramer & Co. Ltd., Deutscher Verlag fur Musik, Fenette Music, Fentone Music, Gemini

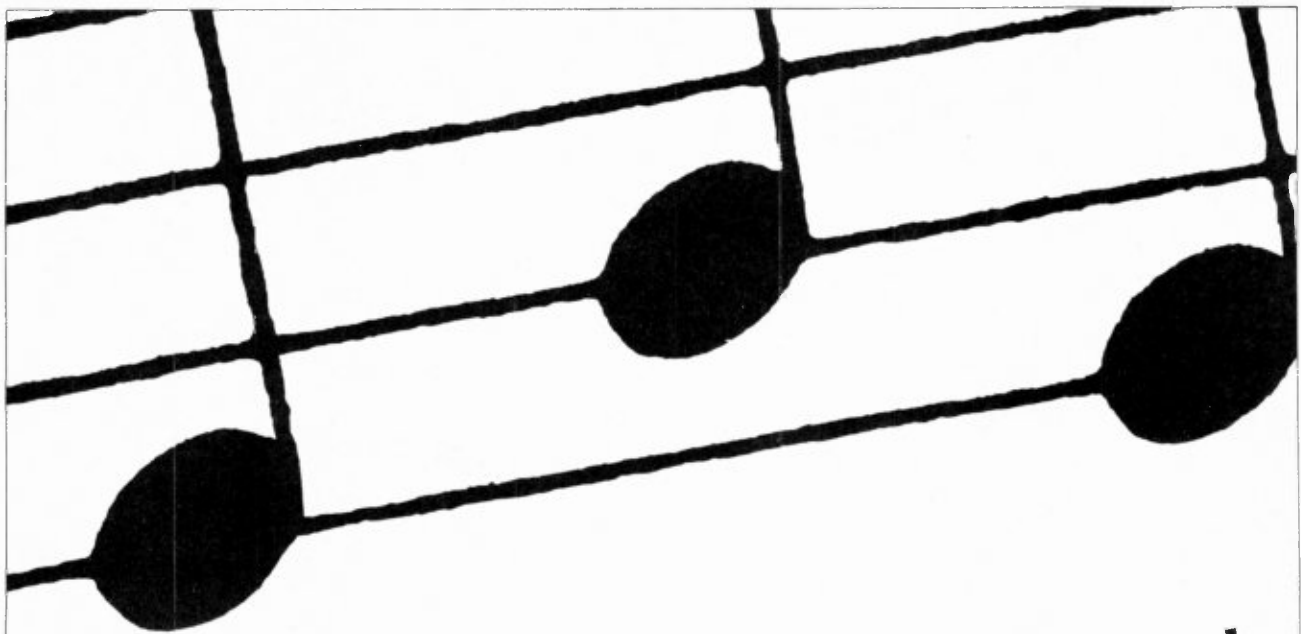

© 1979 April • Blackwood

Copyrights. In the business of music publishing, they're the single resource we seek, develop and market.

We're proud that 1978-79 has seen our catalogue of copyrights yield the fastest and largest growth of any year in our history—with more awards, honors and hits than anybody could've imagined.

We firmly believe the talents of our creative family are second to none.

With our aggressive commitment to excellence, we'll sustain our record of converting great songs into great hits. And strengthen our reputation as the company with the copyrights that mean more than a name and a date.

April • Blackwood: The total music company.

april • blackwood
music



april • blackwood
publications

1350 Ave. of the Americas
New York, NY 10019
(212) 975-4886

31 Music Square West
Nashville, TN 37203
(615) 329-2374

1930 Century Park West
Century City, CA 90067
(213) 556-4790

Press, Glocken Verlag Ltd (Lehar works), Friedrich Hofmeister, Israeli Music Publ'ns, Leonard, Gould & Boltler, MSM, Mount Tahoma Music (Hovhaness works), Neume Music Verlag, Pro Musica, Basil Ramsey, Tetra Music Corp., Transcontinental Music Publ'ns (Jewish music catalog)

Broude/Bregman Music Inc (ASCAP), see Alexander Broude

Broude Bros Ltd (ASCAP), 56 W 45 St., New York, N.Y. 10036 Cable BROUDEBRO Tel (212) 687-4735 VP Ronald Broude

Brougham Hall Music Co Inc (BMI), see ATV

Brouhaha Music (ASCAP), see Copyright Serv Bureau

Brouhahn Music (ASCAP), 221 W 57 St., New York, N.Y. 10019

Brownleaf Music Co (BMI), PO Box 7221, Mobile, Ala 36607 Tel (205) 342-1177 Pres. John N. Blackburn, VP Sara Ann Smith

Brown Moon Music (ASCAP), PO Box 19274, Houston, Tex 77024 Tel (713) 785-5779 Pres. Rusty Holster
Branch: Midland, Tex., PO Box 2661 Zip 79701

Brown Shoes (BMI), see Rondor

Brown Shoes Music Co (ASCAP), see Chappell

Brown Trout Music Inc (BMI), see Chappell

Bruin Music Co (BMI), see Famous

Brusser Music (BMI), see April/Blackwood

Brujo Publ'g (BMI), see Western Head

John Brumage Co., 514 W 57 St., New York, N.Y. 10019 Tel (212) 245-6119 Owner John Brumage; Gen Mgr Linda Brumage

Albert E. Brumley & Sons (SESAC), Powell, Mo 65730 Tel (417) 435-2225 Pres. Bill Brumley Gen Mgr Bob Brumley

Brunswick Music Publ'g Co (BMI), 136 S. Small Dr., Beverly Hills, Calif. 90211 Tel (213) 657-4895 Owner, Pres. & Gen. & Prof. Mgr. Lee Silver

Brushape Music Co Inc (BMI)—VP Gary S. Paxton—see Window

Brut Music Publ'g (ASCAP) (div. of Brut Prod'ns Inc.), 1345 Ave of the Americas, New York, N.Y. 10019 Tel (212) 581-3114

Bryn Mawr Music Co (ASCAP), see Accadia

Bubble Gum Music Co (ASCAP), see Mietus

Backboard Jazz Music (ASCAP), 1108 17 Ave. S., Nashville, Tenn 37212 Tel (615) 327-4571 Pres. Dave Converse

Buckeye Music Inc (ASCAP), see Carlson

Buckhorn Music Publ'rs Inc (BMI), 1007 17 Ave. S., Nashville, Tenn 37212 Tel (615) 255-0543 Pres. Marjorie Wilkin

Int'l reps.: Australia (Castle), Jamaica (Woodwater), Japan (Tokyo Music), South Africa (Reveille), UK (Valentine)

Buckingham Music Co (ASCAP), see Pavanne

Bucksport (BMI), PO Box 24265, Nashville, Tenn. 37203 Tel (615) 824-1169

Bucky Music (ASCAP), see Copyright Serv Bureau (US rights)

Bucenitis Music Co (BMI), see Copyright Serv Bureau (US rights)

Buddah Music Inc (ASCAP), 1350 Ave. of the Americas, New York, N.Y. 10019 Tel (212) 582-6900 Dir., Mktg. & Sales Charles K. Walz (Administered by United Artists)

Int'l rep.: Worldwide (United Artists)

Budd Music Corp (ASCAP), 18531 Wells Dr., Tarzana, Calif. 91356 Tel (213) 345-4204 Pres. Buddy Kaye
Branch: Las Vegas, Nev., 850 Tam O Shanter, Zip 89109

Int'l rep.: UK (Budd)

Bud-Don Music Co (ASCAP), see Glad Music

Budget Music (BMI), see Mietus

Buena Vista Publ'g Co (BMI), PO Box 28553, Dallas, Tex 75228 Tel (214) 328-7770 Owner B. L. Bollman

Buffalo Bill Music (BMI), 2501 S. Ocean Dr., Hollywood, Fla 33019 Tel (305) 921-6550 Pres. Robert S. Taran, Nat'l Sales Evelyn Geldon

Bug Eyes Music (BMI), see Bug Music

Bug Juice Music (BMI), see Bug Music

Bug Music (BMI), see Bug Music Group

Bug Music Group, 6777 Hollywood Blvd., 9th fl., Hollywood Calif. 90028 Tel (213) 466-4352 Pres. Daniel Bourgoise, VP & Gen. Mgr. Fred Bourgoise Copyright Admin'r Lydia Frazier, Prof. Mgr. Bruce Hoffman

In 1 reps.: Australia (Matthews), Belgium (Ardmore & Beechwood), Germany (Roba), Italy (Chappell) Japan (Pacific), Scandinavia (Air in Sweden), Switzerland (EMI) UK (Warner Bros)

Bullet-Proof Music (BMI), see Dozier

Bullfrog Ballades (ASCAP), see Folklore

Bullfrog Music (ASCAP), see Skip Taylor

Bull-Kent Music (ASCAP), see Mercantile

Bull Pen Music Co Inc (BMI), see Perren-Vibes

Bullwinkle Music Co (ASCAP), PO Box 48, Lithia Springs, Ga 30057 Pres. James F. Brannon Jr

Bumpershoot Music Inc (BMI), see Hal Bernard

Burd Music (BMI), see Chappell

Fred Burd Music (BMI), see Cedarwood

Burdette Music Co (BMI), see Jerden

Burlington Music Corp (ASCAP), 539 W. 25 St., New York, N.Y. 10001 Tel (212) 675-6060 Cable FULL-RANGE Mgr. Carolyn Kalet

Int'l branches: Australia (Palace), Canada (Burlington), France & French Union (Palace), Germany (Burlington), Hong Kong (Burlington-Palace), Italy (Palace), Netherlands (Palace), South Africa (Burlington), Spain & Portugal (Burlington), Sweden (Palace), Switzerland (Burlington), UK (Burlington-Palace)

Burning Rope Publ'g Co (BMI), 137 E. Sixth St., Austin, Tex 78701 Tel (512) 477-7100 Owners Charles D. Tullis Jr., Leon Vernon Eagleson

Burresci-Palmiteri Music Prod'ns (ASCAP), 28 Cover Ave., Stewart Manor, N.Y. 11530 Tel (516) 328-1505 Co-Chm. Richard C. Burresci, William L. Palmiteri, Gen. Mgr. Donald T. Burresci, Prof. Mgr. Donald C. Burresci

Branch: Ballerice, N.Y., 73 Huron Rd., Zip 11426 Tel (516) 775 4656 Gen. Mgr. William L. Palmiteri

Burthen Music Co Inc (ASCAP), see Chappell

Burt Topper Music (BMI), see Chappell

Buskirk Music (BMI), see Royalty Control Corp

Butler Music Publ'g Corp (ASCAP), see Chappell

Butterflygurd Music (BMI), see BMG

Buttermilk Sky Music Publ'g Corp (BMI), 515 Madison Ave., Suite 808, New York, N.Y. 10022 Tel (212) 759-2275 Pres. Murray Deutch, Gen. Mgr. Stuart Cantor; Prof. Mgr. Jaime Vaughan

Butter Music (BMI), see Cream

By Full Co. (BMI), see Kropotkin

By Gene Music (BMI), see Chappell & Sounds of Memphis

Bygosh Music Corp (ASCAP), RD 1, Brookfield, Vt 05036 Tel (802) 276-3393 Pres. Bobby Gosh, Gen. Mgr. Al Weissman

Byrdshire Music Co (ASCAP), 1601 N. Orange Grove Ave., Hollywood, Calif. 90046 Tel (213) 874-0044 Partners Betty & Jack Carlton

Bytown Music (BMI), see Copyright Serv Bureau

C

C A M Prod'ns (BMI), 489 Fifth Ave., New York, N.Y. 10017 Tel (212) 682-8400 Cable CAMUSA INC. Telex: 236920 Pres. Vittorio Benedetto

C A M (USA) Inc (BMI), see CAM Prod'ns

C B Music Inc (BMI), see Big Seven

C B G B's Music Inc (ASCAP), see Larry Spier

C B S, see April/Blackwood (SEE ADVERTISEMENT)

C J Publ'g (BMI), 4827 S. Prairie Ave., Chicago, Ill 60615 Tel (312) 285-1616 Pres. Carl Jones

C M G Music (ASCAP), see Music Music Music

C P W Music (ASCAP), see Chappell

C T I Recs. (div. of Creed Taylor Inc.), 1 Rockefeller Plaza, New York, N.Y. 10020 Tel (212) 489-6120 Bd. Chm.: Creed Taylor, Pres. Jerald Wagner, Prof. Mgr.: Amy Roslyn

Int'l reps.: Australia (Matthews), Austria (Schmolzi & Slezak), Benelux (Kluger), Colombia (Ivan Mogull), France (Sugarmusic), Germany (Schmolzi & Slezak), Italy (Sugarmusic), Japan (Seven Seas), Mexico (Gamma), Scandinavia (Multitone), South Africa (Gallo), Spain (Hispaconv), Switzerland (Schmolzi & Slezak), UK (Heathside)

Cabriole Music (BMI), PO Box 7422, Shreveport, La. 71107 Pres. Mary Logan, Prof. Mgr. Don Logan

Cachand Music (BMI), see Curton & Copyright Serv Bureau

Caesar's Music Library (ASCAP), 1022 N. Palm Ave., Los Angeles, Calif. 90069 Tel (213) 659-6034 Pres. Marc Gordon Jr

Cafe Americana (ASCAP), 8255 Sunset Blvd., Los Angeles, Calif. 90046 Contact Andrea Starr

Cajun Crawdaddy Music (BMI), see Bug

Cakewalk Music (BMI), see 20th Century

Caleb Music (ASCAP), see Rondor

Calelo Music (ASCAP), see April/Blackwood

Calico (BMI), see Drive-In

California Music Press, see Copyright Serv Bureau

California's Blue-Rose (BMI), 483 Shadow Ln., Fontana, Wis 53125 Tel (414) 275-3369 Owner Felix Kubik Sr.; Pres. Felix Kubik Jr., Gen. Mgr. Martha Arentsen

Caligula Inc (ASCAP), 1 Hudson St., New York, N.Y. 10013 Tel (212) 962-5522 Pres. David Forman, VP & Gen. Mgr. Charles Baxter

Int'l rep.: UK (Carlin)

Callee Music Corp (ASCAP), see Fourth Floor

Callon-Love Music (BMI), 610 S. Venice Blvd., No 4284, Marina del Rey, Calif. 90291 Tel (213) 399-3984 Co-Admin'r's Jim & Dale Callon

Int'l reps.: Benelux (Dutchy), Canada (Abovewater), Germany (Siegel), UK (Carlin)

Calua Music Co (BMI), see Copyright Serv Bureau

Calumet Music (BMI), see M M Cole

Calwest Songs (BMI), c/o Le Anderson Ents., PO Box 4141, North Hollywood, Calif. 91607 Tel (213) 782-6915 Owner & Pres. Le Anderson, VP Bruce Anderson, Pub. Dir. Beth Anderson

Branch: Bellingham, Wash., 1602 Carolina St. Zip 98225 Tel (206) 671-2860 Gen. Mgr. Bob Wood

Camarillo Music Publ'g (BMI), see Golden West

Camelback Mountain Music Corp. (ASCAP), see Shapiro Bernstein

Camel's Hair (BMI), see KRPCO Music

Camera Music Inc (ASCAP), see CAM Prod'ns

Cameron Org. Inc., 320 S. Waiola Ave., La Grange, Ill 60525 Tel (312) 352-2026 Prof. Mgrs. Scott A. & Jean M. Cameron

Camex Music Inc (BMI), see CAM Prod'ns

Camino Real Music (ASCAP), see Garrett

Campbell Connelly & Co. Inc. (ASCAP), 271 North Ave., New Rochelle, N.Y. 10802 Treas. Nathaniel Miller

Home office: England

Glen Campbell Music Inc (BMI), 1900 Ave. of the Stars, Los Angeles, Calif. 90068 Tel (213) 553-8434 Pres. Glen Campbell, Prof. Mgr. Stanley B. Schneider

Int'l reps.: Europe Orient & UK (all Florida Music)

Camp & Canyon Music Co., see T. B. Harms—Vogue

Canaanland Music (BMI), see Word Music Inc

Canaan Music Inc (ASCAP), see Fourth Floor

Canal Publ'g Inc (BMI), 6325 Guilford, Indianapolis, Ind 46220 Tel (317) 255-3116

Can Do Music (BMI), see Mietus

Candue Music Inc., 19 S. Broadway, White Plains, N.Y. 10601 Tel (914) 682-8069 Pres. Richard Taninbaum (Administered by Copyright Serv Bureau)

Candy Mountain Music (BMI), see Sweet Cherry

Cannes Music Inc (BMI), see Ivan Mogull

Cannette Music Co (BMI), see Mietus

Cannlynn Music Co (BMI), see Mietus

Cannon Point Music Inc (BMI), see Claridge

Can't Stop Music (BMI), 65 E. 55 St., Suite 302, New York, N.Y. 10022 Tel (212) 751-6177 Telex 427317 Pres. Henri Belolo

Int'l firm represented: Scorpio (France)

Cantus Press (ASCAP)—Contact Morgan Lowry—see Triune

Canyon Press Inc., PO Box 1235, Cincinnati, Ohio 45201 Tel (513) 852-7850 Pres. G. W. Fahrer Jr., VP Alison Fahrer

Capano Music (div. of Britone Inc.) (ASCAP), 237 Chestnut

St. Westville, N.J. 08093 Tel (609) 456-4402 Pres. Anthony J. Capano, Gen. Mgr. Patrick Capano, Prof. Mgr. Brian A. Capano

Capaquin Music Publ'g (ASCAP), 750 Kappock St., Suite 1015, Riverdale, N.Y. 10463 Tel (212) 796-2490 Chm. & Pres. Ms. P.J. Watts, Gen. Mgr. Januari Watts, Prof. Mgr. Queen Yahna

Cape Ann Music Inc (BMI), PO Box 120128, Nashville, Tenn 37212 Tel (615) 646-0279 Pres. John D. Richbourg Gen. & Prof. Mgr. Matt Richbourg

Int'l rep.: Worldwide excluding USA & Canada (Inter-song in UK)

Capella Music (ASCAP), see McAfee & Lorenz

Cape May Music (BMI), see Cape Ann

Capitol Dome Music (ASCAP), see Independence

Caplin Music (BMI), see Biograph

Cap Orion Music Publ'g Co Inc (BMI), PO Box 1235, New Rochelle, N.Y. 10802 Tel (914) 961-7189 Gen. Mgr. Joe Messina

Cappy Music Co (ASCAP), see Cherry Lane

Cap Quist Music (BMI), see Copyright Serv Bureau

Caprice (BMI), see Jaspur

Capricorn Music Co (ASCAP), see Copyright Serv Bureau

Capri Music Corp (BMI), see Alfred

Captain Crystal Music (BMI), see Hampstead Heath

Captain Marvel Music (BMI), see Chappell

Captive Music (BMI) (div. of Allases Inc.), Granny White Pike, Nashville, Tenn 37204 Tel (615) 383-6376

Cara Publ'ns (ASCAP), 2000 W. Devon Rd., Columbus, Ohio 43212 Tel (614) 486-3334 Owner John Tattenhorst

Cardio Music (BMI) (div. of Art Attack Recs. Inc.), 964 W. Grant Rd., Tucson, Ariz 85705 Tel (602) 622-8012, 881-6833 Pres. William Cashman

Career Music (BMI), see Arista

Caribbean Music Co (BMI), see Copyright Serv Bureau

Carleen (ASCAP), 20 E. Huron, Chicago, Ill 60611 Tel (312) 943-0305

Carleigh Music (ASCAP), see April/Blackwood

Carlson Music Co (BMI), 4625 NW 44 St., Fort Lauderdale, Fla 33319 Tel (305) 731-4669 Owner Harry Carlson

Carlwood Music (SESAC), see Critique

Carlyle Music Publ'g Corp (ASCAP), see H. B. Webman

Carobell Music Corp (BMI), see Mietus

Carol Nan Music (ASCAP), see Coyote

Carroll Music Inc (BMI), 111 Kentucky Ave., Sheffield, Ala 35660 Tel (205) 383-9587 Owners Pete & Jo Ann Carr

Carrington (BMI), see Curtis Wood

Carr Radio Music Co (ASCAP), see Carrrhorn

Alan Catec Music Inc (BMI), see Music Mill

Carter III Music, 1111-17 Ave. S. Nashville, Tenn 37212 Tel (615) 242-8600

Carvon Music Inc (BMI), see Croma

Carwin Country Int'l., 13357 Lorain Ave., Cleveland, Ohio 44111 Tel (216) 476-2895 Pres. & Gen. Mgr. Carl French, Prof. Mgr. Gail Faught

Carwin Publ'g Co (BMI), see Carwin Country

Cary & Mr. Wilson Music Inc (BMI), PO Box 500, Nashville, Tenn 37202 Tel (615) 242-5400

Casa Latina Inc (ASCAP), see Mexican Music

Don Casale Music (BMI), 377 Plainfield St., Westbury, N.Y. 11590 Tel (516) 333-7898 Pres. & Gen. Mgr. Don Casale

Caseyem Music (BMI), see Triple H

Buzz Cason Publ'ns Inc (ASCAP), see Southern Writers

Cassan Music (ASCAP), see Wilhos

Casserole Music Inc (BMI), see RSO & Chappell

Castalia Music (BMI), PO Box 11516, Milwaukee, Wis 53211 Pres. Jim Spencer, Sales & Promo. E.T. Caldwell

Castle Hill Publ'g Ltd (ASCAP), 635 Madison Ave., Suite 1003, New York, N.Y. 10022 Tel (212) 759-7294

Catalpa Publ'g Co (BMI), 2609 NW 36 St., Oklahoma City, Okla 73112 Tel (405) 942-0462 Pres. Bobby Boyd

Catchup Music (BMI), PO Box 9830, 3507 W. Vickery, Fort Worth, Tex. 76107 Tel (817) 737-9911 Pres. J. P. Kimzey

Cat Clothes Music (BMI), see Bug

Cate Bros Music (BMI), see Segel & Goldman

Catpach Music (BMI)—Pres. Michael Curtis, VP Richard L. Dew-Curtis—see Rondor

Cauldron Music (ASCAP), see Segel & Goldman

Cavendish (ASCAP), see Boosey & Hawkes

Cayman Music Inc (ASCAP), see Copyright Serv Bureau

Cayton Publ'g, PO Box 367, Mayfield Rd., Orwell, Ohio 44076 Tel (216) 437-8422 Pres. Richard Rhodes, Bus. Mgr. Thomas Nordquist

Cayuga Music (BMI), see Chappell

Ceberg Music Corp. (ASCAP)—Pres. Norman Bergen—see Brookside

Cecilian Music Publ'g (BMI), see Jaspur

Cedarwood Publ'g Co Inc (BMI), 39 Music Square E., Nashville, Tenn 37203 Tel (615) 255-8535 Pres. & Gen. Mgr. J. William Denny, Prof. Mgr. John E. Denny

Int'l rep.: Worldwide (Peer-Southern in USA)

Celann Music (BMI), see Pickwick

Celebration Press (ASCAP), see Fred Bock

Celeste Music (ASCAP), see Potnick

Celestial Harmonies (div. of Mayflower Music), 20 W. 64 St., Suite 42-G, New York, N.Y. 10023 Tel (212) 595-6360

Celestine Music (BMI), see Mietus

Cell (BMI), see C. F. Peters

Cellamar Music (BMI), see Copyright Serv Bureau

Cenalia Music (ASCAP), see Martin Cohen

Cenico Music Publ'g Co (ASCAP), see Slide

Centaur Publ'g Corp (ASCAP), see Sagittarius

Centerpoint Music Publ'g (BMI), see Rontom

Centerstream Music (BMI), see April/Blackwood

Central Songs (BMI), see Screen Gems-EMI

Century Music Publ'g Co Inc (SESAC), see Ashley

Century Songs (BMI), see Beechwood

Certron Music Corp (ASCAP), see Copyright Serv Bureau

Cesta Music (ASCAP), see Copyright Serv Bureau

C'est Music (ASCAP), see Quackenbush

Cetra Music Corp (BMI), 5828 S. University Ave., Chicago, Ill 60637 Tel (312) 493-9781 Pres. Morton A. Kaplan

The RBR Companies Strike The Right Chord!

AURUM

RECORDS



BRADLEY
PUBLICATIONS

PRINT

Asilomat
music

dreena music

PUBLISHING



Divisions of RBR Communications, Inc. 43 West 61 Street, New York, N.Y. 10023
(212) 757-8805 (800) 223-2384

- Chachka Music, see R.A. Hodge.
 Chain Gang Music (BMI), see 20th Century.
 Chalco Music (ASCAP), see Copyright Serv. Bureau.
 Chalice Music Group, 326 N. LaCienega Blvd., Los Angeles, Calif. 90048. Tel: (213) 658-7002. Cable: CHAL-PROD. Tel: 691187. Pres. & Gen. Mgr.: Leonard Hodges. Prof. Mgr. Norman Salitt.
Int'l firm represented: Beautiful Sunday (UK), Robin Gibb (UK), Brian Morrison, Son Music.
Int'l reps: Australia (Leeds), Benelux (Veronica), Italy (Sugar), Japan (Pacific), UK (Dick James).
 Challove (BMI), c/o Love Songs Publ'g Group, PO Box 3720, Santa Barbara, Calif. 93105.
 Chalmac (ASCAP), see PPX.
 Champaign Music Corp. (ASCAP), see T.B. Harms.
 Champion Music Corp. (BMI), see MCA Music.
 Chandler Music Co. Inc. (ASCAP), see Loring.
 Chandos Music (ASCAP), see Folklore.
 Chan Music Publ'rs (BMI), see Real To Reel.
 Chanson (Eds.) Co., see Stanyan.
 Chantem Music Inc. (BMI), see Beldock Levine & Hoffman.
 Chantry Music Press Inc. (SESAC), Box 1101, 32-34 N. Center St., Springfield, Ohio 45501. Tel: (513) 325-9992.
 Chappridge Music Publ'g Co. (ASCAP), see Bridge.
 Chappell & Co. Inc. (ASCAP), see Chappell Music Co.
 Chappell Music Co., 810 Seventh Ave., New York, N.Y. 10019. Tel: (212) 399-7373. Cable: SYMPHONY. Pres. Irwin Z. Robinson, Sr. VP, Creative: Irwin Schuster. VP Creative: Frank Military. (Sheet music distributed by Theodore Presser Co.)
Branches: Hollywood, Calif., 6255 Sunset Blvd. Zip: 90028. Tel: (213) 469-5141. VP & Gen. Mgr.: Roger Gordon—Nashville, Tenn., 21 Music Circle E. Zip: 37203. Tel: (615) 244-3382. VP & Mgr.: Henry Hurt.
Int'l branches: Australia, Belgium, Canada, England, France, Germany, Italy, Japan, Netherlands, New Zealand, South Africa, Spain, Sweden, Switzerland.
Int'l firm represented: Snowblind Music (Canada).
 Chappell-Styne Inc. (ASCAP), see Chappell.
 Char Barb Music (BMI), Rt. 1, Box 120A, Swoope, Va. 24479. Tel: (703) 885-3309. Pres. & Gen. Mgr. Barbara R. Flowers. Prof. Mgr.: Charles A. Flowers.
 Char-Belle Music (BMI) (sub. of Anspac Recs. Inc.), 1005 Frank Nelson Bldg., 205 N. 20 St., Birmingham, Ala. 35203. Tel: (205) 252-8271.
 Charing Cross Music Inc. (BMI), 36 E. 61 St., New York, N.Y. 10021. Tel: (212) 751-6590. Gen. Mgr.: Ian E. Hobblyn.
Int'l firms represented: DeShufflin (UK), Pattern (UK).
Int'l reps: UK (DeShufflin, Pattern).
 Charrel Music (BMI), see Mietus.
 Char-Liz Music Inc. (BMI), see CTI (US rights) & Ivan Mogull (int'l rights).
 Charlotte Sounds (ASCAP), see Meteorina.
 Charmlee (BMI), see Peaceable Kingdom.
 Chary Music, see Tree.
 Charter Publ'ns Inc. (ASCAP) (div. of J.W. Pepper & Son), PO Box 850, Valley Forge, Pa. 19482. Tel: (215) 666-0363.
 Chartcap (BMI), 3307 Laurel Dr., Glenshaw, Pa. 15116. Tel: (412) 487-6156. Owner: James Grimes.
 Chatawa Music (ASCAP), see Copyright Serv. Bureau.
 Chatham Music Corp. (ASCAP), see 20th Century.
 Cheavoria Music Co. (BMI), PO Box 1304, Brewton, Ala. 36426. Tel: (205) 867-2228. Pres. Roy Edwards.
 Cheezburger Music Inc. (BMI), see Copyright Serv. Bureau.
 Cheren-Klishins Music Corp. (ASCAP), 254 W. 54 St., New York, N.Y. 10019. Tel: (212) 757-0695.
 Cherie Music (BMI), 3621 Heath Ln., Mesquite, Tex. 75150. Tel: (214) 279-5858. Owners: Jimmy Fields, George McCoy.
 Chero (BMI), c/o Lee Eastman, 39 W. 54 St., New York, N.Y. 10019.
 Cherry Lane Music Co. (ASCAP), 50 Holly Hill Ln., Greenwich, Conn. 06830. Tel: (203) 661-0707; NYC Tieline (212) 824-7711. Partner: Jean Dinegar.
Branch: Beverly Hills, Calif., 9744 Wilshire Blvd. Zip: 90212. Tel: (213) 550-7100. Contacts: Milton Okun, Colin Slater.
Int'l branches: Australia, Japan, South Africa.
Int'l reps: Albama (Ivan Mogull in USA), Austria (Schmolz & Slezak in Germany), Belgium (Interworld in Netherlands), Bulgaria (Ivan Mogull in USA), Czechoslovakia (Ivan Mogull in USA), France (Skoffy Prod'ns in Germany), Hungary (Ivan Mogull in USA), Ireland (Inter Hill in UK), Netherlands (Interworld), Poland (Ivan Mogull in USA), Romania (Ivan Mogull in USA), Scandinavia (Air in Sweden), Switzerland (Skoffy Prod'ns in France), UK (Inter Hill); **Accabonac catalog only—**Austria & Germany (Roads of Music in USA), Ireland & UK (Odelpic Ltd. in UK).
 Cherry Pie Music (ASCAP), see R.A. Hodge.
 Cherry River Music Co. (BMI), see Cherry Lane.
 Cherry Wood Music Co. (ASCAP), see Cherry Lane.
 Chesdel Music Co. (BMI), see Alshire.
 Cheshire Music Inc. (BMI), see TRO.
 Jerry Chesnut Music Inc. (BMI), 40 Music Square E., Nashville, Tenn. 37203. Tel: (615) 244-0270. Pres., Gen. & Prof. Mgr.: Jerry Chesnut.
 Chess Music Inc. (ASCAP), see Pi-Gen.
 Chesyl Publ'g (BMI), see April/Blackwood.
 Chevris Music Inc. (BMI), see Shada.
 Chess Music Ltd. (BMI), see Copyright Serv. Bureau.
 Chez D Music (ASCAP), see Cap-Orion.
 Chic (BMI), c/o Martin Itzler, 110 E. 59 St., New York, N.Y. 10022.
 Chicago Music Publ'g, c/o Greene & Reynolds, 1900 Ave. Of The Stars, Suite 1424, Los Angeles, Calif. 90067. Tel: (213) 553-5434.
 Chicorel Music Corp. Inc., 4447 N. Oakland Ave., Milwaukee, Wis. 53211. Tel: (414) 964-4888.
 Chicory Music Co. (BMI), see Claridge.
 Chilly Winds Music (BMI), see Chappell.
 Ching Music Ltd. (BMI), see Copyright Serv. Bureau.
 Chinnchap (BMI), c/o Leance & Kastner, 9401 Wilshire Blvd., Suite 610, Beverly Hills, Calif. 90212.
 Chinwack Songs (SESAC), see Birthright.
 Chirnowack Music Inc. (BMI), see SuLyn.
 Chip 'N Dale Music Publ'g Inc. (ASCAP), see Gene Kennedy.
 Choice Music Inc. (some copyrights), see T.B. Harms—Bibo.
 Choral Art (ASCAP), see Sam Fox.
 Chris Music Publ'g Co. (BMI), PO Box 268, Manistique, Mich. 49854. Pres.: R.B. Christensen.
 Chrastace Music (BMI), see Martin Cohen.
 Christian Grit Music Press (ASCAP), see Paragon Assocs.
 J. Christopher Music Co. (ASCAP)—Pres.: Vaclar Nelhybel—see Charter Publ'ns.
 Chrysalis Music Corp. (ASCAP), see Chrysalis Music Group.
 Chrysalis Music Group, 9255 Sunset Blvd., Los Angeles, Calif. 90069. Tel: (213) 550-0171. Pres.: Terry Ellis; Gen. Mgr.: Ann Munday; Prof. Mgrs.: (east) Frank D'Amico, (west) Steve Moir.
Home office: England.
 Chu-Fin Music Inc. (BMI), see Shelby Singleton.
 John Church Co. (ASCAP), see Theodore Presser.
 Churn Music (ASCAP), see Cream.
 Ciano Publ'g Co. (BMI), PO Box 263, 37 Woodside Ave., Hartsbrook Heights, N.J. 07604. Tel: (201) 288-8935. Pres.: Ron Luciano.
 Cifi Publ'g Co. (BMI), 3966 Standish Ave., Cincinnati, Ohio 45213.
 Cigar (ASCAP), PO Box 80218, World Way Postal Center, Los Angeles, Calif. 90080.
 Cincinnati Music Co. (BMI), Schwartz Bldg., Rm. 405, 906 Main St., Cincinnati, Ohio 45202. Tel: (513) 241-3447. Pres.: Michael S. Schwartz; Gen. Mgr.: Robert L. Schwartz.
 Cindy Lee Music (SESAC), see Universal.
 Cin-Kay Publ'g Co. (BMI), see Sheri Kay.
 Circle R (ASCAP), 9885 Charleville Blvd., Beverly Hills, Calif. 90212. Tel: (213) 277-3111.
 Cireco Music Inc. (BMI), see Jondora.
 Cissi Music Inc. (BMI), see Copyright Serv. Bureau.
 Cityside Songs (BMI), PO Box 371, Beverly Hills, Calif. 90213. Tel: (213) 652-9627. Gen. Mgr.: F. Stuart Wilson.
 Clamike Music Publ'g Co. Inc. (BMI), see Mietus.
 Clara Music Publ'g Corp. (ASCAP), c/o Leventhal, 250 W. 57 St., Suite 2017, New York, N.Y. 10019. Tel: (212) 586-6553. Pres.: Harry Belafonte.
 Claridge Music (ASCAP), 6381 Hollywood Blvd., Suite 318, Hollywood, Calif. 90028. Tel: (213) 469-8149. Pres.: Frank Slay; Prof. Mgr.: Vic Catala.
 Clarity Music Inc. (BMI), see Copyright Serv. Bureau.
 Clarke Music (BMI) (div. of Contemporary Artist Ent's Inc.), 8500 Wilshire Blvd., Suite 829, Beverly Hills, Calif. 90211. Tel: (213) 652-6220. Pres.: Stanley Clarke, Exec. Dir.: Carolyn Clarke.
Int'l reps: Europe (Intersong), Japan (Taiyo).
 Gene Clark Music (BMI), see Chappell.
 Clark Musical Prod'ns (BMI), PO Box 299, Watseka, Ill. 60970. Tel: (815) 432-5601. Pres. Dr. Paul E. Clark; Gen. Mgr.: Michael K. Spitzer; Prof. Mgr.: Mark Peterson.
 Clark Music Publ'g (BMI), see Clark Music Prod'ns.
 Roy Clark Music (BMI), see Chappell & Jim Halsey.
 Clay Music Corp. (BMI), PO Box 220551, Zip: 28222, 5457 Old Monroe Rd., Charlotte, N.C. 28211. Tel: (704) 536-0552. Chm.: Arthur Smith; Pres.: R. Clayton Smith.
Int'l reps: House of Cash & Song of Cash catalogs only—Worldwide excluding US & Canada (Screen Gems-EMI in USA); **Other catalogs—**Worldwide excluding USA & Canada (CBS Int'l in USA).
 Clayton-Davis & Assocs. Inc. (BMI), 8229 Maryland St., Louis, Mo. 63105. Tel: (314) 862-7800. Pres.: Irvin Davis; Gen. & Prof. Mgr.: Adele K. Solt.
 Norman Clayton Publ'g Co. (SESAC), see Word Inc.
 Clear Light Prod'ns Inc. (ASCAP), PO Box 391, Newton St., Waltham, Mass. 02158. Tel: (617) 893-5860.
 Clear Profit (ASCAP)—Tel: (213) 988-6746. Gen. Mgr.: Eddie Gurren; Prof. Mgr.: Robert Gentile—see E. J. Gurren.
 Clear Sky Music Inc. (BMI) (sub. of Ampex Corp.), 2201 Lunt Ave., Elk Grove Village, Ill. 60007. Tel: (312) 593-6000.
 George Clements Publ'g (ASCAP), see Berdoo.
 Cling Publ'g (ASCAP), see Soprano.
 Clita Music Inc. (BMI), see Mietus.
 Clocks Music Co. (BMI), Star Rt., Milford, Calif. 96121. Tel: (916) 253-3689. Owner: Ed Marmor.
 Closed Door Publ'g Ltd. (ASCAP), see Castle Hill.
 Clotho Music Inc. (BMI), see Beldock Levine & Hoffman.
 Coal Miners Music Inc. (BMI), 7 Music Circle N., Nashville, Tenn. 37203. Tel: (615) 259-9448. Pres. & Prof. Mgr.: O.V. Lynn Jr.; Gen. Mgr.: Meredith Stewart.
Int'l reps: Australia (Allans Music), Canada (RCA), France (Frances Day), Japan (Watanabe), Netherlands (Intersong Basart), Sweden (Sonet), UK (Carlin), West Germany (Siegel).
 Coat of Arms Music (BMI), Box 217, Oak Hill, Ohio 45656. Tel: (614) 682-7771. Pres.: D. Howell.
 Cobblehill Music (BMI), see McAfee & Lorenz.
 Cochise Publ'g Co. (BMI), PO Box 1415, Athens, Tex. 75751. Tel: (214) 675-5683.
 Cocinodan Music (BMI), see Mietus.
 Cockroach Music Inc. (BMI), see Copyright Serv. Bureau.
 Coco Music Inc. (BMI), 1700 Broadway, New York, N.Y. 10019. Tel: (212) 582-6886. Pres.: Harvey Averno; Gen. Mng. Partner: Sam Goff.
 Coconut Grove Music (BMI), see Martin Cohen.
 Coeptis Music Ltd. (BMI), see Annuitt.
 Cog Music (BMI), see Copyright Serv. Bureau.
 George M. Cohan Music Publ'g Co. Inc. (ASCAP), see Edward B. Marks.
 Martin Cohen, 6430 Sunset Blvd., Suite 1500, Los Angeles, Calif. 90028. Tel: (213) 463-1151, TWX (910) 323738. Cable: COBOLEX Admin'r Martin Cohen.
 Bruce Cohn Music, PO Box 359, Sonoma, Calif. 95476. Tel: (707) 938-1212.
 Coke Music (BMI), see Royalty Control Corp.
 Colca Music Co. (BMI), see BC Ent's.
 Cold Zinc (BMI), see Dawnbreaker.
 Cole-Arama Music (BMI), 9000 Sunset Blvd., Suite 503, Los Angeles, Calif. 90069. Tel: (213) 858-7755. Gen. Mgr.: Frank Gould; Prof. Mgr.: Olivia Bower.
 M. M. Cole Publ'g Co. (BMI), 919 N. Michigan Ave., Suite 1602, Chicago, Ill. 60611. Tel: (312) 787-0804. Cable: MMCOLE.
 Colgems-EMI Music Inc. (ASCAP), see Screen Gems-EMI.
 Collbeck Publ'g Co. (BMI), PO Box 6390, Corpus Christi, Tex. 78411. Tel: (512) 854-7376. Pres. & Prof. Mgr.: Gary Beck; Gen. Mgr.: Jada Vaughn.
 Collection Litoff (BMI), see C.F. Peters.
 Collins/Saraceno Music Corp. (ASCAP, BMI), 6000 Sunset Blvd., Suite 201, Hollywood, Calif. 90028. Tel: (213) 462-6606. Pres.: Heyward Collins; VP: Joe Saraceno; Prof. Mgr.: Cynthia Rosen.
Int'l reps: Australia (M7 Recs.-Bellbird Music), Europe (UEP), Japan (Watanabe).
 Columbia Music Co. (ASCAP), see Theodore Presser.
 Columbia Pictures Music Corp. (ASCAP), see Shapiro Bernstein.
 Columbia University Press, see Galaxy.
 Column Music Co. (BMI), see Copyright Serv. Bureau.
 Column One Music (ASCAP), PO Box 4086, Springfield, Mo. 65804. Tel: (417) 881-5150. Pres.: James M. Martin.
Int'l rep: Worldwide excluding USA (Publisher's Licensing Corp. in USA).
 Column Two Music (BMI), see Column One.
 Combine Music Corp. (BMI) (div. of Monument Rec. Corp.), 35 Music Square E., Nashville, Tenn. 37203. Tel: (615) 255-0624. Pres.: Robert J. Beckham; VP: Johnny MacRae; Gen. Mgr.: Al Cooley; Prof. Mgr.: Alan Rush.
Int'l reps: Australia (Festival), France (Rideau Rouge), Germany (Rolf Budde), Italy (G. Ricordi), Japan (Taiyo), Netherlands (Basart), South Africa (Clan), Sweden (Air Scandinavia), UK (Keith Rowse).
 Comet Music Corp. (ASCAP), see ATV Music.
 Commander Publ'ns (ASCAP), 1209 N. Western Ave., Hollywood, Calif. 90029. Tel: (213) 469-3528. Gen. Mgr.: Marshall Robbins.
 Commodores Entertainment Publ'g Corp. (ASCAP), c/o Ashburn Assocs., 39 W. 55 St., New York, N.Y. 10019. Tel: (212) 246-0385.
 Com Music (ASCAP), see Chicago Music.
 Complex Three Ltd. (BMI), see Copyright Serv. Bureau.
 Composers Library Eds., see Alexander Broude.
 Composers Music Corp. (ASCAP), see Carl Fischer.
 Comreco Music Inc. (ASCAP), 3 Kensington Oval, New Rochelle, N.Y. 10805. Tel: (914) 235-1229. Pres.: Milt Gabler.
 Con Brio Music (BMI), PO Box 196, Nashville, Tenn. 37202. Tel: (615) 329-1944. Pres.: Bill Walker; Gen. Mgr.: Jeff Walker; Prof. Mgr.: Jeanne Walker.
Int'l rep: Worldwide excluding USA & Canada (Burlington).
 Concert Music (BMI), see Stone-Rap.
 Concert Music Publ'g Co. (ASCAP), see Studio P/R.
 Con Conrad Music Co. Ltd. (ASCAP), see Denton & Haskins.
 Concorde Publ'g Co. (SESAC), see Con Brio.
 Concordia Publ'g House (SESAC), 3558 S. Jefferson Ave., St. Louis, Mo. 63118. Tel: (314) 664-7000. Cable: CONPUBCO.
 Concord Music Publ'g Co. Inc. (ASCAP), see Henri Elkan.
 Conductive (BMI), c/o Stanley J. Diamond, 10850 Wilshire Blvd., Los Angeles, Calif. 90024.
 Cone Music Co. (BMI), see Joe Keene.
 Conley Music Inc. (ASCAP), see Claridge.
 Connecticut Music Studios (BMI), see Mietus.
 Mike Conner Music Corp. (BMI), see Loring.
 Conn-Lang Publ'g (BMI), 23200 Chagrin Blvd., Cleveland, Ohio 44122. Tel: (814) 455-7729.
 Conquest Music Corp. (ASCAP), see Copyright Serv. Bureau.
 Conquistador Music (ASCAP), see Groovesville.
 Con Conrad Music Co. Ltd. (ASCAP), see Denton & Haskins.
 Conrad Music (BMI), see Goodman Group.
 Consolidated Music Publ'rs (ASCAP), see Music Sales.
 Consort Press—Ed. John Biggs—see Mark Foster.
 Consue Music (BMI), see Copyright Serv. Bureau.
 Contentious Music (SESAC), PO Box 824, Nashville, Tenn. 37202. Tel: (615) 244-8839. Pres. & Gen. Mgr.: Ted Harris; Prof. Mgr.: Jackie Harris.
 Content Music (BMI), see Copyright Serv. Bureau.
 Continuo Music Press Inc. (BMI), see Alexander Broude.
 Controlled Sheet Music Serv. Inc., 112 Hudson St., Copiague, N.Y. 11726. Tel: (516) 842-8080. Pres.: Ronald Ravitz; Gen. Mgr.: Linda Press; Sales: Edward Hurley.
Branch: Fort Lauderdale, Fla., 2990 NW 46 Ave. Zip: 33313. Tel: (305) 735-7777. Gen. Mgr.: Sol Ravitz.
 Cookaway Music Inc. (ASCAP), see Dick James.
 Cook County Music (ASCAP), see Chicago Music.
 Cookie Box Music Inc. (BMI)—Pres.: Phil Hurlt—see Lloyd Zane Remick.
 Cool Duck Music (ASCAP), 2058 First St., Highland Park, Ill. 60035. Tel: (312) 432-0116. Pres.: David J. Dahl.
 Martin Cooper Music (ASCAP), PO Box 3331, Beverly Hills, Calif. 90212. Tel: (213) 275-4508. Owner: Marty Cooper.
Int'l rep: Germany (Francis Day & Hunter).
 Copper Band Music Co. Inc., see T.B. Harms—Hall-Clement.
 Copper Basin Publ'g Co., see Coal Miners.
 Copper Robert Music (ASCAP), see Ivan Hoffman.
 Copyright Serv. Bureau Ltd., 221 W. 57 St., New York, N.Y. 10019. Tel: (212) 582-5030/1188. Cable: COPYSEB. Chm.: Walter Hofer; Pres.: Gitte A. Hofer; Exec. Dir. & Prof. Mgr.: Jeri R. Spencer.
Int'l branches: Argentina (CSB), Australia (Leosong), Belgium (CSB), Brazil (CSB), Denmark (Nordisk), England (Leosong), France (CSB), Germany (CSB Kaminsky), Greece (CSB), Japan (CSB/Hara Int'l), Mexico (CSB), Netherlands (CSB), South Africa (CSB).
 Coquette Music (BMI), see Copyright Serv. Bureau.
 Coral Blossom Music—Contact: Bobby Fischer—see Orange Blossom.
 Cora Lee Music (BMI), 314 S. Goodman St., Rochester, N.Y. 14607. Tel: (716) 244-7526. Owner: Lester W. Osband.
 Coral Reefer (BMI), PO Box 2202, Palm Springs, Calif. 92263.
 Cora Music Co. (BMI), 6823 Leland Way, Hollywood, Calif. 90028. Tel: (213) 462-9510. Pres.: Major Lee Vicente; VP's: Paul Flynn, Annie Skelly.
 Corcovado Music Corp. (BMI), see Helios.
 Cordon Music Corp. (BMI), see Big Seven.
 Cordova Publ'g Co. (BMI), see Alshire.
 Cornsinn Music (BMI)—Pres.: Les Matthews. Tel: (615) 531-9290—see Wyandotte.

Cortlandt Music Publ'g Inc. (ASCAP). see Beldock Levine & Hoffman.
 Cos Cob (ASCAP). see Boosey & Hawkes.
 Don Costa Prods Inc. (BMI), 9229 Sunset Blvd., Los Angeles, Calif. 90069. Tel. (213) 550-8542.
 Coastal Publ'g (ASCAP). see R.A. Hodge.
 Cotaba (BMI), c/o Ned Shankman, 1888 Century Park E., Suite 662, Los Angeles, Calif. 90067.
 Cotillion Music Inc. (BMI), 75 Rockefeller Plaza, New York, N.Y. 10019. Tel. (212) 484-6000. Cable ATCOMUSIC. Pres. Jerry Greenberg; Bus. Affairs Dir. Joanne Feltman.
Int'l reps.: Australia (Warner Bros.), Belgium (PECF), France (PECF), Germany (Musik Unserer Zeit), Greece (Musik Unserer Zeit), Israel (April), Italy (Warner Bros.), Jamaica (Sheila), Japan (Taiyo), Mexico (Gamma), Netherlands (Basart), South Africa (Laetrec), South America (Peer-Southern), Spain (Armonico-Clipper s).
 Cottonhill Publ'g Co. (BMI), PO Box 3128, Roanoke, Va. 24015. Tel. (703) 343-6000. Owner James E. Parcell.
 Cotton Pickin' Music (ASCAP). see Garrett.
 Counterpart Music (BMI), 3744 Applegate Ave., Cincinnati, Ohio 45211. Tel. (513) 661-8810. Pres. Howard Lovdahl.
 Countless Songs Ltd. (BMI), see Ivan Mogull.
 Country Boy Publ'g Co. (BMI), see Glolite Publ'g.
 Country Classics Music Publ'g Co. (BMI), 105 Burk Dr., Oklahoma City, Okla. 73115. Tel. (405) 677-6448. Pres. & Prof. Mgr. Yvonne Delaney; Gen. Mgr. Sonny Lane.
 Country Gentleman Music Inc. (BMI), see Big Seven.
 Country Line Music (ASCAP). see Chappell.
 Country Moods Music (ASCAP). see Autumn Hill.
 Country Mornin' Music (BMI), see Chappell.
 Country Road Music Inc. (BMI), 431 S. Palm Canyon Dr., Palm Springs, Calif. 92262. Tel. (714) 325-5095.
 Country Showcase (BMI), 11350 Baltimore Ave., Beltsville, Md. 20705. Tel. (301) 937-7200. Pres. Frances Gosman.
 Country Star Music (ASCAP), 439 Wiley Ave., Franklin, Pa. 16323. Tel. (814) 432-4633. Pres. Norman Kelly.
Int'l reps.: Canada (Morning Music), UK (B Feldman).
 Country Stream Music (BMI), 5053 Tholozan Ave., St. Louis, Mo. 63109. Tel. (314) 481-3916. Pres. Tony Mazzola; Gen. Mgr. Sam Mazzola.
 County Line Music (ASCAP). see Skinny Zach.
 Courial Music (BMI), see Royalty Control Corp.
 Court of Kings Music (BMI), see Deaton-Young.
 Cousins Music Inc. (BMI), 211 Birchwood Ave., Upper Nyack, N.Y. 10960. Tel. (914) 358-0861. Pres. Louis E. Cicchetti (Administered by Copyright Serv. Bureau).
 Cove (ASCAP). see Pickwick.
 Covina High Music (BMI), 4205 W. Sixth St., Los Angeles, Calif. 90020. Tel. (213) 464-3001. Pres. & Sales Head: Robbie Fields.
 Cowboy Junction Publ'g Co. (BMI), Box 1, Star Rt. 1, Le-canto, Fla. 32661. Tel. (904) 746-2394. Pres. Boris Pastuch.
 Cowboy Kazoo Music (BMI), 5926 El Prado NW, Albu-

querque, N.M. 87107. Tel. (505) 345-4835. Pres. Jeffrey A. Burrows.
 Coyote Prods Inc., 14002 Palawan Way, Marina del Rey, Calif. 90291. Tel. (213) 822-7905. Pres. Leonard Sachs.
Int'l reps.: Worldwide excluding U.S., Canada & Germany (April/Blackwood), Germany (Melodie der Welt).
 Crabshaw Music (ASCAP), 5028 Geary Blvd., San Francisco, Calif. 94118. Tel. (415) 221-8550. Pres. Elvin Bishop (Administered by Gelfand, Brestauer, Rennert & Feldman).
 Cracking Up Music (ASCAP). see Segel & Goldman.
 Craig & Co. Music Publ'rs (ASCAP). see Athon Music.
 Craig-Ellis & Co. Music Publ'rs (ASCAP). see Athon Music.
 Crazydad Music (BMI), see Shelby Singleton.
 Crazy (ASCAP), c/o Timmie Rogers, 1911 Garth Ave., Los Angeles, Calif. 90034.
 Crazy Cajun Music (BMI), 5626 Brock, Houston, Tex. 77023. Tel. (713) 926-4431. Pres. Huey P. Meaux; Gen. Mgr. Beth Thornton.
 Crazy Crow Music (BMI), see Segel & Goldman.
 Crazy Horse Music (BMI)—Pres. Ron Stone; Gen. Mgr. Dotie Ross—see Star Show (US rights) & Rondor (int'l rights).
 Cream Publ'g Group, 8025 Melrose Ave., Los Angeles, Calif. 90046. Tel. (213) 655-0944. Cable BENNCO HOLLYWOOD. Telex 696182. Pres. Al Bennett; VP & Publ'g Dir. Bob Todd; VP & Int'l Dir. Bobby Weiss; Prof. Mgrs. Allan Rider, Greg Gayton; Publ'g Admin'r. Pam Shira.
Branch: Memphis, Tenn., 1320 S. Lauderdale. Zip 38106. Tel. (901) 775-3790. VP & Gen. Mgr. Eddie Ray; VP A&R. Willie Mitchell.
Int'l reps.: Australia (Leeds), Brazil (Latino Ed.), Denmark (Kleinens), France (Traffic), Germany (Melodie der Welt), Hong Kong (EMI), Israel (Musicor), Italy (Curci), Japan (Victor), Philippines (World), Spain (Canciones del Mundo), UK (Mews).
 Creative Concepts Publ'g Corp., 967 E. Ojai Ave., Ojai, Calif. 93023. Tel. (805) 646-4811. Pres. John L. Haag.
 Creative Corps., 6607 W. Sunset, Suite E., Hollywood, Calif. 90028. Tel. (213) 462-6164. Pres. Kurt Hunter.
 Creative Music (ASCAP). see Ovation.
 Creative World Music Publ'ns (BMI & ASCAP), 2340 Saw-telle Blvd., Los Angeles, Calif. 90064. Tel. (213) 477-1509. Pres. Stan Kenton; VP. Phil Herring; Copyright Admin. Nita Bush.
Int'l rep.: Worldwide (Chappell).
 Cremo Music Co. (BMI), see Copyright Serv. Bureau.
 Crescendo Music Sales Co., PO Box 395, 8 Bunting Ln., Naperville, Ill. 60540. Tel. (312) 357-0207. Owner: Ed Adams.
 Crestview Music Corp. (ASCAP). see Ivan Mogull.
 Criga Music (BMI), 13450 Vanowen St., No. 222, Van Nuys, Calif. 91405.
 Crimson Dynasty (ASCAP), PO Box 271, Cedar & West Ave., Jenkintown, Pa. 19046. Tel. (215) 757-8022. Pres. Stan Peahota; Exec. VP. Frank Mulvenna; VP. Alan Meier; Sec'y-Treas. Kathy Peahota.

Cristeval Music (BMI), 5050 Vanalden, Tarzana, Calif. 91356. Tel. (213) 996-1771.
 Criswell Music Press—Contact: Eddie Farqason—see Triune.
 Crited Music (BMI), see Chappell.
 Criticon Music Corp. (ASCAP), 6124 Selma Ave., Hollywood, Calif. 90028. Tel. (213) 469-2296. Pres. & Gen. Mgr. Michael H. Goldsen; VP & Prof. Mgr. Bernard Goldsen (Sheet music distributed by Studio P/R).
Int'l branch: France.
 Critique Music Publ'g Co. (BMI), 125 Main St., Reading, Mass. 01867. Tel. (617) 944-0423. Pres. Carl Strube; Gen. Mgr. Linda Gear; Prof. Mgr.: Steve Dinan (Administered by Intersong).
 Cromma Music Co. (ASCAP), 37 W. 57 St., New York, N.Y. 10019. Tel. (212) 759-8730.
Int'l branches: England, France, Germany, Italy.
 Cromwell Music Inc. (ASCAP). see TRO.
 Crooked Creek Music (BMI), see Sing Me.
 Cross Country, Box 23333, Nashville, Tenn. 37203. Tel. (615) 292-9710.
 Cross Keys Publ'g Co. Inc. (ASCAP). see Tree.
 Crouch Music (ASCAP). see Lexicon.
 Crowbeck Music (BMI), c/o Segel & Goldman, 9200 Sunset Blvd., Suite 1000, Los Angeles, Calif. 90069. Tel. (213) 278-9200 (Administered by Lambert & Potter).
 Crow Jane Alley Music (BMI), see Bug.
 Crown-Aztec Music (ASCAP). see John T. Benson.
 Crown-Black Music (SESAC). see John T. Benson.
 Crown Music Press—Pres. Charles Stine; Gen. Mgr.: Stephen L. Glover—see Brass Press.
 Crown-Royal Music (BMI), see John T. Benson.
 Crusin' Music (BMI), see Bug.
 Crunchy Granola Music (BMI), see Copyright Serv. Bureau.
 Crushing Music (BMI), 200 W. 57 St., New York, N.Y. 10019. Tel. (212) 265-0741.
 The Crystal Jukebox (BMI), c/o CBS Studio Center, 4024 Radford Ave., North Hollywood, Calif. 91604. Tel. (213) 763-8411 x 1161.
 Cube Music Corp. (ASCAP). see Rohm.
 Cudda-Pane Music Inc. (BMI), see Big Seven.
 Cue Music Co. (BMI), see Lee Magid.
 Beverly Culver Music (ASCAP). see Copyright Serv. Bureau.
 Cundy-Bettoney Co. Inc. (ASCAP). see Carl Fischer.
 Curton Rec. Co., 5915 N. Lincoln Ave., Chicago, Ill. 60659. Tel. (312) 769-4676. (Also see Warner Bros.).
 Curzerio Music Publ'g (BMI), see Copyright Serv. Bureau.
 Cusic Music (ASCAP). see April/Blackwood.
 V & M Cutler Music Co. (ASCAP), PO Box 43, Chatsworth, Calif. 91311. Tel. (213) 886-7746. Pres. Victoria-Diane Cutler.
 Cyma Music Co. (ASCAP). see Chappell.
 Czedon Music (BMI), see Mietus.

D R (ASCAP). see Lee Magid.
 D R G Music Inc., 200 W. 57 St., New York, N.Y. 10019.



The measure of success.

ABC Dunhill Music, Inc. (BMI) • American Broadcasting Music, Inc. (ASCAP)

ABC Music Productions

RON SCHUBERT

Director Of Music ABC Inc.
 ABC Music Publishing Companies

Georgett Studnicka

Director of International
 Publishing Administration
 Telex — 673-127

New York Office • 1330 Avenue of the Americas • New York 10019 • (212) 887-4355
 Los Angeles Office • 4151 Prospect Avenue • Los Angeles 90027 • (213) 663-3311

- Tel: (212) 582-3040. Cable: STETRECS. Pres.: Hugh Fordin.
- Daahoud Music (BMI), see Mietus.
- DaAnn Music Inc. (ASCAP), PO Box 54021, Los Angeles, Calif. 90054. Tel: (213) 782-6226.
- D'Accord Music Inc. (ASCAP), see Publishers' Licensing Corp.
- Dacie Music (ASCAP), see Callon-Love.
- Dahlhouse Publ'g House (ASCAP), see Surf City.
- Daje Music (BMI), see Chappell.
- Daleo Music (BMI), see Martin Cohen.
- Dalya Recs. (BMI), see Better-Half.
- Damian Music Publ'g Co. (ASCAP), see Chappell.
- Dana Publ'g Co. (BMI), 824 83 St., Miami Beach, Fla. 33141. Tel: (305) 865-8960. Pres.: Walter Dana; VP Promo.: Gus Dana.
- Danby Music Co. (BMI), see Fisher Music Corp.
- Dandelion Music Co. (BMI), see Jamez.
- Dandy Dittys (ASCAP), see A. Schroeder.
- Danielle Music Co. (ASCAP) (div. of Hilton House Inc.), PO Box 315, Cleveland, Ohio 44127. Tel: (216) 429-1159. Pres.: Donald B. Catalano; Gen. Mgr.: Danielle Catalano; Prof. Mgr.: Marian Discoll.
- Danor Music Inc. (BMI), 1802 Grand Ave., Nashville, Tenn. 37212. Tel: (615) 327-4570. Pres.: David Briggs; Office Mgr.: Ann J. Keener.
- Daramus Inc. (BMI), see Dick James.
- Dar-Jen Music Inc. (BMI), see April/Blackwood & 20th Century.
- Darkhorse Prod'ns, 64 Carol Dr., Carnegie, Pa. 15160. Tel: (412) 276-6833.
- Darla Music (ASCAP), see April/Blackwood & 20th Century.
- Dartmoor Music (ASCAP), see Bicycle.
- Daval Music Co. (ASCAP), see Alshire.
- David Publ'g (BMI), see Davida & Fimmel Connection.
- Davida Rec. & Publ'g Co. (BMI), PO Box 24-A, Detroit, Mich. 48227. Tel: (313) 491-7409, 834-2798. Pres.: David Futch; Gen. Mgr.: Dana V. Andrews; Prof. Mgr.: James Johnson Jr. (Administered by Fimmel Connection Prod'ns).
- Branch: Los Angeles, Calif., PO Box 7761. Zip: 90007. Tel: (213) 235-2835. Prof. Mgr.: Trevor Laing. Int'l firm represented: Eds. & Prod'ns Int'l's (France). Int'l rep.: Germany (Roba-Music).
- David Music (BMI), 1650 Broadway, New York, N.Y. 10019. Tel: (212) 247-2159.
- Davike Music Co. (ASCAP), PO Box 8842, Los Angeles, Calif. 90008. Tel: (213) 385-6838. Owner: Isaiah Jones Jr.
- John Davis Music Inc. (ASCAP)—Pres.: John Davis—see Midsong.
- Davin Music (ASCAP), see Royalty Control.
- Dawnbreaker Music Co. (BMI), 216 Chatsworth Dr., San Fernando, Calif. 91340. Tel: (213) 365-9375.
- Int'l reps.: Australia (Chappell), France (Eddie Barclay), Germany (Global), Italy (RCA), Japan (Pacific), UK (Carlin).
- Dawn Prod'ns (BMI), Cloud 40, Paradise, Pa. 17562. Tel: (717) 299-1600. Cable: URSWALE. Pres.: Joey Wetz; Gen. Mgr.: Dave Smith; Prof. Mgr.: Ray Vernon; Ass't Prof. Mgr.: Randy Boykin.
- Branch: Belair, Md., Box 535, Main St. Zip: 21014.
- Dawsonville Music (ASCAP), see Column One.
- Day Cat Publ'g Co., see Days of Old.
- Daydan Music Corp. (ASCAP), see Acoustic Music.
- Daylight Music (BMI), see Sutton/Miller.
- Days Of Old Publ'g Co. (BMI), 3116 Metairie Rd., Metairie, La. 70001. Tel: (504) 834-5711. Pres.: Traci Borges; Gen. & Prof. Mgr.: Philip A. Borges.
- Int'l firm represented: Carlin (Europe).
- Dayspring Music (BMI), see Word Inc.
- D'Azure Music Inc. (ASCAP), see Music Music.
- Deacon Daniel Music (ASCAP), 17 Ann, Osgining, N.Y. 10562. Tel: (914) 762-0504. Pres.: Richard O. Daniel; Gen. Mgr.: Deborah Horn Daniel.
- Dead Boys Music (ASCAP), see Larry Spier.
- Deaf Monkey Music (ASCAP), PO Box 325, Nashville, Tenn. 37221. Tel: (615) 646-3335. Pres.: Robert A. May; VP: John A. Clark.
- Dean's List Publ'g (ASCAP), see Owlfoot.
- Deaton-Young Publ'ns (BMI, ASCAP), 1300 Division St., Suite 103, Nashville, Tenn. 37203. Tel: (615) 244-7116. Pres. & Prof. Mgr.: Billy Deaton; Gen. Mgr.: Faron Young; Ass't Mgr.: David Hall.
- DebDave Music Inc. (BMI), PO Box 2154, Nashville, Tenn. 37214. Tel: (615) 320-7227. Pres.: James Edward Mallory; Gen. Mgr.: Keni Wehrman.
- Debmar Music (ASCAP), see Ivan Hoffman.
- Debonair Music (BMI), 721 Colman St., Altadena, Calif. 91001. Tel: (213) 292-5330. Pres. & Gen. Mgr.: Treman Trenair.
- De Camera Publ'g Co. (ASCAP), see G. Schirmer.
- Decibel (BMI), c/o Cory Wade, 4901 71 Pl., Miami, Fla. 33155.
- Dedication Publ'g (BMI, ASCAP), 629 S. Dale, Anaheim, Calif. 92804. Tel: (714) 527-4319. Pres.: Mike Jacobs; Gen. Mgr.: Dirk Van Tatenhove.
- Dedrick Bros. Music (ASCAP), see Publishers' Licensing Corp.
- Charlie Dee Music Publ'g Co. (BMI), 1324 Old Yatesville Rd., Thomaston, Ga. 30286. Tel: (404) 647-7995. Owner: Don Buchanan.
- Deejay Music Co. (BMI), 3008 Belden Dr., Los Angeles, Calif. 90068. Tel: (213) 469-2719/8204. Owner: Nick Terry; Gen. Mgr.: Bud Mathis.
- Deep Canyon Music (ASCAP), see Homefire.
- Deep Roots Music Co. (BMI), see Koala.
- Deer Patch Music Inc. (ASCAP), see Clear Sky.
- Deerwood Music (BMI), see Cream.
- Defrantz Monique Music (BMI), see Copyright Serv. Bureau.
- De Gar Music (ASCAP), 665 Harrison, San Francisco, Calif. 94107. Tel: (415) 781-6306. Pres.: Leo de Gar Kulka; Exec. VP: H. Haas.
- Int'l firm represented: Star (Switzerland).
- Pietro Deiro Publ'ns (SESAC), 133 Seventh Ave. S., New York, N.Y. 10014. Tel: (212) 675-5460. Owner & Mgr.: Pietro Deiro.
- Dejamas Inc. (ASCAP), see Dick James.
- Delaware Music Co. (ASCAP), see Mietus.
- Delev Music Co. (BMI), 7231 Mansfield Ave., Philadelphia, Pa. 19138. Tel: (215) 276-8861. Pres. William L. Lucas; Gen. Mgr.: Adele J. Lucas.
- Delhi Publ'ns Inc. (SESAC), see Willis.
- Delicate Music Ltd. (ASCAP), see Rondor.
- Delightful Music Co. Ltd. (BMI), see Mietus.
- Lou DeLise Prod'ns (BMI), 6123 Reach St., Philadelphia, Pa. 19111. Tel: (215) 725-6388. Owner: Lou DeLise.
- Deliverance Music (BMI), Box 576, Litchfield, Ill. 60048. Tel: (312) 367-0107. Pres. & Creative Dir.: John B. DeVos; VP & Music Dir.: Ken Miller.
- Deliver Music Publ'g Co., see Will-Du.
- Delmore Music Co. (ASCAP), PO Box 2324, Menlo Park, Calif. 94025. Tel: (415) 322-2947. Pres.: Cy Cohen; Gen. Mgr.: Mykil Nagel.
- DeLory Music (ASCAP), see Chappell.
- Delsiana Music Publ'g Co. (ASCAP), see Slide.
- Delstone Music Co. (BMI), see Mietus.
- Delta Mirror Music (BMI), 51 Elm St., No. 1, Somerville, Mass. 02144. Tel: (617) 628-5341. Pres.: Steve Kaufman.
- Delta R&E (ASCAP), see Jondora.
- DeLuxe Music (BMI), see M.M. Cole.
- Richard Delvy Ent's Inc. (ASCAP), 8127 Eirita Dr., Los Angeles, Calif. 90046. Tel: (213) 656-6509. Pres.: Richard Delvy; VP & Gen. Mgr.: Ed Fournier; Prof. Mgr.: Vic Gargano.
- Branch: San Francisco, Calif., 480 Melrose. Zip: 94127. Tel: (415) 584-0996. Prof. Mgr.: Ingrid Geyer.
- Delyles Music (BMI), see Red Greg.
- Demain Music (BMI), see Springboard.
- Denny Music Inc. (ASCAP), see Cedarwood.
- Denton & Haskins Corp. (ASCAP), PO Box 340, Radio City Sta., New York, N.Y. 10019. Tel: (212) 227-4714. Pres. Chesley V. Young; VP & Gen. Mgr.: Morris N. Young.
- DePatie-Freleng Music Co. (ASCAP), 6859 Hayvenhurst, Van Nuys, Calif. 91406. Tel: (213) 988-3890.
- Derby Music (SESAC), 3977 Vegas Valley Dr., Las Vegas, Nev. 89121. Tel: (213) 457-4365. Pres., Gen. & Prof. Mgr.: Hank Castro.
- Derringer Music Inc. (BMI), see Organic Mgmt.
- Derry Music Co. (BMI), 240 Stockton St., San Francisco, Calif. 94108. Tel: (415) 433-1800. Mgr.: Richard Singer.
- Desert Moon Songs Ltd. (BMI), see Roadshow.
- Desert Palms Publ'g Co. (BMI), see Renda.
- Desert Rain Music Ltd. (ASCAP), see Roadshow.
- Desert Rose, 72 Brewster Rd., Scarsdale, N.Y. 10583. Chief Exec.: Frederick P. Rose.
- Branch: New York, N.Y., 552 Fifth Ave. Zip: 10036.
- DeShufflin Inc. (ASCAP), see Charing Cross.
- Desiderata Music (BMI), see April/Blackwood.
- DeSylva Brown & Henderson (ASCAP), see Chappell.
- Devin James Music (ASCAP), see Pewter Pal.
- Devon Music Inc. (BMI), see TRO.
- Dew Music Co. (BMI), see Don White & Copyright Serv. Bureau.
- Diabalis Music Corp. (BMI), see Rohm.
- Diagonal Music Inc. (BMI), see Midsong.
- Diamondback Music Co. (BMI) (sub. of Great Pyramid Ltd.), 10 Waterville St., San Francisco, Calif. 94124. Tel: (415) 468-4288. Pres.: Martyn Buchwald; Gen. & Prof. Mgr.: Joseph Buchwald.
- Diamond Gang Music (ASCAP), see Martin Cohen.
- Diamond Touch Music (BMI), see Copyright Serv. Bureau.
- Diana (BMI), c/o Hecht & Co., 1500 Broadway, New York, N.Y. 10036.
- Diane Music Co. (BMI), see Blue River.
- Jimmy Dickens Music (BMI), see Cedarwood.
- Dickerson (BMI), 810 Bellevue Rd., Nashville, Tenn. 37221.
- Dietz Music (ASCAP), see Lone Lake.
- Dig It Music (ASCAP), see Publishers' Licensing Corp.
- Dijon Music Publ'ns (BMI), 9033 Wilshire Blvd., Beverly Hills, Calif. 90211. Tel: (213) 278-8118. Gen. Mgr.: Buddy Epstein. (Administered by April/Blackwood).
- Dimension Music (SESAC), see John T. Benson.
- Dime Prod'ns, see New Dimension.
- Dimitri Publ'g Co. (SESAC), see Catalpa.
- Ding Dong Music Corp. (BMI), see Barton Music.
- Dinsdale Music (BMI), see Copyright Serv. Bureau.
- Dirfarm Music Inc. (ASCAP), see Stevens H. Weiss.
- Discount Music Co. (ASCAP), see Martin Cohen.
- Walt Disney Music Co. (ASCAP), 350 S. Buena Vista St., Burbank, Calif. 91521. Tel: (213) 845-3141. Cable: DISNEY. VP & Gen. Mgr.: Gary Krisel; Publ'g Dir.: Vic Guder.
- Int'l branches: Australia, Canada, Denmark, France, Germany, Japan.
- Int'l reps.: Argentina (Korn), Germany (UFA), Greece (Intersong), Hong Kong (EMI), Israel (Ilanot), Italy (Suvini Zerboni), Mexico (Brambilja), Netherlands (EMI), South Africa (Music Publ'g Co.), Spain (Hispavox), UK (Music Sales, Carlin).
- Oliver Ditson Co. (ASCAP), see Theodore Presser.
- Dixcotech Music (BMI), see Bug.
- Dixiana Publ'g Co., see T.B. Harms—Hall-Clement.
- Dixie Bow Music (BMI), see Garrett.
- Bernard L. Dixon Publ'g (BMI), 7212 S. Wabash Ave., Chicago, Ill. 60619. Tel: (312) 783-3186. Pres.: B.L. Dixon.
- Django Music Inc. (ASCAP), see Sidney A. Seidenberg.
- Djiwa Music (ASCAP), see Martin Cohen.
- Dobbins Music (BMI), see Ironside & Chappell.
- Dobre Music (BMI), see Ray Lawrence Ltd.
- Dobre Publ'g Co. (BMI), Box 49, Rt. 1, Utica, N.Y. 13502. Tel: (315) 724-0895. Pres.: Mario Ketchum; Gen. & Prof. Mgr.: Floyd Ketchum.
- Doc Dick Ent's (BMI), 16 E. Broad St., Mount Vernon, N.Y. 10552. Tel: (914) 668-4488. Pres. Richard Rashbaum; Gen. Mgr.: Elizabeth Rashbaum; Prof. Mgrs.: Howard Strauss, Jack Uram.
- Docrabb Music (ASCAP), see Martin Cohen.
- Dogfish Music (ASCAP), PO Box 278, Inverness, Calif. 94937. Tel: (415) 669-1162. Gen. Mgr.: Lowell Levinger.
- Int'l rep.: Harry Fox in New York, N.Y.
- Dog Soldier Music (ASCAP), see Martin Cohen.
- Doheny Music (BMI), 8571 Holloway Dr., No. 2, Los Angeles, Calif. 90069. Tel: (213) 659-5479. Pres.: J.W. Alexander.
- Dolfi Music Inc. (ASCAP), see Chappell.
- Dolly Bee Music (BMI), 515 E. Racquet Club Rd., Palm Springs, Calif. 92262. Tel: (714) 327-9216. Owner & Pres.: George R. Brown.
- Domax Music Inc. (BMI), see Copyright Serv. Bureau.
- Domestic Music Co. (ASCAP), see Copyright Serv. Bureau.
- Dondee Music Co. (BMI), see Mietus.
- Donna-Dijon Music (BMI), see April/Blackwood.
- Donna Lee Music (ASCAP), 131 E. Magnolia Blvd., Burbank, Calif. 91502. Pres.: Betty L. Chiappetta; Sec'y-Treas.: Frank Chiappetta.
- Donna Marie Music Publ'g (ASCAP), PO Box 6497, Philadelphia, Pa. 19145. Tel: (215) 947-7743. Pres. Danny Luciano; Gen. Mgr.: Ray Royal.
- Donna Music Publ'g Co. (ASCAP), PO Box 1173, Woburn, Mass. 01801. Tel: (617) 933-1474/7651. Pres. Frank P. Pappalardo; Gen. Mgr.: Frank Paul; Prof. Mgr.: Joseph Pappalardo.
- Donnybrooke Music (BMI), see Royalty Control Corp.
- Dooms Publ'g Co. (BMI), PO Box 2072, Waynesboro, Va. 22980. Tel: (703) 942-0106. Owner: John Major.
- Door Knob Music Publ'g (BMI), see Gene Kennedy.
- Doors Music Co. (ASCAP), c/o Greene & Reynolds, 1900 Ave. of the Stars, Suite 1424, Los Angeles, Calif. 90067. Tel: (213) 553-5434. Prof. Mgr.: Robert L. Greene.
- Int'l reps.: Africa (Music Publ'g Co. of Africa), Australia (Rondor), Austria (Altus), Brazil (Mundo Musicale), Central America (CBS Int'l), Denmark (Sweden Music in Sweden), Finland (Sweden Music in Sweden), Germany (Altus), Hong Kong (Pathe Far East), Iceland (Sweden Music in Sweden), Ireland (Rondor), Japan (Taiyo), Malaysia (Pathe Far East), Mexico (CBS Int'l), Norway (Sweden Music in Sweden), Singapore (Pathe Far East), South America (CBS Int'l), Spain (Panta/Quiroga), Sweden (Sweden Music), Switzerland (Altus), UK (Rondor).
- Dooto Inc., see Dootsie Williams.
- Dora Music, PO Box 995, Norfolk, Va. 23501.
- Dorella Music Inc. (ASCAP), see Chappell.
- Dormat Music (ASCAP), see Skinny Zach.
- Dor-Resa Publ'g (ASCAP), see April/Blackwood.
- Dorsey Bros. Music (ASCAP), see Music Sales.
- Buster Doss Music (BMI), PO Box 927, Manchaca Sta., Austin, Tex. 78652. Tel: (512) 282-4010. Pres.: Col. Buster Doss; Gen. Mgr.: Barbara Doss; Prof. Mgr.: Bo Doss.
- Dotted Lion Music (ASCAP), see Chappell.
- Double Diamond Music (BMI), see April/Blackwood & 20th Century.
- Double F (ASCAP), see Mietus.
- Double Helix Music (BMI), see Royalty Control Corp.
- Double R Music Corp. (ASCAP)—Pres.: Charlie Rich—see Makamillion & Tree.
- Double R Publ'g Co. (BMI), see Chappell.
- Douglas Music Co. Inc. (ASCAP), see Chappell.
- Dovetail Music Publ'g Co. (BMI), PO Box 2802, 530 S. Water St., Corpus Christi, Tex. 78403. Tel: (512) 992-5126. Owner: Bruce Taylor.
- Down N' Dixie (BMI), see Rondor.
- Downstairs Music Co. (BMI), see Mighty Three.
- Downtown Music Co. (ASCAP), see The Entertainment Co.
- Dozier Music Inc. (BMI), 8467 Beverly Blvd., Suite 200, Los Angeles, Calif. 90048. (Administered by April/Blackwood.)
- Draft Music (BMI), see Rogan.
- Dragon Int'l Music (BMI), PO Box 8263, Haledon, N.J. 07508. Tel: (201) 942-6810. Pres.: Samuel Cummings; Gen. Mgr.: Patrick Simpson.
- Kelvin Drake Music (BMI), see 20th Century.
- Drayeniv Music Publ'g Co. (BMI), PO Box 934, Edgartown, Mass. 02539. Tel: (617) 627-4639. Owner: Benjamin L. Hall.
- Dreana Music (BMI), see Asilomar.
- Driftaway Music (ASCAP), see T.B. Harms—Jack & Bill.
- Drifter Music (BMI), see Bug.
- Driftwood Publ'g Co. Inc. (BMI), see Cedarwood.
- Drive-In Music Co. Inc. (BMI), 7120 Sunset Blvd., Hollywood, Calif. 90046. Tel: (213) 851-2500.
- Driving Music (ASCAP), see Creative Corps.
- Drucker Publ'g Co. (BMI), 234 W. Green St., West Hazleton, Pa. 18201. Tel: (717) 455-7260. Pres.: Jim Drucker; Gen. Mgr.: Louis P. Butch.
- Drury Lane Music Corp. (BMI), see Copyright Serv. Bureau.
- Duane Music Inc. (BMI), 382 Clarence Ave., Sunnyvale, Calif. 94086. Tel: (408) 739-6133. Pres.: Garrie E. Thompson; Gen. Mgr.: Duane N. Thompson.
- Branch: Albany, Calif., PO Box 6174. Zip: 94706. Tel: (415) 524-4939.
- Dub Music Co. (BMI), see Roncom.
- Duce (ASCAP), c/o TAT Communications Co., 1901 Ave. of the Stars, Los Angeles, Calif. 90067.
- Duchess Music Corp. (BMI), see MCA Music.
- Dudzack Music (ASCAP), see April/Blackwood.
- Dunamis Music (ASCAP), 8319 Lankershim Blvd., North Hollywood, Calif. 91605. Tel: (213) 767-4522. Pres.: Freddie Piro; Gen. Mgr.: Ms. Teri Piro.
- Dundee Music (BMI), see Nor Va Jak.
- Bill Duniven Music (BMI), see Briarmead.
- Dunwich Music (ASCAP), see Yuggoth.
- Dusksongs Music (BMI) (div. of Dusk Rec'g Studios), 2217-A The Alameda, Santa Clara, Calif. 95050. Tel: (408) 727-2840. Prof. Mgr.: Paul Blote.
- Dusty Roads Music Corp. (BMI), see Al Gallico.
- Dwarf Music (ASCAP), PO Box 860, Cooper Sta., New York, N.Y. 10003. Tel: (212) 473-5900. Gen. Mgr.: Naomi Saltzman.
- Dy-Cor Inc. (BMI), 792 Columbus Ave., Apt. 10A, New York, N.Y. 10025. VP: Harvey Court.
- Dyjeta Music (BMI)—Pres.: Clifton Dyson; Gen. & Prof. Mgr.: Robert H. Williams—see Dimitri.
- Dynamic Music (ASCAP), see Paragon Assocs.
- Dynatone Publ'g Co. (BMI), see Chappell.



E B A Music (ASCAP), see Segel & Goldman.
 E D M Music Publ'rs (ASCAP), see Clockus.
 E D W (ASCAP), see Edwin F. Kalmus.
 E & M Publ'g Co. (BMI), 2674 Steele, Memphis, Tenn.

38127. Tel (901) 357-0064. Owner, Pres. & Gen. Mgr.: Marshall E. Ellis.
- E M P Co. (BMI), see The Entertainment Co.
- E S P-Disk Ltd., Acorn Hill Rd., Krumville, N.Y. 12447 Tel (914) 657-6675. Pres.: Bernard Stoliman.
- E V Music Publ'g Co. (ASCAP), 6130 E. Cholla Ln., Scottsdale, Ariz. 85253. Tel: (602) 994-9067. Pres.: Eve Smith. Gen. & Prof. Mgr.: Bill Smith.
- Eagleleaf Music (ASCAP)—Owner: Michael D. Aisner—see Ferndock.
- Earl Music Co. (ASCAP), see Chappell.
- Earlon Music Corp (ASCAP), see Chappell.
- Early Bird Music (BMI), 14702 Canterbury, Tustin, Calif. 92680 Tel (714) 731-2981. Owner & Pres.: Steve Waltner. Sales, Mktg. & Promo: Reggie South.
- Earmark Music Inc. (BMI), see Fourth Floor.
- Ear-Responsible Music, see Beserkeley.
- Earthborn Music Co. (BMI), see Mietus.
- Earthbound Publ'g Co. (BMI), 8428 Kate St., No. 226, Dallas, Tex. 75225 Tel (214) 368-1305. Pres.: Sam Lombello III. Gen. Mgr.: Michael Kubiak.
- Earthing Music (ASCAP), 110 W. 86 St., New York, N.Y. 10024 Tel (212) 799-4181. Pres.: Bob Sakayama; Prof. Mgr.: Lynne Raymond.
- Earth Music (BMI), see Copyright Serv. Bureau.
- East Coast Recs. Inc., 6012 Lindbergh Blvd., Philadelphia, Pa. 19142. Tel (215) 726-6049. Pres.: A. Messina; Gen. Mgr.: Steve Levy; Prof. Mgr.: T. Rocca.
- Eastex Music (BMI), 8537 Sunset Blvd., No. 2, Los Angeles, Calif. 90069 Tel (213) 657-8852.
- Eastman School of Music (ASCAP), see Carl Fischer.
- East / Memphis Music Corp. (BMI), see Cream.
- Eastwick Music Publ'g Co. (BMI), 1314-24 S. Howard St., Philadelphia, Pa. 19147 Tel (215) 334-5662. Pres.: Sam Hodge. VP: Valerie M. Hodge; Sec'y-Treas.: Shirley B. Martocci.
- Easy Listening Music Corp. (ASCAP), see Al Gallico.
- Easy Nine Music (BMI), see Chappell.
- Eat Your Heart Out Music (BMI)—Pres.: Nona Hendryx. Gen. Mgr.: Vicki Wickham; Prof. Mgr.: Josh Gold—see Gospel Birds.
- Eau d'Yeah, see Beserkeley.
- Eboni / Dawn Music (BMI), c/o Jonathan R. Black. Western Savings Bank, Suite 911, Philadelphia, Pa. 19107 Tel: (215) 732-2652. Cable: BLACKJACK. Pres.: Mikki Farrow. Admin'r.: Jonathan R. Black.
- Eddie-O Music Co., see T.B. Harms—Bibo.
- Eddy (Trustees under the will of Mary Baker Eddy) Ed. (ASCAP), see Carl Fischer.
- Eden Music Corp. / Iza Music Corp. (BMI), PO Box 325, Englewood, N.J. 07631. Tel (201) 567-7538. Pres.: Clyde Otis. Gen. Mgr.: Janie Washington.
- Int'l branch:** England.
- Int'l reps.:** Australia (Essex), UK (Essex).
- Don Edgar Music Co. (BMI), 2312 Jasper, Fort Worth, Tex. 76106. Tel (817) 626-3448. Pres. & Gen. Mgr.: Don D. Edgar.
- Edmark Prod'ns (BMI), 20802 Cedar Ln., Tomball, Tex. 77375. Tel (713) 351-1807. Pres.: Edmond A. Evey; Prof. Mgr.: Michael D. Merchant.
- Branch:** Aransas Pass, Tex., PO Box 1147, Zip: 78336. Tel (512) 758-3271. VP: William L. Ellis.
- Edotha Publ'g Co. (ASCAP), see Jondora Music—Tru-Sound.
- Edu-Tainment Publ'g Co. (ASCAP), see G. Schirmer.
- Edwards Music Co. (ASCAP), see Copyright Serv. Bureau.
- Edwood Music (BMI), see American Mutual.
- Effective Music (ASCAP), see Martin Cohen.
- Egap Music (BMI), see Lear.
- Elbejay Ent's. Inc. (BMI), PO Box 40544, Nashville, Tenn. 37204. Tel (615) 297-3767. Pres.: H. Raymond Ligon. Gen. & Prof. Mgr. & Sec'y-Treas.: Sewall B. Jackson.
- El Chicano Music (ASCAP), 20531 Plummer St., Chatsworth, Calif. 91311. Tel (213) 998-0443. Pres.: M. Lespron; Gen. Mgr.: A.E. Sullivan.
- Eldad Music (ASCAP), see Rondor.
- Eldee Music Corp. (ASCAP), see Chappell.
- Electric Mule Music Publ'g (BMI), c/o Jim Foster, 2308 Belmont, Nashville, Tenn. 37212.
- Electron Music Co., see T.B. Harms—Vogue.
- Eleonora Music (ASCAP), see Copyright Serv. Bureau.
- Elephant V. Ltd. (ASCAP), see Big Seven.
- Eleventh Ave. Theatricals Inc. (ASCAP), see Copyright Serv. Bureau.
- Elizabeth Music Publ'g (BMI), 515 E. Racquet Club Rd., Palm Springs, Calif. 92262. Tel (714) 327-9216. Owner: George R. Brown.
- Henn Elkan Music Publ'r (ASCAP), 1316 Walnut St., Philadelphia, Pa. 19107 Tel (215) 735-1900.
- Int'l firms represented:** Ed. Andel-Gervan (Belgium), Ed. Musicales Brogneaux (Belgium), CeBeDeM (Belgium), Ed. A. Cranz (Belgium), Ed. Metropolis (Belgium), Arthur Meulmans-Fonds (Belgium), Molenaar (Netherlands), Scherzando (Belgium), Tieroloff-Rosendaal (Netherlands), J.A.H. Wagenaar (Netherlands) Ed Ysaye (Belgium).
- Elkan-Vogel Inc. (ASCAP), see Theodore Presser.
- Ellebie Music Publ'g Co. (BMI), 410 Union St., Farrell, Pa. 16121. Tel (412) 342-9330. Pres. & Prof. Mgr.: Willie James Ellebie; Gen. Mgr.: Margaret Herrington.
- Ellipsis Music Corp. (ASCAP), see Jamie.
- Ellis & Co. Music Publ'rs (ASCAP), see Athon Music.
- Ellis Music Ent's. Inc. (BMI), 5436 Auckland Ave., North Hollywood, Calif. 91601. Tel (213) 980-8122.
- Elm Publ'g Co. (BMI), PO Box 1100, 14621 Allen St., Westminster, Calif. 92683. Tel (714) 898-7317. Pres.: Edd L. McNeely.
- El Paso Music Co. (ASCAP), PO Box 9398, Fort Worth, Tex. 76107. Tel (817) 267-4915. Pres. & Gen. Mgr.: Sam Atchley. Prof. Mgr.: Frank Henderson.
- El Paso Music Div. (ASCAP), see Peaceful.
- Elrita Music (ASCAP), see Richard Delvy.
- Elsher Music Co. (ASCAP), see April/Blackwood.
- Elva Music Inc. (ASCAP), see Publishers' Licensing Corp.
- Elvis Music Inc. (BMI), 1619 Broadway, New York, N.Y. 10019. Tel (212) 489-8170. Comptroller: Lester Boles.
- Elvitree Rec'g Music Publ'g Co. (BMI), PO Box 3022, Wilmington, N.C. 28401. Tel (919) 762-0474/4706. Pres.: John Lewis Jones; VP: Betty Foy Scavella; Prof. Mgr.: James L. Wheeler; Promos.: Sonny Franks.
- Int'l reps.:** Canada (London), Philippines (Playtex).
- Embamba Music Inc. (ASCAP)—Pres.: Alphonso Johnson—see Lloyd Zane Remick.
- Embassy Music Corp. (BMI), see Music Sales.
- Ember Ent's. Inc., 747 Third Ave., 27th fl., New York, N.Y. 10017. Tel (212) 688-8170. Bd. Chm.: Jeffrey S. Kruger. Pres.: Hal Shaper; VP: Creative Affairs: Mike Berry; VP: Copyright & Licensing: Margaret Brace.
- Int'l branch:** England, Sparta Florida Music Group Ltd.
- Int'l firms represented:** Ed. Musicales Catalogue (France), Florida (UK), Gloucester (UK), Henney (UK), International Music Of Italy—IMI (Italy), Mark Music (UK), Metropole (UK), Mood Music (UK), Sharon (UK), Sleeping Bunny (UK), Soul Music (UK), Sparta (Netherlands), Sparta Florida (UK), York (UK).
- Int'l reps.:** UK (Ember, Sparta Florida Music Group).
- Emeline Music Co. (ASCAP), see Koala.
- Emerald Music (ASCAP), see Snowdrop.
- Emerald Isle Music Inc. (BMI), PO Box 22635, Nashville, Tenn. 37202. Tel (615) 383-8318.
- Emergency Music Inc. (ASCAP), 270 Madison Ave., Suite 1410, New York, N.Y. 10016. Tel (212) 683-5320. Gen. Mgr.: Sergio Cossa.
- Emes Music, see T.B. Harms—Harry Von Tilzer.
- Emilanda Musique (BMI), 731 1/2 N. Croft, West Hollywood, Calif. 90069. Tel (213) 653-7538. Contacts: Bob Brownstein, Steve Cagan.
- Emko Music Corp. (BMI) (div. of Emko Talent Assocs. Corp.), PO Box 176, Monsey, N.Y. 10952. Tel (914) 425-6040. VP: Gen. & Prof. Mgr.: Edward M. Kaplan.
- Emperor Music Inc. (BMI), see H. B. Webman.
- Empire Songs (ASCAP), see Deejay.
- Enchantment Music Co. (BMI), PO Box 998, Mesilla Park 88047, 105 E. Idaho, Las Cruces, N.M. 88001. Tel (505) 524-1889. Owner: Emmitt H. Brooks. (Affiliated with Brooks Bros.)
- Encounter Music Co. (BMI), see Tempi.
- Endeavor Music (ASCAP), 30064 Annapolis Circle, Inkster, Mich. 48141. Tel (313) 729-7836. Pres.: Hardie W. Daniel.
- Branch:** Detroit, Mich., 2043 Clements St. Zip 48238. Tel (313) 865-9582. Gen. Mgr.: Clark Daniel.
- Enoch & Sons (N.Y.) (ASCAP), see Boosey & Hawkes.
- Enrica Music Inc. (BMI), see Rae-Cox & Cooke.
- Ensemble Music Press (ASCAP), see Carl Fischer.
- Ensign Music Corp. (BMI), see Famous.
- Enterprize Music Publ'g (ASCAP), 3036 N. Peoria Rd., Springfield, Ill. 62702. Tel: Pres.: Jerry Haymes. Gen. Mgr.: Betty Jacobs.
- Branch:** Longview, Tex., 1824 Laney Dr. Zip 75601. Tel (214) 758-4063.
- Entertainment Capital Corp., 4 E. 82 St., New York, N.Y. 10028. Tel (212) 734-1652.
- The Entertainment Co. Music Group, 40 W. 57 St., New York, N.Y. 10019. Tel (212) 265-2600, 586-3600.

THE WELK MUSIC GROUP

100 Wilshire Boulevard • Suite 700 • Santa Monica, California 90401 • Telephone (213) 871-0911

LAWRENCE WELK • PRESIDENT **DEAN KAY • EXECUTIVE VICE PRESIDENT-GENERAL MANAGER**

ROGER SOVINE • VICE PRESIDENT/PROFESSIONAL ACTIVITIES

BILL HALL • NASHVILLE DIVISION MANAGER
1509 LAUREL STREET • NASHVILLE, TENNESSEE 37203 • TELEPHONE (615) 256-7648

GAYLON HORTON • HOLLYWOOD DIVISION MANAGER
6255 SUNSET BOULEVARD • SUITE 615 • HOLLYWOOD, CALIFORNIA 90028 • TELEPHONE (213) 467-3197

JOE ABEND • NEW YORK DIVISION MANAGER
200 WEST 57th STREET • SUITE 802 • NEW YORK, NEW YORK 10019 • TELEPHONE (212) 581-3197

STUART McFARLANE • WELK MUSIC GROUP LTD.
184/186 REGENT STREET • LONDON W1, ENGLAND • TELEPHONE (44-1) 439-77-31

T. B. HARMS COMPANY (ASCAP)
 VOGUE MUSIC (BMI)
 CHAMPAGNE MUSIC CORPORATION (ASCAP)
 BIBO MUSIC PUBLISHERS (ASCAP)
 HALL-CLEMENT PUBLICATIONS (BMI)
 HARRY VON TILZER MUSIC PUBLISHING COMPANY (ASCAP)
 JACK AND BILL MUSIC COMPANY (ASCAP)

Telex 666140 Principals Charles Koppelman, Martin Bandier, Publ'g Admin'r Joanne Bors.
Branch: Los Angeles, Calif., 6430 Sunset Blvd. Zip 90028 Tel (213) 466-6127 VP Publ'g Jay Warner.
 (SEE ADVERTISEMENT)

Entertainment Showcase Inc. (BMI), see Erection
 Entropy Ents Ltd. (BMI), see Copyright Serv. Bureau
 Envolv Music Co. (ASCAP), see Envolv Music Group
 Envolv Music Group Ltd., Box 767, Radio City Sta., New York, N.Y. 10019. Tel: (212) 581-4597. Pres. Gene Frank, VP Bob O'Brien (Sheet music distributed by G Schirmer).

Envolv Publ'g Co. (BMI), see Envolv Music Group
 Epitome Music Co. (BMI), see BC Ents.
 Epp's Music Co. (BMI) (div. of Epstein Ents.), PO Box 28123 735 N. Gen. McMullen Dr., San Antonio, Tex. 78228 Tel (512) 434-7006. Pres. A. Epstein.

Equator Music (BMI), see Valgroup
 Equinox (BMI), c/o Raymond Harris, 7060 Hollywood Blvd., Suite 1212, Hollywood, Calif. 90028
 Erection Publ'g (BMI), 4606 Clawson, Austin, Tex. 78745 Tel (512) 444-5489. Pres. Windell Tyler, VP Tommy Byrd, Gen. Mgr. J. Tyler.

Eric Dynamic Co. (BMI), PO Box 14755, Cincinnati, Ohio 45214. Tel (513) 281-8645. Pres. Eric Wilson Jr.
 Ernkell Music Co. (BMI) (div. of Ernest Kelley Inc.), 18329 W. McNichols Rd., Detroit, Mich. 48219. Tel (313) 533-1550. Pres. Ernest Kelley, Gen. Mgr. Irving R. Kelley, Prof. Mgr. John E. Griffith Jr.

Eroom Music (BMI), see Copyright Serv. Bureau
 Erva Publ'g Co. Inc. (BMI), 200 W. 57 St., Suite 1404, New York, N.Y. 10019. Tel (212) 765-5722
 Espirm Ltd. (BMI), see Copyright Serv. Bureau

Essbee Music, see Copyright Serv. Bureau
 Essential (BMI), 9454 Wilshire Blvd., Suite 700, Beverly Hills, Calif. 90212
 Essex Music Inc. (ASCAP), see TRO

Essex Music Int'l Inc. (ASCAP), see TRO
 Estimated Time Of Arrival (BMI), see Copyright Serv. Bureau
 Estimated Time Of Departure (ASCAP), see Copyright Serv. Bureau

Eternity Music (ASCAP), see Martin Cohen
 Ethnic Music Publ'g Co. Inc. (ASCAP), see Ashley
 Eudamonic Publ'g Co. (BMI), see Copyright Serv. Bureau
 Eulenburg (SESAC), see C.F. Peters

European American Music Dist. Corp. (ASCAP), 195 Allwood Rd., Clifton, N.J. 07012. Tel (201) 777-2680, NYC (212) 868-1165. Telex: 252311. Pres. Ronald L. Freed, Prof. Mgr. George Sturm, Copyright Admin'r. Carolyn Hunter, Promo Dir., Norman Auerbach

Int'l firms represented: Barenreiter—partial catalog (Germany), Schott (Germany, Japan, UK), Universal (Australia, Austria, Switzerland, UK)
 Evans Music Co. (ASCAP), see Carl Fischer
 Evansongs (ASCAP), c/o E.S. Prager Inc., 1790 Broadway, New York, N.Y. 10019

Richard Evans Music (ASCAP), see Yuggoth
 Evanton Music (BMI), PO Box 2217, Inglewood, Calif. 90205. Tel (213) 644-8182. Pres. Leonard S. Falconer, Treas. M.P. Falconer
 Evelyn Music Co. Ltd., 1305 North Highland Ave., Hollywood, Calif. 90028. Tel (213) 463-5888

Everybody's Music (BMI), see Intercontinental
 Evie Music Inc. (ASCAP), see Chappell
 Evil Eye Music Inc. (BMI), see TRO

Evilut Music Inc. (ASCAP), see Publishers' Licensing Corp.
 Exbrook Music Co. (BMI), see Chappell
 Exbrook Publ'g Co. (BMI), 9110 Sunset Blvd., Suite 100, Los Angeles, Calif. 90069. Tel (213) 271-1103. Owner: Melville A. Shauer

Excellorec Music Co. Inc. (BMI), 1011 Woodland St., Nashville, Tenn. 37206. Tel (615) 226-5660. Pres. Bob Tubert, Gen. Mgr. Patricia Nolen
 Int'l rep: UK (Campbell Connelly)

Existential Music (BMI), 118 Fifth St., Taylorsville, N.C. 28681. Tel (704) 632-4735. Pres. & Owner: Harry Deal, Office Mgr. Shirley Robinette
 Eyeball Music (BMI), PO Box 60234, Chicago, Ill. 60660. Tel (312) 973-7736. Pres. & Gen. Mgr. Bruce Iglauer
 Int'l rep.: Europe (Sonet), Japan (Pumpkin)

Eyes Havit Music Inc. (BMI), see Chappell
 Ezra (BMI), 8600 Melrose Ave., Los Angeles, Calif. 90069



F E L Publ'ns Ltd. (ASCAP), 1925 S. Pontius Ave., Los Angeles, Calif. 90025. Tel (213) 478-0053
 F Y D A Q Music (BMI), 240 E. Radcliffe Dr., Claremont, Calif. 91711. Tel (714) 624-0677. Pres. Gary Buckley
 Fab Music Inc. (BMI), see Brut

Face Music (BMI), see Copyright Serv. Bureau
 Fairchild Music Publ'g (BMI), PO Box 6495, Buena Park, Calif. 90620. Tel (714) 554-0851. Owner & Gen. Mgr.: Jerry Wood
 Branch: Buena Park, Calif., 6601 San Diego Dr. Zip 90620

Fairfield Publ'ns (BMI), see Novello
 Fairlane Music (ASCAP), see Chappell
 Fairlight Music Co. Inc. (BMI), see Fred Ahlert
 Fairlyland Music Corp. (ASCAP), 240 W. 55 St., New York, N.Y. 10019. Tel: (212) 247-3690. Cable: BENAN-TIMUS. Pres.: Jack Benantny

Fairystone Publ'g Co. (BMI), PO Box 594, Rocky Mount, Va. 24151. Tel (703) 483-0689. Pres. & Gen. Mgr.: W. Rod Shively
 Fallen Angel Publ'g (BMI), 256 S. Robertson, Suite 6124, Beverly Hills, Calif. 90211. Tel (213) 368-0604. Pres. J. Christopher Michel

Fall River Music Inc. (BMI), see Sanga
 Falls City Music (BMI), 9701 Taylorsville Rd., Louisville, Ky. 40299. Tel (502) 267-9658. Pres. Ray Allen
 Falstaff Music (BMI), see Copyright Serv. Bureau
 Fame Publ'g Co. Inc. (BMI), 603 E. Avalon Ave., Muscle Shoals, Ala. 35660. Tel (205) 381-0801

Family Affair Music Co. (ASCAP), see Respect
 Family of Man Music Inc. (ASCAP), see House of Cash
 Family Prod'ns Co. (BMI), see Mietus

Famosonda Music (BMI)—Pres. Art Stewart—see Baradat
 Famous Music Corp. (ASCAP) (div. of Gulf & Western Inds Inc.), 1 Gulf & Western Plaza, New York, N.Y. 10023. Tel (212) 333-3433. Cable: FAMUSIC. Chief Operating Officer: Marvin Cane, VP Admin. Sidney Herman, Creative Dir. (R&B) Lionel Job. (Pop) Ann Gardner, Standards Dept. Dick Milfred

Branches: Hollywood, Calif., 6430 Sunset Blvd. Zip 90028. Tel (213) 461-3091. West Coast Creative Affairs Dir.: Bill Ficks Jr. Prof. Mgr. Julie Chester—Nashville, Tenn., 2 Music Circle S. Zip 37203. Tel (615) 242-3531. Opns. Dir. Judi Götter

Int'l reps.: Austria (Melodie der Welt), Canada (Famous-Chappell), Europe excluding Austria & Germany (Famous-Chappell), Germany (Melodie der Welt), Japan (Nichion), Mexico (Intersong), Philippines (Lustre) (SEE ADVERTISEMENT)

Fania Publ'g Co. Inc. (BMI), 888 Seventh Ave., New York, N.Y. 10019. Tel (212) 397-6730. Pres. Jose Florez. Gen. Mgr. Gertrude Fredd

Fargil Music Publ'g Co. (ASCAP), see Gil Gilday
 Fargo House Int'l (ASCAP), see Prima-Donna & Al Gallico
 Farjay Music Publ'g Co. Inc. (BMI), see Gil Gilday
 Farmer & Thomas Music (BMI), 327 Upshur St. NW, Washington, D.C. 20011. Tel (202) 882-7339. Pres. Clifton Thomas; VP & Exec. Sec'y Charles Farmer

Faro Music Publ'g (BMI), 255 N. New Hampshire Ave., Los Angeles, Calif. 90004. Tel (213) 384-9586. Owner: Edward L. Davis

Far Out Music Inc. (ASCAP), 7417 Sunset Blvd., Hollywood, Calif. 90046. Tel (213) 874-1300
 John Farrar Music (BMI), see Rondor
 Farr Music Inc. (BMI), Box 1098, 350 Grove St., Somerville, N.J. 08876. Tel (201) 725-3850. Bd. Chm. Asa H. Farr, Mgr. & Controller Candace Campbell

Fate (ASCAP), c/o GT Ents., 3128 Cavendish Dr., Los Angeles, Calif. 90064
 Fate Inc. (BMI), see Gallery Square
 Favorite Music Inc. (ASCAP), see Big Seven

Featherbed Music Inc. (BMI), see Chappell
 Feckless (BMI), c/o Jess S. Morgan & Co., 6420 Wilshire Blvd., Los Angeles, Calif. 90048
 Fedora (BMI), see Segel & Goldman

Fee Bee Music Co. (BMI), 4517 Wainwright Ave., Pittsburgh, Pa. 15227. Tel (412) 884-4727/4554. Cable: FEBE. Pres. J.M. Averbach. Gen. Mgr.: G. Phillips. Prof. Mgr.: Al Olvieri

Felsted Music Corp. (BMI), see Burlington
 Fema Music Publ'ns (ASCAP), see Crescendo
 Tex Fenster Superstar Publ'ns (ASCAP), see Miracle
 FERMATA Int'l Melodies Inc. (ASCAP), Sunset-Vine Tower Bldg., Suite 916, 6290 Sunset Blvd., Hollywood, Calif. 90028. Tel (213) 462-7473. TWX (910) 321-4063. Cable: FERMATACAL. Pres.: Enrique Lebendiger, Mgr. & Sec'y: Debora Frenkel.

Home office: Brazil
 Ferndock Music (ASCAP) (div. of Wormwood Projects), 1540 Lehigh St., Boulder, Colo. 80303. Tel (303) 449-1108. Gen. Mgr. Michael D. Ansner

Fervent Sound Music (BMI), see Mietus
 Festive Music (BMI), 15394 Warwick Blvd., Newport News, Va. 23602. Tel (804) 877-6877. Pres. W.H. Smith
 Fez Music Co., see Martin Cohen

Fiber Music (BMI), see Chappell
 Fiction Music Inc. (BMI), see Fourth Floor
 Fiddleback Music Publ'g Co. Inc. (BMI), see Tommy Valando

Jerry Fielding Music Co. (ASCAP), see Gordon
 Fiesta Music Inc. (BMI), PO Box 2450, Hollywood, Calif. 90028. Tel (213) 465-7969
 Fifth Floor Music Inc. (ASCAP), see Martin Cohen

Fifth Star Music (BMI), see Segel & Goldman
 Fifth World Music (BMI), see Copyright Serv. Bureau
 Figgy Music (BMI), see Peter Tevis

Fig-Tree Music (SESAC), see Music City
 Figurette Music Co. (ASCAP), see Lone Lake
 Fillmore Music House (ASCAP), see Carl Fischer
 Filmways Music Publ'g Inc. (ASCAP), see Musicways
 Fi Music Inc. (ASCAP), see Cream

Finchley Music Corp. (ASCAP), c/o Arrow, Edelstein, Gross & Margolis, 1370 Ave. of the Americas, New York, N.Y. 10019. Tel (212) 586-1451
 Finch Rec'g Co., 2430 Spring Grove Ave., Cincinnati, Ohio 45214. Tel (513) 421-0850

Fine Arts Music Press Inc. (ASCAP), Box 45144, Tulsa, Okla. 74145. Tel (918) 437-3144
 Fine Colorado Music (BMI)—Pres. Richard Perry—see Border Star

Finger Music (ASCAP), see Martin Cohen
 Firedrum Music (ASCAP), PO Box 8207, Albuquerque, N.M. 87198. Tel (505) 268-6110. Pres. & Gen. Mgr.: Thomas Bee

Branch: Studio City, Calif., 12403 Ventura Court. Zip 91604. Tel (213) 760-1665, 877-0500. Gen. Mgr.: Ralph L. Seltzer
 Int'l rep.: France (Francis Day)

Fireside Music (ASCAP), see Copyright Serv. Bureau
 Fire Weed Music (ASCAP), see Copyright Serv. Bureau
 First Artists Music Co. (ASCAP), 4000 Warner Blvd., Burbank, Calif. 91522. Tel (213) 843-6000. VP: Gary Le Mel. Ass't: Sandi Beach

First General Music Co. (BMI), see Combine
 First National Music Co. (BMI), see April Twenty-Two
 Carl Fischer Inc. (ASCAP), 62 Cooper Square, New York, N.Y. 10003. Tel (212) 777-0900. Cable: CAR-FISCHER. Pres.: Walter F. Connor
 Branches: Los Angeles, Calif., 1101 S. Hope St. Zip 90015. Tel (213) 749-5227. Mgr.: Morton Baumgard—Chicago, Ill., 312 S. Wabash Ave. Zip 60604. Tel (312) 427-6652. Mgr.: Stephen H. Marlatt—Boston, Mass., 156 Boylston St. Zip 02116. Tel (617) 426-0740. Mgr.: Warren Patterson
 Int'l firm represented: Paterson's Publ'ns Ltd. (U.K.)
 Int'l rep.: UK (Boosey & Hawkes)

10970. Tel (914) 354-7157. Pres. Kevin Misevis, Gen. Mgr. Ulla Misevis (Administered by Mietus Copyright)

Int'l reps.: Canada (RCA), UK (EMI)
 Charlie Fitch Music Co. (BMI), 311 E. Davis, Luling, Tex. 78648. Tel (512) 875-3350. Pres. & Gen. Mgr. Charlie Fitch, Prof. Mgr. Celeste Fitch
 Int'l firm represented: Liberty (Sweden)
 Int'l rep.: Sweden (Liberty)

Fitzpatrick Music (ASCAP), see Copyright Serv. Bureau
 H T FitzSimons Co. Inc. (SESAC), 615 N. La Salle St., Chicago, Ill. 60610. Tel (312) 944-1841. Cable: FITZCO. Pres. & Gen. Mgr.: R. E. FitzSimons

Five & A-Half B Music (BMI), PO Box 932, Honolulu, Hawaii 96808. Tel (808) 623-9958. Owner: Richard R. Riccio
 Fix Square Music (BMI), see Sidney A. Seidenberg
 Fizz Music (ASCAP), see Martin Cohen

Flagship Music Inc. (BMI), PO Box 23062, Nashville, Tenn. 37202. Tel (615) 392-4430
 Flames of Albion Music Inc., see Stevens H. Weiss
 Flammable Music (BMI), see Copyright Serv. Bureau

Harold Flammer Inc. (ASCAP), see Shawnee Press
 Flamm Music Inc. (BMI), see Chappell
 Flanka Music Corp. (ASCAP), see MCA Music
 Flatcar Music (BMI), see Chappell

Flat Lizard Music (ASCAP), see Bruce Cohn
 Flatriver Music (BMI), see Crazy Cajun
 Flat Town Music (BMI), PO Drawer 10, 434 E. Main, Vlye, Platte, La. 70586. Tel (318) 363-2139. Pres. Floyd Soileau

Flatunus Music (ASCAP), see Royalty Control Corp.
 Fleetwood Music Inc. (BMI), see Mietus
 Fleem Music (BMI), 8986 Birwood, Detroit, Mich. 48204. Tel (313) 898-7006. Pres. Arthur J. Fleming

Flu Pub'l'g, see Copyright Serv. Bureau
 Flin-Flon Music (BMI), PO Box 103, Main St., Mullen, Neb. 69152. Tel (308) 546-2293. Gen. Mgr.: L. Earl Walker, Sales Mgr.: David L. Walker
 Fling Music Inc. (BMI), see Don Costa

Flintlock (ASCAP), see Nashville Int'l
 Fix Music Int'l Ltd. (BMI), see Alexander Broude
 Florence Music Co. Inc. (ASCAP), see Chappell
 Florentine Music (BMI), see Dawn Prod'ns

Floss Music (BMI), see Ermo
 Fluffo Tunes (BMI), see Cedarwood
 Flying Address Music (BMI), see Musicways
 Flying Dutchman Music (BMI), see Copyright Serv. Bureau

Flying Fish Music (BMI), 1304 W. Schubert, Chicago, Ill. 60614. Tel (312) 528-5455. Pres.: Bruce Kaplan, Dir.: Charles Gutfield
 Int'l reps.: Europe (Sonet), Japan (Pumpkin)

Flying Fox Music Ltd. (BMI), see Space Potto
 Flying Spur Music Inc. (BMI)—Pres. Eric Weissberg, Gen. & Prof. Mgr.: Richard Golub. Tel (212) 682-8620—see Jackelope

Focal Point Music Publ'g (BMI), 922 McArthur Blvd., Warner Robins, Ga. 31093. Tel (912) 923-6533. Pres. Ray H. Melton; Gen. Mgr.: Jeannette C. Melton; Prof. Mgr.: Eugene Hatfield

Fog City Music Publ'g Co. (BMI), 44 Tucker Ave., San Francisco, Calif. 94124. Tel (415) 467-6567. Pres.: Samuel Powell Jr.; Prof. Mgr.: Robert Powell, PR: Edlo Powell

Charles Foley Co. (ASCAP), see Carl Fischer
 Folia Publ'ns Inc., see T.B. Harms—Hall-Clement
 Folk-Legacy Recs. Publ'g Co. (BMI), Sharon Mountain Rd., Sharon, Conn. 06069. Tel (203) 364-5661

Folklore Music (ASCAP), see Folklore Prod'ns
 Folklore Prod'ns Inc., 1671 Appian Way, Santa Monica, Calif. 90401. Tel (213) 451-0767. Pres. & Gen. Mgr.: Manuel Greenhill, Prof. Mgr.: Martha Seeger

Int'l reps.: Argentina (Melograf), Australia (Essex/Cromwell), Austria (Gloria), Rolf Budde in Germany), Benelux (Rolf Budde in Germany), Brazil (Mundo Musical), Central America (Mundo Musical in Costa Rica), Czechoslovakia (Supraphon), Finland (Sweden Music in Sweden), France (Claude Pascal), Germany (Rolf Budde), Greece (CBS), Iceland (Sweden Music in Sweden), Israel (CBS), Italy (G. Ricordi/Fama), Japan (Sun-kyo), Mexico (Mundo Musical), Portugal (RCA in Spain), Scandinavia (Sweden Music in Sweden), Spain (RCA), Switzerland (Flora), Rolf Budde in Germany), UK (Carlin)

Folkstone Music Publ'g Co. (BMI), c/o Lynn Beckman Music Ents., So. Branch Charge, Rt. 42, Arthur, W. Va. 26816. Tel (304) 749-7688. Pres.: I. Lynn Beckman, Gen. & Prof. Mgr.: Mary Virginia Beckman

Folkways Music Publ'rs Inc. (BMI), see TRO
 Folkworld Inc. (ASCAP), see Copyright Serv. Bureau
 Fontain (BMI), see Jasper
 Fontaine Music Corp. (ASCAP), see MCA Music

Fontaines (BMI), see Bug
 Foojoojoy Publ'g Co. (BMI), see R.A. Hodge & David Rubinson
 Foolish Child Music (ASCAP), see 20th Century
 Fool's Gold (ASCAP), see Segel & Goldman

Foo Music (ASCAP), see Skip Taylor
 Fore Most Music Co. (BMI), see Copyright Serv. Bureau
 Forest Bay Music (ASCAP), 703 Canham Rd., Santa Cruz, Calif. 95060. Tel (408) 438-0729

David Forest Music, see Crabshaw
 Formula Music Inc. (ASCAP), see Muscle Shoals & Copyright Serv. Bureau
 Forrest Hills Music Inc. (BMI), 25 Music Square E., Nashville, Tenn. 37203. Tel (615) 244-1060. Prof. Mgr.: Cecile Light, Sec'y-Treas.: Harold Bradley

Clinton H. Forsman Publ'g Co. (BMI), 210 E. Main, Robstown, Tex. 78380. Tel (512) 387-1615. Pres.: Clinton H. Forsman
 Fortel Music (ASCAP), see Copyright Serv. Bureau
 Fort Knox Music Co. (BMI), 1619 Broadway, New York, N.Y. 10019. Tel (212) 489-8170. Partners: Jerry Leiber, Mike Stoller, Freddy Bienstock
 Fortress Press (ASCAP), 2900 Queen Ln., Philadelphia, Pa. 19129. Tel (215) 848-6800
 Forty Tunes Music (BMI), see Yuggoth
 Fostico Music Press (ASCAP)—Ed. J. McKelvy—see Mark Foster
 Mark Foster Music Co. (ASCAP, BMI), PO Box 4012,

- Champaign, Ill. 61820. Tel: (217) 367-9932. Pres.: Dr. James McKelvy; Gen. Mgr.: Jane Menkhaus.
Branch: Urbana, Ill., 710 S. Goodwyn, Zip: 61801.
 Tel: (217) 367-3939.
- Foundation Music (BMI), see Martin Cohen.
 Four Aces Music Inc. (BMI), see Dwarf.
 Four-Eleven Music (ASCAP), see Chappell.
 Four Four (BMI), 811 Point San Pedro Rd., San Rafael, Calif. 94901. Tel: (415) 456-9694. Pres.: Grace Tindell.
 Four Grand Music Publ'rs (BMI) (div. of Jemki Ents. Inc.), PO Box 680460, Zip 33168; 1100 NE 125 St., Miami, Fla. 33161. Tel: (305) 891-0633.
 Four Knights Music (BMI), 6000 Sunset Blvd., Hollywood, Calif. 90028. Tel: (213) 461-3484. Pres. & Prof. Mgr.: Nesbert Hooper Jr.; Gen. Mgr.: Tom Hooper.
 Four Seasons Music (ASCAP), see Nashville Int'l.
 Four Star Int'l Inc., 400 S. Beverly Dr., Beverly Hills, Calif. 90212. Tel: (213) 277-7444. Pres.: David B. Charnay; VP Bus. Affairs & Treas.: Hervey Shaw; VP & Sec'y: Martha Arnold; VP Joseph J. Doyle.
 4-Star Music Inc., see Copyright Serv. Bureau.
 4 Star Sales (BMI), see Copyright Serv. Bureau.
 Four Tay Music (BMI), see Copyright Serv. Bureau.
 Fourtel Music Publ'g Co. (ASCAP), see Four Star.
 14th Floor Music (BMI), see 20th Century.
 Fourth Floor Music Inc. (ASCAP), 75 E. 55 St., Suite 404, New York, N.Y. 10022. Tel: (212) 751-9560.
 Fourth Landing Music (BMI), see Martin Cohen.
 Fourth Phase Music (BMI), PO Box 39171, Denver, Colo. 80239. Tel: (303) 373-1498. Pres.: Jermaine Hill.
Branch: Buffalo, N.Y., 241 N. Hampton, Suite 401.
 Zip: 14208.
 Wallace Fowler Publ'ns, see T.B. Harms—Vogue.
 Foxborough Jr. Music Inc. (ASCAP), see Mietus.
 Fox Fanfare Music Inc. (BMI), see 20th Century.
 Fox Music Publ'ns (ASCAP), see Fred Bock.
 Sam Fox Film Rights (ASCAP), see Sam Fox Publ'g.
 Sam Fox Publ'g Co. Inc. (ASCAP), 73-941 Hwy. 111, Suite 11, Palm Desert, Calif. 92260. Tel: (714) 568-4144.
 Pres.: Frederick Fox; VP & Gen. Mgr.: Harry Fox Jr.
Branch: Ft. Lauderdale, Fla., 170 NE 33 St. Zip: 33334.
 Tel: (305) 563-1844.
Int'l branch: England.
Int'l rep.: Worldwide (United Artists).
- Fred Foxx Music Co. (BMI), 406 Kehoe Ave., Half Moon Bay, Calif. 94019. Tel: (415) 726-3725. Pres. & Gen. Mgr.: F.H. Nesbitt Jr.; Prof. Mgr.: Vicki Nesbitt.
 Foxy Tunes (BMI), see Kool Kat.
 Fram-Dee Music Ltd. (ASCAP)—Pres.: Dee Anthony—see Beldock Levine & Hoffman & Rondor.
- Frاندoro Music Inc. (BMI), 8 Heather Dr., St. Louis, Mo. 63123. Tel: (314) 843-9142. Pres.: Frank Daniels; Prof. Mgr.: Shawn Daniels.
- Frank & Nancy Music Inc. (BMI), 812 19 Ave. S., Nashville, Tenn. 37203. Tel: (615) 327-2740. VP & Gen. Mgr.: Camille Shelton. (Administered by Hudson Bay).
Int'l firm represented: Carlin (UK).
Int'l rep.: UK (Carlin).
- Frascotti (BMI), 9255 Sunset Blvd., Suite 526, Los Angeles, Calif. 90069.
- Frebar Music Co. (BMI), 5514 Kelly Rd., Brentwood, Tenn. 37027. Tel: (615) 373-4086. Pres. & Gen. Mgr.: Fred Kelly; Prof. Mgr.: Barbara Kelly.
- Fredmel Music (BMI), see Mietus.
- Fredola Music Publ'g Co. (BMI), 7-11 E. Genesee St., Auburn, N.Y. 13021. Tel: (315) 253-5380. Owners: Frank Mucedola, Fred G. Mammoliti.
- Foster Frees Music (BMI), see Rondor.
- Freeway Music (BMI), see Beechwood.
- Carl French Music (ASCAP), see Carwin Country.
- French Market Music (BMI), 915 Louisa St., New Orleans, La. 70117. Tel: (504) 949-2911. Partners: Clive Wilson, Paige Van Vorst.
- French Music Ltd. (ASCAP), see Chappell.
- Friendly Finley Music (BMI), see Shelby Singleton.
- Frito Bandito Music (BMI), see PA Ents.
- Donnie Fritts Music (BMI), see Southern Writers.
- Frituna Music (ASCAP), see Publishers' Licensing Corp.
- Front Lawn Music (BMI), see April/Blackwood.
- Frontwheel Music (BMI), see Homefire.
- Frost Music Corp. (BMI), see Big Seven.
- Fruit Music (BMI), see Boxer.
- Fuente Music Co. (BMI), PO Box 1233, Santa Monica, Calif. 90406. Tel: (213) 822-9022. Owner: Bobby Manrique.
- Full House Inc., PO Box 931, Zip: 38101; 642 N. Second St., Memphis, Tenn. 38107. Pres.: William E. Taylor.
- Full House Music Co. (BMI), see Full House Inc.
- Fullness Music Co. (BMI), see April/Blackwood.
- Lowell Fulson Music (BMI), see ATV Music.
- Fu Manchu Music Ltd. (BMI), see Buttermilk Sky.
- Funk n' Roll Music (BMI), see Martin Cohen.
- Funky Acres Music Co., 145 W. 55 St., New York, N.Y. 10019. Tel: (212) 245-7179. Contacts: Warren Baker, Bob Krinsky.
Branch: Seattle, Wash., United Pacific Bldg., Suite 927.
 Zip: 98104. Tel: (206) 625-9548.
- Funky Flamenco Music (BMI), see Peter Tevis.
- Funky PO Music (ASCAP), see Martin Cohen.
- Funway Prod'ns (ASCAP), see Copyright Serv. Bureau.
- Richie Furay Music (BMI), see Segel & Goldman.
- Furz Music Co. (BMI), see Chappell.
- Future Music Inc. (ASCAP), see Vanguard.



G & C Music Corp. (ASCAP), see Chappell.
 G P Music Corp. (BMI), c/o PBR Music, 7033 Sunset Blvd., Suite 332, Los Angeles, Calif. 90028. Tel: (213) 462-0833. Pres.: Daniel J. Nenishkis; Gen. Mgr.: Patrick Boyle.
Home office: Japan.
Int'l firms represented: Seven Seas Music Co. Ltd., TV Asahi Music (Japan).
 G R S Music & Rec. Group (ASCAP), 416 E. Hugh St., Suite

22, Tampa, Fla. 33603. Tel: (813) 229-9495. Pres.: Russell Smith; Gen. Mgr.: Tony G. Soccio; Prof. Mgr.: Gregory A. Lewis.
Int'l branch: Canada.

G T P Music (BMI)—Pres: M.R. Slick—see Surf City.
 G W Jr. Music Inc. (ASCAP)—Pres.: Grover Washington Jr.—see Lloyd Zane Remick.
 G & W Publ'g (ASCAP), see Publishers' Licensing Corp.
 Gil Gad Music Publ'g Group Inc. (BMI)—Prof. Mgr.: C. King—see Eugene Gold.
 Gaff Music Inc. (BMI), 1245 N. Doheny Dr., Los Angeles, Calif. 90069.

Gailanley Music (BMI), see Copyright Serv. Bureau.

Gaither Music Co. Inc. (ASCAP), PO Box 300, Alexandria, Ind. 46001. Tel: (317) 724-4438. Pres.: William J. Gaither; Gen. Mgr.: Robert G. Huff; Mktg. Mgr.: Robert G. Rist. (Administered by Paragon Assocs.)

Galahad Music Inc. (BMI), see September.

Galamar Music Corp. (BMI), see Al Gallico.

Galanco Music (BMI), 726 Elgin Rd., Newtown Square, Pa. 19073. Tel: (215) 356-0245. Pres.: Ed E. Colletta; VP: Damian Douglas.

Galaxy Music Corp. (ASCAP), 2121 Broadway, New York, N.Y. 10023. Tel: (212) 874-2100.

Represented companies: American Musicological Society, Columbia University Press, SUNY Binghamton Eds., University of Washington Press.

Int'l firms represented: Augener Ed., Galliard, Stainer & Bell, Joseph Williams Ed., Yorke Ed. (UK), Delrieu, Les Eds. Ouvrieres (France).

Gallagher Music (ASCAP), see Doheny.

Gallatin Gateway Music (ASCAP), see Sounds Reasonable.

Galleon Music Inc. (ASCAP), see Al Gallico.

Gallery Square Publ'g Co. (BMI), 4524 283 St., Toledo, Ohio 43611. Tel: (419) 729-2908. Pres.: Phil Crary; Gen. & Prof. Mgr.: Don Malin; Ass't Mgr.: Mark Malin.

Al Gallico Music Corp. (BMI), 120 E. 56 St., New York, N.Y. 10022. Tel: (212) 355-5980. Pres.: Al Gallico; VP Admin.: Linda Landi.
Branches: Los Angeles, Calif., 6255 Sunset Blvd. Zip: 90028.
 Tel: (213) 462-2251—**Nashville, Tenn., 50 Music Square W. Zip: 37203.**
 Tel: (615) 327-2773. Gen. Mgr.: Dan Darst.
Int'l branch: England.

Sammy Gallop Music Co. (ASCAP), see 20th Century.

Gambol Music (ASCAP), see R.A. Hodge.

Gammont & Gurren Music (ASCAP), see E. J. Gurren.

Gandy Dancer Music (BMI), see Mainspring Watchworks.

Gangland Music Inc. (ASCAP), see Chappell & Stone-Rap.

Gang Music Publ'g Co. (BMI), see Mietus.

Garage Music (BMI), 297 E. Reed St., No. 3, San Jose, Calif. 95112. Tel: (408) 289-1897.

Garamoni Music Publ'g Co. (BMI), 676 N. La Salle St., Chicago, Ill. 60610. Tel: (312) 236-3632. Pres.: John Garamoni.

Garden Music Publ'g Co., 9000 Sunset Blvd., Los Angeles, Calif. 90069. Tel: (213) 274-0615.

Garrett Music Ents., 6255 Sunset Blvd., Suite 1019, Holly-

NEW YORK • LONDON • PARIS • SYDNEY • TOKYO • JOHANNESBURG

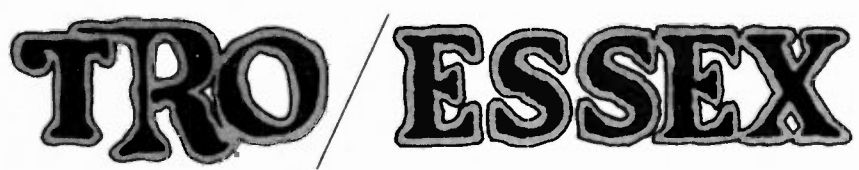

THE SYMBOL OF CREATIVE MUSIC PUBLISHING

COLOGNE • MILAN • AMSTERDAM • STOCKHOLM • BARCELONA • MEXICO CITY

- wood, Calif. 90028. Tel (213) 467-2181. Pres.: Snuff Garrett. VP: Stephen H. Dorff.
- Int'l reps.:** Argentina (Mundo Musical), Australia (Essex), Brazil (Mundo Musical), Germany (Global), France (Pathe Marconi), Italy (Curci), Japan (Pacific), Netherlands (EMI), Sweden (Sweden Music), UK (Campbell Connelly).
- Garson, Hilliard & Day Inc. (ASCAP). see Better-Half
- Gar-Tro Music (BMI), 5137 West Blvd., Los Angeles, Calif. 90043. Tel. (213) 296-4206. Pres.: Jean Wilbourn Carbo
- Gately Publ'g Co. (BMI), see Briarmead
- Gate Music Co. (ASCAP), see Sam Fox
- Gates (BMI), 1 Marine Midland Plaza, Suite 1531, Rochester, N.Y. 14604. Contact Chuck Mangione.
- Gator Music (SESAC)—Pres. Glen Ray—see Hallnote.
- Gatewick Music Co. (BMI), see Pavanne
- Gaucha Music (BMI), 161 W. 54 St., New York, N.Y. 10019. Tel. (212) 581-5398. Pres. Roy Rifkind, VP: Bill Spiralsky, Gen. Mgr. Julie Rifkind.
- Gaviota Music Inc. (BMI), see Manna
- Gazabo Music (ASCAP), see Falls City
- Gear Publ'g (ASCAP) (div. of Hideout Prod'ns), 567 Purdy, Birmingham, Mich. 48009. Tel. (313) 642-0910
- Geeray Music (ASCAP), see Segel & Goldman
- Gee Whiz Music Inc. (BMI), 1202 16 Ave. S., Nashville, Tenn. 37212. Tel. (615) 383-8014
- Gele Music Publ'g (BMI), see Brunswick
- Gello-Cheby Music (ASCAP), see April/Blackwood
- Gemigo Publ'g (BMI), see Curtom
- Gemini Press Inc., see Alexander Broude
- Gen Music Corp. (ASCAP), see Denton & Haskins
- Gemo Music Ltd. (ASCAP), see Rondor
- Gennelle Music Co. (BMI), Rt. 4, Box 986, Tifton, Ga. 31794. Tel. (912) 382-8192. Pres. Gus Statiras, Gen. Mgr.: Gennelle Statiras, Prof. Mgrs. Glen & Perry Statiras.
- Int'l rep.:** Japan (Sunkyo)
- General Music Publ'g Co. Inc. (ASCAP), PO Box 267, Hastings-on-Hudson, N.Y. 10706. Tel. (914) 693-9321. Pres. Gen. & Prof. Mgr. Paul Kapp
- Int'l reps.:** UK (Campbell Connelly, Chappell, Southern, Leeds)
- General Words & Music Co. (ASCAP), see Neil A. Kjos.
- Generic Music (ASCAP), see Copyright Serv. Bureau
- Gentle Wind Publ'g Co. (BMI), 1030 48 St., Sacramento, Calif. 95819. Tel. (916) 451-3400. Owner, Pres., & Prof. Mgr.: Charles M. Brandt, Gen. Mgr.: Edna A. Brandt.
- Gentoo Music Inc. (BMI), c/o Michael R. Shapiro, 315 S. Beverly Dr., Suite 210, Beverly Hills, Calif. 90212. Tel. (213) 553-1601.
- Gentry Publ'ns (ASCAP), see Fred Bob & Theodore Presser.
- Geoff & Eddie Music Co. Inc. (BMI), see MCA & April/Blackwood.
- Gerid Music Publ'g (BMI), see Copyright Serv. Bureau
- Geronimo Music (BMI)—Pres. & Prof. Mgr.: Jerry Chestnut, Gen. Mgr.: Billy Edd Wheeler—see Jerry Chestnut
- Gershwin Publ'g Corp. (ASCAP), see Chappell
- Ghost Creek Canyon Music, see Border Brigands
- Gigantic Publ'g (BMI), see Jonvis
- Gil Gilday Publ'g Co. (ASCAP), PO Box 600516, North Miami Beach, Fla. 33160. Tel. (305) 945-3738, 624-9014. Owner, Gen. & Prof. Mgr.: J. Gilday.
- Int'l firm represented:** Laurel (Canada)
- Gil Music Corp. (BMI), 1650 Broadway, New York, N.Y. 10019. Tel. (212) 245-0110
- Int'l branches:** Australia, Pincus-Gil Music Ltd., England, Ambassador Music Ltd. (SEE ADVERTISEMENT)
- Gimaro Publ'g Co. (ASCAP), see Andria
- Ginger Ale Music (BMI), see Nashville Int'l
- Gingham Music Co. (ASCAP), see Sugarplum
- Ginseng Music (ASCAP), see Sutton/Miller
- Giva Music (ASCAP), see Rondor
- Give Me A Break Music Co. (ASCAP), see The Entertainment Co.
- Glad Hamp Music Inc. (ASCAP), 1995 Broadway, New York, N.Y. 10023. Tel. (212) 787-1222. Contact: Bill Titone.
- Glad Music Co. (BMI), 3409 Brinkman, Houston, Tex. 77018. Tel. (713) 861-3630
- Gladys Music (ASCAP), see Chappell
- Glamorous Music Co. (BMI), see Helios Music & Copyright Serv. Bureau
- Gleam Music Inc. (ASCAP), see BRS Inc.
- Glen Brook Music Corp. (BMI), see Copyright Serv. Bureau
- Glen Helen Music (ASCAP), see R.A. Hodge
- Glenn (BMI), see MacArthur
- Glenn Regan Music Co. (BMI), see Terry
- Glenn To Glenn Publ'g (BMI), PO Box 1214, Hendersonville, Tenn. 37075
- Glenwood Music Corp. (ASCAP), see Beechwood & Screen Gems-EMI
- Global (ASCAP), Schillings Crossing Rd., Canaan, N.Y. 12029. Contact: Lyle K. Engel.
- Gloria Music (BMI), see Martin Cohen
- Gliott Publ'g Co. (BMI), 827 Thomas, Memphis, Tenn. 38107. Tel. (901) 525-0540. Pres.: William E. Glorie, Gen. Mgr.: Greg Oswald, Prof. Mgr.: Frances Light
- Glori Gospel Music (BMI), 246 Richmond Ave., Staten Island, N.Y. 10302. Bd. Chm.: Mel Herman, Pres.: Steven Herman
- Glorious Music Ltd., see Chappell
- G-Major Music Ltd. (BMI), see Alpha-Omega
- Gnosso Music (ASCAP), see Segel & Goldman
- Gnostic Music Co. (ASCAP), see Green Menu
- Goblet Music (BMI), see Chalice
- Gold Book Music Inc. (ASCAP), see Blue Book
- Gold Clef Music Publ'g Co. (BMI), PO Box 43, Chester, Pa. 19016. Tel. (302) 798-1048. Pres.: Alexander Czarenko
- Int'l rep.:** UK (Pedro)
- Gold Coast Music Publ'g Co., 8268 NE Miami Court, Miami, Fla. 33138. Tel. (305) 758-1800. Partner: Danny Poto
- Goldcrest Music Publ'g Co. (ASCAP), see Jondora—Delta RBE
- Gold Dust Music (BMI), see Jack Music
- Golden Age Music (BMI)—Pres.: Johnny Rivers, Gen. Mgr.: Celeste Geller—see Rivers Music
- Golden Bells Prod'ns (ASCAP), see Hayseed Publ'g
- Golden Boy (BMI), see Country Stream
- Golden Chain Music (BMI), see Tannen
- Golden Dawn Music (BMI), 26177 Kinyon Dr., Taylor, Mich. 48180. Tel. (313) 292-5281. Pres.: Peggy LaSorda
- Golden Fleece (BMI), c/o David J. Steinberg, 818 Widener Bldg., Philadelphia, Pa. 19107
- Golden Guitar Music Publ'g (BMI), PO Box 40602, Tucson, Ariz. 85717. Pres.: Jeff Johnson
- Golden Spread Music (ASCAP), see Segel & Goldman
- Golden Syrup Music (BMI), see Segel & Goldman
- Golden Tyrilm Music (BMI), see Copyright Serv. Bureau
- Golden Unlimited Music (BMI), see A. Schroeder
- Golden Valley (ASCAP), see Val-Dare
- Golden West Melodies Inc. (BMI), 5858 Sunset Blvd., Hollywood, Calif. 90028. Tel. (213) 462-7373. Pres.: Gene Autry
- Int'l reps.:** Worldwide excluding USA & Canada (Palace-Burlington), Canada (Sunbury-Dunbar)
- Eugene Gold Music (BMI), (div. of NMI Prod'ns Corp.), 516 W. 75 St., Kansas City, Mo. 64114. Tel. (816) 333-9617. Pres.: Eugene Gold, Gen. Mgr.: Gilbert Roland, Prof. Mgr.: Charles Smith
- Gold Forever Music (BMI), see April/Blackwood
- Goldfresh Music (BMI), 7033 Sunset Blvd., Suite 300, Los Angeles, Calif. 90028. Tel. (213) 462-0833. Pres.: David Gresham, Exec. VP & Mng. Dir.: Patrick Boyle
- Int'l firms represented:** Little Monster Music Ltd., Yackama Music Ltd. (both South Africa)
- Gold Hill Music Inc. (ASCAP), 5032 Lankershim Blvd., North Hollywood, Calif. 91601. Tel. (213) 766-7142. Pres.: Stephen Stills, Mng. Dir.: Ken Weiss, Creative Servs. Dir.: Malcolm J. Jones
- Int'l reps.:** Australia (April), Caribbean (Ivan Mogull), Central America (Ivan Mogull), France (Warner Bros.), Germany (Siegel), Israel (Ivan Mogull), Italy (Warner Bros.), Japan (Victor), Mexico (Ivan Mogull), Netherlands (Basart-Intersong), New Zealand (April), Spain (Armonico), South Africa (EMI Brigadiers), South America (Ivan Mogull), UK (Warner Bros.)
- Gold Horizon (BMI), see Screen-Gems-EMI
- Goldlocks Music Co. (BMI), see DePatie-Freleng
- Goldline Music Inc. (ASCAP), see Silverline
- Manny Gold Music Publ'g (ASCAP), 895 McDonald Ave., Brooklyn, N.Y. 11218. Tel. (212) 435-1910. Pres.: Gen. & Prof. Mgr.: Manny Gold
- Goldmont Publ'g Co. (BMI), 24 Music Square E., Nashville, Tenn. 37203. Tel. (615) 254-3725. Contacts: J. William & Betty McInturff, Frank X. Finke
- Bobby Goldsboro Music Inc. (ASCAP), see House of Gold
- Michael H. Goldsen Inc. (ASCAP), see Criterion
- Gold Sovereign Music (BMI), see Fred Ahlert
- Gold Steak Music (BMI), see Main Stage
- Gold Teak Music Co. (BMI), see Respect
- Golo Publ'g Co. (BMI), see Chappell
- Go Mental Music (BMI), see Bug
- Good Child Music (BMI), see Copyright Serv. Bureau
- Good Flavor Songs Inc. (ASCAP), see Buttermilk Sky
- Good Gratin Music (ASCAP), see Ice Nine
- Good High Inc. (ASCAP), c/o Gelfand, Breslauer, Rennert & Feldman, 1800 Century Park E., Suite 900, Los Angeles, Calif. 90067
- Good, Hot & Fresh Music (ASCAP), see Natural Groove
- Goodman Group, 110 E. 59 St., New York, N.Y. 10022. Tel. (212) 751-7300. Gen. Mgr.: Buddy Robbins.
- Good Music Co. (ASCAP), see Aunt Polly's
- Good Night Kiss Music (BMI)—Pres.: Janet Fisher—see Border Star
- Goodpay Music Co. (BMI), see Mietus
- Good Sam Music (BMI), see Rondor
- Good Sphere Songs (ASCAP), see Hilaria
- Google Music Inc. (ASCAP), 7800 Woodman Ave., No. 15A, Panorama City, Calif. 91402. Tel. (213) 786-3324. Pres.: Jeffrey Wheat, Gen. & Prof. Mgr.: Bob O'Brien
- Branch:** Pittsford, N.Y., 1265 Calkins Rd., Zip 14534. Tel. (716) 334-1700. Gen. Mgr.: Randy Wheat
- Goombay Music (ASCAP), see Copyright Serv. Bureau (US rights)
- Goosepimple Music (BMI), RD 4, Myerstown, Pa. 17067. Tel. (717) 866-5067. Owner: Jean Shade, Mgr.: Al Shade
- Gopam Ent's Inc. (BMI), 11 Riverside Dr., No. 13C-W, New York, N.Y. 10023. Tel. (212) 724-6120. Pres.: John Levy, Mng. Dir.: Laurie Goldstein
- Int'l reps.:** Australia (Jewel), Austria (Melodie der Welt in Germany), Bulgaria (Melodie der Welt in Germany), Czechoslovakia (Melodie der Welt in Germany), France & Monaco (Caravelle), Germany (Melodie der Welt), Hungary (Melodie der Welt in Germany), Italy (Suvini Zerboni), Japan (Shinko), Poland (Melodie der Welt in Germany), Portugal (Quiroga in Spain), South Africa (Laetrec), Spain (Quiroga), Switzerland (Melodie der Welt in Germany), UK (Keith Prowse), USSR (Melodie der Welt in Germany), Yugoslavia (Melodie der Welt in Germany)
- Gordon Music Co. Inc. (ASCAP), 2680 Cherokee Way, Palm Spngs, Calif. 92262. Tel. (714) 328-5312. Pres.: David M. Gordon, Gen. & Prof. Mgr.: Jeff Gordon.
- Int'l reps.:** Australia, France, Germany, Netherlands (all TRO), Italy (Curci, TRO), UK (EMI, TRO)
- David Gorstn (BMI), see Sam Fox
- Gospel Birds Inc. (BMI), 250 W. 57 St., New York, N.Y. 10019. Tel. (212) 765-0540. Pres.: Vicki Wickham, Gen. Mgr.: Ina Meibach
- Gospel Clef Publ'g Co. (BMI), 279 Buffalo Ave., Brooklyn, N.Y. 11213. Tel. (212) 773-5910
- Gospel Int'l Publ'ns (BMI), see Eliebe
- Gospel Message Music Co. (SESAC), see Full House
- Morton Gould Catalog (ASCAP), see G. Schirmer
- Goutris Music, see Kidada
- Goydish Music & Publ'g Co. (BMI), 331 Triangle Rd., Somerville, N.J. 08876. Tel. (201) 359-5520
- Graceland Music Corp., PO Box 1318, Texarkana, Tex. 75501. Tel. (214) 793-0956. Pres.: Glen Martin
- Graduation Music Inc. (ASCAP), 212 N. Kingshighway, St. Louis, Mo. 63108. Tel. (314) 361-4400. Pres.: Julian H. Miller II, Gen. Mgr.: Lynn Schweizer
- Graffiti Music Publ'g Co. (BMI), see Coco
- Roger Graham Music Publ'g (ASCAP), see Athon Music
- Grajonca (BMI), c/o Bill Graham Presents, 201 11 St., San Francisco, Calif. 94103. Tel. (415) 864-0815
- Gramophone Music Co. (ASCAP), see Hall of Fame
- Grand Artists Music (BMI) (div. of Paul Stevens Assocs. Inc.), 1033 Coral Way, Coral Gables, Fla. 33134. Tel. (305) 442-1635. Pres. & Prof. Mgr.: Paul Stevens, Gen. Mgr.: Jeannine Stevens
- Grand Commander Music Inc. (BMI), see Chappell
- Grand Concourse (ASCAP), see Segel & Goldman
- Grand Prize Music (BMI), see Crazy Cajun
- Granite Music Corp. (ASCAP), see Criterion
- Granny White Publ'g Co. (BMI), 428 Riverwood, De Soto, Tex. 75115. Tel. (214) 223-8999
- Gratitude Music (ASCAP), see Argonaut Music Group
- Gravenhurst Music (BMI), 105 Park Ln., Beaver Falls, Pa. 15010. Tel. (412) 843-2431. Pres.: Jerry Reed, Prof. Mgr.: Roz Miller
- Branch:** New Brighton, Pa., 1469 Third Ave., Zip 15066. Tel. (412) 847-0111
- Gravy Publ'g Co. (BMI) (div. of Cookhouse Prod'ns), 2541 Nicollet Ave. S., Minneapolis, Minn. 55404. Tel. (612) 827-5441
- Grawick Music Publ'g (BMI), see James Hendrix Ents
- Greasy King Music Inc. (ASCAP), PO Box 9245, Berkeley, Calif. 94709. Tel. (415) 526-8005. Pres.: John Fogerty
- Greasy Shift Music (BMI), see Bug
- Great American Music Machine Inc. (ASCAP), 1130 W. Evans, Denver, Colo. 80223. Tel. (303) 922-3668
- Great Auk Music (ASCAP), 6 University Mews, Philadelphia, Pa. 19104. Tel. (215) 471-8003. Owner & Pres.: Julian Winston
- Great Honesty Music Inc. (BMI), Box 547, Larkspur, Calif. 94939. Tel. (415) 924-8778. Pres.: Erik Jacobsen
- Great Leewood Music Inc. (ASCAP), 336 S. Cumberland, Lebanon, Tenn. 37087. Tel. (615) 444-3753, 3865. Pres.: Chester E. Johnson, Gen. & Prof. Mgr.: Orlene Johnson
- Branch:** Leewood, Kan., 3012 W. 84 Pl., Zip 66206. Tel. (913) 381-8165. Branch Mgr.: Irene Dierks
- Great Legend Music (BMI), Box 448, Rt. 2, Hendersonville, Tenn. 37075. Tel. (615) 824-7011. Owners: Hank & Jeannie Seely Cochran. **Local branch:** 903-C 18 Ave., Nashville 37212
- Al Green (BMI), 3208 Winchester Rd., Memphis, Tenn. 38118
- Green Apple Music Co. (BMI), 9229 Sunset Blvd., Suite 811, Los Angeles, Calif. 90069. Tel. (213) 657-6752
- Int'l rep.:** UK (Carlin)
- Greenbar Music Corp. (ASCAP), 7235 Hollywood Blvd., Los Angeles, Calif. 90046. Tel. (213) 874-4275. Pres.: Ben Barton
- Green Door Music (BMI), PO Box 9470, Fort Worth, Tex. 76107. Tel. (817) 923-1111. Pres. & Gen. Mgr.: Marvin Moore
- Greene Music Inc. (ASCAP), see Copyright Serv. Bureau
- Greene Pastures Music (BMI), 1022-15 Ave. S., Nashville, Tenn. 37212. Tel. (615) 255-3500. Partners: Lucinda Greene, Ann Stuckey
- Greene-Stone Music (BMI), see Copyright Serv. Bureau
- Green Menu Music Co. (ASCAP), (div. of Green Menu Music Factory Inc.), 50 W. 57 St., New York, N.Y. 10019. Tel. (212) 489-0859/0806. Pres.: Henry Jerome, Ass't to Pres.: Donald Castaldi, VPs: Edward Remusat, Wallace Barneke, Prof. Mgr.: Bob Blume
- Green Mountain Music Corp. (BMI), 747 Pontiac Ave., Cranston, R.I. 02910. Tel. (401) 781-0554. Co-Pres.: Stuart Wiener, Mike Lewis
- Green-Up Music (BMI), see Bo-Gal
- Grenoble Songs (BMI), Box 222, Groveport, Ohio 43125. Tel. (614) 837-7506. Gen. Mgr.: Ed Graham
- Ray Griff Ents. (ASCAP), PO Box 15203, Nashville, Tenn. 37215. Tel. (615) 327-2197. Pres.: Ray Griff, Ass't: Larry D. Hughes
- Grimes Creek Music (ASCAP)—Gen. Mgr.: William H. Schubart—see Other
- Grimora Publ'g (ASCAP), see April/Blackwood
- Grob Music Co. (ASCAP), see Chappell
- Groovesville Music (BMI), 15855 Wyoming Ave., Detroit, Mich. 48238. Tel. (313) 861-2363. Publ'g Dir.: Brian A. Spears
- Gross Den Ren Music (BMI), see Kicking Mule
- Grosvenor House Music (ASCAP), PO Box 1563, Hollywood, Calif. 90028. Tel. (213) 467-7644. Pres. & Prof. Mgr.: Arthur H. Benson, Gen. & Prof. Mgr.: Hy Seaman (Administered by Attrax)
- Groundhog Publ'g (ASCAP), 254 E. 29 St., Los Angeles, Calif. 90011. Tel. (213) 748-6074. Owner: Jerry Hooks
- Ground Round Music (BMI), see R.A. Hodge
- Grovemusic (ASCAP), see Farr
- Growl Music (BMI), see LF Music
- Guard Music (BMI), see De Gar
- Gudi Music (BMI), 157 W. 57 St., New York, N.Y. 10019. Tel. (212) 582-6135. Pres.: John Shoup, Gen. Mgr.: Mark Cosmedy (Administered by Music Music Music)
- Branch:** Chicago, Ill., 205 W. Wacker Dr., Zip 60606. Tel. (312) 368-0032
- Guerilla Music Inc. (BMI), see Segel & Goldman
- Frank Guida Publ'g Co. (BMI), see Rockmasters
- Guitar Player Books/Recs. (div. of Guitar Player Magazine), PO Box 615, Saratoga, Calif. 95070. Tel. (408) 446-1105
- Gullah Music Co. (ASCAP), PO Box 10, Talking Rock, Ga. 30175. Tel. (404) 337-2201. Pres.: Curtis L. Smith
- Branch:** Hilton Head Island, S.C., 97 Flicking Pl., Zip 29928. Tel. (803) 785-4432. Gen. & Prof. Mgr.: Mike Taylor
- E. J. Gurren Music (ASCAP), 3929 Kentucky Dr., Los Angeles, Calif. 90068. Tel. (213) 980-7501. Pres.: Eddie Gurren, Gen. Mgr.: Barnett Williams, Prof. Mgr.: Gloria-anna Monroe (Administered by April/Blackwood)
- Gusman Co. (BMI), 1216 E. Broad St., Savannah, Ga. 31401. Tel. (912) 236-6733. Pres.: Waymon A. Jones
- Guthel (Ed.) (ASCAP), see Boosey & Hawkes
- Gwong Songs (BMI), see Copyright Serv. Bureau
- Gypsy Family (BMI), c/o Ronald Geslin, 7311 Dogwood, Excelsior, Minn. 55331
- Gyrus Music Corp. (ASCAP), see Big Seven



H E Music Inc (ASCAP), see Riva
 Hael Music Co (ASCAP), see Chappell
 Merle Haggard Music Inc (BMI)—Pres. Merle Haggard, Gen & Prof. Mgr. Glenn Martin—see Shade Tree
 Hairtrigger Music (BMI), 2206 Belmont Blvd., Nashville, Tenn. 37212 Tel. (615) 383-6649 Prof. Mgr. Ms. Micki Foster
 Hal Bernard Ents. Inc. PO Box 6507, 2181 Victory Pkwy., Cincinnati, Ohio 45206 Tel. (513) 861-1500 Pres. Stan Hertzman
 Half & Half Music (BMI), see Mietus
 Half-Owned Music (ASCAP), see Sea Three
 Halkey Music Co (BMI), see Mietus
 Albert Hall Music (BMI) (div. of Gilmore Prod. Inc.), 11595 Kelsey St., Studio City, Calif. 91604 Tel. (213) 761-3625
 Hall-Clement Publ'ns (BMI), see T. B. Harms
 John Hall Music (SESAC), PO Box 18344, Fort Worth, Tex. 76118 Tel. (817) 281-6605 Pres. John Hall, Sec'y-Treas. Theta Hall
 Hallnote Music Co (BMI), PO Box 40209, Nashville, Tenn. 37204 Tel. (615) 373-5221 Pres. Tom T. Hall, Gen. Opns. Mgr. Judi Simmons
 Hall of Fame Music Co (BMI), PO Box 921, Beverly Hills, Calif. 90213 Tel. (213) 276-2726 Pres. Oliver Berliner
Int'l firms represented: Brambila (Mexico), Hncs. Marquez (Mexico), Musicabana (Cuba)
 Rick Hall Music (ASCAP), see Fame
 Halnat Publ'g Co (ASCAP), PO Box 37156, Cincinnati, Ohio 45222 Tel. (513) 793-6075 Pres. Saul Halper, VP Steve Halper, Gen. Mgr. Fred A. Halper
Int'l reps.: Australia (J. Albert & Sons), Brazil (Itaipu), France (Caravelle), Japan (Toshiba-EMI), UK (EMI)
 Halseon Music Inc (ASCAP), see Mietus
 Halsey Music Inc (ASCAP), see Mietus
 Halwill Music (ASCAP), see Harlem
 Hamblen Music (ASCAP), see Paragon Assocs.
 Hamman Publ'g Inc (BMI), 122 N. Kirkman Rd., Orlando, Fla. 32811 Publ'g (305) 295-5079 Pres. Glenn Hamman Jr.
 Hammer & Nails Music (ASCAP), see Rondor
 Hampshire House Publ'g Corp (ASCAP), see TRO
 Hampstead Heath Music Publ'rs (ASCAP), PO Box 223, Sky Forest, Calif. 92385 Tel. (714) 337-2802 Pres. Charls Senter
 Hancock Music (BMI), see David Rubinson
 Hankbee Music Co (BMI)—Gen. & Prof. Mgr. Henry Boye—see Joli
 Hankeychp Music Publ'rs (ASCAP), see Derby
 Hank s Music Inc (BMI), see Chappell
 Hanover Music Corp (ASCAP), PO Box 6296, Beverly Hills, Calif. 90212 Pres. Paul Weston, VP Chester A. Kinzelberg, Sec'y-Treas. Marvin Freedman
 Charles H. Hansen Music Inc (ASCAP), see Copyright Serv. Bureau

Hanzell Music (BMI), see Copyright Serv. Bureau
 Happenstance Music (BMI), see Martin Cohen
 Happy Birthday Music (BMI), see Martin Cohen
 Happy Day Music Co (BMI), see Joe Keene
 Happy Tuesday Music (ASCAP), see Garrett
 Harbot Music (SESAC), 2 Music Circle S., Nashville, Tenn. 37203 Owner Joe Talbot
 Harden-Bradford Music (BMI), see April Blackwood
 Hardhit Music (BMI), PO Box 12722, Nashville, Tenn. 37212 Tel. (615) 259-3625 NYC (212) 242-1664 Mgr. Mort Cooperman
 T. M. Hardin, see Copyright Serv. Bureau
 Hargail Music Press (ASCAP), 28 W. 38 St., New York, N. Y. 10018 Tel. (212) 245-7246
 Harlem Music (BMI), 355 Harlem Rd., Buffalo, N. Y. 14224 Tel. (716) 826-9560 WATS (800) 828-7041 TWX (710) 522-1249 Pres. Leonard Silver, Gen. Mgr. David Parker, Publ'g Admin. Mgr. Lynn Boehringer
 Harlene Music Publ'ns (ASCAP), see Dijon & April/Blackwood
 Harmonia Ed (ASCAP), see C. F. Peters
 Harmony Hill Music Publ'g Co (ASCAP), see Nashville Copyright
 T. B. Harms Co (ASCAP), 100 Wilshire Blvd., Suite 700, Santa Monica, Calif. 90401 Tel. (213) 871-0911 Pres. Lawrence Welk, Exec. VP & Gen. Mgr. Dean Kay, VP Prof. Activities Roger Sovine
Branches: Hollywood, Calif., 6255 Sunset Blvd. Zip 90028 Tel. (213) 467-3197 Div. Mgr. Gaylon Horton—New York, N. Y., 200 W. 57 St., Suite 807 Zip 10019 Tel. (212) 581-3197 East Coast Div. Mgr. Joseph Abend—Nashville, Tenn., PO Box 1026, 11 Music Circle S. Zip 37202 Tel. (615) 256-7648 Nashville Div. Mgr. Bill Hall (SEE ADVERTISEMENT)
 Harpath Music Co (ASCAP), see Amestoy
 Harral Music (ASCAP), see Amestoy
 Harrick Music Inc (BMI), PO Box 1780, Hialeah, Fla. 33011 Tel. (305) 888-1685 x 54 Pres. Harry Wayne Casey, Gen. Mgr. Sherry Smith
 Charles K. Harris Music Publ'g Co. Inc. (ASCAP), see Peer-Southern
 Harrison Music Corp (ASCAP), 6381 Hollywood Blvd., Hollywood, Calif. 90028 Tel. (213) 466-3834 Pres. Hannah Russell, Gen. Mgr. Molly Hyman, Prof. Mgr. Jeffrey Spirit
 Hartford Music Co (SESAC), see Albert E. Brumley
 Hartline Music Inc (BMI), 1901 Ave. of the Stars, Suite 305, Los Angeles, Calif. 90067 Tel. (213) 552-2124 Pres. Freddie Hart, Gen. Mgr. Peter S. Brown
 Harvard Music Inc (BMI), see Ivan Mogull
 Harwin Music Corp (ASCAP), see Edwin H. Morris
 William Haskins Music Co. Inc. (ASCAP), see Denton & Haskins
 Hat Band Music (BMI), Sound Seventy Suite, 210 25 Ave. N., Nashville, Tenn. 37203
 Hatfield Music (BMI), see Martin Cohen
 Havana Moon Music (BMI), see Kentucky Colonel
 Hav-A-Tune Inc., see T. B. Harms—Bibo
 Havenhurst Music (ASCAP), see Amestoy

Hawaii Music Co. Inc. (BMI), see MCA
 Hawkes & Sons (ASCAP), see Boosey & Hawkes
 Walter Hawkins Music (BMI), see Lexicon
 Hayako Music (ASCAP), see Martin Cohen
 Hayseed Publ'g (BMI), PO Box 1528, Shreveport, La. 71165 Tel. (318) 742-7803 Pres. & Prof. Mgr. David Kent (Administered by Welbeck)
 Lee Hazelwood Music Publ'g, see Criterion
 Haze Prod'ns, PO Box 1802, Hollywood, Calif. 90028
 Hazy Day Music (ASCAP), see Chappell
 Headlight Music (BMI), see April/Blackwood
 Head Music (BMI), see Copyright Serv. Bureau
 Head Publ'g Co (BMI), see Mietus
 Headquarters of Entertainment & Music (BMI), see Martin Cohen
 Heart Warming Music Co (BMI), see John T. Benson
 Heath-Levy Music Co. Inc. (ASCAP), see MCA & April/Blackwood
 Heavy Gravity Music, see Fourth Floor
 Heavy Jam'n Music (ASCAP), PO Box 4740, Nashville, Tenn. 37216 Tel. (615) 361-5356 Pres. Wade Curtiss
 Heavy Metal Music, see Fourth Floor
 Heavy Music Inc (BMI), 1286 Lawrence Station Rd., Sunnyvale, Calif. 94086 Tel. (408) 734-2910 Telex (910) 339-9201 VP, Bus. Affairs Jim Levy
Int'l reps.: Australia (Chappell), Brazil (Nova), New Zealand (Chappell in Australia), Scandinavia (Air in Sweden) UK (Intersong)
 Heldon Music Inc (ASCAP), see Don Costa
 Helicon Music Corp (BMI), see European American
 Helios (Ed.) (BMI)—Ed. Halsey Stevens—see Mark Foster
 Helios Music Corp (BMI), 1619 Broadway, Suite 603A, New York, N. Y. 10019 Tel. (212) 581-0280 Pres. Claus Ogerman (Mechanical rights administered by Copyright Serv. Bureau Ltd.)
Int'l firm represented: Ebony (Germany)
Int'l rep.: Germany (Ebony)
 Hello Darlin' (SESAC), see Twitty Bird
 Hello There! Music Inc. (ASCAP), see Fred Ahlert
 Hemlane Music Co (ASCAP), see Cherry Lane
 Hemphill Music Co (BMI), see John T. Benson
 Hena! Music (ASCAP), see Copyright Serv. Bureau
 Hendon Music Inc (BMI), see Boosey & Hawkes & Lyra
 James Hendrix Ents. (BMI), PO Box 90639, 902 42 Ave. N., Nashville, Tenn. 37209 Tel. (615) 297-4174 Pres. & Dir. James Hendrix
 Henmar Press (ASCAP), see C. F. Peters
 Heno Publ'g Co (BMI), 8959 S. Oglesby Ave., Chicago, Ill. 60617 Tel. (312) 375-4276 Pres. Oscar Jackson, VP Armond Jackson
 The Herald Ass'n Inc. PO Drawer 218, Wellman Heights, Johnsonville, S. C. 29555 Tel. (803) 386-2600 Pres. & Gen. Mgr. Erv Lewis, Prof. Mgr. Frances B. Lewis
 Heraldic Music (ASCAP), see Herald Ass'n
 Herald Square Music Co (ASCAP), see Hudson Bay
 Herford Music (ASCAP), see Brim
 Heritage Music Press (ASCAP), see Lorenz Inds
 Heritage Music Publ'ns Inc. (SESAC), see Ashley

Interworld
 Music
 Group 

MICHAEL STEWART
 PRESIDENT

NEW WORLD HEADQUARTERS (EFFECTIVE SEPTEMBER 1, 1979)

8304 BEVERLY BLVD. LOS ANGELES, CA 90048 (213) 852-9130 TELEX: 674999 CABLE: INMUSIC

Herman Music Inc. (ASCAP), see Fiesta
 Hexachord Music Ltd. (BMI), see Alexander Broude
 Hibiscus Music Co., see Martin Cohen
 Hickory Hollow Music (BMI), PO Box 23375, Nashville, Tenn. 37202. Pres. Benny Williams
 Hi-Cue Prod'ns (ASCAP), see Irving Mills
 Hierophant Inc. (BMI), see Organic Mgmt.
 Highball Music (BMI), PO Box 40484, Nashville, Tenn. 37204. Tel. (615) 383-6564
 High Class Music Publ'g Ltd. (BMI), see Chappell
 High Class Publ'g (ASCAP), see Segel & Goldman
 Highgate Press (BMI), see Galaxy
 High Seas (BMI), 17175 Ventura Blvd., Encino, Calif. 91318
 Hightree (BMI), c/o Renaissance Mgmt., 433 N. Camden Dr., Suite 950, Beverly Hills, Calif. 90210
 High Wave Music (ASCAP)—Pres. Gary Wright—see Bel-dock Levine & Hoffman
 Highway Publ'g (BMI), see Copyright Serv. Bureau
 Hilaria Music Inc. (ASCAP), 520 University Ave., No. 125, Madison, Wis. 53703. Tel. (608) 251-2644, 255-7875. Pres. Ken Adamany, Gen. & Prof. Mgr. Jeffrey Messenger
 Hillbrow Music Inc. (ASCAP), see Ember Ents.
 Hillgreen Music (BMI), see Folklore
 Hill & Range Songs Inc. (BMI), see Chappell
 Z. Z. Hill Music (BMI), see April/Blackwood
 Hilmer Music (BMI), see Rondor
 Hilmer Publ'g Co. Inc. (ASCAP), c/o Michael Rosenfeld, 270 N. Canon Dr., Beverly Hills, Calif. 90210. Tel. (213) 278-6624. Pres. Nils Lofgren, Gen. Mgr. Arthur Linton, Prof. Mgr. Michael Rosenfeld
 Hindsight Music (ASCAP), see Chappell
 Hinrichsen Ed. (BMI), see C.F. Peters
 Hipolit Music (ASCAP), see Memnon
 His Eye Music (SESAC), see Sparrow Recs.
 HitKit Music (BMI), PO Box 24235, Nashville, Tenn. 37202. Tel. (615) 385-0900. Pres. David N. Gib
 The Hit Machine Music Co. (BMI) (div. of Diversified Mgmt. Group), PO Box 20692, San Diego, Calif. 92120. Tel. (714) 277-3141. Pres. Marty Kuritz, VP. David Sanchez
 Hitmakers (ASCAP), see Bonton
 Hiward Music Co. (ASCAP), see Chappell
 Hobbittion Ents. Inc., (ASCAP) see 20th Century
 Hobby Horse Music (BMI), see Garrett
 R. A. Hodge, c/o Gordon & Hodge, 544 Pacific Ave., San Francisco, Calif. 94133. Tel. (415) 391-4550
 Hodge Music (BMI), see Berkeley Cooperative
 Ivan Hoffman, 2040 Ave. of the Stars, Los Angeles, Calif. 90067. Tel. (213) 556-2804
 Holland-Dozier-Holland Music (ASCAP), see April/Blackwood
 Hollis Music Inc. (BMI), see TRO
 Hollytree Music (BMI), 48 Music Square E., Nashville, Tenn. 37203. Tel. (615) 244-7300. Pres. Sherry Sanders
 Hollyville Music (SESAC), see Manna
 Hollywood Songs (ASCAP), see Sam Fox
 Eddie Holman Inc. (BMI), 905 Robinson Bldg., 42 S. 15 St., Philadelphia, Pa. 19102. Tel. (215) 564-6050. Pres. Eddie Holman, Gen. & Prof. Mgr. Harold Rosenthal
 Homelife Music (BMI), 2049 Century Park E., Los Angeles, Calif. 90067. Cable PHOENREC. Chm. & Pres. David Chackler, Pres. Music Publ'g Leonard Hodes, Ass't to Pres. Music Publ'g Jai Jai Jackson
 Home Grown Music (BMI), see April/Blackwood
 Home Is Where The Heart Is Music (ASCAP), see Martin Cohen
 Home-Made Music Co. Inc. (BMI), see Stone-Rap
 Homer & Jethro Publ'g (BMI), see Copyright Serv. Bureau
 Homewood Music Co. (ASCAP), 80-08 35 Ave., Jackson Heights, N.Y. 11372. Tel. (212) 651-8213. Pres. Sidney Prosen, Music Coord. Stan Free
Branch: Goodlettsville, Tenn., 847 Springfield Hwy. Zip 37202. Tel. (615) 859-2820
 Homewood House (BMI), 9465 Wilshire Blvd., Beverly Hills, Calif. 90212. Tel. (213) 550-1010
 Charles W. Homeyer & Co. (ASCAP), see Carl Fischer
 Honeycomb Music, see T.B. Harms—Bibo
 Honeytree Music Inc. (ASCAP), see Baray
 Honiton Music (BMI), see Arnakata
 Honky Tonk Music (BMI), see Chappell
 Hoochie Coochie Music (BMI)—Dir. Jean M. Cameron—see Cameron
 Hoolie Music Co. (ASCAP), see Tradition
 Hooperman Music (BMI), see Creative World
 Hooster Hill Publ'g (BMI), 1309 Celesta Way, Sellersburg, Ind. 47172. Tel. (812) 246-2959. Owner & Mgr.: Buddy Powell
 Hope Publ'g Co. (ASCAP), 380 S. Main Pl., Carol Stream, Ill. 60187. Tel. (312) 665-3200
 Hornsby Music Co. (BMI), PO Box 13661, Houston, Tex. 77019. A&R Rep. Ezzard Topps, Promo. J.D. Horn
 Horse Creek Music, see T.B. Harms—Vogue
 Horseshoe Canyon Music (ASCAP), see Don Williams
 Horttor Music Co. (BMI), 313 El Tejon Ave., Oildale, Bakersfield, Calif. 93308. Tel. (805) 399-9028. Owner Robert L. Horttor
 Hot City Super Songs, see Artref
 Hot Damn Song Co. (ASCAP), see Skip Taylor
 Hot Rock Music (BMI), see Landers-Roberts
 Hourglass Music (ASCAP), see Publishers' Licensing Corp.
 House of Bryant Publ'ns (BMI), PO Box 120608, Nashville, Tenn. 37212. Tel. (615) 385-3245. Gen. Mgr. Nona Thomas
Int'l reps.: Australia (Chappell), Austria, Germany & Switzerland (Rudolf Slezak in Germany), Scandinavia (Safir Music in Sweden), UK (Showcase)
 House of Cash Inc. (BMI), PO Box 508, Hendersonville, Tenn. 37075. Tel. (615) 824-5110. Co-Pres. John R. & June Carter Cash. (Administered by Clay Music)
 House of David (BMI), see Songs of David
 House of Diamonds (BMI), PO Box 449, Cleburne, Tex. 76031. Owner Jan Diamond
 House of Dreams Music (BMI), see Rondor
 House of Gold Music Inc. (BMI), PO Box 50338, Belle Meade Sta., Nashville, Tenn. 37205. Tel. (615) 383-4667. Pres. Bobby Goldsboro. Exec. VP. Bob Montgomery. Prof. Mgr. Jeff Silbar, Promo. & Pub. Dir. Linda McCoy

House of Hi Ho (BMI), PO Box 8135, Chicago, Ill. 60680. Tel. (312) 254-5612, 787-8220. Exec. VP. R.C. Hillsman
 House Of Knox (ASCAP), 41418 50 St. W., Quartz Hill, Calif. 93534. Owner Robert B. Knox
 House of Living (ASCAP), see Chappell
 House Of Melton (ASCAP), see Focal Point
 House of Rock Music (BMI), 958 W. Edgemont Dr., San Bernardino, Calif. 92405. Tel. (714) 882-6796. Owners Bill & Myral Bellman, Gen. & Prof. Mgr. Bill Bellman
 House of Talley (BMI), see Birthright
 House of Weiss Music Co. (ASCAP), see 20th Century
 Howard Beach Music Inc. (ASCAP), see Sanga
 Harlan Howard Songs, see Tree
 David Hubert & Assocs., 541 Continental Court Bldg., 201 N. Orange Grove Blvd., Pasadena 91103. Tel. (213) 796-9693. Contact David Hubert. (SEE ADVERTISE-MENT)
 Hubris Music (ASCAP), see David Hubert
 Hudmar Publ'g Co. (ASCAP), 24157 Lupin Hill Rd., Hidden Hills, Calif.
 Hudson Bay Music Co. (BMI), 1619 Broadway, New York, N.Y. 10019. Tel. (212) 489-8170. Partners: Freddy Bienstock, Jerry Lieber, Mike Stoller
 Huffman Publ'g Co. (BMI)—Pres. Joe Huffman, Gen. Mgr. Erv Lewis, Prof. Mgr. Frances B. Lewis—see Herald Assn. & Township Group
 Huh Music (BMI), see Placid
 Hungry Mountain Music Inc. (BMI), see House of Gold
 R. L. Huntzinger Inc. (SESAC), see Willis
 Hurdy Gurdy (BMI), see Counterpart
 Hustlers Inc. (BMI), 602 Southern Trust Bldg., Macon, Ga. 31201. Tel. (912) 745-5391

I

Ice Age Music (ASCAP), see Segel & Goldman
 Ice Man Music Corp. (BMI), see Chappell
 Ice Music (ASCAP), see Martin Cohen
 Ice Nine Publ'g Co. Inc. (ASCAP), PO Box 1073, San Rafael, Calif. 94901. Tel. (415) 457-6300. Pres. Robert Hunter, Gen. Mgr. Alan Trist
Int'l rep.: Worldwide except USA & Canada (Warner Bros.)
 Ichabod Music Co. (BMI), see Worthy
 Idress-Brown-Tibbles (ASCAP), see Dolly Bee
 Iffin Music Publ'g Co. (BMI), 34 Music Square E., Nashville, Tenn. 37203. Tel. (615) 254-0825. Pres. Heath Webb, Gen. Mgr. Charles Bragg
 Iffit Fitz Music, 4550 Atteborro St., Jacksonville, Fla. 32205. Owner & Mgr. Michael R. Fitzgerald
 Ila Music (BMI), see Martin Cohen
 Imagination Inc. (ASCAP)—Pres. Billy Edd Wheeler, Gen. & Prof. Mgr. Jerry Chesnut—see Jerry Chesnut
 I'm A Truck Music (BMI), see Ripcord
 Immunity Music (ASCAP), see Schabraf
 Improvat (BMI), see Pablo
 Impulsive Music (ASCAP), c/o Home Run Systems Corp., 14 E. 60 St., New York, N.Y. 10022. Contact: William Joel. (Affiliated with April/Blackwood)
 Impulsive Music Inc., see RCS
 Indaba Ents. (BMI), see April/Blackwood
 Indano Music Co. (ASCAP), see Ivan Mogull
 Independence Corp. of America, 1511 Chester St., Little Rock, Ark. 72202. Tel. (501) 376-4002
 India Music Ink (ASCAP), c/o Greene & Reynolds, 1900 Ave. of the Stars, Suite 1424, Los Angeles, Calif. 90067. Tel. (213) 553-5434. Pres. Lou Adler, Bus. Mgr. Robert L. Greene
Int'l reps.: Asia (Pathe Far East), Australia (Rondor), France (Marouani), Japan (Taiyo), New Zealand (Rondor), UK (Rondor)
 Infinity Music Int'l (ASCAP) (div. of Infinity Recs. Inc.), 485 Madison Ave., New York, N.Y. 10022. Tel. (212) 888-9700. VP. Music Publ'g Lou Ragusa, Copyright Mgr. Victoria Clare, Creative Opns. Dir. Allan Tepper
 Influx Music (BMI), see Royalty Control Corp.
 In Music (ASCAP), see Rondor
 Inner City Trade Publ'g Co. (BMI), see Insurance Music
 Insanity's Music (BMI), 24548 Pierce, Southfield, Mich. 48075. Tel. (313) 559-7630. Pres. Bruce Lorfel
 Insight Music Co. (BMI), see BC Ents.
 Inspirational Sounds, Box 1363, Union, N.J. 07083
 Insurance Music (BMI), 11616 S. Lafayette Ave., Chicago, Ill. 60628. Tel. (312) 264-2166. Pres. William C. Tyson
 Integrity Music Corp. (ASCAP), 1050 Fifth Ave., New York, N.Y. 10028. Tel. (212) 348-6700. Cable: INTEG-MUSIC. Pres. Jack Wolf
 Intercollegiate Syndicate Inc. (ASCAP), see Denton & Haskins
 Intercontinental Music Combine (ASCAP), 16000 Ventura Blvd., Suite 202, Encino, Calif. 91436. Tel. (213) 981-4545. Owner Edward M. Sherman
 Interior Music (BMI), see Rondor
 Interlochen Press (ASCAP), see Crescendo
 Intermountain Music (BMI), PO Box 1067, Hollywood, Calif. 90028. Owner & Pres. R. Chandler
 International Agency & Mgmt. (ASCAP), see April/Blackwood
 International Doorway Music (ASCAP), 3410 Ave. R, Lubbock, Tex. 79412. Tel. (806) 744-5590. Pres. & Prof. Mgr. Bud Andrews
 The International Music Co. (ASCAP), see TIM
 Intersong-USA Inc. (ASCAP), see Chappell
 Interworld Music Group Inc., 8304 Beverly Blvd., Los Angeles, Calif. 90048. Tel. (213) 852-0771. Cable: IN-MUSIC. Telex: 674999. Pres. Michael Stewart; Bus. Affairs Dir. Jeff Brabec, Copyright Mgr. & Int'l Judy Hicks
Branch: New York, N.Y., 25 W. 57 St. Zip 10019. Tel. (212) 582-8810. Prof. Mgr. Lanny Lambert
Int'l branches: Australia, Brazil, England, France, Germany, Italy, Japan, Mexico, Netherlands, Spain, Scandinavia, South Africa. (SEE ADVERTISE-MENT)
 Invador Music (BMI), 8961 Sunset Blvd., Los Angeles, Calif. 90069. Tel. (213) 278-8961. Pres. Don Perry, VP. Phil DiGroia, Secy-Treas. Susan Alcott-Perry

J

J A M F Music (BMI), see April/Blackwood
 J & E Music Inc. (ASCAP), see Copyright Serv. Bureau
 J E D O (ASCAP), 5062 Calatrana Dr., Woodland Hills, Calif. 91364. Tel. (213) 703-0083. Pres. Jon Devirian
 J L T Christian Agape Music Co. (ASCAP), 104 Eighth St., Salem, N.J. 08079. Tel. (609) 935-1908. Owner & Pres.: John L. Tussey Jr.
 J P Music Ltd. (BMI), see Shapiro Bernstein
 J W T Music Inc. (ASCAP) (sub. of J. Walter Thompson Co.), 420 Lexington Ave., New York, N.Y. 10017. Tel. (212) 867-1000. Pres.: Don Johnston, VP & Gen. Mgr. Marion Preston; VP & Sec'y. Hugh P. Connell
 Jabern Music Co. (ASCAP), see Chappell
 Jace Music, see Rammus Music
 Jack & Bill Music Co. (ASCAP), see T.B. Harms
 Jackaroo Music Publ'rs (div. of Vanguard Rec'g Society Inc.), 71 W. 23 St., New York, N.Y. 10010. Tel. (212) 255-7732. Cable: VANMUSICA. Pres. Maynard Solomon; Foreign & Lic. Opns. Dir. Jo Inguanti
Int'l reps.: Austria, Germany, Switzerland (Rudolf Slezak in Germany), Scandinavia (Air in Sweden)
 Judy Jack Music (BMI), see Teddy Jack
 Jack Music Inc. (BMI), PO Box 12534, Nashville, Tenn. 37212. Tel. (615) 383-0330
Int'l rep.: Worldwide except USA (Morning)
 Alice M. Jackson Music (ASCAP), 9000 Sunset Blvd., West Hollywood, Calif. 90069. Tel. (213) 550-0397. Pres. Alice M. Jackson; Gen. Mgr. K.H. Smith
 Gary Jackson (BMI), see Copyright Serv. Bureau
 Jackson-Jodejvan Music (BMI), see Alice M. Jackson
 Jaclyn Music (BMI), Box L-467, 126 Millwood Dr., Nashville, Tenn. 37217. Tel. (615) 255-2289. Pres. Col. Jack Lynch
 Jacou (ASCAP), 2958 N. Beachwood Dr., Los Angeles, Calif. 90068. Contact Jack Conrad
 Jac-Wana (BMI), Box 2875, Washington, D.C. 20013. Tel. (202) 396-3009. Pres. Ben Smalls
Int'l rep.: Japan (Shinko)
 Jadar Music Corp. (BMI), see Chappell
 Jahmilla Music Inc. (ASCAP), 500 N. Michigan Ave., Suite 1042, Chicago, Ill. 60611
 Jake-Carl Publ'ns (BMI), 732 N. Main St., Opelousas, La. 70570. Tel. (318) 942-7092
 Jamerica Publ'g Co. Inc. (BMI), see Artref
 Jamersonian Music (ASCAP), 3654 Barham, No. Q206, Los Angeles, Calif. 90068. Tel. (213) 874-3543
 James Boy Publ'g Co. (BMI), PO Box 128, Worcester 19490; 1834 W. Cheltenham Ave., Philadelphia, Pa. 19126. Tel. (215) 424-0800. Pres. & Gen. Mgr.: Jesse James; Prof. Mgr. Lennie Hawkins
 Dick James Music Inc. (BMI), 119 W. 57 St., New York, N.Y. 10019. Tel. (212) 581-3420. TWX (710) 581-4216. Pres. Dick James; Gen. Mgr. Arthur Braun
Int'l rep.: Japan (Yamaha)
 James S. Ents. (BMI), 3190 Hallmark Ct., Saginaw, Mich. 48603. Pres. James Leach
 Jamie Music Publ'g Co. (BMI), 919 N. Broad St., Philadelphia, Pa. 19123. Tel. (215) 232-8383. Pres.: Harold B. Lipsius
 Jamlin Music Co. (BMI), see Copyright Serv. Bureau
 Jamil Music (BMI), 413 N. Parkerson Ave., Crowley, La. 70526. Tel. (318) 783-1601. Pres. Jay Miller; VP. Bill Miller
 Jamvah Music Inc. (BMI), PO Box 10530, Jackson, Miss. 39209. Tel. (601) 922-5242. Pres. Joe Shamwell
 Jana Music (BMI), see Rondor
 Jando Music (ASCAP), see Jack Music
 Janell Music (BMI), 792 E. Julian St., San Jose, Calif. 95112. Tel. (408) 286-9840
 Jangar Music Publ'rs (BMI), 7025 Claire Ave., Reseda, Calif. 91335. Tel. (213) 343-5764. Pres. Jay Bonner; Gen. Mgr. Warren Beltane
 Janon Music Co. (ASCAP), see Copyright Serv. Bureau
 Jansa Music (ASCAP), see Segel & Goldman
 Jarb Publ'g (BMI), see Tune-Kel
 Jarett Music (BMI), see Shalynn
 Jasmine Music Co. (ASCAP), see Dawnbreaker
 Jason Dee Music (BMI), see Mr. Tort
 Jason Ink Music (BMI), 349 S. Lafayette Park Pl., No. 323, Los Angeles, Calif. 90057. Tel. (213) 383-0720. Chm. & Pres. Jason Schwartz, Gen. Mgr. Richard Schulenberg; Prof. Mgrs.: Jason & Sandra Schwartz; Anita Kagan. Local branch: 5934 Buffalo, Van Nuys 91401. Tel. 997-8819
 Jason Sean Music (ASCAP), see 20th Century
 Jaspur Music Publ'g Co. Ltd. (BMI), 852 Elm St., Manchester, N.H. 03101. Tel. (603) 623-9749, 624-1990. Cable: W&G. Mng. Dir. James Parks

- Home office:** Australia (Woomera)
Int'l firms represented: Angelica (Germany), Banff (Canada), Meisel (Germany), Jaspur (UK), Melbourne (Canada), Rodco (Canada), Woomera (Australia)
Int'l reps: Europe Japan, South Africa, South America (Copyright Serv. Bureau), UK (Chappell, Leeds), Western Hemisphere (Chappell)
- Jatap Publ'g Co. (BMI), see Irving Mills
 Jat Music Inc. (BMI), see Copyright Serv. Bureau
 Javors Music Co. (ASCAP), see 20th Century
 Jayboy Music Corp. (BMI), see Copyright Serv. Bureau
 Jay & Gee Music Corp. (BMI), see Fort Knox
 Jayde Music (BMI), see Copyright Serv. Bureau
 Jay Jay Publ'g Co. (BMI), PO Box 4155, Normandy Branch, Miami Beach, Fla. 33141 Tel. (305) 758-0000
 Owner: W. Jagiello
 Jaymore Publ'g Co. Inc. (BMI), 6260 Meyer St., Brighton, Mich. 48116 Tel. (313) 227-1997 Pres. John W. Morris
 Jay Music (ASCAP), 6654 Allott Ave., Van Nuys, Calif. 91401 Tel. (213) 873-2699 Pres. Johnny Rotella
 Jays Ents. Inc. (ASCAP), see Chappell
 Jay Six Publ'g Co. (BMI), 33 Harbor View Ave., Harwich Port, Mass. 02646 Tel. (617) 432-9070 Pres. Jack Sager
 Jeb Music (BMI), see Pickwick
 Jetsy Music Co. (ASCAP), see Gordon
 Jac Publ'g Co. (BMI), see Cream
 Jeff Tunes (BMI), see Copyright Serv. Bureau
 Jeneva Music Co. (BMI), see Ernkell
 Alfred Jenkins (BMI), see Copyright Serv. Bureau
 Ceaser Jenkins (BMI), see Copyright Serv. Bureau
 Jennejohn Music (BMI), 4123 N. 44 St., Milwaukee, Wis. 53216 Tel. (414) 873-4287 Pres. Ken Wright
 Jennifer (ASCAP), see Croma
 Waylon Jennings (BMI), 1117 17 Ave. S., Nashville, Tenn. 37212 Tel. (615) 244-0081
 Will Jennings Publ'g Co. (BMI), see Rondor
 Jensen Music (ASCAP), see John T. Benson
 Jenson Educational Prod'ns Inc. (BMI), see Jenson Publ's
 Jenson Publ'ns Inc. (ASCAP), 2880 S. 171 St., New Berlin, Wis. 53151 Tel. (414) 784-4620 Pres. Art Jenson, VP Prod. Development: John Higgins, VP Sales: Bill Altice
 Jepalana Music (BMI), 723 Seventh Ave., New York, N.Y. 10019 Tel. (212) 245-7640 Pres. Nathan Schnapf, VP: Jerry Samuels, Prof. Mgr. Paul Friedberger
 Jerden, PO Box 3925, Bellevue Wash. 98009 Tel. (206) 622-0470 Pres. Gerald B. Dennon
 Jerryco Music Co. (ASCAP), see Edwin H. Morris
 Jeryl-Lynn Music (BMI), see Coyote
 Jeistar Publ'rs Inc. (BMI), see Abnak & Publishers' Licensing Corp.
 Jevert Music (BMI), 639 Bulen Ave., Columbus, Ohio 43205 Tel. (614) 258-7112 Pres. Jeffrey V. Smith
 Jewel Music Publ'g Co. Inc. (ASCAP), see Goodman Group
 Jewish Society (ASCAP), see Ashley
 Jibaro Music Co. Inc. (BMI), PO Box 424, Mount Clemens, Mich. 48043 Tel. (313) 791-2678 Pres. & Prof. Mgr. James B. Roach, Gen. Mgr. Ann Roach
Branch: Hollis, N.Y., 193-24 109 Ave. Zip 11412 Tel. (212) 776-8179 Gen. Mgr. Dolores Roach
 Jillbern Music Inc. (BMI), see Chappell
 Jilleam Music Inc. (BMI), see Gopam
 Jimpire Music Inc. (BMI), 110 E. 59 St., New York, N.Y. 10022 Tel. (212) 371-4387
 Jim-Ro Music, see T. B. Harms-Bibo
 Jimskip Music (BMI), see Skip Taylor
 Jitney Jane Songs (BMI), see Copyright Serv. Bureau
 Jo-Al Music Co. (ASCAP), see Shoestring & Copyright Serv. Bureau
 Jobete Music Co. Inc. (ASCAP), 6255 Sunset Blvd., Hollywood, Calif. 90028 Tel. (213) 468-3400 Exec. VP. Robert L. Gordy, VP & Gen. Mgr. Jay S. Lowy, VP. Adm. Karen Hodge, Prof. Mgrs. Natalie Ellington, Rita Ross, Tommy Gordy, Danny Strick
Branch: New York, N.Y., 157 W. 57 St. Zip 10019 Tel. (212) 581-7420 Prof. Activities Dir. Carl Griffin; Prof. Mgr. Roxanne Gordy
Int'l branch: England
Int'l reps: Argentina (Edifon), Australia (Allans), Austria (Discoton), Belgium (Ardmore & Beechwood), Brazil (Top Tape), Denmark (Air), Finland (Air), France (Pathe-Marconi), Germany (Discoton), Iceland (Reuter & Reuter), Israel (Musicor), Italy (Curci), Japan (Taiyo), Mexico (Beechwood), Netherlands (EMI), New Zealand (Allans), Norway (Reuter & Reuter), Philippines (Bayanihan), South Africa (Laetrec), Spain (EGO), Sweden (Air), Switzerland (Francis, Day & Hunter)
 Jo-Burg Music (BMI), see Copyright Serv. Bureau
 JoCher Music Co. (BMI), Box 102C, RD 1, Chubbic Rd., Canonsburg, Pa. 15317 Tel. (412) 746-2540 Pres. Joe Diamond; VP: Cheryl Diamond, Mgr. Jerry Walker
 Jockey (ASCAP), see Croma
 Jodax Music Co. (BMI), see Gopam
 Jodrell Music Inc. (ASCAP), see Rocket Publ'g
 Jody Boye Music (ASCAP), see Copyright Serv. Bureau
 Joelsongs (BMI), see April/Blackwood
 Joeneil (ASCAP), see Ashley
 Little Richie Johnson Music Co. (BMI), PO Box 3, Belen, N.M. 87002 Tel. (505) 864-7185
 Johnstone-Monteir Music (BMI), see Beechwood
 Joka Music (BMI), 403 Summit St., Vineland, N.J. 08360 Tel. (609) 691-5240
 Joli Music Inc. (BMI), 1619 Broadway, New York, N.Y. 10019 Tel. (212) 757-2695 Pres. Jim McCarthy, Gen. & Prof. Mgr. Gil Miller; Prod'n Dir. Henry Boye
Int'l rep: UK (Campbell Connelly)
 Jolly Rogers Publ'g Co. (ASCAP), 902 Tiverton, Westwood, Calif. 90024 (Affiliated with Cherry Lane)
 Jomewa Music (div. of Interflow Inc.), 135 E. 65 St., New York, N.Y. 10021 Tel. (212) 828-6898 Pres. & Prof. Mgr. Melvin Small, Gen. Mgr. Walter Richards
 Jonali Music Inc. (BMI), see Copyright Serv. Bureau
 Jonan Music (ASCAP), see Savgos
 Jondora Music (BMI), 10th & Parker Sts., Berkeley, Calif. 94710 Tel. (415) 549-2500 Mgr. Jack L. Aho
 Jon Music (BMI), 329 N. Main, Church Point, La. 70525 Tel. (318) 684-2176 Pres. & Mgr. Lee Lavergne
 Jonvis Music Co. (BMI), 2233 W. 25 St., Los Angeles, Calif. 90018 Tel. (213) 731-1320 Pres. J. W. Spriggs; Gen. Mgr. D. W. Brown
Int'l rep: France (Tremplin)
 Jop Music Co. (ASCAP), 50 Music Square W., Suite 805, Nashville, Tenn. 37203 Tel. (615) 327-4032 Pres. Bob Witte, Prof. Mgr. Jan Gray Witte
Int'l rep: Worldwide (Intersong)
 Joshua Corp. (BMI), see General Music
 Josomo Music Co. (BMI), see Copyright Serv. Bureau
 Jotolo Music Co. Inc. (BMI), see Four Grand
 Journeyman Music (BMI), 102-37 85 Rd., Richmond Hill, N.Y. 11418 Tel. (212) 847-6377 Pres., Gen. & Prof. Mgr. Ernest C. Petito Jr.
Branch: Coral Springs, Fla., 4123 NW 88 Ave. Zip 33065
 Jova Music Inc. (ASCAP), 159 W. 53 St., New York, N.Y. 10019 Tel. (212) 581-0030 Pres. Paul Vance
 Jowat Music (BMI), see Gopam
 Jowit Music (BMI), see Amestoy
 Joyful Wisdom Music Co. (BMI), see Alkatraz Corner
 Joyous Sounds Music (BMI), see International Doorway
 JoySong Music Publ'ns (SESAC), see Paragon Assocs.
 Joy & Sorrow Music (ASCAP), see April/Blackwood
 Jubal Sound Music (BMI), see Chappell
 Jubilation Music (BMI), see FYDAQ
 Jubilee Music Inc. (ASCAP), see Chappell
 JuBop Music (ASCAP), see Meshugah
 Judy Johnny Music (BMI), see Bug
 Jugumba Music (ASCAP), c/o Jay Cooper, 9465 Wilshire Blvd., Suite 820, Beverly Hills, Calif. 90212 Tel. (213) 278-1111 Cable TRADEMARKS Pres. Jim Golden
 Juldane Music Co. (BMI), 8037 13 St., Silver Spring, Md. 20910 Wash., D.C. Tel. (202) 333-7474 Owner: Jules M. Damian
 Julep Publ'g Co. (BMI) (div. of Julep Inc.), PO Box 15551, Nashville, Tenn. 37215 Tel. (615) 383-5698 Pres. Charlene Sherrill; Gen. Mgr. Ann Sutton
 Julie Music Corp., see Clara
 Jumbuck Music (BMI), see Rondor
 Jump Tunes (BMI), c/o Jess S. Morgan & Co., 6420 Wilshire Blvd., Los Angeles, Calif. 90048
 June 16 Music Co. (BMI), see Mietus
 Ralph Jusko Publ'ns Inc. (SESAC), see Willis
 Just Another Publ'g Co. (BMI), see April/Blackwood
 Just Music Corp. (BMI), see Schwartz
 Just Over The Bridge Music Co. (BMI), see The Entertainment Co.



- K B L Assocs. (BMI), see The Entertainment Co.
 K C M Music (ASCAP), see Triple H
 K-D Music (BMI), (div. of KDP Inc.), 111 Valley Rd., Richardson Park, Wilmington, Del. 19804 Tel. (302) 655-

A Worldwide Organization for TODAY'S MARKET—
 the HITS, the STANDARDS, the FAVORITES . . .



POP & SERIOUS MUSIC DIVISION
 1776 BROADWAY • NEW YORK, N.Y. 10019
 (212) 245-1100

PRINTED PRODUCT ORDERS
 25 DESHON DRIVE • MELVILLE, N.Y. 11747
 (516) 293-3400

7488. Pres.: H. Edwin Kennedy; Gen. Mgr.: Shirley Kay.
- K I L O Music (BMI)**, see Benfel.
- K R P C O Music (BMI)**, (div. of Kiderian Recs. Prod'ns), 4926 W. Gunnison, Chicago, Ill. 60630. Tel: (312) 545-0861. Pres.: Ray Peck; VP: George Peck.
- Kack Klick Inc. (BMI)**, House of Guitar Bldg., 645 Titus Ave., Rochester, N.Y. 14617. Tel: (716) 544-3500. Pres.: Armand Schaubroeck; VP: Jim Degman; Prof. Mgr.: Kim Simons.
- Kae-Lyn Music (BMI)**, see Gopam.
- Kags Music Corp. (BMI)**, see Abkco.
- Gus Kahn Music Co. (ASCAP)**, 6223 Selma Ave., Hollywood, Calif. 90028. Tel: (213) 462-6088. Owner: Donald Kahn.
- Kahuku Publ'g (ASCAP)**, see Martin Cohen.
- Joseph Kaiser Music Co. Inc. (ASCAP)**, see Denton & Haskins.
- Kalimba Music Co.**, see Royalty Control.
- Edwin F. Kalmus & Co. Inc. (ASCAP)**, 13125 NW 47 Ave., Opa Locka, Fla. 33054. Tel: (305) 681-4683. Pres.: Thea Kalmus; Gen. Mgr.: Leon Galison; Prof. Mgr.: Lawrence Galison.
- E. F. Kalmus Orchestra Scores Inc. (ASCAP)**, see Belwin-Mills.
- Kamakazi Music Corp. (BMI)**, 314 W. 71 St., New York, N.Y. 10023. Tel: (212) 595-1330. Pres.: Barry Manilow; Gen. & Prof. Mgr.: Miles J. Lourie.
- Kama Sutra Music Inc. (BMI)**, see Buddha.
- Kamiyah Music (BMI)**, see Martin Cohen.
- J. & J. Kammen (ASCAP)**, see Ashley.
- Kander-Ebb Inc. (BMI)**, see Chappell.
- Les Kangas Music Publ'g (BMI)**, 302 E. Dewey Ave., San Gabriel, Calif. 91776. Tel: (213) 288-5435. Owners: Les & Toni Kangas.
- Karamar Publ'g Co. Ltd.**, see Controlled Sheet Music.
- Karamara Publ'g Co. Ltd.—Tel: (516) 842-8288.** Pres. & Gen. Mgr.: Ronald Ravitz—see Controlled Sheet Music.
- Bob Karcy Music (ASCAP, BMI)**, 437 W. 16 St., New York, N.Y. 10011. Tel: (212) 989-1989. Cable: ROKINTAL. Pres.: Bob Karcy.
- Int'l branch:** France, Pygmalion.
- Edward Kassner Music Co. (ASCAP)**, see Copyright Serv. Bureau.
- Katch Nazir Music (ASCAP)** (div. of Rose Hill Group), 3929 New Seneca Tpk., Marcellus, N.Y. 13108. Tel: (315) 673-1117. Prof. Mgr.: Vincent Taft.
- Katz-Gallin Music (BMI)**, see Segel & Goldman.
- Kaye-Smith Music (ASCAP)**, see Kaye-Smith Prod'ns.
- Kaye-Smith Prod'ns**, 2212 Fourth Ave., Seattle, Wash. 98121. Tel: (206) 624-8651. Chief Exec. Officer: Lester M. Smith.
- Kayteekay Music (ASCAP)**, see Glen Campbell.
- Kece Music Inc. (ASCAP)**, 9440 Santa Monica Blvd., Suite 704, Beverly Hills, Calif. 90210. Tel: (213) 278-3156. Pres.: Larry Gordon; Gen. & Prof. Mgr.: Noreen Rae Cowan.
- Joe Keene Music Co. (BMI)**, PO Box 602, Kennett, Mo. 63857. Tel: (314) 888-3032/2995. Pres. & Gen. Mgr.: Joe Keene.
- Int'l rep.:** UK (Anchor).
- Keeta Music Co. (BMI)**, see Briarmeade.
- Kellaway Music**, see Martin Cohen.
- Kelly & Lloyd Music (ASCAP)—Tel: (615) 367-1215—see Mick Lloyd.**
- Kelly Music Publ'ns (BMI)**, see Country Star.
- Kemo Music Co. (BMI)**, see Beechwood.
- Kenbar Music Corp. (BMI)**, see Greenbar.
- Kendor Music Inc. (SESAC)**, Main & Grove Sts., Delevan, N.Y. 14042. Tel: (716) 492-1254. Pres.: Arthur W. Dedic; VP & Gen. Mgr.: Lester P. Chappell.
- Kendra Music Inc. (BMI)**, see April/Blackwood.
- Ken-Glen Publ'g (BMI)**, see Chappell.
- Kengorus Music (ASCAP)**, c/o P. Potkin & Co., 9200 Sunset Blvd., Suite 607, Los Angeles, Calif. 90069. Pres.: Brenda Gordon Russell; VP: Brian Russell.
- Gene Kennedy Ents.**, 2125 Eighth Ave. S., Nashville, Tenn. 37204. Tel: (615) 383-6002. Pres.: Gene Kennedy; VP & Prof. Mgr.: Linda Kennedy.
- Arthur Kent Music Co. (ASCAP)**, 3 Redbud Dr., Nashville, Tenn. 37215. Tel: (615) 383-8130. Owner: Arthur Kent.
- Kentree Music**, see Tree.
- Kentucky Colonel Music (BMI)**, PO Box 5853, Pasadena, Calif. 91107. Tel: (213) 477-1439. Pres.: John M. Delgatto.
- Int'l rep.:** Netherlands (Ariola-Eurodisc)
- Kenwall Music Publ'g Inc. (ASCAP)**, see Gene Kennedy.
- Kenwood Music Inc. (BMI)**, see Ember Ents.
- Kenya Music Inc. (ASCAP)—Pres.: Eumir Deodato—see Bel-dock Levine & Hoffman.**
- Ketch-Up Music Co. (BMI)**, see Copyright Serv. Bureau.
- Kevin Lee Music (BMI)**, see Universal.
- Kevrick Music (ASCAP)**, see San-Lyn.
- Keymen Music (BMI)**, see Copyright Serv. Bureau.
- Kick-A-Rock (ASCAP)**, c/o Glickman/Marks Mgmt. Corp., 655 Madison Ave., New York, N.Y. 10021.
- Kichelle (ASCAP)**, see Jamerson.
- Kicking Mule Publ'g Inc. (BMI)**, PO Box 3233, Berkeley, Calif. 94703. Tel: (415) 452-1248. VP: Ed Denson.
- Int'l reps.:** Europe (Sonet), Japan (Toshiba-EMI).
- Kidada Music Inc. (BMI)**, c/o A&M Recs., 1416 N. La Brea Ave., Hollywood, Calif. 90028. Tel: (213) 469-2411. Cable: ALPERMOSS. Pres.: Quincy Jones; Gen. Mgr.: Beverly Giddens.
- Int'l firm represented:** RCA Int'l.
- The Kids Music Inc.**, see Martin Cohen.
- Kilkenny Music Inc. (BMI)**, 5825 N. 96 St., Milwaukee, Wis. 53225. Tel: (414) 462-5590. Pres.: Tim Brophy; Nat'l Sales Mgr.: Bob Ambos.
- Kilyn Music Publ'g Inc. (BMI)**, see Mietus.
- Kim-Kev Music (ASCAP)**, see Segel & Goldman.
- Kimkris Music (BMI)**, see 20th Century.
- KimLyn Music Co. (ASCAP)—Gen. Mgr.: Lanny Lambert—see Sheryln.**
- Kim-Pat Publ'g (SESAC)**, Box 654, Hillwood Dr., Fayetteville, Tenn. 37334. Tel: (615) 433-2323. Pres.: Elynn Trigg.
- Kimtra Music (ASCAP)**, see Hat Band.
- Kiner Music Co.**, PO Box 724, Redmond, Wash. 98052. Tel: (206) 885-0523. Owner: L.F. Kiner.
- King Coal Music Inc. (ASCAP)**, see Coal Miners.
- K. L. King Music House (SESAC)**, see C.L. Barnhouse.
- King of Spades Music Inc. (BMI)**, see Munka.
- Kingsland Publ'g Co. (ASCAP)**, see Briarmeade.
- Kingsley Music Inc. (ASCAP)**, see Copyright Serv. Bureau.
- Kingsmen Publ'g Co. (BMI)**, see John T. Benson.
- King Solomon Music (ASCAP)**, see Martin Cohen.
- Kinlu Music (ASCAP)—Pres.: N. L. King—see Playnote.**
- Kiongazi Music (BMI)**, see Rondor.
- Kipahulu Music Co. (ASCAP)**, c/o Colgems-EMI Music Inc., 711 Fifth Ave., New York, N.Y. 10022. Tel: (212) 751-4400.
- Charles Kippis Music Inc. (BMI)**, 1 Lincoln Plaza, New York, N.Y. 10023. Tel: (212) 580-0154. Pres.: Charles H. Kippis Jr.
- Branch:** Springfield, Va., 6901 Old Keene Mill Rd. Zip: 22150. Tel: (703) 569-5330. Gen. Mgr.: Don Flynn.
- Int'l reps.:** Australia (Castle), Italy (Ariston), UK (EMI).
- Kirshner/April Music Publ'g (ASCAP)**, see April/Blackwood.
- Kirshner/CBS Music Publ'g**, 1370 Ave. of the Americas, New York, N.Y. 10019. Tel: (212) 489-0440. Pres.: Don Kirshner; Exec. VP: Herb Moelis; VP, Gen. & Prof. Mgr.: Wally Gold; Talent Development: Felix Di Palma; Copyrights Dir.: Sandy Kerrien.
- Branch:** Los Angeles, Calif., 9000 Sunset Blvd. Zip: 90069. Tel: (213) 278-4160.
- Int'l reps.:** Australia (Warner Bros.), Argentina (Melograf), Belgium (Kirshner), Brazil (ELAM), Central America (Mundo Musical), France (Warner Bros.), Germany (Kirshner), Italy (Kirshner), Japan (Shinko), Mexico (Mundo Musical), South Africa (Laetrec), Spain (April), Sweden (Don Kirshner), UK (Kirshner/Warner Bros.), Venezuela (Mundo Musical).
- Don Kirshner/Blackwood Music Publ'g (BMI)**, see April/Blackwood.
- Kirshner Songs (ASCAP)**, see Don Kirshner.
- Kirzo Music (BMI)**, see Copyright Serv. Bureau.
- Kisco Music Ltd. (BMI)**, see Copyright Serv. Bureau.
- Kiss Me Music (SESAC)**, see Sing Me.
- Kittyhawk Music (ASCAP)**, see 20th Century.
- Neil A. Kjos Music Co. (SESAC)**, 4382 Tutland Dr., San Diego, Calif. 92117. Tel: (714) 270-9800.
- Branch:** Park Ridge, Ill., 525 Busse Hwy. Zip: 60068. Tel: (312) 825-2168.
- Kjos West (SESAC)**, see Neil A. Kjos.
- Kjos West La Jolla Music Publ'g Co. (BMI)**, see Neil A. Kjos.
- Klickitat Music (BMI)**, 1931 SE Morrison St., Portland, Ore. 97214. Tel: (503) 238-4525. Pres.: Russell E. Gorsline.
- Klondike Ents. Ltd. (BMI)**, see Mietus.
- Knee Trembler Music**, see Fourth Floor.
- Howard Knight Music (SESAC)**, see Audway.
- Knollwood Music Corp. (ASCAP)**, see Fred Ahlert.
- Know (ASCAP)**, PO Box 66558, Seattle, Wash. 98166. Tel: (206) 246-9400.
- Knowles Music (BMI)**, see Royalty Control Corp.
- Knud-Feldt Music Co. (BMI)**, c/o Sceneville Inds., 78-08 88 Ave., Woodhaven, N.Y. 11421. Tel: (212) 296-1877. Pres.: Robert L. Knudsen; VP: Arthur J. Kleinfeldt; Nat'l Publ'g Dir.: James Knudsen.
- Koala Music Inc. (ASCAP)**, N.Y., see Music Music Music.
- Koala Recs. Inc.**, 6253 Hollywood Blvd., Los Angeles, Calif. 90028. Tel: (213) 467-3203. Pres.: Irv Kessler; VP: Mary Kessler.
- Kodi Music (ASCAP)**, c/o Baron, Weiss & Singer, 9100 Wilshire Blvd., Suite 220, Beverly Hills, Calif. 90212. Tel: (213) 278-3123.
- Kohaw Music Inc. (ASCAP)**, see Bicycle.
- Koko Music (ASCAP)**, see Boxer.
- Kolber Publ'g Co. (BMI)**, 332 W. 14 St., Upland, Calif. 91786. Tel: (714) 981-2783.
- Kolormark Music (BMI)**, see OCA.
- Kona Kai Publ'g Co.**, see Beechwood.
- Kool Kat Music (BMI)** (div. of Kool Kat Prod'ns Inc.), PO Box 176, Monsey, N.Y. 10952. Tel: (914) 425-6040. Pres.: Edward Kaplan; Gen. Mgr.: Sy Kaplan.
- Kool Music Inc. (BMI)**, see Buttermilk Sky.
- Kool Soul Music (BMI)**, see Mietus.
- Kooper Music Co. (BMI)**, see Mietus.
- Koppelman-Bandier Music Corp. (BMI)**, see The Entertainment Co.
- Kortchma (ASCAP)**, 433 N. Camden Dr., Suite 860, Beverly Hills, Calif. 90210.
- Kosmic Lady Music Publ'g Co. (ASCAP)**, see Studio 10.
- Kountry Kate Music Publ'g Co. (BMI)—Contact: Jim Little—see Acquire.**
- Koussevitzky (Ed.) (ASCAP)**, see Boosey & Hawkes.
- John Krachtus Co. (SESAC)**, see Vitak-Elsnic.
- Kradar Music Co. (ASCAP)**, see Sam Fox.
- Krandon Music Co. (BMI)**, see Copyright Serv. Bureau.
- Kreimers (BMI)**, c/o Dennis Katz, 110 E. 59 St., New York, N.Y. 10022.
- Krishane Music Co. (ASCAP)** (div. of Kris Stevens Ents. Inc.), 14241 Ventura Blvd., Suite 204, Sherman Oaks, Calif. 91423. Tel: (213) 981-8255. Pres. & Gen. Mgr.: Kris Erik Stevens; Prof. Mgr.: Michael Jordan.
- Kris Publ'g Co. (SESAC)**, see Kim-Pat.
- Kristina Music Publ'g Inc. (BMI)**, see April/Blackwood.
- Sid & Marty Krott Prod'ns Inc. (ASCAP)**, see April/Blackwood.
- Kropotkin (ASCAP)**, 273 New York Ave., Huntington, N.Y. Tel: (516) 423-8328. Partner: Tom Pomposell.
- Kryder Music Corp. (BMI)**, see Copyright Serv. Bureau.
- Kulka Music (SESAC)**, see De Gar Music.
- many (J. Michel), Italy (RCA), Sweden (Sweden Music), UK (Andover).
- L P S Corp.**, see Saka Music.
- L S Music (ASCAP)**, see Universal.
- LaBelle Music Publ'g (ASCAP)**, see Brunswick.
- La Brea Music (ASCAP)**, see Rondor.
- Laces & Boots Music (BMI)**, see Chappell.
- La De Ole Music (BMI)**, see Don Williams.
- Ladd Music Co. (BMI)**, 401 Wintermantle Ave., Scranton, Pa. 18505. Tel: (717) 343-6718. Owner: Phil Ladd.
- Lady Casey Music (BMI)**, see Trust Music.
- Lady Jane Music (BMI)**, PO Box 614, Tahoe City, Calif. 95730. Tel: (916) 583-6587. Owner & Pres.: Hoyt Axton; Gen. Mgr.: Marlene Prins.
- Branch:** Hendersonville, Tenn., PO Box 1077. Zip: 37075. Tel: (615) 824-9412. VP: John B. Axton.
- Int'l reps.:** Australia (Rondor), France (Marouani), Germany (Global), Hong Kong (Pathe-Far East), Japan (Pacific), Netherlands (Universal), South Africa (Music Publ'g Co. of Africa), Spain (Quiroga), Sweden (Sweden Music), UK (Rondor).
- J. R. LaFleur (ASCAP)**, see Boosey & Hawkes.
- Laie Publ'g (BMI)**, see Martin Cohen.
- La Jolla Music Publ'g Co. (BMI)**, see Neil Kjos.
- Lake Country Music (BMI)**, PO Box 1073, Graham, Tex. 76046. Tel: (817) 549-5118. Pres.: Larry Wooldridge; Gen. & Prof. Mgr.: Mark House.
- Lakshmi Lakshmi Music Co. (BMI)**, see Stonebass.
- La Lou Music (BMI)**, PO Box 30072, Zip: 70503; 711 Stevenson St., Lafayette, La. 70501. Tel: (318) 234-4118/5577. Pres.: Carol J. Rachou.
- Lambert & Potter Music Co. (BMI)**, 9220 Sunset Blvd., Suite 306, Los Angeles, Calif. 90069. Tel: (213) 278-8970. Cable: MOSSAC. Pres.: Dennis Lambert; Ass't: Marsha Ingraham.
- Laminations Music (ASCAP)**, see Chicago Music.
- Lamplighter (BMI)**, 2227 Fifth Ave., Seattle, Wash. 98121. Tel: (206) 623-2030. Owner: Kearney W. Barton.
- Lamp Music (BMI)**, see Coco.
- Landers-Roberts Music (ASCAP)**, 9255 Sunset Blvd., Los Angeles, Calif. 90048. Tel: (213) 550-8819. Co-Pres.: Hal Landers, Bobby Roberts; VP: Jay Landers; Gen. Mgr.: Barry Jay Josephson.
- Landscape Music Co. (BMI)**, see Lion's Gate.
- Langley Music Co. (BMI)—Prof. Mgr.: Eddie White—see White Way.**
- Stuart Lanis Music Inc. (BMI)**, 1273½ N. Crescent Heights Blvd., Los Angeles, Calif. 90046. Tel: (213) 650-6500. Pres.: Stuart Lanis; VP's: Adam, Jason & Nathan Bank.
- Lantana Music Inc. (BMI)**, PO Box 630175, Miami, Fla. 33103. Tel: (305) 472-7757. Pres. & Gen. Mgr.: Jack P. Bluestein; Prof. Mgr.: Kevin McManus.
- Int'l reps.:** Brazil (Pirate), Canada (CMRRA).
- Larball Music (BMI)**, see Finchley.
- Laredo Publ'ns (BMI)**, see Red River.
- Lark Music Inc. (BMI)**, see Sidney A. Seidenberg.
- La Salle Music Publ'rs Inc. (ASCAP)**, see Peer-Southern.
- Las Palmas Music (ASCAP)**, see Amestoy.
- Late Music**, see BW Music.
- Latimer Music**, see Copyright Serv. Bureau.
- Latin American Music (LAM) (BMI)**, see TIM.
- Laughing Duck Music Publ'g Co. (BMI)**, see Studio 10.
- Lauralan Music (ASCAP)**, see Chappell.
- Laurel Canyon Music Ltd. (ASCAP)**, 75 E. 55 St., New York, N.Y. 10022. Tel: (212) 759-1610.
- Int'l reps.:** Australia (Penjane), Belgium (Hans Kusters), France (Intersong Tutti), Germany (Siegel), Italy (Curci), Mideast (Intersong), Japan (April), Netherlands (New Dayglow), South Africa (Intersong) Sweden (Intersong), UK (Intersong).
- Lauren Kim Music (ASCAP)**, 16 Dundee Rd., Stamford, Conn. 06903. Tel: (203) 322-5778, 329-9646. Pres.: Joan R. Weinberg; Gen. Mgr.: Fred Weinberg.
- Laurentian Music Ltd.**, see Copyright Serv. Bureau.
- Laurie House Music**, see Schwartz.
- Lawco Publ'rs (BMI)**, see PARI.
- Lawday Music Corp. (BMI)**, 49 Music Square E., Nashville, Tenn. 37212. Tel: (615) 244-3450. Pres.: Danny Davis; Prof. Mgr.: Lamar Morris.
- Law Publ'g Co. (BMI)**, 305 N. Hwy. 43, Saraland, Ala. 36571. Tel: (205) 675-4431. Pres.: Lois Anne Whiting; Gen. Mgr.: Doc Whiting; Prof. Mgr.: Jamey Whiting.
- Ray Lawrence Ltd.**, PO Box 1987, Studio City, Calif. 91604. Tel: (213) 552-1000. Pres.: Ray Lawrence.
- Ray Lawrence Music (ASCAP)**, see Ray Lawrence Ltd.
- Lawson-Gould Music Publ'rs Inc. (ASCAP)**, see G. Schirmer.
- Mabel Lawton Music (BMI)**, see Mietus.
- Layback Music (BMI)**, see RCS.
- Lazy Libra Music (ASCAP)**, see April/Blackwood.
- LeAire Music (BMI)**, see Martin Cohen.
- Leandro Music (BMI)**, see Rondor.
- Lea Pocket Scores**, PO Box 138, Audubon Sta., New York, N.Y. 10032. Tel: (212) 866-4026. Pres.: F. Steinhart. (Distributed by European-American).
- Int'l rep.:** Austria & UK (Universal).
- Lear Music Inc. (ASCAP)**, 8899 Beverly Blvd., Los Angeles, Calif. 90048. Tel: (213) 273-4070. Pres.: Jack Rael; Gen. Mgr.: Corinne Shayne.
- Lebasongs (ASCAP)**, see Neil Sedaka.
- The Bill Music Inc. (BMI)**, PO Box 11152, Fort Worth, Tex. 76110. Tel: (817) 738-8843. Pres.: Major Bill Smith.
- Int'l branch:** UK.
- Leblon Music Corp. (BMI)**, see Copyright Serv. Bureau.
- Leecowan Music (BMI)**, see Yuggoth.
- Leeds Music Corp. (ASCAP)**, see MCA.
- Kevin Lee Music (BMI)**, see listing under "K".
- Legz Music (BMI)**, see Ciano.
- Lehua Music Co. (ASCAP)**, 1365 Colburn St., Honolulu, Hawaii 96817. Tel: (808) 847-0855. Pres.: C. Robert Clarke.
- Leigh Group Inc.**, 1650 Oak St., Lakewood, N.J. 08701. Tel: (201) 367-0080. Pres.: Milton Herson; Gen. Mgr.: David Muldowney; Prof. Mgr.: Mitch Leigh.
- Paul Leka Music (BMI)**, 132 Merriman Dr., Trumbull, Conn. 06611. Tel: (203) 261-9610. Pres.: Paul Leka; Gen. Mgr.: Gary Regan; Prof. Mgr.: David Anderson; Barbara Clabby. Local branch: PO Box 9171, Bridgeport 06604. Tel: 364-0254. (Administered by Mietus).
- Branch:** Sharon, Conn., Amenia Rd. Zip: 06069.



Let Soundsheets
sell your music or business
LISTEN!

PLACE COIN HERE IF
33 1/3 RPM
STEREO
SOUNDSHEET SLIPS

TEAR OFF ATTACHED COUPON FOR A FREE IDEA
KIT. IF COUPON IS MISSING . . . WRITE OR CALL:

EVA-TONE SOUNDSHEETS, INC.

Dept. 518, 4801 Ulmerton Rd., Clearwater, Fl. 33520
813-577-7000

Produced by Sound 80, Minneapolis, Minnesota.
Material used with permission of copyright holder.
Special thanks to Ovation, Inc. and their artists
Johnson and Drake

MFD IN U.S.A. BY **EVA-TONE®** CLEARWATER, FL.
SOUNDSHEETS

↓ Detach & return this card for your free Idea Kit. ↓

SELL YOUR SOUND WITH SOUNDSHEETS!



In the 1980's, selling your special sound, music style, company, studio or artists will be no easy task. So how do you make your promotional dollars work harder? One answer begins right here in this free Soundsheet Idea Kit offer.

A complete, "How to Do It", Idea Kit on flexible vinyl Soundsheets has been designed to help you objectively decide if Soundsheets can help fill a variety of your communication needs. Inside the Kit, you'll unlock many of the secrets others have successfully used to sell, teach, entertain or persuade their listeners. In addition, your Idea Kit will contain over a dozen actual Soundsheet samples in various sizes, shapes and formats as well as step-by-step ordering instructions and prices from 500 to over 100,000 Soundsheets.

Don't Miss Out! Learn how to beat the high cost of selling your special sound, company or artist in the 80's. Fill in and return this coupon now for your free Eva-Tone Soundsheet Idea Kit! In a big hurry? Call 813-577-7000 and order your Kit by phone.

Yes, Eva-Tone, send me a FREE Soundsheet Idea Kit. In requesting this material, I certify that I have a direct or indirect buying influence on Sound-sheet purchases.

Name _____

Title _____ Phone _____

Company _____

Address _____

City/State/Zip/City History _____

EVA-TONE Dept. 518
SOUNDSHEETS 4801 Ulmerton Rd.
Clearwater, Fl. 33520
(813) 577-7000
Billboard Buyer's Guide, September 1979

TEAR CAREFULLY ALONG PERFORATIONS ↓

Billboard Buyer's Guide
September, 1979



NO POSTAGE
NECESSARY
IF MAILED
IN THE
UNITED STATES

Billboard Buyer's Guide, September 1979

BUSINESS REPLY CARD

FIRST CLASS

PERMIT NO. 1364

CLEARWATER, FLORIDA

POSTAGE WILL BE PAID BY ADDRESSEE

EATON[®]

SOUNDSHEETS

4801 ULMERTON ROAD

CLEARWATER, FLORIDA 33520



Lemco Music Publ'g Co. (BMI), PO Box 8013, 2518 South-
 view Dr., Lexington, Ky. 40503. Tel (606) 277-1184
 Ty Lemley Music (ASCAP), see Tylena
 Lemor Music (BMI), see M. M. Cole
 Lenel Music Publ'g (ASCAP), see Moon Lake
 Len-Lon Music Publ'g Co. (BMI), c/o Sandra R. Newman,
 1326 N. Flores St., Los Angeles, Calif. 90069. Tel
 (213) 654-4601. Pres. Leonard C. Williams. Gen. &
 Prof. Mgr. Sandra R. Newman
 Int'l rep.: UK (Anchor)
 Lenny Publ'g Co. Inc. (ASCAP), see Su-Ma.
 Cecil Lenox Ltd (BMI), see Copyright Serv. Bureau.
 Leo Lou Publ'g (BMI), PO Box 161565, Sacramento, Calif.
 95816. Tel. (916) 481-8018. Pres. Mitchal Stutes;
 Gen. Mgr. Jonathan Stars. Prof. Mgr. DeAnn Linde-
 boom
 Hal Leonard Publ'g Corp. (ASCAP), 960 E. Mark St., Wi-
 nonna, Minn. 55987. Tel (507) 454-2920. Pres.: Har-
 old Edstrom.
 Branch: Milwaukee, Wis., 8112 W. Bluemound Rd.
 Zip 53213. Tel (414) 774-3630. Exec. VP & Gen.
 Mgr. Keith Mardak.
 Int'l branches: England, Spain (SEE ADVERTISE-
 MENT)
 Leonard Prod'n Inc. (BMI), PO Box 222, Gainesville, Tex.
 76240. Tel. (817) 466-4076. Pres. Joe M. Leonard Jr.
 Leo the Lion Music (BMI), see Chappell
 Lesgor Music (BMI), see Copyright Serv. Bureau
 Les-Ron Music Co. (ASCAP), PO Box 728, Sunland, Calif.
 91040. Contacts Leslie Michaels, Reuben Katz.
 Lessa Music (BMI), see Copyright Serv. Bureau
 Leton Music (BMI), see Copyright Serv. Bureau
 Let There Be Music Inc. (ASCAP), see Southern Writers.
 Levan Publ'g (ASCAP), see Inspirational Sounds.
 Levine & Brown Music Inc. (BMI), see Finchley.
 Irwin Levine Music (BMI), see Finchley.
 Levites Music Inc. (ASCAP), see Copyright Serv. Bureau.
 Adam R. Levy & Father Ent's Inc. (BMI), see Big Seven
 Lou Levy Music Co. Inc. (ASCAP), 26 E. 63 St., New York,
 N.Y. 10021. Tel. (212) 223-0390. Cable: LOU-
 LEVY. Pres. Lou Levy. Gen. Mgrs.: George Levy,
 Sidney Catt. Prof. Mgr. J.A. Watkins
 Jerry Lee Lewis (BMI), see Copyright Serv. Bureau
 Lewy Music Publ'g Co. Inc. (ASCAP), see Ashley.
 Lewis & Sons Music (BMI), see April/Blackwood
 Lexicon Music Inc. (ASCAP), PO Box 296, Woodland Hills,
 Calif. 91365. Tel. (213) 884-0333. Pres.: Ralph Carmi-
 chael; VP. Carl Seal (distributed by Word Inc.)
 Liberation Music (BMI), see Martin Cohen
 Libretto Music Co. (ASCAP), see Chappell.
 Libris Music (BMI), see Lexicon
 Licette Music Corp. (BMI), see Fairyland
 Lichelle Music Co. (ASCAP), 4215 Hood Ave., Burbank,
 Calif. 91505. Tel. (213) 849-7409. Pres.: Michelle
 Kay
 Larry Luck Music (BMI), see Sound Inc.
 Lido (BMI), c/o Fadell, Kaden, Nadell & Co., 405 Park Ave.,
 New York, N.Y. 10022
 Liebstone Music (BMI), see Martin Cohen & Rondor
 Life & Times Music (BMI), see Live Music.
 LifeSong Music Press (BMI), see Paragon Assoc.
 Like A Movie Music (ASCAP), see 20th Century.
 Lit'Bo Blackheart Music (ASCAP), see Rondor
 Lillenas Publ'g Co. (SESAC), PO Box 527, Kansas City, Mo.
 64141. Tel. (816) 931-1900
 Sonny Limbo Music (BMI), PO Box 9869, Atlanta, Ga.
 30319. Tel. (404) 346-0700. Pres.: Gen. & Prof. Mgr.
 Sonny Limbo
 Int'l branch: Denmark
 Lincoln Road Music Co. (BMI), see Joe Keene.
 Lineage Publ'g Co. (BMI), PO Box 211, East Prairie, Mo.
 63845. Tel. (314) 649-2211. Pres.: Tommy Loomas;
 Prof. Mgr. Archie Corlew
 Linseder Prod'n Ltd (BMI), see Rohm.
 Linton Music Publ'g (BMI), 1232 Coon Rapids Blvd., Coon
 Rapids, Minn. 55433. Tel. (612) 757-6666.
 Sandy Linzer Music Co. (BMI), see Chappell
 Lion's Gate Films Inc., 1861 S. Bundy Dr., Los Angeles,
 Calif. 90025. Tel. (213) 820-7751. Pres. Robert B.
 Altman; VP. James W. Quinn; Publicist Cathy Keller.
 Lion's Gate Music Co. (ASCAP), see Lion's Gate Films.
 Lion's Pride Music (ASCAP), see Martin Cohen.
 Lion Tracks Music (BMI), see Chappell.
 Lip-Pick Music (BMI), see Mietus
 Lisa Music (ASCAP), see Notables
 Mosaic Lister Publ'ns (SESAC), 11306 Carrollwood Dr.,
 Tampa, Fla. 33618. Tel. (813) 935-2988. Pres. Mosaic
 Lister.
 List Music (BMI), see Mietus
 Lit Cal Music (BMI), see Copyright Serv. Bureau
 Lifetime Music—Owner Linda Gordon—see Berry Lou
 Lit'l David Music (ASCAP), see Songs of David
 Little Barnum Music (BMI), see Chappell
 Little City Publ'g Co. (BMI), 1922-F Prospect Dr., Charlotte,
 N.C. 28213. Tel. (704) 596-7142. Chm. & Pres.: Leon
 E. Stewart Sr. VP & Prof. Mgr. Wilbur E. Stewart; Gen.
 Mgr. Barbara A. Brooks
 Little D Music (BMI), see 20th Century
 Little Darlin' Music (BMI), see Martin Cooper.
 Little Square Inc. (BMI), c/o Jerry Chesnut, 40 Music
 Square E., Nashville, Tenn. 37203. Tel. (615) 244-
 0270
 Little Debbie Music (ASCAP)—Pres. Thomas Fausto—see
 Mastervest
 Little Dickens Music Publ'rs (ASCAP), see Segel & Goldman.
 Little Dipper Music Corp. (BMI), see Big Seven.
 Little Dove Publ'g Co. (BMI), 1228 Reed St., Philadelphia,
 Pa. 19147. Owner & Chief Operating Officer. Grace
 Marchesani.
 Little Elmo Songs Inc. (BMI), see Copyright Serv. Bureau.
 Little Fishes Music (BMI), see Beldock Levine & Hoffman.
 Little Foxborough Music Inc. (BMI), see Mietus.
 Little Gino Music (BMI), see April/Blackwood
 Little Hurry Music Co. Inc. (BMI), see Big Hurry & Mietus.
 Little Jack Music Co. (BMI), see Larry Spier & Trina Jill.
 Little Jim Music (ASCAP), see Jim McCoy.
 Little Joe Music (BMI), 604 Broad St., Johnstown, Pa.
 15906. Tel. (814) 539-8117. Pres.: Al Page.
 Little John Music (BMI), see April/Blackwood.
 Little Max Inc. (BMI), see April/Blackwood.

Little Mike Music (SESAC), see Buster Doss.
 Little Otis Music (BMI), 101 Westchester Ave., Port Chester,
 N.Y. 10573. Tel. (914) 939-1066. Pres.: Carmine
 Riale.
 Little Switzer Music (BMI), see Chappell.
 Little Switzerland Music (ASCAP), see Garrett
 Liturgical Press Inc., see Theodore Presser.
 Live Music Publ'g Corp. (BMI), see Live Music Publ'g Group.
 Live Music Publ'g Group, 793 Bingham Rd., Ridgewood,
 N.J. 07450. Tel. (201) 447-4700. Pres. Ed New-
 mark; Gen. Mgr.: Fran Schneider.
 Living Music Inc. (BMI), see Chappell.
 Lloyd & Logan Music Inc. (BMI), see Copyright Serv. Bureau.
 Mick Lloyd Music (SESAC), PO Box 17125, Nashville, Tenn.
 37217. Tel. (615) 244-1630.
 Lloyd Music (SESAC), see Rondor.
 Lloyd Price Music (ASCAP), see Lori-Joy & Copyright Serv.
 Bureau.
 Loaded Music (BMI), see Copyright Serv. Bureau.
 Loaves & Fishes Music Co. Inc. (BMI), see Bicycle.
 Lodestar Music Publ'g (SESAC), see Gene Kennedy.
 Loena Music Publ'g Co. (ASCAP), 239 W. 18 St., New York,
 N.Y. 10011. Tel. (212) 989-7200.
 Lollipop Music Corp. (BMI), 132 E. 45 St., New York, N.Y.
 10017. Tel. (212) 288-8728. Pres.: Ed Miller; VP.
 Trade Martin.
 Lombardo Music Inc. (ASCAP), see 20th Century.
 Londontown Music (ASCAP), see Garrett.
 Lone Grove Music Inc. (BMI), 6004 Bull Creek Rd., Austin,
 Tex. 78757. Tel. (512) 451-6764. Pres. & Gen. Mgr.:
 Bobby Earl Smith.
 Lone Lake Songs Inc. (ASCAP), PO Box 126, Elmsford, N.Y.
 10523. Tel. (914) 592-7983. Pres.: Ron Carpenter.
 Longhair Music (ASCAP), see Budd Music.
 Longshot Music (SESAC), see Harrison Tyner.
 Longstreet Music (BMI), see Ironside.
 Lonport Music Corp. (BMI), see Sidney A. Seidenberg.
 Looking Glass Music Inc. (BMI), see Copyright Serv. Bureau.
 Lookout Music Co. (ASCAP), see Excellence.
 Loop Music Publ'g Co. (ASCAP), see Neil A. Kjos.
 Lorber-Scheer Music (BMI), see Chappell.
 Lord Byron Music (ASCAP), see Martin Cohen
 Lord Sutch Music (ASCAP), see Martin Cohen
 Lorenz Inds. (ASCAP), 501 E. Third St., Dayton, Ohio
 45401. Tel. (513) 228-6118. Owners: Ed B., Geoffrey
 R. & Steven R. Lorenz.
 Lorenzo Music (BMI), see Bug.
 Lorenz Publ'g Co. (ASCAP), see Lorenz Inds.
 Lori-Joy Music (BMI), 39 W. 55 St., New York, N.Y. 10019.
 Tel. (212) 586-3350. Cable: LLOYDPRICE. Gen. Mgr.:
 Debra Martinez Franqui; Prof. Mgr. Nathaniel Adams
 Jr.
 Loring Music Co. (BMI), 1048 N. Carol Dr., Los Angeles,
 Calif. 90069. Tel. (213) 276-7103. Pres. Mike Con-
 ner.
 Loucarlray Music (BMI), see April/Blackwood
 Louise-Jack Music Inc. (ASCAP), see Sumac.
 Lou-Lee Music Co. (BMI), see Lee Magid.
 J. C. Love Publ'g Co. (BMI), see Beechwood.
 Love Street Publ'g (BMI), PO Box 2501, Des Moines, Iowa
 50315. Tel. (515) 285-6564. Pres. Art Stenstrom.
 Love That Music (BMI), see Bug.
 Lowball Music (ASCAP), see Highball.
 Low-Bam Music (BMI), see Lowery Group.
 Low Down Music (BMI), see Alfieri.
 Lower Arcade Music (ASCAP), see American Mutual.
 Lowery Group, PO Box 49386, 3051 Clairmont Rd. NE, At-
 lanta, Ga. 30329. Tel. (404) 325-0832. Pres.: Bill Low-
 ery. (SEE ADVERTISEMENT)
 Lowlands Music (BMI), see Bug.
 Low-Note Publ'g Co. (BMI), see Crazy Cajun.
 Low-Sal Music Inc. (BMI), see Lowery Group.
 Low-Twi Music Inc. (BMI), see Lowery Group.
 Loyola Music (BMI), see Mietus.
 Lucky Man Music (ASCAP), The Homeplace, Mount Juliet,
 Tenn. 37122. Tel. (615) 444-8431. Owner Alfred H.
 LeDoux.
 Lucky's Kum-Ba-Ya Publ'g Co. (ASCAP), PO Box 6, Broh-
 man, Mich. 49312. Tel. (616) 689-6886. Owner: Ross
 Fulton.
 Lucky Star Music (BMI), see Lori-Joy.
 Lucky Stroke Music (ASCAP), see Jamil
 Lucky Three Music Publ'g Co. (BMI), see Salsoul & Larry
 Spier.
 Luckyu (BMI), c/o Jess S. Morgan & Co., 6420 Wilshire
 Blvd., Los Angeles, Calif. 90048.
 Lu-Cor Music (ASCAP), 7357 S. Euclid Ave., Chicago, Ill.
 60649. Tel. (312) 471-2035.
 Ludix Publ'g Co. Inc. (BMI), see Mietus.
 Ludlow Music Inc. (BMI), see TRO
 Lujac Music Inc. (ASCAP), see Chappell.
 Luminar Music (SESAC), see Lexicon.
 Luristan Music Inc. (ASCAP), see A-Mark.
 Lu-Tex Publ'g Co., see Jack Redick.
 Luxury Music Co. (BMI)—Pres.: Elliot L. Hoffman—see Bel-
 dock Levine & Hoffman.
 Lynda Songs, see Copyright Serv. Bureau.
 LyndseyAnne Publ'g Co. (BMI), see Sheryln.
 Lyn-Lou Music Inc. (BMI), 1518 Chelsea, Memphis, Tenn.
 38108. Tel. (615) 725-1400.
 Lynnstorm Publ'g Co. (ASCAP), see Irving Mills
 Lyra Music Co. (ASCAP), 133 W. 69 St., New York, N.Y.
 10023. Tel. (212) 874-3360. Owner Don Henry.
 Lylesong Inc. (BMI), 1227 Spring St. NW, Atlanta, Ga.
 30309. Tel. (404) 873-6425. Pres.: Harry Karras; VP.
 Robert B. Richardson; Sec'y-Treas. Babs Richardson.
 Lyrical World Co. (BMI), see Copyright Serv. Bureau.

MUSICOR. Pres. Salvatore T. Chiantia; Contacts: Mark
 Koren, John McKellen, Leeds Levy
 Branches: Los Angeles, Calif., East Tower, Suite 530,
 9100 Wilshire Blvd. Zip: 90212. Tel. (213) 550-
 3913.—Nashville, Tenn., 1106 17 Ave. S. Zip:
 37212. Tel. (615) 242-3551. Contact: Jerry
 Crutchfield.
 Int'l branches: Australia (Leeds), Belgium (MCA), Brazil
 (MCA), Canada (Leeds), France (MCA), Germany (MCA),
 Italy (Pickwick), Japan (MCA), Netherlands (MCA), UK
 (Leeds).
 Int'l firms represented: Le Chant du Monde (France),
 Hans Gerg/Arno Volk (Germany), Suvin Zerboni (Spain),
 Int'l reps.: Argentina (Korn), Mexico (EMLASA), Spain
 (Southern Music Espanola), Sweden (Sweden Music).
 M D K Music Ltd., 515 E. Spring St., No. 1, Bluffton, Ind.
 46714. Pres.: Malcolm Kigar. (Administered by Copy-
 right Serv. Bureau).
 Home office: Brazil.
 M-E Music Co. (ASCAP), 1697 Broadway, Suite 1201, New
 York, N.Y. 10019. Tel. (212) 757-5105. Co-Owners
 William H. Borden, Claire R. Olivier.
 M E W G Music Inc. (BMI), see Sidney A. Seidenberg & Copy-
 right Serv. Bureau.
 m f Music Inc. (ASCAP), see Copyright Serv. Bureau.
 M J Q Music Inc. (BMI), 200 W. 57 St., New York, N.Y.
 10019. Tel. (212) 582-6667. Pres.: John Lewis; Gen.
 Mgr.: Paul Schwartz.
 M M O Music Group Inc., 423 W. 55 St., New York, N.Y.
 10019. Tel. (212) 245-4861. Pres.: Irving Kratka, VP.
 Morton C. Hillman; Prof. Mgr.: Kevin Yatarola.
 Branch: North Hollywood, Calif., 13012 Satcuy St.
 Zip: 91605. Tel. (213) 765-6600. Gen. Mgr. David
 Kratka.
 M P L Communications Inc. (ASCAP), c/o Eastman & East-
 man, 30 Park Pl., East Hampton, N.Y. 11937.
 M R C Music Inc. (BMI), see Chappell.
 M R E Publ'g (ASCAP), see Copyright Serv. Bureau.
 M R I Music (ASCAP) (div. of Music Resources Int'l Corp.)
 161 W. 54 St., Suite 601, New York, N.Y. 10019. Tel.
 (212) 265-6420. Pres.: Andy Hussakowsky; Gen.
 Mgr.: Gene O'Brien; Prof. Mgr.: Joseph Vose. (Adminis-
 tered by Copyright Serv. Bureau).
 Branch: Los Angeles, Calif., 110 N. Alta Loma Rd. Zip
 90069. Tel. (213) 657-5000, 659-6692. Exec. VP.
 Steve Brodie.
 Int'l reps.: Australia, Brazil, England, France, Germany,
 Japan (all Copyright Serv. Bureau in USA).
 Mabrak Music (BMI), see Bug.
 MacArthur Music (BMI), PO Box 82, 1659 Sweetbrier St.,
 Palmdale, Calif. 93550. Tel. (805) 947-1232. Pres. &
 Gen. Mgr.: Glen MacArthur.
 Macaulay Music (ASCAP), see Rondor.
 Mac Lean (BMI), see ATV.
 MacLen Music Inc. (BMI), see ATV.
 Madelon Music (BMI), see Audio Arts.
 Madison Music Ltd. (ASCAP), see Slide.
 Mad Man's Drum Music (ASCAP), see Segel & Goldman.
 Madrid Music Co. (ASCAP), PO Box 504, 4290 Acacia Ave.,
 Bonita, Calif. 92002. Tel. (714) 421-0865. Pres. &
 Gen. Mgr.: Virginia B. Anderson; Exec. VP & Prof. Mgr.:
 Robert Lee Anderson Sr.
 Maffy Music (BMI), see Speed.
 Mafundi Music Co. (BMI), see Chappell.
 Magic Castle Music (BMI), see April/Blackwood
 Magic Fleet Music Inc. (BMI), see Brookside.
 Magicians Music (ASCAP), see April/Blackwood.
 Magic Muffin Music (BMI), see 20th Century.
 Lee Magid Inc., PO Box 532, Malibu, Calif. 90265. Tel.
 (213) 457-2056. Cable: LEEEMAG. Pres. Lee Magid.
 Int'l firm represented: Point Music Ltd. (UK).
 Mag Music (BMI), PO Box 1493, Landover, Md. 21285. Tel.
 (301) 350-3458; Wash. D.C. (202) 232-3060. Pres.
 Michael Angelo Graham.
 Magnanimous Music Co. (ASCAP), see A. Schroeder.
 Magnet (BMI), c/o Albert Gamse, 3313 Corsa Ave., Bronx,
 N.Y. 10469.
 Magnum Music (SESAC), 150 Gorman St., Naugatuck,
 Conn. 06770. Tel. (203) 729-2508. Pres. George Fe-
 dorick; Gen. Mgr.: Andrew C. Doback; Prof. Mgr.
 George Csanka Jr.
 Main Floor (BMI), see McRon.
 MainMan Ltd. (ASCAP), 200 Central Park S., New York, N.Y.
 10019.
 Mainsail Music (BMI), 1126 Boylston St., Boston, Mass.
 02215. Tel. (617) 262-7880. Pres., Gen. & Prof. Mgr.:
 Fred Berk.
 Mainspring Music Corp. (ASCAP), see Al Gallico.
 Mainspring Watchworks Music (ASCAP), PO Box 40133,
 San Francisco, Calif. 94140. Tel. (415) 626-4467.
 Gen. Mgr.: H.S. Carr.
 Main Slave Music (ASCAP), PO Box 3763, Hollywood, Calif.
 90028. Tel. (213) 761-9679. Pres. Jeff G. Oxman;
 Exec. VP: Marko Perko; Copyright Mgr.: Gary Engel;
 Prof. & Royalty Mgr.: K.L. Dossat. (Affiliated with Mir-
 song Music).
 Int'l reps.: Greece (Sun-Pacific), Japan (Pacific) Neth-
 erlands (Number One), South Africa (Sun-Pacific), UK
 (Sun-Pacific).
 Mainstay Music Inc. (BMI), see Al Gallico.
 Makamillion Music (BMI), see Tree.
 Makamint Music (ASCAP), see Makamillion & Tree.
 Maka Music (ASCAP), see MacArthur.
 Make Me Smile Music (ASCAP), see Chicago Music.
 Makemore Music Publ'g Co. (BMI), 11201 Kling St., North
 Hollywood, Calif. 91602. Tel. (213) 760-3204. Pres. &
 Gen. Mgr.: John-Everett Beal.
 Make Music (ASCAP), see Myrna March.
 Malaco Music Co. (BMI), 3023 W. Northside Dr., Jackson,
 Miss. 39213. Tel. (601) 982-4522. Pres.: Tom Couch;
 VP & Prof. Mgr.: Wolf Stephenson.
 Malbiz (BMI), see Segel & Goldman.
 Malcolm Music Ltd. (BMI), see Shawnee Press.
 Mal & Rac Music Ent's. (ASCAP), 3308 Midway Dr., Suite
 120, San Diego, Calif. 92110. Tel. (714) 223-5566 x.
 120. Pres. & Prof. Mgr.: Robert Racouillat; Gen. Mgr.:
 Mal Warner.
 Richard Maltby Inc., see T.B. Harms—Bibo.
 Maltone Music (BMI), see Bug.
 Mamma Sadie Music (ASCAP), see Chappell.

Manacor Music Co. Inc. (ASCAP), see Fred Ahlert
 Management Agency & Music Publ'g Inc. (BMI), see MCA Music
 Manasquan Prod'ns, see Marielle
 Mancuso Music (ASCAP), see Martin Cohen
 Mandan Music Corp. (BMI), see Big Seven
 Mandina Music (BMI), see Trust Music
 Mandrill Music Publ'g (ASCAP), see Chappell
 Mandy Music (ASCAP), see Frank & Nancy
 Manikin Music Co. (ASCAP)—Pres. Carl Maduri, Prof. Mgr. Gary Doberstyn—see Stone-Rap & 20th Century
 Man-Ken Music Ltd. (BMI), 34 Pheasant Run, Old Westbury, N.Y. 11568 Tel. (212) 752-1330 Telex 620400. (Administered by Stevens H. Weiss)
 Int'l rep.: UK (St. Annes)
 Manna Music Inc. (ASCAP), 2111 K. nmore, Burbank, Calif. 91504. Tel. (213) 843-8100
 Herbie Mann Music Corp. (ASCAP), see Mietus
 Mannman Music (BMI), see Segel & Goldman
 Mann & Weil (BMI), see ATV
 Man of Peace Music (ASCAP), 1155 N. Hyperion Ave., Hollywood, Calif. 90029. Tel. (213) 665-2807. Pres.: James H. Freedner
 Mantoloking Music Corp. (ASCAP), see Marielle
 Mantra Music (BMI), 222 E. Garvey Ave., Monterey Park, Calif. 91754. Tel. (213) 280-8783. Owner & Pres.: Johnny Thompson
 Manwin Music (BMI), c/o Chapman Dist'g Co., 1212 Albany St., Los Angeles, Calif. 90015. Tel. (213) 749-9484. Owner: Al Chapman
 Maplehill Music (BMI), see T.B. Harms—Vogue
 Maple Leaf Music Publ'g (BMI), see H.B. Webman
 Maple Music Inc. (ASCAP), see Sure Fire
 Mara-Lane Music Corp. (ASCAP), see Chappell
 Marantha Music Inc. (ASCAP), 2902 W. Garry Ave., Santa Ana, Calif. 92704. Tel. (714) 546-9210. Pres.: Chuck Fromm, Gen. Mgr.: Ted Bleymaier, Prof. Mgr.: Tom Comes
 Maranta Music Publ'g Co. (BMI), see Aguirre
 Maraville Music Corp. (ASCAP), see Barton Music
 Marbert Publ'g Co., 5763 Nassau St., Philadelphia, Pa. 19131. Tel. (215) 477-4417. Contacts: Robert & Mary M. Anstrom
 Marbill Music (BMI), see Le Bill
 Marble Music Publ'g (ASCAP), see Brunswick
 Marcell Music Inc. (BMI), see MBA
 Marcella Music (BMI), see Bug
 March First Music, see Ferndock
 March Music Inc., see T.B. Harms—Harry Von Tilzer
 Myrna March Music Inc. (ASCAP), 400 E. 56, Suite 12-P, New York, N.Y. 10022. Tel. (212) 758-7127. Pres.: Myrna March, Gen. Mgr.: Martin Hoffman
 Marcia Music Co. (BMI), see Ivan Mogull
 Marc-Jean Music Publ'g (BMI), see Elizabeth Music
 Mardanza Music (ASCAP), see Copyright Serv. Bureau
 Mardee Music (ASCAP)—Pres. Dee Anthony—see Beldock Levine & Hoffman & Rondor
 Ma-Ree Music Inc. (ASCAP), see Jim Reeves

Marfre Music Publ'g Co. (BMI), 6118 S. Padre Island Dr., Corpus Christi, Tex. 78412
 Margenia Music (BMI), see Gopam
 Marguerita Music Inc. (ASCAP), see H.B. Webman
 Marian Music Corp. (ASCAP), see Copyright Serv. Bureau
 Mariabus Music Inc. (BMI), see Dick James
 Marielle Music Publ'g Corp. (BMI), PO Box 842, Radio City Sta., New York, N.Y. 10019. Tel. (212) 580-9723
 Pres. & Gen. Mgr.: Don Seat, Gen. & Prof. Mgr.: A. Cole
 Branch: Chicago, Ill., PO Box 11012, Zip 60611. Tel. (312) 266-9611
 Marnwood Music Publ'g (ASCAP), see Jordan
 Marposa Music Inc. (BMI), see Marty Robbins
 Marius Music (ASCAP), see Chappell
 Mar-Ken Music Co. (BMI), see Cherry Lane
 Marko Press (BMI)—Ed. J. McKelvey—see Mark Foster
 Edward B. Marks Music Corp. (BMI), 1790 Broadway, New York, N.Y. 10019. Tel. (212) 247-7277. Cable: MARK-BRO. Pres.: Joseph Auslander, VP Publ'ns Dir.: Bernard Kalban; VP & Prof. Mgr.: Barry Bergman
 Marlen Music Co. (ASCAP), see Gordon
 Bob Marley Music Ltd. (ASCAP), see Rondor
 Marmaduke Music (ASCAP), see Copyright Serv. Bureau
 Marmony Music Co. Inc. (BMI), see Copyright Serv. Bureau
 Marmor Music Co. (BMI), see Clockwork
 Marnel Music Co. Inc. (ASCAP), see Copyright Serv. Bureau
 Marpet Music Corp. (ASCAP), see T.B. Harms—Bibo
 Marsant Music Inc. (BMI), 3809 Clematis Ave., New Orleans, La. 70122. Tel. (504) 949-8386. Pres.: Allen Toussaint, Gen. & Prof. Mgr.: Marshall E. Sehorn. (Administered by Warner Bros. Inc.)
 Marshmitt Music (BMI), see Amestoy
 Marson Inc., 817 18 Ave. S., Nashville, Tenn. 37203. Tel. (615) 329-0212
 Martha Louise Music (BMI), see Nashville Copyright
 A. W. Marullo Music (BMI), 1121 Market St., Galveston, Tex. 77550. Tel. (713) 762-4590. Pres.: A.W. Marullo Sr., Gen. Mgr.: A.W. Marullo Jr.
 Marville Music Co. (BMI), see Lee Magid
 Marvin Music Co. (ASCAP)—Contact: Marvin Fisher—see Fisher Music Corp.
 Josef Marx Music Co. (ASCAP), see McGinnis & Marx
 Marycords (ASCAP), Box 48, Powers Lake, N.D. 58773
 Maryhill Music, see Twin Tail
 Mary Jane Music Inc. (ASCAP), see Mietus
 Mary-Jo Nic Music Publ'g (BMI), see Donna Marie
 Marzique Music (BMI), 5752 Bowcroft St., Los Angeles, Calif. 90016. Tel. (213) 295-0058. Pres.: Harold R. Battiste Jr., Gen. Mgr.: Alvierte M. Battiste
 Dave Mason Music (BMI), see April/Blackwood
 Masong Music (ASCAP), 6632 Belmar Ave., Reseda, Calif. 91335
 Master Fox Music Publ'g Co. (BMI), PO Box 90612, Nashville, Tenn. 37209. Tel. (615) 646-1974. Pres.: Ray Reeves
 Masterlease Music Publ'ns (BMI), PO Box 234, St. Louis, Mo. 63166. Tel. (314) 296-9526. Pres.: Bob J. Bax
 MasterSession Music (ASCAP), see Pablo
 Mastership Music Inc., 1017 N. LaCienega, Los Angeles, Calif. 90069. Tel. (213) 657-8730
 Masterview Music Publ'g Corp. (BMI), Ridge Rd. & Rt. 563, Perkase, Pa. 18944. Tel. (215) 257-9616. Pres.: John Wolf, Gen. Mgr.: Tom Fausto, Prof. Mgr.: Ann Fausto
 Matador Music Publ'g Co. Inc. (BMI), see Copyright Serv. Bureau
 Matchmaker Music (BMI), see April/Blackwood
 Mathematical Music (ASCAP), see Blue Canyon
 Matragun Music Inc. (BMI), c/o Edward Poll, 9777 Wilshire Blvd., Suite 718, Beverly Hills, Calif. 90212. Tel. (213) 550-7201. Pres.: Rick Nelson, Gen. Mgr.: Edward Poll, Office Mgr.: Georgianna F. Matsuhara
 Matrix Publ'g Co. (ASCAP), PO Box 12246, Memphis, Tenn. 38112. Tel. (901) 274-7788. Contacts: Dane & Gala Sullivan
 Int'l rep.: Worldwide except USA & Canada (Ivan Mogull)
 Mavid Music Inc. (BMI), see Copyright Serv. Bureau
 Max Fil Music Co. (ASCAP), see Copyright Serv. Bureau
 Maxim Music Inc. (ASCAP), see Cromia
 Maximus Music, see Marielle
 Ray Maxwell Music Publ'g Co. (BMI), PO Box 317, 1610 N. Argyle Ave., Hollywood, Calif. 90028. Tel. (213) 995-7611. Cable: MOONGLOW. Owner & Gen. Mgr.: Ray Van Hogen
 Maybe Music (ASCAP), see Bruce Cohn
 Mayerling Prod'ns Ltd. (BMI), see Chappell
 Mayfield Music (BMI), see Curtom
 Mayflower Music Corp. (ASCAP), Lincoln Plaza, 20 W. 64 St., New York, N.Y. 10023. Tel. (212) 595-6360
 Mayhew Music Co. (BMI), see Copyright Serv. Bureau
 Mayon Music (ASCAP), see Val-Dare
 Maytime Music Inc., see T.B. Harms—Vogue
 Maz-Kap Music (ASCAP), see Country Stream
 McAfee Music Corp. (ASCAP), 300 E. 59 St., New York, N.Y. 10022. Tel. (212) 838-8721
 Jim McCoy Music (BMI), PO Box 574, Winchester, Va. 22601. Tel. (703) 667-9379. Pres. & Prof. Mgr.: Jim McCoy, Gen. Mgr.: R.J. Alford Jr.
 Van McCoy Music Inc. (BMI), 6901 Old Keene Mill Rd., Suite 500, Springfield, Va. 22150. Tel. (703) 569-5330. Pres.: Van McCoy, Gen. Mgr.: Charles H. Kipps Jr. (Administered by Warner Bros.)
 McCulloch Music (BMI), see Beechwood
 McDonald Music Co. (BMI), see Alkatraz Corner
 McDorsob Music (BMI), see Rondor
 McGinnis & Marx Music Publ'ns (BMI), 201 W. 86 St., Apt. 706, New York, N.Y. 10024. Tel. (212) 799-5214. Owner: Mrs. Josef Marx, Mng. Ed.: Margaret Gresh. Int'l reps.: Europe excluding UK (Baerenreiter in Germany), UK (Peters)
 Jimmy McHugh Music Inc. (ASCAP), 9301 Wilshire Blvd., Suite 400, Beverly Hills, Calif. 90210. Tel. (213) 271-1967, 272-4871. Pres. & Prof. Mgr.: Lucille Meyers
 McLaughlin Publ'g Co. Inc. (BMI), see Mietus
 McNeely Music Co. (ASCAP), see Elm
 McRon Music Co. (ASCAP), 521 Fifth Ave., New York, N.Y. 10017. Tel. (212) 682-5844. Pres.: Tsipora Miron, VP & Prod'n Dir.: Steve Monroe, VP & Int'l Mgr.: Thelma

Moore, Pub. Jon Arthur, Promo. Marie M. Gadreau
 McRovscod Music (ASCAP), see Rondor
 Meadowsee Music (BMI), 1727 Roanoke Ave., Sacramento, Calif. 95838. Tel. (916) 925-4886. Owner: Jerry Parker
 Meadow Ridge (ASCAP), c/o Max Danzinger, 14755 Ventura Blvd., Sherman Oaks, Calif. 91403
 Meadows Music Co., see Eastwick
 Meager Music (BMI), see LF Music
 Me-Benish Music Inc. (ASCAP), see A. Schroeder
 Medad Music (BMI), see Rondor
 Medallion Avenue Music (ASCAP), see Sutton/Miller
 Media Interstellar Music (BMI), (div. of Clay Pigeon Int'l.), PO Box 20346, Chicago, Ill. 60620. Tel. (312) 476-2553. Pres.: Vytautas Beleska; Sales: Rudy Markus
 Mediation Combine, PO Box 203, Evanston, Ill. 60204
 Medicine Hat Music (ASCAP), see Bicycle
 Medicine Music Publ'g Co. (SESAC), see Slide
 Mee Moo Music (BMI), see Copyright Serv. Bureau
 Melbourne Music Publ'g Co. (ASCAP), see Jasper
 Meled Music Corp. (BMI), see Cheren-Klishins
 Mella La Salle Publ'g Co. (ASCAP), see Shanga
 Robert Mellin Music Publ'g Corp. (BMI), 1841 Broadway, New York, N.Y. 10023. Tel. (212) 757-3287. Cable: MELLINMUS. Pres.: Robert Mellin, VP: Sanford Green.
 Int'l branch: England
 Mellyric Music (ASCAP), PO Box 12009, Cleveland, Tenn. 37311. Tel. (615) 479-1415. Pres.: Donald B. Gibson
 Melodisong Music (BMI)—Pres.: Marko Perko—see Mirsong
 Melody Delux (ASCAP), c/o Gregory E. Fischbach, 2029 Century Park E., Los Angeles, Calif. 90067
 Melody House Music Publ'g (BMI), see House of Rock
 Melody Lane Publ'ns Inc. (BMI), see Peet-Southern
 Melody Ranch Music Co. Inc., see Golden West
 Melody Trails Inc. (BMI), see TRO
 Melomega Music Ltd. (ASCAP), see Chappell
 Melster Music (BMI)—Contact: Syble C. Richardson—see Woodrich
 Melway Music Inc. (ASCAP), Ala. Moana Bldg., Suite 1500, Honolulu, Hawaii 96814. Tel. (808) 946-3244
 Memnon Ltd. (ASCAP), PO Box 84, Glen Cove, N.Y. 11542. NYC Tel. (212) 265-1292
 Int'l reps.: France (Bourne France), West Germany (Melodie der Welt)
 Memory Lane Music Corp. (BMI), see Larry Spier
 Men of Progress (BMI), see Copyright Serv. Bureau
 Mentor Music Inc., 18 Broadview Rd., Brookfield, Conn. 06804. Tel. (203) 775-1358. Pres.: Robert Nagel
 Mercantile Music (BMI), PO Box 2271, Palm Springs, Calif. 92262. Tel. (714) 327-3271. Owner: Kent Fox
 Mercer Music (ASCAP), see Commander
 Mercury Bird Music (BMI), see Ivan Hoffman
 Mercury Music Corp. (SESAC), see Theodore Presser
 Meredith Music Inc. (ASCAP)—Pres. & Gen. & Prof. Mgr.: Ronnie Peterson—see Buckhorn
 Meron Music Inc. (BMI), see Theodore Presser
 Merjoda Music Inc. (BMI), see Chappell
 Mernee Music (ASCAP), see Woodrich
 Merritt & Norman Music (BMI), Box 368-A, Rt. 5, Yakima, Wash. 98903. Tel. (509) 966-6334. Pres.: Jerry L. Merritt, VP: Lloyd Jones, Gen. Mgr.: Hiram White, Prof. Mgrs.: Jerry & Larry Merritt
 Merrymount Music Inc. (BMI), see Theodore Presser
 Merry Sounds (ASCAP), (div. of Lisa Sue Music), PO Box 313, Kingsbridge Sta., Bronx, N.Y. 10463. Tel. (212) 543-7770. Pres.: Bruce Hest, Gen. Mgr.: Merry Salos, Prof. Mgr.: Neil Fredman
 Meryl Music (ASCAP), see Chappell
 Me & Sam Music (ASCAP), PO Box 40364, Nashville, Tenn. 37204. Tel. (615) 292-6677. Pres.: Ann J. Morton, Gen. Mgr.: Sam Kirk Patrick
 Meshugah Music (BMI), 3242 Irwin Ave., Kingsbridge, N.Y. 10463. Tel. (212) 549-3655. Pres.: Don Schlitten
 Int'l rep.: Japan (Pumpkin)
 Mesquite Music Corp. (ASCAP), see Edwin H. Morris
 Metedeconk Music Corp. (BMI), see Marielle
 Meteorion Music Corp. (ASCAP), 210 Fifth Ave., New York, N.Y. 10010. Tel. (212) 679-9312
 Home office: Switzerland
 Int'l rep.: Denmark (Multitone)
 Metrolina Publ'g Co. Inc. (BMI), 2624 Chesterfield Ave., Charlotte, N.C. 28205. Tel. (704) 377-3992. Pres.: John Roger Branch, Gen. Mgr.: Mike Branch
 Metronome Music Publ'g Co., 400 W. Glenwood Ave., Philadelphia, Pa. 19140. Tel. (215) 426-5017
 Metropolitan Music Co. (BMI), 4225 University Blvd., Houston, Tex. 77005. Tel. (713) 668-3279. Mgr.: J.R. Lee
 Metro Soul Sound Publ'g (BMI), see Little City
 Stephen Metz Music Ltd. (BMI), see Chappell
 Mexican Music Centre Inc. (ASCAP), 345 W. 58 St., Suite 2-P, New York, N.Y. 10019. Tel. (212) 582-5705. Cable: COPYRIGHT Mng. Dir.: Gerard de La Chapelle
 Joseph Meyer (ASCAP), see Larry Spier
 Jun M'hoon & Assocs. (ASCAP), 10519 S. Forest, Chicago, Ill. 60628. Tel. (312) 928-0778. Pres.: Wilbur L. M'hoon Jr., Gen. Mgr.: Joan M'hoon, Prof. Mgr.: Jun M'hoon, Local Branch: 424 S. Maple, Oak Park 60302. Tel. 848-5935
 Michael Music (ASCAP)—Pres.: Michael Lloyd—see Triple H
 Michavin Music (BMI), PO Box 2061, Daytona Beach, Fla. 32015. Owner & Mgr.: Vincent L. Smith III
 Mi-Da-Mark Music (ASCAP), see AnnBen
 Mid-American Music Publ'g (ASCAP), (div. of Ozark Opry Inc.), 155 First St., Box B, Carlisle, Iowa 50047. Tel. (515) 989-0876. Contact: Harold L. Luck
 Midarich Music (BMI), see Schaffer Publ'g
 Midas Music Corp. (ASCAP), see Chappell
 Midday Music Publ'g (BMI), 233 E. Erie St., Chicago, Ill. 60611. Tel. (312) 664-9119. Pres.: Peter H. Wright
 Middle Eastern Music (ASCAP), see KRPCO Music
 Mideb (ASCAP), see Twin Music
 Midget Music (ASCAP), see Widget
 Midships Music (ASCAP), see Segel & Goldman
 Midsong Music Inc. (ASCAP), 1650 Broadway, New York, N.Y. 10019. Tel. (212) 541-5100. Cable: MIDSONG. Telex: 422308. Pres.: Bob Reno, VP: Opns. Harry Spero
 Int'l reps.: Worldwide excluding Canada, Germany &

*consulting
 in the
 classical tradition*

with specialization in . . .

international licensing

music publishing

*record and tape
 marketing and distribution*

video and digital recording

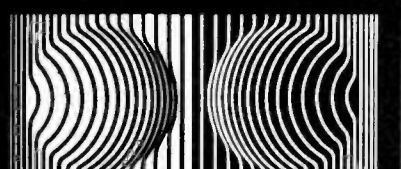

**DAVID HUBERT
 & ASSOCIATES**

541 CONTINENTAL COURT BUILDING
 201 NO ORANGE GROVE BOULEVARD
 PASADENA, CALIFORNIA 91103 (213) 796-9693

UK (Intersong in Netherlands), Germany (Seigel), UK (RMO, Noel Gay).

Midstream Music Publ'rs (BMI), Box 225A, Mountain Falls Rt., Winchester, Va. 22601. Tel (703) 667 7102. Pres. Max Mandel, VP Pete Hand.

Midway Prod'n publ'ns (ASCAP), see Cook Duck.

Midwood Music Corp. (BMI), see Barton Music.

Mietus Copyright Mgmt., 527 Madison Ave., Suite 317, New York, N.Y. 10022. Tel (212) 371-7950. Admin'r Leonard S. Mietus.

Branch: Union, N.J., 2351 Laurana Rd. Zip 07083. Tel (201) 686-0716.

Mifka Music (ASCAP), see Hairtrigger.

Mighty-Fine Music Co. (BMI), 48 Selden St., Dorchester, Mass 02124. Tel (617) 825-5227, 625-6327 Pres. Jackson Whitehead.

Mighty Max Music (ASCAP), c/o Max's Kansas City, 213 Park Ave. S., New York, N.Y. 10003. Tel (212) 777-7870. Pres.: Tommy Dean; Mktg Dir. Andy Husakowsky.

Mighty Mo Music (ASCAP), see A Dish-A-Tunes.

Mighty Music (BMI), 2901 W. Maryland, Phoenix, Ariz. 85017. Tel (602) 276-8520. Pres. Mike Lenaburg; Gen. Mgr. Vero Duffins, Prof. Mgr. Leila Freeman.

Mighty Ram Music (BMI), see Mighty Max.

Mighty Three Music (BMI), 309 S. Broad St., Philadelphia, Pa. 19107. Tel (215) 546-3510. Pres. Earl Shelton; Prof. Mgr. Ed Martinez; Publ'g Admin. Dir. Constance Heigler.

Branch: Seattle, Wash., 117 S. Main St., Suite 200. Zip 98104. Tel (206) 682-5278. Mng. Partner Thom Bell; West Coast Opns. Dir. Jodee O'mer.

Int'l rep.: UK (Carlin). (SEE ADVERTISEMENT)

Mighty Twinn Music (BMI), 9134 S. Indiana Ave., Chicago, Ill 60619. Tel (312) 264-5452. Pres. & Prof. Mgr. Ron Scott; Gen. Mgr. Pearl Duncan.

Branch: New York, N.Y., 310 Greenwich St., Suite 16-A. Zip 10013. Tel (212) 962-3944.

Mijoy Music (BMI), see Show Biz.

Mike's Tune Shop (ASCAP), see Harold Thomas.

Milbern Music Inc. (BMI), see A-Mark.

Milene Music Inc. (ASCAP), see Acuff-Rose.

Earl Miles Publ'g Co. (BMI), 1119 Woodrow St., Redwood City, Calif. 94061. Tel: (415) 368-5619. Owner Earl Miles.

Int'l rep.: South Africa (RCA-Teal)

Milk & Honey Music (BMI), see Tune-Kel.

Milkman's Chivaree, see Fourth Floor.

Milk Money Music (ASCAP), see Segel & Goldman.

Eddy Miller Music, see Tree.

Roger Miller's Music (BMI), 1880 Century Park E., Suite 900, Los Angeles, Calif. 90067. Tel (213) 553-1707. Pres. Roger Miller.

Int'l firm represented: Debcar (Canada)

Int'l rep.: Worldwide (Peer Int'l)

Million Seller Music (BMI), see Copyright Serv. Bureau.

Arnold Mills & Assocs. 8721 Sunset Blvd., Suite 201, Los Angeles, Calif. 90069. Tel: (213) 657-2024. Pres.: Arnold Mills.

Irving Mills Music Publ'rs, 9001 Lindblade, Culver City, Calif. 90066. Tel (213) 870-7517.

Mills & Mills (BMI), c/o Theodore Life Jr., 1400 E. Weaver St., Philadelphia, Pa. 19150.

Mills Music Inc. (ASCAP), see Belwin-Mills.

Mimic Music (BMI), PO Box 201, Smyrna, Ga. 30081. Tel (404) 432-2454. Pres. & Gen. Mgr. Tom Hodges, Prof. Mgr.: Jerry Burke.

Minaret Music Inc. (BMI), see Martin Cohen.

Ministry Music (BMI), see Rondor.

Minnepaul Music Publ'g Co. (BMI), PO Box 228, New Richmond, Wis. 54017. Tel: (715) 246-5410. Pres. David Anthony; Gen. Mgr. Patricia Wachter; Prof. Mgr.: Dennis Johnson.

Branch: Minneapolis, Minn., 6724 Camden Ave. N. Zip 55430. Tel (612) 566-6454.

Minstrel Music Inc. (ASCAP), see Chappell.

Minta Music (BMI), 549 Cheyenne, Walnut Creek, Calif. 94598. Tel: (415) 932-6965. Pres. Philip R. Jones.

Mint Julep Publ'g Co. Inc. (ASCAP), see Julep.

Mio Music Co. Ltd. (BMI), see Chappell.

Miracle-Joy Publ'ns (BMI), 425 Park St., Hackensack, N.J. 07601. Tel: (201) 488-5211. Pres.: Johnny Miracle; Gen. Mgr.: Kenny Luv; Prof. Mgr.: Aileen Joy.

Branch: Knoxville, Tenn., Rt. 2, Ogg Ln. Zip 37918. Tel: (615) 689-5219. Gen. Mgr. William Dahse; Prof. Mgr.: Sam Starr.

Miracle Recs. Publ'g Co. (ASCAP), 170-30 130 Ave., Jamaica, N.Y. 11434. Tel: (212) 723-9727. Pres., Gen. & Prof. Mgr. Harry Fenster.

Miraka Music Inc. (ASCAP), see Copyright Serv. Bureau.

Miraleste Music (BMI), see Richard Delvy.

Mirsong Music (USA) (BMI) (div. of Moonstone Int'l Recs), PO Box 946, Hollywood, Calif. 90028. Tel: (213) 721-1637, 894-9487. Dirs.: Jeff Oxman, Marko Perko.

Mirwood Music Inc. (BMI), see Copyright Serv. Bureau.

Mishagos Music (BMI), see Copyright Serv. Bureau.

Mishawaka Music (BMI), 2420 River Ave., Mishawaka, Ind. 46544. Tel (219) 259-3215. Owner. Juanita Henson.

Misirlou Music Inc. (BMI), see Ivan Mogull.

Miskatonic Music (BMI), see Yuggoth.

Miss Alatex Music (ASCAP), see Garret.

Miss Molly's Music Co. (BMI), see Aunt Polly's.

Missprint Music (BMI), PO Box 925, Hollywood, Calif. 90068. Tel (213) 464-4988.

Mr. Bones Music Publ'g Inc. (BMI)—Pres.: Bones Howe—see Fred Ahlen.

Mr. Dogg Music (BMI), see ATV.

Mr. Mort Music (ASCAP), 44 Music Square E., Nashville, Tenn. 37203. Tel: (615) 255-2175. Pres.: Charles Fields; Gen. Mgr. Bernice Fields.

Mr. Music Co. Inc. (BMI), see Barton Music.

Mr. Par Music (BMI), 5143 Goodland Ave., North Hollywood, Calif. 91607. Tel (213) 763-1616. Owner Paul Robin; Prof. Mgr. Larry Brunswick.

Joni Mitchell Publ'g Corp. (BMI), see Segel & Goldman.

Mitchell Rec'g & Music Publ'g Co. Inc. (BMI)—Pres. W.B. Mitchell—see California's Blue-Rose.

Mizanne Music (ASCAP), 1014 16 Ave. S., Nashville, Tenn. 37212. Tel: (615) 244-3748. (Affiliated with Mick Lloyd Music.)

Mobilized Music (BMI), see Bug.

Modern Lovesongs, see Beserkley.

Modern Music Publ'g Inc. (BMI), 5810 S. Normandie Ave., Los Angeles, Calif. 90044. Tel (213) 753-5121.

Modest Music Inc. (BMI), see Charing Cross.

Modoc Music Inc. (ASCAP)—Pres. Ken Jordan; Gen. Mgr.: Terry Arrington—see Able Music.

Modville Publ'g Co. (BMI), see Andira.

Ivan Mogull Music Corp. (ASCAP), 40 E. 49 St., New York, N.Y. 10017. Tel (212) 355-5636. Cable IMOGULL. Telex 236973. Pres.: Ivan Mogull; Gen. Mgr. Al Wilens; Prof. Mgr. Yolanda Blum.

Int'l branches: Argentina, Australia, Belgium, Brazil, Colombia, Czechoslovakia, France, Germany, Greece, Israel, Italy, Jamaica, Japan, Mexico, Netherlands, Singapore, South Africa, Spain, Sweden, Switzerland, UK.

Int'l firms represented: Worldwide excluding US & Canada—Athens Music Co. (BMI), Bucurelis Music Co. (BMI), Bucky Music Co. (ASCAP), Rolls Royce Music (ASCAP), Ninandy Music Co. (BMI), Southern Pines Music Publ'g Co. (ASCAP), NFL Films Inc. (BMI), Hargrove Music (BMI), Roswell Music Co. (BMI), Multigan Publ'g Co. Inc. (ASCAP), Chicken Fred Music (BMI), Dr. Livingston I Presume Music (BMI), Groper Music (BMI), Neath Music (BMI), Nunn Publ'g (BMI), Ray Willie Hubbard Music (BMI), Serendipity Publ'g Corp. (BMI), 16th Avenue Music Inc. (BMI), Big Ten Music Co. (BMI), Peach Music (BMI), Sue-Miri Music (ASCAP), Passing Clouds Music Inc. (BMI), Ozone Music (BMI), Busybody Music (BMI), **Worldwide excluding US, Canada, UK & Australasia—**Djanga Music Inc. (ASCAP), Lark Music Inc. (BMI), Lomport Music Corp. (BMI), MEWG Music Inc. (BMI), Nevoc Music Corp. (BMI), Skyforest Music Co. Inc. (BMI), Triplot Music Co. Inc. (ASCAP), WEMG Music Inc. (ASCAP), Windbreez Music Ltd. (ASCAP), Glen Campbell Music Inc. (BMI); **Latin America—**Belwin Mills Publ'g Corp. (ASCAP), Mills Music Inc. (ASCAP), American Academy of Music Inc. (BMI), Multi-mood Music Inc. (BMI), Ramsel Publ'g Co. (BMI), Pamoja Music (ASCAP), Bumper Songs Ltd., Daksel Music Corp. (BMI), Magnet Music Ltd.; **Central America, Spain & Portugal—**Bourne Co.; **Latin America, Spain & Portugal—**Ganga Publ'g BV, Harrison's Ltd., Lady Casey Music Inc. (BMI), Material World Charitable Foundation Ltd., Rock Steady Music Inc. (ASCAP); **Latin America, Spain, Portugal, Israel & Rep. of South Africa—**Far Fetched Music, Pond Tunes; **Latin America & Caribbean—**Shapiro Bernstein & Co. Inc., Columbia Pictures Music Corp.; **Parts of Africa—**Shapiro Bernstein & Co. Ltd.; **Latin America, Israel & Caribbean—**Gold Hill Music Inc. (ASCAP), Stephen Stills Music (BMI); **Latin America, Spain, Rep. of South Africa, Japan, Australia & New Zealand—**Round Wound Sounds Inc. (BMI); **Overdrive Music (ASCAP); Latin America, Japan & Parts of the Orient—**Ben Peters Music (BMI); **Japan—**Morgo Music Inc.; **Australasia & Japan—**Salsoul Music Publ'g Corp. (ASCAP), Lucky Three Music

Co. (ASCAP); **Spain & Portugal—**Kiss Songs Inc. (ASCAP).

Int'l reps.: Argentina (Relay), Belgium (Radio Tele-Music), Brazil (Victor), Colombia (Sonolux), Czechoslovakia (Supraphon), France (Bagatelle), Germany (Rolf Budde), Greece (AEP), Israel (ACUM), Italy (RCA), Jamaica (Norman E. Wright), Mexico (Edimusa), Netherlands (Universal Songs), Singapore (Burlington Palace), Sweden (Sweden Music), Switzerland (Musikvertrieb). (SEE ADVERTISEMENT)

Mole Hole Music (BMI), see Bug.

Mole Music Co. (PRS), see Copyright Serv. Bureau.

Momac Music Co. (BMI), see Pietro Deiro.

Mom Bell Music Publ'g Co. (BMI), c/o David J. Steinberg Esq., 818 Widener Bldg., 1339 Chestnut St., Philadelphia, Pa. 19107. Tel (215) 564-3880. Pres. Tony Bell; Attorney David J. Steinberg.

Charles E. Monday—Pres. Charles E. Monday; Gen. & Prof. Mgr. Albert H. Monday—see Al's Written Music.

Mongo Music Inc. (BMI), see Copyright Serv. Bureau.

Monkhouse Music (BMI), Rt. 6, Ashby Dr., Brentwood, Tenn. 37027. Tel (615) 244-9412. Pres. Ann Stuckey.

Monona Music Co. (BMI)—Pres. Jean M. Cameron—see Cameron.

Monroe-Ames Music (BMI), Box 871, 2700 Ford St., Ames, Iowa 50010. Tel (515) 232-2991. Pres. & Gen. Mgr. Steve Monroe.

Myrtle Monroe Music (ASCAP), 10th & Parker Sts., Berkeley, Calif. 94710. Tel (415) 549-2500. Mgr.: Jack L. Aho.

Monsapac Music Inc. (BMI), see Helios & Copyright Serv. Bureau.

Monster Music (ASCAP), see Show Biz.

Montauk Music Inc. (BMI), see H.B. Webman.

Herb Monte Music (BMI), see Beechwood.

Montello Music (BMI), 5709 Hempstead Rd., Madison, Wis. 53711. Tel (608) 271-5924. Pres. & Gen. Mgr. Jon W. Wherry.

Montgomery Publ'g Co. (BMI), 8914 Georgian Dr., Austin, Tex. 78753. Tel (512) 836-3201/3194. Pres.: Roy J. Montgomery Sr.; Gen. Mgr. Shirley A. Montgomery, Prof. Mgr. Elmer J. Montgomery.

Branch: Fort Wayne, Ind., 3408 McKinne Ave. Zip 46808. Tel (219) 743-7561. Gen. Mgr. Charles L. Montgomery.

Jeff Mont Music (ASCAP)—Gen. Mgr. Ronald Kimbrough—see Bakim.

Montroy Music Co. (BMI), 7210 Roos, Houston, Tex. 77074. Tel (713) 774-0075/3075. Pres.: Dr. John D. Montroy.

Mood Music Co. Inc. (ASCAP), see Shapiro Bernstein.

Moogy Music (BMI), 290 West End Ave., New York, N.Y. 10023. Tel (212) 580-7326. Pres. Mark Klingman, VP. David Klingman.

Moo Moo Music Corp. (BMI), see Marille.

Moonbeam Publ'g Corp. (ASCAP), see Jova.

Moonbird Music Co. (ASCAP), see Copyright Serv. Bureau.

Moonbow Music Inc. (BMI), see Appalshop.

Moondust Music (BMI), see Royalty Control Corp.



PRODUCTION/ PUBLISHING

VITTORIO BENEDETTO
Vice-President & Gen. Mgr.

<p>C.A.M.-U.S.A., INC. (BMI)</p> <p>CAMERICA MUSIC, INC. (ASCAP)</p> <p>CAM PRODUCTIONS</p>	<p>489 FIFTH AVENUE, NEW YORK, N.Y. 10017</p> <p>TELEPHONE: (212) 682-8400</p> <p>TELEFAX: 236920 CAM UR</p> <p>CABLE: CAMUSAINC</p>
--	--

Moon June Music (BMI), 4233 SW Marigold, Portland, Ore. 97219. Tel (503) 777-4622. Pres. & Gen. Mgr. Bob Stoutenburg. Local branch: 5821 SE Powell Blvd. Zip 97206.

Moon Lake Publ'g (BMI), 5007 F St., Philadelphia, Pa. 19124. Tel (215) 533-8799. Pres. Len Stark. Gen. Mgr. Ronald Stark.

Moonmaid Music (BMI), see R.A. Hodge.

Moon Meadow Publ'g Co. (ASCAP), see 20th Century Moon & Stars Music (BMI), see Rondor.

Moorpark Music Co.-p. (ASCAP), see Marielle.

Moose Music (ASCAP), see Chicago Music.

Morgan Creek (ASCAP), c/o Taylor Music, 31 Fresh Pond Pkwy., Cambridge, N.J. 02138.

Morhits Publ'rs (BMI), see Duane.

Morley Music Co. (ASCAP), c/o Eastman & Eastman, 39 W. 54 St., New York, N.Y. 10019. Tel (212) 581-1330.

Morning Life Music (ASCAP), see R.A. Hodge.

Morning Music (USA) Inc. (ASCAP), PO Box 120478, Nashville, Tenn. 37212. Toronto Tel (416) 625-2676. Telex (06) 960250. Pres. Jury Krytyuk. Mgr. Mark Altman. Ass't Mgr. Anne Fuller. Prof. Mgr. Avi Altman. Promo. Peter Krytyuk.

Home Office: Canada.

Int'l affiliate: England.

U.S. firms administered worldwide: Joe Allen Music, Annie Over, Aunt Polly's Music, Barlow Music, Binoco Music, Blue Band Music, Blue Candle Music, Blue Echo Music, Blue Melody Music, Boxer Music, Copper Music, Cornbread Music, Dean's List, Enoree, Evening Publ'ns, First Floor, Fruit, Gold Dust Music Inc., Good Music Co., Lloyd Green, Harvey Walbarger Music, HitKit, Jack Music Inc., Jando Music Inc., Kevin Lee Music, Koko, LS Music, Cristy Lane Music, Mogollon Music, Mountainwood Music, Music Craftshop, Myownah Music, Owulufus Music, Pathfinder Music, Poet's Publ'g, Pull-eyebow Music, Shenendoah Music, Sidewalk Publ'ns, Silver Dollar, Silverstar, Starburst, Stonehill Music, Strzelecki Music, Tammy Lee Music, Terrace Music Corp., Tessie's Tunes, Don Wayne Music.

Int'l firms represented: Cabot Trail, Canadian Brass, Crown-Vetch, Debarc, Fogo, Alex Groshak, Izetta, Jah, Morning, Northern Gold, Pinta Paita, Puffin Island, Skiners Pond, Speckled Bird, Time Being, V Music (all Canada), Weltmusik, Wiener Musikproduktion, Wien Melodie (all Austria), Hans Kusters (Belgium), Opus (Czechoslovakia), Rolf Budde, Cycius, Radio-Tele, Ring Musik, Tantis (all Germany), Blue Tulip, Pascale, Universal (all Netherlands), Author's Agency (Poland), Land of Song, Octava, Squirrel, Josef Weinberger (all UK).

Int'l reps.: Australia (Image), Austria (Wien Melodie), Belgium (Hans Kusters), Brazil (Meridional), Colombia (Codiscos), Finland (Fazer), Germany (Melodie der Welt), Greece (Grecophon), Israel (Ilanot), Italy (RCA, Curci), Japan (Yamaha), Mexico (Edimusa), Netherlands (Universal), New Zealand (Image), Philippines (Bayanihan), South Africa (Laetrec, Revellie, Contagious), Spain (Montserrat), Sweden (Sweden Music, Sonet), Switzerland (Melodie der Welt), Venezuela (Unimusic), West Indies (Gorgong).

Morning Picture Music (ASCAP), see April/Blackwood.

Edwin H. Morris & Co. (ASCAP) (div of MPL Communications Inc.), 39 W. 54 St., New York, N.Y. 10019. Tel (212) 581-1330. Cable EASTMANAID. Prof. Mgr.: Robert Jones.

Int'l branches: Argentina, Australia, Canada, England, France, Germany, Italy, South Africa, Sweden.

Int'l reps.: Brazil (Intersong), Japan (Intersong), Mexico (Intersong), Netherlands (Chappell), Spain (Chappell), Switzerland (Chappell).

Morris Music Inc. (BMI), 6255 Sunset Blvd., Suite 1904, Hollywood, Calif. 90028. Tel (213) 463-5102. Pres. Steve Morris. (Administered by Chappell).

Morse Music Inc. (ASCAP)—Pres. Joey Travolta—see Midson.

Mortgage Music (ASCAP), see Rondor.

Rick Moses Music Co. (BMI), see 20th Century.

Herbert H. Moss Publ'g Co. (BMI), see Copyright Serv. Bureau.

Mothball Music Co. (BMI), see Prima-Donna.

Mother Bertha Music Inc. (BMI), PO Box 69529, Los Angeles, Calif. 90069. Tel (213) 846-9900. Pres. Phil Spector. Admin. Dir. Gen. Mgr. Donna Sekulidis.

Mother Fortune Music Inc. (BMI), see Silver Blue.

Mother Pearl Music (ASCAP), see Chalce.

Mother Texas Music, see Criterion.

Mother Tongue (ASCAP), 1204 16 Ave. S., Nashville, Tenn. 37212. Tel (615) 320-0303.

Moth Music Ltd. (BMI), see Chrysalis Music Group.

Motive Music, see Copyright Serv. Bureau.

Moulton Music Inc. (ASCAP), see Larry Spier.

Mountain (BMI), 1229 Alvie Dr., Hollywood, Calif. 90046.

Mountain Railroad Music (ASCAP), 2103 Pleasant Dr., Cambridge, Wis. 53523. Tel (608) 423-4358. Pres. Stephen Powers.

Mounted Music (ASCAP) (div. of Mounted Recs. Inc.), 888 Eighth Ave., New York, N.Y. 10019. Tel (212) 582-4572. Pres. & Prof. Mgr. J. (Billy) Ver Planck. Gen. Mgr.: Barbara Strazza.

Mount Laurel Music (BMI), see 20th Century.

Mount Rainier Music (BMI), Rt. 12, Asbury, W. Va. 24916. Tel (304) 645-6650. Pres. C.R. Freeland.

Int'l rep.: Japan (April).

Mourbar Music Corp. (ASCAP), see Pickwick.

Movietone Music Corp. (ASCAP), see Sam Fox.

Mowbray Music Publ'rs (ASCAP), see Theodore Presser.

M-3 Music Co. (ASCAP), see Cherry Lane.

Much More Music (BMI), see Amalgamated Tulip.

Muckender Music (ASCAP), see Publishers Licensing Corp.

Muffing Music (BMI), see Mietus.

Munienberg (BMI), see World Wide Music Inc.

Muirfield Music Corp. (ASCAP), see Ivan Mogull.

Mulberry Square Publ'g Co. (ASCAP), 10300 N. Central Expwy., No. 120, Dallas, Tex. 75231. Tel (214) 369-2430.

Mullet (BMI), PO Box 487, Springhill, La. 71075.

Mulligan Publ'g Co. Inc. (ASCAP), see Ivan Mogull.

Mull-O-Dee Tunes (ASCAP), see Mull-Ti Hit.

Mull-Ti Hit Music Co. (BMI), 50 Music Square W., Nashville, Tenn. 37203. Tel (615) 329-4487.

Multimood Music Inc. (BMI), see Belwin-Mills.

Multitone Music Corp. (ASCAP), see Meteorion.

Munchkin Music (ASCAP), see Open End.

Muncie Music, see T.B. Harms—Vogue.

Munjale Music, see Martin Cohen.

Munka Music (BMI), 4920 Maiden Ln., La Mesa, Calif. 92041. Tel (714) 464-0910. Pres. & Prof. Mgr. Stephen C. LaVere. Gen. Mgr. Mimosa LaVere.

Murakami-Wolf (ASCAP), see Martin Cohen.

Murbo Music Publ'g Inc. (BMI), see Bourne.

Muscle Shoals Sound Publ'g Co. Inc. (BMI), PO Box 915, 1000 Alabama Ave., Sheffield, Ala. 35660. Tel (205) 381-2060. Pres. Jimmy R. Johnson; VPs: Roger G. Hawkins, Barry E. Beckett; Sec'y-Treas. David Hood; Publ'g Admin'r. Diane Butler.

Musetta Music Co. Inc. (ASCAP)—Pres. Joe Greene—see Loring.

Mushroom Recs. Inc., 9000 Sunset Blvd., Suite 710, Los Angeles, Calif. 90069. Tel (213) 550-4502. TWX (910) 490-2538. Contacts: Marc Gilutin, Rick Block.

Mushtunes (BMI), see Mushroom.

Musia (BMI), see C.F. Peters.

Musical Comedy Prod'ns Inc. (BMI), see TRO.

Music Angel (ASCAP), see Copyright Serv. Bureau.

Musicanza Corp. (ASCAP), 2878 Bayview Ave., Wantagh, N.Y. 11793. Tel (516) 826-2735. Pres. Al Rubin.

Music City Copyrights, see T.B. Harms.

Music City Music Inc. (ASCAP), see Combine.

Music Craftshop (ASCAP), see HitKit.

Music Crusaders (BMI), see H.B. Webman.

Music for Percussion (BMI), 170 NE 33 St., Fort Lauderdale, Fla. 33334. Tel (305) 563-1844.

Music In General (BMI), c/o Michael Tannen Esq., 36 E. 61 St., New York, N.Y. 10021. Tel (212) 752-2276. Cable: MITANNEN.

Music Jems (ASCAP), see Publishers' Licensing Corp.

Music Makers Network of America Prod'ns, see Elvirue.

Musicmaster Publ'ns Inc. (ASCAP), 1650 Broadway, New York, N.Y. 10019. Tel (212) 246-3869. Contact: Frank Metis.

Music Mill Publ'g Co. Inc. (ASCAP), 21 Music Circle E., Nashville, Tenn. 37203. Tel (615) 256-0700.

Music Music Extra, see Elvirue.

Music Music Inc. (ASCAP), 157 W. 57 St., New York, N.Y. 10019. Tel (212) 582-6135. Pres. Chet Gierlach.

Music of Today Inc. (BMI), see Copyright Serv. Bureau.

Music Press (ASCAP), see Theodore Presser.

Music Publ'rs of Hawaii (BMI), PO Box 25141, Honolulu, Hawaii 96825. Tel (808) 521-0041. Pres.: Gil M. Tanaka.

Music Sales Corp. (ASCAP), 33 W. 60 St., New York, N.Y. 10023. Tel (212) 246-0325.

Int'l branches: Japan, West Germany.

Int'l reps.: France (Caravelle), Germany (Rolf Budde), Japan (Toshiba), Sweden (Reuter & Reuter), UK (Dorsey Bros., Essex).

Music 70—Pres.: Walter Gould—see Charter Publ'ns.

Musictone Music (BMI), PO Box 343, Santa Monica, Calif. 90406. Tel (213) 394-5110. Pres. Irvin A. Brock.

Music Treasure Publ'ns, 620 Fort Washington Ave., No. 1-F, New York, N.Y. 10049. Dir. Donald Garvelmann.

Musica 28 (ASCAP), see G. Schirmer.

Musicways Inc. (BMI), 1800 Century Park E., Suite 300, Los Angeles, Calif. 90067. Tel (213) 552-1133. Pres. Terr Fricon. Publ'g Admin'r. G. Jones.

Int'l rep.: Canada (Marming, Skinner's Pond.)

Musica West of the Pecos (BMI), PO Box 8545, Houston, Tex. 77009. Tel (713) 229-8219.

MyStaff Music Publ'rs (BMI), see Palamar.

Musette Sound Inc. (BMI), 193-18 120 Ave., New York, N.Y. 11412. Tel (212) 527-1586. Pres. Brenda Reid. Gen. Mgr. Steve Reid.

Mutual Music Society Inc. (ASCAP), see Chappell.

Muyheco Music (BMI), see Bug.

Muzacan Publ'g Co. (BMI), see Noel's Ark.

My Baby's Music Co. (ASCAP), see A. Schroeder.

Mycaene Music Co. (ASCAP), see Martin Cohen.

James Myers Ent's (ASCAP), see Copyright Serv. Bureau.

Myers Music Inc. (ASCAP), see Copyright Serv. Bureau.

Mylil Music (BMI), see David Schine.

Mylinkewicz Music Inc. (ASCAP), see Bug.

Myownah Publ'g Inc. (BMI), see Owulufus.

Myriad (ASCAP), see H.B. Webman.

My Sisters' Songs (BMI), 616 N. Sierra Bonita Ave., Los Angeles, Calif. 90036. Tel (213) 472-1560. Pres.: Marilyn Wilson, VP's Diane Rowell, Barbara Gaddy.

My Son's Publ'g Co. (BMI), PO Box 2194, De Soto Sta., Memphis, Tenn. 38101. Tel (901) 774-5689. Pres. J. Salvador Cole, Gen. Mgr. Michael Cole. Prof. Mgrs.: Bobby King Jr., James Cole.

Mystery Music Inc. (BMI), 5529 Oak Trail, Dallas, Tex. 75232. Tel (214) 375-3592. VP Pink L. Murphey.

N

N B C Music Inc. (ASCAP), PO Box 392, Brentwood, Tenn. 37027. Tel (615) 793-7085. Pres. Norm Whaler; Prof. Mgr. Linda Adams.

N I P Music Inc.—Pres.: Vince Ippolito; Gen. Mgrs. Roger Pauly, Denny Nowak; Prof. Mgr. Eddie Mascari—see Pauly Ippolito.

N / J Int'l Rec Co., 2337 Neshaminy Blvd., Cornwell Heights, Pa. 19020. Contacts: J.J. & Nathaniel Williams.

N R P Music Group, 92 Forest Rd., Centereach, N.Y. 11720. Tel (516) 585-1223. Contact: Fred Bailin, Sec'y-Treas. Francine Rae.

Nagamus Music (BMI), see Vette.

Naimad Lane (PRS), see Copyright Serv. Bureau.

Nano Music Co. (BMI), see Don Costa.

Nanni Music (BMI), see Chappell.

Narrow Gate Music Inc. (ASCAP), see Dwarf.

Narvel The Marvel Music (BMI), see T.B. Harms—Hall-Clement.

Narwhal Music (BMI), see Skyhill.

Nasetan Publ'g Co. (BMI), PO Box 1485, Lake Charles, La. 70602. Pres.: Eddie Shuler.

Nash-Beau Publ'g Co., see T.B. Harms—Hall-Clement.

Johnny Nash Music Inc. (ASCAP), see Copyright Serv. Bureau.

Nashville Int'l Corp. (ASCAP), 20 Music Square W., Nashville, Tenn. 37203. Tel (615) 256-2885.

Nashwood Music (ASCAP), see Manna.

Natson Music Corp. (ASCAP), see Tannen.

Natural Groove Music & Prod'n Co. Inc. (BMI), 3588 Big Tree Cove, Memphis, Tenn. 38128. Tel (901) 743-0221. Pres. & Prof. Mgr. Ronald Townsend. Gen. Mgr.: Gwendolyn T. Greene.

Natural Songs Inc. (ASCAP), see Lambert & Potter.

Nava Music (ASCAP), see Chappell.

Nayland Music Co. (BMI), see Copyright Serv. Bureau.

Ndebele Music (BMI), see Martin Cohen.

Near North Music Inc. (BMI), see Chappell.

Nebadon Music (BMI), see Martin Cohen & Speed.

Neches Music Co. (BMI), 1812 Procter, Port Arthur, Tex. 77640. Tel (713) 982-7121. Pres. Floyd J. Badaux.

Needahit Publ'g Co. Inc. (BMI), 264 Old Hickory Blvd., Madison, Tenn. 37115. Tel (615) 865-6543.

Neems Music (ASCAP), see Copyright Serv. Bureau.

Neighborhood Music (ASCAP), see April/Blackwood.

Neil Music Inc. (BMI), 8560 Sunset Blvd., Los Angeles, Calif. 90069. Tel (213) 659-7433. Cable: CRESREC. Pres.: Gene Norman.

Int'l reps.: Australia (Festival), Benelux (Vogue), Brazil (Gravacoes Electricas), France (Vogue), Germany (Belmont), Italy (Font-Cetra), Japan (Seven Seas), Switzerland (Vogue), UK (Sonet).

Nemperor Music Ltd. (BMI), Copyright Serv. Bureau.

Nemsong Music Inc. (BMI), see Chappell.

Neostat Music Co. (BMI), 425 Bryn Mawr, Birmingham, Mich. 48009. Tel (313) 647-1662, 538-4444. Pres.: Harvey M. Ates.

Nep Music Inc. (ASCAP), see Nor Va Jak.

Neptune Music Publ'rs (BMI), 82 Aldine St., Rochester, N.Y. 14619. Tel (716) 328-4649. Pres.: Martha Pitoni; Gen. Mgr. Ven Pitoni; Prof. Mgr. Marvin Steffy.

Neuron Music (ASCAP), PO Box 1594, Hollywood, Calif. 90028. Tel (213) 662-8588, 666-9000.

Neurotic Music (BMI), see 20th Century.

Neurp Songs (BMI), see Bug.

Nevar Music Inc. (BMI), 19 Slate Creek Dr., No. 5, Buffalo, N.Y. 14227. Tel (716) 668-3161, 688-7511.

Neverbreak Music (ASCAP), see Twitty Bird.

Never Ending Music (BMI), PO Box 58, Glendora, N.J. 08029. Tel (609) 227-7562. Pres.: Eddie J. Harris. Gen. Mgr. Lem Harris.

Neverland (BMI), c/o David Sonenberg, 919 Third Ave., New York, N.Y. 10022.

Nevoc Music Corp. (BMI), see Sidney A. Seidenberg.

New Ashley Music Co. (ASCAP), see Creative World.

Newbag Music Co. (BMI), Box 131, Rt. 4, Louisa, Va. 23093. Tel (804) 457-4580. Pres.: Martin Gary; VP: Kathleen Gary.

Newban Music (ASCAP), see Rondor.

New Bay Psalter Music Press (ASCAP), see Paragon Assocs.

Moved To: **625 Madison Avenue, New York, N.Y. 10022**



World-Wide Publishing / Record Representation

IVAN MOGULL MUSIC ASSOCIATES

Cable: IMOGULL

Telex: 236973 NEW YORK

New Bentley Music Co (BMI) see Creative World
 New Chatham Music (ASCAP), PO Box 11, Pittsburgh, Pa 15230 Tel (412) 371-0697 Pres Thomas E Morgan
 New Child Music Publ'g (ASCAP), PO Box 524, Kailua-Kona, Hawaii 96740. Tel (808) 329-3174, 322-3177 Cable NAKA. Pres. Jeanne Nakashima.
 Int'l reps.: Japan (Watanabe), Malaysia (Pathe), Philippines (Bayanihan), Singapore (Pathe).
 New Dimension Rec'gs Inc., 218 W. Broad, Statesville, N.C. 28677 Tel (704) 873-0706, 872-7769 Pres H Cowles Bristol, VP Parks Allen; Gen Mgr Jim Barrow
 New Executive Music (BMI), see Brother
 New Ground Music Inc (ASCAP)—Pres Merle Haggard, Gen Mgr. Dave Kirby, Prof Mgr. Glenn Martin—see Shade Tree
 New High Music Publ'g (ASCAP), see Brian Ross.
 New Ideas Music Co (BMI), see NRP Music.
 Newkeys Music Inc (BMI), 49 Music Square W., Nashville, Tenn 37203 Tel (615) 327-2727 Bd Chm E. Jimmy Key, Pres Jack J Key
 New Morning Music (BMI), see Chappell.
 New Music Ed., see Theodore Presser.
 New Outlook Music Inc (BMI), c/o David J. Steinberg, 818 Widener Bldg., 1339 Chestnut St., Philadelphia, Pa. 19107 Tel (215) 564-3880. Pres Wilbert Hart.
 New Pax Music Press (BMI), see Paragon Assocs.
 Newport Music Co (ASCAP), 1105 Little Bldg., 80 Boylston St., Boston, Mass 02116 Tel (617) 482-7678. Owner Harry Paul
 New Soul Music (ASCAP), see 20th Century.
 New Times Music (BMI), see Open End
 New Tone Music Prod'ns Ltd (ASCAP)—Pres Danny Bennett—see Beldock Levine & Hoffman
 Newtonville Music Inc. (ASCAP), see Chappell.
 New Town (ASCAP), see Croma
 New Valley Music Press, Sage Hall, Smith College, Northampton, Mass. 01063 Tel (413) 584-2700 x 2261. Chm Ronald Perera
 New Wine Prod'ns (ASCAP), PO Box 544, Lomita, Calif 90717. Tel (213) 326-8466 Pres G Nelson Stringer
 New World Music Corp (ASCAP), see Warner Bros.
 New York Public Library Music Publ'ns (BMI), see C F Peters
 New York Shakespeare Festival, see Chappell.
 Next Window Music (ASCAP), see Cristevall.
 Nicanda Music Publ'ns (ASCAP)—Pres Nick Therry, Gen Mgr Memo De Andia, Prof. Mgr Bud Mathis—see Deejay
 Nick-O-Val Music, 332 W 71 St., New York, N.Y 10023 Tel (212) 873-2179
 Joseph Nicoletti Music Co (ASCAP), PO Box 2818, Newport Beach, Calif 92663 Tel (714) 497-3758, NYC (212) 787-5400 Pres Joseph Nicoletti, Gen. Mgr Cheryl Lee Gammon, Prof Mgrs Joseph Nicoletti, Cheryl Lee Gammon
 Nida Music Publ'g Co (ASCAP), 4014 Murietta Ave., Sherman Oaks, Calif 91423 Tel (213) 981-5331. Pres. & Gen. Mgr. Nicholas S Carras
 Night Time (BMI), c/o Eric Kronfeld, 1501 Broadway, 30th fl., New York, N.Y 10036 Tel (212) 840-2200.
 Ninandy Music Co (BMI), see Copyright Serv. Bureau (US rights)
 Nine Mile Music (BMI), 24266 Roxana, East Detroit, Mich. 48021 Tel (313) 774-2740
 Ninth Music (BMI), see Saggiore.
 Ben Nisbet Music Inc (ASCAP), see Ivan Mogull.
 Nise Prod'ns Inc. (BMI), PO Box 5132, Philadelphia, Pa 19141 Tel (215) 276-0100 Pres Michael Nise, Gen Mgr Frank Nise, Prof Mgr. Mary Jude McKnight.
 Branch: Camden, N.J., 413 Cooper St Zip 08102 Tel (609) 963-3190 Contacts Robert Bruhns, Tom Crosthwaite
 Nitehler Music Inc (BMI), see Rondor.
 Nitfol Music (BMI), 1502 S Boulder, No. 10-K, Tulsa, Okla. 74119 Tel (918) 587-8945 Pres & Gen Mgr. Dick Loftin
 Nocibur Music (BMI), see 20th Century.
 Nodlew Music (BMI), see Copyright Serv. Bureau
 Noel's Ark Music Co (ASCAP), 44844 Michigan, Canton, Mich 48188 Tel (313) 397-1716 Pres. & Gen. Mgr. Douglas Culbert
 No Exit Music Co Inc (BMI), 535 Cotton Ave., Macon, Ga 31201 Tel (912) 745-8511. Pres Phil Walden; VP Frank Fenter
 Int'l reps.: Austria (RGS), Benelux (New Dayglow), Denmark (Multitone), Finland (Multitone), Germany (RGS), Greenland (Multitone), Iceland (Multitone), Ireland (Carlin), Japan (Taiyo), New Zealand (Coburn in Australia), Norway (Multitone), Southern Africa—including South Africa, S.W Africa, Rhodesia, Lesotho, Swaziland, Botswana & Transkei (Gallo), Spain (Hisvox), Sweden (Multitone), Switzerland (RGS), UK (Carlin).
 No Grease Music (BMI), see Prophecy.
 Kenny Nolan Publ'g Co (ASCAP), see Sound of Nolan.
 Noma Music Inc (BMI), see Chappell
 Nom Music Inc (BMI), see Big Seven
 Noodle Tunes, see Bruce Cohn.
 Northern Music Co (ASCAP), see MCA.
 North 40+3 Music (BMI), see Garrett
 North Shore Music Co (BMI), see Martin Cohen.
 Northshore Publ'g Inc., (ASCAP), see 20th Century.
 North & Son Music Inc (ASCAP), see Shapiro Bernstein
 North Spur (ASCAP), see Bug.
 Northwest (BMI), 911 E Fourth Ave., Olympia, Wash. 98506 Tel (206) 352-9097. Pres. Allen P. Giles
 Nor Va Jak Music Inc (BMI), 1321 W Seventh St., Clovis, N.M. 88101 Tel (505) 763-6931
 Norvik / Hauge Music Publ'g Co., 897 Walker Ave., Oakland, Calif. 94610 Tel (415) 763-5182. Pres. Norman Hauge
 Norway Music (ASCAP), see Segel & Goldman
 Notable Music Co Inc (ASCAP) (div of Cy Coleman Ents.), 161 W 54 St., New York, N.Y 10019 Tel (212) 757-9547 Pres Cy Coleman; Gen Mgr. Eric Colodre
 Int'l firm represented: Campbell Connelly (UK)
 Notebook Music (BMI), see Garage
 Note Filler Music (BMI), see Jamie

Novello Publ'ns Inc. (ASCAP), 145 Palisade St., Dobbs Ferry, N.Y. 10522 Tel (914) 693-5445.
 Home office: England
 Now Music (ASCAP), see Copyright Serv. Bureau.
 Nozak Music (BMI), see John Brumage.
 Nujac Publ'g Co Inc. (BMI), see Jamie
 No. 11 Music (BMI), see Skyhill
 Numb Skull Music (BMI), see Bug
 Nurock Music Publ'g Co. (BMI), see Chappell.

O

O A S Music Group Inc., 805 18 Ave. S., Nashville, Tenn 37203. Tel (615) 327-3900. Co-Dirs. Dane Bryant, Steve Singleton.
 O M P Music Publ'g Co. (ASCAP), 11110 Los Alamitos Blvd., Suite 215, Los Alamitos, Calif. 90720. Tel (213) 431-5013.
 O P I Music Inc (ASCAP)—Owner David Hennessee—see Hal Bernard
 Oahu Publ'g Co., Box 279, 10333 Coggins Dr., Sun City, Ariz. 85351. Tel (602) 933-8283.
 Oak Grove Music (BMI), see No Exit.
 Oak Publ'ns (BMI), see Music Sales.
 Oakridge Music Publ'g Co. (BMI), 2001 Elton Rd., Haltom City, Tex 76117. Tel (817) 838-8001 Owner Homer Lee Sewell
 Oakshire Music (BMI), see Skyhill
 Oak Springs Music (BMI), Box 382, Rt. 5, Yakima, Wash. 98903 Tel (509) 966-1193 Pres. Hiram White, Gen. Mgr. Jerry Merritt
 Obie Music Co (BMI), see Copyright Serv. Bureau.
 Object d'Art (BMI), see Copyright Serv. Bureau.
 Objective Music Co. (BMI), see Ellis.
 Oceans Blue Music (BMI), see Silver Blue
 Octave Higher Music, 524 N. Keystone Blvd., Burbank, Calif 91506 Tel (213) 846-3326 Contact Phillip Kelly
 Odin Music (ASCAP), see Bonton
 Mary Frances Odle Publ'g (BMI), 8431 Howard Dr., Studio 2, Houston, Tex 77017. Tel (713) 649-5579. Pres. & Prof Mgr. Mary Frances Odle; Gen. Mgr.: T.A. Seberger. Local branch: Frances Rollins Music, PO Box 4335, Pasadena 77502 Tel 649-5579.
 Oh Boy Music Co (ASCAP), see Great Honesty
 Ohio Players Music Co. (BMI), see Chappell.
 Oily Maniac Music (BMI), see Bug
 Phil O'Kelsey Music, see Pasha.
 Okra Music Corp. (BMI), see Seesaw.
 Milton Okun Publ'g Co. (BMI), see Cherry Lane
 Old Boston Publ'g (BMI), 622 Rt 3A, Cohasset, Mass. 02025 Tel (617) 383-9494 Pres Richard Tinory, Artist Relations Claire L. Tinory.
 Olde Statesville Towne Publ'g, see New Dimension.
 Old Fox Publ'g Co. (BMI), 2018 E. Center St., Kingsport, Tenn. 37664 Tel (615) 246-8651. Pres. Basil J. Palmer; Gen. Mgr. Edith Isom
 Spooner Oldham Music (BMI), see Southern Writers.

Old Ironsides Music Publ'g Co. (BMI), see Pelton
 Old Sock Music (BMI), see Copyright Serv. Bureau.
 Old Soul Music (BMI), see 20th Century.
 Ole Colony Music (BMI), see Chappell.
 Olenk Recs (ASCAP), G-10282 N. Saginaw Rd., Clio, Mich. 48420 Tel (313) 686-9644. Owner: Nicholas H. Olejnik
 Olga (BMI), 1800 Century Park E., Suite 800, Los Angeles, Calif. 90067.
 Olman Music Servs. Inc. (ASCAP), see TRO.
 Omega Century Music Co. (BMI), see Alpha-Omega.
 Omni Music, see Alexander Broude
 Omy Music Co. (BMI), see Copyright Serv. Bureau.
 One Eye Soul Publ'g Co. (BMI), see Jamie.
 One Four Two Music (PRS), see Copyright Serv. Bureau.
 125th Street Music (ASCAP), see Martin Cohen.
 Oneida Music Publ'g Co. (BMI), 760 Blandina St., Utica, N.Y. 13501. Tel (315) 735-6187. Owner: Stanley Markowski; Gen. Mgr.: Joyce Markowski; Prof. Mgr.: Andrew Cittadino
 One Marble Music (BMI), see Jugumba.
 One Three Nine Music (ASCAP), see Hayseed.
 Onhisown Music (BMI), see OAS.
 Onna Music (BMI), see Copyright Serv. Bureau.
 Onnysay Publ'g Co. (BMI), PO Box 9154, Wells Rd. SW, Knoxville, Tenn. 37920. Tel (615) 573-7775. Pres.: H.S. Watson
 On Stage Music (BMI), see Copyright Serv. Bureau.
 On Strike Music (BMI)—Gen. Mgr., William H. Schubart—see Other.
 On Time (BMI), 839 E. 33 St., Los Angeles, Calif. 90067.
 Open End Music (BMI), 824 N. Robertson Blvd., Los Angeles, Calif. 90069. Tel (213) 278-8715 Cable NEW-TIMES Pres.: Bennett H. Glotzer; Gen. Mgr.: Theresa J. Powers.
 Int'l rep.: Worldwide (Intersong).
 Open Range Music (ASCAP), see Folklore.
 Open Road Music Inc. (BMI), see Jim Reeves.
 Opus Two Thousand Publ'g Co. (BMI), PO Box 720319, Atlanta, Ga. 30328. Tel (404) 393-8432. Publ'r: Jim Single; Exec. Dir.: Lori Leathers.
 Orange Bear Music (BMI), see Scully.
 Orange Blossom Music, United Artists Tower, Penthouse Suite 902, 50 Music Square W., Nashville, Tenn. 37203. Tel (615) 329-0714. Pres.: Bill Sorensen; Gen. Mgr.: Stan Cornelius; Prof. Mgr.: Bobby Fischer.
 Orchid Publ'g (BMI), PO Box 4220, Shreveport, La. 71104. Tel (318) 686-7362. Pres. & Gen. Mgr.: Bill Bohannon.
 Orco Publ'g (BMI), see Copyright Serv. Bureau.
 Orcutt Publ'g (BMI) (div. of Seal Prod'ns), 19 1/2 Free St., Skowhegan, Me. 04976. Tel (207) 474-2375. Owner: Lunis Orcutt.
 Orellia Music Co. (BMI), see Copyright Serv. Bureau.
 Orenbee Music Co. (BMI), see Mietus.
 Organic Mgmt., 745 Fifth Ave., New York, N.Y. 10022. Tel (212) 751-3400.
 Origanes Publ'g Co. (BMI), 8839 Walnut St., Bellflower, Calif. 90706. Tel (213) 866-4146. Owner: Mearl Ellison.

Famous Music Publishing Companies

"YOU CAN'T GO WRONG WITH A FAMOUS SONG"

A Division of Paramount Pictures



A GULF + WESTERN COMPANY

Marvin Cane
Sidney Herman

<p>LOS ANGELES 6430 Sunset Boulevard 90028</p> <p>Julie Chester</p>	<p>NEW YORK 1 Gulf + Western Plaza 10023</p> <p>Ann Gardner Lionel Job Dick Milfred</p>	<p>NASHVILLE 2 Music Circle South 37203</p> <p>Judy Gottier Bill Ficks, Jr.</p>	<p>LONDON 50 New Bond Street, England</p> <p>Ivan Chandler</p>
--	--	--	---

Orpheum Music Co. (BMI), see Jondora.
 John Oscar Music Corp. (ASCAP), see Gopam.
 Osiris Music Inc. (BMI), see Chappell.
 Other Music Inc. (ASCAP), The Barn, North Ferrisburg, Vt. 05473. Tel: (802) 425-2111. TWX: (510) 299-0029. Pres.: Michael Couture, Gen. Mgr.: William H. Schubarb.
 Int'l reps.: Australia (Castle Music), Benelux (Intersong in UK), France (Bagatelle), Germany (Rudolf Slezak), Japan (Taiyo), Sweden (Air Music), UK (Panache)
 Otis Music (BMI)—Pres.: Otis Nelson; Gen. Mgr.: Mable John—see Copyright Serv. Bureau.
 Our Children's Music (BMI), see Goodman Group.
 Outer Banks (BMI), 1100 17 Ave. S., Nashville, Tenn. 37212.
 Ovation Inc. Group, see Terrace.
 Overdrawn Music (BMI), see Rogan.
 Over Easy Music (BMI), see Bug.
 Owepar Publ'g Co. (BMI), 811 18 Ave. S., Nashville, Tenn. 37215. Tel: (615) 327-2338. Pres.: Dolly Parton; Gen. Mgr.: Carla Scarborough.
 Int'l reps.: France (Francis-Day), Germany (Siegel), Japan (Taiyo), Netherlands (Intersong-Bassari), South Africa (EMI-Brigadiers), Scandinavia (April in Sweden), UK (Carlin); South America & Mexico (Southern in USA).
 Owlolus Music Inc. (ASCAP), 25 Music Square W., Nashville, Tenn. 37203. Tel: (615) 254-5721. Pres. & Prof. Mgr.: Bob G. Dean; Gen. Mgr.: Maggie Cavender.
 Oxford Univ. Press Inc. (ASCAP), 200 Madison Ave., New York, N.Y. 10016. Tel: (212) 679-7300. Cable: FROWDE. Music Dept. Mgr.: Susan Brailove.
 Home office: England.
 Oxygen Music Co. (ASCAP), see Chappell.
 Ozone Music (BMI), see R.A. Hodge.

P

P A Ents. Inc., John Hancock Center, Suite 5404, 875 N. Michigan Ave., Chicago, Ill. 60611. Tel: (312) 337-5643. Pres.: Andy Pappas.
 P A Publ'g Co. (ASCAP), see PA Ents.
 P A R L Publ'g Co. (ASCAP), PO Drawer L, 707-709 W. California, Ruston, La. 71270. Tel: (318) 255-0287. Partners: Phillip R. & Roger W. Lawson; Gen. Mgr.: Roger W. Lawson; Prof. Mgr.: Phillip R. Lawson.
 P B R Music (ASCAP), see Valgroup.
 P D A Music Inc. (ASCAP), see Copyright Serv. Bureau.
 P E M Assocs. (ASCAP), see The Entertainment Co.
 P F S Music Co. (ASCAP)—Prof. Mgr.: Rosalie Pettite—see Four Grand.
 P H Factor Music (BMI), see April/Blackwood.
 P P X Publ'rs (BMI), 301 W. 54 St., New York, N.Y. 10019. Tel: (212) 247-6010. Cable: CHALPRISES. Telex: 236287. Pres.: Ed Chalpin.
 Pabito Music (ASCAP), see Chappell.
 Pablo Cruise Music (BMI), see Rondor.
 Pablo Music (BMI), 26 Jane St., New York, N.Y. 10014. Tel:

(212) 243-2018. Cable: IMPROVART. Telex: 237166. Pres.: Paul Bley, Gen. Mgr.: Carol Goss; Prof. Mgr.: David S. Good.
 Branch: Cherry Valley, N.Y., 81 Alden St. Zip: 13320. Tel: (607) 264-3943.
 Int'l rep.: Japan (Yamaha).
 Pace Music Co. (BMI), see Sam Fox.
 Pacific Challenger Music (BMI), 2940 E. Mirloma Ave., Anaheim, Calif. 92806. Tel: (714) 992-6820. Pres. & Gen. Mgr.: C.E. Whittington.
 Pacific Coast Music (BMI), 2930 W. Camelback Rd., No. 225, Phoenix, Ariz. 85017. Tel: (602) 246-0579. Owner & Pres.: Ray Sanders.
 Branch: Nashville, Tenn., 253 Cedar Creek Dr. Zip: 37211. Tel: (615) 833-0893. Gen. Mgr.: Billy Williams.
 Pacific Coast Music Ent's., 280 Cress Rd., Santa Cruz, Calif. 95060. Tel: (408) 438-2373. Pres.: Anthony S. Butterfield; VP & Prof. Mgr.: Tony Butterfield Jr.; Gen. Mgr.: Sarah Butterfield.
 Pacific Press Music Publ'g Co. (BMI), see Bridge.
 Pacific View Music (ASCAP), see Don Williams.
 Package Good Music (BMI), 1145 Green St., Manville, N.J. 08835. Tel: (201) 725-4366. Pres. & Gen. Mgr.: Marc Zydic.
 Packy Music (ASCAP), see Stafree.
 Pacea Music Publ'rs (ASCAP), see Irving Mills.
 Paddleshell Music (BMI), see R.A. Hodge.
 Padua Music Co. (BMI), see Faro.
 Paganians Publ'ns Inc., 211 W. Sylvania Ave., Neptune, N.J. 07763. Tel: (201) 988-8400. Cable: TFHBOOKS, ASBURY PARK. Pres.: Dr. Herbert Axelrod; Exec. VP: Paul L. Paradise.
 Int'l rep.: UK (Forsyth).
 O. Pagani & Bro. Inc. (SESAC), 289 Bleeker St., New York, N.Y. 10014. Tel: (212) 242-6744. Pres.: Frank Gavigan; VP: Theresa Costello.
 Pa-Giz Music (BMI), see Rondor.
 Painted Desert Music Corp. (BMI), see Shapiro Bernstein.
 Painter Music, see Martin Cohen.
 Len Pakula & Assocs. (BMI), PO Box 548, Feasterville, Pa. 19047. Tel: (215) 322-6091. Pres.: Len Pakula; Gen. Mgr.: Franni Schwartz; Artist Relations: Joel Eisenberg.
 Palamar Music Publ'g (BMI), 726 Carlson Dr., Orlando, Fla. 32804. Tel: (305) 644-3853. Pres.: Will Campbell.
 Pallma Music Co. (SESAC), see Neil A. Kjos.
 Palm Music Publ'g Co. (ASCAP), see Slide.
 Pal Publ'g, 10755 Bachelor Valley Rd., Witter Springs, Calif. 95493. Tel: (707) 275-2766.
 Pam Cal Music (ASCAP), see Copyright Serv. Bureau.
 Pamela Music Inc. (ASCAP), see Chappell.
 Pamelarosa Music Inc. (ASCAP), see LF Music.
 Pamlyn Music Co. (BMI), PO Box 6211, Cleveland, Ohio 44101. Pres.: Robert L. Wright; Gen. Mgr.: Becky Strauss; Prof. Mgr.: Otto Mann.
 Pampa Music (BMI), see Copyright Serv. Bureau.
 Panini Music (BMI), PO Box 15808, Honolulu, Hawaii 96815. Tel: (808) 947-4985. Pres.: Steven O. Siegfried; VP: Witt H.P. Shingle.
 Pantego Sound, 2210 Raper Blvd., Pantego, Tex. 76013. Tel: (817) 461-8481. Pres.: Charles Stewart.
 Pantheon Desert Publ'g (BMI), 6325 N. Invergordon Rd., Scottsdale, Ariz. 85253. Tel: (602) 948-5883. Gen. Mgr.: Brent Burns.
 Panther City Music (BMI), see Green Door.
 Panther Music Corp. (ASCAP), see Peer-Southern.
 Pants Down Music (BMI), see Bruce Coch.
 Papa's Love Music (BMI), see Martin Cohen.
 Paper Pills Music Inc. (ASCAP), see Mietus.
 Paragon Assocs. Inc., Box 23618, 19 Ave. N. & Hayes, Nashville, Tenn. 37202. Tel: (615) 327-2835. Pres.: Robert R. MacKenzie; VP: Wayne E. Erickson; Catalog Admin.: Debra K. Shanklin; Paragon Publ'g Group: Randy Cox.
 Int'l reps.: Australia, Germany & Switzerland (Hansler); Benelux (Universal Songs in Netherlands).
 Paragon Music Corp. (ASCAP), see Paragon Assocs.
 Paramount Music Corp. (ASCAP), see Famous.
 Paramount-West Ent's., PO Box B, Mira Loma, Calif. 91752. Tel: (714) 735-5845. Pres.: D.W. Galiffa.
 Parasound Inc. (ASCAP), see Wild Sanctuary.
 Charlie Parker Music Co. (BMI), see Copyright Serv. Bureau.
 Parker Music (BMI), see Jondora.
 Park Lane Music (BMI), see Copyright Serv. Bureau.
 Parks Music Corp. (SESAC), see Neil A. Kjos.
 Partner Music (BMI), 1518 Chelsea Ave., Memphis, Tenn. 38108. Tel: (901) 275-2285. Gen. Mgr.: Larry Rogers.
 Partnership Music (ASCAP), see Partner.
 Party-Time Music (BMI), 525 SW 42, Oklahoma City, Okla. 73109. Tel: (405) 632-3958. Pres.: Tom Jackson; Gen. Mgr.: Wendell Goodman; Prof. Mgr.: Wanda Jackson.
 Pass Alta Music (BMI), 54 E. Colorado Blvd., Pasadena, Calif. 91105. Tel: (213) 681-7126. Pres.: G. Vitale; VP & Gen. Mgr.: Irvin Hunt.
 Passa Ata Music (BMI), see Copyright Serv. Bureau.
 Pasha Music Org. (BMI), 5615 Melrose Ave., Hollywood, Calif. 90038. Tel: (213) 466-3502. Pres.: Spencer D. Proffer; Gen. Mgr.: Ann Sumner-Davis.
 Int'l reps.: Australia (Jonathan Music), Ireland (April), New Zealand (Jonathan), UK (April).
 Passqua Music Co. (BMI), see Chappell.
 Passkey Music Inc. (BMI), see Jerry Chestnut.
 Joseph Patelson Music House (ASCAP), 160 W. 56 St., New York, N.Y. 10019. Tel: (212) 757-5587. Owner: Joseph Patelson.
 Patlow Publ'n Co. (BMI), 17429 Indian Ave., Detroit, Mich. 48240. Tel: (313) 531-9330. Pres.: M.J. Patlow.
 Patricia Music Publ'g Corp. (BMI), see Big Seven.
 Pattiyl Music (ASCAP), see Sutton/Miller.
 Paulbi Music Publ'g Co. (BMI), 3518 Champlain Ave., Youngstown, Ohio 44502. Tel: (216) 755-7794. Owner, Pres. & Gen. Mgr.: Bill Schaffert.
 Paulkie (BMI), c/o Ray Ruff, PO Box 1746, Hollywood, Calif. 90028. Tel: (213) 341-4036.
 Paul-Wayne Music (ASCAP), see People Pleaser.
 Pauly Ippolito Music Inc. (BMI), 800 N. Ridgeland, Oak Park, Ill. 60302. Tel: (312) 848-3322. Pres. & Prof. Mgr.: Roger Pauly; Gen. & Prof. Mgr.: Vincent Ippolito.
 Pavanne Music Co. (ASCAP), 2315 Foxhaven Dr., Franklin,

Tenn. 37064. Owners: Frank Stanton, Andy Badale.
 Branch: New York, N.Y., 157 W. 57 St. Zip: 10019. Tel: (212) 581-9639. Contact: Andy Badale.
 Pawnee Rose Music (SESAC), see Faron Young.
 Paw Paw Music (BMI), see Bug.
 Pax Regina Music Ltd. (ASCAP), see Big Seven.
 George Paxton Corp. (ASCAP), 836 Riomar Dr., Vero Beach, Fla. 32960. Tel: (305) 567-7496.
 Paxwin Music Corp. (BMI), see George Paxton.
 Pay Dirt Music (ASCAP), 1227 Spring St. NW, Atlanta, Ga. 30309. Tel: (404) 873-6425. Pres.: Barbara H. Richardson; Prof. Mgr.: Robert B. Richardson.
 Payline Publ'g Co. (BMI), 3141 NW 27, Oklahoma City, Okla. 73107. Pres.: Wes McMahana; VP: Inez McMahana.
 Branch: Tulsa, Okla., 10826 E. 16 St. Zip: 74128. Tel: (918) 932-3211. VP: Armiel L. Riley.
 Peabo Music (ASCAP), 1290 S. Omni Int'l, Atlanta, Ga. 30303. Tel: (404) 688-2233.
 Peaceable Kingdom (ASCAP), 3525 Encinal Canyon Rd., Malibu, Calif. 90265. Tel: (213) 457-4405. Pres.: C. Randolph Nauer; Gen. Mgr.: Patricia S. Nauer; Prof. Mgr.: Randy Nauer.
 Peaceful Music Co. (BMI) (div. of Pacific Arts Corp. Inc.) PO Box 5547, Carmel, Calif. 93921. Tel: (408) 624-4704. Cable: PACARTS. Telex: 351455.
 Peace Pipe Music (BMI)—Contact: Vicki R. Bee—see Fire-drum.
 Peak Publ'g (BMI) (div. of Stage 3 Sound Prod'ns), 12 E. 39, Kansas City, Mo. 64111. Tel: (816) 531-1375. Pres.: Don Warnock; Gen. Mgr.: Clara Warnock.
 Eugene Pearson (BMI), see Copyright Serv. Bureau.
 Peer Int'l Corp. (BMI), see Peer-Southern.
 Peer-Southern Org., 1740 Broadway, New York, N.Y. 10019. Tel: (212) 265-3910. Cable: SOUTHMUSIC. Telex: 424361. Pres.: Monique I. Peer; 1st VP: Ralph Peer II; 2nd VP: Mario Conti, Int'l Mgr.: Latin American Div.: Provi Garcia.
 Branches: Los Angeles, Calif., 6922 Hollywood Blvd. Zip: 90028. Tel: (213) 469-1667. Mgr.: Roy Kohn—Miami, Fla., Northeast Airlines Bldg., Rm. 1409, 150 SE Second St. Zip: 33131. Tel: (305) 358-1488. Mgr.: Omar Marchant—Santurce, P.R., Edificio Banco Ponce, 1250 Ponce de Leon Ave. Zip: 00908. Tel: (809) 725-2380, 723-3918. Gen. Mgr.: Angel I. Fornias—Nashville, Tenn., 7 Music Circle N. Zip: 37203. Tel: (615) 244-6200. Prof. Assoc.: Debbie Cobb.
 Int'l branches: Argentina (EDAM), Australia (Southern), Austria (Southern), Belgium (Southern), Brazil (EMBI), Canada (Peer-Southern), Chile (Southern), Colombia (Peer), England (Southern), France (SEMI-Meridian), Germany (Peer), Italy (Southern), Japan (Southern), Mexico (EMMI, Musa, PHAM), Netherlands (Holland Music), New Zealand (Southern), South Africa (Southern), Spain (Southern), Sweden (Southern), Switzerland (Southern), Venezuela (Peer).
 Int'l firms represented: Ed. A. Cranz—partial catalog (Belgium), Ediciones Mexicanas de Musica (Mexico), Editorial Argentina de Musica (Argentina), Editorial Cooperativa Interamericana de Compositores (Uruguay), Enoch & Cie—partial catalog (France), Liber-Southern (UK), Pan American Union, Wagner & Levien (Mexico). (SEE ADVERTISEMENT)
 Peg (BMI), c/o Earl Shuman, 111 E. 88 St., New York, N.Y. 10028.
 Peggylou Music Inc. (BMI), see Mietus.
 Peglari Publ'g (BMI), see Donna Lee.
 Pelew Music Inc. (ASCAP), see LF Music.
 Pellegriano Music Co. Inc. (ASCAP), 311 Brook Ave., Bayshore, N.Y. 11706. Tel: (516) 665-1003. Pres.: Joseph V. Pellegriano Jr.; Gen. Mgr.: Frank Pellegriano.
 Pelton Publ'g Co. (BMI), PO Box 182, Midwood Sta., Brooklyn, N.Y. 11230. Tel: (212) 339-3536. Pres.: Jim Pelton; Gen. Mgr.: Dick Alexander; Prof. Mgr.: Nat Courtney; Promo.: John Upton.
 Pembroke Music Inc. (BMI), see Carl Fischer.
 Penetration Publ'g Co. (BMI), 835 N. Federal Hwy., Fort Lauderdale, Fla. 33304. Tel: (305) 763-9196. Pres.: Alan Franklin; VP: Paul Hughes.
 Dan Penn Music (BMI), see Southern Writers.
 Penny Pinchers Inc. (SESAC), see Able Music.
 People Pleaser Music (BMI), 1018 Central Ave., Charlotte, N.C. 28204. Tel: (704) 377-4596. Owner & Mgr.: Wayne Jernigan.
 Peppermint Music (BMI), see Faron Young.
 Pepper Tunes (ASCAP), see Pantheon.
 Pera Music Corp. (BMI), see Peer-Southern.
 Percival Music (BMI), see Copyright Serv. Bureau.
 Perennial Music (BMI), 530 Chenery St., San Francisco, Calif. 94131. Tel: (415) 333-1369. Gen. & Prof. Mgr.: Hillel Resner.
 Perfect Dream Publ'g (ASCAP), PO Box 25012, Lansing, Mich. 48909. Tel: (517) 482-3007. Owner: Greg Blackwell.
 Perfection in Music Publ'g (BMI), see Copyright Serv. Bureau.
 Perfection Music Publ'g (BMI), see Regal.
 Periscope Music Co. (BMI), 129 Bishop St., Brockton, Mass. 02402. Tel: (617) 588-6348. Pres. & Prof. Mgr.: Edward M. Hurvitz.
 Periterra Music (BMI), 45-15 21 St., Long Island City, N.Y. 11101. Tel: (212) 786-2401. Pres.: Franc Peri.
 Periwinkle Music (ASCAP), see Chicago Music.
 Perpetual Music (BMI), 744 W. 28 St., Norfolk, Va. 23508.
 Perren-Vibes Music Co. Inc. (ASCAP), 11740 Ventura Blvd., Studio City, Calif. 91604. Tel: (213) 506-7010. Cable: PERRENT. VP & Gen. Mgr.: Leonard Hodas.
 Perspective Music Co. (BMI), see NRP Music.
 Perterna Music Co. (BMI), see Copyright Serv. Bureau.
 Peso Music (BMI), see Garrett.
 Petco Int'l Inc., 88-20 Corona Ave., Elmhurst, N.Y. 11373. Tel: (212) 699-5258. Pres.: Robert Petrone.
 Int'l branch: Peru.
 Int'l rep.: Worldwide (Mundo Musical).
 Peterbuilt Music Inc. (ASCAP), see Rondor.
 Peter David Music Co. Inc. (SESAC), see Ivan Mogull.
 Peter Jan Publ'g (BMI), 2313 S. 49 Ave., Omaha, Neb. 68106. Tel: (402) 556-5675. Pres.: Charles Canuso.
 Peter Piper Publ'g (ASCAP), see Stuart Lanis.
 Ben Peters Music (BMI), 900 Old Hickory Blvd., Rt. 6, Brent-

GET MORE CASH FLOW OUT OF YOUR PRINT RIGHTS.

Let Hal Leonard add to your royalty income by delivering the "extra" educational market. We're the major force in the home organ market and we publish substantial catalogs for high school and college marching bands, school orchestras and choral groups, jazz enthusiasts, and more.

Domestic:
 Keith Mardak
 8112 West Bluemound Road
 Milwaukee, WI 53213
 Telephone 414-774-3630
 Telex 26668

International:
 Robert Hirschman
 18 Claridge House
 32 Davies Street
 London W1Y 1LG, ENG.
 Telephone 01-499-8527
 Telex 261415

HAL LEONARD PUBLISHING CORPORATION
 © 1979 HAL LEONARD PUBLISHING

wood, Tenn 37027 Tel: (615) 373-5530. Pres.: Ben Peters

C. F. Peters Corp. (BMI), 373 Park Ave. S., New York, N.Y. 10016. Tel (212) 686-4147. Chm.: Mrs. Walter Hirschman, Pres. Henry Hans Hirschman, VP. Walter Bendix, Office Mgr. Martha Hirschman

Int'l branches: England, Germany, Switzerland

Int'l firms represented: Ailsbach (Netherlands), Belsaiff (Germany), Broekmans (Netherlands), Choudens (France), Dessain (Belgium), Donemus (Netherlands), Engstroem (Denmark), Dan Fog (Denmark), Forberg (Germany), Grahl (Germany), Harmonia (Netherlands), Heinrichshofen (Germany), Heuwerkemeyer Chamber Music (Netherlands), Hofmeister (Germany), Hug (Switzerland), Kneusslin (Switzerland), Lienau (Germany), Lyche (Norway), Merseburger (Germany), Mitteldeutscher (Germany), Willy Mueller (Germany), Musik-Huset (Norway), Musikwissenschaftlicher Verlag (rental music) (Austria), Noetzel (Germany), Pegasus (Germany), Reinhardt (Switzerland), Ries & Eriar (Germany), Samfundet (Denmark), Schott Freres (Belgium), Schwann (Germany), Sueddeutscher Musikverlag (Germany), Taunus (Germany), Tonger (Germany), Vieweg (Germany), Westend (Germany), Zanibon (Italy), Zimmermann (Germany)

Pewter Pal Music (BMI), PO Box 133, Ojai, Calif. 93023. Pres. Jim Pewter

Phase Seven Music (ASCAP), see Beef State.

Phase Three Music (BMI), see 20th Century.

Phiela Music (BMI), see Pewter Pal.

Phiimela Music Ltd (BMI), see Chappell.

PhoenixKongs (ASCAP), PO Box 622, Northbrook, Ill. 60062. Tel. (312) 564-2484. Owner James Durst

Phone Publ'g Co. (BMI), 1214 Ave. Q, Lubbock, Tex. 79401 Tel. (806) 747-7047. Pres.: Larry Corbin; VP. Don Caldwell.

Phono Music (SESAC), see HitKit.

Phylmar (ASCAP), 200 W. 57 St., New York, N.Y. 10019. Tel. (212) 581-4890

Piano Picker Music Inc. (BMI), see Loring.

Piccadilly Music Corp. (BMI), see Copyright Serv. Bureau

Picasso Publ'g Co. (ASCAP), 5032 Lankershim Blvd., North Hollywood, Calif. 91601. Tel. (213) 766-7142. Dir.: Ken Weiss, Gen. Mgr. Malcolm J. Jones.

Piccolo Music (BMI), see Shetby Singleton.

Pick-A-Hit Music (BMI), PO Box 1585, Nashville, Tenn. 37202. Tel. (615) 327-3553

Pickaway Music (ASCAP), see Copyright Serv. Bureau

Pickering Music Publ'g (BMI), see Irving Mills.

Pickin' Post (BMI), PO Box 51, Lebanon, Tenn. 37087. Tel. (615) 449-170

Pickwick Int'l Inc., 7500 Excelsior Blvd., Minneapolis, Minn. 55426. Tel. (612) 932-7548

Pickwick Music Corp. (ASCAP), see MCA Music.

Piedmont Music Co. Inc. (ASCAP), see Edward B. Marks.

Pierphill Music Co. (BMI), see Copyright Serv. Bureau.

Pi-Gem Music Inc. (BMI), 1225 16 Ave. S., Nashville, Tenn. 37204. Tel. (615) 320-7800

Pigfoot Music (ASCAP), PO Box 130, Point Reyes Station, Calif. 94956. Tel. (415) 663-1096

Pig Iron Music (BMI), see Column One.

Pig Snoot Music (BMI), see Copyright Serv. Bureau.

Pilgrim Music Publ'g Co. (ASCAP), see Slide.

Pina (ASCAP), see Coco Music.

Pinchpenny Music (ASCAP), see Martin Cohen.

George Pincus & Sons Music Corp. (ASCAP), see Gil Music.

Pineapple Music Publ'g (ASCAP)—VP. Joe A. Johnson—see Big State

Pinebrook Music Corp. (BMI), see H.B. Webman.

Pine Island Music (BMI), PO Box 630175, Miami, Fla. 33163. Tel. (305) 472-7757. Pres.: Jack P. Bluestein; VP. Ethel Kanter

Int'l reps.: Brazil (Pirate), Canada (CMRRA).

Pinelawn Music Publ'g Inc. (BMI), see Copyright Serv. Bureau.

Pinellas Music (BMI), 21315 Ibanez Ave., Woodland Hills, Calif. 91364. Tel. (213) 992-4922. Pres.: Ron Hitchcock; Gen. Mgr.: Bob Schell, Prof. Mgr.: Ben Rodgers. **Branch:** Clearwater, Fla., 1374 E. Cleveland St. Zip 33515. Tel. (813) 441-8159. Chief Exec.: Howard Franklin.

Pink Flower (ASCAP), c/o Eric Eisner, 9885 Chareville Blvd., Beverly Hills, Calif. 90212. Tel. (213) 553-5000

Pink Pelican Music Co. (BMI), see Chappell.

Pinpoint Music Publ'g (BMI), c/o Little Nashville Recs., Box 212, Rt. 3, Nashville, Ind. 47448. Tel. (812) 988-2000. Owners: Don D. & Marti Mae Sheets.

Pirooting Publ'g (ASCAP), see Segel & Goldman.

Pixenbar Music Co. (BMI), see Copyright Serv. Bureau

Pix-Russ Music (ASCAP), 49 Music Square W., Suite 513, Nashville, Tenn. 37203. Tel. (615) 320-5796. Pres.: Bobby Russell, Publ'g Dir.: Michael Snow.

Placid Music Corp. (BMI), c/o A. Halsey Cowan, 1350 Ave. of the Americas, New York, N.Y. 10019. Tel. (212) 246-2060.

Planetary Music Publ'g Corp. (ASCAP), see Big Seven

Plaque Music Publ'g Co. (BMI), see Ripcord.

Platinum Music Publ'g (ASCAP) (div. of The Music Factory Inc.), 567 NW 27 St., Miami, Fla. 33127. Tel. (305) 576-2600. Pres.: Bob Archibald; Gen. Mgr.: Florian Raymond.

Platinum Pen Music Publ'g Co. (sub. of Cloud Born Prod'ns), 18000 Mack Ave., Grosse Pointe, Mich. 48224. Tel. (313) 882-0566. Contacts: Ken Sands, Barry Praeg.

Players Music Corp. (ASCAP), see Chappell.

Playground Music (BMI), see Pewter Pal.

Playnote Music Publ'g (BMI), PO Box 219, Radio City Sta., 400 W. 43 St., Suite 19-H, New York, N.Y. 10036. Tel. (212) 695-6995. Pres.: Lawrence Lucie; VP. Nora Lee Lucie.

Pleasant Ridge Music (BMI)—Pres.: Bob Edwards—see Township Group.

Pleiades Music Inc. (BMI)—Pres. & Gen. Mgr.: William H. Schubart—see Other.

Plex Music (BMI), see Copyright Serv. Bureau.

Plibby Music (BMI), see Wheen.

Plunge Publ'g Co. (BMI), PO Box 441, Northridge, Calif. 91324. Tel. (213) 340-2752. Pres.: David M. Seiden.

Plurb-On Music (ASCAP), see Fourth Floor.

Pocho Music, see Rose.

Poco Loco Music Co. (BMI), see Faro.

Pocono Publ'g Co. Inc. (BMI), see Copyright Serv. Bureau.

Poco Publ'g (ASCAP), see Segel & Goldman.

Poiema Music Publ'g (BMI), PO Box 254452, Sacramento, Calif. 95825. Tel. (916) 383-4387. Pres.: Vladimir Sirotta, Gen. Mgr.: Tom Conrad, Prof. Mgr.: Gary Woltman.

Pointed Star Music Co. (BMI), see Jop.

Pointless Music (BMI), see JEDO.

Poison Oak Music (ASCAP), see Segel & Goldman.

Poison Ring Prod'ns Inc. (ASCAP), see Rohm.

Polar Music (BMI), see Copyright Serv. Bureau.

Polish Prince Music (ASCAP), see Chicago Music.

Polite (ASCAP), 6420 Wilshire Blvd., Los Angeles, Calif. 90048. Tel. (213) 651-1601

Polka Towne Music (BMI) (div. of Polka Music Corp.), 211 Post Ave., Westbury, N.Y. 11590. Tel. (516) 334-6228. Pres. Teresa Zapolska.

Pollyday Publ'g Co. Inc. (BMI), see Su-Ma.

Polo Grounds Music (BMI), see David Robinson.

Poly Tone Music Publ'g Co. (ASCAP), see True Blue.

Pomard (BMI), c/o Dick K. Witters, 7439 Hwy. 70 S., Nashville, Tenn. 37221

Pomona Music Corp. (BMI), see Shapiro Bernstein.

Ponderosa Music Co. Inc. (BMI), see Shapiro Bernstein.

Pop Country (BMI), see Ron Wilson.

Pop Gospel (BMI), see Ron Wilson.

Poplar Tunes Music (SESAC), see Glolite.

Popsicle Music (BMI), see Copyright Serv. Bureau.

Popular Music Co. (ASCAP), see Four Grand.

Porchester Music (ASCAP), see Brantree & Segel & Goldman.

Porpete Music Publ'g Co. (BMI), PO Box 777, Hollywood, Calif. 90028. Tel. (213) 654-3573. Pres. & Gen. Mgr.: Anita Poree

Porsche Music (SESAC), see Judlane.

Portable Music Co. Inc. (BMI)—Pres.: Eric Colodone—see Notable.

Portage Publ'g Co. (BMI), 16634 Gannon W., Rosemount, Minn. 55068. Tel. (612) 432-5737. Pres. Larry La-Pole.

Cole Porter Music Inc. (ASCAP), see Chappell.

Joe Porter Music (BMI), see T.B. Harms.

Portfolio Music Inc. (ASCAP), see Chappell.

Portnow Miller Co. Inc. (ASCAP), 107 E. 35 St., New York, N.Y. 10016. Tel. (212) 683-1282

Portofino Music (ASCAP), see Schiffman.

Portside Music (ASCAP), see Creative Concepts.

Positive Prod'ns (BMI), PO Box 1405, Highland Park, N.J. 08904. Tel. (201) 463-8845. Pres.: J. J. Vincenzo.

Poso Music (ASCAP), see April/Blackwood.

Potnick Music (BMI), 1540 Broadway, Suite 300, New York, N.Y. 10036. Tel. (212) 757-3995. Pres. & Gen. Mgr.: Carl D. Potnick.

Danny Poto Music Publ'g, 8268 NE Miami Court, Miami, Fla. 33138. Tel. (305) 358-1800. Owner: Danny Poto.

Poverty Publ'g Co., see Seaford.

Pov Music (ASCAP), see Judlane.

Powhatan Music Publ'g (BMI), PO Box 993, 211 E. Fourth

St., Salem, Va. 24153. Tel. (703) 389-4829. Pres.: Jack Mullins; Gen. Mgr.: Jim Eanes; Prof. Mgr.: J.R. Mullins

Powe Music (BMI), see Copyright Serv. Bureau.

Power Play Music (BMI) (div. of Gusto Recs. Inc.), 220 Boscobel St., Nashville, Tenn. 37213. Tel. (615) 256-1656

Pow-Pak Music Corp. (BMI), see Big Seven.

Poz Music (ASCAP), see Copyright Serv. Bureau

Practice Music (BMI)—Pres.: William M. Roberts—see Perennial.

Prancer Music (BMI), see Copyright Serv. Bureau.

Preludium Music (BMI), see David Hubert.

Prentice Music Inc. (ASCAP), see Eden.

J. Presbuterian Inc. (BMI), see April/Blackwood.

The Prescription Co. (BMI), 70 Murray Ave., Port Washington, N.Y. 11050. Tel. (516) 767-1929. Owner & Pres.: David F. Gassman.

Elvis Presley Music (BMI), see Chappell.

Theodore Presser Co. (ASCAP), Presser Pl., Bryn Mawr, Pa. 19010. Tel. (215) 525-3636. Cable. RESSERP. Pres.: Arnold P. Broido; VP & Gen. Mgr.: Nicholas J. Elsier Jr.; VP & Publ'ns Dir.: Henson Markham; Adv.: Thomas A. Bolan.

Int'l firms represented: Berben (Italy), Billaudot (France), Ed. Musica Budapest (Hungary), Eds. Francaise de Musique (France), Eds. Reimers (Sweden), Heugel (France), Impero Verlag (Germany), Jean Jobert (France), LeDuc (France), Ongaku No Tomo Sha (Japan), Robertson Publ'ns (UK), Transatlantiques (France); (Eli-Kan-Vogel); Ars Nova (Netherlands), Durand & Cie (France), Consortium Musicale (France), J. Phillippon (France), Heuwerkemeyer (Netherlands), Lemoine (France), Rideau Rouge (France), Hammelle (France), Herralle (France), Procure Generale (France), La Schola Cantorum (France), United (UK).

Prestige Music (BMI), see Jondora.

Presto Music Publ'g Co. (BMI), see Blue River.

Preston Songs (ASCAP), see Rondor.

Pretrorius Publ'g (ASCAP), see Yuggoth.

Pretty Girl Music (BMI), 3109 Park Ave., Memphis, Tenn. 38111. Tel. (901) 324-6786. Gen. Mgr.: Style Wooten.

Janie Price Music (ASCAP), PO Box 30384, Dallas, Tex. 75230. Tel. (214) 387-1101. Pres., Gen. & Prof. Mgr.: Janie Price.

Jimmy Price Music Publ'r (BMI), 1662 Wyatt Pkwy., Lexington, Ky. 40505. Tel. (606) 254-7474. Owner & Pres.: James T. Price; Gen. Mgr.: Harry P. Price; Prof. Mgrs.: Allen Vanderpool, Curtis Cox; Prod'r.: Andy Anderson.

Lloyd Price Music (BMI), see Copyright Serv. Bureau.

Pripan Music Corp. (BMI), see Copyright Serv. Bureau.

Prii Music (BMI), see Gopam.

Prima-Donna Music Co. (BMI) (div. of Prima-Donna Ent. Corp.), PO Box 15385, Nashville, Tenn. 37215. Tel. (615) 373-2390. (Administered by Al Gallico)

Primeval Ltd., see Greasy King.

Primitive West Publ'g (ASCAP), see American Heritage.

Primrose Music Publ'g Co. (BMI), see Byrdshire.



**The
Lowery
Group**

of Music Publishing
Companies

**ATLANTA,
GEORGIA**

**3051 Clairmont Rd., N.E.
(at Century Center)
Atlanta, Georgia 30329
P.O. Box 49386
Atlanta, Georgia 30359
404/325-0832**

**We are proud to be
the publishers of the
"UNDERDOGS"
"The Atlanta Rhythm Section"
and the outrageously brilliant
Alicia Bridges.**

**We'd like to be
your publisher too.**

Low-Sal, Inc.

Primus Artists Music (BMI), see First Artists.
 Princess & Frog Music (BMI), see Chappell.
 Princess Music Publ'g Corp. (ASCAP), see H. B. Webman.
 Pringle Music Publ'rs (BMI), 7021 Hatillo Ave., Canoga Park, Calif. 91306. Tel: (213) 347-3902.
 Pritchett Publ'ns (BMI), 38603 Sage Tree St., Palmdale, Calif. 93550. Tel: (805) 947-4657. Pres.: LeRoy Pritchett.
 Branch: Daytona Beach, Fla., 171 Pine Haven. Zip: 32014. Tel: (904) 252-4849. Gen. & Prof. Mgr.: Charles Vickers.

Prize Music Inc. (ASCAP), see Shelby Singleton.
 Process Music Publ'ns (BMI), see Country Star.
 Proclamation Prod'ns Inc. (ASCAP), Orange Square, Port Jervis, N.Y. 12771. Tel: (914) 856-6686. Pres.: Donald S. Marsh; VP: Richard K. Avery; Prof. Mgr.: Betty Collins.

Producers Music Publ'g Co. Inc. (ASCAP), see Chappell.
 Professor Longhair Music (BMI)—Owner: Henry Roeland Byrd; Admin'r: Parker Dinkins—see Zora Delta.
 Promo Music Co. (ASCAP), see Chappell.
 Promiseland Music (SESAC), see Word Inc.
 Pronto Music Inc. (BMI), see Cottillon.
 Prophecy Publ'g Inc. (ASCAP), PO Box 4945, Austin, Tex. 78765. Tel: (512) 452-9411. Pres.: Larry Watkins; VP, Gen. & Prof. Mgr.: Tommy White.
 Int'l reps.: Australasia (Festival), Austria (ERP), Belgium (New Dayglow), Germany (ERP), Netherlands (New Dayglow), Switzerland (ERP).

Prophet Music Inc. (ASCAP), see Bicycle.
 Prop Publ'g (BMI), see Inspirational Sounds.
 Jeanne Pruett Music Inc. (BMI), 713 18 Ave. S., Nashville, Tenn. 37203. Tel: (615) 327-2165.

Pseudo Songs (ASCAP), see Rondor.
 Pubit Music (BMI), see Copyright Serv. Bureau & Publicare.
 Publicare Publ'g (ASCAP), 2510 Tarrytown Mall, Houston, Tex. 77057. Tel: (713) 780-4506. Pres.: Jim D. Johnson. (Administered by Copyright Serv. Bureau)
 Publishers' Licensing Corp., 488 Madison Ave., New York, N.Y. 10022. Tel: (212) 753-1110. Cable: PHILKURN. Telex 234128. Contact: Philip S. Kurnit; Copyright Mgr.: Joan Coletti.

Publishing South (ASCAP), Gaslight Tower, Suite 1606, 235 Peachtree St., Atlanta, Ga. 30303. Tel: (404) 688-6612. Pres. J. Persico.

Puffin Prod'ns Inc. (BMI), see Copyright Serv. Bureau.
 Pulleybone Music Co. (ASCAP), see Aunt Polly's.
 Pulsation Music (BMI)—Pres.: Herman Eberitzsch—see Penrenial.

Puntina Publ'g Co. (BMI), see Full House & Chappell.
 Gerard W. Purcell Assocs. Ltd. (ASCAP), 133 Fifth Ave., New York, N.Y. 10003. Tel: (212) 475-7100. Cable: PURCELLAS.

Pure Songs (ASCAP), PO Box 80699, Worldway Postal Center, Los Angeles, Calif. 90080.

Pure Soul Music Corp. (BMI), see Big Seven.
 Purple Cow Music (ASCAP), see Adventure.
 Purple Passion Music (BMI), see April/Blackwood.
 Purusa Music Inc. (ASCAP), see Stevens H. Weiss.
 Putzy-Putzy Music (ASCAP), see Segel & Goldman.
 Pyramid Music (BMI)—Prof. Mgr.: Mark Porter—see Rob-Lee.

Q

Q C A Music Inc. (ASCAP), 2832 Spring Grove Ave., Cincinnati, Ohio 45225. Tel: (513) 681-8400. Pres.: Edward R. Bosken; Gen. Mgr.: Daryl Kalmus; Prof. Mgr.: Frank Ruhl.

Quackenbush Music Ltd. (ASCAP), c/o Northrup, 130 E. 67 St., New York, N.Y. 10021. Pres.: Carly Simon; Gen. Mgr.: Arlyne Rothberg.

Quadrafonic Music Inc. (ASCAP), see Danor.
 Quark Music (BMI), see Bruce Cohn.
 Quartet Music Inc. (ASCAP), see Trio.
 Queens Legs Music (BMI), see Picasso.

Quicksilver Music Corp. (BMI), see Copyright Serv. Bureau.
 Quinones Music Co. (BMI), 1344 Waldron, St. Louis, Mo. 63130. Tel: (314) 863-3605. Pres.: Eddie L. Johnson; Gen. Mgr.: Ora Livings; Prof. Mgr.: Clinton Primm.
 Quintet Music Inc. (ASCAP), see Trio.
 Quiston Music Co. (BMI), see Copyright Serv. Bureau.

R

R C S Music Publ'g Inc. (ASCAP), 5220 Essen Ln., Baton Rouge, La. 70808. Tel: (504) 766-3233. TWX: (510)

993-3493. Pres.: Cyril E. Vetter; VP, Gen. & Prof. Mgr.: John Fred.

R F D Music Publ'g Co. Inc. (ASCAP), see Peer-Southern.
 R F T Music Publ'g Corp. (BMI), see Thomas J. Valentino.
 R S O (The Robert Stigwood Org.), 1775 Broadway, New York, N.Y. 10019. Tel: (212) 975-0700. Telex: 125779. Pres.: Fredric B. Gershon; VP Publ'g: Eileen Rothschild. (Administered by Chappell Music).
 Home office: England.
 Branch: Los Angeles, Calif., 8335 Sunset Blvd. Zip: 90069. Tel: (213) 650-1234.

R S O Publ'g Inc. (ASCAP), see RSO & Chappell.
 R W P Music (ASCAP)—Pres.: Robert Parrisi; Prof. Mgr.: Gary Oberstyn—see Stone Rap.

Rabbit's Foot Music Corp. (BMI), see Big Seven.
 Rac Racouillat Music Ent's. (BMI), see Mal & Rac.
 Racuran Music (BMI)—Pres.: Al C. Moffitt; Exec. VP: Bob Montgomery—see House of Gold.
 Radmus Publ'g Inc., 15 E. 48 St., New York, N.Y. 10017. Tel: (212) 838-8660. Pres.: Hubert Terheggen; Gen. Mgr.: Marty Feely.

Rae-Cox & Cooke Music Corp. (ASCAP), 1697 Broadway, Suite 702, New York, N.Y. 10019. Tel: (212) 586-9406. Pres.: Theodore McRae; VP: Fredia Staton.
 Raft Ventures, 300 N. State St., No. 4712, Chicago, Ill. 60610. Tel: (312) 467-4294. Cable: RAVEN. Pres. & Gen. Mgr.: David Hybicki.
 Branch: Austin, Tex., 1218 E. Live Oak. Zip: 78704. Tel: (512) 443-8523. Cable: RAFTEX. Gen. & Prof. Mgr.: Bill Oliver.

Raga Music (BMI), see Chappell.
 Raga Music (ASCAP), see Main Stage.
 Ragged Island Music (BMI), 4307 Saundersville Rd., Old Hickory, Tenn. 37138. Tel: (615) 847-3895. Pres.: Margaret Lewis; Gen. Mgr.: A. Alton Warwick; Prof. Mgr.: Myra Smith.

Ragmar Music Corp. (BMI), 200 W. 57 St., New York, N.Y. 10019. Tel: (212) 265-0741. Pres.: Jerry Ragovery.
 Ragmop Music Corp. (BMI), 850 Seventh Ave., New York, N.Y. 10019. Tel: (212) 582-4975. (Administered by April/Blackwood)

Rahman Music (ASCAP), see Valgroup.
 Rainglow Music (ASCAP), see Martin Cohen.
 Rainwater Music Co. (BMI), see Martin Cohen.
 Rainy Wednesday Publ'g (BMI), see Chappell.
 Raj Kumer Music (BMI), see Chappell.
 Rally Music (BMI), see Ralph's Radio Music.
 Ralph's Music, see Ramms Music.
 Ralph's Radio Music (BMI), PO Box 127, Hwy. 441, Demorest, Ga. 30535. Tel: (404) 778-9117.

Bill Ramal Music (BMI), see Chappell.
 Ramapo Music (BMI), see MMO.
 Rambda Music (BMI), see Ivan Hoffman.
 Ramblin' Rose Publ'ns (ASCAP), see Deaton-Young.
 Ramms Music, 821 N. 23, McAllen, Tex. 78501. Tel: (512) 687-7121. Cable: FALCON. Pres.: A. Ramirez Sr.; Gen. Mgr.: A. Ramirez Jr.
 Int'l rep.: Mexico & Latin America (Leo in Mexico).

Ram's Horn Music (ASCAP), PO Box 860, Cooper Sta., New York, N.Y. 10003. Tel: (212) 473-5900. Admin'r & Gen. Mgr.: N. Saltzman

Rancho Allegre Publ'g Co. (ASCAP, BMI), 4323 Bluffview Blvd., Dallas, Tex. 75209. Tel: (214) 352-4821. Pres.: James Gribble III.

H. & G. Randall Inc. (ASCAP), 29 Elaine Rd., Milford, Conn. 06460. Tel: (203) 878-7383. Pres.: Gerald Randall; VP: Howard Randall.

Branches: Middletown, N.Y., 15 Randall Heights. Zip: 10940. Tel: (914) 343-6918—Syracuse, N.Y., 1900 W. Genesee St. Zip: 13204. Tel: (315) 468-0161.

Teddy Randazzo Music Inc., 51 W. 86, New York, N.Y. 10024. Tel: (212) 873-7179. Pres.: Teddy Randazzo; Gen. & Prof. Mgr.: Hermi Hanlin.

Fred Raphael Music Inc. (ASCAP), 319 Via Don Benito, Cathedral City, Calif. 92234. Tel: (714) 328-0170. Pres. Hermione Greene.

Rapsac Music (BMI), see Copyright Serv. Bureau.
 Rare Blue Music Inc. (ASCAP), see Chrysalis Music Group.
 Raschid Music (BMI), see Jonvis.
 Bill Rase Prod'ns Inc., 955 Venture Court, Sacramento, Calif. 95825. Tel: (916) 929-9181. Pres., Gen. & Prof. Mgr.: Bill Rase

Rashida Music Co. (BMI), see Kidada.
 Rastersons, see John Brumage.
 Rathsinon Music Co. (BMI)—Pres.: Willie Dixon—see Cameron.

Ratmix Music (BMI), see Creative World.
 Raton Songs Inc. (BMI), see Boca.
 Raven Music (BMI), 4107 Woodland Park Ave. N., Seattle,

Wash. 98103. Tel: (206) 632-0887. Publ'rs: Ronald W. Ellis, Michael B. Lynch.

Raw Dog Music (ASCAP), see Cole-Arama.
 Rawhide Music Co. (BMI), 815 18 Ave. S., Nashville, Tenn. 37203. Tel: (615) 329-9339. Pres.: Dave Burgess; VP: Judith Glasser; Office Mgr.: Vicki Branson.
 Int'l rep.: Worldwide excluding Canada (Burlington).
 Raw Milk Music Publ'g Co. (ASCAP), see Bald Mountain.
 Raydee Music Co. (SESAC), see Glad Music.
 Raydiola Music (ASCAP), 8484 Wilshire Blvd., Los Angeles, Calif. 90211. Tel: (213) 855-2962.
 Razor Sharp Music (BMI), see Mighty Three.
 Razzle Dazzle Music Inc. (BMI), 51 W. 86 St., New York, N.Y. 10024. Tel: (212) 873-7179. Pres.: Hermi Hanlin.

Reaction Music Co. (ASCAP), see NRP Music.
 Real Fine Song (BMI), see Musicways.
 Real To Reel Custom Servs., 88 Benz St., Ansonia, Conn. 06401. Tel: (203) 735-5883. Chm. & Pres.: Martin G. Kugell; Gen. & Prof. Mgr.: Sharon L. Kugell.

Rear Exit Music Co. (ASCAP), see No Exit.
 Reb Music Publ'g Co. (ASCAP), see Slide.
 Reborn Music (SESAC), see Giori Gospel.
 Record Junkie (BMI), 9000 Cynthia St., Suite 205, Los Angeles, Calif. 90069. Tel: (213) 276-9731. Co-Pres.: Robert Adels, Toppa Schroeder.

Recordo Music Publ'rs (BMI), see Leon Rene.
 Record Room Music (ASCAP), see Never Ending.
 Red Admiral Music Inc. (BMI), see Chrysalis Music Group.
 Red Cow Music Inc. (ASCAP), see RSO & Chappell.
 Red Day Music (ASCAP), see Dick James.
 Red Greg Ent's., 1650 Broadway, New York, N.Y. 10019. Tel: (212) 586-6543. Pres.: Gregory Carmichael; VP & Gen. Mgr.: Victor M. Carew.

Red Hook Music Corp. (ASCAP), see Music Sales.
 Jack Redick Music Publ'g Co. (BMI), Box 266, Rt. 1, Georgetown, S.C. 29440. Tel: (803) 546-8835. Owner: Jack Redick.

Redleaf Music (BMI), see Autumn Leaves.
 Redmark Music (SESAC), see OCA.
 Red River Songs Inc. (BMI), 100 N. Lincoln St., Burbank, Calif. 91506. Tel: (213) 848-7373, 842-4488. Pres.: Dorothy L. Bond; Gen. Mgr.: Sherry L. Weedman.

Red Rock Music Co. (BMI), PO Box 2671, Denver, Colo. 80201. Tel: (303) 572-9099. Pres.: James C. Scott Sr.; Gen. Mgr.: Beatrice James; Prof. Mgr.: Sherman Johnson.

Red Shoe Publ'g (ASCAP), see Berkeley Cooperative.
 Red Shoes Publ'g Co. (BMI), see R.A. Hodge.
 Red Stripe Music (BMI), see Don Williams.

Redwall Music Co. Inc. (BMI), see No Exit.
 Reekoh Music (BMI), see Copyright Serv. Bureau.

Rees Publ'g Group (ASCAP, BMI), PO Box 902, Provo, Utah 84601. Tel: (801) 224-4263. Pres.: R. Rees.

Jim Reeves Ent's. Inc., PO Drawer 1, 200 Madison St., Madison, Tenn. 37115. Tel: (615) 868-1150.
 Int'l rep.: Worldwide excluding USA & Canada (Burlington).

Regal Music Publ'ns (ASCAP) (div. of Century Recs.), 1429 Hawthorne St., Pittsburgh, Pa. 15201. Tel: (412) 781-4557. Pres. & Prof. Mgr.: Edward J. Moschetti.

Glenn Regan Music Co. (BMI), see Terry.
 Regent Music Corp. (BMI), see Goodman Group.
 Herb Reis Music Corp. (BMI), 15 E. 48 St., Rm. 801, New York, N.Y. 10017. Tel: (212) 759-2372. Mgr. Margo Reis.

Relaxed Music (BMI), see Martin Cohen.
 Reliance Music Corp., see T. B. Harms—Bibo.

Lloyd Zane Remick, 1529 Walnut St., 6th fl., Philadelphia, Pa. 19102. Tel: (215) 568-0500.

Renaissances (Eds.), see European American.
 Renda Music Inc. (BMI), 3830 N. Seventh St., Phoenix, Ariz. 85014. Tel: (602) 277-1336. Pres.: Floyd M. Ramsey.

Leon Rene Publ'ns (ASCAP), 2124 W. 24 St., Los Angeles, Calif. 90018. Tel: (213) 737-5125. (Administered by The Harry Fox Agency).

Renleigh Music Inc. (BMI), see Leigh Group.
 Republic Music Corp. (BMI), see World Music.
 Repus Music (BMI), see Cap-Orion.

Resaca Music Publ'g Co. (BMI), see Combine.
 Reservoir Music (ASCAP), see R.A. Hodge.
 Respect Music Co. (BMI), 1159 S. La Jolla Ave., Los Angeles, Calif. 90035. Tel: (213) 938-3531. Pres.: Miles Grayson; Gen. Mgr.: Peggy Grayson; Prof. Mgr.: Lermon Horton.

Return Music (BMI), see ATV.
 Reudie Valley Music (BMI), see Martin Cohen.

Revelation Music Publ'g Corp. (ASCAP), see Tommy Valando.

Revolver Music (ASCAP), PO Box 11321, St. Petersburg, Fla. 33733. Tel: (813) 531-2576. Gen. Mgr.: Charles R. Klump; Prof. Mgr.: Elbert J. Higgins.

Rex (BMI), see H. B. Webman.
 Reynard Publ'g Co. Inc. (ASCAP), see Sam Fox.

William Rezey Music Co. (BMI), PO Box 1257, Albany, N.Y. 12201. Tel: (518) 462-4462. Pres.: William P. Rezey; Prof. Mgr.: John Conlin.

Rhineland Music Inc. (BMI), see Marseant.
 Rhontana Music (ASCAP), see Martin Cohen.

Rhythm Valley Music (ASCAP), 1304 Blewett St., Graham, Tex. 76046. Tel: (817) 549-1641. Pres. & Prof. Mgr.: Orville Clarida; Gen. Mgr.: Doris Clarida.

Ribowin Music (ASCAP), see Mietus.
 Charles Rich Music Inc. (BMI), 8229 Rockcreek Pkwy., Cordova, Tenn. 38018. Tel: (901) 382-2100.

Richmin Music (BMI), 1026 Columbia St., Kingston, N.Y. 12401. Tel: (914) 336-6080. Pres.: William J. Rich; VP: Brian J. Minasian; Gen. & Prof. Mgr.: Gary Lee Schwartz.

Rick's (BMI), see Cafe Americana.
 Ridge Music Corp. (BMI), see Tannen

Ridge Runner Publ'ns, 7121 W. Vickery, No. 118, Fort Worth, Tex. 76116. Tel: (817) 731-7375. Pres.: Shm Richey; Gen. Mgr.: Jim Colegrove; Prof. Mgr.: Jim Yanaway.

Ridgeway Music Co. (BMI), see Golden West.
 Right Good Music (BMI), see Richard Delvy.
 Tim Riley Music (BMI), 3387 Poplar, No. 325, Memphis, Tenn. 38111. Tel: (901) 458-1421. Pres.: Tim P. Riley; Gen. & Prof. Mgr.: Janet Brotherton.

**SONGS by SOMMERS ARE BETTER NUMBERS!
 "REMINISCING DAYS GONE BY"**

b/w
**"THERE'S GREEN GRASS
 GROWING ON THOSE HILLS"**

Vocal by: Hazel Damron • American Sound Record # 3132

For quick copy, contact Cliff Ayers Productions,
 62 Music Square West, Nashville, Tenn. 37203 • Phone (615) 327-4538

Songs by
HENRY J. SOMMERS, ASCAP

P.O. Box # 322, Silver Spring, Maryland 20907
 Telephone (301) 946-9039

Ringo Pasta Music Ltd. (BMI), see Chappell.
 Ripcord Music (BMI), PO Box 2098, 4009 E. 18 St., Vancouver, Wash. 98661 Tel. (206) 695-2112 Owner Gene Breeden; Gen. Mgr. Ellis Miller, Admin'r Lorraine Walden.
 Ripke Pipke Music (BMI), see Chappell.
 Rip Music Inc. (BMI), see Keca.
 Ripparthur Music (ASCAP), see April/Blackwood.
 Rising Sons Music Inc. (BMI), see Combine.
 Ritchie Music Co. Inc. (ASCAP), see Barton Music.
 Rite Music (BMI), 9745 Lockland Rd., Cincinnati, Ohio 45215, Tel. (513) 733-5533. Pres. Carl J. Burkhardt; VP Philip Burkhardt.
 Riva Music Inc. (ASCAP), c/o Mayer, Nussbaum & Katz, 75 Rockefeller Plaza, New York, N.Y. 10019. Tel. (212) 484-8350.
 Rivers Music (ASCAP), see Copyright Serv. Bureau.
 Rizzum Music (BMI), see Segal & Goldman.
 Roadmaster Music Corp. (BMI), see Al Gallico.
 Road Music (ASCAP), see Chappell.
 Roadrunner Music (BMI), see Forrest Hills.
 Roadshow Music Group, 850 Seventh Ave., Suite 502, New York, N.Y. 10019. Tel. (212) 765-8840. VP & Gen. Mgr. Julie Lipsius.
 Roads of Music Publ'g Corp. (BMI), 850 Seventh Ave., New York, N.Y. 10019. Tel. (212) 582-1250. Telex: 92-6444. Pres.: Niko Joel Anducic, Prof. Mgr. Susan Felich.
Domestic firms represented outside USA: Accabonac Music (BMI), Stormy Forest Prod'ns (ASCAP) (both Austria, Germany, Switzerland).
Int'l firms represented: Filmkunst Musikverlag GmbH/Int'v Musikverlag GmbH (Germany), Ketchup Music (France).
 Roaring Flame Publ'g Co. (BMI), 907 N. Front St., Harrisburg, Pa. 17102. Tel. (717) 232-8651. Pres.: Bruce Rohrbach; Gen. Mgr. Bryan Rohrbach.
 Robadon Music (BMI), PO Box 2094, Sheffield Lake, Ohio 44054 Tel. (216) 949-2078 Owner Robert W. Sellers.
 Marty Robbins Ents., 713 18 Ave. S., Nashville, Tenn. 37203 Tel. (615) 327-4940/3752. Pres.: Marty Robbins, Gen. Mgr. James E. Farmer.
 Robert Music Corp. (BMI), see Ivan Mogull.
 Lee Roberts Music Publ'rs (ASCAP), see G. Schirmer.
 Don Robertson Music Corp. (ASCAP), PO Box 4141, Thousand Oaks, Calif. 91359. Tel. (213) 889-0876. Pres. Don Robertson.
Int'l rep.: Worldwide except USA & Canada (Chappell-Morris).
 Robin Hood Music Co. (BMI), 5531 Tuxedo Terr., Hollywood, Calif. 90028. Tel. (213) 465-9758. Pres.: John Marascalco.
 Robin Sean Music Publ'g (BMI), 5635 Verona Rd., Verona, Pa. 15147. Tel. (412) 793-9503. Pres. & Gen. Mgr.: Jim O'Leary; Prof. Mgr. Pat O'Leary.
 Robin-Styne Music Corp. (ASCAP), see Chappell.
 Rob-Lee Music (BMI), PO Box 1385, Merchantville, N.J. 08109. Tel. (609) 663-4540. Pres. Rob Russen, Gen. Mgr. Rodney Russen, Prof. Mgr. Eric Justin Russen.
Branch: Spring Lake Park, Minn., 358 NE Rosedale Rd. Zip 55432. Gen. Mgr. R.F. Russen, P. of Mgr. R. Richard.
 Rocket Publ'g, 489 Fifth Ave., 32nd fl., New York, N.Y. 10017. Tel. (212) 986-9361. Telex 428013. Pres.: John Reid; Prof. Mgr. Al Altman; Copyright Admin'r. Paula E. Pavlik.
Int'l branch: England.
 Rocket Songs Inc. (BMI), see Rocket Publ'g.
 Rock Island Music (ASCAP), see Rob-Lee.
 Rock Island Music Inc. (BMI), see Bald Mountain.
 Rockmasters Inc. (BMI), 177 Rt. 304, New City, N.Y. 10956. Tel. (914) 634-5101. Cable: ROCKMASTAS. Pres. & Prof. Mgr. Frank J. Guida; Gen. Mgr. Perla Frank.
Branch: Norfolk, Va., 317 Granby St. Zip 23510. Tel. (804) 623-5565, 625-3470. Gen. Mgr.: N. Gargano, Prof. Mgr.: F. Guida.
Int'l firm represented: Pepe Music Ltd. (UK)
Int'l reps.: Argentina (Odeon), Australia (Castle), Belgium (Ardmore & Beechwood), Denmark (Imudico), France (Pathe Marconi), Germany (Accord), Greece (Arion), Hong Kong (Pathe), Italy (Voce del Padrone), Japan (Toshiba), Mexico (Beechwood), Netherlands (Anagon), South Africa (Ardmore & Beechwood), Spain (EGO), Sweden (Odeon), UK (Pepe, Ardmore & Beechwood).
 Rockmore Music (BMI), 1733 Carmona Ave., Los Angeles, Calif. 90019. Tel. (213) 933-6521. Owner & Gen. & Prof. Mgr. Willie H. Rocquemore; Pres.: Perry Rocquemore.
 Rock Music (BMI), see Beechwood.
 Rockslam Music (BMI), see Bug.
 Rocksmith Music (ASCAP), see Trust Music.
 Rock Steady (ASCAP), 645 Madison Ave., New York, N.Y. 10022.
 Rockwork Music (BMI), see Rondor.
 Rodeheaver Co. (ASCAP) (div. of Word Inc.), PO Box 337, 100 Publishers Dr., Winona Lake, Ind. 46590. Tel. (219) 267-5116. Exec. VP N.B. Howe Jr.
 Rodeo (PRO), see Jaspar.
 Roeday Prod'ns Inc. (BMI), see Mietus.
 Rogan Publ'ns (BMI), 3316 Line Ave., Shreveport, La. 71104. Tel. (318) 861-0569.
 Rogette Music (BMI), see Schwartz.
 Roger Music Inc. (ASCAP), 449 S. Beverly Dr., Beverly Hills, Calif. 90212. Tel. (213) 553-8787. Pres.: Joseph S. Shribman.
 Rogers & Van Buren (BMI), 1900 Fifth Ave., Los Angeles, Calif. 90018. Tel. (213) 626-5319. Pres.: Ted Brinson, Gen. Mgr. Lurl Whiteside.
 Roger Talent Ents., PO Box 120306, Nashville, Tenn. 37212. Tel. (615) 244-2222. Pres.: Roger Jaudon.
 Winthrop Rogers, see Boosey & Hawkes.
 Rohm Music (BMI) (div. of Perception Inc.), Box 57, 10 George St., Wallingford, Conn. 06492. Tel. (203) 265-0010. Cable: BIGSODREC. Pres.: Thomas Cavalier, Gen. & Publ'g Mgr. Edyth L. Mercier; Prof. Mgr. Theodore Fantazia.
Branch: New York, N.Y., 2 Washington Square Vil-

lage, Suite 7-D, Zip: 10012. Tel. (212) 260-8645. Mng. Dir. Jon Tiven.
Int'l rep.: Worldwide excluding US & Canada (Celestial Harmonies).
 Roho Music (ASCAP), see Segal & Goldman.
 Rokir Music (BMI), see Copyright Serv. Bureau.
 Rolando Music Publ'g Co. (BMI), 1760 Osborne Dr., Memphis, Tenn. 38127. Tel. (901) 357-4431. Mgr. Roland Jones.
 Rollin Dice Music Publ'rs (ASCAP), see Real To Real.
 Frances Rollins (ASCAP), see Mary Frances Odle.
 Rollit Music (BMI), see Ivan Hoffman.
 Rolls Royce Music (ASCAP), see Copyright Serv. Bureau.
 Romance Music Inc. (BMI), see Wanessa.
 Romar Today Music (BMI), see Chappell.
 Richie Rome Music Inc. (ASCAP)—Pres.: Richard Rome—see Lloyd Zane Remick & April/Blackwood.
 Romona Music (ASCAP), 702 S. 15 St., Newark, N.J. 07013. (Affiliated with Vado Music).
 Roncom Music Co. (ASCAP), 305 Northern Blvd., Great Neck, N.Y. 11021. Tel. (516) 466-5810.
Int'l firm represented: Roncom (UK).
 Rondor Music Inc., 1358 N. La Brea Ave., Hollywood, Calif. 90028. Tel. (213) 469-2411. Cable: ALPERMOSS. Telex: 691282 TWX (910) 321-3593. Pres.: Charles B. Kaye, Exec. VP: Lance Freed, VP Int'l & Bus. Affairs: Evan R. Medow; Int'l Coord. Margo Matthews.
Int'l branches: Australia, Canada, England.
US firms represented outside USA & Canada: in Australia—Branntree Music (BMI), Doors Music (ASCAP), Fifth Floor Music (ASCAP), Four Knights Music (BMI), Fourth Floor Music (ASCAP), G-H Music Ltd., Gypsy Boy Music (BMI), Hibiscus Music, Hollenbeck Music (BMI), India Music (ASCAP), Jasperilla Music (BMI), Lady Jane Music (BMI), Miles Ahead Music, Pal Dog Music (ASCAP), Pamjokeen Music, Porchester Music (ASCAP), Riva Music Ltd., Boz Scaggs Music, John Sebastian Music (BMI), Shillelagh Music, Whitchurch Music (ASCAP), Whittsett Churchil Music (BMI), in UK—Branntree Music (BMI), Hollenbeck Music (BMI), India Music (ASCAP), Jasperilla Music (BMI), Lady Jane Music (BMI), Magiciand Music (ASCAP), Miles Ahead Music, Porchester Music (ASCAP), Racer Music, Shillelagh Music, Tangerine Music; in Hong Kong, Malaysia, Singapore & South Africa—Magiciand Music, others—Catpatch Music (BMI), Crazy Horse Music (BMI), Jowcol Music (BMI), Lost Cabin Music (BMI), Red Setter Music (ASCAP), Sacred Heart Music (BMI).
Int'l firms represented in USA: Harry Dart Publ'g (Australia); Budgie Music, Creek Publ'g Ltd., Deptford Songs, Dormant Music Ltd., Ennismore Music, Fair Music Ltd., Firefly Music Ltd., Geronimo Music Ltd., Manthula Music Ltd., Moondance Music Ltd., Roker Music Ltd., Straitjacket Songs, Tin Lid Music (all UK).
Int'l firm represented in the western hemisphere: Big Secret.
 Rone-Gorse Publ'g Co.—Pres. Charles E. Monday—see Al's Written Music.
 Rongwen Music (BMI), see Proude Bros.

Rontom Music Co. (ASCAP), 110 21 Ave. S., Nashville, Tenn. 37203. Tel. (615) 327-1050. Owner Tom Walls.
 Room 7 Music (BMI) (div. of Seven Arts Press), PO Box 649, Hollywood, Calif. 90028. Pres.: Walter E. Hurst; Gen. Mgr.: Sharon Marshall.
 Rooney Publ'g Co. (ASCAP) see Spina.
 Roots Music (BMI), PO Box 111, Seabright, N.J. 07660. Pres.: Jean Schweitzer, VP Robert N. Bowden.
 Rose Bridge Music Inc. (BMI), see Earl Barton & Publishers' Licensing Corp.
 Fred Rose Music Inc. (BMI), see Acuff-Rose.
 Rose Music, 922 Canterbury Rd. NE., Atlanta, Ga. 30324. Tel. (404) 237-1162. Pres.: Mario W. Peralta; VP's: Larry M. Paul, Frank P. Lappas, Controller Rosalia P. Peralta.
 Rose Tree Music (ASCAP), see Mighty Three.
 Brian Ross Prod'ns, 3884 Franklin Ave., Los Angeles, Calif. 90027. Tel. (213) 662-3121. Pres.: Brian Ross.
 Jerry Ross Music (BMI), see April/Blackwood.
 Roswell Music Co. (BMI), see Ivan Mogull.
 Rosy Publ'g (ASCAP), see Cafe Americana.
 Rotu Music (BMI), see Briarmeade.
 Rough Rider Music (SESAC), see Me & Sam.
 Round Sound Music (BMI), 1918 Wise Dr., Dothan, Ala. 36303. Tel. (205) 794-9067. Pres.: Jerry Wise.
 Route Music, see Martin Cohen.
 RowChar Music (ASCAP), 716 W. 33 St., San Pedro, Calif. 90731. Tel. (213) 833-1233. Pres.: John Rowin, Gen. Mgr. Charlotte Politte.
 Ro West Music Co. (BMI), see Copyright Serv. Bureau.
 R. D. Row Music Co. Inc. (ASCAP), see Carl Fischer.
 Royal Oak Music (ASCAP), see Roger Miller's Music.
 Royal Spin Music Inc. (BMI), 26 Cass Pl., Brooklyn, N.Y. 11235. Tel. (212) 743-3709. Pres.: Nat. Margolis, VP William Rizzo.
 Royal Tease Music (BMI), see Beldock Levine & Hoffman.
 Royal T Music (ASCAP), PO Box 54, Man's Field, Tex. 76063. Tel. (817) 477-2897. Pres.: James Michael Taylor, Gen. Mgr. Barbranne Taylor.
 Roy & Mick Music (SESAC), 1451 Elm Hill Pike, Nashville, Tenn. 37210. Tel. (615) 244-1630. (Affiliated with Mick Lloyd Music).
 Roznyk Music (BMI), see Schwartz.
 Rubank Inc. (ASCAP), 16215 NW 15 Ave., Miami, Fla. 33169. Tel. (305) 625-5323.
 Rubicon Music (BMI), 8319 Lankershim Blvd., North Hollywood, Calif. 91605. Tel. (213) 875-1775. Pres.: Freddie Piro; Gen. Mgr.: Ms. Teri Piro.
 David Rubinson & Friends Inc., 827 Folsom St., San Francisco, Calif. 94107. Tel. (415) 777-2930. Telex 340116. Pres.: David Rubinson, Gen. Mgr. Bruce Good; Prof. Mgr. Kathi Horton.
 Rudall Carte (ASCAP), see Boosey & Hawkes.
 Ru-Dot-To Music (BMI), see Derby.
 Ruffin-Ready Music Inc. (BMI), see Mietus.
 Rug Music Co. (ASCAP), see Martin Cohen.
 Rule One Music Inc. (ASCAP)—Pres. Dee Anthony—see Beldock Levine & Hoffman & Rondor.

our 49th year



**ONE OF THE WORLD'S
FOREMOST
MUSIC LICENSING ORGANIZATIONS**

WORLD HEADQUARTERS:
10 Columbus Circle, New York, NY 10019 • 212-586-3450

REGIONAL OFFICES:
11 Music Circle So., Nashville, TN 37203 • 615-244-1992
9000 Sunset Blvd., Los Angeles, CA 90069 • 213-274-6814

Rumanian Pickleworks (BMI), 1776 Broadway, New York, N.Y. 10019.
 Runaway Inflation Music (BMI), see 20th Century.
 Run It Music Inc., 250 W. 57 St., Suite 632, New York, N.Y. 10019. Tel: (212) 541-7283. Pres.: Dik Fraser; Dir.: Artist Development: Walt O'Brien; Admin. Ass't.: Charlene Colon.
Int'l branch: England, Hit & Run Music Ltd.
 Ruppada Music (BMI), see Mietus.
 Rush Sound Music (BMI), see Segel & Goldman.
 Russe (Ed.) (ASCAP), see Boosey & Hawkes.
 Russell/Cason Music, see T.B. Harms-Bibo.
 Frank Russell Music & Recs. Group Inc. (ASCAP), 170 Linwood Ave., Paterson, N.J. 07502. Tel: (201) 595-7557. Pres.: Frank Russell; VP: Margaret Ruggiero; Nat'l Promo. & Pub.: Tommy Russell.
 Rust Ents. Inc. (ASCAP), see Schwartz.
 Ruster House Music, see Schwartz.
 Rustron Music Prod'n's (BMI), 200 Westmoreland Ave., White Plains, N.Y. 10606. Tel: (914) 946-1689. Exec. Dir. & Prof. Mgr.: Rusty Gordon; Gen. & Prof. Mgr.: Ron Caruso.
Branch: Arcadia, Calif., Rustron Music West, 2804 S. Baldwin Ave. Zip: 91006. Tel: (213) 446-5855. Gen. & Prof. Mgr.: Mike Cohen.
Int'l firm represented: Sono Exit Rec. Co. (Colombia).
Int'l reps.: Colombia (FM Discos & Cintas, Sono Exit).
 Rustron Music West (BMI), see Rustron Music Prod'n's.
 Ruthie Music (ASCAP), see Chappell.
 Ryckman & Beck Music Publ'g & Sales Corp. (ASCAP, BMI), 3299 SW 11 Ave., Fort Lauderdale, Fla. 33319. Tel: (305) 763-9311. Pres. & Prof. Mgr.: Charles G. Ryckman; Gen. Mgr.: James F. Beck.
 Rye-Boy Music, see Beserkeley.
 Rye Bread Music Corp. (ASCAP), see Chappell.

S

S F M Inc. (ASCAP), see McRon.
 S & J Music (ASCAP), see Schwartz.
 S P Q R Music (ASCAP), 609 18 St., Union City, N.J. 07087. Tel: (201) 865-8866. Gen. Mgr.: Fausto Lucignani.
 S & R Music Publ'g Co. (ASCAP), 39 Belmont, Rancho Mirage, Calif. 92270. Owner: Scott B. Seely.
 S U N Y Binghamton Eds., see Galaxy.
 S V G (ASCAP), 3203 36 Ave., Long Island City, N.Y. 11106. Tel: (212) 278-7832. Pres.: Guido Sgambellone; VP & Prof. Mgr.: Jim Pace.
 S W S Music Inc. (ASCAP), 1370 Ave. of the Americas, New York, N.Y. 10019. Tel: (212) 737-8106. 586-1451. Telex: 224600. Pres.: Sverre O. Sundman.
 Sabal (ASCAP), 1722 West End Ave., Nashville, Tenn. 37203.
 Sabina (ASCAP), see Coco Music.
 Sackerson Music (BMI), see Copyright Serv. Bureau.
 Sacred Concert Publ'n's (SESAC), see Spectrum.
 Sacred Music Press (ASCAP), see Lorenz Inds.
 Sacred Songs (ASCAP), see Word Inc.
 Saddle Song Music (BMI)—Pres.: Thomas Schroeder—see TWC.
 Safari Music (BMI), see Bonton.
 Saga Music Corp. (ASCAP), see Barton Music.
 Saggiore Music (BMI), c/o Gelfand, Breslau, Rennert & Feldman, PO Box 2202, 431 S. Palm Canyon Dr., Suite 104, Palm Springs, Calif. 92262. Tel: (714) 325-5095.
 Sagittarius Entertainment Inc., 375 Park Ave., New York, N.Y. 10022. Tel: (212) 758-4530. Cable: SAGITTAR.
 Sahara Music (ASCAP), see Chappell.
 Douglas Sahn Music Co. Inc. (BMI), see Chappell.
 Sailmaker Music (ASCAP), see Chappell.
 St. Francis Music Co. (BMI)—Mgr.: Richard Singer—see Derry.
 St. George Music Ltd., see Copyright Serv. Bureau.
 St. Lawrence Music Inc. (BMI), see Sam Weiss.
 Saint Luther Music, see Martin Cohen.
 St. Martin Music Co. Inc. (BMI), see Sam Fox.
 St. Michael's Alley Music (ASCAP), see Tintagel.
 St. Nicholas Music Inc. (ASCAP), 1619 Broadway, New York, N.Y. 10019. Tel: (212) 582-0970. Pres.: Johnny Marks.
 Saka Music (BMI), 3800 Ocean Dr., Hollywood, Fla. 33019. Tel: (305) 456-0847. TWX: (510) 954-9798. Pres.: Eugene Settler; Exec. VP: John Pudwell; Gen. Mgr.: Ruth Gamba; Nat'l Promo Dir.: Larry Barnes.
Branch: Cos Cob, Conn., 28 Fado Ln. Zip: 06807. Tel: (203) 869-1988. Nat'l Sales Mgr.: George Saydah.

Salabert Music Publ'r (ASCAP), 575 Madison Ave., New York, N.Y. 10022. Tel: (212) 486-9230. Pres.: Mrs. Francis Salabert; Gen. Mgr.: Peter A. Salomone.
Home office: France.
 Sally Music Co. (BMI), see White Way.
 Salsoul Music Publ'g Corp. (ASCAP), 240 Madison Ave., New York, N.Y. 10016. Tel: (212) 889-7340. Telex: 236464. Pres.: Joseph Cayre; Admin'r: Larry Spier.
Int'l reps.: Australia (Ivan Mogull), Austria (Cyclus), Belgium (Anagon), Brazil (Copa), Germany (Cyclus), Italy (RCA), Japan (Ivan Mogull), Netherlands (Anagon), New Zealand (Ivan Mogull), Scandinavia (Air), UK (ATV).
 Salt Water Music (BMI), see April/Blackwood.
 Salvation Music Inc. (BMI), see Stanyan.
 Sambo Music, see Publishers' Licensing Corp.
 Samfred Music Inc. (BMI), see Sam Fox.
 Sandbox Music (ASCAP), see Gaucho.
 Sandburn Music (ASCAP)—Pres.: Charles W. Fields; Gen. Mgr.: Donald L. Riis—see Americus.
 Sandclock Music Inc. (BMI), see Copyright Serv. Bureau.
 San Dino Music Corp. (ASCAP), see Barton Music.
 Sandman Music Publ'g Co. (ASCAP), 6 Morris Ave., Montville, N.J. 07045. Tel: (201) 334-0863. Prof. Mgr.: Sandy Nelson.
 Sandonna Music (BMI), see Mietus.
 Sands Music Corp. (ASCAP), see Barton Music.
 Sanga Music Inc. (BMI), 250 W. 57 St., Suite 2017, New York, N.Y. 10019. Tel: (212) 586-6553. Cable: LEMANA-G. Pres.: Harold Leventhal; Gen. Mgr.: Joy Graeme.
 San Juan Avenue Music, 8909 W. Olympic Blvd., Beverly Hills, Calif. 90211. Tel: (213) 657-8795.
 San-Lyn Music (BMI), PO Box 46, 414 Cortland Ave., Syracuse, N.Y. 13205. Tel: (315) 476-2779. Pres. & Gen. Mgr.: Jack Swanson; Prof. Mgrs.: Jack Swanson, Bob King.
Int'l rep.: Canada (Kinghouse).
 Sanskrit Publ'g Co. (ASCAP), 4120 Excelsior Blvd., Minneapolis, Minn. 55416. Tel: (612) 920-9590. Partner: Keith Christianson.
 Sanson-Antobal (ASCAP), see Fred Ahlert.
 Santa Lucia Music (BMI), see Segel & Goldman.
 Santa Publ'g (SESAC), see Copyright Serv. Bureau.
 Santee Music Press Inc. (ASCAP), see Pietro Deiro.
 Saraceno/Collins Prod'n's Inc., see Collins/Saraceno.
 Sarah (ASCAP), see David Music.
 Saralee Music Publ'g Co. (BMI), see Chris.
 Saran Music Co. (BMI), PO Box 17667, Dallas, Tex. 75217. Tel: (214) 428-3128. Pres.: Dewey Groom.
 Sashay Music Inc. (ASCAP), see Morris Music & Chappell.
 Satori Music Publ'g Inc. (ASCAP), see Symposium.
 Satrycon Music (BMI), PO Box 75692, Los Angeles, Calif. 90075. Tel: (213) 666-6791. Owner: David Austin.
 Satsong Music (ASCAP), PO Box 720636, Atlanta, Ga. 30328. Tel: (404) 252-4713. Contact: Michael Keck.
 Saturday Night Music (ASCAP)—Pres.: James Barton—see Border Star.
 Saucer Eyes Music (BMI), see El Paso.
 Saul Avenue Publ'g Co. Inc. (BMI), see Halnat.
 Savannah Music Inc. (ASCAP), see Denton & Haskins.
 Sa-Vette Music Co. (BMI), see A. Schroeder.
 Savgos Music (BMI), 342 Westminster Ave., Elizabeth, N.J. 07208. Tel: (201) 351-6800. VP & Gen. Mgr.: Fred Mendelsohn; Office Mgr.: Helen Gottesman.
 Savi Music (BMI), see Martin Cohen.
 Savona Music (BMI), see Schiffman.
 Sawgrass Music Publ'rs Inc. (BMI), 1722 West End Ave., Nashville, Tenn. 37203. Tel: (615) 327-4104. Pres. & Gen. Mgr.: Lonnie M. Tillis; Prof. Mgr. Jimmy Darrell.
 Saxon Music Corp. (BMI), see Copyright Serv. Bureau.
 Scales of Justice Music Inc. (BMI), PO Box 2609, 119 1/2 E. Main St., Lafayette, La. 70502. Tel: (318) 235-3587. Pres.: J. Michael Fernandez.
 Scallopini Marsala Music (ASCAP), see April/Blackwood.
 Scarab Publ'g Corp. (BMI), see Famous.
 Scarlet Stallion Music (BMI)—VP R. Rees—see Rees Publ'g Group.
 Scarsdale Music Corp. (ASCAP), see Shapiro Bernstein.
 Sceneville Music (ASCAP), see Knud-Feldt.
 Schabraf Music (BMI) (div. of Bee Jay Booking Agency & Rec'g Studios Inc.), 5000 Eggleston Ave., Orlando, Fla. 32810. Tel: (305) 293-1781. Pres.: Eric T. Schabacker; Gen. Mgr.: James A. Katt.
 Peter Schaffer Music Corp. (BMI), see Copyright Serv. Bureau.
 Schaffer Publ'g Group (BMI), 439 S. La Cienega Blvd., Los Angeles, Calif. 90048. Tel: (213) 225-2827. Pres.: Michael Schaffer; Exec. VP & Gen. Mgr.: Doris Schaffer; Prof. Mgrs.: Ben Brooks, Irwin Honor. **Local branch:** 3888 Elderbank Dr. Zip: 90031.

Schaffer Songs (BMI), see Schaffer Publ'g.
 Schaum Publ'n's Inc. (ASCAP), 2018 E. North Ave., Milwaukee, Wis. 53202. Tel: (414) 276-9984. Pres.: John W. Schaum; VP & Gen. Mgr.: Wesley Schaum.
Int'l rep.: Germany (Bosworth).
 Schiffman Music Co. (BMI), 9200 Sunset Blvd. No. 620, Los Angeles, Calif. 90069. Tel: (213) 550-0200. Pres.: Todd Schiffman.
Int'l reps.: France (Marouani), Germany (Meisel), Japan (Taiyo), Spain (Hispavox).
 David Schine & Co. Inc., 626 S. Hudson Ave., Los Angeles, Calif. 90005. Tel: (213) 937-5000. Pres.: G. David Schine; Gen. Mgr.: Berndt Schine.
 Schine Music (ASCAP), see David Schine.
 E. C. Schirmer Music Co. (ASCAP), 112 South St., Boston, Mass. 02111. Tel: (617) 426-3137. Cable: SCHIR-MUCO. Pres.: Robert MacWilliams.
Int'l firms represented: Camera (UK), Foetisch Freres (Switzerland).
Int'l rep.: British Commonwealth except Canada, Europe & South Africa (Richard Schauer in UK).
 G. Schirmer Inc. (ASCAP), 866 Third Ave., New York, N.Y. 10022. Tel: (212) 935-5100. VP & Gen. Mgr. Edward Murphy; Prof. Mgr.: Howard Scott; Adv. Mgr.: R. Pearce.
Subsidiary co.: Associated Music Publ'rs Inc.
Int'l firms represented: Baerenreiter-Verlag (Germany), Bote & Bock (Germany), Breitkopf & Haertel (Germany), J. Curwen & Sons (UK), Ludwig Doblinger (Austria), Enoch & Cie. (France), Eds. Max Eschig (France), F. E. C. Leuckart (Germany), Faber Music Ltd. (UK), Mezhdunarodnaja Kniga (USSR), Adolph Nagel (Germany), D. Rahter (UK), G. Ricordi (France, Germany, Italy, South America), Eds. Salabert (France), Hans Sikorski (Germany), N. Simrock (UK), Union Musical Espanola (Spain), VAAP (USSR).
 Schlager Music Publ'g Co. (BMI), see De Gar.
 Schlok Publ'g, 1416 Boston Post Rd., Larchmont, N.Y. 10538. Tel: (914) 834-2145. Pres.: Karl Fagan.
 A. P. Schmidt Music Co. Inc. (SESAC), see Summy-Birchard.
 Schmitt Music Center Inc. (ASCAP), see Schmitt Publ'n's.
 Schmitt Publ'n's (div. of Schmitt Music Centers Inc.) (SESAC), 110 N. Fifth St., Minneapolis, Minn. 55403. Tel: (612) 336-4367.
 Schoochiebug Music (ASCAP), see Eddie Holman.
 Schooner Sooner Songs (ASCAP), see Ivan Hoffman.
 Schott Music Corp. (ASCAP), see European American.
 Schroeder Music Co. (ASCAP), 2027 Parker St., Berkeley, Calif. 94704. Tel: (415) 843-2365. Owner: Nancy Schimmel; Mgr.: Ruth Bernstein.
 A. Schroeder Int'l Ltd., 25 W. 56 St., New York, N.Y. 10019. Tel: (212) 582-8810. Cable: SCHROMUS. Pres.: Aaron Schroeder; VP: Abby Schroeder; Ass't to Pres.: James Krueger.
 Schroeder & Gunther (ASCAP), see Associated Music.
 Edward Schubert & Co. Inc. (SESAC), see Ashley.
 Schwartz Music Co. Inc. (ASCAP), 20-F Robert Pitt Dr., Monsey, N.Y. 10952. Tel: (914) 425-7000. Pres.: Gene Schwartz; Gen. Mgr. & Treas.: Robert Schwartz; Prof. Mgr.: Ernie Maresca.
 Scolaron Recs. (BMI), see Plunge.
 Scor-Bra-Ario Music (BMI), see April/Blackwood.
 Scorpicon Music (BMI), see April/Blackwood.
 Andrew Scott Inc. (ASCAP), see Leigh Group.
 G. Scott Music Publ'g Co. (ASCAP), 345 S. Citrus Ave., Los Angeles, Calif. 90036. Tel: (213) 939-3630. Owner: James T. Lester.
 Gregg Scott Music (BMI), see Lauren Kim.
 Scott Music Publ'n's (ASCAP), PO Box 148, Hollywood, Calif. 90028. Tel: (714) 992-1522. Pres.: Scott Fredrickson; Gen. Mgr.: Debra Kuehn.
 Scot Tone (ASCAP), 9229 Sunset Blvd., Suite 616, Los Angeles, Calif. 90069.
 Screaming Chicken Music (BMI), see Martin Cohen & Speed.
 Screamin' Sax Music (BMI), see Don Williams.
 Screen Gems-EMI Music Inc. (BMI), 6255 Sunset Blvd., Hollywood, Calif. 90028. Tel: (213) 469-8371. Pres.: Lester Sill; VP Admin.: Jack Rosner; VP & Prof. Activities Dir.: Paul Tannen; VP Creative Affairs: Ira Jaffe.
Branches: New York, N.Y., 1370 Ave. of the Americas, Zip: 10019. Tel: (212) 489-6740—Nashville, Tenn., 1207 16 Ave. S. Zip: 37212. Tel: (615) 320-7700.
Int'l branches: England, Germany, Italy, Sweden.
Int'l reps.: France (Eco), Japan (Toshiba-EMI).
 Screen Test Music Publ'g Co. (ASCAP), see Slide.
 Scribble Music (BMI), see Bug.
 Scully Music Co. (ASCAP), 800 S. Fourth St., Philadelphia, Pa. 19147. Tel: (215) 755-7000. Pres.: Walter B. Kahn; Pub. & Prof. Mgr.: Cathi Lee.
 Seafood Music (BMI), PO Box 42338, San Francisco, Calif. 94101. Tel: (415) 821-7311. Dir.: Barry Melton.
Int'l reps.: Austria (Rolf Budde), France & SACEM territories (Robinson), Germany (Rolf Budde), Japan (Harry Fox), Netherlands (Anagon), Scandinavia (Sonet), Switzerland (Rolf Budde), UK & Commonwealth (Chrysalis).
 Seal Publ'g Co. (BMI), 13310 Collingwood Terr., Silver Spring, Md. 20904. Tel: (301) 384-8826. Pres.: Larry Sealfon.
 Seaside Publ'g Co. (BMI), see Copyright Serv. Bureau.
 Season Experience Music Prod'n's (ASCAP), PO Box 41425, Jacksonville, Fla. 32203. Owner & Prof. Mgr.: Thomas P. Brown.
 Sea Three Music (BMI), 1310 Tulane, Houston, Tex. 77008. Tel: (713) 864-0705, 869-0417. Pres.: Charlie Bickley.
 John Sebastian Music (BMI), c/o Mitchell, Silberberg & Knupp, 1800 Century Park E., Los Angeles, Calif. 90067. Tel: (213) 553-5000. Cable: SILMITCH. Telex: 691347.
 Second Generation Music Inc. (SESAC), see Counterpart.
 Neil Sedaka Music Publ'g, 1370 Ave. of the Americas, New York, N.Y. 10019. Tel: (212) 586-5712.
 Seesaw Music Corp. (ASCAP), 1966 Broadway, New York, N.Y. 10023. Tel: (212) 874-1200. Pres. & Prof. Mgr.: Raoul R. Ronson; Gen. Mgr.: S. B. Kohn.
Int'l firm represented: Tonos (Germany).
 Segal Publ'g Co. (BMI), see Copyright Serv. Bureau.
 Segel & Goldman Inc., Sunset Towers, Suite 525, 9200 Sunset Blvd., Los Angeles, Calif. 90069. Tel: (213)

GIL MUSIC CORP.
GEORGE PINCUS & SONS MUSIC CORP.
SONGFEST MUSIC CORP.
 Gil Enterprises, Inc.
 George Pincus, President
 1650 Broadway, New York, N.Y. 10019 (212) 245-0110
 Cable: PINCUSGIL

AMBASSADOR MUSIC LTD.
 22 Denmark Street, London W.C.2, England 01-836-5996
 Cable: AMBAMUSIC

278-9200. Pres.: Ralph Goldman; Gen. Mgr.: Marv Mattis.

Sidney A. Seidenberg Inc., 1414 Ave. of the Americas, New York, N.Y. 10019. Tel: (212) 421-2021. Cable: SAS-TALENTS. Adm'nrs: Sidney A. Seidenberg, Floyd Lieberman.

Int'l rep.: Worldwide excluding Australasia, Canada, UK & USA (Ivan Mogull).

Seitu (BMI), c/o Gang, Tyre & Brown, 6400 Sunset Bldg., Los Angeles, Calif. 90028.

Select Music Inc. (ASCAP), see Copyright Serv. Bureau.

Ralph L. Seltzer Inc., 5243 Yarmouth Ave., Suite 26, Encino, Calif. 91316. Tel: (213) 705-1541. Pres.: Ralph L. Seltzer; Ass't to Pres.: Shosh Byron.

Int'l branches: Australia, Germany, Spain, U.K.

Int'l firms represented: Matthews Music (Australia), OctoArts (Philippines), Quiroga (Spain), Reveille (South Africa), TC (Brazil), Toso Musikverlag (Germany), Trindade (Portugal).

Sema Music Ltd., see Alexander Broude.

Semenya Music (BMI), see Gopam.

Semerak Publ'g Co. (BMI), 4327 S. Sacramento Ave., Chicago, Ill. 60632. Tel: (312) 523-3914. Pres.: R.M. Semerak.

Senisa Music (ASCAP), see Epp's Music.

Senor Music (ASCAP), see Garrett.

Sephra Music (ASCAP), see Publishers' Licensing Corp.

September Music Corp. (ASCAP), 250 W. 57 St., Suite 1916, New York, N.Y. 10019. Tel: (212) 581-1338. Cable: MILLSTAN. Pres.: Stanley Mills.

Int'l firms represented: Grenyoco Music (UK), Hush Music Ltd. (UK), Robert Kingston (UK).

Sesame Music (BMI), see Intermountain Music.

Seven Bells Music—Pres.: Eddie Kendrick; Co-Mgrs.: Mark Christini, Jeff Lane—see Arista.

Seven B Music, see Tune-Kel.

Seven-Eleven Music Corp. (BMI), see Shapiro Bernstein.

Sevengali Music, see Copyright Serv. Bureau.

Seven Hills Publ'g Co. Inc. (BMI), 905 N. Main St., Evansville, Ind. 47711. Tel: (812) 423-1861. Pres.: Ed Kriemeyer; Gen. Mgr.: P.J. Hayden.

Seven Of Us Music (BMI), 26 Mountain Ave., Dover, N.J. 07801. Tel: (201) 361-2084. Pres.: Michael F. Matushin Sr.

Seven Songs (BMI), see A. Schroeder.

Seven Valleys (ASCAP), see Dawnbreaker.

Seven Winds Prod'ns (ASCAP), see Copyright Serv. Bureau.

Seyah Music (BMI), 1227 Spring St. NW, Atlanta, Ga. 30309. Tel: (404) 873-6425. Pres.: Barbara H. Richardson.

Shade Tree Music Inc. (BMI), PO Box 500, Bella Vista, Calif. 96008. Tel: (916) 547-3396. Pres. & Prof. Mgr.: Merle Haggard; VP: James L. Haggard.

Int'l rep.: Worldwide excluding USA & Canada (South-ern).

Shadow Fax Music (BMI), see OAS.

Shady Dell Music Inc. (SESAC), see Earl Barton.

Shady Grove Music Inc. (ASCAP), see Mietus.

Shakat Music (ASCAP), see April/Blackwood.

Shakin Music (ASCAP), see Copyright Serv. Bureau.

Shalli Music (ASCAP), see Curtis Wood.

Shalynn Music (ASCAP), PO Box 34131, Dallas, Tex. 75234. Tel: (214) 270-2678, 242-6152, 371-9881. Pres.: Stephen Kediarchuk; Gen. Mgr.: Linwood Henderson; Prof. Mgr.: Rick Jackson.

Branch: San Diego, Calif., 3435 Camino Del Rio S., Suite 113, Zip: 92124. Tel: (714) 280-9803. Gen. Mgr.: David Sahl.

Sharma Publ'g Co. (BMI), 254 E. 29 St., Suite 7, Los Angeles, Calif. 90011. Tel: (213) 937-4540. Pres.: Duffy Hooks III.

Shapiro Bernstein & Co. Inc. (ASCAP), 10 E. 53 St., New York, N.Y. 10022. Tel: (212) 751-3395. Cable: BERNSTEIN. Pres.: Richard M. Voltter; Exec. VP: L.J. Brettler.

Int'l branch: England.

Int'l reps.: Australia (Wallaby), Caribbean, Central America, Mexico, South America (Ivan Mogull).

Shari-Dayna Music (BMI)—Gen. Prof. Mgr.: Ed Michaels—see Periscope.

Shari Music Corp., see Clara.

Sharkey Music Inc. (ASCAP), see Cromia.

Sharp-Gannon Music (ASCAP), see Martin Cohen.

Shattering Publ'ns Inc. (ASCAP), see Copyright Serv. Bureau.

C. Shaw Music (BMI), see Copyright Serv. Bureau.

Eddie Shaw Music Corp. (ASCAP), see Barton Music.

Shawnee Press Inc. (ASCAP), Delaware Water Gap, Pa. 18327. Tel: (717) 476-0550. Pres. & Gen. Mgr.: Ernest R. Farmer; Sales Mgr.: Robert Kranendonk; Licenses Dir.: Steve Kanych.

Sheba Publ'g (BMI), see Copyright Serv. Bureau.

Sheephead Bay Music (ASCAP), see Castle Hill.

Sheet Music Co. Inc., see T.B. Harms—Jack & Bill.

Sheffield Music Corp. (BMI), see Shapiro Bernstein.

Shekere Music (BMI), 4409 Douglas St. NE, Washington, D.C. 20019. Tel: (202) 396-0154. Pres.: Plunky Nkabinde; VP & Gen. Mgr.: James Gray; Prof. Mgr.: Sylvia Potts.

Branch: Richmond, Va., Juju Raga Music (BMI), 3463 Howard Rd. Zip: 23223. Tel: (804) 780-2523. Prof. Mgr.: Greg Branch.

She-La-La Music (SESAC), see Derby.

Shelmer Poe Music (BMI), see Chappell.

Shelros Music Co. (BMI), see April/Blackwood.

Shelton Assocs. (BMI), 2250 Bryn Mawr Ave., Philadelphia, Pa. 19131. Tel: (215) 477-7122. Chm.: Earl Shelton; Co-Pres.: Edith Shelton; George Gues.

Shelvey Publ'ns Co. (BMI), 4148 S. King Dr., Chicago, Ill. 60653. Tel: (312) 624-8060. Pres.: James W. Shelton Jr.

Shema Music (ASCAP), see Hollytree.

John Sheppard Music Press, see European American.

Thomas Sheppard Publ'g Co. (BMI), see Slide.

Sheri Glen Publ'ns Inc. (BMI), 1316 Alford Ave., Birmingham, Ala. 35226. Tel: (205) 823-5602.

Sheriton Music Publ'g Co. (ASCAP), see Blue River.

Sherilyn Publ'g Co. (BMI), 495 SE 10 Court, Hialeah, Fla. 33010. Tel: (305) 888-1885. Pres.: Henry Stone; Co-ord: Maria Lom.

Admin. branch: New York, N.Y., 65 E. 55 St., Suite

604. Zip: 10022. Tel: (212) 752-0160. Gen. Mgr.: Erleen Mohr.

Int'l rep.: Worldwide (CBS Int'l in USA).

Sherm Music (ASCAP), see Intercontinental Music.

Sherwin Music Publ'g Corp. (ASCAP), see Robert Mellin.

Sherwood Music Co. (ASCAP), see Copyright Serv. Bureau.

Shidel Music (BMI), see Bug.

Shingle Music (BMI), see Jerden.

Shoestring Music Corp. (BMI), PO Box 4009, Hollywood, Calif. 90028. Tel: (213) 466-6038. Pres.: Morris I. Diamond. (Administered by Copyright Serv. Bureau).

Shoetunes (BMI), see Bug.

Shongs Music (ASCAP)—Pres.: Shaun Cassidy—see Triple H.

Short Pump Assocs. (BMI), PO Box 11292, 1901-E N. Hamilton St., Richmond, Va. 23230. Tel: (804) 355-4117. Pres.: Ken Brown.

Shotgun Music Co. (BMI), 22 Pine St., Freeport, N.Y. 11520. Tel: (516) 546-8008. Pres.: Anthony Ferrante; Prof. Mgr.: Bill Seabrook.

Int'l rep.: Worldwide excluding USA & Canada (Burlington in UK).

Show Biz Music Inc. (BMI), 110 21 Ave. S., Nashville, Tenn. 37203. Tel: (615) 327-2532.

Shownote Music Co., see Showpiece.

Showoff Publ'g Co., see Showpiece.

Showpiece Prod'ns (BMI), PO Box 79, Main Sta., Yonkers, N.Y. 10702. Tel: (914) 965-0801, 968-5949. Pres.: Robert B. Schoen.

Showtime Publ'g Co. (BMI), PO Box 40074, Washington, D.C. 20016. Tel: (202) 397-6952. Pres.: Charles A. Ables; Gen. Mgr.: Berch L. Salles.

Shroomtunes (ASCAP), see Mushroom.

Shun Frenocity Music (BMI), see Martin Cohen.

Sid-Lee Music Corp., (BMI), see Copyright Serv. Bureau.

Sight & Sound Int'l Inc., 600 Larry Court, Waukesha, Wis. 53187. Tel: (414) 784-5850. Pres.: Zeb Billings; Exec. VP: Chuck Faas; Copyright Mgr.: Conrad W. Kish.

Int'l branch: Netherlands.

Sigma Alpha Iota (BMI), see C.F. Peters.

Signature Music Press (ASCAP), see Carl Fischer.

Silent Giant (ASCAP), see Curton.

Silhouette Music Corp. (ASCAP), see Copyright Serv. Bureau & The Herald Ass'n.

Silicon Music Inc. (BMI), 222 Tulane St., Garland, Tex. 75043. Tel: (214) 278-3079. Pres. & Gen. Mgr.: Gene & Dea Summers.

Int'l reps.: Netherlands (Collector Recs.), Switzerland (Lake County).

Silk Purse Music (BMI), 1516 Oak St., Alameda, Calif. 94501. Tel: (415) 865-2040. Owner: Michael Cogan.

Silverado Music (BMI), see Segel & Goldman.

Silver Blue Music Ltd. (ASCAP), 220 Central Park S., New York, N.Y. 10019. Tel: (212) 586-3535. Pres.: Joel Diamond.

Silver Chalice Music (ASCAP), see Martin Cohen.

Silver Cowboy Publ'g (BMI), PO Box 80032, Smithfield, Tex. 76180. Tel: (817) 498-3447. Pres.: D.M. Holliday.

Silver Dagger Publ'g Co. (ASCAP), see Owepar.

Silver Dollar Music (ASCAP), see Jack Music.

Silver Fiddle (BMI), see Segel & Goldman.

Silverhill Music (BMI), PO Box 39439, Los Angeles, Calif. 90039. Tel: (213) 663-8073. Exec. Ass't: Paul F. Wells.

Silver House Music Co. (ASCAP), see 20th Century.

Silverline Music Inc. (div. of Jim Halsey Co. Inc.), 329 Rockland Rd., Hendersonville, Tenn. 37075. Tel: (615) 824-7273. Pres.: Jim Halsey; Prof. Mgr.: Noel Fox.

Branches: Los Angeles, Calif., 9046 W. Sunset Blvd. Zip: 90069. Tel: (213) 278-3397—Tulsa, Okla., 5800 E. Skelly Dr., Penthouse Suite. Zip: 74135. Tel: (918) 663-8883.

Silver Music (ASCAP), see Blanchris.

Silversongs Music (BMI), see Copyright Serv. Bureau.

Silver Soul Music (BMI), see Combine.

Silver Spur Publ'g (BMI), see R.A. Hodge.

Silver Steed Music Inc. (BMI), see Organic Mgmt.

Silver Stevens Music Inc. (BMI), see Copyright Serv. Bureau.

George Simon Inc. (ASCAP), 1850 S. Camino Real, No. 3, Palm Springs, Calif. 92262. Tel: (714) 327-4464. Pres.: George Simon.

Simon House Inc. (BMI), see George Simon.

Paul Simon (BMI), 36 E. 61 St., New York, N.Y. 10021. Tel: (212) 752-2276. Gen. Mgr.: Ian Hoblyn.

Sinatra Songs (ASCAP), see Barton Music.

Since Music Publ'g Co. (BMI), see Copyright Serv. Bureau.

Sing & Dance Music (ASCAP), see Saka Music.

Renee Singer Music (BMI), see Benfel.

Singing River Publ'g Co. Inc. (BMI), 205 Acacia St., Biloxi, Miss. 39530. Tel: (601) 436-3927. Pres. & Prof. Mgr.: Marion Carpenter; Gen. Mgr.: Winona Carpenter.

Singing Wire Music (BMI), see Widget.

Shelby Singleton Music Inc. (BMI), 3106 Belmont Blvd., Nashville, Tenn. 37212. Tel: (615) 385-1960. Cable: SHELREC. Pres.: Shelby S. Singleton Jr.; VP & Gen. Mgr.: John A. Singleton.

Int'l reps.: Australia (Festival), Austria (Bellver), Belgium (Basart), France (Pathe-Marconi), Germany (Bellver), Netherlands (Basart), Portugal (Canciones del Mundo), South Africa (Clan), South America (Odeon), Spain (Canciones del Mundo), Sweden (Sweden Music), Switzerland (Bellver), UK (Peter Maurice).

Singletree Music Co. (BMI), 815 18 Ave. S., Nashville, Tenn. 37203. Tel: (615) 329-9339. Pres.: Dave Burgess; Office Mgr.: Vicki Branson.

Int'l rep.: Worldwide except Canada (Burlington).

Sing Me Music Inc. (ASCAP), 19 Music Square W. Nashville, Tenn. 37203. Tel: (615) 256-1886. Pres.: Jean Zimmerman; Prof. Mgr.: Mary Louise Smith.

Sing Me Prod'ns, see Sing Me Music.

Singspiration Inc. (SESAC) (div. of The Zondervan Corp.), 1415 Lake Dr. SE, Grand Rapids, Mich. 49506. Tel: (616) 459-6900. Exec. VP: John S. Helder; Music Publ'ns Dir.: Don Wyrzten.

Int'l reps.: UK (Marshall, Morgan & Scott).

Siquomb Publ'g Corp. (BMI), see Segel & Goldman.

Siren Songs (BMI), c/o Loeb & Loeb, 10100 Santa Monica

Suppliers of Music under License to the Entire Recording Industry

CHANGE OF A LIFETIME SALE OF MASTERS

ONE THOUSAND LP MASTERS AND COLOR SEPARATIONS FOR SALE ON COUNTRY BY COUNTRY BASIS

**Non Exclusive or Exclusive • Low Price • Flat Fee
Top Sound • Superb Film Negatives
Compilations Permitted**

**Huge Selection Rock, Disco, Bandleaders, Classics, Cover, Artist Sound
Alike, Original Artists, Jazz, "Beautiful Music," Music from Around the
World, Movie Themes, Marches, Polkas, Dance.**

**OPPORTUNITY TO RELEASE IMMEDIATELY
FIRST CLASS BUDGET SERIES
OF 20, 50, 100 LP's or MORE.**

MASTERS SUITABLE FOR

- Phonograph Records
- Pre-Recorded Cassettes
- Background Music
- Film Music
- TV Music
- TV Packages

Write, telephone, or telex
Ms. Susanne Tarter at . . .

AMPRO

PRODUCTIONS, INC.

**ALSO SEE US AT MIDEM, 4TH
FLOOR, PALAIS DES FESTIVALS,
FOR EXCITING NEW
RELEASES.**

150 FIFTH AVENUE, NEW YORK, NY 10011
TELE: 212/243-7726 TELEX: 425233 AMEX UI.
CABLE ADDRESS: TAPEXXRON NEW YORK

**COMPOSITIONS By
GLADYS SHELLEY**

**HOW DID HE LOOK
LIFE STYLE
HE WILL CALL AGAIN
CLOWN TOWN
NO MAN IS GOING TO CHANGE ME
MY WORLD IS YOU
CHRISTMAS IS CHRISTMAS
IT ONLY TAKES ONE MAN
I BELIEVE IN LOVE
YOU SAY SOMETHING
NICE ABOUT EVERYBODY
SITTING PRETTY IN ATLANTIC CITY
SKYLAB
ROLLIN' AT THE ROLLER disco
IF YOU DON'T KNOW YOUR BIBLE
YOU HAVEN'T GOT A PRAYER**



**Record Corp. &
Music Pub.**
17 West 60th Street
New York, N.Y. 10023
(212) 581-6985

Q: Which companies offer the tape world design/artwork and printing/lithography services?

A: To answer such questions, one book is always at your service. Check out "Tape Services" in TAV: Billboard's Tape/Audio/Video Market Sourcebook. Where three industries rely on one source.

Bld., 22nd fl., Los Angeles, Calif. 90067. Tel (213) 273-7711.

Siri Music Inc. (BMI), 30 Marksman Ln., Levittown, L.I., N.Y. 11756. Tel. (516) 796-2076. Pres.: Howard Marshall.

Sirod Music Co. (ASCAP), see Copyright Serv. Bureau

Sister John Music (BMI), see Blendingwell & Publishers' Licensing Corp.

Svatt Music (BMI), PO Box 7172, Greenville, S.C. 29610. Tel. (803) 269-5529. Pres. Jesse Evatte.

Six Continents Music Publ'g Inc. (BMI), see Interworld.

Sixpence Publ'ns (BMI), 6115 Red Bird Court, Dallas, Tex. 75232. Tel. (214) 337-1272. Pres. Roland Steele.

Six Strings Music (BMI), 126 E. Mayland St., Philadelphia, Pa. 19144. Tel. (215) 849-2485. Owner & Pres. Norman Harris; Prof. Mgr. Caryle Blackwell (Administered by Famous Music—Ensign Music).

Sixth Floor Music (BMI), see Martin Cohen.

Ski Cat Music (BMI), see Garrett.

Skidmore Music Co. Inc. (ASCAP), see Shapiro Bernstein.

Jimmie Skinner Music Publ'g (BMI), 5825 Vine St., Cincinnati, Ohio 45216. Tel. (513) 242-8000. Pres. Lou Ukelson.

Skinny Zach Music Inc. (ASCAP), 6430 Sunset Blvd., Suite 1104, Los Angeles, Calif. 90028. Tel. (213) 461-2988. Pres. Zach Glickman.

Int'l reps.: France (Criterion), Germany (Toledo), UK (Cyril Shane).

Skip Jack Music (BMI), see Mimic.

Skull Music (BMI), see Segel & Goldman & Rondor.

Skunkster Publ'g (ASCAP), see Bruce Cohn.

Sky Blue Music (ASCAP), see R.A. Hodge.

Skydiver Music (ASCAP), 8255 Sunset Blvd., Los Angeles, Calif. 90046. Tel. (213) 650-8300.

Skyforest Music Co. Inc. (BMI), see Sidney A. Seidenberg.

Skyhill Publ'g Co. Inc. (BMI), 5112 Hollywood Blvd., Hollywood, Calif. 90027. Tel. (213) 660-1605. Telex. 674981. Pres.: Denny Cordell; Gen. Mgr. Gary Heaton; Domestic Admin.: Janet Smith; Int'l Admin.: Bernadette Gorman.

Int'l reps.: Australia (Phil Matthews), France (Minoartre), Germany (ERP), Japan (Shinko), Netherlands (New Day-glow), South Africa (Gallo), Sweden (Sonet), UK (Virgin).

Sky's the Limit Music Inc. (SESAC), see Critique.

Skyway Music Inc. (ASCAP), see Neil Music.

Skyway Music Publ'g (BMI), PO Box 133, Hollywood, Calif. 90028. Owner: Everett L. Whenheim.

Slam Music (BMI), see Schaffer Publ'g.

Sleepy Hollow (ASCAP), c/o Billy Edd Wheeler, Bee Tree Rd., Swannanoa, N.C. 28778.

Slide Music Publ'g Co. (ASCAP) (a Lenny McKinnon Empire of Properties Co.), PO Box 691, Reading, Pa. 19601. Tel. (215) 372-7361. Pres. Leonard McKinnon.

Int'l reps.: Argentina (Julio Korn), Australia (Allians), Austria (Ludmilla), Belgium (Disco), Brazil (Copacabana), Canada (Jendale), Chile (Fermata), Denmark (Winckler), Finland (Coda), Germany (Paul C. Arends), Greece (Arion), Ireland (Segway), Israel (Israeli Music Publ'ns), Japan (Crown), Switzerland (Belmont), Sweden (Globe), UK (Cyril Shane, Soulsational Sounds).

Stimbul Music (BMI), see Brim.

Stingshot Music (BMI) (div. of TRC Corp.) c/o TRC Mid-America Rec'g Center, 1330 N. Illinois St., Indianapolis, Ind. 46202. Tel. (317) 638-1491.

Slipped Disc Music (BMI), see Segel & Goldman.

Slippery Jack Song Co. (ASCAP), see Skip Taylor & Bug Music.

Slow Dancing Music Inc. (BMI), see Buttermilk Sky.

Ethel Smith Music Corp. (ASCAP), see Copyright Serv. Bureau.

Harrison Smith (BMI), 31 Pleasant Pl., Brooklyn, N.Y. 11233. Tel. (212) 385-6699.

Int'l reps.: France (Essex), Italy (Aromando & Fox), Netherlands (Basart), UK (Allegro).

Smoke Shop Music (ASCAP), see Martin Cohen.

Smorgaschord (ASCAP)—Owner: Rob Fetters—see Hal Bernard.

Snoqualmie Music (BMI), see Kaye-Smith.

Snorby Music Inc. (ASCAP), see Copyright Serv. Bureau.

Snow (BMI), c/o Jess S. Morgan & Co., 6420 Wilshire Blvd., Los Angeles, Calif. 90048.

Snowblind Music (BMI), see Chappell.

Snowdrop Music (BMI), 400 First National Bank Tower, Garland, Tex. 75040. Tel. (214) 272-8536. Pres. Robert J. Roth; Gen. & Prof. Mgr. R.M. "Dick" Roth.

Snowflake (BMI)—Contact: "Bugs" Bower—see Pelton.

Hank Snow Music Inc. (BMI), see Chappell.

Snug Music (BMI), see Bruce Cohn.

Snyder Music (ASCAP), see Beechwood.

Society for the Publ'n of American Music (ASCAP & BMI), see Theodore Presser.

Society Hill Music (ASCAP), see Ragmar.

Softcharay Music (BMI), see Le Bill.

Soft-Landing Music (BMI), see Mietus.

Soft Music (BMI), see Valgroup.

Sokit Music (BMI), 455 N. Snyder Rd., Dayton, Ohio 45427. Tel. (513) 854-2797. Pres. Al Freeders.

Sola Gratia Music (SESAC), see Schabraf.

Solar Recs. Inc. (div. of Mystic Music Centre Inc.), 6277 Selma Ave., Hollywood, Calif. 90028. Tel. (213) 464-9667. Pres. Doug Moody.

Solar Systems Music (ASCAP), 441 E. 20 St., New York, N.Y. 10010. Tel. (212) 674-1143. Pres. Sheila Davis, Prof. Mgr.: Hal Zachary.

Solid Smoke Songs (ASCAP), PO Box 22372, San Francisco, Calif. 94122. Tel. (415) 731-0500.

Solid State Music (ASCAP), see Copyright Serv. Bureau.

Solo Music Inc. (ASCAP), 4708 Van Noord Ave., Sherman Oaks, Calif. 91423. Tel. (213) 762-2219. Pres. & Gen. Mgr.: Paul Mills.

Somerset Press (ASCAP), see Hope.

Henry J. Sommers (ASCAP), PO Box 322, Silver Spring, Md. 20907. Tel. (301) 946-9039. Owner: Henry J. Sommers. (SEE ADVERTISEMENT)

Son-Deane Publ'ns (ASCAP), Hartsdale, N.Y. 10530. Tel. (914) 693-1590. Pres.: Howard Deanto; Gen. Mgr. Craig Deanto; Prof. Mgr.: Sondra Deanto.

S'one Songs (BMI), 6101 Ridgeview Ave., Baltimore, Md. 21206. Tel. (301) 254-7354. Gen. & Prof. Mgr.: George Brigan.

Songfest Music Inc. (ASCAP), see Gil Music.

Song Mountain Music Publ'rs (ASCAP), see Segel & Goldman.

Song of Cash Inc. (ASCAP), see House of Cash & Clay Music.

Songwriter Music Publ'g (ASCAP)—VP's: Fred Bock, Bob Cotterell—see Fred Bock.

Songs for Today Inc. (SESAC), 1300 Division St., Suite 303, Nashville, Tenn. 37203. Tel. (615) 254-9034. Pres. Jeffrey Kruger, VP & Gen. Mgr.: Sylvia Mays.

Songs of Bander-Koppelman Inc. (ASCAP), see The Entertainment Co.

Songs of Bobby & Ginny Music Co. (BMI), PO Box 302, Wilmington, N.C. 28401. Owners: Bobby & Ginny Stanley.

Songs of David Inc., Box 22653, Nashville, Tenn. 37202. Tel. (615) 327-2331. Pres. Dave Mathes.

Songs Of Manhattan Island Music Co. (BMI), see Entertainment Co.

Songs of Mexico Inc. (ASCAP), see Mexican Music.

Song Yard Music (ASCAP), see Velvet Apple.

Sonlife Music Co. (ASCAP) (div. of Paul Johnson Music Prod'ns Inc.), PO Box 552, Woodland Hills, Calif. 91365. Tel. (213) 703-6707. Pres. Paul A. Johnson; Admin. Ass't: Cheryl Wilks.

Son-Lo Publ'g Co. (BMI), see Fort Knox.

Son Mike Music (BMI), see Sutton/Miller.

Sonshine Prod'ns, see Lorenz.

Sons of Ginza Publ'ns, see T.B. Harms—Vogue.

Sophisticate Music Inc. (BMI), 1619 Broadway, New York, N.Y. 10019. Tel. (212) 757-2695. Pres. Buddy Johnson; Gen. & Prof. Mgr.: Gil Miller; Pub. & Promo. Dir.: Jim McCarthy.

Int'l rep.: Europe (Campbell Connolly).

Soprano Music Publ'g (BMI), 4118 W. 106 St., Lennox, Calif. 90304. Tel. (213) 673-3562. Pres. & Prof. Mgr.: Tina L. Thompson; Gen. & Prof. Mgr.: Joseph Chryar.

Int'l reps.: Belgium (Frankie), France (Michael Meyer).

Soquel Songs (ASCAP), see Bruce Cohn.

Sorority Fraternity Recs. Publ'ns (ASCAP), c/o Mayhams Collegiate Recs., Box 46, Morningside Sta., New York, N.Y. 10026. Tel. (212) 368-7275.

Souci Music Co. (ASCAP), see Chappell.

Soulbar Music (BMI), see Mietus.

Soulset Music Co. (BMI), see Stonebass.

Soul Syndicate Music (BMI), see Bug.

Southern Music Co. Inc. (BMI), see Allied Artists.

Soul West Music Co. (BMI), 319 N. 85 St., Seattle, Wash. 98103. Tel. (206) 783-2524. Pres. & Gen. Mgr. Richard Keefer; VP: Donna-Alisa Keefer.

Sound Approach, 31 Penny Dr., Huntington Station, N.Y. 11746. Tel. (516) 421-3824. Pres. Elaine M. Schoppe; Gen. Mgr.: William R. Schoppe Jr.

Sound Attack Music (BMI), see Bug.

Soundboosters Inc. (BMI), see Chappell.

Sound City Music (ASCAP), see Rogan.

Sound Corp. Music (ASCAP), 907 Main St., Nashville, Tenn. 37206. Tel. (615) 226-0724. Pres. R.E. Lewis; Admin. Mgr.: Barbara M. Lee.

Sound Inc. Music (BMI), 56880 North Ave., New Haven, Mich. 48048. Tel. (313) 749-5182.

Sound Investment Co. (BMI)—Pres. Wilbur L. Mhoon Jr.; Gen. & Prof. Mgr.: Season Allegra Mhoon—see Jun Mhoon & Assocs.

Sound Masters Commercial Rec'g Co., 4702 SW 75 Ave., Miami, Fla. 33155. Tel. (305) 264-5000.

Sound Off Music (BMI), see Sound Corp. Music.

Sound of Nolan Music (BMI), 211 S. Beverly Dr., Suite 108, Beverly Hills, Calif. 90212. Tel. (213) 278-7344. Pres. Kenny Nolan; Gen. Mgr.: Peter C. Bennett.

Soundpost Inc. (ASCAP), see Copyright Serv. Bureau.

Sound-Screen Ltd. (BMI), see Emko.

Sounds Music Co. (ASCAP), PO Box 40-2947, Miami Beach, Fla. 33140. Tel. (305) 861-9396. Owner: Stanley Cooper.

Sounds of Country (BMI), 1210 Palm St., Abilene, Tex. 79602. Tel. (915) 677-1508. Contact: George D. Young.

Sounds of Lucille Inc. (BMI), see Sidney A. Seidenberg.

Sounds of Memphis, 904 Rayner, Memphis, Tenn. 38114. Tel. (901) 725-5467.

Sounds Reasonable Publ'g Inc. (BMI), 2000 P St. NW, Washington, D.C. 20036. Tel. (202) 457-0852. Pres.: Edmund S. Barnett Jr.; Exec. VP: Elizabeth Garrett Bunker.

Soundstage Studios Inc., 10 Music Circle S., Nashville, Tenn. 37203. Tel. (615) 256-2676.

Sound Syndicate, 7769 Melrose Ave., Los Angeles, Calif. 90046. Tel. (213) 653-4818. Pres. Al Durand; Gen. Mgr.: Donna Lee; Prof. Mgr.: Dick Gordon.

Sound View Music (SESAC), see Sound Corp. Music.

South Breeze Music Group & Filmworks Inc., 1018 16 Ave. S., Nashville, Tenn. 37212. Tel. (615) 255-8635. Exec. VP & Prof. Mgr.: B.T. VornDick; Gen. Mgr.: Donnie Cumming.

Southern Crescent Publ'g (BMI), 121 N. Fourth St., Easton, Pa. 18042. Tel. (215) 258-5990. Contact: Jim Kirk.

Branch: New York, N.Y., 320 W. 30 St., No. 5-J Zip 10001. Tel. (212) 564-3246.

Southern Love Music Co. (BMI), see Chappell.

Southern Melody Publ'g Co. (BMI), 122 W. Woodridge Dr., Durham, N.C. 27707. Tel. (919) 489-4349. Pres. Barry Posa.

Southern Music Co. (ASCAP), 1100 Broadway, San Antonio, Tex. 78292. Tel. (512) 226-8167. Pres. & Gen. Mgr.: Arthur Gurwitz; Publ'ns Dir.: Arthur Ephross.

Int'l rep.: UK (Belwin-Mills).

Southern Music Publ'g Co. Inc. (ASCAP), see Peer-Southern.

Southern Writers Group, Box 40764, 2804 Azalea Pl., Nashville, Tenn. 37204. Tel. (615) 383-8682. Pres. Buzz Cason; VP: Bill Martin.

Southfield Music Inc. (ASCAP), see Bridgeport.

South Mountain Music Corp., see T.B. Harms—Vogue.

Southtown Music Inc. (BMI), see Pickwick.

Southwest Music Co. (ASCAP), see Dolly Bee.

Southwest Words & Music (BMI), 14 E. Second St., Tucson, Ariz. 85705. Tel. (602) 792-3194. Pres. Fred Knupe; Country Music Div. Mgr.: Tom Chandler; Prof. Mgr.: Steve Chandler.

Spaceark Ents. (ASCAP), PO Box 4523, North Hollywood, Calif. 91607. Tel. (213) 761-6830. Pres. Troy B. Raglin; Gen. Mgr.: J. McAllister; Prof. Mgr.: T. Dodds.

Space Cowboy Music (BMI), see April/Blackwood.
 Space Potato Music Ltd (ASCAP), 150 E 58 St., New York, N.Y. 10022 Tel: (212) 752-9700. Pres. David Nichtern. Gen. Mgr. E. Judith Berger
 Spame Music, see Copyright Serv. Bureau.
 Spanka Music Corp. (BMI), see MCA Music.
 Sparrow Recs. Inc. (BMI), 8587 Canoga Ave., Canoga Park, Calif. 91304 Tel: (213) 998-1733. Pres. Billy Ray Hearn. Publ'g Dir. Greg Nelson. Mktg. Dir. Steve Potratz. Ass't. Adeline Griffith.
 Sparrow Song (BMI), see Sparrow Recs.
 Spartan Music Co., see T. B. Harms—Harry Von Tilzer.
 Speak Music Co. (BMI), see Window
 Special Rider Music (ASCAP), see Dwarf
 Specific Gravity Music (BMI), see Bug & Martin Cohen
 Spectacular Music Inc. (ASCAP), see Chappell.
 Spectrum Publ'ns (SESAC), PO Box 757, San Carlos, Calif. 94070 Tel: (415) 593-9554. Dir. Dr. Paul L. Weaver.
 Speed Music (BMI), 8465 Shirley Ave., Northridge, Calif. 91324 Tel: (213) 885-7456. Pres. Daniel Moore.
 Spencer Music Co. (ASCAP), 507 Fifth Ave., New York, N.Y. 10017 Tel: (212) 697-5895. Pres. J.C. Algeier. Gen. Mgr. Bruce Spencer. Prof. Mgr. Alan Abel.
 Spicy Music (BMI), see Martin Cohen
 Spider (SESAC), see World Wide Music Inc.
 Larry Spier Inc. (ASCAP), 240 Madison Ave., New York, N.Y. 10016 Tel: (212) 686-1777. Telex 237322. Pres. Larry Spier. VP. Dorothy Spier
Int'l reps.: Australia (Leeds), Austria (Rolf Budde), Belgium (Kluger Int'l), Germany (Rolf Budde), Italy (Essex), Japan (Pacific), Mexico, Central & South America (CBS Int'l), Netherlands (Kluger Int'l), New Zealand (Leeds), Portugal (RCA), Spain (RCA), Switzerland (Rolf Budde), UK (Memory Lane).
 Spikes Music (BMI), see Bruce Cohn
 Spina Music (ASCAP), 2232 Vista Del Mar Pl., Hollywood, Calif. 90068. Tel: (213) 467-6018. Pres. & Prof. Mgr. Harold Spina. Gen. Mgr. Edith Spina.
Int'l rep.: UK (Wilson)
 Spin These Tunes (BMI), see Live Music
 Spiral Rec. Corp. Publ'rs (ASCAP), 17 W. 60 St., New York, N.Y. 10023 Tel: (212) 581-6985. Gen. & Prof. Mgr. Harry Finfer (SEE ADVERTISEMENT)
 Spirefire Music (BMI), see Rondor
 Spook Publ'g Co., see Cedarwood
 Sporo Music Co. (BMI), see Martin Cohen
 Springboard Music Publ'g Group, 947 US Hwy 1, Rahway, N.J. 07065 Tel: (201) 574-1400. NYC (212) 233-7380. Telex (710) 996-5874. Pres. Dante J. Pugliese; Sec'y-Treas. Margaret Johnson; Office Mgr. C. Blackford.
Branch: Hollywood, Calif., 8295 Sunset Blvd. Zip 90048 Tel: (213) 654-6240
 Springcreek Music Inc. (ASCAP), see Southern Writers.
 Bruce Springsteen (ASCAP), c/o Ramrod Music, 36 E. 61 St., New York, N.Y. 10021.
 Springtime Music (SESAC), see Springboard.
 Sprinkle Publ'g (BMI), PO Box 13464, Austin, Tex. 78751. Owner John Blandford.
Branch: Houston, Tex., PO Box 55584. Zip 77055. Gen. Mgr. James Rowe. Tel: (713) 464-4248.
 Sreeby Music Co. (BMI), see Mietus
 Stable Music Co. (BMI), PO Drawer 2176, Zip 78767; 910 Post Oak St., Austin, Tex. 78704 Tel: (512) 442-3375. Owner Rex T. Sherry.
 Stafree Publ'g Co. (BMI) (div. of Fretone Recs. Inc.), 3114 Radford Rd., Memphis, Tenn. 38111 Tel: (901) 327-8187. Pres. Estelle Axton. Prof. Mgr. Steve Gatlin
 Stage Door Music Publ'g Inc. (BMI), see Platinum
 Stairway Music Publ'g (BMI), see Tree
 Stallings Music (BMI), see Valgroup
 Stallion Music Inc. (BMI), see Tree
 Stallman Recs. Inc. (BMI), 333 E. 70 St., New York, N.Y. 10021 Tel: (212) 988-2873. Pres. Lou Stallman
 Standard-Colonial Music Publ'g Co. (BMI), Bldg. 8, 6 Gill St., Woburn, Mass. 01801. Tel: (617) 935-7500. Pres. Robert D. Levinson
 Stanger Music Publ'g, PO Box 130, Glassboro, N.J. 08028. Pres. George Stanger
 Stanton Music (ASCAP), see Lee Magid
 Stanwood Music Corp. (ASCAP), see Barton Music
 Stanyan Music Co. (ASCAP), 8440 Santa Monica Blvd., Hollywood, Calif. 90069 Tel: (213) 656-7311. Pres. Rod McKuen. Gen. Mgr. Wade Alexander
 Staple Music Inc., see Jun Mhoon
 The Staples Music, 255 E. 103 St., Chicago, Ill. 60628 Tel: (312) 785-3838
 Starbase Music (BMI), see April/Blackwood
 Starchild Inc. (ASCAP), see Copyright Serv. Bureau
 Starco Music Publ'g Co. (BMI), 3211 Park Ave., St. Louis, Mo. 63104 Tel: (314) 664-8888. Pres. Jack Allison. Gen. Mgr. Charles Allison. Prof. Mgr. Marv Wilson
 Starcraft Music (ASCAP), PO Box 3415, Granada Hills, Calif. 91344 Tel: (213) 368-1612. Pres. Jack M. Kall
 Star Data Music (BMI) (div. of Spindrift Recs.), PO Box A, Trezevant, Tenn. 38258 Tel: (901) 669-7087. Pres. Bill Stottlemeyer
 Starfox Publ'g (BMI), PO Box 13584, 1957 Kilburn Dr., Atlanta, Ga. 30324 Tel: (404) 876-1073. Owner & Prof. Mgr. Aleck Janoulis
 Starlet Music Co. (ASCAP), 7129 Augsburg Ave., Minneapolis, Minn. 55423 Tel: (612) 861-6516. Pres. Bradford Toy Nelson
 Star Mountain Publ'g & Rec'g (BMI), Box 421, Rt. 1, Monte Ne Rd., Rogers, Ark. 72756 Tel: (501) 636-6231. Pres. & Gen. Mgr. Gladys M. Hunt; Prof. Mgr. Guy Paul Hunt
 Star of David (SESAC), see Songs of David
 Starship Music Inc. (ASCAP), c/o David Chase, 6 E. 45 St., New York, N.Y. 10017 Tel: (212) 661-8720
 Startime Music (ASCAP), PO Box 643, La Quinta, Calif. 92253 Tel: (714) 564-4823. Pres. Frederick H. Rice. Gen. Mgr. Robert S. Rice
 Star Trip Music Ltd (ASCAP), see Buttermilk Sky
 Star Tunes Music (BMI), see Grosvenor House
 Starwest Music (BMI), PO Box 21, Longview, Wash. 98632 Tel: (206) 423-9085. Pres. Dustin Poe. Gen. Mgr. Mike Poe. Prof. Mgr. Derek Poe
 Stasy Music (ASCAP), see Bug
 Statras Music Co. (ASCAP), see Genelle

Stax Music (ASCAP), 10th & Parker Sts., Berkeley, Calif. 94710 Tel: (415) 549-2500. Mgr. Jack L. Aho
 Staysail Music (BMI), see Segel & Goldman
 Stazybo Music (BMI), see Mietus
 Steamboat Gothic (ASCAP), see R. A. Hodge
 Steelchest Music (ASCAP), see Skinny Zach
 Steel Plate Music (ASCAP), see T. B. Harms—Bibo
 Steeple Chase Music (BMI), see Segel & Goldman
 Steeplechase Music (SESAC), see Vector
 Stellar Music Co., see T. B. Harms—Vogue
 Stephanye Music Co. (BMI), see Mietus
 Geoff Stephens Music Inc. c/o Prager & Fenton, 444 Madison Ave., New York, N.Y. 10022 Tel: (212) 751-9660
 Stepping Stone Music (BMI)—VP Jimmy H. Moore—see Mimic
 Sterling Music Co. Inc. (ASCAP)—Pres. Fred Ahlert Jr., VP. Bones Howe—see Fred Ahlert
 Miriam Rose Stern Agency Inc., 301 E. 69 St., New York, N.Y. 10021 Tel: (212) 288-3979 (Administers reversionary rights emanating from United Kingdom, Canada, Australasia, Ireland, Union of South Africa, representing 189 estates of deceased songwriters. Also represents 75 writers, negotiating renewal & "additional years" agreements.)
 Ray Stevens (BMI), 1707 Grand Ave., Nashville, Tenn. 37212
 Stigwood Music Inc. (BMI), see RSO & Chappell.
 Robert Stigwood Org., see RSO
 Stephen Stills Music (BMI), see Gold Hill
 Stinger Music Corp. (BMI), see Firedrum
 Stone Agate Music Div. (BMI), see Jobete
 Stonebass Music Co. (BMI), 163 Orizaba Ave., San Francisco, Calif. 94132. Tel: (415) 334-2247. Pres. Walter C. Stone.
Int'l affiliate: Shark Music (Brazil)
 Stonebridge Music (ASCAP), see Bicycle
 Stone Buffalo (ASCAP), see Copyright Serv. Bureau
 Stone Diamond Music Corp. (BMI), see Jobete
 Stoned Individual (BMI) c/o Joel A. Katz, 5775 Peachtree-Dunwoody Rd. NE, Atlanta, Ga. 30342
 Stoneforest Music (BMI), see Martin Cohen
 Stone Green Music (ASCAP), see Copyright Serv. Bureau
 Stonehill Music Co. (BMI), 50 Music Square W., Suite 201, Nashville, Tenn. 37215. Pres. & Gen. Mgr. Bill Gatzimos. VP. Crystal Gayle
Int'l rep.: Canada (Morning)
 Stone Lane Music Corp. (BMI), see Lou Levy
 Stone Porch (BMI), 818-18 Ave. S., Nashville, Tenn. 37203
 Stone Post Music (BMI), PO Box 1213, Emporia, Kan. 66801. Tel: (316) 343-2727. Pres. Richard Bisterfeldt. Gen. & Prof. Mgr. Jacki Bisterfeldt
Branch: Tulsa, Okla., 1201 E. 63 St., Suite A. Zip 74136 Tel: (918) 747-2355
 Stone-Rap Music Co. Inc. (BMI), 28001 Chagrin Blvd., No. 205, Cleveland, Ohio 44122 Tel: (216) 464-5990. Pres. Mike Belkin. Gen. Mgr. Jules Belkin (Administered by Chappell)
 Stone Row Music Co. (BMI), 2022 Vardon Ln., Flossmoor, Ill. 60422 Tel: (312) 799-7194. Pres. Joanne Swanson
 Stonewall Publ'g Co. (BMI), see Cedarwood
 Stoneway Publ'g Co. (BMI), 2817 Laura Koppe, Houston, Tex. 77093 Tel: (713) 697-7867. Pres. Roy M. Stone
 Stop Light Music (ASCAP), 65 E. 55 St., New York, N.Y. 10022 Tel: (212) 751-6177. Telex 427317. Pres. Henri Belolo. Prof. Mgr. Eileen Mohr
Int'l firm represented: Scorpio Music (France)
 StormKing Music Inc. (BMI), see Sanga
 Storyville Publ'g Co. (BMI), see John Berthelot
 Straight Shooter Tunes Inc. (BMI), see Stone-Rap
 Strait James Music (BMI), see Bug
 Strange Music (SESAC), see Excellorec
 Stratford Music Corp. (ASCAP), see Chappell
 Strawbed Music (ASCAP), see Beechwood
 Strawberry Hill Music (ASCAP), see Earl Barton & Publishers' Licensing Corp.
 Strawhat Music (ASCAP), see Copyright Serv. Bureau
 Streamline (BMI), c/o Bash, Barkin & Besas, 9401 Wilshire Blvd., Beverly Hills, Calif. 90212
 Street People Songs (BMI), see Fourth Floor
 Carl Strube Music (ASCAP), see Critique
 Struggle Music (ASCAP), see Mietus
 Stuckey Publ'g Co. (BMI), PO Box 102, Brentwood, Tenn. 37027 Tel: (615) 244-9412. Pres. Nat Stuckey. Gen. Mgr. Ann Stuckey
 Studio P/R Inc. (BMI), 224 S. Lebanon St., Lebanon, Ind. 46052 Tel: (317) 482-4440. Pres. James G. Houston. VP & Sales Mgr. John F. Welch; VP. Editing & Opns. Tom Johns, Sec'y-Treas. Ann Houston
 Studio 10 Inc. Ltd., 20 Sunnyside Ave., Mill Valley, Calif. 94941 Tel: (415) 383-8122
 Studio 224 (ASCAP), see Studio P/R
 Stygian Songs (ASCAP), see Rondor
 Sudden Rush Music Inc. (BMI), 750 Kappock St., Riverdale, N.Y. 10463 Tel: (212) 884-6014. Pres. Alan Korwin; Creative Dir. Michael Berman
Int'l firm represented: Your Music Ltd. (UK) (SEE ADVERTISEMENT)
 Suede Music Inc. (BMI), see Copyright Serv. Bureau
 Suelor Music (BMI), see Bill Rase
 Sueno Publ'g Co. (BMI), Rt. 2, Troutman, N.C. 28166. Tel: (704) 528-4843. Pres. Gen. & Prof. Mgr. Don E. Moose
 Sufi Pipkin Music (BMI), PO Box 3991, Hollywood, Calif. 90028 Tel: (213) 276-2063. Owner Linda R. Moxley; Prof. Mgr. James Byron
 Sugarbush Music Inc. (ASCAP), see Gus Kahn
 Sugarfree Music (BMI), see Sugar N' Soul
 Sugar N' Soul Music, 3929 Carpenter Ave., Bronx, N.Y. 10466 Tel: (212) 655-8217. Pres. Don Levy. Prof. Mgr. Mark Sameth
 Sugarplum Music Co. (BMI), 1022 16 Ave. S., Nashville, Tenn. 37212. Tel: (615) 255-5711. Pres. Patsy Bruce
 Sug-Sug Music (ASCAP), see Red Greg
 Suite 7 (ASCAP), see Room 7
 Sujay Music, see Bronjo
 Suki (BMI), see JEDO
 SuLyn Publ'g Inc. (BMI), PO Box 28835, Memphis, Tenn.

PEER-SOUTHERN ORGANIZATION



NEW YORK, HOLLYWOOD NASHVILLE, MIAMI, SAN JUAN

- AUCKLAND
- BARCELONA
- BOGOTA
- BRUSSELS
- BUENOS AIRES
- CARACAS
- HAMBURG
- HILVERSUM
- JOHANNESBURG
- LONDON
- MADRID
- MEXICO CITY
- MILANO
- PARIS
- RIO DE JANEIRO
- SANTIAGO
- SAO PAULO
- STOCKHOLM
- SYDNEY
- TOKYO
- TORONTO
- VIENNA
- ZURICH

World Headquarters

1740 Broadway, New York, NY 10019
 TELEX: 424361
 PHONE: (212) 265-3910

38128. Tel: (901) 386-7360. Pres.: Reba Walker. Sec'y-Treas. Louis Chiozza.

Sumac Music Inc. (BMI), 1697 Broadway, Suite 1209, New York, N.Y. 10019. Tel: (212) 246-0575. Pres. Susan McCusker; VP: Jerry Love; Gen. & Prof. Mgr. Deirdre O'Hara.

Int'l reps.: Australia (April), Austria (Butterfly in Germany), Brazil (Fermata), Canada (April), Central America (Chappell in UK), France (Marouani), Germany (Butterfly), Italy (Sugar), Japan (Watanabe), Mexico (Chappell in UK), Scandinavia (Sweden Music in Sweden), Spain (Ego), UK (Carlin).

Su-Ma Publ'g Co. Inc. (BMI), PO Box 1125, Shreveport, La. 71163. Tel: (318) 222-0195. Pres.: Stanley J. Lewis; Gen. Mgr. Laura Sutherland.

Summer Duck Publ'g Corp., 12116 Granby St., Norfolk, Va. 23510. Tel: (804) 625-0534. Pres. D.H. Burlage.

Summerhome Music (ASCAP), Box 118, Pewaukee, Wis. 53072. Tel: (414) 594-2846. Pres.: Bill Camplin.

Gene Summers Music Ltd. (BMI), see Silicon.

Summit Music Corp. (ASCAP)—Pres. Margo Reis; Gen. Mgr. Patricia Bente—see Herb Reis.

Summy-Birchard Music (ASCAP), Box CN-27, Princeton, N.J. 08540. Tel: (609) 896-1411. Pres.: David K. Sengstack.

Int'l firm represented: Zen-On (Japan).

Int'l reps.: Japan (Zen-On), UK (Boosey & Hawkes, Keith Prowse, EMI).

Sun-Bear Corp., 1650 Broadway, New York, N.Y. 10019. Tel: (212) 765-4495. Telex: 237224. Pres. Steve Loeb; VP & Dir. Ezra Cook; VP: Billy Arnell. (Represented by Buzz Cason Ent.).

Int'l reps.: Australia (Castle), France (Pascal, Allo), Germany (Siegel), Japan (Shinko, Toshiba-EMI, Watanabe), Netherlands (Anagon, Intersong-Basart, Universal), Scandinavia (Sweden Music), UK (ATV, EMI, Heath Levy).

Suncat Recs., see Sundaze.

Suncountry Song Co. (ASCAP), see Southwest Words & Music.

Sunday Music Publ'rs (BMI), 1 N. LaSalle St., Chicago, Ill. 60602.

Sundaze Music (BMI), PO Box 66, Manhattan Beach, Calif. 90266. Tel: (213) 371-9578. Pres.: Gary Young; Gen. Mgr. Jim Morris; Prof. Mgr.: Larry Thatt; Pub. Dir.: Linda Green.

Branch: Oklahoma City, Okla., 3313 NW 41 St., Zip 73112. Tel: (405) 947-5907. Gen. Mgr.: Ron Hicks; Prof. Mgr. Gordon Johnston.

Int'l rep.: Worldwide except USA & Canada (Sunbury in UK).

Sunflower Music (BMI), see Rondor.

Sung Words (ASCAP)—Owner Adrian Belew—see Hal Bernard.

Sunie Day Music (BMI), see Chappell.

Sunlight Music, see April/Blackwood.

Sunny Blue Music (ASCAP), see Chappell.

Sunnybrook Music Co. (BMI), PO Box 775, Tyler, Tex. 75710. Tel: (214) 592-7677. Pres. Robin H. Brians Jr.; Gen. Mgr. Randy Fouts.

Int'l rep.: Worldwide (Mietus in USA).

Sunnyslope Music Inc. (ASCAP), see Hal Bernard.

Sunshine Country Ent's Inc. (BMI), 777 S. Central, Richardson, Tex. 75080. Tel: (214) 690-8875. Cable: SUNSHINE. Pres. & Gen. Mgr. Bart Barton; Prof. Mgr.: Pat McKool; Nat'l Sales Mgr. Rusti James.

Sunshine Group Ltd., see Scully.

Sunshine Music Co. (BMI), see Gordon.

Sunshiner Music (BMI), see April/Blackwood.

Superhype Publ'g (ASCAP), see Cotillion.

Superscreen Music (ASCAP), see Dick James.

Super Songs (BMI), see A. Schroeder.

Superstar Music Ltd. (ASCAP), see Chappell.

Supreme Music Corp. (ASCAP), see 20th Century.

Sure-Fire Music Co. Inc. (BMI), 60 Music Square W., Nashville, Tenn. 37212. Tel: (615) 244-1401. Pres.: Doyle Wilburn; VP: Leslie Wilburn.

Sure Music & Rec. Co., PO Box 94, 39 N. Sproul Rd., Broomfield, Pa. 19008. Tel: (215) 356-2996. Pres. Leonard Rosen; Gen. Mgr. Larry Stephens; Prof. Mgr.: Beth Merle.

Sure Thing Music Co. (BMI), see Mietus.

Surething Music Publ'rs (ASCAP), see Real To Reel.

Surface Tension Music (BMI), see Bug Music.

Surf City Music (ASCAP), Box 14, Hollywood, Calif. 90028. Tel: (213) 851-3161. Pres. Gary M. Theroux; Exec. VP: Robert L. Gilbert; Sales Dir.: Mark Charger.

Branch: Northbrook, Ill., 4 Court of Harbinger Falls. Zip: 60062. Tel: (312) 564-3673. Gen. Mgr.: Marjorie Ann Prance.

Surrey Music Co. (ASCAP), see Pavanne.

Susaper Music (ASCAP), see Invador Music.

Sutton/Miller Ltd. (ASCAP, BMI), 8913 Sunset Blvd., Los Angeles, Calif. 90069. Tel: (213) 652-4782. TWX: (910) 490-2565.

Int'l reps.: Australia (Image), France (Marouani), Germany (Roba), Italy (CBS-Sugar), Japan (Tokyo), Netherlands (Dutchy), Spain (Zefiro), UK (Chappell).

Swados Ent's. Inc. (BMI), see April/Blackwood.

Swallow Turn Music (BMI), see Segel & Goldman.

Swamp Music Inc. (ASCAP), see Crazy Cajun.

Sweet Bucks Music (ASCAP), see Bald Mountain.

Sweet Cherry Music (ASCAP), (div. of New Vista Music Corp.), PO Box 801, Williamsville Branch, Buffalo, N.Y. 14221. Pres. Dave Coutts; Gen. Mgr. John Watt.

Int'l firm represented: Maple Creek/Snowberry Music (Canada).

Sweet Cowboy Music, see Copyright Serv. Bureau.

Sweet Home Music (BMI), 16835 Rinaldi St., Granada Hills, Calif. 91344. Tel: (213) 363-8253. Pres.: Manny Freiser; Gen. Mgr. Patti McCarron.

Sweet Mary Music (BMI), see Dwarf.

Sweet N Low Music (BMI), see Madrid.

Sweet Polly Music (BMI), PO Box 521, Hwy. 76, Newberry, S.C. 29108. Tel: (803) 276-0639. Dir.: Hayne Davis; Mgr.: Polly Davis; Relations: O.T. Hudson; Field Rep. Willard Brown.

Sweet River Music Inc. (BMI), see Clear Sky.

Sweet Stuff Music (BMI), see Main Stage.

Sweet Swamp Music (BMI), The Gables, Halcott Rd., Fleischmanns, N.Y. 12430. Tel: (914) 254-4565. Pres.: J. & Prof. Mgr. Barry Drake.

Sweet Tooth Publ'g (BMI), 2716 Springlake Court, Irving, Tex. 75060. Tel: (214) 259-4032. Owner & Gen. Mgr. Kenny Wayne Hagler.

Swell Sounds (ASCAP), c/o Gregory E. Fischbach, 2029 Century Park E., Los Angeles, Calif. 90067.

Swing Bee Publ'g, 1130 Colfax St., Evanston, Ill. 60201. Tel: (312) 328-5593. Owners: Susan L. & James R. Neumann.

Swing & Tempo Music Inc. (BMI), see Glad Hamp.

Swirl Lane (BMI), see WPN Music.

Sydo Music (BMI), see Copyright Serv. Bureau.

Sylco Music (ASCAP), see Chappell.

Sylvanian Music (BMI), see Mietus.

Sylverpride (ASCAP), see Chappell.

Sylverpride & Joy Music (BMI), see Chappell.

Symbol Music Inc. (BMI), see BRS Inc.

Symposium Music Publ'g Inc. (BMI), 204 Fifth Ave. SE, Minneapolis, Minn. 55414. Tel: (612) 331-5750.

Synchrofox Background Music Library, see Sam Fox.

Syndicate Music Inc. (ASCAP), see Copyright Serv. Bureau.

Syndicore Music (BMI), see ESP.

Synergistic Music (SESAC), see Heavy Music.

Szygy (ASCAP), see Bug.

T

T E K Publ'g (BMI), see Nasetan.

T H E Publ'g Co. Inc., see Arترف.

T I M (The International Music Co.) (ASCAP), 214 W. 96 St., New York, N.Y. 10025. Tel: (212) 866-3112. Cable: OTOARECO. Pres. L. Paul Bernard; Gen. Mgr. Raul M. Bernard.

T R O (The Richmond Org.), 10 Columbus Circle, New York, N.Y. 10019. Tel: (212) 765-9889.

Int'l reps.: Australia (Essex), Canada (Essex), France (Essex), Germany (Essex), Italy (Mario Aromando), Japan (E. Japan (Essex), Mexico (Essex), Netherlands (Essex), Scandinavia (Essex in Sweden), South Africa (Essex), Spain (Essex), Switzerland (Essex), UK (Essex). (SEE ADVERTISEMENT)

T W C Music (SESAC), GPO Box 2021, New York, N.Y. 10001. Tel: (212) 691-4565. Pres.: Tommy Blue; Gen. Mgr. Jerome Haggart; Prof. Mgr. Walter Balderson.

Tablerock Music Inc. (BMI), see Publishers Licensing Corp.

Table Top Music (ASCAP), see Leo Lou.

Tad Music Publ'g Co. (ASCAP), see Copyright Serv. Bureau.

Taeper Music (ASCAP), (div. of Barcus-Berry Inc.), 15461 Springdale St., Huntington Beach, Calif. 92649. Tel: (714) 898-9211. Pres. L.M. Barcus; Prof. Mgr.: John F. Berry.

Taggie Music Co. (BMI), see Gopam.

Tahoe Rec. Corp. (ASCAP), see Chappell.

Tairi Music (ASCAP), see Copyright Serv. Bureau.

Taj Music Co. (ASCAP), see Copyright Serv. Bureau.

Takalofme Music (ASCAP), see Paragon Assocs.

Take Home Tunes!, Box 496, Georgetown, Conn. 06829. Tel: (203) 544-8288. Contact: Bruce D. & Doris Yeko.

Takya Music Inc. (ASCAP), 265 W. 20 St., New York, N.Y. 10011. Tel: (212) 989-8048. Pres. Stuart Scharf.

Int'l rep.: Worldwide (DeShufflin).

Talent Finders Inc. (BMI), see Copyright Serv. Bureau.

Tall Corn Publ'g Co. (BMI), see Mid-American.

Tall Texan Publ'g Co., see Adams-Ethridge.

Tall Tunes Publ'g—Pres. Max Gronenthal—see 3rd Street.

Tallyrand Music Inc. (BMI), see Bicycle.

Talmon (BMI), see Pickwick.

Tamara Music Publ'g Co. (ASCAP), see Slide.

Tamarin Music Inc. (ASCAP), see MBA.

Tam-Jet Music Publ'g (BMI), see 20th Century.

Tamkoda Music Co. (BMI), see Faro.

Tammi Music Publ'g Ltd. (BMI), see Rondor.

Tamrose Music (BMI), see Southern Writers.

Tancy Music Co. (ASCAP), see Don Costa.

Tandem Publ'ns (BMI), see No Exit.

Tannen Music Inc. (BMI), 1207 16 Ave. S., Nashville, Tenn. 37212. Tel: (615) 320-7700.

Tan Soul Music Inc. (BMI), see Chappell.

Tamarin Music (ASCAP), see Chappell.

Tapestry Music Corp. (BMI), see T. B. Harms—Vogue.

Tapez Music Inc. (ASCAP), see Don Costa.

Tara Music (BMI), see Shoestring & Copyright Serv. Bureau.

Tarantula Music (ASCAP), see Segel & Goldman.

Tark Music Co. (ASCAP), see Copyright Serv. Bureau.

Tarka Music (ASCAP), see Skyhill.

Tarsan Music Corp. (BMI), see Clay Music.

Tash-Tana Music (BMI), see Martin Cohen.

Taurgo Music (BMI), see Collins/Saraceno.

Tauripin Tunes (ASCAP), see Bruce Cohn.

Taurus Music Co. (BMI), see Sounds Music.

Tauvir Publ'g (BMI), see April/Blackwood.

Taya Music (ASCAP), see Copyright Serv. Bureau.

Creed Taylor Inc., see CTI.

Taylor House Of Music (BMI), see Joe Taylor.

Joe Taylor Music (ASCAP), 2401 Granny White Pike, Nashville, Tenn. 37204. Tel: (615) 385-0035.

Taylor Made Music (BMI), 2501 Franklin Rd., Nashville, Tenn. 37204.

Teakbird (ASCAP)—Owner: Pres. Chris Jolly—see Hal Bernard.

Teamuck Music (BMI), 10 & Parker Sts., Berkeley, Calif. 94710. Tel: (415) 549-2500. Gen. Mgr. Henry Cosby.

Teardrop Music (ASCAP), PO Box 40001, 4701 Trousdale Dr., Nashville, Tenn. 37220. Tel: (615) 385-3726. Pres. Ronnie Hayes.

Tebo Music Ltd. (ASCAP), see JBP Music & Chappell.

Teddy Don't Dance Prod'ns, see Border Brigands.

Teddy Jack Music (BMI), c/o William I. Hoyt, 9255 Sunset Blvd., No. 710, Los Angeles, Calif. 90069. Tel: (213) 278-2303. Owner: Leon Russell; Gen. Mgr.: William I. Hoyt.

Teena Joy Music Publ'g Co. (SESAC), see Songs of Bobby & Ginny.

Tektra Publ'g (BMI), 711 W. Broadway, Minneapolis, Minn. 55411. Tel: (612) 521-7631. Pres.: Dan R. Holmes; VP: Wes Hayne; Gen. Mgr. Sandra Milan; Prof. Mgr.: Susan Oliver.

TeleFunk Music (ASCAP), see Tim Riley.

Telescope Music (BMI)—Gen. Prof. Mgr. Ed Michaels—see Periscope.

Tellaro Music Co. (BMI), see Pavanne.

Tempi Music Co. (BMI), 133 W. 87 St., New York, N.Y. 10024. Tel: (212) 799-5557. Cable: TEMPICO.

Templeton Publ'g Co. Inc. (ASCAP), see Shawnee Press.

Tenalina Music (ASCAP), see Audway.

Tennessee Swamp Fox Music Co. (ASCAP), see Combine.

Ten-Tex Music Co. Inc. (BMI), see Sure-Fire.

Tenuto Publ'ns (ASCAP), see Theodore Presser.

Tequila Music (BMI), see Garrett.

Terlawn Music (BMI), see Martin Cohen.

Termyra Music Publ'g Co. (BMI), 909 Keil Rd., Toledo, Ohio 43607. Tel: (419) 531-2271. Pres. Porter Roberts.

Terrace Music Group, 1249 Waukegan Rd., Glenview, Ill. 60025. Tel: (312) 729-7300. TWX: (910) 651-4856. Pres.: Dick Schory; Pub. Dir.: Cary Baker.

Branch: Nashville, Tenn., 50 Music Square W. Zip: 37203. Tel: (615) 327-4871. Publ'g Dir.: Mike Kosser.

Terry Music Co. (ASCAP), c/o Ben Arrigo, 157 W. 57 St., New York, N.Y. 10019. Tel: (212) 265-6585. Mgr. & Dir. Ben J. Arrigo.

Tescot Music Inc. (ASCAP), see Chappell.

Tessies Tunes (BMI), see Cross Country.

Tetra Music Corp. (ASCAP), see Alexander Broude.

Peter Tevis Music (BMI), PO Box 1102, Burbank, Calif. 91507. Tel: (213) 874-7656. Pres.: Peter Tevis; Prof. Mgr.: Scott Tevis.

Thank You, thank you, thank you Music Inc. (ASCAP), 221 W. 57 St., New York, N.Y. 10019. Tel: (212) 582-4200. Pres.: Alan Amron; VP: Larry Halpern. (Administered by Arista).

Branch: Los Angeles, Calif., 8831 Sunset Blvd. Zip: 90069. Tel: (213) 855-7061.

Then (BMI), see Drive-In.

Theofilim Music Corp. (BMI), see Copyright Serv. Bureau.

There Music Co. (BMI), see Copyright Serv. Bureau.

Thermostat Music Inc. (ASCAP), see Chappell & Stone-Rap.

Bob Thiele Music Ltd. (ASCAP), see Chappell.

Thin Ice Music (ASCAP), see Segel & Goldman.

Think Big Music (CAPAC), see Chappell.

Third Century Music (ASCAP), see Segel & Goldman.

Third Story Music Inc. (BMI), see Martin Cohen.

Third Stream Music Inc. (ASCAP), see MJQ Music.

3rd Street Music, PO Box 480048, Los Angeles, Calif. 90048. Pres. Martin Wolff.

Thirst Music (BMI), see Martin Cohen.

This Is Country Music (ASCAP) (div. of International Heritage Music Assn.), 133 Walton Ferry Rd., Hendersonville, Tenn. 37075. Tel: (615) 822-4827. Pres.: Ralph H. Compton.

Thistle Prod'ns (ASCAP), 6560 Colbert St., New Orleans, La. 70124. Tel: (504) 482-9511. Owner & Pres.: James K. Morrison; Gen. Mgr.: Barbara Morrison; Prof. Mgr.: Roberta James.

Harold Thomas Music (BMI), 203 Culver Ave., Charleston, S.C. 29407. Tel: (803) 766-2500. Pres.: Harold Thomas.

Thom Thom Publ'g Co. (ASCAP), 2112 S. Michigan Ave., Chicago, Ill. 60616. Tel: (312) 225-3270.

Thorkus Publ'g Co. (BMI), see Don Williams.

Thornbrook Publ'ns (BMI), see Pamlyn.

Three Bears Music (BMI), see Martin Cohen.

Three Bridges Music Corp. (ASCAP), see Chappell.

Three Brothers Music Inc. (ASCAP), see CTI (US rights) & Ivan Mogull (Int'l rights).

Three Cheers Music (ASCAP), see Cape Ann.

3-Deal Music (BMI), 2123 N. Seminary Ave., Chicago, Ill. 60614. Tel: (312) 348-3730. Pres.: Carl Bonafede; VP: Frank Pizani.

3' G's Music (ASCAP)—Contact: Gilbert Roland—see Eugene Gold.

3 H's Music (ASCAP), 1103 Neff Ave. S., West Covina, Calif. 91790. Tel: (213) 966-2535. Pres.: Henry Oakes; Gen. Mgr.: Loretta Oakes.

Int'l firms represented: Acetatos (Mexico), J. Albert & Sons (Australia).

Int'l reps.: Europe & UK (Cyril Shane in UK), Italy (Sidel).

Three-Penny Music Publ'g (BMI), PO Box 755, Minneapolis, Minn. 55440. Tel: (612) 636-0841. Pres.: Mike Jann.

Threesome (ASCAP), 1801 Ave. of The Stars, Suite 911, Los Angeles, Calif. 90067.

Three & Three Music Inc. (BMI), see Big Seven.

Three W Music (ASCAP), see Bug.

Thrifty Music (ASCAP), see Jonvis.

Thruppence Music (ASCAP), see Chappell.

Thrush Music Publ'g (BMI), see Brian Ross.

Thunderbird Music Inc., see T. B. Harms—Bibo.

Thursday Music Corp. (BMI), see Fred Ahlert.

BOURNE
CO.

1212 Avenue of the Americas
New York, N.Y. 10036 212/575-1800
6381 Hollywood Blvd., Hollywood CA. 90028

ABC MUSIC CO.
BACH MUSIC
BEN BLOOM MUSIC
BOURNE-FILMUSIC, INC.
BOGAT MUSIC
BURKE & VAN HEUSEN CO.
GOLDMINE MUSIC, INC.
HARBORN MUSIC, INC.
LADY MAC MUSIC CO.
MURBO MUSIC PUB., INC.
SCHUMANN MUSIC CO.
MURBO RECORDS

INTERNATIONAL MUSIC CO.

Tick Tock Music (ASCAP). 260 Kearny, No. 402, San Francisco, Calif. 94108 Tel (415) 421-2216. Exec. VP William A. Parrish

Tideland Music Publ'g Corp. (BMI). see Copyright Serv. Bureau

Tidewater Music Co., PO Box 4192, Huntsville, Ala. 35802 Tel (205) 881-7976 Owner George Wells

Tiffany Music (ASCAP). see Peter Tevis

Tight Corp. (BMI). see Chappell

Floyd Tillman Music Co. (BMI), 400 San Jacinto St., Houston, Tex. 77002 Tel (713) 225-6654 Pres. Byron Benton, Gen. Mgr. Charles Benton, Prof. Mgr. Floyd Tillman

Timberjack Music (BMI). see Harrison Tyner

Timberland Publ'g Co. (BMI). Forest City, Iowa 50436 Tel (515) 582-2992 Pres. Arlo C. Johnson

Timespann Music (BMI)—Contact Morgan Lowry—see Truene

Times Square Music Publ'ns Co. (BMI). see Hudson Bay

Time View Music Co. (BMI). see Jay Music

Tim Music (ASCAP). see Copyright Serv. Bureau

Timsonac Music Inc. (ASCAP). see Loring

Timtobe Music Ltd. (ASCAP). see Chappell

Tiplot Music Co. Inc. (ASCAP). see Sidney A. Seidenberg

Tippy Music Co. (BMI). see Copyright Serv. Bureau

Tipsyl (ASCAP). 9 E. 40 St. New York, N.Y. 10016

Tired Iron Publ'g (BMI). see Copyright Serv. Bureau

Tisra Tit Music (BMI). see Little Giant

Tithonus Music Ltd. (BMI). see Memnon

Tobey Music Corp. (ASCAP). see Chappell

Tobill Music (ASCAP). c/o AudioFidelity Ent's., 221 W. 57 St., New York, N.Y. 10019 Tel (212) 757-7111

Lew Tobin Music. see GRS

Toeshoe Tunes (ASCAP)—Owners: Michael D. Ainsner, Keith D. Avedon—see Ferndock

Tomake Music Co. Inc. (ASCAP). see Window.

Tom Cabin Music (BMI). RD 2, Honesdale, Pa. 18431 Tel (717) 253-3779

Tomcat Music Publ'g Co. (BMI). see Tree

Tom Music Co. (BMI). see Chappell

Tomjon Music (BMI). see 20th Century

Tomlew Publ'g (BMI), 12202 Union Ave., Cleveland, Ohio 44105 Tel (216) 752-3440 Pres. & Gen. Mgr. Thomas R. Boddie

Tomorrow Morning Music (ASCAP). see Copyright Serv. Bureau

Tompalland Music (BMI), 916 19 Ave. S., Nashville, Tenn. 37212 Tel (615) 327-0005

Tompaul Music Co. (BMI), 628 South St., Mount Airy, N.C. 27030 Tel (919) 786-2865 Owner Paul E. Johnson

Tom Thumb Music (ASCAP). (div. of Rhythms Prod'ns), Box 34485, Whitney Bldg., Los Angeles, Calif. 90034 Tel (213) 836-4678 Creative Dir. R.S. White, Prod'r David White

Tone Craft (BMI). see Sure Music

Tonmar Music (BMI). see Mietus

Top Drawer Music (BMI), PO Box 8011, Mobile, Ala. 36608 Tel (205) 344-4250 Pres. M. Brown

Top Five Songs (BMI), 20 Music Square W., Nashville, Tenn. 37203 Tel (615) 254-7553 Pres. Tony Moon

Top of the Town Music Co. (ASCAP). see The Entertainment Co.

Topographic Music Inc. (BMI)—Pres. Elliot L. Hoffman—see Beldock Levine & Hoffman

Topsail Music (BMI), 1126 Boylston St., Boston, Mass. 02215 Tel (617) 262-7880 Co-Pres. Fred Berk, Jeff Gilman

Toreador Music (BMI). see Green Door

Tor Musiccompany (ASCAP). see Gordon

Torpin Music (ASCAP). see Mietus

Total Music Servs Inc. (BMI). see TRO

Touchdown Music Co. (BMI). see Adventure

Touch Of Gold Music Inc. (BMI). see Lambert & Potter

Touchstone Music Inc. (ASCAP). see Copyright Serv. Bureau

Toulouse Music Publ'ns (BMI), PO Box 96, El Cerrito, Calif. 94530 Tel (415) 526-3491 Pres. Jacques Disraeli Bronson, Gen. Mgr. James Bronson Jr. (Administered by Copyright Serv. Bureau)

TouPat Music Publ'g Co. Inc. (BMI), 402 Shotwell Ave., Monroe, La. 71202 Tel (318) 322-2537 Pres. Toussaint L. McCall, Gen. Mgr. Patrick H. Robinson

Gerard Tourneur Inc. (BMI). see Copyright Serv. Bureau

Town & Country Music Co. Inc. (BMI). see Copyright Serv. Bureau

Township Group Inc., 10 Michael Dr., Greenville, S.C. 29611 Tel (803) 269-3961

Track Music Inc. (BMI), 200 W. 57 St., New York, N.Y. 10019 Tel (212) 582-6667 Pres. Kit Lambert, Gen. Mgr. Paul Schwartz

Int'l firm represented: Fabulous (UK)

Tradition Music Co. (BMI), 10341 San Pablo Ave., El Cerrito, Calif. 94530 Tel (415) 525-1495/4996 Pres. C. Strachwitz (Administered in USA, Canada, & Japan by Harry Fox Agency)

Int'l reps. France (Fantasia), Central & South America (CBS Int'l), Germany (April), Netherlands (Sonet), Sweden (Sonet), UK (April)

Tragar Publ'g Co. Inc. (BMI), 799 1/2 Martin Luther King Dr., NW Atlanta, Ga. 30314 Tel (404) 523-3582 Pres. & Prof. Mgr. Jesse J. Jones, Gen. Mgr. Michael Cohen

Trails End Music. see Cedarwood

Trajames Music Co. (ASCAP), 11 Harrison Court, South Orange, N.J. 07079 Tel (201) 762-2504 Pres. Jimmy Wisner, Gen. Mgr. Jane Berson

Transaction Music Ltd., 225 E. 57 St., New York, N.Y. 10022 Tel (212) 838-2590 Cable TRANSMUSIC Telex 421943 Pres. Mildred Fields

Int'l firms represented: Australasia (Festival), Japan (Victor), Scandinavia (Sweden Music), UK (Bocu)

Transatlantic Music (BMI), PO Box 64, Davis, Calif. 95616 Tel (916) 758-2567 Pres. Fred de Rafols

Tray Music Corp. (ASCAP). see Copyright Serv. Bureau

Treasure Chest. see Ashley

Tree Publ'g Co. Inc. (BMI), PO Box 1273, 8 Music Square W., Nashville, Tenn. 37202 Tel (615) 327-3162 Chm. & Chief Exec. Officer Jack Stepp, Pres. Buddy Killen, Sr. VP Don Gant, VP's Donna Hanley, John Sturdivant, Prof. Mgrs. Cliff Williamson, Dan Wilson, Chris Dodson, Terry Choate

Int'l reps.: Argentina (Musica Argentina), Australia (Essex), Belgium (Ardmore & Beechwood), Brazil (Itaipu), Chile (Sochem), Denmark (EMI) France (Francis Day), Germany (Melodie der Welt), Greece (EMI), Hong Kong (EMI) Italy (La Voce del Padrone), Japan (Toshiba-EMI), Mexico (Beechwood), Netherlands (EMI), South Africa (EMI-Brigadiers), Spain (EGO), Sweden (EMI), UK (EMI)

Treetop Music (BMI). see Brownleaf

Tremor Music. see Beserkley

Tres-Lynn Music Co. (ASCAP). see Atterram

Tribal Country (BMI). see Fairchild

Tribute Publ'g Inc. (BMI). see PPX

Trice Publ'g Co. Inc. (BMI), 9006 S. Ridgeland, Chicago, Ill. 60617 Tel (312) 374-0331 Pres. Milton Campbell, VP & Prof. Mgr. Pat Powell

Branch: Chicago, Ill., 9006 S. Ridgeland, Zip 60617 Tel (312) 374-0331

Tri-Chappell Music Inc. (SESAC). see Chappell

Tri-Circle Music (ASCAP). see Gopam

Tricky Music Inc. (ASCAP). see Big Seven

Tridex Music Co. (BMI), PO Box 1646, Burbank, Calif. 91507 Tel (213) 849-5774 Owners Robert L. Bogle, Donald L. Wilson, Gen. Mgr. S. Rivera

Tri-Envolve Music Co. (SESAC). see Envolve Music Group

Trillium Music Co. (ASCAP). see Chappell

Trina Jill Music Corp. (ASCAP), 240 Madison Ave., New York, N.Y. 10016 Tel (212) 889-7340 Pres. Joseph Cayre

Trio Music Co. Inc. (BMI), 1619 Broadway, New York, N.Y. 10019 Tel (212) 489-8170 Co-Pres. Jerry Leiber, Mike Stoller

Triple H Music (BMI) (div. of Hank's Music Ent's Inc.), 11746 Goshen Ave., Suite 7, Los Angeles, Calif. 90049 Tel (213) 479-6091 Pres. Gen. & Prof. Mgr. Hank Haldeman

Int'l reps.: Worldwide excluding Canada, UK & USA (Artemis in UK), UK (Curb Carlin)

Triple K Music Inc. (BMI), 6290 Sunset Blvd., Suite 777, Los Angeles, Calif. 90028 Tel (213) 466-3521 Bd. Chm. Pete Kameron, Pres. Ron Kass, VP Bert Kamerman

Triple O Songs Inc. (BMI). see Roadshow

Trippington Music Publ'g Corp. (BMI). see Copyright Serv. Bureau

Tri-Song Music (ASCAP). see Collins/Saraceno

Tri-State Music Publ'g Co. (BMI), PO Box 121, 300 Court St., Soda Springs, Idaho 83276 Tel (208) 547-3715 Pres. Ronald Watts

Tritone Press (BMI). see Theodore Presser

Truene Music Inc. (ASCAP), 824 19 Ave. S., Nashville, Tenn. 37203 Tel (615) 329-1429 Pres. Buryl Red, VP & Gen. Mgr. Elwyn Raymer

Branch: New York, N.Y., 123 W. 57 St. Zip 10017 Tel (212) 582-7140

Trolley Music (ASCAP) (div. of the Trolley Group Inc.), Tower Place, Suite 2930, 3340 Peachtree Rd. NE, Atlanta, Ga. 30326 Tel (404) 252-3660 Gen. Mgr. Jim Healy

Tromba Publ'ns—Pres. Gerald Endsley, Gen. Mgr. Stephen L. Glover—see Brass Press

Troy Music Co. (BMI). see Chappell

Troyville Music, 66 Highland Ave., Somerville, Mass. 02143 Tel (617) 625-9805 Pres. James Murphy

Truckin' Music Corp. (ASCAP). see Chappell

True Blue Music Publ'g Co. (ASCAP), 16027 Sunburst St., Sepulveda, Calif. 91343 Tel (213) 892-0044 Pres. Larry Fotine

True Music Publ'g (BMI), 9902 Adams Ave., Cleveland, Ohio 44108 Tel (216) 851-6087/8492 Pres. & Gen. Mgr. William Spivery, Prof. Mgrs. Michael & William Spivery

True Note Music Publ'g (BMI). see Copyright Serv. Bureau

Tru-Sound Music (ASCAP). see Jondora

Trust Music Mgmt. Inc., 6255 Sunset Blvd., Los Angeles, Calif. 90028 Tel (213) 462-6933 Telex 69-8356 Pres. & Gen. Mgr. Samuel S. Trust

Trusty Publ'ns (BMI), Nebo, Ky. 42441 Tel (502) 249-3194 Pres. Elsie Childers

Ernest Tubb Music Inc. (BMI). see Cary & Mr. Wilson

Tuckahoe Music Inc. (BMI). see Jim Reeves

Tuckate Music Co. (ASCAP). see Mietus

Tuff Enuff Music Publ'g (BMI). see BAS

Tuff Gong Music (ASCAP). see Rondor

Tuna Fish Music (BMI). see April/Blackwood

Tune-Kel Publ'g Co. Inc. (BMI), PO Box 50650, New Orleans, La. 70150 Tel (504) 392-1525 Pres. Joseph Banashak

Tunesmith Music (BMI). see Caesar's Music Library & Segel & Goldman

Turbine Music (BMI). see Gopam

Turkey Creek Music (BMI). see Adventure

Tuskegee Music Press (SESAC). see Neil A. Kjos

Twelve Tribes Music Co. Inc. (BMI), 1106 E. 17 Ave., Denver, Colo. 80218 Tel (303) 832-3999 Pres. & Gen. Mgr. Jim Ransom, Prof. Mgr. Laura Benson

20th Century Music Corp. (ASCAP), 8544 Sunset Blvd., Los Angeles, Calif. 90069 Tel (213) 657-8210 Pres. Herbert N. Eisenman, Creative Activities Ron Vance; Catalog Exploitation Rick Landy, Copyright Admin. Mgr. Barbara Brunow

Int'l reps.: Argentina (Korn-Intersong), Australia (Chappell), Austria (Francis Day & Hunter, Centfox), Belgium (Kluger), Brazil (Intersong), Canada (Chappell), Colombia (Intersong), Denmark (Chappell), Finland (Chappell), France (Intersong, Francis Day), Germany (Francis Day & Hunter, Centfox), Iceland (Chappell), Israel (Literature), Italy (Curci), Japan (Chappell, Taiyo), Luxembourg (Kluger), Mexico (Intersong), Netherlands (Universal), New Zealand (Chappell), Norway (Chappell), Philippines (Chappell), Portugal (Canciones del Mundo), South Africa (Music Publ'g Co.), Spain (Canciones del Mundo), Sweden (Chappell), Switzerland (Francis Day & Hunter, Centfox), UK (Chappell, Francis Day & Hunter, Boosey & Hawkes, Keith Prowse), Venezuela (Intersong)

Twenty Eight East Music (BMI). see Mietus

Twenty-Nine Songs (ASCAP). see Segel & Goldman

Twiford Music (BMI), 4640 E. Lewis, Phoenix, Ariz. 85008 Tel (602) 959-2076 Owner L. John Twiford

Twig Music Inc. (BMI). see Tree

Twin Music Inc. (BMI), 41-45 39 St., Long Island City, N.Y.

1104 Tel (212) 786-7667 Telex 235976 Pres. Sam Weiss

Twinsong Music Inc. (BMI)—Pres. Orlene Johnson—see Great Leawood

Twin Tail Music (BMI), 8809 N. 115 Rising Sun Ave., Philadelphia, Pa. 19115 Tel (215) 676-8992 Pres. Frank Virtue

Twister Music (ASCAP). see Pine Island

Twitty Bird Music Publ'g Co. (BMI), 8 Music Square W., Nashville, Tenn. 37203 Tel (615) 327-3162 (Administered by Tree)

Conway Twitty Music. see Tree

Two Beat Music (BMI). see MCA Music

Two Day Music Inc. (ASCAP). see Copyright Serv. Bureau

212 Music Co. (BMI). see The Entertainment Co.

Two Speed Music (BMI). see Speed

Twogether Music (BMI). see April/Blackwood

Two Toots Music (BMI), 5017 Bakman Ave., North Hollywood, Calif. 91601 Tel (213) 506-6633 Pres. Robert Stephen Moske, Gen. Mgr. James Phelan, Prof. Mgr. Karen Daily, Local branch: 552 N. Windsor Ave., Los Angeles 90004 Tel 464-8755

Two World Leisure Time Corp. (ASCAP). see Copyright Serv. Bureau

Two Wrongs Don't Make a Right Music Ltd. (ASCAP). see Castle Hill

Tyler Publ'g Co. (BMI), PO Box 231, Tyler, Tex. 75710 Tel (214) 597-2961 Mgr. Curtis Kirk

Tymena Music (BMI), 430 Pearce Rd., Pittsburgh, Pa. 15234 Tel (412) 341-0991 Pres. Ty Lemley, VP & Treas. Tolmena Lemley, Gen. Mgr. Bud Lemley

Tymer Music (BMI), PO Box 1669, Carlsbad, Calif. 92008 Tel (714) 729-8406 Owner Dennis Tymer

Harrison Tyner Int'l Inc., 38 Music Square E., No. 115, Nashville, Tenn. 37203 Tel (615) 244-4224 Pres. Harrison Tyner, Gen. Mgr. Gene Leviner, Prof. Mgr. Dallas Laird

Tyner Music (ASCAP). see Harrison Tyner

Tyree Music (ASCAP). see Martin Cohen

Tyson South (ASCAP). see Morning

U

U S Arabella Music Publ'g (BMI). see Ariola

U S Songs Inc. (ASCAP). see Trio

Ultimate Recs. Music Publ'g (ASCAP, SESAC), 7087 Bark Ln., San Jose, Calif. 95129 Tel (408) 257-2048 Pres. Earl B. Johnson

Umbrago Music (BMI). see PA Ent's

Unart Music Corp. (BMI). see United Artists

Uncanny Music (ASCAP). see Tree

Uncle Albert Music (BMI). see Martin Cohen

Underling Music Co. (ASCAP). see Mietus

Unchappell Music Inc. (BMI). see Chappell

Unicore Music (ASCAP). see ESP

Unicorn Music Co. (ASCAP). see Sam Fox

United Artists Music, 6920 Sunset Blvd., Los Angeles, Calif. 90028 Tel (213) 461-9141 Cables UNARTMUSIC, ROB MUSIC Press. Harold Seider, Exec. Ass't to Pres.; Frank Banyar, Copyright Mgr. Silvia Blach; Professional Staff Suzanne Logan, Peter Pasternak

Branch: New York, N.Y., 729 Seventh Ave. Zip 10019 Tel (212) 575-3000 VP & Legal Sidney Shemel, Prof. Mgr. Stu Greenberg (Print Div.), Big 3 Music Corp. Exec. VP Herman Steiger)—Nashville, Tenn., 1013 16th Ave. S. Zip 37212 Tel (615) 255-1161 Cable UNARTMUSIC VP & Prof. Mgr. Jimmy Gilmer

Int'l branches: Australia, Belgium, Canada, England, France, Germany, Italy, Japan, Mexico, Netherlands, South Africa, Sweden

Int'l reps.: Argentina (Korn), Brazil (Meridional), Far East (Pathe), Israel (Subar), Spain (Hispanovox)

United Artists Music Co. Inc. (ASCAP). see United Artists Music

United Methodist Publ'g House. see Abingdon Press

United Mexican Music Publ'rs Inc. (BMI). see Mexican Music

Universal Entertainment Corp., 120 Hickory St., Madison, Tenn. 37115 Tel (615) 868-7172 Pres. Lee Stoller

Universal Stars Music Inc. (BMI), Box 277, Rt. 3, Leesville, La. 71446 Pres. Sherree Scott

Branch: Magazine, Ark., Box 157, Rt. 1 Zip 72943

University of Miami Music Publ'ns (ASCAP). see Sam Fox

University of Washington Press. see Galaxy

Upam Music Co. (BMI). see Gopam

Upswing Music Corp. (BMI). see Copyright Serv. Bureau

Sudden Rush Music
PUBLISHERS



750 KAPOCK STREET, RIVERDALE, NEW YORK 10463 • (212) 864-6014

GOOD TO THE LAST NOTE

Upward Bound Music Co. (BMI), 12911 SW 82 Terr., Miami, Fla. 33183. Tel: (305) 279-2523. Pres.: Samuel Solomon Jr.
 Up With People (ASCAP), 3103 N. Campbell Ave., Tucson, Ariz. 85719. Tel: (602) 327-7351. Pres.: J.B. Belk.
 Urge Music (BMI), see April/Blackwood.
 Utopia Music (ASCAP), PO Box 5314, Zip: 31208; 380 Riverdale Rd., Macon, Ga. 31204. Tel: (912) 477-0415. Pres. & Gen. Mgr.: Randy L. Howard.

V

V F A Music (ASCAP), see April/Blackwood.
 V I P (BMI), see MacArthur.
 V-Love Music (ASCAP), 155 W. Hermosa Pl., Palm Springs, Calif. 92262. Tel: (714) 325-5757. Pres.: James Stuart.
 Vaam Music (BMI), 3740 Evans Ave., Suite C-114, Los Angeles, Calif. 90027. Tel: (213) 665-6221. Pres.: Pete Martinez.
 Vado Music Co. (ASCAP), 2226 McDonald Ave., Brooklyn, N.Y. 11223. Tel: (212) 373-4468. Pres.: Vincent A. Velardi; Gen. Mgr.: Gloria Bach.
 Tommy Valando Publ'g Corp., 1270 Ave. of the Americas, Suite 2110, New York, N.Y. 10020. Tel: (212) 489-9696. Pres.: Tommy Valando; VP, A.J. Sullivan.
 Valco Music Publ'g (BMI), 1327 Cobb Ave., Kalamazoo, Mich. 49007. Tel: (616) 342-5328. Pres.: Vic La Val; Gen. Mgr.: Val Taylor.
 Val-Dare (BMI), PO Box 4234, Panorama City, Calif. 91412. Tel: (213) 786-6957. Pres.: Hal Southern.
 Rocky Valdez Music, 4640 W. 118 St., Hawthorne, Calif. 90250. Tel: (213) 676-8882. Pres.: Rocky Valdez.
 Thomas J. Valentino Inc. (ASCAP), 151 W. 46 St., New York, N.Y. 10036. Tel: (212) 246-4675. Pres.: R.F. Valentino. (SEE ADVERTISEMENT)
 Valeria Music (BMI), see Martin Cohen.
 Valgroup Music (USA) Co. (BMI), 7033 Sunset Blvd., Los Angeles, Calif. 90028. Tel: (213) 462-0833. Mng. Dir.: Patrick Boyle. Gen. Mgr.: Maritta Boyle.
 Home office: England. Valentine Music Group Ltd. Int'l firms represented: GP (Japan), Arthur's Mother, Bettytunes, Bulldog, Burnt Ash, Corner Stone, Eden Studios, Golora, Latchmere, Maiden, Marathon, Middle Eight, Monkton, Muggleton, Nutmeg, Pickle, Rainbow, Sally, Sapphire, Alan Tew (all UK).
 Int'l rep.: Canada (BC Music).
 Valis Music (ASCAP), see ATV Music.
 Vallarta Music (ASCAP), see Martin Cohen.
 Valsong (ASCAP), see Ascension.
 Valynn Music (BMI), see Aletha Jane.
 Vanguard Music Corp. (ASCAP), 250 W. 57 St., New York, N.Y. 10019. Tel: (212) 246-1343. Pres.: Frank Siegfried; Gen. Mgr.: Bobby MacFarland.
 Int'l branch: England.
 Vanguard Songs (BMI), see Beechwood.
 Van Heusen Music Corp. (ASCAP), 301 E. 69 St., New York, N.Y. 10021. Tel: (212) 288-3979. Pres.: James Van Heusen; VP: Josephine Van Heusen; Sec'y-Treas.: Miriam Stern.
 Van-Jak Music Corp. (ASCAP), 221 W. 57 St., New York, N.Y. 10019. Tel: (212) 757-7111. Cable: AUDIO-FI-DEL.
 Vanlee Music Corp. (ASCAP), see Jova.
 James R. Vanleer Music Inc. (BMI), see 20th Century.
 Vaudell Music Publ'ns (ASCAP)—Gen. & Prof. Mgr.: V.E. Moss—see Apex.
 Vaudeville Music (BMI), see Mainman.
 Vaya Publ'g Inc. (ASCAP), see Fania.
 Vector Music (BMI), 1107 18 Ave. S., Nashville, Tenn. 37212. Tel: (615) 327-4161.
 Vee Ve Music Corp. (BMI), see Mietus.
 Velva Music Inc. (SESAC), see Chappell.
 Velvet Apple Music (BMI), 4321 Esteswood Dr., Nashville, Tenn. 37215. Tel: (615) 292-0432. Gen. Mgr.: Carla Scarborough.
 Int'l reps.: France (Francis Day), Germany (Siegel), Japan (Taiyo), Netherlands (Intersong-Basart), Scandinavia (April in Sweden), South Africa (EMI-Brigadiers), South America & Mexico (Southern in USA), UK (Carlin).
 Velvet Music Inc. (BMI), 10128 NW 80 Ave., Hialeah Gardens, Fla. 33016. Tel: (305) 823-0812.
 Vemco Music (BMI), see Mietus.
 Venice Music Inc. (BMI), 8300 Santa Monica Blvd., Hollywood, Calif. 90069. Tel: (213) 656-7711. VP & Prof. Mgr.: Dorothy D. Rupe.
 Venox Music (BMI), see April/Blackwood.
 Verde Vista Music (ASCAP), 2383 Union St., No. 4, San Francisco, Calif. 94123. Tel: (415) 567-6935. Pres.: S. White.
 Vernon Music Corp. (ASCAP), see 20th Century.
 Very Own Music Co. (BMI), see A. Schroeder, 20th Century & Martin Cohen.
 Vette Music Co. (ASCAP), 6290 Sunset Blvd., Suite 1809, Hollywood, Calif. 90028. Tel: (213) 462-5466. Pres.: Dave Bell; VP: Larry Shayne.
 Branch: New York, N.Y., 250 W. 57 St., Suite 2401. Zip: 10019. Tel: (212) 247-7080. Gen. Mgr.: Randy Irwin; Office Mgr.: Patricia Bente.
 Int'l reps.: Austria (Compass), France (Francis O'Neill), Germany (Compass), Ireland (Larry Shayne), Iron Curtain Countries (Compass in Germany), Italy (Compass in Germany), Japan (Tone), Netherlands (Larry Shayne), Scandinavia (Compass in Germany), UK (Larry Shayne).
 Via Rita Music (BMI), see Mietus.
 Vibration Music Co. (BMI), PO Box 9726, West Gate Sta., San Jose, Calif. 95117. Tel: (408) 353-3284. Pres.: Dr. John E. Morlan.
 Vicki Music (BMI), see Bug.
 Andre Victor Publ'g (BMI), see Segel & Goldman.
 Victory Music Co. (BMI), see Mietus.
 Videon Music (BMI), see Bug.
 Vidor Publ'ns Inc. (BMI), see Red River.
 Vignest Music Inc. (BMI), see Copyright Serv. Bureau.
 Vignette Music (BMI), see Mietus.
 Village Music Co. (BMI), see Hometown.

Villa Reserve Music (BMI), Box 32, Rt. 2, Quaker St., Van-dalia, Mich. 49095. Tel: (616) 476-2110.
 Norm Vincent Publ'g (BMI), 2110 The Woods Dr., Jackson-ville, Fla. 32216. Tel: (904) 246-3216. Pres.: Norman F. Vincent; Gen. Mgr.: Karen W. Vincent.
 Stan Vincent Music (BMI), see April/Blackwood.
 Vintage Music Inc. (BMI), see Combine.
 Viper Music (BMI), see Bug.
 Virginia Music Co. (BMI), 209 Main St., Fort Lee, N.J. 07024. Tel: (201) 947-3900. Pres.: Al Thomas; Gen. Mgr.: Mark Donald; Prof. Mgr.: Jim McCarthy.
 Virtumusic (ASCAP), see Twin Tail.
 Vitak-Elsnic Co. (SESAC), 6400A S. Woodward Ave., Down-ers Grove, Ill. 60515. Tel: (312) 963-0200. Pres.: Lawrence Musielak.
 Jerry Vogel Music Co. Inc. (ASCAP), 58 W. 45 St., New York, N.Y. 10036. Tel: (212) 730-0478. Cable: TIN-PANALLY.
 Vogue Music Inc. (BMI), see T.B. Harms. (SEE ADVERTISE-MENT)
 Vokes Music Publ'g Co. (BMI), PO Box 12, New Kensington, Pa. 15068. Tel: (412) 335-2775. Pres. & Mgr. Howard Vokes.
 Volkwein Bros. Inc. (ASCAP), 117 Sandusky St., Pittsburgh, Pa. 15212. Tel: (412) 322-5100. Bd. Chm. Carl R. Volkwein; Pres.: Carl W. Volkwein; Gen. Mgr.: Walter E. Volkwein.
 Harry Von Tilzer Music Publ'g Co. (ASCAP), see T.B. Harms.
 Voytek Music (BMI), see Autumn Hill.

W

W B Music Corp. (ASCAP), see Warner Bros.
 W E M G Music Inc. (ASCAP), see Sidney A. Seidenberg & Copyright Serv. Bureau.
 W E P Music Corp. (BMI), see Rondor.
 W-G Music Corp. (ASCAP), see Chappell.
 W I M O T Music Publ'g Co. (BMI), see Jondora Music—Parker.
 W P N Music Co. Inc. (ASCAP), 10 Swirl Ln., Levittown, N.Y. 11756. Tel: (516) 796-3698. Pres.: Paul Friedberger, VP & Prof. Mgr.: Warren Schatz; Sec'y-Treas. Nat Schnapf.
 Branch: New York, N.Y., 723 Seventh Ave. Zip 10019. Tel: (212) 245-7640.
 Int'l rep.: UK (Cyril Shane).
 Wah Watson Music (BMI), see Ivan Hoffman.
 Walden Music Inc. (ASCAP), see Cottilion.
 Wall Music Publ'rs (BMI), see Real To Reel.
 Walters Music (ASCAP), see Jay Jay.
 Wanellen Music Inc. (BMI), see Wanessa.
 Wanessa Music Inc. (BMI), PO Box 387, Radio City Sta., New York, N.Y. 10019. Tel: (212) 582-0543. Pres.: George Brown.
 War Drum Publ'g Co. (BMI)—Pres., Gen. & Prof. Mgr.: Ron-nie Sessions; VP: Ray D. Willis—see Buckhorn.
 Warhawk Music (BMI), see Tree.
 Warman Music Inc., see T.B. Harms—Vogue.
 Warminster Music (BMI), see Mietus.
 Warne Marsh, see Copyright Serv. Bureau.
 Warner Bros. Music (ASCAP) (div. of Warner Bros. Inc.), 9200 Sunset Blvd., Los Angeles, Calif. 90069. Tel: (213) 273-3323. Cable: WANG. Chm.: Ed Silvers; Pres.: Mel Bly; Gen. Mgr. Bob Stabile; Prof. Mgrs.: Michael Sandoval, Greg Penny; Copyright Dir.: Al Kohn. Branch: New York, N.Y., 75 Rockefeller Plaza. Zip: 10019. Tel: (212) 484-8000—Nashville, Tenn., 44 Music Square W. Zip: 37203. Tel: (615) 254-8777.
 Int'l branches: Australia, Brazil, England, France, Ger-many, Italy, Netherlands, Scandinavia, South Africa.
 Int'l firms represented: Bright, Bron Group, Fuse, Mog-gie, Pendulum, Pentangle, Skylark, Slim Chance, Sweet, Topographic, Winterfold.
 Warner/Levenson Publ'g Co. (ASCAP), 9 E. 46 St., New York, N.Y. 10017. Tel: (212) 661-2106.
 Warner-Tamerlane Publ'g Corp. (BMI), see Warner Bros.
 Warp Seven Music Co. (BMI), see Chappell.
 Warus Music (BMI), 1410 E. 72 St., Chicago, Ill. 60619. Tel: (312) 752-2755. Pres.: U.S. Warren.
 Waterhouse Music (BMI), 100 N. Seventh St., Minneapolis, Minn. 55403. Tel: (612) 332-6575.
 Water Toys Publ'g Co. (BMI), see 20th Century.
 Watertoons Music (BMI)—Pres.: McKinley Morganfield—see Cameron.
 Waterwheel Music Inc. (BMI), 13 Moore St., Bristol, Va. 24201. Tel: (703) 466-8675. Pres. & Prof. Mgr.: Joe Deaton.
 Watt Works Inc. (BMI), Willow, N.Y. 12495. Tel: (914) 688-5373. Pres.: Michael Mantler.
 WaVe Music Inc. (ASCAP), see Shade Tree.
 Wax Songs Inc. (BMI), see SWS.
 Wayward Music Inc. (ASCAP), see Charing Cross.
 Weatherly Music (BMI), 1415 N. Hudson Ave., Hollywood, Calif. 90028. Tel: (213) 464-0251. Pres.: Samuel L. Weatherly; Prof. Mgr.: Essra Weatherly.
 H. B. Webman & Co., 1650 Broadway, Suite 701, New York, N.Y. 10019. Tel: (212) 586-0240. Cable: WEB-MANMUS.
 Joel D. Webster Music (BMI), see Copyright Serv. Bureau.
 Wedge Music Inc. (BMI), see Skinny Zach.
 Wee-B (ASCAP), see World Wide.
 Weeks Music Co. (BMI), see Mietus.
 Wei Chi Music (BMI), see Rondor.
 Weintraub Music Co., 33 W. 60 St., New York, N.Y. 10023. Tel: (212) 246-0325.
 Ron Weiser Publ'g (BMI), see Bug.
 Weiss & Barry Copyrights Inc. (BMI), see Pickwick.
 Sam Weiss Music Inc. (ASCAP), 6087 Sunset Blvd., Holly-wood, Calif. 90028. Tel: (213) 464-9251. Pres.: Sam Weiss.
 Stevens H. Weiss, 444 Madison Ave., New York, N.Y. 10022. Tel: (212) 752-1330. Cable: SONGBIRD. Adm-in'r: Stevens H. Weiss; Ass't Admin'r: Shelley Kaye.
 Welbeck Music Corp. (ASCAP), see ATV Music.
 W. R. Welch Publ'g House—Pres.: W.R. Welch; Gen. Mgr.: Stephen L. Glover—see Brass Press.
 Eddie Weldon Music Co. (BMI), PO Box 1294 DTS. Zip: 68101; 8402 Blondo, No. D-13, Omaha, Neb. 68134.

Tel: (402) 397-9052. Pres.: Mr. Clair Weldon; Gen. Mgr.: Eddie Weldon. (Affiliated with Accadia Music).
 Wellesley Music Co. (BMI), see Integrity.
 Wells Drive Music (BMI)—Tel: (213) 987-1055—see Budd Music.
 WellSound Music Co. (BMI), see Mietus.
 Welstro Music Co. (BMI), see Copyright Serv. Bureau.
 Welz Music Co. (ASCAP), see Dawn Prod'ns.
 Wembley Music Co. (BMI), see Chappell.
 Wensley Music Ltd. (BMI), see Copyright Serv. Bureau.
 We Prod'ns Inc., 14744 Puritan, Detroit, Mich. 48227. Tel: (313) 273-4635.
 Wesjak Music (BMI), PO Box 743, 317 S. Church St., Lake City, S.C. 29560. Owner: William R. Bragdon Jr.
 Weslous Music, PO Box 10044, Denver, Colo. 80210. Tel: (303) 777-9648. Owner, Gen. & Prof. Mgr.: W.L. Horning.
 Western Head Music Co. (ASCAP), PO Box 19, Bulverde, Tex. 78163. Tel: (512) 438-2465. Pres.: Augie Meyers; Gen. Mgr.: Carol Meyers; Dir.: Lucky Tomblin.
 Western Hemisphere Music Co. (BMI), 252 Broadway Ln., New Hyde Park, N.Y. 11040. Tel: (516) 627-8861. Pres.: Harvey Rachlin; Gen. Mgr.: Steve Rachlin; Prof. Mgr.: Craig Rachlin.
 Western Hills Music Co. (BMI), see Jim Reeves.
 Western Music Publ'g (ASCAP), see Golden West.
 Robert Joseph Weston, see Copyright Serv. Bureau.
 Wet Bull Music (ASCAP), see Martin Cohen & 20th Century.
 We Three Music Inc. (BMI), see H. B. Webman.
 Wet Paint Music, see Copyright Serv. Bureau.
 We've Got Rhythm Music (BMI), see Rondor.
 Wexford Music Ltd., see Copyright Serv. Bureau.
 Whalen Music, see T.B. Harms—Harry Von Tilzer.
 What You Need Music (BMI), see Martin Cohen.
 Wheen Music (ASCAP), c/o Stoy Inc., 279 E. 44 St., New York, N.Y. 10017. Tel: (212) 986-4994. Pres.: Norman Dolph; Prof. Mgr.: Elizabeth Henry.
 Int'l rep.: Australia (Leeds).
 Wheezer Music (ASCAP), 1701 Nichols Canyon Rd., No. 204, Los Angeles, Calif. 90046. Tel: (213) 874-6983.
 Owners: Howard & Beth F. Bloch; Gen. & Prof. Mgr.: Beth F. Bloch.
 Int'l firm represented: Pathe (Italy).
 Int'l rep.: Europe & Asia (Intersong).
 Whiskey Drinkin' Music (BMI), see Bug.
 Whispering Wind (ASCAP), see Copyright Serv. Bureau.
 Whistle Music (BMI), see Coco.
 Whitchurch Music Corp. (ASCAP), see Whitsett Churchill.
 Whitecap (BMI), see Jaspur.
 Don White Publ'g (ASCAP), 2020 Ridge Ave., Philadelphia, Pa. 19121. Tel: (215) 765-4889. Pres. P. Donald White.
 White Haven Music Inc. (ASCAP), 1619 Broadway, New York, N.Y. 10019. Tel: (212) 489-8170.
 White Light Music (BMI), see Copyright Serv. Bureau.
 White Way Music Co. Inc. (ASCAP), 65 W. 55 St., Suite 11G, New York, N.Y. 10019. Tel: (212) 757-4317. Cable: WHITPRODIN. Pres.: Edward R. White.
 Whitewing Music (BMI), see Jamil.
 Whitfield Music Inc. (BMI), see Copyright Serv. Bureau.
 Whiting Music Corp. (ASCAP), see George Paxton.
 Whitsett Churchill Music Corp. (BMI), 4403 Manhattan Dr., Jackson, Miss. 39206. Tel: (601) 366-2076. Pres.: Tim Whitsett; VP: Chick Churchill, Admin'r: Janis R. Whitsett.
 Branch: New York, N.Y., 720 Fifth Ave., Suite 705. Zip: 10019. Contact: Rick Talmadge.
 Int'l branch: England.
 Int'l reps.: Australia (Rondor), Austria, Germany & Swit-zerland (Global), Benelux (Dutchy), New Zealand (Rondor), Scandinavia (Sweden Music).
 Widget Publ'g (BMI) (div. of Widget Rec'g Inc.), PO Box 2446, Muscle Shoals, Ala. 35660. Tel: (205) 381-1300. Pres. & Prof. Mgr.: Ron Ballew.
 Widmont Music (ASCAP), see April/Blackwood.
 Wilco Publ'g Inc. (BMI), see Copyright Serv. Bureau.
 Shane Wilder Music (BMI), 1680 N. Vine St., Suite 313, Hollywood, Calif. 90028. Tel: (213) 467-1958. Pres.: Shane Wilder.
 Int'l branches: Germany, Ireland, UK.
 Wild Sanctuary (BMI), 680 Beach St., No. 411, San Fran-cisco, Calif. 94109. Tel: (415) 673-4544. Cable: DOOBYDOO. Pres.: Bernie Krause; VP: Sid Goldstein.
 Wild Woman Music (ASCAP), see Martin Cohen.
 Wilhos Music (BMI), PO Box 3443, Hollywood, Calif. 90028. Tel: (213) 291-0539. Pres. & Gen. Mgr.: Willie E. Hoskins Jr.
 Wiljex Publ'g Co. (ASCAP), see Con Brio.
 David Wilkes Music Corp. (BMI), see Copyright Serv. Bureau.
 Will-Du Music Publ'g Co. (BMI), 833 N. Orange Grove Ave., Los Angeles, Calif. 90046. Tel: (213) 653-8358. Gen. Mgr.: Lou Duffon.
 Branch: New York, N.Y., 401 W. 56 St., Suite K. Zip: 10019.
 Slim Willet Music (BMI), see Copyright Serv. Bureau.
 Don Williams Music, see T.B. Harms—Vogue.
 Don Williams Music Group, 1888 Century Park E., No. 1222, Los Angeles, Calif. 90067. Tel: (213) 556-2458. Owner & Gen. Mgr.: Don Williams. Prof. Mgr.: Gloria Jackman.
 Dootsie Williams Publ'ns (BMI) (formerly Doot Inc.), 800 W. First St., Los Angeles, Calif. 90012. Tel: (213) 628-7768. Pres. & Prof. Mgr.: Dootsie Williams; Gen. Mgr.: Jo Williams.
 Jerry Williams Music (BMI), see Mietus & 20th Century.
 Parker Williams Music (BMI), see April/Blackwood.
 Williamson Music Inc. (ASCAP), see Chappell.
 Willis Music Co. (SESAC), 7380 Industrial Rd., Florence, Ky. 41042. Tel: (606) 283-2050. Pres.: Edward R. Cran-ley. Controller: Fred N. Dittich.
 Willong Music (BMI), see Pickwick.
 Wilmit Music Prod'rs (BMI), Box 67, Rt. 7, Ridge Rd., Co-lumbus, Miss. 39701. Pres.: W.B. Mitchell.
 Wilojarston Music (ASCAP), see Brother.
 WilSing Music Publ'rs (BMI), Box 100-N, RFD 3, Stuart, Va. 24171. Tel: (703) 694-6128. Pres. & Gen. Mgr.: John F. Williams; Prof. Mgr.: Frank W. Singleton.
 Wilsons (ASCAP), PO Box 66558, Seattle, Wash. 98166. Tel: (206) 246-9400.
 Wilson/Kolber Music (ASCAP), see Kolber Publ'g.

Marty Wilson Co (BMI), see Chappell.
 Ron Wilson Music Prod'ns (BMI), PO Box 285, Beverly Hills, Calif. 90213. Tel (213) 935-0355. Pres. Ron Wilson.
 Tony Wilson Music Ltd. (ASCAP), see Fourth Floor
 Wit-Too Music (ASCAP), 2405 Pennington Bend Rd., Nashville, Tenn. 37214. Tel (615) 883-2457. Pres. Tom Wilkerson.
 Wind Breeze Music Ltd. (ASCAP), see Sidney A Seidenberg
 Windchimes Music Inc. (BMI), see House of Gold
 Windcor Music (BMI), see Bruce Cohn.
 Window Music Publ'g Co. Inc. (BMI), 809 18 Ave. S., Nashville, Tenn. 37203. Tel (615) 327-3211. Pres. Pete Drake. Gen Mgr. Rose Trimble.
 Winds & Dragons Publ'g Co. (BMI), see R A Hodge.
 Windsea Music (BMI), see Cherry Lane
 Windsor Music Co. (BMI), see Newport.
 Windstar Music (ASCAP), see Cherry Lane.
 Windy City Music Co., see T.B. Harms—Harry Von Tilzer
 Windy Jenny Music (BMI), see Cherry Lane
 Mike Wing Music Publ'g (BMI), PO Box 171, Bellevue, Wash. 98009. Tel (206) 828-3642. Owner Mike Wing.
 R P Winkelman Songs (ASCAP), see Bruce Cohn
 Winner Music Inc. (BMI), see Edwin H. Morris
 Winner Music (BMI), c/o International Rec'g Co., 1649 W Evergreen, Chicago, Ill. 60622. Tel (312) 227-2000. Pres. Leonard March.
 Winsor Music (BMI), see Bug
 Winter Blues Music Inc. (BMI), see Organic Mgmt.
 Winthrop Rogers (ASCAP), see Boosey & Hawkes
 Wishbone Music (ASCAP), see Skyhill & Don Williams.
 Within Reach Music (ASCAP), see Martin Cohen.
 Wizard Music Co. (ASCAP), 11 Harrison Court, South Orange, N.J. 07079. Tel (201) 762-2504. Pres. Jimmy Wisner. Gen Mgr. Jane Berson.
 Lanny Wolfe Music (SESAC), see John T. Benson.
 Wonderland Music Co. Inc. (BMI), see Walt Disney
 Curtis Wood Music (ASCAP), 1010 17 Ave. S., Nashville, Tenn. 37212. Tel (615) 256-8076. Pres. Curtis Wood.
 Wooden Bear Music (ASCAP), see Big Heart.
 Wooden Nickel Music Inc. (ASCAP), 9465 Wilshire Blvd., Suite 820, Beverly Hills, Calif. 90212. Tel (213) 550-1010. Pres. James Golden, VP Bill Traut
 Woodglen Publ'ns (BMI), PO Box 35855, Houston, Tex. 77035. Tel (713) 499-5943. Owner & Gen. Mgr. Dan Mechura Sr.
 Woodmont Music (BMI), see Valgroup.
 Woodrich Publ'g Co. (BMI), George Wallace Park Dr., Lexington, Ala. 35648. Tel (205) 247-3983. Pres. Gen & Prof. Mgr. W.P. Richardson
 Int'l rep.: UK (Dick James)
 Woodside Publ'g Co. (BMI), see Earl Miles.
 Woolfsongs Inc. (BMI), see 20th Century & Rondor (certain copyrights)
 Woolnough Music (BMI), see Rondor.
 Woomera see Jaspur
 Word Inc. (ASCAP), 4800 W. Waco Dr., Waco, Tex. 76710. Tel (817) 772-7650.
 The Word of God Music (BMI) (div. of Charismatic Renewal Servs. Inc.), PO Box 8617, Ann Arbor, Mich. 48107.

Tel (313) 761-8505. Pres. George Martin; Dir. James J. Cavnar. Mng. Ed. Mark P. Mathias
 Working Mans Music (BMI), 155 Walton-Nicholson Pike, Walton, Ky. 41094. Tel (606) 356-3928. Pres., Gen. & Prof. Mgr. George W. Napier
 World Library Publ'ns Inc. (SESAC), 2145 Central Pkwy., Cincinnati, Ohio 45214. Tel (513) 421-1090
 World Music Inc. (ASCAP), 18 E. 48 St., New York, N.Y. 10017. Tel (212) 688-6230. Pres. Sammy Kaye; Prof. Mgr. Marie Garbarine.
 World Song Publ'g Inc. (ASCAP), see Interworld.
 World War III Music (BMI), see Mighty Three.
 World Wide Music Inc., 1300 Division St., Nashville, Tenn. 37203. Tel (615) 256-7543. Pres. & Gen. Mgr. Calvin H. Everhart
 Worldwide Music Publ'rs & Dists., 1966 Broadway, New York, N.Y. 10023. Tel (212) 724-4212. Pres. Eric Fletcher
 Int'l firms represented: Musica Rara (UK); Antico, Mapa Mundi, Emerson, Pro Musica
 Worldwide Music Servs. Inc. (ASCAP), see TRO
 Worthless Music (ASCAP), see JEDO & Chappell
 Worthy Music Co., 1909 Ave. K, Brooklyn, N.Y. 11230. Tel (212) 377-4321. Owner Gil Snapper
 Wren Music Co. Inc. (BMI), see Edwin H. Morris
 Writehit Music (ASCAP), see Needahit.
 Writers Music Publ'g Co. (BMI), see April/Blackwood
 Writer's Night (ASCAP), PO Box 22635, Nashville, Tenn. 37202. Tel (615) 383-8318.
 Writing Table Music Co. (ASCAP), see Spaceark Ents
 Wrytree Music Ltd. (PRS), see Copyright Serv. Bureau
 Wynne Music Corp. (ASCAP), see Copyright Serv. Bureau
 Wynwood Music (BMI), see Dawn Prod'ns.

Y

Yahnita Music (BMI)—Mgr. Gwendolyn Dennison—see Capaquarius
 Yahweh Tunes Inc. (BMI), see Copyright Serv. Bureau.
 Yankee Dog Music (ASCAP), see Copyright Serv. Bureau.
 Yankee Hillbilly Music (BMI), see Bug
 Yankee Ingenuity (BMI), see Copyright Serv. Bureau
 Yankee Rose Music (ASCAP), see Martin Cohen
 Yarvar Music Co. (ASCAP), see Four Grand
 Yatahey Music (BMI), PO Box 31819, Dallas, Tex. 75231. Tel (214) 690-4155
 Yatta Songs (BMI), see Ivan Mogull.
 Ybarra Music (ASCAP), PO Box 665, Lemon Grove, Calif. 92045. Tel (714) 462-6538. Owner Richard Braun
 Yeah Inc. (ASCAP), see Rondor
 Year Round Music Co. (BMI), see 20th Century.
 Yellow Bee Music (BMI) (div. of Yellow Bee Prod'ns Inc.), 245 Waverly Pl., New York, N.Y. 10014. Tel (212) 255-3698. Pres. Nick Perls
 Yellow Brick Road Music (ASCAP), see Kidada
 Yellow Dog Music Inc. (ASCAP), see Hudson Bay.
 Yellowtail Music (BMI), see Copyright Serv. Bureau
 Ying Yang Music (BMI), see Coco
 Yo-Ho Publ'g Co. Inc. (BMI), see Mietus
 Yo' Mama's Music (BMI)—Partners Jack Hall, Jimmy Hall,

Marshall Smith & T.K. Lively. Gen. Mgr. Pat Halverson—see Hat Band & April/Blackwood
 Yorktown Music Press Inc. (ASCAP), see Music Sales.
 Yosef Music (ASCAP), see T.B. Harms.
 Vincent Youmans Co. (ASCAP), 8 E. 77 St., New York, N.Y. 10021. Tel (212) 734-6099. Mng. Agent Robert Lissauer
 Int'l rep.: UK (Lissauer)
 Young Carney Music (ASCAP), see Teddy Jack.
 Faron Young Music (ASCAP), see Deaton-Young
 Young Ideas Music (ASCAP), see April/Blackwood & 20th Century.
 Young Music Co. (BMI), 1063 N. Liberty St., Elgin, Ill. 60120. Tel (312) 695-2798. Owner: Kenneth L. Young
 Youngun' Publ'g Co. (BMI), see Combine
 Victor Young Publ'ns (ASCAP), see Chappell.
 Youngwood Publ'g Co. (BMI), 849 Bing Dr., Santa Clara, Calif. 95051. Tel (408) 249-1143
 Young World Music (BMI), see Southern Writers
 Yo-Yo Music (BMI), see Startime.
 Yuggoth Music Co. (BMI), 9465 Wilshire Blvd., Suite 820, Beverly Hills, Calif. 90212. Tel (213) 550-1010. Partners Bill Traut, Jim Golden, Bob Monaco
 Yuma Music Corp. (ASCAP), see Shapiro Bernstein.

Z

Z Z Y Z X Music Publ'g Co. Inc. (BMI), see Rondor.
 Zacko Music Ltd. (BMI)—Pres. Elliot L. Hoffman—see Bel-dock Levine & Hoffman.
 Zag (BMI), see Katch Nazar
 Zakiya Music (BMI)—Gen. Mgr. Ken Baker—see Bakim.
 Zan Music Ltd. (BMI), see Copyright Serv. Bureau.
 Frank Zappa Music Inc. (BMI), see Open End.
 Zap Publ'g Co. (BMI), see Mount Rainer.
 Rex Zano Music (BMI), 3010 N. Front St., Philadelphia, Pa. 19133. Tel (215) 739-7501. Pres. & Gen. Mgr. Rex Zano
 Int'l reps: Australasia (Festival), Benelux (Charles Bens), Germany (Charles Bens), UK (Campbell Connelly, Chappell)
 Zariit Music Publ'g Co. (BMI), 2703 W. Juenau St., Tampa, Fla. 33614. Tel (813) 933-1869.
 Zawinul Music (BMI), see Gopam
 Zeller Music Co., see T.B. Harms—Harry Von Tilzer.
 Zerlad Music Ents. Ltd. (BMI), see TRO.
 Zethus Music (ASCAP), see Chappell.
 Zia Music Press (ASCAP), see Carl Fischer.
 Zizanee Music Inc., see T.B. Harms—Bibo.
 Z-Musique Ltd., see Sight & Sound.
 Znrg Music (BMI), see Chappell.
 Zomba Corp. (ASCAP), see Chappell.
 Zonal Music (BMI), see ATV Music.
 Zoobe (ASCAP), 2600 River Rd., Des Plaines, Ill. 60018.
 Zora Delta (BMI), 1536 Terpsichore St., New Orleans, La. 70130. Tel (504) 529-3062. Owner Parker Dinkins, Adv. Dir. Sharon Dinkins.
 Zuckschank Music Inc. (BMI), see Rondor

Give a little today. Take a lot tomorrow.
 That's what makes United States Savings Bonds
 a great way to secure your future. And why over
 nine million people like you have already joined the
 Payroll Savings Plan.

You see, once you sign up, a small part of each
 paycheck is set aside to buy Bonds. Saving is so
 automatic, you'll soon forget about it.

So buy United States Savings Bonds.
 Automatically, through the Payroll Savings Plan.

You won't even feel like
 you're giving, until all those
 Bonds are yours for the
 taking.



Ad Council A public service of this publication
 and The Advertising Council.

ARIZONA

• **SUN CITY (Area Code 602)**

Oahu Publ'g Co., PO Box 279, 10333 Coggins Dr. Zip 85351. Tel. 933-8283

CALIFORNIA

• **GARDEN GROVE (Area Code 714)**

Largo Music Corp., 7421 Anaconda Ave. Zip 92641 Tel 898-0507. Branch Mgr.: Jack Griffith. Home office: Columbia, Md.

• **LOS ANGELES METROPOLITAN AREA (Area Code 213)**

Alfred Publ'g Co. Inc., 15335 Morrison St. Sherman Oaks 91403. Tel. 995-8811. Pres. Morton Manus. Exec. VP. Sandy Feldstein. Mktg. Dir. Roberta Vaccaro Salerno.

Almo Publ'ns (an affiliate of A&M Recs.), 1312 N. La Brea, Hollywood 90028. Exec. Office Tel. 469-2411. Sales Office Tel. (800) 421-4111. Dir. Joseph R. Carlton. Nat'l Sales Mgr. Bob Benkelman. Licensing & Contracts Mgr. Linda Chelgren. Educational Music Mgr. Ronnie Schiff.

Chappell Music Co., 6255 Sunset Blvd., Suite 1904 Zip 90028. Tel. 469-5141.

Home office: New York, N.Y.

Criterion Music Corp., 6124 Selma Ave. Hollywood 90028. Tel. 469-2296. Pres. & Gen. Mgr. Michael H. Goldsen. Sales Mgr.: Bo Goldsen.

Carl Fischer of Los Angeles Inc., 1101 S. Hope. Zip 90015. Tel. 749-5227. Gen. Mgr. Morty Baumgart.

Branches: Chicago, Ill., Boston, Mass., New York, N.Y.

Inspirational Music, PO Drawer 1, Northridge 91328. Tel. 987-2911. Pres. & Gen. Mgr. Hugh H. Edwards.

MCA Music (div. of MCA Inc.), Wilshire Doheny Plaza, East Tower, Suite 530, 9100 Wilshire Blvd., Beverly Hills 90212. Tel. 550-3913. VP. Warren Brown.

Home office: New York, N.Y.

Peer-Southern Org., 6922 Hollywood Blvd., Hollywood 90028. Tel. 469-1667. Branch Mgr. Roy Kohn.

Home office: New York, N.Y.

Morse M. Preeman Inc., 733 S. Spring St. Zip 90055. Tel. 623-7211. Pres. & Gen. Mgr. Harold L. Preeman. Ass't Gen. Mgr.: Terrence M. Stevens.

Warner Bros. Publ'ns Inc., 9200 Sunset Blvd. Zip 90069. Tel. 273-3323. Pres. Ed Silvers. VP. Mel Bly.

Sales office: 9255 Sunset Blvd., Suite 305. Zip 90069. Tel. 274-7564. Gen. Mgr.: James Cornelius. Sales Mgr.: Ray Kennedy.

Branch: New York, N.Y.

Western Int'l Music Inc., 2859 Holt Ave. Zip 90034. Tel. 870-9381. Pres. William Schmidt.

• **OJAI (Area Code 805)**

Creative Concepts Publ'g Corp., 967 E. Ojai Ave. Zip 93023. Tel. 646-4811. Pres. John L. Haag.

• **SAN FRANCISCO & BAY AREA (Area Code 415)**

Byron Hoyt Sheet Music Serv., 190 Tenth St. Zip 94103. Tel. 431-8055.

Pacific Coast Music Inc., PO Box 42069, 141 Kearny Zip: 94108. Tel. 986-2385. Gen. Mgr. Stan Halverson.

Affiliate: Miami, Fla., Hansen Publ'ns.

COLORADO

• **DENVER (Area Code 303)**

Patka Music Publ'ns, 3425 W. 38 Ave. Zip 80211. Tel. 433-3910.

CONNECTICUT

• **GREENWICH (Area Code 203)**

Cherry Lane Music Co. Inc., PO Box 4247. Zip 06830. Tel. 661-0707. NYC (212) 824-7711. Pres. Murray Frank. VP's: Lauren Keiser, Lorain Levy.

FLORIDA

• **FORT LAUDERDALE (Area Code 305)**

Jim Beck Music Serv. Inc., 1300 W. McNab Rd. Zip 33309. Tel. 971-7910.

Controlled Sheet Music Serv. Inc., 2990 NW 46 Ave. Zip 33313. Tel. 735-7777. Gen. Mgr. Sol Ravitz.

Home office: Copague, N.Y.

Plymouth Music Co. Inc., 170 NE 33 St. Zip 33334. Tel. 563-1844. Gen. Mgr.: Bernard Fisher.

• **MIAMI METROPOLITAN AREA (Area Code 305)**

Columbia Pictures Publ'ns, PO Box 4340, 16333 NW 54 Ave., Hialeah 33014. Tel. 620-1500. VP. Frank J. Hackinson. Sales Mgr.: Newton Sims. (SEE ADVERTISEMENT)

Hansen Publ'ns, 1842 West Ave., Miami Beach 33139. Tel. 532-5461.

Branch: New York, N.Y., Charles Hansen Educational Music & Books.

Affiliates: San Francisco, Calif., Pacific Coast Music Inc.; Peoria, Ill., St. Louis-Peoria Music Co.; Seattle, Wash., Capitol Music Co. Inc.

Mogull's Music Serv., PO Box 402457, Miami Beach 33140. Tel. 865-5638/5640. Owner: Maxwell Mogull.

Peer Int'l Org., Northeast Airlines Bldg., Rm. 1409, 150 SE Second Ave. Zip 33131. Tel. 358-1488.

Home office: New York, N.Y.

T & M Music Dists., PO Box 611684, Zip 33161, 1977 NE 148 St., North Miami 33181. Tel. 949-1109. Pres. Michael Uruski. Sales Mgr. Ron Alberts.

Together Dist'g Co., 450 North Park Rd., Hollywood 33021. Tel. 624-1434.

Home office: Norcross (Atlantic Metropolitan Area), Ga.

• **TAMPA (Area Code 813)**

J. W. Pepper of Florida, 5201 Harney Rd. Zip 33610. Tel. 621-3444. Gen. Mgr. Melvyn Schlegel.

Home office: Valley Forge, Pa.

GEORGIA

• **ATLANTA (Area Code 404)**

Georgia Music Supply Inc., PO Box 490331. Zip 30349. Tel. 996-3385. Pres.: Richard F. DeCourcy. Gen. Mgr. Linda Galgano.

J. W. Pepper of Atlanta, 4273 Wendell Dr. SW. Zip 30336. Tel. 691-6500.

Home office: Valley Forge, Pa.

Together Dist'g Co., 6405 Atlantic Blvd., Norcross 30071. Tel. 449-7900.

Branch: Hollywood (Miami Metropolitan Area), Fla.

• **CLARKESVILLE (Area Code 404)**

Clarkesville Rec. Sales Co. Inc., PO Box 198, 608 N. Washington St. Zip 30523. Tel. 754-2152. Pres. Peter J. Rosetty. Gen. Mgr. James Stockton. Sales Mgr. & Buyer. Wanda Stockton.

IDAHO

• **IDAHO FALLS (Area Code 208)**

Chesbro Music Co., Box 2009, 327 Broadway. Zip 83401. Tel. 522-8691. Pres. Joan Chesbro Griggs. Mktg. Mgr. A. Gary Bennett. Sales Mgr. Doug Goates.

ILLINOIS

• **CHICAGO METROPOLITAN AREA (Area Code 312)**

Carl Fischer of Chicago Inc., 312 S. Wabash Ave. Zip 60604. Tel. 427-6652. Gen. Mgr. Stephen H. Mariati.

Branches: Los Angeles, Calif.; Boston, Mass.; New York, N.Y.

Harris-Teller Inc., 7400 S. Mason. Zip 60627. Tel. 496-3100.

Lyon & Healy Inc., 243 S. Wabash Ave. Zip 60604. Tel. 922-7900.

Martin & Morris, 4312 S. Indiana. Zip 60653. Tel. 268-6676.

Vitak-Elsnic Co., 6400A S. Woodward Ave., Downers Grove 60515. Tel. 963-0200. Pres. Lawrence G. Musielak.

• **PEORIA (Area Code 309)**

St. Louis-Peoria Music Co., 222 SW Adams St. Zip 61602. Tel. 674-3753.

Affiliate: Miami, Fla., Hansen Publ'ns.

• **ROCKFORD (Area Code 815)**

Festival of Song Music Co., 1519 Windsor Rd. Zip 61111. Tel. 654-1260.

INDIANA

• **ALEXANDRIA (Area Code 317)**

Alexandria House Inc., PO Box 300, S. R. 9 S. Zip 46001. Tel. 724-4438. Pres. William J. Gaither. Gen. Mgr. Robert G. Huff. Sales Mgr. Phil M. Fair.

• **LEBANON (Area Code 317)**

Studio P/R Inc., 224 S. Lebanon St. Zip 46052. Tel. 482-4440. Pres. James G. Houston. Exec. VP & Sales Mgr.: John F. Welch.

"Making Music For Music Makers"



Columbia Pictures Publications
 A Division of Columbia Pictures Industries, Inc.
 PO Box 4340
 16333 NW 54th Avenue Hialeah, Florida 33014
 Frank J. Hackinson Vice President
Toll Free (800) 327-7643

- ★ The Most Comprehensive Catalog Available In The Music Industry!
- ★ Top Chart Personalities & Movie Themes!
- ★ Widest Variety Of Mixed Folios!
- ★ Extensive Sheet Music Selections!
- ★ Best Arrangers!
- ★ Educational Programs!
- ★ Keyboard Racking Program!
- ★ New Book Club Program!
- ★ Best Discount Policy!
- ★ Worldwide Sales & Shipping!
- ★ Convenient Toll Free Number!
- ★ Exclusive Distribution of Almo Publications!

KENTUCKY

• FLORENCE (Area Code 606)

Willis Music Co., 7380 Industrial Rd. Zip: 41042. Tel: 283-2050. Pres.: E.R. Cranley.

LOUISIANA

• ALEXANDRIA (Area Code 318)

Gospel Dist. Inc., PO Box 1706, 1212 Main St. Zip: 71301. Tel: 443-2549. Pres., Gen. & Sales Mgr.: J.D. Davis.

MARYLAND

• BALTIMORE (Area Code 301)

Marshall/Mangold Dist'g Co. Inc., 4805 Nelson Ave. Zip: 21215. Tel: 542-7214. Pres.: Manny Goldberg; Gen. Mgr.: Francis Youngblood; Sales Mgr.: William E. Rich.

• COLUMBIA (Area Code 301)

Largo Music Corp., 9195 Red Branch Rd. Zip: 21045. Tel: 792-7330. Pres.: Lawrence M. Goldberg; Gen. Mgr.: Ray Creighton; Opns. Mgr.: Lou Rice; Buyer: Andrea Rahn.
Branch: Garden Grove, Calif.

• ROCKVILLE (Area Code 301)

Harris Music Co., 12260 Wilkins Ave. Zip: 20852. Tel: 770-1950. Owner: Marshall I. Harris.

MASSACHUSETTS

• BOSTON METROPOLITAN AREA (Area Code 617)

Boston Music Co. (a div. of Williamson Music Inc.), 116 Boylston St., Zip: 02116. Tel: 426-5100. Gen. Mgr.: Warren W. Morris. Local branch: Boston Music Co. at Berklee, 146 Massachusetts Ave. Zip: 02215. Tel: 426-5100 x 46. Sales Mgr.: Charles A. Constantine.

Carl Fischer of Boston Inc., 156 Boylston St. Zip: 02116. Tel: 426-0740. Gen. Mgr.: Warren Patterson.
Branches: Los Angeles, Calif.; Chicago, Ill.; New York, N.Y.

Albert Najarian Whse. Music Inc., 295 Huntington Ave. Zip: 02115. Tel: 536-5007. Pres. & Sales Mgr.: Albert Najarian.

MICHIGAN

• BIRMINGHAM (Area Code 313)

Thomas Music Supply Co., 850 S. Woodward Ave. Zip: 48011. Tel: 642-1940.

• DETROIT METROPOLITAN AREA (Area Code 313)

J. W. Pepper of Detroit, Robbins Dr., Troy 48084. Tel: 588-1000.
Home office: Valley Forge, Pa.

MINNESOTA

• MINNEAPOLIS-ST. PAUL AREA (Area Code 612)

Grason—Tel: 336-0725—see World Wide Publ'ns. World Wide Publ'ns, 1303 Hennepin Ave., Minneapolis 55403. Tel: 336-0940.

• WINONA (Area Code 507)

Hal Leonard Publ'g Corp., 960 E. Mark St. Zip: 55987. Tel: 454-2920.

MISSOURI

• SPRINGFIELD (Area Code 417)

Gospel Publ'g House, 1445 Boonville Ave. Zip: 65802. Tel: 862-2781.

NEW JERSEY

• CHERRY HILL (Area Code 609)

Charles Dumont & Son Inc., PO Box 2810, 22 Springdale Rd. Zip: 08034. Tel: 424-5813. WATS: (800) 257-8283. Pres.: Charles J. Dumont; Gen. Mgr.: Charles Dumont; Sales Mgr.: George Biello Jr.

• FAIRFIELD (Area Code 201)

Publisher Sales Inc., 16 Passaic Ave. Zip: 07006. Tel: 575-1804. WATS Tel: (800) 631-1044. Pres.: Leo Artilles; Gen. Mgr.: Tom Massarella; Sales Mgr.: Dick Duffy.

• FAIRLAWN (Area Code 201)

Chain Dist. Inc., 576 Rt. 17. Zip: 07410. Tel: 652-5080. Gen. Mgr.: Morris Bronen.
Home office: Bronx (New York Metropolitan Area), N.Y.

Billboard 1979-1980 International Buyer's Guide

NEW YORK

• COPIAGUE (Area Code 516)

Controlled Sheet Music Serv. Inc., 112 Hudson St. Zip: 11726. Tel: 842-8080. Pres.: Ronald Ravitz; Gen. & Sales Mgr.: Linda Press.
Branch: Fort Lauderdale, Fla.
Music of the Month, see Controlled Sheet Music.

• MELVILLE (Area Code 516)

Belwin-Mills Publ'g Corp., 25 Deshon Dr. Zip: 11746. Tel: 293-3400. Pres.: Martin Winkler.

• NEW YORK METROPOLITAN AREA (Area Code 212)

April/Blackwood Publ'ns, 1350 Ave. of the Americas, 23rd fl. Zip: 10019. Tel: 975-7045. Dir.: Al Kugler; Admin. Ass't: Patricia Sweeting. (Distributed by Bradley Publ'ns)

Big 3 Music Corp., 729 Seventh Ave. Zip: 10019. Tel: 575-2978.

Bradley Publications (div. of RBR Communications Inc.), 43 W. 61 St. Zip: 10023. Tel: 757-8805. Pres. Richard Bradley; VP & Gen. Mgr.: Bill Radics; Sales Dir.: Vincent Martino. (SEE ADVERTISEMENT)

Chain Dist. Inc., 476 E. Fordham Rd., Bronx 10458. Tel: 298-3350. Pres.: Morris Bronen; Gen. Mgr.: Sid Bronen.

Branch: Fairlawn, N.J.
Chappell Music Co., 810 Seventh Ave. Zip: 10019. Tel: 399-7373.

Branches: Los Angeles, Calif.; Nashville, Tenn.
Cherry Lane Music Co. Inc., see listing under Greenwich, Conn.

Pietro Deiro Music Headquarters, 133 Seventh Ave. S. Zip: 10014. Tel: 243-2090. Pres.: Pietro Deiro; Gen. Mgr.: Bruno Borghesan.

Carl Fischer Inc., 56-62 Cooper Sq. Zip: 10003. Tel: 777-0900. Pres.: Walter F. Connor; Gen. Mgr.: William Heese; Sales Mgr.: Dean Pappas.

Branches: Los Angeles, Calif.; Chicago, Ill.; Boston, Mass.

Doris Fisher Music Corp., 1619 Broadway. Zip: 10019. Tel: 586-1545.

Charles Hansen Educational Sheet Music & Books Inc., 1860 Broadway. Zip: 10023. Tel: 246-4175. WATS: (800) 223-9882. Pres.: Ed Griffin; Gen. Mgr.: Ramon Duran; Promo Dir.: Richard Sutter; Ass't Promo Dir.: Daniel G. Wiest.

Home office: Miami, Fla., Hansen Publ'ns.
Lee/Art Graphics Inc., 157 Chambers St. Zip: 10007. Tel: 267-4140. Pres.: Lucie Koppelman; Gen. Mgr.: Charles Koppelman.

MCA Music (div. of MCA Inc.), 445 Park Ave. Zip: 10022. Tel: 759-7500.

Branches: Beverly Hills (Los Angeles Metropolitan Area), Calif.; Nashville, Tenn.

Edward B. Marks Music Corp., 1790 Broadway. Zip: 10019. Tel: 247-7277. Cable: MARKBRO. Telex: 620960. Pres.: Joseph Auslander; VP & Publ'ns Dir.: Bernard Kalban; VP & Prof. Mgr.: Barry Bergman.

Edwin H. Morris & Co. Inc. (div. of MPL Communications Inc.), 39 W. 54 St. Zip: 10019. Tel: 581-1330.

Music Sales Corp., 33 W. 60 St. Zip: 10023. Tel: 246-0325. Pres.: Herbert Wise; Sales Mgr.: Joseph Lyons.
Int'l branches: Australia, Music Sales Australia Pty. Ltd.; England, Music Sales Ltd.; Germany, Music Sales GmbH; Japan, Music Sales Corp.

Peer Southern Org., 1740 Broadway. Zip: 10019. Tel: 265-3910. Pres.: Monique I. Peer; VP: Ralph Peer II.
Branches: Hollywood (Los Angeles Metropolitan Area), Calif.; Miami, Fla.; Nashville, Tenn.

Rashid Sales Co., 191 Atlantic Ave., Brooklyn 11201. Tel: 852-3295/3298. Pres.: Albert Rashid; Gen. Mgr.: Stanley Rashid; Sales Mgr.: Raymond Rashid.

R. L. Silver Assoc. Inc., 527 Madison Ave. Zip: 10022. Tel: 752-3180. Contacts: Roxanne Panero; Stevie Russell.

Tempo Music Inc., 750 Park Ave. Zip: 10021. Tel: 249-7500.

Terminal Musical Supply Inc., 166 W. 48 St. Zip: 10036. Tel: 245-5270. Pres.: Arthur Nitka; Gen. Mgr.: George Rizzo.

Warner Bros. Publ'ns Inc., 75 Rockefeller Plaza, 14th fl. Zip: 10019. Tel: 484-6219. Pres.: Ed Silvers; Gen. Mgr.: Murray Rutkoff; Sales Mgr.: Steve Spooner.

Home office: Los Angeles, Calif.

• WEST BABYLON (Area Code 516)

Mark Music Serv. Ltd., 95 Eads St. Zip: 11704. Tel: 420-8310. Pres.: Harold Goydel; Gen. Mgr.: David Weiss; Sales Mgr.: Harris Kozak.

NORTH CAROLINA

• CHARLOTTE (Area Code 704)

Brodt Music Co., PO Box 1207. Zip: 28231. 1409 E. Independence Blvd. Zip: 28205. Tel: 332-2177.

OHIO

• CINCINNATI (Area Code 513)

Davitt & Hanser Music, 415 Greenwell Ave. Tel: 45238. Tel: 451-5000.
Hainat Publ'g Co., PO Box 37156. Zip: 45222. Tel: 793-6075. Pres.: Saul Halper; Gen. Mgr.: Steven D. Halper.

• CLEVELAND METROPOLITAN AREA (Area Code 216)

Grossman Music Corp., 1278 W. Ninth St. Zip: 44113. Tel: 696-1234. Cable: GROMUSIC. Pres.: Henry S. Gross-

man; Gen. Mgr.: Stanley Dantimo; Sales Mgr.: Joseph H. Berger.

• COLUMBUS (Area Code 614)

Stanton Sheet Music, 100 E. Main St. Zip: 43215. Tel: 224-4257.

PENNSYLVANIA

• PITTSBURGH (Area Code 412)

Volkwein Bros. Inc., 117 Sandusky St. Zip: 15212. Tel: 322-5100. Pres.: Carl W. Volkwein; Gen. & Sales Mgr.: Walter E. Volkwein.

• VALLEY FORGE (Area Code 215)

J. W. Pepper & Son Inc., Box 850, Eisenhower Rd. Zip: 19482. Tel: 666-9600.
Branches: Tampa, Fla.; Atlanta, Ga.; Detroit, Mich.

RHODE ISLAND

• PROVIDENCE (Area Code 401)

Axelrod Music Inc., 251 Weybosset St. Zip: 02903. Tel: 421-4833.

TENNESSEE

• CLEVELAND (Area Code 615)

Pathway Press, 1080 Montgomery Ave. Zip: 37311. Tel: 476-5197.

• MEMPHIS (Area Code 901)

Blackwood Bros., 209 N. Lauderdale. Zip: 38105. Tel: 527-4349. Pres.: James Blackwood; Gen. & Sales Mgr.: Carolyn Pearson.

• NASHVILLE (Area Code 615)

Acuff-Rose Sales Inc., 2510 Franklin Rd. Zip: 37204. Tel: 385-3031. Pres.: Wesley H. Rose; Sheet Music Sales Mgr.: John R. Brown.

The Benson Co., 365 Great Circle Rd. Zip: 37228. Tel: 259-9111. Pres.: Bob Benson Sr.; Sr. VP, Mktg.: Ed Messick.

Chappell Music Co., 21 Music Circle E. Zip: 37203. Tel: 244-3382. Mgr.: Henry Hurt.
Home office: New York, N.Y.

MCA Music (div. of MCA Inc.), 1106 17 Ave. S. Zip: 37212. Tel: 242-3551. Dir.: Jerry Crutchfield.
Home office: New York, N.Y.

Peer-Southern Org., 7 Music Circle N. Zip: 37203. Tel: 244-6200. Professional Assoc.: Deborah Cobb.
Home office: New York, N.Y.

TEXAS

• FORT WORTH (Area Code 817)

Don Edgar Music, 2312 Jasper. Zip: 76106. Tel: 626-3448. Owner & Gen. Mgr.: D.D. Edgar.

• SAN ANTONIO (Area Code 512)

Southern Music Co., 1100 Broadway. Zip: 78215. Tel: 226-8167. Pres. & Gen. Mgr.: Arthur Gurwitz.

WASHINGTON

• SEATTLE (Area Code 206)

Capitol Music Co. Inc., PO Box 21906, 1530 Third Ave. Zip: 98111. Tel: 622-4013. Gen. Mgr.: Paul C. Leaf.
Affiliate: Miami, Fla., Hansen Publ'ns.

WISCONSIN

• MILWAUKEE (Area Code 414)

Hal Leonard Publ'g Corp., 8112 W. Bluemound Rd. Zip: 53213. Tel: 774-3630. Telex: 2-6668. Exec. VP & Gen. Mgr.: Keith Mardak.

Q: How do you contact Charlie Rich Enterprises?

A: Make contact with the "Personal Managers" section of CMS: Billboard's Country Music Sourcebook. The business source for the country business.

The wholesale function(s) of all companies is set in bold face and parenthesis after each listing. The following abbreviations identify these functions: (D) Distributor; (OS) One Stop; (RJ) Rack Jobber; (I) Importer; (E) Exporter. The identification of a branch or home office is indicated only when it differs from that of the listing.

ALABAMA

● ATTALLA (Area Code 205)

Reliable Rec. & Tape Co., Box 6, Rt. 3, Zip 35954. Tel. 538-6043. Owner & Buyer: C.R. O'Neal (Rec. & Tape RJ).

● BIRMINGHAM AREA (Area Code 205)

Music Center Dist. Inc., 1400 Second Ave. N. Zip 35203. Tel. 251-8252. Owner: Virgil C. Lugar Sr.; Mgr. & Buyer: John G. Lugar (Rec. & Tape OS).
Trackdown Rec. Dist., 544 Bessamer Hwy., Midfield 35228 (Rec. D, OS, RJ, I & E).
Home office: Chicago, Ill. (See for prod. distributed)

● BREWTON (Area Code 205)

Known Artist Dist., PO Box 1304, Zip 36426. Tel. 867-2228. Owner: Bobbie Roberson, Mgr., Singles & Albums Buyer: Roy Edwards (Rec. RJ & E).
Branch: New York, N.Y.

● SELMA (Area Code 205)

Trackdown Rec. Dist., 7 Broadway, Zip 36701 (Rec. & Tape D, OS, RJ, I & E).
Home office: Chicago, Ill. (See for prod. distributed)

ARIZONA

● PHOENIX (Area Code 602)

All Label West Inc., 3304 N. 27 Ave. Zip 85017. Tel. 258-1542. Pres.: Cary Budin, VP Mktg.: Jim Robinett, VP &

Gen. Mgr.: Bill Glaseman, Buyer: Cubby Falls (Rec. & Tape RJ).
Accessories: Memorex.

Alta Dist'g Co. (div. of Aldisco Corp.), Southwest Div., 2950 W. Catalina Dr. Zip 85017. Tel. 269-1411. Gen. & RJ Mgr.: Lee Weimar, D Mgr.: Fred Rivers, Buyers: D Rec. & Tape, Fred Rivers, RJ Singles, Jim Brunner, RJ Albums, Dwayne Witten, RJ Tape, Ken Kayes (Rec. & Tape D & RJ), (Rec. & Tape OS as Alta One Stop).

Rec. labels: APA, Abkco, Alston, Ameraba, Archives of Jazz, Argo, BMA, Barnaby, Birthright, Bold, CMH, Casino, Cat, Chimneyville, Chrysalis, Clouds, Conversa-Phone, Cyclone, Dash, Deram, Dore, Drive, Fiesta, 4 Star, GNP, Crescendo, GRT, Gateway, Gusto, Hi, IRDA, Janus, Jeremiah, Juana, Kayvette, Laff, Laurie, Little Eskimo, Living Language, L'Orseau Lyre, London, Malaco, Marlin, Mushroom, Nationwide Sound, Original Sound, Pacific Arts, Parrot, Phase 4, Plantation, Pyramid, Ranwood, Republic, Richmond, Roulette, SSS Int'l, Sesame Street, Shadybrook, Sound Bird, Starday, Stereo Treasury, Sun, Syntonic Research, TK, TMS, Talisman, Telefunken, Threshold, Thunderbird, Tiger Lily, UK, Virgo, WIG, Weird World, West End, Wicked, Wolf.

Tape lines: Abkco, Alston, Ameraba, Argo, BMA, Barnaby, CMH, Cat, Chrysalis, Clouds, Conversa-Phone, Dash, Deram, Drive, GNP, Crescendo, GRT, Glades, Gusto, Hi, Janus, Jeremiah, Juana, Kayvette, Laff, Little Eskimo, Living Language, London, Malaco, Marlin, Mushroom, Original Sound, Pacific Arts, Parrot, Phase 4, Republic, Roulette, Shadybrook, Sound Bird, Starday, Stereo Treasury, TK, Telefunken, Threshold, Thunderbird, Tiger Lily, UK, West End.

Accessories: Audio Magnetics, BASF, Dynasound, Fidelitone, Le-Bo, Maxell, Memorex, Savoy, Scotch, Sound Guard, TDK, Tracs, Watts.

Alta One Stop (Rec. & Tape OS)—Mgr.: Fred Rivers, Buyers: Singles, Jim Brunner, Albums, Dwayne Witten, Tape, Ken Kayes—see Alta Dist'g Co.
Associated Dist. Inc., 3803 N. 36 Ave. Zip 85019. Tel. 278-5584. Principal: Leonard M. Singer, Sales Mgr.: Gus Figueroa, OS Mgr.: Angela C. Singer, Buyers: D & OS Singles, Sandy Powers; D Albums & Tape, Leonard

Singer, OS Albums & Tape, Frances Adams, Lori Turner, Dennis Byron (Rec. & Tape D & OS).

Labels: APA, AVI, Abattor, Abet, Alexander Street, Aligator, Alston, Amazon, Arista, Arth, Artist House, At Home, Audio Fidelity, Audio Rarities, Bach Guild, Barnaby, Blind Pig, Blue Candle, Buddah, CP, CTI, Cardinal, Cat, Channel, Cherry, Chiaroscuro, Chimneyville, Churchill, Clouds, Con Brio, Contempo, Cream, Creed, Dana, Dash, Delmark, Demand, Dharma, Dial, Drive, Entr' Acte, Ernie's, Everyman, Excello, Fantasy, Fiesta, Firecracker, First American, First Generation, Flying Fish, Folkways, Fona, GRP, GRR, Galaxy, Glades, Good Sounds, Gordy, Gospel Roots, Gospel Truth, Great Northwest, Hi, Hob, ICA, Image, Improv, JDC, Janus, Jewel, Joliet, Juana, Kaleidoscope, Karate, Kayvette, Kenwood, Kicking Mule, Klavier, Koko, Konkudo, Kudu, LA, LRC, LRJ, Magnum, Malaco, Mankind, Marlin, Midsong, Milestone, Monitor, Motown, Muse, Nashboro, Natural Resources, Nessa, Novus, Original Sound, Ortega, Ovation, Pacific Arts, Passport, Paula, Phasion, Philo, Potato, Prelude, Prestige, Prism, Prodigal, Rare Earth, Rebel, Red Gregg, Request, Rhino, Ridge Runner, Ronn, Roots, Rounder, SMI, Salvation, Savoy, Scorpion, Shadybrook, Shield, Silverblue, Soul, Stax, Stiff, Stone Dog, Sunshine Sound, Syntonic Research, TK, Talisman, Tama, Taxi, Thimble, Tomato, Vanguard, Venture, Visa, Wanderick, Waterhouse, Weird World, Wolf, Xanadu.

Accessories: Blank tape (BASF), Le-Bo prods.

Pickwick Int'l Inc., Rack Servs. Div., 3422 W. Whitton Ave. Zip 85017. Tel. 272-9343. Opns. Mgr.: Mike Frank; Sales Mgr.: Tom Catchings, Buyer: Bob Fenty (Rec. & Tape RJ).

Home office: Minneapolis, Minn.

Smash Rec. Dist., 2911 W. Fairmount, Zip 85017. Tel. 264-5659. Owners: Jackie & Clarence Elgas, Gen. Mgr. & Singles Buyer: Jackie Elgas (Rec. OS).

Trackdown Rec. Dist., 5802 S. 12 Way, Zip 85040 (Rec. D, OS, RJ, I & E).

Home office: Chicago, Ill. (See for prod. distributed)

● TUCSON (Area Code 602)

Cash Sales Co., 203 E. Congress St. Zip 85701. Tel. 623-1907. Mgr.: Sam Canterman (Rec. D).

Distributes close outs, job lots, overstocks.

Disk Rec. Jobbers, 8111 E. Broadway, Suite 467, Zip 85710. Owner & Mgr.: S.L. Simon (Rec. OS & RJ, also Rec. OS & RJ as Empire Inds.).

Empire Inds. (Rec. OS & RJ), see Disk Rec. Jobbers.

ARKANSAS

● LITTLE ROCK (Area Code 501)

Blaze Recs. & Tapes Ltd., PO Box 1899, 1513 Chester St. Zip 72202. Tel. 375-2911. Owner & Mgr.: James E. Handy II, Buyers: Singles, Gregory Handy, Albums & Tape, James E. Handy II (Rec. & Tape OS & E).

Discount Recs. Inc., 3400 S. University, Zip 72204. Tel. 565-0304. Owner: Jack Garner, Mgr. & Buyer: Jim Ledbetter (Rec. & Tape OS & RJ), (also Rec. & Tape OS as Soul City Recs.).

Sieberts (sub. of Handleman Co.), 6301 Forbing Rd. Zip 72209. Tel. 562-8800. Mgr.: David Siebert, Buyers: Singles, Ben Briley, Albums & Tape, John A. Thomas (Rec. & Tape RJ).

Accessories: Ampex, Data Display, Le-Bo, Memorex, Savoy, Scotch.

Soul City Recs. (Rec. & Tape OS)—Mgr.: Tom Ed Hockersmith. Tel. 371-0464—see Discount Recs. Inc.

● WEST MEMPHIS (Area Code 501)

Boss Ugly Bob Recs. & Tapes, 2314 E. Broadway St. Zip 72301. Tel. 735-6420. Mgr.: Georgia Troupp (Rec. & Tape OS).

Home office: Memphis, Tenn.

CALIFORNIA

● BUENA PARK (Area Code 714)

Brown Rec. Dist. Inc., 7342 Melrose St. Zip 90621. Tel. 522-8351. Owner: Tom Lovell, Pres.: Dave Mingus, Mgr.: John Olson, Buyers: Singles, Craig Doucette, Albums & Tape, Andy Tenzer (Rec. & Tape OS).
Accessories: Audio Technica, Le-Bo, Maxell, Memorex, Planstiehl, Scotch, Sound Guard, TDK, Watts.

● COSTA MESA (Area Code 714)

Living Water Prod'ns, 4901 Morena Blvd., No. 308. Zip 92117. Tel. 273-0460 (Rec. & Tape D & E).
Labels: Birdwing, Good News, Light, Maranatha,

Many Services For The

One Stops — Operators Rack Jobbers — Retail Record Stores

- Juke Box Title Strips, Printed and Blank
- Colored Acetates (Used As Program Indicators)
- Self-Adhesive Price Labels
- Self-Adhesive Artist/Category/Header Strips
(SAVE MONEY! Use This Item On Your Old LP Divider Boards)
- Hot Stamped and Blank White Plastic (.040 Gauge)
LP And 45 RPM Divider Boards
- Printed And Blank 4-Ply Yellow Bin Divider Boards For 45 RPM Records

Tailor Made For Your Needs — Send For Brochure

STAR TITLE STRIP CO., INC.

842 Western Avenue, Pittsburgh, PA 15233
Area Code 412 231-4314

RECORD MERCHANDISING, INC.

THE LARGEST, MOST AGGRESSIVE,
DISTRIBUTOR
ON THE WEST COAST

3101 Exposition Place
Los Angeles, CA 90018
(213) 290-1122

70 Dorman St.
San Francisco, Ca. 94124
(415) 285-0959

Myrrh, New Song, New World, Rainbow, Sparrow, Spirit, Star Song, World.

● **GARDEN GROVE (Area Code 714)**

Abbey Road Rec Dists., 11642 Magnolia St Zip 92641 Tel 539-2375 Owner Martin Lancaster, OS Mgr Bruce Ogilvie, RJ Mgr Doc Bowin, Buyer Arthur Berchan (Rec. & Tape OS & RJ)
Largo Music Corp., 7421 Anaconda Ave. Zip 92641 Tel 898-0507 Mgr Jack Griffith, Buyer Michael Scharwath (Rec. & Tape OS & RJ)
Home office: Columbia (Baltimore Metropolitan Area), Md.

● **HEALDSBURG (Area Code 707)**

Luna Recs Dist., 434 Center St Zip 95448 Tel 433-4138 Owner, Mgr. & Buyer Abel de Luna (Rec. & Tape OS, RJ, I & E)
Branch: San Jose, Calif

● **LOS ANGELES METROPOLITAN AREA (Area Code 213)**

A I A Inc., 349 S. Lafayette Park Pl., Suite 129 Zip 90057 Tel 383-2165 Pres Kumar Ruttan (Rec. & Tape E)
A R V Rec. Sales, see House of Falcon

Aldisc Int'l (Rec. & Tape E), see Record Sales Co. Inc
Alternative Music Dists. Inc., 2702 San Fernando Rd Zip 90065 Tel 227-4141 Cable AMD/BOMP Pres Greg Shaw; Treas. Phil Lubman, Gen. Mgr. Meryl Houser, Sales Mgr. & Buyer Bo Clifford, Ass't Sales Mgr. Rich Schmidt (Rec. D, OS, I & E)
Labels: BFD, BOMP, Blind Pig, Bomb, Brain, Dangerhouse, Missing Link, RFD, Rollin' Rock, Rough Trade, Siren, Spoonfed, Vox, What (SEE ADVERTISEMENT)

Ameria-Mex Dist'g Co., 2534 W Pico Blvd Zip 90006 Tel: 487-4100. Owner Leonard Silver, Mexican Albums & Tape Buyer Elliot Mellman (Rec. & Tape RJ)

American Music Mktg., 2952 W Pico Blvd Zip 90006 Tel 734-1996. Pres. & Buyer Chet Coplen, Sales Joe D'Amore (Rec. & Tape D & E)
Distributes budget lines, cut-outs. (SEE ADVERTISEMENT)

Amex Recs Inc., 267 N Lake Ave., Pasadena 91101, Tel 681-0271 Pres Horacio Von Sydow, Mgr Guillermo Von Sydow (Rec. & Tape RJ)

Amigo Recs. Dist., 2858 W Pico Blvd Zip 90006 Tel 735-1358 Owner & Mgr. Edmund Perez, Buyer Esther Plascencia (Rec. & Tape D)

Rec. labels: ARV, Alhambra, Arcano, Audio Latino, Auditorama, Billo, CR, Caliente, Cara, Carino-Caytronics, Coco, Cronos, Dicesa, Discolando, E&G, Falcon, Fama, Gala, Gas, Gema, Graffiti, Jaguar, Melody, Microfon, Musart, Nova Vox, Orfeon, Peerless, Pronto, Raff, Ramex, Salsoul, Seeco, TR, TH, Tikal, Velver, WS Latino, Zafiro, Zeida.
Tape lines: Same as rec. labels.

Bob Andrews Recs., PO Box 7000-115, Redondo Beach 90277 Tel 378-9674 Owner & Albums Buyer Bob Andrews (Rec. D)
Labels: Interplay, Jazz Chronicles, Nortac, Seabreeze, Straight-Ahead.

Armo Exporting Co., 1212 S Albany St Zip 90015 Tel 746-6973 Pres Moe Arbeitel (Rec. E)

Baly Rec & Tape Dists., 2525 W Pico Blvd, Zip 90006 Tel 487-2155, Owner, Mgr & Buyer Isaac Baly (Rec. D, OS, RJ & I; Tape D & OS—Latin & Spanish prod only)

Labels: Arcano, Arriba, Audiomex, Caytronics, Discolando, Fama, Fania, Gala, Melody, Mericana, Musart, Musimex, Nova Vox, Orfeon, Peerless, Pronto, Ramex, Rio Bravo, Romex, Sonart, Soundmex, Viza

Berklay Air Servs., PO Box 91156 World Way, Zip 90009 Tel 674-6690 (Rec. & Tape E)
Home office: Jamaica (New York Metropolitan Area), N.Y. (SEE ADVERTISEMENT)

Black & White Sales Inc., 9957 Canoga Ave., Chatsworth 91311 Tel 998-2503 VP Sales Bud Borkovec, Gen Mgr Tony Donato. (Rec. & Tape D—cut-outs, overstocks)

CBS Recs., 17337 Ventura Blvd., Encino 91316 Tel 995-1234 VP Western Region Del Costello Reg'l Co-ord Mickey Schwelgien; Branch Mgr Dennis Hannon. (Rec. & Tape D)

Rec. labels: Arc, Bang, Blue Sky, CBS, Caribou, Columbia, Epic, Jet, Kirshner, Melodiya/Columbia, Nempeor, Odyssey, Philadelphia Int'l, Portrait, Starflite, Stuff, T-Neck, Tabu, Tappan Zee, Unlimited Gold
Tape lines: Same as rec. labels

California Music Co., 2933 W Pico Blvd Zip 90006, Tel 733-1181 Pres Sam Ricklin, VP & Gen. Mgr Ronald E. Ricklin, Buyers Albums Nash Lazalde, Singles & Tape, Ron Vermette (Rec. & Tape OS & E) (SEE ADVERTISEMENT)

California Rec Dists Inc., PO Box 4035, Glendale 91202, 1242 Los Angeles St., Glendale 91204 Tel 245-6464, 246-8228 Opns Mgr Harold Baloyan, Sales Mgr. Don Davis, Promo Mgr Ted Higashioka, Sales Tony Jacobs (Rec. D)
Branches: San Rafael (San Francisco & Bay Area), Calif., Seattle, Wash.

Labels: AECC, Abattoir, Accent, Adephi, Advent, Archcheck, Ajax, Alligator, Annuciata, Arcane, Archive of Folk & Jazz, Archive of Piano Music, Arhoolie, Aries, Artist House, Ascension, Ashtree, Audio Fidelity, Audio Rarities, Aviva, BBP, BIJA, Bach Guild, Bar T, Bay, Bean, Beehive, Beet, Big Band Int'l, Big Town, Biograph, Birthright, Biscuit City, Bix Lives, Blind Pig, Blue Angel, Blue Goose, Blue Heaven, Blue Labor, Blue Lantern, Blues Blood, Blues Classics, Bountiful, Broadway, Bull Frog, CIF, CIT, CMH, CRD, Caedmon, Candide, Cardinal, Center, Century, Chiaroscuro, Classical Excellence, Coby, Coco, Columbia Special Prods., Concert Disc, Concord, Contemporary, Cook, Corinthian, Counterpoint, County, Creative World, Creed, Criterion, Curtain Calls, DRG, Dawn Club, Delmark, Demand, Discus, Dixieland Jubilee, Dobre, Dooto, Dove, Dream Street, ENJA, East Coast, Ecker Works, Electric Lemon, Ernie,

Esca, Eubie Blake, Everest, Everyman, Fairmont, Fiddledoo, Fritte, First Heard, Flying Fish, Flying High, Folk Legacy, Folk Lyric, Folkways, Fremont, Fretless, Friends & Co., GNP Crescendo, Gala, Gale, Giants of Jazz, Glendale, Golden Age, Golden Era, Golden Legends, Golden Olden, Good Time Jazz, Graffiti, Greentree, HAM, HDS, HNH, HSS, Halcyon, Harlequin, Hawaii Calls, Herwin, Historical, History in Sound, IRDA, Image, Improvising Artists, India Navigation, Ivory World, JCOA, JRC, JTP, JVC, Jazz a la Carte, Jazz Archives, Jazz Connoisseur, Jazz Treasury, Joliet, Joyce, KBA, Kaleidoscope, Karate, Kenwood, Kicking Mule, King, King Bluegrass, Klavier, LS, Label Aire, Labor, Lariat, Legacy, Legends, Lemco, Longdivity, Long Neck, Los Angeles, Lyric, MF, Mainliner, Mango, Mankind, Mark 56, Melodeon, Metro-nome, Milagro, Monmouth Evergreen, Morning Glory, Morning Star, Morrhythm, Motherlode, Muse, Muskadine, NJP, NTSU, Nashboro, Natural Organ, Nessa, New Orleans Jazz, North Country, Nostalgia, Nostalgia Lane, Old Homestead, Old Timey, Olympic, Orion, Outrageous, Outstanding, PAUSA, PM, PMP, Palm, Passin Thru, Pearl, Period, Philo, Phoenix, Physical, Piedmont, Pine Tree, Pinnacle, Plantation, Polaris, Prism, Progressive Jazz, Puritan, RGB, RVL-RDC, Radio Archives, Radiola, Radio Rarities, Ram, Ramblin, Rainlight, Random, Rebel, Red Rooster, Republic, Request, Retrospect, Revelation, Ridge Runner, Roper, Rounder, Sackville, Saleco, Sandcastle, Sandy Hook, Scala, Semaphore, Shadow, Shamrock, Shiloh, Shoestring, Skyline, Sonet, Sounds, Sountrak, Spivey, Spokane, Standing Room Only, Stanyan, Star Bolt, Starday, Stash, Stet, Storyville, Sugar, Sugar Hill, Sun, Sunbeam, Survival, Syntonic Research, Tahiti, Take Two, Tandem, Taz-Jaz, Telarc, Testament, Thunderhead, Tomorrow, Toshiba, Total, Totem, Tradition, Transatlantic, Trident, Trux, Troubadour, Turnabout, Umbrella, Uncle Bear, Unicorn, Unique Jazz, Uptown Lowdown Jazz, United Nat'l, Valon, Vanguard, Vantage, Varese, Vetco, Vintage Jazz, Voss, Vox, Vox Box, Voyager, WASP, WATT, Waterhouse, Windham Hill, World Jazz, Yazoo, Zafiro, Zap, F/P/M group—Fantasy, Galaxy, Gospel Truth, Milestone, Prestige, Riverside, Stax (SEE ADVERTISEMENT)

Cat-Mex Int'l One Stop, 4819 E Whittier Blvd Zip 90022. Tel 261-6723 Owner, Mgr & Buyer John O'Valle, Tape Mgr Edward G Jaloma. (Rec. D, OS, I & E; Tape D & OS)

Rec. labels: ARV, Alhambra, Arcano, Badboys, Bego, CR, CRC, Caytronics, Cronos, Doubleshot, Eco, Falcon, Fama, Fania, Fuego, Gas, Head, Hi oldies, Latin Int'l, Mares, Marsal, Mericana Melody, Musart, Nasco, Nashboro, Orfeon, Paula, Peerless, Pronto, Raff, Ramex, Ronn, TH, TR, Whiz
Tape lines: ARV, Cronos, Falcon, Fama, Fuego, Gas, Latin Int'l, Musart, Orfeon, Peerless, Raff
Imports Mexican prod

Accessories: Blank tape (BASF, Sound-Pro), carrying cases (Le-Bo), 45 rpm adaptors (Pfanstiehl), head cleaners (Pfanstiehl), needles (Pfanstiehl), rec. care prods (Le-

**SURPLUS GOODS,
CUTOUTS
(LP's & TAPES)**

Importers & Exporters

**"We sell all the
HITS you missed."**

**and, we sell 'em
in box lots, on skids,
& trailer loads
(when available).**

**CALL OR WRITE FOR
CATALOG AND PRICE QUOTES.**

We also Rack Job surplus product.

**(Ask for Chet or Joe
for immediate service)**



AMERICAN MUSIC MARKETING

**2952 West Pico Blvd.
Los Angeles, Calif. 90006
(213) 734-1996**

**ONE
WORLD
GREENWORLD**

ROCK & JAZZ IMPORTS

from

**SCANDINAVIA • JAPAN • AUSTRALIA • IBERIA
BENELUX • EASTERN EUROPE et al...**

Catalog available upon request



**RECORDS
GREENWORLD**

23703 MADISON ST., TORRANCE, CALIFORNIA 90505 U.S.A.
TEL: 213 373-8947 TLX: 181892
WE ALSO EXPORT

**KESTER MARKETING
CUTOUT
SPECIALISTS**

ALBUMS 8 TRACKS
CASSETTES
ACCESSORIES



Ed Barsky—President

KESTER MARKETING
14614 Lanark St.
Panorama City, CA 91402

WATTS LINE CALIFORNIA
800 213
423-3164 781-5488

Bo, Pfantone, Watts), splicers (Le-Bo), splicing tape (Scotch), tape organizers (WeiMac), tape stackers (Le-Bo).
Canterbury Recs. Inc., 805 E. Colorado Blvd., Pasadena 91101. Tel. 681-4922. Gen. Mgr. Charles Gordon. Sec'y-Treas. Leonard Gordon. Buyers: Singles, Jessi Bruno, Ellen Madison. Albums, Charles Gordon. Tape, Jennifer Freedman. (Rec. & Tape OS, RJ & E)
Capitol Recs., 3117 San Fernando Rd. Zip 90065 Tel. 254-9111. 258-3275. (Rec. & Tape D)
Rec. labels: Angel, Ariola America, Capitol, EMI America, Harvest, Liberty, Melodiya/Angel, Seraphim, United Artists
Tape lines: Same as rec. labels
Cayre Inds. of California Inc., Bonnie Brae Bldg., Suite 205, 1830 W. Olympic Blvd. Zip 90006 Tel. 383-1386. Mgr. & Buyer: Joe Ramirez. (Rec. & Tape D)
Home office: New York, N.Y., Caytronics Corp. (Rec. & Tape D, OS, RJ, I & E). (See for prod. distributed)
Celebrity Concert Corp., 315 S. Beverly Dr., Beverly Hills 90212. Tel. 553-0111. Cable: CEBEBRIA Owners: Sidney Justin, Bernard Lubet. (Rec. & Tape I)
Imports all USSR product.
Chapman Dist'g Co. Inc., 1212 S. Albany St. Zip 90015. Tel. 749-9484. Owner: Al Chapman. Mgr., Singles & Albums Buyer: Herb Chapman. (Rec. & Tape D)
Rec. labels: Alshire, Alwin, Audio Arts, Birthright, Cabot, Camden, Canaan, Capitol, Children's Rec. Guild, Copeland, Columbia, Conversa-Phone, Creative Re-

sources, Creative Sound, Cricket, Crystal, Dictation Disc, Disneyland, Gateway, Globe, Glori, Good News, Heart Warming, Heritage Singers, Hilltop, Hob, Jim Swaggert, Lamb, Lamb & Lion, Light, Living Language, Malaco, Manna, Maranatha, Mister Rogers, Monitor, Motivation, Myrrh, Peter Pan, Pickwick, Project 3, QCA, Quintessence, RCA, Ranwood, Road Show, Sacred, Super-scope, TMS, Tempo, 3 Centuries of Music, Waikiki, Word, World, Young People's Recs.
Tape lines: Avant Garde, Cabot, Canaan, Capitol, Columbia, Conversa-Phone, Creative Sound, Heart Warming, Hilltop, Light, Living Language, Monitor, Myrrh, Pickwick, RCA, Sacred, Word (SEE ADVERTISEMENT)
City Hall Recs., 237 S. Tower Dr., Beverly Hills 90211. Tel. 655-5322. District Sales Mgr., Robert Marin. (Rec. D, I & E; Tape D)
Home office: San Francisco, Calif. (See for prod. distributed)
City 1 Stop, 1810 W. Venice Blvd. Zip 90006 Tel. 737-7759. Owner: Sam Billis. Mgr. Sol Zamek. Buyers: Supervisor, Todd Ramcke. Albums: David Hoeltje. Tape, Gary Strong. (Rec. & Tape OS & E) (SEE ADVERTISEMENT)
Frank Cooke Ents., 8052 Vineland Ave., Sun Valley 91352. Tel. 767-3205. Owners: Frank & Tony Cooke. (Rec. & Tape D)
Rec. labels: Cambridge, Chalfont, Citadel, Delos, Delos-FY, Desmar, Desmar IPA, Ensayo, Experiences Anonymes, Gateway Dance, Genesis, Grenadilla, Haydn Society, Impromptu (Shony Alex Braun), Lyrichord, Pandora, Pelican, 1750 Arch, Telarc, Titanic.
Tape lines: Advent, Connoisseur Society, In Sync (SEE ADVERTISEMENT)

**"ONE OF THE WESTS
LARGEST RECORD ONE STOP"**
SINCE 1935

One Of The Largest Selections Of
Pre-Recorded Tapes
8 Track & Cassettes
Albums & Singles

"OLDIES BUT GOODIES"
WORLDWIDE EXPORTERS
LOW DISCOUNT PRICES TO JUKE BOX OPERATORS
RETAIL & WHOLESALE TRADE

733-1181

CALIFORNIA MUSIC CO.
2933 W PICO BLVD (CORNER HARVARD)

Discos Latin Int'l Inc., 1646 S. Vermont Ave. Zip 90006. Tel. 734-1527. Owner: Jose Garcia. Mgr. Oscar Boliver. (Rec. & Tape D)
Branches: Hialeah Garden (Miami Metropolitan Area), Fla., Chicago, Ill., Fernando Vian.
Rec. labels: Fono Rex, Latin Int'l, Microfon, Pega.
Tape lines: Same as rec. labels.
Distribution By Dave, 7220 Owensmouth Ave., Suite 103, Canoga Park 91303. Tel. 887-7930. Mgr. & Buyer: Dave Peters. (Rec. & Tape D—religious prod. only)
Rec. labels: Asylum, Birdwing, Birthright, Bread N Honey, Calvary, Capitol, Chico Holiday, Columbia, Continental Singers, Cream, Cross Country, Day Spring, Dean Brown, Dynamic, Good News, Greetree, Hart-song, Heart Warming, Herald, Hi, Hobbs, Impact, Jimmy Swaggart, John Hall, Ken Copeland, Koala, Lamb & Lion, Light, Lightship, MCA, Manna, Maranatha, Master Disc, Mercury, Messianic, Mighty Wind, Milk & Honey, Myrrh, New Life, New Pax, New Song, New World, Paragon, Paul Johnson, Ranwood, Republic, Shalom, Singcord, Skylite, Solid Rock, Sunrise, Sparrow, Star Song, Tempo, United Artists, Vesper, Warner, Word.
Tape lines: Same as rec. labels.
Fermata Int'l Melodies Inc., 6290 Sunset Blvd., Suite 916, Hollywood 90028. Tel. 462-7473. TWX (910) 321-4063. Cable: FERMATACAL. Owner: Enrique Lebendiger. Mgr. Debora Frenkiel. (Rec. I)
Rec. Labels imported: Discos Premier, Fermata, Imports/Som, Peralta, Pick, RGE, Som/Maior, Young (all Brazil)

G & G Rec. Discs., see Musica Latina.
Global Rec. Ents., PO Box 49345. Zip: 90049. Tel. 995-8627. Pres.: Randy Hoffman. (Rec. & Tape D)
Distributes cut-outs, close-outs, deletions, accessories, videotape & imports.
Greenworld Recs., 23703 Madison St., Torrance 90505. Tel. 373-8947. Telex: 181892. Mng. Dir.: Steve Boudreau, William Hein; Avant Garde Repertoire Mgr.: Archie Patterson; New Wave Repertoire Mgr.: Wesley Hein. (Rec. D, I & E)
Labels: All Ears, Out Music, Ralph, Random Radar, Red, Siren, Windspell.

Labels imported: Affinity (UK), Albert (Australia), Ambient (UK), Bead (UK), Bocaccio (Spain), Carrere (France), Champagne (Australia), Chapa (Spain), Charisma (UK), Charly (UK), Cinevox (Italy), Clearlight of Jupiter (Australia), Cobra (France), Cramps (Italy), Demos (Denmark), Digit (Finland), Dischi Ricordi (Italy), Divergio (Italy), EMI (Australia, Finland, Italy, Netherlands, Sweden), Electric (UK), Energy Discs (Canada), Ensign (UK), Fetish (UK), Golden Hour (UK), Gong (Spain), Gull (UK), Hi-Hat (Finland), If (France), Industrial (UK), Infinity (Australia), Invisible (France), LTM (France), Love (Finland), MNW (Sweden), Manifest (Sweden), Mercury (Netherlands, UK), Mistlur (Sweden), Movieplay (Spain), Mushroom (Australia), Neutron Star (Australia), Numero Uno (Italy), Obscure (UK), Pathe Marconi (France), Philips (Italy, Netherlands, UK), Polydor (Canada, Italy, Netherlands, UK), Pye (UK), RCA (Italy), Re (UK), Silence (Sweden), Sordide Sentimental (France), Svenska Love (Sweden), Tapioca (France), Track (UK), Ultima Spiaggia (Italy), Valentim de Carvalho (Portugal), Vertigo (Netherlands, UK), VWA (UK), Zen (Japan). (SEE ADVERTISEMENT)

Handleman Co., 1544 N. Knowles Ave. Zip 90063. Tel. 261-0268. Mgr.: George Rosenjack. Buyer: Anita Ortiz. (Rec. & Tape RJ)
Home office: Clawson (Detroit Metropolitan Area), Mich.

House of Falcon Inc./ARV Rec. Sales, 2722 W. Pico Blvd. Zip 90006. Tel. 731-7247. Mgr.: Sara Segovia. Promo: Juan Vila. (Rec. & Tape D)
Home office: McAllen, Tex. (Rec. & Tape D, OS & RJ)
Labels: ARV Int'l, Falcon, Ric.

Inspirational Music, 18108 Parthenia St., Northridge 91328. Tel. 987-2911. Owner, Mgr. & Buyer: Hugh H. Edwards. (Rec. & Tape D)
Distributes major religious labels

International Rec. Sales, 2820 W. Pico Blvd. Zip: 90006. Tel. 731-2331. TWX (910) 321-4539. Gen. Mgr.: Andre Fontijn. (Rec. I & E)
Int'l branch: Netherlands.
Labels imported: Coreco (Netherlands), Haast (Netherlands), Kilgarron (UK), Plurex (Netherlands).

J F & H Recs., 975 W. 43 Pl. Zip: 90037. Tel: 231-0518.

Frank Cooke enterprises (213) 767-3205
8052 VINELAND AVENUE
SUN VALLEY, CALIFORNIA 91352 (213) 767-3208
WEST COAST DISTRIBUTOR
for
The Finest Classical and Ethnic Records and Cassettes

Records

1750 ARCH **IMPROMPTU SHONY ALEX BRAUN**

Cassettes

CAMBRIDGE **LYRICHORD**

DELOS **PANDORA**

DESCENDANT **DELICAN**

GENESIS **PROTONE**

GRENADILLA **Telarc**

HAYDN SOCIETY **TITANIC**

Send for catalogs and information

WE CARE Tony and Frank Cooke

DISCRIMINATING... STOCK THE AWARD-WINNING BEST

Owners: Jeraldine Feltus, Jerry Hooks, Mgr.: Jeraldine Feltus. **(Tape I & E)**
Lines imported: Flyright (UK), Sonet (Denmark). Today (UK).
Jem Recs. West Inc., 18624 Topham, Reseda 91335. Tel: 996-6754. Gen. Mgr.: Bob Say, Mgr.: Mark Ferjulan. **(Rec. & Tape D & I)**
Home office: South Plainfield, N.J., Jem Recs. Inc. (See for prod. distributed)
John's Music, 11020 S. Main St. Zip: 90061. Tel: 755-1165. Owner: John L. Jackson; Mgr.: Marie Jackson; Buyers: Singles, Marie Jackson, Albums & Tape: John L. Jackson **(Rec. & Tape OS)**
Kandamerica Inc., 5134 Walnut Grove Ave., San Gabriel 91776. Tel: 286-6611. Telex: 675337. Pres.: Toshi Fujimoto, VP: Birgitta Landmark, Mgr.: Y. Ujije. **(Rec. & Tape I & E)** (SEE ADVERTISEMENT)
Kester Mktg., 14614 Lanark, Panorama City 91402. Tel: 781-5488. TWX: (910) 495-1138. **(Rec. & Tape D, RJ, I & E)**
Distributes cut-outs. (SEE ADVERTISEMENT)
Licorice Pizza Inc., 1747 Flower St., Glendale 91201. Tel: 240-6290. Owner: Jim Greenwood, Purchasing Dir.: Jana Brooks, Singles Buyer: Cary Mansfield. **(Rec. & Tape OS)**
MCA Dist'g Corp., 11312 Penrose St., Sun Valley 91352. Tel: 768-3200. Reg'l Dir.: Des Moines Green, Branch Mgr.: Les Silver. **(Rec. & Tape D)**
Rec. labels: Backstreet, Butterfly, Coral, Infinity, LAX, MCA, Songbird, Source, Vocalion.
Tape lines: Same as rec. labels.
Marsal Prod'ns, 2854 W. Pico Blvd. Zip: 90006. Tel: 737-7771. **(Rec. & Tape D, OS, I & E)**
Home office: San Antonio, Tex. (See for prod. distributed)
Molaman Rec. Dist'g, 1650 21 St., Santa Monica 90404. Tel: 828-4295. Pres.: Steve Gabor. **(Rec. & Tape OS & RJ)**
Musica Latina Inc. (G&G Rec. Dist's), 2360 W. Pico Blvd. Zip: 90006. Tel: 385-2151. **(Rec. D, OS & RJ; Tape D)**
Rec. labels: Ansonia, Arcano, Belter, Caytronics, Columbia, Discolando, Fuentes, Kubaney, Latin Int'l, Miami, Modiner, Orion, Panart, Parnaso, Regal, Remo, Rico, Rico-Vox, Son Art, Sono Lux, Sono Mex, Sono Radio, Top Hits, UA Latino, Velvet, El Zarape.
Tape lines: Same as rec. labels.
Musical Recs. Co./Musical Tapes Inc., 2958 W. Pico Blvd. Zip: 90006. Tel: 737-0937. Gen. Mgr.: Valentin Velasco. **(Rec. & Tape D)**
Home office: Miami, Fla.
Rec. labels: Bueno, Dila, Discuba, Eco, Eli, Musart, Musicdisc, Peerless.
Tape lines: Same as rec. labels.
Musical Tapes Inc., see Musical Recs. Co./Musical Tapes Inc.
Music Brokers (div. of Rainbow Inds. Inc.), 2576 W. Pico Blvd. Zip: 90006. Tel: 386-4937. Owner: Webber & Assoc's. Inc.; Mgr.: Hugh M. Behr; E Mgr.: Robert

McNellis; Albums & Tape Buyer: Helen Flower. **(Rec. & Tape D, OS & E)**
Distributes cut-out & overstock albums & tape. (SEE ADVERTISEMENT)
Phono Rec. Dist'g Corp., 6425 Hollywood Blvd., Hollywood 90028. Tel: 464-4795. **(Rec. & Tape D)**
Rec. labels: Hitbound Int'l, Shaffer, Sky High, Super Star.
Tape lines: Same as rec. labels.
Pickwick Int'l Inc., Distribution Div., 9420 Telfair Ave., Sun Valley 91352. Tel: 875-3960. Branch Mgr.: Bill Shaler; Opns. Mgr.: Dennis Garvey, Sales Mgr.: Rick Lacovara; Mktg. Co-ord.: Paula Swartz; Buyer: Rich Lockwood. **(Rec. & Tape D)** **(Rec. & Tape RJ as Pickwick Int'l Inc., Rack Servs. Div.)**
Home office: Minneapolis, Minn.
Rec. labels: AVI, Ala, Argo, Arista, Buddah, CIME, CTI, Chrysalis, Deram, First American, GRP, Great North-western, Hi, Hob, Kudu, Laff, Le Joint, London, Mid-song, Mushroom, Music Is Medicine, L'Oiseau-Lyre, Ovation, Pacific Arts, Parrot, Passport, Piccadilly, Potato, Savoy, Sesame Street, Sun, Talisman, Telefunken, Threshold, Tomato, Treasury, UKS, Versatile.
Tape lines: AVI, Ala, Argo, Arista, Buddah, CTI, Chrysalis, Deram, GRP, Hi, Hob, Kudu, Laff, Le Joint, London, Midsong, Mushroom, Ovation, Pacific Arts, Parrot, Savoy, Sesame Street, Sun, Threshold, Versatile. (SEE ADVERTISEMENT)
Pickwick Int'l Inc., Rack Servs. Div., 7100 Tujunga Ave., North Hollywood 91605. Tel: 764-5050. Prod. Mgr.: Paul Buetell, Sales Mgr.: Ray Reed. **(Rec. & Tape RJ)** **(Rec. & Tape D as Pickwick Int'l Inc., Distribution Div.)**
Home office: Minneapolis, Minn.
PolyGram Dist'g Inc., 6255 Sunset Blvd., Suite 624. Zip: 90028. Tel: 466-4571. Reg'l VP: Emiel Petrone; Branch Mgr.: Kenny Hamlin; Sales Mgr.: Larry Smith; Depot: 11330 Sherman Way, Sun Valley 91352. Tel: 765-9650. Opns. Mgr.: Dale Johnson; Ass't Opns. Mgr.: Bob Reidy. **(Rec. & Tape D)**
Home office: New York, N.Y.
Rec. labels: American Int'l, Archiv, Capricorn, Casablanca, Charisma, Chocolate City, DJM, De-Lite, Deutsche Grammophon, Emarcy, Festivo, Fontana, Limelight, MGM, Mercury, Monument, Oasis, Parachute, Philips, Polydor, Polydor/BGO, Polydor/Harem, Polydor/Kolob, Polydor/MVP, Polydor/Manken, Privilege, RSO, RSO/Curtom, Riva, Smash, Soundstage Seven, Spring, Vertigo, Verve, Zappa.
Tape lines: Same as rec. labels.
Promo Rec. Dist'g Co. Inc. (Rec. & Tape D)—Tel: 884-8668. Contact: David Greenman—see listing in Pater-son, N.J., for prod. distributed.
Pyramid Dist's., 527 Hill St., Santa Monica 90405. Tel: 399-2222. **(Rec. D)**
Labels: Cheops, SRI, Unity.
RCA & A&M & Assoc'd Labels, 6363 Sunset Blvd., Holly-wood 90028. Tel: 468-4066. Reg'l Sales Dir.: Bill Gra-ham; Branch Sales Mgr.: Jim Bego; Sales Mgr.: Bill Meehan. **(Rec. & Tape D)**



LPs - TAPE - DISCO
 CURRENT • CUTOUT

Write For
 Catalog

MUSIC BROKERS

2576 W. PICO BLVD.
 LOS ANGELES, CALIF. 90006
 (213) 386-4937

EXPORT
 EXPERTS

KANDAMERICA INC.

THE BEST IN EXPORTING

5134 WALNUT GROVE AVENUE, SAN GABRIEL, CALIFORNIA 91776 • (213) 286-6611

A.M.D

»Alternative Music Distributors«

America's largest distributor of small labels, specializing in New Wave, and featuring a complete line of labels including our own **BOMP** label.

STORES: fastest service, most complete fill, personal attention to all orders, big or small, **WORLDWIDE!**

MAIL ORDER COMPANIES: We have thousands of items your customers will want. Oldies, rare records, rock & roll memorabilia, books & magazines. Check us out—we're the mail order experts.

2702 San Fernando Rd., Los Angeles, CA 90065.
Tel: 213-227-4141
Telex: 910-321-3942

IMPORTS EXPORTS WHOLESALE MAIL ORDER

A.M.D

Rec. labels: A&M, Bluebird, Free Flight, Gold Seal, Grunt, Hologram, Millennium, NY Int'l, Pablo, Pablo Live, Pure Gold, RCA, Red Seal, Roadshow, Rocket, Salsoul, Solar, Tortoise, 20th Century, Victrola, Windsong.

Tape lines: Same as rec. labels.

Record Mdsq. Co. Inc., 1525 S. Berendo St. Zip 90006. Tel 385-9161. Pres. Sid Talmadge. (Rec. & Tape D), (Rec. & Tape OS, RJ & E as Record Rack Serv.)

Branches: San Francisco, Calif.; Denver, Colo.

Labels: Abkco, All Platinum, Alston, Ameraba, Amherst, Arctic, Bang, Barnaby, Brunswick, CTI, Cash, Cat, Chimneyville, Claridge, DJM, Dakar, Dana, Dash, Disneyland, Dore, Drive, Era, Fantasy, Fiesta, 49th State, GRT, Glades, Gold Plate, Gordy, H&L, Hi Oldies, Hitsville, Improv, JAS, Jamie, Janus, Kayvette, Kudu, LA, Mainstream, Malaco, Marlin, Metronome, Milestone, Mojo, Motown, Old Town, Original Sound, Phil-L.A. of Soul, Phoenix, Prestige, Private Stock, Produgal, Rare Earth, Roulette, Salvation, Sesame Street, Shadybrook, Shield, Soul, Sound Bird, Specialty, Stang, Stax, Sundt, TK, TMS, Tamla, Three Brothers, Tomato, Turbo, Vibration, Weird World, West End.

Tape lines: Abkco, Bang, Brunswick, CTI, Cat, Dakar, Hob, Kudu, Mainstream, Marlin, Metronome, Milestone, Motown, Original Sound, Prestige, Rare Earth, Salvation, Soul, Tamla, Three Brothers, TK. (SEE ADVERTISEMENT)

Record Rack Serv., 1532 S. Berendo St. Zip: 90006. Tel 487-6440. Owner Sid Talmadge, Gen. Mgr.: Malcolm Talmadge. (Rec. & Tape OS, RJ&E), (Rec. & Tape D as Record Mdsq. Co. Inc.) (SEE ADVERTISEMENT)

Record Sales Co. Inc., 1015 Isabel St., Burbank 91502. Tel 849-4671. Owner Al Sherman, Mgr. Dick Ceja. Sales Jim Wilson. (Rec. D), (Rec. & Tapé E as Aldisc Int'l)

Rec. labels: A/S, Alshire, Aria Senza Voce, Audio Spectrum, Azteca, Grit, Oscar, Peter Rabbit, Somerset, Stereo-Fidelity.

Record Shack of Los Angeles, 300 W. Carob Ave., Compton 90220. Tel: 537-7000. Branch Mgr. Howard Shmuckler. (Rec. & Tape OS, I & E)

Home office: Woodside (New York Metropolitan Area), N.Y., Record Shack of New York City Inc. (SEE ADVERTISEMENT)

Records Ltd. Import/Export, 2818 W. Pico Blvd. Zip. 90006. Tel: 737-2611. (Rec. D, OS, I & E)

Labels: AEI, Broadway Baby, Entr' Acte, Starlog, THT.

Saturn Ents., 2707 W. Pico Blvd. Zip: 90006. Tel 737-0616. Pres.: Gale Phelps; Mgr. Ken Richmond; Buyer Jack Frost. (Rec. OS, I & E)

Sound Music Sales, 2546 W. Pico Blvd. Zip. 90006. Tel 381-6054. Owner: M.J. Pinto, Gen. Mgr.: Jerry Eggert; Buyer: Duncan Brown. (Rec. & Tape OS & E)

M. Stewart & Co., 10289 W. Pico Blvd. Zip 90064. Tel 879-0644. Pres.: Mendel Stewart. Export Mgr.: Louise King. (Rec. & Tape E)

Sun State Music Dists. Inc., 2654 W. Pico Blvd. Zip: 90006. Tel. 383-4137. Mgr.: George Morte; Buyers: George Morte, Ted Ray. (Rec. & Tape OS)

Trackdown Rec. Dists., 5658 Irvine Ave., North Hollywood 91601; 8409 Remmet, Canoga Park 91304; 1113 1/2 Beachwood Dr., Hollywood 90038. (Rec. & Tape D, OS, RJ, I & E)

Home office: Chicago, Ill. (See for prod. distributed)

Ultra Specialty Inc., 20700 Belshaw Ave., Carson 90746. Tel 979-0338. Cable: ULTRASPEC. Telex: 1945666. Ultraspec Crsn. Pres. Don Wong. Pres. Ultraspec Int'l Gary Lyle, VP Mktg. Bill Dawson.

Exports: CBS cassette & 8-tr. tape, du Pont chromium film, Ultrasonic film splicers.

Imports: Ultrasound consumer tape prods.

W I L D, see World Independent Label Dists

Warner/Elektra/Atlantic Corp., 3330 Warner Blvd., Burbank 91505. Tel: 843-6311. Pres. Henry Droz. Local branch: 4510 Vanowen St., Burbank 91505. Tel 849-3941. Mgr. George Rossi. (Rec. & Tape D)

Rec. labels: Asylum, Atco, Atlantic, Bearsville, Beserkley, Big Tree, Cotillion, Curtom, Dark Horse, Discoret, ECM, Elektra, Embryo, Famous Charisma, Finnadar, Little David, Loma, Manticore, Nempcor, Noneseuch, Pacific, Paradise, Reprise, Rolling Stones, SHE, Sire, Slipped Disc, Swan Song, WMOT, Warner Bros., Warner/Curb, Warner Spector, Westbound, Whitfield, Wing & A Prayer, Zephyr

Tape lines: Same as rec. labels

Wellsound One Stop, 11254 Blythe St., Sun Valley 91352. Tel 765-7303. Owner George A. Blackwell Jr., Mgr. Kay Thomas, Buyers: Singles, Terry Blackwell; Albums, Mike Blackwell; Tape, Gwendolyn Blackwell. (Rec. & Tape OS)

West Coast Music Sales, 727 Venice Blvd. Zip 90015. Tel 748-5591. Owner, Mgr., Singles, Albums & Tape Buyer Joel Miller. (SEE ADVERTISEMENT) (Rec. & Tape OS)

World Independent Label Dists. (WILD), 3711 W. Pico Blvd. Zip 90019. Tel 733-7131 (Rec. & Tape D)

Rec. labels: Brownstone, Cordak, Essar, Reynolds.

Tape lines: Same as rec. labels

Y S L Recs., PO Box 8330, Van Nuys 91409; 18308 Rayen St., Northridge 91325. Tel 886-4432. Pres. Brian Ashley. (Rec. D & I—Japanese prod only)

• **POMONA (Area Code 714)**

Corsair-Continental Corp., 1433 E. Mission Blvd. Zip. 91766. Tel: 629-0814. VP & Gen. Mgr. Larry W. Berger. (Rec. D & E)

Distributes all square & round dance labels.

• **ROSEVILLE (Area Code 916)**

Le-Jo Recs. (River City Recs. Inc.), 212-F Harding Way. Zip. 95678. Tel: 782-7348. Owners: John Radakovitz, Ed Lewis. (Rec. & Tape OS & RJ)

• **SAN DIEGO (Area Code 714)**

EURPAC San Diego Inc. (div. of EURPAC Serv. Inc.), 9360-62 Cabot Dr. Zip. 92126. Tel: 566-7661. Mgr.: Thom Brown, Buyer: Myrt D'Onofrio. (Rec. & Tape OS, RJ & E—civilian & military sales).

Folk Arts Rare Recs., 3611 Adams Ave. Zip: 92116. Tel: 282-7833. Owners: Lou & Virginia Curtiss; Mgr.: Lou Curtiss; Buyers: Singles, Wilmer Watts; Albums, Ishman Bracy. (Rec. D)

Labels: ARC, Advent, Banner, Black Patti, Black Swan, Blues Classics, Challenge, Champion, Claxnola, Clear-tone, Conqueror, Continental, Crazy Water, Dial, Dill-pickle, Domino, Gennett, Gillikin, Globe, Grey Gull, Herwin, Homestead, Hytone, Jewel, Khrome Kazoo, Little Wonder, Lyric, Madison, Melotone, Milestone, Moxie, Munchkin, Muse, Muskadine, Noble Turkey, Nome, Okeh, Onole, Paramount, Perfect, Phonolamp, Phonotippia, Pickle, Polk, Punitan, Pyrrxqgl, Quadding, Radiex, Regal, Romeo, Scoodler, Silverstone, Supertone, Van Dyke, Vintage, Vocalion, Zonophone.

• **SAN FRANCISCO & BAY AREA (Area Code 415)**

All Rec. Serv., 425 Alice St., Oakland 94607. Tel: 465-4783. Owners: Michael S. Paikos, Robert Sarenpa; Mgr.: Singles, Albums & Tape Buyer Sandy Skeie. (Rec. OS & E; Tape D, OS & E)

Tape lines: GRT catalog.

Back Room Rec. Dist' Co. (div. of Arhoolie Recs.), 10341 San Pablo Ave., El Cerrito 94530. Tel: 525-4996.

Pres. Chris Strachwitz, Mgr., Singles, Albums & Tape Buyer: Bob Greenberg; Sales & Promo.: Bob Greenberg, John Swift, Jeff Alexson. (Rec. D & I, Tape D)

Rec. labels: Advent, Arhoolie, Azteca, BRI, Baker, Bandy, Bay, Berkeley Rhythm, Bertram Int'l, Blue Goose, Blues Classics, Blues Maker, Briar/Sierra, Broadway, Bullfrog, Cabbage, Collectors Classics, Country Turtle, County, Crazy Cajun, Crown, D, DLB, Davis Unlimited, Delmark, Demo, Disco Grande, Doric, Eckersworks, Esca, F&W, Flying Crow, Flying High, Flyright, Folk Legacy, Folklyric, Folkways, Freckle, Fretless, Front Hall, Gaviota, Goldband, Golden Country, Grass Mountain, Grassound, Helios, Herwin, Hot Times in Tucson, Hush, Iron Horse, JEMF, Jack Rabbit, Jalyn, Jessup, Jin, Juke Joint, Kaleidophone, Kaleidoscope, Kiamichi, Kicking Mule, King Bluegrass, Kris, La Louisianne, Lanor, Lariat, Lehua, Lemco, Lion & Lamb, Lira, Lo Ball, Long Sleeve, Magpie, Mason of Soul, Mamlish, Mardi Gras, Minstrel, Missouri Friends of Old Time Music, Mr. Blues, Montel/Michelle, Muskadine, NCTA, Night-hawk, Norteno, Old Homestead, Old Timey, Omac, Outlet, Owl, P.Vine, Pearl, Philo, Physical, Pine Mountain, Pine Tree, Puritan, Ramblin', Rebel, Red Clay, Revonah, Ridge Runner, Roi de Blues, Roots, Rounder, Saico, Seventy Seven, Shiloh, Sierra/Briar, Smoky Mary, Solid Smoke, Sombrero, Sonet, Sonet/Specialty, Son-yatone, Specialty, Spivey, Steel Guitar Club, Stoneway, Storyville, String, Sugar Hill, Swallow, Teardrop, Temple, Thunderhead, Top Soil, Trix, Troika, Troubadour, Vecco, Voyager, Wagon Tracks, Westwind, Windham Hill, Yazoo.

Rec. labels imported: America (France), Festival (France), Musidisc (France), RCA (France), Swaggie (Australia).



The First and Last Word in Direct Disc Recording

Manufacturer's Representative
LARRY SOCKELL, INC. 516-921-2821
or contact
Sheffield Lab P.O. Box 5332, Santa Barbara, CA 93108
(except Cal., Alaska, Hawaii and Foreign 805-969-4744)

Toll Free 800-235-5737

RECORD RACK

THE MOST COMPLETE ONE-STOP OLDIES OUR SPECIALTY

14,000 OLDIE TITLES CATALOG STILL AVAILABLE DEALERS' PRICE \$4.95 + POSTAGE

3101 Exposition Place
Los Angeles, CA 90018
(213) 290-1122

HARBOR RECORD EXPORT CORP.

The Legendary Exporter high in the Catskill Mountains. Offering lowest export prices on . . . Jazz, Blues, Surplus, Cut-outs, and Budget Brands with superb SERVICE.

**66 Route 55
Kauneonga Lake,
New York 12749
Telex 232696**

Tape lines: Arhoolie, Maison de Soul, Rounder.
Rick Ballard Music, PO Box 5063, Berkeley 94705. Tel: 849-3852. **Owner:** Rick Ballard. **(Rec. D, I & E)**
Labels: Adelphi, Aeoc, Airborne, Ak Ba, All Seasons, Andrew's Music, Arcana, Asha, Aten, Auricle, B.I.J.A., Blackbob, Bee Hive, BetCar, Big City, Birth, Bisharra, Black Fire, Briko, Carousel, Composer's Collective, Contemporary, Dobre, Emanem, Evidence, FKT, Fourth Stream, Freelance, Gramercy 5, Grapevine, Grnts, Hat Hut, Hugo's Music, IBMS, IPS, Ibedon, Improvising Artists, Independent, India Navigation, JCOA, Jam Session, Jazz a la Carte, Jim Lowe, Kabell, Kromel, Labor, Laissez-Faire, Lovely, Madonna, Mary, Masterscores, Metalanguage, Moonbeam, Mozown, Musicworks, Mustevic, Nessa, New Jazz, Nimbus, Ninewinds, Omnisound, Otic, PBR, PM, PZ, Parachute, Passin' Thru, Philly Jazz, Productions of Kharma, Progressive, Pyramid, Quark, Re-entry, Rise, SRP, Segue, Shiah, Strata-East, Sunrise, Survival, Sweet Earth, Tablighi, Third Street, 360 Music, Tiwa, Tomorrow Int'l, Trans Museq, Tribe, Trident, Triumph, Universal Justice, WATT, Wizard, World Artists, Zoar
Labels Imported: Circle (Germany), Classic Jazz Masters (Sweden), Companhia Ind l de Discos (Brazil), Compendium (Norway), ECM (Germany), ENJA (Germany), FMP (Germany), Falcon (UK), First Heard (UK), Fluid (France), Horo (Italy), Ictus (Italy), Japo (Germany), Jazz Society (Sweden), Marge (France), Musica (France), Onari (Canada), RCA (France), Sackville (Canada), Saj (Germany), Saravah (France), Sonet (UK), Spottite (UK), Steeplechase (Denmark), Storyville (Denmark), Sun (France), Swing Classics (Sweden), Swing House (UK), Tax (Sweden), Timeless (Netherlands), Trio (Japan), WAVE (UK), Yoko (Mexico)
Bay Area Recs. & Tapes Express, 760 Bryant St. Zip: 94107. Tel: 777-3870. Owners: Joe Gispán, Carroll Littlejohn. **Mgr. & Buyer:** Ed O'Neill. **(Rec. & Tape OS, RJ & E)**
C B S Recs., 120 Howard St., Suite 740. Zip: 94105. Tel: 495-6910. Branch Mgr. Jerry Pitt. (Rec. & Tape D)
Rec. labels: Arc, Bang, Blue Sky, CBS, Caribou, Columbia, Epic, Jet, Kirshner, Melodiya/Columbia, Nemperor, Odyssey, Philadelphia Int'l, Portrait, Starflite, Stiff, T-Neck, Tabu, Tappan Zee, Unlimited Gold.
Tape lines: Same as rec. labels.
California Rec. Dist. Inc., 41 Brookdale Ave., San Rafael 94901. Tel: 459-0851. Sales Mgr. Walt Calloway. Promo. Mgr.: Ted Higashioka. (Rec. D)
Home office: Glendale (Los Angeles Metropolitan Area), Calif.
Labels: Abattoir, Advent, Arcane, Archive of Folk & Jazz, Archive of Piano Music, Artist House, Ashtree, Audio Fidelity, Audio Rarities, Bean, Big Band Int'l, Big Town, CRD, Caedmon, Candide, Century, Chiaroscuro, Coco, Columbia Special Prods., Concert Disc, Concord, Corinthian, Counterpoint, Creative World, Criterion, Demand, Discus, Dooto, Electric Lemon, Everest, First Heard, Folkways, Fremont, Gala, Giants of Jazz, Glendale, Golden Age, Golden Era, Graffiti, Granite, Greentree, HNH, Harlequin, Hawaii Calls, History in Sound, IRDA, Jazz Treasury, King, Legacy, Los Angeles, Mark 56, Muskadine, Nessa, New Orleans Jazz, Nostalgia, Nostalgia Lane, Old Homestead, Olympic, Orion, Palm, Period, Plantation, Polaris, RGB, RVL-RDC, Radiola, Republic, Request, Retrospect, Revelation, Ridge Runner, Roper, Sackville, Sandcastle, Scala, Semaphore, Shoestring, Sounds, Sountrak, Standing Room Only, Stanyon, Starday, Stash, Sun, Sunbeam, Survival, Syntonic Research, Tahiti, Taz-Jaz, Telarc, Testament, Tradition, Trix, Turnabout, Umbrella, Unicorn, Varese, Vox, Vox Box, World Jazz, Zaliro. (SEE ADVERTISEMENT)
Capitol Recs., 185 Berry St., Suite 4805. Zip: 94107. Tel: 543-3202. (Rec. & Tape D)
Rec. labels: Angel, Ariola America, Capitol, EMI America, Harvest, Liberty, Melodiya/Angel, Seraphim, United Artists.
Tape lines: Same as rec. labels.
China Books & Periodicals Inc., 2929 24 St. Zip: 94110. Tel: 282-2994. Mgr. Henry Noyes. (Rec. I)
Branches: Chicago, Ill., New York, N.Y.
Imports from People's Republic of China.
City Hall Recs., PO Box 18294, Zip: 94118, 254 Scott St. Zip: 94117. Tel: 431-4312/1050. Owner, Mgr. & Albums Buyer: Robin Cohn; Singles Buyer: Jeff Richardson. (Rec. D, I & E; Tape D)
Branches: Beverly Hills (Los Angeles Metropolitan Area), Calif.; Seattle, Wash.
Rec. labels: AEI, AF, Ace of Spades, Adelphi, Advent, Aircheck, Ajax, Ajaz, Alternative Energy, Ambrosia, Arcadia, Aries, Audiophile, Audio Precision, Aviva, Bald Ego, Ballard, Bandstand, Bandy, Barrelhouse, Barron, Beet, Bent, Big Band Int'l, Big Star, Bio-Centennial, Biograph, Bix Lives, Blue Angel Jazz Club, Blue Koala, Blue Lantern, Bomp, Bopalacious, Bountiful, Breakwater, Broadway, Broadway Baby, Bullfrog, CFH, CIF, Cachet, Cadillac, Cassandra, Celtic, Center, Charly, Chatham Square, Clanco, Club of Spade, Columbia Special Prods., Cook, Corinthian, Country Turtle, Cowboy Carl, Crown, Cue, Curtain Calls, Daffodil, Dirty Shame, Dreamstreet, DRG/Stet/Capitol, Eclectic, Ekotse, Emanon, Emily, Enigma, Escape, Eubie Blake, Euphonic, Fairmont, Famous Door, Fanfare, Fat Cat, Fidelity Sound, Filmscore, Flying Crow, Folk Legacy, Front Hall, GHB, GP, Giants of Jazz, Golden Age, Golden Era, Golden Legends, Good Time, Good Time Jazz, Grassroots, Green Linnet, Halcyon, Hamilton, Harrison, Hat Hut, Hefty Jazz, Hep, Herwin, Hidden Meaning, Historical, Hollywood Soundstage, Home Spun, Houndstooth, IAJRC, ID, Inchechronin, Instant Joy, Interplay, Jamey Aebersold, Jazz Archives, Jazz Classic, Jazz Connoisseur, Jazz Guild, Jazzology, Jefferson, Jewel, Jim Taylor Presents, Joliet, Joyce, Juke Joint, Jump, June Appal, Kally-Ope, Kaydee, King, Laureate, Lee, Legends, Leviant, Library of Congress, Longhorn, Lumiere, Lunar 2, MF, MFC, Magi, Makossa, Mamlish, Master Jazz, Melodeon, Merrymakers, Messaround, Michigan Archives, Mineburg, Mr Blues, Monmouth/Evergreen, Morningstar, Motherlode, Musicraft, Muskadine, NOJC, Natural Organic, Newworld, New Orleans, Nighthawk, Old Homestead, Onari, Original Cast, Origin Jazz Library, Outline, PMP, Painted Smiles, Pathfinder, Pelican,

Phoenix Jazz, Progressive, Pumpkin, Radio Archives, Radiola, Ram, Rambler, Rebecca, Release, Retrospect, Rhino, Rhino-Payola, Rollin' Rock, San Diego Jazz Club, Sandy Hook, Shadow, Shamrock, Shanachie, Smoky Mary, Solid Smoke, Sounds Reasonably, Sountrak, Southland, Spittball, Spokane, Straight Room Only, Stardust, Starfire, Starlog, Stash, Straight Ahead, Sunbeam, Sunburn, Take Home Tunes, Take Two, Tandem, The Sirens, Totem, Traditional, Traveler's, Trix, Trout, Uptown Lowdown Jazz, Vantage, Virgin Vinyl, Wagon Tracks, Whid-Isle, Wild Eye, Wins, World Jazz, Zim
Rec. labels imported: AM (UK), Affinity (UK), Amigo (Sweden), Banff (Canada), Blackbird (Ireland), Black Panther (UK), Black Saint (Italy), Bluebeat (Germany), Blue Parrot (UK), CBS (UK), Capitol (UK), Chess (UK), Chiswick (UK), Claddagh (Ireland), Comhallas (Ireland), DJM (UK), Dawn Club (Germany), Dial (UK), Dolphin (Ireland), EMI (UK), Eagan (Ireland), First Heard (UK), Flyright (UK), Fountain/Retrieval (UK), Frog (UK), Gael-Linn (Ireland), Grassroots (Australia), Hawk (Ireland), Jazz Galore (Italy), JSP (UK), Le Roi du Blues (Canada), London (UK), Lyric (Australia), MCA Coral (UK), MGM (UK), Magpie (UK), Mulligan (Ireland), Oats (Ireland), Odeon (UK), Ogham (Ireland), Oldie Blues (UK), Oxford (Italy), Philips (UK), Polydor (Ireland), Pye (UK), RCA (UK), Rarities (Sweden), Red Lightning (UK), Red Vedette (Italy), Redwood (UK), Roller Coaster (UK), Route 66 (Sweden), Sackville (Canada), Shaskeen (Ireland), Silver Hill (Ireland), Soul Note (Italy), String (UK), Sun (UK), Sunset (UK), Swing House (UK), Syndicate Chapter (UK), Tara (Ireland), Topic (UK), Trailer/Leader (UK), Transatlantic (UK), Triskel (Ireland), Union Pacific (UK), Unique Jazz (Italy), United Artists (UK), Vocalion (UK), World (UK), Xtra (UK)
Tape lines: Cachet, Charly, Columbia Special Prods., DRG, Fidelity Sound, Stet.
La Val Dist. of California, 1218 Hollister Ave. Zip: 94124. Tel: 467-5157. Owner & Buyer: Brad Taylor. (Rec. & Tape D)
Rec. labels: Bay-Tone, Comedian Inc., La Val, Makossa Int'l, Seaside, Soul Set, Sun Dance, Vic.
Tape lines: Bay-Tone, Comedian Inc., La Val, Soul Set, Vic.
M C A Dist'g Corp., 185 Berry St. Zip: 94107. Tel: 543-6880. Branch Mgr. Guy Covington. (Rec. & Tape D)
Rec. labels: Backstreet, Butterfly, Coral, Infinity, LAX, MCA, Songbird, Source, Vocalion.
Tape lines: Same as rec. labels.
Major Dist., 4191 First St., Space 108, Livermore 94550. Tel: 455-6868. Mgr. Don Thurman. (Rec. & Tape D & R)
Home office: Tukwila (Seattle) Wash.
Rec. labels: Alshire, Camden, Disneyland, Pickwick, Stoneway.
Tape line: GRT
Playback equip. & phonographs: BSR, Hitachi, Mitsubishi, Panasonic.
Accessories: Batteries (Duracell), blank tape (Ampex),

call . . . GEORGE HOCUTT CALIFORNIA RECORD DISTRIBUTORS, INC.

for . . . FIRST PLACE IN RECORD DISTRIBUTION

servicing the Los Angeles, San Francisco and the Pacific Northwest markets.

**Phone: (213) 245-6464 Address: P.O. Box 4035
(213) 246-8228 Glendale, CA 91202**

CHAPMAN DISTRIBUTING CO., INC.

LA's Finest Distributor

Manufacturer's Inquiries Most Welcome.

Your Product Deserves Personal Attention.

ALSO

Complete Lines of Religious, Gospel and Sacred.

Contact:

CHAPMAN DISTRIBUTING CO., INC.

1212 South Albany
Los Angeles, Calif. 90015
Phone: (213) 749-9484

Herb Chapman, Sales Mgr.

BASF, Memorex, Scotch, needles (Transcriber), Le-Bo, Vanco prods.
 Mighty Fine Dist'g, 99 Park Ln., Brisbane 94005. Tel: 468-4000. Pres.: Sterling Lanier, Mgr.: Ferd Skribeleit, Buyers: Singles, Steve Scott, Albums, Barry Paschall. (Rec. OS)
 Music People Inc., 1025 W. MacArthur Blvd., Oakland 94608. Tel: 653-5811. Pres.: Elliot Blaine. Exec. VP & Gen. Mgr.: Jason Blaine, Buyers: Singles, Ken Hudson, Albums & Tape, Elliot & Jason Blaine. (Rec. & Tape OS)
 Pacific Rec. & Tape Dist's Inc., 5800 Christie St., Emeryville 94608. Tel: 653-8727. Owners: Robert Sarenpa, Michael S. Paikos, Sandy Skeie. Mgr.: Michael S. Paikos, Buyer: Tom Larson. (Rec. & Tape D)
 Branch: Seattle, Wash.
 Labels: AVI, Ala, Alligator, Alston, Artist House, Aural Explorer, Barnaby, Beserkley, Big Sound, Birthright, Blind Pig, Blues Spectrum, CMH, Canaan, Cat, Channel, Chanterelle, Charlie Parker, Chimneyville, Choice, Classic Jazz, Clouds, Con Brio, Cream, Creed, Dash, Dial, Discovery, End, Entr' Acte, Excello, Fantasy, Flying Fish, GNP Crescendo, GRT, Galaxy, Gee, Glades, Good News, Good Sounds, Gospel Roots, Gospel Truth, Hi, Inner City, Janus, Jewel, Joliet, Juana, Kayvette, Kenwood, Koko, LA, LRC, LS, Label 21, Laif, Lamb & Lion, Light, Mainstream, Malaco, Maranatha, Marlin, Milestone, Mountain Railroad, Muse, Mushroom, Myrrh, NSD, Nashboro, Prestige, New Song, Ode, Paragon, Paula, Prelude, Nesses, Pyramid, Ranwood, Riverside, Ronn, Roots, Roulette, Royal Flush, Seed, Seeds & Stem, Shadow, Shadybrook, Shock, Sierra/Bnair, Solid Rock, Sonet, Sound Bird, Specialty, Stax, Sunshine Sound, TK, Takoma, Texas Re-Card, Theresa, Timeless, Tomato, Vanguard, Versatile, Vesper, Visa, Waterhouse, Wee, Weird World, Word, Xanadu.
 Parallax Corp., PO Box 838, Orinda 94563. Tel: 254-6300. Mgr. & Buyer: M.R. Phillips. (Rec. D)
 Label: Orinda.
 Pickwick Int'l Inc., Distribution Div., 375 Sutter, Zip 94108. Tel: 981-8787. Branch Mgr.: Jack Campbell. (Rec. & Tape D) (Rec. & Tape RJ) as Pickwick Int'l Inc., Rack Servs. Div.
 Home office: Minneapolis, Minn.
 Labels: ASI, Argo, Arista, Aspetke, Big Sound, Buddha, CTI, Cherry, Chrysalis, Cime, Con Brio, Deram, First American, Freedom, GRP, Great Northwestern, Hi, Hob, Kudu, L'Oiseau Lyre, Le Joint, London, Midsong Int'l, Music Is Medicine, Novus, Ovation, Pacific Arts, Parrot, Passport, Picadilly, Potomac, Roadshow, Savoy, Sesame Street, Seeds & Stems, TVLP, Talisman, Telefunken, Threshold, Tomato, UK. (SEE ADVERTISEMENT)
 Pickwick Int'l Inc., Rack Servs. Div., 11 Guittard Rd., Burlingame 94010. Tel: 697-6800. Sales Mgr.: Ted Lambeth. (Rec. & Tape RJ). (Rec. & Tape D as Pickwick Int'l Inc., Distribution Div.)
 Home office: Minneapolis, Minn.
 PolyGram Dist'n Inc., 1700 Montgomery St., Suite 211, Zip: 94111. Tel: 433-8755. Mgr.: Bill Follett. (Rec. & Tape D)

Home office: New York, N.Y.
 Rec. labels: American Int'l, Archiv, Capricorn, Casablanca, Charisma, Chocolate City, DJM, DeLite, DeutscheGrammophon, Emarcy, Festivo, Fontana, Limelight, MGM, Mercury, Monument, Oasis, Parachute, Philips, Polydor, Polydor/BGO, Polydor/Harem, Polydor/Kolob, Polydor/MVP, Polydor/Manken, Privilege, RSO, RSO/Curtom, Riva, Smash, Soundstage Seven, Spring, Vertigo, Verve, Zappa.
 Tape lines: Same as rec. labels.
 R C A & Assoc'd Labels, The Showplace, Suite 441, 2 Kansas St. Zip: 94103. Tel: 864-7900. Sales Mgr.: Charlie Rice. (Rec. & Tape D)
 Rec. labels: A&M, Bluebird, Free Flight, Gold Seal, Grunt, Hologram, Millennium, NY Int'l, Pablo, Pablo Live, Pure Gold, RCA, Red Seal, Roadshow, Rocket, Salsoul, Solar, Tortoise, 20th Century, Victrola, Windsong.
 Tape lines: Same as rec. labels.
 Record Mdsq. Co. Inc., 70 Dorman Ave., No. 3, Zip 94124, Tel: 285-0959. Sales Mgr.: Earl Martis, Promo. Mgr.: Larry Karp. (Rec. D)
 Home office: Los Angeles, Calif.
 Labels: Abkco (singles), Brunswick, CTI, Cash, Churchill, Claridge, Dakar, Disneyland, Fiesta, Gordy, H&L, Hi Oldies, Hitsville, JAS, Jamie, Jupar, Kudu, Mojo, Motown, Original Sound, Phil-L-A, of Soul, Phoenix, Private Stock, Prodigal, Quality, Rare Earth, Soul, Sundi, Taml, Three Brothers. (SEE ADVERTISEMENT)
 Rivera Ent's., 1908-1910 Mission St. Zip: 94103. Tel: 626-1212. Owner: M. Castillo Rivera, Mgr.: L. Vargas Rivera. Buyers: Singles, Fatima Escobar, Albums, M. Castillo Rivera. (Rec. & Tape D, I & E)
 Labels: Discos America, Melodias, RKG.
 Trackdown Rec. Dist's., PO Box 514, Oakland 94605. (Rec. D, OS, RJ, I & E)
 Home office: Chicago, Ill. (See for prod. distributed).
 Warner/Elektra/Atlantic Corp., 680 Beach St. Zip: 94109. Tel: 441-6111. Sales Mgr.: Bill Perasso. (Rec. & Tape D)
 Rec. labels: Asylum, Atco, Atlantic, Bearsville, Beserkley, Big Tree, Cotillion, Curtom, Dark Horse, DiscReet, ECM, Elektra, Embryo, Famous Charisma, Finnadar, Little David, Loma, Manticore, Nemporer, Nonesuch, Pacific, Paradise, Reprise, Rolling Stones, SHE, Sire, Slipped Disc, Swan Song, WMOT, Warner Bros., Warner/Curb, Warner Spector, Westbound, Whitfield, Wing & a Prayer, Zephyr.
 Tape lines: Same as rec. labels.
 Western Rec. Sales, 1416 62 St., Emeryville 94608. Tel: 655-4320. Owner & Mgr.: Vern Cupples. (Rec. & Tape D & RJ). (Also see Pacific Rec. Servs., Tukwila (Seattle Area), Wash.
 Distributes: Disneyland, Living Language.
 Accessories: Recoton.
 • SAN JOSE (Area Code 408)
 Luna Recs., 85 S. Second St. Zip: 95448. Tel: 295-3203. Mgr. & Buyer: Glada Medina. (Rec. & Tape OS, RJ, I & E)

Home Office: Healdsburg, Calif.
 • SAN LUIS OBISPO (Area Code 805)
 Square Deal Rec. Co., 169 Prado Rd. Zip: 93406. Tel: 543-3636. TWX: (910) 351-6700. Owner: Richard Ferris. (Rec. & Tape D, OS & E)
 Rec. labels: A&M, Bomp, Columbia, Golden, MDA, Pickwick, RCA, Rhino, Rolling Rock, Shiloh, Sierra/Bnair, 20th Century, Varese/Sarabande, Windham Hill (budget labels & cut outs).
 Tape lines: Same as rec. labels.
 Accessories: BASF, Capitol I, Scotch, TDK.
 • SCOTTS VALLEY (Area Code 408)
 Earth Music Sales, 30 Janis Way, No. H. Zip: 95066. Tel: 438-2025. Mgr. & Buyer: S. Rice. (Rec. & Tape OS)

COLORADO

• DENVER AREA (Area Code 303)
 A & N One Stop, PO Box 2671, Zip: 80201. Tel: 572-9099. Owner: James C. Scott Sr., Mgr.: L. Dean, Buyers: Singles, James C. Scott Jr., Albums, M.A. Scott. (Rec. OS). (Rec. RJ as James Sales Co.)
 Alpha & Omega, 70100 Broadway, Bldg 6, Unit H. Zip: 80221. Tel: 429-4046. Owner: Mel Berg. Mgr.: Bob Dyer. (Rec. & Tape D)
 Labels: Alexandria House, Benson, Consolidated Gospel, Good Life, Foster Co., Messianic, New Life, Singpiration, Sparrow, Star Song, Tempo, Word.
 CBS Recs., 5680 S. Syracuse Circle, Suite 418, Englewood 80110. 837-8333. Branch Mgr.: Mike Waggoner. (Rec. & Tape D)
 Rec. labels: Arc, Bang, Blue Sky, CBS, Caribou, Columbia, Epic, Jet, Kirshner, Melodiya/Columbia, Nemporer, Odyssey, Philadelphia Int'l, Portrait, Starlite, Stiff, T Neck, Tabu, Tappan Zee, Unlimited Gold.
 Tape lines: Same as rec. labels.
 C M D Sales Co., 1855 W. Dartmouth Ave., Englewood 80110. Tel: 761-1715. Owner: Mgr. & Singles Buyer: Ronald J. Staggs. (Rec. & Tape OS & RJ)
 Phonographs: BSR, Garrard, Marantz, Sanyo, Sharp. Playback equip.: Akai, Kenwood, Marantz.
 Accessories: Le-Bo, Maxell, Savoy, Soundsaver, TDK, Tracs, Transcriber.
 Capitol Recs., 4725 W. Quincy Ave. Zip: 80236. Tel: 794-5555. (Rec. & Tape D)
 Rec. labels: Angel, Ariola America, Capitol, EMI America, Harvest, Liberty, Melodiya/Angel, Seraphim, United Artists.
 Tape lines: Same as rec. labels.
 Christy Rec. Sales Dist., PO Box 367, Westminster 80030. Tel: 429-2429. Owner, Mgr. & Buyer: Christina Marquez. (Rec. OS)
 D L M Music Dist's., 4990 Nome, No. 3D. Zip: 80239. Tel: 371-3260. VP: Larry Gentry. Mgr.: Mel Nimon, Buyers: Albums, Bill Hesselbach; Tape, Tom Satriano. (Rec. & Tape OS)
 Accessories: Discwasher, Le-Bo, Maxell, Scotch, TDK, Watts.
 Danjay Music Inc., 10625 E. 47 Ave. Zip: 80239. Tel: 373-1760. Owner: Phil Lasky; Buyer: Roger Adcock. (Rec. & Tape OS)
 Branch: Tukwila (Seattle Area), Wash., P.J.L. Corp.
 Handleman Co., 4860 Nome St. Zip: 80239. Tel: 373-1420. Mgr.: Ed Cook; Buyers: Ron Alanis, Ed Cook. (Rec. & Tape RJ)
 Home office: Clawson (Detroit Metropolitan Area), Mich.
 House Dist's., 1855 S. Sherman St. Zip: 80210. Tel: 733-1420. Mgr.: Bob Ake. (Rec. & Tape D)
 Home office: Kansas City, Mo. (See for prod. distributed) (SEE ADVERTISEMENT)
 Intal Recs. Inc., 2144 Champa St. Zip: 80205. Tel: 892-7141. Owner & Buyer: Victor M. Hernandez. (Rec. & Tape OS, RJ & I)
 James Sales Co., 2327 E. 28 Ave. Zip: 80205. Tel: 572-9099. Owner: C.W. James, Mgr.: James C. Scott Sr., Buyers: Singles, Jim Scott, Albums, M.A. Scott. (Rec. RJ). (Rec. OS as A&N One Stop)
 Lieberman Ent's. Denver, 11000 A.E. 51 Ave. Zip: 80239. Tel: 371-2190. Mgr.: Jack Goodman; Opns. Mgr.: Bruce Voigt; OS Mgr.: Richard Weiner, Buyers: Singles, Cheryl Brungardt; Albums, Rod Schliecher. (Rec. & Tape OS & RJ)
 Home office: Minneapolis, Minn. (SEE ADVERTISEMENT)
 M C A Dist'g Corp., 288 Clayton St., No. 305, Zip: 80206. Tel: 388-9218. Branch Mgr.: Leroy Sather. (Rec. & Tape D)
 Rec. Labels: Backstreet, Butterfly, Coral, Infinity, LAX, MCA, Songbird, Source, Vocalion.
 Tape lines: Same as rec. labels.
 Mile Hi One Stop Inc., 150 Rio Grande Blvd. Zip: 80223. Tel: 629-1960. Mgr.: Bob Jacobs. (Rec. & Tape OS, RJ & I). (Rec. & Tape D as Pan American Rec. Supply)
 Home office: Skokie (Chicago Metropolitan Area), Ill., Sound Unlimited.
 Accessories: Blank tape (Ampex, BASF, Maxell, Memorex, Scotch, TDK), carrying & storage cases (Hagerstown, Le-Bo, Savoy), needles (Pfanstiehl), Discwasher, Sound Guard & Watts prods.
 Mountain Dist's., 50 Rio Grande Blvd. Zip: 80223. Tel: 629-6804. Mgr.: Marty Cern, Singles Buyers: Clem Diedrich, Mary Krug. (Rec. OS)
 Pan American Rec. Supply, 150 Rio Grande Blvd. Zip: 80223. Tel: 629-1960. Mgr.: Bob Jacobs. (Rec. & Tape D). (Rec. & Tape OS, RJ & I as Mile Hi One Stop)
 Home office: Chicago, Ill., Sound Unlimited (Rec. & Tape OS, RJ & I)
 Labels: Artist House, CTI, Caedmon, Conversa-phone, Concord Jazz, GNP Crescendo, Impact, Inner City, Light, Living Language, Mainstream, Monitor, Muse,

SCHWARTZ BROTHERS, INC.
 LARGEST RECORD & TAPE DISTRIBUTOR IN THE EAST
 2146 24th Place, N.E., Washington, D.C. 20018
 (202) 529-5700
 1101 Kings Highway North, Suite 104, Cherry Hill, N.J. 08002
 (609) 482-2130 (215) 923-1271

Serving: PHILADELPHIA · PENNSYLVANIA · MARYLAND · VIRGINIA
 W. VIRGINIA · DELAWARE · WASHINGTON, D.C.

HARMONY HUT
 AREA'S FASTEST GROWING
 RETAIL MUSIC CENTERS
 2146 24th Place, N.E., Wash., D.C. 20018
 (202) 529-5700

TIDEWATER ONE-STOP
 COMPLETE ONE-STOP
 SERVING
 THE VIRGINIA AREA
 1910 Granby Street
 Norfolk, Virginia 23517
 (804) 622 8663

Located in: VIRGINIA · MARYLAND · DISTRICT OF COLUMBIA · PENNSYLVANIA · AND NEW JERSEY

Pyramid, Roulette, Savoy, Syntonic Research, TK group, Versatile
 Pickwick Int'l Inc., Rack Servs. Div., 4675 Kingston St. Zip 80239. Tel. 371-0900. Opns. Mgr.: Larry Thurk, Sales Mgr.: Al Wask, Buyer: Lydia Quigley (Rec. & Tape RJ)
Home office: Minneapolis, Minn.
 PolyGram Dist'n Inc., 2160 S. Holly St., Suite 201. Zip 80222. Tel. 756-8317 (Rec. & Tape D)—sales office only)

Home office: New York, N.Y.
Rec. labels: American Int'l, Archiv, Capricorn, Casa Bianca, Charisma, Chocolate City, DJM, De-Lite, Deutsche Grammophon, Emarcy, Festivo, Fontana, LimeLight, MGM, Mercury, Monument, Oasis Parachute, Philips, Polydor, Polydor/BGO, Polydor/Harem, Polydor/Kolob, Polydor/MVP, Polydor/Manken, Privilege, RSO, RSO/Curtom, Riva, Smash, Soundstage Seven, Spring, Vertigo, Verve, Zappa
Tape lines: Same as rec. labels.

RCA & A&M & Assoc'd Labels, 50 Steele St. Zip 80209. Tel. 759-8181. Sales Mgr.: Mike Ketchum (Rec. & Tape D)

Rec. labels: A&M, Bluebird, Free Flight, Gold Seal, Grunt, Hologram, Millennium, NY Int'l, Pablo, Pablo Live, Pure Gold, RCA, Red Seal, Roadshow, Rocket, Sal-soul, Solar, Tortoise, 20th Century, Victrola, Windsong.
Tape lines: Same as rec. labels.

Record Mdsq. Co. Inc., 2186 S. Holly St. Zip 80222. Tel. 797-5491 (Rec. D)

Home office: Los Angeles, Calif.
Labels: Abkco, Alarm, All Platinum, Alston, Ameraba, Apa, Black Forum, Blue Canada, CTI, Caocet, Cat, Checker, Chess, Chimneyville, Clouds, Dash, Disneyland/Vista, Dore, Drive, Fiesta, Glades, Good Sounds, Gordy, Highland, Hi-Oldies, JAS, Juana, Jupar, Kudu, MC, Mainstream, Malaco, Malcolm X, Marlin, Motown, Old World, Original Sound, Prodigal, Rare Earth, Roots, Sesame Street, Soul, Stang, Stone Dogg, Sunshine Soul, TK, Tamla, Turbo, Vibration, Wanderick, Weird World, West End, Wicked (SEE ADVERTISEMENT)

Ron's Dist's of Denver, 5201 N. Federal Blvd. Zip 80221. Tel. 477-3611. Owners: Rod Lujan, Wayne Gerken, Mgr.: Wayne Gerken, Buyers: Wayne Gerken, Rod Lujan (Rec. RJ)—Spanish prod. only. **Tape RJ**

Twirl Town Toys, 2355 W. 27 Ave. Zip 80211. Tel. 455-2984 (Rec. & Tape D & RJ)
Home office: Salt Lake City, Utah, Western Toy & Hobby Inc.
Labels: Disneyland, Gusto.
Tape line: Pickwick

W M Dist'g, 4105 Holly St. Zip 80216. Tel. 320-4660. Mgr.: Bob Krug, D Buyer: Ken Haughey, OS & RJ Buyer: Jim Reymann (Rec. & Tape D), (Rec. & Tape OS & RJ as Western Mdsrs. Inc.)

Home office: Amarillo, Tex., Western Mdsrs. Inc.
Labels: AVI, Abkco, Amerama, Amherst, Arista, Artists of America, Audio Fidelity, Aspen, Bang, Butterfly, CTI, Caytronics, Chelsea, Chrysalis, Churchill, Claridge, Cream, Disneyland, Fantasy, GRT, H&L, IRDA, Improv, Inner City, LA Int'l, London, Mushroom, Nashboro, October, PA-USA, PBR, Panama, Plantation, Private Stock, Prelude, Ranwood, Republic, Romero Brothers, Shelby Singleton, Soul City, Sound Bird, TMS, Vanguard

Warner Elektra/Atlantic Corp., 1582 S. Park'g Rd., No. 204. Zip 80231. Tel. 750-4850. Sales Mgr.: Bob Stevens (Rec. & Tape D)

Rec. labels: Asylum, Atco, Atlantic, Bearsville, Beserkley, Big Tree, Cotillion, Curtom, Dark Horse, DiscReet, ECM, Elektra, Embryo, Famous Charisma, Finnadar, Little David, Loma, Manticore, Nemperor, Nonesuch, Pacific, Paradise, Reprise, Rolling Stones, SHE, Sire, Slipped Disc, Swan Song, WMOT, Warner Bros., Warner/Curb, Warner Spector, Westbound, Whitfield, Wing & a Prayer, Zephyr
Tape lines: Same as rec. labels.

Western Mdsrs. Inc. (Rec. & Tape OS & RJ), see WM Dist'g.

CONNECTICUT

• **GEORGETOWN (Area Code 203)**
 Take Home Tunes, PO Box 496. Zip 06829. Tel. 544-8288. Owners: Bruce & Doris Yeko, Buyer: Doris Yeko (Rec. D)
Branch: Fort Lee, N.J.
Labels: Broadway Baby, Broadway/Hollywood, Film Music, Original Cast, Take Home Tunes, also distributes demos, original soundtracks, rare records.

• **HAMDEN (Area Code 203)**
 Roger Brouso Phonograph Recs., 24 Scott St. Zip 06514. Tel. 288-3838. Owner & Buyer: Roger Brouso (Rec. OS)

• **HARTFORD AREA (Area Code 203)**
 Alpha Dist'g Corp., 30 Elizabeth St., Vernon 06066. Tel. 872-8411. Contact: Frank Berman (Rec. & Tape D)
Home office: New York, N.Y. (See for prod. distributed) (SEE ADVERTISEMENT)

Aquarius Dist's of New England Inc., 479 Park Ave., East Hartford 06108. Tel. 278-4061. Pres.: Marvin Ginsburg, Sales Mgr.: Sam Diacosavas, Promo: Tracy Garneau (Rec. & Tape D)
Labels: Alston, Antilles, Arista, Barnaby, Cat, Classic Jazz, Clouds, Cyclone, Dash, Disneyland, Fantasy, GRT, Glades, Inner City, JDC, Janus, K-Tel, Kayvette, Laurie, MMO, Malaco, Milestone, Mushroom, Nostalgia, Peter Pan, Prestige, Ranwood, Riverside, Savoy, Shadybrook, Stax, Superscope, TEC, TK, Tomorrow, Visa, Vista, West End, Wonderland.
Accessories: Blank tape (Maxell).

CBS Recs., 60 Washington St., Suite 805. Zip 06106. Tel. 522-7151. Branch Mgr.: Phil Balsam (Rec. & Tape D)

Rec. labels: Arc, Bang, Blue Sky, CBS, Caribou, Colum-

bia, Epic, Jet, Kirshner, Melodiya/Columbia, Nempe-
 r Odyssey, Philadelphia Int'l, Portrait, Starlite, Stuff,
 T-Neck, Tabu, Tappan Zee, Unlimited Gold.
Tape lines: Same as rec. labels.

Central Rec. & Tape Dist's Inc., 145 S. Satellite Rd., South Windsor 06704. Tel. 528-2171. Owner: Edward E. Stein, Mgr.: Robert L. Hoyt, Buyers: Singles, Steve Chamberlain, Albums: Robert L. Hoyt (Rec. & Tape OS & RJ)

M C A Dist'g Corp., 381 Governors Hwy., Unit C, South Windsor 06074. Tel. 289-9555. Branch Mgr.: Harry Borrelli (Rec. & Tape D)

Rec. labels: Backstreet, Butterfly, Coral, Infinity, LAX, MCA, Songbird, Source, Vocalion.
Tape lines: Same as rec. labels.

One-Stop Music Serv. Inc., PO Box 321, 24-26 Clark St., East Hartford 06108. Tel. 528-4126. Owner & Mgr.: Richard J. Godlewski; Owner & Buyer: Frank Sutter (Rec. D)

Labels: Advent, Audio Components, Audio Fidelity, BBP, Bert & I, CMH country, Camden, Chiaroscuro, Children's Recs. of America (Sesame Street), Columbia Special Prods., Contemporary, Conversa-Phone, Corinthian, Creative World, Dana, Delmark, Delos, Desmar, Direkt Disk, Discovery, Dobro, Dyno, ENJA, Education Media (Bruno Walter), Electric Lemon, Environment, Erato, Euphoria, Everest, Excellence, Fiesta, Grecophon, First Heard, Golden Age of Radio, Haydn Soc., Improv, JRC, Jazz, Labb, Living Language, Mark 56, Milagro, Monitor, Muse, Orion, PA/USA, Pelican, Peter Pan, Pickwick, Quintessence, Rego, Republic, Request, Sheba, Sound Effects, Stan Kenton, Stanton, Thimble, Varese, Vox, World Jazz.

Accessories: Blank tape (Memorex, Sony), rec. care prods. (Sound Guard).

Tin Pan Recs. Inc., 157 Charter Oak Ave. Zip 06106. Tel. 278-5222. Owner & Mgr.: Thomas Markoski (Rec. & Tape D, OS & RJ)

Rec. labels: GP, Juno, little Darlin', Peerless Classics, Rebecca, SoCon

Tape lines: All major lines
Accessories: Carrying cases (Peerless), needles (Electro-Voice), Recotom prods.

Warner/Elektra/Atlantic Corp., 851 Marshall Phelps Rd., Windsor 06095. Tel. 688-7581. Sales Mgr.: Mike Fontecchjo (Rec. & Tape D)

Rec. labels: Asylum, Atco, Atlantic, Bearsville, Beserkley, Big Tree, Cotillion, Curtom, Dark Horse, DiscReet, ECM, Elektra, Embryo, Famous Charisma, Finnadar, Little David, Loma, Manticore, Nemperor, Nonesuch, Pacific, Paradise, Reprise, Rolling Stones, SHE, Sire, Slipped Disc, Swan Song, WMOT, Warner Bros., Warner/Curb, Warner Spector, Westbound, Whitfield, Wing & a Prayer, Zephyr.
Tape lines: Same as rec. labels.

• **NEW CANAAN (Area Code 203)**
 The MusicSmith, 103 Main St. Zip 06840. Tel. 972-0002 (Rec. OS, RJ & E; Tape OS & RJ)

• **NOANK (Area Code 203)**

Dean Wallace Rec. Dist. Ltd., PO Box 162. Zip 06340. Tel. 536-4749. Pres.: Dean Wallace Jr. Warehouse: 17 Pearl St. Zip 06340 (Rec. D & I)

Labels: Adelphi, Advent, Alfa, Alligator, Arhoolie, Aztec, Bay, Bert & I, Big Star, Biograph, Blind Pig, Blue Canyon, Blue Goose, Blues Classics, Briar, Bullfrog, CMH, CP Prod'ns, Cardinal, Celest, Chelsea House, Clearwater, Collegium, County, Dobro, East River, Everest, F&W, Flying Fish, Folk-Legacy, Folk Lyric, Folkways, Fretless, Front Hall, Giants of Jazz, Gilead, Grass Sound, Green Linnet, Green Mountain, Historical, Impact, Improving Artists, Innisfree, JCOA, Jay, Jay Round, June Appal, Kaleidoscope, Kicking Mule, Legacy, Living Folk, Meadowlands, Michiagn Archives, Minstrel, Morgan Prod'ns, Muskadine, Old Timey, Orchard, Orinda, PM, Paredon, Philo, Physical, Piedmont, Rebel, Red Rooster, Redwood, Revonah, Ridge Runner, Rounder, Rumbleseat, Sackville, Seed, Shanachie, Shilo, Shoostyrng, Sierra/Briar, Skyline Sonory, Spivey, Stash, Stinson, Strata-East, Swallowtail, Symposium, Syntonic Research, Takoma, 360 Degrees, Titanic, Tradition, Traditional, Trix, Troubadour, Voyager, Waterhouse, Watt, Windham Hill, Zap

Labels imported: Baniff, Big Ben, Blackbird, Breakwater, Celtic, Cezame, Chyne, Claddagh, Combats, Dolphin, Fogarty's Cove, Free Reed, Gael-Linn, Hawk, Horselips, Id, Inchechronin, Leader/Trailer, Mulligan, Oldie Blues Outlet, Philips, Polydor, Release, Rubber, Stooft, Tangent, Tara, Topic, Transatlantic, Triskell, Xtra
Accessories: Limberjacks, Cedar Ridge Crafts

DISTRICT OF COLUMBIA

• **WASHINGTON (Area Code 202)**

Black Fire Dist's., PO Box 38054. Zip 20020. 4409 Douglas St. NE. Zip 20019. Tel. 396-0154. Owner & Pres.: James B. Gray, VP & Gen. Mgr.: Plunky Nkabinde, Albums Buyer: Jimmy Gray (Rec. D)

Labels: AKBA, Black Fire, Divine, Freelance, IPS, India Navigation Co., Mbar, Nodlew, SRP, Strata, Sun, Survival, Third World, Tribe, Trident, Triumph, Ujamaa
 District Recs. Inc. (Rec. & Tape RJ)—Tel. 832-3600. Mgr.: James Schwartz—see Schwartz Bros.
 Schwartz Bros. Inc., 2146 24th Pl. NE. Zip 20018. Tel. 529-5700. Owners: James Bertram & Stuart Schwartz, VP Sales: Jerry Jacobs, Sales Mgr.: Eugene Horn, Buyer: Steve Schwartz (Rec. & Tape D), (Rec. & Tape RJ as District Recs. Inc.)

MIAMI'S Hottest Distributor



Contact
LYNDA STONE

TONE DISTRIBUTORS, INC.
 P.O. BOX 1447/HIALEAH, FLA. 33010/(305) 888-1685

Branches: Philadelphia, Pa.; Norfolk, Va.; Tidewater One Stop (Rec. & Tape OS).
Rec. labels: Alston, Arista, Barnaby, CTI, Century, Chrysalis, Crystal Clear, Dictation Disc, Direct to Disc, Disneyland, Everyman, Fantasy, Flying Fish, Glades, Gordy, Gospel Roots, GRT, Hitsville, Hob, Janus, Jewel, Kudu, Light, Living Language, London, Milestone, Motown, Mushroom, Myrrh, Nashboro, Orinda, Ovation, Pacific Arts, Paula, Prelude, Prestige, Prodigal, Rare Earth, Savoy, Sesame Street, Shadybrook, Sound Bird, Sparrow, Specialty, TK, Tamla, Tomato, Vanguard, Word.
Tape lines: All lines.
Accessories: Ampex, BASF, Maxell, Memorex, Pickering, Recoton, Scotch, Sony, Sound Guard, TDK, Watts. (SEE ADVERTISEMENT)

boro, New Pax, Paragon, Plantation, Pyramid, QCA, Rebel, SSS Int'l, Shadeway, Sparrow, Springboard/Trip, Stoneway, Sun, Supreme, Tempo, Vesper, WIG, Word.
Phonographs: BSR, Dejay, Sharp
Playback equip.: Akai, Sharp
Accessories: Audio prods (CalCo), batteries (Panasonic), blank loaded tape (BASF, Tracs, XHE), cases (Savoy), needles (Pageant, Walco), phono cartridges (Electro-Voice), rec & tape racks (Royal), rec care prods (Calco, Fidelitone)
 Lieberman Ents. Southeast, 9603 N Main St Zip 32218. Tel 751-2600. Opns, Mgr. V.J. Forrest (Warehouse only, also see listing in Atlanta, Ga)

M C A Dist'g Corp., 7370 NW 36 St., Suite 133 Zip 33166 Tel 592-5140 Branch Mgr. Larry Glaser (Rec. & Tape D)
Rec. labels: Backstreet, Butterfly, Coral, Infinity, LAX, MCA, Songbird, Source, Vocalion
Tape Lines: Same as rec. labels.
 M J S Entertainment Corp., 8228 NW 56 St Zip 33166 Tel 592-6085, Telex 51-9739. Cable MJSMU-SICMIA Pres. Michael J. Spector, VP Sales & Opns. Al Zamora; Sales Mgr. David Colburn; Export Sales Mgr. Willy Ramos, Albums & Tape Buyers. Robin Hood, Peter Dunn (Rec. & Tape D & OS), (Rec. & Tape RJ as MJS Rack Inc.), (Rec. & Tape I & E as MJS Int'l Inc.)
Rec. labels: Alshire, Canaan, Disneyland, Increase, Light, Spector Int'l, Word.
Tape lines: ABC, Anchor, Arista, Cadet, Charisma, Chess, Dot, Dunhill, GRT, Janus, Jewel, Paramount, Paula, Private Stock, Ranwood, Roulette, Vanguard
Accessories: Capitol, Duotone, GRT, Le-Bo, Maxell, Memorex, Recoton, Scotch, TDK
 Imports recs & pre-recorded tapes from England.
 M & M Recs. Discs Inc., 501 W 28 St, Hialeah 33010 Tel 887-4522. Owner & Buyer Manuel J. Mato, Mgr. Mariano Rodriguez, (Rec. & Tape D, OS & RJ)
Rec. labels: Atlas, Lad, TH, Velvet
Tape lines: Same as rec. labels

FLORIDA

● **FORT LAUDERDALE (Area Code 305)**
 Raven Recs., 6421 Blvd. of Champions, Suite R Zip 33068 Tel 974-2841. Pres.: Daryl Toor, VP Hal Brodsky. (Rec. D—cutouts)
 Sid's Recs. & Tapes Inc., 2900 E. Sunrise Blvd. Zip 33304. Tel 563-9278. 565-5855. Owner: Sidney Debin, Mgr. & Buyer Skip Asbury. (Rec. OS)

● **GULF BREEZE (Area Code 904)**
 King Rec. Dist., 800 E. Gulf Breeze Pkwy. Zip 32561 Tel 932-2525. Owner: S. Burke; Mgr. & Buyer Jody Wallace (Rec. D & OS, Tape OS)
Labels: Aspen, Crazy Baby, Detroit Sound, Dilo, Excel, Holiday, King, Record Push, Sonic, Soulwish.

● **JACKSONVILLE (Area Code 904)**
 CalCo Dists. Inc., 7656 Lem Turner Rd. Zip 32208 Tel 768-4883. Owner & Mgr. Calvin Davis; Buyers Singles, Jan Morrison. Albums & Tape, B.B. Cubbedge. (Rec. & Tape D & OS)
Rec. labels: Abet, Atina, Boblo, Calvary, Canaan, Creed, Disneyland/Vista, Ernie's, Excello, Good News, Green Tree, Gusto/Starday, HSE, Heart Warming, IRDA, Image Three, Impact, Jewel/Paula, Jim, Jimmie Davis, KCP, Kenwood, Light, Mankind, Michele Audio, Myrrh, Nashboro, New Pax, Paragon, Plantation, Pyramid, QCA, Rebel, SSS Int'l, Shadeway, Sparrow, Spirit of 21st Century, Springboard/Trip, Stoneway, Su-Ann, Sun, Supreme, Tempo, Vesper, WIG, Word.
Tape lines: Abet, Calvary, Canaan, Creed, Excello, GRT, Good News, Green Tree, Gusto/Starday, HSE, Heart Warming, Image Three, Impact, Jim, Jimmie Davis, KCP, Kenwood, Light, Mankind, Michele Audio, Nash-

● **MIAMI METROPOLITAN AREA (Area Code 305)**

Alhambra Dist'g Inc., 552 W. 27 St., Hialeah 33010 Tel 885-4298. Gen Mgr. Miguel Estivill, Singles, Albums & Tape Buyer Ted Santana (Rec. & Tape D)
Labels: Alhambra, Al, Al Mex, Libra
 B B Recs., 4441 NW 74 Ave Zip 33166 Tel 592-7385 Pres. Bernard Binnick (Rec. E—closeouts)
 C B S Recs., Executive Bldg., Suite 605-606, 1175 NE 125 St., North Miami 33161 Tel 893-7030 Branch Mgr. Jim Urie (Rec. & Tape D)
Rec. labels: Arc, Bang, Blue Sky, CBS, Caribou, Columbia, Epic, Jet, Kirshner, Melodiya/Columbia, Nemperor, Odyssey, Philadelphia Int'l, Portrait, Starflite, Stiff, T-Neck, Tabu, Tappan Zee, Unlimited Gold
Tape lines: Same as rec. labels
 Capitol Recs., 7425 NW 48 St Zip 33166 Tel 592-3810 (Rec. & Tape D)
Rec. labels: Angel, Ariola America, Capitol, EMI America, Harvest, Liberty, Melodiya/Angel, Seraphim, United Artists.
Tape lines: Same as rec. labels
 Cayre Dists. of Florida Inc., 10002 NW 80 Ave., Hialeah Gardens 33015. Tel 822-6967 Mgr. & Buyer Pepe Mora. (Rec. & Tape D)
Home office: New York, N.Y., Caytronics Corp (Rec. & Tape D, OS, RJ, I & E). (See for prod distributed)
 Discos Latin Int'l Inc., 10104 NW 80 Ave., Hialeah Gardens 33016 Tel 557-2135. (Rec. & Tape D)
Home office: Los Angeles, Calif
Rec. labels: Fono Rex, Latin Int'l, Microfon, Pega.
Tape lines: Same as rec. labels
 Florida Independent Promos., 8228 NW 56 St Zip 33166 Owner: Joseph Stanzione (Rec. I & E—cut-outs)
 Guinness Rec. Group Inc., 1401 Brckell Zip 33131. Tel 373-1234 Pres. Mgr. & Buyer Marvin L. Popkin (Rec. D)
Label: Dellwood
 Handelman Co., 2346 NW 147 St., Opa Locka 33054 Tel 681-4618 Mgr. Hal Scovill; Buyers Hal Scovill, Connie Goigschea, Joe Reilly (Rec. & Tape RJ)
Home office: Clawson (Detroit Metropolitan Area), Mich.
 Latin Recs. Dists. (Rec. D), see Musical Recs Co

Musical Recs Co./Musical Tapes Inc., 780 W 27 St., Hialeah 33010. Tel 887-2638 Pres. Eliseo Valdes, Gen. Mgr. Angel Tamargo (Rec. & Tape D), (also Rec. D as Latin Recs. Dists.)
Branches: Los Angeles, Calif.; San Antonio, Tex
Rec. labels: Bueno, Dila, Discuba, Ego, Eli, Musart, Musidisc, Peerless.
Tape lines: Alegre, Alhambra, Bornqueno, Caytronics, Columbia, Cotique, Dila, Discuba, Ego, Eli, Fania, Fuentes, Funny, Gema, Inca, International, Kubaney, Latin Int'l, Marvela, Mate, Modiner, Musart, Musidisc, Orfeon, Orion, Panart, Parnaso, Peerless, RCA, Ramy, Rico-Vox, Seeco, Sonolux, Spanoramic, Tico, United Artists, Vaya, Velvet.
 Musical Tapes Inc., see Musical Recs Co /Musical Tapes Inc
 O P One Stop, 1543 NW 163 St. Zip 33169. Tel 625-3122 Zip 33169. Mgr. & Singles Buyer Paul Voss (Rec. OS, I & E)
 Pickwick Int'l Inc., Distribution Div., 13145 NW 45 Ave., Opa Locka 33054. Tel. 685-7601 Mgr. Bob Wilder; Buyers Singles, Gay Levine, Albums, Ben Schlatke, Classical, Leo Nunez, (Rec. & Tape D), (Rec. & Tape RJ as Pickwick Int'l Inc., Rack Servs. Div.)
Home office: Minneapolis, Minn
Labels: ABC/GRT, AVI, Abkco, Argo, Arista, Arista House, Aspetke, Audio Treasury/GRT, Barnaby, Birthright, Blue Thumb/GRT, Buddha, Buena Vista, Buk, Butterfly/GRT, CMH, CRA, CTI, Camden, Chanterelle, Cherry, Chrysalis, Cme, Coconut Grove, Concord Jazz, Connoisseur Society, Cream, De Ram, Disneyland, Dot/GRT, Dunhill/GRT, Fiesta, First American, Flying Fish, GNP Crescendo, GRP, GRT, Golden Age, Gordy, Great Northwestern, H&L, Hi, Hob, Janus, Jem, Kaleidoscope, Kudu, Le Joint, Living Language, L'Oiseau Lyre, London, Midsong, Mike Curb, Music, Motown, Mountain Railroad, Muse, Mushroom, Music, Ms Medicine, NTSU Lab Jazz, Natural Resources, Nessa, Ovation, Pacific Arts, Paramount/GRT, Parrot, Passport, Peacock/GRT, Piccadilly, Pickwick, Potato, Private Stock, Prodigal, Project 3, Quintessence, Ranwood, Rare Earth, Salvation, Savoy, Sesame Street, Shadybrook, Shelter/GRT, Sierra Brar, Sire/GRT, Songbird/GRT, Stiff, Stony Plain, Syntonic Research, Takoma, Talisman, Tamla, Telefunken, Three Brothers, Threshold, Tomato, UK, Visa/Import, Voyage, Xanadu
Accessories: American Lighting, Columbia Magnetics, Dynasound, Memorex, Music Master, Paramount Wire, Service Mfg., Scotch, Soma (SEE ADVERTISEMENT)
 Pickwick Int'l Inc., Rack Servs. Div., 13145 NW 45 Ave., Opa Locka 33054. Tel. 685-7601 Opns Mgr. Manny Perrera; Sales Mgr.: Vince Ferla; Buyer: George Biddle (Rec. & Tape RJ), (Rec. & Tape D as Pickwick Int'l Inc. Distribution Div.)
Home office: Minneapolis, Minn
 PolyGram Dist'n Inc., 8400 NW 52 St., Suite 103 Zip 33166. Tel 592-7970 Mgr. Larry Hensley (Rec. & Tape D)
Home office: New York, N.Y.
Rec. labels: American Int'l, Archiv, Capricorn, Casablanca, Charisma, Chocolate City, DJM, De-Lite, Deutsche Grammophon, Emarcy, Festivo, Fontana, Lighthouse, MGM, Mercury, Monument, Oasis, Parachute, Philips, Polydor, Polydor/BGO, Polydor/Harem, Polydor/Kolob, Polydor/MVP, Polydor/Mankan, Privilege, RSO, RSO/Curtom, Riva, Smash, Soundstage Seven, Spring, Vertigo, Verve, Zappa.
Tape lines: Same as rec. labels.
 R C A & M & Assoc'd Labels, 7220 NW 36 St., Suite 103. Zip 33166 Tel 592-4646 Sales Mgr. Jerry Silhan. (Rec. & Tape D)
Rec. labels: A&M, Bluebird, Free Flight, Gold Seal, Grunt, Hologram, Millennium, NY Int'l, Pablo, Pablo Live, Pure Gold, RCA, Red Seal, Roadshow, Rocket, Salsoul, Solar, Tortoise, 20th Century, Victrola, Windsong.
Tape lines: Same as rec. labels.
 Southern Rec. & Tape Servs Inc., 1020 E 14 St., Hialeah 33010 Tel 885-4625 Owner: Lynda Stone, Mgr. Robert DeFreitas, Buyers Singles, Ron Sansone, Albums & Tape, Norman Nessiss. (Rec. & Tape OS, RJ & E)
Accessories: Duotone, Fidelitone, Le-Bo, Savoy, Tracs
 Specialty Dists. Inc., PO Box 4155, Normandy Sta., Miami Beach 33141 Tel 758-0000. Pres. W. Jay (Rec. & Tape D)
Distributes all polka labels
Accessories: Blank tape (Ampex).
 Tone Dists., PO Box 1447, Hialeah 33011; 495 SE 10 Court, Hialeah 33010. Tel 888-1685 Gen. Mgr. Lynda Stone; Sales Mgr. Fred Held. (SEE ADVERTISEMENT)
 Trackdown Rec. Dists., 6940 NW 186 St., Suite 330, Hialeah 33015. (Rec. & Tape D, OS, RJ, I & E)
Home office: Chicago, Ill. (See for prod distributed)

STONE EXPORT

If It's Records & Tapes
 You Need, You Can Count
 on Tone. Call or Cable
 Us Today for More Information.



STONE DISTRIBUTORS, INC.

P.O. BOX 1447/HIALEAH, FLA. 33010/(305) 888-1685
 TELEX 519250

MJS ENTERTAINMENT CORP.

DISTRIBUTION

EXPORT

ONE-STOP

CLASSICS • LATIN • REGGAE • CUT-OUTS
IMPORTS • DIRECT-TO-DISC • BLANK AUDIO & VIDEO

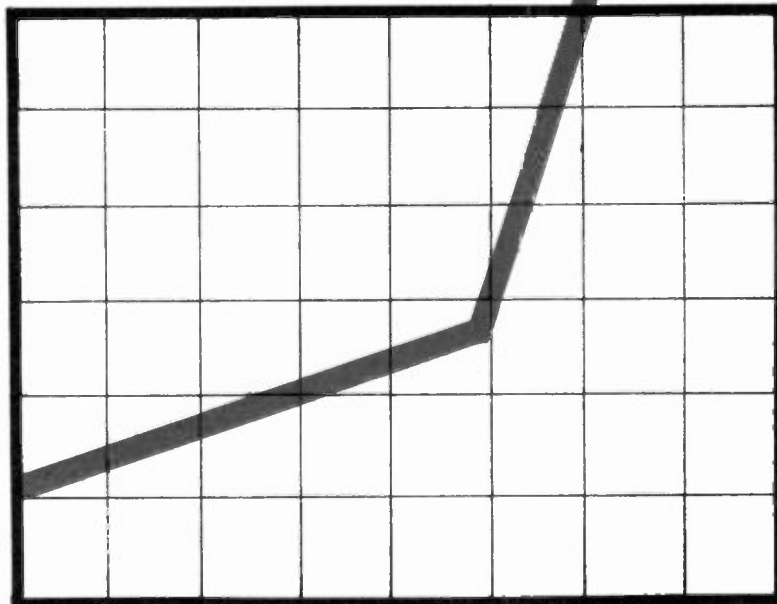

SEPT. '78

SEPT. '79

Projected SEPT. '80

TDK—Maxell
Scotch—Lebo
Recoton
ABC—A&M
Ariola—Arista
Atlantic—Bang
Big Tree—Buddah
Butterfly
Capitol
Casablanca
Chrysalis
Cream—De-Lite
Disneyland
Elektra/Asylum
Epic

Fantasy—GRT
H&L—Island
Janus—Jet
London—MCA
Polydor—RSO
Mercury—Spring
Capricorn
Motown—Mushroom
Private Stock
Salsoul—TK-UA
Warner Bros.—Word
Tamala
LATIN: Vaya—TH
Fania—Tico-Coco
Alhambra—Caytronics
Arcano—Gala-TR

MJS ENTERTAINMENT CORP.

8228 N.W. 56th STREET
MIAMI, FLORIDA 33166
305/592-6085
Telex: 51-9739

MICHAEL J. SPECTOR—President
PHIL VALENTINO—Vice President
PETER BLEI—Vice President Finance
AL ZAMORA—Vice President
WILLIE RAMOS—Export Sales
JOE STANZIONE—Export Sales
DAVID COLBURN—Domestic Sales
JEFF MacDONALD—Singles Buyer
GARY KULLA—Album Buyer
ALICIA BRAVO—International Coordinator

MJS ENTERTAINMENT OF CANADA, INC.

923 Matheson Blvd.
Mississauga, Ontario
L4W 2R7
416/624-0066
Telex: 06-961310

PETER DUNN—Buyer
CHRIS JESTER—Export Manager

MJS ENTERTAINMENT OF GA., INC.

2775 E BANKERS
INDUSTRIAL DRIVE
ATLANTA, GEORGIA 30360
404/448-7772 Telex: 70-0598

President—CHRISTOPHER BARR
Album Buyer—JOHN NORWOOD
Singles Buyer—GENEVIEVE ELLIOTT
Sales—BRAD GILSTRAP
Sales—MARY JANE MERLANO

United Rec. & Tape Inds. Inc., 9880 NW 77 Ave., Hialeah Gardens 33016. Tel: 821-3100. Bd. Chm.: Allan Wolk; VP Mktg. & Sales: Sydney Silverman; VP Opns.: David Jackowitz; Buyers: Marcia Funk, Brad Harrison. (Rec. & Tape RJ)
 Branch: Atlanta, Ga. (SEE ADVERTISEMENT)
 Vibrations, 14700 Biscayne Blvd., North Miami 33181. Tel: 949-7055. Owner: Larry Schaffer. (Rec. & Tape OS, RJ, I & E)
 Warner/Elektra/Atlantic Corp., 1065 NE 125 St., North Miami 33161. Tel: 891-4511. Sales Mgr.: Dave Benjamin. (Rec. & Tape D)
 Rec. labels: Asylum, Atco, Atlantic, Bearsville, Beserkley, Big Tree, Cotillion, Curton, Dark Horse, DiscReet, ECM, Elektra, Embryo, Famous Charisma, Finnadar, Little David, Loma, Manticore, Nemperor, Nonesuch, Pacific, Paradise, Reprise, Rolling Stones, SHE, Sire, Slipped Disc, Swan Song, WMOT, Warner Bros., Warner/Curb, Warner Spector, Westbound, Whitfield, Wing & a Prayer, Zephyr.
 Tape lines: Same as rec. labels.

● **ORLANDO AREA (Area Code 305)**
 Mountaineer Rec. Serv. Inc., 4936 S. Orange, Zip: 32806. Tel: 859-1472. Pres. & Sales Mgr.: H. Holliday; Buyer: Tommy Flisek. (Rec. & Tape OS)
 Southern Music, 30 S. Orange Ave. Zip: 32801. Tel: 422-8671. Owner: Ron Road; Mgr.: George Brymer; Buyers: Singles, Steve Flesher, Albums, George Brymer. (Rec. OS)
 Sunshine Music, 290 Iris Rd., Casselberry 32707. Tel: 831-3330. Owner & Mgr.: Richard Stultz; Buyers: Singles, Richard Stultz; Albums, Barry Dean; Tape, Jim Boylston. (Rec. & Tape OS & RJ)

● **PALM BEACH (Area Code 305)**
 Victor Kislak Ent's., 307 Chilian Ave. Zip: 33480. Tel: 832-1201. Pres.: Victor Kislak. (Rec. & Tape D)
 Distributes cut-outs, budget recs. & tapes.

● **PLANT CITY (Area Code 813)**
 Sunshine Tapes Inc., PO Box T, 802 E. Reynolds St. Zip: 33566. Tel: 754-2618. (Rec. & Tape OS & RJ)

● **SARASOTA (Area Code 813)**
 Distributors Inc., 258 Shopping Ave. Zip: 33577. Tel: 953-3797. Owner: Gary Kuban. (Rec. OS & RJ)

● **TALLAHASSEE (Area Code 904)**
 Community Literature Inc., see Looking Forward Dist.
 Looking Forward Dist. (Community Literature Inc.), 730 W. Gaines St. Zip: 32304. Tel: 224-9490. Mgr.: Richard Shapiro; Sales Mgr.: Tom Baxter; Buyers: Albums, Richard Shapiro; Tape, Tom Baxter. (Rec. & Tape OS)
 Mobile Rec. Serv. Co., 5505 Debbie Dr. Zip: 32304. Tel: 385-3330. Mgr.: John Montgomery. (Rec. OS—singles only)
 Home office: Pittsburgh, Pa.

● **TAMPA (Area Code 813)**
 Mobile Rec. Serv. Co., 7311 Filbert Ln. Zip: 33617. Tel: 988-8468. Mgr.: Stephen Kozakoff. (Rec. OS—singles only)
 Home office: Pittsburgh, Pa.
 Records Unlimited Dist. Inc., PO Box 952. Zip: 33601. 2110 W. Main St. Zip: 33607. Tel: 251-1186. Mgr. & Rec. Buyer: Joe B. Brown; Tape Buyer: Linda L. Santos. (Rec. OS & RJ, Tape OS)
 Tampa Recs., PO Box 5524, 1416 E. Seventh Ave. Zip: 33605. Tel: 876-5314. Owner & Buyer: S. Delgado. (Rec. & Tape RJ—Latin prod. only)

● **WEST PALM BEACH AREA (Area Code 305)**
 Mobile Rec. Serv. Co., 417 San Mateo Dr., Palm Springs 33460. Tel: 965-4498. Mgr.: Rolan J. Eder. (Rec. OS—singles only)
 Home office: Pittsburgh, Pa.

GEORGIA

● **ALBANY (Area Code 912)**
 Gwen Rec. Serv., 319 Highland Ave. Zip: 31706. Tel: 436-6508. Owner, Mgr. & Buyer: Jesse Boone. (Rec. & Tape OS)

● **ATLANTA METROPOLITAN AREA (Area Code 404)**
 C B S Recs., 18 Executive Park Dr. NE. Zip: 30329. Tel: 321-4553. VP Southeast Region: Roger Metting; Reg'l Co-ord.: Barbara Savage; Branch Mgr.: Dave Swengros. (Rec. & Tape D)
 Rec. labels: Arc, Bang, Blue Sky, CBS, Caribou, Columbia, Epic, Jet, Kirshner, Melodiya/Columbia, Nemperor, Odyssey, Philadelphia Int'l, Portrait, Starfite, Stiff, T-Neck, Tabu, Tappan Zee, Unlimited Gold.
 Tape lines: Same as rec. labels.
 Capitol Recs., 1670 NE Freeway Access Rd. Zip: 30329. Tel: 321-5441. (Rec. & Tape D)
 Rec. labels: Angel, Ariola America, Capitol, EMI America, Harvest, Liberty, Melodiya/Angel, Seraphim, United Artists.
 Tape lines: Same as rec. labels.
 Duplex Rec. Dist. of Atlanta, 699 McDaniel St. SW. Zip: 30310. Tel: 524-9174. (Rec. D)
 Labels: Arno, Dove, Duplex Startown, Esprit, Rocksoul, Sidetrack, Soultrack, Spacetown.
 Phonographs: Admiral, Magnavox, Masterworks, Motorola, RCA, Zenith.
 Accessories: Carrying cases (Peerless), cleaners

(Watts), needles, cartridges (E-V); phono jacks & plugs (RCA).
 Georgia Music Supply Inc., PO Box 490331. Zip: 30349. Tel: 996-3385. Owner: Richard F. DeCourcy; Buyer Linda Galgano.
 Handleman Co., 1578 Litton Dr., Stone Mountain 30083. Tel: 938-9467. Mgr.: Mike Negrin; Buyers: Mike Negrin, Rick Tully. (Rec. & Tape RJ)
 Home office: Clawson (Detroit Metropolitan Area), Mich.
 Jacyn Sales Inc., 7185 Cane Leaf Dr., Fairburn 30213. Tel: 964-3837. Owner, Mgr. & Buyer: James H. Alexander. (Rec. & Tape D & RJ)
 Rec. labels: Atteram, Gusto, King, Starday.
 Tape lines: Same as rec. labels.
 Lieberman Ent's. Southeast, 2700 Cumberland Pkwy., Suite 260. Zip: 30339. Tel: 432-0306. Mgr.: Dennis Nichols; Buyers: Singles, G. Black; Albums; J. Scaglione. (Rec. & Tape RJ—sales & purchasing only, also see listing in Jacksonville, Fla.)
 Home office: Minneapolis, Minn. (Rec. & Tape OS & RJ) (SEE ADVERTISEMENT)

M C A Dist'g Corp., 6403 Warren Dr., Norcross 30093. Tel: 448-5584. Reg'l Mgr.: Glenn Hornor; Branch Mgr.: Ron Warren. (Rec. & Tape D)
 Rec. labels: Backstreet, Butterfly, Coral, Infinity, LAX, MCA, Songbird, Source, Vocalion.
 Tape lines: Same as rec. labels.
 M J S Entertainment Corp. of Georgia Inc., 2775-E Bankers Industrial Dr. Zip: 30360. Tel: 448-7772. WATS (800) 241-5390. Telex: 700598. Pres.: Christopher Barr; Buyers: Singles, Genevieve Elliot; Albums & Tape, John Norwood, Ted Williams. (Rec. D & OS, Tape OS)
 Rec. labels: Canaan, Creed, Disneyland, Jewel, Kenwood, Light, Myrrh, Nashboro, Paula, Ronn, Springboard, Trip, Word.
 Accessories: BASF, Capitol, Discwasher, Le-Bo, Maxell, Memorex, Recoton, Scotch, TDK

Music & Video Mdr's Inc., 1424 Kelton Dr. 30083. Tel: 296-1440. Owner & Pres.: John F. Langlois; Opns. Mgr. & Singles Buyer: Gerald M. Hood; Albums, Tapes & Promotions Buyer: John F. Langlois; Ass't Albums, Tape & Promotions Buyer: Gerald M. Hood. (Rec. & Tape RJ)
 One-Stop Rec. House Inc., 1872 Marietta Blvd. Zip: 30318. Tel: 351-9140. Pres. S. R. Freeman; Gen. Mgr.: Hugh West; Buyers: Singles, Carol Sanford; Albums & Tape, Sandy Carter. (Rec. & Tape OS)
 Accessories: Blank tape (BASF, Capitol Magnetic, Memorex), needles (Planstiehl); Le-Bo prods

Pickwick Int'l Inc., Distribution Div., 115 Villanova Dr. Zip: 30336. Tel: 349-5200. Mgr.: Jack Mester; Opns. Mgr.: Lynn Wood; Sales Mgr.: Tom Beckwith; Buyer: Vaughan Jones. (Rec. & Tape D), (Rec. & Tape RJ as Pickwick Int'l Inc., Rack Servs. Div.)
 Home office: Minneapolis, Minn.
 Labels: AFA, AVI, Abet, Abkco, Accent, Ala, Alexander Street, Alston, Amazon, Argo, Arista, Arth, Artist House, At Home, BMA, Barnaby, Birthing, Buck, Buddha, Buffalo, CMH, CTI, Camden, Cat, Chimneyville, Chrysalis, Clouds, Con Brio, Connoisseur Society, Cream, Creed, Dash, Deram, Dial, Dixie Jubilee, Drive, Ernie's, Fantasy, First American, Flying Fish, GNP Crescendo, GRP, GRT, Galaxy, Glades, Good Sound, Gospel Roots, Gospel Truth, Gryphon, HDM, H&L, Heart Warming, Hi, Hilltop, Hitsville, Hot, InPhasion, Janus, Jazzworld, Juana, Ju-Par, Kaleidoscope, Kayvette, Kenwood, Kudu, LRC, Laif, Le Joint, Little Star, Live Wire, Living Language, L'Oiseau Lyre, London, Lyons, Malaco, Marlin, Messenger, Metronome, Midsong Int'l, Milestone, Motown, Mountain Railroad, Muse, Mushroom, Music Is Medicine, Namara, Nashboro, Natural Resources, Novus, Orinda, Ovation, Pacific Arts, Parrot, Passport, Piccadilly, Pickwick, Potato, Prestige, Prodigal, Project 3, Quintessence, Ranwood, Rare Earth, Riverside Jazz, Roadshow, Salvation, Savoy, Seeds & Stems, Sesame Street, Shadybrook, Shield, Silver Blue, Soul, Sound Bird, Sounds South, Stax, Stiff, Sunnyvale, Sunshine Sound, Syntonic Research, TK, Talsman, Tamla, Telefunken, Threshold, Tomato, Venture, Versatile, Wanderick, Weird World, Wicked, Wolf, Xanadu. (SEE ADVERTISEMENT)

Pickwick Int'l Inc., Rack Servs. Div., 365 Patton Dr. SW. Zip: 30336. Tel: 696-1850. Opns. mgr.: Marge Celt; Sales Mgr.: Bernie Hoen; Buyer: Dave Hefner. (Rec. & Tape RJ), (Rec. & Tape D as Pickwick Int'l Inc., Distribution Div.)
 Home office: Minneapolis, Minn.
 Pisce's Rack Serv. & Dist'g Co., 1994 Candler Rd., Decatur 30032. Tel: 288-5864. Mgr.: Evelyn Foster. (Rec. & Tape RJ)
 PolyGram Dist'n Inc., 294 Interstate North, Suite 160. Zip: 30339. Tel: 955-2025. Reg'l VP Herb Heidt; Branch Mgr.: Tim Monnig; Sales Mgr.: Lanny Estes. (Rec. & Tape D)
 Home office: New York, N.Y.
 Rec. labels: American Int'l, Archiv, Capricorn, Casablanca, Charisma, Chocolate City, DJM, De-Lite, DeutscheGrammophon, Emarcy, Festival, Fontana, Limgelint, MGM, Mercury, Monument, Oasis, Parachute, Philips, Polydor, Polydor/BGO, Polydor/Harem, Polydor/Kolob, Polydor/MVP, Polydor/Manken, Privilege, RSO, RSO/Curtom, Riva, Smash, Soundstage Seven, Spring, Vertigo, Verve, Zappa
 Tape lines: Same as rec. labels.
 R C A & A&M & Assoc'd Labels, 3395 Northeast Expwy. Zip: 30341. Tel: 455-3636. Reg'l Sales Dir.: Charlie Hall; Branch Sales Mgr.: Harry Clark; Sales Mgr.: George Jackson. (Rec. & Tape D)
 Rec. labels: A&M, Bluebird, Free Flight, Gold Seal, Grunt, Hologram, Millennium, NY Int'l, Pablo, Pablo Live, Pure Gold, RCA, Red Seal, Roadshow, Rocket, Salsoul, Solar, Tortoise, 20th Century, Victrola, Windsong
 Tape lines: Same as rec. labels.
 Record Dist'n Amalgamated (div. of The Group Inc.), 1957 Kilburn Dr. Zip: 30324. Tel: 872-0266. Mgr.: Scott Markhausen; Buyer: Oliver Cooper. (Rec. & Tape D)
 Rec. labels: Banned, Dance-A-Thon, Glamour & Grease, Hotlanta, Hottrax, Screaming Grease, Stereo Spectrum, Thevis.

Tape lines: Banned, Dance-A-Thon, Hottrax.
 Record Dist's, Inc., 6427 Warren Dr., Norcross 30093. Tel: 449-6035. Gen. Mgr.: Gene Donley; Opns. Mgr.: Norman Montrose; Sales Mgr.: Robert Newell; Buyer: Al Moore; Controller: Lisa Walters. (Rec. & Tape OS)
 Accessories: Discwasher, Maxell, Savoy.
 Record Shack of Atlanta, 3123 Oak Cliff Ind'l St. Zip: 30340. Tel: 455-6886. Telex: 707336. Mgr.: James O'Rourke. (Rec. & Tape OS, I & E)
 Home office: Woodside (New York Metropolitan Area), N.Y., Record Shack of New York City Inc. (SEE ADVERTISEMENT)

Tara Rec. & Tape Dist'g Co. Inc., PO Box 13939, 582 Armour Circle NE. Zip: 30324. Tel: 875-8272. Nationwide WATS: (800) 241-5538, Georgia WATS: (800) 282-4060. Pres.: Gwen M. Kesler; Mgr.: Steve Begor; Buyers: Singles, James Waters; Albums & Tape, Joe Terrebonne, James Waters, Promo.: Jamie Miller. (Rec. & Tape D & OS)
 Labels: AVI, Abattoir, Adelphi, Alston, Audio Book, BMA, Big Town, Bright Orange, Calvary, Canaan, Caprice, Cat, Champ, Charta, Chimneyville, Choice, Church Door, Classic Jazz, Clouds, Country Artist, Creed, Dash, Dictation Disc, Disneyland, Door Knob, Dove, Drive, E & B, Ernie's, Fona, 4 Star, Generation Int'l, Glades, Gori, Gospel Roots, Granny, Groovy, HSE, Heart Warming, Honey Bee, ICA, IRDA, Illusion, Inner City, Jamie, Jerri, Jewel, Jim, Juana, Jupiter, Kayvette, Kent, Kentone, Kenwood, Kid Stiff, King, Konduko, LRC, Light, Living Language, Magic Disc, Malaco, Marlin, Memorial, Merry, Messenger, Midtown, Muscle Shoals, Myrrh, Nashboro, Nelson Barry, Nostalgia Lane, One-Two-Three, Page Boy, Paula, Phono, Plantation, Prairie Dust, Prelude, Reborn, Republic, Rice, Ronn, Roots, Roulette, Rounder, SSS Int'l, Savoy, Scorpion, Scrimshaw, Silver Blue, Sound Plus, Sound Waves, Specialty, Spire, Starday, Su-Ann, Sunshine Sounds, Supreme, TK, Takoma, Tiger Lily, United, Visa, West End, Wicked, Wonderland, Word
 Accessories: Capitol Magnetics, Disc-Washer, Le-Bo, Savoy Leather, Sound Guard.

Trac Rec. Inc., 2070-G Boston Dr. Zip: 30337. Tel: 997-2263. Buyer: Ken Jernigan. (OS)
 Trackdown Rec. Dist's., 615 Watling Ln., No. 4, Stone Mountain 30083. (Rec. & Tape D, OS, RJ, I & E)
 Home office: Chicago, Ill. (See for prod. distributed)
 United Rec. & Tape Inds. Inc., 4300-B Bankers Circle, NE Atlanta Ind'l Park. Zip: 30360. Tel: 448-1500. Branch Mgr.: John Brenner; Buyers: Jack Roberge, Herman Watkins. (Rec. & Tape RJ)
 Home office: Hialeah Gardens (Miami Metropolitan Area), Fla. (SEE ADVERTISEMENT)
 Warner/Elektra/Atlantic Corp., 250 Villanova Dr., Atlanta Gateway Park. Zip: 30336. Tel: 344-4933. Mgr.: Bill Biggs. (Rec. & Tape D)
 Rec. labels: Asylum, Atco, Atlantic, Bearsville, Beserkley, Big Tree, Cotillion, Curton, Dark Horse, DiscReet, ECM, Elektra, Embryo, Famous Charisma, Finnadar, Little David, Loma, Manticore, Nemperor, Nonesuch, Pacific, Paradise, Reprise, Rolling Stones, SHE, Sire, Slipped Disc, Swan Song, WMOT, Warner Bros., Warner/Curb, Warner Spector, Westbound, Whitfield, Wing & a Prayer, Zephyr.

● **AUGUSTA (Area Code 404)**
 Big G Platter Shop, 209 Ninth St. Zip: 30902. Tel: 722-9306. Owner, Singles, Albums & Tape Buyer: Robert Gordon. Local branch: Pyramid Music & More, 826 Broad St. Zip: 30902. Tel: 724-1508. Mgr.: Jephrey Gordon. (Rec. & Tape OS)

● **CLARKESVILLE (Area Code 404)**
 Clarkesville Rec. Sales Co. Inc., PO Box 198, 608 N. Washington St. Zip: 30523. Tel: 754-2152. Pres.: Peter J. Rosetty; Mgr.: James Stockton; Singles & Tape Buyer: Wanda Stockton. (Rec. & Tape OS & RJ)
 Accessories: Audio Vox, Automatic Radio, Conic, Electro Brand, Tenna.

● **COLUMBUS (Area Code 404)**
 Trackdown Rec. Dist's., 6612 Foxboard Dr. Zip: 31907. (Rec. D, OS, RJ, I & E)
 Home office: Chicago, Ill. (See for prod. distributed)

HAWAII

● **HONOLULU (Area Code 808)**
 C B S Recs., 1580 Makaloa St., Suite 840. Zip: 96814. Tel: 955-0774. Branch Mgr.: Kelly Conway. (Rec. & Tape D)
 Rec. labels: Arc, Bang, Blue Sky, CBS, Caribou, Columbia, Epic, Jet, Kirshner, Melodiya/Columbia, Nemperor, Odyssey, Philadelphia Int'l, Portrait, Starfite, Stiff, T-Neck, Tabu, Tappan Zee, Unlimited Gold.
 Tape lines: Same as rec. labels.
 Eric of Hawaii Inc., 2071 S. Beretania St. Zip: 96826. Tel: 946-6522. Owner, Mgr. & Buyer: Irving Pinensky. (Rec. & Tape D)
 Rec. labels: Asylum, Cream, Elektra, Mele, TK, Trim, Warner Bros.
 Tape lines: Same as rec. labels.
 Hailona Dist's. Inc., 663 Sheridan St. Zip: 96814. Tel: 949-4118. Owner: Peter Morn; Mgr. & Buyer: Harvey Roessler. (Rec. & Tape D&E)
 Rec. labels: First Break, HanaOla, Impact, Ka Leo, Naka-hili, Panini, Pocholinga, RLM, Seabird Sound
 Tape lines: Same as rec. labels.
 Island 1-Stop (Rec. & Tape OS & RJ)—Buyer: Norm Winter—see Surfside Dist.
 Major Dist's. Inc., 1007 Dillingham Blvd. Zip: 96817. WATS: (800) 845-3884. Sales: Scott Ferrand. (Rec. & Tape D & RJ)

Home office: Tukwila (Seattle Area), Wash. (see for prod. distributed)

Microphone Music Co., 2077 S. Beretania St. Zip: 96814. Tel: 946-1488 Owner & Mgr.: Ken Kaizawa; Sales & Promo: Paul Fujii. (Rec. & Tape D, I & E)

Rec. labels: Atco, Atlantic, Barnaby, Berlitz, Big Tree, Cotillion, Disneyland, Fiesta, GRT, Golden, Inner City, Janus, Little David, Living Language, Prelude, Ranwood, Rolling Stones, Roulette, Scotti Bros., Shadybrook, Springboard, Swan Song, Trip, Vista, West End.

Tape lines: Atco, Atlantic, Big Tree, Dooto, GRT, Little David, Nemperor, Prelude, Rolling Stones, Swan Song, Trip, West End.

Rec. labels & tape lines imported: Viking (New Zealand), all Japanese labels.

Accessories: Le-Bo, Royal.

Music Craft Dist. of Hawaii Ltd., 636 Queen St. Zip: 96813. Tel: 533-1223 Owner & Mgr.: Walter Y. Kurokawa. (Rec. & Tape D)

Rec. labels: AVI, Ansonia, Arcano, Arista, Artist House, Audio Fidelity, CTI, Cadet, Caytronics, Coco, Concord Jazz, Contemporary, Discovery, Flying Fish, Folkways, 49th State, Hawaii Sons, Kicking Mule, Kudu, Laff, Laurie, Mark 56, Meridian, Miami, Milestone, Monitor, Monmouth Evergreen, Muse, Nashboro, Nashville Jazz, Orfeon, Original Sound, Orinda, PAUSA, PBR Int'l, Paradise, Parnassus, Plantation, Poki, Polynesian, Prestige, Prism, Private Stock, Project 3, Request, Roper, Rounder, SSS Int'l, Sun, Tradewinds, Vanguard, Waikiki, Word, Yazoo.

Tape lines: Arcano, Arista, CTI, Caytronics, Kudu, Milestone, Original Sound, Plantation, Prestige, Project 3, SSS Int'l, Tradewinds, Vanguard, Waikiki.

Nylen Bros. & Co. Ltd., 820 S. Beretania St. Zip: 96813. Tel: 538-1171 Cable: HOTLEN Pres. William Nylen, Gen. & Sales Mgr.: Ed Nielsen. (Rec. & Tape D)

Rec. labels: Black Jazz, Chrysalis, Coco Palms, Creative World, Delilah, Earl, Fantasy, First American, GNP Crescendo, Gordy, Hama Ho, Hitsville, Hui, Kahana, Kikei, Kobe, Kudu, Laka, Makaha, Motown, Mowest, Mushroom, Music Minus One, Ovation, Pacific Arts, Pickwick, Prodigal, Pumehana, Rare Earth, Sesame Street, Silvercloud, Sinergia, Soul, Stax, Syntonic Research, Tamla, Tomato, Turnabout, Varese/Sarabande, Vox.

Tape lines: Chrysalis, Fantasy, Motown, Mushroom, Ovation, Pumehana, Sesame Street, Tamla.

Playback equip. & phonographs: Fisher, Sylvania.

Accessories: Electro-Voice

Pickwick Int'l Inc., Rack Servs. Div., 2298 Alahao Pl., No. B. Zip: 96819. Tel: 847-2258 Ops. Mgr.: Neal Chong; Sales Mgr.: Tim McNeil. Buyer: Sterling Foster. (Rec. & Tape RJ)

Home office: Minneapolis, Minn.

RCA A&M & Assoc. d Labels, 1221 Kapiolani Blvd., Suite 512. Zip: 96814. Tel: 524-3030. Mgr.: Robert Haas. (Rec. & Tape D)

Rec. labels: A&M, Bluebird, Free Flight, Gold Seal, Grunt, Hologram, Millennium, NY Int'l, Pablo, Pablo Live, Pure Gold, RCA, Red Seal, Roadshow, Rocket, Salsoul, Solar, Tortoise, 20th Century, Victrola, Windsong.

Tape lines: Same as rec. labels.

Rack Serv. Hawaii Inc., 2320-A S. King St. Zip: 96814. Tel: 946-7737. (Rec. & Tape OS & RJ)

Surfside Dist., 1365 Colburn St. Zip: 96817. Tel: 841-0414. Gen. Mgr.: Mac Laris. (Rec. D), (Rec. & Tape OS & RJ as Island 1 Stop)

Labels: Lehua, Mahalo

World Wide Dist. Ltd., 1132 Auahi St. Zip: 96814. Tel: 531-0133. Pres.: Paul Spengler Jr. (Rec. & Tape D)

Rec. labels: Melway, Mountain Apple, Music of Polynesia.

Tape lines: Same as rec. labels.

IDAHO

• IDAHO FALLS (Area Code 208)

Slusser Whistle Co., 920 Lincoln Rd. Zip: 83401. Tel: 523-0775. Mgr.: N.M. Bradley. Buyer: Tecla Corbit. (Rec. & Tape RJ)

ILLINOIS

• CHICAGO METROPOLITAN AREA (Area Code 312)

Antares Dist., 3235 W. Fullerton Ave. Zip: 60647. Tel: 772-9444. Owner, Mgr. & Buyer: Leon A. Kelert. (Rec. D & I)

Labels: Adelphi, Amalgamated, Arcadia, Arcane, Aries, Audiophile, Barron, Bent, Big Band Archives, Birch, Blackbeard, Blackbird, Black Eagle, Blue Flame, Blue Goose, Blue Lantern, Bountiful, Briar, Broadway, Claremont, Command Performance, Cook, Daffodil, Dirty Shame, Echoes of Hollywood, Eubie Blake Music, Euphonic, Euphoria, Famous Door, GHB, Giants of Jazz, Golden Era, Herwin, Homespun, IAJRC, Jazz Archives, Jazz Guild, Jazzology, Jewel, Jim Taylor Presents, Kanawha, Land O Jazz, Merry Makers, Mod-Art, Musicraft, Nessa, New Orleans, No Gap, Old Homestead, Origin, PM, Pa Da, Palm Tree, Pelican, Peter Pan, Phorion, Piedmont, Power, Premiere, Progressive, Pumpkin, Puritan, Red Onion, Retrospect, San Diego Jazz Club, Sandpiper, Shoestring, Smoky Mary, Sounds of Swing, Southland, Spitball, Stash, Straight Ahead Jazz, Swing Era, Takoma, Testament, Triad, Uptown Lowdown, Varese Int'l, West Coast, Yazoo, Zim.

Labels imported: Big Bear (Netherlands), Dawn Club (Germany), Jazz Studies (Canada), Munich (Nether-

lands), Oldie Blues (Netherlands), Sidewalk Hot Jazz (Germany).

Balkan Music Co., 6917 W. Cermak Rd., Berwyn 60402. Tel: 484-6436. Owner: Slavco A.V. Hlad; Mgr.: Cynthia Hlad; Singles & Albums Buyer: Louis J. Hlad. (Rec. & Tape D)

Branch: Beaver Falls (Pittsburgh Metropolitan Area), Balkan Rec. Dist. Co

Rec. Labels: Balkan Int'l, Czech, Delta Int'l, Greyko, Marjon, Monitor

Tape lines: Balkan Int'l, Delta Int'l, Greyko, Monitor

Barney's One Stop, 3400 W. Ogden Ave. Zip: 60624. Tel: 521-6300. (Rec. & Tape OS)

CBS Recs., The Tower, Suite 301, 2850 E. Golf Rd., Rolling Meadows 60008. Tel: 640-5900. VP Midwest Region: Don Van Gorp. Reg. I Co-ord: Judy Lucas; Branch Mgr.: Jim Scully. (Rec. & Tape D)

Rec. labels: Arc, Bang, Blue Sky, CBS, Caribou, Columbia, Epic, Jet, Kirshner, Melodiya/Columbia, Nemperor, Odyssey, Philadelphia Int'l, Portrait, Starlite, Stiff, T-Neck, Tabu, Tappan Zee, Unlimited Gold.

Tape lines: Same as rec. labels.

C N S Co. Inc., 10614 S. Mackinaw Ave. Zip: 60617. Tel: 375-4052. Owner: Charles N. Stephens. (Rec. & Tape RJ)

Capitol Recs., 6401 Gross Point Rd., Niles 60648. Tel: 647-8338. (Rec. & Tape D)

Rec. labels: Angel, Ariola America, Capitol, EMI America, Harvest, Liberty, Melodiya/Angel, Seraphim, United Artists.

Tape lines: Same as rec. labels.

Casa Pan-Americana, see Pan American Recs.

Chicago One Stop Inc., 444 N. Lake Shore Dr. Zip: 60611. Tel: 822-9815. Pres. & Mgr.: Irving Rothblatt; VP: Howard M. Rosen. (Rec. & Tape OS)

China Books & Periodicals Inc., 174 W. Randolph. Zip: 60601. Tel: 782-6004. Mgr.: Mr. Kapczynski. (Rec. I)

Home office: San Francisco, Calif.

Imports from People's Republic of China.

Downtown Recs. Mgmt. Corp. (Rec. & Tape OS), see Mid-America Specialty.

Ernie's One Stop Recs. Inc., 1827 S. Michigan Ave. Zip: 60616. Tel: 842-4100. Owner: Ernie Leaner; Mgr.: Bill Leaner. (Rec. OS)

Fletcher's 1 Stop Recs & Tapes, 450 E. 75 St. Zip: 60619. Tel: 874-4484. (Rec. & Tape OS)

Galgano Dist'g Corp., 4147 W. Armitage Ave. Zip: 60639. Tel: 235-3800. Owner: Anthony Galgano; Mgr.: John Galgano; Buyers: Singles, Vinnie Leva; Albums, Joyce Vermilyer; Tape: Gene Gorjaczew. (Rec. & Tape OS)

Playback equip. & phonographs: Hitachi, Pioneer.

Accessories: GRT, Le-Bo, Maxell, Memorex, Recoton, Scotch, TDK. (SEE ADVERTISEMENT)

Tony Galgano Recs. Inc., 4134 W. Armitage Ave. Zip: 60639. Tel: 278-8300. Mgr. & Buyer: Tony Ignoffo. (Rec. & Tape OS)

Gibson's Town & Country One Stop, 1956 W. 51 St. Zip: 60609. Tel: 776-0700. Owners: Gregory & Kathie Gibson; Mgr. & Buyer: G.G. Gibson. (Rec. & Tape OS)

H N H Dist. Ltd., 820 Davis St., Suite 222, Evanston 60201. Tel: 492-9555. Owner: Harvey Neil Hunt; Gen. Mgr.: David C. Town. (Rec. D & I)

Labels: HNH, Unicorn.

Handelman Co., 801 Lunt Ave., Elk Grove Village 60007. Tel: 364-0230. Mgr.: Gary Bankston; Buyers: Gary Bankston, Bill & Jim Guler. (Rec. & Tape RJ)

Home office: Clawson (Detroit Metropolitan Area), Mich.

House Dist., 3410 Lake Shore Dr., Suite 7-E. Zip: 60657. Tel: 549-4614. Mgr.: Carol Bernstein. (Rec. & Tape D)

Home office: Kansas City, Mo. (See for prod. distributed) (SEE ADVERTISEMENT)

J S J Tape Dist. Inc., 6620 W. Belmont. Zip: 60634. Tel: 277-0550. Owner, Mgr. & Buyer: Joseph Swiatek. (Tape OS—cut-outs) (SEE ADVERTISEMENT)

K R P C O Kiderian Rec. Dist., 4926 W. Gunnison St. Zip: 60630. Tel: 545-0861. Owner: Raymond Peck; Mgr.: George Peck; Buyers: Singles, Vince Hartnet; Albums, Ray Peck. (Rec. D)

Labels: Armenian, Black Beauty, Camels Hair, Chicago Sound Factory (CSF), Centaur Talent, Dick/Hike, Ghetto, Glenoaks, Illinois Prod'g Corp., Kid, Kiderian, LRM, Middle Eastern, Newberry, Paw Print, Ray Peck Prod'n, Recordgraph, Rubby, St Lewis, Trinity, Virgin Vinyl, Wind City.

Kiderian Rec. Dist., see KRPCO

Kinnara Rec. & Tape Dist., 4323 N. Elston Ave. Zip: 60641. Tel: 588-7735. 583-5085. Owner & Mgr.: Raeburn Ferlage; Albums & Tape Buyer: Steven Gusler. (Rec. D & I, Tape D)

Rec. labels: Adelphi, Advent, Aerospace, Airways, Alligator, Archive of Folk & Jazz, Archive of Piano Music, Arhoolie, Asch, Atlas, Audio Arts, Avant, Baobab, Barrelhouse, Bartok, Bay, Bet-Car, Blind Pig, Blue Goose, Blue Labor, Blue Ridge, Blues Classics, Blues Factory, Bornand, Briar, Broadside, Bullfrog, CMH, CRI, Cal, Cambridge, Classic Jazz Masters, Clay Pigeon, Con Bro, Contemporary, Conversa-Phone, County, Cowboy Carl, Crystal, Daffodil, Delos, Delos imports, Desmar, Desmar imports, Dictation Discs, Discovery, Dobre, Emily, Ensayo, Erato, Everest group, FKT, Flying Fish, Flying High, Folk Legacy, Folk Lyric, Folkways, Fox Fire, Fretless, Front Hall, GNP Crescendo, Giants of Jazz, Golden Age, Good Time, Good Time Jazz, Gramercy-5, Grapevine, Grenadilla, Grits, Guitar Player, Halcyon, IPS, improvising Artists, India Navigation, Innisfree, International Piano Archives, Interplay, JCOA, Jazz a la Carte, Jazz Archives, Jazz Society, Jin, June Appal, Kaleidoscope, Kicking Mule, Knee Deep, Labor, Lariat, Legend, Leviathan, Lovely Music, Lyricchord, MGD, Maison de Soul, Makossa, Mary, Mbari Messaround, Mr. Blues, Monmouth Evergreen, Morning Glory, Morning Star, Mountain Railroad, Nashville Jazz, Nessa, New World, New Orleans, Nimbus, North Texas State Lab Jazz, Oats imports, Oblivion, Old Timey, Orion, PM, PMP, Pandora, Paredon, Pearl, Pelican, Philly Jazz, Philo, Philomel, Phoenix, Physical, Piedmont, Progressive.



Galgano Distributing Corp.

Our 51st Year

WE CAN HANDLE ALL YOUR MUSICAL NEEDS

- Complete Stocking Warehouse of Catalog Product
All Labels: Albums, Tapes & 45's
- Special Orders Are Our Specialty
Hard to Find Albums, 8-Tracks & Cassettes
- Advertised Specials
Both Weekly & Monthly
- All Brands of Blank Tapes
Scotch Maxell Memorex TDK
- Selected Imports
- Complete Lines of Audio Equipment for Car & Home
Pioneer Hitachi Fisher De Jay



Call or Write:

GALGANO DISTRIBUTING CORPORATION
4147 W. Armitage Ave., Chicago, Ill. 60639
(A-C) 312/235-3800

FREE GIANT CATALOG

7,000 DIFFERENT OLDER LPs

Specialists in sales to other countries.

We now sell to over 50 countries of the world.

Golden Memories Records, Inc.

P.O. BOX 217-A

MOORESVILLE, INDIANA, U.S.A. 46158

TWX: 8102602690-GOLDMEMRE

CABLECODE: GOLDMEMREC

J.S.J. Tape Distributors, Inc.

CUT-OUTS

8-TRACK and CASSETTE OUR SPECIALTY

If you are a Distributor,
rack jobber or exporter,
CONTACT J.S.J. TODAY!

Call or Write for FREE catalog

J.S.J. TAPE DISTRIBUTORS INC.

6620 W. Belmont Ave.

Chicago, Ill. 60634

312-286-4444

Pumpkin, Puritan, Rainbow Morning, Ramblin', Rebel, Red Clay, Rego Irish, Retrospect, Revelation, Ridge Runner, Le Roi du Blues, Rounder, Safo, Scala, Scholastic, 1750 Arch, Shanachie, Shiloh, Sierra, Sirens, Skyline, Sonet, Sonyatone, Spitball, Stash, Streetside, Sugar Hill, Swallow, Sweet Earth, Swing Classics, Syntonic Research, Takoma, Tax, Testament, Thunderhead, Titanic, Tradition, Trend, Trix, Varese Int'l, Vecto, WATT, Wagon Tracks, Wim, Windmill, Yazoo, Zap

Rec. labels imported: Affinity (UK), Big Ben (UK), Blackbird (Ireland), Black Saint (Italy), Charly (UK), Gael-Linn (Ireland), Hawk (UK), Ichechronin (Ireland), Mosaic (UK), Mulligan (Ireland), Music Gallery (Canada), Muza (Poland), Oldie Blues (Netherlands), Panorama (Sweden), Sackville (Canada), Steeplechase (Denmark), String (Ireland), Sun (France), Tangent (UK), Tara (Ireland), Topic (UK), Transatlantic (UK)

Tape lines: Advent, CMH, CMS, CR/70, Cal, Con Brio, Conversa-Phone, Discovery, Folkways, GNP Crescendo, Jin, Maison de Soul, Orion, Rebel, Rounder, Scholastic, Swallow, Takoma

La Voiz Hispana, 1824 W. Division St. Zip 60622. Tel. 525-5135. Owner, Mgr. & Buyer Nelson A. Cruz. (**Rec. & Tape OS**—Latin prod. only)

Lieberman Ents. Inc., 1000 Touhy Ave., Elk Grove Village 60007. Tel. 593-2120. Mgr. Dennis Sinclair, World. Mgr. Jerry Skillicorn; Sales Mgr. Ed Chittim; Buyers: Reg'l, Wayne Grossman, Singles, Terry Tauchen; Albums, Rob Taylor. (**Rec. & Tape RJ**)
Home office: Minneapolis, Minn. (**Rec. & Tape CS & RJ**) (SEE ADVERTISEMENT)

M & A Rec. Whslers (**Rec. RJ & OS**)—Mgr. & Buyer Jack Rose—see Surplus Rec. & Tapes.

MCA Dist'g Corp., 10700 W. Higgins Rd., Suite 100, Rosemont 60018. Tel. 298-6600. Reg'l Dir. John Burns; Branch Mgr. Marty Spieler. (**Rec. & Tape D**)
Rec. labels: Backstreet, Butterfly, Coral, Infinity, LAX, MCA, Songbird, Source, Vocalion

Tape lines: Same as rec. labels.

M S Dist'g Co., 7901 N. Caldwell Ave., Morton Grove 60053. Tel. 478-1133. Bd. Chm. Milton T. Salstone; Pres. Tony Dalesandro; Exec. VP. John Salston; Buyer Mark Esposito. (**Rec. & Tape D**)

Branch: Clayton (St. Louis Metropolitan Area), Mo.
Labels: APA, ASI, AVI, Ala, Alarm, Alexander Street, Aligator, Alston, Amazon, Antilles, Archives of Jazz, Arista, Arth, Audio-Technica, Big Foot, Big Sound, Blind Pig, Blue Candle, Blue Heaven, Blues Spectrum, Buddha, Canaan, Cat, Century, Channel, Cherry, Chimneyville, Chrysalis, Cloud, Country Int'l, Country Porn, Cracker Barrel, Dash, Dayspring, Delmark, Dharma, Dial, Dobre, Doctor Jazz, Dore, Drive, End, Farr, Fiction, First American, Flying Fish, 4 Star, Freedom Jazz, Fretone, Future, GRO, GRP, Gale, Gee, Glades, Golden Moon, Gold Rush, Good News, Good Sound, Gospel Roots, Gospel Tone, Great Northwest Music, Gryphon, HDM, Hob, IBC, ICA, IRDA, Inphasion, JDC, JSP, Jamm Session, Jazz a la Carte, Jazz World, Jefferson Boulevard, Jem, Juana, Kaleidoscope, Kayvette, Kox, LRC, Lab, Laff, Lamb & Lion, Legendary Ladies, Light, Little Darlin', Magnum, Mainstream, Malaco, Maranatha, Marlin, Meridian, Messenger Gospel, Mirror, Mountain Railroad, Muscle Shoals, Mushroom, Music Is Medicine, Myrrh, Nessa, New Pax, New Song, Novus, October, Orinda, Outstanding, Ovation, PAUSA, Panama, Paragon, Passport (Arista), Passport (Visa), Piccadilly, Potato, Prism, Pyramid, QCA, Quadico, RCA (DD), Ray Lawrence, Republic, Roast, Roulette, Royal Flush, Savoy, Sea Breeze, Seed, Seeds & Stems, Shields, Shiloh, Signature, Silver Blue, Solid Rock, Sound Plus, Stash, Stiff, Stone Dog, Su-D-Lu, Sun, Sunshine Sound, TK, TMS, Talisman, Taxi, Telarc, Tiger Lily, Toshiba-EMI, Umbrella, Universal Jazz, Vanguard, Virgo, Visa, WMAQ, Wanderick, Windjammer, Weird World, Wolf, Word, World Int'l Group, Zebra.

Mable Recs. (div. of Magendie Ents. Inc.), 1127 S. Mannheim Rd., Suite 212, Westchester 60153. Tel. 681-4746. Pres.: W.F. Martin. (**Rec. OS**)

Branches: Columbus, Miss.; Gray Court, S.C.

Mid-America Specialty Dist. Inc., 444 N. Lake Shore Dr. Zip 60611. Tel. 822-0822. Pres. Howard M. Rosen. (**Rec. & Tape RJ**), (**Rec. & Tape OS** as Downtown Recs. Mgmt. Corp.)

Mr. T's Volume Rec. & Tape Sales, 1728 E. 87 St. Zip 60617. Tel. 375-8445. Owner: Max Tannenbaum; Sales Mgr.: Johnny Johnson. (**Rec. & Tape D, OS & RJ**)

Distributes cut-outs, overstocks, promotional material.
Multinational Dists. Inc., 3514 W. 26 St. Zip 60623. Tel. 522-1877. Mgr.: Miguel Remon, Singles, Albums & Tape Buyer: Adelqui Boue. Local branch: 1454 N. Milwaukee Ave. Zip 60622. Tel. 227-8181. (**Rec. & Tape OS, RJ, I & E**)

One Way Recs., 3220 W. Cermak Rd. Zip 60623. Tel. 522-9238. Owner & Albums Buyer: Ofte Reese; Mgr. & Singles Buyer: Norma Reese. (**Rec. OS**)

Pan American Recs. Inc. (Casa Pan-Americana), 3751 W. 26 St. Zip 60623. Tel. 521-1100. Pres. Gustavo Silva. (**Rec. & Tape D, OS & RJ**)

Rec. labels: ARV, Alegre, Alhambra, All Art, Ansonia, Antilla, Arcano, Arriba, Audio Latino, Audimex, Audiovox, Azteca, Bego, Bernal, Borinquen, Buena Suerte, CBS de Mexico, CR, Caliente, Capri, Carino, Caytronics, Columbia, Costeno, Cotique, Crazy Cajun, Cri Cri, DLV, Del Rio, Del Sol, Del Sur, Del Topo, Del Valle, Dimsa, Disco Grande, Discolando, Discuba, Disneylandia, Dominante, EGC, East Bend, Eco, Falcon, Fama, Fania Int'l, Flor, Flor Mex, Freddie, Fuentes, GC, Gas, Gema, Good Luck, Guti, Ideal, Impacto, Inca, Keylock, Kubaney, Latin Int'l, Latin Soul, Magda, Marsol, Mate, Mericana, Mexico, Mex Melody, Miami, Mister G, Montilla, Musart, Musimex, Neliz, Norteno, Novavox, Nuevo, ORO, Odeon, Orfeon, Pan Americana, Papatote, Parnaso, El Pato, Peerless, Pronto, Raff, Ramex, Rovi, Safari, Seeco, Sombrero, Son Art, Sonolux, TH, TR, Tear-drop, Tecca, Tex-Mex, Tico, Tikal, Torres, Tropical, UA Latino, Vaya, Velvet, West Side, ZAZ, El Zarape, Zeida
Tape lines: Ansonia, Antilla, Arcano, Arriba, Audio Latino, Audiomex, Audiovox, Bego, Bernal, Buena Suerte, CBS de Mexico, CR, Caliente, Capri, Carino, Caytronics, Columbia, Cotique, Crazy Cajun, Del Rio, Del Sur, Del

Topo, Del Valle, Dominante, EGC, Falcon, Fama, Fania Int'l, Freddie, Fuentes, Gas, Gema, Inca, Keylock, Kubaney, Latin Int'l, Latin Soul, Magda, Marsol, Mex-Melody, Musart, Musicmex, Norteno, Novavox, Orfeon, Parnaso, Peerless, Raff, Ramex, Rovi, Safari, Seaco, TH, TR, Teca, Tex-Mex, Vaya, West Side, ZAZ, El Zarape, Zeida.

Pickwick Int'l Inc., Rack Servs. Div., 779 Church Rd., Elmhurst 60126. Tel. 832-8850. Opns. Mgr. Stewart Gershbaum; Sales Mgr. Bill Silverthorne; Buyer: John Castellanos. (Rec. & Tape RJ)
Home office: Minneapolis, Minn.
Polish Rec. Center of America, 3055 N. Milwaukee Ave. Zip: 60618. Tel. 772-4044. Owner: Jan Wojewodka. (Rec. & Tape I)

Imports from Poland.
PolyGram Dist'n Inc., 4825 N. Scott St., Bldg. 2, Suite 206, Schiller Park 60176. Tel. 671-5380. Reg'l VP: Harry Lask; Branch Mgr.: Ralph Kick. (Rec. & Tape D)
Home office: New York, N.Y.
Rec. labels: American Int'l, Archiv, Capricorn, Casablanca, Charisma, Chocolate City, DJM, De-Lite, Deutsche Grammophon, Emarcy, Festivo, Fontana, Limelight, MGM, Mercury, Monument, Oasis, Parachute, Philips, Polydor, Polydor/BGO, Polydor/Harem, Polydor/Kolob, Polydor/MVP, Polydor/Manken, Privilege, RSO, RSO/Curtom, Riva, Smash, Soundstage Seven, Spring, Vertigo, Verve, Zappa.
Tape lines: Same as rec. labels.

Progress Rec. Dist'g Inc., 930 Lee St., Elk Grove Village 60007. Tel. 593-5955. Pres.: Joe Simone; VP & Gen. Mgr.: Harold Davis; Buyer: Chuck Spedel. (Rec. & Tape D)

Branch: Indianapolis, Ind.—also see listing in Highland Heights (Cleveland Metropolitan Area), Ohio
Labels: Abkco, Argo, Aries II, Barnaby, Beserkley, Birthright, CTI, Churchill, Gime, Concord Jazz, Cream, Creed, Cyclone, Disneyland, Exello, Fantasy, Galaxy, Gordy, Gospel Truth, GRT, Hi, Janus, Kudu, Le Joint, L'Oiseau Lyre, London, Mango, Midson, Milestone, Motown, Muse, Nashboro, Pacific Arts, Parrot, Prelude, Prestige, Prodigal, Ranwood, Rare Earth, Richmond, Riverside, Scorpion, Shadow, Shadybrook, Shock, Soul, Stax, Tamla, Telefunken, Threshold, Tomato, UK, Venture, Vista, Waterhouse, Xanadu.

RCA & A&M & Assoc'd Labels, 1415 W. 22 St., Suite 300, East Oak Brook 60521. Tel. 986-8300. Reg'l Sales Dir.: Bill Swearingen; Branch Sales Mgr.: Tom Potter. (Rec. & Tape D)

Rec. labels: A&M, Bluebird, Free Flight, Gold Seal, Grunt, Hologram, Millennium, NY Int'l, Pablo, Pablo Live, Pure Gold, RCA, Red Seal, Roadshow, Rocket, Sal-soul, Solar, Tortoise, 20th Century, Victrola, Windsong.
Tape lines: Same as rec. labels.

Rac A Recs., 1801 S. Lumber, Zip: 60616. Tel: 666-3828. Owner & Buyer: William Knapp; Mgr.: Charles Knapp. (Rec. & Tape RJ & E)

Rainbow Recs., 144 W. Northwest Hwy., Palatine 60067. Tel. 991-7373. Gen. Mgr.: Norm Rosenthal; Buyer: Chris Lynde. (Rec. & Tape OS)

Ruby Sales Co. Inc., 4038 W. Armitage, Zip: 60639. Tel. 276-5484. Owner, Mgr. & Buyer: R.W. Lawrence. (Rec. & Tape RJ)

Chet Schafer Prod'ns, 864 N. Ashland Ave. Zip: 60622. Tel. 421-4372. Owner & Buyer: Chet Schafer. (Rec. & Tape D)

Rec. labels: Bel-Aire, Chicago Polkas, Dyno, Halo, Halo, Ram, Sound, Starr, Steljo.
Tape lines: Bel-Aire, Chicago Polkas, Dyno, Halo, Sound, Steljo.

Sound Unlimited, 5404 W. Touhy, Skokie 60077. Tel: 674-0850. Pres.: Noel Gimbel. (Rec. & Tape OS, RJ & I)
Branches: Denver, Colo.—Mile Hi One Stop (Rec. & Tape OS & RJ), & Pan American Rec. Supply (Rec. & Tape D)

Imports cut-outs.
Playback equip.: Clarion, Craig, Jensen, Pioneer
Accessories: Blank tape (Maxell, Memorex, Scotch, Sony, TDK), carrying & storage cases (Le-Bo, Hagerstown), needles (Planstiehl), Calibron, Discwasher, Nor-tronics, & Watts prods.

Surplus Recs. & Tapes, 1801 S. Lumber St. Zip: 60616. Tel. 421-1003. Pres.: Merrill Rose; Gen. Mgr. & Buyer: Jack Rose. (Rec. D), (Rec. RJ & OS as M&A Rec. Whslers.)

Branch: Rochelle Park, N.J. (Rec. D & E, Tape E)
Distributes cut-outs & surplus. (SEE ADVERTISEMENT)
Trackdown Rec. Dists., 542 S. Dearborn St., Suite 1102, Zip: 60605. Tel. 486-2989. Owner: S.T. Williams. Local branches: PO Box 295, 1950 Division St., Chicago Heights 60411; PO Box 33, Markham 60426. (Rec. D, OS, RJ, I & E)

Branches: Midfield (Birmingham Area), Selma, Ala.; Phoenix, Ariz.; Canoga Park, Hollywood & North Hollywood (Los Angeles Metropolitan Area), Oakland (San Francisco & Bay Area), Calif.; Hialeah (Miami Metropolitan Area), Fla.; Columbus, Stone Mountain (Atlanta Metropolitan Area), Ga.; Cheneyville, La.; Greenville, Moss, Miss.; Jersey City, N.J.; Albuquerque, N.M.; Asheville, Laurinburg, Lillington, Raleigh, N.C.; Greenville, S.C.; Taylor, Tex.; Richmond, Va.

Labels: Black Kat, Cash in Today, Cherub, Cowyody, Full Speed Ahead, PM, Rhythm, Trackdown.

Fernando Vian, 2151 N. Humboldt Blvd. Zip: 60647. Tel. 278-7613. (Rec. & Tape D)
Home office: Los Angeles, Calif. Discos Latin Int'l.
Rec. labels: Fono Rex, Latin Int'l, Microfon, Pega.
Tape lines: Same as rec. labels.

Warner/Elektra/Atlantic Corp., 222 W. Sivert Court, Bensenville 60106. Tel. 595-6000. Mgr. Al Abrams. (Rec. & Tape D)
Rec. labels: Asylum, Atco, Atlantic, Bearsville, Beserkley, Big Tree, Cotillion, Curtom, Dark Horse, DiscReet, ECM, Elektra, Embryo, Famous Charisma, Finnadar, Little David, Loma, Mantecore, Nemporer, Nonesuch, Pacific, Paradise, Reprise, Rolling Stones, SHE, Sire, Slipped Disc, Swan Song, W.M.O.T., Warner Bros., Warner/Curb, Warner Spector, Westbound, Whitfield, Wing & a Prayer, Zephyr.
Tape lines: Same as rec. labels.



We Hear
The Music!

Rock, Jazz,
Blues, Soul

SPECIALIST

L.P.'s, 8-Tracks, Cassettes, 45's
Worldwide CUT-OUT Supplier
Record Care Accessories
Blank Recording Tape
Import L.P.s

Ask For Our
LP, Tape, & 45's Specials

FATHER'S AND SUN'S, INC.

4100 Industrial Blvd.

Indianapolis, Indiana 46254

317-293-5310 Telex 27-322

-TOLL-FREE ORDER NUMBERS NATIONWIDE-

- **MOLINE (Area Code 309)**
Mobile Rec. Serv. Co., 3500 60 St., Apt. 4, Zip: 61215. Tel: 797-2973. Mgr.: Irwin Baraff. (Rec. OS—singles only)
Home office: Pittsburgh, Pa.
- **PEORIA (Area Code 309)**
Sound Investment Inc., 1109 W. Main, Zip: 61606. Tel: 673-3887. Owner: W.R. Love; Mgr.: Dave Roger; Buyers: Dave Roger, Sheldon Eater, Sue Anderson, Jim Gunn. (Rec. OS)
- **ROCKFORD (Area Code 815)**
Festival of Song Music Co., 1519 Windsor Rd. Zip: 61111. Tel: 654-1260. Pres.: E.L. Myers; Albums Buyer: Richard L. Myers. (Rec. & Tape D)
Rec. labels: Agape, Avant Garde, BeeGee, Bridge, Calvary, Cam, Canaan, Capitol, Chapel, Chime, Columbia, Copeland, Diadem, Discovery, Edify, Goff, Gusto, Harvest, Headline, Heart Warming, Heritage, Hope, Impact, Jim, Kiddyland, Lamb & Lion, Light, London, MCA, Manna, Maranatha, Message, Messianic, Nashboro, New Creation, New Life, One Way, Peacock, Pickwick, QCA, RCA, Rainbow, Ranwood, Reverence, Sacred, Savoy, Sing, Singcord, Skylite, Sunrise, Superior, Supreme, Tempo, Triangle, Vista, Word, Word of God, World Wide.
Tape lines: Same as rec. labels.

INDIANA

- **ANGOLA (Area Code 219)**
Gospelrama, PO Box 267, Zip: 46708. Tel: (219) 665-9540; WATS: (800) 348-4677; Indiana WATS: (800) 552-1794. Owner: F. Michael Colacurci. (Rec. D & OS—religious prod. only)
Labels: Birdwing, Calvary, Canaan, Creative Sound, Foster, GTR, Good Life, Green Tree, Heart Warming, Hope, Housatop, Impact, Jews for Jesus, Light, Maiden, Manna, Messianic, Myrrh, New Life, RCA, Rainbow Sound, Skylite, Sunrise, Sparrow, Star Song, Tempo, Word, Zonderman.
- **DECATUR (Area Code 219)**
Midwest Dist., 138 N. Second St. Zip: 46733. Tel: 724-2066. Mgr. & Buyer: Deane May. (Rec. & Tape RJ)
Home office: Fort Wayne, Ind. (Exec. office only)
- **ELWOOD (Area Code 317)**
New Light Dist. Inc., 521 N. Anderson St. Zip: 46036. Tel: 552-9846. Pres. & Buyer: Jim Cochran. (Rec. D)

Distributes cut-outs & overstocks. (SEE ADVERTISE-
MENT)

- **EVANSVILLE (Area Code 812)**
Mobile Rec. Serv. Co., 2244 E. Virginia St. Zip: 47711. Tel: 477-3927. Mgr.: Mark Dale Schweickart. (Rec. OS—singles only)
Home office: Pittsburgh, Pa.
- **FORT WAYNE (Area Code 219)**
Midwest Dist., 2415 Forest Park Blvd. Zip: 46805. Tel: 483-8230. Owner & Mgr.: Walt Ostermeyer. (Exec. office only)
Branch: Decatur, Ind. (Rec. & Tape RJ)
Mobile Rec. Serv. Co., 5336 Southbrook Rd. Zip: 46815. Tel: 485-9446. Mgr.: Jon R. Didier. (Rec. OS—singles only)
Home office: Pittsburgh, Pa.
Tallman One Stop, 1023 E. Pontiac St. Zip: 46803. Tel: 456-8422. Owner: Robert Hatcher Sr.; Mgr. & Buyer: Patricia Hatcher. (Rec. & Tape OS)
- **GARY (Area Code 219)**
Paradise One Stop, 2035 W. 15 Ave. Zip: 46404. Tel: 944-9273. Owner & Buyer: Quinton Nunn; Mgr. & Buyer: Rose Nunn. (Rec. & Tape OS)
United Nat'l Rec. Sales, 4393-91 Tri-City Plaza. Zip: 46406. Tel: 949-1208, 949-1378. Owners: Bobby & Maxine Joiner. Local branches: 1101 E. 21 Ave. Zip: 46407. Tel: 882-4210—8038 E. Melton Rd. Zip: 46403. Tel: 938-4820—3815 Broadway. Zip: 46409. Tel: 884-7200—4704 Indianapolis Blvd., East Chicago 46312. Tel: 398-7464. (Rec. OS)
Woodard Rec. Serv., 2011 Madison St. Zip: 46407. Tel: 885-1908. Owner & Mgr.: Dewitt W. Woodard. (Rec. & Tape RJ)
- **INDIANAPOLIS (Area Code 317)**
Father's & Sun's Inc., 4100 Industrial Blvd. W. Zip: 46254. Tel: 293 5310. Telex: 272127. Pres.: David Crockett; Exec. VP: Marc Freije; Mktg. & Sales: Steve Druley; Album & Tape Buyer: Don Simpson. (Rec. & Tape OS, I & E)
Labels: JCOA; also distributes cut-outs & overstocks.
Labels imported: ECM (Germany), European rock & jazz labels.
Accessories: Blank tape (Maxell, Memorex, TDK), tape carrying & storage cases (Savoy, Service), sleeves, plastic bags, Audio-Technica, Discwasher, Sound Guard & Watts prods. (SEE ADVERTISE-
MENT)
Lieberman Ents. Inc., 5550 Progress Rd. Zip: 46241. Tel: 247-8491. Mgr.: Ken Sinclair; Opns. Mgr.: Danita La Ban; OS Mgr.: Tom O'Flynn; Buwers: Singles, Patty Johnson; Albums, Jim Coffin. (Rec. & Tape OS & RJ)
Home office: Minneapolis, Minn. (SEE ADVERTISE-
MENT)
PolyGram Dist'n Inc., 4009 S. High School Rd. Zip: 46241.

- Tel: 856-3741. Opns. Mgr.: Ron Corya; Ass't Opns. Mgr.: Chuck Reynolds. (Rec. & Tape D—depot)
Home office: New York, N.Y.
Rec. labels: American Int'l, Archiv, Capricorn, Casa-blanca, Charisma, Chocolate City, DJM, De-Lite, Deutsche Grammophon, Emarcy, Festivo, Fontana, Limelight, MGM, Mercury, Monument, Oasis, Parachute, Philips, Polydor, Polydor/BGO, Polydor/Harem, Polydor/Kolob, Polydor/MVP, Polydor/Manken, Privilege, RSO, RSO/Curtom, Riva, Smash, Soundstage Seven, Spring, Vertigo, Verve, Zappa.
Tape lines: Same as rec. labels.
Progress Rec. Dist'g Inc., 6325 Gilford, Suite 3A, Zip: 46208. Tel: 259-4873. Sales: Michael Holmes. (Rec. & Tape D)
Home office: Elk Grove Village (Chicago Metropolitan Area), Ill.—see for prod. distributed.
Scott's One-Stop Rec. & Tape Serv. Inc., 1319 N. Capitol Ave. Zip: 46202. Tel: 639-5491. Pres.: Lew Jones; Opns. Mgr.: Don Gobrecht; Sales Mgr.: W.L. Busby. (Rec. & Tape OS)

- **MOORESVILLE (Area Code 317)**
Golden Memories Recs. Inc., PO Box 127, 136 Maple Ln. Zip: 46158. Tel: 831-5207. Pres.: William J. Haskett. (Rec. D & E)
Distributes oldies. (SEE ADVERTISE-
MENT)
- **VALPARAISO (Area Code 219)**
Music Mdrs. Inc., 2904 E. Cascade Dr. Zip: 46383. Tel: 465-1567. Owners: Michael Quick, Mark Duggleby. (Rec. & Tape RJ)

IOWA

- **DES MOINES (Area Code 515)**
Pickwick Int'l Inc., Rack Servs. Div., 2400 Sunset Rd. Zip: 50321. Tel: 282-8185. Opns. Mgr.: Wayne Olson; Sales Mgr.: Jerry Parker; Buyer: Ray Munson. (Rec. & Tape RJ)
Home office: Minneapolis, Minn.

KANSAS

- **LAWRENCE (Area Code 913)**
Kief's Rec. & Stereo Supply Inc., PO Box 2, 2100-A W. 25 St. Zip: 66044. Tel: 842-1544. Owner: John J. Kiefer; Buyer: Steve Wilson. (Rec. & Tape OS & RJ)
- **SHAWNEE MISSION AREA (Area Code 913)**
Hoffman Inds. Inc., 8441 Quivira, Lenexa 66215. Tel: 888-4885. Owner, Singles & Tape Buyer: Arnold J. Hoffman. (Rec. & Tape RJ)
Total Sound Dist., 5622 Johnson Dr., Mission 66202. Tel: 384-0300. Owner & Mgr.: Allan Levy. (Rec. & Tape OS)
- **WICHITA (Area Code 316)**
Friends II Music Inc., 2349 Amidon, Zip: 67204. Tel: 838-3375. Pres.: Gary L. Simmons; Mgr.: Ken Long. (Rec. & Tape OS & RJ)
Branch: Kansas City, Mo.

KENTUCKY

- **CAMPBELLSVILLE (Area Code 502)**
Central Electronics, PO Box 340, 113 N. Central Ave. Zip: 42718. Tel: 465-5631. Owner & Buyer: Randall B. Herron. (Rec. & Tape D, OS & RJ)
Rec. labels: Christian Faith, Design, Heart Warming, Hilltop, Little Darlin', Pickwick, Sing, Skylite, Songs of Faith, Stateswood, Temple, Up Front.
Tape lines: Nashboro, Nashville, Paramount, Pickwick, Plantation, Premier, Radiant, SSS Int'l, Scepter, Sing, Skylite, Songs of Faith, Starday-King, Stateswood, Sun, Word.
Playback equip.: Arthur Fulmer, Stellanonic.
Phonographs: Delmonico, Major, Victor.
Accessories: Spindles (BSR), tape caddies (Amberg), head cleaners (Transcriber), needles & cartridges (Electro-Voice, Transcriber).
- **COVINGTON AREA (Area Code 606)**
RCA & A&M & Assoc'd Labels, 2330 Royal Dr., Fort Mitchell 41017. Tel: 331-9300. Sales Mgr.: John Rucker. (Rec. & Tape D)
Rec. labels: A&M, Bluebird, Free Flight, Gold Seal, Grunt, Hologram, Millennium, NY Int'l, Pablo, Pablo Live, Pure Gold, RCA, Red Seal, Roadshow, Rocket, Salsoul, Solar, Tontoise, 20th Century, Victrola, Windsong.
Tape lines: Same as rec. labels.
- **LEXINGTON (Area Code 606)**
R T & E Inc., 1026 Nandino Blvd. Zip: 40582. Tel: 255-8707. Owner: Jim Stivers; Gen. Mgr.: Jeff Aubrey; Buyers: Singles, Mona Lancaster; Albums & Tape, Tony Connor; Sales: Paco Smith. (Rec. & Tape OS & RJ)

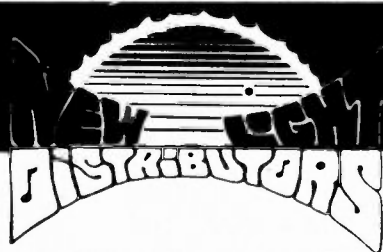

**YOUR JAZZ & ROCK CUT-OUT SOURCE
OF THE 80'S**

Providing you with the best selection from all labels.

Exclusive labels this fall: Blue Note, Takoma.

Exclusive titles on W/E/A, CBS, A & M, Prestige, and others.

ALSO OFFERING

* FULL CATALOGUES MONTHLY	* SAME DAY SERVICE
* COMPETITIVE PRICES	* DEFECTIVE RETURN POLICY
* QUANTITY DISCOUNTS	* EFFICIENT EXPORT SERVICE

*Be serviced by your
Cut - Out supplier this year.*

*If you're not receiving our lists
you're missing the best.*

NEW LIGHT DISTRIBUTORS, INC.
521 N. Anderson St.
Elwood, Ind. 46036
(317) 552-9846

• **LOUISVILLE (Area Code 502)**

Kentuckiana Rec. Sales (div. of Vine Recs. Inc.), 560 S. Fourth St. Zip: 40202. Tel: 582-3331. (Rec. & Tape OS)

Kings Rec. Shop, 240 W. Jefferson St. Zip: 40202. Tel: 584-5535. Owner & Mgr.: Gene King. Buyers: Singles, Ann King. Albums & Tape, Gene King. (Rec. & Tape OS & I)

Labels imported: RCA (Canada, UK)

Orbit Radio, PO Box 1644. Zip: 40201. Tel: 584-5535. Owner & Mgr.: S.A. Cisler. (Rec. & Tape I & E)

Imports recs. & pre-recorded tape from France, Germany, Italy, Japan, Scandinavia, UK; tape playback equip. from Germany & Japan.

Exports pre-recorded tape, playback equip.

Shively One Stop, 4464 Shively Center. Zip: 40216. Tel: 447-4951. Owner & Mgr.: A.R. Brown. (Rec. & Tape OS)

• **OWENSBORO (Area Code 502)**

Wax Works Inc., 325 E. Third St. Zip: 42301. Tel: 926-0008. Owners: Leroy & Terry Woodward; Buyer: Larry Devuono. (Rec. OS & RJ; Tape D, OS & RJ)

Tape lines: ABC, A&M, Capitol, Columbia, Disneyland, GRT, Heart Warming, MCA, MGM, Mercury, Motown, Philips, Polydor, RCA, Smash, WEA, Word.

Webster's Inc., 1308 W. Ninth St. Zip 42301. Tel: 926-4441. Owner & Mgr.: Doug Webster. (Rec. & Tape RJ)

• **WILLIAMSBURG (Area Code 606)**

H & R Dist's., Box 619, Rt. 4. Zip: 40769. Tel: 549-3392. Owners, Mgrs. & Buyers: Glen & Mildred Leger, James E. Taylor. (Tape RJ—budget lines, cut-outs, sound-alikes)

• **NEW ORLEANS AREA (Area Code 504)**

All South Dist'g Corp., 1924 Lafayette St., Zip: 70113. Tel: 568-0971. Owner: Warren K. Hildebrand; Mgr.: Richard Brown; Buyers: Singles, Jeff Fontz; Albums, Warren Hildebrand, Jeff Fontz, Steve Gifford, Gladin Scott. (Rec. & Tape D, OS & RJ)

Rec. labels: ASI, Abet, Abkco, Ala, Alston, American Variety, Anthem, Archives of Jazz, Arhoolie, Arista, BTM, Barnaby, BeeGee, Biograph, Black Forum, Black Gold, Black Jazz, Blue Canyon, Blues Classics, Blue Star, Bold, Brunswick, Buddah, CMH, CTI, Cadet, Caedmon, Calla, Canaan, Cat, Checker, Cherry Red, Chess, Chimneyville, Chisa, Chrysalis, Cin/Kay, Commercial, Cream, Creative World, Creed, Crossover, Dakar, Daybreak, Deram, Dictation Disc, Disneyland, Dooto, Dore, Douglas, Drive, ESP, Excello, Fantasy, 50 States, 4 Star, GRT, GWP, Gamble, Gec, Glades, Gold Cup, Golden, Gordy, Gospel, Grateful Dead, Greedy, Gull, H&L, Heart Warming, Hi, IRDA, Impress, Inner City, JB, Jamie, Janus, Jewel, Jim, Jin, Kayvette, Kent, Koko, Kudu, Lafl, Light, Living Language, London, MAM, Magic Disc, Mainstream, Malaco, Mankind, Mardi Gras, Marlin, Mericana, Milestone, Mojo, Monkey, Motown, Muse, Mushroom, Music Is Medicine, Musicor, Nashboro, Natural, Natural Resources, Olde World, Old Timey, Old Town, Onyx, Original Sounds, Ovation, Parrot, Partee, Passport, Paula, Peter Pan, Phil-L-A, of Soul, Plantation, Platinum, Poppy, Prestige, Prima, Project 3.

LOUISIANA

• **ALEXANDRIA (Area Code 318)**

Gospel Dist. Inc., PO Box 1706, 1212 Main St. Zip: 71301. Tel: 443-2549. Owner & Mgr.: J.D. Davis. (Rec. D, OS & RJ)

Distributes all gospel labels.

Music Racks, 1406 Fourth St. Zip: 71301. Tel: 453-2549. Owner & Mgr.: J.D. Davis. (Tape OS & RJ)

• **BATON ROUGE (Area Code 504)**

New Generation Inc., 10010 Florida Blvd. Zip: 70815. Tel: 272-1700. Mgr.: Irwin Shaab. Local branch: 3332 Highland Rd. Zip: 70808. Tel: 383-9700. Mgr.: Joseph Shaab; Buyer: David Trivanovich. (Rec. & Tape RJ)

• **CHENEYVILLE (Area Code 318)**

Trackdown Rec. Dist's., Box 60-A. Zip: 71322. (Rec. D, OS, RJ, I & E)

Home office: Chicago, Ill. (See for prod. distributed)

• **GONZALES (Area Code 504)**

Gonzales Music Whsle., PO Box 1153, Southland Dr. Zip: 70737. Tel: 644-2801. Owner: Roy J. Shaw. (Rec. OS)

• **LAFAYETTE (Area Code 318)**

Stagg's Music Shoppe, 503 N. University. Zip: 70501. Tel: 232-1575. (Rec. OS)

• **LAKE CHARLES (Area Code 318)**

Goldband Rec. Dist. Corp., PO Box 1485, 313 Church St. Zip: 70602. Tel: 439-8839. Pres.: Eddie Shuler; Buyer: Jeff Le June. (Rec. & Tape D, I & E)

Rec. labels: Adam VIII, Alshire, Americana, Anla, Big D, Bold, Canaan, Commercial, Con Brio, Discus, Esquire, Farm, Folk-Star, Goldband, Gusto, Heart Warming, Impact, Jador, Jeb, Jin, Lanor, Light, Luffcin, Lyric, Myrrh, Pelican, Power Pak, Puget Sound, Resco, Scorpio, Shannon, Soul Unlimited, Sparrow, Starday-King, Strobe, Swallow, Tempo, Word.

Tape lines: Same as rec. labels. (SEE ADVERTISE-
MENT)

IS MUSIC INC.

8700 W. Judge Perez Dr.
Chalmette, Louisiana 70043
(504) 279-1120
(504) 277-7060

**AUTHENTIC NEW ORLEANS,
DIXIELAND, JAZZ, BIG
BANDS, AND RHYTHM & BLUES**

Artists:

SWEET EMA
PAPA FRENCH
MIKE VAX
TOMMY RIDGLEY
BAYOU JAZZ BAND
CATALOG AVAILABLE!

**GOLDBAND
RECORDS**

ONE OF THE
WORLD'S GREATEST
FOR 35 YEARS!

Write For Catalog

**GOLDBAND RECORDING
CORPORATION**

P.O. Box 1485
Lake Charles, LA. 70602

THIRTY-
ONE
YEARS



**PROMOTION
SALES & SERVICE
DISTRIBUTING
THE HITS**

**STAN
THE RECORD MAN**

(HITMAKER OF THE SOUTH)

CHECK OUR LOW PRICES

*the BIG one-stop service
in the south!*

- EXPERT SERVICE AND ADVICE
- COMPLETE STOCK OF SINGLES
- LPs
- GOLD STANDARD CATALOGUE
- OLDIES BUT GOODIES
- SPIRITUALS
- R&B—POP—C&W
- JUKE BOX STANDARDS
- FREE TITLE STRIPS ON ALL CURRENT RELEASES
- ONE DAY SERVICE (ORDERS SHIPPED SAME DAY RECEIVED)

STAN'S, 728 Texas Street, Shreveport, Louisiana 71101
(318) 222-7182

Pyramid, Randy, Ranwood, Rare Earth, Red Coach, Republic, Respect, Right On, Riverside, Ronn, Roulette, Round, Royal American, SSS Int'l, Salvation, Savoy, Scepter, Shadybrook, Shagg, Shakat, Shannon, Shelter, Solid State, Soul, Soul Int'l, Soulmate, Sound Bird, Stang, Stax, Stiff, Stone, Stop, Sun, Swallow, TK, Tarnia, Telegeneral, Three Brothers, Threshold, Tomato, Turbo, United Kingdom, Vanguard, Vibration, Viko, Virgo, Visa, Vists, Wand, Wet Soul, Wicked, Wolf, Word.

Tape lines: All lines.
Accessories: Capitol, Fidelitone, Le-Bo, Memorex, Savoy.

Is Music Inc., 8700 W. Judge Perez Dr., Chalmette 70043. Tel: 279-1120. Mgr. & Buyer: Gary J. Edwards. (Rec. & Tape D & E)

Rec. labels: Bourbon 641, Crescent Country, Dulsi, Fat Tuesday, Nobility, Second Line, Sound of New Orleans.
Tape lines: Same as rec. labels. (SEE ADVERTISEMENT)

Lean Rec. Dist'g Co., 2815 Octavia St. Zip: 70115. Tel: 866-3478. Owner & Buyer: Lou Welsh Jr. (Rec. & Tape D)

Rec. labels: All American group, Biograph, Blue Beat, Con Brio, Cross Country, Deluxe, Dobre, Federal, Firecracker, First Generation, Folly, Golden Moon, Gold Rush, Gusto, Hollywood, Jam Session, Lab Jazz, Little Gem, Ludu Kay, Milagro, Nationwide Sound group, One-Way, Pilot, Power Pak, QCA, Rainbow, Rice, Rob

Chris, SCR, SSS Int'l, Sapphire, Second Generation, Sounds of Music, South Breeze, Starday/King, True, World Int'l group.

Tape lines: Biograph, Gold Rush, Plantation, Power Pak, Starday/King, SSS Int'l, Sun.

Lee Rec. Dist., 4546 S. Park Dr. Metairie 70001. Tel: 888-2406. Owner, Mgr. & Buyer: Paul V. Lee. Local branch: 122 Focis St. (Rec. D)

Labels: ABC, ABC-Dot, ABC-Duke, ABC-Dunhill, ABC-Peccock, ABC-Songbird, Alligator, Benjie, Blue Goose, Delmark, Era, Federal, Fire, Fury, Goldies-45, Riverside, Souffle, Soul-Po-Tion, Specialty, Springboard, Starday-King, Symposium, Takoma, Trip, Trix, Up Front, Yazoo.
One Stop Rec. Shop Inc., PO Box 50833. Zip: 70150; 1400 N. Broad St. Zip: 70119. Tel: 821-1061. Owner & Mgr.: Joe Assunto; Buyer: Lloyd Legendre. (Rec. OS)
Record Sales of New Orleans, 1525 Airline Hwy., Metairie 70001. Tel: 837-8110. Gen. Mgr. & Buyer: Dave Shtrick. (Rec. & Tape OS).

● **SHREVEPORT (Area Code 318)**

B & B Sales Inc., PO Box 7038, 1014 Joseph St. Zip: 71107. Tel: 226-0105. Owner & Mgr.: Al Bell; Buyers: Karen Wasserman, Al Bell. (Tape D)

Tape lines: Adam VIII, Capitol, MCA, Pickwick/Camden, Power Pak, RCA, Starday-King, United.

Playback equip.: Electra Radio, Arthur Fulmer, Pioneer. Stan's Rec. Serv., 728 Texas St. Zip: 71101. Tel: 222-7182. Owner: Stanley J. Lewis; Mgr.: Ronnie Lewis;

Buyers: Singles & Albums, Ronnie Lewis, Jesse Camp, Frankie Spano; Tape, George Willis. (Rec. & Tape OS & RJ) (SEE ADVERTISEMENT)

● **SULPHUR (Area Code 318)**

Keene & Mashburn Inc., 1625 Arizona St. Zip: 70663. Tel: 625-4276. Mgr. & Buyer: Keith Lawrence; Ass't Buyer: Mark Thompson. Local branch: PO Box 1075, 1401 Cypress St. Zip: 70663. Tel: 527-6333. (Rec. & Tape OS & RJ)

● **VILLE PLATTE (Area Code 318)**

Floyd's Whsie. Dist. Co., PO Drawer 10, 434 E. Main. Zip: 70586. Tel: 363-2184. Owner: j. Floyd Soileau; Mgr.: Ray Lafleur; Buyer: Terry Lafleur. (Rec. D, OS & E, Tape D, OS & RJ)

Rec. labels: American Playboy, Arctic, Arhoolie, Bayou, Boo Ray, Cajun Classics, Cajun Jamboree, Canaan, Crazy Cajun, D, Dooto, Eric, GRC, Goldband, Jewel, Jin, Joliette, Lanor, Lyric, Maison de Soul, NSD, Original Sound, Partee, Paula, Rebel, Rounder, Showtime, Specialty, Springboard, Starbarn, Starflite, Swallow, Trash, Tripp, Word.

Tape Lines: Arhoolie, Crazy Cajun, D, Dooto, GRT, Goldband, Jin, Original Sound, Partee, Specialty, Swallow, Trash.

Playback equip.: General Electric, Hitachi, Panasonic. **Accessories:** GRT, Le-Bo, Pfanstiehl, Seebro.

MAINE

● **AUGUSTA (Area Code 207)**

D I S C Inc., PO Box 2207, 10 Front St. Zip: 04370. Tel: 623-3566. Owner: H.J. Wilder; Mgr.: Singles & Albums Buyer: Glen Peabody. (Rec. & Tape D, OS & RJ)

Labels: CBS, Capitol-EMI, MCA, Newworld, Polygram, RCA/A&M, Sine Qua Non, WEA.

Accessories: Discwasher, Hollywood, Maxell, Memorex, Sound Guard.

● **PORTLAND (Area Code 207)**

Commercial Dist., 8 Somerset St. Zip: 04101. Tel: 774-5362. Owners: Jack & Herbert Holmes; Gen. Mgr.: Bill Hemmens; Opns. Mgr.: Bill Tiffany; Buyers: Singles, Ron Hawkes; Albums & Tape, Bill Tiffany. (Rec. & Tape D, OS & RJ)

Rec. labels: CBS, Capitol, London, MCA, MGM, Motown, RCA, United Artists, WEA group.

Tape lines: All lines.

Accessories: Recoton, Savoy, Watts.
East Coast Dist., 200 Anderson St. Zip: 04101. Tel: 772-5665. Owner: John Jannace; Mgr.: David Gonyer; Buyers: Singles, Dick Horton; Albums & Tape, David Gonyer. (Rec. & Tape RJ)

Photographs & Playback equip.: Sony.

MARYLAND

● **BALTIMORE METROPOLITAN AREA (Area Code 301)**

Action Dist'g Co., 3921 Hollins Ferry Rd., Lansdowne 21227. Tel: 242-5055. Owners: Sam & Mark Anoff; Mgr. & Buyer: Sam Anoff; Sales: Mark Anoff. (Rec. & Tape D)

Labels: Abattoir, Alshire, Artist Rec'g Co., Audio Arts, Audio Gospel, Award, Blue Canyon, Blue Diamond, Bobco, Boblo, Boyd, Brogan, Burgundy, CDC, CIE, CJ, Candle, Charta, Checkmate, Commercial, Con Brio, Concorde, Corona, Crescent, Crusader, Current, DER, Dale, Dallas, Darko, DeeMora, Denim, Dharmas, Door Knob, Doylen, Eagle, Edge, Erin, Essar, Fabolus, Farm, Farview, Favorite Song, 50 States, First Generation, Flick, 4 Star, Fretone, From the Country, G-Bar, GC, GMC, Gemini, Genesis, Gil's Funny Recs., Goddess, Golden Angel, Graceland, Group 5, HSE, Heart Warming, Hilltop, Hit & Run, IRDA, Impact, Inergi, It's Just Country, Jade, Jemkt, Jim, KBA, Kansa, Kansas City, King's Music City, Linox, Little Nashville, Little Ritchie, MMI, Marlo, Maverick, Mercantile, Monitor, NSD, Nashville Country, Nu-Trayl, Ortega, Pantheon Desert, Papa Joe's, Phono, Pickwick, Pinnacle, Pot o' Gold, Prairie Dust, QCA, RDS, Rebel, Renegade, Resco, Roundtable, Royal American, Scorpion, Scrimshaw, Silver Sword Audio, Solid Smoke, Soul Town, Soundwaves, South Breeze, Spirit, Spring River, Starday, Stoneway, Su Ann, Sunshine Country, Superior, TAO, TNB, Teddy Bear, 3J, Title, Travel, True, WILD, World Wide Sound, Yahoo.

Artistic Music Dist., 9033-C Red Branch Rd., Columbia 21045. Tel: 997-1060. Owner & Buyer: Ed Fitch. (Rec. I)

Imports from Europe & Japan.

Ellis Dist'g Corp., 33 New Plant Court, Owings Mill 21117. Tel: 363-1212. Owner: Edgar H. Ellis; Gen. Mgr. & Buyer: Florence Cohen; Warehouse Mgr.: Greg Gaslois. (Rec. & Tape RJ)

Handleman Co., 8320 Sherwick Court, Washington Ind'l Park, Jessup 20794. Tel: 953-1771. Mgr.: Herman Knight; Buyers: Herman Knight, John Schlempp. (Rec. & Tape RJ)

Home office: Clawson (Detroit Metropolitan Area), Mich.

Largo Music Corp., 9195 Red Branch Rd., Columbia 21045. Tel: 995-1776. Owner: Lawrence M. Goldberg; Mgr.: Raymond L. Creighton; Singles, Albums & Tape Buyer: Justin Dudley. (Rec. & Tape OS & RJ)
Branch: Garden Grove, Calif.

The Zamoiski Co.
Maryland's Largest Distributor
and Rack Jobber of Records & Tapes

Serving: Washington • Maryland • Virginia • West Virginia
New York • New Jersey • Pennsylvania • Delaware • Texas

- ★ Major Label Distribution
- ★ Complete Sales and Promotion Coverage
- ★ Next Day Delivery
- ★ Promotions Available on Records & Tape

OUR 83rd YEAR

★ Complete Full Line Racking Program

1101 De Soto Road, Baltimore, Md. 21223 • (301) 644-2900

• JIM LAVIS, Gen. Mgr. Rack Jobbing Div. • JOYCE HEIDER, Gen. Mgr. Distributor Div.

we CAN supply your EVERY need

ONE STOP
C & M

5405 Lafayette Place
Hyattsville, Md 20781
(301)699-5888

call toll free • 800-638-0559

Shop and Compare

MCA Dist'g Corp., Standard Courts West, 9160 Red Branch Rd., Columbia 21045. Tel: 992-0020. Branch Mgr.: Ed Keelan. (Rec. & Tape D)
Rec. labels: Backstreet, Butterfly, Coral Infinity, LAX, MCA, Songbird, Source, Vocalion.
Tape lines: Same as rec. labels.

Mar Matic Sales Co. Inc., 1140 E. Cold Spring Ln. Zip: 21239. Tel: 435-1477. Owner: Maurice Sykes; Mgr.: Joseph S. Barranco; Singles Buyer: Phyllis Farinholt. (Rec. OS & E)

Marshall-Mangold Dist'g Co. Inc., 4805 Nelson Ave. Zip: 21215. Tel: 542-7214. Owner: Manny Goldberg; Mgr.: Sandy Miller. (Rec. D & RJ)
Rec. labels: Archive of Folk & Jazz, Camden, Design, Disneyland, Everest, Peter Pan, Pickwick, Up Front.
Tape lines: Disneyland.

Musical Sales Mobile Serv. (Rec. & Tape RJ), see Musical Sales One Stop Inc.

Musical Sales One Stop Inc., 49 W. Oliver St. Zip: 21201. Tel: 837-5757. Pres.: Milton Bereson; Gen. Mgr.: Mashe Mehlman; Buyers: Singles, Walter Meineke; Albums, Joe Stinett; Tape, Allen Martin. (Rec. & Tape OS & E). (Rec. & Tape RJ as Music Sales Mobile Serv.)

Pickwick Int'l Inc. Rack Servs. Div., 142 Alco Pl. Zip: 21227. Tel: 247-2550. Opns. Mgr. & Buyer: Victor Tremmel; Sales Mgr.: Tommy Lenaghan. (Rec. & Tape RJ)
Home office: Minneapolis, Minn.

Potomac Music & Rec. Serv. Inc., 1009 Cathedral St. Zip: 21201. Tel: 837-7726. Mgr.: John Kaminski; Buyer: Regina Schwaab. (Rec. & Tape OS)
Home office: Hyattsville, Md.

Wollman's Music, 233 S. Broadway. Zip: 21231. Tel: 675-7990. Owner & Buyer: Helen Wollman; Mgr.: Sharon Botkin. (Rec. OS)

Zamoiski Co., 1101 De Soto Rd. Zip: 21223. Tel: 644-2900. Owner: Calman J. Zamoiski Jr.; D & OS Mgr.: Joyce Heider; RJ Mgr.: Jim Lavis; Promo. Dir.: Ted Zlatin; Buyers: Singles, Cindy Rocawich; Albums, Joyce Heiders. (Rec. D & RJ; Tape D, OS & RJ)
Rec. labels: ASI, AVI, Abkco, Advent, All Platinum, Amherst, Bar B-Q, Big Sound, Big Town, Biograph, Blue Heaven, Brunswick, Cadet, California, Calliope Festival, Camden, Channel, Checker, Chess, Cin/ Kay, Claridge, Classic Jazz, Con Brio, Concord Jazz, Connoisseur Society, Corral, Country Porn, Cream, Crosswind, Dakar, Dictation Disc, Dooto, Drive, EFS, Emus, Everest, Fiesta, GNP Crescendo, Glori, Greedy, Grenadilla, Gryphone, H&L, Hi, Hickory, Hit Int'l, Hob, Humpin Int'l, ICA, IJE, Inner City, Island, JDC, Jupiter, Kent, LA, LA Int'l, LRC, Libra, Little Darlin', Major Marketing, Malcolm X, Mango, Nostalgia Lane, Olde Worldie, PA/USA, Pacific Arts, Panama, Pickwick, Prism, Project 3, Pyramid, QCA, Quintessence, Rebecca, Red Rooster, Request, Roadshow, Roulette, Sahara, Sandcastle, Shelby Singleton, Signature, Stang, Strawberry, Sun, Syntonic Research, TEC, TK, TPI, Turbo, United, Versatile, West End, Zebra
Tape lines: Same as rec. labels.
Photographs: Zenith
Accessories: Ampro, Le-Bo, Maxell, Memorex, Pacific, Porpatone, Reoton, Service, TDK. (SEE ADVERTISEMENT)

● **GERMANTOWN (Area Code 301)**
Capitol Recs., Century XXI, 20030 Century Blvd. Zip: 20767. Tel: 428-0790. (Rec. & Tape D)
Rec. labels: Angel, Ariola America, Capitol, EMI America, Harvest, Liberty, Melodiya/Angel, Seraphim, United Artists.
Tape lines: Same as rec. labels.

● **GREENBELT (Area Code 301)**
PolyGram Dist'n Inc., 9111 Edmonston Rd., Suite 201. Zip: 20770. Tel: 474-3700. Mgr.: Harvey Rosen. (Rec. & Tape D)
Home office: New York, N.Y.
Rec. labels: American Int'l, Archiv, Capricorn, Casablanca, Charisma, Chocolate City, DJM, De-Lite, Deutsche Grammophon, Emarcy, Festivo, Fontana, Lighthouse, MGM, Mercury, Monument, Oasis, Parachute, Philips, Polydor, Polydor/BGO, Polydor/Harem, Polydor/Kolob, Polydor/MVP, Polydor/Manken, Privilege, RSO, RSO/Curtom, Riva, Smash, Soundstage Seven, Spring, Vertigo, Verve, Zappa.
Tape lines: Same as rec. labels.

Warner/Elektra/Atlantic Corp., 9200 Edmonston Rd., Suite 305-306. Zip: 20770. Tel: 474-6505, 792-7540. Mgr.: J. Del Medico. (Rec. & Tape D)
Rec. labels: Asylum, Atco, Atlantic, Bearsville, Beserkley, Big Tree, Cotillion, Curtom, Dark Horse, DiscReet, ECM, Elektra, Embryo, Famous Charisma, Finnadar, Little David, Loma, Manticore, Nemperor, Nonesuch, Pacific, Paradise, Reprise, Rolling Stones, SHE, Sire, Slipped Disc, Swan Song, WMOT, Warner Bros., Warner/Curb, Warner Spector, Westbound, Whitfield, Wing & a Prayer, Zephyr.
Tape lines: Same as rec. labels.

● **HAGERSTOWN (Area Code 301)**
Interstate Rec. Dist. Inc., 211 S. Locust St. Zip: 21740. Tel: 733-1378. Owners: Richard M. & Melvin C. Greenwald; Mgr.: Carlton Smith. (Rec. & Tape OS & RJ)

● **HYATTSVILLE (Area Code 301)**
C & M One Stop (div. of LDS Inc.), 5405 Lafayette Pl. Zip: 20781. Tel: 699-5888. Owner: Murray A. Berman; Mgr.: Linda Lochte; Buyers: Singles, Lisa Hunter; Albums & Tape, Murray A. Berman, Lisa Hunter. (Rec. & Tape OS). (SEE ADVERTISEMENT)

Drum Major Music Dist., 5611 Landover Rd. Zip: 20784. Tel: 864-3935. Owner: Michael P. Mackulics; Mgr.: Singles, Albums & Tape Buyer: Tom Hodges. (Rec. & Tape OS)

Potomac Music & Rec. Serv. Inc., 2122 Beaver Rd., Landover 20785. Tel: 322-3666. Owner: John E. Kmiec Jr.; Mgr.: Mario Caputo; Buyer: William Coates. (Rec. & Tape OS)
Branch: Baltimore, Md.

● **SILVER SPRING AREA (Area Code 301)**
CBS Recs., 8720 Georgia Ave. Zip: 20910. Tel: 587-5000. Branch Mgr.: Jim Chiado. (Rec. & Tape D)
Rec. labels: Arc, Bang, Blue Sky, CBS, Caribou, Columbia, Epic, Jet, Kirshner, Melodiya/Columbia, Nemperor, Odyssey, Philadelphia Int'l, Portrait, Starlite, Stiff, T-Neck, Tabu, Tappan Zee, Unlimited Gold.
Tape lines: Same as rec. labels.

RCA & A&M & Assoc'd Labels, 8630 Fenton St., Suite 120. Zip: 20910. Tel: 585-5575. Sales Mgr.: Bob Heatherly. (Rec. & Tape D)
Rec. labels: A&M, Bluebird, Free Flight, Gold Seal, Grunt, Hologram, Millennium, NY Int'l, Pablo, Pablo Live, Pure Gold, RCA, Red Seal, Roadshow, Rocket, Sal-soul, Solar, Tortoise, 20th Century, Victrola, Windsong.
Tape lines: Same as rec. labels.

Federated Rec. Co. Inc., 24 Munroe St., Newtonville 02160. Tel: 969-1773. Pres.: Warren Kastner. (Rec. & Tape OS, RJ & E)

Hot Cakes Music Inc., 24 Munroe St., Newtonville 02160. Tel: 969-1773. Pres., Mgr. & Buyer: Michael J. Driscoll. (Rec. & Tape OS, RJ & I—budget labels & cut-outs)

MCA Dist'g Corp., 429 Marrett Rd., Lexington 02173. Tel: 862-5100. Branch Mgr.: Paul Brousseau. (Rec. & Tape D)
Rec. labels: Backstreet, Butterfly, Coral, Infinity, LAX, MCA, Songbird, Source, Vocalion.
Tape lines: Same as rec. labels.

Malco Inds. (div. of Malden Map & Brush Co.), 266 Broad St., Lynn 01901. Tel: 595-7500. Gen. Mgr.: A.T. Goldstein. (Rec. RJ)

Malverne Dist. Inc. of Boston, 77 Summer St. Zip: 02110. Tel: 423-3820. Sales Mgr.: Stan Goodman. (Rec. & Tape D)
Home office: Long Island City (New York Metropolitan Area), N.Y., Malverne Dist. Inc.
Rec. labels: AVI, Abet, Alston, Artist House, Biograph, Blue Candle, Cat, Century, Channel, Chrysalis, Cloud, Concord Jazz, Creed, Dash, Drive, Fantasy, Galaxy, Glade, Gryphon, Hob, Janus, Juana, Kayvette, Kenwood, Konduko, LRC, Light, Malaco, Marlin, Milestone, Muse, Mushroom, Myrrh, Nashboro, Ovation, Penthouse, Prelude, Prestige, Prism, Pyramid, Ranwood, Red Star, Riverside, Roulette, Savoy, Shadybrook, Signature, Specialty, Spy, Stax, Strawberry, Sunshine Sound, TK, Talisman, Weird World, Wolf, Word, Zebra.
Tape lines: AVI, Chrysalis, Fantasy, Milestone, Prestige, Pyramid, Roulette, Specialty. (SEE ADVERTISEMENT)

Massachusetts Rec. Dist'g Co., 633 Massachusetts Ave. Zip: 02118. Tel: 266-1002. (Rec. & Tape OS & RJ)

Music Suppliers Inc., 77 Wexford St., Needham Heights 02194. Tel: 444-9310. Owner: Gordon Dinerstein; Mgr.: Ed Calmus; Buyers: Singles & Albums, Vahan Ag-hajarian, Tape, Ken Handelman. (Rec. & Tape OS & RJ)

Peter's Rec. One-Stop Inc., 880 Providence Hwy., Dedham 02026. Tel: 329-5210. Owner, Mgr. & Singles Buyer: Peter McDermott; Albums Buyer: Donald Moscatelli. (Rec. & Tape OS)

Plums Dist'g, 290 Moody St., Waltham 02154. Tel: 894-4801. Owner & Buyer: Elliot E. Stone. (Rec. D)
Label: Pickwick.
Accessories: Blank Tape (TDK), rec. & tape carrying & storage cases (Pickwick).

PolyGram Dist'n Inc., 200 W. Cummings Park, Suite M-50, Woburn 01801. Tel: 933-8155. Mgr.: Paul Wennik. (Rec. & Tape D)
Home office: New York, N.Y.
Rec. labels: American Int'l, Archiv, Capricorn, Casablanca, Charisma, Chocolate City, DJM, De-Lite, Deutsche Grammophon, Emarcy, Festivo, Fontana, Lighthouse, MGM, Mercury, Monument, Oasis, Parachute, Philips, Polydor, Polydor/BGO, Polydor/Harem, Polydor/Kolob, Polydor/MVP, Polydor/Manken, Privi-

MASSACHUSETTS

● **BOSTON METROPOLITAN AREA (Area Code 617)**
Alpha Dist'g Corp., 5 Priscilla Circle, Weymouth 02188. Tel: 266-0354. Contact: Paul Maged. (Red. & Tape D)
Home office: New York, N.Y. (See for prod. distributed) (SEE ADVERTISEMENT)

Boston Rec. Dist. Inc., 24 Ashmont Rd., Wellesley 02181. Tel: 235-7865. Owner, Mgr. & Buyer: Jerry Flatto. (Rec. & Tape OS & RJ)

CBS Recs., 470 Totten Pond Rd., 4th fl., Waltham 02154. Tel: 890-3814. Branch Mgr.: George Ryan. (Rec. & Tape D)
Rec. labels: Arc, Bang, Blue Sky, CBS, Caribou, Columbia, Epic, Jet, Kirshner, Melodiya/Columbia, Nemperor, Odyssey, Philadelphia Int'l, Portrait, Starlite, Stiff, T-Neck, Tabu, Tappan Zee, Unlimited Gold.
Tape lines: Same as rec. labels.

Capitol Recs., 420 Providence Hwy., Rm. 113, Westwood 02090. Tel: 329-5770. (Rec. & Tape D)
Rec. labels: Angel, Ariola America, Capitol, EMI America, Harvest, Liberty, Melodiya/Angel, Seraphim, United Artists.
Tape lines: Same as rec. labels.

Dick's Rec. Co. Inc., 890 Providence Hwy., Dedham 02026. Tel: 326-8790. Owner: Richard Mitchell; Mgr.: Richard Peach; Buyers: Singles, Richard Peach: Albums & Tape, Melvin Robrish. (Rec. & Tape OS)

Disco Inc., 651 Washington St., Brookline 02146. Tel: 734-1900. VP & Buyer: G. Margolis. (Rec. & Tape OS & RJ)

E-Z One Stop Rec. Serv. Inc., 92 Sagamore St., North Quincy 02171. Tel: 328-7900. Owner & Mgr.: Aaron H. Gross; Buyer: Robert Levin. (Rec. & Tape OS). (Rec. & Tape D & RJ as Royal Dist.)

ROUNDER RECORDS

DISTRIBUTOR • EXPORTER • IMPORTER

JAZZ/FOLK/BLUEGRASS/NOSTALGIA
 ROCKABILLY/ENGLISH/IRISH...

- | | | |
|---------------|--------------|--------------|
| Alligator | Flyright | Rounder |
| Artists House | Folkways | Shanachie |
| Baron | Horo | Specialty |
| Blackbird | JCOA | Starday |
| Black Saint | Kaleidoscope | Stash |
| Charley | Kicking Mule | Steeplechase |
| Concord | Mark 56 | String |
| Contemporary | Mulligan | Sugar Hill |
| County | Philo | Tangent |
| Delmark | Physical | Topic |
| El Saturn | Rebel | Xanadu |
| F&W | Ridgerunner | Yazoo |
| | Flying Fish | |

over 300 labels in all

FAST SERVICE/EXCELLENT FILLS

FOR CATALOGS AND ORDERING INFORMATION

ROUNDER DISTRIBUTION

186 WILLOW AVENUE • SOMERVILLE, MA 02144 USA
 617-354-0700 TELEX: 921724 ROUNDER INT.

lege, RSO, RSO/Curtom, Riva, Smash, Soundstage Seven, Spring, Vertigo, Verve, Zappa.

Tape lines: Same as rec. labels.
RCA & A&M & Assoc'd Labels, 65 Williams St., Wellesley 02181. Tel: 237-6663. Sales Mgr.: Rich Atkinson. (Rec. & Tape D)
Rec. labels: A&M, Bluebird, Free Flight, Gold Seal, Grunt, Hologram, Millennium, NY Int'l, Pablo, Pablo Live, Pure Gold, RCA, Red Seal, Roadshow, Rocket, Soul-soul, Solar, Tortoise, 20th Century, Victrola, Windsong.
Tape lines: Same as rec. labels.

Rounder Recs. Corp., 186 Willow Ave., Somerville 02144. Tel: 354-0700. Owners: Marian Lington, Ken Irwin, Bill Nowlin; Mgrs.: Kathy Kete, Scott Billington; Singles & Albums Buyer: Glenn K. Jones. (Rec. D; Rec. & Tape 1 & E)

Labels: ASI, Ace of Spades, Adelphi, Advent, Affinity, Ahura Mazda, Airborne, Airway, Alligator, American Heritage, Americanto, Arhoolie, Artist House, Ashish, Atteiram, Attic, Auricle, BMA, BRI, Back Door, Banff, Baobab, Barrelhouse, Bay, Bear Family, Bee Hive, Bee Hole, Bent, BetCar, Bija, Biscuit City, Black Eagle, Blind Pig, Blue Canyon, Blues Classics, Boll Weevil, Breakwater, Briar, Broadway, Bullfrog, CCE, CMH, Carawan, Celeste, Celtic, Cezame, Chelsea House, Clockwerke, Collector, Columbia Special Prods., Concord Jazz, Contemporary, Country Life, Country Turtle, County, Cowboy Carl, Crazy Cajun, Creative World, Crown, Davis Unlimited, Delmark, Dharma, Dirty Shame, Discovery, Dolphin, Dominion, Dreamstreet, EMI, EPI, ERC, ESCA, East Virginia, Eckerworks, Eddie Shaw, El Saturn, Emanem, Ember, Equinox, Eubie Blake, Euphonic, FKT, F&W, Fiddledeedoo, Fiddler, First Heard, Flying Crow, Flying Fish, Flying High, Folk Legacy, Folk Lyric, Folkways, Fremar, Fretless, Front Hall, GNP Crescendo, Gateway, Georgie, Gillian, Glendale, Goldband, Grand River, Granite, Grassound, Grass Roots, Green Linnet, Green Mountain, Gusto, HDS, Half Blind's Choice, Hamilton, Harbor, Hawk, Hep, Herald, Herwin, Hoiles, Homestead, Honey Dew, IBMS, ID, IPS, Improvising Artists, Inchechronin, India Navigation, JCOA, JEMF, Jack Rabbit, Jazz Archives, Jessup, Jewel, Jin, Joliet, Juke Joint, June Appal, Just Like Real, Kaleidophone, Kaleidoscope, Kicking Mule, King, Lady of Carlisle, La Louisianne, Lanark, Lariat, Lemco, Le Roi du Blues, Leviathan, Lira, Living Folk, Lo-Ball, Longdivity, MM&R, Maison de Soul, Mamlish, Mar Bren, Mark 56, Mbari, Messaround, Michigan Archives, Midland, Mill City, Mill Wheel, Mineral River, Minstrel, Mr. Blues, Monitor, Morning Glory, Morning Star, Mountain Railroad, Music Is Medicine, Muskadine, NRG, Nama, Nessa, New-orld, Nighthawk, Nimbus, Nymphs & Satyrs, Oats Moo, Okehdokee, Old Homestead, Oldie Blues, Old Timey, Omac, Origin Jazz Library, Outlet (US), Outrageous, PA/USA, PHS, PM, P-Vine, Paredon, Passin' Thru, Pathfinder, Paula, Peaceable, Pearl, Philly Jazz, Philo, Physical, Pine Breeze, Pine Tree, Plantation, Plant Life, Polisar, Poplar, Power Pak, Progressive, Puritan, Quest, Radiola, Rainbow Snake, Ramblin', Rebel, Red Record,

Red Rooster, Relic, Revonah, Rich-R-Tone, Ridge Runner, Rockhouse, Rollin' Rock, Rounder, Rural Rhythm, SJC, Sackville, Sacred Harp, Safco, Sail, Salem, Sandy Hook, Sanskrit, Sequatchie, Seventy Seven, Shadow, Shanachie, Shaskeen, Shiah, Shiloh, Sierra, Sierra Wave, Sirens, Solid Smoke, Sombbrero, Sonet (US), Sonory, Sonyatone, Southland, Specialty, Spivey, Star-day, Stash, Steel Guitar Rec. Club, Straight Ahead, Streetside, String, Sugar, Sugar Hill, Sun, Sunny Mountain, Swallow, Swallowtail, Sweet Earth, Sweet Jane, Symposium, Takoma, Temple, Tennessee, Testament, Texas Re-Cord, Thistle, Three Sixty, Thumbs Up, Thunderhead, Tradition, Transatlantic (US), Trend, Triskel, Trix, Troubador, Turnaround, Vetco, Vintage Classics, Voyager, WATT, Waterhouse, Waylon, Western Heritage, Wet Soul, Windham Hill, Wins, Woodbine, Would'N Shoe Xanadu, Yankee Rhythm Kings, Yazoo, Zap, Zim.

Rec. labels & tape lines imported: Acorn, Big Bear, Big Ben, Blackbird, Black Saint, Charly, Claddagh, Dell'Isola, Flyright, Free Reed, Gael-Linn, Horo, Ictus, Impact, Isle, Leader/Trailer, Leaf, Magpie, Mulligan, One-Up, Osiris, Outlet, Phillips, Polydor, Ram, Release, Rubber, Silver Hill, Sonet, Springwater, Stal, Starline, Steeplechase, Tangent, Tara, Topic, Towa, Transatlantic, Xtra, Village Thing. (SEE ADVERTISEMENT)

Royal Dist., 96 Sagamore St., North Quincy 02171. Tel: 328-1822. Owner & Mgr.: Aaron H. Gross. (Rec. & Tape D & RJ), (Rec. & Tape OS as E-Z One Stop Rec. Serv. Inc.)

Rec. labels: Contessa, Crown, Custom, Mother Goose, overstocks.
Tape lines: Flair 30, Modern; overstocks
Accessories: Recoton.

Sound Sellers Inc., 80 Independence, Quincy 02169. Tel: 472-3660. Owner: James Lawson; Buyer: Arthur Rich. (Rec. & Tape OS & RJ)

Warner/Elektra/Atlantic Corp., 110H Commerce Way, Woburn 01801. Tel: 935-5170. Mgr.: Don Dumont. (Rec. & Tape D)

Rec. labels: Asylum, Atco, Atlantic, Bearsville, Beserkley, Big Tree, Cotillion, Curtom, Dark Horse, DiscReet, ECM, Elektra, Embryo, Famous Charisma, Finnadar, Little David, Loma, Mantecore, Nemperor, Nonesuch, Pacific, Paradise, Reprise, Rolling Stones, SHE, Sire, Slipped Disc, Swan Song, WMMOT, Warner Bros., Warner/Curb, Warner Spector, Westbound, Whitfield, Wing & a Prayer, Zephyr.
Tape lines: Same as rec. labels.

• **BROCKTON (Area Code 617)**

RH Country Promos. Inc., 28 Empire Ave. Zip: 02402. Tel: 587-2685. Pres.: Ron Hopkins. (Rec. & Tape D)
Labels: Age of Woman, Alpoalosa, Audem, BMA, Battlewood, Bell Meade, Bobbo, Brand X, CMA, Candle, Caprice, Cayton, Cee Cee Int'l, Centennial, Charta, Churchill, Comstock, Co-Star, Country Detroit, Country Showcase America, Creole Gold, Day-Dan, Dee Bee, Deltune, Derbytown, Donahue Country, Donjim, Door

Knob, Double Heart, Dove, Doyley, El Dorado, 50 States, 4 Star, Giro, Golden Jubilee, Granny Groovy, Hill Country, Hilltop, Hop-a-long, Inergi, JAM, J-Bird, JED, Jannel, King Coal, Little Darlin', Lucky Man Music, MRC, MRI, Memory, Multi-Media, NSD, New Age, Nu-Sound, Nu-Trayl, Orlando, Page Boy, Panda, Pantheon Desert, Peter Pan, Phono, Pilot, Pinnacle, Player Int'l, Prairie Dust, RVA, Ragamuffin, Raincoat, Red Eagle, Reuben, Richmar, Roseway Int'l, SCR, Sand Mountain, Scott-J, Shangri-la, Snapp, Solitaire, Soundwaves, SPIG, TAM, T&G, Tao, 3J, Time, Trayson, True, Vulcan, Wirt, WRC, Webb Hollow, Wenco, Win, Woodchoppertown, Wooden, Woodsmoke, World Int'l, World Wide Music, Yucca

• **LAWRENCE (Area Code 617)**

NER T of New England, PO Box 268, 641 Haverhill St. Zip: 01841. Tel: 686-4293. Owner, Mgr. & Buyer: Jerry P. Marcus. (Rec. & Tape OS, I & E)

• **NEW BEDFORD (Area Code 617)**

Penco Rec. Co., 428 Wood St. Zip: 02745. Tel: 995-0595. Owner: Francisco A. Penha. (Rec. & Tape I & E)
Rec. labels imported: Alvorada, Belter, Clave, Estudio, Interdisco, Lisboa, Ofir, Onda, Orfeu, Rapsodia, Roda, Telectra (all Portugal).
Tape lines imported: Alvorada, Coimbra, Ofir, Onda, Orfeu, Rapsodia, Roda (all Portugal).
Exports pre-recorded tapes.

• **SHREWSBURY (Area Code 617)**

Music Machine, PO Box 262, Zip: 01545. Owner: Paul Brough. Mgr. & Buyer: M. Faddoul. (Rec. & Tape OS)

• **SOMERSET (Area Code 617)**

Pickwick Int'l Inc., Rack Servs. Div., 185 Riverside Ave. Zip: 02725. Tel: 676-3061. Opns. Mgr.: Jim Curci; Sales Mgr.: Richard Berube; Buyers: Gerri Costa, Geri Chase. (Rec. & Tape RJ)
Home office: Minneapolis, Minn.

• **WEBSTER (Area Code 617)**

Gay Time Rec. Dist., PO Box 381, Zip 01570. Quinebaug, Conn. Tel: (203) 935-5172. Owner: Edward J. Wojcicki-chanski. (Rec. & Tape D)
Rec. labels: Ampol, Bel-Aire, Chicago, Data, Delta, Dyno, Halo, IRM, Jody, Le Mans, Rave, Rex, Rim, Rola, Sound, Starr, Steijo, WAM.
Tape lines: Ampol, Bel-Aire, Chicago, Dyno, Halo, IRM, Jody, Le Mans, Rave, Rex, Rim, Rola, Sound, Starr, Steijo, WAM.

MICHIGAN

• **BRIGHTON (Area Code 313)**

Arc-Jay-Kay Dist'g Co. (div. of Handleman Co.), 1279 Rickert Rd. Zip: 48116. Tel: 963-4376. Gen. Mgr.: Tom Schlesinger; Sales Mgr.: Mike McKenzie; Sales AdMin.: Pauline Fras. (Rec. & Tape D)
Rec. labels: ASI, AVI, Abattor, Abkco, Accent, Adamo, Advent, Alexander Street, All Platinum, Alston, Amazon, Amerama, American Variety, Amherst, Apa, Arista, Arth, At Home, Bach Guild, Barnaby, Bee Gee, Beserkley, Big Town, Birthright, Blue Candle, Bold, Bomp, Buddha, CTI, Cadet, Cadet Concept, Calliope, Cardinal, Cat, Catalyst, Celestial, Chanterelle, Checker, Chelsea, Chess, Chrysalis, Churchill, Clouds, Commercial, Contrast, Country Porn, Cream, Creative World, Crescendo, Cyclone, Dash, Dharm, Dial, Dixieland Jubilee, Dobre, Dore, Drive, Dynamite, Era, Everymen, Fantasy, Farr, Festival, First American, Freedom, Future, GNP, GRP, GRT, Galaxy, Generation Int'l, Glades, Good Sounds, Gordy, Gospel Roots, Great Northwest, Gusto, HDM, Hi, Hitsville, Hollywood, IRDA, Import, Improv, Improvising Artists, Inphasion, JRC, Jam Session, Janus, Jay Jay, Jem, Juana, Jucu, Kayvette, Kent, King, Koko, Konduko, Kruggerand, Kudu, LRC, LS, Lab, Largo, Laurie, Malaco, Malcolm X, Marina, Martin, Metric, Midsong Int'l, Milagro, Milestone, Motown, Mushroom, Music Is Medicine, Mustard Seed, NSD, Natural Resources, Nostalgia Lane, Olde World, Original Sound, Outstanding, Ovation, Pacific Arts, Panama, Passport, Plantation, Platinum, Post, Potato, Prestige, Prima, Private Stock, Prodigal, Pyramid, Ranwood, Rare Earth, Rat City, Reid's World, Republic, Rice, Roast, Roots, Roulette, Rounder, Roxbury, Royal Flush, Salvation, Savoy, Scorpion, Seeds & Stems, Shadybrook, Shield, Silverblue, Simtone, Sketches in Black, Soul, Soundbird, Stang, Starday, Stax, Stiff, Stone Dogg, Sun, Sunshine Sound, Syntonic Research, TK, Tablighi, Tamla, Tiger Lily, Tomato, Turbo, Vanguard, Vee Jay, Versatile, Vesper, Vibration, Vintage, Vintage Jazz, Vite, WIG, Wanderick, Weird World, Wolf.
Tape lines: AVI, Abkco, Alexander Street, Alston, Amazon, American Variety, Amherst, Apa, Arista, Arth, At Home, Barnaby, Beserkley, Big Town, Birthright, Blue Candle, Bold, Buddha, CTI, Calliope, Cat, Chantrelle, Chelsea, Chrysalis, Clouds, Creative World, Crescendo, Cyclone, Dash, Dial, Drive, Fantasy, Farr, Festival, First American, GNP, GRP, GRT, Galaxy, Generation Int'l, Glades, Good Sounds, Gordy, Gospel Roots, Great Northwest, Gusto, HDM, Hitsville, Hollywood, Inphasion, JRC, Janus, Jay Jay, Jem, Jewel, Kayvette, Kent, King, Gusto, Koko, Konduko, Kudu, LRC, LS, Largo, Malaco, Marina, Martin, Midsong Int'l, Milestone, Motown, Mushroom, Music Is Medicine, Natural Resources, Nostalgia Lane, Olde World, Original Sound, Ovation, Pacific Arts, Panama, Passport, Paula, Plantation, Prestige, Prodigal, Pyramid, Rare Earth, Reid's World, Republic, Rice, Roast, Ronn, Roots, Roulette, Rounder, Roxbury, Royal Flush, Salvation, Savoy, Scor-



ROCK COUNTRY JAZZ **BLUES BLUE GRASS SOUL**

VINYL VENDORS

Full Service - One Stop

Tapes
Records
Periodicals
Blank Recording Tape
Record Care Accessories

Same Day Shipping

VINYL VENDORS INC.
 7870 SPRINKLE ROAD, KALAMAZOO, MICHIGAN 49002
 PHONE (616) 323-0131
 MICH. TOLL FREE (800) 632-0870
 BEST IN THE MIDWEST!

ption, Shadybrook, Shield, Silverblue, Simtone, Soul, Soul Power, Starday, Stax, Stiff, Stone Dogg, Sun, Sunshine Sound, TK, Tiger Lily, Versatile, Vesper, Wanderick, Weird World, Wolf.

● **CADILLAC (Area Code 616)**

B & R Music, 2400 E. 30 Rd. Zip: 49601. Tel: 775-3145. Owner, Mgr. & Buyer: Roy Newland. (Rec. & Tape RJ)

● **CHARLOTTE (Area Code 517)**

State-Wide Dist'g, 2370 Brookmead Way, Zip: 48813. Tel: 543-0097. Owner & Mgr.: Norman E. Martens. (Tape OS)

● **DETROIT METROPOLITAN AREA (Area Code 313)**

Ami Dist. Corp., 34411 Industrial Rd., Livonia 48150. Tel: 525-7600. Owners & Buyers: Harry Manoogian, Carl Mooradian, Bernard Schwarz. (Rec. & Tape D)
Rec. labels: AVI, Ala, Amherst, Argo, Arista, Brunswick, Buddha, Conversa-Phone, Dana, Fantasy, Fiesta, Golden, Gospel Truth, H&L, LA, LaF, Living Language, London, Midsong, Milestone, Monitor, Muse, Ode, Prestige, Project 3, Riverside, Savoy, Stax.
Tape lines: Ala, Brunswick, Conversa-Phone, Fantasy, Fiesta, H&L, Monitor, Muse, Onyx, Prestige, Standard.
Accessories: Audio Magnetics, Memorex, Panasonic, Sony, TDK, Toshiba.

Angott Rec. & Tape Sales, 2616 Puritan St. Zip: 48238. Tel: 341-7053. Owners: Ron Rogers, Allen Walker. Rec. Mgr. & Buyer: Ron Rogers. (Rec. OS; Tape D, OS & RJ)
Tape lines: All lines.
Accessories: Le-Bo.

C B S Recs., 24681 Northwestern Hwy., Suite 32, Southfield 48075. Tel: 354-0470. Branch Mgr.: John Farr. (Rec. & Tape D)
Rec. labels: Arc, Bang, Blue Sky, CBS, Caribou, Columbia, Epic, Jet, Kirshner, Melodiya/Columbia, Nemporer, Odyssey, Philadelphia Int'l, Portrait, Starlite, Stiff, T-Neck, Tabu, Tappan Zee, Unlimited Gold.
Tape lines: Same as rec. labels.

Cadet Dist. Co. Inc., 13380 Capitol Ave., Oak Park 48237. Tel: 548-3171. Owners: Harry & Isadore Levin; Buyer: Leo Cheslak. (Rec. & Tape OS). (Rec. & Tape RJ as Cornell Rec. Inc.)
Accessories: Blank tape (Capitol Magnetics), rec. & tape care kits (Recoton).

Capitol Recs., 550 E. Mandoline St., Madison Heights 48071. Tel: 583-9600. (Rec. & Tape D)
Rec. labels: Angel, Ariola America, Capitol, EMI America, Harvest, Liberty, Melodiya/Angel, Seraphim, United Artists.
Tape lines: Same as rec. labels.

Cornell Recs. Inc. (Rec. & Tape RJ), see Cadet Dist. Co. Inc. Gransin Dist., 13731 Woodward Ave., Highland Park 48203. Tel: 867-4500. Mgr. & Buyer: Gary Carpenter. (Rec. & Tape OS—gospel prod. only)
 Handleman Co., 1055 W. Maple Rd., Clawson 48017. Tel: 435-3100. Chm. David Handleman; VP & Rec. Buyer: John S. Kaplan. (Corporate Headquarters).

Dist'n branches: Los Angeles, Calif.; Denver, Colo.; Opa Locka (Miami Metropolitan Area), Fla.; Stone Mountain (Atlanta Metropolitan Area), Ga.; Elk Grove Village (Chicago Metropolitan Area), Ill.; Jessup (Baltimore Metropolitan Area), Md.; North Kansas City (Kansas City Area), Mo.; Latham (Albany Area), N.Y.; Charlotte, N.C.; Blue Ash (Cincinnati Area), Ohio; Youngstown, Ohio; Memphis, Tenn.; Dallas, Tex.; Tukwila (Seattle Area), Wash.

Int'l branches: Canada—Calgary, Alta.; Moncton, N.B.; Toronto, Ont.; St. Laurent (Montreal Metropolitan Area), P.Q.

Inter/Soul Rec. Dist. (div. of Inter/Soul Ent. Inc.), 18329 W. McNichols, Zip: 48219. Tel: 533-1550. Owner & Buyer: Ernest Kelley, Gen. Mgr.; Irving R. Kelley; Mgr.: Jerome Cunningham. (Rec. D)
Labels: Big Hit, Booman, Capsoul, Geneva, Great Joy, Grill, Inter/Soul, Sunburst, Underground.

Jan's One-Stop, 10243 Puritan St. Zip: 48238. Tel: 862-3571. Owner, Mgr. & Buyer: Charles L. Young. (Rec. & Tape OS—gospel prod. only)

Joyline Dist. Inc., 29305 Southfield Rd., Southfield 48076. Tel: 557-4888. Owner: Jay Kravetz; Mgr.: Danny Angott. (Rec. & Tape OS)

Len's One Stop, 3415 Chrysler, Zip: 48201. Tel: 833-5299. Owner & Buyer: Edward Leonard; Mgr.: Lloyd Leonard. **Local branch:** State Song Shop, 9246 Mack Ave. Zip: 48214. Tel: 923-2506. Mgr.: Bootsie Dingle. (Rec. & Tape OS & E)

M C A Dist'g Corp., 20300 Civic Center Dr., Suite 210, Southfield 48075. Tel: 352-2790. Branch Mgr.: Rod Linnum. (Rec. & Tape D)
Rec. labels: Backstreet, Butterfly, Coral, Infinity, LAX, MCA, Songbird, Source, Vocalion.
Tape lines: Same as rec. labels.

Martin & Snyder One Stop, 8880 Hubbell Ave. Zip: 48228. Tel: 272-7800. (Rec. OS & RJ, Tape OS)

Music Peddlers Inc., 1755 E. Maple, Troy 48084. Tel: 524-2800. Pres.: Carl Thom; Gen. Mgr.: Jerry Adams; Buyers: Singles & Pop Albums, Linda Powers; Classical Albums, Bill Close; Tape, Tom Henderson; Accessories, John Beers. (Rec. & Tape OS)
Accessories: Le-Bo, Pfanstiehl.

Music & Video Trend Inc., 24611 Crestview Court, Farmington 48018. Tel: 474-0300. Owner, Mgr. & Buyer: Gene Silverman. (Rec. & Tape D)

Rec. labels: APA, Abet, Alarm, Alston, Amazon, Amara, Arth, Barnaby, Beserkley, Blue Candle, Bold, Candid Jazz, Carnival, Cat, Chimneyville, Clouds, Contempo, Cream, Creed, Dash, Dial, Disneyland/Vista, Doctor Jazz, Dracula, Drive, Excello, GRT, Genesis, Glades, Good Sounds, Gospel Roots, Gryphon, Hi, Honey Bee, Increase, Jam, Janus, Jewel, Juana, Kayvette, Kid Stuff, Konduko, LRC, Little Darlin', Lorio, Malaco, Marlin, Nashboro, Paula, Peter Pan, Power, Prelude, Rebecca, Red Star, Ronn, Roots, Sesame Street, Shield, Silverblue, Signature, Soul Power, Sunshine Sound, TK, Tomato, Vanguard, Wanderick, Weird World, West End, Wolf, XL, Xanadu, Zebra.

Tape lines: Same as rec. labels.

Video tape lines: ABC Films, Avco Embassy, Magnetic Video, 20th Century Fox, Viacom Int'l.

Photographs: Panasonic

Accessories: Plasti-Plex, Savoy, Scotch, TDK.

Pickwick Int'l Inc., Rack Servs. Div., 26010 Pinehurst, Madison Heights 48071. Tel: 398-0400. Opls. Mgr.: John Frie; Sales Mgr.: Mike Neville; Buyer: Donna Mazur. (Rec. & Tape RJ)
Home office: Minneapolis, Minn.

Piks Corp., Mark Plaza, 21411 Civic Center Dr., Suite 108, Southfield 48076. Tel: 353-3230. (Rec. & Tape D)
Home office: Cleveland, Ohio.

Labels: Adkorp, Age of Woman, Alexander Street, Alligator, Amerama, American Gramophone, Antilles, Antonio, Armada, Artist House, Asteroid, Avanti, Axe, BRO, Banner, Barracuda, Bicycle, Buffalo, Busch Country, Butterfly, C-Town, California Gold, Celestial, Century, Century 21, Champion, Chrysalis, Citadel, Covert, Crystal Clear, DG, Denim, Derrick, Direct Disk Labs, Disciple, Dyan, Earthwood, Entr' Act, Eyes, Farr, Fiddlers Wind, First American Music, Flying Fish, Fotoplay, 4 Star, GMC, Gangster, Gateway, Glacier, Gold Rush, Gosco, Gramercy, Grape, Grapevine, Great Northwest, Grenadilla, H&K, Heat, Heavy, Hit Int'l, Hob, Housetop, IBC, ICA, IPM, Import, JDC, Jem, Jeremiah, Karat, LCR, Lamb, Little Darlin', Little Star, Locust, Lucky Man, MCM, Mango, Manila, Mar Brand Metric, Midas, Music Is Medicine, NCS, NSD, Neostat, Network, Ninth Note, Nostalgia Lane, Orlando, Ovation, Pacific Arts, Progressive, QCA, Randa On, Rhino, Ridge Runner, Ridgtop, Riverboat, Roadshow, Robert Lee, Rocking Horse, Rocky, Schubart, Scorpion, Scrimshaw, Shadow, Skyline, Snowdrop, Spoonfed, Starlog, Star Mountain, Strawberry, Sugar Hill, SMS, Talsman, Talpro, Taxi, 3 M's, Timberline, Tomorrow, Versatile, Vista, Waterhouse, Wizard, World Int'l.

PolyGram Dist'n Inc., 755 W. Big Beaver, Suite 508, Troy 48084. Tel: 362-4420. Mgr.: Bill Shulte. (Rec. & Tape D)

Home office: New York, N.Y.
Rec. labels: American Int'l, Archiv, Capricorn, Casablanca, Charisma, Chocolate City, DJM, De-Lite, Deutsche Grammophon, Emarcy, Festivo, Fontana, Lighthouse, MGM, Mercury, Monument, Oasis, Parachute, Philips, Polydor, Polydor/BGO, Polydor/Harem, Polydor/Kolob, Polydor/MVP, Polydor/Manken, Privilege, RSO, RSO/Curtom, Riva, Smash, Soundstage Seven, Spring Vertigo, Verve, Zappa.
Tape lines: Same as rec. labels.

Progress Rec. Dist'g Inc., 19025 W. Ten Mile Rd., Southfield 48075. Tel: 358-3132. Mgr.: Bill Allen. (Rec. & Tape D)

Home office: Highland Heights (Cleveland Metropolitan Area), Ohio
Labels: Bomp, CTI, Cream, Discovery, GRR, Gordy, Hi, Hitsville, Kudu, Motown, Natural Resources, Prodigal, Rare Earth, Ross, Soul, Tamla, Tomato, Venture, Xanadu.

R C A & A&M & Assoc'd Labels, 22255 Greenfield, Suite 140, Southfield 48075. Tel: 569-5980. Sales Mgr.: Mike Duggan. (Rec. & Tape D)

Rec. labels: A&M, Bluebird, Free Flight, Gold Seal, Grunt, Hologram, Millennium, NY Int'l, Pablo, Pablo Live, Pure Gold, RCA, Red Seal, Roadshow, Rocket, Sa-soul, Solar, Tortoise, 20th Century, Victrola, Windsong.
Tape lines: Same as rec. labels.

Simpson's Whislie, Inc., 16540 James Couzens Hwy. Zip: 48221. Tel: 341-1885. Mgr.: Tommy Jackson. (Rec. & Tape OS)

Accessories: BASF, Bib, Le-Bo, Maxell, Memorex, Pfanstiehl, Recoton, Sony, TDK.

Warner/Elektra/Atlantic Corp., 17500 Northland Park Court, Southfield 48075. Tel: 569-4822. Sales Mgr.: Gil Roberts. (Rec. & Tape D)

Rec. labels: Asylum, Atco, Atlantic, Bearsville, Beserkley, Big Tree, Cotillion, Curtom, Dark Horse, DiscReet, ECM, Elektra, Embryo, Famous Charisma, Finnadar, Little David, Loma, Manticore, Nemporer, Nonesuch, Pacific, Paradise, Reprise, Rolling Stones, SHE, Sire, Slipped Disc, Swan Song, WMOT, Warner Bros., Warner/Curb, Warner Spector, Westbound, Whittfield, Wing & A Prayer, Zephyr.
Tape lines: Same as rec. labels.

● **EAST LANSING (Area Code 517)**

Old Fogey Dist'g, 541 E. Grand River, Zip: 48823. Tel: 337-7503. Owner & Mgr.: Stanley Werbin, Singles & Albums Buyer: Bob Blackman. (Rec. D)

Labels: Acorn, Adelphi, Alligator, American Heritage, Archive of Folk Music, Arhoolie, Artist House, Attic, BRI, Banff, Bay, Bear Family, BetCar, Bill & Doc, Biograph, Blackbird, Black Saint, Blind Pig, Blue Goose, Blue Ridge, Blues Classics, Briar, CCE, CMH, Cabbage, Celeste, Celtic, Cezame, Chyme, Claddagh, Country Turtle, County, Davis Unlimited, Dolphin, Everest, F&W, Fiddler, Flying Fish, Flying High, Folk Legacy, Folk Lyric, Folkways, Free Reed, Fretless, Front Hall, Gael-Linn, Golden Age, Grass Mountain, Green Linnet, Guitar World, Gusto, Hawk, Heritage, Historical, Horo, Id, Inchecronn, Innisfree, Iron Horse, June Appal, K&A, Kaleidoscope, Kicking Mule, King, King, Bluegrass, Leader/Trailer, Lemco, Leviathan, Major, Mamlish, Melodion, Michigan Archives, Minstrel, Morning Glory, Morning Star, Mountain, Mountain Railroad, Mulligan, Music Minus One, Nessa, Nirx, Oats, Ogham, Old Homestead, Oldie Blues, Old Timey, Olympic, Outlet (Ireland), Outrageous, Owl, Philo, Physical, Plant Life, Polydor, Power Pak, Ramblin', Rebel, Red Clay, Red Goose, Ridge Runner, Rounder, Rubber, Rural Rhythm, Shanachie, Shaskeen, Shiloh, Sierra, Sierra Wave, Silver Hill, Snowflake, Sonet, Sonatone, Starday/King, Stash, Stouf, String, Sugar Hill, Tangent, Tara, Temple, Thunderhead, Topic, Tradition, Transatlantic, Troubadour, Vetco, Weiser, Wheatland, Xtra, Yazoo.

● **GRAND HAVEN (Area Code 616)**

Tant Ent. Inc., 205 Washington St. Zip: 49417. Tel: 846-

Q: What companies in the Netherlands import recording studio equipment?

A: No need to tiptoe through the tulips. Let your fingers do the walking through the "International" section of Billboard's International Recording Equipment & Studio Directory. The information master in the recording/studio world.

6930. Owners: Billie & Ellen Thomas; Mgr. & Buyer: Billie Thomas. (Rec. D, I & E)
Labels: Adelphi, Advent, Ajax, Alligator, Arcadia, Bay, Bee Hive, Big Band Archives, Big Band Landmarks, Big Star, Birch, Bix Lives, Black Bird, Black Eagle, Blind Pig, Blue Canyon, Blue Goose, Blue Hour, Blue Labor, Blue Lantern, Blues Classics, Bountiful, Briar, Broadway, Bull Frog, Chiaroscuro, Choice, Cinema, Claremont, Classic Jazz Masters, Columbia Special Prods., Command Performance, Cowboy Carl, Curtain Calls, Delmark, Dirty Shame, Discocory, Dogwood, Empire, Entr' Acte, Eubie Blake, Euphonic, Eurodisc, Everest, Extreme Rarities, First Time, Flying Fish, Folk Legacy, Folkways, Fretless, Front Hall, Genesis, Glendale, Golden Era, Green Linnet, Halcyon, Harmony, Herwin, High Street Station, IAJRC, Idiomi, Improv, Improvising Artists, India Navigation, Innisfree, JRC, Jazz Archives, Jazz Showcase, Jazz Studies, Jazz Treasury, Jim Taylor Presents, Joker-Bixology, Joliet, Joyce, June Appal, Kaleidoscope, Kicking Mule, Klavier, Knéedeep, Labor, Log Cabin, Mamlish, Mar Bren, Mark 56, Mary, Michigan Archives, Mill City, Mountain Railroad, Mozovon, Mug Time, Muskadine, Nashville Jazz, Nessa, New Orleans, Nighthawk, Old Homestead, Oldie Blues, Onari, PM, Packo, Pearl, Pelican, Pharaoh, Philo, Phoenix, Piedmont, Prairie Schooner, Premier, Puritan, Rebel, Red Onion, Retrospect, Revelation, Ridge Runner, Rounder, Sackville, San Jacinto, 1750 Arch, Shanachie, Shoestring, Skyline, Sounds of Swing, Soundtrack, Spotlite, Startone, Stash,

Sunbeam, Swallowtail, Swing Era, Takoma, Titanic, Topic, Traditional, Trailer, Trix, Vetco, WATT, World Jazz, Yazoo, Yorkshire, Zim.

• **GRAND RAPIDS (Area Code 616)**

Kent One-Stop, 41 S. Division Ave. Zip: 49503. Tel: 459-2670. Owner: William Van Gessel; Mgr. & Buyer: Don Stickroe. (Rec. & Tape OS)
 Mid-America Music Corp., 505 Jefferson Ave. SE. Zip: 49503. Tel: 774-9444. Pres.: Robert L. Hawley; Gen. Mgr.: Robert Reus; Opns. Mgr.: William Castle. (Rec. & Tape OS & RJ)
 Mobile Rec. Serv. Co., Tel: 399-0283. Mgr.: Steve Brownell. (Rec. OS—singles only)
 Home office: Pittsburgh, Pa.
 Monroe Dist'g Co. Inc., PO Box 8458, 3970 Roger B. Chaffee Mem. Dr. Zip: 49508. Tel: 247-3833. Pres.: Herman Rubin; Mgr.: Alan Rubin; Buyer: Charlie McLaughlin. (Rec. & Tape RJ)

• **KALAMAZOO (Area Code 616)**

La Val Rec. Dist., 226 N. Burdick St. Zip: 49006. Tel: 342-5328. Owner: Vic La Val; Mgr. & Buyer: Vincent Taylor; Promo: Harry Whited, Val Taylor. (Rec. D)
Labels: Ball, Bay Tone, Boss, Comedian, Dooto, Funky Finger, Funny, La Val, Luck, Partee, Soul Set, T&L, Trash, Vic, Weird World.

Vinyl Vendors Inc., 7870 Sprinkle Rd. Zip: 49002. Tel: 323-0131. WATS: (800) 632-0870. Owner & Buyer Jeff Boyd; Owner & Sales Mgr.: Craig Hedeon; Singles Buyer & Rack Servs.: Jim Frazer. (Rec. & Tape OS & RJ) (SEE ADVERTISEMENT)

MINNESOTA

• **MINNEAPOLIS-ST. PAUL AREA (Area Code 612)**

Amity Books (div. of North Western Prods. Inc.), 3255 Spring St. NW, Minneapolis 55413. National WATS (800) 328-8628, Minnesota WATS: (800) 462-5302. Owner: Robert Cutshall; Mgr.: Al Martinsen. (Rec. & Tape D)
Labels: Alexandria House, Benson, Birdwing, Lillinus, Messianic, New Life, Singpiration, Sparrow, Tempo, Word.
 Brown Bros. Inc., 3346 Washington Ave. N., Minneapolis 55412. Tel: 822-6648. Pres.: Raymond W. Brown. (Rec. OS)
 C B S Recs., 4570 W. 77 St., Suite 224, Minneapolis 55435. Tel: 831-8626. Branch Mgr.: Bob Ewald. (Rec. & Tape D)
Rec. labels: Arc, Bang, Blue Sky, CBS, Caribou, Columbia, Epic, Jet, Kirshner, Melodiya/Columbia, Nemperor, Odyssey, Philadelphia Int'l, Portrait, Starlite, Stuff, T-Neck, Tabu, Tappan Zee, Unlimited Gold.
Tape lines: Same as rec. labels.
 Capitol Recs., 10800 Lyndale Ave., South Bloomington 55420. Tel: 884-0444. (Rec. & Tape D)
Rec. labels: Angel, Ariola America, Capitol, EMI America, Harvest, Liberty, Melodiya/Angel, Seraphim, United Artists.
Tape lines: Same as rec. labels.
 Dart Recs. Inc., 1815 W. River Rd. N., Minneapolis 55411. Tel: 529-9571. Pres.: Dick Daly; Buyers: Singles, Irv Gorsen; Albums & Tape, Joel Coryell. (Rec. & Tape RJ)
 Gamco, 858 Decatur Ave. N., Minneapolis 55427. Tel: 545-0129. Owner: Ira Heilicher; Buyer: Jan Jordon. (Rec. & Tape OS & RJ)
 House Distrs., 4027 E. 50, Minneapolis 55417. Tel: 722-7844. Mgr.: Laura Sunday. (Rec. & Tape D)
Home office: Kansas City, Mo. (See for prod. distributed) (SEE ADVERTISEMENT)
 Jim's Rec. Shop, 1724 University Ave., St. Paul 55104. Tel: 646-3357. Owner & Buyer: James Christensen. (Rec. OS)
 Lieberman Ents. Inc., 9549 Penn Ave. S., Minneapolis 55431. Tel: 887-5300. Bd. Chm.: David Lieberman; Pres.: Harold Okinow; VP Opns. Dick Moerbitz; OS Mgr.: Doug Ackerman; Nat'l Buyers: Singles, Larry Ruegger; Albums & Tape, Sylvester Vanyo. Local branch: Opns. Mgr.: Dianne Rasmussen; Buyers: Singles, Sherry Williams; Albums, Pat Weiser. (Rec. & Tape OS & RJ)
Branches: Denver, Colo. (Rec. & Tape OS & RJ); Jacksonville, Fla./Atlanta, Ga. (Rec. & Tape RJ); Elk Grove Village (Chicago Metropolitan Area), Ill. (Rec. & Tape RJ); Indianapolis, Ind. (Rec. & Tape OS & RJ); Kansas City, Hazelwood (St. Louis Metropolitan Area), Mo. (Rec. & Tape OS & RJ); Omaha, Neb. (Rec. & Tape OS & RJ); Mount Laurel, N.J. (Rec. & Tape OS & RJ); Cleveland, Ohio (Rec. & Tape OS & RJ); Portland, Ore. (Rec. & Tape OS & RJ); Dallas, Tex. (Rec. & Tape OS & RJ) (SEE ADVERTISEMENT)
 M C A Dist-g Corp., 4640 W. 77 St., Suite 212, Edina 55435. Tel: 835-6020. Branch Mgr.: Bob Schneiders. (Rec. & Tape D)
Rec. labels: Backstreet, Butterfly, Coral, Infinity, LAX, MCA, Songbird, Source, Vocalion.
Tape lines: Same as rec. labels.
 Pickwick Int'l Inc., Distribution Div., 7500 Excelsior Blvd., Minneapolis 55426. Tel: 932-7548. Sr. VP: Gene Patch; VP & Gen. Mgr.: Jack Mishler; Nat'l Prod. Co-ord.: Barb Grossman. Local branch: Mgr.: Lu Dahle; Sales Mgr.: Mike Meyer; Buyer: Larry Hoof. (Rec. & Tape D), (Rec. & Tape RJ as Pickwick Int'l Inc., Rack Serv. Div.)
Branches: San Francisco, Sun Valley (Los Angeles Metropolitan Area), Calif.; Opa Locka (Miami Metropolitan Area), Fla.; Atlanta, Ga.; St. Louis, Mo.; Memphis, Tenn.; Arlington (Fort Worth Area), Houston, Tex.
Labels: ASI, AVI, Abkco, Accent, Alligator, Alston, Amherst, Argo, Arista, BUK, Bach Guild, Barnaby, Birthright, Buddah, CMH, CTI, Chrysalis, Clouds, Cognito, Con Brio, Concord Jazz, Conversa-Phone, Cream, Creative World, Dash, Deram, Dore, Drive, ERA, Fantasy, First American, Flying Fish, GNP Crescendo, GRT, Galaxy, Glades, Good Sound, Gordy, HNH, Happy Fox, Hi, Import, Juana, Ju Par, Kaleidoscope, Kayvette, Kudu, LRC, LS, London, Malaco, Marlin, Milestone, Motown, Mulberry Square, Muse, Mushroom, Music Is Medicine, NBR TK, L'Oiseau-Lyre, Onyx, Ovation, PA-USA, Pacific Arts, Panaural, Parrot, Passport, Prestige, Prodigal, Project 3, Ranwood, Rare Earth, Republic, Request, Riverside, Roulette, Rounder, Salvation, Sanscrit, Savoy, Shadow, Shadybrook, Sheffield, Soma, Soul, Sound Bird, Stax, Stiff, Syntonic, TK, Takoma, Tarnia, Telefunken, Threshold, Tiger Lily, Tomato, UK, Unicorn-HNH, Vanguard, Vee Jay, Virgo, Wicked.
Phonographs: APF, Audiovox, BSR, Craig, Emerson, Glenburn, Hitachi, Lloyds, McDonald, Panasonic, Royce, Sanyo, Soma, Superscope, Weltron.
Accessories: Amberg File, American Lighting, Ampex, Columbia, Harmony, Hohner, Memorex, Music Master, Paramount Wire, Service, Soma. (SEE ADVERTISEMENT)
 Pickwick Int'l Inc., Rack Servs. Div., 7500 Excelsior Blvd., Minneapolis 55426. Tel: 932-7548. Sr. VP: Gene Patch; VP & Gen. Mgr.: Jack Mishler; Nat'l Rack Buyer: Bob Dahle. Local branch: Sales Mgr.: Chuck Gilbertson; Buyers: Kathy Dosall, Bob Theisen. (Rec. & Tape RJ), (Rec. & Tape D as Pickwick Int'l Inc., Distribution Div.)
Branches: Phoenix, Ariz.; Burlingame (San Francisco &

What's Missing from this Photo?



Nothing, except management by Lieberman Enterprises.

By that we mean a Lieberman Merchandising Specialist who is fully-trained and experienced to help you realize a larger return on investment!

How?

- Ongoing personal service and supervision
- Computerized inventory investment control and national distribution at-hand
- Total knowledge of correct merchandising materials and marketing procedures
- Utilization of a complete advertising department

SALES-TO-SPACE-TO EARNINGS RATIO

is important to You... And to Lieberman Enterprises.

With an extremely capable and qualified field service force PLUS 11 branches nationwide, Lieberman Merchandising Specialists can assure you of rewarding sales/profit per square foot.



LIEBERMAN ENTERPRISES

Call Jim Hanke 800/328-2960

Denver • Indianapolis • Atlanta • Philadelphia • Minneapolis • Chicago
 Dallas • Portland • St. Louis • Kansas City • Cleveland

National Association of Recording Merchandiser's
 Rack Jobber of the Year—1977, 1978, 1979!!



PICKWICK INTERNATIONAL, INC.

**DISTRIBUTION
DIVISION**

**DEDICATED TO
INDEPENDENT DISTRIBUTION**

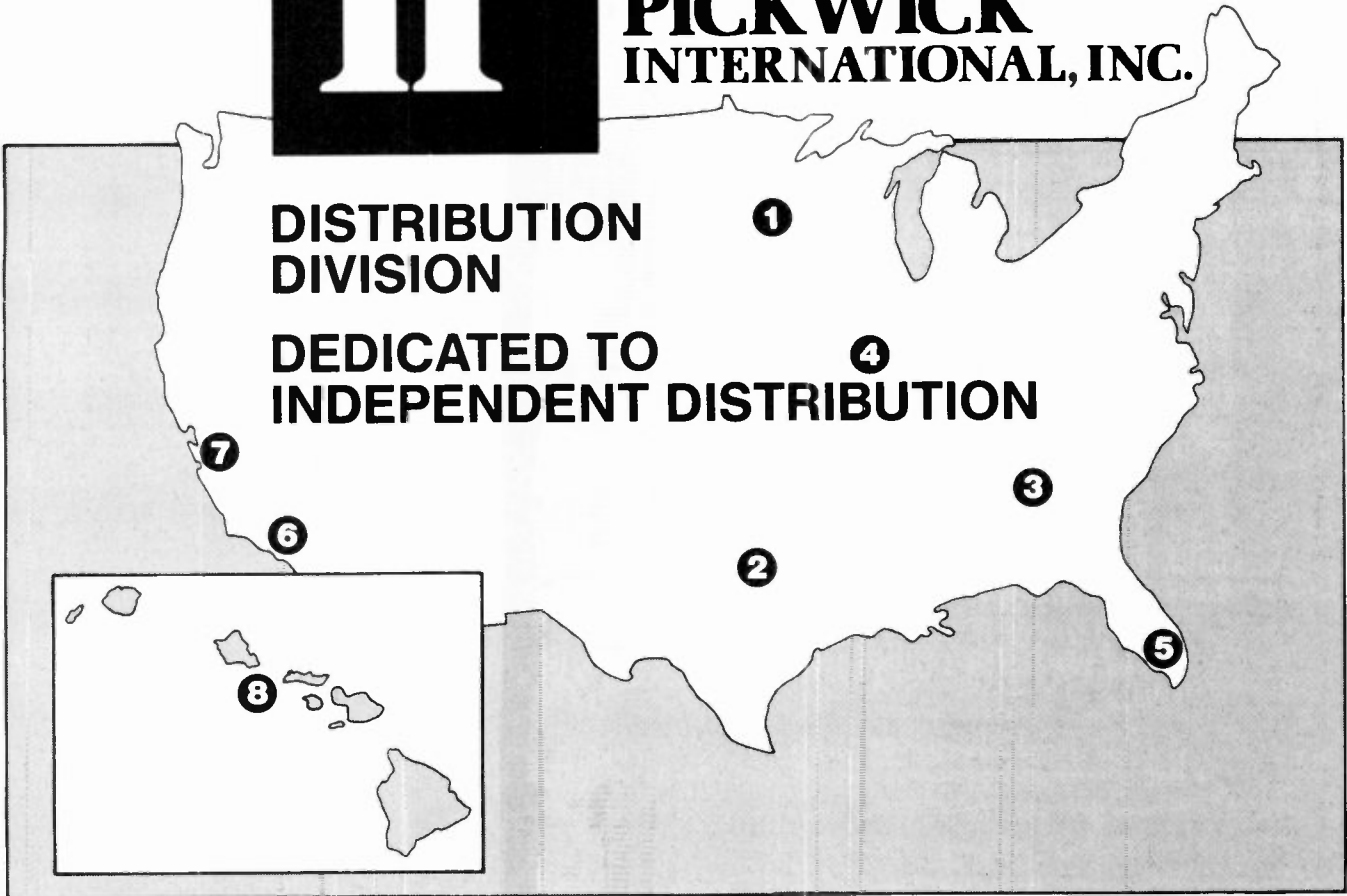

① MINNEAPOLIS

7500 Excelsior Boulevard
Minneapolis, Minnesota 55426 (612) 932-7548

② DALLAS

2200 East Randol Mill Road
Arlington, Texas 76011 (817) 261-4281

③ ATLANTA

115 Villa Nova Drive
Atlanta, Georgia 30336 (404) 349-5200

④ ST. LOUIS

1401 North Price Road
St. Louis, Missouri 63132 (314) 997-1800

⑤ MIAMI

13145 North West 45th Avenue
Opa Locka, Florida 33054 (305) 685-7601

⑥ LOS ANGELES

9420 Telfair
Sun Valley, California 91352 (213) 875-3960

⑦ SAN FRANCISCO

375 Sutter Street
San Francisco, California 94108 (415) 981-8787

⑧ HAWAII

735 Iwilei Drive
Honolulu, Hawaii 96817 (808) 521-1802

Bay Area), North Hollywood, Calif.; Denver, Colo.; Opa Locka (Miami Metropolitan Area), Fla.; Atlanta, Ga.; Honolulu, Hawaii; Elmhurst (Chicago Metropolitan Area), Ill.; Des Moines, Iowa; Baltimore, Md.; Somerset, Mass.; Madison Heights (Detroit Metropolitan Area), Mich.; St. Louis, Mo.; Memphis, Tenn.; Arlington (Fort Worth Area), Houston, Tex.; Seattle, Wash.

RCA & A&M & Assoc'd Labels, 4620 W. 77 St., Edina 55424. Tel: 831-5404. Sales Mgr.: John Swenson. (Rec. & Tape D)
Rec. labels: A&M, Bluebird, Free Flight, Gold Seal, Grunt, Hologram, Millennium, NY Int'l, Pablo, Pablo Live, Pure Gold, RCA, Red Seal, Roadshow, Rocket, Salsoul, Solar, Tortoise, 20th Century, Victrola, Windsong.
Tape lines: Same as rec. labels.

Re-Mark-Co., 2444 Cavell Ave. S., Minneapolis 55426. Tel: 545-1211. Owner & Mgr.: J.L. Goldstein; Mail Order: Mark Goldstein; Buyer: Joan Y. Ostrin. (Rec. & Tape D, OS, RJ & E)
Distributes & exports cut-outs, overstocks & promotional material.

Warner/Elektra/Atlantic Corp., 4930 W. 77 St., Suite 235, Edina 55435. Tel: 835-7255. Sales Mgr.: Chester Sieva. (Rec. & Tape D)
Rec. labels: Asylum, Atco, Atlantic, Bearsville, Beserkley, Big Tree, Cotillion, Curton, Dark Horse, DiscReet, ECM, Elektra, Embryo, Famous Charisma, Finnader, Little David, Loma, Manticore, Nempcor, Nonesuch, Pacific, Paradise, Reprise, Rolling Stones, SHE, Sire,

Slipped Disc, Swan Song, WMOT, Warner Bros., Warner/Curb, Warner Specter, Westbound, Whitfield, Wing & a Prayer, Zephyr.
Tape lines: Same as rec. labels.

MISSISSIPPI

- **COLUMBUS (Area Code 601)**
 Mable Recs. (div. of Magendie Ent's. Inc.), Box 151-A-82, West Columbus 39701. Tel: 327-9977. Promo. Dir.: Allen White. (Rec. OS)
Home office: Westchester (Chicago Metropolitan Area), Ill.
- **GREENVILLE (Area Code 601)**
 Trackdown Rec. Dists., 476 Muscadine. Zip: 38701. (Rec. D, OS, RJ, I & E)
Home office: Chicago, Ill. (See for prod. distributed)
- **JACKSON (Area Code 601)**
 Bennett's Rec. Dists. Inc., Delta Mart Shopping Center,

3152 Delta Dr. Zip: 39213. Tel: 981-4328. Owner & Mgr.: James Bennett; Buyers: Singles, Janice Tolbert, Albums, Doris Ellis; Tape, Annie Ervins. (Rec. & Tape OS)
Playback equip.: Craig.
Accessories: Capitol, Finetone.

● **MOSS (Area Code 601)**
 Trackdown Rec. Dists., PO Box 530. Zip: 39563. (Rec. D, OS, RJ, I & E)
Home office: Chicago, Ill. (See for prod. distributed)

MISSOURI

- **COLUMBIA (Area Code 314)**
 BTR Rec. Serv., 25 S. Ninth. Zip: 65201. Tel: 442-7316. Owner: Phil Bourne, Mgr. Chris Fiorello; Buyers: Singles, Doug Carr; Albums & Tape, Denise White-Cavanah. (Rec. & Tape OS & RJ)
- **JOPLIN (Area Code 417)**
 Gospel Music Dists., 1705 Jackson. Zip: 64801. Tel: 624-6713. Owner, Mgr. & Buyer: Larry E. Yeager. (Rec. & Tape D)
Rec. labels: AB, Calvary, Canaan, Chime, Chrism, Creative Sound, DIP, Dayspring, Deep Roots, Eternal, 4 Star, Freedom, Good News, Gusto, Harvest, Herald, Heritage, Hosanna, Image VII, Jim, John Hall, KCP, King, Lamb & Lion, Light, Lighthouse, Maranatha, Messianic, Mighty Wind, Myrrh, New Day, New Pax, New Song, Paragon, Pax, Petra, Power Pak, Pure Joy, QCA, Rainbow, Sacred, Scripture in Song, Seed, Shilo, Sing, Skyline, Solid Rock, Songs of Faith, Sunrise, Sound III, Starday, Street Level, Superior, Supreme, Tempo, Word.
Tape lines: Same as rec. labels.
- Legg Supply Co., PO Box 2368, 1028 W. Seventh. Zip: 64801. Tel: 781-1491. Owner & Mgr.: Gene F. Legg. (Rec. & Tape OS & RJ)

- **KANSAS CITY AREA (Area Code 816)**
 Friends II Music Inc., 3101 Mercier. Zip: 64111. Tel: 931-1505. Mgr.: Joel Seaman. (Rec. & Tape OS & RJ)
Home office: Wichita, Kan.
- Handleman Co., 1125 Saline St., North Kansas City 64116. Tel: 421-0135. Mgr.: Gary Hancock; Buyers: Gary Hancock, Diana Tate, John Ditch. (Rec. & Tape RJ)
Home office: Clawson (Detroit Metropolitan Area), Mich.
- House Dists., 3101 Mercier, No. 427. Zip: 64111. Tel: 561-2744. WATS: (800) 821-3324. Owner: Harold S. Brody; Sales Mgr.: Kevin Papuga; Buyer: Lane Turner; Opns. Mgr.: Dave Conn; Promo.: Mindy Farber. (Rec. & Tape D)

Branches: Denver, Colo.; Chicago, Ill.; Minneapolis, Minn.; Austin, Tex.

Labels: ASI, Accent, Adelphi, Advent, Aeco, Airborne, Aircheck, Ajax, Alligator, American Gramophone, American Heritage, Archive of Folk & Jazz, Archives, Arhoolie, Artist House, Audio Directions, Aviva, Bandstand, Barrelhouse, Bay, Beehive, Beet, BetCar, Bija, Biograph, Biscuit City, Bix Lives, Black Saint, Blind Pig, Blue Canyon, Blue Goose, Blue Labor, Blues Classics, Brandywine, Briar, Bullfrog, CMH, CRD, CRI, Caedmon, Candy Apple, Center, Century, Chalfont, Chiaroscuro, Choice, Citadel, Classical Excellence, Classical Int'l Filmicals, Collector's Classics, Concord Jazz, Contemporary, Contrast, Corinthian, Cornographic, Country Porn, Country Turtle, County, Cowboy Carl, Crazy Cajun, Creative World, Crystal Clear, Curtain Calls, Delmark, Delos, Demo, Denon, Desmar, Direkt to Disk, Dirty Shame, Discovery, Discwasher, Dobre, Dreamstreet, EPI, ESCA, Eckerworks, Entr' Acte, Epiphany, Epitaph, Equinox, Eubie Blake, Euphoria, Everest, F&W, Fairmont, Famous Door, Famous Owl, Famous Personality, Fanfare, Farm, Fiddledeedoo, Finite, First Heard, Flashlite, Flying Fish, Flying High, Folk Legacy, Folk Lyric, Folkways, Freckle, Fretless, Front Hall, GNP Crescendo, Gael Linn, Giants of Jazz, Glendale, Golden Age, Golden Country, Golden Legends, Gold Mine, Good Time Jazz, Gramercy 5, Grapevine, Grass Mountain, Grenadilla, Guitar Player, Guitar World, Gusto, HNH, Halcyon, Hawk, Hep, Herwin, Historical, Hollywood Soundstage, Homespun, Honey Dew, Horo, Horselips, Improv, Improving Artists, Inchechronin, India Navigation, Innisfree, JCOA, Jam Session, Jazz Archives, Jazz Classics, Jazz Connoisseur, Jazz Guild, Jessup, Jim Taylor Presents, Jin, Joliet, Joyce, June Appal, Kaleidoscope, Kaycee Jazz, Kaydee, Kicking Mule, King, Klavier, Labor, Lamb & Lion, Legacy, Legends, Le Roi du Blues, Leviathan, Light, Lisa, Lo Ball, Log Cabin, Lost, Lyrichord, MCA/JVC, M&K Reel Time, Maison de Soul, Mamlish, Mar Bren, Mark 56, Mark Levinson, Medoleon, Merry Makers, Messaround, Michigan Archives, Midland, Mission Music, Mr. Blues, Monitor, Monmouth Evergreen, Mozown, Mulligan, Musicraft, Muskadine, Myrrh, Nashville Jazz, Natural Organic, Nessa, New World, Nighthawk, North Country Band, Nostalgia Lane, Oblivion, Old Homestead, Oldie Blues, Old Timey, Olympic, Omac, Omnisonnd, Onari, Origin Jazz Library, Orion, Outrageous, Outstanding, PA-USA, PM, Pandora, Pelican, Philly Jazz, Philo, Philomel, Phoenix Jazz, Plantation, Power Pak, Professional Music Prods., Progressive, Pumpkin, Puritan, RE/SE, Radiola, Ramblin', Rebel, Red Rooster, Request, Retrospect, Revelation, Rhino, Ridge Runner, Rounder, Sackville, Sagoma, San Diego Jazz Club, Sandy Hook, Sanskrit, Scala, 1750 Arch, Shadow, Shanachie, Sheepeater, Shiah, Shiloh, Shoestring, Sierra Wave, Sine Qua Non, Sirens, Skyline, Solid Smoke, Sonet, Soundtrack, Spiball, Spivey, Spokane, Spotlight, Standing Room Only, Stanoy, Starday, Starflite, Slash, Stet, Straight Ahead Jazz, String, Studio 7, Sugar Hill, Sun, Sunbeam, Sun-

GREAT ATLANTIC AND PACIFIC MUSIC COMPANY

3310 Lucas Avenue, St. Louis, Missouri 63103
 (Phone) (314) 531-4644
 Norman Hausfater, President

**WE SELL AND BUY SURPLUS ALBUMS,
 8 TRACK AND CASSETTE TAPE**
 WRITE FOR OUR FREE CATALOG
 SPECIALIZING IN JAZZ & ROCK CUT-OUTS

The HOUSE DISTRIBUTORS

Call or write for FREE CATALOG

Classical

Bluegrass

GOOD FILLS

SAME DAY SERVICE

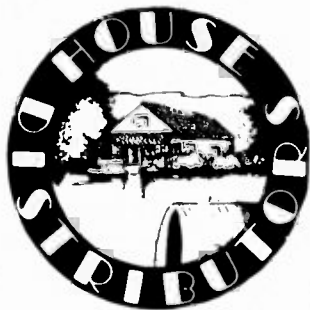

Jazz

Folk

Blues

3101 Mercier Space 427

P.O. Box 5935

Kansas City, Mo. 64111

816-561-2744 • 800-821-3324

timeless tunes aged in limestone

rise, Survival, Swallow, Swallowtail, Sweet Jane Ltd., Symposium, Syntonic Research, TRC, Take Home Tunes, Tangent, Tara, Taz Jazz, Telarc, Testament, Texas Re-Cord, Third Planet, Third Street, 360 Degree Music, Topic, Totem, Tradition, Trailer, Train on the Island, Transatlantic, Trend, Trident, Trix, Troubadour, Unicorn, Unique Jazz, Universal Justice, University of Michigan, VJ Int'l, Uptown Lowdown Jazz, Varese Int'l, Vetc, Vintage Jazz, Voyager, WATT, Waterhouse, Whid Isle, Windham Hill, Word, Xanadu, Yazoo, Zambra, Zap, Zim.

Lieberman Ents. Inc., 6131 Deramus Rd. Zip 64120. Tel: 231-2470. Mgr. Bob Pockrandt; Opns. Mgr. Tony Burasco; OS Mgr. Dennis Price; Buyers: Singles, Nick Simon; Albums: Steve Miller. **(Rec. & Tape OS & RJ)**
Home office: Minneapolis, Minn. (SEE ADVERTISE-
MENT)

Warner/Elektra/Atlantic Corp., Plaza Center Bldg., Suite 323, 800 W. 47 Zip 64112. Tel 561-5623. Mgr. Jim McAuliffe. **(Rec. & Tape D)**

Rec. labels: Asylum, Atco, Atlantic, Bearsville, Beserkley, Big Tree, Cotillion, Curtom, Dark Horse, DiscReet, ECM, Elektra, Embryo, Famous Charisma, Finnadar, Little David, Loma, Mantecore, Nemperor, Nonesuch, Pacific, Paradise, Reprise, Rolling Stones, SHE, Sire, Slipped Disc, Swan Song, WMOT, Warner Bros., Warner/Curb, Warner Spector, Westbound, Whitfield, Wing & a Prayer, Zephyr.

Tape lines: Same as rec. labels.

Windy Dist. Co. Inc., 13624 E. 50 Hwy. Zip 64138. Tel: 524-8766. Pres. & Albums Buyer Jane M. Longmire. Mgr. Weldon Tyler. **(Rec. D)**

Labels: Aslan, Benson, Birdwing, Calvary, Canaan, Chrism, Dayspring, Good News, Greentree, Heart Warming, Heritage, Lamb & Lion, Light, MCA, Maranatha, Mercury, Myrrh, New Pax, New Song, Paragon, RCA, Seed, Singcord, Solid Rock, Sparrow, Sparrow, Spirit, Star Song, Tempo, Warner Bros., White Horse, Word.

● **ST. LOUIS METROPOLITAN AREA**
(Area Code 314)

C B S Recs., 7711 Carondelet Ave., Clayton 63105. Tel: 727-5100. Branch Mgr. Ron Peek. **(Rec. & Tape D)**
Rec. labels: Arc, Bang, Blue Sky, CBS, Caribou, Columbia, Epic, Jet, Kirshner, Melodiva/Columbia, Nemperor Odyssey, Philadelphia Int'l, Portrait, Starflite, Stiff, T-Neck, Tabu, Tappan Zee, Unlimited Gold.
Tape lines: Same as rec. labels.

Great Atlantic & Pacific Music Co., 3310 Lucas Ave. Zip: 63103. Tel: 531-4644. Pres.: Norman Hausfater. **(Rec. & Tape D)**

Distributes cut-outs. (SEE ADVERTISEMENT)

L & R Dist'g Inc., 1901-05 Delmar Blvd. Zip: 63103. Tel: 421-3622/5633. **(Rec. OS)**

Lieberman Ents. Inc., 5610 Anglum Court, Hazelwood 63042. Tel: 731-7171. Mgr.: Darrell Creekmur; Opns. Mgr.: Steve Foerstal; OS Mgr.: Bruce Lowry; Buyers:

Reg'l. Rich Martin; Singles, Doris Gravagna; Albums, Mike Brewer. **(Rec. & Tape OS & RJ)**

Home office: Minneapolis, Minn. (SEE ADVERTISE-
MENT)

M C A Dist'g Corp., 9666 Olive St., Suite 490 Zip 63132. Tel: 991-3015. Branch Mgr. Mike Smith. **(Rec. & Tape D)**

Rec. labels: Backstreet, Butterfly, Coral, Infinity, LAX, MCA, Songbird, Source, Vocalion

Tape lines: Same as rec. labels.

M S Dist'g Co., 200 S. Hanley, Clayton 63105. Tel: 862-7575. Mgr. Richard Presman. **(Rec. & Tape D)**

Home office: Morton Grove (Chicago Metropolitan Area), Ill. (See for prod. distributed)

Middlewest Rec. Dist. Co., 1911 Washington Zip 63103. Tel: 621-8350. **(Rec. D)**

Labels: Ameraba, Big Town, Blue Heaven, Brunswick, Catalyst, Churchill, Commercial, Dakar, 1st Generation, Fretone, Gil's Funny Recs., Gospel Best, Gusto, ICA, Jewel, Kent, King, LRJ, Little City, MRC, NSD, Nostalgia Lane, Ortega, Paula, Ronn, Spire, Starday, Vee Jay, West End, Wig.

P-B One Stop Rec. Serv. Inc., 1919-21 Washington St. Zip: 63103. Tel: 231-2074. Owner: Patrick J. Blunda. Mgr. Perry F. Blunda; Buyers: Singles, Albums & Tape. John Gavin, Perry Blunda. **(Rec. & Tape OS & RJ)**

Playback equip. & phonographs: Rotel of America

Accessories: Blank tape (Audio Magnetics, Capitol Magnetic, Tracs), Le-Bo, Planstiehl & Savoy prods.

Pickwick Int'l Inc., Distribution Div., 1401 N. Price Rd. Zip 63132. Tel: 997-1800. Branch & Sales Mgr.: Barry Raccoff. Buyer: Terry Donovan. **(Rec. & Tape D), (Rec. & Tape RJ)** as Pickwick Int'l Inc., Rack Servs. Div.)

Home office: Minneapolis, Minn.

Labels: APA, ASI, AVI, Abkco, Ala. Alarm, Alexander Street, Alston, American Variety, Argo, Aspetke, At Home, Barnaby, Beserkley, Big Sound, Birthright, Blue Candle, Bold, Butterfly, CMH, CTI, Cat, Chimneyville, Chrysalis, Cime, Clouds, Con Brio, Concord Jazz, Cream, DJM, Dana, Dash, Deram, Derrick Dial, Dingo, Dixieland Jubilee, Drive, Fantasy, Fiesta, First American, Fotoplay, GNP Crescendo, GRT, Galaxy, Glades, Good Sounds, Gordy, Gospel Tone, Gospel Truth, Great Northwestern, Gusto, Hi, Hitsville, Hob, Honeybee, Import, Inphasion, Janus, Jay World, Juana, Jumar, Kayvette, Kudu, LA Int'l, LRC, Laff, Le Joint, Little Darlin', Living Language, L'Oiseau Lyre, London, Mainstremm, Malaco, Mark 56, Marlin, Melodyland, Messenger Gospel, Midsound, Milestone, Motown, Muse, Mushroom, Music Is Medicine, Natural Resources, Ovation, Pacific Arts, Panama, Parrot, Picadilly, Potato, Prelude, Prestige, Prodigal, Project 3, Ranwood, Rare Earth, Republic, Richmond, Riverside, Roadshow, Roots, Roulette, Royal Flush, Salvation, Savoy, Scorpion, Sesame Street, Shadybrook, Shield, Silver Blue, Soul, Sound Bird, Starday, Stax, Stoney Plain, Sunshine Sound, Syntonic Research, TK, Talisman, Tama, Telefunken, Threshold, Tiger Lily, Tomato, UK, Venture, Virgo, Visa, Vox, Voyage, Wanderick, Western Hemisphere.

Wicked, Wolf, World Jazz. (SEE ADVERTISEMENT)

Pickwick Int'l Inc., Rack Servs. Div., 1401 N. Price Rd. Zip 63132. Tel: 997-1800. Opns. Mgr.: George Genovese, Sales Mgr.: John Rabe; Buyers: John Curran, George Genovese. **(Rec. & Tape RJ), (Rec. & Tape D)** as Pickwick Int'l Inc., Distribution Div.)

Home office: Minneapolis, Minn.

PolyGram Dist'n Inc., 9666 Olive St. Zip 63132. Tel: 991-4650. Mgr.: Paul Luckas. **(Rec. & Tape D)**

Home office: New York, N.Y.

Rec. labels: American Int'l, Archiv, Capricorn, Casablanca, Charisma, Chocolate City, DJM, De-Lite, Deutsche Grammophon, Emarcy, Festivo, Fontana, Limelight, MGM, Mercury, Monument, Oasis, Parachute, Philips, Polydor, Polydor/BGO, Polydor/Harem, Polydor/Kolob, Polydor/MVP, Polydor/Mankan, Privilege, RSO, RSO/Curtom, Riva, Smash, Soundstage Seven, Spring, Vertigo, Verve, Zappa.

Tape lines: Same as rec. labels.

R C A & A&M & Assoc'd Labels, 12156 Lackland, Suite 1, Zip 63141. Tel: 878-5454. Sales Mgr.: Don Swengros. **(Rec. & Tape D)**

Rec. labels: A&M, Bluebird, Free Flight, Gold Seal, Grunt, Hologram, Millennium, NY Int'l, Pablo, Pablo Live, Pure Gold, RCA, Red Seal, Roadshow, Rocket, Sal-soul, Solar, Tortoise, 20th Century, Victrola, Windsong.

Tape lines: Same as rec. labels.

Record-Wide Dist. Inc., 1755 Chase Dr., Fenton 63026. Tel: 343-7100. **(Rec. & Tape RJ)**

PERFORMANCE
Record & Tape



Distributors

CUT-OUT & OVERSTOCK
LPs, 8 Tracks, Cassettes

Find out why people say that ours "... is the best cut-out list I've ever seen ..." Specializing in rock and jazz. Call or write for your catalog today.

382 George Street
New Brunswick, N.J. 08901
(201) 545-3004

JEM

***Exclusive national distributors for Antilles, PVC and Virgin International.**
***Through our already established highly effective distribution network, new & exciting recordings are available to retailers, rack jobbers, one-stops and distributors**
***Distributor for many independent American labels.**
***National promotion marketing for Passport Records and Visa Records (Passport & Visa are available from your local independent distributor)**
***The world's largest importer and distributor of rock product from England, Europe, Japan, Canada and Australia.**

JEM Records, Inc., 3619 Kennedy Rd., South Plainfield, NJ 07080, (201) 783-6100
JEM Records West, Inc., 38629 Topham Dr., Redwood, CA 94335, (415) 796-8154
Pacific Records Ltd., P.O. Box 325, 51 Hills St., Benton N.W., 5, Torrance, CA 90503, (213) 247-2917



SURPLUS

Records ★ 8 Track Tapes ★ Cassettes

**SEND FOR
FREE CATALOG LISTING
Huge Selection of Manufacturers'
Deletions, Overruns, Closeouts.**

**POP ★ SHOWS ★ MOVIES ★ JAZZ
COUNTRY & WESTERN ★ ROCK ★ VOCALS
CLASSICS ★ INSTRUMENTALS and much more!**

*Cash In On The Extra Profits
That Surplus Makes Possible.*

IMMEDIATE DELIVERY

**WE BUY AND
SELL SURPLUS**

SURPLUS RECORD and Tape Distributors

84-184 Dayton Ave.
Passaic, N.J. 07055
(201) 843-2670 (212) 695-6117
MANNY WELLS · PETE HYMAN

1801 S. Lumber
Chicago, Ill. 60616
(312) 421-1003
MERRILL OR JACK ROSE

WORLD WIDE TELEX 133404

CUT-OUTS AND MANUFACTURERS' OVERSTOCKS



- AMERICA'S MOST COMPLETE STOCK OF MAJOR LABEL LONG PLAYING RECORDS, 8-TRACKS AND CASSETTES.
- ROCK, COUNTRY, DISCO, JAZZ, CLASSICAL, TV PRODUCT
- LOWEST PRICES IN THE WORLD
- SEND FOR OUR FREE CATALOG

**PLUS
EMUS/GHENT**

**AMERICA'S BEST ECONOMY JAZZ & ROCK LABELS
TRI IT . . . YOU'LL LIKE IT!**

PROMO RECORD DISTRIBUTING COMPANY

160 EAST 5TH STREET, PATERSON, NEW JERSEY 07524
201-279-2010 WORLDWIDE TELEX 130463

Sound Disk-tributors Inc., 34 S. Old Orchard, Webster Groves 63119. Tel: 726-6277, 961-7008. Pres.: John Mandelker. VP: Steve Ferzacca. Buyers: Singles, Tom Lunt; Albums, William Burkhardt; Tape, Terry Perkins. (Rec. OS)
Top Notch Rec. Co., 20 Century Fair Zip: 63141. Tel: 991-0909. (Rec. & Tape RJ)
Uptown Music Inc., 4703 McPherson. Zip: 63108. Tel: 367-2602. Owner & Singles Buyer: Betty Dorrin; Mgr., Albums & Tape Buyer: Mike Dorrin. (Rec. & Tape OS)
Warner/Elektra/Atlantic Corp., 200 S. Hanley, Suite 417, Clayton 63105. Tel: 862-1030. Sales Mgr.: Pete Pruttii. (Rec. & Tape D)
Rec. labels: Asylum, Atco, Atlantic, Bearsville, Beserkley, Big Tree, Cotillion, Curtom, Dark Horse, DiscReet, ECM, Elektra, Embryo, Famous Charisma, Finnadar, Little David, Loma, Manticore, Nemperor, Nonesuch, Pacific, Paradise, Reprise, Rolling Stones, SHE, Sire, Slipped Disc, Swan Song, WMOT, Warner Bros., Warner/Curb, Warner Spector, Westbound, Whitfield, Wing & a Prayer, Zephyr.
Tape lines: Same as rec. labels.

MONTANA

- **BUTTE (Area Code 406)**
C J Co., 1550 Harrison Ave. Zip: 59701. Tel: 792-0747. Owner: Craig Foley. (Rec. RJ)
- **GREAT FALLS (Area Code 406)**
Holm-James Dists. Inc., Fourth Ave. & Sixth St. S. Zip: 59401. Tel: 761-2420. Owner: R.E. Holm; Buyer: J.E. Holm. (Rec. & Tape D & RJ)
Rec. labels: Capitol, Columbia group, Disneyland, London, MCA group, Mercury, RCA, Ranwood, United Artists, WEA.
Tape lines: Capitol, Columbia, GRT, MCA, RCA, United Artists, WEA.
Playback equip.: Akai, Hitachi, Motorola.
Phonographs: Hitachi.
Accessories: Fidelitone, Koss, Le-Bo, Scotch.

NEBRASKA

- **OMAHA (Area Code 402)**
Lieberman Entis. Inc., 809 S. 25 St. Zip: 68105. Tel: 341-3056. Gen. Mgr.: Evelyn Dalrymple. (Rec. OS)
Home office: Minneapolis, Minn. (Rec. & Tape OS & RJ) (SEE ADVERTISEMENT)
Records & Tapes Inc., 3124 Harney St. Zip: 68131. Tel: 344-3344. Mgr.: Brian Harden; Buyers: Curt McKean, Jim Rains, Bill Shearer. (Rec. & Tape OS & RJ)
Research Servs. Inc., PO Box 31110. Zip: 68131. Tel: 393-0265. Owner: C.L. Wintz; Mgr.: R.P. Wintz; Buyer: Daniel J. Wintz. (Rec. & Tape RJ)

NEVADA

- **LAS VEGAS (Area Code 702)**
International Music Prod'n & Publ'g, 714 E. Sahara Ave., Suite 201. Zip: 89104. Tel: 457-3539. Owner: Joseph E. Zerga. (Tape I & E)
Imports pre-recorded tape from Austria, Germany, Italy, Switzerland, UK.

NEW HAMPSHIRE

- **LEBANON (Area Code 603)**
World Wide Whsle. Dist., 15 Parkhurst. Zip: 03766. Tel: 298-7953. Owner, Mgr. & Buyer: Earl Heath. (Rec. & Tape D & RJ)
Rec. labels: American Heritage, Country, Jessup, Melody, Pine Tree, Rebel, Revonah, Rounder, Stoneway.
Tape lines: Rebel, Rounder.
Playback equip.: AITC, AR, Admiral, Aiko, BSR, Craig, Electrographic, Emerson, JVC, Juliette, Magnus, Morse, Panasonic, RCA, Sankyo, Sanyo, Solar, Sony, Sylvania.
- **NASHUA (Area Code 603)**
R M E Inc., Simoneau Plaza, 300 Main St. Zip: 03060. Tel: 883-2454. Owner: Tom Plaut; Mgr. & Buyer: Craig Adams. (Rec. & Tape RJ)

NEW JERSEY

- **CAMDEN AREA (Area Code 609)**
M C A Dist'g Corp., 900 Haddon Ave., Suite 206, Collingswood 08108. Tel: 922-5659. Branch Mgr.: Ron De Marino. (Rec. & Tape D)

Rec. labels: Backstreet, Butterfly, Coral, Infinity, LAX, MCA, Songbird, Source, Vocalion.
Tape lines: Same as rec. labels.

● **CHERRY HILL (Area Code 609)**

PolyGram Dist'n Inc., 20 Brace Rd., Ellensburg Plaza, Zip: 08034. Tel: 795-2400. Mgr.: Jack Iacchei. (Rec. & Tape D)

Home office: New York, N.Y.

Rec. labels: American Int'l, Archiv, Capricorn, Casa-blanca, Charisma, Chocolate City, DJM, De-Lite, Deutsche Grammophon, Emarcy, Festivo, Fontana, Limglight, MGM, Mercury, Monument, Oasis, Parachute, Philips, Polydor, Polydor/BGO, Polydor/Harem, Polydor/Kolob, Polydor/MVP, Polydor/Manken, Privilege, RSO, RSO/Curtom, Riva, Smash, Soundstage Seven, Spring, Vertigo, Verve, Zappa.
Tape lines: Same as rec. labels.

● **CINNAMINSON (Area Code 609)**

Alex Araco Co. Inc., 835 Industrial Hwy, Zip: 08077. Tel: 386-3288/3266. Owner: Alex Araco; VP: Vincent Dattilo; Sales Mgr.: Mark Friedman; Opns. Mgr.: Eddy Garrow. (Rec. & Tape D, OS & RJ)
Distributes cut-out albums & tapes.

● **EAST BRUNSWICK (Area Code 201)**

P R O B Dists. Inc., 742 Hwy. 18, Zip: 08816. Tel: 257-3336. Owners: Powell Gary Saks, Joseph P. Ingegno; Mgr.: Joseph P. Ingegno; Buyer: Powell Gary Saks. (Rec. & Tape D, OS & RJ)

Labels: Caedmon, Camden, Candide, Connoisseur Society, Disneyland, Folkways, Gateway, Golden, Peter Pan, Pickwick, Quintessence, Quintessence/Jazz, RCA educational, Simon Says, Spoken Arts, Turnabout, Turn-On, Vox
Accessories: Maxell, Memorex, Recoton, TDK

● **EDISON (Area Code 201)**

PolyGram Dist'n Inc., 180 Mill Rd. Zip: 08817. Tel: 287-3100. NYC Tel: (212) 962-4000. Opns. Mgr.: Dean White; Ass't Opns. Mgr.: Alan Dorfman. (Rec. & Tape D—depot)

Home office: New York, N.Y.

Rec. labels: American Int'l, Archiv, Capricorn, Casa-blanca, Charisma, Chocolate City, DJM, De-Lite, Deutsche Grammophon, Emarcy, Festivo, Fontana, Limglight, MGM, Mercury, Monument, Oasis, Parachute, Philips, Polydor, Polydor/BGO, Polydor/Harem, Polydor/Kolob, Polydor/MVP, Polydor/Manken, Privilege, RSO, RSO/Curtom, Riva, Smash, Soundstage Seven, Spring, Vertigo, Verve, Zappa.
Tape lines: Same as rec. labels.

● **ENGLEWOOD CLIFFS (Area Code 201)**

German Language Publ'ns Inc., 560 Sylvan Ave. Zip: 07632. Tel: 871-1010. (Rec. & Tape D, I & E)
Home office: New York, N.Y. (See for prod. distributed)

● **FORT LEE (Area Code 201)**

Take Home Tunes, PO Box 15, Zip: 07024. Mgr. & Buyer: Doris Yeko. (Rec. D)

Home office: Georgetown, Conn. (See for prod. distributed)

● **HILLSIDE (Area Code 201)**

Apex-Martin Rec. Sales Inc., 467 Mundet Pl. Zip: 07205. Tel: 923-7474. Owner: Sam Weiss; Pres: Sol Gleit; Buyers: Singles, Joe Martinez; Albums, Howard Kollar. (Rec. & Tape D, OS & RJ)

Labels: APA, Alarm, Alston, Bethlehem, Blue Candle, Bold, Cat, Chimneyville, Clouds, Contempo, Conversa-Phone, Dash, Desmar, Different Drummer, Dream, Drive, Earth, Fantasy, Free Spirit, Glades, Gold Mine, Good Sounds, Gospel Roots, IPA, Juana, Kayvette, Konduko, LRC, Malaco, Marlin, Milestone, Prestige, Reids World, Roots, Salsoul, Sam, Sandcastle, Shield, Silver Blue, Stax, Stone Dogg, Sunshine Sound, TK, Tom n' Jerry, Wanderick, Weird World, Wolf.
Accessories: Amberg, Le-Bo, Maxell, Scotch, Sonic, Walco.

● **IRVINGTON (Area Code 201)**

Dierickx Vending Co. Inc., 1316 Springfield Ave. Zip: 07111. Tel: 371-0777. Owner: Anna C. Dierickx; Buyer: Richard Semple. (Rec. & Tape OS & RJ)

● **JERSEY CITY (Area Code 201)**

Trackdown Rec. Dists., PO Box 525, Zip: 07309. (Rec. & Tape D, OS, RJ, I & E)

Home office: Chicago, Ill. (See for prod. distributed)

● **LINDEN (Area Code 201)**

Hit Recs. Inc., 300 W. Elizabeth Ave. Zip: 07036. Tel: 862-6336. Pres: John Ziinski; VP: Jean Scherer.
Distributes cut-outs, overstocks.

● **MAPLE SHADE (Area Code 609)**

R C A & A&M & Assoc'd Labels, 33A Maplewood Dr. Zip: 08052. Tel: 779-0920. Sales Mgr.: Art Weissman. (Rec. & Tape D)

Rec. labels: A&M, Bluebird, Free Flight, Gold Seal, Grunt, Hologram, Millennium, NY Int'l, Pablo, Pablo Live, Pure Gold, RCA, Red Seal, Roadshow, Rocket, Salsoul, Solar, Tortoise, 20th Century, Victrola, Windsong.
Tape lines: Same as rec. labels.

● **MONTCLAIR (Area Code 201)**

Belmont Rec. One Stop, 350 Bloomfield Ave. Zip: 07042. Tel: 744-5680. Pres. & Buyer: Frank Gottlieb. (Rec. OS—jukebox trade only)

● **MOUNT LAUREL (Area Code 609)**

Lieberman Ents. Inc., 823 Eastgate Dr., Unit 3. Zip: 08054.



SUTTON RECORD CO.

960 E. Hazelwood Avenue · Rahway, New Jersey 07065

WE BUY FOR CASH
ANY AND ALL QUANTITIES OF SURPLUS, CUT-OUTS, DELETES & CURRENT LP'S & TAPES

- ★ Complete Stock of Cut-Outs, Deletes and Surplus Major Label LP's & Tapes
- ★ Current LP's, 8-Track & Cassette Tapes
- ★ Lowest Discount Prices
- ★ Export Professionals
- ★ Same Day Service
- ★ Box Lots to Containers

SEND FOR OUR NEWEST FALL CATALOG

TELEPHONE: 201-382-7770

TELEX 139325

OLDIES ARE TIMELESS

AMERICA'S LARGEST OLDIES ONE-STOP!

SPECIALIZING IN ALL MAJOR AND INDEPENDENT LABELS

STOCKS THE RECORDS YOUR CUSTOMERS ARE LOOKING FOR BUT CAN'T FIND

MOST COMPLETE SELECTION—Over 20,000 TITLES IN STOCK ON ALL LABELS, MANY UNAVAILABLE FROM ANY OTHER SOURCE!

BEST PRICES! IN ONE EASY-TO-USE CATALOG, YOU'LL FIND ALL THE BEST-SELLING BACK-TO-BACK HITS AT OUR LOW ONE-STOP PRICE PLUS NEARLY 800 OLDIES AT VERY COMPETITIVE CUT-OUT PRICES!

• WE SHIP ONLY THE HIGHEST QUALITY PRESSINGS AVAILABLE! ALL RECORDS CAREFULLY INSPECTED BEFORE SHIPMENT



ERIC RECORDS IS OUR OWN HIGH QUALITY OLDIES LABEL. WRITE FOR SEPARATE CATALOG AND SPECIAL PRICE ON ERIC ORDERS OVER 300 PIECES.

- SPECIAL ATTENTION TO EXPORT ORDERS.
- WRITE OR PHONE FOR INFORMATION AND OUR NEW CATALOG LISTING OVER 2300 BEST-SELLING OLDIES.
- OUR FILLS AVERAGE OVER 90%.



american record sales, inc.

p.o. box 287, 1120 crown point rd., westville, n.j. 08093 · (609) 848-1900

ROBERTS FOR RECORDS

Exporters Of All
Labels And Closeouts
"Service & Reliability"

**ALEX S. ROBERTS
ASSOC., INC.**

35 Bleecker St., New York, N.Y. 10012

Tele: (212) 533-3840
Cable: ASROBERTS
Telex: 667593 UW ROBERTS

Tel: 234-9150. Mgr.: Steven Bartell; Opns. Mgr.: Jim Riddle; OS Mgr.: Bill Able; Buyers: Singles, Fred Weinstein. Albums, Ken Abrams. (Rec. & Tape OS & RJ)
Home office: Minneapolis, Minn. (SEE ADVERTISEMENT)
Warner/Elektra/Atlantic Corp., 106 Gaither Dr. Zip: 08057 Tel: 234-5600. Mgr.: Peter Stocke. (Rec. & Tape D)
Rec. labels: Asylum, Atco, Atlantic, Bearsville, Beserkley, Big Tree, Cotillion, Curton, Dark Horse, DiscReet, ECM, Elektra, Embryo, Famous Charisma, Finnadar, Little David, Loma, Mantecore, Nempcor, Nonesuch, Pacific, Paradise, Reprise, Rolling Stones, SHE, Sire, Slipped Disc, Swan Song, WMOT, Warner Bros., Warner/Curb, Warner Spector, Westbound, Whitfield, Wing & a Prayers, Zephyr.
Tape lines: Same as rec. labels.

• **NEWARK (Area Code 201)**

Double B Recs. & Tape Corp., 16 Fenwick St. Zip: 07114. Tel: 242-6667; WATS (800) 631-8672. Mgr.: Fred Reimer; Tape Buyer: Zeke Lenga. (Rec. & Tape OS)
Home office: Freeport, N.Y.
Euro-American Inds., 204 Vanderpool St. Zip: 07114. Tel: 243-0518. (Rec. RJ & E, Tape E)
Folkraft/Dance Rec. Dists. (div. of Folkraft Publ'g Co. Inc.), 10 Fenwick St. Zip: 07114. Tel: 243-8700. Owner: Jerry Shifrin. (Rec. D, I & E; Tape E)
Rec. labels: Belco, Blue Star, Bogen, Folkraft, Grenn, Hi

Hat, Hoctor, J-Bar K, Jewel, Kalox, Kismet, Kolo Festival, MacGregor, Old Timey, Pilgrim, Pulse, Scope, Sets in Order, Square L, Tikva, Top, Wagon Wheel, Windsor, Xopo, Young People's Recs.
Rec. labels imported: Tanz (Germany); Jugoton, RTB (Yugoslavia).
Exports pre-recorded tape & playback equip.

• **NEW BRUNSWICK (Area Code 201)**

Performance Rec. & Tape Dists., PO Box 1459, 382 George St. Zip: 08901. Tel: 545-3004. Principals S. Kaplan, A. Marko, E. Zinis. (Rec. & Tape D)—cut-outs, overstocks, promotional items (SEE ADVERTISEMENT)

• **PATERSON (Area Code 201)**

Promo Rec. Dist'g Co. Inc., 160 E. Fifth St. Zip: 07524. Tel: 279-2010. WATS: (800) 526-5266. West Coast Tel: (213) 884-8668. Contacts: Carl Post, Max Goldstein, Paul Livert; West Coast Contact: David Greenman. (Rec. & Tape D)
Labels: Emus, Ghent, Golden Goodies; also distributes overstocks, cut-outs, TV prod. (SEE ADVERTISEMENT)

• **PENNSAUKEN (Area Code 609)**

Bandstand Rec. Serv. (Rec. & Tape OS & RJ), see Chips Dist'g.
Chips Dist'g (div. of Abkco Inds. Inc.), 9242 Commerce Hwy. Zip: 08110. Tel: 665-8200. Pres. & Gen. Mgr.: Ernie Santone; Sales Mgr.: Mario Daulerio. (Rec. & Tape D), (also Rec. & Tape D as Hitsville of Pennsylvania), (Rec. & Tape OS & RJ as Bandstand Rec. Serv.)
Rec. labels: AVI, Abkco, Ameraba, Aries, Audio Fidelity, Audio Technica group, Bach Guild, Big Band Int'l, CMH, California Recs. group, Candide, Cardinal, Century, Chiaroscuro, Concord Jazz, Contemporary, Conversa-Phone, Cream, Deluxe, Direct Disc, Discovery, Disney, Dobre, Dyno, Environments, Everyman, Fiesta, First Component, GNP, Gateway, Glori, Golden Era, Goodtime Jazz, Gordy, Grecophon, Gusto, Hi, Image, Improv, JDC, Jewel, Karate, Kent, Kid Stuff, King, Klavier, Kudu, LA, LRC, Largo, Lost Nite, MC, Mango, Motown, Muse, NJP, Natural Resources, Omnisound, PA-USA, Paula, Prodigal, QCA, Rampart, Rare Earth, Rebel, Reborn, Ronn, SMI, Sandcastle, Sesame Street, Shamrock, Soul, Spire, Starday, Sure, TEC, Tania, Tandem, Timeless, Trend, Turnabout, Vanguard, Vantage, Vesper, Vista, Vox, West End, Who's Who in Jazz, World Jazz, Xanadu, Zap, Zebra.
Tape lines: All lines. (SEE ADVERTISEMENT)

Hitsville of Pennsylvania (Rec. & Tape D), see Chips Dist'g.
Richman Bros. Recs. Inc., 6935 Airport Hwy. Ln. Zip: 08109. Philadelphia Tel: (215) 477-1742. Owners: Jerold, Allen & Richard Richman; Gen. Mgr.: Jerold Richman; Buyers: Singles, Mike Mix; Albums, Ted Neumann, Tim Comerford. (Rec. & Tape D & OS)
Rec. labels: Adelphi, Alligator, Arhoolie, Biograph, Black Saint, Blue Goose, County, Delmark, Flying Fish, Flying High, Folk Legacy, Folkways, Fretless, Front Hall, Green Linnet, Harbor, June Appal, Kaleidoscope, Kent, Kicking Mule, Leader, Mountain Railroad, Mulligan, Nessa, Owl, Philo, Rounder, Shanachie, Sonyatone, Sugar Hill, Sure, Swallowtail, Takoma, Topic, Troubadour, Vhhd-Isle, Windham Hill, Yazoo.
Tape lines: Capitol, Columbia, Folkways, GRT, Jubilee, Kent, Prestige, Rebel, Rounder, Savoy.
Accessories: Blank tape (CMC, Memorex, Sony), head cleaners (Memorex); Discwasher, Le-Bo, Neushaefer, Peerless, Sound Guard & Watts prods.
Shulman Rec. Co. Inc., 7030 Colonial Hwy. Zip: 08109. Tel: 662-8870. Exec.: Edward Kochman. (Rec. & Tape RJ)

• **RAHWAY (Area Code 201)**

Apex Recs. Inc., 947 US Hwy. 1. Zip: 07065. Tel: 574-1400; NYC Tel: (212) 233-7380. Telex (710) 996-5874. Pres.: Dante J. Pugliese; VP Sales: Al Schiefelbein. (Rec. & Tape D, I & E)

Springboard Int'l Recs. Inc., 947 US Hwy. 1. Zip: 07065. Tel: 574-1400; NYC Tel: (212) 233-7380. Telex (710) 996-5874. Pres.: Dante J. Pugliese; VP Sales: Al Schiefelbein; Mgr.: Vinnie Pisano. (Rec. & Tape D, I & E)
Rec. labels: Buckboard, Forever Oldies, Happy Tunes, Hit Series, Mace, Memorabilia, Mistletoe, Musicor, Nutmeg, Springboard, Top 16, Trip, Up Front.
Tape lines: Same as rec. labels.

Sutton Rec. Co., 960 E. Hazlewood Ave. Zip: 07065. Tel: 382-7770; NYC Tel: (212) 267-6662. Owners: James & David Sutton; Mgr. & Buyer: Jeff Sturman. (Rec. & Tape RJ, I & E)

Imports & exports cut-outs, over-runs & special prods. (SEE ADVERTISEMENT)

• **ROCHELLE PARK (Area Code 201)**

New York Rec. & Tape Dists. Inc. (Rec. D & E, Tape E), see Surplus Rec. & Tape Dist.
Surplus Rec. & Tape Dist./New York Rec. & Tape Dists. Inc., 68 W. Passaic St. Zip: 07662. Tel: 843-2670. NYC Tel: (212) 695-6117. Owners: Manny G. Wells, Merrill Rose; Buyers: Jack Rose, Pete Hyman. (Rec. D & E, Tape E)
Home office: Chicago, Ill.
Distributes cut-outs. (SEE ADVERTISEMENT)

• **SOMERVILLE (Area Code 201)**

Polka Hits, 331 Triangle Rd. Zip: 08876. Tel: 359-5520. Owner & Buyer: B. L. Goydish; Mgr.: C. Goydish. (Rec. & Tape D, OS & RJ)
Rec. labels: Alishire, Ampol, Bayway, Bel-Aire, Chicago Sound, Data, Dyno, Eastwind, Fantastik, Garden State, Goodwill, Ha-Lo, Jay Jay, Jody, Kerebo, L-Kay, Le Mans, MGM, Maxim, Rave, Rex, Ridge, Rim, Roia, Starr, Steljo, Stella, Tip, Usana, Wam.
Tape lines: Same as rec. labels.

• **SOUTH PLAINFIELD (Area Code 201)**

Jem Recs. Inc., PO Box 362, 3619 Kennedy Rd. Zip: 07080. Tel: 753-6100. Pres.: Martin Scott; VP: Ed Grossi; Treas.: Jeff Tenenbaum; Comptroller: Howard Herbitter; Gen. Mgr.: Rick Lawler; Sales Mgr.: Bob



**PREMIUM CUT-OUT & OVERSTOCKED
RECORD & TAPE DISTRIBUTORS.**

CALL OR WRITE FOR OUR FREE CATALOG.

**310B NEW YORK AVENUE - HUNTINGTON, N.Y. 11743
(516) 421-5083/421-5084**

COUNTRYWIDE
RECORD & TAPE DISTRIBUTORS, INC.

Most Exciting Distributor of

- **CUT-OUTS and OVERRUNS**
- **PROMOTIONAL ROCK & R&B LP's**
- **TAPES AND CASSETTES**

We receive letters saying we have the best catalog in the business. *Send for it.*

COUNTRYWIDE
RECORD & TAPE DISTRIBUTORS, INC.

200 ROBBINS LANE, JERICHO, N.Y. 11753
Telex 126316 Answer Back CWTRI-UI-JERI
(516) 433-9550 (212) 380-3900

Satisfied Customers make PRICE RITE RECORDS

The exporter you can rely on!
Can you say this about your supplier?

VIA WUI JUNE 30/79

YOU MAY BE INTERESTED TO KNOW THAT I GOT A CALL, FOLLOWED BY A MILE LONG TLX, FROM JIM LEVENTHAL OF RECORD SHACK TELLING ME HOW AMAZING THEY WERE, THE BEST IN WORLD, BIGGEST IN US, PERSONAL FRIEND OF PRES. CARTER, THAT SORT OF THING...AND THAT I SHOULD DEAL WITH THEM AS THEY TURN ROUND ORDERS IN 24 HOURS, HAD BIGGEST INVENTORY IN WORLD, SUPPLY MOST OF WESTERN HEMISPHERE, HAVE A STAFF OF 2 MILLION...AND VARIOUS OTHER STORIES...HIS PRICES, APART FROM SPECIALS (AND WHO THE HELL CARES ABOUT THEM) ARE DEARER THAN YOU...SO I TOLD HIM POLITELY... NO THANKS. IF HE'S THAT BIG HE CAN'T GIVE ME THE PERSONAL SERVICE THAT YOU CAN, AND HE ALSO DOESN'T NEED MY FEW BUCKS TO ADD TO HIS PILES KEEP TAKING THE TARTAN TABLETS.
BEST WISHES, GORDON.

VIA WUI 1317 12/19:

IF I DON'T SPEAK WITH YOU AGAIN THIS WEEK HAVE A NICE XMAS AND TNKS FOR ALL YOUR HELP OVER THE YEAR I DONT KNOW WHAT WE WOULD DO WITHOUT YOUR SUPERB SERVICE.

REGARDS

NIC

frog music

HELSINKI 12.04.1977

PRICE RITE RECORDS

4245 AUSTIN BOULEVARD

P.O. BOX 309 ISLAND PARK, NEW YORK 11558 ORDER NO. 3

DEAR LARRY:

WE'D LIKE TO ORDER THE FOLLOWING LPS AND ONE CASSETTE LISTED ON PAGES TWO TO FIVE. SEND THEM VIA AIR, FOB, LIKE PREVIOUSLY. WE'RE VERY SATISFIED WITH YOUR EFFICIENCY AND OUR CUSTOMERS, TOO. WE FEEL THAT THE BUSINESS' RUNNING BETTER AND BETTER SINCE WE HAVE BEEN ORDERING FROM YOU, THANK YOU.

HAVE A NICE DAY,

Olli Pasonen

Olli Pasonen
FROG MUSIC

HOW DO WE MAINTAIN THIS DEGREE OF SERVICE AND FILL YEAR AFTER YEAR?

We only accept a limited number of new clients per year, so we can continue personalized service.

NOW IT'S YOUR CHANCE TO ELIMINATE THE PROBLEMS FROM YOUR IMPORT SHIPMENTS.

We provide 95% fill—correct documents—prompt shipment—competitive prices.

19 Years Experience Supplying Distributors and Dealers Worldwide

Contact us today for your export guide, terms, conditions and application.

Larry Sonin, President

PRICE RITE RECORD CORP.

4245 Austin Blvd., Island Park, N.Y. 11558
(516) 431-8783 • Telex: 126575 PRICERITE ISPK • (212) 895-2682

"THE PROFESSIONAL EXPORTERS"

GIREC G

JULY 14, 1978

ATTN: LARRY SONIN

I AM DELIGHTED WITH COMPLETION RATE...WHAT A CHANGE FROM OTHERS I HAVE HAD IN THE PAST. AND YOUR INVOICE METHOD AND GROUPING OF DIFFERENT PRICES IS SUPERB...AT LEAST I KNOW HOW MUCH DIFFERENT ITEMS COST ME...ONCE AGAIN THANKS FOR A GREAT FILL. KEEP SENDING THE NEW RELEASE TELEX MESSAGES AND I'LL BE BANGING IN THE ORDERS.

REGARDS, GORDON

P.S. KEEP TAKING THE TARTAN TABLETS...

FOR PRICE — SERVICE — FILL
ALL LABELS
Complete Catalog & New Releases

Exporting Since 1939

M. SLUIS

Exporters . . .

Of all American labels of phonograph records and pre-recorded tapes . . .

of closeouts and stock lots . . .

of blank cassette and cartridge tapes.

M. SLUIS CO., INC.

15 Park Row
New York, NY 10038
Tel: 212/349-0590
Cable Address: CINAECO
Telex: 223068 (RCA)
667670 (WUI)

CHILDREN'S RECORDS & TAPES DIST.

in English & Spanish

Disneyland • Sesame St. • Pickwick
Wonderland • Superscope
• Folkways • Peter Pan • Caedmon
• Disneylandia
complete fill—fast Service

Buy on an OPEN ACCOUNT
no minimum—for Free Catalog

Call 516-826-2735 or write Musicanza
2878 Bayview Ave., Wantagh, N.Y. 11793

We ship Mom & Pops everywhere.

rego irish records & tapes, inc.



MANUFACTURERS & DISTRIBUTORS OF

IRISH, SCOTTISH, & FOLK
LP's, 45's, 8 track, cassettes.

CARMEL QUINN • HAL ROACH
TOMMY MAKEM • PADDY NOONAN • EAMON KELLY, etc.

84-48 62nd DRIVE,
MIDDLE VILLAGE, N.Y. 
11379 (212) 476-1847

Gross: Mktg. Dir.: Andy Miele; Prod'n Mgr.: Phyllis Pannone-Craig; Art Dir.: Murray Brenman. (Rec. & Tape D & I)
Branch: Reseda (Los Angeles Metropolitan Area), Calif., Jem Recs. West Inc.
Int'l branch: England, Pacific Recs
Labels distributed: Antilles, Big Sound, Egg, Mango, Mountain Railroad, PVC, Passport, Ralph, Rhino, Virgin, Visa
Labels imported: A&M (Canada, UK), Aquarius (Canada), Ariola (Germany), Arista (UK), Attic (Canada), Atlantic (France, Germany, UK), Barclay (France), Brain (Germany), CBS (Canada, Denmark, France, Germany, Netherlands, UK), Charisma (UK), Charley (UK), Chiswick (UK), Chrysalis (UK), Cobra (France), Contour (UK), Cramps (Italy), Cube (UK), Decca (Germany, UK), Deram (UK), EMI (France, Germany, UK), Egg (France), Electra (France, UK), Electric (UK), Ember (UK), Epic (UK), Free Reed (UK), Golden Hour (UK), Gull (UK), Harvest (UK), Isadora (France), Island (UK), MCA (UK), MFP (UK), Metronome (Germany), Mountain (UK), Nems (UK), Oats (Ireland), Obscure (UK), Phonogram (France, Germany, Italy, UK), Polydor (France, UK), Purple (UK), Pye (UK), RAK (UK), RCA (France, Germany, UK), RSO (UK), Rocket (UK), Sky (Germany), Sonet (UK), Stiff (UK), Sunset (UK), Threshold (UK), Topic (UK), Transatlantic (UK), Trojan (UK), United Artists (Canada, UK), Vertigo (Germany, UK), Virgin (UK), Warner Bros. (Germany, UK). (SEE ADVERTISEMENT)

• **SPRINGFIELD (Area Code 201)**

Profit Sales Dist., PO Box 176, Zip 07081, Tel. 379-9640.
Owner: S. Sherman; Mgr.: Joseph Howell; Albums Buyer: Nat. Frapp. (Rec. RJ—budget gospel)
Program One Stop Inc. (Rec. & Tape OS), see Program Recs. Inc.

Program Recs. Inc., c/o Runyon Bldg., Rt. 22 E., Fadem Rd., Zip 07081, Tel. 467-2760. Owners: Ralph Schechtman, Dave Casey; Mgr.: James Hall, Sales & Promo. Mgr.: William Scarborough; Buyers: Dave Casey, James Hall. (Rec. & Tape D), (Rec. & Tape OS as Program One Stop Inc.)

Labels: Abet, Birthright, Canaan, Creed, Dingo, Excellio, Glori, Good News, Gospel Way, Greentree, HSE, Heart Warming, Hob, Image VII, Impact, Inspirational Sounds, Jam Sessions, Jewel, Jubilation group, Kenwood, Light, Locus, Mankind, Myrrh, Nasco, Nashboro, New Pax, Old World, Our World, Paragon, Paula, Peacock, QCA, Reborn, Richburg, Sacred, Savoy, Singarecord, Solid Rock, Song Bird, Specialty, Spire, Su-Ann, Word.
Accessories: Duotone, Le-Bo, Peerless.

• **TEANECK (Area Code 201)**

Hungaria Recs. Inc., PO Box 2073, Zip: 07666, Tel: 343-5240. Exec. Dir.: Kalman Magyar; Prod. Mgr.: Samuel Jackendoff. (Rec. D, I & E)
Labels: Hazam, Hungaria, Hungaroton, Magyar, Pepita, Qualiton, Saban, Supraphon

• **UNION (Area Code 201)**

One Way of New Jersey, 1080 Garden State Rd. Zip: 07083. Tel: 964-6222. VP & Gen. Mgr.: George Zarembo (Rec. OS & Tape E)
Branch: Cleveland, Ohio. (SEE ADVERTISEMENT)
Transcontinent of New Jersey, PO Box 405, 1080 Garden State Rd. Zip: 07083. Tel: 964-6222. VP & Gen. Mgr.: George Zarembo; Buyer: Sharron Hall. Rec. & Tape OS & RJ
Home office: Buffalo, N.Y., Transcontinent Rec. Sales.

• **WESTVILLE (Area Code 609)**

American Rec. Sales Inc., 1120 Crown Point Rd. Zip: 08093. Tel: 848-1900. Pres. & Buyer: Bill Buster; VP: Antony W. Colombet; Mgr.: Bill Carlin; Singles Buyer: Bill Buster. (Rec. D, OS, I & E)
Labels: Eric; all 45 rpm oldies (SEE ADVERTISEMENT)

NEW MEXICO

• **ALBUQUERQUE (Area Code 505)**

Del Norte Rec. Dist., 1930 Gun Club SW. Zip: 87105. Tel: 877-2070. Owner & Buyer: Bennie Martinez; Mgr.: Margaret Martinez. (Rec. & Tape D & OS—Spanish & Indian prod.)
Labels: Alta Vista, Apache Spirit, Christy, DLB, Del Norte, Hermanos, More, Navajo Sundowners.
Hurricane Rec. Dist., PO Box 3547, 1927 San Mateo NE. Zip: 87110. Tel: 265-4039/3049. Owners: Al Morrie & B. Sanchez; Mgr.: Al Sanchez; Buyer: Morrie Sanchez. (Rec. & Tape D & RJ)
Rec. labels: Alegre, Arcano, Buena Suerte, Casanova, Caytronics, Columbia, Cristy, DLV, Dimsa, Discuba, Disneylandia, Dominante, Eco, Falcon, Freddie, Gas, Good Luck, Hurricane, Keyloc, Magda, Marsol, Mex-Melody, Miami, More, Mother Lode, Musart, Musimex, Orfeon, Papalote, Parnaso, El Pato, Peerless, RJC, Rovi, Sonido Int'l, Sunglow, Teardrop, Tex-Mex, Tico, Torres, Tuna, UA Latino, El Zarape, Zaz, Zeida & most labels from Mexico, New Mexico & Texas.
Tape lines: Same as rec. labels.
Tocino Music Ents., 900 Fourth St. SW. Zip: 87102. Tel: 247-8051. (Rec. & Tape D & OS)
Rec. labels: Casanova, Cristy, Del Norte, Hurricane, Kiva, Mother Lode
Tape lines: Same as rec. labels
Accessories: Recoton.
Trackdown Rec. Dist., 7720 Central SE. Zip: 87108. (Rec. D, OS, RJ, I & E)
Home office: Chicago, Ill. (See for prod. distributed)

music
is
our
bag!

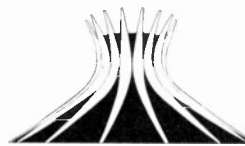

BRASILIA RECORDS & TAPES CORP.

29 West 38th Street - New York, N.Y. 10018
(212) 354-5613 Telex: WUI 666794 BRASREC

**SAMBA — BOSSA NOVA — CARNIVAL
BRAZILIAN FOLK MUSIC
DISCO — DISCO SAMBA
ROCK SAMBA
PORTUGUES MUSIC
FRENCH MUSIC**

Free Catalogues on Request

**EXCLUSIVE IMPORTERS AND DISTRIBUTORS
of records and tapes imported from Brazil**





*32 Years Of
Experience*

ALPHA Distributing Corporation

**20 West End Avenue, New York, New York 10023
212-397-1920**

Telex: 236581 ALCO

In • New York • New Jersey • Connecticut • Massachusetts

**CHERRY PICKED
CUT-OUTS**

Over 1 000 000 Cut-Outs
and overstock LPs & Tapes

- ✓ JAZZ ✓ ROCK ✓ DISCO
 - ✓ MOR ✓ C&W ✓ CLASSICS
 - ✓ IMPORTS & SPECIALS
- Prompt service at all times.

**SPECIAL DEALS
for
VOLUME USERS & EXPORT**

Let our exceptional merchandise offerings
show you the way to healthier Profit Margins
and fast Inventory Turnovers.

For FREE catalog call,
write or Telex NOW!

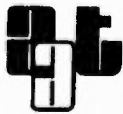

**HOPE INTERNAT'L PROD'NS, LTD.
AMERICAN ALBUM & TAPE, INC.**
850 Seventh Ave.
New York, N.Y. 10019
Tel: (212) 247-3188 (212) 246-0978
Telex: 420001 ETLX

**RECORDS, 8-TRACKS,
CASSETTES**

All Labels

Current and closeouts.
Orders consolidated.
Nearly 30 years
experience.

DARO EXPORTS, LTD.

1468 Coney Island Avenue
Brooklyn, N.Y. 11230
Cables: EXPODARO

*Current Records & Tapes
Close-Out Offers*

**ALL AMERICAN
LABELS COMBINED IN
ONE SHIPMENT**

**ELTRON
EXPORT
COMPANY**

57 Leonard St., New York, N.Y. 10013
(212) 966-4710

Telex: 421234

code: ELTRONCOMP

NEW YORK

● **ALBANY AREA (Area Code 518)**

Bee Gee Dist. Corp., Shaker Park, Latham 12110. Tel: 785-1122. Owner: Leonard Smith; Mgr.: Lawrence Smith; Sales Mgr.: Herbert N. Dorfman; Buyers: Singles, Linda Barnum; Albums, Theron Heath, Dolores McCabe; Tape, Virginia Yaksta. (Rec. & Tape D & RJ), (Rec. & Tape OS as Leonard Smith Inc.)

Rec. labels: AA, Ace of Hearts, Alithia, Ambassador, Audio Fidelity, Berlitz, Bert & I, CMS, Cadet, Canaan, Chiaroscuro, Connoisseur Society, Conversa-Phone, Creative Sound, Crown, Dana, Daybreak, Dyno, ESP, Everest, Fiesta, First Component, Fleetwood, Golden, Grecophon, Greene Mountain, Hotline, Jay Jay, Juno, LMI, Light, Majestic, Mountain Dew, Music Minus One, Musico, Myrrh, Original Sound, Peter Pan, Pickwick, Plantation, Project 3, Ranwood, Rim-Rik, Sacred, Simon Says, Starr, Turnabout, Word, Vox.
Tape lines: Berlitz, ESP, Fiesta, GRT, Original Sound, Sacred, Word.

Accessories: Blank tape (Capitol, Memorex, Scotch), carrying cases (Custom Case, Peerless); Crestmark, E-V Game, Le-Bo, Recoton, Savoy & Watts prods.

Handleman Co., 8 Northway Ln., Latham 12110. Tel: 783-5436. Mgr.: Aileen Browning; Buyers: Colleen O'Neil, Woody Howard. (Rec. & Tape RJ)
Home office: Clawson (Detroit Metropolitan Area), Mich.

Jane's One Stop, 1241 Broadway, Zip: 12204. Tel: 434-8396. Mgr.: Jane Rey. (Rec. & Tape OS)
Home office: Buffalo, N.Y., Transcontinent Rec. Sales (Rec. & Tape RJ)

Mobile Rec. Serv. Co., 587 Broadway, Bldg. B, Apt. 10, Menands 12204. Tel: 274-0492. Mgr.: Edward F. Palyswiat. (Rec. OS—singles only)
Home office: Pittsburgh, Pa.

One-Way Recs. Inc., 12 Commercial Rd. Zip: 12205. Tel: 489-3288. Owner & D Mgr.: David Schlang, OS Mgr.: Joe Paone; Tape & I & E Mgr.: Gerald McCarthy; Buyers: Cut-out & Overstock Albums, David Schlang; OS Albums, Joe Paone; OS Tapes, Gerald McCarthy. (Rec. & Tape D, I & E—cut-out, overstocks), (Rec. & Tape OS & E)

Accessories: Blank tape (Sony), Discwasher & TDK prods. (SEE ADVERTISEMENT)

Leonard Smith Inc. (Rec. & Tape OS), see Bee Gee Dist. Corp.

Trans World Music Corp., PO Box 11580, Zip: 12211; 874 Albany-Shaker Rd., Latham 12110. Tel: 783-5152. Owner & Pres.: Robert J. Higgins; Comptroller: Elliot Steinberg; Gen. Mgr.: Frank Griffin; Opns. Mgr.: Mike Raikowski; Sales Mgr.: Steve Kretser; Buyer, Bob Langford. (Rec. & Tape D & RJ), Rec. OS as Upstate Music) Rec. labels: AA, Audio Fidelity, Bert & I, CMS, CRI, Caedmon, Canaan, Chiaroscuro, Connoisseur Society, Conversa-Phone, Creative Sound, Crown, Dana, Desto, Disneyland, Dyno, Everest, Everyman, Fiesta, First Component, Folkways, GNP, Gateway, Golden, Grecophon, Greene Mountain, Heart Warming, Impact, Light, Lyrichord, Monitor, Monmouth-Evergreen, Mountain Dew, Original Sound, Orion, Oryx, Peter Pan, Philo, Pickwick, Qualiton, Rim, Rounder, Sacred, Sesame Street, Sunnyvale, Supraphon, Thunderbird, Turnabout, Vanguard, Vox, Word.

Tape lines: Fiesta, GRT, Heart Warming, Impact, Original Sound, Pickwick, Project 3, Word.

Playback equip.: Clarion, Craig, Jensen.

Accessories: Capitol, Data Display Systems, Devon Design, Discwasher, Empire, Fidelitone, Le-Bo, Maxell, Memorex, Pacifica, Pfanstiehl, Ray-O-Vac, Recoton, Robins, Scotch, Shure, Sound Guard, TDK, Watts.

Upstate Music, PO Box 1677, Zip: 12201. Tel: 456-1232. Owner & Pres.: Robert J. Higgins; Exec. VP: Louis J. Del Signore. (Rec. OS), (Rec. & Tape D & RJ as Trans World Music)
Branch: Providence, R.I.

● **AMSTERDAM (Area Code 518)**

Almor Playtime Co. Inc., 140 Guy Park Ave, Zip: 12010. Tel: 843-3801. Pres.: Albert A. Hyman; VP: Bruce Hyman; Buyer: Gloria Schlenki. (Rec. & Tape D, OS & RJ)
Branch: South Burlington (Burlington Area), Vt.
Labels: Disneyland, Pickwick Int'l.

Tape lines: Disneyland, GRT, Pickwick Int'l.
Accessories: BASF, Le-Bo, Maxell, Memorex, Recoton, TDK.

● **BEDFORD HILLS (Area Code 914)**

Polyphon Rec. Co., PO Box 124, Zip: 10507. Tel: 666-5287. Owner: Olga Jirakova; Mgr.: Karel B. Weiss. (Rec. D & I)

Labels imported: Supraphon (Czechoslovakia).

● **BUFFALO (Area Code 716)**

Agape Dist'n, 1685 Elmwood Ave., No 208-C. Zip: 14207. Tel: 874-6050. Owners: John Lilley, John Narraway; Sales Mgr.: John Narraway; Albums Buyer, John Lilley. (Rec. D & RJ, Tape D—gospel prod. only)

Labels: AB, Aslan, Birdwing, Bread & Honey, Canaan, Chrism, Dayspring, Fisher Folk, Good News, Greentree, Heartsong, Heart Warming, Impact, Jim, John Hall, Lamb & Lion, Maranatha, Mars Hill, Messianic, Mighty Wind, New Life, New Pax, New World, New Song, Paragon, Pax, Petra, Rainbow, Rock, Sangre, Scripture in Song, Seed, Solid Rock, Sonrise, Sparrow, Spirit, Star-song, Tempo, Word, Word of God.

Alpha Dist'g Corp., 32 Ripley Pl. Zip: 14213. Tel: 883-2936. Contact: Frankie Nestro. (Rec. & Tape D)
Home office: New York, N.Y. (See for prod. distributed) (SEE ADVERTISEMENT)

Best & Gold Rec. Dist's., 355 Harlem Rd. Zip: 14224. Tel: 826-9560. Sales & Promo. Mgr.: Paul Bapst; Buyers:

DISCO IMPORTS

NEW YORK'S ONLY

45's LP's TAPES

DISCO

ONE STOP

RECORD HAVEN

EXPORT SPECIALISTS

Best Fastest Lowest

FILL • SERVICE • PRICE

NEW MODERN WAREHOUSE

- Get the New Releases before your competitors
- Special Deals on \$7.98 list—\$3.85 and up
- Same Day Delivery N.Y. Area
- Catalog Orders filled from huge inventory

12" MIXES

**636 Eleventh Avenue
New York, N.Y. 10036
(212) 247-5900
Telex: 666754 HAVEN**

**ROCK
SOUL
DISCO
JAZZ**

Orders received today . . .

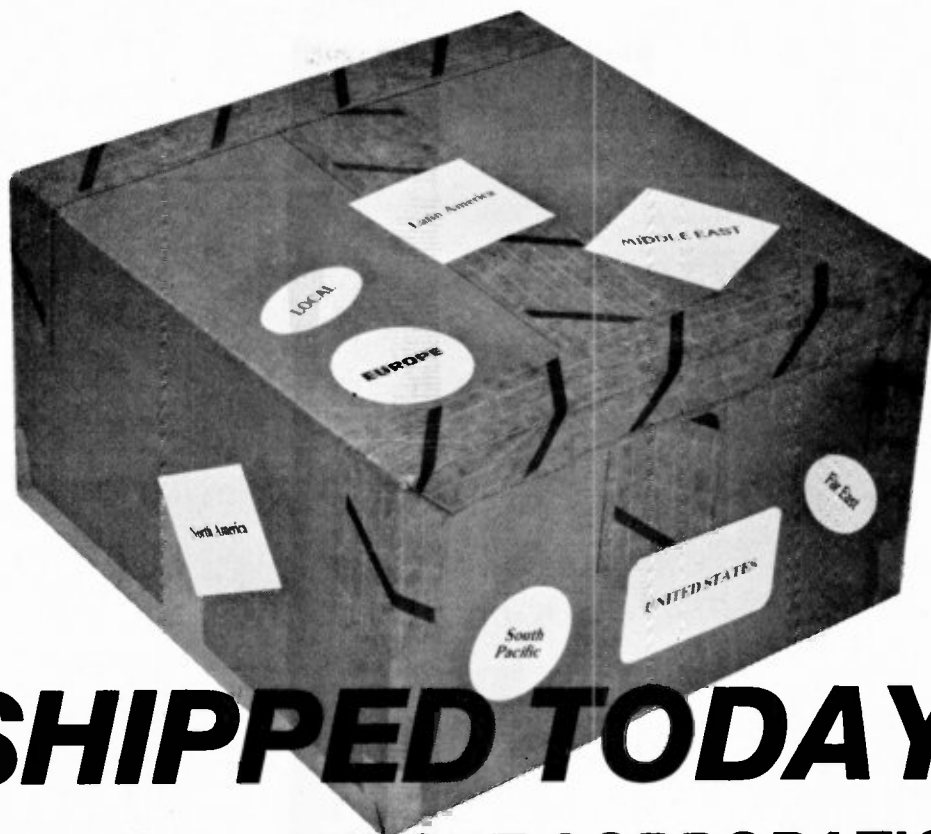

SHIPPED TODAY!

CARDINAL EXPORT CORPORATION
One-Stop/Distributor/Exporter
ships the latest releases Same Day
from New Offices and Warehouse!

We've moved into modern offices and warehousing facilities bulging with a huge inventory of new releases. Top artists! All popular American labels! Virtually the largest selection of records and tapes under one roof—at extremely attractive prices.

Service at Cardinal is designed to meet all your needs! We advise you in advance of new releases and our spectacular close-out deals, and ship the same day as receipt of your order to close-by New York airports and carrier lines.

You get quicker delivery and make more money faster doing business with the oldest and largest export record and tape company in America—Cardinal!

**TELEX OR WRITE FOR PROMPT
AND FAVORABLE QUOTATIONS!**

**THE ONLY SOURCE
YOU'LL EVER NEED FOR—**

- LP's •12" Discos •45 Pops
- Oldies •8 Track Cartridges
& Cassettes
- Video Tapes •Blanks

**ONE-STOP
DISTRIBUTOR/EXPORTER**

#7009



CARDINAL EXPORT CORPORATION

30-55 Vernon Boulevard, Long Island City, New York 11102 U.S.A.
Tel: (212) 545-6200 • Telex: 233486 CEC UR • Cable: COCARDINAL

RECORD SHACK

Best in Fill

Best in Service

Best in Price

RECORD SHACK OF NEW YORK CITY

72-02 51st Avenue, Woodside, NY 11377 Tel: 212/899-0200
Toll Free: 800/221-0204
Telex: 62632

RECORD SHACK OF DALLAS

10701 Stemmons Expy. Dallas, TX 75220
Tel: 214/556-1000
Toll Free: 800/527-5014

RECORD SHACK OF ATLANTA

3123 Oakcliff Industrial St. Atlanta, Georgia 30340
Tel: 404/455-6886
Telex: 707336

RECORD SHACK OF CLEVELAND

5976 Heisley Rd. Mentor, OH 44060
Tel: 216/354-0700
Toll Free: 300/321-1812

RECORD SHACK OF LOS ANGELES

300 West Carob Avenue Compton, California 90220
Tel: 213/537-7000

U.S. SOUNDS

1 Rue Jean Perrin 93155 Le Blanc Mennil Paris France
Tel: 931-11-42

Singles & Disco LP's: Larry Ver Hagen; Albums & Tape: Jim Primerano. (Rec. & Tape D, also see Transcontinent Rec. Sales)

Rec. labels: Amherst (W.N.Y. only), Arista, BMA, Bell Gold, Buddah, Century, Charta, Commercial, Con Brio, Con Rico, Crescendo, Cyclone, Dellwood, Door Knob, Entr' Acte, Farr, Fire Sign, First American, Flashback Oldies, Flying Fish, Free Spirit, GRP, Guinness, ICA, Image, Import, Improv, Kaleidoscope, L.S. Lil Darlin', Mainstream, Muse, Nationwide Sound, Nessa, IX Chains, Panama, Passport, Prelude, Pyramid, Quality, Queen City Albums, Ranwood, Rebecca, Rebel, Red Star, Roulette, Rounder, St. Simon, Savoy, Shannon, Sierra Briar, Sound Waves, Stiff, Struttin', True, Virgo, Visa, Vista, Wig, Win.

Tape lines: Amherst (W.N.Y. only), Arista, Buddah, Butterfly, Dellwood, Farr, Fire Sign, Free Spirit, Guinness, Passport, Prelude, Pyramid, Savoy.

Accessories: Rec. care prods. (Watts)

Buffalo Ents. Inc., 100 McKesson Pkwy. Zip: 14225 Tel: 685-2400 Pres: Carl Cavage; Mgr. Elizabeth Cavage; Buyer: John Grandoni; Ass't Buyer: Tom Kreppenbeck. (Rec. & Tape OS & R.J.)

Buffalo One Stop, 1790 Main St. Zip: 14208 Tel: 882-0427 Mgr. & Buyer: Larry Ver Hagen. (Rec. & Tape OS, also see Transcontinent Rec. Sales)

Piks Corp., 182 Ashland. Zip: 14222. (Rec. & Tape D)

Home office: Cleveland, Ohio.

Rec. labels: ABC imports, AJ's, APA, ARC, Adkorp, Aerospace, Ala, Alanna, Alarm, Alexander Street, Alligator, Alston, Amazon, Ambassador, American Gramophone, American Mutual group, American Sound, American Variety, American Way, Amour, Antilles, Antonio, Appaloosa, Aquarian, Archive of Jazz, Armada, Artemis, Artist House, Audio Arts, Avanti, Axe, BLHE, BMA, BRO, Bam-Buu, Banana Tree, Banner, Bar-B-Q, Barnaby Candid, Barracuda, Beacon, Beck, Bel-Ad, Bella Linda, Belle Meade, Benton, Bertie, Bicycle, Big Town, Birthright, Black Blues, Blackland, Blue Ash, Blue Candle, Blue Heaven, Blue Max, Blues Spectrum, Bobby Robinson, Boblo, Bold, Boogie Man, Braintrust, Breakthrough, Briar, Brown Dogg, Brownstone, Buddah, Buffalo, Busch Country, Butterfly, CC, CRS, C-Town, California Gold, Cambria, Caprice, Carat, Casino, Cat, Catalyst, Celestial, Centennial, Century 21, Champion, Charade, Charmur, Charta, Checkmate, Chimneyville, Chrysalis, Cin-Kay, Citadel, Classical Excellence, Clouds, Commercial, Compass, Comstock, Con Brio, Contempo, Contrast, Co-Star, Counter Parts, Country Porn, Country Showcase of America, County Line, Covert, Cross Country, Crystal Clear, Cyclone, DG, DRG, Dash, Day & Dan, Dee Bee, Delmark, Delux, Demand, Denim, Derrick, Dial, Dingo, Disciple, Dixie Jubilee, Dobre, Don, Door Knob, Doral, Drive, Dyan, Dyo, Earth, Earthwood, El Con, Elka, End-Gee, Entr' Acte, Epitome, Erotic, Essar, Euphoria, Eyes, Fairview, Farr, Fast Track, Fiddlers Wind, 50 States, First American, Flying Fish, Flying High, Fotoplay, 4 Star, Freedom, Free Form, Fretless, Fre-Tone, Funk, Fury, GMC, GNP, Crescendo, GRO, GRR, Gateway, Gillette-Madison, Gil's Funny, Glacier, Glades, Go-Dak, Golden Moon, Golden River, Gold Rush, Gold Star, Good Co., Good Sounds, Gosco, Gospel Tone, Grab Me, Gramercy, Granny White, Grape, Grapevine, Great Northwest, Greedy, Grenadilla, HDM, Hawkeye, Hawk Sound, Heat, Heavy, Hit Bound Int'l, Hit Int'l, Hob, Hobo, Homa, Hop-A-Long, Hoss, Housetop, Humorsonic, IBC, ICA, IMP, Import, Impulse, Inergi, Inphasion, Instant, Irish Rego, Iron Horse, JDC, JRC, Jazz Masters, Jefferson Boulevard, Jerri, Jeremiah, Jerree, Jett Lagg, Jett Sett, Jo Don, Joel, Juana, Jucu, Kaleidoscope, Karat, Kayvette, Kid Stuff, Kimbo, Konduko, LPG, LRC, LS, Laff, Lamb, Libbi, Libra III, Little City, Little Darlin', Little Richie, Little Star, Liz-Be, Los Angeles, Lotta, Love, Lucky Man, MCM, MF, MRC, MRI, Mainstream, Malaco, Mand, Mango, Manilla, Mantan, Mar Bren, Marlin, Masterpiece, Meridian, Messenger Gospel, Metric, Midas, Midsong, Milagro, Ministri, Miracle, Mogul, Monterey, Morhythm, Mountain Railroad, Motown imports, Movie Star, Muse, Music Flow, Music Is Medicine, Mutt & Jeff, NTSU, Nami, Nashville, Rec. Prod'ns, Nationwide Sound, Ned, Neostat, Nessa, New Day, IX Chains, Ninth Note, Nostalgia Lane, Nu-Tray, October, Ode, Olympus, Opus, Orinda, Orlando, Ovation, Owl, PVC, Pacific, Pacific Arts, Pageboy, Pantheon Desert, Paradox, Paragon, Payola, Peppo, Pharaoh, Philo, Phono, Picadilly, Pick-A-Hit, Pinnacle, Polydor imports, Potato, Prairie Dust, Predator, Prima, Progressive, Pure Silk, Pyramid OCA, R&R, RS, Randa On, Ranwood, Redd Fox, Red's World, Request, Rhino, Rickwood, Ridge Runner, Ridgetop, Rim, Rising Star, Riverboat Roadshow, Roast, Robert Lee, Rocking Horse, Rocky, Roots, Roulette, Royal Flush, Rush, Sabre, St. Simon's Schaffer, Schubart, Scorpio, Scorpion, Scrimshaw, Seeds & Stems, Shadow, Shield, Shue, Sierra, Silver Blue, Silver Sword, Simko, Sipra, Sirlion, Skyline, Snowdrop, Soc-A-Gee, Soul Deep, Soultown, Soundbird, Sounds Superb, Soundwaves, Spoonfed, Stanson, Starlog, Star Mountain, Stone Dogg, Stoney Plain, Stop, Storyteller, Strawberry, Studio B, Studio 7, Sugar Hill, Sunnyvale, Sunshine, Sunshine Sound, Superstar, Swar, TK, TMS, Tablighi, Tailored Music, Takoma, Talisman, Talpro, Taxi, Teddy Bear, Thistle, 3M's, Timberline, Timeless, Tomorrow, Topco, True, 12-00 High, 20th Century, US, Underground, Unicorn, Unital, Vaya, Vee Jay, Venice, Versatile, Vintage, Virgo, Visa, Vista, Vistone, Vivo, WILD, WITG, Wanderick, Waterhouse, Weird World, West, Western Hemisphere, Wheeler, Wicked, Wide World Music, Wizard, Wolf, Woodsmoke, World Jazz, World Wide Music, Yucca.

Tape lines: APA, Ala, Alarm, Alexander Street, Alston, American Variety, Archive of Jazz, Barnaby Candid, Blue Candle, Bold, Buddah, Buffalo, Butterfly, Cat, Chimneyville, Chrysalis, Clouds, Con Brio, Contempo, Dash, Dingo, Drive, Dyo, Earth, End-Gee, First American, Flying Fish, 4 Star, GRT partial catalog, Gillette-Madison, Glades, Good Sounds, Gosco, Gospel Tone, Great Northwest, HDM, Hit Int'l, Humorsonic, Import, Impulse, Inergi, Inphasion, Jazz Vold, Juana, Kayvette, LRC, LS, Laff, Little Darlin', Little Star, MF, MRC, Main-

TOWN HALL

RECORD ONE-STOP
New York's Major One-Stop

Now celebrating our 32nd year servicing dealers throughout the USA and all over the world.

Complete inventory—we stock everything that sells:
45 RPM singles—LP's—Tapes—Needles—Accessories—Pop—Rock—Soul—Spirituals—Jazz—Country & Western—Reggae & Calypso

- First with new releases—45's—LP's—Tapes
- Absolutely dependable same-day service
- Low, low prices—weekly super specials
- Most complete fill of your orders
- World's largest inventory of 45 RPM oldies (Write for free giant oldie catalog)
- Complete stock of Reggae and Calypso 45's—LP's—Tapes
- Export specialists—"Super Speed" same day export shipments

TOWN HALL RECORD ONE STOP Inc.

9131 Bedell Lane, Brooklyn, NY 11234
212/272-9702—212/272-9707—Telex: 426728

stream, Malaco, Manilla, Marlin, Messenger Gospel, Mountain Railroad, Muse, Music, Is Medicine, New Day, Nostalgia Lane, Ode, Ovation, PVO, Passport, Piccadilly, Potato, QCA, Ranwood, Redd Foxx, Reid's World, Rim, Royal Flush, Savoy, Seeds & Stems, Shield, Silver Blue, Soundbird, Soundwaves, Stiff, Stone Dogg, Stoney Plain, Strawberry, Sunshine Sound, TK, Tailored Music, Takoma, Talsman, Vee Jay, Versatile, Virgo, Visa, Wanderick, Weird World, Sheeler, Wicked, Wolf

Ruda's Dist'g Co., 915 Broadway, Zip: 14212. Tel: 852-3121. (Rec. & Tape OS—polka prod.)
 Soul Recs. One Stop Inc., 350 Broadway, Zip: 14204. Tel: 856-3051. Pres. Del Broward, Mgr. & Buyer: Audrey A. Broward. (Rec. & Tape OS & RJ)
 Transcontinent Rec. Sales Inc., 355 Harlem Rd. Zip: 14224. Tel: 826-9560. Owner: Leonard Silver, VP & Opns. Mgr. Tom Colson, VP & Sales Mgr. Steve Kugel, VP & Nat'l Buyer. David Colson, Singles Buyer: Larry Ver Hagen, Albums Buyer: Jim Primerano, Tape Buyer: Bob Mueckl. (Rec. & Tape RJ), (Rec. & Tape OS as Buffalo One Stop), (Rec. & Tape D as Best & Gold Rec. Dist.).
 Branches: Union, N.J., Transcontinent of New Jersey (Rec. & Tape OS & RJ); Albany, N.Y., Jane's One Stop (Rec. & Tape OS); Rochester, N.Y., Rochester One Stop (Rec. & Tape OS & RJ); Syracuse, N.Y., Syracuse One Stop (Rec. & Tape OS & RJ); Cincinnati, Ohio, Ambat Recs. (Rec. & Tape OS & RJ); Cleveland, Ohio, Northern Rec. Sales (Rec. & Tape OS & RJ); Dayton, Ohio, Ambat Recs. (Rec. & Tape OS & RJ)

- **CARLE PLACE (Area Code 516)**
 Wilmi Sales, 556 Westbury Ave. Zip: 11514. Tel: 333-0275. Owner & Mgr.: Edward Smith. (Rec. OS & RJ, Tape OS)
- **FARMINGDALE (Area Code 516)**
 Variety Audio (div. of Phoenix Inds. Corp.), 144 Milbar Blvd. Zip: 11735. Tel: 293-5858. Owner: David Shichman; Buyer: Bill Kobrin. (Rec. & Tape RJ)
- **FREEMPORT (Area Code 516)**
 Candy Stripe Recs., 371 S. Main St. Zip: 11520. Tel: 379-5151/5760. NYC Tel: (212) 895-3930. Telex: 126851. Owner & Bd. Chm.: Bernard Keil; Pres.: Stan Gecht; Buyers: Recs. & Tapes, Irving Chaffardet; Accessories, Irving Glasser. (Rec. & Tape D, OS, R.J. I & E)
 Labels: ABC, A&M, AVI, Alston, Angel, Apple, Ariola, Arista, Asylum, Atco, Atlantic, Bearsville, Blue Note, Blue Thumb, Buddah, Butterfly, CTI, Capitol, Capricorn, Casablanca, Columbia, Dash, De-Lite, Deram, Dot, Drive, Dunhill, ECM, EMI, Elektra, Epic, Fantasy, Fiesta, Goldmine, Harvest, Hi, Impulse, Infinity, Island, Janus, LRC, Laff, London, London Int'l, MCA, Mainstream, Mango, Marlin, Mercury, Midsong, Milestone, Monument, Motown, Mushroom, Nashboro, Oasis, Odyssey, Parachute, Parrot, Peacock, Polydor, Prelude, Prestige, Prism, RCA, RSO, Ranwood, Red Greg, Reprise, Rolling



RAVEN
 Record Exports, Inc.

IMPORTERS: Are you looking for a better FILL? Let **RAVEN FILL** your needs. . . .
 New releases, back catalog, cut-outs & hard-to-get labels!



important
 RECORD DISTRIBUTORS, INC.

EXPORTERS: Are you looking for someone to MOVE your product? MOVE over to **IMPORTANT**. . . .
 Complete distribution set-up for imported LP's, EP's, Singles & 12".

147-45 182nd STREET • JAMAICA, N.Y. 11413
 Tel: (212) 995-9200 • Telex: 668694 RAVEN

A-1 RECORD SALES

659 Tenth Ave., N.Y., N.Y. 10036. Phone: (212) 246-1234—246-3330

EXCLUSIVE SPECIALISTS FOR THE JUKE BOX OPERATORS

The One-Stop with a complete selection of Singles, Disco, Soul, Pop and Rock. Oldies, Standards, Latin and Background Music.

TITLE STRIPS WITH ORDERS

*Immediate Delivery
 Mail Orders Our Specialty*

OTTO WILKINSON
 General Manager



(212) 786-7667
 TELEX: 235976

45-50 38th St., Long Island City, N.Y. 11101

records inc.

Over 25 Years of Solid Experience

ONE-STOP HEADQUARTERS

- ★ FULL CATALOGUE • ALL LABELS
- ★ NEW RELEASES • SAME DAY SERVICE
- ★ LP's - TAPES - 45's
- ★ ALWAYS THE LOWEST DISCOUNT PRICES
- ★ LATEST DISCO RECORDS ALWAYS AVAILABLE FIRST
- ★ SI PARLA ITALIANO • ON PARLE FRANCAISE • SE HABLA ESPANOL

EXPORT PROFESSIONALS
 Largest exporter of phonograph records and tapes in the world.

COMPLETE ON HAND INVENTORY ON CATALOGUE AND OLD HARD TO GET ITEMS

For EXPORT ONLY

All Labels, Records & Tapes

ALL

New Releases
 Rock & Pop
 Disco & Jazz
 Afro Cuban
 Nostalgia
 Classical
 Cutouts
 Always in Stock
 Lowest Export Prices
 Fastest Delivery

Free catalogues on request

DAVID ESKIN

International Sales
 400 Riverside Drive
 New York 10025 USA

Tel. (212) 749-4257

Telex 237460 ESKINUR

MET RICHMOND LATIN RECORD SALES

1637 UTICA AVE., BROOKLYN, N.Y. 11234

TEL: (212) 253-4600

Cable Address: "SEECODISC-NY"

DAVID LAST

President

Thanks to our Liscensees
 for making SEECO Records
 Tops in Latin Music

Stone, Rounder, Salsoul, Savoy, Seraphim, Sesame Street, Sire, Swan Song, TK, Takoma, Tamla, Thresh-old, Tomato, 20th Century, United Artists, Vanguard, Victrola, Warner Bros., Westbound.

Phonographs: Emerson.
Accessories: Batteries (Maxell), blank tape (Ampex), Audio Magnetics, BASF, Capitol, Columbia, Fuji, Inter-magnetics, Magnatone, Maxell, Memorex, Recoton, Sony, TDK, cases (Savoy), needles (Recoton), rec. care prods. (Black Magic, Discwasher, Sound Guard), rec. & tape storage units, sleeves, Nortronic prods. (SEE AD-VERTISEMENT)

Double B Recs. & Tape Corp., PO Box 229, 67 Albany Ave. Zip: 11520. Tel: 378-2222. Owner: Bernard Boorstein; Mgr.: Singles & Albums Buyer: Don Liberatore; Tape Buyer: Zeke Lenga. (Rec. & Tape OS)
 Branch: Newark, N.J.

Elroy Ents. Inc., 39 St. Mary's Pl. Zip: 11520. Tel: 223-3910. Pres.: Roy Imber, Buyers: Singles, V. Causeman; Albums, M. Lerner, Tape, S. Lerner; Accessories, M. Goldstein. (Rec. & Tape RJ)

● **GREAT NECK (Area Code 516)**

Playette Corp., 301 East Shore Rd. Zip: 11023. Tel: 487-3064. Owner: Sidney A. Evans. (Rec. & Tape I)

Rec. labels imported: Ades (France), Cetra (Italy), Chant du Monde (France), DG (Germany), Festival (France), GMS-Disc, Hachette, Hispavox (Spain), Lumen (France), Omnivox (France), Visaphon (Germany).

Tape lines imported: Ades (France), Cetra (Italy), Festi-val (France), Hispavox (Spain), Omnivox (France), Pleiade (France), Visaphon (Germany).

Record Warehouse, 16 Canterbury Rd. Zip: 11022. Tel: 487-8569. Telex ETLX 420001 x 222. Pres.: Arthur Danziger. (Rec. D)

Distributes collector's items, cut-outs, Latin prod., rare rock. (SEE ADVERTISEMENT)

● **HAUPPAUGE (Area Code 516)**

Big Red Ents., 40 Oser Ave. Zip: 11787. Tel: 231-7300. Pres.: Lou Sebok; VP: Charles Trepel; Sales Mgr.: Roger Weinand. (Rec. & Tape D)

Labels: Stereo Gold; also distributes promotional mate-rials.

● **HICKSVILLE (Area Code 516)**

Export 33 1/2 Recs./Barry Weisfeld, PO Box 773. Zip: 11802. Tel: 931-7737. Owner: Barry Weisfeld. (Rec. D, I & E—catalog, cut-out, 50's, unavailable & collec-tor's items)

● **HUNTINGTON (Area Code 516)**

Cut Corners Rec. Dist. of New York, 310-B, New York Ave. Zip: 11743. Tel: 423-9081. Sales: Kim Land; Buyer: Dave Witthaus. (Rec. & Tape D—cut-outs & overstocks) (SEE ADVERTISEMENT)

● **HUNTINGTON STATION (Area Code 516)**

Precision Electronics—The Stereo Center, 1335 New York Ave. Zip: 11746. Tel: 427-6900. (Tape OS)

● **ISLAND PARK (Area Code 516)**

Price Rite Rec. Corp., 4245 Austin Blvd. Zip: 11558. Tel: 431-8783. Telex: 126575. Pres. & Buyer: Lawrence Sonin. (Rec. & Tape I & E)

Exports current & close-out records & pre-recorded tape, all US labels.

Accessories: Blank loaded tape (Columbia), record & tape cases (Savoy), Le-Bo prods. (SEE ADVERTISE-MENT)

Scott Dist'g Corp., PO Box 280, 4217 Austin Blvd. Zip: 11558. Tel: 432-1234. Owner: Sidney Kruglick, Sales Alma Lieber; Buyer: Bert Simmerlein. (Rec. & Tape D, I & E)

Branch: Norfolk, Va.
 Distributes promotional recs. & tapes.

● **ITHACA (Area Code 607)**

Swallowtail Recs., PO Box 843. Zip: 14850. Tel: 844-4535

Owner, Mgr. & Buyer: Phillip Shapiro. (Rec. D)
Labels: Folk Legacy, Front Hall, Philo, Swallowtail, other folk music prod.

● **JERICHO (Area Code 516)**

Countrywide Tape & Rec. Dist. Inc., 200 Robbins Ln. Zip: 11753. Tel: 433-9550. NYC Tel: (212) 380-3900. Telex 126316. Pres. & Buyer: Stanley Sirote. (Rec. & Tape D, I & E)

Distributes cut-outs, overstocks, promotions. (SEE AD-VERTISEMENT)

Zim Recs., PO Box 158, 18 Ivy Dr. Zip: 11753. Tel: 681-7102. Owner: Arthur Zimmerman. (Rec. I & E)

Labels imported: A (UK), Alpha (Netherlands), Amigo (Sweden), Artlaxeras (Sweden), Blue Parrot (UK), Cara-col (France), Dawn Club (Germany), Dragon (Sweden), East West (Sweden), FDC (Italy), Family (Italy), First Heard (UK), Flyright (UK), Fountain (UK), Four Leaf Clover (Sweden), Gaps (Netherlands), Gardenia (Nether-lands), Grannyphone (Netherlands), Guilda da Musica (Portugal), Hefty Jazz (UK), Hep (UK), Jackson (Ger-many), Jazz Connoisseur (Italy), Lee Lambert (UK), Mag-pie (UK), Mahogany (France), Munich (Netherlands), Oldie Blues (Netherlands), On the Loose (Italy), Queen Disc (Italy), Raretone (Italy), Rarities (UK), Redondel (Ar-gentina), Retrieval (UK), Right Keyhole (Italy), Stooif (Netherlands), Tangent (UK), Texas Blues Piano (UK), Two Flats Disc (Italy), Unique Jazz (Italy), Vinyl (UK).

● **KAUNEONGA LAKE (Area Code 914)**

Harbor Rec. Export Corp., 66 Rt. 55. Zip: 12749. Tel: 583-4095. Pres.: Jerome Hornig. (Rec. & Tape E) (SEE AD-VERTISEMENT)

● **NEW YORK METROPOLITAN AREA (Area Code 212)**

- A A A Rec. Hunter Dist'g Co., 507 Fifth Ave. Zip: 10017. Tel: 697-8970. Pres.: Jay Sonin. (Rec. & Tape OS & RJ). (Rec. & Tape E as All Brands Rec. & Tape Export Corp., 507 Export Corp.)
- A-1 Rec. Sales, 659 10 Ave. Zip: 10036. Tel: 246-1234/3330. (Rec. & Tape OS) (SEE ADVERTISEMENT)
- A R C Rec. Dist. Ltd., 1194 Nostrand Ave., Brooklyn 11225. Tel: 772-5665. (Rec. D & E)
Labels: African Music Explosion, Fiesta, Jumbo Caribbean Disco, Kola, Makossa group.
- All Brands Rec. & Tape Export Corp. (Rec. & Tape E)—Tel: 986-6077—see AAA Rec. Hunter Dist'g Co.
- Alpha Dist'g Corp., 20 West End Ave. Zip: 10023. Tel: 397-1920. Owner: Harry N. Apostoleris; Mgr. & Buyer: Murray Viscoso; Sales Mgr.: Nick Campanella. (Rec. & Tape D)
Branches: Vernon (Hartford Area), Conn.; Weymouth (Boston Metropolitan Area), Mass.; Buffalo, N.Y.
Rec. labels: Abkco, Amherst, Arista, Buddha, CTI, Children's Recs. of America, Cream, First American, Hi, Living Language, London, M&R, Mainstream, Mango, Midsong, Motown group, Pacific Arts, Passport, Republic, Tamla, Tomato, Vanguard, Venture, Visa
Tape lines: All lines. (SEE ADVERTISEMENT)
- American Album & Tape Dist. / Hope Int'l, 850 Seventh Ave. Zip: 10019. Tel: 247-3188. Pres.: David King; VP: Hope King; Int'l VP: Warren Ashley; Gen. Mgr.: George Curtis. (Rec. & Tape D, I & E)
Rec. labels: Hall of Fame, Jazz Greats; also distributes cut-outs, overstocks.
Imports close-outs, surplus.
Tape lines: Cut-outs, overstocks. (SEE ADVERTISEMENT)
- Antilla Rec. Dist. Inc., 667 10 Ave. Zip: 10036. Tel: 582-4546. Mgr.: J. Hernandez. (Rec. & Tape D, OS & RJ)
Labels: Antilla, Aro, Bravo, Funny, Gema, Maype, Modiner, Musicalia, Musicuba, Orosound, Performance, Rumba, Suave, Tone Latino.
- Apon Rec. Co. Inc., PO Box 3082, Steinway Sta., 44-16 Broadway, Long Island City 11103. Tel: 721-5599. Pres.: Andrej M. Poncic; Sales Mgr.: Donald M. Zemann. (Rec. & Tape I)
Rec. labels imported: Amadeo (Austria), Angelicum (Italy), Christophorus (Germany), Harmonia Mundi (Germany), Jugoton (Yugoslavia), Opus (Czechoslovakia), Panton (Czechoslovakia), Polyphon (Austria).
Tape lines imported: Amadeo (Austria), Christophorus (Germany), Harmonia Mundi (Germany), Jugoton (Yugoslavia), Opus (Czechoslovakia).
- Archer Int'l, 1 Park Ave. Zip: 10016. Tel: 532-2323. VP Sales: Irwin Eisen. (Rec. & Tape I & E)
- Argus Rec. Dist. Inc., 160 W. 46 St., Rm. 506. Zip: 10036. Tel: 765-2585. Mgr.: Rose Saggio. (Rec. D)
Labels: Aries, August, Criterion, GP, Indian House, Juno, Mounted, Pa-Dik, Rex, Riccio, Spiral.

- Arovox Rec. Corp. (Rec. & Tape RJ), see Olympia Rec. Inc.
- Audio Dist. Inc., 1182 Broadway. Zip: 10001. Tel: 725-4570. Pres.: Al Antebi; VP: Buddy Antebi. (Rec. & Tape D)
Distributes cut-outs.
- Audiorama Recs. Corp., 658 10 Ave. Zip: 10036. Tel: 246-9858. Owner: Rafael Diaz Gutierrez; Mgr.: Hilda Diaz Gutierrez. (Rec. D)
Labels: Accion, Atlas, Audiorama, Color, DC, Disco Sur, Duro, Fabuloso, Fonica, Lad, Legal, Madely, Preludio, Quisqueya, Taurus, Top-Hit, Velvet, Virtuoso.
- Berklay Air Servs. Mktg., PO Box 665, JFK Airport, Bldg. 80, Jamaica 11430. Tel: 656-6066. Owner: Bernard Klainberg. (Rec. & Tape E)
Branch: Los Angeles, Calif. (SEE ADVERTISEMENT)
- Beta Recs. Dist. Inc., 599 10 Ave. Zip: 10036. Tel: 239-0440. Pres.: John Halonka; Gen. Mgr.: Jim Demay; Buyer: Clement Cole. (Rec. D, OS, I & E; Tape D)
Labels: BRC, Big Town, Brunswick, Dakar, Dobre, Durium, Light, Plantation, QCA Jazz, Sun, Trojan.
Imports Caribbean, pop, R&B, disco, jazz & classical prod.
- Brasilia Recs. & Tapes Corp., 29 W. 38 St., 8th fl. Zip: 10018. Tel: 354-5613. Telex: 666794 BRASREC. Pres.: Herbert Cszanik; Nat'l Sales Mgr.: Jim Demay. (Rec. & Tape D, I & E)
Rec. labels: Brasilia, Brass, Emergency.
Rec. labels imported: AMC, Beverly, Building, Copaca-

- bona, Fontana, Marcus Pereira, Philips, Phonogram, Polydor, Polygram, RCA, RGE/Fermata, Sabia, Som, Vision (all Brazil), Movie-Play, Polygram (both Portugal).
Tape lines imported: Same as rec. labels. (SEE ADVERTISEMENT)
- C B S Recs., 95-25 Queens Blvd., Rego Park 11374. Tel: 830-3600. VP Northeast Region: Ron Piccolo; Reg'l Coord.: Karen Padgett; Branch Mgr.: Bob Jamieson. (Rec. & Tape D)
Rec. labels: Arc, Bang, Blue Sky, CBS, Caribou, Columbia, Epic, Jet, Kirshner, Melodiya/Columbia, Nemperor, Odyssey, Philadelphia Int'l, Portrait, Starflite, Stiff, T-Neck, Tabu, Tappan Zee, Unlimited Gold.
Tape lines: Same as rec. labels.
- Capitol Recs., 1370 Ave. of the Americas. Zip: 10019. Tel: 757-7470. (Rec. & Tape D)
Rec. labels: Angel, Ariola America, Capitol, EMI America, Harvest, Liberty, Melodiya/Angel, Seraphim, United Artists
Tape lines: Same as rec. labels.
- Cardinal Export Corp., 135 W. 29 St. Zip: 10001. Tel: 736-5855. Owner: Arthur Lerner; Gen. Mgr.: Bernardo Golden. (Rec. & Tape E) (SEE ADVERTISEMENT)
- Caytronics Corp., 240 Madison Ave. Zip: 10016. Tel: 889-0044. Pres.: Joe Cayre; Chm., Gen. Mgr., Buyer & Sec'y-Treas.: Stanley Cayre; VP's: Ken Cayre, Chuck Gregory, David Kerner, Lee Shapiro, Rinal Sousa. (Rec. & Tape D, I & E). Local branch: Cayre Dist., 653 10

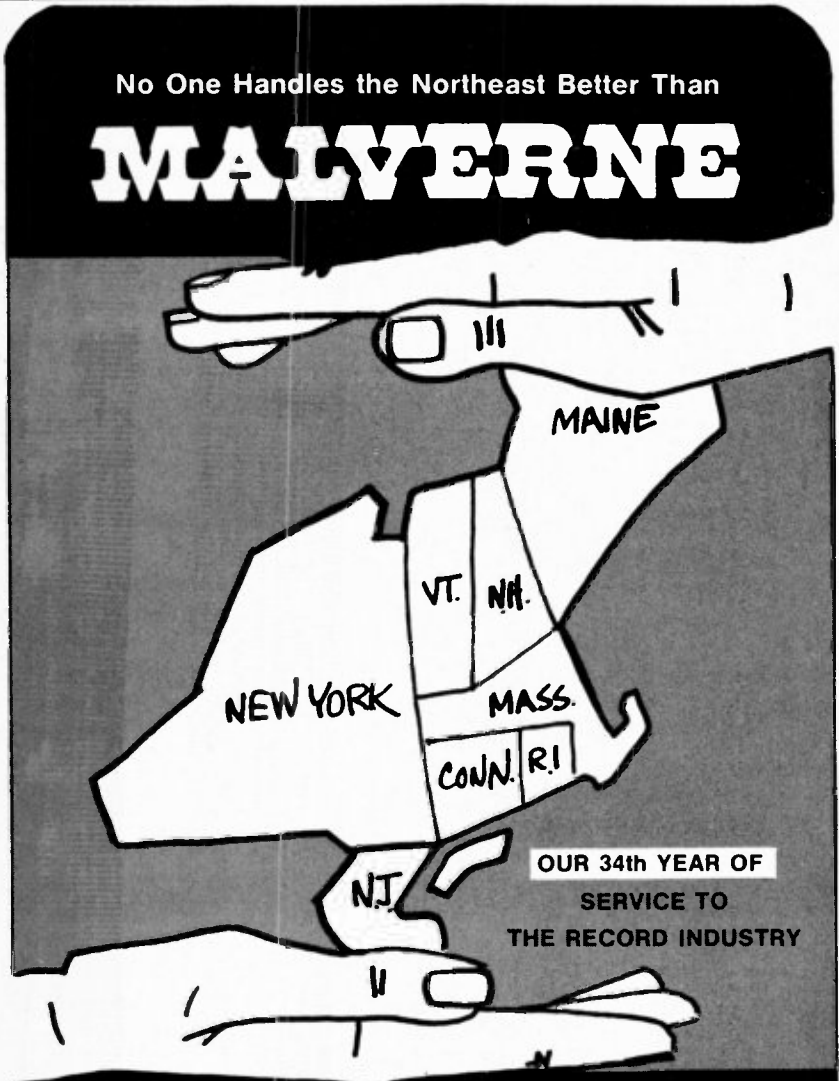

Malverne Distributors, Inc.

New York and New Jersey Offices and Warehouse:
35-35 35th St., L.I.C., N.Y. 11106
Tel: (212) 392-5700 — Toll free wats line: 800-221-1406
Jerry Winston, President; Joe Grippo, V.P. & Dir. of Marketing;
Stan Dravson, Sales Mgr.
New England Office: 77 Summer St., Boston, Mass.
Tel: (617) 423-3820
Stan Goodman, Sales Mgr. for New England Territory



We'll be Happy to export to you American Records and Tape Product

**ROCK—SOUL
JAZZ-LATIN-DISCO
MOR—CLASSICAL
45's & CUTOUTS**

Efficient Service
Individual Attention

New Releases
Catalog Material

WAMID, INC.

200 Hudson St.
New York, N.Y. 10013
(212) 431-3480
TELEX: 236941

J&R MUSIC WORLD
EXPORT DIVISION

OUR TELEX NO. 420961 JRR
EXPORTING
TO ALL COUNTRIES

- We have a full catalog of all labels, same day service.
- LP's, tapes, 45's blank tape & audio- video equipment.

Lowest prices, best service.
Individual attention to all our customers.



23 PARK ROW, NEW YORK, N.Y. 10038 (212) 732-8600
OUR TELEX NO. 420961 JRR

RECORD RETAILERS!
looking for
SERVICE • FILL • PRICE?



ALL RECORD DISTRIBUTORS, INC.
44 Bond Street
Westbury, N.Y. 11590
(516) 997-7160

- ALL** THE TOP SINGLES
THE TOP DISCO SINGLES
THE BEST OF OLDIE '45s
THE TOP SELLING LPs plus 20,000 titles
THE TOP SELLING TAPES plus large inventory
THE SERVICE DISTRIBUTOR OF THE WORLD

- Same Day Service
- Free delivery in New York Metro area, New Jersey, Connecticut, Rhode Island
- Hit Sheets for LPs and 45s supplied FREE
- Distributors for TDK blank type, Le-Bo Accessories

20 YEARS OF SERVICE PROVES WE'RE THE BEST
Send for catalog, weekly specials and terms of sale.

Name.....Address.....
City.....State.....Zip.....

Ave. Zip 10036 Tel 541-4090 Mgr. Fernando Iglesias (Rec. & Tape OS & RJ)
Branches: Los Angeles, Calif., Cayre Inds of California Inc., Hialeah Gardens, (Miami Metropolitan Area), Fla., Cayre Dist. of Florida Inc., San Antonio, Tex., Cayre Dist. of Texas Inc. (All Rec. & Tape D)
Rec. labels: Arcano, Bethlehem, Caliente, Carino, Caytronics, Free Spirit, Gold Mind, Mericana, Mericana-Melody, Normex, Pronto, Salsoul, Salsoul-Salsa
Tape lines: Same as rec. labels

Chapel-Tone Music, 93-12 Hollis Court Blvd. Queens Village 11428. Tel. 464-3642. Owner & Singles Buyer. Ronald Blair. Mgr. & Albums Buyer. Thomas Laura. Local branch Street Corner Recs., 300 E. 39 St Zip 10020. Tel 733-8813 (Rec. D)
Labels: Aljon, Chapel-Tone, Chrystal Ball, Clifton, Grafitti, J&J, Jason, Laurie, Maria, Mohawk, Street Corner, China Books & Periodicals Inc., 125 Fifth Ave Zip 10003. Tel. 677-2650. Mgr. Ruth Micholoff (Rec. I)
Home office: San Francisco, Calif.
Imports from People's Republic of China
Citywide Sales, 419 Park Ave S Zip 10016 Tel 689-2700 Telex 66332 Intel.
Label: Direct to Disk
Accessories: Magnetic cartridges, rec. care prods., styli (ADC, Audio-Technica, Pickering, Shure)
Daro Exports Ltd., 1468 Coney Island Ave., Brooklyn 11230. Tel. 252-4355. Pres. Albert J. Okas. Mgr. G. Okas (Rec. & Tape E)
Exports all rec. labels, pre-recorded tape, rec. & tape accessories (SEE ADVERTISEMENT)
Daylight Transport, 66-00 Long Island Expwy., Maspeth 11378. Tel. 335-8866 (SEE ADVERTISEMENT)
Distribuidora Nacional de Discos de New York, 214 W 96 St Zip 10025 Tel 866-2469 Pres. L. Raul Bernard. VP & Sec'y-Treas. Blanca Bernard (Rec. & Tape D), (Rec. & Tape I & E as Otao Recs. Co. Int'l Ltd.)
Rec. labels: Algo, Banny, Colony, Coqui, Dinsa, Fenix, Kelsa, ORC Taino
Tape lines: Algo, Banny, Colony, Coqui, Kelsa, ORC, Taino
Dolian Prods Corp., 307 Fifth Ave. Zip 10016 Tel 684-6274. Owner David Robin, Mgr. John Robin (Rec. & Tape E)
Downstairs Recs., 55 W 42 St. Zip 10036. Tel. 221-8989
Eltron Export Co., 57 Leonard St. Zip 10013. Tel. 966-4710. Telex 421234. Pres. Werner T. Glaeser (Rec. & Tape E) (SEE ADVERTISEMENT)
David Eskin Inc., 400 Riverside Dr. Zip 10025. Tel. 749-4257. Telex 237460 ESKINUR. Pres. & Buyer David Eskin (Rec. & Tape OS & E)
Exports: recs., tapes, video cassettes & disks (SEE ADVERTISEMENT)
Euroclass Rec. Dist. Ltd., 155 Ave. of the Americas, 11th fl. Zip 10013. Tel. 741-1430. Owner Marcos Klorman, Mgr. Frank Burton; Sales Mgr. Len Sultan (Rec. & Tape D & I)
Rec. labels: Audiophile, Audio Technica, Cambridge, Chalfont, Citadel, Delos, Desmar, Gale, HNH, International Piano Archives, Pelican, RCA (Japan), Telarc, Titanic, Toshiba, Umbrella, Unicorn
Rec. labels imported: Ensayo (Spain), Zambra (Spain)
Tape line: Connoisseur Society/In Sync Labs
507 Export Corp (Rec. & Tape E)—Tel 986-6078—see AAA Rec. Hunter Dist'g Co.
German Language Publ's Inc., 75 Varick St. Zip 10013. Tel. 736-7455. Pres. Peter J. Perske, Rec. Div. Mgr. Renate M. Finetto (Rec. & Tape D, I & E)
Branch: Englewood Cliffs, N.J.
Rec. labels imported: Ariola, Baccarola, Diamant, EMI-Electrola, Europa, Europa-Klassik, Fontana, Hansa, Jupiter, M. Maritim, Metronome, Philips, Polydor, Sonic, Telefunken (all Germany), Amadeo, Polydor (both Austria)
Tape lines imported: Ariola, EMI-Electrola, Eurodisc, Europa, Europa-Klassik, Hansa, Jupiter, Maritim, Metronome, Philips, Telefunken (all Germany)
German News Co. Inc., 218 E. 86 St. Zip 10028. Tel. 288-5500 (Rec. & Tape D & I)
Rec. labels: Arch, DRG, Gemini Hall, MDP, OASI, Past Masters, RRS
Rec. labels imported: Acanta (Germany), Ariola (Germany), Baccarola (Germany), Baccillus (Germany), Baerenreiter (Germany), Brain (Germany), CBS (Germany), Cantate (Germany), Caprice (Sweden), D Sound (Germany), DaCamera (Germany), Discophilia (Germany), EMI-Electrola (Germany), Erato (Germany), Eurodisc (Germany), Finlandia (Finland), Fontana (Germany), Harmonia Mundi (Germany), MPS (Germany), Metronome (Germany), Musik fur Alle (Germany), Pape (Germany), Philips (Germany), Polydor (Germany), Preiser (Germany), RCA (Germany), Schwann (Germany), Telefunken (Germany), Top Classic (Germany), Vista (UK), Wergo (Germany), Club 99
Tape lines imported: Ariola-Eurodisc, Metronome, Philips, Polydor, Telefunken (all Germany)
Sam Goody Int'l Inc., (Rec. & Tape I & E)—Mgr. Sam Stolon—see SMG Dist.
Gotham Dist., 21-51 44 Dr., Long Island City 11101. Tel. 786-5400. Owner Joe Bostic. Mgr. Buddy Franklin; Singles, Albums & Tape Buyer. Maxine Neely (Rec. & Tape OS)
Hope Int'l, see American Album & Tape
Victor Hotho & Co., 353 E. 72. Apt. 4-D. Zip 10021. Tel. 737-5749 (Rec. & Tape RJ)
Home office: Fort Worth, Tex.
House of Menorah Inc., 36 Eldridge St. Zip 10002. Tel. 925-7573. Gen. Mgr. & Buyer Sol Tischler. Nat'l Sales Mgr. Jonathan Tischler. (Rec. & Tape D & I)—Hebrew & Yiddish prod. only
Rec. labels: Aderet, Artistic, Banner, CBS, Columbia, Elektra, Embassy, Emes, Epstein, Famous GIL, Gal-Ton, Hataklit, Hed Arzi, IMF, Isradisc, Israelectra, Israphone, Koliphone, MG, Makolit, Maloh, Menorah, Monitor, Mor, Nachas, Neginah, Noam, Phonodor, Polydor, RCA, Record Collector's Guild, Request, Roulette, Rozanna, Tikva, Vanguard, Zimram, Zimray
Tape lines: Aderet, Ampis, Banner, CBS, Emes, Epstein, GIL, Gal-Ton, Hataklit, Hed Arzi, Isradisc, Israphone,

JEP, Magnatone, Marjanil, Menorah, Monitor, Musique Int'l'e, Nachas, Pirchei, Polydor, Record Collector's Guild, Tikva, Yc, Zimray

Impex Int'l Co., 80 Wall St. Zip 10005. Tel: 425-2770. Pres. Erwin Lustfield (Rec. & Tape E)

Important Rec. Dist's (Rec. & Tape I)—Contact: Barry Kobrin—see Raven Rec. Exports

International Book & Rec. Dist's., 40-11 24 St., Long Island City 11101. Tel: 786-2966 Owners V. Rudenjak, S. Simunovic. Mgr. Kay Jackson. (Rec. I)

Labels imported: Chant du Monde (France), Durium (Italy), EMI Italiana (Italy), EMI Odeon (Spain), Hispavox (Spain), Jugoton (Yugoslavia), Music for Pleasure (France), Pathe Marconi EMI (France), Phonogram (Brazil, France, Spain), Polydor (France), RCA (France), RTB (Yugoslavia), Ri-Fi (Italy), Schwann (Germany), Sonodisc (France), Sunset France (France), Vogue (France)

J A S Co., 77-24 74 St., Glendale 11227. Tel: 456-0974. Owner J. Allen Schwenn. Mgr. Michael Jury. Buyers: Singles, J. Schwenn, Albums, M. Jury (Rec. RJ & E)

J & R Music World, Export Div., 23 Park Row. Zip: 10038. Tel: 732-8600. Telex: 420001 ETLX (Rec. & Tape E) (SEE ADVERTISEMENT)

King Karol Inc., 126 W. 42 St. Zip: 10036. Tel: 354-7684. Owners: Philip King, Benjamin Karol (Rec. & Tape OS) (SEE ADVERTISEMENT)

Known Artist Dist., 1619 Broadway. Zip 10019. Tel: 265-1292. Mgr. Krzysztof Z. Purzycki (Rec. RJ & E) Home office: Brewton, Ala.

Herbert A. Linsky Assocs. Inc., 888 Seventh Ave. Zip: 10019. Tel: 582-2594. Pres.: Herbert A. Linsky. Distributes cut-outs.

M C A Dist'g Corp., 445 Park Ave. Zip: 10022. Tel: 759-7500. Reg. I Dir.: Bob Specca. Branch Mgr.: Tex Weiner. (Rec. & Tape D) Rec. labels: Backstreet, Butterfly, Coral, Infinity, LAX, MCA, Songbird, Source, Vocalion. Tape lines: Same as rec. labels

Malverne Dist's Inc., 35-35 35 St., Long Island City 11106. Tel: 392-5700. Pres.: Jerry Winston; VP: Joe Grippo; Sales Mgr.: Stanley Drayson (Rec. & Tape D) Branch: Boston, Mass., Malverne Dist's Inc. of Boston. Rec. labels: APA, AVI, Abet, Alston, Artist House, Biograph, Blue Candle, Cat, Century, Channel, Chrysalis, Cloud, Concord Jazz, Creed, Crescent, Dash, Drive, Excello, Fantasy, GRT, Galaxy, Glade, Gryphon, Hob, Janus, Juana, Kayvette, Kenwood, Konduko, LRC, Light, Malaco, Mankind, Marlin, Milestone, Muse, Mushroom, Myrrh, Nashboro, Ovation, Penthouse, Prelude, Prestige, Prism, Pyramid, Ranwood, Red Star, Riverside, Roulette, Savoy, Shadybrook, Shield Signature, Silver Blue, Specialty, Stax, Strawberry, Sunshine Sound, TK, Talisman, Weird World, Wolf, Word, Zebra. Tape lines: AVI, Alston, Cat, Chrysalis, Creed, Excello, Fantasy, Glade, Marlin, Milestone, Nashboro, Prestige, Pyramid, Roulette, Savoy, Specialty, TK. (SEE ADVERTISEMENT)

Merchants Music Ltd., Time & Life Bldg., Rockefeller Center. Zip: 10020. Tel: 757-6800. Pres. Lanny Lee, VP & Gen. Mgr.: Linda Tarter; Buyer: Jerry Silver. (Rec. & Tape D, RJ, I & E) Distributes cut-outs, auction close-outs, TV recs., premiums.

Met Richmond Latin Rec. Racks, 1637 Utica Ave., Brooklyn 11234. Tel: 253-4600. Owner: D. Last; Mgr.: Albito Velez. Buyers: Singles, B. Cohen, Albums, Don Erlichman; Tape, Eolides Corniel (Rec. & Tape RJ), (Rec. & Tape E as Met Richmond Latin Rec. Sales) (SEE ADVERTISEMENT)

Met Richmond Latin Rec. Sales (Rec. & Tape E)—Mgr.: Bob Stack—see Met Richmond Latin Rec. Racks

Music Streams Inc., 161 W. 54 St., Suite 1401, Zip: 10019. Tel: 247-5670. Pres.: Jean-Louis Tersiguel, Sec'y-Treas.: Victor W. O'Gilvie, Sales Mgr.: Andy Simonds. (Rec. I) (SEE ADVERTISEMENT)

N M C Corp., 1290 Ave. of the Americas. Zip: 10019. Tel: 765-1530. Bd. Chm.: Jesse Selter, Exec. VP: Maxwell Friedberg (Rec. & Tape D) Distributes overstocks & surplus.

New Music Dist'n Serv. (div. of Jazz Composer's Orchestra Ass'n), 500 Broadway, 4th fl. Zip: 10012. Tel: 925-2121. Mgr.: Anton Fier, Sales: James Eigo, Taylor Storer, Spencer Richards; Promo: Kip Hanrahan. (Rec. D & E) Labels: AKBA, Aardwoof, Adelphi, Advance, Advent, Aesthetic Research Center, Airborne, Allen Hauser, All Seasons, Altsax, Ananda, Andrew's Music, Anima, Arewea, Arise, Asha, Atman, Auricle, Avon Hill, Baker Street Studios, Badger, Baobab, Beep, Bent, BetCar, Beija, Birth, Birdseye, CJR, Capra, Carousel, Chatham Square, Concept, Cornpride, CP, CRI, CSP, Creative Consciousness, Crosswind, Dagget, Divine, Dogtown, EPI, Earth Forms, Earthquack, Eucalyptus, FKT, Finnadar, Folkways, Fourth Stream, Frammis, GTW, Gallery Eds., Grenadilla, Hat Hut, Hoppo, Hugo's Music, IPS, Ibedon, Idibib, Independent India Navigation, JCOA, J. Jasmine, Joe's Smashing, Kabell, Kolimama, Kwela, Line, Lovely Music, Meridian, Metalanguage, Minn, Mission, Morning Sky, Mozown, Muntu, Music Gallery, Music Language, Mustevic, NYAC, Nascent, Nessa, New Frontiers, New Jazz, Nine Winds, Nocturne, Oceanic, Omnisound, Onari, One Ten, Opus One, Otic, Outcat, Parachute, Passin Thru, Performance Philly Jazz, Polaris, Progressive, Pyramid, RE, Riph, Random Radar, Reality Unit Concepts, Re-Entry, SRP, Sackville, Sahara, 1750 Arch, Shi Shi Wu Ai, Somnath, Sonory, Sonus, Soundmasters, Spitalball, Survival, Sweet Earth, Tea, Testament, 360 Music, Titanic, Twa, Trans Music, Transonic, Tribe, Trident, Trutone, Twin Quests, Unanimous Anonymous, Universal Justice, WATI, Wizard, Wranibou, Zoot

Olympia Rec. Int'l Inc., 239 W. 18 St. Zip: 10011. Tel: 989-7200. (Rec. & Tape D), (Rec. & Tape RJ as Arovox Rec. Corp.) Rec. labels: Capitol, Columbia, Disneyland, Goldin, Keith Aurora, MCA, MGM, Pickwick, Polydor, RCA, United Artists. Tape lines: Capitol, Columbia, Disneyland, Dot, Liberty, MCA, Pickwick, RCA, United Artists. Accessories: Le-Bo.

MUSIC STREAMS INC.

One of the Largest Selections of imports available, including:

- Rock • Jazz • Pop • French Folk
- Progressive European
- French Singers
- 7" & 12" Product
- Color Vinyl and Picture Discs

IMPORT RECORDS AT DOMESTIC PRICES

Services Include:

- Free of Discounted Delivery
- Low, Competitive, Flexible Pricing
- Liberal Return Policy • Fast Reliable Service

For free catalog (specify category) write or call (collect) 212-247-5870
161 W. 54th St. (Suite 1401) N.Y., N.Y. 10019 • (212) 247-5670 • Telex: 237906-MSI

ATTENTION!!!

ALL RECORD DEALERS EVERYWHERE!

WE ARE HERE 365 DAYS A YEAR TO SERVE YOU—BY PHONE, TELEX OR IN PERSON

9:00 AM to 9:00 PM Daily & Sat.
11:00 AM to 8:00 PM Sunday & Holidays

We have been in this business for over 30 years.

NO ONE IN THE WORLD CAN MATCH OUR INVENTORY . . . WE HAVE EVERYTHING—ALL THE TIME—INCLUDING ALL MAJOR and OVER 1,000 DIFFERENT MINOR LABELS.

IF YOU DON'T KNOW ABOUT US, IT'S TIME YOU DID!

Come see for yourself. We don't have specials and you don't have to buy any quantity ever. We have the lowest overall prices in the industry every day of the year.

WE WILL NOT BE UNDERSOLD

6.98 list LP/Tape	\$4.00	ea.	7.98 list LP/Tape	\$4.60	ea.	8.98 list LP/Tape	\$5.25	ea.
-------------------------	---------------	-----	-------------------------	---------------	-----	-------------------------	---------------	-----

ALL \$7.98 TAPES—\$4.50 EACH
SINGLES—65¢ EACH

(Prices are for all domestic records & tapes)

WE SHIP ANYWHERE IN THE WORLD.

All prices FOB, New York
\$100 Minimum order shipped



KING KAROL "New York's #1 One-Stop"
126 West 42nd Street
(Between Broadway and 6th Ave.) New York, N.Y. 10036
212/354-7684
Telex: 236601

TAPE KING INC.

220 West 19th St., N.Y., NY 10011
(212) 675-0800 • Telex: 237-891

*America's
Fastest Growing
One Stop Exporting
to all Countries*

TOLL FREE NUMBER
800-221-7938 (Outside New York State)

*Check our monthly specials in Billboard
and come see us
when you are in New York.*

Orders Shipped Same Day

We Catalog All Labels on LP's and Tapes

Minimum Orders are \$50 (CASH, COD or CERTIFIED CHECK only)



EXPORT ONLY

ARE YOU AN OVERSEAS RECORD & TAPE BUYER LOOKING FOR:

1. CLOSEOUT RECORDS & TAPES?
• Largest Assortment, Low, Low Prices.
2. NEW & CURRENT RELEASES — ALL LABELS?
• Fast Service, Competitive Prices.
3. RECORD & TAPE ACCESSORIES & VIDEO CASSETTES?
• Largest and Most Complete Selection.
4. HIGH FIDELITY, DISCOTHEQUE & VIDEO EQUIPMENT?

If so, communicate immediately with a firm that has been serving the overseas record, tape and high fidelity markets FOR 33 YEARS

ALBERT SCHULTZ, INC.

116 West 14th Street, New York, N.Y. 10011 USA
(212) 924-1122/Cable: ALBYREP New York/Telex: 236569 (ALBY UR)

Otoaso Recs. Co. Int'l Ltd., 214 W. 96 St. Zip: 10025. Tel: 866-2469. Owner: L.R. Bernard. Mgr.: D. Vera. (Rec. & Tape I & E). (Rec. & Tape D) Distribuidora Nacional de Discos de New York.

Rec. labels imported: Gransa (Ecuador), Onix (Ecuador), RCA (Brazil), Sonolux (Colombia).

Tape lines imported: Same as rec. labels.

Peters Int'l Inc., 619 W. 54 St. Zip: 10019. Tel: 246-2400. Cable: PETERSRECS. Telex: 666262. Pres.: Chris Peters; Exec. VP: James N. Bailey; VP: Chris Peters Jr.; Mktg. Dir.: Pierre Bourdain. (Rec. D & I, Tape I) Labels: Arion, Aris, Berlitz, Cosmos, Kronos, New World, Peters Int'l, West 54.

Labels imported: Arion (France), Ariston (Italy), Barclay (France), CBS Int'l, CGD (Italy), EMI Int'l, Fonit Cetra (Italy), IPG (France), Minos Matsas (Greece), Music Box (Greece), Opus (Czechoslovakia), Phonogram Int'l, Polydor Int'l, RCA Int'l, Turicophon group.

PolyGram Dist'n Inc., 810 Seventh Ave. Zip: 10019. Tel: 399-7100. Pres.: John Frisoli; VP Sales: Jack Kiernan; VP Opns.: Bert Franzblau; VP Finance: Bob Cappiello; VP Planning: Jules Abramson; VP Mktg. Development: Jon Preisinger; Nat'l Singles Dir.: Rick Bleiweiss; Nat'l Mdsq. Mgr.: Rob Singer; Sales Admin. Dir.: Sterling Devers. (Nat'l office). Local dist'n branch: 15 Columbus Circle. Zip: 10023. Tel: 399-7461. Reg'l VP: Ed Jarman; Branch Mgr.: Shelly Rudin; Sales Mgr.: Jeff Brody. (Rec. & Tape D)

Distribution & sales branches: Los Angeles, San Francisco, Calif.; Denver, Colo.; Miami, Fla.; Atlanta, Ga.; Schiller Park (Chicago Metropolitan Area), Ill.; Greenbelt, Md.; Woburn (Boston Metropolitan Area), Mass.; Troy (Detroit Metropolitan Area), Mich.; St. Louis, Mo.; Cherry Hill, N.J.; Lakewood (Cleveland Metropolitan Area), Ohio; Dallas, Houston, Tex.; Seattle, Wash. Depots: Sun Valley (Los Angeles Metropolitan Area), Calif.; Indianapolis, Ind.; Edison, N.J.

Rec. labels: American Int'l, Archiv, Capricorn, Casablanca, Charisma, Chocolate City, DJM, De-Lite, Deutsche Grammophon, Emarcy, Festivo, Fontana, Lilmelght, MGM, Mercury, Monument, Oasis, Parachute, Philips, Polydor, Polydor/BGO, Polydor/Harem, Polydor/Kolob, Polydor/MVP, Polydor/Manken, Privilege, RSO, RSO/Curtom, Riva, Smash, Soundstage Seven, Spring, Vertigo, Verve, Zappa.

Tape lines: Same as rec. labels.

Procanyn's Polka Palace, 40-22 61 St., Woodside 11377. Tel: 898-9346. Owner & Buyer: Walter Procanyn. (Rec. & Tape D)

Rec. labels: Amigo, Bayway, Bel-Aire, Chicago, Crystal-Tone, Cuca, Delta Int'l, Dyno, Eastwood Int'l Artists, Eurotone, Fantastic, Fiesta, Garden State, Goodwill, IRM, International Artists, Jay Jay, Le Mans, Maxim, Monitor, Polka-Tone, Rave, Request, Rex, Ridge, Rim, Sound, Stamco, Starr, Stejlo, Stella, Studio 5, Trifon, Tip, Tric, Usana, V, Wam.

Tape lines: Bel-Aire, Chicago, Crystal-Tone, Delta Int'l, Dyno, Eastwood Int'l Artists, Eurotone, Fiesta, Goodwill, IRM, Jay Jay, Le Mans, Monitor, Polka, Polka-Tone, Rave, Request, Rex, Ridge, Rim, Sound, Starr, Stejlo, Stella, Usana, V.

Qualiton Recs. Ltd., 39-28 Crescent St., Long Island City 11101. Tel: 937-8515. Owners: Otto & Judith Quittner; Pres.: Otto Quittner; Sales Mgr.: George Volkening; Albums & Tape Buyer: Judith Quittner. (Rec. & Tape D & I)

Labels imported: Aurora (UK), BIS (Sweden), Heritage (UK), Hungaroton (Hungary), Legend (UK), Panton (Czechoslovakia), Pearl (UK), Pepita (Hungary), Prelude (UK), Qualiton (Hungary), Royale (UK), Supraphon (Czechoslovakia), Symphonica (UK).

Tape lines imported: Aurora (UK), Hungaroton (Hungary), Supraphon (Czechoslovakia).

RCA & A&M & Assoc'd Labels, 529 Fifth Ave. Zip: 10017. Tel: 598-4276. Reg'l Sales Dir.: Bill Reilly; Branch Sales Mgr.: Steve Rifici; Sales Mgr.: Mary Beth Connors. (Rec. & Tape D)

Rec. labels: A&M, Bluebird, Free Flight, Gold Seal, Grunt, Hologram, Millennium, NY Int'l, Pablo, Pablo Live, Pure Gold, RCA, Red Seal, Roadshow, Rocket, Salsoul, Solar, Tortoise, 20th Century, Victrola, Windsong.

Tape lines: Same as rec. labels.

R & J Recs. Inc., 108 Sherman Ave. Zip: 10034. Tel: 942-8185. (Rec. & Tape D & OS)

Labels: Alegre, Coco, Cotique, Exitos, Fania, Inca, TR, Tico, Vaya.

Rashid Sales Co., 191 Atlantic Ave., Brooklyn 11201. Tel: 852-3295. Owners: Albert, Raymond & Stanley Rashid; Mgr. & Buyer: Stanley Rashid. (Rec. OS, Rec. & Tape I)

Labels imported: Cairophone, EMI (Arabic prod.), Parlophone, Regal Arabic, Sono Cairo, Sout el Phan, Voice of Lebanon.

Raven Rec. Exports Inc., 147-45 182 St., Jamaica 11413. Tel: 995-9200. Telex: 668694. VP: Brien Fletcher. (Rec. & Tape E), (Rec. & Tape I as Important Rec. Dists.) (SEE ADVERTISEMENT)

Raymar Sales Co., 170-21 Jamaica Ave., Jamaica 11432. Tel: 658-4012. Owner & Buyer: Samuel Keenholz; Gen. Mgr. & Buyer: Hal Kaufman. (Rec. & Tape OS, RJ & E).

Recorded Auditory Materials Inc., 160 W. 46 St. Zip: 10036. Tel: 765-2585. Mgr.: Rose Saggio. (Rec. & Tape D, OS & I)

Labels: AA, Acordia, Adelphi, Advance, Adevkian, Advent, Ajax, Alligator, Alshire, American Albums & Tape, Apollo, Apon, Arhoolie, Artist Direct, Audio Book, Audio Fidelity, Audiophile, Avant, Avant Garde, BJR, Bartok, Bay, Belwin Mills, Berlitz, Bert & J, Biography, Blue Goose, Blue Labor, Bornand, CMS, Caedmon, Cambridge, Canyon, Catalyst, Cayre, Chiaroscuro, Citadel, Colonial Williamsburg, Columbia Special Servs., Composer's Rec'g, Concordia, Connoisseur Society, Consortium, Conversa-Phone, Cook Lab, Cornell Bands, Cornell Bird Songs, Coronet, Country, Crystal, Curtain Calls, Daffodil, Dance, Delmark, Delos, Delphi, Desto, Dictation Disc, Dover, Droll Yankee, Duke University, Dyer-Bennet, Eastman Rochester, Educational Media Ass'n, Educo, Elay, Elysee, Entr'acte, ESP, Epsilon, Everest,

Fairmont, Fat Cat's Jazz, Flicker, Fidelity Sound Rec'gs, Fiesta, Flyright, Folk Dancer, Folk-Legacy, Folkways, GIA, GRC, Genesis, Dan Gibson, Gloria, GNP Crescendo, GRC, Golden Crest, Golden Era, Gregorian, Grenadilla Society, Guirak, Halcyon, Harvard University Band, Harvard University Press, Haydn Society, Hctor, Historical, Houghton Mifflin, Howard Int'l, Hula, ILS, Indian House, Inner City, International Piano Archives, International Rec. Inds., JCOA, Jazz Archives, Joel Finna, Joyce, Kaleidophone, Kanawha, Key, Kilmarnock, Klavier, Kon-Kai, LIRS, Laurel, Lava Mountain, Legend, Limited Editions, Link, Living Language, Louisville, Lyricord, MJR, MMO, MRF, Mace, Mainstream, Major, Mar-Bren, Mark Educational, Mark 56, Master Jazz, Merry Makers, Mister Rogers, Mobile Fidelity, Monitor, Monmouth-Evergreen, Motivation, Murmil, Murray Hill, Musical Heritage, Music Library, Heritage, Muskadine, Nashboro, New Black Eagle, OASI, Oasis, Oblivion, Ogun, Olympic, Operatic Archives, Orion, Oryx, Outlet, Ovation, Owl, Pacific, Pacific Cascade, Painted Smiles, Peter Pan, Philo, Phoenix Jazz, Pickwick, Piper, Playhouse, Pleiades, Poseidon, Project 3, Radiola, Rebel, Red Onion, Redwood, Request, Ridgewood, Robin Hood, Rococo, Roper, Rounder, Rural Rhythm, S&R, Saga Jazz, Scandinavian, Scholastic, Selva, Serenus, Sesame Street, Sheffield, Sine Qua Non, Small World, Sounds, Specialty, Speech Phone, Spivey, Spoken Arts, Spoken Language Serv., Spoken Word, Springboard, Standard Colonial, Stanyon, Stash, Steno Disc, Sinson, Stoneway, Sun, Sunbeam, Takoma, Tempo, Tikva, Trip, Tulip, Unique Opera, Vanguard, Vocab, Waikiki, Westminster, Wicks Organs, Wim, Xanadu, Young People's Recs., Yazoo, Zim.

Record Haven, 636 11 Ave. Zip: 10036. Tel: 247-5900. Telex: 666754 Haven. Owners: Sam & Len Fichtelberg. Gen. Mgr.: Paul Freund, Buyer: Bill Moss, Sales Mgr. Gary Hall; Export Div. Mgr. Alex Neel (Rec. & Tape OS, I & E) (SEE ADVERTISEMENT)

Record People, 66 Greene St. Zip: 10012. Tel: 226-7388. Telex: 425233 Amex UI. Owner: Robert Friedman. (Rec. D)

Labels: Adelphi, Advent, Aeco, Airborne, Aircheck, Ajax, Alligator, Archive of Folk, Archive of Jazz, Archive of Piano, Arhoolie, Aries, Asch, Asha, Audiophile, Auricle, Aviva, Baron, Barrelhouse, Bay, Beehive, Beet, BetCar, Big Band Int'l, Biograph, Biscuit City, Blackbird, Blind Pig, Blue Angel Jazz Club, Blue Goose, Blue Labor, Blues Classics, Bomp, Briar, Broadway, Bullfrog, CMH, Caedmon, Car, Catalyst, Catamount, Center, Cetra, Citadel, Classical Excellence, Classic Int'l, Filmusicals, Comedie Francaise, Concert Disc, Contemporary, Copacabana, Corinthian, Counterpoint/Eoteric, Country Turtle, County, Cowboy Carl, Crazy Cajun, Creative Worlds, Crown, Curtain Calls, DRG, Dawn Club, Delmark, Demand, Dobre, Dream Dancer, Dream Street, East Coast, Entr' Acte, Epitaph, Eubie Blake, Euphoria, Everest, Excalibur, Experiences Anonymes, Family Owl, Fanfare, Finite, Firesign, First Heard, Flying Crow, Flying Fish, Flying High, Folk Legacy, Folk Lyric, Folkways, Fourth Wall, Fretless, Front Hall, GHB, GNP Crescendo, Giants of Jazz, Glendale, Golden Age, Golden Era, Golden Legends, Grassound, Green Linnet, Gusto, HDS, HP Music, Halcyon, Herwin, Hidden Meaning, Hollywood Sound Stage, Honey Dew, Hugo's Music, IPS, Improvising Artists, Inagua, Incheconin, India Navigation, Jazz Archives, Jazz Classics, Jazz Guild, Jazzology, Jennie, Joliet, Joyce, Juke Joint, Jump, June Appal, Kaleidoscope, Kharma, Kicking Mule, King, Labor, Legacy, Legends, Le Roi du Blues, Leviathan, Lisa, Lo Ball, Lovely, Lyricord, MF, Mamlish, Marcus Pereira, Mark 56, Medical, Melodeon, Midland, Migraine, Mr. Blues, Monitor, Monmouth Evergreen, Morning Star, Mozown, Mulligan, Muscraft, Music Works, Muskadine, NRG, Natural Organic, Nervus Rex, Nessa, New World, Night Hawk, Northern Lights, O.J.L., Oats, Oblivion, Ogham, Old Homestead, Oldie Blues, Old Timey, Olympic, Omnisound, Onari, Orange Orion, Outrageous, Outstanding, PAUSA, PM, P-Vine, Paredon, Passin' Thru, Payola, Pearl, Period, Philly Jazz, Philo, Philomel, Phoenix, Phonogram, Pious, Plantation, Power Pak, Power Play, Progressive, Pumpkin, RCA (Brazil), RGE, RPE, Radio Archives, Ram, Rambler, Ramblin', Rebel, Red Lightnin', Red Rooster, Retrospect, Revelation, Request, Rhino, Rice, Ridge Runner, Rounder, Route 66, SRI, SRO, SSS, Sackville, Scala, Sefco, Southland, Spokane, Spottite, Stanyon, Starday, Starfire, Starlog, Stash, Stet, Straight Ahead, Strike, String, Studio Seven, Sugar Hill, Sun, Sunbeam, Survival, Sweet Earth, Symposium, Syndicate Chapter, Syntonic Research, Take Home Tunes, Take Two, Taxi, Testament, Texas ReRecord, Third Street, Total Recording, Totem, Tradition, Transatlantic, Trix, Troubador, Two Dozen Plus, Union Pacific, VJ Int'l, Vantage, Varese Int'l, Vetco, Water House, Wines, Wolf, World Jazz, Xanadu, Xtra, Yazoo, Zap.

Record Shack of New York City Inc., 72-02 51 Ave., Woodside 11377. Tel: 899-0200. Telex: 62632. Owner & Pres.: Edward A. Portnoy; VP: Ed Seligman; Mgr.: Gene Fink. (Rec. & Tape OS, I & E)

Branches: Compton (Los Angeles Metropolitan Area), Calif.; Record Shack of Los Angeles; Atlanta, Ga.; Record Shack of Atlanta, Mentor (Cleveland Metropolitan Area), Ohio; Record Shack of Cleveland; Dallas, Tex.; Record Shack of Dallas; Rutland, Vt.; Record Shack of New England. Int'l branch: France. U.S. Sounds. (SEE ADVERTISEMENT)

Rego Irish Recs. & Tapes Inc., 84-48 62 Dr., Middle Village 11379. Tel: 476-1847, 275-4991. Owner Paddy Noonan. (Rec. & Tape OS & I)

Labels: El-Roy, Rego, Rego Irish Recs. & Tapes, Tifton Irish Party series, Irish Imports. (SEE ADVERTISEMENT) Release Recs. Inc., 4257 Katonah Ave., Bronx 10470. Tel: 325-6308. Owner: Daniel J. Ryan. (Rec. & Tape I).

215 - TR 8-9591-2-3

WATTS - 800-523-4886

Norm Cooper

WHOLESALE RECORDS AND TAPES

NORMAN D. COOPER INC.
WHOLESALE RECORDS & TAPES

1 WINDING DRIVE
PRESIDENTIAL APTS. COMPLEX
PHILA., PA. 19131

WE ARE THE LARGEST & MOST COMPLETE ONE-STOP
SPECIALIZING IN OLDIES BUT GOODIES IN THE USA

- Special Attention To Large Orders
- Same Day Service
- Full Satisfaction
- Complete Fill
- Fast Dependable Service
- Wholesale Only



Write today for our **FREE** catalog

PARAMOUNT RECORDS, INC.

81 Sheer Plaza, Plainview, N.Y. 11803
Dept. HS • (516) 249-1990

*overstock
& cutouts
at*

**ONE
WAY**



**'CRUISING INTO THE EIGHTIES
AT THE SPEED OF MUSIC!'**



ONE WAY RECORDS
12 COMMERCIAL RD./ALBANY, N.Y. 12205
PHONE 518-489-3288/TELEX NO. 145499

Rec. labels imported: ARA, Claddagh, Dolphin, Gael Linn, Hawk, Mulligan, Outlet, Polydor, Release (all Ireland).

Tape lines imported: Same as rec. labels.

Alex S. Roberts Assocs. Inc., 35 Blecker St. Zip: 10012. Tel: 533-3840. Pres.: Edward B. Thom. (Rec. & Tape E) (SEE ADVERTISEMENT)

Henry Rosenberg Co., New York Sheraton Hotel, 870 Seventh Ave., Suite 348. Zip: 10019. Tel: 541-5350. Pres.: Henry Rosenberg; Prod. Control: Ralph Smith. (Rec. & Tape D, I & E)

Distributes close-outs, surplus tape lines, cutouts, over-stock.

S M G Dist. Inc., 46-50 54 Ave., Maspeth 11378. Tel: 937-7200. VP's: Barry Goody, Sam Stolon, Bob Menashe. Buyers: Steven Sturm, David Deutsch. (Rec. & Tape D). (Rec. & Tape I & E as Sam Goody Int'l Inc.) Distributes: cut-outs & over-runs.

Albert Schultz Inc., 116 W. 14 St. Zip: 10011. Tel: 924-1122. Cable: ALBYREP. Telex: 236569. Pres.: Albert Schultz, Mgr.: Jorge Alban; Buyer: Ricardo Leon. (Rec. & Tape E)

Exports all current & cut-out rec. & tape labels, accessories, blank loaded tape, tape supplies for mfrs. of cassette & cartridges, high fidelity equip., blank & pre-recorded videocassettes. (SEE ADVERTISEMENT)

Sight & Sound, 20 W. 22 St. Zip: 10010. Tel: 989-6615. Owner: Robin Imandt. (Rec. D)

Labels: ARS Pro Femina, Bloodleaf, Cassandra, Deep River, Dream Machine, Galaxia, Gemini Hall, Lima Bean, Olivia, Open Door, Pacific Cascade, Paredon, Pleiades, Redwood, Schnarf, Sea Friends, Sea Wave, Sister Sun, Stash, Submaureen, Thunderbird, Urana, Windbag.

M. Sluis Co. Inc., 15 Park Row. Zip: 10038. Tel: 349-0590. Cable: CINAECO. Telex: 223068 (RCA), 667670 (WU). Pres.: M. Sluis; VP: H. Elion; Mgr.: Ms. M. Zylber. (Rec. & Tape E)

Exports all rec. labels, tape lines, blank tape, close-outs & stock lots. (SEE ADVERTISEMENT)

David Sternberg Int'l Sales Inc., 221-20 147 Ave., Jamaica 11413. Tel: 525-6747. Telex: 425129. Pres.: Helmut Marcuse. (Rec. E)

Stratford Dist. Inc., 184-23 Jamaica Ave., Hollis 11423. Tel: 454-8800. Telex: 427324. Pres.: Nathan Kaplan; Buyers: Irving & Allen Silverman. (Rec. & Tape OS, RJ, I & E)

Sunshine Rec. Dist., 710 12 Ave. Zip: 10019. Tel: 265-3530. Owner: Howard Rumack; Mgr.: Pat Monaco. (Rec. D)

Labels: Ameraba, Audio Fidelity, Big Sounds, Chiaroscuro, Dance Disk, Discovery, Electric Cat, Eric, GNP Disco, ICA, Improv, JDC, JRC, Jewel, Kick, LA, Little Darlin', Paula, Ralph, Ramparts, Red Greg, Ronn, Sandcastle, Spire, TEC, Trend, Vesper, West End, Will Power.

Superior Rec. Dist. (Rec. I & E, Tape E), see Win Recs. Inc.

T S Recs. & Tapes, 666 10 Ave. Zip: 10036. Tel: 541-4770. (Rec. & Tape D, OS, I & E)

Home office: San Antonio, Tex., Marsal Prod'ns. Labels: Bernal, Del Rio, Del Topo, Dominante, Magda, Marsal, Son Int'l, Super Mex, West Mex.

Tape King Inc., 220 W. 19 St. Zip: 10011. Tel: 675-0800. Telex: 237891. Owner: Joseph Abady; Mgr.: David Abady; Buyers: Singles, David Abady, David Lubin; Albums, Joseph & David Abady, Claudia Huddleston, David Lubin, Tape, David Abady. (Rec. & Tape OS & E). (SEE ADVERTISEMENT)

Titan United Corp., 25 W. 43 St. Zip: 10036. Tel: 354-5005. (Rec. & Tape D—military sales only)

Town Hall Recs., 9131 Bedell Ln., Brooklyn 11236. Tel: 272-9702. Owner: Ben Reminick; Mgr.: Julius Reminick; Buyers: Singles, Mike Smokeler; Albums, Joe Tortorelli; Tape, Hattie Wilson. (Rec. & Tape OS & E) (SEE ADVERTISEMENT)

Unique Recs., 221-20 147 Ave., Jamaica 11413. Tel: 525-6747. Telex: 425129. Owner: Art Zimmerman. (Rec. E)

Warmid Inc., 200 Hudson St., 12th fl. Zip: 10013. Tel: 541-4490. Telex: 236941. Pres.: William Medeot; Mgr.: Christian Geldreich. (Rec. & Tape E) (SEE ADVERTISEMENT)

Warner/Elektra/Atlantic Corp., 75 Rockefeller Plaza. Zip: 10019. Tel: 484-8580. Mgr.: Bruce Tesman. (Rec. & Tape D)

Rec. labels: Asylum, Atco, Atlantic, Bearsville, Beserkley, Big Tree, Cotillion, Curtom, Dark Horse, Disc-Reet, ECM, Elektra, Embryo, Famous Charisma, Finnadar, Little David, Loma, Manticore, Nemperor, Nonesuch, Pacific, Paradise, Reprise, Rolling Stones, Slipped Disc, SHE, Sire, Swan Song, WMOT, Warner Bros., Warner/Curb, Warner Spector, Westbound, Whitfield, Wing & a Prayer, Zephyr.

Tape lines: Same as rec. labels.

West Side Sound Dist. Inc., 693 10 Ave. Zip: 10036. Tel: 586-2710. Pres.: Arturo J. Saiz; Gen. Mgr.: Hector Varona. (Rec. & Tape D)

Labels: Raiz, WS Latino, West Side.

Win Recs. Inc., 41-43 39 St., Long Island City 11104. Tel: 786-7667. Owner & Pres.: Sam Weiss; VP, Mgr. & Buyer: George Weiss. (Rec. & Tape, OS & RJ). (Rec. I & E, Tape E as Superior Rec. Dist.)

Accessories: Amberg, Le-Bo, Recoton. (SEE ADVERTISEMENT)

Worldtone Music Inc., 230 Seventh Ave. Zip: 10011. Tel: 691-1934. Pres.: Kenneth Spear. (Rec. & Tape D, I & E)

Labels: Hadarim, MIH, Worldtone.

Labels imported: Amiga (East Germany), Balkanton (Bulgaria), Chant du Monde (France), Electrecord (Romania), Eterna (East Germany), Finnlevy (Finland), Nova (East Germany), Swedish Society Discofil (Sweden), Telestar (Sweden).

Worldwide Music Dist., 1966 Broadway. Zip: 10023. Tel: 724-4212. Pres.: Eric Fletcher. (Rec. I)

Labels imported: Abbey (UK), GFH (UK), Guild (UK), Tactus (UK), Viking (UK).

Zemeron Trading Inc., 114 E. 25 St. Zip: 10010. Tel: 673-

2430. Owner: M. Kagen; Gen. Mgr. & Buyer: Hanna Bolick. (Rec. & Tape D & I).

Labels: Gal-Ton, Hed Arzi, Isradisc. (Israeli prod.).

• **NYACK (Area Code 914)**
Knickerbocker Music Co., 101 Gedney St. Zip: 10960. Tel: 358-5086. Owner: Harry Warriner. (Rec. & Tape D) Distributes cut-outs, premiums.

• **PLAINVIEW (Area Code 516)**
Paramount Recs. Inc., 81 Sheen Plaza. Zip: 11803. Tel: 249-1990. Owner: Herb Shenkman. Mgr. & Buyer: Andrew Shenkman. (Rec. OS, RJ & E) (SEE ADVERTISEMENT)

• **POUGHKEEPSIE (Area Code 914)**
Toy House of Hudson Valley (div. of Kustas Bros. Inc.), Manchester Rd. Zip: 12603. Tel: 471-2740. Pres. & Mgr.: Louis J. Kustas. (Rec. OS & RJ; Tape D, OS & RJ) Tape lines: Fiesta, GRT, Pickwick. Accessories: Hagerstown, Le-Bo, Recoton.

• **ROCHESTER AREA (Area Code 716)**
House of Guitars Inc., 645 Titus Ave. Zip: 14617. Tel: 544-3500. Owner: Armand Schaubroek; Mgrs.: Jim Degman, John Fritch; Buyers: Singles, Mike Snowcone; Albums, Jim Degman. Local branch: 1 Grange Pl., Irondequoit 14617. Tel: 266-9584. (Rec. RJ & E). (Rec. D & OS as Kack Klick Inc.). (Rec. & Tape I & E as Mirror Inc.)

Labels: Blank, CBS/Sony (Japan), Capitol (France), GRT (Canada), House of Guitars, Mirror, Ozark, Polydor (Canada), Ralph, Sky Dog (France), Stiff (UK).
Phonographs: Craig, Kenwood, Sony
Accessories: Memorex, RCA, Sony, Sound Guard, TDK.

Kack Klick Inc. (Rec. D & OS)—D Mgr.: Bruce Schaubroek; OS Mgr.: Kim Simons; Buyers: D Singles, Greg Prevost; OS Singles, Mike Snowcone, Albums, Kim Simons—see House of Guitars Inc.

Mirror Inc. (Rec. & Tape I & E)—Owner E)—Owner & Mgr.: Bruce Schaubroek—see House of Guitars Inc.

Rochester One Stop (div. of Transcontinent Rec. Sales), 3047 W. Henrietta Rd. Zip: 14623. Tel: 454-6968. Mgr. & Buyer: Bob Sligar. (Rec. & Tape OS & RJ) Home office: Buffalo, N.Y., Transcontinent Rec. Sales (Rec. & Tape RJ)

• **RONKONKOMA (Area Code 516)**
Artie Lewis Ent. Inc., 59 Remington Blvd. Zip: 11779. Tel: 981-5111. Pres.: Artie Lewis; VP: Itta Lewis; Sales Mgr.: Nelson Arce. (Rec. & Tape D & RJ) Distributes cut-outs, overstocks.

• **SYOSSET (Area Code 516)**
Larry Sockell Inc., 100 Colony Ln. Zip: 11791. Tel: 921-2821. Owner, Mgr. & Buyer: Larry Sockell. (Rec. & Tape sales rep.)

Record Stores!

• AUSTRALIAN, EUROPEAN JAPANESE and U.K. IMPORTS

• The best in U.S. New Wave and Rock Independently-produced Discs.

• Pre-recorded and blank Videocassettes — Rock, Feature, Horror, Sci-Fi, Classic, and many more!

• We also have an Excellent Export Service!

• CONSTANTLY UPDATED CATALOGUE

• FAST SERVICE • LOW PRICES

Stores and Distributors Only
(We do not sell Retail)

the other
import
people...

DISC TRADING COMPANY
POST OFFICE BOX 1988B
DURHAM, N.C. 27702 USA
Telephone: 919/682-9607
tix: 579337

Rec. labels: Aries, Ashgar Int'l, Bandstand, Brasilia, Bruno Walter Soc., Composer's Rec'gs Inc., Converse-Phone, Crystal, Everest, Folkways, GNP Crescendo, Givelo imports, Golden Era, Klavier, Louisville Symp., Lyricord, Monitor, Monmouth-Evergreen, Olympic, Poseidon, Radiola, Sheffield Lab, Town Hall.
Tape lines: Brasilia, Converse-Phone, Everest, Folkways, GNP Crescendo, Givelo imports, Monitor.

● **SYRACUSE (Area Code 315)**

Mage Serv. Mdsq. Inc., 112 Ronnell Dr. Zip: 13219. Tel: 488-2512. Pres.: Mathew Orlando; Buyer: Gerry Orlando. (Rec. & Tape OS & RJ)
Morris Dist'g Co. Inc., 1153 W. Fayette St. Zip: 13201. Tel: 475-6531. Mgr. & Buyer: Marcia Jakubowski. (Rec. & Tape D & OS)
Rec. labels: Pickwick, RCA, Vox.
Tape lines: GRT, RCA.
Accessories: Blank tape (Memorex, Scotch), carrying cases (Le-Bo), rec. care prods. (Recotone, Watts), sleeves.
Syracuse One Stop (div. of Transcontinent Rec. Sales), 333 W. Fayette St. Zip: 13202. Tel: 476-4019. Mgr. & Buyer: Jim Dombrowski. (Rec. & Tape OS & RJ)
Home office: Buffalo, N.Y., Transcontinent Rec. Sales. (Rec. & Tape RJ)

● **WANTAGH (Area Code 516)**

Musicanza Corp., 2878 Bayview Ave. Zip: 11793. Tel: 826-2735. Owner, Mgr. & Albums Buyer: Al Rubin. (Rec. & Tape D—children's prod. only)
Labels: CMS, Caedmon, Camden, Disneyland, Disneylandia (Spanish prod.), Folkways, Peter Pan, Pickwick, Sesame Street, Superscope (English, French, Italian, Portuguese & Spanish prod.), Ultra-Sound, Wonderland. Playback equip.: Superscope. (SEE ADVERTISEMENT)

● **WESTBURY (Area Code 516)**

All Rec. Dists. Inc., 44 Bond St. Zip: 11590. Tel: 997-7160. Owners: Charles Nero, Michael Cono; Mgr.: Stan Schneider; Buyers: Singles, Cliff Fenster; Albums, Michael Mangiacapre. (Rec. & Tape OS & E)
Accessories: Blank tape (Capitol Magnetic Music Tape, Memorex, TDK), Le-Bo prods., rec. & tape cases. (SEE ADVERTISEMENT)
Polka Towne Music, 211 Post Ave. Zip: 11590. Tel: 334-6228. Owner: Teresa Zapolska; Buyers: Teresa Zapolska, Paul Pater. (Rec. & Tape D & OS)
Rec. labels: Adena, Alshire, Amerpol, Amigo, Ampol, Ardene, Bayway, Bel-Aire, Chalet, Chicago, Cuca, D, Dana, Days, Dearborn, Delta Int'l, Don-Joe, Dyno, Eastwind Int'l, Elgin, Eurotone, Fantastik, Fiesta, Garden State, Gold, Goral, Halo, Happy Times, IRM, Imperial Sound, JBL, Jay Jay, Jody, K&B, Kay, Kerobo, L-Kay, Le Mans, Li-Dar Studio, Maxim, Melodie, Micro, Monitor, Muza, Polish Song, Polka Towne, Pronit, Rave, Ray, Request, Resound, Rex, Ridge, Ridgemoor, Rim, Rol, Rola, S&S, Select, Silverball, Sound Spectrum, Spolite, Stamco, Starr, Steljo, Stella, Studio 5, Sure, Tifton, Trash, Usana, Veritor, Vicrom, Vista, Warn, Yar.
Tape lines: Ampol, Bel-Aire, Chicago, Delta Int'l, Dyno, Fiesta, Halo, IRM, Jay Jay, Jody, Le Mans, Monitor, Muza, Polish Song, Polka Towne, Rave, Request, Rex, Ridge, Rim, Rola, Sound, Starr, Steljo, Stella, Trash, Usana, Warn.

● **WOODMERE (Area Code 516)**

Leonard Finkel Assocs., PO Box 39. Zip: 11598. Tel: 374-3221. Pres.: Leonard Finkel.
Distributes 45 rpm adaptors, audio cables, blank loaded tape, bulk poly bags, carrying & storage cases, cartridges, headphones, microphones, needles, phonographs, playback equip., sleeves.

NORTH CAROLINA

● **ASHEBORO (Area Code 919)**

Kenway Sales, PO Box 1553. Zip: 27203. Tel: 625-6354. Owner: H. Wayne McDowell. (Rec. & Tape OS & RJ—gospel prod. only)

● **ASHEVILLE (Area Code 704)**

Trackdown Rec. Dists., 235 Pearson Dr. Zip: 28801. (Rec. & Tape D, OS, RJ, I & E)
Home office: Chicago, Ill. (See for prod. distributed)

● **BREVARD (Area Code 704)**

Omega Music Inc., 105 E. Main St. Zip: 28712. Tel: 884-2320. Bus. Mgr. & Buyer: Linda B. Zuch. (Rec. & Tape D, OS & E)
Labels: Alexandria House, Associated, Benson, Broadman, Calvary, Christian Dupl'ns, Christian World, Copeland, Creative Sound, Discovery, Edify, GNP Crescendo, Good Life, Hope, Intersarsity, Lillenas, MCA, Manna, Maranatha, Moody Press, New Life, North American Liturgy, Pacific Press, Pickwick, QCA, Rainbow Sound, Renwood, Regal Press, Riverside, Savoy, Servant, Sing-spiration, Sparrow, Supreme, Tempo, Triune-Triangle, Weston Priory, Word, Word of God, Zondervan.

● **CHARLOTTE (Area Code 704)**

Bib Dist'g Co., 101 Yorkmont Rd. Zip: 28210. Tel: 527-0440. Pres. & Singles Buyer: Joe Voynow; Mgr. & Albums Buyer: Bill Norman. (Rec. & Tape D, OS & RJ)
Labels: Alarm, Alston, Arista, Buddah, CTI, Canaan, Cat, Chimneyville, Cream, Creed, Dash, Drive, Fantasy, GRT, Glade, Gordy, Granite, Gusto, HSE, Heart Warming, Hi, Impulse, Laff, Light, Milestone, Motown, Mushroom, Nashboro, Prodigal, Rare Earth, Savoy, Su-Ann, TK, TMS, Tamla, Tomato, Weird World, Word.
Accessories: Le-Bo, Pageant.
Dixie Tape & Rec. Co., 900 Atandt Ave. Zip: 28206. Tel: 376-0140. Owners: Dewitt & Othel Brown, Tim Bras-

well; Sales Mgr. & Buyer: John Towles. (Rec. & Tape RJ)

General Music Corp., 1720 Toal St. Tel: 377-5623. Zip: 28206. (Rec. & Tape D—budget prod.)
Handleman Co., 11626-F Wilmer Blvd. Zip: 28203. Tel: 372-1845. Mgr.: Larry Roe; Buyers: Larry Roe, Don Ratliff. (Rec. & Tape RJ)
Home office: Clawson (Detroit Metropolitan Area), Mich.

M O R E Music Inc., 7814 Tyner St. Zip: 28213. Tel: 597-1860. Contacts: Charles A. Hartley, H. Grady Brown Jr. (Rec. & Tape RJ)

Warner/Elektra/Atlantic Corp., Bldg. 2, 6101 Idlewild Rd. Zip: 28212. Tel: 568-0482. Mgr.: Roger Helms. (Rec. & Tape D)

Rec. labels: Asylum, Atco, Atlantic, Bearsville, Beserkley, Big Tree, Cotillion, Curtom, Dark Horse, DiscReet, ECM, Elektra, Embryo, Famous Charisma, Finnadar, Little David, Loma, Manticore, Nempetor, Nonesuch, Pacific, Paradise, Reprise, Rolling Stones, SHE, Sire, Slipped Disc, Swan Song, WMDT, Warner Bros., Warner/Curb, Warner Spector, Westbound, Whitfield, Wing & a Prayer, Zephyr.
Tape lines: Same as rec. labels.

● **DURHAM (Area Code 919)**

Disc Trading Co., PO Box 198. Zip: 27702. Tel: 682-9607. Telex: 579337. Pres.: Jim Enright; Mgr.: Chris Moak:

Buyer: Robert O'Reilly. (D, I & E) (SEE ADVERTISEMENT)

● **FAYETTEVILLE (Area Code 919)**

A A Co. Inc., PO Box 5866, 6232 Bragg Blvd. Zip: 28303. Tel: 867-6111. Pres.: Al Metzger. (Rec. & Tape OS & RJ)

● **LAURINBURG (Area Code 919)**

Trackdown Rec. Dists., 318 McClelland St. Zip: 28352. (Rec. D, OS, RJ, I & E)
Home office: Chicago, Ill. (See for prod. distributed)

● **LILLINGTON (Area Code 919)**

Trackdown Rec. Dists., PO Box 993. Zip: 28326. (Rec. D, OS, RJ, I & E)
Home office: Chicago, Ill. (See for prod. distributed)

● **MOUNT AIRY (Area Code 919)**

Stark Recs., 628 South St. Zip: 27030. Tel: 786-2865. Pres.: Paul E. Johnson. (Rec. & Tape OS & RJ)

● **RALEIGH (Area Code 919)**

Trackdown Rec. Dists., 405 E. Martin St. Zip: 27601. (Rec. & Tape D, OS, RJ, I & E)
Home office: Chicago, Ill. (See for prod. distributed)

when it's action you want

CALL ACTION MUSIC

'Cause we are the best in the Midwest. Serving OHIO, WESTERN NEW YORK, WEST VIRGINIA, NORTHERN KENTUCKY, WESTERN PENNSYLVANIA AND MICHIGAN.

ACTION MUSIC

SALES, INC.

6541 EASTLAND ROAD
HAYES INDUSTRIAL PARK
CLEVELAND, OHIO 44142
(216) 243-0300

ONE WAY →

RECORD SERVICE OF OHIO
1801 East 40th Street, Cleveland, Ohio 44103 • (216) 391-9250

CHOOSE FROM A 5 MILLION DOLLAR INVENTORY

Serving the world with
All Titles — All Labels

LP's, Singles, 8 Track and Cassettes

We will not be undersold!

Check our Box Lot Specials for lowest prices!
SAME DAY SERVICE — CALL 216 391-9250

ONE WAY OF NEW JERSEY

← **ONE WAY**

1080 Garden State, Union, New Jersey 07083 • (201) 964-6222

WHOLESALEERS

OHIO

• AKRON AREA (Area Code 216)

Audio Technica US Inc., 33 Shawwassee Ave., Fairlawn 44313. Tel: 836-0246. Pres. & Gen. Mgr.: Jon R. Kelly; VP Mktg.: Fred W. Nichols (Rec. D, I & E) Labels: Telarc.
Labels imported: Gale (UK), RCA/RVC (Japan), Umbrella (Canada).

Lee Hall Prods., 2748 Canfield Rd. Zip: 44312. Tel: 784-8349. Owner: Lee Hall. (Rec. D & RJ; Tape RJ)
Labels: Capitol, Phonogram & Polydor Group, RCA, Word.

Accessories: Capitol, EV Game, Le-Bo
Twelgremm Ent's Inc., 2775 Yellow Creek Rd. Zip: 44313. Tel: 836-5591. Pres.: J. Hugh Macey; Mgr.: Cam Macey; Buyers: Mrs. C. Zavadny (Rec. D & E—dance recs. only)

Rec. labels: Beico, Blue Ribbon, Blue Star, Bogan, CEM, Chicken Fat, Cross Roads, D & ET, D&R, Dance Along, Dance Ranch, Dancetime, E-Z Fun, Elite, FTC, Family Squares, Flutter Wheel, Folkraft, Ghost Town, Gold Star, Greenwood, Grenn, HAT, HMV, Hanf, HiHat, Hctor, J-Bar K, Jewel, Kalox, Kimbo, Lightning S, Lloyd Shaw, Longhorn, Lore, LouMac, Lucky, MacGregor, Magic, Marian, Marko, Mayflower, Mibs, Mustang, National, Old Timer, Parlophone, Pilgrim, Pioneer, Pulse, Rainbow, Red Boot, Rockin' A, Roper, Scope, Sets in Order, Slaviani, Square Dance USA, Square Tunes, Star Dust, Sunny Hills, Swinging Square, TOP, Telemark, Thunderbird, Tikva, Wagon Wheel, Wild West, Windsor, World of Fun, Worldtone.

Photographs: Newcomb.
Accessories: Carrying cases (Grenn, Newcomb); plastic sleeves for 45 rpm's.

• CANTON AREA (Area Code 216)

Praise Rec'gs, PO Box 8080. Zip: 44711. Pres.: J. Maas. (Rec. D)

Labels: Canaan, Diadem, Heart Warming, Impact, Joyous Melodies, Pickwick, Praise, Sacred, Singcord, Sword, Teen, Tot, Word.

Stark Rec. & Tape Serv. Inc., 8000 Freedom Ave. NW, North Canton 44720. Tel: 494-2282. Owner: Paul David; VP & Buyer: Joe Bressi. (Rec. & Tape RJ)

• CINCINNATI AREA (Area Code 513)

Ambat Recs. (div. of Transcontinent Rec. Sales) 2350 Gilbert Ave. Zip: 45206. Tel: 751-5071. VP & Gen. Mgr.: Vernon Hawk; Sales Supervisor: Skip Hawk; OS Mgr. & Singles Buyer: Earl Schaefer; Albums Buyer: Dennis Isaacs; Tape Buyer: Ron Hawk (Rec. & Tape OS & RJ)
Home office: Buffalo, N.Y., Transcontinent Rec. Sales (Rec. & Tape RJ)

C B S Recs., Tri-County Office Park, 1313 E. Kemper Rd., Suite 302. Tel: 671-0310. Branch Mgr.: Chip DeNigris. (Rec. & Tape D)

Rec. labels: Arc, Bang, Blue Sky, CBS, Caribou, Columbia, Epic, Jet, Kirshner, Melodiya/Columbia, Nempereor, Odyssey, Philadelphia Int'l, Portrait, Starfile, Stiff, T-Neck, Tabu, Tappan Zee, Unlimited Gold.
Tape lines: Same as rec. labels.

Halper's One Stop, PO Box 37156. Zip: 45222. Mgr.: Saul Halper.

Handelman Co., 4550 Cornell Rd., Blue Ash 45241. Tel: 891-9633. Mgr.: Bob Prenatt; Buyers: Bob Prenatt, Tom Holwell, Chris Detwiler. (Rec. & Tape RJ)
Home office: Clawson (Detroit Metropolitan Area), Mich.

M C A Dist'g Corp., Atkinson Square, 11750 Chesterdale Rd. Zip: 45246. Tel: 771-4870. Branch Mgr.: Jack Brown. (Rec. & Tape D)

Rec. labels: Backstreet, Butterfly, Coral, Infinity, LAX, MCA, Songbird, Source, Vocalion.
Tape lines: Same as rec. labels.

Mobile Rec. Serv. Co., 5286 E. Kemper Rd. Zip: 45241. Tel: 984-2730. Mgr.: Thomas M. Cross. (Rec. OS—singles only)

Home office: Pittsburgh, Pa.

P & G Rec. Co., 1667 Central Pkwy. Zip: 45214. Tel: 381-2233. Owner: Paul Smith; Mgr.: Byron Russell; Buyers: Singles, Bill Rosenthal; Albums, Byron Russell; Tape, Kirk Stull. (Rec. & Tape OS) (SEE ADVERTISEMENT)

Piks Corp., 3397 Erie Ave. Zip: 45208. (Rec. & Tape D)
Home office: Cleveland, Ohio. (See for prod. distributed)

Progress Rec. Dist'g Inc., 11750 Chesterdale Rd., Bldg. 3, Suite 301. Zip: 45246. Tel: 771-4190. (Rec. & Tape D)

Home office: Highland Heights (Cleveland Metropolitan Area), Ohio.

Labels: Adelphi, Argo, Aspetke, Bomp, CTR, Cime, Cream, Deram, D'harma, Discovery, GRR, Gordy, Hi, Hitsville, JRC, Kris, Kudu, Le Joint, L'Oiseau Lyre, London, Motown, NCI, Natural Resources, Parrot, Prelude, Prodigal, Rare Earth, Richmond, Ross, Sirius, Soul, Tamla, Telefunken, Threshold, Tomato, Venture, Voyage, Xanadu.

Jimmie Skinner Music, 5825 Vine St. Zip: 45216. Tel: 242-8000. Owner: Lou Ukelson; Buyers: Singles, Laurie Ukelson, Albums & Tape, Lou Ukelson. (Rec. & Tape D & E)

Rec. labels: Arhoolie, Atteimar, Birch, Cook, County, Davis, Flying Fish, Gateway, IRMA, Jalyn, Jewel, Jordan, Kanawha, King Bluegrass, Lemco, Log Cabin, Melody, Old Homestead, Old Timey, Outhouse, Pine Tree, Puritan, QCA, Rebel, Reverend, Ridge Runner, Sugar, Takoma, Vetco, Zap.

Tape lines: Atteimar, Cook, Gateway, IRMA, Jalyn, Jewel, Jordan, Kanawha, King Bluegrass, Lemco, Old Homestead, Pine Tree, QCA, Rebel, Takoma, Vetco.

Supreme Dist'g Co. Inc., 1000 Broadway Zip: 45202. Tel: 421-0747. Mgr.: Singles & Albums Buyer: Al Klayman. (Rec. & Tape D)

Rec. labels: APA, Alston, At Home, Audio Fidelity, Big Town, CMH, Cadet, Candide, Chiaroscuro, Chimneyville, Choice, Clouds, County, Creed, Dash, Deep Roots, Discovery, Disneyland, Dobre, Drive, ENJA, Fantasy, Flying Fish, Galaxy, Glades, Gospel Roots, H&L, HSE, J.E. IRDA, Illusion, Image, Improvising Artists, Inner City, Jamie Guyden, Jazz Forum, Juana, Kayvette, Kenwood, Kid Stuff, King Bluegrass, Ko Ko, LRC, Malaco, Marlin, Milestone, Muse, NSD, Nashboro, Nessa, North Texas State Lab, Old Town, Omni Sound, Original Sound, Philo, Plantation, Prestige, Progressive, Project 3, Ray Lawrence, Rebel, Riverside, Rounder, SSS Int'l, Scorpion, Sierra/Briar, Stax, Sun, Sunshine Sound, TK, Takoma, Turnabout, VSBX, Vetco, Vista, Vox, Vox Historical, Weird World.

Tape lines: Same as rec. labels, including GRT catalog.

Accessories: Needles (Fidelitone)
Warner/Elektra/Atlantic Corp., 11750 Chesterdale Rd., Suite 3201. Zip: 45246. Tel: 772-5800. Sales Mgr.: Terry Cox. (Rec. & Tape D)

Rec. labels: Asylum, Atco, Atlantic, Bearsville, Beserkley, Big Tree, Cotillion, Curton, Dark Horse, Disc-Reel, ECM, Elektra, Embryo, Famous Charisma, Fonnadar, Little David, Loma, Manticore, Nempereor, Nonesuch, Pacific, Paradise, Reprise, Rolling Stones, SHE, Sire, Slipped Disc, Swan Song, W.M.O.T., Warner/Bros., Warner/Curb, Warner Spector, Westbound, Whitfield, Wing & a Prayer, Zephyr.
Tape lines: Same as rec. labels.

• CLEVELAND METROPOLITAN AREA (Area Code 216)

Action Music Sales Inc., 6541 Eastland Rd., Hayes Industrial Park. Zip: 44142. Tel: 243-0300. VP & Mgr.: Dennis Baker; Buyer: Clay Pasternack. (Rec. & Tape D)

Rec. labels: APA, AVI, Abet, Abkco, Ala, Alston, Amazon, Ameraba, Amherst, Archives of Jazz, Arth, Ashtrite, At Home, Audio Arts, Audio Fidelity, Audio Int'l, Audio Rarities, Aural Explorer, Bach Guild, Barnaby, Bean, Betlar, Big Sound, Big Town, Birthright, Blue Candle, Blues Spectrum, Bold, CMH, CRA, Canaan, Cardinal, Carnival, Cat, Century, Channel, Chanterelle, Chiaroscuro, Chimneyville, Choice, Churchill, Classic Jazz, Clouds, Coby, Concord Jazz, Contempo, Contemporary, Cook, Corinthian, Creative Works, Creed, Dana, Dash, Dayspring, Dial, Dingo, Disneyland, Dr. Jazz, Dore, Drive, Dyno, Electric Lemon, Era, Ernie's, Everyman, Excello, Fairmont, Fantasy, Fiesta, First Component, First Generation, First Heard, Fona, GMC, GRT, Galaxy, Gateway, Giants of Jazz, GNP, GTR, Gladioli, Glori, Golden, Golden Age, Good News, Good Sounds, Gospel Roots, Gospel Tone, Gospel Truth, Gramophon, Greccophon, Gryphon, Guitar World, Gusto, HDM, Halper, Happy Fox, Harlequin, Image, Impact Imports, Improv, Inner City, Inphasion, Inspirational Sounds, Janus, Jazz Chronicles, Jazz World, Jeremiah, Jewel, Juana, Karate, Kayvette, Kent, Kenwood, King, Konkudo, LRC, Jaff, Lamb & Lion, Laurie, Light, Living Language, Malaco, Mankind, Maranatha, Mark 56, Marlin, Milestone, Mirror, Modern, Muscle Shoals, Mushroom, Myrrh, N.J.P. Nashboro, Newworld, Newpax, New Song, Nostalgia Lane, Original Sound, Outrageous, PM, Pacific Challenger, Paragon, PA-USA, Paula, Penthouse, Plantation, Power Pak, Prestige, Prism, Project 3, RGB, Radiola, Ramblin', Rampart, Reborn, Reeds World, Revelation, Reverence, Riverside, Ronn, Roots, Rounder, SMI, SSS, Sacred, Sandcastle, Sandyhook, Scorpion, Seed, Shadybrook, Shield, Signature, Silver Blue, Solid Rock, Sound Bird, Sound Effects, Sounds, Spire, Stanyon, Starday, Stax, Stone Dogg, Sun, Sunshine Sound, Sunnysvale, Symbiotic Research, TEC, TK, Tazz Jazz, Testament, Thimble, Thunderbird, Vanguard, Varese, Vesper, Vista, Wanderick, West End, Who's Who in Jazz, Weird World, Wicked, Wolf, Word, World Jazz, ZIV, Zebra.

Tape lines: APA, AVI, Abet, Abkco, Ala, Alston, Amherst, Archives of Jazz, Arth, Ashtrite, Audio Arts, Audio Fidelity, Audio Treasury, Blue Candle, Bold, CMH, CRA, Canaan, Cardinal, Cat, Chimneyville, Clouds, Contempo, Creed, Dash, Dayspring, Disneyland, Drive, Ernie's, Everyman, Excello, Fantasy, Fiesta, First Component, GRT catalog, Galaxy, Glades, Glori, Good News, Gospel Roots, Gospel Tone, Gospel Truth, Gryphon, Gusto, HDM, Inspirational Sounds, Jewel, Laff, Lamb & Lion, Light, Living Language, Malaco, Mankind, Marlin, Milestone, Mushroom, Myrrh, Nashboro, Newworld, Newpax, New Song, Nostalgia Lane, Original Sound,

Orion, Paragon, Paula, Penthouse, Plantation, Power Pak, Prestige, Project 3, Radiola, Ronn, Roots, Rounder, SSS, Sandcastle, Seed, Shield, Silver Blue, Solid Rock, Spire, Starday, Stax, Stone Dogg, Sun, Sunshine Sound, TK, Thimble, Vanguard, Vesper, Vista, Wanderick, West End, Wicked, Weird World, Westminster Gold, Wolf, Word.

Accessories: GRT-Design, Maxell, Memorex, Sound Guard. (SEE ADVERTISEMENT)

Arrow Dist'g Co., 23690 Commerce Park, Beachwood 44122. Tel: 464-5095. Pres.: Don Weiss; Gen. Mgr.: J.W. Owens. (RJ)

C B S Recs., Park Center II, Suite 204, 3681 Green Rd., Beachwood 44122. Tel: 464-7020. Branch Mgr.: Rich Kudolla. (Rec. & Tape D)

Rec. labels: Arc, Bang, Blue Sky, CBS, Caribou, Columbia, Epic, Jet, Kirshner, Melodiya/Columbia, Nempereor, Odyssey, Philadelphia Int'l, Portrait, Starfile, Stiff, T-Neck, Tabu, Tappan Zee, Unlimited Gold.

Tape lines: Same as rec. labels.
Capitol Recs., Commerce Place, 7123 Pearl Rd., Suite 105. Tel: 888-8575. (Rec. & Tape D)

Rec. labels: Angel, Ariola America, Capitol, EMI America, Harvest, Liberty, Melodiya/Angel, Seraphim, United Artists.

Tape lines: Same as rec. labels.
Cleveland One Stop Inc., 3628 Prospect Ave. Zip: 44115. Tel: 881-4393. Mgr.: Singles, Albums & Tape Buyer: Charles Young. (Rec. & Tape OS)

Lieberman Ent's Inc., 5613 Cloverleaf Pkwy. Zip: 44125. Tel: 524-9750. Mgr.: Ken Sattler; Opns. Mgr.: John Holman; Buyers: Reg'l, Dusty Bowling; Singles, Linda Perron; Albums, Hugh Washem. (Rec. & Tape RJ)

Home office: Minneapolis, Minn. (Rec. & Tape OS & RJ) (SEE ADVERTISEMENT)

Sherman Lieberman, 5923 Cantwell Dr., Mayfield Heights 44124. Tel: 461-3342. Owner & Mgr.: Sherman Lieberman. (Rec. D)—also represents House Dist's., Kansas City, Mo., see for prod. distributed)

Labels: Alshire, Conversa-Phone, Everest, Qualitone imports, Telarc.

Accessories: Fidelitone, Savoy.

M C A Dist'g Corp., 1721 Superior Ave. E. Zip: 44114. Tel: 621-9770. Branch Mgr.: Lew Zellman. (Rec. & Tape D)

Rec. labels: Backstreet, Butterfly, Coral, Infinity, LAX, MCA, Songbird, Source, Vocalion.
Tape lines: Same as rec. labels.

Northern Rec. Sales (div. of Transcontinent Rec. Sales), 1811 E. 40 St. Zip: 44103. Tel: 361-2650. Gen. Mgr.: Dave Spaulding; Ass't Mgr.: Tom Hunter; Sales Supervisor: Jim Burns; Buyer: George Klimek; OS Mgr. & Singles Buyer: Sherry Weicheck. (Rec. & Tape OS & RJ)

Home office: Buffalo, N.Y., Transcontinent Rec. Sales (Rec. & Tape RJ)

One Way Recs. of Ohio, 1801 E. 40. Zip: 44103. Tel: 391-9250. Branch Mgr.: William D. Spaulding. (Rec. OS & Tape E)

Branch: Union, N.J. (SEE ADVERTISEMENT)
Piks Corp., 2150 Hamilton Ave. Zip: 44114. Tel: 696-3155. Owners: Ron Schaefer, Harvey Korman; Gen. Mgr.: Harvey Korman; Sales Mgr.: John Horn; Singles, Albums & Tape Buyer: Ken Antonelli. (Rec. & Tape D)

Branches: Southfield (Detroit Metropolitan Area), Mich.; Buffalo, N.Y.; Cincinnati, Ohio; Pittsburgh, Pa.

Rec. labels: ABC imports, A.J.'s, APA, ARC, Adkorp, Aerospace, Ala, Alanna, Alarm, Alexander Street, Alligator, Alston, Amazon, Ambassador, American Gramophone, American Mutual group, American Sound, American Variety, American Way, Amour, Antilles, Antonio, Appaloosa, Aquarian, Archive of Jazz, Arista, Arista Freedom, Arista Novus, Armada, Artemis, Artist House, Audio Arts, Avanti, Axe, BLHE, BMA, BRO, Bambuu, Banana Tree, Banner, Bar-B-Q, Barnaby Candid, Barracuda, Beacon, Beck, Bel-Ad, Bella Linda, Belle Meade, Benton, Bertie, Bicycle, Big Town, Birthright, Black Blues, Blackland, Blue Ash, Blue Candle, Blue Heaven, Blue Max, Blues Spectrum, Bobby Robinson, Bobbo, Bold, Boogie Man, Braintrust, Breakthrough, Briar, Brown Dogg, Brownstone, Buddha, Buffalo, Busch Country, Butterfly, CC, CRS, C-Town, California Gold, Cambria, Caprice, Carat, Casino, Cat, Catalytic, Celestial, Centennial, Century 21, Champion, Charade, Charmur, Charta, Checkmate, Chimneyville, Chrysalis, Cin-Kay, Citadel, Classical Excellence, Clouds, Commercial, Compass, Comstock, Con Brio, Contempo, Contrast, Co-Star, Counter Parts, Country Porn, Country Showcase of America, County Line, Covert, Crystal Clear, DG, DRG, Dash, Day & Dan, Dee Bee, Delmark, Delux, Demand, Denim, Derrick, Dial, Dingo, Direct Disk Labs, Disciple, Dixie Jubilee, Dobre, Don, Door Knob, Doral, Drive, Dyno, Earth, Earthwood, El Con, Elka, End-Ge, Entr' Acte, Epitome, Erotic, Essar, Euro, Eyes, Fairview, Farr, Fast Track, Fiddlers Wind, 50 States, First American, Flying High, Flying High, Fotoplay, 4 Star, Freedom, Free Form, Fretless, Fret-Tone, Funk, Fury, GMC, GNP Crescendo, GRO, GRP, GRR, Gateway, Gillette-Madison, Gil's Funny, Glacier, Glades, Go-Dak, Golden Moon, Golden River, Gold Rush, Gold Star, Good Co., Good Sounds, Gosco, Gospel Roots, Gospel Tone, Grab Me, Gramercy, Granny White, Grape, Grapevine, Great Northwest, Greedy, Grenadilla, HDM, Hawkeye, Hawk Sound, Heat, Hevy, Hit Bound Int'l, Hit Int'l, Hob, Hobo, Homa, Hoop-A-Long, Hoss, Housetop, Humorsonic, IBC, ICA, IMP, Imp, Impulse, Inerti, Inphasion, Instant, Irish Rego, Iron Horse, JDC, JRC, Jazz Masters, Jazz World, Jefferson Boulevard, Jem, Jeremiah, Jerree, Jett Lagg, Jett Sett, Jo Don, Joel, Juana, Juc, Kaleidoscope, Karat, Kayvette, Kid Stuff, Kim, Konkudo, LFG, LRC, LS, Laff, Lamb, Libbi, Libra III, Little City, Little Darlin', Little Richie, Little Star, Liz-Be, Los Angeles, Lotta, Love, Lucky Man, MCM, MF, MRC, MRI, Mainstream, Malaco, Mand, Mango, Manilla, Mantan, Mar Bren, Marlin, Masterpiece, Meridian, Messenger Gospel, Metric, Midas, Midsong, Milagro, Ministri, Miracle, Mogul, Monterey, Morrhythm, Motown, Mountain Railroad, Movie Star, Muse, Music Flow, Music Is Medicine, Mutt & Jeff, NTSU, Nami, Nashville Rec. Prod'n, Nationwide Sound, Ned, Neostat, Nessa, New Day, IX Chains, Ninth Note, Nostalgia, Nu-Trayl, October, Ode, Olym-

P & G RECORD CO

Wholesale Only

LOCATED DOWNTOWN CINCINNATI JUST OFF I-75

Complete One Stop

- 45 R.P.M. Records
- Tapes • Albums
- Complete Oldies Selection

Open Monday Thru Saturday

PAUL SMITH
Owner - Operator
(513) 381-2233
1667 Central Pkwy
Cincinnati, OH 45214

pus, Opus, Orinda, Orlando, Ovation, Owl, PVC, Pacific, Pacific Arts, Pageboy, Pantheon Desert, Paradox, Paragon, Passport, Payola, Pecco, Pharaoh, Philo, Phono, Picadilly, Pick-A-Hit, Pinnacle, Polydor imports, Potato, Prairie Dust, Predator, Prima, Progressive, Pure Silk, Pyramid, QCA, R&R, RS, Randell, Ranwood, Redd Foxx, Reid's World, Request, Rhino, Rickwood, Ridge Runner, Ridgetop, Rim, Rising Star, Riverboat, Roadshow, Roast, Robert Lee, Rocking Horse, Rocky, Roots, Roulette, Royal Flush, Rush, Sabre, St. Simon's, Savoy, Schaffer, Schubart, Scorpio, Scorpion, Scrimshaw, Seeds & Stems, Shadow, Shield, Shue, Sierra, Silver Blue, Silver Sword, Simko, Sipra, Sirlion, Skyline, Snowdrop, Soc-A-Gee, Soul Deep, Soutown, Soundbird, Sounds Superb, Soundwaves, Spoonfed, Stanson, Starlog, Star Mountain, Stiff, Stone Dogg, Stoney Plain, Stop, Storyteller, Strawberry, Studio B, Studio 7, Sugarhill, Sunshine, Sunshine Sound, Sunnyvale, Superstar, Swar, TK, TMS, Tablighi, Takoma, Tailored Music, Talisman, Talpro, Taxi, Teddy Bear, Thistle, 3M's, Timberline, Timeless, Tomorrow, Topco, True, 12:00 High, 20th Century, US, Underground, Unicorn, Unital, Vaya, Vee Jay, Venice, Versatile, Vintage, Virgo, Visa, Vista, Vistone, Vivo, WILD, WITG, Wanderick, Waterhouse, Weird World, West, Western Hemisphere, Wheeler, Wicked, Wide World Music, Wizard, Wolf, Woodsmoke, World Jazz, World Wide Music, Yucca.

Tape lines: APA, Ala, Alarm, Alexander Street, Alston, American Variety, Archive of Jazz, Arista, Barnaby Candid, Blue Candle, Bold, Buddah, Buffalo, Butterfly, Cat, Chimneyville, Chrysalis, Clouds, Con Brio, Contempo, Dash, Dingo, Drive, Dyno, Earth, End-Gee, First American, Flying Fish, 4 Star, GRT partial catalog, Gillette-Madison, Glades, Good Sounds, Gosco, Gospel Tone, Great Northwest, HDM, Hit Int'l, Humorsonic, Import, Impulse, Inergi, Inphasion, Jazz World, Juana, Kayvette, LRC, LS, Laff, Little Darlin', Little Star, MF, MRC, Mainstream, Malaco, Manilla, Marlin, Messenger Gospel, Mountain Railroad, Muse, Music Is Medicine, New Day, Nostalgia Lane, Ode, Ovation, Pacific Arts, Passport, Picadilly, PVC, Potato, QCA, Ranwood, Redd Foxx, Reid's World, Rim, Royal Flush, Savoy, Seeds & Stems, Shield, Silver Blue, Soundbird, Soundwaves, Stiff, Stone Dogg, Stoney Plain, Strawberry, Sunshine Sound, TK, Tailored Music, Takoma, Talisman, Vee Jay, Versatile, Virgo, Visa, Wanderick, Weird World, Wheeler, Wicked, Wolf.

PolyGram Dist'n Inc., 14600 Detroit Ave., Suite 450, Lakewood 44107. Tel: 228-6412. Mgr.: Jack Kanne; Sales Mgr.: Bob Colosi. (Rec. & Tape D)

Home office: New York, N.Y.
Rec. labels: American Int'l, Archiv, Capricorn, Casablanca, Charisma, Chocolate City, DJM, De-Lite, Deutsche Grammophon, Emarcy, Festivo, Fontana, Limelight, MGM, Mercury, Monument, Oasis, Parachute, Philips, Polydor, Polydor/BGO, Polydor/Harem, Polydor/Kolob, Polydor/MVP, Polydor/Manken, Privilege, RSO, RSO/Curtom, Riva, Smash, Soundstage Seven, Spring, Vertigo, Verve, Zappa.

Tape lines: Same as rec. labels.
 Progress Rec. Dist'g Inc., 190 Alpha Park, Highland Heights 44143. Tel: 461-7880. Pres.: Joe Simone; Gen. Mgr.: Brent Marco; Buyer: Ben Delfino. (Rec. & Tape D)
Branches: Southfield (Detroit Metropolitan Area), Mich.; Cincinnati, Ohio—also see listing in Elk Grove Village (Chicago Metropolitan Area), Ill.
Labels: Adelphi, Argo, Aspetke, Bomp, CTI, Cime, Cream, Deram, D'harma, Discovery, Gordy, GRR, Hi, Hitsville, JRC, Kris, Kudu, Le Joint, L'Oiseau Lyre, London, Motown, NCI, Natural Resources, Parrot, Prelude, Prodigal, Rare Earth, Richmond, Ross, Sirius, Soul, Tamla, Telefunken, Threshold, Tomato, Venture, Voyage, Xanadu.
 R C A & A&M & Assoc'd Labels, 601 Rockwell Ave., Rm. 514, Zip: 44114. Tel: 447-1400. Sales Mgr.: Dom Violini. (Rec. & Tape D)
Rec. labels: A&M, Bluebird, Free Flight, Gold Seal, Grunt, Hologram, Millennium, NY Int'l, Pablo, Pablo Live, Pure Gold, RCA, Red Seal, Roadshow, Rocket, Salsoul, Solar, Tortoise, 20th Century, Victrola, Windsong.
Tape lines: Same as rec. labels.
 Record Shack of Cleveland, 5976 Heisley Rd., Mentor 44060. Tel: 354-0700, 951-6650. Mgr.: Robert Wilcox. (Rec. & Tape OS, I & E)
Home office: Woodside (New York Metropolitan Area), N.Y., Record Shack of New York City Inc. (SEE ADVERTISEMENT)

S & M Sales, 4353 Cranwood Court, Warrensville Heights 44128. Tel: 662-6153. Owner: Ernest Furst; Gen. Mgr.: Mark Abram; Buyers: Singles, Mark Abram, Albums & Tape, Ernest Furst. (Rec. & Tape OS & RJ)
 Superior Recs. Inc., 11202 Superior Ave. Zip: 44106. Tel: 421-6770. Owner: Dolores Dean. (Rec. & Tape OS)
 Warner/Elektra/Atlantic Corp., 4560 Willow Pkwy. Zip: 44125. Tel: 271-3900. Gen. Mgr.: Mike Spence. (Rec. & Tape D)
Rec. labels: Asylum, Atco, Atlantic, Bearsville, Beserkley, Big Tree, Cotillion, Curtom, Dark Horse, Disc-Root, ECM, Elektra, Embryo, Famous Charisma, Finnadar, Little David, Loma, Manticore, Nemperor, Nonesuch, Pacific, Paradise, Reprise, Rolling Stones, SHE, Sire, Slipped Disc, Swan Song, WMOT, Warner Bros., Warner/Curb, Warner Spector, Westbound, Whitfield, Wing & a Prayer, Zephyr.
Tape lines: Same as rec. labels.

● **COLUMBUS (Area Code 614)**
 E & L One Stop, 111 E. Town St. Zip: 43215. Tel: 221-2744. Mgr.: Ernestine Moore. (Rec. & Tape OS)
 One Stop Inc., 1185 N. High St. Zip: 43201. Tel: 291-3141. Mgr. & Buyer: Jeff Prince. (Rec. & Tape OS & RJ)
Home office: Pittsburgh, Pa.
 Piks Corp., 4314 Astor Ave. Zip: 43227. Tel: 237-7148. (Rec. & Tape D)

IN PHILADELPHIA
For Volume Sales of
Records & Tapes!

Universal

record distributing
corporation

919 No. Broad St.,
Phila., Pa. 19123
(215) CE 2-3333

LEN RAKLIFF, Gen. Mgr.

**PROMOTION:
Tom Kennedy**

THIS BOOK WILL MAKE YOU FILTHY RICH.

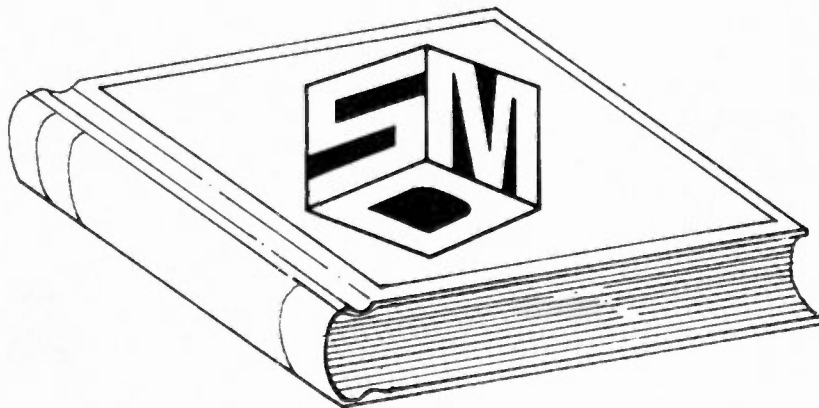

It contains the best selection of cut-out and overstock LPS at the lowest prices in the "known" world. Just write us. It's yours for the asking.

OFFICES and WAREHOUSE
 2933 River Road
 Croydon, PA 19020
 (215) 785-1541
 (215) 698-7707

scorpio
 music distributors, inc

MAILING ADDRESS
 P.O. Box 391
 Cornwells Heights, PA 19020

**TELEX: 843366
 RECSTAPES: CRDN**

©1976 • SCORPIO MUSIC DIST

CHIPS DISTRIBUTING

**PHILADELPHIA'S
MOST COMPLETE
INDEPENDENT
RECORD DISTRIBUTOR**

CHIPSWholesale Distribution & Promotion
BANDSTAND RECORD SERVICEComplete Rack Service
ABKCO PROMOTIONSAdvertising & Marketing
MUSIC FAIRRetail Outlets

55 Employees With 414 Total Years Experience
YOUR RECORDS NEVER HAD IT SO GOOD

CHIPS DISTRIBUTING

Ernie Santone *President*
 Mario Daulerio *Sales Manager*

Promotion
 Richard Cooper
 Jerry Armour
 Nick Duca (Disco)

9242 Commerce Hgy., Pennsauken, N.J. 609-665-8200
 (A Division of ABKCO Ind.)

Home office: Cleveland, Ohio. (See for prod. distributed)
 Robert & Co., 1910 Lockbourne Rd. Zip. 43207. Tel. 444-9842. Owner & Buyer. Robert M. Benjamin. (Rec. & Tape OS—also distributes oldies)

• **DAYTON AREA (Area Code 513)**
 A & B Rec. Co. Inc., 40 Heid Ave. Zip. 45404. Tel. 236-4808. Pres. Morris Kipner. Gen. Mgr.: Larry Frisby; Buyers: Singles, Terry Miller; Albums & Tape, Larry Frisby. (Rec. & Tape RJ)
 Ambat Recs. (div. of Transcontinent Rec. Sales), 509 Xenia Ave. Zip. 45410. Tel: 256-4212. Mgr.: Pete Brown. (Rec. & Tape OS & RJ)
 Home office: Buffalo, N.Y., Transcontinent Rec. Sales (Rec. & Tape RJ)
 Dayton Rec. Serv. Inc., 120 N. Main, Germantown 45327. Tel. 855-6010. (Rec. & Tape RJ)
 Home office: Portsmouth, Ohio.
 Ohio Rec. Rack Dists., 72 S. Main St., Miamisburg 45342. Tel. 866-3629. Owner, Mgr. & Buyer. Chris Kondoff. (Rec. & Tape D, OS, RJ, I & E)
 Distributes overstocks, auction close-outs, cut-outs, promotional premium goods, pre-packs & 45 rpm oldies.

• **NEW ALBANY (Area Code 614)**
 Mobile Rec. Serv. Co., 7809 Walnut St. Zip: 43054. Tel. 855-7970. Mgr. Craig S. Gallagher. (Rec. OS—singles only)
 Home office: Pittsburgh, Pa.

• **NEWARK (Area Code 614)**
 Utopia Ultra-Sound, 38 & 40 S. First St. Zip: 43055. Tel. 345-9426. Pres. & Tape Buyer. Robert H. Kirk Jr.; Mgr. Don Shannon. (Rec. & Tape D & RJ)
 Labels: CSP, Capitol SM, Gusto, Jessup, Pickwick, Mac, Promo, SAM, UUS, Warner SP.

• **PORTSMOUTH (Area Code 614)**
 Dayton Rec. Serv. Inc., 1020 Seventh St. Zip: 45662. Tel. 353-2115. Pres. W.A. Carrington; VP, Mgr. & Buyer Joe Taylor. (Rec. & Tape RJ)
 Branch: Germantown (Dayton Area), Ohio.

• **SANDUSKY (Area Code 419)**
 M. R. Sand & Co., PO Box 2255, 6211 Milan Rd. Zip: 44870. Tel. 625-0028. Owner, Mgr. & Buyer Joseph F. Yost III. (Rec. & Tape OS & RJ) (SEE ADVERTISE-
 MENT)

• **OLON (Area Code 216)**
 Allied Rec. Sales, 34240 Aurora Rd. Zip: 44139. Tel. 248-3090. Pres. R.A. Burke. (Rec. OS & RJ)

• **STEBENVILLE (Area Code 614)**
 Honeycomb Recs., 507 Cedar Ave. Zip: 43952. Tel: 283-

Universal

RECORD AND TAPE CITY

**COMPLETE
RECORD AND
TAPE SERVICE**

Mr. Bob Perloff
UNIVERSAL RECORD AND TAPE CITY
 919 No. Broad Street, Philadelphia, Pa. 19123
 (215) CE 5-2726 (215) CE 5-2714

**Dionne Warwick says:
"Get your blood
into circulation."**



**Call Red Cross now
for a blood donor
appointment.**



A Public Service of This Magazine
 & The Advertising Council

ATT: ONE STOPS, RACK JOBBERS, DEALERS, EXPORTERS & IMPORTERS

**Call or Write for your
FREE CATALOG today!**

R-E-C-O-R-D R-I-O-T!!! Sales slumping? Time for a promotion? We've got just the thing for you. Now you can buy 200 assorted 45's for less than .05¢ a piece. Give 'em away with a purchase and boost sales and goodwill. Sell 'em 10 for .99¢ and make money (50%). Sell 'em 5 for .99¢ and get arrested for making an indecent profit. Sell 'em as Frisbee's, use your imagination! All records are new (unused). 1-10 pieces per selection.

ECONOPAK \$9.95

Box of 200 assorted 45's, less than 05¢ each.

T-100 \$15.95

Box of 200 assorted 45's, all guaranteed to have made the TOP 100, many have made the TOP 40! Less than 08¢ each.

T-40 \$29.95

Box of 200 assorted 45's, all guaranteed to have made the TOP 40! Less than 15¢ each.

R.B-100 \$19.95

Box of 200 assorted RHYTHM & BLUES 45's, all guaranteed to have made the charts, many the TOP 40. Less than 10¢ each.

R.B-40 \$29.95

Box of 200 assorted RHYTHM & BLUES 45's, all guaranteed to have made the TOP 40. Less than 15¢ each.

C.W-100 \$19.95

Box of 200 assorted COUNTRY & WESTERN 45's, all guaranteed to have made the charts, many the TOP 40. Less than 10¢ each.

C.W-40 \$29.95

Box of 200 assorted COUNTRY & WESTERN 45's, all guaranteed to have made the TOP 40. Less than 15¢ each.

XMASPAK \$29.95

Box of 200 assorted XMAS 45's, less than 15¢ each. A really great value! Well known artists.

G-U-A-R-A-N-T-E-E: If for any reason you are not satisfied with the merchandise purchased from us, you may return it within ten days and receive a refund by return mail! Defective merchandise may be returned at any time. No return authorization is required. All returns must be shipped pre-paid.

7" WHITE SLEEVES

Box of 2400

\$22.95

12" WHITE SLEEVES

Box of 1000

\$24.95

**7" HEAVY DUTY
BUFF SLEEVES**

Box of 1000

\$15.95

**12" HEAVY DUTY
GREEN SLEEVES**

Box of 500

\$22.95

7" PLASTIC SLEEVES

Box of 1000

\$17.95

**12" SQ.
PLASTIC SLEEVES**

3 Mils Thick Box of 800

\$28.95

DIAMOND NEEDLES

Made in U.S.A.

Individually Boxed

99¢ Ea.

**12" SQ.
PLASTIC SLEEVES**

5 Mils Thick Box of 500

\$29.95

**45 RPM
PLASTIC INSERTS**

Bag of 1000

\$6.99

**45 RPM
DOME ADAPTORS**

Bag of 100

\$6.99

- BUY BY TITLE AND/OR PREPACKS
- LARGE SELECTION OF OLDIES, CUT OUT 45's, LP's & TAPES. ACCESSORIES, RADIOS, PHONOS, TAPE PLAYERS & VIDEO TAPES.
- SPECIAL ATTENTION TO EXPORT ORDERS
- UNCONDITIONAL GUARANTEE
- FREE MONTHLY CATALOG
- HIGH PERCENTAGE FILL
- FAST, DEPENDABLE SERVICE
- LOW, LOW PRICES

OUR TOLL FREE NUMBER FOR ANYWHERE IN THE CONTINENTAL U.S.A. EXCEPT FOR ALASKA & PENNSYLVANIA IS 800-523-2036

**VINTAGE
RECORDS, INC.**

P.O. BOX 251
DARBY, PA. 19023
(215) 586-5200

**We Ship Anywhere IN The World.
All Shipments F.O.B., Darby, PA.
Wholesale Only!!!**

STOP WASTING TIME AND MONEY!

If you're devoting a sizable portion of your time to accessories and blank tape that represents only 10 to 15% of your sales, you're using time that could be spent on other areas of your business. If you're NOT devoting adequate time to accessories and tape, you're most likely not developing the sales that you could. If this seems like a paradox, at least it's one with a solution.

We'd like to show you how we can help to make YOUR blank tape and accessory business more profitable. Contact us anytime on our toll-free number, (800) 523-2472.

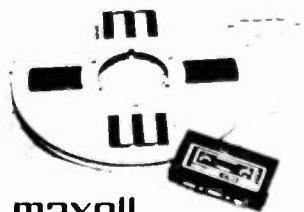

maxell
Its sound
recording tape



discwasher

MEMOREX
HIGH BIAS



MEMOREX
Quality audio recording tape and accessories

TDK AD.
For the hottest
high end.



**DISCOVER
THE WORLD OF
SONY CASSETTES!**



**Scotch Brand
Videocassettes**



24-Hour Freight-Paid Service

RECORDING TAPE & ACCESSORIES

A. I. Rosenthal Associates, INC.

A Complete Tape and Accessory Service

FOR TOLL-FREE ORDERING CALL (800) 523-2472 (PA CALL COLLECT)

SEND FOR FREE CATALOG (DEALERS ONLY)

Dept H 1035 Louis Drive, Warminster, PA 18974 (215)441-8900

Audio Technica • Discwasher • Duracell • Dynasound • Eveready • Maxell • Memorex •
Pickering • Recoton • Savoy • Shure • Sony • Sound Guard • TDK • Watts

4518 Owner, Singles, Albums & Tape Buyer Jeff Johnson (Rec. & Tape RJ)

● **TOLEDO (Area Code 419)**

Northwestern Dists. Inc., 4318 Monroe St. Zip 43606 Tel 744-7114 Pres., Mgr. & Buyer George A. LaCourse (Rec. & Tape RJ)

● **YOUNGSTOWN (Area Code 216)**

Discount Recs. & Tapes, 545 Market St. Zip 44502 Tel 744-7787 Owner & Buyer Tony March (Rec. OS & RJ; Tape OS)

Handleman Co., 625 Bev Rd. Zip 44512 Tel 726-8121 Mgr. Sam Milicia, Buyers Sam Couch, Bill Lestock, Rick Carbine, Sam Milicia (Rec. & Tape RJ)
Home office: Clawson (Detroit Metropolitan Area), Mich.

OKLAHOMA

● **BROKEN ARROW (Area Code 918)**

Crossroads Dist. g Co., PO Box 283, 1008 N. Hickory Zip 74012 Tel 251-6212 Mgr. & Buyer John R. Lepper (Rec. & Tape D)

Rec. labels: Calvary, Canaan, Dip. Image VII, Jim, Jubilation, Light, Maranatha, Myrrh, Paragon, Newpax, Sparrow, Word

Tape lines: Calvary, Canaan, Dip, Jim, Jubilation, Light, Maranatha, Myrrh, Paragon, Newpax, Sparrow, Word

● **NORMAN (Area Code 405)**

Oklahoma Tapes & Recs. Inc., PO Box 946 Zip 73070 Tel 364-5034 Owner Bill Bodin (Tape D—budget lines)

● **OKLAHOMA CITY (Area Code 405)**

All Recs. Inc., 520 Classen Blvd Zip 73106 Tel 235-3381 Mgr. & Buyer Bill Hill (Rec. & Tape OS)

Bromo Dists. Inc., PO Box 60709, 2500 N. Walker Zip 73146 Tel 521-0301 Buyer Buster Bassett (Rec. & Tape OS & RJ)

Phil's One Stop Recs., PO Box 60349, 1736 Linwood Blvd Zip 73106 Tel 235-9671 Pres. & Mgr. Phil Buringame VP Wayne Dunbar Buyer Susan Dubberstein (Rec. OS)

● **TULSA (Area Code 918)**

Bill's T Recs., 19 N. Harvard Zip 74145 Tel 939-6305 (Rec. OS)

Doc's One Stop, 820 E. 36 St. N. Zip 74106 Tel 425-2643 Owner & Buyer Larry Eck, Mgr. Vicki Lane

Oklahoma News Co., 909 W. 23 St. Zip 74107 Tel 584-4754 Mgr. Peter K. White, Ass't Mgr. Wayne Allen, Buyer Kaihi Hayes (Rec. & Tape RJ)

Western Mdsrs. Inc., 8276 E. 41 St. Zip 74145 Tel 664-2540 Mgr. Howard Miller (Rec. & Tape RJ)
Home office: Amarillo, Tex (Rec. & Tape OS & RJ)

OREGON

● **EUGENE (Area Code 503)**

Middle Man Dists., 865 Conger, No. 17 Zip 97402 Tel 484-0434 Co-owner & Mgr. Karl Manseith, Co-owner & Buyer John Marshall (Rec. & Tape RJ)

● **PORTLAND (Area Code 503)**

Downpour Dist. g Ltd., 8778 NE Sandy Blvd Zip 97038 Tel 255-4805 Pres. Donald McCabe, Exec. VP Bruce Chisholm, Opns. Mgr. Bob Cael, Warehouse Mgr. John DeWitt (Rec. & Tape OS)

Lieberman Ents. Inc., 3014 N. Wygant Zip 97217 Tel 283-1293 Mgr. Ron Peterson, Opns. Mgr. Lee Sherry, OS Mgr. Bob Falleur, Buyers Singles, Chere Clifford, Albums, Bob O'Neil (Rec. & Tape OS & RJ)
Home office: Minneapolis, Minn (SEE ADVERTISEMENT)

Northwest Recs. & Tapes Inc., 115 SE Ninth St. Zip 97214 Tel 232-3616 Owner Bert Bas, Mgr. Chris Millegan (Rec. & Tape RJ)

PENNSYLVANIA

● **BETHLEHEM (Area Code 215)**

Capitol Recs., 2980 Ave. B, Lehigh Valley Ind. l Park, No. 1, Zip 18017 Tel 868-1401 (Rec. & Tape D)

Rec. labels: Angel, Ariola America, Capitol, EMI America, Harvest, Liberty, Melodiya, Angel, Seraphim, United Artists

Tape lines: Same as rec. labels
Rave, 415 Buchanan St. Zip 18015 Tel 865-1941 Owner & Mgr. Joe Timmer (Rec. & Tape D)

Rec. labels: Czech, Fiesta, Haller, LeMans, Rave, Ray, Rex, Stella & all polka recs
Tape lines: Fiesta, Jay Jay, Rave, Stella

● **ERIE (Area Code 814)**

Mobile Rec. Serv. Co., 520 W. Sixth St., Apt. 7 Tel 455-9865 Mgr. James Oseroff (Rec. OS—singles only)
Home office: Pittsburgh, Pa

● **HARMONY (Area Code 412)**

Jesus Music Dists., Box 218, RR 2, Zip 16037 Tel. 452-5556 Owner: Louis P. Hanckerick (Rec. & Tape D—contemporary Christian prod.)
Rec. labels: AB, Airborn, Destiny, Dharmca, Good News, Greentree, Lamb & Lion, Loverock, Mars Hill, Messianic, Myrrh, New Song, Solid Rock, Sunrise Sparrow Spirit, Star Song, White Horse
Tape lines: Same as rec. labels

● **HARRISBURG (Area Code 717)**

A I M Dists Inc., 4911 Jonestown Rd (Rear) Zip 17109 Tel. 652-8097 Owner & Buyer Endo Corsetti (Rec. & Tape RJ)
 D & H Dist'g Co., 2525 N Seventh St. Zip 17105 Tel. 236-8001 Mgr. Gene Diveglia, Buyers Singles, Rick Prayer, Albums, Sharon Ruch (Rec. & Tape OS & RJ)
 One Stop Inc., 3016 Pennwood Rd. Zip 17110 Tel. 234-3048 Mgr. & Buyer Chris Lawrence (Rec. & Tape OS & RJ)
Home office: Pittsburgh, Pa

● **JOHNSTOWN (Area Code 814)**

Page Rec'g Co., 604 Broad St. Zip 15906 Tel. 539-8117 Owner & Mgr. Al Page (Rec. & Tape D & RJ)
Rec. labels: Bel-Aire, Chicago Polkas, Dyno Fiesta, Greyko, Hymntone, Jay Jay, Marjon, Nashville, Page, Power-Pak, Rave, Request, Sacred, Silverbell, Sing, Skyline, Sword, Tambura, Word
Tape lines: Bel-Aire, Canaan, Chicago Polkas, Fiesta, Jay Jay, Lee, Marjon, Page, Power-Pak, Request, Word
Playback equip.: Granada, Sharp

● **LEHIGHTON (Area Code 717)**

Barnes Rec. Dists., Box 103, RD 2, Zip 18235 Tel. 645-2321 Owner & Mgr. William H. Barnes (Rec. & Tape OS & RJ)

● **LEWISTOWN (Area Code 717)**

Mobile Rec. Serv. Co., 104 Logan St. Zip 17044 Tel. 248-6442 Mgr. John Houser (Rec. OS—singles only)
Home office: Pittsburgh, Pa

● **MILTON (Area Code 717)**

Music Box, 205 Broadway Zip 17847 Tel. 742-7101 Owner Dale L. Reedy (Rec. & Tape D)

● **PHILADELPHIA METROPOLITAN AREA (Area Code 215)**

(Also see listings in New Jersey)
 Almacenes Asturias (Rec. & Tape D), see Villanueva Asturias Corp.
 Asturias (Rec. & Tape OS), see Villanueva Asturias Corp.
 B S Recs., 2 Bala Cynwyd Plaza, Bala Cynwyd 19004 Tel. 839-0246 Branch Mgr. Irv Medway (Rec. & Tape D)
Rec. labels: Arc, Bang, Blue Sky, CBS, Caribou, Columbia, Epic, Jet, Kirshner, Melody/A Columbia, Nempor, Odyssey, Philadelphia Int'l, Portrait, Starflite, Stiff, T-Neck, Tabu, Tappan Zee, Unlimited Gold.
Tape lines: Same as rec. labels.
 Capitol Recs., 7 Bala Ave., Bala-Cynwyd 19004 Tel. 835-2450 (Rec. & Tape D)
Rec. labels: Angel, Ariola America, Capitol, EMI America, Harvest, Liberty, Melody/Angel, Seraphim, United Artists.
Tape lines: Same as rec. labels.
 Chips Dist'g, see listing in Pennsauken, N.J.
 Coliseum Recs. & Tape Ltd., 134 S. 20 St. Zip 19103 Tel. 698-7710 Pres. Robert Morton (Rec. & Tape E)
Exports: cut-outs, surplus, deletions.
 Norman D. Cooper Inc., Presidential Apts. Complex, 1 Winding Dr. Zip 19131 Tel. 878-9591 Pres. Norman D. Cooper, Mgr. Bob Hamburg, Buyers Singles, David Brown, Albums & Tape, Joe Alteari (Rec. & Tape OS, RJ & E) (SEE ADVERTISEMENT)
 Foreign Ventures Corp., 8423 Ridgeway St. Zip 19111 Tel. 725-6970 Owner Ira Semanoff (Rec. & Tape I & E)
 Heller's Rec. Buyer-Exporter, 3149 Kensington, Zip 19134 Tel. 634-5663 Owner Robert Heller. (Dealer in rec. collections)
 Richard Kastner Co. Inc., 1100 Virginia Dr., Fort Washington 19034 Tel. 628-4111 WATS (outside Pennsylvania) (800) 523-2318 Pres. Richard Kastner, Sales Mgr. Bill Klein (Rec. & Tape D & E—cut-outs)
 Music Scene, 2864 Limekiln Pike, Glenside 19038 Tel. 885-7990 Owner Jerry Rappaport, Gen. Mgr. Lynn Stelle, Buyer Kevin Bernhardt (Rec. & Tape RJ)
 National Rec. & Tape Co. Inc., see Serv-Rite
 Record Rendezvous Inc., 134 S. 20 St. Zip 19103 Tel. 561-7340 (Rec. D, OS, RJ, I & E; Tape OS & RJ)
Labels: Cinwitch, MVH, Oldies Hit Goodies, Pet-Rat, Psychephonic, Rendezvous, Rockin' Richie, sub-distributors: Montgomerys, Scorpio, Tasty Licks, Times Square.
 Richman Bros., see listing in Pennsauken, N.J.
 Ron Del Dist'g Corp., 1100 Block Commerce St. Zip 19107 Tel. 923-8980 (Rec. & Tape RJ)
 David Rosen Inc., 855 N. Broad St. Zip 19123 Tel. 232-2900 VP. Louis Rosen (Rec. & Tape OS)
 A. I. Rosenthal Assocs. Inc., 1035 Louis Dr., Warminster 18974 Tel. 441-8900 Pres. Alfred Rosenthal
Accessories: Audio (Recotone), batteries (Duracell, Eveready), blank tape (Ampex, Capitol, Maxell, Memorex, Recotone, Sony, TDK, 3M), cartridges & styli (Audio Technica, Pickering, Shure), headsets (Audio Technica, Power Drive), needles (Recotone), rec. care products (Audio Technica, Black Magic, Clean Sound, Discwasher, Memorex, Sound Guard, Watts), tape cases (Dynasound, Savoy) (SEE ADVERTISEMENT)
 Schwartz Bros. Inc., 1 Bala Cynwyd Plaza, Suite 227, Bala Cynwyd 19004 Tel. 667-2090 Mgr. Richie Salvador (Rec. & Tape D)
Home office: Washington, D.C.
Labels: Alston, Arista, CTI, Casino, Cat, Catfish, Clouds, Dash, Dictation Disc, Direct to Disc, Drive, Friends & Co., GRT, Gladys, Gospel Roots, Janus, Juldane, Kayvette, LPG, Laurie, Light, Mushroom, Malaco, Marlin,

Myrrh, Nashboro, Orinda, Ovation, Prelude, Red Greg, Roots, Savoy, Sesame Street, Shadybrook, Sound Bird, Starday, Stone Dogg, TK, Weird World, Wicked, Word (SEE ADVERTISEMENT)
 Scorpio Music Dists Inc., PO Box 391, Cornwells Heights 2933 River Rd., Croydton 19020 Tel. 698-7707, 785-1541 Telex 843366 Pres. Michael Adler, VP & Gen. Mgr. John T. Gervasoni (Rec. D, OS, RJ & E)
Distributes: overstocks, close-outs, promotional materials (SEE ADVERTISEMENT)
 Serv-Rite Rec. & Tape Co./National Rec. & Tape Co. Inc., 515 Andrews Rd., Trevose 19047 Tel. 364-1370/1372 Mgr., Sylvan Gross; Albums & Tape Buyers Sylvan Gross, Steve Weed (Rec. & Tape RJ—cut-outs)
 Slotkin Rec. Dist. Co., 111 Forrest Ave., Narberth 19072 Tel. 667-1870 Owner Herbert Slotkin, Mgr. & Buyer Stuart Morris (Rec. & Tape OS)
 Third Street Jazz & Rock, 10 N. Third St. Zip 19106 Tel. 627-3366 Buyer Jerry Gordon (Rec. RJ—cut-out & overstock)
 Universal Rec. Dist., 919 N. Broad St. Zip 19123 Tel. 232-3333 Owner Harold Lipsius, Rec. Mgr. Len Rakliff, Tape Mgr. Robert Perloff, Buyers Singles, Kathy Walsh, Albums, Len Rakliff, Tape, Robert Perloff (Rec. & Tape D & OS)
Labels: Ala, Amherst, Argo, Birthright, Chrysalis, Dearam, Fantasy, First American, Galaxy, Gone, Impact, Jamie, Laff, Le Joint, Living Language, London, Mid-song, Milestone, Original Sound, Parrot, Passport, Prestige, Prism, Ranwood, Republic, Riverside, Roulette, Specialty, Stax, Tomato, Waterhouse
Tape lines: Chrysalis, Fantasy, GRT, London group, Milestone, Original Sound, Prestige
Accessories: Le-Bo (SEE ADVERTISEMENT)
 V A C Dial (Rec. & Tape E), see Villanueva Asturias Corp.
 Villanueva Asturias Corp., 401 W. Girard Ave. Zip 19123 Tel. 236-4544 Mgr. & Buyer Jack Villanueva (Rec. & Tape D), (Rec. & Tape E as VAC Dial) Local branches Almacenes Asturias, 2331 N. Front St. Zip 19133 Tel. 426-9810 Mgr. & Buyer Maria Villanueva (Rec. & Tape D)—Asturias, 1200 N. Fourth St. Zip 19123 Tel. 236-4545 Mgr. Carlos Villanueva, Buyer J. Villanueva (Rec. & Tape OS)
Labels: Alma Hispana, Clubman Dial, VA
Accessories: Needles & phono cartridges (EV Game)
 Vintage Recs Inc., PO Box 251, Quarry & Hamilton Sts., Darby 19023 Tel. 586-5200 Pres. Murray Graber (Rec. & Tape D & E)
Labels: Arctic, Audicon, Bright Orange, Buckboard, Crown, Diann, Eric, Forever, Jamie/Guyden, Kent, Laurie, Legrand, Lost Nite, MSL, Mac, Modern, Mohawk, Montel, Mother Goose, Musicor, Palomino, Peter Pan, Phil-LA of Soul, Pickwick, Radiola, Relic, Rust, Springboard, Sundi, Superscope, Teardrop, Top & Bottom, Trip, Truckstop, Tru-Gems, United, Up Front, Vee Eight, Video Yesterday (video cassettes), cut-out singles, albums & tapes
Accessories: Blank tape & tape accessories (Columbia, Memorex), carrying cases (Hartzell, Savoy), catalogs (Record Research), needles (Rivertone), sleeves, spindles, wire racks (SEE ADVERTISEMENT)
 William's One Stop, 817 N. Broad St. Zip 19123 Tel. 232-2020 Owner Sid Williams (Rec. OS)

● **PITTSBURGH METROPOLITAN AREA (Area Code 412)**

A & C Tape Dists., 1031 Forbes Ave. Zip 15219 Tel. 391-4676 Owners: Eugene T. Jakiela, John R. Hoebler; Buyers: Singles, Bill Holzer, Albums & Tape Eugene T. Jakiela, Anthony Piotrowski, Walt Wilson (Rec. & Tape OS & RJ)
 Balkan Rec. Dist'g Co., RD 2, Concord Church Rd., Beaver Falls 15010 Tel. 843-1962 Mgr. Ivan J. Krilich; Singles, Albums & Tape Buyer Stana Krilich (Rec. & Tape D)
Home office: Berwyn (Chicago Metropolitan Area), Ill.
Rec. labels: Balkan Int'l, Czech, Delta Int'l, Greyko, Marjon, Monitor
Tape lines: Balkan Int'l, Delta Int'l, Greyko, Monitor
 East Coast Dists., 633 Liberty Ave. Zip 15222 Tel. 281-6344 Owner & Mgr. Nick Lomakin (Rec. D, OS & RJ; Tape OS & RJ)
Rec. labels: Argos, Audiotape, Borderline, Contemporary, Dial, Dictation Disc, Dooto, Evergreen, GNP Crescendo, GTJ, Golden Crest, Humorsonic, K&H, Mardi Gras, Music Minus One, Russell Dance, Spotlite, Switchcraft
 Mobile Rec. Serv. Co., PO Box 2879, Zip 15230; 2716 Penn Ave. Zip 15222 Tel. 391-8182 Pres. Maurice F. Oseroff, VP: Harvey Campbell, Sales Mgr. Ted Howell; Sales Programming, Don Bray, Local Branches: 9825 Presidential Dr., Allison Park 15101 Tel. 368-0689 Branch Mgr. David Kotlinski (Rec. OS—singles only)
Branches: Tallahassee, Tampa, West Palm Beach, Fla.; Moline, Ill.; Evansville, Fort Wayne, Ind.; Grand Rapids, Mich.; Menands (Albany Area), N.Y.; Cincinnati, New Albany, Ohio; Erie, Lewistown, Pa.; Houston, Tex.
 One Stop Inc., 1207 Fifth Ave. Zip 15219 Tel. 232-0844 Owner Bill Lawrence; Sales Mgr. Mike Fortunato; Buyer Rich Thomas (Rec. & Tape OS & RJ)
Branches: Columbus, Ohio; Harrisburg, Pa.
 Piks Corp., 354 Cherrydell Dr. Zip 15220 Tel. 341-5801 (Rec. & Tape D)
Home office: Cleveland, Ohio (See for prod. distributed)
 Record World-One Stop, 1332 Fifth Ave. Zip 15219 Tel. 391-7429 Owner Barney Stein; Buyers Singles & Tape, Barney Stein; Albums, Evelyn Stein (Rec. & Tape OS & RJ)
 Sounds Dist'g Corp., 3701 Bigelow Blvd. Zip 15213 Tel. 681-7611 Pres.: Norton L. Kalinsky; Buyers: E.A. McGrogan, George Kalinsky (Rec. & Tape OS & RJ)

● **SCRANTON (Area Code 717)**

Rogers Rec. Dist'n, 2224 Pond Ave. Zip 18508 Tel. 344-7587 Owner, Mgr. & Buyer Bob Rogers (Rec. & Tape D)
Rec. labels: Avoca, Avoca Int'l Folk, Blarney Castle, IMI
Tape lines: Same as rec. labels.

● **WEXFORD (Area Code 412)**

North Country Music, PO Box 311, Rt. 19 N. Zip 15090 Tel. 935-1330 Owner, Mgr. & Buyer C. W. Abbott (Rec. D & RJ)
Labels: American Heritage, Biscuit City, County, Flying Fish, Folk Legacy, Folkways, Front Hall, Green Linnnet, June Appal, Phico, Rebel, Rounder, Sugar Hill

● **WILKES-BARRE (Area Code 717)**

Record Town Inc., Wyoming Valley Mall Zip 18702 Tel. 829-3603 Pres. & Mgr. Joe Nardone (Rec. & Tape RJ)

PUERTO RICO

● **HATO REY (Area Code 809)**

Carrillo Dists (Tape D & I)—Tel. 763-4595—see San Francisco Dists. Inc.
 San Francisco Dists Inc., 340 Barbosa St. Zip 00919 Tel. 764-3481 Cable SAFRA (Tape D & I), also Tape D & I as Carrillo Dists.)

● **SAN JUAN (Area Code 809)**

Caribe Audio Dist. Inc., PO Box 5833 Zip 00906, 70 Conado Zip 00907 Tel. 725-1650, 722 0219 Pres. Fernando Gallardo, Mgr. Francisco Alonso; Buyers Singles & Albums, Francisco Alonso, Tape, Lilliam Alvarez (Rec. D & I, Tape D)
Labels: Arista, Audio-Technica, Capitol, Direct to Disk, Sheffield Labs
Labels imported: Clocos (France), Deutsche Grammophon (Germany), Telefunken (Germany)
Phonographs: Marantz, Technics, Yamaha
Playback equip.: Marantz, Teac, Technics, Yamaha
Accessories: Audio-Technica, Discwasher, Fidelitone, Maxell
 Casa Frago Inc., PO Box 2774, Zip. 00903 Tel. 725-8842, 723-0504 (RJ)
 Martinez Vela Inc., PO Box 2027 Zip 00903 Tel. 722-5171/4373, Cable MARVELA Pres. Felix V. Rodriguez; Gen. Mgr. Felix A. Martinez; Sales Mgr. Juan J. Cue; Controller: Fernando Roman (RJ & I)
 San Francisco Discount Inc., 302 San Francisco St., Old San Juan 00901 Tel. 725-4661 Owner Simon Carrillo; Buyers Simon & Javier Carrillo (Rec. & Tape OS)

● **SANTURCE (Area Code 809)**

Capitol Recs. Inc., PO Box 6886, Loiza St., 2020 Espana St. Zip 00914 Tel. 727-1348 Mgr. & Buyer Antonio Contreras
 Distribuidora Nacional de Discos Inc., 606 Cerra St. Zip 00907 Tel. 724-4964 Pres. Gilberto Gonzalez Arenas; VP & Gen. Mgr. Pedro Roman; Sales Mgr. Rodolfo Gonzalez Jr.
Int'l branch: Dominican Republic, Distribuidora Dominicana de Discos.
Distributes: all Latin & US labels
 S M L Dist'g Corp., 626 Cerra St. Zip 00907 Tel. 724-5165, 723-3540 Pres. & Gen. Mgr. Sergio Ballesteros
Labels: Arcano, Bethlehem, Caliente, Carino, Caytronics, Charro, Melody, Mericana, Nor-Mex, Otra, Pronto, Salsoul, Salsoul Salsa.

RHODE ISLAND

● **PROVIDENCE AREA (Area Code 401)**

Beacon Shops Inc., 821 N. Main St. Zip 02904 Tel. 861-7500 (Rec. & Tape OS)
 Upstate Music, 509-513 N. Main St., University Heights Shopping Center Zip 02904 Tel. 273-9850 (Rec. OS)
Home office: Albany, N.Y.

Cliff Ayers Enterprises
 The Music City Entertainer News
American Sound Records
Emerald Records
Music-Town Distributors
and Promotions
The Bandwagon Gazette
Music & Travel News
 RECORD PROMOTION—ARTIST—
 PUBLISHER REPRESENTATION
Cliff Ayers Ostermeyer
 President
62 Music Square West
Nashville, Tennessee 37203
(615) 256-1693

● **WARWICK (Area Code 401)**

Rhody Rec. & Tape Serv. Inc., 65 Meadow St. Zip 02886. Tel: 738-8003. Pres.: Rubin Zeidman; Mgr.: Arthur Zeidman; Buyer: Inez Marovelli. (Rec. & Tape OS)

SOUTH CAROLINA

● **CHARLESTON (Area Code 803)**

Fox Music House Inc., 483 King St. Zip 29403. Tel. 722-0511 (Rec. OS)

● **GRAY COURT (Area Code 803)**

Mable Recs (div. of Magendie Ent's Inc.), Box 80-A-1, Rt. 1. Zip 29645. Tel: 575-2541 VP. M.D. Tennessee. (Rec. OS)
Home office: Westchester (Chicago Metropolitan Area), Ill.

● **GREENVILLE (Area Code 803)**

Trackdown Rec. Dist., PO Box 632. Zip 29602 (Rec. & Tape D, OS, RJ, I & E)
Home office: Chicago, Ill. (See for prod. distributed)

● **GREENWOOD (Area Code 803)**

Cheshire Cat Music Co., 609-A Trakas Ave. Zip 29646. Tel: 223-9199. Owner: Gary D. Fearon; Mgr.: Sherry D. Fearon. (Rec. & Tape RJ)

● **MYRTLE BEACH (Area Code 803)**

Myrtle Beach Stereo Tape Center, 6203 N. Kings Hwy. Zip 29577. Tel: 449-3056. (Tape RJ)

● **PIEDMONT (Area Code 803)**

Cooper's One Stop, Rt. 1, Hwy. 86. Zip: 29673. Tel 845-6862. Owner: George Cooper; Mgr. & Buyer: George Cooper III. (Tape RJ)

TENNESSEE

● **COOKEVILLE (Area Code 615)**

Rack Ent's Inc., PO Box 3066, 1570 Brown Ave. Zip 38501. Tel: 526-9709. Owner: Bill Amonette; Buyer: Lee Clark. (Rec. & Tape RJ)

● **KNOXVILLE (Area Code 615)**

A & R Dist g Co. Inc., 1301 Prosser Rd. Zip 37914. Tel 546-7881. Owner: Tommy Ayres; Mgr.: Larry Long. Singles, Albums & Tape Buyer: Albert W. Smith. (Rec. & Tape OS & RJ)

Accessories: Ampex, Capitol, Le-Bo, Pfanstiehl
Knox Rec. Rack Co., PO Box 11167, 1539 Amherst Rd. Zip 37919. Tel 584-8531. Owners: Sam Morrison, Jay Jacobs; Mgr.: Jay Jacobs, Buyer: Marty Barbour. Albums & Tape, Jay Jacobs. (Rec. RJ, Tape OS & RJ)

Accessories: Recoton
Michael Ginsburg Dist'n, 716 Haynes Pl. Zip: 37917. Tel 522-5320. Owner, Mgr. & Buyer: Michael Ginsburg. (Rec. D, OS & I)

Labels: Adelphia, Cladagh, Flying Fish, Folk Legacy, Fox Fire, Front Hall, June Appal, Kaleidoscope, Kicking Mule, Philo, Richey, Rounder, Transatlantic, Troubadour
Labels Imported: Cezame, Gael-Linn, Mulligan, Tara, Topic
Tucker's Rec. Shop Inc., 25 Market Square Mall. Zip 37902. Tel: 522-9300. Pres. & Buyer: Martin Tucker. Robertson; Mgr. & Buyer: Pat Towery. (Rec. & Tape OS)

● **MEMPHIS (Area Code 901)**

Boss Ugly Bob Recs & Tapes (BC Ent's of Memphis Inc.), 726 E. McLemore. Zip 38106. Tel 774-6400. Pres: Bob Catron Jr., VP. Claudette Catron. Buyers: Singles, Linda Hillard, Albums & Tape. Claudette & Bob Catron
Local branches: 2440 Chelsea Zip 38108. Tel: 458-7230-1416 Airways. Zip 38114. Tel 323-7289-4234 S. Third Zip 38109. Tel. 785-5151-47 S. Main. Zip 38101. Tel: 527-8492-167 N. Tillman Zip 38114. Tel 327-2740 (Rec. & Tape OS)
Branch: West Memphis, Ark.

Accessories: Duotone, Fidelitone, Arthur Fullmer, Le-Bo, Shure.

C B S Recs., 1755 Lynnfield Rd., Suite 112. Zip 38138. Tel 761-3381 Branch Mgr. Barry Mog. (Rec. & Tape D)

Rec. labels: Arc, Bang, Blue Sky, CBS, Caribou, Columbia, Epic, Jet, Kirshner, Melodiya/Columbia, Nemperor, Odyssey, Philadelphia Int'l, Portrait, Starlight, Stiff, T-Neck, Tabu, Tappan Zee, Unlimited Gold
Tape lines: Same as rec. labels

Handleman Co., 3412 Jackson Ave. Zip. 38108. Tel 332-3650 Mgr & Buyer: George Eng. (Rec. & Tape RJ)

Home office: Clawson (Detroit Metropolitan Area), Mich
Hot Line Rec. Dist. Inc., PO Box 3351, 421 S. Main St. Zip 38103. Tel 525-0756 Gen. Mgr. J. W. Crudgington. Opns. Mgr.: Dwight D. Mullens; Buyers: Singles & D Albums, Sandy Meador, OS Albums, Tom O'Neil; Tape, Earl Elgart. (Rec. & Tape D & OS). (Rec. & Tape RJ as Record Dept. Mdsrs.)

Rec. labels: AJ, AVI, Abet, Ace, Ala, Alarm, Alston, Antique, BTM, Barnaby, Birthright, Blue Candle, Blues Spectrum, Bold, Bright Orange, Cadet, Cadet/Concept,

Cat, Checker, Chess, Chimneyville, Clouds, Comedian Int'l, Country Soul, Courage, Cream, Creed, DJM, Dash, Dictation Disc, Dingo, Drive, Ernie's, Excello, Fantasy, Fretone, GRT, Galaxy, Generation Int'l, Glades, Gospel Corner, Gospel Truth, Hi, Juana, Kayvette, Kent, Kenwood, Ko Ko, Laff, Laurie, MD, Malaco, Mankind, Marlin, Messenger, Milestone, Montuno, Nashboro, Nationwide Sound, October, Plantation, Prelude, Prestige, Randy's Spiritual, Ranwood, Republic, Roots, SOH, SSS Int'l, Shadybrook, Sound Bird, Specialty, Spire, Stax, Stone Dogg, Sun, TK, Tomato, United, Weird World, West End, Wicked, Wolf.

Tape lines: Ala, Cadet, GRT, Nashboro, Specialty, TK
Accessories: Blank tape (Capitol, Memorex), needles (Fidelitone, Gemco), Le-Bo prods.

Pickwick Int'l Inc., Distribution Div., 3387 Poplar, Suite 225. Zip 38111. Tel 454-1286 (Rec. & Tape D - sales only, see office in Atlanta, Ga. for prod. distributed). (Rec. & Tape RJ as Pickwick Int'l Inc., Rack Servs. Div.)

Home office: Minneapolis, Minn.

Pickwick Int'l Inc., Rack Servs. Div., 3387 Poplar, Suite 225. Zip 38111. Tel 454-1286 (Rec. & Tape RJ - sales only). (Rec. & Tape D as Pickwick Int'l Inc., Distribution Div.)

Home office: Minneapolis, Minn.

Poplar Tunes One-Stop, 308 Poplar Ave. Zip 38122. Tel 525-6348. Owners: Frank Berretta, John Novarese, Mgr.: Frank Berretta; Buyers, Singles & Albums, Jim Burge; Tape, Ron McAfee. Local branches: Pop Tunes-East, 4195 Summer Ave. Zip 38122. Tel: 324-3855. Mgr. Rose Slais - Pop Tunes-South, 4622 Faronia. Zip 38116. Tel 346-7172. Mgr.: Rose Slais. (Rec. & Tape OS)

Pop Tunes, see Poplar Tunes
Record Dept. Mdsrs Inc., 511 S. Main St. Zip 38103. Tel 526-0567. Sales Mgr. Danny Stovall, Mdsr. Mgr. Jim McCormick; Buyer, Faye Corline. (Rec. & Tape RJ), (Rec. & Tape D & OS as Hot Line Rec. Dist. Inc.)

Select-O-Hit Recs., 605 Chelsea Ave. Zip 38107. Tel 523-1190 (Rec. & Tape D & OS)

Labels: Audio Arts, Glori, HSE, Jewel, Sparrow.

● **NASHVILLE (Area Code 615)**

Capitol Recs., 38 Music Square E. Zip 37203. Tel 244-1842 (Rec. & Tape D)

Rec. labels: Angel, Anrola America, Capitol, EMI America, Harvest, Liberty, Melodiya/Angel, Seraphim, United Artists.

Tape lines: Same as rec. labels
Central South Music Sales Inc., 3730 Vulcan Dr. Zip 37211. Tel 833-5960. Owner & Mgr. Randall Davidson, Buyers: J.P. Bennett, Charles Adams. (Rec. & Tape OS)

Jimmy's One Stop, 1707 Church St. Zip 37203. Tel 320-1561. Owner: Hoyt Sullivan; Mgr. Hollie Russell, Buyer: Jimmy Lancaster. (Rec. OS)

M C A Dist g Corp., 50 Music Square W., Suite 205. Tel 327-3466. Branch Mgr. Murray Habbaz. (Rec. & Tape D)

Rec. labels: Backstreet, Butterfly, Coral, Infinity, LAX, MCA, Songbird, Source, Vocalion

Tape lines: Same as rec. labels

Music City One Stop, 127 Lafayette St. Zip 37210. Tel 256-4115. Mgr.: John Thomas, Buyers: Singles, Marie Silcox, Albums, John Thomas. (Rec. OS). (Rec. & Tape D as Music City Rec. Dist.)

Music City Rec. Dist's Inc., 25 Lincoln St. Zip 37202. Tel 255-7315. Pres.: Hutch Carlock, Mgr.: Ted Adams. Sales Mgr.: Mike Wise, Buyers: Singles, Ted Adams; Albums, Ted Adams, Hayes Carlock, Bruce Carlock, Tape, Ted Adams, Ronnie Tidwell. (Rec. & Tape D), (Rec. OS as Music City One Stop)

Rec. labels: Abet, Alarm, Alston, Camden, Cat, Chimneyville, County Creed, Crescendo, Disneyland, Dore, Drive, Excello, Flying Fish, Four Star, Glades, Gusto, HSE, Heart Warming, Impact, Jewel, Kayvette, Kenwood, Malaco, Mankind, Nasco, Nashboro, Old Homestead, Ovaton, Paula, Pickwick, Rebel, Ronn, Rounder, Rural Road, Soul Power, Sound City, Specialty, Starday, Su-Ann, TK, TMS, Vanguard, Vetco, Vista, Wicked

Tape lines: Nashboro, Rebel, TK Prod'n's
Accessories: Blank loaded tape (Capitol, Maxell, Memorex, Sony, TDK), carrying cases (Hagerstown, Peerless), needles (Fidelitone), rec. care prods (Discwasher, Empire, Fidelitone, Savoy, Sound Guard, Watts)

Superior Rec. Dist'g Co., 11 Music Circle S. Zip 37203. Tel 244-0461. Mgr. & Buyer: Howard A. Knight Jr. (Rec. & Tape D)

Rec. labels: Bee-Line, Benton, Boss, Colonial, GMC, Grape, IRS, Mighty Fine, NRS, Rising Star, Volunteer, Wago, Yucca

Tape lines: Colonial, GMC, Grape, NRS, Rising Star, Tri-State/Music Town Dist's., 62 Music Square W. Zip: 37203. Tel 256-1693. Owner: Cliff Ayers Ostermeyer, Mgr.: Connie L. Wright, Buyers: Singles, Chris Ostermeyer, Albums, Clarke Ostermeyer. (Rec. D)

Labels: Accent, Advance, All Star, Alto, American Sound, Angeltone, Archway, Arrawak, Art, Arvue, Atlas, Audio Arts, Avenue, Ballad, Bandbox, Baton, Bay Uke, Bee, Beltone, Big Sound, Blackbird, Black Gold, Boxer, Breeze, Bronze, Buddy, Bullseye, B&M, Campus, Canary, Capa, CapCity, Cardinal, Carrie, Cavern, Celebrity Circle, Century City, Chante, Chattahoochee, Chroma, Chytown, Cmamaron, Clare, Cloud 9, Colt, Commerce, Conclave, Confederate, Contour, Country World, Creation Sound, Crest, Crossfire, D-J, Daran, Debby, Delden, De-Lite, Del Mar, Desert, De Venus, Dome, Domino, Dot-Mar, Ebb, Electra, Emerald, Empire, Endeavor, Enterprise, Errol, Event, Fabbri, Fax, Film City, Five-O-Flick, Flo-Jo, Ford, GCM, GRT, Gass, General American, Genesis, Glenolden, Golden World, Gurdy, Gusman, H&L, Hallmark, Harvard, High Country, Hit, Htsville, Hudson, Hugo, Injun, Insko, Insight, Jalap, Jame, Jazz, Jemki, Jemki-Soul, Jessup, Julmar, KEF, K-W, Kangaroo, Kanwick, Kasma, Keen, Kenco, Kid Cuz n, Luv, La Salle, Las Vegas, Lincoln, Limp, Lucky Four, Mars, M-Arts, Major, Malinda, Map City, Marvello, Mayhams, Mecca, Mickey, Millage, Miracle, Molly, Moon, Mossrite, Motif, Motown, Music Factory, Music Town, Neptune

RABBIT

Your Independent Distributor in Houston

Wholesaler of fine Records and Tapes

Please write or call for our free catalog.

Now Full Service One-Stop

RABBIT DISTRIBUTING, 1923 Antoine Dr., Houston, Texas 77055, (713) 682-0997

New England, Nu Joy, Orbit, Patefile, Peacock, Petal, Pinpoint, Plato, Pony, Prestal, Prodigal, Public, RPR, RSVP, Rae-Cox, Ram, Ranwood, Raydar, Rebel, Rena, Reno-Smley, Rev. Rimrock, Riparia d'Oro, Road, Roadrunner, Ro-Ark, Robbins, Rondeliet, Sabine, Sable, Sabre, Sage, Sand, Scoloron, Scram, Serand, Shalom, Shee, Shirley, Silver Seal, Sims, Sir, Smog City, Soultack, Sprint, Starday, Steady, Sylvania, Tania, Tampa, Tapir, Taylor, Tempo, Three Hills, Tidonote, Trode, Twilight, United, Valco, Vanity, Variety, Verusius, Vida, Vita, Wagner, Way-Out, Wayside, Wedge, Wells-Desert, Westport, Zodiac. (SEE ADVERTISEMENT)

TEXAS

• AMARILLO (Area Code 806)

Western Mdsrs. Inc., PO Box 37720, 421 E. 34 St. Zip 79120. Tel 376-6251 Pres Sam Marmaduke; VP Mktg. R. H. Williamson, Buyer Steve Marmaduke. (Rec. & Tape OS & RJ)
Branches: Denver, Colo. (Rec. & Tape OS & RJ); (Rec. & Tape D as WM Dist'g); Tulsa, Okla. (Rec. & Tape RJ); Dallas, Tex. (Rec. & Tape RJ); Houston, Tex. (Rec. & Tape OS & RJ).

• AUSTIN (Area Code 512)

Tom Bishop Co., 6144 Hwy. 290 W. Zip 78735 Tel 892-1570 Owner, Mgr. & Buyer Tom Bishop. (Rec. & Tape OS & RJ)
House Dists., PO Box 312, Zip 78767. Tel 321-6271 Mgr. Susan Jarrett. (Rec. & Tape D)
Home office: Kansas City, Mo. (See for prod. distributed)

• BROWNSVILLE (Area Code 512)

U S Sound Dist. Inc., 1215 E. Washington, Zip 78520. Tel 546-4687. Pres. Alvaro Fajardo; Mgr. Ruben Lozano. (Rec. & Tape RJ & E)

• CORPUS CHRISTI (Area Code 512)

House of Music, 1026 S. Port. Zip 78405. Tel 882-2191 Owner, Mgr. & Buyer John W. Herrera. (Rec. & Tape OS)

• DALLAS AREA (Area Code 214)

(Also see listings in Fort Worth)

Big State Rec. Dist'g Corp., 4830 Lakawana, Suite 121 Zip 75247 Tel 631-1100. Owners H.W. & Don Daily, Bill Emerson, D & RJ Mgr. Bill Emerson, OS Mgr. Mike Emerson, Buyers Bill & Mike Emerson, Alta Hayes. (Rec. D & OS; Tape D, OS & RJ); (Rec. RJ as Records of Dallas)

Labels: APA, Abet, Ala, Alston, BTM, Barnaby, Black Forum, Blue Candle, Bold Cat, Century 21, Chimneyville, Cin/Kay, Clouds, Contempo, Country Int'l, Creed, Crescent, D. Dash, Dial, Dictation Disc, Dooto, Dore, Dr Doug, Dooto, Drive, Excello, Fantasy, 50 States, Four Star, Galaxy, Glades, Good Sounds, Gordy, Gospel, Gospel Roots, HDM, Increase, Inphasion, JMI, Janus, Jeremiah, Jim, Juana, Kayvette, Kent, Kenwood, Kik-R, Laff, Little Darlin', Living Language, Malaco, Mankind, Manticores, Marlin, Melodyland, Messenger, Milestone, Motown, Mowest, Nashboro, Natural Resources, Old Favorites, Plantation, Prestige, Prodigal, Pyramid, Rare Earth, Republic, Roulette, SSS Int'l, Shadybrook, Soul, Sound Bird, Sound Plus, Soundwaves, Specialty, Starday, Stax, Stoneway, Sun, Sunshine Sound, TK, TMS, Tania, Texas Int'l, Texasville, Tiger Lily, Vanguard, Virgo, Wicked, Will Barnes, Wolf, Word.

Photographs: Garrard, Weltron
Playback equip.: Hitachi, Lear Jet
Accessories: Capitol, Fidelitone, Le-Bo, Memorex, Savoy, Sound Guard

Bromo Dist of Dallas Inc., 3373 Garden Brook Zip 75234 Tel 247-7302 Owner Terry Warden, Gen. Mgr. Fran McGill; Adv. Dir. Ray Schmitt; Buyers Singles, Boyd O'Connor, Albums, Tracy Donihoo. (Rec. OS)
Branch: San Antonio, Tex.

C B S Recs., 8700 Stemmons Fwy., Suite 309, Zip 75247 Tel 634-1700. VP Southwest Region Jack Chase, Reg'l Co-ord. Midge Stubbs, Branch Mgr. Danny Yarbrough. (Rec. & Tape D)

Rec. labels: Arc, Bang, Blue Sky, CBS, Caribou, Columbia, Epic, Jet, Kirshner, Melodiya/Columbia, Nempor, Odyssey, Philadelphia Int'l, Portrait, Starlite, Stiff, T-Neck, Tabu, Tappan Zee, Unlimited Gold
Tape lines: Same as rec. labels.

Capitol Recs., 6730 Oakbrook Blvd. Zip 75235. Tel 637-1890. (Rec. & Tape D)
Rec. labels: Angel, Ariola America, Capitol, EMI America, Harvest, Liberty, Melodiya/Angel, Seraphim, United Artists
Tape lines: Same as rec. labels.

Galaxy Sales Co., 9106 Chancellor Row Zip 75247. Tel 688-1931. Mgr. Tom Sims; Sales Mgr. Don Baker; Buyer Brad Kinzbach. (Rec. OS & RJ; Tape D, OS & RJ)
Tape lines: GRT catalog
Playback equip.: Marume, Roadstar
Accessories: Le-Bo, Maxell

H & W One Stop Recs. Inc., 3109 Grand Ave. Zip 75215. Tel 421-7396. Mgr.: Jean Williams. (Rec. & Tape OS)

Handleman Co., 2931 Irving Blvd. Zip 75247. Tel 631-2943. Mgr. Bob Pastiro; Buyers Bob Pastiro, Ron Anderson, Velma Kelly, Bruce Martin. (Rec. & Tape RJ)
Home office: Clawson (Detroit Metropolitan Area), Mich.

Lieberman Ents. Inc., 9670 Chartwell Dr. Zip 75231. Tel 349-2520 Mgr. Jim Sinclair, Opts. Mgr. Robert Smith; OS Mgr. Kenny Wayne; Buyers: Singles, Susan Elder; Albums & Tape, Patty Dawson. (Rec. & Tape OS & RJ)

Home office: Minneapolis, Minn
M C A Dist'g Corp., 11212 Gemini St. Zip 75229 Tel 241-8646 Reg'l Dir. Rod Tremblay, Branch Mgr. Dan Purcell. (Rec. & Tape D)

Rec. labels: Backstreet, Butterfly, Coral, Infinity, LAX, MCA, Songbird, Source, Vocalion
Tape lines: Same as rec. labels.

PolyGram Dist'n Inc., 14200 Midway Plaza, Suite 125. Zip 75244. Tel 387-2797. Branch Mgr. Marty Markowitz, Sales Mgr. Steve Price. (Rec. & Tape D)

Home office: New York, N.Y.
Rec. labels: American Int'l, Archiv, Capricorn, Casablanca, Charisma, Chocolate City, DJM, De-Lite, Deutsche Grammophon, Emarcy, Festivo, Fontana, Lmelight, MGM, Mercury, Monument, Oasis, Parachute, Philips, Polydor, Polydor/BGO, Polydor/Harem, Polydor/Kolob, Polydor/MVP, Polydor/Manken, Privilege, RSO, RSO/Curtom, Riva, Smash, Soundstage Seven, Spring, Vertigo, Verve, Zappa
Tape lines: Same as rec. labels.

R C A & M & Assoc'd Labels, 8700 Stemmons Fwy Zip 75247. Tel 638-6470. Branch Sales Mgr. Jim Yates. (Rec. & Tape D)

Rec. labels: A&M, Bluebird, Free Flight, Gold Seal, Grunt, Hologram, Millennium, NY Int'l, Pablo, Pablo Live, Pure Gold, RCA, Red Seal, Roadshow, Rocket, Salsoul, Solar, Tortoise, 20th Century, Victrola, Windsong
Tape lines: Same as rec. labels.

Rack Suppliers Inc., 519 Gibson St., Seagoville 75159. Tel 287-5451. Owner H.R. Gibson Jr.; Mgr. Lloyd Scott, Buyer Mike Quinones. (Rec. & Tape RJ)

Record Shack of Dallas, 10701 Stemmons Expwy Zip 75220 Tel 556-1000. Mgr. Ken Portnoy. (Rec. & Tape OS, I & E)

Home office: Woodside (New York Metropolitan Area), N.Y., Record Shack of New York City Inc. (SEE ADVERTISEMENT)

Records of Dallas, 4830 Lakawana, Suite 121 Zip 75247. Tel 631-7263 Owners H.W. & Don Daily, Bill Emerson; Mgr. Bill Emerson; Buyers Mike & Bill Emerson, Alta Hayes. (Rec. RJ); (Rec. D & OS; Tape D, OS & RJ as Big State Rec. Dist'g)

Triple S One Stop Recs., 320 S. Lancaster, Kiest Shopping Center Zip 75216. Tel 375-5661 Buyer Jim Sanders. (Rec. & Tape OS)

Warner/Elektra/Atlantic Corp., 1909 Hereford Dr., Irving 75061 Tel 255-2141 Mgr. Paul Sheffield. (Rec. & Tape D)

Rec. labels: Asylum, Atco, Atlantic, Bearsville, Beserkley, Big Tree, Cotillion, Curtom, Dark Horse, Disc-Reet, ECM, Elektra, Embryo, Famous Charisma, Finnadar, Little David, Loma, Manticores, Nempor, Nonesuch, Pacific, Paradise, Reprise, Rolling Stones, SHE, Sire, Slipped Disc, Swan Song, WMOT, Warner Bros., Warner/Curb, Warner Spector, Westbound, Whitfield, Wing & a Prayer, Zephyr
Tape lines: Same as rec. labels.

Western Mdsrs. Inc., 1409 Round Table Dr. Zip 75247 Tel 638-1680. Mgr. George Baldwin. (Rec. & Tape RJ)

Home office: Amarillo, Tex. (Rec. & Tape OS & RJ)
Westex Recs. & Reels, 3151 Commonwealth Zip 75247. Tel 637-1810 Owner Jess Wilson, Mgr. Eddie Childers. Buyers Singles, Debbie Childers, Albums & Tape, Eddie Childers. (Rec. & Tape OS & RJ)

• EL PASO (Area Code 915)
Krupp Dist'g Co., 311 S. Santa Fe St. Zip 79901. Tel 532-4961. (Rec. & Tape OS)

• FORT WORTH AREA (Area Code 817)
Victor Hotho & Co., PO Box 9738 Zip 76107 Tel 335-1833 Owner Victor Hotho, Mgr. Jeanine Allen, Buyer Donna Hotho. (Rec. & Tape RJ)
Branch: New York, N.Y.

Landmark Dist. Inc., 2020 E. Randal Mill Rd., Arlington 76011 Tel 469-1071 WATS (Texas) (800) 792-1039. (Other states) (800) 433-1624. Mgr. John DeBord; Buyer Chuck Mertz. (Rec. & Tape D, RJ & E—religious prod. only)

Rec. labels: Birdwing, Broadman, Calvary, Canaan, Capitol, Cross-Country, Crescendo, Dayspring, Good News, Greentree, Heart Warming, Houseput, Image VII, Impact, Jim, Jubilation group, Lamb & Lion, Light, Maranatha, Myrrh, New Life, New Pax, New World, Paragon, Phonodisc, QCA, RCA, Ranwood, Sacred, Singpiration, SkyLite-Sing, Solid Rock, Sparrow, Star-song, Tempo, Triune, Windchime, Word
Tape lines: Same as rec. labels.

Pickwick Int'l Inc., Distribution Div., 2200 E. Randal Mill Rd., Arlington 76011. Tel 261-4281. Nat'l Sales Mgr.: Jack Bernstein; Nat'l Opts. Mgr.: Allan Roller. Branch Mgr. Don Gillespie, Buyer Bebe Pulliam. (Rec. & Tape D); (Rec. & Tape RJ as Pickwick Int'l Inc.; Rack Servs. Div.)

Home office: Minneapolis, Minn
Labels: ASI, AVI, Abkco, Argo, Arista, Artist House, Aspekto, Aural Explorer, Big Sound, Birthright, Buddah, CTI, Camden, Century, Chantarella, Choice, Chrysalis, Churchill, Cime, Classic Jazz, Con Bro, Concord Jazz, Connoisseur Society, Cream, Decca, Deram, Direkt to Disk, First American, Flying Fish, GNP Crescendo, GRP, Great Northwest, Guitar Player, Gryphon, H&L, Headline, Hi, Hilltop, Hob, Honeybee, Inner City, Jewel, Kaleidoscope, Kudu, LS, Le Joint, L'Oiseau Lyre, London, Mark 56, Midsong, Music, Mushroom, Music Is Medicine, Ovation, Pacific Arts, Parrot, Passport, Paula, Piccadilly, Pickwick, Potato, Prelude, Project 3, Quinestence, RDS, Ranwood, Ronn, Salvation, Savoy, Seeds & Stems, Sesame Street, Stiff, Stoney Plain, Syntonic Research, Takoma, Talsman, Telefunken, Threshold, Tomato, UK, Versatile, Visa, Voyage, Who's Who in Jazz, Xanadu. (SEE ADVERTISEMENT)

Pickwick Int'l Inc., Rack Servs. Div., 2200 E. Randal Mill Rd., Arlington 76011. Tel 261-4281 Opts. Mgr. Jim Newhouse; Sales Mgr. Dwayne Neimeyer, Buyer Jim Weatherston. (Rec. & Tape RJ); (Rec. & Tape D as Pickwick Int'l Inc.; Distribution Div.)

Sell 'Dem Recs., 7121 W. Vickery, Unit 118 Zip 76116.

Tel 731-7375 Owner & Mgr. Slim Richey, Adv. & Promo. James W. Colegrove; Buyers Singles & Albums, James H. Yanaway; Tape, Slim Richey. (Rec. D & E, Tape D)

Rec. labels: Adelphi, Advent, American Heritage, Arhoolie, Atterram, B.I.J.A., Backdoor, Bay, Biscuit City, Blue Goose, Blue Royal, Blues Classics, Briar, Broadway Intermission, Chess, Club of Spades, County, Delmark, Fiddle-De-Do, Flying High, Folk Lyric, Gold Band, Grass Mountain, Guitar Player, Guitar World, HDS, Iron Horse, Kaleidoscope, Kicking Mule, King, King Bluegrass, Lemco, Longevity, Long Neck, Midland, MMO, Old Homestead, Old Timey, Outlet, Outrageous, Pearl, Physical, Plantation, Power Pak, Priority, Puritan, Rambler, Rebel, Red Clay, Red Lightnin', Revonah, Ridge Runner, Rounder, Rural Rhythm, SSS Int'l, Shasta, Solid Smoke, Sonet, Sonyatone, Specialty, Starday, Stash, Sugar, Sun, Swallow, Texas Re-Cord, Vetco, Yazoo, Zap

Tape lines: King, King Bluegrass, Plantation, Power Pak, Rebel, Ridge Runner, Rounder, Rural Rhythm, SSS Int'l, Starday, Sun.

• FRANKSTON (Area Code 214)
Mills Specialty Whsle., 4-2 Three Points Est. Zip 75763. Tel 876-3816 Owner, Mgr. & Buyer E.A. Mills. (Tape OS & RJ)

• HOUSTON AREA (Area Code 713)
Acme Dist'g Co., 3743 University Blvd. Zip 77005. Tel 665-0741. Owner & Mgr. Kenneth Parish. (Rec. & Tape RJ)

C B S Recs., 2190 North Loop W., Suite 100, Zip 77018. Tel 680-8900. Branch Mgr.: John Madison. (Rec. & Tape D)

Rec. labels: Arc, Bang, Blue Sky, CBS, Caribou, Columbia, Epic, Jet, Kirshner, Melodiya/Columbia, Nempor, Odyssey, Philadelphia Int'l, Portrait, Starlite, Stiff, T-Neck, Tabu, Tappan Zee, Unlimited Gold.
Tape lines: Same as rec. labels.

H W Daily Inc., 3409 Brinkman, Zip 77018. Tel 861-9251. Owners: H.W. Daily Jr., Don Daily; Sales Mgr. David Bennett; Buyers: Singles, Ross Craft, Albums & Tape, Skip Smith. (Rec. & Tape D & OS)
Labels: D, Disneyland, KIKR.
Accessories: Le-Bo, Maxell, Scotch, Sound Guard, Watts

Eden Recs./Sound Rec'g Co., 803 Usher, Zip 77009. Tel 861-2176. Pres. Joseph A Zimmerman. (Rec. & Tape D)

Labels: Alshire, Audio Spectrum, Big H, Cadet, Conversa-Phone, Diamante, Discos Corona, Disneyland, Living Language, Memorabilia, Mother Goose, Peter Pan, Pickwick-Camden, Request, Robin Hood, Sesame Street, Springboard, Steno-Disc, Super Sonido, United
Accessories: Le-Bo, Pianstheil, Pickwick

G P Recs. & Tapes Dist., PO Box 21100, 2124 N. Main St. Zip 77026. Tel 223-9293 Owner Gaston C. Ponce; Mgr. Herbe R. Ponce. (Rec. D)

Rec. labels: Bonito, Exito Regional, Firmamento, G-poca, Hit, Novavox, Sabroso.

Lotasso, PO Box 10860, 1634 Wakefield Dr. Zip 77018. Tel 686-1155 Owner Maxine Eickenhorst; Albums & Tape Buyer A.H. Eickenhorst. (Rec. & Tape D, OS & RJ)

Rec. labels: AOLT, Alshire, Camden, Pickwick Int'l, Stoneway, United; also distributes cut-outs & close-outs
Tape lines: Same as rec. labels

M C A Dist'g Corp., 5909 W. Loop S., No. 150, Bellaire 77401. Tel 866-2668 Branch Mgr.: Charlie Johnson. (Rec. & Tape D)

Rec. labels: Backstreet, Butterfly, Coral, Infinity, LAX, MCA, Songbird, Source, Vocalion.
Tape lines: Same as rec. labels

Merbach Rec. Serv., 323 W. 14 St. Zip 77008. Tel 862-7077 Owner N.F. Merbach. (Rec. D)

Rec. labels: Bee Sharp, Blue Star, Bogan, Dance Ranch, E-Z, Lore, Rockin' (A), Swinging Square (All square dance labels)

Mobile Rec. Serv. Co., 8047 Grow Ln., Apt 136 Zip 77040. Tel 939-1958. Mgr.: Joseph McNally. (Rec. OS—singles only)
Home office: Pittsburgh, Pa

Music Serv. Co., 5631 Old Clinton Rd. Zip 77020. Tel 675-7581. Owner & Mgr. Harry Rosmarin; Buyers Singles, Tom Meyer; Albums & Tape, Al Acuna. (Rec. & Tape RJ)

Music Town, 6214 Craigway Rd., Spring 77379. Tel 376-7507. Owner, Mgr.: Singles, Albums & Tape Buyer. James May. (Rec. & Tape OS & RJ)

Pickwick Int'l Inc., Distribution Div., 6400 W. Park, Suite 465 Zip 77057. Tel 780-7650. (Rec. & Tape D—see listing in Fort Worth for prod. distributed); (Rec. & Tape RJ as Pickwick Int'l Inc.; Rack Servs. Div.)

Home office: Minneapolis, Minn

Pickwick Int'l Inc., Rack Servs. Div., 6400 W. Park, Suite 465 Zip 77057. Tel 780-7650. (Rec. & Tape RJ—sales only) (Rec. & Tape D as Pickwick Int'l Inc.; Distribution Div.)

Home office: Minneapolis, Minn

PolyGram Dist'n Inc., 2630 Fountainview, Suite 300, Zip 77057. Tel 780-0407. (Rec. & Tape D—sales office only)

Home office: New York, N.Y.
Rec. labels: American Int'l, Archiv, Capricorn, Casablanca, Charisma, Chocolate City, DJM, De-Lite, Deutsche Grammophon, Emarcy, Festivo, Fontana, Lmelight, MGM, Mercury, Monument, Oasis, Parachute, Philips, Polydor, Polydor/BGO, Polydor/Harem, Polydor/Kolob, Polydor/MVP, Polydor/Manken, Privilege, RSO, RSO/Curtom, Riva, Smash, Soundstage Seven, Spring, Vertigo, Verve, Zappa
Tape lines: Same as rec. labels.

Rabbit Dist'g, 1923 Antoine, Zip 77055. Tel 682-0997. Owner Ray Abbott, Gen. Mgr. Joan Roessler; Sales Mgr. Doug Mattice. (Rec. & Tape D)

(Continued on page 422)

ASSOCIATIONS & PROFESSIONAL ORGANIZATIONS

A C A, see American Composers Alliance.
 A F M, see American Federation of Musicians.
 A F T R A, see American Federation of Television & Radio Artists.
 A G A C, see American Guild of Authors & Composers.
 A G V A, see American Guild of Variety Artists.
 A M U, see American Musicians Union.
 Academy of Country Music, 1777 N. Vine St., Suite 200, Hollywood, Calif. 91504. Tel: (213) 462-2351. Exec. Dir.: Fran Boyd.
 Affiliate Artists Inc., 155 W. 68 St., Suite 35-E, New York, N.Y. 10023. Tel: (212) 580-2000. Pres. Richard Clark; Publ's Mgr.: Janet Kramer.
 Afro-American Music Opportunities Ass'n Inc., 2809 Wayzata Blvd., Minneapolis, Minn. 55405. Tel: (612) 377-3730. Exec. Dir.: C. Edward Thomas.
 Amateur Chamber Music Players Inc., c/o American Symphony Orchestra League, PO Box 547, Vienna, Va. 22180. Tel: (703) 281-1230. Chm.: Samuel P. Hayes; Sec'y: Helen Rice.
 American Academy & Institute of Arts & Letters, 633 W. 155 St., New York, N.Y. 10032. Tel: (212) 368-5900. Pres.: Barbara W. Tuchman.
 American Academy of Teachers of Singing, 340 W. 72 St., New York, N.Y. 10023. Tel: (212) 362-9621. Chm.: Willard Young; Vice Chm.: Dolf Swing.
 American Accordionists' Ass'n Inc., 165 W. 10 St., New York, N.Y. 10014. N.J. Tel: (201) 991-5010. Pres.: Maddalena Belfiore.
 American Ass'n for Music Therapy, 777 Education Bldg., New York Univ., Washington Square, 35 W. Fourth St., New York, N.Y. 10003. Pres.: Dr. Leo Shatin; Sec'y: Dr. Jerrold Ross.
 American Choral Directors' Ass'n, PO Box 5310, Lawton, Okla. 73504. Tel: (405) 355-8161. Nat'l Exec. Sec'y: Dr. Gene Brooks.
 American Choral Foundation Inc., 130 W. 56 St., New York, N.Y. 10019. Tel: (212) 246-3361. Admin. Dir.: Sheldon Soffer.
 American College of Musicians, PO Box 1807, 808 Rio Grande, Austin, Tex. 78767. Tel: (512) 478-5775. Pres.: Irl Allison Jr.

American Composers Alliance (ACA), 170 W. 74 St., New York, N.Y. 10023. Tel: (212) 362-8900. Pres.: Nicolas Roussakis; Exec. Dir.: Francis Thorne.
 American Council for the Arts, 570 Seventh Ave., New York, N.Y. 10018. Tel: (212) 354-6655.
 Branch: Washington, D.C., 2000 P St. NW. Zip 20036. Tel: (202) 659-5161.
 American Dance Therapy Ass'n Inc., 2000 Century Plaza, Columbia, Md. 21044. Tel: (301) 997-4040. Pres.: Judith Bunney.
 American Federation of Musicians (AFM), 1500 Broadway, New York, N.Y. 10036. Tel: (212) 869-1330. Pres.: Victor W. Fuentealba.
 American Federation of Television & Radio Artists (AFTRA), 1350 Ave. of the Americas, New York, N.Y. 10019. Tel: (212) 265-7700. Pres.: Joe Slattery; Nat'l Exec. Sec'y: Sanford I. Wolff.
 American Guild of Authors & Composers (AGAC), 40 W. 57 St., New York, N.Y. 10019. Tel: (212) 757-8833. Cable: SONGRITE. Pres.: Ervin Drake.
 American Guild of Music, PO Box 3, Downers Grove, Ill. 60515. Tel: (312) 968-0173. Pres.: Myrtle Robertson; Exec. Sec'y: E.D. Herrick.
 American Guild of Musical Artists (AFL-CIO), 1841 Broadway, New York, N.Y. 10023. Tel: (212) 265-3687. Pres.: Gene Boucher; Nat'l Exec. Sec'y: DeLloyd Tibbs.
 American Guild of Organists, 630 Fifth Ave., Suite 2010, New York, N.Y. 10020. Tel: (212) 265-5630. Pres.: Dr. Roberta Bitgood.
 American Guild of Variety Artists (AGVA), 1540 Broadway, New York, N.Y. 10036. Tel: (212) 765-0800.
 American Harp Society Inc., 6331 Quebec Dr., Los Angeles, Calif. 90068. Tel: (213) 463-0716. Pres.: Ann Mason Stockton; Office Mgr.: Dorothy Remsen.
 American Liszt Society, Univ. of Florida, Music Dept., Gainesville, Fla. 32611. Tel: (904) 392-6674. Bd. Chm.: Dr. David Z. Kushner.
 American Matthay Ass'n, 19 Hundreds Circle, Wellesley Hills, Mass. 02181. Tel: (617) 235-1992. Pres.: Chandler Gregg.
 American Music Center Inc., 250 W. 57 St., Suite 626-7, New York, N.Y. 10019. Tel: (212) 247-3121. Pres.: Charles Dodge; Exec. Dir.: Margaret F. Jory.
 American Music Conference, 1000 Skokie Blvd., Wilmette, Ill. 60091. Tel: (312) 251-1600. Pres.: Gene C. Wenner; Member Relations Dir.: Drew M. Crandall.
 American Musicians Union Inc. (AMU), 8 Tobin Court, Dumont, N.J. 07628. Tel: (201) 384-5378. Pres.: Bruce Intorpe; VP: Bruce Pollack.
 American Musicological Society, Univ. of Chicago, Music Dept., Chicago, Ill. 60637. Pres.: Howard Mayer Brown.
 American Orff-Schulwerk Ass'n, Cleveland State Univ., Music Dept., Cleveland Heights, Ohio 44115. Tel: (216) 382-0061. 566-7364. Pres.: Lillian Yaross; Exec. Sec'y: Ruth Pollock Hamm.
 American Recorder Society, 13 E. 16 St., 7th fl., New York, N.Y. 10003. Tel: (212) 675-9042. Pres.: Martha Bixler; Office Mgr.: Mary Ann Fleming.
 American Society of Univ. Composers, 250 W. 57 St., Suite 626-7, New York, N.Y. 10019. Tel: (212) 247-3121. Exec. Committee Chm.: Richard Brooks.
 American String Teachers Ass'n, Furman Univ., Greenville, S.C. 29613. Tel: (803) 294-2019. Exec. Dir.: Richard Maag.
 American Symphony Orchestra League, PO Box 669, Vienna, Va. 22180. Tel: (703) 281-1230. Exec. Dir.: Ralph Black.
 American Theatre Ass'n, 1000 Vermont Ave. NW, Washington, D.C. 20005. Tel: (202) 628-4634. Exec. Dir.: Jack Morrison; Admin. Ass't: Marge Tischer.
 Americas Boychoir Federation (div. of International Federation of Children's Choirs), PO Box 677, 125 S. Fourth St., Connelville, Pa. 15425. Tel: (412) 628-8000. Pres.: Rodolfo Torres.
 Amusement & Music Operators Ass'n, 35 E. Wacker Dr., Chicago, Ill. 60601. Tel: (312) 726-2810. Exec. VP: Frederick M. Granger.
 Associated Male Choruses of America Inc., 106 Maplefield Rd., Pleasant Ridge, Mich. 48069. Tel: (313) 544-1995. Exec. Sec'y: Russell R. Fleharty.

Association for Recorded Sound Collections Inc., PO Box 1643, Manassas, Va. 22110. Washington D.C. Tel: (202) 523-3294. Pres.: David Hall.
 Association of American Dance Cos., 162 W. 56 St., Rm. 203, New York, N.Y. 10019. Tel: (212) 265-7824. WATS (800) 223-6573. Pres.: Norma Munn.
 Association of College, Univ. & Community Arts Administrators Inc., PO Box 2137, Madison, Wis. 53701. Tel: (608) 262-0004. Exec. Dir.: William M. Dawson.
 Audio Engineering Society Inc., Lincoln Bldg., Rm. 449, 60 E. 42 St., New York, N.Y. 10017. Tel: (212) 661-8528. Cable: AUDENGSOCT. Exec. Dir.: Peter Berkowitz; Exec. Dir.: Donald J. Plunkett.
 Black Music Ass'n (BMA), 1500 Locust St., Suite 1905, Philadelphia, Pa. 19102. Tel: (215) 545-8600. Sr. VP: Jules Malamud; Exec. Dir.: Glenda Garcia.
 Bluegrass Club of New York, 417 E. 89 St., New York, N.Y. 10028. Tel: (212) 427-1488. Pres.: Douglas Tuchman.
 Louis Braille Foundation for Blind Musicians, 215 Park Ave. S., New York, N.Y. 10003. Tel: (212) 982-7290. Exec. Dir.: Shel Freund.
 Broadcasting Foundation of America, 52 Vanderbilt Ave., New York, N.Y. 10017. Tel: (212) 986-6448. Cable: BRODFOUNAM. Chm.: George E. Probst; VP & Exec. Dir.: Howard L. Kany.
 Bruckner Society of America Inc., PO Box 2570, Iowa City, Iowa 52240. Tel: (319) 338-0313. Pres.: Charles L. Eble.
 C A M E O (Creative Audio & Music Electronics Org.), 10 Delmar Ave., Framingham, Mass. 01701. Tel: (617) 877-6459. Contact: Larry Blakely.
 C M A, see Country Music Ass'n.
 Central Opera Serv., Metropolitan Opera-Lincoln Center, New York, N.Y. 10023. Tel: (212) 799-3467. Admin. Dir.: Maria F. Rich.
 Chamber Music America, 1372 Broadway, 14th fl., New York, N.Y. 10018. Tel: (212) 221-0270. Pres.: Michael Jaffe; Exec. Dir.: Benjamin S. Dunham.
 Chautauqua Institution, Chautauqua, N.Y. 14722. Tel: (716) 357-5635. Pres.: Dr. Robert R. Hesse; VP & Program Dir.: Robert V. Woodside.
 Coleman Chamber Music Ass'n, 202 S. Lake Ave., No. 201, Pasadena, Calif. 91101. Tel: (213) 793-4191. Pres.: Mrs. Clarendon B. Eyer; Mgr.: George Heussenstamm.
 College Band Directors Nat'l Ass'n, c/o Baylor Univ. Bands Waco, Tex. 76703. Tel: (817) 755-1161. Pres.: Frank Battisti; Pres. Elect.: William Foster; VP: H. Robert Reynolds; Sec'y-Treas.: Richard L. Floyd.
 College Music Society Inc., Univ. of Colorado, Regent Box 44, Boulder, Colo. 80309. Tel: (303) 492-5049. Pres.: Chappell White; Exec. Sec'y: Craig Short.
 Composers & Lyricists Guild of America Inc., 10999 Riverside Dr., Suite 100, North Hollywood, Calif. 91602. Tel: (213) 985-4102. Pres.: Elmer Bernstein.
 Concert Music Broadcasters' Ass'n, Terminal Tower, Penthouse East, Cleveland, Ohio 44113. Tel: (216) 241-0900. Sec'y-Treas.: C.K. Patrick.
 Country Music Ass'n Inc. (CMA), 7 Music Circle N., Nashville, Tenn. 37203. Tel: (615) 244-2840. Cable: CMANAS. Bd. Chm.: Tom Collins; Pres.: Ralph Peer; Exec. Dir.: Jo Walker; Exec. VP: Irving Waugh; Pub. Dir.: Marsha Gepner.
 Country Music Foundation Inc., 4 Music Square E., Nashville, Tenn. 37203. Tel: (615) 256-1639. Exec. Dir.: William Ivey.
 Country Music Foundation of Colorado, PO Box 19435, Denver, Colo. 80219. Tel: (303) 936-7762. Pres. & Exec. Dir.: Gladys Hart.
 Dance Films Ass'n Inc., 250 W. 57 St., New York, N.Y. 10019. Tel: (212) 586-2142. Exec. Dir.: Susan Braun.
 Dance Notation Bureau Inc., 505 Eighth Ave., New York, N.Y. 10018. Tel: (212) 736-4350. Dir.: Muriel Topaz; Admin'r.: Gary Lindsey.
 Delta Omicron Int'l Music Fraternity, 1352 Redwood Court, Columbus, Ohio 43229. Tel: (614) 888-2640. Pres.: Kay Calfee Wideman; Exec. Sec'y: Jane W. Kuckuk.
 Branch: QUITMAN, Ga., 806 N. Laurel St. Zip 31643. Tel: (912) 263-8036.
 Electronic Inds. Ass'n (EIA), 2001 I St. NW, Washington, D.C. 20006. Tel: (202) 457-4900. Bd. Chm.: Roland M. Bixler; Pres.: Peter F. McCloskey.
 F E D A P T, see Foundation for the Extension & Development of the American Professional Theatre.
 F I C A P, see Federation of Int'l Country Air Personalities.
 Federation of Int'l Country Air Personalities (FICAP), 1201 16 Ave. S., Nashville, Tenn. 37212. Tel: (615) 320-0115. Pres.: Mike Burger; VP: King Edward IV; Exec. Dir.: Georgia Twitty; Sec'y-Treas.: Mary Sullivan.
 Florida Country Music Foundation & Hall of Fame Inc., PO Box 336, Hwy. 441 & 27, Fruitland Park, Fla. 32731. Tel: (904) 787-1051. Admin'r.: Mama Jo Hunt.
 Foundation for the Extension & Development of the American Professional Theatre (FEDAPT), 1500 Broadway, New York, N.Y. 10036. Tel: (212) 869-9690. Exec. Dir.: Frederic B. Vogel.
 G M A, see Gospel Music Ass'n.
 Gospel Music Ass'n (GMA), PO Box 23201, 38 Music Square W., Nashville, Tenn. 37202. Tel: (615) 242-0303. Pres.: W.F. Myers; Exec. Dir.: Donald W. Butler.
 Harp Renaissance Society, 1036 Beechwood Blvd., Pittsburgh, Pa. 15206. Tel: (412) 661-6161.
 The Hymn Society of America Inc., Wittenburg Univ., Springfield, Ohio 45501. Tel: (513) 327-6308. Exec. Dir.: W. Thomas Smith.
 I A M, see International Ass'n of Auditorium Managers.
 I H F, see Institute of High Fidelity.
 Institute of Audio Research Inc., 64 University Pl., New York, N.Y. 10003. Tel: (212) 677-7580.
 Institute of High Fidelity Inc. (IHF), 489 Fifth Ave., New York, N.Y. 10017. Tel: (212) 682-5131. Pres.: Jerry Kalov.

CONFIDENTIAL!

TO: American Exporters & Foreign Buyers. We ship daily Music Industry products to every city in the world. Best freight rates, from New York & Los Angeles. Banking, insurance, trade services, etc. . . .

VERY PERSONAL ATTENTION!

BERKLY AIR SERVICES

Contact: Bernard Klainberg, Pres.
 Bldg. 80 POB 665, JFK Airport, NY 11430
 Ph. (212) 656-6066 TLX. 425628

Worldwide PROFESSIONAL STORAGE and MANAGEMENT SERVICES

AUDIO VIDEO TAPES • FILMS

50 years of experience

- ENVIRONMENTALLY CONTROLLED FACILITIES
- ELECTRONIC SECURITY • FIRE SUPPRESSION
- COMPUTERIZED INVENTORY CONTROL

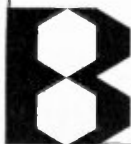

BONDED SERVICES 733 THIRD AVE., N.Y., N.Y. 10017

- New York — (212) 557-6700
- Toronto — (416) 363-6414
- Amsterdam — 41 42 00
- Los Angeles — (213) 654-7575
- Montreal — (514) 866-4919
- Mexico City — (905) 588-1922
- Hong Kong — 3-6577/71

Intercollegiate Musical Council, Univ. of Florida, Gainesville, Fla. 32603. Tel (904) 392-3261. Pres.: John Grigsby.

International Ass'n of Auditorium Managers (IAAM), 1 Illinois Center, 111 E. Wacker Dr., Chicago, Ill. 60601. Tel (312) 565-4100. Pres.: Louis C. Owen. Exec. Dir.: Gay Gelman.

International Ass'n of Organ Teachers USA, 7938 Bertram Ave., Hammond, Ind. 46324. Tel (219) 844-3395. Pres. & Music Dir.: Dorothy S. Greig; Admin. Dir. & Sec'y Treas.: Jack C. Greig.

International Bach Society Inc., 173 Riverside Dr., New York, N.Y. 10024. Tel (212) 873-3551.

International Fan Club Org., PO Box 177, Wild Horse, Colo. 80862. Tel (303) 962-3453. Co-Pres.: Loudilla, Loretta & Kay Johnson.

International Federation of Children's Choirs, PO Box 677, 125 S. Fourth St., Conneville, Pa. 15425. Tel: (412) 628-8000. Pres.: Francis Delvin; Sec'y Gen.: Catherine Martin.

International Mimes & Pantomimists, Valley Studio, Rt. 3, Spring Green, Wis. 53588. Tel: (608) 588-2514. Admin'r Dr. E. Ried Gilbert.

International Rhythm & Blues Ass'n, 11616 S. Lafayette Ave., Chicago, Ill. 60628. Tel (312) 264-2166. Pres.: William C. Tyson.

International Society for Contemporary Music, see League of Composers.

International Society of Bassists, c/o Univ. of Cincinnati, College Conservatory of Music, Cincinnati, Ohio 45221. Tel (513) 475-4730. Exec. Dir.: Barry Green; Admin. Ass't: Debbie Tomlinson.

International Society of Performing Arts Admin'r, c/o Columbia Music Festival Ass'n, 1527 Senate St., Columbia, S.C. 29201. Tel (803) 771-6303. Treas.: Leon Harrelson.

International Trombone Ass'n, Univ. of Arizona, School of Music, Tucson, Ariz. 85721. Tel (602) 626-1655.

International Trumpet Guild, SUC Crane School of Music, Potsdam, N.Y. 13676. Tel (315) 268-3660. Pres.: David Hickman. Sec'y: David Baldwin.

J.C.O.A., see Jazz Composer's Orchestra Ass'n Inc.

Jazz Composer's Orchestra Ass'n Inc. (JCOA), 500 Broadway, 4th fl., New York, N.Y. 10012. Tel (212) 925-2121. Pres.: Timothy F. Marquand; Exec. Dir.: Michael Mantler. Office Mgr.: Anton Fier.

Kappa Kappa Psi, Nat'l Band Fraternity, Oklahoma State Univ., 122 Center for the Performing Arts, Stillwater, Okla. 74074. Tel (405) 372-2333. Exec. Sec'y: Thomas F. Sirdidge.

League of Composers, International Society for Contemporary Music (US Section), c/o American Music Center, 250 W. 57 St., Suite 626-7, New York, N.Y. 10019. Tel (212) 247-3121. Pres.: Brian Fennelly. VP: Paul A. Leir.

Leschetzky Ass'n Inc., 105 W. 72 St., New York, N.Y. 10023. Tel (212) 362-3912. Pres.: Genia Robinov.

Masterwork Music & Art Foundation Inc., 300 Mendham Rd., Morristown, N.J. 07960. Tel (201) 538-1860. Development Dir.: Arthur Marino; Music Dir.: David Randolph.

Memphis Rec'g Prod'rs Ass'n, Commerce Tower, Suite 1590, 1 Commerce Square, Memphis, Tenn. 38103. Tel (901) 523-0533. Cable: HAMCAST. Sec'y-Treas.: Harold C. Streibich.

Metropolitan Opera Nat'l Council, Lincoln Center, New York, N.Y. 10023. Tel (212) 799-3100 x 418. Pres.: Alexander Sanderson.

Mississippi Valley Country & Western Music Ass'n, PO Box 813, Rock Island, Ill. 61201. Tel (319) 381-2382. Pres.: Myrtle Brockmann.

Modern Music Masters Society, PO Box 347, Park Ridge, Ill. 60068. Tel (312) 825-1451. Pres.: Paul E. Thoms. Exec. Sec'y: Genevieve Smith.

Moravian Music Foundation Inc., PO Drawer Z, Salem Sta., 20 Cascade Ave., Winston-Salem, N.C. 27108. Tel (919) 725-0651. Dir.: Karl Kroeger.

Mu Phi Epsilon International Professional Music Fraternity, 7440 W. 89 St., Los Angeles, Calif. 90045. Tel (213) 649-2494. Nat'l Pres.: Marian B. Noonan.

Music Critics Ass'n Inc., 6201 Tuckerman Ln., Rockville, Md. 20852. Tel (301) 530-9527. Pres.: Patrick J. Smith. Exec. Sec'y: Richard D. Freed.

Music Educators Nat'l Conference, 1902 Association Dr., Reston, Va. 22091. Tel (703) 860-4000. Pres. Dr. James A. Mason. Exec. Dir. Dr. A. Theodore Tellstrom.

Music Library Ass'n Inc., 2017 Walnut St., Philadelphia, Pa. 19103. Tel (215) 569-3948. Pres.: Ruth T. Watanabe. Exec. Sec'y: William J. Weichlein.

Music Performance Trust Funds of the Rec'g Inds., 810 Paramount Bldg., 1501 Broadway, New York, N.Y. 10036. Tel (212) 239-8550. Trustee: Martin A. Paulson.

Music Teachers Nat'l Ass'n Inc., 2113 Carew Tower, Cincinnati, Ohio 45202. Tel (513) 421-1420. Pres.: Dr. Robert Sutton. Exec. Dir.: Mariann H. Clinton.

N.A.B., see National Ass'n of Broadcasters.

N.A.C.U.S.A., see National Ass'n of Composers USA.

N.A.R.A.S., see National Academy of Rec'g Arts & Sciences.

N.A.R.M., see National Ass'n of Rec'g Mdsrs. Inc.

Nashville Ass'n of Talent Dirs., 25 Music Square W., Nashville, Tenn. 37203. Tel (615) 254-5721. Pres.: Jack D. Johnson. VP: Ted Fuller. Sec'y: Billy Deaton. Sec'y: Sonny Simmons.

Nashville Songwriters Ass'n Int'l, 25 Music Square W., Nashville, Tenn. 37203. Tel (615) 254-8903.

National Academy of Popular Music & Songwriters Hall of Fame, 1 Times Square, New York, N.Y. 10036. Tel (212) 221-1252. Pres.: Sammy Cahn. Exec. Dir.: Abe Olman.

National Academy of Rec'g Arts & Sciences (NARAS), 4444 Riverside Dr., Suite 202, Burbank, Calif. 91505. Tel (213) 843-8233. Nat'l Exec. Dir.: Christine M. Farnon.

National Ass'n for Music Therapy Inc., PO Box 610, Lawrence, Kan. 66044. Tel (913) 842-1909. Pres.: Wanda B. Latham. Exec. Dir.: Margaret Sears.

National Ass'n of Broadcasters (NAB), 1771 N. St. NW, Washington, D.C. 20036. Tel (202) 293-3516. Pres.: Vincent T. Wasilewski.

National Ass'n of Composers USA (NACUSA), PO Box 49652, Barrington Sta., Los Angeles, Calif. 90049. Tel (213) 541-8213. Pres.: Marshall H. Bialosky.

National Ass'n of Jazz Educators, PO Box 724, Manhattan, Kan. 66502. Tel (913) 776-8744. Exec. Dir.: Matt Betton; Admin. Ass't: Betty Betton.

National Ass'n of Music Merchants Inc., 35 E. Wacker Dr., Chicago, Ill. 60601. Tel (312) 263-0261. Pres.: James W. Johnson; Exec. VP: William R. Gard.

National Ass'n of Organ Teachers Inc., see Int'l Ass'n of Organ Teachers USA.

National Ass'n of Pastoral Musicians, 1029 Vermont Ave., Washington, D.C. 20005. Tel (202) 347-6673. Pres.: Rev. Virgil C. Funk.

National Ass'n of Rec'g Mdsrs. Inc. (NARM), 1060 Kings Hwy N., Suite 200, Cherry Hill, N.J. 08034. Tel (609) 795-5555. Exec. Dir.: Mickey Granberg. Exec. VP: Joseph Cohen.

National Ass'n of Schools of Music, 11250 Roger Bacon Dr., No. 5, Reston, Va. 22090. Tel (703) 437-0700. Pres.: Warner Imig. Exec. Dir.: Samuel Hope.

National Ass'n of Teachers of Singing Inc., 250 W. 57 St., Suite 2129, New York, N.Y. 10019. Tel (212) 582-4043. Pres.: Irvin Bushman. Exec. Sec'y: James Brown-Ing.

National Choral Council, 250 W. 57 St., New York, N.Y. 10019. Tel (212) 582-0870. Exec. Dir.: Martin Josman.

National Entertainment & Campus Activities Ass'n, PO Box 11489, Columbia, S.C. 29211. Tel (803) 799-0768. Exec. Dir.: Gary English.

National Federation of Music Clubs, 310 S. Michigan Ave., Suite 1936, Chicago, Ill. 60604. Tel (312) 427-3683. Pres.: Mrs. Jack C. Ward. Office Mgr.: Marjorie McDonald.

Branch: Greenville, S.C., Rt. 12, Paris Mountain. Zip 29609.

National Guild of Community Schools of the Arts Inc., 175 Fifth Ave., Suite 516, New York, N.Y. 10010. Tel (212) 673-0980. Pres.: Lester G. Gluck; Exec. Dir.: Marcia J. Horwitz.

National Guild of Piano Teachers, Teacher Div. of American College of Musicians, PO Box 1807, 808 Rio Grande, Austin, Tex. 78767. Tel (512) 478-5775. Pres.: Irli Allison Jr., VP: Walter Merchant.

National Music Council, 250 W. 57 St., Suite 626, New York, N.Y. 10019. Tel (212) 265-8132. Pres.: Merle Montgomery. Exec. Sec'y: Doris O'Connell.

National Music Publ'rs Ass'n Inc., 110 E. 59 St., New York, N.Y. 10022. Tel (212) 751-1930. Cable: HAFXO. Pres.: Leonard Feist.

National Opera Ass'n, Hotel Wellington, Suite 823, Seventh Ave. & 55 St., New York, N.Y. 10019. Tel (212) 247-3900 x 823. Pres.: Clifton Ware; Sec'y-Registrar: Constance Oberhart.

National Opera Institute, c/o John F. Kennedy Center, Washington, D.C. 20566. Tel (202) 254-3694. Exec. Dir.: John M. Ludwig; Admin'r: Ruth Sickafus.

National Orchestral Ass'n, 111 W. 57 St., New York, N.Y. 10019. Tel (212) 247-1228. Pres.: Langdon Van Norden; Music Admin.: Claus Adam; Exec. Dir.: Lois Schweitzer.

National Piano Foundation, 435 N. Michigan Ave., Chicago, Ill. 60611. Tel (312) 527-5494. Exec. Dir.: George M. Otto.

National Piano Mfrs. Ass'n of America, see National Piano Foundation.

National School Orchestra Ass'n, c/o Blair Academy of Music, 1208 18 Ave. S., Nashville, Tenn. 37212. Tel (615) 320-5737. Pres.: John Bright.

New Orleans Jazz Club of California, PO Box 1225, Kerrville, Tex. 78028. Tel (512) 896-2285. Pres.: Bill Bacin.

New York Music Task Force, 1345 Ave. of the Americas, New York, N.Y. 10019. Tel (212) 586-4050. Contact: Howard N. Beldock.

New York Singing Teachers' Ass'n, 425 E. 86 St., studio 2-C, New York, N.Y. 10028. Tel: (212) 289-6721, 598-3491. Pres.: Cesare Longo.

Ohio Country & Western Music Ass'n Inc., PO Box 15524, Columbus, Ohio 43215. Tel (614) 272-7861. Pres.: Carl Wendelkin; State Sec'y: Jeanne Johnson.

Opera America Inc., 1010 Vermont Ave. NW, Suite 920, Washington, D.C. 20005. Tel (202) 347-9262. Pres.: John O. Crosby; Exec. Dir.: Thomas A. Rowe; Admin. Ass't: Richard J. Balthazar.

Opportunity Resources for the Arts, 1501 Broadway, New York, N.Y. 10036. Tel (212) 575-1688.

People To People Music Committee Inc., c/o John F. Kennedy Center, Washington, D.C. 20566. Tel (202) 254-3654. Exec. Dir.: Ruth Sickafus.

Phi Beta Fraternity, Shorefront Park, South Norwalk, Conn. 06854. Tel (203) 866-1212. Pres.: Mrs. Robert B. Miller.

Phi Beta Mu, 123 Oak Square S., Lakeland, Fla. 33803. Tel (813) 644-2135. Pres.: Charles Minelli.

Phi Mu Alpha Sinfonia Fraternity, 10600 Old State Rd., Evansville, Ind. 47711. Tel (812) 867-2433. Pres.: Dr. Lucien P. Stark. Exec. Dir.: Dr. Daniel E. Beeman. Office Mgr.: Esther G. Richardson.

Piano Technicians Guild Inc., 113 Dexter Ave. N., Seattle, Wash. 98109. Tel (206) 283-7440, 682-9700. Exec. Dir.: Donald Santny. Mng. Ed. & Art. Dir.: Charlona Rhodes.

Pi Kappa Lambda, Northwestern Univ., School of Music, Evanston, Ill. 60201. Tel (312) 492-7574. Pres.: Thomas W. Miller.

R.I.A.A., see Recording Ind. Ass'n of America.

Radio Registry, 850 Seventh Ave., New York, N.Y. 10019. Tel (212) 582-8800.

Recording Ind. Ass'n of America (RIAA), 1 E. 57 St., New York, N.Y. 10022. Tel (212) 688-3778. Exec. Dir.: Henry Brief.

Branch: Los Angeles, Calif., 9200 Sunflower Blvd., Suite 1005. Zip 90069. Tel (213) 278-5500. Pres.: Stan Gornikow.

S.P.E.B.S.Q.S.A., see Society for the Preservation & Encouragement of Barber Shop Quartet Singing in America.

Society for Ethnomusicology Inc., 201 S. Main St., Rm. 513, Ann Arbor, Mich. 48104. Tel (313) 761-7787. Pres.: William P. Malm.

Society for the Preservation & Encouragement of Barber Shop Quartet Singing in America (SPEBSQSA), 6315 Third Ave., Kenosha, Wis. 53140. Tel (414) 654-9111. Exec. Dir.: Hugh A. Ingraham.

Society for the Preservation of the American Musical Heritage Inc., c/o Library of Congress, Music Div., Washington, D.C. 20540. Tel (202) 287-5000. Founder & Dir.: Karl Krueger. Pres.: Henry H. Reichhold.

Society of the Classic Guitar, 409 E. 50 St., New York, N.Y. 10022. Tel (212) 753-3492. Pres.: Vladimir Bobri. Honorary Pres.: Andres Segovia.

The Sonneck Society, 69 Undine Rd., Brighton, Mass. 02135. Tel (617) 787-2283. Pres.: Irving Lowens. 1st VP: Nicholas E. Tawa.

Southeastern Composers' League, c/o Radford College, Music Dept., Radford, Va. 24142. Tel (703) 731-5000.

T.U.B.A., see Tubist Union Brotherhood Ass'n.

Tau Beta Sigma, Nat'l Band Sorority, see Kappa Kappa Psi.

Theatre Communications Group Inc., 355 Lexington Ave., New York, N.Y. 10017. Tel (212) 697-5230. Dir.: Peter Zeisler.

Tubist Union Brotherhood Ass'n (TUBA), c/o Southwest Texas State Univ., Music Dept., San Marcos, Tex. 78666. Tel (512) 245-2111.

United States Information Agency, ICS/DA, Washington, D.C. 20547. Tel (202) 655-4000.

United States Institute for Theatre Technology Inc., 1501 Broadway, Rm. 1408, New York, N.Y. 10036. Tel (212) 354-5360. Pres.: Charles E. Williams; Exec. Sec'y: Herbert D. Greggs.

Violoncello Society Inc., 101 W. 57 St., Suite 2D, New York, N.Y. 10019. Tel (212) 246-3267. Pres.: Claus Adam; Sec'y-Treas.: Esther Prince.

Young Audiences Inc., 115 E. 92 St., New York, N.Y. 10028. Tel (212) 831-8110. Pres.: J. McLean Stewart. Nat'l Exec. Dir.: Warren H. Yost.

DESIGN & ARTWORK PRINTING & LITHOGRAPHING

The key to the abbreviations used in this category is: (DES) for those companies which execute designs or artwork, and (PRT) for those which do printing or lithographing.

ALABAMA

- DOTHAN (Area Code 205)

Tri-State Publ'g Co. Inc., 120 S. St. Andrews. Zip 36301. Tel. 792-6808. (DES, PRT)

LABELS, JACKETS, & 7" SLEEVES

Call today for fully illustrated brochure and price list.

KEYSTONE PRINTED SPECIALTIES Co. Inc.

321 Pear St., Scranton, Pa. 18505
TWX: (510) 671-4619 Phone: (717) 346-1761

Along with complete art, design, and typesetting dept., full film and color separations, 4-color record label backdrops, label imprinting, 4-color (full bleed) 7" sleeves and unique 7" mini jackets, 12" sleeves, cassette labels and insert cards, cartridge labels, custom and stock jackets with bright full color stock record labels available for imprinting. We specialize in serving the recording industry with fast service and quality printing.

Page 139

ARIZONA

• **PHOENIX (Area Code 602)**

Cre'B Video Servs. Ltd., PO Box 5136, Zip: 85010; Embassy Square, 805 N. Fourth Ave. Zip: 85003. Tel: 257-1978. (DES, PRT—tape only)
 Universal Audio Corp., 6540 E. Lafayette Blvd., Scottsdale 85217. Tel: 949-7577. Pres.: John A. Michaelson; Sales Mgr.: James Noonan; Adv. Mgr.: A.K. Gardner. (DES)

• **TUCSON (Area Code 602)**

Audio Graphics Communications Agency, 601 E. Blackledge Dr. Zip: 85705. Tel: 882-9016. Pres.: Joseph Ostrom; Sales Mgr.: Peggy Kimber. (DES)

CALIFORNIA

• **LOS ANGELES METROPOLITAN AREA (Area Code 213)**

A G I (Album Graphics Inc.), 424 N. Larchmont Blvd. Zip 90004. Tel: 462-0821. VP Edward Dwyer; Sales Mgr. Jim Palmer. (Sales office only) (DES, PRT)
 Home office: Melrose Park (Chicago Metropolitan Area), Ill.
 Album Art Co. (div. of NEHI Rec. Dist'g Corp.), 5500 W. Jefferson Blvd., Culver City 90016. Tel: 930-1722. Pres. Tom Heiman (DES—3-D displays & 6'x6' oil paintings of album jackets)
 Album Graphics Inc., see AGI.
 Allied Rec. Co., 6110 Peachtree St. Zip: 90040. Tel: 725-6900. (PRT—record only)
 American Video Prod'ns, 4265 Marina City Dr., Suite 501, Marina Del Rey 90291. Tel: 823-1228. Pres.: Michael Huemmer; Sales Mgr. Joseph Camacho; Adv. Mgr.: Joseph Gerbino. (DES—tape only)
 Award Rec. Mfg. Inc., 11016 La Cienega Blvd., Inglewood 90304. Tel: 645-2281. Pres.: Martin Ansonian; Sales Mgr.: Bill Dryden; Adv. Mgr.: George Abajian. (PRT—record only)
 Douglas Boyd Design, 309 Santa Monica Blvd., Suite 309, Santa Monica 90401. Tel: 392-5018. (DES—tape only)
 Cadet Recs. Inc., 5810 S. Normandie Ave. Zip: 90044. Tel: 753-5121. Pres.: Jules Bihari; Mgr.: Don Macmillan. (DES, PRT)
 Branch: Park Ridge, N.J.
 California Images Inc., 7611 Fulton Ave., North Hollywood 91605. Tel: 982-1353, 875-1424. (DES & PRT—Customized tee-shirts only)
 Creative Minds Inc., 1560 N. La Brea, Suite M, Hollywood 90028. Pres.: Arthur H. Benson; Sales Mgr.: Howard Wormser. (DES)
 Custom Rec. Mfg. Co., 5810 S. Normandie Ave. Zip: 90044. Tel: 753-5121. Pres.: Jules Bihari; VP James Takeda (DES, PRT)

STUDIO SESSIONS • TYPOGRAPHY
 GRAPHIC DESIGN • COLOR SEPAR
 PRINTING • FABRICATION • PRESSI
 LABELS • MATRIX • MASTERING • T
 TAPE DUPLICATION • STUDIO SESS
 TYPOGRAPHY • DESIGN
 COL • PRINTING
 FAB • LABEL
 MATRI • PE DUPL
 COLOR • PRINTING
 PRESSING • MASTERING
 TAPE DUPL • STUDIO SESS
 LABELS • MA • MASTERING • S
 TAPE DUPLICATION • MASTERING
 MATRIX • LABELS • PRESSING • TYP
 FABRICATION • PRINTING • COLOR
 GRAPHIC DESIGN • TYPOGRAPHY
 STUDIO SESSIONS • TAPE DUPLICA
 MASTERING • MATRIX • LABELS • P
 PRESSING • FABRICATION • LABEL

**COMPLETE
 PRODUCTION
 COORDINATION
 FOR THE
 MUSIC INDUSTRY**

ERH PRODUCTIONS
 221 West 57th Street
 New York, New York 10019
 TWX 710-581-5446
 Telephone 212-582-4200

D A K Inds. Inc., 10845 Vanowen St., North Hollywood 91605. Tel: 984-1559, WATS (800) 423-2636. Pres.: Drew Alan Kaplan (PRT—tape only)
 Discography, 8961 Etiwanda Ave., Northridge 91325. Tel: 886-4419. Exec. Dir.: Robert Shattuck. (DES)
 Rod Dyer Inc., 5550 Wilshire Blvd., Suite 301. Zip: 90036. Tel: 937-4100. (DES)
 Dyna Concept Studios, PO Box 4413, San Pedro 90731. Tel: 548-5731. Mng. Dir.: Julian Reyna. (DES)
 Electrosound Group Inc., 9545 San Fernando Rd., Sun Valley 91352. Tel: 767-8833. Pres. & Adv. Mgr.: Richard H. Burkett; Sales Mgr.: Scott Ross (Sales office only) (PRT—record only)
 Branch: New York, N.Y.
 Plants: Sun Valley (Los Angeles Metropolitan Area), Calif.; Monarch Rec. Mfg. Co.; Holbrook, N.Y.; Goldisc Rec'gs Inc.; Allentown, Pa.; Allentown Rec. Co. Inc. Hope Street Studio, 607 N. Ave. 64. Zip: 90042. Tel: 258-6741. Pres. & Owner: Van Webster. (DES)
 Ivy Hill Communications Inc., 4800 S. Santa Fe Ave. Zip: 90058. Tel: 587-3131. Div. Exec. VP Russell Muir; Sr. VP's: Jack Sclar, Arthur Kern. (DES, PRT)
 Home office: Great Neck, N.Y.
 K M Recs. Inc., 2980 N. Ontario St., Burbank 91504. Tel: 841-3400. Pres.: Glade Merklely; VP Custom Sales: Jim Auchterlone; Sales & Adv. Mgr.: Bruce Leek (PRT—record only)
 Kalny Mds., 4700 S. Santa Fe Ave. Zip: 90058. Tel: 587-1164. Customer Serv.: Arte Hirsh. (DES, PRT)
 Kdisc (sub of Keysor Century Corp.), 6550 Sunset Blvd., Hollywood 90028. Tel: 466-1323. Pres.: Eugene R. Schutz; Gen. Mgr.: Bill Lightner; Sales Mgr.: Dick Maxwell. (DES, PRT—record only)
 Plant: Saugus, Calif. (SEE ADVERTISEMENT)
 John Kehe Studio, 11271/2 S. Robertson Blvd. Zip: 90035. Tel: 275-7161. (DES)
 Kittyhawk Graphics, 7777 Sunset Blvd., Hollywood 90046. Tel: (213) 874-1534. (DES)
 Kosh & Co., 1581 Crossroads of the World, Hollywood 90028. Tel: 466-9755. (DES—record only)
 Lester Music Engraving, 345 S. Citrus Ave. Zip: 90036. Tel: 939-3630. Owner: James T. Lester. (DES)
 Mirage Inc., 6646 Hollywood Blvd. Zip: 90028. Tel: 271-2685. (DES)
 Modern Album of California Inc., 3104 Vanowen St., Burbank 91505. Tel: 845-7655. Pres.: William S. Pine; Gen. Mgr.: Raymond Gardocki. (PRT—record only)
 Home office: Hauppauge, N.Y.; Modern Album & Finishing Co. Inc.
 Monarch Rec. Mfg. Co. (sub of Electrosound Group Inc.), 9545 San Fernando Rd., Sun Valley 91352. Tel: 767-8833. Pres.: Nate Duroff, VP & Gen. Mgr.: Bob Barone. (PRT—record only)
 Sales offices: Sun Valley (Los Angeles Metropolitan Area), Electrosound Group Inc., New York, N.Y.; Electro-sound Group Inc.
 Musicsearch, 9000 Cynthia St., Suite 205. Zip: 90069. Tel: 275-4790. Pres.: Robert Greenfield; VP Creative Servs.: Topper Schroeder. (DES)
 Mustiron Inc., 2534 1/2 W. Pico Blvd. Zip: 90006. Tel: 380-6840. (DES)
 Myriad Prod'ns, 1314 N. Hayworth Ave., Suite 402. Zip: 90046. Tel: 851-1400. Pres.: Ed Harris. (DES)
 Pacific Eye & Ear, 451 N. La Cienega Blvd. Zip: 90048. Tel: 659-2121. (DES)
 Pedersen Label Printing Co., 11152 Fleetwood St., Sun Valley 91352. Tel: 768-3122. Pres.: Herman A. Fredriks; Prod. Mgr.: S. Kadonaga. (PRT) (SEE ADVERTISEMENT)
 Photo/Graphics, 1125 E. Orange Ave., Monrovia 91016. Tel: 359-9414. (DES)
 Prestone Graphics Inc., 1930 Century Park W. Zip: 90067. Tel: 552-9671. (DES, PRT)
 Branch: New York, N.Y.
 Queens Lithographing Corp., 6290 Sunset Blvd., Suite 304, Hollywood 90028. Tel: 464-7700. (DES, PRT)
 Home office: Long Island City (New York Metropolitan Area), N.Y.
 Plant: Indianapolis, Ind.; Rutgers Packaging Corp.
 Radio Central, 427 W. Fifth St. Zip: 90013. Tel: 626-9891. Owner: David B. Sigler; Gen. & Sales Mgr.: Carl Hampson. (DES, PRT—tape only)
 Rainbo Rec. Mfg. Corp., 1738 Berkeley St., Santa Monica 90404. Tel: 829-3476. Pres.: Jack G. Brown; VP & Gen. Mgr.: James Doyle; Prod'n Supervisor: Steve Sheldon. (PRT—record only)
 Roach Inc., 8430 Tujunga Ave., Sun Valley 91352. Tel: 767-8300. Pres.: John Baird (DES & PRT—customized tee-shirts & hats only)
 Home office: Columbus, Ohio.
 Shorewood Packaging Corp., 1830 Glendale Blvd. Zip: 90026. Tel: 660-3043. Sales Mgr.: Marc Shore. (PRT—record only)
 Home office: New York, N.Y.
 Springboard Int'l, 8295 Sunset Blvd. Zip: 90046. Tel: 654-6240. (DES, PRT)
 Home office: Rahway, N.J.
 Stoughton Printing Co., 130 N. Sunset Ave., City of Industry 91744. Tel: 961-3678. (PRT)
 Superior Data/Graphics Corp., 5717 Santa Monica Blvd. Zip: 90038. Tel: 467-5133. (PRT)
 Superscope Tape Dupl'g Prods. Inc. (sub. of Superscope Inc.), 20525 Nordhoff St., Chatsworth 91311. Tel: 998-9333 x 2294. Pres.: Joseph S. Tuchinsky; Mktg. & Sales Mgr.: Jerry Epstein. (DES, PRT)
 Surf City Recs., PO Box 14, Hollywood 90028. Tel: 851-3161. Pres.: Gary M. Theroux; Admin. Ass't: Russell Bidwell; Sales Mgr.: Mark Charger; Adv. Mgr.: Peter Roberts. (DES)
 Westland Graphics, 2237 N. Hollywood Way, Burbank 91505. Tel: 846-1205. (PRT)

• **MONTEREY (Area Code 408)**

Publishers' Art Serv., 455 Pierce St. Zip: 93940. Tel: 375-1191. (DES)

• **SACRAMENTO (Area Code 916)**

Alpha-Media Inc., PO Box 254452. Zip: 95825. Tel: 383-4385. Owner: Vladimir Sirota. (DES)

Bill Rase Prod'ns Inc., 955 Venture Court. Zip: 95825. Tel: 929-9181. Owner & Pres.: Bill Rase. (DES)

• **SAN FRANCISCO & BAY AREA (Area Code 415)**

Conlan Creative Lithographers, PO Box 2763, 800 Forbes Blvd., Suite 260, South San Francisco 94080. Tel: 761-7617. (DES, PRT)
 Fred Foxx Music Co., 406 Kehoe Ave., Half Moon Bay 94019. Tel: 726-3725. Pres.: F.H. Nesbitt Jr.; Sales Mgr.: V.A. Nesbitt. (DES)
 Cathy Furniss & Assocs., 680 Beach St., Suite 445. Zip: 94109. Tel: 885-2807. Pres.: Cathy Furniss; Sales Mgr.: Ruth Maas; Adv. Mgr.: Michel Lipman. (DES)
 Sonic Arts Corp., 665 Harrison St. Zip: 94107. Tel: 781-6307. Pres.: Leo de Gar Kulkka; Gen. Mgr.: Herbert P. Haas; Sales Mgr.: Joseph Speck. (DES)

• **SANTA CRUZ (Area Code 408)**

Suttle Designs, 118 Myrtle St. Zip: 95060. Tel: 426-2819. Owner & Art Dir.: S. Suttle.

• **SAUGUS (Area Code 805)**

Kdisc Plant (sub. of Keysor Century Corp.), 26000 Springbrook Ave. Zip: 91350. Tel: 259-2360. Pres.: Eugene R. Schutz; Gen. Mgr.: Bill Lightner; Sales Mgr.: Dick Maxwell. (DES, PRT—record only) (SEE ADVERTISEMENT)
 Offices: Hollywood (Los Angeles Metropolitan Area), Calif.

• **STANTON (Area Code 714)**

Photo-Lith Int'l, 11816 Western Ave. Zip: 90680. Tel: 893-5037; WATS (800) 854-2489. (DES & PRT—customized tee-shirts only)

• **STOCKTON (Area Code 209)**

Liberty Fixture Inc., 2467 Mariposa Rd. Zip: 95206. Tel: 948-1176. Pres.: Sales & Adv. Mgr.: Leonard Semler. (PRT)

COLORADO

• **BOULDER (Area Code 303)**

Video/Audio Artistry Crop (Vidaac Ltd.), PO Box 4571, 1258 Bear Mountain Court. Zip: 80302. Tel: 499-2001. (DES—record only)

• **DENVER (Area Code 303)**

Audicom Corp., 4950 Nome St., Unit C. Zip: 80239. Tel: 371-3076. Pres.: Jack H. Dunham. (PRT)

CONNECTICUT

• **DARIEN (Area Code 203)**

George Alexander Group Inc., 1063 Post Rd. Zip: 06820. Tel: 655-7791; NYC (212) 886-5600. Pres.: Kev Develjan. (DES, PRT)

• **MONROE (Area Code 203)**

Wildwood Entertainment, 114 W. Maiden Ln. Zip: 06468. Tel: 261-2979. Pres.: Vincent E. Meyer Jr. (DES)

• **TRUMBULL (Area Code 203)**

J & D Litho Serv., 9 Sally Ann Dr. Zip: 06611. Tel: 261-3366. (PRT)

• **UNION CITY (Area Code 203)**

A. C. Hampson Printing Co. Inc., 168 City Hill St. Zip: 06770. Tel: 729-2294. Pres.: Augustus D. Hampson; Sales Mgr.: John W. Berry. (DES, PRT—tape only)

DELAWARE

• **BEAR (Area Code 302)**

Factors Etc. Inc., Geissler Park. Zip: 19701. Tel: 834-1625. Pres.: H. Lee Geissler; Sales Mgr.: Laurence H. Seeney. (DES, PRT—customized tee-shirts only)

• **WILMINGTON (Area Code 302)**

Ken-Del Prod'ns Inc., 111 Valley Rd., Richardson Park. Zip: 19804. Tel: 655-7488. Pres. & Gen. Mgr.: H. Edwin Kennedy; Sales Mgr.: Shirley Kay (DES, PRT)
 National Tape Dupl'rs, see Ken-Del.

DISTRICT OF COLUMBIA

• **WASHINGTON (Area Code 202)**

Lion Rec'g Servs. Inc., 1905 Fairview Ave. NE. Zip: 20002. Tel: 832-7883. Pres.: Hal Lion; Sales & Adv. Mgr.: Jim Fox. (DES)

FLORIDA

• **FORT LAUDERDALE (Area Code 305)**

Alpha Recs. Inc., 1400 NW 65 Ave. Zip: 33313. Tel: 587-6011. (DES—record only)

• MIAMI METROPOLITAN AREA (Area Code 305)

Image Devices Inc., 1825 NE 149 St., North Miami 33181. Tel: 945-1111. Sales Mgr.: Bill Reiter. (PRT)
Miami Tape Inc., 8180 NW 103 St., Hialeah Gardens 33015. Tel: 558-9211. Pres.: Carlos Garcia; Sales Mgr.: Mirell Tunon. (PRT)
Record Dists. of America, 780 W. 27 St., Hialeah 33010. Tel: 887-2638. Pres.: Eliseo Valdes; Gen. Mgr.: Angel Tamargo. (DES, PRT)
Tropical Paper Box Co., 7000 NW 25 St.; Zip: 33122. Tel: 592-5520. Rec. Div. Mgr.: Dale Quartin. (PRT)
Video Music Corp., 770 W. 27 St., Hialeah 33010. Tel: 885-9156. (PRT)

• ORLANDO AREA (Area Code 305)

Magnetix Corp., 770 W. Bay St., Winter Garden 32787. Tel: 656-4494. Pres.: John Lory. (PRT)

GEORGIA

• ATLANTA METROPOLITAN AREA (Area Code 404)

Data-Linear Prods. Inc., 4507-K Mills Pl. SW, College Park 30366. Tel: 691-1254. (DES, PRT)
Home office: New York, N.Y., Linear Prods. Inc.
Project 70 Audio Servs. Inc., 1127 Spring St. NW. Zip: 30309. Tel: 875-7008. Pres.: Jerry L. Connell. (PRT—tape only)
The T-Shirty Inc., 1200 Menlo Dr. NW. Zip: 30318. Tel: 351-9850; WATS (800) 241-1052. Pres.: Jay J. Cohen; Gen. Sales Mgr.: Paul I. Katz. (DES & PRT—customized tee-shirts only)
Wonder Graphics Inc., PO Box 77287. Zip: 30309; 983 Waverly Way. Zip: 30357. Tel: 524-1200. (DES)

• COLUMBUS (Area Code 404)

Capricorn Sales, 4018 Buena Vista Rd. Zip: 31907. Tel: 563-5353. Owner: William Pellegrini. (DES & PRT—customized tee-shirts only)

ILLINOIS

• CHICAGO METROPOLITAN AREA (Area Code 312)

A G I (Album Graphics Inc.) 1950 N. Ruby St., Melrose Park 60160. Tel: 344-9100. Pres.: Donald W. Kosterka; Sales Mgr.: Charles Eaton. (DES, PRT)
Sales offices: Los Angeles, Calif.; New York, N.Y.
Ad-Vertising Unlimited, PO Box 8135. Zip: 60680. Tel: 787-8220. Pres.: R.C. Hilsman; Sales Mgr.: Frank Howard Jr.; Adv. Mgr.: Howard Pittman. (DES)
Album Graphics Inc., see AGI.
Armageddon Talent Assocs., 1604 W. Juneway Terr. Zip: 60626. Tel: 465-3373. Mgr.: Fred Tiekens. (DES)
Audio Accessories Co., 38 W. 515 Deerpath Rd., Batavia 60510. Tel: 879-5998. Sales Mgr.: John S. Maloney. (DES—tape only)
Audio Artists Ltd., PO Box 7, Wheaton 60187. Tel: 668-6682. (DES)
Bruce Packaging Co., 8025 N. Kenneth Ave., Skokie 60076. Tel: 583-2818. Pres.: Joseph Halperin. (DES)
M. M. Cole Music Publ'g Co., Playboy Bldg., Suite 1602, 919 N. Michigan Ave. Zip: 60611. Tel: 527-2160. Pres.: Shepard Stern; Sales Mgr.: J.C. Cole; Adv. Mgr.: Mike Stern. (DES, PRT)
Fort Dearborn Lithograph Co., 6035 W. Gross Point Rd., Niles 60648. Tel: 774-4321. Pres.: Tom Adler; Sales Mgr.: Jerry Adler; Adv. Mgr.: Rich Adler; Prod'n Mgr.: Edward J. Evans. (DES, PRT)
Higgins, Hegner, & Ganovese Int'l, 251 E. Grand Ave. Zip: 60011. Tel: 644-1882. (DES)
Kiderian Recs. Prod'n's, 4926 W. Gunnison St. Zip: 60630. Tel: 545-0861. Pres.: Raymond Peck; Gen. & Sales Mgr.: George Peck. (DES—record only)
Media Int'l Inc., 425 N. Michigan. Zip: 60611. Tel: 467-5430. Pres. & Sales Mgr.: Duane Lundeen; Adv. Mgr.: Margaret Lundeen. (PRT—tape only)
Planet Communications (div. of Clay Pigeon Int'l), PO Box 20346. Zip: 60620. Tel: 476-2553. Pres. & Gen. Mgr.: Vytautas Beleska; Sales Mgr.: Rudy Markus; Special Projects Mgr.: D. Jaras. (DES)
Poly Com Group, 4 E. Huron St. Zip: 60611. Tel: 337-2040. Pres.: Ricard Jablonski; Sales Mgr.: Joseph Hassen; Adv. Mgr.: Carmen Trombetta. (DES)
Pro I Prods., PO Box 33, Highland Park 60035. Tel: 432-5536. Pres.: Roy Pink; Sales Mgr.: Martin Pink; Adv. Mgr.: Deena Pink. (DES, PRT)
Rainbow Bridge Studios Inc., 117 Rockland Rd., Libertyville 60048. Tel: 362-4060. Studio Mgr.: Ron Schwartz. (DES)
Sound Studios, 230 N. Michigan Ave. Zip: 60601. Tel: 236-4814. Pres.: Jerry Markham; VP & Gen. Mgr.: Dan Tynus. (DES)
Trackdown Record Dist. & Record Promo Co., 542 S. Dearborn, Suite 1102. Zip: 60605. Tel: 939-9066. Chm: Hank Williams; Pres.: T.J. Wocker; Adv. Mgr.: J.V. Selendon. (DES, PRT)

• COLLINSVILLE (Area Code 618)

Mar-Kay Rec. Co., 1 Scotch Pine Dr. Zip: 62234. Tel: 344-4443. Pres.: Mary Joyce; VP: Ron Allen; Sales Mgr.: Leslie Darnar; Adv. Mgr.: Hubert Joyce. (DES, PRT)

• ROCKFORD (Area Code 815)

Carter Corp., 1916 11 St. Zip: 61101. Tel: 397-3200. Pres.: Robert L. Fleming; VP Sales & Mktg.: Sandra L. Fleming; Adv. Mgr.: Janet K. Ratner. (DES, PRT)

INDIANA

• INDIANAPOLIS (Area Code 317)

Bowers Rec. Sleeve Co., 5331 N. Tacoma Ave. Zip: 46220. Tel: 251-3918. Pres.: Robert C. Bowers, VP & Sales Mgr.: Charles H. Kaufman. (DES & PRT)
Infithere Inc., 5773 Park Plaza Court. Zip: 46220. Tel: 545-2001. (DES)
Reco-SleevePackaging, 620 S. Belmont. Zip: 46221. Tel: 635-7777. Pres.: Leonard Verebay; Sales & Adv. Mgr.: Leonard Dimond. (PRT)
Rutgers Packaging Corp. (div. of Queens Lithographing Corp.), 620 S. Belmont Ave. Zip: 46221. Tel: 635-7777. Pres.: Abe Garde; Sales & Adv. Mgr.: Morton Schecter. (DES, PRT)
Home office: Long Island City (New York Metropolitan Area), N.Y., Queens Lithographing Corp.

• RICHMOND (Area Code 317)

P R C Rec'g Co. (div. of Richmond Rec'g Corp.), 1600 Rich Rd. Zip: 47374. Tel: 962-9511.
Home office: New York, N.Y.

• TERRE HAUTE (Area Code 812)

Arco Press Inc., PO Box 1445. Zip: 47808. Tel: 232-0926. Pres.: James S. Royse; Sales Mgr.: Don Wilson. (PRT)
Ivy Hill Communications Inc., Fort Harrison Ind'l Park, Fruitridge Ave. Zip: 47805. Tel: 466-9851. Div. VP: Don Ford; Prod'n Mgr.: Dick Bieniek. (PRT)
Home office: Great Neck, N.Y.
Woodburn Printing Co., 25 S. Sixth St. Zip: 47808. Tel: 466-6822. Pres.: Donald P. Pendergast; Sales Mgr.: John Avelis; Adv. Mgr.: John Crippen. (PRT)

IOWA

• CARLISLE (Area Code 515)

Kajac Recs (div. of Ozark Opry Inc.), 155 First St. Zip: 50047. Tel: 989-0876. Contact: Harold L. Luick. (DES, PRT)

• DES MOINES AREA (Area Code 515)

Stenco Graphics, PO Box 2501, 5311 SW Ninth. Zip: 50315. Tel: 285-6564. Contact: Art Smart Stenstrom. (DES & PRT—customized tee-shirts only)
Triad Prods. Inc., 1910 Ingersoll. Zip: 50309. Tel: 243-2125. (DES)

KENTUCKY

• LOUISVILLE (Area Code 502)

Allen-Martin Prod'n's Inc., 9701 Taylorsville Rd. Zip: 40299. Tel: 267-9658. Pres.: Ray Allen; Adv. Mgr.: Carolyn Davidson. (DES)

LOUISIANA

• BATON ROUGE (Area Code 504)

The Record Company of the South (RCS), 5220 Essen Ln. Zip: 70808. Tel: 769-2996. Art Dir.: Agi Vajna.

• VILLE PLATTE (Area Code 318)

Ville Platte Rec. Mfg. Co., 120 E. Cypress St. Zip: 70586. Tel: 363-2104. Pres.: J. Floyd Soileau; Mgr.: J.K. Soileau; Sales Mgr.: Ronnie Soileau. (DES & PRT—record only)

MARYLAND

• BALTIMORE AREA (Area Code 301)

Sontec Corp., 10120 Marble Court, Cockeysville 21030. Tel: 628-2282. (DES—record only)

• HYATTSVILLE (Area Code 301)

The Shirt Xplosion Co. Inc., 5618 Lafayette Pl. Zip: 20781. Tel: 277-4400. (DES & PRT—customized tee-shirts only)

• KENSINGTON (Area Code 301)

Omega Rec'g Servs., 10518 Connecticut Ave. Zip: 20795. Tel: 946-4686. (DES)

• WHEATON (Area Code 301)

Big Ed's Unlimited, 11141 Georgia Ave., Suite A-1. Zip: 20902. Tel: 949-9500. Contact: Edward M. Chambers. (DES & PRT—customized tee-shirts only)

MASSACHUSETTS

• BOSTON METROPOLITAN AREA (Area Code 617)

Fleetwood Communications Co., 321 Revere St., Revere 02151. Tel: 289-6800. Pres.: V.P. Giarrusso; Sales Mgr.: Victor Mancini; Adv. Mgr.: Robin Samora. (DES, PRT)
Ed Hurvitz Music Promos., 129 Bishop St., Brockton 02402. Tel: 588-6348. Pres. & Adv. Mgr.: Edward M. Hurvitz. Sales Mgr.: Linda Berman. (DES—record only)
Rik Tinory Prod'n's, 622 Rt. 3A, Cohasset 02025. Tel: 383-9494. Pres.: Richard F. Tinory; Artist Relations: Claire L. Babcock. (DES, PRT)

The Word Guild, 119 Mount Auburn St., Cambridge 02138. Tel: 492-4656. Pres.: Zelta Fischer. (DES)

• CHICOPEE (Area Code 413)

Dielectrics Inc., 6 Second Ave. Zip: 01020. Tel: 598-8308. Pres.: Earl S. Stahl; Exec. VP: Eric Craig Stahl. (DES, PRT)
Just For the Record, 40 Marion St. Zip: 01013. Tel: 592-0457. Pres.: Robert S. Bator; Adv. Mgr.: C. St. Laurent Bator. (DES)

• TURNERS FALLS (Area Code 413)

Silver Screen Design, 88 Third St. Zip: 01376. Tel: 863-9171. Pres.: David Senior; Sales Mgr.: Ruth Miller; Adv. Mgr.: Sid Jensen. (DES)

MICHIGAN

• DETROIT METROPOLITAN AREA (Area Code 313)

Graphic Design Inc., 23800 Amber, Warren 48089. Tel: 758-0480. (DES, PRT)
Tape-Tronics Inc., 750 E. Mandoline, Madison Heights 48073. Tel: 588-8281. (PRT)

MINNESOTA

• MINNEAPOLIS (Area Code 612)

Ark Rec'g Co. (div. of Fulton Electronics), 4428 Zane Ave. N. Zip: 55422. Tel: 537-7076. (DES)
Bethany Fellowship Inc., 6820 Auto Club Rd., Zip: 55438. Tel: 944-2121. Pres.: T.A. Hegre; Sales & Adv. Mgr.: David W. Anthony. (DES—tape only)
Esco Artist, 2613 NE Garfield St. Zip: 55418. Tel: 789-5650. Owner: Jo Esco. (DES)

MISSOURI

• KANSAS CITY (Area Code 816)

Stage 3 Sound Prod'n's Inc., 12 E. 39 St. Zip: 64111. Tel: 531-1375. Pres.: Don Warnock. (DES)

• ST. LOUIS METROPOLITAN AREA (Area Code 314)

Audio Precision Inc., 6 Grandview Park Dr., Arnold 63010. Tel: 464-2333. Pres.: Robert E. Blevins; VP Sales: Jim Cole. (PRT—record only)
Graffix Traffic Inc., 9677 Page Ave. Zip: 63132. Tel: 427-4460. Pres.: William Moir; Sales Mgr.: Special Mkts.: Chris Pecsok. (DES & PRT—customized tee-shirts only)
Ken Keene Int'l, PO Box 515. Zip: 63166. Tel: 776-2278, 464-1773. Pres. & Adv. Mgr.: Ken Keene; VP & Sales Mgr.: Gene Miller. (DES, PRT)
Int'l branch: England, Seacruise.

MONTANA

• MISSOULA (Area Code 406)

Meadowlark Ventures—Graphic Design by Dolack, PO Box 7218. Zip: 59807. Tel: 728-2180. Pres. & Adv. Mgr.: Chris Roberts.

NEW JERSEY

• ASBURY PARK (Area Code 201)

Sound-Arts Co. Inc., 5 Cindy Ln. Zip: 07712. Tel: 493-8666. Pres.: Charles J. Gspann; VP: Francis M. Gspann. (DES, PRT)

• CAMDEN (Area Code 609)

Recorded Publ'n's Labs. (div. of Recorded Publ'n's Mfg. Co. Inc.), 1100 State St. Zip: 08105. Tel: 963-3000; Phila. (215) 922-8558. Pres.: David H. Goodman; Sales Mgr.: Pat Landon; Adv. Mgr.: Edward J. Goodman. (DES, PRT)
Sales office: New York, N.Y.

• CARLSTADT (Area Code 201)

Q-A-I Inc. (formerly Saxon Adhesive Prods.), 640 Dell Rd. Zip: 07072. Tel: 935-5100; NYC (212) 736-1980. Pres.: Steve Dauman; Sales Mgr.: George Ratowsky. (PRT)

• FARMINGDALE (Area Code 201)

Charlie Roberts Advertising & Promos. Inc., 346 Belmar Blvd. Zip: 07727. Tel: 938-4351. Pres.: Robert Schumann; Sales & Adv. Mgr.: Charlie Roberts. (DES)

• GLENDORA (Area Code 609)

Record Room, 308 E. Evesham Rd. Zip: 08029. Tel: 939-0034. (DES)

• LEONIA (Area Code 201)

S/T Videocassette Dupl'g Corp., 500 Willow Tree Rd. Zip: 07605. Tel: 947-6450. (DES)
Home office: New York, N.Y., Video Corp. of America.

• LYNDHURST (Area Code 201)

Color Seps-Litho Preps Serv., PO Box 151. Zip: 07071. Tel: 438-6729. Pres.: J.G. Principato. (DES)

● **MAPLE SHADE (Area Code 609)**

A M P Rec'gs (div. of IPI), PO Box 14, 307 W. Main St. Zip 08052 Tel. 667-1667 Pres. Donald R. Marsh, Sales Mgr. Gerald Tyson. (DES)

● **MONTCLAIR (Area Code 201)**

Linear Sound Rec'g, 211 Glenridge Ave. Zip 07042 Tel. 744-0686 Pres. M. Kroll, Sales Mgr. Brad Clark, Adv. Mgr. T. Steinmann. (DES)

● **MOUNT LAUREL (Area Code 609)**

Rand-El Advertising, 240 Burnam Wood Dr. Zip 08054 Tel. 667-2739 Pres. & Creative Dir. Eric Lipsman. (DES)

● **NEWARK (Area Code 201)**

Andria Rec. Corp. Custom Servs. Div. 16 Park Pl. Zip 07102 Tel. 642-5991 (DES, PRT)

● **PARK RIDGE (Area Code 201)**

Cadet Recs. Inc., PO Box 176 Zip 07656 Tel. 391-3676 VP Sales. Robert K. Herrington. (Sales office only) (DES, PRT)
Home office: Los Angeles, Calif.

● **RAHWAY (Area Code 201)**

Springboard Int'l, 947 US Hwy 1 Zip 07065 Tel. 574-1400 (DES, PRT)
Branch: Los Angeles, Calif.

NEW YORK

● **CENTRAL ISLIP (Area Code 516)**

Ramart Printing Corp., 3180 J Expwy. Dr. S. Zip 11722 Tel. 234-0050 (PRT)

● **CLARENCE (Area Code 716)**

Mark Custom Rec'g Serv., 10815 Bodine Rd. Zip 14031 Tel. 759-2600 Pres. & Sales Mgr. Vincent S. Morette. (DES)

● **FARMINGDALE (Area Code 516)**

Pressure Sensitive Tape & Label Corp., 135 Schmitt Blvd. Zip 11735 Tel. 293-7300 (DES, PRT)

● **GREAT NECK (Area Code 516)**

Ivy Hill Communications Inc., Community Dr. Zip 11022 Tel. 487-0200 (PRT)
Branches: Los Angeles, Calif., Terre Haute, Ind.

● **HAUPPAUGE (Area Code 516)**

Disc Graphics (div. of Pickwick Int'l), 10 Gilpin Ave. Zip 11787 Tel. 234-1400 Gen. Mgr. Gus Thalasinis. (PRT)

Modern Album & Finishing Co. Inc., Cardinal Ind'l Park, Gilpin Ave. Zip 11787 Tel. 234-1100 NYC (212) 291-7600 Pres. G.D. Thomas, Sales Mgr. R.A. Froehlig. (PRT—record only)
Branches: Burbank (Los Angeles Metropolitan Area), Calif., Modern Album of California Inc., Terre Haute, Ind., Modern Album of Indiana Inc., Nashville, Tenn., Modern Album of Tennessee Inc.
Int'l branch: Canada, Modern Album of Canada Ltd. Pres. Tige Label Corp., 255 Oser Ave. Zip 11787 Tel. 273-0020 (PRT)

● **HOLBROOK (Area Code 516)**

Goldisc Rec'gs Inc. (sub. of ElectroSound Group Inc.), Veterans Hwy & Broadway Zip 11741 Tel. 589-0462 NYC (212) 895-6575 Pres. Richard F. Meixner, Sales Mgr. John Finnegan, Adv. Mgr. Rich Renda. (PRT—record only)
Sales offices: Sun Valley (Los Angeles Metropolitan Area), Calif., ElectroSound Group Inc., New York, N.Y., ElectroSound Group Inc.

● **HUNTINGTON STATION (Area Code 516)**

Shelley Prods. Ltd., 220 Broadway Zip 11746 Tel. 423-7090 (DES, PRT)

● **LINDENHURST (Area Code 516)**

Coastal Specialty Tapes Inc. (formerly Pratt-Spector Corp.), 274 Bangor St. Zip 11757 Tel. 226-5900 Pres. Tom Carroll, Sales Mgr. Stanley Gilman, Adv. Mgr. Dan Dobbs. (DES, PRT—tape only)

● **NEW YORK METROPOLITAN AREA (Area Code 212)**

A G I (Album Graphics Inc.), 125 W. 55 St. Zip 10019 Tel. 489-0793 VP Mktg. Richard Block, Sales Mgr. Gary Sitzer. (DES, PRT) (Sales office only)
Home office: Melrose Park (Chicago Metropolitan Area), Ill.
A. D. Adams Advertising Inc., 145 E. 52 St. Zip 10022 Tel. 755-0845 Pres. A. D. Adams (DES)
Branch: Woodbury, N.Y.
Album Graphics Inc., see ACI
Ampro Prod'ns Inc., 150 Fifth Ave. Zip 10011 Tel. 243-7726 Cable TAPEXRON Telex 452333 Pres. Manuel Kopelman, Exec. VP Mktg. Susanne Tarter, VP Arthur Lipton. (DES) (SEE ADVERTISEMENT)
Anco Packaging Corp., 347 Madison Ave. Zip 10017 Tel. 682-8076 (DES, PRT)
Apon Rec. Co. Inc., PO Box 3082, Steinway Sta. 44-16 Broadway, Long Island City 11103 Tel. 721-5599.

Pres. Andrew M. Poncic, Sales Mgr. Nick Kuzmick, Adv. Mgr. Don Zemann. (DES—record only)
Atwater Press Inc., 207 W. 25 St. Zip 10001 Tel. 675-2710 Pres. Lester H. Dreyfuss, VP Peter Dreyfuss. (DES, PRT)
James Bell Graphic Design Inc., 114 E. 28 St. Zip 10016 Tel. 683-3280 Pres. James Bell, VP S. Campbell, Sales Mgr. Jane Sapiro. (DES)
G. Benson & Co. Printers Inc., 116 Nassau St., Brooklyn 11201 Tel. 596-9100 Pres. Gerald J. Benson, VP Sales. Gil Benson, Adv. Mgr. Roxanne Evans. (DES, PRT)
Ely Besalel Ltd., 235 E. 49 St. Zip 10017 Tel. 759-7820 Pres. Ely Besalel. (DES)
Leo Bliok Advertising, 24 W. 57 St. Zip 10019 Tel. 245-8938 Owner. Leo Bliok. (DES—record only)
Bob Bruce—Graphic Design, 108 Willow St., Brooklyn 11201 Tel. 852-2971 Creative Dir. Bob Bruce. (DES—record only)
Edda Brusco Design, 1751 E. 16 St., Brooklyn 11229 Tel. 645-1794 Pres. Edda Brusco, Sales Mgr. Alexander Shakow. (DES)
Creative Media Agency, 227 E. 69 St. Zip 10021 Tel. 472-0100 Owner & Dir. Arthur Krieger, Sales Mgr. Cindy Freeman, Adv. Mgr. Al Douglas. (DES)
Crystal Magic Promos Inc., 130 W. 57 St., Suite 5-D Zip 10019 Tel. 247-4390 Pres. Curtis Gunn, VP. Sales & Adv. Mgr. Lee Heiman. (DES)
DRG Recs. Inc., 200 W. 57 St. Zip 10019 Tel. 582-3040 Cable. STETRECS Pres. Hugh Fordin, Gen. Mgr. Rick Winter, Sales Mgr. Bob Stern, Admin. Dir. Lorna St. Hill. (DES)
Disc Communications Ltd., 743 Fifth Ave. Zip 10022 Tel. 371-0390 Pres. Jerome Boxer, Art. Dir. Susan Murphy. (DES, PRT)
E R H Sales Corp., 221 W. 57 St. Zip 10019 Tel. 582-4200 Pres. Lee Halpern, Gen. Mgr. Michael Halpern, Sales Mgr. Robert Shavelson. (DES) (SEE ADVERTISEMENT)
ElectroSound Group Inc., 1290 Ave. of the Americas, Zip 10019 Tel. 581-5641 (PRT—record only)
Home office: Sun Valley (Los Angeles Metropolitan Area), Calif.
Plants: Sun Valley (Los Angeles Metropolitan Area), Monarch Rec. Mfg. Co., Holbrook, N.Y., Goldisc Rec'gs Inc., Allentown, Pa., Allentown Rec. Co. Inc., Farmlett & Barsanti, 208 Fifth Ave. Zip 10010 Tel. 686-8230 (DES)
Great American Screen Designs Ltd., 363 Seventh Ave. Zip 10001 Tel. 688-9262 Pres. Charles Taublich, Sales Mgr. Mike Dymburt, Adv. Mgr. Bruce Goodwin. (DES, PRT)
Guaranteed Printing Serv., 119 W. 23 St. Zip 10011 Tel. 929-2410 (DES, PRT)
Stephen P. Haas Advertising, 24 W. 57 St. Zip 10019 Tel. 581-8442 Pres. Stephen Haas. (DES)
Image Creators Inc., 310 E. 65 St. Zip 10021 Tel. 535-0257 Contact. Leonard Brauner. (DES)
Jewelle Signs, 13 E. 31 St. Zip 10016 Tel. 683-4474 (DES)
Laboratory Systems Corp., 37 W. 57 St. Zip 10019 Tel. 753-9854 (PRT)
Lee-Myles Assocs. Inc., 160 E. 56 St. Zip 10022 Tel. 758-3232 Pres. Robert M. Miller. (DES, PRT) (SEE ADVERTISEMENT)
Linear Prods. Inc., 37 W. 20 St. Zip 10011 Tel. 255-2917 (DES, PRT)
Branches: College Park (Atlanta Metropolitan Area), Ga., Data-Linear Prods. Inc., Puerto Nuevo, P.R., Linear Prods. of Puerto Rico
Love Unlimited, 15-32 127 St., College Point 11356 Tel. 359-8500 Pres. Barry Kaminsky. (DES & PRT—customized tee-shirts only)
Mac Murray Press Inc., 230 W. 17 St. Zip 10011 Tel. 924-1530 Pres. Bernard Lerman. (DES, PRT)
Marathon Graphics Ltd., 147 W. 15 St. Zip 10011 Tel. 924-3180 (DES)
Morninglight Prod'ns, 145 E. 52 St., Rm. 403 Zip 10022 Tel. 751-2031, 675-8800 Pres. & Art. Dir. Spencer Drate. (DES—record only)
The Music Agency Ltd., 135 W. 50 St. Zip 10020 Tel. 765-1616 Pres. Jay Leipzig, VP. Joel Borowka. (DES)
Olympic Litho Corp., 116 Nassau St., Brooklyn 11201 Tel. 522-2400 (PRT)
P R C Rec'g Co. (div. of Richmond Rec'g Corp.), 1185 Ave. of the Americas, Zip 10036 Tel. 997-1250 Pres. Hugh Landy, VP & Sales Mgr. David Grant. (PRT)
Branch: Richmond, Ind.
Charlie Passantino Inc., 311 W. 43 St., 5th fl. Zip 10036 Tel. 586-1469 Pres. Charles V. Passantino, Adv. Mgr. Bob Passantino. (DES & PRT—record only)
Pilgrim Press Corp., 36-01 43 Ave., Long Island City 11101 Tel. 937-9515 Pres. Peter Strauss. (PRT)
Prestone Printing, 147 W. 42 St. Zip 10036 Tel. 354-1871 (DES, PRT)
Home office: Los Angeles, Calif.
Progressive Label & Litho Co., 286-290 Stanhope St., Brooklyn 11237 Tel. 497-2320 (DES, PRT) (SEE ADVERTISEMENT)
Promedeus Arts Inc., 1776 Broadway Zip 10019 Tel. 586-3770 Pres. Lew Morris, Sales Mgr. Jerry Present, Adv. Mgr. Ron Parisi. (DES)
Queens Lithographing Corp., 52-35 Barnett Ave., Long Island City 11104 Tel. 457-7700 Pres. Jack L. Hecht, VP. Leonard Verebay. (DES, PRT)
Branch: Hollywood (Los Angeles Metropolitan Area), Calif.
Plant: Indianapolis, Ind., Rutgers Packaging Corp.
R S V P Advertising Inc., 969 Third Ave. Zip 10021 Tel. 535-9020 Pres. Leonard R. Brauner, Adv. Mgr. Lisa Brauner. (DES)
Recorded Publ'ns Labs. (div. of Recorded Publ'ns Mfg. Co. Inc.), 2 Penn Plaza, Suite 1500 Zip 10001 Tel. 868-3115 Reg'l Sales Mgr. Len Louis. (Sales office only) (DES, PRT)
Home office: Camden, N.J.
Jasper Samuel Advertising & Recs., 97-28 57 Ave., Forest Hills 11368 Tel. 271-2418 Pres. Jasper Samuel, Sales Mgr. David Samuel, Adv. Mgr. Joseph Samuel. (DES, PRT)

ServiSound Inc., 37 W. 57 St. Zip 10019 Tel. 753-9888 (PRT)
Shepard Printing Corp., 111 Eighth Ave. Zip 10011 Tel. 255-1930 Pres. Philip M. Rosenbloom. (DES, PRT)
Shorewood Packaging Corp., 10 E. 53 St. Zip 10022 Tel. 371-1500 Pres. Paul Shore, Exec. VP Mktg. Floyd S. Gliner, VP Sales. Ken Rosenbloom. (PRT)
Branch: Los Angeles, Calif.
Soundtek Inc., 50 W. 57 St. Zip 10019 Tel. 489-0806, Tri-Lon Color Lithographers Ltd. 54 W. 21 St. Zip 10010 Tel. 255-6140 Pres. Morris Strickler, VP. David Strickler. (PRT)
Video Corp. of America, 231 E. 55 St. Zip 10022 Tel. 355-1600 (DES)
Branch: Leonia, N.J., S/T Videocassette Dupl'g Corp. Morton D. Wax & Assocs., 1650 Broadway Zip 10019 Tel. 247-2159 Pres. Morton D. Wax. Local branch: 200 W. 51 St. Zip 10019 (DES) (SEE ADVERTISEMENT)

● **RENSELAE (Area Code 518)**

Wildwood Entertainment, 223 Broadway Zip 12144 Tel. 434-2014 VP. Erich Borden. (DES)

● **SPRING VALLEY (Area Code 914)**

Pro/Creatives Corp., 25 W. Burda Ln. Zip 10977 Tel. 356-4623 Pres. Sales & Adv. Mgr. David Rapp. (DES—record only)

● **UTICA (Area Code 315)**

Oneida Video-Audio Tape Cassette Corp., 760 Blandina St. Zip 13501 Tel. 735-6187 Pres. Stanley Markowski, Sales Mgr. Joyce Markowski, Adv. Mgr. Andrew Cittadino. (DES & PRT—record only)

● **YONKERS (Area Code 914)**

Crackerjack Studio (div. of Crackerjack Ent's Inc.), 262 Rose-dale Rd. Zip 10710 Tel. 793-2649 Pres. & Art. Dir. Suzanne Newman, Sales Mgr. Ralph M. Newman. (DES)

NORTH CAROLINA

● **CANTON (Area Code 704)**

Recording Servs. of Western North Carolina, 10 Penland St. Zip 28716 Tel. 648-6012 Owner. J. Ted Evans Jr., Sales Mgr. Don Barber, Adv. Mgr. Kay Evans. (DES, PRT)

● **THOMASVILLE (Area Code 919)**

Adtees Corp., PO Box 608, Stanley Ave. Zip 27360 Tel. 475-0111 Pres. Tim L. Batten, Sales Mgr. Glenn Brown, Adv. Mgr. Bob Livengood. (DES & PRT—customized tee-shirts only)

OHIO

● **CINCINNATI (Area Code 513)**

Artists Rec'g Co. Inc., 320 Mill St. Zip 45215 Tel. 761-0011 (DES)
Counterpart Creative Studios Inc., 3744 Applegate Ave. Zip 45211 Tel. 661-8810 Pres. Gen. & Sales Mgr. Shad O'Shea, Adv. Mgr. Marilyn Aker. (PRT)
Alex Gellen Design, 405 Executive Bldg Zip 45202 Tel. 651-1308 Pres. Alex Gellen. (DES)
Jewel Rec'g Co., 1594 Kinney Ave. Zip 45231 Tel. 522-9336 Pres. Charles York, Sales Mgr. Linda York, Adv. Mgr. Harry Urschel. (DES—record only)
Rite Rec. Prod'ns Inc., 9745 Lockland Rd. Zip 45215 Tel. 733-5533 Pres. Carl J. Burkhardt, VP. Philip M. Burkhardt, Sales Mgr. Dan Burkhart. (DES, PRT)

● **CLEVELAND METROPOLITAN AREA (Area Code 216)**

Alcon Rec'g Studios Inc., 35100 Euclid Ave., Suite 300, Willoughby 44094 Tel. 951-0910 Pres. Alan M. Peabody. (DES)
Boddie Rec. Mfg. & Rec'g Inc., 12202 Union Ave. Zip 44105 Tel. 752-3440 Pres. Thomas R. Boddie, Sales Mgr. Dennis R. Boddie. (DES, PRT)

● **COLUMBUS (Area Code 614)**

Graphics of Columbus Inc., 5211 N. High St. Zip 43214 Tel. 846-6126 (PRT)
Hillside Recs., 948 Studer Ave. Zip 43206 Tel. 252-7116 Owner & Pres. Larry McKenzie. (DES)
Roach Inc., PO Box 16548, 2255 Westbelt Dr. Zip 43216 Tel. 876-9951 WATS (800) 848-7970 Pres. John H. Baird, VP Sales. Stuart Levine, Adv. Mgr. Mary Ann MacLeod. (DES & PRT)—customized tee-shirts only
Branch: Sun Valley (Los Angeles Metropolitan Area), Calif.

● **NEWARK (Area Code 614)**

Utopia Ultra Sound, 38-40 S. First St. Zip 43055 Tel. 345-9426 Pres. Robert H. Kirk Jr. (DES)

● **YOUNGSTOWN (Area Code 216)**

United Audio Rec'g Studio, 5947 Stillson Pl. Zip 44512 Tel. 758-5463 (DES)

OKLAHOMA

● **TULSA (Area Code 918)**

I T T Studios (International Teaching Tapes), 4235 S. Memorial Dr. Zip 74145 Tel. 663-7700 Pres. Meredith R. Gray, Sales Mgr. Sonny Gray. (DES, PRT)

OREGON

- **EUGENE (Area Code 503)**
Ad Creations & Consultants Inc., 696 Country Club Rd. Zip 97401 Tel: 686-9669 (DES)

PENNSYLVANIA

- **ALLENTOWN (Area Code 215)**
Allentown Rec. Co. Inc. (sub. of ElectroSound Group Inc.), 1002-10 Walnut St. Zip 18102 Tel: 433-7405 Pres. Sanford L. Wartell (PRT—record only)
Sales offices: Hollywood (Los Angeles Metropolitan Area), Calif., ElectroSound Group Inc.; New York, N.Y., ElectroSound Group Inc.

- **CARLISLE (Area Code 717)**
Gail Sharon Gardens, HUB 783, Dickinson College Zip 17013 (DES)

- **MECHANICSBURG (Area Code 717)**
H R C Printing, 5252 E Trindle Rd. Zip 17055 Tel: 766-0943 Gen. Mgr. Donald E. Baldwin (DES, PRT) (SEE ADVERTISEMENT)

- **PHILADELPHIA (Area Code 215)**
Community Press, 6047-49 Woodland Ave. Zip 19142 Tel: 729-4655 (DES & PRT—record only)
Benjamin Johnson Jr. Ent's., 5025 Penridge St. Zip 19143 Tel: 474-6613 Pres. Benjamin Johnson Jr., Sales Mgr. Richard Simone (DES—record only)
Kalstein Graphics, 6128 York Rd. Zip 19141 Tel: 549-5085 (DES)

- **PITTSBURGH (Area Code 412)**
Matthews Int'l Corp., 1910 Cochran Rd., Manor Oak Two Zip 15220 Tel: 344-9433 (PRT—film masters, symbol consultation & testing) (SEE ADVERTISEMENT)

- **SCRANTON (Area Code 717)**
Keystone Printed Specialties Co. Inc., 321 Pear St. Zip 18505 Tel: 348-1761 Pres. P.G. Fischer Jr., Sales & Adv. Mgr. Martin C. Fischer (DES, PRT) (SEE ADVERTISEMENT)

- **SHARON (Area Code 412)**
Marjon Recs. Inc., 159 Easton Rd., Hermitage 16146 Tel: 347-4726 Pres. John T. Krizancic, Sales Mgr. Martha Krizancic, Adv. Mgr. Ruth Toth (DES, PRT)

PUERTO RICO

- **PUERTO NUEVO (Area Code 809)**
Linear Prods. of Puerto Rico, Old Long Bldg., Matadera Rd. Zip 00936 Tel: (809) 783-4986 (DES, PRT—tape only)
Home office: New York, N.Y., Linear Prods. Inc.

RHODE ISLAND

- **WARWICK (Area Code 401)**
Great Graphics!, PO Box 3, Zip 02887, 151 Keeley Ave. Zip 02886 Tel: 738-6914 Owner & Pres. Bill Montella Jr. (DES, PRT)

TENNESSEE

- **FAYETTEVILLE (Area Code 615)**
Kim-Pat Ent's., PO Box 654, Hillwood Dr. Zip 37334 Tel: 433-2323/5661. Owner Bill Trigg, Sales Mgr. Rita Armstrong (DES)

- **MEMPHIS (Area Code 901)**
T-Shirts Int'l, 239 S. Cooper St. Zip 38104 Tel: 522-8383 (DES, PRT)

- **NASHVILLE AREA (Area Code 615)**
American Sound Recs., 62 Music Square W. Zip 37203 Tel: 256-1693 Pres. Cliff Ayers Ostermeyer, Sales Mgr. Chris Ostermeyer, Adv. Mgr. Connie L. Wright (DES & PRT)
Chumley Prod'ns., PO Box 7195, 2802 Foster Ave. Zip 37211 Tel: 833-6184 Pres. P.E. Chumley (PRT—record only)
Color Graphics Inc., 305 Church St., Goodlettsville 37072 Tel: 859-4001 (PRT)
Creative Concepts, Faron Young Exec. Bldg., 1300 Division St. Suite 106 Zip 37203 Tel: 259-3790 Partners Jim Kent, Vernell Hackett (DES, PRT)
Custom Tape Dupl'rs Inc., 341 Hill Ave. Zip 37210 Tel: 256-1729 Pres. L.C. Tant, Sales Mgr. Mike Tant (DES, PRT—tape only)
International Rec. Dist'g Assocs. (IRDA), 260 W. Main St., Suite 107, Hendersonville 37075 Tel: 824-9100 Pres. Hank Levine, Sales Mgr. Mike Shepherd, Adv. Mgr. Susie Johnson (DES)
M F Inc., 453 Chestnut St. Zip 37203 Tel: 256-6161 (PRT—record only)

- Nashville Album Prod'ns Inc., 617 Seventh Ave. S. Zip 37203 Tel: 256-0121 Pres. Steve Botts (DES, PRT)
Nashville Int'l Corp., 20 Music Square W. Zip 37203 Tel: 256-2885/3271 (DES, PRT)
Pinwheel Art & Photography Studios Inc., 1211 16 Ave. S. Zip 37212 Tel: 327-9125 (DES)
Superior Sound Studios, 329 Rockland Rd., Hendersonville 37075 Tel: 824-5141 (DES)
Home office: St. Louis, Mo., Ken Keene Int'l.
United Rec. Pressing Inc., 453 Chestnut, Zip 37122 Tel: 259-9396 Pres. Ozell Simpkins (DES, PRT—record only)
Williams Printing Co., 417 Commerce, Zip: 37219 Tel: 256-7151. Pres. & Gen. Mgr. B.G. Johnson (DES, PRT)
World Wide Music Inc., 1300 Division St., Suite 201, Zip 37203 Tel: 256-7543 Pres. Calvin H. Everhart, Sales Mgr. Dabi Ward, Adv. Mgr. Shirley Sans (DES—record only)

TEXAS

- **DALLAS (Area Code 214)**
Continental Graphics Inc., PO Box 5057, Zip 75222 Tel: 741-3236, 263-0776. WATS (800) 527-5662. Tex WATS (800) 492-5418. (DES, PRT)
Rainbow Sound Inc., 1322 Inwood Rd. Zip 75247 Tel: 638-7712. Pres.: Bob Cline, Exec. VP. Jim Grier. VP. Jack Whitt. (DES—record only)

- **FORT WORTH AREA (Area Code 817)**
Ink Inc., PO Box 54, Mansfield 76063. Tel: 477-2897. Pres.: James Michael Taylor, Sales Mgr. Charles Bowles, Adv. Mgr. Barbara Anne Taylor (DES)

- **HOUSTON (Area Code 713)**
Riverside Albums, 7400 Pinemont Zip 77040 Tel: (713) 462-2700. Pres.: Earl Thomas, Sales Mgr. Brenda Cox (DES, PRT—record only).

- **SAN ANTONIO (Area Code 512)**
B C L Ent's Inc., 1002 Hoefgen St. Zip 78210 Tel: 532-3216. Pres.: C. Foy Lee, Sales Mgr. Jimmy Burton, Adv. Mgr. Jeannie Hill (DES, PRT)

- **SAN BENITO (Area Code 512)**
Rio Grande Music Co., 119 S. Sam Houston Blvd. Zip 78586 Tel: 399-5377 Pres. & Adv. Mgr. Lionel C. Betancourt, Sales Mgr.: John F. Phillips (DES)

- **WACO (Area Code 817)**
Creative Communications Inc. (sub. of SMI), 918 N. Valley Mills. Zip 76710 Tel: 776-6553 (DES)
Mike's Print Shop, 2507 Grim. Zip 76707 Tel: 752-2321 (PRT)

UTAH

- **SALT LAKE CITY (Area Code 801)**
Covenant Rec'gs Inc., 1345 Major St. Zip 84115 Tel: 487-1096. Pres. & Sales Mgr.: V. Lewis Kofford, Adv. Mgr. Jeff Lund (DES)

WISCONSIN

- **ELKHART LAKE (Area Code 414)**
Sohn Mfg. Inc., Box X, Zip 53020 Tel: 876-3361 Pres. W.J. Beaudry, Sales Mgr.: Deane Jenkins (DES, PRT)

- **MILWAUKEE AREA (Area Code 414)**
Holubek Studios Inc., 4712 N. 125 St., Butler 53007 Tel: 781-4800; WATS (800) 558-0566 Pres. Verne Holubek, Sales Mgr.: R.C. Presendoler, Adv. Mgr.: Michael Dillon. (DES & PRT—iron-on transfers & customized tee-shirts only)

- Orange Prod'n House, 6055 W. Fond du Lac Ave. Zip 53218 Tel: 461-3600. Pres.: Larry Hansen, Sales Mgr.: Ellen Westendorf. (DES)

WYOMING

- **CHEYENNE (Area Code 307)**
Rocky Mountain Rec'g. Box 1354A, Rt. 2 Zip 82001 Tel: 638-8733. Pres. Ray Alexander, Sales & Adv. Mgr.: Georgia Alexander. (DES, PRT—record only)

MUSIC LICENSING ORGANIZATIONS

- A M R A (American Mechanical Rights Ass'n), 250 W. 57 St., Suite 2632, New York, N.Y. 10019 Tel: (212) 246-4077 Exec. Dir. Rosalie W. Miller. (Mechanical rights only)
- A S C A P (American Society of Composers, Authors & Publ'rs), ASCAP Bldg., 1 Lincoln Plaza, New York, N.Y. 10023 Tel: (212) 595-3050. Pres. Stanley Adams; (Performing rights only)
Membership offices: Hollywood, Calif., 6430 Sunset Blvd., Suite 1002 Zip 90028 Tel: (213) 466-7681—Nashville, Tenn., 2 Music Square W. Zip 37203 Tel: (615) 244-3936.
Licensing offices: San Francisco, Calif., Equitable Life Bldg., Rm. 1020, 120 Montgomery St. Zip 94104. Tel: (415) 781-2141—North Miami, Fla., 1065 NE 125 St. Zip 33161. Tel: (305) 895-6390—Atlanta, Ga., 1 Perimeter Way NW, Suite 415, Zip 30339 Tel: (404) 952-8843—Rosemont, Ill., 10400 W. Higgins Rd., Suite 235 Zip 60618 Tel: (312) 827-6810—New Orleans, La., International Trade Mart Bldg., Suite 1322 Zip 70130 Tel: (504) 524-7701—Framingham, Mass., 10 Speen St. Zip 01701 Tel: (617) 873-3515—Troy, Mich., 755 W. Big Beaver Rd., Suite 306 Zip 48064 Tel: (313) 362-2444—Minneapolis, Minn., 7850 Metro Pkwy., Suite 106 Zip 55402 Tel: (612) 854-0763—Cleveland, Ohio, 772 Hanna Bldg., Playhouse Square, Zip 44115 Tel: (216) 771-6722—Allison Park, Pa., 4084 Mount Royal Blvd. Zip 15101 Tel: (412) 486-2625—Jenkinstown, Pa., Benjamin Fox Pavilion, Suite 807, Old York Rd. Zip 19046 Tel: (215) 885-2510—Santurce, P.R., SPACEM (Society of Puerto Rican Authors, Composers & Editors of Music), PO Box 9692, Zip: 00908 Tel: (809) 722-0495—Houston, Tex., Communications Center, Suite 340, 3901 Westheimer, Zip 77027 Tel: (713) 621-5692—Seattle, Wash., 444 NE Ravenna Blvd., Suite 306, Zip: 98115 Tel: (206) 524-8185.
Int'l membership office: England
- B M I (Broadcast Music Inc.), 320 W. 57 St., New York, N.Y. 10019 Tel: (212) 586-2000 Cable: BROADCASTMUS. Pres.: Edward M. Cramer, Sr. VP: Theodor Zavim. (Performing rights only)
Branches: Hollywood, Calif., 6255 Sunset Blvd. Zip 90028 Tel: (213) 465-2111—San Mateo, Calif., 1650 Borel, Zip 94402 Tel: (415) 349-9590—Coral Gables, Fla., 1320 S. Dixie Hwy. Zip 33146 Tel: (305) 666-6122—Skokie, Ill., 4711 Golf Rd., Suite 508 Zip 60076 Tel: (312) 677-6026—Boston, Mass., 888 Worcester Rd. Zip 02181 Tel: (617) 237-3885—Nashville, Tenn., 10 Music Square E. Zip: 37203 Tel: (615) 259-3625. VP: Frances Preston—Houston, Tex., 3115 West Loop S., Suite 50-51 Zip 77027 Tel: (713) 626-8570.
- C S C (Copyright Sharing Corp.), PO Box 3738, Olympic Sta., Beverly Hills, Calif. 90212 Tel: (213) 477-1064. Pres.: Dennis J. Fitzpatrick, VP & Treas.: James D. Boyd; Sec'y: Thomas L. Cook. (Reprint rights only)
Copyright Serv. Bureau Ltd., 221 W. 57 St., New York, N.Y. 10019 Tel: (212) 582-5030. Chm.: Walter Hofer; Pres.: Gitte A. Hofer, Exec. Dir.: Jeri Spencer. (Mechanical & performing rights)
Harry Fox Agency Inc., 110 E. 59 St., New York, N.Y. 10022 Tel: (212) 751-1930.
Italian Book Corp., 1119 Shore Pkwy., Brooklyn, N.Y.



**THE NEWEST
PLANT MAKES THE
BEST RECORDS**

Record pressing & tape
duplicating. Send for free price list.

DISKMAKERS

925 N. 3rd St., Philadelphia, Pa. 19123
212-966-3185 and 215-627-2277

BUILDING TO SERVE THE RECORD INDUSTRY IN THE 1980's

MICRO-POINT MATRIX TOOL REPAIRS; MASTERS, MOTHERS & STAMPERS

This is a new product developed by Micro-Point, the leading U.S.A. manufacturer of recording styli.

Write for information.



8 Westchester Plaza, Elmsford, New York 10523 • U.S.A.

(914) 592-7627

TWX 710-567-1223



Sun Plastics Company, Inc.
Dynamic L.P. Record Pressing Co., Inc.

900 Passaic Avenue East Newark, N.J. 07029

Phones: N.J. 201-482-6749

N.Y. 212-349-0977

32 YEARS OF SERVICE TO THE RECORD INDUSTRY

11214 Tel. 236-5803 Pres. Frank Tudisco VP & Gen. Mgr. Lyvia DeMartino (Performing & mechanical rights)

L A F C A P (Latin American Federation of Composers, Authors & Publrs), 345 W. 58 St., New York, N.Y. 10019 Tel. (212) 582-5705 Pres. Rogelio Brambila Mng. Dir. Gerard de La Chappelle (Mechanical rights only)

Mietus Copyright Mgmt., 527 Madison Ave., New York, N.Y. 10022 Tel. (212) 371-7950 Pres. Leonard S. Mietus (Mechanical rights only)

Music-Interchange/Vaughn-Lesser Co., 433 Airport Blvd., Burlingame, Calif. 94010 Tel. (415) 342-8480 Telex 339514 Exec. VP. Charlotte Vaughn (Mechanical rights only)

S E S A C Inc., 10 Columbus Circle, New York, N.Y. 10019 Tel. (212) 586-3450 Chm. Alice H. Prager; Pres. Norman S. Weiser; VP Mktg. Sidney Guber; VP Adv. & PR Charles Scully
Branches: Los Angeles, Calif., 9000 Sunset Blvd. Zip 90023 Tel. (213) 274-6814—Nashville, Tenn., SE-SAC Bldg., 11 Music Circle S. Zip 37203 Tel. (615) 244-1992 (Mechanical & performing rights) (SEE ADVERTISEMENT)

S P A C E M (Society of Puerto Rican Authors, Composers & Editors of Music), see ASCAP

LICENSORS, RECORD & TAPE

Alshire Int'l 1015 Isabel St. Burbank, Calif. 91502 Tel. (213) 849-4671 Pres. Al Sherman; Sales Mgr. Dick Ceja

American Sound Recs., 62 Music Square W., Nashville, Tenn. 37203 Tel. (615) 256-1693 Pres. Cliff Ayers Ostermeyer; Sales Mgr. Chris Ostermeyer; Adv. Mgr. Connie L. Wright

Ampro Prod'ns Inc. 150 Fifth Ave., New York, N.Y. 10011 Tel. (212) 243-7726 Cable TAPEXXRON Telex 425233 Pres. Manuel Kopelman; Exec. VP Mktg. Susanne Tarter; VP. Arthur Lipton (SEE ADVERTISEMENT)

Apon Rec. Co. Inc. PO Box 3082, Steinway Sta., 44-16 Broadway, Long Island City, N.Y. 11103 Tel. (212) 721-5599 Pres. Andrew M. Poncic; Sales Mgr. Nick Kuzmick; Adv. Mgr. Don Zemann (Classical music only)

Arlo Recs. Inc./BHR Recs. Inc. 7635 Telephone Rd., Le Roy, N.Y. 14482 Tel. (716) 442-9112 Pres. Kenneth Bearce; Sales Mgr. Jill Welzel; Adv. Mgr. James L. Bearce

Bernard S. Brody Inc. 3808 Riverside Dr., Suite 400, Burbank, Calif. 91505 Tel. (213) 849-1911 Pres. Bernard S. Brody (Music clearance serv. for television shows)



LEADING MANUFACTURER OF CASSETTES



**...THEY SAY WE ARE THE BEST...
...WE STILL TRY TO IMPROVE...**

CASSETTE COMPONENTS DROP OUT COUNTERS PLAY AND WIND TESTERS

CO CASSETTES
C-BOX SNAP BOX SYSTEMS

ICM LTD.
MÜHLEBACHSTR. 27 CH-8800 THALWIL TEL: 41 1 720 2942 TELEX 53759

Cadet Recs Inc., 5810 S Normandie Ave., Los Angeles, Calif. 90044 Tel (213) 753-5121 Pres Jules Bihari, Mgr Don Macmillan
Branch: Park Ridge, N.J., PO Box 176 Zip 07656
 Tel (201) 391-3676 VP Sales Robert K Herrington
 Covenant Rec's Inc., 1345 Major St., Salt Lake City, Utah 84115 Tel. (801) 487-1096. Pres & Sales Mgr V Lewis Kofford, Adv Mgr Jeff Lund
 Curtis Universal Rec Master Lease & Sales, PO Box 4740 Nashville, Tenn. 37216. Tel (615) 361-5356 Pres Wade Curtiss, VP Curt Edwards.
 Double H Licensing Corp., 221 W. 57 St., New York, N.Y. 10019 Tel (212) 581-2424. Pres. Lee Halpern, Ass't to Pres. Harry Ringler: VP Sales Larry Halpern, VP Int'l Michael Halpern.
 Fleetwood Communications Co. Inc., 321 Revere St. Revere, Mass 02151 Tel (617) 289-6800 Pres Vincent Giarrusso; Gen Mgr. & Treas Raymond G Samora; Sales Mgr Victor Mancini; Adv. Mgr. Robin Samora.
 Earl Horwitz, 1242 Los Angeles St., Glendale, Calif 91204. Tel (213) 245-6464.
 David Hubert & Assocs., 541 Continental Court Bldg 201 N Orange Grove Blvd., Pasadena, Calif 91103. Tel (213) 796-9693 Contract: David Hubert.
Represents: Bearsrvile, CRI, Century, First American. (SEE ADVERTISEMENT)
 The Image Factory Inc., 1900 Ave. of the Stars, Los Angeles Calif. 90067 Tel (213) 552-3596. Pres. Stanford Blum
 Indalo Int'l, PO Box 49284, Atlanta, Ga. 30359 Tel (404) 634-0578 Pres. & Int'l Dir Richard M Singer
 Jewel Rec'g Co., 1594 Kinney Ave., Cincinnati, Ohio 45231. Tel. (513) 522-9336. Pres., Charles York, Sales Mgr Linda York; Adv. Mgr Harry Urschel
 Ray Lawrence Ltd., PO Box 1987, Studio City, Calif 91604 Tel (213) 552-1000 Pres & Sales Mgr Ray Lawrence; Adv Mgr. Connie Lawrence.
 Michele Audio Corp., Andrew Street Rd., Massena, N.Y. 13662 Tel 769-2448. Pres Ginette Cormier, Sales Mgr Harold Friedman; Mgr Jack Daniels
 Music Resources Int'l Corp., 161 W 54 St., Suite 601 New York, N.Y. 10019 Tel (212) 265-6420. Pres. Andy Hussakowsky, Exec VP & Sales Mgr Steve Brodie
Branch: Los Angeles, Calif., 1100 N Alta Loma Rd Zip 90069 Tel (213) 657-5000
 Nostalgia Lane Inc., 211 W 56 St., Suite 33J, New York N.Y. 10019. Tel (212) 583-5390. Owners Lee Halpern, Nina Mattikow, Customer Relations Supervisor Yvonne Simpkins, Sales Mgr Paul Kahan
 One World of Music, 17208 Braxton St., Granada Hills Calif 91344 Tel (213) 360-8088 Cable WEISSWORLD. Pres. Marjorie Weiss
 Overseas Music Servs Inc., 30 Rockefeller Plaza, New York, N.Y. 10020 Tel (212) 541-8862. Pres John E. Nathan; Ass't to Pres Nancy Weshkoff
 Paradiso Inc., PO Box X, Wilton, Conn 06897 Tel (203) 762-5188 Pres L. von Kleydorff
 Peter Pan Inds., 145 Komorn St., Newark, N.J. 07105 Tel (201) 344-4214 Pres Martin Kasen; VP Donald Kasen; Nat'l Sales Mgr James Monaghan, Sales Admin'r Adele Breitbarth **Local branch: 88 St Francis St Zip 07105 Tel 344-4214.**
 Poema Music, 8996 Fruitridge Rd., Sacramento, Calif 95826 Tel (916) 383-4387. Pres. Vladimir Sirota VP Thomas Conrad; A&R Gary Woltmon.
 Record Masters Inc., PO Box 4740, Nashville, Tenn. 37216 Tel (615) 361-5356. Pres Wade Curtiss, Sales Mgr S. Neal.
 San Juan Music Group, 1637 Utica Ave., Brooklyn, N.Y. 11234. Tel: (212) 253-4600 Cable MUSICLEASE NEW YORK. Pres. David Last; Sales Mgr. B Cohen
 Ralph L. Seltzer Inc., 5243 Yarmouth Ave., Suite 26, Encino, Calif 91316. Tel (213) 705-1541. Pres.: Ralph L Seltzer; Ass't to Pres.: Shosh Byron
 Sonic Arts Corp., 665 Harrison St., San Francisco, Calif 94107. Tel (415) 781-6307 Pres. Leo de Gar Kulka Gen. Mgr. Herbert P. Haas, Sales Mgr Joseph Speck
 Take Home Tunes Musicals, PO Box 496, Georgetown Conn. 06829 Tel (203) 544-8288. Pres Doris Yeko

PLATING, PROCESSING & PRESSING PLANTS

ARIZONA

● PHOENIX (Area Code 602)

Universal Audio Corp., 6540 E. Lafayette Blvd., Scottsdale 85217 Tel 949-7577. Pres John A. Michaelson; Sales Mgr. James Noonan, Mgr Allen K. Gardner (Plating & processing only)
 Wakefield Mfg Inc., PO Box 6037, 1745 W Linden, Zip 85005 Tel 252-5644. Pres. Richard A Wakefield. Admin. Mgr. George Kaleta

CALIFORNIA

● CAMARILLO (Area Code 805)

Record Technology Inc., 486 Dawson Dr Zip 93010. Tel 484-2747 Pres. W D Bauer

● LOS ANGELES METROPOLITAN AREA (Area Code 213)

Alberts Rec. Mfg. Co., 312 Monterey Pass Rd., Monterey Park 91754 Tel: 282-5181, 283-5446 Pres & Adv Mgr. S.J. Alberts; Sales Mgr John J. Alberti. (Pressing only)
 Alco Research & Eng'g Inc., 6201 Santa Monica Blvd., Hol-

Billboard 1979-1980 International Buyer's Guide

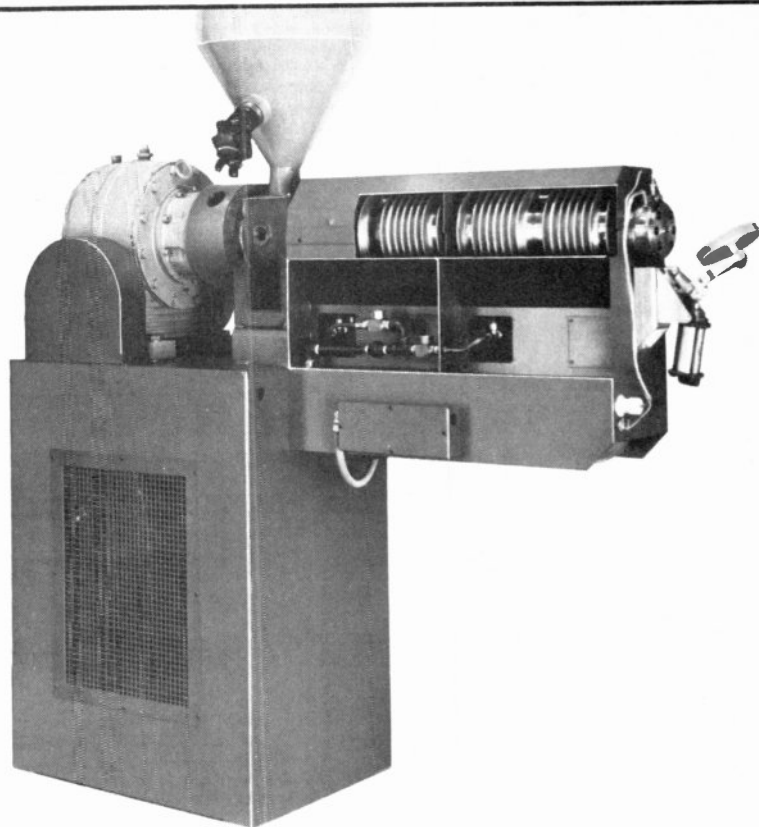

THE SHEAR-SHAFT* EXTRUDER

The Right Choice for All Reasons

Extruda-Products Inc. has the *only* extruders that are currently in phonograph-record production lines employing Hamilton, Lened and SMT automatic presses. In fact, EPI extruders adapt to every production line, manual or automatic.

The secret to the success of the EPI extruder line is a patented shear-shaft invented by EPI's extruder designer, Bob Tillis. By eliminating costly breakdowns caused by broken screws, this exclusive feature has proved to save users thousands of dollars.

Take your choice: the EPI Horizontal Extruder, the EPI Vertical Bottom-Drive Extruder, or the EPI Vertical Top-Drive Extruder.

The best news of all: EPI maintains a complete stock of interchangeable spare parts for all extruders, and offers quick delivery and very competitive prices.



EXTRUDA-PRODUCTS INC.

100 S. Washington Avenue, Dunellen, NJ 08812
 201-752-2144/CABLE: EXPRO, NJ

*U.S. Patent No 3,923,290;
 other patents pending.

VERTICAL
 BOTTOM-DRIVE
 EXTRUDER



VERTICAL
 TOP-DRIVE
 EXTRUDER



IT'S FANTASTIC!

You spent a fortune getting the right sound. Make sure it gets on record. You deserve the best quality pressing available and intend to get it. Sounds easy. But it's not. Why? Because all records are "Pressed" or molded from metal stampers. These stampers contain the fortune you just spent getting "The Sound." If these stampers fall short in quality, there can be no quality records pressed. Get the picture! Don't take chances with your product! To get quality records, you've got to get the best stampers available and we think we make the best, but you be the judge. We think our Record Presses and Extruders are also the best. Ask around.

RECORD PLATING - RECORD PRESSES - HORIZONTAL AND VERTICAL EXTRUDERS
Manufacturing for the Phonograph Record Industry

TRACY-VAL CORPORATION
GENTRY MACHINE CORP. Somerdale Industrial Park
201 Linden Avenue • Somerdale, N.J. 08083 • Code (609) 627-3000

33520. Tel: 577-7000. Pres.: R. Evan Evans; Mktg. Mgr.: Laurance Johnson; Adv. Mgr.: Mel Ardelean (Flexible disk pressing only). (SEE ADVERTISEMENT)

● **FORT LAUDERDALE (Area Code 305)**
Alpha Recs. Inc., 1400 NW 65 Ave. Zip 33313. Tel: 587-6011.

● **MIAMI METROPOLITAN AREA (Area Code 305)**
Miami Tape Inc., 8180 NW 103 St., Hialeah Gardens 33015. Tel: 558-9211. Pres.: Carlos Garcia; Sales Mgr.: Mirella Tunon. (Plating & processing only)
Prosound Inc., 8194 NW 103 St., Hialeah 33015. Tel: 558-0152. (Pressing only)
Record Dists. of America, 780 W. 27 St., Hialeah 33010. Tel: 887-2638. Pres.: Eliseo Valdes; Gen. Mgr.: Angel Tamargo.

GEORGIA

● **ATLANTA METROPOLITAN AREA (Area Code 404)**
Tres-Lanta Rec. Pressing Co., 190 Boulevard SE. Zip: 30312. Tel: 522-8106.

ILLINOIS

● **CHICAGO METROPOLITAN AREA (Area Code 312)**
Columbia Rec. Prod'ns, 630 N. McClurg Court. Zip: 60611. Tel: 944-6000. Midwest Reg'l Sales Mgr.: Dick Hutter. (Sales office only) (Pressing only)
Plants: Santa Maria, Calif.; Terre Haute, Ind.; Pitman, N.J.
The Diskwerks, 1244 Remington Rd., Schaumburg 60195. Tel: 885-1330. Mgr.: Gary Hedden.
Kiderian Recs. Prod'ns, 4926 W. Gunnison St. Zip: 60630. Tel: 545-0861. Pres.: Raymond Peck; Gen. & Sales Mgr.: George Peck. (Pressing only)
Musical Prods. Inc., 521 W. 26 St. Zip: 60616. Tel: 225-9117.
Sound Studios, 230 N. Michigan Ave. Zip: 60601. Tel: 236-4814. VP & Gen. Mgr.: Dan Tynus. (Pressing only)
Trackdown Record Dist. & Record Promo Co., 542 S. Dearborn, Suite 1102. Zip: 60605. Tel: 939-9066. Nat'l Dir. & Bd. Chm.: Hank Williams; Pres.: T.J. Wocker; Adv. Mgr.: J.V. Seldon.

● **JACKSONVILLE (Area Code 217)**
Capitol Inds., 1 Capitol Way. Zip: 62650. Tel: 245-9631. (Pressing only)

Presswell Records MFG. CO.

Complete Custom Record Pressing & Plating Facilities

ADDITIONAL SERVICES INCLUDE:

- Label Printing
- Warehousing
- Promotional Mailings
- Drop Shipping

White Horse Pike
Ancora, N.J. 08037

PHONE: 609 - 561-5250
TWX: 510 - 684-6880

WE'RE IN THE THICK OF IT!

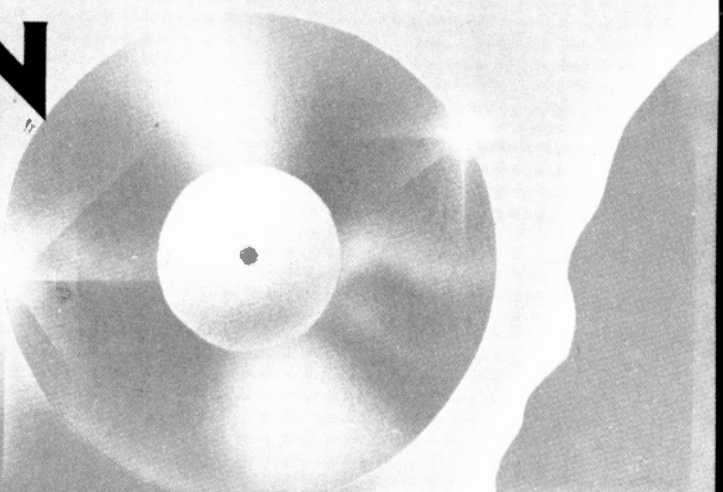

62% OF THE POPULATION OF THE U. S. IS LOCATED WITHIN 600 MILES OF OUR DOOR!

AUTOMATIC CUSTOM PRESSING, PRINTING & JACKET FABRICATION, NEUMAN MASTERING, PLATING, DESIGN SERVICES, COLOR SEPARATIONS



QCA CUSTOM PRESSING

2832 SPRING GROVE AVE., CINCINNATI, OHIO 45225
PHONE: (513) 681-8400 TELEX: QCA CUSTOM CINN 810-461-2789

The Nation's Largest "Under One Roof" Facility

INDIANA

● INDIANAPOLIS (Area Code 317)

R C A Recs. 6550 E. 30 St. Zip: 46219. Tel: 542-6301.
Mfg. Div. VP Ernest Ruggieri.
Home office: New York, N.Y.

● RICHMOND (Area Code 317)

P R C Rec'g Co. (div. of Richmond Rec'g Corp.). 1600 Rich Rd. Zip: 47374. Tel: 962-9511.
Home office: New York, N.Y.

● TERRE HAUTE (Area Code 812)

Columbia Rec. Prod'ns. 1400 Fruitridge Ave. Zip: 47805.
Tel: 466-8770. Plant Mgr.: Ken Lemry; Tape Mgr.: Ed Sharton.
Sales offices: Century City (Los Angeles Metropolitan Area), Calif.; Chicago, Ill.; New York, N.Y.; Nashville, Tenn. (Pressing only)

LOUISIANA

● VILLE PLATTE (Area Code 318)

Ville Platte Rec. Mfg. Co., 120 E. Cypress St. Zip: 70586.
Tel: 363-2104. Pres.: J. Floyd Soileau; Mgr. J.K. Soileau; Sales Mgr. Ronnie Soileau.

MARYLAND

● BALTIMORE AREA (Area Code 301)

Sontec Corp., 10120 Marble Court, Cockeysville 21030.
Tel: 628-2283. (Pressing only)

MICHIGAN

● DETROIT METROPOLITAN AREA (Area Code 313)

Archer Rec. Pressing Co., 7401 E. Davison. Zip: 48077. Tel: 365-9545.

MISSOURI

● ST. LOUIS (Area Code 314)

Audio Precision Inc., 6 Grandview Park Dr., Arnold 63010.
Tel: 464-2333. Pres.: Robert E. Blevins; VP Sales: Jim Cole. (Pressing only)

NEW JERSEY

● ANCORA (Area Code 609)

Presswell Recs. Mfg. Co., White Horse Pike & Ehrke Rd. Zip: 08037. Tel: 561-5250. Gen. Mgr.: William Joseph. (SEE ADVERTISEMENT)

● CRANBURY (Area Code 609)

Hub-Servall Rec. Mfg. Corp., Cranbury RR. Zip: 08512. Tel: 655-2166. Pres.: Frank Cocchiaraley; Sales Mgr.: Barry Ruegg. (Pressing only)

● ELIZABETH (Area Code 201)

Lened Int'l Corp., 489 Henry St. Zip: 07201. Tel: 354-5205. Pres.: Joseph Flustfeder. (SEE ADVERTISEMENT)

● MOUNTAINSIDE (Area Code 201)

Bestway Prods. Inc., 1105 Globe Ave. Zip: 07092. Tel: 232-8383. (Pressing only)

● NEWARK (Area Code 201)

Andira Rec. Corp., Custom Servs. Div., 16 Park Pl. Zip: 07102. Tel: 642-5991.
Dynamic LP Stereo Rec. Pressing Co. Inc., see Sun Plastics.
Peter Pan Inds., 145 Komorn St. Zip: 07105. Tel: 344-4214. Pres.: Martin Kasen; VP: Donald Kasen; Sales Mgr.: James Monaghan; Sales Admin'r: Adele Breitbarth. Local branch: 88 St. Francis St. Zip: 07105. Tel: 344-4214. (Pressing only)
Sun Plastics Co. Inc./Dynamic LP Stereo Rec. Pressing Co. Inc., 900 Passaic Ave., East Newark 07029. Tel: 482-6749; NYC (212) 349-0977. Pres.: Jerry Salerno; Sales Mgr.: Rocco Salerno. (SEE ADVERTISEMENT)

● PARK RIDGE (Area Code 201)

Cadet Recs., PO Box 176. Zip: 07656. Tel: 391-3676. VP Sales: R. K. Herrington. (Sales office only)
Home office: Los Angeles, Calif.

● PITMAN (Area Code 609)

Columbia Rec. Prod'ns. Woodbury-Glassboro Rd. Zip: 08071. Tel: 589-8000.
Sales offices: Century City (Los Angeles Metropolitan Area), Calif.; Chicago, Ill.; New York, N.Y.; Nashville, Tenn. (Pressing only)

● RAHWAY (Area Code 201)

Apex Rec. Pressing Co., 947 US Hwy. 1. Zip: 07065. Tel: 574-1400. (Pressing only)
Springboard Int'l. 947 US Hwy. 1. Zip: 07065. Tel: 574-1400.
Branch: Los Angeles, Calif.

Two industry superstars are now one great team.

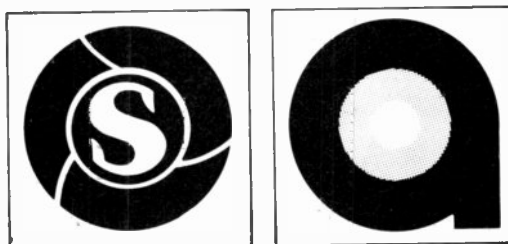

Two industry leaders are now co-ordinating their quality pressing and duplicating services **coast to coast.**

The best of both worlds from:
Specialty Records Corporation

210 North Valley Avenue,
Olyphant, Pennsylvania 18447
Phone (717) 383-2471
TXW 510-671-4580

Allied Record Company

6110 Peachtree Street
Los Angeles, California 90040
Phone (213) 725-6900
TWX 910-580-4731

The new supergroup in records and tapes.

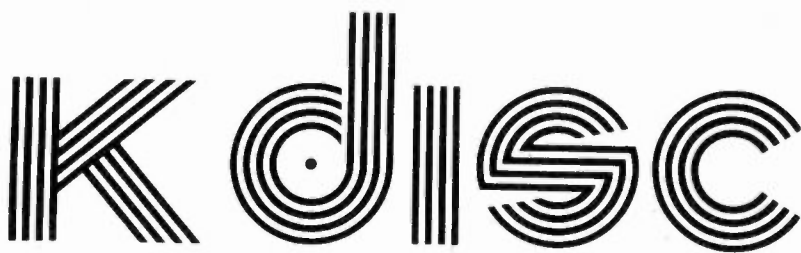

A Subsidiary of Keysor-Century Corporation
FORMERLY CENTURY RECORDS

MASTERING • PLATING • PRESSING • PRINTING



6550 Sunset Boulevard
Hollywood, California 90027
[213] 466-1323

26000 Springbrook Avenue
Saugus, California 9135
[805] 259-2360
[213] 365-3991

WE DESIGN AND BUILD RECORD MANUFACTURING PLANTS

That's all we do, but we do that very well. Complete worldwide turnkey service using our experienced installation crews. We are not equipment manufacturers — let us specify the most suitable equipment for your particular needs and local conditions.



VALLEY EXPORTS INTN'L., INC.

P.O. BOX 8, MERION STATION, PA. 19066
CABLE: VALLEYEXP, MERION, PA. USA

● **ROSELLE (Area Code 201)**

All Disc Recs. Inc. (div. of Capitol Recs. Inc.), 625 W. First Ave. Zip 07203 Tel. 245-7415. NYC (212) 267-1523. Gen. Mgr. Art Conrad, Sales & Admin. Steve Ladden.
Home office: Los Angeles, Calif., Capitol Recs. Inc. (SEE ADVERTISEMENT)

● **SOMERDALE (Area Code 609)**

Superior Rec. Pressing Corp., 900 Kennedy Blvd. Zip 08083 Tel. 784-6600. Pres. John H. Dunn.
Tracy-Val Corp., Somerdale Ind'l Park, 201 Linden Ave. Zip 08083 Tel. 627-3000. Pres. James A. Miller (Plating only) (SEE ADVERTISEMENT)

NEW YORK

● **HAUPPAUGE (Area Code 516)**

Keel Mfg. (div. of Pickwick Int'l Inc.), Cardinal Ind'l Park, 15 Gilpin Ave. Zip 11787. Tel. 234-0200. (Pressing only)

● **HOLBROOK (Area Code 516)**

Goldisc Rec'gs Inc. (sub. of Electrosound Group), Veterans Hwy. & Broadway. Zip 11741. Tel. 589-0462. NYC (212) 895-6575. Pres. Richard F. Meixner, Sales Mgr. John Finnegan, Adv. Mgr. Rich Renda.
Sales offices: Hollywood (Los Angeles Metropolitan Area), Calif., Electrosound Group Inc., New York, N.Y., Electrosound Group Inc.

● **HOLTSVILLE (Area Code 516)**

Donora Mfg. Co. Inc., 658 Blue Point Rd. Zip 11742. Tel. 654-1110. NYC (212) 895-1955. Pres. Ray Kissel.

● **HUNTINGTON STATION (Area Code 516)**

Shelley Prods. Ltd., 220 Broadway. Zip 11746. Tel. 423-7090.

● **NEW YORK METROPOLITAN AREA (Area Code 212)**

Audio Matrix Inc., 915 Westchester Ave., Bronx 10459. Tel. 589-3500. Pres. Milton B. Gelfand, VP. Plating Processes. Carl M. Rodia, Sales Mgr. Martin Feder, Adv. Mgr. J.P. Lohman (Plating & processing only). Sales office: Audiomatic Corp., 1290 Ave. of the Americas, Rm. 3737. Zip 10019. Tel. 582-4870.

Columbia Rec. Prod'ns. 49 E. 52 St. Zip 10022. Tel. 975-4881. Div. VP. Tom Van Gessel, East Coast Reg'l Sales Mgr. Donald Olesen. (Sales office only) (Pressing only). Plants: Santa Maria, Calif., Terre Haute, Ind., Pitman, N.J.

Direct Rec'gs Inc., 18 E. 50 St. Zip 10022. Tel. 759-7979. Pres. & Sales Mgr. Norman Levin. (Pressing only)

Disc Communications Ltd., 743 Fifth Ave. Zip 10022. Tel. 371-0390. Pres. Jerome Boxer. Art Dir. Susan Murphy.

E R H Sales Corp., 221 W. 57 St. Zip 10019. Tel. 582-4200. Pres. Lee Halpern. Sr. Exec. VP. Howard Roseff. Gen. Mgr. Michael Halpern. Sales Mgr. Robert Shavelson. (SEE ADVERTISEMENT)

Electrosound Group Inc., 1290 Ave. of the Americas. Zip 10019. Tel. 581-5641. Pres. Richard H. Burkett. Sales Mgr. Ron Roberto. (Sales office only)
Home office: Sun Valley (Los Angeles Metropolitan Area), Calif.

Plants: Sun Valley (Los Angeles Metropolitan Area), Calif., Monarch Rec. Mfg. Co., Holbrook, N.Y., Goldisc Rec'gs Inc., Allentown, Pa., Allentown Rec. Co. Inc. Europadisk Plating Co., 333 W. 52 St. Zip 10019. Tel. 765-5571. (Plating & processing only)

Mastercraft Rec. Plating Inc., 609 W. 51 St. Zip 10019. Tel. 265-6040. Gen. Mgr. David Moldauer. (Plating & processing only)

P R C Rec'g Co. (div. of Richmond Rec'g Corp.), 1185 Ave. of the Americas. Zip 10036. Tel. 997-1250. Pres. Hugh Landy. VP & Sales Mgr. David Grant.

Plants: Compton (Los Angeles Metropolitan Area), Calif., Richmond, Ind.

R C A Recs., 1133 Ave. of the Americas. Zip 10036. Tel. 598-5900. (Sales office only)

Sales offices: Los Angeles, Calif., Nashville, Tenn. Plant: Indianapolis, Ind.

R G H Rec. Mfg. Corp., 750 Eighth Ave. Zip 10036. Tel. 354-4336. (12" Pressing only) (SEE ADVERTISEMENT)

Soundtek Inc., 50 W. 57 St. Zip 10019. Tel. 489-0806. (Plating & processing only)

● **UTICA (Area Code 315)**

Oneida Video-Audio Tape Cassette Corp., 760 Blandina St. Zip 13501. Tel. 735-6187. Pres. Stanley Markowski. Sales Mgr. Joyce Markowski. Adv. Mgr. Andrew Cittadino. (Pressing only)

OHIO

● **CINCINNATI (Area Code 513)**

Artists Rec'g & Rec. Pressing Co. Inc., 320 Mill St. Zip 45215. Tel. 761-0011

Counterpart Creative Studios Inc., 3744 Applegate Ave. Zip 45211. Tel. 661-8810. Pres. & Sales Mgr. Shad O'Shea. Adv. Mgr. Marilyn Aker. (Plating & processing only)

Q C A Custom Pressing, 2832 Spring Grove Ave. Zip 45225. Tel. 681-8400. Pres. Edward R. Bosken. VP & Gen. Mgr. Frank E. Ruhl. Sales Mgr. Keith Myers. Adv. Mgr. D. Kalmus. (SEE ADVERTISEMENT)

Rite Rec. Prod'ns Inc., 9745 Lockland Rd. Zip 45215. Tel.

733-5533. Pres.: Carl J. Burkhardt; VP: Philip M. Burkhardt; Sales Mgr.: Dan Burton.
 Studio Pressing Serv., 320 Mill St. Zip: 45215. Tel: 761-8294. Pres.: Joseph Sluder; Sec'y: Connie Sluder (Pressing only)

● **CLEVELAND (Area Code 216)**

Boddie Rec. Mfg. & Rec'g Inc., 12202 Union Ave. Zip: 44105. Tel: 752-3440. Pres.: Thomas R. Boddie; Sales Mgr.: Dennis R. Boddie.

● **COLUMBUS (Area Code 614)**

Mus-I-Col Inc., 780 Oakland Park Ave. Zip: 43224. Tel: 267-3133. Owners: John W. Hull, Boyd P. Niederlander. (Pressing only)

PENNSYLVANIA

● **ALLENTOWN (Area Code 215)**

Allentown Rec. Co. Inc. (sub. of Electrosound Group Inc.), 1002-10 Walnut St. Zip: 18102. Tel: 433-7405. Pres.: Sanford L. Wartell.
 Sales offices: Hollywood (Los Angeles Metropolitan Area), Calif.; Electrosound Group Inc.; New York, N.Y.; Electrosound Group Inc.

● **PHILADELPHIA METROPOLITAN AREA (Area Code 215)**

Diskmakers Inc., 925 N. Third St. Zip: 19123. Tel: 627-2277. NYC (212) 966-3185. Pres.: Morris Ballen. (Pressing only) (SEE ADVERTISEMENT)
 Hodge Rec. Mfg. Co., 13141-24 S. Howard St. Zip: 19147. Tel: 334-5662. (Pressing only)
 Plastic Ents. Corp., 1360 Industrial Hwy., Southampton 18966. Tel: 355-7555. Pres.: Joe Stewart.
 Valley Exports Int'l Inc., PO Box 8, Merion Station 19066. Tel: 627-2277. Contact: Larry Balen. (Designer & builder of pressing plants) (SEE ADVERTISEMENT)

● **SCRANTON AREA (Area Code 717)**

North American Music Inds. Inc., 300 Brook St. Zip: 18505. Tel: 346-9781. Pres.: Don Evans; Sales Mgr.: R.P. Stearns.
 Specialty Recs. Corp., 210 N. Valley Ave., Olyphant 18447. Tel: 383-2471. Pres.: Richard C. Marquardt; VP Sales: John R. Williams. (SEE ADVERTISEMENT)

TENNESSEE

● **LAFAYETTE (Area Code 615)**

Deltion Rec. Pressing Inc., 704 Bennete St. Zip: 37083. Tel: 666-2818. Pres.: Roger Ricker; Sales Mgr.: D.W. Kehoe; Adv. Mgr.: W.E. Kehoe.

● **MEMPHIS (Area Code 901)**

Plastic Prods. Co., 1746 Chelsea Ave. Zip: 38108. Tel: 276-7160. (Pressing only)

● **NASHVILLE (Area Code 615)**

Chumley Prod'ns, PO Box 7195, 2802 Foster Ave. Zip: 37211. Tel: 833-6184. Pres.: P.E. Chumley.
 Columbia Rec. Prod'ns, 34 Music Square E. Zip: 37203. Tel: 259-4321. Account Exec.: Jerry Parkins. (Sales office only). (Pressing only)
 Plants: Santa Maria, Calif.; Terre Haute, Ind.; Pitman, N.J.
 Dixie Rec. Pressing Inc., 631 Hamilton Ave. Zip: 37203. Tel: 254-3481. Pres.: James B. Gann. (Pressing only)
 G R T Corp., 1110 48 Ave. N. Zip: 37209. Tel: 383-7881. VP & Opns. Mgr.: Chuck Duncan.
 Home office: Sunnyvale, Calif.
 Nashville Album Prod'ns Inc., 617 Seventh Ave. S. Zip: 37203. Tel: 256-0121. Pres.: Steve Bots; Sec'y-Treas.: Robbie McWey.
 Nashville Int'l Prod., 20 Music Square W. Zip: 37203. Tel: 256-2885. (Pressing only)
 Nashville Phono Matrix Inc., 310 Chestnut St. Zip: 37210. Tel: 244-2405. Pres.: Betty J. Kemp; Sales Mgr.: Thomas E. Kemp; Adv. Mgr.: Michael J. Kemp. (Plating & pressing only)
 R C A Recs., 30 Music Square W. Zip: 37203. Tel: 244-9880. VP: Jerry Bradley.
 Home office: New York, N.Y.
 Plant: Indianapolis, Ind.
 Sound of Nashville Inc., 1207 Demonbreun St. Zip: 37203. Tel: 256-2521. Pres.: John Ivanits; Sales Mgr.: Gary W. Moore. (Plating & pressing only)
 Southern American Rec. Pressing Co. Inc., see Sound of Nashville.
 Joe Talbot III, 2 Music Circle S. Zip: 37203. Tel: 256-8978. Pres.: Joe Talbot III. (Pressing only) (SEE ADVERTISEMENT)
 United Rec. Pressing Inc., 453 Chestnut St. Zip: 37203. Tel: 259-9396. Pres.: Ozell Simpkins.

TEXAS

● **AUSTIN (Area Code 512)**

M B A Prod'ns, 8914 Georgian Dr. Zip: 78753. Tel: 836-3201/3194. Pres.: Roy J. Montgomery Sr.; VP: Shirley A. Montgomery.
 P S G Rec'g Studio, PO Box 1482, 4322A N. Lamar Blvd. Zip: 78767. Tel: 454-5653. Pres.: Pedro S. Gutierrez. (Pressing only)

● **DALLAS (Area Code 214)**

Rainbow Sound Inc., 1322 Inwood Rd. Zip: 75247. Tel:

638-7712. Pres.: Bob Cline; Exec. VP: Jim Grier; VP: Jack Whitt. (Pressing only)

● **SAN ANTONIO (Area Code 512)**

B C L Ents. Inc., 1002 Hoefgen St. Zip: 78210. Tel: 532-3216. Pres.: C. Foy Lee; Sales Mgr.: Jimmy Burton; Adv. & Promo Mgr.: Jeannine Hill.
 Joey Recs., 6703 W. Commerce. Zip: 78207. Tel: 432-7893. Pres.: Joey Lopez. (Pressing only).

● **SAN BENITO (Area Code 512)**

Rio Grande Music Co., 119 S. Sam Houston Blvd. Zip: 78586. Tel: 399-5377. Pres. & Adv. Mgr.: Lionel C. Betancourt; Sales Mgr.: John F. Phillips. (Pressing only)

VIRGINIA

● **WINCHESTER (Area Code 703)**

Capitol Inds., Kernstown Rt. 652, Shawnee Dr. Zip: 22601. Tel: 667-8125. (Pressing only)

WYOMING

● **CHEYENNE (Area Code 307)**

Rocky Mountain Rec'g, Box 1354A, Rt. 2. Zip: 82001. Tel: 638-8733. Pres.: Ray Alexander; Sales & Adv. Mgr.: Georgia Alexander.

RECORD PROMOTION

ALABAMA

● **BIRMINGHAM (Area Code 205)**

Char-Belle Prod'ns Inc., PO Box 10612, Frank Nelson Bldg. 205 N. 20 St., Suite 1005. Zip: 35203. Tel: 252-8271. Pres. & Sales Mgr.: Ann Scott; Adv. Mgr.: C.A. Kilpatrick.

ARKANSAS

● **LITTLE ROCK (Area Code 501)**

Blaze Org. Ltd., PO Box 1899. Zip: 72203. Tel: 375-2911. Pres.: James E. Handy II; Exec. VP: James H. Ellison; VP Promo: Michael Bailey.

CALIFORNIA

● **ANAHEIM (Area Code 714)**

50 State Dist'g Co. Inc., 1174 Knollwood Circle. Zip: 89109. Tel: 761-8051.
 Home office: Las Vegas, Nev.

● **BAKERSFIELD (Area Code 805)**

D J Rec. Serv., 2200 Freemont. Zip: 93304. Te: 832-6633/6897. Owner & Pres.: Angie Woods.

● **LOS ANGELES METROPOLITAN AREA (Area Code 213)**

Ad-Korp, PO Box 1437, Covina 91722. Tel: 966-1227.
 Advanced Ventures Promo. Agency, 1400 N. Hayworth, Suite 14, Hollywood 90046. Tel: 876-2834. Pres.: Patrick Jenkins; Sales Mgr.: Jim Samora; Adv. Mgr.: Louie Beljack.
 Alfie Recs. (div. of Sound Syndicate), 7769 Melrose Ave. Zip: 90046. Tel: 653-4818. Pres. Al Durand; Sales Mgr.: Dick Gordon; Adv. Mgr.: Donna Durand.
 Alshire Int'l, 1015 Isabel St., Burbank 91502. Tel: 849-4671. Pres.: Al Sherman; Sales Mgr.: Dick Cera.

American Video Prod'ns, 4265 Marina City Dr., Suite 501, Marina del Rey 90291. Tel: 823-1228. Pres.: Michael Huemmer; Sales Mgr.: Joseph Camacho; Adv. Mgr.: Joseph Gerbino.
 Apple Juice Prod'ns, 6381 Hollywood Blvd., Suite 604, Hollywood 90028. Tel: 464-2482.
 Art Benson Promos., 1560 N. La Brea, Suite M, Hollywood 90028. Pres.: Arthur H. Benson; Sales Mgr.: Howard Wormser.
 Fred Benson Promo., PO Box 869, Hollywood 90028. Tel: 463-9311. Pres.: Fred Benson.
 Bly/Hakim Org., 12457 Ventura Blvd., Studio City 91604. Tel: 760-0280. Contacts: Stan Bly, Jack Hakim.
 Mike Borchetta Independent Rec. Promos., 6290 Sunset Blvd., Hollywood 90028. Tel: 461-8488. Pres.: Mike Borchetta; Sales Mgr.: Scott Borchetta; Adv. Mgr.: Diane Davis.
 Jane Britton Disco Rec. Promo, 8170 Beverly Blvd. Zip: 90048.
 California Images Inc., 7611 Fulton Ave., North Hollywood 91605. Tel: 982-1353. (Customized tee-shirts only)
 Carman Prod'ns, 15456 Cabrito Rd., Van Nuys 91406. Tel: 873-7370. Pres.: T.R. Skeeter; Mgr.: J. Eddy; Sales Mgr.: W. Trowbridge.
 Creative Minds Inc., 1560 N. La Brea, Suite M, Hollywood 90028. Pres.: Arthur H. Benson; Sales Mgr.: Howard Wormser.
 Dejay "Gold & Platinum" Rec. Plaques Co., 3010 W. Burbank Blvd., Burbank 91505. Tel: 845-0744, 849-5347. Pres.: Dave Goldstein; Sales Mgr.: Jackie Goldstein.
 Dyna Concept Studio's, PO Box 44113, San Pedro 90731. Tel: 548-5731. Mng. Dir.: Julian Reyna.
 Int'l branch: Surinam
 Lu Fields Promos. Inc., PO Box 1269, Hollywood 90028. Tel: 469-7101. Owner & Pres.: Lu Fields.
 Bruce Hinton, 6255 Sunset Blvd., Suite 1001, Hollywood 90028. Tel: 462-6808.
 Earl Horwitz, 1242 Los Angeles St., Glendale 91204. Tel: 245-6464. (Nat'l Rec. & Tape Sales & Mktg.)
 The Image Factory Inc., 1900 Ave. of the Stars. Zip: 90067. Tel: 552-3596. Pres.: Stanford Blum.
 Image Mktg. & Media, 1420 N. Beechwood Dr. Zip: 90028. Tel: 464-8341. Co-Pres.: Leanne Meyers, Shelly Heber, George Jay & Assocs., 1608 Argyle, Hollywood 90028. Tel: 462-6608. Owner: George Jay.
 Kosh & Co., 1581 Crossroads of the World, Hollywood 90028. Tel: 466-9755.
 Ray Lawrence Ltd., PO Box 1987, Studio City 91604. Tel: 552-1000. Pres. & Sales Mgr.: Ray Lawrence; Adv. Mgr.: Connie Lawrence.
 Levinson Assocs. Inc., 927 N. La Cienega Blvd. Zip: 90069. Tel: 657-8800. Pres.: Bob Levinson.
 Branch: New York, N.Y.
 M K Dance Promos., 9300 Wilshire Blvd., Suite 201, Beverly Hills 90212. Tel: 550-3955. Contacts: Marc Kreiner, Rusty Gartner.
 Branch: New York, N.Y.

PRINT DIRECT

ALBUM JACKETS

Short Runs • Low Prices

H.R.C. Printing

P.O. Box 1152-B

Mechanicsburg, Pa. 17055

(717) 766-0943

Manufacturers of MASTER RECORDING BLANKS

Transco Products Corp.

609 West Elizabeth Ave., Linden, N.J. 07036
 Tel: (201) 862-0030-33 Cable: REGNIS



Mahoney/Wasserman & Assocs Inc. 117 N Robertson
Zip 90048. Tel 550-3922. Pres Jim Mahoney
Branch: New York, N.Y.

Music Resources Int'l Corp. 1100 N Alta Loma Rd Zip
90069. Tel: 657-5000 Exec. VP Steve Brodie
Branch: New York, N.Y.

Musicsearch, 9000 Cynthia St., Suite 205, Zip 90069 Tel
275-4790. Pres. Robert Greenfield, VP Creative
Servs. Topper Schroeder

Tony Richland Promo., 1680 N. Vine St., Hollywood
90028 Tel 467-2151. Pres. Tony Richland, VP Tom
Richland, Sales Mgr. Jo-Jo Richland, Adv. Mgr. Lizzie
Richland

Roach Inc., 8430 Tujunga Ave., Sun Valley 91352 Tel
767-8300. (Customized tee-shirts & hats only)
Home office: Columbus, Ohio.

Jon Roseman Prod'ns, 6218 W. Sixth St. Zip: 90048 Tel
934-4577.

Pete Senoff Ent's, 320 Wilshire Blvd., Suite 308, Santa
Monica 90401 Tel 395-8494. Pres., Pete Senoff
Solters & Roskin Inc., 9255 Sunset Blvd. Zip 90069 Tel
275-5303

Home office: New York, N.Y.
Steinberg Lipsman & Assocs., 8961 Sunset Blvd. Zip
90069 Tel: 278-3838.

Surf City Recs., PO Box 14, Hollywood 90028 Tel 851-
3161. Pres.: Gary M. Theroux; Admin. Ass't Russell
Bidwell, Sales Mgr. Mark Charger, Adv. Mgr. Peter
Roberts.

Tar Prod'ns Inc., 12029 Ventura Blvd., Studio City 91604
Tel 985-3560. Nat'l Consultant Tom Ray

Nick Therry Rec. Promo., 3008 Belden Dr. Zip 90068 Tel
469-2719. Pres. Nick Therry

Whittemore Corp., 21608 Arcos Dr., Woodland Hills
91364. Tel 657-2327. Pres. Don Whittemore

Norman Winter/Assocs Publicity, 6255 Sunset Blvd. Suite
714, Hollywood 90028. Tel: 462-7453. Pres. Norman
Winter.

● **SAN FRANCISCO & BAY AREA
(Area Code 415)**

Augie Blume & Assocs. PO Box 190, San Anselmo 94960
Tel 457-0215. Pres. August G. Blume, VP Nancy D.
Blume; Mktg. Mgr. Carol Lee Keller, Northern Calif
Promo Mgr. John Tobin, LP Promo. Ron Middag

Fred Fox Music Co., 406 Kehoe Ave., Half Moon Bay
94019 Tel 726-3725. Gen Mgr. F.H. Nesbitt Jr.,
Sales Mgr. V.A. Nesbitt

Cathy Furniss & Assocs., 680 Beach St., Suite 445 Zip
94109 Tel 885-2807. Pres. Cathy Furniss, Sales
Mgr. Ruth Maas, Adv. Mgr. Michel Lipman

Ice Promo, 544 Central Ave., Suite 302, Alameda 94501
Tel 522-8131. Pres. Craig Walker

Sonic Arts Corp., 665 Harrison St. Zip 94107. Tel 781-
6307. Pres.: Leo de Gar Kulkka, Gen. Mgr. Herbert P.
Haas, Sales Mgr. Joseph Speck

Sylvia White, 2383 Union St., No. 4 Zip 94123 Tel 567-
6935.

● **STANTON (Area Code 714)**

Photo-Lith Int'l, 11816 Western Ave. Zip 90680 Tel 893-
5037. (Customized tee-shirts only)

COLORADO

● **BOULDER (Area Code 303)**

Video/Audio Artistry Corp (Vidaac Ltd.), PO Box 4571,
1258 Bear Mountain Court. Zip 80302. Tel: 499-
2001

CONNECTICUT

● **GEORGETOWN (Area Code 203)**

Broadway Baby Rec Covers, PO Box 496 Zip 06829 Tel
544-8288.

● **GREENWICH (Area Code 203)**

Hallahan Communications (Halcom), 35 Greenwich Hills Dr.
Zip 06830. Pres. Gene Hallahan.

● **MONROE (Area Code 203)**

Wildwood Entertainment, 114 W. Maiden Ln. Zip 06468.

Tel 261-2979. Pres. Vincent E Meyer Jr
Branch: Rensselaer, N.Y.

● **WILTON (Area Code 203)**

Paradiso Inc., PO Box X Zip 06897 Tel 762-5188. Pres.
L von Kleydorff; Mgr. Patricia Rowell

DELAWARE

● **BEAR (Area Code 302)**

Factors Etc. Inc. Geissler Park Zip 19701 Tel 834-1625.
WATS (800) 441-7650. Pres. H. Lee Geissler, Sales
Mgr. Laurence H. Seeneey (Customized tee-shirts)

DISTRICT OF COLUMBIA

● **WASHINGTON (Area Code 202)**

Carwar Rec. Promo Inc (sub of Carwar Co Corp), 1527 14
St. NW Zip 20005. Tel 332-1790. Pres.
C.A. Warren, VP Charles H. Montague; Dir. & Gen
Mgr. Angie Bell.

FLORIDA

● **GULF BREEZE (Area Code 904)**

Prewitt Rose & Assocs., Box 652 Zip 32561 Tel 932-
6893. Promo Dir. Terry Rose

● **MIAMI METROPOLITAN AREA
(Area Code 305)**

Stu Chernoff Artist & Rec. Promo, 14920 NE 10 Ave. North
Miami 33161 Tel 949-6010. Pres. Stu Chernoff
Florida Independent Promos., 8228 NW 56 St Zip 33166
Tel 592-6085. Pres. Joseph Stanzone

Eddie Lambert, 985 NE 149 St., North Miami 33161 Tel
947-8140.

GEORGIA

● **ATLANTA (Area Code 404)**

C D E Promos, PO Box 41551, 3200 Stone Rd., Suite V-8
Zip 30331 Tel 344-2039. Pres. Charles Edwards
Duplex Rec. Dist. & Rec. Promos., PO Box 4003 Zip
30303 Tel 524-9174

Stan Green & Assocs., 34 Peachtree, No 2410 Zip 30303
Tel 233-1333. Pres. Stan Green

Wade Pepper Promos., 1195 Mount Paran Rd. NW. Zip
30327 Tel 233-5167. Pres. Wade G. Pepper

Pro-Talent Consultants, Bldg. M, Suite 1, 162 Cranfill Rd.,
Marietta 30060 Tel 424-1684. Co-ord. J. Richard
Eckert, Prod. Mgr. Glen Elliott

The T-Shirtery Inc., 1200 Menlo Dr. NW Zip 30318 Tel
351-9850. WATS (800) 241-1052. Pres. Jay J. Co-
hen; Gen. Sales Mgr. Paul I. Katz (Customized tee-
shirts only)

● **COLUMBUS (Area Code 404)**

Capricorn Sales, 4018 Buena Vista Rd. Zip 31907 Tel
563-5353. Owner William Pellegrini. (Customized tee-
shirts only)

ILLINOIS

● **CHICAGO METROPOLITAN AREA
(Area code 312)**

Ad-Vertising Unlimited, PO Box 8135. Zip 60680 Tel
787-8220. Pres. R.C. Hillsman, Sales Mgr. Frank
Howard Jr., Adv. Mgr. Howard Pittman

Bedno/Wright Assocs., 233 E Erie Zip 60611 Tel 664-
6054. Pres. Howard Bedno, Promo Cy Gold, Adv.
Mgr. Peter Wright.

Corinne Carpenter Communications, 2840 N. Lake View
Zip 60614 Tel 248-1478. Pres. Corinne Carpenter

M M Cole Publ'g Co., Playboy Bldg., Suite 1602, 919 N
Michigan Ave Zip 60611 Tel 527-2160. Pres.
Shepard Stern, Sales Mgr. J.C. Cole, Adv. Mgr. Mike
Louis Stern

Paul Gallis, 1801 Cree Lane, Mount Prospect 60056 Tel
827-6414.

Tony Gideon Promos., PO Box 21413, 822 W 71 St Zip
60621 Tel 873-8774, 643-4117. Pres. Tony Gi-
deon

Kiderian Recs. Prod'ns, 4926 W Gunnison St Zip 60630.
Tel 545-0861. Pres. Raymond Peck; Gen. & Sales
Mgr. George Peck

Musical Prods. Inc., 521 W 26 St Zip 60616 Tel 225-
9117

National Radiophone, PO Box 235, Highland Park 60035
Tel 432-0116. Pres. David J. Dahl

Planet Communications (div. of Clay Pigeon Int'l), PO Box
20346 Zip 60620 Tel 476-2553. Pres. & Gen.
Mgr. Vytautas Beleska; Sales mgr., Rudy Markus; Spe-
cial Projects Mgr., D. Jaras

Rainbow Bridge Studios Inc., 117 Rockland Rd., Libertyville
60048 Tel 362-4060. Studio Mgr. Ron Schwartz

Trackdown Record Dist. & Record Promo Co., 542 S. Dear-
born, Suite 1102. Zip 60605 Tel 939-9066. Nat'l
Dir. & Bd. Chm. Hank Williams; Pres. T.J. Wocker;
Adv. Mgr. J.V. Seldon.

Wax & Assocs., 2200 Forestview Rd., Evanston 60201 Tel.
328-8880. Chief Exec. Joyce Bresnahan

● **COLLINSVILLE (Area Code 618)**

Mar-Kay Rec. Co., 1 Scotch Pine Dr Zip 62234. Tel. 344-
4443. Exec. Pres. Mary Joyce; VP. Ron Allen; Sales &
PR Mgr. Les Darnier, Adv. Mgr. Hubert Joyce

INDIANA

● **ANDERSON (Area Code 317)**

New Day Promos, 1109 Jackson St. No 201 Zip 46016
Tel 644-0934. Exec. Dir. Michael L. Breese.

● **GARY (Area Code 219)**

Ron Wheeler Ent's., PO Box 1900, 4788 Connecticut Ave
Zip 46409 Tel 887-0924. Pres. Ronald E. Wheeler

● **INDIANAPOLIS (Area Code 317)**

Bowers Rec. Sleeve Co., 5331 N. Tacoma Ave Zip 46220
Tel 251-3918. Pres. Robert C. Bowers, VP & Sales
Mgr. Charles H. Kaufman

IOWA

● **CARLISLE (Area Code 515)**

Iowa Sound Promos. & Advertising (div. of Kajac Recs.), 155
First St Zip 50047 Tel 989-0876. Gen. Mgr. Harold
L. Luick

● **DES MOINES AREA (Area Code 515)**

Stenco Graphics, Box 2501, 5311 SW Ninth Zip 50315
Tel 285-6564. Pres. Art Stenstrom (Customized tee-
shirts only)

● **OTTUMWA (Area Code 515)**

Operation Music Ent's., 233 W Woodland Ave Zip 52501
Tel 682-8283. Pres. Nada C. Jones

KANSAS

● **OVERLAND PARK (Area Code 913)**

United States Promo. Group, 9431 Reeder Zip 66214.

KENTUCKY

● **LEXINGTON (Area Code 606)**

Joe Middleton, 2212 Clays Mill Rd. Zip 40503. Tel 278-
4194

LOUISIANA

● **NEW ORLEANS (Area Code 504)**

Sapphire Rec. Co., 2815 Octavia St Zip 70115 Tel 866-
3478. Pres. Lou Welsch Jr.

● **SHREVEPORT (Area Code 318)**

Stan's Rec. Dist., 728 Texas St Zip 71102 Tel 222-7182
Pres. Stanley J. Lewis; VP & Sales Mgr. Ronnie Lewis,
Adv. Mgr. Marcia Fuller

MARYLAND

● **BALTIMORE (Area Code 301)**

Charles von Nordeck Promos., 853 University Ave Zip
21210 Tel 235-8028

● **GREENBELT (Area Code 301)**

Leo 13 Ltd., see Lion
Lion Prod'ns-Promos. & Leo 13 Ltd., 5829 Cherrywood
Terr., Suite 203 Zip 20770. Tel. 345-5587. Owner &
Pres. Lester L. Fredman, Sales & Adv. Mgr. Jim Jordan.

● **HYATTSVILLE (Area Code 301)**

The Shirt Xplosion Co. Inc., 5618 Lafayette Pl Zip 20781
Tel 277-4400. Pres., Sales & Adv. Mgr. Fred Fillah;
Opns. Dir. Bob Stolman (Customized tee-shirts only)



RICHARD GERSH ASSOCIATES, INC.
Public Relations
200 West 57 Street, New York, N. Y. 10019
(212) 757-1101

● **KENSINGTON (Area Code 301)**

Omega Rec'g Servs., 10518 Connecticut Ave. Zip 20795. Tel: 946-4686.

● **MARLOW HEIGHTS (Area Code 301)**

Promotional Mgmt. Unlimited Inc., 4400 Stamp Rd. Zip: 20031 Tel: 423-6772 Pres.: Clarence Williams

● **WHEATON (Area Code 301)**

Big Ed's Unlimited, 11141 Georgia Ave., Suite A-1. Zip: 20902 Tel: 949-9500 (Customized tee-shirts only)

MASSACHUSETTS

● **BOSTON METROPOLITAN AREA (Area Code 617)**

Fleetwood Communications, 321 Revere St., Revere 02151. Tel: 289-6800 Pres.: Vincent Giarrusso; Gen Mgr. & Treas.: Raymond G. Samora; Sales Mgr.: Victor Mancini; Adv. Mgr.: Robin Samora.

Ed Hurvitz Music Promos., 129 Bishop St., Brockton 02402. Tel: 588-6348. Pres. & Adv. Mgr.: Edward M. Hurvitz; Sales Mgr.: Linda Berman.

Charles Martignette Mgmt., PO Box 9295. Zip: 02114. Tel: 734-5400. Pres.: Charles Martignette Jr.; Adv. Mgr.: Dudley Winchester.

Rik Tinory Prod'ns, 622 Rt. 3A, Cohasset 02025. Tel: 383-9494. Pres.: Richard F. Tinory; Artist Relations: Claire L. Babcock.

● **BROCKTON (Area Code 617)**

Park Ave Prod'ns, 180 Highland St., Suite 25. Zip 02401. Home office: Eastchester, N.Y.

● **LAWRENCE (Area Code 617)**

N E R T (New England Rec. & Tape) (div. of PBN Survey), PO Box 268. Zip 01842; 641 Haverhill St. Zip: 01841. Tel: (617) 686-4293 Pres.: Jerry P. Marcus; Sales Mgr: Melvin L. Marcus, Adv. Mgr.: B.J. Kankey

MICHIGAN

● **DETROIT METROPOLITAN AREA (Area Code 313)**

Leo Cheslak, 25315 Lyndon Ave., Redford Township 48239. Tel: 548-3171. Pres.: Leo Cheslak. Graphic Design Inc., 23800 Amber, Warren 48089. Tel: 758-0480.

Saul Star Promos. Unlimited, 6940 Carriage Hills Dr., Plymouth 48170. Tel: 525-7600. Pres.: Saul Star. Kelyvn Ventour Promos. Inc., 14234 Grandmont. Zip 48227. Tel: 493-0210. Pres.: Kelyvn Ventour.

MINNESOTA

● **MINNEAPOLIS (Area Code 612)**

A S I Recs., 711 W. Broadway, Zip 55411. Tel: 521-7631. Pres.: Dan R. Holmes; Sales Mgr.: Wes Hayne; Adv. Mgr.: Sandra Milani.

Doug Lee Midwest Promos., 4120 Excelsior Blvd. Zip 55416. Tel: 929-6727. Owner: Doug Lee. Edwin Neuger & Assocs., 800 Baker Bldg. Zip 55402. Tel: 335-6621.

MISSISSIPPI

● **COLUMBUS (Area Code 601)**

Startown Recs., Box 151-A, Rt. 3, Hwy. 82 W. Zip: 39701. Tel: 327-9977. Pres.: Allen White. Sales Mgr.: Annie Mae White; Adv. Mgr.: Bobby Little. Home office: Mable Recs., Gray Court, S.C.

MISSOURI

● **ST. LOUIS (Area Code 314)**

Grafic Traffic Inc., 9677 Page Ave., Zip: 63132. Tel: 427-4460. Pres.: William Moir; Sales Mgr.: Chris Pecsok (Customized tee-shirts only)

Ken Keene Int'l, PO Box 515, Zip: 63166. Tel: 776-2278, 464-1773. Pres. & Adv. Mgr.: Ken Keene; VP & Sales Mgr.: Gene Miller. Int'l branch: England, Seacruise.

NEVADA

● **CARSON CITY (Area Code 702)**

Gopher Prods Corp., PO Box 1812, 2201 Lockheed Way. Zip: 89701. Tel: 882-9333. Pres.: Warren Perkins. (SEE ADVERTISEMENT)

● **LAS VEGAS (Area Code 702)**

50 State Dist'g Co. Inc., 3044 S. Highland. Zip: 89109. Tel: 732-0333. Int'l branch: Canada, 7 Province Dist'g Branch: Dallas, Tex.

NEW JERSEY

● **CHERRY HILL (Area Code 609)**

Fred DiSipio Assocs., 999 W. Marlton Pike, Suite 201. Zip 08002. Tel: 795-6111.

● **FARMINGDALE (Area Code 201)**

Charlie Roberts Advertising & Promo Inc., 346 Belmar Blvd. Zip 07727. Tel: 938-4351. Pres.: Robert Schumann; Sales & Adv. Mgr.: Charlie Roberts.

● **GLENDORA (Area Code 609)**

Record Room, 308 E. Evesham Rd. Zip: 08029. Tel: 939-0034.

● **MONTCLAIR (Area Code 201)**

Linear Sound Rec'g, 211 Glenridge Ave. Zip: 07042. Tel: 744-0686. Pres.: M. Kroll; Sales Mgr.: Brad Clark; Adv. Mgr.: T. Steinmann.

● **MOUNT LAUREL (Area Code 609)**

Rand-El Advertising, 240 Burnam Wood Dr. Zip: 08054. Tel: 667-2738. Pres.: Eric Lipsman.

● **NEW MILFORD (Area Code 201)**

Sol Abrams Assocs. Inc., 331 Webster Dr. Zip: 07646. Tel: 262-4111. Pres.: Sol Abrams.

NEW MEXICO

● **BELEN (Area Code 505)**

Little Richie Johnson Agency, 610 Dalies Ave. Zip: 87002. Tel: 864-7441. Pres.: Little Richie Johnson.

NEW YORK

● **BINGHAMTON (Area Code 607)**

American Renaissance Music (ARM) Int'l Consultants, PO Box 1124. Zip: 13902. Tel: 754-5748. Pres.: A.R. Moss.

● **BUFFALO (Area Code 716)**

Marty Angelo's Disco Promos. Inc., 19 Slate Creek Dr., No. 5. Zip: 14227. Tel: 668-3161. Pres.: Marty Angelo; Sales Mgr.: Louis Mersola; Adv. Mgr.: Alpine Randusco.

● **EASTCHESTER (Area Code 914)**

Park Ave Prod'ns, 72 Tuckahoe Ave. Zip: 10707. Exec. Dir.: Richard Perez Jr.; Assoc. Dir.: David T. Weiss. Branch: Brockton, Mass.

● **LARCHMONT (Area Code 914)**

Tea Pot Prod'ns, 1416 Boston Post Rd. Zip: 10538. Tel: 834-2145. Pres.: Kal Fagan.

● **LE ROY (Area Code 716)**

Arlo Recs. Inc./BHR Recs. Inc., 7635 Telephone Rd. Zip: 14482. Tel: 442-9112. Pres.: Kenneth Bearce; Sales Mgr.: Jill Welzel; Adv. Mgr.: James L. Bearce.

● **NEW YORK METROPOLITAN AREA (Area Code 212)**

Sol Abrams Assoc. Inc., see listing under New Milford, N.J. A. D. Adams Advertising Inc., 145 E. 52 St. Zip: 10022. Tel: 755-0845. Pres.: A. D. Adams. Branch: Woodbury, N.Y.

Advanced Ventures Rec. Promo Agency, 200 W. 51 St., Suite 1114. Zip: 10019. Tel: 765-1864. Pres.: Patrick Jenkins. Sales Mgr.: Rich Aronstein; Adv. Mgr.: Jim Samora.

Atwater Press Litho Corp., 207 W. 25 St. Zip: 10001. Tel: 675-2710.

B B Publicity, 3025 Ocean Ave., Brooklyn 11235. Tel: 646-0352. Pres.: Bob Bank; Sales Mgr.: Sheryl Krackow.

James Bell Graphic Design Inc., 114 E. 28 St. Zip: 10016. Tel: 683-3280. Pres.: James Bell; VP: S. Campbell; Sales Mgr.: Jane Sapiro.

J. Bingo Prod'ns Inc., 1456 Ohm Ave., Bronx 10465. Tel: 829-9117. Pres.: Joe Bingo.

Paul Brown, 507 Fifth Ave., Suite 1008. Zip: 10017. Tel: 687-3072.

Budd Prod'ns, 157 W. 57 St. Zip: 10019. Tel: 247-4896. Pres.: Budd Hellawell.

Lee Canaan Assocs. Ltd., 205 E. 42 St., Penthouse. Zip: 10017. Tel: 682-4155. Pres.: Lee Canaan; Promo. Dir.: Ruth Schechter.

George Clark/USA, 127 E. 59 St. Zip: 10022. Tel: 421-1950. Pres.: George Clark.

Copy-Art Photographers (div. of James J. Kriegsmann Inc.), 165 W. 46 St. Zip: 10036. Tel: 757-0233. Pres. & Adv. Mgr.: James J. Kriegsmann.

Crystal Magic Promos Inc., 130 W. 57 St., Suite 5-D. Zip: 10019. Tel: 247-4390. Pres.: Curtis Gunn; VP, Sales & Adv. Mgr.: Lee Heiman.

Direct Rec'gs Inc., 18 E. 50 St. Zip: 10022. Tel: 759-7979. Pres. & Sales Mgr.: Norman Levin.

Disc Communications Ltd., 743 Fifth Ave. Zip: 10022. Tel: 371-0390. Pres.: Jerome Boxer; Art Dir.: Susan Murphy.

Juggy Gayles Inc., 67-45E 190 Ln., Fresh Meadows 11365. Tel: 454-6593. Pres.: Juggy Gayles.

Richard Gersh Assocs. Inc., 200 W. 57 St. Zip: 10019. Tel: 757-1101. (SEE ADVERTISEMENT)

Glenn Prod'ns & Promos., 157 W. 57 St. Zip: 10019. Tel: 265-6585. Pres.: Ben Arrigo.

Ren Grevatt Assocs. Ltd., 200 W. 57 St., Suite 907. Zip: 10019. Tel: 582-0252. Pres.: Ren Grevatt.

Berne Ilson Inc., 65 W. 55 St. Zip: 10019. Tel: 245-7950.

Image Creators Inc., 310 E. 65 St. Zip: 10021. Tel: 535-0257. Contact: Leonard Brauner.

Steven Leeds Promos., 130 W. 57 St., Suite 12B. Zip: 10019. Tel: 765-8553.

Since 1957 The Music Industry's Leading Promotion/Public Relations Organization

Promotion
Public Relations

Top 40 • Disco • Black • AOR • C&W • Classical • Jazz • MOR

MORTON DENNIS WAX
& ASSOCIATES

200 West 51st Street, New York, New York 10019 212/247-2159
Telex: ATT: MORTWAX 420001 (ETLX)

Partial Credit List:

Neil Diamond, RSO Records, SATURDAY NIGHT FEVER (Robert Stigwood), 7635 Gibb Tour (RSO), Paramount Pictures: HEAVEN CAN WAIT, GREASE, FOUL PLAY, DAYS OF HEAVEN, DEATH ON THE NILE, Paramount TV: HAPPY DAYS, BAD NEWS BEARS, Barbra Streisand, Marvin Hamlisch, A STAR IS BORN (soundtrack), THE SPY WHO LOVED ME (soundtrack), Carole Bayer Sager, Chick Corea, Millie Jackson, Joe Simon, Fatback Band, Famous Music Publishing, CBS International Music Group, Screen Gems-Colgems-EMI, RCA Records, Midsong International, Columbia Records, London Records, MCA Records, Chappell Music.

Levinson Assocs. Inc., 10 W. 66 St., Suite 126. Zip: 10023. Tel: 595-3336.
Home office: Los Angeles, Calif.
 Peter Levinson Communications, 505 Park Ave. Zip: 10022. Tel: 935-1036.
 M K Dance Promos., 1500 Broadway. Zip: 10036. Tel: 398-0511. Contacts: Tom Cossie, Cathy Jacobson.
Branch: Beverly Hills (Los Angeles Metropolitan Area), Calif.
 Mahoney/Wasserman & Assocs. Inc., 510 Madison Ave. Zip: 10022. Tel: 751-2060. Exec. VP: Larry Eisenberg.
Home office: Los Angeles, Calif.
 Morninglight Prod'ns, 145 E. 52 St., Rm. 403. Zip: 10022. Tel: 751-2031. 675-8800. Pres. & Art Dir.: Spencer Crane
Music Resources Int'l Corp., 161 W. 54 St., Suite 601. Zip: 10019. Tel: 265-6420. Pres.: Andy Hussakowsky; Exec. VP & Sales Mgr.: Steve Brodie.
 Nostalgia Lane Inc., 211 W. 56 St., Suite 33J. Zip: 10019. Tel: 583-5390. Owners: Lee Halperin, Nina Mattikow; Customer Relations Supervisor: Yvonne Simpkins; Sales Mgr.: Paul Kahan.
 Okun Sez; Promo. Consultants, 157 W. 47 St. Zip: 10036. Tel: 245-6090. Pres.: Henry Okun; Sales Mgr.: Cary Silkin; Adv. Mgr.: Phil Leon.
 Myrna Post Assocs., 9 E. 53 St. Zip: 10022. Tel: 935-7122.
Programming Aids For Progressive Radio, 80-24 257 St., Floral Park 11004. Tel: 347-1208. Pres.: Jay Rosen. Adv. Mgr.: Jim Cohn.
 Prometheus Arts Inc., 1776 Broadway. Zip: 10019. Tel: 586-3770. Pres.: Lew Morris; Sales Mgr.: Jerry Present; Adv. Mgr.: Ron Parisi.
 R S V P Advertising Inc., 969 Third Ave. Zip: 10021. Tel: 535-9020. Pres.: Leonard R. Brauner; Adv. Mgr.: Lisa Brauner.
 Rockbill Inc., 130 W. 57 St. Zip: 10019. Tel: 977-9680. Pres.: Jay I. Coleman; Mktg. Dir.: Lloyd Alan Silverman.
 Richard H. Roffman Assocs., 697 West End Ave. Zip: 10025. Tel: 749-3647. Bd. Chm.: Richard Roffman; Sales Mgr.: Malvina Cohn; Adv. Mgr.: John Bowman.
 Jasper Samuel Advertising & Recs., 97-28 57 Ave., Forest Hills 11368. Tel: 271-2418. Pres.: Jasper Samuel; Sales Mgr.: David Samuel; Adv. Mgr.: Joseph Samuel.
 Howard Sherman Public Relations, 682 Broadway. Zip: 10012. Tel: 777-4711. Pres.: Howard Sherman.
 Billy Smith Public Relations, PO Box 130. Zip: 10024. Tel: 787-8111. Pres.: Billy Smith.
 Solters & Roskin Inc., 62 W. 45 St. Zip: 10036. Tel: 840-3500.
Branch: Los Angeles, Calif.
 Fred Stuart Assocs., 45 E. 66 St. Zip: 10021. Tel: 988-4619. Pres.: Fredric R. Stuart; VP: Nancy Sanderson.
 Morton D. Wax & Assocs., 1650 Broadway. Zip: 10119. Tel: 247-2159. Pres.: Morton D. Wax. **Local branch:** 200 W. 51 St. Zip: 10019. (SEE ADVERTISEMENT)

● **RENSSELAER (Area Code 518)**
 Wildwood Entertainment, 223 Broadway. Zip: 12144. Tel: 434-2014. VP: Erich Borden.

● **SPRING VALLEY (Area Code 914)**
 Pro/Creatives Corp., 25 W. Burda Ln. Zip: 10977. Tel: 356-4623. Pres., Sales & Adv. Mgr.: David Rapp.

● **UTICA (Area Code 315)**
 Oneida Video-Audio Tape Cassette Corp., 760 Blandina St. Zip: 13501. Tel: 735-6187. Pres.: Stanley Markowski; Sales Mgr.: Joyce Markowski; Adv. Mgr.: Andrew Cittadino.

● **WOODBURY (Area Code 516)**
 A. D. Adams Advertising Inc., Chemical Bank Bldg., 8243 Jericho Tnkp. Zip: 11797. Tel: 692-5044. VP & Gen. Mgr.: George Kovacs.
Home office: New York, N.Y.

NORTH CAROLINA

● **THOMASVILLE (Area Code 919)**
 AdTees, PO Box 608, Stanley Ave., Zip: 27360. Tel: 475-0111. Pres.: Tim Batten; Sales Mgr.: Glenn Brown; Adv. Mgr.: Bob Livengood. (Customized tee-shirts only)

● **WILMINGTON (Area Code 919)**
 Elvitree Rec'g Music Publ'g Co. & Music Makers Network of America Prod'ns, PO Box 3022. Zip: 28401. Tel: 762-0474/4706/0539. Pres.: John Lewis Jones; VP: Betty F. Scavilla; Sales Mgr.: James L. Wheeler; Adv. Mgr.: J.D. Johnson.

OHIO

● **CINCINNATI (Area Code 513)**
 Counterpart Creative Studios Inc., 3744 Applegate Ave. Zip: 45211. Tel: 661-8810. Pres. Gen. & Sales Mgr.: Shad O'Shea; Adv. Mgr.: Marilyn Aker.
 Jewel Rec'g Co., 1594 Kinney Ave. Zip: 45231. Tel: 522-9336. Pres.: Charles York; Sales Mgr.: Linda York; Adv. Mgr.: Harry Urschel.
 Roosevelt Lee Int'l., 3966 Standish Ave. Zip: 45213. Tel: 793-8191. Pres.: Roosevelt Lee; Sales Mgr.: Robert Williams; Adv. Mgr.: Ronald Lee.
 Q C A Custom Pressing, 2832 Spring Grove Ave. Zip: 45225. Tel: 681-8400. Pres.: Edward R. Bosken; VP & Gen. Mgr.: Frank E. Ruhl; Sales Mgr.: Keith Myers; Adv. Mgr.: D. Kalmus.
 Record Promo. Serv., 1730 Lantaville Rd. Zip: 45237. Tel: 531-4317. Pres. & Sales Mgr.: Edward Saphier.
 Rite Rec. Prod'ns Inc., 9745 Lockland Rd. Zip: 45215. Tel: 733-5533. Pres.: Carl J. Burkhardt; VP: Philip M. Burkhardt; Sales Mgr.: Dan Burton.

● **CLEVELAND METROPOLITAN AREA (Area Code 216)**
 Alcon Rec'g Studios Inc., 35100 Euclid Ave., Suite 300, Willoughby 44094. Tel: 951-0910. Pres. Alan M. Peabody.
 Boddie Rec. Mfg. & Rec'g Inc., 12202 Union Ave. Zip: 44105. Tel: 752-3440. Pres. Thomas R. Boddie; Sales Mgr. Dennis R. Boddie.
 Bold Soul & GPI Jazz Prod'ns, 1605 Euclid Ave. Zip: 44115. Tel: 241-8288, 283-4582. Pres. Sam Baylor; Sales Mgr. William Merritt; Adv. Mgr.: Anthony Luke.
 Solid Soul Prod'ns & Promo. Consultants, 3282 E. 119 St. Zip: 44120. Pres. Fred Fluellen; Sales Mgr. William Merritt; Adv. Mgr. & Exec. VP: Tony Luke.
 Perry Stevens, 29839 Cedar Rd., Mayfield Heights 44124. Tel: 461-3845. Pres.: Perry Stevens

● **COLUMBUS (Area Code 614)**
 Hillside Recs., 948 Studer Ave. Zip 43206 Tel 252-7116 Owner & Pres.: Larry McKenzie.
 Kingsmill Rec'g Studio, 1033 Kingsmill Pkwy Zip 43229 Tel: 846-4494
 Roach Inc., PO Box 16548, 2255 Westbelt Dr. Zip 43216 Tel 876-9951. WATS (800) 848-7970 (except Ohio). Pres.: John Baird. (Customized tee-shirts only)
Branch: Sun Valley (Los Angeles Metropolitan Area), Calif.
 Dave Segel Promos of Ohio, 1304 Cranwood Square S. Zip 43229. Tel 885-2789. Owner Dave Segel.

OREGON

● **EUGENE (Area Code 503)**
 Ad Creations & Consultants Inc., 2100 W. Broadway Zip 97402. Tel 686-9669.

PENNSYLVANIA

● **PHILADELPHIA (Area Code 215)**
 Dick Colanzi, 1302 Sigel St. Zip 19148. Tel. 334-7133.
 Benjamin Johnson Jr. Ent's., 5025 Penridge St. Zip 19143. Tel 474-6613. Pres. Benjamin Johnson Jr., Sales Mgr.: Richard Simone.
 London Debut Ent's., 2201 Benjamin Franklin Pkwy. Suite 814. Zip 19130. Tel 567-0112.

● **PITTSBURGH (Area Code 412)**
 Star Title Strip Co. Inc., 842 Western Ave. Zip 15233 Tel 231-4314 Pres. & Adv. Mgr. Norman W. Morgan; Sales Mgr. William P. Miller. (SEE ADVERTISEMENT)

● **SCRANTON (Area Code 717)**
 White Rock Recs. Inc., 401 Wintermantle Ave. Zip 18505 Tel 343-6718. Pres. Phil Ladd

● **SHARON (Area Code 412)**
 Marjon Recs. Inc., 159 Easton Rd., Hermitage 16146 Tel: 17-4726 Pres. John T. Krizancic. Sales Mgr. Martha Krizancic; Adv. Mgr. Ruth Toth.

SOUTH CAROLINA

● **COLUMBIA (Area Code 803)**
 Chardell Ent. Prom. Mktg., PO Box 1523. Zip 29202 Tel 254-5488 Pres. Charles Adell, Sales Mgr. Wanza Adell; Adv. Mgr. Charles Adell Jr

● **GRAY COURT (Area Code 805)**
 Mable Recs. Rt. 1, Box 80-A-1 Zip 29645 Tel 575-2541 Pres. M.D. Ralph; Sales Mgr.: Allen White. Adv. Mgr. Annie Mae White.
Branch: Startown Recs., Columbus, Miss.

TENNESSEE

● **MEMPHIS (Area Code 901)**
 H-O-W-E Country Prod'ns Inc., PO Box 38852. Zip 38138. Pres. Bucky Wooten; Sales Mgr. Jason Wooten.
 Southern Rec. Promo., 3387 Poplar Ave., Suite 325. Zip: 38111. Tel 458-1421 Pres. Tim Riley; Mdsgr: Janet Brotherton, Album Oriented Rock. Lee McLemore; Top 40: Lyn Jackson.
 T-Shirts Int'l, 239 S. Cooper St. Zip. 38104. Tel: 522-8383. (Customized tee-shirts only)

● **NASHVILLE AREA (Area Code 615)**
 American Promos. & Cross Country Prod'ns, 3422 Hopkins St. Zip: 37215. Tel. 244-7827. Gen. & Sales Mgr.: Bobby Fischer; Adv. Mgr. L. Fischer.
 American Sound Recs., 62 Music Square W. Zip: 37203. Tel: 256-1693. Pres. Cliff Ayers Ostermeyer; Sales Mgr.: Chris Ostermeyer; Adv. Mgr.: Connie L. Wright.
 Chuck Chellman Co. Inc., 1201 16 Ave. S. Zip 37212. Tel: 320-7287.
 Creative Concepts (div. of Specialized Office Servs.), 1300 Division St., Suite 106 Zip 37203. Tel. 259-3790. Partners: Jim Kent, Vernell Hackett.
 Deltron Prod'n & Promo Co., United Artists Tower, Suite 309, 50 Music Square W. Zip: 37203. Tel: 327-3464. Pres.: Roger Ricker; Sales Mgr.: Dennis Kehoe; Adv. Mgr.: Bill Kehoe.
 Disc-Play Promos, PO Box 60443. Zip: 37206. Tel: 226-2991. Pres. Mike L. Hastings.

Bobby Fisher Ent's., PO Box 23333 Zip 37202. Tel: 244-7827. Pres.: Bobby Fisher.
 John Fisher Assocs. Inc., 1300 Division St. Zip 37203. Tel: 259-3692. Owner John Fisher; VP Hayseed Wingham.
 Horseshoe Dist's. & Promos, 420 Welshwood Dr., Suite 14. Zip: 37211. Tel: 331-1125. Pres.: R.L. Brown; Sales Mgr. Webb Foley.
 Don Houser, 907 Main. Zip: 37206. Tel. 226-0724.
 I R D A (Int'l Rec. Dist'g Assocs.), City Square, Suite 107, 260 W. Main St., Hendersonville 37075. Tel 824-9100. Pres.: Hank Levine; Exec. VP & Sales Mgr.: Mike Sheperd; Adv. Mgr. Susie Johnson; Promo Dir.: Keith Stewart.

Kathy's Country Promos., PO Box 24407 Zip 37202 Tel: 834-4789. Contact Kathy Lawson.
Branch: Slaton, Tex., Rt. 1, Box 123 Zip 79364. Tel: (806) 828-6676.
 Gene Kennedy Ent's., 2125 Eighth Ave. S. Zip: 37204. Tel: 383-6002
 Howard Knight Ent's. Inc./ Superior Rec. Dist'g Co., SESAC Bldg., 11 Music Circle S Zip 37203 Tel 244-0461. Pres. Howard A. Knight Jr
 Mull-Ti-Hit Promos., 50 Music Square W., Suite 604. Zip 37203. Tel: 329-4487. Pres. Frank Mull.
 Music City Mktg. Co., 1014 17 Ave. S Zip 37212. Tel: 327-4615. Owner W. Lee Trimble.
 Nashville Album Prod'ns Inc., 617 Seventh Ave. S. Zip: 37203. Tel: 256-0121. Pres. Steve Botts; Sec'y-Treas. Robbie McWay.
 Nashville Int'l Prod., 20 Music Square W. Zip: 37203. Tel: 256-2885

Nationwide Sound Dist's., PO Box 23262. Zip: 37202. Tel: 385-2704. Pres. Joe F. Gibson; Sales Mgr. & Nat'l Promo. Dir.: Betty Gibson.
 Pro Motions Plus Inc., PO Box 120691, 3106 Belmont Blvd. Zip: 37212. Tel: 385-1960. Pres. Jonathan E. Fricke.
 Special Delivery Promos., 210 25 Ave. N., The Sound Seventy Suite Zip 37203. Tel: 327-1711
 Harrison Tyner Int'l Inc., 38 Music Square E., Suite 115. Zip: 37203. Tel: 244-4224. Owner & Pres. Harrison Tyner. Sales Mgr. Dallas Laird; Adv. Mgr. Gene Levner.
 Curtis Wood Rec. Promo., 1010 17 Ave S Zip 37212; Tel: 255-8076. Owner & Pres. Curtis Wood
 World Int'l Group (WIG), 2125 Eighth Ave. S. Zip 37204 Tel: 383-6540
 World Wide Music Inc., 1300 Division St., Suite 201. Zip: 37203. Tel: 256-7543. Pres. Calvin H. Everhart; Sales Mgr. Debi Ward; Adv. Mgr. Shirley Sans

TEXAS

● **CLEBURNE AREA (Area Code 817)**
 P. Svendsen Promos., PO Box 297. Zip 76031. Tel: 641-7875. Owner Peter Svendsen.

● **DALLAS (Area Code 214)**
 Bollman Int'l Recs., PO Box 28553. Zip 75228. Tel: 328-7770. Owner: B. L. Bollman.
 50 State Dist'g Co. Inc., 8383 Stemmons Fwy. Zip: 75247. Tel: 263-0742
Home office: Las Vegas, Nev.
 Scotty McKay Promos, 3424 Winged Foot. Zip: 75229. Tel: 358-2318. Pres. Scotty McKay.

● **GAINESVILLE (Area Code 817)**
 TanDen Prod'ns, PO Box 382. Zip 76240. Tel: 665-6759. Pres. Bobby Dennis; Sales Mgr.: Gregg Ballew; Adv. Mgr. Roger Christian.

● **HOUSTON (Area Code 713)**
 Slick Norris Artists & Promos, PO Box 653, Highlands 77562. Tel: 424-4235. Pres.: Slick Norris

● **SAN BENITO (Area Code 512)**
 Rio Grande Music Co., 119 S. Sam Houston Blvd. Zip: 78586. Tel: 399-5377. Pres. & Adv. Mgr. Lionel C. Betancourt; Sales Mgr. John F. Phillips.

● **WACO (Area Code 817)**
 Charles Wallis Inc., 4708 W. Waco Dr. Zip: 76710. Tel: 776-5113

UTAH

● **SALT LAKE CITY (Area Code 801)**
 Covenant Rec'gs Inc., 1345 Major St. Zip: 84115. Tel: 487-1096. Pres. & Sales Mgr.: V. Lewis Kofford; Adv. Mgr. Jeff Lund.

VERMONT

● **SPRINGFIELD (Area Code 802)**
 Gregorie Nelson Ficara Ent's., 40 Clinton St. Zip: 05156. Tel: 885-3820. Pres. & Gen. Mgr.: G.N. Ficara; Sales Mgr.: Patty de Greenia; Adv. Mgr.: Greg Ficara.

WEST VIRGINIA

● **BERKELEY SPRINGS (Area Code 304)**
 Ruppenthal Ent's., PO Box 235. Zip: 25411. Tel: 258-2627. Pres. & Music Dir.: Virgil H. Ruppenthal.

WISCONSIN

• **MILWAUKEE (Area Code 414)**

Holoubek Studios Inc., 4712 N. 125 St., Butler 53007 Tel 781-4800; WATS (800) 558-0566 Pres. Verne Holoubek; Sales Mgr. R.C. Presendorfer, Adv. Mgr. Michael Dillon. (Iron-on heat transfers & customized tee-shirts only)

**TAPE CUSTOM DUPLICATORS
TAPE PACKAGING & LABELING**

The Audio and Video lines indicate the configurations which the firms duplicate. Companies which offer packaging and labeling of tape product are indicated by: (PKG) which appears after the main body of their respective listings.

ALABAMA

• **MUSCLE SHOALS (Area Code 205)**

Fame Rec'g Studios Inc., 603 E. Avalon Ave. Zip 35660. Tel 381-0801
Audio: Cassette, open reel.

• **OPELIKA (Area Code 205)**

Ampex Corp., Magnetic Tape Div., PO Box 190. Zip: 36801. Tel 745-7643 (Plant only) (PKG)
Home office: Redwood City (San Francisco & Bay Area), Calif.
Audio: 8-tr., 8-tr. quadrasonic, cassette, open reel, open reel quadrasonic.

ARIZONA

• **PHOENIX (Area Code 602)**

Audio-Video Rec'rs of Arizona Inc., 3830 N. Seventh St. Zip 85014. Tel 277-4723
Audio: Cassette, open reel.
Video: 3/4" cassette.
Cre'8 Video Servs. Ltd., PO Box 5136, Zip: 85010; Embassy Square, 805 N. Fourth Ave. Zip 85003. Tel 257-1978. (PKG)
Video: 1" open reel, 3/4" cassette, 1/2" EIAJ open reel, 1/2" EIAJ cartridge.
General Cassette Corp., 1324 N. 22 Ave. Zip: 85009. Tel: 257-1880. Pres. Bill Johnson; Sales Mgr. William Wallace. (PKG)
Audio: 8-tr., cassette, open reel.
Universal Audio Corp., 6540 E. Lafayette Blvd., Scottsdale 85217. Tel 949-7577. Pres.: John A. Michaelson; Sales Mgr. James Noonan; Adv. Mgr. A.K. Gardner.
Audio: 8-tr., cassette, open reel.

• **TUCSON (Area Code 602)**

Kyric Corp., 2111 E. 20 St. Zip: 85719. Tel: 624-2408. Pres. & Sales Mgr. Keyvan Mokhtarian. (PKG)
Audio: 8-tr., cassette, open reel.

ARKANSAS

• **LITTLE ROCK (Area Code 501)**

Pinnacle Sound Prod'ns Inc., 1 Warren Dr. Zip: 72209 Tel 565-2800.
Audio: Cassette, open reel.

CALIFORNIA

• **ANAHEIM (Area Code 714)**

Harry McCune Sound Serv. Inc., 1773 W. Lincoln Ave. Zip 92801. Tel 533-7650; LA (213) 656-0112. Pres.: Harry McCune Jr., Mgr.: Herbert Shor. (Sales office only) (PKG)
Home office: San Francisco, Calif.
Audio: Cassette, open reel
Video: 1" open reel, 3/4" cassette, 1/2" EIAJ open reel.

• **CAMPBELL (Area Code 408)**

Nestape, 503-C Vandell Way. Zip: 95008. Tel 379-0871. Sales Mgr. Mike Papp
Audio: Cassette, open reel.

• **CUCAMONGA (Area Code 714)**

Phylco Audio, 8111D Foothill Blvd. Zip: 91730 Tel 982-5996. Owner: Robert Deates.
Audio: Cassette, open reel.

• **GARDEN GROVE (Area Code 714)**

Tapette Corp., 7221 Garden Grove Blvd., Suite C. Zip 92641. Tel 638-7960. Pres. Jim Neiger II; Sales Mgr. Patrick Kenny; Customer Servs. Mgr. Mary Deery
Audio: Cassette
Video: 3/4" cassette, 1/2" Beta & VHS cassette.

• **LOS ANGELES METROPOLITAN AREA (Area Code 213)**

A G I (Album Graphics Inc.), 424 N. Larchmont Blvd. Zip: 90004. Tel 462-0821. VP. Ed Dwyer. Sales Mgr. Jim Palmer. (Sales office only) (PKG)
A S R Rec'g Servs. Inc., 8960 Eton Ave., Canoga Park 91304. Tel 341-1124. VP. Sales Howard Shapiro. Gen. Mgr.: Robert Goldman. (PKG)
Home office: Fairfield, N.J.
Audio: 8-tr., 8-tr. quadrasonic, cassette, open reel, open reel quadrasonic. (SEE ADVERTISEMENT)
A T & T (Able Turntable & Tape) Rec'g Inc., 725 N. Highland Ave., Hollywood 90038. Tel 933-5701. (PKG)
Audio: 8-tr., 8-tr. quadrasonic, cassette, open reel, open reel quadrasonic.
Video: 3/4" cassette
Abbey Tape Dupl'rs, 5358 Cartwright Ave., North Hollywood 91601. Tel 985-3136. Gen. Mgr.: Norman C. Cooke. (PKG)
Audio: Cassette, open reel
Able Turntable & Tape, see AT&T
Album Graphics Inc., see AGI
American Sound Corp., 8120 Webb Ave., North Hollywood 91605. Tel 768-6100. Gen. Mgr.: Michael S. Emerson; Reg'l Sales Mgr.: Richard Hutchinson. (PKG)
Home office: Warren (Detroit Metropolitan Area), Mich.
Audio: 8-tr., 8-tr. quadrasonic, cassette, open reel, open reel quadrasonic.
American Video Prod'ns, 4265 Marina City Dr., Marina del Rey 90291. Tel 823-1228. Pres. Michael Huemmer, Sales Mgr. Joseph Camacho; Adv. Mgr. Joseph Gerbino.
Video: 3/4" cassette.
Ampex Corp., Magnetic Tape Div., 500 Rodier Dr., Glendale 91201. Tel 240-5000. (Sales office only) (PKG)
Home office: Redwood City (San Francisco & Bay Area), Calif.
Audio: 8-tr., 8-tr. quadrasonic, cassette, open reel, open reel quadrasonic.
Audio Encounter, 9614 Cozycroft Ave., Unit H, Chatsworth 91311. Tel 998-7455. Pres.: Elinore Freeland.
Audio: Open reel
Cadet Recs. Inc., 5810 S. Normandie Ave. Zip 90044. Tel 753-5121. Pres.: Jules Bihari; Mgr.: Don Macmillan. (PKG)
Branch: Park Ridge, N.J.
Audio: 8-tr., cassette.
Capitol Recs. Inc., 6920 Sunset Blvd., Hollywood 90028. Tel 461-9141. Nat'l Plant Mgr.: Curt Kendall.
Branch: Council Bluffs, Iowa, Liberty/UA Tape Dupl'g. (SEE ADVERTISEMENT)
Certron Corp., 8920 Wilshire Blvd., Beverly Hills 90211. Tel 659-5950. Dupl'g Div. Sales Mgr. Lester P. Edwards.
Columbia Rec. Prod'ns, 1801 Century Park West, Century City 90067. Tel 556-4820. West Coast Reg'l Sales Mgr.: Mike Coolidge. (Sales office only)

Plants: Santa Maria, Calif.; Terre Haute, Ind.; Pitman, N.J.
Audio: 8-tr., 8-tr. quadrasonic, cassette, open reel.
Custom Dupl'n Inc., 6330-36 Arizona Circle. Zip: 90045. Tel 670-5575; 776-4810. Pres. Leonard Gross; Sales Mgr.: Frank Rohloff; Prod'n Jeri Gonzales. (PKG)
Audio: 8-tr. cassette
Custom Rec. Mfg. Co., 5810 S. Normandie Ave. Zip 90044. Tel 753-5121. Pres.: Jules Bihari. VP James Takeda. (PKG)
Audio: 8-tr.
D A K Inds Inc., 10845 Vanowen St., North Hollywood 91605. Tel 984-1559; WATS (800) 423-2636. Pres.: Drew Alan Kaplan. (PKG)
Audio: Cassette
E M C Corp., 6855 Santa Monica Blvd., Hollywood 90038. Tel 463-3282. (Sales office only) (PKG)
Home office: St. Paul (Minneapolis-St. Paul Area), Minn.
Audio: Cassette, open reel.
H I Ents. Inc., 9537 Telstar Ave., Suite 121, El Monte 91731. Tel 444-9224. (PKG)
Audio: Cassette, open reel.
J & I Cassette, 23947 Ventura Blvd., Calabasas 91302. Tel 992-6200. Pres. John F. Brennan, Sales & Adv. Mgr.: Ivy Brennan. (PKG)
Audio: 8-tr., cassette
Ray Jacobs Audio Inc., 2739 Signal Pkwy., Long Beach 90806. Tel 595-6811. Pres. Ray Jacobs; Sales Mgr.: Larry Stagnaro; Adv. Mgr.: Robert Ellsworth. (PKG)
Audio: Cassette
M L Tape Dupl'g, 16834 Superior St., Sepulveda 91343. Tel 988-2737. Owner & Pres.: Bill Ball. (PKG)
Audio: 8-tr., cassette
Magtec Corp., 8125 Lankershim Blvd., North Hollywood 91605. Tel 768-6200.
Audio: Open reel
Mustron Inc., 2534 1/2 W. Pico Blvd. Zip: 90006. Tel 380-6840.
R C A Recs., 6363 Sunset Blvd., Hollywood 90028. Tel: 468-4000. (Sales office only)
Home office: New York, N.Y.
Plant: Indianapolis, Ind.
Audio: 8-tr., 8-tr. quadrasonic, cassette
Radio Central, 427 W. Fifth St., Suite 611. Zip: 90013. Tel: 626-9891. Owner: David B. Sigler; Gen. & Sales Mgr.: Carl Hampson. (PKG)
Audio: Cassette, open reel
Martin Roberts & Assocs. Inc., 9171 Wilshire Blvd., Beverly Hills 90210. Tel: 273-0381. (PKG—audio only)
Shorewood Packaging Corp., 1830 Glendale Blvd. Zip 90026. Tel 660-3043. Sales Mgr.: Marc Shore. (PKG only—audio)
Home office: New York, N.Y.
Springboard Intl., 8295 Sunset Blvd. Zip 90046. Tel 654-6240. (PKG)
Home office: Rahway, N.J.
Audio: 8-tr.
Superscope Tape Dupl'g Prods. Inc. (sub. of Superscope

When you need

CASSETTE DUPLICATION



Benefit from the Quarter-Century of Experience & Expertise of

JULIUS A. KONINS

President of Cassette Productions, Inc. Creator and inventor of, and holder of patents on, the most advanced cassette duplicating equipment in the world.

STATE OF THE ART duplicating standard and esoteric premium tapes.

Request FREE demo tape on your business letterhead.

Call JULIE KONINS at 201-327-1707 or address him personally at:

CASSETTE PRODUCTIONS, INC.

118 State Highway No. 17, Upper Saddle River, N.J. 07458

Inc.), 20525 Nordhoff St., Chatsworth 91311. Tel: 998-9333 x. 2294. Contact: G.T. Thalberg. (PKG)
 Audio: 8-tr., 8-tr. quadrasonic, cassette, open reel, open reel quadrasonic.
 Tape-A-Thon Corp., 502 S. Isis, Inglewood 90301. Tel: 776-7933. Pres.: Lee Tate; Exec. VP & Sales & Mktg. Dir.: Wally Rubin (PKG)
 Audio: Open reel, NAB cartridge.
 Tape Specialty Inc., 13411 Saticoy St., North Hollywood 91605. Tel: 873-5400, 786-6111. Contact: Len Feldman.
 Trans-American Video Inc., 1541 N. Vine St., Hollywood 90028. Tel: 466-2141. Pres.: Murray Schwartz; VP Sales: Harvey Plotnick, Lou Selener; VP Comm'l Sales: Jeff Ross. (PKG—video only)
 Video: ½" quad.
 Video Dup'n Inc., 1136 N. Highland Ave., Hollywood 90038. Tel: 464-7579. Pres.: Andy McIntyre; VP & Sales Dir.: Robert Creamer. (PKG—video only)
 Video: 2" quad & helical scan, ¾" cassette, ½" Beta & VHS cassette.
 Vine Street Video Centre, 1224 N. Vine St., Hollywood 90038. Tel: 462-5860.
 Mgr.: John Alden.
 Video: 1" open reel, ¾" cassette, ½" EIAJ cartridge.
 Whitney Studios, 1516 W. Glenoaks Blvd., Glendale 91201. Tel: 245-6801. (PKG)
 Audio: Cassette, open reel, open reel quadrasonic.

STUDIO SESSIONS • TYPOGRAPHY
 GRAPHIC DESIGN • COLOR SEPAR
 PRINTING • FABRICATION • PRESSI
 LABELS • MATRIX • MASTERING • T
 TAPE DUPLICATION • STUDIO SESS
 TYPOGRAPHY • DESIGN
 COLLECTING
 FABRICATING LABEL
 MATRIX • TAPE DUPL
 COLOR • PRINTING
 PRESSING • MASTERING
 TAPE DUPL • STUDIO SESS
 LABELS • MA • MASTERING • S
 TAPE DUPLICATION • MASTERING
 MATRIX • LABELS • PRESSING • TYP
 FABRICATION • PRINTING • COLOR
 GRAPHIC DESIGN • TYPOGRAPHY
 STUDIO SESSIONS • TAPE DUPLICA
 MASTERING • MATRIX • LABELS • P
 PRESSING • FABRICATION • LABEL

COMPLETE PRODUCTION COORDINATION FOR THE MUSIC INDUSTRY

ERH PRODUCTIONS
 221 West 57th Street
 New York, New York 10019
 TWX 710-581-5446
 Telephone 212-582-4200

• SACRAMENTO (Area Code 916)

Alpha Media Inc., PO Box 254452, Zip: 95825. Tel: 383-4385. Owner: Vladimir Sirota. (PKG)
 Audio: Cassette, open reel.
 Bill Rase Prod'n Inc., 955 Venture Court. Zip: 95825. Tel: 929-9181. Owner & Pres.: Bill Rase. (PKG—audio only)
 Audio: Cassette, open reel.
 Video: ¾" cassette, ½" EIAJ open reel, ½" EIAJ cartridge, ½" Beta & VHS cassette.

• SAN DIEGO (Area Code 714)

Studio West, 5042 Ruffner St. Zip: 92111. Tel: 277-4714.
 Owner: LeRoy H. Carrou.
 Audio: Cassette.

• SAN FRANCISCO & BAY AREA (Area Code 415)

Ampeg Corp., Magnetic Tape Div., 401 Broadway, Redwood City 94063. Tel: 367-2011. Pres.: A.H. Hausman; Sales Mgr.: R.A. Antonio; Adv. Mgr.: A. Fisher. (PKG)
 Sales offices: Glendale (Los Angeles Metropolitan Area), Calif.; Denver, Colo.; Orlando, Fla.; Atlanta, Ga.; Overland Park, Kan.; Baton Rouge, La.; Bethesda, Md.; Framingham (Boston Metropolitan Area), Mass.; Hackensack, N.J.; Pittsford, N.Y.; Dallas, Tex.; Salt Lake City, Utah.
 Plants: Opelika, Ala.; Elk Grove Village (Chicago Metropolitan Area), Ill.
 Audio: 8-tr., 8-tr. quadrasonic, cassette, open reel, open reel quadrasonic.

Coast Rec'rs, 1340 Mission St. Zip: 94103. Tel: 864-5200.
 Pres.: M.T. Putnam; Gen. Mgr.: Steve Atkin. (PKG)
 Audio: Cassette, open reel.

Cory Sound Co., 440 Brannan St. Zip: 94107. Tel: 543-0440. Pres.: George Cory; VP & Prod'n Mgr.: Phillip C. Markinson; VP Sales: Lou Sinclair. (PKG)
 Audio: Cassette, open reel, open reel quadrasonic.

Fred Fox Music Co., 406 Kehoe Ave., Half Moon Bay 94019. Tel: 726-3725. Pres.: F.H. Nesbitt; Sales Mgr.: V.A. Nesbitt.
 Audio: 8-tr., cassette, open reel.

Cathy Furniss & Assocs., 680 Beach St., Suite 445. Zip: 94109. Tel: 885-2807. Pres.: Cathy Furniss; Sales Mgr.: Ruth Maas; Adv. Mgr.: Michel Lipman.
 Audio: Cassette.

Geis Audio Tape Ent's., 351 G St., San Rafael 94901. Tel: 456-8035. Pres.: Don Geis; Sales Mgr.: Mary Geis; Adv. Mgr.: John Geis.
 Audio: Open reel.

Highland Labs., 90 Tehama St. Zip: 94105. Tel: 986-5480. (PKG—video only)
 Video: ¾" cassette, ½" Beta & VHS cassette.

Harry McCune Sound Serv. Inc., 951 Howard St. Zip: 94103. Tel: 777-2700. Pres.: Harry McCune Jr. (PKG)
 Branch: Anaheim, Calif.
 Audio: Cassette, open reel.

Sonic Arts Corp., 665 Harrison St. Zip: 94107. Tel: 781-6307. Pres.: Leo de Gar Kulka; Gen. Mgr.: Herbert P. Haas; Sales Mgr.: Joseph Speck. (PKG)
 Audio: PCM-Digital Dupl'n.

Television Assocs. Inc., 2410 Charleston Rd., Mountain View 94043. Tel: 967-6040. Pres.: Ed Carlstone. (PKG)
 Video: 2" quad, ¾" cassette, ½" EIAJ open reel, ½" EIAJ cartridge, ½" Beta cassette.

• SAN JOSE (Area Code 408)
 Audiodyne Co., PO Box 825. Zip: 95106. Tel: 287-3520.
 Pres.: Louis R. Chiaramonte.
 Audio: 8-tr., cassette, open reel, open reel quadrasonic.

• SUNNYVALE (Area Code 408)
 GRT Corp., 1286 N. Lawrence Station Rd. Zip: 94086. Tel: 734-2910. Pres.: Robert Jacobs; Opls. Mgr.: Fred Muhl.
 Branch: Nashville, Tenn.
 Audio: 8-tr., cassette.

Recortec Inc., 777 Palomar Ave., Zip: 94086. Tel: 735-8821. Pres.: Dr. Lester H. Lee; Sales Mgr.: Ron R. Troxell.
 Audio: Cassette.

COLORADO

• DENVER AREA (Area Code 303)

Ampeg Corp., Magnetic Tape Div., 2121 S. Birch. Zip: 80222. Tel: 757-6491. (Sales office only) (PKG)
 Home office: Redwood City (San Francisco & Bay Area), Calif.

Audio: 8-tr., 8-tr. quadrasonic, cassette, open reel, open reel quadrasonic.
 Aspen Ltd., PO Box 92, 77 E. Floyd Ave., Englewood 80110. Tel: 789-2239. Pres.: Sid Laks; Sales Mgr.: Bill Bystrom; Adv. Mgr.: K. Davis.
 Audio: 8-tr.

Audicom Corp., 4950 Nome St., Unit C. Zip: 80239. Tel: 371-3076. Pres.: Jack H. Dunham. (PKG)
 Audio: Cassette, open reel.

CONNECTICUT

• ANSONIA (Area Code 203)

Reel to Reel Custom Servs., 98 Benz St. Zip: 06401. Tel: 735-5883. Bd. Chm.: Martin G. Kugell.
 Audio: 8-tr., cassette, open reel, open reel quadrasonic.

• DARIEN (Area Code 203)
 George Alexander Group Inc., 1063 Post Rd. Zip: 06820. Tel: 655-7791; NYC (212) 886-5600. Pres.: Kev Devajan. (PKG—audio only)

• NORWALK AREA (Area Code 203)
 Cook Labs Inc., 375 Ely Ave., South Norwalk 06854. Tel: 853-3641. Pres.: Emory Cook; Adv. Mgr.: Frank Stall. (PKG)
 Audio: Cassette.

• STAMFORD (Area Code 203)
 P & P Studios Inc., 17 Viaduct Rd. Zip: 06907. Tel: 327-9204. Bd. Chm.: Terry L. Puffer; Pres.: John R. Fishback. (PKG)
 Audio: Cassette, open reel.

Tapecom Inc., 45 Jefferson St. Zip: 06902. Tel: 325-1541; NYC (212) 581-9855. Pres.: Gene Tornatore; Sales Mgr.: Carm Tornatore; Adv. Mgr.: Fred Luminoso. (PKG)
 Audio: 8-tr., cassette, open reel. (SEE ADVERTISEMENT)

• UNION CITY (Area Code 203)
 A.C. Hampson Printing Co. Inc., PO Box 97. Zip: 06770. Tel: 729-2294. (PKG—audio only)

DELAWARE

• WILMINGTON (Area Code 302)

E. I. du Pont de Nemours & Co. Inc., Magnetic Prods. Div., Photo Prods. Dept., Old du Pont Airport, Bldg. 1. Zip: 19898. Tel: 999-4251. Pres.: Edward R. Kane; Mktg. Mgr.: E. Richard Buckley; Adv. Mgr.: Grif Harrison. (PKG)

Ken-Del Prod'n Inc., 111 Valley Rd., Richardson Park. Zip: 19804. Tel: 655-7488. Pres. & Gen. Mgr.: H. Edwin Kennedy; Sales Mgr.: Shirley Kay. (PKG)
 Audio: 8-tr., cassette, open reel, open reel quadrasonic.
 Video: ¾" cassette.

National Tape Dupl'rs, see Ken-Del.

DISTRICT OF COLUMBIA

• WASHINGTON (Area Code 202)

Lion Rec'g Servs. Inc., 1905 Fairview Ave. NE. Zip: 20002. Tel: 832-7883. Pres.: Harold H. Lion; Sales & Adv. Mgr.: Jim Fox. (PKG)
 Audio: Cassette, open reel.

FLORIDA

• FORT LAUDERDALE AREA (Area Code 305)

Cassettes Inc., Cook Consultants Inc., PO Box 22857, 2510 SW Third Ave. Zip: 33315. Tel: 522-0222. (PKG)
 Audio: Cassette, open reel.

Cook Consultants Inc., see Cassettes Inc.
 Trackmaster Inc., 1310 S. Dixie Hwy., West Pompano Beach 33060. Tel: 943-2334. Pres.: Roy Parsons; Sec'y-Treas.: Lupe Parsons.
 Audio: 8-tr., 8-tr. quadrasonic, cassette, open reel. (SEE ADVERTISEMENT)

• MIAMI METROPOLITAN AREA (Area Code 305)
 Miami Tape Inc., 8180 NW 103 St., Hialeah Gardens 33015. Tel: 558-9211. Pres.: Carlos Garcia; Sales Mgr.: Mirella Tunon. (PKG)
 Audio: 8-tr., 8-tr. quadrasonic, cassette.

Tape Dupl'rs of Florida Inc., 785 W. 83 St., Hialeah 33014. Tel: 822-7585. Pres.: John R. Urgell; Sales Mgr.: Alberto Mestre. (PKG)
 Audio: 8-tr., 8-tr. quadrasonic, cassette.

Video City (div. of Record Dists. of America), 12100 NE 16 Ave., North Miami 33161. Tel: 895-6400.
 Video: 1" open reel, ¾" cassette, ½" EIAJ open reel.

45 JEFFERSON ST., STAMFORD, CT 06902

Tapecom

INC.

New England's LARGEST Duplicator!

(203) 325-1541
 (212) 581-9855

Video Music Corp., 770 W. 27 St., Hialeah 33010. Tel: 885-9156. Gen. Mgr.: Angel Tamargo. Audio: 8-tr., 8-tr. quadrasonic, cassette.

• ORLANDO AREA (Area Code 305)

Amplex Corp., Magnetic Tape Div., PO Box 15008-B. Zip: 32808. Tel: 423-2962. (Sales office only) (PKG)
Home office: Redwood City (San Francisco & Bay Area), Calif.
 Audio: 8-tr., 8-tr. quadrasonic, cassette, open reel, open reel quadrasonic.
 Christian Dupl'ns Inc., 1710 Lee Rd. Zip: 32810. Tel: 299-7363 (PKG)
Audio: Cassette.
 Magnetix Corp., 770 W. Bay St., Winter Garden 32787. Tel: 656-4494. Pres.: John Lory. (PKG)
Audio: 8-tr., cassette, open reel.

GEORGIA

• ATLANTA (Area Code 404)

Amplex Corp., Magnetic Tape Div., 3135 Chestnut Dr., Suite 101. Zip: 30340. Tel: 451-7112. Southeast Reg'l Sales Mgr.: R.E. Douglass Jr. (Sales office only) (PKG)
Home office: Redwood City (San Francisco & Bay Area), Calif.
Audio: 8-tr., 8-tr. quadrasonic, cassette, open reel, open reel quadrasonic.
 Cartridge Control Corp., 2091 Faulkner Rd. NE. Zip: 30324. Tel: 633-4577. Pres.: R. Don Comstock. Gen. Mgr.: Matt Polakoff.
Audio: 8-tr., cassette.
 Doppler Studios Inc., 1922 Piedmont Circle NE. Zip: 30324. Tel: 873-6941. Pres.: Pete Caldwell.
Audio: Open reel.
 Project 70 Audio Servs. Inc., 1127 Spring St. NW. Zip: 30309. Tel: 875-7008. Pres.: Jerry L. Connell. (PKG)
Audio: Cassette, open reel.
 Video Dupl'ns Inc., 5891 New Peachtree Rd. NE. Zip: 30340. Tel: 458-6111. Contact: Carl Marxer.
Video: All formats

ILLINOIS

• CHICAGO METROPOLITAN AREA (Area Code 312)

A G I (Album Graphics Inc.), 1950 N. Ruby St., Melrose Park 60160. Tel: 344-9100. Pres.: Donald W. Kosterka. Sales Mgr.: Charles Eaton. (PKG only)
Sales offices: Los Angeles, Calif.; New York, N.Y.
 Album Graphics Inc., see AGI.
 Amplex Corp., Magnetic Tape Div., 2201 Lunt Ave., Elk Grove Village 60007. Tel: 593-6000. (PKG)
Home office: Redwood City (San Francisco & Bay Area), Calif.
Audio: 8-tr., 8-tr. quadrasonic, cassette, open reel, open reel quadrasonic.
 Audio Accessories Co., 38 W 515 Deerpath Rd., Batavia 60510. Tel: 879-5998. Sales Mgr.: John S. Maloney. (PKG)
Audio: 8-tr., cassette, open reel.
 Audio Artists Ltd., PO Box 7, Wheaton 60187; 429 St. Charles Rd., Carol Stream 60187. Tel: 668-6682. Gen. Mgr.: Doug Lazzara. (PKG)
Audio: Cassette, open reel.
 Bell & Howell Video Div., 720 Landwehr Rd., Northbrook 60062. Tel: 291-1150. Pres.: T.J. Wheeler; Nat'l Sales Mgr.: John Borger. (PKG)
Video: 2" quad, 1" open reel, 1/4" cassette, 1/2" Beta & VHS cassette.
 Boulevard Rec'g Studios Inc., 609 N. La Salle St. Zip: 60610. Tel: 944-2752. Pres.: Hal Kaitchuck.
Audio: Cassette, open reel.
 Century Audio & Development Inc., 1018 Busse Hwy., Park Ridge, Ill. 60068. Tel: (312) 696-0675. Pres. & Sales Mgr.: Carol Anspaugh; Adv. Mgr.: Roberta Genovese. (PKG)
Audio: Cassette.
 Chicago Stereo Mastering, 626 W. 26 St. Zip: 60616. Tel: 326-3400. (Mastering only)
Audio: 8-tr.
 Columbia Rec. Prod'ns, 630 N. McClurg Court. Zip: 60611. Tel: 944-6000. Reg'l Sales Mgr. (Central States) Dick Hutter. (Sales office only)
Plants: Santa Maria, Calif.; Terre Haute, Ind.; Pitman, N.J.
Audio: 8-tr., 8-tr. quadrasonic, cassette, open reel.
 International Audio Inc., 2934 Malmo Dr., Arlington Heights 60005. Tel: 956-6030. (PKG)
Audio: 8-tr., 8-tr. quadrasonic, cassette, open reel.
 International Rec'g Co., 1649 W. Evergreen Ave. Zip: 60622. Tel: 227-2000. Pres.: Leonard March.
Audio: Cassette, open reel.
 M B S Rec'g Studio, 228 S. Wabash. Zip: 60604. Tel: 939-0866. Dir. & Pres.: Fred Robbins.
Audio: 8-tr., cassette, open reel.
 Media Int'l Inc., 425 N. Michigan. Zip: 60611. Tel: 467-5430. Pres. & Sales Mgr.: Duane Lundeen; Adv. Mgr.: Margaret Lundeen. (PKG)
Audio: 8-tr., cassette, open reel, open reel quadrasonic.
 Musical Prods. Inc., 521 W. 26 St. Zip: 60616. Tel: 225-9117. (PKG)
Audio: 8-tr., cassette, open reel.
 Poly Com Group, 4 E. Huron St. Zip: 60611. Tel: 337-2040. Pres.: Richard Jablonski; Sales Mgr.: Joseph Hassen; Adv. Mgr.: Carmen Trombetta.
Video: 2" quad, 1" open reel, 1" cartridge, 3/4" cassette, 1/2" EIAJ open reel, 1/2" EIAJ cartridge.
 Pro I Prods., PO Box 33, Highland Park 60035. Tel: 432-5536. Pres.: Roy Pink. Sales Mgr.: Martin Pink; Adv. Mgr.: Deena Pink. (PKG only—audio)

Sound Studios, 230 N. Michigan Ave. Zip: 60601. Tel: 236-4814. Pres.: Jerry Markham; VP & Gen. Mgr.: Dan Tynus. (PKG)
Audio: Cassette.
 T D K Electronics Corp., 2906 W. Peterson Ave. Zip: 60645. Tel: 274-6661. (PKG)
Home office: Garden City, N.Y.
Audio: 8-tr., 8-tr. quadrasonic, cassette, open reel, open reel quadrasonic.
Video: 1/4" cassette, 1/2" VHS cassette.
 Tono-Tapes Inc., 5932 N. Northwest Hwy. Zip: 60631. Tel: 763-0980. (PKG)
Audio: 8-tr., cassette, open reel, open reel quadrasonic.
 Vinyl-Weld Inc., 1900 S. Western Ave. Zip: 60608. Tel: 243-0606. (PKG)

• JACKSONVILLE (Area Code 217)

Capitol Inds., 104 Bypass. Zip: 62650. Tel: 245-9631.
Audio: 8-tr., 8-tr. quadrasonic.

• KANKAKEE (Area Code 815)

Imperial Int'l Learning Corp., PO Box 548. Zip: 60901. Tel: 933-7735.
 Mgr.: David Anderson.
Audio: Cassette, open reel.

• SPRINGFIELD (Area Code 217)

TeleVisual Prod'ns, 1414 S. Fifth. Zip: 62703. Tel: 525-1238. Pres.: Dave Beatty; Sales Mgr.: Bill Beatty, Adv. Mgr.: Kevin Beatty.
Audio: 8-tr., cassette, open reel.
Video: 1" open reel, 3/4" cassette, 1/2" EIAJ open reel, 1/2" EIAJ cartridge, 1/2" Beta & VHS cassette.

INDIANA

• GOSHEN (Area Code 219)

Precision Audio Inc., 16722 County Rd. 40. Zip: 46526. Tel: 642-3852. Pres.: Sanford Swartzendruber. (PKG)
Audio: 8-tr., cassette, open reel.

• INDIANAPOLIS (Area Code 317)

Commercial Features Inc., 3650 N. Washington Blvd. Zip: 46205. Tel: 926-5570. Pres.: Paul R. Bender.
Audio: Cassette, open reel.
 R C A Recs., 6550 E. 30 St. Zip: 46219. Tel: 542-6301. Div. VP: Ernest Ruggieri.
Home office: New York, N.Y.
Audio: 8-tr., 8-tr. quadrasonic, cassette.
 Rutgers Packaging Corp. (div. of Queens Lithographic Corp.), 620 S. Belmont Ave. Zip: 46221. Tel: 635-7777.

Pres.: Abe Garde; Sales & Adv. Mgr.: Morton D. Shecter. (PKG only)
Home office: Long Island City (New York Metropolitan Area), N.Y., Queens Lithographing Corp.

• MICHIGAN CITY (Area Code 219)

Infonics Inc., PO Box 1111, 238 Hwy. 212. Zip: 46360. Tel: 879-3381. Pres.: Paul C. Lloyd.
Audio: 8-tr., cassette, open reel.

• RICHMOND (Area Code 317)

P R C Rec'g Co. (div. of Richmond Rec'g Corp.), 1600 Rich Rd. Zip: 47374. Tel: 962-9511. (PKG)
Home office: New York, N.Y.
Audio: 8-tr., cassette.

• TERRE HAUTE (Area Code 812)

Columbia Rec. Prod'ns, 1400 N. Fruitridge Ave. Zip: 47805. Tel: 466-8125.
Sales offices: Hollywood (Los Angeles Metropolitan Area), Calif.; Chicago, Ill.; New York, N.Y.; Nashville, Tenn.
Audio: 8-tr., 8-tr. quadrasonic, cassette, open reel.

IOWA

• CARLISLE (Area Code 515)

Kajac Recs. (div. of Ozark Opry Inc.), 155 First St. Zip: 50047. Tel: 989-0876. Contact: Harold L. Luick.
Audio: 8-tr., 8-tr. quadrasonic, cassette.

• COUNCIL BLUFFS (Area Code 712)

Liberty/UA Tape Dupl'g Inc. (div. of Capitol Recs. Inc.), 2101 S. 35 St. Zip: 51501. Tel: 328-8060. Gen. Mgr.: Marv King.
Home office: Los Angeles, Calif., Capitol Recs. Inc. (SEE ADVERTISEMENT)

Moss Rec'g Serv., PO Box 417, 708 W. Broadway. Zip: 51501. Tel: 322-4513. (PKG)

• DES MOINES (Area Code 515)

Studio 2000 Ltd., 515 28 St. Zip: 50312. Tel: 282-8306. Dir.: Robert Dow; Sales Mgr.: Karen Winchester; Adv. Mgr.: Doyle Smith.
Audio: Cassette, open reel.
 Triad Prods. Inc., 1910 Ingersoll. Zip: 50309. Tel: 243-2125. (PKG)
Audio: Cassette, open reel.

Why Pay More For The Best In Quality!

CUSTOM TAPE DUPLICATORS



- **Finest Engeering & Mastering**
- **Quick Delivery**
- **Large Capacity**
- **Most Competitive Prices**
- **Drop Shipment Available**
- **Customer Service Dept.**

at

AMERICAN TAPE CORPORATION

1116 EDGEWATER AVENUE RIDGEFIELD, N. J. 07657 · TEL (201) 943 7860

Remember, at American Tape, you'll not only see the difference -- you'll hear it as well!

KANSAS

● OVERLAND APRK (Area Code 913)

Ampex Corp., Magnetic Tape Div., PO Box 7282, Zip 66207. Tel: 383-1951. (Sales office only) (PKG)
Home office: Redwood City (San Francisco & Bay Area), Calif.
Audio: 8-tr., 8-tr. quadrasonic, cassette, open reel, open reel quadrasonic.

● WICHITA (Area Code 316)

High Fidelity Rec'g Inc., 1059 Porter, Zip: 67203. Tel: 262-6456. Pres.: James Strattan. (PKG)
Audio: 8-tr., 8-tr. quadrasonic, cassette, open reel.
Video: 1/4" cassette, 1/2" Beta & VHS cassette.

KENTUCKY

● LEXINGTON (Area Code 606)

Lemco Custom Rec'g, 2518 Southview Dr. Zip: 40503. Tel: 277-1183.
Audio: Cassette, open reel.

● LOUISVILLE (Area Code 502)

Allen-Martin Prod'ns Inc., 9701 Taylorsville Rd. Zip 40299. Tel: 267-9658. Pres. Ray Allen; Adv. Mgr. Carolyn Davidson.
Audio: Cassette.

LOUISIANA

● BATON ROUGE (Area Code 504)

Ampex Corp., Magnetic Tape Div., PO Box 14754, Zip 70808. Tel: (504) 766-6270. (Sales office only) (PKG)
Home office: Redwood City (San Francisco & Bay Area), Calif.
Audio: 8-tr., 8-tr. quadrasonic, cassette, open reel, open reel quadrasonic.

MARYLAND

● BETHESDA (Area Code 301)

Ampex Corp., Magnetic Tape Div., 10215 Fernwood Rd. Zip: 20034. Tel: 530-8800. (Sales office only) (PKG)
Home office: Redwood City (San Francisco & Bay Area), Calif.
Audio: 8-tr., 8-tr. quadrasonic, cassette, open reel, open reel quadrasonic.

● KENSINGTON (Area Code 301)

Omega Rec'g Servs., 10518 Connecticut Ave. Zip: 20795. Tel: 946-4686
Audio: 8-tr., cassette, open reel.

MASSACHUSETTS

● BOSTON METROPOLITAN AREA (Area Code 617)

Ampex Corp., Magnetic Tape Div., PO Box 1020, Framingham 01701. Tel: 877-8060. (Sales office only) (PKG)
Home office: Redwood City (San Francisco & Bay Area), Calif.
Audio: 8-tr., 8-tr. quadrasonic, cassette, open reel, open reel quadrasonic.

Continental Rec'gs Inc., 210 South St. Zip: 02111. Tel: 426-3131. Pres., Sales & Adv. Mgr.: L. Daniel Flynn. (PKG)
Audio: Cassette, open reel.

Data Packaging Corp., 205 Broadway, Cambridge 02139. Tel: 868-6200. Exec VP. Greg Mathus; VP Mktg.: Jere R. Hill; Nat'l Sales Mgr.: Gene Hull. (PKG only—audio (SEE ADVERTISEMENT))

Fleetwood Communications Co., 321 Revere St., Revere 02151. Tel: 289-6800. Pres.: V.P. Giarrusso; Sales Mgr.: Victor Mancini; Adv. Mgr.: Robin Samora. (PKG)
Audio: 8-tr., cassette, open reel.
Video: 1" open reel, 1" cartridge, 3/4" cassette.

Rik Tinory Prod'ns, 622 Rt. 3A, Cohasset 02025. Tel: 383-9494. Pres. Richard F. Tinory; Artist Relations: Claire L. Babcock.
Audio: 8-tr., cassette, open reel.

● CHICOPEE (Area Code 413)

Dielectrics Inc., 6 Second Ave. Zip 01020. Tel: 598-8308. Pres. Earl S. Stahl; Exec. VP, Sales & Adv. Eric Craig Stahl. (PKG only)

● NORTH MARSHFIELD (Area Code 617)

Eastern Audio Rec'g (EAR), PO Box 173, Zip 02059. Tel: 834-8117. Owner: Lambert W. Brandes.

MICHIGAN

● DETROIT METROPOLITAN AREA (Area Code 313)

American Sound Corp., 3319 E. Ten Mile Rd., Warren 48091. Tel: 539-2900. Pres.: Frank Day; VP & Sales Mgr.: Paul E. Adams. (PKG)
Branches: North Hollywood (Los Angeles Metropolitan Area), Calif.; Demarest, N.J.
Audio: 8-tr., 8-tr. quadrasonic, cassette, open reel.

Arrie Fields Prod'ns, 9430 Woodward Ave. Zip: 48202. Tel: 873-8900. (PKG)
Audio: Open reel.

General Television Network, 13225 Capital Ave., Oak Park 48237. Tel: 548-2500. Pres.: R. Randolph Hippler. (PKG)

Video: 2" quad, 1" open reel, 1" cartridge, 3/4" cassette, 1/2" EIAJ open reel, 1/2" EIAJ cartridge.

Magnetic Video Corp., 23434 Industrial Park Court, Farmington Hills 48024. Tel: 477-6066. Pres.: Andre A. Blay; VP Consumer Prods.: Bob Vandegrift; Sales Mgrs. (audio) Kevin Youngs, (video) Al Eicher.
Audio: 8-tr., cassette.

Video: 1" open reel, 3/4" cassette, 1/2" EIAJ open reel, 1/2" Beta (I&II) & VHS cassette.

Sound Patterns DXM, 38180 Grand River, Farmington Hills 48018. Tel: 477-6444. Pres.: Dan Dallas.
Audio: Cassette, open reel.

Tape-Tronics Inc., 750 E. Mandoline, Madison Heights 48073. Tel: 588-8281
Audio: 8-tr., cassette.

● MOUNT CLEMENS (Area Code 313)

Bazzy Electronics Corp., 39 N. Rose, Zip: 48043. Tel: 463-2592. Pres.: L. Allan Bazzy; Gen. Mgr.: Mike Tattan. (PKG)
Audio: 8-tr., 8-tr. quadrasonic, cassette.

MINNESOTA

● MINNEAPOLIS-ST. PAUL AREA (Area Code 612)

A S I (Audioteck Systems Inc.), 711 W. Broadway, Minneapolis 55411. Tel: 521-7631. Pres.: Dan R. Holmes; Sales Mgr.: Wes Hayne; Adv. Mgr.: Sandra Milani.
Audio: Cassette, open reel.

Bethany Fellowship Inc., 6820 Auto Club Rd., Minneapolis 55438. Tel: 944-2121. Pres. T.A. Hegre; Sales & Adv. Mgr.: David W. Anthony. (PKG)
Audio: Cassette

Communication Arts Inc., 2526 27 Ave. S., Minneapolis 55406. Tel: 721-5357. Pres. Roger F. Kletz; Gen. Mgr.: Kathleen Dale; Sales Mgr.: Mike Pallansch.
Audio: Cassette.

E M C Corp., 180 E. Sixth St., St. Paul 55101. Tel: 227-7366. Pres.: David E. Feinberg; Sales Mgr.: Richard T. Stevens. (PKG)
Sales office: Hollywood (Los Angeles Metropolitan Area), Calif.

Audio: Cassette, open reel.
 Metacomp Inc., 1401-B W. River Rd. N., Minneapolis 55411. Tel: 588-2781. Pres. James I. McCann; Sales Mgr.: Phillip T. Levin; Adv. Mgr.: J.J. Binsfeld. (PKG)
Audio: Cassette, open reel.

MISSISSIPPI

● JACKSON (Area Code 601)

Malaco Sound Rec'g (div. of Malaco Inc.), 3023 W. Northside Dr. Zip: 39213. Tel: 982-4522.
Audio: Open reel.

MISSOURI

● KANSAS CITY (Area Code 816)

Warren C. Moore & Assocs., PO Box 8451, Zip: 64114. Tel: 333-7654. Owner: W.C. Moore.
Audio: 8-tr., cassette

N M I/Master Sound Studios, 516 W. 75 St. Zip: 64114. Tel: 333-9617. Pres.: Mike Green; Sales Mgr.: Eugene Gold; Adv. Mgr.: Charles Smith.
Audio: 8-tr., cassette, open reel.

Stage 3 Sound Prod'ns Inc., 12 E. 39 St. Zip: 64111. Tel: 531-1375. Pres.: Don Warnock. (PKG)
Audio: Cassette, open reel.

● ST. LOUIS METROPOLITAN AREA (Area Code 314)

K B K Earth City Sound Studio, 4288 Riverline, Earth City 63045. Tel: 291-4840. Pres.: Kent Kesterson; VP: Jim Lake.
Audio: Cassette, open reel.

Technisonic Studios Inc., 1201 S. Brentwood Blvd. Zip: 63131. Tel: 727-1055. Pres.: Edward H. Canter.
Audio: Cassette, open reel.

● SPRINGFIELD (Area Code 417)

Aard-Vark Rec'g, 335 S. Jefferson, Zip: 65806. Tel: 866-4104. Owner: John Jacobson.
Audio: Cassette.

National Audio Co. Inc., 1911 S. Stewart, Zip: 65804. Tel: 883-5377.
Audio: Cassette, open reel.

MONTANA

● HELENA (Area Code 406)

Valtron Rec'g Studio, 305 Allen St. Zip: 59601. Tel: 442-0734. Pres. & Adv. Mgr.: Lester Liedle; Sales Mgr.: Sandy Liedle.
Audio: Cassette, open reel.

NEW JERSEY

● ASBURY PARK (Area Code 201)

Sound-Arts Co. Inc., 5 Cindy Ln. Zip: 07712. Tel: 493-

8666. Pres.: Charles J. Gspann; VP: Francis M. Gspann. (PKG)
Audio: Cassette, open reel.

● CAMDEN (Area Code 609)

Recorded Publ'ns Labs (div. of Recorded Publ'ns Mfg. Co. Inc.), 1100 State St. Zip: 08105. Tel: 963-3000; Philly (215) 922-8558. Pres.: David H. Goodman; Sales Mgr.: Pat Landon; Adv. Mgr.: Edward J. Goodman. (PKG)
Sales office: New York, N.Y.

Audio: 8-tr. quadrasonic, cassette, open reel quadrasonic, special cartridges for background music & audio/visual.

● CRESSKILL (Area Code 201)

Unaworld Corp., 210 Knickerbocker Rd. Zip: 07626. Tel: 871-0555. Pres.: Fred Cooper.
Audio: 8-tr., 8-tr. quadrasonic, cassette.

● DEMAREST (Area Code 201)

American Sound Corp., 18 Christie, Zip: 07627. Tel: 767-9033

Home office: Warren (Detroit Metropolitan Area), Mich.
Audio: 8-tr., 8-tr. quadrasonic, cassette, open reel.

● FAIRFIELD (Area Code 201)

A S R Rec'g Servs. Inc., 344 Kaplan Dr. Zip: 07006. Tel: 575-7010. Co-Pres.: Allen Weintraub, Sani Rothberg; VP Sales: Charles Cerasia. (PKG)
Branch: Canoga Park (Los Angeles Metropolitan Area), Calif.

Audio: 8-tr., 8-tr. quadrasonic, cassette, open reel, open reel quadrasonic. (SEE ADVERTISEMENT)

● HACKENSACK (Area Code 201)

Ampex Corp., Magnetic Tape Div., 65 Commerce Way, Zip: 07601. Tel: 489-7400. (Sales office only) (PKG)
Home office: Redwood City (San Francisco & Bay Area), Calif.

Audio: 8-tr., 8-tr. quadrasonic, cassette, open reel, open reel quadrasonic.

● LEONIA (Area Code 201)

S/T Videocassette Dupl'g Corp., 500 Willow Tree Rd. Zip: 07065. Tel: 947-6450. (PKG)
Home office: New York, N.Y.; **Video Corp. of America**

Video: 2" quad, 2" helical, 1" open reel, 3/4" cassette, 1/2" Beta & VHS cassette, 1/2" EIAJ open reel, 1/2" EIAJ cartridge.

● MAPLE SHADE (Area Code 609)

A M P Rec'gs (div. of IPI), 307 W. Main St. Zip: 08052. Tel: 667-1667. Pres.: Donald R. Marsh; Sales Mgr.: Gerald Tyson.
Audio: Cassette, open reel.

● MONTECLAIR (Area Code 201)

Linear Sound Rec'g, 211 Glenridge Ave. Zip: 07042. Tel: 744-0686. Pres.: Mike Kroll; Sales Mgr.: Brad Clark, Adv. Mgr.: T. Steinmann. (PKG)

● NEWARK (Area Code 201)

Andira Rec. Corp., Custom Servs. Div., 16 Park Pl. Zip: 07102. Tel: 642-5991.
Audio: 8-tr., 8-tr. quadrasonic, cassette, open reel, open reel quadrasonic.
Audio: 2" quad, 2" open reel 3/4" cassette

● PARK RIDGE (Area Code 201)

Cadet Recs., PO Box 176, Zip: 07656. Tel: 391-3676. VP Sales: Robert K. Herrington. (Sales office only) (PKG)
Home office: Los Angeles, Calif.
Audio: 8-tr., cassette.

● PITMAN (Area Code 609)

Columbia Rec. Prod'ns, Lambs & Woodbury Rds. Zip: 08071. Tel: 589-8000
Sales offices: Hollywood (Los Angeles Metropolitan Area), Calif.; Chicago, Ill.; New York, N.Y.; Nashville, Tenn.
Audio: 8-tr., 8-tr. quadrasonic, cassette, open reel.

● RAHWAY (Area Code 201)

Springboard Int'l, 947 US Hwy. 1, Zip: 07065. Tel: 574-1400. (PKG)
Branch: Los Angeles, Calif.
Audio: 8-tr

● RIDGEFIELD (Area Code 201)

American Tape Corp., 1116 Edgewater Ave. Zip: 07657. Tel: 943-7860. Pres.: Donald H. Gabor; VP Mktg. K.M. Marani; Plant Mgr.: Francis A. Dermody. (PKG)
Audio: 8-tr., cassette, open reel. (SEE ADVERTISEMENT)

● SCOTCH PLAINS (Area Code 201)

H M R Prod'ns Inc., 574 W. Court, Zip: 07076. Tel: 889-1767. Owner: Harry M. Randel; Pres.: Lillian M. Randel.
Audio: Cassette.

● UPPER SADDLE RIVER (Area Code 201)

Cassette Prod'ns Inc., 118 Rt. 17, Zip: 07458. Tel: 327-1707. Pres.: Julius A. Konins. (PKG)
Audio: CASSETTE. (SEE ADVERTISEMENT)

● **WEST CALDWELL (Area Code 201)**

R K O Nat'l Tape Serv., 3 Fairfield Crescent, Zip 07C06, Tel. (201) 575-8484, VP & Gen. Mgr.: Hugh Wallace; Sales Mgr.: Lee Gray. (PKG)
Audio: Cassette, open reel

● **WEST ORANGE (Area Code 201)**

House of Music, 1400 Pleasant Valley Way, Zip 07052, Tel. 736-3062, NYC Tel. (212) 964-7444, Pres. C.E. Conrad.
Audio: 8-tr., cassette, open reel.

NEW YORK

● **BOHEMIA (Area Code 516)**

Studio Magnetics Co. Inc., 83 Carlough Rd, Zip 11716, Tel. 589-4300, Pres. George Clahane; VP: Craig M. Balaban. (PKG only)

● **CLARENCE (Area Code 716)**

Mark Custom Rec'g Serv., 10815 Bodine Rd, Zip 14031, Tel. 759-2600, Pres. & Sales Mgr.: Vincent S. Morette.
Audio: Cassette.

● **FARMINGDALE (Area Code 516)**

Pressure Sensitive Tape & Label Corp., 135 Schmitt Blvd, Zip 11735, Tel. 293-7300. (PKG)

● **FRANKLIN SQUARE (Area Code 516)**

Master Sound Prod'ns Inc., 921 Hempstead Tnkp, Zip 11010, Tel. 354-3374, Pres. Ben Rizzi; VP: Maxine Chreйн.
Audio: Cassette.
Video: 3/4" cassette.

● **GARDEN CITY (Area Code 516)**

T D K Electronics Corp., 755 Eastgate Blvd, Zip 11530, Tel. 746-0880, VP: Ken Kohda, Nat'l Mktg. Mgr.: Bud Berger, Ass't Adv. Mgr.: Bob Miller. (PKG)
Branch: Chicago, Ill.
Audio: 8-tr., 8-tr. quadrasonic, cassette, open reel, open reel quadrasonic.
Video: 3/4" cassette, 1/2" Beta & VHS cassette.

● **HAUPPAUGE (Area Code 516)**

Allison Audio Prods. Inc., 1290 Motor Pkwy, Zip 11787, Tel. 234-2010, NYC (212) 895-6449.
Audio: 8-tr., 8-tr. quadrasonic, cassette
Pres-Tige Label Corp., 255 Oser Ave, Zip 11787, Tel. 273-0020. (PKG—audio only)

● **HUNTINGTON STATION (Area Code 516)**

Shelley Prods. Ltd., 220 Broadway, Zip 11746, Tel. 423-7090.
Audio: 8-tr., 8-tr. quadrasonic, cassette, open reel, open reel quadrasonic.

● **LE ROY (Area Code 716)**

Arlo Recs. Inc./BHR Recs. Inc., 7635 Telephone Rd, Zip 14482, Tel. 442-9112, Pres. Kenneth Bearce, Sales Mgr.: Jill Wetzel; Adv. Mgr.: James L. Bearce.
Audio: 8-tr. quadrasonic, open reel.

● **LINDENHURST (Area Code 516)**

Coastal Specialty Tapes Inc. (formerly Pratt-Spector Corp.), 274 Bangor St, Zip 11757, Tel. 226-5900, Pres. Tom Carroll; Sales Mgr.: Stanley Gilman; Adv. Mgr.: Dan Dobbs. (PKG only—audio)

● **MAMARONECK (Area Code 914)**

Cine Magnetics Video, 650 Halstead Ave, Zip 10543, Tel. 698-3434, NYC (212) 542-0700, WATS (800) 431-1102, Contacts: Bob Orzack, June Johnston.
Plant: Rye, N.Y., Cine Magnetics Audio.
Video: 3/4" cassette, film to tape transfers.

● **MASSENA (Area Code 315)**

Michele Audio Corp., Andrew Street Rd, Zip 13662, Tel. 769-2448, Pres. Ginette Cormier; Sales Mgr.: Harold Friedman; Adv. Mgr.: Jack Daniels. (PKG)
Audio: 8-tr., cassette.

● **MOUNT VERNON (Area Code 914)**

Sentry Inds. Inc., 221 N. Macquesten Pkwy, Zip 10550, Tel. 664-2909, Pres.: Harold Rosen; Sales & Adv. Mgr.: Barry Rosen. (PKG—audio only)

● **NEW YORK METROPOLITAN AREA (Area Code 212)**

AG I (Album Graphics Inc.), 125 W. 55 St, Zip 10019, Tel. 489-0793, VP Mktg.: Richard Block; Sales Mgr.: Gary Sitzer. (Sales office only) (PKG)
Adwar Video Corp., 100 Fifth Ave, Zip 10011, Tel. 691-0976, Pres. Samuel Adwar; Sales Mgr.: Ken Levy; Adv. Mgr.: Claudia Kane.
Video: 3/4" cassette, 1/2" Beta & VHS cassette.
Album Graphics Inc., see AGI.
Andol Audio Prods. Inc., 4212 14 Ave., Brooklyn 11219, Tel. 435-7322, Pres.: Anthony A. Maniere; Sales Mgr.: Rocco Salvatore; Adv. Mgr.: Domenick Salvatore. (PKG)
Audio: 8-tr., cassette.

Audio-Tech Labs., 2819 Newkirk Ave., Brooklyn 11226, Tel. 469-7134, Owner: Joseph Giovanelli
Audio: Cassette.
Nelson Barry Corp., 319 E. 44 St, Zip 10017, Tel. 679-7900, Pres. Franklin B. Lieberman; Sales Mgr.: Roslyn Schlesinger. (PKG—video only)
Audio: Cassette.
Video: 2" quad, 3/4" cassette.

Broadcasting Foundation of America, 52 Vanderbilt Ave., Rm 1810, Zip 10017, Tel. 986-6448, VP & Exec. Dir.: Howard L. Kany; Program Dir.: Catherine Probst. (PKG)
Audio: Open reel.

Cassette Rec'g Corp., see National Rec'g Studios
Columbia Rec. Prod'ns, 49 E. 52 St, Zip 10022, Tel. 975-4881, VP: Tom Van Gessel, Reg'l Sales Mgr.: Donald Olesen. (Sales office only)
Plants: Santa Maria, Calif.; Terre Haute, Ind.; Pitman, N.J.
Audio: 8-tr., 8-tr. quadrasonic, cassette, open reel.

Cue Rec'gs, 1156 Ave. of the Americas, Zip 10036, Tel. 757-3841, Pres.: Mel Kaiser. (PKG—audio only)
Audio: Cassette, open reel.
Video: 3/4" cassette

Delta Rec'g Corp., 16 W. 46 St, Zip 10036, Tel. 840-1350.
Audio: 8-tr., 8-tr. quadrasonic, cassette, open reel.
Direct Rec'gs Inc., 18 E. 50 St, Zip 10022, Tel. 759-7979, Pres. & Sales Mgr.: Norman Levin (PKG)
Audio: Cassette, open reel.

Disc Communications Ltd., 743 Fifth Ave, Zip 10022, Tel. 371-0390, Pres.: Jerome Boxer; Art Dir.: Susan Murphy. (PKG)
Audio: 8-tr., 8-tr. quadrasonic, open reel.

E R H Sales Corp., 221 W. 57 St, Zip 10019, Tel. 582-4200, Pres. Lee Halpern; Gen. Mgr. Michael Halpern; Sales Mgr.: Robert Shavelson. (PKG)
Audio: 8-tr., 8-tr. quadrasonic, cassette, open reel. (SEE ADVERTISEMENT)

E U E/Screen Gems, 222 E. 44 St, Zip 10019, Tel. 867-4030.
Video: 2" quad, 3/4" cassette.

Intercontinental Televideo Corp., 10 W. 66 St., Suite 11-F, Zip 10023, Tel. 595-9454, Pres. Gerald Citron; VP: Nigel Toovey.
Video: 3/4" cassette, 1/2" Beta & VHS cassette

Marvell Packaging Co., 230 W. 17 St, Zip 10011, Tel. 929-8435. (PKG)
National Rec'g Studios Inc. & National Video Center, 730 Fifth Ave, Zip 10019, Tel. 757-6440, Pres.: Harold Lustig; VP & Gen. Mgr.: Jeff Pastolove. (PKG—audio only)

Audio: 8-tr., cassette, open reel.
Video: 1" open reel, 3/4" cassette

National Video Center, see National Rec'g Studio
P R C Rec'g Co. (div. of Richmond Rec'g Corp.), 1185 Ave. of the Americas, Zip 10036, Tel. 997-1250, Pres.: Hugh Landy; VP & Sales Mgr.: David Grant. (PKG)
Plants: Compton (Los Angeles Metropolitan Area), Calif.; Richmond, Ind.

Audio: 8-tr., 8-tr. quadrasonic, cassette.
Professional Video Servs., 145 E. 52 St, Zip 10022, Tel. 759-2515.

Video: 2" quad, 3/4" cassette, 1/2" cartridge, 1/2" EIAJ open reel European TV standards conversion
Queens Lithographing Corp., 52-35 Barnett Ave., Long Island City 11104, Tel. 457-7000, Pres.: Jack L. Hecht; VP: Leonard Verebay. (PKG only—audio & video)
Branch: Hollywood (Los Angeles Metropolitan Area), Calif.

Plant: Indianapolis, Ind., Rutgers Packaging Corp.
R C A Recs., 1133 Ave. of the Americas, Zip 10036, Tel. 598-5900. (Sales office only)
Sales offices: Los Angeles, Calif.; Indianapolis, Ind.; Nashville, Tenn.

Plant: Indianapolis, Ind.
Audio: 8-tr., 8-tr. quadrasonic, cassette, open reel, open reel quadrasonic.

Recorded Publ'ns Labs (div. of Recorded Publ'ns Mfg. Co. Inc.), 2 Penn Plaza, Suite 1500, Zip 10001, Tel. 868-3115, Reg'l Sales Mgr.: Len Louis (Sales office only) (PKG)
Home office: Camden, N.J.

Audio: 8-tr., 8-tr. quadrasonic, cassette, open reel, open reel quadrasonic, special cartridges for background music & audio/visual.
Regent Sound Studios Inc., 25 W. 56 St, Zip 10019, Tel. 245-2630. (PKG)
Audio: Cassette, open reel, open reel quadrasonic.
Video: 3/4" cassette

Reliance Audio Visual Corp., 550 W. 43 St, Zip 10036, Tel. 736-0700, Pres.: S. Sanford Schlitt, Exec. Ass't: Carol Lynn.
Audio: Cassette, open reel, open reel quadrasonic.
Video: 3/4" cassette, 1/2" EIAJ open reel, 1/2" EIAJ cartridge.

Rombex Prod'ns Corp., 245 W. 55 St, Zip 10019, Tel. 757-3681, Pres.: Richard Marcus; Mktg. Dir.: Joel Willis. (PKG—video only)
Video: 2" quad, 1" open reel, 3/4" cassette, 1/2" EIAJ open reel, 1/2" EIAJ cartridge, 1/2" Beta & VHS cassette.

Sadler Rec'g, 120 W. 44 St, Zip 10036, Tel. 575-0295, Pres.: John Sadler.
Audio: Cassette, open reel

Jasper Samuel Advertising & Recs., 97-28 57 Ave., Forest Hills 11368, Tel. 271-2418, Pres.: Jasper Samuel; Sales Mgr.: David Samuel; Adv. Mgr.: Joseph Samuel. (PKG only—audio & video)

ServiSound Inc., 37 W. 57 St, Zip 10019, Tel. 753-9888. (PKG)
Audio: Cassette, open reel, open reel quadrasonic.

Shorewood Packaging Corp., 10 E. 53 St, Zip 10022, Tel. 371-1500, Pres.: Paul Shore, Exec. VP Mktg.: Floyd S. Gliner; VP Sales: Ken Rosenblum. (PKG only)
Branch: Los Angeles, Calif.

T V R Inc., 333 W. 52 St, Zip 10019, Tel. 541-4030, VP Mktg.: Allen Schulman; Opns. Mgr.: James C. Mahoney.
Video: 2" quad, 3/4" cassette.

Video Corp. of America, 231 E. 55 St, Zip 10022, Tel. 355-1600. (PKG)
Branch: Leonia, N.J., S/T Videocassette Dupl'g Corp.
Video: 3/4" cassette, 1/2" Beta & VHS cassette, 1/2" EIAJ open reel, 1/2" EIAJ cartridge.

Visual Information Systems, 15 Columbus Circle, Zip 10023, Tel. 541-8080.
Video: All formats.

Windsor Total Video, 565 Fifth Ave, Zip 10017, Tel. 725-8080, Pres.: B.B. Goodman; Sales Mgr.: R.J. Henderson. (PKG)
Video: 2" quad, 1" open reel, 3/4" cassette, 1/2" Beta & VHS cassette, 1/2" EIAJ open reel, 1/2" EIAJ cartridge.

● **NORTH BELLMORE (Area Code 516)**

Telephone Dynamics Corp., 2473-A Jerusalem Ave, Zip 11710, Tel. 221-9470.
Audio: Cassette.

● **PITTSFORD (Area Code 716)**

Ampex Corp., Magnetic Tape Div., PO Box 175, Zip 14534, Tel. 586-2580. (Sales office only) (PKG)
Home office: Redwood City (San Francisco & Bay Area), Calif.
Audio: 8-tr., 8-tr. quadrasonic, cassette, open reel, open reel quadrasonic.

● **PORT CHESTER (Area Code 914)**

Associated Audio Servs. Inc., 14-16 Willett Ave, Zip 10573, Tel. 837-5129. (PKG)
Audio: 8-tr., 8-tr. quadrasonic, cassette, open reel, open reel quadrasonic.

● **ROCHESTER (Area Code 716)**

Visual Horizons, 208 Westfall Rd, Zip 14623, Tel. (716) 442-3600.
Home office: Park Ridge (Chicago Metropolitan Area), Ill., Studio West Inc.
Audio: Cassette.

● **RYE (Area Code 914)**

Cine Magnetics Audio, Nursery Ln, Zip 10580, Tel. 698-3434, NYC (212) 542-0700, Sales Mgr.: Bob Orzack. (Plant only)
Home office: Marzouneck, N.Y., Cine Magnetics Video.
Audio: 8-tr., cassette, open reel.
Preferred Sounds (a CMI Group Co.), Nursery Ln, Zip 10580, Tel. 967-7701, Pres.: Sal Nastro; VP Opns. & Admin.: Dave Goldstein; VP Sales: Bob Schultz; VP Mfg.: Baron Lee. (PKG)
Audio: 8-tr., 8-tr. quadrasonic, cassette, open reel.

● **STONY POINT (Area Code 914)**

Gabriel Mfg. Co. Inc., 125 S. Liberty Dr, Zip 10980, Tel. 942-0100. (PKG—audio only)

● **YONKERS (Area Code 914)**

Cassette Masters Corp., 2 Bashford St, Zip 10701, Tel. 968-1605.
Audio: Cassette.
Video Software & Prod'n Center Inc., 165 Tuckahoe Rd, Zip 10710, Tel. 423-4400, Pres.: Stanley Rosenberg; Sales Mgr.: Steve Hoffman. (PKG)
Video: 2" quad, 1" open reel, 3/4" cassette, 1/2" EIAJ open reel, 1/2" EIAJ cartridge, 1/2" Beta & VHS cassette.

NORTH CAROLINA

● **CANTON (Area Code 704)**

Recording Servs. of West North Carolina, 10 Penland St, Zip 28716, Tel. 648-6012, Owner: J. Ted Evans Jr.
Audio: 8-tr. 8-tr. quadrasonic, cassette, open reel.

● **CHARLOTTE (Area Code 704)**

Arthur Smith Studios, PO Box 17551, 5457 Old Monroe Rd, Zip 28212, Tel. 536-0424, Pres.: Arthur Smith; Sales Mgr.: Clay Smith; Adv. Mgr.: Jean Hyman.
Audio: Open reel.

OHIO

● **CINCINNATI (Area Code 513)**

Audiocraft Rec'g Co., 915 W. Eighth St, Zip: 45203, Tel. 241-4304, Pres.: Earl T. Herzog Jr. (PKG)
Audio: 8-tr., cassette, open reel.
Video: 1" open reel, 3/4" cassette, 1/2" Beta & VHS cassette, 1/2" EIAJ open reel, 1/2" EIAJ cartridge.
Counterpart Creative Studios Inc., 3744 Applegate Ave, Zip: 45211, Tel. 661-8810, Pres., Gen. & Sales Mgr.: Shad O'Shea; Adv. Mgr.: MarilynAKER. (PKG)
Audio: 8-tr., cassette, open reel.

Q C A Custom Pressing, 2832 Spring Grove Ave, Zip: 45225, Tel. 681-8400, Pres.: Edward R. Bosken; VP & Gen. Mgr.: Frank E. Ruhl; Sales Mgr.: Keith Myers; Adv. Mgr.: D. Kalmus. (PKG)
Audio: 8-tr., cassette. (SEE ADVERTISEMENT)

Rite Rec. Prod'ns Inc., 9745 Lockland Rd, Zip: 45215, Tel. 733-5533, Pres.: Carl J. Burkhardt; VP: Philip M. Burkhardt; Sales Mgr.: Dan Burton. (PKG)
Audio: 8-tr., cassette, open reel.

● **CLEVELAND METROPOLITAN AREA (Area Code 216)**

Alcon Rec'g Studios Inc., 35100 Euclid Ave., Suite 300,

Willoughby 44094. Tel: 951-0910. Pres.: Alan M. Peabody.
Audio: Cassette.
 Boddie Rec. Mfg. & Rec'g Inc., 12202 Union Ave. Zip 44105. Tel: 752-3440. Pres.: Thomas R. Boddie; Sales Mgr.: Dennis R. Boddie. (PKG)
Audio: 8-tr., 8-tr. quadrasonic, cassette, open reel.
 The Little Warehouse Inc., 1820 W. Schaaf Rd. Zip 44109. Tel: 398-9438. Pres.: James D. Lesnick. (PKG)
Audio: 8-tr., cassette.

● COLUMBUS (Area Code 614)

Kingsmill Rec'g Studio, 1033 Kingsmill Pkwy. Zip 43229. Tel: 846-4494.
Audio: 8-tr., cassette, open reel.
 Magnetic Studios, 4784 N. High St. Zip 43214. Tel: 262-8607. Pres.: Nils Lindquist. Chief Eng.: John Fippin.
Audio: Cassette, open reel.
 Mus-I-Col Inc., 780 Oakland Park Ave. Zip 43224. Tel: 267-3133. Owners: John W. Hull, Boyd P. Niederlander.
Audio: 8-tr., cassette, open reel.

● NEWARK (Area Code 614)

Utopia Ultra-Sound, 38-40 S. First St. Zip 43055. Tel: 345-9426. Owner: Robert H. Kirk Jr. (PKG)
Audio: 8-tr., 8-tr. quadrasonic, cassette.

● YOUNGSTOWN (Area Code 216)

United Audio Rec'g Studio, 5947 Stillson Pl. Zip 44512. Tel: 758-5463.
Audio: 8-tr., 8-tr. quadrasonic, cassette, open reel, open reel quadrasonic.

OKLAHOMA

● TULSA (Area Code 918)

C E S Rec'g Inc., 4960G S. 83 East Ave. Zip: 74145. Tel: 627-8474. (PKG)
Audio: 8-tr., cassette.
 I T I Studios (International Teaching Tapes), 4235 S. Memorial Dr. Zip: 74145. Tel: 663-7700. Pres.: Meredith R. Gray. Sales Mgr.: Sonny Gray. (PKG)
Audio: 8-tr., cassette, open reel.

OREGON

● PORTLAND (Area Code 503)

Northwestern Inc., Motion Pictures & Rec'g, 1224 SW Broadway. Zip: 97205. Tel: 226-0170. Pres.: Robert M. Lindahl; Sales Mgr.: Paul A. Buescher.
Audio: Cassette, open reel.
 Victory Press Inc., 600 SW 10, Suite 502. Zip: 97205. Tel: 222-6138. Pres.: Dan E. Gordon; Sales Mgr.: J. E. Gordon. Adv. Mgr.: S.R. Gordon. (PKG)
Audio: Cassette.

PENNSYLVANIA

● BROOMALL (Area Code 215)

E. J. Stewart Inc., 388 Reed Rd. Zip: 19008. Tel: 543-7600. Pres.: Eric R. Address; Gen. & Adv. Mgr.: Howard S. Lipman; Sales Mgr.: Kathleen DeBay. (PKG—video only)
Video: 2" broadcast; ¾" cassette.

● NEW PROVIDENCE (Area Code 717)

The King's Place Inc., PO Box 148. Zip: 17560. Tel: 284-4165. Pres. & Sales Mgr.: John O. Yoder.
Audio: 8-tr., cassette, open reel.

● PHILADELPHIA METROPOLITAN AREA (Area Code 215)

AudioVisual Communications Inc., 435 Crooked Ln., King of Prussia, Pa. 19406. Tel: 272-8500. Pres.: John Balantyne; VP Sales: John Butterworth. (PKG)
Audio: Cassette, open reel.
 Diskmakers Inc., 925 N. Third St. Zip: 19123. Tel: 627-2277. NY Tel: (212) 966-3185. Pres.: Morris Ballen; VP: Larry Ballen.
Audio: 8-tr., cassette. (SEE ADVERTISEMENT)
 MarketDyne Int'l, 1600 Arch St. Zip: 19101. Tel: 241-2935. (PKG)
Video: 1" open reel, ¾" cassette, ½" EIAJ open reel, ½" EIAJ cartridge.

● PITTSBURGH (Area Code 412)

Audio Innovators Inc., 216 Blvd. of the Allies. Zip: 15222. Tel: 281-9605. Pres. & Gen. Mgr.: Norman J. Cleary; Opns. Mgr.: Martha J. Wilson.
Audio: Cassette, open reel.

● WARREN (Area Code 814)

Loranger Mfg. Corp., Entertainment Prods. Div., 10-38 Clark St. Zip: 16365. Tel: 723-8600. Pres.: J. Albert Loranger; VP: Robert Loranger. (PKG only—audio) (SEE ADVERTISEMENT)

SOUTH CAROLINA

● GREENVILLE (Area Code 803)

Duplication Serv. (div. of Custom Rec'g & Sound Inc.), PO

Box 7647, 1225 Pendleton St. Zip: 29611. Tel: 269-5018. Pres.: Robert W. Edwards. (PKG)
Audio: 8-tr., cassette, open reel.

● MOORE (Area Code 803)

Southern Charisma, PO Box 267. Zip: 29369. Tel: 576-5553. Pres.: Edward L. Bayro

● MYRTLE BEACH (Area Code 803)

Dee-Bee Rec'g Serv., 704 Ninth Ave. S. Zip: 29577. Tel: 448-8091. Pres.: Stan Deppen Jr.; Sales Mgr.: Kenneth Deppen; Adv. Mgr.: Pat Gerrick. (PKG)

TENNESSEE

● FAYETTEVILLE (Area Code 615)

Kim-Pat Ents., PO Box 654, Hillwood Dr. Zip: 37334. Tel: 433-2323/5661. Owner: Bill Trigg; Sales Mgr.: Rita Armstrong. (PKG)
Audio: 8-tr., 8-tr. quadrasonic, cassette, open reel, open reel quadrasonic.

● MEMPHIS (Area Code 901)

Shoe Prod'ns Inc., PO Box 12025, 485 N. Hollywood. Zip: 38112. Tel: 458-4496. (PKG)
Audio: Cassette, open reel.

● NASHVILLE AREA (Area Code 615)

Columbia Rec. Prod'ns, 34 Music Square E. Zip: 37203. Tel: 259-4321. Acct. Exec.: Jerry Parkins. (Sales office only)
Plants: Terre Haute, Ind.; Pitman, N.J.
Audio: 8-tr. quadrasonic, cassette, open reel.
 Custom Tape Dupl'rs Inc., 341 Hill Ave. Zip: 37210. Tel: 256-1728. Pres.: L.C. Tant; Sales Mgr.: Mike Tant. (PKG)
Audio: 8-tr., cassette.
 Fanta Professional Servs., 1213 16 Ave. S. Zip: 37212. Tel: 327-1731. Pres.: Johnny Rosen.
Audio: 8-tr., 8-tr. quadrasonic, cassette, open reel.
Video: 2" quad, ¾" cassette.
 G R T Rec. Pressing/Tapes, 1110 48 Ave. N. Zip: 37209. Tel: 383-7881. VP & Opns. Mgr.: Chuck Duncan.
Home office: Sunnysvale, Calif.
Audio: 8-tr., cassette.
 Globe Rec'g Studio Inc., 1313 Dickerson Rd. Zip: 37207. Tel: 226-0811. Gen. Mgr.: Jim Maxwell; Sec'y-Treas.: Glenna Maxwell.
Audio: Cassette, open reel.
 Nashville Album Prod'ns Inc., 617 Seventh Ave. S. Zip: 37203. Tel: 256-0121. Pres.: Steve Botts. (PKG)
Audio: 8-tr., cassette.
 Nashville Int'l Corp., 20 Music Square W. Zip: 37203. Tel: 256-2885/3271. (PKG)
Audio: 8-tr., cassette, open reel.
 R C A Recs., 30 Music Square W. Zip: 37203. Tel: 244-9880. VP: Jerry Bradley.
Home office: New York, N.Y.
Plant: Indianapolis, Ind.
Audio: 8-tr., 8-tr. quadrasonic, cassette, open reel, open reel quadrasonic.
 Sound of Nashville Inc., 1207 Demonbreun St. Zip: 37203. Tel: 256-2521. Pres.: John Ivanits; Sales Mgr.: Gary W. Moore. (PKG only—Audio)

TEXAS

● DALLAS (Area Code 214)

Amplex Corp., Magnetic Tape Div., 1615 Prudential Dr. Zip: 75235. Tel: 637-5100. (Sales office only) (PKG)
Home office: Redwood City. (San Francisco & Bay Area), Calif.
Audio: 8-tr., 8-tr. quadrasonic, cassette, open reel, open reel quadrasonic.
 Mother Dubbers Inc., 2537 Carlisle. Zip: 75201. Tel: 651-9544. (PKG)
Audio: 8-tr., cassette, open reel.

● FORT WORTH AREA (Area Code 817)

Oakridge Music Rec'g Serv., 2001 Elton Rd., Haltom City 76117. Tel: 838-8001. Eng.: Homer Lee Sewell.
Audio: 8-tr., cassette, open reel.

● SAN ANTONIO (Area Code 512)

A S I (Abaddon/Sun Inc.), PO Box 6520, 10330 Kotzebue. Zip: 78209. Tel: 824-8781. Pres.: Galen Carol.
Audio: Cassette.
 B C L Ents. Inc., 1002 Hoefgen St. Zip: 78210. Tel: 532-3216. Pres.: C. Foy Lee; Sales Mgr.: Jimmy Burton; Adv. Mgr.: Jeannie Hill. (PKG)
Audio: 8-tr., 8-tr. quadrasonic.
 Marsal Prod'ns, 2015 Castroville Rd. Zip: 78237. Tel: 433-9351. Pres.: Antonio J. Mendez.

● SAN BENITO (Area Code 512)

Rio Grande Music Co., 119 S. Sam Houston Blvd. Zip: 78586. Tel: 399-5377. Pres. & Adv. Mgr.: Lionel C. Betancourt; Sales Mgr.: John F. Phillips.
Audio: 8-tr., cassette.

● WACO (Area Code 817)

Creative Communications Inc. (sub. of SMI), 918 N. Valley Mills. Zip: 76710. Tel: 776-6553. (PKG)
Audio: Cassette.

UTAH

● PROVO (Area Code 801)

Sound Concepts Corp., PO Box 299, 108 W. Center. Zip: 84601. Tel: 375-7333. Pres.: Michael Jensen; Sales Mgr.: Kaye Jensen. (PKG)
Audio: Cassette.

● SALT LAKE CITY (Area Code 801)

Amplex Corp., Magnetic Tape Div., 2880 S. Main St., Suite 105. Tel: 84115. Tel: 487-8181. (Sales office only) (PKG)
Audio: 8-tr., 8-tr. quadrasonic, cassette, open reel, open reel quadrasonic.
 Bonneville Prod'ns, 130 Social Hall Ave. Zip: 84111. Tel: 237-2400. Gen. Mgr.: Dick Alsop; Sales Mgr.: Dave Whipple; Studio Mgr.: Dave Michelsen.
Audio: Cassette, open reel.
 Chase Media Inc., Beneficial Life Tower, Suite 1723. Zip: 84111. Tel: 363-5858. Pres. & Adv. Mgr.: Randal S. Chase; Sales Mgr.: Irel L. Chase.
Audio: 8-tr., cassette, open reel, open reel quadrasonic.
 Covenant Rec'gs Inc., 1345 Major St. Zip: 84115. Tel: 487-1096. Pres. & Sales Mgr.: V. Lewis Kofford; Adv. Mgr.: Jeff Lund. (PKG)
Audio: Cassette.

VIRGINIA

● MANASSAS (Area Code 703)

Memory Makers, 9202 Amelia Court. Zip: 22110. Tel: 631-9465. Pres.: Jim Corrado; VP: Donna Corrado. (PKG)
Audio: 8-tr., cassette, open reel, open reel quadrasonic.

WASHINGTON

● OLYMPIA (Area Code 206)

Sound Preservers Co., 911 E. Fourth Ave. Zip: 98506. Tel: 352-9097. Owner: Allen P. Giles.
Audio: 8-tr., cassette, open reel.

● SEATTLE (Area Code 206)

Cinema Sound Corp., see Investment Technology.
 Investment Technology Inc., 1940 124 Ave. NE, Bellevue 98005. Tel: 454-7720. Pres.: David P. Hilliard; VP: George Woodley.
 Music Farm Inc., 615 E. Pike St. Zip: 98122. Tel: 323-6847. Pres.: Jim Wolfe.
Audio: Open reel

WISCONSIN

● MILWAUKEE (Area Code 414)

Dave Kennedy Rec'g Studios, 231 W. Wisconsin Ave. Zip: 53203. Tel: 273-5720. Pres.: Dave Kennedy; Chief Eng.: Larry Drydyk. (PKG—labeling service only)
Audio: 8-tr., 8-tr. quadrasonic, cassette, open reel
 Orange Prod'n House, 6055 W. Fond du Lac. Zip: 53218. Tel: 461-3600. Pres.: Larry Lee Hansen; Sales Mgr.: Ellen Westendorf. (PKG)
Audio: 8-tr., cassette, open reel
Video: 1" open reel, ¾" cassette, ½" EIAJ open reel, ½" EIAJ cartridge.

TAPE DUPLICATOR/ MARKETERS OF 8-TR., CASSETTE & OPEN REEL

Ampro Prod'ns Inc., 150 Fifth Ave., New York, N.Y. 10011. Tel: (212) 243-7726. Cable: TAPEXXRON. Telex: 425233. Pres.: Manuel Kopelman; Exec. VP Mktg.: Susanne Tarter; VP: Arthur Lipton.
Tape lines: Ampro, Locomotive, Omega. (SEE ADVERTISEMENT)
 Barclay-Crocker, 11 Broadway, New York, N.Y. 10004. Tel: (212) 952-0068. Partner: Henry A. Barclay Jr.
Open reel: Argo, Desmar, Entr'acte, Halcyon, Musical Heritage Society, L'Oiseau-Lyre, Telefonkunst, Unicorn, Vanguard.
 Kim-Pat Ents., PO Box 654, Hillwood Dr., Fayetteville, Tenn. 37334. Tel: (615) 433-2323/5661. Owner: Bill Trigg.
Tape lines: Blaze, Davis Unlimited, HSE, JSJ, Jima, Ken-Tone, Kim-Pat, Sav-All, Su-Ann.
StereoTape (div. of Magtek), 8125 Lankershim Blvd., North Hollywood, Calif. 91605. Tel: (213) 768-6200.
Open reel & open reel quadrasonic: London, Polydor, RCA, Warner Bros.
 Utopia Ultra-Sound, 38-40 S. First St., Newark, Ohio 43055. Tel: (614) 345-9426. Owner: Robert H. Kirk Jr.
 8-tr.: Jessup, Mac, SAM, Shields, UUS.

ENTERTAINMENT LAWYERS

This listing includes attorneys believed to have experience in the music industry based upon professional listings and our subscription information.

• CHICAGO METROPOLITAN AREA (Area code 312)

The Law Firm of Richard E. Alexander, Ltd., 33 North Dearborn St. Zip 60602. Tel.: 726-7800.

Allegretti, Newitt, Witcoff & McAndrews, 125 S. Wacker Dr. Zip 60606. Tel.: 372-2160. TWX 910-221-5317.

Alter and Weiss, 208 S. LaSalle St., Suite 510. Zip 60604. Tel.: 337-2100. Cable ALT.

Arvey, Hodess, Costello & Burman, 180 N. LaSalle St. Zip 60601.

Berz, Herbst, Kravets & Sandler, 55 E. Monroe St., Suite 1650. Zip: 60603. Tel.: 372-1555.

Bloom & Denberg, Ltd., One N. LaSalle St., Suite 2100. Zip 60602. Tel.: 368-4455.

Burmeister, York, Palmatier, Hamby & Jones, 135 S. LaSalle St., Suite 1046. Zip 60603. Tel.: 782-6663.

Charles B. Cannon, 135 S. LaSalle St., Suite 640. Zip 60603. Tel.: 236-1585, 236-2141. Cable CANPAT. CHICAGO.

Joel M. Carlins, 120 S. LaSalle St. Zip 60601.

Cook, Wetzel & Egan, Ltd., A Professional Corporation, 135 S. LaSalle St., Suite 60603. Tel.: 236-8500.

Joseph M. Crispino, 6914 W. North Ave. Zip 60635.

Dominik, Knechtel, Godula & Demeur, Twenty N. Wacker Dr., Suite 4020. Zip 60606. Tel.: 726-5342.

Dressler, Goldsmith, Clement, Gordon & Shore, Ltd. 1825 Prudential Plaza. Zip 60601. Tel.: 527-4025. Cable: SCHNEIDRES.

Branch office: 609 Crystal Plaza 1, Arlington, Virginia. Tel. (703) 521-1880.

Law Offices of Jacques M. Dulin, A Professional Corporation, 135 S. LaSalle St., Suite 606. Zip: 60603. Tel.: 236-4038, 236-4039. Cable: LAWBYRINTH.

Branch office: 1333 Imperial Dr., Libertyville, Ill. Tel. (312) 362-5242.

Emrick, Root, O'Keefe & Lee, 150 N. Wacker Dr., Suite 3000. Zip 60606. Tel.: 368-8575. Cable: PATMARK. Telex 28 3506 PATMARK-CGO.

Fritch, Even, Tabin & Luedeka, 135 S. LaSalle St. Zip 60603. Tel.: 372-7842. Cable: PATLAW.

Branch offices: 505 Gay Street, S.W., Suite 1230, Knoxville, Tenn. Tel. (615) 546-4305. 401 Russ Bldg., San Francisco, Calif. Tel. (415) 981-8008.

Fitzgibbon, Roehrig, Greenawalt & Stone, 135 S. LaSalle St., Zip 60603. Tel.: 346-6550.

Foreman, Roscoe C., 39 S. LaSalle, Ste. 1521. Zip 60603.

Gary, Juetner & Pyle, 33 N. Dearborn St., Suite 231. Zip 60602. Tel.: 236-8123. Cable: FRANBEL.

Robert Gottschalk, 150 S. Wacker Dr., Zip 60604. Tel.: 372-3813. Cable: ROGOLAW. Telex 910-221-5150.

John B. Hirsch, 33 N. Dearborn St. Zip 60602. Tel.: 372-4250.

Hosier, Nuro & Daleiden, Ltd., 135 S. LaSalle St. Zip 60603. Tel.: 236-0733.

Hume, Clement, Brinks, Willian & Olds, Ltd., A Professional Corporation, One IBM Plaza. Zip 60611. Tel.: 822-9800. Cable: JUDICATURE CHICAGO. Telex 25-4300.

Kegan, Kegan & Berkman, 79 W. Monroe St. Zip 60603. Tel.: 782-6495. Cable: JADEF.

Keil, Thompson & Shurtleff, 135 S. LaSalle St., Suite 1260. Zip 60603. Tel.: 236-5030. Cable: COUNSEL-CHICAGO. Telex 25-3862. KTS LAW CGO.

Kinzer, Plyer, Dorn & McEachran, 55 E. Monroe St. Zip 60603. Tel.: 726-4421, 236-1112. Cable: ELEC-TRIFY.

Laff, Whitesel & Rockman, 875 N. Michigan Ave. Zip 60611. Tel.: 649-0200. Cable: LAWHRO.

Lee & Smith, Ten S. Riverside Plaza, Suite 330. Zip 60603. Tel.: 726-1982.

Lettvin & Green, 135 S. LaSalle St., Suite 140D. Zip 60603. Tel.: 641-3320.

Levenfeld, Karter, Baskes & Lippitz, 10 S. LaSalle, 8th Fl. Zip 60603.

Leydig, Vott, Osann, Mayer & Holt, Ltd., One IBM Plaza, Suite 4600. Zip 60611. Tel.: 822-9666. Cable: WOLFEHUB.

Branch office: 815 N. Church St., Rockford, Ill. Tel. (815) 963-7661.

Lockwood, Dewey, Zickert & Alex, One First National Plaza, Suite 3030. Zip 60670. Tel.: 782-4860. Telex: 25-3631.

Mason, Kolehmainen, Rathburn & Wyss, 20 N. Wacker Dr. Zip 60606. Tel.: 621-1300. Cable: MAKRAW. TWX 221-5342.

McWilliams & Mann, 53 W. Jackson Blvd., Suite 1215. Zip 60604. Tel.: 427-1351. Cable: MANBRO.

Merriam, Marshall & Bicknell, Two First National Plaza, Suite 2100. Zip 60603. Tel.: 346-5750. Telex 25-3856.

Neuman, Williams, Anderson & Olson, 77 W. Washington St. Zip 60602. Tel.: 346-1200. Cable: JONAD TV. Telex 910-221-5530.

Olson, Trexler, Wolters, Bushnell & Fosse, Ltd., 141 W. Jackson Blvd. Zip 60604. Tel.: 427-9092.

Branch office: 1911 Jefferson Davis Highway, Crystal Mall #1, Room 503, Arlington, Virginia. Tel. (202) 920-4988.

John L. Parker & Associates, 39 S. LaSalle St. Zip 60603. Tel.: 263-6560.

Pattishall, McAuliffe & Hofstetter, Prudential Plaza. Zip 60601. Tel.: 642-9518. Cable: ROWOOD. Telex 254473.

Piggott & Gerstman, Ltd., 105 W. Adams St., Suite 2390. Zip 60603. Tel.: 263-4350.

Silverman Cass, Ltd., 105 W. Adams St. Zip 60603. Tel.: 726-6006. Cable: SILCASS. Telex 25-4359.

Tilton, Fallon, Lungmus & Chestnut, 209 S. LaSalle St. Zip 60604. Tel.: 263-1841. Cable: PATRAC.

Vogel, Dithmar, Stotland, Stratman & Levy, 105 W. Adams St. Zip 60603. Tel.: 372-2552.

Wagner & Aubel, A Professional Corporation, 135 S. LaSalle St. Zip 60603. Tel.: 236-0013.

Wallenstein, Spangenberg, Hattis & Strampel, 135 S. LaSalle St., Suite 2106. Zip 60603. Tel.: 263-7831.

Wegner, Stellman, McCord, Wiles & Wood, 20 N. Wacker Dr. Zip 60606. Tel.: 346-1630. Cable: CHIPAT. TWX 910-221-5147.

Anthony S. Zummer, 134 S. LaSalle St. Zip 60603. Tel.: 236-7017.

• LOS ANGELES METROPOLITAN AREA (Area Code 213)

Armstrong, Hender & Barnett, A Professional Corporation, 1888 Century Park East, Suite 1888. Zip 90067. Tel.: 553-0305.

Arrow, Edelstein Gross & Margolis, 9200 Sunset, Suite 1210. Zip 90069. Tel.: 274-6184.

Sheldon G. Bardach, 1269 Westholme Ave. Zip 90024. Tel.: 475-7353.

Barger & Wolen, 333 S. Hope St., 38th floor. Zip 90071. Tel.: 680-2800. Cable: BARWOL. Telex 181074.

Branch offices: 4299 MacArthur Blvd., Newport Beach, Calif. Tel. (714) 752-5400, 100 Van Ness Ave., 18th floor, San Francisco, Calif. Tel. (415) 552-4900.

Beehler, Mockabee, Arant & Jagger, 3435 Wilshire Blvd., Suite 1100. Zip 90010. Tel.: 385-7087.

Branch office: Beehler, Mockabee, Arant, Jagger & Bethel, 610 Newport Center Drive, Newport Beach, Calif. Tel. (714) 640-0900, 640-0901.

Belcher, Henzie & Biengenzahn, A Professional Corporation, 333 S. Hope St., Suite 3650. Zip 90071. Tel.: 624-8293.

Arthur I. Berman, 9454 Wilshire Blvd., 10th floor, Beverly Hills, Calif. 90212. Tel.: 274-9973.

Henry Bressell, A Professional Corporation, 6820 La Tijera Blvd. Zip: 90045. Tel.: 776-3122. Cable: WATER-GATE.

Blakely, Sokoloff, Taylor & Zafman, 9601 Wilshire Blvd., Suite 244, Beverly Hills, Calif. 90210. Tel.: 550-8282.

Samuel H. Brown, 3701 Wilshire Blvd., Suite 700. Zip 90010. Tel.: 651-3344.

Brown & Brown, A Professional Corporation, 10100 Santa Monica Blvd., Suite 2080. Zip 90067. Tel.: 552-1919, 879-0131.

Buchalter, Nemer, Fields & Chrystie, A Professional Corporation, 700 S. Flower St., 7th floor. Zip 90017. Tel.: 626-6700.

Branch office: 1900 Avenue of the Stars, Suite 1780.

Bushkin, Koppelson, Garms & Gaines, 270 North Canon Drive, 3rd floor, Beverly Hills, Calif. 90210. Tel.: 273-7505. Cable: FILMINTER. TWX 698109.

Cairdin, Kalman & Sampson, 9454 Wilshire Blvd., Suite 209, Beverly Hills, Calif. 90212. Tel.: 274-6971, 272-9041.

Jerome Cohen, 9465 Wilshire Blvd., Suite 725. Zip 90212. Tel.: 274-9387.

Collier, Gillin, Gottesman & Menes, 1901 Ave. Of The Stars, Suite 1240. Zip 90067. Tel.: 277-4895, 879-0594.

Cooper, Epstein & Hurewitz, A Professional Corporation, 9465 Wilshire Blvd., Suite 800, Beverly Hills, Calif. 90212. Tel.: 278-1111. Cable: TRADEMARKS. Telex 698217.

Dern, Mason, Swerdlow & Floom, A Professional Corporation, 700 S. Flower St., 7th floor. Zip 90017. Tel.: 552-0700.

Diamond, Tilm & Colden, 10850 Wilshire Blvd. 12th floor. Zip 90024. Tel.: 879-3444. Cable: DIALAW. Telex 67-4758.

Dolman, Wolfe & Linden, Professional Corporation, 1888 Century Park East, 6th floor. Zip 90067. Tel.: 277-2236.

I. Morley Drucker, A Professional Corporation, 9465 Wilshire Blvd., Suite 328, Beverly Hills, Calif. 90212. Tel.: 278-6852. Cable: DRUPAT.

Joseph S. Dubin, 1880 Century Park East, Suite 1400. Zip 90067. Tel.: 553-2841, 879-4044. Cable: MARKKRIS.

Ervin, Cohen & Jessup, 9401 Wilshire Blvd., 9th floor, Beverly Hills, Calif. 90212. Tel.: 273-6333; 272-7833.

Fain, Lavine, Kaufman & Young, A Professional Corporation, 121 S. Beverly Dr., Beverly Hills, Calif. 90212. Tel.: 275-5132; 272-7807.

Fierstein & Sturman, Law Corporation, 1888 Century Park East, Suite 1500. Zip 90067. Tel.: 553-5500.

Fischer, Shapiro & Krane Law Corporation, 433 N. Camden Drive, Beverly Hills, Calif. 90210. Tel.: 273-7444.

John T. Frankenheimer, 10100 Santa Monica Blvd., Suite 2200. Zip: 90069. Tel.: 552-7783.

Freshman, Marantz, Comsky & Deutsch Law Corporation, 9100 Wilshire Blvd., 9th floor, East Tower, Beverly Hills, Calif. 90212. Tel.: 273-1870, 878-1870.

Gang, Tyre & Brown, 6400 Sunset Blvd. Zip 90028. Tel.: 463-4863. Cable: GANKOT.

Gibson, Dunn & Crutcher, 515 S. Flower St. Zip 90071. Tel.: 488-7000. Cable: GIBTRASK. Telex 67-4930. Telex office: (213) 485-0492.

Branch offices: 2029 Century Park East, Suite 4000, Los Angeles, Calif. 90067. Tel.: (213) 552-8500. Telex 67-4264. Telex office: (213) 273-7220. 660 Newport Center Drive, Suite 1600, Newport Beach, Calif. Tel. (714) 644-2071. Telex office: (714) 644-0432. 600 "B" St., Suite 2300, San Diego, Calif. Tel. (714) 231-1100. Telex office: (714) 231-1100. 818 Connecticut Ave. N.W., Washington, D.C. Tel. (202) 862-5500. Telex: 89-2501. Telex office: (202) 862-5530. 104 Avenue Raymond Poincare, 75116, Paris, France. Tel.: 704-5292. Cable: GIBTRASK PARIS. Telex 613092.

Lessing E. Gold, 8500 Wilshire Blvd., Suite 614, Beverly Hills, Calif. 90211. Tel.: 552-0490, 655-5163.

Goodstein, Copes & Field, 1901 Avenue of the Stars, Suite

1600. Zip 90067. Tel.: 277-0200. Cable: MORWIL. Telex: 67-4039.

Branch office: 660 Newport Center Drive, Suite 545, Newport Beach, Calif. Tel.: (714) 759-1831.

Greenberg & Glusker, 1900 Avenue of the Stars, 20th floor. Zip 90067. Tel.: 553-3610. Cable: GREENLER.

Haberman & Klein Law Corporation, 1901 Avenue of the Stars, Suite 1630. Zip 90067. Tel.: 277-2833. Cable: STANLAW.

Hardee, Barovick, Konecky & Braun, 9665 Wilshire Blvd., Beverly Hills, Calif. 90212. Tel.: 278-2752.

Branch office: One Dag Hammarskjold Plaza, New York, N.Y. Tel. (212) 940-8200.

Harris & Donovan, 611 W. 6th St., Suite 1520. Zip 90017. Tel.: 629-4861.

Hertzberg & Childs, 9454 Wilshire Blvd., Suite 500, Beverly Hills, Calif. 90212. Tel.: 278-8460. Cable: HERCHILD.

Herzig & Walsh, Inc., 9465 Wilshire Blvd., Beverly Hills, Calif. 90212. Tel.: 272-8671. Cable: HERZIPAT.

Huebner & Worrel, 900 Wilshire Blvd., Suite 1000. Zip 90017. Tel.: 626-7766. Cable: HUEPAT.

Branch office: 1171 Fulton Mall, Suite 1202, Fresno, Calif. Tel. (209) 486-4526.

Irell & Manella, 1800 Avenue of the Stars, Suite 900. Zip 90067. Tel.: 879-2600; 277-1010. Cable: IRELLA. Telex: 181258.

Irwin, Hale & Jacobs, 1901 Avenue of the Stars, Suite 1551. Zip 90067. Tel.: 277-3700.

Jacobs & Baumgarten, A Professional Law Corp., 433 N. Camden Drive, 6th floor, Beverly Hills, Calif. 90210. Tel.: 550-8046.

Jessup & Beecher, 2040 Avenue of the Stars, 4th floor. Zip 90067. Tel.: 556-3178.

Branch office: 15233 Ventura Blvd., Suite 716, Sherman Oaks, Calif. Tel.: 788-8330.

Jonas, Fern & Simpson, 10880 Wilshire Blvd., Suite 1115. Zip 90024. Tel.: 475-9711; 879-3960. Cable: CORPLAW. TWX 910-3427570.

James Day, Reavis & Pogue, 2029 Century Park East. Zip 90067. Tel.: 553-3939.

Branch offices: 1700 Union Commerce Bldg., Cleveland, Ohio. Tel. (216) 696-3939. Cable: ATTORNEYS CLEVELAND. 1100 Connecticut Ave., N.W., Washington D.C. Tel. (202) 452-5800. Cable: REPLAW.

Jones & Wilson, 11620 Wilshire Blvd., Suite 300. Zip 90025. Tel.: 478-9756.

Kadison, Pfaelzer, Woodard, Quinn & Rossi, 707 Wilshire Blvd., 40th floor. Zip 90017. Tel.: 688-9000. Cable: GRAYBIN. Telex 67-3230.

Robert O. Kaplan, 12301 Wilshire Blvd., Suite 616. Zip 90025. Tel.: 820-7555.

Kaplan, Livingston, Goodwin, Berkowitz & Selvin, 450 N. Roxbury Dr., Beverly Hills, Calif. 90210. Tel.: 274-8011; 878-0600. Cable: KAPTON. Telex: 67-4858. Telex office: (213) 278-4667.

Maurice H. Katz, A Professional Law Corporation, 1880 Century Park East, Suite 615. Zip 90067. Tel.: 553-4500, 879-2335.

Keatinge, Pastor & Mintz, A Professional Corporation, 700 S. Flower St., 6th floor. Zip: 90017. Tel.: 625-5241. Cable: KEARN. Telex: 69-1208. Telex office: 489-1683.

George David Kieffer, 1888 Century Park East, 21st floor. Zip 90067. Tel.: 556-1500.

Kindel & Anderson, 555 S. Flower St., 26th floor. Zip 90071. Tel.: 680-2222. Cable: KAYANDA. Telex 67-7497.

Branch office: 1020 N. Broadway, Santa Ana, Calif. Tel. (714) 558-7777.

Richard D. Kirshberg, 1800 Avenue of the Stars. Zip 90067. Tel.: 879-2600.

Kleinberg, Morganstern, Scholnick & Mann, A Professional Corporation, 9100 Wilshire Blvd., Suite 710, Beverly Hills, Calif. 90212. Tel.: 550-8161. Cable: INTEL-PROP.

Leonard Korobkin, 1801 Avenue of the Stars, Suite 310. Zip 90067. Tel.: 277-8200.

Lederer & Levy, A Professional Corporation, 433 N. Camden Dr., Suite 1200, Beverly Hills, Calif. 90210. Tel.: 550-0345. Cable: LENLAW.

Norton J. Lehman, 404 N. Roxbury Drive, Beverly Hills, Calif. 90210. Tel.: 273-5614. Cable: LEHLAW.

Levine & Krom, 404 N. Roxbury Dr., Beverly Hills, Calif. 90210. Tel.: 273-3555; 878-4848. Cable: LEVKRO.

Jerome L. Levine, 1801 Century Park East, Suite 2400. Zip 90067. Tel.: 556-1000. TWX: 910-490-2514.

Libott, Yaspian and Mundy, 1888 Century Park East, Suite 1408. Zip: 90067. Tel.: 277-9411.

Lillick, McHose & Charles, 707 Wilshire Blvd. Zip: 90017. Tel.: 620-9000. Cable: IRALILICK. Telex: 67-7013. Telex office: 629-1033.

Branch offices: 2550 5th Ave., Suite 709, San Diego, Calif. 2 Embarcadero Center, 26th floor, San Francisco, Calif. 1225 19th St. N.W., Washington, D.C.

Lindenberg, Freilich, Hornbaker, Wasserman, Rosen & Fernandez, P.C., 10960 Wilshire Blvd., Suite 1434. Zip 90024. Tel.: 477-0578.

Litz & Usher, A Professional Corporation, 9595 Wilshire Blvd., Suite 710, Beverly Hills, Calif. 90212. Tel.: 273-4330; 878-4330.

Loeb and Loeb, One Wilshire Blvd., 16th floor. Zip: 90017. Tel.: 629-0200; 278-7351. Cable: LOBAND. Telex 67-3106. Telex office: 629-0435.

Branch offices: 10100 Santa Monica Blvd., Suite 2200. Zip: 90067. Tel.: 552-7700. Telex office: 552-7750. 550 Newport Center Drive, Suite 555, Newport Beach, Calif. Tel. (714) 759-1272.

Walter L. M. Lorimer, 1801 Century Park East. Zip 90067. Tel.: 879-1500.

Loveless, Simon & Migdal, 5900 Wilshire Blvd., Suite 2100. Zip 90036. Tel.: 938-4251.

Lyon & Lyon, 800 Wilshire Blvd., 9th floor. Zip: 90017. Tel.: 489-1600.

Maiden, Rosenbloom & Wintroub, 1930 Century Park West, Suite 400. Zip 90067. Tel.: 277-0440; 879-1570.

Manatt, Phelps, Rothenberg & Tunney, 1888 Century Park East, 21st floor. Zip 90067. Tel.: 556-1500. Cable: MANATOP. Telex 910 490-5744.

Mason & Sloane, 9200 Sunset Blvd., Suite 1207. Zip 90069. Tel.: 273-8351.

Maupin Chaum Cutler & Teplinsky, 1801 Century Park East, Suite 910. Zip: 90067. Tel.: 879-3051.

Memel, Jacobs, Pierno & Gersh, 1801 Century Park East, 25th floor. Zip: 90067. Tel.: 556-2000. Cable: LAVOCAT LSA. Telex (TWX): (910) 490-5923.

Branch offices: 555 Capitol Mall, Suite 785, Sacramento, Calif. Tel.: (916) 446-6941. 610 Newport Center Drive, Suite 1530, Newport Beach, Calif. Tel.: (714) 640-9244.

Miller, Glassman & Browning, Inc., 360 N Bedford Dr., Beverly Hills, Calif. 90210. Tel.: 278-5100; 8781600. Cable: MILLAW.

Mitchell, Silberberg & Knupp, 1800 Century Park East, 9th floor. Zip: 90067. Tel.: 553-5000. Cable: SILMITCH. Telex: 69-1347.

Henry T. Moore, Jr., 1901 Avenue of the Stars, Suite 1475. Zip: 90067. Tel.: 879-0505; 879-0888. 277-8888.

Nilsson, Robbins, Dalgam, Berliner, Carson & Wurst, 707 Wilshire Blvd., Suite 4750. Zip: 90017. Tel.: 620-0600. Cable: LAPAT.

O'Melveny & Meyers, 611 W. 6th St. Zip: 90017. Tel.: 620-1120. Cable: MOMS.

Branch offices: 1800 Century Park East. Zip: 90067. Tel.: 553-6700. 4 Place de la Concorde, Paris 8e, France. Tel.: 265 39-33. Cable: MOMS PARIS. 1800 M Street N.W., Washington, D.C. Tel.: (202) 457-5300.

Pacht, Ross, Warne, Bernhardt & Sears, Inc., 1800 Avenue of the Stars, Suite 500. Zip: 90067. Tel.: 277-1000; 879-2020. Cable: PAWARB. TWX: 910 4902597.

Averill C. Passarov, 6380 Wilshire Blvd. Zip: 90048. Tel.: 653-2321.

Phillips, Moore, Weissenberger, Lempio & Majestic, 700 S. Flower St., Suite 509. Zip: 90017. Tel.: 627-6319.

Branch offices: 3 Embarcadero Center, 29th floor, San Francisco, Calif. Tel.: (415) 421-2674. 2 N. 2nd St., Suite 225, San Jose, Calif. Tel.: (408) 287-8278. 1500 Newell Ave., Walnut Creek, Calif. Tel.: (415) 932-4211.

Pollock, Pollock and Fay, A Professional Corporation, 1888 Century Park East, Suite 1520. Zip: 90067. Tel.: 879-0111; 553-3811.

Pollock, Rigrod and Bloom, 9255 Sunset Blvd. Zip: 90069. Tel.: 278-8622. Cable: PRELAW.

Poms, Smith, Lande & Glenn, Professional Corporation, 1888 Century Park East, Suite 1000. Zip: 90067. Tel.: 879-4181; 277-4181. Cable: POMPAT. Telex: 698271.

Todd Russell Reinstein, A Professional Corporation, 1880 Century Park East, Suite 615. Zip: 90067. Tel.: 553-4500; 879-2335.

Michael L. Robins, 2049 Century Park East, Suite 1800. Zip: 90067. Tel.: 879-4407.

Rogers & Harris, 9200 Sunset Blvd., Suite 404. Zip: 90069. Tel.: 278-3142; 272-8489.

Romney, Schaap, Golant, Scillari, Disner & Ashen, 9720 Wilshire Blvd., 6th floor, Beverly Hills, Calif. 90212. Tel.: 550-7121.

Rosenfield, Meyer & Susman, 9601 Wilshire Blvd., 4th floor, Beverly Hills, Calif. 90210. Tel.: 271-9144. Cable: ROMERSU.

R. R. Rosenthal, 12301 Wilshire Blvd., Suite 610. Zip: 90025. Tel.: 820-8585.

Roston and Schwartz, A Professional Corporation, 5900 Wilshire Blvd, Suite 1430. Zip: 90036. Tel.: 938-3657. Cable: ROSCHPAT.

Rudin and Perlstein, 9601 Wilshire Blvd., Suite 526. Beverly Hills, Calif. 90210. Tel.: 278-6060. Cable: RUD-LAW.

Rutter & Ebbert, 1900 Avenue of the Stars, Suite 2200. Zip: 90067. Tel.: 879-9494.

Schiff, Hirsch and Schreiber, Professional Corporation, 9777 Wilshire Blvd., Suite 800, Beverly Hills, Calif. 90212. Tel.: 278-1500; 878-2500. Cable: LITLAW. Telex: 69-8267.

J. Brin Schulman, 1888 Century Park East. Zip: 90067. Tel.: 553-5500.

Schurmer, Drane, Bullis & McCarthy, 10880 Wilshire Blvd., Suite 1000. Zip: 90024. Tel.: 475-0651; 879-1428.

Branch offices: 233 E. Carrillo St., Santa Barbara, Calif. Tel.: (805) 962-6464. 619 S. Broadway, Santa Maria, Calif. Tel.: (805) 922-7869.

Sedgwick, Detert, Moran & Arnold, 3600 Wilshire Blvd., Suite 1934. Zip: 90010. Tel.: 386-2833.

Branch office: 111 Pine St., 11th floor, San Francisco, Calif. Tel.: (415) 982-0303. Cable: SEDMA. Telex: 356455. Telecopier: (415) 982-0303.

Selvin and Weiner, A Professional Corporation, 1900 Avenue of the Stars, Suite 2400. Zip: 90067. Tel.: 277-1555; 879-1555. Cable: SELCOLAW.

Shahin, Wawro & Lorimer, A Law Corporation, 1801 Century Park East. Zip: 90067. Tel.: 556-0200; 879-1500.

Shearer, Fields, Rohner & Shearer, 9255 Sunset Blvd., Suite 616. Zip: 90069. Tel.: 272-8252; 274-5434.

Simon & Sheridan, 2404 Wilshire Blvd., Suite 400. Zip: 90057. Tel.: 380-3330.

Silverberg, Rosen, Leon, 2029 Century Park East, Suite 1900. Zip: 90067. Tel.: 879-2818.

Sklar, Coben, Stashower, Kelly & Knapp, Inc., 6399 Wilshire Blvd. Zip: 90048. Tel.: 651-2333; 651-5130. Cable: CODALEX.

Slaff, Mosk & Rudman, 9200 Sunset Blvd., Suite 825. Zip: 90069. Tel.: 275-5351. Cable: SEMINAR. Telex: 69-8309.

Slavitt, King & Weiser, A Law Corporation, 2049 Century Park East, Suite 900. Zip: 90067. Tel.: 553-1600. Telex: 67-4305.

Owen J. Sloane, P.C., 1888 Century Park East, Suite 1500. Zip: 90067. Tel.: 277-6635.

Smaltz & Neelley, 523 W. 6th St., Suite 440. Zip: 90014. Tel.: 625-1666.

Chester Leo Smith, 10889 Wilshire Blvd., Suite 1245. Zip: 90024. Tel.: 477-0046; 270-4147.

Smyth, Pavitt, Siegmund, Jones & Martella, A Professional Corporation, 4262 Wilshire Blvd., Suite 320. Zip: 90010. Tel.: 938-6251. Cable: INTERPAT.

Spensley, Horn, Jubas & Lubitz, 1880 Century Park East, Suite 500. Zip: 90067. Tel.: 553-5050. Cable: TECH-LAW.

Stephens, Martin & Mandel, A Professional Corporation, 555 S. Flower St., Suite 2020. Zip: 90071. Tel.: 629-3111.

Stern & Stambul, A Professional Corporation, 11661 San Vicente Blvd., Suite 1010. Zip: 90049. Tel.: 476-7311; 272-9216.

Robert H. Touralet, 1880 Century Park East, Suite 1418. Zip: 90067. Tel.: 972-0101. Cable: TORLAW.

Troy, Main & Pottinger, Professional Corporation, 1801 Century Park East, 16th floor. Zip: 90067. Tel.: 553-4441. Cable: TROMALAW. Telex: 69-1737.

Branch offices: 44 Avenue des Champs Elysees, Paris, France. Tel.: 256 14 00. Telex: 280023. 2033 M St. N.W., 7th floor, Washington, D.C. Tel.: (202) 466-4560. Telex: 8-9590.

Raymond Wallenstein, 2049 Century Park East, Suite 1550. Zip: 90067. Tel.: 553-6002. Cable: WALFED.

Ward & Heyler, 1901 Avenue of the Stars, Suite 1475. Zip: 90067. Tel.: 879-0888; 277-8888.

Jerome E. Weinstein, A Professional Corporation, 9401 Wilshire Blvd., Beverly Hills, Calif. 90212. Tel.: 274-7157; 274-6863.

Weisman and Grush, A Professional Corporation, 1880 Century Park East, Suite 817. Zip: 90067. Tel.: 553-4337; 879-2810. Cable: JUGLAS.

Whann & McManis, 315 W. 9th St., Suite 920. Zip: 90015. 622-7163.

Branch office: 510 Tumble Creek Lane, Fallbrook, Calif. Tel.: (714) 726-4764.

Jack A. Whitley II, 6331 Hollywood Blvd., Suite 414. Zip: 90028. Tel.: 461-8186.

Wills, Green & Muehl, Law Corporation, 700 S. Flower St., Suite 1120. Zip: 90017. Tel.: 688-7407. Cable: WILL-PAT.

Joseph Wolf, 10960 Wilshire Blvd. Zip: 90024. Tel.: 477-7011; 879-1795. Cable: FIRFILMICAL. TWX: 910-3426491. Filmlaw LSA.

Werner Wolfen, 1800 Avenue of the Stars, Suite 90. Zip: 90067. Tel.: 277-1010.

Wyman, Bautzer, Rothman & Kutchel, 2049 Century Park East, 14th floor. Zip: 90067. Tel.: 556-8000; 879-8000. Cable: WYBAROK. Telex: 69-1304.

Branch office: 600 New Hampshire Ave., N.W., Washington, D.C. Tel.: (202) 466-2222.

Youngman, Hungate & Leopold, 1801 Century Park East, Suite 1101. Zip: 90067. Tel.: 277-3333. Cable: YOLEO.

Ziffren and Ziffren, 10889 Wilshire Blvd., Suite 1260. Zip: 90024. Tel.: 478-0377; 272-6557.

• NASHVILLE (Area Code 615)

Richard L. Albers, 5131 Brucewood Dr. Zip: 37211. Tel.: 832-0138.

H. Stanley Allen, Jr., Life & Casualty Tower. Zip: 37219. Tel.: 244-0847.

Barksdale, Whalley, Gilbert and Frank, 7th Floor, Third National Bank Bldg. Zip: 37219. Tel.: 244-0020.

Jean Nelson Beckner, P. O. Box 2757. Zip: 37219. Tel.: 244-4994.

Craig Benson, 112 21 Ave. S. Zip: 37203. Tel.: 327-3334.

William T. Bozeman, P. O. Box 2829. Zip: 37219. Tel.: 256-2134.

Dennis Brewington, American Trust Bldg., 305 Union St. Zip: 37201. Tel.: 255-4497.

Gerald Authur Burkett, Stahlman Bldg., Suite 531. Zip: 37201. Tel.: 242-9489.

Laurence Canter, 4515 Harding Rd., Suite 303. Zip: 37205. Tel.: 383-3190.

W. Ovid Collins, Jr., Third National Bank Bldg., 18th Floor. Zip: 37219. Tel.: 244-1440.

Kinian Cosner, First American Ct. Zip: 37238. Tel.: 259-2179.

Harlan Dodson, P. O. Box 2524. Zip: 37219. Tel.: 244-6840.

Fred O. Ellis, Jr., 112 21 Ave. S. Zip: 37203. Tel.: 327-3334.

Farris, Evans & Warfield, 18th Floor, Third National Bank Bldg. Zip: 37219. Tel.: 244-5200.

Richard H. Frank, Jr., Third National Bldg., Seventh Floor. Zip: 37219. Tel.: 244-0020.

Goodpasture, Carpenter & Woods, Suite 1911, One Commerce Pl. Zip: 37239. Tel.: 244-2042.

S. Ralph Gordon, 404 James Robertson Pkwy., Parkway Towers, Suite 1112. Zip: 37219. Tel.: 244-1568.

Jack Green, 201 Thompson Ln., Suite 2. Zip: 37211. Tel.: 834-0456.

James H. Harris III, 2 Music Circle South. Zip: 37203. Tel.: 259-4507.

Aubrey B. Harwell, Jr., 800 3rd National Bank Bldg. Zip: 37219. Tel.: 244-1713.

Jonathan Harwell, 400 Home Federal Bldg. Zip: 37219. Tel.: 256-0500.

Don Hildebrand, 214 3rd Ave. N. Zip: 37201. Tel.: 244-2070.

Hooker, Keeble, Dodson & Harris, P.O. Box 2524. Zip: 37201. Tel.: 244-6840.

Rodger B. Kesley, United American Bank Bldg., Suite 1110. Zip: 37219. Tel.: 244-0267.

Harrington A. Lackey, 1033 Stahlmann Bldg. Zip: 37201. Tel.: 254-0371.

Lewis Laska, 1231 17 Ave. S. Zip: 37212. Tel.: 251-1251.

Charles A. Leach, 2 Music Circle S. Zip: 37203. Tel.: 259-4507.

Jude T. Lenahan, 217 Second Ave. N. Zip: 37201. Tel.: 244-2202.

John Lentz, 226 Third Ave. N. Zip: 37201. Tel.: 327-3000.

Ralph Levy, Jr., 6501 Harding Rd. N-21. Zip: 37205. Tel.: 244-0020.

David Ludwick, 3rd National Bank Bldg., 7th fl. Zip: 37219. Tel.: 244-0020.

Richard R. Lynn, 2016 Parkway Towers. Zip: 37219. Tel.: 242-1886.

H. McKinley Marlow, Jr., 404 James Robertson Pkwy., Suite 107. Zip: 37219. Tel.: 259-9288.

Robert G. McDowell, United American Bank Bldg., Suite 1110. Zip: 37219.

W. Michael Milom, Third National Bank Bldg., Seventh Floor. Zip: 37219. Tel.: 244-0020.

Malcolm L. Mimms, Jr., Third National Bank Bldg., Seventh Floor. Zip: 37219. Tel.: 244-0020.

Pack & Price, 18th Floor, Life And Casualty Tower. Zip: 37219. Tel.: 244-0626.

Rose Palermo, 43 Music Square W. Zip: 37203. Tel.: 244-4270.

Stephen K. Rush, Third National Bank Bldg., Seventeenth Floor. Zip: 37219. Tel.: 244-5200.

Val Sanford, P. O. Box 2757. Zip: 37219. Tel.: 244-4994.

Joe Saperstein, 100 25th Ave. N., Suite 1001. Zip: 37203. Tel.: 327-4280.

Grant W. Smith, P. O. Box 2725, 100 J.C. Bradford Bldg. Zip: 37219. Tel.: 244-3696.

James Randolph Smith, 2016 Parkway Towers. Zip: 37219. Tel.: 242-1886.

Robert L. Sullivan, 800 3rd National Bank Bldg. Zip: 37204. Tel.: 244-1713.

W. Robert Thompson, 2 Music Circle S. Zip: 37203. Tel.: 259-4507.

Eugene W. Ward, A-103 Cordell Hull Bldg. Zip: 37219. Tel.: 741-3191.

Larry L. Westbrook, P. O. Box 15324. Zip: 37215. Tel.: 383-3327.

Willis & Knight, 700 Union St. Zip: 37219. Tel.: 259-9600.

Larry Woods, 121 17 Ave. S. Zip: 37203. Tel.: 259-4366.

Woods & Woods, A Professional Association, 121 17 Ave. S. Zip: 37203. Tel.: 259-4366.

• NEW YORK METROPOLITAN AREA (Area Code 212)

Abeles, Clark and Osterberg, 4 E. 52nd St. Zip: 10022. Tel.: 755-0812. Cable: LAWANLAW.

Amster, Rothstein & Engleberg, 90 Park Ave. Zip: 10016. Tel.: 697-5995. Cable: AMROTHPAT. Twx: (710) 581-4766.

Anderson & Goldman, 295 Madison Ave. Zip: 10017. Tel.: 679-2400. Cable: ANGOATLY. Tlx: 236-402.

Arrow, Edelstein, Gross & Margolis, P.C., 1370 Avenue of the Americas. Zip: 10019. Tel.: 586-1451. Cable: SUM-MALEX. Tlx: 224-600.

Branch office: 9200 Sunset Blvd., 90069. Los Angeles, California. Tel.: (213) 274-6184. Cable: SUM-MACAL.

Arum, Friedman & Katz, 450 Park Ave. Zip: 10022. Tel.: 644-9800.

Austrian, Lance & Stewart, P.C. 630 5th Ave. Zip: 10020. Tel.: 489-9500. Cable: AUSTRANCE. Tlx: WU 126-719. "Subject NYK." RCA 235-941 "ALSUR."

Barandes, Rabbino & Arnold, 18 E. 48th St. Zip: 10017. Tel.: 421-7070. Cable: BARRABARN. Tlx: 42-8768.

Becker & London, 15 Columbus Circle. Zip: 10023. Tel.: 541-7070. Cable: BECLOND.

Beldock, Levine & Hoffman, 565 5th Ave. Zip: 10017. Tel.: 490-0400. Cable: TELHOFFLAW. Tlx: 42-2046.

Bierman & Bierman, 437 Madison Ave. Zip: 10022. Tel.: 752-7550. Cable: PATENLAW. Tlx: 423-527.

Branch office: 202 Manaronek Ave., White Plains. Tel.: (914) 948-1384.

Blum, Moscowitz, Friedman & Kaplan, 730 Third Ave., 10017. Tel.: 867-2200. Cable: MOSBLUM. Tlx: 4262971.

Bobrow, Greenapple, Burton, Distler & Midler, A Partnership Including A Professional Corporation, 919 Third Ave. Zip: 10022. Tel.: 752-2604.

Brooks, Haidt, Haffner & Delahunty, 99 Park Ave. Zip: 10016. Tel.: 697-3355. Cable: BROHAD. Tlx: 236306.

Brumbaugh, Graves, Donohue & Raymond, 30 Rockefeller Plaza. Zip: 10020. Tel.: 489-3300. Cable: CAM-BRUFREE. Tlx: 238555.

Burgoyne, Rose, 451 Fifth Ave. Zip: 10017. Tel.: 986-0060.

Burns, Jackson, Miller, Summit & Jacoby, 445 Park Ave. Zip: 10022. Tel.: 980-3200. Cable: BURNLEX. Tlx: 74-8376.

Branch office: 1025 Fifteenth St. NW, Washington, DC. Tel.: (202) 659-3300.

Burns, Lobato & Adams, P.C., 253 Broadway. Zip: 10007. Tel.: 732-1570. Cable: BURNLAW. ITT Tlx: 421-487. RCA Tlx: 235-451.

Cohn, Glickstein, Curie, Ostrin & Lubell, 1370 Avenue of the Americas. Zip: 10019. Tel.: 757-4000. Cable: COH-GLICK.

Colton, Weissberg, Hartnick & Yarnin, 505 Park Ave. Zip: 10022. Tel.: 371-4350. Cable: EDECOLT NEWYORK.

Connor & Chopnick, 9 E. 46th St. Zip: 10017. Tel.: 697-8130. Cable: LACONIC.

Cooper, Dunham, Clark, Griffin and Moran, 30 Rockefeller Plaza. Zip: 10020. Tel.: 977-9550. Cable: KERCURTIS. Tlx: 422-523 COOP VI.

Cowan, Leibowitz & Latman, P.C., 200 E. 42nd St. Zip: 10017. Tel.: 986-6272. Cable: COWLIELAT. Tlx: 428143.

Curtis, Morris & Safford, P.C., 530 Fifth Ave. Zip: 10036. Tel.: 682-7171. Cable: CUMOSAT. Tlx: 222517.

Q: Who wrote the book in Tape/Audio/Video fact-finding?

A: Billboard. It's called The Tape/Audio/Video Market Sourcebook. Where three industries rely on one source.

GRANDMOTHER HANDED DOWN A LOT MORE THAN HER CHINA.



Grandmother was a child abuser. No one ever taught her how to be a good parent. Or how to cope with her problems. Helpless as she was, Grandmother took those problems out on her daughter. Today that daughter has children of her own. They endure child abuse from a mother who learned it from Grandmother. **Help destroy a family tradition.** It is estimated that there are at least one million cases of child abuse in America every year. And many of the children in those cases grow up to be child abusers themselves. Child abusers can be helped. Find out how.

PREVENT CHILD ABUSE. WRITE:



National Committee for
Prevention of Child Abuse.
Box 2866, Chicago, Ill. 60690.

Darby & Darby, Professional Corporation, 405 Lexington Ave. Zip 10017. Tel. 697-7660. Cable YBRAD.

Davis & Gilbert, 850 Third Ave. Zip 10022. Tel. 593-0707. Cable DAVANGIL. Tlx 12-6593.

Davis, Hoxie, Faithful & Hargood, 45 Rockefeller Plaza. Zip 10020. Tel. 757-2200. Cable EXPLICIT. Tlx 12-8162. Int'l Tlx 42-1236.

Delson & Gordon, 230 Park Ave. Zip 10017. Tel. 661-9800. Cable DELEGOR. Tlx: 23-6153. Twx 710-581-4437.

Branch office: 840 Ellison Ave., Westbury, NY. Tel. (516) 222-0020. 1900 L St., NW, Washington, DC. Tel. (202) 833-9540. Zip 20036. 145 Main St., West Port, Conn. Tel. (203) 226-3366. Zip 06880. Gani Djemat & Associates, Iman Bonjaf 76-78, Jakarta, Indonesia. Tel. 56341. Cable GASSLAW. Tlx 44114.

Eyre, Mann, Lucas & Just, 155 E. 44th St. Zip 10017. Tel. 682-4980. Cable ANMANN.

Feit & Ahrens, 488 Madison Ave. Zip 10022. Tel. 371-6220. Cable LAWSMAT. Tlx 238527.

John R. Fernbach, 1350 Avenue of the Americas. Zip 10019. Tel. 246-2000.

Fiddler And Levine, 3424 Empire State Building. Zip 10001. Tel. 279-6088. Cable FIDPATRA.

Fish & Neave, 277 Park Ave. Zip 10017. Tel. 826-1050. Cable FISHNEAVE. Tlx 12-5806.

Franklin, Weinrib, Rudell & Vassallo, 950 Third Ave. Zip 10022. Tel. 935-5500. Tlx 42-7453.

Frankfurt, Garbus, Klem & Selz, 485 Madison Ave. Zip 10022. Tel. 980-0120. Cable MATMITO.

Phillip Furgang, 605 3rd Ave., 11th Floor. Zip 10016. Tel. 226-5159. Cable FURGANGLAW. Tlx 42-5658.

Goldstein & Schrang, 99 Park Ave. Zip 10016. Tel. 986-3036. Cable STANHERBAT.

Gottlieb, Rackman & Reisman, P.C. 260 Madison Ave. Zip 10016. Tel. 689-0040. Cable COPATMARK. Tlx 23-9398.

Granett & Gold, P.C., 1350 Avenue of the Americas. Zip 10019. Tel. 246-2060.

Greenbaum, Wolff & Ernst, 437 Madison Ave. Zip 10022. Tel. 758-4010. Cable GREWOLFERN. Tlx: ITT 423007. RCA 236009.

Greenwald, Kouner & Goldsmith, 521 Fifth Ave. Zip 10017. Tel. 687-6660. Cable HAGREENLAW.

John B. Griffin, 60 E. 42nd St. Zip 10017. Tel. 687-9099. Cable GRIFFINLAW.

Hall, Dickler Lawler, Kent & Howley, 460 Park Ave. Zip 10022. Tel. 838-4600. Cable HALCASRO.

Hall, McNichol, Hamilton & Clark, 330 Madison Ave. Zip 10017. Tel. 682-3060. Cable LANDWATER.

C. Bruce Hamberg, 535 Fifth Ave. Zip 10017. Tel. 986-2340. 986-2341. Cable PATENTMARK.

Hardee, Barovick, Koneck & Braun, One Dag Hammarskjold Plaza. Zip 10017. Tel. 940-8200. Cable HARBARKGG. Tlx 12-7231.

Branch office: 9665 Wilshire Blvd., Beverly Hills, CA. (213) 278-2752.

Harris & Pienek, P.C., 425 Park Ave. Zip 10022. Tel. 935-5810. Cable LEWLENCEL.

Hess, Segall, Guterman, Pelz & Steiner, 230 Park Ave. Zip 10017. Tel. 689-2400. Cable TIMMY. Tlx 12-7400.

Holland, Armstrong, Wilkie & Preuito, Empire State Bldg. Zip 10001. Tel. 736-2080.

Hopgood, Calimafore, Kallil, Blaustein & Lieberman, 60 E. 42nd St. Zip 10017. Tel. 986-2480. Cable ARCEEHOP.

Hubbell, Cohen, Stiefel & Gross, 551 5th Ave. Zip 10017. Tel. 687-1360. Cable HUPATLAW. Tlx 42-3051.

Jacobs & Jacobs, 521 Fifth Ave. Zip 10017. Tel. 687-1636. Cable PATRADELAW. Tlx 42-1751.

Janklow & Traum, 375 Fifth Ave. Zip 10022. Tel. 421-1700. Cable JANKKRAUM. Tlx 23-5272.

Javitz & Javitz, 1345 Avenue of the Americas. Zip 10019. Tel. 586-4050. Cable BAJJULTS. Tlx RCA 23-7188. Teletypewriter (212) 586-4053.

Johnson & Tannenbaum, 250 W. 57th St., 10019. Tel. (212) 265-4072, 265-4073.

Kane, Dalsimer, Kane, Sullivan and Kurvez, 420 Lexington Ave. Zip 10017. Tel. 687-6000. Cable DUELSON. Tlx ITT 42-6767.

Kenyon & Kenyon, Reilly, Carr & Chapin, 59 Maiden Lane. Zip 10038. Tel. 425-7200. Night Line 425-7205. Cable AMAXIA. Int'l Tlx 42-2141. Domestic Tlx 12-7799. Teletypewriter (212) 425-5288.

Evelyn B. King, 215 E. 68th St. Zip 10021. Tel. 628-5500.

Kirschstein, Kirschstein, Ottinger & Corrin, P.C., 666 Fifth Ave. Zip 10019. Tel. 581-8770. Cable KIRSCHMOR. Tlx 42-7115. KKF06 VI.

Harold S. Klein, 4 W. 56th St. Zip 10019. Tel. 757-4611.

Krause, Hirsch & Gross, 41 E. 42nd St. Zip 10017. Tel. 986-1122. Cable KRAUSCHIRSH.

Lackenbach, Lilling & Siegel, 41 E. 42nd St. Zip 10017. Tel. 986-7630. Cable BURTIJIM. Tlx 23-6181.

Branch offices: One Chase Road, Scarsdale, NY. Tel. (914) 723-6444. Zip 10583. Cable BURTJIM SCARSDALE.

Lankenau Kovner & Bickford, 30 Rockefeller Plaza. Zip 10020. Tel. 489-8230. Telex 237522 LKB. Cable LANKOFORD.

Lans, Feinberg & Cohen, 555 Madison Ave. Zip 10022. Tel. 421-0700. TWX: 710-581-2711. Cable: SIMASH.

Branch offices: 1801 Century Park East, Century City. Zip 90067. Tel. (213) 556-1000. TWX 910-490-2514.

Laporte & Meyers, 1 East 57th Street. Zip 10022. Tel. 421-9390.

Lewin, Harley I. 888 Seventh Ave. Ste 2400. Zip 10019.

Liddy, Sullivan, Hart, Daniels & Stemple, 253 Broadway. Zip 10007. Tel. 267-7400. Cable LISHADS.

Linden & Deutsch, 110 East 59th Street. Zip 10022. Tel. 758-1100. Cable ANALOGUE. New York. Telex 424286.

Mandeville & Schweitzer, 230 Park Avenue. Zip 10017. Tel. 986-3377. Cable MANSWEITZ.

Arthur A. March, 60 East 42nd Street. Zip 10017. Tel. 661-3686. Cable MAILVIES.

McAulay, Fields, Fisher & Goldstein, 20 Exchange Place. Zip 10005. Tel. 248-5330. Cable LAURJAMES.

McGrinley, Jones & Lederer, 220 East 42nd Street. Zip 10017. Tel. 682-5686.

Migdal, Tenney, Glass & Pollack, 598 Madison Avenue. Zip 10022. Tel.: 832-4900. Cable: RAMIGLO. Telex: 66388.

Milgrin Thomajan & Jacobs, 25 Broadway. Zip 10004. Tel. 952-9292. Cable MILATOM. Telex 12-6965.

Morgan, Finnegan, Pine, Foley & Lee, 345 Park Avenue. Zip 10022. Tel. 758-4800. Cable FINDURPINE. Telex ITT 421792.

Nims, Howes, Collison & Isner, 60 East 42nd Street. Zip 10017. Tel. 682-4590. Cable NIMS.

Nolte & Nolte, P.C., 405 Lexington Avenue. Zip 10017. Cable EQUILAW.

Branch offices: 350 Jericho Turnpike, Jericho, New York. Zip 11753. Tel. (516) 935-0180. Washington Building, Washington, D.C. Tel. (202) 628-3375.

Harold Orenstein, P.C., 110 West 57th Street. Zip 10019. Tel. 247-6460. Cable HOMUSLAW. Telex 237409.

Ostrotenk, Faber, Gerb & Soffen, 260 Madison Avenue. Zip 10016. Tel. 685-8470. Cable OSTROFABER. Telex 2306925.

O'Sullivan Wolff Karabell & Graev, 280 Park Avenue. Zip 10017. Tel. 661-3600. Cable APPLELAW.

Parcher & Herbert, 1370 Avenue of the Americas. Zip 10019. Tel. 586-1451.

Parker, Duryee, Zunino, Malone & Carter, 1 East 44th Street, Suite 3300. Zip 10017. Tel. 573-9330. Cable PAR-DUR.

Paskus, Gordon & Hyman, 733 Third Avenue. Zip 10017. Tel. 557-9300. Cable PACOLOGO. Telex 148325.

Pacologo NYK, Teletypewriter 687-4035.

Pennie & Edmonds, 330 Madison Avenue. Zip 10017. Tel. 986-8686. Cable PENANGOLD. Telex 66141-Pennie.

Branch offices: Pennsylvania Building, Washington D.C. Zip 20004. Tel. (202) 628-6138.

Pepper & Pepper, 55 Liberty Street. Zip 10005. Tel. 964-0285.

Phillips, Nizer, Benjamin, Krim & Bailon, 40 West 57th Street. Zip 10019. Tel. 977-9700. Cable PHILLNIZER. Telex 126127.

Pryor, Cashman, Sherman & Flynn, 410 Park Avenue. Zip 10022. Tel.: 421-4100. Telex 640221. Cable PRYCOURT.

Branch Office: 9665 Wilshire Blvd., Beverly Hills, California. Zip 90212. Tel. (213) 278-6624.

Regan Goldfarb Heller Wetzler & Quinn, 445 Park Avenue. Zip 10022. Tel. 754-3000. Cable REGOLAW. Telex 125843.

Branch Office: 9601 Wilshire Blvd., Beverly Hills, California. Zip 90210. Tel.: (213) 273-5540.

Rembar, Wolf & Curtis, 19 West 44th Street. Zip 10036. Tel.: 575-8500. Cable REMBARLAW.

Rogers & Wells, Pan Am Building, 200 Park Avenue. Zip 10017. Tel. 972-7000. Cable YOSKLAW, New York. Telex 224493.

Branch offices: 1666 K St., N.W., Washington, Zip 20002 D.C. Tel. (202) 331-7760. Cable WALAW, Washington. Telex 248439. 75008 Paris, France. Office: 24, Rue de Madrid. Tel. 522-42-20. Cable EUR-LAW, Paris. Telex 290617. London EC2A 1AD, England. Office One Finsbury Square. Tel. 01-628-0101. Cable USLAE, London. Telex 884964.

Roth & Bucholz, 52 Park Avenue. Zip 10016. Tel. 889-8530. Cable ROTHBUC.

Ryan and Silberberg, 200 Park Avenue. Zip 10017. Tel. 687-1470. Cable SILRLAW.

Sargoy, Stein & Hanft, 105 Madison Avenue. Zip 10016. Tel.: 889-1420.

Schwab & Goldberg, 1185 Avenue of the Americas, 36th Floor. Zip 10036. Tel. 575-8150. Cable NOMOSUS.

Conrad Shadlen, 375 Park Avenue, Suite 3403. Zip 10022. Tel. 752-5250. Cable LAWSHADLEN, New York. Telex 234869.

Siegel, Khalif & Winn, P.C., 261 Madison Avenue. Zip 10016. Tel.: 697-6625. Cable: HYGALCO. Telex 237064.

Silverman & Shulman, P.C., 1370 Avenue of the Americas. Zip 10019. Tel. 586-1451. Telex 224600.

Smith, Steibel, Alexander & Sankor, P.C., 460 Park Avenue. Zip 10022. Tel. 751-2660. Cable YORKSMITH, New York. Telex 424036.

Solinger & Gordon, 250 Park Avenue. Zip 10017. Tel. 687-1140. Cable SOLGOLAW.

Stuart & Zavin, 60 East 42nd Street, Suite 2340. Zip 10017. Tel. 661-5380.

Toren, McGeady and Stanger, P.C., 521 Fifth Avenue. Zip 10017. Tel. 867-2912. Cable TORPATENT. Telex 236025 torp.

Townsend Rabinowitz Pantaleoni & Valente, 575 Madison Avenue. Zip 10022. Tel. 688-4443. Cable TOWRAPAN.

Turchin & Topper, 60 East 42nd Street. Zip 10017. Tel. 661-0420.

Watson Leavenworth Kelton & Taggart, 100 Park Avenue. Zip 10017. Tel. 683-4220. Cable WATSOLAW. Telex 620866.

Wehringer & Kojima, 25 West 43rd Street. Zip 10036. Tel. 736-9380. Cable CAMWEHR, New York.

Branch office: RFD No 3, Cameron Kingsley Wehringer, Washington, New Hampshire. Zip 03280. Tel. (603) 478-3223.

Weiss Dawid Fross & Lehrman, 880 Third Avenue. Zip 10022. Tel. 826-0770. Cable LEHRMARKS, New York. Telex 422455.

Weissberger & Harris, 120 East 56th Street. Zip 10022. Tel. 758-0800. Cable ARNWEISLAW, New York.

Wolder & Gross, 521 Fifth Avenue. Zip 10017. Tel. 687-3233. Cable WOLGROSPAT, NEWYORK.

Wyatt, Gerber, Shoup & Reardon, 261 Madison Avenue. Zip 10016. Tel. 687-0911. Cable GEDRIGHT. Telex ITT-421733.

Carl L. Zanger, 500 Fifth Avenue. Zip 10036. Tel. 840-2940.

Zelnick & Bressler, One World Trade Center, Suite 1535. Zip 10048. Tel. 466-1123. Cable LEGIBUS. Telex 424848.

Zissu, Stein, Couture & Mosher, 270 Madison Avenue. Zip 10016. Tel. 683-5320. Cable ZISMARC.

SUPPLIES

For The U.S. Music-Record-Tape Industry

CARTRIDGE & CASSETTE PARTS MANUFACTURERS

Alinabal (div. of MPB Corp.), 28 Woodmont Rd., Millford, Conn 06460 Tel: (203) 877-3241 Prod. Sales Mgr.: John Robertson.

Audio: Liners, pressure pads & shields

Ampex Corp. Magnetic Tape Div., 401 Broadway, Redwood City, Calif. 94063 Tel: (415) 367-2011 Pres. A.H. Hausman, Sales Mgr.: R.A. Antonio, Adv. Mgr.: A. Fisher

Sales offices: Glendale, Calif., 500 Rodier Dr. Zip 91201 Tel: (213) 240-5000—Denver, Colo., 2121 S. Birch, Zip 80222 Tel: (303) 757-6491—Orlando, Fla., PO Box 15008-B Zip 32808 Tel: (305) 423-2962—Atlanta, Ga., 3135 Chestnut Dr., Suite 101, Zip 30340 Tel: (404) 451-7112—Overland Park, Kan., PO Box 7282, Zip: 66207. Tel: (913) 383-1951—Baton Rouge, La., PO Box 14754, Zip 70808 Tel: (504) 766-6270—Bethesda, Md., 10215 Fernwood Rd Zip 20034 Tel: (301) 530-8800 District Mgr.: Max McCollough—Framingham, Mass., PO Box 1020 Zip 01701 Tel: (617) 877-8060—Hackensack, N.J., 65 Commerce Way, Zip 07601 Tel: (201) 489-7400—Pittsford, N.Y., PO Box 175 Zip 14534. Tel: (716) 586-2580—Dallas, Tex., 1615 Prudential Dr Zip 75235 Tel: (214) 637-5100—Salt Lake City, Utah, 2880 S. Main St., Suite 105 Zip 84115 Tel: (801) 487-8181

Plants: Opelika, Ala., PO Box 190 Zip: 36801 Tel: (205) 745-7643—Elk Grove Village, Ill., 2201 Lunt Ave Zip 60007 Tel: (312) 593-6000

Audio: 8-tr. plastic parts

J.C. Anglum Co. Inc. / Tapeonics Inc., Box 236, 36 Midvale Rd., Mountain Lakes, N.J. 07046 Tel: (201) 263-1442 Pres. J. Clifford Anglum

Audio: 8-tr. pinch rollers & Pressure pads

Associated Audio Servs. Inc., 14 Willett Ave., Port Chester, N.Y. 10573 Tel: (914) 937-5129 Pres. D. Richard Kraus, Sales & Adv. Mgr.: Robert Pinchbeck

Athena Inds. Inc., 2200 Industrial Way S., Toms River, N.J. 08753 Tel: (201) 244-8500 Pres. Sales, & Adv. Mgr.: Charles Beres Jr.

Audio: All cassette parts. (SEE ADVERTISEMENT)

Audio Accessories Co., 38 W 515 Deerpath Rd., Batavia, Ill.

60510. Tel: (312) 879-5998. Sales Mgr.: John S. Maloney

Audio: Cassette plastic hub locks.

Audio Inds. Inc., Broad & Linden Aves., Ridgefield, N.J. 07657 Tel: (201) 945-4545 Pres. M. Donalds; Customer Serv.: Michael Kates

Audio: 8-tr. & cassette parts. (SEE ADVERTISEMENT)

Bazzy Electronics Corp., 39 N. Rose, Mount Clemens, Mich. 48043 Tel: (313) 463-2592 Pres.: L. Allan Bazzy; Gen. Mgr.: Mike Tattan.

Audio: 8-tr. parts.

Burlington Audio Tapes Inc., 10 Commercial St., Hicksville, N.Y. 11801 Tel: (516) 433-4466 Pres.: Ruth Schwartz; VP. Sales & Adv. Mgr.: Rudy Schwartz

Cadet Recs. Inc., 5810 S. Normandie Ave., Los Angeles, Calif. 90044 Tel: (213) 753-5121 Pres.: Jules Bihari; Mgr.: Don Macmillan.

Branch: Park Ridge, N.J., PO Box 176 Zip 07656. Tel: (201) 391-3676. VP Sales: Robert K. Herrington.

Audio: 8-tr.

Capitol Magnetic Prods. (div. of Capitol Recs. Inc.), 1750 N. Vine St., Los Angeles, Calif. 90028. Tel: (213) 462-6252. Mktg. Dir.: Harry Preston; Prod. Prods. Sales Mgr.: Larry Hockemeyer.

Sales offices: Niles, Ill., 6401 Gross Point Rd. Zip 60648. Tel: (312) 775-7101—Germantown, Md., Century XXI, 20030 Century Blvd Zip 20767 Tel: (301) 428-0795—New York, N.Y., 1370 Ave. of the Americas Zip 10019 Tel: (212) 757-7470—Cleveland, Ohio, 7123 Pearl Rd. Zip 44130. Tel: (216) 888-6010—Dallas, Tex., 6730 Oakbrook Blvd Zip 75235 Tel: (214) 637-1890

Int'l branches: England, Singapore.

Audio: 8-tr. parts

Certron Corp., 1701 S. State College Blvd., Anaheim, Calif. 92806 Tel: (714) 634-4280. WATS (800) 854-3943 Pres. Edwin Gamson, VP Mktg.: Ray Allen, Adv. Mgr.: Hal Wilde

Audio: 8-tr. & cassette parts

Custom Cartridge Inc., 341 Hill Ave., Nashville, Tenn. 37210 Tel: (615) 244-5668 Pres. Cliff Tant

Audio: 8-tr. (SEE ADVERTISEMENT)

D A K Inds. Inc., 10845 Vanowen St., North Hollywood, Calif. 91605 Tel: 984-1559. WATS (800) 423-2636. Pres.: Drew Alan Kaplan

Audio: Cassette liners, hubs, housings, pins, rollers & pressure pads

Data Packaging Corp., 205 Broadway, Cambridge, Mass. 02139 Tel: (617) 868-6200. Exec. VP. Greg Malthus; VP Mktg.: Jere R. Hill; Nat'l Sales Mgr.: Gene Hull

Audio: 8-tr. & cassette parts. (SEE ADVERTISEMENT)

Dixon Inds. Corp. (a Bundy Co.), 386 Metacom Ave., Bristol, R.I. 02809 Tel: (401) 253-2000 Telex: 92-7706. Pres.: Bert Katzanek; Sales Mgr.: John F. McCurdy Jr.

Audio: Cassette shims, acetate post rollers, cartridge top rings & teflon thrust washers.

Video: U-matic, Beta & VHS cassette tabs, guides & teflon thrust pads. (SEE ADVERTISEMENT)

Donnak Inds., PO Box 422, Ridgefield, N.J. 07657. Tel: (201) 945-6820. Pres.: Marvin Donalds; VP: Rudolph Puntillo; Customer Serv.: Michael Kates

Audio: Cassette hubs, flanged rollers, slip sheets, stainless steel pins, spring pads, shields, sonic & screw-type shells & windows. (SEE ADVERTISEMENT)

Chet Dunn Assocs. Mfg. Rep., 20 Locke Rd., Billerica, Mass. 01821. Tel: (617) 663-2000. Pres.: Chet Dunn

Audio: Staking rods, leader locks. (SEE ADVERTISEMENT)

Dyna/Day Plastics Inc., 3319 E. Ten Mile Rd., Warren, Mich. 48091. Tel: (313) 755-2530. Pres.: Frank Day; VP: Paul M. Hayes; Plant Mgr.: Phil Kelly

Audio: Cassette hubs, rollers, shells

El Mar Plastics Inc., 821 E. Artesia Blvd., Carson, Calif. 90746. Tel: (313) 327-3180. Pres.: Harry Schor; VP Mktg.: Allen Schor.

Audio: 8-tr. & cassette parts. (SEE ADVERTISEMENT)

Filam Nat'l Plastics, 416 W. El Segundo, Los Angeles, Calif. 90061. Tel: (213) 515-0623. Pres.: Vic Flores; VP Sales: Mike Bolong

Audio: Hub locks, 1/4" NAB hubs.

Gabriel Mfg. Co. Inc., 125 S. Liberty Dr., Stony Point, N.Y. 10980. Tel: (914) 942-0100. Adv. Mgr.: William Meyer

Audio: Hubs, pins, rollers, shells.

Hi-Flex Corp., 289 Huyler St., South Hackensack, N.J. 07606. Tel: (201) 487-3027.

Audio: Cassette shims & pressure pads

Horian Eng'g Inc., 12381 Schaefer Hwy., Detroit, Mich. 48227. Tel: (313) 933-6900. Pres.: Richard C. Horian; Sales Mgr.: Robert L. Horian; Adv. Mgr.: Claudette Orr.

Audio: 8-tr. & cassette shells.

Imco Inc., PO Box 444, Huntington, Ind. 46750. Tel: (219) 356-4810. Pres.: John J. Abbott; VP Sales & Mktg.: W.P. Kelley

Audio: Elastomeric pinch rollers.

Kyric Corp., 2111 E. 20 St., Tucson, Ariz. 85703. Tel: (602) 624-2408. Pres. & Sales Mgr.: Keyvan Mokhtarian.

Audio: All cassette parts.

Lenco Co., PO Box 29128, 3901 N. 69 St., Lincoln, Neb. 68507. Tel: (402) 464-7488. Pres.: Don Leonhardt; Sales & Adv. Mgr.: Daryl O. Chapelle

Branch: Indianapolis, Ind., Box 507, Rt. 2. Zip:

ICM
SWITZERLAND



LEADING MANUFACTURER
OF CASSETTES

...THEY SAY WE ARE THE BEST...
...WE STILL TRY TO IMPROVE...

CO CASSETTES

C-BOX SNAP BOX SYSTEMS

CASSETTE COMPONENTS DROP OUT COUNTERS PLAY AND WIND TESTERS

ICM LTD.

MÜHLEBACHSTR. 27 CH-8800 THALWIL TEL: 41 1 720 2942 TELEX 53759



**THERE
HAS
NEVER
BEEN A
BETTER
TIME
TO**

**EMPHASIZE
QUALITY.**

The cost of doing business—both buying and selling—keeps going up, and up, and up. And along with it, the importance of quality. Data Packaging quality products—cassettes, C-0s, and 8-track cartridges—stay sold. That means fewer returns, more reorders, and a lower cost of sales for you. In a word, value.

At Data Packaging we've been designing and building the world's highest quality cassettes and 8-tracks for over a decade. We're not about to change now.



DATA PACKAGING CORPORATION

Where you get what you pay for.

205 Broadway, Cambridge, MA 02139, Tel: 617-868-6200. TWX: 710-320-0885
C-0 Cassettes (weld and screw type) • Mini-Cassettes • Digital Cassettes • 8-Track Cartridges • Custom Tape Winding
Storage Units for Cassettes, 8-Tracks, and Records

World Radio History

No. 410
FLAT SHIELD

No. 470M
CASSETTE FULL SHIELD

No. 510
FLAT-FOAM SHIELD

No. 570
FULL-FOAM SHIELD

No. 901
SPECIAL
FOAM SHIELD

No. 302
CASSETTE PINS

No. 508
8 TRACK FOAM PAD

No. 201
CASSETTE
SPRING PAD

No. 208
8 TRACK
CARTRIDGE
SPRING PAD

OVERLAND PRODUCTS

P.O. Box 6
515 North Pierce St.
Fremont, Nebr. 68025
Phone 402-721-7270

SPECIAL DESIGNS ON REQUEST

AUDIO TAPE PRODUCTS

- **Q-Splice®** — for 8-tracks.
Pre-cut cueing and sensing splices.
5,000/roll.
- **Splicette** —
for cassettes.
Pre-cut lead splices. 5,000/roll.
- **Roll tape** — for
automatic splicing equipment.
8-track and cassette.
- **Cassette liners**
Individually die-cut (creased type available).
Continuous rolls.
Solid or zone coated Mylar.
Stock and custom.

SPLICE CARRIER TAB

WEBTEK CORPORATION
4326 W. Pico Blvd., Los Angeles, CA 90019
(213) 937-3511

For information and samples, call or write:

"Q-Splice" is a reg. TM of Webtek Corp.

46231 Tel (317) 839-6673 Mgr. Scott Bartlett.
Audio: Cassette hubs, shells, rollers, tab inserts, hub locks.

Loranger Mfg. Corp., Entertainment Prods. Div., 10-38 Clark St., Warren, Pa. 16365 Tel (814) 723-8600 Pres. J. Albert Loranger, VP Robert Loranger.
Audio: 8-tr & cassette parts (SEE ADVERTISEMENT)

Mastro Inds. Inc., 3040 Webster Ave., Bronx, N.Y. 10467 Tel (212) 547-5600 Pres. Mario Maccaferri.
Audio: Cassette guide rollers, keyhole hubs (SEE ADVERTISEMENT)

Minnesota Rubber Co., 3630 Wooddale Ave. S., Minneapolis, Minn. 55416 Tel (612) 927-1400.
Audio: 8-tr pinch & drive rollers

Overland Prods. Co. Inc., PO Box 6, 515 N. Pierce St., Fremont, Neb. 68025 Tel (402) 721-7270. Pres. & Sales Mgr. Howard J. Pearson.
Audio: 8-tr & cassette pressure pads, pins & shields (SEE ADVERTISEMENT)

Rivertone Corp., Dillon Rd., Monticello, N.Y. 12701 Tel (914) 794-8888
Audio & Video: Plastic & rubber injection molding machines for tape parts.

Roller Corp. of America, 3601 S. Clinton Ave., South Plainfield, N.J. 07080 Tel (201) 757-7330 Pres. Edward Monett, VP Jack E. Monett.
Audio: 8-tr pinch rollers

Shape, Inc., PO Box 366, Biddeford Ind'l Park, Biddeford, Me. 04005 Tel (207) 282-6155, Telex 944325. Pres. Anthony L. Gelardi; Sales & Mktg. Mgr. Joe Ciccone, Adv. Mgr. Bob MacLeod.
Audio: Cassette hubs, pins, pressure pads, rollers, shells, shields (SEE ADVERTISEMENT)

Specialty Composites Corp., Delaware Ind'l Park, Newark, Del. 19713 Tel (302) 738-6800. Sales Mgr. R. Prybutok, Adv. Mgr. J. Welsh
Audio: Pressure pads

Swire-Intermagnetics Co., 1311 Colorado Ave., Santa Monica, Calif. 90404 Tel (213) 393-9281 Pres. George Johnson, VP Sales & Mktg. Robert Dunn; VP Communications. Bruce Weber.
Audio: All 8-tr & cassette parts.

Tape Packaging Assocs., 740 W. Collins, Orange, Calif. 92667 Tel (714) 997-4173/4177. Pres. & Sales Mgr. William L. Starling Jr., Adv. Mgr. Joyce A. Starling.
Audio: 8-tr parts.

Tapeponents Inc., see J.C. Anglum

Trans-Am Inds. Inc., 845 Broad Ave., Ridgefield, N.J. 07657 Tel (201) 945-2000. Pres. Marvin Donalds; VP Rudolph J. Puntillo, Customer Serv. Michael Kates.
Audio: Cassette hubs, double flanged rollers, slip sheets, stainless steel pins, tabs.

Troy Hills Mfg. Corp., 501 Division St., Bonton, N.J. 07005 Tel (201) 334-2020. Pres. Edward F. Joyce Sr.; VP Sales. Edward F. Joyce Jr.
Audio: Pinch rollers & pressure pads (SEE ADVERTISEMENT)

Unique Prods. Inc., 2501 W. 237, Suite C, Torrance, Calif. 90505 Tel (213) 530-7500. TWX (910) 347-6236. Pres. George Lusko; VP Ernie Klingler.
Audio: Cassette pressure pads, pins, shields & windows, screws, special design reels (digital, continuous).

Universal Tape Corp. Inc., 821 E. Artesia Blvd., Carson, Calif. 90746 Tel (213) 327-3203. Pres. Edward O. Praeger.
Audio: 8-tr.—snap & screw type halves, bronze & foam type pressure pads, platforms, cassette—sonic, screw & snap type halves, stainless steel pins, pressure pads, mu-metal shields, hubs, double flanged idler rollers, window, teflon, graphite & polyester shield gaskets & liners & stainless steel pins.
Video: 1" open reel, 1/4" cassette, 1/2" EIAJ open reel.

Webtek Corp., 4326 W. Pico Blvd., Los Angeles, Calif. 90019 Tel (213) 937-3511. Pres. Joseph Klein; VP & Prod. Mgr. John A. Pace; Sales Mgr. Ken George. Branch: **Northfield, Ill.**, 778 Frontage Rd., Suite 115. Zip 60093. Tel (312) 446-6046.
Audio: Cassette liners. (SEE ADVERTISEMENT)

EMPTY CARTRIDGE, CASSETTE & REEL MANUFACTURERS

A & E Data Technology Corp., 350-C Fischer Ave., Suite C, Costa Mesa, Calif. 92626 Tel (714) 549-8353. Pres. Kenneth L. Smith; VP Mktg. William H. Adair; Sales Serv. Mgr. Sue Carpenter.
Video: 1/4" U-matic cassette, 1/2" VHS cassette

A/V Paragon, see Universal Tape

Ampex Corp., Magnetic Tape Div., 401 Broadway, Redwood City, Calif. 94063 Tel (415) 367-2011. Pres. A.H. Hausman; Sales Mgr. R.A. Antonio; Adv. Mgr. A. Fisher.
Sales offices: **Glendale, Calif.**, 500 Rodier Dr. Zip 91201 Tel (213) 240-5000—**Denver, Colo.**, 2121 S. Birch, Zip 80222 Tel (303) 757-6491—**Orlando, Fla.**, PO Box 15008-B, Zip 32808, Tel (305) 423-2962—**Atlanta, Ga.**, 3135 Chestnut Dr., Suite 101, Zip 30340 Tel (404) 451-7112—**Overland Park, Kan.**, PO Box 7282, Zip 66207 Tel (913) 383-1951—**Baton Rouge, La.**, PO Box 14754, Zip 70808 Tel (504) 766-6270—**Bethesda, Md.**, 10215 Fernwood rd, Zip 20034 Tel (301) 530-8800. District Mgr. Max McCollough—**Framingham, Mass.**, PO Box 1020, Zip 01701 Tel (617) 877-8060—**Hackensack, N.J.**, 65 Commerce Way, Zip 07601 Tel (201) 489-7400—**Pittsford, N.Y.**, PO Box 175, Zip 14534 Tel (716) 586-2580—**Dallas, Tex.**, 1615 Prudential Dr., Zip 75235 Tel (214) 637-5100—**Salt Lake City, Utah**, 2880 S. Main St., Suite 105, Zip 84115 Tel (801) 487-8181.
Plants: **Opelika, Ala.**, PO Box 190, Zip 36801 Tel

(205) 745-7643—Elk Grove Village, Ill., 2201 Lunt Ave. Zip 60007 Tel (312) 593-6000
Audio: 8-tr., cassette, metal & plastic reels
Ampro Prod's Inc., 150 Fifth Ave., New York, N.Y. 10011 Tel (212) 243-7726 Cable TAPEXKRON Telex 425233 Pres. Manuel Kopelman, Exec. VP Mktg. Susanne Tarter; VP Arthur Lipton.
Audio: 8-tr., cassette. (SEE ADVERTISEMENT)
Athena Inds. Inc., 2200 Industrial Way S., Toms River, N.J. 08753 Tel (201) 244-8500 Pres. Sales & Adv. Mgr. Charles Beres Jr.
Audio: Cassette, & sub-assemblies of cassette parts (SEE ADVERTISEMENT)
Audio Inds. Inc., Broad & Linden Aves., Ridgefield, N.J. 07657 Tel: (201) 945-4545. Pres. M. Donalds; Customer Serv. Michael Kates
Audio: 8-tr., cassette (SEE ADVERTISEMENT)
Audiomatic Corp., 1290 Ave. of the Americas, New York, N.Y. 10019 Tel (212) 582-4870 Telex 126419 Pres. Milton B. Gelfand, VP Customer Servs. Carolyn T. DeVries; Adv. Mgr. J.P. Lohman
Int'l branch: France.
Audio: 8-tr., cassette (SEE ADVERTISEMENT)
Burlington Audio Tapes Inc., 10 Commercial St., Hicksville, N.Y. 11801 Tel (516) 433-4466. Pres. Ruth Schwartz, VP & Sales & Adv. Mgr. Rudy Schwartz
Audio: Reels.
Brand name: Olympic.
Cadet Recs. Inc., 5810 S. Normandie Ave., Los Angeles, Calif. 90044 Tel (213) 753-5121 Pres. Jules Bihari, Mgr. Don Macmillan.
Branch: Park Ridge, N.J., PO Box 176 Zip 07656 Tel: (201) 391-3676. Sales Mgr. Robert K. Herrington.
Audio: 8-tr.
Carter Corp., 1916 11 St., Rockford, Ill. 61101 Tel (815) 397-3200 Pres. Robert L. Fleming, VP Sales & Mktg. Sandra L. Fleming, Adv. Mgr. Janet K. Ratner.
Audio: Reels.
Cassette Masters Corp., 2 Bashford St., Yonkers, N.Y. 10701 Tel (914) 968-1605.
Audio: Screw-type cassettes
Certron Corp., 1701 S. State College Blvd., Anaheim, Calif. 92806 Tel (714) 634-4280, WATS (800) 854-3943 Pres. Edwin Gamson, VP Mktg. Ray Allen, Adv. Mgr. Hal Wilde
Audio: 8-tr., cassette, reels
Custom Cartridge Inc., 341 Hill Ave., Nashville, Tenn. 37210 Tel (615) 244-5668 Pres. Cliff Tant
Audio: 8-tr. (SEE ADVERTISEMENT)
Custom Dupl'n Inc., 6330-36 Arizona Circle, Los Angeles, Calif. 90045 Tel (213) 670-5575, 776-4810. Pres. Leonard Gross, Sales Mgr. Frank Rohloff, Prod'n Jeri Gonzales
Audio: 8-tr., cassette
D A K Inds. Inc., 10845 Vanowen St., North Hollywood, Calif. 91605 Tel (213) 984-1559, WATS (800) 423-2636 Pres. Drew Alan Kaplan.
Audio: Cassette, open reel
Dalsung America Inc., 51 E. 42 St., New York, N.Y. 10017. Tel (212) 682-6045.
Home office: Korea.
Audio & Video: Cassette
Brand names: Seca, Solfa
Data Packaging Corp., 205 Broadway, Cambridge, Mass. 02139 Tel (617) 868-6200 Exec. VP Greg Malthus, VP Mktg. Jere R. Hill, Nat'l Sales Mgr. Gene Hull
Audio: 8-tr., cassette.
Video: ¾" cassette (SEE ADVERTISEMENT)
Dyna/Day Plastics Inc., 3319 E. Ten Mile Rd., Warren, Mich. 48091 Tel (313) 755-2530 Pres. Frank Day, VP Paul M. Hayes, Plant Mgr. Phil Kelly.
Audio: 8-tr., cassette.
E H C. see Electronic Homes
Electronic Homes Co., 24-64 Crescent St., Astoria, N.Y. 11102 Tel (212) 545-3094 Bd. Chm. George T. Saddler; Pres. Paula Saddler; Sales Mgr. Elias Smyrnakis
Audio: Cassette
Brand name: EHC
El Mar Plastics Inc., 821 E. Artesia Blvd., Carson, Calif. 90746. Tel: (213) 327-3180. Pres. Harry Schor; VP Mktg. Allen Schor
Audio: 8-tr., cassette (5-screw & sonic welded), 3", 5" & 7" open reels. (SEE ADVERTISEMENT)
Fidelipac (div. of Harvel Inds.), 109 Gaither Dr., Mount Laurel, N.J. 08057 Tel (609) 235-3511. Pres. Roger Cappello, Sales & Mktg. Mgr. Arthur Constantine.
Audio: NAB cartridges (A, B & C sizes)
Brand names: Fidelipac, Master Cart
Filam Nat'l Plastics, 416 W. El Segundo Blvd., Los Angeles, Calif. 90061 Tel (213) 515-0623 Pres. Vic Flores, VP Sales Mike Bolong
Audio: 8-tr.
Gabriel Mfg. Co. Inc., 125 S. Liberty Dr., Stony Point, N.Y. 10980 Tel (914) 942-0100
Audio: Cassette
I P S., 107 Bridge Rd., Hauppauge, N.Y. 11787 Tel (516) 234-3322. Contacts Bill Prechtel, Richard Diamond
Audio: Cassette (SEE ADVERTISEMENT)
I T I. see Investment Technology
Investment Technology Inc., 1940 124 Ave. NE, Bellevue, Wash. 98005 Tel (206) 454-7720 Pres. David P. Hilliard, VP George Woodley.
Audio: Cassette
Brand name: ITI
Ray Jacobs Audio Inc., 2739 Signal Pkwy., Long Beach, Calif. 90806 Tel (213) 595-6811 Pres. Ray Jacobs; Sales Mgr. Larry Stagnaro, Adv. Mgr. Robert Ellsworth
Audio: 8-tr., cassette
Brand name: RJA
Jet Pak. see Tape-A-Thon
Kyric Corp., 2111 E. 20 St., Tucson, Ariz. 85719 Tel (602) 624-2408 Pres. & Sales Mgr. Keyvan Mokhtarian
Audio: Cassette
Lenco Co., PO Box 29128, 3901 N. 69 St., Lincoln, Neb. 68507 Tel (402) 464-7488 Pres. Don Leonhardt, Sales & Adv. Mgr. Daryl O. Chapelle
Branch: Indianapolis, Ind., Box 507, Rt. 2 Zip 46231. Tel (317) 839-6673 Mgr. Scott Bartlett.

Audio: Cassette.
Loranger Mfg. Corp., Entertainment Prods. Div., 10-38 Clark St., Warren, Pa. 16365. Tel: (814) 723-8600. Pres. J. Albert Loranger; VP Robert Loranger
Audio: 8-tr., cassette (SEE ADVERTISEMENT)
M I P. see Molded Ind'l Plastics
M J S., 2514 Seaboard Ave., San Jose, Calif. 95131 Tel (408) 262-8793 Pres. Michael Steiner
Audio: 8-tr., cassette, reels
M M C. see Magnetic Mktg
Magnetic Mktg. Corp., 29 Valley View Terr., Wayne, N.J. 07470. Tel (201) 694-3502. Pres. Thomas J. Hofbauer; Sales Mgr. Brendan F. Browne; Adv. Mgr. M. Judge
Audio: 8-tr., cassette
Brand name: MMC (SEE ADVERTISEMENT)
Magnetic Media Corp., 500 Eastern Pkwy., Farmingdale, N.Y. 11735 Tel (516) 293-1010 Pres. Aaron Wasserstrom; Gen. Sales Mgr. Douglas Scott
Audio: Cassette.
Marmac. see Mastro
Master Cart. see Fidelipac
Mastro Inds. Inc., 3040 Webster Ave., Bronx, N.Y. 10467. Tel (212) 547-5600. Pres. Mario Maccaferri.
Audio: 8-tr., cassette.
Brand name: Marmac (SEE ADVERTISEMENT)
Meister Mfg. Co., Washburn Rd., Downey, Calif. 90241 Tel (213) 861-3198
Audio: 7", 8½", 10½" aluminum reels
Miami Tape Inc., 8180 NW 103 St., Hialeah Gardens, Fla. 33015 Tel (305) 558-9211 Pres. Carlos Garcia, Sales Mgr. Mirella Tunon.
Audio: 8-tr., cassette
Molded Ind'l Plastics Inc., Ansonia, Conn. 06401 Tel (203) 735-2331
Audio & Video: Reels.
Brand name: MIP
Olympic. see Burlington
P R C Rec'g Co. (div. of Richmond Rec'g Corp.), 1185 Ave. of the Americas, New York, N.Y. 10036 Tel (212) 997-1250 Pres. Hugh T. Landy, VP Sales David Grant.
Plants: Compton, Calif., 187000 Laurelpark Rd. Zip 90220 Tel (213) 979-8545 Plant Mgr. Ray Githero—Richmond, Ind., 1600 Rich Rd. Zip 47374 Tel (317) 962-9511 Plant Mgr. Greg Speer.
Audio: Cassette
Plastic Reel Corp. of America, 640 S. Commercial Ave., Carlstadt, N.J. 07072 Tel (201) 933-9125 Pres. Robert A. Miller; Sales Mgr. Pat Baccarella
Audio: 2½"-7" reels, hubs.
Video: Open reel for ½", 1", & 2" tape
Brand name: Plio-Magic.
Plio-Magic. see Plastic Reel
Polyline Corp., 1233 Rand Rd., Des Plaines, Ill. 60016 Tel (312) 298-5300. Pres. John Kaiser
Audio: Plastic reels
Pro I Prods., PO Box 33, Highland Park, Ill. 60035 Tel (312) 432-5536. Pres. Roy Pink; Sales Mgr. Martin Pink, Adv. Mgr. Deena Pink.

The MONEY-SAVER!



Poly Box
for audio cassettes
soft, hinged, see-through

We make it. We ship it from stock. You can rely on the consistently high quality of our cassette boxes.

Call us for prices.
 312/297-0955

Polyline
Corp.

1233 Rand Road
 Des Plaines, Illinois 60016
 19

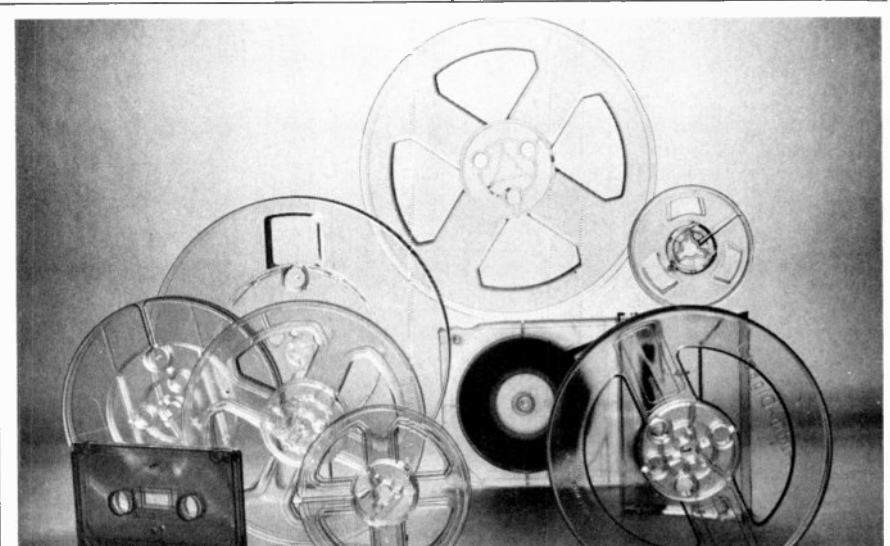

SOUND QUALITY PRODUCTS FOR THE TAPE INDUSTRY

El Mar Plastics manufactures a complete line of 8-track cartridges quadrasonic cartridges cassettes and component parts Norelco style, soft poly and Ampex style cassette boxes reels for ¼" tapes pre-leaded cassettes



and we can offer prompt delivery anywhere in the world!
 Please call or write:

El Mar Plastics, Inc.

821 E. Artesia Blvd., Carson, California 90746 • Telephone (213) 327-3180

LEADER LOCK



THE HEART OF YOUR CASSETTE

That little piece of staking rod is the big difference in the quality of your cassette.

Our Leader Lock is better because of our unique Double Extrusion process which delivers a rod diameter tolerance of not more than $\pm .0005"$ (.0127mm).

— Sizes from .049" (1.2446mm) to .068" (1.7272mm).

— Extruded in increments of .001" (.0254mm).

— Tolerance not more than $\pm .0005"$ (.0127mm).

— Popular sizes — .052" (1.320mm) and .062" (1.575mm) stocked for immediate shipment.

Designed and engineered for the cassette industry by the Burnhams of New York, our staking rod virtually eliminates cassette failure due to leader tape pull-out.

We also make special extrusions for particular requirements.

Ask us.!

Exclusive Agents for the Burnhams:

CHET DUNN ASSOCIATES

Manufacturers' Representatives
20 Locke Road
Billerica, Mass. 01821
(617) 663-2000
TELEX 947429

- Audio:** 8-tr. & cassette
R J A, see Ray Jacobs Audio.
Raynor Sales Co. Inc., 2698 W. Pico Blvd., Los Angeles, Calif. 90006. Tel (213) 737-3737 Pres & Adv Mgr Ray Abrams Sr., Sales Mgr. Ray Abrams Jr.
Audio: 8-tr.
Recording Supply Co. (div of Polyline Corp.), 1233 Rand Rd., Des Plaines, Ill 60016 Tel (312) 297-0955. Pres.: John Kaiser.
Audio & video: Reels.
Robins Inds Corp., 75 Austin Blvd., Commack, N Y 11725 Tel (516) 543-5200 Pres. Herman Post; Nat'l Sales & Adv. Mgr.: Stu Caine.
Audio: Cassette, open reel.
Brand name: Brand 5.
Royal Sound Co. Inc., 248 Buffalo Ave., Freeport, N. Y. 11520. Tel: (516) 868-2880. Pres. Mervin A. Dayan.
Audio: 8-tr., cassette
Scotch, see 3M.
Seca, see Dalsung.
Sentry Inds. Inc., 221 N. Macquessen Pkwy., Mount Vernon, N.Y. 10550. Tel (914) 664-2909. Pres. Harold Rosen; Sales & Adv. Mgr. Barry Rosen.
Audio: 8-tr., cassette, open reel. (SEE ADVERTISEMENT)
Shape Inc., PO Box 366, Biddeford Ind'l Park, Biddeford, Me. 04005. Tel (207) 282-6155. Pres. Anthony L Gelardi; Sales & Mktg. Mgr. Joe Ciccone; Adv Mgr. Bob MacLeod.
Audio: 8-tr., cassette. (SEE ADVERTISEMENT)
Sofa, see Dalsung
Studio Magnetics Co. Inc., 83 Carrough Rd., Bohemia, N Y 11716. Tel (516) 589-4300. Pres. George Clahane; VP Craig M. Balaban.
Audio: Screw-type cassette
Swire-Intermagnetics Co., 1311 Colorado Ave., Santa Monica, Calif 90404. Tel (213) 393-9281 Pres. George Johnson; VP Sales & Mktg.: Robert Dunn; VP Communications: Bruce Weber.
Audio: 8-tr. & cassette
Tape-A-Thon Corp., 502 S. Isis, Inglewood, Calif 90301. Tel: (213) 776-7933. Pres.: Lee Tate, Exec. VP & Sales & Mktg. Dir.: Wally Rubin.
Audio: NAB cartridge
Brand name: Jet-Pak, Trak-4
Tape Packaging Assocs 740 W. Collins Ave., Orange, Calif 92267 Tel (714) 997-4173/4177. Pres.: William L. Starling Jr.; Adv. Mgr.: Joyce A. Starling.
Audio: 8-tr.
Telex Communications Inc., 9600 Aldrich Ave S., Minneapolis, Minn. 55420. Tel (612) 884-4051 Pres. Ansel Kleiman; VP Mktg. James S. Arrington; Adv. & Sales Promo. Dir. Peter Schwarz
Audio: NAB broadcast cartridges
3 M Co., Magnetic Audio/Video Prods. Div., 3M Center, Bldg. 223-5N, St. Paul, Minn. 55101 Tel (612) 733-1110. Div VP John E. Povolny; Mktg Dir. Bill Madden; Retail Prods. Mgr. D.E. Rushin; Nat'l Sales Mgr. S.R. Frederickson; Mkt. Communications & Mdsq. Su-

- pervisor: Vicki Hanson, Mkt. Development Mgr. R.F. Burnett, Adv. Mgr. Peter M. Gavin
Branches: Anchorage, Alaska, 5531 Minnesota Dr. Zip 99502. Tel (907) 276-2363—Burbank, Calif., 126 W. Elm Court. Zip 91502 Tel (213) 848-5534—Los Angeles, Calif., 6023 S. Garfield Ave. Zip 90040. Tel (213) 726-6300—South San Francisco, Calif., 320 Shaw Rd. Zip 94080. Tel (415) 589-2663—Washington, D.C., 1101 15 St. NW. Zip 20005. Tel (202) 331-6900—Atlanta, Ga., 2860 Bankers Ind'l Dr. Zip 30360. Tel (404) 447-7000—Honolulu, Hawaii, 2880 Ualena St. Zip 96819. Tel (808) 841-0147—Argo, Ill., 6850 S. Harlem Ave. Zip 60501. Tel (312) 496-6500—Needham Heights, Mass., 155 Fourth Ave. Zip 02194. Tel (617) 449-0300—Farmington, Mich., 23923 Research Dr. Zip 48024. Tel (313) 477-5000—Eagen, Minn., PO Box 3211, St. Paul 55133; 3130 Lexington Ave. S. Zip 55121. Tel (612) 733-3300—St. Louis, Mo., PO Box 510, 10725 Baur Blvd. Zip 63166. Tel (314) 991-1320—West Caldwell, N.J., PO Box 76, 15 Henderson Dr. Zip 07006. Tel: (201) 575-2000—Cincinnati, Ohio, 4835 Para Dr. Zip 45237. Tel: (513) 242-2313—Cleveland, Ohio, 12200 Brookpark Rd. Zip 44130. Tel (216) 267-1800—Philadelphia, Pa., 5698 Rising Sun Ave. Zip: 19120. Tel: (215) 728-5300—Dallas, Tex., 2121 Santa Anna Ave. Zip 75228. Tel (214) 324-3100—Seattle, Wash., Andover Ind'l Park, 100 Andover Park W. Zip: 98188. Tel: (206) 244-7200.
Audio: 8-tr., cassette, open reel
Video: Reels for 2" & 1" tape.
Brand name: Scotch.
Trak-4, see Tape-A-Thon.
Trans-Am Inds. Inc., 845 Broad Ave., Ridgefield, N.J. 07657. Tel: (201) 945-2000. Pres. Marvin Donalds; VP: Rudolph J. Puntillo; Customer Serv. Michael Kates.
Audio: Sonic & screw-type cassette. (SEE ADVERTISEMENT)
U T C, see Universal Tape.
Universal Tape Corp. Inc., 821 E. Artesia Blvd., Carson, Calif. 90746. Tel (213) 327-3203. Pres.: Edward O. Praeger.
Audio: 8-tr., cassette, open reel
Brand name: A/V Paragon, UTC, Universal.

ENVELOPES & MAILERS

The key to the abbreviations following the listing is: (M) Manufacturer, (D) Distributor, (I) Importer.

CALIFORNIA

- **LOS ANGELES METROPOLITAN AREA (Area Code 213)**
The Bert-Co Entis. Inc., 1855 Glendale Blvd. Zip 90026. Tel: 665-5137 (M)
Branch: New York, N.Y.
Container-Kraft Inc., 8321 De Celis Pl., Sepulveda 91343. Tel 893-9721 (M)
Gilmore Envelope Corp., 4540 Worth St. Zip 90063. Tel 268-3401 (M)
Ivy Hill Communications Inc., 4800 S. Santa Fe Ave. Zip 90058. Tel 587-3131. Div. Exec VP Russell Muir; Sr. VP's Jack Sclar, Arthur Kern, (M)
Home office: Great Neck, N.Y.
Kalny Mdsq., 4700 S. Santa Fe Ave. Zip 90058. Tel 587-1164. Customer Serv.: Arte Hirsch.
Prestone Graphics Inc., 1930 Century Park W. Zip 90067. Tel 552-9671
Branch: New York, N.Y.
Westland Graphics, 2237 N. Hollywood Way, Burbank 91505. Tel 846-1205. (M)

FLORIDA

- **FORT LAUDERDALE (Area Code 305)**
Esmond Inds. Inc., 2455 E. Sunrise Blvd. Zip 33304. Tel: 564-6435. Pres. Bennett Asquith; Sales Mgr.: Jeff Asquith; Adv. Mgr. Shirlee Duffy. (M)

ILLINOIS

- **CHICAGO METROPOLITAN AREA (Area Code 312)**
Bruce Packaging Co., 8025 N. Kenneth Ave., Skokie 60076. Tel 583-2818 Pres. Joseph Halperin (M)
M. M. Cole Publ'g Co., Playboy Bldg., Suite 1602, 919 N. Michigan Ave. Zip: 60611. Tel: 527-2160. Pres.: Sheperd Stern. (7" & 12" mailers) (MD)
Forest Packaging Corp., 542 Factory Rd., Addison 60101 Tel 543-7035. Pres.: John R. Kisscock; VP Sales R.H. Napp (Mailers only).
Pro I Prods., PO Box 33, Highland Park 60035. Tel 432-5536. Pres. Roy Pink; Sales Mgr. Martin Pink; Adv. Mgr.: Deena Pink. (MD)

INDIANA

- **INDIANAPOLIS (Area Code 317)**
Bowers Rec. Steeve Co., 5331 N. Tacoma Ave Zip 46220 Tel 251-3918. Pres. Robert C. Bowers; VP & Sales Mgr.: Charles H. Kaufman. (MD)

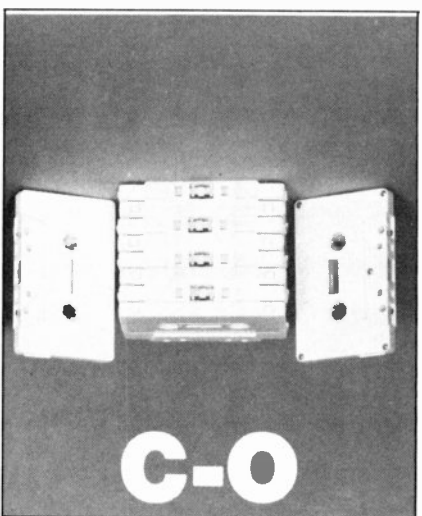

5 screw professional quality at competitive prices or sonic welded budget type for less demanding needs.

Tabs in or Tabs out. We also offer leaderless cassettes.

Immediate delivery from stock.

Dependability and reliability you can count on.

Call us for cassette boxes.

El Mar Plastics, Inc.

821 E. ARTESIA BLVD., CARSON, CA
90746 TELEPHONE (213) 327-3180

● **TERRE HAUTE (Area Code 812)**

Ivy Hill Communications Inc., Fort Harrison Ind'l Park, Fruitridge Ave. Zip: 47805. Tel: 466-9851. (M)
Home office: Great Neck, N.Y.

MASSACHUSETTS

● **CHICOPEE (Area Code 413)**

Dielectrics Inc., 6 Second Ave. Zip: 01020. Tel: 598-8308.
Pres.: Earl S. Stahl, Exec. VP & Nat'l Sales & Adv. Mgr.: Eric C. Stahl.

NEVADA

● **CARSON CITY (Area Code 702)**

Gopher Prods. Corp., Box 1812, 2201 Lockheed Way. Zip: 89701. Tel: 882-9333. Pres.: Warren Perkins. (M) (SEE ADVERTISEMENT)

NEW JERSEY

● **BLOOMFIELD (Area Code 201)**

Ever-Ready Packaging & Assembly (div. of Reliance Folding Carton Corp.) 225 Belleville Ave. Zip: 07003. Tel: 748-6677. (M)

● **ELIZABETH (Area Code 201)**

Lened Int'l Corp., 489 Henry St. Zip: 07201. Tel: 354-5205. Pres.: Joseph Flusfeder. (M)

NEW YORK

● **ALBANY (Area Code 518)**

Pak-Wik Corp., 128 Tivoli St. Zip: 12207. Tel: 465-4556.
Pres.: Samuel A. Strasser; Sales Mgr.: Myron S. Strasser Jr. (Mailers only). (SEE ADVERTISEMENT)

● **GREAT NECK (Area Code 516)**

Ivy Hill Communications Inc., Community Dr. Zip: 11022. Tel: 487-0200. (M)
Branches: Los Angeles, Calif.; Terre Haute, Ind.

● **NEW YORK METROPOLITAN AREA (Area Code 212)**

G. Benson & Co. Printers Inc., 116 Nassau St., Brooklyn 11201. Tel: 596-9100. Pres.: Gerald J. Benson; VP Sales: Gil Benson; Adv. Mgr.: Roxanne Evans. (M)
Bert-Co Ents. Inc., 241 E. 34 St. Zip: 10016. Tel: 683-6300. (M)
Home office: Los Angeles, Calif.
Brown Paper Co. Inc., 186 Seventh St., Brooklyn 11215. Tel: 965-3600. (MD)
Disc Communications Ltd., 743 Fifth Ave. Zip: 10022. Tel: 371-0390. Pres.: Jerome Boxer; Art Dir.: Susan Murphy. (M)
E R H Sales Corp., 221 W. 57 St. Zip: 10019. Tel: 582-4200. Pres.: Lee Halpern; Sr. Exec. VP: Howard Roseff; Gen. Mgr.: Michael Halpern; Sales Mgr.: Robert Shavelson. (M)
Gem-Built Container Corp., 48-20 50 Ave., Woodside 11377. Tel: 784-8800. (M)
Guaranteed Printing Serv. Co. Inc., 119 W. 23 St. Zip: 10011. Tel: 929-2410. (M)
Prestone Printing Co., 147 W. 42 St. Zip: 10036. Tel: 354-1871.
Home office: Los Angeles, Calif.
Edward R. White Inc., 18 E. 41 St. Zip: 10017. Tel: 687-2167. Pres. & Sales Mgr.: Lawrence Goldstein. (MD)

OHIO

● **TOLEDO (Area Code 419)**

Pioneer Inds., PO Box 4653, Old West End Sta. Zip: 43620.
Mgr.: Lowell P. Amos.
Chief products: Envelopes, mailers, backer boards, mailer cartons.

WYOMING

● **CHEYENNE (Area Code 307)**

Rocky Mountain Rec'g, Box 1354A, Rt. 2. Zip: 82001. Tel: 638-8733. Pres.: Ray Alexander; Sales & Adv. Mgr.: Georgia Alexander. (MD)

JACKETS & SLEEVES

The key to the abbreviations following the company listings is: (M) Manufacturer, (D) Distributor, (I) Importer.

CALIFORNIA

● **LOS ANGELES METROPOLITAN AREA (Area Code 213)**

A G I, 424 N. Larchmont Blvd. Zip: 90004. Tel: 462-0821.

VP: Edward Dwyer; Sales Mgr.: Jim Palmer. (Sales office only) (M)

Home office: Melrose Park (Chicago Metropolitan Area), Ill.

Album Graphics Inc., see AGI

Allied Rec. Co., 6110 Peachtree St. Zip: 90040. Tel: 725-6900. Pres.: Samuel M. Broadhead; VP & Gen. Mgr.: John F. Wegner; Customer Serv. & Quality Assurance Dir.: Stephen R. Broadhead. (Sleeves only) (M)

The Bert-Co Ents. Inc./Bert-Co Graphics, 1855 Glendale Blvd. Zip: 90026. Tel: 665-5137. (M)

Branch: New York, N.Y.

Bluebelle Shoppe, PO Box 14466, Long Beach 90803. Dir.: Mark Slater. (Holographic custom work)

Electrosound Group Inc., 9545 San Fernando Rd., Sun Valley 91352. Tel: 767-8833. Pres. & Adv. Mgr.: Richard H. Burkett; Gen. Sales Mgr.: Scott Ross. (Sales office only) (Sleeves only) (M)

Branch: New York, N.Y.

Plant: Hicksville, N.Y., Andrews-Nunnery Envelope & Paper Corp.

Gilmore Envelope Corp., 4540 Worth St. Zip: 90063. Tel: 268-3401. (M)

Imperial Pacific Sales Corp., 4528 Brazil St. Zip: 90039. Tel: 245-8583. VP: A.W. Fink; Sales Mgr.: Lincoln Stegman. (Jackets only) (M)

Home office: Brooklyn (New York Metropolitan Area), N.Y., Imperial Paper Box Corp.

Ivy Hill Communications Inc., 4800 S. Santa Fe Ave. Zip: 90058. Tel: 587-3131. Div. Exec. VP: Russell Mur; Sr. VP's: Jack Sclar, Arthur Kern, (M)

Home office: Great Neck, N.Y.

Kdisc (sub. of Keycor Century Corp.), 6550 Sunset Blvd., Hollywood 90028. Tel: 365-3991. Pres.: Eugene R. Schutz; Gen. Mgr.: Bill Lightner; Sales Mgr.: Dick Maxwell (Jackets only).

Plant: Saugus, Calif. (SEE ADVERTISEMENT)

K M Recs. Inc., 2980 N. Ontario St., Burbank 91504. Tel: 841-3400. Pres.: Glade Merkley; VP Custom Serv.: Jim Auchterlonie; Sales & Adv. Mgr.: Bruce Leek. (Jackets only)

Modern Album of California Inc., 3104 Vanowen St. Burbank 91505. Tel: 845-7655. Pres.: William S. Pine; Gen. Mgr.: Raymond Gardocki. (Jackets only)

Home office: Hauppauge, N.Y., Modern Album & Finishing Co. Inc.

Pedersen Label Printing Co., 11152 Fleetwood St., Sun Valley 91352. Tel: 768-3122. Pres.: Herman A. Fredriks; Prod. Mgr.: S. Kadonaga. (M) (SEE ADVERTISEMENT)

Prestone Graphics Inc., 1930 Century Park W. Zip: 90067. Tel: 552-9671.

Branch: New York, N.Y.

Queens Lithographing Corp., 6290 Sunset Blvd., Suite 304, Hollywood 90028. Tel: 464-7700. (M)

Home office: Long Island City (New York Metropolitan Area), N.Y.

Plant: Indianapolis, Ind., Rutgers Packaging Corp.
Raynor Sales Co. Inc., 2698 W. Pico Blvd. Zip: 90006. Tel: (213) 737-3737. Pres.: Ray Abrams. (Gift sleeves only)

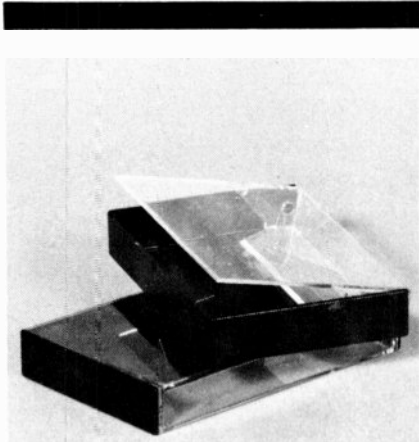

cassette boxes

Immediate shipment from stock on Norelco, Ampex and soft poly boxes.

Quality products for the tape industry from . . .

El Mar Plastics, Inc.

821 E. ARTESIA BLVD., CARSON, CA
90746 TELEPHONE (213) 327-3180



**THIS AD
WON'T TAKE**

**YOUR MIND OFF THE GASOLINE SHORTAGE !
BUT . . . IF YOU WERE USING OUR TOP QUALITY LINE OF:**

**8-TRACK CARTRIDGES
C-O CASSETTES
NORELCO C-BOXES**

You would have one less worry on your mind. Our products are of the highest quality: Designed and manufactured to exceed industry standards. That's why Loranger products are the choice of so many of the world's leading recording companies. Give us a call today . . . We'll show you what quality is all about.



Entertainment Products Division

P.O. Box 940, Warren, Pa. 16365 • 814 723-8600

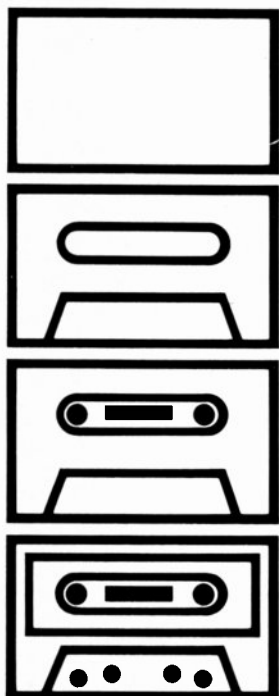

IPS
INC.

**SUPPLIERS OF
C-O CASSETTES**

NORELCO BOXES

**CASSETTE
HEAD CLEANERS**

**107 BRIDGE ROAD
HAUPPAUGE,
NEW YORK 11787**

516-234-3322

Shorewood Packaging of Calif., 1830 Glendale Blvd. Zip: 90026. Tel: 660-3043. Sales Mgr.: Marc Shore. (M)
Home office: New York, N.Y.

● **SAN FRANCISCO & BAY AREA (Area Code 415)**

Conlan Creative Lithographers, PO Box 2763, 800 Forbes Blvd., Suite 260, South San Francisco 94080. Tel: 761-7617. (Jackets only) (M)

● **SAN JOSE (Area Code 408)**

M J S, 2514 Seaboard Ave. Zip: 95131. Tel: 262-8793. Owner: Michael Steiner. (Jackets only) (M)

● **SAUGUS (Area Code 805)**

Kdisc (sub. of Keysor Century Corp.), 26000 Springbrook Ave. Zip: 91350. Tel: 259-2360. Pres.: Eugene R. Schutz; Gen. Mgr.: Bill Lightner. Sales Mgr.: Dick Maxwell. (Jackets only) (M)
Office: Hollywood (Los Angeles Metropolitan Area), Calif. (SEE ADVERTISEMENT)

CONNECTICUT

● **UNION CITY (Area Code 203)**

A.C. Hampson Printing Co., 168 City Hill St. Zip: 06770. Tel: 729-2294. Pres.: Augustus D. Hampson; Sales Mgr.: John W. Berry. (Jackets only)

DELAWARE

● **WILMINGTON AREA (Area Code 302)**

Ken-Del Prod'ns Inc., 111 Valley Rd., Richardson Park. Zip: 19804. Tel: 655-7488. Pres. & Gen. Mgr.: H. Edwin Kennedy; Sales Mgr.: Shirley Kay. (Jackets only) (M)
National Tape Dupl'rs, see Ken-Del.

FLORIDA

● **MIAMI METROPOLITAN AREA (Area Code 305)**

Prosound Inc., 8194 NW 103 St., Hialeah 33015. Tel: 558-0152. (Jackets only) (M)
Tropical Paper Box Co., 7000 NW 25 St. Zip: 33122. Tel: 592-5520. Rec. Div. Mgr.: Dale Quartin. (Jackets only)

GEORGIA

● **ATLANTA METROPOLITAN AREA (Area Code 404)**

Tres-Lanta Rec. Pressing Co., 190 Boulevard SE. Zip: 30312. Tel: 522-8106.

ILLINOIS

● **CHICAGO METROPOLITAN AREA (Area Code 312)**

A G I, 1950 N. Ruby St., Melrose Park 60160. Tel: 344-9100. Pres.: Donald W. Kosterka; Sales Mgr.: Charles Eaton. (M)
Sales offices: Los Angeles, Calif.; New York, N.Y.
Fine Design Prods. Inc., 1433 S. Wabash Ave. Zip: 60605. Tel: 939-5420. (Jackets only)
Musical Prods. Inc., 521 W. 26 St. Zip: 60616. Tel: 225-9117. (Jackets only) (M)

INDIANA

● **INDIANAPOLIS (Area Code 317)**

Bowers Rec. Sleeve Co., 5331 N. Tacoma Ave. Zip: 46220. Tel: 251-3918. Pres.: Robert C. Bowers, VP & Sales Mgr.; Charles H. Kaufman. (Sleeves only) (MD)
Imperial Packaging Co. Inc., 7800 Records St. Zip: 46226. Tel: 545-7476. (Jackets only)
Home office: Brooklyn (New York Metropolitan Area), N.Y.; Imperial Paper Box Corp.
Reco-Sleeve Packaging, 620 S. Belmont. Zip: 46221. Tel: 635-7777. Pres.: Leonard Verebay; Sales & Adv. Mgr.: Len Dimond. (M)
Rutgers Packaging Corp. (div. of Queens Lithographing Corp.), 620 S. Belmont Ave. Zip: 46221. Tel: 635-7777. Pres.: Abe Garde; Sales & Adv. Mgr.: Morton D. Shecter. (M)
Home office: Long Island City (New York Metropolitan Area), N.Y.; Queens Lithographing Corp.

● **TERRE HAUTE (Area Code 812)**

Ivy Hill Communications Inc., Fort Harrison Ind'l Park, Fruitridge Ave. Zip: 47805. Tel: 466-9851. (M)
Home office: Great Neck, N.Y.
Modern Album of Indiana Inc., 1299 Voorhees St. Zip: 47808. Tel: 235-6001. (Jackets only)
Home office: Hauppauge, N.Y.; Modern Album & Finishing Co. Inc.
Woodburn Printing Co., 25 S. Sixth St. Zip: 47808. Tel: 466-6822. Pres.: Donald P. Pendergast; Sales Mgr.: John Avelis; Adv. Mgr.: John Crippen. (Jackets only) (M)

LOUISIANA

● **VILLE PLATTE (Area Code 318)**

Ville Platte Rec. Mfg. Co., 120 E. Cypress St. Zip: 60586. Tel: 363-2104. Pres.: J. Floyd Soileau; Mgr.: J. K. Soileau; Sales Mgr.: Ronnie Soileau. (Jackets only) (M)

MASSACHUSETTS

● **CHICOPEE (Area Code 413)**

Dielectrics Inc., 6 Second Ave. Zip: 01020. Tel: 598-8308. Pres.: Earl S. Stahl; Exec. VP & Nat'l Sales & Adv. Mgr.: Eric C. Stahl.

MICHIGAN

● **DETROIT METROPOLITAN AREA (Area Code 313)**

Archer Rec. Pressing Co., 7401 E. Davison. Zip: 48077. Tel: 365-9545. (Jackets only) (M)
Horian Eng'g Inc., 12381 Schaefer Hwy. Zip: 48227. Tel: 933-6900. Pres.: Richard C. Horian; Sales Mgr.: Robert L. Horian; Adv. Mgr.: Claudette Orr. (Sleeves only)

MISSOURI

● **ST. LOUIS (Area Code 314)**

Ken Keene Int'l, PO Box 515. Zip: 63166. Tel: 776-2278, 464-1773. Pres. & Adv. Mgr.: Ken Keene; VP & Sales Mgr.: Gene Miller. (MD)
Branch: Nashville, Tenn., TP Prod'ns.
Int'l branch: England, Seacruise.

NEVADA

● **CARSON CITY (Area Code 702)**

Gopher Prods. Corp., Box 1812, 2201 Lockheed Way. Zip: 89701. Tel: 882-9333. Pres.: Warren Perkins. (Sleeves only) (M) (SEE ADVERTISEMENT)

NEW JERSEY

● **ELIZABETH (Area Code 201)**

Lened Int'l Corp., 489 Henry St. Zip: 07201. Tel: 354-5205. Pres.: Joseph Flustfeder. (M) (SEE ADVERTISEMENT)

● **LYNDHURST (Area Code 201)**

Colorseps-Lithopreps Serv., PO Box 151. Zip: 07071. Tel: 438-6729. Pres.: J.G. Principato. (M)

NEW YORK

● **COMMACK (Area Code 516)**

Robins Inds. Corp., 75 Austin Blvd. Zip: 11725. Tel: 543-5200. Pres.: Herman Post; Sales & Adv. Mgr.: Stu Caine. (M)

● **GREAT NECK (Area Code 516)**

Ivy Hill Communications Inc., Community Dr. Zip: 11022. Tel: 487-0200. (M)
Branches: Los Angeles, Calif.; Terre Haute, Ind.

● **HAUPPAUGE (Area Code 516)**

Disc Graphics (div. of Pickwick Int'l), Cardinal Ind'l Park, 10 Gilpin Ave. Zip: 11787. Tel: 234-1400. Gen. Mgr.: Gus Thalasin. (Jackets only) (M)
Modern Album & Finishing Co. Inc., Cardinal Ind'l Park, Gilpin Ave. Zip: 11787. Tel: 234-1100; NYC (212) 291-7600. Pres.: G.D. Thomas; Sales Mgr.: R.A. Froehlig. (Jackets only)
Branches: Burbank (Los Angeles Metropolitan Area), Calif.; Modern Album of California Inc.; Terre Haute, Ind.; Modern Album of Indiana Inc.
Int'l branch: Canada, Modern Album of Canada Ltd.

● **HICKSVILLE (Area Code 516)**

Andrews-Nunnery Envelope & Paper Corp. (sub. of Electro-sound Group Inc.), 74 Alpha Plaza. Zip: 11801. Tel: 931-6500. Pres.: Stuart M. Andrews Jr.; Sales Mgr.: John F. Muller Jr.; Ass't Plant Mgr.: Robert J. Andrews. (Sleeves only) (M)
Sales offices: Hollywood (Los Angeles Metropolitan Area), Calif.; Electro-sound Group Inc.; New York, N.Y.; Electro-sound Group Inc.

● **NEW YORK METROPOLITAN AREA (Area Code 212)**

A G I, 125 W. 55 St. Zip: 10019. Tel: 489-0793. VP Mktg.: Richard Block; Sales Mgr.: Gary Sitzer. (Sales office only) (M)
Home office: Melrose Park (Chicago Metropolitan Area), Ill
Album Graphics Inc., see AGI
G. Benson & Co. Printers Inc., 116 Nassau St., Brooklyn 11201. Tel: 596-9100. Pres.: Gerald J. Benson; VP Sales: Gil Benson; Adv. Mgr.: Roxanne Evans. (M)
Bert-Co Ents. Inc., 241 E. 34 St. Zip: 10016. Tel: 683-6300. (M)
Home office: Los Angeles, Calif.

Brown Paper Co. Inc., 186 Seventh St., Brooklyn 11215 Tel. 965-3600 (MD)

Disc Communications Ltd., 743 Fifth Ave. Zip 10022 Tel. 371-0390 Pres. Jerome Boxer, Art Dir. Susan Murphy (M)

E R H Sales Corp., 221 W. 57 St. Zip 10019. Tel: 582-4200 Pres. Lee Halpern, Sr. Exec. VP Howard Roseff; Gen. Mgr. Michael Halpern, Sales Mgr. Robert Shavelson (M)

Electrosound Group Inc., 1290 Ave. of the Americas, Zip 10019 Tel. 581-5641 Pres. Richard H. Burkett; Sales Mgr. Ron Roberto. (Sales office only) (Sleeves only) (M)

Home office: Sun Valley (Los Angeles Metropolitan Area) Calif.

Plant: Hicksville, N.Y., Andrews-Nunnery Envelope & Paper Corp.

Guaranteed Printing Serv. Co. Inc., 119 W. 23 St. Zip 10011 Tel. 929-2410 (M)

Imperial Paper Box Corp., 252 Newport St., Brooklyn 11212 Tel. 346-6100 Pres. L. Sukoff (Jackets only)

Branches: Los Angeles, Calif., Imperial Pacific Sales Corp., Indianapolis, Ind., Imperial Packaging Co. Inc., Le-Bo Prods. Co. Inc., 58-60 Grand Ave., Maspeth 11378 Tel. 894-5155 Chm. Peter Dayton; Pres. Al Alexander, Mktg. Dir. Gary Schwarz, Nat'l Sales Mgr. Arthur Klein (Sleeves only) (M) (SEE ADVERTISEMENT)

Lee-Myles Assocs. Inc., 160 E. 56 St. Zip 10022 Tel. 758-3232 Pres. Robert M. Miller. (M) (SEE ADVERTISEMENT)

Mac Murray Press Inc., 230 W. 17 St. Zip 10011 Tel. 924-1530 Pres. Bernard Lerman. (M)

Pilgrim Press Corp., 36-01 43 Ave., Long Island City 11011, Tel. 937-9515 (Jackets only) (M)

Prestone Printing Co., 147 W. 42 St. Zip 10036 Tel. 354-1871

Home office: Los Angeles, Calif.

Progressive Label & Litho Co., 286-290 Stanhope St., Brooklyn 11237 Tel. 497-2320 (Jackets only) (M) (SEE ADVERTISEMENT)

Queens Lithographing Corp., 52-35 Barnett Ave., Long Island City 11104 Tel. 457-7700 Pres. Jack L. Hecht; VP Leonard Verebay (M)

Branch: Hollywood (Los Angeles Metropolitan Area), Calif.

Plant: Indianapolis, Ind., Rutgers Packaging Corp.

Shepard Printing Corp., 111 Eighth Ave. Zip 10011 Tel. (212) 255-1930 (Jackets only) (M)

Home office: Edison, N.J.

Shorewood Packaging Corp., 10 E. 53 St. Zip 10022 Tel. 371-1500 Pres. Paul Shore; Exec. VP Mktg. Floyd S. Glinert; VP Sales Ken Rosenblum (M)

Branch: Los Angeles, Calif.

● **PLAINVIEW (Area Code 516)**

Delrama Int'l, 37 Newtown Rd. Zip 11803 Tel. 293-8740 (M)

NORTH CAROLINA

● **CANTON (Area Code 704)**

Recording Servs. of Western North Carolina, 10 Penland St. Zip 28716 Tel. 648-6012 Owner J. Ted Evans Jr.; Sales Mgr. Don Barber, Adv. Mgr. Kay Evans (Jackets only)

OHIO

● **CINCINNATI (Area Code 513)**

Artists Rec'g Co. Inc., 320 Mill St. Zip 45215 Tel. 761-0011 (Jackets only) (M)

Jewel Rec'g Co., 1514 Kinney Ave. Zip 45231 Tel. 522-5808/9336 Pres. Charles York; Sales Mgr. Linda York, Adv. Mgr. Harry Urschel (Jacket fabrication & high speed LP shrinkwrapping only)

Q C A Custom Pressing, 2832 Spring Grove Ave. Zip 45225 Tel. 681-8400 Pres. Edward R. Bosken; VP & Gen. Mgr. Frank E. Ruhl; Sales Mgr. Keith Myers; Adv. Mgr. D. Kalmus (Jackets only) (M)

Studio Pressing Serv., 320 Mill St. Zip 45215 Tel. 761-8294 Pres. Joseph Sluder; Sec'y. Connie Sluder (Jackets only) (M)

PENNSYLVANIA

● **MECHANICSBURG (Area Code 717)**

H R C Printing, 5252 E. Trindle Rd. Zip 17055 Tel. 766-0943 Gen. Mgr.: Donald E. Baldwin. (M) (SEE ADVERTISEMENT)

● **PHILADELPHIA METROPOLITAN AREA (Area Code 215)**

Community Press, 6047-49 Woodland Ave. Zip 19142 Tel. 729-4655

Hodge Rec. Mfg. Co., 1314024 S. Howard St. Zip 19147 Tel. 334-5662. (Sleeves only) (MD)

● **PITTSBURGH METROPOLITAN AREA (Area Code 412)**

Record-Rama, 635 Butler St. Zip 15223 Tel. 781-2155

Owner Paul C. Mawhinney; Sales Mgr. Mark Mawhinney, Adv. Mgr. Colette Mawhinney (Jackets—D, 45 rpm copyrighted record history sleeves—M)

● **SCRANTON (Area Code 717)**

Keystone Printed Specialties Co. Inc., 321 Pear St. Zip 18505 Tel. 346-1761 Pres. P.G. Fischer Jr.; Sales Mgr. Martin C. Fischer. (M) (SEE ADVERTISEMENT)

● **SHARON (Area Code 412)**

Marjon Recs. Inc., 159 Easton Rd., Hermitage 16146 Tel.

347-4726 Pres. John T. Krzancic; Sales Mgr. Martha Krzancic, Adv. Mgr. Ruth Toth (Jackets only) (M)

PUERTO RICO

● **SAN JUAN (Area Code 809)**

Rio Piedras Rec. Mfg. Inc., GPO Box 4785 Zip 00936 Tel. 790-4286/3726/2188 Pres. Dario Gonzalez Fajardo (M)

TENNESSEE

● **NASHVILLE (Area Code 615)**

Color Graphics Inc., 305 Church St., Goodlettsville 37072, Tel. 859-4001 Pres. Randal L. Miller. (Jackets only) (M)

Nashville Album Prods Inc., 617 Seventh Ave. S. Zip 37203 Tel. 256-0121 Pres. Steve Botts, Sec'y. Treas. Robbie McWey (M)

Nashville Int'l Prod., 20 Music Square W. Zip 37203 Tel. 256-2885 (M)

Pinwheel Art & Photography Studios Inc., 1211 16 Ave. S. Zip 37212 Tel. 327-9125

T & P Prod'ns, PO Box 1561 Zip 37202 Tel. 242-1037 (MD)

Home office: St. Louis, Mo., Ken Keene Int'l

Williams Printing Co., 417 Commerce Zip 37219 Tel. 256-7151 Pres. B.G. Johnson. (M)

TEXAS

● **DALLAS (Area Code 214)**

Continental Graphics Inc., PO Box 5057 Zip 75222 Tel. 741-3236 (Jackets only) (M)

● **FORT WORTH METROPOLITAN AREA (Area Code 817)**

Wills Printing Co., PO Box 211, Arlington 76010 Tel. 572-1414 Pres. Calvin Wills (Jackets only) (M)

● **HOUSTON (Area Code 713)**

Riverside Albums, 7400 Pinemont Zip 77040 Tel. 462-2700 Pres. Earl Thomas; Sales Mgr. Brenda Cox (Jackets only)

● **WACO (Area Code 817)**

Mike's Print Shop, 2507 Grim, Zip 76707 Tel. 752-2321 (Jackets only) (M)

UTAH

● **SALT LAKE CITY (Area Code 801)**

Chase Media Inc., Beneficial Life Tower, Suite 1723, Zip 84111 Tel. 363-5858 Pres. Randal S. Chase; Sales Mgr. Irel L. Chase. (MD)

WYOMING

● **CHEYENNE (Area Code 307)**

Rocky Mountain Rec'g. Box 1354A, Rt. 2 Zip 82001 Tel. 638-8733 Pres. Ray Alexander, Sales & Adv. Mgr. Georgia Alexander. (Jackets only)

LABELS

The key to the abbreviations following the company listings is: (M) Manufacturer, (D) Distributor, (I) Importer.

CALIFORNIA

● **LOS ANGELES METROPOLITAN AREA (Area Code 213)**

Allied Rec. Co., 6110 Peachtree St. Zip 90040 Tel. 725-6900 Pres. Samuel M. Broadhead, VP & Gen. Mgr. John F. Wegner, Customer Serv. & Quality Assurance Dir. Stephen R. Broadhead. (M)

Award Rec. Mfg. Inc., 11016 La Cienega Blvd., Inglewood 90304 Tel. 645-2281 Pres. Martin Ansooriaw, Sales Mgr. Bill Dryden, Adv. Mgr. George Abajian

The Bert-Co Ents. Inc., 1855 Glendale Blvd. Zip 90026 Tel. 665-5137 (M)

Branch: New York, N.Y.

Bluebelle Shoppe, PO Box 14466 Long Beach 90803 Dir. Mark Slater. (Holographic custom work)

Ivy Hill Communications Inc., 4800 S. Santa Fe Ave. Zip 90058 Tel. 587-3131 Div. Exec. VP Russell Muir, Sr. VP's Jack Sclar, Arthur Kern. (M)

Home office: Great Neck, N.Y.

Kdisc (sub. of Keycor Century Corp.), 6550 Sunset Blvd., Hollywood 90028 Tel. 466-1323 Pres. Eugene R. Schutz; Gen. Mgr. Bill Lightner, Sales Mgr. Dick Maxwell (M)

Plant: Saugus, Calif. (SEE ADVERTISEMENT)

K M Recs. Inc., 2980 N. Ontario St., Burbank 91504 Tel.

841-3400 Pres.: Glade Merkley, VP Custom Servs. Jim Auchterlonie; Sales & Adv. Mgr. Bruce Leek.

Mustron Inc., 2834 1/2 W. Pico Blvd. Zip 90006 Tel. 380-6840

Queens Lithographing Corp., 6290 Sunset Blvd., Suite 304, Hollywood 90028 Tel. 464-7700 (M)

Home office: Long Island City (New York Metropolitan Area), N.Y.

Plant: Indianapolis, Ind., Rutgers Packaging Corp.

● **SAN FRANCISCO & BAY AREA (Area Code 415)**

Conlan Creative Lithographers, PO Box 2763 800 Forbes Blvd., Suite 260, South San Francisco 94080 Tel. 761-7617 (M)

● **SAUGUS (Area Code 805)**

Kdisc (sub. of Keycor Century Corp.), 26000 Springbrook Ave. Zip 91350 Tel. 259-2360 Pres. Eugene R. Schutz; Gen. Mgr. Bill Lightner; Sales Mgr. Dick Maxwell (M)

Office: Hollywood (Los Angeles Metropolitan Area), Calif. (SEE ADVERTISEMENT)

CONNECTICUT

● **UNION CITY (Area Code 203)**

A.C. Hampson Printing Co., 168 City Hill St. Zip 06770, Tel. 729-2294 Pres. Augustus D. Hampson; Sales Mgr. John W. Berry.

DELAWARE

● **WILMINGTON AREA (Area Code 302)**

Ken-Del Prod'ns Inc., 111 Valley Rd., Richardson Park 19804, Tel. 655-7488 Pres. H. Edwin Kennedy; Sales Mgr. Shirley Kay. (M)

National Tape Dupl'rs, see Ken-Del.

FLORIDA

● **MIAMI METROPOLITAN AREA (Area Code 305)**

Prosound Inc., 8194 NW 103 St., Hialeah 33015 Tel. 558-0152. (M)

● **SARASOTA (Area Code 813)**

Vaughan Assocs., PO Box 5808, Zip 33579 Tel. 924-3734.

GEORGIA

● **ATLANTA (Area Code 404)**

Linear Prods. Inc., 4507 K Mills Pl. SW, Zip 30336 Tel. 691-1254

Home office: New York, N.Y.

ILLINOIS

● **CHICAGO METROPOLITAN AREA (Area Code 312)**

A G I Plant Inc., see Album Graphics Inc.

Album Graphics Inc. (AGI Plant Inc.), 1950 N. Ruby St., Melrose Park 60160 Tel. 344-9100 Pres. Donald W. Kostelka; Sales Mgr. Charles Eaton. (M)

Sales offices: Los Angeles, Calif.; New York, N.Y.

Fort Dearborn Lithograph Co., 6035 W. Gross Point Rd., Niles 60648 Tel. 647-8730

Musical Prods. Inc., 521 W. 26 St. Zip 60616 Tel. 225-9117. (M)

● **ROCKFORD (Area Code 815)**

Carter Corp., 1916 11 St. Zip: 61101, Tel. 397-3200 Pres. R.L. Fleming; VP Sales & Mktg. S.L. Fleming; Adv. Mgr. Janet K. Ratner.

INDIANA

● **INDIANAPOLIS (Area Code 317)**

Rutgers Packaging Corp. (div. of Queens Lithographing Corp.), 620 S. Belmont Ave. Zip 46221 Tel. 635-7777 Pres. Abe Garde; Sales & Adv. Mgr. Morton D. Schecter. (M)

Home office: Long Island City (New York Metropolitan Area), N.Y., Queens Lithographing Corp.

● **TERRE HAUTE (Area Code 812)**

Artco Press Inc., PO Box 1445, Zip 47808 Tel. 232-0926 Pres. James S. Royse; Sales Mgr. Don Wilson. (M)

Ivy Hill Communications Inc., Fort Harrison Ind'l Park, Fruitridge Ave. Zip 47803 Tel. 466-9851 (M)

Home office: Great Neck, N.Y.

Woodburn Printing Co. (div. of Unique Graphics Corp.), 25 S. Sixth St. Zip 47808 Tel. 466-6822 Pres. Donald P. Pendergast; Sales Mgr.: John Avelis; Adv. Mgr.: John Crippen. (M)

LOUISIANA

● **VILLE PLATTE (Area Code 318)**

Ville Platte Rec. Mfg. Co., 120 E. Cypress St. Zip 70586, Tel. 363-2104 Pres. J. Floyd Soileau, Sales Mgr.: Ronnie Soileau, Mgr.: J.K. Soileau. (M)

MASSACHUSETTS

● **CHICOPEE (Area Code 413)**
Dielectrics Inc., 6 Second Ave. Zip 01020 Tel: 598 8308
Pres.: Earl S. Stahl; Exec. VP & Nat'l Sales & Adv. Mgr.:
Eric C. Stahl.

MICHIGAN

● **DETROIT METROPOLITAN AREA (Area Code 313)**
Archer Rec. Pressing Co., 7401 E. Davison Zip 48077 Tel:
365-9545 (M)

NEW JERSEY

● **JERSEY CITY (Area Code 201)**
Q.A.I. Inc. (formerly Saxon Adhesive), 640 Dell Rd. Zip
07072 Tel: 935 5100, NYC (212) 736-1980 Pres.:
Steven Dauman; Sales Mgr. George Ratosky (M)

● **LYNDHURST (Area Code 201)**
Colorseps-Lithopreps Serv., PO Box 151, Zip 07071 Tel:
438-6729 Pres. J.G. Principato (M)

NEW YORK

● **GREAT NECK (Area Code 516)**
Ivy Hill Communications Inc., Community Dr. Zip 11022
Tel 487-0200 (M)
Branches: Los Angeles, Calif.; Terre Haute, Ind.

● **HAUPPAUGE (Area Code 516)**
Disc Graphics (div. of Pickwick Int'l), Cardinal Ind'l Park, 10
Gilpin Ave. Zip 11787 Tel 234-1400 Gen. Mgr. Gus
Thalasinis (M)

● **NEW YORK METROPOLITAN AREA (Area Code 212)**
G. Benson & Co. Printers Inc., 116 Nassau St., Brooklyn
11201 Tel 598-9100 Pres. Gerald J. Benson, VP
Sales Gil Benson; Adv. Mgr. Roxanne Evans (M)
Bert-Co Ent's Inc., 241 E. 34 St. Zip 10016 Tel 683-
6300 (M)
Home office: Los Angeles, Calif.
Brown Paper Co. Inc., 186 Seventh St., Brooklyn 11215.
Tel. 965-3600 (MD)
Disc Communications Ltd., 743 Fifth Ave. Zip 10022 Tel:
371-0390 Pres. Jerome Boxer, Art Dir. Susan Mur-
phy (M)
E R H Sales Corp., 221 W. 57 St. Zip 10019 Tel 582-
4200 Pres. Lee Halpern; Sr. Exec. VP Howard Roseff;
Gen. Mgr. Michael Halpern; Sales Mgr. Robert Shavel-
son (M)
Guaranteed Printing Serv. Co. Inc., 119 W. 23 St. Zip:
10011 Tel 929-2410 (M)
Lee-Myles Assocs Inc., 160 E. 56 St. Zip 10022 Tel 758-
3232 Pres. Robert M. Miller (M) (SEE ADVERTISE-
MENT)
Linear Prods Inc., 37 W. 20 St. Zip 10011 Tel 255-2917.
Branches: Atlanta, Ga.; Puerto Nuevo, P.R.
Mac Murray Press Inc., 230 W. 17 St. Zip 10011 Tel 924-
1530 Pres. Bernard Lerman (M)
Progressive Label & Litho Co., 286-290 Stanhope St.,
Brooklyn 11237 Tel 497-2320 (M) (SEE ADVERTISE-
MENT)
Promedeus Arts Inc., 1776 Broadway Zip 10019 Tel
586-3770 Pres. Lew Morris; Sales Mgr. Jerry
Present; Adv. Mgr. Ron Paris (Promotional tape & la-
bels) (M)
Queens Lithographing Corp., 52-35 Barnett Ave., Long Is-
land City 11104 Tel 457-7700 Pres. Jack L. Hecht;
VP: Leonard Verebay (M)
Branch: Hollywood (Los Angeles Metropolitan Area),
Calif.
Plant: Indianapolis, Ind.; Rutgers Packaging Corp

● **UTICA (Area Code 315)**
Oneida Video Audio Tape Cassette Corp., 760 Blandina St.
Zip 13501 Tel 735-6187 Pres. Stanley Markowski;
Sales Mgr. Joyce Markowski; Adv. Mgr. Andrew Citta-
dino (M)

OHIO

● **CINCINNATI (Area Code 513)**
Artists Rec'g Co. Inc., 320 Mill St. Zip 45215 Tel: 761-
0011 (M)
Q C A Custom Pressing, 2832 Spring Grove Ave. Zip
45225 Tel 681-8400 Pres. Edward R. Bosken; VP &
Gen. Mgr. Frank E. Ruhl; Sales Mgr. Keith Myers; Adv.
Mgr. D. Kalmus (M)

PENNSYLVANIA

● **MECHANICSBURG (Area Code 717)**
H R C Printing, 5252 E. Trindle Rd. Zip 17055 Tel: 766-
0943 Gen. Mgr. Donald E. Baldwin (M) (SEE ADVER-
TISEMENT)

● **PHILADELPHIA METROPOLITAN AREA (Area Code 215)**
Fenton Label Co., Coral & Buckius Sts. Zip 19124 Tel 288-
2910.

● **SCRANTON (Area Code 717)**
Keystone Printed Specialties Co. Inc., 321 Pear St. Zip
18505 Tel 346-1761 Pres. P.G. Fischer Jr.; Sales
Mgr. Martin C. Fischer (M) (SEE ADVERTISEMENT)

● **SHARON (Area Code 412)**
Marjon Recs. Inc., 159 Easton Rd., Hermitage 16146 Tel:
347 4726 Pres. John T. Krzancic; Sales Mgr. Martha
Krzancic; Adv. Mgr. Ruth Toth (M)

PUERTO RICO

● **PUERTO NUEVO (Area Code 809)**
Linear Prods. Inc., Old Long Bldg., Matadero Rd. Tel: 783-
4986
Home office: New York, N.Y.

TENNESSEE

● **NASHVILLE (Area Code 615)**
M F P Inc., 453 Chestnut St. Zip 37203 Tel 259-9396.
Owner John Dunn; Pres. Ozell Simpkins
Nashville Album Prods Inc., 617 Seventh Ave. S. Zip
37203 Tel 256-0121 Pres. Steve Botts; Sec'y
Treas. Robbie McWey (M)
Nashville Int'l Prod., 20 Music Square W. Zip 37203 Tel
256 2885 (M)
Pinwheel Art & Photography Studios Inc., 1211 16 Ave. S.
Zip 37212 Tel 327-9125
United Rec. Pressing Inc., 453 Chestnut St. Zip 37203 Tel
259-9396 Pres. Ozell Simpkins (M)
Williams Printing Co., 417 Commerce. Zip 37219 Tel
256-7151 Pres. B.G. Johnson (M)

TEXAS

● **FORT WORTH METROPOLITAN AREA (Area Code 817)**
Wills Printing Co., PO Box 211, Arlington 76010 Tel: 572-
1414. Pres. Calvin Wills (M)

● **WACO (Area Code 817)**
Mike's Print Shop, 2507 Grim Zip 76707 Tel 752-2321

UTAH

● **SALT LAKE CITY (Area Code 801)**
Chase Media Inc., Beneficial Life Tower, Suite 1723. Zip

84111. Tel 363-5858 Pres. Randal S. Chase; Sales
Mgr. Irel L. Chase (MD)

WISCONSIN

● **ELKHART LAKE (Area Code 414)**
Sohn Mfg. Inc., Box X Zip 53020 Tel 876-3361 Pres.
Wallace J. Beaudry; Sales Mgr.: Deane Jenkins.

WYOMING

● **CHEYENNE (Area Code 307)**
Rocky Mountain Rec'g, Box 1354A, Rt. 2 Zip 82001 Tel:
638-8733 Pres. Ray Alexander; Sales & Adv. Mgr.:
Georgia Alexander (MD)

POLYETHYLENE BAGS

*The key to the abbreviations following the com-
pany listings is: (M) Manufacturer, (D) Distrib-
utor, (I) Importer.*

CALIFORNIA

● **LOS ANGELES METROPOLITAN AREA (Area Code 213)**
Container-Kraft Inc., 8321 De Celis Pl., Sepulveda 91343
Tel 893-9721 (M)
Ivy Hill Communications Inc., 4800 S. Santa Fe Ave. Zip
90058 Tel 587-3131 Div. Exec. VP. Russell Muir, Sr.
VP's Jack Selar, Arthur Kern
Kalny Mdsq, 4700 S. Santa Fe Ave. Zip 90058 Tel 587-
1164 Customer Serv. Arte Hirsch
M. Litter Mfg. & Sales, 3208 W. Jefferson Blvd Zip
90018 Tel 737-0440 Owner Mel Litter
Queens Lithographing Corp., 6290 Sunset Blvd., Suite 304,
Hollywood 90028 Tel 464 7700 (M)
Home office: Long Island City (New York Metropolitan
Area), N.Y.
Plant: Indianapolis, Ind.; Rutgers Packaging Corp

● **SAN JOSE (Area Code 408)**
M J S, 2514 Seaboard Ave. Zip 95131 Tel 262-8793.
Owner Michael Steiner (M)

ILLINOIS

● **CHICAGO METROPOLITAN AREA (Area Code 312)**
Bruce Packaging Co., 8025 N. Kenneth Ave., Skokie
60076 Tel 583-2818 Pres. Joseph Halperin (M)

INDIANA

● **INDIANAPOLIS (Area Code 317)**
Bowers Rec. Sleeve Co., 5331 N. Tacoma Ave. Zip 46220
Tel 251-3918 Pres. Robert C. Bowers, VP & Sales
Mgr. Charles H. Kaufman (MD)
Reco-Sleeve Packaging, 620 S. Belmont, Zip 46221 Tel
635-7777 Pres. Leonard Verebay; Sales & Adv. Mgr.
Len Dimond (M)
Rutgers Packaging Corp (div. of Queens Lithographing
Corp.), 620 S. Belmont Ave. Zip 46221 Tel 635-
7777 Pres. Abe Garde; Sales & Adv. Mgr. Morton D.
Shteter (M)
Home office: Long Island City (New York Metropolitan
Area), N.Y.; Queens Lithographing Corp

NEW YORK

● **COMMACK (Area Code 516)**
Robins Inds. Corp., 75 Austin Blvd. Zip 11725 Tel 543-
5200 Pres. Herman Post; Sales & Adv. Mgr. Stu
Caine (M)

● **HAUPPAUGE (Area Code 516)**
Arista Ent's Inc., 35 Hoffman Ave. Zip 11787 Tel 234-
7000 Pres. Alan E. Leifer (I)

● **NEW YORK METROPOLITAN AREA (Area Code 212)**
Brown Paper Co. Inc., 186 Seventh St., Brooklyn 11215.
Tel. 965-3600 (MD)
Copy Art Photographers (div. of James J. Kriegsmann Inc.)
165 W. 46 St. Zip 10036 Tel 757-0233 Pres.
James J. Kriegsmann
Disc Communications Ltd., 743 Fifth Ave. Zip 10022 Tel:
371-0390 Pres. Jerome Boxer, Art Dir. Susan Mur-
phy (M)
E R H Sales Corp., 221 W. 57 St. Zip 10019 Tel 582-
4200 Pres. Lee Halpern; Sr. Exec. VP Howard Roseff;
Gen. Mgr. Michael Halpern; Sales Mgr. Robert Shavel-
son (M) (SEE ADVERTISEMENT)
Le-Bo Prods Co. Inc., 58-60 Grand Ave., Maspeth 11378.
Tel. 894-5155. Chim.: Peter Dayton; Pres.: Al Alex-

BERNIE STEIN JERRY ROOD
TEL. (212) 497-2320

PROGRESSIVE LABEL & LITHO CO.
286 STANHOPE ST., BROOKLYN, N.Y. 11237

from the inventor of modern
record plating

THE NEW AUDIOMATIC A-V PLATING PROCESS

with 15 dramatic new, exclusive
features for sophisticated audio and
video applications

1

all-new, fully-enclosed design (nothing exposed but the "start" button)

2

completely automated (operator puts matrix on, pushes "START," takes plate off)

3

factory-assembled, with only one electric and as few as three plumbing connections on site

4

corrosion-free, heavy-duty fiberglass tank and tank cover

5

absolute filtration to 0.2 micron, with all-new two-stage filter system

6

new automatic two-step electrolytic purification technique that really purifies

7

automatic cathode rinsing before and after cycle

8

automatic cathode/cover raising and lowering at each position

9

pre-programmed plating cycles for three different specifications

10

continuous digital readout of pH, temperature, current and voltage

11

automatic digital solution temperature controller

12

automatic 52-day-chart recording of vital data

13

totally-enclosed rectifiers with water-cooled radiators

14

external fail-safe electronic solution-level control

15

improved hydrodynamics to keep impurities away from cathode

Distributed in the US
and worldwide by
audio
AUDIO MATRIX, INC.



1290 Avenue of the Americas
New York, NY 10019
Cable Audiomatic
Phone 212/582-4870
Telex 12-6419

Other offices: Paris Hong Kong Mexico City Representatives throughout the world

ander, Mktg. Dir.: Gary Schwarz; Nat'l Sales Mgr.: Arthur Klein. (M) (SEE ADVERTISEMENT)
 Poly Plastic Packaging Co. Inc., 44-80 11 St., Long Island City 11101. Tel: 392-8670.
 Queens Lithographing Corp., 52-35 Barnett Ave., Long Island City 11104. Tel: 457-7700. Pres.: Jack L. Hecht; VP: Leonard Verebay. (M)
 Branch: Hollywood (Los Angeles Metropolitan Area), Calif.
 Plant: Indianapolis, Ind., Rutgers Packaging Corp.
 Recoton Corp., 46-23 Crane St., Long Island City 11101. Tel: 392-6442. Pres.: Robert Borchardt; Sales Mgr.: George Calvi; Adv. Mgr.: Peter Wish. (MD)
 Tong Dah Plastics Co. Ltd., 663 Fifth Ave. Zip: 10022. Tel: 688-1268. (M)
 Home office: Republic of China.

● **PLAINVIEW (Area Code 516)**

Delrama Int'l, 37 Newtown Rd. Zip: 11803. Tel: 293-8740. (M)

TENNESSEE

● **NASHVILLE (Area Code 615)**

Nashville Album Prod'ns Inc., 617 Seventh Ave. S. Zip: 37203. Tel: 256-0121. Pres.: Steve Botts; Sec'y-Treas.: Robbie McWey. (M)

**RAW MATERIALS
 MANUFACTURERS &
 IMPORTERS**

Alcoa, PO Box 9158, Alcoa, Tenn. 37701. Tel: (615) 977-2011.
 Product: Aluminum substrates.
 Allied Rec'g, 3232 Greenpoint Ave., Long Island City, N.Y. 11101. Tel: (212) 784-2318.
 Product: Blank disks
 J. C. Anglum Co. Inc. / Tapeponents Inc., Box 236, 36 Midvale Rd., Mountain Lakes, N.J. 07046. Tel: (201) 263-1442. Pres.: J. Clifford Anglum.
 Product: Vinyl resin & compounds, styrene resin & compounds, color concentrates.
 Audiocdiscs, see Capitol Magnetic.
 Cabot Corp., 200 Raritan Center Pkwy., Edison, N.J. 08817. Tel: (201) 225-1000.
 Product: Carbon black.

Capitol Magnetic Prods. (div. of Capitol Recs. Inc.), 1750 N. Vine St., Hollywood, Calif. 90028. Tel: (213) 462-6252.
 Product: Blank disks
 Brand name: Audiocdiscs.
 Celanese Plastics, 26 Main St., Chatham, N.J. 07928. Tel: (201) 635-2600.
 Product: Celanar polyester film.
 Gotham Audio Corp., 741 Washington St., New York, N.Y. 10014. Tel: (212) 741-7411.
 Product: Blank disks.
 Brand name: Pyral.
 Lenahan Inc., PO Box 397, Pitman, N.J. 08071. Tel: (609) 589-5755.
 Product: Custom milling compounds.
 Pyral, see Gotham Audio.
 Rainville Co. Inc., 200 Clay Ave., Middlesex, N.J. 08846. Tel: (201) 752-8100. Pres.: Dewey Rainville; Sales Mgr.: Donald Rainville.
 Product: PVC/carbonblack conveying systems, size reduction & silos.
 Randolph Prods. Co., Box 67, Carlstadt, N.J. 07072. Tel: (201) 438-3700. Pres.: John H. Randolph.
 Product: Record lacquer.
 Richardson Co., Polymeric Systems Div., 15 Meigs Ave., Madison, Conn. 06443. Tel: (203) 245-0441. Gen. Mgr.: A.J. Raiche; Prod. Mgr.: D.J. Alaconis.
 Product: Injection molding, polystyrene compounds—standard black & custom transparent colors.
 Tenneco Chemical Corp., Turner Pl., Piscataway, N.J. 08854. Tel: (201) 981-5170, (adv.) 646-3882. Mktg. Dir.: G.E. Disch; Adv. Dir.: Don Beyer.
 Product: Record compounds. (SEE ADVERTISEMENT)
 Transco Prods. Corp., 609 W. Elizabeth Ave., Linden, N.J. 07036. Tel: (201) 862-0030.
 Product: Blank disks. (SEE ADVERTISEMENT)

**RECORD PROCESSING
 EQUIPMENT MANUFACTURERS/
 IMPORTERS**

Al-Be Inds. Inc., 16633 Minnesota Ave., Paramount, Calif. 90723. Tel: (213) 636-2563. Pres.: D.J. Shaw; VP: M.L. McLaren.
 Chief product: Matic preplasticizer.
 Aragon, see Certain-Teed Machinery.
 Audiomatic Corp., 1290 Ave. of the Americas, New York, N.Y. 10019. Tel: (212) 582-4870. Telex: 126419.
 Pres.: Milton B. Gelfand; VP Customer Serv.: Carolyn T. DeVries; Adv. Mgr.: J.P. Lohman.
 Int'l branch: France.

Chief product: Presses, plating systems. (SEE ADVERTISEMENT)
 Audio Matrix Inc., 915 Westchester Ave., Bronx, N.Y. 10459. Tel: (212) 589-3500. Pres.: Milton B. Gelfand; VP Plating Processes: Carl M. Rodia; Sales Mgr.: Martin Feder; Adv. Mgr.: J.P. Lohman.
 Chief product: Phonograph & videodisk processing equip. (SEE ADVERTISEMENT)
 Certain-Teed Machinery Corp., PO Box 279, 5501 N. 119 St. W., Maize, Kan. 67101. Tel: (316) 722-2811. Pres.: Ken McKown; Sales Mgr.: William Hoebener.
 Chief product: Extruders.
 Brand name: Aragon.
 D D W, 533 Hagan St., Nashville, Tenn. 37203. Tel: (615) 256-2183.
 Chief product: Extruder.
 Brand name: Sure Shot.
 Diacoustic Lab., 23958 Craftsman Rd., Calabasas, Calif. 91302. Tel: (213) 888-8010. Owner & Pres.: Ernest Knight; Sales Mgr.: K.D. Vredenburg.
 Chief product: Disk recording styli, blank disks, stereo disk cutting lathes.
 Diskmakers Inc., 925 N. Third St., Philadelphia, Pa. 19123. Tel: (215) 627-2277, NYC (212) 966-3185. Pres.: Morris Ballen.
 Chief product: Used equip. (SEE ADVERTISEMENT)
 E P I, see Extruda-Prod'ns.
 Europa Film, see Gotham.
 Extruda-Prod's Inc., 100 S. Washington Ave., Dunellen, N.J. 08812. Tel: (201) 752-2144. Pres.: Robert Tillis; Adv. Mgr. Abe Schwartz
 Chief product: Compounding extruders & preplasticizers.
 Brand name: EPI. (SEE ADVERTISEMENT)
 Finebilt Mfg. Co. Inc., 931 N. Citrus Ave., Los Angeles, Calif. 90038. Tel: (213) 466-9511. Pres.: Alwin P. Schmid; VP: Joseph Bouzaglou.
 Chief product: Pressing equip., nickel matrix production units.
 Gentry Machine Corp., Somerdale Ind'l Park, 201 Linden Ave., Somerdale N.J. 08083. Tel: (609) 627-3000. Pres.: Paul Miller.
 Chief products: Presses, extruders.
 Brand names: Hydramold 150, Miller Compounder.
 Gotham Audio Corp., 741 Washington St., New York, N.Y. 10014. Tel: (212) 741-7411. Pres.: Stephen F. Temmer; VP: Eli Passin.
 Product: Plating equip.
 Brand name: Europa Film.
 Hamilton Mfg. (div. of Valley Metallurgical Processing Co. Inc.), 510 First Ave., West Haven, Conn. 06516. Tel: (203) 933-1625.
 Chief product: Manual & automatic record presses; 7", 10" & 12" molds, insert molds & frame assemblies, mold accessories & accessory equip. (SEE ADVERTISEMENT)
 Hydramold 150, see Gentry Machine.
 I C R, see Ranstelee.
 M. Lattier Mfg. & Sales, 3208 W. Jefferson Blvd., Los An-



EXTRUDERS

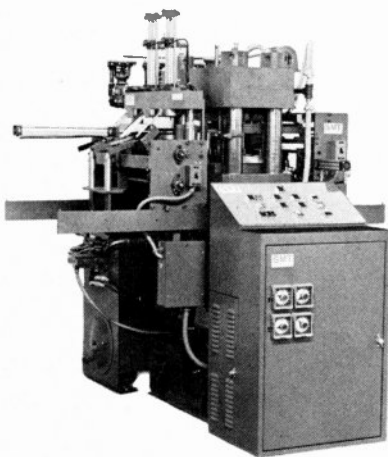

**MODEL 3600
 DUAL 7" AUTOMATION**

The world's finest 7" & 12" record manufacturing systems, extruders, hydraulic presses, complete matrix manufacturing equipment, automatic material loading equipment and other related items.

Ask about 70 record pressing plants in the U.S. and 10 other countries who use our automation and extruders.

Fabrication of complete record pressing and matrix electroforming plants anywhere in the world.

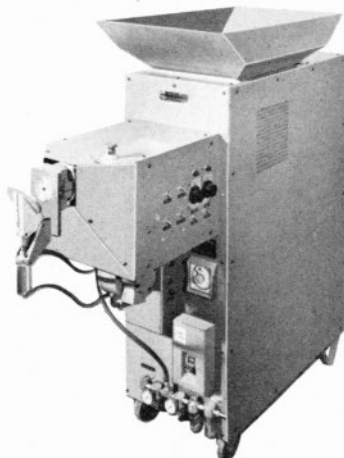

**SOUTHERN MACHINE & TOOL CORP.
 533 HAGAN STREET
 NASHVILLE, TENN. 37203
 (615) 256-2183**

TLX: 554302
 Bill Westermann, Pres.

geles, Calif. 90018. Tel: (213) 737-0440. Owner: Mel Latter
Chief product: Shrink packaging equip. & plastic shrink film.
 James G. Lee Rec. Processing Inc., 145 W. 154 St., Gardena, Calif. 90247. Tel: (213) 321-2187.
Chief product: Record matrices, masters, mothers, stampers.
 Lened Int'l Corp., 489 Henry St., Elizabeth, N.J. 07201. Tel: (201) 354-5205. Pres.: Joseph Flusfeder.
Chief product: Automatic record pressing systems. (SEE ADVERTISEMENT)
 Maple Clamp Corp., 1278 Underwood Ave., San Francisco, Calif. 94124. Tel: (415) 822-8855. Pres.: Paul Joulsch.
Chief product: Record trimmers.
 Mastercraft Rec. Plating Inc., 609 W. 51 St., New York, N.Y. 10019. Tel: (212) 265-6040. Gen. Mgr.: David Moldauer.
Chief product: Plating equip.
 Micro-Point Inc., 8 Westchester Plaza, Elmsford, N.Y. 10523. Tel: (914) 592-7627. TWX (710) 567-1223. Gen. Mgr.: Edward Schwartz.
Chief product: Matrix tool. (SEE ADVERTISEMENT)
 Miller Compounder see Gentry Machine.
 Musical Prods. Inc., 521 W. 26 St., Chicago, Ill. 60616. Tel: (312) 225-9117.
Chief product: Plating equip.
Brand name: Vans.
 Nelson Machine Works Inc., Hydraulic Div., 12615 S. Main St., Los Angeles, Calif. 90061. Tel: (213) 754-2823.
Chief product: Pneumatic hydraulic & compression presses.
 Ranstele Audio Inc., 1697 Broadway, New York, N.Y. 10019. Tel: (212) 265-5563. Pres.: Thomas S. Steele.
Chief product: Disk mastering equip., cutterheads, cutterhead driver pre-amplifiers, power amplifiers, cutting lathe control systems, variable pitch & depth control computers, meter-monitor switching analyzers, custom control consoles, lathe rebuilding, customizing & updating of equip.
Brand names: ICR, Ranstele.
 Record Prods. of America Inc., 700 Sherman Ave., Hamden, Conn. 06514. Tel: (203) 248-6371. Pres.: Stanley Roczynski; VP & Sales Mgr.: Steve Suzanski.
Chief products: Record molds & accessories.
 S M T, see Southern Machine
 Scandia Packaging Machinery Co., 180 Brighton Rd., Clifton, N.J. 07012. Tel: (201) 473-6100.
Chief product: Packaging machinery for wrapping, cartoning, labeling & shrinking. (SEE ADVERTISEMENT)
 Schiff Machine Co. Inc., 28 E. Hanover Ave., Morris Plains, N.J. 07950. Tel: (201) 539-5100.
Chief product: Pneumatic label cutting press.
 Southern Machine & Tool Corp., 533 Hagan St., Nashville, Tenn. 37203. Tel: (615) 256-2183.
Chief product: 7" & 12" completely automatic presses.
Brand name: SMT. (SEE ADVERTISEMENT)
 Standard Paper Box Machine Co. Inc., 476 Broome St., New

York, N.Y. 10013. Tel: (212) 925-9818. Pres.: Paul Adams; Treas.: Aaron Adams; Adv. Mgr.: Bruce Adams.
Chief product: Jacket machines.
 Transco Prods. Int'l, 875 Merrick Ave., Westbury, N.Y. 11590. Tel: (516) 333-2000. Pres.: Arthur A. Singer; Admin. Mgr.: Richard Ermolovich; Adv. Mgr.: Sheldon M. Berman.
Chief product: Master record blanks.
 Vans, see Musical Prods.
 Worlindex Mfg. Co. Ltd., 1212 N. La Brea Ave., Hollywood, Calif. 90038. Tel: (213) 466-3324. Pres.: Louis R. Baptista.
Chief product: Record presses, electroplating plants, dies, edging machines.

2803 Butterfield Rd., Suite 200, Zip: 60521. Tel: (312) 242-1915. Zone Mgr.: Fred Schaezting—Lexington, Mass., Lexington Office Center, Hayden Ave. Zip: 02173. Tel: (617) 890-5430. Reg'l Mgr.: R. Kleine—Waldwick, N.J., 150 Hopper Ave. Zip: 07463. Tel: (201) 444-8500—New York, N.Y., 1 Penn Plaza, Rm. 3527. Zip: 10001. Tel: (212) 279-2560—Dallas, Tex., 3003 LBJ Fwy., Suite 100. Zip: 75234. Tel: (214) 243-7315.
Video: 2" quad, 3/4" U-matic cassette, 1/2" cassette. (SEE ADVERTISEMENT)
 Aiwa America Inc., 35 Oxford Dr., Moonachie, N.J. 07074. Tel: (201) 440-5220. Pres.: Shigeru Inagaki; VP Sales Bill Hoard; Nat'l Sales Mgr.: Bob Fisher.
Audio: Cassette (60, 90, 120).
 Alpha Media Inc., PO Box 254452, Sacramento, Calif. 95825. Tel: (916) 383-4385. Owner: Vladimir Sirota.
Audio: Cassette (30, 45, 60, 90 & custom lengths).
Brand name: AMP.
 American Sound Corp., 3319 E. Ten Mile Rd., Warren, Mich. 48091. Tel: (313) 539-2900. Pres.: Frank S. Day; Group VP: Paul M. Hayes; VP Mktg.: Paul E. Adams. (PKG)
Branches: North Hollywood, Calif., 8120 Webb Ave. Zip: 91605. Tel: (213) 768-6100. Gen. Mgr.: Michael S. Emerson, Reg'l Sales Mgr.: Richard Hutchinson—Demarest, N.J., 18 Christie. Zip: 07627. Tel: (201) 767-9033.
Audio: 8-tr. & cassette (custom lengths), open reel.
 American Tape Corp., 1116 Edgewater Ave., Ridgeland, N.J. 07657. Tel: (201) 943-7860. Pres.: Donald H. Gabor; VP Mktg.: K.M. Marani; Plant Mgr.: Francis A. Dermody.
Audio: 8-tr. cassette, open reel.
Brand name: Remington.
 Ampex Corp., Magnetic Tape Div., 401 Broadway, Redwood City, Calif. 94063. Tel: (415) 367-2011. Pres.: A.H. Hausman; Sales Mgr.: R.A. Antonio; Adv. Mgr.: A. Fisher.
Sales offices: Glendale, Calif., 500 Rodier Dr. Zip: 91201. Tel: (213) 240-5000—Denver, Colo., 2121 S. Birch. Zip: 80222. Tel: (303) 757-6491—Orlando, Fla., PO Box 15008-B. Zip: 32808. Tel: (305) 423-2962—Atlanta, Ga., 3135 Chestnut Dr., Suite 101. Zip: 30340. Tel: (404) 451-7112—Overland Park, Kan., PO Box 7282. Zip: 66207. Tel: (913) 383-1951—Baton Rouge, La., PO Box 14754. Zip: 70808. Tel: (504) 766-6270—Bethesda, Md., 10215 Fernwood Rd. Zip: 20034. Tel: (301) 530-8800. District Mgr. Max McCollough—Framingham, Mass., PO Box 1020. Zip: 01701. Tel: (617) 877-8060—Hackensack, N.J., 65 Commerce Way. Zip: 07601. Tel: (201) 489-7400—Pittsford, N.Y., PO Box 175. Zip: 14534. Tel: (716) 586-2580—Dallas, Tex., 1615 Prudential Dr. Zip: 75235. Tel: (214) 637-5100—Salt Lake City, Utah, 2880 S. Main St., Suite 105. Zip: 84115. Tel: (801) 487-8181.
Plants: Opelika, Ala., PO Box 190. Zip: 36801. Tel:

TAPE, BLANK LOADED, MANUFACTURERS

The numbers in parentheses following the 8-track & cassette configurations show recording time in minutes; those following open reel configurations show length of tape in feet.

A A, see Audio Accessories.
 A M P, see Alpha Media.
 A T-Pro, see Abbey Tape
 A T & T (Able Turntable & Tape) Rec'g Inc., 725 N. Highland Ave., Hollywood, Calif. 90028. Tel: (213) 933-5701.
Audio: Cassette (1-1:22).
 A/V Paragon, see Universal Tape.
 Aard-Vark Rec'g, 335 S. Jefferson, Springfield, Mo. 65806. Tel: (417) 866-4104. Owner: John Jacobson.
Audio: 8-tr., cassette.
 Abbey Tape Duplicators, 5358 Cartwright Ave., North Hollywood, Calif. 91601. Tel: (213) 985-3136. Gen. Mgr.: Norman C. Cooke.
Audio: Cassette (2-1:20).
Brand name: AT-Pro
 Able Turntable & Tape, see AT&T.
 Agfa-Gevaert Inc., 275 North St., Teterboro, N.J. 07608. Tel: (201) 288-4100, NYC (212) 279-2560. Pres.: Robert Coppenrath; Nat'l Sales Mgr.: Maria A. Curry; Adv. Mgr.: Miles Adler.
Sales offices: Burlingame, Calif., 1633 Old Bayshore Hwy. Zip: 94010. Tel: (415) 692-2432. Reg'l Mgr.: James Heller—Glendale, Calif., 1025 Grand Central Ave. Zip: 91201. Tel: (213) 245-8886—Atlanta, Ga., 380 Interstate N., Suite 200. Zip: 30339. Tel: (404) 955-4326. Zone Mgr.: Forrest Cole—Oak Brook, Ill.,

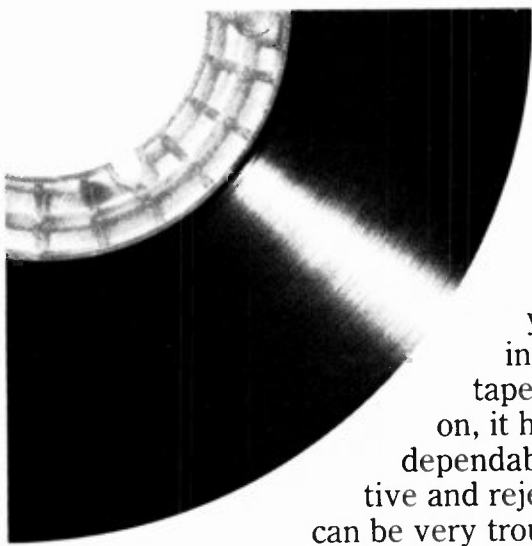

Why buy tape from a giant?

When you buy industrial tape to record on, it has to be dependable. Defective and rejected tapes can be very troublesome.

And our High Speed bulk cassettes give you AudioMagnetics Low-Noise/High-Density tape in our premium cassette housing. They feature specially engineered components and assembly, designed for high speed duplicating.

Not to mention expensive. That's why it makes sense to buy from the world's largest tape manufacturer, AudioMagnetics.

So whether you buy tape or bulk cassettes from AudioMagnetics, you're getting the best quality tape available.

And that takes one giant load off your mind.

When you buy our cassette tape or 1/4 inch lubed tape you get a combination of ultra high-density gamma ferric oxide particles and an advanced binder system that gives AudioMagnetics tape the characteristics necessary for creating the finest quality recordings.

AudioMagnetics

Irvine, Calif. 92716, 2602 Michelson Drive, P.O. Box B-G, (714) 833-0020
 New York, New York 10001, 2 Penn Plaza, Suite 1500, (212) 757-1244
 Toronto, Ont. M9W 5M9, Canada, 1180 Martingrove Road, Rexdale, Ontario, (416) 245-4400
 Geneva, Switzerland 2 Route des Acacias CH 1227 (022) 435115 Telex: 845-27152

- (205) 745-7643—**Elk Grove Village, Ill.**, 2201 Lunt Ave. Zip 60007. Tel: (312) 593-6000.
Audio: 8-tr. (45,90), cassette (45,60,90,120), open reel (1200', 1800', 2500', 3600') broadcast (600', 900', 2500', 3600', 5000').
Video: 1" open reel, 1/2" cassette (10-60), 1/2" EIAJ open reel (1250', 2400'), 1/2" Beta cassette (30,60,120).
- Ampro Prods Inc.**, 150 Fifth Ave., New York, N.Y. 10011. Tel: (212) 243-7726. Cable TAPEXXRON. Telex: 425233. Pres.: Manuel Kopelman; Exec. VP Mktg.: Susanne Tarter; VP: Arthur Lipton.
Audio: 8-tr. (40,60,80), cassette (30,60,90,120). (SEE ADVERTISEMENT)
- Andol Audio Prods. Inc.**, 4212 14 Ave., Brooklyn, N.Y. 11219. Tel: (212) 435-7322. Pres.: Anthony A. Maniere; Sales Mgr.: Rocco Salvatore; Adv. Mgr.: Domenico Salvatore.
Audio: 8-tr. & cassette (1-90).
- Arista Ent's Inc.**, 35 Hoffman Ave., Hauppauge, N.Y. 11787. Tel: (516) 234-7000. Pres.: Alan Leifer.
Audio: 8-tr. (40,45,80,90), cassette (60,90).
- Arrow Trading Co. Inc.**, 1115 Broadway, New York, N.Y. 10010. Tel: (212) 255-7688. (Audio only)
- Athana Audio Prods. (div. of Arber Inds.)**, PO Box 3696, 1815 Mullin Ave., Torrance, Calif. 90510. Tel: (213) 320-1451.
Audio: Cassette (custom lengths)
- Athena Inds. Inc.**, 2200 Industrial Way S., Toms River, N.J. 08753. Tel: (201) 244-8500. Pres.: Sales & Adv. Mgr.: Charles Beres Jr.
Audio: Cassette (custom lengths). (SEE ADVERTISEMENT)
- Audicom Corp.**, 4950 Nome St., Unit C, Denver, Colo. 80239. Tel: (303) 371-3076. Pres.: Jack H. Dunham.
Audio: Cassette & open reel (custom lengths)
- Audio Accessories Co.**, 38 W 515 Deerpath Rd., Batavia, Ill. 60510. Tel: (312) 879-5998. Sales Mgr.: John S. Maloney.
Audio: 8-tr., cassette, endless loop cassette (custom lengths)
Brand name: AA.
- Audiodyne Co.**, PO Box 825, San Jose, Calif. 95106. Tel: (408) 287-3520. Pres.: Louis R. Chiaramonte.
Audio: 8-tr., cassette, open reel & broadcast (custom lengths)
- AudioFax**, see Cassettes Inc.
- Audio Inds. Inc.**, Broad & Linden Aves., Ridgely, N.J. 07657. Tel: (201) 945-4545. Pres.: M. Donalds; Customer Serv.: Michael Kates.
Audio: 8-tr., cassette. (SEE ADVERTISEMENT)
- Audio Magnetics Corp.**, 2602 Michelson Dr., Irvine, Calif. 92716. Tel: (714) 833-0020. Pres.: Isidore Philosoph; VP Sales: James W. Lantz; VP Ind'l Prods.: Stewart B. Schlosberg.
Audio: 8-tr., cassette (45,60,90,120), open reel (1200', 1800', 2400').
Brand names: Tracs, High Performance. (SEE ADVERTISEMENT)
- Audiopak**, see Capitol.
Audiotrack, see Little Warehouse.
- AudioVisual Communications Inc.**, 435 Crooked Ln., King of Prussia, Pa. 19406. Tel: (215) 272-8500. Pres.: John Ballantyne; VP Sales: John Butterworth.
Audio: Cassette (custom lengths up to 120 minutes), open reel (up to 10 1/2" reels)
- B A S F Systems**, Crosby Dr., Bedford, Mass. 01730. Tel: (617) 271-4000
Branches: **Santa Monica, Calif.**, 1307 Colorado Ave. Zip 90404. Tel: (213) 451-8781—**Melrose Park, Ill.**, 1800 N. 30 Ave. Zip: 60160. Tel: (312) 343-6618—**Clifton, N.J.**, 149 Rt. 48. Zip: 07011. Tel: (201) 546-9111—**Dallas, Tex.**, Dallas Petroleum Center, 13610 Midway, Suite 255. Zip: 75240. Tel: (214) 233-6607
Audio: 8-tr. (45,90), cassette (45,60,90,120), open reel (7"—1800', 2400', 3600'; 10 1/2"—3600').
Brand names: Performance, Professional, Studio.
- Kenneth A. Bacon Assocs.**, 216 Montego Key, Novato, Calif. 94947. Tel: (415) 883-5041. Contact: Kenneth A. Bacon.
Audio: Cassette. (SEE ADVERTISEMENT)
- Bazzy Electronics Corp.**, 39 N. Rose, Mount Clemens, Mich. 48043. Tel: (313) 463-2592. Pres.: L. Allan Bazzy; Gen. Mgr.: Mike Tattan.
Audio: 8-tr. & cassette (custom lengths).
- Betamax**, see Sony
- Bethany Fellowship Inc.**, 6820 Auto Club Rd., Minneapolis, Minn. 55438. Tel: (612) 944-2121. Pres.: T. A. Hegre; Sales & Adv. Mgr.: David W. Anthony.
Audio: Cassette (custom lengths up to 120 minutes).
- Boddie Rec. Mfg. & Rec'g Inc.**, 12202 Union Ave., Cleveland, Ohio 44105. Tel: (216) 752-3440. Pres.: Thomas R. Boddie; Sales Mgr.: Dennis R. Boddie.
Audio: 8-tr., cassette (custom lengths)
- Bonneville Prods. Inc.**, 130 Social Hall Ave., Salt Lake City, Utah 84111. Tel: (801) 237-2400. Gen. Mgr.: Dick Allsop; Sales Mgr.: Dave Whipple; Studio Mgr.: Dave Michelsen.
Audio: Cassette (30,45,60,90,120).
- Brand 5**, see Robins.
- Broadcast Electronics Inc.**, 4100 N. 24 St., Quincy, Ill. 62301. Tel: (217) 224-9600. Pres.: Lawrence J. Cervon; VP Mktg.: Curtis I. Kring; Adv. Mgr.: Robert C. Davis.
Brand name: Spotmaster.
- C E S Rec'g Inc.**, 4960G S. 83 East Ave., Tulsa, Okla. 74145. Tel: (918) 627-8474.
Audio: 8-tr., cassette (custom lengths up to 90 min.) (SEE ADVERTISEMENT)
- C L C**, see International Audio.
- Capitol Magnetic Prods. (div. of Capitol Recs. Inc.)**, 1750 N. Vine St., Los Angeles, Calif. 90028. Tel: (213) 462-6252. Mktg. Dir.: Harry Preston; Prof. Prods. Sales Mgr.: Larry Hockemeyer.
Sales offices: Niles, Ill., 6401 Gross Point Rd. Zip: 60648. Tel: (312) 775-7101—**Germantown, Md.**, Century XXI, 20030 Century Blvd. Zip: 20767. Tel:
- (301) 428-0795—**New York, N.Y.**, 1370 Ave. of the Americas. Zip: 10019. Tel: (212) 757-7470—**Cleveland, Ohio**, 7123 Pearl Rd. Zip: 44130. Tel: (216) 888-6010—**Dallas, Tex.**, 6730 Oakbrook Blvd. Zip: 75235. Tel: (214) 637-1890
Int'l branches: England, Singapore.
Audio: 8-tr. (45,60,90,100), cassette (45,60,90,120), open reel (600', 900', 1200', 2400').
Brand name: Audiopak, Capitol, Music Tape by Capitol.
Carter Corp., 1916 11 St., Rockford, Ill. 61101. Tel: (815) 397-3200. Pres.: Robert L. Fleming; VP Sales: Sandra L. Fleming; Adv. Mgr.: Janet K. Ratner.
Audio: Cassette.
- Cassette Masters Corp.**, 2 Bashford St., Yonkers, N.Y. 10701. Tel: (914) 968-1605.
Audio: Cassette.
Video: 3/4" cassette.
- Cassettes Inc.**, Cook Consultants Inc., PO Box 22857, 2510 SW Third Ave., Fort Lauderdale, Fla. 33315. Tel: (305) 522-0222.
Audio: Cassette (30,45,60,90,120).
Brand name: AudioFax.
- Century Audio & Development Inc.**, 1018 Busse Hwy., Park Ridge, Ill. 60068. Tel: (312) 696-0675. Pres. & Sales Mgr.: Carol Anspaugh; Adv. Mgr.: Roberta Genovese.
Audio: Cassette (47,62,92,122).
- Certron Corp.**, 1701 S. State College Blvd., Anaheim, Calif. 92806. Tel: (714) 634-4280. WATS (800) 854-3943. Pres.: Edwin Gamson; VP Mktg.: Ray Allen; Adv. Mgr.: Hal Wilde.
Audio: 8-tr., cassette & open reel (custom lengths).
- Chase Media Inc.**, Beneficial Life Tower, Suite 1723, Salt Lake City, Utah 84111. Tel: (801) 363-5858. Pres. & Adv. Mgr.: Randall S. Chase; Sales Mgr.: Irel L. Chase.
Audio: 8-tr. (standard lengths), cassette, open reel (custom lengths).
- Christian Dupl'n's Inc.**, 1710 Lee Rd., Orlando, Fla. 32810. Tel: (305) 299-7363.
Audio: Cassette, open reel (custom lengths)
- Columbia Magnetics (div. of CBS Inc.)**, 51 W. 52 St., New York, N.Y. 10019. Tel: (212) 765-4321. Dir.: Glenn Hart.
Branch: **Century City, Calif.**, 1930 Century Park W. Zip: 90067. Tel: (213) 556-4836. Nat'l Sales Dir.: Jerry Bronaugh.
Plant: **Danbury, Conn.**, 15 Great Pasture Rd. Zip: 06810. Tel: (203) 744-3555. Plant Mgr.: Ray Hughes.
Audio: 8-tr. (40-100), cassette (40,60,90,120).
- Comsette Corp.**, 12417 W. Olympic Blvd., Los Angeles, Calif. 90064. Tel: (213) 826-4528. Pres.: Richard W. Moore; Sales Mgr.: J. A. Buchanan.
Audio: Cassette (10-120).
- Continental Electronics**, 4087 Glencoe Ave., Marina del Rey, Calif. 90291. Tel: (213) 822-2045. Sales Mgr.: John Adams.
Audio: Cassette (45,60,90,120).
- Cook Consultants Inc.**, see Cassettes Inc.

"We can cut the red tape out of your import tape business."

Bill Dawson, Vice President, Marketing
Ultra Specialty Inc.

Q: How does U.S.I. overcome the pricing difficulties and unreliable delivery dates of importing cassette tapes?

DAWSON: We have the complete series of quality *Ultra-sound Cassette tapes*, manufactured to our specifications, at a budget price. We also import a complete line of *duplicator quality cassettes* as well as C-O's. And we have the facility to warehouse them here.

Q: So when you receive an order?
DAWSON: We can ship them immediately.

Q: Is this the only venture Ultra Specialty deals with?

DAWSON: We have a network of contacts both worldwide and domestically, and we do business in almost every area. For example, many of our overseas clients also come to us for *Duplicating and Record Manufacturing Equip-*

ment. If we don't have it, we find it. You see, our philosophy is based on the trading concept. Our services for our clients works both ways. One day we can be buying the next, we can be supplying. It's quite unique, and it makes for good business.



Ultra Specialty Inc.

For more information contact Bill Dawson • (213) 979-0338 • Telex: 194566 ULTRASPEC. CRSN. • Cable: ULTRASPEC.

Get into Shape

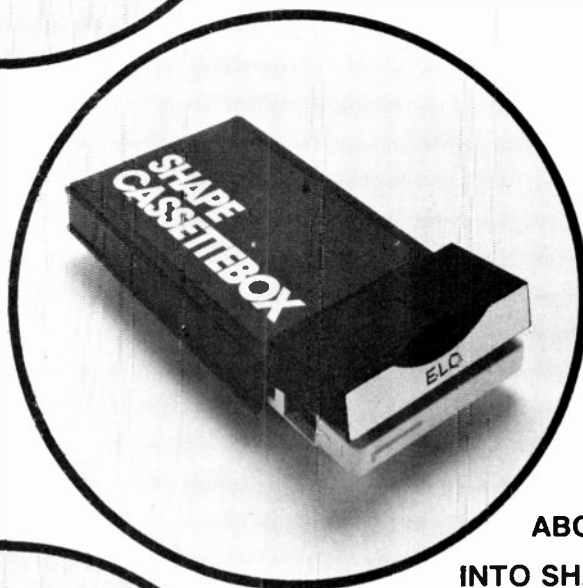
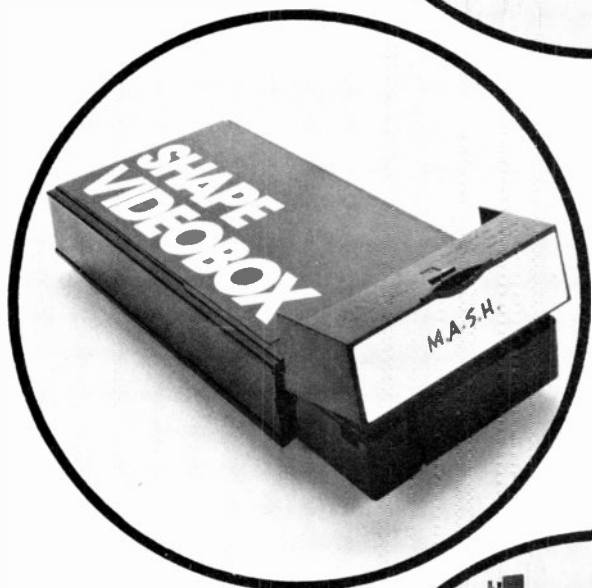

WHAT IS SO SPECIAL
ABOUT GETTING
INTO SHAPE?



PRIDE.

We are proud of our high standards of design and craftsmanship, our quality control and most important our quality products.

- COMPLETE LINE OF CASSETTE AND CARTRIDGE AUTOMATION EQUIPMENT
- C-O CASSETTES SONIC SEALED, SCREW-TYPE COMPUTER GRADE and/or OTHER CONFIGURATIONS
- NORELCO BOXES
- BULK CASSETTE LOCKS
- 8/TRACK AND QUAD CARTRIDGES
- CASSETTEBOXES
- VIDEOBOXES
- MULTISTANDS
- RECORD GRIPS

WE TAKE PRIDE IN BEING THE BEST.

SHAPE

SHAPE INC. P.O. BOX 366, BIDDEFORD, MAINE 04005 U.S.A. 207-282-6155 TELEX 944325 SHAPE INC. BIFD

World Radio History

Cory Sound Co., 440 Brannan St., San Francisco, Calif. 94107. Tel: (415) 543-0440. Pres.: George Cory; VP & Prod'n Mgr.: Phillip C. Markinson; VP Sales: Lou Sinclair.
Audio: Cassette, open reel & broadcast (custom lengths).

Creative Communications Inc. (sub. of SMI), 920 N. Valley Mills, Waco, Tex. 76710. Tel: (817) 776-6553.
Audio: Cassette.

Cre'8 Video Servs. Ltd., PO Box 5136, Zip: 85010; Embassy Square, 805 N. Fourth Ave., Phoenix, Ariz. 85003. Tel: (602) 257-2978
Video: 1" open reel, 3/4" cassette, 1/2" EIAJ open reel, 1/2" EIAJ cartridge (custom lengths).

Criterion, see Lafayette.

Crolyn, see E.I. du Pont.

Custom Dupl'n Inc., 6330-36 Arizona Circle, Los Angeles, Calif. 90045. Tel: (213) 670-5575, 776-4810. Pres.: Leonard Gross; Sales Mgr.: Frank Rohloff; Prod'n: Jeri Gonzales.
Audio: 8-tr., cassette.

Custom Tape Dupl'rs Inc., 341 Hill Ave., Nashville, Tenn. 37210. Tel: (615) 256-1728. Pres.: L.C. Tant; Sales Mgr.: Mike Tant.
Audio: 8-tr. (5-90), cassette (5-120).

D A K Inds. Inc., 10845 Vanowen St., North Hollywood, Calif. 91605. Tel: (213) 984-1559; WATS (800) 423-2636. Pres.: Drew Alan Kaplan.
Audio: Cassette (30,60,90,120), open reel.
Video: 1/2" EIAJ open reel.

Dalsung America Inc., 51 E. 42 St., New York, N.Y. 10017. Tel: (212) 682-6045
Home office: Korea.
Audio: 8-tr., cassette (30,60,90,120), open reel.

Data Packaging Corp., 205 Broadway, Cambridge, Mass. 02139. Tel: (617) 868-6200. Exec. VP: Greg Malthus; VP Mktg.: Jere R. Hill; Nat'l Sales Mgr.: Gene Hull.
Audio: 8-tr. & cassette (custom lengths). (SEE ADVERTISEMENT)

Delta Magnetics, 1901 McDonald Ave., Brooklyn, N.Y. 11223. Tel: (212) 627-6556.
Audio: 8-tr. (40,64,80,100,120), cassette (60,90,120), open reel (7"-1200', 1800' 2400', 3600'; 5"-1200'; 1800').

Duotone Co. Inc., 6875 SW 68 Ave., Miami, Fla. 33143. Tel: (305) 665-1121. Pres.: Stephen Nester Sr.; Sales & Adv. Mgr.: Stephen Gibson Nester.
Audio: 8-tr. (35,70,80), cassette (30,60,90,120).

Duplicator Premium, see Recordex Corp.

E. I. du Pont de Nemours & Co. Inc., Magnetic Prods. Div., Photo Prods. Dept., Old du Pont Airport, Bldg. 1, Wilmington, Del. 19898. Tel: (302) 999-4251. Pres.: Edward R. Kane; Mktg. Mgr.: Richard Buckley; Adv. Mgr.: Grif Harrison.
Audio: Cassette (60,90,120).
Video: 3/4" cassette (10-90), 1/2" EIAJ open reel (1250', 1800', 2400', 3600'); 1/2" Beta (60-180 min.) & VHS (60-360 min.) cassette.
Brand name: Crolyn.

Duratape, see Mallory.

Electronic Homes Co., 24-64 Crescent St., Astoria, N.Y. 11102. Tel: (212) 545-3094. Chm.: George T. Sadler; Pres.: Paula Saddler; Sales Mgr.: Elias Smyrnakis.
Audio: 8-tr., cassette, mini-cassette, open reel.
Video: 3/4" cassette.
Brand names: Mr. Cassette, Toyota.

El Mar Plastics Inc., 821 E. Artesia Blvd., Carson, Calif. 90746. Tel: (213) 327-3180.
Audio: 8-tr. (1-90). (SEE ADVERTISEMENT)

Elvitru Rec'g Music Publ'g Co. & Music Makers Network of America-Prod'ns, PO Box 3022, Wilmington, N.C. 28401. Tel: (919) 762-0474/4706/0539. Pres.: John Lewis Jones; VP: Betty F. Scavilla; Sales Mgr.: James L. Wheeler; Adv. Mgr.: J.D. Johnson.
Audio: Cassette, open reel.
Brand name: Excellence.

Emerald, see Irish Magnetic.

Exactime, see SSK.

Excellence, see Elvitru.

Ferrodyn, see Westape.

Fidelipac (div. of Harvell Inds.), 109 Gaither Dr., Mount Laurel, N.J. 08057. Tel: (609) 235-3511. Pres.: Roger Cappello; Sales & Mktg. Mgr.: Arthur Constantine.
Audio: Broadcast cartridge (all lengths).

Finebilt Mfg. Co. Inc., 931 N. Citrus Ave., Los Angeles, Calif. 90038. Tel: (213) 466-9511. Pres.: Alwin P. Schmid; Sales Mgr.: Joseph Bouzaglou.
Audio: 8-tr., cassette, open reel.

Fleetwood Communications Co., 321 Revere St., Revere, Mass. 02151. Tel: (617) 289-6800. Pres.: V.P. Giarrusso; Sales Mgr.: Victor Mancini; Adv. Mgr.: Robin Samora.
Audio: 8-tr., cassette, open reel & broadcast (custom lengths).

4 Starr, see Le-Bo.

Fuji Photo Film USA Inc., Magnetic Tape Div., 350 Fifth Ave., 70th fl., New York, N.Y. 10001. Tel: (212) 736-3335. VP & Gen. Mgr.: John Dale; Sales Mgr.: (audio) Gary Conway, (video) Al Bedross; Adv. Mgr.: Paul Kaufman.
Audio: 8-tr. (45,90), cassette (46,60,90,120), open reel (900', 1200', 1800', 3600'); broadcast (2200', 3400', 66600', 9600').
Video: 1" open reel, 3/4" cassette (10,15,20,30,60), 1/2" Beta & VHS cassette.

Gabriel Mfg. Co. Inc., 125 S. Liberty Dr., Stony Point, N.Y. 10980. Tel: (914) 942-0100.
Audio: 8-tr. (10-60), cassette (1-120).

Heritage, see International Audio.

High Fidelity Rec'g Inc., 1059 Porter, Wichita, Kan. 67203. Tel: (316) 262-6456.
Audio: 8-tr., cassette.

High Performance, see Audio Magnetics.

Hilo, see Magnetic Mktg.

Hitachi Sales Corp. of America, 401 W. Artesia Blvd., Compton, Calif. 90220. Tel: (213) 537-8383. Pres.: I. Kawamoto; Sales Mgr.: J. Henricks; Adv. Mgr.: B. Tyngenhof.

Audio: Cassette (60,90).

Infonics Inc., PO Box 1111, 238 Hwy. 212, Michigan City, Ind. 46360. Tel: (219) 879-3381. Pres.: Paul C. Lloyd.
Audio: 8-tr., cassette, open reel & broadcast (custom lengths).
Brand name: Phoenix. (SEE ADVERTISEMENT)

International Audio Inc., 2934 Malmo Dr., Arlington Heights, Ill. 60005. Tel: (312) 956-6030.
Audio: 8-tr. (45,64,90), cassette (1-120), broadcast (10 sec.-12 min.).
Video: 3/4" cassette (5,10,20,30,60).
Brand names: CLC; Heritage, International Audio, Videospot.

Irish Magnetic Rec'g Tape (div. of Morhan Nat'l Sales Co. Inc.), 270-78 Newtown Rd., Plainview, N.Y. 11803. Tel: (516) 293-5582. Cable: MORHANEX. Telex: 96-7880. Pres.: Sol Zigman; Sales Mgr.: George Krug; Adv. Mgr.: George Taub.
Audio: 8-tr., cassette, open reel.
Video: 3/4" cassette, 1/2" EIAJ open reel, 1/2" Beta cassette.
Brand names: Emerald, Irish.

Itera Ltd., 1535 Broad St., North Bellmore, N.Y. 11710. Tel: (516) 785-6480.
Audio: 8-tr. (35-80), cassette (30-120).

J & I Cassette, 23947 Ventura Blvd., Calabasas, Calif. 91302. Tel: (213) 992-6200. Pres.: John F. Brennan; Sales & Adv. Mgr.: Ivy Brennan.
Audio: 8-tr. & cassette (custom lengths).

J V C Inds. Co., 58-75 Queens Midtown Expwy., Maspeth, N.Y. 11378. Tel: (212) 476-8010.
Video: 3/4" cassette (15,20,30,60), 1/2" EIAJ open reel, 1/2" VHS cassette.

Ray Jacobs Audio Inc., 2739 Signal Pkwy., Long Beach, Calif. 90806. Tel: (213) 595-6811. Pres.: Ray Jacobs; Sales Mgr.: Larry Stagnaro; Adv. Mgr.: Robert Ellsworth.
Audio: 8-tr., cassette, open reel (standard & custom lengths).
Brand name: RJA.

Javelin Electronics, 6357 Arizona Circle, Los Angeles, Calif. 90045. Tel: (213) 641-4490.
Video: 1/2" EIAJ open reel.

Jet Pak, see Tape-A-Thon.

Ken-Del Prod'n Inc., 111 Valley Rd., Richardson Park, Del. 19804. Tel: (302) 655-7488. Pres.: H. Edwin Kennedy; Sales Mgr.: Shirley Kay.
Audio: 8-tr., cassette, open reel & broadcast (standard & custom lengths).

Kim-Pat Ents., PO Box 654, Hillwood Dr., Fayetteville, Tenn. 37334. Tel: (615) 433-2323 / 5661. Pres.: Bill Trigg.
Audio: 8-tr. (custom lengths).

King's Place Inc., PO Box 148, New Providence, Pa. 17560. Tel: (717) 284-4165. Pres. & Sales Mgr.: John O. Yoder.
Audio: 8-tr. (1-60), cassette (1-90).

Kyric Corp., 2111 E. 20 St., Tucson, Ariz. 85719. Tel: (602) 624-2408. Pres. & Sales Mgr.: Keyvan Mokhtarian.

MASTRO INDUSTRIES, INC.

RELIABLE • FUNCTIONAL • SUPERIOR

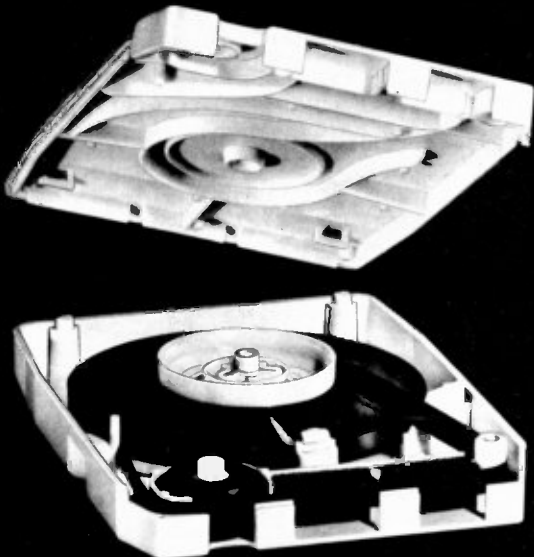

- 8T Cartridges, assembled . . . ready for loading
- *8T Cartridges, tape loaded, 45 & 90 minutes, or made to order
- Cassette Parts: housing, hubs & roller guides
- C-O Cassettes
- *Cassettes, tape loaded: C-30, C-45, C-60, C-90, C-120, or made to order



* Ask for our MARMAC high quality line of tape-loaded cartridges and cassettes.

Mastro Products are precision engineered for top performance and smooth functioning.

MASTRO INDUSTRIES, INC. 3040 Webster Ave. New York, N.Y. 10467 (212) 547-5600

There are other ways to improve your sales record besides selling records.



Scotch® Recording Tapes — they make a profit center all on their own. And no wonder — because you can't sell a line of tapes with truer, purer sound than Scotch Recording Tape. And we have a very effective advertising campaign to make them very easy to sell. *Sports Illustrated*, *People*, *Playboy*, and the audio buff magazines are just some of the publications. There's television advertising too — plus

extensive merchandising.

Maybe that's why we're the best-selling brand of all blank tape in America.

So, get in touch with your local Scotch Recording Tape representative and find out how you can make another profit center right in your store.

Before you know it, you'll be recording big sales with more than just records.

Scotch® Recording Tape. The truth comes out.

3M

Audio: 8-tr., cassette & open reel (custom lengths)
Lafayette Radio Electronics, 111 Jericho Trpk., Syosset, N.Y. 11791 Tel (516) 921-7700
Audio: 8-tr., cassette, open reel
Brand name: Criterion

Lear Jet Stereo, see Electronic Homes

Le Bo Prods Co. Inc., 58-60 Grand Ave., Maspeth, N.Y. 11378 Tel (212) 894 5155 Chm. Peter Dayton, Pres. Al Alexander, Mktg. Dir. Gary Schwarz, Nat'l Sales Mgr. Arthur Klein
Audio: 8-tr. (30,40,45,80,90), cassette (60,90,120)
Brand names: Le Bo, 4 Starr (SEE ADVERTISEMENT)

Lecture Brand, see Robins

Leda, see Continental Electronics

Little Warehouse Inc., 1820 W. Schaaf Rd., Cleveland Ohio 44109 Tel (216) 398 9438 Pres. James D. Lesnick
Audio: 8-tr. (1,100), cassette (1,120), open reel
Brand name: Audiotrack

M J S, 2514 Seaboard Ave., San Jose, Calif. 95131 Tel (408) 262-8793 Pres. Michael Steiner
Audio: 8-tr. (46,60,90,100), cassette (46,62,92,120), open reel (1800'), broadcast (1-22 min.)

M M C, see Magnetic Mktg

M R S, see M R Sand

Magnetic Mktg. Corp., 29 Valley View Terr., Wayne, N.J. 07470 Tel (201) 694 3502 Pres. Thomas J. Hofbauer, Sales Mgr. Brendan F. Browne, Adv. Mgr. M. Judge

Audio: 8-tr., cassette (60,90,120) open reel, broadcast
Brand name: Hilo, MMC (SEE ADVERTISEMENT)
Magnex Corp., 770 W. Bay St., Winter Garden, Fla. 32787 Tel (305) 656 4494 Pres. John Lory
Audio: 8-tr., cassette, open reel, broadcast
Video: 1" open reel 1/2" EIAJ open reel

Mallory Dist. Prods. Co., 4760 Kentucky Ave., Indianapolis, Ind. 46222 Tel (317) 856-3731
Audio: 8-tr. (45,90), cassette (30,45,60,90,120)
Brand name: Duratape

Mann Endless Cassette Inds. Corp., PO Box 1347, San Francisco, Calif. 94101 Tel (415) 221-2000 Pres. Donald Mann, Sales Mgr. Robert Wells, Adv. Mgr. Bob Kline
Audio: Endless cassette (standard Phillips type)
Marmac, see Mastro

Mastro Inds. Inc., 3040 Webster Ave., Bronx, N.Y. 10467 Tel (212) 547-5600 Pres. Mario Maccaferri
Audio: 8-tr. (45,90), cassette (30,45,60,90,120)
Brand name: Marmac (SEE ADVERTISEMENT)

Maxell Corp. of America, 60 Oxford Dr., Monroeville, N.J. 07074 Tel (201) 440 8020 Pres. T. Okada, VP Consumer Audio/Video Gene LaBrie, Nat'l Sales Mgr. Professional Industrial Prods. Jim Ringwood, Adv. & Prod. Mgr. Paul Miller
Audio: 8-tr. (46,60,90), cassette (46,60,90,120), open reel (1200', 2400', 2500', 3600')
Video: 3/4" cassette (30,60), 1/2" EIAJ open reel (1200', 2400'), 1/2" VHS cassette (60-120 min.)

Media Int'l Inc., 425 N. Michigan, Chicago, Ill. 60611 Tel (312) 467-5430 Pres. & Sales Mgr. Duane Lundeen, Adv. Mgr. Margaret Lundeen
Audio: 8-tr., cassette, open reel, broadcast (custom lengths)

Memorex Corp., 1600 Memorex Dr., Santa Clara, Calif. 95052 Tel (408) 987 1752 Pres. Robert C. Wilson, Sales Mgr. John R. Humphreys, Promo. Co. ord. Elizabeth D. Nash, Local branch: 2400 Kifer Rd. Zip 95052 Tel 987-2620
Branches: Los Angeles, Calif., 11340 W. Olympic Blvd. Zip 90064 Tel (213) 478-3051 - Lombard, Ill., 335 Eisenhower Ln. S. Zip 60148 Tel (312) 620-3240 - Southfield, Mich., 24681 Northwestern Hwy. Suite 24, Zip 48075 Tel (313) 354 0240 353 2670 - New York, N.Y., 1700 Broadway Zip 10019 Tel (212) 541-7780 - McLean, Va., 7798 Old Spinghouse Rd. Zip 22101 Tel (703) 821 3300
Audio: 8-tr. (45,60,90), cassette (30,45,60,90,120), open reel (1200', 1800', 2400', 3600')
Video: 1" open reel 3/4" cassette 1/2" EIAJ open reel
Brand name: Memorex Pro (SEE ADVERTISEMENT)

Memory Media Prods., 1417 E. Edinger Ave., Santa Ana, Calif. 92705 Tel (714) 835-0317 Pres. Edward A. Conti, Sales & Adv. Mgr. Michael Bartlett
Audio: Cassette, open reel
Video: 1" open reel, 3/4" cassette, 1/2" EIAJ open reel, 1/2" Beta & VHS Cassette
Brand name: Spectrum

Metacom Inc., 1401 B W. River Rd. N., Minneapolis, Minn. 55411 Tel (612) 588 2781 Pres. James I. McCann, Sales Mgr. Phillip T. Levin, Adv. Mgr. J.J. Binsfeld
Audio: Cassette (33,60,63,90,93,120,123)
Brand name: Rezound

Miami Tape Inc., 8180 NW 103 St., Hialeah Gardens, Fla. 33015 Tel (305) 558-9211 Pres. Carlos Garcia, Sales Mgr. Mirella Tunon
Audio: 8-tr. (40,60,90), cassette (40,60,90,120)

Michele Audio Corp., Andrew Street Rd., Massena, N.Y. 13662 Tel (315) 769 2448 Pres. Ginette Cormier, Sales Mgr. Harold Friedman, Mgr. Jack Daniels
Audio: 8-tr. (40,60,80,90), cassette (60,90,120)
Brand names: Michele, Michele
Mr. Cassette, see Electronic Homes

Warren C. Moore & Assocs., PO Box 8451, Kansas City, Mo. 64114 Tel (816) 333 7654 Owner W.C. Moore
Audio: 8-tr. cassette & broadcast (custom lengths)

Mother Dubbers Inc., 2537 Carlisle, Dallas, Tex. 75201 Tel (214) 651-9544
Audio: 8-tr., cassette & open reel (custom lengths)
Brand name: Motherlode

Motherlode, see Mother Dubbers

Music Tape by Capitol, see Capitol

Musitron Inc., 2534 1/2 W. Pico Blvd., Los Angeles, Calif. 90006 Tel (213) 380-6840
Audio: 8-tr., cassette

N M I, Master Sound Studios, 516 W. 75 St., Kansas City, Mo. 64114 Tel (816) 333-9617 Pres. Mike Green, Sales Mgr. Eugene Gold, Adv. Mgr. Charles Smith

Audio: 8-tr., cassette
Nagra Magnetic Rec's Inc., 19 W. 44 St., New York, N.Y. 10036 Tel (212) 840 0999
Audio: Open reel

Nakamichi Research (USA) Inc., 1101 Colorado Ave., Santa Monica, Calif. 90401 Tel (213) 451-5901 Pres. E. Nakamichi, Mktg. Dir. Ted Nakamichi, Sales Dir. Ken Ohba, Technical Dir. Harron K. Appleman
Audio: Cassette (60,90)

Nassau, see Telephone Dynamics

National Audio Co. Inc., 1911 S. Stewart, Springfield, Mo. 65804 Tel (417) 883-5377
Audio: 8-tr. (42,84), cassette (42,60,90,120 & custom lengths), open reel, broadcast

Northwestern Inc., 1224 SW Broadway, Portland, Ore. 97205 Tel (503) 226 0170 Pres. Robert M. Lindahl, Sales Mgr. Paul A. Buescher
Audio: Cassette (custom loaded)

Olson Electronics Inc., 260 S. Forge St., Akron, Ohio 44327 Tel (216) 535-1800 Pres. W.R. Wolf, VP. Mktg. Jack D. Hardke, Sales Mgr. Tom Wilkinson, Adv. Mgr. John Gaylor
Audio: 8-tr. (45,90), cassette (45,60,90,120), open reel
Brand names: Olson, Shield, Teledyne

P S C Prod. ns, 1754 Lustrana St., Honolulu, Hawaii 96813 Tel (808) 537-1251
Audio: Cassette (30,45,60,90 & custom lengths), open reel (1200', 1800')

Panasonic (div of Matsushita Electronic Corp. of America), 1 Panasonic Way, Secaucus, N.J. 07094 Tel (201) 348 7000
Branches: Duluth, Ga., 2 Meca Way Zip 30136 Tel (404) 448-5683 Video Systems Div. Mgr. Leroy Wright - Elk Grove Village, Ill., 1098 Greenleaf Ave. Zip 60007 Tel (312) 593 0710 Video Systems Div. Mgr. Gary Olson - Irving, Tex., 1825 Walnut Hills Ln. Zip 75062 Tel (214) 256 1388 Video Systems Div. Mgr. Terry Conner
Audio: Cassette (60,90)
Video: 3/4" cassette, 1/2" VHS cassette, 1/2" EIAJ open reel, 1/2" EIAJ cartridge

Park, see Robins

Pentagon Inds. Inc., 4751 N. Olcott Ave., Chicago, Ill. 60656 Tel (312) 867-9200 Pres. Tom Horton, VP. Mktg. James R. Dow, Sales Mgr. Joe Hollenkamp
Audio: Cassette (10-120) (SEE ADVERTISEMENT)

Performance, see BASF

Philips High Fidelity Labs. Ltd., 1700 Magnavox Way, Fort Wayne, Ind. 46801 Tel (219) 432-8516 Pres. & Adv. Mgr. Gerald Orbach, Nat'l Sales Mgr. Phil Welch
Audio: Cassette (60,90)

Phoenix, see Infonics

Pro, see Memorex

The Pro, see Utopia Ultra Sound

Professional, see BASF

Project 70 Audio Servs. Inc., 1127 Spring St. NW, Atlanta, Ga. 30309 Tel (404) 875-7008 Pres. Jerry L. Conner
Audio: Cassette (custom lengths for duplicators)

Quantitape, see Sound Studios

R J A, see Ray Jacobs Audio

R K O Nat'l Tape Serv. Inc., 3 Fairfield Crescent, West Caldwell, N.J. 07006 Tel (201) 575 8484 Pres. George Cabalbo, VP & Gen. Mgr. Hugh Wallace
Audio: Cassette (60,90)

Radio Shack (div of Tandy Corp.), 1 Tandy Center, Fort Worth, Tex. 76102 Tel (817) 390-3011 Pres. Lewis Kornfeld, Sales Mgr. Bernard Appel, Adv. Mgr. David Beckerman, Nat'l Publ. & Promo. Mgr. Hy Siegel
Audio: 8-tr. (45,90), cassette (30,45,60,90,120), open reel (900', 1200', 1800', 2400', 3600')
Brand names: Realistic, Supertape

Bill Rise Prod'ns Inc., 955 Venture Court, Sacramento, Calif. 95825 Tel (916) 929 9181 Owner & Pres. Bill Rise
Audio: Cassette (custom lengths)

Raynor Sales Co. Inc., 2698 W. Pico Blvd., Los Angeles, Calif. 90006 Tel (213) 737-3737 Pres. & Adv. Mgr. Ray Abrams Sr., Sales Mgr. Ray Abrams Jr.
Audio: 8-tr.

Realistic, see Radio Shack

Recorder Corp., 1300 Booth Ave., Atlanta, Ga. 30318 Tel (404) 351 7062 Pres. Tom Allen
Audio: Cassette (5-120)

Brand name: Duplicator Premium

Recortec Inc., 777 Palomar Ave., Sunnyvale, Calif. 94086 Tel (408) 735 8821 Pres. Lester H. Lee, Sales Mgr. Ron R. Troxell
Audio: Cassette (custom lengths)
Video: 3/4" cassette (5,60 min.) (SEE ADVERTISEMENT)

Recoton Corp., 46-23 Crane St., Long Island City, N.Y. 11101 Tel (212) 392 6442 Pres. Robert Borchardt, Sales Mgr. George Calvi, Adv. Mgr. Peter Wish
Audio: 8-tr. (40,45,80,90,100), cassette (45,60,90,120), open reel (5" reel-600', 900', 1200', 1800', 7" reel-1200', 1800', 2400', 3600')

Redding Radio (div of SJ Inds. Inc.) PO Box 344, Fairfield, Conn. 06430 Sales Mgr. Sascha Deale, Adv. Mgr. P. Barnum
Audio: Cassette (60,90), open reel (1200', 1800', 2500', 3600'), broadcast

Remington, see American Tape

Rezound, see Meta-Com

Rite Rec. Prod'ns Inc., 9745 Lockland Rd., Cincinnati, Ohio 45215 Tel (513) 733 5533 Pres. Carl J. Burkhardt, VP. Philip M. Burkhardt, Sales Mgr. Dan Burton
Audio: 8-tr., cassette, open reel (custom lengths)

Robins Inds. Corp., 75 Austin Blvd., Commack, N.Y. 11725 Tel (516) 543 5200 Pres. Herman Post, Nat'l Sales & Adv. Mgr. Stu Caine
Audio: 8-tr. (40,64,80), cassette (60,90,120), minicassette (30), open reel (300', 900', 1200', 1800', 2400', 3600')

Brand names: Brand Five, Lecture, Park

Royal Sound Co. Inc., 248 Buffalo Ave., Freeport, N.Y. 11520 Tel (516) 868-2880 Pres. Mervin A. Dayan
Audio: Cassette (60,90)

S D S Tape Inc., 6730 Santa Barbara Court, Baltimore, Md.

*We're
not a rumor
anymore.*

soundpro

*Now we're in over 4,000
independent stores
in the U.S. & Canada!*

High Output - Low Noise
Blank Recording Tape
LIFETIME GUARANTEE

For further information or for the distributor nearest you, write or call:

SOUND PRO INDUSTRIES, INC.
347 Culver Boulevard,
Playa del Rey, CA 90291
(213) 822-0510

**Beat the Big One
-Heart Attack**

GIVE... HEART FUND



When The Others Don't Come Up To Level



AGFA-GEVAERT Magnetic Tape will ... and then surpass it!

It doesn't matter if your needs are studio mastering tape, video tape, or bulk audio tape, AGFA-GEVAERT has been answering the high level requirements of a demanding professional European and U.S. market for a long time. And surpassing it everytime—with quality, performance, reliability, and availability.

Our PEM 468 Studio mastering Tape has been accepted on the highest level as "the tape" for top quality original recording. It's available to the discerning as a low-noise, high-output, low-print, in 1/4", 1/2", 1" and 2"; Bintape in 1/4", 1/2" and 1"; and in Duplicating Tape, 1/4" x 3600'.

When your needs for video tape are varied, AGFA-GEVAERT Video Tape has the range to fill them. From 2" Quad to 1" Helical; 1/2" VIDEOCHROM to 3/4" U-matic cassette; and 3/4" bulk tape to magnetic film. Whether you're producing professional, semi-professional, or amateur programming, with our Video Tape you'll project a high level image.

The Professional Cassette Bulk Tape has long held the reputation as the one tape that really "stacks up". Supplied in pancake form

on stacking hubs, it is offered to the blank loader and duplicator as a Super High Density Tape, or a SUPER FERRO DYNAMIC Tape, in lengths up to 11,500'. Also available is a Mini-Cassette Tape with 2 micron foil, and a Splicing Tape in 150' lengths.

When your standards for recording and duplicating demand the highest, come up to that level, and surpass it, with AGFA-GEVAERT Magnetic Tape. We've been helping others to do it for years. Contact us TODAY!

VIDEOCHROM and SUPER FERRO DYNAMIC are the trademarks of AGFA-GEVAERT, Antwerp/Leverkusen.



MAGNETIC TAPE

from AGFA-GEVAERT

21227. Tel: (301) 796-7122. Pres.: Barry W. Dennis; Mktg. Mgr.: Donn Elliott; Sales Mgr.: Marvin Soloff.

S S K Ent's, Inc., 2488 Townsgate Rd., Westlake Village, Calif. 91361. Tel: (805) 495-1214.
Audio: 8-tr. (1-99).
Brand name: Exactime

M. R. Sand & Co., PO Box 2255, 6211 Milan Rd., Sandusky, Ohio 44870. Tel: (419) 625-0028. Pres. & Sales Mgr.: Joseph F. Yost III.
Audio: 8-tr. (30,45,60,90).
Brand name: MRS

Sankyo Seiki (America) Inc., 149 Fifth Ave., New York, N.Y. 10010. Tel: (212) 260-0200.
Audio: Cassette.

Scotch, see 3M.

Sentry Inds. Inc., 221 N. Macquesten Pkwy., Mount Vernon, N.Y. 10550. Tel: (914) 664-2909. Pres.: Harold Rosen; Sales & Adv. Mgr.: Barry Rosen.
Audio: 8-tr. (40,80,100), cassette (30,60,90,120), open reel (1200',1800',2400'). (SEE ADVERTISEMENT)

Shield, see Olson Electronics.

Sony Corp. of America, 9 W. 57 St., New York, N.Y. 10019. Tel: (212) 371-5800. **Local branch:** 47-47 Van Dam St., Long Island City 11101. Tel: 361-8600.
Sales & distribution branches: Brisbane, Calif., Crocker Ind'l Park, 230 W. Hill Pl. Zip: 94005. Tel: (415) 467-4900.—Compton, Calif., 700 W. Artesia Blvd. Zip: 90220. Tel: (313) 537-4300.—Miami, Fla., 5125 NW 165 St. Zip: 33104. Tel: (305) 624-1651.—Atlanta, Ga., 2300 Peachford Rd., Suite 2131. Zip: 30338. Tel: (404) 451-7501.—Honolulu, Hawaii, 1020 Auahi St. Zip: 96814. Tel: (808) 531-5981.—Niles, Ill., 6801 W. Jarvis St. Zip: 60648. Tel: (312) 792-3600.—Ferndale, Mich., 10610 Galaxie. Zip: 48220. Tel: (313) 548-9325.—Cleveland, Ohio, 4650 W. 160 St. Zip: 44135. Tel: (216) 433-7722.—Dallas, Tex., 9004 Ambassador Row. Zip: 75247. Tel: (214) 631-3431.
Audio: 8-tr. (40,60,80), cassette (45,60,90,120), open reel.
Video: 2" quad, 1" open reel, 3/4" cassette, 1/2" EIAJ open reel, 1/2" Beta cassette
Brand name: Betamax, U-matic.

Sound/Pro Inds. Inc., 347 Culver Blvd., Playa del Rey, Calif. 90291. Tel: (213) 822-0510. Pres.: Donald K.M. Rothger; Sales Mgr.: Pierre Basbous; Adv. Mgr.: Linda Newton.
Audio: 8-tr. (45,60,90), cassette (45,60,90). (SEE ADVERTISEMENT)

Sound Studios, 230 N. Michigan Ave., Chicago, Ill. 60601. Tel: (312) 236-4814. Pres.: Jerry Markham; VP & Gen. Mgr.: Dan Tynus.
Audio: Cassette, open reel, broadcast (custom lengths).
Brand name: Quantitape.

Spectrum, see Memory Media.

Spotmaster, see Broadcast Electronics.

Studio, see BASF.

Studio Magnetics Co. Inc., 83 Carlough Rd., Bohemia, N.Y. 11716. Pres.: George Clahane; VP: Craig Balaban
Audio: Cassette (custom lengths), open reel.
Video: 3/4" cassette (custom lengths)
Brand names: Studio Magnetics, Studio Master, Studio Pro, Studio Standard

Super Avilyn, see TDK

Superscope Inc., 20525 Nordhoff St., Chatsworth, Calif. 91311. Tel: (213) 998-9333.
Branches: Itasca, Ill., 1300 Norwood Ave. Zip 60143. Tel: (312) 569-2147.—Troy, Mich., 591 Executive Dr. Zip 48084. Tel: (313) 588-7200.—Woodside, N.Y., 56-08 37 Ave. Zip: 11377. Tel: (212) 446-7227.—Bellevue, Wash., 12842 NE 15 Pl. Zip: 98005. Tel: (206) 454-5162.
Audio: 8-tr. (45,90), cassette (62,92,122).
Supertape, see Radio Shack

Swire-Intermagnetics Co., 1311 Colorado Ave., Santa Monica, Calif. 90404. Tel: (213) 393-9281. Pres. George Johnson; VP Sales & Mktg.: Robert Dunn; VP Communications: Bruce Weber.
Audio: 8-tr. (45,90), cassette (45,60,90,120).

T D K Electronics Corp., 755 Eastgate Blvd., Garden City, N.Y. 11530. Tel: (516) 746-0880. VP: Ken Kohda; Nat'l Mktg. Mgr.: Bud Barger; Ass't Adv. Mgr.: Bob Miller.
Branches: Irvine, Calif., 17072 Daimler St. Zip: 92705. Tel: (714) 979-5811. Div. Sales Mgr.: Sandy Cohen.—Chicago, Ill., 2906 W. Peterson Ave. Zip: 60645. Tel: (312) 973-1222.
Audio: 8-tr. (45,90), cassette (30,45,60,90,120,180), open reel (1200',1800',3600').
Video: 3/4" cassette, 1/2" VHS cassette.
Brand name: Super Avilyn. (SEE ADVERTISEMENT)

Tape-A-Thon Corp., 502 S. Isis, Inglewood, Calif. 90301. Tel: (213) 776-7933. Pres.: Lee Tate; Exec. VP & Sales & Mktg. Dir.: Wally Rubin.
Audio: Super cassette (16 hours).
Brand name: Jet Pak, Trak-4

Tape Duplrs of Florida Inc., 785 W. 83 St., Hialeah, Fla. 33014. Tel: (305) 822-7585. Pres.: John R. Urgell; Sales Mgr.: Alberto Mestre.
Audio: 8-tr., cassette

Tape Head Co Inc., 665 S. State St., Salt Lake City, Utah 84111. Tel: (801) 521-3838. Pres.: Stan Schubach.
Video: 3/4" cassette, 1/2" Beta & VHS cassette.
Brand name: Teleprosys.

Tapemaker Sales Co. Inc., 629 W. Merrick Rd., Valley Stream, N.Y. 11582. Tel: (516) 561-6080. Pres.: Arthur Brandwein; Sales Mgr.: M. Medina.
Video: 1/2" Beta & VHS cassette.

Tape Packaging Assocs., 740 W. Collins, Orange, Calif. 92667. Tel: (714) 997-4173/4177. Pres. & Sales Mgr.: William L. Starling Jr.; Adv. Mgr.: Joyce A. Starling.
Audio: 8-tr., cassette.
Video: 3/4" cassette, 1/2" EIAJ open reel (30,60), 1/2" Beta & VHS cassette.

Tape Specialty Inc., 13411 Satcoy St., North Hollywood,

Calif. 91605. Tel: (213) 873-5400, 786-6111. Contact: Len Feldman.
Audio: Cassette (2-122).

Tapette Corp., 7221 Garden Grove Blvd., Suite K, Garden Grove, Calif. 92641. Tel: (714) 638-7960. Pres.: Jim Neiger II; Sales Mgr.: Patrick Kenny; Customer Servs. Mgr.: Mary Deery.
Audio: Cassette (1-94).

Teledyne, see Olson Electronics.

Telephone Dynamics Corp., 2473-A Jerusalem Ave., North Bellmore, N.Y. 11710. Tel: (516) 221-9470
Audio: Cassette, open reel (custom lengths).
Brand name: Nassau.

Teleprosys, see Tape Head.

3 M Co., Magnetic Audio/Video Prods. Div., 3M Center, Bldg. 223-5N, St. Paul, Minn. 55101. Tel: (612) 733-1110. Div. VP: John E. Povolny; Sales Mgr.: S.R. Frederickson; Adv. Mgr.: Peter M. Gavin.
Branches: Anchorage, Alaska, 5531 Minnesota Dr. Zip: 99502. Tel: (907) 276-2363.—Burbank, Calif., 126 W. Elm Court. Zip: 91502. Tel: (213) 848-5534.—Los Angeles, Calif., 6023 S. Garfield Ave. Zip: 90040. Tel: (213) 726-6300.—South San Francisco, Calif., 320 Shaw Rd. Zip: 94080. Tel: (415) 589-2663.—Washington, D.C., 1101 15 St. NW. Zip: 20005. Tel: (202) 331-6900.—Atlanta, Ga., 2860 Bankers Ind'l Dr. Zip: 30360. Tel: (404) 447-7000.—Honolulu, Hawaii, 2880 Ualena St. Zip: 96819. Tel: (808) 841-0147.—Argo, Ill., 6850 S. Harlem Ave. Zip: 60501. Tel: (312) 496-6500.—Needham Heights, Mass., 155 Fourth Ave. Zip: 02194. Tel: (617) 449-0300.—Farmington, Mich., 23923 Research Dr. Zip: 48024. Tel: (313) 477-5000.—Eagan, Minn., PO Box 3211, St. Paul 55133; 3130 Lexington Ave. S. Zip: 55121. Tel: (612) 733-3300.—St. Louis, Mo., PO Box 510, 10725 Baur Blvd. Zip: 63166. Tel: (314) 991-1320.—West Caldwell, N.J., PO Box 76, 15 Henderson Dr. Zip: 07006. Tel: (201) 227-9100.—Cincinnati, Ohio, 4835 Para Dr. Zip: 45237. Tel: (513) 242-2313.—Cleveland, Ohio, 12200 Brookpark Rd. Zip: 44130. Tel: (216) 267-1800.—Philadelphia, Pa., 5698 Rising Sun Ave. Zip: 19120. Tel: (215) 728-5300.—Dallas, Tex., 2121 Santa Anna Ave. Zip: 75228. Tel: (214) 324-3100.—Seattle, Wash., Andover Ind'l Park, 100 Andover Park W. Zip: 98188. Tel: (206) 244-7200.
Audio: 8-tr. (45,90), cassette (45,60,90,120), open reel (1200',1800',2400',3600'), broadcast.
Video: 2" quad, 1" helical, 1" open reel, 3/4" cassette (5,10,15,20,30,40,50,60), 1/2" VHS cassette (60-120 & 120-240 min.), 1/2" Beta cassette (30-60 & 60-120 min.)
Brand name: Scotch. (SEE ADVERTISEMENT)

Tracs, see Audio Magnetics.

Trak-4, see Tape-A-Thon.

Triad Prods. Inc., 1910 Ingersoll, Des Moines, Iowa 50309. Tel: (515) 243-2125.
Audio: Cassette (5-94).

U-matic, see Sony.

U T C, see Universal Tape.

Ultra Specialty Inc., 20700 Belshaw Ave., Carson, Calif. 90746. Tel: (213) 979-0338. Cable: ULTRASPEC. Telex: 194566 Ultraspec Crsn. Pres.: Don Wong; Pres. Ultraspec Int'l: Gary Lyle; VP Mktg.: Bill Dawson.
Audio: Exports—CBS 8-tr., cassette, duPont chromium film; imports—Ultrasound consumer tape prods., duplicator cassettes. (SEE ADVERTISEMENT)

Universal Tape Corp. Inc., 821 E. Artesia Blvd., Carson, Calif. 90746. Tel: (213) 327-3203. Pres.: Edward O. Praeger.
Audio: 8-tr., cassette & open reel (custom lengths).
Video: 1" open reel, 3/4" cassette, 1/2" EIAJ open reel, 1/2" EIAJ cartridge (custom lengths).
Brand name: A/V Paragon, UTC, Universal.

Utopia Ultra-Sound, 38-40 S. First St., Newark, Ohio 43055. Tel: (614) 345-9426. Pres.: Robert H. Kirk Jr.
Audio: 8-tr., cassette
Brand name: The Pro

Victory Press Inc., 600 SW 10, Suite 502, Portland, Ore. 97205. Tel: (503) 222-6138. Pres.: Dan E. Gordon; Sales Mgr.: J.E. Gordon; Adv. Mgr.: S.R. Gordon.
Audio: Cassette (custom lengths)

Video Music Corp., 770 W. 27 St., Hialeah, Fla. 33010. Tel: (305) 885-9156. Gen. Mgr.: Angel Tamargo.
Audio: 8-tr., cassette.

Videospot, see International Audio.

Westtape, 503-C Vandell Way, Campbell, Calif. 95008. Tel: (408) 379-0871. Sales Mgr.: Mike Papp.
Audio: 8-tr. (90), cassette (custom lengths in 1 minute increments).
Brand name: Ferrodyne

Zenth Radio Corp., 1900 N. Austin Ave., Chicago, Ill. 60639. Tel: (312) 745-2000.
Audio: 8-tr. (45,90), cassette (30,45,60,90,120).

THE SWEET SOUND OF SUCCESS BEGINS WITH TENNECO PVC RECORD RESINS AND COMPOUNDS



Tenneco Chemicals Polymers
 A Tenneco Company

P.O. Box 365
 Piscataway, NJ 08854

Reg. Trademark, Tenneco Inc

TAPE, BULK RAW, MANUFACTURERS

A/V Paragon, see Universal Tape

Agfa-Gevaert Inc., 275 North St., Teterboro, N.J. 07608. Tel: (201) 288-4100; NYC (212) 279-2560. Pres.: Robert Coppenrath; Nat'l Sales Mgr.: Maria A. Curry; Adv. Mgr.: Myles Adler.
Sales offices: Burlingame, Calif., 1633 Old Bayshore Hwy. Zip: 94010. Tel: (415) 692-2432. Reg'l Mgr.: James Heller.—Glendale, Calif., 1025 Grand Central Ave. Zip: 91201. Tel: (213) 245-8886.—Atlanta, Ga., 380 Interstate N., Suite 200. Zip: 30339. Tel: (404) 955-4326. Zone Mgr.: Forrest Cole.—Oak Brook, Ill., 2803 Butterfield Rd., Suite 200. Zip: 60521. Tel: (312) 242-1915. Zone Mgr.: Fred Schaezting.—Lexington, Mass., Lexington Office Center, Hayden Ave. Zip: 02173. Tel: (617) 890-5430. Reg'l Mgr.: R. Kleine.—Waldwick, N.J., 150 Hopper Ave. Zip: 07463. Tel:

Stevie Wonder and TDK. Both bring great music to millions.

There's nothing like music to bring people together. Your TDK cassette customers care about music. And Stevie Wonder makes the kind of music they care about. With seven gold albums and 22 gold singles, it makes perfect sense to bring Stevie Wonder and TDK together.

Beginning this fall, Stevie Wonder will be singing the praises of TDK's full line of quality cassettes. Exciting TV and radio advertising will turn on your customers across the country. A full schedule of TDK magazine and newspaper ads will be read by millions. And Stevie Wonder in-store displays and posters will create the kind of store traffic you've always dreamed about.

As our featured cassette this fall, TDK D offers co-op and promotional opportunities unprecedented in the history of premium cassette merchandising. Tie-in with TDK advertising and take advantage of special promotions including TDK D in multi-packs. Remember, with hardware sales slowing down, tape has never been a more important profit-center. And economical TDK D has never been a more attractive value. Your customers recognize TDK quality, and the D cassette delivers it consistently. Watch for Stevie Wonder and TDK D this fall. Millions will.



TDK.

The Amazing Profit Machine.

(201) 444-8500—**New York, N.Y.**, 1 Penn Plaza, Rm. 3527. Zip: 10001. Tel: (212) 279-2560—**Dallas, Tex.**, 3003 LBJ Fwy., Suite 100. Zip: 75234. Tel: (214) 243-7315.

Audio: Cassette, broadcast. (SEE ADVERTISEMENT)
Ampex Corp., Magnetic Tape Div., 401 Broadway, Redwood City, Calif. 94063. Tel: (415) 367-2011. Pres. A.H. Hausman; Sales Mgr.: R.A. Antonio; Adv. Mgr.: A. Fisher.

Sales offices: **Glendale, Calif.**, 500 Rodier Dr. Zip: 91201. Tel: (213) 240-5000—**Denver, Colo.**, 2121 S. Birch. Zip: 80222. Tel: (303) 757-6491—**Orlando, Fla.**, PO Box 15008-B. Zip: 32808. Tel: (305) 423-2962—**Atlanta, Ga.**, 3135 Chestnut Dr., Suite 101. Zip: 30340. Tel: (404) 451-7112—**Overland Park, Kan.**, PO Box 7282. Zip: 66207. Tel: (913) 383-1951—**Baton Rouge, La.**, PO Box 14754. Zip: 70808. Tel: (504) 766-6270—**Bethesda, Md.**, 10215 Fernwood Rd. Zip: 20034. Tel: (301) 530-8800. District Mgr. Max McCollough—**Framingham, Mass.**, PO Box 1020. Zip: 01701. Tel: (617) 877-8060—**Hackensack, N.J.**, 65 Commerce Way. Zip: 07601. Tel: (201) 489-7400—**Pittsford, N.Y.**, PO Box 175. Zip: 14534. Tel: (716) 586-2580—**Dallas, Tex.**, 1615 Prudential Dr. Zip: 75235. Tel: (214) 637-5100—**Salt Lake City, Utah**, 2880 S. Main St., Suite 105. Zip: 84115. Tel: (801) 487-8181.

Plants: **Opelika, Ala.**, PO Box 190. Zip: 36801. Tel: (205) 745-7643—**Elk Grove Village, Ill.**, 2201 Lunt Ave. Zip: 60007. Tel: (312) 593-6000.

Audio: 8-tr., cassette, open reel.

Andol Audio Prods. Inc., 4212-14 Ave., Brooklyn, N.Y. 11219. Tel: (212) 435-7322. Pres. Anthony A. Maniere; Sales Mgr.: Rocco Salvatore; Adv. Mgr.: Domenico Salvatore.

Audio: 8-tr., cassette.

Associated Audio Servs. Inc., 14 Willett Ave., Port Chester, N.Y. 10573. Tel: (914) 937-5129. Pres. D. Richard Kraus; Sales & Adv. Mgr.: Robert Pinchbeck.

Audio: Cassette.

Audicom Corp., 4950 Nome St., Unit C, Denver, Colo. 80239. Tel: (303) 371-3076. Pres. Jack H. Dunham; Richard Sanders, Chief Eng.; David Howard.

Audio: Cassette, open reel.

Audio Inds. Inc., Broad & Linden Aves., Ridgefield, N.J. 07657. Tel: (201) 945-4545. Pres. M. Donalds; Customer Serv.: Michael Kates.

Audio: 8-tr., cassette. (SEE ADVERTISEMENT)

Audio Magnetics Corp., 2602 Michelson Dr., Irvine, Calif. 92716. Tel: (714) 833-0020. Pres. Isidore Philoppe; VP Sales: James W. Lantz; VP Int'l Prods.: Stewart B. Schlosberg.

Audio: 8-tr., cassette, open reel.

Brand names: Tracs High Performance. (SEE ADVERTISEMENT)

Audiotape, see Capitol
B A S F Systems, Crosby Dr., Bedford, Mass. 01730. Tel: (617) 271-4000.

Branches: Santa Monica, Calif., 1307 Colorado Ave.

Zip: 90404. Tel: (213) 451-8781—**Melrose Park, Ill.**, 1800 N. 30 Ave. Zip: 60160. Tel: (312) 343-6618—**Clifton, N.J.**, 149 Rt. 48. Zip: 07011. Tel: (201) 546-9111—**Dallas, Tex.**, Dallas Petroleum Center, 13610 Midway, Suite 255. Zip: 75240. Tel: (214) 233-6607.

Audio: Cassette.
Burlington Audio Tapes Inc., 10 Commercial St., Hicksville, N.Y. 11801. Tel: (516) 433-4466. Pres. Ruth Schwartz; VP Sales & Adv. Mgr. Rudy Schwartz.

Audio: 8-tr., cassette, open reel, broadcast.

Video: 1" open reel, 1" cartridge, 3/4" cassette, 1/2" EIAJ open reel, 1/2" EIAJ cartridge.

Brand name: Olympic.

Capitol Magnetic Prods. (div. of Capitol Recs. Inc.), 1750 N. Vine St., Los Angeles, Calif. 90028. Tel: (213) 462-6252. Mktg. Dir. Harry Preston; Prof. Prods. Sales Mgr. Larry Hockemeyer.

Sales offices: **Niles, Ill.**, 6401 Gross Point Rd. Zip: 60648. Tel: (312) 775-7101—**Germentown, Md.**, Century XXI, 20030 Century Blvd. Zip: 20767. Tel: (301) 428-0795—**New York, N.Y.**, 1370 Ave. of the Americas. Zip: 10019. Tel: (212) 757-7470—**Cleveland, Ohio**, 7123 Pearl Rd. Zip: 44130. Tel: (216) 888-6010—**Dallas, Tex.**, 6730 Oakbrook Blvd. Zip: 75235. Tel: (214) 617-8390.

Int'l branches: England, Singapore.

Audio: 8-tr., cassette.

Brand Name: Audiotape.

Certron Corp., 1701 S. State College Blvd., Anaheim, Calif. 92806. Tel: (714) 634-4280; WATS (800) 854-3943. Pres. Edwin Gamson; VP Mktg.: Ray Allen; Adv. Mgr.: Hal Wilde.

Audio: 8-tr., cassette, open reel.

Columbia Magnetics (div. of CBS Inc.), 51 W. 52 St., New York, N.Y. 10019. Tel: (212) 765-4321. Dir.: Glenn Hart.

Branch: **Century City, Calif.**, 1930 Century Park W. Zip: 90067. Tel: (213) 556-4836. Nat'l Sales Dir.: Jerry Branough.

Plant: **Danbury, Conn.**, 15 Great Pasture Rd. Zip: 06810. Tel: (203) 744-3555. Plant Mgr.: Ray Hughes.

Audio: 8-tr., cassette.

Comsette Corp., 12417 W. Olympic Blvd., Los Angeles, Calif. 90064. Tel: (213) 826-4528. Pres.: Richard W. Moore. Sales Mgr.: J.A. Buchanan.

Audio: 8-tr., cassette.

Cory Sound Co., 440 Brannan St., San Francisco, Calif. 94107. Tel: (415) 543-0440. Pres. George Cory; VP & Pres. Ngr Mgr.: Phillip C. Markinson. VP Sales: Lou Sinclair.

Audio: Cassette, open reel, broadcast.

Crolyn, see E I du Pont.

D A K Inds. Inc., 10845 Vanowen St., North Hollywood, Calif. 91605. Tel: (213) 984-1559; WATS (800) 423-2636. Pres.: Drew Alan Kaplan.

Audio: 8-tr., cassette, open reel, broadcast.

Video: 1/2" EIAJ open reel.

Delta Magnetics, 1901 McDonald Ave., Brooklyn, N.Y. 11223. Tel: (212) 627-6556.

Audio: 8-tr., cassette, open reel.

Donnak Inds., PO Box 422, Ridgefield, N.J. 07657. Tel: (201) 945-6820. Pres.: Marvin Donalds; VP: Rudolph Puntilio; Customer Serv.: Michael Kates.

Audio: Cassette. (SEE ADVERTISEMENT)

E I du Pont de Nemours & Co. Inc., Magnetic Prods. Div., Photo Prods. Dept., Old du Pont Airport, Bldg. 1, Wilmington, Del. 19898. Tel: (302) 999-4251. Pres. Edward R. Kane; Mktg. & Sales Mgr.: E. Richard Buckley; Adv. Mgr.: Grif Harrison.

Audio: Cassette.

Brand name: Crolyn.

Electronic Homes Co., 24-64 Crescent St., Astoria, N.Y. 11102. Tel: (212) 545-3094. Chm.: George T. Sadtler; Pres. Paula Sadtler; Sales Mgr. Elias Smyrnakis.

Audio: 8-tr., cassette, open reel.

El Mar Plastics Inc., 821 E. Artesia Blvd., Carson, Calif. 90746. Tel: (213) 237-3180.

Audio: 8-tr. (SEE ADVERTISEMENT)

Fidelipac (div. of Harvell Inds.), 109 Gaither Dr., Mount Laurel, N.J. 08057. Tel: (609) 235-3511. Pres. Roger Cappello; Sales & Mktg. Mgr.: Arthur Constantine.

Audio: Broadcast cartridge.

Finebit Mfg. Co. Inc., 931 N. Citrus Ave., Los Angeles, Calif. 90038. Tel: (213) 466-9511. Pres. Alwin P. Schmid; VP: Joseph Bouzoglou.

Audio: 8-tr., cassette.

Video: 3/4" cassette, 1/2" EIAJ cartridge.

Gabriel Mfg. Co. Inc., 125 S. Liberty Dr., Stony Point, N.Y. 10980. Tel: (914) 942-0100.

Audio: 8-tr., cassette.

High Performance, see Audio Magnetics.

Hilo, see Magnetic Mktg.

Infonics Inc., PO Box 1111, 238 Hwy. 212, Michigan City, Ind. 46360. Tel: (219) 879-3381. Pres.: Paul C. Lloyd.

Audio: Cassette. (SEE ADVERTISEMENT)

Irish Magnetic Rec'g Tape (div. of Morhan Nat'l Sales Co. Inc.), 270 78 Newtown Rd., Plainview, N.Y. 11803. Tel: (516) 293-5582. Cable: MORHANEX. Telex: 96-7880. Pres.: Sol Zigman; Sales Mgr.: George Krug; Adv. Mgr.: George Taub.

Audio: 8-tr., cassette, open reel.

Video: 3/4" cassette, 1/2" EIAJ open reel, 1/2" Beta cassette.

M M C, see Magnetic Mktg.

Magnetic Mktg. Corp., 29 Valley View Terr., Wayne, N.J. 07470. Tel: (201) 694-3502. Pres.: Thomas J. Hofbauer; Sales Mgr. Brendan F. Browne; Adv. Mgr.: M. Judge.

Audio: 8-tr., cassette, open reel, broadcast.

Brand name: Hilo, MMC (SEE ADVERTISEMENT)

Magnetic Media Corp., 500 Eastern Pkwy., Farmingdale, N.Y. 11735. Tel: (516) 293-1010. Pres.: Aaron Wasserstrom; Gen. Sales Mgr.: Douglas Scott.

Int'l branch: Korea, IPO Box 5006, Seoul.

Audio: Cassette.

Brand name: TM-100.

Magnetix Corp., 770 W. Bay St., Winter Garden, Fla. 32787. Tel: (305) 656-4494. Pres. John Lory.

Audio: 8-tr., cassette, open reel, broadcast.

Video: 1" open reel, 1/2" EIAJ open reel.

Miami Tape Inc., 8180 NW 103 St., Hialeah Gardens, Fla. 33015. Tel: (305) 558-9211. Pres.: Carlos Garcia; Sales Mgr.: Mirella Tunon.

Audio: 8-tr., cassette.

Olympic, see Burlington.

Scotch, see 3M.

Sentry Inds. Inc., 221 N. Macquesten Pkwy., Mount Vernon, N.Y. 10550. Tel: (914) 664-2909. Pres.: Harold Rosen; Sales & Adv. Mgr.: Barry Rosen.

Audio: 8-tr., cassette, open reel. (SEE ADVERTISEMENT)

Swire-Intermagnetics Co., 1311 Colorado Ave., Santa Monica, Calif. 90404. Tel: (213) 393-9281. Pres. George Johnson; VP Sales & Mktg.: Robert Dunn. VP Communications: Bruce Weber.

Audio: 8-tr., cassette.

T D K Electronics Corp., 755 Eastgate Blvd., Garden City, N.Y. 11530. Tel: (516) 746-0880. VP Ken Kohda; Nat'l Mktg. Mgr.: Bud Barger; Ass't Adv. Mgr.: Bob Miller.

Branches: **Irvine, Calif.**, 17072 Daimler St. Zip: 92705. Tel: (714) 979-5811. Div. Sales Mgr.: Sandy Cohen—**Chicago, Ill.**, 2906 W. Peterson Ave. Zip: 60645. Tel: (312) 973-1222.

Audio: 8-tr., cassette, open reel.

Video: 3/4" cassette, 1/2" cassette. (SEE ADVERTISEMENT)

T M-100, see Magnetic Media

Tape Packaging Assocs., 740 W. Collins Ave., Orange, Calif. 92667. Tel: (714) 997-4173/4177. Pres. & Sales Mgr.: William L. Starling Jr.; Adv. Mgr.: Joyce A. Starling.

Audio: 8-tr., cassette.

3 M Co., Magnetic Audio/Video Prods. Div., 3M Center, Bldg. 223-5N, St. Paul, Minn. 55101. Tel: (612) 733-1110. Div. VP John E. Povolny; Sales Mgr.: S.R. Fredrickson; Mkt. Development Mgr.: R.F. Burnett; Adv. Mgr.: Peter M. Gavin.

Branches: **Anchorage, Alaska**, 5531 Minnesota Dr. Zip: 99502. Tel: (907) 276-2363—**Burbank, Calif.**, 126 W. Elm Court. Zip: 91502. Tel: (213) 848-5534—**Los Angeles, Calif.**, 6023 S. Garfield Ave. Zip: 90040. Tel: (213) 726-6300—**South San Francisco, Calif.**, 320 Shaw Rd. Zip: 94080. Tel: (415) 589-2863—**Washington, D.C.**, 1101 15 St. NW. Zip: 20005. Tel: (202) 331-6900—**Atlanta, Ga.**, 2860 Bankers Ind'l Dr. Zip: 30360. Tel: (404) 447-7000—**Honolulu, Hawaii**, 2880 Ualena St. Zip: 96819. Tel: (808) 841-0147—**Argo, Ill.**, 6850 S. Harlem Ave. Zip: 60501. Tel: (312) 496-6500—**Needham Heights, Mass.**, 155 Fourth Ave. Zip: 02194. Tel: (617) 449-0300—**Farmingington, Mich.**, 23923 Research Dr. Zip: 48024. Tel: (313) 477-5000—**Eagan, Minn.**, PO Box 3211, St. Paul 55133; 3130 Lexington Ave. S. Zip: 55121. Tel: (612) 733-3300—**St. Louis, Mo.**, PO Box 510, 10725 Baur Blvd. Zip: 63166. Tel: (314) 991-1320—**West Caldwell, N.J.**, PO Box 76, 15 Henderson Dr. Zip: 07006. Tel: (201) 227-9100—**Cincinnati, Ohio**, 4835 Para Dr. Zip: 45237. Tel: (513) 242-2313—

COLOR CASSETTE LABELS

READY FOR IMPRINTING
OR IMPRINTED TO ORDER
SHEETS ONLY
20 ITEMS IN WHITES & COLORS
SEND FOR SAMPLES AND PRICES



PAULI PRODUCTS
P.O. BOX 29 • DEPT. BD
COLLINGSWOOD, N.J. 08108
(609) 547-8925

The Self Feed King

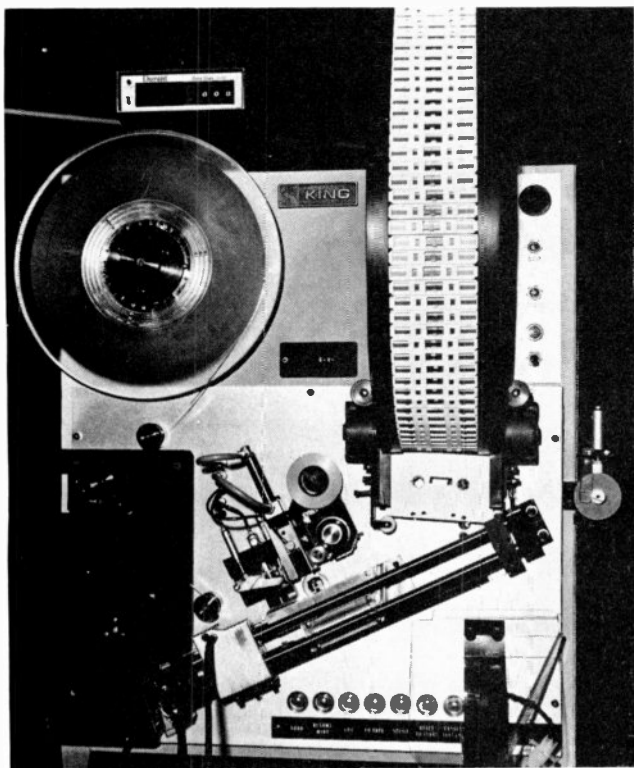

This Self Feed King automatically positions, loads and ejects blank or pre-recorded tape cassettes faster and more reliably than any cassette loader made. And you need fewer operators. Companies around the world depend on this King.

The Manual King

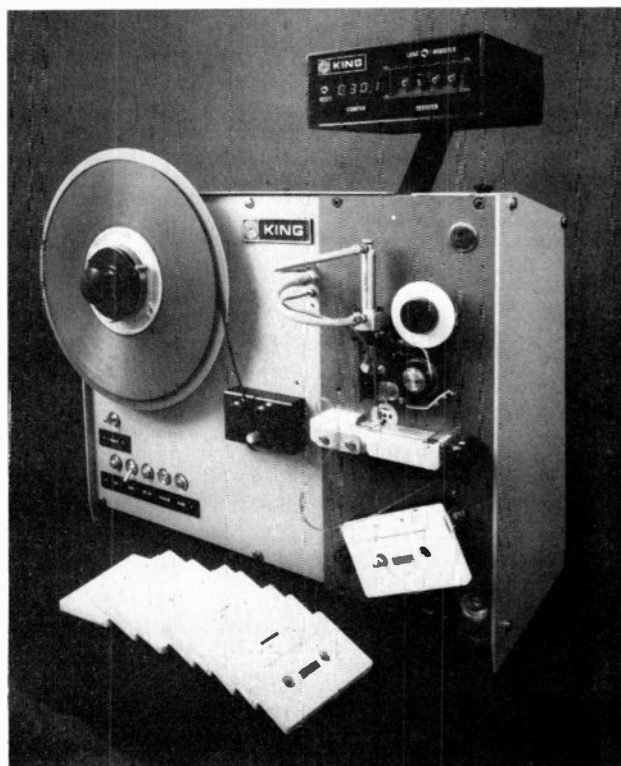

The "Basic One", the new manual King produces blank and recorded tape cassettes faster, more accurately than any manual cassette loader made. This King is designed for smaller companies with low labor costs, high import duties, who need a faster more accurate cassette-loader.

Introducing The "Basic One"

- High Production — Users report over 1200 C 60's per operator on one machine per 8 hour shift with perfect splices.
- Fast and Simple — Full electric motor drive, self contained vacuum. Only 5 simple manual switches to produce precise length blank or pre-recorded tapes at high production speeds.
- Low Cost — \$5890 (U.S. Dollars FOB our factory) including complete operations manual.
- Minimal Maintenance — The "Basic One" has been designed to be virtually maintenance free and includes complete operation service and repair manual. Designed to King's exact, proven engineering standards.
- Maintenance Training Film — A 25 minute Super 8 sound and color training film on the King Splicer is available for just \$128.00.



World Leader in Tape Tailoring Systems®

All King Instruments are manufactured under one or more of the following patents: U.S. Pat. Nos. 3637153, 3753834, 3787270, 3737358, 3717314, 3753835, 3825461. Other U.S. and foreign patents pending.

For more information and a quotation write or call:

Mr. William E. Cline
Vice President of Sales

King Instrument Corporation
80 Turnpike Road

Westboro, Massachusetts 01581, U.S.A.

Phone (617) 366-9141 • Cable KINGINST • Telex 94-8485

IF IT'S GAUSS, YOU'LL HEAR

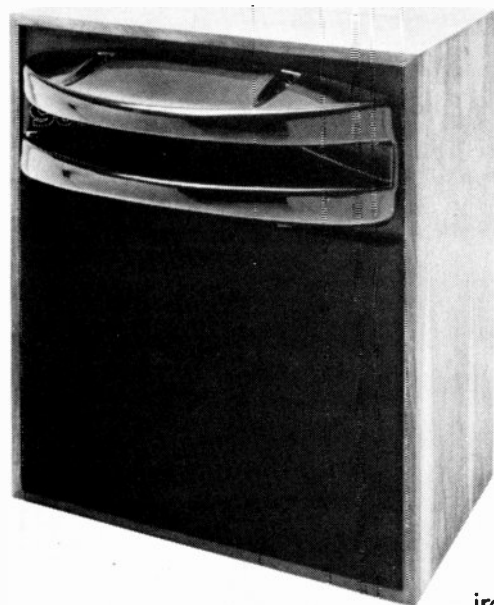

Gauss offers a complete range of speakers and monitors. From compression drivers to compression tweeters. From 10" to 18" loudspeakers. Studio monitors. Disco monitors. Horns. And now, a new and more powerful line of 12," 15" and 18" dynamic cone loudspeakers. Loudspeakers that typically offer double the power, (400 watts RMS), at the same prices you used to pay for our 200 watts RMS speakers.

New speakers. Better speakers. But, with the built in reliability and cast iron warranty you've come to expect from Gauss. Reliability that comes from our unique double-spider construction and die cast frame. Reliability that comes from hours of 400 watts RMS testing.

Gauss' quality standards in both design and manufacture add up to quality you can hear. But don't take our word for it. See your professional equipment dealer. Test one of our speakers against two of theirs. You'll hear the difference.

Whenever you turn on a high quality stereo tape, you're probably hearing Gauss. Because Gauss high speed audio tape duplicating systems are operating in major duplicating facilities worldwide. It's no accident. Gauss high speed tape duplicating equipment was developed specifically for superb quality for up to 8 track, 1/4" or cassette duplication.

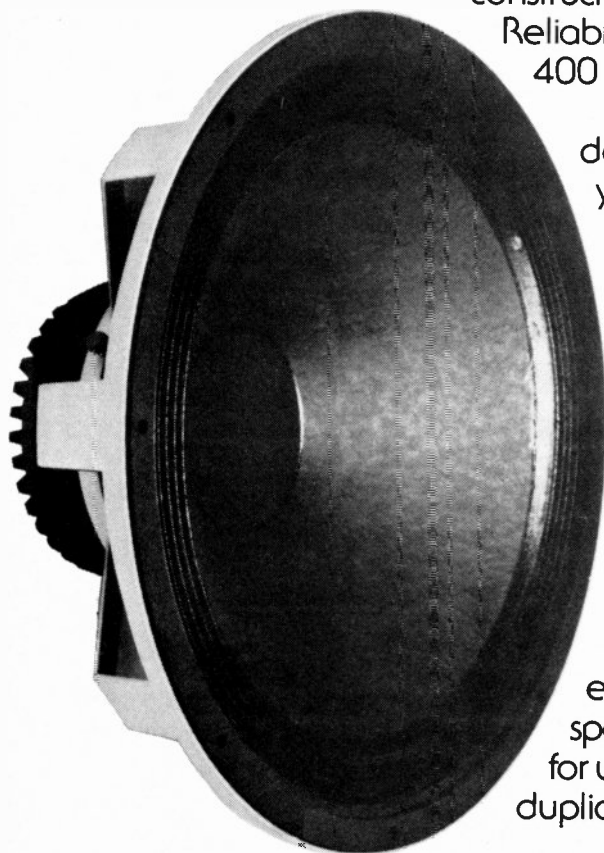
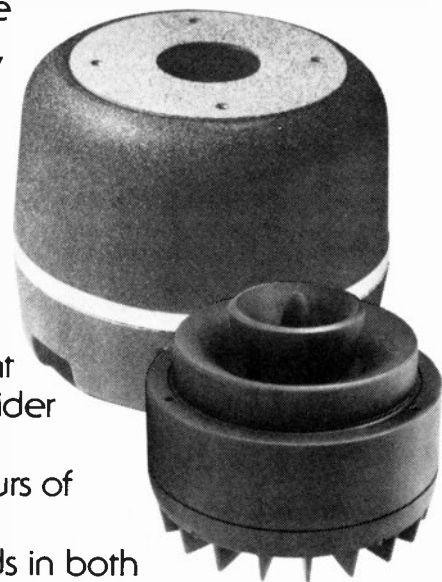

THE DIFFERENCE.

With a duplication ratio up to 64:1, Gauss' closed-looped dual capstan drive virtually eliminates wow and flutter. And, the Gauss 10 MHz bias system assures less noise and distortion on the duplicated tape. But that's not the only reason Gauss is in the leading studios.

Gauss systems are modularly engineered. That means you can start with a master and slave...then add up to 20 slaves as your business grows. And, Gauss' modular design means you'll never have to own a system that's out of date. As we improve the equipment, we improve it modularly. You add the improved modules (like 64:1 duplicating), when you need them.

Gauss engineering brings you a better product in sound. In speakers. In high speed tape duplicators. Listen. You'll hear the difference.

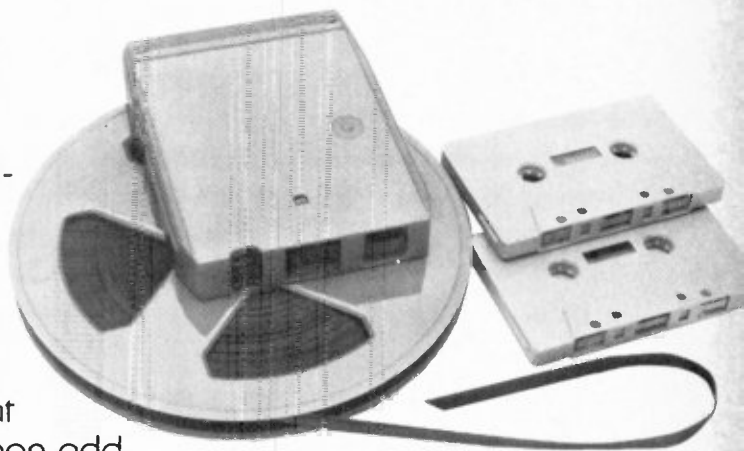

FULL-RANGE PROFESSIONAL SPEAKERS AND MONITORS · HIGH SPEED AUDIO TAPE DUPLICATORS

gauss by Cetec

CETEC GAUSS
13035 Saticoy Street
North Hollywood, CA 91605
(213) 875-1900 TWX 910-499-2669

CETEC INTERNATIONAL LTD.
16 Uxbridge Rd.
Ealing, London W5 2BP, England
01-579-9145 TLX: 935847

Divisions of Cetec Corporation

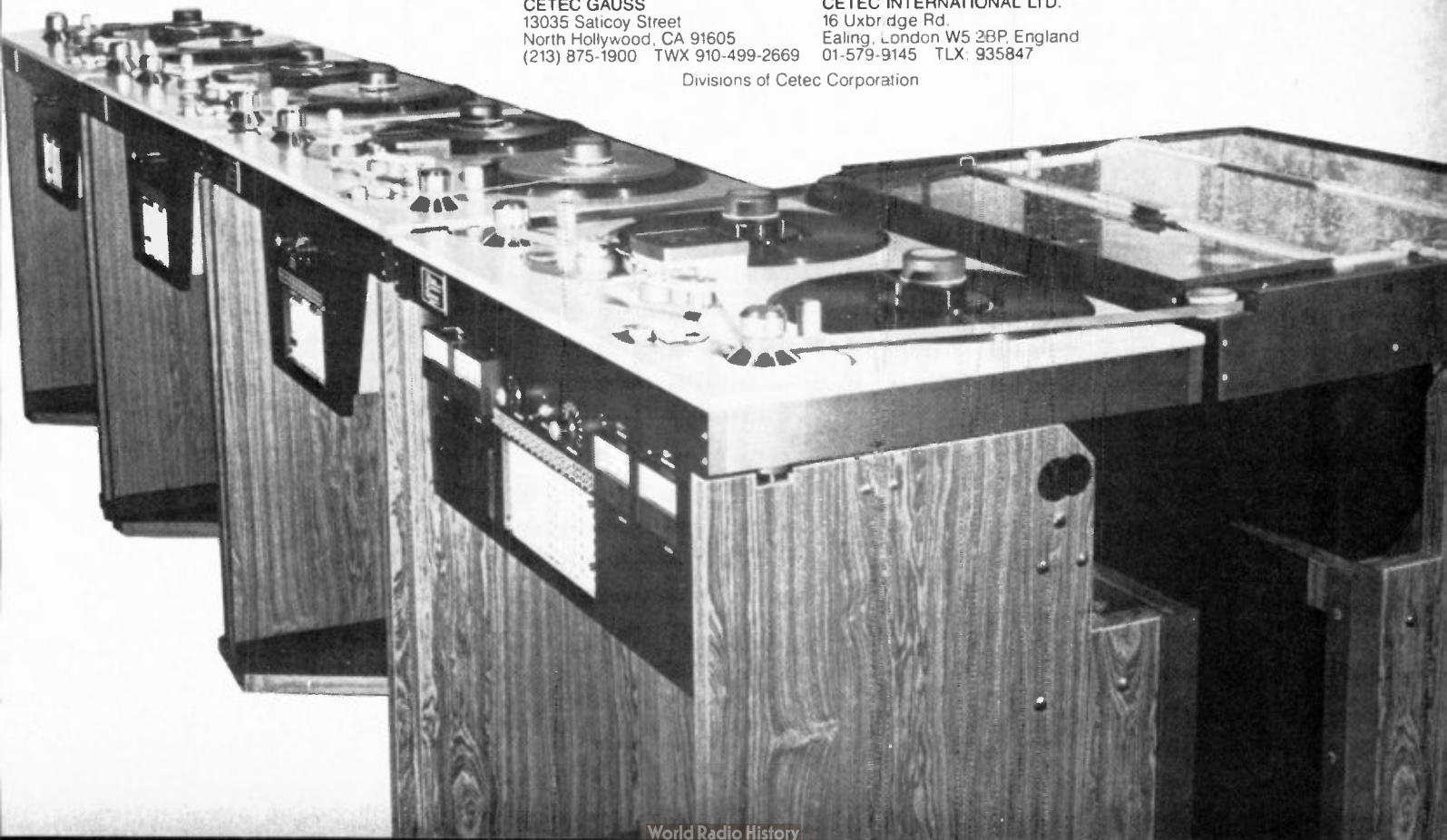

PROVEN QUALITY & RELIABILITY

2 LOCATIONS FOR PROMPT DELIVERY

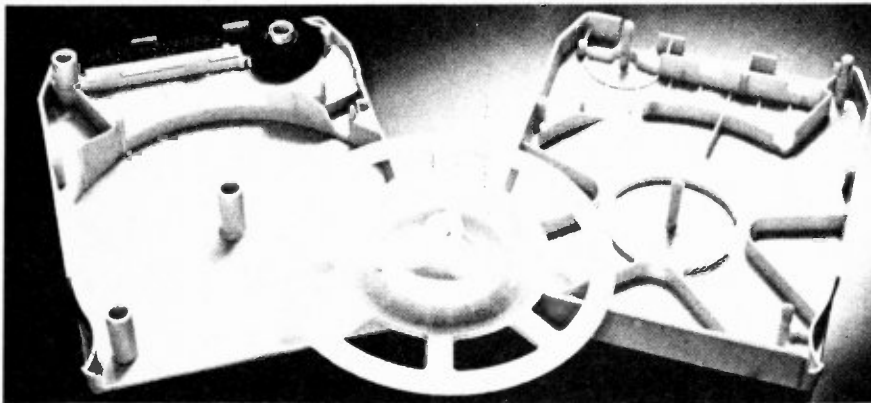

for more information call Clif Tant (615) 244-5668



CUSTOM CARTRIDGE, INC.
341 HILL AVE. NASHVILLE, TENN. 37210

Cre'8 Video Servs. Ltd., PO Box 5136, Zip 85010; Embassy Square, 805 N. Fourth Ave., Phoenix, Ariz. 85003. Tel: (602) 257-2978.
Video: Film-to-tape, tape-to-tape & tape-to-film duplicators.

Ed-Pic, see Pickering Audio-Tronics.

Electro Sound Inc. (sub. of ElectroSound Group Inc.), 160 San Gabriel Dr., Sunnyvale, Calif. 94086. Tel: (408) 245-6600. Pres.: Raymond J. Schaaf.
Branch: Omaha, Neb., Electro Sound Midwest, 3528 Dodge St. Zip: 68131. Tel: (402) 344-4114. Mktg. Mgr.: Jim Cook (Sales office).
Audio: Duplicators, QC reproducers, automatic 8-tr. & cassette winders, loaders, splicers & recorders/reproducers.
Brand names: Electro Sound, Liberty.

Ferrocube Corp., 5083 Kings Hwy., Saugerties, N.Y. 12477. Tel: (914) 246-2811.
Audio: 8-tr., 8-tr. quadraphonic & cassette duplicating head assemblies.

Finebilt Mfg. Co. Inc., 931 N. Citrus Ave., Los Angeles, Calif. 90038. Tel: (213) 466-9511. Pres.: Alwin P. Schmid. VP: Joseph Bouzaglou.
Audio: Magnetic tape coaters & slitters, test equip.

Gauss, see Cetec.

Gotham Audio Corp., 741 Washington St., New York, N.Y. 10014. Tel: (212) 741-7411. Pres.: Stephen F. Temmer. VP: Eli Passin.
Audio: Duplicators, cassette tape winders.
Brand name: Magnetophon, Telefunken.

Grandy, see MTI.

I E M, see International Electro-Magnetics.

I T I, see Investment Technology.

Infonics Inc., PO Box 1111, 238 Hwy. 212, Michigan City, Ind. 46360. Tel: (219) 879-3381. Pres.: Paul C. Lloyd.
Audio: Duplicators.
Brand names: Infonics, Phoenix (SEE ADVERTISEMENT)

Intermagnetics Corp., 1311 Colorado Ave., Santa Monica, Calif. 90404. Tel: (213) 393-9281. Pres.: Terry C. T. Wherlock. VP Sales: Doug Rowlands. VP Communications: Bruce Weber.
Audio & video: Coaters, slitters, calanders, assembly & test equip. (SEE ADVERTISEMENT)

International Audio Inc., 2934 Malmö Dr., Arlington Heights, Ill. 60005. Tel: (312) 956-6030.
Audio: In-cassette duplicators.
Brand name: Alpha.

International Electro-Magnetics Inc., 350 N. Eric Dr., Palatine, Ill. 60067. Tel: (312) 358-4622. Pres.: John Pretto. Sales & Adv. Mgr.: Tony Pretto.
Audio: Heads, tape transports.
Brand name: IEM.

Investment Technology Inc., 1940 124 Ave. NE, Bellevue, Wash. 98005. Tel: (206) 454-7720. Pres.: David P. Hilliard. VP: George Woodley.
Audio: Air-driven loop bin.
Brand names: Air Bin, ITI.

Ray Jacobs Audio Inc., 2739 Signal Pkwy., Long Beach,

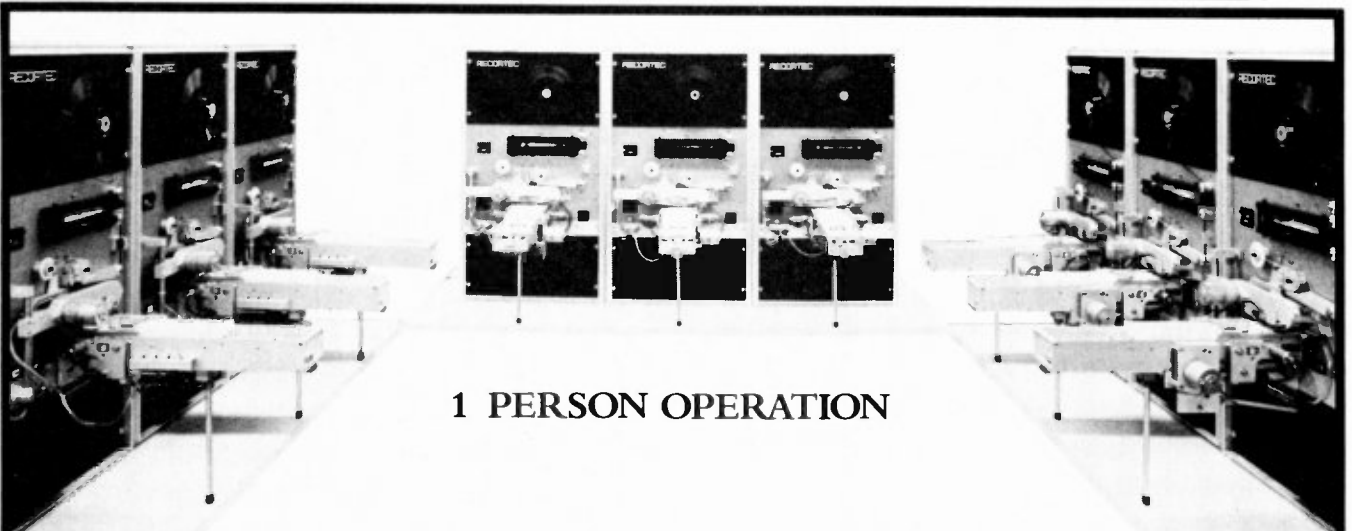

1 PERSON OPERATION

AUTOMATED CASSETTE LOADING

THROUGHPUT per operator can be significantly increased using Automatic Cassette Feeders on Recortec loaders. One operator will then be able to handle up to 10 units loading C-90 length cassettes. The operator's only task is to keep the loaders supplied with C-zeros and tape pancakes.

QUALITY of output is improved by automated cassette handling and leader threading. The constant tension packing of tape in the cassette assures no tape stretching and trouble free cassette operation. Defective C-zeros and high friction cassettes are automatically rejected and segregated by the loader.

EFFICIENCY of Recortec equipment is evident when the same unit can handle C-10 to C-180 tape without adjustment. The same loader can be used for loading either prerecorded or blank tape. The unit is also less dependent on operator proficiency because of the automatic functions.

RECORTEC, INC. 777 PALOMAR AVE., SUNNYVALE, CA 94086 TEL: (408) 735-8821 TWX: 910-339-9367

Calif 90806 Tel (213) 595-6811 Pres Ray Jacobs.
Sales Mgr Larry Stagnaro. Adv Mgr Robert Ellsworth

Audio: High-speed duplicators.
Brand name: Wollensak

King Instrument Corp., 80 Turnpike Rd., Westboro, Mass 01581 Tel (617) 366-9141. Pres. James L King. VP Sales William E. Cline. Mktg Dir. Paul McGonigle.
Audio: Automatic tape tailoring equip., self-feed cassette loaders.
Video: 1/4" loaders (U-matic), 1/2" (Beta & VHS) cassette winders & loaders. (SEE ADVERTISEMENT)

Liberty, see Electro Sound.
M M C, see Magnetic Mktg
M Q C, see Magnetic Mktg
M T D, see Magnetic Mktg

M T I Corp., 124 Montclair Ave., Montclair, N.J. 07042 Tel (201) 744-2220 Pres Timothy A. Cole
Audio: High-speed duplicators & loaders
Brand name: Audio/Tek Grandy. (SEE ADVERTISEMENT)

Magnecord, see Telex.
Magnetic Mktg. Corp., 29 Valley View Terr., Wayne, N.J. 07470 Tel (201) 694-3502 Pres Thomas J. Hofbauer. Sales Mgr. Brendan F. Browne. Adv Mgr M. Judge
Audio: In-cassette duplicators & loaders, pancake duplicator degaussers.
Brand name: MMC, MQC, MTD. (SEE ADVERTISEMENT)

Magnetophon, see Gotham Audio.
Mini Max, see Recordex Corp.
Otari Corp., 981 Industrial Rd., San Carlos, Calif 94070 Tel (415) 593-1648 Pres Jack Soma. Sales Mgr. S. Krampf. Adv. Mgr. David McClurg.
Audio: In-cassette duplicators, open reel & cassette duplicators.

P C E, see Professional Cassette Equip.
Passavant Corp., PO Box 2503, Birmingham, Ala. 35201 Tel (205) 853-6290.
Audio & Video: Unwinders, conditioning units, copiers, dryers, calendars, rewinders, slitters. (SEE ADVERTISEMENT)

Pentagon Inds. Inc., 4751 N. Olcott Ave., Chicago, Ill 60656. Tel (312) 867-9200 Pres. Tom Horton. VP Mktg. James Dow. Sales Mgr. Joe Hollenkamp
Audio: In-cassette, reel-to-reel & reel-to-cassette duplicators. (SEE ADVERTISEMENT)

B. F. Perkins (div. of Roehlen Inds.), PO Box 366, 939 Chicopee St., Chicopee, Mass. 01021. Tel (413) 536-1311
Audio: Magnetic tape calendars, filled & nylon shell rolls, cooling rolls, unwinds, rewinds, splice jumping & edge guiding.

Phoenix, see Infonics
Pickering Audio-Tronics Inc., 7625 E. Rosecrans Blvd., Unit 34, Paramount, Calif 90723 Tel (213) 531-3454 Pres. Edward F. Pickering. (Exported by Singer Prods.)
Audio: Duplicating systems (all formats), tape winders



Reel-to-reel
Reel-to-cassette
Cassette-to-cassette
Cassette-to-reel

Expands to
forty 2-channel
or twenty
4-channel slaves

PENTAGON'S "PRO": THE STANDARD OF EXCELLENCE IN AUDIO TAPE DUPLICATION

Pentagon's Pro gives the superb duplication, versatility and high production professionals demand. It is rugged, dependable and simple to operate. Copy from either open reel or cassette masters to any combination of reels and cassettes simultaneously.

Write or call for full color brochure

PENTAGON

4751 N. Olcott, Chicago, IL 60656
(312) 867-9200
TLX 25 3058



1 PERSON OPERATION

32 OR 64 TIMES

AUTOMATED CASSETTE DUPLICATOR

COMBINING duplication and loading into one operation is Recortec's contribution to cutting your labor costs. And, the Bi-Directional Master eliminates the master bin loop! With the system pictured, one operator keeps the C-zero hoppers supplied, puts on new pancakes and spot checks the finished product.

QUALITY is built into this professional equipment to provide the best in open reel type duplication systems. The standard 32 times duplication ratio provides the highest fidelity attainable in high speed duplication. Even at 64 times, the bandwidth is sufficient for most recording applications.

PRODUCTIVITY of your operation can be continually expanded from a start-up 1 x 1 system, to a 1 x 8 as pictured and even to larger configurations. Our systems provide highest productivity, and a quality product with fewer operators. Only Recortec offers automated duplication and loading in one operation!

RECORTEC, INC. 777 PALOMAR AVE., SUNNYVALE, CA 94086 TEL: (408) 735-8821 TWX: 910-339-9367

From Electro Sound everything you need for tape duplicating

QCV all-new quality control reproducer

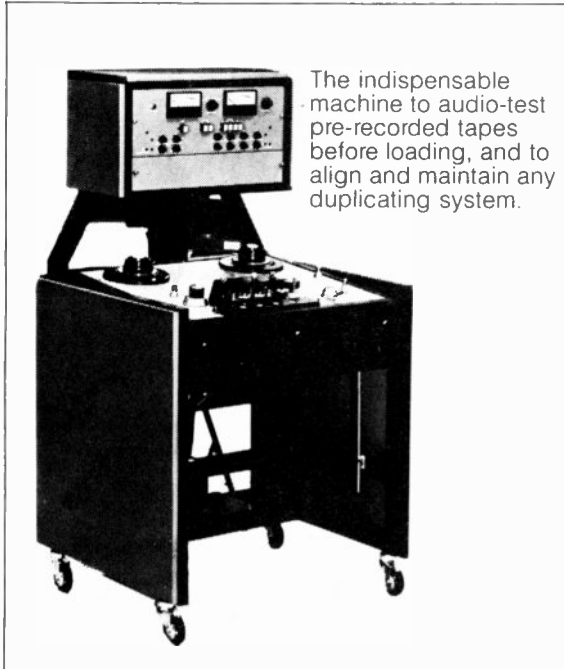

The indispensable machine to audio-test pre-recorded tapes before loading, and to align and maintain any duplicating system.

ES1800 Cassette Loader

with new improvements and refinements including these major features:

300 ips wind speed.
One operator can handle 3 or 4 loaders.
Master air supply control on front panel.
Lift-top cabinet design for easy internal component access. Dual

mode counter operates as safety stop in cue tone mode. Accepts European standard and NAB standard reels. Accepts all C-O shells without adjustment.



The first mastering equipment designed especially for 64:1

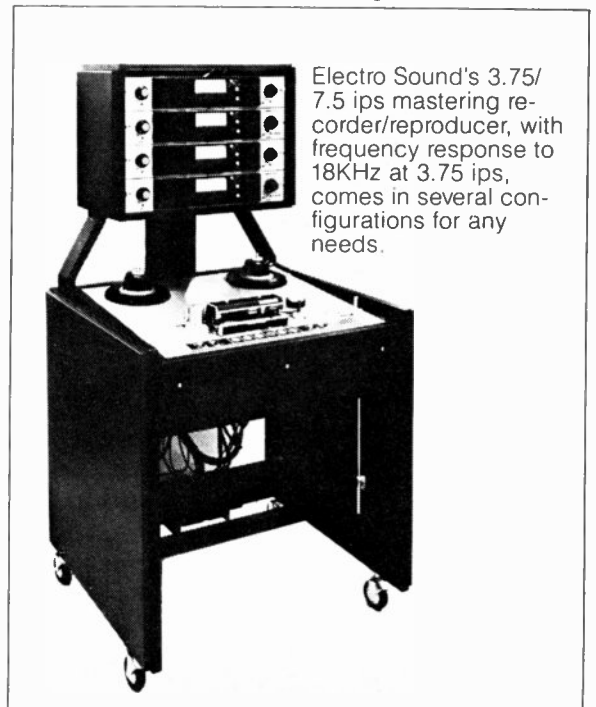

Electro Sound's 3.75/7.5 ips mastering recorder/reproducer, with frequency response to 18KHz at 3.75 ips, comes in several configurations for any needs.

Distributed in the U.S.
and worldwide by

audio
AUDIOMATIC CORPORATION

1290 Avenue of the Americas
New York, NY 10019
Cable Audiomatic
Phone 212-582-4870
Telex 12-6419

Other offices:
Paris HongKong Mexico City

Representatives
throughout the world

The all-new Electro Sound Series 8000

The most advanced microprocessor-based 64:1/32:1
cassette duplicating in the world

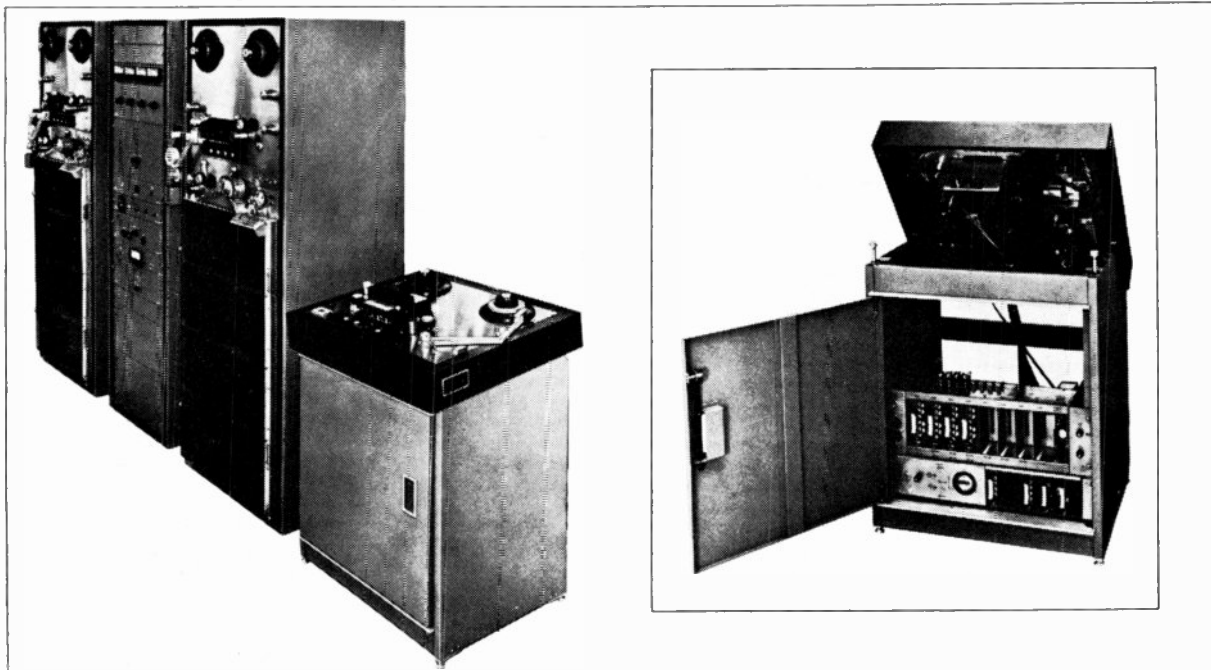

System 8000 uses sophisticated microprocessor technology and completely redesigned electronics to achieve a real breakthrough in duplicating quality, ease of operation and maintenance, and over-all cost effectiveness.

From its sparkling cabinetry to its smallest component, System 8000 is a real milestone in the advancement of the tape duplicating art.

Here are just a few of the features: The microprocessor introduces automatic process safeguards by continuously monitoring bias, Q-tone and tape speed. Tape handling is all new, with a constant-tension system and torque motor that eliminate eddy-current clutch motors, and with a packer arm system for smooth and consistent tape pack. Slave redesign affords complete access from the front, including tilted, lift-up top plate for easy operation and maintenance and saving of floor space.

And you won't believe the sound of the finished tapes.

Call or send for details

We have all the equipment and accessories you need for a complete duplicating plant.

Distributed in the U.S.
and worldwide by
audio
AUDIOMATIC CORPORATION

1290 Avenue of the Americas
New York, NY 10019
Cable Audiomatic
Phone 212/582-4870
Telex 12-6419

Other offices:
Paris Hong Kong Mexico City

Representatives
throughout the world

IMPORTANT NOTICE

AUDIO INDUSTRIES

Announces

- **NORELCO STYLE BOXES**
- **40 MILLION PER YEAR**
- **C-O CASSETTES**
- **CASSETTE & 8 TRACK TAPE**
- **CASSETTE COMPONENTS**
- **CASSETTE TABS**
- **BLANK CASSETTES**
- **C-30, C-60, C-90, HEAD CLEANERS**

HIGHEST QUALITY • LOW PRICES
Call or Write

AUDIO INDUSTRIES

Broad & Linden Aves. • Ridgely, N.J. 07657
Tel: 201-945-4545 • Telex 133396

(all formats), quality control playback systems (all formats).
Brand names: Ed-Pic, Recordex.
Professional Cassette Equip. Co. (PCE), 1660 20 St., Santa Monica, Calif. 90404. Tel: (213) 829-2282.
Audio: Cassette loader.
Recordex Corp., 1300 Booth Ave., Atlanta, Ga. 30318. Tel (404) 351-7062. Pres.: Tom Allen. (Also see Pickering Audio-Tronics & Singer Prods.)
Audio: Cassette & reel to cassette duplicators, in-cassette duplicating systems.
Brand name: Mini Max, Recordex, Super Pro.
Recortec Inc., 777 Palomar Ave., Sunnyvale, Calif. 94086. Tel: (408) 735-8821. Pres.: Lester H. Lee, Sales Mgr.: Ron R. Troxell.
Audio: Automated cassette duplicators & loaders. (SEE ADVERTISEMENT)
Rockford Automation, 3381 Forest View Rd., Rockford, Ill. 61109. Tel: (815) 398-7601. Prod. Mgr.: Jay Treadway.
Audio & Video: Cassette automatic assembly systems
S S K Ents. Inc., 2488 Townsgate Rd., Westlake Village, Calif. 91361. Tel: (805) 495-1214.
Audio: Reel to cassette, reel to hub & continuous loop to pancake for 8-tr.
Shape Inc., PO Box 366, Biddeford Ind'l Park, Biddeford, Me. 04005. Tel: (207) 282-6155. Pres.: Anthony L. Gelardi; Sales & Mktg. Mgr.: Joe Ciccone; Adv. Mgr.: Bob MacLeod.
Audio: Automatic & semi-automatic cassette & 8-tr. assembly equip., automatic 8-tr. splicers & winders. (SEE ADVERTISEMENT)
Singer Prods. Co. Inc., 875 Merrick Ave., Westbury, N.Y. 11590. Tel: (516) 333-2000. Pres.: Arthur A. Singer; Sales Mgr. Steven Schiffman; Adv. Mgr.: S.M. Beriman. (Export only)
Audio: Tape winders & duplicators.
Brand name: Recordex
Studer Revox America Inc., 1819 Broadway, Nashville, Tenn. 37203. Tel: (615) 329-9576. Pres.: Bruno Hochstrasser, Nat'l Sales Mgr.: Rob Robinson.
Audio: Master recorders, quality control recorder/reproducer. (SEE ADVERTISEMENT)
Super Pro, see Recordex Corp.
Superscope Tape Dupl'g Prods. Inc. (sub. of Superscope Inc.), 20525 Nordhoff St., Chatsworth, Calif. 91311. Tel: (213) 998-9333 x.2294. Pres.: Joseph S. Tuchinsky; Mktg. & Sales Mgr.: Jerry Epstein.
Audio: Automatic cassette loader.
T D K Electronics Corp., 755 Eastgate Blvd., Garden City, N.Y. 11530. Tel: (516) 746-0880. VP. Ken Kohda; Nat'l Mktg. Mgr.: Bud Barger; Ass't Adv. Mgr.: Bob Miller.
Branches: Irvine, Calif., 17072 Daimler St. Zip: 92705. Tel: (714) 979-5811. Div. Sales Mgr.: Sandy Cohen—Chicago, Ill., 2906 W. Peterson Ave. Zip: 60645. Tel: (312) 973-1222.
Audio: Cassette & open reel pancakes.
Tapemaker Sales Co. Inc., 629 W. Merrick Rd., Valley

Stream, N.Y. 11582. Tel: (516) 561-6080. Pres.: Arthur Brandwein; Sales Mgr.: M. Medina
Audio: Programmable cassette testing unit, loop bin.
Telectro Systems Corp., 96-18 43 Ave., Corona, N.Y. 11368. Tel: (212) 651-8900. Pres.: Harry Sussman.
Audio: High speed duplicators.
Telefunken, see Gotham Audio.
Telex Communications Inc., 9600 Aldrich Ave. S., Minneapolis, Minn. 55420. Tel: (612) 884-4051. Pres. Ansel Kleiman; VP Mktg.: James S. Arrington; Adv. & Sales Promo. Dir.: Peter Schwarz.
Audio: Cassette & open reel modular duplicators/copiers, broadcast reel & cartridge recorders/reproducers.
Brand name: Magnecord, Telex.
Trackmaster Inc., 1310 S. Dixie Hwy. West, Pompano Beach, Fla. 33060. Tel: (305) 943-2334. Pres.: Roy Parsons; Sec'y-Treas.: Lupe Parsons.
Audio: 8-tr. duplicators. (SEE ADVERTISEMENT)
U M C Electronics Co., 460 Sackett Point Rd., North Haven, Conn. 06472. Tel: (203) 288-7731.
Audio: 8-tr. tape machine.
Brand name: Beaucart.
United Research Lab. Corp., 681 Fifth Ave., New York, N.Y. 10022. Tel: (212) 751-2663. Pres.: George Adams; Sales Mgr.: Lee Rand; Adv. Mgr.: Anita Adams.
Audio: Exact duplicate replacement parts for professional recorders.
Brand name: Auto-Tec.
Verbatim Corp., 323 Sequel Way, Sunnyvale, Calif. 94086. Tel: (408) 245-4400. Pres.: Dr. Peter McCuen; Sales Mgr.: Scott Cochran; Adv. Mgr.: Linda Mancini.
Audio: Cassette tension monitors, head & guide gauge, torque tester.
Wollensak, see Ray Jacobs

TAPE PACKAGING & LABELING EQUIPMENT & SUPPLIES MANUFACTURERS

Adhere-On, see Q-A-1.
Amaray Int'l Corp., 1901 Old Middlefield Way, Suite 11, Mountain View, Calif. 94043. Tel: (415) 968-2840.
Product: Cassette boxes. (SEE ADVERTISEMENT)
Anco Packaging Co., 347 Madison Ave., New York, N.Y. 10017. Tel: (212) 682-8076.
Product: Pressure-sensitive labels & automatic applicators.
Artco Press Inc., PO Box 1445, Terre Haute, Ind. 47808.

magnetic marketing
CORPORATION

THE COMPLETE SOURCE FOR TAPE DUPLICATING EQUIPMENT & SUPPLIES

- **HIGH-SPEED DUPLICATORS***
- **SIDEWINDERS**
- **MASTERING EQUIPMENT**
- **QUALITY CONTROL EQUIPMENT**
- **DEGAUSSERS**
- **LOW-COST LABELERS**
- **SHRINK PACKAGERS**
- **BLANK-LOADED CASSETTES & C-O's**
- **BULK TAPE CASSETTE & LUBE**

* 8:1, 16:1, 32:1 & 64:1

CASSETTE DUPLICATORS

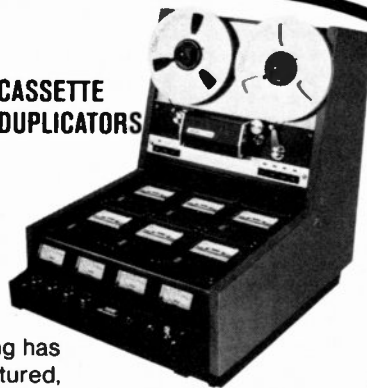

CASSETTE LOADERS

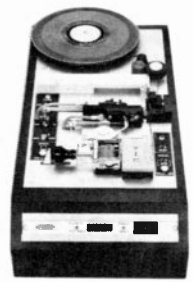

For over 16 years Magnetic Marketing has invented, manufactured, sold and serviced equipment and materials for the tape duplicating industry.

Magnetic Marketing is the one organization that can design and equip YOUR ENTIRE PLANT tailored to your needs at great savings. In addition to the equipment that we

manufacture and the major lines we represent, we offer great savings on rebuilt and demo master makers, winders, duplicators, and packaging equipment. Also, Magnetic Marketing offers the best prices on bulk tape, cartridges and cassettes.

Call Today!
(201) 694-3502

magnetic marketing
CORPORATION

29 Valley View Terrace
Wayne, New Jersey 07470

Tel (812) 232-0926. Pres. James S. Royse. Sales Mgr. Don Wilson.
Product: Cassette folders.

Athena Inds. Inc., 2200 Industrial Way S., Toms River, N.J. 08753. Tel (201) 244-8500. Pres., Sales & Adv. Mgr. Charles Beres Jr.
Product: Norelco-style cassette boxes. (SEE ADVERTISEMENT)

Audico Ltd., 219 Crossen Ave., Elk Grove Village, Ill. 60007. Tel (312) 640-1030. Pres. J.W. Holmes, VP Sales. Claudia Yarbrough, Sales Mgr. Norman Deletzke.
Product: Cassette labels.

Audicom Corp., 4950 Nome St., Unit C, Denver, Colo. 80239. Tel (303) 371-3076. Pres. Jack H. Dunham.
Product: Cassette labels & custom packages.

Audio Accessories Co., 38W515 Deerpath Rd., Batavia, Ill. 60510. Tel (312) 879-5998. Sales Mgr. John S. Maloney.
Product: Boxes, labels, cassettes & printed materials in styro block (book) formats.
Brand name: Infopak.

Audio Inds. Inc., Broad & Linden Aves., Ridgefield, N.J. 07657. Tel (201) 945-4545. Pres. M. Donalds. Customer Serv. Michael Kates.
Product: Norelco-style boxes. (SEE ADVERTISEMENT)

Audiomatic Corp., 1290 Ave. of the Americas, New York, N.Y. 10019. Tel (212) 582-4870. Telex. 126419. Pres. Milton B. Gelfand, VP Customer Servs. Carolyn T. DeVries, Adv. Mgr. J.P. Lohman.
Int'l branch: France.
Product: Printers, inserters, wrappers. (Distributor for Apex Machine & others). (SEE ADVERTISEMENT)

Audiopack, see A.C. Hampson.

AudioVisual Communications Inc., 435 Crooked Ln., King of Prussia, Pa. 19406. Tel (215) 272-8500. Pres. John Ballantyne, VP Sales. John Butterworth.
Product: Cassette labels.

Kenneth A. Bacon Assocs., 216 Montego Key, Novato, Calif. 94947. Tel (415) 883-5041. Contact: Kenneth A. Bacon.
Product: Cassette labels; cartons. (SEE ADVERTISEMENT)

Bazzy Electronics Corp., 39 N. Rose, Mount Clemens, Mich. 48043. Tel (313) 463-2592. Pres. L. Allan Bazzy, Gen. Mgr. Mike Tattan.
Product: Shrink wrap sealer & film.

G. Benson & Co. Printers Inc., 116 Nassau St., Brooklyn, N.Y. 11201. Tel (212) 596-9100. Pres. Gerald J. Benson, VP Sales. Gil Benson; Adv. Mgr. Roxanne Evans.
Product: 8-tr. & cassette pressure-sensitive labels.

Blackbourn Inc., 1821 University Ave., St. Paul, Minn. 55104. Tel (612) 646-2781. Pres. George F. Snelgrove, Sales Mgr. Tom Sabow.
Product: Audio & video vinyl packaging.

Bruce Packaging Co., 8025 N. Kenneth Ave., Skokie, Ill. 60076. Tel (312) 583-2818. Pres. Joseph Halperin.
Product: Open reel boxes, cassette packaging & boxes, corrugated packaging.

Cheshire (a Xerox Co.), 408 Washington Blvd., Mundelein, Ill. 60060. Tel (312) 949-2000.
Product: Labeling machines.

Cinema Sound Corp., see Investment Technology.

Coastal Specialty Tapes Inc. (formerly Pratt-Spector Corp.), 274 Bangor St., Lindenhurst, N.Y. 11757. Tel (516) 226-5900. Pres. Tom Carroll; Sales Mgr. Stanley Gilman, Adv. Mgr. Dan Dobbs.
Product: 8-tr. & cassette labels & labeling machines, tape mailer packages.

Comsette Corp., 12417 W. Olympic Blvd., Los Angeles, Calif. 90064. Tel (213) 826-4528. Pres. Richard W. Moore, Sales Mgr. J.A. Buchanan.
Product: Pressure-sensitive cassette labels, shrink-wrap equip., Norelco-style & soft poly style cassette boxes.

Container-Kraft Inc., 8321 De Celis Pl., Sepulveda, Calif. 91343. Tel (213) 893-9721.

Copy-Art Photographers (div. of James J. Kriegsmann), 165 W. 46 St., New York, N.Y. 10036. Tel (212) 757-0233. Pres. James J. Kriegsmann. **Local branch:** 1619 Broadway Tel 757-0236.
Product: 8-tr. & cassette labels.

Cre'8 Video Servs. Ltd., PO Box 5136, Zip 85010, Embassy Square, 805 N. Fourth Ave., Phoenix, Ariz. 85003. Tel (602) 257-1978.
Product: Covers, stickers, labels.

Cross Int'l, see MTI.

D A K Inds. Inc., 10845 Vanowen St., North Hollywood, Calif. 91605. Tel (213) 984-1559, WATS (800) 423-2636. Pres. Drew Alan Kaplan.
Product: Cassette labels.

Delta Magnetics, 1901 McDonald Ave., Brooklyn, N.Y. 11223. Tel (212) 627-2556.
Product: Norelco style boxes.

Disc Printing (div. of Pickwick Int'l), Cardinal Ind'l Park, Gilpin Ave., Hauppauge, N.Y. 11787. Tel (516) 234-1400.
Product: 8-tr. & cassette labels.

Dyna/Day Plastics Inc., 3319 E. Ten Mile Rd., Warren, Mich. 48091. Tel (313) 755-2530. Pres. Frank Day; VP. Paul M. Hayes, Plant Mgr.; Phil Kelly.
Product: Norelco-style boxes.

E-System, see Econocorp.

Econocorp Inc., 71 Fourth Ave., Needham Heights, Mass. 02194. Tel (617) 444-8070. Pres. Richard G. Lee, Sales & Mktg. Mgr. James F. Zavatore.
Product: Horizontal-loading packaging equip.
Brand name: E-System, Econoseal.

Econoseal, see Econocorp.

El Mar Plastics Inc., 821 E. Artesia Blvd., Carson, Calif. 90746. Tel (213) 327-3180.
Product: Ampex, Norelco, soft poly style & open reel boxes. (SEE ADVERTISEMENT)

Ever-Ready Packaging & Assembly (div. of Reliance Folding Carton Corp.), 225 Belleville Ave., Bloomfield, N.J. 07003. Tel (201) 748-6677.
Product: Cardboard boxes & mailers.

Fenton Label Co., Coral & Buckius Sts., Philadelphia, Pa. 19124. Tel (215) 288-2910.
Product: 8-tr. & cassette labels. (M)

How's 100 Cassettes per minute for starters?

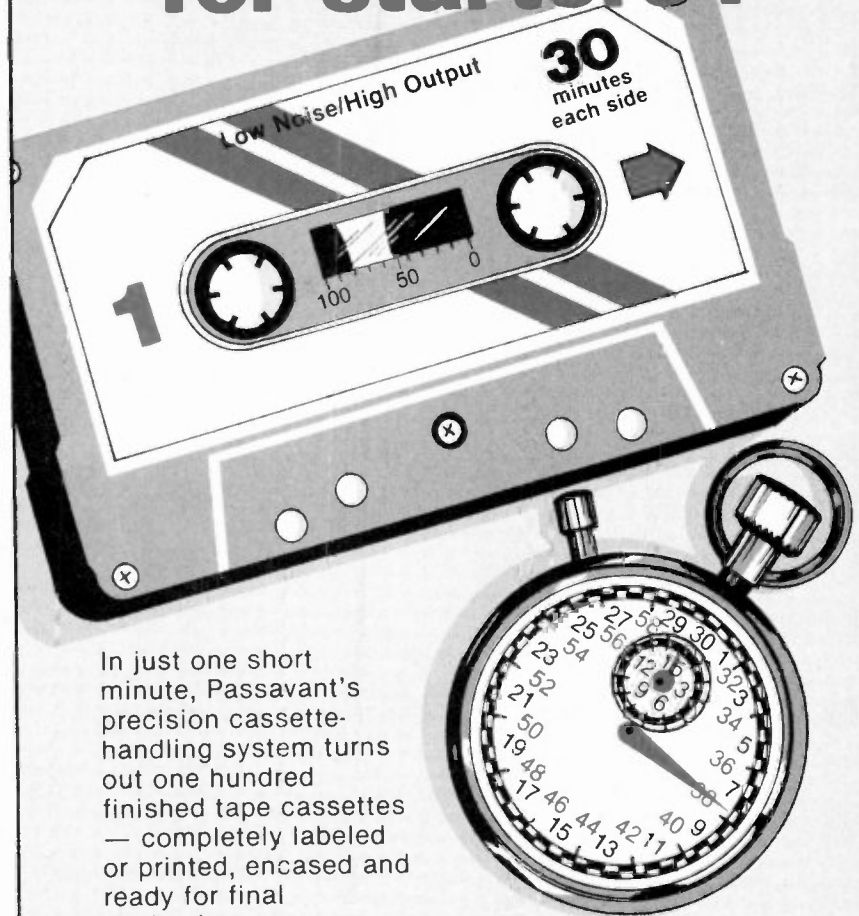

In just one short minute, Passavant's precision cassette-handling system turns out one hundred finished tape cassettes — completely labeled or printed, encased and ready for final packaging.

The fully-automated cassette processing system does the entire job from presorting through counting and stacking quickly and efficiently. And we've engineered quality right into every moving part to assure a system that's dependable and virtually maintenance-free.

Of course, if you don't need the complete system right now, the Auto-sorter, Printer, Labeler, Encasing Machine, and Collecting Table are available as individual units which can be engineered into your present system in record time.

So, take a minute and give us a call or drop us a line.

Cassette handling equipment manufactured under license of Preisel-Berlin

PASSAVANT

Passavant Corporation • P.O. Box 2503 • Birmingham, AL U.S.A. 35201

**Buy Direct From
Manufacturer...**

PINCH ROLLS

■
**PRESSURE
PADS**

■
**NORELCO
BOXES**



**Standard
Sizes in Stock**

- Pinch Rolls—Silicone or SBR Rubber
- Pressure Pads—Four Lb. Density Foam Heat Tested
- Specials Made To Order
- Norelco Boxes
- Teflon* Washers and Mylar Rings in Stock

*Du Pont Trademark

**TROY HILLS
MANUFACTURING CORP.
JOYCE
MOLDING CORP.**

501 DIVISION ST. • BOONTON, N.J. 07005
phone: 201-334-2020

**Ten reasons why InterMagnetics is your only
source for tape equipment and technology.**



INTERMAGNETICS SINGAPORE

INTERMAGNETICS THAILAND

INTERMAGNETICS INDONESIA

SWIRE MAGNETICS HONG KONG

INTERMAGNETICS TAIWAN

INTERMAGNETICS TRANSKEI

INTERMAGNETICS INDIA

INTERMAGNETICS EGYPT

INTERMAGNETICS THE PHILIPPINES

INTERMAGNETICS GREECE

InterMagnetics Corp., 1311 Colorado Ave., Santa Monica, Calif. 90404, U.S.A. (213) 393-9281.
TWX: 910-343-6454 INTERMAG SM

Manufacturers of production equipment and technology for
audio, digital and video tape, stamping foil and other technologies.

Fidelipac (div. of Harvell Inds.), 109 Gaither Dr., Mount Laurel, N.J. 08057. Tel: (609) 235-3511. Pres.: Roger Cappello. Sales & Mktg. Mgr.: Arthur Constantine.
Product: 8-tr. labels.

Filam Nat'l Plastics, 416 W. El Segundo, Los Angeles, Calif. 90061. Tel: (213) 515-0623. Pres.: Vic Flores. VP Sales: Mike Bolong.
Product: Norelco boxes.

Gabriel Mfg. Co. Inc., 125 S. Liberty Dr., Stony Point, N.Y. 10980. Tel: (914) 942-0100.
Product: All types of plastic cassette boxes.

Gem-Bit Container Corp., 48-20 50 Ave., Woodside, N.Y. 11377. Tel: (212) 784-8800.
Product: Corrugated cartons, folders & mailers.

Golly Co., 2320 E. 26 St., Minneapolis, Minn. 55406. Tel: (612) 721-7466. Pres.: Ken Lawrence. Mktg.: Rick Muscoplat.
Product: Audio & video cassette labels.

Gopher Prods. Corp., PO Box 1812, 2201 Lockheed Way, Carson City, Nev. 89701. Tel: (702) 882-9333. Pres.: Warren Perkins.
Product: Labelers.
Brand names: Rotex, Uniline. (SEE ADVERTISEMENT).

A. C. Hampson Printing Co. Inc., 168 City Hill St., Union City, Conn. 06770. Tel: (203) 729-2294. Pres.: Augustus D. Hampson. Sales Mgr.: John W. Berry.
Product: Pressure-sensitive & heat-seal cassette labels, cassette inserts.
Brand name: Audiopack.

I.P.S., 107 Bridge Rd., Hauppauge, N.Y. 11787. Tel: (516) 234-3322. Contacts: Bill Prechtel, Richard Diamond.
Product: Norelco-style boxes. (SEE ADVERTISEMENT).

I.T.I., see Investment Technology.

Image Devices Inc., 1825 NE 149 St., North Miami, Fla. 33181. Tel: (305) 945-1111. Sales Mgr.: Bill Reiter.
Product: Pressure-sensitive labels.

Infopak, see Audio Accessories.

Investment Technology Inc., 1940 124 Ave. NE, Bellevue, Wash. 98005. Tel: (206) 454-7720. Pres.: David P. Hilliard. VP: George Woodley.
Product: Cassette labeler, label printing equip.
Brand name: ITI.

Keystone Printed Specialties Co. Inc., 321 Pear St., Scranton, Pa. 18505. Tel: (717) 346-1761. Pres.: P.G. Fischer Jr. Sales & Adv. Mgr.: Martin Fischer.
Product: 8-tr. & 4-tr. labels. (SEE ADVERTISEMENT).

M. Lattar Mfg. & Sales, 3208 W. Jefferson Blvd., Los Angeles, Calif. 90018. Tel: (213) 737-0440. Owner: Mel Lattar.
Product: Shrink packaging machinery & plastic film.

Lenco Co., PO Box 29128, 3901 N. 69 St., Lincoln, Neb. 68507. Tel: (402) 464-7488. Pres.: Don Leonhardt. Sales & Adv. Mgr.: Daryl O. Chapelle.
Branch: Indianapolis, Ind., Box 507, Rt. 2, Zip 46231. Tel: (317) 839-6673. Mgr.: Scott Bartlett.
Product: Ampex, Norelco, C-Box & soft poly cassette boxes.

Linear Prods. Inc., 37 W. 20 St., New York, N.Y. 10011. Tel: (212) 255-2917.
Branches: Collage Park, Ga., Data-Linear Prods. Inc. 4507-K Mills Pl. SW. Zip: 30366. Tel: (404) 691-1254—**Puerto Nuevo, P.R.,** Linear Prods. of Puerto Rico, Old Long Bldg., Matadera Rd. Zip: 00936. Tel: (809) 783-4986.
Product: Automatic applying equip., pressure-sensitive labels & stickers.

Loranger Mfg. Corp., Entertainment Prods. Div., 10-38 Clark St., Warren, Pa. 16365. Tel: (814) 723-8600. Pres.: J. Albert Loranger. VP: Entertainment Prods. Div.: Robert Loranger.
Product: Norelco-style cassette boxes. (SEE ADVERTISEMENT).

M.I.P., see Molded Ind'l Plastics.

M.M.C., see Magnetic Mktg.

M.T.I. Corp., 124 Montclair Ave., Montclair, N.J. 07042. Tel: (201) 744-2220. Pres.: Timothy A. Cole.
Product: Labeling & wrapping machines.
Brand name: Cross Int'l, Stoddard. (SEE ADVERTISEMENT).

MacMurray Press Inc., 230 W. 17 St., New York, N.Y. 10011. Tel: 924-1530. Pres.: Bernard Lerman.
Product: Cassette labels & cards.

Magnetic Mktg. Corp., 29 Valley View Terr., Wayne, N.J. 07470. Tel: (201) 694-3502. Pres.: Thomas J. Hofbauer. Sales Mgr.: Brendan F. Browne. Adv. Mgr.: M. Judge.
Product: Cassette labeler.
Brand name: MMC. (SEE ADVERTISEMENT).

Mastro Inds. Inc., 3040 Webster Ave., Bronx, N.Y. 10467. Tel: (212) 547-5600. Pres.: Mario Maccalferri.
Product: Ampex & Norelco-style boxes. (SEE ADVERTISEMENT).

Mike's Print Shop, 2507 Grim, Waco, Tex. 76707. Tel: 752-2321.
Product: Pressure-sensitive cassette labels.

Molded Ind'l Plastics Inc., Ansonia, Conn. 06401. Tel: (203) 735-2331.
Product: 5", 7" & 10½" hinged paper boxes.
Brand name: MIP.

N.A.C., see National Audio.

N.J.M. Inc., 16 St. & Willow Ave., Hoboken, N.J. 07030. Tel: (201) 659-0483. Pres.: Richard Wellbrock. Sales Mgr.: M.C. Smith. Adv. Mgr.: G.K. Leeson.
Branches: San Mateo, Calif., 307 S. B St. Zip: 94401. Mgr.: T.A. Paul—**Des Plaines, Ill.,** 2720 Des Plaines Ave. Zip: 60018. Tel: (312) 296-1021. Mgr.: E. Kristensen.
Product: Pressure sensitive labeling equip.
Brand name: Pony Label-DRI, Pony Pacer, Pace Setter.

Nashville Int'l Corp., 20 Music Square W., Nashville, Tenn. 37203. Tel: (615) 256-2885.
Product: Labels & sleeves.
Brand name: Nisco.

National Audio Co. Inc., 1911 S. Stewart, Springfield, Mo. 65804. Tel: (417) 883-5377.
Product: Cassette boxes, 8-tr. & cassette library labels.
Brand name: NAC.

Nisco, see Nashville Int'l.

Pace Setter, see NJM.

Pak-Wik Corp., 128 Tivoli St., Albany, N.Y. 12207. Tel:

Tape Duplicators

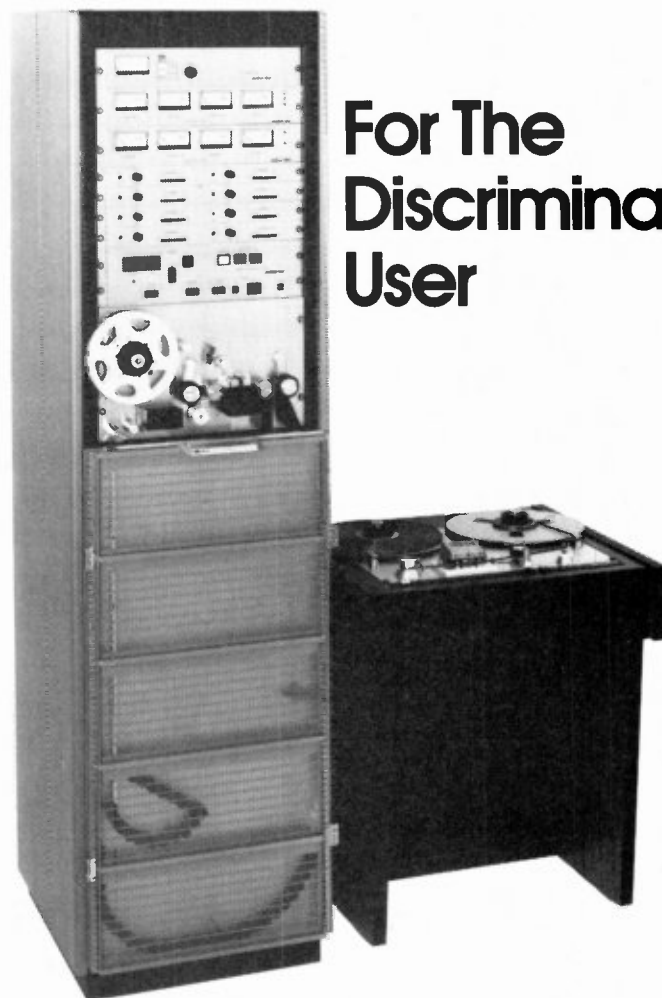

For The Discriminating User

For many years, AUDIO/TEK duplicating systems have enjoyed an enviable reputation in the tape duplicating industry. The basic philosophy in design and construction has been proven under the most demanding conditions throughout the world. This exemplifies the professional standard of quality that can be expected from the AUDIO/TEK line of duplicating systems and equipment.

AUDIO/TEK

502-D Vandell Way, Campbell, California 95008
 Telephone (408) 378-5586, Cable: AUDIOTEK

Worldwide Distribution by

mti
 MAGNETIC TECHNOLOGY
 INTERNATIONAL CORPORATION

MTI CORPORATION

124 Montclair Avenue
 Montclair, N.J. 07042
 Phone: (201) 744-2220
 Telex: 642611 MTI CORP
 Cable: MTICORP

THROUGH
AUTOMATION
CONSISTENT QUALITY WITH COMPETITIVE PRICES IN THE U.S.A.

C-0 CASSETTES

SONIC OR SCREW

NORELCO STYLE BOXES

Custom Length Blank Cassettes

**CASSETTE
PARTS**

ATHENIA INDUSTRIES INC.
2200 INDUSTRIAL WAY SO., TOMS RIVER, N.J. 08753
(201) 244-8500



OUR NEW HEADQUARTERS
TO SERVE YOU BETTER

KNOW YOUR CASSETTE SUPPLIER

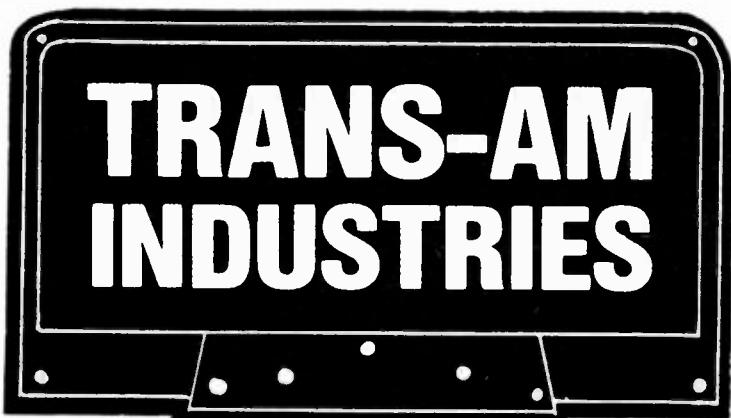

- Meets all industry standards
- Provides high reliability
- Offers immediate delivery
- Has the capacity—
~~over 50 million~~
over 85 million
per year.

C-0 CASSETTES

(Colors Available)

**SONIC
SEALED**

(Tabs In Tabs Out)

**SCREW
TYPE**

(Tabs In Tabs Out)

Contact us today for price list and samples.

TRANS-AM INDUSTRIES

845 BROAD AVE., RIDGEFIELD, N.J. 07657
Tel: (201) 945-2000 · Telex: 133396



SCANDIA

offers

**automatic
packaging machinery
& systems**

designed
for

stereo tape industry

. . .

**labelling-cartoning
wrapping-bundling
inserting operations**



For information, call or write

Scandia Packaging Machinery Co.

P.O. Box 575, Allwood Station
180 Brighton Road, Clifton, N.J. 07012 (201) 473-6100

*over fifty years designing & building automatic packaging
machinery and systems.*

World Radio History

GRANDY Audio Heads...

The way to stay ahead!

When you think of Grandy, you naturally think of quality audio heads. And why not? We've been at it for more than 20 years meeting the needs of the recording industry with a product line that's second to none. And we intend to keep it that way. So if it's...

- Studio Replacement
- Mastering
- Quality Control
- Tape Duplicating
- Relapping Services
- Custom Applications

...or just about any kind of audio requirement for that matter.

If it's QUALITY...It's GRANDY

Call or write today for complete information.

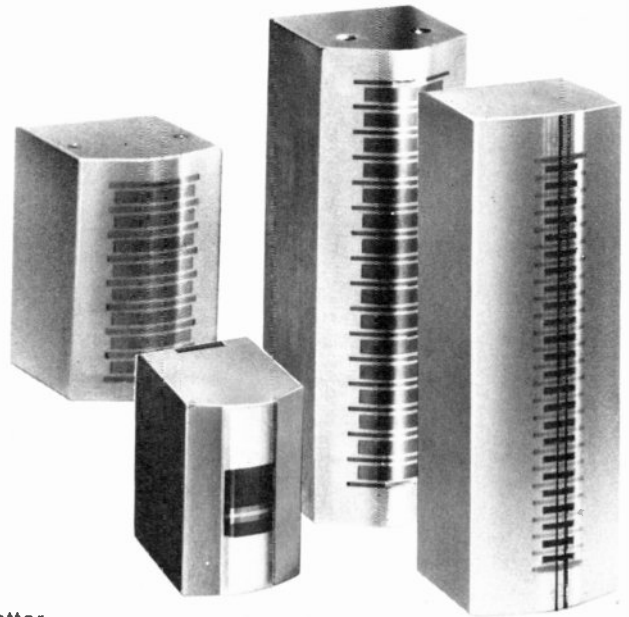

Now Featuring Ferrite Heads.

Grandy

1275 Bloomfield Ave., Fairfield, N.J. 07006 (201)575-1433



Lenco Company

10240 Deerpark Road, Waverly, Nebraska 68462

C-O CASSETTES All American Made

- * 5-Screw
- * Sonic Welded
- * Multiple Leader Colors
- * Poly, Graphite, or Paper Liners
- * Tabs In or Out, Chrome Tabs

Boxes

- * Ampex, Soft Poly, Norelco & C-Box.

WRITE OR CALL
LENCO COMPANY

Eastern Office
9625 West Bradley Drive
Indianapolis, Indiana 46231
(317) 839-6673

Home Office
P.O. Box 160
Waverly, Nebraska 68462
(402) 786-7488

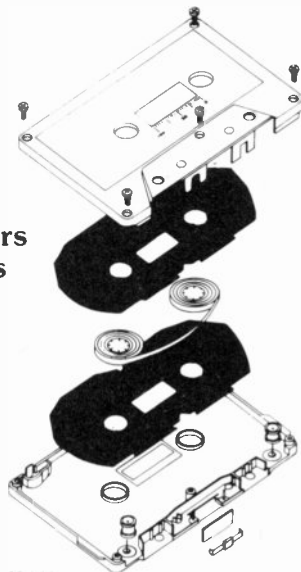

* PINS

Antimagnetic stainless steel lubricated pins for smooth tape movement.

* PRESSURE PAD

Of spring phosphor bronze with wool felt pad to insure positive head contact. Optional; foam pad attached to shield.

* SHIELD

Nickel alloy or silicon steel ensures low noise due to stray magnetic fields.

* ROLLERS

Double flanged one-piece rollers to insure proper tape alignment and low friction.

* HUBS

True circle self lubricating pin lock hubs for smooth winding.

* SHELL

High heat impact grade material for maximum performance.

* WINDOWS

Oriented styrene, sonically welded for dust free operation.

* LINERS

Polyolefin, Graphite coated mylar and Impregnated paper; having a low coefficient of friction with fillers added to eliminate static electricity.

Graham Fraser Packaging Machinery Ltd.

50 DON PARK ROAD, UNIT 5, MARKHAM ONTARIO - CANADA L3R 1J3 TEL. (416) 495-6944. 495-9378

CONVEYORS, CARTONERS, FULLY AUTOMATIC SYSTEMS

FAST

Packages 40 to 60 cassettes per minute

STRONG

Rugged steel construction

COMPACT

96 in. long, 26 in. wide, INFEED AND EXIT 28 in. to 39 in.

FULLY AUTOMATIC

...and at a reasonable price

the cassetter 50

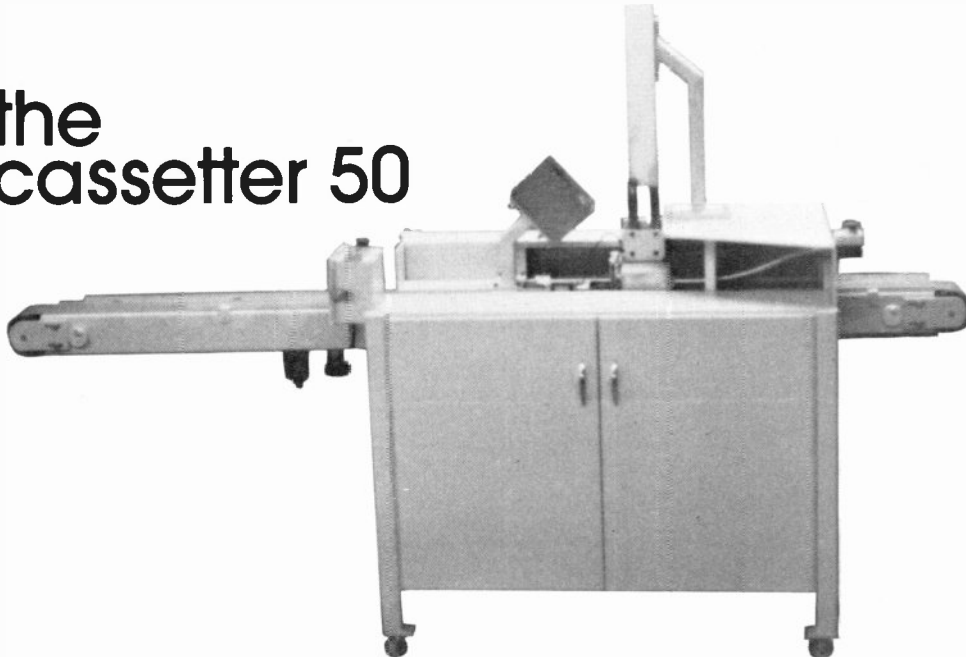

**AUTOMATICALLY
LOADS CASSETTES AND INSERTS INTO NORELCO TYPE BOXES**

OPERATION

Inserts and cassettes are automatically loaded into boxes;
boxes closed and discharged. Standard magazine holds 50 boxes.

Optional available: A fully automatic rotary magazine
holding 250 boxes.

**CASSETTE-PARTS
STANDARD-SPECIAL**

- DOUBLED FLANGED ROLLERS**
- KEYHOLE HUBS**
- LEADER TAPE** **WINDOWS**
- SHIELDS** **SPRING PADS**
- STAKING ROD** **PINS**
- GRAPHITE COATED LINERS**
- CASSETTE SHELLS**
- SONIC - SCREW**
- RECORD TABS**
- CASSETTE TAPE**
- 8 TRACK LUBE TAPE**

**DONNAK
INDUSTRIES**

P.O. Box 422
Ridgefield, N.J. 07657
(201) 945-6820
Telex: 133396

(518) 465-4556. Pres.: Samuel A. Strasser; Sales Mgr.: Myron S. Strasser Jr.
Product: Folding cartons, pilfer-proof cassette & 8-tr. boxes, backer cards for 45's & LP's (inside shrink wrap), 45 RPM & reel-to-reel boxes. (SEE ADVERTISEMENT)
 Pauli Prods., PO Box 29, Dept. BD, Collingswood, N.J. 08108. Tel: (609) 547-8925.
Product: Cassette labels. (SEE ADVERTISEMENT)
 Pederson Label Printing Co., 11152 Fleetwood St., Sun Valley, Calif. 91352. Tel: (213) 768-3122. Pres.: Herman A. Fredriksz; Prod. Mgr.: S. Kadonago.
Product: 8-tr., cassette & box labels, cassette inserts. (SEE ADVERTISEMENT)
 Peerless Vid-Tronics Corp., 60 West St., Bloomfield, N.J. 07003. Tel: (201) 429-8600. Pres.: Herb Ravis; VP & Mktg. Dir.: Jerome Geller; Sales Mgr.: Andy Danzico.
Product: Videocassette packaging.
 Polyline Corp., 1233 Rand Rd., Des Plaines, Ill. 60016. Tel: (312) 298-5300. Pres.: John Kaiser.
Product: Soft hinge & Ampex-style cassette boxes. (SEE ADVERTISEMENT)
 Poly-Matrix Inc., Downing Ind'l Park, 40 Downing Pkwy., Pittsfield, Mass. 01201. Tel: (413) 499-3550. Pres.: William A. Rufo.
Product: Norelco-type cassette boxes. (SEE ADVERTISEMENT)
 Poly Plastic Packaging Co. Inc., 44-80 11 St., Long Island City, N.Y. 11101. Tel: (212) 392-8670.

Product: Polypropylene & polyethylene packages.
 Pony Label-DRI, see NJM.
 Pony Pacer, see NJM.
 Pres-Tige Label Corp., 255 Oser Ave., Hauppauge, N.Y. 11787. Tel: (516) 273-0020.
Product: 8-tr. & cassette pressure-sensitive labels & stickers.
 Progressive Label & Litho Co., 286-290 Stanhope St., Brooklyn, N.Y. 11237. Tel: (212) 497-2320. Pres.: Jerome J. Rood; Sales Mgr.: Eric P. Rood. Prod. Mgr.: Bernard Stein.
Product: 8-tr. & cassette labels. (SEE ADVERTISEMENT)
 Q-A-I Inc. (formerly Saxon Adhesive Prods.), 640 Dell Rd., Carlstadt, N.J. 07072. Tel: (201) 935-5100; NYC (212) 736-1980. Pres.: Steve Dauman; Sales Mgr.: George Ratowsky.
Product: 8-tr. & cassette labels.
Brand name: Adhere-on.
 Queens Lithographing Corp., 52-35 Barnett Ave., Long Island City, N.Y. 11104. Tel: (212) 457-7700. Pres.: Jack L. Hecht; VP: Leonard Verebay.
Branch: Hollywood, Calif., 6290 Sunset Blvd., Suite 304. Zip: 90028. Tel: (213) 464-7700.
Plant: Indianapolis, Ind., Rutgers Packaging Corp., 620 S. Belmont Ave. Zip: 46221. Tel: 635-7777. Plant Mgr.: William Swanson.

STEREO 8 and CASSETTE CARTONS

In Stock Usually Shipped Same Day Order is Received

- **BEAUTIFUL PRINT LAYOUTS AND DESIGNS**
- **AVAILABLE IN A RAINBOW OF COLORS**
- **AVAILABLE IN BOTH 5 3/8" FORM FIT & 12" PILFER PROOF PACKAGES** (12" Long Package won't fit in pockets as plain tape would)

The same store will sell several times more tapes when they are not locked up but are left out where customers can pick them up.

WE'LL SHIP SMALL QUANTITIES AT LOW PRICES, FREE SAMPLES. PHONE COLLECT: (518) 465-4556

We also manufacture printed 45 RPM record backers with center hole cut out so label can be read on front and back of record.

PAK-WIK CORPORATION 128 Tivoli St., Albany, NY 12207

MAGNETIC TAPE PROCESSING EQUIPMENT

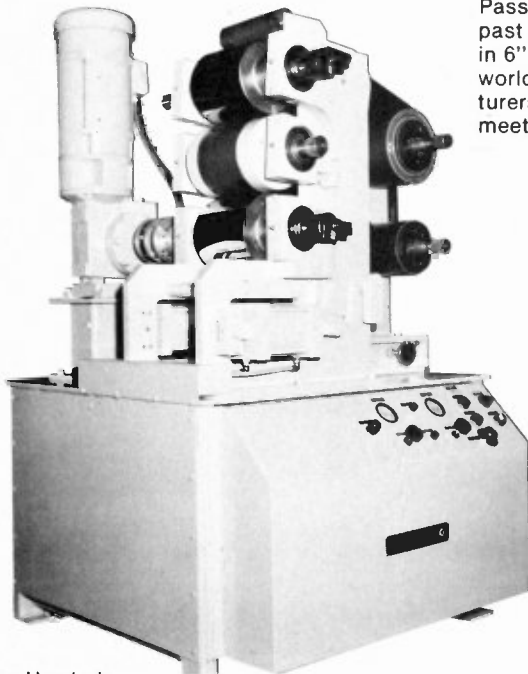

Passavant, the quality name in magnetic tape processing equipment for the past 20 years, manufactures a complete line of coating and slitting machinery in 6", 12", 16" and 26" web widths. Passavant equipment is sold and serviced worldwide and used by many of the world's leading magnetic tape manufacturers. We provide complete package magnetic tape manufacturing facilities to meet your production needs. For more information contact:

Passavant Corporation,
P.O. Box 2503,
Birmingham, Ala. U.S.A. 35201

- Unwinds
- Film Conditioners
- Film Cleaners & Washers
- Gravure & Reverse Roll Coaters
- Smoothing & Orientation Equipment
- Floater Dryers
- Cure Ovens
- Calenders
- Rewinds
- Slitting Machines

PASSAVANT

Good-bye, paper labels



profit by the advantages of

the Apex Printer

No more inventory problems
No more costly over-runs
No more short-run problems
Save 3¢ or more per cassette



1290 Avenue of the Americas
New York, NY 10019 Phone 212/582-4870
Cable Audiomatic Telex 12-6419

Other offices:
Paris Hong Kong Mexico City
Representatives throughout the world

for
**QUALITY
 CASSETTES**
DIXON
COMPOUND
954

Outperforms
 All Existing
**Shims and
 Cartridge Components**

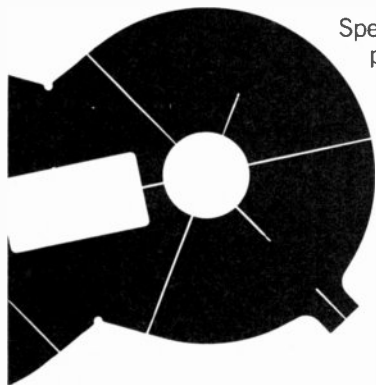

Specialists in low friction
 polyolefin for audio and
 video components. First
 choice of major cassette
 producers.

Send for Samples

 **DIXON**

NEW DIMENSIONS IN ENGINEERED PRODUCTS
 DIXON INDUSTRIES CORPORATION

A Bundy Company 

Bristol, Rhode Island 02809 • 401-253-2000 • Telex No. 92-7706

Product: 8-tr. & cassette labels, boxes, inserts, slipsases & collars.
 Ramart Printing Corp., 3180 J Expwy. Dr. S., Central Islip, N.Y. 11722. Tel: (516) 234-0050.
Product: 8-tr. & cassette inserts & labels.
 Recording Supply Co. (div. of Polyline Corp.), 1233 Rand Rd., Des Plaines, Ill. 60016. Tel: (312) 297-0955. Pres.: John Kaiser.
Product: Open reel & cassette boxes.
 Reco-Sleeve Packaging, 620 S. Belmont, Indianapolis, Ind. 46221. Tel: (317) 635-7777. Pres.: Leonard Verebay; Sales & Adv. Mgr.: Leonard Dimond.
Product: Cassette inserts.
 Reliance Plastics & Packaging Div., Reliance Folding Carton Corp., 108-18 Queens Blvd., Forest Hills, N.Y. 11375. Tel: (212) 544-9800. Pres.: Marshall Weingarden; Sales Mgr.: Alison Knaperek; Adv. Mgr.: Barbara Weingarden.
Product: Audio & video cassette corrugated mailers.
 Robins Inds. Corp., 75 Austin Blvd., Commack, N.Y. 11725. Tel: (516) 543-5200. Pres.: Herman Post; Nat'l Sales & Adv. Mgr.: Stu Caine.
Product: Cassette mailers, & boxes, open reel boxes.
 Rotex, see Gopher.
 Rutgers Packaging Corp., see Queens Lithographing.
 Scandia Packaging Machinery Co., 180 Brighton Rd., Clifton, N.J. 07012. Tel: (201) 473-6100.
Product: Packaging machinery for wrapping, cartoning, labeling & shrinking. (SEE ADVERTISEMENT).
 Shape Inc., PO Box 366, Biddeford Ind'l Park, Biddeford, Me. 04005. Tel: (207) 282-6155. Pres.: Anthony L. Gelardi; Sales & Mktg. Mgr.: Joe Ciccone; Adv. Mgr.: Bob MacLeod.
Product: Automatic cassette packaging machines, automatic 8-tr. & cassette labelling equip. (SEE ADVERTISEMENT).
 Shorewood Packaging Corp., 10 E. 53 St., New York, N.Y. 10022. Tel: (212) 371-1500. Pres.: Paul Shore; Exec. VP Mktg.: Floyd S. Glinert; VP Sales: Ken Rosenblum.
Branch: Los Angeles, Calif., 1830 Glendale Blvd. Zip 90026. Tel: (213) 660-3043. Sales Mgr.: Marc Shore.
Product: 6" x 6" 8-tr. & cassette package.
 Stoddard, see MTI.
 Studio Magnetics Co. Inc., 83 Carlough Rd., Bohemia, N.Y. 11716. Tel: (516) 589-4300. Pres.: George Clahane; VP: Craig M. Balaban.
Product: Cassette soft plastic Ampex & Norelco-style boxes, pressure-sensitive labels & mailing envelopes.
 T D K Electronics Corp., 755 Eastgate Blvd., Garden City, N.Y. 11530. Tel: (516) 746-0880. VP: Ken Kohda; Nat'l Mktg. Mgr.: Bud Berger; Ass't Adv. Mgr.: Bob Miller.
Branches: Irvine, Calif., 17072 Daimler St. Zip 92705. Tel: (714) 979-5811. Div. Sales Mgr.: Sandy Cohen—Chicago, Ill., 2906 W. Peterson Ave. Zip 60645. Tel: (312) 973-1222.
Product: Labels & cartons.
 Tapemaker Sales Co. Inc., 629 W. Merrick Rd., Valley Stream, N.Y. 11582. Tel: (516) 561-6080. Pres.: Arthur Brandwein; Sales Mgr.: M. Medina.
Product: Cassette labels.
 Tape Packaging Assocs., 740 W. Collins Ave., Orange, Calif. 92667. Tel: (714) 997-4173/ 4177. Pres. & Sales Mgr.: William L. Starling Jr.; Adv. Mgr.: Joyce A. Starling.

Q: Which companies in New Jersey handle cassette duplication?

A: For the quickest answer, the one-and-only place to find out is "Services" in IBG: Billboard's International Buyer's Guide. Your global guide to buying and selling.

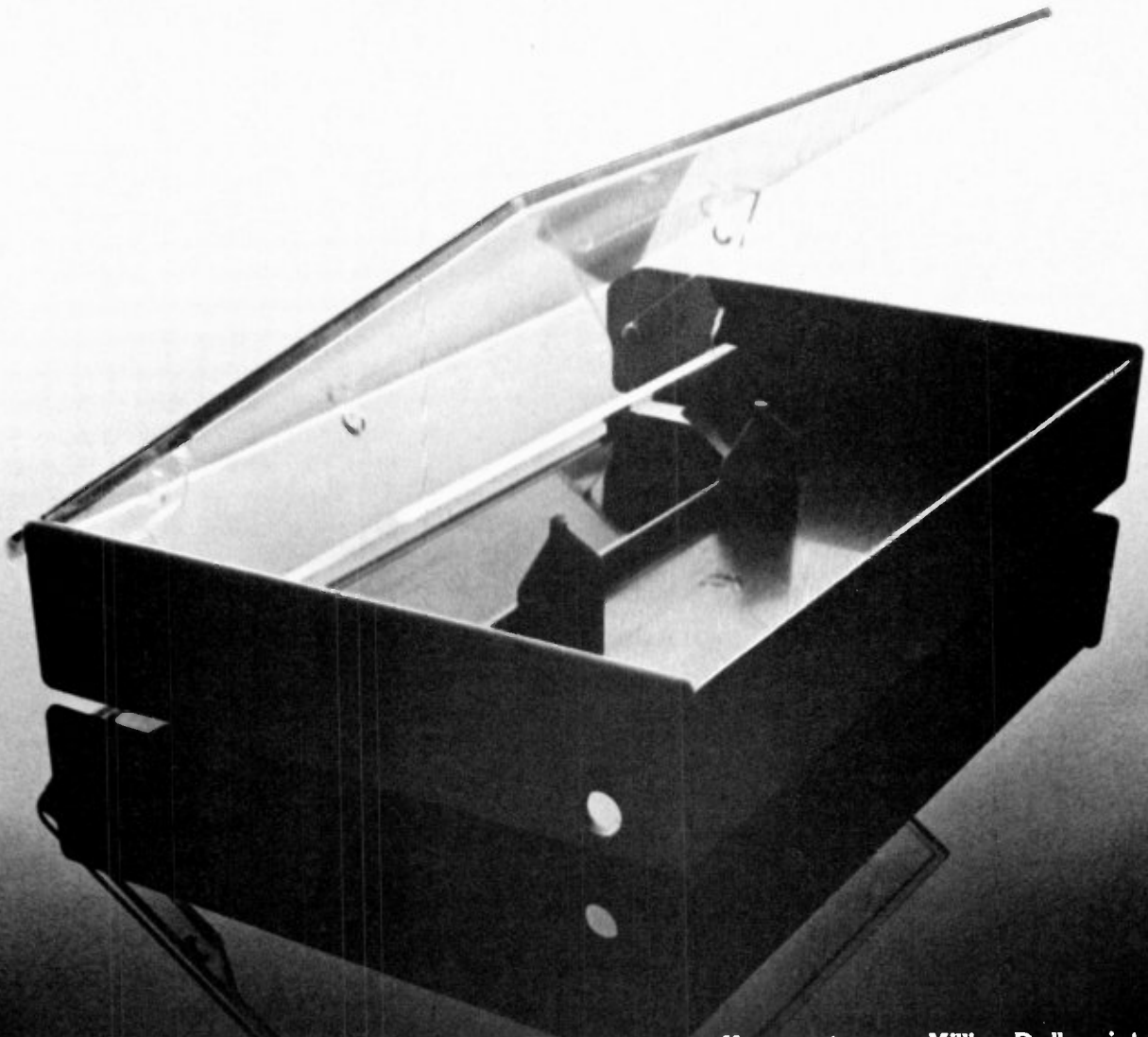

THE \$1,000,000 CASSETTE BOX THAT COSTS PENNIES.

poly-matrix INC.

For more information write:
Poly-Matrix, Inc., Director of Marketing
40 Downing Parkway, Downing Industrial Park
Pittsfield, MA 01201 U.S.A.
413-499-3550

If you put over a Million Dollars into the design, development and manufacturing of a Cassette Box, you would certainly want to be the leader in the field.

We did... We are... And it will only cost you a few pennies!

Because we are the leaders and produce more Cassette Boxes than all other manufacturers combined, we specialize in this product. So you can count on us for delivery.

We could sell you on the quality of our molds, or the unique radius edge for improved handling, or even our recessed scuff-resistant clear lid. But what really makes Poly-Matrix number one is the way we manage our huge stocking and inventory program. Standard colors are black and clear, with custom color on request.

Don't settle for less. For a few pennies you can make your product look like a Million Dollars.

Product: Shrink wrapping systems, videocassette (Beta & VHS) shipping cases
 Thalco, 2 Dickens Ave., Dix Hills, N.Y. 11746. Tel: (516) 667-1616.
Product: 8-tr. & cassette Norelco-style boxes.
 Tri-Lon Color Lithographers Ltd., 54 W. 21 St., New York, N.Y. 10010. Tel: (212) 255-6140. Pres.: Morris Strickler. VP: David Strickler.
Product: Norelco-style cassette inserts & labels.
 Tropical Paper Box Co., 7000 NW 25 St., Miami, Fla. 33122. Tel: (305) 592-5520. Rec. Div. Mgr.: Dale Quartin.
Product: 8-tr. & cassette boxes.
 Troy Hills Mfg. Corp., 501 Division St., Boonton, N.J. 07005. Tel: (201) 334-2020. Pres.: Edward F. Joyce Sr.; Sales Mgr.: Edward F. Joyce Jr.
Product: Norelco-style cassette boxes. (SEE ADVERTISEMENT)
 Uniline, see Gopher.
 Universal Marking Systems Inc., 2320 E. 26 St., Minneapolis, Minn. 55406. Tel: (612) 721-7466. Pres.: Ken Lawrence. Mktg. & Sales Mgr.: Rick Muscoplat.
Product: Audio & video cassette labels.
 Vulcan Binder & Cover (div. of EBSCO Inds. Inc.), PO Box 29, Vincent, Ala. 35178. Tel: (205) 672-2241. VP. R. Denison Parker; Sales Mgr.: Dudley Pendleton III; Adv. Mgr.: B.R. Cummings.
Product: Audio & video cassette albums.

TAPE, PROFESSIONAL SUPPLIES, MANUFACTURERS

J.C. Anglum Co. Inc./Tapeponents Inc., Box 236, 36 Midvale Rd., Mountain Lakes, N.J. 07046. Tel: (201) 263-1442. Pres.: J. Clifford Anglum.
Audio: Cassette boxes.
 Audiolab Electronics, 3725 Esperanza Dr., Sacramento, Calif. 95825. Tel: (916) 485-0500. Pres.: R.E. Stefan; Sales & Adv. Mgr.: J. Hodges.
Audio: Degaussers.
 Audiomatic Corp., 1290 Ave. of the Americas, New York, N.Y. 10019. Tel: (212) 582-4870. Telex: 126419. Pres.: Milton B. Gelfand; VP Customer Servs.: Carolyn T. DeVries; Adv. Mgr.: J.P. Lohman.
Int'l branch: France.
Audio: Splicing, cleaning & leader tapes. (SEE ADVERTISEMENT)
 Beucart, see UMC.
 Bogen—Germany, see International Rec'g.
 W. H. Brady Co., 2221 W. Camden Rd., Milwaukee, Wis.

53201. Tel: (414) 332-8100. A/V Prods. Mgr.: John Arnold; Sales Mgr.: John Griffiths.
Audio: 8-tr. & cassette leader & splicing tape, 8-tr. sensing tape, master splicing tape.
 Burlington Audio Tapes Inc., 10 Commercial St., Hicksville, N.Y. 11801. Tel: (516) 433-4466. Pres.: Ruth Schwartz; VP. Sales & Adv. Mgr.: Rudy Schwartz.
Brand name: Olympic.
 Celanese Plastic Materials Co., Hood Rd., Greer, S.C. 29651. Tel: (803) 877-8471. Pres.: J. Mitchell; Sales Mgr.: John Sten; Adv. Mgr.: Jack Lazar.
Audio & video: Celanar polyester film tape base.
 Cetec Broadcast Group, Mark Ave., Carpinteria, Calif. 93013. Tel: (805) 684-7686.
Audio: Bulk erasers.
 Coastal Specialty Tapes Inc. (formerly Pratt-Spector Corp.), 274 Bangor St., Lindenhurst, N.Y. 11757. Tel: (516) 226-5900. Pres.: Tom Carroll; Sales Mgr.: Stanley Gilman; Adv. Mgr.: Dan Dobbs.
Audio: Splicing & sensing tape, splicer, paper leader tape.
Video: Helical video lead-in splicing tape.
 Columbia Magnetics (div. of CBS Inc.), 51 W. 52 St., New York, N.Y. 10019. Tel: (212) 765-4321. Dir.: Glenn Hart.
Branch: Century City, Calif., 1930 Century Park W. Zip: 90067. Tel: (213) 556-4836. Nat'l Sales Dir.: Jerry Bronaugh.
Plant: Danbury, Conn., 15 Great Pasture Rd. Zip: 06810. Tel: (203) 744-3555. Plant Mgr.: Ray Hughes.
Audio: Splicing & abrasive tape, liquid magnetic pattern detecting kit (Magna See).
 El Mar Plastics Inc., 821 E. Artesia Blvd., Carson, Calif. 90746. Tel: (213) 327-3180.
Audio: 8-tr. & cassette splicing tape. (SEE ADVERTISEMENT)
 Film Nat'l Plastics, 416 W. El Segundo Blvd., Los Angeles, Calif. 90061. Tel: (213) 515-0623. Pres.: Vic Flores; VP Sales: Mike Bolong.
Audio: Cassette boxes (Norelco type), 1/4" NAB hubs, cassette hub locks.
 Fuji Photo Film USA Inc., Magnetic Tape Div., 350 Fifth Ave., New York, N.Y. 10001. Tel: (212) 736-3335. VP & Gen. Mgr.: John Dale; Sales Mgr.: (audio) Gary Conway, (video) Al Bedross; Adv. Mgr.: Paul Kaufman.
Product: Fire retardant plastic shippers for 1" & 2" tape.
 Gotham Audio Corp., 741 Washington St., New York, N.Y. 10014. Tel: (212) 741-7411. Pres.: Stephen F. Temmer, VP: Eli Passin.
Audio: Splicing & editing equip. (Gotham), precision tape timer (Lyrec).
 Grandy Inc., 1275 Bloomfield Ave., Fairfield, N.J. 07006. Tel: (201) 575-1433. Pres.: John R. French; Adv. Mgr.: Jesse Rosenzweig.
Audio: Studio duplicating & ferrite replacement heads. (SEE ADVERTISEMENT)
 Hi-Flex Corp., 289 Huyler St., South Hackensack, N.J. 07606. Tel: (201) 487-3027.

High performance & dependability make
 • **Trackmaster**® • A Better Choice



Cartridge Winder Model PL501D Cassette Duplicator Model CS403 Duplicator Model PD401

We specialize in Custom Duplication • 8 track & cassette.
 Duplicators: Model PD400, 401
 Cassette Winders, 8-Track Winders,
 Sleeves, Labels, Shrink Tunnels, Shrink Wrap,
 Complete Line of Audio Tape Equipment

Trackmaster, Inc. 1310 South Dixie Highway, West
 (305) 943-2334 Pampano Beach, Fla. 33060

8 TRACK

CASSETTE

Specialists in

TAPE DUPLICATING SERVICES

for Music, Education & Industry

P.D.Q.

THE AGE OLD TRIANGLE OF
 PRICE • DELIVERY • QUALITY



WE HAVE IT ALL!

From your Master Tape to a truck for delivery to your distributors, Personal Care is taken to assure Top Quality Product, On Time, At a Price that is **COMPETITIVE!**

THE ONLY INDEPENDENT QUALITY TAPE DUPLICATOR THAT HAS PLANTS ON BOTH COASTS TO BETTER SERVICE YOUR ENTIRE TAPE NEEDS CROSS COUNTRY!!

Audio: Cassette leader tape
 I C I United States Inc., Plastics Div., New Murphy Rd., Wilmington, Del. 19897. Tel. (302) 575-3000.
Audio & video: Polyester film tape base.
Brand name: Melinex
 Infonics Inc., PO Box 1111, 238 Hwy. 212, Michigan City, Ind. 46360 Tel. (219) 879-3381 Pres. Paul C. Loyd
Audio: Alignment tapes, kits, duplicator peripherals. (SEE ADVERTISEMENT)
 International Rec'g Co., 49 Desmond Ave., Bronxville, N.Y. 10708 Tel. (914) 337-5726 Pres. Claire Rie
Audio: Heads (Bogen—Germany)
 Lafayette Radio Electronics Corp., 111 Jericho Tpkn., Syosset, N.Y. 11791 Tel. (516) 921-7700.
Audio: Tape splicers.
 Lenco Co., PO Box 29128, 3901 N. 69 St., Lincoln, Neb. 68507 Tel. (402) 464-7488. Pres. Don Leonhardt; Sales & Adv. Mgr. Daryl O. Chapelle
Branch: Indianapolis, Ind., Box 507, Rt. 2, Zip 46231 Tel. (317) 839-6673. Mgr. Scott Bartlett
Audio: Cassette leader tape
 Lipps Inc., 1630 Euclid St., Santa Monica, Calif. 90404 Tel. (213) 450-1324 Pres. Bernard D. Lipps; Mktg. Dir. Lorne R. Law
Audio: Magnetic heads
 Lyrec, see Gotham
 M P M (div. of Pfizer Inc.), 640 N. 13 St., Easton, Pa. 18042 Tel. (215) 253-6261. Pres. J.P. Bartels; Int'l Mktg. Mgr. C. Alan Lindquist Jr.; Adv. Mgr. H.F. Stolte
Audio & video: Magnetic iron oxide for tape coating.
 M R L, see Magnetic Reference Lab
 Magna, See, see Columbia Magnetics.
 Magnetic Reference Lab, Inc., 229 Polaris Ave., Suite 4, Mountain View, Calif. 94043. Tel. (415) 965-8187. Pres. John G. McKnight
Audio: Test tapes (MRL)
 Mastro Inds. Inc., 3040 Webster Ave., Bronx, N.Y. 10467. Tel. (212) 547-5600 Pres. Mario Maccaferri
Audio: Reels for bulk cassette tape. (SEE ADVERTISEMENT)
 Melinex, see ICI.
 Nortronics Co. Inc., 8101 10 Ave. N., Minneapolis, Minn. 55427 Tel. (612) 545-9837.
Audio: Magnetic heads
 Olympic, see Burlington Audio
 Permatap Prods. Co. Inc., Rt. 1, Social Circle, Ga. 30279. Tel. (404) 787-1910 Pres. W.B. Thompson
Audio: Splicing tape & pre-cut tabs.
 Phoenix Ents., see Infonics
 Q/Splice, see Webtek.
 Q-A-I Inc. (formerly Saxon Adhesive Prods.), 640 Dell Rd., Carlstadt, N.J. 07072. Tel. (201) 935-5100; NYC (212) 736-1980 Pres. Steven Dauman; Sales Mgr. George Ratowsky
Audio: Cueing & splicing tapes, end tabs
 S T L, see Standard Tape Lab. & Taber Mfg.
 Saki Magnetics Inc., 1649 12 St., Santa Monica, Calif. 90404. Tel. (213) 450-1551.
Audio: Magnetic recording heads.
 Speedex Electronics, 400 S. Wyman, Rockford, Ill. 61101. Tel. (815) 968-9661.
Audio: Head demagnetizers, test tape, bulk erasers, splicing & editing equip.
 Splicette, see Webtek
 Standard Tape Lab, Inc., 26120 Eden Landing Rd., Hayward, Calif. 94545. Tel. (415) 786-3546
Audio: Test tapes (STL)
 Studio Magnetics Co., Inc., 83 Carlough Rd., Bohemia, N.Y. 11716. Tel. (516) 589-4300. Pres. George Clahane; VP. Craig M. Balaban
Audio: 1/4" ferro dynamic mastering tape, cassette editing kit, splicing, sensing & leader tape.
 Switchcraft Inc., 5555 N. Elston Ave., Chicago, Ill. 60630. Tel. (312) 792-2700.
Audio: Connectors, cable assemblies, adapters, patch cord systems, jacks & plugs
 T D K Electronics Corp., 755 Eastgate Blvd., Garden City, N.Y. 11530. Tel. (516) 746-0880. VP. Ken Kohda; Nat'l Mktg. Mgr. Bud Barger, Ass't Adv. Mgr. Bob Miller
Branches: Irvine, Calif., 17072 Daimler St. Zip: 92705. Tel. (714) 979-5811. Div. Sales Mgr. Sandy Cohen—**Chicago, Ill.,** 2906 W. Peterson Ave. Zip: 60645. Tel. (312) 973-1222. (SEE ADVERTISEMENT)
 Taberasers, see Taber Mfg.
 Taber Mfg. & Eng'g Co., 2081 Edison Ave., San Leandro, Calif. 94577. Tel. (415) 635-3831. Pres. Veldon Leverich. Gen. Mgr. R.H. Kearns
Audio: Heads (Taber), bulk erasers (Taber-erasers) test tapes (STL)
 Tapemaker Sales Co. Inc., 629 W. Merrick Rd., Valley Stream, N.Y. 11582. Tel. (516) 561-6080. Pres. Arthur Brandwein; Sales Mgr. M. Medina
Audio: Splicing & sensing tape, pre-cut Q-tabs.
Video: Splicing tabs & leader tape.
 Tapeponents Inc., see J.C. Anglum
 U M C Electronics Co., 460 Sackett Point Rd., North Haven, Conn. 06472. Tel. (203) 288-7731.
Audio: Heads, motors (Beaumont).
 Veritas Electronics Corp., 22 Grand Ave., Farmingdale, N.Y. 11735. Tel. (516) 541-5373.
Audio: Head demagnetizers, bulk erasers, cassette & open reel splicers.
 W R E, see Wide Range Electronics
 Webtek Corp., 4326 W. Pico Blvd., Los Angeles, Calif. 90019. Tel. (213) 937-3511. Pres. Joseph Klein; VP & Prod. Mgr. John A. Pace, Sales Mgr. Ken George.
Branch: Northfield, Ill., 778 Frontage Rd., Suite 115, Zip 60093. Tel. (312) 446-6046.
Audio: Pre-cut tape splices (Q/Splice for 8-tr., Splicette for cassettes), cassette splicing & splicing/sensing roll tape. (SEE ADVERTISEMENT)
 Wide Range Electronics Corp., 2119 Schuetz Rd., St. Louis, Mo. 63141. Tel. (314) 567-5366
Audio: Bulk erasers, degaussers, magnetic erasing pencil (WRE).
 Xcel Corp., 290 Ferry St., Newark, N.J. 07105. Tel. (201) 344-2300.
Product: Acetate film base

EVERY YEAR UNITED WAY VOLUNTEERS WORK TIME AND A HALF SO YOU'RE NOT BOTHERED TIME AND AGAIN.

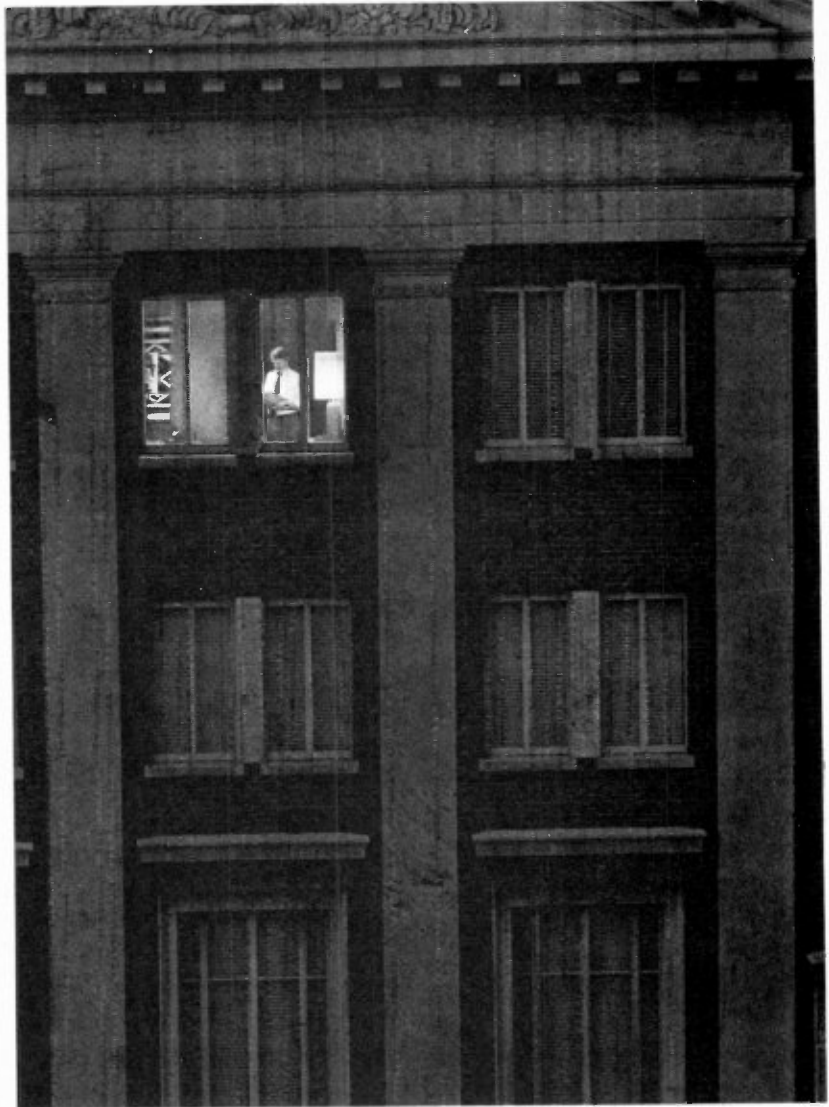

Once a year — and only once — United Way raises money to support really needed human services.

And once is enough, thanks to the outstanding efforts of the dedicated people who work without pay for United Way each year. Because one efficiently run campaign not only minimizes fund-raising costs and volunteer time devoted to fund-raising. It also reduces the number of times you're contacted each year and asked for a contribution.

United Way's continued success year after year proves a very basic point. People who really want to help don't have to be asked twice. When you ask the American people for help, they respond.



Thanks to you, it works. For all of us. **United Way**



Ad Council A Public Service of This Magazine & The Advertising Council

The key to the abbreviation following the company listing: (M) Manufacturer, (D) Distributor, (I) Importer.

- A A, see Audio Accessories
- A B C Schwann Publ'ns Inc., 137 Newbury St., Boston, Mass 02116 Tel (617) 261-3143 Pres. & Chief Exec. Officer William Schwann
Branch: Great Barrington, Mass., Zip 01230 Tel (413) 528-1300 Adv. Mgr. Robert Uri
Product: Record & tape catalog servs
- A-Bee Syndicate Inc., 230 Fifth Ave., New York, N.Y. 10001 Tel (212) 684-7850
Product: Record & tape carrying & storage cases (M)
- A/V Paragon, see Universal Tape
- Add'n Stac, see Royal Sound & Studio Magnetics
- Adhere on, see Q-A-I
- Advance Prods. Co. Inc., 1101 E. Central, Wichita, Kan. 67201 Tel (316) 263-4231 Pres. William D. DeVore Sales & Adv. Mgr. Paul Keck
Product: Storage cabinets (Pleximobile) (M)
- Akro Mils. 1293 S. Main St., Akron, Ohio 44319 Tel (216) 253-5593
Product: Record & tape carrying & storage cases (Record Mate Tape-Mate) (M)
- Aldshir Mfg. Co. Inc., 63 E. Sandford Blvd., Mount Vernon, N.Y. 10552 Tel (914) 668-1297 Pres. & Adv. Mgr. Gerald Shirley, Sales Mgr. Lindley Nichols
Product: 45 rpm adapters (Televox) (M)
- George Alexander Group Inc., 1063 Post Rd., Darien, Conn. 06820 Tel (203) 655-7791 NYC (212) 886-5600 Pres. Kev Devejian
Product: Record & tape catalog servs
- Allsop Automatic Inc., 4201 Meridian, Bellingham, Wash. 98225 Tel (206) 734-9090 Pres. Ivor Allsop Sales & Adv. Mgr. Jim Allsop, Ass't Sales Ron Morgan
Product: Cassette deck cleaners
- Amaray Int'l Corp., 1901 Old Middlefield Way, Suite 11, Mountain View, Calif. 94043 Tel (415) 968-2840 Pres. Lloyd L. Neal Sales & Mktg. Dir. Ron Garrett
Product: Video cassette carrying & storage cases (M) (SEE ADVERTISEMENT)
- Amberg, see Vernon McMillan
- American Lighting Specialties Inc., 1942 W. Artesia Blvd., Torrance, Calif. 90504 Tel (213) 532-9262
Product: Record & tape carrying & storage cases (M)
- American Sound Corp., 3319 E. Ten Mile Rd., Warren, Mich. 48091 Tel (313) 539-2900 Pres. Frank S. Day Group VP Paul Hayes VP Mktg. Paul E. Adams
Branches: North Hollywood, Calif., 8120 Webb Ave. Zip 91605 Tel (213) 768-6100 Gen. Mgr. Michael S. Emerson Reg'l Sales Mgr. Richard Hutchinson—**Demarest, N.J.,** 18 Christie, Zip 07627 Tel (201) 767-9033
- Product:** Head cleaners (M)
- Ampex Corp., Magnetic Tape Div., 401 Broadway, Redwood City, Calif. 94063 Tel (415) 367-2011 Pres. A.H. Hausman Sales Mgr. R.A. Antonio Adv. Mgr. A. Fisher
Sales offices: Glendale, Calif., 500 Rodier Dr. Zip 91201 Tel (213) 240-5000—**Denver, Colo.,** 2121 S. Birch, Zip 80222 Tel (303) 757-6491—**Orlando, Fla.,** PO Box 15008-B, Zip 32808 Tel (305) 423-2962—**Atlanta, Ga.,** 3135 Chestnut Dr., Suite 101, Zip 30340 Tel (404) 451-7112—**Overland Park, Kan.,** PO Box 7282, Zip 66207 Tel (913) 383-1951—**Baton Rouge, La.,** PO Box 14754, Zip 70808 Tel (504) 766-6270—**Bethesda, Md.,** 10215 Fernwood Rd, Zip 20034 Tel (301) 530-8800 District Mgr. Max McCollough—**Framingham, Mass.,** PO Box 1020, Zip 01701 Tel (617) 877-8060—**Hackensack, N.J.,** 65 Commerce Way, Zip 07601 Tel (201) 489-7400—**Pittsford, N.Y.,** PO Box 175, Zip 14534 Tel (716) 586-2580—**Dallas, Tex.,** 1615 Prudential Dr, Zip 75235 Tel (214) 637-5100—**Salt Lake City, Utah,** 2880 S. Main St., Suite 105, Zip 84115 Tel (801) 487-8181
Plants: Opelika, Ala., PO Box 190, Zip 36801 Tel (205) 745-7643—**Elk Grove Village, Ill.,** 2201 Lunt Ave, Zip 60007 Tel (312) 593-6000
Product: Head cleaners, demagnetizers, leader & splicing tape (M)
- Ampro Design Prods Inc (sub. of GRT Corp.), 1624 Toal St., Charlotte, N.C. 28206 Tel (704) 334-5341 VP & Gen. Mgr. Fred E. Martintz
Product: Record & tape carrying & storage cases, cleaners, cloths & brushes (Dustbuster) (M)
- R B Annis Co., 1101 N. Delaware St., Indianapolis, Ind. 46202 Tel (317) 637-9282 Owner R.B. Annis
Product: Demagnetizers (Han-D-Mag), pocket magnetometer (Annis) (M)
- Arista Ent's Inc., 35 Hoffman Ave., Hauppauge, N.Y. 11787 Tel (516) 234-7000 Pres. Alan E. Leifer
Product: Cleaners, cloths, brushes, 45 rpm adapters, head cleaners, demagnetizers, needles, leader & splicing tape
- Aspen Ltd., PO Box 92, 77 E. Floyd Ave., Englewood, Colo. 80110 Tel (303) 789-2239 Pres. Sid Laks Sales Mgr. Bill Bystrom Adv. Mgr. K. Davis
Product: Head cleaners & demagnetizers, test tape, stylus cleaner, dustcover wax (M)
- Athenia Inds. Inc., 2200 Industrial Way S., Toms River, N.J. 08753 Tel (201) 244-8500 Pres. Sales & Adv. Mgr. Charles Beres Jr.
- Product:** Cassette head cleaners (M) (SEE ADVERTISEMENT)
- Audio Accessories Co., 38 W. 515 Deerpath Rd., Batavia, Ill. 60510 Tel (312) 879-5998 Sales Mgr. John S. Maloney
Product: Splicing block, cassette hub locks (AA), cassette repair kit (Sav-A-Tape)
- Audio Aids, see Audio Works
- Audio Buff, see Elpa
- Audio Groom, see Empire
- Audio Inds. Inc., Broad & Linden Aves., Ridgefield, N.J. 07657 Tel (201) 945-4545 Pres. M. Donalds, Customer Serv. Michael Kates
Product: Head cleaners, leader tape (M) (SEE ADVERTISEMENT)
- Audio-Kare (div. of Hammond Inds. Inc.), 155 Michael Dr., Syosset, N.Y. 11791 Tel (516) 364-1900 Pres. Colin E. Hammond, Prod. Mgr. Morton Leslie
Product: Cleaners (Quietone), head cleaners (TPC), turntable level (M)
- Audiolab Electronics, 3725 Esperanza Dr., Sacramento, Calif. 95825 Tel (916) 485-0500
Product: Demagnetizers (MD)
- Audiomatic Corp., 1290 Ave. of the Americas, New York, N.Y. 10019 Tel (212) 582-4870 Telex 126419 Pres. Milton B. Gelfand, VP Customer Servs. Carolyn T. DeVries, Adv. Mgr. J.P. Lohman
Int'l branch: France
Product: Leader & splicing tape (SEE ADVERTISEMENT)
- Audio-Stac, see Stac-All
- Audio-Technica U.S. Inc., 33 Shawnee Ave., Fairlawn, Ohio 44313 Tel (216) 836-0246 Pres. & Gen. Mgr. Jon R. Kelly, Sales Mgr. Paul A. McGuire, Mkt. Communications Dir. Don Kirkendall, VP Mktg. Fred Nichols
Product: Cleaners, brushes, needles (M) (SEE ADVERTISEMENT)
- Audiotex (div. of GC Electronics), 400 S. Wyman St., Rockford, Ill. 61101 Tel (815) 968-9661 Pres. Anthony C. Valulis, VP Mktg. Ken Rolnicki, VP Sales Ed Crockett, Adv. Mgr. William S. Sutherland, Adv. & Sales Promo. Mike Smith
Product: Cleaners (Record Basic, Record Plus), cloths (Blue Max, Record Purifier), cleaner & Destatizer, 45 rpm adapters, head cleaners, demagnetizers, splicers, anti-static turntable mat (M)
- Audio Works, 840 Piner Rd., Suite 14, Santa Rosa, Calif. 95401 Tel (707) 528-0422 Pres. Tim Bynon, Nat'l Sales Mgr. Melody Bynon

Good ideas sound right. . .

WITH PFANSTIEHL & PFANTONE PRODUCTS

If we aren't careful, we think of ourselves as being in the phonograph needle business. Or the 8-track cassette business. Or the cable and connector business. Or the complete audio accessory business.

While it is true, of course, that Pfanstiehl is in all of those businesses, in reality our *ultimate* business is the superior reproduction of sound. Our first requirement for any product that bears the Pfanstiehl (pronounce it fan' - steel) or Pfantone (fan' - tone) label is that it delivers superior sounding results.

That's the idea behind every one of our products. . . and in our business, the only good ideas are the ones that sound right!

Write in for complete needle and audio accessories catalogues.

See if we don't sound right to you!

 **Pfanstiehl**

3300 WASHINGTON STREET WAUKEGAN, IL. 60085
(312) 623-1360



*The Revolutionary Record Care Breakthrough
Sweeping the Country... because it really works!*

Permostat™

from Stanton

eliminates record static permanently
with only **one** application!

© Stanton Magnetics, Inc. 1979

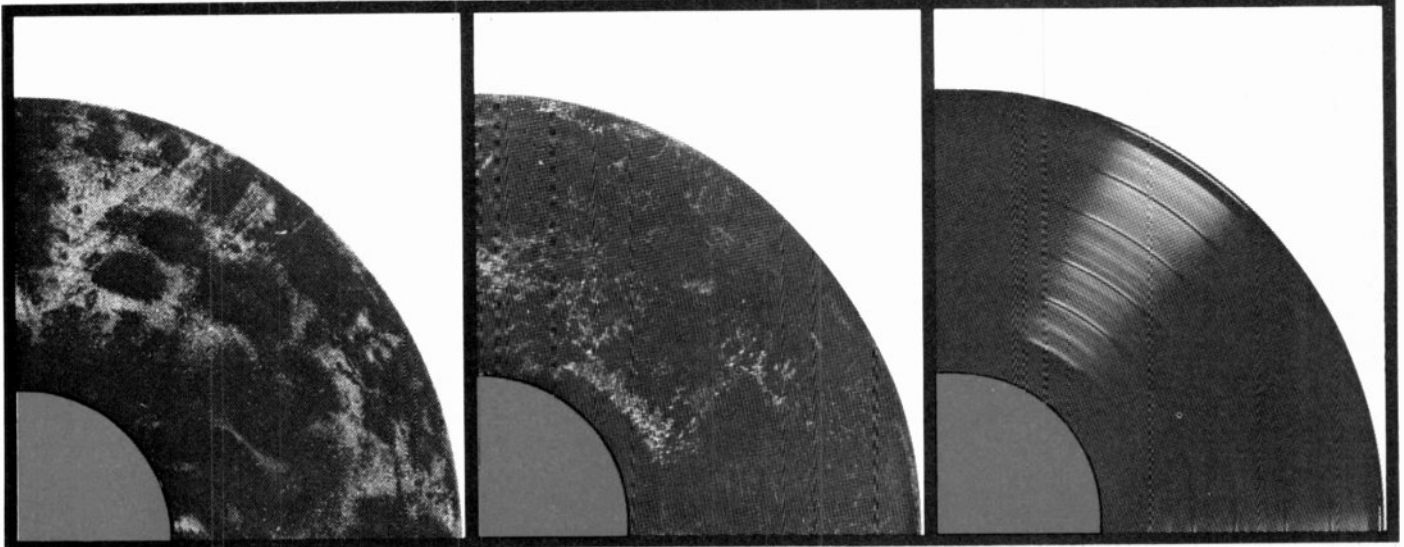

UNTREATED RECORD

BRAND X

PERMOSTAT

Permostat from Stanton is a new and uniquely formulated fluid, which permanently eliminates record static and accompanying noise with a single application... with no degradation in sound quality.

To demonstrate Permostat's anti-static qualities, Stanton constructed a dust chamber to perform accelerated dust pickup tests. Three records were suspended vertically within the chamber... the first untreated... the second treated with anti-static products currently available (piezo electric guns, fluids, cloths and conducting brushes)... and the third treated with Permostat.

Only the Permostat-treated record showed no visible evidence of dust and no residual charge.

Each Permostat kit provides permanent protection for 25 records (both sides). Just spray it on, buff it in and eliminate static for the life of your records.*

You'll never play a dusty record!

Suggested retail:
Complete Kit:...\$19.95
Refill:...\$15.95

*Normal considered record life expectancy is 100 plays.

For further information contact: Stanton Magnetics, Inc., Terminal Drive, Plainview, New York 11803



STANTON

THE CHOICE OF THE PROFESSIONALS™

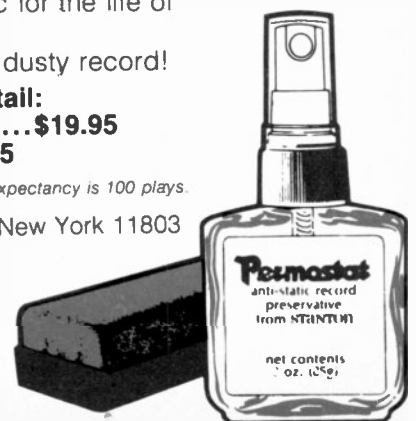

The only record care product selected for the 1979 Summer Consumer Electronics Show Design and Engineering Exhibition.

Product: Record & tape carrying & storage cases (Audio Aids, Stack-Rack), cleaners, brushes
B A S F Systems, Crosby Dr., Bedford, Mass. 01730. Tel (617) 271 4000.
Branches: **Santa Monica, Calif.,** 1307 Colorado Ave. Zip: 90404. Tel (213) 451-8781—**Melrose Park, Ill.,** 1800 No. 30 Ave. Zip: 60160. Tel (312) 343-6618—**Clifton, N.J.,** 149 Rt. 48. Zip: 07011. Tel (201) 546-9111—**Dallas, Tex.,** Dallas Petroleum Center, 13610 Midway, Suite 255. Zip: 75240. Tel (214) 233-6607.
Product: Tape carrying & storage cases, head cleaners. (M)
Kenneth A. Bacon Associates, 216 Montego Key, Novato, Calif. 94947. Tel (415) 883-5041. Contact: Kenneth A. Bacon.
Product: Splicing blocks (SEE ADVERTISEMENT)
Ball Corp., 345 S. High St., Muncie, Ind. 47302. Tel (317) 747-6247. Pres. Richard M. Ringo; Nat'l Sales Mgr.: Stephen L. Oseman, Adv. Mgr. Jay W. Troyka.
Product: Record preservative & cleaner sprays (Sound Guard) (SEE ADVERTISEMENT)
Bazzy Electronics Corp., 39 N. Rose, Mount Clemens, Mich. 48043. Tel (313) 463-2592. Pres. L. Allan Bazzy; Gen. Mgr. Mike Tattan.
Product: Head cleaners & demagnetizers.
Bib Hi Fi Accessories Inc., 3363 Garden Brook Dr., Dallas, Tex. 75234. Tel (214) 243-8971. Pres. & Sales Mgr. Trevor Glangier.
Product: Tape carrying & storage cases, cleaners, cloths, brushes, head cleaners, demagnetizers, splicing tape.
Blackbourn Inc., 1821 University Ave., St. Paul, Minn. 55104. Tel (612) 646-2781. Pres. & Adv. Mgr. George F. Snelgrove, Sales Mgr. Thomas F. Sabow.
Product: Carrying & storage cases. (M)
Black Magic, see Recoton.
Blue Max, see Audiotech.
Bowers Rec. Sleeve Co., 5331 N. Tacoma Ave., Indianapolis, Ind. 46220. Tel (317) 251-3918. Pres. Robert Bowers, VP & Sales Mgr. Charles H. Kaufman.
Product: Replacement record sleeves (Lifetime Protectors, Protect Your Records), LP & tape gift packages, polyethylene jacket covers. (M)
W H Brady Co., 2221 W. Camden Rd., Milwaukee, Wis. 53201. Tel (414) 332-8100. AV Prods. Mgr. John Arnold; Sales Mgr. John Griffies.
Product: Leader & splicing tape.
Burlington Audio Tapes Inc., 10 Commercial St., Hicksville, N.Y. 11801. Tel (516) 433-4466. Pres. Ruth Schwartz; VP, Sales & Adv. Mgr. Rudy Schwarz.
Product: Head cleaners, leader & splicing tape. (M)
C D I, see Custom Dupl'n.
C M C, see Coastal Specialty.
Calibron, see Horian.
Carola, see Devon Design.
Carter Corp., 1916 11 St., Rockford, Ill. 61101. Tel (815) 397-3200. Pres. Robert L. Fleming, VP Sales & Mktg.: Sandra L. Fleming, Adv. Mgr. Janet K. Ratner.
Product: Cleaners, cloths & brushes, head cleaners & demagnetizers.

Clean Sound, see Recoton.
 Clean-Sweep, see Horian.
 Clean-Track, see Horian.
Coastal Specialty Tapes Inc. (formerly Pratt-Spector Corp.), 274 Bangor St., Lindenhurst, N.Y. 11757. Tel (516) 226-5900. Pres. Tom Carroll; Sales Mgr. Stanley Gilman, Adv. Mgr. Dan Dobbs.
Product: Leader tape; splicing tape (CMC)
Comsette Corp., 12417 W. Olympic Blvd., Los Angeles, Calif. 90064. Tel (213) 826-4528. Pres. Richard W. Moore, Sales Mgr. J.A. Buchanan.
Product: Head cleaners. (M)
Continental Electronics, 4087 Glencoe Ave., Marina del Rey, Calif. 90291. Tel (213) 822-2045. Sales Mgr. John Adams.
Product: Record cleaners, cloths & brushes, head cleaners, splicing tape (Leda)
Crestmark Inds., 500 Eighth Ave., New York, N.Y. 10018. Tel (212) 947-9166. Pres. Leon Beda.
Product: Record & tape carrying & storage cases. (M)
Custom Case Mfg. Co., 6232 Bragg Blvd., Fayetteville, N.C. 28303. Tel (919) 867-4106. Pres. Al Metzger; Nat'l Sales Mgr. Judy Harris.
Product: Record & tape carrying & storage cases. (M)
Custom Dupl'n Inc., 6330-36 Arizona Circle, Los Angeles, Calif. 90045. Tel (213) 670-6675, 776-4810. Pres. Leonard Gross, Sales Mgr. Frank Rohloff; Prod'n. Jerni Gonzales.
Product: Head cleaners (CDI) (M)
D A K Inds. Inc., 10845 Vanowen St., North Hollywood, Calif. 91605. Tel (213) 984-1559; WATS (800) 423-2636. Pres. Drew Alan Kaplan.
Product: Tape carrying & storage cases, auto-sensing & mylar leader tape.
D M I, see Display Media.
D-Stat II, see Discwasher.
Data Packaging Corp., 205 Broadway, Cambridge, Mass. 02139. Tel (617) 868-6200. Exec. VP. Gregory Mathus, VP Mktg. Jere R. Hill, Nat'l Sales Mgr. Gene Hull.
Product: Record & tape carrying & storage cases (Dynosound) (M) (SEE ADVERTISEMENT)
Delrama Int'l, 37 Newtown Rd., Plainview, N.Y. 11803. Tel (516) 293-8740.
Product: Tape carrying & storage cases, cleaners, cloths & brushes. (M)
Dielectrics Inc., 6 Second Ave., Chicopee, Mass. 01020. Tel (413) 598-8308. Earl S. Stahl, Exec. VP. Eric Craig Stahl.
Product: Record & tape carrying & storage cases (custom fabrication) (M)
DISContinued Recs., 444 S. Victory Blvd., Burbank, Calif. 91502. Tel (213) 849-4791. Owner: Les Szarvas.
Product: Reference library of out-of-print recorded material.
DiscTraker, see Discwasher.
Discwasher Group of Cos., 1407 N. Providence Rd., Columbia, Mo. 65201. Tel (314) 449-0941. Pres. Bruce R. Maier; Nat'l Sales Mgr.: James D. Hall, Adv. Mgr. Vickie Hargrove.

Product: Record cleaner (Discwasher System), stylus cleaner (SC-1), piezoelectric anti-static gun (Zerostat), audio connector cables (Gold-ens), anti-static turntable mat (D-Stat II), tonearm/cartridge damper (Disc Traker). (SEE ADVERTISEMENT)
Display Media Inc., 120 Laura Dr., Addison, Ill. 60101. Tel (312) 543-8330.
Product: Carrying & storage cases (DMI) (M)
Donnak Inds., PO Box 422, Ridgefield, N.J. 07657. Tel (201) 945-6820. Pres. Marvin Donalds, VP Rudolph Puntillo, Customer Serv. Michael Kates.
Product: Head cleaners, leader tape. (SEE ADVERTISE-
 MENT)
Dosix, see Double Sixteen.
Double Sixteen Co., PO Box 1616, Wheaton, 407 Gundersen Ave., Carol Stream, Ill. 60187. Tel (312) 653-1616.
Product: Tape carrying & storage cases (Dosix) (M)
Duotone Co. Inc., 6875 SW 68 Ave., Miami, Fla. 33143. Tel (305) 665-1121. Pres. Stephen Nester Sr.; Sales & Adv. Mgr. Stephen Gibson Nester.
Product: Tape carrying & storage cases, cleaners, cloths, brushes, 45 rpm adapters, head cleaners, demagnetizers, needles, splicing tape. (M)
Dustbuster, see Ampro.
Dynosound, see Data Packaging.
EV Game Inc., 186 Buffalo Ave., Freeport, N.Y. 11520. Tel (516) 378-0440. Pres. Michael Damsky, Nat'l Accounts Mgr. Bill Ranshous; Sales Mgr. Syl Landro; Adv. Co-ord.: Charlotte Larson.
Product: Cleaners, cloths, brushes, 45 rpm adapters, head cleaners (EV Game), needles (Electro-Voice) (M) (SEE ADVERTISEMENT)
Editall, see Elpa.
Electronic Homes Co., 24-64 Crescent St., Astoria, N.Y. 11102. Tel (212) 545-3094. Chm. George T. Saddler; Pres. Paula Saddler; Sales Mgr. Elias Smyrnakis.
Product: Tape storage cases; head cleaners, demagnetizers (Toyota) (M)
Electro-Voice, see EV Game.
El Mar Plastics Inc., 821 E. Artesia Blvd., Carson, Calif. 90746. Tel (213) 327-3180. Pres. Harry Schor; VP Sales. Allen Schor.
Product: Cassette storage box, head cleaners, demagnetizers, splicing tape (M) (SEE ADVERTISEMENT)
Elpa Mktg. Inds. Inc., Thornes & Atlantic Aves., Garden City Park, N.Y. 11040. Tel (516) 746-3002.
Branch: **Scottsdale, Ariz.,** 7301 E. Evans Rd. Zip 85260. Tel (602) 948-1070.
Product: Cleaners, cloths, brushes (Audio Buff, Watts Recordcare), splicing block & tape (Editall) (M)
Empire Scientific Corp., 1055 Stewart Ave., Garden City, N.Y. 11530. Tel (516) 222-1400. Exec. VP & Gen. Mgr.: Kenneth Busch, Adv. Mgr. John Hegquist; Tech. Dir.: Mitch Ravitz.
Product: Cleaners & brushes (Audio Groome, Watts) (M)
Erase-Sure, see Magnisonics.
Esmond Inds. Inc., 2455 E. Sunrise Blvd., Fort Lauderdale, Fla. 33304. Tel: (305) 564-6435. Pres. Bennett As-

EVG Presents
The PRO-MAG™ Series

Professional Magnetic Replacement Styli at Popular Prices

We offer high quality, high fidelity replacement styli for popular brands such as ADC, Pickering, Shure and many others at low prices. Try our Pro-Mag Series. We invite inquiries.

EVG **EV-GAME Inc.**
 a gulton company
 186 Buffalo Ave. • Freeport, N.Y. 11520 • (516) 378-0440

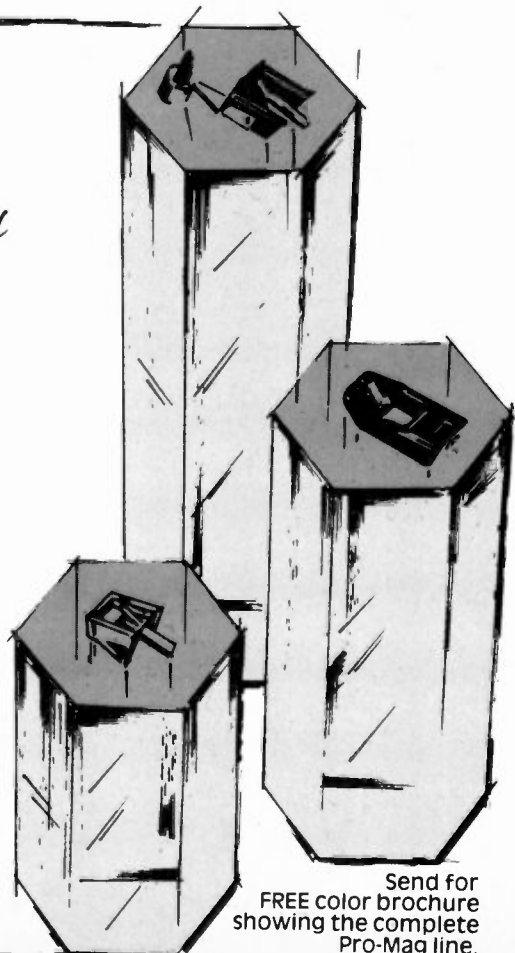

Send for FREE color brochure showing the complete Pro-Mag line.

SHOW and SELL.

LE-BO, the number one company in the industry, introduces a new self-selling, coordinated packaging program.

Display our *profitable* cassette and cartridge tape carry cases, carded product and promotional goods in their new packaging and they do the rest. This fabulous new design features bright, striking colors that are visible from anywhere in the store or department. Full color product photos, in attractive settings, show your customers exactly what's inside. We use the same colorful design on our record carry cases, hang tags and blistered accessory products.

It's a completely new co-ordinated program designed to let you SHOW and SELL more with a minimum of effort. So write or call for our full color catalog today.

serving the world with quality products

LE-BO®

Products, Co., Inc.
58-60 Grand Ave., Maspeth, N.Y. 11378
(212) 894-5155

- Record & Tape Carry Cases
- Tape & Record Care Products
- Home Storage Units
- Video Storage Units & Accessories



EXPORTER INQUIRIES WELCOME. PRIVATE LABELING AVAILABLE.

Distributed in Canada by Phonodisc, Ltd., Scarborough, Canada





If you're not selling Sound Guard, you're only scratching the surface.

If you sell records or audio at the retail level, you know that accessories are a highly profitable and increasingly important part of your business. Last year record care products alone accounted for \$40 million in retail sales. With higher record prices and heightened consumer awareness, this segment of the market can only continue to grow.

At Sound Guard we make the record care product line that gives you a selling advantage. Our Record Preservative is a revolutionary dry lubricant that virtually ends record wear. Our superior Record Cleaner, for both touch-up and thorough cleaning, is a proven sales winner. Our Total Record

Care System combines both the preservative and the cleaner at a competitive retail price point. Our Record Care Work Pad, Stylus Care Kit and Refills complete our unique line of fast selling record care products.

And to support your retail efforts, we have developed aggressive, far-reaching marketing and merchandising programs:

- Attractive full-color packaging
- Heavy national advertising
- Attention-getting POP pieces

- Musical event sponsorship program
- Retail sales contests
- Special college programs

In short, we'll be doing more than ever to get customers into your store and turn your sales force on to Sound Guard.

Remember, everyone who has a record collection is a potential Sound Guard customer... a profitable Sound Guard customer.

Sound Guard. Everything else is a lot of noise.



Sound Guard preservative - Sound Guard™ cleaner
 Sound Guard™ Total Record Care System.
 Sound Guard is Ball Corporation's registered trademark.
 Copyright © Ball Corporation, 1979, Muncie, IN 47302.



Select what you want in a record cleaner.

Convenience in use and storage.

You shouldn't need a separate shelf, elaborate motions or an act of Congress to clean your records. A comfortable, hand-held instrument that works best on a rotating turntable is ideal.

Effectiveness against micro-dust.

Tiny, invisible dust particles hide in delicate record grooves and can be ground into the vinyl. Only a slanted (directional) fiber using special ultra-small fiber tips can scoop up, rather than rearrange, this micro-dust contamination.

Effectiveness against chemical contamination.

Fingerprints and vapor-borne oils will deposit into channels of a record groove. Such contamination hides from adhesive rollers and all dry cleaning systems. Only a special fluid plus micro-fibers can safely remove such audible, impacted deposits.

Total removal of contamination/fluid.

Capillary action—the lifting of fluid by small fiber surface tension—is totally effective. You want to get contamination off the record, along with any fluid traces.

Lasting construction.

You want quality. A record cleaner can last a lifetime. A plastic wonder can crack into oblivion—or you can purchase the hand-rubbed elegance of milled walnut befitting the rest of your audio system.

Ultimate economy.

The value of a truly fine record cleaner is justified by the cost of replacing your record collection. Fifteen dollars is a small investment in long-term protection.

All of the above.

**DISCWASHER, the Superior
Record Cleaner.**

See the finer audio dealers for a demonstration.



discwasher, inc. 1407 N. Providence Rd., Columbia, MO 65201

quith, Sales Mgr. Jeff Asquith; Adv. Mgr. Shirlee Duffey.
Product: Record & tape carrying & storage cases, video-cassette storage cases (M)
 Esselte Pendaflex Corp., 300 Garden City Plaza, Garden City, N.Y. 11530 Tel (516) 741-4404 Pres. Hans Friedst; Mktg. Dir. Kevin Botkin; Communications Dir. Harry Dion; Sales Mgr. David Geller.
Product: Record & tape carrying & storage cases (Music Library) (M)
 Ever-Ready Packaging & Assembly (div. of Reliance Folding Carton Corp.), 225 Belleville Ave., Bloomfield N.J. 07003 Tel (201) 748-6677
Product: Cassette albums (M)
 Fidelipac (div. of Harvell Inds.), 109 Gaither Dr., Mount Laurel, N.J. 08057. Tel (609) 235-3511. Pres.: Roger Cappello; Sales & Mktg. Mgr. Arthur Constantine
Product: Tape carrying & storage cases, head cleaners, demagnetizers, splicing tape. (M)
 Filam Nat'l Plastics, 416 W. El Segundo, Los Angeles, Calif. 90061 Tel (213) 515-0623. Pres.: Vic Flores; VP Sales: Mike Bolong.
Product: Tape storage cases.
 Finebilt Mfg. Co. Inc., 931 N. Citrus Ave., Los Angeles, Calif. 90038. Tel (213) 466-9511 Pres. Alwin P. Schmid; Sales Mgr. Joseph Bouzoglou
Product: Head cleaners, leader tape (Finetape).
 Fine Design Prods. Inc., 1433 S. Wabash Ave., Chicago, Ill. 60605. Tel (312) 939-5420
Product: Record & tape carrying & storage cases (M).
 Finetape, see Finebilt.
 Gabriel Mfg. Co. Inc., 125 S. Liberty Dr., Stoney Point, N.Y. 10980. Tel (914) 942-0100.
Product: Head cleaners. (M)
 Gold-ens, see Discwasher.
 Gusdorf Corp., 6900 Manchester Ave., St. Louis, Mo. 63143. Tel (314) 647-1207
Product: Carrying & storage cases, record storage cabinets.
 Han-D-Mag, see R.B. Annis
 Hartzell Custom Prods., Turtle Lake, Wis. 54889. Tel: (715) 986-4407
Product: Audio & video record & tape carrying & storage cases (The Organizer). (M) (SEE ADVERTISEMENT)
 Herald Electronics (div. of American Electronic Parts Corp.), 6611 Lincoln Ave., Chicago, Ill. 60645. Tel: (312) 675-1100 Pres. Charles F. Kellner; Sales Mgr. Hank Katz
Product: Tape carrying & storage cases, 45 rpm adapters, demagnetizers.
 Horian Eng'g Inc., 12381 Schaefer Hwy., Detroit, Mich. 48227. Tel (313) 933-6900. Pres. Richard C. Horian; Sales Mgr. Robert L. Horian; Adv. Mgr.: Claudette Orr
Product: Record & tape carrying & storage cases; cleaners, cloths & brushes (Calibron, Clean-Sweep); head cleaners & demagnetizers (Calibron, Clean-Track) (M)
 I P S., 107 Bridge Rd., Hauppauge, N.Y. 11787. Tel: (516) 234-3322. Contacts: Bill Prechtel, Richard Diamond.
Product: 8-tr & cassette head cleaners. (SEE ADVERTISEMENT)

Barry Imhoff Prod'ns Inc., 4 E. Eighth St., New York, N.Y. 10003 Tel (212) 533-9550.
Product: Mirrors from album jackets.
 Irish Magnetic Rec'g Tape (div. of Morhan Nat'l Sales Co. Inc.), 270-78 Newtown Rd., Plainview, N.Y. 11803. Tel (516) 293-5582 Cable: MORHANEX, Telex 96-7880. Pres.: Sol Zigman, Sales Mgr. George Krug; Adv. Mgr.: George Taub.
Product: Head cleaners. (M)
 Itera Ltd., 1535 Broad St., North Bellmore, N.Y. 11710 Tel (516) 785-6480
Product: Cassette storage library, tape carousels & storage centers, demagnetizers, needles
 Jacksonville Ginter Box Co. Inc., 2527 Walnut St., Jacksonville, Fla. 32206. Tel (904) 355-8341.
Product: LP storage rack (Pack Rack), 8-tr carrying case.
 King Instrument Corp., 80 Turnpike Rd., Westboro, Mass. 01581 Tel (617) 366-9141. Pres. James L. King; VP Sales: William E. Cline; Mktg. Dir. Paul McGonigle.
Product: Splicing tape (SEE ADVERTISEMENT)
 Kustom Kreations Inc., 19316 Londelius St., Northridge, Calif. 91324. Tel (213) 886-8383. Pres. William Lang; Sales Mgr. Floyd Sanders; Adv. Mgr. Bruce Lang.
Product: Tape carrying & storage cases (M)
 Lafayette Radio Electronics Corp., 111 Jericho Trnkp., Syosset, N.Y. 11791 Tel (516) 921-7700.
Product: Demagnetizers (M)
 Le-Bo Prods. Co. Inc., 58-60 Grand Ave., Massapeh, N.Y. 11378. Tel (212) 894-5155. Chm.: Peter Dayton. Pres.: Al Alexander; Mktg. Mgr.: Gary Schwarz. Nat'l Sales Mgr.: Arthur Klein.
Product: Record & tape carrying & storage cases, cleaners, cloths, brushes, 45 rpm adapters, head cleaners, demagnetizers, leader & splicing tape (SEE ADVERTISEMENT)
 Lifetime Protectors, see Bowers
 List-O-Tapes, see Trade Serv.
 Loranger Mfg. Corp., Entertainment Prods. Div. 10-38 Clark St., Warren, Pa. 16365. Tel (814) 723-8600 Pres. J. Albert Loranger; VP Robert Loranger
Product: Tape carrying & storage cases. (M) (SEE ADVERTISEMENT)
 M J S, 2514 Seaboard Ave., San Jose, Calif. 95131. Tel (408) 262-8793 Pres.: Michael Steiner
Product: Head cleaners.
 M M C, see Magnetic Mktg.
 M M W (Mechanical Mirror Works) Inc., 41 Madison Ave., New York, N.Y. 10010. Tel: (212) 889-3036. Pres. David Bezborodko, VP Mktg. Howard Cohen
Product: Album jacket & rec'g artist silk-screened mirrors
 M R S, see M.R. Sand
 Magnesonics Sales & Mfg. Co., 3740-E Transport, Ventura, Calif. 93003. Tel: (805) 642-3092 Pres.: Donald P. Grogglight.
Product: Bulk erasers (Erase-Sure), cassette rewriter (Rapid-Winder).
 Magnetic Mktg. Corp., 29 Valley View Terr., Wayne, N.J. 07470 Tel (201) 694-3502 Pres. Thomas J. Hofbauer, Sales Mgr. Brendan F. Browne; Adv. Mgr. M. Judge
Product: Demagnetizers (MMC). (M) (SEE ADVERTISEMENT)
 Magnetic Media Corp., 500 Eastern Pkwy., Farmingdale, N.Y. 11735 Tel (516) 293-1010 Pres. Aaron Wasserstrom, Gen. Mgr.: Douglas Scott
Int'l branch: Korea, IPO Box 5006, Seoul
Product: Leader tape. (M)
 Mallory Dist. Prods. Co., 4760 Kentucky Ave., Indianapolis, Ind. 46222. Tel (317) 856-3731
Product: Head cleaners. (M)
 Marsand Inds. Inc., 5150 W. Jefferson Blvd., Los Angeles, Calif. 90016 Tel: (213) 938-2755 Exec. VP Martin A. Waterman; Sales Mgr. Ron Newswander.
Product: Record & tape carrying & storage cases (M)
 Mastro Inds. Inc., 3040 Webster Ave., Bronx, N.Y. 10467. Tel (212) 547-5600. Pres. Mario Maccafferi
Product: Head cleaners, 8-tr. dust caps. (SEE ADVERTISEMENT)
 Vernon McMillan Inc., 801 Newark Ave., Elizabeth, N.J. 07208 Tel: (201) 352-8800
Product: Record & tape carrying & storage cases (Amberg). (M)
 Mechanical Mirror Works Inc., see MMW
 Memorex Corp., 1600 Memorex Dr., Santa Clara, Calif. 95052. Tel (408) 987-1752. Pres. Robert C. Wilson. Sales Mgr.: John R. Humphreys; Promo. Co-ord. Eliza Beth D. Nash. Local branch: 2400 Kifer Rd. Zip 95052. Tel: 987-2620.
Branches: Los Angeles, Calif., 11340 W. Olympic Blvd. Zip 90064. Tel: (213) 478-3051—Lombard, Ill., 335 Eisenhower Ln. S. Zip 60148. Tel (312) 620-3240—Southfield, Mich., 24681 Northwestern Hwy., Suite 24. Zip: 48075. Tel (313) 354-0240. 353 2670—New York, N.Y., 1700 Broadway. Zip 10019. Tel (212) 541-7780—McLean, Va., 7798 Old Spring house Rd. Zip 22101. Tel: (703) 821-3300
Product: 8-tr & cassette head cleaner, 8-tr. head & cap stan cleaner, cassette cleaning kit, record cleaner & cleaning fluid, record care kit. (SEE ADVERTISEMENT)
 Metacom Inc., 1401-B W. River Rd. N., Minneapolis, Minn. 55411 Tel (612) 588-2781. Pres. James I. McCann. Sales Mgr.: Phillip T. Levin; Adv. Mgr.: J. J. Binsfeld.
Product: Tape carrying & storage cases (MD)
 Metocare, see RNS.
 Metrosound, see RNS
 Micro-Trak Corp., 620 Race St., Holyoke, Mass. 01040. Tel: (413) 536-3551. Pres. & Adv. Mgr. William E. Stacy. Sales Mgr.: Alan G. Newhouse.
Product: Tape carrying & storage cases (M)
 Microtran Co. Inc., PO Box 236, 145 E. Mineola Ave., Valley Stream, N.Y. 11582. Tel: (516) 561-6050
Product: Head cleaners & demagnetizers. (M)
 Mid America Plastics Corp., PO Box 1713, Santa Monica, Calif. 90406. Tel: (213) 451-2565. Pres. Jarl Brey. Sales Mgr. Hal Brey; Adv. Mgr. Gary Brey.
Plant: Reseda, Calif., 6850 Canby. Zip 91335.

Branch: Denver, Colo., 7255 E. Quincy Zip 80209. Tel (303) 758-0663. Mgr. Jerry O'Neill.
Product: Audio & Video cassette albums
 M. A. Miller, see Pageant Miller
 Music Library, see Esselte Pendaflex.
 N E R T (New England Record & Tape) (div. of PBN Survey), PO Box 268, 641 Haverhill St., Lawrence, Mass. 01841 Tel (617) 686-4293. Pres. Jerry P. Marcus; Sales Mgr.: Melvin L. Marcus; Adv. Mgr.: B.J. Kankey.
Product: Record & tape catalog serves. (PBN Survey)
 Nakamichi Research (USA) Inc., 1101 Colorado Ave., Santa Monica, Calif. 90401. Tel (213) 451-5901. Pres.: E. Nakamichi; Mktg. Dir. Ted Nakamichi; Sales Dir.: Ken Ohba; Technical Dir.: Harron K. Appleman
Product: Demagnetizers (MDI)
 Nortronics Co. Inc., 8101 10 Ave. N., Minneapolis, Minn. 55427. Tel (612) 545-9837.
Product: Tape carrying & storage cases, head cleaners, demagnetizers, splicing tape. (M)
 Nuclear Prods. Co., PO Box 5178, El Monte 91734; 2519 N. Merced Ave., South El Monte, Calif. 91733. Tel: (213) 283-2603, 444-3852. Pres. & Gen. Mgr.: Richard M. Evlth.
Product: Record cleaning brush (Staticmaster). (M)
 Olson Electronics Inc. (sub. of Teledyne Corp.), 260 S. Forge St., Akron, Ohio 44327. Tel: (216) 535-1800. Pres.: W. R. Wolf; VP Mdsq: Jack D. Hardke; Sales Mgr.: Tom Wilkinson; Adv. Mgr.: John Gaylor.
Product: Demagnetizers, splicing & editing equip.
 One-Spot Publ'g (div. of Trade Serv. Publ'ns Inc.), 701 E. Prospect Ave., Mount Prospect, Ill. 60056. Tel (312) 392-1720. Pres.: J.A. Simpson; VP & Gen. Mgr.: E.V. Mironko.
Product: Record catalog serves. (New Release Reporter, Numerical Index, Popular Guide)
 The Organizer, see Hartzell.
 P B N Survey, see NERT.
 P/M I, see Pageant Miller
 Pack Rack, see Jacksonville
 Pageant Miller Inds., 605 Northern Blvd., Chinchilla, Pa. 18410. Tel (717) 587-4771. Owner & Pres. Alan F. Wormser; Nat'l Sales Mgr.: M.J. Fields; Adv. Mgr.: J.A. Johndrow.
Product: Cleaners, cloths, brushes, 45 rpm adapters, head cleaners (all P/M I); needles (M.A. Miller, Pageant). (M)
 Paramount Housewares, 1035 Westminster Ave., Alhambra, Calif. 91803. Tel (213) 570-1601. Pres.: Joseph D. Winston; Sales & Adv. Mgr.: Charles W. Holmes.
Product: Tape storage cases.
 Peerless Vid-Tronics Corp., 60 West St., Bloomfield, N.J. 07003. Tel (201) 429-8600. Pres.: Herb Ravis; VP & Mktg. Dir. Jerome Geller; Sales Mgr.: Andy Danzico.
Product: Record & tape carrying & storage cases, head cleaners, demagnetizers (M)
 PermUstat, see Stanton.
 Pfanstiel Chemical Corp., 3300 Washington St., Wauke-

**EQUIPMENT & SUPPLIES FOR:
 CASSETTE LOADING
 DUPLICATING
 A—V PRODUCTION**

- Loaders - Cassette/Cartridge/Reel Duplicators - Loop Bin & In-Cassette
- **EDP Cassette Labels Blank & Printed**
REWINDERS/EXERCISERS/TIMERS
 A/V SYNCH-SOUND PULSERS
- Premium & Economy Cassettes Standard & Custom Lengths
- **AGFA & 3-M Magnetic Tapes**
- Private Label Cassette Production
- 12-Up Cassette Label Sheets
 10 Colors - Blank & Custom Printed
- **C-ZEROS**
SPlicing BLOCKS & TAPE
 CASSETTE SHIPPING CARTONS
- Headline Lettering System
 FM Wireless Mike Systems
- **Norelco Boxes Polyboxes, Albums**
AURATONE SPEAKERS
 SUPERSCOPE RECORDERS

FOR CATALOGS, SPECS, PRICES, WRITE OR CALL
KENNETH A. BACON ASSOCIATES
 216 MONTEGO KEY, NOVAJO, CA 94947
 (415) 883-5041
 TOLL FREE 24 HR. MESSAGE CENTER
 FROM CALIF. (800) 552-7777
 ALASKA & HAWAII (800) 824-7919
 ALL OTHER STATES (800) 824-7888
 ASK FOR OPERATOR 751

**A REVOLUTIONARY
 NEW TAPE SALES
 TOOL:**

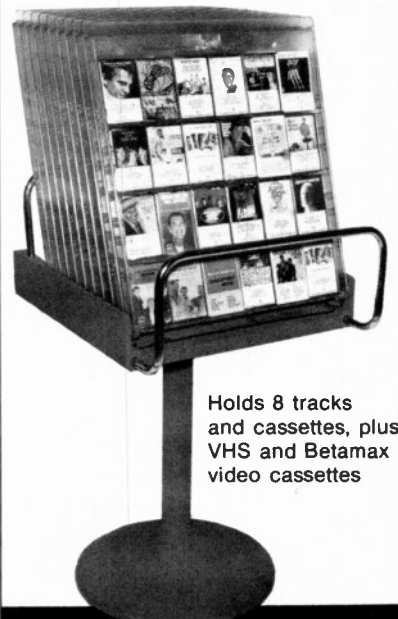

Holds 8 tracks and cassettes, plus VHS and Betamax video cassettes

Ampro, Inc.
 1624 Toal Street, Charlotte, NC 28206
 (704) 334-5341

Ever wonder where
they put all
those records
and tapes?



If you've been overlooking the tremendous profit potential of the booming music storage business, it's time you looked over Dynasound. We offer an extensive line of storage units for records, cassettes and 8-tracks—portable and permanent, stylish and sturdy. Attractive packaging, attractive prices and fast turnover mean very attractive profits for you.

To find out more, call Dynasound. Because a music store without music storage isn't nearly as profitable as it can be. Dynasound division of Data Packaging Corporation, 205 Broadway, Cambridge, Mass. 02139, Telephone 617-868-6200, TWX: 710-320-0885.

 **Dynasound**[®]





SENTRY

THE SOUND/TAPE EXPORT SPECIALISTS Known Worldwide for Sales, Service & Price!

 **SANYO**

 **TDK**

Scotch 

SONY



 **SENTRY**

AMPEX

maxell

 **BASF**

SPECIAL! Betamax and VHS Format — Video Cassettes — Blank and Pre-Recorded



TDK

3M SCOTCH

SONY

ATTENTION TAPE IMPORTERS! We cater to the International Market . . . with an expert sales/service staff to consolidate your audio product orders and meet special needs . . . promptly.

Importers . . . Dealers . . . Inquiries Invited!

SEND FOR "FREE" CATALOG TAPES, AUTO SOUND & RECORD ACCESSORIES

TOP SUPPLIER OF NAME BRAND
TAPES AND ACCESSORIES . . .

SANYO • TDK • SONY • BASF • SCOTCH
MEMOREX • AMPEX • SENTRY • WATTS
SOUNDGUARD • DISCWASHER • LECO
RECOTON • KOSS • NATIONAL SEMICONDUCTOR

SAME DAY SHIPPING



SENTRY IND. INC.

221 NO. MACQUESTEN PKWY.
MT. VERNON, N.Y. 10550 914-664-2909
Cable: SENTINE

gan, Ill. 60085. Tel: (312) 623-1360. Pres.: Merle H. Nelson; Sales Mgr.: C. Al Clinton.

Product: Cleaners, cloths, brushes, 45 rpm adapters, head cleaners (all Pfantone); needles (Pfanstiehl) (SEE ADVERTISEMENT)

Pfantone, see Pfanstiehl.

Phonolog, see Trade Serv.

Pickwick Mfg. Co., 7500 Excelsior Blvd., Minneapolis, Minn. 55426. Tel: (612) 932-7641. Pres.: C. Charles Smith; Nat'l Sales Mgr.: Duane Halter.

Product: Record & tape carrying & storage cases, cleaners, cloths & brushes, head cleaners, needles. (M)

Pixmobile, see Advance Prods.

Pixoff, see Sonic Research.

Plasti Plex Corp., 1209 Chicago Rd., Troy, Mich. 48084. Tel: (313) 589-1771. Pres.: Joseph E. Stanton.

Product: 8-tr. & cassette storage cases.

Port-A-Tune (div. of Action Leathercraft Inc.), 5340 E. Harbor, Commerce, Calif. 90040. Tel: (213) 728-1155. VP & Gen. Mgr.: Arnold Gilden; Sales & Adv. Mgr.: Andy Livian; Customer Serv. Mgr.: Cathy Burgess.

Product: Record & tape carrying & storage cases.

Pro I Prods., PO Box 33, Highland Park, Ill. 60035. Tel: (312) 432-5536. Pres.: Roy Pink; Sales Mgr.: Martin Pink; Adv. Mgr.: Deena Pink.

Product: Record & tape carrying & storage cases.

Protect Your Records, see Bowers.

Q-A-I Inc. (formerly Saxon Adhesive Prods.), 640 Dell Rd., Carlstadt, N.J. 07072. Tel: (201) 935-5100; NYC (212) 736-1980. Pres.: Steve Dauman; Sales Mgr.: George Ratowsky.

Product: Splicing & cueing tape (Adhere-On).

Q R K Electronic Prods. Inc., 1568 N. Sierra Vista Ave., Fresno, Calif. 93703. Tel: (209) 251-4213.

Product: Needles.

Quad Inc. Publ'g Co., PO Box 19, Capron, Va. 23829. Tel: (804) 653-2671. Ed. & Publ'r: Larry Clifton.

Product: Catalog servs.

Quietone, see Audio-Kare.

R M S Electronics Inc., 50 Antin Pl., Bronx, N.Y. 10462. Tel: (212) 892-6700. Pres.: Arthur A. Fink; Sales Mgr.: Seymour Goldberg.

Product: Tape carrying & storage cases. (M)

R N S Inc., 7 Manor Dr., Oak Ridge, N.J. 07438. Tel: (201) 697-2212. Pres.: Robert N. Schwartz; Customer Serv. Mgr.: Elizabeth Schwartz.

Product: Tape carrying & storage cases; cleaners, cloths & brushes (Metrocare, Metrosound); head cleaners, leader & splicing tape. (I)

Radio Shack (div. of Tandy Corp.), 1 Tandy Center, Fort Worth, Tex. 76102. Tel: (817) 390-3011. Pres.: Lewis Kornfeld; Sales Mgr.: Bernard Appel; Adv. Mgr.: David Beckerman; Nat'l Pub. Mgr.: Hy Siegel.

Product: Record & tape carrying & storage cases, cleaners, cloths, brushes, 45 rpm adapters, head cleaners, demagnetizers, needles, leader & splicing tape, 8-tr. & cassette repair kits (Realistic). (M)

Rapid-Winder, see Magnesonics.

Raynor Sales Co. Inc., 2698 W. Pico Blvd., Los Angeles, Calif. 90006. Tel: (213) 737-3737. Pres. & Adv. Mgr.: Ray Abrams Sr.; Sales Mgr.: Ray Abrams Jr.

Product: Carrying & storage cases, cleaners, cloths, brushes, 45 rpm adapters, head cleaners, demagnetizers, needles, record grid sleeves, leader & splicing tape.

Realistic, see Radio Shack.

Record Basic, see Audiotex.

Record-Mate, see Akro-Mils.

Record Plus, see Audiotex.

Record Purifier, see Audiotex.

Record Research Inc., PO Box 200, Menomonee Falls, Wis. 53051. Tel: (414) 251-4508. Pres.: Joel Whitburn.

Product: Record chart compilation servs

Recoton Corp., 46-23 Crane St., Long Island City, N.Y. 11101. Tel: (212) 392-6442. Pres.: Robert Borchardt; Sales Mgr.: George Calvi; Adv. Mgr.: Peter Wish.

Product: Record & tape carrying & storage cases, 45 rpm adapters, needles, leader & splicing tape (all Recoton); cleaners, cloths & brushes (Black Magic, Clean Sound); head cleaners & demagnetizers (Black Magic & Recoton). (M)

Reliance Plastics & Packaging Div., Reliance Folding Carton Corp., 108-18 Queens Blvd., Forest Hills, N.Y. 11375. Tel: (212) 544-9800. Pres.: Marshall Weingarden; Sales Mgr.: Alison Knaperek; Adv. Mgr.: Barbara Weingarden.

Product: Record & audio & video cassette vinyl storage cases. (M)

Rivertone Corp., Dillon Rd., Monticello, N.Y. 12701. Tel: (914) 794-8888.

Product: Carrying & storage cases, cleaners, cloths, brushes, 45 rpm adapters, head cleaners, needles (custom plastic & rubber injection molding only).

Robins Inds. Corp., 75 Austin Blvd., Commack, N.Y. 11725. Tel: (516) 543-5200. Pres.: Herman Post; Nat'l Sales & Adv. Mgr.: Stu Caine.

Product: Tape carrying & storage cases, cleaners, cloths & brushes, 45 RPM adpators, head cleaners, demagnetizers, leader, splicing & sensing tape, bulk erasers, tape cleaners (Soundtrack Scrubber); splicing & editing equip., cassette & 8-tr. repair kits, cassette tension winders, tape clips, stylus pressure gauge (Gramee); ionic static neutralizing gun (Rob-O-Stat); stylus microscope, phono pads & cushions.

Rotel of America Inc., 1055 Saw Mill River Rd., Ardsley, N.Y. 10502. Tel: (914) 693-3355.

Product: Cleaners & Brushes. (M)

Royal Sound Co. Inc., 248 Buffalo Ave., Freeport, N.Y. 11520. Tel: (516) 868-2880. Pres.: Mervin A. Dayan.

Product: Record & tape carrying & storage cases (Add 'n' Stac) (M); head cleaners & demagnetizers (Royal Sound) (I).

S C-1, see Discwasher.

S S K Entis Inc., 2488 Townsgate Rd., Westlake Village, Calif. 91361. Tel: (805) 495-1214. Pres. Mrs. S.F. Kara.

Product: Head cleaners. (M)

M. R. Sand & Co., PO Box 2255, 6211 Milan Rd., Sandusky, Ohio 44870. Tel: (419) 625-0028. Pres. & Sales Mgr.: Joseph F. Yost III.

Product: Head cleaners (MRS). (M)

Sav-A-Tape, see Audio Accessories.

Savoy Leather Mfg. Corp., PO Box 176, Ward Hill Ind'l Park, Neck Rd., Haverhill, Mass. 01830. Tel: (617) 374-0351. Pres.: Norman E. Savoy; Sales Mgrs.: (USA) Frank Rockman, Ed Dougherty; (Canada) George Kosmes.

Sales office: Newton Upper Falls, Mass., 1039 Chestnut St. Zip: 02164. Tel: (617) 964-0530.

Product: Record & tape carrying & storage cases.

Saxton Prods. Inc., 215 N. Rt. 303, Congers, N.Y. 10920. Tel: (914) 268-6846.

Product: Demagnetizers (DI), needles (M).

Scotch, see 3M.

Seebro Prods. Co., 2416 S. Michigan Ave., Chicago, Ill. 60616. Tel: (312) 842-8221. Pres.: I. Siegal; Sales Mgr.: R. Siegal.

Product: Record & tape carrying & storage cases, wire record racks, pole record racks, record carts. (MD)

Sentry Inds. Inc., 221 N. Macquesten Pkwy., Mount Vernon, N.Y. 10550. Tel: (914) 664-2909. Pres.: Harold Rosen; Sales & Adv. Mgr.: Barry Rosen.

Product: Cleaners, cloths, brushes, head cleaners, demagnetizers, leader & splicing tape. (MD) (SEE ADVERTISEMENT)

Service Mfg. Co. Inc., 155 Saw Mill River Rd., Yonkers, N.Y. 10701. Tel: (914) 476-1700. Pres.: Joseph L. Berkman; VP Sales: Richard Rosenberg.

Product: Record & tape carrying & storage cases, video-cassette storage cabinets. (M)

Shape Inc., PO Box 366, Biddeford Ind'l Park, Biddeford, Me. 04005. Tel: (207) 282-6155. Pres.: Anthony L. Gelardi Jr.; Sales & Mktg. Mgr.: Joe Ciccone; Adv. Mgr.: Bob MacLeod.

Product: Audio & Video carrying & storage cases. (SEE ADVERTISEMENT)

Snap Jack Inc., 805 Clifton Ave., Clifton, N.J. 07013. Tel: (201) 779-0225.

Product: LP jacket wall frames.

Sonic Research Inc., 27 Sugar Hollow Rd., Danbury, Conn. 06810. (203) 792-8822. Pres.: Peter E. Prichard; Mktg. Mgr.: George Petetin.

Product: Cleaners (Pixoff) (I), cartridges & needles (Sonus) (M)

Sonus, see Sonic Research.

The Sound Bug, see Trans Continental.

Sound Containers Corp., 1425-A N. Manzanita St., Orange, Calif. 92667. Tel: (714) 771-1080. Pres.: Maxine J. Knorr.

Product: 8-tr. & cassette storage systems (Sound-stacker)

Sound Furniture Co., PO Box 11499, Clayton, Mo. 63105. Tel: (314) 241-1759. Pres.: Bernie Hochman.

Product: Tape carrying & storage cases (The Spinner). (M)

Sound Guard, see Ball.

Sound/Pro Inds. Inc., 347 Culver Blvd., Playa del Rey, Calif. 90291. Tel: (213) 822-0510. Pres.: Donald K.M. Rothery; Sales Mgr.: Pierre Basbous; Adv. Mgr.: Linda Newton.

Product: Tape carrying & storage cases, head cleaners. (SEE ADVERTISEMENT)

Soundstacker, see Sound Containers.

Soundtrack Scrubber, see Robins.

Speaker Uppers, 20946 Currier Rd. Zip: 91789. Tel: 598-1906. Pres.: Steve Karsh; Sales Mgr.: Bruce Gellis; Adv. Mgr.: Dick Gary.

Branch: Downers Grove, Ill., Audiocore, 2460 Wisconsin Ave. Zip: 60515. Tel: (312) 960-1616. Eastern Reg'l Sales Mgr.: Dave Larson.

Product: Speaker stands.

Speedex Electronics, 400 S. Wyman, Rockford, Ill. 61101. Tel: (815) 968-9661. Pres.: Anthony C. Valiulis; VP Mktg.: Ken Rolnicki; VP Sales: Ed Crockett; Adv. Mgr.: William S. Sutherland; Adv. & Sales Promo.: Mike Smith.

Product: Cleaners, cloths, brushes, 45 rpm adapters, head cleaners, demagnetizers, tape erasers & spicers (M)

The Spinner, see Sound Furniture.

Stac-All Inc., PO Box 771, Rochester, Mich. 48063. Tel: (313) 652-9711.

Product: Tape carrying & storage cases (Audio-Stac). (MD)

Stack-Rack, see Audio Works.

Stanton Magnetics Inc., 200 Terminal Dr., Plainview, N.Y. 11803. Tel: (516) 681-0200. Pres.: Walter O. Stanton; VP Prod. Prods.: Jim Fox; Prof. Prods. Nat'l Sales Mgr.: Peter Bidwell.

Product: Antistatic record preservative (PermOstat). (SEE ADVERTISEMENT)

Staticmaster, see Nuclear Prods.

Sterling Prods. Co. Inc., 1689 Oakdale Ave., West St. Paul, Minn. 55118. Tel: (612) 455-6691.

Product: Tape carrying & storage cases.

Studio Magnetics Co. Inc., 83 Carrough Rd., Bohemia, N.Y. 11716. Tel: (516) 589-4300. Pres.: George Clahane; VP: Craig M. Balaban.

Product: Non-abrasive cassette head cleaners, aerosol head cleaners, cassette storage modules (Add 'n' Stac). (M)

T D K Electronics Corp., 755 Eastgate Blvd., Garden City, N.Y. 11530. Tel: (516) 746-0880. VP: Ken Kohda; Nat'l Mktg. Mgr.: Bud Barger, Ass't Adv. Mgr.: Bob Miller.

Branches: Irvine, Calif., 17072 Daimler St. Zip: 92705. Tel: (714) 979-5811. Div. Sales Mgr.: Sandy Cohen—Chicago, Ill., 2906 W. Peterson Ave. Zip: 60645. Tel: (312) 973-1222.

Product: Tape carrying & storage cases, head cleaners, demagnetizers. (M) (SEE ADVERTISEMENT)

T P C, see Audio-Kare.

Taberaser, see Taber Mfg.

Taber Mfg. & Eng'g Co., 2081 Edison Ave., San Leandro, Calif. 94577. Tel: (415) 635-3831. Pres.: Veldon Leverich; Gen. Mgr.: R.H. Kearns.

Product: Demagnetizers (Taberaser). (M)

Tapemaker Sales Co. Inc., 629 W. Merrick Rd., Valley Stream, N.Y. 11582. Tel: (516) 561-6080. Pres.: Arthur Brandwein; Sales Mgr.: M. Medina.

Product: Audio & video head cleaners, leader & splicing tape, video leader tape & splicing tabs. (M)

Tape-Mate, see Akro-Mils.

Tape Servs. Inc., Cherry Hill Ind'l Park, 1 Keystone Ave., Cherry Hill, N.J. 08003. Tel: (609) 424-9450. Sales Mgr.: Michael T. Mulcahy.

Product: Cleaners, cloths, brushes (private label), head cleaners, demagnetizers. (M)

Teac Corp. of America, 7733 Telegraph Rd., Montebello, Calif. 90640. Tel: (213) 726-0303. Pres.: Norio Tamura; Sales Mgrs.: Barry Goldman, David Oren, Bill Mohrhoff; Adv. Mgr.: Tay Hotta.

Product: Head cleaners & demagnetizers. (M)

Televex, see Aldshire.

Tempo (div. of Hagerstown Leather Goods Co.), 858 Willow Circle, Hagerstown, Md. 21740. Tel: (301) 797-6600. Pres.: Dr. H.N. Taylor; VP Mktg.: David L. Handler.

Product: Record, tape & videocassette carrying & storage cases.

3 M Co., Magnetic Audio/Video Prods. Div., 3M Center Bldg. 223-5N, St. Paul, Minn. 55101. Tel: (612) 733-1466. Div. VP: John E. Povolny; Sales Mgr.: S.R. Fredrickson; Adv. Mgr.: Peter M. Gavin.

Branches: Anchorage, Alaska, 5531 Minnesota Dr.

(Continued on page 424)

**We Print
(213) 768-3122**

**specialists in
8 TRACK/CASSETTE/VIDEO
LABELS
CASSETTE INSERT CARDS**

Short run record jackets
And picture record-record labels

WE SHIP ANYWHERE

**PEDERSON LABEL CO.
11152 Fleetwood St., Unit 10
Sun Valley, CA 91352**

**KEEP YOUR TAPE LIBRARY
IN MINT CONDITION**

Protect your video treasures from dust and damage in book-style storage boxes that are handsome in appearance, constructed of sturdy polypropylene, and available in VHS and Beta formats in decorator colors with reversible labels for program information.

Dealer inquiries answered promptly.

**AMARAY CORPORATION
1901 Old Middlefield Way, Suite 11
Mt. View, CA 94043 • (415) 968-2840**

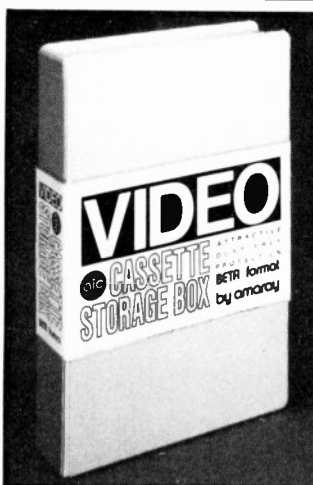

MERCHANDISING

Aids & Store Fixtures Manufacturers & Importers

The key to the abbreviations following the company listings is: (M) Manufacturer, (D) Distributor, (I) Importer.

- A-Bee Syndicate Inc., 230 Fifth Ave., New York, N.Y. 10001. Tel. (212) 684-7850
Product: Record & tape display racks (M)
- Al-Len Cutting Co., 11 E. Fourth St., New York, N.Y. 10003. Tel. (212) 254-7864. Pres. Sam Lempert.
Product: Record & tape divider cards. (SEE ADVERTISEMENT)
- George Alexander Group Inc., 1063 Post Rd., Darien, Conn. 06820. Tel. (203) 655-7791. NYC (212) 886-5600. Pres. Kev Devejan
Product: Record & tape browser boxes, record & tape display racks, record & tape divider cards. (M)
- Ampro Inc. (sub. of GRT Corp.) 1624 Toal St., Charlotte, N.C. 28206. Tel. (704) 334-5341 VP & Gen. Mgr. Fred E. Martinitz
Product: Record & tape browser boxes, record & tape display racks, record & tape divider cards. (M)
- Art-Phyl Creations, 162-50 NW 48 Ave., North-Miami, Fla 33127. Pres. Art Hochman. Adv. Mgr. Lori Sidlar
Product: Record browser boxes, record display racks (M)
- Ted Bushman Signs, 627 Broadway, Massapequa, N.Y. 11758. Tel. (516) 798-8590. Owner Ted Bushman
Product: Record & tape divider cards & signs. (M)
- C E S Rec'g Inc., 49606 S. 83 East Ave., Tulsa, Okla 74145. Tel. (918) 627-8474
Product: Tape display racks (M)
- Carter Corp., 1916 11 St., Rockford, Ill. 61108. Tel. (815) 397-3200. Pres. Robert L. Fleming, VP Sales & Mktg. Sandra L. Fleming, Adv. Mgr. Janet K. Ratner
Product: Record display racks (Carter-Craft). (M)
- Container-Kraft Inc., 8321 De Celis Pl., Sepulveda, Calif. 91343. Tel. (213) 893-9721
Product: Record & tape browser boxes, record & tape display racks
- Creative Store Equip. Inc., PO Box 933, 1000 Airport Rd., Terrell, Tex. 75160. Tel. (214) 563-5869, 226-7248. Pres. Jerry G. White. Sales Mgr. John Bowen, Adv. Mgr. Jackie Featherston
Product: Record & tape display racks. (SEE ADVERTISEMENT)
- Custom Case Mfg. Co., 6232 Bragg Blvd., Fayetteville N.C. 28303. Tel. (919) 867-4106. Pres. Al Metzger. Nat'l Sales Mgr. Judy Harris
Product: Record & tape divider cards. (M)
- Dajim Corp., 1 Park St., Amsterdam, N.Y. 12010. Tel. (518) 842-4800
Product: Record browser boxes, record & tape display racks (Monark) (M)
- Design Fabrications, 1215 Wheaton St., Troy, Mich 48064. Tel. (313) 689-8206. Pres. Bruce R. Dych
Product: Record & tape display racks. (M)
- Dielectrics Inc., 6 Second Ave., Chicopee, Mass. 01020. Tel. (413) 598-8308. Pres. Earl S. Stahl. Exec. VP. Eric C. Stahl
Product: Record & tape divider cards (custom fabrication)
- Display Media Inc., 120 Laura Dr., Addison, Ill. 60101. Tel. (312) 543-8330
Product: Tape Display racks (Securette). (I)
- E V Game Inc., 186 Buffalo Ave., Freeport, N.Y. 11520. Tel. (516) 378-0440
Product: Record & tape display racks. (M) (SEE ADVERTISEMENT)
- Elpa Mktg. Inds. Inc., Thornes & Atlantic Aves., Garden City Park, N.Y. 11040. Tel. (516) 746-3002
Branch: Scottsdale, Ariz., 7301 E. Evans Rd. Zip 85260. Tel. (602) 948-1070
Product: Record display racks, record divider cards
- Fidelipac (div. of Harvell Inds.), 109 Gaither Dr., Mount Laurel, N.J. 08057. Tel. (609) 235-3511. Pres. Roger Cappello. Sales & Mktg. Mgr. Arthur Constantine.
Product: Tape display racks. (M)
- Fixture Concepts Inc. (formerly Display Equip. Mfg. Co.), 104 Nelson Pl., Tukwila, Wash. 98188. Tel. (206) 226-1450. Gen. Mgr. Jerry Schoeler. Sales Mgr. Peter Scott. Adv. Mgr. Lynda Hobson.
Product: Record & tape fixtures, tables, counters & related items for display & merchandising.
- Freedman Aircraft Eng'g Corp., PO Box 228, Charlevoix, Mich. 49720. Tel. (616) 547-6501. Pres. Jack C. Grubaugh. Sales Mgr. L. L. Espich, Adv. Mgr. Max E. Hosmer
Branch: City of Industry, Calif., 14424 Bonellist, Zip 91744. Tel. (213) 968-9591. Sales & Opns. Mgr. Ren Lloyd
Product: Record & tape browser boxes, record & tape display racks
- Gopher Prods. Corp., PO Box 1812, 2201 Lockheed Way, Carson City, Nev. 89701. Tel. (702) 882-9333. Pres. Warren Perkins
Product: Record & tape divider cards. (M) (SEE ADVERTISEMENT)
- Hamilton Fixture Co., PO Box 658, Zip 45012, 4805 Hamilton-Middletown Rd., Hamilton, Ohio 45011. Tel. (513) 868-2144. Pres. John Schlegel. Sales Mgr. John Overmann
Product: Record & tape browser boxes, record & tape display racks. (MO) (SEE ADVERTISEMENT)
- Ivy Hill Communications Inc., 4800 S. Santa Fe Ave., Los Angeles, Calif. 90058. Tel. (213) 587-3131. Exec. VP. Russell Muir, Sr. VP's: Jack Sclar, Arthur Kern.
Product: Record & tape browser boxes, record & tape display racks, record & tape divider cards.
- Kajac (div. of Ozark Opry Inc.), 155 First St., Carlisle, Iowa 50047. Tel. (515) 989-0876. Contact Harold L. Luick
Product: Record & tape display racks. (M)
- Kalny Mdsq., 4700 S. Santa Fe Ave., Los Angeles, Calif. 90058. Tel. (213) 587-1164. Customer Serv. Arte Hirsch
Product: Record browser boxes, record display racks, record divider cards.
- Kobrin Store Fixture Co., 254 Wallabout St., Brooklyn, N.Y. 11206. Tel. (212) 387-1747. Sales Mgr. Samuel Kobrin
Product: Record & tape browser boxes, record & tape display racks. (M)
- Le-Bo Prods. Co. Inc., 58-60 Grand Ave., Maspeth, N.Y. 11378. Tel. (212) 894-5155. Chm.: Peter Dayton; Pres. Al Alexander, Mktg. Dir.: Gary Schwarz; Nat'l Sales Mgr. Arthur Klein
Product: Record & tape divider cards. (M) (SEE ADVERTISEMENT)
- Liberty Fixture Inc., 2467 Mariposa Rd., Stockton, Calif. 95206. Tel. (209) 948-1176. Pres., Sales & Adv. Mgr.: Leonard Semler
Product: Browser boxes, display racks. (M)
- Loranger Mfg. Corp., Entertainment Prods. Div., 10-38 Clark St., Warren, Pa. 16365. Tel. (814) 723-8600. Pres. J. Albert Loranger, VP. Robert Loranger
Product: Tape Browser boxes. (M) (SEE ADVERTISEMENT)
- Mallory Dist. Prods. Co., 4760 Kentucky Ave., Indianapolis, Ind. 46222. Tel. (317) 856-3731
Product: Tape display racks. (M)
- Monark see Dajim
- N E R T (New England Record & Tape) (div. of PBN Survey), PO Box 268, 641 Haverhill St., Lawrence, Mass. 01841. Tel. (617) 686-4293. Pres. Jerry P. Marcus; Sales Mgr. Melvin L. Marcus, Adv. Mgr. B. J. Kankey
Product: Record browser boxes, record display racks, Nontronics Co. Inc., 8101 10 Ave. N., Minneapolis, Minn. 55427. Tel. (612) 545-9837
Product: Tape display racks
- Nostalgia Lane Inc., 211 W. 56 St., Suite 33J, New York, N.Y. 10019. Tel. (212) 583-5390. Owners: Lee Hal-

HAMILTON

THE COMPLETE LINE

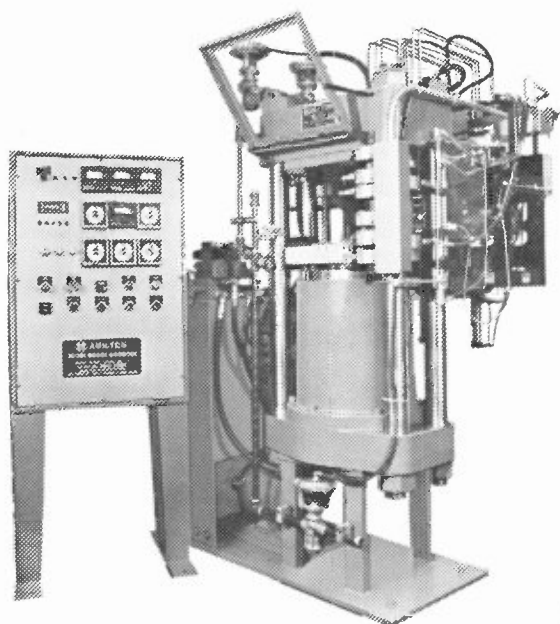

WORLDWIDE

RECORD PRESSING EQUIPMENT & ACCESSORIES 30 YEARS

- AUTOMATIC PRESSES
- SEMIAUTOMATIC PRESSES
- EXTRUDERS
- ELECTRONIC CONTROLS
- MOLDS
- INSERT FRAMES
- INSERTS
- TRIMMERS
- FORMING PRESSES
- STAMPER FORMING
- SALVAGE PUNCHES
- CUSTOM MACHINERY



HAMILTON MANUFACTURING

510 First Ave., West Haven, CT 06516
 203-933-1625 TWX 710-465-2982

DIVIDER CARDS

10¢

and up

Why Pay More?

Call or Write
Sam Lempert
(212)254-7864

11 East 4th Street New York, NY 10003
AL-LEN CUTTING CO.

pern, Nina Mattikow; Customer Relations Supervisor: Yvonne Simpkins; Sales Mgr.: Paul Kahan.
Product: Record browser racks, record display racks, record divider cards.

Paramount Housewares, 1035 Westminster Ave., Alhambra, Calif. 91803. Tel: (213) 570-1601. Pres.: Joseph D. Winston; Sales & Adv. Mgr.: Charles W. Holmes.
Product: Record browser boxes, record display racks, tape storage cases. (M)

Pickwick Mfg. Co., 7500 Excelsior Blvd., Minneapolis, Minn. 55426. Tel: (612) 932-7641. Pres.: C. Charles Smith; Nat'l Sales Mgr.: Duane Halter.
Product: Browser boxes, display racks. (M)

Pro I Prods., PO Box 33, Highland Park, Ill. 60035. Tel: (312) 432-5536. Pres.: Roy Pink; Sales Mgr.: Martin Pink; Adv. Mgr.: Deena Pink.
Product: Tape display racks.

Raynor Sales Co. Inc., 2698 W. Pico Blvd., Los Angeles, Calif. 90006. Tel: (213) 737-3737. Pres. & Adv. Mgr.: Ray Abrams Sr.; Sales Mgr.: Ray Abrams Jr.
Product: Record & tape browser boxes, record & tape display racks, record & tape divider cards.

Record Wide Dists., 1755 Chase Dr., Fenton, Mo. 63026. Tel: (314) 343-7100. Contact: Jim Adams.
Product: Record & tape browser boxes, record & tape display racks.

Recoton Corp., 46-23 Crane St., Long Island City, N.Y. 11101. Tel: (212) 392-6442. Pres.: Peter Borchardt; Sales Mgr.: George Calvi; Adv. Mgr.: Peter Vish.
Product: Record & tape browser boxes, record & tape display racks, record & tape divider cards.

Rockford Central Plastics, see Central Plastics.

Scotch, see 3M.

Securette, see Display Media

Seebro Prods. Co., 2416 S. Michigan Ave., Chicago, Ill. 60616. Tel: (312) 842-8221. Pres.: I. Siegal; Sales Mgr.: R. Siegal.
Product: Record display racks, wire pegboard baskets.

Star Title Strip Co., 842 Western Ave., Pittsburgh, Pa. 15233. Tel: (412) 231-4314. Pres. & Adv. Mgr.: Norman W. Morgan; Sales Mgr.: William P. Miller.
Product: Record divider cards. (MD) (SEE ADVERTISEMENT)

3 M Co., Magnetic Audio/Video Prods. Div., 3M Center, Bldg. 223-5N, St. Paul, Minn. 55101. Tel: (612) 733-1110. Div. VP: John E. Povolny; Mktg. Dir.: Bill Madden; Retail Prods. Mgr.: D.E. Rushin; Nat'l Sales Mgr.: S.R. Frederickson; Mkt. Communications & Mdsq. Supervisor: Vicki Hanson; Mkt. Development Mgr.: R.F. Burnett; Adv. Mgr.: Peter M. Gavin.
Branches: Anchorage, Alaska, 5531 Minnesota Dr. Zip: 99502. Tel: (907) 276-2363—Burbank, Calif., 126 W. Elm Court, Zip: 91502. Tel: (213) 848-5534—Los Angeles, Calif., 6023 S. Garfield Ave. Zip: 90040. Tel: (213) 726-6300—South San Francisco, Calif., 320 Shaw Rd. Zip: 94080. Tel: (415) 589-2663—Washington, D.C., 1101 15 St. NW. Zip: 20005. Tel: (202) 331-6900—Atlanta, Ga., 2860 Bankers Ind'l

Dr. Zip: 30360. Tel: (404) 447-7000—Honolulu, Hawaii, 2880 Ualena St. Zip: 96819. Tel: (808) 841-0147—Argo, Ill., 6850 S. Harlem Ave. Zip: 60501. Tel: (312) 496-6500—Needham Heights, Mass., 155 Fourth Ave. Zip: 02194. Tel: (617) 449-0300—Farmington, Mich., 23923 Research Dr. Zip: 48024. Tel: (313) 477-5000—Eagan, Minn., PO Box 3211, St. Paul 55133, 3130 Lexington Ave. S. Zip: 55121. Tel: (612) 733-3300—St. Louis, Mo., PO Box 510, 10725 Baur Blvd. Zip: 63166. Tel: (314) 991-1320—West Caldwell, N.J., PO Box 76, 15 Henderson Dr. Zip: 07006. Tel: (201) 575-2000—Cincinnati, Ohio, 4835 Para Dr. Zip: 45237. Tel: (513) 242-2313—Cleveland, Ohio, 12200 Brookpark Rd. Zip: 44130. Tel: (216) 267-1800—Philadelphia, Pa., 5698 Rising Sun Ave. Zip: 19120. Tel: (215) 728-5300—Dallas, Tex., 2121 Santa Anna Ave. Zip: 75228. Tel: (214) 324-3100—Seattle, Wash., Andover Ind'l Park, 100 Andover Park W. Zip: 98188. Tel: (206) 244-7200.
Product: Tape display racks (Scotch). (M) SEE ADVERTISEMENT

Vulcan Binder & Cover (div. of EBSCO Inds. Inc.), PO Box 29, Vincent, Ala. 35178. Tel: (205) 672-2241. VP: R. Denison Parker; Sales Mgr.: Dudley Pendleton III; Adv. Mgr.: B. R. Cummings.
Product: Tape display racks. (M)

Westland Graphics, 2237 N. Hollywood Way, Burbank, Calif. 91505. Tel: (213) 846-1205.
Product: Record & tape browser boxes, record & tape display racks, record & tape divider cards.

Wiremaid Prod. Corp. (div. of Cove Four Slide), 60 West Ave., Patchogue, N.Y. 11772. Tel: (516) 475-0193. Pres.: Barry Jaffe; Sales Mgr.: A. Boden; Adv. Mgr.: Leigh Boden.
Product: Record & tape display racks. (M)

Q: What does NARP stand for?

A: Dip into the answer in the "Disco Pools" section of IDS: Billboard's International Disco Sourcebook. Your one-stop source for a non-stop industry.

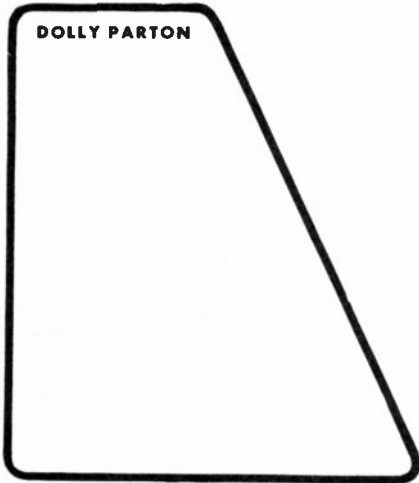

DIVIDER CARDS

By  **GOPHER**

- IN STOCK DIVIDER CARDS
- CUSTOM & PROMOTION DIVIDERS
- 16 YEARS OF QUALITY & SERVICE

TOLL FREE
(800) 648-0958

SILKSCREENED: T-SHIRTS, IN-STORE SIGNS & PROMOTION ITEMS



GOPHER PRODUCTS CORP.

Box 1812 Carson City, Nev. 89701

Jukebox Manufacturers

Rock-Ola Mfg. Corp., 800 N. Kedzie Ave., Chicago, Ill. 60651. Tel: (312) 638-7600. Pres. Donald C. Rock-ola; Sales Mgr.: Lester C. Rieck; Adv. & Sales Promo. Mgr.: Joseph E. Senesac.

Rowe Int'l Inc. (sub. of Triangle Inds. Inc.), 75 Troy Hills Rd., Whippany, N.J. 07981. Tel: (201) 887-0400. Pres.: Merrill Krakawer; Sales Mgr.: Paul Huebsch; Adv. Mgr. & Communications Dir.: Walter Koch.

Branches: Phoenix, Ariz., 2911 W. Fairmount Ave. Zip: 85017. Tel: (602) 279-2314—Los Angeles, Calif., 1433 W. Pico Blvd. Zip: 90015. Tel: (213) 747-9326—San Francisco, Calif., 1400 Minnesota St. Zip: 94107. Tel: (415) 285-0300—Denver, Colo., 2830 W. Ninth St. Zip: 80204. Tel: (303) 534-6308—Jacksonville, Fla., 60 Riverside Ave. Zip: 32202. Tel: (904) 356-0256—Miami, Fla., 1160 NW 163 Dr. Zip: 33169. Tel: (305) 625-8307—Tampa, Fla., 1725 W. Cypress. Zip: 33606. Tel: (813) 251-1801—New Orleans, La., 1601 S. Gayoso. Zip: 70125. Tel: (504) 822-0050—Dedham, Mass., 888 Rear Providence Hwy. Zip: 02026. Tel: (617) 329-3300—Kansas City, Mo., 2900 Main St. Zip: 64108. Tel: (816) 531-5715—St. Louis, Mo., 2832 Washington Ave. Zip: 63103. Tel: (314) 533-5575—Omaha, Neb., 8603 G St. Zip: 68127. Tel: (402) 339-2520—Albany, N.Y., 47A Railroad Ave. Zip: 12205. Tel: (518) 489-8501—Cheektowaga, N.Y., 92 Benbro Dr. Zip: 14225. Tel: (716) 681-3010—Syracuse, N.Y., PO Box 103. Salina Sta., 1901 Lemoyne Ave. Zip: 13208. Tel: (315) 455-5611—Columbia, S.C., 1104 Shop Rd. Zip: 29201. Tel: (803) 799-3540—Memphis, Tenn., 628 Madison Ave. Zip: 38103. Tel: (901) 525-3609—Nashville, Tenn., 1010 Foster Ave. Zip: 37211. Tel: (615) 244-6646—Dallas, Tex., 3115 Halifax. Zip: 75247. Tel: (214) 638-4280—Houston, Tex., 91 Dennis St. Zip: 77006. Tel: (713) 523-7464.

Int'l branch: Canada.

Seeburg Prods. (div. of Seeburg Inds. Inc.), 1500 N. Dayton St., Chicago, Ill. 60622. Tel: (312) 642-0800.

Title Strip Manufacturers

Don's Title Strip Co. Inc., 1146 W. Montrose Ave., Chicago, Ill. 60613. Tel: (312) 271-7290. Pres.: Don Cihak.

Ray Lawrence Ltd., PO Box 1987, Studio City, Calif. 91604. Tel: (213) 552-1000. Pres. & Sales Mgr.: Ray Lawrence; Adv. Mgr.: Connie Lawrence.

Hit Program Serv., see Sterling Title Strip.

Star Title Strip Co. Inc., 842 Western Ave., Pittsburgh, Pa. 15233. Tel: (412) 231-4314. Pres. & Adv. Mgr.: Norman W. Morgan; Sales Mgr.: William P. Miller. (SEE ADVERTISEMENT)

Sterling Title Strip Co. Inc., 1175 Broad St., Newark, N.J. 07114. Tel: (201) 243-0222. Pres.: Dick Steinberg; Sales Mgr.: William Thomas.

Rik Tinory Prod'ns, 622 Rt. 3A, Cohasset, Mass. 02025. Tel: (617) 383-9494. Pres.: Richard F. Tinory; Artist Relations: Claire L. Babcock.

Q: What's black and white and red all over the country?

A: The listings in CMS: Billboard's Sourcebook. The business source for the country business.

With
"Quick-Vue"[®]
displayers,
browsers
become
buyers!

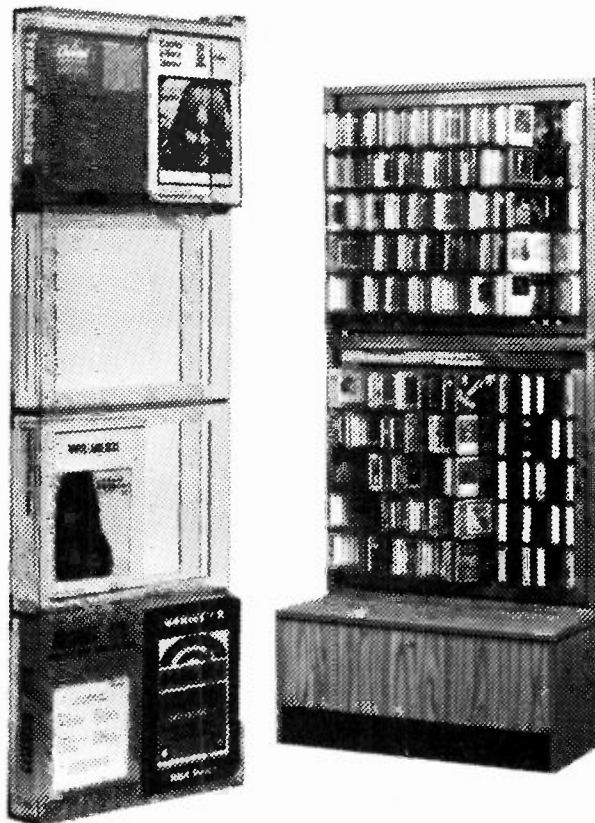

Your store or department can attract and promote impulse buying with our unique designs in 8-track and cassette tape merchandising. Each tape is completely visible to the shopper in an attractive, pilfer-proof displayer that can be flipped through as simply as turning pages in a book: "QUICK-VUE" displayers are available in eight different models with tape capacities from 40 to 960.

We also have a combination holder that displays 8-track and Cassette. Model W-2-5.

"NOBODY DOES IT BETTER"

We design and build store fixtures especially for the music industry.

Send for our free color catalog and we are sure you will agree that the **QUICK-VUE** system is the most profitable way to increase sales.

creative
store
equipment,
inc.

P.O. Box 933
Terrell, Texas 75160
Phone: (214) 563-5869 or
Dallas (214) 226-7248

ARGENTINA

Population: 27,000,000.

Rate of exchange: \$1 (US) = 1352 pesos.

Per capita income: \$3,450.

Holidays: January 1, February 14 & 15, Carnival Monday & Tuesday (40 days before Easter), Holy Thursday, Good Friday, May 1 (Labor Day), May 25 (Anniversary of the 1810 Revolution), June 20 (Flag Day), July 9 (Independence Day), August 15 (Assumption), August 17, October 12 (Discovery of America), November 1 (All Saints' Day), December 8 (Immaculate Conception), December 25.

RECORDS:

Records sold domestically: LP's 1978—\$22,800,000; EP's 1978—\$156,000; Singles 1978—\$7,600,000.

Average retail price per record: LP's—\$11.50; EP's—\$4.00; Singles—\$3.20.

TAPE:

Pre-recorded tape sold domestically: 8-tr. 1978—\$1,900,000; Cassette 1978—\$10,000,000.

Average retail price per tape: 8-tr.—\$13.00; Cassette—\$12.50.

● **record & tape manufacturers / distributors / importers**

Accord, see Musidisc.
America, see Musidisc.
Angel, see EMI-Odeon.
Archiv, see Phonogram.
Ariel, see Famous.

Artaria-Kotrona SrL, Esmeralda 459, Buenos Aires 1007. Tel. 392-2683. Cable ARIADISC. Execs: Ingrid Roehre, Elizabeth Kallay, Bruno Iannice; A&R: Marta Alicia Blejer; Sales Mgr.: Claudio Davila.

Home office: Germany, Artaria.

Labels: (Owned) Artaria, Kontrast, Kotrona, Propilei, Specialty (licensed) Amerindian (Germany), Arion (France), Cetra (Italy), Deutche Harmonia Mundi (Ger-

many), Fono (Germany), Scorpios (France), Supraphon (Czechoslovakia), Wergo (Germany).

Int'l rep.: Germany (Amerindian)

Bang Bang, see Circle Line.

CBS SAICF (Discos), Emilio Mitre 1819, Buenos Aires. Tel. 922-4041. Cable COLRECORD. Telex 17091. Pres. Juan Truden; Mng. Dir.: Hecio Cuomo.

Labels: (Owned) CBS, Columbia, Epic, Odyssey, Orfeo, Portrait, (licensed) Aguamanda (Italy), Amber Antique (USA), Astarite (Spain), Black Magic (UK), Blue Sky (USA), Bus (Italy), CGD (Italy), Cannel (USA), Caribou (USA), Cartwheel (USA), Cleveland Int'l (USA), Dan (Mexico), Daniel (Mexico), Devel (USA), Dimeca (Mexico), La Discoteca (Venezuela), Douglas (USA), Erre (Italy), Fillmore (USA), Freddie (USA), Full Moon (USA), Goodear (UK), Great Western Gramophone (USA), Heriba (Bolivia), Jet Pad (Switzerland), Kinetic (USA), Kirshner (USA), Le Cam (USA), Libra (Italy), Lifesong (USA), Lozano (Mexico), Memo (USA), Monument (USA), Movieplay (Spain), Mums (USA), Nemperor (USA), New Design (USA), Norteno (Mexico), Ode (USA), PIR (USA), Prophecy (USA), Shakat (USA), Sherbet (Australia), Smash (Italy), Som (Brazil), Sondor (Uruguay), Sono Radio (Peru), Spindizzy (USA), Splash (Italy), Sweet City (USA), TK (USA), T-Neck (USA), Tabu (USA), Tappan Zee (USA), Unlimited Gold (USA), Windfall (USA), Zarape (USA).

Calmex SrL, Cuidado de la Paz 2506, 3rd fl., 1428 Buenos Aires. Tel. 982-3037.

Int'l branch: USA.

Labels: (Owned) Calmex, Top; (licensed) Eagle (USA), Insieme (Italy), PPX (USA), Sirocco (USA), Yep (Italy).

Camden, see RCA.

Capitol, see EMI-Odeon.

Carmusic SAIC, Mexico 2833, Buenos Aires. Tel. 97-7185. Pres.: Laura Roma Casella; Gen. Mgr.: Alba Casella.

Labels: (Owned) Carmusic; (represented) Monica (USA), Europa (Germany).

Int'l rep.: Uruguay (APSA).

Cauce, see Trova.

Circle Line Producciones SrL, Agüero 1920, 8th fl., 18, 1425 Buenos Aires. Tel. 826-0034. Cable CIRCLE-LINE BAIRES. Gen. Dir.: J. Olzevicki Fried; Gen. Mgr.: A. M. Hernandez.

Labels: (Owned) Bang Bang, Circle Line, (licensed foreign) Albatros (France), Dial (Spain), Elver (Belgium), Ibach (France), Multipix (UK), Tommy (Uruguay), Victoria (Germany).

Domestic labels represented: Alos (worldwide), Arfon (worldwide except Uruguay), Argentina Prod'ns (worldwide except UK), Campo (worldwide except Bolivia).

Mburucuya (worldwide), Paraguari (worldwide), TK (Europe, Japan), Tonodisc (Europe, Japan).

Int'l reps.: Chile (Quatro), Colombia (Codiscos), Ecuador (Fadisa), France (Elypeyrot), Japan (Musicamigos), Spain (Dial), Uruguay (Maloa, Tommy).

Columbia, see CBS.
D G, see Phonogram.

Discolandia Dueri & Cia Ltda., Ave. Belgrano 3459, 3rd fl., Dept. 15, Buenos Aires.

Home office: Bolivia.

EMI-Odeon SAIC (IFPI), Mendoza 1660, 1428 Buenos Aires. Tel. 781-4061/9. Cable TURNTABLE. Telex: 22796. Pres. & Mng. Dir.: Luis Aguado; Label Mgr.: Adolfo San Martin; Sales Mgr.: Alfredo Porcini; Finance & Admin. Dir.: Carlos Benveniste; Comm'l. Dir.: Norberto Tejero.

Labels: (Owned) Angel, Capitol, EMI, Harvest, Odeon, Odeon Pops, Parlophone; (licensed) A&M (USA), Arista (USA), Decca (UK), Discomoda (Venezuela), London (USA), Magnet (UK), PDU (Italy), Private Stock (USA), Rocket (UK), United Artists (USA).

Int'l reps.: Bolivia (Discolandia), Ecuador (IFESA), Peru (EMPESA), Uruguay (R. & R. Giosia), USA (Discos Latin), Venezuela (Los Ruices).

EPSA (Electrical Prods. SAIC), Mexico 2835, Buenos Aires. Tel. 93-8316, 97-4609. Pres. & Gen. Mgr.: Laura Roma Casella. (Distributor—Tape only)

Epic, see CBS.

Famous SrL, Anasco 1015, Buenos Aires. Tel. 59-2918.

Labels: (Owned) Ariel; (represented) EMI (UK).

Festival, see Musidisc.

Fontana, see Phonogram.

Harvest, see EMI-Odeon.

Heliodor, see Phonogram.

Jazz Anthology, see Musidisc.

Kontrast, see Artaria-Kotrona.

Kotrona, see Artaria-Kotrona.

Linea Tres, see RCA.

M G M, see Phonogram.

Mercury, see Phonogram.

Microfon Argentina SA, Lavalle 1430, 4th fl., Buenos Aires. Tel. 49-6128, 40-9728. Cable MICROFON BAIRES.

Telex: 17774 MIFON AR. Pres.: Mario Ruben Kaminsky, VP: Norberto Kaminsky.

Labels: (Owned) Micsa; (licensed foreign) Alshire (USA), Ariola (Mexico, Spain), Audio Fidelity (USA), Coco (USA), Coro (Mexico), Gamma (Mexico), Continental (Brazil), Hispavox (Spain), Infopesa (Peru), Motown (USA), Orfeon (Mexico), Ri-Fi (Italy), Vogue (France), Velvet (Venezuela).

Int'l reps.: Brazil (Continental), Bolivia (Heriba), Central

"CBS has increased their overseas sales 300% in the past 2 years, and it's still growing." Gary Lyle, President Ultra Spec. Intl.

Q: You're the sole distributor worldwide for CBS. How did U.S.I. create this incredible growth?

LYLE: Well, that's a long story. The bottom line is, we have exceptionally good products. CBS Professional Tapes. And, we deliver what we promise, on time. So as the word gets around, more and

more people want to do business with us.

Q: Are you doing business this way with any other products?

LYLE: Oh, with many products. We have a network of contacts and clients worldwide. For example, we export U.S. Duplicating and Record Manufacturing Equip-

ment and we have just taken on a product we're very excited about: The Ultra Sonic Film Splicer. It's the only one of its kind, (used here by Technicolor and MGM) and we want to introduce it to the rest of the world.

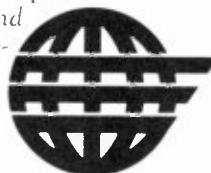

Ultra Specialty Inc.

For more information contact Gary Lyle • (213) 979-0338 • Telex: 194566.ULTRASPEC. CRSN. Cable: ULTRASPEC.

We speak the language of music all over the world.

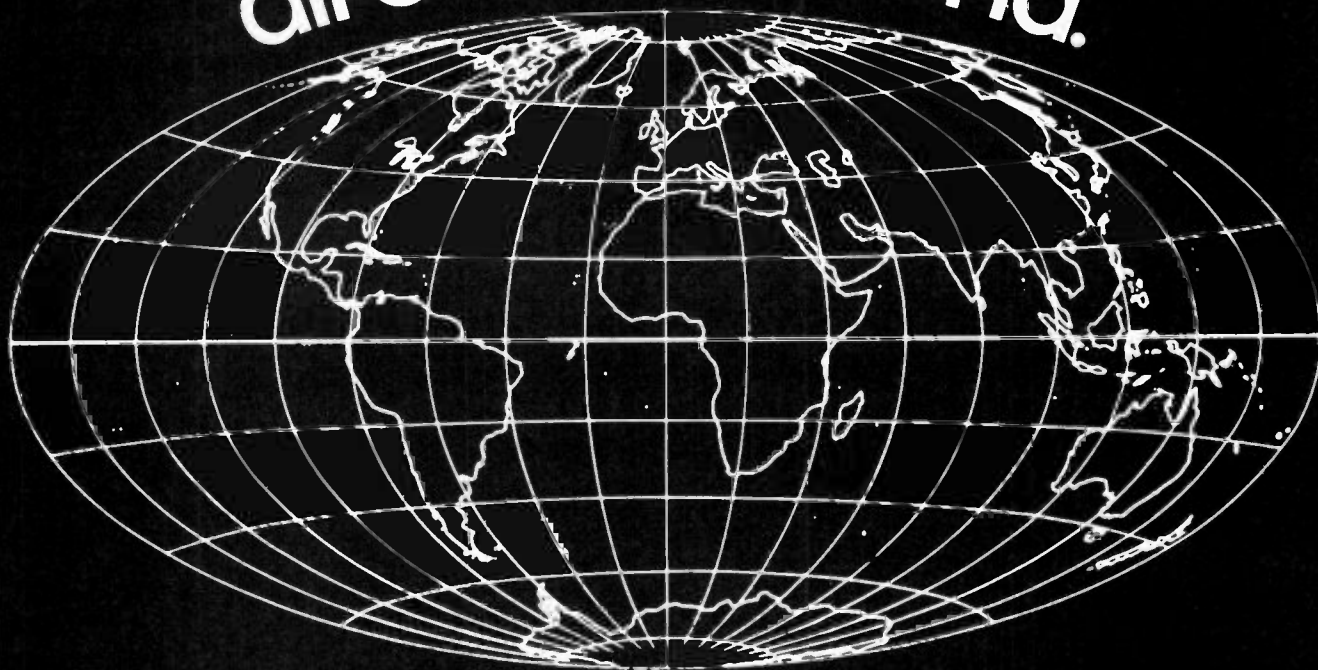

Music. The Universal Language.

At CBS Records International (CRI) we have nearly 8,000 people around the world fluent in that language.

In fact, CRI is America's most comprehensive, diversified and sophisticated international music organization. With more owned companies in more countries than anyone. So we can provide the international coordination artists need to achieve international success.

In addition to bringing American artists to the rest of the world, our subsidiaries are constantly adding to their own local rosters, developing talent not only for their own marketplace but for other territories as well.

And tying all our local companies together are regional offices that allow us to spread our success from one country to another.

Because of all this, CRI has been able to grow in new ways each year. Toto, Cheap Trick, Bob Dylan, Earth, Wind & Fire, Billy Joel, Meat Loaf, The Jacksons, Art Garfunkel, Frank Zappa, Supertramp,* Anita Ward** and Julio Iglesias are just a few of the artists who have grown with us this year — to new levels of international success.

In short, we speak music all over the world. And that's real communication.

CBS Records International

"CBS"  are trademarks of CBS Inc. © 1979 CBS Inc.

America (Lyra), Colombia (Codiscos), Ecuador (IFESA), Mexico (Ariola), Peru (Intopasa), Spain (Ariola), Uruguay (EDISA), Venezuela (Velvet)

Micsa, see Microfon

Music Hall, see Sicomericana

Musidisc Europe Sudamericana SAICF, Uruguay 1037, 4th fl., 1037 Buenos Aires. Tel 41-0464/7091 Cable MUSIDISC BAIRES. Pres Juan M.L. Fano, Gen Mgr J Olszewicki

Home Office: France

Labels: (Owned) Accord, America, Festival, Jazz Anthology, Musidisc, Score, Visadisc, (Licensed—domestic) Circle Line Prods

N G, see Tonodisc

Odeon, see EMI-Odeon

Odeon Pops, see EMI-Odeon

Odyssey, see CBS

Orfeo, see CBS

Parlophone, see EMI-Odeon

Philips, see Phonogram

Phonogram SAIC, Calle Moreno 2038, Buenos Aires. Tel 48-7709/5524/6728 Mng. Dir. John Lear

Labels: (Owned) Archiv DG, Fontana, Heliodor, MGM, Mercury, Philips, Polydor, Verve; (represented) Casablanca (USA), Charisma (UK), Chrysalis (UK), Disney-Vista (USA), Island (UK), MCA (USA), Pablo (USA), RSO (USA), 20th Century (USA), Vertigo (UK), Virgin (UK), Zafiro (Spain)

PhonoMusical (Argentina), Zapata 121, 1426 Buenos Aires

Polydor, see Phonogram

Portrait, see CBS

Prodisco, see Tonodisc

Promusica, see Tonodisc

Propitei, see Artaria-Kotrona

Pure Gold, see RCA

R C A Ltd. (Sucursal Argentina), Paroissien 3930, 1430 Buenos Aires Tel 70-4171, Cable RCAAAR 0113, Gen. Mgr Jorge Oscar Schutt, Sales Mgr. Horacio Luis Bulnes; Creative Mgr., Osmar Mario Pizzorno

Labels: (Owned) Camden, Linea Tres, Pure Gold, RCA, Red Seal, Victrola, Vik; (licensed) Barclay (France), Can't Stop Prod'n (USA), Erato (France), Fantasy (USA), Hansa (Germany), Mellow (Netherlands), Ricordi (Italy)

Red Seal, see RCA

Rhombus, see Trova

Ritmo, see Sicomericana

Rondó Musical S.R.L., La Pampa 2586, 1428 Buenos Aires

Tel 784-0747, Gen. Mgr Jorge C Esperon

Score, see Musidisc

Sheraton, see Sicomericana

Sicomericana SACIFI (IFPI), Jose E Uriburu 40-42, Buenos Aires Tel 46-9800, Pres Nestor Selasco

Labels: (Owned) Music Hall, Ritmo, Sheraton; (licensed) ABC group (USA), Ariston (Italy), Belter (Spain), Charly (UK), Durium (Italy), Ember (UK), Musart (Mexico), Pys (UK), Vanguard (USA), WEA group (USA)

Specialty, see Artaria-Kotrona

Tema, see Trova

Tonodisc SA (IFPI), Culpina 375, 1406 Buenos Aires. Tel 612-4873/5107, Pres Natalio Garber; Gen. Mgr: Francisco Vidal; Sales Mgr. Luis Pissolito; Promo. Mgr. Julio Garcia

Labels: (Owned) NG, Prodisco, Promusica, Tonodisc, (licensed) Chantecler (Brazil), Continental (Brazil), Project 3 (USA), Saar (Italy)

Int'l reps.: Colombia (Bonif), Japan (Victor), Mexico (Musart), Venezuela (BASF), Yugoslavia (Ljubljana)

Top, see Calmex

Trova Inds Musicales SA (IFPI), Cangallo 4378/80/82, Buenos Aires Tel 811-0890/0990/2810, Pres. Felix Horowitz; Gen. Mgr. & A&R Nahun Roberto Rudaeff

Labels: (Owned) Cauce, Rhombus, Tema, Trova, Vernal; (distributed—not licensed) CID (Brazil), Carosello (Italy), Erre TV (Italy), Gravacos Elétricas (Brazil), Phonogram (Brazil), Som Livre (Brazil)

Int'l reps.: Brazil (CID, Continental, Phonogram, RGE/Fermata, Sigla), Chile (Quatro), France (Pathe Marconi-EMI), Italy (Carosello), Japan (Victor), Mexico (Gamma), Spain (CBS), Uruguay (Clave), Venezuela (BASF)

Vernal, see Trova

Verve, see Phonogram

Victrola, see RCA

Vik, see RCA

Visadisc, see Musidisc

● music publishers

Acorde (Ed.), see Edami

Calmex S.R.L., Ciudad de la Paz 2506, 3rd fl., 1428 Buenos Aires. Tel 782-3037

Int'l firms represented: Intersong (Germany), Sugar Music (Italy)

Edami S.R.L. (Ed. Argentina de Musica Int'l), Lavalle 1494, Buenos Aires. Tel 40-1613/8853

Int'l firms represented: EMMI (Mexico), PHAM (Mexico), Peer (USA), SEMI (France), Southern (Italy, Spain, UK, USA)

Edifon S.R.L., Tucuman 1455, 9th fl., A, Buenos Aires. Tel: 45-7142, Cable MICROFON BAIRES, Telex 17774 MIFON AR. Pres. Mario Ruben Kaminsky, Gen. Mgr. Beatriz Lupu

Int'l firms represented: Arabella (Spain), Black Bull (USA), Jobete (USA), Ollantay (Peru), Stone Diamond (USA)

Int'l reps.: Peru (Ollantay), USA (Pampa)

Korn SAIC (Ed. Musical), Av. Cordoba 1351, 2nd fl., Buenos Aires. Tel 44-0611/5142/9798, Cable EDIKORN. Gen. Mgr. Nelida Lopez French

Int'l firms represented: United Artists group (USA)

M A I (Musica Argentina & Internacional) SA Ed., Talcahuano 68, 1391 Buenos Aires. Tel: 37-9441, Cable EDIMAI. Telex: 22796. Pres.: Luis S. Aguado; Gen. Mgr. Maria Hajdenwurcel

Int'l firms represented: Discorama (Spain), EGO (Spain), EMI (UK), Ecomus (Colombia), ITAIPU (Brazil), Sochem (Chile), Unimusic (Venezuela)

Int'l reps.: Brazil (ITAIPU), Spain (EGO)

Melograf S.R.L. (CBS Music Publ'g), Suipacha 476, Buenos Aires. Tel: 49-3551, Gen. Mgr.: Beatriz Lupu

Int'l firms represented: ATV/Maclen, B O Cult, Blue Seas/Jac, Doors, Frank, Garrett, Albert Hammond Ents., Herophant, Lady Jane, Robert Mellin, Mighty Three, Mine, Music Maximus, Neighborhood, Petra, Playboy, Sheryl, Third Story, Tuna Fish (all USA), Northern Songs, RAK (both UK)

Int'l reps.: Australia (Aral), Brazil (ELAM, Mundo Musical), Canada (April/Blackwood), Colombia (Mundo Musical), Costa Rica (Mundo Musical), France (April), Germany (April), Israel (April), Italy (April), Japan (April), Mexico (Mundo Musical), Netherlands (April), Sweden (April), UK (April), USA (April/Blackwood), Venezuela (Mundo Musical)

Mundo Musical S.R.L. (Eds.), see Melograf

Musica Argentina & Internacional, see MAI

Odeon (Ed.), see MAI

Jaime Olszewicki, Agüero 1920, 8th fl., 18, 1425 Buenos Aires Tel 826-0034, Cable CIRCLE LINE BAIRES

Gen. Dir., J Olszewicki Fried; Gen. Mgr. A.M. Hernandez

Int'l firms represented: Paul Beuscher (France), Bretagne (France), Claude Carrere (France), Coda (Belgium), Elpeyrot (Europe), Isabelle (France), Melodie der Welt (Germany), Johann Michel (Germany), Sforzando (France), Tremplin (France)

P A M S C O SAC (Pan American Music Serv. Corp.), Jose E Uriburu 40-42, 3rd fl., Buenos Aires Tel 49-0399, 46-9807/00, Cable PAMESCO

Int'l firms represented: CAM (Italy, Spain), Curci (Italy), Comme il Vento (Italy), Constand DeFourny (Belgium), Durium (Italy), Marouani (France), Orbemusa (Venezuela), Pema (France), Pham (Mexico), Pull (Italy), G. Ricordi (Italy), Sparta Florida group (UK)

Int'l rep.: Colombia (Exitos), Mexico (Pham), Venezuela (Orbemusa)

Puma (Publicaciones Musicales Americanas) S.R.L., Culpina 375, Buenos Aires Tel 611-4819, Pres Lila T. Nunez

Relay SAIC, Paroissien 3930, Buenos Aires Tel 70-4171, Cable RCAAAR, VP Jorge Oscar Schutt, Mgr. Buddy McCluskey

Int'l firms represented: Arabella (Spain, USA), Ariola America (USA), Cherry Lane (USA), Erasmus (USA), Infinity (USA), Ivan Mogull (USA), Jondora (USA), RCA affiliates (worldwide), Sheryl (USA)

Int'l reps.: Worldwide (RCA affiliates)

S I G E M (Sistema Globo de Ediciones Musicales), 683 Florida, Buenos Aires. Tel 392-9962

Trompos Publ'g, S.R.L., see Edifon

Ultramoderna (Ed.), see MAI

● services

ASSOCIATIONS & PROFESSIONAL ORGANIZATIONS

Asociacion Wagneriana de Buenos Aires, Santa Fe 1243, 1st fl., Buenos Aires

Collegium Musicum de Buenos Aires, Libertad 1630, Buenos Aires

Comar (Corp. Argentina), Montevideo 641, Buenos Aires

Mozarteum Argentino, Rodriguez Pena 1882, Buenos Aires Tel: 44-4836, Pres Jeannette Arata de Erize

DESIGN & ARTWORK

Artaria-Kotrona S.R.L., Esmeralda 459, 1007 Buenos Aires. Tel 392-2683, Cable ARIADISC. Gen. Mgr. Bruno Iannice; Sales Mgr. Claudio Davila

LICENSING ORGANIZATION, MUSIC

S A D A I C (Sociedad Argentina de Autores & Compositores de Musica), Lavalle 1547, Buenos Aires. (Mechanical & performing rights)

LICENSORS, RECORD & TAPE

T A T S A SA, Florida 239, Buenos Aires Tel 49-6936/5801, Telex: 122322 AT/COB

PLATING, PROCESSING & PRESSING PLANTS

C B S SAICF (Discos), Emilio Mitre 1819, Buenos Aires Tel 922-4041, Cable COLRECORD Telex 17091, Pres. Juan Truden; Mgr. Hecio Cuomo

EMI-Odeon SAIC (Industrias Electricas & Musicales), Montaneses 2150, 1428 Buenos Aires. Tel 781-4061/69, Cable TURNTABLE Telex: 22796 (Pressing only)

Galvadis S.R.L., 11 de Septiembre 481, Ramos Mejia, Buenos Aires Tel 653-6844/6826, Cable MICROFON BAIRES, Telex 17774 MIFON AR. Pres. Mario Ruben Kaminsky; VP: Norberto Kaminsky, Gen. Mgr. Raul Iglesias

PRINTERS & LITHOGRAPHERS

Artaria-Kotrona S.R.L., Esmeralda 459, 1007 Buenos Aires. Tel 392-2683, Cable ARIADISC. Gen. Mgr. Bruno Iannice; Sales Mgr. Claudio Davila

RECORD PROMOTION

Artaria-Kotrona S.R.L., Esmeralda 459, 1007 Buenos Aires. Tel 392-2683, Cable ARIADISC. Gen. Mgr. Bruno Iannice; Sales Mgr. Claudio Davila

TAPE CUSTOM DUPLICATORS TAPE PACKAGING & LABELING

The Audio and Video lines indicate the configurations which the firms duplicate. Companies which offer packaging and labeling of tape product are indicated by: (PKG) which appears after the main body of their respective listings.

American Rec'g SAICFIA, Manuela Pedraza 2649/51,

Buenos Aires. Tel: 701-2159/8954, Cable AUTORRADIO. Pres. Claudio Mario Nadal; VP Francisco Herba; Gen. Mgr. Miguel Angel Pettinato; Sales Mgr. Luis Galvez Santana

Audio: 8-tr., cassette, open reel

Artaria-Kotrona S.R.L., Esmeralda 459, 1007 Buenos Aires. Tel 392-2683, Cable ARIADISC. Gen. Mgr. Bruno Iannice; Sales Mgr. Claudio Davila. (PKG)

Audio: Cassette, open reel, open reel quadraphonic.

E P S A (Electrical Prods SAIC), Mexico 2835, Buenos Aires. Tel 93-8316, 97-4609, Pres & Gen. Mgr. Laura Roma Casella

Audio: 8-tr., cassette, open reel

Phonogram SAIC, Moreno 2038, Buenos Aires. Tel 48-7709/5524, Mng. Dir. John Lear

● supplies

CARTRIDGE & CASSETTE PARTS EMPTY CARTRIDGES, CASSETTES & REELS

American Rec'g SAICFIA, Manuela Pedraza 2649/51, Buenos Aires. Tel 701-2159/8954, Cable AUTORRADIO. Pres. Claudio Mario Nadal; VP Francisco Herba; Gen. Mgr. Miguel Angel Pettinato; Sales Mgr. Luis Galvez Santana

Artaria-Kotrona S.R.L., Esmeralda 459, 1007 Buenos Aires. Tel 392-2683, Cable ARIADISC. Gen. Mgr. Bruno Iannice; Sales Mgr. Claudio Davila

Audio: 8-tr., cassette

TAPE, RAW & BLANK LOADED

Agfa-Gevaert Argentina SACI, Bme Mitre 1902/10, Buenos Aires Tel 45-9012/7726/8465, Cable ARGEVA

Audio: Blank—compact cassette, open reel, raw—cassette, broadcast, studio

Brand names: Agfa Carat, Agfa Stereochrom, Agfa Videochrom

American Rec'g SAICFIA, Manuela Pedraza 2649/51, Buenos Aires. Tel 701-2159/8954, Cable AUTORRADIO. Pres. Claudio Mario Nadal; VP Francisco Herba; Gen. Mgr. Miguel Angel Pettinato; Sales Mgr. Luis Galvez Santana. (Blank only)

Artaria-Kotrona S.R.L., Esmeralda 459, 1007 Buenos Aires. Tel 392-2683, Cable ARIADISC. Gen. Mgr. Bruno Iannice; Sales Mgr. Claudio Davila. (Blank only)

Audio: Cassette, open reel

B A S F (Argentina) SA, PO Box 4800, Av. Corrientes 327, 1000 Buenos Aires. Tel 32-9491/9496, Telex 121067

Audio & Video: Cassette, open reel

TAPE DUPLICATING & PROCESSING EQUIPMENT

B A S F (Argentina) SA, PO Box 4800, Av. Corrientes 327, 1000 Buenos Aires. Tel 32-9491/9496, Telex 121067

Product: Pancakes

● accessories manufacturers

American Rec'g SAICFIA, Manuela Pedraza 2649/51, Buenos Aires. Tel 701-2159/8954, Cable AUTORRADIO. Pres. Claudio Mario Nadal; VP Francisco Herba; Gen. Mgr. Miguel Angel Pettinato; Sales Mgr. Luis Galvez Santana

Product: Carrying & storage cases, catalog servs., leader tape

Artaria-Kotrona S.R.L., Esmeralda 459, 1007 Buenos Aires. Tel 392-2683, Cable ARIADISC. Gen. Mgr. Bruno Iannice; Sales Mgr. Claudio Davila

Product: Carrying & storage cases, catalog servs., cleaners, cloths & brushes, head cleaners, demagnetizers, needles, leader & splicing tape

Brescia Electronica SAIC, Fitz Roy 1929, Buenos Aires Tel 771-0863

Product: Needles

C B S SAICF (Discos), Emilio Mitre 1819, Buenos Aires. Tel: 922-4041, Cable COLRECORD. Telex: 17091, Pres.: Juan Truden; Mgr.: Hecio Cuomo

Product: Catalog servs.

Holmar S.R.L., Cespedes 2670, Buenos Aires. Tel 73-8127, (Importer)

Product: Needles (Ortofon)

Ortofon, see Holimar

● store fixtures & merchandising aids

Artaria-Kotrona S.R.L., Esmeralda 459, 1007 Buenos Aires. Tel: 392-2683, Cable ARIADISC. Gen. Mgr. Bruno Iannice; Sales Mgr. Claudio Davila

Product: Record browser boxes, display racks, divider cards

AUSTRALIA

Population: 14,000,000

Rate of exchange: \$1 (US) = 0.86 Australian dollars.

Per capita income: \$5,540

No. of homes with record players: 95%

Holidays: January 1, January 26 (Australia Day), Good Friday, Easter Monday, April 25 (Anzac Day), Queen's Birthday, December 25, December 26 (Boxing Day)

RECORDS & TAPE:

Total records & pre-recorded tape sold: \$200,000,000.
Average retail price per record: LP's \$8.50; singles—\$1.50.
Average retail price per tape: Cassette—\$8.50.
Stereo sales: 99% of total.
Quadraphonic sales: 1% of total.
Record club sales: 3-5% of total.
Discounting: Approximately 5% of total.
Type of distribution: Manufacturer-to-retailer predominates.
 Rack jobbing is virtually unknown. Budget racking has all but disappeared in the last three years. EMI is the only company that runs its own retail outlets (Palings stores).
Type of promotion: Radio exposure predominates, but TV film clips have usually been very effective and discos have had an increasing influence. The music press is still relatively unimportant, but its influence is increasing. Free-form government rock radio station 2JJ (Sydney) can have a large influence on out-of-mainstream product sales.
Jukeboxes: 5,000.

RADIO STATIONS:

No. of commercial 126; No. of government 88.
Comment: Primarily independent operations, with specialized programming occurring only in metropolitan areas. Pop/rock stations are usually dominant in the metropolitan areas, with MOR and country stations dominating elsewhere. Jazz and black music is nonexistent. There's a 20% local performance content regulation.

TELEVISION STATIONS:

No. of commercial 50; No. of government 87.
Comment: American and English shows are dominant, with locally produced shows accounting for approximately 20% of programming.

IMPORT / EXPORT REGULATIONS:

Import duty is 35% on tapes; there is no import duty on records. Government sales tax 27½% imports, 27½% local manufacturer.

MARKET ANALYSIS:

1978 in Australia was the year of the "gorilla." The record market was dominated by a small number of multi-platinum sellers which effectively took away the bucks from standard hit sellers and back catalog.
 Despite this proliferation of "gorillas," actual growth in the overall market was stagnant if not in fact—it did not actually regress. PolyGram, which handled the two biggest selling albums of the year ("Saturday Night Fever" and "Grease"), estimated a nil growth, as did the independent Festival Records.
 Such was the huge gap between the sales of the top three albums and the remainder of the chart that No. 1 became a somewhat inadequate term of achievement.
 1978 also saw radio lose a great deal of its hitmaking power as more and more singles were broken by discos and television. Disco itself grew enormously in the Australian marketplace during 1978, accounting for approximately a quarter of all hits.
 Not so dramatic, however, was the chart action of local artists. 1978 was the worst year since 1968 for the number of Australian singles in the top 100 (only 10) and likewise for albums (only nine). Ironically, 1978 was the year when Australian recording truly came of age on the world's charts.
 Glenn Baker

● record & tape manufacturers / distributors / importers

A O, see Recording Industry Mktg. Servs.
 A T A Recs., 96 Glebe Point Rd., Glebe, Sydney, NSW 2037. Tel: (02) 660-3466. Cable: SHOWBIZ. Telex: 22429. Mng. Dir.: Kevin Jacobsen, Col. Joye. (Distributed by Festival)
 A W A, Ashfield Div., 554 Parramatta Rd., Ashfield, NSW 2131.
Label: (Represented) Denon PCM (Japan).
 Aboriginal Arts, see Larrikin.
 J. Albert & Son Pty. Ltd., 139 King St., Sydney, NSW 2000. Tel: (02) 232-2144. Cable: MUSIC. Mng. Dir.: Edward F. Albert. (Licensed to EMI)
Label: (Owned) Albert Prod'ns.
 Albert Prod'ns, see J. Albert & EMI.
 Archiv, see PolyGram.
 Arrival Recs., 390 Eastern Valley Way, Roseville East, NSW 2069. Tel: (02) 407-3201. Contact: Phil Israel.
 Astor Recs. Pty. Ltd. (IFPI), 1092 Centre Rd., Clayton, Melbourne, Vic. 3168. Tel: (03) 544-2444. Cable: SCHÜH. Telex: 31244. Gen. Mgr.: Rex M. Barry; Mktg. Mgr.: Vin A. Forbes.
Labels: (Owned) Astor, W&G (licensed—domestic) Fable, Image, Indigo, Pisces (licensed—foreign) Alshire (USA), Attic (Canada), Casablanca (USA), Chelsea (USA), Cream (USA), Europa (Germany), Everest (USA), Lismor (UK), MCA (USA), Motown (USA), Playboy (USA), Pye (UK), Redifusion (UK), Sommerset (Germany), Springboard (USA), Vanguard (USA).
Int'l rep.: New Zealand (Music World).
 Asylum, see WEA.
 Atco, see WEA.
 Atlantic, see WEA.
 Avan-Guard Music Pty. Ltd. (IFPI), 524 Kent St., Sydney, NSW. Tel: (02) 61-3278. Mng. Dir.: Ali Knoll; Gen. Mgr. Judith Knoll, Sales Mgr.: Stuart Emanuel, A&R: Rosemond Johnson.
Labels: (Owned) Avan-Guard, Pepito; (licensed foreign) Five Star (New Zealand), Meridian (UK), Muse (USA), Nina (USA), Ode (New Zealand), Tilton (Germany, Netherlands); (distributed—not licensed) Ar-tone (Netherlands), CBS Int'l (worldwide), Epic Int'l (worldwide), Hed Arzi (Israel), Hungaroton (Hungary),

Murray Hill (USA), Pepita (Hungary), Qualiton (Hungary), Tempo, Vanguard (USA).
Int'l reps.: Fiji (Morris Headstrom), Hong Kong (Hong Kong Recs.), Hungary (Kultura), New Zealand (Ode).
 Axis, see EMI.
 Banner, see Dal Myles.
 Batfolk, see Battyman.
 Batgas, see Battyman.
 Batjazz, see Battyman.
 Battyman Recs. Australia, PO Box 94, 101 William St., Bathurst, NSW 2795. Tel: (063) 315-708, 312-062. Cable: BATRECORDS. Proprietor: Christopher Battye; A&R: Tony Ansell; Sales Mgr.: Ian Frame; Adv. & Album Cover Design: Marc Battye. (Also see RCA)
Labels: (Owned) Batfolk, Batgas, Batjazz.
 Big Time, see Wizard.
 Bluebird, see RCA.
 Blue Goose, see 7 Recs.
 Bootleg, see Fable.
 Bullet, see Recording Industry Mktg. Servs.
 Bunyip Recs., 1/17 Wilgar St., Bondi, NSW 2026. Tel: (02) 2718. Contact: Ian B. McLeod.
 C B S Recs. Australia Ltd. (IFPI), PO Box 941, 15 Blue St., North Sydney, NSW 2060. Tel: (02) 31-0255. Cable: COLRECORD. Telex: 21246. Mng. Dir.: William Smith; Gen. Mgr.: Alfred Watts; Mktg. Mgr.: Barry Bull.
Labels: (Owned) CBS, Epic, Harmony, Odyssey, Portrait; (licensed) Bethlehem, Blue Sky, Caribou, GTO, Jet, Kirshner, Nempcor, Philadelphia Int'l, TK, T-Neck, Tabu, Tappan Zee, Unlimited Gold.
Int'l rep.: Worldwide (CBS).
 Camden, see RCA.
 Candle/Basket, see Larrikin.
 Capitol, see EMI.
 Carinia Co. Pty. Ltd., PO Box 126, Carinia House, 6 Arramoon Rd., Willoughby (Sydney), NSW 2068. Tel: (02) 95-2005. Cable: CARINIA. Mng. Dir.: Mrs. N. Kalakowski; Gen. Mgr.: C.R. Barlow.
Labels: (Owned) Carinia, Chic, Classics-For-All, Line 99, Opera-For-All; (represented) Ariola (Germany), Audio Fidelity (USA), Baccarola (Germany), Belter (Spain), Candide (USA), Chiaroscuri (USA), Elite Special (Switzerland), Eurodisc (Germany), Fiesta (USA), Folkways (USA), Fomit-Cetra (Italy), Grecophone (USA), Harmonia Mundi (Germany), Jugoton (Yugoslavia), MPS (Germany), Metronome (Germany), Monitor (USA), PWM (Poland), RTB (Yugoslavia), C.N. Rood (Netherlands), Scascia (Italy), Telefunken (Germany), Turnabout (USA), Viking (New Zealand), Vox (USA).
Int'l rep.: New Zealand (Viking).
 Caronna & Cromaphon Recs. Ltd., GPO Box 1414M, Melbourne, Vic. 3001. Tel: (03) 318-3258. Cable: CACROMAPHON. Owner & Gen. Mgr.: Carmelo Alessi; Sales Mgr.: Bill Willis; Int'l Mktg.: Carmelo Viatreddo.
Int'l branch: Italy, Colossal & Caronna.
Int'l reps.: France (Phonodisc), Italy (A&C, Ala, Bruzia, Captain, Colossal, Galatea).
 Cascade, see Delron.
 Casino, see Delron.
 Chaluz Ents. Pty. Ltd., 74B Trafalgar St., Annandale, NSW 2038. Tel: (02) 660-0385. Mng. Dir.: Charles Fisher; Gen. & Sales Mgr.: Michael McMartin, Ass't Mgr.: Donna Reed.
Label: (Owned) Trafalgar.
 Cherry Pie Recs. (Graeme Davar Assocs.), PO Box 84, Turramurra 2074; 28 Paling St., Thornleigh, NSW 2120. Tel: (02) 84-5506. Mng. Dir.: Charles Reed (Distributed by 7 Recs.)
 Chic, see Carinia.
 Clarion Recs., 17 Airlie St., Unit 1, Peppermore Grove, WA 6011. Tel: 384-6491. Mng. Dir.: Martin Clarke.
 Classics-For-All, see Carinia.
 Classics For Pleasure, see EMI.
 Colossal Recs. of Australia, 28 Milton St., West Melbourne, Vic. 3003. Tel: (03) 329-0316. Mng. Dir.: Mimmo Lo Prete; Sales Mgr.: Steve Colombo; Branch Mgr.: Sam Lo Prete.
Labels: (Owned) Colossal, DEMA; (licensed) Ala, Alpha, Ariston, Carosello, Durium, Phonogram, Ricordi, Ri-Fi, WEA (all Italy); D'Amato (Malta); Columbia, Marfer, Zahro (all Spain); Galaxy, President (both UK).
 Columbia, see EMI.
 Columbia Studio Two, see EMI.
 Concert Rec'g, PO Box 108, 10 Caloola Rd., Wentworthville, NSW 2145. Tel: (03) 321-6189. Gen. Mgr.: John Clancy; Sales Mgr.: Mary Clancy.
Home office: USA.
Labels: (Owned) Concert, Moonlight.
 Copperfield Sound Prod'ns, PACT Bldg., 173 Sussex St., Sydney, NSW 2000. Tel: (02) 29-2824
Labels: (Owned) Copperfield; (represented) Symphony Tone (Switzerland).
Int'l rep.: UK (Spark).
 Cotillion, see WEA.
 Country Music Ents., PO Box 41W, West Tamworth, NSW 2340.
Label: (Represented) Sierra/Briar (USA).
 Crest, see Recording Industry Mktg. Servs.
 Crest Int'l, see Recording Industry Mktg. Servs.
 Customs, see Larrikin.
 D E M A, see Colossal.
 D G, see PolyGram.
 Delron Recs. (div. of Ibbate & Co. Pty. Ltd.), PO Box 64, 10-14 W. Parade, West Ryde, NSW 2114. Tel: (02) 80-3193/6334. (Importer/Exporter as World Wide Rec. Imports)
Labels: (Owned) Cascade, Casino, Delron, Solid Gold; (distributed) Dewdrop, Peter Pan, Tiny Tot; (represented) DG, Rickatik, Vee Jay (USA).
 Dewdrop, see Delron.
 Discuno, York House Basement, 294 Little Collins St., Melbourne, Vic. (Distributor/Importer).
 Dyna House Pty. Ltd., 107 Walker St., North Sydney NSW 2060. Tel: (02) 222-2444.
 E M I Recs. Australia (IFPI), 301 Castlereagh St., Sydney, NSW 2000. Tel: (02) 2-0912. Cable: EMIRECORD. Telex: 24182. Mng. Dir.: Stephen Shrimpton; Mktg. Mgr.: Brian Harris; Prod. & Promos. Mgr.: Rob Walker.
Branches: Adelaide, SA 5007, 96 Rundle St., Kent

Town, Tel: (08) 42-7771. Telex: 88312. Sales Mgr.: Andrew Eves—Brisbane, Qld. 4006, 83 Robertson St., Fortitude Valley, Tel: (07) 52-5271. Telex: 41912. Sales Mgr.: Peter Minty—Melbourne, Vic. 3122, 109/123 Burwood Rd., Hawthorn, Tel: (03) 818-0211. Telex: 33359. Sales Mgr.: Geoff Greenstill—Perth, WA 6104, 94 Daly St., Belmont, Tel: (09) 277-5433. Telex: 93146. Sales Mgr.: Larry O'Brien.
Home office: UK.
Labels: (Owned) Axis, Capitol, Classics For Pleasure, Columbia, Columbia Studio Two, EMI, EMI America, EMI Int'l, Electrola, Harvest, His Master's Voice (HMV), Listen For Pleasure, Odeon, Oz, Parlophone, Pathe, Pathe Marconi, Regal, Regal Zonophone, Stateside, Studio 301, Toshiba, (licensed domestic) Albert Prod'ns, (licensed foreign) Argo (UK), Arista (USA), Big Sound (USA), Brunswick (USA), Cube/Fly (UK), Decca (UK), Deram (UK), Logo (UK), London (USA), MAM (UK), Magnet (UK), Private Stock (USA), Purple (UK), RAK (UK), Rolling Stones (UK), Sesame Street (USA), T-Rex (UK), Threshold (UK), Waverly (UK).
Int'l reps.: France (Pathe Marconi), Germany (Electrola-EMI), Japan (Toshiba), Netherlands (Bovema-EMI), New Zealand (EMI), Philippines (Dyna), UK (EMI), USA (Capitol).
 E M S Sound Inds. Pty. Ltd., 18-20 Deeds Rd., Camden Park, SA 5038. Tel: (08) 294-6577. Mng. Dir.: John Evans, Graham Morphet.
 Earth Media Rec'g Co., 14 Glen St., Milsons Point, NSW. Tel: (02) 929-8669.
 Electrola, see EMI.
 Elektra, see WEA.
 Epic, see CBS.
 Eureka Recs., PO Box 113, North Ryde, NSW 2113. Tel: (02) 888-6470. Mng. Dir.: Les Simmonds; Mktg. Mgr.: Helen Matthews. (Distributed by RCA)
Labels: (Owned) Eureka, Stockade; (licensed foreign) Adelphi (USA), Rounder (USA), Sonet (UK).
 Fable Rec. Co. Pty. Ltd., 137 Moray, South Melbourne, Vic. 3205. Tel: (03) 699-9999. Telex: 33609. Mng. Dir.: Ron Tudor. (Distributed by Astor)
Labels: (Owned) Bootleg, Fable.
 Festival Recs. Pty. Ltd. (IFPI), 63-79 Miller St., Pyrmont, NSW 2009. Tel: (02) 660-4022. Cable: FESTIVAL. Telex: 25686. Mng. Dir.: Allan Hely; Gen. Mgr.: Jim White; Sales Mgr.: Noel W. Brown.
Int'l branches: England, New Zealand, USA.
Labels: (Owned) Festival, Festival Int'l, Infinity, Interfusion; (distributed) ATA, Mushroom, Mushroom Int'l, Razzle, Regular; (represented) A&M (USA), Barclay (France), Bearsville (USA), Beserkley (USA), Bronze (UK), Butterfly (USA), Chrysalis (UK), Crescendo (USA), DJM (UK), Fantasy (USA), Hispavoc (Spain), Island (UK), USA, Monument (USA), Musicov (USA), Project 3 (USA), Shelter (USA), Shelby Singleton (USA), Stiff (UK), United Artists (UK, USA), Virgin (UK). (SEE ADVERTISEMENT)
 Fiddling Fool Prod'ns, 19 Adolphus St., Balmain 2041. Tel: (02) 827-2203
 Focus, see Spotlight.
 Folkways, PO Box 162, Paddington, NSW 2021. Tel: (02) 33-3980.
Labels: (Represented) Adelphi, Bay, Folk-Legacy, Stinson (all USA).
 Fontana, see PolyGram.
 Fontana Gold, see PolyGram.
 44, see PolyGram.
 Gold Seal, see RCA.
 Grass Roots Recs., PO Box 243, Epping, NSW 2121. Tel: (02) 86-3817. Owners: Phil & Chris Matthews. (Distributed by PolyGram)
 Ron Gray, 12 Sheffield St., Merryland, NSW 2160.
Label: (Represented) Jazzology-GHB (USA).
 Grevillea, see Larrikin.
 H M V, see EMI.
 Hadley Recs., Egret Pl., Calala, Tamworth, NSW 2340. Tel: (067) 65-7813. Mng. Dir.: Eric W. Scott; Gen. Mgr.: Hilary B. Scott.
Labels: (Owned) Hadley; (licensed) Vokes (USA); (distributed—not licensed) Opal.
Int'l reps.: New Zealand (EMI, Master, Viking).
 Hammar Recs., 21 Wangaratta St., Richmond, Vic. 3121. Tel: (03) 42-1618. Contact: Sino Guzzardi.
 Happening Prod'ns Pty. Ltd., Umline House, 4th fl., 5-13 Northcliff St., Milsons Point, Sydney, NSW 2061. Tel: (02) 922-4100. Cable: SEMUS. Telex: 26405.
 Harbour, see 7 Recs.
 Harmony, see CBS.
 Harvest, see EMI.
 Heliodor, see PolyGram.
 His Master's Voice, see EMI.
 Billy Hyde Inds., 100 Mt. Alexander Rd., Flemington Vic. Telex: 35739. Pres.: Gary Hyde; Gen. Mgr.: Ivor McGuffin.
Label: (Represented) Latin Percussion Ventures (USA).
 Image Recs. Pty. Ltd. (IFPI), 137 Moray St., South Melbourne, Vic. 3205. Tel: (03) 699-9999. Cable: IMAGE-RECORD. Telex: 33609. Mng. Dir.: John E. McDonald; Gen. Mgr.: Keith Colias; Sales Mgr.: Dick Barnes; Promo. & A&R Mgr.: Steve Rawlins. (Licensed to Astor).
Int'l branch: USA, American Image Music Inc.
Labels: (Owned) Image, Music Plus; (licensed) Ampro Prod'ns (USA), Axe (Canada), Boot (Canada), Emerald (UK), Gateway (USA), Hawk (Ireland), Jupiter (Germany), MWC (Canada), Midsong (USA), Music World (New Zealand), Palette (Belgium), Release (Ireland), Shadybrook (USA), Specialty (USA), Takoma (USA), Sydney Thompson (UK), Who's Who in Jazz (USA).
Int'l reps.: Canada (Axe, Boot), France (Michel Laguens), Germany (Telefunken), Netherlands (Basart), New Zealand (Phonogram, Music World), South Africa (Record & Tape), UK (Emerald).
 Indigo Recs., 22 Bendo St., Richmond 3121, Melbourne, Vic. Tel: (03) 429-4299. Telex: 31413. Gen. Mgrs.: Christopher Baynes, Barry Coburn. (Distributed by Astor)
Labels: (Owned) Indigo, Seabird; (licensed) Re/Se (USA).
 Infinity, see Festival.
 Interfusion, see Festival.

J & B Recs., 501/107 Walker St., North Sydney, NSW 2060. Tel: (02) 929-5977. Mng. Dir.: Brian Nicholls; Dir.: John Evans; Sales Mgr.: Tony Paris.
 Janda Recs., 47 Wellington St., Rozelle, NSW 2039. Tel: (02) 82-0628. Contact: Andrew Steele. (Distributor)
 Jazz & Jazz, see PolyGram.
 Jazznote, see Larrikin.
 Junction, see 7 Recs.
 K G C Magnetic Tape Pty. Ltd., PO Box 118, 40 Applebee St., St. Peters, Sydney, NSW 2044. Tel: (02) 519-2677. Cable: TOWVEY Telex: 22809. Gen. Mgr.: W. Gordon.
Labels: (Owned) KGC, (licensed foreign) Bartlett Bliss (UK), Federal (USA), Gusto (USA), King (USA), Pinnacle (UK), RK (UK), Starday (USA).
 K-tel Int'l, PO Box 121, 46 Pyrmont Bridge Rd., Pyrmont, NSW 2009. Tel: 660-0011. Telex (790) 24810.
Home office: USA
 Karussell, see PolyGram.
 Krass, see Wizard.
 L & S Educational Equipment Pty. Ltd., 259 E. Boundary Rd., East Bentleigh, Vic. 3165
Label: (Represented) Caedmon (USA).
 Larrikin Recs. Pty. Ltd., 282 Oxford St., Paddington, NSW 2021. Tel: (02) 319-567. Mng. Dir.: Warren Fahey; Sales Mgr.: Alex McCubbin.
Labels: (Owned) Larrikin, (licensed-domestic) Aboriginal Arts, Candle/Basket, Customs, Grevillea, Jazznote, (licensed-foreign) Alligator, Arhoolie, Biograph, County, Flying Fish, Hexagon, Jazz Archives, Kicking Mule, Lyrichord, Rounder, Stash (all USA), Melodiya (USSR), Sonet (UK), Topic (UK)
Int'l reps.: New Zealand (Kiwii), USA (Rounder).
 Laser, see Living Sound & RCA.
 Line 99, see Carinia.
 Listen For Pleasure, see EMI.
 Living Sound Recs., 3 Lanceley Pl., Artarmon, Sydney, NSW 20. Tel: (02) 438-1488
Labels: (Owned) Laser, Living Sound.
Int'l rep.: USA (RCA).
 Lyomim Trading, PO Box 517, Crows Nest, NSW 2065
Label: (Represented) Crystal (USA).
 M G M, see PolyGram.
 MR Acoustics, PO Box 110, Albion, Brisbane 4010. Tel: 48-7598, 284-6764, 265-1582. Contact: Colin H. Robertson.
Label: (Represented) Richardson (USA).
 Megasound Pty. Ltd., 220 West St., Crows Nest, Sydney, NSW.
Label: (Represented) Sheffield Lab (USA).
 Mercury, see PolyGram.
 Mercury/Emarcy, see PolyGram.
 Mercury Golden Imports, see PolyGram.
 Metro, see PolyGram.
 Midi, see WEA.
 Minstrel (Italian) Recs., PO Box 142, Roseberry, NSW 2018. Tel: (02) 699-2720. Contact: Peter Cian.
 Miracle, see Wizard & RCA.
 Missing Link Recs. Pty. Ltd., 247 Collins St., Melbourne,

Vic. 3000. Tel: (03) 63-5507. Mng. Dir. Keith Glass; A&R: Ross Wilson.
Labels: (Owned) Missing Link, (distributed-not licensed) Ralph (USA), Regular.
Int'l reps.: Bomp (USA), Rough Trade (UK)
 Moonlight, see Concert.
 Move Recs., PO Box 266, Carlton South 3053. Tel: (03) 497-3105. Partners: Nicholas Alexander, Martin Wright.
Labels: (Owned) Move, (represented) Avant Garde (USA), Reflection (UK).
 Mushroom Recs. Holdings Pty. Ltd., 59 Wellington St., Windsor, Vic. 3181. Tel: (03) 51-9821. Cable: MUSH-REC. Telex: 31738. Mng. Dir.: Michael Gudinski; Dir.: Ray Evans; Gen. Mgr.: Gary Ashley. (Distributed by Festival)
Labels: (Owned) Mushroom, Mushroom Int'l
Int'l rep.: New Zealand (Festival). (SEE ADVERTISE-MENT)
 Music Plus, see Image.
 Dal Myles Ent. (div. of Damvyn Holdings Pty. Ltd.), 694-696 Pittwater Rd., Brookvale, NSW 2100. Tel: (02) 939-2433.
Label: (Owned) Banner.
 Nonesuch, see WEA.
 Ode Record Co. Ltd., 12 Barrack St., Sydney NSW 2000.
Int'l branch: New Zealand.
 Odeon, see EMI.
 Odyssey, see CBS.
 Old Tyme Recs., 350 Centre Rd., Bentleigh, Vic. 3204.
Label: (Represented) DRG (USA).
 Opera-For-All, see Carinia.
 Outlet Rec'g Co. Ltd., 1 Jane St., Smithfield, Sydney, NSW.
Home office: UK—Northern Ireland.
 Oz, see EMI.
 Parlophone, see EMI.
 Pathe, see EMI.
 Pathe Marconi, see EMI.
 Papito, see Avian-Guard.
 Peter Pan, see DeLron.
 Philips, see PolyGram.
 Philips Int'l, see PolyGram.
 Pisces, see Astor.
 Polydor, see PolyGram.
 PolyGram Recs. Pty. Ltd., PO Box 314, Westfield Towers, 2nd fl., 100 William St., Kings Cross, NSW 2011. Tel: (02) 357-3277. Cable: PHONREC. Telex: 26856. Mng. Dir. Ross Barlow. Mktg. Mgr. Graham Newman, A&R Mgr. Dermot Hoy; Admin. Mgr. A. Waller.
Labels: (Owned) Archiv, DG, Fontana, Fontana Gold, 44, Heliodor, Karussell, MGM, Mercury, Mercury/Emarcy, Mercury Golden Imports, Metro, Philips, Philips Int'l, Polydor, Polyphon, Polystar, Privilege, RSO, Resonance, Vertigo, Verve; (distributed) Grass Roots, Jazz & Jazz, Warm & Genuine; (licensed) BBC (UK), CTI (USA), Capricorn (USA), Charisma (UK), Chess (USA), Gladdy (UK), Kudu (USA), Mercury/Delite (USA), Mercury/Lone Star (USA), Pablo (USA), Pablo Live (USA), Polydor/EG (UK), Polydor/Kolob (USA), Polydor/MVP

(USA), Polydor/Oyster (USA), RSO/Curtom (USA), Rocket (UK), Salvation (USA), Phil Spector Int'l (UK), Track (UK), Universe.
 Polyphon, see PolyGram.
 Polystar, see PolyGram.
 Portrait, see CBS.
 Powderworks, see 7 Recs.
 Privilege, see PolyGram.
 Pumpkin Recs. Pty. Ltd., PO Box 83, Westgate 2048; 215 Parramatta Rd., Annandale, NSW.
 Pure Gold, see RCA.
 R C A Ltd., 11 Khartoum Rd., North Ryde, NSW 2113. Tel: (02) 888-5444. Cable: RCAAUST. Telex: 21654. Mng. Dir.: Robert F. Cook; Gen. Mgr.: Brian Smith.
Home office: USA
Labels: (Owned) Bluebird, Camden, Gold Seal, Pure Gold, RCA, Victor, Victrola, Vintage; (licensed-domestic) Laser, (licensed-foreign) ABC (USA), ABC/Blue Thumb (USA), ABC/Command (USA), ABC/Dot (USA), ABC/Impulse (USA), ABC/Paramount, ABC/Westminster (USA), AVI (USA), Anchor (UK), Ariola (USA), Ariola Eurodisc (Germany), BTM (UK), Bluesway (USA), Buddah (USA), Can't Stop (USA), Direction (Canada), Equinox (USA), Erato (France), Flying Dutchman (USA), GRT (USA), Grand Award (USA), Grunt (USA), Gryphon (USA), Gusto (USA), Hansa (Germany), LTD Exchange (USA), Lifesong (USA), Lollipop (Germany), Mericana (USA), Midsong (USA), Neon (UK), Numero Uno (Italy), Ovation (USA), Phantom (USA), Polar (Sweden), Prelude (USA), Probe (USA), RKM (Belgium), Signature (USA), Solar (USA), TMI (USA), Teal (South Africa), Bob Thiele Music (USA), Utopia (USA), Windsong (USA); (distributed) Battyman Recs. group, Eureka group, 7 Recs. group, Wizard group.
 R S O, see PolyGram.
 Ramrod, see Johnny Rebb.
 Raven Recs., PO Box 261, Baulkham Hills, NSW 2153. Contact: Glenn A. Baker.
 Razzle, see Festival.
 Reader's Digest Servs. Pty. Ltd., 26-32 Waterloo St., Surry Hills, Sydney, NSW 2010. Tel: (02) 699-0111. Cable: READIGEST. Telex: 20260. Rec. & Tape Dept. Mgr.: Richard P. Sammon.
Home office: USA.
 Johnny Rebb Ent's. Pty. Ltd., PO Box 341, 370A Port Hacking Rd., Caringbah, NSW 2229. Tel: (02) 525-7124, 522-7139. Pres.: Johnny Rebb; Gen. Mgr. Syd McDonagh; Music Co-ord.: Russ Kruger
Label: (Owned) Ramrod
 Record Dists. (Australia) Pty. Ltd., 32 Railway Parade, Granville, NSW 2142. Tel: (02) 637-3087. Cable: IBNATE. (Distributor)
 Recording Industry Mktg Servs. Pty. Ltd., PO Box 270, 122 Chapel St., St. Kilda, Vic. 3182. Tel: 531-1588. Mng. Dir.: Marcus Herman; Chief Consultant: Don Fraser.
Labels (Owned) AO, Bullet, Crest, Crest Int'l
 Regal, see EMI.
 Regal Zonophone, see EMI.
 Regular, see Festival & Missing Link.

**AUSTRALIA'S HOTTEST INDEPENDENT MUSIC GROUP
 CAN DO THE JOB FOR YOU
 REPRESENTING**

**MUSHROOM
 RECORDS & PUBLISHING**

**RECORDING — HOME GROWN
 REPRESENTATION WORLD WIDE**

THE SPORTS
 SPLIT ENZ
 SKYHOOKS
 RENEE GEYER
 JO JO ZEP
 & THE FALCONS

TMG
 DAVE WARNER
 CHRISTIE ALLEN
 RUSSELL MORRIS
 STARS
 THE ALIENS

PUBLISHING

STREET MUSIC (STIFF)
 VIRGIN MUSIC
 ZOMBA MUSIC
 BLACKHILL MUSIC (IAN DURY)
 CITY BOY MUSIC
 ALBION MUSIC (JOE JACKSON)

BRINGING HOME WINNERS EVERY WEEK

Mushroom Records Print
MANAGING DIRECTOR: MICHAEL GUDINSKI

P.O. Box 121, St. Kilda, Victoria, Australia 3182. Ph. (03) 51 9821. Telegrams: "Mushroom" Melbourne. Telex: 31738.
 New York: Bunyip International Ltd., 65E 55th Street, N.Y. 10022 U.S.A.

Reprise, see WEA.
 Resonance, see PolyGram.
 Rhema Recs., PO Box 52, Redfern 2016. Tel: (02) 699-6957.

Label: (Represented) Benson Co. (USA).
 Scala Rec. Import Co., 504-520 Pacific Hwy., St. Leonards, NSW 2065. Tel: (02) 43-0243. Mng. Dir.: George Polgar.

Seabird, see Indigo.
 7 Recs. Pty. Ltd., 28 Cross St., Brookvale, NSW 2100. Tel: (02) 938-2200. Cable: SEVENRECORDS Chief Exec.: Ken Harding; A&R Mgr.: Tony Waide-Ferrell; Nat'l Mktg. Mgr.: Mike Delaney. (Also see RCA)

Labels: (Owned) Junction, Powderworks, 7, (licensed domestic) Harbour, (licensed foreign) Acrobat (UK), Aura (UK), Change (Canada), Con Brio (USA), Ember (UK), Ibach (France), Inphasion (USA), Penny Farthing (UK), Rampage (UK), Transatlantic (UK); (distributed—not licensed) Blue Goose, Cherry Pie.
Int'l rep.: New Zealand (RCA).

Solid Gold, see Delron.
 Sound & Film Ents. of Australia Pty. Ltd., 122 Chapel St., St. Kilda, Vic. 3182.

Label: (Represented) CMH (USA).
 Spotlight Music Pty. Ltd., 262 Pitt St., Sydney, NSW 2000. Tel: (02) 235-7922. Dir.: Michael J. O'Neill.

Labels: (Owned) Focus, (licensed) Celebration Servs. (UK), Image VII (Canada), Messianic (USA), Sparrow/Birdwing (USA), (distributed—not licensed) World-wide Ventures (Canada).
Int'l reps.: New Zealand (Osborn Inds.), UK (Kingsway).

Staseside, see EMI.
 Stockade, see Eureka.
 Studio 301, see EMI.

Summit Recs., 176 S. Creek Rd., Dee Why West, NSW 2099. Tel: (02) 982-6577. Mng. Dir.: Simon Comper.

Swaggie Recs., PO Box 125, South Yarra, Vic. 3141. Tel: (03) 288-6280. Exec.: Nevill L. Sherburn.

Tempo, see Avon-Guard.
 Tennessee Toons, 62 Alfred St., Suite 36, Milsons Point, NSW. Tel: 922-1277.

Tiny Tot, see Delron.
 Together Ents. Pty. Ltd., 79-81 Berry St., North Sydney, NSW 2060. Tel: (02) 922-7720.

Toshiba, see EMI.
 Trafalgar, see Chaluz.
 Vertigo, see PolyGram.

Verve, see PolyGram.
 Victor, see RCA.
 Victrola, see RCA.

Viking Rec. Co. Pty. Ltd., B.O. Smith & Son, ANZ Bank Bldg., 20th fl., 68 Pitt St., Sydney, NSW 2000. Tel: (02) 233-6933. Cable: BABRUC. Telex: 22929 (Sales office only).

Home office: New Zealand, Viking Sevenses Ltd.
 Vintage, see RCA.

W E A Recs. Pty. Ltd. (IFPI), 7/9 George Pl., Artarmon, Sydney, NSW 2064. Tel: (02) 428-3633. Cable: WEAREC. Telex: 24653. Mng. Dir.: Paul M. Turner; Mktg. Mgr.: Peter Ikin.

Home office: USA, WEA Int'l.
Labels: (Owned) Asylum, Atco, Atlantic, Cotillion, Elektra, Midi, Nonesech, Reprise, WEA Int'l, Warner Bros.; (licensed) Bearsville (USA), Beggars Banquet (UK), Big Tree (USA), Black Lion (UK), Brother (USA), Clean (USA), Damont (UK), Dark Horse (UK, USA), DiscReet (USA), Finnadar (USA), Lightning (UK), Little David (USA), Manticores (USA), Pacific (USA), Paradise (USA), Planet (USA), Pogo (UK), Radar (UK), Riva (UK, USA), Rolling Stones (USA), Scotti Bros. (USA), Sire (USA), Swan Song (USA), TDS (UK), Target (UK), Warner Curb (USA), Westbound (USA), Whitfield (USA).

W & G, see Astor.
 Warm & Genuine, see PolyGram.
 Warner Bros., see WEA.

Wizard Recs. Pty. Ltd., 2 Dind St., 9th fl., North Sydney, NSW 2061. Tel: (02) 929-0244. Mng. Dir.: Tony Hogarth; Exec. Dir.: Robie G. Porter; PR Mgr.: Alan Blake. (Also see RCA)

Labels: (Owned) Big Time, Krass, Miracle, WEA, (licensed foreign) Big Bear (UK).
Int'l reps.: Canada (Polydor), Hong Kong (Wizart), New Zealand (RCA), UK (Logo).

Word Recs. Australia, 18-26 Canterbury Rd., Heathmont, Vic. 3135. Tel: (03) 729-3777. Gen. Mgr.: Stanley R. Moulton.

Branch: Sydney, NSW 2000, 309 Pitt St. Tel: (02) 212-5977.
Labels: (Licensed) Jim, Koala, Lamb & Lion, Paragon, Tempo, Word (all USA).
 World Wide Rec. Imports—Tel: (02) 80-6631—see Delron.

● music publishers

Abigail Music (Australia) Pty. Ltd., see Penjane.
 Accolade Music Pty. Ltd., see Leeds.
 Acuff-Rose Publ'ns Pty. Ltd., see Allans.

Albert Int'l Music, see J. Albert.
 J. Albert & Son Pty. Ltd. (APRA), 139 King St., Sydney NSW 2000. Tel: (02) 232-2144. Cable: MUSIC.

Allans Music Australia Pty. Ltd., PO Box 513J, Melbourne 3001, 276 Collins St., Melbourne, Vic. 3000. Tel: (03) 63-0451. Cable: PIANOFORTE. Mng. Dir.: P.J. Green; Music Dir.: F.I. Baxter.

Int'l firms represented: Alfred (USA), Associated (USA), Beacon (USA), Belwin-Mills (USA), Boston (USA), Box & Cox (UK), Breitkopf & Hartel (Germany), Canadian Music Sales (Canada), J. & W. Chester (UK), J.B. Cramer (UK), Eds. Durand (France), Edu-Tainment (USA), William Elkin (UK), Carl Fisher (USA), Handy Bros. (USA), Hargail (USA), Frederick Harris (UK), Heugel (France), Jobete (USA), Alfred A. Kalmus (UK), Leduc (France), F.E.C. Leuckart (Germany), Novello (UK), Robertson (UK), G. Schirmer (USA), Schott Eulenburg (UK), Suvini Zerboni (Italy), Gordon V. Thompson (Canada), Willis (USA).

Angle Music, see July.

Antipodes Music Pty. Ltd., see Tumbleweed.
 April Music Pty. Ltd., 15 Blue St. North, Sydney, NSW 2060. Tel: (02) 31-0255. Cable: COLRECORD. Telex: 21246. Mng. Dir.: William Smith; Mgr.: John Anderson.

Int'l firms represented: Alotogood, Blackwood, Canopy/White Oaks, Country Road, Dickiebell, Frank, Gold Hill, Albert Hammond, Inaba, Jeolsons, Kool, Manhattans, Oceans Blue, Ron Powell, RSVP/Westbrook, Saybrook, Sherlyn, Silver Blue, Stephen Stills, Sumac (all USA).

Associated Music Pty. Ltd., 306/30 Glen St., Milsons Point, NSW 2061. Tel: 929-6787. Telex: 21474. Mng. Dir.: Robert F. Cook; Gen. Mgr.: Barry Kimberley.

Int'l firms represented: Alaska (UK), American Broadcasting (USA), Ampar (USA), Ampco (USA), Anchor (UK), Apt (USA), Ariola America (USA), Artists Music (USA), Birth (UK), Blendingwell (USA), California (USA), Cents & Pence (USA), Cherry Lane (USA), Chicago (USA), Contempo (UK), Coulgriss, Crabshaw, Cyclus, Miki Dallon (UK), Daywin (USA), Don (USA), Dunbar (USA), Egg (USA), Erva (USA), 57th Street, Global, Green Mountain (USA), Horse Hairs (USA), Imagination (USA), Kidada (USA), Kimlyn (USA), Ladysmith (UK), Laetrec (South Africa), Lion (USA), Linnal (USA), Melcher (USA), Joni Mitchell (USA), Naked Snake (USA), One of a Kind, Owepar (USA), Pamco (USA), Papa Joe's (USA), Porgie (USA), RCA (Argentina, Brazil, Canada, France, Germany, Italy, Mexico, Spain, UK), Rabbit, Rashida (USA), Sailor (USA), Scorpio (France), Seagrape, Bobby Sherman (USA), Silver Dagger (USA), Silver Fiddle/Neil Young (USA), Siren, Al Stewart (USA), Summit (UK), Artie Wayne (USA), Westpar (USA), Windson (UK), Windstar (USA), Wingate, Winter Hill (USA), York, Young Blood (UK), Zevon.

Int'l reps.: Argentina, Brazil, France, Germany, Italy, Mexico, Spain (all RCA); Japan (Global), South Africa (Laetrec), UK (Sunbury), USA (Interworld).

Banksia Music, see Larrikin.
 Barrelhouse Music, see Image & July.
 Barton Music Pty. Ltd., see Chappell.

Batgas & Co. Publ'g, PO Box 94, 101 William St., Bathurst, NSW 2795. Tel: (063) 315-708, 312-062. Cable: BATRECORDS. Proprietor: Christopher Battye; A&R Tony Ansell.

Belinda Music, see Castle.
 Bellbird Music Publ'g Co. Pty. Ltd., 28 Cross St., Brookvale, NSW 2100. Tel: (02) 938-2200. Chief Exec.: Ken Harding.

Int'l firms represented: Creole (UK), Quality (UK).
 Belwin-Mills Music Pty. Ltd., see Leeds.
 Better Half Music, see Together.

Breakfast Music Publ'g (APRA), PO Box 767, Surfers Paradise, Qld. 4217. Tel: (075) 31-2107.
Int'l rep.: USA (TRO).

Bruzia Music Ed. Musicali, GPO Box 1414M, Melbourne, Vic. 3001. Tel: (03) 318-3258. Cable: BRUZIAMUSIC. Owner: Carmelo Alessi; Gen. Mgr.: Carmelo Vialfredro.

Int'l firms represented: Alessi, Bruzia, Colossal, Dema, Morgans (all Italy).
Int'l reps.: Italy (Alessi), Bruzia, Colossal, Dema, Morgans).

Campbell Connelly (Australia) Pty. Ltd., see Norman Whitley.
 Canyon Realty Pty. Ltd., see Essex.
 Castle Music Pty. Ltd. (APRA), 120 Christie St., St. Leonards, Sydney, NSW 2065. Tel: (02) 439-6688. Cable: BELL MUSIC. Telex: 22872. Mng. Dir.: Frank Donley.

Int'l firms represented: Big Pig (UK), Black Bull (UK), Compass (USA), Walt Disney (USA), EMI (UK), Al Gallico (USA), Noel Gay (UK), Health Levy (UK), Magnet (UK), RAK (UK), Stonebridge/Prophet (USA).
Int'l reps.: UK (EMI), USA (Screen Gems-EMI).

Cellar Music, see Eparaima.
 Chappell & Co. (Australia) Pty. Ltd. (APRA), GPO Box 1486, Sydney 2001, 225 Clarence St., 7th fl., Sydney, NSW 2000. Tel: (02) 290-3500. Cable: SYMPHONY. Telex: 25799. Mng. Dir.: Colin Cornish; Financial Dir.: Ron Preston.

Int'l firms represented: ABC Dunhill (USA), Ralf Arnie (Germany), Artemis (Netherlands), Barn (UK), Barn-Slade (UK), Bema/Blaise (USA), Irving Berlin (USA), Stephen Bishop (USA), Brut (USA), Bullhorn (USA), CTA Carlin (UK), Chess (USA), Clarke (USA), Crazy (UK), Davray (USA), Dynatone-Belinda (USA), Famous (USA), Fleetwood Mac (USA), Fuse (UK), Gershwin (USA), Happy (Germany), Heavy (USA), Hensley (UK), Hobbittion (USA), House of Bryant (USA), Justin Case (USA), Kamakazi (USA), Kenya (UK), Kiss Songs (USA), Kolob (USA), Leros (France), Litha (USA), Lowery (USA), Luckyy (USA), Midsong (USA), Mooncrest (UK), Music Publ'rs Holding (USA), Music Ways (USA), New Dayglow (Netherlands), Newkeys (USA), Normal (USA), Pabito (USA), Pi-Gems (USA), RSO (UK), Cyril Shane (UK), Subiddu (UK), Sparkle (UK), Sweet (UK), 20th Century (USA), Tommy Valando (USA), Joseph Weinberger (UK), Wescrat (USA).

Int'l reps.: Germany (Intersong); UK & USA (Chappell, Intersong).

Chart Music, see Festival.
 Cherry Pie Music, PO Box 84, Turramurra 2074, 28 Paling St., Thornleigh, NSW 2120. Tel: (02) 84-5506. Mng. Dir.: Graeme Rule.

Cherry River Music Pty. Ltd., 30 Glen St., Suite 304, Milsons Point, NSW 2061. (Administered by Associated Music)
Home office: USA, Cherry Lane.

Christmas Music, see Together.
 Coburn Music Ltd., see Sundowner.
 Coburn Songshop Ltd., see Sundowner.

Comet Music (Australia) Pty. Ltd., see Chappell.
 Cromwell Music of Australia Pty. Ltd., see Essex.
 Crown Music Publ'g Pty. Ltd., see Festival.
 Crystal Clear Music, see July.

Dale Music, see Image.
 Harry Dart Music, see Rondor.
 Davidson Music, see Rondor.

D. Davis & Co. Pty. Ltd., see Allans.
 Walt Disney Prod'ns Pty. Ltd., 149 Castlereagh St., Sydney, NSW 2000. Tel: (02) 61-8942. Cable: MICKMOUSE.
 Contact: Walter Granger.

Int'l firm represented: Walt Disney (USA).
 Doo Dah Music Pty. Ltd., see Tumbleweed.
 Du Monde Music, see Festival.

Eastman Publ'rs Pty. Ltd., see Chappell.
 Eparaima/Cellar Music, 19 Adolphus St., Balmain, NSW 2041. Tel: (02) 877-2203. Chief Exec.: Angus McNeil; Gen. Mgr.: Mr. Dalvanius. (Affiliated with Ephraim Music)

Ephraim Music, PO Box 867, Potts Point, NSW 2011. Tel: (02) 660-5218. Cable: FESTIVAL. Telex: 25686. Chief Exec.: Mr. Dalvanius; Mgr. Mgr. Barletta Prime.

Int'l branch: New Zealand.
 Essex Music Group (APRA), Uniline House, 4th fl., 5-13 Northcliff St., Milsons Point, Sydney, NSW 2061. Tel: (02) 922-4100. Cable: SEMUS. Telex: 26405. Gen. Mgr.: Bruce Powell.

Int'l firms represented: Baby Chick (USA), Early Morning (Canada), Essex group (UK), Garrett (USA), House of Gold (USA), Purple (USA), St. Anne's (UK), TRO (USA), Tree (USA).

Int'l reps.: USA (TRO), rest of world (Essex).
 Eureka Music (APRA), PO Box 113, North Ryde, NSW 2113. Tel: (02) 888-6470. Mng. Dir.: Les Simmonds; Gen. Mgr.: Phil Matthews.

Int'l firm represented: Happy Valley (USA).
 Festival Music Pty. Ltd. (APRA), Festival House, 1st fl., 1 Bulwara Rd., Pyrmont, Sydney, NSW 2009. Tel: (02) 660-5218. Cable: FESTIVAL. Telex: 25686. Gen. Mgr.: Peter Hebbes; Prof. Mgr.: Ray Farley; Nat'l Promos. Mgr.: David Hayes.

Int'l branch: England.
Int'l firms represented: Andorra (USA) Andustin (USA), Antisia (USA), Beserley group (USA), Blackwing (Canada), Blue Gum (UK), Boca (USA), British Lion (UK), Carlin (UK), Cherry (UK), Chrysalis (UK), Combine (USA), Danor (USA), Dawnbreaker (USA), Decoy (UK), Frank & Nancy (USA), Gannet (UK), Golden Mountain (Canada), Gold Forever (USA), Lee Hazelwood (USA), Interior (USA), Island (UK, USA), Jacou-Darnoc (USA), Josley (UK), Kaiser (USA), Levine & Brown (USA), Louvigny (UK), Magic Land (USA), Mine (USA), Neighborhood (USA), Neil (USA), Newkeys (USA), Playboy (USA), Prestige (UK), Prophecy/Black Coffee (USA), Purple (UK), Resaca (USA), Safari (UK), Shelby Singleton (USA), Skyhill (USA), Song Tailors/I've Got The Music (USA), Story Songs (USA), Tahlia (UK), Teddy Jack (USA), Tembo (UK), Times Square (USA), Touch of Gold (USA), United Artists (UK, USA), Larry Weiss (USA), Bruce Welch (UK), Window (USA), Xavier Music (UK).

Int'l rep.: USA (Canberra).
 Firewater Music, see Associated.

Sam Fox, see Southern.
 John J. Francis Music Publ'g Co. (APRA), 173 Sussex St., Sydney, NSW 2000. Tel: (02) 29-2824.

Goodman Music, see Festival.
 Happening Prod'ns Pty. Ltd., see Essex.
 Hayloft Music, see July.

Image Music (APRA), 137 Moray St., South Melbourne, Vic. 3205. Tel: (03) 699-9999. Cable: IMAGERECORD. Telex: 33609. Mng. Dir.: John E. McDonald; Gen. Mgr.: Terry Dean.

Int'l branch: USA, American Image Music Inc.
Int'l firms represented: Joe Allen Music (USA), American Image (USA), Axe (Canada), Backyard-Frontlawn (USA), Blue Echo (USA), Butterfly-Meridian (Germany), Brian Cadd (USA), Contagious (South Africa), Cumberland group (USA), Emerald (Ireland), Gold Dust (USA), Homewood House (USA), Jack (USA), Jando (USA), Intro Gebr. Meisel (Germany), Morning group (Canada), Nimbus Nine (Canada), Pacific (Japan), Prodigal Sun (USA), Rip/ Keca (USA), Hal Shaper (UK), Siegel (Germany), Squirrel (Ireland).

Int'l reps.: Canada (Morning), Japan (Pacific), Netherlands (Intersong-Basart group), South Africa (Contagious), UK (Angle), USA (American Image).

Intersong Music Pty. Ltd., see Chappell.
 Interworld Music Pty. Ltd., see Associated Music
 J. O'K Music Pty. Ltd., see Festival.

Kurt Jacob & Co. Pty. Ltd., PO Box 91, 74-78 Brandling St., Alexandria, NSW 2015. Tel: (02) 519-4916.

Int'l firms represented: Ed. Meloidie (Switzerland), Hohner (Germany, UK, USA), Pelikan (Switzerland).

Dick James Music Pty. Ltd., see Leeds.
 Jonathan Music (Australia) Pty. Ltd., 30 Glen St., Suite 306, Milsons Point, NSW 2061. Tel: (02) 929-6787. Cable: JONATHAN. Telex: 21474. Dirs. Barry & Vicki Kimberley.

Int'l firms represented: Stephen Bishop, Martin Cooper, Ghandara Edzactly, Bob James, Roland Kluger, Raydiola, Paul Simon, Bruce Springsteen, Topanga.

Int'l reps.: Belgium (Roland Kluger), Japan (Pacific), Luxembourg (Roland Kluger).

Joye Publ'g, 98 Gleebe Point Rd., Gleebe, Sydney, NSW 2037. Tel: (02) 660-3166. Cable: SHOWBIZ. Telex: 22429.

July Music (APRA), 137 Moray St., South Melbourne, Vic. 3205. Tel: (03) 699-9999. Telex: 33609. Mng. Dir.: Ron Tudor.

Kangaroo Music Corp. Pty. Ltd., see Leeds.
 Larrikin Music Ltd., PO Box 162, Paddington, NSW 2021. Tel: (02) 333-9800. Mng. Dir.: Warren Fahey; Gen. Mgr.: Phil Matthews.

Int'l firms represented: Kicking Mule (USA), Ewan MacColl (UK), Pickin' (USA), Sing out (USA), Traditional (UK).

Leeds Music Pty. Ltd., Universal House, 23 Pelican St., Darlinghurst, Sydney, NSW 2010. Tel: (02) 61-6088. Cable: LEEDSMUSIC. Telex: 25687. Mng. Dir.: Jack Howard Argent.

Home office: USA, MCA.
Int'l firms represented: Churn (USA), Cookhouse (USA), East Memphis (USA), Everblue (UK), Far Out (France), First (UK), First Artists (USA), Goblent (UK), Mother Tongue (USA), Theodore Presser (USA), Satrii (UK), Valley (UK), Vector (USA).

Leeway Music Pty. Ltd., see Leeds.
 Leiber-Stoller Music (Australia) Pty. Ltd., see Penjane.
 Leosong Copyright Serv., 30 Glen St., Suite 304, Milsons

Point, NSW 2061. Telex: 21474. Contact: Barry Kimberley

Int'l firm represented: Copyright Serv. Bureau (USA). Living Sound Music (APRA), 3 Lancelay Pl., Artarmon, Sydney, NSW 20. Tel: (02) 438-1488

Lupus Music (Australia) Pty. Ltd., see Penjane.

M A M Music Pty. Ltd., see Leeds

Martin-Coulter Music (Australia) Pty. Ltd., see Penjane.

Martins Music, 17 Airline St., Unit 1, Peppermint Grove, WA 6011. Tel: 384-6491. Mng. Dir.: Martin Clarke.

Int'l rep.: Worldwide (Festival).

Matthews Music (APRA), PO Box 243, Epping, NSW 2121. Tel: (02) 86-3817. Cable: MATTMUS. Telex: 21641. Owners: Phil & Chris Matthews.

Int'l firms represented: Air & Graces (UK), Arcade (USA), Big Secret (UK), Bug (USA), Char-Liz (USA), Barry Mason Music (UK), Plangent Vision (UK), Rock (UK), Skyhill group (USA), Three Brothers (USA).

McGarrett Music (APRA), see Chaluz.

Midnight Music, see Together.

Ivan Mogull Music (Australia) Pty. Ltd., see Essex.

Moonlight Music, see Rondor.

Morton Music, see Rondor.

Mushroom Music, 59 Wellington St., Windsor, Vic. 3181. Tel: (03) 51-9821. Cable: MUSHREC. Telex: 31738. Mng. Dir.: Michael Gudinski; Gen. Mgr.: Gary Ashley.

Int'l firms represented: Blackhill, Street, Virgin, Zomba (all UK).

Int'l rep.: UK (ATV).

Musical Rights (Australia) Pty. Ltd., see Chappell.

Music Music Pty. Ltd., see Sundowner.

Music Publ'g of Australia, see Southern.

Music Sales Australia Pty. Ltd., 27 Clarendon St., Artarmon, Sydney, NSW 2064. Tel: (02) 439-8855. Gen. Mgr.: Neville Prentice.

Home office: England.

Natures Music, see Tumbleweed.

Northern Songs Pty. Ltd., see Leeds.

Pamper Music of Australia Pty. Ltd., see Penjane.

Peer Int'l, see Southern.

Penjane Music (Australia) Pty. Ltd. (Norman Whiteley Holdings Pty. Ltd.) (APRA), PO Box 159, Uniline Bldg., 4th fl., 5-13 Northcliff St., Milsons Point, NSW 2061. Tel: (02) 922-6540/6503. Cable: ABISONG. Telex: 22859. Chm. & Mng. Dir.: Kathleen M. Whiteley; Gen. Mgr.: Penny J. Whiteley.

Pincus-Gil Music Pty. Ltd., see Leeds.

Planetary-Nom (Australia) Pty. Ltd., see Penjane.

R P M Prod'ns Pty. Ltd., see P.J.

Rainbird Music (APRA), see Image.

Rango Music Pty. Ltd., see Castle.

Razze Music, 76 Spring St., Bondi Junction, NSW 2022. Tel: (02) 389-5011. Telex: 23482. Contact: Roger Davies.

Ready Mister Music, see Cellar.

Johnny Rebb Ent's Pty. Ltd. Publ'g (APRA), PO Box 341, 370a Port Hacking Rd., Caringbah, NSW 2229. Tel: (02) 525-7124, 522-7139. Gen. Mgr.: Syd McDonagh. Mgr.: Russ Kruger.

Rondor Music (Australia) Pty. Ltd. (AMPAL, APRA), 104-108 Mount St., North Sydney, NSW 2060. Tel: (02) 96-666. Cable: IRVINGALMO. Mng. Dir.: John Bromell; Gen. Mgr.: Jane Moore.

Int'l firms represented: Arnakata, Forever, GH Music, RMO, Riva, Rondor, Strange, Whitsett-Churchill (all UK), Alchemical, Almo, Big Bay, Big Hill, Blue Street, Braintree, Doors, John Farrar, Fifth Floor, Four Knights, Fourth Floor, Hibiscus, Hollenbeck, India, Irving, Jowck, Jumbuck, Lady Jane, Bob Marley, Medicine Hat, Muscle Shoals Sound, Pal Dog, Porchester, Saggfire/Pamyokeen, Boz Scagg, John Sebastian, Shillelagh, Wolfsongs (all USA), Almo (Canada), Gallo (South Africa), Global (Germany), Interchange (Canada), Irving (Canada).

Saints Music, see Together.

Sandy Music Co. Ltd., see Sevenses.

A. Schroeder Music (Australia) Pty. Ltd. (APRA), ADC House, 12th fl., 99 Elizabeth St., Sydney, NSW 2000. Tel: (02) 233-1588.

Home office: USA.

Int'l firms represented: Aloud, Anim, Arbutus, Arch, Avaris, Bagimin, Bella Godiva, Boscoe, Burlac, Catch Fire, Cat Mother, Dandy Dittys, Dreams & Visions, Emm-Jay, Fitness King, Fool Killers, Foorvus Survival, Kim Fowley, Golden Unlimited, Great Montana, Hedley Songs, Homecoming, Humdrum, January, Jenji, Joans Bones, Joint, LaLanne, Larball, Lassie, Last Laugh, Lazy Canary, Magnanimous, Manistee, Mempro, Mile Wide River, Mother Hen, My Baby's, Next Stop, One Stop, Pierhead, Pitfield, Rebecca Raccoon, Rel-Nel, Rojnorh, Sa-Vette, Sea-Lark, Sepe, Skin, Stewart-Nims, Summertree, Super Songs, Tijuca, Va-Detta, Vancouver, Very Own, Wraith, Yameta, Zekelief Follies.

Sevenses Publ'g Pty. Ltd., c/o B.O. Smith & Sons, ANZ Bank Bldg., 20th fl., 68 Pitt St., Sydney, NSW 2000. Tel: (02) 233-6933. Cable: BABRUC.

Int'l firms represented: Modo (USA), Revolution (USA).

Int'l rep.: UK (Emerald, MCPS).

Songways Serv. of Australia Pty. Ltd., see Essex.

Soul Music, 10-14 W. Parade, West Ryde, NSW 2114.

Southern Music Publ'g Co. Australasia Pty. Ltd., Carlton House, 38-40 York St., Sydney, NSW 2000. Tel: (02) 29-2547. Cable: SOUTHMUSIC.

Home office: USA. Peer-Southern Org.

Sparmac Music, 2 Dind St., 9th fl., North Sydney, NSW 2061. Tel: (02) 929-0244.

Spoone Music Pty. Ltd., see Leeds.

Spotlight Music Pty. Ltd. (AMPAL), 262 Pitt St., Sydney, NSW 2000. Tel: (02) 235-7922. Dir.: Michael J. O'Neill.

Int'l firms represented: Birdwing, Candle, Latter Rain, Shaundra, Sparrow (all USA).

Sugarmusic Australasia Pty. Ltd., see Allans.

Sundowner Music Pty. Ltd. (APRA), PO Box 215, Armadale, Melbourne, Vic. 3143. Tel: (03) 509-4031. Dir.: Barry M. Coburn.

Int'l firms represented: Collins (UK), No Exit (USA), Rear Exit (USA), Spaniel Music (UK).

Int'l rep.: UK (Spaniel).

Swaggie Music (APRA), 21 Renown St., Burwood, Vic. 3125. Tel: (03) 288-6280. Exec. Nevill L. Sherburn.

Sweet City Songs Pty. Ltd., see Associated Music.

Sydney Tree Pty. Ltd., see Essex.

Tangerine Music Pty. Ltd., see Leeds.

Tasty Music, see July.

Together Ent's Pty. Ltd., 79-81 Berry St., North Sydney, NSW 2060. Tel: (02) 922-7720.

Int'l reps.: Scandinavia (Air), UK (ATV).

Trafalgar Music, 748 Trafalgar St., Annandale, NSW 2038. Tel: (02) 660-0385. Mng. Dir.: Charles Fisher; Gen. Mgr.: Michael McMartin.

Tumbleweed Music Pty. Ltd. (APRA), 88 Richardson St., Albert Park, Vic. 3206. Tel: (03) 699-5366. Cable: OZRECORDS. Telex: 35906. Mng. Dir.: Glenn Wheatley; Gen. Mgr.: Paul Wheatley.

Int'l branch: USA, Australian Tumbleweed.

Int'l firms represented: Arista/Careers (USA), Billabong (UK).

Int'l reps.: Belgium (Martin-Coulter), France (Pathe Marconi), Germany (Melodie der Welt, Siegel Musikverlage), Japan (Taiyo), Luxembourg (Martin-Coulter), Netherlands (Anagon), Scandinavia (Air), UK (EMI).

United Artists Music (Australia) Pty. Ltd., see Festival.

Wallaby Music Pty. Ltd., see Chappell.

Warner Bros. Music (Australia) Pty. Ltd. (APRA), 319b Penhurst St., Willoughby, Sydney, NSW 2068. Tel: (02) 406-5322. Cable: WARNERMUSE. Telex: 24653. Mng. Dir.: Bill Flemming; Gen. Prof. Mgr.: Joanne Dolan.

Int'l firms represented: Big Bang, Blue Oyster Cult, Bridgeport, Broken Bird, C'est, Chimmy, Cotillion, Custom, Daly City, Diamondback, Divine's, Douglas, East, Evansongs, Feckless, Flat Lizard, Fozbass, Giving Room, Guerilla, Hightree, Ice Age, Ice Nine, Jefferson Starship, Jump Tunes, Know, Kru, Mad Man's Drum, Marsaint, Martin-Coulter, Maybe, Mews, Play My, Primal Energy, Pronto, Quackenbush, Quark, Rosebud, Sergeant, Skunkster, Snug, Soquel, Somerset, Southfield, Staysail, Stoneflower, Superhype, Taupain, Tessa, Thin Ice, Topographic, Viva, Walden, Warner Bros., Wilsons, Windcor, Wow & Flutter.

Int'l reps.: Brazil, France, Germany, Italy, Netherlands, Scandinavia, South Africa, UK, USA (all Warner Bros.).

Hans Wewerka (Australia) Pty. Ltd., see Penjane.

Wheel Publ'g, see Joye Publ'g.

Norman Whiteley Holdings Pty. Ltd., PO Box 159, Uniline Bldg., 4th fl., 5-13 Northcliff St., Milsons Point, NSW 2061. Tel: (02) 922-6540/6503. Cable: ABISONG. Telex: 22859. Chm. & Mng. Dir.: Kathleen M. Whiteley; Gen. Mgr.: Penny Whiteley.

Int'l firms represented: Big Seven (USA), Fame (USA), Gale (UK), Gambi (USA), Jump (Italy), Larball (UK), Laurel Canyon (USA), Lupus (UK), Penjane (UK), Pink Floyd (UK), Rudolf Slezak (Germany), Time (USA), Tree Int'l (USA), Trio/Hudson Bay (USA), Venice (USA), Hans Wewerka (Germany), Wizard (UK).

Int'l reps.: Japan (Intersong), South Africa (Intersong), UK (Penjane), USA (Royalty Control, Venice).

Ross Wilson Publ'g Pty. Ltd., see Tumbleweed.

Woomera Music Co. (APRA), 17-19 Radford Rd., Reservoir, Vic. 3073. Tel: 460-4522. Cable: DUALSCALE MELBOURNE.

Int'l branch: USA, Jasper.

Int'l firms represented: Banff (Canada), Hansa (Germany), Rodeo (Canada), Sparta-Florida (UK).

Int'l rep.: Worldwide (Jaspar).

Word Books Australia, 18-26 Canterbury Rd., Heathmont, Vic. 3135. Tel: (03) 729-3777. Gen. Mgr.: Stanley R. Moulton.

Int'l firm represented: Word (USA).

World Music, see Southern.

Yeldah Music (APRA), Egret Pl., Calala, Tamworth, NSW 2340. Tel: (067) 65-7813. Mng. Dir.: Eric W. Scott; Gen. Mgr.: Hilary Scott.

Int'l rep.: Worldwide excluding New Zealand (Robert Mellin).

E M I (Australia) Ltd., 301 Castlereagh St., Sydney, NSW 2000. Tel: (02) 20912. Cable: EMIRECORD. Telex: 24182. Music Opns. Mng. Dir.: Stephen Shrimpton; Mktg. Mgr.: Brian Harris.

Hadley Recs., Egret Pl., Calala, Tamworth, NSW 2340. Tel: (067) 65-7813. Mng. Dir.: Eric W. Scott; Gen. Mgr.: Hilary Scott.

Kettle Art, 3 Systurum St., Ultimo, NSW 2007. Tel: (02) 211-0835. Contact: Rick Godfrey.

Klarion Ent's Pty. Ltd., 63 Kingsway, South Melbourne, Vic. 3205. Tel: (03) 61-3801. Mng. Dir.: B.K. Horman; Sales Mgr.: R. Welch. (Tape only).

Move Recs., PO Box 266, Carlton South 3053. Tel: (03) 497-3105. Partners: Nicholas Alexander, Martin Wright.

Mushroom Art, 59 Wellington St., Windsor, Vic. 3181. Tel: (03) 51-9821. Cable: MUSHREC. Telex: 31738. Mng. Dir.: Michael Gudinski; Gen. Mgr.: Alan Scholz.

Gary Pearton, 42 NW Arm Rd., Gympie, NSW. Tel: (02) 29-2824, 521-5485.

Recording Industry Mktg. Servs. Pty. Ltd., PO Box 270, 122 Chapel St., St. Kilda, Vic. 3182. Tel: 531-1588. Mng. Dir.: Marcus Herman; Chief Consultant: Don Fraser.

W & G Rec. Processing Co. Pty. Ltd., 17 Radford Rd., Reservoir, Melbourne, Vic. 3073. Tel: (03) 460-4522. Cable: DUALSCALE. Dir.: R.J. Gillespie; Gen. Mgr.: A.E. White.

LICENSING ORGANIZATIONS, MUSIC

A P R A (Australasian Performing Right Ass'n) Ltd., 25-27 Albany St., Crows Nest, Sydney, NSW 2065. Tel: (02) 439-8666. Mng. Dir.: J.L. Sturman. (Performing rights only)

Int'l branch: New Zealand.

Phonographic Performance Co. of Australia Ltd., 222 Pitt St., Sydney, NSW 2000. Tel: (02) 233-5677. Gen. Mgr.: John L. Hayes. (Performing rights only)

PLATING, PROCESSING & PRESSING PLANTS

C B S Recs. Australia Ltd., 15 Blue St., North Sydney, NSW 2060. Tel: (02) 31-0255. Mng. Dir.: William Smith; Gen. Mgr.: Alfred Watts. (Pressing only).

E M I (Australia) Ltd., 301 Castlereagh St., Sydney, NSW 2000. Tel: (02) 20912. Cable: EMIRECORD. Telex: 24182. Music Opns. Mng. Dir.: Stephen Shrimpton; Mktg. Mgr.: Brian Harris.

Festival Recs. Pty. Ltd., Festival House, 63-79 Miller St., Pyrmont, Sydney, NSW 2009. Tel: (02) 660-4022. Telex: 25686.

R C A Ltd., 11 Khartoum Rd., North Ryde, NSW 2113. Tel: (02) 888-5444. Cable: RCAAUST. Telex: 21654. Mng. Dir.: Robert F. Cook; Gen. Mgr.: Brian Smith.

7 Recs. Pty. Ltd., 28 Cross St., Brookvale, NSW 2100. Tel: (02) 938-2200. Cable: SEVENRECS. Chief Exec.: Ken Harding; Nat'l Mktg. Mgr.: Mike Delaune.

W & G Rec. Processing Co. Pty. Ltd., 17 Radford Rd., Reservoir, Melbourne, Vic. 3073. Tel: (03) 460-4522. Cable: DUALSCALE. Dir.: R.J. Gillespie; Gen. Mgr.: A.E. White. (Plating & processing only)

PRINTERS & LITHOGRAPHERS

C B S Recs. Australia Ltd., 15 Blue St., North Sydney, NSW 2060. Tel: (02) 31-0255. Cable: COLRECORD. Telex: 21246. Mng. Dir.: William Smith; Gen. Mgr.: Alfred Watts.

E M I (Australia) Ltd., 301 Castlereagh St., Sydney, NSW 2000. Tel: (02) 20912. Cable: EMIRECORD. Telex: 24182. Music Opns. Mng. Dir.: Stephen Shrimpton; Mktg. Mgr.: Brian Harris.

Klarion Ent's Pty. Ltd., 63 Kingsway, South Melbourne, Vic. 3205. Tel: (03) 61-3801. Mng. Dir.: B.K. Horman; Sales Mgr.: R. Welch. (Tape only).

R C A Ltd., 11 Khartoum Rd., North Ryde, NSW 2113. Tel: (02) 888-5444. Cable: RCAAUST. Telex: 21654. Mng. Dir.: Robert F. Cook; Gen. Mgr.: Brian Smith.

RECORD PROMOTION

Festival Recs. Pty. Ltd., Festival House, 63-79 Miller St., Pyrmont, Sydney, NSW 2009. Tel: (02) 660-4022. Telex: 25686.

Patch Prod'ns Pty. Ltd., 8 Yeo St., Sydney, NSW 2089. Tel: (02) 909-2584.

Recording Industry Mktg. Servs. Pty. Ltd., PO Box 270, 122 Chapel St., St. Kilda, Vic. 3182. Tel: 531-1588. Mng. Dir.: Marcus Herman; Chief Consultant: Don Fraser.

TAPE CUSTOM DUPLICATORS TAPE PACKAGING & LABELING

The Audio and Video lines indicate the configurations which the firms duplicate. Companies which offer packaging and labeling of tape product are indicated by: (PKG) which appears after the main body of their respective listings.

C B S Recs. Australia Ltd., 15 Blue St., North Sydney, NSW 2060. Tel: (02) 31-0255. Cable: COLRECORD. Telex: 21246. Mng. Dir.: William Smith; Gen. Mgr.: Alfred Watts.

Audio: Cassette.

Caras Emporium Pty. Ltd., 215 Lonsdale St., Melbourne, Vic. 3000. Tel: (03) 663-3605. Telex: 31501 (Manufacturers' rep.).

Audio: 8-tr., 8-tr. quadraphonic, cassette, open reel.

Brand name: Trackmaster.

Copperfield Sound Prod'ns, PACT Bldg., 173 Sussex St., Sydney, NSW 2000. Tel: (02) 29-2824.

Audio: Cassette, open reel.

E M I (Australia) Ltd., 301 Castlereagh St., Sydney, NSW 2000. Tel: (02) 20912. Cable: EMIRECORD. Telex: 24182. Music Opns. Mng. Dir.: Stephen Shrimpton; Mktg. Mgr.: Brian Harris.

Audio: Cassette.

● sheet music jobber / supplier

Music Sales Australia Pty. Ltd., 27 Clarendon St., Artarmon, Sydney, NSW 2064. Tel: (02) 439-8855. Gen. Mgr.: Neville Prentice.

Home office: England.

● services

ASSOCIATIONS & PROFESSIONAL ORGANIZATIONS

A R I A (Australian Rec. Ind. Ass'n), 222 Pitt St., Sydney, NSW 2000. Tel: (02) 233-5677. Cable: PHONOCORD. Exec. Dir.: John L. Hayes.

Australian Copyright Council Ltd., 24 Alfred St., Milsons Point, NSW 2061. Tel: (02) 92-1151. Chm.: G. O'Donnell.

Australian Music Publ'rs Ass'n Ltd., 215-217 Clarence St., Sydney, NSW 2000. Tel: (02) 29-7631. Dir.: A.J. Turner.

Musica Viva Australia, 68-70 Clarence St., Sydney, NSW 2000. Tel: (02) 29-8441. Concerts Mgr.: Kim Williams. Admin. & Int'l Tours Mgr.: Suzanne Gleeson.

Recording Society of Australia, 4 Harston Ave., Mosman, Sydney, NSW.

DESIGN & ARTWORK

A T A Sound, 96 Glebe Point Rd., Glebe, Sydney, NSW 2037. Tel: (02) 660-3372. Cable: SHOWBIZ. Telex: 22429. (Rec. only).

Concert Rec'g, PO Box 108, 10 Caloola Rd., Wentworthville, NSW 2145. Tel: 631-6189.

Home office: USA, Los Angeles, Calif.

Copperfield Sound Prod'ns, PACT Bldg., 173 Sussex St., Sydney, NSW 2000. Tel: (02) 29-2824.



Festival records

FESTIVAL MUSIC

AUSTRALIA'S LARGEST INDEPENDENT

AUSTRALIA

FESTIVAL RECORDS PTY. LTD.
FESTIVAL MUSIC PTY. LTD.
63-79 Miller Street,
PYRMONT. 2009
Tel: (02) 660 4022 Telex: 25686

NEW ZEALAND

FESTIVAL RECORDS (N.Z.) LTD.
69 Carlton Gore Road,
AUCKLAND. 1 N.Z.
Tel: 33885
Telex: 21057

LONDON

FESTIVAL RECORDS INTERNATIONAL LTD.
14 Harley House,
Upper Harley St.
LONDON. NW1 4PZ
Tel: (01) 486 4182
Telex: 269086

NEW YORK

FESTIVAL MUSIC PTY. LTD.
C/- TRANSACTION MUSIC LTD.
225 East 57th Street,
NEW YORK.
NEW YORK. 10022 U.S.A.
Tel: (212) 838 2590 Telex: 421943

E M S Sound Inds. Pty. Ltd., 18-20 Deeds Rd., Camden Park, SA 5038. Tel: (08) 294-6577. Mng. Dirs. John Evans, Graham Morphett.
Audio: Cassette.
Festival Recs. Pty. Ltd., Festival House, 63-79 Miller St., Pyrmont, Sydney, NSW 2009. Tel: (02) 660-4022. Telex: 256866.
K G C Magnetic Tape Pty. Ltd., PO Box 118, 40 Applebee St., St. Peters, Sydney, NSW 2044. Tel: (02) 519-2677. Cable: TOWVEY. Telex: 22809. Gen. Mgr.: W. Gordon; Sales Mgr.: E. Black; Audio Sales Mgr.: Carlo Ferrante.
Audio: 8-tr., cassette, open reel.
Video: 1/4" cassette, 1/2" cassette VHS, Beta, Philips.
Klarion Ent's. Pty. Ltd., 63 Kingsway, South Melbourne, Vic. 3205. Tel: (03) 61-3801. Mng. Dir.: B.K. Horman; Sales Mgr.: R. Welch.
Audio: 8-tr., 8-tr. quadrasonic, cassette, open reel.
Video: 1/4" cassette.
R C A Ltd., 11 Khartoum Rd., North Ryde, NSW 2113. Tel: (02) 888-5444. Cable: RCAAUST. Telex: 21654. Mng. Dir.: Robert F. Cook; Gen. Mgr.: Brian Smith.
Audio: Cassette.
Recording Industry Mktg. Servs. Pty. Ltd., PO Box 270, 122 Chapel St., St. Kilda, Vic. 3182. Tel: 531-1588. Mng. Dir.: Marcus Herman; Chief Consultant: Don Fraser. (PKG only)
Tape Duplicators Pty. Ltd., 3 Chard Rd., Brookvale, NSW 2100. Tel: (02) 938-1539. Dir.: Don Thomson.

● **supplies**

CARTRIDGE & CASSETTE PARTS

Greencorp Magnetics Pty. Ltd., 80 Perry St., Matraville, NSW 2036. Tel: (02) 661-6511. Telex: 24761. Mng. Dir.: Jack N. Green; Gef. Mgr.: Warren A. Green; Sales Mgr.: Stephen L. Green; Technical Mgr.: Peter Price.
Int'l branches: Hong Kong, Israel, UK.

EMPTY CARTRIDGES, CASSETTES & REELS

Ampex Australia Pty. Ltd., 4 Carlotta St., Artarmon, Sydney, NSW 2064. Tel: (02) 439-4077. Cable: VIDEOTAPE. Mgr./Dir.: Greg Nixon; Magnetic Tape Div. Mktg. Mgr.: Richard Blackett.
Branch: West Melbourne, Vic., 541 King St. Tel: (03) 329-0388.
Audio: 8-tr., cassette, open reel.
Greencorp Magnetics Pty. Ltd., 80 Perry St., Matraville, NSW 2036. Tel: (02) 661-6511. Telex: 24761. Mng. Dir.: Jack N. Green; Gen. Mgr.: Warren A. Green; Sales Mgr.: Stephen L. Green; Technical Mgr.: Peter Price.
Int'l branches: Hong Kong, Israel, UK.
Audio: 8-tr., cassette, open reel.
K G C Magnetic Tape Pty. Ltd., PO Box 118, 40 Applebee St., St. Peters, Sydney, NSW 2044. Tel: (02) 519-2677. Cable: TOWVEY. Telex: 22809. Gen. Mgr.: W. Gordon; Sales Mgr.: E. Black; Audio Sales Mgr.: Carlo Ferrante.
Audio: cassettes, 5" & 7" reels.
Klarion Ent's. Pty. Ltd., 63 Kingsway, South Melbourne, Vic. 3205. Tel: (03) 61-3801. Mng. Dir.: B.K. Horman; Sales Mgr.: R. Welch.
Audio: Open reel.

LABELS

E M I Recs. Australia, 301 Castlereagh St., Sydney, NSW 2000. Tel: (02) 20912. Cable: EMIRECORD. Telex: 24182. Music Opts. Mng. Dir.: Stephen Shrimpton; Mktg. Mgr.: Brian Harris.
R C A Ltd., 11 Khartoum Rd., North Ryde, NSW 2113. Tel: (02) 888-5444. Cable: RCAAUST. Telex: 21654. Mng. Dir.: Robert F. Cook; Gen. Mgr.: Brian Smith.
W & G Rec. Processing Co. Pty. Ltd., 17 Radford Rd., Reservoir, Melbourne, Vic. 3073. Tel: (03) 460-4522. Cable: DUALSCALE. Dir.: R.J. Gillespie; Gen. Mgr.: A.E. White.

RECORD PROCESSING MACHINERY

Nylex Corp. Ltd., Pine Rd., Yennora, NSW 2165. Tel: (02) 632-0155. Dir.: Peter J. Derham; Gen. Mgr.: Douglas Weir; Sales Mgr.: M. Scott.
Chief product: Vinyl compound (dry blend, granules or biscuit).

PROFESSIONAL TAPE SUPPLIES

Ampex Australia Pty. Ltd., 4 Carlotta St., Artarmon, Sydney, NSW 2064. Tel: (02) 439-4077. Cable: VIDEOTAPE. Mgr./Dir.: Greg Nixon; Magnetic Tape Div. Mktg. Mgr.: Richard Blackett.
Branch: West Melbourne, Vic., 541 King St. Tel: (03) 329-0388.
Product: Audio & video mastering tape.

TAPE, RAW & BLANK LOADED

Agfa Carat. see Agfa-Gevaert.
Agfa-Gevaert Ltd., PO Box 48, Whitehorse Rd. 372-380, Nunawading, Vic. 3131. Tel: 878-8000. Cable: AGFAGEVAERT. Telex: 30702 Melbourne.
Audio: Blank—compact-cassette, open reel; raw—cassette, broadcast, studio.
Video: Cassette, open reel.
Brand names: Agfa Carat, Agfa Stereochrom, Agfa Videochrom.
Agfa Stereochrom. see Agfa-Gevaert.
Agfa Videochrom. see Agfa-Gevaert.
Ampex Australia Pty. Ltd., 4 Carlotta St., Artarmon, Sydney, NSW 2064. Tel: (02) 439-4077. Cable: VIDEOTAPE. Mgr./Dir.: Greg Nixon; Magnetic Tape Div. Mktg. Mgr.: Richard Blackett.
Branch: West Melbourne, Vic., 541 King St. Tel: (03) 329-0388.
Audio: 8-tr., cassette, open reel.
Audiotape. see Klarion.
B A S F Australia Ltd., PO Box 4705, Melbourne, Vic. 3001. Tel: 329-9555. Telex: 30448. Sales Mgr.: N. Price.
Audio & Video: Cassette, open reel.

Caras Emporium Pty. Ltd., 215 Lonsdale St., Melbourne, Vic. 3000. Tel: (03) 663-3605. Telex: 31501. (Manufacturers' rep.)
Audio: 8-tr., cassette.
Brand name: Trackmaster.
Crescendo. see KGC.
Crest Int'l. see Recording Industry Mktg. Servs.
G-tape. see Greencorp.
Greencorp Magnetics Pty. Ltd., 80 Perry St., Matraville, NSW 2036. Tel: (02) 661-6511. Telex: 24761. Mng. Dir.: Jack N. Green; Gen. Mgr.: Warren A. Green; Sales Mgr.: Stephen L. Green; Technical Mgr.: Peter Price.
Int'l branches: Hong Kong, Israel, UK.
Audio: 8-tr., cassette, open reel.
Video: 1/2" EIAJ open reel, 1/4" cassette.
Brand names: G-tape, Greencorp, Opus.
K G C Magnetic Tape Pty. Ltd., PO Box 118, 40 Applebee St., St. Peters, Sydney, NSW 2044. Tel: (02) 519-2677. Cable: TOWVEY. Telex: 22809. Gen. Mgr.: W. Gordon; Sales Mgr.: E. Black; Audio Sales Mgr.: Carlo Ferrante.
Audio: Blank—8-tr., cassette.
Video: Raw—1/4" cassette, 1/2" cassette VHS, Beta, Philips.
Brand name: Crescendo.
Klarion Ent's. Pty. Ltd., 63 Kingsway, South Melbourne, Vic. 3205. Tel: (03) 61-3801. Mng. Dir.: B.K. Horman; Sales Mgr.: R. Welch.
Audio: Blank—cassette, open reel; raw—8-tr., cassette, open reel.
Brand names: Audiotape, Klarion.
Opus. see Greencorp.
R C A Ltd., 11 Khartoum Rd., North Ryde, NSW 2113. Tel: (02) 888-5444. Cable: RCAAUST. Telex: 21654. Mng. Dir.: Robert F. Cook; Gen. Mgr.: Brian Smith. (Blank only)
Audio: Cassette.
Recording Industry Mktg. Servs. Pty. Ltd., PO Box 270, 122 Chapel St., St. Kilda, Vic. 3182. Tel: 531-1588. Mng. Dir.: Marcus Herman; Chief Consultant: Don Fraser. (Blank only)
Audio: Cassette.
Brand name: Crest Int'l.
Trackmaster. see Caras.

TAPE DUPLICATING & PROCESSING EQUIPMENT

B A S F Australia Ltd., PO Box 4705, Melbourne, Vic. 3001. Tel: 329-9555. Telex: 30448. Sales Mgr.: N. Price.
Audio: Pancakes.
Caras Emporium Pty. Ltd., 215 Lonsdale St., Melbourne, Vic. 3000. (Manufacturers' rep.)
Audio: Winders, exercisers, 8-tr. duplicators, verifiers, 8-tr. & cassette loaders.
Brand name: Trackmaster.
Klarion Ent's. Pty. Ltd., 63 Kingsway, South Melbourne, Vic. 3205. Tel: (03) 61-3801. Mng. Dir.: B.K. Horman; Sales Mgr.: R. Welch.
Audio: Checkers, duplicators, loaders.
Brand name: Otari.
Otari. see Klarion.
Trackmaster. see Caras.

● **accessories manufacturers**

Ampex Australia Pty. Ltd., 4 Carlotta St., Artarmon, Sydney, NSW 2064. Tel: (02) 439-4077. Cable: VIDEOTAPE. Mgr./Dir.: Greg Nixon; Magnetic Tape Div. Mktg. Mgr.: Richard Blackett.
Branch: West Melbourne, Vic., 541 King St. Tel: (03) 329-0388.
Product: Head cleaners & demagnetizers, leader & splicing tape.
Bib Hi-Fi Accessories Australia Pty. Ltd., PO Box 755, North Sydney, NSW 2060. Tel: (02) 922-3495. Dir.: R.A. Archer. (Distributor/Importer)
Home office: England.
Product: Tape carrying & storage cases, cleaners, cloths & brushes, head cleaners & demagnetizers, splicing & editing equipment, test tape.
Colossal Recs. of Australia, 28 Milton St., West Melbourne, Vic. 3003. Tel: (03) 329-0316. Mng. Dir.: Mimmo Lo Prete; Sales Mgr.: Steve Colombo.
Product: Carrying & storage cases.
Greencorp Magnetics Pty. Ltd., 80 Perry St., Matraville, NSW 2036. Tel: (02) 661-6511. Telex: 24761. Mng. Dir.: Jack N. Green; Gen. Mgr.: Warren A. Green; Sales Mgr.: Stephen L. Green; Technical Mgr.: Peter Price.
Int'l branches: Hong Kong, Israel, U.K.
Product: Carrying & storage cases, cleaners, cloths, brushes, 45 rpm adapters, head cleaners, demagnetizers, leader & splicing tape.
K G C Magnetic Tape Pty. Ltd., PO Box 118, 40 Applebee St., St. Peters, Sydney, NSW 2044. Tel: (02) 519-2677. Cable: TOWVEY. Telex: 22809. Gen. Mgr.: W. Gordon; Sales Mgr.: E. Black; Audio Sales Mgr.: Carlo Ferrante.
Product: Head cleaners, demagnetizers, leader & splicing tape.
Klarion Ent's. Pty. Ltd., 63 Kingsway, South Melbourne, Vic. 3205. Tel: (03) 61-3801. Mng. Dir.: B.K. Horman; Sales Mgr.: R. Welch.
Product: Head cleaners, demagnetizers, leader & splicing tape.

● **store fixtures & merchandising aids manufacturers**

Ampex Australia Pty. Ltd., 4 Carlotta St., Artarmon, Sydney, NSW 2064. Tel: (02) 439-4077. Cable: VIDEOTAPE. Mgr./Dir.: Greg Nixon; Magnetic Tape Div. Mktg. Mgr.: Richard Blackett.

Branch: West Melbourne, Vic., 541 King St. Tel: (03) 329-0388.
Product: Tape display racks.
Colossal Recs. of Australia, 28 Milton St., West Melbourne, Vic. 3003. Tel: (03) 329-0316. Mng. Dir.: Mimmo Lo Prete; Sales Mgr.: Steve Colombo.
Product: Display racks.
Greencorp Magnetics Pty. Ltd., 80 Perry St., Matraville, NSW 2036. Tel: (02) 661-6511. Telex: 24761. Mng. Dir.: Jack N. Green; Gen. Mgr.: Warren A. Green; Sales Mgr.: Stephen L. Green; Technical Mgr.: Peter Price.
Int'l branches: Hong Kong, Israel, UK.
Product: Divider cards.

AUSTRIA

Population: 7,508,400.
Rate of exchange: \$1 (US) = 13.70 schillings.
Per capita income: \$7,012.
No. of homes with record players: 1,350,000.
Holidays: January 1 (New Year's); Easter Monday, May 1 (Labor Day), Ascension Day, Pentecost, Corpus Christi, August 15 (Assumption), October 26 (National Holiday), November 1 (All Saints' Day), December 8 (Immaculate Conception), December 25, 26 (Christmas).

RECORDS

Records sold domestically including imports (retail value): LP's 1978—6,960,000 units, \$48,233,000; 1977—5,800,000 units, \$38,670,000. EP's 1978—6,000 units, \$24,000; 1977—12,000 units, \$44,800. Singles 1978—3,250,000 units, \$10,660,000; 1977—2,520,000 units, \$7,560,000.
Records imported from USA (factory value): 1978—\$303,723; 1977—\$249,000.
Records exported to USA (factory value): 1978—\$60,438; 1977—\$37,400.
Records imported from countries other than USA (factory value): 1978—\$17,177,900; 1977—\$14,387,000.
Records exported to countries other than USA (factory value): 1978—\$3,101,000; 1977—\$2,617,000.
Average retail price per record: LP's—\$6.93; EP's—\$4.09; singles—\$3.28.
Stereo sales: 99.5% of total.
Record club sales: 18% of total.
Discounting: Frequent.
Type of distribution: The manufacturer-to-retailer system predominates with a market share of approximately 82%; the manufacturer-to-wholesaler-to-retailer system has 14%; rack jobbing has 4%.
Type of promotion: Austrian TV and the broadcasting system owned by the government is the main source, followed by newspapers and fan clubs.
Jukeboxes: 10,000.

TAPE:

Market: The music cassette system continues to dominate in tape, posting a 20% increase over last year. The market for 8-track is virtually nonexistent.
Pre-recorded tape sold domestically: 8-tr. 1978—2,000 units, \$22,000; 1977—6,000 units, \$61,200. Cassette 1978—3,560,000 units, \$37,665,000; 1977—2,970,000 units, \$28,710,000.
Average retail price per tape: 8-tr.—\$11.17; cassette—\$10.58.

RADIO STATIONS:

No. of government 3 (2 AM & 3 FM).

TELEVISION STATIONS:

No. of channels: 2 government; 85% color (PAL).

IMPORT/EXPORT REGULATIONS:

Record imports from EFTA (European Free Trade Ass'n) and EWG (European Common Market) countries are tax free; those from the USA are taxed 18%. Tape imports from EFTA countries and EWG countries are tax free, those from the USA are taxed 10%.

MARKET ANALYSIS:

1978 was a good year for the cartel dominated Austrian record and tape industry. The cartel member companies showed a strong yearly sales increase amounting to 20%, while the non-member firms and the increasingly important record clubs both posted an 18% average increase. Unit sales of singles are on the rise, posting an impressive 29% jump over 1977. Pop and country categories accounted for 82% of sales, while classical rounded out the remaining 18%. As in recent years, direct imports continue to gain importance.
 Although pre-recorded cassette sales increased almost 20% over 1978, sales of blank cassettes are becoming more prominent, outselling their pre-recorded cousins by almost 3 to 1. Even with the jump in both formats, it is felt that the market is still not saturated.
 As is the case for most of the rest of the world, the incidence of piracy is on the rise even though the industry is attempting to combat the problem in the courts via test cases.

Manfred Schreiber

● **record & tape manufacturers / distributors / importers**

A V O Schallplatten GmbH, Kohlgasse 23, A-1050 Vienna. Tel: (0222) 55 13 57. Telex: 77307. Gen. Mgr.: Picco Pacher.
Labels: (Owned) AVO; (distributed—not licensed)

Baca (Germany), Concord (Germany), Earl, Image (Switzerland), Opp (Germany), Topsound (Germany), Trio (Switzerland).

Accord Schallplatten Produktion GmbH & Co. KG, Herzog Friedrich Str. 8, A-6020 Innsbruck. Tel: (05222) 27 3 64. Gen. Mgr.: Wolfgang Lochbihler.

Air, see Musiscand.

Aktuell, see Musiscand.

Amadeo Oesterreichische Schallplatten GmbH (IFPI), Mariahilferstr. 127, A-1060 Vienna. Tel: (0222) 56 35 60, 56 35 68. Cable: AMADEODISC. Telex: 75261. Mng. Dir.: Dominique Dauphin-Meunier; Sales Mgr.: Julius Payer.

Labels: (Owned) Amadeo, Atom; (distributed domestic—not licensed) Mojam, WM Produktion; (distributed foreign—not licensed) Brain (Germany), CTI (USA), Can't Stop (USA), Chiswick (UK), Christophorus (Germany), Cream (USA), DJM (UK), Elite Special (Switzerland), Intercord (Germany), Kudu (USA), Lax / Far Out (USA), Logo (UK), MCA (USA), MPS (Germany), Metronome (Germany), Nems (UK), Ricordi (Italy), Scepter (USA), Storyville (Sweden), Tempo (Germany), Toledo (Germany), Transatlantic (UK), Tudor (Switzerland), WAM (Germany).

Int'l reps.: Belgium (Polydor), Finland (Finnlevy), France (Phonogram), Germany (Metronome), Italy (Ricordi), Luxembourg (Polydor), Japan (Phonogram), Netherlands (Polydor), Norway (Norsk Phonogram), Portugal (Phonogram), South Africa (EMI), Spain (Hisavox), Sweden (Sonet), Switzerland (Metronome), UK (Sonet), USA (Apon).

Angel, see EMI.

Archiv, see Polydor.

Ariola Schallplatten GmbH (IFPI), Hofmoklgasse 1-5, A-1150 Vienna. Tel: (0222) 83 56 05. Mng. Dir.: Stephan von Friedberg; Mktg. Mgr.: Erich Kräpfenbacher.

Home office: Germany, Ariola-Eurodisc.

Labels: (Owned) Ariola, Baccarola, Eurodisc, Pan; (licensed) Albion (UK), Bronze (UK), CMH (USA), Caroline (UK), Cian Celentano (Italy), Dawn (UK), Ember (UK), Front Line (UK), Golden Hour (UK), Hansa (Germany), Island (UK), Jupiter (Germany), Lifesong (USA), Mantecore (UK), Marble Arch (UK), Maritim (Germany), Melodia (USSR), Montana (Germany), Mustza (Italy), Oasis (Germany), PBR (USA), President (UK), Pve (UK), Real (UK), Roulette (USA), Shelter (USA), Sire (USA), Supraphon (Czechoslovakia), Sky (Germany), Tomato (USA), Virgin (UK); (distributed—not licensed) Arcade (Germany).

Int'l reps.: See Ariola-Eurodisc listing in Germany.

Artone, see CBS.

Atom, see Amadeo.

Baccarola, see Ariola.

Bacillus, see Bellaphon.

Bellaphon Recs., Grundsteingasse 5-7, A-1160 Vienna. Tel: (0222) 43 61 22. Telex: 759222. Gen. Mgr.: Gunther Zitta; A&R Mgr.: Josef Ofenboeck.

Home office: Germany.

Labels: (Owned) Bellaphon, Bacillus, Pflifikus; (licensed) Acanta (Germany), America (France), Arhoolie (USA), Barclay (France), Casablanca (USA), Chant du Monde (France), Charly (UK), Chelsea (USA), Concord Jazz (USA), Contour (France), Deesse (France), Disneyland (USA), ECM (Germany), ENJA (Germany), Fantasy (USA), FMP (Germany), Festival (France), Happy Bird (Germany), Immediate (UK), JAPO (Germany), Kaleidoscope (France), Lyricord (USA), Milestone (USA), Musicdisc (France), Penny Fathing (UK), Prestige (USA), Riverside (USA), Riviera (France), Roulette (USA), Saga (UK), Sastruphon (Germany), Schwann (Germany), Stanyan (USA), Steeplechase (Denmark), Sun (USA), Trojan (UK), Vogue (France).

Blue Danube, see Musidisc.

A. Burkl oHG Schallplatten Gross & Einzelhandel, Reisnerstr. 32, A-1030 Vienna. Tel: (0222) 72 14 59. (Distributor).

CBS Schallplatten GmbH (IFPI), Hofmoklgasse 1-5, A-1150 Vienna. Tel: (0222) 83 56 08. Cable: COLRECORD. Telex: (8470) 12123. Gen. Mgr.: Jaroslav Sevcik; Sales Mgr.: Friedrich Graf; Mktg. Mgr.: Stefan Hajek.

Labels: (Owned) Artone, CBS, Embassy, Epic, Harmony, Maestro, Masterworks, Odyssey, Portrait, Robbi; (licensed) A&M (USA), Blue Sky (USA), CGD (Italy), Caribou (USA), GTO (UK), Horizon (USA), Invictus (USA), Jet (UK), Kirshner (USA), Monument (USA), Philadelphia Int'l (USA), TK (USA).

Capitol, see EMI.

Columbia, see EMI.

Comunica, Schottengasse 1, A-1010 Vienna. Tel: (0222) 63 55 52, 63 24 45. Chief Exec.: Wolf-Dieter Hugelmann. (Distributed by Ariola, Discotrade & Phonogram).

Int'l rep.: Germany (Intercord).

Court Opera Classics, see Otto G. Preiser.

D C M, see Johann Kaplan.

D G, see Polydor.

Dacapo, see EMI.

Discotrade Gesellschaft mbH, Neulerchenfelderstr. 12, A-1160 Vienna. Tel: (0222) 43 89 45. Telex: 75967. Gen. Mgr.: Erich Kahr, Peter Winkler. (Distributor/Importer).

Labels: (Distributed—not licensed) Amati, Bella Musica, Clear Sound, Delta, Europa, Jet, Multisound, SST, Sonic, Song, Supertone (all Germany).

DisqueD Autriche, see Musidisc.

Donauton, see Musidisc.

E M I America, see EMI Columbia.

E M I Columbia Austria GmbH (IFPI), Webgasse 43, A-1060 Vienna. Tel: (0222) 57 36 76. Cable: EMICO. Telex: 1-13386. Mng. Dir.: Frank W. Beh; Sales Mgr.: Roland Beck; Finance & Admin. Dir.: W. Hawlik; PR & Artist Promo. Mgr.: Joe Artnr; Int'l Label Mgr.: Christine Hruska. Local branch: Kaerntnerstr. 30. Tel: (0222) 52 36 75.

Branch: A-5020 Salzburg, Universitätsplatz 15. Tel: (0222) 43 215.

Labels: (Owned) Angel, Capitol, Columbia, Dacapo, EMI, EMI America, Electrola, Harvest, His Master's Voice, Odeon, Pathe, Regal, Seraphim, Sidewalk, Stimme Seines Herrn, Talisman, (licensed) AVI (USA), Aladin (Germany), Apple (UK), Arista (USA), Artists

House (USA), Blue Note (USA), Butterfly (USA), Chandlers (Germany), Claves (Switzerland), Colorit (Germany), Crystal (Germany), Folkways (USA), Gordy (USA), Harmonia Mundi (Germany), Hoer Zu (Germany), Kaleidoskop (Germany), Kling Klang (Germany), MAM (UK), MFP (UK), MRC (Germany), Magnet (UK), Motown (USA), Negram (Netherlands), OZ (Australia), One Up (UK), Passport (USA), Prisma (Germany), Prodigal (USA), RAK (UK), Rare Earth (USA), Red Bus (UK), Rolling Stones (UK), Ruessl Raekords (Germany), Savoy (USA), Songbird (Germany), Soul (USA), Sunbird (UK), Tania (USA), Unicorn (UK), United Artists (UK, USA), Vanguard (USA), Zoom (UK).

Earl Recs., Goldschmiedgasse 3, A-1010 Vienna. Tel: (0222) 52 13 41. Chief Exec.: Renate A. Herzog.

Electrola, see EMI.

Embassy, see CBS.

Epic, see CBS.

Eurodisc, see Ariola.

Euroton Austria GmbH, Nobilegasse 40 42, A-1150 Vienna. Tel: (0222) 92 11 02. Mng. Dir.: E. Kozak. Sales Mgr.: Gerhard Hoke.

Labels: (Owned) Optima, Souvenir; (distributed) Olympia, Rex Royal; (represented) ASA (Germany), Ampex (Italy), BYG (France), Boulevard (UK), Camden (UK), Clear Sound (Germany), Documentary Series (Germany), Enterprise (UK), Eurosound (Germany), Europa (Germany), Everest (USA), Falcon (Germany), Flag (UK), Gala (Germany), Golden Sound (Germany), Hallmark (UK), Hit (Germany), Intercord (Germany), International Artists (UK), Interdisc (Sweden), Melodic (Germany), Monkey (France), Musidisc (France), PIT (Germany), Pickwick (France, USA), Plaene Platten (Germany), Rondo (Germany), Silver Sound (Germany), Topas (Germany), Windmill (UK).

Fontana, see Phonogram.

Galaxy, see Toka.

Gig Sound Recs., Favoritenstr. 72, A-1040 Vienna. Tel: (0222) 65 91 46. Telex: 133906. Mng. Dir.: Markus Spiegel; Import Mgr.: Wolfgang Strobl. (Importer)

Harmony, see CBS.

Harvest, see EMI.

Heliodor, see Polydor.

Help Int'l, see Help Recs.

Help Recs., Johann Schaschweg 9, A-9020 Klagenfurt. Tel: (04222) 31 558. Chief Exec.: Eddy Korsche.

Labels: (Owned) Help, Help Int'l, Life.

His Master's Voice, see EMI.

Intraton, see Musidisc.

H. Joehcher, PO Box 22, A-6425 Haiming, Tirol.

K-tel Int'l GmbH, Mariannengasse 32, A-1090 Vienna. Tel: 076923. Pres.: Philip Kives; Gen. Mgr.: Wolfgang Simon.

Kabarett aus Wien, see Otto G. Preiser.

Johann Kaplan Schallplattenvertrieb, Schonbrunnerstr. 46, A-1050 Vienna. Tel: (0222) 55 78 304. Gen. Mgr.: Johann Kaplan.

Labels: DCM, Offers, Vienna.

Karussell, see Polydor.

Lebendige Vergangenheit, see Otto G. Preiser.

Lesborne, see Musiscand.

Life, see Help.

M G M, see Polydor.

Maestro, see CBS.

Masterworks, see CBS.

Mercury, see Phonogram.

Metro, see Polydor.

Migo Schallplatten, Fuchsthallerergasse 11, A-1090 Vienna. Tel: (0222) 31 54 96. Gen. Mgr.: Rudolf Matissovics. (Distributor/Importer)

Labels: All labels from UK & USA.

Mojam, see Amadeo & Montego.

Montego Mgmt. (IFPI), Kohlenhofgasse 4/8, A-1150 Vienna. Tel: (0222) 83 05 52. Gen. Mgr.: Lance Lumsden; Promo. Ass't: Alice Gautier.

Label: (Owned) Mojam.

Musica Schallplatten Vertrieb GmbH (IFPI), Neustiftgasse 3, A-1071 Vienna. Tel: (0222) 93 65 48. Cable: MUSICA. Gen. Mgr.: Franz J. Wallner; Sales Mgr.: Franz Brenner. (Distributor)

Labels: (Distributed—not licensed) Aquarius, Argo, Arion, Audion, Aves, BBZ, BTM, Beggar's Banquet, Berkeley, Big Mouth, Box, Buddha, CNR, Cantaglio, Con-tempo, Creole, Cube, DRG, Decca, Delphine, Deram, Diamant, EMG, Electric, Erato, Floyda Dutchman, Fuer Dich, GEM, Gold Mind, Good Earth, Grunt, Heimat-Melodie, Ibach, Janus, Kama Sutra, Kayvette, Kick, Line, Lollipop, London, London-Crossover, Malaco, Midland, Millennium, Nova, Nova-Godear, Numero Uno, Opus, Phantom, Pinball, Pool, Produttori Associati, RCA, Riatio, Roadshow, Saga, Salsoul, Soul Train, Spaghetti, Spark, Stiff, Storyville, Strand, Tattoo, Tele-union, Threshold, Tomato, Trojan, Vinyl, Windsong, Wooden Nickel, Zerolandia.

Musiscand GmbH, Franzensweg 14, A-1100 Vienna. Tel: (0222) 68 53 27. Telex: 135309. Pres.: Gian Carlo Astor; Gen. Mgr.: Herbert Lebeda; Sales Mgr.: Peter Brunner.

Home office: Switzerland.

Labels: (Owned) Air, Aktuell, Musiscand, Vega; (distributed—not licensed) K-tel, Lesborne, Sexy.

Musidisc Schallplatten, Stuwertstr. 35, A-1020 Vienna. Tel: (0222) 24 34 01, 92 25 73.

Labels: (Owned) Blue Danube, Disque D'Autriche, Donauton, Intraton, Musidisc, Popcord, Viewtone.

Odeon, see EMI.

Odyssey, see CBS.

Offers, see Johann Kaplan.

Olympia, see Euroton.

Optima, see Euroton.

Paltram Prod'n, Gebr. Lang-G 11/18, A-1150 Vienna. Tel: (0222) 83 89 154. Gen. Mgr.: Evelyn Sperker. (Distributed by Phonogram)

Labels: Paltram, Roots, Soundbird, Truth.

Pan, see Ariola.

Pathe, see EMI.

Pflifikus, see Bellaphon.

Philips, see Phonogram.

Phonodisc GmbH, Kreiplatz 1, A-1195 Vienna. Tel: (0222) 37 15 45.

Phonogram, Mariahilfer Guertel 32, A-1061 Vienna 6. Tel: (0222) 57 62 41, 57 62 77. Telex: 012512. Pres.: Gerald J. Jacobs; A&R Mgr.: Horst Bichler.

Labels: (Owned) Fontana, Mercury, Philips, Verigo; (distributed) Paltram, Roots; (licensed) Charisma (UK), Chrysalis (UK), 20th Century (USA).

Polydor GmbH (IFPI), Mariahilfer Guertel 32, A-1061 Vienna 6. Tel: (0222) 57 05 94. Cable: POLYDOR DISC.

Labels: (Owned) Archiv, DG, Heliodor, Karussell, MGM, Metro, Polydor, Verve; (represented) Barn (UK), Capricorn (USA), Carissima (France), Carrere (France), Curtom (USA), Disco Train (Germany), EG (UK), GTO (UK), Harlekin (Netherlands), Hispavox (Spain), Karma (Germany), Pablo (USA), Polar (Sweden), RSO (UK), Spring (USA).

Polygram Musikunternehmen GmbH, Mariahilfer Guertel 32, A-1061 Vienna 6. Tel: (0222) 57 63 66. Telex: 12512. Pres.: Wolfgang Arming; Procurist: Franz Rauscher.

Polyhymnia, Goldschmiedgasse 3, A-1010 Vienna Tel: (0222) 52 13 41. Chief Exec.: Renate A. Herzog.

Popcord, see Musidisc.

Portrait, see CBS.

Otto G. Preiser & Co., Fischerstiege 9, A-1010 Vienna. Tel: (0222) 63 62 41, 63 18 53. Pres.: Otto G. Preiser.

Labels: (Owned) Court Opera Classics, Kabarett aus Wien, Lebendige Vergangenheit, Preiser; (licensed) Turnabout (USA), Vox (USA).

Int'l reps.: France (Dave), Germany (EMI-Electrola), Japan (Nippon Columbia), Switzerland (Jecklin), UK (EMI Int'l), USA (German News).

Regal, see EMI.

Rex Royal, see Euroton.

Robbi, see CBS.

Roots, see Paltram & Phonogram.

S A M Produktion, Erdbergstr. 27/V, A-1030 Vienna. Tel: (0222) 72 35 64. Chief Exec.: Manuela Stinauer. Prod'r: Peter Lossack.

Seraphim, see EMI.

Sexy, see Musiscand.

Sidewalk, see EMI.

Sonotrade, Gumpendorferstr. 13, A-1060 Vienna. Mng. Dir.: Alfred Kretschmer. (Rec. Wholesaler)

Soundbird, see Paltram.

Souvenir, see Euroton.

Stimme Seines Herrn, see EMI.

Talisman, see EMI.

Teldec/Musica Austria, Neustiftgasse 3, A-1071 Vienna. Tel: 93 65 68. Telex: 13274. Mng. Dir.: Franz J. Wallner. (Distributor)

Toka Vertriebsgesellschaft mbH, Rieneossgasse 9, A-1040 Vienna. Tel: (0222) 57 91 64. Pres.: Hugo von Blumenthal; Gen. Mgr.: Helmut Zak.

Home office: Switzerland.

Labels: (Owned) Galaxy, Toka.

Truth, see Paltram.

V A M O (Verband der Arbeiter Musikvereine Oesterreich), Fischerstiege 4, A-1010 Vienna. Tel: (0222) 63 91 65.

Vega, see Musiscand.

Vertigo, see Phonogram.

Verve, see Polydor.

Vienna, see Johann Kaplan.

Viewtone, see Musidisc.

W E A Music, Florianigasse 50, A-1080 Vienna. Tel: (0222) 43 46 30. Gen. Mgr.: Gunther Zitta; Promo. Mgr.: Jeff Maxian.

W M Produktion, see Wiener & Amadeo.

Wiener Musikproduktion (IFPI), Neulerchenfelderstr. 3-7, A-1160 Vienna. Tel: (0222) 43 59 91. Cable: WMPRODUKTION. Gen. Mgrs.: Thomas Albrecht, Richard Toeman, Johann Michel; Ass't Mgrs.: Hans Granzer, Peter Jirka. (Distributed by Amadeo).

Label: (Owned) WM Produktion.

● music publishers

Aberbach Musikverlag, see Arena.

Allround Music, Goldschmiedgasse 3, A-1010 Vienna. Tel: (0222) 52 13 41. Chief Exec.: Renate A. Herzog.

Arena Musikverlag, Gluckgasse 1, A-1010 Vienna. Tel: (0222) 52 63 46.

Arends Music KG, Goldschmiedgasse 3, A-1010 Vienna. Tel: (0222) 52 13 41. Gen. Mgr.: Renate A. Herzog.

Int'l firms represented: Paul C. Arends, Burlington, Hazyland, Shirley, Trumph (all Germany).

Austro-Gerig, see Edith Hochmuth.

Bellver Music, Grundsteingasse 5, A-1160 Vienna. Tel: (0222) 43 61 22. Gen. Mgr.: Gunther Zitta.

Int'l branch: Germany.

Bosworth & Co. Ltd. GmbH, Dr. Karl Lueger Platz 2, A-1010 Vienna. Tel: (0222) 52 81 40.

Int'l branches: England, Germany.

Franz Christ Wiener Arion Verlags-GmbH, Schoenbrunnerstr. 124, A-1050 Vienna. Tel: (0222) 55 83 92. Gen. Mgrs.: Gottfried Indra, Margaretha Hrubes. (Affiliated with Feuerschutz [Ed.])

Columbia Music (Austria) Verlags GmbH, Webgasse 43, A-1060 Vienna. Tel: (0222) 57 36 76. Telex: 1-13386. Gen. Mgr.: Herbert Kefeder.

Int'l firms represented: ERP Musikverlag, Global Music Group, Montana (Ed.) (all Germany).

Int'l reps.: Germany (ERP, Global, Montana), UK (EMI).

Condor Musikverlag GmbH, PO Box 591, A-6021 Innsbruck; Siemensstr. 4, A-6041 Neu-Rum/Innsbruck. Tel: (05222) 63 45 10. Cable: MUSIKDEMATE. Telex: (05) 4222.

Int'l firms represented: Arnie Musikverlag (Germany).

Dacapo Musik & Buehnenverlag Eva Hein, see Josef Weinberger.

Danubius Musikverlag GmbH, Wurmsergasse 28/18, A-1150 Vienna. Tel: (0222) 95 13 52. Gen. Mgrs.: Rudolf Slezak, Gottfried Indra.

Int'l firms represented: ABC/Dunhill (USA), Barn (UK), Ben Ghazi (USA), Big Secret (UK), Bruno (UK), Carnbro (UK), Catrine (UK), Char-Liz (USA), Cirrus (Canada), Fennario (USA), Fiddler's (UK), GH (UK), Gambi (USA), Robin Gibb (UK), Grever (Mexico), Heathside (UK), JGK (UK), Joyride (USA), Katzenjammer (Canada), Lambda (Germany), Lollipop (Germany), Luddington House

(UK), Macauley (UK), No Exit (USA), Ornum (Germany), Penjane (Australia), Pippin the Friendly Ranger (UK), RGS (Germany), Rear Exit (USA), Ryerson (USA), Schmolzi & Slezak (Germany), Silver Cloud (UK), Slane (UK), Rudolf Slezak (Germany), Strange (UK), Stratus (Canada), Sunspot (Canada), Tembo (UK), Three Bros. (USA), Trillium (Canada), Venice (USA).

Ludwig Dobliger (Bernhard Herzmann) KG, Dorotheergasse 10, A-1010 Vienna. Tel: (0222) 52 35 04. Cable: MUSICDOB. Comm'l Mgr.: Christian Wolff.

Int'l firms represented: Associated (USA), Bote & Bock (Germany), Henle (Germany).

Int'l reps.: France (BMB Mario Bois), Germany (MGS-Zimmerhansl), Italy (Messagerie), South Africa (Criterion), UK (Alfred A. Kalmus), USA (Associated).

Eberle-Verlag, see Edith Hochmuth.
Eddyton Ed. Johann Schashlweg 9, A-9020 Klagenfurt. Tel: (04222) 31 558.

Feuerschwert (Ed.), Hofmoklgasse 1-5, A-1150 Vienna. Tel: (0222) 83 56 05. Mng. Dir.: Stephen von Friedberg; Gen. Mgr.: Gottfried Indra. (Affiliated with Franz Christ).
Gloriette Verlag, see Thomas Sessler.

Helbing KG E. Harm & Co. (Ed.), PO Box 416, A-6021 Innsbruck; Kaplanstr. 9, A-6064 Neu-Rum/Innsbruck. Tel: (05222) 62-333. Cable: HELBLINGMUSIK. Chief Exec.: Helmut Winkler.

Int'l firms represented: Michael Jary (Germany), Hans Sikorski (Germany).

Edith Hochmuth Verlags GmbH, Seilerergasse 12, A-1010 Vienna. Tel: (0222) 52 27 51, 52 21 42, 52 27 14. Telex: 75049.

Int'l firms represented: Peer-Southern Org. (USA), Siegel Musikverlage (Germany).

Josef Hochmuth Musikverlag, see Edith Hochmuth.

Gottfried Indra Musik & Bühnenverlags GmbH, Wurmsergasse 28, A-1150 Vienna. Tel: (0222) 95 13 52. Cable: INDRAMUSIK. Chief Exec.: Gottfried Indra. Local branch: Schulstr. 109, A-2103 Langenzerdorf. Tel: (02244) 25 37.

Int'l firms represented: Big Three Music, Metric Music, UA Music Int'l.

Jenisch (Musikverlag), Alberichgasse 8, A-1150 Vienna. Tel: (0222) 92 32 62, 92 56 50. Contact: Erwin H. Jenisch.
Jungbrunnen (Verlag), PO Box 583, Rauchensteingasse 5, A-1011 Vienna. Tel: (0222) 52 12 99.

Johann Kliment, Kolingasse 15, A-1090 Vienna. Tel: (0222) 34 51 47.

Ludwig Krenn GmbH, Reindorfegasse 42, A-1150 Vienna. Tel: (0222) 839-9474.

M M S-Music, Erdbergstr. 27, A-1030 Vienna. Tel: (0222) 72 35 64. Gen. Mgr.: Manuela Stinauer.

Georg Marton Verlag, see Thomas Sessler.

Meisel Produktion Musikverlag Winkler & Harm oHG, Box 591, A-6021 Innsbruck; Siemensstr. 4, A-6041 Neu-Rum/Innsbruck. Tel: (05222) 63 45 10. Cable: MUSIKDEMATE. Telex: (05) 4222. Chief Exec.: Helmut Winkler.

Int'l firm represented: Meisel (Germany).

Metroton, see Edith Hochmuth.

Montego Mgmt., Kohlenhofgasse 4/8, A-1150 Vienna. Tel: (0222) 83 05 52. Gen. Mgr.: Lance Lumsden.

Novaton, see Helbing.

Oesterreichischer Budesverlag, Schwarzenbergstr. 5, Vienna 1.

Papageno Buch & Musikalienverlag & Bühnenvertriebs GmbH, see Josef Weinberger.

Adolf Robitschek, Graben 14, A-1011 Vienna. Tel: (0222) 52 32 89.

Int'l branch: Germany.

Rubato, Hollandstr. 18, A-1020 Vienna. Tel: (0222) 33 92 42.

Hermann Schneider Musik, Glück 1, A-1010 Vienna. Tel: (0222) 52 63 46.

Screenmusic Musikverlags GmbH, Penzingerstr. 66, A-1140 Vienna. Tel: (0222) 82 26 84, 82 73 58. Gen. Mgrs.: Gerhard Heinz, Karl Spiehs, Gottfried Indra.

Thomas Sessler Verlag GmbH, Johannesgasse 12, A-1010 Vienna. Tel: (0222) 52 32 84.

Int'l branch: Germany.

Solisten-Verlag, Neulerchenfelderstr. 3-7, A-1160 Vienna. Tel: (0222) 43 59 91. Telex: 113705. Gen. Mgr.: Thomas Albrecht; Ass't Mgrs.: Hans Granzer, Peter Jirka.

Int'l firm represented: Jemara Musikverlag (Germany).

Step Two Musikverlag GmbH, Neulerchenfelderstr. 3-7, A-1160 Vienna. Tel: (0222) 43 59 91. Cable: STEPTWO. Telex: 113705. Gen. Mgrs.: Ralph Siegel, Thomas Albrecht.

Symphonia, Lothringenstr. 20, A-1030 Vienna. Tel: (0222) 72 44 48.

Universal Ed., Karlsplatz 6, A-1010 Vienna.

V A M O (Verband der Arbeiter Musikvereine Oesterreich), Fischerstiege 4, A-1010 Vienna. Tel: (0222) 63 91 65.

Int'l reps.: Germany (Johann Andree), USA (Dr. Fred Schadler).

Josef Weinberger Vienna, Neulerchenfelderstr. 3-7, A-1160 Vienna. Tel: (0222) 43 59 91. Telex: 113705. Cable: WEINJOS. Gen. Mgrs.: Thomas Albrecht, Richard Toeman, Johann Michel; Ass't Mgrs.: Hans Granzer, Peter Jirka.

Int'l firms represented: Josef Weinberger—ATV (USA), AVI (USA), Ackee (UK, USA), After Dark (USA), Fred Ahlert (USA), Alien (USA), Aliencore (USA), Alshire (USA), Aran Prod'ns (Switzerland), Associated (Australia), BL&H (USA), Baby Chick/La De Da (USA), Backfin (USA), Baldham (Germany), Bay City (UK), Beaver (USA), Beechmont (USA), Big Secret (UK), Blue Mountain (UK), Boca (USA), Bosso Fataka (USA), Bourne group (USA), Bowling Green (USA), Butterfly (Germany), Cannon group (UK), Carlyle (USA), Carmen (UK), Christabel (UK), Clendalee (USA), Co Jac (USA), Colour Me Gone (UK), Compass (Germany, Netherlands, UK, USA), Conducive (USA), Cosima (Germany), Creedmore (UK), Crusty (UK), Cuckoo (UK), Curtis (UK), Cycilus (Germany), Diamondback (USA), Dog Soldier (USA), Dump (USA), Dunbar (Canada), Eurocord (Germany), Famous group (USA), Far Out (USA), Festival Attraction (USA), Firesky (USA), Fish-Scent (USA), Frabjous (USA), Freedom (UK), Give Me A Break (USA), Global (Japan), God Tunes (USA), Great Honesty (USA),

Gull (UK), Icebag (USA), Interart (UK), Island group (UK), Jana (USA), KBL Assocs. (USA), Kaiser (USA), Keca (USA), Kidada (USA), Kilaotons (Canada), La Cienega (USA), Lady Casey (USA), Larball (USA), Ledaclan (USA), Le Rideau Rouge (France), Leviantan (UK), Libra (UK), Light (USA), Little Dragon (USA), Lucky Three (USA), Lunatones (USA), MPL Communications (UK, USA), Mandina (USA), Manticores (UK), Marksmen (UK), Mar/Vista (USA), Metal Machine (USA), Mews (UK), Micache (USA), J. Michel (Germany), Milwaukee (USA), Mole (USA), Montauk (USA), Montunes (USA), Morgen (Germany), Musical Crusaders (USA), Myriad (USA), Nightwind (USA), Nineteen Eighty Five (USA), Nobile (Germany), Oakfield Ave. (USA), One Time (USA), Panache (UK), Peach Cobbler (USA), Pearlized (USA), Petra (USA), Playboy (USA), Plurkran Krunde (USA), Pods (USA), Princess (USA), RCA group (Argentina, Brazil, France, Italy, Mexico, Spain, USA), Rashida (USA), Rip (USA), Rocksmith (USA), Leonard Sachs (USA), Salsoul (USA), Cyril Shane (USA), Songs of Manhattan Island (USA), Sugar (France, Germany, Italy), Sunbury (Canada, UK), Supertop (Germany), Sure Enough Tunes (Canada), 34 Music (UK), Tone/Carlin (UK), Tree (USA), Tumbleweed (Australia), Utopia (UK), Warfare (UK), H.B. Webman (USA), We Three (USA), Wicked Fly (UK), Widomaker (UK), Wildflowers (USA), R.P. Winkelman Tunes (USA); Wiener Musik-

produktion group—Cheap Thrills (USA), Cheerio (USA), Chinnichap (UK), Martin Cohen (USA), Covered Wagon (UK), Diamond (UK), Hubtones (USA), Alexis Korner (USA), Levine & Brown (USA), Lee (USA), Martin-Coulter (UK), Munchkin (USA), Pic (USA), Ring Musik (Germany), Rytovok (USA), Third Story (USA), Warrock (USA), Frank Zappa (USA); Wien Melodie group—Aunt Polly's (USA), Background (UK), Bathurst (USA), Blue Seas (USA), Canadian Brass (Canada), Copper (USA), Cornbread (USA), Crown Vetch (Canada), Evening (USA), First Floor (USA), Gale (UK), Gold Dust (USA), Good (USA), Alex Groshak (Canada), Jac (USA), Jack (USA), Jando (USA), Melodie der Welt (Germany), Morning (Canada, USA), Mountain Wood (USA), Programme (UK), Pulleybone (USA), Ring (Germany), Silver Dollar (USA), Skinner's Pond (Canada), Speckled Bird (Canada), Stonehill (USA), Strzelecki (USA), Time Being (Canada), Tyson South (USA), V Music (Canada).

Int'l reps.: Papageno—Germany (Heross), UK (Josef Weinberger); Josef Weinberger—Germany (Melodie der Welt, Josef Weinberger), UK (Josef Weinberger); Wiener Musikproduktion—Germany (Melodie der Welt); Wien Melodie—Germany (Melodie der Welt, Josef Weinberger), UK (Josef Weinberger).

Wiener Boheme Verlag, Erdbergstr. 27, A-1030 Vienna. Tel: 72 35 64. Mgr.: Manuela Stinauer.

Wiener Musikproduktion, see Josef Weinberger.

Wiener Verlagsanstalt, see Thomas Sessler.

Wien Melodie GmbH, see Josef Weinberger.

Wertung mechanisch-musikalischer Urheberrechte, Baumannstr. 10, A-1031 Vienna. Tel: (0222) 72 63 62. Bd. Pres.: Herman Schneider; Gen. Mgr.: Helmut Steinmetz.

Literar-Mechana GmbH (Wahrnehmungsgesellschaft fuer Urheberrechte), Linke Wienzeile 18, A-1060 Vienna 6. Tel: (0222) 57 21 61. Dir. Franz-Leo Popp.

Symphony Tone Prod'ns, Konzerthaus, Lothringenstr. 20, A-1030 Vienna. Tel: (0222) 57 54 82, 72 44 48. Cable: IMROSA. Pres.: Imre Rozsa; Gen. Mgr.: L. Manhart; Gen. Sec'y: Margarete Spevak. (Performing rights only)

Int'l branch: Switzerland.

PLATING, PROCESSING & PRESSING PLANTS

A K G (Akustische Tontraeger Gesellschaft), A-2433 Margarethen am Moos/Burgenland. Tel: (02230) 454. (Pressing only)

Phonodisc GmbH, Kreilplatz 1, A-1195 Vienna. Tel: (0222) 37 15 45. Gen. Mgr. Dr. Helmut Hofmann.

Polydor GmbH, Mariahilfer Guertel 32, A-1060 Vienna. Tel: (0222) 57 05 94.

Otto G. Preiser & Co., Fischerstiege 9, A-1010 Vienna. Tel: (0222) 63 62 28, 63 18 53. Pres. Otto G. Preiser.

RECORD PROMOTION

Communica, Schottengasse 1, A-1010 Vienna. Tel: (0222) 63 55 52, 63 24 45. Chief Exec.: Wolf-Dieter Hugelmann.

I M Z (International Music Centre Vienna), Lothringenstr. 20, A-1030 Vienna. Tel: (0222) 72 57 95.

Point Promo. Poetsch, Hofmoklgasse 1-5, A-1151 Vienna. Tel: (0222) 83 56 05. Telex: 11862. Gen. Mgr.: Wolfgang Poetsch.

TAPE CUSTOM DUPLICATORS

Musidisc Schallplatten, Stuwertstr. 35, A-1020 Vienna. Tel: (0222) 24 34 01, 92 25 73.

Phonodisc GmbH, Kreilplatz 1, A-1195 Vienna. Tel: (0222) 37 15 45. Gen. Mgr. Dr. Helmut Hofmann.

Polydor GmbH, Mariahilfer Guertel 32, A-1060 Vienna. Tel: (0222) 57 05 94.

Audio: Cassette.

supplies

EMPTY CARTRIDGES, CASSETTES & REELS

C C T (Compact Cassettes Trading)/Toka Vertriebsgesellschaft mbH, Rienoesslgasse 9, A-1040 Vienna. Tel: (0222) 57 91 64. Gen. Mgr. Helmut Zak.

Home office: Switzerland.

Musidisc Schallplatten, Stuwertstr. 35, A-1020 Vienna. Tel: (0222) 24 34 01, 92 25 73. (Importer)

CARTRIDGE & CASSETTE PARTS

C C T (Compact Cassettes Trading)/Toka Vertriebsgesellschaft mbH, Rienoesslgasse 9, A-1040 Vienna. Tel: (0222) 57 91 64. Gen. Mgr. Helmut Zak.

Home office: Switzerland.

LABELS

Phonodisc GmbH, Kreilplatz 1, A-1195 Vienna. Tel: (0222) 37 15 45. Gen. Mgr. Dr. Helmut Hofmann.

Polyethylene Bags

Musidisc Schallplatten, Stuwertstr. 35, A-1020 Vienna. Tel: (0222) 24 34 01, 92 25 73. (Importer)

TAPE, RAW & BLANK LOADED

Agfa-Gevaert GmbH, Mariahilferstr. 198, A-1153 Vienna 15. Tel: 83 36 41, 83 23 41. Telex: 2715. Mng. Dir.: H.-J. Kaminski; Sales Mgr.: A. Pollatschek.

Audio: Blank—compact-cassette, open reel; raw—cassette, broadcast, studio.

Video: Cassette, open reel.

Brand names: Agfa Carat, Agfa Stereochrom, Agfa Videochrom.

Audio Magnetics, see Inter Import.

B A S F (Austria) GmbH, Hauptstr. 50, Hietzinger, A-1131 Vienna 13. Tel: 82 36 61, 82 94 31. Telex: 12830, 11208. Sales Mgr.: Hans Kemptner.

Audio: Cassette, open reel.

Video: Blank—1" open reel, 3/4" cassette, 1/2" EIAJ cartridge.

Brand names: BASF, Philips.

Inter Import oHG, Czerningasse 6, A-1020 Vienna.

Audio: 8-tr. cassette, open reel.

Brand name: Audio Magnetics.

Musidisc Schallplatten, Stuwertstr. 35, A-1020 Vienna. Tel: (0222) 24 34 01, 92 25 73. (Importer) (Blank only)

Philips, see BASF.

accessories manufacturers / importers

A K G-Akustische & Kinogeräte GmbH, Brunhildeng. 1, A-1150 Vienna. Tel: (0222) 92 16 47. Telex: 11839.

Mng. Dir.: L. Steinkellner; Sales Mgr.: H.-J. Schnabel.

Product: Needles.

Boyd & Haas, Rupertplatz 3, A-1170 Vienna. Tel: (0222) 47 27 015.

Product: Needles.

Euroton Austria GmbH, Nobilegasse 40-42, A-1150 Vienna. Tel: (0222) 92 11 02. Mng. Dir.: E. Kazak; Sales Mgr.: Gerhard Hoke.

Product: Carrying & storage cases, 45 rpm adapters.

Migo Schallplatten, Fuchsthalergasse 11, A-1090 Vienna. Tel: (0222) 31 54 96. Gen. Mgr.: Rudolf Matiasovics.

Product: Catalog servs., cleaners, cloths & brushes.

services

ASSOCIATIONS & PROFESSIONAL ORGANIZATIONS

Austrian Music Publ'rs Union (Musikerleger Union Oesterreich), Baumannstr. 10, A-1030 Vienna. Tel: (0222) 73 15 55.

Austrian Society for Contemporary Music, Parkring 4, A-1010 Vienna 1.

Austrian Society for Music (Oesterreichische Gesellschaft fuer Musik), Hanuschgasse 3, A-1010 Vienna. Tel: (0222) 52 42 99.

European Jazz Federation, PO Box 671, A-1011 Vienna; Andreegasse 10/17, A-1070 Vienna. Tel: (0222) 93 54 29.

I G J—Internationale Gesellschaft fuer Jazzforschung (Int'l Society For Jazz Research), Leonhardstr. 15, A-8010 Graz. Tel: (03122) 32 0 53.

I M Z (International Music Centre Vienna), Lothringenstr. 20, A-1030 Vienna. Tel: (0222) 72 57 95.

International Bruckner Society, Backerstr. 18, A-1010 Vienna 1.

Internationale Gesellschaft fuer Alte Musik (International Society for Old Music), Minoritenplatz 2, A-1010 Vienna. Tel: (0222) 63 55 31. Cable: ANTICMUSIC.

Chief Execs.: Bernhard Kiebel, Hans Radbauer; Gen. Mgr.: Gerold Seidl.

International Gustav Mahler Society, Wiedner Guertel 6/2, A-1040 Vienna 4. Tel: (0222) 65 08 35, 82 73 75.

International Hugo Wolf Society, Backerstr. 12, A-1010 Vienna 1.

International Jazz Federation, Andreegasse 10/17, A-1070 Vienna.

International Society for Contemporary Music, Hanuschgasse 3, A-1010 Vienna. Tel: (0222) 52 42 99.

Mediacult (International Institute for Audio-Visual Communication & Cultural Development), Metternichgasse 12, A-1030 Vienna. Tel: (0222) 72 53 44, 75 12 86. Cable: MEDIACULT.

Mozart Society of Vienna, Boesendorferstr. 12, A-1010 Vienna.

Mozart Union, Metternichgasse 8, A-1030 Vienna 3.

Musikalsche Jugend Oesterreichs (Jeunesses Musicales), Boesendorferstr. 12, A-1010 Vienna. Tel: (0222) 65 63 56.

Musikergewerkschaft (Gewerkschaft Kunst, Medien, Freie Berufe), Maria Theresienstr. 11, A-1090 Vienna.

O R F (Austrian Radio & Television Broadcasting), Wurzburggasse 30, A-1137 Vienna. Tel: (0222) 82010. Telex: (01) 3601.

Society of the Friends of Music in Vienna (Gesellschaft der Musikfreunde in Wien), Boesendorferstr. 12, A-1010 Vienna. Tel: (0222) 65 86 81.

LICENSING ORGANIZATIONS, MUSIC.

A K M Gen. mbH (Staatlich genehmigte Gesellschaft der Autoren, Komponisten & Musikverleger), Baumannstr. 8-10, A-1030 Vienna. Tel: (0222) 73 15 55. Cable: MUSIKAUOTREN. Pres.: Dr. Marcel Rubin; Gen. Mgr.: Ernst Huemer. (Performing rights only)

Austro-Mechana GmbH (Gesellschaft zur Verwaltung & Aus-

Musidisc Schallplatten, Stuwstr. 35, A-1020 Vienna. Tel: (0222) 24 34 01, 92 25 73. (Importer)
Product: Carrying & storage cases, cleaners, cloths & brushes.

● store fixtures & merchandising aids manufacturers / importers

Euroton Austria GmbH, Noblegasse 40-42, A-1150 Vienna. Tel: (0222) 92 11 02. Mng. Dir.: E. Kozak; Sales Mgr.: Gerhard Hoke.

Product: Browser boxes, display racks.
Musidisc Schallplatten, Stuwstr. 35, A-1020 Vienna. Tel: (0222) 24 34 01, 92 25 73. (Importer)
Product: Display racks.

BAHAMAS

Population: 210,000.

Rate of exchange: \$1 (US) = 1.0 Bahamian dollars.

Per capita income: \$3,000.

Holidays: January 1, Good Friday, Easter Monday, Whit Monday, May 24 (Commonwealth Day), First Friday in June (Labor Day), first Monday in August (Emancipation Day), Thursday & Friday before first Monday in August, October 12 (Columbus Day), December 25, 26.

Records, record blanks & pre-recorded media imported from USA: 1977—\$205,813.

● record & tape manufacturers / distributors / importers

International House of Music Ltd., PO Box N8208, Mackay St., Nassau, N.P. Tel: (809) 325-0331. Cable: MUSIC. Pres.: Bradley B. Roberts. (Distributor/Importer).

O H B Recs. Co., Box 521, Nassau, N.P.
Home office: USA.

BELGIUM

Population: 9,890,000.

Rate of exchange: \$1 (US) = 32.8 Belgian francs.

Per capita income: \$5,851.

Holidays: January 1, May 1 (Labor Day), Whit Monday, Ascension, July 21 (Independence Day), August 15 (Assumption), November 11 (Armistice Day), November 15 (King's Birthday), December 25.

RECORDS:

Records sold domestically: Pop LP's 1978—11,500,800 units; Classical LP's 1978—1,000,000 units; Singles 1978—17,000,000 units.

Records, record blanks & pre-recorded media imported from USA: 1977—\$1,270,040.

Average retail price per record: LP's—\$5.12; EP's—\$3.00; singles—\$2.30.

Stereo sales: 100% of total.

Type of distribution: Manufacturer/licensor/importer-to-retailer—57% of all sales; wholesaler-to-retailer—25%; rackjobbing—18%.

Type of promotion: Records are promoted mainly either through radio and TV or personal appearances by the artists.

Jukeboxes: 30,000.

TAPE:

Classical cassettes sold domestically: 1978—2,500,000 units.

Market: Most pre-recorded tape is sold for car players. 8-track cartridge sales are declining because European manufacturers are not producing enough 8-track hardware.

Import sales: 90% of total.

Average retail price per tape: 8-tr. & cassette—\$8.59.

● record & tape manufacturers / distributors / importers

A R S A, see Anvers Radio.
A R S Recs. PvbA, 52 Hopland, B-2000 Antwerp. Tel: (031) 33-31-55. Owners: P. Busschots, L. Verammen.

A Z, see Polydor.

Adele, see Phonogram.

Ades, see Polydor.

Albatros, see Phonogram.

Alpha, see Leman & Gorle.

Alpha Recs., 116 Ledesteenweg, B-9410 Erpe-Mere. Tel: (053) 70-43-23. (Distributor)

Animato, see Basart.

Anvers Radio SA (IFPI), 10 Place de l'Yser, B-1000 Brussels. Tel: (02) 218-7400. Cable: ANRAD. Telex: 62526. Admin'r Dir.: Y. Jordens; Admin'r: W. Goldschmidt; Sales Mgr.: Jan Kolsteren; PR: Vidal Miguel.

Labels: (Owned) ARSA; (distributed) Hebra, Olympia, WB Sound (distributed—not licensed) Audion, (Ger-

many), Buckboard (USA), Carabine (France), Cellier (Switzerland), Christophorus (Germany), Deesse (France), De Plein Vent (France), Documentary (Liechtenstein), Dynamic/Mustang (France), Elite (Switzerland), Musidor (USA), Springboard (USA), Storyville (Germany), Strand/Cantagallo (Germany), Telefunken (Germany), Trip (USA), Up Front (USA), Vinyl (Germany), Warwick (UK), World Jazz (UK).

Apollo SA (Disques), Av. Louise 384, Brussels. Tel: (02) 640-0600, 649-1733. Telex: 24247.

Int'l repps.: Austria (EMI), Canada (Gamma), France (Carere), Germany (EMI Electrola), Netherlands (Phonogram), Portugal (Imavox), Switzerland (Carere).

Arcade, see PMP.

Archiv, see Polydor.

Ariola Benelux NV (IFPI), 75 Rode Kruislaan, B-1020 Brussels. Tel: (02) 267-2140. Telex: 62354. Gen. Mgr.: Martin Kleinjan; Sales Mgr.: Bernard Carbonez; Financial Mgr.: Wim Peynenburg. (Distributed by Record Serv. Benelux).

Labels: (Owned) Ariola, Ariola-Eurodisc, Baccarola; (licensed) Anchor (UK), Ariola America (USA), Ariola-Clan Celentano (Italy), Beserkley (USA), Bronze (UK), Chiswick (UK), Chrysalis (UK), Fleet (Netherlands), Hansa (Germany), Island (UK), Jupiter (Germany), Lifesong (USA), M-Recs. (Germany), Maritim (Germany), Melodiya (USSR), Shelter (USA), Tomato (USA), Virgin (UK).

Artibano (Disques), 55 Rue Delfosse, B-6538 Manage. Tel: (064) 55-25-04. Dir. Gen.: Benedetto Artibano.

Asylum, see WEA.

Atco, see WEA.

Atlantic, see WEA.

B E A M Int'l, Leopoldstr. 6, B-2000 Antwerp. Tel: (031) 33-45-37. Cable: BEAMAUDIO. Telex: 33941. (Distributor/Importer/ Exporter)

B R M, see Baltic.

Baccarola, see Ariola-Eurodisc.

Baltic-Didact, see Baltic.

Baltic PvbA-Brian Millan Int'l Foundation (IFPI), 105 bus 20 Carnotstraat, B-2000 Antwerp. Tel: (031) 36-38-56, 28-40-84. Telex: 33140. Pres.: M. Wuyts; Gen. Mgr.: Ben Gyselincx; Sales Mgr.: Ronald Dom.

Labels: (Owned) BRM, Baltic, Baltic-Didact, (licensed) Carlton (UK), Gold Star (UK), Panton (Czechoslovakia), Redifusion (UK), Soul Vista (USA), Supraphon (Czechoslovakia), (distributed—not licensed) Aurora (UK), Fidelio (Netherlands), Heritage (UK), Legend (UK), Prelude (UK), Rim (UK), Royale (UK), Symphonica (UK), Themes (UK); (not licensed—distributed by PMP) Agram (Netherlands), Arhoolie (USA), Concord Jazz (USA), ENJA (Germany), Electrocord (Romania), Hungaroton (Hungary), Intercord (Germany), Melodiya (USSR), Muza (Poland), Nimbus (UK), Opus (Czechoslovakia), Pepita (Hungary), Qualiton (Hungary), Saphir (Germany), Spotlite (USA), Unicorn (UK), Xanadu (USA).

Barclay (Compagnie Phonographique Franco-Belge), 31 Rue du Lombard, B-1000 Brussels. Tel: (02) 511-8197. Telex: 23379.

Home office: France.

Labels: (Owned) Barclay, Riviera, Triangle; (distributed) Horizons, Pims; (represented) Buddha (USA), CNR (Netherlands), Chant du Monde (France), Dakar (USA), Explosive (France), Kama Sutra (USA), Intercord (Germany), Melodiya (USSR), Metronome (Germany), ORTF (France), PES (France), Saphir (Germany), Zapa (France).

Basart Recs. Belgium PvbA (IFPI), 91-97 Maurice Lemonnierlaan, B-1000 Brussels. Tel: (02) 513-0592/1137. Telex: 61354.

Labels: (Owned) Europhon, Goldstar, Groovy, Papillon, Park, Poker, Vier Wieken; (distributed) Animato, Canto di Vangelo; (represented) Axe (Canada), Candide (USA), Durium (Italy), Folkways (USA), Turnabout (USA), Vox (USA).

Belgram, see Sinus.

Bestseller, see International Bestseller.

Biac Recs. SA, 76 Av. Sobieski, B-1020 Brussels. Tel: (02) 478-9209. Telex: 25188.

Labels: (Owned) Biac, JSEC, (licensed) Disco, Moon-glow, Ronnex & Teeny; (distributed—not licensed) Carabine (France), Guide du Disques (France), Jacques Canetti (France), Mirilton (France), Napoleon (USA), PBR (USA), Pickwick (France), SERP (France), Sorriso (Italy), Vee Jay (USA), Vernou (France).

Biram Recs., 86 Av. Moliere 83, B-1180 Brussels. Tel: (02) 345-4129/4203. Telex: 26350 (c/o RKM). Chief Exec: Jean Kluger. (Distributed by Phonogram)

Bizet Prod'n & Publ'n SprL (IFPI), 13 Madeleine St.,

B-1000 Brussels. Tel: (02) 511-5120, 512-1583. Pres. & Gen. Mgr.: Felix R. Faecq; VP's: J.P. & V. Bizet.

Labels: (Owned) Bravo, Expo, IMC, Jazz Club, Sphinx, (licensed) Guarani (Brazil).

Black & Blue, see Polydor.

Black Tulip, see Rec Track.

Blomhof SA (Ets.), 172a Rue Brogniez, B-1070 Brussels. Tel: (02) 522-1813. Cable: BLOMRAD. Gen. Mgr.: C. Janssen; Sales Mgr.: W. Menge.

Labels: (Licensed foreign) Approche (France), Century (USA), Crystal Clear (USA), Gale (UK), Sheffield Lab (USA).

Blue Jeans, see Brauer-Hebra.

Brauer-Hebra Recs. SprL (IFPI), 30 Rue St. Christophe, B-1000 Brussels. Tel: (02) 512-7361/9375. Pres. & Mgr.: Mrs. H. Brauer; Gen. Mgr.: Jean Darlier.

Labels: (Owned) Hebra (dist. by Anvers Radio), Blue Jeans, Costa Brava, Folklore, Horizons, Leo, Meteor, New Fly, New Music Corp., Vedette; (licensed foreign) Carisch (Italy), De Wolfe (UK), Epervier (France), Hudson (UK), Rouge (UK).

Int'l repps.: Brazil (Scorpius), Lebanon (Melody).

Bravo, see Bizet.

C B A Music (Connection Business Artists Inc.), 23 Rue Aristide Briand, B-4100 Seraing. Tel: (041) 36-85-24. Mng. Dir.: Tomis Chitare; Sales Mgr.: Alan Desutter; Copyright Serv.: Patrick Lalou.

C B S Disques/Grammofoonplaten SA/NV, 20 Rue Adolphe Lavallee, B-1080 Brussels. Tel: (02) 428-8007. Telex: 22642. Gen. Mgr.: Alain J. Olivier; Sales Mgr.: Ali Janty; Int'l A&R Mgr.: Frank Devos; Mktg. Ass't: Claude Geller.

Labels: (Owned) CBS, Epic, GTO, Portrait; (distributed—not licensed) A&M (USA), Arion (France), CGD (Italy), Caribou (USA), DJM (UK), Escargot (France), Jet (USA), PIR (USA), TK (USA).

Cannon, see PMP.

Canto di Vangelo, see Basart.

Capitol, see EMI.

Capricorn, see Polydor.

Caravan, see Cardinal.

Cardinal Recs. Int'l, 13 bis Wouter Haecklaan, B-2100

Deurne. Tel: (031) 21-78-74. Dir.: Rocco Granata.

Labels: (Owned) Cardinal, Caravan, Dolphin

Charisma, see Phonogram.

Classics for Pleasure, see Music for Pleasure & International

Bestseller.

Clown Music NV (IFPI) (div. of Johnny Hoes Benelux Music Inds.), PO Box 24, 93-bus 30 Van Eycklaan, B-3680 Maaseik. Tel: (11) 56-59-13. Dir.: Jacquie Hoes; Gen. Mgr.: Joseph Verbiest.

Labels: (Owned) Clown, Gnome, Start.

Columbia, see EMI.

Costa Brava, see Brauer-Hebra.

Cotillion, see WEA.

Cube, see Polydor.

Curling, see Discosoul.

Davoli Krunadal Benelux SprL, 357 Av. Rogier, B-1030

Brussels. Tel: (02) 733-4568.

Labels: (Licensed) Davoli (Italy), Ef-EI (Italy), Elgam (Italy), Gi-Esse (Italy), Grassi (Italy), Iida (Japan), Soprani (Italy), Terada (Japan), Vox (UK), Wonder (Japan).

Decibel Music, 15 Europalaan, Industriezone 2, B-9800 Deinze. Tel: (091) 86-48-81. Telex: 12197. Mng. Dirs.: Chris R. Van Oost, Jules G. Callebaut Sr.

Delphine, see Polydor.

Deutsche Grammophon, see Polydor.

Disco, see Biac.

Discobal SA, 50 Regentlaan, Brussels. Tel: (02) 13-39-45.

Labels: (Owned) Discostar, Saturnus; (represented) Europa (Germany), Hallmark (UK), Killroy (Netherlands), Somerset (Germany), Sonic (Germany), Telstar (Netherlands).

Discosoul Int'l, 31 Nationalestraat, B-2000 Antwerp. Tel: (031) 31-11-47. Telex: 31635. Dirs.: H. Lelieu, Jeffrey Maes.

Label: (Owned) Curling.

Int'l rep.: USA (Radio Shack). (SEE ADVERTISEMENT)

Discostar, see Discobal.

Discovery, see Rec Track.

Dolphin, see Cardinal.

Domino (Disques), 6 Route de Charleroi, B-7140 Ressaix-lez-Binche, Hainaut. Tel: (064) 33-35-86.

Dwarf, see International Bestseller.

EMI Belgium SA (IFPI), 65 Rue de la Clinique, B-1070 Brussels. Tel: (02) 524-0090. Telex: 24769. Mng. Dir.: E. J. de Klerk; Deputy Mng. Dir.: A. Sarboer; Gen. Mgr.: E. J. Garin; Sales Mgr.: H. Hendricks; Label Mgrs.: B. Robert, J. Govaerts, L. Arys; Classical Label Mgr.: J. Langlois;

DISCOSOUL INTERNATIONAL

LEADING BELGIAN IMPORTERS AND EXPORTERS
ALL BRANDS RECORDS AND TAPES
SPECIALISTS IN DISCO, SOUL AND POP

ADDRESS: NATIONALESTRAAT 31,
2000 ANTWERPEN,
BELGIUM

TELEPHONE: 031.31.1147 or
031.31.4368

TELEX: 31635 DISCOS B

CONTACT: HARRY LELIEU, MANAGING DIRECTOR

WE DON'T PROMISE TO BE THE BEST . . . WE TRY.

Press Mgr.: E. Wolfs, Adv. Mgr.: R. Vandenbosch.
Labels: (Owned) Capitol, Columbia, Electrola, HMV, Harvest, Odeon, Parlophone, Pathe, Punch, Regal-Zonophone; **(licensed)** Arista (USA), Blue Note (USA), Harmonia Mundi (Germany), Infinity (USA), Liberty (USA), MAM (USA), MCA (USA), MPS (USA), Magnet (UK), Motown (USA), Private Stock (UK), Purple (UK), RAK (UK), Rebel (UK), Red Bus (UK), Rocket (UK), United Artists (USA), Vanguard (USA).

Electrola, see EMI.
 Elektra, see WEA.
 Elver Recs., 97 Rue de la Marliere, B-7700 Monscon. Tel. (056) 33-15-45. Gen. Mgr.: Marcel de Keukeleire; Int'l Mgr.: Pierre Vandemaële. (Distributed by Fonior)

Epic, see CBS.
 Erec, see Euroco.
 Euroco PvbA, 88 Av. Charles Quint, B-1080 Brussels. Tel. (02) 25-63-29.
Labels: (Owned) Erec, Euroco, Tyrec; **(represented)** BRT Prod'n (Netherlands), Enterprise (UK), Honold Prod'n (Germany), Jump (Italy), Pure Joy Prod'n (Germany), Relight Prod'n (Netherlands).
 Int'l reps.: Australia, Ireland, New Zealand, South Africa, UK (all Enterprise).

Eurodisc, see Ariola-Eurodisc.
 Europhon, see Basart.
 Explorer, see WEA.
 Expo, see Bizet.
 Fabeldis SA (IFPI), 4-10 Rue Ste Marie, B-1080 Brussels. Tel. (02) 426-8317, 425-6501.
 Fiesta, see Fonior.
 Flandria, see Monopole.
 Fleche, see Phonogram.
 Fleet Benelux, Kenaustr. 3, Haarlem. Tel. (023) 31-35-43. Owners: Robert A. Aardse, Peter Meisel.
 Flemish Import Whslrs., 118 Zegersdreef, B-2130 Brasschaat. Tel. (031) 51-74-37.
 Folklore, see Brauer-Hebra.
 Fonior SA, 26/28 Quai des Charbonnages, B-1080 Brussels. Tel. (02) 25-40-10. Pres.: E.W. Pelgrims de Biard; Gen. Mgr.: A.E. Palmans; Sales Mgr.: R. Dauw.
Labels: (Owned) Fiesta, GIP, Omega Int'l, Week-End; **(distributed)** Elver; **(represented)** Ace of Clubs (UK), Ace of Hearts (UK), CTI (USA), Carrere (France), Charles Talar (France), Decca (UK), Deram (UK), ECM (Germany), Elf Provincien (Netherlands), Keystone (USA), Kudu (USA), Milestone (USA), O La La (Netherlands), Penny Farthing (UK), Storyville (Sweden), Te Deum (Netherlands), Temporel (France), Threshold (UK), Vega (France).

Fontana, see Phonogram.
 Frankie Music PvbA, 74 Greinstr., Antwerp. Tel. (03) 32-24-85, 31-60-60, 33-65-99. Cable: FRASUPREME.
Labels: (Owned) Frankie, Pims (dist. by Barclay), Supreme; **(represented)** DJM (UK), Dolphin (UK), Ember (UK), Evolution (UK), Mabel (Switzerland), Music-O (USA), Page One (UK), Pama (UK), Norman Petty Prod'ns (USA), Rediffusion (UK), Republic (USA), Swampfire (USA), W&G (Australia).
 Int'l reps.: Australia (W&G), Germany (Ariola), Netherlands (Phonogram), UK (Dick James), USA (Norman Petty).

G I P, see Fonior.
 G T O, see CBS.
 Gamma-Rec., Lange van Bloerstraat 78/80, B-2000 Antwerp. Tel. (031) 35-21-11. Telex: 33713 Gen. Mgrs.: Leo Felsenstein, Stonne Holmgren. (One Stop/Importer/Exporter)
Labels: (Licensed domestic) JW's, Snow; **(licensed foreign)** Ogun (UK).

Gnome, see Clown.
 Golden Music, see Monopole.
 Goldstar, see Basart.
 Groovy, see Basart.
 H M V, see EMI.
 Hans, see Hans Kusters & Phonogram.
 Harlekijn, see Phonogram.
 Harvest, see EMI.
 Hebra, see Brauer-Hebra & Anvers Radio.
 Hifi Home Producties PvbA, 67 Gulden Vlieslaan, B-8000 Brugge. Tel. (050) 33-95-16.
Labels: (Owned) Hifi Home Producties, Indigo, Parsifal; **(distributed—not licensed)** Cezame (France), ENJA (Germany), FMP (Germany), Kicking Mule (UK), Leader/Trailer (UK), Oldie Blues (Netherlands), Red Rag (UK), Rounder (USA), Sonet (UK), Specialty (UK), Storyville (Denmark), Sydney Thompson (UK), Tangent (UK), Topic (UK), Transatlantic (UK), Vogel, X-tra (UK).

Hispavox, see Polydor.
 Honey Bee Recs., PO Box 1448, B-1000 Brussels; 93 Rue de la Cambre, B-1150 Brussels. Tel. (02) 218-6747. Gen. Mgr.: J. Bagno.
Labels: (Owned) Honey Bee; **(distributed—not licensed)** Charly (UK). (Also imports cutouts from UK & USA).

Horizons, see Brauer-Hebra & Barclay.
 Hurrh, see Palette.
 I M C, see Bizet.
 Ibach, see Phonogram.
 Indigo, see Hifi Home.
 Inelco Belgium SA (IFPI), 68 Chaussee de Vilvorde, B-1120 Brussels. Tel. (02) 241-6570. Cable: INELCOBEL. Telex: 22090. Pres.: Pierre-Jean Goemaere, Recs. & Tapes Div. Mgr.: Roger Colpin.
Labels: (Owned) Lark; **(licensed)** BTM (UK), Bluebird (USA), Bob Thiele (USA), Camden (USA), Cavalier (France), Erato (France), Fiori Musicali (France), Flying Dutchman (USA), Grove (UK), Grunt (USA), Gryphon (USA), Kangaroo (Italy), Millenium (USA), Phantom (USA), Prelude (USA), RCA (USA), Red Seal (USA), Saravah (France), Satril (UK), Signature (USA), Solar (USA), Tabu (USA), Tattoo (USA), Tortoise (USA), Victor (USA), Victrola (USA), Windsong (USA); **(distributed—not licensed)** AZ (France), BBZ (France), BTM (UK), Crypto (France), Ecoute S'il Pleut (France), Equinox (USA), 57th Street (USA), Free Flight (USA), FY (France), Gem (UK), Gold Seal (USA), Grove (UK), Gryphon (USA), IB (France), International (USA), Kebec Disc (Canada), Lineatre (Italy), Numero Uno (Italy), Prelude (USA), Roadshow (USA), Salsoul (USA), Seon

Germany), Solar (USA), Tomato (USA), Wooden Nickel (USA).

Inside Recs. NV, Berendrechtstraat 92-94, B-2020 Antwerp. Tel. (031) 16-06-60.
 Interclub Belgium (International Rec & Music Business), 3 Kleine Barelstraat, B-2800 Mechelen. Tel. (015) 41-13-31. (Distributor/Importer)
 International Bestseller Co (IFPI), 65 Rue de la Clinique, B-1070 Brussels. Tel. (02) 524-0900 Telex 24769 Mng. Dir.: E. J. de Klerk; Deputy Mng. Dir.: A. Sarboer; A&R & Mktg. Mgr.: H. Heymans; Promo. & Label Mgr.: U. Declerck.
Labels: (Owned) Bestseller; **(licensed domestic)** Dwarf, Palette, RKM; **(licensed foreign)** Big Bear, Negrain, Trojan; **(distributed—not licensed)** Classics for Pleasure, Fantasy, PFP, Perides, Saga, Sonic, Sounds Superb, Stax.
 J S E C, see Biac.
 J W's, see Gamma.
 Jazz Club, see Bizet & Palette.
 K-tel Int'l Inc., 158 Ave de Tervuren, B-1150 Brussels. Tel. (322) 762-4000. Telex: 22088. Pres.: Raymond Kives; Gen. Mgr.: George Lukan.
 Roland Kluger Music (RKM), 8 Fernand Neuray St., B-1060 Brussels. Tel. (02) 344-4840. Pres.: Roland Kluger; Int'l Mgr.: Ida Halila; Exploitation Mgr.: Herman van Laar. (Dist. by Vogue)
Label: (Owned) RKM.
 Int'l reps.: Australia (RCA), France (Vogue), Germany (Hansa), Greece (Music-Box), Italy (Durium), Netherlands (WEA), South Africa (RPH), Spain (EMI-Odeon), UK (Sire), USA (Sire).
 Hans Kusters Music PvbA, 9A Langestraat, B-1700 Asse. Tel. (02) 452-7203/8963 Cable KUSTERMUSIC Telex 62228. Pres.: Hans-P. Kusters.
Label: (Owned) Hans.
 Lark, see Inelco.
 Leman & Gorle SprL, 52 Av. Notre Dame de Lourdes, Brussels 9. Tel. (02) 27-33-72.
Labels: (Owned) Alpha, Monumenta Belgicae Musicae—MBM; **(represented)** Argo (UK), Edici (France), L'Oiseau Lyre (UK).
 Int'l reps.: Netherlands (Negrain-Delta), Switzerland (Musikverlag zum Pelikan).
 Leo, see Brauer-Hebra.
 M B M, see Leman & Gorle.
 M F P, see Music for Pleasure.
 M G M, see Polydor.
 Maison Bleue SA, 34/36 Rue du Midi, Brussels. Tel. (02) 12-16-84. (Rack Jobber)
 Mercury, see Phonogram.
 Meteor, see Brauer-Hebra.
 Midi, see WEA.
 Monopole Recs., 7 Kwadenplaastrat, B-3100 Heist o/d Berg. Tel. (015) 24-16-25.
Labels: (Owned) Flandria, Monopole, Paprika; **(distributed)** Golden Music, Passe-Partout.
 Monumenta Belgicae Musicae—MBM, see Leman & Gorle.
 Moonglow, see Biac.
 Mountain, see Phonogram.
 Music for Pleasure (Belgium) NV (IFPI), 65 Rue de la Clinique, B-1070 Brussels. Tel. (02) 524-0900. Telex: 24769 Mng. Dir.: E. J. de Klerk; Gen. Mgr.: A. Sarboer; Mgr.: J. Brunel; Label Mgr.: H. Heymans. (Distributed by International Bestseller)
Labels: (Owned) Classics for Pleasure, MFP, PFP, Sounds Superb.
 Music Radio Promos, Benelux, Postbus 31, Luchtbal, B-2030 Antwerp 3 Tel. (031) 64-73-08. Dir.: Louisa Eyckmans; Gen. & Sales Mgr.: Jozef Segers. (Distributor/Importer)
 New Fly, see Brauer-Hebra.
 New Music Corp., see Brauer-Hebra.
 Nonesuch, see WEA.
 Odeon, see EMI.
 Olympia Music Publ'g, PO Box 1, 99 Marie de Hongrie, B-1080 Brussels. Tel. (02) 425-2810. (Distributed by Anvers Radio)
Label: (Owned) Olympia.
 Omega Int'l, see Fonior.
 Oyster, see Polydor.
 P F P, see Music for Pleasure & International Bestseller.
 P M P PvbA (IFPI), 82 Rederykersstraat, B-2610 Wilryk. Tel. (031) 28-40-84 Cable EUROHOUSE. Pres.: Louis Van Rymenant; Gen. Mgr.: Ben Gyselink.
Labels: (Owned) Arcade, Cannon; **(distributed—not licensed)** Abbey (UK), Balkanton (Bulgaria), Bis (Sweden), Black Lion (Germany), CRD (UK), Concord (USA), Double Twelve (UK), Electrecro (Romania), Flyright (USA), Freedom (Germany), Hungaroton (Hungary), Intercord (Germany), Muza (Poland), Oryx (UK), Peerless (UK), Pepita (Hungary), Polskie Nagrania (Poland), Qualiton (Hungary), Rarities (UK), Red Lightnin' (USA), Saphir (Germany), Spotlite (UK), Star Portrait (Germany), Starpower (Germany), Supraphon (Czechoslovakia), Unicorn (UK), Velvet (UK), Vista (UK), Xanadu (USA).
 Pablo, see Polydor.
 Palette Recs., 8 Rue Fernand Neuray, B-1060 Brussels. Tel. (02) 344-4840. Telex: 26350. Pres.: Felix Faecq; VP & A&R: Roland Kluger. (Licensed to International Bestseller)
Labels: (Owned) Hurrh, Jazz Club, Palette, Saphir.
 Papillon, see Basart.
 Paprika, see Monopole.
 Park, see Basart.
 Parlophone, see EMI.
 Parsifal, see Hifi Home.
 Passe-Partout, see Monopole.
 Pathe, see EMI.
 Perides, see International Bestseller.
 Philips, see Phonogram.
 Phil Spector, see Polydor.
 Phonogram, (div. of Polygram Recs.), 215 Rue Victor Hugo, B-1040 Brussels. Tel. (02) 733-9690. Gen. Mgr.: Charles Licoppe.
Labels: Adele, Albatros, Biram, Charisma, Fleche, Fontana, Hans, Harlekijn, Ibach, Mercury, Mountain, Philips, Rocket, Telstar, Trema, 20th Century, Vertigo, Zagora.
 Pims, see Frankie & Barclay.

Poker, see Basart.
 Polydor (div. of Polygram Recs.), 215 Rue Victor Hugo, B-1040 Brussels. Tel. (02) 735-9170. Gen. Mgr.: Maurice Mertens.
Labels: AZ, Ades, Archiv, Black & Blue, Capricorn, Cube, Delphine, Deutsche Grammophon, Hispavox, MGM, Oyster, Pablo, Phil Spector, Polydor, RSO, Topkapi, Verve, Walt Disney
 Polygram Recs., 215 Rue Victor Hugo, B-1040 Brussels. Tel. (02) 733-9724. Mng. Dir.: Hans G. Gout. (See Phonogram & Polydor)
 Portrait, see CBS.
 Punch, see EMI.
 R F C, see WEA.
 R K M, see Roland Kluger.
 R S O, see Polydor.
 Radar, see WEA.
 Recommended Recs., 4 Chemin de D'Hodimont, B-7498 Brane le Comte. Tel. (067) 63-76-71. Dirs.: E. Faes, M. Hollander.
Home office: England.
 Rec Track PvbA, Kipdorp 21, Antwerp
Home office: Netherlands.
Labels: (Owned) Black Tulip, Discovery.
 Regal-Zonophone, see EMI.
 Reprise, see WEA.
 Riviera, see Barclay.
 Rocket, see Phonogram.
 Ronnex & Teeny, see Biac.
 Saga, see International Bestseller.
 Saturnus, see Discobel.
 Schott Freres SprL, 30 Rue St Jean, B-1000 Brussels. Tel. (02) 512-3980. Mgr.: J.J. Junne. (Distributor/Importer)
Labels: (Imported) Astree, Barenreiter-Musicaphon (Germany), Candide, Claves (Switzerland), Da Camera (Germany), Folkways (USA), Harmonia Mundi (France), Jacklin (Switzerland), Monitor (USA), Music Minus One (USA), SFP, Schwann (Germany), Tocatta, Turnabout, Vox Box, Wergo (Germany).
 Selection, see Will.
 Shiva SprL/PvbA, Merodestraat 56, B-1060 Brussels. Tel. (02) 53-87-54. Telex 63084. Gen. Mgr.: Jack Mauer.
 Sinus Music (AFM Group), 17 Rue de Brabant, B-1030 Brussels. Tel. (02) 217-8986, 218-4774. Telex 62596.
 Gen. Mgrs.: Alfie Falckenbach, Claude Arnou; Financial Dir.: Hubert Declerck
Labels: (Owned) Sinus (dist. by Barclay), Surprise, Surprise Deluxe (dist. by Barclay); **(represented)** Ariston (Italy), Baby (Italy), MC (USA), Psycho (UK), Redwood (Canada).
 Int'l reps.: France (Societe Phonogramme Int'l), Netherlands (VIP).
 Snow Music, Berendrechtstraat 92/94, B-2020 Antwerp. Tel. (031) 16-06-60, 35-21-11. (Licensed to Gamma)
 Sonic, see International Bestseller.
 Sonobel, Sonobel Bldg., 15 Pl. Rouppe, B-1000 Brussels. Tel. (02) 512-0928
Labels: (Owned) Sonobel; **(represented)** AFA (France), BYG (France), Camden (USA), DOM (France), EPN (France), Everest (USA), Harmony (Italy), Joker (Italy), Motors (France), National (France), Pickwick (USA), President (France), Tradition (USA), Vedette (Italy).
 Sounds Superb, see Music for Pleasure & International Bestseller.
 Sphinx, see Bizet & Palette.
 Start, see Clown.
 Supreme, see Frankie.
 Surprise, see Sinus.
 Telstar, see Phonogram.
 Topkapi, see Polydor.
 Trema, see Phonogram.
 Triangle, see Barclay.
 Tryec, see Euroco.
 20th Century, see Phonogram.
 V-King, see Vogue.
 Vedette, see Brauer-Hebra.
 Vertigo, see Phonogram.
 Verve, see Polydor.
 Vier Wielen, see Basart.
 Vogel, see Hifi Home.
 Vogue PIP SA, (IFPI), 35 Blvd. Barthelemy, B-1000 Brussels. Tel. (02) 511-7991. Cable VOGDISC. Telex: 22560
Home office: France.
Labels: (Owned) V-King, Vogue; **(licensed)** Buddha (USA), Casablanca (USA), Copacabana (Brazil), Ember (UK), Fonit Cetra (Italy), GNP Crescendo (USA), Laurie (USA), Motors (France), Parachute (USA), Pye (UK), Pyramid (USA), Roulette (USA), Safari (UK), Satril (UK), Sonet (UK), VIP (Netherlands).
 Int'l reps.: Netherlands (VIP), Switzerland (Vogue).
 W B Sound, see Anvers-Radio.
 W E A European Coordinating Inc., 363 Ave. Louise, B-1050 Brussels. Tel. (064) 79-963. Telex: 62030. Mng. Dir.: Brigitta Peschko.
Home office: USA.
 W E A Recs. SA/NV, (IFPI), 79 Blvd. Lambertmont, B-1030 Brussels. Tel. (02) 242-5757. Mng. Dir.: Ben Bunders; Gen. Mgr.: Ted Sikkink; Sales Mgr.: Jean Marie Somie; Prod. & Label Mgr.: Dirk de Vries, Promo Mgr.: Herman Schuermans
Labels: (Owned) Asylum, Atco, Atlantic, Cotillion, Elektra, Explorer, Midi, Nonesuch, RFC, Radar, Reprise, WEA, Warner Bros.; **(licensed foreign)** Bearsville (USA), Big Three (USA), Curb (USA), Lollipop (Germany), Malignator (France), Planet (USA), Real (UK), Riva (UK), Sire (USA), Swan Song (UK), Westbound (USA).
 Walt Disney, see Polydor.
 Warner Bros., see WEA.
 Week-End, see Fonior.
 Will Recs., 42 Av. Clays, B-1030 Brussels. Tel. (02) 241-4186. Dir. Gen.: Pierre Pletincxk.
Labels: (Owned) Selection, Will; **(represented)** Canopo (Italy), Gemilli (Italy), MP 2000 (France), Monophonie (France), Musique pour l'Image (France), New Times (France), Orly (France), Production Mad Unity, Tele Music (France), A. Verchuren (France).

● music publishers

A A Music, 77 Rue de Louvreix, B-4000 Liege.
 Acuff-Rose Benelux, see World Music Group.
 Afterglow Music Publ'g Co., 27 Rue Fontaine d'Amour, B-1030 Brussels. Tel (02) 41-51-64.
 Angus Music PvbA, see Eurovox.
 Apollo Music SA, 384 Av. Louise, Brussels. Tel (02) 649-1733, 640-0600. Telex: 24247.
 April Music Belgium SA/NV, 20 Rue Adolphe Lavallee, B-1080 Brussels. Tel (02) 428-8007. Telex: 22642.
 Gen. Dir.: Alain Olivier
Int'l firms represented: Alessi (USA), April/Blackwood (worldwide), Bovina (USA), CRI (USA), Albert Hammond (USA), Joel (USA), Kirshner (USA), Light (USA), Notas Magicas (Spain), Oceans Blue/Silver Blue (USA), Sheryl (USA).
Int'l rep.: Worldwide (April/Blackwood).
 Ardmore & Beechwood SA, 65 Rue de la Clinique, B-1070 Brussels. Tel (02) 524-0090. Telex: 24769 Mng. Dir.: E. J. de Klerk.
Int'l firms represented: Algee (USA), Amphonic (UK), Beechwood (USA), Big Ben (UK), Budd (USA), Chibell (UK), Colgems (USA), EMI (Scandinavia), ERM Int'l (UK), Easy Listening (USA), Al Gallico (USA), Hearts Delight (USA), Hurricane (UK), Jobete (USA), KPM group (UK), Mother Goose (UK), My Songs (UK), New Town Sound (UK), Our Music (UK), Rebel (UK), Red Bus (UK), Screen Gems (USA), Stein & Van Stock (USA), Stone Diamond (USA).
Int'l reps.: Argentina (Musica Argentina & Int'l), Australia (Castle), Canada (Beechwood), France (Pathe-Marconi), Germany (Accord), Italy (Voce del Padrone), Mexico (Beechwood), Netherlands (Anagon), South Africa (Ardmore & Beechwood), Spain (EGO Musical), UK (Ardmore & Beechwood).
 Artibano (Eds.), 55 Rue Delfosse, B-6538 Manage Tel (064) 55-25-04. Dir. Gen.: Benedetto Artibano.
 Audio-Video Music Co., see World Music Group.
 Balance Music, see Bizet.
 Baltic Publ'ns, 105-bus 20 Carnotstraat, B-2000 Antwerp. Tel: (031) 36-38-56, 31-81-83, 87-65-11/60-20. Pres.: Ke Riema; Gen. Mgr.: Ben Gijssels.
Int'l branches: Canada (Brian Millan Corp.), Netherlands.
Int'l firms represented: Vincent Chiarelli (USA), Lemmel (UK), Mason (UK), Brian Millan (Canada), Rimusic (UK), Supraphon (Czechoslovakia).
 Basart Belgium (Eds.) PvbA, 91-97 Maurice Lemonnierlaan, B-1000 Brussels. Tel (02) 512-5034. Gen. Mgr. Alain Lelievre.
Int'l firms represented: Black Sheep (UK), Burlington (UK), Combine (USA), Ray Fenwick (UK), Muscle Shoals (USA), Palace (UK), Resaca (USA), Shelby Singleton (USA), Sparta Florida (UK), Valentine (UK).
 Bens (Eds. Musicales), 1 Av. J.P. Ballings, B-1090 Brussels. Tel: (02) 479-9984 Cable: BENSMUSIC.
 Biram Benelux SprL, see Jean Kluger.
 Bizet Music Group, 13 Madeleine St., B-1000 Brussels. Tel: (02) 511-5720, 512-1583. Pres. Felix R. Faecq; Gen. Mgr.: Lucienne Bizet-Hegelbach.
Int'l firms represented: Balance (Luxembourg), IMC (France), Mangione (Brazil).
Int'l reps.: France (IMC), Italy (Sweet Melody), Switzerland (Bizet), UK (Bizet), USA (Bizet).
 Bospel Music, see Bens.
 Brain Trust Music (SABAM), 54A Victor Jacobslei, B-2600 Berchem (Antwerp). Tel (031) 39-54-91.
 Herman Brauer, see New Music.
 Bruxelles Music, see New Music.
 Budde Basart, see Basart.
 C B A Music (Connection Business Artists Inc.), 23 Rue Aristide Briand, B-4100 Seraing. Tel (041) 36-85-24. Mng. Dir.: Tomis Chilaren; Sales Mgr.: Alan Desutter; Copyright Serv.: Patrick Lalou.
 Capitol Music, see New Music.
 Carola Music, see New Music.
 Champs-Elysees, see Francis-Day.
 Chappell Ed. Musicales, see Intersong-Primavera.
 Chapska Music, 104a Rue Beekman, B-1180 Brussels. Tel: (02) 43-73-73.
 Clown Music (div. of Johnny Hoes Benelux Music Inds.), 93-bus 30 Van Eycklaan, B-3680 Maaeick. Tel: (11) 56-59-13. Dir.: Jacquie Hoes; Gen. Mgr.: Joseph Verbiest.
Int'l firm represented: Benelux Music (Netherlands).
 Coda (Eds.), 97 Rue de la Marliere, B-7700 Mouscron. Tel: (056) 33-15-39. Owner: Elaine Verhoyen.
 Connelly Basart BV, see Basart.
 A. Cranz, see New Music.
 Crescendo, see Metropolis.
 Cupido, see Metropolis.
 Debram Music, see Bens.
 Decibel Music, 15 Europalaan, Industriezone 2, B-9800 Deinze. Tel (091) 86-48-81. Telex: 12197 Mng. Dirs. Chris R. Van Oost, Jules G. Callebaut Sr.
 Derby Belgique, see New Music.
 Digit, Lange van Bloerstraat 78/80, B-2000 Antwerp. Tel (031) 35-21-11. Telex: 33713. Gen. Mgrs. Leo Felsenstein, Stonne Holmgren, Luc Ardijs.
 Discosoul Int'l, 31 Nationalestraat, B-2000 Antwerp. Tel: (031) 31-11-47. Telex: 31635. Dir.: H. Lelieu. (SEE ADVERTISEMENT)
 Eurovox Music PvbA (SABAM), 82 Rederykersstraat, B-2610 Wilryk. Tel (031) 28-40-84. Cable: EUROHOUSE. Telex: 33140. Owner & Pres.: Louis Van Rymanant; Gen. Mgr. Maria Wuyts.
Int'l firms represented: Big Bopper (USA), Bixio (Italy), Dave Brubeck (USA), Glen Campbell (USA), Tom T. Hall (USA), Mews (UK), New Keys (USA), Charlie Rich (USA), Sparta Florida (UK), Valentine group (UK).
 Feldman, see Francis-Day.
 Fleet Benelux, see World Music Group.
 Fleet Publ'g SA, 8-10 Rue Fernand Neuray, B-1060 Brussels. Tel (02) 344-4840. Mng. Dirs.: Robert A. Aardse, Roland Kluger.
Int'l firm represented: Intro (Germany).

Focus Music PvbA, see Eurovox.
 Froner SA, 26/28 Quai Charbonnages, B-1080 Brussels. Tel: (02) 25-40-10.
 Francis-Day SA, see Francis-Day.
 Francis-Day SA (Eds.), 65 Rue de la Clinique, B-1070 Brussels. Tel: (02) 524-0090. Telex: 24769 Mng. Dir.: E. J. de Klerk, Admin. Mgr.: A. Devaux.
Int'l firms represented: Big Big, Kate Bush (UK), Cross Keys (USA), Herman Darewski, Dix, Donna (EMI), Feldman (France), B. Feldman, France Melodie (France), Francis Day (France), Francis Day & Hunter, Hermus, Kennedy Street, Kipahula (USA), Manchester, Marouani (France), Queen, Roar, Robbins, Rolling Stones (UK), Screen Gems/EMI, Tree (USA).
 Fri Fri Music (SABAM), see Zoom.
 Glorious Music Ents. PvbA, see Eurovox.
 Gnome Music, see Clowin.
 Gold Crown Music (SABAM), Box 10, Blvd. Louis Mettwie 11, B-1080 Brussels. Tel (02) 426-2256. Pres. & Gen. Mgr.: Roger D. Feinberg.
 Granata Music Eds., 13 bis Wouter Haeccklaan, B-2100 Deurne. Tel: (031) 21-55-81. Dir.: Rocco Granata.
 Hebra Music, see New Music.
 Intermision Music (SABAM), see Rakki.
 Intersong-Primavera SA (SABAM), 45 Place de Jamblinne de Meux, B-1040 Brussels. Tel: (02) 733-9789. Telex: 24516. Mng. Dir.: Tim Vesterin.
Int'l firms represented: Auriluis, Bron, Carmen, Chappell (Africa), Chappell (Australia), Chappell (Canada), Chappell (Germany), Chappell (Italy), Chappell (Netherlands), Chappell (Spain), Chappell (Sweden), Chappell (Switzerland), Chappell (USA), French Music, Gorima, Harbot/Sesac/Contention, Intersong Basart, Intersong Music Ltd., Intersong Paris, Intersong USA, Melodie, Melody Nelson, S. Miller, Nouvelles Prod'n Michel Legrand, Progressive, Rocket, St. Annes, Eds. & Prod'n Theatrales, Train Trichappell (USA), Unichappell (USA), J. Weinberger, Belinda/Artemis group—Blue Gum, CTA/Carlin, Davray, Elvis/White Heaven, Fast Western, Getaway, Harlene, Donna/Dijon, Leon Henry, Hudson Bay, Josley, Kama Sutra, Lark, Jeff Lynne/United Artists/Jet, Marson, Midlands/Diagonal/Midland, Mountain/Carlin, Noma/Scheffrin Zager, Peterman, Pickwick Int'l, Ramsel, Ryan, Sam, Ten East/Five West, Tomeja/Elbomo, Tone, Trio, Roy Wood, Yellow Dog, Belinda/Carlin group—AMP, Abacus, Alston, Aven, Big Top/K. Lynch, Carlin, Cathrye & Nomat, Davray, Design, Dukeslodge, Escort, Fluke/Enquiry, GTO, Getaway, Gloria, Gold Disc, Joaneline, Lynn, Marilyn, Miracle, Oaktree, Peterman, Alan Price, Pynar, Ryan, Shadown, Slamina, Swanson, Sweet City, Warland, Waterloo, Zan; Belinda/Hill & Range group—Aberbach, Atzal, Beckie, Bennie Benjamin, Brenner, Central, Cotillion, Crown, Doffie, European Plays & TV, Frederick & Katrina, Gladys, Hill & Range, Home Foks, Intersong USA/Gauchou/Belinda, Kentucky, MEC Milano, Monument, Mother Bertha, Noma, Noma & Marizona, Noma & Marty's, Elvis Presley, Progressive, Quarter, Anne Rachel, Red River, Roosevelt, Rumbalero, S.P.R., St. Louis, Sito, Hank Snow & Open Road, Southwind, TM, Tee Pee, Ernest Tubbs, U.S. Venice, Vicki, Bob Willis, Chappell group—AM, A&R, Acuff Rose, Larry Adler, Admiral, Advanced, Alexcar, Algonquin, Ambassador, Ameb, American Int'l Pictures, Ample, Andrew, Anton, D. & J. Arlon, Ariou, Ascherberg Hopwood & Crew, Athenaeum, Athenaise, John Marshall Austin, Avenue, Avocet, BAM, BBC, BDM, David Ball, Bar-Nome, Barton, Bay, Beautiful, Bedrock, Begonia, Bema, Bennie Benjamin, Alan Benson, Benton, Irving Berlin, Big Fuss, Big Sandy, Big Six, Big Wind, Bitter Suite, Bleu Disque, Karl Blore, Boston, Brackenkje, Bradbury Wood, Bregman Vocco & Conn, Britannia, Miquel Brown, Brown Shoes, Brown Tour, Bundin, Burthen, Butler, John Cameron, Porgie Campbell, Canadiana, Capitol, Captain Beaky, Carlyle Alpina, Carmichael, Carnaby, Carolintone, Carvold, Celenia, Cepcor, Chandler, Chann, Chappell, Chappell-Styne, Charisma, Chatham, Brian Chatton, Chilly Winds, Clara, Alan Clare, Roy Clark, Gene Clark, Claurus, Clondyke, Cloud Cookoo, Clover, Alan Coates, Tanta & Susan Collins, Communicated, Coop/Garden Rake, Cortab, Cosmic Echoes, Crawford, Crazy, Robert Cross, Tony Crombie, Cyma, DBH, Trevor Darks, Deane & Doo, Delaware, Delev, Delory, Delstone, Dena, De Sylva Brown & Henderson, Dirk, Dobbins, Dr. Music, Dorella, Double R, Douglas, EFDs, Earlon, Echoes of the Cosmos, Elbomo, Eldee, Empire Cosnol, Enschedesche, Era, Erle, Esco, European, Evie, Fairlane, Fame, Featherbed, Fiber, Fiddleback, Finger, Fred Fischer, Florence, Wayne Fontana, Four-Eleven, Frank, Freedom, Furze, G&C, Galaneye, Galoping Films, Garden Rake/Coop, Kay Garner, General, Gershwin, Gimcrack, Glorious, Green Dream, Green & Stept, Grob Chappell, Mike Guchron, Hael, Haimcaria, Halmel, Handle, Hanna-Barbera, Bo Hansson, Eddie Harkin, Harms, T.B. Harms, Graham Hart, Heritage, James Michael Heron, Hindsight, Brian Holloway, Amanda Jane & Roger Holman, Homemade, House of the Living, Jay Hugueuly, Hummit, Horace Hutchinson, Ivanhoe, Raymonde Ivor, Ivy, JP, Jabern, Jacmar, Jarmarie, J.W. Jenkins, John Jennings, Jilbern, Jubilee, Julie, Kalimba, Kalmar & Ruby, Kander & Ebb, Kandidate, Joldi Karo, Steve Kazan, George Keady, Brian Keith, Jerome Kern, Paul King, G. Jonah Koslen, Labrador, Langham, Lauralan, Lee, Leslie, Marysia Lessnau, Le Vien, Lou Levy, Sandy Linzer, Little Gravel, Little People, Living Music, Lombardo, Loring, Low, Lowery Chappell, Sal Low, Thom Low, Tui Low, Lujac, MBP, ME, MRC, Paul MacDonnel, Machetta, Mac Hugh & Adamson, Robert MacLeod, Mafundi, Magic Mouth, Manger, Mara-Lane, Marius, Martin, Mashy, Massey, Maureen, Maxana, Maxey, Mburu, Megusta, Merjoda, Meryl, Stephen Metz, Midas, Glen Mikkelsen, Milene, Millrose, Minstrel, Mio, Ivan Mogull, Mountie & Coyote, Mud Int'l, Muhon, Murdoch, Music Machine, Mutual, Namrac, Near North, Nemsong, Newkeys, New Morning, Newtonville, Night, Northern, Nurrock, Terry Oates, Ohio Players, Ole Colony, Omar, Osmond, Oxygen, Pabito, Pamela, Andy Park, Jim Parker, John

Paul, George Paxton, Paxwin, Pearl, Pee Wee Valley, Pendulum, John Dallas Phelps, Phonogram Int'l, Picasso, Pillow, Pink Pelican, Pippin the Friendly Ranger, Planetary, Play One, Please & Thank, Shelmer Poe, Polyscope, Cole Porter, Portfolio, Producers, Promco, Pure Noise, Quintet, R&R, Rah, Fred Raphael, John Raynor, Real, Red Anchor, Red Bullet, Red Coat, Redrock, Redwood, Dennis Reid, Revelation, Rhineland, Ringo Pasta, Rinimer, Road, Robbins, Maurice Rodgers, Rolando, Romano, David Rose, Fred Rose, Rosemaded, Rumbalero, Paul Ryan, Rye Bread, Saggiore, Sahara, Douglas Sahn, Salmon, Chris Sanford & Bob Saker, Sarah, G. Schirmer, Scorpio, Scotia, Selbnon, Sesac, Set to Music, J. & J. Shakespear, Shari, Jules Shear, Paul Melvin Shuttleworth, George Simon, Christopher Simpson, Songs of Faith, Souci, Southern Love, Spectacular, Larry Spier, Springfield, Stafree, Michael Stanley, Starshine, Steampower, J. Stokkermans & B. Bos, Storybook, Stratford, Subiddu, Sunflower, Sunnie Day, Superficial, Superior, Supreme, Sylverpride, Sylverpride & Joy, Tahoe, Tanglewood, Tebo, Tee Kaye, Tee Pee, Tescot, The Ritz, Thiele, Think Big, Three Bridges, Tight Corporation, Tin Lid, Tivoli, Tobey, Henry Tobias, Tomeja, Tom Tom, Top Hat, Triangle, Tri-Chappell, Trillium, Tropical Soundtracks, Truckin', Keith Turner, 29th & Dearborn, Unichappell, Tommy Valando, John Vallins, Vernon, Victoria, Vogue Choice, WG, Wardo, Warnes, Warp Seven, Welzheim, Wembley, White Cloud, White Lie, David Williams, Kathryn Williams, Williamson, Marty Wilson, Windchime, Murray Wizell, Wombat, Wonder, Graham Wyzill, Yachts, Victor Young, Jim Yule, Zargon, Zethus, Znarq; Chappell Morris group—Adams Strouse, Aee Cee, Albums, Amino, Alphaventure, Anvil, Ardmore, Balladeer, Banes, Barwin, Bedack, Beechwood, Beldock & Kushnick, Betaventure, Biba, Big B, Big H, Big L, Bobwhite, Bradshaw, Breezy Willow, Breshanan, Buddha, Bullfrog, Burke-Van Heusen, Burning Bush, Carwin, Champagne, Charling, Cherrybell, Cinema, Clover, Country Music, Creative, Crestview, Darian, Joe Davis, Degar, De Vorzan, Educational Music Serv., Fancy Space, Wes Farrell, Fenwood, Jose Ferrer, Foo, Frank, Georgia, Simon George, Graphe, Gramophone, Grayfriar, Guard, Hall of Fame, Harwin, Hit, Holly Vene, Hod Damn, Iero, Iron March, JAF, Jerry, Les John, KFK, Kittyhawk, Ledgfield, Leonia, Lero, Lin-De, Lion, MRC, Mara, March, Mayfair, Melrose, Mercedes, Mercer & Morris, Meridian, Mesquite, Momar, Monopoly, Montecito, Morley, E.H. Morris, Motion Picture, Mount Royal, Muirfield, Music for Albums, New Christy, Oriole, PK, Patricia, Peak, Picturetone, Quail, Ralton, Rango, Ravenswood, Reis, Reis Dart, Herb Reis, Rondell, Satrycon, Schlager, Sherbourne, Simon House, Slippery Jack, South Mountain, Space, Sparrow, Spartan, Spina, Stanwood, Streeterville, Suchan, Summit, TC, TPI, Tamerlane, Telekew, Thunderbird, Toluca, Truck, Upario, Valeness, Van Winkle & Darian, Vogue, Harry Von Tilzer, Warner Tamerlane, Welcome, Whalen, Whiskey Joe, White Smith, Windy City, Winmore, Wren, Zianne; Famous Chappell group—AH, Accadia, Addax, Ampco, Beverly, Blue Flame, Bob, Brazmton, Brind, Brougham, Bruin, Burke-Van Heusen & Assocs., Burvan, Charles Gilsenan, Chrissica, Crisco, Crowfoot, Daverdian, Diplomat, Directors Company, Engagement, Ensign, Fameville, Famous, Fat Mama, Forrest Hills, Freewheeled, Charles Gilsenan, Gomcalo, Grand Theft, Heiness, Higher, High Sierra, Infinite, Kaiser, Loe Lias Bleeding, Mario, Matter, Meadowlane, David Melia, Mother Mistro, Para-Andi, Parabat, Para-Ed, Para-Kim, Paramount, Paramount/Roy Rogers, Para-Nowgen, Para-Sac, Parathal, Para-Thumb, Para-Tracy, Para-Wag, Popular Melodies, Robert Rigby, Roxbury, Same Old Songs, Scarab, Scrolie of the North, Silbury Hill, Snowden Spier & Caslow, Sun Vine, Martin Teltow, Tinker Street, Tomake, Top Floor, Universal, Vin Sun, Window; Intersong Int'l group—A Deshe, Ajay, Argus, Roy Ayers Ubiquity/Ayers Bird, Baron, Bear Brown, John Beland & Kings Point, Beni & Medulla, William Bell & Bell-Kat, Big Shorty, Black Bud & Omaha, Blue Oyster Cult, Hamilton Bohannon, Breeze, Bridge House, Brother, Bulk, Bull Horn, CAM USA, Cafe Americana, Cape Ann/Three Cheers/Cape May/John Richbourg, Charlotte/Timote, Cherry, Stanley Clarke/Clarke, Laurie Kaye Cohen/Skyforest, Mike Kroy/Caseyem, Davray, Dog Soldier, Double Exposure, Double Trouble, Doughty, Betty Earland, Fabel, Wes Farrell, Wes Farrell/Wescraft, Fairfield, Father, Father/Claudia, Fifth

for the Benelux:



UNIVERSAL SONGS
 26, AVENUE PALMERSTON
 1040 BRUSSELS, BELGIUM
 PHONE: 2-230 4159

Floor, Fleetwood Mac, Fleetledge, Fort Knox, Four Knights, Fuse, Golden Syrup, Richard Gottetehr & Jiru, Harbor, Hardcore, Hazy, Heath Levy, Hensley, Hit & Run, Ilo/Good Morning, Intersong/A. Clarke, Irod, Ion, Jadar/Golo/Dynatone/Cried/Tansoul, Jimpire, Jiru, Jop & Pointed Star, Josley, Kaskat, Kenya/Eumir Deodato, Klub, Kolob, Kongride, Limey/Every Little Tune, Litha/Thalian, Little Fugitive, Little Lasso/Moonhill/Kurley/Pinson/Strobe Light, Luckyu, Magnat, Martin/Coulter, Mayday, Matragun/Hilliard/Nelson, Mews, Mobbetta, David Mok/Damont, Gayle Moran & Affinitia, Mured/Barbrob, Music Mgmt., Nineteen Eighty Five, Normal, Omfug/Shirts, Open End & Oyster, Orange, Pal Dog, Plainview, Pocket Full of Tunes, Polypub/Phonopub, Quick Mix, RSO, Razzle, Ricks, Rising Sun, Rock, Rockhopper, Rodra & Berna, Ru-Da, Sambo, Scorpio, Seabreeze, Sire, Sky Writing, Sleepy Dumping, Song, Spitfire, Stanyan, Sugartown, Sweet, TH, Tauripin/Flat Lizard/Skunkster/Quark/Windecor/McMaybe/Souzel & Noodle, Teenage Heaven/Carlin, Time/Redwall, Times Square/Herald Square, Tito, Toneshire, Wednesday Morning, Winkelman/Pants Down/Brown Sound, Zum.

Int'vex Music PvbA, see Eurovox.
Italmusic, see World Music Group.

Kassner Music (Ed.), see Bens.
Kluger Int'l, 8 Rue Fernand Neuray, B-1060 Brussels. Tel: (02) 344-4840. Telex: 26350. Gen. Mgr.: Roland Kluger; Exploitation Mgr.: Herman van Laar.

Int'l firms represented: Bob Dylan, Heavy, Le Minotaure, Paul Simon, Sugar Daddy, 20th Century, Wherefore (all USA).

Jean Kluger SprL (Eds.), 86 Av. Moliers B3, B-1180 Brussels. Tel: (02) 345-4129/4203. Telex: 26350 (c/o RKM). Mng. Dir.: Jean Kluger; Ass't: Myriam DeKoster.

Int'l firms represented: Bleu Blanc Rouge, Topkapi, Zagora (all France).

Hans Kusters Music PvbA, 9A Langestraat, B-1700 Asse. Tel: (02) 452-8963/7203. Cable: KUSTERSMUSIC. Telex: 62228. Pres.: Hans-P. Kusters.

Int'l firms represented: ATV (UK, USA), Barn (UK), Bron Org. (UK), Gambi & Ben Ghazi (USA), Halcyon (UK), Andrew Heath (UK), Heath Levy (UK), Island (UK, USA), Ladysmith (UK), Macaulay (UK), No Exit (USA), Panache (UK), Plangent Visions (UK), Prophet (USA), Rock Artistes (UK), Rock (UK), State (UK), Stonebridge (USA), Tallyrand (USA).

Int'l reps.: Netherlands (Nada), UK (ATV).
Lupus Music Benelux NV, see Eurovox.

M A M Music Pub'g, 8 Rue Fernand Neuray, B-1060 Brussels. Tel: (02) 344-4840. Telex: 26350. Gen. Mgr.: Roland Kluger; Exploitation Mgr.: Herman van Laar.

M C A Music Belgium, 8 Rue Fernand Neuray, B-1060 Brussels. Tel: (02) 344-4840. Telex: 26350. Gen. Mgr.: Roland Kluger; Exploitation Mgr.: Herman van Laar.

Int'l firms represented: Goal, Dick James, Leeds, M&M, Rock, Rock Artists.

Mairrepol, see Metropolis.

Martha Music, see April & New Music.

Maxwell Music SA, 61 Ave. Legrand, Brussels. Tel: (02) 640-6850. Mng. Dir.: Serge Barkowski; Gen. Mgr.: Roland Vanbeneden.

Int'l firms represented: Albatross (Germany), Francis Dreyfus (France), Labrador (France), Quint (Germany), Ram (Germany), Rideau Rouge (France).

Int'l reps.: France (Francis Dreyfus), Germany (Albatross, Quint, Ram).

Mendaur-Belgium, see New Music.

Metropolis, 5 Van Ertbornstraat, B-2000 Antwerp. Tel: (031) 33-11-42. Owner: Albert Rollewagen.

Int'l reps.: Brazil (Fermata), Spain (Union), UK (Peters), USA (Henri Elkan).

Mistral Music, see New Music.

Mood Music Tape Library, see Eurovox.

Musette, see New Music.

Music Rights Society, see New Music.

Muziekfonds, see Metropolis.

New Music Corp., 30 Rue St. Christophe, B-1000 Brussels. Tel: (02) 512-7361/9375. Pres.: Mrs. H. Brauer; Gen. Mgr.: Jean Darlier.

Int'l firms represented: Acapulco (Mexico), Paul Beuscher (France), Bideri (Italy), Cadencia (Spain), De Wolfe (UK), EDIM (Mexico), Hudson (UK), Frederic Leibovitz (France), Leonardi (Italy), Lutereau (France), Madrid No. 2 (Spain), Robert Mellin (UK, USA), Mendaur (Spain), Rouge (UK), Tanday (France).

Int'l reps.: Brazil, France, Germany, Mexico, Netherlands, Switzerland (all New Music); Colombia, Portugal, Spain, Venezuela (all Cadencia).

Olympia Music Pub'g (SABAM), PO Box 1, 99 Av. Marie de Hongrie, B-1080 Brussels. Tel: (02) 425-2810.

P M P Music PvbA, see Eurovox.

Pentagramma Music, see Baltic.

Prestation Music/Multi Sound, 42 Av. Clays, B-1030 Brussels. Tel: (02) 241-4186. Gen. Mgr.: A. Pletinckx.

Int'l reps.: France (New Times, Orly, St. Germain des Pres).

Primavera, see Intersong.

Prop, see Metropolis.

Radio Tele Music SA, 11 Av. Lloyd George, B-1050 Brussels. Tel: (02) 640-0600. Telex: 24247. Gen. Mgr.: Hubert Terheggen.

Int'l firms represented: Ivan Mogili (USA).

Rakki Music PvbA (SABAM), 74 Roguinstraat, Antwerp. Tel: (03) 32-24-85, 31-60-60, 33-65-99. Cable: FRASUPREME.

Int'l firms represented: Dundee (USA), Hazyland (Switzerland).

Int'l rep.: USA (Dundee).

Rockarolla Music (AFM Group) (SABAM), 77 Rue de Brabant, B-1030 Brussels. Tel: (02) 217-8986, 218-4774. Telex: 62596. Gen. Mgr.: Alfie Falckenbach.

Int'l firms represented: KPM, Pianola, Tabitha, Themes.

Roses Music, 138-139 Zeedijk, B-8390 Knokke Heist. Tel: (050) 51-40-91. Owner & Pres.: Rose Windels.

Sab, see Voix du Rhythme.

Schott Freres SprL, 30 Rue St. Jean, Brussels. Tel: (02) 512-3980. Mgr.: J.J. Junne.

Schroeder Basart, see Basart.

Semaco, see Metropolis.

Shiva SprL/PvbA, Merodestraat 56, B-1060 Brussels. Tel: (02) 53-87-54. Telex: 63084. Gen. Mgr.: Dirk Bogaert.

Sikorski Basart, see Basart.

Sing-A-Song Music Pub'g Co., see Baltic & Rockarolla.

Slootmakers, see Metropolis.

Southern Music Belgium SA, see World Music Group.

Start Music, see Clown.

Sugar Benelux, see World Music Group.

Tarot Prod'n's & Pub'l'g PvbA, Pretoriastr. 54, Berchem. Tel: (031) 35-88-91.

Tempo (Ed.), see Clown.

Gerard Tournier (Eds.), see Bens.

United Artists Music (Belgium), 8 Rue Fernand Neuray, B-1060 Brussels. Tel: (02) 344-4840. Telex: 26350. Gen. Mgr.: Roland Kluger; Exploitation Mgr.: Herman van Laar.

Universal Songs SA (SABAM), 26 Palmerstonlaan, B-1040 Brussels. Tel: (02) 230-4159. Cable: UNISON. Telex: 22090. Gen. Mgr.: Wim Landman; Professional Mgr.: Linda Van Waesberge.

Int'l branch: Netherlands

Int'l firms represented: J. Albert & Son (Australia), Antisia (USA), Arnakata (UK), John T. Benson (USA), Bibo (USA), British Lion (UK), Chinnichap (UK), Clandalee (USA), Cookhouse (USA), Crown-Vetch (Canada), Deep Purple (UK), 57th Street Entertainment (USA), Glove (UK), Heaths (UK), Hope (USA), Glen Hughes (UK), Interworld (UK, USA), Janz (Germany), Kidada (USA), Koppelman-Bandier (USA), Ledeclan (USA), Logo (UK), Maranatha (USA), Metal Machine (USA), Morning (Canada), Nimbus 9 (Canada), Oakfield Avenue (USA), Pal (UK), Paragon (USA), Angel Parker (UK), Purple (UK), Quarry (UK), Quatermass/Rustler (UK), RAK (UK), RCA (Brazil), Rashida (USA), Rondor (UK, USA), Rug/Rustler (UK), SP (UK), Scott/Wolfe (UK), Shillelagh (USA), Skippers Pond (Canada), Spaniel (UK), Strange (UK), Sunbury (UK), Tembo (UK), Universal Songs (Netherlands), Virgin (UK), Woodwater (Jamaica), Word (UK) (SEE ADVERTISEMENT)

V E P Benelux, see World Music Group.

Valentine Music PvbA, see Eurovox.

Marcel Vansippe & Bekar (Eds. Musicales), 6 Route de Charleroi, B-7140 Ressaix-lez-Binche, Hainaut. Tel: (064) 33-35-86.

Int'l firm represented: Marth Cayla (France).

Vedette, see New Music.

Virgo Music, see Baltic.

Vitale Music Benelux, see World Music Group.

Vogue Int'l SprL, 35 Blvd. Barthelemy, B-1000 Brussels. Tel: (02) 577-5417. Cable: VOGDISC. Telex: 22560.

Home office: France.

Int'l firms represented: Carrousel (France), Tony Hiller (UK).

Voix de Rhythme, 42 Ave. Clays, 81030 Brussels. Tel: (02) 241-4186.

Washington Music, see Clown.

West Music, see Baltic.

Wood Side Music, 2 Charleslei, B-2130 Brasschaat. Tel: (03) 51-52-03.

Int'l branches: France, Italy, Netherlands.

Int'l rep.: UK (Enterprise).

World Music Group, 8 Rue Fernand Neuray, B-1060 Brussels. Tel: (02) 344-4840. Telex: 26350. Pres.: Felix R. Faecq; Assoc. Exec. Mgr.: Roland Kluger.

Int'l firms represented: Comufra (France), Format (UK), Sam Fox (USA), IMC (France), Moss Rose (USA), Thames (UK), Ray Ventura group (France), Irmaos Vitale (Brazil), partial catalogs represented: KPM (UK), Leeds (UK), Mills (USA).

Int'l reps.: Argentina (Europa), Australia (World), Austria (Welt Musik), Canada (Transcanada, Zodiac), Czechoslovakia (State Pub'l'g House), France (Vendome), Germany (Ton & Kunst, Trumpf), Greece (Apollon), Italy (World), Japan (Shinko), Luxembourg (Luxembourg Music, Magellan), Mexico (Brambila), Netherlands (IMC), New Zealand (Southern), Scandinavia (Intrecco), South Africa (Good), Spain (World), Switzerland (World), UK (Good), USA (Columbus, Compton, Zodiac).

Ysaye (Fondation-Eds.), 39 Rue de l'Escrime, B-1190 Brussels. Tel: (02) 543-8196. Chief Exec.: Antoine Ysaye.

Int'l reps.: Canada (Henri Elkan); Eastern Europe, Netherlands & Scandinavia (J. von Roebel in Germany); Central & South America & Mexico (MCA in Brazil); USA (Henri Elkan).

Zoom Music (SABAM), 77 Rue Lincoln, B-1180 Brussels. Tel: (02) 343-4590. Gen. Mgr.: Michel Heilawell.

● services

ASSOCIATIONS & PROFESSIONAL ORGANIZATIONS

C N U D A (Comite Nat'l des Usagers du Droit d'Auteur), Cite de la RTB, Schaerbeek-Linthout.

Centrale Generale des Syndicats Liberaux de Belgique, 2 Rue Brederode, Brussels.

Chambre Syndicale des Editeurs de Musique de Belgique, 13 Rue de la Madeleine, B-1000 Brussels. Tel: (02) 511-5120. Pres. & Int'l PR: F.R. Faecq; VP's: J. Junne (Classical), R. Kluger (Pop), A. Rollewagen (Brass Bands). Gen. Sec'y: Maryse Cappendyk. (Publishers' Ass'n)

Chambre Syndicale des Fabricants d'Instruments de Musique, 271 Rue Royale, B-1000 Brussels. (Musical Instrument mfrs. ass'n)

European Broadcasting Union (Technical Centre), 32 Av. Albert Lancaster, B-1180 Brussels. Tel: (02) 374-5830. Cable: UNIRADIO. Telex: 21230, 21939.

Federation Int'l des Jeunesses Musicales, Palais des Beaux Arts, 10 Rue Royale, B-1000 Brussels. Tel: (02) 513-9774. Cable: PALARTES. Telex: 61825. Sec'y Gen.: Hadelin Donnet.

Philharmonic Society of Brussels, Palais des Beaux-Arts, 11

Rue Baron Horta, B-1000 Brussels. Tel: (02) 512-1001. Pres.: Count Boel, Dirs.: Herve Thys, Jan Poot. S A B E S A (Syndicat de l'Industrie Belge d'Enregistrements Sonores & Audio-Visuels) Asbl, 28 Rue des Colonias, B-1000 Brussels. Tel: (02) 513-5383. Pres.: S. Robins; 1st VP: H. Gout; 2nd VP: A. Olivier; Admin'r-Treas.: R. Meylmans; Admin'r's: P. Goemaer, X. Pelgrims de Bigard; Dir.: P. Lebbink.

Secteur Activites Culturelles de la Centrale Generale des Services Publiques, 9-11 Pl. Fontaines, B-1000 Brussels. Tel: (02) 11-22-31.

Syndicat de Spectacle, 20 Av. de l'Astronomie, Brussels.

Union of Belgian Composers, 1 Av. du Cor de Chasse, or 1 Jachthoornlaan, B-1170 Brussels. Tel: (02) 672-7590. Pres.: W. Pelemans.

DESIGN & ARTWORK

C B A Music (Connection Business Artists Inc.), 23 Rue Aristide Briand, B-4100 Seraing. Tel: (041) 36-85-24.

Mng. Dir.: Tomis Chilaren; Sales Mgr.: Alan Desutter. Druco Printing Office, 273 Beerstraat, B-1500 Halle. Tel: (02) 356-3835. Telex: 25832. Sales Mgr.: Jan Neef.

Music Radio Promos., Postbus 31, Luchtbal; B-2030 Antwerp 3. Tel: (031) 64-73-08. Dir.: Louisa Eyckmans; Gen. & Sales Mgr.: Jozef Segers.

LICENSING ORGANIZATIONS, MUSIC

S A B A M (Societe Belge des Auteurs, Compositeurs & Editeurs), 75-77 Rue d'Arion, B-1040 Brussels. Tel: (02) 230-2660. Chm.: J. Maes; Gen. Mgr.: E. Hoolants.

Int'l affiliates: Austria (Austro-Mechana, Literar Mechana), Czechoslovakia (OSA), France (SDRM), Germany—East (AWA), Germany—West (GEMA), Greece (AEP), Hungary (Artisjus), Israel (ACUM), Italy (SIAE), Japan (Jasrac), Netherlands (STEMRA), Poland (ZAIKS), Portugal (SPA), Scandinavia (NCB), Spain (SGAE), Switzerland (Mechanizenz), USSR (UAAP), UK (Britico, MCPS), USA (Harry Fox), Yugoslavia (SAKOJ).

S O G E D I (Societe de Gestion de Droits Intellectuels) Asbl, 13 Rue de la Madeleine, B-1000 Brussels. Tel: (02) 511-5120. Pres.: Felix R. Faecq; VP: Lucienne Bizez; Gen. Sec'y: Maryse Cappendyk.

Int'l affiliates: Austria (Austro-Mechana), Czechoslovakia (OSA), France (SDRM), Germany (GEMA), Greece (AEP), Italy (SEDRIM), Netherlands (STEMRA), Scandinavia (NCB), South Africa (SARRAL), Spain (SGAE), Switzerland (Mechanizenz), UK (MCPS), USA (AMRA).

PLATING, PROCESSING & PRESSING PLANTS

C B A Music (Connection Business Artists Inc.), 23 Rue Aristide Briand, B-4100 Seraing. Tel: (041) 36-85-24.

Mng. Dir.: Tomis Chilaren; Sales Mgr.: Alan Desutter. Clown Music NV, PO Box 24, B-3680 Maseik. Tel: (11) 56-59-13. Dir.: Djamschidi Scharyar.

Fabeldis SA (div. of Sobelpress), 30 Gossetlaan, B-1720 Groot-Bijgaarden. Tel: (02) 466-0666. Pres. & Gen. Mgr.: E.W. Pelgrims de Bigard; Sales Mgr.: Georges Martens.

PRINTERS & LITHOGRAPHERS

Bizez Prod'n's & Publ'n's SprL, 13 Rue de la Madeleine, B-1000 Brussels. Tel: (02) 511-5120. Pres. & Gen. Mgr.: Felix R. Faecq; VP's: J.P. & V. Bizez.

C B A Music (Connection Business Artists Inc.), 23 Rue Aristide Briand, B-4100 Seraing. Tel: (041) 36-85-24.

Mng. Dir.: Tomis Chilaren; Sales Mgr.: Alan Desutter. Clown Music NV, PO Box 24, B-3680 Maseik. Tel: (11) 56-59-13. Dir.: Djamschidi Scharyar.

Druco Printing Office, 273 Beerstraat, B-1500 Halle. Tel: (02) 356-3835. Telex: 25832. Sales Mgr.: Jan Neef.

Fabeldis SAL (div. of Sobelpress), 30 Gossetlaan, B-1720 Groot-Bijgaarden. Tel: (02) 466-0666. Pres. & Gen. Mgr.: E.W. Pelgrims de Bigard; Sales Mgr.: Georges Martens.

RECORD PROMOTION

Bizez Prod'n's & Publ'n's SprL, 13 Rue de la Madeleine, B-1000 Brussels. Tel: (02) 511-5120. Pres. & Gen. Mgr.: Felix R. Faecq; VP's: J.P. & V. Bizez.

Brain Trust Music, 54A Victor Jacobslei, B-2600 Berchem. Tel: (031) 39-54-91.

C B A Music (Connection Business Artists Inc.), 23 Rue Aristide Briand, B-4100 Seraing. Tel: (041) 36-85-24.

Mng. Dir.: Tomis Chilaren; Sales Mgr.: Alan Desutter. Discosoul Int'l, 31 Nationalestraat, B-2000 Antwerp. Tel: (031) 31-11-47. Telex: 31635. Dirs.: H. Lelieu, Jeffrey Maes. (SEE ADVERTISEMENT)

Fleet Benelux, Kenastru 3, Haarlem. Tel: (023) 31-35-43. Owners: Robert A. Aardse, Peter Meisel.

Interclub Belgium (International Rec. & Music Business), 34 Kleine Barelstraat, B-2800 Mechelen. Tel: (015) 41-13-31.

Lion Promos., Mechelsesteenweg 210A, B-2000 Antwerp. Tel: (031) 37-20-60. Telex: 34170.

Music Radio Promos., Postbus 31, Luchtbal; B-2030 Antwerp 3. Tel: (031) 64-73-08. Dir.: Louisa Eyckmans; Gen. & Sales Mgr.: Jozef Segers.

Zoom Music, 77 Rue Lincoln, B-1180 Brussels. Tel: (02) 343-4590. Gen. Mgr.: Michel Heilawell.

TAPE CUSTOM DUPLICATORS

Ampex SA, 5 Rue de l'Industrie, B-1400 Nivelles. Tel: (067) 22-49-21. Telex: 57432. Sales Mgr.: R. Thys.

Clown Music NV, PO Box 24, B-3680 Maseik. Tel: (11) 56-59-13. Dir.: Djamschidi Scharyar.

Audio: 8-tr. cassette.

Fabeldis SA (div. of Sobelpress), 30 Gossetlaan, B-1720 Groot-Bijgaarden. Tel: (02) 466-0666. Pres. & Gen. Mgr.: E.W. Pelgrims de Bigard; Sales Mgr.: Georges Martens.

Audio: Cassette.

● supplies

ENVELOPES & MAILERS

Druco Printing Office, 273 Beerstraat, B-1500 Halle. Tel:

(02) 356-3835. Telex: 25832. Sales Mgr.: Jan Neef. Interclub Belgium (International Rec. & Music Business), 34 Kleine Barelstraat, B-2800 Mechelen. Tel: (015) 41-13-31.

JACKETS & SLEEVES

Druco Printing Office, 273 Beerstraat, B-1500 Halle. Tel: (02) 356-3835. Telex: 25832. Sales Mgr.: Jan Neef. Interclub Belgium (International Rec. & Music Business), 34 Kleine Barelstraat, B-2800 Mechelen. Tel: (015) 41-31-13.

LABELS

Druco Printing Office, 273 Beerstraat, B-1500 Halle. Tel: (02) 356-3835. Telex: 25832. Sales Mgr.: Jan Neef. Fabeldis SA (div. of Sobelpress), 30 Gossetlaan, B-1720 Groot-Bijgaarden. Tel: (02) 466-0666. Pres. & Gen. Mgr.: E.W. Pelgrims de Bigard; Sales Mgr.: Georges Martens.

POLYETHYLENE BAGS

Honey Bee Recs., 93 Rue de la Cambre, B-1150 Brussels. Tel: (02) 218-6747. Gen. Mgr.: J. Bagno. (Importer) Interclub Belgium (International Rec. & Music Business), 34 Kleine Barelstraat, B-2800 Mechelen. Tel: (015) 41-31-13.

RECORD PROCESSING MACHINERY

Fabeldis SA, 4-10 Rue Ste. Marie, B-1080 Brussels. Tel: (02) 425-6501, 426-8317. Chief product: Label presses, Fabelmix extruders, Fabelmo dies, Fabelbo record edging machines, Fabelcut magnetic cutting press for 7". Brand name: Fabel.

TAPE, RAW & BLANK LOADED

Advent, see BEAM. Agfa-Gevaert NV, Verkooporganisatie Benelux, Septestr. 27, B-2510 Mortsel. Tel: (031) 40-59.00. Telex: 31223. Mng. Dir.: J. Davignon; Sales Mgr.: B. van den Broek. Audio: Cassette, open reel. Video: 1" open reel, 1" cartridge, 3/4" cassette. Brand names: Agfa Carat, Agfa Ferrocolor, Agfa Magneteband, Agfa Stereochrom, Agfa Superchrom, Agfa Superferro, Agfa Videochrom.

Ampex SA, 5 Rue de l'Industrie, B-1400 Nivelles. Tel: (067) 22-49-21. Telex: 57432. Sales Mgr.: R. Thys. (Blank only)

Audio: 8-tr., cassette, open reel. Video: 1" open reel, 3/4" cassette. Audio Magnetics, see Trialco. B A S F Chimie SA, 14 Av. Hamoir, B-1180 Brussels. Tel: (02) 375-2400. Cable: BASFBRU. Telex: 22016. Sales Mgr.: Jacky Swaelens. Audio & Video: Cassette, open reel.

B E A M Int'l, Leopoldstr. 6, B-2000 Antwerp. Tel: (031) 33-45-37. Cable: BEAMAUDIO. Telex: 33941. Mng. Dir.: Edward S. Savoir; Sales Mgr.: Jimmy Guze; PR Mgr.: Charles Lipschutz. (Importer—blank only) Audio: Cassette. Brand name: Advent.

Blomhof SA (Ets.), 172a Rue Brogniez, B-1070 Brussels. Tel: (02) 522-1813. Dir.: C. Janssen; Sales Mgr.: W. Menge.

Audio: 8-tr., cassette, open reel. Brand name: Maxell. Discosoul Int'l, 31 Nationalstraat, B-2000 Antwerp. Tel: (031) 31.11.47. Telex: 31635. Dirs.: H. Lelieu, Jeffrey Maes. (Importer—blank only) Audio: Cassette. (SEE ADVERTISEMENT)

Honey Bee Recs., 93 Rue de la Cambre, B-1150 Brussels. Tel: (02) 218-6747. Gen. Mgr.: J. Bagno. (Importer—blank only)

Audio: Cassette. Brand name: Ross Electronics. Trialco, 25 Rue des Alcyons, B-1080 Brussels. Audio: 8-tr., cassette, open reel. Brand name: Audio Magnetics.

● accessories manufacturers

Anvers Radio SA, 10 Pl. de l'Yser, B-1000 Brussels. Tel: (02) 218-7400. Cable: ANRAD. Telex: 62526. Admin. Dir.: Y. Jordans; PR: Vidal Miguel. (Importer) Product: Record & tape carrying & storage cases, cleaners, cloths, brushes.

Aracor SA, 12 Blvd. Sylvain Dupuis, B-1070 Brussels. Tel: (02) 521-2370, 522-9327. Telex: 61450. Mng. Dir.: Werner Huys. Product: Carrying & storage cases, cleaners, cloths, brushes, 45 rpm adapters, head cleaners, demagnetizers, needles.

Blomhof SA (Ets.), 172a Rue Brogniez, B-1070 Brussels. Tel: (02) 522-1813. Dir.: C. Janssen; Sales Mgr.: W. Menge. Product: Carrying & storage cases, cleaners, cloths, brushes, needles.

De Graef (Ets.), 367 Chaussée d'Alsemberg, B-1180 Brussels. Tel: (02) 345-3918. Cable: MATRADIO. Mng. Dir.: F. Morris; Gen. Mgr.: P. Moulart. Product: Needles. Brand name: Stanton.

Discosoul Int'l, 31 Nationalstraat, B-2000 Antwerp. Tel: (031) 31.11.47. Telex: 31635. Dirs.: H. Lelieu, Jeffrey Maes.

Product: Record carrying & storage cases, record catalog servs., cleaners, cloths, brushes, 45 rpm adapters. (SEE ADVERTISEMENT)

Honey Bee Recs., 93 Rue de la Cambre, B-1150 Brussels. Tel: (02) 218-6747. Gen. Mgr.: J. Bagno. (Importer) Product: Cleaners, cloths & brushes, head cleaners & demagnetizers.

Interclub Belgium (International Rec. & Music Business), 34 Kleine Barelstraat, B-2800 Mechelen. Tel: (015) 41-13-31.

Product: Catalog servs., cleaners, cloths & brushes. Vogue SA, 35 Blvd. Barthelemy, B-1000 Brussels. Tel: (02) 511-7991. Telex: 22560.

Product: Record & tape carrying & storage cases, head cleaners & demagnetizers.

● store fixtures & merchandising aids manufacturers

Blomhof SA (Ets.), 172a Rue Brogniez, B-1070 Brussels. Tel: (02) 522-1813. Dir.: C. Janssen; Sales Mgr.: W. Menge.

Product: Tape display racks. Discosoul Int'l, 31 Nationalstraat, B-2000 Antwerp. Tel: (031) 31.11.47. Telex: 31635. Dirs.: H. Lelieu, Jeffrey Maes.

Product: Record & tape browser boxes, record & tape display racks, record & tape divider cards (SEE ADVERTISEMENT)

BERMUDA

Population: 60,000. Rate of exchange: \$1 (US) = 1.0 Bermudan dollars. Holidays: January 1, Good Friday, July 28 (Cup Match Day), July 29 (Somers Day), November 11 (Remembrance Day), December 25, 26. Records, record blanks & pre-recorded media imported from USA: 1977—\$416,760.

● record & tape manufacturers / distributors / importers

Duane, see Edmar. Edmar Recs., PO Box 204, Harrington Hundreds, Ham Iton 5, Tel: (809) 295-4839. Owner & Pres.: Edward De Mello; Sales Mgr.: Joseph De Mello. Labels: (Owned) Duane, Edmar. Int'l rep.: Canada (Holborne).

BOLIVIA

Population: 5,790,000. Rate of exchange: \$1 (US) = 20.20 pesos. Per capita income: \$329. Holidays: January 1, Carnival (late February), Corpus Christi, Holy Week, May 1 (Labor Day), July 16 (La Paz Day—La Paz only), August 5, 6 (Independence Day), September 14 (Cochabamba Day—Cochabamba only), October 12 (Columbus Day), November 1 & 2 (All Souls' Day), December 25.

● record & tape manufacturers / distributors / importers

Ande, see Jallalla. Discolandia Dueri & Cia. Ltda. (IFPI), Calle Potosi 814, 3rd fl., La Paz. Tel: 3-28513. 3-56656. Cable: DISCOLANDIA. Telex: 5458. Pres.: Miguel A. Dueri; Gen. Mgrs.: Miriam S. de Dueri, Alberto Espinoza, Sales Mgr.: Oscar Prieto; Int'l Dept. Exec. Sec'y: Lourdes M. de Schulze.

Branches: Cochabamba, Agencia Discolandia, Plaza 14 de Septiembre 6175. Tel: 2-2239—Oruro, Casa Alanes, Ave. 7 de Octubre 1450. Tel: 5-2302—Potosi, Sociedad Comercial del Sud Ltda., Casilla 20, Calle Bolivar 845. Tel: 1041—Santa Cruz, Agencia Discolandia, Casilla 2103, Libertad 220 & 224. Tel: 2-8975—Sucre, Calle San Alberto 1. Tel: 1669. Mgr.: Elias Sabag—Tarija, Discofoto Rodriguez, Casilla 134, Sucre 646-652. Int'l branch: Argentina.

Labels: (Owned) Exito, Inbofon, Lyra: (licensed) ABC/Dunhill (USA), Decca (UK), EMI (UK), Favedica (Venezuela), IEMPSA (Peru), London (USA), MCA (USA), MGM (USA), Mercury (USA), Musart (Mexico), Music-Hall (Argentina), Philips (Netherlands), Polydor (West Germany), Sono-Radio (Peru). Int'l reps.: Chile (EMO Odeon), Peru (IEMPSA), Spain (Philips).

Exito, see Discolandia Dueri. Heriba Ltda., Abdon Saavedra 2190, La Paz. Tel: 5-1744, 4-3580. Cable: HERIBA. Gen. Mgr.: Eduardo Ibanez Wigger; Sales Mgr.: Elba Wigger; Prod'n Mgr.: Dora de Ibanez.

Labels: (Owned) Heriba: (licensed) CBS (worldwide), Microfon (Argentina). Int'l reps.: Central America, Argentina, Mexico (all CBS).

Inbofon, see Discolandia Dueri. Industria Boliviana del Fonograma Srl, Edif. Alameda, 6th fl., Dept. 205, El Prado, Bloque B, La Paz.

Label: (Represented) RCA (USA). Jallalla (Discos), Figueroa 788, Dept. 1, 2nd fl., La Paz. Tel: 320-647. Cable: JALLALLA. Pres. & Dir. Gen.: Julio Martinez Arteaga; Sales Mgr.: Emma Calderon.

Labels: (Owned) Ande, Jallalla. Lauro & Cia. Ltda., Av. de las Heroínas 4462, Cochabamba. Tel: 2-6632. Cable: LAURO. Owner: Laureano Rojas Alcocer; Sales Mgr.: Orlando Bustamante; Int'l Mgr.: Vickie de Valenzuela. Local branch: Calle Sucre 3509. Tel: 2-1241.

Branches: La Paz, Av. America 115. Tel: 2-5697—Oruro, Galeria del Disco, Calle Potosi 1621. Tel: 51448. Mgr.: Alfredo Lujan—Potosi, Calle Bolivar 956. Tel: 2091. Mgr.: Alfredo Zamora—Santa Cruz, Ayacucho 238. Tel: 2-5130. Mgr.: Enrique Duran—Sucre, Calle Nicolas Ortiz 2, Casilla 239. Tel: 2434. Mgr.: Alfredo Chalup—Tarija, Disco Foto Rodriguez, Calle Sucre 646-652, Casilla 134. Tel: 3101.

Labels: (Owned) Lauro, Lauro Int'l, (licensed) Ariola (Germany, Mexico, Spain, USA), Barclay (France), Columbia (Spain), Gamma (Mexico), Hispavox (Spain), TK (Argentina), Zafiro (Spain).

Lauro Int'l, see Lauro. Lyra, see Discolandia Dueri.

● music publishers

Andes Cancionero, see Khollasuyo. Heriba (Ed. Musical), Abdon Saavedra 2190, La Paz. Tel: 5-1744, 4-3580. Cable: HERIBA. Gen. Mgr.: Eduardo Ibanez Wigger.

Khollasuyo (Ed.) (GEMA), Figueroa 788, Dept. 1, 2nd fl., La Paz. Tel: 320-647. Pres. & Dir. Gen.: Julio Martinez Arteaga.

Lyra (Ed.), Casilla 422, Calle Potosi 814, 3rd fl., La Paz. Tel: 3-56656, 3-28513. Pres.: Miguel A. Dueri.

● services

DESIGN & ARTWORK

Discolandia Dueri & Cia. Ltda., Calle Potosi 814, 3rd fl., La Paz. Tel: 3-56656, 3-28513. Pres.: Miguel A. Dueri; Gen. Mgrs.: Miriam S. de Dueri, Alberto Espinoza, Sales Mgr.: Oscar Prieto; Int'l Dept. Exec. Sec'y: Lourdes M. de Schulze.

LICENSING ORGANIZATION, MUSIC

Sobodaycom (Sociedad Boliviana de Autores & Compositores de Musica), Figueroa 788, Dept. 1, 2nd fl., La Paz. Tel: 320-647. Cable: SOBODAYCOM. Pres. & Dir. Gen.: Julio Martinez Arteaga; Gen. Sec'y: Benjamin Tapia Vargas.

PLATING, PROCESSING & PRESSING PLANTS

PRINTERS & LITHOGRAPHERS

TAPE CUSTOM DUPLICATORS

Discolandia Dueri & Cia. Ltda., Calle Potosi 814, 3rd fl., La Paz. Tel: 3-56656, 3-28513. Pres.: Miguel A. Dueri; Gen. Mgrs.: Miriam S. de Dueri, Alberto Espinoza, Sales Mgr.: Oscar Prieto; Int'l Dept. Exec. Sec'y: Lourdes M. de Schulze.

Heriba Ltda., Abdon Saavedra 2190, La Paz. Tel: 5-1744, 4-3580. Gen. Mgr.: Eduardo Ibanez Wigger; Sales Mgr.: Elba Wigger; Prod'n Mgr.: Dora de Ibanez.

● supplies

ENVELOPES & MAILERS

JACKETS & SLEEVES

LABELS

POLYETHYLENE BAGS

PROFESSIONAL TAPE SUPPLIES

RECORD PROCESSING MACHINERY

TAPE, BLANK LOADED

TAPE DUPLICATING & PROCESSING EQUIPMENT

Discolandia Dueri & Cia. Ltda., Calle Potosi 814, 3rd fl., La Paz. Tel: 3-56656, 3-28513. Pres.: Miguel A. Dueri; Gen. Mgrs.: Miriam S. de Dueri, Alberto Espinoza, Sales Mgr.: Oscar Prieto; Int'l Dept. Exec. Sec'y: Lourdes M. de Schulze.

● accessories & store fixtures & merchandising aids manufacturer

Discolandia Dueri & Cia. Ltda., Calle Potosi 814, 3rd fl., La Paz. Tel: 3-56656, 3-28513. Pres.: Miguel A. Dueri; Gen. Mgrs.: Miriam S. de Dueri, Alberto Espinoza, Sales Mgr.: Oscar Prieto; Int'l Dept. Exec. Sec'y: Lourdes M. de Schulze.

Product: Cleaners, cloths, brushes, head cleaners, demagnetizers, needles, leader & splicing tape, record & tape browser boxes, record & tape display racks, record & tape divider cards.

BRAZIL

Population: 120,000,000. Rate of exchange: \$1 (US) = 27.0 cruzeiros. Holidays: January 1, Carnival, Good Friday, Holy Saturday, May 1, September 7 (Independence Day), November 2 (Memorial Day), December 25.

RECORDS:

Records sold: LP's 1978—33,000,000 units. EP's 1978—6,000,000 units. Singles 1978—11,000,000 units.
Records, record blanks & pre-recorded media imported from USA: 1977—\$870,966
Records exported to USA: 1978—121,827 units; 1977—\$199,467
Average retail price per record: LP's—\$7.70; EP's \$3.00, singles—\$2.70
Jukeboxes: 100

TAPES:

Tapes sold: Cassettes 1978—8,000,000 units.
Average retail price per tape: Cassettes—\$8.00

RADIO & TELEVISION STATIONS

No. of TV stations: 75
No. of radio stations: 903 AM, 98 FM

● record & tape manufacturers / distributors / importers

A E S C R J, see Top Tape.
 Alvorada, see Gravacoes Chantecler.
 Amazon Recs., Rua Alice 121, Laranjeiras, 20000 Rio de Janeiro ZC-01 Tel. (021) 285-2780. Telex (21) 23923 Dir. Jose R. Sobrinho.
 Angel, see EMI-Odeon.
 Aquarela, see Top Tape.
 Archiv, see Polygram.
 Arco-Iris, see Top Tape.
 Asylum, see WEA.
 Atco, see WEA.
 Atlantic, see WEA.
 Banderantes, see WEA.
 Bemol, see Tapecar.
 Building, see Som Industria & Comercio.
 C B S Industria & Comercio Ltda. (Discos), Rua Buenos Aires 2, 7th fl., 20000 Rio Janeiro, Tel. (021) 221-5956. Cable: COLRECORD Mng. Dir.: Juan Truden; SAs: Mgr. Jose Victor Rosa Jr.
Labels: (Owned) CBS, Entre, Epic, Odyssey, Okeh, Tropicana, Uirapuru; **(licensed foreign)** TK (USA).
Int'l rep.: Worldwide (CBS).
 C I D, see Companhia Ind'l de Discos.
 Caboclo, see Gravacoes Eletricas.
 Camden, see RCA.
 Campeao Discos, Rua Otavio Correia 202/102, 20000 Rio de Janeiro, Tel. (021) 246-7214. Pres.: Wilson F. Falcao; Gen. Mgr.: Ilka F. Brito; Sales Mgr.: Gilda C. Falcao.
Labels: (Owned) Campeao; **(represented)** Alcore (USA), BPL (Germany), Beat (Italy), Colt (USA), Destiny (USA), Dixie (Germany), Esprit (USA), Firma (USA), Galio (USA), Genuine (USA), Jody (USA), K-Arc (USA), Mayhams (USA), Milsmi (USA), Mishawaka (USA), Northland (USA), Novelty (USA), Panorama (Germany), R&R (USA), TJB (Germany), Unity (Germany).
Int'l reps.: Angola (Vadeca), Argentina (Jow), Belgium (Vadeca), France (Vadeca), Germany (Vadeca), Mexico (Panamusic), Netherlands (Parade), Portugal (J. C. Donas), South Africa (RPM), Venezuela (Favedica).
 Capitol, see EMI-Odeon.
 Carroussel, see Companhia Ind'l de Discos.
 Chantecler, see Gravacoes Chantecler.
 Charger, see Som Industria & Comercio.
 Cirandinha, see IBC.
 Clack, see WEA.
 Companhia Ind'l de Discos (IFPI), Rua 7 de Marco 331, Bonscusselo, 20000 Rio de Janeiro, Tel. (021) 280-9222. Cable: CIDISCOS. Pres.: Hermann Zuckermann; VP Int'l: Harry Zuckermann; Gen. Mgr.: Rodolfo Zuckermann.
Labels: (Owned) CID, Carroussel, Crazy Cat, Itamaraty, Magic Music, Square; **(licensed)** Ember (UK), Oasis (Germany), Pickwick (USA), Saar (Italy).
Int'l reps.: Argentina (Sicamericana), France (Barclay), Venezuela (BASF).
 Concorde, see Gravacoes Eletricas.
 Continental, see Gravacoes Eletricas.
 Copacabana, see Som Industria & Comercio.
 Copa Musical, see Top Tape.
 Coronado, see EMI-Odeon.
 Cotillion, see WEA.
 Crazy Cat, see Companhia Ind'l de Discos.
 Crazy Gravadora & Ed. Ltda., Alameda Dos Arapanes 1384, 04524 Sao Paulo.
 D G, see Polygram.
 Dark Horse, see WEA.
 Discao, see Gravacoes Eletricas.
 Disc Test, see Mangione, Filhos & Cia.
 Disquinho, see Gravacoes Eletricas.
 Dragon, see WEA.
 E M I-Odeon Fonografica Industrial & Eletronica SA, Caixa Postal 2752, ZC-00, Rua Mena Barreto 151, Botafogo, 20000 Rio de Janeiro, Tel. (021) 286-1212. Cable: TURNTABLE. Telex: 3678. Mng. Dir.: Rolf Duhlmann; Mktg. Mgr.: Roberto Augusto; Int'l A&R Mgr.: Antonio Duncan.
Labels: (Owned) Angel, Capitol, Coronado, EMI, Harvest, Imperial, Odeon, Parlophone; **(licensed)** A&M (USA), Arista (USA), Decca (UK), London (UK, USA), Magnet (UK), Passport (USA), Pathe (France), Private Stock (USA), Pyramid (USA), RAK (UK).
Int'l rep.: Worldwide (EMI).
 Elektra, see WEA.
 Elenco, see Polygram.
 Emblema, see Padrao.
 Entre, see CBS.
 Epic, see CBS.
 Equipe, see Padrao.
 Fermata, see RGE/Fermata.
 Festa, see Polygram.
 Fontana, see Polygram.
 Formula, see Gravacoes Eletricas.

Galinho, see Gravacoes Chantecler.
 Gato Seal, see RCA.
 Gravacoes Chantecler Ltda., Av. do Estado 4667, 01515 Sao Paulo, Tel. (011) 279-6811. Telex (11) 23239 Chm. Alberto Jackson Byington Neto, Comm'l Mgr.: Victor Sertanejo; Int'l Mgr.: Geraldo L. Loewenberg.
Labels: (Owned) Alvorada, Chantecler, Galinho, Rosicler, Scramble, Sertanejo; **(licensed)** Pye (UK), Radio Triunfo (Portugal), Roda (Portugal), Teldec (Germany).
Int'l rep.: Portugal (Radio Triunfo).
 Gravacoes Eletricas SA (IFPI), Av. do Estado 4667, 01515 Sao Paulo, Tel. (011) 279-6811. Telex (11) 23239 Chm. Alberto Jackson Byington Neto, Comm'l Mgr.: Wilson Rodrigues Poso, Label Mgr.: Angelo Penedo; Int'l Mgr.: Geraldo L. Loewenberg.
Labels: (Owned) Caboclo, Concorde, Continental, Discao, Disquinho, Formula, Musicolor, Strawberry, Surf; **(licensed)** Audio Fidelity (USA), Cream-Hi (USA), Gamma (Mexico), Hispavox (Spain), Ri-Fi (Italy).
 Groove, see RCA.
 Guarani, see Mangione, Filhos & Cia.
 Hara Internacional Musica & Filmes Ltda., Rua Joaquim Silva 56, 5th fl., Rio de Janeiro, Tel. (021) 252-4256, 222-0972. Dir.: Nilo S. Pinto; Gen. Mgr.: Ruth de Castro Savaget.
Labels: (Owned) Musicdisc, Oxala.
Int'l reps.: Bolivia (Heriba Ltda.), Colombia (Fonogramas), Ecuador (Famoso), El Salvador (Boni), Mexico (Guitarra), Peru (FTA), USA (Musical Recs.), Venezuela (Fonografica del Caribe).
 Harvest, see EMI-Odeon.
 Heliodor, see Polygram.
 I B C Discos (IBC Audio Comunicacoes Ltda.), Rua Senador Pompeu 229 A, Centro, 20221 Rio de Janeiro, Tel. (021) 223-3134. Cable: INDISCO. VP Finance & Admin.: Amadeu da Silva Resende; Int'l Mgr.: Fernando Mattos; A&R Mgr.: Sergio Abreu; Gen. Mgr.: Alberto Ingber; Sales Mgr.: Peter Schnaider.
Labels: (Owned) IBC, Super Show, Tropical; **(licensed foreign)** Casino (USA), Junction Int'l (USA), Orange (Germany) Revival (Italy); **(distributed—not licensed)** Cirandinha.
Int'l reps.: France (International Shows), Spain (Belter), USA (JDC).
 I N A, see WEA.
 Imperial, see EMI-Odeon.
 International, see RCA.
 Itamaraty, see Companhia Ind'l de Discos.
 Joias Musicais, see Mangione, Filhos & Cia.
 K-tel do Brasil Comercial Ltda., Rua Tobias do Amaral 46, Cosme Velho, Rio de Janeiro RJ, Tel. (021) 205-4545. Gen. Mgr.: Alan Joel Cordover; Sales Dir.: Bernd Peter Vogels; Artistic Dir.: Ricardo Barley.
Labels: (Owned) K-tel, Kelo; **(licensed foreign)** Antler (USA), Attic (Canada), Creole (UK), Ibach (France), Ibis (USA), Imphasion (USA), JDC (USA), Key Seven (Canada), Malaco (USA), Quality (Canada), Splash (UK), State (UK).
 Kelo, see K-tel.
 M G M, see Polygram.
 Magic Music, see Companhia Ind'l de Discos.
 Mangione, Filhos & Cia. Ltda., Rua do Ouvidor 183, 1st fl., Suites 14-119a, 20000 Rio de Janeiro ZC-00, Tel. (021) 242-3223/3698. Cable: EDMANGIONE. Pres.: Estevam Sciangula Mangione; Sales Mgr.: Ubaldo S. Mangione.
Labels: (Owned) Disc Test, Guarani, Joias Musicais, Red Lips.
Int'l reps.: Europe (Bizet), Japan (Uni Music), USA (Bizet).
 Master, see WEA.
 Mercury, see Polygram.
 Mis, see Som Industria & Comercio.
 Musicolor, see Gravacoes Eletricas.
 Musicdisc, see Hara.
 News, see Som Industria & Comercio.
 Nonesuch, see WEA.
 Odeon, see EMI-Odeon.
 Odyssey, see CBS.
 Okeh, see CBS.
 One Way RBR, see Top Tape.
 Oxala, see Hara.
 Padrao Distribuicao de Fonogramas Ltda., Rua Sao Francisco Xavier 961, 20000 Rio de Janeiro, Tel. (021) 284-1332/1992.
Labels: (Owned) Emblema, Equipe, Padrao, Spot; **(licensed)** Alshire Int'l (USA), Arrowtaps (UK), Candice (USA), International Artists (UK), Turnabout (USA), Vox (USA).
 Parlophone, see EMI-Odeon.
 Peralta, see RGE/Fermata.
 Marcus Pereira Ltda. (Discos), Rua Minas-Gerais 201, 01244 Sao Paulo, Tel. (011) 257-1622. (Distributed by Som Industria & Comercio).
 Philips, see Polygram.
 Phonodisc Industria & Comercio de Discos & Fitas Ltda., Av. do Estado 4667, 01515 Sao Paulo, Tel. (011) 279-6811. Telex: (11) 23239. Chm.: Alberto Jackson Byington Neto, Comm'l Mgr.: Wilson Rodrigues Poso; Int'l Mgr.: Geraldo L. Loewenberg.
Labels: (Owned) Phonodisc; **(licensed)** Elite Special (Switzerland), Fonit Cetra (Italy).
 Pick, see RGE/Fermata.
 Polydor, see Polygram.
 Poly Star, see Polygram.
 Polygram Discos Ltda., Av. Rio Branco 311, 4th fl., 20040 Rio de Janeiro, Tel. (021) 252-6195, 242-2895. Cable: POLYGRAM Mng. Dir.: Antonio Coelho Ribeiro; Sales Mgr.: Helene de Oliveira; Int'l Dept.: Maria Creusa.
Branch: Sao Paulo, Av. Nove de Julho 3766, Jardim. America, Tel. 881-6111
Labels: (Owned) Archiv, DG, Elenco, Festa, Fontana, Heliodor, MGM, Mercury, Philips, Polydor, Polyforn, Polystar, Sinter, Vertigo, Verve; **(licensed)** Capricorn (USA), Casablanca (USA), Charisma (UK), Chrystal (UK), Haven (USA), Island group (UK), MCA (USA), Mountain (UK), Pablo (USA), RSO (UK), Rocket (UK), 20th Century (USA), Virgin (UK).
 Polystar, see Polygram.

Premier, see RGE/Fermata.
 Pure Gold, see RCA.
 R C A Elettronica Ltda. (IFPI), Rua Santa Clara 50, Cobertura 01, 22041 Rio de Janeiro, Tel. (021) 255-7225. Telex: (21) 22425. Pres.: Adolfo Pino, Int'l: Helcio A. Carmo; Mktg. Gen. Mgr.: Oswaldo Gurzoni.
Labels: (Owned) Camden, Gold Seal, Groove, International, Pure Gold, RCA Victor, Red Seal, Vic, Victrola; **(licensed—domestic)** Sigla, Som Livre; **(distributed—not licensed)** Ariola America (USA), Aristo (Italy), Audio Latino (USA), Barclay (France), Bronze (UK), Can't Stop (USA), Disques Jbach (France), Erato (France), Gem (UK), Good Earth (USA), Grunt (USA), Hansa (Germany), Millennium (USA), Larry Page (UK), Pickwick (UK), Polar (Sweden), Ricordi (Italy), Roadshow (USA), Roulette (USA), Soul Train (USA), Tortoise (USA), Vanilla (Italy), Weiman (France).
 R G E/Fermata (Discos) (IFPI), Rua do Triunfo 177, 01212 Sao Paulo, Tel. (011) 220-9480/9308/0537/8839. Cable: FERMATABRASIL Telex 1121735. Pres.: Enrique Lebendiger; Gen. Mgr.: Marcos Silva; A&R Dirs.: Helio Eduardo Costa Manso, Yehuda Szapiro; Sales Mgr.: Carlos Claro.
Int'l branches: Chile, USA.
Labels: (Owned) Fermata, Peralta, Pick, Premier, RGE, Som Maior, Young; **(licensed foreign)** AB Prod'n (France), Alshire (USA), Amadeo (Austria), BBC (UK), Carosello (Italy), Coombe (UK), Countdown (Germany), Cube (UK), Durium (Italy), Everest (USA), Fediscos (Ecuador), Galaxy (UK), Hansa (Germany), Dick James (UK), Jupiter (Germany), Miller Int'l (Germany), Nems (UK), Noeland (UK), Odyssey (USA), Pick (Switzerland), President (UK), Promus (Venezuela), Ranwood (USA), Sonet (Sweden), Symphony Tone (Switzerland), Vadeca (Portugal), Victor (Japan).
Int'l reps.: Mexico (Musart), Switzerland (Int'l Melodies Geneve).
 Red Lips, see Mangione, Filhos & Cia.
 Red Seal, see RCA.
 Reprise, see WEA.
 Rolling Stones, see WEA.
 Rosicler, see Gravacoes Chantecler.
 Rural, see Tapecar.
 Sabia, see Som Industria & Comercio.
 Saci, see Som Industria & Comercio.
 Scramble, see Gravacoes Chantecler.
 Sertanejo, see Gravacoes Chantecler.
 Sigem (Sistema Globo de Edoicos Musicais), Rua Joao Afonso 15, Botafogo, Rio de Janeiro, Tel. (021) 286-5244/3846. Cable: TEVEGLOBO. Telex (21) 22795. Pres.: Bruno Quiano.
Branch: Sao Paulo, Rua Augusta 2945, Tel. (011) 282-5533. Mgr.: Victor Francisco Mello.
Int'l branches: Argentina, France.
Label: (Owned) Sigem; **(licensed)** Albatros (France), BBZ (France), Crisler (Italy), Fonit-Cetra (Italy), Motors (France), Polydor (France), Sirocco (France), Societe Creations Artistiques (France), Spot (France), Trema (France), 23 (Eds.) (France).
 Sigla, see RCA.
 Sinter, see Polygram.
 Som Industria & Comercio SA (IFPI), Rua dos Gusmos 235, 01212 Sao Paulo, Tel. (011) 221-7855. Telex: (11) 24569. Pres.: Adiel Macedo de Carvalho; Mng. Dir.: Otavio Antonio Bianco; Gen. Mgr.: Gunter Casznik; Sales Mgr.: Rosvaldo Cury; Plant Mgr.: Joao F. Blumenschein.
Int'l distributor: USA, Brasilia Recs. & Tapes Corp.
Labels: (Owned) Building, Charger, Copacabana, News, Sabia, Saci, Som, Underground, Vision; **(licensed)** Abbey Road (UK), Baby (Italy), Buddha (USA), Columbia (Spain), Contagious (South Africa), Delphine (France), Eleven (Italy), Fuentes (Colombia), Harmonia Mundi (Germany), IBACH (France), Intermusique (Luxembourg), MPS (Germany), PPX (USA), Prelude (USA), Project 3 (USA), Quatro (Chile), Springboard (USA), Supraphon (Czechoslovakia), Vanguard (USA), Vogue (France), West One (USA), West Side Latino (USA), Yep (Italy); **(distributed—not licensed)** Mis, Marcus Pereira.
Int'l reps.: Argentina (CBS, Interdisc), Australia (RCA), Benelux (Vogue), Canada (Brasilia in USA), Chile (Quatro), Colombia (Fuentes), France (Vogue), Germany (Metronome, Teldec), Greece (CBS), Israel (CBS), Italy (Baby, Eleven), Japan (Global, RCA), Korea (RCA), New Zealand (RCA), Philippines (Victor), Portugal (Radio Triunfo, Rossi), Scandinavia (Metronome), Spain (Columbia, Hispavox), Switzerland (Vogue), Turkey (Onku-Plak), UK (Decca), USA (RCA, Salsoul, West One, West Side Latino), Venezuela (Grabaciones Mondiales).
 Som Livre, see RCA.
 Som/Maior, see RGE/Fermata.
 Sosamba, see Tapecar.
 Spot, see Padrao.
 Square, see Companhia Ind'l de Discos.
 Strawberry, see Gravacoes Eletricas.
 Super Show, see IBC.
 Surf, see Gravacoes Eletricas.
 Swan Song, see WEA.
 T C, see Tapecar.
 Tapecar Gravacoes SA (IFPI), Rua Aguiar Moreira 639, 20000 Rio de Janeiro, Tel. (021) 280-5582. Pres. & Dir.: Manuel Valls Camero; Gen. Mgr.: Fernando de Araujo Neves; Sales Mgr.: Ary Perdigao; Int'l Mgr.: Paulo Roberto Correa de Araujo.
Labels: (Owned) Rural, Sosamba, TC, Tapecar; **(distributed)** Bemol; **(represented)** Bareback (USA), Basart (Netherlands), Cinevox (Italy), Count Down (Germany), D&M (USA), Damil (UK), Disques Direction (Canada), Everest (USA), Fonior (Belgium), Honeybee (USA), Mainstream (USA), Parachute (USA).
 Top Tape Musica SA, Rua Alice 97, Laranjeiras, 20000 Rio de Janeiro ZC-01, Tel. (021) 205-5552. Cable: MUSI-TOP. Telex: (21) 23923. VP A&R & Promo: Joel B. Leibovitz; VP Int'l Opns.: Myrian Sylvia Avanzi; VP Sales: Salomao Sobrinho, VP Prod.: Teresa Brito.
Branch: Sao Paulo, Rua Osorio Duque Estrada 39, Vila Nova Tupi, Ibrapuera, 04001 Sao Paulo, Tel. (011) 287-8676. Sales Mgr.: Alberto Bantsotti Neto, Promo. Mgr.: Dorival Rosa.

Labels: (Owned) Aquarela, Arco-Iris, Copa Musical, One Way RBR, Top Tape. **(Licensed-domestic)** AESCRJ. **(Licensed-foreign)** AVI (USA), Carabine (France), Carrere (France), Cinevox (Italy), De-Lite (USA), Dream (USA), Fantasy (USA), Gang (USA), Greedy (USA), Gold Mind (USA), Gordy (USA), Lifesong (USA), Lollipop (Germany), Milestone (USA), Motown (USA), Olde World (USA), Penny Farthing (UK), Playboy (USA), Prestige (USA), Prodigal (USA), Rare Earth (USA), Salsoul (USA), Stamy (Switzerland), Stax (USA), Tamla (USA), Vigor (USA)

Int'l reps.: Argentina (RCA), Portugal (Imavox)

Tropical, see IBC.
Tropicana, see CBS
Uirapuru, see CBS
Underground, see Som Industria & Comercio
Vertigo, see Polygram
Verve, see Polygram
Vic, see RCA
Victrola, see RCA
Vision, see Som Industria & Comercio
W E A Discos Ltda (IFPI), Rua Itaipava 44, Jardim Botânico, 20000 Rio de Janeiro Tel (021) 246-2215 Mng Dir: Haidar Midani; Gen Mgr: Michael Gregory, Sales Mgr: Paulo Genaro, A&R Mgr: Marco Aurelio de Silva.
Labels: (Owned) Asylum, Atco, Atlantic, Cotillion, Dark Horse, Elektra, Nonesch, Reprise, Rolling Stones, Swan Song, WEA, WEA Int'l, Warner Bros. **(Licensed-domestic)** Banderantes, Clack, Dragon, INA, Master
Int'l rep.: Worldwide (WEA)
Warner Bros., see WEA
Young, see RGE/Fermata

● **music publishers**

A M O R (SICAM), see Fermata
Alvorada (Grupo Ed.), Rua dos Gusmos 235, 01212 Sao Paulo Tel (011) 221-7855. Cable SOMDISCOS. Dir.: Olavo Antonio Bianco; Gen. Mgr. Antonio D'Almeida Santos

Int'l firms represented: Contagious (South Africa), Robbins (USA), Televis (Italy), Tremplin (France), United Artists (USA)

Int'l reps.: Argentina (Melograf), Canada (Bevorada, Meridional), Central America (EMLASA), Chile (Equus), Colombia (EMLASA), Ecuador (EMLASA), France (Vogue), Italy (Televis), Japan (Global), Mexico (EMLASA), Peru (EMLASA), Portugal (Sociedade Portuguesa de Autores), Spain (Notas Magicas), UK (Burlington), USA (Bevorada, Meridional), Venezuela (EMLASA)

Alvorada Ltda (Ed. Musical), see Alvorada Grupo.
Amazon Musica Ltda., Rua Alice 121, Laranjeiras, 20000 Rio de Janeiro ZC-01 Tel (021) 285-2780 Telex (21) 23923

Arapua (SBACEM), see Fermata
Arlequim Ltda. (Ed. Musical), Caixa Postal 3264, Villa Biarque, Rua Frederico Steidel 267, 01225 Sao Paulo, Tel (011) 220-3494/1343

Ata (UBC), see Fermata
Augusta Ltda (Ed.) (SICAM), Av. Ipiranga 1123, 9th fl., 01039 Sao Paulo Tel (011) 229-3411 Pres. Enrique Lebendiger; Gen. Mgr. David Vogel

Avenida (UBC), see Fermata
Balaio Ltda (Ed. Musical), see Sigem.
Bandeirante (UBC), see Fermata.
Bela Musi (Ed.), see Top Tape

Betina Edicoes & Promocoos Ltda., see CID
Beverly Ltda (Ed. Musical) (UBC), see Alvorada
C A M Brazil, see Arlequim

C I D Edicoes & Promocoos Ltda (UBC/ASCAP), Rua 29 de Julho 152, 20000 Rio de Janeiro, Tel (021) 280-9222 Cable CIDISCOS. Gen. Mgr. Harry Zuckerman.
Campeao (Ed.), see Falcao

Caroca Ed. Musical Ltda (SBACEM), Av. do Estado 4667, 01515 Sao Paulo Tel (011) 279-6811 Telex (11) 22329 Chm. Alberto Jackson Byington Neto; Int'l Mgr. Geraldo L. Loewenberg; Publ'g Co-ord.: Vitor Martins

Cash (SICAM), see Fermata
Catavento Ltda (Ed. Musical), see Sigem.
Copa Musical Ltda (Ed.) see Top Tape
Crazy Gravadora & Ed. Ltda., Alameda Dos Arapanes 1384, 04524 Sao Paulo

Drink (UBC), see Fermata
Duchess Ed. Musical Ltda., see MCA
E L A M—Ed. Latino Americana de Musica Ltda., see Mundo Musical

E M B I, see Editora de Musica
E S I (Sadembra), see Fermata
Editora de Musica Brasileira & Internacional SA (EMBI), Rua Teofilo Ottoni 135, 3rd fl., Rio de Janeiro, G B Tel (021) 234-6454, 243-6294 Cable EMBISA

Branch: 01205 Sao Paulo, Av. Rio Branco 233, Rm. 91 Tel (011) 221-0851

Home office: USA, Peer-Southern Org.
Int'l firms represented: Alrhodes, Cedarwood, Combine, Cotillion, Charles K. Harris, La Salle, Melody Lane, Roger Miller, Panther, Peer Int'l, Pera, Pronto, RFD, Royal Oak, Southern, Walden, Warner Bros. (all USA)

Emblema Ed., see Equipe
Equipe Producoes Musicais Ltda (UBC), Rua Sao Francisco Xavier 961, 20000 Rio de Janeiro Tel (021) 284-1332/1992

Falcao Ed (UBC), Rua Otavio Correia 202/102, 20000 Rio de Janeiro Tel (021) 246-7214. Pres.: Wilson F. Falcao; Gen. Mgr. Ilka F. Brito

Int'l firms represented: R. Barbey (Belgium), Beat (Italy)

Int'l reps.: Italy (Beat), Japan (Nicolme), Mexico (Panamusic), Portugal (Valentim de Carvalho), Venezuela (Orbe)

Ferman (Ed. Musical), see TC.
Fermata do Brasil Ltda (UBC), Av. Ipiranga 1123, 6th fl., 01039 Sao Paulo Tel (011) 229-3411 Cable FERMATA BRASIL. Pres.: Enrique Lebendiger; Gen. Mgr. Juvenal Fernandes; Copyright Dept.: Neide Martin Alves Pereira; Royalties Dept.: Nydia Mazzino de Lagna Fiatta

Int'l firms represented: Arista (USA), Bourne (UK, USA), Sidney Brion group (UK), Burlington (UK), Butterfly (Germany), Chrysalis (UK), Core (Canada), Curci (Italy), Essex group (UK), Far Out (USA), Heathside (UK), Dick James group (UK), Klaatoons (Canada), Love-Zager (USA), MCA group (USA), Manticore (UK), Muscle Shoals (USA), Nickle Shoe (USA), Panache (UK), Sands/Barton (USA), Satril (UK), Scorpio (France), Valentine group (UK), Virgin group (UK)

Int'l reps.: Chile (Fermata), Switzerland (Int'l Melodies Geneva), USA (Bendig, Fermata Int'l)

G G Producoes Ltda., see Intersong
Gapa Ltda., see Intersong
Viuva Gurreiro (Ed.) (UBC), see Mangione

Helio Ltda (Ed. Musicais), see Intersong.
I T A I P U Eds. Musicais Ltda (UBC), Caixa Postal 2752, ZC-00; Rua Mena Barreto 151, Botafogo, 20000 Rio de Janeiro Tel (021) 286-1212 Cable TURNTABLE Mng. Dir. Rolf Dihlmann; Gen. Mgr. Romeo Brayner Nunes Dos Santos

Int'l firms represented: Bull Pen-Perren Vibes (USA), Colgems-EMI (USA), EMI group (UK), Earl Barton (USA), Hal Nat (USA), Lupus (UK), Our (UK), Pink Floyd (UK), Red Bus (UK), Rondor (USA), Screen Gems-EMI (USA), Sug-Sug Music (USA), Wizard (UK)

Int'l rep.: Worldwide (EMI group)

Indus Ltda (Ed. de Musica), see Editora de Musica
Intersong Ltda (Eds.) Av. Rio Branco 277, Grupo 708/710, 20047 Rio de Janeiro Tel (021) 252-2502/6549 Cable EDISINTER; Gen. Mgr. Jose Loureiro

Int'l firms represented: ABC, ATV, Aurelia, Baarn, Bicycle, Bregman Vocco & Conn, Carlin, Casablanca, Chappell, Charisma group, Famous, Fuse, Gambi, Gentoo, Hanna Barbera, T B Harms, Heath Levy, Hit & Run, Island, Kamakazi, Man-Ken, Edwin H. Morris, Pocketful of Tunes, RSO, 20th Century

Int'l reps.: Worldwide (Chappell, Intersong)
Irmaos Vitale SA, Rua Franco Pinto 42, Sao Paulo
Japeri (Ed. Musical), see TC

Latino Americana de Musica Elam (Ed.) Ltda see Mundo Musical

Latino Ed. Musical Ltda (SICAM), Av. do Estado 4667, 01515 Sao Paulo, Tel (011) 279-6811 Telex (11) 22329 Chm. Alberto Jackson Byington Neto; Int'l Mgr. Geraldo L. Loewenberg; Publ'g Co-ord.: Vitor Martins

Lotus Ltda (Eds. Musicais), Rua Tobias do Amaral 46, Cosme Velho, Rio de Janeiro RJ Tel (021) 205-4545
Mgr. Robert Liot Backer

Luciana Ltda (Ed. Musical), see Sigem.
Lyra Ltda (Ed. de Musica), see Editora de Musica
M C A do Brasil Ed. Musical Ltda., Rua Aurora 914, 01209 Sao Paulo Tel (011) 222-0273. Cable: EDITAMUS

Home office: USA
Int'l firms represented: Belwin Mills (USA), Big Pig (UK), Groovy (UK), Isaye (Belgium), Joaneline (UK), Kalmus (USA), Leeds (USA), MAM (UK), Melanie (UK), Northern (USA), Snafesbury (UK), Spanka (USA), Threshold (UK), Valley (UK)

Int'l rep.: Worldwide (MCA)

M D K Music Ltd (SICAM), Caixa Postal 13030, 01000 Sao Paulo, Rua Parque da Fonte 194, 02345 Barro Branco Sao Paulo Tel (011) 203-6692 Cable CAMPUSBRASIL. Pres.: Malcolm Kigar

Int'l branch: USA
Int'l firms represented: Apanacea, Art in Space, Birthright, Bodi, Chinwah Songs, Dirty Martha, Early Bird, Edwood, Good Luvin, Gudi, House of Talley, Lambourne, Lantana, Marullo, Mid-America Music Designers, New Chatham, James P O Brock & Boot, Provo, Glenn Regan, Shelview, Spaceark, George W. Sith, Stonebass, Till Corn, Vibration, Whalebone (all USA); Centreum, Montrose (both Canada)

Int'l rep.: Worldwide, excluding Brazil (Copyright Serv Bureau in USA)

Mangione Filhos Ed., Rua do Ovidor 183, 1st fl., Suites 14-19-a, 20000 Rio de Janeiro ZC-00 Tel (021) 242-3223/3698 Cable EDIMANGIONE Pres. Estevam Scianguela Mangione

Int'l firms represented: Bizet (Belgium, USA), International Music (France), Uni (Japan)

Int'l reps.: Belgium (Bizet), France (International Music) Japan (Uni), USA (Bizet)

Marajo (Sadembra), see Fermata
Marajora Ltd (Eds.), see ITAIPI

Melodias Americana (UBC), see Fermata
Melograf (Ed.) Ltda., see Mundo Musical

Meridional Ltda (Eds. Musicais) (SICAM), see Alvorada
Mundo Musical Ltda (Ed.) (div of CBS), Rua Buenos Aires 2, 16th fl., 20000 Rio de Janeiro Tel (021) 231-2957 Cable SAMIRE; Mng. Dir. Juan Trudner; Gen. Mgr. Rotterdam Salomao

Int'l firms represented: Blackwood, Burlington, Chandos, Fourth Floor, Fulness Music, Gabriel Eall, Garrett, Kool, Lowery, Robert Mellin, Miles Ahead, Naccopy, Paul Simon, Strong Arm, Tuna Fish, Verice (all USA)

Int'l rep.: Worldwide (CBS group)

Musica Brasileira Moderna (UBC), see Fermata
Musicolor Ed. Musical Ltda (SADEMBRA), Av. do Estado 4667, 01515 Sao Paulo Tel (011) 279-6811 Telex (11) 22329 Chm. Alberto Jackson Byington Neto; Int'l Mgr. Geraldo L. Loewenberg; Publ'g Co-ord.: Vitor Martins

Musirama Ed. Musical Ltda., see MCA
Arthur Napoleao (UBC), see Fermata
Nossa Terra (UBC), see Fermata
Nova Musica Ltda., see Top Tape
Novo Rumo Ltda (Ed. Musical), see Sigem

One Way Prod's Ed. Ltda (Sadembra), see Top Tape
Marcus Pereira Ltda (Discos), Rua Minas Gerais 201, 01244 Sao Paulo Tel (011) 257-1622

Pergola Ltda (Ed. Musicais), see Intersong
Pipoca (Eds.) Ltda., see Intersong
Bruno Quino Material Musical Ltda., Rua da Quitanda 194, 20000 Rio de Janeiro Tel (021) 253-7227 Cable QUAINO; Gen. Mgr. Tania Regina G Souza

Int'l firms represented: (Classical catalogues only) Barry (Argentina), Paul Beuschler (France), Choudens (France), Delrieu & Cie (France), Durand & Cie (France),

Enoch & Cie (France), Jobert & Cie (France), Alphonse Leduc (France), Rideau Rouge (France), Tonos (Germany)

R C A Jaguarre Ltda (Ed. Musical), see Victor.
R C A Leme Ltda (Ed. Musical), see Victor.
R C A Ltda (Ed. Musical), see Victor.

Red Lips (Ed.) (SICAM), see Mangione
Saturno Ltda (Ed. Musicais), see Intersong
Scorpius Musica Ltda (Sicam), see Top Tape.
Seresta (Sadembra), see Fermata

7 Notas Ltda (Ed. Musical), see Alvorada
Sidomar (SICAM), see Fermata

Sigem (Sistema Globo de Edicoes Musicais), Rua Joao Alfonso 15, Botafogo, Rio de Janeiro Tel (021) 286-3846 Telex (21) 22795. Pres.: Bruno-Quaino; Mgr.: Danilo Rocha

Branch: Sao Paulo, Alameda Barros 403, Tel (011) 826-1130 Mgr. Victor Francisco de Mello

Int'l branches: Argentina (Trompos), France, USA
Int'l firms represented: Art-Musique (France), Bretagne (France), Ri-Fi (Italy), Tropical (Germany)

Int'l reps.: Germany (Tropical), Italy (Ri-Fi), Portugal (Valentim de Carvalho), Spain (Notas Magicas), USA (Ivan Mogull)

Sonata (SICAM), see Fermata
Studio Hara Eds. Musicais Ltda (UBC), Rua Joaquim Silva 56, 5th fl., Rio de Janeiro Tel (021) 222-0972. Dir.: Nilo S. Pinto; Gen. Mgr.: Ruth de Castro Savaget

Sugarmusic do Brasil, Ltd. (Ed.) (UBC), Edif. Avenida Central Sala 627, Av. Rio Branco 156, Rio de Janeiro Tel (021) 231-3231 Cable COPYGAN; Contact: H. Gandelman

Home office: Italy
T C Ltda (Ed. Musical) (SICAM), Rua Aguiar Moreira 639, 20000 Rio de Janeiro Tel (021) 230-5469 Cable TAPACAR; Dir.: Manuel Valls Camero; Gen. Mgr.: Waldomiro Oliveira

Int'l reps.: Germany (Hanseatic), Mexico (Edimusa), USA (Eibomo & Tomeja)

Tappajus Ltd. (Eds.), see ITAIPI
Tapecar (Ed. Musical), see TC
Tecla Ltda (Ed. de Musica), see Editora de Musica

Templo (Ed.), see ITAIPI
Terra Plana (UBC), see Fermata

Top Tape (Grupo Ed.), Rua Alice 97, Laranjeiras, 20000 Rio de Janeiro ZC-01 Tel (021) 245-3515 Cable MUSITOP; Dir.: Joel B. Leibovitz; Gen. Mgr.: Rotterdam Salomao

Int'l firms represented: At Home, Black Bull, Boca, Equinox, Four Knights, Hibiscus, Jobete group, Joyfully Sad, Lowery, Rip Keca, Raton, Wild Flowers (all USA), AA (Belgium), Paris Tour Eiffel (France)

Torres (Sadembra), see Fermata
Tres Siminhos Ed. Musical Ltda (UBC), Av. do Estado 4667, 01515 Sao Paulo Tel (011) 279-6811 Telex (11) 22329 Chm. Alberto Jackson Byington Neto; Int'l Mgr. Geraldo L. Loewenberg; Publ'g Co-ord.: Vitor Martins

Victor Ltda (Ed. Musical) (UBC), Rua Barata Ribeiro 181, Loja 1, 20000 Rio de Janeiro Tel (021) 255-1069
Cable BRARCA Telex (021) 22714 Mng. Dir.: Adolfo Piro; Gen. Mgr.: Omer Leite Jundi

Int'l firms represented: Acapulco (Mexico), Antisia (USA), Ariola America (USA), Associated (Australia), Big Seven (USA), CAM (USA), Camerica (USA), Camex (USA), Can't Stop (USA), Clandalee (USA), Compass (Netherlands), Cyclus (Germany), Edim (Mexico), Edimusa (Mexico), Global (Japan), Green Mountain (USA), Interworld (USA), Kidada (USA), Kiss Songs (USA), Ledacian (USA), Metal Machine (USA), Ivan Mogull (USA), Naked Snake (USA), Oakfield Avenue (USA), Planetary (USA), Polar (Sweden), RCA (France, Italy, Spain), RCA Int'l (USA), Rashida (USA), Relay (Argentina), Rocket (UK), Scorpio Black Scorpio (France), Scott-Wolfe (UK), Six Continents (USA), Street Music (UK), Sunbury (UK), Sunbury/Dunbar (Canada), Thomas Fun (USA), UA Arabella (USA), Union Songs (Sweden), Valgroup (USA), World Song (USA)

Int'l reps.: Argentina (Relay), Australia (Associated), Belgium (Universal Songs), Bolivia (Imbofon), Canada (Sunbury/Dunbar), Chile (SIAE), Colombia (Sonolux), Denmark (EMI), Ecuador (Orama), France (RCA), Germany (Cyclus), Italy (RCA), Japan (Global), Mexico (Edim), Netherlands (Universal Songs), Peru (SIAE), Portugal (Telectra), Spain (RCA), Switzerland (Melodie), UK (Sunbury), USA (Interworld), Venezuela (Unimusic)

Warner Bros. Ltda (Eds. Musicais), Rua Itaipava 44, Jardim Botânico, 20000 Rio de Janeiro Tel (021) 246-2215 Mng. Dir.: Haidar Midani

Int'l firms represented: Curtom (USA), T B Harms (USA), Viva (UK), WB (USA), Warner Bros. (UK, USA), Warner-Tamerlane (USA), M. Witmark (USA)

Zoom (Eds. Musicais) Ltd., see Intersong
Zorra (Eds. Musicais) Ltd., see Intersong

● **services**

ASSOCIATIONS & PROFESSIONAL ORGANIZATIONS

Associacao Brasileira dos Produtores de Discos, Rua Sao Jose 90, Rms. 1406/10, Rio de Janeiro Tel (021) 263-6377

Museu Villa-Lobos, Ministerio da Educacao & Cultura, Palacio da Cultura, Rua da Imprensa 16, Rms. 911-914, 20000 Rio de Janeiro ZC-P Tel. 222-2917, 242-6671

DESIGN & ARTWORK

Lidervideo Comunicacao Audiovisual SA, Rua da Assembleia 58, 12th fl., 20000 Rio de Janeiro Tel (021) 231-0327, 232-9047 Pres.: Antonio Luiz Mendes de Almeida; Gen. Mgr. Ricardo Jorge Nick; Sales Mgr. Helidio Nogueira; Development Mgr.: Gustavo Moraes Rego

Polygram Discos Ltda., Av. Rio Branco 311, 4th fl., 20040 Rio de Janeiro Tel (021) 252-6195, 242-2895

Tapcar Gravacoes SA, Rua Aguiar Moreira 639, 20000 Rio de Janeiro, Tel: (021) 280-5282. Pres.: Manuel Valls Camero, VP: Fernando de Araujo Neves; Plant Dir. & Sales Mgr.: Ademir Pereira.

LICENSING ORGANIZATIONS, MUSIC

S B A C E M (Sociedade Brasileira de Autores, Compositores & Escritores de Musica), Praca Mahatma Gandhi 2, 709-710 Cinelandia, Rio de Janeiro. Tel: (021) 221-2886. Pres.: Adelinio Moreira de Castro; Sales Mgr.: Gustavo Thomas Filho; Treas.: Newton C. Teixeira.

S B A T (Sociedade Brasileira de Autores Teatrais), Av. Almirante Barroso 97, 3rd fl., Rio de Janeiro. Tel: (021) 221-4464/4844. Superintendent: Djalma Bittencourt. (Represents the interests of BMI & SESAC).

S I A E, Rua Evaristo da Veiga 35, Rio de Janeiro. Tel: (021) 222-7219. (Mechanical rights only).

S I C A M (Sociedade Independente de Compositores & Autores Musicais), Largo Paissandu 51, 10th-16th fls., 01034 Sao Paulo. Tel: 35-0374. Cable: MUSAU-TORES. Pres.: A.T. Godoy; Gen. Mgr.: Rosa Palma. (Mechanical & performing rights)

U B C (Uniao Brasileira de Compositores), Rua Visconde Inhauma 134, Rio de Janeiro. Tel: 23-1693.

PLATING, PROCESSING & PRESSING PLANTS

Companhia Ind'l de Discos, Rua 7 de Marco 331, Bonsucesso, 20000 Rio de Janeiro. Tel: (021) 280-9222. Pres.: Herman Zuckermann; VP Int'l: Harry Zuckermann; Gen. Mgr.: Rodolfo Zuckermann.

E M I-Odeon Fonografica Industrial & Electronica SA, Caixa Postal 2752, ZC-00; Rua Mena Barreto 151, Botafogo, 20000 Rio de Janeiro. Tel: (021) 286-1212. Cable: TURNTABLE. Mng. Dir.: Rolf Dohlmann; Studio Mgr.: Zoltan Merky; Pressing Plant Mgr.: Hamilton Dos Santos.

Gravacoes Eletricas SA, Av. do Estado 4667, 01515 Sao Paulo. Tel: (011) 279-6811. Telex: (11) 22329. Chm.: Alberto Jackson Byington Neto; Comm'l Mgr.: Wilson Rodrigues Poso; Int'l Mgr.: Geraldo L. Loewenberg. (Pressing only)

Polygram Discos Ltda., Estrada das Furnas 1467, Rio de Janeiro. (Pressing only)

R C A Electronica Ltda., Av. Engenheiro Billings 2227, Sao Paulo. Tel: (011) 268-2133. Pres.: Adolfo Pino; Ind'l Mgr.: Marco Antonio Altafini.

R G E/Fermata (Discos), Rua Josef Kryss 90, Sao Paulo. Tel: (011) 826-5359/5559/5548/5438. Cable: FERMATABRASIL. Telex: 1121735. Pres.: Enrique Lebendiger; Gen. Mgr.: Morency B. Monte; Sales Mgr.: Carlos Claro.

Som Industria & Comercio SA, Rua Eugenia S. Vitale 173, San Bernardo do Campo. Tel: 457-2299. Cable: SOMDISCOS. Gen. Mgr.: Gunter Csasznik; Plant Mgr.: Joao F. Blumenschein; Sales Mgr.: Rosvaldo Cury.

Tapcar Gravacoes SA, Rua Aguiar Moreira 639, 20000 Rio de Janeiro. Tel: (021) 280-5282. Pres.: Manuel Valls Camero; VP: Fernando de Araujo Neves; Plant Dir. & Sales Mgr.: Ademir Pereira.

PRINTERS & LITHOGRAPHERS

Lidervideo Comunicacao Audiovisual SA, Rua da Assembleia 58, 12th fl., 20000 Rio de Janeiro. Tel: (021) 231-0327, 232-9047. Pres.: Antonio Luiz Mendes de Almeida; Gen. Mgr.: Ricardo Jorge Nick; Sales Mgr.: Helder Nogueira; Development Mgr.: Gustavo Moraes Rego.

Som Industria & Comercio SA, Rua Eugenia S. Vitale 173, San Bernardo do Campo. Tel: 457-2299. Cable: SOMDISCOS. Gen. Mgr.: Gunter Csasznik; Plant Mgr.: Joao F. Blumenschein; Sales Mgr.: Rosvaldo Cury.

Tapcar Gravacoes SA, Rua Aguiar Moreira 639, 20000 Rio de Janeiro. Tel: (021) 280-5282. Pres.: Manuel Valls Camero; VP: Fernando de Araujo Neves; Plant Dir. & Sales Mgr.: Ademir Pereira.

RECORD PROMOTION

Tapcar Gravacoes SA, Rua Aguiar Moreira 639, 20000 Rio de Janeiro. Tel: (021) 280-5282. Pres.: Manuel Valls Camero; VP: Fernando de Araujo Neves; Plant Dir. & Sales Mgr.: Ademir Pereira.

**TAPE CUSTOM DUPLICATORS
TAPE PACKAGING & LABELING**

The Audio and Video lines indicate the configurations which the firms duplicate. Companies which offer packaging and labeling of tape product are indicated by: (PKG) which appears after the main body of their respective listings.

A P G Electronica SA, Rua Funchal 314, 04551 Sao Paulo. Tel: (011) 210-4755, 211-9721, 212-4337. Telex: (011) 24278. Pres.: Sebastiao R. Bastos; Superintendent: William Schaefer Jr.; Consumer Sales Mgr.: Richard Banfield; Industrial Sales Mgr.: Maria Antonieta Chalmers.

Audio: 8-tr., cassette.

Lidervideo Comunicacao Audiovisual SA, Rua da Assembleia 58, 12th fl., 20000 Rio de Janeiro. Tel: (021) 231-0327, 232-9047. Pres.: Antonio Luiz Mendes de Almeida; Gen. Mgr.: Ricardo Jorge Nick; Sales Mgr.: Helder Nogueira; Development Mgr.: Gustavo Moraes Rego.

Video: 2" open reel, 1 1/2" open reel, 3/4" cassette, 1/2" EIAJ open reel, 1/2" EIAJ cartridge.

R G E/Fermata (Discos), Rua Josef Kryss 90, Sao Paulo. Tel: (011) 826-5359/5559/5548/5438. Cable: FERMATABRASIL. Telex: 1121735. Pres.: Enrique Lebendiger; Gen. Mgr.: Morency B. Monte; Sales Mgr.: Carlos Claro.

Audio: Cassette.

Som Industria & Comercio SA, Rua Eugenia S. Vitale 173, San Bernardo do Campo. Tel: 457-2299. Cable: SOMDISCOS. Gen. Mgr.: Gunter Csasznik; Plant Mgr.: Joao F. Blumenschein; Sales Mgr.: Rosvaldo Cury.

Audio: Cassette.

Tapcar Gravacoes SA, Rua Aguiar Moreira 639, 20000 Rio de Janeiro. Tel: (021) 280-5282. Pres.: Manuel Valls Camero; VP: Fernando de Araujo Neves; Plant Dir. & Sales Mgr.: Ademir Pereira. (PKG)

Audio: Cassette.

● supplies

CASSETTE PARTS

A P G Electronica SA, Rua Funchal 314, 04551 Sao Paulo. Tel: (011) 210-4755, 211-9721, 212-4337. Telex: (011) 24278. Pres.: Sebastiao R. Bastos; Superintendent: William Schaefer Jr.; Consumer Sales Mgr.: Richard Banfield; Industrial Sales Mgr.: Maria Antonieta Chalmers.

Audio: Housings, hubs, pins, press pads, rollers, shields, shims.

Som Industria & Comercio SA, Rua dos Gusmos 235, 01212 Sao Paulo. Tel: (011) 221-7855. Cable: SOMDISCOS. Pres.: Adiel Macedo de Carvalho; Gen. Mgr.: Gunter Csasznik; Sales Mgr.: Rosvaldo Cury.

EMPTY CARTRIDGES, CASSETTES & REELS

A P G Electronica SA, Rua Funchal 314, 04551 Sao Paulo. Tel: (011) 210-4755, 211-9721, 212-4337. Telex: (011) 24278. Pres.: Sebastiao R. Bastos; Superintendent: William Schaefer Jr.; Consumer Sales Mgr.: Richard Banfield; Industrial Sales Mgr.: Maria Antonieta Chalmers.

Audio: Cassette.

B A S F Brasileira SA, Av. Sao Luis 86, 01000 Sao Paulo. Tel: (011) 257-0011. Telex: 1122745. Magnetic Prods. Div. Gen. Mgr.: Hector Urbina; Sales Mgr.: Mauricio Parise; Prod. Mgr.: Joao Carlos Gaya.

Audio: Cassette & open reel.

Som Industria & Comercio SA, Rua dos Gusmos 235, 01212 Sao Paulo. Tel: (011) 221-7855. Cable: SOMDISCOS. Pres.: Adiel Macedo de Carvalho; Gen. Mgr.: Gunter Csasznik; Sales Mgr.: Rosvaldo Cury.

**POLYETHYLENE BAGS
SLEEVES**

Som Industria & Comercio SA, Rua dos Gusmos 235, 01212 Sao Paulo. Tel: (011) 221-7855. Cable: SOMDISCOS. Pres.: Adiel Macedo de Carvalho; Gen. Mgr.: Gunter Csasznik; Sales Mgr.: Rosvaldo Cury.

LABELS

Tapcar Gravacoes SA, Rua Aguiar Moreira 639, 20000 Rio de Janeiro. Tel: (021) 280-5282. Pres.: Manuel Valls Camero; VP: Fernando de Araujo Neves; Plant Dir. & Sales Mgr.: Ademir Pereira.

RECORD PROCESSING EQUIPMENT

R C A Electronica Ltda., Av. Engenheiro Billings 2227, Sao Paulo. Tel: (011) 268-2133. Pres.: Adolfo Pino; Ind'l Mgr.: Marco Antonio Altafini.

Product: 7" & 12" molds.

TAPE, RAW & BLANK LOADED

A P G Electronica SA, Rua Funchal 314, 04551 Sao Paulo. Tel: (011) 210-4755, 211-9721, 212-4337. Telex: (011) 24278. Pres.: Sebastiao R. Bastos; Superintendent: William Schaefer Jr.; Consumer Sales Mgr.: Richard Banfield; Industrial Sales Mgr.: Maria Antonieta Chalmers.

Audio: Cassette, open reel.

Brand names: Blank—Ampex, Hitex, XHF; Raw—Ampex.

B A S F Brasileira SA, Av. Sao Luis 86, 01000 Sao Paulo. Tel: (011) 257-0011. Telex: 1122745. Magnetic Prods. Div. Gen. Mgr.: Hector Urbina; Sales Mgr.: Mauricio Parise; Prod. Mgr.: Joao Carlos Gaya.

Audio: Cassette & open reel.

Video: 1" open reel & 3/4" cassette.

Som Industria & Comercio SA, Rua dos Gusmos 235, 01212 Sao Paulo. Tel: (011) 221-7855. Cable: SOMDISCOS. Pres.: Adiel Macedo de Carvalho; Gen. Mgr.: Gunter Csasznik; Sales Mgr.: Rosvaldo Cury. (Blank only)

Audio: Cassette.

Brand name: Beverly.

**TAPE PACKAGING & LABELING
EQUIPMENT & SUPPLIES**

A P G Electronica SA, Rua Funchal 314, 04551 Sao Paulo. Tel: (011) 210-4755, 211-9721, 212-4337. Telex: (011) 24278. Pres.: Sebastiao R. Bastos; Superintendent: William Schaefer Jr.; Consumer Sales Mgr.: Richard Banfield; Industrial Sales Mgr.: Maria Antonieta Chalmers.

Product: Philips boxes.

B A S F Brasileira SA, Av. Sao Luis 86, 01000 Sao Paulo. Tel: (011) 257-0011. Telex: 1122745. Magnetic Prods. Div. Gen. Mgr.: Hector Urbina; Sales Mgr.: Mauricio Parise; Prod. Mgr.: Joao Carlos Gaya.

Product: Cassette snap boxes.

PROFESSIONAL TAPE SUPPLIES

A P G Electronica SA, Rua Funchal 314, 04551 Sao Paulo. Tel: (011) 210-4755, 211-9721, 212-4337. Telex: (011) 24278. Pres.: Sebastiao R. Bastos; Superintendent: William Schaefer Jr.; Consumer Sales Mgr.: Richard Banfield; Industrial Sales Mgr.: Maria Antonieta Chalmers.

Product: Duplicating & mastering tape.

Brand name: Ampex.

B A S F Brasileira SA, Av. Sao Luis 86, 01000 Sao Paulo.

Tel: (011) 257-0011. Telex: 1122745. Magnetic Prods. Div. Gen. Mgr.: Hector Urbina; Sales Mgr.: Mauricio Parise; Prod. Mgr.: Joao Carlos Gaya.

Audio: 1/4" tape.

Video: 1" tape.

**● accessories
manufacturers**

A P G Electronica SA, Rua Funchal 314, 04551 Sao Paulo. Tel: (011) 210-4755, 211-9721, 212-4337. Telex: (011) 24278. Pres.: Sebastiao R. Bastos; Superintendent: William Schaefer Jr.; Consumer Sales Mgr.: Richard Banfield; Industrial Sales Mgr.: Maria Antonieta Chalmers.

Product: Head cleaners, demagnetizers, leader tape.

B A S F Brasileira SA, Av. Sao Luis 86, 01000 Sao Paulo. Tel: (011) 257-0011. Telex: 1122745. Magnetic Prods. Div. Gen. Mgr.: Hector Urbina; Sales Mgr.: Mauricio Parise; Prod. Mgr.: Joao Carlos Gaya.

Product: Leader & splicing tape.

Som Industria & Comercio SA, Rua dos Gusmos 235, 01212 Sao Paulo. Tel: (011) 221-7855. Cable: SOMDISCOS. Pres.: Adiel Macedo de Carvalho; Gen. Mgr.: Gunter Csasznik; Sales Mgr.: Rosvaldo Cury.

Product: Carrying & storage cases, catalog servs., head cleaners.

Tapcar Gravacoes SA, Rua Aguiar Moreira 639, 20000 Rio de Janeiro. Tel: (021) 280-5282. Pres.: Manuel Valls Camero; VP: Fernando de Araujo Neves; Plant Dir. & Sales Mgr.: Ademir Pereira.

Product: Cleaners, cloths, brushes, head cleaners, demagnetizers, leader & splicing tape.

BULGARIA

Population: 8,800,000.
Rate of exchange: \$1 (US) = 0.96 leva.
Per capita income: \$1,770.
Holidays: January 1, May 1, September 9 (Liberation Day).

**● record & tape
manufacturers/
distributors/importers**

Balkanton Rec., 6 Haydoushka Polyana St., 1612 Sofia. Tel: 52-54-51/31-96/23-00. Gen. Dir.: Alexander Yossifov; Gen. Mgr.: Konstantin Dragnev; Int'l Mgr.: Gizella Sorsich.

Int'l reps.: Argentina (Planeta), Canada (Archambault), France (Harmonia Mundi), Italy (Font-Cetra), Spain (Edigsa), USA (Monitor).

● services

**ASSOCIATIONS & PROFESSIONAL
ORGANIZATIONS**

National Committee of the Int'l Music Council, c/o Bulgarian Composers' Union, 2 ul Ivan Vazov, Sofia.
Union of Bulgarian Composers, 2 ul Ivan Vazov, Sofia. Cable: COMPOSITORI.
Union of Musicians in Bulgaria, Alabin 52, Sofia.

PRESSING PLANT

Balkanton Rec., 6 Haydoushka Polyana St., 1612 Sofia. Tel: 52-54-51/31-96/23-00. Gen. Dir.: Alexander Yossifov; Gen. Mgr.: Konstantin Dragnev; Int'l Mgr.: Gizella Sorsich.

CANADA

Population: 23,500,000.
Rate of exchange: \$1 (US) = \$1.12 (Canadian).
Per capita income: \$5,838.
Holidays: January 1, Good Friday, Easter Monday, May 22 (Victoria Day & Queen's Birthday), July 1 (Dominion Day), September 4 (Labor Day), October 9 (Thanksgiving Day), November 11 (Remembrance Day), December 25 (Christmas Day). Additional holidays observed in P.Q. only: January 6 (Epiphany), February 8 (Ash Wednesday), May 4 (Ascension Day), June 24 (St. John Baptist), November 1 (All Saints' Day), December 8 (Conception Day).

RECORDS

Records sold domestically: LP's 1978—53,865,405 units; 1977—45,979,151 units. Singles 1978—17,277,632 units; 1977—19,821,491 units.
Records, record blanks & pre-recorded media imported from USA: 1977—\$10,720,369.
Records exported to USA (factory value, FOB): LP's 1978—2,764,989 units. Singles, EP's & blanks 1978—835,975 units.
Stereo sales: 99% of total.
Quadrasonic sales: 1% of total.
Record club sales: 8% of total.
Discounting: Frequent.
Type of distribution: Approximately 91% of all distribution operates through manufacturer to sub-distributor (rack jobbers & one stops) to retailer arrangements. The remaining 9% is manufacturer to retailer.
Type of promotion: Radio still stands as the major

promotional vehicle in English Canada. Television has some music shows but they appeal to minority record buying audiences, such as ethnic, MOR & country. Artists on these shows generally are not picked because of outstanding record sales. The major daily newspapers are devoting an increasing amount of space to music coverage. Quebec, which is predominately French speaking, receives complete support from all the media for local and international acts.

TAPE:

Pre-recorded tape sold domestically: 8-tr 1978-15.. 707,211 units, 1977-15,003,376 units Cassette 1978-7,211,635 units; 1977-4,480,458 units.
Average retail price per tape: All configurations \$7.98.

● record & tape manufacturers

A & M Recs. of Canada Ltd., 939 Warden Ave., Scarborough, Ont. M1L 4C5. Tel: (416) 752-7191. Telex: 06-9636552. Pres.: Gerry Lacoursiere, Sr. VP & Gen. Mgr. Joe Summers; VP Promo.: Doug Chappell; VP Finance: Gary Hubbard; Nat'l Promo. Mgr.: J.P. Guilbert; Nat'l Sales Mgr.: Bill Ott; A&R Co-ord.: Michael Godin; Nat'l Pub. Mgr.: James Monaco; Mushroom Nat'l Pub.: Lorna Richards; Nat'l Opns. Mgr.: Alex Fedorow; Creative Servs. Mgr.: David Andoff; Local Branch Mgr.: Ray Rosenberg.

Home office: USA.

Branches: Calgary, Alta., 6812A Sixth St. SE. Postal Code: T2H 2K4. Tel: (403) 253-8411. Telex: 03-825736 District Mgr.: Paul McClure; Branch Mgr.: Al Harrison—Lachine, P.Q., 9434 Cote de Liesse. Postal Code: H8T 1A1. Tel: (514) 636-9741. Telex: 05-821659 Branch Mgr.: Gary Kouri; Eastern Promo. Mgr.: Nick Carboni.

Labels: (Owned) A&M; (licensed foreign) Horizon; (distributed—not licensed) Mushroom.

Int'l reps.: See listing in USA.

A R C/Grayson Publ's & Rec'g's, PO Box 3044, Vancouver, B.C. V6B 3X5. Tel: (604) 291-8992. Dir.: J. Grayson.

A R C (USA), see CBS.

A V I, see Quality.

Abkco, see London.

Able Recs. Co. Ltd., 450 Beaumont St. E., St-Bruno, P.Q. J3V 2R3. Tel: (514) 653-7838. Pres.: Christian Lefort; Gen. Mgr.: Louis Lefort.

Labels: (Owned) Able (distributed by London), Domino, Eden, Emotion, VIP (distributed by Alta Musique). **Int'l reps.:** France (Albatros, BBZ, Disc'AZ, Ibach, International Shows), USA (Can't Stop).

Ace of Clubs, see London.

Ace of Diamonds, see London.

Adelphi, see TCD.

Airedale, see London.

Alouette, see Archambault.

American Century, see Brian Millan.

Angel, see Capitol.

Anthem Recs. of Canada, c/o Oak Manor, PO Box 1000, 12261 Yonge St., Oak Ridges, Ont. L0G 1P0. Tel: (416) 881-3212. Telex: 06-986530. Chm.: Ray Daniels; Pres.: Vic Wilson; Mng. Dir.: Tom Berry. (Distributed by Capitol)

Apex, see MCA.

Aquarius Recs. of Canada Ltd., 354 Youville St., Montreal P.Q. H2Y 2C3. Tel: (514) 284-1001. Telex: 055-60958. Pres.: Terry Flood; VP: Dan Lazare; VP Pub. & Adv.: Bob Lemm; VP Promo.: Don Tarleton; Sec'y-Treas.: Jack Lazare; A&R: Bob Rags, Keith Brown. (Distributed by Capitol)

Aquitaine, see CBS.

Archambault Inc. (Ed.), 500 St. Catherine St. E., Montreal, P.Q. H2L 2C6. Tel: (514) 849-6201. Cable: ARCH-MUSIC. Co-Proprietor: Rosaire Archambault Sr.; Gen. Mgr.: Rosaire Archambault Jr.; Sales Mgr.: John Damant; Adv. & Promo. Mgr.: Celine Gravel.

Labels: (Owned) Alouette, Select; (licensed foreign) Studio SM (France); (distributed—not licensed) Assimil Language Courses, Chant du Monde, Deesse, Eurodisc, Music For Pleasure, Tranan, Unidisc

Arc Sound Co. Ltd., 142 Sparks Ave., Toronto, Ont. M2H 2V9. Tel: (416) 499-5000.

Argo, see London.

Ariola, see Quality.

Aris, see Peters Int'l

Arista, see Capitol.

Artofonic Ltd., 6275 2E Ave., Montreal, P.Q. H1Y 2Z3. Tel: (514) 272-7734. Pres.: Jean De Ladurantaye; Gen. Mgr.: Yvon Martneau. (Distributed by RCA)

Label: (Owned) Musicus.

Int'l rep.: USA (RCS Audio)

Ashtree, see Phonodisc

Assimil Language Courses, see Archambault.

Asylum, see WEA.

Atco, see WEA.

Atlantic, see WEA.

Attic Recs. Ltd. (IFPI), 98 Queen St. E., Suite 3, Toronto, Ont. M5C 1S6. Tel: (416) 862-0352. Telex: 06-219815. Pres.: Alexander Mair; VP & Sales Mgr.: Tom Williams. (Distributed by CBS)

Labels: (Owned) Attic; (licensed foreign) EMI (UK), RKM (Netherlands), Rockburgh (UK), Safari (UK).

Int'l reps.: Australia (Astor), Mexico (Musart), New Zealand (Phonogram), France (Sonopresse), South Africa (RPM), UK (CBS, Mirallo).

Audat, see World.

Audiodefinitely, see Phonodisc

Axe Recs. Ltd., 70 Craighurst Ave., Toronto, Ont. M4R 1J8. Tel: (416) 481-2922. Pres.: Greg Hambleton. (Distributed by London)

B S S T, see London.

Baby, see RCA.

Banff, see London.

Bang, see RCA.

Barclay, see Polygram

Bearsville, see WEA.

Beggar's Banquet, see WEA.

Beltona, see London.

Berandol Recs., 111 St. Joseph St., Toronto, Ont. M4Y 1J8.

Tel: (416) 924-8121.

Beta, see London.

Big Tree, see WEA.

Birchmount, see Quality.

Black & White, see RCA.

Bleu (Disque), see London.

Bluebird, see RCA.

Blue Note, see Capitol.

Blue Sky, see CBS.

Bluestime, see RCA.

Bomb Recs., 1635 Sismet Rd., Unit 30, Mississauga, Ont.

L4W 1W5. Tel: (416) 624-0510. Telex: 06-961479.

Principals: Wolfgang Spegg, Phil Lubman.

Labels: (Owned) Bomb; (licensed foreign) Bomp (USA)

Bomp, see Bomb.

Boot Recs. Ltd., 1343 Matheson Blvd. W., Mississauga, Ont. L4W 1R1. Tel: (416) 625-2676. Cable: BOOT-GROUP. Telex: 06-960-250. Pres.: Jury Krytiuk; VP: Tom Connors; Gen. Mgr.: Peter Krytiuk.

Int'l branch: USA.

Labels: (Owned) Boot, Cynda, Generation, MOR (all distributed by London); Boot Master Concert Series.

Bouquet, see PCRL.

Bridge, see Chapel/Bridge.

Broadland, see Quality.

Buckshot, see Concord.

Buddah, see Quality.

Buffalo, see Calart.

Bullet, see RCA.

Butterfly, see RCA.

C A M Canada Ltd., 1180 W. St. Antoine, Suite 600, Montreal, P.Q. H3C 1B4. Tel: (514) 861-9917. Telex: 05-24111. VP: Alain Leroux; Label Mgr.: Luc Martel. (Distributed by London)

C B S Recs. (Canada) Ltd., 1121 Leslie St., Don Mills, Ont. M3C 2J9. Tel: (416) 447-3311. Telex: 06-966792.

TWX (416) 492-1366. Chm.: Arnold Gosewich; Pres.: Terry Lind; Exec. VP: Jack Robertson; VP Bus. Development: Stan Kulin; VP Finance: Fred Rich; VP Mfg. Martin Keyes; VP Personnel: Glen Lane; VP Sales: Bert Dunseith; VP Mktg.: Jean Desjardins; Bus. Affairs Dir.: Richard Aaronson; Nat'l Account Sales Dir.: Ed Colero;

Columbia Label Mktg. Dir.: Bill Bannon; E/P/A Labels Mktg. Dir.: Graham Powers; Artist Development, Nat'l Press & Pub. Dir.: Terry McGee; Creative Servs. Dir.: Marty Herzog; Columbia Label Nat'l Promo. Mgr.: Graham Thorpe; E/P/A Labels Nat'l Promo. Mgr.: Brad Weir; Admin. & Mktg. Dir.: Maurice Kissel; English A&R Dir.: Bob Gallo; English A&R Mgr.: Don Lorusso; CBS Disques A&R Dir.: Paul Hebert; CBS Disques A&R Admin.: Francine Fiore. Local branch: 5621 Finch Ave. E., Scarborough M1B 2T9. Tel: (416) 444-6651. TWX: (610) 421-3509. Telex: 06-966792. Ontario Reg'l Dir.: Don Oates; E/P/A Promo.: Peter Budge; Columbia Promo.: Mike Watson.

Branches: Calgary, Alta., Glenmore Centre, 7004M Fifth St. SE. Postal Code: T2H 2G3. Tel: (403) 253-8719. Telex: 03-825827. Western Region Dir.: Bill Bouvette; E/P/A Promo.: Bill Neily; Columbia Promo.: Karen Lacey—Vancouver, B.C., 1847 W. Broadway, Suite 101. Postal Code: V6J 1Y6. Tel: (604) 734-5151. Telex: 04-55350. Reg'l Sales Mgr.: Garry Newman; E/P/A Promo.: Dave Chesney; Columbia Promo.: Frank Gigliotti—Winnipeg, Man., 1625 Dublin Ave., Suite 130. Postal Code: R3H 0W3. Tel: (204) 774-2536. Reg'l Sales Mgr.: Don Gunter; Promo. Rep.: Dave Brian—Moncton, N.B., 1133 St. George Blvd., Suite 350. Postal Code: E1C 8R9. Tel: (506) 386-3993. Reg'l Sales Mgr.: Jim Bradley; Promo. Rep.: Brian Horne—St. Laurent, P.Q., 1550 Rue Beaulac. Postal Code: H4R 1W8. Tel: (514) 342-2231. Quebec Region Dir.: Paul Gallant; E/P/A Promo.: Francis Tassart; Columbia Promo.: Alex Paterson.

Labels: (Owned) CBS, CBS Direct, Columbia, Columbia Legacy collection, Columbia Masterworks, Epic, Odyssey, Okeh, Versailles; (distributed) ARC, Aquitaine, Attic, Blue Sky, Caribou, Chagnel, Cleveland Entertainment Int'l, L'Escargot, GTO, IGM, Invictus/Hot Wax, Jet, Kirshner, Lifesong, Magnet, Monument, Nemperor, Ode, Philadelphia Int'l, REL, Sweet City, TK, T-Neck, TSOP, Tabu, Tappan Zee, True North, Unlimited Gold.

C B/Star, see London.

C T I, see RCA.

C T L, see World.

Calart Rec'g Studios Ltd., 1568 Angus St., Regina, Sask. S4T 1Z1. Tel: (306) 352-6694. Chief Exec. W. E. Brown.

Labels: (Owned) Buffalo, Calart, Soundaround.

Camden, see Pickwick.

Canaan, see Word.

Canadian Cavalcade, see London.

Canada Int'l, see RCA.

Canadian Talent Library, 2 St. Clair Ave. W., Toronto, Ont. M4V 1L6. Tel: (416) 924-1411.

Caparo, see RCA.

Capitol Recs. -EMI of Canada Ltd. (IFPI), 3109 American Dr., Mississauga, Ont. L4V 1B2. Tel: (416) 677-5050.

Cable: CAPITOLREC. Pres.: J.D. Evans; VP Finance: D. Williamson; VP Legal Counsel: W.J. MacLeod; VP & Retail Gen. Mgr.: B.T. Josling; VP Mktg.: R. Rowe; VP Sales: M. Rosicki; Talent Acquisition Dir.: D. Cameron; Special Prods. Mgr.: M. Zurba; Nat'l Mdsgr. & Adv. Mgr.: D. Elliot; Artist Relations Mgr.: S. Irwin; Press & Pub. C. Mulhern; Mfg. Dir.: H. Weits; Tape Plant Mgr.: W. Gow.

Branches: Calgary, Alta., 519 Manitou Rd. SE. Postal Code: T2G 4C2. Tel: (403) 287-0823. Western Reg'l Sales Mgr.: A. Andruchow; Western Reg'l Mktg. Mgr.: W. Franchuk; Promo.: O. Kornelson—Vancouver, B.C., Century Plaza, Suite 503, 1015 Burrard St. Postal Code: V6Z 1Y5. Tel: (604) 689-8667. Sales: D. Bertsch, B. Manlove; Promo.: P. Taylor, L. Wilson—Dorval, P.Q., 9245 Cote de Liesse Rd. Postal Code: H9P 2N9. Tel: (514) 631-9073. Eastern Reg'l Sales Mgr.: W. Rotari; Promo.: V. D'Amico, D. Morrison.

Labels: (Owned) Capitol; (licensed domestic) Daffodil; (licensed foreign) Angel (USA), Arista (USA), Blue Note (USA), Chrysalis (USA), EMI America (USA), Harvest (UK), Imperial (USA), Liberty (USA), Muse (France), Pacific Jazz (USA), Pathe (France), Seraphim (USA), Sunset (USA), United Artists (USA), World Pacific (USA); (distributed—not licensed) Anthem, Aquarius.

Caprice, see London.

Capricorn, see Polygram.

Carats, see PCRL & London.

Caribou, see CBS.

Carriere, see RCA.

Carrousel, see RCA.

Casablanca, see Polygram.

Celebration, see Quality.

Celtic, see London.

Centennial, see RCA.

Century, see Word.

Chair-Man Mills, see London.

Champagne, see RCA.

Champion, see RCA.

Change, see MCA.

Channel, see CBS.

Chanterelle, see Mushroom.

Chant du Monde, see Archambault.

Chapel/Bridge Recs. (div. of Pacific Press Publ'g Ass'n), PO Box 398, Oshawa, Ont. L1H 7N4. Tel: (416) 579-2311.

Home office: USA.

Labels: (Owned) Bridge, Chapel.

Charisma, see GRT.

Charity, see Intermodal.

Chiaroscuro, see Phonodisc.

Chi-Sound, see RCA.

Chocolate City, see Polygram.

Chouette, see London.

Chrysalis, see Capitol.

Circa, see Bruce Thompson.

Cleveland Entertainment Int'l, see CBS.

Club Series, see RCA.

Coach, see Holborne.

Colgems, see RCA.

Columbia, see CBS.

Columbia Legacy collection, see CBS.

Columbia Masterworks, see CBS.

Con Brio, see Quality.

Condor Music Corp. Ltd., 1145 Bellamy Rd., Scarborough, Ont. Tel: (416) 438-9211.

Labels: (Owned) Buckshot, Condor.

Cosmic Recs. of Canada, 292 Lorraine Dr., Baie d'Urfe, P.Q. H9X 2R1. Tel: (514) 457-5959. Pres. & A&R Dir.: Hugh D. Dixon; VP & Controller: Clementine Dixon; Promo. Co-ord.: C.M.A. van Ogtrop.

Labels: (Owned) Cosmic, Crunch, DED, Happinessville, Hexagon, Nemo, Pamplemousse.

Cosmos, see Peters Int'l.

Cottillon, see WEA.

Crossover, see London.

Crunch, see Cosmic.

Cubbyhole, see Rising.

Cynda, see Boot & London.

D E D, see Cosmic.

D G, see Polygram.

D J M, see GRT.

D R G, see RCA.

Daffodil, see Capitol.

Damon Prod'n Ltd., 6844 76 Ave., Edmonton, Alta. T6B 0A8. Tel: (403) 465-1071. Telex: 037-3764. Pres.: A&R & Prod'r: Garry L. McDonald; Sec'y-Treas.: Wallis Petrak. (Distributed by RCA)

Labels: (Owned) Damon, Mustard.

Dark Horse, see WEA.

Dawn Club, see Sackville.

Dayspring, see Word.

Decca, see London.

Deesse, see Archambault.

De-Lite, see Polygram.

Deram, see London.

Dice, see Phonodisc.

Dipper 7 Ents., 1414 Hillside Ave., Suite 101, Victoria, B.C. V8T 2B8. Tel: (604) 595-6709. Owner: Lou Jean Mollin; Gen. Mgr.: Arthur Trolley; Sales Mgr.: Robert Paul Mollin.

Label: (Owned) Expo.

Direction, see Polygram.

DiscReet, see WEA.

Disneyland, see Walt Disney.

Walt Disney Music Canada Ltd., 2323 Yonge St., Toronto, Ont. M4P 2C9. Tel: (416) 486-1166.

Int'l branch: USA, Disneyland/Vista Recs.

Labels: (Owned) Disneyland, Vista.

Domino, see Able.

Durium, see London.

Dynacom Communications Int'l, PO Box 702, Snowdon Sta., Montreal, P.Q. H3X 3X8. Tel: (514) 342-5200. Pres.: David Leonard.

Labels: (Owned) Dynacom, Monticans.

Dynamic, see Holborne.

E C M, see WEA.

E G G, see Polygram.

E M I (USA), see Capitol.

E M I (UK), see Attic.

Ehanson, see London.

Eden, see Able.

Edmar, see Holborne.

Elektra, see WEA.

Emotion, see Able.

Enigma, see London.

Epic, see CBS.

Erato, see RCA.

Fiesta Rec. Corp. of Canada, 1420 Sherbrooke St. W., Montreal, P.Q. H3G 1K5 (Also see Holborne)
Home office: USA

Finnadar, see WEA.

Fleur, see PCRL.

Flying Fish, see Stony Plain & London.

Fontana, see London.

Force One, see London.

Foreign Exchange, see PCRL & London.

Formule 1, see RCA.

Free Flight, see RCA.

Frontenac, see Phonodisc.

G-Clef Rec. & Music Ltd., 21 Vaughan Rd., Toronto, Ont. M6G 2N2. Tel: (416) 653-7102.

G E M, see RCA.

G R T of Canada Ltd., 3816 Victoria Park Ave., Willowdale, Ont. M2H 3H7. Tel: (416) 497-2340. Acting Gen. Mgr.: Claude Sassoon, VP & Gen. Mgr. Magnum Recs. Jeff Burns, Mktg. & Sales Dir., Alex Petchkin, Prod'n Mgr.: Liz Nox; Nat'l Press: Nancy Oldam, Eastern Reg'l Promo. Mgr.: Perry Goldberg.

Branches: **Calgary, Alta.**, 7003B Fifth St. SE. Postal Code: T2H 2G2. Tel: (403) 259-5252. Western Reg'l Mgr.: Doug Byrne; Western Reg'l Promo. Mgr.: Neil MacGonigall—Sales Rep.: Randy Stark—**Vancouver, B.C.**, 181 W. Broadway, Suite B. Postal Code: V5Y 1P4. Tel: (604) 879-0646. Sales Reps.: Don Grant, Gerry MacKay—**Winnipeg, Man.**, 388 Donald St., Suite 200. Postal Code: R3B 2J4. Tel: (204) 944-7274. Sales Rep.: Rick Vivier—**Montreal, P.Q.**, 59 W. St. James St., Suite 302. Postal Code: H2Y 1K9. Tel: (514) 844-3062. Eastern Reg'l Sales Mgr.: Ken Dion; Quebec Promo.: Sylvia Oman.

Labels: **(Owned)** GRT, Magnum; **(licensed foreign)** Charisma (UK), DJM (UK), Fantasy (USA), Passport (USA), Tomato (USA), Vogue (France).

G T O, see CBS.

Gaiety Recs. Ltd., 55 S. Cumberland St., Thunder Bay, Ont. P7B 2T6. Tel: (807) 344-7963. Pres., A&R, Pub. & Promo.: Don Grashey.

Gala, see Pickwick.

Galaxy Recs. & Tapes Ltd., 744 Polson Ave., Winnipeg, Man. R2X 1M2. Tel: (204) 582-3371.

Gamma Recs. Ltd., 9375 Meaux St., St.-Leonard, P.Q. H1R 3H3. Tel: (514) 327-5010. Cable: GAMREC. Telex: 05-828592. Pres.: Jack Lazare; Gen. Mgr.: Daniel Lazare; Promo. Dir.: Francine Audette.

Gem Toby, see RCA.

Generation, see Boot & London.

Golden Greats, see RCA.

Gold Mind, see RCA.

Gold Seal, see RCA.

Good Earth, see RCA.

Good News, see Word.

Gordy, see Motown.

Grapevine, see Pilgrim Recs.

Grit, see RCA.

Grunt, see RCA.

Gull, see Phonodisc.

Gusto, see Quality.

H & L, see Quality.

Hansa, see Quality.

Happinessville, see Cosmic.

Harvest, see Capitol.

Hexagon, see Cosmic.

Hilltop, see Pickwick.

Hitsville, see Motown.

Holborne Dist. Co. Ltd., PO Box 9, Mount Albert, Ont. LOG 1M0. Tel: (416) 294-9398. Pres.: Frank P. Swain; Gen. Mgr.: H. Littlejohn; Sales Mgr.: Ray Johnston; West Indian Repertoire Mgr.: Stanley Gittens.

Labels: **(Owned)** FP Series, Island Series; **(licensed foreign)** (Barbados), Wiri (Barbados), (distributed—not licensed) Coach (UK), Fiesta (USA), Ica (UK), Murril (USA), Penny.

Int'l rep.: Bermuda (Edmar).

Hologram, see RCA.

Honey Dew, see London.

Horizon, see A&M & Praise.

I G M, see CBS.

Ibis, see RCA.

Ice, see Holborne & London.

Image, see Phonodisc.

Image VII, see Word.

Imperial, see Capitol.

Improv, see Phonodisc.

Infinity Recs. Canada, 2450 Victoria Park Ave., Toronto, Ont. M2J 4A2. Tel: (416) 491-7770. Telex: 06-966876. TWX: (610) 492-5204. VP & Gen. Mgr.: Martin Onrot; Nat'l Promo. Dir.: Jean-Marie Heimrath.

Home office: USA.

Interdisk, see London.

Intermodal Prod'n's Ltd., PO Box 2199, Vancouver, B.C. V6B 3V7. Tel: (604) 688-1820. Pres.: John Rodney; VP Ops.: Evelyn Rodney.

Labels: **(Owned)** Laser, Lasso, Ranch House, **(distributed)** Charity, Pops Update.

Invictus/Hot Wax, see CBS.

Island, see RCA.

Island Series, see Holborne.

Jake Recs., 50 Peach Willoway, Toronto, Ont. M2J 2B6.

Tel: (416) 869-1937. (Distributed by London)

Janz, see Word.

Jare Int'l, see RCA.

Jet, see CBS.

Jim, see Word.

Le Joint, see London.

K-tel Int'l Ltd., 1670 Inkster Blvd., Winnipeg, Man. R2X 2W8. Tel: (204) 633-8860. Telex: 07-587597. Gen. Mgr.: Morley Myren; Sales Mgr.: Ken Paige.

Branch: **Montreal, P.Q.**, 6665 St. James St. W. Tel: (514) 487-2382. Telex: 05-268800.

Home office: USA.

Kama Sutra, see Quality.

Kebec Disc, 2322 Sherbrooke E., Montreal, P.Q. H2K 1E5. Tel: (514) 527-2397.

Kicking Mule (USA), see TCD.

King, see Quality.

Kiras Musical Works, see Musicorp.

Kirschner, see CBS.

Kneptune Int'l Recs. Ltd., Box 5236, Vancouver, B.C. V6B 4B3. Tel: (604) 531-9331, 522-2711. Pres.: Kenny Harris.

Int'l rep.: USA (Kneptune Int'l).

Kosmos, see London.

Kronos, see Peters Int'l.

Kudu, RCA.

Lamb & Lion, see Word.

Lars, see Peters Int'l.

Laser, see Intermodal.

Lasso, see Intermodal.

Legendary Performers, see RCA.

Liberty, see Capitol.

Lifesong, see CBS.

Light, see Word.

Lyrus, see RCA.

Listen Foundation, see Praise.

Little David, see WEA.

Little Pilgrim, see Pilgrim Recs.

Living Water, see Bruce Thompson.

Lollipop, see London.

London Recs. of Canada (1967) Ltd. (IFPI), 6265 Cote de Liesse, St.-Laurent, P.Q. H4T 1C3. Tel: (514) 341-5350. Cable: FULLRANGE. Telex: 05-824570. Pres.: F.C. Jamieson; VP: A. Koury; VP Mktg. & English Div. A&R: K. Verdoni; Admin. Chief.: G. Ayliffe; Western Reg'l Mktg. Mgr.: A. Bilodeau; Eastern Reg'l Mktg. Mgr.: A. Guadagno; French Div. A&R: G. Bonneville; Classical A&R: F. Dans; Controller/Sec'y-Treas.: S. Christie; Local Branch Mgr.: Fred Refica; Local Sales Mgr.: Yves Dupuis.

Branches: **Calgary, Alta.**, 429 Manitou Rd. SE. Postal Code: T2G 4C2. Tel: (403) 243-1313. Telex: 038-22572. Mgr.: D. McBeth—**Burnaby, B.C.**, 3166 Lake City Way. Postal Code: V5A 3A4. Tel: (604) 298-6471. Telex: 04-354544. Mgr.: O. L. Jones—**Winnipeg, Man.**, 15-1100 Waverley St. Postal Code: R3T 3X9. Tel: (204) 452-7918. Mgr.: 07-57695. Mgr.: G. Young—**Scarborough, Ont.**, 1630 Midland Ave. Ont., 1630 Midland Ave. Postal Code: M1P 3C2. Tel: (416) 755-3373. Telex: 06-963754. Mgr.: Armand Beau-din—**Quebec City, P.Q.**, 1303 Rue Conway. Postal Code: G1J 3S3. Tel: (418) 529-0261. Telex: 051-3799. Mgr.: Fred Refica.

Labels: Abkco (tape only), Able, Ace of Clubs, Ace of Diamonds, Airedale, Argo, Axe, BSST, Banff, Beltona, Beta, Bleu, Boot, CAM, CB/Star, Canadian Cavalcade, Caprice, Carats, Celtic, Chair-Man Mills, Chouette, Crossover, Cynda, Decca, Deram, Durium, Echanson, Enigma, Flying Fish, Fontana, Force One, Foreign Exchange, Generation, Honey Dew, Ice, Interdisk, Le Joint, Jake, Kosmos, Lollipop, London, Magique, Manibelle, Morning, Musinter, Nuage, L'Oiseau-Lyre, Owl Blues, Parrot, Phase 4, Philips, Philo, Pingouin, Project 3, Quatre Saisons, Richmond, Riot, Rodeo, Rosa, Sky, Stereo Treasury, Stony Plain, Talsman, Telefunken, Telson, Threshold, UK, VIP, Vinyl, WAM, Wonderland, Wow.

Lone Star, see Polygram.

Lotus, see RCA.

M C A Recs. (Canada) (div. of MCA Canada Ltd.) (IFPI), 2450

Victoria Park Ave., Willowdale, Ont. M2J 4A2. Tel: (416) 491-3000. TWX: 610-492-5204. Telex: 06-966876. VP Mktg.: Scott Richards; Nat'l Promo. Mgr.: Keith Patten; Nat'l Mktg. Mgr.: Herb Forgie.

Branches: **Calgary, Alta.**, 5737 Burbank Rd. SE. Postal Code: T2H 1Z5. Tel: (403) 253-0401. Sales Mgr.: Geoff Gibbons—**Vancouver, B.C.**, 1200 W. 73 Ave., Suite 506. Postal Code: V6P 6G5. Tel: (604) 263-1761. Sales Mgr.: William Tait—**Winnipeg, Man.**, 365 Hargrave St., No. 300A. Postal Code: R3B 2K3. Tel: (204) 942-2413. Sales Mgr.: Jack Skelly—**Montreal, P.Q.**, 8444 St. Laurent Blvd. Postal Code: H2P 2M3. Tel: (514) 382-8475. Sales Mgr.: Robert Hamel.

Labels: **(Owned)** Apex, MCA, Source; **(licensed)** Change.

M G M, see Polygram.

M O R, see Boot & London.

M W C, see Quality.

Magique, see London.

Magnet, see CBS.

Magnum, see GRT.

Malaco, see RCA.

Mango, see RCA.

Manibelle, see London.

Manna, see Word.

Manicore, see WEA.

Maranathal, see Praise.

Master's Collection, see Pilgrim Recs.

Ben McPeck Ltd., 131 Hazleton Ave., Toronto, Ont. M5R 2E4. Tel: (416) 923-3316.

Mercury, see Polygram.

Merrydisc, see RCA.

Metronome, see Holborne.

Michele Audio Canada Ltd., 491 Brimly Rd., Scarborough, Ont. M1J 1A4. Tel: (416) 264-4181. Pres.: Clyde McGregor.

Home office: USA.

Midsong Int'l, see RCA.

Brian Millan Music Corp., PO Box 1905, Succ. Postal Place d'Armes, Montreal, P.Q. H2Y 1S6. Tel: (514) 288-4950. Pres.: Brian Millan; Gen. Mgr.: Steve Voros; Art-ist Relations & Art Dir.: Eileen Haines.

Home office: Belgium; Baltic-Brian Millan Int'l Foundations.

Labels: **(Owned)** American Century, Soul Vista Int'l reps.: Belgium (Eurovox), Germany (Bosworth), Switzerland (Musikproduktionen).

Mr. Pickwick, see Pickwick.

Monticana, see Dynacomp.

Monument, see CBS.

Morning, see London.

Moss Music Group (Canada) Inc., 510 Coronation Dr., West Hill, Ont. M1E 4X6. Tel: (416) 284-0126. Pres.: John Leatham.

Home office: USA.

Motown Recs. (Canada) Ltd., 1960 Ellesmere Rd., Unit 9, Scarborough, Ont. M1H 2V9. Tel: (416) 438-2855. Telex: 065-25387. VP: Gordon Prince; Gen. Mgr.: Denis Fenwick; Sales Mgr.: Leo DeRocher; Promo. Mgr.: Jerry Hochberg.

Labels: **(Owned)** Gordy, Hitsville, Motown, Prodigal, Rare Earth, Soul, Tamla.

Murril, see Holborne.

Muse, see Capitol.

Mushroom Recs. Canada Inc., 1234 W. Sixth Ave., Vancouver, B.C. V6H 1A5. Tel: (604) 736-7207. Telex: 04-54667. Pres. & Gen. Mgr.: Wink Vogel; Nat'l Sales & Promo. Dir.: Jay Gold; Bus. Affairs Dir.: Rick Block. (Also see A&M)

Int'l branch: USA

Labels: **(Owned)** Chanterelle, Mushroom.

Music For Pleasure, see Archambault.

Music is Medicine, see Stony Plain.

Muscorp Ltd., 3015 Kennedy Rd., No. 10, Scarborough, Ont. M1V 1E7. Tel: (416) 292-9619. Pres.: Douglas Hill; Gen. Mgr.: Paul A. Gross.

Label: **(Owned)** Kiras Musical Works.

Int'l rep.: Worldwide (Discwasher).

Musicus, see Artofonic.

Musinter, see London.

Mustard, see Damon & RCA.

Myrrh, see Word.

Nemo, see Cosmic.

Nemperor, see CBS.

New Life, see Praise.

NewPax, see Word.

New Song, see Word.

New Ventures, see Phonodisc.

Nonesuch, see WEA.

Nuage, see London.

Ode, see CBS.

Odyssey, see CBS.

L'Oiseau-Lyre, see London.

Okeh, see CBS.

Onari, see Sackville.

Ovation, see RCA.

Owl Blues, see London.

P C R L (Productions Carole Rich Ltd.), 2364 Sherbrooke St. E., Montreal, P.Q. H2K 1E6. Tel: (514) 526-2831. Telex: 055-61375. Pres. & Dir. Gen.: Carole Rich; Ass't: Irene Burdyl. (Distributed by London)

Labels: **(Owned)** Bouquet, Carats, Fleur, Foreign Exchange, Quatre Saisons, Sterling.

P M, see Post Meridiam.

Pablo, see RCA.

Pablo Live, see RCA.

Pacific, see WEA.

Pacific Jazz, see Capitol.

Pamplemousse, see Cosmic.

Parachute, see Polygram.

Paradise, see WEA.

Paragon, see Word.

Parrot, see London.

Passport, see GRT.

Pathe, see Capitol.

Penny, see Holborne.

SAM THE RECORD MAN

Canada's Largest Retail Chain

Now 120 Stores Strong

Offering the best
Export Prices
and Service

please TELEX

ROBLAN
DISTRIBUTORS LTD.
#06-22500

or call

1-416-363-2437

Periwinkle Recs., 1262 Don Mills Rd., Suite 3A, Don Mills, Ont. M3B 2W7. Tel: (416) 445-0878.

Peters Int'l Canada Ltd., 1608 The Queensway, Toronto, Ont. M8Z 1V4. Tel: (416) 259-5029.

Home office: USA.

Labels: (Owned) Aris, Cosmos, Kronos, Lars, Peters Int'l

Petra, see Praise.

Phase 4, see London.

Philadelphia Int'l, see CBS.

Philips, see London & Polygram.

Philly Groove, see RCA.

Philo, see London.

Phonodisc Ltd., 30 Malley Rd., Scarborough, Ont. M1L 2E3. Tel: (416) 751-9610. Telex: 06-963-629. Pres.: Jim Trainor; Gen. Mgr.: Laurence Heselton.

Branches: **Calgary, Alta.**, 4718 14 St. NE. Postal Code: T2E 6L7. Tel: (403) 276-5543. Sales Rep.: Brian Burrows—**St-Laurent, P.Q.**, Place Trans Canada, Suite 223A, 7033 Trans Canadienne. Postal Code: H4T 1S2. Tel: (514) 337-1022. Sales Rep.: Pierre St. Georges.

Labels: (Owned) Frontenac, New Ventures, Phonodisc; (licensed foreign) Ashtree, Audiofidelity, Chiaroscuro, Gull, Image, Improv, Pye, Radar, Sydney Thompson; (distributed—not licensed) Dice

Pickwick Recs. of Canada Ltd., 106-108 McMaster Ave., Ajax, Ont. L1S 2E7. Tel: (416) 683-1466. Telex: 06-981378. Gen. Mgr.: Alan Reid; Nat'l Mdsgr. Mgr.: Allan Matthews.

Labels: (Owned) Hilltop, Mr. Pickwick, Pickwick, Quintessence, (licensed) Camden, Gala, Sessame Street.

Pilgrim Praise, see Pilgrim Recs.

Pilgrim Recs., Box 189, Sta. W., Toronto, Ont. M6M 4Z9.

Tel: (416) 746-1991. Mng. Dir.: Paul J. Young.

Branch: **New Westminster, B.C.**, 231 Queens Ave., Postal Code: V3L 1J7. Tel: (604) 524-3565. Mktg. Consultant: Sandford E. Tompson.

Labels: (Owned) Grapevine, Little Pilgrim, The Master's Collection, Pilgrim, Pilgrim Praise, Sharon.

Pingouin, see London.

Planet, see WEA.

Plantation, see Quality.

Playboy, see Quality.

Pleiad, see WAM.

Polydor, see Polygram.

Polygram Inc., 6000 Cote de Liesse, St-Laurent, P.Q. H4T 1E3. Tel: (514) 739-2701. Cable: POLYDISC. Telex: 05-825690. TWX: (610) 421-3509. Pres.: Tim Harold; VP Finance: Peter Erdmann; VP Sales & Mktg.: Dieter Radecki; VP Prod. Mgmt.: Leo da Silva; Classical Mktg. Dir.: Vassilios Pollakis; English A&R Mgr.: Larry Mayson; French Prod. A&R Dir.: Yvan Gadoua; Prod. Mgrs.: Derek Steede, Michael Theriault; Nat'l Promo. Mgr. & Disco Contact: Bob Ansell; General Opns. & Systems: Don Wedge; Eastern Region Sr. Mgr.: Gaston Careau; Promo. Mgr.: Pierre Parent.

Branches: **Calgary, Alta.**, 105 Bow Valley Square 1, 202 Sixth Ave. SW. Postal Code: T2P 2R9. Tel: (403) 265-5007. Telex: 03-821859. Sr. Reg'l Mgr.: Ken Graydon; Promo. Mgr.: Harry Hrabinsky—**Vancouver, B.C.**, 805 W. Broadway, Mezzanine. Postal Code: V5Z 1K1. Tel: (604) 873-2466. Telex: 045-4410. Branch Mgr.: Peter Behnke; Promo.: Monica Netupsky—**Winnipeg, Man.**, 3 Donald St., Suite 304. Postal Code: R3L 2P6. Tel: (204) 453-4048. Telex: 07-55306. Promo.: Nancy Pellick—**Toronto, Ont.**, Etobico Tower, 7th flr., 555 Burnhamthorpe Rd. W., Etobicoke M9C 2Y3. Tel: (416) 622-6680. Telex: 06-967755. Nat'l Accounts Dir.: Alun Elias; Reg'l Sales Mgr.: Herb Bradley; Reg'l Promo.: Wendy Lockwood, Gerry Young.

Labels: Barclay (France), Capricorn (USA), Casablanca (USA), Chocolate City (USA), DG (Germany), De-Lite (USA), Direction, EGG (France), Festivo, Lone Star (USA), MGM (USA), Mercury (USA), Parachute (USA), Philips (Netherlands), Polydor, RSO (USA), Raal (France), Resonance, Riviera (France), Rockland (USA), Spring (USA), TGO, Verve (France), Virgin (UK), Voyage (France), Zappa (USA).

Pops Update, see Intermodal.

Portrait, see CBS.

Posterity, see TCD.

Posterity/Woodshed, see TCD.

Post Meridien Prod'ns Ltd., PO Box 103, Sta. A, Toronto, Ont. M5W 1A2. Tel: (416) 534-7951. Pres.: Gene Perla; Dir.: Lois Oki.

Home office: USA, PM.

Label: (Owned) PM.

Praise Recs. of Canada Ltd., 6979 Curragh Ave., Burnaby, B.C. V5T 4V6. Tel: (604) 438-8266. Gen. Mgr.: Paul Yaroshuk.

Labels: (Owned) Faith, Horizon, Praise, Quest, Quest Organ Master; (licensed—foreign) Listen Foundation, Maranathal, New Life, Petra (all USA).

Int'l reps.: UK (Fisher Folk), USA (Creative Sound, Herold, Lamb, Star Song).

Prelude, see Quality.

Private Stock, see Quality.

Prodigal, see Motown.

Project 3, see London.

Psi Recs., 1747 W. Third Ave., Vancouver, B.C. V6J 1K7. Tel: (604) 732-3761.

Pure Gold, see RCA.

Pye, see Phonodisc.

Q C A, see RCA.

Quadradis, see RCA.

Quality Recs. Ltd., 380 Birchmount Rd., Scarborough, Ont. M1K 1M7. Tel: (416) 698-5511. Telex: 06-219624. Pres.: George R. Struth; VP Finance: David Ford; VP Mfg.: Ron Gardner; Mktg. Dir.: Barry Stafford; A&R Dir.: John Driscoll; Bus. Affairs Mgr.: Nadine Langlois.

Branches: **Calgary, Alta.**, 4524 Manilla Rd. SE. Postal Code: T2G 4B7. Tel: (403) 243-0252. Mgr.: John Davies—**Winnipeg, Man.**, Galt Bldg., 4th fl. Postal Code: R3B 0R7. Tel: (204) 943-6563. Mgr.: Chuck Porter—**Toronto, Ont.**, 130 Mack Ave. Postal Code: M1L 4P5. Tel: (416) 698-5643. Mgr.: Barry Stafford; Promo. Frank Daller—**Montreal, P.Q.**, 2215 Beaconsfield Ave. Postal Code: M4A 2G9. Tel: (514) 481-1167. Promo. & A&R: Gaston Gravel.

Labels: (Owned) Birchmount, Broadland, Celebration,

Quality, Ringside; (licensed domestic) MWC, Skyline; (licensed foreign) AVI, Ariola, Buddha, Con Brio, Gusto, H&L, Hansa, Kama Sutra, King, Millennium, Plantation, Playboy, Prelude, Private Stock, Ranwood, Roulette, SSS Int'l, Scorpion, Starday.

Quatre Saisons, see PCRL & London.

Quest, see Praise.

Quest Organ Master, see Praise.

Quintessence, see Pickwick.

R C A Ltd. (Rec. Div.), 101 Duncan Mill Rd., Suite 300, Don Mills, Ont. M3B 1Z3. Tel: (416) 449-9500. Telex: 06-986577. TWX: (610) 492-4746. VP & Gen. Mgr.: J. Edward Preston; Pres. Sunbury-Dunbar Jack Feehey; Creative Affairs & Int'l Dir.: Andy Napp; Opns. Servs. Dir.: K.R. Gillies; Finance Dir.: David Long; Mktg. Servs. Mgr.: Wayne R. Jordan; Mktg. Dir.: John Ford; Studio Mgr.: Edward T. Traynor.

Branches: **Calgary, Alta.**, 4432 10 St. NE. Postal Code: T2E 6K3. Tel: (403) 276-8231. District Sales Mgr.: J. Fotheringham—**Vancouver, B.C.**, 2876 Rupert St. Postal Code: V5M 3T7. Tel: (604) 438-7172. District Sales Mgr.: Leigh Alden—**Winnipeg, Man.**, 1320 Church Ave. Postal Code: R2X 1G4. Tel: (204) 633-2666. Sales Rep.: Robert Tait—**Halifax, N.S.**, 3611 Commission St. Postal Code: B3V 2X1. Tel: (902) 455-8015. District Sales Mgr.: H. Josey—**Scarborough, Ont.**, 680 Progress Ave., Unit 1. Postal Code: M1H 3E5. Tel: (416) 438-9882. District Sales Mgr.: G. Murphy—**Montreal, P.Q.**, PO Box 987, Tour La Cite, 300 Leo Parizeau. Postal Code: H2W 2N1. Tel: (514) 849-3251. District Sales Mgr.: R. Galibois.

Labels: (Owned) Bluebird (USA), Canada Int'l, Centennial, Club Series, Golden Greats, Gold Seal (USA), Gold Standard, Legendary Performers (USA), Uryx, Lotus, Pure Gold, Quadradis, RCA (USA), Red Seal (USA), Vault Treasure, Victor (USA), Victrola (USA), Vik; (licensed domestic) Caparo, Carriere, Carrousel, Champagne, Damon, Fantel, Formula 1, Mustard, Sesame, Special, Tambo, 36; (licensed foreign) Baby (Italy), Bang (USA), Black & White (France), Bluestime (France), Bullet (USA), Butterfly (USA), CTI (USA), Champion (USA), Chi-Sound (USA), Colgems (USA), DRG (USA), Erato (France), Free Flight (USA), GEM (UK), Gem Toby (USA), Gold Mind (USA), Good Earth (USA), Grit (USA), Grunt (USA), Hologram (USA), Ibis (USA), Island (USA), Jare Int'l (France), Kudu (USA), Malaco (USA), Mango (USA), Matronome (USA), Midsong Int'l (USA), Ovation (USA), Pablo (USA), Pablo Live (USA), Philly Groove (USA), OCA (USA), Republic (USA), Roadshow (USA), Salvation (USA), Saravah (France), Sirrocco (France), Solar (USA), Tattoo (USA), Three Brothers (USA), Tom n Jerry (USA), Tortoise Int'l (USA), Trema (France), 20th Century-Fox (USA), Windsong (USA), Wooden Nickel (USA), Zagora (France).

R E L, see CBS.

R K M, see Attic.

R S O, see Polygram.

Raal, see Polygram.

Radar, see Phonodisc.

Ranch House, see Intermodal.

Ranwood, see Quality.

Rare Earth, see Motown.

Red Seal, see RCA.

Reprise, see WEA.

Republic, see RCA.

Resonance, see Polygram.

Richmond, see London.

Ringside, see Quality.

Riot, see London.

Rising Recs. Ltd., 111 Peter St., Suite 204, Toronto, Ont. M5V 2H1. Tel: (416) 363-4343. Pres.: Robert H. Hahn. (Distributed by London)

Labels: (Owned) Cubbyhole, Rising.

Riviera, see Polygram.

Roadshow, see RCA.

Rockburgh, see Attic.

Rockland, see Polygram.

Rodeo, see London.

Rolling Stones, see WEA.

Rosa, see London.

Roulette, see Quality.

Royalty Recs. of Canada Ltd., 9229 58 Ave., Edmonton, Alta. T6E 0B7. Tel: (403) 436-0665. Pres.: Jack Dubasz; VP: R. Harlan Smith; Sales Mgr.: Ian Douglas; Pub. Dir.: Brenda Rudiger.

Int'l reps.: Ireland (Emerald), UK (Emerald).

S G M Recs. Ltd., PO Box 34374, Sta. D, Vancouver, B.C. V6J 4P3. Tel: (604) 879-7255.

S S S Int'l, see Quality.

Sackville Rec'gs, PO Box 87, Sta. J, Toronto, Ont. M4J 4X8. Tel: (416) 368-3149. Chief Execs.: John Norris, William E. Smith.

Labels: (Owned) Sackville; (licensed) Dawn Club, Onari.

Int'l reps.: Denmark (SteepleChase), Germany (International Music Serv.), Italy (Hi-Fi), Japan (Victor), Switzerland (America Sound, Plainisphere), UK (Jazz Horizons), USA (Rick Ballard, City Hall, House Dist., Kinnard, New Music, Record People, Rounder, Tanti).

Sacred, see Word.

Sacred Songs, see Word.

Safari, see Attic.

Salsoul, see RCA.

Salvation, see RCA.

Saravah, see RCA.

Scorpion, see Quality.

Scotti Bros., see WEA.

Select, see Archambault.

Seraphim, see Capitol.

Sesame, see RCA.

Sesame Street, see Pickwick.

Sevots, see World Recs.

Sharon, see Pilgrim Recs.

She, see WEA.

Sire, see WEA.

Sirrocco, see RCA.

Sky, see London.

Skyline, see Quality.

Smile Recs. (div. of Northern Light & Sound Entertainment Corp.), 1659 Bayview Ave., Toronto, Ont. M4G 3C1.

Tel: (416) 485-1157. Pres.: David Coutts; VP A&R &

Promo.: Brian Ayres; VP Mktg.: John Watt.

Solar, see RCA.

Solid Rock, see Word.

Soul, see Motown.

Soul Vista, see Brian Millan.

Soundaround, see Calart.

Source, see MCA.

Sparrow, see Word.

Special, see RCA.

Spring, see Polygram.

Springwater Prod'ns Ltd., 56 Clinton St., Guelph, Ont. N1H

5G5. Tel: (519) 824-7885. Pres.: Homer Hogan; VP:

Dorothy Hogan.

Starday, see Quality.

Stereo Treasury, see London.

Sterling, see PCRL.

Stony Plain Rec'g Co. Ltd., 9108 116 St., Edmonton, Alta.

T6G 1P9. Tel: (403) 433-7426. Mng. Dir.: Holger Petersen;

Bus. Mgr.: Alvin Jahns. (Distributed by London)

Labels: (Owned) Stony Plain; (licensed foreign) Flying

Fish (USA), Music is Medicine.

Int'l reps.: Central America (Dideca), Japan (Trio), USA

(First American).

Studio SM, see Archambault.

Summit, see Word.

Sun-Scape Recs., PO Box 793, Sta. F, Toronto, Ont. M4Y

2N7. Tel: (416) 221-2461. Gen. Mgr./Co-ord.:

Amedeo Barbini; Sales Mgr.: Valerie Webster.

Int'l branch: USA.

Sunset, see Capitol.

Swan Song, see WEA.

Sweet City, see CBS.

Syntonic Research (USA), see TCD.

T C D Recs. & Tapes Ltd., 1050 Baxter Rd., Ottawa, Ont.

K2C 3P1. Tel: (613) 820-1224. Pres.: Harvey Glatt;

Bus. Mgr.: Neil McVean; Sales Mgr.: Colin Cross;

Prod'n Mgr./Buyer: Richard Spearman.

Labels: (Owned) Posterity; (licensed) Adelphi (USA),

Kicking Mule (USA), Posterity/Woodshed, Syntonic Research

(USA), Transatlantic (UK).

Int'l reps.: USA (Adelphi, Cream).

T G O, see Polygram.

T K, see CBS.

T-Neck, see CBS.

T S O P, see CBS.

Tabu, see CBS.

Talisman, see London.

Tamla, see Motown.

Tappan Zee, see CBS.

Tattoo, see RCA.

Tee Vee Recs. Inc., 60 Bullock Dr., Markham, Ont. L3P 3P2.

Tel: (416) 294-4603.

Branch: **Edmonton, Alta.**, 1021 Toronto Dominion

Tower. Tel: (403) 422-5366.

Int'l branch: USA.

Telefunken, see London.

Telson, see London.

WE ARE YOUR CANADIAN CONNECTION

EXPORT IMPORT

New Releases Overstock Deletions

Cash One Stop Ltd.

1050 Baxter Road
Ottawa, Ontario
Canada K2C 3P1
Phone: (613) 820-4522

Telex: 053 3778

Tembo, see RCA.
36, see RCA.

Bruce Thompson Music Corp. Ltd., PO Box 2248, Calgary, Alta. T2P 2M7. Tel: (403) 269-7270. Pres. & Gen. Mgr.: Bruce Thompson; Promos. Mgr.: C. Montoya.
Labels: (Owned) Circa, Living Water.

Sydney Thompson, see Phonodisc.

Three Brothers, see RCA.

Threshold, see London.

Tomato, see GRT.

Tom n Jerry, see RCA.

Tortoise Int'l, see RCA.

Transatlantic (UK), see TCD.

Trema, see RCA.

Trionon, see Archambault.

True North Recs., 98 Queen St. E., Suite 2B, Toronto, Ont. M5C 1S6. Tel: (416) 364-6040. Contacts: Bernard Finkelstein, B.C. Fiedler. (Distributed by CBS)

20th Century-Fox, see RCA.

U K, see London.

Umbrella Recs. (div. of Nimbus 9 Prod's Ltd.), 39 Hazelton Ave., Toronto, Ont. M5R 2E3. Tel: (416) 961-9688. Telex: 06-22364. Mgr.: Wendy Shore.

Int'l reps.: Australia (MR Acoustics), Austria & East European Countries (Hi-Fi), EEC & Middle East countries (Quadrail in UK), Malaysia (United Bearings), Singapore (United Bearings), UK (Quadrail), USA (Audio-Technica).

Unidisc, see Archambault.

United Artists, see Capitol.

Unlimited Gold, see CBS.

V I P, see Able & London.

V V Prod's Ltd., 2433 Rue L.O. David, Montreal, P.Q. H2E 1M2. Tel: (514) 729-4277/7977. Pres.: Vincent Ciabrone.

Val, see Velerio.

Vamp, see Velerio.

Vault Treasure, see RCA.

Velerio Americana Recs., 79 Lunness Rd., Toronto, Ont. M8W 4M7. Tel: (416) 259-9182. Mng. Dir.: Jose Osana.

Labels: (Owned) Val, Vamp, Velerio.

Versailles, see CBS.

Verve, see Polygram.

Victor, see RCA.

Victrola, see RCA.

Vinyl, see London.

Virgin, see Polygram.

Vista, see Walt Disney.

Vogue, see GRT.

Voyage, see Polygram.

W A M Music Corp. Ltd., 901 Kenilworth Rd., Montreal, P.Q. H3R 2R5. Tel: (514) 341-6721. Chief Execs.: Leon Aronson, Dixon Van Winkle. (Also see London)

Labels: (Owned) Pleiade (Disques), WAM.

W E A Music of Canada Ltd., 1810 Birchmount Rd., Scarborough, Ont. M1P 2J1. Tel: (416) 291-2515. Cable: WEATOR. Telex: 24534. Pres.: Ken Middleton; Exec. VP: Ross Reynolds; VP Mktg.: Don Grant; Bus. Af-

fairs: Joe Edwards; Controller: D. Kollar; Nat'l Sales Mgr.: A. Abbate; Nat'l Promo. Mgr.: Larry Green; English A&R: G. Muth; Artist Relations: R. Desjardins; Local Branch Mgr.: M. Gaitt.

Branches: Calgary, Alta., 6325 12 St. SE., Unit 7. Postal Code: T2H 2K1. Tel: (403) 259-3000. Western Reg'l Mgr. Alex Clark—Vancouver, B.C., 40 E. Fifth Ave. Postal Code: V5T 1G8. Tel: (604) 879-8681—Winnipeg, Man., 24 Stevenson Rd., St. James R3H 0H8. Tel: (204) 633-9284. Mgr.: Don Coward—Montreal, P.Q., 735 Renaud Ave., Dorval. Tel: (514) 697-7440. Mgr.: R. Belec.

Labels: (Owned) Asylum, Atco, Atlantic, Big Tree, Cotillion, Elektra, Nonesuch, Reprise, Warner Bros.; (Licensed) Bearsville, Beggars Banquet, Dark Horse, Disc-Reet, ECM, Famous Charisma, Finnadar, Little David, Mantecore, Pacific, Paradise, Planet, Rolling Stones, Scotti Bros., She, Sire, Swan Song, Warner Curb, Warner-Spector, Westbound, Whitfield, Wing & A Prayer (all USA).

Warner Bros., see WEA.

Warner Curb, see WEA.

Warner-Spector, see WEA.

Westbound, see WEA.

Whitfield, see WEA.

Windsong, see RCA.

Wing & A Prayer, see WEA.

Wiril, see Holbrooke.

Wonderland, see London.

Wonderworld, see Word.

Wooden Nickel, see RCA.

Word Recs. Ltd., 250 SW Marine Dr., Vancouver, B.C. V6B 4B5. Tel: (604) 321-6785. Pres. & Adv. Dir. Gerry B. Scott. VP: J. E. Scott, Sales & Mktg.: Phil Crofton, Doug Stark, Don Harbridge, Carl Teeple, Dwayne Daku, Lowden Ashley.

Int'l branch: USA.

Branches: Edmonton, Alta., 4332 114 A St. Postal Code: T6S 1N7. Tel: (403) 436-5956—London, Ont., 152 Wellesley Crescent. Postal Code: N5V 1J7. Tel: (519) 455-2097.

Labels: (Owned) Canaan, Century, Image VII, Myrrh, Sacred, Word, (distributed) Dayspring, Good News, Janz, Jim, Lamb & Lion, Light, Manna, NewPax, New Song, Paragon, Sacred Songs, Solid Rock, Sparrow, Summit, Wonderworld.

World Pacific, see Capitol.

World Recs., 484 Waterloo Court, Oshawa, Ont. L1H 3X1. Tel: (416) 576-0250. Toronto Tel: (416) 686-2828. Pres.: William Hewson; Gen. Mgr.: Bob Stone.

Labels: (Owned) Audat, CTL, Sevoté, World.

Wow, see London.

Zagora, see RCA.

Zappa, see Polygram.

Ashley Music (PRO), see Black & White.
Athenas Music, see Chappell—Chappell.
Attic Publ'g Group, 98 Queen St. E., Toronto, Ont. M5C 1S6. Tel: (416) 862-0352. Telex: 06-21985. Pres.: Alexander Mair; Prof. Mgr.: Lorraine Hume.
Int'l firms represented: Arista/Carers Music (USA), Roger Cook Music (USA), Lollipop Music (Germany), Medicine Hat Music (USA), RPM (Netherlands), State Music (UK).

Int'l reps.: Australia (Essex, Rondor), France (Claude Pascal, Germany (Global), Netherlands (April), UK (ATV, RMO).

Axehandle Music, see Chappell—Chappell.

Axe Music (CAPAC), 70 Craighurst Ave., Toronto, Ont. M4R 1J8. Tel: (416) 481-2922. Pres. & Prof. Mgr.: Greg Hambleton.

Int'l rep.: Australia (Image Music).

B A T Music Ltd., see Chappell—Chappell.

B D M Music Ltd., see Chappell—Chappell.

B + 3, see Montana.

Ba-Be-Bi-Bo-Bu (Les Eds.), see Chappell—Chappell.

P E Baker Music Ltd., see Chappell—Chappell.

Bald Mountain, see Chappell—Bregman Vocco & Conn.

Banner Music, see Chappell—Chappell.

Barnass Music Ltd., see Chappell—Chappell.

Barwin Music, see Chappell—Chappell.

Basse-Ville (CAPAC), see Intermede.

Beaver Mountain Music (PRO), see Morning.

Bedford, see Chappell—Edwin H. Morris.

Beechwood Music of Canada (PRO), see Screen Gems listing in USA.

Charles Begg, see Chappell—Chappell.

Begonia Melodies Inc., see Chappell—Chappell.

Belinda (Canada) Ltd., see Chappell—Chappell.

Belsize Park Music (PRO), see Axe.

Benaventure Music Publ'g Co., see Chappell—Chappell.

Benton Publ'ns, see Chappell—Chappell.

Berandol Music Ltd (PRO), 11 St. Joseph St., Toronto, Ont. M4Y 1J8. Tel: (416) 924-8121.

Int'l firms represented: Hargail (USA), Universal (UK).

Int'l reps.: Australia (Boosey & Hawkes), Japan (Zen-On), UK (Universal).

Irving Berlin, see Chappell.

Betanne Music Publ'g Co. (CAPAC), see Halben.

Big Bay Music (PRO), see Attic.

Big Beat, see Chappell—Chappell.

Big Fuss Music (PRO), see WAM & Chappell.

Big Heather, see Chappell—Chappell.

Big Sandy, see Chappell—Chappell.

Big Six Music Co., see Chappell.

Big Three Music (Canada) Ltd. (CAPAC), see UA Music.

Black & White Music (CAPAC), 121 Don Park Rd., Markham, Ont. L3R 1C2. Tel: (416) 495-1905. Telex: (06) 986816. Pres.: Gary Salter, Gen. Mgr.: Doreen Elmironski.

Int'l firms represented: Arabella, Butterfly, Siegel (all Germany).

Blackwing Music Ltd. (CAPAC)—Pres.: Murry McLaughlin; Gen. Mgr.: Bernie Finkelstein; Prof. Mgr.: Bernie Fiedler—see Golden Mountain.

Blackwood Music (Canada) Ltd. (PRO), see April Music.

Ben Bloom Music Corp., see Chappell—Chappell.

Karl Blore Music, see Chappell—Chappell.

Blue Fame Music, see Chappell—Chappell.

Blue Rose Music (CAPAC), see Axe.

Blue River Music Inc., see Chappell—Edwin H. Morris.

Bondola, see Chappell—Chappell.

Bottom Line Music, see Chappell—Chappell.

Brackenjuice Music, see Chappell—Chappell.

Bradshaw, see Chappell—Edwin H. Morris.

Brandy Publ'g (PRO), see Core.

Brass Bad Publ'g (CAPAC), see Almo/Irving.

Bregmont Music Corp., see Chappell—Chappell.

Bregman, Vocco & Conn, see Chappell.

Breton-Cyr (CAPAC), see Intermede.

British Columbia Music (PRO), see Mushroom Recs.

Broccoli Ballads (PRO), see Tomato Tunes.

Brown Trout Music, see Chappell—Chappell.

Bruce Music Ltd., see Chappell—Chappell.

Brunin, see Chappell—Chappell.

Burdin Music, see Chappell—Chappell.

Burke & Van Heusen Inc., see Chappell—Edwin H. Morris.

Burlington Music of Canada Ltd. (CAPAC), 6265 Cote de Liesse, St. Laurent, P.Q. H4T 1C3. Tel: (514) 341-5350.

Home office: England, Burlington-Palace Group.

Int'l branches: Australasia (Palace in Australia), Austria (Burlington), Benelux (Palace in Netherlands), France (Palace), Germany (Burlington), Italy (Palace), Orient (Burlington-Palace in Hong Kong), Portugal (Burlington), Scandinavia (Palace in Sweden), Spain (Burlington), Switzerland (Palace), USA (Burlington/Felsted).

Burthen, see Chappell—Chappell.

Burvan, see Chappell—Chappell.

Butler Music Corp., see Chappell—Chappell.

Buxton Hill, see Chappell—Chappell.

Cabot Trail Music (CAPAC), see Morning.

Cakewalk, see Chappell—Bregman Vocco & Conn.

Canadiana Music, see Chappell—Chappell.

Canadian Brass Publ'ns (CAPAC), see Morning.

CanCon Music (PRO), see Rising.

Capitol Music of Canada (CAPAC), see Screen Gems listing in USA.

Capri Music Ltd., see Chappell—Chappell.

Captain Beaky Music Ltd., see Chappell.

Captain Marvel Music, see Chappell—Chappell.

Carmel, see Chappell—Edwin H. Morris.

Carnaby Music Ltd., see Chappell—Chappell.

Carricatum (CAPAC), see Intermede.

Carthay Music Inc., see Chappell—Chappell.

Casserole Music Inc., see Chappell—Chappell.

Caveat Music Publ'ns Ltd. (PRO), see E.C. Kerby.

Cee & Cee Music (CAPAC), see Berandol.

Celebrity, see Chappell—Chappell.

Cepcor Ltd., see Chappell.

Chain Gang, see Chappell—Bregman Vocco & Conn.

Chanteclair Music (PRO), see Gordon V. Thompson.

Chanter Music Ltd., see Chappell—Chappell.

Chappell-Aznavour SA, see Chappell—Chappell.

● music publishers

A M, see Chappell—Chappell.

A Q E M Ltee. (Agence Quebecoise de l'Ed. Musicale) (CAPAC), see SMCL.

A & R Publ'g Co. Ltd., see Chappell.

A T V Music Publ'g of Canada Ltd., 14 Dundonald St., Toronto, Ont. M4Y 1K2. Tel: (416) 967-3375. Gen. Mgr.: Bernard Solomon. (Administered by Cherry Lane Music in USA).

Abigail Music Ltd., see Chappell—Chappell.

Abovewater Music (PRO), see Attic.

Accadia, see Chappell—Chappell.

Act III Music Inc., see Chappell—Chappell.

Addax, see Chappell—Chappell.

Ah! Music, see Chappell—Chappell.

Ailes Du Nord (PRO), see Intermede.

A La Portee (CAPAC), see Intermede.

Alexscar Music, see Chappell—Chappell.

Algord Music Ltd. (CAPAC), 372A Yonge St., Toronto, Ont. M5B 1S6. Tel: (416) 597-0066.

Alicia Musik (CAPAC), see Intermede.

Alltime Music Co., see Chappell—Chappell.

Almo/Irving Music Of Canada Ltd. (CAPAC, PRO), 939 Warden Ave., Scarborough, Ont. M1L 4C5. Tel: (416) 752-7191. Telex: 06-963652. VP: Gerry Lacoursiere.

Int'l rep.: Worldwide excluding US & Canada (Rondor).

Alphaventure Music Publ'g Co., see Chappell—Chappell.

Ancre (CAPAC), see Intermede.

Anderssen Music (CAPAC), see SMCL.

Andval Music Co., see Chappell—Edwin H. Morris.

Anglo-Pic Music, see Chappell—Chappell.

Angry Giant, see Chappell—Bregman, Vocco & Conn.

Anandale Music Co., see Chappell—Edwin H. Morris.

Antique Music, see Chappell—Chappell.

Antrim Publ'ns, see Chappell—Chappell.

Antrim Music (PRO), PO Box 4486, Vancouver, B.C. V6B 3Z8. Tel: (604) 681-8311. Gen. Mgr.: Les Weinstein.

Int'l rep.: Worldwide exclusive of Canada & USA (Essex).

Aout (PRO), see Intermede.

April Music (Canada) Ltd. (CAPAC), 160 Milner Rd., Scarborough, Ont. M1S 3R3. Tel: (416) 292-9972. Cable: COLRECORD. Dir.: Wayne Patton; Opns. Mgr.: Vivien E. Hicks.

Int'l firms represented: April (Australia, Belgium, France, Germany, Israel, Italy, Japan, Netherlands, Spain, Sweden, South Africa, UK, USA), Blackwood (Greece), Favorite (Yugoslavia), Melograf (Argentina), Ed. Latino Americana (South America), Mundo Musical (Brazil, Costa Rica, Mexico, Venezuela).

Int'l reps.: Belgium (April), USA (April Blackwood).

Aquarius Recs. Ltd. (CAPAC), 354 Youville St., Montreal, P.Q. H2Y 2C3. Tel: (514) 284-1001. Telex: 055-60958. Pres.: Terry Flood; Gen. Mgr.: Dan Lazare.

Archambault Inc. (Ed.) (CAPAC), 500 St. Catherine St. E., Montreal, P.Q. H2L 2C6. Tel: (514) 849-6201. Cable: ARCHMUSIC. Co-Owner & Gen. Mgr.: Rosaire Archambault.

Arko Music, see Chappell—Chappell.

Arlou, see Chappell—Chappell.

Ascherberg Hopwood & Crew Ltd., see Chappell—Chappell.

★ ★ ★ ★ ★ ★ ★ ★ ★ ★ ★ ★ ★ ★ ★ ★
★ The best catalog ★
★ in Canada ★
★ is NOW bigger and better ★

★ BEACHES ★
★ RECORDS and TAPES LTD. ★

★ 250 Don Park Rd., Unit 2, ★
★ Markham, Ontario L3R 2V1 ★

★ SEND FOR IT ★
★ Write or phone today ★
★ for free catalogue ★

★ (416) 495-1175 ★
★ (dealers only please) ★

★ BARGAINS AT ★
★ ROCK BOTTOM PRICES ★

- Chappell & Co. Ltd. (PRO, CAPAC), 14 Birch Ave., Toronto, Ont. M4V 1C9. Tel: (416) 922-2159. Cable SYM-PHONY. Gen. Mgr.: Jerry Renewych.
- Charleston, see Chappell—Chappell.
- Charlot (CAPAC), see Intermede.
- Charlton (Les Eds.), see Chappell—Chappell.
- Chat (CAPAC), see Intermede.
- Chatham, see Chappell—Bregman Vocco & Conn.
- Checkmate Music, see Chappell—Chappell.
- Cherry Lane, see Chappell—Chappell.
- Jean Chevrier (CAPAC), see Intermede.
- Chien Noir (CAPAC), see Intermede.
- Chinguacusey Music (PRO), see Fivetake Group.
- Chinook Music Publ'g (PRO), Box 269, RR 1, Bentley, Alta. T0C 0J0. Tel: (403) 748-2673. Pres. & Gen. Mgr.: Dick Damron.
- Chrissica Music, see Chappell—Chappell.
- Cirrus Music (PRO) (div. of Nimbus 9 Prod'ns Ltd.), 39 Hazelton Ave., Toronto, Ont. M5R 2E3. Tel: (416) 961-9688. Pres.: Jack Richardson; Exec. VP: H.A. Macmillan.
- Int'l affiliates:** Septima Music Inc. (BMI), Trillium Music Inc. (ASCAP) (both USA).
- Int'l reps.:** Australia (Image), Austria (Rudolf Slezak in Germany), Belgium (Universal Songs), Central America (CBS in USA), Czechoslovakia (Rudolf Slezak in Germany), France (Alto), Germany (Rudolf Slezak), Greece (Grecophon), Israel (Ilsrazemer), Italy (RCA), Japan (Asia), Netherlands (Universal Songs), New Zealand (Image in Australia), Poland (Rudolf Slezak in Germany), Scandinavia (Sweden Music in Sweden), South Africa (Laetrec), South America (CBS in USA), Spain (Armonico), Switzerland (Rudolf Slezak in Germany), USA (Septima).
- Clara, see Chappell—Chappell.
- Roy Clark Music, see Chappell—Chappell.
- Clayhall Publ'g (CAPAC), see Black & White.
- Clondyke Music Ltd., see Chappell—Chappell.
- Cloud Cuckoo Songs Ltd., see Chappell—Chappell.
- Cofranc Music Publ'g Corp. (PRO)—Pres.: Franco Colombo—see E.C. Kerby.
- Comstock Music Inc., see Chappell—Chappell.
- Conception (CAPAC), see Intermede.
- Condor Music Corp. Ltd., 1145 Bellamy Rd. N., Toronto, Ont. M1H 1H5. Tel: (416) 438-9211.
- Conestoga Music (PRO), see Deer Park.
- Consonant Music Inc., see Chappell—Edwin H. Morris.
- Cool Springs Publ'g Co. Inc., see Chappell—Chappell.
- Core Music Publ'g (CAPAC), c/o Oak Manor, PO Box 1000, 12261 Yonge St., Oak Ridges, Ont. L0G 1P0. Tel: (416) 881-3212. Telex: 06-9866530. Pres.: Vic Wilson.
- Corinth Music (PRO)/Tarana Music (CAPAC) (div. of GRT of Canada Ltd.), 3816 Victoria Park Ave., Willowdale, Ont. M2H 3H7. Tel: (416) 497-2340. Telex: 065-25321. Pres.: Gord Edwards; Mgr.: Jeanne Easton.
- Int'l firm represented:** Charisma (UK), Lady Casey (USA).
- Int'l reps.:** France, Italy, Japan, South Africa, USA (Interworld).
- Cornerstone Music Co., see Chappell—Edwin H. Morris.
- Cosmic Echoes Publ'g Co., see Chappell—Chappell.
- Country Line Music, see Chappell—Chappell.
- Country Mornin' Music, see Chappell—Chappell.
- Crea Sound Ltd., 5275 Rue Berri, Montreal, P.Q. H2J 257. Pres.: Louis Delacour.
- Int'l reps.:** Belgium (Multisound), France (Sonimage), Germany (Sonoton), Netherlands (Holland Music), Portugal (Musiteca in Spain), Spain (Musiteca), Switzerland (Dorema).
- Creemore Music (CAPAC), see Fivetake Group.
- Crement Street Music, see Chappell—Chappell.
- Crisch Music (PRO), 2364 Sherbrooke E., Montreal, P.Q. H2K 1E6. Tel: (514) 526-2831. Telex: (055) 61375. Pres.: Carole Risch; Gen. Mgr.: Irene Burdyl.
- Crisco Music, see Chappell—Chappell.
- Crited Music Inc., see Chappell—Chappell.
- Critremfort Music, see Chappell—Chappell.
- Crowfoot Music, see Chappell—Chappell.
- Crown Vetch Music Ltd. (CAPAC), see Morning.
- Cutbank Music, see Chappell—Chappell.
- Cyprine (CAPAC), see Intermede.
- D & L Music Publ'ns (PRO), 55 S. Cumberland St., Thunder Bay, Ont. P7B 2T6. Tel: (807) 344-7963. Pres. & Prof. Mgr.: Don Grashey.
- Int'l reps.:** Benelux, France, Italy, Portugal, South Africa, Spain, UK (Mervyn Music in UK); USA (Cedarwood, Screen Gems-EMI).
- Danboro Publ'g Co. (PRO) (div. of Optam Ltd. V. PO Box 2199, Vancouver, B.C. V6B 3V7. Tel: (604) 688-1820. Pres.: John Rodney; VP: Evelyn Rodney.
- Dar-Jen Music, see Chappell—Bregman Vocco & Conn.
- Darla Music, see Chappell—Bregman Vocco & Conn.
- David Synthesizer Publ'g (CAPAC), see Black & White.
- Dawn of Creation Music Publ'g Co. (PRO), PO Box 452, Cambridge, Ont. N1R 5V5. Tel: (416) 924-8121. Pres.: Robert Liddell; Prof. Mgr.: Ralph Cruickshank.
- Debarc Music (PRO), see Morning.
- Deer Park Music (CAPAC), 2 St. Clair Ave. W., Toronto, Ont. M4V 1L6. Tel: (416) 924-1411.
- Delaware, see Chappell—Bregman Vocco & Conn.
- Delfonte, see Chappell—Chappell.
- Delstone, see Chappell—Bregman Vocco & Conn.
- Dena, see Chappell—Chappell.
- Deposit Music Ltd., see Chappell—Chappell.
- De Sylva Brown & Henderson, see Chappell—Chappell.
- Dicap Music Publ'g Co. (CAPAC), see Hugh Dixon.
- Dipro Music Publ'g Co. (PRO), see Hugh Dixon.
- Direct Music Publ'ns, 65-B Emmett Ave., Suite 1011, Toronto, Ont. M6M 2E5. Tel: (416) 247-5910. Contact: Jay Hunt.
- Home office:** USA.
- Directors Co., see Chappell—Chappell.
- Walt Disney Music (Canada) Ltd., 2323 Yonge St., Toronto, Ont. M4P 2C9. Tel: (416) 486-1166.
- Hugh Dixon Music Org. (PRO), 292 Lorraine Dr., Baie d'Urfe, P.Q. H9X 2R1. Tel: (514) 457-5959. Pres. & Gen. Mgr.: Hugh D. Dixon.
- Dog Tired Music, see Chappell—Chappell.
- Donna, see Chappell—Edwin H. Morris.
- Dorella, see Chappell—Chappell.
- Dorsey Bros. Music Inc., see Chappell—Edwin H. Morris.
- Do-Sol Publ'g (Eds.) (PRO), 990-A Chatelaine, Chomedey, Laval, P.Q. H7W 4J4. Tel: (514) 688-2074. Pres. & Prof. Mgr.: M. Robert Salagan.
- Dotted Eighth Music Publ'g (PRO), 61 Clinton St., Toronto, Ont. M6G 2Y4. Tel: (416) 533-7854. Exec.: Barry Kaplan.
- Int'l reps.:** Australia & New Zealand (Festival in Australia), Europe (Tembo in UK), South & East Africa (Gallos in South Africa).
- Double Diamond, see Chappell—Bregman Vocco & Conn.
- Down Music, see Chappell—Bregman Vocco & Conn.
- Draftleat Ltd., see Chappell—Chappell.
- Dyna Music (CAPAC), see Morning.
- Dynatone Publ'g Co., see Chappell—Chappell.
- E F D S, see Chappell—Chappell.
- Earth Born Music Inc. (PRO), see Halben.
- Eastend Music (CAPAC), see Halben.
- Easy Street Music (PRO), see Intermede.
- Eddie, see Chappell—Chappell.
- El Patricio Music, see Chappell—Chappell.
- Elsinore Music (PRO), 8553 Main, Vancouver, B.C. V5X.
- Elsinore Music (PRO), see Rising.
- Emarcy Publ'g Inc., see Chappell—Chappell.
- Empire Music Co. (PRO), 8553 Main, Vancouver, B.C. V5X 3M3. Tel: (604) 324-7732.
- Engagement Music Inc., see Chappell—Chappell.
- Ensign, see Chappell—Chappell.
- Enteka (CAPAC), see Intermede.
- Entr'acte Music Publ'g Co. (CAPAC), see Halben.
- Era, see Chappell—Chappell.
- Espor (CAPAC), see Intermede.
- Etnos (CAPAC), see Intermede.
- Euphonie Music Publ'g (CAPAC), 61 Clinton St., Toronto, Ont. M6G 2Y4. Tel: (416) 533-7854. Exec.: Barry Kaplan.
- Evie Music, see Chappell—Chappell.
- Eyeball Wine Music (CAPAC), see Kitchen Table.
- Eyes Havitt Music, see Chappell—Chappell.
- Fab, see Chappell—Chappell.
- Fairway, see Chappell—Chappell.
- Fameville Music, see Chappell—Chappell.
- Famous Music Corp., see Chappell—Chappell.
- Fat Mama Music Corp., see Chappell—Chappell.
- Featherbed Music, see Chappell—Chappell.
- Felsted Music of Canada Ltd. (PRO), see Burlington.
- Fervil Music (PRO), see Halben.
- Fiddleback Music, see Chappell—Chappell.
- Fiesta Music Inc., see Chappell—Edwin H. Morris.
- Five Continents, see Chappell—Chappell.
- Fivetake Group Prod'ns Ltd., 484 Waterloo Court, Oshawa, Ont. L1H 3X1. Tel: (416) 576-0250. Pres.: William Hewson; Gen. Mgr.: Bob Stone.
- Fivetake Music Ltd. (PRO), see Fivetake Group.
- Fogo Music (CAPAC), see Morning.
- Foresite Music, see Chappell—Chappell.
- Forestful of Music Ltd., see Chappell—Chappell.
- Four Score Music Corp., see Chappell—Chappell.
- Four Star Music Co., see Chappell—Edwin H. Morris.
- Fox Fanfare Music Inc., see Chappell—Bregman Vocco & Conn.
- Freewheeled Music (ASCAP), see Corinth Music.
- French Music, see Chappell—Chappell.
- Front Polaire (CAPAC), see Intermede.
- Frank Furtado Ed. (PRO), see Intermede.
- G & C, see Chappell—Chappell.
- G R S Music & Rec. Group, 323 Steelcase Rd. Markham, Ont. M2J 4K3. Tel: (416) 475-1517. Chief Exec.: Gil Wilshire.
- Home office:** USA.
- Lucien Gagnon (PRO), see Intermede.
- Gallant Robertson Inc. (CAPAC), 1115 Sherbrooke St. W., Suite 2504, Montreal, P.Q. H3A 1H3. Tel: (514) 288-8880. Pres.: P. Gallant; Gen. Mgr.: Ian Robertson.
- Gangland Music Inc., see Chappell—Chappell.
- Gershwin, see Chappell—Chappell.
- Gigue Eternelle (CAPAC), see Intermede.
- Giguet (CAPAC), see Intermede.
- Gimbleco West Music (PRO), see Kitchen Table.
- Gipe (CAPAC), see Intermede.
- Glamorous, see Chappell—Chappell.
- Glaser Bros., see Chappell—Chappell.
- Glaser Publ'ns, see Chappell—Chappell.
- Gloosecap Music Ltd. (PRO), 1202 Yonge St., Toronto, Ont. M4T 1W1. Tel: (416) 922-1600.
- Glorious Music Inc., see Chappell—Chappell.
- Gog & Magog (PRO), see Intermede.
- Golden Cornflakes Music Co., see Chappell—Chappell.
- Golden Mountain Music (PRO), 98 Queen St. E., Suite 2B, Toronto, Ont. M5C 1S6. Tel: (416) 364-6040. Pres.: Bruce Cockburn; Gen. Mgr.: Bernie Finkelstein (Administered by American Broadcasting in USA).
- Samuel Goldwyn Music Corp., see Chappell—Chappell.
- Golo Music Inc., see Chappell—Chappell.
- Gone Fishin' Music Ltd. (PRO), 6945 Isleview Rd., West Vancouver, B.C. Tel: (604) 922-2683. Pres.: Terry Jacks.
- Int'l firm represented:** Rockfish (USA).
- Int'l reps.:** Worldwide except Canada (Edward B. Marks in USA).
- Jim Grady, see Chappell—Bregman Vocco & Conn.
- Bette Graham Prod'ns (PRO), see Morning.
- Grand Commander Music Inc., see Chappell—Chappell.
- Grand Fanal (CAPAC), see Intermede.
- Grand Leo (CAPAC), see Intermede.
- Green Dream Music Ltd., see Chappell—Chappell.
- Greenwich Mean Music (PRO), see Direct Music.
- Gregory Music Corp., see Chappell—Chappell.
- Grob Music Co., see Chappell—Chappell.
- Groove Merchant Int'l, see Chappell—Chappell.
- Alex Groschak Music Publ'g (PRO), see Morning.
- Growl Music, see Chappell—Chappell.
- Hagood Hardy Music (PRO), see Attic.
- Bob Hahn Prod'ns Ltd., 111 Peter St., Suite 204, Toronto, Ont. M5V 2H1. Tel: (416) 363-4343. Pres.: Robert H. Hahn.
- Int'l rep.:** Laurentian—USA (Copyright Serv. Bureau).
- Halben Music Publ'g Co. (CAPAC), 4824 Cote des Neiges Rd., Suite 38, Montreal, P.Q. H3V 1G4. Tel: (514) 739-4774.
- Halcyon Music, see Chappell—Chappell.
- Haldonal, see Chappell—Chappell.
- Happy Bear Publ'g (PRO), see Condor.
- Harbar Music, see Chappell—Chappell.
- Harman Music Inc., see Chappell—Edwin H. Morris.
- Harmuse Publ'ns (PRO), see Frederick Harris.
- Frederick Harris Music Co. Ltd. (CAPAC), 529 Speers Rd., Oakville, Ont. L6K 2G4. Tel: (416) 845-3487.
- Int'l firm represented:** Alfred Lengnick (UK).
- Int'l rep.:** Australia, South Africa, UK (Alfred Lengnick).
- Harwin Music, see Chappell—Chappell.
- Herress Music Inc., see Chappell—Chappell.
- Helping Hand Music (div. of Royalty Recs. Mgmt. Ltd.), 9229 58 Ave., Edmonton, Alta. T6E 0B7. Tel: (403) 436-0665. Pres.: Jack Dubasz; Gen. Mgr.: R. Harlan Smith.
- Int'l rep.:** UK (Emerald).
- Herman Music Inc., see Chappell—Edwin H. Morris.
- Higher Music Publ'g Inc., see Chappell—Chappell.
- Hilly-Le Music, see Chappell—Chappell.
- Hindesight Music, see Chappell—Chappell.
- Hiward Music Co., see Chappell—Chappell.
- Hoadley House Music (PRO), Box 5236, Vancouver, B.C. V6B 4B3. Tel: (604) 531-9331. 522-2711. Gen. Mgr.: Kenny Harris.
- Homemade Music Ltd., see Chappell—Chappell.
- Honky-Tonk Music, see Chappell—Chappell.
- House of the Fox, see Chappell—Chappell.
- House of Weiss, see Chappell—Chappell.
- How About Music (CAPAC), see Mushroom Recs.
- Huckleberry Creek, see Chappell—Chappell.
- Jay Huguley Music Co., see Chappell—Chappell.
- Hungry Bear Publ'g (CAPAC), see Condor.
- Ross Hunter Publ'g Co., see Chappell—Chappell.
- Hutchinson, see Chappell—Chappell.
- Iceman Music Corp., see Chappell—Chappell.
- Hot (PRO), see Intermede.
- Impulsions (CAPAC), see Intermede.
- Infinite Music Corp., see Chappell—Chappell.
- Intermede Music, 82 W. St. Joseph Blvd., Montreal, P.Q. H2T 2P4. Tel: (514) 849-3776. Pres.: Christopher J. Reed; Gen. Mgr.: Lydie Wanner.
- Intersong Canada Ltd., see Chappell—Chappell.
- In the Black Music, see Chappell—Chappell.
- In the Red Music, see Chappell—Chappell.
- Irving Music, see Palas House.
- Richard Irwin Music Corp., see Chappell—Chappell.
- Italcanto (Eds. Musicales) (CAPAC), see Intermede.
- Ivy, see Chappell—Chappell.
- Izetta Brass Publ'ns (PRO), see Morning.
- J.P. Music Ltd., see Chappell—Chappell.
- Jabern Music, see Chappell—Chappell.
- Louise Jack Publ'g Co., see Chappell—Chappell.
- Jacmar Music Ltd., see Chappell—Chappell.
- Jadar Music Corp., see Chappell—Chappell.
- Jah Music (CAPAC), see Morning.
- Jay's Ents. Inc., see Chappell—Chappell.
- Jerome (CAPAC), see Intermede.
- Jerryco, see Chappell—Chappell.
- Jilbren Music, see Chappell—Chappell.

Once you've stripped off the
hype and exaggerations
Once you've toned down the
bold type and exclamations
Once you've whispered to yourself
Who will stay for generations . . .
You're down to one name —

(CAPAC)
**MORNING
MUSIC** LIMITED

1343 Matheson Blvd. W. Mississauga Ontario L4W 1R1 Canada
Telephone (416) 625-2676
Cable: BOOTGROUP • Telex: 06 960250

- Jiloral Music (CAPAC), see Troika.
 Jim-Edd, see Chappell—Bregman Vocco & Conn.
 Joenell Music Corp., see Chappell—Bregman Vocco, & Conn.
 Jour de L'An (CAPAC), see Intermede.
 Jubal Sound Music, see Chappell—Chappell.
 Jubilee, see Chappell—Chappell.
 Julie, see Chappell—Chappell.
 Just Her Music (CAPAC), see Intermede.
 K D M Music Enr. (CAPAC), see Intermede.
 Phil Kahl, see Chappell—Chappell.
 Kander & Ebb, see Chappell—Chappell.
 Kapocire (CAPAC), see Intermede.
 Karol Music (CAPAC), see SMCL.
 Kashago Publ'g (PRO), see Fivetake Group.
 Katzenjammer Music (PRO), see Cirrus.
 Ken-Glen Music, see Chappell—Chappell.
 E. C. Kerby Ltd. (CAPAC), 198 Davenport Rd., Toronto, Ont. M5R 1J2. Tel: (416) 922-9934. Pres. & Gen. Mgr.: Elvira C. Kerby. Prof. Mgr.: Franco Colombo.
Int'l firms represented: Amphion (France), Consort (USA).
Int'l rep.: France (Amphion), Netherlands (Albersen), Rest of Europe (G. Ricordi).
 Keyboard Pendulum Ltd., see Chappell—Chappell.
 Kimberley Music (CAPAC), see Condor.
 Kingen-Gale Music Corp., see Chappell—Chappell.
 Kinghouse Music Publ'g (PRO), RR 1, Navan, Ont. K0A 2S0. Tel: (613) 833-2236. Gen. Mgr.: Bob King.
Int'l firm represented: San-Lyn (USA).
 Kitchener Music (CAPAC), see Axe.
 Kitchen Table Music (PRO), 9108 116 St., Edmonton, Alta. T6G 1P9. Tel: (403) 433-7426. Dir.: Holger Petersen.
Int'l firms represented: Baron County Music, Dil Doug Music, John Hartford Music, Rolin Music, Weems Music (all USA).
Int'l reps.: Europe (Heathside), Japan (Watanabe), USA (Bainbridge, Southern Pines).
 Kustor Music (PRO), see Halben.
 Michel LaFrancois (CAPAC), see Intermede.
 Lampshade Music (CAPAC), see Black & White.
 LaPelle Music Publ'g (PRO), PO Box 2248, Calgary, Alta. T2P 2M7. Tel: (403) 269-7270. Pres. & Gen. Mgr.: E. Bruce Thompson.
 La Rochelle (CAPAC), see Intermede.
 Lauralan Music, see Chappell—Chappell.
 Laurentian Music Ltd. (PRO), see Bob Hahn.
 Leeds Music (Canada) (CAPAC) (div. of MCA Canada Ltd.), MCA Bldg., 2450 Victoria Park Ave., Willowdale, Ont. M2J 4A2. Tel: (416) 491-3000. Cable: LEEDSMUSIC. Pres. & Gen. Mgr.: Bailey Bird; Prof. Mgr.: Harry Hinde.
Home office: USA.
 Lero, see Chappell—Edwin H. Morris.
 Leslie Music Co., see Chappell—Chappell.
 Leslie Music Supply, PO Box 471, Oakville, Ont. L6J 5A8. Tel: (416) 844-3109.
Int'l firms represented: Brodt (USA), J.B. Cramer (UK), Leonard Gould & Boltitt (UK), Pitman Hart (UK).
Int'l rep.: UK (Robertson).
 Le Vien, see Chappell—Chappell.
 Libra Music Ltd., see Chappell—Chappell.
 Libretto Music Co., see Chappell—Chappell.
 Lin-da, see Chappell—Edwin H. Morris.
 Sandy Linzer, see Chappell—Chappell.
 Lion, see Chappell—Edwin H. Morris.
 Lirana (CAPAC), see Intermede.
 Little Barnum Music, see Chappell—Chappell.
 Little Feature Music, see Chappell—Chappell.
 Little Heather Music, see Chappell—Chappell.
 Lombardo, see Chappell—Bregman Vocco & Conn.
 Lorber-Sheer Music, see Chappell—Chappell.
 Lori, see Chappell—Chappell.
 Loring Music Co., see Chappell—Chappell.
 Lorion, see Chappell—Chappell.
 Love-Lies-Bleeding Music (PRO)—Pres.: Francis W.H. Davis—see Corinth Music.
 Lu-Jac, see Chappell—Chappell.
 M A C H Music (CAPAC), see Halben.
 M B P Music, see Chappell—Chappell.
 M E Publ'g, see Chappell—Chappell.
 M R C Music Inc., see Chappell—Chappell.
 Mafundi Music, see Chappell—Chappell.
 Magic, see Chappell—Chappell.
 Magic Mouth Music, see Chappell—Chappell.
 Makhnan Publ'g (PRO), see Aquarius.
 Mamy, see Chappell—Chappell.
 Manda Music (CAPAC), see Tomato Tunes.
 Mander Music Ltd., see Chappell—Chappell.
 Manhole Music (PRO), 11602 75 Ave., Edmonton, Alta. T6G 0J2. Tel: (403) 436-3096. Pres.: N. MacIver; Gen. Mgr.: F. Phillet.
Int'l rep.: Japan (GP Music).
 Manikin, see Chappell—Bregman Vocco & Conn.
 Manitou Music (PRO), see Leeds.
 Manna Music (ASCAP), PO Box 6900, Vancouver, B.C. V6B 4B5. Contact: Gerry Scott.
Home office: USA.
 Maple Creek Music (PRO), see Snowberry.
 Marais Boulour (PRO), see Intermede.
 Marielle, see Chappell—Chappell.
 Marius Music, see Chappell—Chappell.
 Mark-Cain Music Publ'g (CAPAC), see Core.
 Marmalade Music Ltd., see Chappell—Chappell.
 Martin Music Corp., see Chappell—Chappell.
 Massi, see Chappell—Chappell.
 Master's Collection Publ'g (PRO), see Piigirm Recs.
 Match Music Corp. Ltd. (CAPAC) (La Corp. de Musique Match Ltd.), 1966 Prospect, Sherbrooke, P.Q. J1J 1K7. Tel: (819) 569-7321. Pres.: Russell M. Marois.
 Maxander Music, see Chappell—Chappell.
 Maxx Music (CAPAC), see Rising.
 Maxwell, see Chappell—Chappell.
 Maya Prod'ns Inc., see Chappell—Chappell.
 Mayerling Prod'ns Ltd., see Chappell—Chappell.
 McMusic Ltd. (CAPAC), Box 6241, Sta. J, Ottawa, Ont. K2A 1T3. Tel: (613) 592-1375. Pres.: Ian McLeish.
 Meager Music, see Chappell—Chappell.
 Mede Musique Int'l (PRO), see Intermede.
 Melissa, see Chappell—Chappell.
 Melomega Music Ltd., see Chappell—Chappell.
 Merjoda Music Inc., see Chappell—Chappell.
 Merven Music, see Chappell—Chappell.
 Mesquite Music, see Chappell—Chappell.
 Metronome Recs., see Chappell.
 Stephen Metz Ltd., see Chappell—Chappell.
 Don Michael Music Inc., see Chappell—Edwin H. Morris.
 Midas, see Chappell—Chappell.
 Midnight Blue Music (PRO), 42 Brahm's Ave., Willowdale, Ont. M2H 1H4. Tel: (416) 492-9916. Pres. & Gen. Mgr.: Birgitta Graham; Prof. Mgr.: Prakash John.
 Brian Millan Music Corp. (CAPAC), PO Box 1905, Succ. Postal Place d'Armes, Montreal, P.Q. H2Y 1S6. Tel: (514) 288-4950. Cable: BMUSIC. Telex: 055-60027. Pres.: Brian Millan; Gen. Mgr.: Steve Voros; Artist Relations: Eileen Haines.
Home office: Belgium.
Int'l firms represented: Baltic (Belgium), Bosworth (Germany), Brandom (USA), Vincent Chiarelli (USA), Eurovox (Belgium), Musikproduktionen (Switzerland), Wooden (USA).
Int'l reps.: Worldwide excluding USA & Canada (Baltic)—Belgium, Bosworth—Germany, Eurovox—Belgium, Musikproduktionen—Switzerland.
 Minnalouche Music (PRO), PO Box 1175, Victoria, B.C. V8W 2T6. Tel: (604) 479-1002. Pres. & Gen. Mgr.: Jürgen Gothe.
 Mio Music Co., see Chappell—Chappell.
 Miss Nitz Music, see Chappell—Chappell.
 Modeles Enr. (Les Eds.) (PRO), 65 54 Ave., Pointe-aux-Trembles, P.Q. H1A 2T1. Tel: (514) 642-0648. Gen. Mgr.: Pat Di Stasio.
 Ivan Mogull Music Corp., see Chappell—Chappell.
 Mojak Music, see Chappell—Chappell.
 Momar Music, see Chappell—Chappell.
 Mondiphone-Neully, see Crea Sound.
 Montage Music Publ'g Inc., see Chappell—Chappell.
 Montina Music (PRO), PO Box 702, Snowdon Sta., Montreal, P.Q. H3X 3X8. Tel: (514) 342-5200. Pres. & Prof. Mgr.: David P. Leonard.
 Moo Moo, see Chappell—Chappell.
 Moorpark, see Chappell—Chappell.
 Morley, see Chappell—Edwin H. Morris.
 Morning Music Ltd. (CAPAC), 1343 Matheson Blvd. W., Mississauga, Ont. L4W 1R1. Tel: (416) 625-2676. Cable: BOOTGROUP. Telex: 06-960250. Pres.: Jerry Krytiuk; VP: Tom C. Connors; Gen. Mgr.: Mark Altman; Prof. Mgr.: Avi Altman Admin. Mgr.: Ann Fuller; Copyright Mgr.: Mary Krytiuk; Promo: Peter Krytiuk.
Int'l branches: England, Ireland, USA.
Int'l firms represented: ATV (USA), Air (Sweden), Joe Allen (USA), Altona (Netherlands), Altona (USA), American Rainbird (USA), Angel Wing (USA), Annie Over (USA), Anton's Songs (New Zealand), Apollo (Belgium), Arabella (Germany), Arapaho (USA), Artray (USA), Aunt Polly's (USA), Author's Agency, Avert (USA), Background (UK), Baldham (Germany), Barlow (USA), Barrelhouse, Bathurst (USA), Beckroo's (USA), Benelus (Belgium), Berry Hill (USA), Berrywood (USA), Bibb (USA), Binoco (USA), Black Sheep (USA), Blue Band (USA), Blue Candle (USA), Blue Creek (USA), Blue Echo (USA), Blue Lake (USA), Blue Melody (USA), Blue Tulip, Bluffer (USA), Boomerang (USA), Bospel (Netherlands), Boxer (USA), Braeburn (USA), Rolf Budde (Germany), Bullfrog Ballades (USA), Canary (USA), Candle (USA), Caribeso (USA), Buzz Cason (USA), Champagne (USA), Chandos (USA), Charlie Boy (USA), Cherry Tree (USA), Choral Arts (USA), Cielho, Cineidic (Belgium), Cinnamon (USA), Compton (USA), Copper (USA), Cornbread (USA), Country Star (USA), Crier (USA), Cyclus (Germany), Dathi (UK), Dayglow/Tripper (Netherlands), Dean's List (USA), Discovery (Netherlands), Doree, Johnny & Bill (USA), Drawbridge (USA), Emma (Ireland), Enoree (USA), Entrance (USA), Evening (USA), Fazer (Finland), Feather (USA), Femous (UK), Filmways (USA), First Floor (USA), Flintock (USA), Fly (Belgium), Folklore (USA), Sam Fox (USA), Donnie Fritts (USA), Frontier (UK), Fruit (USA), Galahad (USA), Gate (USA), Gaylene (USA), Gaylo (USA), Gee Whiz (USA), Glad (USA), Globe (Belgium), Gnome (Netherlands), Gold Dust (USA), Good Music (USA), David Gornston (USA), Green Grass (Ireland), Lloyd Green (USA), Halifax (Netherlands), Hall-Clement (USA), Hansa (Germany), Hanseatic (Germany), T.B. Harms (USA), Harvey Wall-banger (USA), Heater-Quigley (USA), Hiligreen (USA), Hollywood (USA), Ilanot, Image (Australia), Indian Lake (USA), Inter Arts (UK), Intersong-Basart (Netherlands), JBR (USA), Jack (USA), Jack & Bill (USA), Jando (USA), Jeanome (USA), Jim Sue (USA), July, Jump (Italy), Kelly (USA), Kevin Lee (USA), Jean Kluger (Belgium), Koko (USA), Kradar (USA), Hans Kusters (Belgium), LS (USA), Laetrec (South Africa), Land of Song (UK), Crisly Lane (USA), Lani (Sweden), Let There Be Music (USA), Lurch (USA), Ricci Mareno (USA), Mata Hari (Netherlands), Maypole (UK), McGuigan (Ireland), Meisel (Germany), Melodie der Welt (Germany), Meridian (Germany), Mogollon Mountain (USA), Molenaar (Netherlands), Monserrat (Spain), Mountainwood (USA), Movietone (USA), Music Craftshop (USA), Musicways (USA), Mydow (USA), Myownah (USA), Octava (UK), Spooner Oldham (USA), Omega (USA), Open Range (USA), Opus (Czechoslovakia), Orania-Hans Gerig (Germany), Owlfofus (USA), Pace (USA), Palette (Belgium), Parade (Belgium), Pascale (Netherlands), Pathfinder (USA), Pedro (USA), Dan Penn (USA), Photoplay (UK), Pix-Russ (USA), Poet's Publ'g (USA), Presto Jac Jorgensen (Germany), Primus-Rolf Budde (Germany), Prisma (Germany), Process (USA), Programme (UK), Pulleybone (USA), Radio-Tele Music (Germany), Rainbird, Reveille (South Africa), Reynard (USA), Rhythmus-Rolf Budde (Germany), Rialto-Hans Gerig (Germany), Rocky Belle (USA), Rolling Meadows (USA), Fred Rose (USA), Ruby (Ireland), S&R (USA), St. Martin (USA), Samfred (USA), Sandy (Australia), August Seith (Germany), September (USA), Silver Fire Hits (UK), Shenandoah (USA), Sidewalk (USA), Selver Dollar (USA), Silverstar (USA), Simba (Belgium), Nina Simone (USA), Simton (Germany), Soul Songs (USA), Southcoast (USA), Spartan (USA), Springcreek (USA), Squirrel (Ireland), Starburst (USA), Starrite (USA), Starsong (USA), Start (Belgium), Stonehill (USA), R.M. Stone (USA), Stoneway (USA), Street (UK), Strzelecki (USA), Sublime Arts (UK), Sunday (USA), Supersound (USA), Supraphon (Czechoslovakia), Sweet Dreams (USA), TEK (USA), Taku (USA), Tammy Lee (USA), Tamrose (USA), Tantris (Germany), Televis (Italy), Tempton-Hans Sikorski (Germany), Terrace (USA), Terra Songs (USA), Tessie's Tunes (USA), Toledo (Germany), Topkapi, Troja (Germany), Twosome (USA), Tyson South (USA), Unicorn (USA), Unimusic (Venezuela), Union (Sweden), Universal (Belgium, Netherlands), Univ. of Miami (USA), Vabo (Netherlands), Vector (USA), Victoria-Werner Scharfenberger (Germany), Vogue (USA), Harry Von Tilzer (USA), Wall to Wall (USA), Don Wayne (USA), Wednesday (UK), Josef Weinberger (UK), Welbeck (USA), Weltmusik (Austria), Wheeling (USA), Wiener Musikproduktion (Austria), Wien Melodie (Austria), Wilder (USA), Paul Woitschach Radio (Germany), Yamaha (Japan), Yellow Tavern (USA), Young (Germany), Young World, Zebco's (USA), Zodiac (USA), Zomba Corp. (Switzerland, UK).
Int'l reps.: Australia (Brazel), Austria (Wien Melodie), Benelux (Universal), Image (Mentional), Central America (Edimusic), Colombia (Codiscos), Czechoslovakia (Supraphon), Finland (Fazer), Germany (Melodie der Welt), Greece (Grecophon), Iceland (Iceland Music), Israel (Ilanot), Italy (Curci, RCA), Japan & S.E. Asia (Yamaha), Mexico (Edimusic), New Zealand (Magpie), South Africa (Laetrec, Reveille, Contagious), Spain (Monserrat), Sweden (Sweden Music), Switzerland (Musikvertrieb), Venezuela (Unimusic).
 Edwin H. Morris (Canada), see Chappell.
 Moss Music Group (Canada) Inc., 510 Coronation Dr., West Hill, Ont. M1E 4X6. Tel: (416) 284-0126. Pres.: John Leatham.
 Mozusse (CAPAC), see Intermede.
 Muffinman Music (CAPAC), see Fivetake Group.
 Muirfield, see Chappell—Edwin H. Morris.
 Mushroom Recs. (Canada) Inc., 1234 W. Sixth Ave., Vancouver, B.C. V6H 1A5. Tel: (604) 736-7207. Telex: 04-54667. VP Publ'g: Ian Warner.
Int'l firms represented: Andorra Music, MushTunes Music (both USA).
Int'l reps.: Australia (Festival), Europe (UA Music), Japan (Watanabe), USA (Andorra, MushTunes).
 Music People Ltd., see Crea Sound.
 Musique Frisee (CAPAC), see Intermede.
 Musiquette (CAPAC), see Intermede.
 Muziki Music, see Chappell—Bregman Vocco & Conn.
 N P P, see Chappell—Chappell.
 Nam (CAPAC), see Intermede.
 Nava Music, see Chappell—Chappell.
 Near North Music, see Chappell—Chappell.
 Neiljoy Music Publ'g Inc. (PRO), see Halben.
 Neurotic Music, see Chappell—Bregman Vocco & Conn.
 New Morning Music, see Chappell—Chappell.
 Newtonville Music, see Chappell—Chappell.
 New World, see Chappell—Chappell.
 New York Shakespeare Festival, see Chappell—Chappell.
 Roger Nichols Music Inc., see Chappell—Chappell.
 Nor-Brand, see Chappell—Chappell.
 Northern Gold Music (PRO), see Morning.
 Northern Light Music Publ'rs (PRO) (div. of Dipper 7 Ents.), 1414 Hillside Ave., Suite 101, Victoria, B.C. V8T 2B8. Tel: (604) 595-6709. Owner: Lou Jean Molin; Gen. Mgr.: Arthur Trolley.
 Northshore Publ'g, see Chappell—Bregman Vocco & Conn.
 Notre Musique (CAPAC), see Crisch.
 Nu-Gen Publ'g Co., see Danboro.
 Nurock, see Chappell—Chappell.
 O K (CAPAC), see Intermede.
 Oak Island Music (PRO), see Fivetake Group.
 Ole Colony Music, see Chappell—Chappell.
 Omar, see Chappell—Chappell.
 1, 2, 3, 4 (CAPAC), see Intermede.
 One West Publ'g, see Chappell—Chappell.
 Oriole Music Corp., see Chappell—Edwin H. Morris.
 Osiris Music Inc., see Chappell—Chappell.
 Osmond Music, see Chappell—Chappell.
 Our Songs, see Chappell—Chappell.
 Oxygen Music, see Chappell—Chappell.
 P K Music, see Chappell—Chappell.
 P L (CAPAC), see Intermede.
 Pabito Music, see Chappell—Chappell.
 Page One Music (CAPAC), see Black & White.
 Palas House Publ'g (PRO), Box 7, RR 1, Beaverbank Rd., Lower Sackville, N.S. B4C 2S6. Tel: (902) 865-8023. Pres.: Joe Palaschuk.
 Pamela, see Chappell—Chappell.
 Pamelarosa, see Chappell—Chappell.
 Para-Ande Music Corp., see Chappell—Chappell.
 Parabut, see Chappell—Chappell.
 Para-Kim, see Chappell—Chappell.
 Paramount, see Chappell—Chappell.
 Paramount-Roy, see Chappell—Chappell.
 Para-Nowgen Music Corp., see Chappell—Chappell.
 Para-Tal, see Chappell—Chappell.
 Para-Thumb Music, see Chappell—Chappell.
 Para-Tracs Music Corp., see Chappell—Chappell.
 Para-Wag Music Corp., see Chappell—Chappell.
 Par-Ed Music Co., see Chappell—Chappell.
 Sheldon Park Music, see Chappell—Chappell.
 Pasqua/Namrac Music, see Chappell—Chappell.
 Patricia Music Publ'g Corp., see Chappell—Edwin H. Morris.
 George Paxton, see Chappell—Chappell.
 Paxwin Music Corp., see Chappell—Chappell.
 Peer Int'l (Canada) Ltd. (PRO), see Peer-Southern.
 Peer-Southern Org. (Canada) Ltd. (PRO, CAPAC), 4 New St., Suite 107, Toronto, Ont. M5R 1P6. Tel: (416) 924-5781. Cable: SOUTHMUSIC. Mng. Dir.: Matthew Heft.
Home office: USA.
 Pelew Music, see Chappell—Chappell.
 Pet-Mac Publ'g (PRO), 6844 76 Ave., Edmonton, Alta. T6B 0A8. Tel: (403) 465-1071. Pres.: Garry L. McDonald; Gen. Mgr.: Wallis A. Petruk; Prof. Mgr.: Leonard A. Petruk.
 Philimela Music Ltd., see Chappell—Chappell.
 Phillet/Maclver Music (PRO), see Manhole.
 Pig-Weed Music (PRO), see Bob Hahn.
 Pilgrim Recs., PO Box 189, Sta. W. Toronto, Ont. M6M 4Z9. Tel: (416) 746-1991. Mng. Dir.: Paul J. Young.

Int'l firm represented: Parchment Music (UK).
Pillow Musical Prod'ns, see Chappell—Chappell
Pilot Music Ltd., see Chappell—Chappell
George Pincus Music Corp., see Chappell—Chappell
Pine Woods, see Chappell—Chappell
Pink Pelican Music, see Chappell—Chappell
Pippin the Friendly Ranger, see Chappell—Chappell
Pitta Patta Music (PRO), see Morning
Placid, see Chappell—Chappell
Play One Publ'g Co., see Chappell—Chappell
Pocus Plum Publ'g (CAPAC), see Intermede.
Poly-Sonne Enr. (CAPAC), see Intermede.
Pondwater Music (CAPAC), see Attic.
Cole Porter Music Inc., see Chappell—Chappell.
Sarah Porte (PRO), see Intermede.
Portrush Music (CAPAC), see Antrim.
Presqu'île (CAPAC), see Intermede.
Promco Music Co., see Chappell.
Pyros Publ'g Co., see Danboro
Q T Saker, see Chappell—Chappell
Quaker Ridge, see Chappell—Chappell
Quality Music Publ'g Ltd. (PRO), 380 Birchmount Rd.,
Scarborough, Ont. M1K 1M7 Tel (416) 691-2757.
Pres. George R. Struth; Gen. Mgr.: William B. Kearns;
Bus. Affairs Mgr.: Nadine Langlois.
Int'l firms represented: AVI Music Publ'g, Editions In-
tro, Emerald Music, Koobla Music, Kool Music, Owepar
Music, Rycha Music, **Shediac Catalog only**—Alota-
good Music, Old Shanty
R & R, see Chappell—Chappell
R S O Publ'g Inc., see Chappell—Chappell
Radview Ent's., see Chappell—Chappell
Rags, see Chappell—Chappell
Rainy River Music Ltd. (PRO), see Halben.
Rainy Wednesday, see Chappell—Chappell
Raj Kumer, see Chappell—Chappell
Bill Ramal Music, see Chappell—Chappell.
Ramitory Music Corp., see Chappell—Chappell.
Rand Double (PRO), see Intermede.
Fred Raphael, see Chappell—Chappell.
Red (CAPAC), see Intermede.
Red Cow Music Inc., see Chappell.
Redheads, see Chappell—Chappell.
Redwood Music, 1015 Burrard St., Suite 502, Vancouver,
B.C. V6Z 1Y5 Tel (604) 669-4834. Contact Graham
Wood.
Revelation Music, see Chappell—Chappell
Rich Harvest Music Inc., see Chappell—Chappell
Rideau Music Ltd. (CAPAC), see Bob Hahn.
Ringo Pasta, see Chappell—Chappell.
Rising Recs Ltd., 111 Peter St., Suite 204, Toronto, Ont.
M5V 2H1 Tel (416) 363-4343 Pres. Robert H.
Hahn
Int'l reps.: CanCon—Ireland & UK (Valentine), Eisi-
nore—World excluding Canada (Belwin Mills).
Riverson (PRO), see Aquarius.
Robgal Music (PRO), see Gallant Robertson.
Robinson Music, see Chappell—Chappell.
Rock Island, see Chappell—Bregman Vocco & Conn.
Lelan Rogers Music, see Chappell—Chappell.
Rojan, see Chappell—Chappell.
Rolyn, see Chappell—Chappell.
Romar Today Music Inc., see Chappell—Chappell.
David Rose, see Chappell—Bregman Vocco & Conn.
Rosemeadow, see Chappell—Bregman Vocco & Conn.
Andre Roussel (Ed.) (CAPAC), see Match.
Rye Bread Music Corp., see Chappell—Chappell.
S L S Music, see Chappell—Chappell.
S M C L Inc. (Les Prod'ns), 450 Beaumont E., St. Bruno, P.Q.
J3V 2R3 Tel (514) 653-7838. Pres.: Christian Lefort,
VP & Gen. Mgr. Louis Lefort.
Int'l firms represented: Bagatelle, Bretagne, Le Minota-
ure, Rideau Rouge, Scorpio, Tremplin-Delphine
(all France), Durium (Italy).
Sad Music, Ltd., see Chappell—Chappell
Douglas Sahn, see Chappell—Chappell
St. George Music, see Chappell—Chappell
Sam-Sam Music Ltd., see Brian Millan.
Sandstorm Music Inc., see Chappell—Chappell.
Sans Nom (PRO), see Intermede.
Sarah Music, see Chappell
Satriyon Music Co., see Chappell—Edwin H. Morris.
Scarab Publ'g Corp., see Chappell.
Schaumann-Roberts Music, see Midnight Blue.
Scorpio Music, see Chappell—Chappell
Scotia Songs, see Chappell—Chappell
Scrotie of the North Music, see Chappell—Chappell
Jason Sean Music, see Chappell—Bregman Vocco & Conn.
Sebonds, see Chappell—Bregman Vocco & Conn.
Senor George Music, see Chappell—Chappell
Sergeant Music Co., see Chappell—Edwin H. Morris.
Set to Music Ltd., see Chappell—Chappell.
Sevy Music (PRO), see Halben.
Shari, see Chappell—Chappell.
Sharrell Music Publ'rs (PRO), see Empire
Shediac Music Publ'g Ltd. (CAPAC), see Quality.
Shee Gwee Publ'g (PRO)—Pres.: Will R. Millar—see Antrim.
Sherbourne, see Chappell—Edwin H. Morris.
Shetland Music Ltd., see Chappell—Chappell.
Silver House, see Chappell—Bregman Vocco & Conn.
George Simon Inc., see Chappell—Edwin H. Morris.
Simon House Inc., see Chappell—Edwin H. Morris.
Skinners Pond Music (PRO), see Morning.
Slalom (PRO), see Aquarius.
Snowberry Music (CAPAC) (div. of Northern Light & Sound
Entertainment Corp. Ltd.), 1659 Bayview Ave., Toronto,
Ont. M4G 3C1 Tel (416) 485-1157. Pres. David
Coutts; VP Brian Ayres; Pres. Mgr. John D. Watt.
Int'l reps.: Australia (Leeds), UK (ATV), USA (Candy
Mountain/Sweet Chery).
Snowblind Music, see Chappell—Chappell.
Snycor Publ'g, see Chappell—Edwin H. Morris.
Soundboosters Inc., see Chappell—Chappell
Southern Love Music, see Chappell—Chappell.
Space Music, see Chappell—Edwin H. Morris.
Sparkel, see Chappell—Chappell.
Sparwood Music Publ'ns (PRO), see Chinook
Speckled Bird Music (CAPAC), see Morning.
Sprindrift Music Ltd., see Chappell—Chappell.
Springwater Prod'ns Ltd. (CAPAC), 56 Clinton St., Guelph,

Ont. N1H 5G5 Tel (519) 824-7885. Pres. Homer Ho-
gan; VP Gen. & Prof. Mgr. Dorothy Hogan.
Int'l branch: USA.
Squamish (PRO), see Corinth Music.
Square Root Music (PRO), PO Box 581, Adelaide St. Sta.,
Toronto, Ont. M5C 2J6 Tel (416) 364-3815 Cable
DBSMUSIC, Pres. Don Bell.
Stage & Screen, see Chappell—Chappell.
Steel River Music (PRO), see Morning.
Stigwood Music, see Chappell—Chappell.
Stirling Music (CAPAC), see Black & White.
Stone Rap Music Inc., see Chappell—Chappell.
Stony Plain Music (CAPAC), see Kitchen Table.
Stown, see Chappell—Chappell.
Stratford, see Chappell—Chappell.
Stratus Music (CAPAC), see Cirrus.
Styne & Cahn Music Corp., see Chappell—Edwin H. Morris.
Subiddu Music, see Chappell—Chappell.
Suchan Music, see Chappell—Edwin H. Morris.
Sud, see Peer-Southern
Sunbury/Dunbar Music (Canada) Ltd. (PRO), 101 Duncan
Mill Rd., Suite 305, Don Mills, Ont. M3B 1Z3 Tel.
(416) 449-4346 Telex (06) 966577 Pres. John R.
Feeney; Admin. Mgr. Vicki Walters.
Int'l firms represented: Associated Music (Australia),
Coal Miner's Music (USA), First-O-Funk Ltd. (USA), Fre-
bar Music (USA), Global Music (Japan), Golden West
Melodies (USA), Ovation Inc. (USA), RCA (Brazil,
France, Italy, Spain), Relay (Argentina), Scott-Wolfe
Songs Ltd. (UK), Singletree (USA), Sunbury (UK).
Int'l reps.: Belgium (Universal), Colombia (Sorolux),
Finland (Coda), Israel (Musicor), Netherlands (Univer-
sal), Norway (A/S Disco), Philippines (Mareco), South
Africa (Laetwyg/Sweden), Switzerland (Musik-
vertrieb).
Sunie Day Music, see Chappell—Chappell.
Sunspot Music (PRO), see Cirrus.
Sun-Vine, see Chappell—Chappell.
Superstar Music Ltd., see Chappell—Chappell.
Supreme, see Chappell—Bregman Vocco & Conn.
Surprise (CAPAC), see Intermede.
Frank Swain Music (PRO), PO Box 9, Mount Albert, Ont. L0G
1M0 Tel (416) 884-2320. Pres.: Frank P. Swain.
Sylviohn Music, see Chappell—Chappell.
Silverpride, see Chappell—Chappell.
Synchro Publ'g Co., see Danboro.
T M C Publ'g (CAPAC), see Pilgrim Recs.
T P I, see Chappell—Edwin H. Morris.
Talisman Music Corp., see Chappell—Chappell.
Tamerlane Music Inc., see Chappell—Edwin H. Morris.
Tansoul Publ'g Co., see Chappell—Chappell.
Tanta Music, see Chappell—Chappell.
Taradem Music Inc., see Chappell—Chappell
Tarana Music (CAPAC), see Corinth.
Taurus Music Ltd., see Chappell—Chappell.
Tebos Music, see Chappell—Chappell.
Tee-Pee Music Corp., see Chappell—Chappell.
Teetoc, see Chappell—Chappell.
Thermot Music Inc., see Chappell—Chappell.
Bob Thiele Music, see Chappell—Chappell.
Think Big Music (CAPAC), see WAM & Chappell
Gordon V. Thompson Ltd. (CAPAC), 29 Birch Ave., Toronto,
Ont. M4V 1E2 Tel (416) 923-7329 Cable GOR-
THOM. Pres. & Gen. Mgr. John C. Bird, Prof. Mgr.
Jack Denton Illingworth
Int'l firms represented: Aden Music Co., Amidan Music Co.,
Anacrusis Music Publ'g Co., Arian Music, Avas
Music Publ'g Co., Abel Baer Music Corp., Balfieff, Bar-
ton, Benson Co., Big Seven, Big 3, Boca Music Inc.,
Fred Bock Music Co., Bourne Co., Michael Brent Publ'ns
Inc., Bulls-Eye Music Inc., George M. Cohan, Creston
Music Co., Deerhaven Music Corp., Carl Fischer, Fred
Fisher, Four Jays Music Co., Forster, Gaitner Music,
Gamble-Hinged Music, George Music Inc., Hollywood
Music Ent's. Ltd., Hope Publ'g Co., Hy-Lo Music, Kohn
Music Corp., Laertes Music Co., Lansdowne Music
Publ'rs, L'Aries Music Corp., Leo Talent Inc., Lichelle
Music Co., Lido Music Inc., Lincoln Music Corp., Lorenz
Publ'g Co., Marpet, Milene, Montgomery, Music-Music-
Music, Oakland Music Inc., Pattern Music Inc., George
Pincus & Sons, Plymouth, Rocket Music Co., Rodehea-
ver Co., Royal Music Publ'rs, St. Nicholas, G. Schirmer,
Andrew Scott Inc., Shapiro Bernstein, Larry Spier, Tam-
bilene Music Publ'g Co., Top Notch Music Corp., Trina
Jill Music Corp., True Blue Music Publ'g Co., Walton,
H B Webman, Wendy Music Inc., Winston Music
Publ'rs, Word Inc.
Three Bridges Music Corp., see Chappell—Chappell.
Three Eagles Music Inc., see Chappell—Chappell.
3 PM Music (CAPAC), see Pet-Mac.
Throat Music Ltd., see Chappell—Chappell.
Thruppence Music, see Chappell—Chappell.
Tight Corporation, see Chappell—Chappell.
Time Being Music Co. (PRO), see Morning
Tinker Street Tunes, see Chappell—Chappell
Tivoli, see Chappell—Bregman Vocco & Conn.
Tobey Music Corp., see Chappell—Chappell.
Tobi-Ann, see Chappell—Chappell.
Henry Tobias Music Co., see Chappell—Chappell
Tomato Tunes (CAPAC), 1050 Baxter Rd., Ottawa, Ont. K2C
3P1 Tel (613) 820-1224. Pres. Harvey Glatt.
Tomi Music Co., see Chappell—Chappell.
Tom Tom Music, see Chappell—Chappell.
Top Hat Music Ltd., see Chappell
Transfusion (CAPAC), see Intermede.
Travis, see Chappell—Edwin H. Morris.
Triangle, see Chappell—Bregman Vocco & Conn.
Triangle (CAPAC), see Intermede.
Triboro Music Corp., see Chappell—Chappell.
Tri-Chappell, see Chappell—Chappell.
Triumph Songs (CAPAC), see Attic.
Troika Music (PRO), 1262 Don Mills Rd., Suite 3A, Don
Mills, Ont. M3B 2W7 Tel (416) 445-0878
Truckin' Music Corp., see Chappell—Chappell.
Tuneville, see Chappell—Chappell.
Twentieth Century Music Corp., see Chappell—Bregman
Vocco & Conn.
Conway Twitty Music, see Chappell—Chappell.
Two Brothers Music (PRO), see Condo.

U A Music (Canada) Ltd. (CAPAC), 2180 Yonge St., Toronto,
Ont. M4S 2B9 Tel: (416) 482-3599
U P A, see Chappell—Edwin H. Morris.
Unart Music (Canada) Ltd. (PRO), see UA Music.
Uner-Bubble, see Chappell—Chappell.
Unichappell Music Inc., see Chappell—Chappell.
United Artists, see UA Music
Universal Songs Ltd., see Chappell.
Universol (CAPAC), see Intermede.
Upario, see Chappell—Edwin H. Morris.
V Music Publ'g Co. (CAPAC), see Morning.
Val D'Espoir (CAPAC), see Intermede.
Valley Spring, see Chappell—Chappell.
Vanessa Music (CAPAC), see Halben.
Vanguard Music Corp., see Chappell—Chappell.
Vani Music (CAPAC), see SMCL.
Vaughn, see Chappell—Chappell
Veler Americana Music Publ'g (VAMP) (CAPAC), 79 Lun-
ness Rd., Toronto, Ont. M8W 4M7 Tel: (416) 259-
9182 Mng. Dir.: Jose Osana
Vent Qui Vire (CAPAC), see Intermede.
Vernon, see Chappell—Bregman Vocco & Conn.
Vert Pays (CAPAC), see Intermede.
Very Own Music, see Chappell—Bregman Vocco & Conn.
Vibrations (CAPAC), see Intermede
Victory Music Ltd., see Chappell—Chappell.
Vingt-Deux/22 Music (CAPAC), see Intermede.
Vin-Sun, see Chappell—Chappell.
Vision, see Chappell—Chappell.
Vogue, see Chappell—Edwin H. Morris.
Vogue-Choice Ltd., see Chappell—Chappell
W A M Music Corp. Ltd., 901 Kenilworth Rd., Montreal, P.Q.
H3R 2R5 Tel: (514) 341-6721 Gen. Mgr.: Leon Aro-
nson (Publishing administered by Chappell Music.)
Waldheim Music (PRO), see Bob Hahn.
Wedge Publ'g, see Chappell—Chappell
Weiss & Barry Inc., see Chappell—Chappell.
Larry Weiss Music, see Chappell—Chappell.
Welbeck Music of Canada Corp., see ATV.
Welcome, see Chappell—Edwin H. Morris.
Welzheim, see Chappell—Bregman Vocco & Conn.
West Bound, see Chappell—Chappell.
Westend Music (PRO), see Halben
White Cloud Music, see Chappell—Chappell.
White Light Music, see Chappell—Chappell.
Whitney-Kramer-Zaret, see Chappell—Chappell.
Williamson Music Inc., see Chappell—Chappell.
Marty Wilson Music Co., see Chappell—Chappell.
Windchime Music Inc., see Chappell—Chappell.
Windmill Music Ltd., see Chappell—Chappell.
Windy Bay Music (PRO), see Halben
Winmor Music, see Chappell—Chappell.
Woodbine Music Inc., see Chappell—Edwin H. Morris.
Wren Music, see Chappell—Chappell.
Y D (CAPAC), see Intermede.
Year Round, see Chappell—Bregman Vocco & Conn.
York, see Chappell—Chappell.
Young Ideas, see Chappell—Bregman Vocco & Conn.
Victor Young, see Chappell—Chappell.
Zax Music Publ'g, see Morning.
Zethus Music, see Chappell—Chappell.
Znarg Music Inc., see Chappell—Chappell.

● sheet music jobbers/suppliers

Academy Music Studios Ltd., 146 N. Christina St., Sarnia,
Ont. N7T 5T8 Tel: (519) 344-1401. Pres.: R. F. Need-
ham, Gen. Mgr.: G. Ivany. Local branch: 1249 London
Rd. Postal Code: N7S 4T3 Tel: 344-3923.
Algrid Music Ltd., 372A Yonge St., Toronto, Ont. M5B 1S6
Tel: (416) 597-0066 Pres.: Gen. & Sales Mgr. Edward
G. Hough.
Chappell & Co. Ltd., 14 Birch Ave., Toronto, Ont. M4V 1C9
Tel: (416) 922-2159. Pres. & Gen. Mgr.: Jerry Renew-
ych, Sales Mgr.: John Loweth.
Empire Music Co. Ltd., 8553 Main St., Vancouver, B.C. V5X
3M3 Tel: (604) 324-7732
Frederick Harris Music Co. Ltd., 529 Speers Rd., Oakville,
Ont. L6K 2G4 Tel: (416) 845-3487.
E. C. Kerby Ltd., 198 Davenport Rd., Toronto, Ont. M5R
1J2 Tel: (416) 922-9934.
Leslie Music Supply, PO Box 471, Oakville, Ont. L6J 5A8.
Tel: (416) 844-3109.
Morning Music Ltd., 1343 Matheson Blvd. W., Mississauga,
Ont. L4W 1R1. Tel: (416) 625-2676 Cable: BOOT-
GROUP. Telex: 06-960250. Pres.: Jury Krytiuk; VP:
Tom C. Connors; Gen. Mgr.: Mark Altman.
Gordon V. Thompson Ltd., 29 Birch Ave., Toronto, Ont. M4V
1E2 Tel: (416) 923-7329 Pres.: John C. Bird.

● record & tape wholesalers

*The wholesale function(s) of all com-
panies is set in bold face and paren-
theses after each listing. The following ab-
breviations identify these functions: (D)
Distributor; (OS) One Stop; (RJ) Rack
Jobber; (I) Importer; (E) Exporter. The
identification of a branch or home office is
indicated only when it differs from that of
the listing.*

ALBERTA

● CALGARY (Area Code 403)

A & M Discs (Calgary), 6812-A Sixth St. SE. Postal Code
T2H 2K4. Tel: 253-8411. District Mgr.: Paul McClure.
Branch Mgr.: Al Harrison. (Rec. & Tape D).

- Home office: Scarborough (Toronto Metropolitan Area), Ont., A&M Recs. of Canada Ltd. (See for prod. distributed)
- A R S Recs. Canada** (div. of CBS Recs. Canada Ltd.), 4532 Manilla Rd. SE. Postal Code: T2G 4B7. Tel: 287-2679. Mgr.: Dennis Theary. (Rec. & Tape OS & RJ).
Home office: Agincourt (Toronto Metropolitan Area), Ont.
- C B S Recs. Canada Ltd.**, 7004-M Fifth St. SE, Glenmore Centre. Postal Code: T2H 2G3. Tel: 253-8719. Telex: 03-825827. Western Mktg. Dir.: Bill Bouvette. (Rec. & Tape D)
Home office: Scarborough (Toronto Metropolitan Area), Ont. (See for prod. distributed)
- Capitol Recs.-EMI of Canada Ltd.**, 519 Manitou Rd. SE. Postal Code: T2G 4C2. Tel: 287-0823. Western Sales Mgr.: A. Andruchow. (Rec. & Tape D—see office in Toronto, Ont., for prod. distributed)
- D J's Music Servs. Ltd.**, (Rec. OS), see Dee Jay's Music Dist.
- Dee Jay's Music Dist.**, 4524 Manilla Rd. SE. Postal Code: T2G 4B7. Tel: 243-0252. Owners: J. Davies, M. Stech. Mgr.: Singles & Albums Buyer: J. Davies; Sales Mgr.: M. Stech. (Rec. D), (Rec. OS as DJ's Music Servs. Ltd.)
Label: Quality.
- G R T of Canada Ltd.**, 7003-B Fifth St. SE. Postal Code: T2H 2G2. Tel: 259-5252. Western Reg'l Mgr.: Doug Byrne; Western Promo. Mgr.: Neil MacGonigall; Sales Rep.: Randy Stark. (Rec. & Tape D)
Home office: Willowdale (Toronto Metropolitan Area), Ont. (See for prod. distributed)
- Handleman Co. of Canada Ltd.**, 1135 64 Ave. SE, No. 106. Postal Code: T2H 3K7. Tel: 259-2806. Mgr.: Wayne Johnson; Buyer: Nigel Higginbottom. (Rec. & Tape RJ).
Home office: USA—Clawson (Detroit Metropolitan Area), Mich.
- London Recs. of Canada (1967) Ltd.**, 429 Manitou Rd. SE. Postal Code: T2G 4C2. Tel: 243-1313. Telex: 038-22572. Mgr.: D. McBeth. (Rec. & Tape D)
Home office: St.-Laurent (Montreal Metropolitan Area), P.Q. (See for prod. distributed)
- M C A Dist'n (Canada)** (div. of MCA Canada Ltd.), 5737 Burbank Rd. Postal Code: T2H 1Z5. Tel: 253-0401. TWX: 610-821-6408. Sales Mgr.: Geoff Gibbons. (Rec. & Tape D)
Home office: Willowdale (Toronto Metropolitan Area), Ont. (See for prod. distributed)
- M C T R Dist.** Ltd. 4604 13 St. NE. Postal Code: T2E 6M3. Tel: 276-4776. (Rec. & Tape RJ)
Home office: Winnipeg, Man.
- Phonodisc Ltd.**, 4718 14 St. NE. Postal Code: T2E 6L7. Tel: 276-5543. Mgr.: Brian Burrows. (Rec. & Tape D)
Home office: Scarborough (Toronto Metropolitan Area), Ont. (See for prod. distributed)
- Polygram Inc.**, 105 Bow Valley Square 1, 202 Sixth Ave. SW. Postal Code: T2P 2R9. Tel: 265-5007. Telex: 03-821859. Sr. Reg'l Mgr.: Ken Graydon. (Rec. & Tape D)
Home office: St.-Laurent (Montreal Metropolitan Area), P.Q. (See for prod. distributed)
- R C A Ltd.**, Rec. Div., 4432 10 St. NE. Postal Code: T2E 6K3. Tel: 276-8231. District Sales Mgr.: J. Fotheringham. (Rec. & Tape D—see office in Toronto, Ont., for prod. distributed)
- W E A Music of Canada Ltd.**, 6325 12 St. SE, Unit 7. Postal Code: T2H 2K1. Tel: 259-3000. Mgr.: Alex Clark. (Rec. & Tape D)
Home office: Scarborough (Toronto Metropolitan Area), Ont. (See for prod. distributed)
- **EDMONTON (Area Code 403)**
- Northland Music Dist.** Co. Ltd., 6846 76 Ave. Postal Code: T6B 0A8. Tel: 469-5066. Telex: 037-3764. Pres.: Gen. Mgr. & Buyer: Bill Maxim. (Rec. D, OS & RJ).
Branch: Vancouver, B.C.
Rec. label: Disneyland.
Accessories: Cecil Watts, Le-Bo.
Word Recs. Ltd., 4332 114 A St. Postal Code: T6S 1N7. Tel: 436-5956. (Rec. & Tape D)
Home office: Vancouver, B.C. (See for prod. distributed)
- BRITISH COLUMBIA**
- **VANCOUVER AREA (Area Code 604)**
- A & M Dist.**, 1234 W. Sixth St. Postal Code: V6A 1A5. Tel: 736-7207. Sales Rep.: Rudy Levalley; Mdr.: Louise Lavoie. (Rec. & Tape D)
Home office: Scarborough (Toronto Metropolitan Area), Ont., A&M Recs. of Canada Ltd. (See for prod. distributed)
- A R S Recs. Canada** (div. of CBS Recs. Canada Ltd.), 4125 McConnell Dr., Burnaby V5A 3A7. Tel: 420-3920. Telex: 04-354722. Mgr.: Fred Hatchard. (Rec. & Tape OS & RJ).
Home office: Agincourt (Toronto Metropolitan Area), Ont.
- Almada Corp.**, 1010 Nanton Ave. Postal Code: V6H 2C2. Tel: 738-8275. Mgr.: Jack Spanton. (Rec. & Tape D & I)
Home office: Montreal, P.Q. (See for prod. distributed)
- C B S Recs. Canada Ltd.**, 1847 W. Broadway, Suite 101. Postal Code: V6J 1Y6. Tel: 734-5151. Telex: 04-55350. Reg'l Sales Mgr.: Gary Newman. (Rec. & Tape D)
Home office: Scarborough (Toronto Metropolitan Area), Ont. (See for prod. distributed)
- Capitol Recs.-EMI of Canada Ltd.**, Century Plaza, Suite 503, 1015 Burrard St. Postal Code: V6Z 1Y5. Tel: 689-8667. Sales Rep.: D. Bertsch. (Rec. & Tape D—see office in Toronto, Ont., for prod. distributed)
- Emerson Short**, 1599 W. Fourth Ave. Postal Code: V6J 1L6. Tel: 733-0415. Owner & Sales Mgr.: Emerson Short. (Rec. & Tape D, I & E), (Rec. OS & RJ as One Stop Rec. g Supplies).
Rec. labels: Advent, Ajax, All Ears, Alligator, Apon, Aviva, Blind Pig, Brnr, Brko, Bullfrog, CMH, CMS, Cabot, Crystal Clear, DRG, Desmar, Dobre, Emus, Entr' Acte (Canada), Entr' Acte imports, Fanfare, Four Leaf
- Clover, First American, Flying Fish, Gryphon, HNH, Improving Artists, India Navigation, JCOA/ WATT, Jazz Archives, Jazz Guild, Joyce, Mother Necessity, Muse, Music Minus One, Muscitratt, Muskadine, Nessa, Onari, PBR, Peter Pan, Potato, Rebel, Retrospect, Rocking Horse, Roper, Sackville, Spottite, Stash, Suite, Tilton, Unicorn, Varese/Sarabande, Versatile, Zim.
Rec. labels imported: Black Saint (Italy), Varese/Sarabande (Japan, USA).
Tape lines: Apon, CMH, CMS, Gryphon, Peter Pan, Rebel.
Accessories: Plastic-lined envelopes.
- G R T of Canada Ltd.**, 181 W. Broadway, Suite B. Postal Code: V5Y 1P4. Tel: 879-0646. Sales Reps.: Don Grant, Gerry MacKay. (Rec. & Tape D)
Home office: Willowdale (Toronto Metropolitan Area), Ont. (See for prod. distributed)
- La-Go Ent.** (div. of Rembrandt Holdings Ltd.), 3446 Bridge-way St. Postal Code: V5K 1B6. Tel: 294-6226. (Rec. & Tape D)
Rec. labels: Audio Fidelity, BASF, Black Lion, Camden, Chiaroscuro, Dawn, Enja, Folk & Jazz, Golden Hour, Hill-top, Marble Arch, Pickwick, Pye, Quad, Quintessence, Sesame Street, Thunderbird, World Jazz.
Tape lines: Audio Fidelity, BASF, Black Lion, Camden, Dawn, Marble Arch, Pickwick, Pye, Thunderbird.
Accessories: Le-Bo.
- London Recs. of Canada (1967) Ltd.**, 3166 Lake City Way, Burnaby V5A 3A4. Tel: 298-6471. Telex: 04-354544. Mgr.: O. L. Jones. (Rec. & Tape D)
Home office: St.-Laurent (Montreal Metropolitan Area), P.Q. (See for prod. distributed)
- M C A Dist'n (Canada)** (div. of MCA Canada Ltd.), 506-1200 W. 73 Ave. Postal Code: V6P 6G5. Tel: 263-1761. TWX: 610-922-1625. Sales Mgr.: William Tait. (Rec. & Tape D)
Home office: Willowdale (Toronto Metropolitan Area), Ont. (See for prod. distributed)
- Northland Music Dist.** Co. Ltd., 3206-1733 Comox. Postal Code: V6G 9Z9. Tel: 689-5914. Mgr.: Debbie Petryga. (Rec. D, OS & RJ)
Home office: Edmonton, Alta.
Rec. label: Disneyland.
Accessories: Cecil Watts, Le-Bo.
One Stop Rec'g Supplies. (Rec. OS)—Tel: 732-7313—see Emerson Short
- Pindoff Rec. Sales Ltd.**, 8048 Winston St., Burnaby V5A 2H5. Tel: 299-4394. Mgr.: Bud Farquharson. (Rec. & Tape RJ)
Home office: Rexdale (Toronto Metropolitan Area), Ont.
- Polygram Inc.**, 805 W. Broadway, Mezzanine. Postal Code: V5Z 1K1. Tel: 873-2466. Telex: 045-4410. Mgr.: Peter Behnke. (Rec. & Tape D)
Home office: St.-Laurent (Montreal Metropolitan Area), P.Q. (See for prod. distributed)
- Praise Recs. of Canada Ltd.**, 6979 Curragh Ave., Burnaby V5J 4V6. Tel: 438-8266. (Rec. & Tape D)
Branch: Toronto, Ont.
Int'l branch: USA—Bellingham, Wash.
Rec. labels: Faith Fisher Folk, Harald, Horizon, Little People, Maranatha, New Born, New Life, Praise, Sunrise, Starsong.
Tape lines: Same as rec. labels.
- R C A Ltd.**, Rec. Div., 2876 Rupert St. Postal Code: V5M 3T7. Tel: 438-7172. District Sales Mgr.: L. Alden. (Rec. & Tape D—see office in Toronto, Ont., for prod. distributed)
- Shannock Mktg. Assoc.**, Box 82314, 294 E. First Ave. Postal Code: V5C 5P8. Tel: 684-9625. Pres.: W. McCartney. (Rec. & Tape D)
Labels: Disneyland, direct-to-disk labels.
Accessories: Dynasound, Recoton, Savoy, TDK
- W E A Music of Canada Ltd.**, 40 E. Fifth Ave. Postal Code: V5T 1G8. Tel: 879-8681. Western Reg'l Mgr.: Alex Clark. (Rec. & Tape D)
Home office: Scarborough (Toronto Metropolitan Area), Ont. (See for prod. distributed)
- Word Recs. Ltd.**, PO Box 6900, 250 SW Marine Dr. Postal Code: V6B 4B5. Tel: 321-6785. Pres. & Adv. Dir.: Gerry B. Scott; VP: J. E. Scott. Sales & Mktg.: Phil Cron-ton, Lowden Ashley, Dwayne Daku, Doug Stark, Don Harbridge, Carl Teeple. (Rec. & Tape D).
Affiliate: USA, Word Inc.
Branches: Edmonton, Alta.; London, Ont.
Rec. labels: Birdwing, Canaan, Century, Dayspring, Good News, Image VII, JIM, Janz, Lamb & Lion, Light, Manna, Myrrh, New Pax, New Song, Paragon, Sacred, Solid Rock, Sparrow, Spirit, Summit, Word.
Tape lines: Canaan, Good News, Image VII, JIM, Lamb & Lion, Light, Manna, Myrrh, Newpax, New Song, Paragon, Sacred, Solid Rock, Sparrow, Spirit, Summit, Word.
- MANITOBA**
- **WINNIPEG (Area Code 204)**
- A & M Dist.** (Manitoba), 118 Campbell St. Postal Code: R3N 1B2. Tel: 944-1872. Sales/Promo.: Tom Jones. (Rec. & Tape D)
Home office: Scarborough (Toronto Metropolitan Area), Ont., A&M Recs. of Canada. (See for prod. distributed)
- A R S Recs. Canada** (div. of CBS Recs. Canada Ltd.), 1415 Church Ave. Postal Code: R2X 1G5. Tel: 632-5524. Mgr.: Peter Anderson. (Rec. & Tape RJ)
Home office: Agincourt (Toronto Metropolitan Area), Ont. (Rec. & Tape OS & RJ)
- C B S Recs. Canada Ltd.**, 1625 Dublin Ave., Suite 130. Postal Code: R3H 0W3. Tel: 774-2536. Reg'l Sales Mgr.: Don Gunter. (Rec. & Tape D)
Home office: Scarborough (Toronto Metropolitan Area), Ont. (See for prod. distributed)
- G R T of Canada Ltd.**, 388 Donald St., Suite 220. Postal Code: R3B 2J4. Tel: 944-7274. Sales Rep.: Rick Vivier. (Rec. & Tape D)
Home office: Willowdale (Toronto Metropolitan Area), Ont. (See for prod. distributed)
- Laurel Rec. Ltd.**, 120 Isabel St. Postal Code: R3A 1G4. Tel: 783-0436, 774-1052. Telex: 07-587504. Pres. W. V. Sokulsky. Sales: Al Wolfman (Man. & Sask.), Darryl
- Cope (Alta.), Roy Rindahl (B.C.), Customer Serv.: Rick Dmytrychyn, Marie-Ann Zikman; Promo. Dir.: Glen Gore-Smith. (Rec. & Tape D)
Rec. labels: JC Ent's., Motown, Total.
Tape lines: Same as rec. labels.
Accessories: Memorex, Savoy
- London Recs. of Canada (1967) Ltd.**, 15-1100 Waverley St., Postal Code: R3T 3X9. Tel: 452-7918. Telex: 07-57695. Mgr.: Gerry Young. (Rec. & Tape D)
Home office: St.-Laurent (Montreal Metropolitan Area), P.Q. (See for prod. distributed)
- M C A Dist'n (Canada)** (div. of MCA Canada Ltd.), 365 Hargrave St., No. 300A. Postal Code: R3B 2K3. Tel: 942-2413. TWX: 610-671-8120. Sales Mgr.: Jack Skelly. (Rec. & Tape D)
Home office: Willowdale (Toronto Metropolitan Area), Ont. (See for prod. distributed)
- M C T R Dist.** Ltd., 1733 St. Matthews Ave. Postal Code: R3H 0V8. Tel: 783-7201. (Rec. & Tape RJ).
Branch: Calgary, Alta.
- Metrodisc Dist.**, Galt Bldg., 4th Fl. Postal Code: R3B 0R7. Tel: 943-6563. Mgr.: Chuck Porter. (Rec. & Tape D)
Home office: Toronto, Ont. (See for prod. distributed)
- National Rec. Dist. Ltd.**, 8 Plymouth St. Postal Code: R3C 2K9. Tel: 633-1412. Pres.: S. Sodomsky; Exec. VP: R. L. Lauze; Sales Mgr.: K. J. Grouette Sr.; Buyer: G. Postnikoff. (Rec. & Tape RJ)
- Polygram Inc.**, 3 Donald St., Suite 304. Postal Code: R3L 2P6. Tel: 453-0408. Telex: 07-55306. (Rec. & Tape D)
Home office: St.-Laurent (Montreal Metropolitan Area), P.Q. (See for prod. distributed)
- R C A Ltd.**, Rec. Div., 1320 Church Ave. Postal Code: R2X 1G4. Tel: 633-2666. Sales Rep.: Robert Tait. (Rec. & Tape D—see office in Toronto, Ont., for prod. distributed)
- W E A Music of Canada Ltd.**, 24 Stevenson Rd. & St. James. Postal Code: R3H 0H8. Tel: 633-9284. Mgr.: Don Coward. (Rec. & Tape D).
Home office: Scarborough (Toronto Metropolitan Area), Ont. (See for prod. distributed)
- NEW BRUNSWICK**
- **MONCTON (Area Code 506)**
- C B S Recs. Canada Ltd.**, 1133 St. George Blvd., Suite 350. Postal Code: E1C 8R9. Tel: 386-3993. Reg'l Sales Mgr.: Jim Bradley. (Rec. & Tape D)
Home office: Scarborough (Toronto Metropolitan Area), Ont. (See for prod. distributed)
- Handleman Co. of Canada Ltd.**, 450 Edinburgh Dr. Postal Code: E1C 3B2. Tel: 389-9141. Mgr.: David Manship; Buyer: Georgena LeBlanc. (Rec. & Tape RJ).
Home office: USA—Clawson (Detroit Metropolitan Area), Mich.
- Trans-Canada** (div. of Les Distributions Quebec Inc.), 770 Main St., Compartiment 6001, Suite 204-B. Postal Code: E1C 1E7. Tel: 854-5510. Mgr.: Corale Cou-lombe. (Rec. & Tape D & OS)
Home office: St.-Laurent (Montreal Metropolitan Area), P.Q. (See for prod. distributed)
- NEWFOUNDLAND**
- **ST. JOHN'S (Area Code 709)**
- A R S Recs. Canada** (div. of CBS Recs. Canada Ltd.), 58 Kenmount Rd. Postal Code: A1B 3M9. Tel: 726-6970. Mgr.: Paul Atzema. (Rec. & Tape RJ)
Home office: Agincourt (Toronto Metropolitan Area), Ont. (Rec. & Tape OS & RJ).
- NOVA SCOTIA**
- **DARTMOUTH (Area Code 902)**
- A R S Recs. Canada** (div. of CBS Recs. Canada Ltd.), 100 Wright Ave., Burnside Industrial Park. Postal Code: B3B 1L2. Tel: 463-9344. Mgr.: William Edgecombe. (Rec. & Tape RJ)
Home office: Agincourt (Toronto Metropolitan Area), Ont. (Rec. & Tape OS & RJ).
- **HALIFAX AREA (Area Code 902)**
- A & M Dist.** (Maritimes), PO Box 3173. Postal Sta. Halifax South. Postal Code: B3J 1P4. Tel: 423-6533. Mgr.: Blake Clark. (Rec. & Tape D)
Home office: Scarborough (Toronto Metropolitan Area), Ont., A&M Recs. of Canada. (See for prod. distributed)
- R C A Ltd.**, Rec. Div., 3611 Commission St. Postal Code: B3J 2X1. Tel: 455-8015. District Sales Mgr.: Hanson Jo-sey. (Rec. & Tape D—see office in Toronto, Ont., for prod. distributed)
- ONTARIO**
- **LONDON (Area Code 519)**
- Word Recs. Ltd.**, 152 Wellesley Crescent. Postal Code: N5V 1J7. Tel: 455-2097. (Rec. & Tape D).
Home office: Vancouver, B.C. (See for prod. distributed)
- **MOUNT ALBERT (Area Code 416)**
- Holborne Dist'g Co. Ltd.**, PO Box 9. Postal Code: LOG 1M0. Tel: 294-9398. Mgr. & Buyer: Frank P. Swain. (Rec. & Tape D & I).
Rec. labels: Dynamic, Edmar, Elite, Fiesta, Grecophone, Island series, Merrymen, Murray Banks, Pebblegroove, Penny, REC, Trinidad.
Tape lines: Edmar, Fiesta, Grecophone, Merrymen, Pebblegroove, Penny.
Imports: Caribbean prod.
- **OSHAWA (Area Code 416)**
- World Recs.** (div. of Shotgun Gimme Holdings Ltd.), 484 Waterloo St. Postal Code: L1H 3X1. Tel: 576-0250. Mgr.: R. Stone. (Rec. & Tape D & I).

● OTTAWA (Area Code 613)

Cash One Stop Ltd., 1050 Baxter Rd. Postal Code: K2C 3P1
Tel: 820-4522. VP Sales: Ivor Liss. (Rec. & Tape OS)
(SEE ADVERTISEMENT)

Eastern Ontario Rec. Dist. Ltd., 383 Winona Ave. Postal
Code K1Z 5H8. Tel: 722-1000. Pres.: Jack Slumkoski;
Mgns. Jan & James Slumkoski. Buyer: Jan Slumkoski.
(Rec. & Tape RJ)

Accessories: Ampex, Le-Bo.

T C D Recs. & Tapes Ltd., 1050 Baxter Rd. Postal Code: K2C
3P1 Tel: 820-1224. Pres. Harvey Glast. Bus. Mgr.
Neil McVean; Sales Mgr.: Colin Cross; Buyer Richard
Spearman (Rec. & Tape D, I & E).

Labels: Amber, Appella, Barnswallow, Black Tie, Break-
water, Cherry Hill Music, Cine Sources, Clode Sound,
Cubby Hole, Cut Throat, Dalrymple, Dapah, Diana, Duck
Tail, Eagle Creek, Fist, Fogarty's Cove, Glencoe Music,
Good Day, Honeybee, Impulse Magazine, Ixtlan, Jade,
Kinck, Knight II, Likeable, Manohar, Marc Prod'ns,
Marigold, Matrix, Metro, Music Gallery Eds., Naja, Nel-
vana, Nick, North Track, PM Jazz, Parklane, Posterity,
Posterity/Woodshed, Ram, Red Squirrel, Redwood,
Royalty, Rumour, Rutabaga, SRM, Salt, Second Avenue
Songs, Sevate, Singwell, Snocan/Icicle, Solar,
Springwater, Squash, Sunshine, T-Bow, Truly Fine, Ul-
tra, Viper, Will-O-Wind, World.
Labels imported: Adelphi (USA), Kicking Mule (USA),
Synchronic Research (USA), Transatlantic (UK).

● TORONTO METROPOLITAN AREA

(Area Code 416)

A & M Recs. of Canada Ltd., 939 Warden Ave., Scarborough
M1L 4C5. Tel: 752-7191 Telex 06-963652. Pres.
Gerry Lacoursiere; VP & Gen. Mgr. Joe Summers; Nat'l
Sales Mgr.: Bill Ott; Branch Mgr.: Ray Rosenberg. (Rec.
& Tape D)

Home office: USA

Branches: Calgary, Alta.; South Burnaby (Vancouver
Area), B.C.; Winnipeg, Man.; Halifax, N.S.; Lachine
(Montreal Metropolitan Area), P.Q.
Rec. labels: A&M, Horizon, Mushroom, Troubadour.
Tape lines: Same as rec. labels.

A R S Recs. Canada (div. of CBS Recs. Canada Ltd.), 160 Mil-
ner Ave., Agincourt M1S 3B2. Tel: 293-1941. VP
Mktg. Jerry Wipf; VP Opn.: Ron Irwin; Gen. Mgr.
Jacques Gagne; Dist'n Branch Mgr. Lyle Drake. (Rec. &
Tape OS & RJ)

Branches: Calgary, Alta. (Rec. & Tape OS & RJ); Burn-
aby (Vancouver Area), B.C. (Rec. & Tape OS & RJ);
Winnipeg, Man. (Rec. & Tape RJ); St. John's, Nfld.
(Rec. & Tape RJ); Dartmouth, N.S. (Rec. & Tape RJ);
St. Laurent (Montreal Metropolitan Area), P.Q. (Rec. &
Tape OS & RJ)

Aldisc Disks Ltd., 64 Bullock Dr., Markham L3P 3P2. Tel:
294-9298. Pres. Tony R. Frank, Gen. Mgr. Paul Bor-
donaro. (Rec. & Tape OS & RJ)

Almada Corp., 321 Chaplin Crescent, Suite 606. Postal
Code M5P 1B2. Tel: 489-1173. Mgr. Jonathan Lip-
sin. (Rec. & Tape D & I)

Home office: Montreal, P.Q. (See for prod. distributed)
Beaches Recs. & Tapes Ltd., 250 Don Park Rd., Markham
L3R 2V1. Tel: 495-1175/1585. Pres. Bernie
Letosky; VP: Willie Sportello. (Rec. & Tape OS) (SEE
ADVERTISEMENT)

Black & White Sales Consultants Ltd., 121 Don Park Rd.,
Markham L3R 1C2. Tel: 495-1905. Telex: 06-
986816. Pres. Gary Salter; VP Finance Rick Sobotta,
VP Int'l Doreen Elminowski. (Rec. & Tape E), (Rec. &
Tape I as Inter Global Music)

Labels imported: Jupiter (Germany), Ariola Eurodisc
(Germany).

C B S Recs. Canada Ltd., 5621 Finch Ave. E., Scarborough
M1B 2T9. Tel: 447-3311 Cable COLRECORD. Telex
06-966792. Reg'l Dir. Don Oates. (Rec. & Tape D)
Branches: Calgary, Alta.; Vancouver, B.C.; Winnipeg,
Man.; Moncton, N.B.; St. Laurent (Montreal Metropolitan
Area), P.Q.

Rec. labels: Aquitaine, Arc-American, Attic, Blue Sky,
CBS, CBS Direct, Caribou, Channel, Cleveland Entertain-
ment Int'l, Columbia, Columbia Legacy collection,
Columbia Masterworks, Epic, L'Escargot, GTO, IGM, In-
victus/Hot Wax, Jet, Kirshner, Lifesong, Magnet,
Monument, Nempor, Ode, Odyssey, Okeh, Philadel-
phia Int'l, Portrait, REL, Sweet City, TK, T-Neck,
TSOP, Tabu, Tappan Zee, True North, Unlimited Gold,
Versailles.

Tape lines: Same as rec. labels.

Canada Rec. Sales, 686 Richmond St. W. Postal Code M6J
1C3 Tel: 363-1019. Owner: Herbert Berne. (Rec. &
Tape OS & RJ).

Cantrade, 18 Spadina Ave. Postal Code M5V 2H6. Tel:
364-7766. Pres. Gabby Gottlieb

Distributes cut-outs.

Capitol Recs.-EMI of Canada Ltd., 3109 American Dr., Mal-
ton L4V 1B2. Tel: 677-5050. VP Mktg.: R.H. Rowe.
(Rec. & Tape D)

Rec. labels: Angel, Anthem, Aquarius, Arista, Capitol,
Chrysalis, EMI, EMI-America, Harvest, Melody, Muse,
Pathe, Savoy, Seraphim, United Artists group.

Tape lines: Same as rec. labels.

Coda Publ'ns, 337 King St. W. Postal Code: M5V 1J5. Tel:
368-3149. (Rec. D)

Rec. labels: Black Saint, Blue Angel, Bountiful, Broad-
way, Cat, Circle, Dawn Club, EBM, FMP, Jazz Society,
Jazz Studies, Jim Taylor Presents, Jump, Kabell, Ogun,
Progressive, Pumpkin, Queen Discs, Tax.

Continental Prod'ns Recs., PO Box 2013, Bramalea L6T
3S3. Tel: 792-2048. Owner & Buyer: Neil Patte. (Rec. D,
OS, I & E)

Distributes oldies, RCA collector's series.

G R T of Canada Ltd., 3816 Victoria Park Ave., Willowdale
M2H 3H7. Tel: 497-2340. Pres. Gordon R. Edwards;
Mktg. & Sales Dir. Alex Petchkin. (Rec. & Tape D)

Branches: Calgary, Alta.; Vancouver, B.C.; Winnipeg,
Man.; Montreal, P.Q.

Rec. labels: Barnaby, Charisma, Chess, Churchill,
Cream, DJM, Fantasy, GRT, Galaxy, Gospel Truth, Hi,

Import/Visa, Janus, Magnum, Milestone, Passport,
Prestige, Riverside, Smile, Stax, Tomato, Vogue.
Tape lines: Same as rec. labels.

Handleman Co. of Canada Ltd., 2358 Midland Ave.,
Scarborough M1S 4A9. Tel: 298-0411. Buyer: Jane
Bell. (Rec. & Tape RJ)

Home office: USA—Clawson (Detroit Metropolitan
Area), Mich.

Inter Global Music (Rec. & Tape I), see Black & White Sales
Consultants.

Ital Rec. Dist'g Co., 1339 St. Clair Ave. W. Postal Code: M6E
1C3. Tel: 654-8272. Owner: Pasquale Colangelo;
Mgr.: Etore Colangelo. (Rec. & Tape D, I & E)

Rec. labels: CP, Ital, Moon, Venus.

Rec. labels imported: CBS, CGD, Durium, Fonit Cetra,
Phonogram, RCA, Ricordi.

Tape lines: Same as rec. labels.

London Recs. of Canada (1967) Ltd., 1630 Midland Ave.,
Scarborough M1P 3C2. Tel: 755-3373. Telex: 06-
963754. Mgr. Armand Besudin. (Rec. & Tape D)

Home office: St. Laurent (Montreal Metropolitan Area),
P.Q. (See for prod. distributed)

M C A Dist'n (Canada) (div. of MCA Canada Ltd.), 2450 Victo-
ria Park Ave., Willowdale M2J 4A2. Tel: 491-3000.
TWX: 610-492-5204. Telex: 06-966876. VP Dist'n:
George Burns; Local Sales Mgr.: Mike McKelvie. (Rec.
& Tape D)

Branches: Calgary, Alta.; Vancouver, B.C.; Winnipeg,
Man.; Montreal, P.Q.

Rec. labels: Coral budget, Cycle, Infinity, MCA, Source,
Vocalion.

Tape lines: Same as rec. labels.

Metrodisc Disks, 130 Mack Ave. Postal Code: M1L 4P5. Tel:
698-5643. Mgr. B.J. Stafford. (Rec. & Tape D)

Branches: Winnipeg, Man.; Montreal, P.Q.

Labels: AVI, Alishre, Ariola, Attack, Birchmount,
Broadland, Buddha, Celebration, Con Bro, Evolution,
Grand Slam, H&L, Hansa, Kama Sutra, Kanata, King,
Mega, Millennium, Musicor, Plantation, Playboy,
Poppy, Prelude, Private Stock, Pyramid, Quality, Ran-
wood, Ringside, Roulette, Rounder, SMI, SSS Int'l,
Scorpion, Semaphore, Skyline, Starday, Sun, Track,
Vera Cruz.

P J Imports, 1635 Sismet Rd., Unit 30, Mississauga L4W
1W5. Tel: 624-0510. Telex: 06-961479. Principals:
Wolfgang Spegg, Phil Lubman. (Rec. D, I & E)

Labels: Airwaves, Anubis, Bomb, Brain, MPS, Metro-
nome, PM, Rebel, S&M, Stageflight.

Labels imported: CBS/Sony, Charly, ECM, EMI, Poly-
dor, RCA, Radar, Stiff, Teldec, WEA.

Phonodisc Ltd., 30 Malley Rd., Scarborough M1L 2E3. Tel:
751-9610. Telex: 06-963629. Pres. Jim Trainer, Gen.
Mgr. Laurie Heselton. (Rec. & Tape D)

Branches: Calgary, Alta.; St. Laurent (Montreal Metropolitan
Area), P.Q.

Rec. labels: Ashtree, Audio Fidelity, Black Lion, Chiaro-
curo, Frontenac, Image, Improv, MWS, Phonodisc, Pye,
Radar, World Jazz.

Tape lines: Same as rec. labels.

Accessories: Le-Bo.

Pindorf Rec. Sales Ltd., 37 Haas Rd., Rexdale M9W 3A1.
Tel: 741-4182. Pres. K. Pindorf; VP & Gen. Mgr.: E.T.
Campbell. (Rec. & Tape RJ)

Branches: Burnaby (Vancouver Area), B.C.; St. Laurent
(Montreal Metropolitan Area), P.Q.

Polygram Inc., Etobicoke Tower, 7th fl., 555 Burnhamthorpe
Rd. W., Etobicoke M9C 2Y3. Tel: 622-6680. Telex: 06-
967755. Nat'l Accounts Dir.: Alun Elias; Reg'l Sales
Mgr. Herb Bradley. (Rec. & Tape D)

Home office: St. Laurent (Montreal Metropolitan Area),
P.Q. (See for prod. distributed)

Praise Recs. of Canada Ltd., 3194 Dundas St. W. Postal
Code: M6P 2A3. Tel: 767-2510. (Rec. & Tape D)

Branch: Vancouver, B.C.

Int'l branch: USA—Bellingham, Wash.

Rec. labels: Faith, Fisher Folk, Harald, Horizon, Little
People, Maranatha, New Born, New Life, Praise, Son-
rise, Starsong

Tape lines: Same as rec. labels.

R C A Ltd., Rec. Div., 101 Duncan Mill Rd., Don Mills M3B
1Z3. Tel: 449-9500. Mktg Servs. Mgr.: Wayne R. Jordan.
Sales office: 680 Progress Ave., Unit 1,
Scarborough M1H 3E5. Tel: 438-0982. Distinct Sales
Mgr. G. Murphy. (Rec. & Tape D)

Labels: Baby, Bang, Bazaar, Black & White, Bluebird,
Bluestime, Bullet, Butterfly, CTI, Canada Int'l, Caparo,
Carriere, Carrousel, Centennial, Champagne, Cham-
pion, Chi Sound, Club series, Colgems, DRG, Damon,
Erato, Fanti, Formule 1, Free Flight, GEM, Gem Toby,
Golden Greats, Gold Mind, Gold Seal, Gold Standard,
Good Earth, Grit, Grunt, Hologram, Ibis, Island, Jare
Int'l, Kudu, Legendary Performers, Lirys, Lotus, Malaco,
Mango, Metronome, Midsong Int'l, Mustard, Ovation,
Pablo, Pablo Live, Philly Groove, Pure Gold, QCA, Quad-
radisc, RCA, Red Seal, Republic, Roadshow, Salsoul,
Salvation, Saravah, Sesame, Sirocco, Solar, Special,
Tattoo, Tembo, 36, Three Brothers, Tom 'n Jerry, Tor-
torise Int'l, Trema, 20th Century, Vault Treasure, Victor,
Victrola, Vik, Windsong, Wooden Nickel, Zagora

Records on Wheels Ltd., 21 Progress Ave. No. 9-12,
Scarborough M1P 4S8. Tel: 293-4911. Owners & Buy-
ers: Vito & Don Ierullo. Local branch: 629 Yonge St.,
Toronto M4Y 1Z5. Tel: 961-4957. Mgr. Rosa Ierullo;
Buyer Alan McKinlay. (Rec. OS, I & E; Tape OS)

Roblan Disks Ltd., 274 Church St. Postal Code: M5B 1Z5.
Tel: 363-2437. Telex: 06-22500. Pres. Sam Snider-
man, VP Robert Sniderman, Export Mgr. Terry Gil-
hooly. (SEE ADVERTISEMENT)

Sound 21 Ltd., 1224 Dundas St. E., Unit 6, Mississauga
L4Y 4A2. Tel: 279-7682. Mgr. Jim Lemyre; Buyer
Bruce MacKenzie. (Rec. & Tape OS & RJ)

Stereodyne (Canada) Ltd., 3121 Universal Dr., Mississauga
L4X 2E2. Tel: 625-8311. Pres. R.B. Kerr; Sales Mgr.
W.J. Laing. (Rec. & Tape D)

Rec. labels: Impact, Starpak.

Tape lines: Arrow, Dynapak, Impact, Starpak.

Accessories: Dynapak blank cartridges & head cleaners.

Sunrise Rec. Disks, 602 Gordon Baker Rd., Willowdale M2H
3B4. Tel: 498 6601. Pres.: Malcolm Perlman. (Rec.
OS & RJ)

Trend Recs. & Tapes Ltd., 1655 Sismet Rd., Unit 25, Missis-
sauga L4W 1Z4. Tel: 223-3720. Owners: Jack Inhaber,
Allan Freedman; Mgr.: Lyne McLean; Singles, Albums &
Tape Buyer: Howard Cramer. (Rec. & Tape D & I)
Labels: Acanta, Advent, Ajax, All Ears, Alligator, Apon,
Aviva, Blind Pig, Briar, Briko, Bullfrog, CMH, Cabot,
Chalfont, Citadel, Contemporary, Crystal Clear, Curtain
Calls, DRG, Desmar, Dobie, Entr' Acte, Famous Person-
ality, Fanfare, First American, Flying Fish, Four Leaf
Clover, Gryphon, HNH, Harmonia Mundi, Improving Art-
ists, India Navigation, Interplay, JCOA, Jamey
Abersold, Jazz Archives, Jazz Chronicle, Jazz Guild,
Joyce, MNM, Nussa, Music Minus One, Musicraft, Mus-
kadine, Nese, Onari, PBR, Pelican, Peter Pan, Philly
Jack, Potato, Rebel, Retrospect, Rocking Horse, Roper,
Sackville, Spotlite, Stash, Sugar Hill, Tifton, Unicorn,
Varese/Sarabande, WATT, Zim.

W E A Music of Canada Ltd., 1810 Birchmount Rd.,
Scarborough M1P 2J1. Tel: 291-2073. Cable:
WEATOR. VP Mktg. Don Grant, Nat'l Sales Mgr. Andy
Abbate; Sales Mgr. Mike Gaitt. (Rec. & Tape D)

Branches: Calgary, Alta.; Vancouver, B.C.; Winnipeg,
Man.; Dorval (Montreal Metropolitan Area), P.Q.

Rec. labels: Asylum, Atco, Atlantic, Beggar's Banquet,
Big Tree, Cotillion, Dark Horse, DiscReet, ECM, Elektra,
Famous Charisma, Finnadar, Little David, Manticore,
Nonesuch, Pacific, Paradise, Planet, Rolling Stones,
Scotti Bros., She, Sire, Swan Song, Warner Bros.,
Warner/Curb, Warner/Spector, Westbound, Whitfield,
Wing & a Prayer.

Tape lines: Same as rec. labels.

Wilson Int'l Dist. Ents. (WIDE), PO Box 738, Station A,
Scarborough M1K 5C4; 544 Birchmount Rd., No. 902,
Scarborough M1K 1P3. Owner: Patrick D. Wilson;
Mgr. Norman Wilson. (Rec. & Tape I & E)

Labels imported: Acanta (Germany), Amigo (Sweden),
Ars Nova (Italy), Artia (Czechoslovakia), Attaca (Ger-
many), Bellaphon (Germany), CRD (UK), Cassiopee
(Italy), Classical (UK), Coronet (UK), Discophil (Ger-
many), Ducale (Italy), Enigma Classics (UK), Exploring
World (UK), Heritage (UK), Hungarator (Hungary), Lyr-
icon (Sweden), Lyrita (UK), Muza (Poland), Nimbus
(UK), Pepita (Hungary), Pronit (Poland), Quadrifolia
(Italy), Sonic (Germany), Unicorn (UK), Veriton (Poland),
Vista (UK), Wergo (Germany).

● WATERLOO (Area Code 519)

Carl H. Sattler & Assocs. Ltd., 321 Weber St. N. Postal Code:
N2J 3H8. Tel: 885-0670. Owner & Mgr.: Carl H. Sat-
tler; Buyer: Doug Robinson. (Tape RJ)

PRINCE EDWARD ISLAND

● CHARLOTTETOWN (Area Code 902)

Watts Ents. Ltd., 97 St. Peters Rd. Postal Code: C1A 5N9.
Tel: 894-7549. Owners: Edison, Robert & Dean Watts.
(Rec. & Tape D, OS & RJ)

Rec. labels: Audio, Columbia, Impact, London, MCA,
Praise, Quality, RCA, Tee Vee, World.

Tape lines: Columbia, London, MCA, RCA, Tee Vee,
World.

Photographs: BSR, Sony, Yamaha.

Playback equip.: Sony, Lloyd's Yamaha.

Accessories: BASF, TDK, Tracs, Watts.

QUEBEC

● MONTREAL METROPOLITAN AREA

(Area Code 514)

A & M Disks (Montreal), 9434 Cote de Liesse, Lachine H8T
1A1. Tel: 636-9741. Telex: 05-821659. Mgr.: Andre
Gauthier. (Rec. & Tape D)

Home office: Scarborough (Toronto Metropolitan Area),
Ont.; A&M Recs. of Canada Ltd. (See for prod. distribut-
ed)

A R S Disques Canada (div. of CBS Recs. Canada Ltd.), 9429
Cote de Liesse, Dorval H9P 2N9. Tel: 636-9081. Mgr.:
Jean Couture. (Rec. & Tape OS & RJ)

Home office: Agincourt (Toronto Metropolitan Area),
Ont.

Almada Corp., 380 St. Antoine St. W. Postal Code: H2Y
1J9. Tel: 844-1127. Owners: Aaron Lipsin, Marv Dri-
mer; Mgr.: Marv Drimer; Buyer: Aaron Lipsin. (Rec. &
Tape D & I)

Branches: Vancouver, B.C.; Toronto, Ont.

Rec. labels: AJ/ALA, AJP, ASA, Abbey, Aircheck, Antho-
logy, Arad, Archive of Folk, Archive of Jazz, Ar-
chive of Piano, Arcobaleno, Arhoolie, Attack, Aural Ex-
plorer, Aurora, BBC, Backdoor, Bay, Bear Family, Big
Ben, Biograph, Blue Goose, Blues Classics, Blues Spec-
trum, Broadside, Broadway, Bulldog, CMS, Caedmon,
Cameron, Canon, Center, Choice, Classic Jazz, La Com-
die Francaise, Concord, Connoisseur Society, Conversa-
Phone, Cook, Cooking Fat, Coran, Cosmopolitan, Coun-
try Porn, County, Deesse, Discourses, Dixieland Jubilee,
Double Twelve, Dover, Dragon, Dyno, Electric Lemon,
Elephant, Ember, Emery Cook, Esperance, Euphoria, Ev-
erest, Experiences Anonymes, Folklyric, Folkways, Frei-
less, Front Hall, GNP, Gateway, Golden Age, Gold Star,
Grampan, Green Linnet, Guitar World, Gusto, Hall of
Fame, Heritage, Historical, Inner City, Iron Horse, Ital,
Jay Jay, Jazz World, Joker, Kaleidophone, Kicking
Mule, King, Klavier, Laif, Legacy, Legend, Lismor, Liv-
ing Language, Lowbitte, Lyrichord, Major, Mark 56,
McGill Univ., Melodeon, Monitor, Monmouth-Ever-
green, Mooncrest, Murray Hill, Music World, Nevis, No
Holds Barred, L'Oiseau Musicien, Old Homestead, Old
Timey, Olympic, Om Kalsoum, Ornis, Oryx, Outrageous,
Paredon, Passage, Pearl, Philo, Plantation, Power Pak,
Prelude, Radio Archives, Radiola, Ramblin', Request,
Revonah, Ridge Runner, Rim, Rock-Land, Rounder,
Royale, SLD, Saga, Sandy Hook, 1750 Arch, Sha-
nachie, Sierra Wave, Sonafisc, Sono Cairo, Sounds Su-
perb, Spokane, Starday, String, Sun, Supradisc, Syl-
phone, Takoma, Tangent, Til, Topic, Totem, Tradition,
Tretaux, Trix, Trojan, Tropical, Venus, Vetco, Who's
Who in Jazz, Wildwood, Windham Hill, Yazoo

Tape lines: American Entertainment, Archive of Folk,

Archive of Jazz, Archive of Piano, Betty White, Bright Orange, CMS, Conversa-Phono, Elephant, Everest, Folkways, GNP Crescendo, Golden Age, Gold Star, Insync, Legend, Lismor, Living Language, Monitor, Olympic, Party, RCA Camden, Radiola, Request, Rounder, Saga, Tradition.

Accessories: Jackets & sleeves, rec. cleaners (Disc-Stat).

Alta Musique Dist'n Ltee., 9375 Meaux St., St.-Leonard H1R 3H3. Tel: 327-5040. Telex: 05-828592. Pres.: Alain Guillemette; Sales Mgr.: Jehan Valiquet. (Rec. & Tape D)

Labels: Alta, Daisy, Domino, Emotion, Gamma, Heritage, Impact, Jade, Motown, MBW, Pickwick, Smash-Disco, Sonotel, Tamanoir, 13 Aout.

Accessories: Memorex, Recoton.

C B S Recs. Canada Ltd./CBS Disques Ltee., 1550 Rue Beaulac, St.-Laurent H4R 1W8. Tel: 342-2231. Reg'l Dir.: Paul Gallant. (Rec. & Tape D)

Home office: Scarborough (Toronto Metropolitan Area), Ont. (See for prod. distributed)

Capitol Recs.-EMI of Canada Ltd., 9245 Cote de Liesse Rd., Dorval H9P 2N9. Tel: 631-9073. Eastern Sales Mgr.: W. Rotari. (Rec. & Tape D—see office in Toronto, Ont., for prod. distributed)

D J Recs. Ltd., 146 Francois, No. 304, Nuns Island H3E 1G3. Tel: 761-7118. (Rec. & Tape OS, RJ, I & E)

Downstairs Recs., 668 Deslauriers St., St. Laurent H4N 1W5. Tel: 334-2373. Telex: 05-827542. Owners: G. Cucuzzella, G. Tortorici; Buyer: G. Cucuzzella. (Rec. & Tape OS & RJ), (Rec. & Tape I & E as Unidisc of Canada)

Labels: Broadway, Champagne, Dice, Glass, Igloo, Scorpio, Unidisc.

G R T of Canada Ltd., 751 Jarry St. E. Postal Code: H2P 1W3. Tel: 274-3587. Eastern Reg'l Mgr.: Ken Dion; Sales Rep.: Jacques Grandbois. (Rec. & Tape D)

Home office: Willowdale (Toronto Metropolitan Area), Ont. (See for prod. distributed)

Gamma Recs. Ltd., 9375 Meaux St., St.-Leonard H1R 3H3. Tel: 327-5010. Cable: GAMREC. Telex: 05-828592. Gen. Dir.: Daniel Lazare, Pres.: Jack Lazare. (Rec. I)

Rec. labels: Aavalanche, Cool Music, Cyclon, Hexagone, Sunset.

Handleman Co. of Canada Ltd., 4215 Poirier Blvd., St. Laurent H4R 2A4. Tel: 337-7040. Mgr.: Yvon LaBelle; Buyer: Robert Reboull. (Rec. & Tape RJ)

Home office: USA—Clauson (Detroit Metropolitan Area), Mich.

London Recs. of Canada (1967) Ltd., 6265 Cote de Liesse, St.-Laurent H4T 1C3. Tel: 341-5350. Telex: 05-824570. VP Mktg.: Kenneth Verdoin, Eastern Reg'l Mktg. Mgr.: Armand Guadagno; Western Reg'l Mktg. Mgr.: A. Bilodeau; Local Branch Mgr.: Fred Refica; Local Sales Mgr.: Yves Dupuis. (Rec. & Tape D)

Branches: Calgary, Alta.; Burnaby (Vancouver Area), B.C.; Winnipeg, Man.; Scarborough (Toronto Metropolitan Area), Ont.; Quebec City, P.Q.

Labels: Abiko (tape only), Able, Ace of Clubs, Ace of Diamonds, Airedale, Argo, Axe, BSST, Banff, Beltona, Beta, Boot, CB/Star, Canadian Cavalcade, Caprice, Carats, Celtic, Chair-Man Mills, Chouette, Crossover, Cynda, Decca, Deram, Disque Bleu, Durium, Echanson, Enigma, Flying Fish, Fontana, Force One, Foreign Exchange, Generation, Honey Dew, Ice, Interdisk, Jake, Kosmos, Le Joint, Lollipop, London, Magique, Manibelle, Morning, Musinter, Nuage, Oiseau-Lyre, Owl Blues, Parrot, Phase 4, Philips, Philo, Pingouin, Project 3, Quatre Saison, Richmond, Riot, Rodeo, Rosa, Sky, Stereo Treasury, Stony Plain, Talisman, Telefunken, Telson, Threshold, UK, VIP, Vinyl, WAM, Wow, Wonderland.

MCA Dist'n (Canada) (div. of MCA Canada Ltd.), 8444 Blvd. St. Laurent, Postal Code: H2P 2M3. Tel: 382-8475. TWX: 610-421-3225. Sales Mgr.: Robert Hamel. (Rec. & Tape D)

Home office: Willowdale (Toronto Metropolitan Area), Ont. (See for prod. distributed)

Metrodisc Dists., 2215 Beaconsfield Ave. Postal Code: H4A 2G9. Tel: 481-1167. Mgr.: Gary Kouri. (Rec. & Tape D)

Home office: Toronto, Ont. (See for prod. distributed)

Milbank Music Corp., 245 Montee de Liesse, Postal Code: H4T 1N8. Tel: 341-4511. Telex: 05-825621. MIL-BANKMUS Contact: Jerry Shapiro. (OS, I & E)

Mr. Music of Canada Ltd., PO Box 1626, Sta. B. Postal Code: H3B 3L3. Tel: 737-0557. Owner & Mgr.: Van H. Pette-way. (Rec. RJ & I, Tape I)

Imports rec. & tape cut-outs.

Multidisc Inc., 9375 Meaux St., St.-Leonard H1R 3H3. Tel: 327-5070. Telex: 05-828592. Pres.: Robert Corbin; Sales Dir.: Claude Dore; Buyers: Singles, Jean Baril, Albums & Tape, Richard Vincent. (Rec. & Tape OS & RJ)

Branch: Quebec City, P.Q. (Rec. & Tape I & E)

Phonodisc Ltd., Place Trans Canada, Suite 223-A, 7033 Trans Canadienne Rte., St. Laurent H4T 1S2. Tel: 337-1022. (Rec. & Tape D)

Home office: Scarborough (Toronto Metropolitan Area), Ont. (See for prod. distributed)

Pindoff Rec. Sales Ltd., 245 Montee de Liesse, St. Laurent H4T 1P5. Tel: 341-1210. Mgr.: Jacques Marquis. (Rec. & Tape RJ)

Home office: Rexdale (Toronto Metropolitan Area), Ont.

Polygram Inc., 6000 Cote de Liesse, St.-Laurent H4T 1E3. Tel: 739-2701. Telex: 05-825690. TWX: 610-421 3509. VP Mktg. & Sales: Dieter Radacki; Eastern Sales Mgr.: Gaston Careau. (Rec. & Tape D)

Branches: Calgary, Alta.; Vancouver, B.C.; Winnipeg, Man.; Etobicoke (Toronto Metropolitan Area), Ont.

Labels: Barclay, Capricorn, Casablanca, Chocolate City, DG, De-Lite, Direction, Egg, Festivo, Lone Star, MGM, Mercury, Parachute, Philips, Polydor, RAAL, RSO, Resonance, Riviera, Rockland, Spring, TGO, Verve, Virgin, Voyage, Zappa.

RCA Ltd., Rec. Div., PO Box 987, Tour de la Cite; 300 Leo Parizeau, Postal Code: H2W 2N1. Tel: 849-3251. District Sales Mgr.: R. Galibois. (Rec. & Tape D—see office in Toronto, Ont., for prod. distributed)

R M P Rec. Sales Co. Ltd., 300 Bates Rd. Postal Code: H3S 1A3. Tel: 739-5662. Owner & Buyer: Leslie Faludi. (Rec. & Tape OS & RJ)

Superior Electronics Inc., 1330 Trans Canada Hwy. S., Dorval H9P 1H8. Tel: 683-6331. Pres. R. Golick, Sr. VP: F. Lawrence Plotnick, VP & RJ Mgr.: Sydney Goldstein; D Buyer: B.R. Klempner; RJ Buyer: P. Griffiths. (Rec. D & RJ, Tape RJ)

Labels: Concord Jazz, East Wind, Orinda, Philips, RCA direct-to-disc, Telarc, Toshiba-EMI.

Trans Canada (div. of Les Distributions Quebecor Inc.), 7033 Trans Canada Hwy., St. Laurent H4T 1S2. Tel: 336-7151. Dir. Gen. Pierre Boivin, Sales Mgr.: Robert Brault; Buyer: Bruce Schneider. (Rec. & Tape D & OS)

Branches: Moncton, N.B.; Quebec City, Rimouski, Rouyn, P.Q.

Rec. labels: Amour, Baccara, Bonanza, Catalogne, Chemin du Roi, Colibri, Disco 1, Discotel, Fleur, Fontane, Generation, Gyp Int'l, Jyto, Kebec-Disc, Martin, Melon-Miel, Mercure, Mirabel, NSB, Nobel, Parapluie, Pax, Reserve, Rico, SPPS, Safi, Trm-Pax, Total, Totem, Traffic, Unison.

Tape lines: Same as rec. labels.

Unidisc of Canada (Rec. & Tape I & E), see Downstairs Recs.

Varietes Musicales de l'Est Inc., 189 Rockland Rd. Postal Code: H3P 2W4. Tel: 735-1694. (Rec. OS—singles only)

W E A Music of Canada Ltd., 735 Renaud Ave., Dorval H9P 2N1. Tel: 636-8503. Mgr.: Richard Belec. (Rec. & Tape D)

Home office: Scarborough (Toronto Metropolitan Area), Ont. (See for prod. distributed)

● QUEBEC CITY (Area Code 418)

London Recs. of Canada (1967) Ltd., 1303 Rue Conway, Postal Code: G1J 3S3. Tel: 529-0261. Telex: 051-3799. Mgr.: Fred Refica. (Rec. & Tape D)

Home office: St.-Laurent (Montreal Metropolitan Area), P.Q. (See for prod. distributed)

Multidisc Inc., 2347 D'Alton, Parc Colbert, Postal Code: G1P 3S3. Tel: 653-6433. Mgr.: Bill Mathieu. (Rec. & Tape I & E)

Home office: Montreal, P.Q. (Rec. & Tape OS & RJ)

Trans Canada (div. of Les Distributions Quebecor Inc.), 2659 Watt St., Local G. Parc Colbert, Postal Code: G1P 3T5. Tel: 651-6512. Mgr.: Jacques Charest. (Rec. & Tape D & OS)

Home office: St.-Laurent (Montreal Metropolitan Area), P.Q. (See for prod. distributed)

● RIMOUSKI (Area Code 418)

Trans Canada (div. of Les Distributions Quebecor Inc.), 339 Rivard St., Plaza Industrielle G5L 7J6. Tel: 722-6333. Mgr.: Carol Coulombe. (Rec. & Tape D & OS)

Home office: St.-Laurent (Montreal Metropolitan Area), P.Q. (See for prod. distributed)

● ROUYN (Area Code 819)

Trans Canada (div. of Les Distributions Quebecor Inc.), 165 Dallaire, Postal Code: J9X 4T3. Tel: 764-6128. Mgr.: Robert Perusse. (Rec. & Tape D & OS)

Home office: St.-Laurent (Montreal Metropolitan Area), P.Q. (See for prod. distributed)

SASKATCHEWAN

● SASKATOON (Area Code 306)

Radel Racking Ltd., Box 9200, Postal Code: S7K 3T4. Tel: 652-1977. Owner: W.A. Murphy, Mgr. & Buyer: P. Bateman. (Rec. & Tape RJ)

● services

ASSOCIATIONS & PROFESSIONAL ORGANIZATIONS

A C T R A, see Association of Canadian Television & Radio Artists.

A F M, see American Federation of Musicians.

Academy of Country Music Entertainment, PO Box 574, Thornhill, Ont. L3T 4A2. Tel: (416) 225-8171. Pres.: David Charles; Exec. Ass't: Sheila Petersen.

American Federation of Musicians (AFM), 101 Thorncliffe Park Dr., Toronto, Ont. M4H 1M1. Tel: (416) 425-1831

Association of Canadian Orchs., 151 Bloor St. W., Suite 503, Toronto, Ont. M5S 1T6. Tel: (416) 961-1660. Exec. Sec'y: Betty Webster.

Association of Canadian Television & Radio Artists (ACTRA), 105 Carlton St., Toronto, Ont. M5B 1M2. Tel: (416) 363-6335.

British Columbia Touring Council, 575 Beatty St., Vancouver, B.C. V6B 2L7. Tel: (604) 669-2800. Exec. Dir.: Stephen Chitty.

C A M M A C (Canadian Amateur Musicians—Musiciens Amateurs du Canada), PO Box 353, Westmount, P.Q. H3Z 2T5. Tel: (514) 932-8755.

Canadian Amateur Music Making, 1165 Greene Ave., Westmount, P.Q. H3Z 2A2. Tel: (514) 932-8755.

Canadian Bureau for the Advancement of Music (CBAM), Exhibition Place, Queen Elizabeth Bldg., Toronto, Ont. M6K 3C3. Tel: (416) 366-7551. Mng. Dir.: Lt. Col. C. O. Hunt.

Canadian Folk Music Soc., c/o Societe Radio-Canada, PO Box 6000, Montreal, P.Q. H3C 3A8. Tel: (514) 285-3211.

Canadian League of Composers, 1263 Bay, Toronto, Ont. M5R 2C1. Tel: (416) 961-6601.

Canadian Music Centre/Centre de Musique Canadienne (CMC), 1263 Bay St., Toronto, Ont. M5R 2C1. Tel: (416) 961-6601. Cable: CENTRECAN.

Canadian Music Council, c/o Guy Huot, 36 Elgin, Ottawa, Ont. K1P 5K5. Tel: (613) 238-5893. Sec'y-Gen.: Guy Huot.

Canadian Music Educators Ass'n (CMEA), Nat'l Resource Centre, PO Box 1461, St. Catharines, Ont. L2R 7J8. Pres.: Paul Murray; Exec. Sec'y: Wallace Laughton.

Canadian Music Publ'rs Ass'n, 111 Avenue Rd., Toronto, Ont. M5R 3J8. Contact: Matthew Heft.

Canadian Rec'g Ind. Ass'n, 89 Bloor St. E., Toronto, Ont.

M4W 1A9 Tel: (416) 967-7272. Pres.: Brian Robertson.

Council of Business & the Arts in Canada, PO Box 84, Toronto Dominion Centre, Suite 1810, Toronto, Ont. M5K 1E7. Tel: (416) 869-3016.

Jeunesses Musicales du Canada, 5253 Ave. du Parc, Suite 600, Montreal, P.Q. H2V 4P2. Cable: JEUMUSICA. Tel: (514) 271-2566.

N A B E T, see National Ass'n of Broadcast Employees & Technicians.

National Ass'n of Broadcast Employees & Technicians (NABET), 1010 St. Catherine St. W., Montreal, P.Q. H3B 3R3. Tel: (514) 878-3141.

National Youth Orchestra of Canada (NYO), 76 Charles St. W., Toronto, Ont. M5S 1K8. Tel: (416) 922-5031. Gen. Dir.: John Brown.

Recording Arts & Sciences Institute of Canada, PO Box 865, Snowdon Sta., Montreal, P.Q. H3X 3X9. Tel: (514) 288-1853. Pres. & Exec. Dir.: David P. Leonard.

DESIGN & ARTWORK

Cinram Ltd., 8355 Devonshire Rd., Montreal, P.Q. H4P 2L1. Tel: (514) 739-2281. Telex: (05) 827788.

Dynacom Communications Int'l, PO Box 702, Snowdon Sta., Montreal, P.Q. H3X 3X8. Tel: (514) 342-5200. Pres.: Dave Leonard. (Record only)

Global Prods., 350 Sorauene Ave., Toronto, Ont. M6R 2G8. Tel: (416) 531-5751. Cable: GLOBOLPROD. Pres.: G. Kyron; Gen. Mgr.: Jerry Stevens. (Tape only).

Golden Rec. Mfg. Ltd., 500 Coronation Dr., West Hill, Ont. M1E 4V7. Tel: (416) 281-9522.

Bill Hicks Design & Photography, 611 Gertie St., 2nd fl., Winnipeg, Man. R3A 1B5. Tel: (204) 943-1868.

Intermodal Prods Int'l, PO Box 2199, Vancouver, B.C. V6B 3V7. Tel: (604) 688-1820. Pres. & Sales Mgr.: John Rodney; Adv. Mgr.: Evelyn Rodney.

Sheldon Kagan & Assocs. Ltd., 2555 Cote Vertu, Montreal, P.Q. H4R 1Z6. Tel: (514) 331-7282. (Record only)

Kitsch, Baroque & Rococo Advertising Counsellors, PO Box 85, Stoney Creek, Ont. L8G 3X7. Tel: (416) 544-7569. Pres. & Gen. Mgr.: Lawrence M. Bedder.

Lithobec Canada Ltd., 600 Port-Royal W., Montreal, P.Q. H3L 2C5. Tel: (514) 388-1133.

Metro-Graphic Corp., 2800 Francis-Hughes Ave., Chomedey, P.Q. H7L 3M4. Tel: (514) 663-0370. (Record only)

Ok! Assocs., PO Box 103, Sta. A, Toronto, Ont. M5W 1A2. Tel: (416) 534-7951. Owner: Lois Ok!; Art Dir.: Tom Ok!

Parr's Print & Litho Ltd., 341 Nantucket Blvd., Scarborough, Ont. M1P 2P2. Tel: (416) 759-5601. Pres.: V.W. Parr; Sales Mgr.: R.A. Gray.

Praise Recs. of Canada Ltd., 6979 Curragh Ave., Burnaby, B.C. V5J 4V6. Tel: (604) 438-8266. Gen. Mgr.: Paul Yaroshuk.

Promotivation Agency Inc., 354 Youville St., Montreal, P.Q. H2Y 2C3. Tel: (514) 284-0330.

Ross-Ellis Ltd., 300 Ann St., Montreal, P.Q. H3C 2K2. Tel: (514) 861-2411. Pres.: L.E. Rossini; Gen. Mgr.: H.B. Ellis; Sales Mgr.: Shaun Bernard.

Branch: Markham, Ont., 227 Idema Rd. Postal Code: L3R 1B1. Tel: (416) 495-9811. Telex: (06) 22819. Sales Mgr.: Jim Austin.

Shorewood Packaging Corp. of Canada Ltd., 1160 Bellamy Rd. N., Scarborough, Ont. M1H 1H2. Tel: (416) 438-5301. Telex: (065) 25228.

Branch: Montreal, P.Q., 100 Alexis Nihon Blvd., Suite 583, Postal Code: H4M 2P1. Tel: (514) 748-7959/9024.

Home office: USA, New York, N.Y.

Studio Lorraine, 310 Ann St., Montreal, P.Q. H3C 2K1. Tel: (514) 861-2759. Telex: 05-267411.

World Recs., 484 Waterloo Court, Oshawa, Ont. L1H 3X1. Tel: (416) 576-0250. Pres. Bill Hewson; Gen. Mgr.: Bob Stone.

LICENSING ORGANIZATIONS, MUSIC

Canadian Musical Reproduction Rights Agency Ltd. (CMRRA), 111 Avenue Rd., Toronto, Ont. M5R 3J8. Tel: (416) 922-4170. Cable: MUSRITES. Pres. Al Mair; Gen. Mgr.: C.C. Devereux. (Mechanical rights only)

Composers, Authors & Pub'rs Ass'n of Canada Ltd. (CAPAC), 1240 Bay St., Toronto, Ont. M5R 2C2. Tel: (416) 924-4427. Gen. Mgr.: John V. Mills. (Performing rights only)

Branch: Vancouver, B.C., 1 Alexander St. Postal Code: V6A 1B2. Tel: (604) 689-8871—Montreal, P.Q., 1245 W. Sherbrooke, Postal Code: H3G 1G2. Tel: (514) 288-4755. Mgr.: Michael Rock.

P R O Canada (Performing Rights Org. of Canada Ltd.), 41 Valleybrook Dr., Don Mills, Ont. M3B 2S6. Tel: (416) 445-8700. Cable: CANMUS TORONTO. Telex: (06) 966634. Pres.: Gordon F. Henderson; Mng. Dir.: S. Campbell Ritchie; Pub. & PR Mgr.: Nancy Gyokeres.

Branches: Vancouver, B.C., 1462 W. Pender St. Postal Code: V6G 2S2. Tel: (604) 688-7851—Montreal, P.Q., 2001 University St., Suite 1140. Postal Code: H3A 2A6. Tel: (514) 849-3294.

PLATING, PROCESSING & PRESSING PLANTS

Arc Sound Co. Ltd., 142 Sparks Ave., Willowdale, Ont. Tel: (416) 499-5000.

Capitol Recs.-EMI of Canada Ltd., 3109 American Dr., Mississauga, Ont. L4V 1B2. Tel: (416) 677-5050. Cable: CAPITOLREC. Pres. J.D. Evans; VP Mktg. R. Rowe; VP Sales M. Rosicki; Nat'l Edging & Adv. Mgr. D. Elliott. (Pressing only)

Branches: Calgary, Alta., 519 Manitou Rd. SE. Postal Code: T2G 4C2. Tel: (403) 287-0823. Western Reg'l Sales Mgr.: A. Andruchow—Vancouver, B.C., Century Plaza, Suite 503, 1015 Burrard St. Postal Code: V6Z 1Y5. Tel: (604) 689-8667. Sales D. Bertsch, B. Manlove—Dorval, P.Q., 9245 Cote de Liesse Rd. Postal Code: H9P 2N9. Tel: (514) 631-9073. Eastern Reg'l Sales Mgr.: W. Rotari.

Golden Rec. Mfg. Ltd., 500 Coronation Dr., West Hill, Ont. M1E 4V7. Tel: (416) 281-9522.

Holbrook Dist. Co. Ltd., PO Box 9, Mount Albert, Ont. L0G 1M0. Tel: (416) 294-9398. Pres.: Frank P. Swain; Custom Sales Mgr.: M.C. Swain. (Plating & Processing only) Intermodal Prod's Ltd., PO Box 2199, Vancouver, B.C. V6B 3V7. Tel: (604) 688-1820. Pres. & Sales Mgr.: John Rodney. Adv. Mgr.: Evelyn Rodney

Keel Rec. Mfg. of Canada Ltd., 460 Fairhill St., Ajax, Ont. L1S 1R6. Tel: (416) 683-1461. (Pressing only)

London Recs. of Canada (1967) Ltd., 6265 Cote de Liesse, St. Laurent, P.Q. H4T 1C3. Tel: (514) 341-5350. Cable: FULLRANGE MONTREAL. Telex: (05) 824570. Pres.: F.C. Jamieson; VP: A. Koury.

Branches: Calgary, Alta., 429 Manitou Rd. SE. Postal Code: T2G 4C2. Tel: (403) 243-1313. Telex: (038) 22572. Mgr.: D. McBeth—Burnaby, B.C., 3166 Lake City Way. Postal Code: V5A 3A4. Tel: (604) 298-6471. Telex: (04) 354544. Mgr.: O.L. Jones—Winnipeg, Man., 15-1100 Waverly St. Postal Code: R3T 3X9. Tel: (204) 452-7918. Telex: (07) 57695. Mgr.: Gerry Young—Scarborough, Ont., 1630 Midland Ave. Postal Code: M1P 3C2. Tel: (416) 755-3373. Telex: (06) 963754. Mgr.: Armand Beaudin—Quebec, P.Q., 1303 Rue Conway. Postal Code: G1J 3S3. Tel: (418) 529-0261. Telex: (051) 37399. Mgr.: Fred Refica.

Praise Recs. of Canada Ltd., 6979 Curragh Ave., Burnaby, B.C. V5J 4V6. Tel: (604) 438-8266. Gen. Mgr.: Paul Yaroshuk. (Pressing only)

Quality Recs. Ltd., 380 Birchmount Rd., Scarborough, Ont. M1K 1M7. Tel: (416) 698-5511. Telex: 06-219624. Pres.: George R. Struth; Sales Dir.: Barry J. Stafford; VP Mfg.: Ronald P. Gardner; VP Finance: David M. Ford.

Branches: Winnipeg, Man., Galt Bldg., 4th fl. Postal Code: R3B 0R7. Tel: (204) 943-6563. Mgr.: Charles Porter—Toronto, Ont., 130 Mack Ave. Postal Code: M1L 4P5. Tel: (416) 698-5643. Mgr.: Barry J. Stafford—Montreal, P.Q., 2215 Beaconsfield Ave. Postal Code: H4A 2G9. Tel: (514) 481-1167. Mgr.: Danielle Gagnon. (Pressing only)

R C A Ltd., 101 Duncan Mill Rd., Suite 300, Don Mills, Ont. M3B 1Z3. Tel: (416) 449-9500. Telex: (06) 966577. TWX: (610) 492-4746. VP & Gen. Mgr.: J. Edward Preston; Opns. Servs. Dir.: K.R. Gilles.

Plant: Smiths Falls, Ont., 91 Cornelia St. Tel: (613) 283-4010.

World Recs., 484 Waterloo Court, Oshawa, Ont. L1H 3X1. Tel: (416) 576-0250. Pres.: Bill Hewson; Gen. Mgr.: Bob Stone. (Pressing only)

PRINTERS & LITHOGRAPHERS

Capitol Recs.-EMI of Canada Ltd., 3109 American Dr., Mississauga, Ont. L4V 1B2. Tel: (416) 677-5050. Cable: CAPITOLREC. Pres.: J.D. Evans; VP Mktg.: R. Rowe; VP Sales: M. Rosicki; Nat'l Mdsq. & Adv. Mgr.: D. Elliot.

Branches: Calgary, Alta., 519 Manitou Rd. SE. Postal Code: T2G 4C2. Tel: (403) 287-0823. Western Reg'l Sales Mgr.: A. Andruchow—Vancouver, B.C., Century Plaza, Suite 503, 1015 Burrard St. Postal Code: V6Z 1Y5. Tel: (604) 689-8667. Sales: D. Bertsch, B. Manlove—Dorval, P.Q., 9245 Cote de Liesse Rd. Postal Code: H9P 2N9. Tel: (514) 631-9073. Eastern Reg'l Sales Mgr.: W. Rotari.

Global Prods., 350 Sorareun Ave., Toronto, Ont. M6R 2G8. Tel: (416) 531-5751. Cable: GLOBOLPROD. Pres.: G. Kyrton; Gen. Mgr.: Jerry Stevens. (Tape only)

Golden Rec. Mfg. Ltd., 500 Coronation Dr., West Hill, Ont. M1E 4V7. Tel: (416) 281-9522.

Lithobac Canada Ltd., 600 Port-Royal W., Montreal, P.Q. H3L 2C5. Tel: (514) 388-1133.

Parr's Print & Litho Ltd., 341 Nantucket Blvd., Scarborough, Ont. M1P 2P2. Tel: (416) 759-5601. Pres.: V.W. Parr; Sales Mgr.: R.A. Gray.

Quality Recs. Ltd., 380 Birchmount Rd., Scarborough, Ont. M1K 1M7. Tel: (416) 698-5511. Telex: 06-219624. Pres.: George R. Struth; Sales Dir.: Barry J. Stafford; VP Mfg.: Ronald P. Gardner; VP Finance: David M. Ford.

Branches: Winnipeg, Man., Galt Bldg., 4th fl. Postal Code: R3B 0R7. Tel: (204) 943-6563. Mgr.: Charles Porter—Toronto, Ont., 130 Mack Ave. Postal Code: M1L 4P5. Tel: (416) 698-5643. Mgr.: Barry J. Stafford—Montreal, P.Q., 2215 Beaconsfield Ave. Postal Code: H4A 2G9. Tel: (514) 481-1167. Mgr.: Danielle Gagnon.

Ross-Ellis Ltd., 300 Ann St., Montreal, P.Q. H3C 2K2. Tel: (514) 861-2411. Pres.: L.E. Rossini; Gen. Mgr.: H.B. Ellis; Sales Mgr.: Shaun Bernard.

Branch: Markham, Ont., 227 Idema Rd., Postal Code: L3R 1B1. Tel: (416) 495-9811. Telex: 06-22819. Sales Mgr.: Jim Austin.

Shorewood Packaging Corp. of Canada Ltd., 1160 Bellamy Rd. N., Scarborough Ont. M1H 1H2. Tel: (416) 438-5301. Telex: (065) 25228.

Branch: Montreal, P.Q., 100 Alexis Nihon Blvd., Suite 583. Postal Code: H4M 2P1. Tel: (514) 748-7959/9024.

Home office: USA, New York, N.Y.

World Recs., 484 Waterloo Court, Oshawa, Ont. L1H 3X1. Tel: (416) 576-0250. Pres.: Bill Hewson; Gen. Mgr.: Bob Stone.

RECORD PROMOTION

Don Bell Servs., PO Box 581, Adelaide St. Sta., Toronto, Ont. M5C 2J6. Tel: (416) 364-3815. Cable: DBSMUSIC. Mgr.: Don Bell.

Dynacom Communications Int'l, PO Box 702, Snowdon St., Montreal, P.Q. H3X 3X8. Tel: (514) 342-5200. Pres.: Dave Leonard.

Bill Hicks Design & Photography, 61 Gertie St., 2nd fl., Winnipeg, Man. R3A 1B5. Tel: (204) 943-1868.

Inside Track, 583 Roosevelt Ave., Ottawa, Ont. K2A 2A2. Tel: (613) 224-7902. Gen. Mgr.: James A. Nichols.

Intermodal Prod's Ltd., PO Box 2199, Vancouver, B.C. V6B 3V7. Tel: (604) 688-1820. Pres. & Sales Mgr.: John Rodney. Adv. Mgr.: Evelyn Rodney

Sheldon Kagan & Assocs. Ltd., 2555 Cote Vertu, Montreal, P.Q. H4R 1Z6. Tel: (514) 331-7282.

Kitsch, Baroque & Rocco Advertising Counselors, PO Box 85, Stoney Creek, Ont. L8G 3X7. Tel: (416) 544-7569. Pres. & Gen. Mgr.: Lawrence M. Bedder.

Brian Millan Music Corp., PO Box 1905, Succ. Postal Place

d'Armes, Montreal, P.Q. H2Y 1S6. Tel: (514) 288-4950. Pres.: Brian Millan; Gen. Mgr.: Steve Voros; Art & Artist Relations Dir.: Eileen Haines.

Oki Assocs., PO Box 103, Sta. A, Toronto, Ont. M5W 1A2. Tel: (416) 534-7951. Owner: Lois Oki; Art Dir.: Tom Oki.

7 Province Dist'g., 185 Bay St., Suite 312, Toronto, Ont. M5J 1K6. Tel: (416) 869-0605.

Home office: 50 State Dist'g Co. Inc., Las Vegas, Nev.

**TAPE CUSTOM DUPLICATORS
TAPE PACKAGING & LABELING**

The Audio and Video lines indicate the configurations which the firms duplicate. Companies which offer packaging and labeling of tape product are indicated by: (PKG) which appears after the main body of their respective listings.

Capitol Recs.-EMI of Canada Ltd., 3109 American Dr., Mississauga, Ont. L4V 1B2. Tel: (416) 677-5050. Cable: CAPITOLREC. Pres.: J.D. Evans; VP Mktg.: R. Rowe; VP Sales: M. Rosicki; Nat'l Mdsq. & Adv. Mgr.: D. Elliot.

Branches: Calgary, Alta., 519 Manitou Rd. SE. Postal Code: T2G 4C2. Tel: (403) 287-0823. Western Reg'l Sales Mgr.: A. Andruchow—Vancouver, B.C., Century Plaza, Suite 503, 1015 Burrard St. Postal Code: V6Z 1Y5. Tel: (604) 689-8667. Sales: D. Bertsch, B. Manlove—Dorval, P.Q., 9245 Cote de Liesse Rd. Postal Code: H9P 2N9. Tel: (514) 631-9073. Eastern Reg'l Sales Mgr.: W. Rotari.

Audio: 8-tr., 8-tr. quadraphonic, cassette.

Cinram Ltd., 8355 Devonshire Rd., Montreal, P.Q. H4P 2L1. Tel: (514) 739-2281. Telex: (05) 827788.

Plant: Scarborough, Ont., 225 Markham Rd., Postal Code: M1J 3C6. Tel: (416) 298-8190.

Audio: 8-tr. quadraphonic, cassette.

Eastern Sound Co. Ltd., 48 Yorkville Ave., Toronto, Ont. M4W 1L4. Tel: (416) 920-2211. Gen. Mgr.: Salim Sachedina; Studio Mgr.: John Ellison.

Audio: Cassette, open reel.

Global Prods., 350 Sorareun Ave., Toronto, Ont. M6R 2G8. Tel: (416) 531-5751. Cable: GLOBOLPROD. Pres.: G. Kyrton; Gen. Mgr.: Jerry Stevens. (PKG—audio)

Audio: 8-tr. & cassette.

Golden Rec. Mfg. Ltd., 500 Coronation Dr., West Hill, Ont. M1E 4V7. Tel: (416) 281-9527. (PKG)

Audio: 8-tr., cassette.

Hardman Inds. Ltd., 34 Greensboro Dr., Rexdale, Ont. M9W 1E1. Tel: (416) 245-7890. Chm. Eric H. Hardman; Pres.: Eric S. Hardman; Sales Mgr.: Walter Strleic. (PKG only—audio)

Intermodal Prod's Ltd., PO Box 2199, Vancouver, B.C. V6B 3V7. Tel: (604) 688-1820. Pres. & Sales Mgr.: John Rodney. Adv. Mgr.: Evelyn Rodney.

Audio: 8-tr., cassette.

L S J Cassette Corp., 50 Don Park Rd., Unit 14, Markham, Ont. L3K 1J3. Tel: (416) 495-9378. Contact: Gordon Fraser. (PKG)

Audio: Cassette. (SEE ADVERTISEMENT)

London Recs. of Canada (1967) Ltd., 6265 Cote de Liesse, St. Laurent, P.Q. H4T 1C3. Tel: (514) 341-5350. Cable: FULLRANGE MONTREAL. Telex: (05) 824570. Pres.: F.C. Jamieson; VP: A. Koury.

Branches: Calgary, Alta., 429 Manitou Rd. SE. Postal Code: T2G 4C2. Tel: (403) 243-1313. Telex: (038) 22572. Mgr.: D. McBeth—Burnaby, B.C., 3166 Lake City Way. Postal Code: V5A 3A4. Tel: (604) 298-6471. Telex: (04) 354544. Mgr.: O.L. Jones—Winnipeg, Man., 15-1100 Waverly St. Postal Code: R3T 3X9. Tel: (204) 452-7918. Telex: (07) 57695. Mgr.: Gerry Young—Scarborough, Ont., 1630 Midland Ave. Postal Code: M1P 3C2. Tel: (416) 755-3373. Telex: (06) 963754. Mgr.: Armand Beaudin—Quebec, P.Q., 1303 Rue Conway. Postal Code: G1J 3S3. Tel: (418) 529-0261. Telex: (051) 37399. Mgr.: Fred Refica.

Audio: 8-tr., 8-tr. quadraphonic, cassette.

Magna-Tape Mfg. Inc., 34 Greensboro Dr., Rexdale, Ont. M9W 1E1. Tel: (416) 245-7890. Telex: (06) 989393. Pres.: Eric H. Hardman; VP & Gen. Mgr.: John M. Morgan. (PKG—audio)

Audio: 8-tr., cassette.

Pan Canada Magnetics Ltd., 1072 Rangeview Rd., Port Credit, Ont. L5E 1H3. Tel: (416) 278-9851. Telex: (06) 960159. (PKG)

Piasetzki Recordtape Ontario Ltd. (PRT Tapes), 1489 Merivale Rd., Ottawa, Ont. K2E 5P3. Tel: (613) 224-6692. (PKG)

Polygram Inc., 6000 Cote de Liesse, St. Laurent, P.Q. H4T 1E3. Tel: (514) 739-2701. Cable: POLYDISC. Telex: (05) 825690. Pres.: Tim Harrold; VP Mktg. & Sales: Dieter Radecki.

Branches: Calgary, Alta., 105 Bow Valley Square, 202 Sixth Ave. SW. Postal Code: T2P 2R9. Tel: (403) 265-5007. Telex: (03) 821859. Sr. Reg'l Mgr.: Ken Graydon—Vancouver, B.C., Mezzanine, 805 W. Broadway. Postal Code: V5Z 1K1. Tel: (604) 873-2466. Telex: (045) 4410. Promo.: Monica Netupsky—Winnipeg, Man., 3 Donald St., Suite 304. Postal Code: R3L 2P6. Tel: (204) 453-4048. Telex: (07) 55306. Mgr.: Don Ullman—Etobicoke, Ont., Etobicoke Tower, Suite 707, 555 Burnhamthorpe Rd. W. Postal Code: M9C 2Y3. Tel: (416) 622-6680. Telex: (06) 967755. Nat'l Accounts Dir.: Alun Elias.

Audio: 8-tr., cassette.

Praise Recs. of Canada Ltd., 6979 Curragh Ave., Burnaby, B.C. V5J 4V6. Tel: (604) 438-8266. Gen. Mgr.: Paul Yaroshuk.

Audio: 8-tr., cassette, open reel.

Quality Recs. Ltd., 380 Birchmount Rd., Scarborough, Ont. M1K 1M7. Tel: (416) 698-5511. Telex: 06-219624. Pres.: George R. Struth; Sales Dir.: Barry J. Stafford; VP Mfg.: Ronald P. Gardner; VP Finance: David M. Ford.

Branches: Winnipeg, Man., Galt Bldg., 4th fl. Postal Code: R3B 0R7. Tel: (204) 943-6563. Mgr.: Charles

Porter—Toronto, Ont., 130 Mack Ave. Postal Code: M1L 4P5. Tel: (416) 698-5643. Mgr.: Barry J. Stafford—Montreal, P.Q., 2215 Beaconsfield Ave. Postal Code: H4A 2G9. Tel: (514) 481-1167. Mgr.: Danielle Gagnon. (PKG)

Audio: 8-tr., cassette.

Stereodyne (Canada) Ltd., 3121 Universal Dr., Mississauga, Ont. L4X 2E2. Tel: (416) 625-8311. (PKG)

Audio: 8-tr., cassette.

World Recs., 484 Waterloo Court, Oshawa, Ont. L1H 3X1. Tel: (416) 576-0250. Pres.: Bill Hewson; Gen. Mgr.: Bob Stone.

Audio: 8-tr., cassette.

Video: ½" EIAJ open reel, ½" EIAJ cartridge.

TAPE DUPLICATOR/MARKETERS

Piasetzki Recordtape Ontario Ltd., (PRT Tapes), 1489 Merivale Rd., Ottawa, Ont. K2E 5P3. Tel: (613) 224-6692.

Audio: 8-tr.

Stereodyne (Canada) Ltd., 3121 Universal Dr., Mississauga, Ont. L4X 2E2. Tel: (416) 625-8311.

8-tr. & cassette: Alshire.

supplies

The key to the abbreviations following the company listings is: (M) Manufacturer, (D) Distributor, (I) Importer.

CARTRIDGE & CASSETTE PARTS

Ampex of Canada Ltd., 132 East Dr., Bramalea, Ont. L6T 3T9. Tel: (416) 791-3100. VP & Gen. Mgr.: J.L. Major; Magnetic Tape Div. Mgr.: J.R. Pariselli.

Branches: Calgary, Alta., 5421 11 St. NE, Suite 104. Postal Code: T2E 6K4. Tel: (403) 276-8523—Dorval, P.Q. 681 Lepine. Postal Code: H9P 1G3. Tel: (514) 636-4840.

Audio: 8-tr. & cassette parts.

Capitol Recs.-EMI of Canada Ltd., 3109 American Dr., Mississauga, Ont. L4V 1B2. Tel: (416) 677-5050. Cable: CAPITOLREC. Pres.: J.D. Evans; VP Mktg.: R. Rowe; VP Sales: M. Rosicki; Nat'l Mdsq. & Adv. Mgr.: D. Elliot.

Branches: Calgary, Alta., 519 Manitou Rd. SE. Postal Code: T2G 4C2. Tel: (403) 287-0823. Western Reg'l Sales Mgr.: A. Andruchow—Vancouver, B.C., Century Plaza, Suite 503, 1015 Burrard St. Postal Code: V6Z 1Y5. Tel: (604) 689-8667. Sales: D. Bertsch, B. Manlove—Dorval, P.Q., 9245 Cote de Liesse Rd. Postal Code: H9P 2N9. Tel: (514) 631-9073. Eastern Reg'l Sales Mgr.: W. Rotari.

Audio: 8-tr.

Global Prods., 350 Sorareun Ave., Toronto, Ont. M6R 2G8. Tel: (416) 531-5751. Cable: GLOBOLPROD. Pres.: G. Kyrton; Gen. Mgr.: Jerry Stevens.

Audio: 8-tr. & cassette.

Swire Intermagnetics Canada, 77 Steelcase Rd. W., Unit C, Markham, Ont. L3R 2S5. Tel: (416) 495-0631. VP Canada: Brian Lundstram.

Home office: USA.

EMPTY CARTRIDGES, CASSETTES & REELS

Ampex of Canada Ltd., 132 East Dr., Bramalea, Ont. L6T 3T9. Tel: (416) 791-3100. VP & Gen. Mgr.: J.L. Major; Magnetic Tape Div. Mgr.: J.R. Pariselli.

Branches: Calgary, Alta., 5421 11 St. NE, Suite 104. Postal Code: T2E 6K4. Tel: (403) 276-8523—Dorval, P.Q. 681 Lepine. Postal Code: H9P 1G3. Tel: (514) 636-4840.

Audio: 8-tr., cassette, open reel.

Capitol, see Will Farrow Assocs. Ltd.

Will Farrow Assocs. Ltd., 5200 Dixie Rd., Unit 33, Mississauga, Ont. L4W 1E4. Tel: (416) 625-8151. Pres. & Adv. Mgr.: Will Farrow; Sales Mgr.: Julie Thompson. (Canadian sales office for Capitol Magnetic Tape Div.)

Audio: 8-tr., cassette, open reel.

Brand name: Capitol.

Global Prods., 350 Sorareun Ave., Toronto, Ont. M6R 2G8. Tel: (416) 531-5751. Pres.: G. Kyrton; Gen. Mgr.: Jerry Stevens.

Audio: 8-tr., cassette

Hardman Inds. Ltd., 34 Greensboro Dr., Rexdale, Ont. M9W 1E1. Tel: (416) 245-7890. Telex: (06) 989393. Chm.: Eric H. Hardman; Pres.: Eric S. Hardman; Sales Mgr.: Walter Strleic.

Audio: 8-tr. shells & 5 screw cassette shells (sonic welded).

Pacific Int'l Magnetics Inc., 11031 Bridgeport Rd., Suite 200, Richmond, B.C. V6X 3A2. Tel: (604) 273-6015. Pres.: Paul Brown; Mktg. Dir.: Brian Larsen.

Pan Canada Magnetics Ltd., 1072 Rangeview Rd., Port Credit, Ont. L5E 1H3. Tel: (416) 278-9851. Telex: (06) 960159.

Audio: All configurations.

Swire Intermagnetics Canada, 77 Steelcase Rd. W., Unit C, Markham, Ont. L3R 2S5. Tel: (416) 495-0631. VP Canada: Brian Lundstram.

Home office: USA.

ENVELOPES & MAILERS

Golden Rec. Mfg. Ltd., 500 Coronation Dr., West Hill, Ont. M1E 4V7. Tel: (416) 281-9522. (M)

Metro-Graphic Corp., 2800 Francis-Hughes Ave., Chomey, P.Q. H7L 3M4. Tel: (514) 663-0370. (M)

Ross-Ellis Ltd., 300 Ann St., Montreal, P.Q. H3C 2K2. Tel: (514) 861-2411. Pres.: L.E. Rossini; Gen. Mgr.: H.B. Ellis; Sales Mgr.: Shaun Bernard.

Branch: Markham, Ont., 227 Idema Rd. Postal Code: L3R 1B1. Tel: (416) 495-9811. Telex: (06) 22819. Sales Mgr.: Jim Austin.

Bruce Thompson Music Corp. Ltd., Box 2248, Calgary, Alta. T2P 2M7. Tel: (403) 269-7270. Pres. & Gen. Mgr.: Bruce Thompson.

World Recs., 484 Waterloo Court, Oshawa, Ont. L1H 3X1

Tel (416) 576-0250. Pres.: Bill Hewson; Gen. Mgr.: Bob Stone (M).

JACKETS & SLEEVES

Custom Converters Printers Ltd., 563 The Queensway E., Mississauga, Ont. L5A 3X6 Tel (416) 279-5256 Telex (06) 961191. Sales Contact: Don E. Stagniere (Plastic inner sleeves for LP's)

Golden Rec. Mfg. Ltd., 500 Coronation Dr., West Hill, Ont. M1E 4V7 Tel (416) 281-9522 (M)

Lithobac Canada Ltd., 600 Port-Royal W., Montreal, P.Q. H3L 2C5 Tel (514) 388-1133 (Jackets only) (M)

Metro-Graphic Corp., 2800 Francis-Hughes Ave., Chomey, P.Q. H7L 3M4 Tel (514) 663-0370 (Sleeves only) (M)

Modern Album of Canada Ltd., 2450 Finch Ave. W., Unit 7, Weston, Ont. M9M 2E9 Tel (416) 745-5033 (Jackets, sleeves, record set boxes) (M)

Parr's Print & Litho Ltd., 341 Nantucket Blvd., Scarborough, Ont. M1P 2P2 Tel (416) 759-5601. Pres.: V.W. Parr. Sales Mgr.: R.A. Gray (Jackets only)

Ross-Ellis Ltd., 300 Ann St., Montreal, P.Q. H3C 2K2. Tel (514) 861-2411. Pres.: L.E. Rossini; Gen. Mgr.: H.B. Ellis. Sales Mgr.: Shaun Bernard.

Branch: Markham, Ont., 227 Idema Rd. Postal Code L3R 1B1. Tel (416) 495-9811. Telex: 06-22819. Sales Mgr.: Jim Austin.

Shorewood Packaging Corp. of Canada Ltd., 1160 Bellamy Rd. N., Scarborough, Ont. M1H 1H2. Tel (416) 438-5301. Telex (065) 252228 (M)

Branch: Montreal, P.Q., 100 Alexis Nihon Blvd., Suite 583. Postal Code H4M 2P1. Tel (514) 748-7959/9024.

Home office: USA, New York, N.Y.

World Recs., 484 Waterloo Court, Oshawa, Ont. L1H 3X1. Tel (416) 576-0250. Pres.: Bill Hewson; Gen. Mgr.: Bob Stone.

LABELS

Arc Sound Co. Ltd., 142 Sparks Ave., Willowdale, Ont. Tel. (416) 499-5000. (M)

Golden Rec. Mfg. Ltd., 500 Coronation Dr., West Hill, Ont. M1E 4V7 Tel (416) 281-9522 (M)

Metro-Graphic Corp., 2800 Francis-Hughes Ave., Chomey, P.Q. H7L 3M4 Tel (514) 663-0370 (M)

Parr's Print & Litho Ltd., 341 Nantucket Blvd., Scarborough, Ont. M1P 2P2 Tel (416) 759-5601. Pres.: V.W. Parr. Sales Mgr.: R.A. Gray.

Quality Recs. Ltd., 380 Birchmount Rd., Scarborough, Ont. M1K 1M7 Tel (416) 698-5511. Telex: 06-219624. Pres.: George R. Struth. Sales Dir.: Barry J. Stafford. VP Mfg.: Ronald P. Gardner. VP Finance: David M. Ford.

Branches: Winnipeg, Man., Galt Bldg., 4th fl. Postal Code R3B 0R7. Tel (204) 943-6563. Mgr.: Charles Porter—Toronto, Ont., 130 Mack Ave. Postal Code: M1L 4P5. Tel (416) 698-5643. Mgr.: Barry J. Stafford—Montreal, P.Q., 2215 Beaconsfield Ave. Postal Code: H4A 2G9. Tel (514) 481-1167. Mgr.: Danielle Gagnon (M)

Ross-Ellis Ltd., 300 Ann St., Montreal, P.Q. H3C 2K2. Tel (514) 861-2411. Pres.: L.E. Rossini; Gen. Mgr.: H.B. Ellis. Sales Mgr.: Shaun Bernard.

Branch: Markham, Ont., 227 Idema Rd. Postal Code L3R 1B1. Tel (416) 495-9811. Telex: 06-22819. Sales Mgr.: Jim Austin

World Recs., 484 Waterloo Court, Oshawa, Ont. L1H 3X1. Tel (416) 576-0250. Pres.: Bill Hewson; Gen. Mgr.: Bob Stone (M)

POLYETHYLENE BAGS

Phonodisc Ltd., 30 Malley Rd., Scarborough, Ont. M1L 2E3. Tel (416) 751-9610. Telex (06) 963629. Pres.: Jim Trainor; Gen. Mgr.: Laurence Heseltine.

Branches: Calgary, Alta., 4718 14 St. NE. Postal Code: T2E 6L7. Tel (403) 276-5543. Sales Rep.: Brian Burrows—Vancouver, B.C., La-Go Music Ltd., 3446 Bridgeway St. Postal Code: V5K 1B6. Tel (604) 294-6226—Winnipeg, Man., Box 57, Group 550, RR #5. Postal Code: R2C 2Z2. Tel (204) 889-9545. Sales Rep.: Fred Crookes—St. Laurent, P.Q., Place Trans Canada, Suite 223-A, 7033 Trans Canadienne. Postal Code: H4T 1S2. Tel (514) 337-1022. Sales Rep.: Pierre St. Georges.

PROFESSIONAL TAPE SUPPLIES

Edital, see McKen Electronics.

McKen Electronics Ltd., PO Box 4054, 780 Bank St., Ottawa, Ont. K1S 5B1. Tel (613) 236-7242.

Audio: Bulk erasers (WRE), splicing & editing equip. (Edital).

W R E, see McKen Electronics.

TAPE, BLANK LOADED

The numbers in parentheses following the 8-track & cassette configurations show recording time in minutes; those following open reel configurations show length of tape in feet.

Ampex of Canada Ltd., 132 East Dr., Bramalea, Ont. L6T 3T9 Tel (416) 791-3100. VP & Gen. Mgr.: J.L. Major. Magnetic Tape Div. Mgr.: J.R. Pariselli.

Branches: Calgary, Alta., 5421 11 St. NE, Suite 104. Postal Code: T2E 6K4. Tel (403) 276-8523—Dorval, P.Q., 681 Lepine. Postal Code: H9P 1G3. Tel (514) 636-4840.

Audio: 8-tr., (45.90) cassette (45.60, 90, 120), open reel (1500', 2150', 2440', 3000', 3600'), broadcast. **Video:** 1" open reel, 3/4" cassette (10, 20, 30, 40, 50, 60), 1/2" EIAJ open reel (1250', 2400').

Audio Magnetics Corp. of Canada Ltd., 1180 MartinGrove Rd., Rexdale, Ont. M9W 5M9. Tel (416) 245-4400.

Audio: 8-tr (40,80), cassette (45, 60, 90, 120), open reel.

Brand names: Cycles, Tracs, Tracs Plus, XHE

B A S F (Canada) Ltd., PO Box 430, Sta. St. Laurent, Mon-

real, P.Q. H4L 4V8, 5850 Cote de Liesse Rd., Town of Mt. Royal, P.Q. H4T 1B2. Tel (514) 341-5411. Telex: (05) 827777.

Audio: Cassette, open reel.

Capitol Recs.—EMI of Canada Ltd., 3109 American Dr., Mississauga, Ont. L4V 1B2. Tel (416) 677-5050. Cable: CAPITOLREC. Pres.: J.D. Evans; VP Mktg.: R. Rowe; VP Sales: M. Rosicki; Nat'l Mdsng. & Adv. Mgr.: D. Elliot. (Also see Will Farrow Assocs.)

Branches: Calgary, Alta., 519 Manitou Rd. SE. Postal Code: T2G 4C2. Tel (403) 287-0823. Western Reg'l Sales Mgr.: A. Andrichow—Vancouver, B.C., Century Plaza, Suite 503, 1015 Burrard St. Postal Code: V6Z 1Y5. Tel (604) 689-8667. Sales: D. Bertsch, B. Manlove—Dorval, P.Q., 9245 Cote de Liesse Rd., Postal Code: H9P 2N9. Tel (514) 631-9073. Eastern Reg'l Sales Mgr.: W. Rotari.

Audio: 8-tr., cassette.

Cinram Ltd., 8355 Devonshire Rd., Montreal, P.Q. H4P 2L1. Tel (514) 739-2281. Telex: (05) 827788.

Audio: 8-tr., cassette.

Brand name: TM-100

Cycles, see Audio Magnetics Corp. of Canada Ltd.

Deramic Sound, see London Recs. of Canada Ltd.

Dynapak, see Stereodyne (Canada) Ltd.

Edmund Scientific Prods. Co., 3500 Bathurst St., Toronto, Ont. M6A 2C6. Tel (416) 787-4583.

Audio: Endless-loop cassette.

Will Farrow Assocs. Ltd., 5200 Dixie Rd., Unit 33, Mississauga, Ont. L4W 1E4. Tel (416) 625-8151. Pres. & Adv. Mgr.: Will Farrow. Sales Mgr.: Julie Thompson. (Canadian sales office for Capitol Magnetic Tape Div.)

Audio: 8-tr. (32, 40, 45, 60, 64, 80, 90, 100, 120), cassette (20, 30, 45, 60, 90, 120), open reel.

Brand name: Capitol

Finetape Canada Ltd., 800 Islington Ave., Toronto, Ont. M8Z 4N7. Tel (416) 252-7209. Pres.: J. Bouzaglou; Sales Mgr.: Herbert A. Guinness.

Audio: 8-tr. (40, 45, 60, 90), cassette (30, 45, 60, 90, 120), open reel (600', 900', 1200', 1800').

Video: 3/4" cassette, 1/2" Beta & VHS cassette.

Global Prods., 350 Sorauren Ave., Toronto, Ont. M6R 2G8. Tel (416) 531-5751. Cable: GLOBOLPROD. Pres.: G. Kyrton; Gen. Mgr.: Jerry Stevens.

Audio: 8-tr. (40, 45, 80, 90 & custom lengths), cassette (40, 45, 60, 90 & custom lengths), open reel.

Hardman Inds. Ltd., 34 Greensboro Dr., Rexdale, Ont. M9W 1E1. Tel (416) 245-7890. Telex: (06) 989393. Chm. Eric H. Hardman; Pres.: Eric S. Hardman; Sales Mgr.: Walter Strielec.

Audio: 8-tr. (45, 90), cassette (60, 90).

International Audio Visual Ltd., PO Box 1096. Postal Code: V3J 6Z4, 224 Cayer St., Coquitlam, B.C. V3K 5A9. Tel (604) 522-7955. Pres.: Dr. Peter P. Allinger; Sales Mgr.: Spencer Coles; Gen. & Adv. Mgr.: A. Dirks. (Audio only)

Brand name: Pacific Tape.

London Recs. of Canada Ltd., 6265 Cote de Liesse, St. Laurent, P.Q. H4T 1C3. Tel (514) 341-5350. Cable: FULL-RANGE MONTREAL. Telex (05) 824570. Pres.: F.C. Jamieson. VP: A. Koury.

Branches: Calgary, Alta., 429 Manitou Rd. SE. Postal Code: T2G 4C2. Tel (403) 243-1313. Telex: (038) 22572. Mgr.: D. McBeth—Burnaby, B.C., 3166 Lake City Way. Postal Code: V5A 3A4. Tel (604) 298-6471. Telex: (04) 354544. Mgr.: O.L. Jones—Winnipeg, Man., 15-1100 Waverly St. Postal Code: R3T 3X9. Tel (204) 452-7918. Telex: (07) 57695. Mgr.: Gerry Young—Scarborough, Ont., 1630 Midland Ave. Postal Code: M1P 3C2. Tel (416) 755-3373. Telex: (06) 963754. Mgr.: Armand Beaudin—Quebec, P.Q., 1303 Rue Conway. Postal Code: G1J 3S3. Tel (418) 529-0261. Telex: (051) 3799. Mgr.: Fred Refka.

Audio: 8-tr., cassette.

Brand name: Deramic Sound.

Magna Tape Mfg. Inc., 34 Greensboro Dr., Rexdale, Ont. M9W 1E1. Tel (416) 245-7890. Telex: (06) 989393. Pres.: Eric H. Hardman; VP & Gen. Mgr.: John M. Morgan.

Audio: 8-tr., cassette, open reel

Maxell, see Tri-Tel Assocs.

Pacific Int'l Magnetics Inc., 11031 Bridgeport Rd., Suite 200, Richmond, B.C. V6X 3A2. Tel (604) 273-6015. Pres.: Paul Brown; Mktg. Dir.: Brian Larsen.

Audio: Cassette.

Pacific Tape, see International Audio Visual.

Pan Can, see Pan Canada Magnetics.

Pan Canada Magnetics Ltd., 1072 Rangeview Rd., Port Credit, Ont. L5E 1H3. Tel (416) 278-9851. Telex: (06) 960159.

Audio: 8-tr., cassette, open reel.

Brand name: Pan Can, Pan Canada.

Phonodisc Ltd., 30 Malley Rd., Scarborough, Ont. M1L 2E3. Tel (416) 751-9610. Telex: (06) 963629. Pres.: Jim Trainor; Gen. Mgr.: Laurence Heseltine.

Branches: Calgary, Alta., 4718 14 St. NE. Postal Code: T2E 6L7. Tel (403) 276-5543. Sales Rep.: Brian Burrows—Vancouver, B.C., La-Go Music Ltd., 3446 Bridgeway St. Postal Code: V5K 1B6. Tel (604) 294-6226—Winnipeg, Man., Box 57, Group 550, RR #5. Postal Code: R2C 2Z2. Tel (204) 889-9545. Sales Rep.: Fred Crookes—St. Laurent, P.Q., Place Trans Canada, Suite 223-A, 7033 Trans Canadienne. Postal Code: H4T 1S2. Tel (514) 337-1022. Sales Rep.: Pierre St. Georges.

Audio: 8-tr., cassette.

Praise Recs. of Canada Ltd., 6979 Curragh Ave., Burnaby, B.C. V5J 4V6. Tel (604) 438-8266. Gen. Mgr.: Paul Yaroshuk.

Audio: Cassette.

Brand name: Presonic.

Presonic, see Praise.

Sony Of Canada Ltd., 1370 Sony Pl., Winnipeg, Man. R3C 3C3. Tel (204) 284-7160. Pres.: A.D. Cohen; VP, Sales: B.E. Martin; Adv. Mgr.: D.G. Willox.

Branches: Calgary, Alta., 110 11th Ave. S.E. Postal Code: T2G 0X6. Tel (403) 264-0055—Edmonton, Alta., 11245 120 St. Postal Code: T5G 2X9. Tel (403)

453-3911—Richmond, B.C., 1135A Bridgeport Rd. Tel: (604) 273-1921—Vancouver, B.C., 855 W. Broadway St. Postal Code: V5Z 1K2. Tel: (604) 873-3511—Ottawa, Ont., 1140 Morrison Dr. Postal Code: K2H 8S9. Tel: (613) 820-6060—Toronto, Ont., 88 Horner Ave. Postal Code: M8Z 4X8. Tel: (416) 252-3581—Willowdale, Ont., 405 Gordon Baker Rd. Postal Code: M2H 2S6. Tel: (416) 499-5111—Montreal, P.Q., 6465 Trans Canada Hwy. Postal Code: H4T 1S3. Tel: (514) 748-9331.

Home office: Japan.

Stereodyne (Canada) Ltd., 3121 University Dr., Mississauga, Ont. L4X 2E2. Tel: (416) 625-8311.

Audio: 8-tr. (40, 45, 60, 90), cassette (60, 90).

Brand name: Dynapak.

Superior Electronics Inc., 1330 Trans Canada Hwy. S., Dorval, P.Q. H9P 1H8. Tel: (514) 683-6331.

Audio: 8-tr. (45, 90), cassette (30, 45, 60, 90, 120), open reel (1200', 1800', 3600').

Brand name: TDK.

Swire Intermagnetics Canada, 77 Steelcase Rd. W., Unit C, Markham, Ont. L3R 2S5. Tel (416) 495-0631. VP Canada: Brian Lundstram.

Home office: USA.

T D K, see Superior Electronics Inc.

T M 100, see Cinram.

Teac, see White Electronic.

Tracs, see Audio Magnetics.

Tracs Plus, see Audio Magnetics.

Tri-Tel Assocs. Ltd., 105 Sparks Ave., Willowdale, Ont. M2H 2S5. Tel (416) 499-5044. Telex: (06) 23443. Mktg. Mgr.: R.W. Finkle. (Audio only)

Brand name: Maxell

White Electronic Development Corp. (1966) Ltd., 6300 Northam Dr., Malton, Ont. L4V 1H7. Tel (416) 676-9090. Telex (06) 983584. Pres.: Murray Fiebert; Nat'l Sales Mgr.: Chris Tooteil. (Importer)

Branch: Montreal, P.Q., 4750 Blvd. des Grandes Prairies. Postal Code: H1R 1A1. Tel (514) 326-4075.

Audio: Cassette, open reel.

Brand name: Teac.

X H E, see Audio Magnetics.

TAPE, BULK RAW

Agfa Gevaert, see Photo.

Ampex of Canada Ltd., 132 East Dr., Bramalea, Ont. L6T 3T9. Tel (416) 791-3100. VP & Gen. Mgr.: J.L. Major. Magnetic Tape Div. Mgr.: J.R. Pariselli.

Branches: Calgary, Alta., 5421 11 St. NE, Suite 104. Postal Code: T2E 6K4. Tel (403) 276-8523—Dorval, P.Q., 681 Lepine. Postal Code: H9P 1G3. Tel (514) 636-4840.

Audio: 8-tr., cassette, open reel.

Audio Magnetics Corp. of Canada Ltd., 1180 MartinGrove Rd., Rexdale, Ont. M9W 5M9. Tel (416) 245-4400.

Audio: 8-tr., cassette, open reel.

B A S F (Canada) Ltd., PO Box 430, Sta. St. Laurent, Montreal, P.Q. H4L 4V8, 5850 Cote de Liesse Rd., Town of Mt. Royal, P.Q. H4T 1B2. Tel (514) 341-5411. Telex: (05) 827777.

Audio: Cassette, open reel.

Capitol, see Will Farrow.

Will Farrow Assocs. Ltd., 5200 Dixie Rd., Unit 33, Mississauga, Ont. L4W 1E4. Tel (416) 625-8151. Pres. & Adv. Mgr.: Will Farrow. Sales Mgr.: Julie Thompson. (Canadian sales office for Capitol Magnetic Tape Div.)

Audio: 8-tr., cassette, open reel.

Brand name: Capitol.

Finetape Canada Ltd., 800 Islington Ave., Toronto, Ont. M8Z 4N7. Tel (416) 252-7209. Pres.: J. Bouzaglou; Sales Mgr.: Herbert A. Guinness.

Audio: 8-tr., cassette.

Global Prods., 350 Sorauren Ave., Toronto, Ont. M6R 2G8. Tel (416) 531-5751. Cable: GLOBOL PROD. Pres.: G. Kyrton; Gen. Mgr.: Jerry Stevens.

Audio: 8-tr., cassette, open reel.

Magna-Tape Mfg. Inc., 34 Greensboro Dr., Rexdale, Ont. M9W 1H1. Tel (416) 245-7890. Telex: (06) 989393. Pres.: Eric H. Hardman; VP & Gen. Mgr.: John M. Morgan.

Audio: Cassette.

Pacific Int'l Magnetics Inc., 11031 Bridgeport Rd., Suite 200, Richmond, B.C. V6X 3A2. Tel (604) 273-6015. Pres.: Paul Brown; Mktg. Dir.: Brian Larsen.

Audio: Cassette.

Pan Canada Magnetics Ltd., 1072 Rangeview Rd., Port Credit, Ont. L5E 1H3. Tel (416) 278-9851. Telex: (06) 960159.

Audio: 8-tr., cassette, open reel.

Photo Importing Agencies Ltd., 29 Gurney Crescent, Toronto, Ont. M6B 1S9. Tel (416) 787-5691. Telex: 22631. Mng. Dir.: L.F. Verhulst; Sales Mgr.: Peter Humick.

Audio: 8-tr., cassette, open reel.

Brand name: Agfa Gevaert.

Swire Intermagnetics Canada, 77 Steelcase Rd. W., Unit C, Markham, Ont. L3R 2S5. Tel (416) 495-0631. VP Canada: Brian Lundstram.

Home office: USA.

TAPE DUPLICATING & PROCESSING EQUIPMENT

Ampex of Canada Ltd., 132 East Dr., Bramalea, Ont. L6T 3T9. Tel (416) 791-3100. VP & Gen. Mgr.: J.L. Major. Magnetic Tape Div. Mgr.: J.R. Pariselli.

Branches: Calgary, Alta., 5421 11 St. NE, Suite 104. Postal Code: T2E 6K4. Tel (403) 276-8523—Dorval, P.Q., 681 Lepine. Postal Code: H9P 1G3. Tel (514) 636-4840.

Product: Bin-loop duplicators, master reproducers.

Brand names: Ampex, Stencil.

B A S F (Canada) Ltd., PO Box 430, Sta. St. Laurent, Montreal, P.Q. H4L 4V8, 5850 Cote de Liesse Rd., Town of Mt. Royal, P.Q. H4T 1B2. Tel (514) 341-5411. Telex: (05) 827777.

Product: Pancakes

Finetape Canada Ltd., 800 Islington Ave., Toronto, Ont. M8Z 4N7. Tel (416) 252-7209. Pres.: J. Bouzaglou; Sales Mgr.: H. Guinness.

Product: Audio tape coating, slitting machines.
Global Prods., 350 Soraura Ave., Toronto, Ont. M6R 2G8
 Tel: (416) 531-5751. Cable: GLOBOLPROD. Pres.: G.
 Kyrton; Gen. Mgr.: Jerry Stevens.
Audio: "In cassette" duplicator.
 Stencil, see Ampex of Canada.

**TAPE PACKAGING & LABELING
 EQUIPMENT & SUPPLIES**

Graham Fraser Pkg. Machinery Ltd., 50 Don Park Rd., Unit
 5, Markham, Ont. L3K 1J3. Tel: (416) 495-9378. Contact:
 Graham Fraser.
Product: Conveyors, cartons, fully automatic systems,
 specialty designs. (SEE ADVERTISEMENT)
L S J Cassette Corp., 50 Don Park Rd., Unit 14, Markham,
 Ont. L3K 1J3. Tel: (416) 495-9378. Contact: Graham
 Fraser.
Product: Cassette assembly, packaging & winding;
 Norelco cassette, mini & micro cassette loads. (SEE
 ADVERTISEMENT)

● **accessories**

Ampex of Canada Ltd., 132 East Dr., Bramalea, Ont. L6T
 3T9. Tel: (416) 791-3100. VP & Gen. Mgr.: J.L. Major.
Magnetic Tape Div. Mgr.: J.R. Pariselli.
Branches: Calgary, Alta., 5421 11 St. NE, Suite 104,
 Postal Code: T2E 6K4. Tel: (403) 276-8523—Dorval,
 P.Q., 681 Lapine. Postal Code: H9P 1G3. Tel: (514)
 636-4840.
Product: Head cleaners & demagnetizers, leader &
 splicing tape.
Duotone, see Wilf Farrow.
Empire Scientific Corp. Ltd., 65 Martin Ross Ave.,
 Downsview, Ont. M3J 2L6. Tel: (416) 661-3910.
Home office: USA.
Product: Needles.
Wilf Farrow Assocs. Ltd., 5200 Dixie Rd., Unit 33, Missis-
 sauga, Ont. L4W 1E4. Tel: (416) 625-8151. Pres. &
 Adv. Mgr.: Wilf Farrow; Sales Mgr.: Julie Thompson.
Product: Tape carrying & storage cases, cleaners,
 cloths, brushes, 45 rpm adapters, head cleaners & de-
 magnetizers, needles, leader splicing tape (Duotone).
Finetape Canada Ltd., 800 Islington Ave., Toronto, Ont.
 M8Z 4N7. Tel: (416) 252-7209. Pres.: J. Bouzagliou;
 Sales Mgr.: H. Guinness.
Product: Head cleaners, leader tape.
Global Prods., 350 Soraura Ave., Toronto, Ont. M6R 2G8.
 Tel: (416) 531-5751. Cable: GLOBOLPROD. Pres.: G.
 Kyrton; Gen. Mgr.: Jerry Stevens.
Product: Record & tape carrying & storage cases, cleaners,
 cloths, brushes, 45 rpm adapters, head cleaners &
 demagnetizers, needles, leader & splicing tape.
Hardman Inds. Ltd., 34 Greensboro Dr., Rexdale, Ont. M9W
 1E1. Tel: (416) 245-7890. Telex: (06) 989393. Chm.:
 Eric H. Hardman; Pres.: Eric S. Hardman, Sales Mgr.:
 Walter Strleac.
Product: Head cleaners (Hi-Performance)
Hi-Performance, see Hardman.
International Audio Visual Ltd., PO Box 1096. Postal Code:
 V3J 6Z4; 224 Cayer St., Coquitlam, B.C. V3K 5A9. Tel:
 (604) 522-7955. Cable: IAVSOUND. Pres. Dr. Peter P.
 Allinger; Sales Mgr.: Spencer Coles; Gen. & Adv. Mgr.:
 A. Dirks.
**Product: Head cleaners & demagnetizers: splicing &
 editing equip.**
Kitsch, Baroque & Rococo Advertising Counsellors, PO Box
85, Stoney Creek, Ont. L8G 3X7. Tel: (416) 544-7569.
 Pres. & Gen. Mgr.: Lawrence M. Bedder.
Product: Record & tape catalog servs.
Magna-Tape Mfg. Inc., 34 Greensboro Dr., Rexdale, Ont. M9W
 1E1. Tel: (416) 245-7890. Telex: (06) 989393.
 Pres.: Eric H. Hardman; VP & Gen. Mgr.: John M. Mor-
 gan.
**Product: Tape carrying & storage cases, tape catalog
 servs., head cleaners, demagnetizers, leader & splicing
 tape.**
Motown Recs. (Canada) Ltd., 1960 Ellesmere Rd., Unit 9,
 Scarborough, Ont. M1H 2V9. Tel: (416) 438-2855.
 Telex: (065) 25387.
**Product: Tape carrying & storage cases, cleaners,
 cloths, brushes, 45 rpm adaptors, needles (Recoton—
 Ont. only).**
Nakamichi, see Superior.
Pan Canada Magnetics Ltd., 1072 Rangeview Rd., Port
 Credit, Ont. L5E 1H3. Tel: (416) 278-9851. Telex: (06)
 960159.
**Product: Tape carrying & storage cases, head cleaners &
 demagnetizers, leader tape.**
Parr's Print & Litho Ltd., 341 Nantucket Blvd., Scarborough,
 Ont. M1P 2P2. Tel: (416) 759-5601. Pres.: V. Parr;
 Sales Mgr.: R. A. Gray.
Product: Catalog servs.
Phonodisc Ltd., 30 Malley Rd., Scarborough, Ont. M1L 2E3.
 Tel: (416) 751-9610. Telex: (06) 963629. Pres.: Jim
 Trainor; Gen. Mgr.: Laurence Heseltine.
Branches: Calgary, Alta., 4718 14 St. NE. Postal
 Code: T2E 6L7. Tel: (403) 276-5543. Sales Rep.: Brian
 Burrows—Vancouver, B.C., La-Go Music Ltd., 3446
 Bridgeway St. Postal Code: V5K 1B6. Tel: (604) 294-
 6226—Winnipeg, Man., Box 57, Group 550, RR #5.
 Postal Code: R2C 2Z2. Tel: (204) 889-9545. Sales
 Rep.: Fred Crookes—St. Laurent, P.Q., Place Trans
 Canada, Suite 223-A, 7033 Trans Canadienne. Postal
 Code: H4T 1S2. Tel: (514) 337-1022. Sales Rep.:
 Pierre St. Georges.
**Product: Record & tape carrying & storage cases, cleaners,
 cloths & brushes, 45 RPM adaptors, head cleaners
 & demagnetizers, needles, leader & splicing tape.**

Pixall/Permostat, see Tri-Tel Assocs.
Record Care, see Smyth.
Recoton, see Motown.
Smyth Sound Equip. Ltd., 595 Parc Industriel, Longueuil,
 P.Q. J4H 3V7. Tel: (514) 679-5490.
**Product: Cleaners, cloths, brushes (Watts, Record
 Care).**
Sony Of Canada Ltd., 1370 Sony Pl., Winnipeg, Man. R3C

3C3. Tel: (204) 284-7160. Pres.: A. D. Cohen VP,
 Sales: B.E. Martin; Adv. Mgr.: D.G. Willox.
Branches: Calgary, Alta., 110 11 Ave. S.E. Postal
 Code: T2G 0X6. Tel: (403) 264-0055—Edmonton,
 Alta., 11245 120 St. Postal Code: T5G 2X9. Tel: (403)
 453-3911—Richmond, B.C., 1135A Bridgeport Rd.
 Tel: (604) 273-1921—Vancouver, B.C., 855 W.
 Broadway St. Postal Code: V5Z 1K2. Tel: (604) 873-
 3511—Ottawa, Ont., 1140 Morrison Dr. Postal Code:
 K2H 8S9. Tel: (613) 820-6060—Toronto, Ont., 88
 Horner Ave. Postal Code: M8Z 4X8. Tel: (416) 252-
 3581—Willowdale, Ont., 405 Gordon Baker Rd.
 Postal Code: M2H 2S6. Tel: (416) 499-6111—Mon-
 treal, P.Q., 6465 Trans Canada Hwy. Postal Code: H4T
 1S3. Tel: (514) 748-9331.

Home office: Japan.
Product: Head demagnetizers, splicing & editing equip.
Sound Guard, see Tri-Tel Assocs.
Stereodyne (Canada) Ltd., 3121 Universal Dr., Mississauga,
 Ont. L4X 2E2. Tel: (416) 625-8311.
Product: Head cleaners.

Superior Electronics Inc., 1330 Trans Canada Hwy. S., Dor-
 val, P.Q., H9P 1H8. Tel: (514) 683-6331.
**Product: Head demagnetizers & bulk erasers (Naka-
 michi).**

Tri-Tel Assocs. Ltd., 105 Sparks Ave., Willowdale, Ont. M2H
 2S5. Tel: (416) 499-5044. Telex: (06) 23443. Mktg.
 Mgr.: R.W. Finkle.
Product: Record care products.
Brand names: Pixall/Permostat, Sound Guard.

Watts, see Smyth.
White Electronic Development Corp. (1966) Ltd., 6300
 Northam Dr., Malton, Ont. L4V 1H7. Tel: (416) 676-
 9090. Pres.: Murray Fiebert; Nat'l Sales Mgr.: Chris
 Tootell.
Branch: Montreal, P.Q., 4750 Blvd. des Grandes
 Prairies. Postal Code: H1R 1A1. Tel: (514) 326-4075.
**Product: Cleaners, cloths & brushes, head cleaners &
 demagnetizers.**

● **store fixtures &
 merchandising aids**

Wilf Farrow Assocs. Ltd., 5200 Dixie Rd., Unit 33, Missis-
 sauga, Ont. L4W 1E4. Tel: (416) 625-8151. Pres. &
 Adv. Mgr.: Wilf Farrow; Sales Mgr.: Julie Thompson.
Product: Tape display racks (Devon Design)
Global Prods., 350 Soraura Ave., Toronto, Ont. M6R 2G8.
 Tel: (416) 531-5751. Cable: GLOBOLPROD. Pres.: G.
 Kyrton; Gen. Mgr.: Jerry Stevens.
**Product: Record & tape browser boxes, record & tape
 display racks, record & tape divider cards.**
Magna-Tape Mfg. Inc., 34 Greensboro Dr., Rexdale, Ont. M9W
 1E1. Tel: (416) 245-7890. Telex: (06) 989393.
 Pres.: Eric H. Hardman; VP & Gen. Mgr.: John M. Mor-
 gan.
Product: Tape Browser boxes, tape display racks.

Phonodisc Ltd., 30 Malley Rd., Scarborough, Ont. M1L 2E3.
 Tel: (416) 751-9610. Telex: (06) 963629. Pres.: Jim
 Trainor; Gen. Mgr.: Laurence Heseltine.
Branches: Calgary, Alta., 4718 14 St. NE. Postal
 Code: T2E 6L7. Tel: (403) 276-5543. Sales Rep.: Brian
 Burrows—Vancouver, B.C., La-Go Music Ltd., 3446
 Bridgeway St. Postal Code: V5K 1B6. Tel: (604) 294-
 6226—Winnipeg, Man., Box 57, Group 550, RR #5.
 Postal Code: R2C 2Z2. Tel: (204) 889-9545. Sales
 Rep.: Fred Crookes—St. Laurent, P.Q., Place Trans
 Canada, Suite 223-A, 7033 Trans Canadienne. Postal
 Code: H4T 1S2. Tel: (514) 337-1022. Sales Rep.:
 Pierre St. Georges.
Product: Record display racks, record divider cards.

Praise Recs. of Canada Ltd., 6979 Curragh Ave., Burnaby,
 B.C. V5J 4V6. Tel: (604) 438-8266. Gen. Mgr.: Paul
 Yaroshuk.
**Product: Record browser boxes, record display racks,
 record divider cards.**

● **jukebox
 manufacturer**

Rowe Int'l Inc., 9341 Cote de Liesse, Dorval, P.Q. H9P 2N9.
 Tel: (514) 636-4680.
Branches: Burnaby, B.C., 6909 Antrim Ave. Postal
 Code: V5J 4M5. Tel: (604) 438-6431—Mississauga,
 Ont., 6447 Northam Dr. Postal Code: L4V 1J1. Tel:
 (416) 677-1587.
Home office: USA.

CHILE

Population: 10,450,000
Rate of exchange: \$1 (US) = 35.25 pesos.
Per capita income: \$890
Holidays: January 1, May 1 (Labor Day), May 21 (Navy
 Day), June 29 (Bank Holiday), August 15 (Assumption),
 September 18 (Independence Day), September 19
 (Army Day), October 12 (Columbus Day), November 1
 (All Saints' Day), December 8, December 25 & all
 important Christian religious holidays.
**Records, record blanks & pre-recorded media imported
 from USA:** 1977—\$312,420.

● **record & tape
 manufacturers/
 distributors/importers**

Alba, see Industria de Radio & Television.

Archiv, see Philips.
Arena, see Quatro.
Asfona (Asociacion Fonografica Nacional), Agustina 1185,
 Of. 71, Santiago. Tel: 30-637, 83-877, 35-499.
Labels: (Owned) Asfona, Astral; (distributed) Avant
 Music, Los 4 de Chile, Gato Negro, Chris Heart Prod's
 Buddy Richard Prod's, (licensed) Durium (Italy),
 Hispavox (Spain), Microfon (Argentina), Music Hall
 (Argentina), Vox (USA), WEA group (USA).
**Int'l reps.: Argentina (S Americana), Bolivia (Heriba),
 Colombia (Codiscos), Venezuela (Suramericana).**

Astral, see Asfona.
Avant Music, see Asfona.
D G G, see Philips.
E M I Odeon Chilena SA (IFPI), Av. Vitacura 2899, Santiago
 10. Tel: 287-118. Cable: TURNTABLE. Mng. Dir.:
 David H. Stockley; Sales Mgr.: Guillermo Vera Larrain;
 Int'l A&R Mgr.: Alfredo Acuna.
Labels: (Owned) EMI-Odeon; (licensed) A&M (USA),
 Apple (UK), Arista-Bell (USA), CBS (USA), Codiscos
 (Colombia), Favedica (Venezuela), IEMPSA (Peru),
 Island (UK), London (UK), Miera Perego, Musart
 (Mexico), Private Stock (USA), Purple (UK).

Fermata Ltda. (Eds. Musicales), Agustinas 853, Of. 619,
 Santiago. Tel: 32-720. Gen. Mgr.: Eliana Cisternas C.
Home office: Brazil, Discos RGE/Fermata.
Labels: (Owned) Fermata, Pick, Premier, RGE, Som/
 Maior, Young.
Fontana, see Philips.
Los 4 de Chile, see Asfona.
Gato Negro, see Asfona.
Chris Heart Prod's, see Asfona.
Heliodor, see Philips.
I R T, see Industria de Radio & Television.

Industria de Radio & Television SA (IFPI), Bustamante 596,
 Santiago. Tel: 46-5596. Cable: RADIOINTER. Telex:
 278. Mgr.: Jose Manuel Silva.
Labels: (Owned) Alba; (licensed) Ariola (Spain),
 Parnaso (Argentina), RCA (USA), United Artists (UK,
 USA).
**Int'l reps.: Argentina (Parnaso), Ecuador (IFESA), El
 Salvador (Dicesa), Mexico (Musart), Peru (FTA),
 Venezuela (Cordica).**

M G M, see Philips.
Mercury, see Philips.
Odeon, see EMI.
Philips Chilena SA (IFPI), Casilla 2687, Av. Santa Maria
 0760, Santiago. Tel: 378-371. Cable: PHILCHISA.
 Telex: 40239. Mng. Dir.: Jorge Undurraga; Label Mgr.:
 Manuel Vera.

Labels: (Owned) Archiv, DGG, Fontana, Heliodor,
 MGM, Mercury, Philips, Polydor, Smash, Vertigo,
 Verve; (licensed) All Platinum (USA), H. Astric
 (Monaco), Charisma (UK), Chelsea (USA), Chrysalis
 (UK), De-Lite (USA), Flying Dutchman (USA), Fresh Air
 (UK), Tony Hall Prod's (UK), Infopesa (Peru),
 Interbang, Jet (UK), MCA (USA), Midsong (USA),
 Mooncrest (UK), Mountain (UK), Onix (Ecuador), Pablo
 (USA), Peerless (Mexico), RSO (UK), Red Bullet
 (Netherlands), Rocket (USA), Roxbury (USA), Sono-
 radio (Peru), State (UK), Track (UK), 20th Century
 (USA), Virrey (Peru), WWA (UK), Wam (Canada).

Pick, see Fermata.
Polydor, see Philips.
Premier, see Fermata.
Quatro Ltda. (Productora & Distribuidora de Discos) (IFPI),
 Rancagua 154, Santiago. Tel: 252-960, 231-811.
 Cable: DISCOSQUATRO. Dir. Gen.: Roberto Rario;
 Creative Dir.: Jaime Roman; Sales Mgr.: Julio Pardo;
 Int'l Mgr. & A&R Chief: Eduardo Canestracci.
Labels: (Owned) Arena; (licensed) Ariston (Italy), Cabal
 (Argentina), Carosello (Italy), Casablanca (USA), Circle
 Line (Argentina), Continental (Brazil), Copacabana
 (Brazil), Eleven (Italy), Famoso (Ecuador), Fonica
 (Guatemala), Gamma (Mexico), Gas (Mexico), Hispavox
 (Spain), Impacto (Spain), Melody (Mexico), Microfon
 (Argentina), Olympo (Spain), Orbe (Colombia), Orfeon
 (Mexico), PMA (Argentina), Ri-Fi (Italy), Som (Brazil),
 Springboard (USA), Trova (Argentina), Vanguard (USA).
Int'l rep.: Brazil (Som/Copacabana).

R G E, see Fermata.
Buddy Richard Prod's, see Asfona.
Smash, see Philips.
Som/Maior, see Fermata.
Utz Corp., Fernando Manterola 0453, Casilla 403-V,
 Santiago. Tel: 377-692. Cable: UTZCORP. Telex: SGO
 260. Gen. Mgr.: Ramon Utz Monsalve; A&R & Int'l
 Liaison: Sonia Figari Letelier.
Labels: (Represented) Arrowtabs (UK), GNP Crescendo
 (USA), JVC (Japan), Prelude (USA).
Vertigo, see Philips.
Verve, see Philips.
Young, see Fermata.

● **music publishers**

Asfona (Asociacion Fonografica Nacional), Agustina 1185,
 Of. 71, Santiago. Tel: 30-637, 83-877, 35-499.
**Int'l firms represented: BIEM (Europe), SADAIC
 (Argentina), Southern (USA).**
Equus (Ediciones Musicales), Rancagua 554, Santiago. Tel:
 252-960, 231-811. Dir. Gen.: Jaime Roman; Int'l
 Mgr.: Carlos Quezada.
**Int'l firms represented: Alvorada (Brazil), Arlequim
 (Brazil), Beverly (Brazil), Gamma (Mexico), Meridional
 (Brazil), Quiroga (Spain), Seven Notas (Brazil).**
Fermata Ltda. (Eds. Musicales), Agustinas 853, Of. 619,
 Santiago. Tel: 32-720. Gen. Mgr.: Eliana Cisternas C.
Home office: Brazil.
**Int'l firms represented: Arapua (Brazil), Bourne group
 (USA), Combine (USA), Fermata (Brazil), Frank (USA),
 Dick James group (UK), Minerva, Arthur Napoleao
 (Brazil), Pedro, Portico, Seresta, Solmi, Sonata (Brazil).
Sochem (Sociedad Chilena de Eds. Musicales) Ltda., Av.
 Vitacura 2899, Santiago 10. Tel: 287-118. Cable:
 TURNTABLE. Mng. Dir.: Roberto Lopez.
**Int'l firms represented: Accord (Germany), Anagon
 (Netherlands), Ardmore & Beechwood (Belgium),
 Beechwood (Mexico, USA), Colombiana de Musica****

(Colombia), Consorcio de Eds. Musicales Peruanas (Peru), EGO (Spain), EMI (UK), MAI (Argentina), Pathe Marconi (France), Toshiba (Japan), La Voce del Padrone (Italy), Universal (Venezuela)
Southern Music Int'l, Cruz 1469, Santiago.
Home office: USA, Peer-Southern Org.

● services

ASSOCIATIONS & PROFESSIONAL ORGANIZATIONS

Instituto de Extension Musical, Compania 1264, Santiago. Tel: 89-438.
S A T C H (Sociedad de Autores Teatrales de Chile), San Diego 246, Santiago. Tel: 67-101, 66-2760.

DESIGN & ARTWORK

Alba/Colorado-Industria de Radio & Television SA, Catedral 1029-Subte., Santiago. Tel: 50-081, 80-461.

LICENSING ORGANIZATION, MUSIC

D A I C (Departamento del Derecho de Autor de la Universidad de Chile), San Antonio 427, 2nd fl., Santiago. Tel: 392-335. (Performing rights only)

PLATING, PROCESSING & PRESSING PLANTS

Alba/Colorado-Industria de Radio & Television SA, Catedral 1029-Subte., Santiago. Tel: 50-081, 80-461.
E M I Odeon Chilena SA, Casilla 186D, Av. Vitacura 2899, Santiago. Tel: 287-118. Cable: TURNTABLE. Mng. Dir.: David H. Stockley. (Pressing only)

PRINTERS & LITHOGRAPHERS

Alba/Colorado-Industria de Radio & Television SA, Catedral 1029-Subte., Santiago. Tel: 50-081, 80-461.
Philips Chilena SA, Casilla 2687, Av. Santa Maria 0760, Santiago. Tel: 378-371. Cable: PHILCHISA. Telex: 40239.

TAPE CUSTOM DUPLICATORS

Philips Chilena SA, Casilla 2687, Av. Santa Maria 0760, Santiago. Tel: 378-371. Cable: PHILCHISA. Telex: 40239.
Audio: Cassette.
Utz Corp., Fernando Manterola 0453, Casilla 403-V, Santiago. Tel: 377-692. Cable: UTZCORP. Telex: SGO 260. Owner & Gen. Mgr.: Ramon Utz Monsalve; Int'l Liaison: Sonia Figari Letelier.
Audio: 8-tr., cassette.

● supplies

ENVELOPES & MAILERS JACKETS & SLEEVES LABELS POLYETHYLENE BAGS

Alba/Colorado-Industria de Radio & Television SA, Catedral 1029-Subte., Santiago. Tel: 50-081, 80-461.

TAPE, RAW & BLANK LOADED

Agfa-Gevaert Chilena de Productos Fonograficos Ltda., Casilla 139-D, Carlos Fernandez 260, Santiago. Tel: 50-051, 56-7548. Telex: 289.
Audio: Blank—compact-cassette, open reel; raw—cassette, broadcast, studio.
Video: Cassette, open reel.
Brand names: Agfa Carat, Agfa Stereochrom, Agfa Videochrom.
Utz Corp., Fernando Manterola 0453, Casilla 403-V, Santiago. Tel: 377-692. Cable: UTZCORP. Telex: SGO 260. Owner & Gen. Mgr.: Ramon Utz Monsalve; Int'l Liaison: Sonia Figari Letelier.
Audio: 8-tr., cassette.
Brand name: UTZ.

● accessories & store fixtures & merchandising aids manufacturer

Alba/Colorado-Industria de Radio & Television SA, Catedral 1029-Subte., Santiago. Tel: 50-081, 80-461.
Product: Cleaners, cloths & brushes, record display racks.

CHINA, REPUBLIC OF (TAIWAN)

Population: 16,171,569.
Rate of exchange: \$1 (US) = 38.02 yuans.
Per capita income: \$800.
Records, record blanks & pre-recorded media imported from USA: 1977—\$259,394.

● record & tape manufacturers / distributors / importers

Baal Recs. (Taiwan) Ltd., PO Box 65, Chains Bldg., 66 Sec. 2, Taipei. Tel: 361-2151.

Labels: (Owned) Baal. Best of Everything. (licensed) ABC (USA).

Best of Everything, see Baal.
First Recs. Ltd., 116 Cheng-ye N. Rd., San-Chung City, Taipei 241. Tel: 971-2462.

Label: (Licensed) Arrowbats (UK).
Fontana, see Philips.

Four Seas Rec. Publ'g Co. Ltd. (IFPI), 167 Si-Ning Rd., Taipei. Tel: 961-0187, 381-6142. Cable: FOURSEAS. Telex: 21475. Gen. Mgr.: C.Y. Liao; Sales Mgr.: C.Y. Tan.

Labels: (Owned) Four Seas; (licensed) Phonogram (Netherlands), WEA (USA).

Hsin Chao Childhood Education Publ'n Co., 115 Chung Hua Market, 2nd fl., Section 8, Taipei. Tel: (02) 331-7748, 361-1493.

Leico Rec. Factory Co. Ltd., PO Box 3360, 1 Ln. 19, Chung Teh Rd., Taipei. Tel: (02) 541-3792, 571-4927. Plant: 9 Ln. 57, Hua Chang Rd., Hsin Chung Chen.

Linfair Magnetic Sound Ltd. (IFPI), No. 7, 7th fl., Jen-Ai Rd., Sec. 2, Taipei. Tel: (02) 321-4455. Cable: LINFAIR. Telex: 22563. Pres.: Linfair L.F. Chang; Gen. Mgr.: Denia S.M. Chang.

Labels: (Licensed) Decca (UK), Polar (Sweden). (distributed—not licensed) Cam (Italy), Coombe (UK), Yupiteru (Japan).

Lucky Rec. Co. Ltd., No. 2-8, Ln. 116, Section 2, Chung-Shang N. Rd., Taipei 104. Tel: (02) 511-8115, 521-8182. Cable: BAOJANG. Pres. & Gen. Mgr.: Chiu-San Tseng.

Mercury, see Philips.
Modern Musical Instruments Corp., PO Box 3811, Taipei. Tel: 391-7815/7817. Cable: MODRNMUSIC. (Distributor/Importer)

Label: (Represented) MMO (USA).
Orient Trading & Ind. Ltd., PO Box 3240, 50 Nanking E. Rd., 5th fl., Section 1, Taipei. Tel: (02) 551-0484, 511-2415, 571-2379. Cable: OTCLTD. (Importer of tapes).

Pacific Int'l Music & Publ'g, PO Box 46-338, Taipei. Tel: (02) 511-4580. Telex: 11524. Chief Exec.: Harry Heide; Gen. Mgr.: Michael Chiang.

Label: (Owned) Pacific, (licensed) EMI (Hong Kong, Singapore), Polar Int'l (Sweden).

Philips Taiwan Ltd., PO Box 22978, 57-1 Chung Shan N. Rd., Section 2, 7th fl., Taipei. Tel: (02) 571-3231. Cable: PHILCHINE. Telex: 21570.

Labels: (Owned) Fontana, Mercury, Philips, Vertigo; (distributed—not licensed) All Platinum, Bang, Charisma, H&L, Sire, 20th Century (all Netherlands).

Pony, see Taiwan Pony.
R O C Corp., President Bldg., Rm. 602, 592 Linsheng N. Rd., Taipei. Tel: (02) 581-2603.

Ring Ring Recs. Ind. Co. Ltd., 33 Ln. 190, Cheng-I N. Rd., Sanchung City, Taipei Hsien. Tel: (02) 971-2432.

Song Jwu Rec. Co., 19-7 Chung Hua II Rd., Kaohsiung. Tel: 273312.

Taiwan Electric Development Corp., Tedco House, 25 Chung Shan N. Rd., Section 2, Taipei 104. Tel: (02) 541-3525, 551-2525. Cable: TEDCO. Pres. & Gen. Mgr.: Chengchih Chen; Sales Mgr.: Weyway Chen.

Labels: (Distributed—not licensed) Angel (USA), Capitol (USA), DG (Germany), Decca (Germany), Polydor (Germany), RCA (Germany), Seraphim (USA), Telefunken (Germany).

Taiwan Pony Music Ent. Co. Ltd., Pony Bldg., 5th fl., 92-1 Kum Minn St., Taipei 100. Tel: (02) 381-7188.

Label: (Represented) EMI.
Int'l rep.: Worldwide (EMI).
Vertigo, see Philips.

● music publishers

ASSOCIATIONS & PROFESSIONAL ORGANIZATIONS

Taiwan Importers & Exporters Ass'n, Taipei. Tel: (02) 311-4049/1687.
Taiwan Regional Ass'n of Record Mfrs., 55 Chung Hwa Market, 3rd fl., Jen Section, Taipei. Tel: (02) 311-0276.

DESIGN & ARTWORK

Taiwan Pony Music Ent. Co. Ltd., Pony Bldg., 5th fl., 92-1 Kum Minn St., Taipei. Tel: (02) 381-7188.

PLATING, PROCESSING & PRESSING PLANTS

Eagle Ents. Co. Ltd., PO Box 22655, 1C Kuang Lung Bldg., 3-1 Chen Chiang St., Taipei 100. Tel: (02) 391-4823/4926/0215. Cable: EAGLECOLTD. Telex: 11387. (Pressing only).

Four Seas Rec. Publ'g Co. Ltd., 167 Si-Ning Rd., Taipei. Tel: 961-0187, 381-6142. Cable: FOURSEAS. Telex: 21475. Gen. Mgr.: C.Y. Liao; Sales Mgr.: C.Y. Tan.

Gold Well Chemical Inds. Co. Ltd., 135 Chung XII Rd., Shih Ln District, Taipei. Tel: (02) 871-4556.

Linfair Eng'g & Trading Co., No. 7, 7th fl., Jen-Ai Rd., Sec. 2, Taipei. Tel: (02) 321-4455. Cable: LINFAIR. Telex: 22563. Mng. Dir.: Linfair L.F. Chang.

Lucky Rec. Co. Ltd., No. 2-8, Ln. 116, Section 2, Chung-Shang N. Rd., Taipei 104. Tel: (02) 511-8115, 521-8182. Cable: BAOJANG. Pres. & Gen. Mgr.: Chiu-San Tseng.

Taiwan Pony Music Ent. Co. Ltd., Pony Bldg., 5th fl., 92-1 Kum Minn St., Taipei. Tel: (02) 381-7188. (Pressing only)

PRINTERS & LITHOGRAPHERS

Kuo Fong Colored Printing Co., 231 Fu Chiang Rd., Tainan. Tel: 26900, 31688.
Linfair Eng'g & Trading Co., No. 7, 7th fl., Jen-Ai Rd., Sec. 2, Taipei. Tel: (02) 321-4455. Cable: LINFAIR. Telex: 22563. Mng. Dir.: Linfair L.F. Chang. (Record only)
Taiwan Pony Music Ent. Co. Ltd., Pony Bldg., 5th fl., 92-1 Kum Minn St., Taipei. Tel: (02) 381-7188.

RECORD PROMOTION

Four Seas Rec. Publ'g Co. Ltd., 167 Si-Ning Rd., Taipei. Tel: 961-0187, 381-6142. Cable: FOURSEAS. Telex: 21475. Gen. Mgr.: C.Y. Liao; Sales Mgr.: C.Y. Tan.
Taiwan Pony Music Ent. Co. Ltd., Pony Bldg., 5th fl., 92-1 Kum Minn St., Taipei. Tel: (02) 381-7188.

TAPE CUSTOM DUPLICATORS

Four Seas Rec. Publ'g Co. Ltd., 167 Si-Ning Rd., Taipei. Tel: 961-0187, 381-6142. Cable: FOURSEAS. Telex: 21475. Gen. Mgr.: C.Y. Liao; Sales Mgr.: C.Y. Tan.
Audio: Cassette.

Oriental Trading Corp., PO Box 55-186, 145-9 Chang Chun Rd., Taipei. Tel: (02) 581-6286. Cable: ORTACO.
Audio: 8-tr., 8-tr. quadraphonic, cassette, open reel.

Taiwan Pony Music Ent. Co. Ltd., Pony Bldg., 5th fl., 92-1 Kum Minn St., Taipei. Tel: (02) 381-7188.
Audio: 8-tr. & cassette.
Video: 3/4" cassette.

● supplies

CARTRIDGE & CASSETTE PARTS

Four Seas Rec. Publ'g Co. Ltd., 167 Si-Ning Rd., Taipei. Tel: 961-0187, 381-6142. Cable: FOURSEAS. Telex: 21475. Gen. Mgr.: C.Y. Liao; Sales Mgr.: C.Y. Tan.

Liang Ming Trading Co. Ltd., 9-2 Hsin Sheng S. Rd., Section 3, Taipei. Tel: (02) 721-8436, 711-3061. Cable: MSETCO. (Importer)

Oriental Trading Corp., PO Box 55-186, 145-9 Chang Chun Rd., Taipei. Tel: (02) 581-6286. Cable: ORTACO.

EMPTY CARTRIDGES, CASSETTES & REELS

Fuyuan Trading Co., PO Box 939, 22-1 Ln. 42, 2nd fl., Chung Shan N. Rd., Section 2, Taipei. Tel: (02) 511-3016. (Importer)

Liu Bros. (Taiwan) Ltd., PO Box 58534, 1 Ta Hu St., Nei Hu District, Taipei. Tel: (02) 711-0658. (Importer)

Taiwan Pony Music Ent. Co. Ltd., Pony Bldg., 5th fl., 92-1 Kum Minn St., Taipei. Tel: (02) 381-7188.
Audio: Cassette.

JACKETS & SLEEVES LABELS

Eagle Ents. Co. Ltd., PO Box 22655, 1C Kuang Lung Bldg., 3-1 Chen Chiang St., Taipei 100. Tel: (02) 391-4823/4926/0215. Cable: EAGLECOLTD. Telex: 11387. (Sleeves & labels only)

Lucky Rec. Co. Ltd., No. 2-8, Ln. 116, Section 2, Chung-Shang N. Rd., Taipei 104. Tel: (02) 511-8115, 521-8182. Cable: BAOJANG. Pres. & Gen. Mgr.: Chiu-San Tseng.

POLYETHYLENE BAGS

An Loh Plastics Ind'l Co. Ltd., 29 Ln. 63, Yung Fu Rd., Tainan. Tel: 54057. Plant: 31 Susanchia, Cheng Kung Village, Jen Teh Hsiang.

Chi Lin Plastic Ind'l Co. Ltd., 339 Yen Cheng, Tainan. Tel: 25176.

Chin Cheng Plastics Works Co. Ltd., 16 Ln. 328, Fuchiang Rd., Tainan. Tel: 25366, 20826. Telex: 5366.

Chu Nan Plastic Industry Co., 11 Alley 12, Ln. 265, Hsin-I Rd., Section 4, Taipei. Tel: (02) 681-2856/3856, 781-8275. Plant: 208 Chun Ying St., Shulin Chen.

Cosmos Containers Mfg. Co. Ltd., 60 Hsin Shu Rd., Hsin Chuang Chen, Taipei Hsien. Tel: 907431.

Eagle Ents. Co. Ltd., PO Box 22655, 1C Kuang Lung Bldg., 3-1 Chen Chiang St., Taipei 100. Tel: (02) 391-4823/4926/0215. Cable: EAGLECOLTD. Telex: 11387.

Fong Chang Textile Co. Ltd., 108 Chang Mei Rd., Section 6, Ho Mei Chen, Changhua Hsien. Tel: 142. Cable: FON-CHANTEX.

Hsieh Hsing Plastic Bag Mfg. Co., 150 Tai Ping Rd., Hsing Chung Li, Pu Tai Chen, Chia-I Hsien. Tel: 137.

Jeou Long Plastic Works Ltd., 37 Tatu St., Tatu Hsiang, Taichung Sheng. Tel: (046) 99-22-90, 99-26-47. Pres.: R.H. Hwang; Gen. Mgr.: C.M. Lai.
Plant: 950 San Tien Rd., Section 3, Tatu Hsiang.
Branch: Taipei, Morson Trading Co. Ltd., 74 Section 2, Chang-An E. Rd. Tel: (02) 521-0364/5838, 561-3789.

Kai Tai Plastics Co. Ltd., 278 Min Sheng E. Rd., 2nd fl., Taipei. Tel: (02) 971-9109. Plant: 1-6 Wu Ku Keng Rd., Wu Ku Village, Wu Ku Hsiang.

Mien Teh Plastic Film Co. Ltd., 13 Mei Teh St., Shih Lin District, Taipei.

Nan Yang Chemical Co. Inc., 63 Ln. 45, Hsinyi Rd., Chiayi. Tel: (052) 22356, 70984.

San Chih Plastic Ind'l Co. Ltd., 53 Hsin Ho Shun, Tainan. Tel: 25374, 57074. Telex: 71194.

San Chu Plastic Prods. Co. Ltd., 161 Chung Cheng Rd., Hsin Chuang Chen, Taipei Hsien. Tel: 975870, 982859.

Shing Sheng Plastic Ind'l Co. Ltd., 74 Alley 35, Ln. 181, Fu Chiang Rd., Tainan. Tel: 55744.

Shung Mei Plastic Co. Ltd., PO Box 63, 14 Kuang Ming Rd., Ching Shui Chen, Taichung Hsien. Tel: 22468.

Ta Fu Plastic Ind'l Co. Ltd., 23 Ln. 67, Lin Shien N. Rd., Taipei. Tel: (02) 531-6337.
Plant: Tainan, 47 Ln. 233, Fu Chin Rd.
Tai-Ichi Ind'l Co. Ltd., 20 Ln. 19, Han Chi St., Taichung. Tel: 26238.
Plant: Chia-I, 2 Ln. 136, Hsi Tsai Rd., Ta Lin Chen. Tel: 205.

Ta San Plastics Factory Co. Ltd., 3 Alley 9, Ln. 320, Hsi Yuan Rd., Section 2, Taipei. Tel: (02) 371-0006.

Tong Dah Plastics Co. Ltd., 28 Shih Chia Ln., Shih Chia Li.

East District, Taichung Tel 224844, 236384 Cable TONDA. Local branch: 54 Shih Fu Rd. Tel: 226688
Int'l branch: USA

Tong Yi Plastic Co. Ltd., 3-5 Min Sheng Ln., San Min District, Kaohsiung, Tel 225264, 295450
Tytone Inds (Taiwan) Ltd., PO Box 3608, 18 Ln 135, Chung Shan N. Rd., Section 1, Taipei Tel (02) 522-3237 Bd Chm. H.N. Ze. Sec'y Janny Shaw
Plant: **Tao Yuan**, 3 Hsing Lu Rd., Kuei Shan Ind'l Zone.
Yih Cheng Plastic Factory Co. Ltd., 139 Chang Hsin Rd., Hsin Chuan Li, Ho Mei Chen, Changhua Hsien. Tel 26203
Branch: Taipei, 23 Ln. 19, I-Tung St. Tel (02) 581-5056

RECORD PROCESSING MACHINERY

Gold Well Chemical Inds. Co. Ltd., 135 Chung XII Rd., Shih Lin District, Taipei, Tel (02) 871-4556
Chief product: Vinyl rec. plates & compounds

TAPE, BLANK LOADED & RAW

A D I, see Oriental Trading.
Betamax, see Shinlee.
Liu Bros (Taiwan) Ltd., PO Box 58534, 1 Ta Hu St., Nei Hu District, Taipei, Tel (02) 711-0658 (Importer—audio, blank only)
Mercuries & Assocs. Ltd., PO Box 3155, 138-140 Chungking N. Rd., Section 4, Shih Lin District, Taipei, Tel (02) 881-9471/80. Cable: MERCURY. (Importer—audio, blank only)
Oriental Trading Corp., PO Box 55-186, 145-9 Chang Chun Rd., Taipei, Tel 581-6286 Cable: ORTACO.
Audio: 8-tr., cassette & open reel.
Brand name: ADI.
Overseas Friend Co. Ltd., PO Box 878, 144 Hankou St., Rm. 808, Section 1, Taipei, Tel 331441. Cable: IRVING-TONG (Importer—audio, blank only).
Brand name: Philips.
Philips, see Overseas Friend.
Shinlee Co. Ltd., 372 Lin Sen N. Rd., 2nd fl., Taipei, Tel (02) 521-0282 Telex 11154. (Importer)
Audio: Blank—8-tr., cassette, open reel
Video: Blank—1" open reel, 3/4" U-matic, 1/2" EIAJ open reel, 1/4" cassette; raw—3/4" U-matic, 1/2" EIAJ open reel
Brand name: Betamax
Taiwan Southeastern Asia Ent. Corp. Ltd., PO Box 670, 111 Chungking S. Rd., 2nd fl., Section 1, Taipei, Tel (02) 311-6596, 361-4802. Cable: SEACO. Telex 11175 (Importer—audio, blank only).

TAPE DUPLICATING & PROCESSING EQUIPMENT

Four Seas Rec. Publ'g Co. Ltd., 167 Si-Ning Rd., Taipei, Tel 961-0187, 381-6142. Cable: FOURSEAS. Telex 21475. Gen. Mgr. C.Y. Liao; Sales Mgr. C.Y. Tan.
Kuo Yi Trading Co. Ltd., 12-2 Chang An Rd. E. Section 1, Taipei, Gen. Mgr. S.L. Lin (Importer)
Oriental Trading Corp., PO Box 55-186, 145-9 Chang Chun Rd., Taipei, Tel (02) 581-6286 Cable: ORTACO

accessories manufacturers

Linfair Eng'g & Trading Co., No. 7, 7th fl., Jen-Ai Rd., Sec. 2, Taipei, Tel (02) 321-4455. Cable: LINFAR. Telex 22563. Mng. Dir. Linfair L.F. Chang
Product: cleaners, cloths, & brushes, head cleaners & demagnetizers, needles.
Magellan Ent. Co. Ltd., 25 Chung Hua Rd., 3rd fl., Section 1, Taipei, Tel (02) 371-8331
Product: Needles
Oriental Trading Corp., PO Box 55-186, 145-9 Chang Chun Rd., Taipei, Tel (02) 581-6286 Cable: ORTACO
Product: Head cleaners & demagnetizers, leader & splicing tape
Taiwan Pony Music Ent. Co. Ltd., Pony Bldg., 5th fl., 92-1 Kum Minn St., Taipei, Tel (02) 381-7188 (Importer)
Product: Leader & splicing tape

store fixtures & merchandising aids manufacturers

Oriental Trading Corp., PO Box 55-186, 145-9 Chang Chun Rd., Taipei, Tel (02) 581-6286 Cable: ORTACO
Product: Display racks.

COLOMBIA

Population: 28,000,000.
Rate of exchange: \$1 (US) = 42.74 pesos.
Per capita income: \$515.
Holidays: January 1, March 19 (St. Joseph's Day), Good Friday, May 1 (Labor Day), Ascension Day, Corpus Christi, May 23, June 29 (Sts. Peter & Paul Day), July 20 (Independence Day), August 7 (Battle of Boyaca), August 15 (Assumption), October 12 (Columbus Day), November 1 (All Saints' Day), November 11 (Independence of Cartagena), December 8 (Immaculate Conception), December 25.
Records, record blanks, & pre-recorded media imported from USA: 1977—\$103,651.

Billboard 1979-1980 International Buyer's Guide

record & tape manufacturers / distributors / importers

Antillano, see Tropical.
Archiv, see Philips.
Atriz, see Chaves.
CBS SA (Discos), 10-A-23 Carrera 34, Bogota, D.E. Tel (2) 77-24-00. Cable: COLRECORD Mng. Dir. Caslos A. Gutierrez T., Sales Mgr. Fidel Jaramillo, Finance Dir. Juan Fernando Villamil.
Labels: (Owned) CBS, Epic; (licensed) Belter (Spain), Capitol (USA), DJM (UK), Disneyland (USA), EMI (UK), Sono-Radio (Peru).
Caliente, see Sonolux.
Candil, see Chaves.
Caribe, see Fuentes.
Carrizal, see Sonolux.
Chaves (Discos), PO Box 304, 18-43 Carrera 23, Pasto, Tel. 20-51, 3138. Cable: DISCHAVES. Gen. Mgr.: Ramiro Chaves L., Sales Mgr. Iliá de Chaves.
Labels: (Owned) Atriz, Candil, Chaves, Emerald.
Int'l reps.: Costa Rica (Nueva Ola), Ecuador (Centenario), Netherlands (Dureco), Venezuela (BASIF).
Codiscos (Compania Colombiana de Discos) SA, Apdo. Aereo 1428, 65-304 Calle 2, Medellin, Tel 55-08-35, 55-08-95. Cable: CODISCOS. Telex 6570. Pres. Alfredo Diez M., VP. Alvaro Arango G., A&R Mgr. Rafael Mejia P., A&R Dir. Marco F. Eusse.
Labels: (Owned) Costeno, Famoso, Vereda, Zeida, (licensed) AVI (USA), Alshire (USA), Barclay (France), Continental (Brazil), Danny Daniel (Spain), Dila (Guatemala), Discuba (USA), Fantasy (USA), GYG (Argentina), Gamma (Mexico), Hispavox (Spain), IEMPSA (Peru), Ricardo Kleiman (Argentina), LEM (France), Macon (Argentina), Microfon America (USA), Musart (Mexico), Nicolas (Argentina), Peruvox (Peru), Proas (Argentina), Ri-Fi (Italy), Riviera (France), Salsoul-Mexicana (USA), Sciamericana (Argentina), Trova (Venezuela), Weyman (Italy).
Int'l reps.: Central America (Dideca), Mexico (Musart), Panama (Sono Mundi), Peru (IEMPSA), USA (TH), Venezuela (Discoteca).
Corporacion Musical Ltda., Carrera 47, No. 52-62, Apdo. Aereo 7011, Medellin. Cable: COMMUSICAL. Tel. 34-14-51. Gen. Mgr. Hernan Restrepo Duque
Label: (Represented) House of Falcon (USA).
Costeno, see Codiscos.
D.G., see Philips.
Daro Ltda. (Importaciones), 6-47 Calle 18, 11th fl., Bogota, Tel (91) 41-12-18, 43-36-66. Cable: IMPODARO. Pres. Simon Daro, Gen. Mgr. Dr. Carlos G. Navarro.
Int'l branch: USA, New York, N.Y.
Labels: (Licensed) Decca (UK), London (USA), Phase 4 (UK), Teldec (Germany), Vega (France).
Int'l reps.: Costa Rica (Indica), Ecuador (Fediscos), Mexico (Musart), Venezuela (La Discoteca, Top Hits).
Delujo, see Fuentes.
Discomoda de Colombia Ltda., 46-65 Avda. Caracas, Bogota, D.E. Tel (92) 85-03-11, 69-81-10. Cable: DISCOMODA. Telex: 29585. Pres. Cesar Roldan; Gen. Mgr. Enrique Estrada Duque, Sales Mgr.: Alfonso Gaitan.
Home office: Venezuela, El Disco de Moda
Labels: (Owned) Discomoda (licensed) ABC group (USA), Alegre (USA), Belter (Spain), Discolando (USA), FTA (Peru), Favedita (Venezuela), Inca (USA), Lyra (Costa Rica), Mustiron (USA), Tico (USA), West Side Latino (USA).
Int'l reps.: Central America (Lyra), Ecuador (Fediscos), Peru (FTA), USA (Discolando).
Emerald, see Chaves.
Epic, see CBS.
Extra, see Tropical.
Famoso, see Codiscos.
Fonoarte Ltda., Apdo. Aereo 83-03, 41-20 Calle 10, Medellin, Tel 46-69-07. Gen. Mgr. Francisco J. Correa C. (Distributor/Importer)
Labels: (Distributed—not licensed) Amadeo (Austria), Asylum (USA), Centrocord (Austria), Columbia (USA), Elektra (USA), Ensayo (Spain), Harmonia Mundi (France), Hungaroton (Hungary), Inner City (USA), Lynchord (USA), MMO (USA), Mace (USA), Melodiya (USSR), Pepita (Hungary), Pueblo (Mexico), Qualiton (Hungary), Springboard (USA), Supraphon (Czechoslovakia), Turnabout (USA), Vanguard (USA), Vox (USA), Warner Bros. (USA).
Fontana, see Philips.
Fuentes (Fabrica De Discos) Ltda. (IFPI), 13-223 Carrera 51, Medellin, Tel 35-13-00. Cable: DISFUENTES Co. Pres. Pedro & Jose Maria Fuentes Estrada, Gen. Mgr. Dr. Conrado Dominguez, Sales Mgr. Jorge Gonzalez Botero, Int'l Dir. Javier Garcia Munoz.
Labels: (Owned) Caribe, Delujo, Fuentes; (licensed) Accion (Mexico), Ariston (Italy), Arrowtabs (UK), Auvy (Spain), Baby (Italy), Belter (Spain), Butterfly (USA), Carosello (Italy), Casablanca (USA), Cisne Raff (Mexico), Compania Fonografica Espanola (Spain), Continental (Panama), Copacabana (Brazil), Corito (Mexico), Coro (Mexico), Corpodisco (Venezuela), Dial (USA), Disquerias Unidas (Venezuela), Doremi (Peru), Dynamic Sounds (Jamaica), Eleven (Italy), Fania (USA), Fonica (Guatemala), Hit Power (Peru), Jupiter (Germany), Lotus (Italy), Met Richmond (USA), Miami (USA), Palacio (Venezuela), Panart (USA), Peerless (Mexico), Quality (Canada), Secco (USA), TK (Argentina), Vaya (USA), Velvet (USA, Venezuela), Verve (USA), El Virrey (Peru); (distributed—not licensed) Eva.
Int'l reps.: Bolivia (Lauró & Cia), Brazil (Copacabana), Ecuador (Fediscos), Guatemala (Fonica), Mexico (Peerless), Panama (Continental), Peru (El Virrey), USA (Miami), Venezuela (Disquerias Unidas).
H.B., see Incolve.
Ideal, see Tropical.
Impacto, see Sonolux.
Incolve (Industria Musical Colombo Venezolana) Ltda., 21-73 Carrera 7a, 5th fl., Bogota, Tel (02) 41-91-99, 83-

83-45. Cable: INCOLVE. Gen. Mgr. Fanny Frasser.
Home office: Venezuela, El Palacio de la Musica
Labels: (Owned) HB, Solex; (licensed) A&M (USA), Cream (USA), Motown (USA).
Lyra, see Sonolux.
M.G.M., see Philips.
Mercury, see Philips.
Philips de Colombia SA (Industrias) (IFPI), Music Dept., 51-39 Calle 13, Bogota, D.E. Tel. 60-06-00. Cable: DISCOPHIL. Telex: 44776. Pres. Hank Retera, Gen. Mgr. Alfonso Escobar N., Sales Mgr. Luis Garcia, Int'l Repertoire Label Mgr. Patrick Mildenberg.
Labels: (Owned) Archiv, DG, Fontana, MGM, Mercury, Philips, Polydor, RSO, Vertigo, Verve; (licensed) Alhambra (Spain), All Platinum (USA), Capricorn (USA), De Lite (USA), EG (UK), Fania (USA), H&L (USA), Pablo (USA), 20th Century (USA), Vaya (USA).
Int'l reps.: Worldwide (Phonogram, Polydor).
Polydor, see Philips.
R.S.O., see Philips.
Kamal Ramirez, Apdo. Aereo 18002, Cali, Tel 89-18-55 (Importer/Distributor)
Real, see Sonolux.
Solex, see Incolve.
Sonolux Industria Electro-Sonora SA (IFPI), 43 A-5 Calle 29, Medellin, Tel 32-09-99. Pres. Sergio Berdugo Cuartas; Artist Dir. Leon Cardona Garcia, Sales Mgr. Juan Fernando Restrepo C., Gen. Sec'y Eugenio Quintero Regino.
Labels: (Owned) Caliente, Impacto, Lyra, Real, Sonolux; (licensed domestic) Carrizal; (licensed foreign) Ariola America (USA), Ariola-Eurodisc (Spain), CTI (USA), DCM (Mexico), Dicesa (El Salvador), Fenix (Ecuador), Grunt (USA), Gryphon (USA), Hansa (Germany), Kudu (USA), Marfer (Spain), Melody (Mexico), Millennium (USA), Padisco (Panama), Polar (Sweden), Promus (Venezuela), RCA (worldwide), Ricordi (Italy), Salvation (USA), Sigla (Brazil), Sonover (Venezuela), Trama (Spain), Trema (France), Turquesa (Spain), United Artists (worldwide), Vogue (France), VWEA (USA).
Int'l reps.: Central America (Dicesa in El Salvador), Ecuador (Fediscos), Mexico (Discos & Cartuchos), Panama (Padisco), Peru (Prodmasa), USA (Discolando), Venezuela (Sonover).
Swing, see Tropical.
Tropical (Discos) Ltda. (IFPI), 68-73 Calle 68-B, Barranquilla, Tel 316-509, 325-858, 315-645, 325-362. Cable: RADIAG. Pres. Emilio Fortou P.; Gen. Mgr.: Jaime Cabrera M., A&R Mgr.: Jorge Fortou E.; Int'l Sales Mgr. Tony Fortou E.
Labels: (Owned) Antillano, Extra, Ideal, Swing, Tropical; (licensed) Amour (Canada), Ariola Eurodisc (Germany), Armada & Rodriguez (USA), Baby (Italy), Basart Int'l (Netherlands), Carrere (France), Contempo Int'l (UK), Countdown (Germany), Crystal (Germany), Fleche (France), Gema (Puerto Rico-USA), Hansa (Germany), Alfred D. Herger (Puerto Rico-USA), Image Magique (USA), Melodie Der Welt (Germany), Miami (USA), Satrii (UK), Son'Art (Mexico), El Sonido (USA), Victor (Japan), West End (USA).
Int'l reps.: Mexico (Son'Art), USA (Miami), Venezuela (Fonodisco).
Universe, see Victoria.
Vereda, see Codiscos.
Vertigo, see Philips.
Verve, see Philips.
Victoria (Industrias Fonograficas) Ltda., Apdo 3308, Carrera 52, 251-44, Medellin, Tel 35-06-52, 35-48-24. Pres. Otoniel Cardona Uran, Gen. Mgr. Otoniel Cardona Jr. Labels: (Owned) Universe, Victoria; (licensed) Borinquen (Puerto Rico), Suramericana del Disco (Venezuela).
Int'l reps.: Mexico (Ariola).
Zeida, see Codiscos.

music publishers

Ecomus (Ed. Colombiana & Int'l de Musica Ltda.), 11 A-40 Carrera 43-A, Medellin, Tel. 46-51-38. Cable: ECOMUS. Mgr. Sylvia N. Arango Duque.
Int'l firms represented: Beechwood (Mexico), Brambilla (Mexico), Prodema (Peru), Quiroga (Spain), SADRAM (Ecuador), Sochem (Chile).
Int'l reps.: Argentina (MAI), Chile (Sochem), Ecuador (SADRAM), Mexico (Brambilla), Peru (Prodema), Spain (Quiroga), USA (Morro), Venezuela (Alfonso Sanchez Lopez).
Edimusic (Ed. Int'l de Musica Ltda.), 13-223 Carrera 51, Medellin, Tel 35-45-90. Cable: DISFUENTES. Pres.: Gonzalo Pelaez C.; Gen. Mgr.: Hugo Giraldo M.
Int'l firms represented: Conedisa (Peru), Fania (USA), Predisca (Mexico), Vaya (USA), Vicary (Venezuela).
Int'l reps.: Mexico (Predisca), Peru (Conedisa), Venezuela (Velvessa).
Fonoton Ltda. (Ed.), 51-39 Calle 13, Bogota, Tel. 60-06-00 x 259. Cable: DISCOPHIL. Telex 44776. Mgr. Alfonso Escobar N.; Gen. Mgr.: Bertha Alvarado.
Int'l firm represented: Intersong (Mexico).
Int'l rep.: Mexico (Intersong).
Mundo Musical, 10-A-23 Carrera 34, Bogota, Tel (2) 77-24-00. Cable: COLRECORD.
Int'l firms represented: Beechwood (USA), Blackwood (USA), EMI publ'g cos. (UK), ITAIPU (Brazil), Orrfa (USA), Sadaic (USA).
Int'l reps.: Argentina (MAI, Melografi), Brazil (ELAM, ITAIPU), UK (Apple), USA (Blackwood).
Orbemusa, 46-65 Avda. Caracas, Bogota, Tel (92) 69-81-10. Dir. Cesar Roldan, Gen. Mgr. Enrique Estrada Duque, Sales Mgr. Alfonso Gaitan.
Home office: Venezuela, Orbe.
Peer de Colombia Ltda., 8-92 Calle 18, Bogota, Tel: 241-9864. Cable: PEERCO. Gen. Mgr. Marie Rojas.
Home office: USA, Peer-Southern Org.
Prodemus (Promotora Colombiana de Musica) Ltda., Apdo. Aereo 1428, Medellin, Tel 46-51-38. Cable: PRODEMUS. Mgr. Sylvia N. Arango Duque.
Int'l firms represented: Arabella (Spain), Conedisa (Peru), Continental (Peru), Discorama (Spain), Edimus

(Venezuela), Edimusa (Mexico), Maya (Guatemala), Rimo (Mexico), SOCHEM (Chile), Sunmusica (Venezuela).
Int'l reps.: Argentina (Relay), Chile (SOCHEM), Ecuador (SADRAM), Guatemala (Maya), Mexico (Edimusa), Peru (Conedis), Spain (Quiroga), USA (Morro), Venezuela (Alfonso Sanchez Lopez)
Sonolux Int'l SA (Promotora), 43 A-5 Calle 29, Medellin, Tel: 32-09-99. Pres. Carlos Julio Ardiola Gaviria; Gen. Mgr.: Sergio Berdugo Cuartas.
Int'l firms represented: Edicosa (El Salvador), Edim (Mexico), Jaguare (Brazil), Ivan Mogull (USA), RCA (Brazil, Italy), Leme (Brazil), Relay (Argentina), Victor (Brazil).
Int'l reps.: Argentina (Relay), Brazil (Victor), Ecuador (SADRAM), Italy (RCA), Mexico (Edim), Peru (Prodemsa), Spain (RCA), Venezuela (Orfrra-Unimusic), USA (Morro)

● **sheet music jobber / supplier**

Fonoarte Ltda., Apdo. Aereo 83-03, 41-20 Calle 10, Medellin, Tel: 46-69-07. Gen. Mgr.: Francisco J. Correa C.

● **services**

DESIGN & ARTWORK

Codiscos (Compania Colombiana de Discos SA), Apdo. Aereo 1428, 11A-40 Carrera 43A, Medellin, Tel: 46-51-38. Cable: PRODEMUS. Pres.: Alfredo Diez M.; VP: Alvaro Arango G.

Fuentes (Fabrica de Discos) Ltda., 13-223 Carrera 51, Medellin, Tel: 35-13-00. Cable: DISFUENTES Co-Pres. Pedro & Jose Maria Fuentes Estrada; Gen. Mgr.: Dr. Conrado Dominguez H.; Sales Mgr.: Jorge Gonzalez Botero; Int'l Mgr.: Javier Garcia Munoz
 Litho Plastics Ltda., 68-73 Calle 68-B, Barranquilla, Tel: 316-509. Cable: RADIAG. Pres.: Emilio Fortou P.; Gen. Mgr.: Cecilia de Fortou; Sales Mgr.: Tony Fortou E.

LICENSING ORGANIZATION, MUSIC

S A Y C O (Sociedad de Autores & Compositores de Colombia), 20-47 Carrera 12, Bogota, Tel: 43-93-50 (Performing rights only.)

PLATING, PROCESSING & PRESSING PLANTS

C B S S A (Discos), 10-A-23 Carrera 34, Bogota, D.E. Tel: (2) 77-24-00. Cable: COLRECORD. Mng. Dir.: Carlos A. Gutierrez

Codiscos (Compania Colombiana de Discos SA), Apdo. Aereo 1428, 11A-40 Carrera 43A, Medellin, Tel: 46-51-38. Cable: PRODEMUS. Pres.: Alfredo Diez M.; VP: Alvaro Arango G.

Fuentes (Fabrica de Discos) Ltda., 13-223 Carrera 51, Medellin, Tel: 35-13-00. Cable: DISFUENTES Co-Pres. Pedro & Jose Maria Fuentes Estrada; Gen. Mgr.: Dr. Conrado Dominguez H.; Sales Mgr.: Jorge Gonzalez Botero; Int'l Mgr.: Javier Garcia Munoz

Litho Plastics Ltda., 68-73 Calle 68-B, Barranquilla, Tel: 316-509. Cable: RADIAG. Pres.: Emilio Fortou P.; Gen. Mgr.: Cecilia de Fortou; Sales Mgr.: Tony Fortou E.

Philips de Colombia SA (Industrias), Music Div., 51-39 Calle 13, Bogota, D.E. Tel: 60-06-00. Gen. Mgr.: Alfonso Escolar N.

Sonolux Industria Electro-Sonora SA, 43 A-5 Calle 29, Medellin, Tel: 32-09-99. Pres.: Sergio Berdugo Cuartas; Gen. Mgr.: Leon Cardona Garcia; Sales Mgr.: Juan Fernando Restrepo C.

PRINTERS & LITHOGRAPHERS

Codiscos (Compania Colombiana de Discos SA), Apdo. Aereo 1428, 11A-40 Carrera 43A, Medellin, Tel: 46-51-38. Cable: PRODEMUS. Pres.: Alfredo Diez M.; VP: Alvaro Arango G.

Fuentes (Fabrica de Discos) Ltda., 13-223 Carrera 51, Medellin, Tel: 35-13-00. Cable: DISFUENTES Co-Pres. Pedro & Jose Maria Fuentes Estrada; Gen. Mgr.: Dr. Conrado Dominguez H.; Sales Mgr.: Jorge Gonzalez Botero; Int'l Mgr.: Javier Garcia Munoz

Litho Plastics Ltda., 68-73 Calle 68-B, Barranquilla, Tel: 316-509. Cable: RADIAG. Pres.: Emilio Fortou P.; Gen. Mgr.: Cecilia de Fortou; Sales Mgr.: Tony Fortou E.

Sonolux Industria Electro-Sonora SA, 43 A-5 Calle 29, Medellin, Tel: 32-09-99. Pres.: Sergio Berdugo Cuartas; Gen. Mgr.: Leon Cardona Garcia; Sales Mgr.: Juan Fernando Restrepo C.

RECORD PROMOTION

Fuentes (Fabrica de Discos) Ltda., 13-223 Carrera 51, Medellin, Tel: 35-13-00. Cable: DISFUENTES Co-Pres. Pedro & Jose Maria Fuentes Estrada; Gen. Mgr.: Dr. Conrado Dominguez H.; Sales Mgr.: Jorge Gonzalez Botero; Int'l Dir.: Javier Garcia Munoz

Litho Plastics Ltda., 68-73 Calle 68-B, Barranquilla, Tel: 316-509. Cable: RADIAG. Pres.: Emilio Fortou P.; Gen. Mgr.: Cecilia de Fortou; Sales Mgr.: Tony Fortou E.

Promosonic Ltda., 68-73 Calle 68-B, Barranquilla, Tel: 316-509, 325-362. Cable: RADIAG. Gen. & Sales Mgr.: Tony Fortou E.

TAPE CUSTOM DUPLICATORS

Codiscos (Compania Colombiana de Discos SA), Apdo. Aereo 1428, 11A-40 Carrera 43A, Medellin, Tel: 46-51-38. Cable: PRODEMUS. Pres.: Alfredo Diez M.; VP: Alvaro Arango G.
Audio: Cassette.

Fuentes (Fabrica de Discos) Ltda., 13-223 Carrera 51, Medellin, Tel: 35-13-00. Cable: DISFUENTES Co-Pres. Pedro & Jose Maria Fuentes Estrada; Gen. Mgr.: Dr. Conrado Dominguez H.; Sales Mgr.: Jorge Gonzalez Botero; Int'l Mgr.: Javier Garcia Munoz.
Audio: Cassette.

Ingeson Ltda., 6-27 Calle 22, Bogota, Tel: 43-60-44. Pres.: Manuel Drezner.

Audio: 8-tr. cassette.

Litho Plastics Ltda., 68-73 Calle 68-B, Barranquilla, Tel: 316-509. Cable: RADIAG. Pres.: Emilio Fortou P.; Gen. Mgr.: Cecilia de Fortou; Sales Mgr.: Tony Fortou E.

Audio: Cassette, open reel.
Video: 1/2" Beta II cassette.

Philips de Colombia SA (Industrias), Music Div., 51-39 Calle 13, Bogota, D.E. Tel: 60-06-00. Gen. Mgr.: Alfonso Escolar N.

Audio: Cassette.

● **supplies**

CARTRIDGE & CASSETTE PARTS

Fuentes (Fabrica de Discos) Ltda., 13-223 Carrera 51, Medellin, Tel: 35-13-00. Cable: DISFUENTES Co-Pres. Pedro & Jose Maria Fuentes Estrada; Gen. Mgr.: Dr. Conrado Dominguez H.; Sales Mgr.: Jorge Gonzalez Botero; Int'l Mgr.: Javier Garcia Munoz.
Chief product: Hubs, rollers, shields, base & cover.

EMPTY CARTRIDGES, CASSETTES & REELS

Fuentes (Fabrica de Discos) Ltda., 13-223 Carrera 51, Medellin, Tel: 35-13-00. Cable: DISFUENTES Co-Pres. Pedro & Jose Maria Fuentes Estrada; Gen. Mgr.: Dr. Conrado Dominguez H.; Sales Mgr.: Jorge Gonzalez Botero; Int'l Mgr.: Javier Garcia Munoz.

Ingeson Ltda., 6-27 Calle 22, Bogota, Tel: 43-60-44. Pres.: Manuel Drezner.

Philips de Colombia SA (Industrias), Music Div., 51-39 Calle 13, Bogota, D.E. Tel: 60-06-00. Gen. Mgr.: Alfonso Escolar N.

Audio: Cassette.
 Singer Prods. Cia. Ltda., 19-64 Carrera 10, Of. 703-5, Bogota, Tel: 81-24-74, 34-74-37. Cable: COREGNIS.
Brand name: Fidelipac.

ENVELOPES & MAILERS

Codiscos (Compania Colombiana de Discos SA), Apdo. Aereo 1428, 11A-40 Carrera 43A, Medellin, Tel: 46-51-38. Cable: PRODEMUS. Pres.: Alfredo Diez M.; VP: Alvaro Arango G.

JACKETS & SLEEVES LABELS

Codiscos (Compania Colombiana de Discos SA), Apdo. Aereo 1428, 11A-40 Carrera 43A, Medellin, Tel: 46-51-38. Cable: PRODEMUS. Pres.: Alfredo Diez M.; VP: Alvaro Arango G.

Fuentes (Fabrica de Discos) Ltda., 13-223 Carrera 51, Medellin, Tel: 35-13-00. Cable: DISFUENTES Co-Pres. Pedro & Jose Maria Fuentes Estrada; Gen. Mgr.: Dr. Conrado Dominguez H.; Sales Mgr.: Jorge Gonzalez Botero; Int'l Mgr.: Javier Garcia Munoz

Litho Plastics Ltda., 68-73 Calle 68-B, Barranquilla, Tel: 316-509. Cable: RADIAG. Pres.: Emilio Fortou P.; Gen. Mgr.: Cecilia de Fortou; Sales Mgr.: Tony Fortou E.

POLYETHYLENE BAGS

Codiscos (Compania Colombiana de Discos SA), Apdo. Aereo 1428, 11A-40 Carrera 43A, Medellin, Tel: 46-51-38. Cable: PRODEMUS. Pres.: Alfredo Diez M.; VP: Alvaro Arango G.

RECORD PROCESSING EQUIPMENT

Singer Prods. Cia. Ltda., 19-64 Carrera 10, Of. 703-5, Bogota, Tel: 81-24-74, 34-74-37. Cable: COREGNIS.
Chief product: Lathe.
Brand name: Scully (USA)

TAPE, BLANK LOADED

Fuentes (Fabrica de Discos) Ltda., 13-223 Carrera 51, Medellin, Tel: 35-13-00. Cable: DISFUENTES Co-Pres. Pedro & Jose Maria Fuentes Estrada; Gen. Mgr.: Dr. Conrado Dominguez H.; Sales Mgr.: Jorge Gonzalez Botero; Int'l Mgr.: Javier Garcia Munoz (Blank only)

Ingeson Ltda., 6-27 Calle 22, Bogota, Tel: 43-60-44. Pres.: Manuel Drezner.

Audio: 8-tr. & cassette.
Brand names: Coronett, Myltext, Sonex.

Philips de Colombia SA (Industrias), Music Div., 51-39 Calle 13, Bogota, D.E. Tel: 60-06-00. Gen. Mgr.: Alfonso Escolar N.

TAPE DUPLICATING & PROCESSING EQUIPMENT

Ingeson Ltda., 6-27 Calle 22, Bogota, Tel: 43-60-44. Pres.: Manuel Drezner.
Chief product: Duplicators & winders

● **accessories manufacturers**

Fonoarte Ltda., Apdo. Aereo 83-03, 41-20 Calle 10, Medellin, Tel: 46-69-07. Gen. Mgr.: Francisco J. Correa C.

Product: Cleaners, cloths & brushes, head cleaners & demagnetizers, needles.

Philips de Colombia SA (Industrias), Music Div., 51-39 Calle 13, Bogota, D.E. Tel: 60-06-00. Gen. Mgr.: Alfonso Escolar N.

Products: Carrying & storage cases, catalog servs., cleaners, cloths, brushes, head cleaners & demagnetizers.

Singer Prods. Cia. Ltda., 19-64 Carrera 10, Of. 703-5, Bogota, Tel: 81-24-74, 34-74-37. Cable: COREGNIS.
Product: Tape carrying & storage cases, tape catalog

servs., head cleaners & demagnetizers, needles, leader & splicing tape.

● **store fixtures & merchandising aids manufacturer**

Fuentes (Fabrica de Discos) Ltda., 13-223 Carrera 51, Medellin, Tel: 35-13-00. Cable: DISFUENTES Co-Pres. Pedro & Jose Maria Fuentes Estrada; Gen. Mgr.: Dr. Conrado Dominguez H.; Sales Mgr.: Jorge Gonzalez Botero; Int'l Mgr.: Javier Garcia Munoz.
Product: Record display racks.

● **jukebox title strip manufacturer**

Fuentes (Fabrica de Discos) Ltda., 13-223 Carrera 51, Medellin, Tel: 35-13-00. Cable: DISFUENTES Co-Pres. Pedro & Jose Maria Fuentes Estrada; Gen. Mgr.: Dr. Conrado Dominguez H.; Sales Mgr.: Jorge Gonzalez Botero; Int'l Mgr.: Javier Garcia Munoz.

COSTA RICA

Population: 2,010,000
Rate of exchange: \$1 (US) = 8.47 colon
Per capita income: \$899
Holidays: January 1, Easter Festival, April 1 (Battle of Rivas), May 1 (Labor Day), May 26 (National Revolution Day), July 25 (Annexation of Guanacosta), August 2 (Our Lady of Angels), September 15 (Independence Day), October 12 (Columbus Day), December 25 & all important Christian religious holidays
Records, record blanks & pre-recorded media imported from USA: 1977—\$73,193

● **record & tape manufacturers / distributors / importers**

Dideca (Discos de Centroamerica SA), Apdo. 6360, Edif. situado 50 varas al sur de la esq. de la Iglesia La Dolorosa, 1st fl., Apto. 1, San Jose, Tel: 21-92-19. Cable: RUSAF

Home office: Guatemala (see for labels)
 Indica (Industria de Discos Centroamericana) SA (IFPI), Apdo 4093, San Jose, Tel: 35-93-22. Dir. Guillermo Lopez, Gen. Mgr.: Eduardo Soto, A&R Mgr.: Luis N. Salas

Int'l branches: El Salvador, Distribuidora Salvadorena de Discos SA, Guatemala, Distribuidora Guatemalteca de Discos SA, Honduras, Nicaragua, Panama, Distribuidora Panamena de Discos SA

Labels: (Owned) Indica, (licensed) Art (USA), Audio Fidelity (USA), Billo (Venezuela), CBS (worldwide), Discoteca (Venezuela), Fonograma (Venezuela), Heriba (Bolivia), Lea (Panama), London (UK), Montilla (Spain), Music Hall (Argentina), Onix (Ecuador), Palacio (Venezuela), Peerless (Mexico), Seeco (USA), Sono Radio (Peru), TK (USA)
Int'l rep.: Worldwide (CBS)

● **music publisher**

Mundo Musical SA, Apdo. 4093, San Jose, Tel: 25-95-55.
Int'l firms represented: April (USA), Blue Seas (USA), Four Star (USA), Jac (USA), Lowery (USA), Melograf (Argentina), Mundo Musical (Brazil, Mexico)
Int'l reps.: Argentina (Melograf), Brazil (Mundo Musical), Mexico (Mundo Musical), USA (April)

● **services**

ASSOCIATION & PROFESSIONAL ORGANIZATION

Asociacion de Musicos & Compositores Costarricenses, Apdo. 4365, San Jose

DESIGN & ARTWORK PLATING, PROCESSING & PRESSING PLANT

PRINTER & LITHOGRAPHER RECORD PROMOTION

Indica (Industria de Discos Centroamericana) SA, Apdo. 4093, San Jose, Tel: 35-93-22

TAPE CUSTOM DUPLICATOR

Indica (Industria de Discos Centroamericana) SA, Apdo. 4093, San Jose, Tel: 35-93-22
Audio: 8-tr. cassette

● **accessories manufacturer**

Indica (Industria de Discos Centroamericana) SA, Apdo. 4093, San Jose, Tel: 35-93-22
Product: 45 rpm adapters.

CYPRUS

Population: 660,000.
 Rate of exchange: \$1 (US) = 0.37 Cypriot pound.
 Per capita income: \$1084.
 Holidays: January 1, January 6 (Epiphany), March 25 (Greek Independence Day), Good Friday, Easter Monday, April 14, August 15 (Independence Day), October 1, October 28 (OHI Day), October 29 (Turkish Republic Day), December 25, 26.

● record & tape manufacturer / distributor / importer

C B S UK Ltd., 30-34 Sophoulis St., Nicosia. Tel: 41251.
 Cable: COLRECORD. Branch Mgr.: Gregory Konyanlian.
 Labels: (Owned) CBS, Epic; (represented) CBS/Columbia (worldwide), Epic (worldwide), GRT (USA), MCA (USA), Minos (Greece), Panvox (Greece), Phonogram (Greece, Netherlands), Pickwick/Hallmark (UK), RCA (UK), Ricordi (Italy), United Artists (USA), Vanguard (USA).
 Int'l rep.: Worldwide (CBS).
 Epic, see CBS.

● services

RECORD PROMOTION

C B S Recs. Ltd., 30-34 Sophoulis St., Nicosia. Tel: 41251.
 Cable: COLRECORD. Branch Mgr.: Gregory Konyanlian.

TAPE CUSTOM DUPLICATOR

C B S Recs. Ltd., 30-34 Sophoulis St., Nicosia. Tel: 41251.
 Cable: COLRECORD. Branch Mgr.: Gregory Konyanlian.
 Audio: Cassette.

● supplies

TAPE, BLANK LOADED

C B S Recs. Ltd., 30-34 Sophoulis St., Nicosia. Tel: 41251.
 Cable: COLRECORD. Branch Mgr.: Gregory Konyanlian.
 Audio: Cassette.

● accessories manufacturer

C B S Recs. Ltd., 30-34 Sophoulis St., Nicosia. Tel: 41251.
 Cable: COLRECORD. Branch Mgr.: Gregory Konyanlian.
 Product: Cleaners, cloths, brushes, head cleaners & demagnetizers, leader & splicing tape.

● store fixtures & merchandising aids manufacturer

C B S Recs. Ltd., 30-34 Sophoulis St., Nicosia. Tel: 41251.
 Cable: COLRECORD. Branch Mgr.: Gregory Konyanlian.
 Product: Tape browser boxes, display racks.

CZECHOSLOVAKIA

Population: 15,000,000.
 Rate of exchange: \$1 (US) = 5.33 koruna.
 No. of homes with record players: 30% of total.
 Holidays: January 1, Easter Monday, May 1 (Labor Day), May 9 (Liberation Day), December 25, 26.

RECORDS:

Records sold domestically including imports (retail value): LP's 1978—6,537,000 units, \$59,682,810; 1977—5,696,000 units, \$50,419,960. Singles & EP's 1978—3,633,000 units, \$8,174,250; 1977—3,477,000 units, \$7,718,940.

Records imported from countries other than USA: 1978—380,000 units; 1977—300,000 units.

Records exported to countries other than USA: 1978—1,390,000 units; 1977—1,439,000 units.

Average retail price per record: LP's—\$9.13; singles—\$2.25.

Stereo sales: 95% of total.
 Record club sales: 20% of LP's.

Discounting: Rarely.

Type of distribution: Opus and Supraphon own a chain of specialized retail shops. Pantan also sells through these. This accounts for 75% of total sales. The remainder is done through the manufacturer-to-wholesaler-to-retailer system, with the importance of manufacturers' wholesale departments growing.

Type of promotion: Government-controlled radio plays an important role in the promotion of pop records. Supraphon Record Club, which also sells Opus and Pantan records, is important in the sale of classical and some jazz and rock records. Supraphon's monthly magazine "G" and the company's advertising in cinemas are notable means of promotion.

Jukeboxes: 2,500.

Billboard 1979-1980 International Buyer's Guide

TAPE:

Market: There still is a lively interest in cassettes, but local production is low due to insufficient production capacities, and there is little importing. Both 8-track cartridge and pre-recorded video tapes are practically unknown.

Pre-recorded tape sold domestically including imports (retail value): Cassette 1978—250,000 units, \$3,047,500; 1977—286,000 units, \$3,540,680. Open reel 1977—7,700 units, \$170,170.

Average retail price per tape: Cassette—\$12.19.

RADIO STATIONS:

No. of stations: 1 AM, 3 FM.
 Comment: One radio station programs pop music almost exclusively, another is devoted to classical music. Almost 50% of broadcast music derives from records, mostly of domestic production. Regional programs may serve as talent scouts for new pop talent.

TELEVISION STATIONS:

No. of channels: 2 government, 50% color (SECAM).
 Comment: Easy listening and middle-of-the-road music predominates, with some emphasis also placed on local brass band music. Jazz and rock are featured in rare special youth programs. Most programs are of local production, some imported from other Socialist countries.

IMPORT/EXPORT REGULATIONS:

Both license contracts and export/import deals are made with Socialist countries, importing of records from the West on a commercial basis is non-existent except for a minor amount of imports from India based on a governmental bilateral clearing agreement.

MARKET ANALYSIS:

The demand for records and cassettes is growing faster than the supply from local production. Efforts are being made to increase the production capacities, but this will take some time. A more immediate solution is increasing imports and custom pressing from other Socialist countries.

Classical music forms the backbone of exports to the West. Cooperation with Nippon Columbia allows for some digital recordings. In pop music, the middle-of-the-road (MOR) orientation is moving toward more contemporary sounds. There also is an active interest in disco music. Nevertheless, the best selling items are still MOR-styled recordings by Karel Gott (a local phenomenon: 11 years the "number one" artist without any serious competition) or popular brass bands. Both types are successfully exported to Germany. However, export deals are more frequently done on a license basis rather than on a finished product basis.

Lubomir Doruzka

● record & tape manufacturers / distributors / importers

Artia (Foreign Trade Corp. for the export & import of cultural commodities), Ve Smeckach 30, Prague 1. Tel: 246-284/392. Cable: ARTIAGRAMO. Telex 121065. Pres. & Dir.: Ing. Miroslav Maruska; Ass't Dir.: Jirina Koncelikova; Sales Mgr.: Lubos Cmuchar. (All international licensing contracts are conducted in cooperation with Artia, sole exporter & importer of records).
 Labels: (Distributed—not licensed) Pantan, Supraphon.

Opus Recs. & Publ'g House (IFPI), Dunajska 18, 899 23 Bratislava. Tel: 532-41, 507-83, 531-57. Telex: 92219. Pres.: Dr. Ivan Stanislav; VP Bus. Affairs: Alexius Aust; VP A&R: Marian Jurik; Int'l Relations Dir.: Oldrich Horak. (Exported by Slovart).

Labels: (Owned) Opus; (licensed) Polygram group (worldwide), RCA (worldwide); (distributed—not licensed) Balkanton (Bulgaria), Deutsche (East Germany), EMI (India), Electrecord (Romania), Hungaroton (Hungary), Jugoton (Yugoslavia), Melodija (USSR), Pantan (Czechoslovakia), Polskie Nagrania (Poland), Polydor (India), Supraphon (Czechoslovakia).
 Int'l reps.: Worldwide (RCA) excluding Japan (Victor), Spain (Zafiro).

Pantan (Publ'rs of the Czech Music Fund), Ricni 12, 118 39 Prague 1. Tel: 538-151. (Distributed by Artia & Opus)
 Slovart Co. Ltd. (Foreign Trade Corp. for the import & export of cultural commodities), Gottwaldovo nam. 6, 805 32 Bratislava. Tel: 488-41, 407-14. Telex: 93394. Gen. Mgr.: Vladimir Micuda; Rec. Dept. Mgr.: Peter Hrozičik; Pub. Dept. Mgr.: Juraj Jurasek.

Supraphon (IFPI), Palackeho 1, 112 99 Prague 1. Tel: 262-562, 261-608. Dir.: Viktor Kasak; Music Dir.: Dr. Olga Sotolova; Comm'l Dir.: Vladimir Vobornik; Int'l Dept. Mgr.: Dr. Pavel Smolr. (Distributed by Artia & Opus)
 Labels: (Owned) Supraphon; (distributed) Opus, Pantan; (represented) Amiga (East Germany), Ariola (West Germany), Barclay (France), CBS (France, USA), EMI (UK), Eterna (East Germany), Jugoton (Yugoslavia), Melodiya (USSR), Motown (USA), Muza (Poland), Polydor (West Germany), Qualiton (Hungary), WEA group (USA).

Int'l reps.: Austria (Ariola), Belgium (Baltic), Brazil (Som), Denmark (Hede Nielsen), Finland (Discophon), France (Arabella), East Germany (Deutsche), West Germany (Ariola), Italy (Ricordi), Japan (Nippon Columbia), Mexico (Gamma), Norway (Disco), Spain (Discophon), Sweden (Electra), Switzerland (Ariola), UK (Rediffusion), USA (Qualiton).

● music publishers

Dilia (Theatrical & Literary Agency), Vysehradská 28, 128 24 Prague 2. Tel: 296-651. Mng. Dir.: Robert Jurak. (Sole representative for music-dramatic works in Czechoslovakia).

Opus Music Publ'g House, Dunajska 18, 899 23 Bratislava. Tel: 532-41, 507-83, 531-57. Telex: 92219. Pres.: Dr. Ivan Stanislav; VP Bus. Affairs: Alexius Aust; VP A&R: Marian Jurik; Int'l Relations Dir.: Oldrich Horak.
 Int'l firms represented: Page Full of Hits (UK), Rondor (Worldwide).
 Int'l reps.: Austria, Germany & Switzerland (Classical—Baerenreiter); British Commonwealth, Canada, Mexico, UK, USA (Wilson/DI).

Pantan (Publ'rs of the Czech Music Fund), Ricni 12, 118 39 Prague 1. Tel: 538-151.

Int'l reps.: Austria, Benelux, Germany, Switzerland (all Baerenreiter in Germany); Canada, Mexico, Philippines (all General Music in USA).

Supraphon, Palackeho 1, 112 99 Prague 1. Tel: 262-562, 261-608. Dir.: Viktor Kasak; Music Dir.: Dr. Olga Sotolova; Comm'l Dir.: Vladimir Vobornik; Int'l Dept. Mgr.: Dr. Pavel Smola.

Int'l firms represented: ATV (UK), Barclay (France), Chappell (West Germany), Francis Day & Hunter (West Germany), Dick James (UK), Intersong (West Germany), Ivan Mogull (USA), Claude Pascal (France), RAK (UK), Hermann Schneider (Austria), Tree (USA).

Int'l reps.: Austria (Baerenreiter in West Germany), Belgium (Baltic), Denmark (Hansen), France (Boosey & Hawkes), West Germany (Baerenreiter), Japan (Yamaha), Netherlands (Baerenreiter in West Germany), Norway (Harald Lyche), South America (Ricordi Americana), Sweden (Nordiska), Switzerland (Baerenreiter in West Germany), UK (Alfred Kalmus), USA (Boosey & Hawkes).

● services

ASSOCIATIONS & PROFESSIONAL ORGANIZATIONS

Association of Slovak Composers & Concert Artists, Sladkovicova 11, Bratislava. Tel: 33-794. Pres.: Eugen Suchon.
 Bratislavská Lyra (Int'l Pop Song Festival Bureau), Leningradska 5, Bratislava. Tel: 381-41, 349-48.
 Czech Music Fund, Besedni 3, 118 00 Prague 1. Tel: 530-546. Dir.: Vladimir Sevcik.

Dilia (Theatrical & Literary Agency), Vysehradská 28, 128 24 Prague 2. Tel: 296-651. Mng. Dir.: Robert Jurak.

Guild of Czech Composers & Concert Artists, Valdejskeho nam. 1, Prague 1. Tel: 531-814. Pres.: Lubomir Zelazny; Gen. Mgr.: Dr. Vaclav Kucera.

Music Information Centre of the Czech Music Fund, Besedni 3, 118 00 Prague 1. Tel: 530-546.

Pragokoncert (Czechoslovak Art & Entertainment Agency), Maltezske nam. 1, 118 13 Prague 1. Tel: 537-248, 539-676. Telex: 12181. Dir.: Dr. Frantisek Hrabal. (Exclusive agency for all Czech & international artists & performers).

Slovak Music Fund, Fucikova 29, 801 00 Bratislava. Dir.: Alojz Stuska.

Slovkoncert (Czechoslovak Artistic Agency), Leningradská 5, 890 36 Bratislava. Tel: 381-41, 382-16. Telex: 93485. Co-Dir.: Hammel Pavol. (Exclusive agency for all Slovak artists & performers).

LICENSING ORGANIZATIONS, MUSIC

O S A (Ochranný svaz autorský pro práva k dílu hudebnímu—Authors' Ass'n for Protection of Rights on Musical Works), Trida cs. armady 20, 160 56 Prague 6. Tel: 325-341. Cable: OSAUTOR. Gen. Mgr.: Oldrich Flosman. (Mechanical & performing rights). (Affiliated with BIEM, OISAC).

S O Z A (Slovenský Ochranný Zvaz Autorský), Zivnostenska 1, 883 27 Bratislava. Tel: 541-41, 557-96. Dir.: Andrej Gadus; Gen. Mgr.: Kristina Nemcova. (Mechanical & performing rights).

DENMARK

Population: 5,200,000.
 Rate of exchange: \$1 (US) = 5.28 kroner.
 Per capita income: \$6,245.
 Holidays: January 1, Maundy Thursday, Good Friday, Easter Monday, Store Bededag (Danish Public Holiday—fourth Friday after Easter), Ascension Day, Whitmonday, June 5 (Constitution Day), December 25, 26.

RECORDS:

Records sold domestically including imports (retail value): LP's 1977—4,203,622 units, \$34,000,000. Singles 1977—908,760 units, \$2,000,000.

Records, record blanks & pre-recorded media imported from USA: 1977—\$1,020,918.

Average retail price per record: LP's—\$8.21; singles—\$2.60.

No. of homes with record players: 1,180,000.

Stereo sales: 99% of total.

Quadraphonic sales: 0.1% of total.

Record club sales: 15% of total.

Discounting: Frequent.

Type of distribution: Manufacturer-to-retailer system predominates. There are two rack jobbers, the larger being owned by the five largest record companies. 80% of sales are through 600 retail shops; 11% through the rack jobbers; 9% through direct import.

Type of promotion: Radio and TV are the most important, followed by the two biggest national daily newspapers, which have regular information about the music business. Vi Unge (40,000 circulation), a monthly, and several very small papers cover the young music scene. One such small paper MM (10,000 circulation), covers the jazz and rock scene.

Jukeboxes: 8,000.

TAPE:

Market: 8-tr. is virtually non-existent while the sale of both

NADA MUSIC B.V. NEW DAYGLOW MUSIC B.V. RED BULLET PRODUCTIONS B.V.

FOR HITS IN/FROM HOLLAND

NADA MUSIC B.V.
NEW DAYGLOW MUSIC, B.V.
RED BULLET
PRODUCTIONS, B.V.

Alexanderlaan 2,
P.O. Box 231,
1213XS
HILVERSUM,
HOLLAND
Phone: 035-857841
Telex: 43956

pre-recorded/blank cassettes and auto/home cassette players is growing: 60% of Danish households or 1,225,000 people own cassette recorders. The sales of cassette recorders are still around 180,000 per year. The cassette market increased by 27% in 1977.
Pre-recorded tape sold domestically (retail value): Cassette 1977—3,592,294 units, \$24,000,000.
Average retail price per tape: Cassette \$6.83.

RADIO STATIONS:

No. of government 1 (1 AM & 3 FM channels).
Comment: Program 1: News & culture; Program 2: Culture, Program 3: News & stereo music (6am—2am). There are 2,000,000 radios in use.

TELEVISION STATIONS:

No. of channels: 1 government, 55% color.
Comment: Danmarks Radio is the only national channel, but 50% are able to see the two Swedish channels, 30% the three German stations, and 5% the one East German channel. There are 1.9 million TV's in use, half of them color models.

IMPORT/EXPORT REGULATIONS

There are no special regulations, but around 30% in tax and V.A.T. are added to the retail price of every record. 0075
Knud Orsted

● record & tape manufacturers/ distributors/importers

A M Import, Jaegergaardsgade 43, DK-8000 Aarhus C. Tel. (06) 12-32-04. Mng. Dir.: John Landerholm. (Importer/Exporter)

Abra Cadabra, see Metronome.
Adelkrone Music, PO Box 5, DK-2750 Ballerup Tel. (02) 97-08-90. Telex: 35342. Gen. Mgr.: Erik Lykke Jensen. Promo.: Karen Johansen. (Distributor/Importer)
Labels: (Imported) Cut-outs.

Agitpop, see Metronome.
Amar Recs., Strandlodsvej 85, DK-2300 Copenhagen S. Tel. (01) 59-12-00. Gen. Mgr.: Freddy Hansson. Sales Mgr.: Karsten Sommer.
Labels: (Owned) Amar, Sweet Silence.

Angel, see EMI.
Archiv, see Polydor.
Artist, see Ed. Wilhelm Hansen.
B A S F, see Badilin.
B B, see Oktav.

Badilin A/S (IFPI), Ved Stadsgraven 15, DK-2300 Copenhagen S. Tel. (01) 57-00-11. Telex: 16275. Label Mgr. Ejvind Breck; Sales Mgr.: Ole Norkaer; PR: Peter Moeller.

Home office: Germany, BASF.
Labels: (Owned) BASF, (distributed) Scan Folk; (licensed) Amadeo (Austria), Atom (Austria), Buk (UK), Buddha (USA), Cornet (Germany), Creole/Cactus (UK), Euronett (Norway), First Class (Germany), Four Leaf Clover (Sweden), Harmonia Mundi (France, Germany), Kama Sutra (USA), MPS (Germany), Marilla (Sweden), Punkt (Germany), Safari (UK), Splash (UK), Wind Mill (UK).

Blue Fox, see Montax.
Bumbo, see Per Meistrup.

C B S Recs. ApS (IFPI), Bogholder Alle 40, DK-2720 Vanlose. Tel. (01) 71-31-33. Telex: 27520. Gen. Mgr.: Soren Nissen; Sales Mgr.: Jon Bremerskov. Int'l A&R Gary Williams; Comp.roller Jorgen D. Larsen.
Labels: (Owned) CBS, Cupol, Embassy, Epic, Mona Lisa, Portrait; (licensed) A&M (UK, USA), Blue Sky, Caribou, Cleveland Int'l, Harmony, Horizon, Invictus, Jet, Kirshner, Lifesong, Monument, Odyssey, Okeh, Philadelphia Int'l, T, T-Neck, Tappan Zee (all USA), GTO (UK); (distributed—not licensed) Fagot, Ferry, Kong Paere, Mandragora, Medley, Stuk.

C F A, see FMS.

C S A Music ApS, Koebmagergade 59, DK-1150 Copenhagen K. Tel. (01) 11-10-15. Cable: CITAGENCY. Telex: 27204. Gen. Mgr.: Henning Schaedler.
Labels: (Owned) CSA, Collectors Classics; (distributed—not licensed) America (France), Arhoolie (USA), Baerenreiter (Germany), Biograph (USA), Black & Blue (France), Black Lion (UK), Blue Goose (USA), Blue Classics (USA), CRD (UK), Center (USA), Chant du Monde (France), Contour (UK), Fairmont (USA), Folkways (USA), Hallmark (UK), Harmonia Mundi (France), Herwin (USA), Jazz Anthology (France), Jazz Panorama (Sweden), Jazum (USA), Joker (Italy), Kicking Mule (UK), Muse (USA), Onyx (USA), Ophelia (Denmark), Rarities (UK), Rounder (USA), Saga (UK), Savoy (USA), 77 (UK), Supraphon (Czechoslovakia), Topic (UK), Vogue (France), Wergo (Germany), Windmill (UK), Yazoo (USA).

California, see Moerks.
Capitol, see EMI.
Circle, see Jacks.
Classics for Pleasure, see EMI.
Collectors Classics, see CSA.
Columbia, see EMI.
Crystal, see EMI.
Cupol, see CBS.
D G, see Polydor.
Dansk, see Sonet/Dansk.
Dansk Musik Antologi, see EMI.
Diplom, see Oktav.
Dita, see FMS.
Double Up, see EMI.
E M I (Electric & Musical Inds. Dansk-Engelsk) A/S (IFPI), Hoeffdingsvej 18, DK-2500 Valby-Copenhagen. Tel. (01) 30-67-11. Cable: GRAMMOPHONE. Telex: 16631. Mng. Dir.: Kurt Hviid Mikkelson; A&R Mgr.: Per Soerensen; Sales Mgr.: Ole Jersee; Labels Mgrs.: Cai Leitner, Kenneth Valet, Alan Dessau; Int'l Repertoire Mgr.: Jerry Ritz.
Labels: (Owned) Angel, Capitol, Classics For Pleasure, Columbia, Crystal, Double Up, EMI, EMI Int'l, Electrola,

Emidisc, HMV, Harvest, Hoerzu, Music for Pleasure, N-gram, Odeon, One Up, Parlophone, Pathe, Regal Zonophone, Seraphim, Starline; (licensed) Apple (UK), Arista (USA), Bell (UK), Blue Note (USA), Carrere (France), Casablanca (USA), Chisound (USA), Chocolate City (USA), Dansk Musik Antologi (Denmark), Ember (UK), Fantasy (USA), Gordy (USA), Grateful Dead (USA), Hitville (USA), Jet (USA), MAM (UK), MPL (USA), Magnet (UK), Milestone (USA), Motown (USA), Oasis (Germany), PDU (Italy), Parachute (USA), Passport (USA), Pickwick (USA), Polar (Sweden), Prestige (USA), Private Stock (UK), Prodigal (USA), Purple (UK), RAK (UK), Rare Earth (USA), Red Bus (UK), Roadshow (USA), Rocket (UK), Soul (USA), Sunset (USA), Tamlia (USA), Unicorn (UK), United Artists (USA); (distributed—not licensed) Barclay (France), Mariann (Sweden), Sveriges Radio (Sweden).

E M I Int'l, see EMI.
Electrola, see EMI.
Embassy, see CBS.
Emidisc, see EMI.
Epic, see CBS.
Exlibris, see Metronome.

F M S Focus Music, Vejlegardsvej 59, DK-2660 Brøndby Strand. Tel. (02) 54-05-25, 73-46-77. Mng. Dir.: Carsten Broesch; Prod. & Mktg. Co-ord. Aase Petersen.
Labels: (Owned) FMS; (licensed domestic) CFA, Dita, Nikolaj, Point, Roy Music, Wedo; (licensed foreign) Caprice (Sweden), Falcon (Germany), Rikskonsert (Sweden).

Fagot, see CBS.
Favorit, see Polydor.
Ferry, see CBS.
Fiasco, see Sonet/Dansk.
Fona Radio A/S, Marielundvej 28, DK-2730 Herlev. Tel. (01) 91-70-00. Sales Mgr.: J. Johansen.
Labels: (Owned) Fona, Vibe.

Fontana, see Phonogram.
Frode Herloev & Co., Borgergade 14, DK-1300 Copenhagen K. Tel. (01) 14-98-50. Cable: SELECTAHERLOEV. Pres.: Henning B. Petersen; Sales Mgr.: John Hansen. (Wholesaler/Importer)

Global Trading Recs. ApS, Stejthøjvej 17, DK-4400 Kalundborg. Tel. (03) 51-42-00. Telex: 44366. Dir.: L.M. Bagai. (Wholesaler)

Gold Label, see Per Meistrup.
Grammo Serv. A/S, Sandtoften 25, DK-2820 Gentofte. Tel. (02) 88-04-33. Gen. Mgr.: Jergen Seiero. (Importer, Rack Jobber as Music Rack A/S)

H M V, see EMI.
Hamlet Prod'n ApS (IFPI), Karlslunde Landevej 24, DK-2690 Karlslunde. Tel. (03) 15-22-24. Cable: TAJMERSHOW. Telex: 43140. Chief Exec.: Eugen Tajmer; Prod.: Allan Mortensen.

Wilhelm Hansen (Ed.), Gothersgade 9-11, DK-1123 Copenhagen K. Tel. (01) 11-78-88. Cable: MUSIK-HANSEN. Telex: 19912. Co-Pres.: Hanne & Lone Wilhelm Hansen; A&R: Svend Schat-Holm; Sales Mgr.: Allan Jeppesen. (Distributed by Metronome)
Labels: (Owned) Artist, Ed. Wilhelm Hansen
Int'l rep.: Norway (Artist, Norsk Musikforlag), Sweden (Artist, Nordiska).

Harvest, see EMI.
Heliodor, see Polydor.
Hoerzu, see EMI.
Hookfarm, Brohusgade 6, DK-2200 Copenhagen N. Tel. (01) 39-18-08. Chief Exec.: Michael Krosgaard.
Int'l reps.: Germany (ENJA, Scan), Norway (Polydor), Sweden (Sonet).

J K, see Kleinerts.
Jacks Recs., Nedergardsvej 48, DK-8200 Aarhus N. Tel. (06) 10-24-11. Pres. & Gen. Mgr.: Jack Fridthjof.
Labels: (Owned) Circle, Jacks, Selskab

K B Musik ApS, PO Box 66, DK-2730 Herlev. Tel. (02) 84-47-69. Gen. Mgr.: Klaus Soerensen; Promo.: Janni Jensen. (Importer/Exporter)

K M F, see Kleinerts.

K-tel Int'l (Denmark) ApS, Tempovej 22, DK-2750 Ballerup. Tel. (02) 65-12-42. Telex: 35342. Pres.: Philip Kives; Gen. Mgr.: Erik Adelkrone; Financial Controller: Bjoern Hartmann.

Home office: USA.
Labels: (Owned) K-tel; (licensed) Arrival (Sweden), Can't Stop Prod'ns (USA), Chart (Sweden), Chimo (UK), Commonwealth (Netherlands), ERA (USA), Highlight (UK), Ibis (France), Imperial (Canada), Lotus (UK), Prelude (USA).
Int'l reps.: Worldwide (K-tel).
Karussell, see Polydor.
Kleinerts Musik Forlag AS, Christian IX's Gade 7, DK-1111 Copenhagen K. Tel. (01) 12-34-32. Cable: MUSICKMF. Telex: 16600. Pres.: John Rasmussen. (Distributed by Metronome)
Labels: (Owned) JK, KMF. Play; (licensed foreign) Cream/Hi (USA), Xanadu (USA) (SEE ADVERTISE-MENT)

Kong Paere, see Medley & CBS.
Life, see Sonet/Dansk.
M V, see Montax.
Mandragora, see CBS.
Mascot, see Sonet/Dansk.
Medium, see Moerks.

Medley Recs. ApS, Skelmosevej 10, DK-2500 Valby. Tel. (01) 17-14-11. Chief Execs.: Poul Bruun, Michael Ritto; Press Officer: Kit Nielsen. (Distributed by CBS)
Labels: Kong Paere, Medley.

Per Meistrup Prod'ns, Artillerivej 40-3, DK-2300 Copenhagen S. Tel. (01) 57-09-10. Cable: MUSICABLE. Pres.: Per Meistrup; A&R: Tony Waldron.
Labels: (Owned) Bumbo, Gold Label, Ra, Rainbow.
Int'l rep.: Finland (Allstars).

Melody, see Polydor.
Mercury, see Phonogram.
Metronome Recs. A/S, Jydeholmen 15, DK-2720 Vanlose. Tel. (01) 71-28-11. Cable: METRORECORDS. Telex: 27204. Mng. Dir.: Peter Abrahamson; A&R: Olav Benneke.
Labels: (Owned) Metronome; (licensed) Asylum, Atco, Atlantic, Bearsville, Big Tree, Cotillion, Dark Horse, DiscReet, Elektra, Embryo, Hilltak, Nonesuch, Orbit, Pa-

ific, Paradise, Planet, RFS, Reprise, Scotti Bros., Sire, Swan Song, Warner Bros., Westbound, Whitfield, (all USA); Lighting, Radar, Real (all UK), Hexagon (France); (distributed—not licensed) Abra Cadabra, Agitpop, Ex Libris, Wilhelm Hansen, Kleinerts, Partner & Komp., Pentagon Prod'n, Quick, RECA.

Moerks Musikforlag (IFPI), Christian IX's Gade 7, DK-1111 Copenhagen K, Tel: (01) 12-34-32. Cable: MUSICKMF. Telex: 16600. Pres.: John Rasmussen.

Labels: (Owned) California, Medium, Triola; (licensed) Durium (Italy), Explosion (UK), Flora (Norway), Im Press (USA), Megafon (Sweden), Ranwood (USA), Reddiffusion (UK).

Mona Lisa, see CBS.

Montax, Bransagervej 4-6, DK-9491 Pandrup, Tel: (08) 24-76-77. Telex: 69868. Chm. Mogens Villadsen, Gen. Mgr.: Willy Soerensen, Sales Mgr.: Ejnar Johansen, Export Mgr.: Finn Jaffe.

Labels: (Owned) Blue Fox, MV, Queen, Stopp; (licensed) Alshire Int'l.

Int'l reps.: Norway (Montax), Sweden (Montax) (SEE ADVERTISEMENT)

Music for Pleasure, see EMI.

Music Rack A/S, Sandtoften 25, DK-2820 Gentofte, Tel: (02) 88-04-33. Mgr.: Jorgen Seiero (Rack Jobber, Importer as Grammo Serv. A/S)

Musikhuset, Algade 44, DK-4760 Vordingborg, Tel: (03) 77-08-37. Cable: CHRISMUSIC, Dir. & Gen. Mgr.: Einar Christiansen; Sales Mgr.: Erik Hansen.

Label: (Represented) Music Minus One (USA).

Negram, see EMI.

Hede Nielsen A/S (IFPI), Glentevej 70B, DK-2400 Copenhagen NV, Tel: (01) 19-33-00. Cable: HENIGRAM. Telex: 22621. Gen. Mgr.: Leif Risell; Sales Mgr.: Ole Jochimsen; Promo. Mgr.: Bengt Svan.

Labels: (Licensed) Aura (UK), Black Lion (UK), Buddha (USA), Camden (USA), Contempo (UK), Erato (France), Freedom (UK), Free Flight (USA), Gem (UK), Grunt (USA), Intercord (Germany), Janus (USA), Kama Sutra (USA), Logo (UK), Millennium (USA), Pickwick (UK), Playboy (USA), RCA (worldwide), Roadshow (USA), Salsoul (USA), Solar (USA), Supraphon (Czechoslovakia), Swedish Society Discofil (Sweden), Telear (Sweden), Transatlantic (UK), Victor (USA), Victrola (USA), Wind-song (USA).

Nikolaj, see FMS.

Odeon, see EMI.

Oktav Musik (IFPI), Lundely 12, DK-2900 Hellerup, Tel: (01) 61-10-44. Gen. Mgr.: Fru Ella Binderup; Music Adviser: George Swensson.

Labels: (Owned) BB, Diplom, Oktav, Zac.

One Up, see EMI.

Ophelia, see CSA.

Parlophone, see EMI.

Partner & Komp., see Metronome.

Pathe, see EMI.

Pengram, see Pentagram.

Pentagon Prod'n, see Metronome.

Pentagram Prod'n ApS, Gl. Kongevej 47-B, DK-1610 Copenhagen, Tel: (451) 22-70-44. Telex: 16600. Chief Exec.: Michael Hobbs; Gen. Mgr.: Klaus Soerensen; A&R Mgr.: Michael Bevert.

Labels: (Owned) Pengram, Pentagram, Rose; (licensed) Hillechien.

Philips, see Phonogram.

Phonogram A/S (IFPI), Emdrupvej 115A, DK-2400 Copenhagen NV, Tel: (01) 69-25-22. Telex: 19202. Mng. Dir.: Stefan Fryland. (Also see PolyGram).

Labels: (Owned) Fontana, Mercury, Philips, Vertigo; (licensed) Ace of Clubs (UK), Ace of Diamonds (UK), Ace of Hearts (UK), All Platinum (USA), Argo (UK), Baby (Germany), Beltona (UK), Biograph (USA), Chapter One (UK), Charisma (UK), Chess (USA), DJM (UK), Decca (UK), Deram (UK), Eclipse (UK), Emerald (UK), Ensign (UK), Haven (USA), Haworth (USA), Lansdowne (UK), London (UK), Mountain (UK), L'Oiseau Lyre (France), On Record (UK), Rex (UK), Rocket (UK), Tembo (UK), Threshold (UK), 20th Century (USA), Utopia (UK).

Pilot, see Royal.

Play, see Kleinerts.

Point, see FMS.

Polydor A/S, Emdrupvej 115A, DK-2400 Copenhagen NV, Tel: (01) 69-25-22. Telex: 19202. Gen. Mgr.: Hardy Larsen. (Also see PolyGram).

Labels: (Owned) Archiv, DG, Favorit, Heliodor, Karussell, Melody, Polydor, Resonance, Tip, Verve; (licensed) Barn (UK), Brain (Germany), Capricorn (USA), Walt Disney (USA), EG (UK), Hispavox (Spain), Karma (Germany), Kolob (USA), MCA (USA), MCA Coral (USA), MPS (Germany), Oyster (UK), Pablo (USA), Phil Spector Int'l (UK), RSO (UK), Ring-O' (UK), Spring (USA), Track (UK).

PolyGram Recs. A/S (IFPI), Emdrupvej 115A, DK-2400 Copenhagen NV, Tel: (01) 69-25-22. Telex: 19202. Mng. Dir.: Stefan Fryland.

Affiliates: Phonogram A/S, Polydor A/S.

Popic Prod'n, PO Box 1278, DK-2300 Copenhagen S, Tel: (01) 95-05-71. Dir.: O. Trosborg; Sales Mgr.: Otto Waldorf; A&R: Peer Ivan.

Portrait, see CBS.

Queen, see Montax.

Quick, see Metronome.

RECA Music Prod'n, Nykoebingvej 18, DK-4571 Grevinge, Tel: (03) 45-93-89. Dir.: Finn Reiner; Gen. Mgr.: Ole Steen Pedersen; Sales Mgr.: Carl C. Dalgaard. (Distributed by Metronome)

Labels: (Owned) RECA; (distributed—not licensed) Bestseller (Belgium), Jerome (Sweden), SMA (Sweden), Sounds Superb (Belgium).

Int'l reps.: Austria (Scan), Belgium (Bestseller, Scan), Germany (Scan), Netherlands (Scan), Norway (Metronome), Sweden (Metronome, SMA), Switzerland (Scan).

Ra, see Per Meistrup.

Rainbow, see Per Meistrup.

Regal-Zonophone, see EMI.

Remi Music, Hedeparken 179, DK-2750 Ballerup, Tel: (02) 65-06-92. Pres.: Rene Gøsvig.

Label: (Owned) Remi.

Resonance, see Polydor.

Rose, see Pentagram.

Royal (Forlaget), Kronprinsens Gade 7, Copenhagen.

Home office: Sweden, Pilot Music AB.

Labels: (Owned) Pilot; (licensed) Green Tree, Heart Warming, Impact, Lamb & Lion, Manna (all USA).

Roy Music, see FMS.

S A C Audio ApS, Høllerupvej 78, DK-2900 Hellerup, Tel: (01) 62-00-55. Pres.: Sven Carl.

Labels: (Distributed—not licensed) Century (USA), Crystal Clear (USA), Salisbury (Canada), Sheffield (USA), 2000 bc (USA).

Scan Folk, see Badiin.

Selskab, see Jacks.

Seraphim, see EMI.

Soe Høeyem A/S, Alhambravej 12, DK-1826 Copenhagen V.

Label: (Represented) Denon PCM (Japan).

Sonet/Dansk Grammofon A/S (IFPI), St. Kongensgade 40, DK-1264 Copenhagen K, Tel: (01) 12-01-12. Cable: DANRECORD. Telex: 15252. Mng. Dir.: Henning Schaedler; Gen. Mgr. & A&R: Paul Bach.

Labels: (Owned) Fiasco, Life, Mascot, Sonet, Storyville; (licensed) America (France), Amigo (Sweden), Beserky (USA), Bronze (UK), Caroline (UK), Chiswick (UK), Chrysalis (UK), Frituna (Sweden), Grand Prix (Sweden), Island (UK), Kicking Mule (UK), Musidisc (France) Pye (UK), Roulette (USA), Savoy (USA), Sonet (UK), Sun (USA), Virgin (UK), Vogue (France).

Int'l reps.: Austria (Teldec), Belgium (Musidisc), Finland (Scandia), France (Musidisc), Germany (Teldec), Japan (Teichiku), Netherlands (Sound Prods.), Norway (Aner Bendiksen), Sweden (Sonet), Switzerland (Teldec), UK (Musidisc), USA (Moss Prod'n).

Starbox ApS (IFPI), Store Kongensgade 40, DK-1264 Copenhagen K, Tel: (01) 12-01-12. Cable: STARBOX. Telex: 15252. Pres. & Gen. Mgr.: Johnny Reimar; Admin. Mgr.: Gerhard Rehling, A&R Mgr.: John Ertlov; PR Mgr.: Birgit Jochimsen. (Distributed by Sonet/Dansk)

Labels: (Owned) Starbox, Superstar.

Starline, see EMI.

SteepleChase Recs. ApS (IFPI), Rosenvaengets Alle 5, DK-2100 Copenhagen O, Tel: (01) 26-01-44. Cable: STEEPRECORDS. Pres. & Mng. Dir.: Nils Winther; Sales Mgr.: Per Hermansen; Booking & Promo Mgr.: Mihoko Maruno.

Labels: (Owned) SteepleChase; (distributed—not licensed) Attlaxeras (Sweden), Black Saints (Italy), Circles (Germany), ECM (Germany), ENJA (Germany), Emanem (UK), Japo (Germany), Phoenix (USA), Queen Disc (Italy), Sackville (Canada), Spotlite (UK), Timeless (Netherlands), Watts (Germany).

Int'l reps.: Austria (Bellaphon), Belgium (Do Re Mi), Finland (Discophon), Germany (Bellaphon), Italy (Hi-Fi & Rec. Center), Japan (Nippon Phonogram, Shinsei, Sound Trading), Netherlands (Wim Wigt), Norway (Disc), Portugal (Dargill), Switzerland (Phonag), UK (Spotlite), USA (Rick Ballard, Rounder).

Stoa Grammofonselskab, Midtgaardsvvej 28, DK-8800 Viborg, Tel: 62-29-27.

Stopp, see Montax.

Storyville, see Sonet/Dansk.

Strike Grammofon AB, Mikkelbryggersgade 10, DK-1460 Copenhagen K, Tel: (01) 12-15-58.

Home office: Sweden.

Stuk, see CBS.

Superstar, see Starbox.

Sun Music ApS (IFPI), Vallekildevej 10, DK-4534 Hoerve, Tel: (03) 45-61-50. Pres.: Knud Thormod; Sales Mgr.: Bjarne Jensen; A&R Mgr.: Svend Christiansen.

Labels: (Owned) Sun, Tip Top; (licensed) Jingles (UK), Scranta (Sweden), Talent (Norway).

Sweet Silence, see Amar.

Telefunken, Roskildevej 8-10, DK-2620 Albertslund, Tel: 64-85-22.

Tempo Music of Scandinavia, Ved Gadekaeret 6, DK-3650 Olstykke, Tel: (03) 17-70-38.

Home office: USA.

Tip, see Polydor.

Tip Top Music, Vallekildevej 10A, DK-4534 Hoerve, Tel: (03) 45-69-90. Dir.: Bjarne Jensen. (Licensed to Sun)

Tony's Recs., PO Box 955, DK-2400 Copenhagen NV.

Label: (Represented) Delmark (USA).

Triola, see Moerks.

Vertigo, see Phonogram.

Verve, see Polydor.

Vibe, see Fona.

Vilfort Music Import, 29 Nyrnbergsgade, DK-2300 Copenhagen S, Tel: 57-66-55. Cable: VILMUSIMP. Telex: 16600. Mng. Dirs.: Per Victor Vilfort, Frank Obel; Ass't Mgr.: Kurt Wohler; Chief Accountant: Lizzie Poulsen.

Labels: (Distributed—not licensed) BBC (UK), Bis (Sweden), Cetra (Italy), Gold Star (UK), Hefty (UK), In-victa (UK), JVC (Japan), Lamme (Norway), Melodia (USSR), Rarities (UK), Rediffussion (UK), Schwann (Germany), Springboard (USA), Sydney Thompson (UK), Tara (Ireland), Wam (Germany).

Wado, see FMS.

Gustav Winckler A/S, Mosede By, DK-2670 Greve Strand, Tel: (02) 61-03-25.

Zac, see Oktav.

● music publishers

Stig Anderson Musikforlag A/S, Vesterbrogade 6D, DK-1620 Copenhagen V, Tel: (01) 12-16-09.

Home office: Sweden.

Ariston Music Inc., see EMI—United Artists.

Asa Music Co., see EMI—United Artists.

Avant Garde Music Publ'g Inc., see EMI—United Artists.

Barnegat Music Corp., see EMI—United Artists.

Bayberry Music Inc., see EMI—United Artists.

Beauiolais Music (NS), see EMI—United Artists.

Big Three Scandinavia, see EMI.

Blue Horizon Music Inc., see EMI—United Artists.

Buddah Music Inc., see EMI—United Artists.

Carleen Music Inc., see EMI—United Artists.

Carwin Music Inc., see EMI—United Artists.

One of Scandinavia's most efficient Publishing Groups
Music Publishing & Record Production

Kleinerts Musik Forlag as
Mørks Musikforlag
Acuff Rose Scandia as
JK Music
KMF Records

Director
John Rasmussen

IKIMIF

Christian IX's gade 7 · DK 1111 Copenhagen K · Denmark
Phone 45 1 12 34 32

Casasida, Skelmosevej 10, DK-2500 Valby. Tel: (01) 17-14-11. Chief Execs: Poul Bruun, Michael Ritto.
Int'l firm represented: Sonny Limbo (USA).
 Choral Art Publ'ns, see EMI—United Artists.
 Clown's Music Ltd., see EMI—United Artists.
 Reg Connelly Musik-Forlag A/S, see Ed. Wilhelm Hansen.
 Cuban Music Corp., see EMI—United Artists.
 Dacapo, Pilestræde 2, DK-1112 Copenhagen. Tel: (01) 15-95-49. Mgr. Sven-Erik Joergensen.
 Detail Music Inc., see EMI—United Artists.
 Dobo Publ'g Co., see EMI—United Artists.
 Dominion Mudee Music Ltd., see EMI—United Artists.
 EMI Music Publ'g (Denmark) A/S, Ny Oestergade 10, DK-1101 Copenhagen K. Tel: (01) 11-56-26. Gen. Mgr.: J. Joergensen, Prof. Mgr.: John Roger.
Home office: Sweden.

Int'l firms represented: Accord (Germany), Ambleside (UK), Anagon (Netherlands), Ardmore & Beechwood (Belgium, Mexico, South Africa, UK), Arion (Greece), Beechwood (Canada, USA), Belcas (New Zealand), Big Pig (UK), Black Swan (UK), Bowling Green (UK), Britten (UK), Castle (Australia), Central Songs (USA), Chanklin (UK), Coppa (UK), Coronado (UK), Donna (UK), EGO (Spain), EMI (Greece, Switzerland, UK), Elstree (UK), Episode (UK), Ferris (UK), First Floor (UK), Francis Day & Hunter (France, Germany, Scandinavia, UK), Genius (USA), Good Time (USA), Heart's Delight (USA), ITAIPU (Brazil), Initial (UK), KPM group (UK), Kipper Songs (UK), Macmelodies (UK), Manhattan (UK), Marouani (France), Peter Maurice (UK), Minta (USA), Mutual (UK), Nightingale (UK), Odeon (Argentina), Open Door (USA), Pathe (Far East), Pathe-Marconi (France), Pedro (UK), Pepe (UK), Keith Prowse (UK), Reynolds (UK), Saffron (UK), Saturday (USA), Cyril Shane (UK), Shanfid (UK), Shanklin (UK), Sunlight (UK), Supersongs (UK), Telescope (UK), Tip Top Songs (UK), Tomorrows Tunes (USA), Toshiba-EMI (Japan), Univista (UK), Varda (UK), Voce del Padrone (Italy), W&R (UK), World Wide (UK).
Int'l reps.: Argentina (Odeon), Australia (Castle), Belgium (Ardmore & Beechwood), Brazil (ITAIPU), Canada (Beechwood), Far East (Pathe), France (Francis Day & Hunter, Pathe-Marconi), Germany (Accord, Francis Day & Hunter), Greece (EMI), Italy (Voce del Padrone), Japan (Toshiba-EMI), Mexico (Beechwood), Netherlands (Anagon), New Zealand (Belcas), Spain (EGO), South Africa (Ardmore & Beechwood), UK (EMI), USA (Beechwood).

Esteem Music Corp., see EMI—United Artists.
 Leo Feist Inc., see EMI—United Artists.
 Sam Fox Publ'g Co. Inc., see EMI—United Artists.
 Francis, Day & Hunter Scandinavia ApS, see EMI.
 Fresco Music Inc., see EMI—United Artists.
 Gaetana Music Inc., see EMI—United Artists.
 Gate Music, see EMI—United Artists.
 Glasco Music, see EMI—United Artists.
 Golden Apple Music Inc., see EMI—United Artists.
 David Gomston, see EMI—United Artists.
 Groovesville/Conquistador, see EMI—Screen Gems-EMI.
 Wilhelm Hansen (Ed.), Gothersgade 9-11, DK-1123

Copenhagen K. Tel: (01) 11-78-88. Cable: MUSIKHANSEN. Telex: 19912. Co-Pres.: Hanne & Lone Wilhelm Hansen; Prof. Mgr.: Svend Schat-Holm.
Branches: DK-8000 Aarhus, Graven 4-6—DK-5000 Odense, Klaregade 15.

Int'l branches: England, Germany, Norway, Sweden, USA.

Int'l firms represented: Anglo-Continental (UK), Ars Polona (Poland), Associated (USA), Boosey & Hawkes (France, UK), Campbell Connelly & Co. (UK), Cesky Hudebni Fond (Czechoslovakia), J.&W. Chester (UK), Durand & Cie. (France), Faber (UK), Israel Music Institute (Israel), Kultura (Hungary), Moeck (Germany), Nordic Songs (Norway), Nordiska (Sweden), Norsk (Norway), Novello (UK), Oxford Univ. Press (UK), PWM (Poland), Schauer (UK), G. Schirmer (USA), Schott (Germany), Sonzogno (Italy), Union (Spain), Universal (Austria), Walton (USA).

Int'l reps.: Andorra (Boosey & Hawkes in France), Argentina (Gerard), Australia (James), Austria (Universal), Belgium (Boosey & Hawkes in France), Brazil (Irmaso Vitale), Canada (Leeds), France (Boosey & Hawkes), Italy (G. Ricordi), Luxembourg (Boosey & Hawkes in France), Mexico (Ricordi), Monaco (Boosey & Hawkes in France), Morocco (Boosey & Hawkes in France), Norway (Nordic Songs, Norsk), Portugal (Vidal Limona & Boceta in Spain), South Africa (Criterion), Spain (Vidal Limona & Boceta), Sweden (Nordic Songs, Nordiska), Tunisia (Boosey & Hawkes in France), UK (J.&W. Chester), USA (Alexander Broude, Magna, G. Schirmer, Walton), Uruguay (Gerard in Argentina).

Hastings Music Corp., see EMI—United Artists.
 Hip Trip Music Co., see EMI—United Artists.
 Hollywood Songs Inc., see EMI—United Artists.
 Homecoming Music/Summertime Music, see EMI—Screen Gems-EMI.

House of Cash, see EMI—Screen Gems-EMI.
 Imudico A/S Musikforlaget, see EMI.

Interior Music Corp., see EMI—United Artists.
 Justinian Music Inc. (NS), see EMI—United Artists.

Kama Rippa Music Inc., see EMI—United Artists.
 Kama Sutra Music Inc., see EMI—United Artists.

Kama Sutra Music Ltd., see EMI—United Artists.
 Kirola Musik & Grammfonopladeforlag, Kobmager 45, Copenhagen Tel: (01) 11-60-22.

Kleinerts Musik Forlag A/S, Christian IX's Gade 7, DK 1111 Copenhagen K. Tel: (01) 12-34-32. Cable: MUSICKMF. Telex: 16600. John Rasmussen.

Int'l firms represented: Acuff-Rose Scandia (USA), Mel Bay (USA), Belwin-Mills (UK, USA), Birdes (USA), Butter (USA), Churn (USA), Franco Colombo (USA), East Memphis (USA), Fi (USA), J. Fischer (USA), H.W. Gray (USA), Jac (USA), Edwin H. Kalmus (USA), Panache (UK), Hans Sikorski (Germany), Southern (USA). (SEE ADVERTISEMENT)

Buddy Knox Music, see EMI—United Artists.
 Kobenhavns Musikforlag se Viking, Frdborgg 46, Copenhagen. Tel: (01) 14-22-03.

Legacy Music, see EMI—Screen Gems-EMI.
 Lion Music Corp., see EMI—United Artists.

Per Meistrup Prod'ns, Artillerivej 40-3, DK-2300 Copenhagen 5. Tel: (01) 57-09-10. Cable: MUSICABLE. Pres.: Per Meistrup.

Mermaid Music, see EMI.
 Metric Music Co., see EMI—United Artists.

Miller Music Corp., see EMI—United Artists.
 Moerks Musikforlag A/S, Christian IX's Gade 7, DK-1111 Copenhagen K. Tel: (01) 12-34-32. Cable: MUSICKMF. Telex: 16600. Co-Pres.: Jorgen Kleinert, John Rasmussen.

Int'l firm represented: Reuter & Reuter (Sweden).
 Morro Music Corp., see EMI—United Artists.

Movietone Music Corp., see EMI—United Artists.
 Multitone A/S, Bogholder Alle 40, DK-2720 Vanlose. Tel: (01) 74-85-09. Gen. Mgr.: Harry Jensen.

Int'l firm represented: Multitone (Sweden).
Int'l rep.: Sweden (Multitone).

Nordic Songs ApS, see Wilhelm Hansen.
 Nordiska Teaterfoerlaget, see Wilhelm Hansen.

Oktav Music, Lundely 12, DK-2900 Hellerup-Copenhagen. Tel: (01) 61-10-44. Gen. Mgr.: Fru Ella Binderup. Music Advisor: George Swensson.

Pace Music Co., see EMI—United Artists.
 Parnes Music Ltd., see EMI—United Artists.

Paulanne Music Inc., see EMI—United Artists.
 Penn Francklin Music Corp., see EMI—United Artists.

Phonix Musikverlag GmbH, see EMI—United Artists.
 Pine Ridge Music Corp., see EMI—United Artists.

Post Music Inc., see EMI—United Artists.
 Powder Music Inc., see EMI—United Artists.

Presto Musikforlag, see Moerks.
 Ranbach Music, see EMI—Screen Gems-EMI.

Remi Music, Hedeparken 179, DK-2750 Ballerup. Tel: (02) 65-06-92. Pres.: Rene Gosvig.

Reynard Publ'g Co. Inc., see EMI—United Artists.
 Robbins Music Corp., see EMI—United Artists.

Rogers Music Ltd., see EMI—United Artists.
 St. Martin Music Co. Inc., see EMI—United Artists.

Samfred Music Inc., see EMI—United Artists.
 Samfundet til Udgivelse af Dansk Musik (Society for Publishing Danish Music), Valkendorfsgade 3, DK-1151 Copenhagen K. Tel: (01) 13-54-05. Chm.: Svend Erik Tarp. Gen. Mgr.: Kaethie Kirk.

Int'l reps.: Chester (UK), Eriks (Sweden), Eschig (France), Harassowitz (Germany), C.F. Peters (USA).

Sand B Music, see EMI—United Artists.
 Santiago Music Co. Inc., see EMI—United Artists.

Screen Gems/Colegems, see EMI—Screen Gems-EMI.
 Screen Gems-EMI Music AB, see EMI.

Skandinavisk Musikforlag A/S, see Wilhelm Hansen.
 So-Bur Music, see EMI—United Artists.

Sonet/Dansk Musik, Jydholmens 15, DK-2720 Vanlose. Tel: (01) 71-22-11. Mng. Dir.: Henning Schaeffer; Gen. Mgr.: Paul Bach.

Int'l firms represented: Black Sheep, Hawkana, Strawberry, Summerland (all UK).

Spectrum VII Music, see EMI—United Artists.
 Starbox ApS, Store Kongensgade 40, DK-1264 Copenhagen K. Tel: (01) 12-01-12. Telex: 15252. Pres.: Johnny Reimar; Pop Mgr.: Birgit Jochimsen.

SteepleChase Music, Rosenvaengets Alle 5, DK-2100 Copenhagen O. Tel: (01) 26-01-44. Chief Exec.: Nils Winther.

Sun Music ApS, Vallekildevej 10, DK-4534 Hoerlev. Tel: (03) 45-61-50. Pres.: Knud Thormod.

Tempo Musikforlag, see Moerks.
 Tender Tunes Inc., see EMI—United Artists.

Thorsing Musikforlag ApS, see Wilhelm Hansen.
 Tree Publ'g Co., see EMI.

U A Music Ltd., see EMI—United Artists.
 U A Music (Canada) Ltd., see EMI—United Artists.

Unart Music (Canada) Ltd., see EMI—United Artists.
 Unart Music Corp., see EMI—United Artists.

Unicorn Music Co., see EMI—United Artists.
 Unigold Music Inc., see EMI—United Artists.

United Artists Music Co. Inc., see EMI—United Artists.
 United Artist Musikforlag AB, see EMI.

United Artists Musik GmbH, see EMI—United Artists.
 University of Miami Music Publ'ns, see EMI—United Artists.

Waryn Musikforlag ApS, see Wilhelm Hansen.
 West Coast Music Publ'ns Co., see EMI—United Artists.

Willow Way Music, see EMI—United Artists.

● services

ASSOCIATIONS & PROFESSIONAL ORGANIZATIONS

Danish Composers' Society, Valkendorfsgade 3, DK-1151 Copenhagen K. Tel: (01) 13-54-05.

Danish Music Dealers' Ass'n, Frederiksberg Alle 29, Copenhagen V.

Danish Music Publ'rs' Ass'n, Gothersgade 9-11, DK-1123 Copenhagen K. Tel: (01) 11-78-88.

Den Danske Gruppe af IFPI, Dag Hammarskjoldts Alle 14, DK-2100 Copenhagen. Tel: (01) 12-97-65. Sec'y: Johan Schlueter.

Jazzcenter, Svennerupskov, DK-4683 Roseneide. Contact: Arvid Meyer.

Musikforlaeggerforeningen af 1972 (The Association of Danish Music Publ'rs of 1972), Gothersgade 9-11, DK-1123 Copenhagen K. Tel: (01) 11-78-88.

National Committee of the International Music Council, Raadhustr. 1, Copenhagen.

National Committee of the International Society for Contemporary Music, Montergade 6a, DK-1116 Copenhagen K.

S C A W C (Scandinavian Country & Western Corp.), PO Box 1278, DK-2300 Copenhagen S. Tel: (01) 95-05-71.

Society for Publishing Danish Music (Samfundet Til Udgivelse Af Dansk Musik), Valkendorfsgade 3, DK-1151 Copenhagen K. Tel: (01) 13-54-05. Chm.: Svend Erik Tarp. Gen. Mgr.: Kaethie Kirk.

Union of Danish Musicians, Vendersgade 25, DK-1363 Copenhagen K.

DESIGN & ARTWORK

Jesper Kilde Design, Havenej 2, DK-3060 Espergaerde.

Johnsen + Johnsen A/S, Aldersroegade 8, DK-2100 Copenhagen. Tel: (01) 29-86-86. Cable: DOUBLE-JOHNSEN. Mgr.: Borge Thorsted; Sales Mgr.: Helge Moller Hansen.

Notex Offset A/S, St. Kongensgade 63, DK-1264 Copenhagen K. Tel: (01) 11-97-00. (SEE ADVERTISEMENT)

LICENSING ORGANIZATIONS, MUSIC

Gramex, Gothersgade 103-4, DK-1123 Copenhagen K. Tel: (01) 11-95-00. Gen. Mgr.: Otto Lassen. (Performing rights only—records)

K O D A, Rosenvaengets Hovedvej 14, DK-2100 Copenhagen O. Tel: (45) 138-9702. Cable: INTERKODA. Gen. Mgr.: H. Lund Christiansen. (Performing rights only)

Nordisk Copyright Bureau, A.L. Drewsensvej 1, DK-2100 Copenhagen O. Tel: (01) 26-25-00. Cable: COPY-RIGHT. (Mechanical rights only)

PLATING, PROCESSING & PRESSING PLANTS

EMI (Dansk-Engelsk) A/S, Hoeffdingsvej 18, DK-2500 Valby-Copenhagen. Tel: (01) 30-67-11. Cable: GRAMMOPHONE. Telex: 16631. Mng. Dir.: Kurt Hvid Mikkelsen; Sales Mgr.: Ole Jersee.

United Rec. Mfg. Co., Frederikssundsvej 375, DK-2700 Copenhagen-Bronshoj. Tel: (02) 94-02-00. Mng. Dir.: Ib Sorensen. (Pressing only)

PRINTERS & LITHOGRAPHERS

Borch Tryk A/S, Kogevej 14, Ringsted. Tel: (03) 61-07-77. Pres.: P. Borch.

Johnsen + Johnsen A/S, Aldersroegade 8, DK-2100 Copenhagen. Tel: (01) 29-86-86. Cable: DOUBLE-JOHNSEN. Mgr.: Borge Thorsted; Sales Mgr.: Helge Moller Hansen.

Notex Offset A/S, St. Kongensgade 63, DK-1264 Copenhagen K. Tel: (01) 11-97-00. (SEE ADVERTISEMENT)

Printex, Oesterbergsgade 72, DK-2100 Copenhagen O. Tel: (01) 26-22-71.

RECORD PROMOTION

Danish Music Centre, Grundtvigsvej 27B, Copenhagen. Tel: (01) 21-00-99.

Popic Prod'ns, PO Box 1278, DK-2300 Copenhagen S. Tel: (01) 95-05-71. Contact: Otto Waldorf.

R E C A Music Prod'n, Nykoebingvej 18, DK-4571 Grevinge. Tel: (03) 45-93-89. Dir.: Finn Reinert; Gen. Mgr.: Ole Steen Pedersen; Sales Mgr.: Carl C. Dalgaard.

Scandinavian Sound Serv., Solhjoevaenget 32, DK-2750 Ballerup-Copenhagen. Tel: (02) 97-71-10.

Society for Publishing Danish Music (Samfundet Til Udgivelse Af Dansk Musik), Valdendorfsgade 3, DK-1151 Copenhagen K. Tel: (01) 13-54-05. Chm.: Svend Erik Tarp. Gen. Mgr.: Kaethie Kirk.

Sun Mgmt., PO Box 3, DK-8362 Aarhus-Hoerlev. Tel: (06) 13-17-66/78-09. Mgr.: Karl-Heinz Bartel.

Knud Thorbjornsen ApS, Gronnegade, Copenhagen. Tel: (01) 12-26-10. Owner: Knud Thorbjornsen.

Home office: Sweden, EMA-Telstar.

VISTA RECORDS

THE ONLY ONE DISTRIBUTOR,
 MANUFACTURER AND IMPORTER
 SPECIALIZING IN
 CLASSICAL AND RELIGIOUS
 LABELS IN THE NETHERLANDS
 (EVENTUALLY ALSO IN BELGIUM AND GERMANY)

WE ARE STILL INTERESTED
 IN THE REPRESENTATION
 OF MORE LABELS

Please send us your
 catalogue. Write us your
 export prices and terms.

For more details
 see our listing

VISTA RECORDS

FLAGELSTRAAT 11, 5306 AW BRAKEL
 HOLLAND. TEL. (04187) 1885
 DIR.: JOHN A. VIS;
 SALE MR.: FOKKE ANTONIDES

TAPE CUSTOM DUPLICATORS

F H C-Electronics, Landgreven 7, DK-1301 Copenhagen K. Tel (01) 14-69-93. Cable SELECTAHERLOEV. Pres Henning B. Petersen.
Audio: Cassette.
 Per Meistrup Prod'ns, Artillerivej 40-3, DK-2300 Copenhagen 5. Tel: (01) 57-09-10. Cable MUSICABLE. Pres. Per Meistrup, Prod'n Supervisor. Helle Hansen.
Audio: Cassette.
 Metronome Cassette A/S, Svanevej 12, DK-2400 Copenhagen NV. Tel (01) 81-13-33. Cable METROMUSIC. Telex. 27204. Mng. Dir. Bent Fabricius-Bjerre, Mgr. Joergen Holm
 Tocano Cassette ApS, Vallekildevej 103, DK-4534 Hoerve. Tel (03) 45-67-89. Gen. Mgr. Alex Frederiksen, Studio Mgr. Preben Graves.

● **supplies**

EMPTY CARTRIDGES, CASSETTES & REELS

Steen Hauerbach AS, Lyngbyvej 217, DK-2900 Hellerup-Copenhagen. Tel (01) 61-10-11. Cable MAGNETS-TEN. Telex: 16600. Pres. Steen Hauerbach; Gen. Mgr.: Allan Ramby; Sales Mgr. Jorgen Thybro. (Importer)
Audio: Cassette.

ENVELOPES & MAILERS

Borch Tryk A/S, Kogevej 14, Ringsted. Tel: (03) 61-07-77. Pres. P. Borch.
 Johnsen + Johnsen A/S, 8 Aldersrogade 8, DK-2100 Copenhagen. Tel (01) 29-86-86. Cable DOUBLE-JOHNSEN. Mgr. Borge Thorsted; Sales Mgr. Helge Moller Hansen

JACKETS

Borch Tryk A/S, Kogevej 14, Ringsted. Tel: (03) 61-07-77. Pres. P. Borch
 Knud Hansen, Hejrevej, Copenhagen.

**LABELS
POLYETHYLENE BAGS**

Borch Tryk A/S, Kogevej 14, Ringsted. Tel: (03) 61-07-77. Pres. P. Borch.
 Norlip, Princessegade 29A, DK-1422 Copenhagen K. Tel (01) AS 30-30

PROFESSIONAL TAPE SUPPLIES

E M I (Dansk-Engelsk) A/S, Hoeffdingsvej 18, DK-2500 Valby-Copenhagen. Tel (01) 30-67-11. Cable GRAMMOPHONE. Telex. 16631. Mng. Dir.: Kurt Hviid Mikkelsen; Sales Mgr. Ole Jersee.
Audio: ¼" & 2" hub & NAB reels.
Brand name: Emitape.
 Steen Hauerbach AS, Lyngbyvej 217, DK-2900 Hellerup-Copenhagen. Tel (01) 61-10-11. Cable MAGNETS-TEN. Telex: 16600. Pres. Steen Hauerbach; Gen. Mgr.: Allan Ramby; Sales Mgr. Jorgen Thybro. (Importer)
Audio: 2", 1" & ¼" master tape.
Video: 2", 1", ¾" cassette, ½" & ¼" tape.
Brand name: Ampex
 Per Meistrup Prod'ns, Artillerivej 40-3, DK-2300 Copenhagen 5. Tel (01) 57-09-10. Cable MUSICABLE. Pres. Per Meistrup.
Audio: 2", 1", ½", ¼" master tape.
Brand name: Rascal-Zonal.

RECORD PROCESSING MACHINERY

Ortofon Mfg. A/S, Mosedalvej 11B, DK-2500 Copenhagen-Valby. Tel (01) 46-24-22. Cable ORTOFON. Telex 27587. Technical Mgr. Ib Petersen; Gen. Mgr. Erik Rohmann; Prot. Export Mgr. Frits Nygaard; Financial Mgr. Niels Bornhoej
Chief product: Cutting heads & disk cutting systems

TAPE, BLANK LOADED & RAW

Agfa-Gevaert A/S, Farverland, DK-2600 Glostrup. Tel. 96-67-66. Telex: 19214. Mng. Dir.: H.W. Elbrecht; Sales Mgr.: E. Hendrup
Audio: Blank—compact-cassette, open reel; raw—cassette, broadcast, studio.
Video: Cassette, open reel
Brand names: Agfa Carat, Agfa Stereochrom, Agfa Videochrom
 Ampex, see Steen Hauerbach.
 Audio Magnetics, see Schmidt & Blessing.
 B A S F, see Badelin
 Badelin A/S, Ved Stadsgraven 15, DK-2300 Copenhagen S. Tel (01) 57-00-11. Cable BADILINAGENT. Telex 31400. Sales Mgr. Hans Noerland.
Audio: Cassette, open reel.
Video: 1" open reel, ¾" cassette, VCR, Betamax.
Brand name: BASF
 E M I (Dansk-Engelsk) A/S, Hoeffdingsvej 18, DK-2500 Valby-Copenhagen. Tel (01) 30-67-11. Cable GRAMMOPHONE. Telex 16631. Mng. Dir. Kurt Hviid Mikkelsen; Sales Mgr. Ole Jersee. (Blank only)
Audio: Cassette, open reel
Brand name: Emitape, Memorex.
 Fuji, see Steen Hauerbach.
 Steen Hauerbach AS, Lyngbyvej 217, DK-2900 Hellerup-Copenhagen. Tel (01) 61-10-11. Cable MAGNETS-TEN. Telex: 16600. Pres. Steen Hauerbach; Gen. Mgr.: Allan Ramby; Sales Mgr. Jorgen Thybro. (Importer)
Audio: 8-tr., cassette, open reel.
Video: 1" open reel, 1" cartridge, ¾" cassette, ½" EIAJ open reel, ½" Beta & VHS cassette.
Brand name: Ampex, Fuji.
 Per Meistrup Prod'ns, Artillerivej 40-3, DK-2300 Copenhagen 5. Tel (01) 57-09-10. Cable MUSICABLE. Pres. Per Meistrup
Audio: Cassette, open reel.
Brand names: Mastertape, Rascal-Zonal.

Memorex, see EMI
 Schmidt & Blessing A/S, Motorgangen 7-9, DK-2690 Karlslunde.
Audio: 8-tr., cassette, open reel.
Brand name: Audio Magnetics, SB.

TAPE DUPLICATING EQUIPMENT

E M I (Dansk-Engelsk) A/S, Hoeffdingsvej 18, DK-2500 Valby-Copenhagen. Tel (01) 30-67-11. Cable: GRAMMOPHONE. Telex 16631. Mng. Dir.: Kurt Hviid Mikkelsen; Sales Mgr. Ole Jersee.
Audio: 15" C60 pancakes.
Brand name: Emitape.
 Steen Hauerbach AS, Lyngbyvej 217, DK-2900 Hellerup-Copenhagen. Tel (01) 61-10-11. Cable MAGNETS-TEN. Telex: 16600. Pres.: Steen Hauerbach; Gen. Mgr.: Allan Ramby; Sales Mgr.: Jorgen Thybro. (Importer)
Audio: Cassette loaders.
Brand name: TTL.

TAPE PACKAGING & LABELING EQUIPMENT & SUPPLIES

K-tel Int'l (Denmark) ApS, Tempovej 22, DK-2750 Ballerup. Tel (02) 65-12-42. Telex 35342. Pres.: Philip Kives; Gen. Mgr. Erik Adelskrone.
Audio: Cassette boxes.

● **accessories manufacturers**

Audioscan, Oester Farimagsgade 28, DK-2100 Copenhagen O. Tel: (01) 76-80-00.
Product: Needles
Brand name: Pickering.
 Hagen-Olesen, Torpvej 56, DK-3050 Humlebaek. Tel: (03) 19-14-47.
Product: Needles.
Brand name: Stanton.
 Steen Hauerbach AS, Lyngbyvej 217, DK-2900 Hellerup-Copenhagen. Tel: (01) 61-10-11. Cable: MAGNETS-TEN. Telex: 16600. Pres.: Steen Hauerbach; Gen. Mgr.: Allan Ramby; Sales Mgr.: Jorgen Thybro.
Product: Tape carrying & storage cases, leader & splicing tape.
 K-tel Int'l (Denmark) ApS, Tempovej 22, DK-2750 Ballerup. Tel: (02) 65-12-42. Telex: 35342. Pres.: Philip Kives; Gen. Mgr. Erik Adelskrone.
Home office: USA.
Product: Record & tape carrying & storage cases, cleaners, cloths & brushes.
 Ortofon Mfg. A/S, Mosedalvej 11B, DK-2500 Copenhagen-Valby. Tel: (01) 46-24-22. Cable: ORTOFON. Telex: 27587. Technical Mgr.: Ib Petersen; Gen. Mgr.: Erik Rohmann; Prot. Export Mgr.: Frits Nygaard; Financial Mgr.: Niels Bornhoej.
Product: Needles.

● **store fixtures & merchandising aids**

Johnsen + Johnsen A/S, Aldersrogade 8, DK-2100 Copenhagen. Tel: (01) 29-86-86. Cable: DOUBLE-JOHNSEN. Mgr.: Borge Thorsted; Sales Mgr.: Helge Moller Hansen
Product: Record display racks.
 K-tel Int'l (Denmark) ApS, Tempovej 22, DK-2750 Ballerup. Tel: (02) 65-12-42. Telex: 35342. Pres.: Philip Kives; Gen. Mgr. Erik Adelskrone.
Home office: USA.
Product: Record browser boxes.

● **jukebox manufacturers**

Bally-automater A/S, Roedager Alle 133, DK-2610 Roedovre. Tel: (01) 70-10-87. Cable: BALCOP. Mng. Dir.: Kaj Harders; Sales Mgr.: Jesper Maslooe.
Brand names: Bally (USA), Midway (USA), NSM (Germany)
 Broedr. Joergensen, Rygaards Alle 104, DK-2900 Hellerup. Tel: (01) 29-75-11.
 Pan-Nordic Automatic A/S, Vesterbrogade 188, DK-1800 Copenhagen V. Tel: (01) 21-70-11.
 Skandinavisk Grammofoon Automat, Faborgvej 50, Himmellev, Roskilde. Tel: (03) 35-55-50.

DOMINICAN REPUBLIC

Population: 4,840,000.
Rate of exchange: \$1 (US) = 1 peso.
Per capita income: \$702.
Holidays: January 1, January 21 (Altigracia Day), January 26 (Day of Duarte), February 27 (Independence Day), Good Friday, Corpus Christi, May 1 (Labor Day), August 16 (Restoration of Independence), September 24 (Mercedes Day), December 25.

● **record & tape manufacturers / distributors / importers**

Continental de Discos SA, Zona Ind'l Herrera, Calle I, Esq. L, Santo Domingo. Tel: 566-0511. Cable: CONTIDIS SANTO DOMINGO. Pres.: Miguel Angel Antor Yamin;

Check out our offer, and your Financial Director will love you.



One of Scandinavia's most powerful printing companies

Design / Artwork / Typesetting / Graphic Film /
Color Separations / Offset Printing

Specialists in: Labels / Covers / Innersleeves /
Cassette Insert Cards / Posters

We export all over Europe

NOTEX OFFSET A/S
ST. KONGENSGADE 63
DK-1264 COPENHAGEN K
PHONE 01 - *11 97 00

Gen. Mgr.: Jose Antor Yamin; Sales Mgr.: Angel Antonio Alba B.; Promo. & Sales Rep.: Benjamin Bujosa M.

Labels: (Owned) Fonograma, Hermanos Antor; **(licensed)** CBS group (USA). **Int'l reps.:** USA (CBS), Venezuela (Fonorama, Hermanos Antor).

Discomundo SA, Calle El Conde 404, Santo Domingo. Tel. 685-2576

Labels: (Owned) Discomundo; **(licensed)** Gas (Mexico), Mini (USA), Teca (UCA)

Distribuidora Dominicana de Discos CporA, Conde 464, Santo Domingo. Tel. 682-4058/2538. Cable DISNADISCOS.

Labels: (Owned) Musicalia; **(licensed)** Alhambra (USA), Ansonia (USA), Borinquen (USA), CTI (USA), Casablanca (USA), Kubaney (USA), Movieplay (Spain), Musart (Mexico), Parachute (USA), Prelude (USA), Salsoul (USA), Seeco/Tropical (USA), TR (USA), Velvet (USA, Venezuela).

Fonograma, see Continental.

La Guarachita (Empresas), PO Box 375, Calle El Conde 108, Santo Domingo. Tel. 689-2545. Pres.: Rhadames Aracena; VP: Zunilda Read de Aracena.

Labels: (Owned) Guarachita, Ketty, Lucienne, Madalit, Zuni; **(licensed)** Audio Fidelity (USA), Billo (Venezuela), Decca (UK), Dorado (USA), Fuentes (Colombia), London (USA), Mariel (USA), Mary Lou (USA), Musicor (USA), Peerless (Mexico), Sonolux (Colombia), Sonus (Venezuela), Starbright (USA), Suaritos (USA), Top Hits (Venezuela).

Hermanos Antor, see Continental.

Ketty, see La Guarachita

Lucienne, see La Guarachita

Madalit, see La Guarachita

Musicalia, see Distribuidora Dominicana de Discos.

Productores Musicales CporA (Promuca), PO Box 174-9, Ave. Nunez de Caceres S/N, Santo Domingo. Tel. 567-1041. Cable IEMCA. Pres.: Matilde Hasbun Vda Selman; Gen. & Sales Mgr.: Ramon A. Blandino.

Salon de Estudios Mozart CporA, Calle El Conde 82, Santo Domingo. Tel. 682-2640. Mng. Dir.: A. Blandino Soto. **Labels: (Licensed)** Phonogram group.

Zuni, see La Guarachita.

● services

DESIGN & ARTWORK

La Guarachita (Fabrica de Discos), Autopista Duarte Km. 6½, Santo Domingo. Tel. 565-5717

Productores Musicales CporA (Promuca), PO Box 174-9, Ave. Nunez de Caceres S/N, Santo Domingo. Tel. 567-1041. Cable IEMCA. Pres.: Matilde Hasbun Vda Selman; Gen. & Sales Mgr.: Ramon A. Blandino.

PLATING, PROCESSING & PRESSING

PLANTS

La Guarachita (Fabrica de Discos), Autopista Duarte Km. 6½, Santo Domingo. Tel. 565-5717

Industrias Antor CporA, Zona Ind'l Herrera, Calle I, Esq. L, Santo Domingo. Tel. 566-8666. Cable ANTOR SANTO DOMINGO. Pres.: Miguel Angel Antor Yamin; Gen. Mgr.: Juan Dahajre; Prod'n & Sales Mgr.: Angel Antonio Alba (Plating & pressing only)

Productores Musicales CporA (Promuca), PO Box 174-9, Ave. Nunez de Caceres S/N, Santo Domingo. Tel. 567-1041. Cable IEMCA. Pres.: Matilde Hasbun Vda Selman; Gen. & Sales Mgr.: Ramon A. Blandino (Plating, processing & pressing only)

Productores Musicales CporA (Promuca), PO Box 174-9, Ave. Nunez de Caceres S/N, Santo Domingo. Tel. 567-1041. Cable IEMCA. Pres.: Matilde Hasbun Vda Selman; Gen. & Sales Mgr.: Ramon A. Blandino (Plating, processing & pressing only)

Productores Musicales CporA (Promuca), PO Box 174-9, Ave. Nunez de Caceres S/N, Santo Domingo. Tel. 567-1041. Cable IEMCA. Pres.: Matilde Hasbun Vda Selman; Gen. & Sales Mgr.: Ramon A. Blandino (Plating, processing & pressing only)

RECORD PROMOTION

Productores Musicales CporA (Promuca), PO Box 174-9, Ave. Nunez de Caceres S/N, Santo Domingo. Tel. 567-1041. Cable IEMCA. Pres.: Matilde Hasbun Vda Selman; Gen. & Sales Mgr.: Ramon A. Blandino

● supplies

JACKETS & LABELS

La Guarachita (Fabrica de Discos), Autopista Duarte Km. 6½, Santo Domingo. Tel. 565-5717.

● accessories

Productores Musicales CporA (Promuca), PO Box 174-9, Ave. Nunez de Caceres S/N, Santo Domingo. Tel. 567-1041. Cable IEMCA. Pres.: Matilde Hasbun Vda Selman; Gen. & Sales Mgr.: Ramon A. Blandino. **Product:** Record carrying & storage cases, needles.

● record & tape manufacturers / distributors / importers

Aguilar (Discos) SA, Apdo. 933, Velez 409 of 203, Guayaquil. Tel. 352-248. 516-208. Cable DISCFENIX. Pres. Dr. Luis Aguilar Maldonado; Gen. Mgr.: Carlos E. Aguilar Maldonado; Sales Mgr.: Fernando Aguilar Maldonado; Ass't Mgr.: Roberto Aguilar Maldonado

Labels: (Owned) Aguilar, Fam. Fenix, Folklore **(licensed)** IEMPSA (Peru), Ramy (USA), Virrey (Peru). **Int'l reps.:** Colombia (Sonolux, Preludio), Mexico (DCM), Peru (IEMPSA, Virrey)

Centenario Recs. Cia. Ltda., Av. Quito 4014 & El Oro, Guayaquil, Guayas. Tel. 346-069. Cable CENTERRECORDS. Gen. Mgr.: Medardo A. Silva; Sales Mgr.: Beatrice Lopez de Silva

Labels: (Owned) Centenario, Cosmos, Ecuatoriano, Mio, **(licensed foreign)** Orfeon (Mexico). **Int'l reps.:** Colombia (Chavez, Tropical), Peru (Cobos), USA (Dial), Venezuela (Promus)

Coloso, see Famoso

Cosmos, see Centenario

Ecuatoriano, see Centenario

Emporio Musical SA, Apdo. 1276, Lorenzo de Garaicoa 2803, Guayaquil. Tel. 514-174. Mgr.: Carlos Pino Plaza

Labels: (Represented) CBS, Columbia, Marifer

Estelar, see IFESA

Fadisa (Fabrica de Discos SA) (IFPI), Casillas 1339 & 2001, Kilometro 13 Via Los Chillos, Quito. Tel. 311-157

Labels: (Owned) Fadisa, Rondador, **(licensed)** Ariola (Spain), Ariola America (USA), Peerless (Mexico), RCA (USA), El Virrey (Peru), Zafiro (Spain)

Int'l reps.: El Salvador (Dicesa), Luxembourg (Inter Musicque), Peru (IEMPSA), Spain (Columbia), USA (Borinquen)

Fam, see Aguilar

Famoso Cia. Ltda. (Industrias) (IFPI), Capitan Ramos 623, Quito. Tel. 453-393. 248-033. Cable FAMOSO Telex 2580. Gen. Mgr.: Gonzalo Jimenez Posada; Sales Mgr.: Fausto Carrera

Labels: (Owned) Coloso, Famoso, **(licensed)** Barclay (France), Carosello (Italy), Cisine (Mexico), Codiscos (Colombia), Columbia (Spain), INS (Colombia), Infopesa (Peru), Melody (Mexico), Musart (Mexico), El Palacio de la Musica (Venezuela), Sicomerciana (Argentina), TR (USA), Top Hits (USA, Venezuela)

Int'l reps.: Chile (Quatro), Colombia (Codiscos), Guatemala (Dideca), Mexico (Melody), Peru (IEMPSA), USA (Top Hits), Venezuela (Suramericana del Disco)

Fediscos (Fabrica Ecuatoriana de Discos SA) (IFPI), Apdo. 856, Kilometro 7½ via La Costa, Guayaquil. Tel. 350-100/309/861. Cable FEDISCOS Telex 3606 Pres. Francisco Feraud-Aroca; Gen. Mgr.: Bronislaw Wierdak; Sales Mgr.: Mario Wierdak; Int'l Dept. Mgrs.: Lucila Feraud, Jacinto Aspizu, Jorge Macias

Labels: (Owned) Festival, Onix, Teen, **(licensed)** A&M (USA), Casablanca (USA), Coco (USA), Discomoda (Venezuela), Fermata (Brazil), Fuentes (Colombia), Motown (USA), Philips (Netherlands), Polydor Int'l (Germany), Sonolux (Colombia), Velvet (Puerto Rico), Velvet (Venezuela), Victoria (Colombia), WEA Int'l

Int'l reps.: Central America (Indica in Costa Rica), Argentina (TK), Brazil (Fermata), Chile (Philips), Colombia (Fuentes), Peru (IEMPSA), USA (Discolando), Venezuela (Unidas)

Fenix (Discos) SA, see Aguilar.

Festival, see Fediscos

Folklore, see Aguilar

I F E S A (Industria Fonografica Ecuatoriana SA) (IFPI), Apdo. 3885, Calicuchima 704, Guayaquil. Tel. 400-700, 401-930, 403-516. Cable IFESA Telex 04-3512. Pres.: Luis Pino Yerovi; Gen. Mgr.: Leticia Pino de Ortega; Mgr.: Augusto Villegas (Distributed by Emporio)

Labels: (Owned) Estelar, Lluvia de Estrellas, Sona **(licensed)** ABC (USA), Aquario (Canada), Arista (UK), Arista (USA), Baby (Italy), Capitol (USA), DJM (UK), Discos Latin (USA), EMI (UK), Fantasy (USA), Gamma (Canada, Mexico), Hispavox (Spain), Magnet (UK), Mericana (USA), Microfon (Argentina), Odeon (UK), PDU (Switzerland), Prelude (USA), Private Stock (UK), Salsoul (USA), Sono-Radio (Peru), Televis (Italy), Victor (Japan)

Lluvia de Estrellas, see IFESA

Mio, see Centenario

Mundo Musical Ltda., PO Box 6499, Quito. Tel. 242-912. Pres.: Bernardo Wright; Gen. Mgr.: Thomas Wright; Sales Mgr.: Ivan Puebla (Distributor/Importer)

Labels: (Licensed foreign) Continental (Brazil), PMA (Argentina), Trova (Argentina)

Onix, see Fediscos

Rondador, see Fadisa

Sona, see IFESA

Teen, see Fediscos

● services

ASSOCIATIONS & PROFESSIONAL ORGANIZATIONS

Casa de la Cultura Ecuatoriana, Apdo. 67, Quito. **Branches:** Cuenca—Guayaquil, Casilla 3542

DESIGN & ARTWORK

Fediscos SA (Fabrica Ecuatoriana de Discos), Kilometro 7½ via La Costa, Guayaquil. Tel. 350-309/861. Gen. Mgr.: Bronislaw Wierdak; Sales Mgr.: Mario Wierdak

I F E S A (Industria Fonografica Ecuatoriana SA), Apdo. 3885, Calicuchima 704, Guayaquil. Tel. 400-700, 403-516, 401-930. Pres.: Luis Pino Yerovi; VP: Jeronimo Aviles Alfaro; Gen. Mgr.: Leticia Pino de Ortega; Mgr.: Augusto Villegas.

LICENSING ORGANIZATION, MUSIC

S A D R A M (Sociedad Anonima de Representacion & Administracion Musical Cia. Ltda.), Apdo. 3456, Lorenzo de Garaicoa 2811. Tel. 523-676

PLATING, PROCESSING & PRESSING PLANTS

PRINTERS & LITHOGRAPHERS

Aguilar (Discos) SA, Km. 16 via a Daule, Guayaquil. Tel. 352-248. 516-208. Cable DISCFENIX. Pres. Dr. Luis Aguilar Maldonado; Gen. Mgr.: Carlos E. Aguilar Maldonado; Sales Mgr.: Fernando Aguilar Maldonado; Ass't Mgr.: Roberto Aguilar Maldonado (Plating processing & pressing only)

Fediscos SA (Fabrica Ecuatoriana de Discos), Kilometro 7½ via La Costa, Guayaquil. Tel. 350-309/861. Gen. Mgr.: Bronislaw Wierdak; Sales Mgr.: Mario Wierdak

I F E S A (Industria Fonografica Ecuatoriana SA), Apdo. 3885, Calicuchima 704, Guayaquil. Tel. 400-700, 403-516, 401-930. Pres.: Luis Pino Yerovi; VP: Jeronimo Aviles Alfaro; Gen. Mgr.: Leticia Pino de Ortega; Mgr.: Augusto Villegas

Audio: Cassette

I F E S A (Industria Fonografica Ecuatoriana SA), Apdo. 3885, Calicuchima 704, Guayaquil. Tel. 400-700, 403-516, 401-930. Pres.: Luis Pino Yerovi; VP: Jeronimo Aviles Alfaro; Gen. Mgr.: Leticia Pino de Ortega; Mgr.: Augusto Villegas

Audio: 8-tr., cassette

Labels: (Represented) EMI group (UK)

Labels: (Licensed foreign) Continental (Brazil), PMA (Argentina), Trova (Argentina)

Labels: (Licensed foreign) Continental (Brazil), PMA (Argentina), Trova (Argentina)

Labels: (Licensed foreign) Continental (Brazil), PMA (Argentina), Trova (Argentina)

Labels: (Licensed foreign) Continental (Brazil), PMA (Argentina), Trova (Argentina)

Labels: (Licensed foreign) Continental (Brazil), PMA (Argentina), Trova (Argentina)

Labels: (Licensed foreign) Continental (Brazil), PMA (Argentina), Trova (Argentina)

Labels: (Licensed foreign) Continental (Brazil), PMA (Argentina), Trova (Argentina)

Labels: (Licensed foreign) Continental (Brazil), PMA (Argentina), Trova (Argentina)

Labels: (Licensed foreign) Continental (Brazil), PMA (Argentina), Trova (Argentina)

Labels: (Licensed foreign) Continental (Brazil), PMA (Argentina), Trova (Argentina)

Labels: (Licensed foreign) Continental (Brazil), PMA (Argentina), Trova (Argentina)

Labels: (Licensed foreign) Continental (Brazil), PMA (Argentina), Trova (Argentina)

Labels: (Licensed foreign) Continental (Brazil), PMA (Argentina), Trova (Argentina)

Labels: (Licensed foreign) Continental (Brazil), PMA (Argentina), Trova (Argentina)

Labels: (Licensed foreign) Continental (Brazil), PMA (Argentina), Trova (Argentina)

Labels: (Licensed foreign) Continental (Brazil), PMA (Argentina), Trova (Argentina)

Labels: (Licensed foreign) Continental (Brazil), PMA (Argentina), Trova (Argentina)

Labels: (Licensed foreign) Continental (Brazil), PMA (Argentina), Trova (Argentina)

Labels: (Licensed foreign) Continental (Brazil), PMA (Argentina), Trova (Argentina)

Labels: (Licensed foreign) Continental (Brazil), PMA (Argentina), Trova (Argentina)

Labels: (Licensed foreign) Continental (Brazil), PMA (Argentina), Trova (Argentina)

Labels: (Licensed foreign) Continental (Brazil), PMA (Argentina), Trova (Argentina)

Labels: (Licensed foreign) Continental (Brazil), PMA (Argentina), Trova (Argentina)

Labels: (Licensed foreign) Continental (Brazil), PMA (Argentina), Trova (Argentina)

Labels: (Licensed foreign) Continental (Brazil), PMA (Argentina), Trova (Argentina)

Labels: (Licensed foreign) Continental (Brazil), PMA (Argentina), Trova (Argentina)

ECUADOR

Population: 7,310,000

Rate of exchange: \$1 (US) = 28.02 sucres.

Per capita income: \$577

Holidays: January 1, March 1, 2 (Carnival), Easter, May 1 (Labor Day), May 24 (Battle of Pichincha), July 24 (Birthday of Simon Bolivar), August 10 (Independence Day), October 9 (Guayaquil Independence), October 12 (Columbus Day), November 3 (Cuenca Independence), December 6 (Founding of Quito), December 25 & religious holidays.

Records, record blanks & pre-recorded media imported from USA: 1977—\$83,541.

EGYPT

Population: 38,070,000

Rate of exchange: \$1 (US) = 0.70 Egyptian pound

Per capita income: \$279

Holidays: April 11 (Moslem New Year), June 18 (Evacuation Day), July 23 (Anniversary of the Revolution), traditional Christian & Mohammedan holidays

● record & tape manufacturers / distributors / importers

Sono Cairo Audio Video Co. (IFPI), Maspero TV Bldg., Kornish El Nil St., Cairo. Tel. 754-809. 749-311. Bd. Chm. Taha Nasr; Gen. Mgr.: Mohamad Gomaa; Comm'l Mgr.: Michel Gerges

Int'l reps.: Austria, Canada, Switzerland, Tunisia, USA, Common Market (all Cofinex), Greece (EMI Greece), Kuwait (Buzed Phone), Libya (El Torky), Morocco (Afrassia)

Michael Yacoumopoulos, 28 Saad Zaghloul, Alexandria. Tel. 805-934. Cable YALOS. Owner: Michael Yacoumopoulos; Sales Mgr.: George Yacoumopoulos (Distributor/Importer)

Branches: Alexandria, 9 Stamboul St.—Cairo, 24 Soliman Pacha

Labels: (Represented) EMI group (UK)

● services

DESIGN & ARTWORK

PLATING, PROCESSING & PRESSING PLANT

PRINTER & LITHOGRAPHER

RECORD PROMOTION

Sono Cairo Audio Video Co., Maspero TV Bldg., Kornish El Nil St., Cairo. Tel. 754-809. 749-311. Bd. Chm. Taha Nasr; Gen. Mgr.: Mohamad Gomaa; Comm'l Mgr.: Michel Gerges

EL SALVADOR

Population: 4,120,000.

Rate of exchange: \$1 (US) = 2.50 colon.

Per capita income: \$382.

Holidays: January 1, Good Friday, Easter Sunday, May 1 (Labor Day), June 29, 30 (Bank Holidays), Fiesta (July-August), Worker's Day, September 15 (Independence Day), October 12 (Columbus Day), November 1 (First Cry for Independence), December 25, 30, 31.

Records, record blanks & pre-recorded media imported from USA: 1977—\$102,553.

● record & tape manufacturers / distributors / importers

Boni Discos, Apdo. (06) 1393, Blvd. del Ejercito Kilometro 5, San Salvador. Tel: 27-15-93, 27-05-20. Gen. Mgr. & Int'l Affairs: Manuel Lombardo Aguilar, Exec. Mgr.: Ana Enriqueta Aguilar, Promo. & Sales Mgr.: Fabio Alonso Aguilar.

Dicesa (Discos Centroamericanos SA) (IFPI), Apdo. 847, Blvd. del Ejercito Nacional Kilometro 5, Soyapango. Tel: 27-08-55. Pres.: Jose Antonio Hutt; Sales Mgr.: Alejandro Hutt; Opns. Dir.: Eduardo Hutt.

Int'l branches: Costa Rica, Honduras (Representante de Padisco en Honduras, Callejon Castillo Barahona 1219, Tegucigalpa), Nicaragua, Panama, Discos de Panama. Labels: (Licensed) Amanecer Del 76 (Spain), Atlantic (USA), Delphine (France), Disneyland (USA), Elektra/Asylum/Nonesuch (USA), Gas (Mexico), IEMPSA (Peru), Pye (UK), RCA (USA), Sonolux (Colombia), Trova (Spain), Warner Bros. (USA), Zafiro (Spain). Int'l reps.: Colombia (Sonolux), Mexico (Gas), USA (Taurus Sound), Venezuela (Sono-Vent).

Dideca, see Musi Centro. Distribuidora Salvadoreña de Discos SA, Apdo. (06) 960, San Salvador. Tel: 24-11-84, 24-38-46. Pres.: Eduardo Soto; Gen. Mgr.: Jose M. Chavarria. Home office: Costa Rica, Indica (see for labels).

Indica, see Distribuidora Salvadoreña de Discos SA. Mercado de Discos, Apdo. (06) 1393, Blvd. del Ejercito Kilometro 5, San Salvador. Tel: 27-15-93, 27-05-20. Exec. Mgr.: Ana Magdalena de Aguilar. (Importer/Distributor)

Musi Centro, Apdo. (06) 111, 47 Avda. Sur, 118, San Salvador. Tel: 23-02-40, 23-78-98. Cible: MUSICENTRO. Gen. Mgr.: Rene Fuentes, Promo. Dir.: Wilfredo Fuentes. Home office: Guatemala, Dideca (see for labels).

● music publisher

Edicesa (Ed. Centroamericana SA), Apdo. (06) 847, Blvd. Ejercito Nacional Kilometro 5, Soyapango. Tel: 27-08-55. Pres.: Jose Antonio Hutt; Exec. Dir.: Alejandro Hutt. Int'l firms represented: Brambila (Mexico), Jaguare (Brazil), Mexicana de Musica (Mexico), Sono-Inter (Colombia). Int'l reps.: Colombia (Sono-Inter), Mexico (Mexicana de Musica).

● services

PRESSING PLANT

Estudio de Grabaciones e Impresiones SA de CV (EGEISA), Apdo. (06) 847, Blvd. Ejercito Nacional Kilometro 4½, San Salvador. Tel: 27-08-55. Pres.: Jose Antonio Hutt.

PRINTERS & LITHOGRAPHERS

El Bonito (Graficos), Apdo. (06) 1393, Blvd. del Ejercito Kilometro 5, San Salvador. Tel: 27-15-93, 27-05-20. Gen. Mgr.: Fabio Aguilar Murcia. (Lithographer)

FINLAND

Population: 4,757,457.

Rate of exchange: \$1 (US) = 4.00 markka.

Per capita income: \$6,875.

No. of homes with record players: 500,000.

Holidays: New Year's Day, Epiphany, Good Friday, Easter Monday, May 1 (Labor Day), Ascension Day, Whitmonday, Midsummer Day, All Saints' Day, December 6 (Independence Day), December 25, 26.

RECORDS:

Records sold domestically (IFPI member sales only; retail, including tax): 1978—2,037,000 units, \$17,880,000; 1977—2,347,000 units, \$18,236,000. EP's 1978—37,733 units, \$132,000; 1977—10,925 units, \$30,200. Singles 1978—396,000 units, \$990,000; 1977—451,430 units, \$1,010,000.

Records imported from USA (factory value, CIF): 1978—\$880,000; 1977—\$750,000.

Records exported to USA (factory value, FOB): 1978—\$12,540; 1977—\$12,300.

Records imported from countries other than USA (factory value, CIF): 1978—\$4,200,000; 1977—\$3,880,000.

Records exported to countries other than USA (factory value, FOB): 1978—\$463,000; 1977—\$483,000.

Billboard 1978-1980 International Buyer's Guide

Average retail price per record: Full-priced LP's—\$9.95;

EP's—\$3.75, singles—\$2.50.

Stereo sales: 99% of total.

Quadraphonic sales: 1% of total.

Record club sales: 10% of total.

Discounting: Frequent. The Aeaenilevytuottajat (IFPI) suggested retail prices were dropped on Jan. 1, 1977.

Type of distribution: Manufacturer-to-wholesaler-to-retailer system is becoming popular again with Finnscandia, EMI Finland, Discophon and Polarvox as leading distributors. Aeaenilevytuottajat ry (The Finnish Group of IFPI) accounts for some 60 to 65 per cent of the total record and pre-recorded tape sales in Finland. Rackjobbers are responsible for 40 per cent of retail sales inside Aeaenilevytuottajat. Some 30 to 40 per cent of Aeaenilevytuottajat sales are through conventional record retail outlets. Direct imports, dumping and pirate sales are major problems.

Type of promotion: Government-controlled radio and TV networks are most important. Jukeboxes and discoteques (nearly 200) are other useful outlets. Radio Luxembourg with its good medium wave reception is quite popular among teenagers. Three summer rock and pop festivals feature many international acts. Three well established pop magazines, Musa, Soundi and Suosikki with a total circulation of 225,000 monthly copies give good coverage on both international and local artists. Television advertising is rather popular, though very expensive. There is no radio advertising. Newspaper and magazine advertisements are used regularly.

Jukeboxes: 3,500.

TAPE:

Market: The sales ratio between records and pre-recorded tapes is 52 to 48 in favor of records. 8-track and open reel are now virtually non-existent. There are currently some 1,300,000 cassette recorder/players in consumer use. Most of these units are owned by teenagers, tax drivers and other people on the move. Gasoline service stations are important retail outlets. Video is still on a small scale. Some 4 million blank loaded cassettes, mainly C-60, were sold in 1978.

Pre-recorded tape sold domestically (IFPI; retail, including tax): Cassette 1978—1,830,500 units, \$15,573,500; 1977—2,214,672 units, \$17,762,000.

Pre-recorded tape imported from USA (factory value, CIF): 1978—\$108,390; 1977—\$179,000.

Pre-recorded tape exported to USA (factory value, FOB): 1978—\$1,435; 1977—\$2,350.

Pre-recorded tape imported from countries other than USA (factory value, CIF): 1978—\$1,915,000; 1977—\$1,763,000.

Pre-recorded tape exported to countries other than USA (factory value, FOB): 1978—\$247,000; 1977—\$243,300.

Average retail price per tape: Full-priced cassette—\$10.50.

RADIO STATIONS:

No. of government 3.

Comment: Program 1 is mainly spoken word, plays & topical shows. Program 2 is mostly popular, classical and jazz music with news and sports. Program 3 is Swedish language programming, available in coastal areas only. The share of music in the two Finnish language networks is about 60%, of which 30% is of domestic origin. Most musical programs, nonstop or with a DJ, are recorded. Live pop and rock concerts are rare.

TELEVISION STATIONS:

No. of channels: 2 government; 80% color (PAL).

Comment: Oy Yleisradio AB, the parliamentary controlled broadcaster, is working on two channels nationwide. Television 1 is solely on VHF, while television 2 operates on both VHF and UHF. A private commercial company, Oy Mainos-TV-Reklam AB, buys time and sells it to advertisers (maximum 15% per hour). Programming is diversified and usually of high quality, though good musical shows are rarities. Private CATV broadcasting companies are operating here and there.

IMPORT/EXPORT REGULATIONS:

There are no custom duties on imports from EFTA, United Kingdom, Denmark and the USSR. All imports, without regard to country of origin, bear an additional 2% surcharge. No licenses are needed, except for trading with Socialist Block countries. Exports are duty free.

MARKET ANALYSIS

1978 was a big disappointment for the Finnish industry. Demand for domestic product declined badly, resulting in a 15% drop in IFPI group sales. Two IFPI members, both greatly dependent upon domestic material, encountered serious financial troubles, with one eventually going bankrupt. All this seemed to be closely connected to the recession.

Nevertheless, last year also saw the beginning of several independent record companies, with most being modestly run "workshops" that specialized in Sex Pistols-influenced new wave artists or talent despised by major companies. New firms making their chart debut in 1978 included Levytuottajat, Poko Records and Pekani Musiikki.

Television advertising of records and pre-recorded tapes hit high gear as a result of the launching of K-tel Int'l (Finland) Oy in January. Dealing with foreign material only, the company reportedly sold over 300,000 units by the end of 1978. Finlevy and Scandia Musiikki, two pioneers of local television marketing, accepted the challenge by releasing many domestically compiled "foreign" tv-albums.

The first long tape pirate was caught last fall and will soon hear his sentence. Pirating is a serious problem and has prompted the music licensing organization TEOSTO and the local IFPI to begin an extensive search. It is estimated that one out of every ten pre-recorded cassettes sold in Finland is by some means dubious. Home taping is widespread and TEOSTO claims that composers and

artists are losing \$7.5 to \$10 million per year. Because local pressing plants can be easily controlled, however, record pirating is impossible. Kari Helopaltio.

● record & tape manufacturers / distributors / importers

A L R Musiikki Oy, c/o Hi-Hat Recs., Takomontie 1B, SF-00380 Helsinki 38. Tel: 556-501. Contact Tommi Liihala.

Aanitemussiikki Oy, Kahakya 8C, SF-02940 Espoo 94. Tel: 597-993.

Angel, see EMI.

Anuco, see Pekani.

Ape, see Finndisc.

Audiomark Oy, HitaajanKatu 5, 08100 Helsinki 81. Tel: (90) 782-011.

B A S F, see Mercantile Oy.

Blue Master, see PSO.

C B S Recs. Oy (IFPI), Hoylaamotie 18, Pitajankmaki, SF-00380 Helsinki 38. Tel: (90) 556-506. Gen. Mgr.: Antti Holma.

Labels: (Owned) CBS, Cupol, Embassy, Epic; (licensed) Blue Sky (USA), Caribou (USA), Monument (USA), Philadelphia Int'l (USA), Young Blood (UK); (distributed—not licensed) A&M (USA), TK (USA).

C-Myynti Oy, Box 1503, Hameenpuisto 33 A 1, SF-33211 Tampere 21. Tel: (931) 33-506. Pres. & Gen. Mgr.: Lasse Martinen.

Labels: (Represented) Belter, Clave, Gaviota, Hispavox, Impacto, Olympos (all Spain).

Capitol, see EMI.

Columbia, see EMI.

Concert Hall Society, Hameentie 157, Helsinki 56. Tel: (90) 790-022. Mng. Dir.: Harry Soderholm.

Label: (Owned) Concert Hall.

Cornet, see Mercantile Oy.

Cupol, see CBS.

Delta, see Finndisc.

Digelius Music Oy, Laivurinne 2, SF-00120 Helsinki 12. Tel: (90) 666-375. Gen. Mgr.: Ilkka Lehtinen. (Importer)

Label: (Distributed—not licensed) O-Records.

Digit, see Finnlevy.

Disco-Lux Oy, Ulvilaantie 5, SF-00350 Helsinki 35. Tel: 551-414.

Discophon Oy (AB) (IFPI), Lansiportti 4A, SF-02210 Espoo 21. Tel: (90) 880-022. Cable: DISCOY Telex (12) 2705. Mng. Dir.: Johan Vikstedt; A&R Mgr.: Narhi Majja; Sales Mgr.: Risto Kajanen.

Labels: (Licensed) ABC (USA), ABC-Impulse (USA), Buddah (USA), Erato (France), Flying Dutchman (USA), Grunt (USA), Mainstream (USA), Musica (Sweden), Polar (Sweden), RCA (USA), Salsoul (USA), Supraphon (Czechoslovakia), Swedish Society Discophil (Sweden), Telefunken (Germany), Telestar (Sweden), Viking (Sweden).

Discovox, see Fonovox.

EMI Finland AB (Oy) (IFPI), Arinatie 6 E, SF-00370 Helsinki 37. Tel: (90) 558-421. Cable: GRAMMOPHON Telex: (12) 2482. Mng. Dir.: Richard Lyttelton; A&R Mgr.: Raimo Henriksson; Gen. Sales Mgr.: Rolf Kronqvist.

Labels: (Owned) Angel, Capitol, Columbia, Electrola, HMV, Harvest, Odeon, Parlophone, Pathe, Regal, Starline; (licensed domestic) Love, Okay, (licensed foreign) AVI (USA), Air (UK), Arista (USA), Barclay (France), Blue Note (USA), Cactus (UK), Carrere (France), Casablanca (USA), Creole (UK), Ember (UK), EMG (UK), Fantasy (USA), Flamingo (Sweden), Four Leaf Clover (Sweden), Frituna (Sweden), Hungaroton (Hungary), MAM (UK), Magnet (UK), Marian (Sweden), Milestone (USA), Negram (Netherlands), PDU (Italy), Pickwick (USA), Platina (Sweden), Prestige (USA), Private Stock (USA), RAK (UK), Riviera (France), Rocket (UK), Rondo (Sweden), Stax (USA), Sunset (USA), Tamlam Motown (USA), Target (UK), Tors (Sweden), Tyfon (Sweden), United Artists (USA).

Electrola, see EMI.

Embassy, see CBS.

Epic, see CBS.

Fazerin Musiikkikerho AB (Oy) (Fazer Music Club) (IFPI), PL6, SF-00381 Helsinki 38. Tel: (90) 556-541. Telex: (12) 1738. Mng. Dir.: Pauli Leimio; Mktg. Mgr.: Seppo Lindqvist. (Distributor)

Label: (Owned) Suomalainen Musiikkikirjasto (Finnish Music Library).

Fennica, see Society of Finnish Composers.

Finlandia, see PSO.

Finndisc AB (Oy) (IFPI), Takomontie 3C, SF-00380 Helsinki 38. Tel: (90) 556-811, 553-162. Telex: (12) 2782. Mng. Dir.: Jaakko Salo; Gen. Mgr.: John Eric Westoe.

Label Mgr.: Robert Lindberg; Sales Mgr.: Georg Dahlstrom.

Labels: (Owned) Ape, Delta, Rondo; (licensed foreign) Ariola (Germany), MPA (Switzerland), O (Sweden).

Finn Gospel Oy, Roedbergsgatan 3, SF-00120 Helsinki.

Home office: Sweden, Pilot Music.

Labels: (Owned) Pilot; (licensed) Green Tree, Heart Warming, Impact, Lamb & Lion (all USA); (distributed—not licensed) Manna (USA).

Finnish Music Library, see Fazerin.

Finnlevy AB (Oy) (IFPI), PO Box 584, SF-00101 Helsinki 10; Takomontie 3, SF-00380 Helsinki 38. Tel: (90) 558-797. Telex: 12-2782. Bd. Chm.: John Eric Westoe.

Mng. Dir.: Hannu Stroem; Mktg. Dir.: Osmo Ruuskanen; Prod. Dir.: Kim Kuusi; PR Mgr.: Vesa Nuotio; Sales Mgr.: Timo Jokela.

Labels: (Owned) Digit, Finnlevy, Kraek, Rytmis, Savel, Shokki; Triola; (licensed) All Platinum (USA), Amadeo (Austria), Bis (Sweden), Capricorn (USA), Charisma (UK), Chess (USA), Columbia (Spain), DG (Germany), DJM (UK), Decca (UK), ECM (Germany), Ensign (UK), Fontana (Netherlands), h&h (USA), London (UK), MCA (USA), MGM (USA), Manhatt (USA), Manticore (UK), Melody (USSR), Mercury (USA), Metronome (Germany), Mountain (UK), Pablo (USA), Philips (Nether-

lands), Phil Spector Int'l (UK), Polydor Int'l (USA), RSO (UK), 20th Century (USA), UK (UK), Utopia (UK), Vertigo (UK), Walt Disney (USA).

Finnscaandia Musiikki Oy, Takomontie 1-3, SF-00380 Helsinki 38. Tel: 558-797. Mng. Dir. John Eric Westoe.
Note: Finnscaandia is an administrative company for Finnlevy, Finndisc, Finlandia, Fazerin, Levyypiste and Scandia.

Fonovox Recs., Uiskotie 10, SF-00950 Helsinki 95. Tel: 327-277. Mng. Dir. Henry Haapalainen.
Labels: (Owned) Discovox, Fonovox, Hitvox; (distributed—not licensed) Moondisc (Sweden).
Int'l rep.: Sweden (Radio Soppen).

Frog Music/Salo, Tuuri & Co., Jivisniemenaukio 2A6, 02260 Espoo 26. Tel: (90) 885-494. Telex (12)-3135. Chief Execs. Harri Salo, Gen. Gen. Mgr. Olli Pasonen. (Wholesaler/Importer)

Fuga Oy, Unioninkatu 28, SF-00100 Helsinki 10. Tel: (90) 631-181. Mng. Dir. Markku Nuoto.
Labels: (Owned) Fuga; (distributed—not licensed) Abbey (UK), CRD (UK), Claves (Switzerland), Da Camera (Germany), Fermat (Sweden), Harmonia Mundi (France), Keyboard (UK), Konsertikeskus (Finland), Organum (Finland), SFPP (France), Studio SM (France), Unicorn (UK), Wergo (Germany).

Gold Disc, see Levytuottajat.
 H M V, see EMI.
 Harmonia Mundi, see Mercantile Oy.
 Harvest, see EMI.
 Hi-Hat (div. of Scandia-Musiikki Oy), Lapinlahdenkatu 21, SF-00180 Helsinki 18. Tel: (90) 648-738. Mgr. Lasse Norres.
 Historia, see Sauna.
 Hitvox, see Fonovox.
 Indigenous Recs., c/o Nils-Erik Valkeapaa, SF-99470 Karasuvanto.
 J & J Kustannus Oy, Kammerintie 4B, 00750 Helsinki 75. Tel: 365-719. Mgr. Jarmo Jylha.
 J P Musiikki Oy, Kammerintie 4B, SF-00750 Helsinki 75. Tel: 365-719. Mng. Dir. Erkki Puumalainen.
 Jack-Off, see Original.
 K-tel Int'l (Finland) Oy, Hameentie 4A, 00530 Helsinki 53. Tel: 739-455. Telex (12) 3438. Gen. Mgr.: Timo Fleming.
Home office: USA.
 Karas-Sana Oy, Pursimiehenkatu 26 I, SF-00151 Helsinki 15. Tel: (90) 650-655. Cable LOGOS. Pres. Mauri Tiilikainen; Gen. Mgr.: Bruno Salo, Sales Mgr.: Olli Johansson.
Label: (Owned) Sana Ja Savel.
 Karva-levyt, Box 124, SF-48101 Kotka 10.
 Kirjastopalvelu Oy, (Library Servs. Ltd.), Museokatu 18, SF-00100 Helsinki 10. Tel: (90) 44-11-01. Mng. Dir.: Timo E. Karvinen. (Distributor)

Kiss, see Polarvox.
 Koivu, see Sauna.
 Kompass Recs. Oy (IFPI), Hakolahdenkuja 4B, 00200 Helsinki 20. Tel: (90) 676-445. Pres. Christian Schwandt.
Labels: (Owned) Kompass; (distributed—not licensed) Rounder (USA).
Int'l reps.: Norway (Apollot), Sweden (Scranta).
 Konsertikeskus, see Fuga.
 Kotka, see Satsanga-Markkinointi.
 Kraek, see Finnlevy.
 Kustannuskeskus Paiva Oy, PO Box 10, SF-13101 Haemeenlinna 10. Tel: (917) 65-211. Dir. Risto Kotkavuori.
 Ladyland Oy, Vuolukiventie 11-L, 00710 Helsinki 71. Tel: 645-997. Mng. Dir.: Henrik Satohunsala. (Importer)

Levyypiste, AB (Oy), Takomontie 3, SF-00380 Helsinki 38. Tel: (90) 558-797. Telex 12-2782. Mng. Dir.: Leif Lindblad. (Wholesaler/Rack Jobber)

Levytuottajat Kustannus Oy, Sakkottajankatu 2F, 00520 Helsinki 52. Tel: (90) 143-244. Mng. Dir.: Dennis Livson; Prod. Mgr.: Veksi Salmi.
Labels: (Owned) Gold Disc, Mars, Rockin'.
 Lobo Recs., c/o Harri Saksala, Laaksoitie 9, SF-00750 Helsinki 75. Tel: 384-466.
Label: (Owned) Lobo.
 Love, see EMI.
 Lovberd, see Polarvox.
 M P S, see Mercantile Oy.
 M & T Prod'n Oy, Kaskenkatu 2B, 20100 Turku 10. Tel: (921) 330-323. Mng. Dir.: Matti Ruuhonen.
 Mars, see Levytuottajat.
 Mello-Musiikki, Valtakatu 3, SF-11110 Riihimäki II.
 Mercantile Oy, Mannerheimintie 12, SF-00100 Helsinki 10. Tel: (90) 6-09-81. Telex: (12)-416. BASF Label Mgr.: Veikko Laiho.
Labels: (Distributed) BASF, Cornet, Harmonia Mundi, MPS, Paradiso, Polyband.
 Mika Mika, see Satsanga.
 Minimusik Harry Aaltonen, Haapakyla, SF-03100 Nummela.
 Music Radio Promos., Kierretie 10, SF-01650 Vantaa 65. Tel: (90) 846-721. Dir.: Antti Marvia.
Int'l firm represented: Flashback Promos. (UK).
 Musiikkikonsultit Ky (Music Consultants Co.), Kauppakuja 12, 11100 Riihimäki 10. Tel: (914) 30944. Chief Exec.: Juhani Lahti.
 Nukku-Matti, see Polarvox.
 O-Records, see Digelius.
 Odeon, see EMI.
 Okay, see EMI.
 Olarin Musiikki Oy, Sarmalkalliontie 6 E 116, SF-02210 Espoo 21. Tel: 882-334. Mng. Dir.: Timo Narvainen.
Label: (Owned) Olarin Musiikki.
 Organum, see Fuga.
 Original Recs./Musiikkijussi Oy, Aleksis Kivenkatu 10, SF-33210 Tampere 21. Tel: (931) 38-124. Mgr.: Jukka Keltto; Prod'r & A&R: Jorma-Veikko Sappinen.
Labels: (Owned) Rokit; (licensed domestic) Jack-Off; (distributed not licensed) Free Red (UK).
 Osmo Kalpala (Oy)/Radio-Nord, Purpurinpolku 3-5, SF-00420 Helsinki 42. Tel: (90) 53-80-88.
Label: (Owned) Silversound.
 Otava, Uudenmaankatu 8-12, SF-00120 Helsinki 12. Tel: (90) 170-471.
 P L Recs. Oy, Ruoholahdenkatu 16B, SF-11080 Helsinki 18. Contact: Pentti Lasanen.
 P S O-Musiikki Oy (IFPI), Vaimontie 13, SF-00380 Helsinki

38. Tel: (90) 556-551. Cable: NEA. Mng. Dir.: Lauri Rokkanen; Gen. Mgr.: Arto Haekkinen; Sales Mgr.: Jarl Lund.
Labels: (Owned) Blue Master, Finlandia, Top Voice; (represented) Accordia (USA), Audio Fidelity (USA), Black Saint (USA), Butterfly (USA), Elite Special (Switzerland), MMO (USA), Moon Disc (Sweden), Muse (USA), Ri-Fi (Italy), Saga (UK), Vogue (France).

Paradiso, see Mercantile Oy.
 Parlophone, see EMI.
 Pathe, see EMI.
 Pekan Musiikki Oy, Aurakuja 5, SF-01630 Vantaa 63. Tel: 844-767. Mng. Dir.: Pekka Harkonen.
Label: Anuco.
 Pilot, see Finn Gospel.
 Poko Rekords, PO Box 104, 33201 Tampere 20. Tel: (931) 20-500. Telex: 22460. Mng. Dir.: Kari Helenius. (Also see Untor)

Polarvox Oy (formerly Reeb Oy), Annatie 2, Helsinki. Tel: (90) 554-454. Cable: JUVOX. Chief Exec.: Leena Juuranto; Sales Mgr.: Maija Enonen; Mgr.: Boerje Wiik.
Labels: (Owned) Kiss, Lovebird, Nukku-Matti, Polarvox; (licensed foreign) Charly (UK), Marilla (Sweden), Virgin (UK). (distributed—not licensed) DRG (USA), Impact (France), K-tel, Springboard (USA).
 Polyband, see Mercantile Oy.
 Polymusiikki Oy, Juhana Herttuantie 7 C, SF-00600 Helsinki 60. Tel: (90) 795-942. (Distributor)
 Prisma, see Ristin Voitto.
 Quality Recs. Oy, PO Box 216, SF-00531 Helsinki 53. Tel: (90) 603372. Pres.: Matti Laipio. Sales Mgr.: Jarmo Santavuori.
Labels: (Owned) Quality, (distributed—not licensed) Advent, Delmark, Yazoo (all USA), Route 66 (Sweden).
 Regal, see EMI.
 Ristin Voitto Ry, Sinikellonpolku, SF-01300 Vantaa. Tel: (90) 826-377. Pres.: Eino O. Vanhala; Music Dept. Mgr.: Seppo J. Jaervinen.
Label: (Owned) Prisma.
 Rockin', see Levytuottajat.
 Rokit, see Original.
 Rondo, see Finndisc.
 Ryimi, see Finnlevy.
 Sana Ja Savel, see Karas-Sana Oy.
 Satsanga-Markkinointi Oy, Pietarinkatu 5, SF-00140 Helsinki 14. Tel: (90) 628-311. Mng. Dir.: Jukka Kuoppamäki; Sales Mgr.: Sirpa Kuoppamäki.
Labels: (Owned) Kotka, Mika Mika, Satsanga.
 Sauna-Musiikki Oy (Sauna Music Co. Ltd.), Alkutie 41, 00660 Helsinki 66. Tel: (90) 748-559, 745-050. Cable: SAUNAMUSIC. Admin. Dir.: Anja Lehtinen; Gen. & Sales Mgr.: Rauno Lehtinen.
Labels: (Owned) Historia, Koivu, Sauna, Sex-6, Yes-Jees.
 Savel, see Finnlevy.
 Scandia-Musiikki Oy (Scandia-Music Co. Ltd.) (IFPI), Takomontie 1b, SF-00380 Helsinki 38. Tel: (90) 556-501. Cable: SCANDIAMUSIC. Telex (12)-1738. Bd. Chm.: John Eric Westoe, Mng. Dir.: Gugi Kokljuschkin; WEA Label Mgr.: Riva Karhula; Bronze, Chrysalis, Island, Pye & Sonet Label Mgr.: Perttu Rousi; Local Label Mgr.: Lasse Norres; Local A&R Mgrs.: Olli Heikkilä, Tommi Luuhala; Sales Mgr.: Georg Dahlstrom.
Labels: (Owned) Hi-Hat, Scandia; (licensed) Asylum (USA), Atco (USA), Atlantic (USA), Bronze (UK), Chrysalis (UK), Elektra (USA), Island (UK), Metronome (Sweden), Pye (UK), Reprise (USA), Sonet (Sweden, UK), Warner Bros. (USA).
Int'l reps.: Scandinavia (Metronome & Sonet in Sweden).
 Sex-6, see Sauna.
 Sexyvox Oy, Raitalahdentie 11 B, SF-00570 Helsinki 57. Tel: (90) 688-112.
 Shokki, see Finnlevy.
 Silversound, see Osmo Kalpala/Radio-Nord.
 Society of Finnish Composers, Runeberginkatu 15 A 11, SF-00100 Helsinki 10. Tel: (90) 445-589.
Label: (Owned) Fennica.
 Sokeain Keskusliitto ry, Maelaeläntie 52, SF-00510 Helsinki 51. Tel: (90) 718-622. Mng. Dir.: Pentti Lappalainen. (Cassette manufacturer for the blind)
 Sokos Sound, see Suomen Osuuskauppojen Keskuskunta.
 Sound Center Oy, Museokatu 8, Helsinki 10. Tel: (90) 440-301. Telex (12)-3135. Mng. Dir.: Richard E. Woods.
Labels: (Represented) Connoisseur (USA), Ensayo (Spain), Turnabout (USA), Vox (USA).
 Starline, see EMI.
 Suni Oy, Koulukatu 1, SF-53100 Lappeenranta 10. Tel: (953) 12-800. Cable: SUNI. Sales Mgr.: Viljo Suni. (Importer)

Suomalainen Musiikkikirjasto, see Fazerin.
 Suomen Osuuskauppojen Keskuskunta (SOK), Vilhonkatu 7, SF-00100 Helsinki 10. Tel: (90) 650-611. Cable: KESKUSKUNTA. (Distributor/Importer)
Labels: (Owned) Sokos Sound; (licensed) Alshire (USA), Falcon (Germany), Oscar (USA), Pickwick (UK, USA).
 Suuri Suomalainen Kirjakerho Oy, Koydenpuojankatu 2, SF-00180 Helsinki 18. Tel: (90) 601-522. Mng. Dir.: Pertti Aravirta.
 Suuri Suomalainen Musiikkikerho Oy, Annatie 2 A, SF-00370 Helsinki 37. Tel: 554-532. Contact: Borje Wiik. (Record club)
 Taborrolaget, Albertsgatan 31, 00180 Helsinki 18. Tel: (90) 605-193. Chief Exec.: Freddy Rohde-Nielsen.
Labels: (Represented) Dove (UK), Hemmets Harold (Sweden), Maranath (USA), Prim (Sweden), Word.
 Teknopiste Oy, Kuusisaarentie 3, SF-00340 Helsinki 34. Tel: (90) 480-011. Dir. & Gen. Mgr.: Risto Vayrynen; Sales Mgr.: Esko Vayrynen. (Distributor/Importer)
Labels: (Distributed—not licensed) Roadstar, Senn-Sound (both Japan).
 Tophits-Finnhits, Lemmikkitie 19, SF-01350 Vantaa 35. Contact: Jorma Helander.
 Top Voice, see PSO.
 Triola, see Finnlevy.
 Untor Oy, Hallituskatu 11 A, SF-33201 Tampere 20. Tel: (931) 20-500. Telex: 22-460. Mng. Dir.: Kari E. Helenius; Sales Mgr.: Jukka Hynninen; Prod'n Mgr.: Perttu

Palkoaho.
Labels: (Owned) Poko.
 Vainon Sointi, Vainonkatu 32, SF-40100 Jyväskylä 10. Tel: 941-11015. (Importer/Mail Order)
 Valintatalo Oy, PL 176, 00121 Helsinki 12. Tel: 602-011. Contact: Esko Koliseva. (Importer/Wholesaler)
 Valitut Palat-Resko's Digest Ab (Oy), Halsuante 4, SF-00420 Helsinki 42. Tel: (90) 563-2011. Telex (12) 2489. Mng. Dir.: Martti Immonen, Prod. Mgr.: Martti Virtanen. (Mail Order)
 Yes-Jees, see Sauna.

● music publishers

Coda (Ed.) (TEOSTO), Lansiportti 4A, SF-02210 Espoo. Tel: (90) 880-022. Cable: DISCOY. Telex (12)-2705. Mng. Dir.: Johan Vikstedt.
Int'l firms represented: AdO (Italy), Dunbar (USA), RCA (Italy), Sunbury (UK, USA).
 Fazer-Musiik AB (Oy Musiikki) (TEOSTO), Takomontie 3 C, SF-00380 Helsinki 38. Tel: (90) 558-991. Telex: 12-2782. Publ'g Mgr.: Antti Alaspää.
 Finnmusic (Ed.), Ky Rauno Lehtinen, Osuuskunnantie 50A, 00660 Helsinki 66. Tel: (90) 748-559. Cable: FINNMUSIC. Sec'y: Anja Lehtinen, Gen. Mgr.: Rauno Lehtinen.
 Fonovox (TEOSTO), Alkutie 67, SF-00660 Helsinki 66. Tel: (90) 745-177. Mng. Dir.: Henry Haapalainen.
 Imudico Kuustannusliike, Armatie 6 E, SF-00370 Helsinki 37. Tel: (90) 558-421. Telex (12) 2482. Mgr.: Raimo Henriksson.
Home office: Denmark.
 J K C Music (Jukka Kuoppamäki & Co.) (TEOSTO), Pietarinkatu 5, SF-00140 Helsinki 14. Tel: (90) 628-311. Dir.: Jukka Kuoppamäki, Gen. Mgr.: Sirpa Kuoppamäki.
Branch: SF-02170 Haukilahti, Mellsteninranta A 3. Tel: (90) 425-234.
Int'l firm represented: WPN (USA).
Int'l reps.: France (Bagatelle), USA (WPN).
 Jasemusiikki Ky, PO Box 136, 13101 Haemeenlinna 10. Tel: (917) 23146. Chief Exec.: Jarmo Semilae.
 Jee Jee Music Oy, Pakkamestarinkatu 1, SF-00520 Helsinki 52. Tel: (90) 143-133. Telex: 123396. Chief Exec.: Timo Vaaenänen.
Int'l rep.: Sweden (Sonet).
 Jukka Kuoppamäki & Co., see JKC.
 Karas-Sana Oy, Pursimiehenkatu 26 I, 00120 Helsinki 12. Kirkon Nuorisoyön Keskus, Lisankatu 27-B, SF-00170 Helsinki 17.
 Kompass Recs. Oy, Hakolahdenkuja 4B, 00200 Helsinki 20. Tel: (90) 676-445. Gen. Mgr.: Chris Schwandt.
 Rauno Lehtinen, see Finnmusic.
 Leveys Oy, Valimontie 13, SF-00380 Helsinki 38. Tel: 556-551. Mng. Dir.: Lauri Rokkanen.
 Levytuottajat Oy Kustannus, Sakkottajankatu 2F, 00520 Helsinki 52. Tel: (90) 143-244. Gen. Mgr.: Dennis Livson; Contact: Kaisa Luuhala.
 Erik Lindstrom Kustannus, Paivankilontie 7 A1, SF-02210 Espoo 21.
 Musiikkikonsultit Ky, Kauppakuja 12, Valtakatu 3, SF-11110 Riihimäki 10. Tel: (914) 30944. Chief Exec.: Juhani Lahti.
 Polarmusic, Oy, Annatie 2, Helsinki. Tel: (90) 554-454. Cable: JUVOX. Chief Exec.: Leena Juuranto.
 Ristin Voitto, Sinikellonpolku, SF-01300 Vantaa. Tel: (90) 826-377. Pres.: Eino O. Vanhala; Music Dept. Mgr.: Seppo J. Jaervinen.
 Scandia-Kustannus Oy (Scandia Publ'g Co. Ltd.), Takomontie 3C, SF-00380 Helsinki 38. Tel: (90) 556-818. Telex (12) 2782. Gen. Mgr.: Paavo Eimoe.
Int'l firms represented: Agril, Warner Bros.
 Sulasoit Ry, Kluuvinkatu B, 00100 Helsinki 10.
 Suomen Kanttori Urkuriitto, Keskuskatu 44, SF-38700 Kankaanpää.
 TopHits-FinnHits Oy, Kurintie 27, SF-01300 Vantaa. Tel: 833-622.
 X-Savel, Kumalintontkatu 17 A-5, SF-00250 Helsinki 25.

● services

ASSOCIATIONS & PROFESSIONAL ORGANIZATIONS

Aeae-ja Kuvatalennetuottajat ry (Finnish National Group of IFPI), Takomontie 3, SF-00380 Helsinki 38. Tel: (90) 558-991. Telex (12) 2782. Contact: Arto Alaspää.
 Association of Finnish Musical Artists, Mannerheimintie 33, SF-00250 Helsinki. Tel: (90) 419-244.
 Association of Finnish Music Institutes, Kampinkatu 8 C 30, SF-00100 Helsinki. Tel: (90) 644-094.
 Automaattivokkuraajat ry (Renters of coin-operated machines ass'n), Orivedenkatu 12A, SF-33720 Tampere 72. Tel: (931) 170-500.
 Composers of Film & Popular Music, Risto Rytintie 28 D, SF-00570 Helsinki 57. Tel: (90) 687-976. Chm.: Arthur Fuhrmann.
 Elektronikan Tukkukauppiat (Importers & whslers of electronic & hi fi installations & household appliances prods. org.), Fabianinkatu 23, SF-00130 Helsinki 13. Tel: (90) 171-806. Contact: Heikki Peutere.
 Finnish Blues Society, Telakkakatu 2, SF-00150 Helsinki 15. Tel: 639-143.
 Finnish Music Information Centre, Runeberginkatu 15 A 1, SF-00100 Helsinki 10. Tel: (90) 409-134. Pres.: Pekka Kallio. Exec. Sec'y: Kauko Karjalainen.
 Finnish Rock Festivals Ass'n, Sepetilahentie 14 B-10, SF-02230 Espoo 23. Pres.: Kan A. Elo.
 Helsinki Festival, Unioninkatu 2B, SF-00100 Helsinki 10. Tel: (90) 659-688. Cable: FINNFEST. Entertainment Dept. Mgr.: Tapani Naerhi.
 I F P I, see Aeae-ja.
 Lavamusikot ry (Ship Musicians), Manankatu 15a A 12, SF-00170 Helsinki 17. Tel: (90) 662-218.
 Musiikkialan Ammattiyhdistysten Federaatio ry (MAF) (Federation of Trade Unions in the Field of Music), Manankatu 15a A 12, SF-00170 Helsinki 17. Tel: (90) 662-218.

Note: MAF is the controlling organization for Lavamusikot, Popmuusikot, Ravintolamuusikot, National Committee of the International Music Council, Vilkenintie 1, SF-00640 Helsinki 64. Sec'y Anu Karlsson.

National Section of the International Society for Contemporary Music, Erottajankatu 1-3 A 10, SF-00130 Helsinki 13.

Popmuusikot ry (Pop Musicians), Mariankatu 15a A 12, 00170 Helsinki 17. Tel (90) 662-218.

Radioliikkeiden Liitto ry (Retailers of electronic leisure prods. org.), Vuorimiehentatu 21, SF-00140 Helsinki 14. Tel (90) 174-233. Chm., Erkki Raitala; Deputy Sec'y-Gen.: Risto Soeder.

Ravintolamuusikot ry (Restaurant Musicians), Mariankatu 15a A 12, SF-00170 Helsinki 17. Tel (90) 662-218.

Society of Finnish Composers, Runeberginkatu 15 A 11, SF-00100 Helsinki 10. Tel (90) 445-589.

Suomen Jazzliitto (Finnish Jazz Federation), PL 54, SF-00101 Helsinki 10.

Suomen Muusikkojen Liitto (Finnish Musicians Union), Uudenmaankatu 36 D 21, SF-00120 Helsinki 12. Tel (90) 669-160.

Suomen Postimyynti ja Suoramainontaliitto Ry, (organization for mail order firms), Topeliuksenkatu 41a, SF-00250 Helsinki 25. Tel 418-795.

Suomen Soitinteollisuusyritykset (Musical instrument mfrs. ass'n), Mariankatu 26 B 23, SF-00170 Helsinki 17. Tel (90) 170-322. Contact Ilpo Tarjamo.

Suomen Työväen Musiikkiliitto, Hallituskatu 19, SF-33200 Tampere 20. Tel (931) 24957.

Tiskijukat ry (Professional disk jockey ass'n), Yrjön Katu 3A9, SF-15100 Lahti 10. Tel (90) 662-218.

DESIGN & ARTWORK

Moonshine Oy, Pakkamestarinkatu 1, SF-00520 Helsinki 52. Tel (90) 143-133. Telex 123396. Gen. Mgr.: Timo Vaaenaenen; Prod'n Mgr.: Richard C. Stanley.

Rock-Along (Finland) Ltd., Sepetlahdentie 14 B-10, SF-02230 Espoo 23. Pres.: Kari A. Elo.

Rocking Turtle Studio, Hameentie 30 D 45, SF-00530 Helsinki 53. Tel (90) 761-099.

Safra, Laivanvarustajankatu 3, SF-00140 Helsinki 14. Tel (90) 666-718.

LICENSING ORGANIZATIONS, MUSIC

Gramex, Runeberginkatu 15 A 11, 00100 Helsinki 10. Tel (90) 494-280. Contact Jukka Liedes. (Radio/TV performance fees)

Sulasol (Suomen Laulajain ja Soittajain Liitto ry), Fredrikinkatu 61, SF-00100 Helsinki 10. Tel (90) 640-174. Contact: Ahti Sonninen; Gen. Mgr.: Jukka Kankainen.

T E O S T O ry (Säveltaajain Tekijänoikeustoimisto—Finnish Composers Int'l Copyright Bureau), Lauttasaarentie 1, 00200 Helsinki 20. Tel (90) 692-2511. Gen. Mgr.: Pekka Kallio. (Mechanical & performing rights)

PLATING, PROCESSING & PRESSING PLANTS

Cutting Room Oy, Eliaksentie 9, SF-00370 Helsinki 37. Tel 552-331. Mgr.: Rauno Luukkunen.

Lejos Oy/Finnvox Studios, Arinatie 8, SF-00370 Helsinki 37. Tel (90) 554-521. Gen. Mgr.: Kurt Juuranto; Mgr.: Erkki Ertesuo.

Mainos-TV-Reklam AB (Oy) (MTV), Pasilankatu 44, SF-00240 Helsinki 24. Tel (90) 413-300. Cable COMTELE. Telex (12) 1544. Gen. Mgr.: Pentti Hanski; Deputy Gen. Mgr.: Jaakko Paavela; Sales Mgr.: Matti Kemiläinen; Prod'n Mgr.: Kalevi Mattila.

Stereokasetti (Oy)-Stereolevy AB, PO Box 40, SF-11101 Riihimäki 10. Tehtaankatu 13, SF-11100 Riihimäki 10. Tel (914) 307 31. Export, Import, Foreign Affairs Chief: Per-Eric Holmberg. (Pressing only)

PRINTERS & LITHOGRAPHERS

Kirjapaino E. Kuronenky, Hoelyaeeamentoie 18, SF-00380 Helsinki 38. Tel (90) 558-955. Gen. Mgr.: Erkki Kuronen; Contact: Risto Mehtonen.

Original Recs./Musikkijussit Oy, Aleksis Kivenkatu 10, SF-33210 Tampere 21. Tel (931) 38-124. Mgr.: Jukka Keltto.

Ristin Voitto, Sinkellonpolku, SF-01300 Vantaa. Tel (90) 826-377. Pres.: Eino O. Vanhala; Gen. Mgr.: Seppo J. Jaervinen.

RECORD PROMOTION

Moonshine Oy, Pakkamestarinkatu 1, SF-00520 Helsinki 52. Tel (90) 143-133. Telex: 123396. Gen. Mgr.: Timo Vaaenaenen; Prod'n Mgr.: Richard C. Stanley.

Music Radio Promos., Kierretie 10, SF-01650 Vantaa 65. Tel (90) 846-721. Dir.: Antti Marvia.

Rock-Along (Finland) Ltd., Sepetlahdentie 14 B-10, SF-02230 Espoo 23. Pres.: Kari A. Elo.

TAPE CUSTOM DUPLICATORS

Elektro-Audio Oy, Yhdystiestie 1, SF-00320 Helsinki 32. Tel: 575-733.

Finnscandia Musiikkiosakeyhtio, PO Box 584, SF-00101 Helsinki 10, Takomontie 1-3, SF-00380 Helsinki 38. Tel (90) 558-797. Telex: 12-2782. Mgr.: Hannu Linna.

Audio: Cassette
Kasettimonistus Oy, Waino Aaltosentie 11 A, SF-00570 Helsinki. Tel (90) 688-122.

Audio: Cassette
Lejos Oy/Finnvox Studio, Arinatie 8, SF-00370 Helsinki 37. Tel (90) 554-521. Gen. Mgr.: Kurt Juuranto; Mgr.: Erkki Ertesuo.

Audio: Cassette
Mainos-TV-Reklam AB (Oy) (MTV), Pasilankatu 44, SF-00240 Helsinki 24. Tel (90) 413-300. Cable COMTELE. Telex (12) 1544. Gen. Mgr.: Pentti Hanski; Deputy Gen. Mgr.: Jaakko Paavela; Sales Mgr.: Matti Kemiläinen; Prod'n Mgr.: Kalevi Mattila.

Audio: Cassette.
Video: ¾" cassette, ½" cassette.

Stereokasetti (Oy)-Stereolevy AB, PO Box 40, SF-11101 Riihimäki 10. Tehtaankatu 13, SF-11100 Riihimäki 10. Tel (914) 307 31. Export, Import, Foreign Affairs Chief: Per-Eric Holmberg.
Audio: Cassette.

● **supplies**

EMPTY CASSETTES

Pyrkija Oy, Tastonie, SF-20380 Turku 38. Tel (921) 779-555. Contact: Arto Palm.

T P Tuotanto Oy, Kadetintie 106, SF-00330 Helsinki 33. Tel (90) 488-544. Gen. Mgr.: Erkki Erbbi O. Hautanen.

JACKETS & SLEEVES

Offset Oy, Tehtaankatu 27-29, SF-00150 Helsinki 15. Tel 659-608. Mng Dir.: K. Jarvinen.

Original Recs./Musikkijussit Oy, Aleksis Kivenkatu 10, SF-33210 Tampere 21. Tel (931) 38-124. Mgr.: Jukka Keltto.

Painomestari Oy, Kasarminkatu 15, SF-00130 Helsinki 13. Tel (90) 13-061.

T P Tuotanto Oy, Kadetintie 106, SF-00330 Helsinki 33. Tel (90) 488-544. Gen. Mgr.: Erkki O. Hautanen. (Jackets only)

Tanner-Paino Oy, Sammonkatu 52, SF-33540 Tampere 54.

Labels
Original Recs./Musikkijussit Oy, Aleksis Kivenkatu 10, SF-33210 Tampere 21. Tel (931) 38-124. Mgr.: Jukka Keltto.

Labels
Original Recs./Musikkijussit Oy, Aleksis Kivenkatu 10, SF-33210 Tampere 21. Tel (931) 38-124. Mgr.: Jukka Keltto.

Labels
Original Recs./Musikkijussit Oy, Aleksis Kivenkatu 10, SF-33210 Tampere 21. Tel (931) 38-124. Mgr.: Jukka Keltto.

Labels
Original Recs./Musikkijussit Oy, Aleksis Kivenkatu 10, SF-33210 Tampere 21. Tel (931) 38-124. Mgr.: Jukka Keltto.

Labels
Original Recs./Musikkijussit Oy, Aleksis Kivenkatu 10, SF-33210 Tampere 21. Tel (931) 38-124. Mgr.: Jukka Keltto.

Labels
Original Recs./Musikkijussit Oy, Aleksis Kivenkatu 10, SF-33210 Tampere 21. Tel (931) 38-124. Mgr.: Jukka Keltto.

Labels
Original Recs./Musikkijussit Oy, Aleksis Kivenkatu 10, SF-33210 Tampere 21. Tel (931) 38-124. Mgr.: Jukka Keltto.

Labels
Original Recs./Musikkijussit Oy, Aleksis Kivenkatu 10, SF-33210 Tampere 21. Tel (931) 38-124. Mgr.: Jukka Keltto.

Labels
Original Recs./Musikkijussit Oy, Aleksis Kivenkatu 10, SF-33210 Tampere 21. Tel (931) 38-124. Mgr.: Jukka Keltto.

Labels
Original Recs./Musikkijussit Oy, Aleksis Kivenkatu 10, SF-33210 Tampere 21. Tel (931) 38-124. Mgr.: Jukka Keltto.

Labels
Original Recs./Musikkijussit Oy, Aleksis Kivenkatu 10, SF-33210 Tampere 21. Tel (931) 38-124. Mgr.: Jukka Keltto.

Labels
Original Recs./Musikkijussit Oy, Aleksis Kivenkatu 10, SF-33210 Tampere 21. Tel (931) 38-124. Mgr.: Jukka Keltto.

Labels
Original Recs./Musikkijussit Oy, Aleksis Kivenkatu 10, SF-33210 Tampere 21. Tel (931) 38-124. Mgr.: Jukka Keltto.

Labels
Original Recs./Musikkijussit Oy, Aleksis Kivenkatu 10, SF-33210 Tampere 21. Tel (931) 38-124. Mgr.: Jukka Keltto.

Labels
Original Recs./Musikkijussit Oy, Aleksis Kivenkatu 10, SF-33210 Tampere 21. Tel (931) 38-124. Mgr.: Jukka Keltto.

Labels
Original Recs./Musikkijussit Oy, Aleksis Kivenkatu 10, SF-33210 Tampere 21. Tel (931) 38-124. Mgr.: Jukka Keltto.

Labels
Original Recs./Musikkijussit Oy, Aleksis Kivenkatu 10, SF-33210 Tampere 21. Tel (931) 38-124. Mgr.: Jukka Keltto.

Labels
Original Recs./Musikkijussit Oy, Aleksis Kivenkatu 10, SF-33210 Tampere 21. Tel (931) 38-124. Mgr.: Jukka Keltto.

Labels
Original Recs./Musikkijussit Oy, Aleksis Kivenkatu 10, SF-33210 Tampere 21. Tel (931) 38-124. Mgr.: Jukka Keltto.

Labels
Original Recs./Musikkijussit Oy, Aleksis Kivenkatu 10, SF-33210 Tampere 21. Tel (931) 38-124. Mgr.: Jukka Keltto.

Labels
Original Recs./Musikkijussit Oy, Aleksis Kivenkatu 10, SF-33210 Tampere 21. Tel (931) 38-124. Mgr.: Jukka Keltto.

Labels
Original Recs./Musikkijussit Oy, Aleksis Kivenkatu 10, SF-33210 Tampere 21. Tel (931) 38-124. Mgr.: Jukka Keltto.

Labels
Original Recs./Musikkijussit Oy, Aleksis Kivenkatu 10, SF-33210 Tampere 21. Tel (931) 38-124. Mgr.: Jukka Keltto.

Labels
Original Recs./Musikkijussit Oy, Aleksis Kivenkatu 10, SF-33210 Tampere 21. Tel (931) 38-124. Mgr.: Jukka Keltto.

Labels
Original Recs./Musikkijussit Oy, Aleksis Kivenkatu 10, SF-33210 Tampere 21. Tel (931) 38-124. Mgr.: Jukka Keltto.

Labels
Original Recs./Musikkijussit Oy, Aleksis Kivenkatu 10, SF-33210 Tampere 21. Tel (931) 38-124. Mgr.: Jukka Keltto.

Labels
Original Recs./Musikkijussit Oy, Aleksis Kivenkatu 10, SF-33210 Tampere 21. Tel (931) 38-124. Mgr.: Jukka Keltto.

Labels
Original Recs./Musikkijussit Oy, Aleksis Kivenkatu 10, SF-33210 Tampere 21. Tel (931) 38-124. Mgr.: Jukka Keltto.

Labels
Original Recs./Musikkijussit Oy, Aleksis Kivenkatu 10, SF-33210 Tampere 21. Tel (931) 38-124. Mgr.: Jukka Keltto.

Labels
Original Recs./Musikkijussit Oy, Aleksis Kivenkatu 10, SF-33210 Tampere 21. Tel (931) 38-124. Mgr.: Jukka Keltto.

Labels
Original Recs./Musikkijussit Oy, Aleksis Kivenkatu 10, SF-33210 Tampere 21. Tel (931) 38-124. Mgr.: Jukka Keltto.

Labels
Original Recs./Musikkijussit Oy, Aleksis Kivenkatu 10, SF-33210 Tampere 21. Tel (931) 38-124. Mgr.: Jukka Keltto.

Labels
Original Recs./Musikkijussit Oy, Aleksis Kivenkatu 10, SF-33210 Tampere 21. Tel (931) 38-124. Mgr.: Jukka Keltto.

Labels
Original Recs./Musikkijussit Oy, Aleksis Kivenkatu 10, SF-33210 Tampere 21. Tel (931) 38-124. Mgr.: Jukka Keltto.

Labels
Original Recs./Musikkijussit Oy, Aleksis Kivenkatu 10, SF-33210 Tampere 21. Tel (931) 38-124. Mgr.: Jukka Keltto.

Labels
Original Recs./Musikkijussit Oy, Aleksis Kivenkatu 10, SF-33210 Tampere 21. Tel (931) 38-124. Mgr.: Jukka Keltto.

Labels
Original Recs./Musikkijussit Oy, Aleksis Kivenkatu 10, SF-33210 Tampere 21. Tel (931) 38-124. Mgr.: Jukka Keltto.

Labels
Original Recs./Musikkijussit Oy, Aleksis Kivenkatu 10, SF-33210 Tampere 21. Tel (931) 38-124. Mgr.: Jukka Keltto.

Labels
Original Recs./Musikkijussit Oy, Aleksis Kivenkatu 10, SF-33210 Tampere 21. Tel (931) 38-124. Mgr.: Jukka Keltto.

Labels
Original Recs./Musikkijussit Oy, Aleksis Kivenkatu 10, SF-33210 Tampere 21. Tel (931) 38-124. Mgr.: Jukka Keltto.

Labels
Original Recs./Musikkijussit Oy, Aleksis Kivenkatu 10, SF-33210 Tampere 21. Tel (931) 38-124. Mgr.: Jukka Keltto.

Labels
Original Recs./Musikkijussit Oy, Aleksis Kivenkatu 10, SF-33210 Tampere 21. Tel (931) 38-124. Mgr.: Jukka Keltto.

Labels
Original Recs./Musikkijussit Oy, Aleksis Kivenkatu 10, SF-33210 Tampere 21. Tel (931) 38-124. Mgr.: Jukka Keltto.

Labels
Original Recs./Musikkijussit Oy, Aleksis Kivenkatu 10, SF-33210 Tampere 21. Tel (931) 38-124. Mgr.: Jukka Keltto.

Labels
Original Recs./Musikkijussit Oy, Aleksis Kivenkatu 10, SF-33210 Tampere 21. Tel (931) 38-124. Mgr.: Jukka Keltto.

Labels
Original Recs./Musikkijussit Oy, Aleksis Kivenkatu 10, SF-33210 Tampere 21. Tel (931) 38-124. Mgr.: Jukka Keltto.

Labels
Original Recs./Musikkijussit Oy, Aleksis Kivenkatu 10, SF-33210 Tampere 21. Tel (931) 38-124. Mgr.: Jukka Keltto.

Labels
Original Recs./Musikkijussit Oy, Aleksis Kivenkatu 10, SF-33210 Tampere 21. Tel (931) 38-124. Mgr.: Jukka Keltto.

Labels
Original Recs./Musikkijussit Oy, Aleksis Kivenkatu 10, SF-33210 Tampere 21. Tel (931) 38-124. Mgr.: Jukka Keltto.

Labels
Original Recs./Musikkijussit Oy, Aleksis Kivenkatu 10, SF-33210 Tampere 21. Tel (931) 38-124. Mgr.: Jukka Keltto.

Labels
Original Recs./Musikkijussit Oy, Aleksis Kivenkatu 10, SF-33210 Tampere 21. Tel (931) 38-124. Mgr.: Jukka Keltto.

Labels
Original Recs./Musikkijussit Oy, Aleksis Kivenkatu 10, SF-33210 Tampere 21. Tel (931) 38-124. Mgr.: Jukka Keltto.

Labels
Original Recs./Musikkijussit Oy, Aleksis Kivenkatu 10, SF-33210 Tampere 21. Tel (931) 38-124. Mgr.: Jukka Keltto.

00100 Helsinki 10. Tel: 60-981. Telex: 12416. Sales Mgr.: Erik Martin.

Audio & Video: Cassette, open reel.

Brand name: BASF.

Teknillinen Hankkija, PO Box 80, Sähkökojeosasto, SF-00100 Helsinki 10. Tel: (90) 7-291. Cable: HANKKIIJA. Telex: (12) 660.

Audio: Cassette.

Video: ½" EIAJ open reel.

Brand names: JVC, Maxell, Memorex.

TAPE PACKAGING & LABELING EQUIPMENT & SUPPLIES

Pyrkija Oy, Tastonie, SF-20380 Turku 38. Tel (921) 779-555. Contact: Arto Palm.

T P Tuotanto Oy, Kadetintie 106, SF-00330 Helsinki 33. Tel (90) 488-544. Gen. Mgr.: Erkki O. Hautanen.

● **accessories manufacturers**

Compass Recs. Oy, Hakolahtenkujat 4B, 00200 Helsinki 20. Tel: 676-445. Dir.: Chrissie Schwindt, Lasse Martensson.

Product: Cleaners, cloths & brushes.

Finnlevy AB (Oy), Takomontie 3, SF-00380 Helsinki 38. Tel: (90) 558-797.

Product: Cleaners, cloths & brushes, headcleaners.

Finnmende Oy, Karvaamokuja 3, SF-00380 Helsinki 38. Tel 558-858.

Product: Needles.

Brand name: Shure.

Moonshine Oy, Pakkamestarinkatu 1, SF-00520 Helsinki 52. Tel (90) 143-133. Telex: 123396. Gen. Mgr.: Timo Vaaenaenen; Prod'n Mgr.: Richard C. Stanley.

Product: Carrying & storage cases, cleaners, cloths & brushes, head cleaners & demagnetizers, leader & splicing tape.

Musiikki Mosse AB (Oy), Eerikinkatu 9B, SF-20110 Turku 11. Tel (921) 11-362. Gen. Mgr.: Mosse Seera. (Importer)

Product: Carrying & storage cases.

Original Recs./Musikkijussit Oy, Aleksis Kivenkatu 10, SF-33210 Tampere 21. Tel (931) 38-124. Mgr.: Jukka Keltto.

Product: Record catalog servs.

Sound Center Inc. (Oy), Museokatu 8, SF-00100 Helsinki 10. Tel: 440-301. (Importer)

Product: Needles.

Brand name: Pickering.

T P Tuotanto Oy, Kadetintie 106, SF-00330 Helsinki 33. Tel (90) 488-554. Gen. Mgr.: Erkki O. Hautanen.

Product: Carrying & storage cases.

R. Vikstrom Ltd (Oy), Ulviantie 29/4, SF-00350 Helsinki 35. Tel (90) 551-647. (Importer)

Product: Needles.

Brand name: Stanton.

● **store fixtures & merchandising aids manufacturers**

Finnlevy AB (Oy), Takomontie 3, SF-00380 Helsinki 38. Tel: (90) 558-797.

Product: Display racks.

Fonovox, Alkutie 67, SF-00660 Helsinki 66. Tel (90) 745-177. Mng. Dir.: Henry Haapalainen.

Product: Display racks.

Moonshine Oy, Pakkamestarinkatu 1, SF-00520 Helsinki 52. Tel (90) 143-133. Telex: 123396. Gen. Mgr.: Timo Vaaenaenen; Prod'n Mgr

Pre-recorded tape imported: 1976—1,066,366 units (1,014,283 of total from EEC).

Pre-recorded tape exported: 1976—1,653,448 units (901,630 of total to EEC).

RADIO STATIONS:

No. of commercial 6; No. of government 1; No. of AM 6; No. of FM 1.

TELEVISION STATIONS:

No. of government 3; No. of commercial 2 (RTL, TMC).

IMPORT/EXPORT REGULATIONS:

All imported records, cartridges and cassettes are subject to the French value added tax.

MARKET ANALYSIS:

After a year and a half, with only one increase of 3 per cent granted in 1978, wholesale price fixing has been abandoned. Further, the government has refused to permit the record companies to use price coding at the wholesale level or to propose retail prices.

● record & tape manufacturers / distributors / Importers

A B Prod'n SA, 55 Rue Pierre Charron, 75008 Paris. Tel: (01) 225 77 30. Telex: 660894. Pres. Dir. Gen.: Claude Berda; Gen. Mgr.: Jean Luc Azoulay; Sales Mgr.: Jean Bigot. (Distributed by CBS Disques)
Label: (Owned) AB.

Int'l reps: Benelux (Fleet), Brazil (Fermata), Israel (CBS), Portugal (Rossi).

A F A-Discara (Disques), 23 Rue Pierre Semard, 75009 Paris. Tel: (01) 526 52 47. Dir.: Freddy Carrara; PR: Florence Carrara. **Local branch:** 75019 Paris, 50 Blvd. Serurier. Tel: (01) 205 68 19.
Labels: (Owned) AFA, Discara.

A & M Recs. Europe (IFPI), 35 Av. Franklin D. Roosevelt, 75008 Paris. Tel: (01) 266 91 41. Mng. Dir.: Marcus Bicknell; Mktg. Mgr.: Russ Curry; Financial Dir.: David Clapham; Promo.: Cathy Oudemans. (Distributed by CBS)
Labels: (Owned) A&M, Horizon.

Int'l reps: Austria (CBS), Belgium (CBS), Denmark (CBS), Finland (CBS), France (CBS), Germany (CBS), Greece (CBS), Israel (CBS), Italy (CBS), Netherlands (CBS), Norway (CBS), Portugal (Carvalho), Spain (CBS), Sweden (CBS), Switzerland (CBS), Yugoslavia (RTB).

A M P, see SFPP.

A Z, see Disc'AZ.

Abbey Road Recs., 94-96 Rue Lauriston, 75116 Paris. Tel: (161) 505 91 02. (Distributed by EMI Sonopresse.)

Accord, see Musidisc.

Acrobat, see Carrere.

Ades SA, 54 Rue St. Lazare, 75009 Paris. Tel: (01) 874 85 30. Telex: 280422.

Labels: (Owned) Ades (distributed by Polydor), Enfants Sages, Petit Menestrel, Saita-Anthologie Sonore; (distributed) Disneyland, Vista.

Adria, see Daems.

Affinity, see Charly.

African, see Societe Francaise du Son.

Aggy Music Prod'ns, 134 Rue d'Avron, 75020 Paris. Tel: (01) 373 66 75. Dir.: Tony Amaraggi; Sales Mgr.: Maria Amaraggi.

Label: (Owned) Aggy Music.

Agoria (Eds. Musicales), 10 Rue Frederic Bastiat, 64 Bayonne. Tel: 25 18 73. Dir.: Mr. Meyzenc. (Distributed by Chant du Monde)

Ajaccio, see Daems.

Alamac Jazz Kings, see Societe Francaise du Son.

Albatros Prod'ns, 43 Rue Fessart, 92100 Boulogne/Bilancourt. Tel: 603 41 93. (Distributed by Discodis)
Label: (Owned) Albatros.

Aldiana, see PAA.

Allo Music SA, 17 Rue Ballu, 75009 Paris. Tel: (01) 280 61 07. Telex: 280245. Pres.: Max Amphoux; Int'l Mgr.: Maurice Bouchoux.

Label: (Owned) Contact.

Alvares, see Disc'AZ.

Ambient Music (Societe), 10 Rue Rene Bazin, 75016 Paris. Tel: (01) 224 84 96. (Mood music libraries)

Labels (Owned) Fressound, Musical Touch; (represented) Bosworth, Bruil, Cinemusic, Harmonic.

L'Amé de ..., see Hugues Desalle.

America, see Musidisc.

Anaxis, see Caravage.

Antares, see Verseau.

Aquarius, see CBS Disques.

Arabella Sarl, 136 Rue Peronnet, 92200 Neuilly sur Seine. Tel: (01) 745 42 42. Telex: 613815. Mng. Dir.: Rene Cacheux; Prod'n Mgr.: Sylvain Label; Int'l Dir.: Jacques Chabron.

Home office: Germany, Ariola-Eurodisc.
Labels: (Owned) Eurodisc; (licensed) Nems (UK), Shelter (USA), Supraphon (Czechoslovakia), Tomato (USA).

Int'l reps: Benelux, Germany, Spain, UK, (all Ariola-Eurodisc); Mexico, USA (both Ariola America).

Arcade Recs., 9 Rue Louis Armand, 92600 Asnieres. Tel: 790 45 70/92 41. Telex: 611281. Pres.: Larry Levine; Dir. Gens.: Larry Levine, Emmanuel Chamboredon; Press & Promo.: Patricia Bakcha.

Arcane, see WEA Filipacchi.

Arc En Ciel, see Studio SM.

Arfolk, see Societe Bretonne d'Enregistrement.

Argo, see Societe Francaise du Son.

Arias, 75 Rue Porte Dijaux, Bordeaux. Tel: (56) 48 74 16. Chief Exec.: Guy Arias; Sales Mgr.: Bernard Caubert. (Importer)

Arion (Disques), 36 Av. Hoche, 75008 Paris. Tel: (01) 753 76 70. Mng. Dir. & A&R: Ariane Segal; Technical Dir.: Claude Morel; Co-ord. & Int'l: Frederic Segal; Art: Suzanne Nonette; Mfg.: Beatrix Farians; Promo.: Margareth Losowski. (Distributed by CBS).

Labels: (Owned) Arion, Quintessence.

Int'l reps: Argentina (Arteria), Australia (Discurio), Belgium (CBS), Brazil (CBS), Canada (J.M. Marchand), Germany (Teldec), Italy (Ducalle), Japan (Nippon Columbia), Mexico (Gamma), Norway (Durho), Netherlands (CBS), Spain (Hispanvox), Sweden (Electra), Switzerland (Disques Office), UK (Conifer), USA (MHS, Peters Int'l).

Ariston, see Carrere.

Art & Musique, see Societe Bretonne d'Enregistrement.

Assimil, 13 Rue Gay Lussac, 94430 Chennevières Sur Marne. Tel: 933 87 37. Chm.: Jean Loup Cherel; Gen. Mgr.: Jean LeGal; Technical Mgr.: J.M. Simoni.

Label: (Owned) Assimil Langues Vivantes.

Astree, see Baerenreiter & Chant du Monde.

Asylum, see WEA Filipacchi.

Atco, see WEA Filipacchi.

Atlantic, see WEA Filipacchi.

Atmosfera, see Musidisc.

Atmosphere, see International Rec.

Atoll, see RCA.

Audio Graphic Inds., 124 bis Av. de Villiers, 75017 Paris. Tel: (01) 754 65 70. Telex: 290833. Pres.: Jean Berge; Dir. Gen.: Philippe Berge

Auvidis, 14 Rue Jean-Baptiste Potin, 92170 Vanves. Tel: (01) 645 93 45. Gen. Mgr.: Louis Bricard; Sales Mgr.: Jean-Paul Lemaire; Prod'n Mgr.: Pierre Jacob.

B A M, see Disc'AZ.

B B Z (Prod'ns) (IFPI), 10 Rue la Boetie, 75008 Paris. Tel: (01) 265 27 46. Pres.: Rolande Bismuth; Int'l Mgr.: Denis Wolff. (Distributed by RCA).

Labels: (Owned) BBZ, Slim Pezin.

Int'l reps: Austria (RCA), Belgium (Inelco), Canada (Able), Germany (RCA), Israel (Hatakit), Netherlands (Inelco).

B Y G, see Promodisc.

Baboo, see Vogue.

Baby, see Carrere.

Baccara Int'l, 7 Rue Saint-Germer, 31000 Toulouse. Tel: (61) 62 21 31.

Baerenreiter (Eds.), 1 Allee Jean de Ockeghem, 37170 Chambray les Tours. Tel: (47) 28 10 02. Dir.: Mr. Bernstein.

Labels: (Owned) Astree, Valois; (licensed) Cantate. Musicaophon (both Germany).

Int'l rep.: Worldwide (Teldec).

Bagatelle SA, 10 Rue Washington, 75008 Paris. Tel: (01) 256 17 99, 359 42 56. Telex: 640328. Pres. Denis Bourgeois; Gen. & Int'l Mgr.: Brigitte Bertholier-Spahn.

Labels: (Owned) Bagatelle, Sava, Studio 10.

Ballon Noir, see CBS Disques.

Barclay (Compagnie Phonographique Francaise), 143 Av. Charles de Gaulle, 92521 Neuilly-sur-Seine. Tel: (01) 758 12 77. Cable: BARCLAYDISC. Pres.: Eddie Barclay; VP & Int'l Label Mgr.: Jean Fernandez; Gen. Mgr.: Roger Maruani; Sales Mgr.: Jean-Claude Corbineau;

Int'l Sales Mgr.: Cyril Brilliant, Finance Mgr.: Nicolas Tritz, Admin. Mgr.: Henri Rossi, Barclay A&R: Claude Righi, Riviera A&R: Leo Missir.

Int'l branches: Belgium, Netherlands, Switzerland.
Labels: (Owned) Barclay, Blue Star, EGG, Riviera; (licensed domestic) Kuklos, Malypense, Mitchell, Nuages, ORF, Sylvestre, Teme; (licensed foreign) (Chiswick UK), De-Lite (USA), Sex Pistols (UK), Stiff (UK), Track 2 (UK).

Int'l reps: Argentina (RCA), Australia (Festival), Austria (Bellaphon), Brazil (RCA), Canada (Polygram), Colombia (Codiscos), Denmark (EMI), Ecuador (Famoso), Finland (EMI), Germany (Metronome), Greece (Minos Matsas), Hong Kong (Shun Cheong), Israel (Hatakit), Italy (Ricordi), Japan (King), Malta (Exotique), Mexico (Musart), Netherlands (CNR), Nicaragua (Sonido), Norway (EMI), South Africa (Teal), Spain (Movieplay), Sweden (EMI), UK (Logo), USA (Jem, Peters), Venezuela (Suramerica), Yugoslavia (Jugoton).

Bearsville, see Carrere.

Belior, see Radio Programmes.

Bella, see Daems.

Belles Plages, see Daems.

Biram France, 9 Rue de Versailles, 92430 Marnes-La-Coquette. Tel: (01) 741 61 98. Cable: KLUGER. Telex: 203249. Mgr.: Huguette Ferly-Kluger. (Distributed by Phonogram)

Labels: Biram, Topkapi, Zagora.

Black & Blue, see Societe Francaise du Son.

Bleu (Disques), 12 Blvd. Poissonniere, 75009 Paris. Tel: (01) 523 29 81.
Labels: (Owned) Bleu; (distributed) Donal.

Bluebird, see RCA.

Blue Elephant, see Societe Francaise du Son.

Blue Note, see Sonopresse.

Blue Star, see Barclay.

Boite a Musique, 133 Blvd. Raspall, 75006 Paris. Tel: (01) 548 16 12.

Bonnet, see Daems.

Bouton d'Or, see Daems.

Box Office, 58 Av. de Wagram, 75017 Paris. Tel: (01) 924 42 56.
Labels: (Owned) Box Office, Tuba.

C A D I, 143 Rue du Chateau, 75014 Paris. Tel: (01) 563 17 27, 322 47 82. Telex: 202270. Pres. Dir. Gen.: Raphael Ouskine. (Distributor/Importer/Exporter)

C A N F, see Verseau.

C B, see Societe Francaise du Son.

CBS Disques (IFPI), 3 Rue Freycinet, 75116 Paris. Tel: (01) 723 54 22. Cable: COLRECORD. Telex: 620646. Pres. & Mng. Dir.: Alain Levy; Gen. Mgr.: Jean Queinac; Sales Mgr.: Jean-Francois Loury; Mktg. Mgr.: Jean-Claude Gastineau.

Labels: (Owned) Versailles; (licensed foreign) A&M (USA), CBS (USA), Epic (USA), GTO (UK), Jet (USA), Lifesong (USA), Monument (USA), Philadelphia Int'l (USA), Portrait (USA), TK (USA), Vox (USA); (distributed—not licensed) AB (France), Aquarius (France), Arion (France), Ballon Noir (France), DJM (UK), Deesse (France), Francis Dreyfus (France), Escargot (France), Neys (France), Charles Talar (France).

Int'l rep.: Worldwide (CBS).

C B S Int'l SA (European Regional Headquarters) (IFPI), 35 Av. Franklin D. Roosevelt, 75008 Paris. Tel: (01) 266-

91 41. Cable: EUROCRIT. Telex: 640329. Sr. VP European Opns.: Peter de Rougemont; VP Opns.: Patrick W. Hurley; VP Creative Opns.: Alain Levy; Financial Controller: Jeremy Carter; Bus Affairs Dir.: Jeremy Pearce.

C B S Masterwork, 8 Rue Louis-Armand, 92600 Asnieres. Tel: 790 61 13. Telex: 610742. Dir.: Michel Boucays.

C E C E (Centre d'Enregistrement des Champs-Elysees), 15 Av. Montaigne, 75008 Paris. Tel: (01) 225 01 37, 359 62 35.

Label: (Owned) Charlin.

C E R A (Centre d'Etudes & de Realisations Audio-Visuelles), 33 Rue Landouzy, 51100 Reims. Tel: (26) 88 18 69.

C I D I S (Polygram Inds & Messageries) (IFPI), Av. Maurice Ravel, 92160 Antony. Tel: 666 21 65. Pres.: Edmond Lang; Ind'l Dir.: Fernand Pasquier; Sec'y Gen.: Bruno d'Orgeval; Technical Dir.: Christian March; Factory Dir.: P. Crapard; Comm'l Dir.: Jean-Michel Allays.

C N A I Fidsound (Compagnie Nationale d'Applications Ind'lles) (IFPI), 19 Rue Coyssevox, 75018 Paris. Tel: (01) 228 05 91, 229 24 61. Pres. & Dir. Gen.: Jean-Claude Thuel-Chassaigne.

Label: (Owned) Fidsound.

C N R, see Chant du Monde.

C T, see Disc'AZ.

C Y, see RCA.

Calliope, see WEA Filipacchi.

Calumet, see IHP.

Camden, see RCA.

Cam Film Music Collection, see Pema Music.

Jacques Canetti, see Radio Programmes & Disc'AZ.

Cappriccio, see Music Control.

Carabine Music, 124 Rue la Boetie, 75008 Paris. Tel: (01) 225 80 30. Co-Pres. Raymonde Drouet, Nadege Labrue; Gen. & Sales Mgr.: Charles Ibguy; Artistic Dir.: Daniel Belolo; Promo. Jean Distinghin.

Labels: (Owned) Carabine, Dynamic, Mustang (distributed by Polydor).

Caravage, 6 Rue Alfred Roll, 75017 Paris. Tel: (01) 754 86 79. Pres. & Gen. Mgr. Jean-Paul Smet.

Labels: (Owned) Anaxis, Caravage.

Carissima, 71 Rue de Clignancourt, 75018 Paris. Tel: (01) 076 75 64, 252 21 90. Mng. Dir.: Mya Simille; Dir. Gen.: Michel Delancray; PR Mgr.: Claude Pierre-Bloch. (Distributed by Polydor)

Carlyne Music, 82 Rue Chardon-Lagache, 75016 Paris. Tel: 224 08 80, 709 69 51. Contact: Jeanne de Mirbeck.

Caroline Melody, see Carrere.

Carrere (Disques), 27 Rue de Surenne, 75008 Paris. Tel: (01) 261 51 37. Telex: 641591. Pres. & Dir. Gen. Claude Carrere; Gen. Mgr. Pierre Haquet; Sales Mgr.: Lionel Delaure; Int'l. Nanou Lambin; Export: Roger Durao.

Labels: (Distributed) Acrobat, Ariston, Baby, Bearville, Caroline Melody, Cezame, Flamingo, Fleche, Force, Formule I, General, Hansa, Heloise, Jupiter, K-tel, LCO, Lazer, I.S. Orlando, Zagora.

Int'l reps: Australia (EMI), Belgium (Carrere), Brazil (Top Tape), Germany (Carrere), Greece (Phonogram), Israel (CBS), Italy (Carrere), Mexico (Peerless), New Zealand (EMI), Portugal (Phonogram), Scandinavia (EMI), Spain (EMI), Switzerland (Carrere), UK (Carrere).

Cathedrales, see Studio SM.

Cavalier, see RCA.

Centre d'Ant National Francais, see Disco Shop.

Centre Culturel du Chateau, see Disco Shop.

Centre d'Etudes & de Realisations Audio-Visuelles, see CERA.

Cereste, see Sopredim.

Cezame, 2 Rue Flechier, 75009 Paris. Tel: (01) 878 45 23. Mng. Dir.: Jean-Michel Gallois Montbrun; Frederic Lebovitz; Sales Mgr.: Valerie Cacheux; Promo. Mgrs.: Alain Pons, Philippe Cadot. (Distributed by Carrere)

Labels: (Owned) Cezame, Cobra.

Int'l reps: Germany (Membran), USA (Music Minus One, Rounder).

Chant du Monde (IFPI), 64 Rue Ampere, 75017 Paris. Tel: (01) 924 67 73/38 30. Cable: CHAMODISC. Pres. & Dir. Gen.: Jean Roire, Gen. Mgr.: Jean Maillet; Sales Mgr.: Denis Plumet.

Branch: 94600 Choisy le Roi, 164 Rue Constant Coquelain. Tel: 680 13 78.

Labels: (Licensed domestic) Chevance, Galata, Musee de l'Homme; (licensed foreign) Folkways (USA), La Louisianne (USA), Melodiya (USSR), Plane (Germany); (distributed—not licensed) Agoria, Astree, CNR, Nuteleidis, Valois (all France).

Chapter One, see Societe Francaise du Son.

Charlin, see CECE.

Charly Recs (France) Sarl, 42 Rue Monge, 75005 Paris. Tel: (01) 633 33 28.

Labels: (Owned) Affinity, Charly, Immediate, Smack (licensed foreign) CC (UK), Georgio Gomelsky (USA), Plantation (USA), Red Bird (USA), SSS Int'l (USA), Sun (USA).

Charmilles (Disques), 62 Mail des Charmilles, 10000 Troyes. Tel: (25) 81 05 62. Gen. Mgr. Gilbert Delforge.

Chevance, see Chant du Monde.

Chicago 2000, see Societe Francaise du Son.

Cinderella, see Daems.

Circle Line Productions, 23 Rue Scheffer, 75016 Paris. Tel: (01) 727 04 07. Cable: ELYPEYROT.

Home office: Argentina.

Classics for Pleasure, see Music for Pleasure.

Cobra, see Cezame.

Coda, see Disco Shop.

Coccinelle, see EPS.

Armand Colin (Librairie), 103 Blvd. St. Michel, 75005 Paris. Cable: ARCOLIN. Chief Exec.: Jean Max Leclerc; Sales Mgr.: Remy Bourrelier.

Label: (Owned) Armand Colin-Bourrelier.

Colombe (Disques), 4 Rue de la Colombe, 75004 Paris. Tel: (01) 633 37 08.

Columbia (UK), see Pathe Marconi EMI.

Comanche, see Delta France & WEA Filipacchi.

Comedis, 24 Rue Condorcet, 94430 Chennevières Sur Marne. (Distributor)

Compagnie Generale du Disque (sub. of Vogue PIP), 20bis Rue Louis Philippe, 92 Neuilly-sur-Seine. Tel: 821 25 00.
Label: (Owned) Orpheo.

Compagnie Ind'le de Dist'n & du Son, see CIDIS.
 Consul-CM Recs. (Disques), 43 Rue de la Fraternite, 93100
 Montreuil-sous-Bois. Tel. 858.38.44.
 Contact, see Allo.
 Context Recs., 8 Rue Emile-Allez, 75017 Paris. Tel. (01)
 924.27.88. Dir. Philippe Doiteau, Gen. Mgr. Jacques
 Galissant.
 Contrepoint, see Vogue.
 Copains de la Boheme, see Desams.
 Corinor (Societe), 11 Av. Division-Lelerc, 78210 Saint-Cyr-
 l'Ecôle. Tel. 045.02.61. 953.08.94.
 Cornelia, see Studio Damiens.
 Crypto, 24 Blvd de Latre-de-Tassigny, 90000 Belfort. Tel.
 (84) 21 31 84/33 47. Gen. Mgr. Jean-Claude Pog-
 nant, Sales Mgr. Brigitte Leyual (Distributed by RCA).
**Labels: (Owned) Crypto, Vizir, (not licensed—distrib-
 uted) Lizard.**
Int'l reps: Belgium (RCA), Spain (Phonic), Switzerland
 (Phonogram).
 Cyclus, see Musidisc.
 Cyracuse, see Daems.
 D E M/Disc A7, 2 Av. Brown-Sequart, 06000 Nice. Tel.
 81.11.31. Pres. Victor Cohen; Dir. Gen. Gilbert Co-
 hen.
 D O M Disques, 67 Rue Dulong, 75017 Paris. Tel. (01)
 227.46.57. 267.01.46. 924.31.19.
 Daems (Disques), 69 Rue des Archives, 75003 Paris. Tel.
 272.74.83 (apres midi). Dir. Gen. Victor Generaud.
**Labels: (Owned) Adria, Ajaccio, Bella, Belles Plages,
 Bonnet, Bouton d'Or, Cinderella, Copains de la Boheme,
 Cyracuse, Daems, Eriean, Faure, Flammes de Velours,
 Fonta, Les Grands d'Espagne, Iberia, Jacinthe, Je-
 nesse de France, Ladybird, Lecomte, Legal, Loopings,
 Magiciens du Rythme, Miroara Venter, Music for Ever,
 Pastori, Promotion, Reflets d'Alsace, Reflets du Poitou,
 Rois du Musette, Rosario, Santeliso, Special Accord-
 seon, Super Stars, Teurlay, Victor Michel, Wilybay.**
 Dasora Prod'ns, 6 Rue Saint-Charles, 75015 Paris. Tel. (01)
 577.27.60. Telex. 660970. Dir. Roland Davan.
 Dave Music, 50 Rue Stendhal, 75020 Paris. Tel. (01)
 636.66.36. Telex. 210611. Dir. David Muffaz; Gen.
 Mgr. Edith Muffaz.
**Labels: (Owned) Stip, (Licensed) Rockhouse (Nether-
 lands), (distributed—not licensed) Discocorp (USA),
 Music Minus One (USA), Preiser (Austria). (SEE AD-
 VERTISEMENT)**
 Deesse, see Deesse-Septentrión & CBS Disques.
 Deesse-Septentrión (IFPI), 11 Rue Lepic, 75018 Paris. Tel.
 (01) 606.94.30. 255.92.19. Telex. 270105. Gen.
 Mgr. Pierre Celie, Artistic Dir. Michel Celie; Sec'y-
 Gen. R.N. Tallera (Distributed by CBS).
Label: (Owned) Deesse.
Int'l reps: Belgium (Anvers-Radio), Benelux (CNR),
 Canada (Almada, Fleur, Frank Henry), Portugal (Plan-
 graf), Spain (Auv), Switzerland (Disques-Office).
 Deller Rec's SA (IFPI), St. Michel de Provence, 04300 For-
 calquier. Tel. 33.80. Telex. 430519. Pres. Bernard
 Coutaz; Gen. Mgr. & A&R, Alfred Deller; Int'l Mgr.:
 Rene Emile Goffon. (Distributed by Harmonia Mundi).
Label: (Owned) Deller.
 Delmark, see Societe Francaise du Son.
 Delphine, see Disc'AZ.
 Delta France (Eds. & Prod'ns Musicales), 12 Rue Ernest Ps-
 chari, 75007 Paris. Tel. (01) 555.01.78. 705.57.39.
 Mng. Dir. Jacques Arnoul; Gen. Mgr. Frederique
 Brion; Catalog Roger Corsin; Promo. Michel Bellamari;
 Pub., Jean-Paul Griffouliere. (Distributed by WEA Fil-
 pacchi).
Labels: (Owned) Comanche, Delta France.
 Delta Magnetics, 41 Quai des Martyrs de la Resistance,
 78700 Conflans Sainte Honorine.
Label: (Represented) Sheffield Lab (USA).
 Deram, see Societe Francaise du Son.
 Hugues Desalle (Realisations Sonores) (IFPI), 5 Rue d'Artois,
 75008 Paris. Tel. (01) 359.41.38. 278.77.88. Chief
 Exec., P. Douez.
**Labels: (Owned) L'Ame de... Disques Culturels
 Francais, Francais de Notre Temps, Hommes
 d'Aujourd'hui, Poesie pour Tous.**
 Detry Recs., 11 bis Rue Cdt. Pilot, 92200 Neuilly. Tel. (01)
 624.84.85. Telex. 610753. Commeta. Pres.: Jean-
 Louis Detry.
Labels: (Owned) Genal, OM, Orange, Pilot.
 De Valprivas, see Disco Shop.
 Diffudisc SA, PO Box, 15, 25 Rue Didot, 75661 Paris Cedex
 14. Tel. (01) 722.25.48. Pres. & Gen. Mgr.: Ginette
 Cacheux.
**Labels: (Owned) Soul Rec., Tonus-Plaisir des Dieux,
 (represented) Archambault (Canada).**
 Disc Africana, see Safari-Ambiance.
 Disc'AZ-Discodis (IFPI), 32 Rue Francois 1er, 75008 Paris.
 Tel. (01) 256.76.76. Telex. 290496. Pres. Paul de
 Senneville, Sec'y-Gen. Mireille Celerier; Admin. Finan-
 cial Mgr. Guy Delavier; Sales Mgr. Jean-Claude Gang-
 neux; Artistic Mgr. Jean Baudlot; Int'l Mgr.: Marion de
 Froment.
**Labels: (Owned) AZ, BAM; (licensed domestic) Jazz
 Odyssey, Locomotive, Mouloudji, Verchuren; (licensed
 foreign) Ensayo (Spain), Hungaroton (Hungary), Salsoul
 (USA), 20th Century (USA); (distributed—not li-
 censed) Alvares, CT, Jacques Canetti, Delphine, Disc'R,
 H.G. Carlo Ferrari, Carlo Ferrari, HS, Ibach, Perides.
 Int'l reps.: Belgium (Polydor), Brazil (Som Industria &
 Comercio), Canada (Able), Japan (Victor), Lebanon (So-
 ciete Libanaise du Disque), Luxembourg (Polydor), Por-
 tugal (Imavox), Spain (Hispavox), Switzerland (Barclay).**
 Discara, see AFA.
 Discobird, 21 Rue Germain Pilon, 75018 Paris. (Distributor)
 Discodis, see Disc'AZ.
 Disco-France SA, 124 bis Av. de Villiers, 75017 Paris. Tel.
 (01) 754.65.70. Telex. 290833. Dir. Gen.: Philippe
 Berge; Gen. Mgr.: Jean Berge.
 Discoparade, 3 Rue Suzanne-Lanoy, 59490 Somain. Tel.
 (20) 80.05.42.
 Disco Shop, 22 Rue de la Republique, Saint Mandé, 94160
 Paris. Tel. (01) 328.48.45. 365.14.37. Telex. 94160.
 Gen. Mgr. Arlette Albohair.
**Labels: (distributed—not licensed) Centre Culturel du
 Chateau, Centre d'Art National Francais, Coda, De Val-
 privas, Solstice, Verseau.**

Discotheque de Paris, 55 bis Rue de Ponthieu, 75008 Paris
 Tel. (01) 225.41.10. Dir. Gen.: Pierre Corby.
 Disc'R, see Disc'AZ.
 Disneyland, see Walt Disney & Ades.
 Walt Disney Prod'ns France, 44 Av. des Champs-Elysées,
 75008 Paris. Tel. (01) 359.17.80/02.20. Cable
 MICKMOUSE. Telex. 64062. Pres. & Dir. Gen. Ar-
 mand Bigle (Distributed by Ades).
Home office: USA.
Labels: (Owned) Disneyland, Vista.
 Disques H, see Phonogram.
 Disques Culturels Francais, see Hugues Desalle.
 Disques du Cavalier (IFPI), 84750 Viens. Tel. (90)
 75.22.13.
 Donali, see Bleu.
 Dragon Phenix, see Safari-Ambiance.
 Francis Dreyfus, see CBS.
 Ducrétet Thomson, see Pathe Marconi EMI.
 Dynamic, see Carabine.
 E D I M (Eds. Disques Musique), 3 Cite Magenta, 75010
 Paris. Tel. (01) 202.68.96. Dir. Michel Herault.
Labels: (Owned) Googa-Mooga, HeM, Homere
G, G, see Barclay.
 E M I, see Pathe Marconi EMI.
 E P S (Disques Coccinelle), 8 Rue Albert Samain, 75017
 Paris. Tel. (01) 745.51.15. 491.12.85. Dirs. Daniel
 Jenny & Robert Pons.
 Ecoute S'Il Pleut, see RCA.
 Eden Roc, see Motors.
 Edico, see International Rec.
 Edwards Recs., 58 Rue du Docteur Calmette, (en Cours)
 Sequedun, 59320 Haubourdin. Tel. (20) 50.42.42.
 07.16.82. Gen. Mgr.: Theodore Edwards, A&R Dir.
 Jean Pascal Hevens.
**Labels: (Owned) Edwards; (distributed—not licensed)
 Biograph (USA), Criminal (UK), Free Reed (UK), Inter-
 cord (Germany), Musantica (Canada), Oldie Blues (Neth-
 erlands), Oversea (Switzerland), Parsifal (Belgium), Sha-
 nache (USA), String (UK), Topic (UK).**
**Int'l reps.: Belgium (Parsifal), Canada (Musantica), Ger-
 many (Oversea), Luxembourg (Tele Disc), Netherlands
 (Sound Prods.), Switzerland (Vogue).**
 Elektra, see WEA Filipacchi.
 Encyclopedie Cecumenique Audiovisuelle, see Studio SM.
 Enfants Sages, see Ades.
 Epidaure, see Musidisc.
 Erato (Disques), 60 Rue de la Chaussée d'Antin, 75009
 Paris. Tel. (01) 280.69.19. Cable COSTERAT. Pres. &
 Dir. Gen. Philippe Loury; Dir.: Michel Garcin. (Distrib-
 uted by RCA).
 Eriean, see Daems.
 Eroll, see SFPP.
 Escargot, see Sibecar & CBS Disques.
 Esperance, see Sonodisc.
 Etoile, see Societe Francaise du Son.
 Eurodisc, see Arabella & WEA Filipacchi.
 Experience, 8 Rue Emile Allez, 75017 Paris. Tel. (01)
 345.73.30. 344.62.25. Dir. Gen. Philippe Doiteau.
Labels: (Owned) Experience, Impulse; (distributed)

Polyphone, Verseau; (represented) Serenata (Portugal).
 Int'l rep.: Portugal (Radio Triunfo).
 F N A C SA, 136 Rue de Rennes, Paris. Tel. 544.39.12.
 Pres. Dir. Gen. Andre Essel; Gen. Mgrs.: Max Theret,
 Louis Kalusznyer; Sales Mgr. Patrick Schoenahl. (Dis-
 tributor).
 F Y (Disques), 147 Rue de Bercy, 75012 Paris. Tel. (01)
 345.64.81. Mng. Dirs.: Francois & Yvette Carbou.
**Labels: (Owned) FY (distributed by RCA), Solstice (dis-
 tributed by Disco Shop).**
**Int'l reps.: Canada (Andre Perrault—P.Q.), USA
 (Delos—partial).**
 Fass Bee Int'l, see Studio Damiens.
 Faure, see Daems.
 Fauves, see Polydor.
 Carlo Ferrari, see Disc'AZ.
 H G Carlo Ferrari, see listing under "H."
 Festival, see Musidisc.
 Fidsound, see CNAI Fidsound.
 Fiesta, see Societe Francaise du Son.
 Flamingo Recs., 25 Rue Saint Sulpice, 75006 Paris. Tel.
 (01) 326.02.91. (Distributed by Carrere).
 Flammes de Velours, see Daems.
 Flamophone, 12-14 Blvd. de l'Hopital, 75005 Paris. Tel.
 (01) 707.11.83. Dir. Gen. Claude Puterflam. (Also see
 WEA Filipacchi).
 Flash, see WEA Filipacchi.
 Fleche (Disques), 122 Blvd. Exelmans, 75016 Paris. Tel.
 (01) 651.46.41. Telex. 630295. Gen. Mgr.: Claude
 Francois; Artistic Dir.: Guy Floriant; Admin. Dir.: Nicole
 Gruyer. (Distributed by Carrere).
Int'l rep.: Belgium (Phonogram).
 Flyright, see Societe Francaise du Son.
 Folk Imports, 88 Rue Saint Martin, 75004 Paris.
Label: (Distributed) Sierra/Briar (USA).
 Fonta, see Daems.
 Fontana, see Phonogram.
 Force, see Carrere.
 Formule 1 (Prod'ns Disques) (IFPI), 16 Rue Felicien David,
 75016 Paris. Tel. (01) 524.69.10. Dir.: Guy Bayle.
 (Distributed by Carrere).
 Francais de Notre Temps, see Hugues Desalle.
 France Radio Club, 37 Rue Georges Carel, 76450 Cany.
 Dir. Daniel Lefebvre.
Int'l firm represented: Flashback Promos (UK)
 Free Bird, 19-23 Av. Jean Aicard, 75011 Paris. Tel. (01)
 357.23.70. (Distributor).
 Freesound, see Ambient.
 Frituna France SA, 11 bis Blvd. Delessert, 75016 Paris. Tel.
 (01) 520.08.98.
Home office: Sweden.
 G B Prod'ns, 96 Rue de Rivoli, 75006 Paris. Tel. (01)
 277.60.22. Telex. 230301. Dir. Gabriel Banon; Gen.
 Mgr. Jack-Henri Soutere; Sales Mgr. P. Loison.
 G I D (Guilde Int'l de Disque), Tour Franklin, 92081 Paris La
 Defense, Cedex 11. Tel. 776.42.21. Telex. 610053.
 Dir. Claude Chuteau; Int'l Dir. David Josefowitz.
**Branch: 27000 Evreux, 1 Rt. de Cocherel. Tel.
 3233.1062.**

YOUR FRENCH CONNECTION!

LEADING
 WORLD WIDE
 EXPORTERS
 FOR ALL
 FRENCH LABELS.
 LOWEST PRICES
 FAST SERVICE



dave music

EXPORT AND DISTRIBUTION

PLEASE CONTACT US 50 rue Stendhal 75020 Paris
 Tel: (1) 636.66.36—636.66.35 TELEX: DAVEMUS 210.611

PROMOSTART

- 887.02.98. Telex: 270618 x 217. Pres. Dir. Gen.: Serge Kniazeff (Distributor/Importer/Exporter)
- Red, see Sopredim
- Red Seal, see RCA
- Reflets d'Alsace, see Daems
- Reflets du Pottou, see Daems
- Reprise, see WEA Filipacchi
- Ricordi, 3 Rue Rocquepine, 75008 Paris. Tel: (01) 359.15.07. Pres. Guido Rignano.
- Rigolo, see Salvador
- Riverboat, see Societe Francaise du Son
- Riviera, see Barclay
- Rockland Discobox, 11 Rue de Provence, 75009 Paris. Tel: (01) 246.34.17, 246.34.85.
- Rois du Musette, see Daems
- Rosario, see Daems
- Roy, see Societe Valant
- S E M A SarL, PO Box 232, 03208 Vichy Cedex. Tel: (70) 98.37.21.
- S E R P (Societe d'Etudes & Relations Publiques) Disques (IFPI), 6 Rue de Beaune, 75007 Paris. Tel: (01) 261.09.73.
- Int'l rep.: Belgium (BIAC)
- S F P P (Societe Francaise de Prod'ns Phonographiques) (IFPI), 10 Rue Pasteur, 92300 LeVallois. Tel: (01) 270.81.40. Mng. Dir.: Michel Bachelet
- Labels: (Owned) AMP, SFP, Sloughy, Spalax, (licensed foreign) Gamma (Canada); (distributed domestic—not licensed) Eroll, (distributed foreign—not licensed) Tangent (UK)
- Int'l reps: Belgium (Schott), Canada (Musmart), Germany (Bellaphon), Netherlands (Hosat), Sweden (SAM), Switzerland (Evasion)
- S M, see Studio SM
- S T GDP, see Montparnasse 2000
- Safari-Ambiance, 118-130 Av. Jean-Jaures, 75019 Paris. Tel: (01) 200.56.42, 201.59.81. Gen. Mgr. Charles Maniatakis; A&R Dir. Colette Lacoste
- Labels: (Owned) Disc Africana, Dragon Phenix, Volta Symphonie; (licensed foreign) Charlie's (USA), (distributed—not licensed) Univers (Antilles)
- Safta-Anthologie Sonore, see Ades
- Saga Recs., 55 Rue Pierre Charron, 75008 Paris. Tel: (01) 225.32.66. Mgr. Jean-Luc Azoulay
- Saiga, 49 bis Av. Hoche, 75008 Paris. Tel: (01) 227.16.34. Artistic Dir.: Andre Tissot, Claude Lemoine, Prod'n Dir.: J. Milgram, Promo. Dir. Gerome Camilly
- Salvador (Prod'ns Artistiques & Musicales), 6 Pl. Vendome, 75001 Paris. Tel: (01) 260.87.80, 260.87.05. Pres. & Dir. Gen.: Jacqueline Salvador; Gen. Mgr.: Henri Salvador
- Labels: (Owned) Or. Rigolo, Salvador
- Santaliseo, see Daems
- Sarahav, (Eds.), 22 Rue des Abbesses, 75018 Paris. Tel: (01) 252.47.20. Telex: 64438. (Distributed by RCA)
- Sava, see Bagatelle
- Schott Freres SarL (IFPI), 35 Rue Jean Moulin, 94300 Vincennes. Tel: 374 30 95. Dir.: Jean-Jacques Junne. (Distributor/Importer)
- Labels: (Distributed—not licensed) Alpha (Belgium), Amadeo (Austria), Baerenreiter (Germany), Cantate (Germany), Carus (Germany), Claves (Switzerland), Da Camera (Germany), Jecklin (Switzerland), Monitor (USA), Musique en Wallonie (Belgium), Schwann (Germany), Toccata (Germany), Unisono (Germany), Wergo (Germany), Zephyr (Belgium)
- Score, see Musidisc
- Scorpius (Disques), 16 Rue Gregoire-de-Tours, 75006 Paris. Tel: (01) 033.50.76. Dir.: Nikos Athanassiou (Distributed by Chant du Monde)
- Home office: Greece
- Sedec, see WEA Filipacchi
- Segpa, see WEA Filipacchi
- Select Sound, see Societe Francaise du Son
- Sermon, see RCA
- Sforzando/Sirocco (Eds. Musicales) (IFPI), 42 Rue Laugier, 75017 Paris. Tel: (01) 267.04.69, 766.23.64. Telex: 260717. Dir.: Roger Tokarz. (Distributed by Polydor)
- Label: (Owned) Sirocco
- Int'l reps.: Australia (EMI, RCA), Austria (Ariola, Hansa, Teldec), Belgium (Barclay, Polydor), Brazil (Tapacar), Canada (RCA), France (Polydor), Germany (Ariola, Hansa, Teldec), Italy (Atlas, Phonogram), Japan (Phonogram), Mexico (CBS), Netherlands (Bovema, EMI), New Zealand (RCA), Scandinavia (Hansa), Spain (Zafiro), Switzerland (Polydor), UK (GTO, Hansa), USA (TK)
- Shandar-Andsom 40 Rue Nazarine, 75006 Paris. Tel: (01) 326.84.35. Dir. Chantal Darcy
- Label: (Owned) Shandar
- Sibecar, Prod'ns Musicales, 99 Rue de Vaugirard, 75006 Paris. Tel: (01) 544.55.31. Dir.: Gilles Bleiveis; Ass't Dir.: Sylvie Cuau. (Distributed by CBS)
- Labels: (Owned) Escargot, Petit Escargot; (licensed foreign) Le Nordet, Presqu'ile (both Canada)
- Int'l reps.: Belgium (CBS), Canada (CBS), Spain (CFE), Switzerland (Evasion)
- Sigem (Sistema Globo de Edicoes Musicais), 23 Rue Scheffer, 75016 Paris. Tel: (01) 704.12.20. Contact: Elyane Georgette Peyrot
- Home office: Brazil
- Sirens Musique SarL, 13 Rue de l'Argenterie, 34000 Montpellier. Tel: (67) 72.83.40. Dir.: Robert Frances. (Distributor/Importer/Exporter)
- Label: (Licensed foreign) Mark Lee (USA)
- Sirocco, see Sforzando/Sirocco & Polydor
- Slim Pezin (Prod'n), see BBZ
- Sloughy, see SFPF
- Smack, see Charly
- Societe Bretonne d'Enregistrement/Arfolk, 14 Passage du Blavet, 56100 Lorient. Tel: (97) 21.23.91. Dir.: Georges Gragnic; Sales & Promo. Mgr.: G. Bono
- Labels: (Licensed domestic) Arfolk, Art & Musique, Kelta III
- Int'l reps.: Belgium (Edibon), Germany (Discofon), Sweden (Engelbert), Switzerland (Disques-Office)
- Societe Francaise du Son (Sofrason) (IFPI), 30 Rue Beaujeu, 75008 Paris. Tel: (01) 766.01.01. Cable DECCADIS. Telex: 280150. Pres.: E.W. Pelgrims de Bigard; Gen. Mgr.: X. Pelgrims de Bigard; Sales Mgr.: C. Boutin
- Deputy Sales Mgr.: C. Filiard; Coordinating Dir.: Yves Roy
- Labels: (Owned) African, Argo, Blue Elephant, Chapter One, Deram, Fiesta, London, L'Oiseau Lyre, Select Sound, Vega, (licensed) Beserkley (USA), Decca (UK); (distributed—not licensed) Adele, Black & Blue, CB, Cat, Chicago 2000, Delmark, Etoile, Flyright, M. Nommo, Riverboat
- Int'l reps.: Belgium (Fonior), Colombia (Daro), Italy (CGD), Japan (King), Netherlands (Dureco)
- Societe Volant, PO Box 436, 4 Rue de Picardie, 95310 Saint Omer l'Aumone. Tel: (01) 464.57.87/58.14. Telex: TOPDISC 697064. Dir.: Guy Volant, Gen. Mgr.: Yves Volant
- Labels: (Licensed domestic) National, President, Roy, Vgson
- Soda, 29 Rue de Marignan, 75008 Paris. Tel: (01) 225.68.19, 633.68.48. Telex: 250973. Pres. Roger Choukroun
- Labels: (Owned) Soda; (licensed) Cotton (USA)
- Sofradim, 82 Rue Baudin, 92300 Levallois-Perret. Tel: 270.91.91, 292.03.95
- Sofrason, see Societe Francaise du Son
- Soleil Masque, see PALM
- Solstice, see FY
- Sonafric, see Sonodisc
- Sonart (Disques), PO Box 1, 38700 La Tronche. Tel: (76) 88.01.58. Dir.: Yves Chauvet
- Label: (Owned) Sonart
- Sonodisc (Societe Nouvelle de Distribution de Disques), 85 Rue Fondary, 75015 Paris. Tel: (01) 577.30.34. Telex: 204018. Gen. Mgr.: Marcel Perse; Sales Mgr.: Michel David
- Labels: (Owned) Esperance, Kouma, Sonafric, (licensed) Ararad (Armenia), Coco (Latin America), Gema (Latin America), Lys (Armenia), SLD (Lebanon), Secco (Latin America), Songhoi (Africa), Sono Caro (Egypt), Tapeacar (Brazil), Tropical (Latin America), Voice of Stars (Lebanon), WS Latno (Latin America), (distributed—not licensed) Debs (West Indies), Francis Bebey (Africa), Vacances (West Indies), Voix du Liban (Lebanon)
- Int'l reps.: Australia (Carinia), Canada (Almada), Egypt (Sono Cairo), Germany (Bellaphon), Italy (CBS-Sugar), Japan (Japan Musical Express), Lebanon (Voice of Stars), Morocco (Univers Dist'n), Netherlands (Sound Prods.), South Africa (CCP), Sweden (Amigo), Switzerland (Disques-Office), Tunisia (Khari-Rie Fiscoor), UK (Conifer), USA (International Book). (SEE ADVERTISEMENT)
- Sonopresse SA, 26 Rue de Berré, 75008 Paris. Tel: (01) 359.05.89
- Labels: (Owned) Gerard Tournier, Sonopresse, (distributed) Big Box, Blue Note, CS, Capitol, Carabine, Carla, Dany Music, Durium, Espace Vert, International Shows, Junior Prod'ns, MAM, MPS, Magnet, Mouche, PARR, Panda, Private Stock, Rockhouse, Starter Music, Tonus, Transatlantic, Trianon, United Artists
- Sopredim, 14-bis Cite Bauer, 75014 Paris. Tel: (01) 542.91.04. Chief Exec.: Suzy Ham
- Labels: Ceresite Red
- Soul Posters, 6-8-10 Blvd Jourdan, 75014 Paris. Tel: (01) 589.43.72. Telex: 204741. Pres. & Dir. Gen.: Jean-Christophe Pelletier
- Soul Recs., see Diffidisc
- Spalax, see SFPF
- Special Accordeon, see Daems
- Star Series, see RCA
- Stern, see Musidisc
- Stip, see Dave Music
- Studio ABM/Disques JBP, 29 Rue Royale, 69001 Lyon. Tel: (78) 28.33.19
- Studio Damiens, 7 Rue Damiens, 92100 Boulogne. Tel: 608.51.51. Dir.: Guy Boyer, Gen. Mgr.: Elaine Boyer; Studio Mgr.: Andy Scott
- Labels: (Owned) Cornelia, Fass Bee Int'l
- Studio SM (IFPI), 3 Rue Nicholas Chiquet, 75017 Paris. Tel: (01) 267.01.37/02.63. Pres.: Maurice Robreau; Gen. Mgr.: Marc Bonnin; Sales Mgr.: Monique Ewertz
- Labels: (Owned) Arc en Ciel, Encyclopedie Cecumenique Audiovisuelle, Cathedrales, Lumen, Monasteres, SM, Suyapa
- Int'l reps.: Belgium (Edibon), Canada (Archambault), Germany (Oversea), Switzerland (Barclay)
- Studio 10, see Bagatelle
- Sun Recs., 128 Blvd. Richard Lenoir, 75011 Paris. Tel: (01) 355.96.15. Chief Exec.: Sebastien Bernard
- Labels: (Owned) Sun, (licensed domestic) Impro-music; (licensed foreign) Arica, Altsax, Center of the World, Maignelay (all USA)
- Int'l rep: USA (Audiofidelity)
- Sunbar, see RCA
- Super Stars, see Daems
- Suyapa, see Studio SM
- Swing, see Vogue
- Sylvestre, see Barclay
- Charles Talar, see CBS Disques
- Tam-Tam (Disques Orientaux), 13 Av. de la Rosiere, 13012 Marseille. Tel: (91) 93.34.12
- Teleson, 56 Rue General Giraud, 76000 Rouen. Tel: (35) 71.28.74. Dir.: Jacques Maigret
- Int'l branch: USA
- Label: (Owned) Grand Orgue
- Tem Disques, 10 Rue Saint-Florentin, 75001 Paris. Tel: (01) 260.18.98
- Terme, see Barclay
- Temporel, 2 Rue du Marquis-de-Mores, 92380 Garches. Tel: 970.46.00. Dir.: Guy Beart. (Distributed by RCA)
- Teurlay, see Daems
- Tin Tin, see Pin Pin
- Tonus-Plaisir des Dieux., see Diffidisc
- Topkapi, see Biram
- Trema (IFPI), 62 Rue Pierre Charron, 75008 Paris. Tel: (01) 256.08.82. Cable TREMATCH. Co-Pres.: Jacques Revaux, Regis Talar; Mktg. Mgr.: Alain Revaud; Int'l Mgr.: Claude Ebrard (Distributed by RCA)
- Labels: (Owned) Jare Int'l, Trema
- Int'l reps.: Belgium (Phonogram), Canada (RCA), Switzerland (Disques-Office)
- Treteaux Int'l, 20 Allee St. Exupery, 92390 Villeneuve-la-Garenne. Tel: 752.16.55, 798.12.84
- Trianon, see Pathe Marconi EMI
- Triumph, see Polydor
- Trois Mousquetaires, 26 Rue du General Delestraint, 75016 Paris. Tel: (01) 527.83.77
- Int'l branch: USA
- Label: (Owned) LTM
- Trump, see Polydor
- Tuba, see Box Office
- Twin-Trees, see Hexagone
- Typic (Ed. Julio Garzon), 13 Rue de l'Echiquier, 75010 Paris. Tel: (01) 770.39.15. Pres. & Dir. Gen.: Louis Garzon
- U S Sounds Int'l of Paris, 1 Rue Jean-Perrin, 93155 Le Blanc Mesnil. Tel: 931.31.02. Telex: 212073. Mgr.: Henri Halpern (Distributor/Importer)
- 1-2-3, see PALM
- Unidisc, 31 Rue de Fleurus, 75006 Paris. Tel: (01) 544.38.34. Pres.: Guy Dupuy, Gen. & Sales Mgr.: Serge Letort
- Int'l reps.: Belgium (Edibon), Canada (Archambault), Germany (Oversea), Switzerland (Evasion)
- United Artists, see Sonopresse
- Uniteledis, see Chant du Monde
- Utopia, see Godelsky Eggers
- Valois, see Baerenreiter
- Vega, see Societe Francaise du Son
- Velia (Disques), 11 Blvd. Arago, 22000 Saint-Brieuc. Tel: 61.43.29
- Verchuren, see Disc'AZ
- Vernou (Disques), Domaine de Vernou, PO Box 22, 37130 Langeais. Tel: (47) 55.80.59
- Versailles, see CBS Disques
- Versaue-Centre d'Art, PO Box 44, 31012 Toulouse Cedex: 76 Quai de Tounis, 31000 Toulouse. Tel: (61) 52.86.71. Mgrs.: Michel Barthes, Pierre Lavie
- Labels: (Owned) CANF, Polymnie, Versaue (distributed by Disco Shop); (Distributed) Antares, Kiosque d'Orpheus
- Vertigo, see Phonogram
- Vice Versa, 354 Rue Lecourbe, 75015 Paris. Tel: (01) 531.56.35. Pres.: Gerard Entremont
- Victor, see RCA
- Victrola, see Daems
- Victrola, see RCA
- Video Concept, 34 Rue Auber, 06000 Nice. Tel: 88.78.29
- Comm'l Dir.: Mr. Maillot (Distributor)
- Visadisc, see Musidisc
- Vista, see Walt Disney & Ades
- Vizir, see Crypto
- Vogue Prod'ns Internationales Phonographiques (Vogue PIP) (IFPI), 82 Rue Maurice Grandcoing, 93430 Villeneuve. Tel: 821.25.00. Cable VOGDISC Paris. Telex: 620380. Pres.: Leon Cabat; Gen. Mgr.: Cesar Rossini
- Int'l branches: Belgium (Vogue SA), Netherlands (VIP), Switzerland (CPSA)
- Labels: (Owned) Contrepoint, Jazz Legacy Jazz Selection, Jazz Today, Kaleidoscope, Mode, Mondo Music, Pacific, Swing, Vogue, (licensed domestic) Baboo, (licensed foreign) AVI (USA), Buddha (USA), Casablanca (USA), Cream/HI (USA), D&M Sound (USA), Dami (USA), Danova (UK), GNP Crescendo (USA), Kingdom (UK), Midsong (USA), Musart (Mexico), Parachute (USA), Pys (UK), Pyramid (USA), Roadshow (USA), Roulette (USA), Safari (Germany), Satril (UK), Som-Copacabana (Brazil), Sonet (UK), Trindade (Portugal), Xanadu (USA)
- Int'l reps: Argentina (Microfon), Australia (Festival), Brazil (Som), Canada (Solo/Mecano), Colombia (Sonolux), El Salvador (Bonidiscos), Israel (Hataklit), Mexico (Musart), Portugal (Trindade), South Africa (Teal), Spain (Hispavox), UK (Pye), Venezuela (Discorona), Yugoslavia (Jugoton)
- Voix de Son Maitre—VSM, see Pathe Marconi EMI
- Volta Symphonie, see Safari-Ambiance
- Vygson, see Societe Valant
- W E A Filipacchi Music (IFPI), 70 Av. des Champs-Elysees, 75008 Paris. Tel: (01) 359.12.90. Telex: 660816. Pres.: Daniel Filipacchi; Gen. Mgr.: Bernard de Bosson; Sales Mgr.: Geoffrey du Laz, A&R Mgr.: Dominic Lamblin
- Distribution & accounting branch: 18-30 Rue St-Antoine, 93 Montreuil
- Home office: USA, WEA Int'l
- Labels: (Owned) Asylum, Atco, Atlantic, Elektra, Flamophone, Nonesuch, Reprise, Warner Bros.; (licensed domestic) Arcane, Calliope, Comanche, Delta France, Eurodisc, Flash, General Music France, Henry Hexagone, Ion, Mad Music, Pergola, Sedec, Segpa, WIP, Yuki Music; (licensed foreign) Bearville (USA), Big Tree (USA), Bronze (UK), Cutoom (USA), DiscReet (USA), Embryo (USA), Evasion (Switzerland), Les Gemeaux (Canada), Little David (USA), Manticore (UK), Midi (USA), Pacha (Canada), Rolling Stones (USA), Signpost (USA), Swan Song (USA), Westbound (USA), Whitefield (USA); (distributed—not licensed) Krokos, Malligator (both France)
- W I P Prod'ns SA, 50 Rue de Miromesnil, 75008 Paris. Tel: (01) 265.09.71, 266.56.83. Pres. Dir. Gen.: Simon Wajnrot, Alain Krief; Promo.: Jean-Paul Barkoff. (Licensed to WEA Filipacchi)
- Warner Bros., see WEA Filipacchi
- West-Music, 64 Rue Sadi-Carnot, 93170 Bagnolet. Tel: 360.54.74, 360.95.52. Radio Tel: 391.31.40. Dir. Gen.: Benoit Kaufman; Admin. Dir.: Michel Cron
- Wilyban, see Daems
- Yuki Music, see WEA Filipacchi
- Zagora, see Biram
- Zero Int'l, see Montparnasse 2000

● music publishers

- A C O Music, 98 Rue la Fontaine, 75016 Paris. Tel: (01) 525.84.35
- A R B (Eds.), 21 Av. de l'Opera, 75001 Paris. Tel: (01) 261.61.02. Pres. Dir. Gen.: Anne Revel-Bertrand

- A R T Music-France**, 62 Rue Pierre Charron, 75008 Paris. Tel. (01) 256 08 82. Cable: TREMATCH. Telex: 630170. Pres. Regis Talar; Int'l Mgr.: Claude Ebrard; Prof. Mgr.: Adrian Pandrea-Chapuis.
- Int'l firms represented:** Filmways (USA), Hush/Hugh Acme (UK), Lambert & Potter (USA), M&M (UK), Natural Songs (USA), Touch of Gold (USA).
- Int'l reps.:** Canada (Benalex), Japan (Watanabe).
- Abilene Music**, see Robert Salvat.
- Acuff-Rose Sarl**, see Chappell.
- Adele**, La Garde Dieu, 77370 Nangis. Tel: 408 10 30. Pres.: Simone Perret; Artistic Dir.: Pierre Perret.
- Ades (Eds.)**, 54 Rue St. Lazare, 75009 Paris. Tel: (01) 874 85 30. Telex: 280422.
- Adorna Music**, 12 Rue Desire Ruggieri, 75018 Paris. Tel: (01) 254.14.20, 747.86.72. Writer: Jacques Duchene.
- Agef (Eds.)**, see Paul Beuscher.
- Agence Musicale Int'l**, see Sonopresse.
- Aggy Music (SACEM)**, 134 Rue d'Avron, 75020 Paris. Tel: (01) 373.66.75. Dir.: Tony Amaraggi.
- Agoria (Eds. Musicales)**, 10 Rue Frederic Bastiat, 64 Bayonne. Tel 25 18 73. Dir. Mr. Meyzenc.
- Louis Alberti (Musical EP)**, 252 Rue du Faubourg St. Honore, 75008 Paris. Tel (01) 227 06.30, 924.43.70. Gen. Mgr. Louis Alberti.
- Norbert Aleman (Eds.)**, see Robert Salvat.
- Afie**, see Groupe "1".
- Ailleuia**, 10 Rue St. Florentin, 75001 Paris. Tel: (01) 260 85 05, 260 18 36. Mgr. Gerard Meys.
- Alfimus-Beuscher (Eds.)**, see Paul Beuscher.
- Allo Music**, 17 Rue Ballu, 75009 Paris. Tel (01) 280 61 07. Cable: ALLOMAX. Telex: 280245. Pres. Max Amphoux; Int'l Mgr. Maurice Bouchoux.
- Int'l firms represented:** ATV (UK, USA), Andustin (USA), News (UK), St. Annes (UK), R. Scott & Wolfe (UK), Strange (UK), Three Hats (Canada).
- Alpha (Eds. Musicales)**, 20 bis Rue Louis-Philippe, 92200 Neuilly. Tel: 624 96.24. Mng. Dir. Jacques Wolfson.
- Ambient Music**, see Brull.
- Ammo James**, see Dick James.
- Amour (Eds.)**, 30 Rue Pierre Semard, 75009 Paris. Tel: (01) 878 02 28.
- Amphon Sarl**, 12 Rue Rougemont, 75009 Paris. Tel: (01) 246 24 97. Gen. Mgr. Isabelle Berthou.
- Int'l firms represented:** Kerby (Canada), Ricordi (Italy), B. Schott's Soehne (Germany), Universal (Austria, UK).
- Int'l reps.:** Austria (Universal), Canada (Kerby), Denmark (Wilhelm Hansen), Italy (Ricordi), UK (UMP).
- Andorra**, 52 Rue de Faubourg St. Martin, 75010 Paris. Tel: (01) 607 45 91.
- Anglo-Pic**, see Intersong.
- April Music**, 3 Rue Freycinet, 75116 Paris. Tel: (01) 723.54.22. Telex: 62046.
- Int'l firms represented:** Andover, Arden, Assorted, Aud-Lee, Barnaby & Claudine, Bengal Tunes, Benja-boone, Boom, Bread & Butter, Byrdland, Carrots, Concentric Prod'ns, Curnor, Dandelion, Dare, Destination, Durning, Efremer, Great Stoned, Integrity, Jaypaul, Kangaroo, Knob Hill, MacFaye, Van McCoy, Mighty Three, Music Music Music, Music Maximus, Music Pool, Nelchell, Notes Show, Polygon, Red Stick, Rhineland, Robwil, Rock On, Conrad Rocks, Ronnat, Tuna Fish, Jeff Wayne, Wizard.
- Int'l reps.:** Worldwide (April/Blackwood).
- April Music Europe**, 35 Av. Franklin D. Roosevelt, 75008 Paris. Tel: (01) 266 91 41. Cable: EUROCR1. Telex: 640329. Dir.: Pierre Hebrard.
- Aquitania**, 52 Cours d'Alsace-Lorraine, 33000 Bordeaux. Tel: (56) 48 83 11.
- Arabella Sarl (Eds. Musicales)**, 136 Rue Peronnet, 92200 Neuilly sur Seine. Tel: (01) 745.42.42. Telex: 613815. Mng. Dir. Rene Cacheux.
- Int'l firms represented:** Austria, Belgium, Germany, Netherlands, Spain, USA.
- Int'l rep.:** Germany.
- Arpege (Eds.)**, see Paul Beuscher.
- Arree Music**, see Dick James.
- Art Scene Music**, see You You.
- Atalante (Eds.)**, 10 Rue Damremont, 75018 Paris. Tel: (01) 606 88 35. Dir.: I.S. Orlando.
- Automatic Banana**, 37 Rue Violet, 75015 Paris. Tel: (01) 567 12 10.
- Ayachi Music**, see Francis Dreyfus/Labrador.
- Charles Aznavour**, see Chappell.
- Baboo Eds.**, 20 bis Rue Louis-Philippe, 92200 Neuilly. Tel: 745 47 50. Dir. Gen. Cesar Rossini.
- Bacchanales (Eds.)**, 2 Rue de Puits-d'Affet, 77230 Mussy-le-Vieux. Tel: 430 93 53. Dir.: Alain Pommier.
- Branch: 75018 Paris**, 88 Rue Lamarck. Tel: (01) 257 47 61.
- Back to Paris**, see Allo.
- Baerenreiter (Ed.)**, 1 Allee Jean de Ockeghem, 37170 Chambray les Tours. Tel: (47) 28 10 02. Dir.: Mr. Bernstein.
- Pierre Baetz & Co.**, 52 Rue du Faubourg St. Martin, 75010 Paris. Tel: (01) 607 45 91. Mgr.: Pierre Baetz.
- Bagatelle SA (SACEM)**, 10 Rue Washington, 75008 Paris. Tel: (01) 256 17 99, 359.42.56. Telex: 640328. Pres.: Denis Bourgeois; Gen. & Int'l Mgr.: Brigitte Berthouier-Spahn.
- Int'l firms represented:** Alkatraz Corner, Athens, Big Sky, Big Ten, Black Leather, Bourne, Bucky, Bucrennis, Busybody, Callee, Cape Ann, C'est Music, Cheap Thrills, Chicken Fried, Circustent, Coco, Curtom, Djengo, Dr. Livingstone I Presume, Dwarf, Earmark, Elbomo, Fiction, Fourth Floor, Gaucho, Grasshopper, Groper, Har-grove, Heavy Gray, Ray Willie Hubbard, Jelly Roll, Joy-ride, Knee Tremble, Lark, Life Dance, Light, Lively Arts, Lonport, Lunch, McJohn, Mewg, Micache, Missing Link, Ivan Moguil, Mulligan, Music Mgmt., NFL Films, Neath, Nevoc, Niranady, Nunn, Ozono, Passing Clouds, Peach, Petra, Pink, Plur-on Music, Pommie, Public Domain Foundation, Quackenbush, Rami's Horn, Rolls Royce, Roswell, Sandbox, Scar, Serendipity, Sixteenth Avenue, Sky Forest, Songbirds of Paradise, Sorn, Southern Pines, Special Rider, Street People, Strong Arm, Suemir, Three Dog Night, Timgale, Tomeja, Trine, Triplot, Weng, Whistle, Wind Breeze, Yabone Yatta Song, Ying Yang (all USA), Broune, Bron, Osibosounds, Photoplay (all UK).
- Int'l rep.:** Canada (BAG).
- Banana**, 37 Rue Violet, 75015 Paris. Tel: (01) 567.12.10. Dir. Gen.: Jean Pierre Martel.
- Banco (Eds.)**, see Robert Salvat.
- Eddie Barclay (Nouvelles Eds.)**, 44 Rue de Miromesnil, 75008 Paris. Tel: (01) 265.87.80. Pres.: Eddie Barclay; Mgrs.: Patrick Vialere, Georges Le Derf.
- Int'l firms represented:** Dawnbreaker (USA), EMP (USA), Franco London (UK), Ricordi (Italy).
- Francis Baxter**, 33 Rue du Faubourg St. Martin, 75010 Paris. Tel: (01) 607.89.05. Dir. Gen.: Francis Baxter.
- Belwin Mills France**, 71 Rue de Provence, 75009 Paris. Tel: (01) 874 15 68. Cable: FONOMUSIC. Mng. Dir.: Francis O'Neill; Dir.: Monique Villain.
- Jean Bergougnot (Les Eds. Musicales)**, 3 Square Paul-Claudel, 92390 Villeneuve-la-Garenne. Tel: 752.16.55, 798 12 84.
- Irving Berlin Sarl**, see Chappell.
- Paul Beuscher (SACEM)**, 23-29 Blvd. Beaumarchais, 75004 Paris. Tel: (01) 271.22.11. Cable: ALLMUSIC. Telex: 670877. Artistic Mgr.: Guy Adamik; Gen. Mgr.: Philippe Seiller.
- Int'l firms represented:** Edward B. Marks (USA), New Music Corp. (Belgium).
- Int'l rep.:** Belgium (Vedette).
- Gerard Billaudot**, 14 Rue de l'Échiquier, 75010 Paris. Tel: (01) 770 14 46. Gen. Mgr.: Gerard Billaudot.
- Int'l reps.:** Germany (Muencher Musikgrossortiment), Italy (Carisch), Japan (Buffet-Crampon), Spain (Real Musical), UK (United Music Publ'rs), USA (Theodore Presser).
- Bimbo Music**, 78 Av. des Champs-Élysées, 75008 Paris. Tel: (01) 359.67.80. Pres.: Laurent Rossi.
- Biram France (Eds.)**, see Bleu Blanc Rouge.
- Bixio France**, see Eddie Barclay.
- Bleu Blanc Rouge (Les Eds.)**, 9 Rue de Versailles, 92430 Marnes-La-Coquette. Tel: (01) 741.6198. Cable: KLU-GER. Telex: 203249. Pres. & Gen. Mgr.: Huguette Ferly-Kluger; Ass't.: Dominique Vacroux.
- Int'l rep.:** Belgium (Jean Kluger).
- Boosey & Hawkes**, 4 Rue Drouot, 75009 Paris. Tel: (01) 770 73 44.
- Bornemann (Eds.)**, 15 Rue de Tournon, 75006 Paris. Tel: (01) 326 05 88.
- Int'l reps.:** UK (United), USA (Belwin-Mills).
- Bourne France**, see Bagatelle.
- Bousquet**, 61 Faubourg St. Denis, 75010 Paris. Tel: (01) 770 15 35.
- Bretagne (Eds. Musicales)**, 43 Rue Fessart, 92100 Boulogne. Tel: 603 41 93. Contact: Martine Grossemy.
- Breton (Eds.)**, 3 Rue Rossini, Paris. Tel: (01) 824.86.19. Pres. Dir. Gen.: Mme. Raoul Breton.
- Briand**, see Eddie Barclay.
- Bridget Music**, see Bagatelle.
- Brull (Eds.)**, 18 Rue de Provence, 75009 Paris. Tel: (01) 527 69 67. Owner: Mary Therese Fiacre; Gen. Mgr.: Roger Charles Friant.
- C B E Le Vepar**, 95 Rue Championnet, 75018 Paris. Tel: (01) 255 49 95.
- C N A I Fidsound**, 19 Rue Coysouev, 75018 Paris. Tel: (01) 228 05 91, 229.24.61. Pres. & Dir. Gen.: Jean-Claude Thuel-Chassaingne.
- C R E A C**, 118 Blvd. Malesherbes, 75017 Paris. Tel: (01) 622 09 69. Pub. Head: Alain Hanel.
- C S B Ltd.**, 40 Rue Jean Jaures, 93170 Bagnolet.
- Calonn (Ed.)**, 30 Rue Dr. Finlay, 75015 Paris. Tel: (01) 578 24 75, 578 15 18. Dir.: Patrick Chevalier.
- Gerard Calvi**, 20 bis Rue Louis-Philippe, 92200 Neuilly. Tel: 637 50 04.
- Camera One Eds.**, 106 Av. de Villiers, 75017 Paris. Tel: (01) 924 89 60, 757 68 05. Cable: PAMYS. Telex: 640451. Mng. Dir.: Michel Seydoux.
- Campbell Connelly France**, 71 Rue de Provence, 75009 Paris. Tel: (01) 874 15 68. Cable: FONOMUSIC. Dir.: Francis O'Neill.
- Carabine Music**, see Syrinx.
- Caradam**, see Baboo.
- Caramel**, see Baboo.
- Caravage (SACEM)**, 6 Rue Alfred Roll, 75017 Paris. Tel: (01) 754.86.79. Pres. & Gen. Mgr.: Jean-Paul Smets.
- Caravelle (Nouvelles Eds. Musicales)**, 35 Blvd. Malesherbes, 75008 Paris. Tel: (01) 265 08 93.
- Carissima (Eds. & Prod'ns Musicales)**, see 12.000.
- Carlyne Music (SACEM)**, 82 Rue Chardon-Lagache, 75016 Paris. Tel: (01) 224 08 00. Contact: Caroline Jeanne de Mirbeck.
- Carrara**, 86 Rue de Faubourg St. Martin, 75010 Paris. Tel: (01) 206 43 37.
- Claude Carrere (Eds.)**, see Robert Salvat & Tonus.
- Carrousel**, see Vogue.
- Casanova Music**, see Dick James.
- Castel Music**, 44 Rue de Miromesnil, 75008 Paris. Tel: (01) 265 87 80. Dir.: Gilbert Chemouny.
- Cat Music**, see Minotaure.
- Cayla**, 33 Rue du Faubourg St. Martin, 75010 Paris. Tel: (01) 208 91 66.
- Celine (Eds.)**, see Marouani.
- Centreurope**, see Tabata.
- Cerrone Music**, see You You.
- Cezame Eds.**, 2 Rue Flechier, 75009 Paris. Tel: (01) 878 45 23. Mng. Dirs.: Jean-Michel Gallois-Montbrun, Frederic Leibovitz.
- Chant du Monde**, 64 Rue Ampere, 75017 Paris. Tel: (01) 924 67 73. Pres. & Dir. Gen.: Jean Roire; Gen. Mgr.: Jean Mialhe.
- Chappell SA**, 12 Rue de Penthièvre, 75008 Paris. Tel: (01) 266 40 42. Cable: SYMPHONY. Pres. & Dir. Gen.: Gerard Davoust.
- Int'l rep.:** Worldwide (Chappell).
- Charly Music (France) Sarl**, 42 Rue Monge, 75005 Paris. Tel: (01) 633 33 28.
- Chiffre Neuf (Les Eds. du)**, 5 Rue d'Alsace, 75010 Paris. Tel: (01) 264 23 24. Gen. Mgr.: Helene Bignon.
- Choudens (Eds.)**, 38 Rue Jean Mermoz, 75008 Paris. Tel: (01) 225 17 21.
- Chouette Musique**, see Allo.
- Circle Eds Internacionales**, 23 Rue Scheffer, 75016 Paris. Tel: (01) 727 04 07. Cable: ELYPEYROT.
- Home office:** Argentina.
- Cirta (Eds.)**, see Marouani.
- Colline**, see Eddie Barclay.
- Comtesse**, see Eddie Barclay.
- Comufra**, see Michel Legrand.
- Cookaway Music**, see Dick James.
- Cornelia (Eds.)**, see Presta.
- Costallat (Eds.)**, 60 Rue de la Chaussée d'Antin, 75009 Paris. Tel: (01) 280 69 19. Cable: COSTERAT. Pres.: Philippe Loury.
- Edward Cox Music**, see Dick James.
- Crazy Horse**, see Eddie Barclay.
- Crea Sound**, 58 Rue Auguste Buisson, 92250 La Garenne-Colombes. Tel: 780 71 00, 780 08 67.
- Home office:** Canada.
- Int'l firms represented:** Montparnasse 2000, Multi-Sound, Tele (all Canada); Mondiphone, Neuilly (both Canada, USA).
- Int'l reps.:** Belgium (Multisound), Germany (Sonoton), Portugal (Musiteca), Spain (Musiteca), Switzerland (Tefima).
- Crest Music**, see Dick James.
- Criterion de Paris**, 6 Rue Rukmkorf, 75017 Paris. Tel: (01) 380 34 62.
- Home office:** USA.
- Cromwell (Eds.)**, see Essex.
- Crypto**, 24 Blvd. de Lattre-de-Tassigny, 90000 Belfort. Tel: (84) 21 31 84/33 47. Gen. Mgr.: Jean-Claude Pog-nant.
- Crystal Music**, see Dick James.
- Curci France**, see Marouani.
- d'Anella (Eds.)**, 7 Rue St. Lazare, 75009 Paris. Tel: (01) 878 76 96. Pres.: Marcel D'Anella; PR & Pub.: Marc Degat.
- Dany Music**, 28 Rue de la Reine Blanche, 75013 Paris. Tel: (01) 535 03 96. Dir.: Danyel Gerard.
- Dasora Prod'ns**, 6 Rue Saint-Charles, 75015 Paris. Tel: (01) 577 27 60. Telex: 660970. Dir.: Roland Dayan.
- Dauphine**, see Eddie Barclay.
- Spencer Davis Music**, see Dick James.
- Debonnaire Music**, see Dick James.
- Decibel (Prod'ns)**, 124 Rue La Boetie, 75008 Paris. Tel: (01) 225 80 30.
- De Clercq**, 44 Rue du Colisee, 75008 Paris. Tel: (01) 359 46 89.
- Gilbert Delforge (Eds. Musicales)**, 62 Mail des Charmilles, 10000 Troyes. Tel: (25) 81 05 62. Gen. Mgr.: Gilbert Delforge.
- Delrieu (Ed.)**, 14 Rue Trachel, 06000 Nice. Pres. Gen. & Sales Mgr.: Gerard Delrieu.
- Int'l reps.:** UK (Elkin), USA (Galaxy).
- Delta France**, 12 Rue Ernest Pichari, 75007 Paris. Tel: (01) 555 01 78, 705 57 39. Mng. Dir.: Jacques Arnoul; Gen. Mgr.: Frederique Brion.
- Des Alouettes (Eds.)**, 36 Rue des Alouettes, 75019 Paris. Tel: 200 33 04. Dir.: Henri Spade.
- Detry Music**, 11 bis Rue Cdt. Pilot, 92200 Neuilly. Tel: (01) 624 84 85. Telex: 610753. Pres.: Jean-Louis Detry.
- Discotheque de Paris**, 55 bis Rue de Ponthieu, Paris. Tel: (01) 225 61 73.
- Walt Disney Prod'ns France**, 44 Av. des Champs-Élysées, 75008 Paris. Tel: (01) 359 17 80/02 20. Cable: MICKMOUSE. Telex: 64062. Pres. & Dir. Gen.: Armand Bigle.
- Home office:** USA.
- Dominic Music**, see Dick James.
- Francis Dreyfus Music/Ed. Labrador**, 26 Av. Kleber, 75116 Paris. Tel: (01) 500 77 07, 500 68 03. Telex: 611130. Pres.: Francis Dreyfus; Int'l Mgr.: Stanislas Witold.
- Int'l firms represented:** And Son (UK), Arista/Careers (USA), Arnakata (UK), Black Neon (UK, USA), Charly (UK), Sam Fox (USA), Fuse (UK), Al Jarreau (USA), Lupus (UK), Rockin' (UK).
- Int'l reps.:** Belgium (Maxwell), Canada (Labrador), UK (Francis Dreyfus—Black Neon, Labrador—Fuse), USA (Francis Dreyfus—Black Neon).
- Du Lavain (Eds. Musicales)**, 1 Rue de l'Abbe Gregoire, 75006 Paris. Tel: (01) 222 15 84. Gen. Mgr.: Daniel Truchot; Sales Mgr.: Christian Truchot; Technical Mgr.: Jean Truchot.
- Int'l firm represented:** Centre Alpec (Canada).
- Int'l reps.:** Belgium (Edibon), Canada (Serv. de Documentation Pastorale).
- Durand & Cie. (Eds.)**, 4 Place de la Madeleine, 75008 Paris. Tel: (01) 260 34 08. Pres.: Mme. Rene Dommange; Co-Dir.: Guy Kaufmann.
- E C A P**, see Emilhenco.
- E M A S (Eds. Musicales Ariane Segal)**, 36 Av. Hoche, 75008 Paris. Tel: (01) 563 76 70. Mng. Dir.: Ariane Segal.
- E M C**, see Emilhenco.
- E P O C (Eds. & Prod'ns Musicales)**, see Francis O'Neill.
- Eco (Ed.)**, see Pathe Marconi.
- Eden-Roc (Societe)**, 35 Blvd. Malesherbes, 75008 Paris. Tel: (01) 265 08 93.
- Egg Music France**, see Marouani.
- Emilhenco Music Sarl**, 143 Blvd. Lefebvre, 75015 Paris. Tel: (01) 250 64 46. Contact: Albert Cohen.
- Int'l firms represented:** Beat (Italy), Boosey & Hawkes (UK), Cavendish (UK), New Music (Belgium).
- Int'l reps.:** Belgium (New Music), Italy (Beat), Netherlands (Dennis), UK (ATV).
- Enoch**, 27 Blvd. des Italiens, 75002 Paris. Tel: (01) 742 69 95.
- Epis**, 14 Blvd. des Filles-du-Calvaire, 75011 Paris.
- Erkan**, 3 Blvd. de la Liberation, 93 St. Denis. Tel: 752 50 58.
- Max Eschig (Eds.)**, 48 Rue de Rome, 75008 Paris. Tel: (01) 522 66 64. Dir. Gen.: Jean Marietti; Gen. Mgr.: Philippe Marietti.
- Int'l firms represented:** Associated (USA), Bosworth & Co. (UK), Carisch (Italy), Ricordi (Italy), Schott & Co. (UK), B. Schott's Soehne (Germany).
- Int'l reps.:** Germany (B. Schott's Soehne), Italy (Carisch, Ricordi), UK (Bosworth & Co., Schott & Co.), USA (Associated).
- Espace**, 2 Rue du Marquis de Mores, 92380 Garches. Tel: 970 49 41.
- Esperance**, see Sonodisc.
- Essex SA (Eds.)**, TRO—The Richmond Org., 34 Av. des

- Champs-Elysees, 75008 Paris. Tel: (01) 225.69.60. 359.71.40. Pres. & Dir. Gen. Ellen C. Nathan.
Home office: England & USA.
Int'l firms represented: Essex (Belgium, UK), TRO—The Richmond Org. (USA).
Int'l reps: Worldwide including UK (Essex), Canada & USA (TRO—The Richmond Org.)
Europa, 34 Rue Truffaut, 75017 Paris. Tel: (01) 522.58.20.
Europasonor-Paris, see Futura-France.
Experience, 8 Rue Emile-Allez, 75017 Paris. Tel: (01) 380.27.10, 924.27.88. Dir.: Philippe Doiteau. Gen. Mgr.: Jacques Galissant.
Int'l firms represented: Experience (UK).
Famous Chappell Sarl, see Chappell.
Fantasia (Ed.), 13 Rue Pages, 92152 Suresnes. Tel: 772.70.36. Telex: 630946. Pres.: Jean Grandchamp des Raux.
Int'l firm represented: Tradition (USA).
Fass Bee (Ed.), see Presta.
Feldman, see Francis-Day.
Fidsound, 19 Rue Coysvoix, 75018 Paris. Tel: (01) 228.05.91, 229.24.61. Pres. & Dir. Gen.: J.C. Thuel-Chassaingne.
Fiesta, see Calonn.
Film Music, see Dick James.
Fil Rouge, see Baboo.
Flamophone, 12-14 Blvd. de l'Hopital, 75005 Paris. Tel: (01) 707.11.83.
Formule 1 (Eds.), 89 Rue de la Boetie, 75008 Paris. Tel: (01) 359.76.54. Mgr.: Angele Salvat.
France-Etoile, 19 Rue Lord Byron, 75008 Paris. Tel: (01) 225.23.92.
France-Melodie (Eds.), 94-96 Rue Lauriston, 75116 Paris. Tel: (01) 505.91.02. Cable: FRANDAY Telex: 612738. Gen. Mgr.: Andre Hackiere.
Int'l firms represented: Algee (UK), Al Gallico (USA).
France-Rec., 33 Rue Marc Seguin, 75018 Paris. Tel: (01) 206.71.08.
Francis-Day SA Publ'ns, 94-96 Rue Lauriston, 75116 Paris. Tel: 505.91.02. Cable: FRANDAY Telex: 612738. Gen. Mgr.: Andre Hackiere.
Int'l firms represented: Big Pig (UK), Cam-Al (UK), Buzz Cason (USA), Coal Miners (USA), Cookhouse (USA), Alan Hawkshaw (UK), Marksman (USA), Owepar (USA), Pennine (UK), Window (USA), Zargon (USA).
French Music, see Chappell.
Frituna France SA, 1 bis Blvd. Delessert, 75016 Paris. Tel: (01) 520.08.98.
Home office: Sweden.
Frizza, 56 Rue de Paradis, 75010 Paris. Tel: (01) 770.19.64.
Futura-France, 3 Rue Clotaire, 75005 Paris. Tel: (01) 325.13.88.
Int'l rep.: Belgium (Hebra).
Garlick Music, see Marouani.
J. Garson, 13 Rue de l'Echiquier, 75010 Paris. Tel: 770.39.15.
Louis Gaste (Eds.), 5 Rue du Bois de Boulogne, 75116 Paris. Tel: (01) 704.53.53.
Int'l firms represented: K&L Music (USA).
Int'l rep.: USA (Convention).
Gimmick, see Bagatelle.
Gleen Gleen Music, see MCA.
Goeland, see Eddie Barclay.
Gralt Music, see Dick James.
Grande Avenue (Les Eds. Musicales), 1 Av. Christophe Colomb, 94600 Choisy-le-Roi. Tel: (01) 853-11.12. Dir.: E.W. Pelgrims de Bigard, Gen. Mgr.: Alain Evans.
Groc Music, see Rideau Rouge.
Groupe "1", 8 Rue Balzac, 75008 Paris. Tel: (01) 723.45.45/47. Pres.: Jean-Philippe Ilesco. Gen. Mgr.: Jean-Pierre Imbrohros.
Guyaki, see Syrinx.
Gwineth Music, see Dick James.
H S, 6 Av. Franklin Roosevelt, 75008 Paris. Tel: (01) 225.66.70. Dir. Gen. Haim Saban.
Hamelle & Cie., 24 Blvd. Malesherbes, 75008 Paris. Tel: (01) 265.36.39.
Int'l reps: UK (United Music), USA (Theodore Presser).
Harmonic Music, see Brull.
Helian, 252 Rue du Faubourg St. Honore, 75008 Paris. Tel: (01) 622.50.16.
Hexagone (Eds.) (SACEM), 19 Rue Galilee, 75116 Paris. Tel: (01) 723.72.72. Pres.: Rene Boyer; Int'l Mgr.: Gabriel Ilos.
Int'l firms represented: Cibell, Grade One, Impact, Mother Goose, Nib, Our Music, Red Bus. (all UK).
Hohner, 19 Rue Van Loo, 75016 Paris. Tel: (01) 224.63.50.
Homere (Eds. Musicales), 3 Cite Magenta, 75010 Paris. Tel: (01) 208.93.80.
Int'l firms represented: Barry (UK), Daedalian, Mikel Hooks (USA), New Music (Belgium).
Hortensia, 46 Rue de Douai, 75009 Paris. Tel: (01) 874.52.64.
Int'l rep.: Italy (Sugarmusic).
L'illustration Musicale Sarl., 6 Rue Leon Bonnat, 75016 Paris. Tel: (01) 224.44.54. Gen. Mgr. Eddie Warner.
Int'l firms represented: Amphonik (UK), Beat (Italy), Berry (UK), Discant (Germany), Intersound (Germany), Jump (Italy), Studio One (Germany), Ultra Music Serv. (USA).
Int'l reps: Canada (Music People), Germany (Discant), Italy (Beat), South Africa (Plymouth), Switzerland (Tefima), UK (Amphonik).
Illustration Musical E. Warner, see Tabata.
Import Diffusion Music, 42-44 Rue du Fer a Moulin, 75005 Paris. Tel: (01) 535.44.25. Mng. Dir.: Alain Pierson. Gen. Mgr.: P. Agon.
Int'l firms represented: Big 3 (USA), Columbia (USA), EMI (USA), Hal Leonard (USA), Music Sales (UK), SPR (USA), Warner Bros. (USA).
Int'l reps: Belgium (Marcom), Switzerland (Songbook).
Industrial Music, see Marouani.
Intersong Paris, 6 Av. Franklin D. Roosevelt, 75008 Paris. Tel: (01) 225.66.70, 225.37.85. Telex: 270673. Pres. Dir. Gen. Jean-Jacques Tiche.
Int'l firms represented: Big Secret (UK), Blue Oyster Cult (USA), Blue Seas Music (USA), Burlington/Palace (UK), Carlin (UK), Casa David (USA), Caseyem (USA), Cherry (UK), Chicago (USA), Dymatone (USA), 5th Floor (USA), Fort Knox (USA), Hill & Range (USA), Hit & Run (UK), Hudson Bay (USA), Jac (USA), Klarke (USA), Lita (USA), Lollipop (Germany), MPL (UK), Magnet (UK), Michael (USA), Midland (USA), Midsong (USA), New York Times (USA), Open End (USA), Elvis Presley (USA), Rocket (UK), Rock Hopper (USA), Street (UK), Trio (USA), 20th Century Fox (USA), Yellow Dog (USA), Casa David (USA).
Intune Music, see Dick James.
Isabelle Musique, 122 Blvd. Exelmans, 75016 Paris. Tel: (01) 651.46.41. Telex: 630295. Dir. Nicole Lhuillier. Gen. Mgr.: Claude Francois.
Int'l rep.: Canada (CF).
Isadora, 69 Rue Rochechouart, 75009 Paris. Tel: 878.73.45. Pres. Jean Louis Tersiguel, Dirs.: Agnes Lable, Jean Sabouraud.
Jaep Music, see Dick James.
Dick James Music France, 1 Rue Lamennais, 75008 Paris. Tel: (01) 359.66.83. Gen. Mgr. Rene Talar.
Int'l firms represented: Alto, Amgo James, Arrgee, Casanova, Cookaway, Debonnaire, Dominic, Gralto, Gwineth, Intune, Maribus, Nuova, Pageant, Shair, Spencer Davis, Utopia.
Jamil Music, see Dick James.
Jamsham Music, see Dick James.
Janta Ponsa, see Dick James.
Jobert SA (Societe des Eds.), 44 Rue du Colisee, 75008 Paris. Tel: (01) 359.26.82.
Int'l firms represented: Elkan Vogel, Merion, Theodore Presser (all USA).
Int'l reps: Canada (Theodore Presser in USA), Mexico (Theodore Presser in USA), UK (JUMP), USA (Theodore Presser).
Jo Biss Int'l, see Presta.
Johanna (Eds.)/K J C D Music (Ed.), 64 Rue Sadi-Carnot, 93170 Bagnoleux. Tel: 360.95.52/54.74. Gen. Mgrs.: B. Kaufman, M. Cron.
Josephine, see Eddie Barclay.
Josid Music, see Dick James.
Jouben, 25 Rue d'Hauteville, 75010 Paris. Tel: (01) 770.15.73.
K J C D Music (Ed.), see Johanna.
Kalendour, see Sibecar.
Ketchup Music, 9 Rue Villebois Mareuil, 75017 Paris. Tel: (01) 755.78.18, 267.22.09. Mng. Dir. Philippe Duwat; PR: Jean-Pierre Domboy.
Kiswell Music, see Francis Dreyfus/Labrador.
L M C E (Lido Music Champs Elysees), 78 Av. des Champs-Elysees, 75008 Paris. Tel: (01) 359.53.30.
L S B (Lewis Show Business), 122 Rue du Faubourg-St. Martin, 75010 Paris. Tel: (01) 203.70.30. Telex: 280245. Gen. Mgr.: Willy Lewis; Int'l Relations: Gisela Clark.
Labrador (Eds.), see Francis Dreyfus.
Michel Laguens Org., 47 Av. Paul Doumer, 75016 Paris. Tel: (01) 520.37.53. Telex: 611650. Pres. Michel Laguens.
Int'l firms represented: Audiomasters Int'l (USA), Heremans (Belgium), Edi Masters (Spain), Polyband (Germany).
A. Lasry, 62 Blvd. de Clichy, 75018 Paris. Tel: (01) 606.53.00.
Alphonse Leduc (Eds. Musicales) (SACEM), 175 Rue St. Honore, 75040 Paris Cedex 01. Tel: (01) 260.62.47/48.61/65.26. Gen. Mgrs.: Claude & Gilbert Leduc.
Int'l reps: Brazil (Bruno Quaino), Japan (Buffet Crampon), UK (United Music Publ'rs).
Michel Legrand (Prod'ns), 252 Rue du Faubourg St. Honore, 75008 Paris. Tel: (01) 622.51.05. Pres.: Marcelle Legrand; Gen. Mgr.: Marcel Rothel. (Administered by Chappell).
Frederic Leibovitz (Eds.) (SACEM), 2 Rue Flecher, 75009 Paris. Tel: (01) 878.40.88.
Francis Lemarque, 18 Av. du Mesnil, 94 La Varenne, St. Maur. Tel: 883.34.21.
Henry Lemoine (Eds.), 17 Rue Pigalle, 75009 Paris. Tel: (01) 874.09.25. Dirs.: Max & Andre Lemoine.
Int'l reps: Belgium (Schott), Japan (Buffet-Crampon), UK (United Music Publ'rs), USA (Theodore Presser).
Leros Music, see Allo.
Lords Music, see Dick James.
Louis III (Eds.), see Claude Pascal.
Love Song Music, see Dick James.
M A M, 1 Rue Lamennais, 75008 Paris. Tel: (01) 720.38.51, 359.66.83. Dir.: Charlie Ganen.
Int'l firms represented: Spanka (USA).
Int'l reps: UK (MAM), USA (MAM).
M C A Music (France), 1 Rue Lamennais, 75008 Paris. Tel: (01) 359.66.83, 720.38.51. Dir.: Charlie Ganen; European Co-ord.: Michael Levine.
Int'l reps: UK (Leeds), USA (MCA).
M K (Eds. Musicales) (SACEM), 44 Rue Etienne Marcel, 75002 Paris. Tel: (01) 233.07.30. Pres. & Gen. Mgr. Monique Knuchel.
M P D, 35 Rue du Bac, 94210 La Varenne. Tel: 883.53.29.
Madeine, see Intersong.
Majestic Sarl (SACEM/SDRM), 252 Rue du Faubourg St. Honore, 75008 Paris. Tel: (01) 563.69.70.
Major (Les Eds.), Rt. Natle 307, 78810 Feucherolles. Tel: (01) 461.45.11. Cable COMODD.
Maneges, 35 Rue La Boetie, 75008 Paris. Tel: (01) 225.03.02. (Administered by Chappell).
Mangas Music, 3 Rue Freycinet, 75116 Paris. Tel: (01) 723.61.02.
Charles Maniatakis (SACEM), 118-130 Av. Jean Jaures, 75019 Paris. Tel: (01) 200.56.42, 201.59.81.
March Music, 62 Rue Pierre-Charon, 75008 Paris. Tel: (01) 256.08.82. Telex: 630170. Mng. Dir. Marie-France Seyrat.
Maribus, see Dick James.
Marine, see Eddie Barclay.
Eddy Marnay, 91 Rue Lepic, 75018 Paris. Tel: (01) 254.77.89.
Marouani (Les Eds.), 37 Rue Marboeuf, 75008 Paris. Tel: (01) 723.54.51. Telex: 640578. Pres. Gina Marouani; Technique Mgr.: Gilbert Marouani.
Int'l firms represented: ABC (UK), ATV (UK, USA), Blendingwell (USA), Broken Arrow (USA), Broken Bird (USA), Bushka (USA), Canopy (USA), Charing Cross (USA), Curci (Italy), Dino Di Laurentis (USA), East Memphis (USA), Gnosso (USA), Kiss (USA), Lady Jane (USA), Little Dickens (USA), Joni Mitchell (USA), Siqomb (USA), Trane (USA).
Int'l reps: Europe (EMI) excluding Germany (Siegel).
Mary Melody, 6 Rue d'Helicopolis, 75017 Paris. Tel: (01) 754.73.37. Dirs. Marie-Claude Lagarde, B.R. Itic.
Masouza Music, 9 Rue Goethe, 75116 Paris. Tel: (01) 723.61.02. Gen. Mgr.: O. Zameczkowski.
Masq (Prod'ns Eds. Musicales), 9 Passeage Dagorno, 75020 Paris. Tel: (01) 370.88.32. Mgr.: Herve Bergerat.
Masspacher SA (Eds.), 6 Rue Eugene Varlin, 75010 Paris. Tel: (01) 203.51.72. Gen. Mgr.: Jean Lecomte.
Peter Maurice (Eds.), see Pathe Marconi & Francis-Day.
Maybeline Music, see Francis Dreyfus/Labrador.
Medallion, see Dick James.
Melba, see Baboo.
Mellin, see Eddie Barclay.
Melorhin (Les Eds. Musicales), PO Box 22, 13 Rue Maurice Ravel, 68001 Colmar-Cedex. Tel: (89) 41.47.74, 41.80.01. Pres. & Gen. Mgr.: Fernand Erbsland.
Metropolitaines (Eds.), 11 Rue de Provence, 75009 Paris. Tel: (01) 246.60.33. Contact: Pierre Ribert.
Michel Meyer & Cie. (SACEM), 180 Rue de Billancourt, 92100 Boulogne. Tel: (01) 603.27.77.
Gerard Meys Eds Musicales, see Alleluia.
Micro, 13 Rue Washington, 75008 Paris. Tel: (01) 225.43.03.
Minerva, 142 Rue Montmartre, 75002 Paris. Tel: (01) 236.92.03.
Minotaure (Eds.) (SACEM, SDRM), 21 Rue Jean Mermoz, 75008 Paris. Tel: (01) 265.27.46. Gen. Mgr.: Mrs. Rolande Bismuth; Int'l: Denis Wolf.
Int'l firms represented: Audigram, Beggar's Banquet, Cat, Fania, Food, Number 11, Shelter group, Skyhill, Tarka, Vaya, Wishbone.
Int'l reps: Belgium (Roland Kluger), Canada (Christian LeFort), Germany (Montana), Israel (Ilanot), Japan (Alfa), Netherlands (Arabella).
Mirabel, see Eddie Barclay.
Eddy Mitchell Music, 12 Av. George V, 75008 Paris. Tel: (01) 359.12.68. Mgr.: Jean-Pierre Sammut; PR Mgr.: Michel Bellamari.
Peggy Monclair (Prod'ns Musicales), 4 Rue du Bac, 78290 Croissy. Tel: 976.28.29.
Monia Music, c/o P. Wittig, 28 Av. Hoche, 75008 Paris. Tel: (01) 227.61.58.
Monica, see SEMI.
Montana, 71 Av. Kleber, 75016 Paris. Tel: (01) 727.04.05.
Montparnasse 2000, Rue Brea 27, 75006 Paris. Tel: (01) 325.02.02, 326.41.72. Dir. Gen. Andre Farry.
Int'l firms represented: Canciones del Mundo (Spain), Canopo group (Italy), Gemelli (Italy), Guitarra (Spain), Inmus (Germany), Lutto (Italy), Omega (Italy), Polyband (Germany), Prestation (Belgium), Sermi Films (Italy).
Int'l reps: Argentina (Annibal Libenson), Belgium (Prestation), Canada (Crea Sound), Germany (Inmus), Japan (Yanami), Lebanon (SMT Film), Scandinavia (Nordiska in Sweden), UK (United Artists), Uruguay (Annibal Libenson).
Edwin H. Morris Sarl, see Chappell.
Mouche Music, see Rideau Rouge.
Music Control (SACEM), 35 Rue La Boetie, 75008 Paris. Tel: (01) 225.90.89/17.44. Gen. Mgr. C. Flinaux.
Music 18, 3 Rue Freycinet, 75016 Paris. Tel: (01) 723-61.02. Telex: 620646. Dir.: Jacques Plait.
Musique Pour l'Image, 77 Rue du Faubourg St. Martin, 75010 Paris. Tel: (01) 926.48.34. Dir. Robert Viger.
Int'l firms represented: Charles Brull (UK), Multisound (Belgium), Sonoton (Germany).
N F C, see Essex.
NW 8 Music, 94-96 Rue Lauriston, 75116 Paris. Tel: (161) 505.91.02. Chief Exec. Richard H. Cavassuto; Gen. Mgr.: Richard Lord.
Home office: Monaco.
Int'l reps: Worldwide (EMI group/Francis-Day).
Nautilus (Eds. Musicales), 39 Rue des Jeuneurs, 75002 Paris. Tel: (01) 236.63.68.
Melody Nelson Publ'g, see Chappell.
Neully, 11 Av. Bourgain, 92130 Issy les Moulineaux. Tel: 645.17.01. Gen. Mgr.: Claude Horvais; Promo.: Jean-Michel Benichou.
Normandy Music, see Masq.
Nouvelles Eds. Contemporaines (NEC), 23 Rue Pierre Semard, 75009 Paris. Tel: (01) 526.52.47. Chief Exec. Freddy Carrara.
Nuages Music, 83 Av. de Segur, 75015 Paris. Tel: (01) 567.93.55. Gen. Mgr.: Frank Thomas.
Numera Int'l (Eds.), 52 Rue de Crimee, 75019 Paris. Tel: (01) 205.71.34.
Nuova, see Dick James.
Francis O'Neill Org. (FONO), 71 Rue de Provence, 75009 Paris. Tel: (01) 874.15.68. Cable FONOMUSIC. Pres. Francis O'Neill, Prof. Mgrs.: Jean-Pierre Besson, Paul Ives.
Int'l firms represented: Belwin-Mills France (UK, USA), Campbell Connelly (UK), Compass (UK, USA), Heathside (UK).
Orfeus (Eds.), 38 Av. de l'Opera, 75002 Paris. Tel: (01) 633.66.10, 555.53.36. Chief Exec.: Stephan Tabakov; Gen. Mgr. Irene Kulikowski.
Osha Music, see X Music.
Ouvriers (Les Eds.), 12 Av. Soeur Rosalie, 75621 Paris Cedex 13. Tel: (01) 337.93.85. Gen. Mgr.: Max Pinchard.
Int'l firms represented: Galaxy (USA), Stainer & Bell (UK).
Int'l rep: Belgium, Canada, & Germany (Chappell).
P A L M (Prod'ns Artistiques Litteraires & Musicales), 86 Rue du Faubourg St. Denis, 75010 Paris. Tel: 770.21.29. Chief Exec. Jef Gilson.
P E C F (Productions & Eds. Cinematographiques Francaises) (SACEM), 18 Rue Troyon, 75017 Paris. Tel: (01) 267.15.35. Telex: COLUMFILM 650676. Mng. Dir.: Jean Davoust.
Int'l firms represented: Advanced, Anterior (Esther Philips), Athwarn, Atlas, Attraction, Baby Monica, Backfin, Bar None (Chris Hillman), Benchmark, Bil-Mar, Stephen Bishop, Bountiful, Brown's Mill, Burbank,

- Burda, Caledonia Soul, Camad, Camulus, Camwood, Castleford, Castle Hill, Chicken Flats, Chinmoy, Chi Sound, Cinco, Coffeepot, Bruce Cohn, Companion, Cotillion, Curton, Daedalus, Dakar, Daley City, Danor, Datnew, Davalbo, Dew, Desert Moon, Desert Rain, Diamondback, Don Pro, Elektra, Ezra, Far Feched, Farina, Fleckless Ferguson, Festival First Artists, Flat Town, Fleetwood, Foscoe, Fox-Gimbel, Freyda, Fry King, Fry Queen, Gamble Hinged, Golden Spread, Gold Hill, Gold Line-Silverline, Good Friends, Grand National, Gringo, Van Halen, Hanbo, Harms, High Wave, High Tree, Hustlers, Icarus, Ice 9, Inherit, Inherit Todd Mark, Inner Earth, Jalynne, Jazz Bird, Jefferson, Jumptunes, Kapralik, Kicking Bear, Don Kirshner, Kirshner Songs, Kittyhawk, Kuumba, Loma Alto, Ludmilla, Mae-Ken, Mansa, Mansfield, Marsaint, Don McCoy, Montunes, New World, Nina, Nine Star, Nipper, Numero Uno, Open Love, Oracle, Oriandaa, Overdrive, Painless, Paisley Paradox, Paternoster, Pepamari, Philjo, Phlipsongs, Pond Tunes, Pronto, Radio, Remick, Richbare, Road Canon, Rock Steady, Rodart, Romulus, Rose Hips, Round Wound Sound, Saloon Songs, Schubert, Seagrape (Karla Bonoff), Sedaka, Sesame Street, Siesta, Skol, Sky Harbor, Skylark, Slim Chance, Stephen Stills, Stinson Day, Stone Canyon, Stone Flower, Superhype, Sure Enough (Dictators), Swallow Turn, Sweetpea, Tamerlane, Tash Howard, Tea Time, Tessa, Topographic, Triple O, Upward Spiral, Van Cleef, Van Jan, Viva, WB, W7, Walden, Warner Bros., Warner Sevarts, Warner Tamerlane, Wax Tablet, Weillbrecht Harms, Wet Dreams, Whispering, Widescreen, Windecor, Winners Circle, Witmark, Wolper, Wow & Flutter, Yessongs, Zapata (all USA), J. Albert (Australia), Astra (UK), MUZ (Germany), Stutter (UK), Warner Bros. (Australia, UK), Winterfold (UK)
- Int'l reps.:** Australia, Italy, UK, USA (all Warner Bros.), Germany (MUZ)
- Pacer, see Dick James.
Pageant, see Dick James.
Paille Music, see Allo.
Palaca, see Intersong.
Paledi, see Eddie Barclay.
Pall Mall, see Dick James.
Panache SarL (Eds.), 11 Rue de la Ville L'Evêque, 75008 Paris Tel (331) 266 12 46 Telex 641927 Dir. Paul Banes
- Int'l firms represented:** Ackee (USA), Arabella (UK), British Lion (UK), Bruce Welch (UK), Canaan (USA), Deep Purple (UK), Eiger (UK), GH (UK), Getaway (UK), Glenn Hughes (UK) Glove (UK), Gull (UK), Hancock (USA), IGB (UK) Ian Gillan (UK), Inkwell (UK), Island (UK, USA), LED (UK), Mayflower (USA), Nazongs (UK), Owl (UK), Pal (UK), Quarry (UK), Quatermass (UK), Riva (UK), Rock (UK), Rug (UK), Rustler (UK), SP (UK), Static (UK)
- Int'l rep:** Worldwide (Panache)
- Paris-Elysees (Ed.), see Pathe Marconi.
Paris Etoile, see Sonopresse.
Paris-Inter, see d'Anella.
Paris-Provence, 10 Rue de la Terrasse, 75017 Paris Tel (01) 267 00 73.
Claude Pascal (Eds. Musicales), 5 Rue Denis Poisson, 75017 Paris Tel (01) 574 43 72, 574 43 77, 574 25 57 Telex 641477 Gen Mgr. Claude Pascal
- Int'l firms represented:** Black Sheep (UK), Blue Street (USA), Camex (USA), Chandos (USA), Chrysalis (UK), Eaton (UK), First Artists (USA), Folklore (USA), Golden Syrup (USA), Gypsy Boy (USA), Heath Levy (UK), Hillgreen (USA), Hush (UK), Ladysmith (UK), Noel Gay (UK), Pondwater (Canada) Razzle (Argentina), Retrac (USA), Sailor (USA), Satril (UK), Sonet (Sweden), Springtime (USA), State (UK), Superwool (UK), Swell Sounds (USA), Valentine (UK), Venice (USA), Welk (USA), Wherefore (USA)
- Pathe Marconi (Eds & Prod'ns Musicales), 94/96 Rue Lauriston, 75116 Paris Tel (01) 505 91 02 Cable EDIMARCO Telex: 612738 Pres: Francois Minchin; EMI Publ'g Supervisor Alain de Ricou, Gen Mgr. Jean Yves LeRoy
- Int'l firms represented:** Alan Cantee / Shoals Music Mill, Braintree / Porchester, Cayman / Cissi, Cole A Rama, Crystal Jukebox, Dayn, Distinctbeat, Dixie Bow / Little Switzerland, Garrett, Gigolo, Haapala, Heart's Delight / Dawson Cover, Jasperrilla, Jobete / Stone Diamond, John Sebastian, Manticore, Medicine Hat, Modern American / Charleville, Open Door / Gold Time, Peacock / Stone Gold, Quarter / Genesis, Rebel, Ringo Starr, Rondour, Saints, Saturday, Shelby Singleton, Stranger, Tumbleweed, Trane, Water Rose / Fox Fanfare
- Int'l reps.:** Worldwide (EMI)
- Patricia, see SEMI
- Pema Music, 35 Rue Washington, 75008 Paris Tel (01) 359 95 70 Telex 260648 Gen Mgr. Georges Bacri
- Int'l firms represented:** CAM (Italy, Spain)
- Int'l reps.:** Argentina, Australia, Canada, Germany, Italy, Scandinavia, Spain, UK, USA (all CAM); Switzerland (Campana)
- Nicolas Perides (Eds.) (SACEM), 44 Rue Etienne Marcel, 75002 Paris Tel (01) 233 07 30 Gen. Mgr.: Nicolas Perdes
- Petit Cheval (Eds. du), 84750 Viens Tel (90) 75 22 13.
Philippo, 24 Blvd. Poissonniere, 75009 Paris Tel (01) 824 89 24
- Piano Blanc, see Eddie Barclay.
Pianola Music, 124 Rue La Boetie, 75008 Paris Tel (01) 225 80 30 Publ'r Philippe Renaux
- Int'l firm represented:** Contempo (UK)
- Pin Pin Music, 16 Rue Larrey, 75005 Paris Tel (01) 587 00 22 Gen Mgr. Odette Scioc
- Int'l firms represented:** Fonit-Cetra (Italy), New Music (Belgium), Usignolo (Italy)
- Plateforme 2000, 20 Rue Ballu, 75009 Paris Tel (01) 285 83 00 Telex ALPHACO 461549 Pres. Hubert Ballay Gen. Mgr. Lucien Salles
- Please Music Sweetie, see Robert Salvat
- Plein Soleil SarL (Eds. Musicales), 6 Rue Galilee, 75116 Paris Tel (01) 723 90 10 Co-Pres.: Harry Auerhaan, Bernard Ricci
- Poplico Music, see Claude Pascal
- Presence, 33 Rue du Faubourg St. Martin, 75010 Paris Tel: (01) 607 89 05
Presses d'Ile de France, 12 Rue de la Chaise, 75007 Paris Tel (01) 222 37 30
Presta Music, 7 Rue Damiens, 92100 Boulogne Tel (01) 608 51 51 Gen. Mgr. Guy Boyer
Procure Generale de Musique / Schola Cantorum (Eds.), 76 bis Rue des Saints-Peres, 75007 Paris Tel (01) 548 70 50
Prosadef, see Prosadis
Prosadis SA, 14 Av. Hoche, 75008 Paris Tel (01) 561 16 55 Mgr. Claude Defe
Pygmalion Publ'g (SACEM), 10 Rue Rene Bazin, Paris. Gen. Mgr. Jack Arel
Home office: USA
Quadra Universal, 56 Rue d'Auteuil, 75016 Paris Tel: (01) 224 76 74
Quelquepart (Eds.), Av. du Val Fleuri-Immeubles Cagnes, 2 Etoiles 06170 Cros-de-Cagnes Tel (93) 31.01.58 Dir. Gen. Georges Colleul
- R C A / Publ'g Dept., 9 Av. Matignon, 75008 Paris Tel (01) 256 70 70 359 92 60 Telex 650703 Publ'g Mgr.: Michel Larmand
- Int'l firms represented:** Antisia (USA), Cyclus (Germany), Dunbar-Sunbury (USA), Kidada (USA), Koppelman-Bandier (USA), Laetrec (South Africa), Oakfield-Metal Machine (USA), RCA (Brazil, Italy, Mexico, Spain), Relay (Argentina)
- Int'l reps.:** Argentina (Relay), Canada (Dunbar-Sunbury), Germany (Cyclus), UK (Dunbar-Sunbury), worldwide (RCA)
- R J M, 6 Rue du Chateau, 91590 D'Huisson Longueville. Tel: 498 60 25 Dir.: Jean-Marie Migot
R M F (Radio-Music France), 22 Rue Bayard, 75002 Paris. Tel (01) 720 44 44, 225 10 10 Gen. Mgr. Gust Graas, Artistic Dir. Roger Kreicher
R O G (SACEM), see d'Anella
Radio-Music France, see RMF
Rakowski (Eds.), 72 Av. des Champs-Elysees, 75008 Paris. Tel (01) 225 04 89
Rempia, see Tabata
Rhinoceros, 2 Rue Flechier, 75009 Paris Tel (01) 878 40 88 Dir. Gen. Frederic Leibovitz
Rideau Rouge, 24 Rue de Longchamp, 75116 Paris. Tel (01) 553 19 35 Cable RIDOROU Telex 613725 Pres. Gilbert Beaud, Mng. Dir. Marcel Leclerc
- Int'l firms represented:** Average White Band (USA), Black Bull (USA), Combine (USA), Ganga (UK), Harrison (UK), Resaka (USA), Stonebridge (USA)
- Int'l rep.:** Canada (SMCL), Germany (Melodie der Welt)
- Robin Song Music, 17 Rue Ballu, 75009 Paris. Tel (01) 280 61 07 Owner & Mgr. Jack Robinson
- Int'l firms represented:** Cranston (USA), Criterion (USA), Finger (Germany), Four Knights (USA), Global (Germany), Jondora (USA), Modern (USA), Space Songs (USA), Third Story (USA)
- Int'l reps.:** Germany (Finger), Netherlands (Anagon)
- Royalty, 25 Rue d'Hautville, 75015 Paris Tel (01) 770 67 26
- S E M I (Societe d'Eds. Musicales Int'l'es), 5 Rue Lincoln, 75008 Paris Tel (01) 359 06 22 Cable SOUTHMUSIC Gen Mgr. Fernande Fay
- Int'l firms represented:** Alhronn, Astronaut, Baccardi, Bad Boy, Barlow, Blue Lake, Cedarwood, Cherry, Concentric, Drawbridge, Eight Power, Fairhome, Flint Lock, Kirk Freeman, Gambi, Henry, Jacknie, Jloral, Kassner, MacCartney, Magpie, Malaco, Ricci Mareno, Meadow, Melody Lane, Roger Miller, Mutual Films, Paddington, Parchment, Peer Int'l, Rolling Meadows, Payal Oak, Shade Tree, Shenandoah, Southern, Terrace, Troika
- S M (Eds.), 3 Nicolas Chuquet, 75017 Paris Tel: (01) 267 01 37 / 02 63, 924 15 56 Chief Exec.: Maurice Robreau Ass't Marc Bonnin
- Salabert (Eds.), 22 Rue Chauchat, 75009 Paris. Tel: (01) 824 55 60
Int'l branch: USA
Salad Music, 44 Rue Mirosmesnil, 75008 Paris Tel (01) 265 87 80 Pres. Bernard Saint-Paul
Int'l firm represented: Teddy Jack (USA)
Jean-Marie Salhani, 3 Rue Cesar-Franck, 75015 Paris. Tel (01) 566 42 00 Gen. Mgr. Jean Marie Salhani
Henri Salvador (Eds. Musicales), 6 Pl. Vendome, 75001 Paris Tel (01) 260 87 80 / 05 Pres. & Dir. Gen. Jacqueline Salvador, Gen. Mgr. Henri Salvador
Robert Salvat (Eds.), 89 Rue La Boetie, 75008 Paris Tel (01) 359 76 54 Chief Exec.: Angele Salvat; Gen. Mgr. Robert Salvat
Dominique Samarq (Eds.), 136 Rue Championnet, 75018 Paris Tel (01) 255 64 62
Saravah (Eds.) (SACEM), 22 Rue des Abbesses, 75018 Paris Tel (01) 252 47 20
Schott Freres, 35 Rue Jean Moulin, 94300 Vincennes Tel: 374 30 95 Dir.: Jean-Jacques Junne
Home office: Belgium
Int'l firms represented: Cranz (Belgium), Kalmus (USA), Peters (UK, USA)
Int'l reps.: Belgium, Germany (Schott), UK, USA (Peters)
- A Schroeder (Eds. Musicales) SarL, 37 Rue Violet, 75015 Paris Tel (01) 567 67 01
Home office: USA
Int'l firms represented: Aloud, Anim, Arbutus, Arch, Avaris, Bagimin, Bella Godiva, Boscoe, Burlac, Catch Fire, Cat Mother, Dandy Dittys, Dreams & Visions, Emm-Jay, Fitness King, Fofy Killers, Fooruvus Survival, Kim Fowley, Golden Unlimited, Great Montana, Hedley Songs, Homecoming, Humdrum, January, Janj, Joans Bones, Joint, LaLanne, Larbell, Lassie, Last Laugh, Lazy Canary, Magnanimous, Manistee, Membro, Mile Wide River, Mother Hen, My Baby's, Next Stop, One Stop, Pierhead, Pitfield, Rebecca Raccoon, Rel-Nel, Roynorth, Sa-Vette, Sea-Lark, Sepe, Skin, Stewart-Nims, SummerTree, Super Songs, Tijuca, Va-De-Tta, Vancouver, Very Own, Wraith, Yameta, Zekefield Follics
- Ariane Segal (Eds. Musicales), see EMAS
Septentrion (Eds. Musicales), 11 Rue Lepic, 75018 Paris Tel (01) 606 94 30, 255 92 19 Telex 270105 Gen Mgr.: Pierre Celie
- Int'l firm represented:** Coda (Belgium)
Int'l rep.: Switzerland (Twenty)
- 707, see Eddie Barclay
Sforzando / Sirocco (Eds. Musicales) (SACEM / SDRM), 42 Rue Laugier, 75017 Paris Tel (01) 766 23 64 Telex: 260717 Dir. Gen. Roger Tokarz
Int'l firms represented: Selected Sound (Germany), J. Weinberger (UK)
Shair, see Dick James.
Sibecar (SACEM), 99 Rue de Vaugirard, 75006 Paris. Tel: (01) 544 55 31. Dir.: Gilles Bleiveis
- Int'l firms represented:** Carricatum, Le Vent Qui Vire (both Canada)
Int'l rep.: Canada (Le Vent Qui Vire)
- Sigem (Sistema Globo de Edicoes Musicais), 23 Rue Scheffer, 75016 Paris Tel (01) 704 12 20 Contact: Elyane Peyrot
Home office: Brazil
Sikorski France, see Intersong
Sirocco, see Sforzando / Sirocco
Soda Music (SACEM), 29 Rue de Marignan, 75008 Paris. Tel (01) 225 68 19, 633 36 48 Cable SODAMUS. Telex 250973 Pres. Roger Choukroun
Int'l firms represented: Springfield (USA), World Wide (USA)
- Sonodisc (Societe Nouvelle de Distribution de Disques), 85 Rue Fondary, 75015 Paris. Tel: (01) 577 30 34 Telex: 204018
Sonopresse SA, 26 Rue de Berni, 75008 Paris. Tel (01) 359 05 89
Sopredim Pulcinella, 14-bis Cite Bayer, 75019 Paris. Tel: (01) 542 91 04. Dir.: Suzy Haim.
Sugarmusic France (Eds.), 90 Av. des Champs-Elysees, 75008 Paris. Tel (01) 256 35 49 Gen. Mgr. Marcel Marouani
Home office: Italy
Int'l firms represented: Luna Park (Italy)
Int'l rep.: Worldwide (Sugarmusic)
- Surova (SACEM), see PECCF
Suzelle (SNEPM), 67 Rue de Provence, 75009 Paris. Tel: (01) 280 57 57. Pres. Dir. Gen.: Jean Renard.
Suzie Music, see X Music.
Sylva SA, see Chappell
- Syrinx (Eds. Musicales) (SACEM), 124 Rue La Boetie, 75008 Paris. Tel: (01) 225 80 30 Co-Pres.: Raymond Drouet, Nadege Labrue, Gen. Mgr. Charles Ibgui.
Int'l rep.: Canada (Machine)
- T R O—The Richmond Org., see Essex.
Tabata Music, 28 Rue Pasteur, 92210 Saint Cloud. Tel: 602 58 56 Telex: 60574. Dir.: Ted Scotto; Gen. Mgr.: Jacques Braibant
Int'l firms represented: Apollo Sound (UK), BTW (UK), Bianka Skorzeska (Poland), Fuchs (Germany), Hebra (Belgium), Immus (Germany), Mangione (Brazil), Global (Canada), Roses (Belgium), Universal (Netherlands), Violinda (Switzerland)
Int'l reps.: Belgium (Gnome, New), Canada (Crea Sound), Germany (Immus), UK (Light)
- Charles Talar, see Sonopresse
Tanday Music (SACEM), 19 Rue Vignon, 75008 Paris. Tel: (01) 742 68 62. Dir.: Eddie Vartan; Press. Claude Pierre Bloch
Int'l firms represented: Demain (USA), Frank & Nancy (USA), MAJ (USA), Mandy (USA)
Int'l reps.: Belgium (New Music), Germany (Montana), Italy (Curci), Japan (Watnabe)
- Tapioqa, Cour de Lorraine, Rue de l'Entrepot, 94220 Charenton. Tel: 368 34 90 Telex: 212028. PR. Elisabeth Charles
- Telemusic, see Sforzando / Sirocco
Thalie Music, see X Music
Together Music, see Dick James.
Tonus Musica Andorra (SACEM), 128 Av. Merikell, Andorra la Vieille, Andorra. Tel: 22.071. Dir.: Patrick Van Der Gucht
- Top 2000, see Train Bleu Monte Carlo
Top Instrumental Music, see Emilhenco
Topkapi (Eds. & Prod'ns), see Bleu Blanc Rouge
Topomic Music (SACEM), 105 Rue de Normandie, 92400 Courbevoie. Tel: 788 09 46. Pres.: Pierre Jaubert
Int'l reps.: Germany (SMV), Japan (Pacific), UK (Creole), USA (Ice)
- Toto Music, see Francis Dreyfus / Labrador
Gerard Tournier (Prod'ns Musicales), see Sonopresse
Traffic Music, see Vogue
- Train Bleu Monte Carlo, 12 Rue Magellan, 75008 Paris. Tel: (01) 260 35 05, 720 96 60 Cable: TECHSONOR. Telex 610035 Dir. Gen.: Jean Gauthier; Gen. Mgr.: Raymond Gamerdingier; Int'l: Francis Gramende
- Transatlantiques (Eds. Musicales), 50 Rue Joseph de Maistre, 75018 Paris. Tel: (01) 228 21 40. Dir.: Patrick Marcland
- Int'l firms represented:** Albersen (Netherlands), Buffet-Crampon (Japan), Carisch (Italy), Henn (Switzerland), Otto Junne (Germany), Theodore Presser (USA), United (UK)
- Transit, see RCA
Tremplin, 32 Rue Francois I, 75008 Paris. Tel: (01) 256 76 76 Telex: 290496. Pres.: Paul de Senneville; Ass'ts: Monique Noulin, Daniele Poloni
Int'l firm represented: Salsou (USA)
Int'l reps.: Brazil (Beverly), Canada (SMCL), Germany (Nolf Budde), Japan (Taiyo)
- Trois Mousquetaires, 26 Rue du General Delestraint, 75016 Paris. Tel: (01) 527 83 77
Int'l branch: USA
Tub (Eds.), see Robert Salvat
Tudor, see Dick James
21,000 (Eds. Musicales), 71 Rue de Clignancourt, 75018 Paris. Tel: (01) 252 21 90, 076 75 64
Universelles, 52 Rue du Faubourg St. Martin, 75010 Paris. Tel (01) 607 45 91
Utopia, see Dick James
Vamp Music, see Francis Dreyfus / Labrador
Vendome (Eds.), see SEMI
Veranda, see Pathe Marconi EMI
Andre Verchuren (Eds. SarL), 33 Rue du Faubourg St. Martin, 75010 Paris Tel (01) 607 89 05
Verseau-Centre d'Art, PO Box 44, 31012 Toulouse; 76 Quai

de Tounis, 31000 Toulouse. Tel: (61) 52.86.71. Mgrs.: Michel Barthes, Pierre Lavie.

Vogue Int'l (SACEM), 20 bis Rue Louis-Philippe, 92200 Neuilly sur Seine. Tel: 745.00.10. Pres.: Leon Cabat.

Volant (Eds.) (SACEM), PO Box 436, 4 Rue de Picardie, 95310 Saint Ouen l'Aumone. Tel: (01) 464.57.87/58.19. Telex: TOPDISC 697064. Dir.: Yves Volant.

W I P Prod'ns SA, 50 Rue de Miramesnil, 75008 Paris. Tel: (01) 265.09.71. 266.56.83. Pres. & Dir. Gen.: Simon Wajntrob. Promo.: Jean-Paul Barkoff.

Warner Bros. Music, see PCF.

Wonder Music, see Dick James.

X Music, 44 Rue La Boetie, 75008 Paris. Tel: (01) 563.52.89/48.66. Dir.: Jean-Max Riviere. Gen. Mgr.: Thomas Noton.

You You Music (SACEM), 8 Rue Marbeuf, 75008 Paris. Tel: (01) 359.53.90. Cable: WANGMUSIC. Telex: 660816. Chm. Jean-Louis Sorin; Gen. Mgr.: Christian de Ronseray.

Int'l firms represented: Intro, Gebr. Meisel, OHG/Say Yes (all Germany), Sigem (Brazil).

Int'l reps: Australia (Warner Bros.), Germany (Muz), Italy (Warner Bros.), Scandinavia (Warner Bros.), UK (Warner Bros.), USA (Warner Bros.).

Zagora (Eds. & Prod'ns), see Bleu Blanc Rouge.

Aug Zurluh (Eds.), 73 Blvd. Raspail, 75006 Paris. Tel: (01) 548.68.60. Gen. Mgr.: Fernand Masson.

Int'l firms represented: Berandol (Canada), Hug Fottisch (Switzerland), Moeck (Germany).

Zoom Music, see Dick James.

● services

ASSOCIATIONS & PROFESSIONAL ORGANIZATIONS

A S D E P (Association Syndicale des Editeurs de Publications Musicales), 1 Rue de Courcelles, 75008 Paris. Tel: (01) 359.49.53.

Artistes Musiciens Associes, 72 Champs-Elysees, 75008 Paris. Tel: (01) 359.66.28.

Association de Recherches & d'Applications des Techniques Psychomusicales, 14 Rue des Freres-Morane, 75015 Paris. Tel: (01) 533.27.07.

Association Musicale Int'l de l'Echange, 39 Blvd. des Capucines, 75002 Paris. Tel: (01) 261.17.13. Gen. Mgr.: Catherine Colonna.

B I E M (Bureau Int'l des Societes Gerant Les Droits d'Enregistrement & de Reproduction Mecanique), 11 Rue Keppler, 75116 Paris. Tel: (01) 720.55.91, 720.61.15. Cable: BIEMUSICO. Sec'y Gen.: Jean Elissabide.

C A N F (Centre d'Art Nat'l Français), PO Box 98, 31030 Toulouse Cedex. 76 Quai de Tounis, 31000 Toulouse. Tel: (61) 52.86.71.

C E D A C (Centrale d'Editions Artistiques & Culturelles), 4 Rue Cassette, 75006 Paris. Tel: (01) 222.13-07. Gen. Mgr.: Ed Wagner.

C I S A C (Confederation Int'l des Societes d'Auteurs & Compositeurs), 11 Rue Keppler, 75116 Paris. Tel: 720.59.37/22.52. Cable: INTERAUTEURS. Sec'y Gen.: J.A. Ziegler.

C O G D E P (Compagnie du Distribution & d'Edition Phonographiques & Litteraires), 33 Rue des Ardennes, 75940 Paris Cedex 19.

Centre Nat'l d'Animation Musicale, 55 Rue de Varenne, 75006 Paris. Tel: (01) 222.93.60. Dir.: Michel Briguet.

Chambre Syndicale de la Facture Instrumentale (Musical Instrument Mfrs. Ass'n), 57 Av. de Villiers, 75017 Paris. Tel: (01) 267.05.50. Pres.: Bernard Maillot.

Chambre Syndicale de l'Edition Musicale, 57 Av. de Villiers, 75017 Paris. Tel: (01) 267.05.50. Pres.: G. Roquier.

Chambre Syndicale des Administrateurs de Concerts, 252 Rue du Faubourg St. Honore, 75008 Paris. Tel: (01) 563.79.55.

Comite Nat'l de la Musique, 252 Rue du Faubourg St. Honore, 75008 Paris. Tel: (01) 563.48.58. Pres.: Claude A. Leduc; Gen. Mgr.: Jacques Masson-Forestier.

F N I E (Federation Nat'l des Industries Electroniques), see GIEL.

F N M (Federation Nat'l de la Musique), 57 Av. de Villiers, 75017 Paris. Tel: (01) 267.05.50.

G A V E (Groupe Audio Visuel de l'Edition), 117 Blvd. St. Germain, 75006 Paris. Tel: (01) 329.21.01.

G I C A (Groupement Intersyndical de la Communication Audiovisuelle), 117 Blvd. St. Germain, 75006 Paris. Tel: (01) 329.21.01.

G I E P A (Groupement d'Interet Economique l'Edition Phonographique & Audiovisuelle), 7 Rue du Helder, 75002 Paris. Tel: (01) 267.05.50.

G I E L (Groupement des Industries Electroniques) (formerly FNIE), 11 Rue Hamelin, 75783 Paris Cedex 16. Tel: (01) 505.14.27. Telex: 611045.

G P A V (Groupement des Professionnels de l'Audio-Visuel), 117 Blvd. St. Germain, 75006 Paris. Tel: (01) 329.21.01.

I F C O M (Institut Francais de Formation aux Commerces & Metiers de la Musique), 93 Rue St. Lazare, 75009 Paris. Tel: (01) 280.05.42. Dir.: Christian Kiefer.

Institut National de l'Audiovisuel, Groupe de Recherches Musicales (INA-GRM), 116 Av. du President Kennedy, 75016 Paris. Tel: (01) 224.29.88.

International Confederation of Popular Societies of Music, 121 Rue Lafayette, 75008 Paris.

International Music Council, c/o UNESCO, 1 Rue Miollis, 75015 Paris. Tel: (01) 577.16.10 x 4835. Pres.: John P.L. Roberts; Exec. Sec'y: John Bornoff.

International Society for Contemporary Music, Conservatoire de Musique, 7 Pl. de la Republique, Strasbourg.

Jeunesses Musicales de France, 14 Rue Francois-Miron, 75004 Paris. Tel: (01) 278.19.54, 887.64.81. Pres.: Louis LePrince-Ringuet; Dir. Gen.: Jean-Pierre de Lavigne.

Int'l branch: Belgium, Federation Int'l des Jeunesses Musicales.

National Section of the International Society for Contemporary Music, Bureau de Concerts Marcel de Valmete, 7-11 Av. Delcasse, 75008 Paris. Tel: (01) 359.28.38.

O R E P (Office de Relations Exterieurs & de Promotion), 10 Rue Marechal-Foch, 06400 Cannes. Tel: 39.04.96, 99.16.40.

Reunion des Theatres Lyriques Municipaux de France, 7 Rue du Helder, 75009 Paris. Tel: (01) TAI 73.16. Pres.: Dr. Rambert.

S C A R T (Syndicat des Constructeurs d'Appareils Radiorecepteurs & Televiseurs), 11 Rue Hamelin, 75783 Paris Cedex 16. Tel: (01) 505.14.27. Telex: SYCELEC 611045.

S F A (Syndicat Francais des Artistes Interpretes), 21 bis Rue Victor-Masse, 75009 Paris. Tel: (01) 285.88.11.

S I E R E (Syndicat des Industries Electroniques de Reproduction & d'Enregistrement), 11 Rue Hamelin, 75783 Paris Cedex 16. Tel: (01) 505.14.27. Telex: SYCELEC 611045.

S N E P A (Syndicat Nat'l de l'Edition Phonographique & Audio-Visuelle), 57 Ave. de Villiers, 75017 Paris. Tel: (01) 267.05.50. Delegate Gen.: Pierre Chesnais.

S N V C (Syndicat Nat'l de la Video-Communication), Tele 2000-Press, 43 Rue du Faubourg St. Honore, Paris. Tel: (01) 265.30.06.

S O C A R A (Centre des Artistes Associes & Reunis), 28 Rue Pascal, 16 Cognac. Tel: (16.45) 82.22.06. Telex: 16105. Pres.: Jacques Lacroix.

S O D I P (Societe de Distribution de Phonogrammes), 22 Rue de l'Equerre, Z.A. de Bethunes, 95310 Saint Ouen l'Aumone. Tel: 037.92.27. Dir. Gen.: Michel Berson.

S P P I (Syndicat des Producteurs Phonographiques Independants), 252 Rue du Faubourg St. Honore, 75008 Paris. Tel: (01) 227.60.24.

Snaccam (Syndicat Nat'l des Chefs d'Orchestre & des Cadres de la Musique), Maison du Musicien, 21bis Rue Victor Masse, 75009 Paris.

Societe des Auteurs & Compositeurs Dramatiques, 9 Rue Ballu, 75009 Paris. Tel: (01) 874.44.97.

Syndicat des Artistes Musiciens de Paris, 21bis Rue Victor Masse, 75009 Paris. Tel: (01) 878.25.84.

Syndicat des Chansonniers, Theatre des 2 Anes, 100 Blvd. de Clichy, 75009 Paris.

Syndicat des Constructeurs d'Appareils Radiorecepteurs & Televiseurs, see SCART.

Syndicat Francais des Artistes Interpretes (SFA), 21bis Rue Victor Masse, 75009 Paris. Tel: (01) 285.88.11.

Syndicat Nat'l des Agents Artistiques de France, 33 Champs d'Elysees, Office 604, 75008 Paris. Tel: (01) 225.67.24.

Syndicat Nat'l des Auteurs & des Compositeurs, 80 Rue Taibout, 75442 Paris Cedex 09. Tel: (01) 874.96.30, 526.31.83. Pres.: Jean Delanoy.

Syndicat Nat'l des Producteurs de Spectacles de Varietes, 7 Rue du Helder, 75009 Paris. Tel: (01) 706.76.87. Pres.: Jack-Henri Sumere.

Syndicat Nat'l Libres des Artistes de Varietes, 8 Rue d'Enghien, 75010 Paris. Tel: (01) 770.07.97, 824.69.73, 702.44.34.

Syndicat Professionnel de la Critique Dramatique & Musicale, 52 Rue Richer, 75009 Paris. Tel: (01) 824.65.71.

U S D A, see Union Syndicale des Artistes.

Union des Artistes, 7 Rue Henri-Rochefort, 75017 Paris. Tel: (01) 924.35.02.

Union Syndicale des Artistes (USDA) (Choreography, Drama, Lyrics, Variety), 18 Av. Carnot, 75017 Paris. Tel: (01) 766.55.10, 380.10.04.

DESIGN & ARTWORK

Amphion, 12 Rue Rougemont, 75009 Paris. Tel: (01) 246.24.97.

Carabine Music, 124 Rue La Boetie, 75008 Paris. Tel: (01) 225.80.30. Co-Pres.: Raymond Drouet, Nadege Labrue; Gen. Mgr.: Charles Ibgui.

Dillard & Cie., 47-49 Rue Poulouzeau, 75018 Paris. Tel: (01) 255.43.21. Telex: 650123. Dir.: Jean-Pierre Dillard; Sales Mgr.: Jean-Marc Delaye.

Fiesta, 30 Rue du Dr. Finlay, 75015 Paris. Tel: (01) 578.15.18/24.75. Dir.: Patrick Chevalier.

Fleche (Disques), 122 Blvd. Exelmans, 75016 Paris. Tel: (01) 525.20.73. Gen. Mgr.: Claude Francois; Admin. Dir.: Nicole Gruyer.

France-Imprimerie (div. of AGI—Audio Graphic Inds.), 124bis Av. de Villiers, 75017 Paris. Tel: (01) 754.65.70. Telex: 290833. Gen. Mgr.: Jean Berge; Sales Mgr.: Philippe Berge; Technical Mgr.: Mr. Courgnaud.

Branch: 28260 Anet, Boite Postale 32, 28520 Sorel Mousseil.

International Shows, 10 Rue Damremont, 75018 Paris. Tel: (01) 606.88.35. Chief Exec.: Orlando; Admin. Serv.: Rosy Nosek.

Michel Laguens Org., 47 Av. Paul Doumer, 75016 Paris. Tel: (01) 520.37.53. Telex: 611650. Pres.: Michel Laguens; Gen. Mgr.: Monique Dupuy.

Jean-Pierre Leloir, 26 Rue Notre Dame des Victoires, 75002 Paris. Tel: (01) 296.27.97. Gen. Mgr.: Jean-Pierre Leloir.

LICENSING ORGANIZATIONS, MUSIC

A C E (Societe des Auteurs, Compositeurs & Editeurs), 62 Rue Blanche, 75009 Paris. Tel: (01) 874.94.81. Pres.: Lucien Ades. (Mechanical rights only).

S A C E M (Societe des Auteurs, Compositeurs & Editeurs de Musique), 225 Av. Charles de Gaulle, 92521 Neuilly-sur-Seine Cedex. Tel: (01) 747.56.50. Cable: MUSICA (Mechanical & performing rights).

S D R M (Societe pour l'Administration du Droit de Reproduction Mecanique des Auteurs, Compositeurs & Editeurs), 225 Av. Charles de Gaulle, 92521 Neuilly-sur-Seine Cedex. Tel: (01) 747.56.50. Cable: MUSICA.

S P E D I D A M E (Societe de Perception & de Distribution des Droits des Artistes Musiciens Executants), 14 Rue Notre Dame de Lorette, 75009 Paris. Tel: (01) 285.13.75. Pres.: Roland Puig (Mechanical & performing rights).

PLATING, PROCESSING & PRESSING PLANTS

A R E A C E M (Les Applications & Realisations Acoustiques Electromecaniques), 1 Rue Christophe Colomb, 94600 Choisy-le-Roi. Tel: 853.11.12. Telex: 20869. Cable:

AREADIS. Pres.: E.W. Pelgrims de Bigard; Gen. Mgr.: Xavier Pelgrims de Bigard; Gen. Sec'y: Jacques Mar-mouset.

Plants: 61190 Tourouvre, Rt. d'Alencon. Tel: Tourouvre 25.06.13. Telex: 170662—27130 Verneuil sur Avre, Z.I. Tel: 32.03.23. Telex: 180742.

C I D I S (Polygram Inds. & Messageries), Av. Maurice Ravel, 92160 Antony. Tel: (19) 666.21.02. Pres. & Dir.: Edmond Lang. Sec'y Gen.: Bruno d'Orgeval. Ind't Dir.: Fernand Pasquier; Comm'l Dir.: Jean-Michel Allays, Dist'n Dir.: Christian Marchi; Factory Dir.: Pierre Crapard.

C N A I Fidsound (Compagnie Nationale d'Applications Ind'lles), 19 Rue Coysvoix, 75018 Paris. Tel: (01) 228.05.91, 229.24.61. Pres. & Dir. Gen.: Jean-Claude Thuel-Chassaingne.

Dimoplast, Rue de la Vallee, 91610 Ballancourt.

Disco-France (div. of AGI—Audio Graphic Inds.), 124bis Av. de Villiers, 75017 Paris. Tel: (01) 754.65.70. Telex: 290833. Dir. Gen.: Philippe Berge, Sales Mgr.: Mrs. S. Fritschke.

Branch: 28260 Anet, Usine de Saussay.

Eden, 188 Rue Gambetta, 59000 Lille. Tel: (20) 54.25.88. (Pressing only).

Fleche (Disques), 122 Blvd. Exelmans, 75016 Paris. Tel: (01) 525.20.73. Gen. Mgr.: Claude Francois; Admin. Dir.: Nicole Gruyer. (Pressing only).

Libet (Disques), 18 Rue Carnot, 76700 Harfleur. Gen. Mgr.: Guy Libet.

Moulage Plastique de l'Ouest, 53700 Averton. Tel: 16.43.03.27/35. Pres. & Dir. Gen.: Pierre de Poix; Sales Mgr.: Monique de Poix.

Multi-Techniques, 55 bis Rue de Ponthieu, 75008 Paris. Tel: (01) 359.25.14. Telex: 654111. (Pressing only).

Offset Press, 9 Rue Edouard Renault, 93000 Le Blanc-Mesnil. Tel: (01) 931.16.82. Telex: 641431. Chief Exec.: Yves Volant; Gen. Mgr.: Guy Volant. (Pressing only).

P F D (Production Francaise de Disques), 67 Rue des Freres Lumiere, 93330 Neuilly sur Marne. Tel: 300.53.00, 300.58.00. Telex: 212092. Chm.: E. Arav. Gen. Mgr.: N. Alshech; Sales Mgr.: J. Arav, Mfg. Mgr.: I. Alshech; PR: H. Arav. (Pressing only).

Pathe Marconi EMI, 19 Rue Lord Byron, 75008 Paris. Tel: 561.95.00. Pres.: Philip N. Brodie; Deputy Mng. Dir.: Michel P. Bonnet.

Factory: 78400 Chatou, 2 Rue Emile-Pathe. Tel: 071.92.00. Telex: 600268.

Phonogram SA, 24 Blvd. de l'Hopital, 75005 Paris. Tel: (01) 336.32.30. Pres.: Jacques Caillart; Gen. Mgr.: Jacques Caillart; Sales Mgr.: Marc Grandemange.

Promodisc, 77440 Tracy en Multien. Tel: 435.51.08. (Pressing only).

Satav, 44 Rue Pierre Joseph Proudhon, 78800 Houilles. Tel: 968.60.95. Bd. Chm. & Gen. Mgr.: Jean Aepheris.

Saters, Allee du Guerau, 28130 Maintenon. (Pressing only).

Stereopress, 21 Rue Pierre-Semard, 75010 Paris. Tel: (01) 878.02.28. (Pressing only).

Vogue MPP (Manufacture de Prod'ns Phonographiques), 84 Rue Maurice Grandcoing, 93430 Villetaneuse. Tel: 826.55.00. Cable: VOGDISC Paris. Telex: 620380. Pres.: Cesar Rossini. (Pressing only).

PRINTERS & LITHOGRAPHERS

A G P Mazarine, 22 Ave. du President Wilson, 94230 Cachan.

A R E A C E M (Les Applications & Realisations Acoustiques Electromecaniques), 1 Rue Christophe Colomb, 94600 Choisy-le-Roi. Tel: 853.11.12. Telex: 20869. Cable: AREADIS. Pres.: E.W. Pelgrims de Bigard; Gen. Mgr.: Xavier Pelgrims de Bigard; Gen. Sec'y: Jacques Mar-mouset.

Plants: 61190 Tourouvre, Rt. d'Alencon. Tel: Tourouvre 25.06.13. Telex: 170662—27130 Verneuil sur Avre, Z.I. Tel: 32.03.23. Telex: 180742.

Amphion, 12 Rue Rougemont, 75009 Paris. Tel: (01) 246.24.97.

C N A I Fidsound (Compagnie Nationale d'Applications Ind'lles), 19 Rue Coysvoix, 75018 Paris. Tel: (01) 228.05.91, 229.24.61. Pres. & Dir. Gen.: Jean-Claude Thuel-Chassaingne.

Chaumes, 10 Rue du Dr. Lebel, 94300 Vincennes.

Dorel (Les Procédés), 45 Rue de Tocqueville, 75017 Paris. Tel: (01) 227.70.50.

Dyam Music, 8 Rue Gustave Dore, 75017 Paris. Tel: (01) 227.03.13.

Eimco, 17 Rue Bavastro, 06000 Nice. Tel: (1593) 85.51.18.

Fleche (Disques), 122 Blvd. Exelmans, 75016 Paris. Tel: (01) 525.20.73. Gen. Mgr.: Claude Francois; Admin. Dir.: Nicole Gruyer.

France-Imprimerie (div. of AGI—Audio Graphic Inds.), 124bis Av. de Villiers, 75017 Paris. Tel: (01) 754.65.70. Telex: 290833. Gen. Mgr.: Jean Berge; Sales Mgr.: Philippe Berge; Technical Mgr.: Mr. Courgnaud.

Branch: 28260 Anet, Boite Postale 32, 28520 Sorel Mousseil.

Geneix, 6 Rue Jouvenet, 75016 Paris. Tel: (01) 288.08.52.

Glory Impression Cartonage, 7 Rue Louis Armand, 92602 Asnieres. Tel: 790.62.31. Pres. Dir. Gen.: Marcel Gosly; Technical Mgr.: Jacques Lesueur; Sales Mgr.: Frederic Bussiere.

Graphicolor, 24 Rue Thomas-Lemaitre, 92000 Nanterre. Tel: 204.74.50.

Grenouilleau-Landais & Les Fils, 18 Rue Dom.-Devienne, 33000 Bordeaux. Tel: (56) 91.49.56.

I M C I, 122 bis Rue Aristede-Briand, 92300 Levallois-Perret. Tel: 737.69.08.

Imprimerie de Saint-Michel, 12 Rue de Monthery, 91240 Saint-Michel-sur-Orge. Tel: 901.22.83.

Imprimerie du Nord, 79 Rue du General Leclerc, 78400 Chatou. Tel: 071.38.80. Telex: 696040. Dir.: Jean Roubinet; Gen. Mgr.: Norman J. Garrod.

Imprimerie Saint-Roch, 144 Rue du Chemin-Vert, 75011 Paris. Tel: (01) 805.21.98.

International Shows, 10 Rue Damremont, 75018 Paris. Tel: (01) 606.88.35.

Jat (Imprimerie), 58-60 Rue Louveau, 92230 Châtillon. Tel: (01) 253.20.63.

Levain (Eds.), 1 Rue de l'Abbe-Grégoire, 75006 Paris. Tel. (01) 222 15 84
 M K, 44 Rue Etienne Marcel, 75002 Paris. Tel. 233.07.30.
 Pres. & Gen. Mgr. Monique Knuchel
 Montreuil Offset, 50 Rue Voltaire, 93100 Montreuil. Tel. 374 46 39 Pres. & Dir. Gen. Roger Mandin; Gen. Mgr. Maurice Delaunay
 Mood Duplication, RN 307, 78810 Feucherolles. Tel. 461 45 11 Telex 600574 Pres. H. da Silva Ramos; Gen. Mgr. P. Campiot; Prod'n Mgr. Mr. Papaleukas.
 Moulage Plastique de l'Ouest, 53700 Averton. Tel. 16.43.03.27/35 Pres. & Dir. Gen.: Pierre de Poix, Sales Mgr. Monique de Poix.
 Offset Press, 9 Rue Edouard Renault, 93000 Le Blanc-Mesnil. Tel. (01) 931 16 82 Telex 641431. Chief Exec.: Yves Volant; Gen. Mgr. Guy Volant
 Photochrome, (La) 79 Av Raspail, 94250 Gentilly. Tel. 588 70 71
 Polysonor, 92 Rue de la Pompe, 75116 Paris. Tel. (01) 553 47 15 Gen. Mgr. Mr. Moureaux-Nery
 Publ. GD, 62 Mail des Charmilles, 10000 Troyes. Tel. (25) 81 05 62 Gen. Mgr. S. Delforge
 Resonances, 62 Rue du Faubourg-Saint-Denis, 75010 Paris. Tel. (01) 607 48 11
 Rojo, 19 bis Allée des Sansonnets, 93320 Pavillon-sous-Bois. Tel. 738 53 79
 Rolland, 82 Rue de Faubourg-St. Martin, 75010 Paris. Tel. (01) 208 76 83
 Soder, 35 Rue Rene-Leynaud, 69000 Lyon. Tel. (78) 27 30 04
 Studio 92, 3 & 5 Rue Solferino, 92100 Boulogne. Tel. 608 03 11
 Translab, 12-14 Blvd de l'Hopital, 75005 Paris. Tel. (01) 707 54 86
 Verdier (Les Ateliers), 142 Rue de Clignancourt, 75018 Paris. Tel. (01) 606 53 97, 606 54 48
 Vogue MPP (Manufacture de Prod'n Phonographiques), 84 Rue Maurice Grandcoing, 93430 Villetaneuse. Tel. (01) 826 55 00 Cable VOGDISC Telex 620380 Pres. Cesar Rossini
 Voxigrave, 6 Rue de Lisbonne, 75008 Paris. Tel. (01) 522 66 84

RECORD PROMOTION

Aggy Music Prod'ns, 134 Rue d'Avron, 75020 Paris. Tel. (01) 373.66 75 Dir. Tony Amaraggi, Sales Mgr. Maria Amaraggi
 Amphion, 12 Rue Rougemont, 75009 Paris. Tel. (01) 246 24 97
 B L O C Promo, 7-9 Rue Steinlen, 75008 Paris. Tel. (01) 255 52 50
 Context Recs., 8 Rue Emile-Allez, 75017 Paris. Tel. (01) 924 27 88 Dir. Philippe Doteau; Gen. Mgr. Jacques Galissant
 Robert Donat, 5 Rue Cardinet, 75017 Paris. Tel. (01) 766 50 50 Chief Exec. Robert Donat
 F N A C SA, 136 Rue de Rennes, Paris. Tel. 277.11 33 Pres. Dir. Gen. Andre Essel; Gen. Mgrs. Max Theret, Louis Kaluszynier Sales Mgr. Patrick Schoenhahl
 Fiesta, 30 Rue du Dr Finlay, 75015 Paris. Tel. (01) 578 15 18/24 75 Dir. Patrick Chevalier
 France Radio Club, 37 Rue Georges Carel, 76450 Cany. Dir. Daniel Lefebvre
 International Shows, 10 Rue Damremont, 75018 Paris. Tel. (01) 606.88 35
 M A B Publicite SA, 81 Blvd. Beaumarchais, 75003 Paris. Tel. 277 50 25
 M M Int'l, 122 Av du Wagram, 75007 Paris. Tel. (01) 157 12 84 Dir. Mash Worthington III
 Nautilus (Eds. & Prod'ns), 39 Rue des Jeuneurs, 75002 Paris. Tel. (01) 236 63 68
 Sofac (Normandie), PO Box 12, Rue de Verdun, 76503 Elbeuf. Tel. (35) 77 41 41
 Johnny Stark, 122 Av Wagram, 75017 Paris. Tel. (01) 924 23 67
 Verseau-Centre d'Art, PO Box 44, 31012 Toulouse Cedex; 76 Quai de Tounis, 31000 Toulouse. Tel. (61) 52 86 71 Mgrs. Michel Barthes, Pierre Lavie

TAPE CUSTOM DUPLICATION

Audio Magnetics France, 147 Av. Charles de Gaulle, 92200 Neuilly. Tel. (01) 745 62 62 Telex 611698 Gen. Mgr. J. Arrighi de Casanova.
Audio & Video.
 B A S F (Compagnie Francaise), 140 Rue Jules Guesde, 92303 Levallois. Tel. 739 33 22 Telex: 620445 Comm'l Dir. Robert Kaplan.
Audio: Cassette & open reel
 C I D I S (Polygram Inds & Messageries), Av. Maurice Ravel, 92160 Antony. Tel. (19) 666 21 02 Pres. & Dir. Edmond Lang; Sec'y Gen. Bruno d'Orgeval; Ind'l Dir. Fernand Pasquier; Comm'l Dir. Jean-Michel Allays; Dist'n Dir. Christian Marchi; Factory Dir. Pierre Crapard
Audio: Cassette
 C N A I Fidsound (Compagnie Nationale d'Applications Ind'lles), 19 Rue Coysvoix, 75018 Paris. Tel. (01) 228 05 91, 229 24 61 Pres. & Dir. Gen. Jean-Claude Thuel-Chassaigne.
Audio: 8-tr., 8-tr. quadrasonic, cassette, open reel & open reel quadrasonic.
 Context, 30 Rue de Citeaux, 75012 Paris. Tel. (01) 345 73 30, 344 62 25 Dir. Gen. Philippe Doteau.
Audio: 8-tr., 8-tr. quadrasonic, cassette & open reel
 Disco-France (div. of AGI—Audio Graphic Inds.), Sono Tape Dept., 124bis Av. de Villiers, 75017 Paris. Tel. (01) 754 65 70 Telex 290833 Gen. Mgr. Jean Berge
Branch: 28260 Anet, Usine de Saussay
 E D S, 20-A Rue Gay Lussac, 94430 Chennievieres sur Merne. Tel. 594.21 42. Dir. J.M. Simon; Technical Mgr. M. Girardot
Audio: Cassette
 Fiesta, 30 Rue du Dr Finlay, 75015 Paris. Tel. (01) 578 15 18/24 75 Dir. Patrick Chevalier. Contacts Charlotte Oriant, Philippe Vuarnes
Audio: Cassette
 Michel Laguens Org., 47 Av. Paul Doumer, 75016 Paris. Tel. (01) 520 37 53 Telex 611650 Pres. Michel Laguens. Gen. Mgr. Monique Dupuy; Sales Mgr. Francois Maderon

Mood Duplication, RN 307, 78810 Feucherolles. Tel. 461 45 11 Telex 600574 Pres. H. da Silva Ramos; Gen. Mgr. P. Campiot; Prod'n Mgr. Mr. Papaleukas.
Audio: 8-tr., 8-tr. quadrasonic, cassette, open reel & open reel quadrasonic.
 Moulage Plastique de l'Ouest, 53700 Averton. Tel. 16.43.03.27.35. Pres. & Dir. Gen. Pierre de Poix; Sales Mgr. Monique de Poix.
Audio: 8-tr., 8-tr. quadrasonic, cassette.
 Multi-Techniques, 55 bis Rue de Ponthieu, 75008 Paris. Tel. (01) 359 25 14 Telex 654111
 Pathe Marconi EMI, 19 Rue Lord Byron, 75008 Paris. Tel. 561 95 00 Pres. Philip N. Brodie; Deputy Mng. Dir.: Michel P. Bonnet.
 Stereophonic, 9 Rue Pestalozzi, 75005 Paris. Tel. (01) 331 08 35 010.45.79. Chief Exec. Roger Delangeas.
Audio: Cassette
 Vogue MPP (Manufacture de Prod'n Phonographiques), 84 Rue Maurice Grandcoing, 93430 Villetaneuse. Tel. 826 55 00 Cable VOGDISC Paris. Telex: 620380 Pres. Cesar Rossini.
Audio: 8-tr. & cassette.

● supplies

CARTRIDGE & CASSETTE PARTS

B A S F (Compagnie Francaise), 140 Rue Jules Guesde, 92303 Levallois. Tel. 739 33 22. Telex: 620445. Comm'l Dir. Robert Kaplan.
 C N A I Fidsound (Compagnie Nationale d'Applications Ind'lles), 19 Rue Coysvoix, 75018 Paris. Tel. (01) 228 05 91, 229 24 61. Pres. & Dir. Gen.: Jean-Claude Thuel-Chassaigne
 Moulage Plastique de l'Ouest, 53700 Averton. Tel. 16 43 03 27/35. Pres. & Dir. Gen.: Pierre de Poix; Sales Mgr. Monique de Poix
 Publison Audio Professional, 7-9 Rue Crespin du Gast, 75011 Paris. Tel. (01) 357 64 07. Dir.: Peter Dean; Gen. Mgr. Dany Dean
 Pyral SA, 47 Rue de l'Echat, 94000 Creteil. Tel. 207 48 90. Telex 230742. Chm. R. Piani; Gen. Mgr. Claude Goudal, Mgr. Marc Lamotte.

EMPTY CARTRIDGES, CASSETTES & REELS

B A S F (Compagnie Francaise), 140 Rue Jules Guesde, 92303 Levallois. Tel. 739 33 22. Telex: 620445. Comm'l Dir. Robert Kaplan.
 C N A I Fidsound (Compagnie Nationale d'Applications Ind'lles), 19 Rue Coysvoix, 75018 Paris. Tel. (01) 228 05 91, 229 24 61. Pres. & Dir. Gen.: Jean-Claude Thuel-Chassaigne
 Disco-France (div. of AGI—Audio Graphic Inds.), Sono Tape Dept., 124bis Av. de Villiers, 75017 Paris. Tel. (01) 754 65 70. Telex 290833 Gen. Mgr. Jean Berge.
 Ma-Co Sarl, 10 Rue Malakoff, 92600 Asnieres. Tel. 793 37 83 Gen. Mgr. Ms. Benadon.
Audio: Cartridges.
 Moulage Plastique de l'Ouest, 53700 Averton. Tel. 16 43 03 27/35. Pres. & Dir. Gen.: Pierre de Poix; Sales Mgr. Monique de Poix.
 Pyral SA, 47 Rue de l'Echat, 94000 Creteil. Tel. 207 48 90. Telex 230742 Chm. R. Piani; Gen. Mgr. Claude Goudal, Prod Mgr. Marc Lamotte.

ENVELOPES & MAILERS

C N A I Fidsound (Compagnie Nationale d'Applications Ind'lles), 19 Rue Coysvoix, 75018 Paris. Tel. (01) 228 05 91, 229 24 61 Pres. & Dir. Gen. Jean-Claude Thuel-Chassaigne.
 Disco-France (div. of AGI—Audio Graphic Inds.), Sono Tape Dept., 124bis Av. de Villiers, 75017 Paris. Tel. (01) 754 65 70. Telex 290833 Gen. Mgr. Jean Berge.
Branch: 28260 Anet, Usine de Saussay.

JACKETS & SLEEVES

A R E A C E M (Les Applications & Realisations Acoustiques Electromecaniques), 1 Rue Christophe Colomb, 94600 Choisy-le-Roi. Tel. 853 11 12. Telex 20869 Cable AREADIS. Pres.: E.W. Pelgrims de Bigard; Gen. Mgr.: Xavier Pelgrims de Bigard; Gen. Sec'y Jacques Marmouset.
Plants: 61190 Tourouvre, Rt. d'Alencon. Tel. Tourouvre 25.06.13. Telex. 170662—27130 Verneuil sur Avre, Z.I. Tel. 32.03.23 Telex 180742.
 C I D I S (Polygram Inds & Messageries), Av. Maurice Ravel, 92160 Antony. Tel. (19) 666 21 02. Pres. & Dir. Edmond Lang; Sec'y Gen. Bruno d'Orgeval; Ind'l Dir. Fernand Pasquier; Comm'l Dir.: Jean-Michel Allays; Dist'n Dir. Christian Marchi; Factory Dir. Pierre Crapard
 C N A I Fidsound (Compagnie Nationale d'Applications Ind'lles), 19 Rue Coysvoix, 75018 Paris. Tel. (01) 228 05 91, 229 24 61. Pres. & Dir. Gen.: Jean-Claude Thuel-Chassaigne.
 Chaumes, 10 Rue du Docteur-Lebel, 94300 Vincennes. Tel. 808 37 87
 Dillard & Cie., 47-49 Rue Polonceau, 75018 Paris. Tel. (01) 255 43 21 Telex 650123. Dir. Jean-Pierre Dillard; Sales Mgr. Jean-Marc Delaye.
 Dorel (Les Procédes), 45 Rue de Tocqueville, 75017 Paris. Tel. (01) 227 70 50
 Est Typo-Offset, 10 Rue du Dr. Lebel, 94300 Vincennes. Tel. 808 37 87
 France-Imprimerie (div. of AGI—Audio Graphic Inds.), 124bis Av. de Villiers, 75017 Paris. Tel. (01) 754 65 70. Telex 290833 Gen. Mgr.: Jean Berge; Sales Mgr. Philippe Berge; Technical Mgr. Mr. Courgnaud (Jackets only)
Factory: 28260 Anet, Boite Postal 32, 28520 Sorel Mousseil
 Glory Impression Cartonnage, 7 Rue Louis Armand, 92602 Asnieres. Tel. 790 62 31. Pres. Dir. Gen.: Marcel Glory; Technical Mgr.: Jacques Lesueur; Sales Mgr.: Frederic Bussiere
 Grenouilleau-Landaux & Les Fils, 18 Rue Dom-Deviennes, 33000 Bordeaux. Tel. (56) 91 49 56.

I M C I, 122 bis Rue Aristide-Briand, 92300 Levallois-Perret. Tel. 737 69 08
 Imprimerie du Nord, 79 Rue du General Leclerc, 78400 Chatou. Tel. 071.38.80. Telex: 696040. Dir.: Jean Roubinet; Gen. Mgr.: Norman J. Garrod (Sleeves only)
 Imprimerie St-Roch, 144 Rue du Chemin-Vert, 75011 Paris. Tel. (01) 805 21 98
 Libet (Disques), 18 Rue Carnot, 76700 Harfleur. Gen. Mgr.: Guy Libet
 M K, 44 Rue Etienne Marcel, 75002 Paris. Tel. 233.07.30. Pres. & Gen. Mgr. Monique Knuchel (Jackets only)
 Mood Duplication, RN 307, 78810 Feucherolles. Tel. 461 45 11. Telex 600574 Pres. H. da Silva Ramos; Gen. Mgr. P. Campiot; Prod'n Mgr. Mr. Papaleukas.
 Moulage Plastique de l'Ouest, 53700 Averton. Tel. 16.43.03.27/35 Pres. & Dir. Gen.: Pierre de Poix; Sales Mgr.: Monique de Poix (Jackets only)
 Offset Press, 9 Rue Edouard Renault, 93000 Le Blanc-Mesnil. Tel. (01) 931 16 82. Telex 641431. Chief Exec.: Yves Volant; Gen. Mgr.: Guy Volant
 Pathe Marconi EMI, 19 Rue Lord Byron, 75008 Paris. Tel. 561 95 00. Pres. Philip N. Brodie; Deputy Mng. Dir.: Michel P. Bonnet. (Jackets only)
 Rolland, 82 Rue du Faubourg-St. Martin, 75010 Paris. Tel. (01) 208.76.83.
 Satav, 44 Rue Pierre Joseph Proudhon, 78800 Houilles. Tel. 968.60.95. Bd. Chm. & Gen. Mgr.: Jean Apherghis.
 A. Tempo, 14 Rue Mollien, 92100 Boulogne. Tel. 605.35.74
 Verdier (Les Ateliers), 142 Rue de Clignancourt, 75018 Paris. Tel. (01) 606 53 97, 606 54 48
 Vogue MPP (Manufacture de Prod'n Phonographiques) 84 Maurice Grandcoing, 93430 Villetaneuse. Tel. (01) 826 55 00. Cable: VOGDISC. Telex: 620380 Pres.: Cesar Rossini. (Jackets only).

LABELS

A R E A C E M (Les Applications & Realisations Acoustiques Electromecaniques), 1 Rue Christophe Colomb, 94600 Choisy-le-Roi. Tel. 853 11 12. Telex 20869 Cable AREADIS. Pres.: E.W. Pelgrims de Bigard; Gen. Mgr.: Xavier Pelgrims de Bigard; Gen. Sec'y Jacques Marmouset.
Plants: 61190 Tourouvre, Rt. d'Alencon. Tel. Tourouvre 25.06.13. Telex. 170662—27130 Verneuil sur Avre, Z.I. Tel. 32.03.23 Telex 180742.
 C I D I S (Polygram Inds & Messageries), Av. Maurice Ravel, 92160 Antony. Tel. (19) 666 21 02. Pres. & Dir.: Edmond Lang; Sec'y Gen.: Bruno d'Orgeval; Ind'l Dir.: Fernand Pasquier; Comm'l Dir.: Jean-Michel Allays; Dist'n Dir.: Christian Marchi; Factory Dir.: Pierre Crapard
 C N A I Fidsound (Compagnie Nationale d'Applications Ind'lles), 19 Rue Coysvoix, 75018 Paris. Tel. (01) 228 05 91, 229 24 61. Pres. & Dir. Gen.: Jean-Claude Thuel-Chassaigne
 Charmilles (Disques), 62 Mail des Charmilles, 10000 Troyes. Tel. (25) 81.05.62. Gen. Mgr.: S. Delforge
 Dorel (Les Procédes), 45 Rue de Tocqueville, 75017 Paris. Tel. (01) 227 70 50.
 France-Imprimerie (div. of AGI—Audio Graphic Inds.), 124bis Av. de Villiers, 75017 Paris. Tel. (01) 754 65 70. Telex: 290833 Gen. Mgr.: Jean Berge; Sales Mgr.: Philippe Berge; Technical Mgr.: Mr. Courgnaud.
Factory: 28260 Anet, Boite Postale 32, 28520 Sorel Mousseil
 Glory Impression Cartonnage, 7 Rue Louis Armand, 92602 Asnieres. Tel. 790.62.31. Pres. Dir. Gen.: Marcel Glory; Technical Mgr.: Jacques Lesueur; Sales Mgr.: Frederic Bussiere
 Grenouilleau-Landaux & Les Fils, 18 Rue Dom-Deviennes, 33000 Bordeaux. Tel. (56) 91 49 56
 I M C I, 122 bis Rue Aristide-Briand, 92300 Levallois-Perret. Tel. 737 69 08
 Imprimerie Saint-Roch, 144 Rue du Chemin-Vert, 75011 Paris. Tel. (01) 805 21 98
 Mood Duplication, RN 307, 78810 Feucherolles. Tel. 461 45 11. Telex 600574 Pres. H. da Silva Ramos; Gen. Mgr.: P. Campiot; Prod'n Mgr.: Mr. Papaleukas.
 Moulage Plastique de l'Ouest, 53700 Averton. Tel. 16 43 03 27/35. Pres. & Dir. Gen.: Pierre de Poix; Sales Mgr.: Monique de Poix.
 Offset Press, 9 Rue Edouard Renault, 93000 Le Blanc-Mesnil. Tel. (01) 931 16 82. Telex: 641431. Chief Exec.: Yves Volant; Gen. Mgr.: Guy Volant
 Rolland, 82 Rue du Faubourg-St. Martin, 75010 Paris. Tel. (01) 208 76 83
 Satav, 44 Rue Pierre Joseph Proudhon, 78800 Houilles. Tel. 968.60.95. Bd. Chm. & Gen. Mgr.: Jean Apherghis.
 Verdier (Les Ateliers), 142 Rue de Clignancourt, 75018 Paris. Tel. (01) 606 53 97, 606 54 48.

PROFESSIONAL TAPE SUPPLIES

Publison Audio Professional, 7-9 Rue Crespin du Gast, 75011 Paris. Tel. (01) 357 64 07. Dir.: Peter Dean; Gen. Mgr.: Dany Dean.
Audio: 1/4", 1/2", 1", 2" tape
Brand names: Pyral, Scotch.

RECORD PROCESSING MACHINERY

Audiomatic Corp., 4 Rue Ficatier, 92400 Courbevoie. Tel. (01) 333 30 90. Telex: 620282. Gen. Mgr.: Serge Doublin
Home office: USA
Product: Automatic & manual presses, record-plateing equip.
Brand names: Audiomatic, Hamilton.
 M A P (Material Applications Plastiques) (div. of AGI—Audio Graphic Inds.), 124bis Av. de Villiers, 75017 Paris. Tel. (01) 754 65 70. Telex: 290833. Mng. Dir.: Jean Berge; Gen. Mgr.: J. Charviat
Chief product: Automated injection-compression presses, automatic inking & bagging machines for 7" or 12" records.
 Pyral SA, 47 Rue de l'Echat, 94000 Creteil. Tel. 207 48 90. Telex 230742. Chm. R. Piani; Gen. Mgr. Claude Goudal, Mgr. Louis Delaister.
Product: Lacuers.

TAPE, RAW & BLANK LOADED

Audio Magnetics France, 147 Av. Charles de Gaulle, 92200 Neuilly. Tel: (01) 745.62.62. Telex: 611698. Gen. Mgr.: J. Arrighi de Casanova

B A S F (Compagnie Francaise), 140 Rue Jules Guesde, 92303 Lavallois. Tel: 739.33.22. Telex: 620445. Comm'l Dir.: Robert Kaplan

Audio & Video: Cassette & open reel

C N A I Fidsound (Compagnie Nationale d'Applications Ind'elles), 19 Rue Coysvoix, 75018 Paris. Tel: (01) 228.05.91, 229.24.61. Pres. & Dir. Gen.: Jean-Claude Thuél-Chassaingne

Audio: 8-tr., cassette, open reel

M F P, see Music for Pleasure

Moulage Plastique de l'Ouest, 53700 Averton. Tel: 16.43.03.27/35. Pres. & Dir. Gen.: Pierre de Poix; Sales Mgr.: Monique de Poix

Audio: 8-tr., cassette

Music for Pleasure, 57 Blvd. de la Republique, 78400 Chatou. Tel: (01) 071.30.79. Telex: 698730. Mng. Dir.: M.P. Bonnet; Gen. Mgr.: A. Peier; Mktg. Mgr.: J. Chazeau; Sales Mgr.: G. Durampart

Audio: Cassette

Brand name: MFP

Pathe Marconi EMI, 19 Rue Lord Byron, 75008 Paris. Tel: 561.95.00. Pres.: Philip N. Brodie; Deputy Mng. Dir.: Michel P. Bonnet

Audio: Blank—cassette & open reel; raw—8-tr., cassette & open reel

Publison Audio Professional, 7-9 Rue Crespin du Gast, 75011 Paris. Tel: (01) 357.64.07. Dir.: Peter Dean; Gen. Mgr.: Dany Dean

Audio: 8-tr., open reel

Video: Blank—1" open reel, 1/2" EIAJ open reel

Brand names: Pyral, 3M

Pyral SA, 47 Rue de l'Echat, 94000 Creteil. Tel: 207.48.90. Telex: 230742. Chm.: R. Piani; Gen. Mgr.: Claude Goudal; Mgr.: Marc Lamotte

Audio: Cassette & open reel

Video: 1" & 1/2" EIAJ open reels

TAPE DUPLICATING & PROCESSING EQUIPMENT

Audiomatic Corp., 4 Rue Ficatier, 92400 Courbevoie. Tel: (01) 333.30.90. Telex: 620282. Gen. Mgr.: Serge Doubine

Home office: USA

Product: On-cassette printers, high-speed & in-cassette duplicators, QC machines, loaders

Brand names: Apex, ElectroSound, Infonics

B A S F (Compagnie Francaise), 140 Rue Jules Guesde, 92303 Lavallois. Tel: 739.33.22. Telex: 620445. Comm'l Dir.: Robert Kaplan

C N A I Fidsound (Compagnie Nationale d'Applications Ind'elles), 19 Rue Coysvoix, 75018 Paris. Tel: (01) 228.05.91, 229.24.61. Pres.: & Dir. Gen.: Jean-Claude Thuél-Chassaingne

● accessories manufacturers

B A S F (Compagnie Francaise), 140 Rue Jules Guesde, 92303 Lavallois. Tel: 739.33.22. Telex: 620445. Comm'l Dir.: Robert Kaplan

Product: Leader & splicing tape

Delta Magnetics, 41 Quai des Martyres de la Resistance, 78700 Conflans. Tel: 972.69.81

Product: Needles (Stanton)

Impregna SarL, 167 Rt. de St. Lev., Epinay Sur Seine. Tel: (01) 822.64.32. Contact: Jacques Fallard

Product: Anti-static record cleaning material

Lavaine, 62 Rue des Deportes, 45200 Montargis. Tel: (38) 85.24.17. Gen. Mgr.: M. Lavaine

Product: Cleaners, cloths & brushes

Ma-Co SarL, 10 Rue Malakoff, 92600 Asnieres. Tel: 793.37.83. Gen. Mgr.: Ms. Benadon

Product: Cleaners, cloths & brushes, 45 rpm adaptors, head cleaners & demagnetizers, needles

Mageco Electronic, 119 Rue du Dessous des Berges, 75013 Paris. Tel: 583.65.19

Product: Needles (Pickering)

Publison Audio Professional, 7-9 Rue Crespin du Gast, 75011 Paris. Tel: (01) 357.64.07. Dir.: Peter Dean; Gen. Mgr.: Dany Dean

Product: Carrying & storage cases, catalog servs., head cleaners & demagnetizers, leader tape, splicing tape

Pyral SA, 47 Rue de l'Echat, 94000 Creteil. Tel: 207.48.90. Telex: 230742. Chm.: R. Piani; Gen. Mgr.: Claude Goudal; Mgr.: Louis Delaistier

Product: Leader & splicing tape

Topodis, Le Petit Parc, Zone Industrielle, 78920 Ecquevilly. Tel: 475.50.21. Telex: 698074. Gen. Mgr.: Andre Gervy

Product: Rec. & tape carrying & storage cases, cleaners, cloths & brushes, 45 rpm adaptors, head cleaners & demagnetizers

Vogue MPP (Manufacture de Prod'ns Phonographiques) 84 Rue Maurice Grandcoing, 93430 Villeneuve. Tel: (01) 826.55.00. Cable: VOGDISC. Telex: 620380. Pres.: Cesar Rossini

Product: 45 rpm adaptors

● store fixtures & merchandising aids manufacturers

Glory Impression Cartonage, 7 Rue Louis Armand, 92602 Asnieres. Tel: 790.62.31. Pres. Dir. Gen.: Marcel Glory; Technical Mgr.: Jacques Lesueur; Sales Mgr.: Frederic Bussiere

Product: Rec. browser boxes, divider cards

Topodis, Le Petit Parc, Zone Industrielle, 78920 Ecquevilly

Tel: 475.50.21. Telex: 698074. Gen. Mgr.: Andre Gervy

Product: Rec. & tape browser boxes, display racks, divider cards

Vogue MPP (Manufacture de Prod'ns Phonographiques) 84 Rue Maurice Grandcoing, 93430 Villeneuve. Tel: (01) 826.55.00. Cable: VOGDISC. Telex: 620380. Pres.: Cesar Rossini

Product: Display racks

GERMAN DEMOCRATIC REPUBLIC (EAST)

Population: 17,700,000

Rate of exchange: \$1 (US) = 8 ost-marks

Per capita income: \$2,400

Holidays: January 1, Good Friday, Easter Sunday, May 1 (Labor Day), May 8 (Liberation Day), Ascension, Whitsunday, October 7 (Republic Day), December 25, 26

RECORDS:

Records sold domestically including imports: LP's & singles 1977—17,000,000 units

Average retail price per record: LP's—\$1.80. Singles—\$0.75

TAPE:

Pre-recorded tape sold domestically including imports: Cassette 1977—1,000,000 units

Average retail price per tape: Cassette—\$2.50

● record & tape manufacturers / distributors / importers

Amiga, see Deutsche Schallplatten

Buchexport (Volkseigener Aussenhandelsbetrieb der Deutschen Demokratischen Republik), Leninstr. 16, DDR-701 Leipzig. Tel: (05611) 76-61

Deutsche Schallplatten (VEB), Reichstager 4/5, 108 Berlin. Tel: (0311) 220-9201

Labels: (Owned) Amiga, Eterna, Litera, Nova

Eterna, see Deutsche Schallplatten

Litera, see Deutsche Schallplatten

Nova, see Deutsche Schallplatten

● music publishers

Breitkopf & Haertel Musikverlag (VEB), Karlstr. 10, DDR-701 Leipzig. Tel: (05611) 73-51. Pres.: Dr. Gunter Hempel; Gen. Mgr.: Werner Hennig

Int'l reps.: Austria (Globus), Canada (Alexander Broutde), West Germany (Breitkopf & Haertel—Wiesbaden), Mexico (Alexander Broutde), Netherlands (De Eerste Muziekcentrale), UK (Breitkopf & Haertel), USA (Alexander Broutde)

Deutscher Verlag fuer Musik (VEB), see Breitkopf & Haertel

Harth Musik Verlag/Pro Musica Verlag, Karl-Liebknechtstr. 12, DDR-701 Leipzig. Tel: (05611) 3-26-12

Int'l reps.: Australia, Canada, UK (Breitkopf & Haertel in UK); West Germany (Apollo)

Friedrich Hofmeister Musikverlag (VEB), see Breitkopf & Haertel

Lied der Zeit (VEB), Postfach 10, Rosa-Luxemburgstr. 41, DDR-102 Berlin. Tel: (0311) 28-2-50-81

Litloff (Collection), see Peters

Peer Musikverlag GmbH, PO Box 602129, 2000 Hamburg 60, Muhlenkamp 43. Tel: (040) 271-33-71. Cable: SOUTHMUSIC. Telex: 213388

Peters (Ed.) (VEB), Postfach 746, Talstr. 10, DDR-701 Leipzig. Tel: (05611) 29-59-53

Affiliate: Collection Litloff

Int'l firms represented: (Loans only) EDSS & ZAMP (Yugoslavia), PWM (Poland), C.F. Peters/Belaeff (West Germany), Universal (Austria)

Int'l reps: (Purchase) Denmark (Engstrom & Soedring), Netherlands (Eerste Muziekcentrale), Switzerland (Eulenberg), West Germany (C.F. Peters), rest of the world (C.F. Peters in UK); (loans) West Germany (C.F. Peters), Yugoslavia (EDSS)

Pro Musica Verlag, see Harth

● services**ASSOCIATIONS & PROFESSIONAL ORGANIZATIONS**

Association of Composers & Musicologists of the German Democratic Republic, Leipzigerstr. 26, DDR-108 Berlin. Tel: 220-2051

National Committee of the International Music Council, Leipzigerstr. 26, DDR-108 Berlin. Tel: 229-2772

Neue Bachgesellschaft, Int'le Vereinigung, Karlstr. 10, DDR-701 Leipzig

Staatliches Komitee fuer Rundfunk (Radio & TV), Nalepastr. 18-50, DDR-116 Berlin. Tel: 63-60 6328-31

LICENSING ORGANIZATION, MUSIC

A W A (Anstalt zur Waehrung der Auffuehrungsrechte auf dem Gebiete der Musik), Storkowerstr. 134, DDR-1055 Berlin. Tel: 434-2757. Gen. Dir. Klaus Eisenbarth. (Mechanical & performing rights)

GERMAN FEDERAL REPUBLIC (WEST)

Population: 62,000,000

Rate of exchange: \$1 (US) = 1.80 marks

Per capita income: \$6,029

Holidays: January 1, Good Friday, Easter, May 1 (Labor Day), Ascension Day, Whit Monday, June 17, November (Repentance Day), December 25, 26

RECORDS:

Records sold domestically: LP's 1978—100,400,000 units; 1977—87,800,000 units. Singles 1978—46,500,000 units, 1977—39,800,000 units

Import sales: LP's & singles—additional 10% of total

Records imported from USA (factory value, CIF): 1977—2,815,324 units, \$3,982,000

Records exported to USA (factory value, FOB): 1977—2,863,270, \$3,238,000

Records exported worldwide (factory value, FOB): 1977—32,745,000 units, \$81,000,000

Average retail price per record: LP's—\$6; singles—\$3.30

Stereo sales: 100% of total

Record club sales: 15% of total

Discounting: Widespread

Type of distribution: Manufacturer-to-retailer accounts for 70% of total sales. Manufacturers-to-wholesaler-to-retailer & rack jobbing (there are 2 rack jobbers) divide another 12%, and direct importing by retailers constitutes the remaining 18%. Total wholesale transactions have increased by 20%. Export sales to the United Kingdom and United States are increasing

Type of promotion: All radio and TV stations are important sources. Also, there are about 1200 discotheques and 1000 key publications. Twelve radio stations have weekly hit parades; three tv channels carry weekly international pop-shows. Second German Television (ZDF) has a monthly "Hit-parade" with 13 singers. All stations are controlled by representatives of private organizations, government and the public

Jukeboxes: 90,000

TAPE:

Prerecorded tape sold domestically: 8-tr. 1977—6,000 units, 1976—8,000 units. Cassette 1978—41,400,000 units, 1977—36,300,000 units

Average retail price per tape: Cassette—\$4.00; open reel—\$10.00

Wolfgang Spahr

● record & tape manufacturers / distributors / importers

A A R, see Heinz Ulm

A G M Schallplattenproduktion & Vertrieb, Kisslingweg 44, D-7130 Muhlacker. Tel: (07041) 47-66, 66-63. Telex: (07) 263721. Dir. Arno Graul

A M S Musica Sacra, see Schwann

A S A Musikvertrieb GmbH, Potsdamer Str. 58, D-1000 Berlin 30. Tel: (030) 261-13-25. Telex: (01) 83065

Abacca, see Inmus

Abanori, see Mixtur

Acanta, see Fonotem & MusiContact

Ada, see Welaton

Admiral, see Bellaphon

Agil-Music Musikverlag GmbH, Karlstr. 36, D-8000 Munich 2. Tel: (089) 59-16-26. Contact: Franz Seelos

Labels: (licensed) Help, Life, (represented) Video Rec. Albums (USA)

Ahorn, see Teldec

Air, see All-Music

Airlift Tontraeger Vertriebs GmbH (IFPI), Clausewitzstr. 4/III, D-1000 Berlin 12, Dirs. Maria Kopp, Wolfgang Maeder; Prod'rs: Andy Novello, Lennie Partner, Alf Carde. (Distributor)

Branch: D-8400 Regensburg, Portnergasse 6. Tel: (0941) 56-13-51

Labels: (Owned) Airlift, Fire Bird, (distributed—not licensed) IDS

Aktuell, see All-Music

Aladin (Peter Orloff) GmbH & Co. KG, Rauhe Hecke 2, D-5000 Cologne 91. Tel: (0221) 86-23-02, 86-20-32. Telex: (08) 873698. Mng. Dir. Peter Orloff

Labels: (Owned) Aladin (Distributed by EMI Electrola), Black Prince (Distributed by Crystal)

Alcomusic, see Alcophon

Alcophon Albinger KG, PO Box 1270, Reeperbahn 35, D-2058 Lauenburg. Tel: (04153) 30-22. Telex: (02) 189612

Labels: Alcomusic, Alcophon, Alcophon Super, Blacky, Multi, Multipack

Alcophon Super, see Alcophon Albinger

All-Music Vertriebs GmbH, Werner-Sombartstr. 21, D-7750 Konstanz. Tel: (07531) 55-03-6. Telex: (07) 33239. Pres. Alfons Bocklet, Gen. Mgr. Fredy P Frei

Home office: Switzerland

Labels: (Owned) Air, Aktuell, MPV, Musicland, Vega 2000

Des Alpes Schallplatten Produktion GmbH (IFPI), Theodor Koerner Str. 7, D-8700 Wuerzburg. Tel: (0931) 73884, 71286. Telex: (06) 8810 Mng. Dir. Hans-Richard Danner. (Distributor/Importer)

Labels: (Owned) Da, Echo, Lilliput, Main, (distributed) Amati, Bella Musica, Supertone, Welt Melodie

Die Alte Orgel, see Da Camera

Alternum, see Thorofon

Amati, see Supertone & Des Alpes

Amaton, see Heinz Ulm

Amayana, see Heinz Ulm

Amerindian Recs., An Der Alte Muehle 9, D-5067 Wessel-

- ing-Berzdorf Tel (02) 232-51780 Chief Exec.: Ingrid Renate Rohere (Distributor/Importer)
- Labels: (Owned) Amerindian; (distributed) Artaria** (Argentina), Kotrona (Argentina), Paganì/Eleven (Italy)
- Int'l reps.:** Argentina (Artaria, Kotrona)
- Der Andere Song, see Hansa Musik
- Christian Anders Musikverlag & Produktion, Hoerwarthstr 26, D-8000 Munich 40 Tel (089) 18-42-23 Pres.: Christian Anders, Gen. Mgr. Ann Busse (Distributed by EMI Electrola)
- Labels: (Owned) Chranders**
- Angel, see EMI Electrola
- Angel Musikverlag & Produktion A. Engel KG, PO Box 11124, Drakestr 16, D-3280 Bad Pyrmont Tel (05281) 5664 Chief Exec. & Gen. Mgr. Anneliese Engel, Sales Mgr. Bernd Plato, Vice Mgr. Guenter Engel
- Label: (Owned) Days**
- Angelo, see EMI Electrola
- Antagon Musikgesellschaft Jens Michow (IFPI), Lenhartstr 15, D-2000 Hamburg 20 Tel (040) 48-44-43 Telex (02) 173473 Mng. Dir.: Jens Michow (Also see Music Distributor)
- Aquarium 2000, see Polyband
- Arcade Recs. (Deutschland) GmbH (IFPI), Leimenrode 29, D-6000 Frankfurt/Main Tel (0611) 59-81-19/29 Telex (04) 189319 Mng. Dir.: Michael Levene, Sales Mgr. Helmut Mohr, Mktg. Mgr. Ruediger Schaefer
- Home office:** England
- Label: (Owned) Arcade**
- Int'l reps.:** Austria (Ariola), Switzerland (Phonag)
- Archiv Produktion, see DGG & Wiydler
- Arendo, see Jaguar
- Ariola, see Ariola-Eurodisc
- Ariola-Eurodisc GmbH (IFPI), Steinhäuserstr 3, D-8000 Munich 80 Tel (089) 4-13-61 Cable EURODISC Telex (05) 23487 Pres. Monti Lueftner, Mng. Dir. Friedel Schmidt, Deputy Mng. Dir. Wolfgang Wegmann, VP Int'l Div.: Dorus Sturm, Sales Mgrs. Hans Knappe, Heinz Holle, Mktg. & Promo. Albert Czapski, Export Dept. Geiso Mampel **Ariola Int'l Group**—Pres.: Monti Lueftner, Sr. VP. Friedel Schmidt, VP A&R Mktg.: Wim Schipper, VP Latin America Activities: Ramon Segura, VP Int'l Finance & Admin.: Dr. Wolfgang Wegmann, VP Int'l Opns.: Hardy Schuetze
- Export Dept. Geiso Mampel
- Int'l branches:** Austria, Belgium, France (Ariabella), Mexico (Disco Libro), Netherlands, Spain, Switzerland, UK USA (Ariola)
- Labels: (Owned) Ariola Eurodisc; (licensed domestic) Hansa, Jupiter, Oasis, Maritim; (licensed foreign) Albion (UK), Bronze (UK), CMH (USA), Clan Celentano (Italy), DJM (UK), Island (UK), JCOA (USA), Lifesong (USA), Manticore (UK), Melodia (USSR), Musiza (Italy), PBR (USA), Pinnacle (UK), President (UK), Pye (UK), Real (UK), Red Star (USA), Roulette (USA), Shelter (USA), Sierra Brar (USA), Sire (USA), Supraphon (Czechoslovakia), Tomato (USA), Virgin (UK)**
- Int'l reps.:** Argentina (RCA), Australia (Carina, RCA), Bolivia (Lauro), Brazil (Gravacoes, RCA Copacabana), Canada (German-Canadian News, Interglobal), Colombia (Tropical), Czechoslovakia (Supraphon), Denmark (AEG), East Germany (VEB), Ecuador (Fadisa), El Salvador (Leo), Finland (Finndisc), France (Ariabella, WEA), Greece (Veran, General Publ'g Co.), CBS, Minos Matsas, Guatemala (Discos de Centroamericana), Hong Kong (Studer Revox), India (Grammophone of India), Indonesia (Studer Revox), Israel (Hed Arzi), Italy (Fonti-Cetra, Disch Ricordi, Musik Import, RCA), Japan (Nippon Columbia), Kenya (AI Recs.), Lebanon (Societe Libanaise du Disque), Malaysia (Studer Revox), Mexico (Discolibro), Nigeria (Phonogram), Norway (Disco A. S.), Philippines (Studer Revox), Portugal (Phonogram), Rep. of China (Summit Ents.), Singapore (Studer Revox), South Africa (Teal, Gallo), South Korea (Asia Rec. Co., Studer Revox), Sweden (CBS), Thailand (Studer Revox), UK (RCA, Pye), USA (German Language Publ'ns, Salsoul, German News), USSR (Meshdunarodnaja Kniga), United Arab Emirates (Vithaldas V & Sons), Yugoslavia (Rec. Prod'ns of Radio-Television Belgrad). (SEE ADVERTISEMENT)
- Armnia Musikproduktion Erich Storz (IFPI), Hauptstr 114, D-3360 Osterode am Harz Tel (05522) 45-11 Telex (09) 65154 Gen. Dir.: Erich Storz, Gen. Mgr.: Marianne Opitz, Sales Mgr. Marianne Storz (Also a Wholesaler as Storz GmbH)
- Branches: D-2000 Hamburg, Heidenkampsweg 54 Tel (040) 280-2939 Telex (02) 162989—D-3000 Hannover, Am Klagesmarkt 22 Tel (0511) 15028 Telex (09) 23814—Bielefeld, Am Kampchen 4 Tel (0521) 25017 Telex (09) 38058**
- Labels: (Owned) Armnia, Storz**
- Int'l rep.:** Switzerland (Musiland)
- arOnda Schallplattenproduktion & Vertrieb, Frankfurter Landstr 7, D-6380 Bad Homburg Tel (06172) 4-68-36 Dir. Gunther Mueller
- Labels: (Owned) arOnda, (represented) Kaibala (USA)**
- Int'l reps.:** Argentina (CBS), Benelux (Dureco in Netherlands), Brazil (CBS), Central America (CBS), Italy (Saar), Mexico (CBS), Spain (Belter), Switzerland (Carex)
- Arteg Prod'ns, Schanzenstr. 16-18, D-2000 Hamburg 6 Tel (040) 43-44-42 Chief Exec.: Arno H. van Vught Jr. Prod'ns: A.H. & W.B. van Vught
- Labels: (Owned) Arteg, Mento Music Pop Sounds**
- Asphalt, see WPL
- Asylum, see WEA
- Atco, see WEA
- Atlantic, see WEA
- Attacca-Musikverlag, Dr. Hammacherstr 3, D-4100 Duisburg-Ruhrort Tel (0203) 8-13-78
- Label: (Owned) Attacca**
- Audio Components Vertriebs GmbH, PO Box 3822, Hegestr. 64, D-2000 Hamburg 20 Tel (040) 46-51-00 (Importer)
- Label: Richardson (USA)**
- Audio Int'l, Gonzzheimstr. 2b, D-6000 Frankfurt am Main Tel 50-47-33 Telex (04) 13039 (Distributor)
- Labels: (Distributed—not licensed) 1984 Recs., Real Time, (represented) Sheffield Lab (USA)**
- Audiophon Classic, see Mutibrand
- Audite, see Fono & MusicContact
- Audition, see Videothek & Teldec
- Aulos, see Fono
- Autogram & Folk Recs., Burgstr 9, D-4405 Nottuln (Kreis Muenster), Tel (02502) 61-51 Gen. Mgr.: Willy Schwenken
- Labels: Autogram, Doctor, Monogram**
- Int'l reps.:** Austria (Eulenspiegel), Belgium (Parsifal), France (Discovale), Netherlands (Munich) Switzerland (Eulenspiegel), UK (Saydisc)
- Autoplay, see Polyband
- Aves Recs & Tapes, Harvesthuderweg 21, D-2000 Hamburg 13 Tel (040) 44-60-21 Telex 21345 Owners: Rudolf G. Slezak, Horst F. Schmolzi (Distributed by Intercord)
- Labels: Aves, Avia, Beggar's Banquet, Cube, EMG, Electric Rec., Fania**
- Aw, see Peter Gleissner
- B F C Int'l Rec. Co., PO Box 350245, D-5000 Cologne 30 Tel (0221) 50-36-47 Mktg. Dir.: Rudolf E. Kamphausen, Gen. Mgr.: Gunther R. Kamphausen
- Labels: (Owned) Compass, (licensed) Hookfarm (Denmark), Trutone (South Africa)**
- Int'l reps.:** Philippines (Music World), Spain (Euterpe)
- Babylon, see Membran & Music Distributor
- Bacillus, see Bellaphon
- Baerenreiter-Musicaphon, see Baerenreiter-Verlag & Disco-Center
- Baerenreiter-Verlag, Karl Voetterle KG, Heinrich-Schuetz-Allee 35, D-3500 Kassel/Wilhelmshohe Tel (0561) 300-1117 Telex (09) 92376 Mng. Dir.: Wolfgang Matthei
- Int'l branches:** England, France, Switzerland
- Labels: (Owned) Baerenreiter-Musicaphon, Bosse Musik (Distributed by Disco-Center)**
- Baltic-Recs., PO Box 4544, Holstenplatz 1-2, D-2300 Kiel Tel (0431) 9-11-04 Owner: Heinz Ziemann
- Barclay Schallplatten GmbH, Glockengieserwall 27, D-2000 Hamburg 1 Tel (040) 33-08-17
- Bear Family Recs. (IFPI), Eduard Grunow Str. 12, D-2800 Bremen 1 Tel (0421) 78874 Dir. & Gen. Mgr. Richard Weize, Sales Mgr.: Hermann Knuelle (Licensed to Membran, distributed by Music Distributor)
- Int'l branch: England**
- Label: (Owned) Bear Family**
- Int'l reps.:** Japan (King), USA (Back Room, Country)
- Bella Musica, see Supertone & Des Alpes
- Bellaphon Int'l, see Bellaphon
- Bellaphon Recs. GmbH & Co. KG Tontraegergesellschaft (IFPI), Mainzer Landstr. 87-89, D-6000 Frankfurt/Main 1 Tel (0611) 23-08-0 Telex (04) 16046 Pres.: Branko Zivanovic, Sales Mgr.: Wolfgang Sattler, Int'l Prod. Mgr.: George Zeiss, Bellaphon Import Mgr.: Winfried Merkle, Press Officer: Wolfgang Fiedler
- Int'l branches:** Austria, Switzerland
- Labels: (Owned) Admiral, Bacillus, Bellaphon, Bellaphon Int'l, Panoptikum, Piffikus, Pick Up, Schluessloch, (licensed domestic) First Class, Peg, Peggy; (licensed foreign) Alaska (UK), Aristocarte (France), Audio Fidelity (USA), Bang (USA), Black Bear (UK), Bullet (USA), Casablanca (USA), Charly (France), Direction (USA), Fantasy (USA), Greensleeves Honeybee (UK), Jackson Sound (USA), King, Midnight Sun (USA), Milestone (USA), Penny Farthing (UK), Pick, Plantation (USA), Pompeii (USA), Power, Prestige (USA), RAK, Roadshow (USA), Roxbury (USA), SSS Int'l (USA), Shout, Starday-King (USA), Stax (USA), Stereo Dimension, Sun (USA), Swing, Tapestry, Youngblood, (distributed—not licensed) Concord Jazz, Free Bird, Free Music, Lynchrod, Riverside, Steeple Chase, Victory**
- Int'l reps.:** Austria (Bellaphon), Greece (Columbia Grammophone), Italy (Fonti Cetra), Japan (Nippon Phonogram), Portugal (Imavox), Spain (RCA), Switzerland (Bellaphon), USA (Fantasy)
- Berlinton, see Mixture-Schallplatten
- Berolina KG, Hallerstr. 76, D-2000 Hamburg 13 Tel: (04106) 7-13-16 (Also see Fonoteam)
- Labels: Berolina, Peg, Peggy**
- Das Beste GmbH (Verlag), Augustenstr. 1, D-7000 Stuttgart 1 Tel (0711) 66-02-1 Telex (07) 23539 Mng. Dir.: Werner Weidemann, Mktg. Dir.: Helge Weisner, Prod'n Mgr.: Klaus D. Mandl
- Bild am Sonntag Recs. (IFPI), Kaiser Wilhelm Str. 6, D-2000 Hamburg 36 Tel 347-4254 Telex (02) 11898 Gen. Mgr.: Joachim Luedicke
- Bild & Funk, see Burda
- Bingola, see Rudolf Bohnen
- Black Prince, see Aladin & Crystal
- Blacky, see Alcapphon
- Blossom, see Intersound
- Blubber Lips Recs. GmbH, Sofienstr. 7a, D-6900 Heidelberg 1 Tel (06221) 3-37-79 Telex (04) 61538 Chief Exec. & Sales Mgr.: Ruediger Eggert (Distributed by Discovetrieb)
- Labels: (Owned) Blubber Lips, Offers**
- Blues Beacon, see Peter Gleissner & Christmann/SchAAF
- Boccaccio, see Jaguar
- Dieter Boek, Koelner Landstr. 179, D-4000 Duesseldorf 13 Tel (0211) 76-38-07 Gen. Mgr.: Dieter Boek (Distributor/Importer/Exporter)
- Label: (Owned) NPR**
- Rudolf Bohnen (Musikverlag & Prod'n), Klenzestr. 65, D-8000 Munich 5 Tel (089) 26-66-56
- Labels: (Owned) Bingola, Peggy**
- Bosse Musik, see Baerenreiter
- Brain, see Metronome
- G. Braun (Verlag), PO Box 1709, Karl-Friedrich-Str. 14-18, D-7500 Karlsruhe, Tel (0721) 2-69-51, Telex (07) 826904
- Label: dhfi-Testschallplatten**
- Brittke, see Maritim
- Brockhoff (Ed.), see Fono
- Brunswick, see DGG
- Buena Vista, see Walt Disney
- Bunny, see WEA
- Burny, see Burda
- Burda-Schallplatten-Vertrieb, Burda-Hochhaus, D-7600 Offenburg Tel (0781) 8-41
- Labels: (Owned) Bild & Funk, Bunte, Freundin, Freizeit & Raetsel-Revue, Freizeit-Magazin, Meine Familie & Ich, Mein Schoner Garten**
- Busch-Phonothek, see Polyband
- C A C, see Henry Fono
- C A M Germany Musikverlag GmbH, Rottalstr. 5, D-8000 Munich 80 Tel (089) 40-35-73
- Home office: Italy**
- C B S Schallplatten GmbH (IFPI), Bleichstr. 64-66a, D-6000 Frankfurt/Main 1 Tel (0611) 1-30-51 Cable COLRECORD Telex 416735 Mng. Dir.: Rudolf Wolpert, Deputy Mng. Dir.: Karl G. Arbenz
- Home office: USA, CBS Recs. Int'l**
- Labels: (Owned) CBS, Embassy, Epic, GTO, Linda, Portrait, Robbi, (licensed domestic) Music, Schiarwari, (licensed foreign) A&M, Blue Sky, Caribou, Invictus, Jet, Kirshner, Monument, Neighborhood, Philadelphia Int'l, TK (all USA), CGD (Italy)**
- C C A-Schallplatten-Produktion, PO Box 2802, D-4500 Osnabruck Tel (05406) 452 Owner: Hans Werner Kuntze
- Labels: (Owned) CCA, Help (licensed to Agil-Music), Instrumental, Mami, Newcomer, Sextase**
- C D B, see Eurotape
- C M S, see Christmann/SchAAF
- C R P Musikproduktion, Am Gutleuthofhang 26a, D-6900 Heidelberg 1 Tel (06221) 86-09-98, 80-10-10 Mng. Dir.: Rüdiger Eck (Distributed by Blubber Lips)
- Labels: (Owned) CRP, MOT**
- Cady, see OPP
- Caligula, see Calig Verlag
- Calig Verlag GmbH, Renatastr. 71, D-8000 Munich 19 Tel (089) 16-34-76 Pres.: Wolfgang Walter, Prod. Mgr.: Doris Hagen; Mktg. Dir.: Manfred Steinberg (Distributed by Disco-Center)
- Labels: (Owned) Calig, Caligula**
- Int'l reps.:** Austria (Cura), Italy (Hi-Fi Rec.), Japan (Universal Corp.), Switzerland (Metronome)
- Camérata, Hoffman von Fallerslebenstr. 8, D-3340 Wolfenbuettel Tel (05331) 4-41-32 Owner: K-M Moesler
- Cantagallo, see Teldec
- Cantate GmbH, Heinrich-Schulz-Allee 35, D-3500 Kassel-Wilhelmshohe Tel (0561) 3-00-13 Telex (09) 92376 Mng. Dir.: Wolfgang Matthei (Distributed by Disco-Center)
- Labels: (Owned) Cantate, SDG**
- Canto Musikproduktion GmbH & Co. KG (IFPI), Harmstorfer Weg 11, D-2106 Bendestorf Tel (04183) 62-46 Pres. & Gen. Mgr.: Fred Christman (Distributed by Bellaphon)
- Label: (Owned) Pastels**
- Capella, see Thorofon
- Capitol, see EMI Electrola
- Carosound, see Deutsche Austrophon
- Carus, see Fono
- Cassetta, see Thomas Voigt Org.
- Cassetton Musik-Cassetten-Werk, Wallensteinstr. 2, D-8192 Geretsried 2 Tel (08171) 42-40, 3-17-74 Telex (05) 26331 (Tape only)
- Champ Recs., Gartenstr. 15a, D-8011 Baldham/Munich Tel (08106) 45-55 Contact: Robert Jung
- Cherry-Int'l, see Flower
- Chranders, see Christian Anders & EMI Electrola
- Chrischaabues, see Christmann/SchAAF
- Christmann/SchAAF (Musikproduktion) GmbH, Goerresstr. 3, D-5400 Koblenz 1 Tel (02611) 3-61-23 Cable CHRISCHAA, Chief Exec.: Siegfried A. Christmann, Harold P. SchAAF
- Labels: (Owned) CMS, Chrischaabues, Ornament, (licensed domestic) Blues Beacon**
- Int'l reps.:** USA (Alligator, Blue Labor)
- Christophorus-Verlag Herder GmbH, Hermann Herder Str. 4, D-7800 Freiburg im Breisgau, Tel (0761) 27-171 Telex (07) 72603 Mng. Dir.: Heribert Mohr, Promo. Horst Newmann (Distributed by Deutsche Austrophon)
- Cine Art Int'l, see Jaguar
- Clarino, see Polyband
- Claudius-Verlag, see Disco-Center & Fono
- Clear Sound, see Hanseschte
- Coconut Music GmbH, 18 Wittelsbacherstr., D-1000 Berlin 13 Tel 88 10 81 Telex 184174, Dirs.: Karin Hartmann, Tony Hendrik
- Coda, see Radio-Music-Recs
- Colonia Musik Produktion GmbH (IFPI), Mauritiussteinweg 5, D-5000 Cologne 1 Tel (0221) 24-89-00 Mng. Dir. & Prod'r.: Peter Pover, Sales Mgr.: Manfred Schmidt; Promo. Mgr.: Uily Jonas
- Label: (Owned) Colonia**
- Colorit, see EMI Electrola
- Colosseum, see Fono
- Columbia, see EMI Electrola
- Comes, see Suewe
- Compass, see BFC
- Concert Hall, Eibingerstr. 1-3, D-6000 Frankfurt/Main
- Labels: (Owned) Concert Hall, Jazzone, Varieton**
- Concord, see Polyband
- Le Connaissance Schallplatten, Waldstr. 62, D-7500 Karlsruhe 1 Tel (0721) 2-56-12 Gen. Mgr.: Klaus Obodda (Importer/Exporter/Mail Order)
- Connyland, see Phon & Ton
- Cosmic Couriers, see Ohr & Cosmic News
- Cosmic Music, see Ohr & Cosmic News
- Cosmic News GmbH, PO Box 850227, D-5000 Cologne 80 Tel (0221) 68-25-74 Telex 8873445 Gen. Mgr.: Rolf-Ulrich Kaiser
- Branch: D-1000 Berlin 31, Wittelsbacherstr. 18**
- Labels: (Distributed—not licensed) Cosmic Couriers, Cosmic Music, Ohr, Pliz, Sound of the Cosmic Couriers, Starmaiden**
- Cottillon, see WEA
- Coup, see Jaguar
- Credo, see Junge Gemeinde
- Crystal Schallplatten GmbH, Pletschmuehlenweg 70-72, D-5024 Pulheim Tel (02238) 5-10-91 Telex (08) 881646 Mng. Dir.: Dr. Bernhard Krajewski, Nat'l A&R: Bernd Goeke, Int'l A&R, Mktg. & Promo. Mgr.: Juergen Thurnau, Sales Mgr.: Siegfried Wozny; Admin. Mgr.: Juergen Scholl
- Labels: (Owned) Crystal, Emidisc, MFP Exclusiv, MFP Super, Prisma, Safari, (licensed domestic) Black Prince, Hoer Zu, Universe, (licensed foreign) Abbey Road (France), Bareback (USA), Capitol (USA), MAM (UK), Magnet (UK), Rebel (UK), Vanguard (USA)**
- Int'l rep.:** Worldwide (EMI)

D A, see Des Alpes.
 D C M Schallplatten & Musicassetproduktion (IFPI), Wisbacherstr. 1, D-8230 Bad Reichenhall, Tel (08651) 47-60. Mgr: Alfred Dostal.
 D G, see DGG & Polydor.
 D G G (Deutsche Grammophon GmbH) (sub. of Polydor Int'l GmbH) (IFPI), PO Box 301240, Hohe Bleichen 14-16, D-2000 Hamburg 36. Tel: (0411) 35-96-1 Telex (02) 163923. Pres.: Richard Busch, Exec. VP Oskar Drechsler; Sr. VP Reinhard Stehn
Labels: (Owned) Archiv Produktion, Brunswick, Deutsche Grammophon (DG), Heliodor, Karussell, MGM, Poly, Polydor, Verve. **(licensed domestic)** ECM, Karma; **(licensed foreign)** Capricorn (USA), Carrere (France), Pablo (USA), Phil Spector Int'l (USA), RSO (UK), Splash Recs. (UK), Track (USA).
 dhfi-Testschallplatten, see G. Braun.
 Da Camera Schallplatten-Ed. GmbH (IFPI), Lameystr. 10/12, Mannheim, Tel (0621) 1-34-45. Pres.: Dr. Klaus Preis; Gen. Mgr.: Martin Engelhardt; Sales Mgr. Nikolaus Sastruphu. (Distributed by Disco-Center, Exported by MusiContact)
Labels: (Owned) Die Alte Orgel, Da Camera, Impromptu, Sastruphu.
 Dacapo, see EMI Electrola
 Danny's Pan, see Membran & Music Distributor.
 Days, see Angel.
 Decca, see Teldec.
 Delta Acoustic, see Membran & Music Distributor.
 Delta Music GmbH (IFPI), Zur Muehle 2, D-5020 Frechen 4. Tel: (02234) 61015. Cable DEMUS. Telex (08) 89299. Pres. Dr. K.J. Moll; Gen. Mgr.: P.H. Saoutot, Sales Mgr.: Dr. W. Ammel.
Labels: (Owned) Delta, Pandora.
 Derby, see Tonomatic.
 Deutsche Austrophon GmbH (IFPI), Auf dem Esch 8, D-2840 Diepholz. Tel (05441) 13-44 Telex (09) 41 221. Gen. Mgr. Rolf Neumann, Sales Mgr.: (south) Fritz Winterbur, (north) Peter Stunhofer; Mktg. Rainer Koppermann
Labels: (Owned) Carsound, Mandolino, Orchestrola, Racket; **(licensed)** Artyphon (Switzerland), ESP-Collection (Switzerland), Elite Special (Switzerland) (Distributed by Turicaphon); **(distributed—not licensed)** Christophorus, Phaene, Riillenschlange, Selected Sound, Sky, WAM.
 Deutsche Buch-Gemeinschaft (C.A. Koch's Verlag Nachf.) Abt. Schallplatten-Gemeinschaft (IFPI), Berliner Allee 6, D-6100 Darmstadt. Tel (06151) 866-1. Telex (04) 19261 Mng. Dir. Ernst Leonhard; Gen. & Sales Mgr. Hans Moeller.
Labels: (Owned) Impression, Meteor
 Deutsche Grammophon, see DGG & Polydor
 Deutsche Grammophon Int'l Music Serv. (dept. of DGG), Wendenstr. 29, D-2000 Hamburg 1. Tel (040) 24-16-01 Telex 2163116 Mgr. Michael Schalke (Importer)
 Deutsche Oversea Recs. GmbH (IFPI), Muntpratstr. 18, D-7750 Konstanz. Tel (07531) 245-17. Pres. Michel Liber; Gen. Mgr. Alice Liber; Sales Mgr. Armin Troesch
Int'l branch: Switzerland
Labels: (Owned) Oversea **(licensed)** Athenee (Greece), Diskosan (Turkey), Dunum (Italy), Equipe (Italy), Fonit-Cetra (Italy), Jugoton (Yugoslavia), Maietti (Italy), Opera Live (Italy), Palobal (Spain), Popular (Greece), Pull (Italy), SM (France), Said (Italy), Select (Greece), Sonora (Italy), Togo (Italy), Umidisc (France), Vanilla (Italy), Variety (Italy), Zephyr (Italy), **(distributed—not licensed)** Orange (Italy), Rubini (UK), Spark (Italy), Start (Italy), Taize (France).
Int'l rep.: Greece (Plomaris).
 Deutscher Schallplatten-Club im Deutschen Buecherbund GmbH & Co., Libanonstr. 3-5, D-7000 Stuttgart 1 Tel (0711) 2-17-91. Telex (07) 23829 Mng. Dir. Gerhard Fink
 Deutsches Rotes Kreuz, see Phonogram.
 Deutsche Tanzmusik Produktion, Ohmstr. 9, D-8000 Munich 40 Tel (089) 39-68-74 Mng. Dir. Hans Lang.
Label: (Owned) Royal Splendid
 Dierks Studio/Venus Recs. (IFPI), Hauptstr. 33, D-5024 Pulheim 3 Tel. (2238) 2004, 3333. Telex: 8883241 Pres.: Dieter Dierks; Gen. Mgr. Fred Hoock; Sales Mgr. Frieder Viehman; Prof. Mgr. Dagmar Wolf. (Licensed to Membran; Distributed by Music Distributor)
Label: (Owned) Venus
 Direkt to Disk, see Sonic Arts.
 Disc Int'l GmbH, PO Box 120164, Bismarckstr. 66, D-6100 Darmstadt. Tel (06151) 2-37-60. Mng. Dir. Gangolf Zimmermann. (Distributor/Importer/Exporter)
 Disco-Center (Vereingte Schallplatten-Vertriebs GmbH), Baerenreiterweg 6-8, Kassel-Wilhelmshoehel Tel (0561) 3-20-21. Telex (09) 92376. Mng. Dir. Wolfgang Matthe; PR Eberhard Schoepner
Labels: (Owned) Disco-Center, Sastruphu; **(distributed)** Baerenreiter-Musicaphon, Baltic-Recs., Calig, Camerata, Cantate, Christophorus, Claudius-Verlag, Da Camera, FidulaFon, Impromptu, Koegler, Quadrigaton, RBM-Musik, SDG, Sun five, Visaphon; **(represented)** Afrontone (USA), Albatros (Italy), Anthology (USA), Bis (Sweden), Caprice (Sweden), Claves (Switzerland), Ethnosound (USA), Eurotone (USA), Hungaroton (Hungary), Muza (Poland), Pantone (Czechoslovakia), Pelca (Switzerland), Pepita (Hungary), Quadrifoglio (Italy), Qualiton (Hungary), Serenus (USA), Tikva (USA), Tudor (Switzerland), Zodiaco (Italy)
 Discophon, Sandweg 113, D-6000 Frankfurt/Main 1.
Label: (Represented) Bee Hive.
 Discophon Tontragerproduktion & Vertrieb, Von-der-Pforten-Str. 19, D-8000 Munich 21 Tel (089) 580-30-69/60 Mng. Dir. Gabriele Eckhardt-Jahr, Dr. Bernd Eckhardt.
Labels: Discophon, Weissblaues Schmanckerl
 Discoport GmbH & Co. KG, Industriest. 49, D-4044 Kaarst. Tel (02101) 6-80-25. Telex. (08) 517424 Gen & Sales Mgr. Hans Rabe; Contact Marcel Neidl. (Distributor/Importer/Exporter)
 Disco-Train, see Karma.
 Discovertrieb-Peter Steyrer, Nordendstr. 8, D-8019 Moosach. Tel (08091) 95-88. Pres. & Dir. Peter Steyrer, Gen. Mgr. Rudolf Sax; Dist'n Coord. Sabine Spalke.

Labels: (Owned) Steyrer-Disco; **(distributed—not licensed)** Blubber Lips, CRP. HOT. Hinterhof, Kingsound, Kingtone. Offers. Weissblaues Schmanckerl.
 Disneyland, see Walt Disney
 Walt Disney Prod'ns GmbH, Savignystr. 76, D-6000 Frankfurt/Main. Tel (0611) 74-77-74. Dir.: Horst Koblicsek.
Labels: (Owned) Buena Vista, Disneyland.
 Divina, see Erich Jung
 Doctor, see Autogram.
 Domino, see Membran & Music Distributor.
 Double Up, see EMI Electrola
 Drive-In, see Suede.
 E B G, see Europaesische
 E C M Recs./Verlag GmbH (IFPI), Gleichmannstr. 10, D-8000 Munich 60. Tel (089) 85-10-48. Cable ECMUSIC. Telex (05) 21717 Co-Pres. Manfred Eicher, Karl Egger, Sales Mgr. Thomas Stoewsand. (Distributed by DGG).
Labels: (Owned) ECM, JAPO; **(licensed)** WATT (USA) Int'l reps.: Andorra (Establishments Comand), Australia (Janda), Austria (Bellaphon), Belgium (Fonior), Canada (Warner Bros.), Denmark (SteepleChase), Finland (PSO), France (Phonogram), Greece (EMI), Iceland (Budini), Italy (Guciar), Japan (Trio), Luxembourg (Dureco), Netherlands (Dureco), New Zealand (Phonogram), Norway (Polydor), Poland (International Jazz Federation), Portugal (Dargil), South Africa (Polydor), Sweden (Amigo), Switzerland (Phonag), UK (Virgin), USA (Warner Bros.), Yugoslavia (Mladosti).
 E H A, see Voggenreiter.
 E J M, see Erich Jung Musik.
 E M I America, see EMI Electrola
 E M I Electrola GmbH (IFPI), Maarweg 149, D-5000 Cologne 41. Tel (0221) 4-90-21 Cable ELECTROLATON. Telex (08) 881 290. Mng. Dir. Friedrich E Wottawa, Nat'l A&R Dir. Manfred Zunkeller; Int'l A&R Dir. Helmut Fest, Sales Dir. Dr. B. Krajewski
Labels: (Owned) Angel, Angelo, Capitol, Columbia, Dacapo, Double Up, EMI, EMI America, Electrola, Emidisc, HMV, Harvest, Odeon, Parlophone, Pathe Marconi, Regal Zonophon, Starline, Stateside, Voce del Padrone, Voix de Son Maître, Die Volksplatte, La Voix de Su Amo, Waverly; **(distributed)** Aladin, Chandlers, Colort, Hoer Zu, Kaleidoskop, Klingklang, Ruesst Raekorders, Trebol (Mexico), Wien Melodie (Austria); **(licensed domestic)** Emly, Musician's Rec. Co., Satellit, Sunrise, **(licensed foreign)** AVI (USA), Acrobat (UK), Apple (UK), Arista (USA), Athenee (Greece), Avalon (Greece), BAM (France), Butterfly (USA), Carophon (Egypt), Catfish (Netherlands), Discophon (Greece), Encore (UK), Favorit (Austria), Gordy (USA), Jugoton (Yugoslavia), Kabarett aus Wien (Austria), Lebendige Vergangenheit (Austria), Lyra (Greece), Ma, Magnet (UK), Miranda M., (Greece), MAM (UK), Monitor (USA), Motown (USA), Musart (Mexico), Music Guild (USA), OZ (Australia), Panvox (Greece), Passport (USA), Polyphone (Greece), Preiser (Austria), Private Stock (USA), Prodigal (USA), RAK (UK), Rare Earth (USA), Red Bus (UK), Rhythmophone (Greece), Rolling Stones (UK), Salonica (Greece), Seraphim (USA), Sono Cairo (Egypt), Soul (USA), Soutelphar (Egypt), Stella (Greece), Sunburst (UK), Talsman (UK), Toshiba (Japan), Trianon (France), Unicorn (UK), United Artists (UK, USA), Vanguard (USA), Voix du Liban (Lebanon), Voix de Dono (Portugal), World (UK), Zapple (UK).
Int'l rep.: Worldwide (EMI).
 E N J A, see European New Jazz & Heinz Ulm-Musik (tape only)
 Echo, see Des Alpes
 Electric Bird, see Henry From.
 Electrola, see EMI Electrola.
 Elektra, see WEA
 Eltern, see Maritim
 Elwephon Recs., Nord-Ost-Ring 11, D-7024 Filderstadt/Bernhausen 1 Tel (0711) 70-27-49, Dir. Luciano Wurzbürger, Gen. Mgr. Jack Cunningham
 Embassy, see CBS
 Emidisc, see EMI Electrola & Crystal
 Emly, see EMI Electrola
 Emston Musikproduktion, Diekamp 19, D-4410 Warendorf. Tel (02581) 34-39. Mng. Dir.: Heinz Baggeroer
Labels: (Owned) Emston, Emston Int'l.
 Epic, see CBS
 Eros, see Polyband
 Erotica, see Polyband
 Esplanade, see Welaeton, Membran & Music Distributor.
 Eurocassetta GmbH & Co., Mehringdamm 32/34, D-1000 Berlin 61 Tel (030) 251-0331 Telex (01) 83369 (Tape only)
Labels: Multicassette, SST
 Eurodisc, see Anrola-Eurodisc.
 Europa, see Miller.
 Europaesische Bildungsgemeinschaft Verlags GmbH, Lindenspuerstr. 32, D-7000 Stuttgart 1 Tel (0711) 6-68-31. Owner Reinhard Mohn.
Labels: (Owned) EBG, Opera; **(distributed)** Anrola, CBS, Deutsche Grammophon, EMI Electrola, Phonogram, Teldec, WEA
 European New Jazz GmbH (ENJA), Nymphenburgerstr. 209, D-8000 Munich 19 Tel (089) 16-17-77. Gen. Mgr. Horst Weber, Sales Mgr.: Matthias Winkelmann. (Distributed by Bellaphon)
Label: (Owned) ENJA.
 Eurotape, PO Box 233, D-2408 Timmendorfer Strand Tel (04503) 38-49 (Tape only)
Labels: CDB, Eurotape, PA
 Extra, see RCA.
 F S M, see Fono
 Falcon Schallplatten Rosner & Co., Gutenbergring 63, D-2000 Norderstedt. Tel (040) 523-60-46. Telex (02) 174646.
Labels: (Owned) Falcon, Golden Sound, Hit.
 Far Musikverlag, 18 Wittelsbacherstr., D-1000 Berlin 13 Tel 80-10-81 Telex 184174 Dir. Frank Farran.
 Fass, see Phonogram
 FidulaFon, see Fidula-Verlag & Disco-Center.
 Fidula-Verlag Johannes Holzmeister KG, Ahornweg 19/21, D-5407 Boppard-Buchanan. Tel (06742) 24-88
Labels: (Owned) FidulaFon (dist by Disco-Center)

Fire Bird, see Airlift
 First Class, see Bellaphon & Fonoteam
 Flop Music Produktions GmbH, Hansa Str 47, D-2000 Hamburg 13. Tel (040) 45-67-07 Mgrs Peter Uecker, Reinhard Zaum. (Distributed by Deutsche Austro-phon).
Labels: (Owned) Flop
 Floraton, see Polyband
 Flower-Recs. Schallplatten, Rheinweg 29, D-5300 Bonn Tel (02221) 23-49-55, 23-31-82. Owner & Gen. Mgr. Horst Goetze, Sales Mgr. Walburg Jenke.
Labels: (Owned) Flower-Recs., Cherry Int'l, **(distributed)** Juventus
 Folk-Song, see Thorofo.
 Folk Variety Recs., PO Box 110142, D-2800 Bremen (Distributor).
 Fono (Schallplattengesellschaft mbH), PO Box 2762, Friedrich-Eberstr. 110, D-4400 Muenster. Tel (0251) 7-71-91 Pres. & Gen. Mgr. Henrich Brockhoff
Labels: (Owned) FSM, **(distributed)** Anrola-Eurodisc, Audite, Aulos, Brockhoff (Ed.), Carus, Claudius-Verlag, Colosseum, Pape-Orgel-Dokumente, toccata, (represented) Armida (Switzerland), Basart (Netherlands), Candide (USA), Disques du Cavalier (France), Fono (Switzerland), Jecklin (Switzerland), Turnabout (USA), Vox (USA).
 Fonoteam Produktions & Vertriebsgesellschaft mbH, Iseplatz 8, D-2000 Hamburg 20 Tel (040) 47-40-64 (Distributed by Bellaphon).
Labels: Acanta, Berolina, First Class, Peg, Peggy
 Fontana, see Phonogram.
 Fortuna, see Sikrola
 Franke & Co. KG (Vereingte Verlags-Gesellschaften), Alpenstr. 29, D-8192 Geretsried 1 Tel (08171) 6-00-51. Mng. Dir. Paul Franke.
Labels: (Owned) Gloriphon, Hypnopaeida, Lingua Quick, Primaphon.
 Freizeit-Magazin, see Burda
 Freizeit & Raetsel-Revue, see Burda.
 Freundin, see Burda.
 Die Froehliche Pfalz, see Fred Kersten.
 Henry From Music Co., PO Box 321, D-8450 Amberg 2.
Labels: (Owned) Electric Bird, Vanilla Fudge, **(distributed)** CAC, Rega
 Funk Rec. Kuhl & Co., Am Hof 34-36, D-5000 Cologne. Tel (0221) 21-22-76, 21-85-03
 G M G Recs., Niederlingerstr. 21, D-8000 Munich 19. Tel (089) 15-10-63 Cable GLOBALMUSIC. Telex (05) 215019. Pres. Peter Kirsten, Label Mgr. Horst Mueller. (Licensed to WEA)
Int'l reps.: Worldwide (WEA Int'l)
 G T O, see CBS.
 Gala, see Multibrand.
 Galaxy, see Toka
 Gammarock Musik GmbH, Herzog-Rudolf-Str. 3, D-8000 Munich 22. Tel (089) 22-13-63. Cable GAMMA-ROCK Telex (05) 29378 Co-Owners Gerhard Augustin, Patrick Gammou, Sales Mgr. Jutta Gebert (Represented by Polydor).
Labels: (Owned) Gammarock (Distributed by Polydor Int'l); **(licensed)** Mr. Pleasure
Int'l reps.: France (Barclay, Phonogram), Italy (Durium), USA (Motown).
 W Gielow, Theaterstr. 35, D-8000 Munich 2 Tel 22-72-14 Exec. W Gielow. (Distributor/Importer)
Labels: (Distributed—not licensed) Hektor, Idea, Kimbo, Roper, S&R, Statler (all USA).
 Gillette, see Sonic Arts.
 Peter Gleissner Music Prod'n, Apt 02-06. Tulpenstr. 28, D-8192 Geretsried 1 Tel (08171) 65-49 Telex 728418 (Distributed by European New Jazz—Bavaria & Bellaphon).
Labels: (Owned) Aw, Blues Beacon, Sherawood
 Globeton, see Polyband
 Gloriphon, see Franke
 Glorlyton, see Glory Tontrager
 Glory Tontrager GmbH MusiCassetten KG, Haynauerstr. 69, D-1000 Berlin 46. Tel (030) 775-5051.
Label: Glorlyton. (Tape only)
 Golden Soul, see Sonic Arts
 Golden Sound, see Falcon.
 Golden State, see Sonic Arts
 Golden 12 Schallplattenproduktion, Schöne Aussicht, D-2106 Bedestorf. Tel (04183) 26-36. (Distributed by RCA)
Labels: Golden 12 Pan.
 Gong, see Maritim.
 Grins, see Hansa Musik
 Gruppe & Lied, see Thorofo.
 H H G Henning Handelsgesellschaft mbH, PO Box 1150, D-7263 Bad Liebenzell 1 Tel (07243) 1-40-14 Telex (07) 82864.
Branch: Ettlingen bei Karlsruhe, Englerstr. 24
 H & L, see Schwann
 H M V, see EMI Electrola.
 H O T, see Discovertrieb.
 H T V, see Hanseatische.
 Hammer, see Spring.
 Hammonia Recs. KG, Eppendorfer Weg 87, D-2000 Hamburg 19. Tel (040) 491-10-77 Telex (02) 11183 Dir. Erwin Schulz, PR E K W Schulz
 Hannoton, see Studio-Ton
 Hansa Int'l, see Hansa Musik
 Hansa Musik Prod'n GmbH, Wittelsbacherstr. 18, D-1000 Berlin 31. Tel (030) 88-10-81, Cable INTRONMUSIK Telex 183008. Dirs. Irmtrud, Peter & Thomas Meisel. Sales Mgr. Hans-Eberhard Blume. (Licensed to Anrola-Eurodisc)
Labels: (Owned) Der Andere Song, Grins, Hansa, Hansa Int'l
 Hanseatische mbH, Geschwister-Scholl-Str. 120, D-2000 Hamburg 20. Tel (040) 48-44-22. Telex (02) 164047. (Tape only)
Labels: Clear Sound, HTV, Melo Cord, TT
 Happy Bird, see Music Distributor & Membran
 harmonia mundi Schallplatten GmbH & Co. Musik-produktion, Karlsr. 60, D-7800 Freiburg. Tel (0761) 25471, 25313. Telex (07) 72552 Dir. Rudolf Ruby. (Distributed by EMI; Exported by MusiContact)

Studio-Compander telcom c4
for live and production

When every sound matters!



THE NEW CHANCE FOR TOP SOUND-QUALITY – 30dB OF DYNAMIC GAIN!

Improving the dynamic range of sound-recording – Records can be produced with dynamic of direct cuts. Improving the dynamic range for optical sound recording and with analog or digital time delay or echo units. Noise suppression on audio-transmission lines.

STUDIO-COMPANDER-SYSTEM telcom c4

- Gain in dynamic range up to 30 dB
- No "breathing" tape noise
- No level adjustments
- No sound overshooting in ensuing systems
- Total harmonic distortion $\leq 0,2\%$ at low frequencies
- Integrated system-identification



Studio-technique by
AEG-TELEFUNKEN

World Radio History

Coupon

we ask for:

- descriptive literature
- consulting without obligation

Address

AEG-TELEFUNKEN
Nachrichten- und Verkehrstechnik
Fachbereich Elektro-Akustik
Lindener Straße 15
D-3340 Wolfenbüttel
Telephone 05331/83-287
Telex 95651

- Label: (Owned) harmonia mundi**
Int'l reps.: Australia (Carinia), Brazil (SOM), France (harmonia mundi), Italy (Fonit-Cetra), Japan (Teichiku), Spain (Odeon)
- Harocord, see Mirror.**
Haro-Music, see Mirror.
Harvest, see EMI Electrola.
Heimat Melodie, see RCA.
Heliodor, see DGG & Polydor.
Helm, see Heinz Ulm.
Help, see CCA & Agil-Music.
Henning, see Polyband.
Herkules-Recs., Suedring 11, D-3502 Vellmar 1/Kassel. Tel (0561) 82-27-73 Owner Regina Theis.
Hinterhof, see Discovertrieb.
Historia, see Membran & Music Distributor.
Hit, see Falcon.
Hitburger Musik GmbH, Geiseltal-Str 80, D-8000 Munich 90 Tel (089) 64-03-57, 64-02-67 Mng. Dir. Andrea Andergest
Hoeren & Lernen, see Schwann.
Hoer Zu, PO Box 100927, D-5000 Cologne 1. (Distributed by Crystal & EMI Electrola).
Branch: D-2000 Hamburg 36, Kaiser-Wilhelm Str 6, Juliana Hopp GmbH, Backnangerstr 74, D-7152 Gross-Aspach. Tel (07191) 2-02-05, Telex 7262116. Gen. Mgr. Peter Hopp (Record & Tape Wholesaler/Importer/Exporter) (SEE ADVERTISEMENT)
Hypnopædia, see Franke
I D S (International Disc Serv.) (IFPI), PO Box 140105, D-8500 Nuernberg 14, Schwabach 7, D-8540 Nuernberg. Tel (0911) 64-96-44, 88-20-23. Telex (06) 23987 Dir. Hans-Joachim Rabe; Gen. Mgr.: Walter Ruff; Sales Mgr.: Sigrid Lohr. (Distributed by Airlift)
Int'l branches: France (Trimicron), USA (Trimicron)
Labels: (Owned) IDS, Programm, Trimicron
I R S/Hjalmar Harms, PO Box 104501, D-2800 Bremen. Tel (0421) 32-67-26 Mng Dir. Hjalmar Harms (Distributor/Importer/Exporter).
Impression, see Deutsche Buch-Gemeinschaft.
Impromptu, see Da Camera & Disco-Center.
Immus (Internationaler Musik-Serv.), Elisabethstr. 38, D-8000 Munich 40 Tel (089) 37-37-81 Chief Exec & Gen. Mgr. Hans Wewerka
Label: (Owned) Abacca
Instrumental, see CCA
Intercord Tongesellschaft mbH (IFPI), Aixheimerstr 26, D-7000 Stuttgart 75 Tel (0711) 47-51-41 Telex (07) 22814 Gen. Mgrs. Herbert Kollisch, Herbert Nabbe-feld, Mktg Mgr. Ingo Kleinhammer, Int'l A&R Juergen Kramar; Nat'l A&R Karl-Heinz Rothenberg; Classic Prod Mgr. Peter Springer; Press & Promo. Eva-Maria Brede; Marion Koenig; Sales Mgr. Volker A W. Bell.
Labels: (Owned) Intercord, Saphir, Spiegeler: (Distributed—not licensed) Aves, BBC, Beggar's Banquet, Big Bear, Black Lion, Blue Rose, Cube, Electric, Erkoenig, Freedom, Gull, Hi-Cream, Ovation, Shark, Springboard, Toledo, Xanadu, Xenophon
Int'l reps.: Australia (Quality), Austria (Amadeo), Belgium (PMP-Eurovox), Canada (Bootgroup/Attic), Denmark (RCA-Hede Nielsen), Finland (Discophon), France (L'Oiseau Musicien), Greece (Veran), Hong Kong (Studio-Revox, Hong Kong Recs.), Israel (Radiounion), Italy (Braconnier), Japan (Teichiku), Luxembourg (SEI), Netherlands (EMI-Bovema), Norway (Disco A/S), Portugal (Movieplay), South Africa (U Naumann), Spain (Movieplay), Sweden (Electra), Switzerland (Phonag), USA (Artistic Music, Jem Recs., Peters Int'l)
Intermedium Verlag GmbH, Zugspitzstr. 6, D-8132 Tutzing. Tel (08158) 65-44
Labels: Bavaria, Intermedium, Munda
International Musikproduktion, Hochhaus, D-6096 Raunheim Tel (06142) 2-23-92. Cable INTERMUSIC Mng Dir. Wolfgang Heinrich; Adv. Press & PR. Hedi Zoller
Intersound Musikverlag-Musikproduktion-Musikvertrieb GmbH & Co. KG (IFPI), Schleibinger Str. 10, D-8000 Munich 80 Tel (089) 48-81-51 Dirs. Gerhard & Rotheide Narholz
Labels: (Owned) Blossom, Intersound, Pro, Studio One, (licensed) Crea Sound (Canada)
Int'l rep.: UK (Selecta/Decca)
Intervox Musikverlag GmbH, Kaiserstr 39, D-8000 Munich 40 Tel (089) 3950-1314 Contact Katja Reising
Isarton Beka Schallplatten, Königswieserstr 16, D-8035 Gauting bei Munich Tel (089) 850-1098/4111/4008 Mng Dir. Alfons Bauer
Iton Musikproduktion-Verlag, Ludwigstr 11, D-8033 Krailling Tel (089) 857-4499 Mng Dir. Ingo Klingbell
J A P O, see ECM
Jaguar Musikproduktion (IFPI), Schierbrockerstr 29, D-2875 Ganderkesee 3 Tel (04221) 53497, 87622 Cable JAGUARMUSIC Dir. H. Schweitzer, Gen. Mgr. Rolf Tobis, Sales Mgr. H.J. Schweitzer Jr., PR Mgr. Frank Bartel
Int'l branches: Denmark, France
Labels: (Owned) Cine Art Int'l, Coup, Jaguar: (distributed) Arendo, Boccaccio, PA
Int'l reps.: Benelux (Cero), Switzerland (Intercord)
Jazz at the Cotton Club, see WAM.
Jazztone, see Concert Hall
Jeans, see Jupiter
Jolly, see Rhenus.
Juke Box, Steinstr 53, D-8000 Munich 80 Tel (089) 48-79-30, 48-77-95 Dir. Harry Fox
Labels: (Owned) Juke Box, Sex.
Junge Gemeinde (Verlag), PO Box 979, Fangelsbachstr 11, D-7000 Stuttgart 1 Tel (0711) 64-30-15 Gen. Mgr. Siegfried Krumrey
Labels: (Owned) Credo, Trimedia
Int'l reps.: Austria (Buchhandlung der Methodisten Kirche), Switzerland (Christliches Verlagshaus)
Erich Jung Musik & Schallplatten-Produktion & Verlag, Lederhosenweg 19, D-6550 Bad Kreuznach, Tel (0671) 6-18-62 Pres. Erich Jung; Gen. Mgr. W. Kullmann; Sales Mgr. G. Kossmann
Labels: Divina, EJM, Mirata
Jupi, see Jupiter
Jupinchen, see Jupiter
Jupiter-Recs GmbH & Co. KG Hoehelstr 2, D-8000 Munich 80 Tel (089) 98-49-26 Telex (05) 22946 Owner & Pres.: Ralph Siegel; Gen. Mgr. Werner Schueler, Sales Mgr.: Red Herrschmann. (Distributed by Ariola)
Labels: (Owned) Jeans, Jupi, Jupinchen, Jupiter
Int'l reps.: Austria, Benelux, France, Portugal, Scandinavia, Spain, Switzerland (all Ariola-Eurodisc); Australia (Image), Brazil (Fermata), Canada (IGM), Italy (Durium), Japan (Victor), New Zealand (Music World)
Juventus, see Flower
K, see Walter Koegler
K-tel Int'l GmbH, Schlitzerstr. 6-8, D-6000 Frankfurt/Main Tel (0611) 41-01-91. Telex (04) 17292 Gen. Mgr. Jens R. Boldt; Sales Mgr. Frank Pletsch.
Home office: USA
Kaleidoskop, see EMI Electrola.
Kanon, see MusiContact
Karma Musikproduktion GmbH, Hofbrunnstr 11b, D-8000 Munich 71. Tel (089) 79-73-25, 79-90-41 Telex (05) 28403 Pres. Helmar Kunte, Promo Head Karin Wirthmann. (Licensed to DGG)
Labels: (Owned) Disco-Train, Karma
Int'l reps.: Austria, Benelux, Germany, Switzerland, Scandinavia (Polydor)
Karusell, see DGG & Polydor.
Fred Kersten Schallplatten-Produktion, Rambachstr 3, D-6750 Kaiserslautern 31 Tel (0631) 5-56-24 Owner Fred Kersten
Labels: (Owned) Die Froehliche Pfalz, Kersten
Kick, see OBH
Kingsound, see Discovertrieb
Kingtone, see Discovertrieb.
Kiosk, see Sueue.
Klingklang, see EMI Electrola
Knock Out, see Relax.
Koegler, see Walter Koegler & Disco-Center
Walter Koegler Verlag, Fleischhauser Str. 50, D-7000 Stuttgart 80 Tel (0711) 71-05-39 (Distributed by Disco-Center)
Label: (Owned) K. Koegler
Kopf, see Rimpotraeger & Roof-Music.
D. Kretz (Automaten-Serv.), Sofienstr 179, D-7500 Karlsruhe 1. Tel (0721) 55-56-60, 59-07-20 Pres. Diethelm Kretz; Sales Mgr.: Gertrud Drost. (Distributor/Importer)
Kuckuck Schallplatten, Habsburgerplatz 2/2, D-8000 Munich 40 Tel (089) 33-20-78 Cable RAHNPRODUCTIONS Telex (05) 215497
L & P (Leuenhagen & Paris), Lister Melle 39, D-3000 Hannover. Tel (0511) 31-30-55.
L S, see Sueue.
L S K, see Sueue
Lanteorn Produktion Wort & Music & Bild, PO Box 660226, D-2000 Hamburg 25 Tel (040) 6-07-064
Life, see Agil-Music.
Lilliput, see Des Alpes.
Linda, see CBS.
Line, see Teldec.
Lingua Quick, see Franke
Lollipop Musik-Juergen S. Korduletsch KG, Harvestehuder Weg 21, D-2000 Hamburg 13 Tel (040) 44-60-21. Telex (02) 13425. Mng Dir. Juergen S. Korduletsch (Licensed to Teldec)
Labels: (Owned) Lollipop, Vinyl. (licensed) Claridge (USA), Laurie (USA)
Luxor, see Richter
Luxor Gold, see Richter
M Music, see CBS
M C R Soundstar, see Rhenus.
M F P Exclusiv, see Crystal.
M F P Super, see Crystal
M G M, see DGG & Polydor.
M O T, see CRP & Blubber Lips
M P S Recs. GmbH (IFPI), PO Box 1750, Richtofenstr. 3, D-7730 Villingen Tel (07721) 5-20-07. Telex 792548 Pres. & Gen. Mgr. Hans Georg Brunner-Schwer; Creative Servs. Head Hans Pflizer, Financial Dir. & Sec'y Hans Wollschlaeger (Distributed by Metronome)
Label: (Owned) MPS
Int'l reps.: Australia (Carinia), Austria (Amadeo), Belgium (EMI), Brazil (SOM), France (Sonopresse), Italy (EMI), Japan (Teichiku), Netherlands (EMI-Bovema), New Zealand (Viking), Scandinavia (EMI), Spain (EMI-Odeon), Switzerland (Metronome), USA (Capitol)
M P V, see All-Music.
M W M Recs. Munich, Ungererstr 43, D-8000 Munich 40 Tel (089) 36-150-53. Dir. Michael Wilke.
Label: (Owned) MWM
Int'l reps.: Austria (Music 2000), Switzerland (Werner Baehler), UK (Roy Belcher-Big Bands)
Maerchenland, see OPP & Polyband.
Magna Tontraeger Produktions GmbH (IFPI), Juliusstr 10-11, D-1000 Berlin 44. Tel (030) 68-440-28 Telex (01) 83845 Dirs. Juergen Freidank, Karl Moessnang (Tape only)
Labels: (Owned) Magna, Music Mobile, Sandmaennchen, (licensed) International Artist (UK)
Main, see Des Alpes.
Maisonette, see UBM
Mami, see CCA.
Mandolino, see Deutsche Austrifophon.
Helmut Marcuse (Schallplatten-Import), Thomasstr 8, D-6000 Frankfurt/Main 1 Tel (0611) 43-97-94, 44-10-22 Telex (04) 189306 Chief Exec. Helmut Marcuse (Importer)
Labels: (licensed) Black & Blue (France), Bethlehem (USA), Canyon (USA), CBS Int'l, Folkways (USA), Hed-Arzi (Israel), Les Treteaux (France), Lynchord (USA), Musica (France), Pan Vox (Greece), Pickwick (USA), Queen (Italy), RCA Int'l, Reddiffusion (UK), Trip (USA), Bruno Walter Soc. (USA)
Marifon, see Maritim
Marino Recs., Limbeckstr 128, D-4600 Dortmund 72 Tel (0234) 23-17-60 Owner Heinz Meiser
Label: (Owned) Marino
Maritim Schallplatten Gruener & Jahr AG & Co., PO Box 302040, Alsterufer 10, D-2000 Hamburg 36 Tel (404) 41-18-21-05 Telex (02) 11850 Mktg Mgr. Manfred Heydeweller (Distributed by Ariola-Eurodisc)
Labels: (Owned) Brigitte, Eltern, Gong, Marifon, Maritim, Maritim-New, Maritim-Senator-Serie, Sternchen Int'l rep.: Worldwide (Ariola)
Maritim-Senator-Serie, see Maritim Schallplatten.
Mediafon Recs., Lortzingstr 25, D-7000 Stuttgart 1. Tel (0711) 69-31-30 Mng Dir. Dr. Udo Unger
Meine Familie & Ich, see Burda.
Mein schöner Garten, see Burda.
Melo Cord, see Hanseatische.
Membran GmbH (Musik-Vertrieb), Weidestr. 120, D-2000 Hamburg 76 Tel (040) 220-12-56 Dirs. Juergen Jacobsen, Claus-Holger Lehfeld; Gen. Mgr. O. Lange; Sales Mgr. Juergen Jacobsen, A&R Mgr. M. Nagel; Export Sales Mgr. R. Martens (Distributed by Music Distributor)
Labels: (Owned) Babylon, Danny's Pan, Domino, Happy Bird, (licensed domestic) Antagon, Bear Family Recs., Delta Acoustic, Espanale, Historia, Pastels, Venus: (licensed foreign) Archive of Jazz (Italy), Cezarne (France), Churchhill (USA), Cobra (France), Mulligan (Ireland), Music 2000 (Austria), Vintage (Italy), Vogue (France)
Mento Music Pop Sounds, see Artge
Mercury, see Phonogram
Meteor, see Deutsche Buch-Gemeinschaft
Metronome Musik GmbH (IFPI), Uebersering 21, D-2000 Hamburg 60. Tel (040) 63-80-31. Telex (02) 174735. Mng. Dir. Rudolf Gassner; Deputy Mng. Dir. Guenter Hensler; A&R & Mktg Mgr. Klaus Ebert; Sales Mgr.: Heiner Wieland; Int'l A&R & Prod. Mgr.: Horst Hohenboeken
Labels: (Owned) Brain, Metronome, Nature, Zebra: (licensed foreign) Amadeo (Austria), Barclay (France), CTI (USA), Car't Stop (USA), Chiswick (UK), DJM (UK), Disney (France, USA), Infinity (USA), Kudu (USA), Logo (UK), MCA (USA), Nems (UK), Ricordi (Italy), Ri-Fi (Italy), Riviera (France), Sonet (Sweden, UK), Speciality (USA), Transatlantic (UK), (licensed domestic) MPS
Int'l reps.: Australia (Carinia), Austria (Amadeo), Belgium (Barclay), Brazil (SOM), Canada (P.J. Impey), Central America (Ricardo Boet), Denmark (Metronome), Finland (Finley), France (Phonogram), Israel (Litrato), Japan (Teichiku), Malaysia (Phonogram), Netherlands (Ariola), Norway (Polydor), Portugal (Phonogram), Singapore (Phonogram), South Africa (Gallo), Spain (Hispano), Columbia), Sweden (Metronome), Switzerland (Metronome), UK (EMI, Logo), USA (German News, JEM, Peters Int'l)
Michael & Co. (Schallplatten Vertriebsgesellschaft), Sittardsberger Alee 95-99, D-4100 Duisburg Tel (0203) 70-00-34. Telex 855-337. Mng. Dir. Hans-Georg Michael (Distributor)
Branches: D-2000 Hamburg 1, Wendenstr. 29. Tel (040) 280-3435. Telex (02) 162916—D-8000 Munich 45, Ingolstaedterstr 63 Tel (089) 31-61-70. Telex: (05) 215910.
Micula Recs., Goethestr. 11, D-8023 Pullach. Tel (089) 793-0260 Gen. & Sales Mgr. Hans Schmidbauer
Label: (Owned) Micula
Midi, see WEA.
Miller Int'l Schallplatten GmbH (IFPI), Justus von Liebig-Ring 2-4, D-2085 Quickborn. Tel (04106) 50-01 Cable QUICKBORN. Telex (02) 12386 Gen. Mgr. Harald A. Kirsten
Labels: (Owned) Europa
Int'l reps.: Australia (Astor Recs.), Austria (Discotrade), Belgium (IBC), Brazil (RGE/Fermata), Denmark (Irish Lydband), France (Sopholect), Iceland (Thorleifsson), Israel (Unatek), Luxembourg (Societe Electro Industrielle), Netherlands (Rec. Trade), New Zealand (Europa Recs.), Philippines (OctoArts, Velmas Home Inds.), Spain (Distribuidora de Productos Magneticos), Switzerland (Record Serv.), UK (Studio Import-Export), USA (German Language Publ'ns, International Music Dist.)
Mirata, see Erich Jung.
Mirror Int'l Recs. (IFPI), Schnackenburgallee 180, D-2000 Hamburg 54. Tel (040) 540-2573. Gen. Mgr. Hans-Robert Koch
Labels: (Owned) Harocord, Haro-Music, Mirror Int'l.
Mitra, see Mixtur.
Mixtur-Schallplatten GmbH, Rosenheimerstr 35, D-1000 Berlin 30. Tel (030) 211-2050 Gen. Mgr. Manfred Ganady
Labels: (Owned) Mixtur, (distributed domestic—not licensed) Abanori, Beriton, Mitra, (distributed foreign—not licensed) Abbey (UK), Advent (USA), Alpha (Belgium), BMG (Netherlands), Bombarde (Netherlands), Bongiovanni (Italy), CRD (UK), Calliope (France), Cantilena (Netherlands), Canto di Vangelo (Netherlands), Cathedral (UK), Duchesne (Belgium), Eco (Italy), Eufoda (Belgium), Eurosound (Netherlands), Festivo (Netherlands), Gallo (Switzerland), Jubal (Netherlands), Laran (Netherlands), MBM (Belgium), Mirasound (Netherlands), Mizar (Italy), Monumenta (Belgium), Musica Magna (Belgium), NKF (Norway), Norsk Kulturfund (Norway), Omega Classic (Belgium), Omega Int'l (Netherlands), Paviljong (Netherlands), Philips (Norway), Religioso (Netherlands), Sonclair (Netherlands), VDE-Gallo (Switzerland), Vista (Netherlands, UK), Welkom (Netherlands)
Int'l reps.: Italy (Bongiovanni), Netherlands (Vista)
Mondial, see Rhenus
Mondo, see Rhenus
Monogram, see Autogram
Mowe, see Welaton
Multi, see Alphon
Multibrand oHG Volker Ahrens & Co., August Mogler Str 23, D-7100 Heilbronn/Neckar. Tel (07131) 4-10-68 Telex 728366. Mng Dir. Volker Ahrens
Labels: (Owned) Audiophon Classic, Gala, Silversound, Viola Classic.
Multicassette, see Eurocassette
Multipack, see Alphon
Multi Sound, see Supertone.
Munda, see Intermedium
Musica, see Rhenus
Music Distributor GmbH, Wendenstr 25, D-2000 Hamburg 1 Tel (040) 24-25-96 Gen. Mgr. Dieter Moench; Ass't Mgr. Astrid Priil. (Distributor)
Labels: (Distributed domestic—not licensed) Anta-

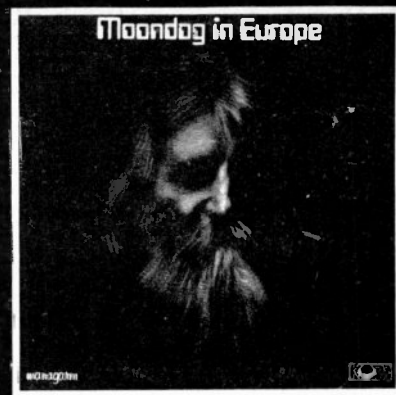

Living Legend : American composer MOONDOG!

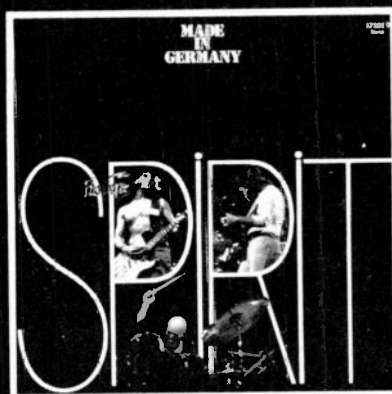

Export to all countries

If you need records and tapes from Germany: our REXPO Dept. is always at your service – all labels distributed.

Import from all countries

If you think you have something really worthwhile to offer – come and join the ranks of our worldwide distributors.

We don't promise to be the best . . . we just try.

**“if it's music,
we have it”**

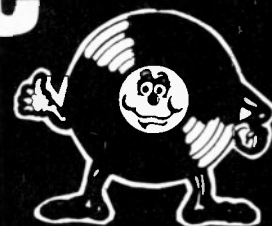

Prinz-Regent-Str. 50-60

4630 Bochum

Tel. (02 34) 7 20 54-57

Telex 08-25 756 rimpo

RIMPO Tonträger GmbH & Co KG GERMANY

gon, Babylon, Bear Family, Danny's Pan, Delta Acoustic, Domino, Espanade, Happy Bird, Historia, Pastels, Venus (distributed foreign—not licensed) Archive of Jazz (Italy), Cazame (France), Churchill (USA), Cobra (France), Mulligan (Ireland), Music 2000 (Austria), Vintage (Italy), Vogue (France).

Music Factory GmbH, PO Box 3640, Weihergarten, D-6500 Mainz. Tel: (06131) 10-741. Pres. Dr. Peter Hanser-Strecker; Gen. Mgr.: Guenther Schneider-Schott. **Label: (Owned)** Songbird.

Musician's Rec. Co., see EMI Electrola.

Musicaland, see All-Music.

Music Mobile, see Magna.

MusicContact GmbH, Wietlandstr. 36, D-6900 Heidelberg. Tel: (06221) 4-40-90. Gen. Mgr.: Hanno Pfisterer. (Wholesaler & Exporter).

Labels: (Licensed worldwide) Kanon; (Licensed worldwide excluding Germany, Austria & Switzerland) Acanta; (Exclusive worldwide representation excluding Germany, Austria & Switzerland) Audite; (Exclusive representation in US, Canada & Israel) Harmonia Mundi (Germany); (Exclusive representation in US & Canada) Harmonia Mundi (France), Da Camera. (SEE ADVERTISEMENT)

Music Radio Promos., Klingelhöhl 35, D-5600 Wuppertal 2. Tel: (0202) 50-12-78. Dir.: Peter Messingfeld.

Int'l firm represented: Music Radio Promos. (UK).

NPR, see Dieter Book.

Nature, see Metronome.

New Blood Recs., Dauner Str. 14, D-5000 Cologne 41. Tel: (0221) 41-10-41. Owner: Manfred Wehrhahn, Sales Mgr.: Horst Graf; A&R Mgr.: Manfred Hemmersbach. **Labels: (Owned)** New Blood, Sound Record; (licensed) Popcorn.

Newcomer, see CCA.

Niederdeutsche Stimmen, see Schuster.

1984 Recs., see Audio Int'l.

Noa-Musikproduktion, PO Box 2550, Lindenstr. 8, D-4830 Gutersloh 1. Tel: (05241) 2-06-06, 2-06-26. Contact: Chris Fischer.

Nonesuch, see WEA.

Nostalgia, see Sonic Arts.

Nova, see Teldec.

O B H Musikverlag (Otto B. Hartmann) (IFPI), Koenigsbergerstr. 18, D-8130 Starnberg. Tel: (08151) 13432. Pres.: Otto B. Hartmann. (Distributed by RCA). **Labels: (Owned)** Kick, OBH.

O P P Schallplatten GmbH, Bonnerstr. 311/313, D-5000 Cologne-Bayenthal. Tel: (0221) 38-54-28. Telex: 08-882628. Mng. Dir.: Ellen Jurgens. **Labels: (Owned)** Cady, Opp; (distributed—not licensed) Maerchenland, Polyband, TopSound, TopSound-Classik.

Oasis Recs., Arabellastr. 5/139, D-8000 Munich 81. Tel: (89) 92-32-30-00. Telex: (05) 22393. Gen. Mgr.: George Naschke. (Distributed by Ariola-Eurodisc). **Label: (Owned)** Oasis.

Int'l reps.: Austria (Ariola-Eurodisc), Canada (Casablanca), Ireland (GTO), Mexico (RCA), Switzerland (Ariola-Eurodisc), UK (GTO), USA (Casablanca).

Odeon, see EMI Electrola.

Offers, see Blubber Lips & Discovertrieb.

Ohr Musik Produktion GmbH, PO Box 850227, D-5000 Cologne 80. Tel: (0221) 68-25-74. Telex: 8873445. Gen. Mgr.: Rolf-Ulrich Kaiser. (Distributed by Cosmic News). **Branch: D-1000 Berlin 31, Wittelsbacherstr. 18. Labels: (Owned)** Cosmic Couriers, Cosmic Music, Ohr, Pilz, Sound of the Cosmic Couriers.

Opera, see Europaeische.

Orchestra, see Deutsche Austrophon.

Ornament, see Christmann/Schaff.

Oversea, see Deutsche Oversea.

P A Schallplatten, PO Box 657, Hafendamm 46, D-2390 Flensburg. Tel: (0461) 2-71-90. Pres.: Jens Dieter Badora. **Labels: (Owned)** PA, P A Int'l, Pyramid, Werba-Ton.

Pallas GmbH (Schallplattenfabrik), PO Box 186, Auf dem Esch 8, D-2840 Diepholz. Tel: (05441) 22-93, 28-12. Telex: (09) 41221. Gen. Mgrs.: Rolf Neumann, Hans Oestreicher Sr.

Pan, see Golden 12.

Pandora, see Delta.

Panoptikum, see Bellaphon.

Pape-Organ-Dokumente, see Fono.

Parlophone, see EMI Electrola.

Pastels, see Canto, Music Distributor & Membran.

Pathe Marconi, see EMI Electrola.

Pat Patmos, see Schwann.

Peg, see Bellaphon, Berolina & Fonoteam.

Peggy, see Bellaphon, Berolina, Rudolf Bohnen & Fonoteam.

Pergola, see Phonogram.

Piffikus, see Bellaphon.

Philips, see Phonogram.

Phonogram GmbH (IFPI), Roedingsmarkt 14, D-2000 Hamburg 11. Tel: (040) 36-09-91. Cable: PHONOGRAM. Telex: (02) 15024. Mng. Dir.: Roland Kommerell; Deputy Mng. Dir.: Dr. Gerhard Weber, Pop Nat'l Div. Mgr.: Juergen Saueremann; Pop Int'l Div. Mgr.: Louis Spillmann; Classical Div. Mgr.: Dr. Wilfried Daenicke; Sales Div. Mgr.: Claus Heesch; Mdsq. & Exploitation Div. Mgr.: Helmut Schalek; Finance & Admin. Div. Mgr.: Wingolf Mielke. **Branches: D-5000 Cologne 1, Hansaring 69-73. Tel: (0221) 13-50-13—D-6000 Frankfurt 16, Muenchnerstr. 7. Tel: (0611) 23-00-21—D-2000 Hamburg 1, Wendenstr. 29. Tel: (040) 280-13-61—D-8000 Munich 46, Ingolstaedterstr. 55. Tel: (089) 35-23-95.**

Import Serv.: D-6000 Frankfurt, Taunustr. 40-42. Tel: (0611) 23-07-76. **Labels: (Owned)** Fass, Fontana, Mercury, Pergola, Philips, Polystar, Power Exchange, Star-Club, Vertigo; (licensed domestic) Deutsches Rotes Kreuz; (licensed foreign) Charisma (UK), Chrysalis (UK), DeLite (USA), Ensign (UK), Lighthouse, Lone Star (USA), Manhattan, Mountain Recs. (UK), Orpheus, Rocket (UK), Smash, Stable, Theatre Projects (Netherlands), 20th Century Fox (USA), Uno/Worl Festival (USA).

Int'l reps.: Argentina (Phonogram), Australia (Phonogram), Austria (Phonogram), Belgium (Phonogram), Bo-

livia (Discolandia), Brazil (Compannia Brasileira de Discos—Phonogram), Canada (Polydor), Chile (Philips), Colombia (Philips), Denmark (Phonogram), Ecuador (Fedisos), Ethiopia (Philips), Finland (Finnlevy), France (Phonogram), Ghana (Phonogram), Greece (Phonogram), Guatemala (Dideca), Hong Kong (Polydor), Iceland (Thorleifsson), India (Polydor), Ireland (Polydor), Israel (Litratone), Italy (Phonogram), Japan (Nippon Phonogram), Kenya (Phonogram), Lebanon (Philips), Mexico (Polydor), Morocco (Siemens), Netherlands (Phonogram), Nigeria (Phonogram), Norway (Phonogram), Paraguay (Philips), Peru (El Virrey), Portugal (Phonogram), Singapore (Phonogram), South Africa (Trutone), Spain (Fonogram), Sweden (Phonogram), Switzerland (Phonogram), Taiwan (Philips), Turkey (Gruenberg Ticaret), UK (Phonogram), USA (Phonogram), Uruguay (EDISA), Venezuela (Polydor), West Indies (West Indies Rec.), Zaire (Phonogram).

Phon & Ton Schallplatten KG (IFPI), Alte Dorfstr. 22, D-2000 Hamburg 65. Tel: (040) 605-0405. Gen. Mgr. Konrad Wolf, Sales Mgr. Irmgard Nuding, Promo Mgr. Bernd Schroeder. **Label: (Owned)** Connyland.

Pick Up, see Bellaphon.

Pilot, see Spring.

Pilz, see Ohr & Cosmic News.

Pinball Recs. GmbH, Nithackstr. 5, D-1000 Berlin 10. Tel: (030) 342-2219. Mng. Dir. Joachim Heider, Gen. Mgr.: Juergen Otterstein. (Licensed to Teldec).

Plaene, see Deutsche Austrophon.

plane GmbH (Verlag) (IFPI), PO Box 827, Braunschweigerstr. 20, D-4600 Dortmund 1. Tel: (0231) 81-89-25. Telex: (08) 22292. Gen. Mgr.: Wolfgang Frickenhaus; Sales Mgr.: Michael Poerschke, PR: Sonja Kappel. **Labels: (Owned)** plane; (licensed) Dicap (Chile); (distributed—not licensed) Le Chant du Monde (France). Int'l reps.: Austria (Int'l Buch), Belgium (Agitap), France (Le Chant du Monde), East Germany (Deutsche), Netherlands (Pegasus), Switzerland (Pinkus).

Playsound, see Polyband.

Poly, see DGG.

Polyband Gesellschaft fuer Tontraeger GmbH & Co. KG, Sonnenstr. 20, D-8000 Munich 2. Tel: (089) 55-41-98, 59-41-00. Telex: (05) 22636. (Also see OPP).

Labels: Aquarium 2000, Autopy, Busch-Phonothek, Clarino, Concord, Eros, Erotica, Floraton, Globeton, Henning, Maerchenland, Playsound, Polyband, TopSound, Ynphon.

Polydor Int'l GmbH (IFPI) (a Polygram Co.), PO Box 132266, Harvestehuder Weg 1-4, D-2000 Hamburg 13. Tel: (040) 44-18-11. Telex: 27133. Pres. Dr. Werner Vogelsang; VP's: Freddie Haayens, Roland Kommerell, Classical A&R Dir.: Dr. Hans Hirsch; Pop Music Mgr.: Graham Haysom. Creative Servs. Mgr.: Pali Meller Marcovic. **Labels: (Owned)** Archiv Produktion, DG (Deutsche Grammophon), Heliodor, Karussell, MGM, Polydor, Verve; (licensed) Barn (UK), Capricorn (USA), EG (UK), Gold Hawke (UK), Oyster (USA), Pablo (USA), Phil Spector Int'l (USA), RSO (UK), Ring O' Recs. (UK).

Polygram GmbH, PO Box 132266, Harvestehuder Weg 1-4, D-2000 Hamburg 13. Tel: (040) 44-18-11. Cable: POLYGRAM. Telex: (02) 12434. Pres. Coen Solleveld, Exec. VP's: Johannes van der Velden, Kurt Kinkle, Dr. Wolfgang Hix; Sr. VP: Dr. Hermann Franz; VP's: Pieter R. Scheelvis, Dr. Werner Vogelsang, Heinz T. Voigt, Willem L. Zalsman; PR Dir.: Herbert Winter. **Note: Polygram controls, among other companies, in the field of music: Phonogram Int'l, Baarn, and Polydor Int'l, Hamburg; in publishing: Chappell Int'l and Intersong Int'l; in TV-films: Polytel Int'l, and in video: Polymedia. (SEE ADVERTISEMENT)**

Polystar, see Phonogram.

Popcorn, see New Blood.

Popular, see Richter.

Portrait, see CBS.

Power Exchange, see Phonogram.

Primaphon, see Franke.

Prisma, see Crystal.

Pro, see Intersound.

Profi, (Walter Fitz & Fred Bertelmann KG), Eichenstr. 17, D-8033 Krailling. Tel: (089) 857-1454. **Labels: (Owned)** Profi, Zwofler.

Programm, see IDS.

Promoton Ton & Bildproduktions-ges mbH & Co., Montgelastr. 2, D-8000 Munich 80. Tel: (089) 98-61-07. Telex: (05) 22493. Mng. Dir.: Hans E. Haberfeld. Prom Verlags GmbH (IFPI), Ohmstr. 1, D-8000 Munich 40. Tel: (089) 335-001. Telex: (05) 215456. Chief Exec. Bernd Majewski; Gen. Mgr.: Dr. Yehuda Zwick.

Pyramid, see PA Recs.

Quadrige-Ton, see Disco-Center.

R B M-Musik, see Disco-Center.

R C A Schallplatten GmbH (IFPI), PO Box 7613, Osterstr. 116, D-2000 Hamburg 19. Tel: (040) 49-02-1. Telex: (02) 14193. Mng. Dir.: Hans-Georg Baum; Finance & Admin. Mgr.: Helmut Hecht; A&R Mgr.: Manfred Helms; PR Mgr.: Leon Deane; Sales Mgr.: Harald Heilmann; Adv. Mgr.: Stefan Boehle; Int'l Pop Prod. Mgr.: Jimi Boydys; Pop Prod. Mgr. (UK & USA): Wolfgang Riehl. **Home office: USA. Labels: (Owned)** Extra, Special; (licensed domestic) Golden 12, Heimat Melodie, Sean, Ulstein Musik; (licensed foreign), Camden, Culture Classics, Culture Lyrique, Free Flight (USA), Gem (UK), Gold Seal, Grant, International, Italiana, Logo, Millennium, Neon, Red Seal, Salsoul (USA), Special, Toscanini Edition, Utopia, Victor, Victrola (all USA); ARC (France), Erato (France), Numero Uno (Italy).

Racket Recs., see Deutsche Austrophon.

Radio-Music-Recs., Bregenzerstr. 13a, D-1000 Berlin 15. Tel: (030) 881-4280. Mng. Dir.: Paul Woltschach. **Labels: (Owned)** Coda, Radio Music (RMC).

Rainbow Rec & Concert GmbH, Burgstr. 80, D-6000 Frankfurt/Main. Tel: (0611) 44-10-04. Telex: 413037. Gen. Mgr.: Dattu Ruhl; Ass't to Gen. Mgr.: Sibylle Kurz; Sales Mgr.: Klaus Mewes. (Distributor/Importer of UK labels). (SEE ADVERTISEMENT)

Raphael Recs., PO Box 107, Liebigstr. 1 1/2, D-8230 Bad

Reichenhall. Tel: (08651) 32-19. Pres. Dr. Gustav Zagler; Gen. Mgr.: Guenther Zagler, Sales Mgr.: Peter Siwek. **Labels: (Owned)** Raphaelae, Zagler.

Real Time, see Audio Int'l.

Recommended Recs. Germany, PO Box 103441, D-2800 Bremen 1.

Home office: England

Rega, see Henry From.

Regal Zonophone, see EMI Electrola.

Relax-Musikverlag, Kleekamp 44, D-2000 Hamburg 63. **Label: Knock Out.**

Repertoire, see Sonic Arts.

Reprise, see WEA.

Resono Musikproduktion GmbH & Co. KG, Friesenwall 19, D-5000 Cologne. Tel: (0221) 23-60-36. Telex: (08) 881 865.

Rhenus Gesellschaft Musikproduktion mbH & Co. KG, PO Box 511007, Caesarstr. 6/10, D-5000 Cologne 51. Tel: (0221) 38-01-47. Telex: (08) 881404. Pres. & Gen. Mgr.: K.H. Muenchow. **Labels: (Owned)** Mondial, Mondo, Musica, Spezi; (distributed) Jolly, MCR Soundstar, OPP, Weltmelodie.

Richter GmbH (IFPI), Sittardberger Alee 95/99, D-4100 Duisburg. Tel: (0203) 70-00-34/42-36. Telex: (08) 55337. Mng. Dir.: Hans-Georg Michael. **Labels: (Owned)** Luxor, Luxor Gold, Popular, Silberhit.

Rillenschlange, see Deutsche Austrophon.

Rimpo Tontraeger GmbH Co. KG, Prinz-Regentstr. 50-60, D-4630 Bochum 1. Tel: (0234) 7-20-54. Telex: 825756. Gen. Mgr.: Herbert Ludwig, Import Mgr.: Jens Schoeneich, Sales Mgr.: Bernd S. Kowalzik (Wholesaler/Importer/Exporter/Distributor).

Labels: (Distributed—not-licensed): Kopf, Roof-Music. (SEE ADVERTISEMENT)

Ring Recs., PO Box 1612, D-4130 Moers 1. (Distributor). **Labels: (Represented)** Delmark, Mustevic Sound, Nessa.

Robbi, see CBS.

Rocamar Music, Gardeschutzenweg 61/63, D-1000 Berlin 45. Tel: (030) 834-5161. Chief Exec.: Annette Meier-Hardy. **Label: (Owned)** Rocamar.

Roof-Music Schallplatten & Verlags GmbH (IFPI), Hattinger Str. 344, D-4630 Bochum 1. Tel: (0234) 43-55-62. Telex: (08) 25756. Dir.: Horst Krause; Gen. Mgr.: Juergen Triebel; Sales Mgr.: Bernd Kowalzik. **Labels: (Owned)** Kopf, Roof; (licensed) Potato (USA).

Rotaria, see Simon.

Royal Splendid, see Deutsche Tanzmusik.

Ruessl Raecord, see EMI Electrola.

S A C P C M Digital, see Sonic Arts.

S D G, see Cantate & Disco-Center.

S S T, see Eurocassetta.

Safari, see Crystal.

Sandmaennchen, see Magna.

Saphir, see Intercord.

Sastraphon, see Da Camera & Disco-Center.

Satellit, see EMI Electrola.

Scotch Wergo, see Wergo.

Schariwari, see CBS.

Hans-Juergen Schipper Musik-Produktion, PO Box 1161, Fritz Reuter Str. 52, D-2940 Wilhelmshaven. Tel: (04421) 6-08-82. Mng. Dir.: Hans-Juergen Schipper. **Schlussselloch, see Bellaphon.**

Schmolzi & Slezak Music, see Aves.

Schuster (Verlag), PO Box 944, Muehlenstr. 17, D-2950 Leer/Ostfriesland. Tel: (0491) 27-73. Owner: Theo Schuster. (German dialects recs. only). **Labels: (Owned)** Schuster, Niederdeutsche Stimmen.

Schwann Paedagogischer Verlag GmbH (IFPI), Am Wehrhahn 100, D-4000 Düsseldorf. Tel: (0211) 36-03-01. Dir.: Dr. Paul Boehring; Gen. Mgr.: Wilhelm Biswanger; Sales Mgr.: Elyert Koch. **Labels: (Owned)** AMS Musica Sacra, H&L (Hoeren & Lernen), Pat Patmos, Schwann Studio, VMS Musica Mundi.

Int'l reps.: Australia (Discurio), Austria (Bellaphon), Belgium (Schott), Canada (Polydor), France (Schott), Italy (Bongiovanni), Luxembourg (Schott), South Africa (Kramer Ltd.), Switzerland (Polydor), USA (German News).

Schwann Studio, see Schwann.

Scout, see Texel.

Sean, see RCA.

Selected Sound Musikverlag GmbH & Co. KG (IFPI), Poessel-dorfer Weg 20, D-2000 Hamburg 13. Tel: (040) 410-5005. Telex: (02) 14909. Owner & Pres.: Peter M. Majewski. (Distributed by Deutsche Austrophon). **Labels: (Owned)** Selected Sound; (represented) Tele-music (France).

Int'l reps.: France (Sforzando), Italy (Video), Netherlands (Dennis Music), Scandinavia (Nordiska), Spain (Phonorecord), UK (Brull), USA (Peer-Southern).

777 Musik-Produktion-Verlag, Kirchstr. 8, D-4100 Duisburg 14. Tel: (02135) 61-16-7. Cable: ACORN Pres.: Lambertus B. de Jonge.

Sex, see Juke Box.

Sextase, see CCA.

Sherwood, see Peter Gleissner.

Arthur Shishmanian Export-Import, Boeckmanstr. 15, D-2000 Hamburg 1. Tel: (040) 24-67-74. (Importer/Exporter).

Show Business (Ed.), Gunter Greffenhuis & Co. oHG, Schumannstr. 8, D-8000 Munich 80. Tel: (089) 47-10-95. **Labels: Beat, Carduin, Cenacolo, Duse, Music Parade, Nelson, Neraida, New Bingo, Penta Phon, Picci, Pony, Rhombus, Sevenman, Show Business.**

Sieg Ton, see WPL.

Sikrola Musik GmbH (Produktion & Musikverlag), Duisburgerstr. 7, D-1000 Berlin 15. Tel: (030) 883-4845. Mng. Dir.: Elsa Sichert. **Labels: (Owned)** Fortuna, Sikrola.

Silberhit, see Richter.

Silversound, see Multibrand.

Simon Recs. (IFPI), Zigeunerweg 45, D-8104 Grainau. Tel: (08821) 88-71. Chief Exec.: Hans Arno Simon. **Labels: (Owned)** Rotaria, Simon.

Peter Steyler Discovetrieb, Nordenstr. 8, D-8019 Moosach bei Muenchen. Tel: (08091) 95-88.

Taunus Ton Technik

the supplier of a complete line
of equipment for the economic
production of high quality records

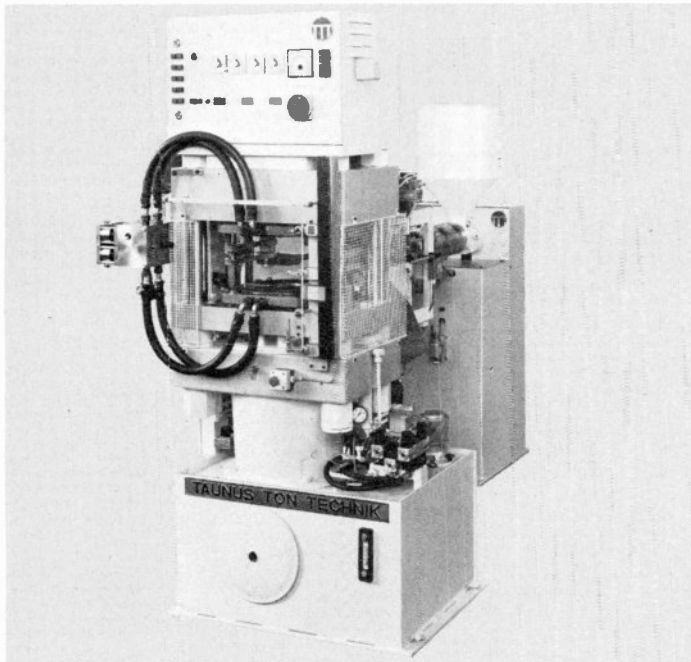

Fully Automatic Record Press (available in left or right hand version)

- Automatic and Manual Presses
- Extruders
- High Speed Moulds
- Trimmers
- Cooling Water Pumps
- Steam Boilers
- Hydraulic Supply Systems
- Packing Machines

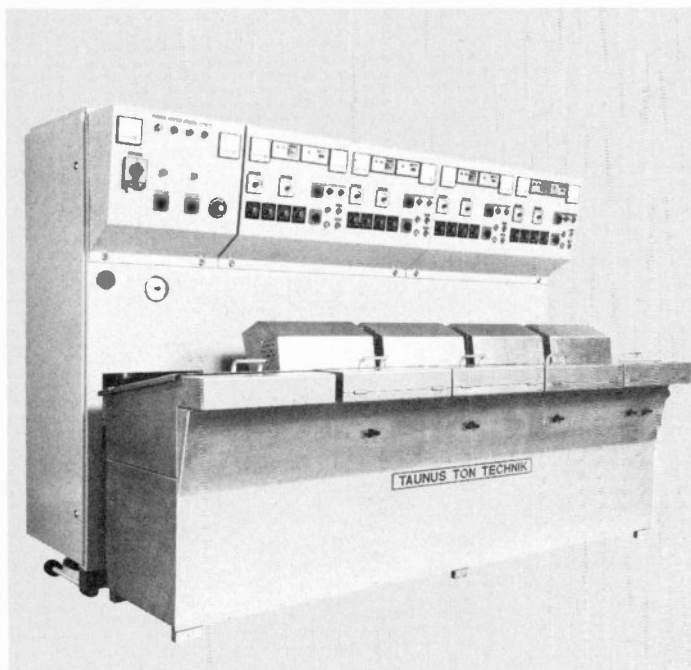

Record and Video Disk Plating Unit

- Galvanoplast Fine and Heavy
Nickel Plating Equipment up
to 400 Amps
- Automatic Silverplating Units
- Matrix Centering Units
- Automatic Matrix Grinders
- Chemicals

For complete information write or call:

TAUNUS TON TECHNIK

Alfred Petith KG · P.O. Box 1520 · Max-Planck-Straße · D-6382 Friedrichsdorf 1
Germany · Telephone: (06172) 7 12 55 or 7 25 88 · Telex: 4 18 131 taton



- SkyLab, see WPL.
 Sky Recs. GmbH & Co. (IFPI), Nordhaeuser Weg 16, D-2000 Hamburg 61. Tel (040) 551-2641. Owners: Guenter Koerber, Hans-Joachim Viehr, Frank-Michael Wiegand. (Distributed by Deutsche Austrophon).
Int'l reps.: Austria (Ariola), Belgium (Caroline), Canada (P.J. Imports), France (RCA), Hong Kong (Hong Kong Recs.), Italy (Discoteca Pick-Up), Japan (Teichiku), Netherlands (Bertus Dists.), Norway (Strawberry), Portugal (Valentin de Carvalho), Sweden (Swecont), Switzerland (Metronome), UK (Projection), USA (JEM).
- Snoopy, see UBM.
 Songbird, see Music Factory.
 Sonic Arts Corp., Liebknechtstr. 91, D-6072 Dreieich. Tel (049) 63-746-921. Exec. VP Herbert P. Haas.
Labels: (Owned) Direkt to Disk, Gilette, Golden Soul, Golden State, Nostalgia, Repertoire, SAC-PCM Digital, Sonic Arts, Super Dimension Six.
Int'l reps.: Switzerland (Star), USA (Golden State, Sonic Arts).
- Soul City Rec. Shop, Budapeststr. 44, D-2000 Hamburg 4. Tel (040) 439-79-19. Dir. & Sec'y Karl B. Mills; Sales Mgr.: Katja Triefel, Ass't Mgr. Elaine Davis. (Distributor/Importer)
Labels: (Distributed—not licensed) Cha Cha, D-Roy, Grove, Hawkeye (all UK).
- Sound of the Cosmic Couriers, see Ohr & Cosmic News.
 Sound Record, see New Blood.
 Special, see RCA.
 Spezi, see Rhenus.
 Spiegelei, see Intercord.
 Spotlight, see Supertone.
 Spring Music-Verlag & Produktion GmbH (IFPI), Leyboldstr. 1, D-5000 Cologne 51. Tel (0221) 38-44-48. Chief Exec. Ursula Vogt, Gen. Mgr. Guenther Faust.
Labels: (Owned) Hammer, Pilot.
- Star-Club, see Phonogram.
 Starlet, see Supertone.
 Starline, see EMI Electrola.
 Starmaiden, see Cosmic News.
 Stateside, see EMI Electrola.
 Johannes Studada-Verlag GmbH, see Cantate.
Labels: (Owned) Cantate, SDG.
- David Sternberg Int'l Sales Inc., Thomasstr. 8, D-6000 Frankfurt 1.
Label: (Represented) DRG.
- Sternchen, see Stern & Maritim.
 Stern Schallplatte, Pressehaus, D-2000 Hamburg 1. Tel (040) 41-18-36-60. Telex (02) 161757. Dir.: Wilfried Achterfeld; Press: Andreas Odenwald.
Labels: (Owned) Stern Musik, Sternchen.
- Steyrer-Disco, see Discovertrieb-Peter Steyrer.
- Stockfisch Produktion, Verlag & Vertrieb, Sanddornweg 13b, D-3300 Braunschweig Tel (0531) 5-10-38. Owners: Hansi Dobratz, Gunter Pauler.
- Storz, see Arminia.
 Strand, see Teldec.
 Studio One, see Intersound.
 Studio-Ton MusiCassetten & Schallplatten R Produktion, Jordanstr. 18-A, D-3000 Hannover. Tel (0511) 81-33-34.
Labels: (Owned) Hannoton, Studiotion.
- Studio Union im Lahn-Verlag, PO Box 140, Wiesbadenstr. 1, D-6250 Limburg/Lahn Tel (06431) 40-12-11. Mng. Dir. Engelbert Tauscher. Press & PR Raimund B. Zoellner.
- Suewe (Vertriebs & Dienstleistungs GmbH & Co.) KG, Pressezentrum 06, D-6800 Mannheim 2. Tel (0621) 19-21. Chief Exec.: Ernst Feuser, Gen. Mgr.: Klaus Meiser; Sales Mgr.: Hans-Joachim Kerwer.
Labels: (Owned) Comes, Drive-In, Kiosk, LS (Leser-Service), LSK (Leser-Service-Kiosk).
- Summer, see WAM.
 Sun five, see Disco Center.
 Sunflower Prod'n AG & Co., Roddestr. 5, D-4400 Munster. Tel (0251) 7-73-11, 7-73-12. Telex (08) 92123. Mng. Dir.: Fritz Heymann; Mktg & Sales Mgr.: Ulrich Haverkamp.
- Sunrise, see EMI Electrola.
 Super Dimension Six, see Sonic Arts.
 Supertone Schallplatten Vertrieb (IFPI), Alfonsstr. 9/11, D-8000 Munich 19. Tel (089) 18-12-29, 18-37-88. Pres. Juergen Rintschler; Gen. Mgr.: Dr. Heinz Stein. (Distributed by Des Alpes)
Labels: (Owned) Amati, Bella Musica, Multi Sound, Spotlight, Starlet, Supertone, Welt Melodie
Int'l reps.: Austria (Disco-Trade), Denmark (Dansk), Switzerland (Allround).
- T T, see Hanseatische.
 T V O, see Thomas Voigt Org.
 T W R, see Trans World.
- Teldec Import Serv., Max Nonne Str. 45, D-2000 Hamburg 62. Tel (040) 531-1075. Telex (02) 174537. Import Div. Mgr. Rolf Baehnk.
Labels: (Licensed) Contemp, Contemporary, Decca Group (UK), ERP, Produttori Associati (Italy), RCA, Salsoul (USA), Stiff (UK), Storyville (Denmark), Trojan/B&C (UK), WEA (USA) & all Teldec Telefunken-Decca labels.
- Teldec (Telefunken-Decca) Schallplatten GmbH (IFPI), Heussweg 25, D-2000 Hamburg 19. Tel (040) 40-19-1. Telex (02) 13545. Mng. Dir.: Kurt Richter, Gerhard Schulze; Gen. Mgr. Int'l Nobby Varenholz; Mktg. Dir.: Manfred Peter. Export Sales Mgr.: Elmar Hussing.
Labels: (Owned) Decca, Nova, Telefunken, (Licensed domestic) Ahorn, Audition, Catagallo, Line, Pinball, Strand, (Licensed foreign) Arion (France, Italy), Beserkley (UK, USA), Big Mouth (Switzerland), Buddah (USA), CNR, Creole, Delphine (France), GRT (USA), Janus (USA), H&L, London, Stiff, Storyville, Trojan, Yep.
Int'l reps.: Australia (Carnia), Austria (Musica), Belgium (Anvers Radio), Brazil (Gravocoes), Canada (London), Denmark (AEG-Telefunken), Finland (Discophon), France (Pathe Marconi), Hong Kong (Studer-Revox), Italy (Decca), Japan (King), Luxembourg (AEG-Telefunken), Mexico (Peerless), Netherlands (CNR), Norway (A/S Disco), Rep. of China (Studer-Revox), Singapore (Studer-Revox), South Africa (Gallo), Spain (Columbia), Sweden (Electra), Switzerland (Musikvertrieb), UK (Decca>Selecta), USA (London), Yugoslavia (Heidon).
 Teledisc-Ed-Produktion, Tiedgestrane 5A, D-3000 Hannover 1. Tel (0511) 81-60-41. Mng. Dir.: Wolfgang Borges.
Label: UTV Film-Recs.
- Telefunken, see Teldec.
 Tempo (Schallplatten-Vertrieb) Meissner & Co., PO Box 226, Rotwandstr. 16, D-8023 Pullach-Grosshesselohe. Tel (089) 79-42-86/66. Telex (05) 212035. Mng. Dir.: Kurt Meissner.
- Tennessee Tonstudios GmbH, Wandsbeker Zollstr. 85-87, D-2000 Hamburg 70. Tel (040) 652-2981. Gen. Mgr.: Ronald David. (Importer/Exporter)
- Texel (Ed.), PO Box 1165, Burgstr. 4, D-7830 Emmendingen. Tel (07641) 21-78. Contacts: Reinhard Egin, Eva Morgenstern.
Labels: (Owned) Scout, Texel, Whistler Music.
- Thoronon Schallplatten KG, Am Sande 7, D-3002 Wedemark 1. Tel (05130) 41-76. Dir.: Helga Koenig, Gen. & Sales Mgr.: Helmut Koenig.
Labels: (Owned) Alternum, Capella, Folk-Song, Gruppe & Lied, Thoronon.
- Tip Sound Schallplatten-Produktion GmbH, An der Alster 26, D-2000 Hamburg 1. Tel (040) 280-2662. Mng. Dir.: Hans Juergen Fruenicht.
- Toccata Schallplatten GmbH, Am Schlosspark 7, D-7812 Bad Krozingen. Tel (07633) 37-00. Mng. Dir.: Rolf Junghans, PR: Daniela-Maria Brandt. (Distributed by Fonof)
- Toka Vertriebsgesellschaft mbH, Im Gaessle 13, D-7250 Leonberg 7. Tel (0611) 73-20-71. Pres.: Hugo von Blumenthal.
Home office: Switzerland.
Labels: (Owned) Galaxy, Toka
- Toledo Recs., Wittelsbacher Str. 18, D-1000 Berlin 31. Tel (030) 88-10-81. Pres.: Guenter Henne
- Tonomatic Tontraeger GmbH, Schwabelfstr. 2, D-8011 Hoehnenkirchen bei Munich. Tel (08102) 81-36. Dir.: Johann Winkler; Gen. Mgr.: Margarethe Winkler; Sales Mgr.: Wolfgang Kyau; Promo.: Marie-Luise Geil.
Labels: (Owned) Derby, Tonomatic, Tonosound, Top Hat.
- Tonosound, see Tonomatic.
 Top Hat, see Tonomatic.
 Topsound, see OPP & Polyband.
- Trans World Recs., Bornickerstr. 39a, D-1000 Berlin 20. Tel (030) 361-90-19. Mng. Dir.: Horst Fuchs. (Distributed by Ariola-Eurodisc)
Label: (Owned) TWR.
- Trefiton Studio, see Treptita.
 Trend Recs., Heinrich Lanz Str. 33, D-6800 Mannheim. Tel (0621) 44-84-33, 44-16-82. Gen. Mgr.: Klaus R. Nagel.
- Treptita-Film-Ton-Studio, Romerstr. 113, D-4234 Alpen. Tel (02802) 25-89.
Label: Trefiton Studio, Trepton
- Trepton, see Treptita.
 Trimedia, see Junge Gemeinde.
 Trimicon, see IDS.
- U B M Prod'ns, Glockengasse 1, D-5000 Cologne 1. Tel (0221) 21-08-18. Telex (088) 881935. Pres.: Uwe Buschkotter; Dir.: Harry Rosenstein.
Labels: Maitonette, Snoopy, UBM.
- U F A Int'l GmbH, Sonnenstr. 19, D-8000 Munich 2. Tel (089) 55-79-57. Cable: UFATON. Telex (05) 23265. Gen. Mgr.: Dr. Josef Bamberger.
- U T V-Film-Recs., see Promoton.
- Ullstein Recs. (IFPI), Kaiser Wilhelm Str. 6, D-2000 Hamburg 36. Tel (040) 347-4254. Telex (02) 11898. Mgr.: Joachim Luedicke. (Distributed by RCA)
Label: (Owned) Ullstein.
- Heinz Ullm-Musik Suedetenstr. 5, D-8081 Altheggenberg. Tel (08202) 555, (0821) 51-55-55, 51-68-68. Cable: HELMMUSIC. Dir. & Gen. Mgr.: Heinz Ullm.
Labels: (Owned) Amaton, Helm, AAR, Amayana (Distributed in Austria, Germany & Switzerland by Bellaphon), (Licensed) ENJA (cassette & cartridge only)
Int'l reps.: Austria, Germany & Switzerland (Bellaphon).
- Universe Music & Movie GmbH, Mauritiussteinweg 5, D-5000 Cologne 1. Tel (0221) 24-89-00. Mng. Dir.: Peter Power. (Distributed by Crystal)
- V M S Musica Mundi, see Schwann.
- Vanilla Fudge, see Henry From.
- Varia Recs. (IFPI), Eichenstr. 30a, D-8000 Munich 70. Tel (089) 70-74-74. Dir. & Gen. Mgr.: Werner H. Theisen; Sales Mgr.: Christa Meininger.
- Varieton, see Concert Hall.
 Vega 2000, see All-Music.
- Venus—Sales Mgr.: Christine Schoenherr—see Dierks Studio, Membran & Music Distributor.
- Vertigo, see Phonogram.
 Verve, see DGG & Polydor.
- Videothek Programm GmbH, Possmoorweg 1, D-2000 Hamburg 60. Tel (040) 27171. Telex (02) 13214.
Label: Audition
- Vinyl, see Lollipop.
 Viola Classic, see Multibrand.
 Visaphon, see Disco-Center.
 Voce del Padrone, see EMI Electrola.
- Voggenreiter Verlag, Viktoriastr. 25, D-5300 Bonn-Bad Godesberg. Tel (02221) 35-50-51. Telex (08) 885662.
Labels: (Owned) EHA, Xenophon (licensed to Intercord)
- Thomas Voigt Org. GmbH (TVO), Bodekerstr. 53, D-3000 Hannover 1. Tel (0511) 31-10-11. Mng. Dir.: Thomas Voigt.
Labels: (Owned) Cassette, TVO, Windkraft.
- Voix de Son Maitre, see EMI Electrola.
 Die Volksplatte, see EMI Electrola.
 La Voz de Su Amo, see EMI Electrola.
- W A M Schallplatten Produktions GmbH (IFPI), Meteorstr. 11, D-2200 Elmshorn. Tel (0421) 6-15-32. Exec. & Sales Mgr.: Klaus Meyer, A&R & Prod'ns Mgr.: Dr. Peter Wehrspann.
Labels: (Owned) WAM (Distributed by Deutsche Austrophon), Jazz at the Cotton Club (Distributed by
- d&p musicservice), (Licensed) Summer (Distributed by d&p musicservice).
- Int'l reps.:** Australia (Quality), Denmark (Vilford Music Imports), Netherlands (Spronk), Spain (Belter), UK (Great Jazz), USA (Bill Barry, Triangle Jazz).
- W E A Musik GmbH (IFPI), Gustav Freytagstr. 13-15, D-2000 Hamburg 76. Tel (040) 220-1431. Telex (02) 14881. Mng. Dir.: Siegfried E. Loch; Deputy Mng. Dir.: Klaus Ollman, Johann Speyer; Mktg. Dir.: Johann Speyer; Sales & Finance: Klaus Ollman, A&R Dir.: Killy Kumberger.
Branches: D-5110 Alsdorf, Record Serv. Dist'n Center, Max Plankstr. 1-9. Tel (02404) 2-00-01. Gen. Mgr.: Friedrich C. Koch—D-1000 Berlin, Daimolderstr. 15. Tel (030) 853-4011. Telex (01) 84616. Rep. Gerd Rehn—D-8000 Munich, Mauerkircherstr. 5. Tel (089) 98-49-81. Telex (05) 215177. Rep. Rudi Martini.
Labels: (Owned) Asylum, Atco, Atlantic, Bunnycottillon, Elektra, Mtdi, Nonesuch, Reprise, Warner Bros. (Licensed domestic) GMMG, (Licensed foreign) Bearsville (USA), Big Tree (USA), Curiom (USA), Dark Horse (USA), DiscReet (USA), Finnadar (USA), Little David (USA), Nemperor (USA), State (UK), Swan Song (USA), Target (UK), Whirlfield (USA).
- Int'l reps.:** Austria (Ariola), Switzerland (Musikvertrieb)
- W P L-Vertriebs U Musikproduktion GmbH & Co. KG (IFPI), PO Box 6160, Hubertusstr. 11, D-5340 Bad Honnef 6. Tel (02224) 80726. Mng. Dir.: Wolfgang Paul Lentz; Sales Mgr.: Werner Stinkens; PR: Beata Lentz.
Labels: (Owned) Asphalt, WPL, WPL Int'l, (Licensed) Sieg Ton, SkyLab, see WEA.
- Warner Bros., see WEA.
- W D Warren Co. KG, Im Steingrund 5, D-6072 Dreieich-Buchschlag. Tel (06103) 6-10-51. Cable: WAMESCO. Telex (04) 185331. Owner: William-Dirk Warren; Exec. VP: Eugene Elskens, VP: Sales: Helmut Rossmaier, VP & Controller: Karl Schoon. (Distributor/Importer)
- Waverley, see EMI Electrola.
 Josef Weinberger GmbH, Oederweg 26, D-6000 Frankfurt/Main. Tel (0611) 59-03-19. Telex (04) 189248. Pres.: Johann Michel.
- Weissblaues Schmarkenr. see Discovertrieb.
 Welaton (Westphal & Lange KG), Hainhaus 2, D-3012 Langenhagen 5. Tel (0511) 73-80-31. Telex (09) 24057.
Label: (Owned) Ada, Esplanade, Mowe, welaTon.
- Welt Melodie, see Supertone, Des Alpes & Rhenus.
 Werba-Ton, see PA.
- Wergo Jazz, see Wergo Schallplatten.
 Wergo Spectrum, see Wergo Schallplatten.
 Wergo Schallplatten GmbH, PO Box 3640, D-6500 Mainz. Tel (0631) 10741. Co-Pres. Dr. Peter Hanser-Stracker, Gerhard Kamleiter, Sales Mgr.: Per Lauke.
Labels: (Owned) Wergo, Wergo Jazz, Wergo Spectrum, Schott. Wergo: (represented) Image (Switzerland), MMO (USA).
- Int'l reps.:** Belgium & France (Schott Freres), Japan (Trio), Spain (Hispavox), Switzerland (Record Serv.), USA (EAM).
- Whistler Music, see Texel.
 Windkraft, see Thomas Voigt Org.
 Xenophon, see Intercord & Voggenreiter.
 Ynphon, see Polyband.
 Zagler, see Raphaele.
 Zebra, see Metronome.
 Zeroone Ton & Bildtraegerproduktion GmbH, Boedekerstr. 53, D-3000 Hannover 1. Tel (0511) 31-10-11.
 Zwoelfer, see Prof.

● music publishers

- A L F I E-Joachim Heider, see UFA.
 A M E Musikverlag Edward Kassner GmbH, Uhlhornstr. 1, D-3000 Hannover 61. Tel (0511) 55-52-62.
Home office: England, Kassner Assoc'd Publ'rs.
- A-Tempo-Verlag (Vienna), see Hans Wewerka.
 Abacus Music, Meteorstr. 11, D-2200 Elmshorn. Tel (0421) 6-15-32. Gen. Mgr.: Klaus Meyer.
- Accord GmbH (Ed.), PO Box 450369, Stolberger Str. 90, D-5000 Cologne 41. Tel (0221) 54-30-36. Cable: ACCORDMUSIC. Telex (088) 8883534. Gen. Mgr.: Rudi Petry; Prof. Mgr.: Bob Bobzien.
Int'l firms represented: Ardmore & Beechwood (UK), Beechwood (USA), Central Songs (USA), EMI group (Worldwide), Gallico (USA), Heart's Delight (USA), KPM (UK), Marsaint (USA), Peter Maurice (UK), Open Door (USA), Prophet (USA), Saturday (USA), Stonebridge (USA), Tallyrand (USA).
- Int'l rep.:** Worldwide (EMI group).
- Acquis Ed., see ERP.
- Acuff-Rose Musikverlag KG, Heinrich Barth Str. 30, D-2000 Hamburg 13. Tel (040) 410-1912, 44-15-31. Telex (02) 13211. Rep.: Sabine Mackprang.
- Agil-Music Musikverlag GmbH, Karlstr. 36, D-8000 Munich 2. Tel (089) 59-16-26.
Int'l branch: USA.
- Ahn & Simrock Bühnen & Musikverlag, Mommsenstr. 71, D-1000 Berlin 12. Tel (030) 881-4766.
Branch: D-6200 Wiesbaden, Taunusstr. 66. Tel (06121) 52-00-17.
- Akkordeon, see Willi Griesinger.
 Akla Musikverlag, see Plessow-Musikverlage.
 Alba Musikverlag GmbH (GEMA), see Peer.
 Alcali Music, see Finger.
 Alexis Musikverlag Dr. Hans Sikorski, see Hans Sikorski.
 Alfie (Ed.) & Joachim Heider Musikverlag, Nithackstr. 5, D-1000 Berlin 10. Tel (030) 342-2219. Owner: Joachim Heider; Gen. Mgr.: Christina Lehmann.
- Allegro Theaterverlag, see Oktave.
 Altus Musikverlag, see Global.
 Amati (Ed.), see Quint.
 Christian Anders Musikverlag & Prod'n, Hoerwarthstr. 26, D-8000 Munich 40. Tel (089) 36-53-66. Pres.: Christian Anders; Gen. Mgr.: Ann Busse.
- Angel Musikverlag & Produktion A. Engel KG, PO Box 1124, Drakestr. 16, D-3280 Bad Pyrmont. Tel (05281) 5664. Chief Exec. & Gen. Mgr.: Anneliese Engel.
- April Musikverlag GmbH, An der Alster 83, D-2000

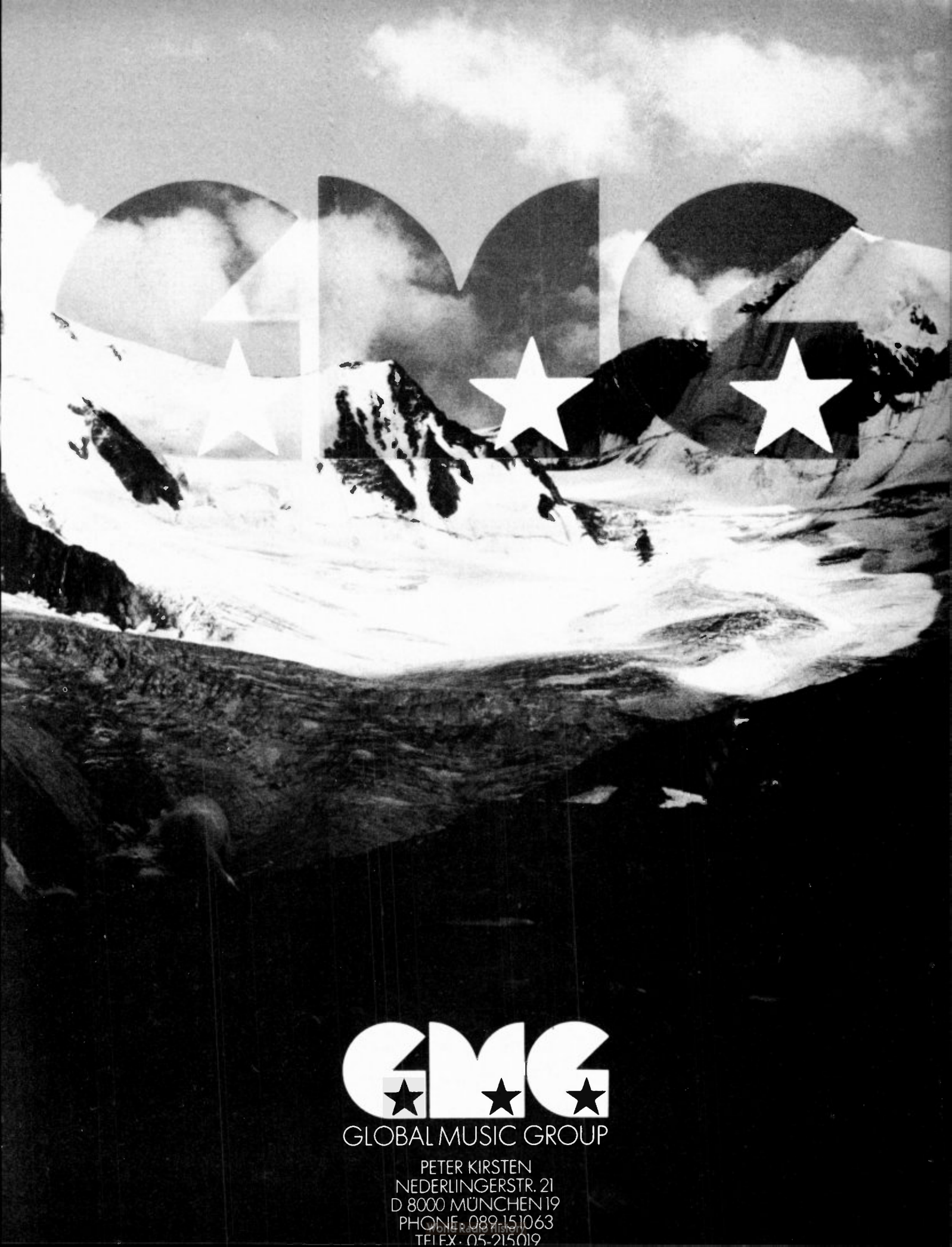

G.M.G.
GLOBAL MUSIC GROUP

PETER KIRSTEN
NEDERLINGERSTR. 21
D 8000 MÜNCHEN 19
PHONE 089 151063
TELEX 05-215019

You don't need Robot-Innovations

ASONA's CMS 2011 - most compact duplicating machinery in the world. Floor space of less than 1 m² brings you a daily production of 1200 recorded cassettes.™

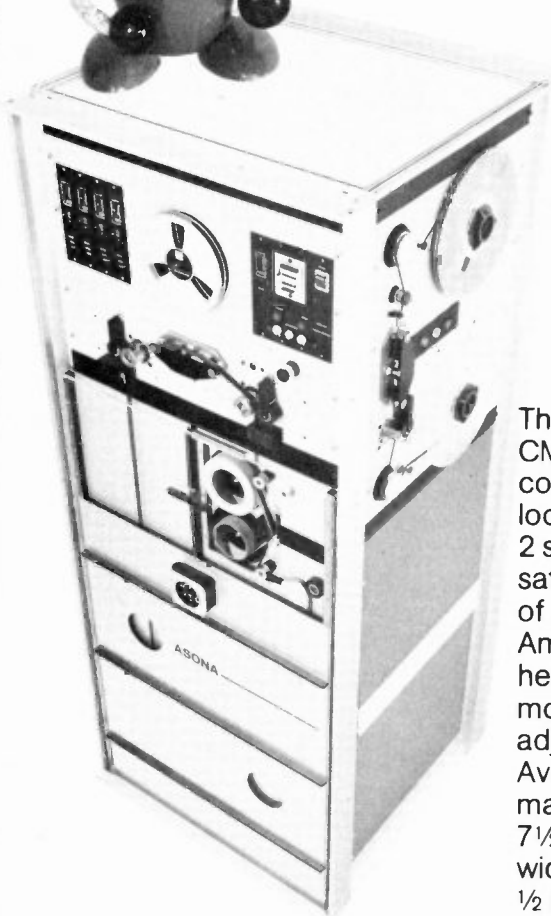
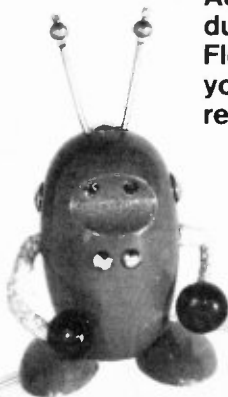

The new ASONA CMS 2010 tower contains 1 master loop-bin and 2 slaves, a working safe speed ratio of 32:1, the best American ferrite heads, and all modules with front adjustment. Available for masters of 3¾, or 7½ ips, and tape widths of ¼, and ½ inches.

Ask for ASONA's competitive price.
Write now to

ASONA

Stollbergstraße 7, 8000 Munich 22
Telephone (089) 22 50 57
Telex 522084 auvis d West Germany

Hamburg 1 Tel. (040) 24-07-45 Telex 02-161240.
Publ'g Mgr.: Volker Spielberg Mng. Dir.: Rudolf
Wolpert, Deputy Mng. Dir.: Karl G. Arbenz

Home office: USA

Int'l firms represented: Airs & Graces Music (UK), American Int'l Pictures (USA), Blending Music (USA), Brother Publ'g Co. (USA), Clay Music Corp. (USA), Country Road Music Inc. (USA), Frank Music Corp. (USA), GTO Publ'g Ltd. (UK), Albert Hammond Ents. (USA), Joelsongs/Impulsive Music (USA), Kirshner (USA), Dave Mason Music (USA), Mine Music (USA), Mister Mellow Music Ltd. (UK), Olofson Music (UK), Rockin' Music (UK), Sherlyn Music Co. (USA), Stave & Nickelodeon (UK), Tradition Music (USA).

Int'l rep.: Worldwide (April/Blackwood)

Arabella Musikverlag GmbH, Steinhäuserstr. 3, D-8000 Munich 80 Tel. (089) 4-13-61 Gen. Mgr.: Manno Ullrich

Int'l firms represented: Hawkana, Summerland (both UK)

Int'l reps.: France, Netherlands, Spain (all Arabella), USA (Anola America, US Arabella)

Araldoton-Verlag Hans Sikorski, see Hans Sikorski

Arbos Musikverlag-Hans Gerig, see Hans Gerig

Arcadia-Verlag GmbH, see Hans Sikorski

Arcona-Musikverlag GmbH, see Hans Sikorski

Paul C.R. Arends Verlag (GEMA), Hoehenweg 36, D-8211 Rimsting/Chiemsee Tel. Prien 16-34 Pres. Gerda Arends, Gen. Mgr.: Michael Arends

Int'l firms represented: Hazyville (Switzerland), Noslen (USA)

Int'l reps.: Austria (Arends), Scandinavia (Lapland), Switzerland (Hazyville)

Areta Musikverlag GmbH (GEMA), see Peer

Argus Musikverlag, Schwabelstr. 2, D-8011 Hoehenkirchen bei Munich Tel. (08102) 81-36 Exec. Johann Winkler

Arios Musikverlag, see ERP

Ralf Arnie, Wrangelstr. 5, D-2000 Hamburg 20, Tel. (040) 460-1056 Chief Exec.: Ralf Arnie, Ass't Mgr.: Jenny Kreye

Ars Viva Verlag, see B. Schott's Soehne

Arteg Productions (GEMA), see Mento

Asphalt Musikverlag, see WPL

Astoria Verlag GmbH, Brandenburgischestr. 22, D-1000 Berlin 31, Tel. (030) 881-8898 Contact: Keine Aenderung

Atlas Musikverlag, Dr. Wernerstr. 4, D-8031 Groebezell, Tel. (08142) 94-91 Owner & Mng. Dir.: Kriemhild Steidner

Attacca-Musikverlag (GEMA), Dr. Hammacherstr. 3, D-4100 Duisburg-Ruhrort Tel. (0203) 8-13-78

Audio Musikverlag GmbH Co. KG Ostpreussendam 137/138, D-1000 Berlin 45 Tel. (030) 772-4054 Pres.: Joerg Schmeier

Avanti (Ed.), see Werner H. Theisen

B.M.V. (Barock-Musik-Verlag), see Theis

B.P.V.-Musikverlag (GEMA), see Mento

Badenia-Music (GEMA), see Trend

Baerenreiter-Verlag, PO Box 100329, Heinrich-Schuetz-Allee 31-37, D-3500 Kassel Tel. (0561) 3-00-11

Int'l branches: England, France, Switzerland

Baldham Music, see Cyclus

Barock-Musik Verlag (BMV), see Theis

Bavana (Ed.), see Munich

Bavariaton-Verlag, see UFA

Beboton-Verlag GmbH, see Hans Sikorski

Beco-Musikverlag GmbH, see Oktave

Bel Canto (Ed.), see UFA

Belfort Music GmbH, Otto-Heilmann-Str. 16, D-8022 Munich-Grunwald Tel. (089) 641-2700 Telex 523141 Mng. Dir.: Richard Belfort

Bellver Music, Riedel & Co. KG, Mainzer Landstr. 87-89, D-6000 Frankfurt/Main Tel. (0611) 23-33-22 Telex (04) 16046 Gen. Mgr.: Branko Zivanovic

Int'l branch: Austria

Int'l firms represented: Birth (UK), Miki Dallon (UK), Dign (UK), Heavy (USA), Page Full of Hits (UK), Prize (USA), Shelby Singleton (USA)

Int'l reps.: Brazil (Copa), Spain (Montserrat)

Belmont Musikverlag GmbH & Co. KG (GEMA), Zur Muehle 2, D-5021 Grosskoenigsdorf bei Cologne Tel. (02234) 39-61

Int'l firms represented: Hob & Nob (USA), Miki Dallon (UK), Neil (USA), Skyview (USA), Vogue Int'l (France)

Int'l reps.: Austria (Hochmuth Weltmusik), Switzerland (Belmont), USA (Hob & Nob)

Belwin-Mills Musikverlag, see Rolf Budde

Anton J. Benjamin GmbH, Werderstr. 44, D-2000 Hamburg 13, Tel. (040) 45-12-25/66-53

Int'l firms represented: Henri Elkan (USA), Casa Musicale Giuliana (Italy), Alfred Lengnick (UK), Muzicka Nakalada (Yugoslavia), G. Schirmer (USA)

Int'l reps.: USA (AMP)

Albert Bennefeld, Schopenhauerstr. 23, D-1000 Berlin 38, Tel. (030) 801-5008

Benyet Music-Bernd Simon, see Siegel

Karl Berbuer Musikverlag & Co., see Otto Kuhl

Besser Musik GmbH, see Prom

BiBa (Ed.), see Finger

Bibiena (Ed.), see Oktave

Big 3 Musik Germany, see United Artists

Bingo Music Germany, see Accord

Black Fooss-Musikverlag GmbH, see Hans Gerig

Blubber Lips Music GmbH, Sofienstr. 7a, D-6900 Heidelberg 1 Tel. (06221) 3-37-79 Telex: (04) 61538 Chief Exec.: Ruediger Eggert

Hermann Bohne Musikverlag, Bodanstr. 34, D-7750 Konstanz Tel. (07531) 24-75-94

Rudolf Bohne (Musikverlag & Prod'n), Klenzestr. 65, D-8000 Munich 5 Tel. (089) 26-66-56

Boosey & Hawkes Music (GEMA), Schanzenstr. 16-18, D-2000 Hamburg 6, Tel. (040) 43-44-42, Dir.: Terry Moss, Gen. Mgr.: Arno H. van Vught Jr.

Int'l firm represented: Boosey & Hawkes (UK)

Int'l rep.: Worldwide (Boosey & Hawkes)

Bosworth & Co., Richartzstr. 10, D-5000 Cologne 1, Tel. (0221) 21-14-79, 23-08-82 Pres.: Margaret Sinclair, Gen. Mgr.: Reimar Segebrecht

Int'l branches: Austria, England

Int'l firms represented: Schaum (USA), Solisten-Verlag (Austria)

Bote & Bock, Hardenbergstr 9a, D-1000 Berlin 12. Tel (030) 312-3081

Int'l rep.: USA (AMP)

Boy Ton (Ed.), see PA

Brauns Musikproduktion, Hardstr 39, D-8510 Fuerth Tel (0911) 74-39-03

Breeze Music (GEMA), Hauptstr 33, D-5024 Pulheim 3 Tel (2238) 33-33, 20-04 Telex: (08) 883241 Pres. Dieter Dierks, Gen. Mgr. Corina Dierks-Fortmann

Int'l branch: Switzerland

Breitkopf & Haertel, PO Box 1707, Walkmühlstr 52, D-6200 Wiesbaden, Tel (06121) 40-20-31

Int'l branch: England

Int'l reps.: Australia (Allians), Brazil (Irmaos Vitale), France (Costallat), Japan (Nippon Gakki), USA (AMP)

Brilliant Musik-Hans Gerig oHG, see Hans Gerig

Broadway GmbH (Musikverlag), see AME

Rolf Budde Musikverlage, Hohenzollerndamm 54A, D-1000 Berlin 33, Tel (030) 823-4015, Telex (01) 84770. Owners & Mng Dirs.: Annemarie, Andreas & Rolf Budde

Int'l firms represented: Admont (USA), Alkatraz Corner (USA), Arabella (UK), Arnakata (UK), Associati (Ed.) (Italy), Belwin-Mills (UK, USA), Bewlay Bros. (USA), Big Game (UK), Big Sky (USA), Brent (USA), British Lion (UK), Carrousel (France), Chandos (USA), Combine (USA), Consolidated (USA), Daybreak (USA), Delphine (France), Dorsey Brothers (USA), Dwarf (USA), Fourth Floor (USA), Grade & Lynton (UK), Hillgreen Music (USA), Al Jarreau (USA), Joyful Wisdom (USA), Edward B. Marks (USA), Joe McDonald (USA), Ivan Mogull (USA), New Town Sound (UK), Purple (UK), Ram's Horn (USA), Resaca (USA), G. Ricordi & Co. (Italy), Larry Spier (USA), Springtime (USA), Stillmann Song Co. (USA), Special Rider Music (USA), Stranger (USA), Vogue Int'l (France)

Int'l reps.: Austria (Gloria), Switzerland (Flora)

Burlington Musikverlag GmbH (GEMA), Hoehenweg 36, D-8211 Rimsting/Chiemsee Tel. Prien 16-34, Chm.: Dr. H.H. von Rauscher auf Weeg; Gen. Mgr.: Gerda Arends; Ass't Mgr.: Michael Arends

Promo. branch: D-2000 Hamburg 6, Schanzenstr 16, Tel (040) 43-44-42 Contact: Arno H. van Vught Jr.

Int'l firms represented: Acclaim (USA), Burlington (UK), Con Brio (USA), Four Star (USA), Mikim (USA), Palace (UK), Singletree (USA), Stevenson, Tuckahoe (USA), Wiljex (USA)

Int'l rep.: Austria (Arends)

Butterfly Musikverlag GmbH (GEMA), Otto Heilmannstr. 8, D-8022 Gruenwald Tel (089) 641-1214 Telex: (05) 22279. Pres.: Michael Kunze; Gen. Mgr.: Roswitha Kunze

Int'l firm represented: Sumac/Louise-Jack Music (USA)

Int'l rep.: Rosalba (USA)

C C C-Ton, see Oktave

CSB Kaminsky (Copyright Serv. Bureau) GmbH, Wilhelmstr.

10, D-2407 Bad Schwartau. Tel (0451) 2-15-30. Contact: Pia Kaminsky

Home office: USA

Calig Verlag GmbH, Renatastr 71, D-8000 Munich 19 Tel (089) 16-34-76 Mng. Dir.: Wolfgang Walter; Prod. Mgr.: Doris Hagen; Mktg. Dir.: Manfred Steinberg

Canzonetta (Ed.), PO Box 0108, Petzowstr 13, D-1000 Berlin 39 Tel (030) 805-2740 Pres. & Sales Mgr.: Frances Bochmann

Capella (Ed.)-Hans Gerig KG, see Hans Gerig

Capriccio Musikverlag GmbH, see Intersong Musikverlag

Capri (Musik-Ed.), see Europaton/Peter Schaeffers

Carlton Musikverlag-Hans Gerig KG, see Hans Gerig

Carrera Musikverlag, see Storz

Casapark Music (Ed.), see Peer

Casino Musikverlag Alfred Schacht, Adolfstr 45, Hamburg Tel (040) 22-51-43, Chief Exec. & Gen. Mgr. Alfred K. Schacht

Catena KG, see Storz

Cavendish Music, see Boosey & Hawkes

Centifox Musikverlag GmbH, see Francis, Day & Hunter

Chappell & Co GmbH, Heinrich Barth Str 30, D-2000 Hamburg 13, Tel (040) 44-15-31 Telex (02) 13211. Mng Dirs.: Heinz T. Voigt, George Hildebrand, Nat'l Exploitation: Kuno Dreyse, Int'l Willi Schloesser; Promo Mgr.: Michael Koening; Special Projects: Juergen Tegge

Int'l firms represented: Belfern (UK), Disque Blue (USA), Early Morning/Moose (Canada), Frank (USA), Helmal (USA), T B Harms (USA), Lowery (USA), Morris-Chappell (UK), Pippin The Friendly Ranger (UK), RSO (UK), Saggiore (USA), Williamson (USA)

Chrischaa/Ornament Musikverlag, Goerresstr 3, D-5400 Koblenz 1, Tel (0261) 3-61-23, Chief Exec.: Siegfried Christmann, Harold Schaafl

Int'l reps.: USA (Eyeball, Tradition)

Christiana Music, see Europaton/Peter Schaeffers

Fred Christmann (Musikverlag), Harmstorfer Weg 11, D-2106 Bendorfstr Tel (04183) 62-46, Chief Exec. & Gen. Mgr.: Fred Christmann

Int'l firms represented: John S. Hardy Music (USA), Windham Hill Music (USA)

Int'l rep.: UK (Wilson Eds)

Cineton-Verlag GmbH, see Hans Sikorski

City Irene Retford (Musikverlag), see Anton J. Benjamin

Clarino (Ed.), see Wolfgang G. Winkel

Coconut Music GmbH, 18 Wittelsbacherstr., D-1000 Berlin 13, Tel. 88 10 81, Telex: 184174, Dirs.: Karin Hartmann; Tony Hendrik

Cocorda Musikverlag, see April

Colorit Music-Hans Gerig KG, see Hans Gerig

Compact Musik Verlag GmbH, Mauritiussteinweg 5, D-5000 Cologne 1 Tel: (0221) 24-25-49, (02972) 63-89, Telex (02) 11898, Gen. Mgr. Willy Braeutgam

Compass Musik GmbH, see Melodie der Welt

Conga Musik, see Intro. Gebr. Meisel

Connolly Musikverlag Dr. Hans Sikorski KG, see Hans Sikorski

Contella Sound, see Otvara

Copyright Serv. Bureau Ltd., see CSB Kaminsky

Cordial Musikverlag Rolf Budde, see Rolf Budde

Corona (Ed.) Rolf Budde, see Rolf Budde

Cortina-Musikverlag, see Siegfried Cycler

Cosima Music-Hans Falkenberg, see Cycler

Cosmic News Music Verlag GmbH, PO Box 850227, D-5000 Cologne 80, Tel: (0221) 68-25-74, Telex (08) 873445, Gen. Mgr. Rolf-Ulrich Kaiser

Branch: D-1000 Berlin 31, Wittelsbacherstr. 18

Cosmoton Verlag, see Hans Wewerka

Countdown Music, Dorfstr. 76, D-2081 Hasloh (Hamburg), Tel (04106) 24-14, 6-73-37, Telex: 214534, Owner & Gen. Mgr. Rainer Etzrodt

Crescendo Theater & Musikverlag, see Ahn & Simrock

Cyclus Musikverlage GmbH, Hallerstr. 76, D-2000 Hamburg 13, Tel (040) 410 2071, Telex: (02) 11389, Gen. Mgr. Peter A. Ingwersen

Int'l firms represented: Clandalee/Ledaclan (USA), Keca/Rip (USA), Kidada/Rashida (USA), Marksmen Music (UK), Metal Machine (USA), RCA group, Salsoul/Lucky Three (USA), Songs of Manhattan Island (USA)

Int'l reps.: Worldwide excluding Austria (RCA), Austria (Josef Weinberger)

Des Alpes (Ed.), Simon-Breu-str. 32, D-8700 Wuerzburg, Tel: (0931) 71286, Telex: (06) 8810, Mng. Dir.: Hans Richard Danner

Deutsche Tanzmusik, see Royal

Diana Musikverlag GmbH, see Intro. Gebr. Meisel

Otto Dietrich (Musikverlag), see Rolf Budde

Discant Musik, see Konrad Wolf

Discoton (Music Ed.), see UFA

Dominante (Musikedition), see Paul C.R. Arends

Domino Musikverlag, see Hans Gerig

Dreiklang-Dreimasken Buehnen & Musikverlag, see UFA

Drei Ringe Musikverlag, see Rolf Budde

E N J A (European New Jazz) Musik GmbH, Nymphenburgerstr. 209, D-8000 Munich 19, Tel: (089) 16-17-77, Chief Exec.: Horst Weber; Gen. Mgr.: Matthias Winckelmann

Int'l firms represented: Colex, Cloudpash, Hocham, Pat Lab Music, Lemac, Lob Music III Co., Matron Music, Phoebe Music, Prinedcon, Stanshirl (all USA); Fly Rec. Ed. Music (Italy)

Int'l reps.: Italy (Fly Recs.), Japan (Sunkyo), USA (Mayflower)

E R P Musikverlag Eckart Rahn (GEMA), Habsburgerplatz 2/2, D-8000 Munich 40, Tel: (089) 33-20-78, Cable: RAHNPRODUCTIONS, Telex: (05) 215497, Pres.: Eckart Rahn

Int'l branch: Switzerland

Int'l firms represented: Candlewood (UK), Castle Hill (USA), d'Abo Songs (USA), De Wolfe (UK), Dorallo/Bleu Disque (USA), Getaway (UK), Highgate (USA), Home Grown (USA), Immediate (UK), J&H (USA), Jasperilla (USA), Johi (USA), Leonardi (Italy), Mayflower (USA), Mystery (USA), Plan (UK), Sanah (UK), Skyhill (USA), Sympathy (UK), Toneshire (UK), Train (UK), Uncle Doris (UK), Windfall (USA)

Hand in hand with
Pickwick, mfp
and other fine
budget labels,
Rainbow Records
would like
to offer you
a hand —
working together,
succes is only a hand-
shake away.

In our catalogs you'll find budget labels at budget prices, major label cutouts and overruns. Plus nationally advertised tv-products and of course a large selection of cassettes. Our flexible sale offers makes us the best in price.

ORIGINAL
HITS
ORIGINAL
ARTISTS

Rainbow Record and
Concert GmbH
Burgstr. 80
D-6000 Frankfurt (Main) 60



West Germany
Telephone 06 11/44 10 02
Telex 41 30 37 rarco



Why magazines are

The tangible values of magazine advertising don't change from year to year. But times change. And whenever they do, the values take on a sense of importance that no advertiser can ignore.

Price

Magazines aren't impulse items. The average magazine costs more than a dollar per copy.

Readership

Magazines aren't easily ignored. Starch INRA Hooper finds that the increase in advertising pages has had no effect on the level of advertising readership. It's as high as ever.

Recall

Magazines aren't easily forgotten. Gallup Robinson finds that magazine advertising recall is on the increase.

Response

Magazines aren't passive. Opinion Research Corporation finds that the prime prospects for most products are more likely to respond to a magazine ad than to a television commercial.

Depth

Magazines aren't limited by a stopwatch. A magazine ad can deliver its selling points, in depth, in as many words as it takes.

Believability

Magazines aren't easily dismissed. In a recent Opinion Research Corporation study, no less than 60 percent of those surveyed rated magazine advertising believable. And less than 40 percent rated television advertising believable.

Usefulness

Magazines aren't trivial. They satisfy the need to know—in depth. And they cater to special personal interests like no other medium.

Tangibility

Magazines don't disappear before your eyes. A magazine ad can put a message, a coupon, an offer, a recipe right in a prospect's hands to be reread, saved, clipped, mailed, acted on.

Long-Term

Magazines aren't short-lived. Direct-response advertisers have proved that a magazine ad can produce results six months, and even a year, after publication.

Short-Term

Magazines don't work slowly. For instance, one of the most immediate and effective media weapons in a sluggish sales climate is a multi-page magazine effort that coincides with specific promotion dates.

Magazines. The

tough to put down.

Efficiency

Magazines don't cost the earth. They've held their advertising rates below the Cost of Living Index and the Wholesale Price Index. And in the past five years, their CPMs have increased at about *half* the rate of television's.

Selectivity

Magazines don't reach for the world. And when it comes to zeroing in on prime prospects who are in the market for specific products, they're the number-one medium.

Compatibility

Magazines don't have to fight for attention in a constantly changing environment. They create environments of their own. As a result, the advertiser purchases a frame of mind as well as a frame of reference for his ads.

Portability

Magazines aren't stationary. They're take-alongs that fit into briefcases and tote bags for the beach, the boat, the train, the plane.

Accessibility

Magazines aren't relegated to easily missed time slots. They wait for their readers to turn to them in their own good time.

Segmentation

Magazines aren't inflexible. Almost one out of every five magazine ads runs in either a regional or demographic edition.

Relevance

Magazines aren't passing whims. They're considered purchases. And the relevance of every issue must pass the supreme test: repeat sales.

And magazines have nothing to hide. That's why the MPA invites you to re-evaluate the balance of power between television and magazines in your media planning. And that's why we offer you an IMS computer run based on the Media Imperatives[®] and your prospects, your data, your dollars.

Just call or write
Magazine Publishers Association, Inc.
575 Lexington Avenue, New York, N.Y. 10022.
(212) 752-0055.

©Simmons Market Research Bureau

balance of power.



Int'l reps.: Austria (Weltmusik), Canada (Mayflower), UK (Getaway), USA (Doralflo/Bleu Disque)

Gerhard Ebeler Musikverlag, see Hans Gerig

Egghead (Ed.), see Guenter Faust

Ela Musikverlag, see Intro Gebr. Meisel

Elbtal-Musikverlag, see OBH

Elite (Musikverlag Ed.), Rhoenstr. 30, D-6204 Taunusstein 2, Tel. (06128) 2-33-62, 4-33-62 Gen. Mgr.: Dieter Popping

Erdo Verlag, see Rolf Budde

Esperanza/Casarcas Musikverlag (Werner Triepke & Co.), Heimhuderstr. 73, D-2000 Hamburg 13, Tel. (040) 44-52-76 Gen. Mgr. Werner Triepke

Esplanade GmbH (Ed.), Alsterdorferstr. 365, D-2000 Hamburg 60, Tel. (040) 51-82-11 Chief Exec. Lotar Ollas; Gen. Mgr. R. Liebe

Essex Music Prod'ns GmbH, see Hans Gerig

Essex Musikvertrieb GmbH, see Hans Gerig

Ernst Eulenburg GmbH, see B. Schott's Soehne

Europaton/Peter Schaeffers (Musik-Ed.), Petersplatz 11, D-8000 Munich 2, Tel. (089) 260 4091

Branch: D-1000 Berlin 19, Reichsstr. 4, Tel. (030) 302 084

Excelsior, (Ed.)-Hans Gerig KG, see Hans Gerig

Far Musikverlag, 18 Wittelsbacherstr., D-1000 Berlin 13, Tel. 88 10 81, Telex 184174 Dir.: Frank Farran

Fanfare Musikverlag, see Global

Guenter Faust, Leyboldstr. 1, D-5000 Cologne 51, Tel. (0221) 38-44-48

Fidelio-Verlag, see Paul Woitschach

Figurata Musikverlag-Musikproduktion-Rotheide Narholz, see Sonoton

Filmhansa (Musik-Ed.), see Europaton/Peter Schaeffers

Filmkunst Musik Verlag GmbH, see Intervox

Finger Music Cos., Kreuzweg 28, D-8131 Berg 2, Tel. (08131) 51-150 Cable FIMUS Telex (05) 27759

Owner & Pres. Peter Peters; Gen. Mgr. Annia Peters

Int'l firms represented: Elbomo (USA), Finger (UK, USA), Joker (Italy), Paro (France), Pebo (USA), Ragmar (USA), Rintenhous (USA), Robin Song (France), Society Hill (USA), Spacesongs/Alvin Lee (UK), Static (UK), Tomeja (USA), Voyage (UK), Waxstar (USA), Artie Wayne (USA), Wayne Art (USA), Malcolm West (UK)

Int'l reps.: Austria (MMS, Steinauer), Canada (Finger), Central & South America (Finger), France (Robin Song), Ireland (Finger), Switzerland (MCI), UK (Finger), USA (Finger)

Flensia-Music, see PA

Floranz (Ed.), see Wolfgang G. Winkel

Florida Musikverlag, see August Seith

Folklore Musikverlag, see UFA

Fortuna (Ed.), see Europaton/Peter Schaeffers

Francis, Day & Hunter GmbH Musikverlag, Harvesterhuderweg 21, D-2000 Hamburg 13, Tel. (040) 44-30-61 Cable ARPEGGIO Telex (02) 12530 Gen. Mgr.: Gerd Mueller

Home office: England

Friedrich Wilhelm Froehlich, Ansbacherstr. 52, D-1000 Berlin 30, Tel. (030) 24-13-77

Fund of Music, see Global

Heinz Funke Musikverlag, see Rolf Budde

Siegfried Gabler (Corina-Musikverlag), PO Box 1926, D-7500 Karlsruhe 1, Tel. (0721) 69-54-89

Gabriel (Ed.) KG, Hahnenkampstr. 88, D-4970 Bad Oeynhausen 2, Tel. (05731) 5-12-00

Gamma (Ed.), see Agil-Music

Gammareck Musik GmbH, Herzog-Rudolf-Str. 3, D-8000 Munich 22, Tel. (089) 2-13-63, Cable GAMMAROCK Telex (05) 29378 Co-Owners: Gerhard Augustin, Patrick Gammon; Gen. Mgr. Werner Hauschildt

Int'l reps.: USA (Jobete, United Artists)

Gustav Gerdes (Verlag), see Hans Gerig

Hans Gerig (Musikverlage), Drususgasse 7-11, D-5000 Cologne 1, Tel. (0221) 23-48-33 Telex (08) 881233

Mng. Dir.: Erwin Boche, Guenter Ilgner

Int'l firms represented: AA Music (Belgium), Curci (Italy), RTV (Italy), Mondia Music (Switzerland), Sidem (Eds.) (Switzerland), Coda Music Ltd., Cromwell Music Ltd., Duchess Music Ltd., Eaton Music Ltd., Eel Pie Publ'g Ltd., Essex Music Int'l Ltd., Fabulous Music Ltd., Harmarlane Music Ltd., Leeds Music Ltd., MAM Music Publ'g Ltd., Shawbury Music Ltd., Sundergrade Music Co., Tyler Music Ltd (all UK); ABKCO, Cintercor Music Co., Cromwell Music Inc., Duchess Music Corp., Essex Music Inc., Evil Eye Music Inc., Folkways Music Publ'g Inc., Golden Syrup Music, Hoffis Music Inc., Leeds Music Corp., Ludlow Music Inc., MCA Music Inc., TRO (all USA). (SEE ADVERTISEMENT)

German News Musikverlag-Guenter Koerber OHG, Nordhaeuser Weg 16, D-2000 Hamburg 61

Int'l reps.: Austria (Allround), Japan (GP Music)

German Sound (Ed.), see Europaton/Peter Schaeffers

Global Musik GmbH, Niederlangerstr. 21, D-8000 Munich 19, Tel. (089) 15-10-63 Cable GLOBALMUSIC Telex (05) 215019, Owner & Mng. Dir.: Peter Kirsten

Int'l firms represented: Alaska, Alchemical, Earl Barton/Rose Bridge/Strawberry Hill, Big Heart/Wooden Bear, Big Smoke, Blue Chip, B.O. Cult Songs, Braintree/Porchester, Broken Arrow/Silver Fiddle, Broken Bird/Thin Ice, Canopy, Caesar's/Tunesmith, Cashew, Chicago Music Publ'g, Crystal Jukebox, Crabshaw, Cram Renraft/Brew Music, D'Accord, Danor, Dawnbreaker, Dixie Bow/Little Switzerland, Doors, Easy Music, Fifth Star/Balloon, 57th Street Entertainment/EMP/Music Maximus, Fotomaker/Adrian Leighton, Ganga, Gannet, Garrett, Gnossos, Guerilla/Staysail, Hancock, Harrissons, Hickory Grove, Hightree/Camwood Ice Age, International Aten, Intune, Ja-Ma, Jacon/Darnoc, Dick James, Jasperilla, Justin Case, Kamakazi, Lady Jane, Lido, Little Dickens/Fool's Gold, Lornhole, MC/Mervyn, Rod McKuen, Medicine Hat, Miles Ahead, Minas, Joni Mitchell/Crazy Crow/Siquomb, Pixruss, Poco, Polo Grounds, Pondwater, Rain Forest, Remohy Music, Brian Rohan, Rondor, Rosy, David Rubinson & Friends, Sailor/Ohio River Valley, Boz Scaggs, John Sebastian, Paul Simon, Stevca BV/Richorony/Wobble, Time Step/Celeidia, Topanga, Whitsett-Churchill, Wilsons/Know/Make Me Smile/Play My Music, Zevon; **Fanfare**

Musikverlag—Bron, Creole. (SEE ADVERTISEMENT)

Gloriette Verlag, see Thomas Sessler

R. G. Gnauch (Musikverlag), see Paul Woitschach

Goldberg (Ed.)-Hans Gerig KG, see Hans Gerig

Goldy-Musikverlag Hans Sikorski KG, see Hans Sikorski

Willi Griesinger Musikverlag, Possenhofenerstr. 27, D-8130 Starnberg, Tel. (08151) 1-36-17 Chief Exec. Willi Griesinger

Adolf Hampe Musikverlag, see Rolf Budde

Hansa Musik Produktion GmbH, see Intro Gebr. Meisel

Hanseatic Musikverlag GmbH, see Intersong Musikverlag

Happy Music Verlag GmbH & Co. KG, see Intersong Musikverlag

Harmonie Verlagsgesellschaft mbH, see Intersong Musikverlag

Hausmusik-Verlag, Kaekenfur 24, D-2000 Hamburg 62, Tel. (040) 527-6916 Owner Irmgard Roenicke

Hazyland (Ed.), see Paul C.R. Arends

Joachim Heider Musikverlag, see Albie & Intro Gebr. Meisel

Heinrichsofen's Verlag, PO Box 620, Liebigstr. 16, D-2940 Wilhelmshaven, Tel. (04421) 2-65-55 Pres. Otto Heinrich Noetzel; Gen. Mgr. Dr. Viktor Kreiner; Sales Mgr. Florian Noetzel

Int'l firms represented: Galaxy (USA), Galiardi (UK), Highgate (USA), Israeli Music Publ'ns (Israel), Pegasus (Ed.) (Switzerland), Stainer & Bell (UK)

Int'l reps.: Austria (Friedrich Hofmeister-Figaro), Israel (Israeli Music Publ'ns), Italy (Hortus Musicus), Netherlands (Heinrichshofen), Switzerland (Heinrichshofen), UK (Peters), USA (C.F. Peters)

Helbling Prod'n, see Europaton/Peter Schaeffers

G. Henle Verlag, PO Box 710466, Forstnieder Allee 122, D-8000 Munich 71, Tel. (089) 75-40-96 Telex (05) 216392

Hirburger Musik GmbH, Geiselgastegstr. 80, D-8000 Munich 90, Tel. (089) 64-03-57 Pres.: Andrea Andergast

Hornburg Music-Hans Gerig KG, see Hans Gerig

I D T Music GmbH, Reuterkaeserstr. 30, D-4000 Duesseldorf, Tel. (0411) 32-67-71 Chief Exec. Dirk Tillen

Idee Verlag, Bornickerstr. 39a, D-1000 Berlin 20, Tel. (030) 361-9019

Imperator-Musikverlag, see Paul Woitschach

Impero Verlag GmbH, see Heinrichshofen's

Inter Musik/J. Michel KG, see Melodie der Welt

Interphon (Ed.), Severusstr. 55, D-6000 Frankfurt/Main 50, Tel. (0611) 57-98-26 Contact Gerlinde Engelhardt

Intersong Int'l Musikverlag GmbH, Harvesterhuderweg 1-4, D-2000 Hamburg 13, Tel. (040) 410 4061 Telex (021) 2434 Pres. Heinz T. Voigt VP's: Nick Firth, Ton Smit

Note: This is the head office for the Intersong Org.

Int'l affiliates: Argentina (Korn), Australia (Intersong), Austria (Aberbach Intersong), Belgium (Intersong-Primavera), Brazil (Intersong), Canada (Intersong), Denmark (Intersong), France (Intersong), Greece (Intersong), Italy (Intersong), Japan (Intersong), Mexico (Intersong), Netherlands (Intersong-Basart), Singapore (Intersong), South Africa (Intersong), Spain (Aberbach, Canciones del Mundo, Fontana), Sweden (Intersong), Switzerland (Aberbach, Arena), UK (Intersong), USA (Intersong)

Int'l firms represented: (See Artemis, Netherlands)

Intersong (Musikverlag) GmbH, Hallerstr. 40, D-2000 Hamburg 13, Tel. (040) 41-29-31, Cable INSONG Pres.: Heinz T. Voigt; Gen. Mgr. Horst Fuchs

Int'l firms represented: Ajay (UK), Aretta (UK), John Beland & Kings Point (USA), Bellkat (USA), Berna (USA), Johnny Bienstock (USA), Big Apple (USA), Black Sheep (UK), Blue Gum (UK), Bohannon (USA), Boomtown Rats (Switzerland), Bridgehouse (USA), Bulk (UK), CTA (UK), Cape Ann (USA), Carlin (UK), Caseyem (USA), Charlotte (UK), Clarke (UK), Damont (USA), Dai Davies (UK), Davray (UK), Doobie Bros. (USA), Double Exposure (USA), Dough Boy (USA), Francis Dreyfus (France), Betty Earland (USA), Fabel (Netherlands), Fairfield (USA), Father Prod'ns (USA), Fleetwood Mac (USA), Fuse (UK), Noel Gay (UK), Harbar (UK), Hardcore/Mighty (USA), Hensley (UK), Hill & Range (USA), Hit & Run (UK), Hudson Bay (USA), Ilza (USA), Jimpire (USA), Jiru (USA), Josley (UK), Kaskat (USA), Kenya (USA), Klub (UK), Linda (USA), Litha (USA), Little Fugitive (USA), Little Lasso/Moonhill/Kurcey/Pinson (USA), Lois (USA), Luckyu (USA), Magnet (UK), Matragun (USA), Mayday (USA), Mobetta (USA), Gayle Moran (USA), Normal (USA), Omflug/Shirts (UK), Orange (UK), Oyster (USA), Angel Parker (UK), Phonopub (USA), Pickwick Int'l (USA), Elvis Presley (USA), Quickmix (USA), Ramsel (USA), Rare Blue/Monster Island (USA), Rising Sun (USA), Rock Artists (UK), Rodra (USA), Sambo (USA), Satsong (USA), Seabreeze (UK), Sky Writing (UK), Sleepy Dumpling (UK), Song (USA), Sweet (UK), TH (UK), Teenage Heaven (USA), Ten East/Five West (USA), Thames Talent Music (USA), Times Square/Herald Square (USA), Toneshire (UK), Trio (USA), Wescraft/Bullhorn (USA), White Heaven (USA), Yellow Dog (USA), Zum Publ'g (UK)

Int'l reps.: See Int'l affiliates of Intersong Int'l

Intervox Musikverlag GmbH (GEMA), Kaiserstr. 39, D-8000 Munich 40, Tel. (089) 34-10-41

Interworld Musikverlag GmbH c/o UFA-Musikverlage, Sonness 19, D-8000 Munich 2

Intro Gebr. Meisel, see listing under "M"

Italmelodie (Ed.), see Paul C.R. Arends

Iton Music (GEMA), Fichtenstr. 37, D-8043 Unterfoehring, Tel. (089) 39-77-95, 950-3532, Dir.: Juergen S. Korduletsch, Gen. Mgr. Ingo Klingbeil

Dick James Musikverlag GmbH, see Rolf Budde

Peter Janssens Musik Verlag, Am Jaegerhaus 8, D-4404 Teigte, Tel. (02504) 24 74

Int'l rep.: UK (Evelyn & Hilary Talbot-Ponsonby)

Michael Jary Produktion, see Melodie der Welt

Jessica Musikverlag GmbH, Justus-von-Liebig-Ring 2-4, D-2085 Quickborn, Tel. (04106) 50-01, Gen. Mgr. Harald A. Kirsten

Jowi-Pressediens, Samsnitzerstr. 9, D-1000 Berlin 33, Tel. (030) 823-4875 Telex (01) 84398, Chief Execs.: Joachim Wilhelm, Horst Lindow

Juicy People/J. Pratt (GEMA), Anklamer Ring 18, D-2000

Hamburg 73, Tel. (040) 647-6280 Telex (02) 13540

Owner Jimmy Pratt

Juke Box, Steinstr. 53, D-8000 Munich 80, Tel. (089) 48-79-30 Dir.: Harry Fox

Junior Musikverlag Rolf Budde, see Rolf Budde

Rudolf E. Kamphausen (Musik Verlag) (GEMA), PO Box 350245, 7 Alfred Doebelinstr., D-5000 Cologne 30, Tel. (0221) 50-36-47 Mktg. Dir. Rudolf Kamphausen, Gen. Mgr. Gunther R. Kamphausen

Kanon Musikverlag GmbH, Wielandstr. 26, D-6900 Heidelberg, Tel. (6221) 44030 Gen. Mgr. Hagen Frank; Int'l Mgr. H.S. Pfisterer

Edward Kassner & Co. Musikverlag, see AME

Klawei Musikverlag, PO Box 40, Suedring 4, D-8069 Schweitenkirchen, Tel. (08444) 570 Owner Klaus Weiss; Gen. Mgr. Heide Weiss

Otto H. Knoechel (Musikverlag), Gartenstr. 28, D-8711 Oberbreit, Tel. (09331) 23-38, (09332) 619 Owner & Dir.: Edi Hornischer

Konzept-Musik-Verlag, Heinrich-Vogl-Str. 9, D-8000 Munich 71, Tel. 79-91-28, 791-6480 Pres.: Joachim Ludwig

Koster/Hanseatic Musikverlage (Ed.), Hallerstr. 40, D-2000 Hamburg 13, Tel. (040) 41-29-31 Chief Exec.: Horst Fuchs

Kronen Musikverlag, see Quint

Constantin Kuhl & Co. (Ed.), see Otto Kuhl

Otto Kuhl Musikverlag, Am Hof 34-36, D-5000 Cologne, Tel. (0221) 21-22-76

Michel Laguens Org., 22 Sonnenstr., D-8000 Munich, Tel. 55-41-98 Telex 522636 VP Wolfgang Winkel

Lambda Music GmbH (GEMA), see Rudolf Slezak

Lapapala Music, see Summerlea

Leeds Music-Hans Gerig KG, see Hans Gerig

F. E. C. Leuckart (GEMA), Nibelungenstr. 48, D-8000 Munich 19, Tel. (089) 17-39-28

Int'l reps.: Australia (Allans), Austria (Erich), Canada (AMP), Italy (Carisch), UK (Novello), USA (AMP)

Libraphone Music, see April

Liedermacher Musikverlag Vivi Eckelberg GmbH, see Intro Gebr. Meisel

Litton Musikverlag GmbH & Co. KG, see Intersong Musikverlag

Lollipop (Ed.) (GEMA), see Rudolf Slezak

Lupocord (Ed.), see Konrad Wolf

M A M Music Publ'g GmbH, see Hans Gerig

M A M P F, see Siegel

M C A Music GmbH, see Hans Gerig

M I M (Ed.), Zur Muehle 2, D-5020 Frechen 4, Tel. (02234) 61017 Cable DEMUS Telex (08) 89299 Pres. Dr. W. Ammel

M M M Verlags GmbH, see Peer

Magazine-Music Musikverlag GmbH & Co. (GEMA), PO Box 302040, Mittelweg 180, D-2000 Hamburg 36, Tel. (040) 41-18-21 05 Telex (02) 11850 Dir.: Hubert Terheggen, John Jahr Jr., Gen. Mgr. Wolf Brummel

Int'l firms represented: Notas Magicas (Spain), Pilot (UK)

Int'l reps.: Belgium (RTM), France (Radio Music), Japan (Lux), Netherlands (Radio Music), Spain (Radio Pop), UK (Louvigny Marquee), USA (Radmus)

Maisonette Music, see UBM

Majestic (Ed.) Erwin Paesike, see Intro Gebr. Meisel

Manta-Music, Widenmayerstr. 38, D-8000 Munich 22, Tel. (089) 22-41-45 Chief Exec. Dieter Weidenfeld; Gen. Mgr.: Gerd Bietel

Marabu Musik/J. Michel KG, see Melodie der Welt

Marbot GmbH (Ed.) (GEMA), see Peer

Maredo Musikverlag GmbH, see Rolf Budde

Marino Musikverlag-Produktion, Limbeckstr. 128, D-4600 Dortmund 72, Tel. (0234) 23-17-60 Owner Heinz Meiser

Georg Marton Verlag, see Thomas Sessler

Maxim (Ed.), Muehlenfeldstr. 23, D-2800 Bremen 33, Tel. (0421) 25-92-91 Procurator Klaus Jacob; Gen. Mgr.: Barbara Kist

Mayflower Music Corp., Habsburgerplatz 2, D-8000 Munich 40, Tel. (089) 33-20-78 Telex (05) 215497 Pres. Eckart Rahn

Medox Recs., Gertigstr. 12-14, D-2000 Hamburg 60, Tel. 279-66-66 Telex (02) 174076 Owner B. Gordon

Intro Gebr. Meisel oHG (Ed.) (GEMA), Wittelsbacherstr. 18, D-1000 Berlin 31, Tel. (030) 88-10-81

INTROMUSIK Telex 184174 Dir.: Irmitruder, Peter & Thomas Meisel, Gen. Mgr. K.H. Klemponow

Int'l firms represented: ATV-Northern (UK), Ahab (USA), Beekeeper/Silly Music (USA), Bibo (USA), Blendingwell (USA), Bleu Disque (USA), Breeze (Switzerland), Bron-Osibra (UK), Bushka (USA), Ron Carter (USA), Child (UK), Choral (UK), Core (Canada), DebDave/Briarpatch (USA), Geoff & Eddie (USA), Hall-Clement (USA), T.B. Harms (USA), Heath-Levy (UK), I've Got The Music (USA), Jack & Bill (USA), Ladysmith (UK), My Mama's Music (USA), Willie Nelson (USA), Perren-Vibes (USA), Planetary (USA), Rock Steady (USA), Scorpio (France), State (UK), Song Tailors (USA), Sylvia's (USA), Tri-Song (USA), Vogue (USA), Bruce Welsh (UK)

Melodia (Ed.)-Hans Gerig, see Hans Gerig

Melodie der Welt/J. Michel KG Musikverlag, Grosse Friedbergerstr. 23-27, D-6000 Frankfurt/Main Tel. (0611) 28-78-47 Cable MELODIE Telex (04) 189248 Gen. Mgr. Johann Michel, Ass't Mgrs.: Wolfgang Mewes, Paul Lenz, Guenter Koch

Int'l firms represented: Melodie der Welt group—ATV (USA), AVI (USA), Ackee (UK, USA), After Dark (USA), Fred Ahlert (USA), Alien (USA), Alienecho (USA), Alshire (USA), Aran Prod'ns (Switzerland), At Home (USA), Baby Chick (USA), Big Secret (UK), Blue Seas (USA), Blue Mountain (UK), Boca (USA), Bosso Fataka (USA), Bourne group (USA), Bowling Green (USA), Cannon group (USA), Charleville (USA), Cheap Thrills (USA), Chinnichap (UK), Martin Cohen (USA), Co. Jac (USA), Colour Me Gone (UK), Conduive (USA), Covered Wagon (Canada), Cream group (USA), Crusty (UK), Curtis (UK), Dacapo (Austria), Diamond (UK), Diamond Back (USA), Dog Soldier (USA), Dump (USA), E.M.A. (Switzerland), Edito (Switzerland), Famous (USA), Far Out (USA), Firesky (USA), Fish-Scent (USA), Fleetwood (UK), Four Knights (USA), Frabjous (USA),

With Compliments



**Rudolf Slezak
Musikverlag GmbH**



World Radio History

Freedom (UK), Gale (UK), God Tunes (USA), Gold Forever (USA), Gold Sovereign (USA), Gopam (USA), Great Honesty (USA), Gull Songs (UK), Hello There (USA), Hubtones (USA), Icebag (USA), Island group (UK), Jac (USA), Jana (USA), Jec (USA), Kaiser (USA), Klaatoons (Canada), Knollwood (USA), LBG Artistes (Netherlands), La Cienega (USA), La-De-Da (USA), Lady Casey (USA), Larball (USA), Leviathan (UK), Levine & Brown (USA), Libra (UK), Light (USA), Little Dragon (USA), Lunatunes (USA), Mabel Songs (Denmark), Mandina (USA), Manticore (UK), Martin Coulter (UK), Mar Vista (USA), Mews (UK), Micache (USA), Milwaukee (USA), Mister Bones (USA), Modern American (USA), Mole (USA), Montunes (USA), Morning (Canada), Munchkin (USA), Musikvertrieb (Switzerland), Nightwind (USA), Nineteen Eighty-Five (USA), Onaje (USA), On Time (USA), Panache (UK), Peach Cobbler (USA), Pearlized (USA), Petra (USA), Pedro (USA), Playboy (USA), Plangent Visions (UK), Plurkantz Krundie (USA), Pods (USA), Rak (UK), Raton Songs (USA), Relaxed (USA), Le Rideau Rouge (France), Rock Music Ltd (UK), Rocksmith (USA), Ronin (USA), SSP (UK), Leonard Sachs (USA), Cyril Shane (USA), Sterling (USA), Street (UK), Sure Enough Tunes (Canada), Third Story (USA), Thursday (USA), Tree (USA), Tone/Carlin (UK), Tumbleweed (Australia), Warfare (UK), Weed High Nightmare (USA), Josef Weinberger (Austria), Wicked Fly (UK), Wiener Musikproduktion (Austria), Wien Melodie (Austria), Wildflowers (USA), R P Winkelman Tunes (USA), Frank Zappa (USA), **Compass Music GmbH group**—Compass (Netherlands, UK, USA), **Frankfurt Tree group**—Ally, Chu-Fin, Cross Keys, Double R, Green Grass, Kentree, Lonzo & Oscar, Makamillion, Makamint, Eddie Miller, Music in Colour, Ruler, Southdown, Stairway Stallion, Tata Grande, Tree, Twitty Bird, Uncanny, Vassar, Warhawk, **Inter Musik group**—Anglo-Pic (USA), Backfin (USA), Cheerio (USA), Festival Attractions (USA), Llee (USA), MPL (UK, USA), Pic (USA), Rytvoc (USA), Warock (USA), **Johann Michel group**—Aran Prod'ns (Switzerland), BL&H (USA), Beaver (USA), Beechmont (USA), Carlyle (USA), Montauk (USA), Music Crusaders (USA), Myriad (USA), Princess (USA), H B Webman (USA), We Three (USA)

Int'l reps.: Austria (Josef Weinberger), Wiener Musikproduktion, Wien Melodie, Switzerland (Edifo, Musikvertrieb).

Melodie (Musikverlag) Froboess & Budde, see Rolf Budde.
Mento Music Group KG (GEMA), Schanzenstr. 16-18, D-2000 Hamburg 6 Tel (040) 43-44-42 Dir. G. van Vught-Witte, Gen Mgr. Arno H. van Vught Jr

Int'l firms represented: Auteursunie BV (Netherlands), Boosey & Hawkes (UK), Cavendish Music (UK), Emilhenco Music (France), Lapapala Music (Canada), Summerlea Music (Canada), Winterlea Music (Canada)

Int'l reps.: Canada (Summerlea), France (Emilhenco), Netherlands (Auteursunie), UK (Valentine), USA (PBR), Guenter B. Merkel (Musikverlag), see SWP.

Mersey Publ'g Rudolf & Gunther Kamphausen Music Group, see Rudolf E. Kamphausen

Meta Musikverlag, Mauritiussteinweg 5, D-5000 Cologne 1, Tel (0221) 24-25-49 Owner Tom Astor, Gen. Mgr. Ulyly Jonas

Meteor-Musik, see Siegel

Meteorion Etabl & Co (Ed.), see Oktave

Metric Musik Germany (Ed.), Herzog Rudolfstr. 3, D-8000 Munich 22 Tel (089) 22-51-75 Mng. Dir. Gabriele Richt

Home office: USA

Int'l firms represented: Asa, Blue Horizon, Cornerstone Publ'g, Dobo Publ'g, Minnt, Post, Travis (all USA)

Int'l rep.: Worldwide (United Artists)

Metro (Ed.) Annermarie Budde, see Rolf Budde

Johann Michel (Musikverlag), see Melodie der Welt

Mr Pleasure Music, see Gammarock

Moderato Musikverlag, see Intro Gebr. Meisel

Modern (Ed.), see Hans Wewerka

Mondial Verlag-Hans Gerig KG, see Hans Gerig

Montana (Ed.) (GEMA), Koeniginstr. 121, D-8000 Munich 40 Tel (089) 34-30-36 Cable MONTANAMUSIC, Telex 215200 Owner Hans R. Beierlein, Gen. Mgr. Rudolf Figge

Int'l firms represented: Editions 23 (France), Mabelsongs (Denmark), Tanday Music (France)

Int'l rep.: France (Rosemarie Schmittler)

Moorea Music, Ulrike Schoen, see Cyclus

Mop-Musikverlag Hans Sikorski KG, see Hans Sikorski

Moravia Music GmbH, see Cyclus

Morel Music Peer Musikverlag GmbH (GEMA), see Peer

More Music Musikverlag GmbH, see Rolf Budde

Morendo Musikverlag, see April

Morgen Musikverlag GmbH, see Cyclus

Guenther Mueller (Musikverlag) (GEMA), Frankfurter Landstr. 7, D-6380 Bad Homburg Tel (06172) 4-68-36

Int'l firms represented: Coda, Esclarmonde, Melodie, Violinada (all Switzerland)

Int'l reps.: Benelux (Radio Music Nederlands, Universal Songs), Worldwide (Accord, Magazin, Radio Music Int'l)

Multi Media Music Verlags GmbH, see Peer
Munich (Ed.), Schopenhauerstr. 87, D-8000 Munich 13, Tel (089) 35-41-90

Music Factory, see B. Schott's Soehne

Music Land, see Intro Gebr. Meisel

Music Sales GmbH, Kolnerstr. 199, D-5000 Cologne 90

Home office: USA

Musictown (Ed.), Portnergasse 6, D-8400 Regensburg Tel (0941) 5-47-76 Owner & Dir. Wolfgang Maeder, Gen. Mgr. Maria Maeder

Musikkandel Verlag Ltd., Friedrich-Wilhelm-Str. 31, D-5300 Bonn 1 Tel (02221) 23-85-65 Chief Exec. Dr. H. H. Wittgen

Musikon Musikverlag, see Siegel

Musik Unserer Zeit Verlag GmbH, see Warner Bros.

Nadja (Ed.), see WPL

Nero Musikverlag, see Intro Gebr. Meisel

Das Neue Lied, see UFA

Neuer Theater-Verlag GmbH, see Hans Sikorski

Neue Welt Musikverlag GmbH, see Warner Bros.

Neuton Musikverlag, see UFA

Nevergreen Music, see Finger

Otto Heinrich Noetzel Verlag, see Heinrichshofen's

Nord-Sud Verlag, see Otto Kuhl
O B H Musikverlag (Otto B. Hartmann), Koenigsbergerstr. 18, D-8130 Starnberg Tel (08151) 1-34-32 Pres. Otto B. Hartmann

Int'l rep.: Japan ('Hara)
Oktave Musikverlag (GEMA), Adolfstr. 45, D-2000 Hamburg 76 Tel (040) 22-51-43 Telex (02) 13723

Int'l firms represented: Brull (UK)

Int'l rep.: UK (Brull)

Olymp Edition, Mittermayrstr. 10, D-8000 Munich 40 Tel 30-19-27 Gen. Mgr. Michael Theodore

Opella Musikverlag, see Accord

Orania Music-Hans Gerig KG, see Hans Gerig

Orlando-Musikverlag, Kaprunerstr. 11, D-8000 Munich 21, Tel (089) 56-74-26 Gen. Mgr. H. Gartenmaier

Ornumusic, see Rudolf Slezak

Willi Ostermann Verlag, see Hans Gerig

Otvari Music (GEMA), Schierbrokerstr. 29, D-2875 Ganderkesee 3 Tel (04221) 87622 53497 Cable OTVARI Dir. H. Schweitzer Sr., Gen. Mgr. Carlo Tossa

Int'l firms represented: Einhorn (Brazil)

Int'l rep.: Brazil (Einhorn)

Oversea Music, Muntpratstr. 18, D-7750 Konstanz

Int'l branch: Switzerland

Int'l firm represented: Cecil (Switzerland)

P A-Recs Music Ed., Halendamm 46, D-2390 Flensburg Tel (0461) 2-71-90 Chief Exec. Jens Dieter Badura, Gen. Mgr. Frank Melan

Int'l reps.: Austria (Tyrolis), Belgium (F. M. Huppermans), Scandinavia (Fred Jensen), UK (Frank Bartelt), USA (K. Hausch)

Palma Musikverlag, see August Seith

Panorama Song Musikverlag GmbH, see Francis Day & Hunter

Papagelo-Verlag Dr. Hans Sikorski, see Hans Sikorski

Papa Tango, see Rudolf Slezak

Paragon GmbH, Bundesallee 86-88, D-1000 Berlin 41 Tel (030) 852-2007, Dir. Hans-Peter Baumann

Paro Music, see Finger

Patras-Verlag, see Fred Rabold

Peer Musikverlag GmbH (GEMA), Muehlenkamp 43, D-2000 Hamburg 60 Tel (040) 271-3371 Cable SOUTHMUSIC Telex (02) 13387, Mng. Dir. Michael Karnstedt

Home office: USA, Peer-Southern

Int'l firms represented: Astronaut (USA), Bacardi (USA), Cedarwood (USA), Jiloral (USA), MUSA (Mexico), Parchment (USA), Peer-Southern Org (Worldwide), Shade Tree (USA), Sunbird Music (USA), Troika (USA)

Int'l rep.: Worldwide (Peer-Southern)

Peer Southern Prod'ns GmbH (GEMA), see Peer

Pegasus GmbH (Ed.), see Heinrichshofen's
Penthouse (Ed.), Josef Raps-Str. 3, D-8000 Munich 40 Tel (089) 32-58-39 Chief Exec. & Gen. Mgr. Karl-Heinz Ruff

Pera-Verlag, see Fred Rabold

Peso Musikverlag, see Toso

C. F. Peters Musikverlag, Kennedyallee 101, D-6000 Frankfurt/Main 70 Tel (0611) 63-30-66 Cable PETERSEDITION, Gen. Mgr. Dr. Johannes Petschull

Home office: USA

Int'l rep.: UK (Hinrichsen)

Phoenix Musikverlag GmbH, see United Artists

Picky Musikverlag GmbH, see Siegel

Pirol Musikverlag, see UFA

Plessow-Musikverlage, Nuernbergerstr. 17, D-1000 Berlin 30 Tel (030) 24-58-47

Polyphon Musikverlag GmbH, see Hans Gerig

Toni Precht Verlag, see Willy Rupprecht

Josef Preissler (Musikverlag), Braeuhausstr. 8, D-8000 Munich 2 Tel (089) 22-40-51 Publ'r Inge Emslander-Preissler, Gen. Mgr. Reinhard Tafferner

Int'l firms represented: Berben (Italy), Charnwood (UK), Deffner (USA), A. Forlivesi (Italy), Frederick Harris (Canada), Waterloo (Canada)

Presto-Jac Joergensen Buehnen & Musikverlag & Co., see Hans Gerig

Primus (Ed.) Rolf Budde KG, see Rolf Budde

Prisma Musikverlag Rolf Budde, see Rolf Budde

Progressive GmbH (Musikverlag), see Intersong Musikverlag

Prom Verlagsgesellschaft mbH, Ohmstr. 1, D-8000 Munich 40 Tel (089) 33-50-01 Telex (05) 215456 Publ'g Mgr. Bernd Majewski, Gen. Mgr. Dr. Yehuda Zwick

Pro Nova (Ed.), see Sonoton

Quadrphonie (Ed.), see Werner H. Theissen

Quint Musikverlag Stein & Co., Alfonsstr. 9/11, D-8000 Munich 19 Tel (089) 18-37-88 Pres. & Gen. Mgr. Dr. Heinz Stein

Int'l reps.: Austria (Weltmusik), Italy (Adora), Switzerland (Adora)

R CA Musik GmbH, see Cyclus

R G S Musik Rudolf G. Slezak, see Rudolf Slezak

Fred Rabold Musikverlage, Hellenstr. 42, D-7501 Busenbach Tel (07243) 6-11-89 Dir. Fred Rabold

Radio-Tele Musikverlag, see Intro Gebr. Meisel

D. Rahter, see Anton J. Benjamin

Raphaelle (Ed.), Liebigstr. 11/2, D-8230 Bad Reichenhall, Tel (08651) 32-19, Pres. & Gen. Mgr. Dr. Gustav Zagler

Record (Ed.) Rolf Budde KG, see Rolf Budde

Retford & Braunsberg, see Anton J. Benjamin

Rex (Ed.), see UFA

Rheingold (Musikverlag), see Paul Woitschach

Rheinischer Musikverlag Kuhl & Co., see Otto Kuhl
Rhein-Ruhr-Film Musikverlag (GEMA), Koenigsallee 124, D-4630 Bochum 1 Tel (0234) 3-78-14 Telex (08) 25729 Owner Erwin Erlenkaemper, Gen. Mgr. Helmut Rohlfing

Rhine Music-Hans Gerig KG, see Hans Gerig

Rhythmus (Ed.) Rolf Budde KG, see Rolf Budde

Riatio (Ed.)-Hans Gerig KG, see Hans Gerig

We are 50 years young and still growing.

The  Group

partner of

Walt Disney Music, Wonderland Music, Jobete Music, Virgin Music,
Joachim Heider, Angelo Branduardi, Satril, Peacock Music,
Desert Songs, Portrait Records, Tony Hiller Music,
Everblue, Interworld Music Group

UFA-MUSIKVERLAGE · Berlin - Munich
Sonnenstr. 19 · D-8000 Munich 2

MusiCassetten-Verpackungs- Maschine Typ KZM 3

Packaging Machine Typ KZM 3

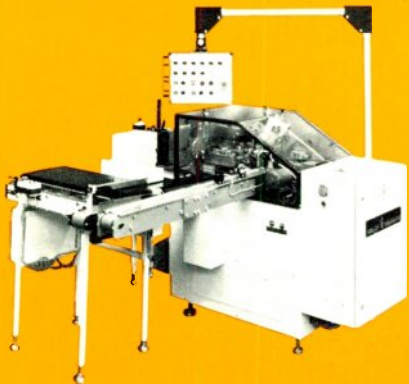

Für das vollautomatische Konfektionieren von Compact-Cassette, Beilage und Etui. Durch in die Maschine eingebaute Sondereinrichtungen können die Beilagen auch innerhalb der Maschine gefalzt werden.
Leistung: bis 80/Min.

For the fully automatic loading of compact cassettes and descriptive literature into plastic boxes. Inserts can be folded within machine by built-in special equipment.
Capacity: up to 80/min.

Etikettierer Typ ETK 1 und ETK 1 S für MusiCassetten

Labeller Type ETK 1 and ETK 1 S for compact cassettes



Leistung: bis 80 oder bis 120 Takte/Min.
Capacity: up to 80 or up to 120 Cycl./min.

HEINO ILSEMANN GmbH

Zum Panrepel 24 · D-2800 Bremen 44

Tel.: (04 21) 483083 · Telex: 244055 himab d

Bitte beachten Sie auch die Innenseite.

Bitte fordern Sie bei uns Prospekte an.

Please pay attention to the inner side of brochure.

Please contact us for leaflets

**Besides this,
please contact us
also with regard
to**

and

HEINO I LSEMANN
CARTONING MACHINES TYP MCB 1 K
CELLOPHANE WRAPPING
MACHINES TYP CM 1

Riccardo-Ton-Verlag, see Hans Gerig
 Ingrid Richter Musikvertrieb & Verlag, Pohlstr. 58, D-1000 Berlin 30, Tel. (030) 261-4689/2682
 Ring Music GmbH, Oederweg 26, D-6000 Frankfurt/Main, Tel. (0611) 59-03-19 Cable WEINJOS. Gen Mgrs.: Johann Michel, Adolf Wilms
 Ripabella Verlag, see Hans Weverka
 Riva (Ed.), see August Seith
 Roba Music, Feldbrunnstr. 50, D-2000 Hamburg, Tel. (040) 44-50-86 Owner: Hildegard Baierle, Gen. Mgr.: Rolf Baierle
 Robin Musikverlag GmbH (GEMA), see Peer
 Rockoko Music GmbH, Wittelsbacherstr. 18, D-1000 Berlin 31, Tel. (030) 88-10-81 Cable INTROMUSIK Telex. 183008 Gen. Mgrs.: Peter Hauke, Peter & Thomas Meisel
 Ro Co-Ton (Ed.), Sigmund-Freud-Str. 36, D-5300 Bonn/Venusberg 1, Tel. (02221) 28-17-06 Owner & Dir.: Heinz Romeisen
 Rondo-Verlag GmbH, see Intersong Musikverlag
 Ronny (Hamburg) Musikverlag GmbH, see Intersong Musikverlag
 Roof Music Publ'g (GEMA), Hattingers Str. 344, D-4630 Bochum 1, Tel. (0234) 43-55-62 Telex (08) 25756 Chief Exec.: Juergen Triebel, Gen. Mgr.: Horst Krause
 Rotation Musikverlag GmbH, see Intro Gebr. Meisel
 Roulette (Ed.), see Montana
 Royal Musikverlag (Ed.)-Hans Lang, Ohmstr. 9/0, D-8000 Munich 40, Tel. (089) 39-68-74, Chief Exec.: Hans Lang
 Willy Rupprecht (Musikhaus), Obere Baustr. 39, D-8500 Nuernberg Tel. (0911) 46-42-22
 S M V Schacht Musikverlage, Adollstr. 45, Hamburg 76, Tel. (022) 51-54, 51-43 Owner: Alfred Schacht
 S N B-Music, see Maxim
 S W P (Suedwest Promo.) / Musikverlag Guenter B. Merkel, PO Box 9, D-6800 Mannheim 61, Hoeheweg 22, D-6901 Wilhelmsheld, Tel. (06220) 1306 Dir.: Guenter B. Merkel, Gen. Mgr.: Bernd W. Gukelberger, Exploitation Dept.: Sharon Levinson
 Satellit Verlag GmbH, Herrnbaustr. 9, D-6232 Bad Soden, Tel. (06196) 2-50-30, Gen. Mgr.: Wolfgang Neumann
 Schacht Musikverlage, see Oktave
 Peter Schaeffers Musikverlag, see Europaton/Peter Schaeffers
 Walter Scheibe Musikverlag, see Paul Woitschach
 Pepi Scherfler (Ed.), see Werner H. Theisen
 Schipper Music, see Otvari
 Hans Schmid Musikverlage, Netzstr. 1-3, D-6689 Merchweiler 1, Tel. (06825) 50-21, Telex: (04) 44826, Pres.: Hans Schmid
 Jupp Schmitz Musikverlag, see Hans Gerig
 Schmolzi & Slezak Musik (GEMA), see Rudolf Slezak
 August Schnorrenberg Musikverlag, see Hans Gerig
 B. Schott's Soehne, Weihergarten 11, D-6500 Mainz, Tel. (06131) 1-07-41, Cable SCOTSON, Co-Pres.: Dr. Peter Hanser-Streckler, G. Schneider-Schott, Ludolf Freiherr von Canstein, Gen. Mgr.: Gerhard Kamleiter
Int'l firms represented: Max Eschig (France), Furstner (UK), Schott Freres (Belgium), Suvini Zerboni (Italy), Universal (Austria)
Int'l reps.: Austria (Universal) France (Max Eschig), Japan (Schott), South America (Ricordi in Argentina & Brazil), UK (Schott), USA (EAM)
 Schulenburg Musikverlag, see Plessow-Musikverlage
 V. Scott Musikverlag GmbH, see Intro Gebr. Meisel
 Screen Gems-Columbia Music GmbH, see Francis, Day & Hunter
 August Seith Musikverlag, Haydnstr. 2, 3rd fl., D-8000 Munich 2, Tel. (089) 53-41-22
Int'l rep.: Switzerland (Ed. Habiaton)
 Selected Sound Musikverlag GmbH & Co. KG (GEMA), Poesseldorfer Weg 20, D-2000 Hamburg 13, Tel. (040) 410-5005 Telex. (02) 14909 Owner & Gen. Mgr.: Peter M. Majewski
Int'l firms represented: Maya (Switzerland), Sforzando (France)
Int'l reps.: France (Sforzando), Italy (Video), Netherlands (Dennis Music), Scandinavia (Nordiska), Spain (Phonorecord), UK (Brull), USA (Southern)
 Sereno Musikverlag GmbH, Chemnitzstr. 56, D-5000 Cologne 80, Tel. (0221) 62-92-72 Telex 8873638 A&R Mgr.: Thomas Brueck, Gen. Mgr.: Irmgard Helmig
Int'l reps.: Benelux (Chris Back), UK (Alex Johnson)
 Thomas Sessler Verlag GmbH, Theresienstr. 7, D-8000 Munich 2, Tel. (089) 28-32-13 Cable SESSLERPLAY
Home office: Austria
 Shandy Musikverlag Rolf Budde KG, see Rolf Budde
 Shirley (Ed.), see Paul C.R. Arends
 Sidemton Verlag GmbH, see Hans Gerig
 Siegel Musikverlage, Hoehchstr. 2, D-8000 Munich 80, Tel. (089) 98-49-26 Telex 522946 Owner & Pres. Ralph Siegel, Gen. Mgr.: Werner Schueler, Dir.: Joachim Neubauer, Int'l Mgr.: Helgard V. Schenckendorff
Int'l reps.: Austria (Siegel/Hochmuth, Step Two), Brazil (Step Five), Netherlands (Step One), Switzerland (Yellow Bird), UK (Sound of Jupiter), USA (Siegel, Sound of Jupiter)
 Sieg-Ton Georg Russman (Ed.), Drei Kaisereiche 19, D-5202 Hennesf./Sieg 1
 Hans Sikorski (Int'l Musikverlage) (GEMA), Johnsallee 23, D-2000 Hamburg 13, Tel. (040) 44-62-45 Telex (02) 11027 Gen. Mgrs.: Dr. Hans Wilfred & Hanna Sikorski
Int'l firms represented: Campbell Connelly (UK), Soviet State Publ'rs (USSR)
Int'l reps.: Austria (Novaton-Ed. Helbling), Denmark (Sikorski-Scandinavia), France (Sikorski-France), Italy (Maggiore), Netherlands (Sikorski-Basart), Spain (Sikorski Espanola), Switzerland (Nova), USA (Sikorski USA)
 Silverland Music-Ralph Siegel, see Siegel
 Silver Sound (Ed.), see PA
 Simon Music (Ed.), Zigeunerweg 45, D-8104 Grainau, Tel. (08821) 88-71, Gen. Mgr.: Ingeborg Simon
 Simon Musikverlag, see UFA
 N. Simrock, see Anton J. Benjamin
 Singing Bird, see Siegel
 Sinus Musikverlag H.U. Weigel GmbH, see Intro Gebr. Meisel
 Sirius Verlag, see Heinrichshofen's

Rudolf Slezak Musikverlage GmbH (GEMA), Harvestehuder Weg 21, D-2000 Hamburg 13, Tel. (040) 44-60-21, Cable SLEZAKMUSIC Telex 213425 Mng Dir.: Rudolf G. Slezak
Int'l firms represented: RGS Musik Rudolf G. Slezak—Barn (UK), Bruno (UK), Fiddlers (UK), George & Dragon (UK), Jackaroo (USA), Macaulay (UK), No Exit (USA), Rear Exit (USA), Silkie (USA), Silver Cloud (UK), Venice (USA), **Schmolzi & Slezak Musik**—ABC/Dunhill (USA), ABM (USA), Anchor (UK), Ben-Ghazi (USA), Bibo (USA), John Carter (UK), Char-Liz (USA), Gamba (USA), Andrew Heath (UK), Incense (USA), Magicland (USA), Noon (UK), One of A Kind (USA), Quarry (UK), Three Brothers (USA), Tomake (USA), Tower (UK), Vogue (USA), White Dove (UK), Window (USA) **Rudolf Slezak Musikverlag GmbH**—Blackhill (UK), Cirrus (Canada), Crazy Cajun (USA), Flat River (USA), GH (UK), Grever Int'l (Mexico), Heathside (UK), Katzenjammer (Canada), Mickey's Monkey (USA), Penjane (Australia), Silverhill (USA), Slane (UK), Strange (UK), Stratus (Canada), Sunspot (Canada), Swamp (USA), Trillium (Canada)
Int'l reps.: Australia (Penjane), Austria (Danubius), Benelux (AVIA), Mexico (Grever Int'l), UK (Robin Gibb, Lupus—Lambda), USA (RGS, Schwartz—Lambda & Lollipop) (SEE ADVERTISEMENTS)
 Snoopy Music, Musikverlag-Musikproduktion UBM
 Songbird, see B. Schott's Soehne
 Song Ed. Rolf Budde KG, see Rolf Budde
 Sonoton Musikverlag-Musikproduktion, Schleibinger Str. 10, D-8000 Munich 80, Tel. (089) 48-82-82, Dir.: Gerhard Narholz
Int'l firms represented: Emil Ascher (USA), Berry Music (UK), Crea Sound (Canada), KPM (UK), Musique Pour L'Image (France), Sonimage (France)
Int'l reps.: Australia (Penjane), Austria (G. Narholz), Canada (Sonatina), France (L'illustration Muscale, Sonimage), South Africa (Plymouth), UK (KPM), USA (Sonatina)
 Stablo Musikverlag-Vilko Zanki & Co., see Francis, Day & Hunter
 Albrecht Stahl Musikverlag, see Rolf Budde
 Standard Musikverlag Erich Plessow (Ed.), see Plessow-Musikverlage
 Starmaden, see Cosmic News
 Star Musikproduktion GmbH, see Ralf Arnie
 Stein Musikverlag, see Quint
 Stereo Tape AG/Ed. Famira, PO Box 3846, Eppendorfer Landstr. 54, D-2000 Hamburg 20, Gen. Mgr.: Jan Famira
Home office: Switzerland
 Sternemaedchen (Starmaden) Media Serv. GmbH, see Cosmic News
 Storz KG (Musikverlag), Hauptstr. 114, D-3360 Osterode, Tel. (05522) 45-11, Telex: (09) 65154, Gen. Mgr.: Erich Storz
Branches: Bielefeld Am Kaempchen 4, Tel. (0521) 25017, Telex (09) 38058—D-2000 Hamburg, Heidenkampsweg 54, Tel. (040) 280-2939 Telex (02)

162989—D-3000 Hannover, Am Klagesmarkt 22, Tel. (0511) 15028, Telex (09) 23814
 Sugar Baby (Ed.), see United Artists
 Sugar Music Verlag KG, Tuerkenstr. 55, D-8000 Munich 40, Tel. (089) 280-93-69, Gen. Mgr.: Elio Gariboldi
Int'l firms represented: Brut (USA), Fab (USA), Sugar (France, Italy)
 Summerlea Music (GEMA), Schanzenstr. 16-18, D-2000 Hamburg 6, Tel. (040) 43-44-42, Gen. Mgr.: Arno H. van Vught Jr.
Int'l firms represented: Lapapala, Winterlea (both Canada)
 Sunday Musikverlag, see Intro Gebr. Meisel
 Sunshine Recs Music Co., Kraiberg 42, D-8074 Gaimersheim, Tel. (08458) 488, Contact Margot Liebeld
 Super Top Musikverlag GmbH, see Melodie der Welt
 Swingtone (Ed.) (GEMA), Richthofenstr. 3, D-7730 VS-Villingen Tel. (7721) 52-007, Pres.: Hans Georg Brunner-Schwer, Contact Willi Fruth
 T M Musikverlag, PO Box 3912, D-3000 Hannover 1, Tel. (0511) 66-47-69, Chief Exec.: Joerg Matthey, Gen. Mgr.: Ly von Braumueller, (Affiliated with Intersong Musikverlag)
 Takt & Ton GmbH (Ed.), see Rolf Budde
 Tanzmelodie/Peter Schaeffers (Ed.), see Europaton/Peter Schaeffers
 Taunentzien Musikverlag Rolf Budde, see Rolf Budde
 Taurus (Ed.), see Hans Sikorski
 Team Musikverlag GmbH (GEMA), see Peer
 TeeGee Music, see Finger
 Telemusica (Ed.), Nikolaistr. 2, D-8000 Munich 23, Tel. (089) 39-75-90
 Tempton-Verlag Hans Sikorski, see Hans Sikorski
 Testa-Music, Guentzelstr. 54, D-1000 Berlin 31, Tel. (030) 87-07-40, Chief Exec.: Walter Ruff
Int'l rep.: Triad Music (USA)
 Tetrachord Musikverlage AG, Redwitzstr. 4, D-8000 Munich 81, Tel.: 98-91-57, Telex (05) 215592, Mgr.: Hans Bieg
 Texel (Ed.), PO Box 1165, Burgstr. 4, D-7830 Emmendingen Tel. (07641) 21-78, Contacts Reinhard Egin, Eva Morgenstern
 Theis (Musikverlag), Suedring 11, D-3502 Vellmar 1/Kassel, Tel. (0561) 82-27-73
 Werner H. Theisen Musikverlage, Eichenstr. 30a, D-8000 Munich 70, Tel. (089) 70-74-74, Owner & Gen. Mgr.: Werner H. Theisen
Int'l reps.: Denmark (Gustav Winckler), Switzerland (Willi Bestgen), USA (Demainick)
 Thorofon H. Koenig KG, Am Sande 7, D-3001 Mellendorf, Tel. (05130) 41-76, Dir.: Helga Koenig
 Tischer & Jagenberg, see F.E.C. Leuckart
 Titania (Ed.)-Hans Gerig KG, see Hans Gerig
 Toeger Musikverlag, see Toso
 Tolido Musikverlag, see Intro Gebr. Meisel
 Tonarchiv (Ed.), see Sonoton
 Tonika Musikverlag, see Oktave
 Tonleiter (Ed.), see Europaton/Peter Schaeffers

BUSINESS WITH GERMANY

CONTACT US FOR

- EXPORT/IMPORT
- LICENSING
- PUBLISHING
- REPRESENTATION
- BUSINESS CONSULTING



AND FOR THESE
 OUTSTANDING
 CLASSICAL CATALOGS

MusiContact GMBH

WIELANDTSTRASSE 26, 6900 HEIDELBERG, W-GERMANY. TEL.: 06221/4 4090

GENERAL MANAGER
 HANNO PFISTERER



The International Record-Family

Austria

Belgium

France

Germany

Mexico

Netherlands

Spain

Switzerland

United

Kingdom

USA

Top-Szene Hamburg (Ed.), see Hans Sikorski
 Toso Musikverlag (GEMA), Leonrodstr 42, D-8000 Munich
 Tel (089) 18-60-68 Cable TOGERMUSIC Telex (05)
 215781 Owners & Gen. Mgrs Mal Sondock Jerry
 Toger
Int'l firms represented: Kenny, Slik, Yan (all UK)
 Transcendent Musikverlag Betriebs KG, see Intro. Gebr
 Meisel
 Trend Music-Verlag (GEMA), PO Box 201, Heinrich Lanzstr
 33, D-6800 Mannheim 1, Tel (0621) 44-84-33, 44-
 16-82. Chief Exec & Gen. Mgr Klaus R Nagel
 Tresonora Music & Media, Wilhelm-Ostwald-Str. 5, D-8000
 Munich 40, Tel. (089) 36-20-84 Telex. (05) 215294
 Pres Hans-Guenther Stadelmayr-Maiyores
 Troja Musikverlag, see Intro Gebr. Meisel
 Trumpf GmbH (Ed.), see Paul C.R. Arends
 U B M (GEMA), Glockengasse 1 D-5000 Cologne 1 Tel
 (0221) 21-08-18 Telex (08) 881935. Pres Uwe
 Buschkotter; Dir Harry Rosenstein
 U F A-Musikverlag, Sonnenstr 19, D-8000 Munich 2, Tel.
 (089) 55-79-57. Cable UFATON Telex (05) 23265
 Gen Mgr. Dr Josef Bamberger
Int'l firms represented: Abovewater (Canada),
 Amphonic (UK), Corinth (Canada), Cumberland/Strong
 Box (USA), Walt Disney (USA), Everblue (UK), Tony
 Hiller (UK), Hobbiron (USA), Neighborhood (USA),
 Peacock/Stonegold (USA), Satril (UK), Six Continents
 (USA), Virgin (UK), Wonderland (USA), World Song
 (USA)
Int'l reps.: Austria (MMS), Switzerland (Hush-A-Bye)
 (SEE ADVERTISEMENT)
 Ufaton-Verlag, see UFA
 Heinz Ulm-Musik, Voelkstr 34, D-8900 Augsburg Tel
 (08202) 555; (0821) 51-55-55 Cable HELM-MUSIC
 Dir Heinz Ulm
 United Artists Musik GmbH, PO Box 201, Herzog Rudolfstr
 3, D-8000 Munich 22 Tel (089) 22-51-75 Mng Dir
 Gabriele Richt
Int'l firms represented: Antisia, Buddha/Kama Sutra,
 First State Holding, Gaetana, Glasco, Interior, Jet,
 M&W, Nice Songs & Lovely Music, Paulanne, Pen-In-
 Hand, Tempo
Int'l rep.: Worldwide (United Artists)
 Valentine Musikverlag (GEMA), Schanzenstr 16-18 D-
 2000 Hamburg 6 Tel (040) 43-44-42 Dirs Pat
 Seward, M. Grinham, John Nice, Gen Mgr. Arno H.
 van Vught Jr.
Home office: England
Int'l firms represented: Buckhorn (USA), Bettytunes
 (UK), Bulldog (UK), Jerry Chestnut (USA), Derry (USA),
 A. Dimartino (USA), Hallnote (USA), Jimmy's (USA),
 Middle Eight (UK), Mugglefunktion (UK), North Country
 (Canada), Nutmeg (UK), PBR (USA), Pegliari (Canada),
 Powder Keg (USA), St Francis (USA), Silverhill (USA),
 Stallings (USA), Valentine (Netherlands, UK), War Drum
 (USA)
Int'l rep.: Worldwide (Valentine in UK)
 Van Der Bourg Musikverlag, see Telemusica
 Van Vught (Musikverlage) (GEMA), see Mento.
 Chr Friedrich Vieweg, see F.E.C. Leuckart
 Viktoria Musikverlag-Werner Scharfenberger KG, see Hans
 Gerig
 Vineta Musikverlag (GEMA), see Trend
 Vivatone Eds., see Sonoton
 Vivo-Ton Musikverlag, see Theis
 Arno Volk Verlag-Hans Gerig KG, see Hans Gerig
 Vox (Ed.) Rolf Budde, see Rolf Budde
 A. H. van Vught (Musikverlage), see Mento
 W P L (Ed.), see WPL Verlags
 W P L Verlags-Vertriebs & Musikproduktion, Hubertusstr
 11, D-5340 Bad Honnef 6, Tel (02224) 80726 Chief
 Exec. & Gen. Mgr Wolfgang P Lentz
Int'l firms represented: Dancing Musikverlag
 (Belgium), RMI (Luxembourg)
Int'l reps.: Belgium (Dancing), Luxembourg (RMI),
 Spain (RMI)
 Warner Bros. Music (Germany) GmbH, Mauerkircher Str. 5,
 D-8000 Munich 80 Tel (089) 98-49-91 Telex (05)
 215177. Mng Dir. Siegfried E Loch; Gen. Mgr Ed
 Heine
Int'l firms represented: Advanced, Carmine Appice,
 Aria, Athawarn, Atlas, Attraction, Badco, Bald Medusa,
 Barkay, Beverly Hills, Bilmar/Norway, Brown's Mill,
 Burkay, Caledonia Soul, Castleford, C'est, Chic,
 Chinmoy, David Allen Coe, Coffee-Pot, Cotillon, Dakar,
 Devalbo, Dgga, Dobro, Don Pow, Douglas, East
 Publ'ns, El Sueno, Evansongs, Far Fetched/Pond
 Tunes, Feckless, Ferguson, Five '3's, Fleet Artists, Fry
 King/Fry Queen, Gavadima, Glitterbest, Good Friends,
 Hanbo, Harms, Havana, High Wave, Holmes Line of
 Music, Ice Nine, Inhent, Inner Earth, Jakmax Jalynne,
 Jazz Bird, Jude-Anne, Jumper Tunes, Howard Kenny,
 Kicking Bear, Kittyhawk, Krn Ltd., Kumba, Language
 Of Sound, Ludmilla, Mainspring, Mansfield, Marsaint,
 May 12th, Van McCoy, Lonette McKee, Midnight Our,
 Mississippi Mud, Naked Snake, New World, Nima, Nine
 Star, Northern Hemisphere, Old Canyon, Open
 Window, Overdrive, Painless, Peabo, Peaceful,
 Pendulum, Pepamar, Quackenbush, Remick, Richbar,
 Road Canon, Rodart, Round Wound, Saloon Songs,
 Sanctum, Seethalaskhmi, Sergeant, Shan, Somerset
 Songs, Southern Hemisphere, Southfield, Space Songs
 (Alvin Lee), Speed, Stone Canyon, Story & Sandy
 Songs, Superhype, Swallow Turn, Sweet Harmony,
 Tessa, Tonopah & Tidewater, Topographic Music Ltd.,
 Upward Spiral, Van Jan, Vera Cruz, WB, Walden,
 Warner Tamerlane, Wax Table, Widescreen, Wow &
 Flutter, Xamo, Zipcode
Int'l reps.: Australia, Brazil, Canada, Italy, Netherlands,
 Scandinavia, South Africa, UK & USA (all Warner
 Bros.), France (PECF)
 Waterkant-Music, see PA
 Josef Weinberger GmbH, Oederweg, D-6000 Frankfurt/Main
 26 Tel (0611) 59-03-19 Telex (04) 189248 Pres
 Johann Michel
 Berthold Wengert (Musikverlag), Hauptstr. 100, D-7507
 Pfinztal-Soellingen Contact Berthold Wengert
 Werba-Ton (Ed.), see PA
 Westend Verlag, see Heinrichshofen's
 Westsongs (Ed.), see Rudolf Slezak

West Ton Verlag, see Otto Kuhl
 Westwind (Ed.), see Francis, Day & Hunter
 Hans Wewerka (Musikverlage), Elisabethstr 38, D-8000
 Munich 40 Tel (089) 37-37-81 Chief Exec & Gen
 Mgr Hans Wewerka
Int'l firms represented: Alrac (France), Barton (USA),
 Jugoton (Yugoslavia), Modern (USA, Switzerland,
 UK), Reimers (Sweden), Sands (USA), Sparta Florida
 music group (UK), Transatlantiques (Eds.) (France),
 WATTS (USA)
 Wiener Boheme Verlag, see UFA
 Wiener Verlagsanstalt, see Thomas Sessler
 Wolfgang G. Winkel Musikverlag, Sonnenstr. 20, D-8000
 Munich 15, Tel (089) 55-41-98
 Enno Winkler Musikedition (GEMA), Tambacherstr 4, D-
 1000 Berlin 46 Tel (030) 775-5004 Gen Mgr Dr
 Enno A Winkler
Branch: D-2057 Reinbek/Hamburg, Hebbelstr 14
 Tel (040) 727-9287
Int'l firm branch: England
Int'l firm represented: Quincy (USA)
 Winterlea Music, see Summerlea
 Wintrup-Music (GEMA), Bahnhofstr 15, D-4934 Hori-Bad
 Meinberg 1 Tel (05234) 2976 Dir Walter Holzbaun
Int'l reps.: Denmark (PDH), Japan (GP Music), UK (Gull
 Songs), USA (PBR)
 Paul Woitschach Radio-Musikverlag, Bregenzstr 13a, D-
 1000 Berlin 15 Tel (030) 881-4280 Contact Paul
 Woitschach
 Konrad Wolf Musikproduktion, Alte Dorfstr 22 D-2000
 Hamburg 65 Tel (040) 605-2333 Owner & Gen
 Mgr Konrad Wolf
 The Wurzbürger Music Publ'g Co. (GEMA), Nord-Ost-Ring
 11, D-7024 Filderstadt/Bernhausen 1, Tel (0711) 70-
 27-49 Dir Luciano Wurzbürger; Gen Mgr Jack
 Cunningham, Press & Pub Heinz Drossner
Int'l rep.: Italy (Alberto Avitabile)
 Young Musikverlag GmbH, see Intro Gebr Meisel
 Zimmermann (Musikverlag), Montana,
 19-23, D-6000 Frankfurt/Main 90 Tel (0611)
 784547 Gen Mgr Maja-Maria Reis
Int'l reps.: UK (Novello), USA (C F Peters)
 23 (Eds.), see Montana
 Zorro GmbH, Peter Orloff Musikverlage, Rauhe Hecke 2, D-
 5000 Cologne Tel (0221) 86-38-77 Telex
 8873698. Owner Peter Orloff

● services

ASSOCIATIONS & PROFESSIONAL ORGANIZATIONS

Arbeitsgemeinschaft Musikerziehung & Musikpflege des
 Deutschen Musikrates, Michaelstr 4a, D-5300 Bonn-
 Bad Godesberg Tel (02221) 36-30-31
 Automaten-Verband Baden Wuerttemberg eV, Knoedelstr 6,
 D-7000 Stuttgart 1 Tel (0711) 48-31-41 Contact
 Dieter Schittenhelm
 Automaten-Verband Niedersachsen eV, Yorckstr 11, D-
 3000 Hanover Tel (0511) 31-30-66
 Automaten-Verband Rheinland-Pfalz, 153 Kaiserstr
 Karlsruhe
 Bayerischer Automaten-Verband eV, Neuhauserstr 34/III,
 D-8000 Munich 2, Co-Pres. Paul Damm, Otto
 Saumweber
 Bundesverband der Phonographischen Wirtschaft eV,
 Katharinenstr 11, D-2000 Hamburg 11 Tel (040) 36-
 75-13 Telex (02) 13546 Gen. Mgr Dr Norbert
 Thurow
 D A G V (Deutscher Automaten-Grosshandels-Verband) eV,
 Grosse Baeckerstr. 3, D-2000 Hamburg 1 Tel (040)
 36-57-45
 D A V (Deutscher Automaten-Verband) eV, Kaiser-Wilhelm-
 Ring 6-8, Cologne Tel (0221) 23-63-44
 D M U (Deutsche Musik-Union) eV, Mauerkircherstr 3, D-
 8000 Munich 80, Tel (089) 98-12-53 Pres Lutz
 Helger; VP Paul Haletzki (Union for Composers of Pop,
 Film & TV Music)
 Deutsche Jazz-Föderation eV, Kleine Bockenheimerstr. 12,
 D-6000 Frankfurt/Main Tel (0611) 85-21-53
 Deutsche Landesgruppe der IFPI eV, Katharinenstr. 1, D-
 2000 Hamburg 11 Tel (040) 36-74-05 Telex (02)
 13546 Gen Mgr Dr Norbert Thurow
 Deutsche Mozart-Gesellschaft eV, Halderstr. 12, D-8900
 Augsburg Tel 51-85-88
 Deutsche Orchestervereinigung eV, Charlotte-Niese-Str. 8,
 D-2000 Hamburg 52 Tel (040) 82-55-51 Chief Exec
 Guenther Engelmann, Gen Mgr Peter Girth
 Deutscher Komponisten-Verband, Bergengruenstr. 28, D-
 1000 Berlin 38 Tel (030) 801-8065 Gen. Mgr
 Marianne Augustin, (Composers Ass'n)
 Deutscher Musikrat (Sektion Bundesrepublik Deutschland im
 Internationalen Musikrat) eV, Michaelstr 4a, D-5300
 Bonn-Bad Godesberg Tel (02221) 36-30-31
 Deutscher Musikverleger-Verband eV, Friedrich Wilhelm-Str
 31, D-5300 Bonn, Tel (02221) 23-85-65 Gen Mgr
 Dr. H.H Wittgen; Contact Dr. A. Schneider (Music
 Publ'rs Ass'n)
 Deutscher Sangerbund eV, Bernhardtstr 166, D 5000
 Cologne-Bayenthal, Tel (0221) 38-60-01 (Choral
 Federation)
 Deutsche Stiftung Musikleben, Brahmsallee 70, D 2000
 Hamburg 13, Tel (040) 44-71-58
 Gemeinschaft Deutscher Musikverbaende, Friedrich
 Wilhelm Str 31, D-5300 Bonn, Tel (02221) 23-85-
 65, Gen Mgr Dr H H Wittgen, Contact Dr A.
 Schneider
 Genossenschaft Deutscher Buehnen-Angehoeigen,
 Feldbrunnstr. 74, D-2000 Hamburg 13 Tel (040)
 44-51-85, 44-38-70 Telex (02) 162684 Pres. Hans
 Herdlein (Theater Union)
 Gesamtverband Deutscher Musikfachgeschaeft eV,
 Friedrich Wilhelm Str 31, D-5300 Bonn Tel (02221)
 23-85-65 Gen Mgr Dr H H Wittgen, Contact Dr A
 Schneider (German Music Trade Ass'n)
 Gesellschaft fuer Musikforschung eV, Heinrich-Schutz-Allee
 35, D-3500 Kassel-Wilhelmshohe, Tel (0561) 300-12,
 Gesellschaft fuer Neue Musik eV, Appellhofplatz 1, D 5000
 Cologne 1 Tel (0221) 220-23-42

IFU (International Film Union), Schloss Calmuth, Remagen.
 Tel 82-51
 Institut fuer Neue Musik & Musikerziehung eV, Grafenstr
 26, D-6100 Darmstadt, Tel 2-30-62
 Intefessengemeinschaft Deutschen Discotheken,
 Braunschweiger Str 21, D-3253 Bad Gandersheim,
 Tel (05382) 18-85 Chm: Stefan Zerowitzsch
 Internationales Musikinstitut, Nieder-Ramstaederstr 190,
 D-6100 Darmstadt Tel 1-34-16
 Musikalische Jugend Deutschlands eV—Jeunes
 Musicales, Marktplatz 12, D-6992 Weikersheim
 Tel (07934) 280, Telex (5) 212511 Gen Mgr Joerg
 Steidl
 Musiker-Verband Hamburg, Besenbinderhof 67, D-2000
 Hamburg Tel (040) 24-67-68
 Neue Bachgesellschaft, Internationale Vereinigung,
 Rumanstr 10, D-3000 Hannover Tel (0511) 2-84-
 88
Branch: East Germany
 Nordwestdeutscher Automaten-Verband, Sogestr. 76, Ecke
 Wall, Bremen
 Staatliches Institut fuer Musikforschung Preussischer
 Kulturbesitz, Stauffenbergstr. 14, D-1000 Berlin 30
 Tel (030) 261-1561 Dir Prof Dr Hans-Peter
 Reinecke, Rep. Dr. Dagmar Droyen
 United European Publ'rs, Wittenbacherstr. 18, D-1000
 Berlin 31 Coord.: Nanou Lambelin
 V D A I (Verband der Deutschen Automatenindustrie) eV,
 Aachenerstr. 197-199, D-5000 Cologne 41
 (Lindenthal) Tel (0221) 40-10-09 Telex (08)
 881829 (Coin Machine Ind Ass'n)
 V D M K (Verband Deutscher Musikerzieher &
 Konzentrierender Kunstler), Bismarckstr. 17, D-1000
 Berlin 12 Tel (030) 342-2013 (Musicians & Music
 Teachers Ass'n)
 Verband der Deutschen Konzertdirektionen eV, Geisbergstr
 40, D-1000 Berlin 30
 Verband der Norddeutschen Automaten-Gewerbes eV,
 Ahrensburgerstr 58, D-2000 Hamburg-Wandsbek 70,
 Tel: (040) 656-0456
 Verband des Automaten-Gewerbes Schleswig-Holstein,
 Holsteinstr 88/90, D-2300 Kiel 1 Tel (0431) 9-12-
 56 Chief Exec Siegfried Hohmann, Gen. Mgr Dr
 Peter Theede
 Verband Hessischer Automaten-Aufsteller, Gluckstr 7,
 Frankfurt/Main
 Z O A (Zentralverband der Organisationen den Automaten-
 A-stell-Gewerbes), Emserstr. 45, D-1000 Berlin 15 Tel
 (030) 881-1975 (Operators Ass'n)
 Zentralverband der Elektrotechnischen Industrie eV,
 Stresemannallee 19, D-6000 Frankfurt/Main 70 Tel
 (0611) 6-30-21, Telex (04) 11035

DESIGN & ARTWORK

Bellaphon Recs. GmbH & Co KG, Mainzer Landstr 87-89,
 D-6000 Frankfurt, Tel (0611) 23-08-01, Telex (04)
 16046 Pres Branko Zivanovic, Sales Mgr. Wolfgang
 Sattler
 Blubber Lips Verlags GmbH, Sofienstr. 7a, D-6900
 Heidelberg 1, Tel: (06221) 3-37-79, Telex (04)
 61538
 Cosmic News GmbH, PO Box 850227, D-5000 Cologne 80,
 Tel (0221) 68-25-74 Telex (08) 873445, Pres Rolf-
 Ulrich Kaiser
Branch: D-1000 Berlin 31, Wittelsbacherstr. 18
 Druck-Verlag-Werbung, Freiburgerstr. 21, D-6900
 Heidelberg 1, Tel (06221) 3-37-79, Telex: 61538
 Offshore Spezialversand, Klingelhof 35, D-5600 Wuppertal
 2, Tel (0202) 50-12-78
 Ohr Musik Produktion GmbH, PO Box 850227, D-5000
 Cologne 80, Tel (0221) 68-25-74, Telex: 8873445,
 Pres. Rolf Kaiser
 Rhein-Ruhr-Film Tonstudio, Koenigsallee 124, D-4630
 Bochum 1, Tel (0234) 3-78-14, Telex (08) 25729,
 Chief Exec: Helmut Rohlfing; Sales Mgr. Erwin
 Erlenkaemper, (Record only)
 Hans Sikorski (Int'l Musikverlage), Johnsallee 23, D-2000
 Hamburg 13, Tel (040) 44-62-45 Telex: (02) 11027,
 Co-Pres.: Dr. Hans & Hanna Sikorski
 Sonopress Gesellschaft fuer Tontraegerherstellung mbH,
 Carl Bertelsmannstr 161, D-4830 Guetersloh, Tel
 (05241) 831, Telex 933822, Gen. Mgr. Dr. Uwe
 Swentek, Sales Mgr. Heinz Kirchberg
 Sternmaedchen (Starmaiden) Media Serv. GmbH, see
 Cosmic News
 Tonomatic Tontraeger GmbH, Schwabelstr. 2, D-8011
 Hoehnenkirchen bei Munich, Tel (08102) 81-36 Chief
 Exec Johann Winkler; Sales Mgr.: Margarethe
 Winkler
 Heinz Ulm-Music & Promos., Voelkstr. 34, 8900 Augsburg,
 Tel: (08202) 555; (0821) 51-55-55, Cable:
 HELMMUSIC, Dir. Heinz Ulm

LICENSING ORGANIZATIONS, MUSIC

G E M A (Gesellschaft fuer Musikalische Auffuehrungs-
 uo Mechanische vervielfaeltigungsrechte), Herzog-
 Wilhelmstr. 28, D-8000 Munich 2, Tel. (089) 5-59-91,
 Pres. & Gen. Mgr.: Prof. Dr. Erich Schulte; Int'l Dir.
 Wolfgang Schiedung, (Mechanical & performing rights),
 G V L (Gesellschaft zur Verwertung von Leistungsschutz-
 rechten mbH), Esplanade 36a, D-2000 Hamburg 36,
 Tel (040) 34-19-61 Gen Mgrs Rolf Duennwald,
 Norbert Thurow.

LICENSORS, RECORD & TAPE
 MusiContact GmbH, Wielandstr. 26, D-6900 Heidelberg,
 Tel (06221) 4-40-90 Gen Mgr. Hanno Pfisterer (SEE
 ADVERTISEMENT)

PLATING, PROCESSING & PRESSING PLANTS
 Attacca Musikverlag, Dr. Hammacherstr. 3, D-4100
 Duisburg-Ruhrort, Tel (02131) 8-13-78
 Bellaphon Recs. GmbH & Co. KG, Mainzer Landstr. 87-89,
 D-6000 Frankfurt, Tel. (0611) 23-08-01, Telex: (04)
 16046, Pres.: Branko Zivanovic; Sales Mgr.: Wolfgang
 Sattler

C B S Schallplatten GmbH, Bornstr. 44, D-6380 Bad Homburg 6. Tel. (06172) 42813. (Pressing only)

Delta Music GmbH, Zur Muehle 2, D-5020 Frechen 4. Tel. (02234) 61015. Cable: DEMUS. Telex. (08) 89299. Pres.: Dr. K.J. Moll; Gen. Mgr.: P.H. Sautot; Sales Mgr.: Dr. W. Ammel. (Pressing only)

E M I Electrola GmbH, Maarweg 149, D-5000 Cologne 41. Tel. (0221) 4-90-21. Cable: ELECTROLATON. Telex. (08) 881290. Mng. Dir.: Friedrich E. Wottawa; Sales Dir.: Dr. B. Krajewski, Technical Dept. & Dist'n Serv. Dir.: Klaus Brachtmauser, Int'l A&R Dir.: Helmut Fest. (Pressing only)

Hamburg Schallplattenpresswerk, Werner-von-Siemensstr., D-2358 Kaltenkirchen-Industriegebiet Sud. Tel. (04191) 27-71. (Pressing only)

I D S (International Disc Serv.), PO Box 140105, Siedlungsstr. 22, D-8500 Nuernberg 14. Tel. (09122) 8-64-40, (0911) 63-64-08. Telex. (06) 23987. Gen. Mgr.: Hans-Joachim Rabe; Sales Mgr.: D. Stecher. (Pressing only)

M P S Recs. GmbH, Richthofenstr. 3, D-7730 Villingen. Tel. (07721) 5-20-07. Pres. & Gen. Mgr.: Hans Georg Brunner-Schwer; Creative Serv. Dir.: Hans Pflizer. (Plating & processing only)

M S Schallplatten GmbH & Co. KG, Mehlbachstr. 10, D-3140 Lueneburg. Tel. (04131) 3-31-40. (Pressing only)

Miller Int'l Schallplatten GmbH, Justus-von-Liebig-Ring 2-4, D-2085 Quickborn. Tel. (04106) 50-01. Cable: MILIN. Telex. (02) 12386. Gen. Mgr.: Harald A. Kirsten.

Pallas (Schallplattenfabrik) GmbH, Auf dem Esch 8, D-2840 Diepholz. Tel. (05441) 22-93, 28-12. Cable: PALLAS. Telex. 941221. Chief Execs.: Rolf Neumann, Hans Oestreicher Sr. (Pressing only)

Polygram Rec. Serv. GmbH, PO Box 1409, D-3000 Hannover 1. Tel. (0511) 73061. Telex. (09) 24077.

S W B Schallplattenpresswerk Bayern GmbH, Alpenstr. 29, D-8192 Geretsried. Tel. (08171) 68-39, 6-00-51. Dirs.: Franz Woehrmueller, Stanislaus Zaoralek. (Pressing only)

Sonopress Gesellschaft fuer Tontraegerherstellung mbH, Carl-Bertelsmann-Str. 161, D-4830 Guetersloh 1. Tel. (05241) 831. Telex. 933822. Gen. Mgr.: Dr. Uwe Swientek; Sales Mgr.: Heinz Kirchberg.

Teldec Telefonken-Decca Schallplatten GmbH, Heussweg 25, D-2000 Hamburg 19. Tel. (040) 40-19-1. Cable: TELDEC. Telex. (02) 13545. Mng. Dirs.: Gerhard Schulze, Kurt Richter, Comm'l. Opns. Dir.: John L. Schubach, Technical Dir.: Herbert Knothe.

Tempo (Schallplatten-Vertrieb) Meissner & Co., Rotwandstr. 16, D-8023 Pullach-Grosshesselohe. Tel. (089) 79-42-86. Telex. (05) 212035. Mng. Dir.: Kurt Meissner.

PRINTERS & LITHOGRAPHERS

Amerindian, An Der Alte Muehle 9, D-5067 Wesseling-Berzdorf. Tel. (02232) 51780. Chief Exec.: Ingrid Renate Roehre

Attacca Musikverlag, Dr. Hammacherstr. 3, D-4100 Duisburg-Ruhrort. Tel. (02131) 8-13-78

Blubber Lips Verlags GmbH, Sofienstr. 7a, D-6900 Heidelberg 1. Tel. (06221) 3-37-79. Telex. (04) 61538

Cosmic News GmbH, PO Box 850227, D-5000 Cologne 80. Tel. (0221) 68-25-74. Telex. (08) 873445. Pres.: Rolf-Ulrich Kaiser.
Branch: D-1000 Berlin 31, Wittelsbacherstr. 18.

Druck-Verlag-Werbung, Freiburgerstr. 21, D-6900 Heidelberg 1. Tel. (06221) 3-37-79. Telex. 61538

I D S (International Disc Serv.), PO Box 140105, Siedlungsstr. 22, D-8500 Nuernberg 14. Tel. (09122) 8-64-40, (0911) 63-64-08. Telex. (06) 23987. Gen. Mgr.: Hans-Joachim Rabe; Sales Mgr.: D. Stecher

Hans Sikorski (Int'l Musicverlage), Johnsallee 23, D-2000 Hamburg 13. Tel. (040) 44-62-45. Telex. (02) 11027. Co-Pres.: Dr. Hans & Hanna Sikorski

Sonopress Gesellschaft fuer Tontraegerherstellung mbH, Carl Bertelsmann-Str. 161, D-4830 Guetersloh. Tel. (05241) 831. Telex. 933822. Gen. Mgr.: Dr. Uwe Swientek; Sales Mgr.: Heinz Kirchberg.

Tempo (Schallplatten-Vertrieb) Meissner & Co., Rotwandstr. 16, D-8023 Pullach-Grosshesselohe. Tel. (089) 79-42-86. Telex. (05) 212035. Mng. Dir.: Kurt Meissner.

Tonomatic Tontraeger GmbH, Schwabelstr. 2, D-8011 Hoehenkirchen bei Munich. Tel. (08102) 81-36. Chief Exec.: Johann Winkler; Sales Mgr.: Margarethe Winkler.

The Wurzbürger Music Publ'g Co., Nord-Ost-Ring 11, D-7024 Filderstadt/Bernhausen 1. Tel. (0711) 70-27-49. Dir.: Luciano Wurzbürger; Gen. Mgr.: Jack Cunningham.

RECORD PROMOTION

Amerindian, An Der Alte Muehle 9, D-5067 Wesseling-Berzdorf. Tel. (02232) 51780. Chief Exec.: Ingrid Renate Roehre

Antagon Musikgesellschaft mbH, Lenhartstr. 15, D-2000 Hamburg 20. Tel. (040) 48-44-43. Telex. (02) 173473. Mng. Dir.: Jens Michow

Artist Serv. Eike R. Heitkamp, Eppendorfer Baum 13, D-2000 Hamburg 20. Tel. (040) 47-80-22. Telex. (02) 174471. Chief Exec.: Eike R. Heitkamp

B F C Int'l Promo Co., PO Box 350245, D-5000 Cologne 30. Tel. (0221) 50-36-47. Gen. Mgr.: Gunther R. Kamphausen, Mktg. Dir.: Rudolf E. Kamphausen

Bellaphon Recs GmbH & Co. KG, Mainzer Landstr. 87-89, D-6000 Frankfurt. Tel. (0611) 23-08-01. Telex. (04) 16046. Pres.: Branko Zivanovic; Sales Mgr.: Wolfgang Sattler

Blubber Lips Verlags GmbH, Sofienstr. 7a, D-6900 Heidelberg 1. Tel. (06221) 3-37-79. Telex. (04) 61538

Cosmic News GmbH, PO Box 850227, D-5000 Cologne 80. Tel. (0221) 68-25-74. Telex. (08) 873445. Pres.: Rolf-Ulrich Kaiser.
Branch: D-1000 Berlin 31, Wittelsbacherstr. 18.

D & P Music Serv., Meteorstr. 11, D-2200 Elmshorn. Tel. (04121) 61532. Owner: Klaus Meyer

Hoffman-Musikpublicity, Savignystr. 51, D-6000 Frankfurt/Main

I D S (International Disc Serv.), PO Box 140105, Siedlungsstr. 22, D-8500 Nuernberg 14. Tel. (09122) 8-64-40, (0911) 63-64-08. Telex. 0623987. Gen. Mgr.: Hans-Joachim Rabe; Sales Mgr.: D. Stecher

Juke Box, Steinstr. 53, D-8000 Munich 80. Tel. (089) 48-79-30, 48-77-95. Dir.: Harry Fox

Jumbo Prod'ns, Lempead 79, D-2000 Hamburg. Mgr.: Wilfried Mannes

Mento Music Group KG, Schanzenstr. 16, D-2000 Hamburg 6. Tel. (040) 43-44-42. Gen. Mgr.: Arno H. van Vught Jr.

Offshore Spezialversand, Klingelhöhl 35, D-5600 Wuppertal 2. Tel. (0202) 50-12-78. Dir.: Peter Messingfeld

Ohr Musik Produktion GmbH, PO Box 850227, D-5000 Cologne 80. Tel. (0221) 68-25-74. Telex. 8873445. Pres.: Rolf Kaiser

Oktave Musikverlag, Adolfstr. 45, D-2000 Hamburg 76. Tel. (040) 22-51-43. Telex. (02) 13723

Hans Sikorski (Int'l Musicverlage), Johnsallee 23, D-2000 Hamburg 13. Tel. (040) 44-62-45. Telex. (02) 11027. Co-Pres.: Dr. Hans & Hanna Sikorski

Sternenmaedchen (Starmaden) Media Serv. GmbH, see Cosmic News

TVO-Thomas Voigt Org. GmbH, Boedekerstr. 53, D-3000 Hannover 1. Tel. (0511) 31-10-11. Mng. Dir.: Thomas Voigt

Toger Musik GmbH, Leonrodstr. 42, D-8000 Munich 19. Tel. (089) 18-60-68. Owner & Gen. Mgr.: Jerry Toger

Tonomatic Tontraeger GmbH, Schwabelstr. 2, D-8011 Hoehenkirchen bei Munich. Tel. (08102) 81-36. Chief Exec.: Johann Winkler; Sales Mgr.: Margarethe Winkler

Triad Musicverlag, Guentzelstr. 54, D-1000 Berlin 31. Tel. (030) 87-07-40. Chief Exec.: Walter Ruff

Heinz Ulm-Music & Promos., Voelkstr. 34, D-8900 Augsburg. Tel. (08202) 555; (0821) 51-55-55. Cable: HELMMUSIC. Dir.: Heinz Ulm

The Wurzbürger Music Publ'g Co., Nord-Ost-Ring 11, D-7024 Filderstadt/Bernhausen 1. Tel. (0711) 70-27-49. Dir.: Luciano Wurzbürger; Gen. Mgr.: Jack Cunningham.

Audio: Cassette, open reel.

TAPE CUSTOM DUPLICATORS TAPE PACKAGING & LABELING

The Audio and Video lines indicate the configurations which the firms duplicate. Companies which offer packaging and labeling of tape product are indicated by: (PKG) which appears after the main body of their respective listings.

Amerindian, An Der Alte Muehle 9, D-5067 Wesseling-Berzdorf. Tel. (02232) 51780. Chief Exec.: Ingrid Renate Roehre

Audio: Cassette, open reel.

Attacca Musikverlag, Dr. Hammacherstr. 3, D-4100 Duisburg-Ruhrort. Tel. (02131) 8-13-78

Avis-Asona KG, Stollbergstr. 7, D-8000 Munich 22. Tel. (089) 22-50-57. Cable: ASONA. Telex. (05) 22084. Dir.: Alf Kuezeder; Gen. Mgr.: Horst Koffmane
Audio: Cassette, open reel.

Bauer GmbH & Co. KG (Tonstudio), Markgroeningerstr. 46, D-7140 Ludwigsburg-Eglosheim 10. Tel. (07141) 3-10-97. Telex. (07) 264806. Mng. Dir.: Rolf Bauer.
Audio: Cassette, open reel.

Bellaphon Recs. GmbH & Co. KG, Mainzer Landstr. 87-89, D-6000 Frankfurt. Tel. (0611) 23-08-01. Telex. (04) 16046. Pres.: Branko Zivanovic; Sales Mgr.: Wolfgang Sattler. (PKG)
Audio: Cassette.

Cassetton, Wallensteinstr. 22, D-8192 Geretsried 2. Tel. (08171) 42-40. Telex. (05) 26331.
Audio: Cassette.

E M I Electrola GmbH, Postfach 450363, Maarweg 149, D-5000 Cologne 41. Tel. (0221) 4-90-21. Cable: ELECTROLATON KOLN. Telex. (08) 881290. Mng. Dir.: Friedrich E. Wottawa; Sales Mgr.: B. Krajewski.
Audio: Cassette.

I D S (International Disc Serv.), PO Box 140105, Siedlungsstr. 22, D-8500 Nuernberg 14. Tel. (09122) 8-64-40, (0911) 63-64-08. Telex. (06) 23987. Gen. Mgr.: Hans-Joachim Rabe; Sales Mgr.: D. Stecher. (PKG only)

I T P Tonband-Produktions KG, Riwo Verwaltungs GmbH & Co., Ballinstr. 16-18, D-1000 Berlin 47. Tel. (030) 684-80-69. Cable: 184378. Gen. Mgr.: Karl Blatz; Label Mgr.: Jutta Buschenhagen

M C S Music & Cassette Supply GmbH, Lenzburgerstr. 2, D-7890 Waldshut. Tel. (07751) 32-58. Gen. Mgr.: Mario Taravella
Audio: 8-tr., 8-tr. quadraphonic, cassette.

M D R (Magnetic Disc Rec'g) GmbH, Germany, PO Box 140105, D-8500 Nuernberg. Tel. (0911) 63-64-08; (09122) 8-64-40. Telex. (06) 23987. Dir.: Erich Rabe; Sales Mgr.: M. Rabe. (PKG—video only)

Miller Int'l Schallplatten GmbH, Justus-von-Liebig-Ring 2-4, D-2085 Quickborn. Tel. (04106) 50-01. Cable: MILIN. Telex. (02) 72386. Gen. Mgr.: Harald A. Kirsten.
Audio: Cassette.

Orchestra 1a GmbH, PO Box 186, Auf Dem Esch 8, D-2840 Diepholz. Tel. (05441) 22-93, 1812. Cable: PALAS. Telex. (09) 41221. Gen. & Sales Mgr.: Rolf Neumann; Ass't: Ingeborg Grossmann.
Audio: Cassette.

Polyband Gesellschaft fuer Tontraeger mbH & Co. KG, Sonnenstr. 20, D-8000 Munich 2. Tel. (089) 55-41-98, 59-41-00. Telex: 522636.
Audio: Cassette.
Video: 3/4" cassette, 1/2" cassette.

Polydor Int'l GmbH, PO Box 1409, Podbielskistr. 164, D-3000 Hannover 1. Tel. (0511) 69-68-1. Telex. 922807.

Rhenus Music Fuer Fernseh, Film & Musicproduktion mbH & Co. KG, Otto Hahnstr., D-5000 Cologne 50. Tel. (0221) 38-01-47. Telex. 08881404. Gen. Mgr.: Karl-Heinz Muenchow

Dietrich Scharschmidt Studioausruestung, Gernotstr. 11, D-8000 Munich 40. Tel. (089) 30-65-46. Cable: PROSTUDIO. Pres.: Dietrich Scharschmidt.
Audio: Cassette, open reel.

Arthur Shishmanian Export-Import, Boeckmanstr. 15, D-2000 Hamburg 1. Tel. (040) 24-67-74.

Sonopress Gesellschaft fuer Tontraegerherstellung mbH, Carl-Bertelsmann-Str. 161, D-4830 Guetersloh 1. Tel. (05241) 831. Telex. 933822. Gen. Mgr.: Dr. Uwe Swientek; Sales Mgr.: Heinz Kirchberg.
Audio: Cassette.

Teldec Telefonken-Decca Schallplatten GmbH, Heussweg 25, D-2000 Hamburg 19. Tel. (040) 40-19-1. Mng. Dirs.: Gerhard Schulze, Kurt Richter; Comm'l. Opns. Dir.: John L. Schubach; Technical Dir.: Herbert Knothe.
Audio: Cassette.
Video: Videodisk.

Tonomatic Tontraeger GmbH, Schwabelstr. 2, D-8011 Hoehenkirchen bei Munich. Tel. (08102) 81-36. Chief Exec.: Johann Winkler; Sales Mgr.: Margarethe Winkler.
Audio: Cassette.

Heinz Ulm-Music & Promos., Voelkstr. 34, D-8900 Augsburg. Tel. (08202) 555; (0821) 51-55-55. Cable: HELMMUSIC. Dir.: Heinz Ulm. (PKG)
Audio: Cassette.

W. D. Warren Co. KG, Im Steingrund 5, D-6072 Dreieich-Buchschiag. Tel. (06103) 6-10-51. Cable: WAMESCO. Telex. (04) 185391. Owner: William-Dirk Warren, Exec. VP: Eugene Elskens; VP Sales: Helmut Rossmaier; VP & Controller: Karl Schoon.
Video: 3/4" cassette, 1/2"; EIAJ open reel.

● supplies

CARTRIDGE & CASSETTE PARTS

C C M Kunststoffe GmbH, Schwarzwaldstr. 19, D-7893 Jestetten 1. Tel. (07745) 75-08. Telex: 7921476. Pres. & Gen. Mgr.: Peter K. Wirz
Audio: Cassette parts.

Magna Tontraeger Produktions GmbH, Juliusstr. 10-11, D-1000 Berlin 44. Tel. (030) 684-4028. Telex. 183845. Dirs.: Karl Moegsngang, Juergen Freidank.
Audio: Compact cassette parts.

Dietrich Scharschmidt Studioausruestung, Gernotstr. 11, D-8000 Munich 40. Tel. (089) 30-65-46. Cable: PROSTUDIO. Pres.: Dietrich Scharschmidt.
Audio: All cassette parts.

Arthur Shishmanian Export-Import, Boeckmanstr. 15, D-2000 Hamburg 1. Tel. (040) 24-67-74.

3 M Deutschland GmbH, Carl Schurzstr. 1, D-404 Neuss 1. Tel. (02101) 141. Gen. Mgr.: Bo Ekman; Sales Mgr.: Juergen Wagner.

EMPTY CARTRIDGES, CASSETTES & REELS

Agfa-Gevaert AG, D-5090 Leverkusen 1. Tel. (02172) 30-48-83. Telex: 8510871. Contact: Georg Rindfleisch.

WORLDWIDE-TRADE

EXPORT

of all German brands of records
Jazz, Classical and Pop
competitive prices—quick service
excellent transport facilities

Request information from—

IMPORT

of all kinds of records
also special and small labels
Jazz, Classical and Pop
new effective business connections
always welcome

Please send offers to—



JULIANA HOPP

Backnanger Strasse 74
D-7152 Gross-Aspach, W-Germany • Telex: 7 262 116

Audio: Cassette, open reel.
Amerindian, An Der Alte Muehle 9, D-5067 Wesseling-Berzdorf. Tel: (02232) 51780. Chief Exec.: Ingrid Renate Roehre.
Audio Club, see Magna.
C C M Kunststoffe GmbH, Schwarzwaldstr. 19, D-7893 Jestetten 1. Tel: (07745) 75-08. Telex: 7921476. Pres. & Gen. Mgr.: Peter K. Wirtz.
Audio: 8-tr., cassette.
Eurotape, PO Box 233, D-2408 Timmendorfer Strand. Tel: (04503) 38-49.
Audio: 8-tr., cassette.
M D A, see Dietrich Schar Schmidt.
Magna Produktions GmbH, Juliusstr. 10-11, D-1000 Berlin 44. Tel: (030) 684-4028. Telex: 183845. Dirs.: Karl Moegsnang, Juergen Freidank.
Audio: Open reel.
Video: VCR.
Brand names: Audio Club, Magna.
Dietrich Schar Schmidt Studioausruestung, Gernotstr. 11, D-8000 Munich 40. Tel: (089) 30-65-46 Cable: PROSTUDIO. Pres.: Dietrich Schar Schmidt.
Audio: Cassette.
Brand name: MDA.
Scotch, see 3M.
3M Deutschland GmbH, Carl Schurzstr. 1, D-404 Neuss 1. Tel: (02101) 141. Gen. Mgr.: Bo Ekman, Sales Mgr.: Juergen Wagner.
Audio: 8-tr., cassette, open reel.
Video: Cartridge, cassette, open reel.
Brand name: Scotch.

ENVELOPES & MAILERS

Bellaphon Recs. GmbH & Co. KG, Mainzer Landstr. 87-89, D-6000 Frankfurt. Tel: (061) 23-08-01. Telex: (04) 16046. Pres.: Branko Zivanovic; Sales Mgr.: Wolfgang Sattler.
Tempo (Schallplatten-Vertrieb) Meissner & Co., Rotwandstr. 16, D-8023 Pullach-Grosshesselohe. Tel: (089) 79-42-86. Telex: (05) 212035. Mng. Dir.: Kurt Meissner.
Triad Musicverlag, Guentzelstr. 54, D-1000 Berlin 31. Tel: (030) 87-07-40. Chief Exec.: Walter Ruff.
The Wurzbürger Music Publ'g Co., Nord-Ost-Ring 11, D-7024 Filderstadt 1, Bernhausen. Tel: (0711) 70-27-49. Dir.: Luciano Wurzbürger; Gen. Mgr.: Jack Cunningham.

JACKETS & SLEEVES

Attacca Musikverlag, Dr. Hammacherstr. 3, D-4100 Duisburg-Ruhrort. Tel: (02131) 8-13-78.
Bellaphon Recs. GmbH & Co. KG, Mainzer Landstr. 87-89, D-6000 Frankfurt. Tel: (061) 23-08-01. Telex: (04) 16046. Pres.: Branko Zivanovic; Sales Mgr.: Wolfgang Sattler.
Sonopress Gesellschaft fuer Tontraegerherstellung mbH, Carl-Bertelsmann-Str. 161, D-4830 Guetersloh 1. Tel: (05241) 831. Telex: 933822. Gen. Mgr.: Dr. Uwe Swientek; Sales Mgr.: Heinz Kirchberg. (Jackets only)

Tempo (Schallplatten-Vertrieb) Meissner & Co., Rotwandstr. 16, D-8023 Pullach-Grosshesselohe. Tel: (089) 79-42-86. Telex: (05) 212035. Mng. Dir.: Kurt Meissner.
The Wurzbürger Music Publ'g Co., Nord-Ost-Ring 11, D-7024 Filderstadt/Bernhausen 1. Tel: (0711) 70-27-49. Dir.: Luciano Wurzbürger; Gen. Mgr.: Jack Cunningham. (Jackets only)

LABELS

Attacca Musikverlag, Dr. Hammacherstr. 3, D-4100 Duisburg-Ruhrort. Tel: (02131) 8-13-78.
Bellaphon Recs. GmbH & Co. KG, Mainzer Landstr. 87-89, D-6000 Frankfurt. Tel: (061) 23-08-01. Telex: (04) 16046. Pres.: Branko Zivanovic; Sales Mgr.: Wolfgang Sattler.
Arthur Shishmanian Export-Import, Boeckmanstr. 15, D-2000 Hamburg 1. Tel: (040) 24-67-74.
Tempo (Schallplatten-Vertrieb) Meissner & Co., Rotwandstr. 16, D-8023 Pullach-Grosshesselohe. Tel: (089) 79-42-86. Telex: (05) 212035. Mng. Dir.: Kurt Meissner.
Heinz Ulm-Music & Promos., Voelkstr. 34, D-8900 Augsburg. Tel: (08202) 555; (0821) 51-55-55. Cable: HELMMUSIC. Dir.: Heinz Ulm.
The Wurzbürger Music Publ'g Co., Nord-Ost-Ring 11, D-7024 Filderstadt/Bernhausen 1. Tel: (0711) 70-27-49. Dir.: Luciano Wurzbürger; Gen. Mgr.: Jack Cunningham.

POLYETHYLENE BAGS

Amerindian, An Der Alte Muehle 9, D-5067 Wesseling-Berzdorf. Tel: (02232) 51780. Chief Exec.: Ingrid Renate Roehre.
Attacca Musikverlag, Dr. Hammacherstr. 3, D-4100 Duisburg-Ruhrort. Tel: (02131) 8-13-78.
Tempo (Schallplatten-Vertrieb) Meissner & Co., Rotwandstr. 16, D-8023 Pullach-Grosshesselohe. Tel: (089) 79-42-86. Telex: (05) 212035. Mng. Dir.: Kurt Meissner.

PROFESSIONAL TAPE SUPPLIES

Audio Magnetics GmbH, PO Box 10226, Dieselstr. 13-15, D-6072 Dreieich 1. Tel: (06103) 37-06. Telex: 417913.
Product: Cassette duplication tape.
Dietrich Schar Schmidt Studioausruestung, Gernotstr. 11, D-8000 Munich 40. Tel: (089) 30-65-46. Cable: PROSTUDIO. Pres.: Dietrich Schar Schmidt.
Audio: Heads.
Brand name: Photovox-Vacodur.

RECORD PROCESSING MACHINERY

Zipperling Kessler & Co. (GmbH & Co.), PO Box 1464, Kornkamp 50, D-2070 Ahrensburg. Tel: (04102) 51201. Telex: (02) 189842. Chief Exec.: Juan Plass Giral.
Chief product: Presses, extruders & plating equip.
A E G-Telefunken, Lindenerstr. 15, D-3340 Wolfenbuettel. Tel: (05331) 83-287. Telex: 95651.
Chief product: Studio compander. (SEE ADVERTISE-MENT)

TAPE, BLANK LOADED & RAW

Agfa-Gevaert AG, D-5090 Leverkusen 1. Tel: (02172) 30-48-83. Telex: 8510871. Contact: Georg Rindfleisch.
Audio: Cassette.
Video: 1" open reel, ½" cassette.
Brand names: Agfa, Agfa Stereochrom, Agfa Videochrom.
Amerindian, An Der Alte Muehle 9, D-5067 Wesseling-Berzdorf. Tel: (02232) 51780. Chief Exec.: Ingrid Renate Roehre. (Blank only).
Audio: Cassette, open reel.
Amplex Europa GmbH, Walter Kolbstr. 9-11, D-6000 Frankfurt 70. Tel: (0611) 60581. Telex: 0413774. Gen. Mgr.: E. Sadeler; Tape Sales Mgr.: B. Schwartz; Video Sales Mgr.: L. Nietsch; Audio Sales Mgr.: P. Classen.
Audio: Cassette, open reel.
Brand name: Grand Master/20:20+.
Video: Blank—2" open reel, 1" open reel, ¾" cassette, ½" EIAJ open reel.
Audio Magnetics GmbH, PO Box 102226, Dieselstr. 13-15, D-6072 Dreieich 1. Tel: (06103) 37-06. Telex: 417913. (Also see Waltham)
Audio: 8-tr., cassette, open reel.
B A S F Ag., Gottlieb-Daimlerstr. 10, D-6800 Mannheim 1. Tel: (0621) 40081. Telex: 462621. Chief Exec.: H. Thurn; Gen. Mgr.: H.J. Versemann; Sales Mgr.: H.J. Seitz.
Audio: Cassette, open reel.
Video: Blank—1" open reel, ¾" cassette, ½" cassette.
Cassetton, Wallensteinstr. 22, D-8192 Geretsried 2. Tel: (08171) 60840. Telex: (05) 26331.
Galaxy, see Toka.
Grundig AG, Kurgartenstr. 37, 8510 Furth/Bay. Tel: (0911) 70-31. Telex: (06) 23431.
I D S (International Disc Servs.), PO Box 140105, Siedlungsstr. 22, D-8500 Nuernberg 14. Tel: (09122) 8-64-40, (0911) 63-64-08. Telex: (06) 23987. Gen. Mgr.: Hans-Joachim Rabe; Sales Mgr.: D. Stecher.
Audio: Cassette.
Inter-Cassette Ltd., Poststr. 14, D-2000 Hamburg 36. Tel: (040) 35-30-79. (Blank only) (Imporтер)
Home office: USA.
Int'l branch: Hong Kong
Audio: Cassette.
M C S Music & Cassette Supply GmbH, Lenzburgerstr. 2, D-7890 Waldshut. Tel: (07751) 32-58. Gen. Mgr.: Mario Taravella.
Audio: 8-tr., cassette.
Magna Tontraeger Produktions GmbH, Juliusstr. 10-11, D-1000 Berlin 44. Tel: (030) 684-4028. Telex: 183845. Dirs.: Karl Moegsnang, Juergen Freidank.
Audio: Blank—cassette, open reel.
Video: Blank—¾" cassette, ½" EIAJ open reel, ½" EIAJ cartridge.
Maxell Europe GmbH, Stresemannstr. 9, D-4000 Dusseldorf 1. Tel: (0211) 8-41-31. Telex: (08) 587288. Dir.: A. Matsumoto; Ass't Dir.: H. Hayashi.

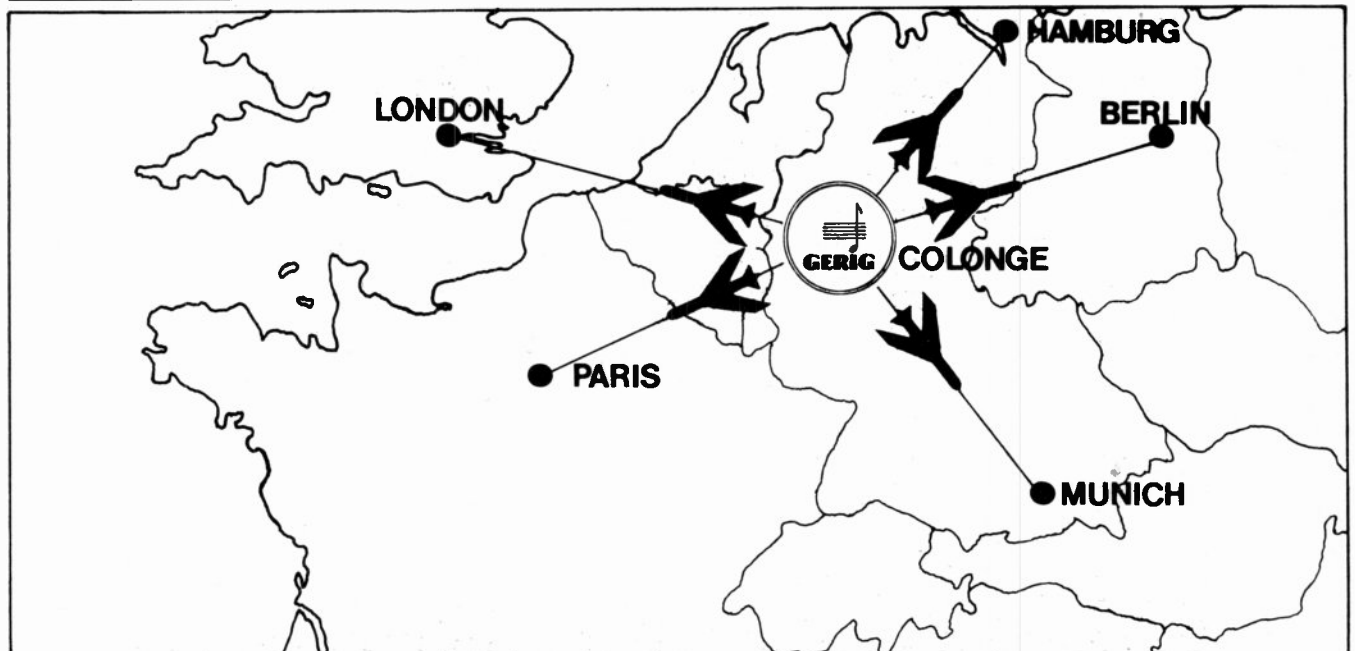

MUSIKVERLAGE HANS GERIG IS THE CREATIVE CENTER-POINT OF MUSIC PUBLISHING BUSINESS

MUSIKVERLAGE HANS GERIG, DRUSUSGASSE 7-11, 5000 KÖLN 1, PHONE: (0221) 23 48 33, TELEX: 888 1233

Home office: Japan.

Audio: Blank—8-tr., cassette, open reel; raw—8-tr., cassette.

Video: Blank— $\frac{3}{4}$ " cassette.

Memorex, see W.D. Warren.

Orchestra GmbH, PO Box 186, Auf Dem Esch 8, D-2840 Diepholz. Tel: (05441) 2293, 1812. Cable: PALAS. Telex: (09) 41221. Gen. & Sales Mgr.: Rolf Neumann; Ass't: Ingeborg Grossman.

Audio: Cassette

S E C I, see Dietrich Scharnschmidt.

Dietrich Scharnschmidt Studioausrüstung, Gernotstr. 11, D-8000 Munich 40. Tel: (089) 30-65-46. Cable: PROSTUDIO. Pres.: Dietrich Scharnschmidt.

Audio: Cassette, open reel.

Video: 1" open reel, $\frac{1}{2}$ " EIAJ open reel.

Brand name: SECI.

Scotch, see 3M.

Arthur Shishmanian Export-Import, Boeckmanstr. 15, D-2000 Hamburg 1. Tel: (040) 24-67-74. (Blank only)

Sony, see W.D. Warren.

T D K Electronics Europe GmbH, Georg Glock Str. 14, D-4000 Dusseldorf.

Audio: Cassette

3 M Deutschland GmbH, Carl Schurzstr. 1, D-404 Neuss 1. Tel: (02101) 141. Gen. Mgr.: Bo Ekman; Sales Mgr.: Juergen Wagner.

Audio: 8-tr., cassette, open reel.

Video: 1" open reel, 1" cartridge, $\frac{3}{4}$ " cassette, $\frac{1}{2}$ " EIAJ open reel, $\frac{1}{2}$ " EIAJ cartridge.

Brand name: Scotch.

Toka Vertriebsgesellschaft mbH, Im Gaessle 13, D-7250 Leonberg 7. Tel: (0611) 73-20-71. Pres.: Hugo von Blumenthal.

Audio: Cassette.

Brand names: Galaxy, Toka.

Triad Musikverlag, Guentzelstr. 54, D-1000 Berlin 31. Tel: (030) 87-07-40. Chief Exec.: Walter Ruff.

Audio: Raw—cassette, open reel.

Video: Blank— $\frac{3}{4}$ " cassette.

Waltham Electronics GmbH, Anzingerstr. 1, D-8000 Munich 80.

Audio: 8-tr., cassette, open reel.

Brand name: Audio Magnetics.

W. D. Warren Co. KG, Im Steingrund 5, D-6072 Dreieich-Buchsschlag. Tel: (06103) 6-10-51. Cable: WAMESCO. Telex: (04) 185391. Owner: William-Dirk Warren; Exec. VP: Eugene Elskens; VP Sales: Helmut Rossmairer; VP & Controller: Karl Schoon.

Video: $\frac{3}{4}$ " cassette, $\frac{1}{2}$ " eiaj open reel.

Brand names: Memorex, Sony.

TAPE DUPLICATING & PROCESSING EQUIPMENT

Agfa-Gevaert AG, D-5090 Leverkusen 1. Tel: (02172) 30-48-83. Telex: 8510871. Contact: Georg Rindfleisch.

Audio: Calibration tapes, cutter sets.

Asona, see Avuis-Asona

Avuis-Asona KG, Stollbergstr. 7, D-8000 Munich 22. Tel: (089) 22-50-57. Cable: ASONA. Telex: (05) 22084. Dir.: Alf Kuerzeder, Gen. Mgr.: Horst Koffmann.

Audio: Turnkey cassette duplicating plants.

Brand name: Asona (SEE ADVERTISEMENT)

Bellaphon Recs. GmbH & Co. KG, Mainzer Landstr. 87-89, D-6000 Frankfurt. Tel: (061) 23-08-01. Telex: (04) 16046. Pres.: Branko Zivanovic; Sales Mgr.: Wolfgang Sattler; Technical Dir.: Helmut Schmilewski.

Audio: see Dietrich Scharnschmidt.

Magna Tontraeger Prod'ns GmbH, Juliusstr. 10/11, D-1000 Berlin 44. Tel: (030) 684-4028. Telex: 183845. Dirs.: Karl Moegsnang, Jurgen Freidank.

Audio: Cassette equip.

Dietrich Scharnschmidt Studioausrüstung, Gernotstr. 11, D-8000 Munich 40. Tel: (089) 30-65-46. Cable: PROSTUDIO. Pres.: Dietrich Scharnschmidt.

Audio: Cassette screwing machines.

Brand name: Machi.

3 M Deutschland GmbH, Carl Schurzstr. 1, D-404 Neuss 1. Tel: (02101) 141. Gen. Mgr.: Bo Ekman; Sales Mgr.: Juergen Wagner.

Audio: Cassette duplicators

Brand name: Wollensak.

Eberhard Vollmer, Schillerstr. 7, D-7310 Plochingen/N. Tel: (07153) 2-10-04. Cable: VOLLMERWERK. Gen. Mgr. & Eng.: Eberhard Vollmer; Sales Mgr.: Ms. I. Marcon. Wollensak, see 3M.

TAPE PACKAGING & LABELING EQUIPMENT & SUPPLIES

Heino Ilsemann GmbH, Zum Pannepel 24, D-2800 Bremen 44. Tel: (0421) 48-30-83. Telex: 244055 (SEE ADVERTISEMENT).

Magna Tontraeger Produktions GmbH, Juliusstr. 10/11, D-1000 Berlin 44. Tel: (030) 684-4028. Telex: 183845. Dirs.: Karl Moegsnang, Juergen Freidank.

● accessories manufacturers

Agfa-Gevaert AG, D-5090 Leverkusen 1. Tel: (02172) 30-48-83. Telex: 8510871. Contact: Georg Rindfleisch.

Product: Head cleaners, leader & splicing tapes.

Amerindian, An Der Alte Muehle 9, D-5067 Wesseling-Berzdorf. Tel: (02232) 51780. Chief Exec.: Ingrid Renate Roehre.

Product: Record & tape catalog servs., cleaners, cloths & brushes, needles, leader & splicing tape.

Ampex Europa GmbH, Walter Kolbstr. 9-11, D-6000 Frankfurt 70. Tel: (0611) 60581. Telex: 0413774. Gen. Mgr.: E. Sadeler; Tape Sales Mgr.: B. Schwartz; Video Sales Mgr.: L. Nietsch; Audio Sales Mgr.: P. Classen.

Product: Head cleaners, demagnetizers.

Bellaphon Recs. GmbH & Co. KG, Mainzer Landstr. 87-89, D-6000 Frankfurt. Tel: (061) 23-08-01. Telex: (04) 16046. Pres.: Branko Zivanovic; Sales Mgr.: Wolfgang Sattler.

Product: Record & tape carrying & storage cases, catalog servs., cleaners, cloths, brushes, 45 RPM adaptors, head cleaners, demagnetizers, needles, leader & splicing tape.

I D S (International Disc Servs.), PO Box 140105, Siedlungsstr. 22, D-8500 Nuernberg 14. Tel: (09122) 8-64-40, (0911) 63-64-08. Telex: (06) 23987. Gen. Mgr.: Hans-Joachim Rabe; Sales Mgr.: D. Stecher.

Product: Splicing tape.

Inter-Cassette Ltd., Poststr. 14, D-2000 Hamburg 36. Tel: (040) 35-30-79.

Home office: USA.

Int'l branch: Hong Kong.

Product: Record cleaners, head cleaners, record sweep arms.

D. Kretz (Automaten-Serv.), Sofienstr. 179, D-7500 Karlsruhe 1. Tel: (0721) 55-56-60, 59-07-20. Pres.: Diethelm Kretz; Sales Mgr.: Gertrud Drost.

Product: Carrying & storage cases, cleaners, cloths, brushes, head cleaners, demagnetizers, needles.

Magna Tontraeger Produktions GmbH, Juliusstr. 10-11, D-1000 Berlin 44. Tel: (030) 684-4028. Telex: 183845. Dirs.: Karl Moegsnang, Juergen Freidank.

Product: Tape carrying & storage cases, catalog servs., head cleaners, demagnetizers, leader & splicing tape.

Maxell Europe GmbH, Stresemannstr. 9, D-4000 Dusseldorf 1. Tel: (0211) 8-41-31. Telex: (08) 587288. Dir.: A. Matsumoto; Ass't Dir.: H. Hayashi.

Home office: Japan.

Product: Head cleaners.

C. Melchers & Co., Schlachte 39-40, D-2800 Bremen. Tel: (0421) 316-9323.

Product: Cartridges & needles.

Brand name: Pickering.

Orchestra GmbH, PO Box 186, Auf Dem Esch 8, D-2840 Diepholz. Tel: (05441) 2293, 1812. Cable: PALAS. Telex: (09) 41221. Gen. & Sales Mgr.: Rolf Neumann; Ass't: Ingeborg Grossman.

Product: Carrying & storage cases, cleaners, cloths, brushes, 45 rpm adaptors, head cleaners & demagnetizers.

Pickering, see C. Melchers.

Dietrich Scharnschmidt Studioausrüstung, Gernotstr. 11, D-8000 Munich 40. Tel: (089) 30-65-46. Cable: PROSTUDIO. Pres.: Dietrich Scharnschmidt.

Product: Head cleaners & demagnetizers, leader tape.

Schweizer Design Eurosale GmbH, Koenigsweg 3, D-4973 Vlotho. Tel: (05733) 50-41. Telex: 971217. Mng. Dirs.: G. Deja, Dr. M. Gaier.

Product: Carrying & storage cases, cleaners, cloths, brushes, head cleaners & demagnetizers.

Stanton, see Teledyne.

Teac Tonband-Anlagen-Vertriebs GmbH, Egerstr. 2, D-6200 Wiesbaden-Erbenheim. Tel: (06121) 742-25. Telex: (04) 186159. Pres.: Katsumi Tani; Gen. & Sales Mgr.: Haruo Onda.

Product: Head cleaners & demagnetizers.

Teledyne Acoustic Research, Burgstr. 6-8, D-6200 Wiesbaden. Tel: (06121) 3-91-71.

Product: Needles (Stanton).

3 M Deutschland GmbH, Carl Schurzstr. 1, D-404 Neuss 1. Tel: (02101) 141. Gen. Mgr.: Bo Ekman; Sales Mgr.: Juergen Wagner.

Product: Leader & splicing tape.

W. D. Warren Co. KG, Im Steingrund 5, D-6072 Dreieich-Buchsschlag. Tel: (06103) 6-10-51. Cable: WAMESCO. Telex: (04) 185391. Owner: William-Dirk Warren; Exec. VP: Eugene Elskens; VP Sales: Helmut Rossmairer; VP & Controller: Karl Schoon.

Product: Tape carrying & storage cases, needles.

● store fixtures & merchandising aids manufacturers

Amerindian, An Der Alte Muehle 9, D-5067 Wesseling-Berzdorf. Tel: (02232) 51780. Chief Exec.: Ingrid Renate Roehre.

Product: Record display racks & divider cards

Bellaphon Recs. GmbH & Co. KG, Mainzer Landstr. 87-89, D-6000 Frankfurt. Tel: (061) 23-08-01. Telex: (04) 16046. Pres.: Branko Zivanovic; Sales Mgr.: Wolfgang Sattler.

Product: Browser boxes, display racks, divider cards.

D. Kretz (Automaten-Serv.), Sofienstr. 179, D-7500 Karlsruhe 1. Tel: (0721) 55-56-60, 59-07-20. Pres.: Diethelm Kretz; Sales Mgr.: Gertrud Drost.

Product: Display racks.

Schweizer Design Eurosale GmbH, Koenigsweg 3, D-4973 Vlotho. Tel: (05733) 50-41. Telex: 971217. Mng. Dirs.: G. Deja, Dr. M. Gaier.

Product: Browser boxes, display racks.

3 M Deutschland GmbH, Carl Schurzstr. 1, D-404 Neuss 1. Tel: (02101) 141. Gen. Mgr.: Bo Ekman; Sales Mgr.: Juergen Wagner.

Product: Display racks.

W. D. Warren Co. KG, Im Steingrund 5, D-6072 Dreieich-Buchsschlag. Tel: (06103) 6-10-51. Cable: WAMESCO. Telex: (04) 185391. Owner: William-Dirk Warren; Exec. VP: Eugene Elskens; VP Sales: Helmut Rossmairer; VP & Controller: Karl Schoon.

Product: Display racks.

(Assumption), October 28 (National Day), December 25, 26.

RECORDS:

Total records & pre-recorded tape sold at the retail level: 1978—5,000,000 units, \$32,400,000.

Records imported: 1978—\$1,344,573; 1977—\$617,937.

Records imported from USA: 1978—\$177,642; 1977—\$49,375.

Records exported: 1978—\$1,276,602; 1977—\$1,256,160.

Records exported to USA: 1978—\$164,483; 1977—\$128,887.

Average retail price per record: LP's \$5.13-\$7.83; maxi singles \$3.24; singles \$1.62-\$1.75.

Stereo sales: 100% of LP's.

Discounting: Frequent.

Type of distribution: Manufacturer-to-retailer predominates, with manufacturer-to-one-stop a second favorite. All the major record companies have their own branch offices in Thessaloniki, the second largest market after Athens.

Type of promotion: Television and radio are considered the best media for boosting sales. Greek artists and popular international singers such as Raffaella Carrà, Joe Dassin, Julio Iglesias, among others, have seen an impressive rise of their record sales after appearing on local television to promote their new recordings. Very much desired from both television channels are film clips of international acts which are given on loan by the seven major record companies. The two radio networks allot 15 to 30 minutes of daily airtime to each company for playing and advertising their new local and international releases. Although considered very expensive, airtime is a must for its daily repetition of records. ERT's Second Program, from 5-8 P.M. on Saturday, has a large audience, with one major record company after another having their commercial shows. Pirate radio stations run by students in cities such as Athens and Thessaloniki are very popular, with their continuous music (rock, disco and local music) having proved influential in record sales. The number one radio show in Greece is "Pop Club," broadcast every afternoon by ERT's First Program. Of the magazines that feature music news, "Pop & Rock" is first in sales, followed by "Ehos," "Mousiki" and "18."

The Greek Song Festival, held every September during the International Fair of Thessaloniki, is another important means of promoting new songs and artists. Some popular singers and composers have found national tours, which have become frequent in the past two years, to be most prosperous.

Jukeboxes: 6,000.

TAPE:

Market: Cassettes now command 98% of the local tape market while 8-track has the remaining 2%. Open reel is used only by recording studios, radio stations and a few audio enthusiasts. Most pre-recorded cassettes are bought for automobile playback equipment. During the past few years more people have been buying expensive playback equipment for their homes. Since most consumers prefer to record their own choice of music, blank cassettes are popular with the home models. Tape piracy has become the most important problem for record companies and artists.

Pre-recorded tape imported: 1978—\$153,229; 1977—\$87,083.

Pre-recorded tape imported from USA: 1977—\$5,209.

Pre-recorded tape exported: 1978—\$6,529,871; 1977—\$5,142,127.

Pre-recorded tape exported to USA: 1978—\$953,504; 1977—\$49,393.

Average retail price per tape: 8-tr. \$4.72-\$6.48; cassette—\$4.72-\$6.75.

RADIO STATIONS:

No. of government 22; No. of AM 22; No. of FM 3.

Comment: Seventy percent of all programs feature recorded music, although during the past three years more programs of live music are being broadcast. There are two networks: ERT (Greek Radio and Television) and YENED (Armed Forces Radio & Television Service) which have their main studios in Athens and smaller studios in other cities. These branches carry most of the Athens broadcast programs interspersed with local news, music & commercials. Three ERT stations broadcast simultaneously on AM and FM, and are heard nationwide.

TELEVISION STATIONS:

No. of channels: 2 government, 50% color (PAL & SECAM).

Comment: Programs now include Greek, American and British serials, cartoons, talk show, sports, news, educational lessons, etc., with frequent links to Eurovision for the televising of such events as the Eurovision Song Contest, the San Remo Song Festival, among others.

MARKET ANALYSIS:

Tape piracy, with an annual loss exceeding \$54,000,000 and mounting, is the main problem of the Greek market. Record companies, with the help of police and private detectives, have taken more severe measures by raiding illegal tape factories and depots, seizing thousands of unauthorized copies. Meanwhile, P. Mikrelis, a manager of AEPI (Societe Hellenique Pour La Protection de la Propriete Intellectuelle SA) is being held in prison, accused of receiving large amounts of money from tape pirates. Still under consideration is a new law that would prohibit tape piracy and provide stiff penalties for conviction, which the current 40-year-old law does not provide.

In 1978, the "Saturday Night Fever" soundtrack was the first international double album to sell over 50,000 copies, and "Grease" followed closely behind. "Lemon Popicle," an Israeli film with two dozen hits of the late 1950's and early 1960's, gave CBS the best seller of the first half of 1979. Boney M., Abba, La Bionda, the Bee Gees, and Julio Iglesias also were winners in a market which is now dominated by disco product. The num-

GREECE

Population: 9,170,000.

Rate of exchange: \$1 (US) = 37 drachmas.

Per capita income: \$2,500.

No. of homes with record players: 480,000.

Holidays: January 1, Epiphany, Carnival Monday, March 25 (National Day), Easter Monday, May 1, August 15

ber of discos doubled in the last year, while in Athens, Thessaloniki, and the Aegean Sea Islands, records played by disk jockeys include almost the entire Billboard disco chart. An old trend, now gaining momentum, is the Greek version of international hits by artists such as Yiannis Parios, Yiannis Pouloupoulos, Antonis Kaloyiannis, among others.

Lefty Kongalides

● record & tape manufacturers / distributors / importers

Angel, see Columbia-EMI & EMIal.
 Apollon, see Spiros Piperakis.
 Apple, see Columbia-EMI & EMIal.
 Archiv, see Polygram.
 Astron, see Spiros Piperakis.
 Boem, see Spiros Piperakis.
 British Prod'n Import, 13 Third September St., Athens. Tel: 821-3918. Gen. Mgr.: D. Patrinos.
 Label: New Sty (UK).
 C B S (Diski) AEBE (IFPI), PO Box 2533, 19 Syngrou Ave., Makryianni, Athens 403. Tel: (01) 922-3618, 923-7862. Cable: COLRECORD. Mng. Dir.: Sol Rabinowitz; A&R Dir.: Stelios Elliniadis; Int'l A&R: George Kyvelos.
 Labels: (Owned) CBS, Epic, (licensed) AB (France), Ariola (USA), A&M (USA), ARC (USA), Alshire (USA), Anla (Germany), Audio (Germany), Baby (Italy), Boona (Switzerland), CGD (Italy), Gold Unlimited (USA), Jupiter (Germany), Lifesong (USA), Philadelphia Int'l (USA), Portrait (USA), Ricordi (Italy), Som (Brazil), Sonet (Sweden), TK (USA), United Artists (USA), Vanguard (USA).
 Int'l rep.: Worldwide (CBS).
 Calypso, see Music Box.
 Capitol, see Columbia-EMI & EMIal.
 Columbia-EMI Greece SA (IFPI), PO Box 287, Central Sta., 127 Heracliou St., Rizopolis, Athens. Tel: (021) 251-6429. Cable: EMIRECORD. Telex: 214192. Mng. Dir.: Alan C. Boxer; Finance & Admin. Dir.: D. Gaetanakis; Sales Mgr.: E. Terzis; Mfg. & Studios Dir.: C. Kyriakos. (Also see EMIal).
 Labels: (Owned) Angel, Apple, Capitol, Columbia, EMI, HMV, Harvest, MFP, Odeon, Parlophone, Pathe, Regal, Sonopresse, Toshiba; (licensed) Arista (USA), Ashark (Saudi Arabia), Baidaphon (Lebanon), Balkanton (Bulgaria), Bovema Negrin (Netherlands), Bronze (UK), Buzidaphone (Kuwait), Byblos (Syria), Cairophon (Lebanon), DJM (UK), Duniaphon (Lebanon), ECM (Germany), El Fen (Tunisia), Ima (Libya), Island (UK), Koutoubiaphone (Morocco), MAM (UK), MCA (USA), Magnet (UK), Melloulouphone (Tunisia), Moriphon (Egypt), Nefertiti (Egypt), Olivia Newton-John (USA), PDU (Italy), Passport (USA), Private Stock (USA), Promotone (Netherlands), Queen (UK), RAK (UK), Rajaphone (Saudi Arabia), Red Bus (UK), Rocket (UK), Sono Cairo (UK), Soutelohob (Egypt), Sout El Hayat (Egypt), Soutelophon (Egypt), Sout El Rabee (Libya), Sout Omnia (Saudi Arabia), Tamla/Motown (USA), Trema (France), Victor (Japan), Voice of Lebanon (Lebanon), Voix de l'Islam (Egypt), Voix de l'Orient (Lebanon), Wings (UK), Zida (Lebanon).
 Int'l reps.: Canada (Peters Int'l), Cyprus (Electrosound), Netherlands (Pastor), USA (Peters Int'l), worldwide (EMI).
 Control, see Spiros Piperakis.
 Coronnet, see Spiros Piperakis.
 Crete, see Panivar.
 D G, see Polygram.
 Dionysos, see General.
 Do-Re, see Spiros Piperakis.
 E M I, see Columbia-EMI & EMIal.
 Echo Ltd., 2 Korae St., Athens 132. Tel: (01) 323-4774. Gen. Mgr.: Zgnon Themelis. (Distributor/Importer/Exporter).
 EMI SA (EMI-Lambropoulos Bros. Ltd.) (IFPI), 127 Heracliou St., Rizopolis, Athens 904. Tel: (021) 251-6924/6458. Cable: EMIDISC Greece. Telex: 214192. Chm.: Alan C. Boxer; Mng. Dir.: Marco Bignotti; A&R Mgr.: George Petsilas; Adv. & PR: B. Apostolides; Sales Mgr.: S. Xanthopoulos; Finance & Admin.: S. Sgouras; Int'l Repertoire: Theo Sarantis; Classical Repertoire & Imports: Georgia Zissi. (Distributor/Importer)
 Branch: Salonica, 18 Chrys. Smyrnis. Tel: (031) 263-110, 224-669. Mgr.: Basil Metaxopoulos.
 Labels: (Licensed domestic) Angel, Apple, Capitol, Columbia, EMI, HMV, Harvest, MFP, Odeon, Parlophone, Pathe, Regal; (licensed foreign) Arista (USA), Balkanton (Bulgaria), Bovema Negrin (Netherlands), Bronze (UK), DJM (UK), ECM (Germany), EMI America (USA), Island (UK), MAM (UK), MCA/ABC (USA), Magnet (UK), Olivia Newton-John (USA), PDU (Italy), Private Stock (USA), Promotone (Netherlands), Queen (UK), RAK (UK), Red Bus (UK), Sonopresse (France), Tamla/Motown (USA), Toshiba-EMI (Japan), United Artists (USA), Victor (Japan), Wings (UK).
 Epic, see CBS.
 Fidelity, see Polygram.
 Fontana, see Polygram.
 Galaxy, see General.
 General Publ'g Co. SA (IFPI), 11 Kriezotou St., Athens 134. Tel: (01) 361-5529/6798. Cable: LYRAHELLAS. Pres. & Mng. Dir.: Alexander Patsifas; Sales Mgr.: Kyriakos Maravelias; Int'l Mgr.: Takis Tsiros.
 Branch: Thessaloniki, 64 Tsimiski St. Tel: (031) 277-306. Mgr.: Arsenis Stergiou.
 Labels: (Owned) Dionysos, Lyra, Minerva, Notos, Zodiac; (licensed) Crocos (France); (distributed—not licensed) Galaxy, Polytron.
 Int'l reps.: Australia (Politis), Canada (Peters Int'l), Cyprus (Electroacoustic Supply), USA (Peters Int'l).
 Greek Communications Co., 17 Stournara St., Athens. Tel: 627-796. Int'l Mgr.: Alex G. Carras.
 Greka, see Spiros Piperakis.
 H M V, see Columbia-EMI & EMIal.
 Harvest, see Columbia-EMI & EMIal.
 Heliodor, see Polygram.
 Independent Prod'rs, 13 Third September St., Athens. Tel:

(031) 522-7472. Cable: MELODY ATHENS. Pres.: Anthony Ploma; Sales Mgr.: Georges Plomaritis. PR: A. Plomaritis Jr.
 Labels (Owned) Independent, Lucky, Patrinos; (distributed—not licensed) Oversea (Switzerland).
 Int'l reps.: USA (Dino Joanidides).
 Lakis Kleopas Prod'ns, 10 Salamonis St., Thessaloniki. Tel: (31) 516-493. Telex: 418339. Pres. & Gen. Mgr.: Lakis Kleopas; Sales Mgr.: George Kleopas; Artistic Mgr.: Lefty Kongalides.
 Kyklades, 33 Veranzeroi St., Athens.
 Kyklos Recs., 3 Karageorgi Servias, Athens 126. Tel: (01) 233-2312. Gen. Mgr.: D. Themelis. (Distributor/Importer/Exporter).
 Lucky, see Independent.
 Lyra, see General.
 M F P, see Columbia-EMI & EMIal.
 M G M, see Polygram.
 Macedonia, see Panivar.
 Margo, see Minos Matsas.
 Minos Matsas & Son Co. Ltd. (IFPI), 245-247 Messoghion Ave., Athens. Tel: (021) 671-1811. Cable: MINOSMAR. Bd. Chm.: Makis Matsas; Gen. Mgr.: Roulia Matsa; Sales Mgr.: Antonis Vassiliatos; Int'l Dept. Mgr.: Mikis Corinthios.
 Labels: (Owned) Margo, Minos, Standard; (licensed) Disc'AZ (France), Barclay (France), Casablanca (USA), Cream (USA), Dureco (Netherlands), Prelude (USA), RCA (USA), Salsoul (USA).
 Int'l reps.: Australia (George Young), Canada (Peters Int'l), USA (Peters Int'l).
 Melody, see Spiros Piperakis.
 Mercury, see Polygram.
 Minerva, see General.
 Minos, see Minos Matsas.
 Monitor, see Spiros Piperakis.
 Music-Box Martin Th. Gesar (IFPI), 2 Nikis St., Athens 126. Tel: (021) 322-1574, 323-5391, 324-4591. Cable: THOMS. Pres.: Martin T. Gesar; Gen. Mgr.: Marika Gesar; Ass't Mgr.: Tula Akasoglou.
 Labels (Owned) Calypso, Music-Box, Pan-Vox; (licensed) Aris (Italy), Ariston (Italy), Biram (Belgium, France), Decca (UK), Durium (Italy), Fantasy (USA), Hansa (Germany), Hispavox (Spain), Jupiter (Germany), London (USA), Milestone (USA), Polar (Sweden), Prestige (USA), Fye (UK), RKM (Belgium), Satrii (UK), Springboard (USA), West End (USA).
 Int'l reps.: Australia (Caras Emporium), Canada (Peters Int'l), Sweden (Zorbas), UK (KEAM, Andreas Pattalis), USA (GFS, Peters Int'l).
 Notos, see General.
 Odeon, see Columbia-EMI & EMIal.
 Olympia, see Panivar.
 Olympic, see Polygram.
 Panivar Recs. SA, 18 Pireos St., Athens 101. Tel: (021) 523-5867. Cable: PANIVAR. Pres.: Pavlos Vardoulakis; Gen. Mgr.: Noul Vardoulakis; Sales Mgr.: Dimitri Vardoulakis. Local branches: 21 Zinonos St. Tel: 523-6384; 63 Athinas St. Tel: 324-2764.
 Branches: Erakleion, Crete, 24 1978 St. Tel: 88758—Khania, Crete, 1 Koraka St. Tel: 53765—Piraea, 38 Akti Poseidonos. Tel: 417-8059.
 Labels: (Owned) Crete, Macedonia, Olympia, Panivar, Special, Victory; (licensed foreign) Criminal (UK), Ri-Fi (Italy).
 Int'l reps.: Australia (Theodoros Petropoulos, Salapatas), Belgium (Bullanis), Canada (Peters Int'l), Cyprus (Garabet Indijriyan), Germany (George Krakas, George Lazos/Do-Re-Mi, Stylianos Serafim), UK (KK, Nik. Andreas Patalis), USA (Peters Int'l).
 Pan-Vox, see Music-Box.
 Parlophone, see Columbia-EMI & EMIal.
 Pathe, see Columbia-EMI & EMIal.
 Patrinos, see Independent.
 Philips, see Polygram.
 Spiros Piperakis, 59 Miaouli St., Moscato-Athens 59. Tel: (021) 481-5508.
 Labels (Owned) Greka; (distributed) Apollon, Astron, Boem, Control, Coronnet, Do-Re, Melody, Monitor, Panivar, Revans, Venteta.
 Polydor, see Polygram.
 Polygram Recs. SA (IFPI), 296 Messoghion Ave., Cholargos, Athens. Tel: (021) 652-4213. Cable: POLYGRAM ATHENS. Telex: 216124. Mng. Dir. & Gen. Mgr.: Nicolas Antipapas; Sales Mgr.: Pantelis Emmanuilidis; Foreign Repertoire Prod. Mgr.: John Petridis; PR Mgr.: Jacques Menahem.
 Branch: Salonica, 15 Proxenoou Koromila. Tel: (031) 267-121, 274-543. Mgr. John Socratidis.
 Labels: (Owned) Archiv, DG, Fidelity, Fontana, Heliodor, MGM, Mercury, Olympic, Philips, Polydor, Vertigo, Verve; (licensed) Baby (Italy), Buddha (USA), Butterfly (USA), Cadet (USA), Capricorn (USA), Charisma (UK), Charly (UK), Checker (USA), Chess (USA), Chrysalis (UK), EG (UK), H&L (USA), Kama Sutra (USA), King (USA), Mooncrest (UK), Orlando (France), Oyster (USA), Pablo (USA), Prosidis (France), RSO (UK), Splash (UK), Spring (USA), Stiff (UK), Track (UK), 20th Century (USA), Virgin (UK), Zagora (Belgium).
 Int'l reps.: Cyprus (CBS), USA (Peters Int'l), worldwide (Polygram).
 Polyphon, 2 Third September St., Athens. Tel: (021) 538-790.
 Polytron, see General.
 Regal, see Columbia-EMI & EMIal.
 Revans, see Spiros Piperakis.
 Seagull, 17 Stournara St., Athens.
 Sonopresse, see Columbia-EMI.
 Special, see Panivar.
 Standard, see Minos Matsas.
 Studio 1 Hi Fi, 51 Proxenoou Koromila St., Thessaloniki. Tel: (031) 221-212, 262-889. Gen. Mgr.: Leandre Kupur.
 Labels: (Distributed—not licensed) Crystal Clear (USA), Denon PCM (Japan).
 Toshiba, see Columbia-EMI.
 Venteta, see Spiros Piperakis.
 Vertigo, see Polygram.
 Verve, see Polygram.
 Victory, see Panivar.

W E A Recs. Ltd., PO Box 116, Psychico; 319 Mesogheion, Halandri, Athens. Mng. Dir.: Evdoros Demetrioou.
 Zodiac, see General.

● music publishers

Blackwood Music Publ'g Co. Ltd., PO Box 2533, 19 Syngrou Ave., Makryianni, Athens 403. Tel: (01) 923-0771. Cable: COLRECORD. VP: Sol Rabinowitz; Gen. Mgr.: George Kyvelos.
 Int'l firms represented: ABC, Agencja Autorska, Alotagood/Kool, American Broadcasting, Badboy/KYO, Earl Barton, Bengal Tunes, Benjaboone, Big Seven, Blend-ingwell, Blue Oyster Cult, Boom, Byrdland, Chandos, Claudine/Barnaby, Clay, Concentric, Country Road, Coverdale, Coyote/Jeryl Lynn/Carol Nan, Derringer, Desert Moon/Tash Howard, Destination, Dickiebird, Dog, Dolot, Drummer, Dunhill, Ether, Flying Crown, Gamma, Great Honesty, Albert Hammond, Hierophant, Joelsongs, Knob Hill, Knob Hill/Lio Dan, Lambert-Porter, Light, Mac Faye, Madison, Mainsail, Matzo Ball, Mecca/Kahlil/Gibran, Micache, Mine, Mouse House, Music Pool/Notes, Neighborhood, Nelchell, Nicoya, Northchester, Oceans Blue/Silver Blue, Owepar, PPI/Palopic, Petra, Quincy, RSVP, Red Stick, Rhineland, Sailor/Haworth, Saybrook, Sherlyn, Sheronda, Silver Stead, Spangold—one song, Star Spangled/American Wordway, Strong Arm, Sweet Jenny, Teak, Triple O/Tash Howard, Tuna Fish, Twinbrook Nine, Weather Report, Westbrook, Winter Blues, Winter Wind, Zap, Zap/Aud-Lee (all USA); ATV (UK), Arabella—one song (Germany), Cielo (Italy), Robert Mellin (UK), Northern/Maclen (UK), Rondor/Robert/Almo (worldwide).
 C S B / Greece, c/o Arc Music Ltd., 10 Kadmos Milision St., Nea Smyrni, Athens.
 Int'l firm represented: Copyright Serv. Bureau (USA).
 Cora (Ed.), 59 Miaouli St., Moscato-Athens 59. Tel: (021) 481-5508.
 E M I Music Publ'g (Greece) Ltd., PO Box 287, Central Sta., 127 Heracliou St., Rizopolis, Athens. Tel: (021) 251-8170. Cable: EMIRECORD. Telex: 214192. Gen. Mgr.: Marco Bignotti.
 Int'l firms represented: Accord (Germany), Alkatraz (USA), Alpha (USA), Anagon (Netherlands), Ardmore & Beechwood (Belgium, UK), Art (France), Arvee (USA), Bagatelle (France), Beechwood (USA), Belriver (Italy), Big Pig (UK), Bron (UK), Castle (Australia), Colgems-EMI (USA), Dawn Prod'ns (USA), Donna (UK), EMI (Denmark, Sweden, Switzerland, UK), EMI-Brigadiers (South Africa), Eco (France), Ego (Spain), B. Feldman (UK), Francis Day (France), Francis, Day & Hunter (Denmark, Germany, UK), Dick James (UK), KPM (UK), Kipahulu (USA), MPL (UK), Peter Maurice (France, UK), Claude Pascal (France), Pathe-Marconi (France), Purple (UK), RFT (USA), Rebel (UK), Red Bus (UK), Robbins (UK), Rolling Stones (UK), Andrew Scott (USA), Screen Gems-EMI (USA), Toshiba (Japan), Virgin (UK), Voce del Padrone (Italy).
 General Publ'g Co. Ltd., 11 Kriezotou St., Athens 134. Tel: (01) 361-5529/6798. Cable: LYRAHELLAS.
 Grecophon (Eds. Musicales), 3 Karageorgi Servias St., Athens 126. Tel: (021) 322-5921. Cable: GRECO-PHONE. Dir.: Marika Gesar.
 Int'l firms represented: Boot (Canada), Walt Disney (USA), Valentine (UK).
 Icaros Publ'g Co., see General.
 International Publ'ns, see Select.
 Intersong Hellas Ltd., 296 Messoghion Ave., Cholargos, Athens 142. Tel: (021) 652-4213. Cable: POLYGRAM. Telex: 216124. Mng. Dir.: Nicolas Antipapas; Gen. Mgr.: Costas Zougiris.
 Int'l firms represented: Abigail (USA), Affinitia (USA), Alamenta (USA), Andustin (USA), Roy Ayers (UK), Bar-mour (USA), Barn (UK), Belkat (USA), Berna (USA), Hamilton Bohannon (USA), Boomtown Rats (Switzerland), Brightwater (USA), Brown Sound (USA), CAM (USA), CTA (UK), Canopy (USA), Cape Anne (USA), Cape May (USA), Carlin (worldwide), Causho (UK), Chappell (worldwide), Charlotte (UK), Cherry (UK), Allan Clarke's (UK), Clarke's (USA), Bob Cor (UK), Cried (USA), Mike Curb, Daway (UK), Emur Deodato (USA), Diagonal (USA), Walt Disney (USA), Doraflo/Bleu Disque (USA), Double Exposure (USA), Francis Dreyfus (France), Dynatone (USA), Betty Earlard (USA), Elbomo (USA), Elvis (USA), Every Little Tune (USA), Fairfield (USA), Fantasia (France), Wes Farrell (USA), Fast Western (USA), Fescue (UK), Four Knights (USA), Fuse (UK), Golden Syrup, Good Morning (UK), Hazlan (UK), Hinky Dink (UK), Hit & Run (UK), I Ain't In It (UK), Island (UK), Jadar (USA), Jimpire (UK), Jiru (USA), Tom Johnston (USA), Josley (UK), KasKat (USA), Kenya (USA), Kingsley Sound (USA), Kings Point (USA), Kurlay (USA), Laurel Canyon (USA), Litha (USA), Little Dickens (USA), Little Lasso (USA), Edward B. Marks (USA), Martin-Coulter (UK), McFleet (USA), Mews (UK), Midland (USA), Midsong (USA), Joni Mitchell (USA), Arnie Mogg (USA), Montunes (UK), David Mook (USA), Moonhill (USA), Mourbar (USA), Mountain (UK), Nineteen Eighty-Five (USA), Omaha (UK), Open End (USA), Oyster (USA), Pants Down (USA), Peterman (UK), Pickwick Int'l (USA), Piedmont (USA), Pinson (USA), Pocket Full of Tunes (USA), Propane (UK), RSO (UK), Rare Bird (UK), John Richbourg (USA), Rockhopper (USA), Rock-mere (UK), Steve Rowland (UK), Ryan (UK), Sam Songs (UK), Siquomb (USA), Sky Forest (USA), Song (UK), Stevca (USA), Strobe Light (USA), Sweet (UK), TH (USA), Talmont (USA), Tan Soul (USA), Third Story (USA), Three Cheers (USA), Tuff (UK), Wednesday Morning (USA), White Heaven (USA), R.P. Winkelman Tunes (USA), Yellow Dog (USA), Frank Zappa (USA).
 Int'l rep.: Worldwide (Intersong).
 Minos Matsas & Son Co. Ltd., 5 Harilaou Trikoupi, Athens 142. Tel: (021) 360-8806/1601. Cable: MINOSMAR. Mng. & Gen. Dir.: Makis Matsas; Sales Mgr.: B. Mihailides.
 Mediterranean Publ'g, Biskini 29, Athens 622. Tel: 770-9994, 778-1830. Owner: Evangelos Pitsiladis.
 Int'l branch: Switzerland.
 Melody Publ'g, see Select.

Ivan Mogull Music Assocs., c/o AEPI, 14 Delighianni St., Athens 148.
 Select Publ'rs, 13 Eptanissou Kypseli, Athens. Tel: (031) 821-3920. Gen. Mgr.: G.P. Lucky.
 Int'l branches: Canada, England, France, Italy, Switzerland, USA.
 Int'l firms represented: Ariston (Italy), Constantinidis (Egypt), Cora (Italy), Curci (Italy), El Fan (Egypt), Haddad (Lebanon), King (Japan), Leonard (Italy), Melodia (Italy), Mohamed Nasr (Libya), Perou (France), G. Ricordi (Italy), Ri-Fi (Italy).
 Int'l reps.: Australia (Caras), Canada (Christofer Papis, Parthenon Cassettes), France (Perou), Italy (Cora), South Africa (Gallo), USA (Dinos Constantinou, Dino Joannidis, Petropouleas).

● **services**

ASSOCIATIONS & PROFESSIONAL ORGANIZATIONS

Association of Greek Composers, 38 Mitropoleos St., Athens.
 E I P T (Ethnikon Idyha Radiophonias-Tileoraseos—Hellenic Nat'l Radio-TV), 16 Mourouzi St., Athens 138. Tel: 724-811. Cable: RADIOSTATHENS. Telex: 216066.
 Federation of Musical Ass'ns of Greece, 3 Averoff St., Athens.
 Jazz & Pop Club, Thessaloniki.
 National Committee of the International Music Council, 38 Mitropoleos St., Athens. Tel: 223-302.
 National Section of the International Society for Contemporary Music, 5 Rue Eptanissou, Athens 801.
 Panhellenic Musical Society, 24 Halkokondyli St., Athens.
 Union of Greek Musicians, 38 Mitropoleos St., Athens.
 Union of TV Viewers & Radio Listeners, 57 Panepistimiou St., Athens.

LICENSING ORGANIZATION, MUSIC

A E P I (Societe Hellenique pour la Protection de la Propriete Intellectuelle SA), 14 Delighianni St., Athens 148. Tel: (021) 821-3917, 822-8006. Mng. Dir.: Constantin Macris.

DESIGN & ARTWORK PLATING, PROCESSING & PRESSING PLANT

PRINTER & LITHOGRAPHER

Columbia-EMI Greece SA, PO Box 287, Central Sta., 127 Heracliou St., Rizopolis, Athens. Tel: (021) 251-6429. Cable: EMIRECORD. Telex: 214192. Mng. Dir.: Alan C. Boxer; Finance & Admin. Dir.: D. Gaetanakis; Sales Mgr.: E. Terzis; Mfg. & Studios Dir.: C. Kyriakos.

RECORD PROMOTION

Columbia-EMI Greece SA, PO Box 287, Central Sta., 127 Heracliou St., Rizopolis, Athens. Tel: (021) 251-6429. Cable: EMIRECORD. Telex: 214192. Mng. Dir.: Alan C. Boxer; Finance & Admin. Dir.: D. Gaetanakis; Sales Mgr.: E. Terzis; Mfg. & Studios Dir.: C. Kyriakos.
 Lakis Kleopas Prod'ns, 10 Salamoniou St., Thessaloniki. Tel: (31) 516-493. Telex: 418339. Pres. & Gen. Mgr.: Lakis Kleopas; Sales Mgr.: George Kleopas; Artistic Mgr.: Lefty Kongalides.

TAPE CUSTOM DUPLICATOR PACKAGING & LABELING

Columbia-EMI Greece SA, PO Box 287, Central Sta., 127 Heracliou St., Rizopolis, Athens. Tel: (021) 251-6429. Cable: EMIRECORD. Telex: 214192. Mng. Dir.: Alan C. Boxer; Finance & Admin. Dir.: D. Gaetanakis; Sales Mgr.: E. Terzis; Mfg. & Studios Dir.: C. Kyriakos. (PKG) Audio: 8-tr., cassette.

● **supplies**

CARTRIDGE & CASSETTE PARTS

Costas Vlassopoulos & Co., 2 Alex. Papanastasiou St., New Fildelfia, Athens. Tel: (01) 252-0696. Cable: INTERSONIC. Telex: 214312. Mng. Dir.: Costas Vlassopoulos; Import & Export Mgr.: A. Primikyris. Chief product: All 8-tr. & cassette parts.

EMPTY CARTRIDGES, CASSETTES & REELS

Costas Vlassopoulos & Co., 2 Alex. Papanastasiou St., New Fildelfia, Athens. Tel: (01) 252-0696. Cable: INTERSONIC. Telex: 214312. Mng. Dir.: Costas Vlassopoulos; Import & Export Mgr.: A. Primikyris. Audio: 8-tr. & cassette. Brand name: Intersonic.

JACKETS & SLEEVES LABELS

Columbia-EMI Greece SA, PO Box 287, Central Sta., 127 Heracliou St., Rizopolis, Athens. Tel: (021) 251-6429. Cable: EMIRECORD. Telex: 214192. Mng. Dir.: Alan C. Boxer; Finance & Admin. Dir.: D. Gaetanakis; Sales Mgr.: E. Terzis; Mfg. & Studios Dir.: C. Kyriakos.

TAPE, RAW & BLANK LOADED

Agfa-Gevaert AE, PO Box 17, Stilianou Gonata 16, Athinoplisteri, Tel: 574-2311. Gen. Mgr.: A. Nothdurft; Sales Mgr.: A. Bouboulas. Audio: Blank—cassette, open reel; raw—cassette. Brand names: Agfa Carat, Agfa Ferrocolor, Agfa Stereochrom, Agfa Super Ferro Dynamic, Agfa Videochrom.
 Columbia-EMI Greece SA, PO Box 287, Central Sta., 127 Heracliou St., Rizopolis, Athens. Tel: (021) 251-6429. Cable: EMIRECORD. Telex: 214192. Mng. Dir.: Alan C. Boxer; Finance & Admin. Dir.: D. Gaetanakis; Sales Mgr.: E. Terzis; Mfg. & Studios Dir.: C. Kyriakos. Audio: Blank—8-tr. & cassette.

Dr. D.A. Delis AG, Paleologou Benizelou 5, Athens 117. Tel: 325-0301. Telex: 215336. Cable: DELICHIMIK. Chief Exec.: Antonios Fotopoulos; Sales Mgr.: T. Kokkinopoulos. Audio & Video: CASSETTE. Brand name: BASF.
 Echo Ltd., 2 Korae St., Athens 132. Tel: (01) 323-4774. Gen. Mgr.: Zenon Themelis. (Distributor/Importer/Exporter) Audio: Blank—cassette.
 Magnetic Hellas Ltd., 6-8 Frangon St., Thessaloniki. Audio: 8-tr., cassette, open reel. Brand name: Audio Magnetics.
 Costas Vlassopoulos & Co., 2 Alex. Papanastasiou St., New Fildelfia, Athens. Tel: (01) 252-0696. Cable: INTERSONIC. Telex: 214312. Mng. Dir.: Costas Vlassopoulos; Import & Export Mgr.: A. Primikyris. Audio: Blank—8-tr. & cassette. Brand name: Intersonic.

● **accessories manufacturers**

Echo Ltd., 2 Korae St., Athens 132. Tel: (01) 323-4774. Gen. Mgr.: Zenon Themelis. (Distributor/Importer/Exporter) Product: Record & tape carrying & storage cases, cleaners, cloths, brushes, head cleaners & demagnetizers. Kinotexnik OE, 47 Stournara, Athens. Tel: 360-6998. Product: Needles. Brand name: Stanton.
 Spiros Piperakis, 59 Miaouli St., Moscato-Athens 59. Tel: (021) 481-5508. Product: 45 rpm adapters.
 Plomaritis Prod'ns, 3rd September 13, Athens. Tel: (031) 527-472, 821-3918. Cable: MELODY. Pres.: Anthony Plomaritis; Sales Mgr.: Georges Plomaritis. Product: Carrying & storage cases.
 Costas Vlassopoulos & Co., 2 Alex. Papanastasiou St., New Fildelfia, Athens. Tel: (01) 252-0696. Cable: INTERSONIC. Telex: 214312. Mng. Dir.: Costas Vlassopoulos; Import & Export Mgr.: A. Primikyris. Product: 45 rpm adapters.

GUATEMALA

Population: 6,260,000
 Rate of exchange: \$1 (US) = 1.0 quetzal.
 Per capita income: \$470.
 Holidays: January 1, May 1 (Labor Day), June 30 (Army Day), July 4 (Bank Holiday), July 15, August 15, September 15 (Independence Day), October 12 (Columbus Day), October 20 (Revolution of 1944), November 1, December 8, December 24, 25.
 Records, record blanks & pre-recorded media imported from USA: 1977—\$79,031.

● **record & tape manufacturers / distributors / importers**

Adan, see Dideca.
 Casa Avelar—Grabadora Tikal, 18 Calle 3-59 & 6-61, Zone 1, Guatemala City. Tel: 80-243, 28-545, 81-465. Gen. Mgr.: Salvador Avelar Guerra; Sales Mgr.: Jose Luis Martinez. Labels: (Owned) Leo, Tikal, Xelaju; (licensed) Sasian (Mexico). Int'l reps.: Mexico (Rex), USA (Discolando).
 Dideca (Discos de Centroamerica) (IFPI), Apartado Postal 1792, 12 Calle 3-27, Zone 1, Guatemala City. Tel: 84-976, 510-442, 519-602. Cable: DIDECA. Telex: 5413. Pres.: Roberto Galvez Gutierrez; Admin. Mgr.: Juan Jose Pezzarossi; Gen. Mgr.: Byron Galvez Thompson; Sales Mgr.: Byron Hernandez. Int'l branches: Costa Rica, El Salvador, Musi Centro; Honduras; Nicaragua; Panama, Sonomundi. Labels: (Owned) Adan, Dideca, Eva, Sombbrero; (licensed) ABC (USA), A&M (USA), Oscar Anderle (Argentina), Ariola (Mexico, Spain), Bay Bay (Argentina), CR (USA), CTI/Kudu (USA), Capitol (USA), Caracol (Chile), Chrysalis (UK), Codiscos (Colombia), EMI (UK), EMI-Capitol (Mexico), Falcon (USA), Fantasy (USA), Gamma (Mexico), Guitarra (Mexico), Hispavox (Spain), JCV (Argentina), Melody (Mexico), Movieplay (Spain), Oscar Novo (Argentina), Phonogram (Netherlands), Picaro (El Salvador), Polydor (Germany), Suradisc (Venezuela), United Artists (USA), Virgin (Netherlands), M. Zalberg (Argentina). Int'l reps.: Mexico (Discos y Cintas), USA (Discolando).
 Dila (Discos Latinoamericanos SA), Av. de las Americas 14-15, Zone 14, Guatemala City. Tel: 681-530. Pres.: Augusto Diaz-Duran; Gen. Mgr.: Marco Antonio Garcia; Sales Mgr.: Sylvia de Molina. Labels: (Owned) Dila; (licensed) Alhambra (Spain), Musart (Mexico). Int'l reps.: Argentina (Cordobesa), Colombia (Codiscos), Ecuador (Famoso), Mexico (Musart), Peru (IEMPSA), USA (Record Dists. of America).
 Discos Centroamericanos SA, see Dideca.
 Discos de Centroamerica, see Dideca.
 Discos Latinoamericanos SA, see Dila.
 Distribuidora Guatemalteca de Discos SA, 4 Ave. 13-25, Zone 9, Guatemala City. Tel: 31-65-64. Pres.: Eduardo Soto; Gen. Mgr.: Arnold Calvo. Home office: Costa Rica, Indica (see for labels). Int'l rep.: Worldwide (CBS).
 Eva, see Dideca.
 Indica, see Distribuidora Guatemalteca.
 Leo, see Casa Avelar.

Musical Inc. M. & R. Wunderlich, 13 Calle 9-62, Zone 1, Guatemala City. Tel: 29-645. Cable: MUSICAL. Telex: 5485. (Importer) Sombbrero, see Dideca. Tikal, see Casa Avelar. Xelaju, see Casa Avelar.

● **music publishers**

Dimasi, 12 Calle 3-27, Zone 1, Guatemala City. Tel: 519602. Cable: DIDECA. Telex: 5413. Gen. Mgr.: Otto Schwarz; Gen. Mgr.: Blanca Avila.
 Maya Musical SA, Av. de las Americas 14-15, Zone 14, Guatemala City. Tel: 681-530. Pres.: Augusto Diaz-Duran; Gen. Mgr.: Luis Estrada Roy. Int'l firms represented: ABC Dunhill (USA), Acapulco (Mexico), American Broadcasting (USA), Brambila (Mexico), Discorama (Spain), Edimusa (Mexico), Estrella (Mexico), Fermata (Brazil), Hnos. Marquez (Mexico), Morning (Canada), Prodemus (Colombia), Sadram (Ecuador). Int'l reps.: Colombia (Prodemus), Ecuador (Sadram), Mexico (Edimusa).

● **services**

ASSOCIATIONS & PROFESSIONAL ORGANIZATIONS

A G A Y C (Asociacion Guatemalteca de Autores & Compositores), 14 Calle 11-42, Zone 1, Guatemala City. Tel: 84-921-251.

DESIGN & ARTWORK PRINTER & LITHOGRAPHER PLATING, PROCESSING & PRESSING PLANT

Discos de Centroamerica SA, Apdo. 1792, 12 Calle 3-27, Zone 1, Guatemala City. Tel: 519602, 84976, 510442. Cable: DIDECA. Telex: 5413. Gen. Mgr.: Byron Galvez Thompson; Sales Mgr.: Byron Hernandez.

TAPE CUSTOM DUPLICATOR

Discos de Centroamerica SA, Apdo. 1792, 12 Calle 3-27, Zone 1, Guatemala City. Tel: 519602, 84976, 510442. Cable: DIDECA. Telex: 5413. Gen. Mgr.: Byron Galvez Thompson; Sales Mgr.: Byron Hernandez. Audio: Cassette.

HONG KONG

Population: 4,440,000
 Rate of exchange: \$1 (US) = 5.16 Hong Kong dollars.
 Per capita income: \$1300.
 Holidays: January 1, Chinese New Year, April (Queen's Birthday), Mid-Autumn Festival & Christian holidays.
 Records, record blanks & pre-recorded media imported from USA: 1977—\$525,542.

● **record & tape manufacturers / distributors / importers**

Ace of Clubs, see Decca.
 Ace of Diamonds, see Decca.
 Amo Rec. Corp. (IFPI), PO Box 95170, Tsim Sha Tsui Sta., 68 Waterloo Rd., Flat A-1, Kowloon. Tel: (3) 039847. Gen. Mgr.: Paul Leung. Labels: (Owned) Amo, Kinder, Musa.
 Angel, see EMI.
 Archiv, see Polydor.
 Argo, see Decca.
 Baal Recs., Imperial Bldg., 2nd fl., 58 Canton Rd., Tsim Sha Tsui, Kowloon. Tel: 682168. Labels: (Owned) Baal, Best of Everything; (licensed) ABC, H&L (both USA).
 Beltona, see Decca.
 Best of Everything, see Baal.
 Capitol, see EMI.
 Chapter One, see Decca.
 Columbia, see EMI.
 Cosdel (Hong Kong) Ltd. (IFPI), PO Box 2650, Central Sta., 1309-1310 Champion Bldg., 301-9 Nathan/Jordan Rd., Kowloon. Tel: (3) 302347. Cable: HKCOLTEK. Mng. Dirs.: Kenneth L. Cole, T.K. Whang; Dir. & Sales Mgr.: Robert Wong. Reg'l branch: Singapore. Labels: (Licensed) Bethlehem (USA), Colgems (USA), Flying Dutchman (USA), Gem Tobby (USA), Grunt (USA), Hologram (USA), Millennium (USA), Phantom (USA), RCA group (USA), Roadshow (USA), Sigla (USA), Tabu (USA), Tattoo (USA), Tortoise Int'l (USA); distributed—not licensed Pickwick (UK).
 Crown Rec. Co. (IFPI), 34A Kennedy Rd., 7th fl., Hong Kong. Tel: (5) 237845, 249534. Mng. Dir.: Tung Lau. Labels: (Owned) Crown, Eagle; (licensed) Michelle (USA).
 D G, see Polydor.
 Decca Orient (Pte) Ltd., 1112 Star House, 3 Salisbury Rd., Kowloon. Tel: (3) 676310. Mng. Dir.: Derrick J. Coupland; Dir.: H.K. Franklin; Mgr.: Esther Lim. (Distributed by Moutrie & Co.) Reg'l headquarters: Singapore. Labels: (Owned) Ace of Clubs, Ace of Diamonds, Argo, Beltona, Chapter One, Decca, Deram, Eclipse, Emerald, Greenwich, Gull, Headline, London, London Globe, L'Oiseau Lyre, Nova, Qualiton, Rex, Threshold, Vocalion, Vox, York; (represented) All Platinum (USA).

Biograph (USA), Boot (USA), Capri (France), Coccinelle Varieties (France), Cynda (USA), Ember (UK), Horoscope (USA), London/AOA (USA), Maple (USA), O'Be (USA), Pye (UK), Spiral (UK), Stang (USA), Summus (USA), Sonet (UK), Sydney Thompson (UK), Turbo (USA), Vega (France).

Int'l reps.: Ceylon (Lewis Brown), China (Linfair), India (Gramophone), Japan (King), Korea (Sung Eum), Pakistan (EMI), Philippines (Super), Thailand (Kinex).

Deram, see Decca.

Diamond, see Polydor.

Double Up, see EMI.

EMI (Hong Kong) Ltd. (IFPI), 11 Fa Po St., Yau Yat Tsuen, Kowloon, Tel: (3) 810321. Cable: EMITRON. Tel: 63512. Mng. Dir.: Neil Sarfield, Creative Dir.: K.K. Wong; Mktg. Mgr.: Joe Chen, Sales Mgr.: Joseph Koo. **Labels: (Owned)** Angel, Capitol, Columbia (UK), Double Up, EMI, Encore, HMV, Harvest, (MFP) Music for Pleasure, Odeon, One Up, Parlophone, Pathe, Phoenix, Regal, Regal Zonophone, Sounds Superb, Starline, Talisman, United Artists, Waverley, (represented) Arista (USA), Bronze (UK), Disneyland (USA), Island (UK), MAM (UK), Magnet (UK), Motown (USA), Private Stock (USA), RAK (UK).

Eagle, see Crown.

Eclipse, see Decca.

Emerald, see Decca.

Encore, see EMI.

Fontana, see Polydor.

Greenwich, see Decca.

Gull, see Decca.

H K, see Studer-Revox.

H M V, see EMI.

Harvest, see EMI.

Headline, see Decca.

Hong Kong King Yoko, Far East Mansion, Rm. K 17/F, 5-6 Middle Rd., Kowloon.

Label: (Distributed—not licensed) Denon PCM (Japan).

Hong Kong Recs. Co. Ltd., Kai It Bldg., 9th fl., 58 Pak Tai St., Kowloon, Tel: (3) 02-52-51. Mng. Dir.: Klaus Heymann. (Distributor for Studer-Revox)

Jones Co., 722 Tung Ying Bldg., 7th fl., 100 Nathan Rd., Kowloon. (Distributor)

Kan's Int'l Co. Ltd., 90A Broadway, 20th fl., MFSC, Kowloon, Tel: (3) 727478.

Label: (Distributed) IAG (USA).

Kinder, see Amo.

London, see Decca.

London Globe, see Decca.

M F P (Music For Pleasure), see EMI.

M G M, see Polydor.

Mercury, see Polydor.

Moutrie & Co. (Hong Kong) Ltd. (IFPI), PO box 404, Prince's Bldg., 5D, UG20 & UG23, Ice House St. Tel: (5) 239-305. Dir.: Samson Sun; Gen. Mgr.: Napoleon Ng; Sales Mgr.: C. T. Fung; Shops' Mgr.: Constance Chan. (Distributor/Importer)

Labels: (Represented) Decca group (UK), London group (USA).

Musa, see Amo.

Nova, see Decca.

Odeon, see EMI.

L'Oiseau Lyre, see Decca.

One Up, see EMI.

Parlophone, see EMI.

Pathe, see EMI.

Philips, see Polydor.

Phoenix, see EMI.

Polydor Ltd., 1001 Garley Bldg., 10th fl., 233-239 Nathan Rd., Kowloon, Tel: (3) 674138. Mng. Dir.: Norman Cheng; A&R Dir.: Ricky Fung; Pop Mktg. Mgr.: Douglas Chan; Classical Mktg. Mgr.: Peter D'Almada e Castro. **Labels: (Owned)** Archiv, DG, Diamond, Fontana, MGM, Mercury, Philips, Polydor, Vertigo, Verve; (represented) DJM (UK), Hansa (Germany), Jupiter (Germany), MCA, (USA), RSO (USA).

Qualiton, see Decca.

Regal, see EMI.

Regal Zonophone, see EMI.

Rev, see Decca.

Shun Cheong Trading Co., 1208/9 Bank Centre, 636 Nathan Rd., Kowloon, Tel: (3) 853007, 316558. Cable: SHUNMARIO. Telex: 83314. Owner & Gen. Mgr.: Raymond K.P. Ng; Sales Mgr.: Mok Yip Ping. (Distributor/Importer/Exporter)

Labels: (Represented) AVI (USA), Alshire (USA), Barclay (France), Can't Stop Prod'ns (USA), Casablanca (USA), Chocolate City (USA), Egg (France), Elastic (Singapore), Prelude (USA), Transatlantic (UK), Vogue (France).

Sounds Superb, see EMI.

Starline, see EMI.

Studer-Revox (Hong Kong) Ltd., Kai It Bldg., 9th fl., 58 Pak Tai St., Kowloon, Tel: (3) 02-52-51. Cable: REVOXSOUND. Mng. Dir.: Klaus Heymann; Gen. Mgr.: John D. Bishop; Sales Mgr.: Thomas Yeung. (Distributed by Hong Kong Recs.)

Labels: (Owned) HK, (licensed) Ariola/Eurodisc (Germany, UK, USA), Chrysalis (UK), Cream/Hi (USA), DJM (UK), Europa (Germany), Fantasy (USA), Hungaroton (Hungary), Intercord (Germany), Supraphon (Czechoslovakia), Turnabout (USA), Virgin (UK), Vox (USA); (distributed—not licensed) Erato (France), Hispavox (Spain), Inner City (USA), Melodiya (USSR), Rediffusion (UK), Sonet (UK), Unicorn (Germany).

Int'l reps.: EEC except UK (Ariola/Eurodisc), Japan (Victor), UK (RCA), USA (RCA).

Talisman, see EMI.

Threshold, see Decca.

United Artists, see EMI.

Vertigo, see Polydor.

Verve, see Polydor.

Vocalion, see Decca.

Vox, see Decca.

Watermelon Prod'ns, 70 Conduit Rd., Flat 1C, Hong Kong, Tel: (5) 451719. (Distributor/Importer)

Waverley, see EMI.

Yes Recs. Ltd., Sincere Insurance Bldg., 4th fl., West Wing.

Rm. 3. Wanchai, Tel: (5) 279531, 280795. Telex: 83429. (Distributor/Importer)
York, see Decca.

● music publishers

Burlington-Palace Music Orient Ltd. (sub. of Burlington-Palace in UK), 1112 Star House, 3 Salisbury Rd., Kowloon, Tel: (3) 676310. Mng. Dir.: Derrick J. Coupland; Dir.: H.K. Franklin; Far East Mgr.: Esther Lim. **Reg'l branches:** Malaysia, Singapore.

Int'l firms represented: Angela (UK), Bellbird (Australia), Burlington (UK), GH (UK), Tony Hiller (UK), Island (UK), Logo Music (UK), Ivan Mogull (USA), Palace (UK), Panache (UK), RAK (UK), Rocket (UK), Sparta Florida (UK), State (UK), Sunbury (UK), Union Songs (Sweden), Valentine Music (UK).

EMI Music Publ'g (S.E. Asia) Ltd., 11 Fa Po St., Yau Yat Tsuen, Kowloon, Tel: (3) 805373/5. Cable: EMIMUS. Telex: 63512. Dir. & Gen. Mgr.: Josephine Lau.

Reg'l branches: Malaysia, Singapore.

Int'l firms represented: ABC/Dunhill (USA), ATV (UK), Admont (USA), J. Albert & Son (Australia), Alchemical (USA), Alfa (Japan), American Broadcasting (USA), Ardmore & Beechwood (UK), Arrgee (UK), Blythwood (Canada), Brintree (USA), Brent (USA), Bron (UK), Caleb (USA), Campbell Connelly (UK), Carlin (UK), Charing Cross (USA), Cheson (USA), Chibell (UK), Chrysalis (UK), Combine (USA), Cookaway (UK), Copyright Service Bureau (USA), Cream (USA), Spencer Davis (UK), Doors (USA), The Dreamers (UK), Dwarf (UK), EMI Music (UK), Early Morning (Canada), Edwardson (UK), Essex (Australia), B. Feldman (UK), Francis Day & Hunter group including Robbins & Donna (UK), Robin Gibb (UK), Golden Egg (UK), Gralto (UK), Gypsy Boy (USA), HEC (UK), Hollenbeck (USA), India (USA), Intune (UK), Dick James (UK), Jasperilla (USA), Kennedy Street (UK), Kuptillo (USA), Lady Jane (USA), Lupus (UK), Maribus (UK), Miles Ahead (USA), Mother Goose (UK), Northern Songs (UK), Our Music (UK), Purple (UK), Razzle (Australia), Red Bus (UK), Rondor (USA), Cyril Shane (UK), Shillelagh (USA), Swardager (USA), Tic Toc (UK), United Artists (USA), Warner Bros. (UK), Walt Disney (USA), Wonderland (USA), Lawrence Wright (UK), Zambezi (USA).

Int'l reps.: Argentina (Odeon), Australia (Castle), Belgium (Ardmore & Beechwood), Brazil (ITAIPU), Canada (Beechwood), Denmark (Imudico), France (Pathe Marconi), Germany (Accord), Italy (La Voce del Padrone), Japan (Toshiba), Mexico (Beechwood), Netherlands (Anagon), New Zealand (Belcas), South Africa (Ardmore & Beechwood), Spain (EGO), Sweden (Odeon), UK (Ardmore & Beechwood), USA (Beechwood).

● services

DESIGN & ARTWORK RECORD PROMOTION

Creative Workshop Ltd., 1105-1406 Korea Center, Tel: 447483, 436399, 436390. Mng. Dir.: Michael Pope.

TAPE CUSTOM DUPLICATORS

Crown Rec. Co., 34A Kennedy Rd., 7th fl., Hong Kong, Tel: (5) 237845. Mng. Dir.: Tung Lau.
Audio: Cassette.

● supplies

CARTRIDGE & CASSETTE PARTS

Greencorp Magnetics Ltd., 801 China Bldg., Pedder St., Hong Kong, Tel: (5) 254527. Telex: 83583.

Yorknetics Ltd., GPO Box 9789, 313 Central Bldg., Pedder St., Hong Kong, Tel: (5) 23-29-72. Mgr.: G.K. Lau.

Audio: Cassette.

EMPTY CARTRIDGES, CASSETTES & REELS

Yorknetics Ltd., GPO Box 9789, 313 Central Bldg., Pedder St., Hong Kong, Tel: (5) 23-29-72. Mgr.: G.K. Lau.

Audio: Cassette.

TAPE, RAW & BLANK LOADED

Crown Rec. Co. (IFPI), 34A Kennedy Rd., 7th fl., Hong Kong, Tel: (5) 237845.

Audio: Cassette.

Greencorp Magnetics Ltd., 801 China Bldg., Pedder St., Hong Kong, Tel: (5) 254527. Telex: 83583.

Audio: 8-tr., cassette & open reel.

Video: ½" EIAJ open reel.

Inter-Cassette (Hong Kong) Ltd., Man Foong Ind'l Bldg., Cheung Lee St., Chai Wan, Tel: (5) 572282. Telex: 85938. Dir.: Terrance Ma. (Blank only)

Home office: USA.

Audio: Cassette.

Jebson & Co. Ltd., Agfa-Gevaert Dept., PO Box 97, Pedder Bldg., 6th fl., Hong Kong, Tel: (5) 253061. Telex: 73221. 73769.

Audio: Blank—compact-cassette, open reel, raw—cassette, broadcast, studio

Video: Cassette, open reel.

Brand names: Agfa Carat, Agfa Stereochrom, Agfa Videochrom

Phoenix Audio Ltd., Tung Sun Commercial Centre, 200 Lockhart Rd., Hong Kong, Tel: (5) 74-72-99. Cable: PHNIXAUDIO. Telex: 65855.

Brand name: Agfa Gevaert.

Studer-Revox (HK) Ltd., Kai It Bldg., 9th fl., 58 Pak Tai St., Kowloon, Tel: (3) 02-52-51. Cable: REVOXSOUND.

Mng. Dir.: Klaus H. Heymann; Gen. Mgr.: John D. Bishop; Sales Mgr.: David Ling; Service Mgr.: Peter Ling. (Raw only)

Audio: Open reel.

Brand name: Revox.

Yorknetics Ltd., GPO Box 9789, 313 Central Bldg., Pedder St., Hong Kong, Tel: (5) 23-29-72. Mgr.: G.K. Lau. (Blank only)

Audio: Cassette.

Brand name: Aria.

TAPE DUPLICATING & PROCESSING EQUIPMENT PROFESSIONAL TAPE SUPPLIES

Phoenix Audio Ltd., Tung Sun Commercial Centre, 200 Lockhart Rd., Hong Kong, Tel: (5) 74-72-99. Cable: PHNIXAUDIO. Telex: 65855.

Audio: Infonics duplicators.

● accessories manufacturers

Greencorp Magnetics Ltd., 801 China Bldg., Pedder St., Hong Kong, Tel: (5) 254527. Telex: 83583.

Product: Carrying & storage cases, cleaners, cloths, brushes, 45 rpm adapters, head cleaners, demagnetizers, leader & splicing tape.

Inter-Cassette (Hong Kong) Ltd., Man Foong Ind'l Bldg., Cheung Lee St., Chai Wan, Tel: (5) 572282. Telex: 85938. Dir.: Terrance Ma.

Home office: USA

Product: Cleaners, cloths & brushes, head cleaners

Studer-Revox (HK) Ltd., Kai It Bldg., 9th fl., 58 Pak Tai St., Kowloon, Tel: (3) 02-52-51. Cable: REVOXSOUND.

Mng. Dir.: Klaus H. Heymann; Gen. Mgr.: John D. Bishop; Sales Mgr.: David Ling; Service Mgr.: Peter Ling.

Product: Cleaners, cloths & brushes, head cleaners & demagnetizers, leader & splicing tape.

Yorknetics Ltd., GPO Box 9789, 313 Central Bldg., Pedder St., Hong Kong, Tel: (5) 23-29-72. Mgr.: G.K. Lau.

Product: Tape carrying & storage cases, cleaners, cloths, & brushes, head cleaners & demagnetizers, leader tape.

● store fixtures & merchandising aids manufacturers

Greencorp Magnetics Ltd., 801 China Bldg., Pedder St., Hong Kong, Tel: (5) 254527. Telex: 83583.

Product: Divider cards.

● jukebox importer

Cosdel (Hong Kong) Ltd., PO Box 2650, Central Sta. 1309-1310 Champion Bldg., 301-9 Nathan/Jordan Rd., Kowloon, Tel: (3) 302347. Cable: HKCOLTEK. Mng. Dirs.: Kenneth L. Cole, T.K. Whang; Dir. & Sales Mgr.: Robert Wong.

Brand name: Wurlitzer (Germany)

HUNGARY

Population: 10,500,000
Rate of exchange: \$1 (US) = 18.94 forints.
Per capita income: \$2,040
Holidays: January 1, Easter Monday, April 4 (Liberation Day), May 1 (Labor Day), November 7 (Russian October Revolution Day), December 25, 26.

RECORDS:

Records sold domestically including imports (retail value):

LP's 1978—3,548,000 units, \$14,876,700; 1977—3,759,000 units, \$15,557,900. EP's & Singles

1978—1,556,000 units, \$2,042,500; 1977—1,689,000 units, \$2,326,840

Records imported from USA (factory value—CIF): 1978—300 units, \$1,060; 1977—280 units, \$94.

Records exported to USA (factory value—FOB): 1978—162,392 units, \$302,518; 1977—49,800 units, \$64,850.

Records imported from countries other than USA (factory value—CIF): 1978—1,005,000 units, \$3,235,000; 1977—1,276,148 units, \$1,910,000.

Records exported to countries other than USA (factory value—FOB): 1978—1,264,602 units, \$1,967,916; 1977—1,024,000 units, \$1,573,300.

Average retail price record: LP's—\$4.32; EP's & Singles—\$1.63

Stereo sales: 100%.

Discounting: Rare.

Type of distribution: Manufacturer-to-retailer. There is only one record manufacturer in Hungary, and it controls all the distribution. It also owns some retail outlets. Most of the retail shops belong to Book Sales Ent., and all of them do not specialize in record and sheet music sales.

Type of Promotion: Several radio and television programs, announced by editors (disk jockeys), feature recorded music. A "hit list" is compiled by the weekly "Hungarian Youth" and the National Radio. Voting is done by mail and the list is not regarded as accurate.

Jukeboxes: 500.

TAPE:

Market: Only classical music is available on pre-recorded cassettes, but blank tape is available, and there is a special radio program for owners of playback equipment who record broadcast music. There are no pre-recorded 8-track cartridges or open reels on the market.

Pre-recorded tape sold domestically including imports (retail value):

tail value): Cassette 1978—236,000 units, \$1,505,200; 1977—241,000 units, \$1,594,390.
Pre-recorded tape exported to USA (factory value—FOB): 1978—4,317 units, \$8,893; 1977—1,530 units, \$3,200.
Pre-recorded tape imported from countries other than USA (factory value—CIF): 1978—20,000 units, \$76,200; 1977—18,000 units, \$69,150.
Pre-recorded tape exported to countries other than USA (factory value—FOB): 1978—10,100 units, \$22,200; 1977—3,210 units, \$6,742.
Average retail price per tape: Cassette—\$7.50.

RADIO STATIONS

No. of AM 2; no. of FM 1 (all government).
Comment: AM and FM are relayed through an FM network of 28 outlets.

TELEVISION STATIONS:

No. of government channels 2 (40% SECAM color).
Comment: Many serials are of German (both the Federal and Democratic Republics), British and French origin. News, commentary, politics, and specials are presented. In addition, many sports are offered, with football (soccer) being the most preferred.

IMPORT/EXPORT REGULATIONS:

Records and pre-recorded cassettes can be exported and imported only by Kultura—Hungarian Foreign Trading Co., which has exclusive rights.

MARKET ANALYSIS

Since Hungaroton has its own factory/galvanoplant, printing plant, printing shop, etc., the demand for records has been increasing. A new development during the past year has been the receiving of royalties by performing artists for records sold.
 Tourists traveling to Hungary can import five LP's per person. When sending records as a gift, one LP can be sent duty free; for two records the duty is \$7.50 (150 florints), and for the maximum of five that can be sent, the duty is \$15 (300 florints).

Paul Gyongy

● **record & tape manufacturers / distributors / importers**

Hungarian Gramophon Recs., Vorosmarty ter 1, Budapest V. Tel: 176-222. Cable: QUALITON. Gen. Dir.: Jenő Bors. (Distributed by Kultura)
Labels: (Owned) Hungaroton, Pepita, Qualiton; (Licensed) Barclay (France), Decca (UK), EMI (UK), Phonogram (Netherlands), Polydor (West Germany).
 Hungaroton, see Hungarian Gramophon & Kultura.

Kultura—Hungarian Foreign Trading Co., PO Box 149, H-1389 Budapest 62. Tel: 159-450. Telex: 22-4441. Music Dept. Mng. Dir.: Jozsef Meszaros. Export/Import Mgr.: Mrs. Wiszkidenszky.
Labels: (Distributed) Hungaroton, Pepita, Qualiton; (Licensed) Decca (UK), EMI (UK), Philips (Netherlands), Polydor (Germany).
Int'l reps.: Argentina (Fonema), Australia (Avant Garde, Read & Co.), Austria (Libro-Disco), Belgium (Baltic), Canada (Alexander Trading), Denmark (Record), Egypt (General Egyptian Book Org.), Finland (EMI), France (Disc'AZ), Germany (Disco-Center), Greece (Music Box), Hong Kong (Studer-Revox), India (Gramophone), Italy (Carisch), Japan (King), Lebanon (Ste. Libanaise), Mexico (Gamma), Netherlands (Sound Prods.), Spain (Hispa-vox), Sweden (EMI), Switzerland (Sade), Turkey (Faruk Erengul), UK (Selecta), USA (Qualiton), Yugoslavia (Forum, Jugoton). (SEE ADVERTISEMENT)
 Pepita, see Hungarian Gramophon & Kultura.
 Qualiton, see Hungarian Gramophon & Kultura.

● **music publishers**

Kultura—Hungarian Foreign Trading Co., PO Box 149, H-1389 Budapest 62. Tel: 159-450. Telex: 22-4441. Music Dept. Mng. Dir.: Jozsef Meszaros; Export/Import Mgr.: Mrs. Kovacs.
Int'l reps.: Australia (Boosey & Hawkes), Austria (Hofmeister), Canada (Boosey & Hawkes), Denmark (Engstrom), Finland (Musik Fazer), France (Boosey & Hawkes), West Germany (Boosey & Hawkes), Greece (Nakas), Israel (From Music Supply), Italy (Carisch), Japan (Nippon, Academia Music, Kawai), Luxemburg (Scala), Netherlands (Broekmans & van Poppel), Norway (Musik-Huset, Norsk), Spain (Real Musical), Sweden (Boosey & Hawkes), Switzerland (Eulenburg), UK (Boosey & Hawkes), USA (Boosey & Hawkes), Yugoslavia (Muzicka Naklada, Mladost). (SEE ADVERTISEMENT)
 Musica Budapest (Ed.), Vorosmarty ter 1, H-1051 Budapest. Tel: 184-228. Cable: EDITIOMUSICA. Mng. Dir.: Laszlo Sarlos.
Int'l firms represented: Boosey & Hawkes (UK), Ricordi (Italy).
Int'l reps.: Canada, France, Germany, Sweden, UK, USA (all Boosey & Hawkes), Austria (Universal), Finland (Fazer), Italy (Ricordi), Netherlands (Broekmans & van Poppel), Spain (Real), Switzerland (Eulenburg).

● **services**

ASSOCIATIONS & PROFESSIONAL ORGANIZATIONS

Budapesti Zenei Versenyek es Festivalok Irodaja (Budapest Office of Music Competitions & Festivals, Office of Bartok Seminar), PO Box 80, Vorosmarty ter 1, H-1366 Budapest V. Tel: 176-222. Cable: FESTIVALBURO. Dir.: Peter Gorog; Gen. Sec'y: Edith Galambos.

Institute for Musicology of the Hungarian Academy of Sciences (including Bartok Archives & Museum of History of Music), PO Box 28, H-1250 Budapest I. Tel: 161-522/208. Dir.: Prof. Jozsef Ujfalussy.
 Interconcert (International Concert Mgmt.), Vorosmarty ter 1, H-1368 Budapest V. Tel: 176-222. Cable: INTER-KONCERT. Press Officer: Karoly Sailer.
 Magyar Nepkoztarsasag Muveszeti Alajja (Artistic Foundation of the Hungarian Peoples Republic), Bathori utca 10, Budapest V. Chief Musical Section Vice Dir.: Paul Gyongy.
 Magyar Zenemuveszek Szovetsége (Association of Hungarian Musicians), Vorosmarty ter 1, H-1364 Budapest V. Tel: 184-243. Cable: MUSICUNION. Sec'y Gen.: Istvan Lang.
 O R I (Orszagos Rendezo Iroda—Hungarian Nat'l Mgmt. of Light Music), Vorosmarty ter 1, H-1815 Budapest. Tel: 176-353. Telex: 224121. Gen. Mgr.: Gyorgy Bali.
 Union of Hungarian Musicians, Gorkij fasor 38, Budapest VI. Tel: 211-120. Cable: MUDOSZ.

DESIGN & ARTWORK

Kultura—Hungarian Foreign Trading Co., PO Box 149, H-1389 Budapest 62. Tel: 159-450. Telex: 22-4441. Music Dept. Mng. Dir.: Jozsef Meszaros; Export/Import Mgr.: Mrs. Wiszkidenszky. (SEE ADVERTISEMENT)

LICENSING ORGANIZATIONS, MUSIC

Artisjus (Bureau Hongrois pour la Protection des Droits d'Auteur), Vorosmarty ter 1, H-1051 Budapest. Tel: (0361) 176-222, 184-629. Gen. Mgr.: Mihaly Ficsor; Dir. & Music Dept. Head: Dr. Imre Mora (Mechanical & performing rights).
 Kultura—Hungarian Foreign Trading Co., PO Box 149, H-1389 Budapest 62. Tel: 159-450. Telex: 22-4441. Music Dept. Mng. Dir.: Jozsef Meszaros; Export/Import Mgr.: Mrs. Wiszkidenszky. (SEE ADVERTISEMENT)

PLATING, PROCESSING & PRESSING PLANT

Villamoszigitelo es Muanyaggyar. Jozsef utca 120, Budapest XI. Tel: 450-950.

PRINTER & LITHOGRAPHER RECORD PROMOTION

Kultura—Hungarian Foreign Trading Co., P.O. Box 149, H-1389 Budapest 62. Tel: 159-450. Telex: 22-4441. Music Dept. Mng. Dir.: Jozsef Meszaros; Export/Import Mgr.: Mrs. Wiszkidenszky. (SEE ADVERTISEMENT)

● **supplies**

ENVELOPES & MAILERS JACKETS & SLEEVES

Kultura—Hungarian Foreign Trading Co., PO Box 149, H-

YOUR MUSICAL GUIDE FROM HUNGARY:

HUNGAROTON

Beside the classical repertoire in the interpretation of talented new names, we can offer many **World Premiere Recordings** to music fans collecting unique releases. Looking through the Hungaroton catalogue you will come across quite a few releases that you cannot find in any other catalogue.

General distributor:

Kultura Hungarian Foreign Trading Company
 H-1389 Budapest,
 P.O. Box 149, Hungary

Represented in the U.S.A. by
 Qualiton Records, Ltd.
 39-28 Crescent Street,
 Long Island City, N.Y. 11101



1389 Budapest 62. Tel: 159-450 Telex: 22-4441. Music Dept. Mng. Dir. Jozsef Meszaros; Export/Import Mgr. Mrs. Wiszkidenszky. (SEE ADVERTISEMENT)

● **accessories manufacturer**

Kultura—Hungarian Foreign Trading Co., PO Box 149, H-1389 Budapest 62. Tel: 159-450 Telex: 22-4441 Music Dept. Mng. Dir. Jozsef Meszaros; Promo Mgr. Gyorgy Sarai. Product: Catalog servs. (SEE ADVERTISEMENT)

ICELAND

Population: 220,000. Rate of exchange: \$1 (US) = 256.41 krona. Per capita income: \$4,682. Holidays: January 1, Easter Monday, May 1 (Labor Day), Whitsun, June 17 (National Day), December 1 (Anniversary of Independence), December 25. Records, record blanks & pre-recorded media imported from USA: 1977—\$168,014.

● **record & tape manufacturers / distributors / importers**

Boka og Bladautgavan, Hatuní 2, Reykjavik. Falkinn Ltd. (IFPI), PO Box 5420, Sudurlandsbraut 8, Reykjavik. Tel: (91) 8 46 70. Telex 2078. Labels: (Distributed—not licensed) A&M (UK), Atlantic (UK), B&C (UK), Chrysalis (UK), DJM (UK), Decca (UK), EMI (UK), Elektra (UK), Island (UK), Polydor (Germany, UK), RCA (UK), Teldec (Germany), Warner Bros. (UK). Geimsteinn HF, Skolavog 12, 230 Keflavik. Tel: (92) 27 17. Hijodfaerhaus Reikjaurkur HF., Laufavegi 96, Reykjavik. Tel: (91) 1 36 56. (Importer) Radio Budin HF, Klapparstig 26, Reykjavik. (Distributor / Importer) Stal Ltd. (IFPI), PO Box 5420, Sudurlandsbraut 8, Reykjavik. Tel: (91) 8 46 70. Cable: STALCO. Labels: (Distributed—not licensed) CBS (UK), Epic (UK), Fontana (Netherlands, UK), Mercury (Netherlands, UK), Philips (UK, Netherlands), WWA (UK), Vertigo (Netherlands, UK).

● **music publisher**

Geimsteinn HF, Skolavog 12, 230 Keflavik. Tel: (92) 27 17.

● **services**

ASSOCIATIONS & PROFESSIONAL ORGANIZATIONS

Iceland Div. of Int'l Federation of the Phonographic Inds. (IFPI), Sudurlandsbraut 8, Reykjavik. Tel: (91) 8 46 70. Icelandic Composers Society (Tonksaldafelag Islands), Laufasvegur 40, Reykjavik. Tel: (91) 1 61 73. Iceland Music Information Center, Laufasvegur 40, Reykjavik. Tel: (91) 2 11 85. Society of Icelandic Musical Artists (Felag islenzkra tonlistarmanna), Skolagerdi 47, Kopavogi. Tel: 4 17 40.

LICENSING ORGANIZATION, MUSIC

S T E F (Samband Tonkslada og Eigenda Flutningsrettar), Laufasvegur 40, Reykjavik.

● **accessories manufacturers**

Falkinn Ltd., Sudurlandsbraut 8, Reykjavik. Tel: (91) 8 46 70. Telex: 2078. Product: Carrying & storage cases, catalog servs., cleaners, cloths, brushes, 45 rpm adapters, needles, leader & splicing tape. E. Farestreet & Co. H.S., Bergstadastreti 10, Reykjavik. Tel: 21565. Product: Needles. Brand name: Pickering.

● **store fixtures & merchandising aids manufacturer**

Falkinn Ltd., Sudurlandsbraut 8, Reykjavik. Tel: (91) 8 46 70. Telex: 2078. Product: Browser boxes, display racks, divider cards.

INDIA

Population: 610,080,000. Rate of exchange: \$1 (US) = 7.92 rupees. Per capita income: \$136.

Billboard 1979-1980 International Buyer's Guide

Holidays: January 1, January 26 (Republic Day), August 15 (Independence Day), October 2 (Mahatma Gandhi's Birthday), December 25.

Records exported to USA: LP's 1978—77,414 units. Singles, EP's & blanks 1978—41,892 units.

● **record & tape manufacturers / distributors / importers**

Angel, see The Gramophone Co. Archiv, see Polydor. Capitol, see The Gramophone Co. Columbia, see The Gramophone Co. D G, see Polydor. Fontana, see Polydor. The Gramophone Co. of India Ltd., PO Box 699, Calcutta 700001; 33 Jessore Rd., Dum Dum, Calcutta 700028. Tel: 57-2431/4163. Cable: EMITRON. Telex (021) 7007 Mng. Dir. Anil Sud; Sales Mgr. M.A. Rafique; Nat'l A&R & Gen. Mgr. V.K. Dubey; Mktg & Promo Mgr. P.K. Banerjee; Export Mgr. G. Vijayakumar; Rec'g, Copyright & Royalties Mgr. T.P. Roy Choudhury. Local branch: 2 Ripon St. Branches: Bombay, Calcutta, Delhi, Gauhati, Kanpur, Madras. Labels: (Owned) Angel, Capitol, Columbia, HMV, Odeon, Regal, (licensed) A&M (USA), Bronze (UK), Decca (UK), Island (UK), Motown (USA), Pye (UK), RCA (USA), United Artists (USA), WEA (USA).

H M V, see The Gramophone Co. Karussell, see Polydor. M G M, see Polydor. Mercury, see Polydor. Odeon, see The Gramophone Co. Phipps, see Polydor. Polydor of India Ltd. (IFPI), Sterling Centre, 16/2 Dr. Annie Besant Rd., Worli, Bombay 400018. Tel: 39-5995, 37-9556, 37-6645. Mng. Dir. S.A. Patel; Mktg. & Sales Mgr. V.J. Lazarus. Home office: Germany. Labels: (Owned) Archiv, DG, Fontana, Karussell, MGM, Mercury, Phipps, Polydor, Vertigo, Verve, (represented) BBC, GTO, Hispavox, Jet, Kolob, Metro, Pablo, RSO, Ring-O', State, Track. Regal, see The Gramophone Co. Vertigo, see Polydor. Verve, see Polydor.

● **services**

ASSOCIATIONS & PROFESSIONAL ORGANIZATIONS

The Madras Musical Ass'n, PO Box 1412, 53 Sir Thyagaraya Rd., T. Nagar, Madras 600017.

DESIGN & ARTWORK PLATING, PROCESSING & PRESSING PLANT

The Gramophone Co. of India Ltd., PO Box 699, Calcutta 700001; 33 Jessore Rd., Dum Dum, Calcutta 700028. Tel: 57-2431. Cable: EMITRON. Telex: (021) 7007 Mng. Dir. Anil Sud; Sales Mgr. M.A. Rafique.

TAPE CUSTOM DUPLICATOR

The Gramophone Co. of India Ltd., PO Box 699, Calcutta 700001; 33 Jessore Rd., Dum Dum, Calcutta 700028. Tel: 57-2431. Cable: EMITRON. Telex: (021) 7007 Mng. Dir. Anil Sud; Sales Mgr. M.A. Rafique. Audio: 8-tr., cassette.

● **supplies**

CARTRIDGE & CASSETTE PARTS

Vimal Ents. Ltd., 64 Industrial Estate, Umbergaon, Gujarat 396171. Tel: 342,234,338. Exec. Dir.: P.G. Sutaria; Gen. Mgr. J.M. Raja; Sales Mgr.: Mrs. R.V. Shah; Tech. Exec. M. Sajjad. Audio: Cassette. Brand name: Yogesh.

EMPTY CARTRIDGES, CASSETTES & REELS

Vimal Ents. Ltd., 64 Industrial Estate, Umbergaon, Gujarat 396171. Tel: 342,234,338. Exec. Dir. P.G. Sutaria; Gen. Mgr. J.M. Raja; Sales Mgr. Mrs. R.V. Shah; Tech. Exec. M. Sajjad. Audio: Cassettes, reels. Brand names: Vimaltape, Yogesh.

JACKETS & SLEEVES

Vimal Ents. Ltd., 64 Industrial Estate, Umbergaon, Gujarat 396171. Tel: 342,234,338. Exec. Dir. P.G. Sutaria; Gen. Mgr. J.M. Raja; Sales Mgr. Mrs. R.V. Shah; Tech. Exec. M. Sajjad.

TAPE, RAW & BLANK LOADED

B A S F India Ltd., PO Box 19108, Maybaker House, Sudam Kalu Ahire Marg, Bombay 400025. Tel: 463-703. Cable: BASFINDIA. Telex: (011) 2538, 6223. Sales Mgr.: H. E. Kizelbash. Audio & Video: Cassette, open reel. Vimal Ents. Ltd., 64 Industrial Estate, Umbergaon, Gujarat 396171. Tel: 342,234,338. Exec. Dir. P.G. Sutaria; Gen. Mgr. J.M. Raja; Sales Mgr. Mrs. R.V. Shah; Tech. Exec. M. Sajjad. Audio: Cassette, open reel. Brand name: Vimaltape.

TAPE DUPLICATING & PROCESSING EQUIPMENT

B A S F India Ltd., PO Box 19108, Maybaker House, Sudam Kalu Ahire Marg, Bombay 400025. Tel: 463-703. Cable: BASFINDIA. Telex: (011) 2538, 6223. Sales Mgr. H. E. Kizelbash. Audio: Pancakes.

● **accessories manufacturer**

The Gramophone Co. of India Ltd., PO Box 699, Calcutta 700001; 33 Jessore Rd., Dum Dum, Calcutta 700028. Tel: 57-2431/4163. Cable: EMITRON. Telex: (021) 7007 Mng. Dir. Anil Sud; Sales Mgr. M.A. Rafique. Product: Record catalog servs., needles.

IRELAND

Population: 3,192,000. Rate of exchange: \$2 07 (US) = 1 pound. Per capita income: \$1 131. Holidays: January 1, March 17 (St. Patrick's Day), Good Friday, Easter Monday, First Mondays in June & August, Last Monday in October, December 25, 26.

RECORDS:

Records, record blanks & pre-recorded media imported from USA: 1977—\$66,518. Records exported to USA: 1977—55,293 units, \$110,723; 1976—46,439 units, \$91,791. Average retail price per record: LP's \$6.37; singles \$1.55. Stereo sales: 97% of total. Quadraphonic sales: 2%. Record club sales: Minimal. Type of distribution: Manufacturer-to-wholesaler-to-retailer predominates. There are two rack jobbers. Type of promotion: Mainly radio and to a much lesser extent, television. There are weekly, fortnightly and monthly magazines.

TAPE:

Market: 8-tr. is rapidly losing popularity, cassettes outselling them by 9 to 1. Tape sales account for about 40% of the industry. In rural areas tape exceeds record sales. Average retail price per tape: 8-tr. & cassette—\$6.68.

RADIO & TELEVISION STATIONS:

There is only one government-operated commercial radio and television station, but there are many pirate radio stations which continue on the air because of legal loopholes.

IMPORT / EXPORT REGULATIONS:

There is a 40% VAT rate, payable at the point of import on the CIF value (30% of which is irrecoverable). For non-members of the EEC there is an additional duty of 10% which is levied before VAT and on which VAT is also payable. Ken Stewart

● **record & tape manufacturers / distributors / importers**

A R A, see EMI. Archiv, see Polydor. Avoca Musical Inds. Inc., Upper Market St., Ennis, County Clare. Tel: Ennis 21644. Dir.: Sylvester Keane. Int'l branch: USA. Labels: (Owned) Avoca, Blarney Castle, IMI. Blackbird, see CBS. Blarney Castle, see Avoca. Bonus, see Irish Rec. Factors. C B S Recs (IFPI), 111 Cork St., Dublin 8, Tel: 780-133/375 / 673. Gen. Mgr. David E. Duke; Sales Mgr. Jackie Hayden. Labels: (Owned) CBS, Embassy, Epic, Harmony; (distributed—not licensed) ABC, A&M, Anchor, Blackbird (Ireland), CMR (Ireland), DJM, ID / Heritage (Ireland), Island, Jet, Mulligan (Ireland), Shanachie, Virgin. C M R Ltd., Carrick Rd., Drumshanbo, Co. Leitrim, Tel: Drumshanbo 13, Dublin 174229. Dir. Paschal C. Mooney; Gen. Mgr. & Dir. Done Cassidy. Labels: (Owned) CMR; (licensed) RK (UK). Capitol, see EMI. Chyme Music Ltd., John F. Kennedy Dr., Dublin 12. Tel: 514-044, 505-773. Chief Exec. Robert McGrattan; Gen. Mgr.: Patrick Trundle; Sales Mgr. Vincent Smialek. Int'l reps.: Germany (Membran), Netherlands (Sound Prods.), Northern Ireland (Outlet), UK (Spartan). Claddagh Recs. Ltd. (IFPI), Dame House, Dame St., Dublin 2. Tel: 778-034/943. Chm.: Garech Browne; Gen. Mgr.: Patricia Pretty. Labels: (Owned) Claddagh; (distributed—not licensed) Tara. Int'l rep.: Worldwide except Ireland (CBS). Classics for Pleasure, see EMI. Columbia, see EMI. Comhallas, see Irish Rec. Factors & Hawk. D G, see Polydor. Demesne Rec. Co. Ltd. (IFPI), 22 Ellis Quay, Dublin 7. Tel: (01) 720-411. Chm. John M. Walsh; Mng. Dir. & Gen. Mgr.: Patrick O'Neill; Dir. & Sales Mgr.: Anthony McEvoy. (Distributor / Importer) Labels: (Licensed) Pickwick (UK); (distributed—not li-

censed) CBS, Claddagh, Denver, Dolphin, EMI, Heritage, Philips (UK), RCA (UK), Release, WEA (UK).
 Dirty Nellys, see Dolphin.
 Dolphin Traders Ltd. (IFPI), 97-A Talbot St., Dublin 1. Tel: 777-788. Chm. & Dir.: Joseph P. O'Reilly; Dir. & Gen. Mgr. Brian J. Barker.
Labels: (Owned) Dirty Nellys, Dolphin, Spire, Triskel; **(distributed—not licensed)** Avoca
 Int'l reps.: Canada (Boot), France (Nevez Diffusion), UK (Outlet in Northern Ireland, I&B), USA (Release).

Double Up, see EMI.

EMI (Ireland) Ltd. (IFPI), Dublin Ind'l Estate, 130 Slaney Rd., Finglas, Dublin 11. Tel: (01) 309-077. Cable: EMITRON. Telex: 4535. Mng. Dir.: Brian Dockery; Sales Mgr.: John Condren; Comm'l Mgr.: Michael F. Roberts; Finance Mgr.: Terry O'Rourke.
Labels: (Owned) Capitol, Classics for Pleasure, Columbia, Double Up, EMI, EMI Int'l, Fantasy, HMV, Harvest, Music for Pleasure, One Up, Parlophone, Regal Zonophone, Sovereign, Starline, Stateside, Talisman, Waverley, World, **(licensed)** Ariola America, Arista/Bell, Big Bear, Bronze, Hitsville, Liberty, MAM, MCA-Coral, MCF, Motown, Mowest, Oyster, Prudential, Private Stock, Purple, RAK, Rare Earth, Retreat, Rocket, Sunset, United Artists, **(distributed—not licensed)** ARA, Claddagh, Dolphin, Outlet/Homespun, Shamrock.

EMI Int'l, see EMI.

Embassy, see CBS.

Emerald, see Solomon & Peres & Irish Rec. Factors.

Epic, see CBS.

Fantasy, see EMI.

Fontana, see Polydor.

Gael-Linn, 54 Sraid Grafton, Dublin 2. Tel: 776-624.

Globe, see Irish Rec. Factors.

H M V, see EMI.

Harmony, see CBS.

Harp, see Shamrock.

Harvest, see EMI.

Hawk Recs. (IFPI), IMS House, 5/6 Lombard St., Dublin 2. Tel: (01) 774-229/220, 779-762. Mng. Dir.: Brian Molloy; Gen. Mgr.: Marcus Connaughton.

Labels: Comhaltas, Hawk, Immediate, Lunar, Misty, Nems, Opal, Puck, Ram, Stop, Target.

Int'l rep.: Canada (Boot).

Heliodor, see Polydor.

Heritage, see Demesne.

Hit, see Release.

Horslips Recs. Ltd. (IFPI), 66 Dartmouth Square, Dublin 6. Tel: (01) 689-366. Chief Exec.: Jim Slye; Gen. Mgr.: Angela Caffrey.

Int'l rep.: Worldwide (Phonogram) excluding Ireland.

I D/Heritage, see CBS.

I M I, see Avoca.

Immediate, see Hawk.

Independent Music Sales, 5/6 Lombard St., Dublin 2. Tel: (01) 779-046, 720-498, 723-364. Gen. Mgr.: Gerry O'Byrne; Sales Mgr.: Peter O'Beirne (Distributor)

Labels: (Distributed) Claddagh, Hawk, Hit, Musikelt, Nems, Oats, Outlet, Play, Prize, R&O, Ram, Release, Shaft, Solo, Tap, Topspin.

Irish Rec. Factors Ltd. (IFPI), PO Box 377, 9/10 Hanover St. E., Dublin 2. Tel: (01) 784-755. Cable: IRECFACFS. Gen. Mgr.: Michael H. Geoghegan; Promo. Mgr.: Phyl Mitton.

Labels: (Owned) Rex; **(licensed)** Free Reed (UK), Rego (USA), Supraphon (Czechoslovakia); **(distributed)** Berserker (UK), Bonus, Comhaltas, Denver, Dolphin, Emerald, Gael-Linn, Globe, Mercier, Mooncrest (UK), NIRC, Oryx (UK), Outlet, Peerless (UK), Power Exchange (UK), Ros, Rounder (USA), Sail, Ton; **(represented)** Argo, Avoca, B&C, Barclay, CRD, Cube, Daily Express, Deram, Fantasy, Grunt, Nevis, Nonesuch, L'Orseau Lyre, Qualiton, RCA, Reflection, Rockfield, Rubber, Spoken Arts, Threshold, Topic, Trojan, Turnabout, Unicorn, Viva, Vocalion, Vox.

K-tel Int'l (Ireland) Ltd., 66 Dame St., Dublin 2. Tel: (01) 710-811. Telex: 4263. Mng. Dir.: Brendan Harvey. Home office: USA.

Livia Recs. (Davis Stationery Ltd.), 11 Capel St., Dublin 1. Tel: 748-169/792. Dir.: Gerald Davis.

Lunar, see Hawk.

M G M, see Polydor.

M P I Recs., 39 Serpentine Ave., Dublin 4. Telex: 683638. Mng. Dir.: Philip Green.

Menlo-Int'l Recs., Ballincurra, Limerick. Tel: Limerick 47375.

Mercier, see Irish Rec. Factors.

Mercury, see Polydor.

Mint, see Solomon & Peres.

Misty, see Hawk & Solomon & Peres.

Mulligan, see CBS.

Music for Pleasure, see EMI.

Musikelt, see Independent Music.

N I R C, see Irish Rec. Factors.

Nems, see Hawk.

Oats, see Independent Music.

One Up, see EMI.

Opal, see Hawk.

Outlet, see Irish Rec. Factors.

Outlet/Homespun, see EMI.

Parlophone, see EMI.

Philips, see Polydor.

Play, see Release.

Polydor Ltd. (IFPI), 49 Middle Abbey St., Dublin 1. Tel: (01) 42579. Cable: POLYDOR LTD. Telex: 852-4129-5341. Mng. Dir.: John J. Woods.

Labels: (Owned) Archiv, DG, Fontana, Heliodor, MGM, Mercury, Philips, Polydor, Vertigo, Verve; **(licensed)** All Platinum, Big Ben, Bradley's, CTI, Charisma, Chelsea, Dawn, Disneyland, GTO, GVC, Golden Hour, H&L, Kama Sutra, Kudu, Pablo, Pyc, RSO, Ring-O, Sire, Spark, State, Stax, Tangent, Track, 20th Century, UK, Vanguard, Volcan, **(distributed—not licensed)** Precision, Ram.

Precision, see Polydor.

Puck, see Hawk.

Quartz Recs., 20 Shielmartin Dr., Sutton, Dublin 13. Tel:

(01) 325-437. Mng. Dir.: Jerry Hughes; Gen. Mgr.: Pete St. John; Sales Mgr.: Pat Reilly.

R & O, see Independent Music.

Ram, see Hawk & Polydor.

Regal Zonophone, see EMI.

Release Recs. Ltd. (IFPI), 5/6 Lombard St., Dublin 2. Tel: (01) 779-046, 784-529/182. Mng. Dir.: Michael Clerkin; Gen. Mgr.: Michael O'Riordan.

Int'l branch: USA.

Labels: (Owned) Hit, Play, Release, Solo
 Int'l reps.: UK (Northern Ireland—Independent Music, England—Shannon).

Rex, see Irish Rec. Factors.

Rip-Off, see Solomon & Peres.

Ros, see Irish Rec. Factors.

Sail, see Irish Rec. Factors.

Shaft, see Independent Music.

Shamrock Souvenir Rec. Co. Ltd., 13-14 Magennis Pl., Dublin 2.

Labels: (Owned) Harp, Shamrock; **(distributed—not licensed)** Quartz

Solo, see Release.

Solomon & Peres Ltd., Dublin Ind'l Estate, 106-B, Finglas, Dublin 11. Tel: (0001) 309-922. Telex: 30937. Mng. Dir.: Mervyn A. Solomon; Gen. Mgr.: Shay Hennessy.

Home office: Northern Ireland in UK.
Labels: (Owned) Emerald, Mint, Rip-Off; **(distributed—not licensed)** Arade, Charley, Chiswick, Decca, Ember, Enterprise, Galaxy, Logo, RCA, Stiff, WEA (all UK); Claddagh, Hawk, Misty, Release.

Sovereign, see EMI.

Spin, see Symphola.

Spire, see Dolphin.

Starline, see EMI.

Stateside, see EMI.

Stop, see Hawk.

Symphola Co. Ltd., 56 Harcourt St., Dublin 2. Tel: (01) 758-523. Cable: EIRE.

Home office: Northern Ireland in UK.

Labels: (Owned) Spin; **(represented)** DJM.

Talisman, see EMI.

Tap, see Independent Music.

Tara Ents. Ltd., 5 Tara St., Dublin 2. Tel: (01) 776-921, 771-650. Mng. Dir.: John Cook.

Labels: (Owned) Tara; **(distributed—not licensed)** Shanachie (USA)

Int'l reps.: Germany (Eulenspiegel), UK (I&B), USA (Rounder, Shanachie).

Target, see Hawk.

Ton, see Irish Rec. Factors.

Topspin, see Independent Music.

Triskel, see Dolphin.

Vertigo, see Polydor.

Verve, see Polydor.

Waverley, see EMI.

World, see EMI.

● music publishers

Celtic Songs, 97A Talbot St., Dublin 1. Tel: 777-788. Mng. Dir.: Brian J. Barker; Gen. Mgr.: Maureen McNamee.

Emerald Music, Dublin Ind'l Estate, 106-B, Finglas, Dublin 11. Tel: (0001) 309-922/209. Gen. & Sales Mgr.: Louis Solomon.

Home office: Northern Ireland in UK.

Int'l firms represented: Aesop's Fable (USA), Jumping Jade (USA), SPR (USA).

Int'l reps.: Australia (Loeds), France (Nouvelles, OK), South Africa (Intersong), Odyssey (USA).

Emitune, Dublin Ind'l Estate, 130 Slaney Rd., Finglas, Dublin 11. Tel: 309-077. Cable: EMITRON. Telex: 4535. Mng. Dir.: Brian Dockery; Comm'l Mgr.: Michael F. Roberts.

Emma Music Ltd., 5/6 Lombard St., Dublin 2. Tel: (01) 784-420. Mng. Dir.: Michael Clerkin; Gen. Mgr.: Michael O'Riordan.

Int'l firms represented: Morning (Canada), Red Bus (UK).

Frontier Music, see Emma.

Green Grass Music (MCPS, PRS), Carrick Rd., Drumshanbo, County Leitrim. Tel: Drumshanbo 13, Dublin 305118. Mng. Dir.: Paschal C. Mooney.

Int'l firms represented: Contention (USA), Hello Darlin' (USA), Ricci Mareno (USA), Morning (Canada), Window (USA).

Keady Music, see Squirrel.

Pat Kerry Music, see Celtic.

McGuigan Music, see Celtic.

Mild Music, 5 Tara St., Dublin 2. Tel: (01) 776-921, 771-650. Mng. Dir.: John Cook.

Music Publ'rs of Ireland, 39 Serpentine Ave., Dublin 4. Tel: 683638. Mng. Dir.: Philip Green.

Pintz Music, see Sally Ann.

Raglan Music, J.F. Kennedy Estate, Naas Rd., Dublin 12. Tel: (01) 508-256. Telex: 30434. Chief Exec.: John J. Woods.

Int'l firm represented: Intersong (UK)

Regina Music, 9/10 Hanover St. E., Dublin 2. Tel: (01) 784-755. Gen. Mgr.: Michael H. Geoghegan; Promo. Mgr.: Phyl Mitton.

Saint Music, see Sally Ann.

Sally Ann Songs, 5/6 Lombard St., Dublin 2. Tel: (01) 779-046. Mng. Dir.: Jerry Hughes; Gen. Mgr.: Pete St. John.

Int'l rep.: USA (Tony Dirizziano)

Segway Music Ltd., see Squirrel.

Simon Music, see Emma.

Simpa Music, see Squirrel.

Skin Music, see Celtic.

Squirrel Music, IMS House, Lombard St., Dublin 2. Tel: (01) 774-229/220, 778-701, 779-762, 763-862. Gen. Mgr.: Marcus Connaughton.

Int'l firms represented: Amphonic (UK), Harner (Spain), Kleinerts (Denmark).
 Int'l reps.: Denmark (Kleinerts), Spain (Harner).

Woodtown Music Publ'ns Ltd., Dame House, Dame St., Dublin 2. Tel: (01) 778-943/034. Chm. Gareth Browne.

● services

ASSOCIATIONS & PROFESSIONAL ORGANIZATIONS

Irish Arts Council, 70 Merrion Square, Dublin 2. Tel: (0001) 764-685.

Irish Federation of Musicians & Assoc'd Professions, 63 Lower Gardiner St., Dublin 1. Tel: (001) 744-645.

Irish Music Inds., 15 Herbert St., Dublin 2. Tel: 766-940. Gen. Mgr.: Michael O'Riordan.

Music Ass'n of Ireland Ltd., 11 Suffolk St., Dublin 2. Tel: (01) 770-976. Chm.: Pat O'Kelly; Organizer: Eoin Garrett.

DESIGN & ARTWORK

Diana O'Donnell (Commercial Designs), 81/82 Aungier St., Dublin 2. Tel: (01) 780-044/721.

LICENSING ORGANIZATIONS, MUSIC

M C P S (Mechanical-Copyright Protection Society) Ltd., 15 Herbert St., 2nd fl., Dublin 2. Tel: 766-940/996. Gen. Mgr.: David Buskell.

P R S (Performing Right Society) Ltd., 15 Herbert St., Dublin 2. Tel: 767-388, 761-181. Mgr.: Pat Condon.

PLATING, PROCESSING & PRESSING PLANTS

Carlton Prod'n's Ltd., John F. Kennedy Dr., Naas Rd., Dublin 12. Tel: (01) 505-773, 514-044. Cable: DISCXTAPE. Telex: 30544. Mng. Dir.: Robert McGrattan; Gen. Mgr.: Patrick Trundle; Sales Mgr.: Vincent Smialek.

EMI (Ireland) Ltd., Dublin Ind'l Estate, 130 Slaney Rd., Finglas, Dublin 11. Tel: 309-077. Cable: EMITRON. Telex: 4535. Mng. Dir.: Brian Dockery; Sales Mgr.: John Condren; Comm'l Mgr.: Michael F. Roberts. (Pressing only)

Solomon & Peres Ltd., Dublin Ind'l Estate, 106-B, Finglas, Dublin 11. Tel: (0001) 309-922. Telex: 30937. Mng. Dir.: Mervyn A. Solomon; Gen. Mgr.: Shay Hennessy.

RECORD PROMOTION

EMI (Ireland) Ltd., Dublin Ind'l Estate, 130 Slaney Rd., Finglas, Dublin 11. Tel: 309-077. Cable: EMITRON. Telex: 4535. Mng. Dir.: Brian Dockery; Sales Mgr.: John Condren; Comm'l Mgr.: Michael F. Roberts.

Hughes Int'l Mgmt. Ltd., 5/6 Lombard St., Dublin 2. Tel: (01) 779-046. Mng. Dir.: Jerry Hughes; Gen. Mgr.: Pete St. John; Sales Mgr.: Pat Reilly.

Music Mktg., 71 Middle Abbey St., Dublin 1. Tel: (01) 742-627, 851-128.

Solomon & Peres Ltd., Dublin Ind'l Estate, 106-B, Finglas, Dublin 11. Tel: (0001) 309-922. Telex: 30937. Mng. Dir.: Mervyn A. Solomon; Gen. Mgr.: Shay Hennessy.

TAPE CUSTOM DUPLICATORS

Apex Electrical Co. Ltd., 3 Burgh Quay, Dublin 2. Tel: 777-788. Chief Exec.: Joseph P. O'Reilly; Gen. Mgr.: Maureen McNamee; Sales Mgr.: Peter Doyle.

Audio: Cassette.

Carlton Prod'n's Ltd., John F. Kennedy Dr., Naas Rd., Dublin 12. Tel: (01) 505-773, 514-044. Cable: DISCXTAPE. Telex: 30544. Mng. Dir.: Robert McGrattan; Gen. Mgr.: Patrick Trundle; Sales Mgr.: Vincent Smialek.

Audio: 8-tr., cassette.

EMI (Ireland) Ltd., Dublin Ind'l Estate, 130 Slaney Rd., Finglas, Dublin 11. Tel: 309-777. Cable: EMITRON. Telex: 4535. Mng. Dir.: Brian Dockery; Sales Mgr.: John Condren; Comm'l Mgr.: Michael F. Roberts.

Audio: Cassette.

● supplies

CARTRIDGE & CASSETTE PARTS EMPTY CARTRIDGES, CASSETTES & REELS

Agfa-Gevaert Ltd., PO Box 368A, John F. Kennedy Dr., Naas Rd., Dublin 12. Tel: (01) 506-733. Telex: 5429. Mng. Dir.: Mr. Vervoort; Sales Mgr.: Mr. Eggers.

Audio: Blank—compact-cassette, open reel; raw—cassette, broadcast, studio.

Video: Cassette, open reel.
 Brand names: Agfa Carat, Agfa Stereochrom, Agfa Videochrom.

Denis Coakley Ltd., Clonee, County Meath. Tel: (01) 214-011. Cable: DECO. Telex: 5277. Gen. Mgr.: Mervyn Groves. (Raw & blank loaded tape only)

Audio: Cassette, open reel.
 Video: Blank—1" open reel, ¾" cassette, VCR.

Brand name: BASF.

Contek Teoranta, Carraroe, County Galway. Tel: Galway 72144. Mng. Dir.: Joe Jamieson.

Branch: England.
 Audio: Cassette.

● accessories
 manufacturers / importers

Contek Teoranta, Carraroe, County Galway. Tel: Galway 72144. Mng. Dir.: Joe Jamieson.

Branch: England.
 Product: Head cleaners & demagnetizers, leader & splicing tape.

Demmes Recs. Ltd., 22 Ellis Quay, Dublin 7. Tel: (01) 720-411. (Distributor/Importer)

Product: Tape carrying & storage cases.

Independent Music Sales, 5/6 Lombard St., Dublin 2. Tel: (01) 779-046. Gen. Mgr.: Gerry O'Byrne; Sales Mgr.: Peter O'Beirne.

Product: Tape carrying & storage cases, cleaners, cloths, brushes, head cleaners & demagnetizers.

Product: Tape carrying & storage cases, cleaners, cloths, brushes, head cleaners & demagnetizers.

Product: Tape carrying & storage cases, cleaners, cloths, brushes, head cleaners & demagnetizers.

Product: Tape carrying & storage cases, cleaners, cloths, brushes, head cleaners & demagnetizers.

Product: Tape carrying & storage cases, cleaners, cloths, brushes, head cleaners & demagnetizers.

Irish Rec. Factors Ltd., PO Box 377, 9/10 Hanover St. E., Dublin 2. Tel: (01) 784-755. Cable: IREFACTS. Gen. Mgr.: Michael H. Geoghegan.
Product: Carrying & storage cases, cleaners, cloths, brushes, 45 rpm adapters, head cleaners & demagnetizers.
 Solomon & Peres Ltd., Dublin Ind'l Estate, 106-B, Finglas, Dublin 11. Tel: (0001) 309-922. Telex: 30937. Mng. Dir.: Mervyn A. Solomon. Gen. Mgr.: Shay Hennessy.
Product: Record & tape carrying & storage cases, record & tape catalog servs., cleaners, cloths, brushes, 45 rpm adapters, head cleaners, demagnetizers, needles, leader & splicing tape.

● store fixtures & merchandising aids manufacturers / importers

August Engraving Co. Ltd., 9 Burgh Quay, Dublin 2. Tel: (01) 783-288/325. Mng. Dir.: Tony Byrne.
Product: Record & tape divider cards.
 Independent Music Sales, 5/6 Lombard St., Dublin 2. Tel: (01) 779-046. Gen. Mgr.: Gerry O'Byrne; Sales Mgr.: Peter O'Beirne.
Product: Tape display racks.

ISRAEL

Population: 3,540,000.
 Rate of exchange: \$1 (US) = 25.45 pounds.
 Per capita income: \$3,038.
 Holidays: April 23 (Independence Day), Rosh Hashanah, Yom Kippur, Succoth.
Records, record blanks & pre-recorded media imported from USA: 1977—\$208,524.
Records exported to USA: 1977—56,939 units, \$131,720.

● record & tape manufacturers / distributors / importers

Amir, see Isradisc.
 Arton, see Hed Arzi.
 C B S Recs. Ltd. (IFPI), PO Box 681, Tel Aviv 61000; 50 Thon St., Industrial Zone, Holon 58811. Tel: (972 3) 80.01.91. Cable: COLRECORD. Telex: 33422. Mng. & A&R Dir.: Shirley Schmidt; Classical A&R & Copyright Dir.: Ran Kedar; Mktg. Dir.: Alan Feinberg; Int'l Serv. Co-ord.: Jennifer Aruch; Mtg. & Warehousing Dir.: Daniel Yadin.
Reg'l branch: Cyprus, CBS (UK) Ltd.
Labels: (Owned) CBS, Embassy, Epic, Portrait; **(licensed)** ABC (USA), A&M (worldwide), ARC (USA), Arista (USA), Baccara (France), CGD (Italy), Caribou (USA), Carrere (France), EMI group (worldwide), Hansa (Germany), Jet (USA), Karma (Germany), Kirshner (USA), Lifesong (USA), MCA (USA), Minos (Greece), Monument (USA), PIR (USA), Pinnacle (UK), Polar (Sweden), Private Stock (USA), Purple (UK), RAK (UK), Salsoul (USA), Satril (UK), Tappan Zee (USA), T-Neck (USA), United Artists (worldwide), Vanguard (USA).
Int'l rep.: Worldwide (CBS).

Carmel, see Hataklit.
 Chimo, see K-tel.
 D R G, see Gal-Ron.
 Disneyland, see Hataklit.
 Dzigan, see Gal-Ron.
 Eastonics Ltd. (IFPI), PO Box 39300, 11 Rozanis St., Tel Baruch, Tel Aviv. Tel: (03) 47-51-51. Cable: EASTRONIX. Telex: 33638. Mng. Dir.: Dov Peleg; Rec. Div. Mgr.: Noah Eitan.
Labels: (Owned) Maestro; **(represented)** Acanta (Germany), Affinity (UK), CTI (USA), Charly (UK), Cream (USA), Erato (France, UK), Grunt (USA), Harmonia Mundi (Germany), Hi (USA), Inner City (USA), Kudu (USA), Logo (UK), MMO (USA), Motown (USA), RCA (worldwide), Salsoul (USA), Springboard (USA), Xanadu (USA).

Embassy, see CBS.
 Ephrat, see Isradisc.
 Epic, see CBS.
 F H M M, see Gal-Ron.
 Folk 2000, see Hataklit.
 Gal-Ron Ltd. (IFPI), 94 Allenby St., Tel Aviv. Tel: (03) 61-48-38/14-45/21-62. Cable: ZELREX. Gen. Mgr.: A. Zborowski; Sales Mgr.: I. Levi.
Labels: (Owned) DRG, Dzigan, Gal-Ton, Gloria, Ron-Phon; **(distributed)** FHMM, Studio; **(licensed)** Evasion (Switzerland), Festival (France), GSF (USA), MK (USSR), Motors (France), OSI (France), Ri-Fi (Italy), Sonoplay (Spain), Victor (Japan).
 Gal-Ton, see Gal-Ron.
 Gloria, see Gal-Ron.
 Good Music, see Hataklit.
 Hataklit Ltd. (IFPI), PO Box 4292, 11 Herzl St., Haifa. Tel: (04) 64-55-21. Cable: RECOMUSIC. Mng. Dir.: Dov Zeira; Gen. Mgr.: Sara Zeira; Int'l A&R Mgr.: Gedi Livneh; Sales Mgr.: Henri Teicher.
Branch: Tel Aviv, 19 Pinksler St. Tel: (03) 29-30-08, 28-31-17. A&R Mgr.: Zvi Kagan.
Labels: (Owned) Carmel, Disneyland, Folk 2000, Good Music, Idan, Ilanot, Krypton, Moody Sound, Teen, Top Hits; **(distributed)** Hazamir, Makolit; **(licensed)** AVI (USA), Ashire (USA), Archive of Folk & Jazz Music (USA), Archive of Piano Music (USA), Arion (France),

BBZ (France), Barclay (France), Bellaphon (Germany), Biram (France), Bradley's (UK), CNR (Netherlands), Carabine (France), Casablanca (USA), Chartbusters (UK), Chorus (France), Chrysalis (UK), Clave (Spain), Concert Disk (USA), Contempo (UK), Counterpoint (USA), DJM (UK), Daily Mirror (UK), Dawn (UK), Disneyland Vista (USA), Dynamic (France), Esoteric (USA), Everest (USA), Fantasy (USA), GRT (USA), Gaviotta (Spain), Golden Hour (UK), Hi-Fi (USA), Hispavox (Spain), La Comedia Francaise (USA), Legacy (USA), Magnet (UK), Marble Arch (UK), Mashine (France), Milestone (USA), Mode (France), Mystic Moods (USA), Oasis (USA), Olympic (USA), Palette (Belgium), Peerless (UK), Period (USA), Picadilly (UK), Pop Club (UK), Pop 12 (France), Prestige (USA), Fye (UK), RKM (Belgium), Riviera (France), Roadshow (USA), Roulette (USA), Satbel (South Africa), Shadybrook (USA), Silverline (UK), Sound Bird (USA), Sutton Miller (USA), Topkapi (France), Tradition (USA), Trema (France), 20th Century (USA), Up (Belgium), Virtuoso (UK), Vogue (France).
Int'l reps.: Benelux (RKM), France (Vogue), Netherlands (CNR), USA (House of Menorah).

Hazamir Music Ltd. (IFPI), 68 Jaffa St., Jerusalem. Tel: (02) 23-31-46. Telex: 44801. Mng. Dir. & Gen. Mgr.: Eli Mamane; Promo. Dir.: Sima Cohen. (Distributed by Hataklit).
Label: (Distributed—not licensed) Metronome (Germany).
 Hed Arzi (1973) Ltd. (IFPI), 4 Hilazon St., Ramat Gan. Tel: (03) 72-20-03. Telex: 341667. Mng. Dir.: Zeev Lewin; Gen. Mgr.: Uzi Netanel; Sales Mgr.: Adi Diskin; A&R Mgr.: Avi Brand. (Distributor as General Music Co. Ltd.).
Labels: (Owned) Arton, Hed Arzi; **(licensed)** Ariola America (USA), Ariola (Germany), Atlantic (USA), Elektra/Asylum (USA), Fonit-Cetra (Italy), WEA (USA), Warner Bros. (USA).
Int'l rep.: USA (Zemeran Trading).

Idan, see Hataklit.
 Ilanot, see Hataklit.
 Isradisc Ltd., PO Box 230, 5 Smolenski St., Tel Aviv. Tel: (03) 22-19-79, 24-91-93. Dir.: Abshalom Rubin.
Labels: (Owned) Amir, Ephrat, Israel.
 Isreal, see Isradisc.
 K-tel Int'l (Israel) Ltd. (IFPI), 75 Rehov Dizengoff, Tel Aviv. Tel: (03) 28-44-14. Cable: KTEL. Telex: 35770. Mng. Dir.: Carey Budnick.
Labels: (Owned) Chimo, K-tel, Orange Int'l; **(licensed foreign)** Baby (Italy), Can't Stop (USA), Chrysalis (UK), Durium (Italy), Goody (USA), Ibach (France), Ibis (France), Island (UK), Midsong Int'l (USA), Panarecord (Italy), Prelude (USA), Sirocco (France), Stiff (UK).
Int'l rep.: Worldwide (K-tel).

Koliphone Recs., 29 Razieli St., Jaffa-Tel Aviv. Tel: (03) 82-60-47, 83-23-70.
 Krypton, see Hataklit.
 Litratone Ltd. (IFPI), 7 Harugey St., Tel Aviv 69714. Tel: (03) 48-31-65. Dir.: David Fuchs.
Labels: (Owned) Phonodor, Rec-O-Hit; **(licensed)** Amadeo (Austria), Archiv (Germany), Capricorn (USA), Casablanca (USA), Charisma (UK), Cube (UK), DG (Germany), Fontana (France, UK), H&L (USA), Haven (USA), Heliodor (Germany), MGM (USA), Mercury (France, USA), Metronome (Germany), Pablo (USA), Philips (France, Netherlands, USA), Polydor (Germany), RSO (UK, USA), Rocket (UK), Track (UK), Vertigo, Verve (USA).
Int'l rep.: Worldwide (Phonogram).

Maestro, see Eastonics.
 Makolit, see Hataklit.
 Moody Sound, see Hataklit.
 Orange Int'l, see K-tel.
 Phonodor, see Litratone.
 Portrait, see CBS.
 Rec-O-Hit, see Litratone.
 Ron-Phon, see Gal-Ron.
 Studio One, 33 Allenby Rd., Tel Aviv. Tel: (03) 5-66-56. (Distributed by Gal-Ron).
Label: (Owned) Studio.
 Teen, see Hataklit.
 Top Hits, see Hataklit.

Unatex Import Export Ltd. (IFPI), 29 Lilienblum St., Tel Aviv. Tel: (03) 5-57-76, 59841. Cable: UNAIMEX. Gen. Mgr.: Jerry Janowski; Sales Mgr.: Ronnie Janowski.
Labels: (Represented) Audiofidelity (USA), Baerenreiter (Germany), Carabin (France), Durium (Italy), Lollipop (Germany), Miller Int'l (Germany), Telefonken (Germany), Vox Turnabout (USA).

● music publishers

April Music Ltd. (ACUM), PO Box 681, Tel Aviv 61000; 50 Thon St., Industrial Zone, Holon 58811. Tel: (972 3) 80.01.91. Cable: COLRECORD. Telex: 33422. Gen. Mgr.: Ran Kedar.
Int'l firms represented: April/Blackwood (worldwide), Boom (USA), Chandos (USA), Clay (USA), Hammond (USA), Joelsongs (USA), Mine/Strong Arm (USA), Rock (USA), Rondo/Irving/Almo (UK, USA), Sheryl (USA), Tuna Fish (USA), Union Songs (Sweden).
Int'l rep.: Worldwide (April/Blackwood).
 I C L P (Israel Composers League Publ'ns Ltd.), 73 Nordau Blvd., Tel Aviv. Tel: (03) 44-03-95.
 Ilanot Music Publ'g, PO Box 4292, 11 Herzl St., Haifa. Tel: (04) 66-99-50, 64-55-21. Cable: RECOMUSIC HAIFA. Mng. Dir.: Dov Zeira; Prof. Mgr.: Gedi Livneh.
Int'l firms represented: Abigail (USA), Bleu Blanc Rouge (France), Cayman (USA), Cissi (USA), Walt Disney (USA), Ladysmith (UK), Levin & Brown (USA), Robert Mellin (UK), Minotaur (France), Johnny Nash (USA), RKM (Belgium), Rocket (UK), State (UK), ATV group (USA)—Attache, Bayshore, Billy Bob, Brother Karl's, Caseyem, Cliffhouse, Colhand, Comet, Emily, Lowell Fulsom, Group One, Hill & Range, Liza Jane, Lloyds, Mr. Dogg, Plaque, Return, Riverbank, Sequel, Sounds of Memphis, Sweco, Welbeck, Jerry Williams, Zonal, ATV group (UK)—Tony Hiller, Kirshner, Northern Songs, Pamscene, Tic Toc, Lawrence Wright; **Alshire**

group (USA)—Chesdel, Daval; Heath Levy group (UK)—Arreta, Blue Eyes, Copenstar, Geoff & Eddie, Gold Dust, Jack, Lazy Lizard, David Martin, Xavier, Island group (UK)—Acorn, BBK, Boggsey, Burdock River, Creedmore, Dai Davis, Faith, Fantasy Songs, Freedom Songs, Freshwater, GO, Harakiri, House of Dreams, Jamarnie, Karma, Keepers Cottage, Lemon, Libra, Lunar, Malpas, Porpois, Rockbottom, Savage Ayris, Sharks, Showfield, Smash Bros., Socks, Trees, Warlock; Morning group (Canada)—Canadian Brass, Critique, Crown-Vetch, Alex Groshak, Homeland, Izetta Brass, Land of Song, Skinners Pond, Time Being; V. Morning Group (USA)—Joe Allen, Annie Oving, Arapaho, Aunt Polly's, Barlow, Bathurst, Berrywood, Blue Band, Blue Echo, Blueford, Blue Melody, Dean's List, Enoree, Evening, Gold Dust, Good, Lloyd Green, Hitkit, Indian Lake, Jack, Jando, Miss Molly's, Mogollon Mountain, Music Craftshop, Myonah, Pulleybone, Razan, Rolling Meadows, Owlflow, Shenandoh, Sidewalk, Silver Dollar, Skinner Pond, Starburst, Stonehill, Terrace, Tessie's Tunes; **Welbeck group (USA)—Blue Monday, Crazy Creek, Dawnbreaker, Sequel, Sounds of Memphis, Sweco.
Int'l reps.: France (Bleu Blanc Rouge), UK (ATV).
 Israeli Music Publ'ns Ltd. (ACUM), PO Box 6011, 105 Rehov Ben Yehuda, Tel Aviv. Tel: (03) 23-20-78. Cable: ISMUSIC.**

Int'l firms represented: Bote & Bock (Germany), Carisch (Italy), Curci (Italy), Durand (France), Eschig (France), Faber (UK), Hans Gerig (Germany), Heinrichshofen-Impero-Pegasus (Germany, Switzerland), Leduc (France), Oxford Univ. Press (UK), Schott (Germany, UK), Hans Sikorski (Germany).
Int'l reps.: Germany (Impero-Verlag), Benelux, France, Italy, Portugal, Spain & UK (Peters); USA (Alexander Broude).

Israel Music Institute (IMI), PO Box 11253, 6 Chen Blvd., Tel Aviv. Tel: (03) 28-43-97. Mng. Dir.: William Elias.
Int'l firms represented: Baerenreiter (West Germany), Durand (France), Eschig (France), Leduc (France), Novello (UK), G. Ricordi (Italy), Universal (Austria, UK).
Int'l reps.: Argentina (Ricordi Americana), Austria (Universal), Canada (Boosey & Hawkes), Denmark (Wilhelm Hansen), France (Boosey & Hawkes), Germany (Baerenreiter), Italy (G. Ricordi), Netherlands (Alberson), Norway (Harald Lyche), Sweden (Nordiska), Switzerland & UK (Universal), USA (Boosey & Hawkes).
 Isratav, PO Box 230, 5 Smolenski St., Tel Aviv. Tel: (03) 22-91-79, 24-91-93. Mng. Dir.: Abshalom Rubin.

Israzemer Music Publ'g Ltd., see Ilanot.
 Litratone Publ'g Ltd., 7 Harugey Malchut St., Tel Aviv 69714. Tel: (03) 48-31-64. Cable: ISRALECTRA. Dir.: David Fuchs.
Int'l firms represented: Artemis, Chappell, Intersong, Music Library, Culture & Education Ents Ltd., General Federation of Labor, 53 Weitzman St., Tel Aviv. Tel: (03) 25-63-28. Gen. Mgr.: Sami Zur.
 Muscor Ltd., 11 Rozanis St., Tel Baruch, Tel Aviv. Tel: (03) 47-51-51. Cable: EASTRONIX. Telex: 33638. Dir.: Dov Peleg.
Int'l firms represented: Arista, Birdsee, Butter, Career, Churn, Cream, East/Memphis, Fi, Jec (all USA).
 Osnath Publ'g Ltd., 4 Hilazon St., Ramat Gan. Tel: (03) 72-20-03. Telex: 32470. Gen. Mgr.: Zeev Lewin; Sales Mgr.: Uzi Netanel.
 Pa'amomim, see Subar.
 Sharon, see Subar.

Subar Music Publ'g Co. Ltd. (ACUM), 21 Any Ma'amim St., Ramat-Hasharon 47212. Tel: (03) 47-13-23. Gen. Mgr.: Dr. Ophira Bar-Elan.
Int'l firms represented: Charing Cross (UK), Playboy (USA), Screen Gem-EMI (USA), Sparta Florida (UK), Sugarmusic (Italy), Suvini Zerboni (Italy), United Artists group (USA), World (Belgium).

● services

ASSOCIATIONS & PROFESSIONAL ORGANIZATIONS

International Society for Contemporary Music, League of Composers in Israel, PO Box 11180, Tel Aviv. Tel: (03) 44-03-95.
 Israel Centre of the International Music Council, PO Box 176, Jerusalem.
 Israel Music Institute (IMI), PO Box 11253, 6 Chen Blvd., Tel Aviv. Tel: (03) 28-43-97.

DESIGN & ARTWORK

Domain Magnetics Ltd., PO Box 27085, Atarot, Jerusalem. Tel: (02) 85-62-80. Dir.: Warren Green; Sales Mgr.: F.G. Kinney. (Tape only)

LICENSING ORGANIZATION, MUSIC

A C U M (Authors Composers & Music Publ'rs Ass'n), PO Box 11201, 118/120 Rothschild Blvd., Tel Aviv 61110. Tel: (03) 24-01-05, 23-14-61. Cable: ACUMEMIS TEL-AVIV. Dir. Gen. & Bd. Delegate: Menahem Avidom; Gen. Sec'y: J. Ben-David.

PLATING & PROCESSING & PRESSING PLANTS

C B S Recs. Ltd., PO Box 681, Tel Aviv 61000; 50 Thon St., Industrial Zone, Holon 58811. Tel: (972 3) 80.01.91. Cable: COLRECORD. Telex: 33422. Mng. Dir.: Shirley Schmidt; Mktg. Dir.: Daniel Yadin.
 Hed Arzi (1973) Ltd., 4 Hilazon St., Ramat Gan. Tel: 72-20-03. Telex: 32470. Gen. Mgr.: Zeev Lewin; Sales Mgr.: Uzi Netanel.

PRINTER & LITHOGRAPHER

C B S Recs. Ltd., PO Box 681, Tel Aviv 61000; 50 Thon St., Industrial Zone, Holon 58811. Tel: (972 3) 80.01.91. Cable: COLRECORD. Telex: 33422. Mng. Dir.: Shirley Schmidt; Mktg. Dir.: Daniel Yadin.

TAPE CUSTOM DUPLICATORS TAPE PACKAGING & LABELING

The Audio & Video lines indicate the configurations which the firms duplicate. Companies which offer packaging & labeling of tape product are indicated by: (PKG) which appears after the main body of their respective listings.

CBS Recs. Ltd., PO Box 681, Tel Aviv 61000; 50 Thon St., Industrial Zone, Holon 58811. Tel: (972.3) 80.01.91. Cable: COLRECORD. Telex: 33422. Mng. Dir.: Shirley Schmidt; Mktg. Dir.: Daniel Yadin.
Audio: Cassette.

Domain Magnetics Ltd., PO Box 27085, Atarot, Jerusalem. Tel: (02) 85-62-80. Dir.: Warren Green; Sales Mgr.: F.G. Kinney. Audio: Cassette.

Hed Arzi (1973) Ltd., 4 Hilazon St., Ramat Gan. Tel: 72-20-03. Telex: 32470. Gen. Mgr.: Zeev Lewin; Sales Mgr.: Uzi Netanel.
Audio: 8-tr., cassette.

● supplies

CARTRIDGE & CASSETTE PARTS

Domain Magnetics Ltd., PO Box 27085, Atarot, Jerusalem. Tel: (02) 85-62-80. Dir.: Warren Green; Sales Mgr.: F.G. Kinney.
Audio: Cassette, open reel.

EMPTY CARTRIDGES, CASSETTES & REELS

Domain Magnetics Ltd., PO Box 27085, Atarot, Jerusalem. Tel: (02) 85-62-80. Dir.: Warren Green; Sales Mgr.: F.G. Kinney.
Audio: Cassette, open reel.

Palatchi & Co., PO Box 36572, Tel Aviv; 111 Allenby St., Tamar Passage. Tel: (03) 61-56-14. Telex: 341118 x 5998. Mng. Dir.: Isaac E. Palatchi; Gen. Mgr.: Yakov Bensinyor; Sales Mgr.: Rosette Palatchi. (Importer/Exporter)
Audio: Cassette.

ENVELOPES & MAILERS

Unatex Import Export Ltd., 29 Lilienblum St., Tel Aviv. Tel: (03) 5-57-76, 5-98-41. Cable: UNAIMEX. Gen. Mgr.: Jerry Janowski; Sales Mgr.: Ronnie Janowski. (Importer/Exporter)

JACKETS & SLEEVES LABELS

CBS Recs. Ltd., PO Box 681, Tel Aviv 61000; 50 Thon St., Industrial Zone, Holon 58811. Tel: (972.3) 80.01.91. Cable: COLRECORD. Telex: 33422. Mng. Dir.: Shirley Schmidt; Mktg. Dir.: Daniel Yadin.

Unatex Import Export Ltd., 29 Lilienblum St., Tel Aviv. Tel: (03) 5-57-76, 5-98-41. Cable: UNAIMEX. Gen. Mgr.: Jerry Janowski; Sales Mgr.: Ronnie Janowski. (Importer/Exporter)

PROFESSIONAL TAPE SUPPLIES

Palatchi & Co., PO Box 36572, Tel Aviv; 111 Allenby St., Tamar Passage. Tel: (03) 61-56-14. Telex: 341118 x 5998. Mng. Dir.: Isaac E. Palatchi; Gen. Mgr.: Yakov Bensinyor; Sales Mgr.: Rosette Palatchi. (Importer/Exporter)
Audio: Test & alignment cassette tapes.
Brand name: TDK.

TAPE, BLANK LOADED & RAW

Agfa-Gevaert, see S. Getter.

Aria, see Palatchi.

Domain Magnetics Ltd., PO Box 27085, Atarot, 18 Hamagid St., Jerusalem. Tel: (02) 85-62-80. Dir.: Warren Green; Sales Mgr.: F.G. Kinney.
Audio: Cassette, open reel.
Brand name: Opus.

S. Getter (Photo) Ltd., 98 Jabotinsky Rd., Petah Tiqwa, Kirjat Arze. Tel: 92-69-12. Cable: GETTERCO TELAVIV. Mng. Dir.: Paul Heger.
Audio: Blank—Compact-cassette, open reel, raw—cassette, broadcast, studio.
Video: Cassette, open reel.
Brand names: Agfa Carat, Agfa Stereochrom, Agfa Videochrom.

Opus, see Domain.

Palatchi & Co., PO Box 36572, Tel Aviv; 111 Allenby St., Tamar Passage. Tel: (03) 61-56-14. Telex: 341118 x 5998. Mng. Dir.: Isaac E. Palatchi; Gen. Mgr.: Yakov Bensinyor; Sales Mgr.: Rosette Palatchi. (Importer/Exporter)
Audio: Blank—8-tr., cassette, open reel; Raw—Cassette.
Video: Blank—½" EIAJ cartridge, VHS & Beta.
Brand names: Aria, TDK.

T D K, see Palatchi.

TAPE DUPLICATING & PROCESSING EQUIPMENT

Comhol Ltd., PO Box 39840, 24 Feinberg St., Tel Aviv. Tel: (03) 22-49-22, 41-03-40. Telex 341118 X 5518. Mng. Dir.: Eddie Wiegenfeld. (Importer)
Audio: High speed duplicators, 8-tr. & cassette loaders & tape exercisers.
Brand names: Audiomatic, Electro Sound, Pentagon.

Palatchi & Co., PO Box 36572, Tel Aviv; 111 Allenby St., Tamar Passage. Tel: (03) 61-56-14. Telex: 341118 x 5998. Mng. Dir.: Isaac E. Palatchi; Gen. Mgr.: Yakov Bensinyor; Sales Mgr.: Rosette Palatchi. (Importer/Exporter)
Audio: Cassette pancakes.

TAPE PACKAGING & LABELING EQUIPMENT & SUPPLIES

Domain Magnetics Ltd., PO Box 27085, Atarot, 18 Hamagid St., Jerusalem. Tel: (02) 85-62-80. Dir.: Warren Green; Sales Mgr.: F.G. Kinney.
Audio: Cassette Boxes.

● accessories manufacturers

Domain Magnetics Ltd., PO Box 27085, Atarot, Jerusalem. Tel: (02) 85-62-80. Dir.: Warren Green; Sales Mgr.: F.G. Kinney.

Product: Head cleaners, demagnetizers, leader & splicing tape.

Electron Csilag Ltd., 107 Hachashmonaim St., Tel Aviv. Tel: 26-05-33.

Product: Needles.

Brand name: Pickering.

Palatchi & Co., PO Box 36572, Tel Aviv; 111 Allenby St., Tamar Passage. Tel: (03) 61-56-14. Telex: 341118 x 5998. Mng. Dir.: Isaac E. Palatchi; Gen. Mgr.: Yakov Bensinyor; Sales Mgr.: Rosette Palatchi. (Importer/Exporter)

Product: Tape carrying & storage cases, head cleaners & demagnetizers.

Unatex Import Export Ltd., 29 Lilienblum St., Tel Aviv. Tel: (03) 5-57-76, 5-98-41. Cable: UNAIMEX. Gen. Mgr.: Jerry Janowski; Sales Mgr.: Ronnie Janowski. (Importer/Exporter)

Product: Record & tape carrying & storage cases, cleaners, cloths & brushes, 45 rpm adapters, head cleaners & demagnetizers.

● store fixtures & merchandising aids manufacturers

Domain Magnetics Ltd., PO Box 27085, Atarot, Jerusalem. Tel: (02) 85-62-80. Dir.: Warren Green; Sales Mgr.: F.G. Kinney.

Product: Tape divider cards.

Unatex Import Export Ltd., 29 Lilienblum St., Tel Aviv. Tel: (03) 5-57-76, 5-98-41. Cable: UNAIMEX. Gen. Mgr.: Jerry Janowski; Sales Mgr.: Ronnie Janowski. (Importer/Exporter)

Product: Record display racks.

ITALY

Population: 56,585,000

Rate of exchange: \$1 (US) = 849 lire.

Per capita income: \$3,000

No. of homes with record players: 7,000,000

Holidays: January 1, January 6 (Epiphany), Easter Monday, April 25 (Liberation Day), May 1 (Labor Day), August 15 (Assumption), November 1 (All Saints' Day), December 8 (Immaculate Conception), December 25, December 26 (St. Stephen's Day).

RECORDS:

Records: sold domestically including imports (retail value): LP's 1978—18,000,000 units; 1977—16,000,000 units. Singles 1978—25,000,000 units; 1977—21,000,000 units.

Average retail price per record (including 14% AVT): LP's—\$5.89; Singles—\$1.53.

Stereo sales: 96% of total.

Record club sales: 1% of total.

Discounting: Frequent.

Type of distribution: The manufacturer-to-retailer system predominates. There is no rack jobbing. Wholesalers account for about 30% of the market. About 800 of the nearly 1,500 to 2,000 specialist shops are seen as being fully reliable by the industry.

Type of promotion: Radio and television are the most important promotion channels; tours and live appearances by the artists are also highly effective. A few consumer newspapers (one of them a weekly magazine) prove influential.

Jukeboxes: 20,000.

TAPE:

Market: 8-track is virtually disappearing. Open reel and videotape data are unavailable but sales appear to be growing. Cassettes dominate the market with hardware sales constantly increasing. In addition to the figures reported below, at least eight million more units were sold in 1978 as pirated or counterfeited product, currently amounting to nearly \$33 million. In 1978, the share of the cassette market going to illegal manufacturers was estimated to be 50-55%. (The 1977 estimated data included pirated product.)

Pre-recorded tape sold domestically including imports: 8-tr. 1978—800,000 units, 1977—1,000,000 units. Cassette 1978—8,000,000 units; 1977—13,500,000 units.

Average retail price per tape: 8-tr. & Cassette—\$5.89.

RADIO STATIONS:

No. of commercial 2,000; no. of government 3.

Comment: Local radio stations, mostly FM, have established themselves through wide but fractionated audiences. A few are seen by the industry as powerful promotion channels. National radio stations (RAI) are more into talk shows.

TELEVISION STATIONS:

No. of commercial 300; no. of government 2 (80% PAL color).

Comment: National television stations (RAI) program music shows with wide promotional impact. Local stations, mostly UHF, are a recent innovation and they rely on movie films for programming. Music, however, is gaining some time with them.

IMPORT/EXPORT REGULATIONS:

No customs are charged to members of the European Economic Community, but a 14% VAT must be paid on imports from all countries.

MARKET ANALYSIS:

1978 proved to be an important year in the recent history of the Italian record industry as it meant expansion for most of the leading companies, with an overall growth between 13% and 20%, which indicates the market is overcoming the previous years' slump. Greater interest in disco music and the success of the "Saturday Night Fever" and "Grease" films and relevant soundtracks contributed much to the sales increase, but in general, the demand for all kinds of music increased, and the trend continued during the early months of 1979.

Italian artists, producers and composers found wider acceptance abroad than ever before, both in the conventional melody song-easy listening field and in the latest music business development—Italian-made disco music. This helped to bring in foreign currency, with companies such as CGD, CBS, Baby, Goody Music, Ariston, and RFI especially taking advantage.

The industry had to face stronger competition from record importers who secured a 10% share of the record market that is destined to grow to nearly 20% in 1979. Major record companies are particularly hard hit by the importers' action, as they also see their profits being eroded by piracy that represents a limited percentage of the record market but heavily affects the pre-recorded tape market. During the last months of 1978 and in early 1979 the industry was hindered by strikes concerning the renewal of the workers' national contract, which was eventually signed in the summer of 1979. The Italian consumers showed they are open to various types of music, from classical to rock to jazz, and this diversification of tastes is intensifying in 1979.

Daniele Caroli

● record & tape manufacturers / distributors / importers

Abici, see Fonit-Cetra.

Ace of Clubs, see Decca.

Ace of Diamonds, see Decca.

Agumanda Recs. Srl, Largo Cairoli 2, 20121 Milan. Tel: (02) 803.750. Local branch: Int'l Dept., Via Montepulciano 29. Tel: (02) 782.159.

Albatros, see Sciascia.

Alpha, see CGD.

America Recs. di Angeramo Nunzia, Galleria del Corso 2, 20122 Milan. Tel: (02) 704.006. Chief Exec. & Gen. Mgr.: Giovambattista Samele; Sales Mgr.: Sonia Samele. (Distributed by CLS).

Analecta, see Polygram.

Analogy, see Panarecord.

Angel, see EMI.

Angelicum, see Sciascia.

Antenna Nord, see CGD.

Antoniano, see Ri-Fi.

Appaloosa, fisee IREC.

Archivi Sonori, see Bella Ciao.

Archophon, see Sciascia.

Area, see Studio G.

Argo, see Decca.

Argo Prod'n, see CGD.

Ariete, see Carosello.

Aris Eds. Musicali & Discografiche, Via Eleonora Pimentel 2, 00195 Rome. Tel: (06) 311.979, 312.296. Cable: DISCARIS. Artistic Dir.: Aldo Pomilia; Musical Adviser & Label Mgr.: Claudio Tallino.
Labels: (Owned) Aris; (licensed) Central Park (Brazil), Martin Meyer (Argentina), Productura Musical (Venezuela), Satril (UK); (distributed—not licensed) Dany, Peerless (UK), Picci, Pinciana.
Int'l reps.: Argentina (Martin Meyer), Brazil (Central Park), Spain (Columbia), Venezuela (Productura Musical).

Ariston Srl (IFPI), Via Massimo Gorki 21, Strada Zivido, 20098 San Giuliano (Milan). Tel: (02) 984.6974. Telex: 321466. Pres.: Alfredo Rossi; Sales Mgr.: Riccardo Benini; Int'l Mgr.: Graham Johnson. (Distributed by Ricordi)

Branch: 00195 Rome, Via Cantore 17, Tel: (06) 386.259. Telex: 614509.

Labels: (Owned) Ariston, Auditorio Classico, Cultura Popolare, Jazz Story, Oxford; (licensed foreign) Charly (UK), Hexagone (France), Shelter (USA).

Int'l reps.: Argentina (RCA), Australia (Colossal), Brazil (RCA), Canada (Global), Chile (Quatro), Colombia (Fuentes), Greece (Music Box), Japan (King), Mexico (Gamma), Portugal (Arnaldo Trindade), Switzerland (Musikvertrieb), Venezuela (Promus).

Ars Nova, see Sciascia.

Ascolto, see CGD.

Asylum, see WEA.

Atlantic, see WEA.

Atlas Recs., Corso Buenos Aires 10, 20124 Milan. Tel: (02) 271.5972, 273.163. Pres. & Gen. Mgr.: Alessandro Coppola; Press & Promo. Mgr.: Daniela Festari. (Distributed by Polygram)

Labels: (Owned) Atlas, Clover. (SEE ADVERTISEMENT) Audiogram SpA, Via Vallosa 38, 25050 Passirano (Brescia). Tel: (030) 657.360. Telex: 300260. Owner & Mng. Dir.: Edoardo Cattaneo; Gen. Mgr.: Francesco Nervi; Sales Mgr.: Luciano Bassani.

Label: (Owned) Audioson. (SEE ADVERTISEMENT)
Audioson, see Audiogram
Auditorio Classico, see Armon.
B C E, see WEA
Baby Recs. Srl, Piazza Della Repubblica 26, Milan Tel (02) 657 1402/1491 Cable: BABYRECORD. Mng. Dir. Freddy Naggiar. (Distributed by CGD) (SEE ADVERTISEMENT)
Baffi, see CGD.
Ballo, see Belmusic
Base Rec., Via Castiglione 109, Bologna, Tel (051) 237 528, 504 095, Telex 511483. Dir. Giuseppe Nannucci; Gen. Mgr. Alberto Caroli; Sales Mgr. Antonio Foresti. (Distributed by Giucar)
Labels: (Owned) Base. (licensed foreign) ESP (USA), Uniteledisc (France)
Bazar Srl, Via Manfredi 5, 42100 Reggio Emilia, Tel (0522) 36825. Mng. Dir. & Gen. Mgr. Luigi Rinaldi
Labels: (Owned) Bazar. Record Executive.
Beat Recs. Co. Srl (IFPI), Via Filippo Nicolai 16, 00136 Rome Tel: (06) 348 497, 347 139. Gen. Mgr. Franco de Gemini; Int'l Mgr. Luciana Morello. (Distributed by Font-Cetra)
Labels: (Owned) Beat. Pentaphon, Perladisc, Pony Recs., (distributed—not licensed) Amphonic (UK), ECAP (France), Eurobeat (UK), Euroson (UK), Show Business (Germany)
Int'l rep.: UK (Eurobeat)
Bella, see Phonotype
Bella Ciao Srl (Eds.), Via Melzo 9, 20129 Milan Tel (02) 228 192
Labels: (Owned) Archivi Sonori. Dischi del Sole, Linea Rossa
Belmusic Srl, Via Tolmezzo 18, 20132 Milan, Tel (02) 282 8905. Gen. Mgr.: Severino Pecchenini, Sales Mgr. Domizia Gandolfi.
Labels: (Owned) Ballo, Belmusic, Gemini; Oh Bej, Oh Bej, Piggy; Snap.
Big, see Studio 7
Bla Bla Recs. Srl, Galleria del Corso 2, 20122 Milan, Tel (02) 796 149
Black Saint, see IREC
Blue, see Ricordi
Blue Jean, see Spark
Francesco Bongiovanni Recs., Via Rizzoli 28-E, 40125 Bologna Tel (051) 225722. Gen. Mgr.: Giancarlo Bongiovanni
Labels: (Owned) Bongiovanni. Il mito dell'opera. (licensed) Mizar, (distributed—not licensed) Adriano, Mixtur (Germany)
Int'l rep.: Germany (Mixtur)
Broadway, see Ducale
C A M (Creazioni Artistiche Musicali) SpA, Via Virgilio 8, 00193 Rome, Tel (06) 382 021. Cable: CAMUSIC. Telex 611374. Pres.: Giuseppe Campi; Prod'n Dir.: Giuseppe Giacchi, Sales Mgr. Bruno Bianchi (Distributed by RCA)
C B S Dischi SpA (IFPI), Via Amedeo 9, 20123 Milan, Tel (02) 809.521. Telex 332806. Mng. Dir. Piero La

Falce, Sr. Dir. Ervin R. Veg. A&R & Publ'g Dir.: Antonio Marrapodi; Controller: Ferdinando Magni (Distributed by CGD-Messaggerie Musicali)
Labels: (Owned) CBS, Epic, Masterworks. Portrait. (licensed) A&M (USA), ARC (USA), Bang (USA), Blue Sky (USA), Caribou (USA), Full Moon (USA), GTO (UK), Jet-ELO, Kirshner (USA), Lifesong (USA), Monument (USA), Musica Columbia-Iglesias, Nemperor (USA), Philadelphia Int'l (USA), Polar, TK (USA), Tappan Zee (USA), Unlimited Gold (USA)
C G D-Messaggerie Musicali SpA (IFPI), Via Quintiliano 40, 20138 Milan, Tel: (02) 50 84. Cable: CIGIDISC. Telex 350663. Pres.: Ladislao Sugar; Mng. Dirs. Piero Sugar, Franco Crepax, Exec. VP's Giuseppe Giannini, Sandro Delor; Financial Mgr.: Cesare Vajani, Comm'l Mgr. Roberto Guerrazzi; Sales Mgr. Romano Razzini; Admin. Dir.: Alberto Ferrari; Promo Mgr. Johnny Porta, A&R Dir.: Alfredo Cerutti; A&R Co-ord. Gianni Dal Dello, Prod'n Mgr. Cesare Brunelli; Pressing Plant Mgr. Luigi Zernigiani; Legal & Personnel Mgr.: Silvana Pervilli; Rome Office: Magda Reggiani.
Branches: Bologna, Catania, Florence, Naples, Padua, Rome.
**Labels: (Owned) Ascolto, CGD, CGD Classics, CGD Paradiso, Clan, Derby, EGYD, Record Bazaar, VIP. (licensed) AVI/Derby (USA), Bareback/Derby (USA), Berserkley (USA), Big Bear/Derby (UK), Buena Vista (USA), Butterfly/Derby (USA), CTI (USA), Cream (USA), DJM (UK), Disneyland (USA), Ibis/Derby (USA), Kudu (USA), Rockland, Vortex (UK), (distributed) Alpha, Antenna Nord, Argo Prod'n, Baby, Baffi, CBS, Centotre (103), Ciao, Clan, Della Quercia, Dig It, Disaster, Disco Piu, G&G, Goody Music, Il Disco, Insieme, Kontiki, Lasapa, Moon, New Polar, L'Orchestra, Pacha, Pom, Ponzio, Real Music, SIF, Splash, Teen
Int'l reps.: CGD—Japan (King), worldwide excluding Japan (CBS Int'l in USA); Clan—Europe (Anola-Eurodisc in Germany), worldwide excluding Europe (CBS Int'l in USA)
C L S Recs. SaS, Viale Sabotino 2, Milan, Tel: (02) 871.370. Pres. Detto Mariano; Gen. Mgr. Lina De Sutti; Sales Mgr. Silvio De Sutti. (Distributed by Ricordi)
Labels: (Owned) CLS, Camaleo, Love. (distributed—not licensed) America, Kris, MB.
C & M Discografica Cavalieri & C. Ed. Musicali Srl, Via Isonzo 206, Bari, Tel (080) 224 610. Gen. Dir.: Lino Cavalieri; PR: Giuseppe Accettura (Distributed by Panarecord)
Labels: (Owned) C&M, Flop, Fonocomer, Sinusoid
Int'l rep.: North & South America (Panarecord)
C R A M P S, see Memoria
C R A M P S Diverso, see Memoria
C R A M P S Nova Musica, see Memoria
Cadis, see Phonotype
Camaleo, see CLS
Canadian American, see Produttori Associati
Canopo (Gruppo Ed.), Via A. Riboty 22, 00195 Rome, Tel (06) 315.615.**

Labels: (Owned) Canopo, Deneb, Flirt, Flower, Folk-music, Octopus; (represented) MP 2000 (France)
Capitol, see EMI
Car Juke Box, Viale Bianca Maria 5, 20122 Milan, Tel (02) 795.444, 74.90.835
Carosello CEMED Srl (IFPI), Galleria del Corso 4, 20122 Milan, Tel: (02) 793.088. Cable: CURCIMUSIC. Telex: 332683. Pres.: Giuseppe Gramitto Ricci; Gen. Mgr.: Luciano Montesion. (Distributed by Ricordi)
Labels: (Owned) Ariete, Carosello, Costanza, Curci, Frog. (licensed) Pyramid, Roulette (both USA).
Int'l reps.: Austria (Metronome), Brazil (RGE/Fermata), Colombia (Fuentes), Germany (Metronome), Spain (Ensayo), Switzerland (Metronome), Venezuela (Velvet). (SEE ADVERTISEMENT)
Caru Dischi, Piazza Garibaldi 6B, 21013 Gallarate.
Label: (Represented) Sierra/Briar (USA)
Centotre, see 103 & CGD-Messaggerie
Cetra, see Font-Cetra
Chantalain, Via A. Riboty 22, Rome, Tel (06) 314 030, 352.384. Exec. Dir.: Rolando D'Angeli; Gen. Mgr.: Paolo Ormi; Sales Mgr.: Dario Tiribello; Film Prod'n: Franco Vitolo. (Distributed by WEA)
Label: (Owned) Chantalain
Int'l rep.: Worldwide (WEA)
Charter, see WEA
Ciao Recs. Srl (IFPI), Corso Buenos Aires 45, Milan, Tel (02) 225 710/117, 220.490. Cable: CIAORECORDS. Mng. Dir.: Giorgio Pertici; Ass't to Mng. Dir.: Flora Brocchetti; Admin. Mgr.: Mario Turri; Sales Mgr.: Irma Faretina (Distributed by CGD-Messaggerie Musicali)
Branch: Rome, Viale Mazzini 4, Tel (06) 382 668, 383.532. Mgr.: Luciana Mazzoleni
Labels: (Owned) Ciao. (licensed) GRT. (SEE ADVERTISEMENT)
Cicala, see Durium
Cielo-Video (Ed. Musicali), Galleria del Corso 2, 20122 Milan, Tel (02) 705.231. Pres.: Virgilio Panzuti; Gen. Mgr.: Dante Panzuti; Sales Mgrs.: Dante & Virgilio Panzuti
Labels: (Owned) Play, VIP, Video. (represented) Selected Sound (Germany), Tele-Music (France)
Int'l reps.: France (Sforzando), Germany (Selected Sound)
Cinevox Recs. SpA (IFPI), Via Romeo Romei 15, Rome, Tel (06) 311 280, 311 870. Pres.: Carlo Bixio; Sales Mgr.: Gianni Dell'Orso. (Also see Ricordi)
Labels: (Owned) Cinevox, Rang
Int'l reps.: Belgium (Barclay), Brazil (Top Tape), France (Barclay), Portugal (Imavox), Switzerland (Barclay)
City Recs., Galleria del Corso 4, 20122 Milan, Tel: (02) 794 266. Gen. & Sales Mgr.: Alessandro Friggieri; Artistic Mgr.: Paolo Gatti.
Labels: (Owned) City, Metropoli
Clan, see CGD
Classic For Pleasure, see EMI
I Classici, see Ricordi
Clou, see Panarecord
Clover, see Atlas

COMP-RAY C.O CASSETTE:

traditional soft window

TECHNO-RAY C.O CASSETTE:

integral new design hard window.

Both types feature the patented air cushion damping and the electrostatic discharge guiding device.

Friction 30% lower than Philips standards, AGFA tape.

Unmatched winding smoothness for all the automatic winders.

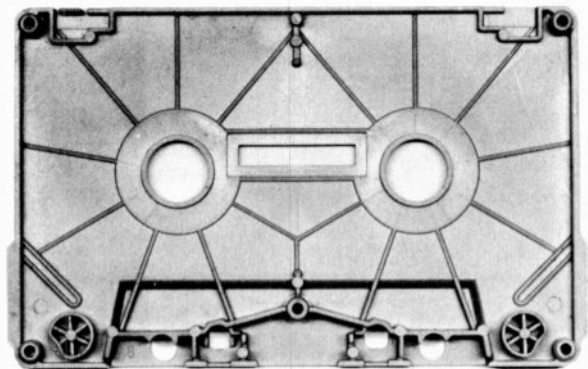
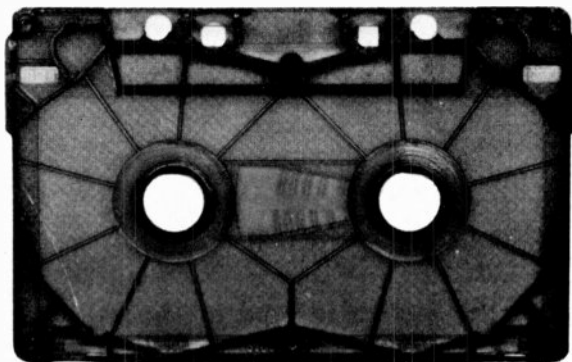

START INCORPORATED: a 65,000 sq./ft. modern moulding factory with own mould machining dept.

U.S. representatives welcome.

START INC.

Corso Garibaldi 120, SEVESO 20030 (MILANO), ITALY
Telex: 312080 START I — teleph.: (0362) 508701/5

- Cobra, see Omnia.
 Colledge, see R-Fi.
 Colossal Recs. Ed. Discografiche S.R.L. PO Box 10, 89029 Taurianova. Tel (0966) 41 030. Owner Rag Carmelo Alessi. Gen. Mgr. Comm. Tommaso Luvara. Sales Mgr. C. Vialfredo.
Home office: Australia.
Int'l reps.: Australia (Caronna), Brazil (Caravelle), France (Phonobox), UK (A&C).
 Columbia, see EMI.
 Combo, see Record Serv.
 Come Il Vento S.R.L. (Ed. Musicali & Discografiche), Via Montanapoleone 29, 20121 Milan. Tel (02) 700 725/574, 791 665, 782 159. Gen. Mgr. Michele del Vecchio, Ass't Gen. Mgr. Antonino Antonucci Ferrara.
 Convention Music, see Fonit-Cetra.
 Corsair, see Sciascia.
 Costanza, see Carosello.
 Cricket, see Fonit-Cetra.
 Cronache del Sud, see Fonola.
 Cultura Popolare, see Ariston & Sciascia.
 Curci, see Carosello & Ricordi.
 D D F, see Due Pi di Gianfranco Coda.
 D G, see Polygram.
 D K F, see Due Pi di Gianfranco Coda.
 D S E Recs. (Ed. Musicali Edera di De Sanzuane Emilio), Casella Postale 103, 30100 Venice, Cannaregio 2954b, 30121 Venice. Tel. 924 431. Gen. Mgr.: Emilio De Sanzuane.
 Dany, see Pinciana.
 Das Alte Werk, see Decca.
 Decca Dischi Italia SpA (IFPI), Via Brisa 3, 20123 Milan. Tel: (02) 809 136. Cable: DECCITAL. Mng. Dir.: Romano Bacchini, A&R Mgr.: Paolo Tosi, Sales Mgr.: Luigi Negro.
Home office: UK.
Labels: (Owned) Ace of Clubs, Ace of Diamonds, Argo, Das Alte Werk, Decca, Deram, Eclipse, London, L'Oiseau Lyre, Storyville, Strand, Telefunken, Threshold.
 Della Quercia (Dischi), see CGD & IREC.
 Delta, see RCA.
 Denab, see Canopo.
 Deram, see Decca.
 Derby, see CGD.
 Devil, see Saar.
 Diapasons, see Ecofina.
 The Dig It Int'l Recs. S.R.L. (IFPI), Corso Vittorio Emanuele 22, Milan. Tel (02) 780 778. Gen. Mgr. Pippo La Rosa.
Labels: (Represented) Key (USA), Trema (France), Yona (France).
Int'l reps.: France (Eurodisc, Trema), Germany (Teldec).
 Dire, Corso Venezia 7, 20100 Milan. Tel: (02) 700 027 (Distributed by IREC).
 Disaster, see CGD.
 Dischi del Sole, see Bella Ciao & Sciascia.
 Disco Action, see Saar.
 Disco Piu S.R.L., Via Ascanio Sforza 41, Milan. Tel (02) 839 1810 / 4385. Mng. Dir. Maria Cantadore, Gen. Mgr. Gian Piero Simoniacchi (Distributed by CGD-Messaggerie Musicali).
 Discoteca Classica, see EMI.
 Divergo S.R.L., Piazza De Angeli 7, 20146 Milan. Tel: (02) 495 609. Pres. Sergio Lodi (Distributed by Polygram).
 Ducale Int. Musicali SpA, Via Per Cadrezzate 5, 21020 Brebbia (Varese) Tel (0332) 770 784/189. Telex 380231. Pres. & Gen. Mgr.: Davide Matalon (Distributed by Sciascia).
Labels: (Owned) Broadway, Ducale, EDM, Italdisc, (licensed) Anon (France), Charly (France). (SEE ADVERTISEMENT).
 Due Pi di Gianfranco Coda, Delle Vigne 1, Reano (Turin) Tel (011) 932 711.
Labels: (Owned) DDF, DKF, Folklore, Nastroteca.
Int'l rep.: USA (Fiesta).
 Duplimatic S.R.L., Via Natale Battaglia 4, Milan. Tel (02) 281 226. Gen. Mgr. Guido Mezzadra, Sales Mgr. Enrico Mezzadra.
 Durium SpA (IFPI), Via Manzoni 40/42, 20121 Milan. Tel (02) 701 0108, 701 705. Telex 333564. Pres. & Gen. Mgr. Krikor Mintiangian, A&R Mgr.: Aurelio Ajroldi, Sales Mgr. Amleto Silvestri, Int'l Mgr. Elisabet Mintiangian, Admin'r. Giulio Galimberti.
Labels: (Owned) Cicala, Durium, Equipe, Sprint, Start, (licensed) Can't Stop Prod'ns (USA), Casablanca (USA), Hansa (Germany), Jupiter (Germany), RKM (Belgium), (distributed—not licensed) Wesley Int'l.
Int'l reps.: Argentina (Sicamericana), Australia (Colossal), Canada (Global), France (Sonopresse), Germany (Deutsche Oversea, Hansa), Greece (Music Box), Israel (K-tel), Jamaica (Federal), Japan (Cosdel), Kuwait (Kanawati), Lebanon (Societe Libanaise du Disque), Mexico (Musart), Netherlands (Phonogram), South Africa (Teal), Switzerland (Finsterwald & Cantacuzene), Syria (Kanawati), Turkey (Yasef Alguadis), Uruguay (Sondor), Venezuela (BASF). SEE ADVERTISEMENT.
 Dynamic, see Florence Int'l.
 E D M, see Ducale & Sciascia.
 E M I Italiana SpA, Viale dell'Oceano Pacifico 46, 00144 Rome. Tel: (06) 592 0751. Cable: EMIRIOM. Telex: 64208. Mng. Dir. John L. Bush, Deputy Mng. Dir. Vittorio Magnoli, Comm'l Mgr. Nerio Alunni, A&R Mgr. Bruno Tibaldi.
Labels: (Owned) Angel, Capitol, Classic For Pleasure, Columbia, Discoteca Classica, EMI, EMI Int'l, Emidisc, Harvest, Music for Pleasure, Odeon, Parlophone, Pathe, Regal, Regal Zonophone, Seraphim, La Voce del Padrone, (distributed) Libra, PDU, Taurus, (licensed) Arista (USA), Artists House (USA), MAM (UK), Magnet (UK), Melodiya (USSR), Motown (USA), Oz (Australia), Prudigal (USA), RAK (UK), Rebel (UK), Red Bus (UK), Rolling Stones (UK), Sunburst (UK), United Artists (USA).
 Eclipse, see Decca.
 Ecofina S.R.L., Via Leopardi 8, 20123 Milan. Tel: (02) 86 90 121, 806 125. Chief Exec.: Mourad Sabet. Factory Technical Mgr. Ronald F. Goodwin.
Factory: Milan, Via Monviso 21. Tel (02) 314 766.
Labels: (Owned) Diapasons, Ecofina. (SEE ADVERTISEMENT).
 Edibi, see Sviluppo Discografico del Mezzogiorno.
 Edizioni Del Isola, see Sciascia.
 Elektra, see WEA.
 Eleven Music Co. S.R.L., Via Correggio 27, Milan. Tel (02) 482 456, 656 553. Cable: PAGANMUSIC. Gen. Mgr. Aldo Pagani (Distributed by Fonit-Cetra).
 Ellecci, see Interbeat.
 Emidisc, see EMI.
 Emilia, see Publilart.
 Energy, see CGD.
 Epic, see CBS.
 Equipe, see Durium.
 Excelsius, see Fonit-Cetra.
 F M A S.R.L. (Ed. Musicali & Discografiche), Galleria del Corso 2, 20122 Milan. Tel (02) 796 823, 796 266. Mng. Dir.: Federico Monti Arduini.
 F 1 Team, see Panarecord.
 Fans, see Phonotype.
 Fantasia, see Panarecord.
 Feeling Rec. Italiana SpA, Via Bersezio 7, 10152 Turin. Tel (011) 287 829, 850 776. Gen. Mgr.: Renato Pent (Distributed by Panarecord).
 Fiammetta's, see Stereomaster.
 Flag, see Studio 7.
 Flirt, see Canopo.
 Flop, see C&M.
 Florence Int'l, Via Camillo Cavour 60, 50129 Florence. Tel (055) 216 645. Cable: FLINT. Gen. Mgr. Roberto Bartoli (Distributor/Importer).
Labels: (Distributed—not licensed) Da Camera Magna (Germany), Dynamic (Italy), Harmonia Mundi (France), Vergo (Germany).
 Flower, see Canopo.
 Fly, see Horo.
 Folklore, see Due Pi di Gianfranco Coda.
 Folkmusic, see Canopo.
 Fonit-Cetra SpA (IFPI), Via G. Meda 45, 20142 Milan. Tel (02) 843-2551. Pres.: Renato Zaccone, Gen. & Sales Mgr.: Mario Zanoletti, Dir.: Luigi Arduino, Int'l Mgr.: Dante Notti.
Branch: 00153 Rome, Via Pietro Roselli 4, Tel (06) 580 6159.
Labels: (Owned) Cetra, Cricket, Excelsius, Fonit, International, (distributed) Abici, Beat, Convention Music, Eleven, General Music, Patto, Pull, Vanilla, Voovoom, (licensed foreign) Acanta (USA), Audiofidelity (USA), Can't Stop Prod'ns (USA), Carabine (France), Carrere (France), Chiaroscuro (USA), Fantasy (USA), GNP Crescendo (USA), Galaxy (USA), Harmonia Mundi (Germany), Image (USA), Impact (Switzerland), Intermusic (Switzerland), Milestone (USA), Prestige (USA), Satril (UK), Stax (USA).
Int'l reps.: Argentina (American Rec.), Australia (Carina), Brazil (Gravacoes Eletricas), France (Carrere), Israel (Hed-Arzi), Japan (King), Portugal (Rapsodia), Spain (Zafiro), Venezuela (BASF).
 Fonocomer, see C&M.
 Fonola Fonotecnica, Via Ariberto 21, 20123 Milan. Tel (02) 84 84 626.
Labels: (Owned) Cronache del Sud, Fonola, Fonomatic, Melody, Souvenir.
 Fonomatic, see Fonola.
 Fonorama C.A. Rossi S.R.L., Via Barletta 11, 20141 Milan. Tel (02) 53 92 392.
 Fontana, see Polygram.
 Frog, see Carosello.
 Futura, see Panarecord.
 G & G, see CGD.
 Gemini, see Belmusic.
 General Music, Viale Liegi 41, 00198 Rome. Tel (06) 850 358, 865 307. Gen. Mgr.: Enrico de Melis (Distributed by Fonit-Cetra).
Label: (Owned) General Music.
Int'l rep.: France (WEA Filipacchi).
 Giucar Rec., Via Ciamician 3A, Bologna. Tel: (051) 504 095, 504 028. Telex 511483. Dir. Giuseppe Nannucci, Gen. Mgr. Antonio Foresti, Sales Mgr. Luca Nascetti, Sales Mgr. Guerrino Lolli (Distributor/Importer/Exporter).
Labels: (Distributed—not licensed) America (France), Banana Base, ECM (Germany), ESP-Base (USA), Festival (France), Jazz Anthology (France), Musicidisc (France), Shandar (France).
 Golden Rec., Via San Paolo 15, 20121 Milan. Tel (02) 874 460. Owner & Prod'r. Pericle Boschetti.
 Goody, see CGD.
 Green Light, see Saar.
 Grog, see Studio G.
 Harmony, see Saar.
 Harvest, see EMI.
 Hello, see RCA.
 Horo Recs., Via Asiago 2, 00195 Rome. Tel: (06) 318 601. Pres. Aldo Sinesio, Gen. Mgr. Donald G. Adams, Sales Mgr.: Cristina Ripamonti.
Labels: (Owned) Fly, Horo.
Int'l reps.: Austria (Bellaphon), France (Musica), Germany (Bellaphon), Japan (CAM), Switzerland (Bellaphon), UK (Cadillac).
 Humor, see Record Serv.
 I R D S.R.L., Via San G. B. de la Salle 4, 20132 Milan. Tel (02) 259 1700/2064. Telex 321497. Pres. Giovanni Bonandrini, Sales Mgr. Franco Ratti.
Labels: (Distributed—not licensed) Adelphi (USA), Afinty (UK), AK-BA (USA), Alligator (USA), Amadeo (Austria), Amigo (Sweden), Andrew's (USA), Arhoolie (USA), Birth (Germany), Biscuit City (USA), Black & Blue (France), Blue Beat (UK), Blue Goose (USA), Blues Classic (USA), Calig (Germany), Charlie (UK), Choice (USA), Circle (Germany), Classic Jazz Masters (Sweden), Contemporary (USA), Dawn (Germany), Delmark (USA), Dragon (Sweden), Enja (Germany), FMP (Germany), Fluid (France), Flying Fish (USA), Flyright (UK), Folk Lyric (USA), Fountain Retrieval (UK), Four Leaf Clover (Sweden), Good Time Jazz (USA), Hat Hut (Switzerland), IAI (USA), IPS (USA), Incus (UK), India Navigation (USA), Inner City (USA), Jazz Craft (Denmark), Jazz Society (Sweden), Kaleidoscope (USA), Kharma (USA), Lynchord (USA), Mamlish (USA), Marge (France), Met-alanguage (USA), Mosaic (UK), Mulligan (Ireland), Muse (USA), Musica (France), Muscraft (USA), Muste-

vic (USA), Nessa (USA), Ogun (UK), Onari (Canada), Owl (France), PALM (France), Pearl (USA), Philly Jazz (USA), Philo (USA), Quark (USA), Queen Disc (Italy), RCA (Black & White, Bluebird, Master—France), Rarities (Denmark), Rebel (USA), Red Lightnin' (UK), Ridge Runner (USA), Ring (Germany), Rounder (USA), Sackville (Canada), Sierra Briar (USA), Sky (Germany), Spotlite (UK), Stash (USA), Steeple Chase (Denmark), Sun (France), Tapioca (France), Tax (Sweden), Timeless (Netherlands), Three Blind Mice (Japan), Untieledis (France), VJM (UK), Vinyl (Germany) Waterhouse (USA), Waterland (Netherlands), Wave (UK), World Jazz (UK), Xanadu (USA), Yazoo (USA). (SEE ADVERTISEMENT).

I R E C S.R.L., Via San G. B. de la Salle 4, 20132 Milan. Tel (02) 259 2326. Telex: 321497. Pres.: Giovanni Bonandrini.

Labels: (Owned) Appaloosa, Black Saint, Soul Note, (distributed—not licensed) Dire, Dischi Della Quercia, Modern Jazz, Queen Disc, Red.

Int'l reps.: Austria (Bellaphon), Denmark (Steeple-Chase), Finland (Audiovis), France (Musica), Germany (Bellaphon), Japan (Super Stop), Netherlands (Wim Wigt), Sweden (Amigo), UK (Projection), USA (Rounder). (SEE ADVERTISEMENT).

I T, see RCA.
 Ictus Recs. SaS, PO Box 59, Via Tazzarina 11, 51100 Pistoia. Tel (0573) 570 272, 24266, 22202. Gen. Mgr. Carla Lugli, Prod'r & Art. Dir.: Andrea Centazzo.
Label: (Owned) Ictus.

Int'l reps.: Austria (Bellaphon), Germany (Bellaphon), Juliana Hopf, Ring, Sweden (Forsyte), UK (Cadillac), USA (Rick Ballard, Daybreak).

Il Disco, see CGD.
 Insieme S.R.L., Piazza Missori 3, 20123 Milan. Tel (02) 799 515. (Distributed by CGD-Messaggerie Musicali).

Interbeat S.R.L. Ed. Musicali, Via Alessio Nazari 4, Rome. Tel (06) 532 767. Chief Exec. & Gen. Mgr. Giuseppe Cassia, Sales Mgr.: Marialuisa Cocca.

Labels: (Owned) Ellecci, Interbeat, Picci.

Interdisc S.N.C. (formerly Ronchini), Via Buffolara 102, Parma. Tel (0521) 967 80. Telex 53660. Gen. Mgr.: M. Interlandi, Sales Mgr.: E. Asti. (Distributor/Importer).

International, see Fonit-Cetra.

Intingo Recs. S.R.L., Piazza Mirabello 1, 20121 Milan. Tel (02) 651 753. Gen. Mgr.: Felix Piccarreda, Ass't Mgr.: Alessandra Tosca. (Distributed by Ricordi).

Ippopotamo, see Polygram.

Italdisc, see Ducale.

Itwhy, see WEA.

Jazz Story, see Ariston.

Jet Sound, see Senn Sound.

Joker, see Saar.

Jump Recs., Galleria del Corso 2, 20122 Milan. Tel: (02) 705 231. Pres.: Luigi Ferracioli, Gen. & Sales Mgr.: Dante Panzuti.

Labels: (Owned) Jump, Music Scene, (licensed) Selection (Belgium), Themes (UK).

Int'l reps.: Australia (Penjane), Austria (Vineta/Liveton/Bavariation/Tip Top), Belgium (Multisound), Canada (Morning), France (Presence/Warner/Atoll), Germany (Vineta/Liveton/Bavariation/Tip Top), Ireland (Lemmel), Japan (Illust), Netherlands (Multisound), New Zealand (Penjane), Portugal (Phonorecord), Scandinavia (Camp), South Africa (Gallos), Spain (Phonorecord), Switzerland (Vineta/Liveton/Bavariation/Tip Top), UK (Lemmel), USA (TRF).

Junghans, see Phonotype.
 K-tel Int'l Italy S.R.L., Piazza Mirabello 1, 20121 Milan. Tel (02) 657 2696/2791. Pres.: Raymond Kives; Gen. Mgr.: Victor Cordani; A&R Mgr.: Liliana Azzolini (Distributed by RCA).

Home office: USA.
 Kangaroo, see Ricordi.
 Kansas & Lunapark, Viale Maino 34, 20129 Milan. Tel: (02) 278 118.

Labels: (Owned) Kansas, Lunapark.
 Kappa-O, see Phonotype.

Kings of Classic, see Omnia.

Kings of Jazz, see Omnia.

Kontiki, see CGD.

L D C Audiovisio, Corso Francia 214, 10096 Leumann (Turin). Tel (011) 95.80.555. Gen. Mgr.: Giuseppe Tabarelli; Sales Mgr.: Pietro Semprini.

Label: (Owned) LDC.

L G, see Studio 7.

Laboratorio, see Produttori Associati.

La Luna, see Produttori Associati.

La Pera, see Senn Sound.

Lasapa, see Studio 21 & CGD.

Las Vegas, see Sidet.

Leondisco, see Phonotype.

Leonsolco, see Stereomaster.

Linea Azzurra, see Senn Sound.

Linea Rossa, see Bella Ciao.

London, see Decca.

Libra, see EMI.

Lotus, see Saranbandas & Saar.

Love, see CLS.

Lunapark, see Kansas.

Lupus, see Ricordi.
 M G M, see Polygram.
 M R C, see Spark.
 Magma, see Studio G.
 Manhattan, see Panarecord.
 Masterworks, see CBS.
 Melody, see Fonola.
 Memoria SpA, Via Leopardi 14, 20123 Milan. Tel: (02) 876 689. Pres. & Gen. Mgr. Gianni Sassi (Distributed by Polygram).
Labels: (Owned) CRAMPS, CRAMPS Diverso, CRAMPS Nova Musica.
Int'l reps.: Benelux (Barclay), France (Barclay), Japan (Warner-Pioneer), Portugal (Carvalho).

Mercury, see Polygram.
 Metro, see Polygram.
 Metropoli, see City.
 Millenote, see Sidet.
 Mirto, see Polygram.



Il mito dell'opera, see Francesco Bongiovanni.
 Mizar, see Francesco Bongiovanni.
 Modern Jazz, see IREC.
 Moon, see CGD.
 The Morgans, Via Marchesi Imperiali 26a, Manduria, Tel: (099) 671 598. Gen. Mgr.: Enzo Morgante, Sales Mgr.: Anthony G. Morgante.
 Music Collection, see Polygram.
 Music for Pleasure, see EMI.
 Music Power, see Saar.
 Music Scene, see Jump.
 N W A, see Polygram.
 Napoleon, see Omnia.
 Nasrotteca, see Due Pl di Gianfranco Coda.
 New Jazz Collection, see Sciascia.
 New Polaris, see CGD.
 Nonesuch, see WEA.
 Numero Uno SpA, Galleria del Corso 2, 20122 Milan, Tel: (02) 799 331 / 127. Cable: NUMERUNO. Pres.: Giuseppe Ornato; Gen. Mgr.: Antonio Coni. (Distributed by RCA)
Int'l rep.: Worldwide (RCA).
 Octopus, see Canopo.
 Odeon, see EMI.
 Off, see Produttori Associati.
 Oh Bej, Oh Bej, see Belmusic.
 L'Oiseau Lyre, see Decca.
 Omnia SpA (IFPI), Galleria del Corso 4, 20122 Milan, Tel: (02) 702 464, 701 168.
Labels: (Owned) Cobra, Kings of Classic, Kings of Jazz, Napoleon, Omnia, Showbusiness Kings.
Int'l reps.: Belgium (AFM), France (RCA), Germany (Al-pha), Switzerland (Finsterwald & Cantacuzene).
 103 Ed. Musicali & Discografiche Srl, Piazza S. Eustorgio 6, 20122 Milan, Tel: (02) 404 7574, (051) 911 163. Admin.: Luigi Barion. (Distributed by CGD-Messaggerie Musicali).
 Orange, see Spark & Panarecord.
 L'Orchestra-Societa Cooperativa a Responsabilita Limitata, Via Moscova 13, Milan, Tel: (02) 653 160, 657 5635. Pres.: Franco Fabbri, Sales Mgr.: Lidia Brasca; PR: Umberto Silvestri. (Distributed by CGD).
Int'l reps.: Germany (Neue Welt, Trikont), Switzerland (Voxpop), UK (Re)
 Orizzonte, see Ricordi.
 Out, see Ri-Fi.
 Oxford, see Ariston.
 P C C, see Pro Civitate Christiana.
 P D U Italiana Srl (IFPI), Via Senato 12, 20121 Milan, Tel: (02) 790 971, 783 114. Mng. Dir.: Germano Alberti; Gen. Mgr.: Vittorio Buffoli, Sales Mgr.: Renzo Gramagna. (Distributed by EMI)
Home office: Switzerland.
Label: (Owned) PDU.
Int'l reps.: Argentina, France, Greece, Spain (all EMI).
 Pacha, see CGD.
 Panarecord SpA, Via Cimarosa 4, 20144 Milan, Tel: (02) 430 046, 485 609. Pres.: Sergio de Gennaro; Gen. Mgr.: Mario Paretotti. **Warehouse:** Via Malaga 4. Tel: (02) 479 405
Labels: (Licensed domestic) Analogy, C&M, Clou, F1 Team, Fantasia, Feeling, Futura, Manhattan, Orange, La Strega, Symbol, Top, Wag, Wep. **(Licensed foreign)** Albion (UK), Atomic Art (USA), Red Greg (USA) **(distributed—not licensed)** WEA classical—Calliope, Enigma, Nonesuch. (SEE ADVERTISEMENT)
 Parlophone, see EMI.
 Pathe, see EMI.
 Patto, see Fonit-Cetra.
 Penny, see Ri-Fi.
 Pentaphon, see Beat.
 Perladisc, see Beat.
 Petrus, see Stop.
 Philips, see Polygram.
 Phoenix, see Sarabandas & Saar.
 Phonorama, see Stereomaster.
 Phonotype Rec. del Filii, Esposito SnC, Via Enrico de Marinis 4, 80134 Naples, Tel: (081) 205 873, 206 642. (Distributed by RCA).
Labels: (Owned) Cadis, Fans, Kappa-O, Leondisco, Phonotype, Universal; **(distributed)** Bella, Junghans.
Int'l reps.: Australia (Minstrel), Canada (International Rec'g), Japan (King), USA (L. Rossi), Venezuela (Radio Capri).
 Picci, see Interbeat.
 Piggy, see Belmusic.
 Pinciana Music Srl (IFPI), Via Giovanni Branca 35, 00153 Rome, Tel: (06) 578 776.
Labels: (Owned) Dany, Pinciana.
 Play, see Cielo-Video.
 Polydor, see Polygram.
 Polygram Dischi SpA (IFPI), Viale Regina Giovanna 29, 20129 Milan, Tel: (02) 20484. Cable: COMINFON. Telex: 334140. Mng. Dir.: Alain C. Trossat, Admin. & Financial Mgr.: Luigi Sanvito; Gen. Affairs Mgr.: Lidia Cameroni Gallas; Mktg. Mgr.: Franco Cabrini; Creative Mgr.: Claudio Gobbi; A&R Mgr.: Claudio Fabi.
Branch: Rome, Viale Carso 20, Tel: (06) 315 416, 360 9447. Promo. Mgr.: Aldo Patriarca.
Labels: (Owned) Analecta, DG, Fontana, MGM, Mercury, Metro, Mirto, Philips, Polydor, Theatre Project, Vertigo, Verve; **(licensed foreign)** Barn, Capricorn (USA), Charisma (UK), Chess (USA), Cube (UK), Pablo (USA), Rocket (UK), RSO (UK), 20th Century (USA); **(distributed—not licensed)** Atlas, CRAMPS, Chrysalis (UK), Divergo, Ippopotamo, Music Collection, NWA.
Int'l reps.: Worldwide (Phonogram, Polydor, Polygram)
 Pom, see CGD.
 Pony Recs., see Beat.
 Ponzio, see CGD.
 Portrait, see CBS.
 Premier, see Publilart.
 Primary, see Ri-Fi.
 Pro Civitate Christiana (Ed. Fonografiche & Musicali), Cittadella Cristiana, 06081 Assisi, Tel: (075) 812 234, 812 410. Dir.: Nora Cervi; Gen. Mgrs.: Adelaide Vaccira, Nena Loffredo; Sales Mgr.: Antonio Sartori.
Label: (Owned) PCC.
 Produttori Associati Srl (IFPI), Via General Fara 39, 20124 Milan, Tel: (02) 666 176. Pres.: Antonio Casetta
Labels: (Owned) Canadian American, Laboratorio, La Luna, Off, Produttori Associati.
 Publilart Srl, Via Manfredi 5, 42100 Reggio Emilia, Tel: (0522) 36825. Mng. Dir.: Leda Ferranini; Gen. Mgr.: Ivano Burani.
Labels: (Owned) Emilia, Premier.
 Publidisco, see Ri-Fi.
 Pull Srl, Via della Camilluccia 701, 00135 Rome, Tel: (06) 32 73 050. (Distributed by Fonit-Cetra)
Int'l rep.: (UK) Pye.
 Quadrifoglio, see Sciascia.
 Queen Disc, see IREC.
 R C A SpA, Via San Alessandro 7, Rome, Tel: (06) 43 661. Telex: 61428. Pres.: Giuseppe Ornato; Gen. Mgr.: Ennio Melis; Mktg. Mgr.: Luciano Bernacchi; Int'l Dir.: Francesco Lamberto Fanti.
Home office: USA.
Distribution branches: Bari, Via Camillo Rosalba, Tel: 414 651, 416 218. Mgr.: R. Buzzanca—Bologna, Via le Oriani 2, Tel: 393 800, 396 954. Mgr.: P. Margelli—Catania, Piazza Nettuno 10-15, Tel: 491 486 / 464. Mgr.: S. Sparaventi—Florence, Via Ghibellina 3 / R, Tel: 679 868, 675 063. Mgr.: A. Barsotti—Genoa, Piazza Rossetti 8 / R, Tel: 591 610, 581 123. Mgr.: M. Biotti—Milan, Piazza Umanitaria 2, Tel: 542 467, 546 16 32. Mgr.: G. Rossi—Naples, Vico Dattero alla Maddalena 5-6, Tel: 334 636 / 572. Mgr.: F. Zezza—Padua, Via B. Pellegrino 115, Tel: 35 639, 651 652. Mgr.: A. Papi—Pescara, Via L'Aquila 25, Tel: 32 977. Mgr.: F. Pietrostefani—Rome, Via Tiburtina Km. 12, Tel: 415 177 / 349. Mgr.: A. Celli—Turin, Via Gorizia 144, Tel: 328 570 / 458. Mgr.: A. Occhetti.
Labels: (Owned) RCA Cinemathe, RCA Int'l, RCA Italiana, RCA Lineatre, RCA Original Cast, Red Seal, Victor, Victrola, **(licensed domestic)** CAM, Delta, Hello, IT, Numero Uno, Phonotype, Sidet, Spaghetti, Valiant; **(licensed foreign)** Buddha (USA), Chiswick (UK), Erato (France), Grunt (USA), Immediate (UK), The Label (UK), Midsong (USA), Millennium (USA), Nems (UK), Penny Farthing (UK), Prelude (USA), Red Star (USA), Roadshow (USA), Salsoul (USA), Savoy (USA), Sire (USA), Solar (USA), Stiff (UK).
Int'l rep.: Worldwide (RCA).
 R R C (Roman Rec. Co.) Srl, Via San Martino della Battaglia 3, 00185 Rome, Tel: (06) 49 56 682 / 366.
 R T Club, see Record Serv.
 Radio Recs., see Sidet.
 Rally, see Senn Sound.
 Rang, see Cinevox.
 Real, see CGD.
 Record Bazaar, see CGD.
 Recordclam, see Sidet.
 Record Executive, see Bazar.



These are all labels produced by the EDITORIALE SCIASCIA record and music group, an independent Italian record company producing records, tapes, educational/cultural books and texts about music and with three music publishing companies (Sciascia, Eliseo and I.M.I.).

Our recording studios are the most modern in Italy. We're strong in classical, ethnic/folk and "serious" music, but are also very much involved in all the latest musical phenomena, including DISCO, on our new PINEAPPLE label. **TRY US!**

WE CAN HELP YOU IN PUBLISHING SERVICES, DISTRIBUTION AND PROMOTION OF YOUR PRODUCT. YOU NAME IT! BUT WE ARE ALSO LOOKING FOR MASTERS AS WELL AS OFFERING OURS.

WRITE OR CALL US! WE WOULD LOVE TO MEET YOU AND MAKE PLANS FOR THE FUTURE TOGETHER.



EDITORIALE SCIASCIA RECORD GROUP

20089 Rozzano (Milano) Italy Tel. 825.80.41/2/3/4

Tapematic is top reliability for total productivity

design: S. Perogo



TMD 900
For faster
and accurate loading
of blank or prerecorded
tape cassettes



TMD 800
For direct and faultless
printing of the label
on the cassette.

TMD 530
Automatic
Labelling machine

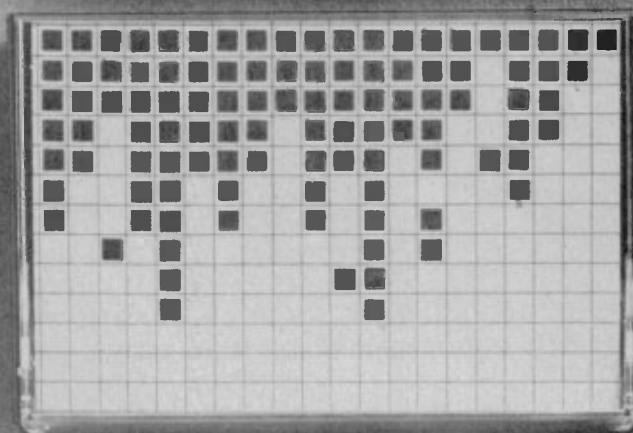

TMD 670
Automatic
Boxing machine
for a final
and complete product.



Record Serv. Srl, Via Stendhal 13, 20144 Milan. Tel: (02) 479.427, 42.24.757. Gen. Mgr.: Roberto Trevisan; Sales Mgr.: Paolo Trevisan.
Labels: (Owned) Combo, Humor, RT Club, Sympathy; (represented) Fiesta (USA), Marler (Spain).
Int'l reps.: Australia (Minstrel), Canada (Leon Vellone), South Africa (L'Edicola Mico), Spain (Marler), USA (Carosello, Fiesta).
 Red, see IREC.
 Red Seal, see RCA.
 Regal see EMI.
 Regal Zonophone, see EMI.
 Reprise, see WEA.
 Ricordi SpA (Dischi) (IFPI), Via Berchet 2, 20121 Milan. Tel: (02) 88.81. Cable IDROCIR. Telex: 310777. Pres.: Gianni Babini; Mng. Dir.: Guido Rignano; Gen. Mgr.: Lucio Salvini; Sales Mgr.: Renzo Benini.
Labels: (Owned) I Classici, Orizzonte, Ricordi; (licensed domestic) Cinevox, Curci; Kangaroo, Lotus, Lupus, Yep; (licensed foreign) ABC (USA), Amadeo (Austria), Ariola America (USA), Barclay (France), Blue Note (USA), Bronze (UK), Coral (USA), Egg (France), Infinity (USA), Island (UK), Liberty (USA), Logo (UK), Lollipop (Germany), MCA (USA), Mantecore (UK), Pye (UK), Riviera (France), Safari (UK), Sonet (Sweden), Sunset (USA), Supraphon (Czechoslovakia), Transatlantic (UK), Unicorn (UK), United Artists (USA), Vanguard (USA), Virgin (UK); (distributed) Arston, Blue, CLS, Carosello, Intingo, Playphone.
Int'l reps.: Argentina (RCA), Austria (Amadeo), Bolivia (Lauro), Brazil (RCA), Chile (IRT), Colombia (Industria Electro-Sonora), El Salvador (Discos Centroamericanos), Germany (Metronome), Greece (CBS), Japan (King), Mexico (RCA), Panama (Discos de Panama), Spain (Ariola), Switzerland (Metronome), Uruguay (American Prods.).
 Ri-Fi Rec. Co. SpA (IFPI), Corso Buenos Aires 77, 20124 Milan. Tel: (02) 27.36.41. Cable: RIFIRECORD. Chm.: Giovanni Battista Ansoldi; A&R Mgr.: Antonio Ansoldi; Sales Mgr.: Mario Giampietro; Int'l Mgr.: Gianfranco Finamore; Export Luigi Fedele; Promo. Mgr.: Wladimiro Albera.
Branch: Rome, Via A. Cantore 19. Tel: (06) 31.92.10. Contact: Gianfranco Soffiatti.
Labels: (Owned) Antoniano, Collette, Out, Penny, Primary, Publidisco, Ri-Fi, Studio, Variety; (licensed) Apollo (Belgium), Atoll (France), Attack (UK), Continental (Brazil), Direction (Canada), Everest (USA), Formula (Brazil), Horse (UK), Ibach (France), Karma (Germany), Miami (UK), Mooncrest (UK), RMP (Germany), Saga (UK), Trojan (UK), Victor (Japan).
Int'l reps.: Argentina (Microfon), Austbralia (Minstrel) Austria (Bellaphon), Belgium (Lido), Brazil (Continental), Canada (Global), Chile (Quatro), Colombia (Codiscos), Ecuador (Codiscos), France (Atoll, Ibach), Germany (Metronome), Greece (Panivar), Israel (Gal Ron), Japan (King), Lebanon (SLD), Luxembourg (Discosol), Malta (Brizzi, D'Amato, Exotique, Vella), Netherlands (Sound Prods.), Peru (FTA), Portugal (Valentim de Carvalho),

South Africa (Myco), Spain (Columbia), Switzerland (Disques-Office), USA (Fiesta, Little, Peters Int'l), Venezuela (Disco de Moda) (SEE ADVERTISEMENT)
 Rusty Recs., Via Cuore Immacolato di Maria 10/A, 20141 Milan. Tel: (02) 849.0283.
 S D M, see Sviluppo Discografico del Mezzogiorno.
 S I F, see CGD.
 Saar Srl (IFPI), viale di Porta Vercellina 14, 20123 Milan. Tel: (02) 46.96.251. Cable: SAAR. Pres.: Walter Guertler; Gen. & Sales Mgr.: Sergio Balloni.
Labels: (Owned) Devil, Disco Action, Green Light, Harmony, Joker, Music Power, Signal, Up; (distributed) Lotus, Phoenix.
 Sabrina, see Stereomaster.
 Sarabandas Ed. Musicali & Produzioni Srl, Via Capecelatro 91, Milan. Tel: (02) 469.6251. Gen. Mgr.: Mario Rapallo. (Distributed by Saar).
Labels: (Owned) Lotus, Phoenix.
 Sciascia SaS (Ed.) (IFPI), Via Brodolini, 20089 Rozzano (Milan). Tel: (02) 82.58.041. Pres. & Gen. Mgr.: Armando Sciascia; Sales Mgr.: Sergio Sciascia.
Labels: (Owned) Albatros, Angelicum, Arcophon, Ars Nova, Corsair, New Jazz Collection, Quadrifoglio, 6-Phase Superstereo, Spider, Vedette, Way Out, Zodiaco; (distributed—not licensed) Arion, Cultura Popolare, Dischi Del Sole, Ducale, ECP, EDM, Edizioni Del Isola, Red, Universo Musica; (licensed) Baerenreiter-Musicaphon (Germany), CRD (UK), Chant du Monde (France), Folkways (USA), Harmonia Mundi (France), Lyra (Greece), Paredon (USA), Rounder (USA), UNESCO collection (Germany).
Int'l reps.: Argentina (Kenia), Belgium (Sonobel), France (Dom Disques), Germany (Disco Center), Greece (Philodisc), Switzerland (Phonag). (SEE ADVERTISEMENT)
 Senn Sound Italiana Srl, Via Edison 100, 20019 Settimo Milanese (Milan). Tel: (02) 32.82.366/337. Chief Exec.: Francesco De Paola; Gen. Mgr.: Franco De Paolis.
Labels: (Owned) Jet Sound, La Pera, Linea Azzurra, Rally, Senn Sound, Shocking, Vis Radio.
 Seraphim, see EMI.
 Shocking, see Senn Sound.
 Showbusiness Kings, see Omnia.
 Sidet Ed. Srl, Piazzetta Pattari 2, 20122 Milan. Tel: (02) 804.818, 861.165. Cable: MILLENOTE. Pres.: Emanuele Daniele; Gen. Mgr.: Franca Daniele; PR: Luciana Medini. (Distributed by RCA).
Labels: (Owned) Las Vegas, Millenote, Radio Recs., Recordclam, Telespazio.
Int'l rep.: Worldwide (RCA). (SEE ADVERTISEMENT)
 Signal, see Saar.
 Sinusoid, see C&M.
 Sirio, see Sviluppo Discografico del Mezzogiorno.
 6-Phase Superstereo, see Sciascia.
 Smash, Via Umberto Moricca 33, 00167 Rome. Tel: 638.4369.
 Snap, see Belmusic.
 Sonorex SpA, Via Bonfadina 14, 25046 Cazzago San Martino (Brescia). Tel: (030) 725.382. Telex: 30826.

Pres.: Giuseppe Zani; Gen. Mgr.: Bruno Raineri; Sales Mgr.: Italo Capoferri.
Labels: Audiogramm, Sonorex.
 Soul Note, see IREC.
 Souvenir, see Fonola.
 Spaghetti Recs. & Tapes, Galleria del Corso 2, Milan. Tel: (02) 794.129/729. Pres.: Sandro Colombini, VP: Shel Shapiro. (Distributed by RCA).
Labels: (Owned) Spaghetti, Spaghetti Blues.
 Spark Italiana Srl (IFPI), Piazza del Liberty 2, 20121 Milan. Tel: (02) 796.180. Mng. Dir.: Alberto Carisch; Sales Mgr.: Romeo Frumento; Admin.: Mrs. J. Olmi.
Labels: (Owned) Blue Jean, MRC, Orange, Spark.
 Spider, see Sciascia.
 Splash SaS, Via Enea Zanfagna 7, Naples. Tel: (081) 635.183, 627.222. Chief Exec.: Peppino di Capri; Gen. Mgr.: Giuseppe Faiella. (Distributed by CGD-Messaggerie Musicali)
 Sprint, see Durium.
 Starmaker, see Stereomaster.
 Start, see Durium.
 Stereomaster & Phonografic Center Co. Srl, Galleria del Corso 2, 20122 Milan. Tel: (02) 790.096. Owner: Giuseppina Bagatta; A&R & Prod'n: Giuseppe De Vecchi; Press & Pub.: Yvonne Saltarelli.
Labels: (Owned) Fiammetta's, Leoncollo, Phonorama, Sabrina, Starmaker, Stereomaster.
 Stop Recs., Via Pineta Sacchetti 484, 00168 Rome. Tel: (06) 628.0210. Gen. Mgr.: Pietro Perdoni.
Labels: (Owned) Petrus, Stop.
 Storm, see Sviluppo Discografico del Mezzogiorno.
 Storyville, see Decca.
 Stradivarius Club, Via Stradivari 8, 20131 Milan. (Importer)
 Strand, see Decca.
 La Strega Rec., Via San Lucifero 41, 09100 Cagliari, Sardinia. Tel: (070) 668.291, 667.769. Mng. Dir.: Margello Mazzella; Gen. Mgr.: Pierpaolo Pisano; Mgr.: Giancarlo Colombo. (Distributed by Panarecord)
 Studio, see Ri-Fi.
 Studio G Srl, Via al Forte di San Martino 11, 16145 Genoa. Tel: (010) 301.920, 369.723. Pres.: G.B. De Scatzi; Gen. Mgr.: Gianni Basilio.
Labels: (Owned) Grog, Magma (both distributed by Fonit-Cetra); Area.
Int'l reps.: France (Arabella), Germany (Ariola Eurodisc), USA (Peters Int'l).
 Studio 7, Via Santa Lucia 20, 80132 Naples. Tel: (081) 390.643.
Labels: (Owned) Big, Flag, LG, Studio 7.
 Studio 21 SpA, Via Zamenhof 21, 20136 Milan. Tel: (02) 839.7916, 837.5916. Pres.: Areggasc Savorelli Silvana; Procurator: Pier Quinto Cariaggi. (Distributed by CGD-Messaggerie Musicali).
Label: (Owned) Lasapa.
Int'l reps.: Worldwide (CBS), except Brazil (Copacabana), Bulgaria (Bulkanton), Japan (RCA), Portugal (Rossil).
 Suono Recs. Srl, Via Manin 111, 30174 Venice-Mestre. Tel: (041) 984.991, 972.229. Dir.: Tony Tasinato.



AUDIOGRAMM

A FULL PRODUCTION CYCLE OF:

- C-O CASSETTES AS WELL AS COMPONENT PARTS AND ACCESSORIES TO BE ASSEMBLED BY CUSTOMER
- BLANK CASSETTES OF ANY LENGTH, WHICH CAN BE PERSONALIZED WITH CUSTOMER'S TRADE-MARK BOTH ON LABEL AND PLASTIC CASE
- THIRD PARTY DUPLICATION ON PAN-CAKE ONLY AS WELL AS WINDING, LABELING AND PACKAGING UNTIL THE MUSICASSETTE FORMAT.
- PRODUCTION AND CUTTING OF BLANK TAPE AND LEADER.

Audiogramm s.p.a. - Via Vallosa, 38 - Passirano (Brescia) Italy - Tel. (030) 657360 - Telex 300260 camercom

WE ARE NOT LOVED

by our competitors

BECAUSE WE PAY ^{very} HIGH ROYALTIES

to our licensors

For sure you want to turn your records
into hits in Italy. All you have to do
is to contact

PANARECORD Sp.A.

we are looking for record catalogues
on a licence or import or distribution basis

we can offer complete facilities
(pressing, duplication, sleeve and jacket
printing, promotion, etc.)

we can grant full exploitation of your catalogue
because our philosophy is
not to have our own record production
but concentrate on a third party service

panarecord s.p.a. via cimarosa 4/20144 milano/italy/phone 430046 - 485609

sergio de gennaro, president

mario paroletti, v. president

u.s.a. representative - marisa de luca - new york phone 7675684

Sviluppo Discografico del Mezzogiorno SpA, Via dei Fiorentini 21, 80133 Naples.

Labels: (Owned) Edibi, SDM, Sirio, Storm.
Symbol SaS, Via Giotto 23/A, 30031 Dolo (Venice). Tel: (041) 412-254. Mng. Dir.: Renato Ulvioni. (Distributed by Panarecord)

Sympathy, see Record Serv.
Roy Tarrant, Via Prudenziana 2B, 22100 Como. Tel: (031) 266.560. Mgr.: Roy Tarrant. (Importer/Exporter)
Int'l branches: England, Switzerland.

Tauro, see EMI.
Teen, see CGD.
Telefunken, see Decca.
Telespazio, see Sidat.
Theatre Project, see Polygram.
Threshold, see Decca.
Top, see Panarecord.

Transex Srl, Via Dogana 1, 20123 Milan. Tel: (02) 805.7645, 862.730. Cable: TRANSEXPORT. Telex: 320405. Gen. Mgr.: Edip Saban. (Distributor/Importer/Exporter)
Label: (Imported) Melodiya (USSR).

Unifunk Srl, Corso di Porta Romana 106, 20122 Milan. Tel: (02) 54.63.756.
Int'l reps.: Austria (Ariola-Eurodisc), Belgium (Canon), France (Arabella), Germany (Ariola-Eurodisc), Ireland (Contour), Japan (Herald), Luxembourg (Canon), Netherlands (Canon), Portugal (Ariola-Eurodisc), South Africa (Arrowtaps), Spain (Ariola-Eurodisc), Switzerland (Ariola-Eurodisc), UK (Arrowtaps), USA (Capitol).

Universal, see Phonotype.
Up, see Saar.
V I P, see CGD & Cielo-Video.

Valiant, see RCA.
Vanilla Recs. Srl, Via Vittorio Veneto 7, 00187 Rome. Tel: (06) 463.294. Cable: VANILLAROMA. Gen. Sec'y: Alessandra Perlux; Artistic Co-ord.: Alberigo Crocetta. (Distributed by Fonit-Cetra).

Int'l reps.: Argentina (RCA), Austria (WEA), Benelux (Pema), Brazil (RCA), Chile (Industria de Radio & Television), Colombia (Sonolux), France (Pema), Germany (WEA), Japan (CAM), Spain (Hispanovox), Switzerland (WEA), Uruguay (APSA), Venezuela (Cordica).

Variety, see Ri-Fi.
Vedette, see Sciascia.
Vertigo, see Polygram.
Verve, see Polygram.
Victor, see RCA.
Victrola, see RCA.
Video, see Cielo-Video.
Vis Radio, see Senn Sound.
La Voce del Padrone, see EMI.
Voom-Voom, see Fonit-Cetra.
W E A Int'l, see WEA Italiana.

W E A Italiana SpA (IFPI), Via Milano (ang. via Cuneo), 20090 Redecesio di Segrate (Milan). Tel: (02) 213.8641/8551. Telex: 346888. Mng. Dir.: Giuseppe Velona; Mktg. Mgr.: Franco Vincenzini; Int'l A&R Mgr.: Ernesto Tabarelli.

Branch: 00195 Rome, Via Cantore 17. Tel: (06) 359.95.26, 388.317.

Home office: USA, WEA Int'l.
Labels: (Owned) Asylum, Atlantic, Charter, Elektra, Itwhy, Nonesuch, Reprise, WEA Int'l, Warner Bros. (licensed) Big Tree (USA), Calliope (France), Curton (USA), Dark Horse (USA), Enigma (UK), Radar (UK), Scotti Brothers (USA), State (UK), Swan Song (UK), Westbound (USA); (distributed—not licensed) BCE.

W J R, see Yep.
Wag, see Panarecord.
Warner Bros., see WEA.
Way Out, see Sciascia.
Wep, see Panarecord.
Wesley Int'l, see Durium.

Yep Rec., Via della Giuliana 44, 00195 Rome. Tel: (06) 389.361. (Distributed by Ricordi)
Int'l dept., Via Montepanoleone 29, 20121 Milan. Tel: (02) 782.159, 700.725, 791.665.

Labels: (Owned) WJ R, Yep
Zeus Rec. Srl (IFPI), Piazzetta Matilde Serao 15, 80132 Naples. Tel: (081) 406.791, 415.997. Contact: Ciro Barucci; Gen. Mgr.: Antonio Barucci.
Zodiaco, see Sciascia.

● music publishers

A B R, see Sugarmusic.
Giuseppe Accettura, Viale de Laurentis 6, Bari. Tel: (080) 420.113, 363.964. Chief Exec.: Giuseppe Accettura.

Acqua Azzurra (Ed. Musicali), see Numero Uno.
Acuff-Rose, see Sugarmusic.

Adora Ed. Italia, see Cielo-Video.
Agenda Ed. Musicali, Via Castiglione 109, Bologna. Tel: (051) 237.528, 504.095. Telex: 511483. Mng. Dir.: Alberto Caroli; Gen. Mgr.: Silvano Silvi.

Int'l firms represented: United International Copyright Reps. (USA), Syndicore (USA).

Aguamanda Eds. Musicali Srl, Largo Cairoli 2, 20121 Milan. Tel: (02) 803.750.

Allegro Srl, see Bixio Music Group.
Abramo Allione Eds. Musicali (SIAE), PO Box 1226, 20100 Milan; Via Enrico Toti 4, 20123 Milan. Tel: (02) 463.920, 435.093. Pres.: Abramo Allione; Gen. Mgr.: Italo Allione.

Apollo, see Sugarmusic.
April Music Srl, Via Amadei 9, 20123 Milan. Tel: (02) 809.521. Telex: 332806. Dir.: Antonio Marrapodi.

Home office: USA, April/Blackwood.
Int'l rep.: USA (April/Blackwood).

Argo Eds. Musicali Srl (SIAE), Via Vittorio Veneto 7, 00187 Rome. Tel: (06) 463.294. Gen. Sec'y: Alessandra Perlux.

Aris Eds. Musicali & Discografiche, Via Eleonora Pimentel 2, 00195 Rome. Tel: (06) 311.979, 312.296. Cable: DISCARIS. Artistic Dir.: Aldo Pomilia; Int'l Publ'g Mgr.: Fulvio Corradini.
Int'l firms represented: Central Park (Brazil), Martin

Meyer (Argentina), Productora Musical (Venezuela).
Int'l reps.: Argentina (Martin Meyer), Brazil (Central Park), Venezuela (Productora Musical).

Ariston Ed. Musicali Srl, see Ariston Srl.

Ariston Srl (SIAE), Via Massimo Gorki 21, Strada Zivido, 20098 San Giuliano (Milan). Tel: (02) 98.46.974. Telex: 321466. Pres.: Alfredo Rossi; Int'l Mgr.: Graham Johnson; Copyright Dept.: Fermo Tonali.

Branch: 00195 Rome, Via Cantore 17. Tel: (06) 386.259. Telex: 614509.

Int'l firms represented: Mister Mellow, RAK, Rocket, Valentine (all UK); Charles Kipps (all USA).

Aromando, see Sugarmusic.
Associati (Ed.), see G. Ricordi.

Atlas Music, Corso Buenos Aires 10, 20124 Milan. Tel: (02) 271.5972. Pres. & Gen. Mgr.: Alessandro Coppola. (SEE ADVERTISEMENT)

Audisam di Angeramo Nunzia (Ed. Musicali), Galleria del Corso 2, Milan. Tel: (02) 704.006. Gen. Mgr.: Giovambattista Samele.

Baruth Music, Via Mulini 38, 38015 Lavis. Tel: (0461) 46.499. Europe Pres.: Raymond Baruth Jr.; Europe Mgr.: Marta Sabastiani.
Home office: USA.

Beat Recs. Co. Ed. Musicali Srl (SIAE), Via Filippo Nicolai 16, 00136 Rome. Tel: (06) 348.497, 347.139. Gen. Mgr.: Franco de Gemini.

Int'l firms represented: Amphonic (UK), Emilhenco (France), Eurobeat (UK), Illustration (France), Jerry William (USA), Show Business (Germany).

Int'l rep.: UK (Eurobeat)

Belriver Srl, see La Voce del Padrone.
Bixio CA, see Bixio Music Group.

Bixio CEMSA SpA, see Bixio Music Group.
Bixio Music Group (SIAE), Via Romeo Romei 15, Rome. Tel: (06) 311.280, 311.870. Pres.: Carlo Bixio.

Int'l reps.: Belgium, France, Germany, USA (all Bixio); Japan (Nippon Herald).

Bixio Sam, see Bixio Music Group.

Bla Bla Ed. Musicali Srl (SIAE), Galleria del Corso 2, 20122 Milan. Tel: (02) 796.149.

Blue Sky Ed. Musicali, see Sidat.
Blue Team Ed. Musicali SpA, Via Milano (ang. via Cuneo), 20090 Redecesio di Segrate (Milan). Tel: (02) 213.8641/8551. Mng. Dir.: Giuseppe Velona.

Bongiovanni (Ed. Musicali), Via Rizzoli 28, 40125 Bologna. Tel: (051) 225.722. Gen. Mgr.: Giancarlo Bongiovanni.

Int'l rep.: USA (Belwin-Mills)
Bruzia Ed. Musicali, PO Box 10, 89029 Taurianova. Tel: (0966) 41.030. Owner: Rag. Carmelo Alessi; Gen. Mgr. Elvio Monti.

Home office: Australia
Int'l firms represented: Alex (Canada), Beat (France), Dema (Australia, New Zealand), Mangione (Brazil).

Int'l reps.: Australia (Dema), Brazil (Mangione), Canada (Alex), France (Beat), New Zealand (Dema).

Buffalo Bill, see Sugarmusic.
La Bussola Ed. Musicali, see Ariston.
C A M (Creazioni Artistiche Musicali) SpA (SIAE), Via Virgilio

CLAY-PAKY s.n.c.

24068 SERIATE BERGAMO-ITALIA - 035/29.30.77

VIBRATING HALF-BALL OLIMPIC



cod. 500/2
Vibrating half-ball in woody box covered by aluminum II is moved by an impeller that receives a signal from acoustic boxes, that is converted into an impulse that provokes the movement of olimpic. For the illumination of the half-ball we recommend the projector LX-3 with super optics focal mm. 480 cod. 100.5)

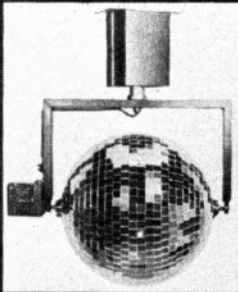

LITTLE ROLLING MIRROR BALL cod. 600/6

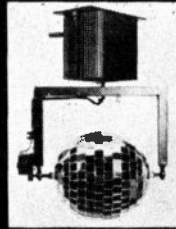

BIG ROLLING MIRROR BALL cod. 600/7



LX/3 MAGIC RAY cod. 600/4
— Feature like LX/3
— Audio input W 3/100
— Sensitivity potentiometer
— Fuse 0.5 A
— It operates by a monochannel modulator, built in an adaptor connected to acoustic boxes, turns the sound signal into a changing intensity impulse, and moves the ray



ODISSEA ADAPTOR cod. 200/17
— Five geometrical rays rolling on 180

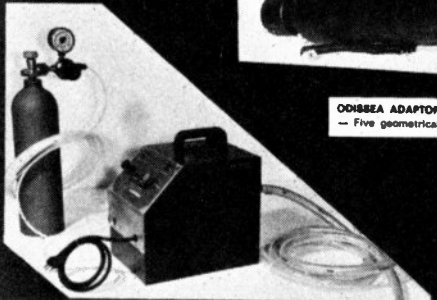

SMOKE MACHINE cod. 800/8
— Input V 220 HZ 50
— Absorption W 750
— The smoke is obtained with a special oil sterilized and shovied by a CO/2 adjustable casting

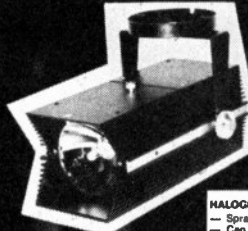

HALOGEN SPOT cod. 100/8
— Sprayed aluminum body
— Cap 25
— Halogen lamp V 24 W 150
— Connected transformer



PROJECTOR LX-3
— A.B.S. antihate body
— Quartz iodine-lamp v 24 w 150
— Incorporated transformer
— Turbine-cooling
— Interchangeable object-glass
— Double condenser
— Parabolic mirror
— Antihate incorporated filter
— Manual control of object-glass
— Feeding v 220 Hz 50

Special feature:
— Switch for reduction of light
— Frontal cap for eventual suitable parts
— Bright and brilliant projection even from large distance

YOU NEED RIFI!



- The Great Fully Independent Record and Publishing Company
- The Dynamic Licensee for Your Productions and Songs in Italy
- The Hit Producer also for Your Country

RIFI RECORD CO AND RIFI PUBLISHING GROUP - CORSO B. AIRES 77
20124 MILANO - TEL. 02/273641 - CABLE RIFIRECORD MILANO
RECORDING STUDIOS - VIA STROMBOLI 18 - MILANO - TEL. 02/463900
PRESSING PLANTS - IRI - VIA VESPOLATE 22 - CONFENZA (PV) - TEL. 0384/64054
ROME BRANCH OFFICES - VIA A. CANTORE 19 - TEL. 06/319210

EXCLUSIVE LICENSEES:

ARGENTINA - MICROFON
AUSTRALIA - COLOSSAL - MINSTREL
BRASIL - CONTINENTAL
HOLLAND - SOUND PRODUCTS
FRANCE - IBACH/ATOLL
BELGIUM - LIDO/SONOBEL
AUSTRIA - BELLAPHON

GREECE - PANIVAR
COLOMBIA - ECUADOR - CODISCOS
PERU - FTA
CHILE - QUATRO
SPAIN - COLUMBIA
SWITZERLAND - DISQUE OFFICE
VENEZUELA - FAVEDICA

CANADA - GLOBAL
GERMANY - METRONOME
JAPAN - KING

BRASIL - SIGEM/GLOBO
SPAIN - RIFI ESPANOLA
U.K. - NOEL GAY
U.S.A. - RIFI MUSIC INC.

Pickwick Srl (Ed. Musicali), Corso Europa 5/7, 20122 Milan Tel (02) 706 510 Gen. Mgr. Monica Dahl. (Also see Sugarmusic)
Int'l firms represented: Gredge (UK), Johnsons (UK), Leeds (UK), MAM (UK), MCA group (USA), Spanka (UK), Tomo Tunes (UK), Valley (UK)
 Pinciana Music Srl (SIAE), Via Giovanni Branca 35, 00153 Rome Tel (06) 578 776
 Prima Linea Srl, Via Guido Banti 46, 00191 Rome Tel (06) 328 4390/4936 Chief Execs. Albert Weyman, Roberto Conrado
 Pull Eds. Srl (SIAE), Via della Camilluccia 701, Rome Tel (06) 32 73 050
 R C A SpA (Ed. Musicali) (SIAE), Via San Alessandro 7, 00131 Rome Tel (06) 436 61 Telex 61428 Pres. Giuseppe Ornato, Dir. Mario Contini, Foreign Catalogs Mgr. Aldo Mazzetti, Int'l Copyright Mgr. Sante Cecconi
Home office: USA
Int'l firms represented: Aberbach (USA), Almo/Irving (USA), Associated (Australia), Belwin-Mills (UK, USA), Bleu Disque (USA), Brantree (USA), Cayman (USA), Copyright Serv. Bureau (USA), Cyclus (Germany), 57th Street Entertainment Group (USA), Formula (USA), Sam Fox (USA), Gladys (USA), Hill & Range (USA), Hudson Bay (USA), Isadora (France), Kidada (USA), Edward B. Marks (USA), Metal Machine (USA), Ivan Mogull (USA), Morning Music Group (Canada, UK, USA), Muscle Shoals Sound (USA), Oakfield Ave. (USA), Page Full Of Hits (UK), Plangent Visions (UK), Porchester (USA), Elvis Presley (USA), RCA (Brazil, France, Spain), Rashida (USA), Red Network/Blue Network (USA), Relay (Argentina), Rondor (Australia, Canada, UK, USA), Salsoul group (USA), Scott-Wolfe (UK), Street Music (UK), Sunbury/Dunbar (Canada, UK)
Int'l reps.: Argentina (Relay), Australia (Associated), Brazil (RCA), Canada (Sunbury/Dunbar), France (RCA), Germany (Cyclus), Japan (Global), Mexico (EDIM), Spain (RCA), UK (Sunbury), USA (Blue Network/Red Network)
 R C A Musica SpA, see RCA SpA
 R U M, see Sugarmusic
 Radio Ed. Musicali, see Sidet
 Radio Rec. RRR, see G. Ricordi
 Rekon Ed. Musicali, see Cielo-Video
 Resolute, see Sugarmusic
 Revelation, see Sugarmusic
 G. Ricordi & C. SpA (SIAE), Via Berchet 2, 20121 Milan, Tel. (02) 88 81 Cable RADIOREK, Telex 310177, Mng. Dir. Guido Rignano, Int'l Publ'g Mgr.: Vittorio Somalvico
Int'l firms represented: ABC (USA), ATV (UK, USA), Ackee (USA), Admond (USA), Alien (USA), Alshire Int'l (USA), Ariola America (USA), Average (USA), Eddie Barclay (France), Big Elk group (USA), Blue Street (USA), Broken Arrow (USA), Bron (UK), C'est Music (USA), Chrysalis (UK), Combine (USA), Cottillion/Walden (USA), Crazy Crow (USA), Dark Horse (USA), Debmar/Rambled (USA), Doobie Brothers' New

Repertoire (USA), Easy (USA), Five Continents (USA), Fleetwood (UK), Freshwater (UK), Ganga (USA), Giving Room (USA), Gnosso (USA), God Tunes (USA), Gold Hill (USA), Goodman group (USA), Grade & Lynton (UK), Guerrilla (USA), Hancock (USA), Harrison (USA), Heath Levy (UK), Tony Hiller (UK), Icebag (USA), Island (UK, USA), Dick James (UK), Krundle (USA), Leatherhead (USA), John Lennon (UK), Libra (UK), Light (USA), Little Dragon (USA), Lunatunes (USA), Manticore (UK), Material World (USA), Medicine Hat (USA), Micache (USA), Joni Mitchell (USA), Moby Grape (USA), Mole (USA), Northern Songs (UK), Nuestra Canterbury (USA), Pamscene (UK), Pink Floyd (UK), Plurkantz (USA), Pods (USA), Portofino (USA), Quackenbush (USA), Ramsel (USA), Razzle (UK), Resaca (USA), Rocket (UK), Savona (USA), Boz Scaggs (USA), Scent (USA), Shillelagh (USA), Shot (USA), Silver Fiddle (USA), Siquomb (USA), Staysail (USA), Strong Arm (USA), Thin Ice (USA), Trane (USA), UFO (USA), VAAP (USSR), Venice (USA), Warner Bros. (UK, USA), Bruce Welch (UK), West Berkeley Soundcigum (USA), Windcor (USA), Wizard (UK), Lawrence Wright (UK)
Int'l reps.: Argentina (Ricordi Americana), Belgium (Nada), France (Barclay), Germany (Drei Ringe), Greece (Blackwood), Japan (Watanabe), Mexico (EMLASA), Netherlands (Nada), Spain (Armonico-Clipper), Switzerland (Seventh Music)
 R-Fi Music Publ'g Group (SIAE), Corso Buenos Aires 77, 20124 Milan, Tel. (02) 273 641, Cable RIFIRECORD, Chm. Giovanni Battista Ansoldi, Mgr. Marinko Rigaldi, Int'l Mgr.: Gianfranco Finamore
Int'l branches: Spain, USA
Int'l firms represented: Atoll (France), Noel Gay (UK), New Town Sound (UK), Notas Magicas (Spain), Sigem/Globo (Brazil)
Int'l reps.: Brazil (Sigem/Globo), UK (Noel Gay). (SEE ADVERTISEMENT)
 Rimi Ed. Musicali (SIAE), Piazzetta Pattari 1/3, 20122 Milan Tel. (02) 871 370, 891 815 Cable MARIART
 Ritmi & Canzoni (Ed. Musicali), see G. Ricordi
 C. A. Rossi Gruppo Ed. (SIAE), Via Barletta 11, 20141 Milan Tel. (02) 53 92 251
 Le Rotonde Ed. Musicali VC SpA, see Sidet
 S C A L Ltd., Galleria del Corso 2, 20122 Milan, Tel. (02) 784 580
 Saar Srl (SIAE), Viale di Porta Vercellina 14, 20123 Milan, Tel. (02) 437 162, 490 171, Cable SAAR, Pres. Walter Guertler
 Santa Cecilia Ed. Musicali Srl, see Ariston
 Sarabandas Srl, Via Capecelatro 91, 20148 Milan Tel. (02) 469 6251 Gen. Mgr. Mario Rapallo
 A. Schroeder Music (Italy) Srl (Ed.), Via Quintiliano 40, 20138 Milan, Tel. (02) 50 84
Home office: USA
Int'l firms represented: Aloud, Anim, Arbutus, Arch, Avaris, Bagimin, Bella Godiva, Boscoe, Burlac, Catch Fire, Cat Mother, Dandy Dittys, Dreams & Visions, Emm-Jay, Fitness King, Fool Killers, Fourouvs Survival, Kim

Fowley, Golden Unlimited, Great Montana, Hedley Songs, Homecoming, Humdrum, January, Jenr, Joans Bones, Joint, LaLanne, Larbell, Lassie, Last Laugh, Lazy Canary, Magnanimous, Manistee, Mempro, Mile Wide River, Mother Hen, My Baby's, Next Stop, One Stop, Pierhead, Pitfield, Rebecca Raccoon, Rel-Nel, Rojorth, Sa-Vette, Sea-Lark, Sepe, Skin, Stewart-Nims, Summer-tree, Super Songs, Tijuca, Va-Detta, Vancouver, Very Own, Wrathor, Yameta, Zekefield Follies
 Sciascia Ed. Musicali (SIAE), Via Brodolini, 20089 Rozzano (Milan) Tel. (02) 82 58 041 Pres. Armando Sciascia (SEE ADVERTISEMENT)
 Senza Fine Srl (Ed.) Piazzetta Pattari 2, 20122 Milan Tel. (02) 898 909/968
Int'l branch: England
Int'l firms represented: Barn, Barn-Stade, Bay City, Carlin (UK), Catrine (UK), Robin Gibb (UK), Lupus (UK), Pink Floyd (UK), Skyhill (USA), Space Songs, State, Robert Stigwood Org. (UK), Walrus (UK), Wizard
 Settebello Srl (SIAE), see R-Fi
 Sette Note, see Southern
 71 (Eds.), see Beat
 Sidet (Ed.) (SIAE), Piazzetta Pattari 2, 20122 Milan, Tel. (02) 804 818, 861 165 Cable MILLENOTE, Owner. Emanuele Daniele, Gen. Mgr. Franca Daniele
Int'l rep.: Germany (Amalpa) (SEE ADVERTISEMENT)
 Sofia, see Sugarmusic
 Southern Music (SIAE), Piazza del Liberty 2, 20121 Milan, Tel. (02) 796 473 Gen. Mgr. Alberto Carisch
Home office: USA, Peer-Southern Org
Int'l firm represented: Southern (worldwide)
Int'l rep.: Worldwide (Southern)
 Spaghetti Music, Galleria del Corso 2, Milan, Tel. (02) 794 129/729 Pres. Sandro Colombini
 Sprint, see Durium
 La Strega (Eds. Musicali) (SIAE), see Carsalmaz
 Strum Ed. Musicali Srl (SIAE), Piazza Bonomelli 7, Milan, Tel. (02) 53 93 639 Mng. Dir. Carmelo La Bionda
Int'l firm represented: Strum (UK)
Int'l rep.: UK (Strum)
 Successo, see Sugarmusic
 Sugarmusic Group (SIAE), Via Quintiliano 40, 20138 Milan, Tel. (02) 50 84, Telex 35063 Dirs. Ladislao & Piero Sugar, Giuseppe Gianni, Ettore Carrera, Co-Pres.: Ladislao & Piero Sugar, Gen. Mgr. Ettore Carrera, Int'l Promoter & Plugger Alex Perucchini, Int'l Prof. Mgr. Mariangela Roveda, Prod. Mgr. Franco Dal Dello
Int'l branches: Argentina, Australia, Benelux, Brazil, Canada, France, Germany, Greece, Japan, Mexico, Scandinavia, Spain, Switzerland, UK, USA
Int'l firms represented: Acuff-Rose group (UK, USA), Airborne (USA), J. Albert & Son Pty. Ltd. (Australia), Algee (USA), American Dream (USA), Andover (UK), Antisia (USA), Audre Mae (USA), Baboo group, Bibo (USA), Boca (USA), Brand (USA), Brandom (USA), Raoul Breton (France), Bruil (UK), Brut (USA), Buttermik Sky (USA), Caleb (USA), Carlin (UK), Alan

Sidet

Edizioni S.r.l.



INCLUDING

BLUE SKY edizioni musicali s.r.l.

DANIELE edizioni musicali s.r.l.

MILLENOTE edizioni musicali s.r.l.

SIDET edizioni musicali s.r.l.

TICKLE edizioni musicali s.r.l.

and RADIO RECORDS

SIDET edizioni s.r.l.

piazzetta pattari 2 I 20122 milano Italy
 tel. (02) 804818 - 861165
 cable millenote

MUSIC PUBLISHERS

CARLO FRANCHI casa editrice musicale

LE ROTONDE edizioni musicali vc s.p.a.

RADIO edizioni musicali s.r.l.

TELESPAZIO edizioni musicali s.r.l.

TORNADO edizioni musicali

Cartee (USA), Caspat (UK), Chameleon (USA), Champagne (USA), Char-Liz (USA), Martin Cohen group (USA), Common Good (USA), Crystal Jukebox (USA), Damont (USA), Deep Canyon (USA), Desert Moon (USA), Desert Rain (USA), Walt Disney Music (USA), Ear Responsible (USA), Easy Listening, Eau D'Yeah (USA), Elbomo (USA), Equinox (USA), Fab (USA), Ferris Wheel, Four Knights Music Co (USA), Galleon (USA), Al Gallico (USA), Noel Gay (UK), Gear (USA), Robin Gibb Publ'g Ltd. (UK), Goblet (USA), Gold Sovereign (USA), Good Flavour (USA), Gopam group (USA), Great Honesty (USA), Hevpsy Boy (USA), Hall-Clement (USA), Heavy (USA), Hello There (USA), Home Fire (USA), Infinity (USA), Jack & Bill (USA), Jacon (USA), Jarak (USA), Jasperilla (USA), Josley (UK), KL West Coast (USA), Kingsize, Klaatoons Inc. (Canada), Knollwood (USA), Lady Casey (USA), Lornhole (USA), Louise Jack (USA), Lupus (UK), Lynal (USA), March Hare (USA), Mericana (USA), Mariposa (USA), Quinn Martin (USA), Marvy (USA), Milene (USA), Mr. Bones (USA), Modern Love (USA), Mother Pearl Music (USA), Octave (USA), Owepar (USA), QM Music (USA), Radar (USA), Teddy Randazzo (USA), Rateo (USA), Raton Songs (USA), Razzle Dazzle (USA), Fred Rose (USA), Rye-Boy (USA), Seawind (USA), Shoals (USA), Slow Dancing (USA), Sonet group (Sweden), Stainless (USA), State (UK), Sumac Music Inc. (USA), Synergistic (USA), Three Brothers (USA), Thursday (USA), Tomeja, Tremor (USA), Triple O (USA), Vanilla (UK), Velvet Apple (USA), Vogue (USA), Wonderland (USA).

Suono Ed. Musicali (SIAE), Via Manni 111, 30174 Venice/Mestre, Tel. (041) 984.991, 972.229. Gen. Mgr.: Tony Tasinato. (Affiliated with Franton Music Srl)

Int'l firms represented: Alucard, Excellency, Hawkana, Heat, Nicky James, Jonathan, March, Milmerran, Strange, Summerland Songs, Toneshire, Yessongs (all UK).

Suvini Zerboni, see Sugarmusic.
Suzy Ed. Musicali, see Ducale.
Telespazio Ed. Musicali, see Sidet.
Televiz Eds. Musicali Srl, Piazza Missori 3, 20123 Milan, Tel. (02) 65.71.491. Gen. Mgr.: Freddy Naggiar.
Tender, see Sugarmusic.
Tiber, see Sugarmusic.
Tickle Ed. Musicali Srl, Piazzetta Pattari 2, Milan, Tel. (02) 861.165, 804.818 Cable MILLENOTE, Owner: Franca Daniele. (Affiliated with Sidet)
Tornado Ed. Musicali, see Sidet.
Traccia, see Franton.
Tre Stelle, see C.A. Rossi.
23 Italie Srl (Ed.) see listing under Venti.
Unifunk Srl, Corso di Porta Romana 106, 20122 Milan, Tel. (02) 54.63.756.
Int'l reps.: Austria (Eurobeat), Belgium (Intervox), France (Eurobeat), Germany (Eurobeat), Ireland (Eurobeat), Japan (Herald), Luxembourg (Intervox), Netherlands (Intervox), Portugal (Eurobeat), South Africa (Eurobeat), Spain (Eurobeat), Switzerland (Eurobeat), UK (Eurobeat), USA (Opal).

United Artists (Italy) Srl (Ed. Musicali), Corso Europa 5/7, 20122 Milan, Tel. 794.841
Universale (Ed. Musicali), see Numero Uno.
Usignolo Ed. Musicali, Via G. Meda 45, 20141 Milan, Tel. (02) 84.32.551. Chief Exec. Wilma Battigelli Gen. Mgr. Ettore Minorette.
23 Italie Srl (Ed.) (SIAE), Via Albani 7, 20149 Milan, Tel. (02) 49.86.449. Mng. Dir.: Liliana Azzolini.
Int'l rep.: UK (Mansen).
La Voce del Padrone, Galleria del Corso 2, 20122 Milan, Tel. (02) 704.401/603. Cable ARPEGGIO. Telex: 312679. Admin'r: John Bush; Gen. Mgr.: Alexis Rotelli; Deputy Gen. Mgr.: Roberto Citterio.
Int'l firms represented: Big Ben (UK), Deep Purple (UK), EMI group (worldwide), Our Music (UK), Purple (UK), Red Bus (UK).
Int'l rep.: Worldwide (EMI group).
Warner Bros. Music Italy, see G. Ricordi.
West Eds. Musicali, see Beat.
Worldmusic, see Sugarmusic.

● services

ASSOCIATIONS & PROFESSIONAL ORGANIZATIONS

A F I (Associazione dei Fonografici Italiani), Via Vittor Pisani 22, 20124 Milan, Tel. (02) 652.636 (Association of Italian rec. cos.)
A I D E M (Associazione Italiana Degli Ed. di Musica), Piazza del Liberty 2, 20121 Milan, Tel. (02) 796.473. (Italian Music Publ'rs Ass'n).
U N E M I (Unione Editori di Musica Italiani), Via Berchet 2, Milan, Tel. (02) 88.81 Cable IDROCIR. Telex: 31177. Pres. Eugenio Clausetti. (Union of Italian Music Publ'rs).

DESIGN & ARTWORK

C G D-Messaggerie Musicali SpA, Via Quintiliano 40, 20138 Milan, Tel. (02) 50.84 Cable CIGIDISC. Telex: 35063. Pres.: Ladislao Sugar; Mng. Dirs.: Piero Sugar, Franco Crepax; Exec. VP's: Giuseppe Giannini, Sandro Delor; Comm'l Mgr.: Roberto Guerrazzi, Sales Mgr. Romano Razzini; Promo. Mgr.: Johnny Porta.
Branches: Bari, Bologna, Catania, Florence, Naples, Padua, Pescara, Rome, Turin.
Mario Convertino, Via Giovannino dei Grassi 3, Milan, Tel. (02) 808.716.
Durium SpA, Via Manzoni 40/42, Milan, Tel. (02) 701.703. Telex: 25564. Pres. & Mng. Dir.: Krikor Mintangian; Chief Admin'r: Giulio Galimberti; Sales Mgr. Amleto Silvestri. (SEE ADVERTISEMENTS)
Gianni Greguoli, Via Vincenzo Monti 77, Milan, Tel. (02) 498.9467. Ass't Luca Greguoli
L E M (Lavorazione Nastro Magnetico) SpA, Via G.b. de La Salle 4/A, 20132 Milan, Tel. (02) 256.9998. Gen. Mgr. Roberto Arnoldi. (Tape only)
Sciascia SaS (Ed.), Via Giacomo Brodolini, 20089 Rezzano

(Milan), Tel. (02) 825-8041. Pres.: Armando Sciascia. Gen. & Sales Mgr.: Sergio Sciascia. (SEE ADVERTISEMENTS)
Studio 52, Via Pasteur 16, Milan, Tel. (02) 285.3463. Chief Exec. Halmut Ebnel.
Luciano Tallarini, Via Washington 25, 20146 Milan, Tel. (02) 804.908. Chief Exec.: Luciano Tallarini

LICENSING ORGANIZATION, MUSIC

S I A E (Societa Italiana Degli Autori Editori), Viale della Letteratura 30, 00100 Rome, Tel. (06) 59.90. Pres.: Luigi Conte; Gen. Mgr.: Giacomo di Iorio. (General Performing & Mechanical Rights Society).

PLATING, PROCESSING & PRESSING PLANTS

Ambrosio Discografica SaS, Via Brasile 13, 20090 Limito di Pioltello (Milan), Tel. (02) 904.7861
Branch: 20121 Milan, Via San Paolo 15 Tel. (02) 865.578.
Ariston Srl, Via Massimo Go'ri 21, Strada Zivido, 20098 San Giuliano (Milan), Tel. (02) 984.6974. Telex: 35466. Pres.: Alfredo Rossi; Factory Mgr.: Carlo Barbareschi.
Branch: 00195 Rome, Via Cantore 17 Tel. (06) 386.259.
Audiogram SpA, Via Vallosa 38, 25050 Passirano (Brescia), Tel. (030) 657.360. Telex: 300260 Owner & Mng. Dir.: Edoardo Cattaneo; Gen. Mgr.: Francesco Nervi; Sales Mgr.: Luciano Bassani. (SEE ADVERTISEMENTS)
C G D-Messaggerie Musicali SpA, Via Quintiliano 40, 20138 Milan, Tel. (02) 50.84 Cable CIGIDISC. Telex: 35063. Pres. Ladislao Sugar; Mng. Dirs.: Piero Sugar, Franco Crepax; Exec. VP's: Giuseppe Giannini, Sandro Delor; Comm'l Mgr.: Roberto Guerrazzi; Sales Mgr. Romano Razzini; Promo. Mgr.: Johnny Porta; Pressing Plant Mgr.: Luciano Zamignani.
Branches: Bari, Bologna, Catania, Florence, Naples, Padua, Pescara, Rome, Turin.
Ducale Ind. Musicali SpA, Via Per Cadrezzate 5, 21020 Brebbia (Varese), Tel. (0332) 770.784/189. Cable DUCALEMUSIC BREBBIA (VARESE). Telex: 380231. Pres. & Gen. Mgr.: Davide Matalon. (SEE ADVERTISEMENTS)
Durium SpA, Via Manzoni 40/42, Milan, Tel. (02) 701.703. Telex: 25564. Pres. & Mng. Dir.: Krikor Mintangian; Chief Admin'r: Giulio Galimberti; Sales Mgr. Amleto Silvestri. (Pressing only) (SEE ADVERTISEMENTS)
E M I Italiana SpA, Viale dell'Oceano Pacifico 46, 00144 Rome, Tel. (06) 592.0751. Cable: EMIROM. Telex: 613208. Mng. Dir.: John L. Bush; Deputy Mng. Dir.: Vittorio Magnoli; Comm'l Mgr.: Nerio Alunni
Factory: Caronno Pertusella, Varese, Via Bergamo 315. Tel. (02) 965-0701. Cable: EMITAL. Factory Mgr. Claudio Cattaneo.
Fonit-Cetra SpA, Via Giuseppe Meda 45, 20141 Milan, Tel. (02) 804.908.

**WE HAVE MADE
MANY HITS
FOR OURSELVES
AND FOR OTHERS.
ATLAS
COULD MAKE
YOUR NEXT HIT
CONTACT US NOW!
ATLAS
RECORD &
PUBLISHING**



CORSO BUENOS AIRES 10-
20124 MILANO-ITALY
TEL (02) 2715972/273163

(02) 843 2551. Cable FONITCETRA. Pres.: Giuseppe Piccioni; VP: Giorgio Agosti; Gen. Dir.: Mario Zanoletti. Fonola Fonotecnica. Via Ariberto 21, 20123 Milan. Tel: (02) 848-4626. (Pressing only)

IRI (Industrie Riunite Italiane) SrL, Via Vespolate 22, 27030 Confienza (Pavia). Tel: (0384) 64.054.

Industria Italiana Lingue Vive nel Mondo. Via IV Novembre 5, 20078 San Colombano al Lambro (Milan). Tel: 890.05. (Pressing only)

Microwatt Srl, Principato 2, Vimercate (Milan). Tel: (039) 669.106. Mng. Dir.: Giorgio Cagnola. (Pressing only)

Phono-Plast SaS, Via G. Grandi 50, 20068 Peschiera Borromeo (Milan). Tel: (02) 716.435. (Pressing only)

Phonoster SpA, Via G. Rossini 3, 20067 Tribiano (Milan). Tel: (02) 906.0711. Telex: 310239. Gen. Mgr.: Giuliano Bearzi.

Phonotype Rec. Srl, Via Enrico de Marinis 4, 80134 Naples. Tel: (081) 206.642, 205.873. Chief Exec. Vincenzo Esposito; Gen. Mgr.: Fernando Esposito; Sales Mgr.: Roberto Esposito.

R C A SpA, Via San Alessandro 7, Rome. Tel: (06) 43.661. Telex: 61428. Pres.: Giuseppe Ornato; Gen. Mgr.: Ennio Melis; Mktg. Mgr.: Luciano Bernacchi. Home office: USA.

Ri-Fi Rec. Co. SpA, Corso Buenos Aires 77, 20124 Milan. Tel: (02) 273.641. Mng. Dir. & Gen. Mgr.: Giovanni Battista Ansoldi; Sales Mgr.: Mario Giampietro. (SEE ADVERTISEMENT)

Saar Srl, Via Gramsci 4, 20016 Pero (Milan). Tel: 353-0573/0564. Pres.: Walter Gutler; Mgr.: Luigi Maurizio.

Senn Sound Italiana Srl, Via Edison 100, 20019 Settimo Milanese (Milan). Tel: (02) 328-2366/2337. Mng. Dir.: Francesco de Paola; Gen. Mgr.: Franco de Paolis. (Pressing only)

Start Inc., Corso Garibaldi 120, 20030 Seveso (Milan). Tel: (0362) 508.701. Telex: 312080. Pres.: Mario Colombo; Gen. Mgr.: Dr. Dario De Benedetti; Sales Mgr.: Dr. Luigi Cane. (Pressing only) (SEE ADVERTISEMENT)

Studio G Srl, Via al Forte di San Martino 11, 16145 Genoa. Tel: (010) 301.920, 369.723. Pres. & Gen. Mgr.: G.B. De Scalzi.

Zeus Rec. Srl, Piazzetta Matilde Serao 15, 80132 Naples. Tel: (081) 406.791, 415.997

PRINTERS & LITHOGRAPHERS

CG D-Messaggerie Musicali SpA, Via Quintiliano 40, 20138 Milan. Tel: (02) 50.84. Cable CIGIDISC. Telex: 35063. Pres.: Ladislao Sugar; Mng. Dirs.: Piero Sugar, Franco Crepax; Exec. VP's: Giuseppe Giannini, Sandro Delor; Comm'l Mgr.: Roberto Guerrazzi; Sales Mgr.: Romano Razzini; Promo. Mgr.: Johnny Porta. Branches: Bari, Bologna, Catania, Florence, Naples, Padua, Pescara, Rome, Turin.

Ecofina Srl, Via Leopardi 8, 20123 Milan. Tel: (02) 869-0121, 806.125. Chief Exec.: Mourad Sabet. Factory: Via Monviso 21. Tel: (02) 314.766. Factory Technical Mgr.: Ronald F. Goodwin. (SEE ADVERTISEMENT)

G T E (General Tape Equip.) Srl, Via Ragusa 8, Milan. Tel:

(02) 689.8065. Telex: 25046. Gen. Mgr.: Ottaviano Clerici Baggio; (tape only)

IRI (Industrie Riunite Italiane) SrL, Via Vespolate 22, 27030 Confienza (Pavia). Tel: (0384) 64.054.

LE M (Lavorazione Nastro Magnetico) SpA, Via G.B. Battista de La Salle 4/A, 20132 Milan. Tel: (02) 256.9998. Gen. Mgr.: Roberto Arnoldi. (Tape only)

Ri-Fi Rec. Co. SpA, Corso Buenos Aires 77, 20124 Milan. Tel: (02) 273.641. Mng. Dir. & Gen. Mgr.: Giovanni Battista Ansoldi. (SEE ADVERTISEMENT)

Sciascia SaS (Ed.), Via Giacomo Brodolini, 20089 Rozzano (Milan). Tel: (02) 825-8041. Pres.: Armando Sciascia; Gen. & Sales Mgr.: Sergio Sciascia. (SEE ADVERTISEMENT)

RECORD PROMOTION

America Recs. di Angeramo Nunzia, Galleria del Corso 2, Milan. Tel: (02) 704.006. Gen. Mgr.: Giovambattista Samele; Sales Mgr.: Sonia Samele.

CG D-Messaggerie Musicali SpA, Via Quintiliano 40, 20138 Milan. Tel: (02) 50.84. Cable CIGIDISC. Telex: 35063. Pres.: Ladislao Sugar; Mng. Dirs.: Piero Sugar, Franco Crepax; Exec. VP's: Giuseppe Giannini, Sandro Delor; Comm'l Mgr.: Roberto Guerrazzi; Sales Mgr.: Romano Razzini; Promo. Mgr.: Johnny Porta. Branches: Bari, Bologna, Catania, Florence, Naples, Padua, Pescara, Rome, Turin.

Paolo Cattaneo Ents., Via Monte Napoleone 29, Milan. Tel: (02) 700.725.

C & M Di Cavalieri & C. Srl Recording Studios, Via Isonzo 206, Bari. Tel: (080) 224.610. Chief Exec.: Lino Cavalieri.

Il Motore, Via Bazzoni 12, Milan. Tel: (02) 498.9448/9646.

Panarecord SpA, Via Cimarosa 4, 20144 Milan. Tel: (02) 430.046, 485.609. Pres.: Sergio De Gennaro; VP: Mario Paroletti. Branch: Bologna, Disco Express, Via Barberia 13. Tel: (051) 276.697. (SEE ADVERTISEMENT)

Promoerre, Galleria Del Corso 4, Milan. Tel: (02) 701.162, 782.726. Mng. Dir. & Gen. Mgr.: Renata Meroni; Assoc. Mgr.: Cesare Zucca.

Promo Esse, Via Dante 31, 35100 Padova. Tel: (049) 45.483, 45.386. Gen. Mgr.: Vittorio Salvetti.

Task, Via G. Leopardi 14, 20123 Milan. Tel: (02) 865.871/897.

TAPE CUSTOM DUPLICATORS TAPE PACKAGING & LABELING

The Audio & Video lines indicate the configurations which the firms duplicate. Companies which offer packaging & labeling of tape product are indicated by: (PKG) which appears after the main body of their respective listings.

Ambrosio Discografica SaS, Via Brasile 13, 20090 Limito di Pioltello (Milan). Tel: (02) 904-7861.

Branch: 20121 Milan, Via San Paolo 15. Tel: (02) 865.678.

Audio: 8-tr., cassette.

American Recs. di Angeramo Nunzia, Galleria del Corso 2, 20122 Milan. Tel: (02) 704.006. Gen. Mgr.: Giovambattista Samele; Sales Mgr.: Sonia Samele.

Ampex Italiana SpA, Via Riccardo Gigante 4, Rome. Tel: (0396) 546.991. Cable AMPEX ROME. Telex: 61492. Mng. Dir.: Riccardo Crippa; Sales Mgr.: Domenico Rossi. Home office: USA. Audio: 8-tr., cassette

Ariston Srl, Via Massimo Gorki 21, Strada Zivido, 20098 San Giuliano (Milan). Tel: (02) 984-6974. Telex: 35466. Pres.: Alfredo Rossi; Factory Mgr.: Carlo Barbareschi; Sales Mgr.: Riccardo Benini; Int'l Mgr.: Graham Johnson. (Audio only) (PKG) Branch: 00195 Rome, Via Cantore 17. Tel: (06) 386.259. Audio: 8-tr., cassette.

Audiogramm SpA, Via Vallosa 38, 25050 Passirano (Brescia). Tel: (030) 657.360. Telex: 300260. Owner & Mng. Dir.: Edoardo Cattaneo; Gen. Mgr.: Francesco Nervì; Sales Mgr.: Luciano Bassani. (SEE ADVERTISEMENT)

Audio: 8-tr., 8-tr. quadraphonic, cassette, open reel.

Avelca Srl, Via Emanuella 16, 21047 Saronno. Tel: (02) 960.5413. Admin'r & Gen. Mgr.: Sergio Moretti; Sales Mgr.: Ambrogio Campanari. (PKG) Audio: Cassette. (SEE ADVERTISEMENT)

Avelca Video Rec. SpA, Via Lumiere 4, 20093 Cologno Monzese (Milan). Tel: (02) 253.2524. Telex: 26502. Mng. Dir. & Gen. Mgr.: Luciano Podilli; Mktg. Mgr.: Ambrogio Campanari. (PKG) Audio: 8-tr., cassette. Video: 1" open reel, 1" cartridge, 3/4" U-matic, 1/2" EIAJ cartridge.

CG D-Messaggerie Musicali SpA, Via Quintiliano 40, 20138 Milan. Tel: (02) 50.84. Cable CIGIDISC. Telex: 35063. Pres.: Ladislao Sugar; Mng. Dirs.: Piero Sugar, Franco Crepax; Exec. VP's: Giuseppe Giannini, Sandro Delor; Comm'l Mgr.: Roberto Guerrazzi; Sales Mgr.: Romano Razzini; Promo. Mgr.: Johnny Porta. (PKG) Branches: Bologna, Catania, Florence, Naples, Padua, Rome. Audio: cassette

Cinevox Rec. SpA, Via Romeo Romei 15, Rome. Tel: (06) 311.280, 311.870. Branch: Milan, Via Borgogna 7. Tel: (02) 701.107.

Ducale Ind. Musicali SpA, Via Per Cadrezzate 5, 21020 Brebbia (Varese). Tel: (0332) 770.784/189. Telex: 380231. Cable: DUCALEMUSIC. Pres. & Gen. Mgr.: Davide Matalon. (PKG) Audio: 8-tr., 8-tr. quadraphonic, cassette, open reel. (SEE ADVERTISEMENT)

Duplimatic Srl, Via Natale Battaglia 4, 20127 Milan. Tel:

IT WAS ALREADY A HIT BEFORE BEING RELEASED

There was a great demand for and here is the first LP by . . .

TOTO CUTIGNO

CAROSSELLO

RICORDI

20122 MILANO - GALLERIA DEL CORSO 4 - TEL. 784748

disco CAROSSELLO CLN 25082

distribuzione DISCHI RICORDI S.p.A.

high output levels

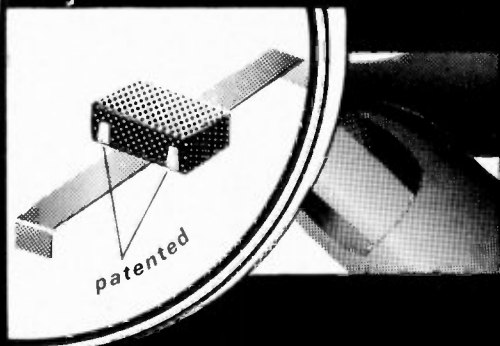
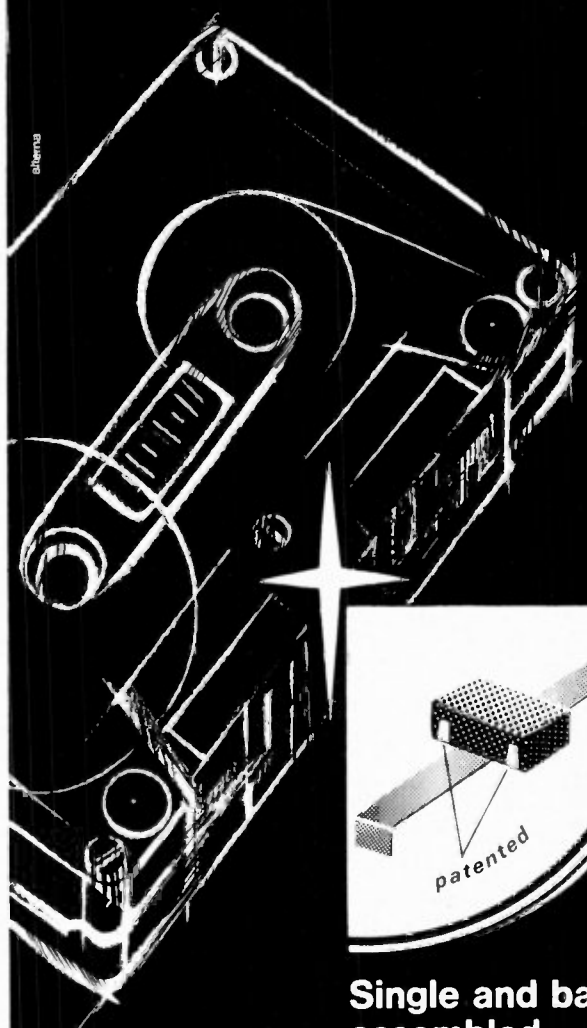

Single and band assembled components for cassettes

Spring pads and anti-friction liners. Full, flat and flat-foam shields in any magnetic alloy.



**A.T.B. spa
20030 Senago
(Milano) Italy
30, via Palmiro Togliatti
telefono 02 9989976-7-8**

- (02) 281.226. Gen. Mgr.: Guido Mezzadra; Sales Mgr.: Enrico Mezzadra.
Audio: 8-tr., 8-tr. quadrasonic, cassette, open reel, open reel quadrasonic.
 Duplo Magnetic, Via Leida 8, 37100 Verona. Tel: (045) 504.491.
Audio: 8-tr., 8-tr. quadrasonic, cassette, open reel, open reel quadrasonic.
 Durema (Duplicazioni Registratori Magnetiche) SpA, Via Imperia 28, 20142 Milan. Tel: (02) 843.7344/0740. Mng. Dir., Gen. & Sales Mgr.: Dr. Claudio Occhiena; Technical Mgr.: Paolo Maggiolini.
Audio: 8-tr., cassette, open reel.
Video: 1" open reel, 3/4" cassette, 1/2" VHS.
 Durium SpA, Via Manzoni 40/42, Milan. Tel: (02) 701.703. Telex: 25564. Pres. & Mng. Dir.: Krikor Mintangian; Chief Admin'r: Giulio Galimberti; Sales Mgr.: Amleto Silvestri (PKG)
Audio: 8-tr., 8-tr. quadrasonic, cassette. (SEE ADVERTISEMENT)
 E M I Italiana SpA, Viale dell'Oceano Pacifico 46, 00144 Rome. Tel: (06) 592.0751. Cable: EMIROM. Telex: 613208. Mng. Dir.: John L. Bush; Deputy Mng. Dir.: Vittorio Magnoli; Comm'l Mgr.: Nerio Alunni.
Audio: 8-tr., cassette.
 Ecolina Srl, Via Leopardi 8, 20123 Milan. Tel: (02) 869.0121. Chief Exec.: Mourad Sabet. **Factory:** Via Monviso 21. Tel: (02) 314.766. **Factory Technical Mgr.:** Ronald F. Goodwin.
Audio: 8-tr., 8-tr. quadrasonic, cassette, open reel, open reel quadrasonic. (SEE ADVERTISEMENT)
 Exhibo Italiana Srl, Via F. Frisi 22, 20052 Monza. Tel: (039) 360.021. Cable: EXHIBOMI. Telex: 25315. Pres.: F. Anguissola d'Altoe; Prod. Mgr.: G. Granito; Adv. Mgr.: L. Porfirio.
Branch: Rome, Via P. Emilio 7. Tel: (06) 318.026. Contact: S. Bertoli.
Audio: 8-tr., cassette.
 Fiven, Via Di Bandecca 8, Galleria Giusti, Vecchiano (Pisa). Tel: (050) 868.079.
Audio: Cassette, open reel.
 Fonit-Cetra SpA, Via Giuseppe Meda 45, 20141 Milan. Tel: (02) 843.2551. Cable: FONITCETRA. Pres.: Giuseppe Piccione; VP: Georgio Agosti; Gen. & Sales Mgr.: Mario Zanoletti.
 Genca (General Cassette) SaS, Via Don Minzoni 16, 20061 Carugate (Milan). Tel: (02) 904.8815. Telex: 31371. 37607.
Audio: 8-tr., 8-tr. quadrasonic, cassette.
 I R I (Industrie Riunite Italiane) Srl, Via Vespolate 22, 27030 Confindenza (Pavia). Tel: (0384) 64.054.
Audio: 8-tr., cassette.
 L E M (Lavorazione Nastro Magnetico) SpA, Via G.B. Battista de La Salle 4/A, 20132 Milan. Tel: (02) 256.9998. Gen. Mgr.: Roberto Arnoldi. (PKG)
Audio: 8-tr., cassette.
 M D A Srl, Via San Giuseppe 137, 21047 Saronno. Tel: (02) 962.0914. Telex: 380426. Gen. Mgr.: Pinuccia Grassi.
Audio: 8-tr., cassette.
 Manplast Srl, Via G. Di Vittorio 307/6, 20099 Sesto San Giovanni (Milan). Tel: (02) 248.5019.
Audio: 8-tr., cassette.
 Phonoster SpA, Via G. Rossini, 20067 Tribiano (Milan). Tel: (02) 90.64.646.
 Phonotype Rec. Srl, Via Enrico de Marinis 4, 80134 Naples. Tel: (081) 206.642, 205.873. Chief Exec.: Vincenzo Esposito; Gen. Mgr.: Fernando Esposito; Sales Mgr.: Roberto Esposito.
Audio: 8-tr., cassette.
 R C A SpA, Via San Alessandro 7, Rome. Tel: (06) 43.661. Telex: 61428. Pres.: Giuseppe Ornato; Gen. Mgr.: Ennio Mellis; Comm'l Mgr.: Luciano Bernacchi.
Home office: USA.
Audio: 8-tr., cassette.
 Ricordi SpA (Dischi) Via Barletta 11, 20100 Milan. Tel: (02) 539.2392. Admin. Mgr.: Giuseppe Maurelli.
Audio: Cassette.
 Ri-Fi Rec. Co. SpA, Corso Buenos Aires 77, 20124 Milan. Tel: (02) 273.641. Mng. Dir. & Gen. Mgr.: Giovanni Battista Ansoldi. (SEE ADVERTISEMENT)
 Saar Srl, Via Gramsci 4, 20016 Pero (Milan). Tel: 353-0573/0564. Pres.: Walter Gurtler; Mgr.: Luigi Maurizio.
Audio: Cassette.
 Sciascia SaS (Ed.), Via Giacomo Brodolini, 20089 Rozzano (Milan). Tel: (02) 825-8041. Pres.: Armando Sciascia; Gen. & Sales Mgr.: Sergio Sciascia. (PKG—audio only) (SEE ADVERTISEMENT)
 Senn Sound Italiana Srl, Via Edison 100, 20019 Settimo Milanese (Milan). Tel: (02) 328-2366/2337. Mng. Dir.: Francesco de Paola; Gen. Mgr.: Franco de Paolis.
Audio: 8-tr., 8-tr. quadrasonic, cassette.
 Start Inc., Corso Garibaldi 120, 20030 Seveso (Milan). Tel: (0362) 508.701. Telex: 312080. Pres.: Mario Colombo; Gen. Mgr.: Dario De Benedetti; Sales Mgr.: Luigi Cane. (PKG only—audio) (SEE ADVERTISEMENT)
 3 M Italia SpA, San Felice Segrate (Milan). Tel: (02) 75.451. Mng. Dir.: T.S. Skoog. (PKG)
Audio: 8-tr., cassette, open reel.
Video: 1" open reel, 3/4" cassette, 1/2" EIAJ open reel, 1/2" EIAJ cartridge.

● **supplies**

CARTRIDGE & CASSETTE PARTS

- A T B SpA, Via Palmiro Togliatti 30, 20030 Senago (Milan). Tel: (02) 998-9976. Cable: ATIBISENAGO. Telex: 36479. Mng. Dir.: Abramo Bordignon.
Audio: Single- & band-assembled components for cassettes, digital cassettes & 8-tr.; spring pads & antifriction liners; full, flat & flat-foam shields in any magnetic alloy; customer-designed supplies (SEE ADVERTISEMENT)
 Alfapolymer Srl, Via Lamarmora 33, Milan. Tel: (02) 546-6986.
Audio: Cassette bodies, hubs, rolls, foils, pads, shields, all cartridge parts, library cases.

Ampex Italiana SpA, Via Riccardo Gigante 4, Rome Tel (00396) 546.991 Cable AMPEX ROME Telex 61492. Mng. Dir.: Riccardo Crippa; Sales Mgr. Domenico Rossi.

Home office: USA

Audio & Video: Plastic cassette parts.

Audio Devices, see Neumannacustic.

Audiogram SpA, Via Vallosa 38, 25050 Passirano (Brescia) Tel (030) 657 360 Telex 300260 Owner & Mng. Dir.: Edoardo Cattaneo; Gen. Mgr.: Francesco Nervi; Sales Mgr. Luciano Bassani. (SEE ADVERTISEMENT)

Avelca Srl, V. Emanuella 16, Saronno. Tel: (02) 960.5413 / 3248. Mng. Dir. & Gen. Mgr. Sergio Moretti (SEE ADVERTISEMENT)

Bresolin Corrado, Via XXV Aprile 205, 20092 Cinisello Balsamo (Milan). Tel (02) 618-8064. Pres. Corrado Bresolin.

Audio: All parts. (SEE ADVERTISEMENT)

Fraem (Societa Individuale di Gaetani Cesare), Via Niccodemi 5, 20154 Milan. Tel (02) 367.693 Gen. Mgr. Cesare Gaetani.

Genca (General Cassette) SaS, Don Minzoni 16, 20061 Carugate (Milan). Tel (02) 904-8815 Telex 31371, 37607.

Audio: Hubs & rollers.

L E M (Lavorazione Nastro Magnetico) SpA, Via G. B. de La Salle 4/A, 20132 Milan Tel (02) 256-9998. Gen. Mgr.: Roberto Arnoldi.

M D A Srl, Via San Giuseppe 137, 21047 Saronno. Tel (02) 962-0914 Telex 380426 Gen. Mgr. Pinuccia Grassi.

Neumannacustic di Roberto Beppato, Via G. Spontini 3, 20131 Milan. Tel (02) 228.120, 276.893 Cable BEPPATOMIL Owner Roberto Beppato; Sales Mgr. David Butterworth.

Branch: 00143 Rome, Via G. Armellini 31 Tel (06) 591-4609. Contact: Livio Argentin.

Brand name: Audio Devices.

Nuova SIAT (Societa Italiana Articoli Tecnici) Srl, Via dell'Orto 21, 21047 Saronno (Varese) Tel (02) 960-7485/7450. Cable: NSIAT. Telex. 334502. Mng. Dir.: Edoardo Benetton. (SEE ADVERTISEMENT)

Polimek Srl, Via Pace 64, 20017 RHO (Milan). Tel (02) 930.1742/9484. Telex 330270, 330501 Chief Exec.: Rosario Mandina; Gen. Mgr.: Girolamo Magott.

Audio: 8-tr., cassette

Sonorex Tape SpA, Via Bonfadina 14, Cazzago San Martino (Brescia). Tel: (030) 725.382. Telex: 30826. Chief Exec.: Dr. Giuseppe Zani; Sales Mgr.: Italo Capoferr.

T K L di F. Maga, Superstrada San Marino 149, Km. 6,300, 47040 Cerasolo di Coriano (Forly). Mng. Dir. F. Maga. (SEE ADVERTISEMENT)

EMPEX CARTRIDGES, CASSETTES & REELS

A T B SpA, Via Palmiro Togliatti 30, 20030 Senago (Milan). Tel. (02) 998-9976. Cable: ATIBISENAGO Telex 36479. Mng. Dir.: Abramo Bordignon. (SEE ADVERTISEMENT)

Alfapolymer Srl, Via Lamarmora 33, Milan Tel (02) 546-6986

Audio: C-O cassettes.

Ampex Italiana SpA, Via Riccardo Gigante 4, Rome Tel (00396) 546.991 Cable AMPEX ROME Telex 61492. Mng. Dir. Riccardo Crippa, Sales Mgr. Domenico Rossi.

Home office: USA

Audio: 8-tr., cassette, open reel

Video: 2", 1", 1/2", 1/4" open reel, 1/4" cassette, 1/2" Beta cassette

Brand names: Ampex, Shamrock

Audio Devices, see Neumannacustic

Audiogram SpA, Via Vallosa 38, 25050 Passirano (Brescia) Tel (030) 657 360 Telex 300260 Owner & Mng. Dir.: Edoardo Cattaneo; Gen. Mgr. Francesco Nervi, Sales Mgr. Luciano Bassani.

Audio: 8-tr., cassette. (SEE ADVERTISEMENT)

Avelca Srl, V. Emanuella 16, Saronno. Tel (02) 960.5413 Mng. Dir. & Gen. Mgr. Sergio Moretti.

Audio: 8-tr., cassette (SEE ADVERTISEMENT)

Bresolin Corrado, Via XXV Aprile 205, 20092 Cinisello Balsamo (Milan) Tel (02) 618-8064 Pres. Corrado Bresolin.

Audio: 8-tr., cassette. (SEE ADVERTISEMENT)

Comp-Ray, see Start.

Cable Ind Musicali SpA, Via Per Cadrezzate 5, 21020 Brebbia (Varese). Tel (0332) 770 784/189. Cable DUCALEMUSIC BREBBIA (VARESE). Telex. 382031 Pres. & Gen. Mgr. Davide Matalon (SEE ADVERTISEMENT)

Fraem (Societa Individuale di Gaetani Cesare), Via Niccodemi 5, 20154 Milan. Tel (02) 367.693 Gen. Mgr. Cesare Gaetani

G T E (General Tape Equip.) Srl, Via dei Cybo 4, 20127 Milan. Tel (02) 689-8065. Telex 25046 Gen. Mgr. Ottaviano Clerici Bagozzi

Audio: 8-tr., cassette

Genca (General Cassette) SaS, Via Don Minzoni 16, 20061 Carugate (Milan). Tel (02) 904-8815 Telex 31371, 37607.

Audio: Cassette.

Brand name: King Sound

King Sound, see Genca

L E M (Lavorazione Nastro Magnetico) SpA, Via G. B. de La Salle 4/A, 20132 Milan Tel (02) 256-9998 Gen. Mgr. Roberto Arnoldi

Lear Jet, see Start

M D A Srl, Via San Giuseppe 137, 21047 Saronno Tel (02) 962-0914. Telex 380426. Gen. Mgr. Pinuccia Grassi

Audio: 8-tr., cassette

Magnex SpA, Via G. B. Grassi 97, 20157 Milan Tel (02) 355 5146, 357 0946. Cable SELECHIMIT. Telex 331269 Pres. Dr. Luigi Lang. Gen. Mgr. Dr. Roberto Sanzone, Sales & Mktg. Mgr.: Dr. Nikolay Karadjov.

Audio: Cassette, professional 1/4" open reel (SEE ADVERTISEMENT)

Neumannacustic di Roberto Beppato, Via G. Spontini 3, 20131 Milan. Tel: (02) 228.120, 276.893. Cable

BEPPATOMIL Owner: Roberto Beppato; Sales Mgr. David Butterworth.

Branch: 00143 Rome, Via G. Armellini 31 Tel (06) 591-4609 Contact Livio Argentin

Brand name: Audio Devices

Nuova SIAT (Societa Italiana Articoli Tecnici) Srl, Via dell'Orto 21, 21047 Saronno (Varese) Tel (02) 960-7485/7450 Cable NSIAT Telex: 334502 Mng. Dir. Edoardo Benetton.

Audio: 8-tr., cassette & open reel, boxes

Brand name: SIAT (SEE ADVERTISEMENT)

S E C I, see Magnex.

S I A T, see Nuova

Scotch, see 3M

Shamrock, see Ampex

Sonorex SpA, Via Bonfadina 14, 25046 Cazzago San Martino (Brescia) Tel (030) 725 382 Telex 30826 Pres.: Giuseppe Zani; Sales Mgr. Italo Capoferr.

Audio: 8-tr., cassette.

Start Inc., Corso Garibaldi 120, 20030 Seveso (Milan) Tel (0362) 508 701 Telex 312080 Pres. Mario Colombo; Gen. Mgr. Dr. Dario De Benedetti, Sales Mgr. Dr. Luigi Cane

Audio: 8-tr., cassette.

Brand names: Lear Jet, Comp-Ray, Techno-Ray (SEE ADVERTISEMENT)

T K L di F. Maga, Superstrada San Marino 149, Km. 6,300, 47040 Cerasolo di Coriano (Forly) Mng. Dir. F. Maga. (SEE ADVERTISEMENT)

Techno-Ray, see Start.

3 M Italia SpA, San Felice-Segrate (Milan) Tel (02) 75 451. Mng. Dir. T. S. Skoog

Audio: Open reel

Brand name: Scotch

JACKETS & SLEEVES

Barbieristampa, Via San Rocco 6, Milan. Tel (02) 541 964 (Sleeves only)

C G D-Messaggerie Musicali SpA, Via Quintiliano 40, 20138 Milan. Tel (02) 50.84. Cable CIGIDISC Telex 35063. Pres. Ladislao Sugar, Mng. Dirs. Piero Sugar, Franco Crepax, Exec. VP's Giuseppe Giannini, Sandro Delor, Comm'l Mgr. Roberto Guerrazzi, Sales Mgr. Romano Razzini, Promo. Mgr. Johnny Porta

Branches: Bologna, Catania, Florence, Naples, Padua, Rome

Pizzi Amilcare, Via de Vizzi 86, Cinisello Balsamo (Milan) Tel 928.88/21 (Sleeves only)

LABELS

C G D-Messaggerie Musicali SpA, Via Quintiliano 40, 20138 Milan Tel (02) 50.84. Cable CIGIDISC Telex 35063. Pres. Ladislao Sugar; Mng. Dirs. Piero Sugar, Franco Crepax, Exec. VP's Giuseppe Giannini, Sandro Delor, Comm'l Mgr. Roberto Guerrazzi, Sales Mgr. Romano Razzini; Promo. Mgr. Johnny Porta

Branches: Bologna, Catania, Florence, Naples, Padua, Rome

L E M (Lavorazione Nastro Magnetico) SpA, Via G. B. de La Salle 4/A, 20132 Milan Tel (02) 256-9998 Gen. Mgr. Roberto Arnoldi

Magnex SpA, Via G. B. Grassi 97, 20157 Milan Tel (02) 355 5146, 357 0946. Cable SELECHIMIT. Telex 331269 Pres. Dr. Luigi Lang. Gen. Mgr. Dr. Roberto Sanzone, Sales & Mktg. Mgr.: Dr. Nikolay Karadjov.

Audio: Cassette, professional 1/4" open reel (SEE ADVERTISEMENT)

Neumannacustic di Roberto Beppato, Via G. Spontini 3, 20131 Milan. Tel: (02) 228.120, 276.893. Cable

POLYETHYLENE BAGS

C G D-Messaggerie Musicali SpA, Via Quintiliano 40, 20138 Milan Tel (02) 50.84. Cable CIGIDISC Telex 35063. Pres. Ladislao Sugar; Mng. Dirs. Piero Sugar, Franco Crepax; Exec. VP's Giuseppe Giannini, Sandro Delor, Comm'l Mgr. Roberto Guerrazzi; Sales Mgr. Romano Razzini; Promo. Mgr. Johnny Porta

Branches: Ban, Bologna, Catania, Florence, Naples, Padua, Pescara, Rome, Turin

L E M (Lavorazione Nastro Magnetico) SpA, Via G. B. de La Salle 4/A, 20132 Milan Tel (02) 256-9998 Gen. Mgr. Roberto Arnoldi

Magnex SpA, Via G. B. Grassi 97, 20157 Milan Tel (02) 355 5146, 357 0946. Cable SELECHIMIT. Telex 331269 Pres. Dr. Luigi Lang; Gen. Mgr. Dr. Roberto Sanzone; Sales & Mktg. Mgr.: Dr. Nikolay Karadjov.

Audio: High speed duplicating tape (SEE ADVERTISEMENT)

S E C I, see Magnex

3 M Italia SpA, San Felice-Segrate (Milan). Tel (02) 75 451. Mng. Dir. T. S. Skoog

Audio & Video: Open reel tape

Brand name: Scotch.

RECORD PROCESSING MACHINERY

Alpha Toolex, see Neumannacustic

Ducale Ind. Musicali SpA, Via Per Cadrezzate 5, 21020 Brebbia (Varese) Tel (0332) 770 784/189 Cable DUCALEMUSIC BREBBIA (VARESE). Telex 382031 Pres. & Gen. Mgr. Davide Matalon. (Importer) (SEE ADVERTISEMENT)

Europa Film, see Neumannacustic

G B F Costruzioni Meccaniche, Via Vittorio Veneto 12/18, 20091 Bresso (Milan) Tel (02) 920-1641

I D R A, Via Palestrina 2, 20124 Milan. Tel (02) 203 842

Fontana Luigi & Cia. SaS, Via Brioschi 62, 20141 Milan. Tel (02) 849-3231

Chief product: Presses.

Metalmeccanica Plast SpA, Via Feloni 83, 22070 Bulgarograsso (Como). Tel (031) 931.464. Cable METAL-MEC Telex 381069 Gen. Mgr. Franco Gran; Sales Mgr. Franco Fedriga

Chief product: Record injection molding machines.

Negri-Bossi SpA, PO Box 3784, 20100 Milan, Viale Europa 64, 20093 Cologno Monzese (Milan). Tel: (02) 254-7922/9751. Cable NEGRIBOS. Telex: 33008.

Chief product: Injection molding machines

Neumannacustic di Roberto Beppato, Via G. Spontini 3, 20131 Milan. Tel (02) 228.120, 276.893. Cable BEPPATOMIL. Owner Roberto Beppato, Sales Mgr. David Butterworth

YOUR BEST BUY OF THE YEAR DELIVERS EACH WEEK, EVERY WEEK.

Order the source that keeps you in tune with the changes as they evolve. Drop us a line to find out how **BILLBOARD** works with you.

BONUS! Buyer's Guide included with each paid subscription ordered. Write to us for details:

**Circulation Department/BG
Billboard
9000 Sunset Blvd.
Los Angeles, CA 90069**

Branch: 00143 Rome, Via G. Armellini 31. Tel: (06) 591-4609. Contact: Livio Argentini.
Chief product: Presses, plating & transfer equip.
Brand names: Alpha Toolex, Europa Film, Neumann.
O B M, Ripa di Porta Ticinese 55, 20143 Milan. Tel: (02) 832-3346.
Philips SpA, Piazza IV Novembre 3, 20214 Milan. Tel: (02) 69 94.
Pressvit Srl, Via Voghera 20, 20144 Milan. Tel: 832-2141.
Chief product: Pressure & injection moulds, trimmers, mastering equip., centering & punching machines, stamping shears.
Sandretto (Filli), Via de Amicis 44, 10097 Regina Margherita (Turin). Tel: 790 270.
Terenzio, Via Soffredini 34, 20126 Milan. Tel: (02) 257-2239/2242.

TAPE, BLANK LOADED & RAW

Agfa-Gevaert SpA, Viale de Gasperi, 20151 Milan. Tel: (02) 307 401. Telex: 37182. Chief Exec.: Benito Chiucchini; Sales Mgr.: Giorgio Dordoni.
Audio: Cassette, open reel.
Video: 1" open reel.
Amplex Italiana SpA, Via Riccardo Gigante 4, Rome. Tel: (00396) 546 991. Cable: AMPEX ROME. Telex: 61492. Mng. Dir.: Riccardo Crippa; Sales Mgr.: Domenico Rossi.
Home office: USA.
Audio: 8-tr., cassette, open reel.
Video: Blank—2" quad, 1" open reel, 3/4" cassette, 1/2" EIAJ open reel, 1/2" Beta cassette.
Audio Devices, see Neumannacoustic.
Audiogram SpA, Via Vallosa 38, 25050 Passirano (Brescia). Tel: (030) 657 360. Telex: 300260. Owner & Mng. Dir.: Edoardo Cattaneo; Gen. Mgr.: Francesco Nervi; Sales Mgr.: Luciano Bassani.
Audio: Cassette. (SEE ADVERTISEMENT)
Audio Magnetics, see Melchioni.
Avelca Srl, V. Emanuella 16, Saronno. Tel: (02) 960-5413/3248. Mng. Dir. & Gen. Mgr.: Sergio Moretti.
Audio: 8-tr., cassette. (SEE ADVERTISEMENT)
B A S F, see SASEA.
Bresolin Corrado, Via XXV Aprile 205, 20092 Cinisello Balsamo (Milan). Tel: (02) 618-8064. Pres.: Corrado Bresolin. (Blank only)
Audio: 8-tr., cassette. (SEE ADVERTISEMENT)
C G D-Messaggerie Musicali SpA, Via Quintiliano 40, 20138 Milan. Tel: (02) 50.84. Cable: CIGIDISC. Telex: 35063. Pres.: Ladislao Sugar; Mng. Dirs.: Piero Sugar, Franco Crepax; Exec. VP's: Giuseppe Giannini, Sandro Delor; Comm'l Mgr.: Robert Guerrazzi; Sales Mgr.: Romano Razzini; Promo. Mgr.: Johnny Porta. (Blank only)
Branches: Bari, Bologna, Catania, Florence, Naples, Padua, Pescara, Rome, Turin.
Audio: Cassette.
Diamante, see Start
Duplicmatic Srl, Via Natale Battaglia 4, 20127 Milan. Tel: (02) 281 226. Gen. Mgr.: Guido Mezzadra; Sales Mgr.: Enrico Mezzadra.

Audio: 8-tr., cassette, open reel.
E M E C SpA, Via Baracchini 10, 20122 Milan. Tel: (02) 863 849. (Importer—blank only)
Audio: Cassette.
Brand name: Memorex.
Ecofina Srl, Via Leopardi 8, 20123 Milan. Tel: (02) 869-0121, 806 125. Chief Exec.: Mourad Sabet. **Factory:** Via Monviso 21. Tel: (02) 314 766. **Factory Technical Mgr.:** Ronald F. Goodwin. (Blank only)
Audio: Cassette. (SEE ADVERTISEMENT)
Ellepielle Srl, Viale San Gimignano 11, 20146 Milan. Tel: (02) 418 315. (Blank only)
Audio: 8-tr., cassette.
Fraem (Societa Individuale di Gaetani Cesare), Via Niccodemi 5, 20156 Milan. Tel: (02) 367.693. Gen. Mgr.: Cesare Gaetani. (Blank only)
Audio: 8-tr., cassette, open reel.
G T E (General Tape Equip.) Srl, Via Ragusa 8, 20127 Milan. Tel: 689-8065. Telex: 25046. Gen. Mgr.: Ottaviano Clerici Bagozzi. (Blank only)
Audio: 8-tr., cassette.
Gilberto Gaudi SpA, Corso di Porta Nuova 48, 20121 Milan. Tel: (02) 664 981, 655 272. (Importer—blank only)
Audio: Cassette, open reel.
Brand name: TDK.
Genca (General Cassette) SaS, Via Don Minzoni 16, 20061 Carugate (Milan). Tel: (02) 904-8815. Telex: 31371, 37607. (Blank only)
Audio: 8-tr., cassette.
L E M (Lavorazione Nastro Magnetico) SpA, Via G. B. de La Salle 4/A, 20132 Milan. Tel: (02) 256-9998. Gen. Mgr.: Roberto Arnoldi.
Audio: 8-tr., cassette, open reel.
M D A Cassettes Srl, Via San Giuseppe 137, 21047 Saronno. Tel: (02) 962-0914. Gen. Mgr.: Pinuccia Grassi.
Audio: 8-tr., cassette.
Magnex SpA, Via G. B. Grassi 97, 20157 Milan. Tel: (02) 355 5146, 357 0946. Cable: SELECHIMIT. Telex: 331269. Pres.: Dr. Luigi Lang; Gen. Mgr.: Dr. Roberto Sanzone; Sales Mgr.: Dr. Nikolay Karadjov.
Audio: 8-tr., cassette, open reel. (SEE ADVERTISEMENT)
Melchioni SpA, Via P. Coletta 37, 20135 Milan. Tel: (02) 57 94. Telex: 320321. Pres.: Mario Melchioni; Gen. Mgr.: Aurelio Reali.
Audio: 8-tr., cassette, open reel.
Brand name: Audio Magnetics.
Memorex, see EMEC.
Neumannacoustic di Roberto Beppato, Via G. Spontini 3, 20131 Milan. Tel: (02) 228 120, 276 893. Cable: BEPPATOMIL. Owner: Roberto Beppato; Sales Mgr.: David Butterworth.
Branch: 00143 Rome, Via G. Armellini 31. Tel: (06) 591-4609. Contact: Livio Argentini.
Audio: 8-tr., cassette, open reel.
Brand name: Audio Devices.
Nuova SIAT (Societa Italiana Articoli Tecnici) Srl, Via dell'Orto 21, 21047 Saronno (Varese). Tel: (02) 960-

7485/7450. Cable: NSIAT. Telex: 334502. Mng. Dir.: Edgardo Benetton. (Blank only)
Audio: 8-tr. cassette. (SEE ADVERTISEMENT)
Panarecord SpA, Via Cimarosa 4, 20144 Milan. Tel: (02) 430 046, 485 609. Pres.: Sergio De Gennaro; VP: Mario Paoletti.
Branch: Bologna, Disco Express, Via Barberia 13. Tel: (051) 276 697.
Audio: Cassette.
Video: 3/4" cassette. (SEE ADVERTISEMENT)
Polmek Srl, Via Pace 64, 20017 RHO (Milan). Tel: (02) 930.1742/9484. Telex: 330270. 330501. Chief Exec.: Rosario Mandina; Gen. Mgr.: Girolamo Magotti. (Blank only)
Audio: 8-tr., cassette.
S A S E A (Societa Aniline Solventi & Affini) SpA, Via Vincenzo da Seregno 40/48, 20161 Milan. Tel: (02) 64.08. Telex: 37257. Sales Mgr.: Claudio Barlucchi.
Home office: Germany, BASF.
Audio: 8-tr., cassette.
Brand name: BASF.
Scotch, see 3M
S E C I, see Magnex.
Sonorex SpA, Via Bonfadina 14, 25046 Cazzago San Martino (Brescia). Tel: (030) 725.382. Telex: 30826. Pres.: Giuseppe Zani; Sales Mgr.: Italo Capoferri.
Audio: 8-tr., cassette, open reel.
Start Inc., Corso Garibaldi 120, 20030 Seveso (Milan). Tel: (0362) 508.701. Telex: 312080. Pres.: Mario Colombo; Gen. Mgr.: Dr. Dario De Benedetti; Sales Mgr.: Dr. Luigi Cane. (Blank only).
Audio: Cassette.
Brand name: Diamante. (SEE ADVERTISEMENT)
T D K, see Gilberto Gaudi.
3 M Italia SpA, San Felice-Segrate (Milan). Tel: (02) 75.451. Mng. Dir.: T. S. Skoog.
Audio: 8-tr., cassette, open reel.
Video: 1" open reel, 1" cartridge, 3/4" cassette, 1/2" cassette, 1/2" EIAJ open reel, 1/2" EIAJ cartridge.
Brand name: Scotch.

TAPE DUPLICATING & PROCESSING EQUIPMENT

A E G-Telefunken SpA, Via Pirelli 12, 20124 Milan. Tel: (02) 61798. Cable: AEGITAL. Telex: 310473. Pres.: Dr. M. Bortolussi; Gen. Mgr.: Dr. B. Lenzi; Sales Mgr.: A. Bosco.
Audio: Duplicators & winders.
Brand name: Telefunken.
Amplex Italiana SpA, Via Riccardo Gigante 4, Rome. Tel: (00396) 546 991. Cable: AMPEX ROME. Telex: 61492. Mng. Dir.: Riccardo Crippa; Sales Mgr.: Domenico Rossi.
Home office: USA.
Audio: Duplicators.
Audio Prods. Int'l, Via Spontini 3, 20131 Milan. Tel: (0039) 222 8120. Cable: BEPPATOMIL. Owner: Beppato Ro-

ecofina

1964 *** 1979

15

years experience

YOUR CASSETTE CUSTOM DUPLICATOR IN EUROPE

Quality * Quantity * Price

for further information please contact:

ECOFINA HEAD OFFICE

VIA LEOPARDI, 8 - 20123 MILANO (ITALY) - TEL. 8690121 - 806125

ECOFINA FACTORY

VIA MONVISO, 21 - 20154 MILANO (ITALY) - TEL. 314766 - 3182272

**Fasten Your Seat Belts!
We are off with the fastest
and the most up-to-date Artists:**



International

**DONNA SUMMER
BONEY M
GIORGIO MORODER
KISS
DEE D. JACKSON
VILLAGE PEOPLE
ERUPTION
PLASTIC BERTRAND
THE RITCHIE FAMILY
GENGHIS KHAN
DENNIS PARKER
MUNICH MACHINE**

Local

**FAUSTO PAPETTI
NINI ROSSO
NANNI SVAMPA
WESS & DORI GHEZZI
GINO PAOLI
CAMALEONTI
ERMINIO MACARIO
ANN STEEL
IDEA 2
OPERA
VITO PARADISO
WESS**

**DURIUM - Italy
Italian Members of UEP**

berto, Gen Mgr G Munafa, Sales Mgr. David Butterworth (Audio only)
Brand name: Studer

Ducale Ind Musicali SpA, Via Per Cadrezzate 5, 21020 Brebbia (Varese) Tel (0332) 770.784/189. Cable DUCALEMUSIC BREBBIA (VARESE). Telex: 380231 Pres & Gen Mgr Davide Matalon. (Audio only) (SEE ADVERTISEMENT)

Exhibo Italiana Srl, Via F. Frisi 22, 20052 Monza. Tel (039) 360 021 Cable EXHIBOMI Telex 25315. Pres F. Angussola d'Altoe, Prod Mgr. G. Granito; Adv Mgr. L. Portiri.
Branch: Rome, Via P. Emilio 7 Tel (06) 318.026. Contact S Bertoli.
Audio: Duplicators.
Brand name: Otari

Fraem (Societa Individuale di Gaetani Cesare), Via Niccodemi 5, 20156 Milan. Tel (02) 367.693. Gen. Mgr. Cesare Gaetani
Audio: Assembling & winding equip.

G T E (General Tape Equip.) Srl, Via Ragusa 8, 20127 Milan. Tel 689-8065 Telex 25046 Gen. Mgr.: Ottaviano Clerici Bogazzio.
Audio: Automatic, semi-automatic & manual tape winders, ultra high speed duplicators, automatic cassette assemblers & automatic cassette screwdriver.

M D A Srl, Via San Giuseppe 137, 21047 Saronno. Tel (02) 962 0914 Gen Mgr Pinnuccia Grassi. (Audio only)
Audio: Processing equip

M I P (Music Industry Prods) Srl, Via San Luca 10, 20100 Milan Tel (02) 837 0908 Telex 380231. Contact D Matalon
Audio: Fully automatic cassette assembly equip (SEE ADVERTISEMENT)

Magnex SpA, Via G B Grassi 97, 20157 Milan. Tel (02) 355 5146, 357 0946 Cable SELECHIMIT Telex 331269 Pres Dr Luigi Lang; Gen. Mgr. Dr Roberto Sanzone, Sales & Mktg Mgr Dr. Nikolay Karadjov.
Audio: Coating & slitting equip. (SEE ADVERTISEMENT)

Neumannacustic de Roberto Beppato, Via G. Spontini 3, 20131 Milan Tel (02) 228 120, 276.893. Cable BEPPATOMIL Owner Roberto Beppato; Sales Mgr David Butterworth.
Branch: 00143 Rome, Via G. Armellini 31, Tel (06) 591-4609 Contact Livio Argentin.
Audio: Duplicators, winders.

Otari, see Exhibo Italiana

Roje Telecomunicazioni SpA, Via Sant' Anatalone 15, 20147 Milan Tel (02) 415 4141 Cable TELEROJE Telex 332202

S E C I, see Magnex

Siemens (Societa Italiana Telecomunicazioni), Piazzale Zavattari 12, 20149 Milan Tel (02) 4388 Cable AUSOSIEMENS Telex 39015

Sonorex Tape SpA, Via Bonfadina 14, Cazzago San Martino (Brescia) Tel (030) 725 382 Telex 30826 Chief Exec. Dr Giuseppe Zani, Sales Mgr Italo Capoferrri
 Studer, see Audio Prods

Sumat Srl, Via San Giuseppe 137, Saronno (Varese) Tel (02) 962-0915 Gen Mgr Roberto Macchi (Manufacturer/Importer)
Audio: Automatic cassette winders, tools.

T T L (Tape Technology Lab.) di Rizza Attilio, Via Pirandello 4/A, 20144 Milan Tel (02) 469-5213, 498-4371 Pres Attilio Rizza
Audio: Cassette winders

Tapematic, Via Unione 13, 20050 Mezzago (Milan), Tel (039) 692 359 Dir Luciano Perego; Technical Mgr. Giovanni Brignani
Audio: Tailoring machines w/loaders. (SEE ADVERTISEMENT)

Telefunken, see AEG-Telefunken

TAPE PACKAGING & LABELING EQUIPMENT & SUPPLIES

Ecofina Srl, Via Leopardi 8, 20123 Milan Tel (02) 869-0121, 806 125 Chief Exec Mourad Sabet, Factory Technical Mgr Ronald F Goodwin
Product: Boxing machines
Brand name: Ponzone & Vico (SEE ADVERTISEMENT)

G T E (General Tape Equip.) Srl, Via Ragusa 8, 20127 Milan Tel 689 8065, 376 4171
Product: Automatic cassette labeling & boxing machines

M D A Srl, Via San Giuseppe 137, 21047 Saronno Tel (02) 962-0914 Telex 380426 Gen Mgr. Pinnuccia Grassi Ponzone, see Ecofina

S T M (System Transfer Matic), Strada Cassanese Km. 9, Vignate (Milan) Tel (02) 958-0227
Product: Cassette assembly & packaging equip (SEE ADVERTISEMENT)

Start Ltd., Corso Garibaldi 120, 20030 Seveso (Milan) Tel (0362) 508 701 Telex 312080. Pres.: Mario Colombo, Gen Mgr Dr Dario De Benedetti; Sales Mgr Dr Luigi Cane.
Product: 8-tr & cassettes library cases.
Brand names: Comp-Ray, Techno-Ray (SEE ADVERTISEMENT)

Sumat Srl, Via San Giuseppe 137, 21047 Saronno Tel (02) 962-0915 Gen Mgr Roberto Macchi (Manufacturer/Importer)
Product: Cassette & cartridge plastic shelves pressing machines, boxes pressing machines, cassettes-into-boxes automatic injectors

Tapematic, Via Unione 13, 20050 Mezzago (Milan) Tel (039) 692 359 Dir Luciano Perego; Technical Mgr. Giovanni Brignani (Audio only)
Product: Boxing & labeling machines (SEE ADVERTISEMENT)

Vico, see Ecofina

● accessories manufacturers

Agla-Gevaert SpA, Viale de Gasperi, 20151 Milan. Tel (02)

307 401 Telex 37182. Chief Exec. Benito Chiucchini; Sales Mgr. Giorgio Dordoni
Product: Head cleaners, demagnetizers, leader & splicing tape

Alfapolymer Srl, Via Lamarmora 33, Milan Tel (02) 546-6986
Product: Carrying & storage cases, head cleaners & demagnetizers.

Ampex Italiana SpA, Via Riccardo Gigante 4, Rome Tel (00396) 546991 Cable AMPEX ROME. Telex 61492. Mng. Dir. Riccardo Crippa; Sales Mgr Domenico Rossi
Home office: USA.
Product: Head cleaners, demagnetizers, leader & splicing tape.

Audel, Via Ximenes 3, Milan (Importer)
Product: Needles (Ortofon).

Audio SnC, Strada di Caselle 63, 10040 Leini. Tel 998-8841. (Importer)
Product: Needles (Pickering).

Audiogram SpA, Via Vallosa 38, 25050 Passirano (Brescia). Tel (030) 657.360. Telex: 300260. Owner & Mng Dir Edoardo Cattaneo; Gen. Mgr. Francesco Nervi; Sales Mgr. Luciano Bassani.
Product: Leader tape (SEE ADVERTISEMENT)

Audio-Technica, see NTC

Avelca Srl, V. Emanuela 16, Saronno. Tel (02) 960 5413 Admin'r & Gen. Mgr Sergio Moretti; Moretti; Sales Mgr. Ambrogio Campanari.
Product: Cleaners, cloths & brushes. (SEE ADVERTISEMENT)

Bresolin Corrado, Via XXV Aprile 205, 20092 Cinisello Balsamo (Milan) Tel (02) 618-8064. Pres Corrado Bresolin
Product: Tape carrying & storage cases, head cleaners & demagnetizers (SEE ADVERTISEMENT)

Centro Leader Hi-Fi, Via J. Palma 5, 20146 Milan Tel (02) 408-2458 (Importer)
Product: Record brush & cleaner (Decca), anti-static gun (Zerostat)

Codea Srl, Via G.B. Caruà 36, Milan. Tel (02) 256-3189 (Importer)
Product: Cleaners, cloths & brushes (Metrosound)

D B D, Via Giovanni XXIII 33, 50040 Settignano di Calenzano (Florence) Tel (055) 887-7464.
Product: Record cleaner & brush.

Decca, see Centro Leader

Ducale Ind. Musicali SpA, Via Per Cadrezzate 5, 21020 Brebbia (Varese) Tel (0332) 770.784/189 Telex 382031 Pres & Gen. Mgr. Davide Matalon
Product: Leader & splicing tape (SEE ADVERTISEMENT)

Dust Jockey, see Musica Diffusione

Gilberto Gaudi SpA, Corso di Porta Nuova 48, 20121 Milan Tel (02) 664 981, 655.272. (Importer)
Product: Record cleaner (Sound Guard), needles (Sansui)

Kental, Via Guercino 8, Milan (Importer)
Product: Needles (Kenwood)

Kenwood, see Kental

L E M (Lavorazione Nastro Magnetico) SpA, Via G B de La Salle 4/A, 20132 Milan. Tel (02) 256-9998 Gen Mgr Roberto Arnoldi.
Product: Leader & splicing tape

M D A Srl, Via San Giuseppe 137, 21047 Saronno Tel (02) 962-0914 Telex: 380426. Gen. Mgr. Pinnuccia Grassi
Product: Head cleaners & demagnetizers, cassette testers, cassette tools & moulds, tape certifiers.

Magnex SpA, Via G B Grassi 97, 20157 Milan Tel (02) 355-5146, 357 0946 Cable SELECHIMIT Telex 331269 Pres Dr Luigi Lang; Gen Mgr. Dr Roberto Sanzone, Sales Mgr Dr Nikolay Karadjov.
Product: Head cleaners, demagnetizers, leader tape. (SEE ADVERTISEMENT)

Metrosound, see Codea

Musica Diffusione, Via Del Gambero 30, 00187 Rome
Product: Record cleaner & brush (Dust Jockey), anti-static turntable mat

N T C s a s di Giuseppe Gianani & Co., Via Montebello 27 Milan Tel (02) 65 98 181, 63.27.17 Cable NETICI Mng Dir Giuseppe Gianani, Gen Mgr Carlo Ferrario (Importer)
Product: Needles (Audio-Technica)

Net-tronic, see Phonola

Otofon, see Audel

Pickering, see Audio

Phonogram SpA, Via Borgogna 2, 20122 Milan Tel (02) 796 541 Cable COMINFON. Telex (843) 26140 Mng Dir & Gen Mgr. Alain C. Trossat
Product: Catalog servs., cleaners, cloths & brushes

Phonola, Via Montenapoleone 10, 20121 Milan. Tel (02) 708 781
Product: Record brush (Net-tronic).

Saar Srl, Viale di Porta Vercellina 14, 20123 Milan. Tel 469-6251 Pres Walter Gurtler, Sales Mgr Sergio Balloni.
Product: Catalog servs

Sansui, see Gilberto Gaudi

S E C I, see Magnex

Siemens SpA (Societa Italiana Telecomunicazione), Via A Canova 19/A, Milan Tel (02) 43 88 (Importer)
Audio: Needles (Stanton)

Sonorex Tape SpA, Via Bonfadina 14, Cazzago San Martino (Brescia) Tel (030) 725 382 Telex 30826 Chief Exec. Dr Giuseppe Zani, Sales Mgr Italo Capoferrri
Product: Head cleaners & demagnetizers, leader tape

Sound Guard, see Gilberto Gaudi

Stanton, see Siemens

Start Inc., Corso Garibaldi, No 120, 20030 Seveso (Milan) Tel (0362) 508 701. Telex 33080 Pres Mario Colombo Gen Mgr Dr Dario De Benedetti, Sales Mgr Dr Luigi Cane
Product: Head cleaners & demagnetizers (SEE ADVERTISEMENT)

Sumat Srl, Via San Giuseppe 137, 21047 Saronno Tel (02) 962-0915 Telex 380426 Gen Mgr Roberto Macchi
Product: Head cleaners & demagnetizers

3 M Italia SpA, Milano San Felice (Segrate). Tel (02)

75.451. Telex: 31275, 31159. Mng. Dir. T. Skoog; Sales & Mktg Mgr.: M. Bianchi
Product: Carrying & storage cases, catalog servs., head cleaners, demagnetizers, leader & splicing tape
 Zerostat, see Centro Leader.

● store fixtures & merchandising aids manufacturers

Alfapolymer Srl, Via Lamarmora 33, Milan Tel (02) 546-6986
Product: Display racks.

Phonogram SpA, Via Borgogna 2, 20122 Milan. Tel (02) 796 541 Cable COMINFON. Telex (843) 26140. Mng Dir & Gen Mgr. Alain C. Trossat.
Product: Browser boxes, display racks

Saar Srl, Viale di Porta Vercellina 14, 20123 Milan. Tel 469-6251. Pres: Walter Gurtler, Sales Mgr. Sergio Balloni
Product: Browser boxes, display racks

IVORY COAST, REPUBLIC OF

Population: 6,673,013.
 Rate of exchange: \$1 (US) = 234.74 CFA francs.
 Per capita income: \$600.
 Holidays: January 1, May 1, August 7, November 1, December 25.
Records, record blanks & pre-recorded media imported from USA: 1977—\$112,907.

● record & tape manufacturers / distributors / importers

Cinterdisc, c/o Societe Ivoirienne du Disque, 10 BP 503, Abidjan 10 Pres. & Gen. Mgr. Catherine Oro; Sales Mgr. Waly N'Diaye. (Importer/Distributor/Rack Jobber)
Home office: Societe Ivoirienne du Disque.
Labels: (Owned) Cinterdisc, (distributed—not licensed) Goss, SID.

Kibaru, see Societe Ivoirienne du Disque

S I D, see Societe Ivoirienne du Disque

Societe Ivoirienne du Disque (IFP), 10 BP 503, Abidjan 10. Tel 36 10 25. Cable SID. Telex 3193 Pres & Gen. Mgr. Catherine Oro (Manufacturer/Distributor/Importer)
Labels: (Owned) Kibaru, SID, Sound Explosion; (licensed) Amour (Canada), EMI (Nigeria), Namaco (Nigeria) Olumo (Nigeria), AIT, Africa, Ba-Ba, Bana Beru, Do-7, King Kong, Lolwe, Moto Moto, Muziki du Zaire, Nyang Omaki, Owang Jabek, POK, Sungura (all Kenya); (distributed—not licensed) Zaire Promotion (Zaire)

Sound Explosion, see Societe Ivoirienne du Disque

W E A West Africa BP 4335 Poste D'Abidjan, Plateau D'Abidjan. Tel 361-577/268 Mng Dir Guy Guydon
Home office: USA

● services

DESIGN & ARTWORK

Societe Ivoirienne du Disque, 10 BP 503, Abidjan 10. Tel 36 10 25. Cable SID. Telex 3193 Pres & Gen Mgr. Catherine Oro.
Local branch: Cinterdisc

PRESSING PLANT

Societe Ivoirienne du Disque, 10 BP 503, Abidjan 10. Tel 36 10 25. Cable SID. Telex 3193. Pres & Gen Mgr. Catherine Oro
Local branch: Cinterdisc.

RECORD PROMOTION

Cinterdisc, c/o Societe Ivoirienne du Disque, 10 BP 503, Abidjan 10 Pres. & Gen. Mgr.: Catherine Oro; Sales Mgr. Waly N'Diaye.

● supplies

JACKETS & SLEEVES LABELS POLYETHYLENE BAGS

Societe Ivoirienne du Disque, 10 BP 503, Abidjan 10. Tel 36 10 25. Cable SID. Telex 3193. Pres & Gen Mgr. Catherine Oro.

● accessories

Cinterdisc, c/o Societe Ivoirienne du Disque, 10 BP 503, Abidjan 10 Pres. & Gen. Mgr. Catherine Oro, Sales Mgr. Waly N'Diaye
Home office: Societe Ivoirienne du Disque
Product: Cleaners, cloths & brushes, 45 rpm adapters

Societe Ivoirienne du Disque, 10 BP 503, Abidjan 10. Tel 36 10 25. Cable SID. Telex 3193 Pres & Gen. Mgr. Catherine Oro
Local branch: Cinterdisc
Product: Leader & splicing tape

JAMAICA

Population: 2,060,000
Rate of exchange: \$1 (US) = 1.55 Jamaican dollars.
Per capita income: \$1,273.
Holidays: January 1, May 23 (Labor Day), June 8 (Queen's Birthday), August 5 (Independence Day), December 25, 26, December 27 (Public Holiday) & all Christian holidays.

● record & tape manufacturers / distributors / importers

Blank, see Record Specialists.
 Carifta, see Record Specialists
 Champion, see Record Specialists.
 Crystal, see Federal.
 Disc Disk Joint Recs., 127 King St., Kingston.
Home office: USA.
 Dynamic, see Dynamic Sounds.
 Dynamic Sounds Rec'g Co. Ltd. (IFPI), 15 Bell Rd., Kingston 11. Tel: 933-9138/9168. Cable: DYNASOUND. Telex: 2296. Pres.: Byron A. Lee; VP & Comptroller: Cecil Warren; Gen. Mgr.: Michel Khouri; Sales Mgr.: L. Gray.
Labels: (Owned) Dynamic, Jaguar, Lion, Melrose, Panther, Tiger, Tysott, Wede Bete; (licensed) Archiv (Germany), Ariola America (USA), Atlantic (USA), Bang (USA), CTI (USA), Casablanca (USA), Creole (UK), H&L (USA), Polar (Sweden), Polydor (Germany), Ranwood (USA), Salsoul (USA), Springboard (USA), State (UK), TK (USA).
Int'l reps.: Africa (WEA), South Africa (EMI), UK (Creole, State).
 Federal Rec. Mfg. Co. Ltd. (IFPI), 220 Marcus Garvey Dr., Kingston 11. Tel: 923-9978/7375. Telex: 2294. Cable: FEDERREC.
Labels: (Owned) Federal LTD, Wildflower; (licensed) Buddha (USA), CBS (UK, USA), Columbia (UC, USA), Epic (USA), Hi (UK, USA), Marlin (USA), Philadelphia Int'l (USA), Portrait (USA), RCA (USA), T-Neck (USA), TSOP (USA); (distributed—not licensed) Crystal, Playback.
 Gorgon, see Sonic Sounds.
 Jaguar, see Dynamic Sounds.
 L T D, see Federal.
 Lion, see Dynamic Sounds.
 Melrose, see Dynamic Sounds.
 Panther, see Dynamic Sounds.
 Playback, see Federal.
 Record Dists. Ltd., 103 Orange St., Kingston. Tel: 932-4989. Cable: RECDISC.
Labels: (Licensed) BRC, Brunswick, Dakar, Hob, Nashboro, Noodle, Scepter, Wand (all USA).
 Record Specialists Ltd (IFPI), 1-3 Torrington Rd., Kingston. Tel: (809) 922-4865/6287. Cable: SOUNDTRACK Telex: 2252. Exec. Dir. George Benson.
Labels: (Owned) Blank, Carifta, Champion, Saturn, Star, Venus; (licensed) ABC group (USA), Capitol (USA), DJM (UK), Disneyland-Vista (USA), MCA (USA), Majestic (USA), Motown (USA), Phonogram (Netherlands, UK, USA), Pickwick (USA), Roulette (USA), Universal group (USA), Word (UK).
 Saturn, see Record Specialists.
 Snapper, see Sonic Sounds.
 Sonic Sounds Rec. Mfg. Co. Ltd., 14 Retirement Rd., Kingston 5. Tel: 926-2036/61204. Cable: VIBES. Mng. Dir. Neville O. Lee.
Labels: (Owned) Gorgon, Snapper, Sonic, Tuna; (licensed foreign) Arista (USA), Buddha (USA), EMI (UK), Private Stock (USA), United Artists (USA), WIRL (Barbados).
 Star, see Record Specialists.
 Tiger, see Dynamic Sounds.
 Tuff Gong, see Total Sounds.
 Tuna, see Sonic Sounds.
 Tysott, see Dynamic Sounds.
 Venus, see Record Specialists.
 Wede Bete, see Dynamic Sounds.
 Wildflower, see Federal.

● music publishers

Ivan Mogull Caribbean Ltd., c/o Norman E. Wright, 9-11 Church St., Kingston.
 Par-Lay-Voo Music Ltd., see Woodwater.
 Record Specialists Ltd., 1 Torrington Rd., Kingston, W1. Tel: 922-4865/6287. Cable: SOUNDTRACK. Telex: 2252. Exec. Dir.: George Benson.
Int'l firm represented: Big Seven (USA).
 Sheila Music Corp. Ltd. (BMI), 15 Bell Rd., Kingston 11. Tel: 933-9138/9130. Cable: DYNASOUND. Mng. Dir. Sheila Lee.
Int'l firms represented: Cotillion, Devalbo, Douglas, Ice Nine/Fry King, Marsaint, Quackenbush, Sergeant Music/Saloon Songs, Story Songs, Viva, Warner Bros. group (all USA); State (UK).
Int'l reps.: South Africa (Plymouth), rest of world (State).
 Woodwater Music Ltd., 220 Marcus Garvey Dr., Kingston 11. Tel: 923-8817. Cable: FEDERREC. Telex: 2294.
Int'l firms represented: ATV (UK), Buckhorn (USA), Burlington (UK), Keymen (USA), Morning (Canada), Palace (UK).
Int'l reps.: Benelux (Universal Songs), Canada (Morning), Europe (April, Blackwood), South Africa (Impact), USA (Wetwater).

● services

DESIGN & ARTWORK PLATING, PROCESSING & PRESSING PLANTS PRINTERS & LITHOGRAPHERS RECORD PROMOTION

Federal Rec. Mfg. Co. Ltd., 220 Marcus Garvey Dr., Kingston 11. Tel: 923-7375. Cable: FEDERREC. Telex: 2294.
 Multitapes Ltd., Dynamic Sounds Rec'g Co. Ltd., 13 Bell Rd., Kingston 11. Tel: 933-9168. Telex: 2296.

TAPE CUSTOM DUPLICATORS

Multitapes Ltd., Dynamic Sounds Rec'g Co. Ltd., 13 Bell Rd., Kingston 11. Tel: 933-9168. Telex: 2296.
Audio: 8-tr., cassette, open reel.
 X-9 Electronics & Rec'g Tapes Ltd., PO Box 306, 14 Northside Plaza, Kingston 6. Tel: 927-0939, 937-0212. Gen. Mgr. Suelan Chung.
Home office: USA, Aries Int'l.
Audio: 8-tr., cassette, open reel.

TAPE DUPLICATOR / MARKETER

Multitapes Ltd., Dynamic Sounds Rec'g Co. Ltd., 13 Bell Rd., Kingston 11. Tel: 933-9168. Telex: 2296.
Tape line: BASF

● supplies

CARTRIDGE & CASSETTE PARTS EMPTY CARTRIDGES, CASSETTES & REELS

Dynamic Sounds Rec'g Co. Ltd., 15 Bell Rd., Kingston 11. Tel: 933-9168. Pres. Byron Lee; Sales Mgr. Junior Gray.
Brand name: Dynasette

JACKETS & SLEEVES LABELS

Dynamic Sounds Rec'g Co. Ltd., 15 Bell Rd., Kingston 11. Tel: 933-9168. Pres. Byron Lee; Sales Mgr. Junior Gray.
 Federal Rec. Mfg. Co. Ltd., 220 Marcus Garvey Dr., Kingston 11. Tel: 923-8817. Cable: FEDERREC. Telex: 2294

TAPE, BLANK LOADED

X-9 Electronics & Rec'd Tape Co. Ltd., PO Box 306, 14 Northside Plaza, Kingston 6. Tel: 927-0939. Gen. Mgr.: Suelan Chung.
Home office: USA, Aries Int'l.
Audio: 8-tr., cassette.

JAPAN

Population: 115,822,000
Rate of exchange: \$1 (US) = 215 yen (floating).
Per capita income: \$6,249.
No. of homes with stereo record players: 19,630,000.
Holidays: January 1, January 15 (Adult's Day), February 11 (Founding Day), Vernal Equinox Day, April 29 (Emperor's Birthday), May 3 (Constitution Day), May 5 (Children's Day), September 15 (Respect for Aged Day), Autumnal Equinox Day, October 10 (Athletics Day), November 3 (Culture Day), November 23 (Labor Thanksgiving Day). (If a holiday falls on a Sunday, it is celebrated on Monday)

RECORDS:

Records sold domestically including imports (retail value):
 LP's 1978—96,767,000 units, \$620,000,000; 1977—95,685,000 units, \$601,000,000. Singles 1978—103,028,000 units, \$196,000,000; 1977—91,614,000 units, \$173,000,000.
Records imported from USA (factory value, CIF): 1978—3,870,909 units, \$14,483,000. 1977—3,248,226 units, \$13,033,000.
Records exported to USA (factory value, FOB): 1978—752,000 units, \$2,280,000; 1977—349,000 units, \$1,140,000.
Records imported from countries other than USA (factory value, CIF): 1978—1,305,914 units, \$4,890,000; 1977—985,290 units, \$3,950,000.
Records exported to countries other than USA (factory value, FOB): 1978—858,000 units, \$2,610,000; 1977—648,000 units, \$2,120,000.
Average retail price per record: LPs—\$11.62, Singles—\$2.79.
Stereo sales: 90% of total.
Record club sales: 10% of total.
Discounting: Rare
Type of distribution: Manufacturer-to-retailer. "Contracted stores," record retailers who are directly connected with record manufacturers, constitute the core of the distribution system. This distribution system is supplemented by wholesalers who have their own distribution route made up of "non-contractors." Major mass merchandise discount chains and students' cooperative stores also handle records. Some retailers specialize in handling imported records.
Type of promotion: Radio and discotheques for international music and TV for domestic music are the most important means of promotion. There are several fan magazines which cover both the domestic and international music scenes extensively.

TAPE:

Market: Music tapes are posting broad-based value gains. In 1978, for instance, they recorded a 24% advance over 1977, and prospects for the future are bright. One factor behind the high-flying sales is the growth of cassette tapes. 8-tracks appear headed for a downswing, partly because of their steady replacement by cassettes in car stereos. Cassettes now account for as much as 75% of the total tape output in Japan.
Pre-recorded tape sold domestically including imports (retail value): 8-tr 1978—11,699,000 units, \$56,000,000; 1977—9,055,000 units, \$53,286,000. Cassette 1978—34,855,000 units, \$285,000,000; 1977—25,612,000 units, \$166,257,000. Open reel 1978—6,000 units, \$84,000; 1977—15,000 units, \$156,000.
Average retail price per tape: 8-tr—\$13.02-13.95; Cassette—\$11.62-13.02; open reel—\$13.95-18.60.

RADIO STATIONS:

No. of commercial 48 AM, 4 FM; no. of government 2 AM, 1 FM

TELEVISION STATIONS:

No. of government channels: 2, commercial channels: 88 (all color)

MARKET ANALYSIS:

Japan's record production has been making a small increase, but the momentum of music tape sales has been much more impressive. Because of the effects of the yen appreciation, sales of Western records have been slow. One of the important problems of Japan's record industry is the taping of broadcasts, tapes and records by individual consumers. The government is moving to debate the issue of resale price maintenance, which has been in effect among distributors for many years.
 Haruhiko Fukuhara, Kazu Fukatsu

● record & tape manufacturers / distributors / importers

A N Z Inc., 27 Hishiyama-cho, Itabashi-ku, Tokyo 174. (Distributor)
Label: (represented) Jazzology-GHB (USA)
 Aard-Vark, see Canyon
 Abeno-Meikyoku-Do, 4-13-19 Abenosuji, Abeno-ku, Osaka 545. Tel: (06) 622-0373. (Distributor)
 Alfa Recs. Inc., Studio City Bldg, 3-5-39 Shibaura, Minato-ku, Tokyo 108. Tel: (03) 455-1791. Cable: ALAS-SOCIA. Pres. Kunihiko Murai, VP A&R Sho Kawazoe; Gen. Mgr. Chiuichi Kaneko; Sales Mgr. Junichi Yanai. (Distributed by Victor)
Labels: (Owned) Alfa; (licensed foreign) A&M (USA), Horizon (USA).
Int'l rep.: USA (A&M).
 Apollon Music Ind'l Corp., 1-5 Wakaba, Shinjuku-ku, Tokyo 160. Tel: (03) 353-0191. (Tape only)
 Archiv, see Polydor
 Asahi Music Servs. Inc., c/o Asahi Broadcasting Corp., 2-2-48 Ohyo-do-Minami, Ohyo-do-ku, Osaka 531. Tel: (06) 458-5321. Pres. Kinkichi Kanbara, Gen. Mgr. Kazuyuki Yagi, Sales Mgr. Shuzo Asai
Label: (Owned) Asahi Musipak
Branch: Tokyo, 2-6-3 Shiba Park, Minato-ku, Zone 105. Tel: (03) 436-5771. Cable: ASAHIHOSO TOKYO.
 Asylum, see Warner-Pioneer.
 Athene Rec. Ind. Co. Ltd., 3-4-9 Ginza, Chuo-ku, Tokyo 104. Tel: (03) 542-6651. Cable: ATHENCORD. Pres. Hiroshi Hirano
 Atlantic, see Warner-Pioneer.
 B O M Serv. Ltd., 6-5-18 Kawamo, Takarazuka, Hyogo 665. Tel: (079) 87-0561. Pres. Toshio Watanabe, VP Saburo Watanabe
Labels: (Owned) Red Clay; (licensed) American Heritage, Bay, County, Flying Fish, Grassound, Old Homestead, Outlet, Puritan, Rebel, Revonah, Ridge Runner, Rounder, Shloh, Sonyatone, Sugar Hill (all USA); (distributed—not licensed) Biograph, CMH, Takoma, Vetco (all USA).
 Black, see Teichiku.
 Black Hawk & Co., 2-18-3 Dogenzaka, Shibuya-ku, Tokyo. Contact Yoshinori Mizukami. (Distributor)
Label: (Represented) Biscuit City (USA)
 Bluegrass Ents. Tokyo, Kasai Bldg, 6-15-1 Honkomagome, Bunkyo-ku, Tokyo 113. Tel: (03) 946-4663. (Distributor)
 Blues Interactions Inc., 5-18-11-201 Daizawa, Setagaya-ku, Tokyo 155. Tel: (03) 412-1293. Cable: PEAVINE. Pres. Yasufumi Higurashi; Gen. Mgr. Akira Kochi.
Labels: (Owned) P-Vine Special; (licensed foreign) Giant (USA), Joliet (USA), Joromi (Nigeria), One-Derful (USA), Rotel (USA); (distributed—not licensed) Superstar (Haiti) (SEE ADVERTISEMENT)
 Bourbon, see Tokuma.
 CBS/Sony Inc. (IFPI), PO Box 17, Tokyo Int'l Airport, Tokyo 149. 1-4 Ichigaya-Tamachi, Shinjuku-ku, Tokyo 162. Tel: (03) 266-5770. Cable: CBSONYRECORD. Telex: 24766. Pres. Nonno Ohga; Exec. VP & Sales Mgr. Toshio Ozawa, Gen. Mgr. Hiroshi Kanai
Labels: (Owned) CBS/Sony, Epic, Little Gang, People, Tee, UMI; (licensed foreign) ARC, Bang, Bethlehem, Blue Sky, Calla, Caribou, Channel, Columbia, Jet, Kirshner, Lifesong, Monument, Nemperor, Odyssey, Philadelphia Int'l, Sam, Starlight, TK, T-Neck, Tabu, Tappan Zee, Unlimited Gold (all USA); DJM (UK), Ricordi (Italy).
Int'l reps.: Worldwide (CBS); Hong Kong (CBS/Sony), Korea (Jigu), Malaysia (EMI), Philippines (Biograph), Singapore (EMI)
 Camellia, see Polydor
 Canyon Recs. Inc., World Trade Center Bldg, 24F, 2-4-1 Hamamatsu-cho, Minato-ku, Tokyo 105. Tel: (03) 435-4951. (Tape distributed by Pony).
Labels: (Owned) Aard-Vark, Canyon, NAV, Pony.

Godiego

THE REVOLUTIONARIES

For the first time in the history of the Japanese music industry, GODIEGO, a Japanese group are shipping their monthly singles and albums GOLD.

What's so new about this?

ALL GODIEGO'S RECORDS ARE IN ENGLISH!!!

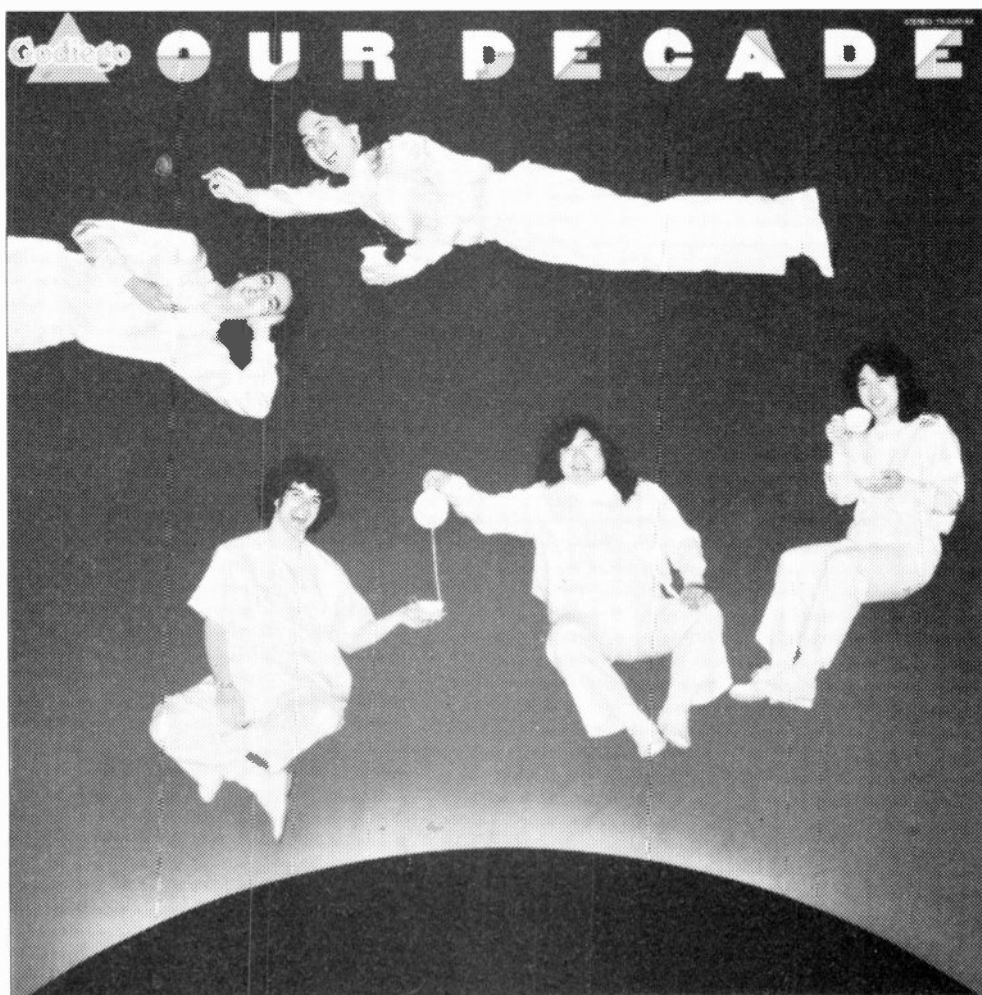

Their latest album **"OUR DECADE"** made No.1 upon release.

Available for distribution in the U.S.A.

For information please contact NIPPON COLUMBIA CO., LTD.

14-14, 4-chōme. Akasaka, Minato-ku, TOKYO, JAPAN.

Phone. 03-584-8111 TELEX: J22591

World Radio History

Columbia, see Nippon Columbia.
 Cosdel (Japan) Ltd., Hibuya Park Bldg., Rm. 923, 1-8-1 Yuraku-cho, Chiyoda-ku, Tokyo 100. Tel: (03) 271-5861.
 Rep. Dir.: Kenneth L. Cole (Distributor/Importer).
Label: (Licensed) Durium (Italy).
 Crown Rec. Co. Ltd., 2-10-8 Akasaka, Minato-ku, Tokyo 107. Tel: (03) 582-4741. Pres. Masanori Itoh; Gen. Mgr.: Noboru Saito, Sales Mgr.: Kazushige Tsuyuki.
 D G, see Polydor.
 Dan, see Tokuma.
 Denon, see Nippon Columbia.
 Disc Center Co. Ltd., CPO Box 874, Osaka 530-91. Tel: (06) 323-6350. Cable: DISCAREA. Telex: 64488. Pres. Yasutoshi Goroh; Gen. Mgr.: Hidekazu Yokoo; Sales Mgr.: Takatsugu Yonekura. (Distributor/Importer/Exporter).
Branch: Tokyo. Miyamasuzaka Bldg., Rm. 806, 2-19-15 Shibuya, Shibuya-ku, Zone. 150. Tel: (03) 406-4563. Mgr. Kaoru Umeda.
 Disco Co. Ltd. (IFPI), Akasaka Makabe Bldg., 3-4-3 Akasaka, Minato-ku, Tokyo 107. Tel: (03) 585-9111. Telex: 2425228. Pres.: Takayasu Yoshioka; VP: Toshiro Hoshino; Domestic Sales Mgr.: Ikuo Kogasaka; Int'l: Gordon Iiyama. (Distributed by Victor).
Label: (Owned) Discamate. (SEE ADVERTISEMENT).
 Discamate, see Disco Co. & Victor.
 Disk Union Co. Ltd., Nakashige Bldg., 2-10-5 Kanda-Surugadai, Chiyoda-ku, Tokyo 101. Tel: (03) 264-7930.

Cable: DISKUNION. Telex: 25425. Pres.: Teruichi Hirohata, Dir.: Kazuo Fukuda. (Importer/Exporter).
 Doughtnut, see Toshiba-EMI.
 E M I, see Toshiba-EMI.
 East Wind, see Nippon Phonogram.
 Elektra, see Warner-Pioneer.
 Epic, see CBS/Sony.
 Express, see Toshiba-EMI.
 Flying Disc, see Victor.
 Flying Dog, see Victor.
 For Life Recs. Inc., 10F Odakyu Minamiyama Bldg. 7-8-1, Minato-ku, Tokyo. Tel: (03) 406-6955.
 Frasco, see Nippon Phonogram.
 Free Flight, see Warner-Pioneer.
 G & G Sounds Corp., 3-15-15 Izumi, Higashi-ku, Nagoya, Aichi 461. Tel: (052) 932-3456. Pres.: Yoshio Tanahashi. (Distributor/Importer).
 Gyugiyu Kawahara-cho Ten, Sangyonan, Kawahara-cho, Cyukyo-ku, Kyoto.
Label: (Represented) Sierra/Briar (USA).
 Harmony House Recs., 3-1 Kanda Surugadai, Chiyoda-ku 101, Tokyo.
Label: (Represented) Sierra/Briar (USA).
 Harvest, see Tokuma.
 Heliodor, see Polydor.
 Herald Music Inc., 2-20-15 Shimbashi, Minato-ku, Tokyo. Tel: (03) 573-1287. Cable: HERALDPICTURE. (Distributor/Importer).

Invitation, see Victor.
 J V C, see Victor.
 Japan Publ'ns Trading Co. Ltd., 1-2-1 Sarugaku-cho, Chiyoda-ku, Tokyo 101. Tel: (03) 292-3751. Cable: SHUT-SUBO. Telex: 27161. Pres. Masakatsu Mochizuki; Dir.: T. Kishi; Mgr.: S. Kakazu; Section Chief: M. Kokubo. (Exporter).
 Japan Rec. Trading Co. Ltd., Daichi Honan Bldg., 2-8-17 Minami Ikebukuro, Toshima-ku, Tokyo 171. Tel: (03) 984-1587. Telex: 2722447. Pres.: Sigeru Ouchi; Dir.: Shunji Obata. (Importer).
 Japan Soul Agency, Mena Co-op., 1-13-18 Gohtokuji, Setagaya-ku, Tokyo 154. Tel: (03) 426-4333. Cable: JSATRCO. Telex: 2424586. Chief Exec.: Kazuo Akimoto; VP: Taiko Akimoto; Gen. Mgr.: Nobuhiro Shindo; Sales Mgr.: Eiko Yamaguchi. (Distributor/Importer).
 Juijiya Gakki, 3-21 Nishiki-cho, Kanda, Chiyoda-ku, Tokyo 100. Tel: (03) 293-4671.
 K-tel Int'l (Japan) Ltd., 1-2-8 Nihombashi, Chuo-ku, Tokyo 103. Tel: (03) 274-4391.
Home office: USA.
 Kenwood, see Trio.
 Kikka Trading Co. Inc., 1-7-9 Asagaya Minami, Suginami-ku, Tokyo 166. Tel: (03) 583-5476, 311-1682. Cable: KIKKAINC. Mng. Dir.: Arata Yamamoto. (Exporter).
Labels: (Exported) Major jazz & rock labels & soundtracks.
 King Rec. Co. Ltd. (IFPI), 2-12 Otowa, Bunkyo-ku, Tokyo 112. Tel: (03) 945-2131. Telex: 24963. Pres. Kazumitsu Machijiri; Mng. Dir.: Minoru Suzuki.
Labels: (Owned) King; (distributed) Argo, Ariston, Artist House, Barclay, Blue Note, Butterfly, CAM, CGD, CR, CTI, Cetra, Contemporary, Deram, Disneyland, EGG, Good Time Jazz, Hungaroton, Kudu, London, Paddle Wheel, Parachute, Ri-Fi, Salvation, Seven Seas, Telefunken, Threshold, 20th Century-Fox, United Artists, Vanguard, Windmill.
Int'l reps.: Australia (Festival), Brazil (Altaplay), France (Compagnie Phonographique Francaise, Societe Francaise du Son), Hong Kong (Hong Kong King Yoko), Israel (Unatex), Mexico (Son'Art), Spain (Mayo), USA (London, Vanguard), Venezuela (Favedica). (SEE ADVERTISEMENT).
 Kitty Ents. Inc., Kobayashi Bldg., 7th fl., 1-14-11 Shibuya, Shibuya-ku, Tokyo 150. Tel: (03) 499-4711. Telex: 2425338. Pres.: Harumi Ogawa; Promo. Mgr. Yutaka Tanaka; Int'l Mgr.: Kazuo Munakata. (Also see Polydor).
 Kyushu-Ongaku-Sangyo, Ishii Bldg., 3-16-13 Hakataekimae, Hakata-ku, Fukuoka-shi 812. Tel: (092) 29-0117. (Distributor).
 Lilac Shoji, 10, Daihoji-machi, Minami-ku, Osaka 542. Tel: (06) 244-0901. (Distributor).
 Little Gang, see CBS/Sony.
 Lost City Co. Ltd., 3-22 Sannomiya-cho, Iktaku, Kobe 650. Tel: (078) 331-3770. (Distributor/Importer).
 Lucky Shokai, 2-4-1 Iwamoto-cho, Chiyoda-ku, Tokyo 101. Tel: (03) 861-7134. (Distributor).
 M G M, see Polydor.
 Mama, see Tokuma.
 Marutani Trading Co., Kaiun Bldg., 2-14-4, Chuo-ku, Tokyo.
Label: (Represented) Sheffield Lab (USA).
 Max, see Super Stop.
 Mercury, see Nippon Phonogram & Nihon Mercury.
 Minorophone, see Tokuma.
 Muse Trading Co. Ltd., Meiwa Bldg., Sakuragawa, Shiba, Nishikubo, Minato-ku, Tokyo 105. Tel: (03) 504-2525. (Distributor/Importer).
Branch: Osaka, Tel: (06) 362-7146.
 Music Minus One Japan, 3-25 Azabu Iikura, Minato-ku, Tokyo 106. (Distributor).
Home office: USA.
 Music Shop Kunihara, 8 Nijo, Asahikawa, Hokkaido. Tel: (0166) 23-5266. (Distributor).
 N A V, see Canyon.
 Nadja, see Trio.
 Nihon Mercury Rec. Ltd., 2-7-3 Yamato-cho, Nakano-ku, Tokyo 165. Tel: (03) 337-8970.
Label: (Owned) Mercury.
 Nippon Columbia Co. Ltd. (IFPI), 4-14-14 Akasaka, Minato-ku, Tokyo 107. Tel: (03) 584-8111. Cable: NIPPONCOLUMBIA. Telex: 22591. Pres. Takami Shobochi; Dir.: Toshio Kikutsugi; Rec. Div. Dir. & Gen. Mgr.: Mitsugu Kumamoto; A&R Div. Dir. Gen. Mgr.: Toshio Nemoto; Int'l Repertoire Gen. Mgr.: Toshihiko Hirahara; Admin. Mgr.: Tamotsu Hanzawa; Licensing Mgr.: Hajime Saito.
Labels: (Owned) Columbia, Denon; (licensed) ABC (USA), ABC/Blue Thumb (USA), ABC/Dot (USA), Alvares (France), Ariola-Eurodisc (Germany), Arion (France), Baerenreiter-Musicaphon (Germany), Bruno Walter Society (USA), Cantate (Germany), Cassipee (France), Chiswick (UK), Claudius (Germany), Concert-Disc (USA), Counterpoint/Esoteric (USA), Da Camera (Germany), Desmar (USA), Eurodisc (Germany), Everest (USA), Ex Libris (Switzerland), Folkways (USA), Inmus (Germany), Melodiya (USSR), Mondiodis (France), Mouloudji (France), Musicalitera (Germany), Muza (Poland), Nobody's Business (UK), Orion (USA), Pelca (Switzerland), Phonag (Switzerland), Preiser (Austria), Protone (USA), Public Image (UK), Rococo (Canada), Roulette (USA), Seeco (USA), Sex Pistols (UK), Supraphon (Czechoslovakia), Trema (France), Turicaphon (Switzerland), Turnabout (USA).
Int'l reps.: Brazil (Altaplay), France (Erato, Sofrason), Mexico (Cisne), Spain (Discophon, Hispavox), USA (CBS, Everest, Vox).
Int'l reps. for Denon PCM: Australia (Amalgamated Wireless Australasia Ltd.), Canada (Tri-Tel Assocs.), Denmark (So & Hoyem), France (Jid-Dinelec), Germany (Transonic Intersonic), Hong Kong (Tailin Radio Serv.), Italy (Franco Crippa), Netherlands (Penhold), Switzerland (Audio Compo), USA (Discwasher). (SEE ADVERTISEMENT).
 Nippon Gakki Co. Ltd., 7-9-18 Ginza, Chuo-ku, Tokyo 104. Tel: (03) 572-3111. Cable: YAMAHAPIANO. Telex: 252-2824. (Distributor/Importer).
 Nippon Gakki Shibuya-Ten, 2-10-7 Dogenzaka, Shibuya-ku, Tokyo.
Label: (Represented) Sierra/Briar (USA).
 Nippon Phonogram Co. Ltd. (IFPI), Wako Bldg., 4-8-5 Roppongi, Minato-ku, Tokyo 106. Tel: (03) 479-3712.

AGGRESSIVE BUT CREATIVE

WE ARE THE NEWEST PROMOTER IN JAPAN.

CONCERT PROMOTE/ARTISTS MANAGEMENT
TANAKA MANAGEMENT, INC.

SHIRAIISHI BLDG., 1-2 YOTSUYA, SHINJUKU-KU, TOKYO, JAPAN

TELEPHONE: 03-355-5178
 TELEX: 0232-5059 TANMAN J.
 CABLE: TANACARRO TOKYO

SOUND INN



We opened a studio called "SOUND INN" to commemorate our 10th anniversary this year of 1979.

Our office also moved next to this fantastic fully-equipped dream studio in a newly built complex.

New Address NTV Yonbancho Annex
 5-6, Yonbancho, Chiyoda-ku, Tokyo, Japan
 New Telephone Tokyo (03) 262-2221
 New Telex J29410 NTVMUSIC
 New Cable NTVM



NIPPON TELEVISION MUSIC CORPORATION

YONBANCHO ANNEX 5-6 YONBANCHO
 CHIYODA-KU TOKYO JAPAN
 TEL: 03-262-2221
 Cable: NTV MUSIC Telex: J29410

What's New?

WATANABE
WATANABE
WATANABE
WATANABE

WATANABE PRODUCTIONS

1-6-8, Yurakucho, Chiyoda-ku, Tokyo, Japan
Tel(03)502-0541 Telex:2224387 Cable:PROWATANABE

SMS
SOUND MANAGEMENT SYSTEM INC
RECORDS

1-8-10 Azabudai, Minato-ku, Tokyo, Japan
Tel(03)586-9031 Cable:SMSRECORDS

WATANABE MUSIC PUBLISHING CORP.

1-8-10 Azabudai Minato-ku, Tokyo, Japan
Tel(03)585-1531 Telex:2426848 Cable:WATMUS

WATANABE PRODUCTIONS-EUROPE
185 Pavilion Rd., London SW1 England
Tel(01)235-0525 Telex:8612808

WATANABE PRODUCTIONS-AMERICA
5231 Veloz Ave., Tarzana, Calif 91356, USA
Tel(213)706-2534 Telex:698212

Cable: NIPHILDISC. Telex 2423224. Pres. Nobuya Itoh; Gen. Mgr.: R. Itoh; Sales Mgr.: H. Koizumi; Int'l Mgr. T. Sekiguchi.
Labels: (Owned) East Wind, Frasco, Mercury, Philips, Vertigo; **(licensed domestic)** Three Blind Mice; **(licensed foreign)** Arista (USA), Buddha (USA), Charisma (UK), ENJA (Germany), Gryphon (USA), Shelter (USA), SteepleChase (Denmark), Timeless (Netherlands) (SEE ADVERTISEMENT)
 Nonesuch, see Warner-Pioneer.
 O M Recs.: 3-7-15 Inagehigashi, Chiba-shi, Chiba 281. (Distributor/Importer)
Label: (Represented) Mustevic Sound (USA).
 Overseas, see Teichiku.
 P-Vine Special, see Blues Interactions.
 Pirates, see CBS/Sony.
 Phenix Trading, Central PO Box 631, Osaka 530-91. Tel: (06) 363-7106, 365-5521. Telex 64219. Pres. Kikuo Taramoto; Gen. Mgr. Mono Nakatsu; Sales Mgr. Toshio Hashioka; Ass't Mgr. Yutaka Matsumura. (Distributor/Importer).
 Philips, see Nippon Phonogram.
 Pioneer, see Warner-Pioneer.
 Pirates, see World Rec.
 Polydor KK, 1-8-4 Ohashi, Meguro-ku, Tokyo 153. Tel: (03) 462-5131. Pres. Seiichiro Koh; Mng. Dirs. Juro Ohta, Hideo Murakami; Mktg. Mgr. Takao Mori; A&R Mgr. Yasuhiro Igarashi; Int'l Mgr. Atsutaka Torio.
Labels: (Owned) Archiv, Camellia, DG, Heliodor, Kitty.

MGM, Polydor, Sanrio, Verve; **(licensed)** Amadeo (Austria), Barn (UK), Claves (Switzerland), Oyster (UK), Pablo (USA), RSO (UK), Ricordi (Italy), Ring-O (UK), Safari (Germany), Seon (Germany).
 Pony Inc., World Trade Center Bldg., 24F, 2-4-1 Hamamatsu-cho, Minato-ku, Tokyo 105. Tel: (03) 435-4970. (Tape only) (Also see Canyon)
 Pooh Yokochi Co. Ltd., Printemps Bldg., 2F, 447-14 Kajicho, Kawaramachi-Imadegawasagaru, Kamigyoku-ku, Kyoto 602. Tel: (075) 256-2856. Pres. Hideaki Matsuoaka; Gen. Mgr.: Hirokata Sakai; Sales Mgr. Yumiko Ohta. (Distributor/Importer)
Labels: (Distributed—domestic), CBS/Sony, Epic/Sony, Nippon Phonogram, Polydor, RVC, Red Clay, Toshiba-EMI, Trio, Victor, Warner-Pioneer, (distributed—foreign) County, Flying Fish, Kicking Mule, Philo, Rebel, Ridge Runner, Rounder, Sugar Hill (all USA)
 R C A, see RVC.
 R V C Corp., 1-7-8 Shibuya, Shibuya-ku, Tokyo 150. Tel: (03) 499-3311. Cable. RVCRCARECORD. Telex 2425162. Pres. Ichiro Okuno.
Labels: (Licensed) Erato (France), RCA (USA) (SEE ADVERTISEMENT)
 Radio City Rec. Ltd., 1-5 Wakaba, Shinjuku-ku, Tokyo 160. Tel: (03) 357-2511
 Rainbow Recs., Xerox Corner, Taiseido 8F, 1-22-4 Jinnan, Shibuya-ku, Tokyo 150. Tel: (03) 464-6038. Chief Exec. Satoshi Sasaki; Gen. Mgr. Midori Ochiai; Sales

Mgr. Naoya Yamauchi. (One Stop/Distributor/Importer)
 The Reader's Digest of Japan Ltd., Palace Side Bldg., 1-1-1 Hitotsubashi, Chiyoda-ku, Tokyo 100. Tel: (03) 284-4141. (Distributor)
 Recommended Recs. Japan, 105 Green Heights, 4-14-14 Honmachi, Kichijoji Musashino-shi, Tokyo.
Home office: England.
 Red Clay, see BOM.
 Reprise, see Warner-Pioneer.
 Ryogaiya Co. Ltd., PO Box 10, 2-2-7 Honcho, Nagaoka, Niigata 940. Tel: (0258) 35-4500. Cable: RYONGO. Telex: 03232108. Pres. Tamakichi Shimizu; Gen. Mgr.: Yoshio Shimizu; Sales Mgr.: Katsumi Kodama. (Distributor/Importer/Exporter)
 S M S, see Sound Mktg.
 Sanrio, see Polydor.
 Seikodo Co. Ltd., 2-65-8 Itabashi, Itabashi-ku, Tokyo 173. Tel: (03) 961-6171. Pres. Masanobu Iihara. (Distributor)
 Shinjuku Rec. Co., 7-9-6 Nishi-Shinjuku, Shinjuku-ku, Tokyo. Tel: (03) 363-3669. Chief Exec.: M. Fujiwara; Gen. Mgr. T. Ohtake (Importer)
Label: (Represented) Sierra/Briar (USA).
 Shinsei Serv. Co. Ltd., 3-51 Andojibashidori, Minami-ku, Osaka 542. Tel: (06) 245-6061. Cable: SALWELL. Telex: 63753. Pres.: T. Sakata; Gen. Mgr.: H. Kawaguchi; Sales Mgr.: S. Nakajima. (Importer)
Branch: Tokyo, 2-10-3 Roppongi, Minato-ku
 Sounds Mktg. Systems Inc., Kaisei Bldg., 1-8-10 Azabudai, Minato-ku, Tokyo. Tel: (03) 586-9031. Cable: SMSRECORDS. Chief Exec.: Shin Watanabe.
 Sound Trading Co. Ltd., Fukide Bldg., 4-1-13 Toranomon, Minato-ku, Tokyo 105. Tel: (03) 438-0291. Telex: 28254. Pres.: Masao Yorozu; Sales Mgr.: Takaya Yamaguchi; Planning Mgr. Hisaichi Urushiyama; Import Mgr. Kunihiko Yashiro. (Importer)
 Sumiya Ltd., 7-16 Ohtemachi, Shizuoka-shi, Shizuoka-ken 420. Tel: (0542) 51-1234. Pres.: Shigeru Kawabe. (Distributor/Importer)
Branch: Tokyo, 2-10-16 Shibuya, Shibuya-ku. Zone: 150. Tel: (03) 406-4966. Telex: 2422097.
 Sunkyo Music Co. Ltd., Yamagata Bldg., 1-14-7 Nishi-Shimbashi, Minato-ku, Tokyo 105. Tel: (03) 501-2667. Pres.: Ichiro Takeuchi. (Importer of recorded masters).
 Super Stop Inc., 2-26-11 Bishoen, Abeno-ku, Osaka 545. Tel: (06) 713-2715. Telex 5278643. Pres. Hirakazu Sasabe; Sales Mgr.: Tomizo Miyagawa. (Distributor/Importer/Exporter)
Labels (Owned) Max; **(distributed—not licensed)** Black Saint (Italy), Dragon (Sweden), Queen Disc (Italy), T K R, see Takara.
 Takara Mfg. Co. Ltd., 2-29-12 Tamagawa, Ohta-ku, Tokyo 144. Tel: (03) 759-3151.
Label: (Owned) Takara "TKR".
 Tam, see Toho.
 Tee, see CBS/Sony.
 Teichiku Recs. Co. Ltd. (IFPI), 1-2 Nishi-Shimbashi, Minato-ku, Tokyo 105. Tel: (03) 502-7213. Pres. Shigeji Nanko; Gen., Int'l & Copyright Div. Mgr. Ichiro Kinoue; Sales Mgr. Minoru Ozaki.
Labels: (Owned) Black, Overseas, Teichiku, Union, (licensed) Audio Fidelity (USA), Beserkley (USA), Catalyst (USA), Chiaroscuro (USA), Contempo (UK), Hansa (Germany), Harmonia Mundi (Germany), IPG (France), MPS (Germany), Metronome (Germany), Meys (France), Progressive (USA), Pye (UK), Sonet (Sweden), Storyville (Denmark), Temey (France), Vee Jay (USA), Xanadu (USA).
 Three Blind Mice, see Nippon Phonogram.
 Toho Recs. Co. Ltd., 1-2-1 Yuraku-cho, Chiyoda-ku, Tokyo 100. Tel: (03) 503-9531. (Distributed by Victor)
Int'l branches: Brazil, Italy, Hong Kong, USA.
Labels: (Owned) Tam, Toho; **(licensed)** BYG (France), Black Jazz (USA), Ovation (USA), Vogue (France)
 Tokuma Musical Inds. Co. Ltd. (IFPI), 1-2-2 Iwamoto-cho, Chiyoda-ku, Tokyo 101. Tel: (03) 862-1381. Cable: TOKUMAONKOH. Telex: 28438.
Labels: (Owned) Bourbon, Dan, Harvest, Mama, Minorophone, **(represented)** Black Saint (Italy), Eterna (East Germany), Strata-East (USA), Xanadu (USA).
Int'l rep.: Worldwide (Island).
 Tokyo Denka Co. Ltd., 577 Hamasaki, Asaka-shi, Saitama-ken 351. (Distributor).
 Toshiba-EMI Ltd., 2-2-19 Akasaka, Minato-ku, Tokyo 107. Tel: (03) 585-8780. Cable: EMIGRAM. Telex: 2422112. Pres.: Noboru Takamiya, Dirs.: H. Tsurumi, M. Kawai, M. Suda, K. Ueno.
Labels: (Owned) Doughnut, Express, Toshiba; **(licensed)** Angel (UK), Arista (USA), Bronze (UK), Capitol (USA), Chrysalis (UK), Concord (USA), DJM (UK), EMI (UK), Island (UK), MAM (UK), Magnet (UK), Odeon (worldwide), Private Stock (USA), RAK (UK), Red Bus (UK), Rocket (UK), Rolling Stones (UK), Savoy (USA), Stateside (UK).
Int'l reps.: France (Pathe Marconi-EMI), Germany (EMI Electrola), Netherlands (EMI Holland), UK (EMI), USA (Capitol).
 Towa Kikaku & Co. Inc., c/o Bluegrass Ents. Tokyo, Kasai Bldg., 6-15-1 Honkomagome, Bunkyo-ku, Tokyo 113. Tel: (03) 946-4663. (Distributor).
 Trio Recs./Trio Kenwood Corp., 5-2-1 Roppongi, Minato-ku, Tokyo 106. Tel: (03) 404-4391. Cable: TRIODISC. Telex: 22913. Exec. Dir. Makoto Oka; Gen. Mgr.: Kazuaki Maeda; Sales Mgr.: Taizo Fujii. Int'l Chief: Kenny Inaoka.
Labels: (Owned) Nadja, Trio, Whynot; **(licensed)** Abattoir (USA), Alshire (USA), Black Lion (UK), Choice (USA), Delmark (USA), ECM (Germany), Flying Fish (USA), Freedom (UK), Lax (USA), Mooncrest (UK), Rounder (USA), Stony Plain (Canada), Trojan (UK).
Int'l rep.: USA (Inner City). (SEE ADVERTISEMENT)
 U D C, see URC.
 U M I, see CBS/Sony.
 U R C Recs. Inc., 311 Yamayasu Bldg., 1 Togano-cho, Kita-ku, Osaka 530. Tel: (06) 314-1631.
Labels: (Owned) URC, UDC.
 Union, see Teichiku.
 Universal Corp. of Japan Ltd., 1-17-9 Uchikanda, Chiyoda-ku, Tokyo 101. Tel: (03) 291-0326. Cable: UNI-

P-VINE SPECIAL

a promising recording label

JAPAN'S FIRST SPECIALIZED OUTLET FOR THE BLACK MUSIC

Our Specialty: Blues/R&B/Reggae & Caribbean/Modern Afro

If you have old masters/new recordings, please contact:

BLUES INTERACTIONS

No.18-11-201, 5-chome, Daizawa, Setagaya-ku, Tokyo, Japan.

WE PROVE OURSELVES'

NOT BY WORDS'

BUT BY HARD WORK AND RESULTS'



nippon phonogram co.,ltd.

Wako Bldg., 8-5, Roppongi 4-chome, Minato-ku, Tokyo 106
 Cable Address : NIPHILDISC TOKYO Tel : (03)479-3711 Telex : (242)3224

MUSIC TOKYO COMPANY

(formerly called Tokyo Music Pub Co., Ltd.)

Wako Bldg., 8-5, Roppongi 4-chome, Minato-ku, Tokyo 106
 Cable Address : MUSICATO TOKYO Tel : (03)401-9327 Telex : (242)3224

MUSIC TOKYO

Pop Music? Yamaha has it.

*exciting new sounds,
the pacesetters of the '80s.*

And what better way to hear and be captivated by the latest and the best in pop music than right where the action is at the annual World Popular Song Festival in Tokyo, in November.

Since its inception in 1970, the Festival has steadily grown in scope and scale. With added significance. The 3-day Festival gives you full exposure to the best that pop music's got to offer. We planned it that way.

**World
Popular Song
Festival
in Tokyo
'80**



It's all yours—a galaxy of inspiring, new and original songs composed and presented by songwriters and artists of international renown . . . Young and upcoming musicians from the world over, the birth of new songs and the launching of new artists into stardom. You'll hear *tomorrow's* sounds today—songs that will set the stage for popstardom in the '80s. Songs you'll cherish for the rest of your life.

Share with others the fun and excitement
of the once-a-year musical spectacle! The **YAMAHA**-way.

For further information:

FESTIVAL COMMITTEE '80
 **YAMAHA MUSIC FOUNDATION**

24-22, 3-chome, Shimomeguro, Meguro-ku, Tokyo, Japan
Phone: Tokyo (03) 719-3101
CABLE: WORLD FESTIVAL TOKYO
TELEX: 2466571 YAMAHA J

CORECORD Mng. Dir.: Kiyoshi Narita; Gen. Mgr.: Junji Narita (Importer)
 Vertigo, see Nippon Phonogram.
 Verve, see Polydor.
 Victor Musical Inds. Inc. (IFPI), Harajuku-Piazza Bldg., 4-26-18 Jingumae, Shibuya-ku, Tokyo 150. Tel. (03) 405-5151. Cable: VICRECORD. Telex: 242-4293. Pres.: Saburo Watanabe; Sr. Mng. Dir.: Shoo Kaneko; Int'l Div. Mgr.: Yoshihisa Honda.
 Int'l branch: USA, JVC Cutting Center Inc.
 Labels: (Owned) Flying Disk, Flying Dog, Invitation, JVC, Victor, Zen; (licensed foreign) Ariola, Atomic Art, Barnaby, Capricorn, Casablanca, Cream, De-Lite, Emanem, Fantasy, Firesign, GRT, Galaxy, Gusto, H&L, Hi, Infinity, Janus, MCA, Midsong, Milestone, Motown, Musicor, Nippon Mr. Dogg, Prelude, Prestige, Prodigal, Pyramid, Riverside, Springboard Int'l, Stax, Tomato (all USA); Ariola Hansa, Aura, Enigma, Gull, Incus, Nimbus, Penny Farthing, Pinnacle, Rockburgh, Stiff, Symphonica, Virgin (all UK); Arabella, Boona, Calliope, Delphine, Disc AZ, Frederic Prod'ns, Harmonia Mundi (all France); Aereo (Cuba), Baby (Italy), Change (Canada), Electrecord (Romania), Hispavox (Spain), Jugoton (Yugoslavia), Jupiter (Germany), Melodiya (USSR), Opus (Czechoslovakia), Pantan (Czechoslovakia), Sackville (Canada), Trova (Argentina), Turicaphon (Switzerland), (distributed—not licensed) Alfa, Discamate, Toho.
 Int'l reps.: Brazil (Fermata), Canada (JJ), Chile (Utz),

Cuba (Aereo), Ecuador (IFESA), France (Disc AZ), Hong Kong (King Yoko), Israel (Gal-Ron), Italy (Ri-Fi), New Zealand (Music World), Philippines (Vico), Portugal (Trindade), Singapore (Chang Huat), Spain (Zafiro), Switzerland (Turicaphon), USA (JJ). (SEE ADVERTISEMENT)
 Vivid Sound Corp., 2-23-8 Shimomeguro, Meguro-ku, Tokyo 153. Tel. (03) 490-1070. Cable: VIVIDSOUND. Pres.: Fumio Nagano; VP: Masayasu Odakawa; Gen. Mgr. Kazuo Nagano.
 Labels: (Licensed foreign) Ace, Alarm/Murco, Crajon, Goldwax/Music Garden, Imagination, JR Prod'ns, Le Cam/Charley, Malaco/Chimneyville (all USA). (SEE ADVERTISEMENT)
 Warner Bros., see Warner-Pioneer.
 Warner-Pioneer Corp. (IFPI), Aoyama Twin Tower Bldg., 14th fl., 1-1-1 Minami, Aoyama, Tokyo. Tel. (03) 475-2051. Cable: WARBPIONE. Pres.: Kichibei Sawa; Mng. Dirs.: Keith Bruce, Yukio Sakamoto.
 Home office: USA, WEA Int'l.
 Labels: (Owned) Asylum, Atlantic, Elektra, Nonesuch, Pioneer, Reprise, Warner Bros.; (licensed domestic) Free Flight, (licensed foreign) Dark Horse (USA), Radar (UK), Swan Song (UK).
 Whynot, see Trio.
 Winners Recs. Shop, Saneihouse 505, Saneicho 25, Shinjuku-ku, Tokyo Tel. (03) 341-1835. Pres.: T. Kohno (Importer) (SEE ADVERTISEMENT)

World Family Rec. Co. Ltd., Minami-Aoyama Daiichi Bldg., 5-1-10 Minami-Aoyama, Minato-ku, Tokyo 107. Tel. (03) 407-5121. Pres. Shigeru Saito. (Distributor)
 World Rec. Co. Ltd., Aisan Bldg., 4F, 1-9-3 Hiraakawa-cho, Chiyoda-ku, Tokyo 102. Tel. (03) 230-0526.
 Label: (Owned) Pirates
 Yamano Music Co. Ltd., 4-5-6 Ginza, Chuo-ku, Tokyo 154. Tel. (03) 562-5051. Telex: 2523773. Pres.: Mike M. Yamano; Gen. Mgr.: Susumu Watanabe; Sales Mgr.: Kiyoshi Okano. (Distributor/Importer)
 Yupiteru Kogyo KK, 5-4-35-408 Minami Aoyama, Minato-ku, Tokyo 107. Tel. (03) 406-1711.
 Zen, see Victor.

● music publishers

A B C Sounds Inc., Nikko Bldg., No. 614, 1-4-26 K Takana, Minato-ku, Tokyo 108. Tel. (03) 445-0558.
 A M P Co. Ltd. (Jasrac), Horaiya Bldg., 5-2-1 Roppongi, Minato-ku, Tokyo 106. Tel. (03) 404-9115. Cable: AOYAMAMUSICPRO
 Int'l firms represented: Rolf Budde (Germany), Meridian (Germany), Michael (USA), Ron Myers (USA), Poplico (France), SIF (Italy).
 Akizuki Music (Jasrac), Magatani Bldg. 10-13, Toranomon 5, Minato-ku, Tokyo 105. Tel. (03) 434-6668. Dir.: Tomomi Akizuki; Gen. Mgr.: Shizuko Ohtomo.
 Alfa Music Ltd., Studio City Bldg., 3-5-39 Shibaura, Minato-ku, Tokyo 108. Tel. (03) 452-7976. Cable: ALFALFAPUB. Telex: 2424537. Pres. Kay Murai; Gen. Mgrs.: Ken-ichi Nomura, Nobuaki Shibuya.
 Int'l firms represented: Eddie Barclay (France), Canopy (USA), Kamakazi (USA), Marouani (France), Masong (USA), White Oak (USA).
 All Staff Music Co. Ltd. (Jasrac), Fontaine Bldg., 5-13-13 Roppongi, Minato-ku, Tokyo 106. Tel. (03) 583-9841. Pres. Takao Imaizumi; Gen. Mgr. Atsuko Iwasaki.
 April Music Inc. (Japan), PO Box 17, Tokyo Int'l Airport, Tokyo 149. Tel. (03) 266-5770. Cable: CBSONY-RECORD. Telex: 24766. Pres. Norio Ohga; Dir. & Gen. Mgr. Hiroshi Kanai.
 Int'l firms represented: April/Blackwood (worldwide); Bovina, Derringer, Dickiebird, Double Diamond, Frank, Albert Hammond, Hierophant, Homegrown, Hudmar, Impulsive, Joelsongs, Little Johno, Mine, Petra, Rare Blue, Sherlyn/Kimlyn, Silver Blue, Strong Arm, Tuna Fish, Winter Blues (all USA).
 Arrow Music Corp., 4-11-10 Roppongi, Minato-ku, Tokyo 106. Tel. (03) 401-1014. Telex: 26876. Pres. Jushiro Matsuda; Gen. Mgrs. Keith Bruce, Tetsu Aoyagi.
 Int'l firms represented: Aguabella, Canterbury, Chesson, Ebbets Field, Fatback, Kuptillo, Mobetia, Nuestra, Polo Grounds, Smadagerg, Steamboat Gothic, Zambezi (all USA).
 Associated Music Publ'rs Co. Ltd., see AMP.
 Barbara Music Publ'rs, Sakuragaoka Urban Life Bldg., A-309, 21-12 Sakuragaoka, Shibuya-ku, Tokyo 150. Tel. (03) 496-2635.
 Big Hill Music Publ'rs, No. 101, Chateau Akasaka, 6-5-22 Akasaka, Minato-ku, Tokyo 107. Tel. (03) 582-7870.
 Bond Music Publ'r, see Pacific.
 Bon Music Publ'r, 2-5-5 Hiraakawa-cho, Chiyoda-ku, Tokyo 102. Tel. (06) 263-5847.
 Int'l reps.: Brazil (RCA), South Africa (EMI-Brigadiers), USA (Southern).
 Burning Publ'rs Co. Ltd., 102 Akasakada Mansion, 7-6-11 Akasaka, Minato-ku, Tokyo 107. Tel. (03) 586-1968/2076. Chief Exec. Ikuo Suho; Gen. Mgr. Norio Higuchi; Sales Mgr.: Takamasa Takeyama.
 C A M Japan Ltd., 2-6-4 Ginza, Chuo-ku, Tokyo 104. Tel. (03) 562-0111. Cable: TOWATOWA. Telex: J24141. Pres. Nagamasa Kawakita; Gen. Mgr. Shigeaki Oeda; Sales Mgr.: Yoshihiko Suzuki.
 Home office: Italy.
 C B C Music KK, CBC Kaikan-nar, 4-15 Shinei-cho, Naka-ku, Nagoya-shi, Aichi-ken 460. Tel. (052) 241-8080.
 C S B Ltd./Hara Int'l, 1-2-5 Shirokanedai, Minato-ku, Tokyo 108.
 Int'l firm represented: Copyright Serv. Bureau (USA).
 Carrot Music Inc., Shiraishi Bldg., 1-2 Yotsuya, Shinjuku-ku, Tokyo. Tel. (03) 357-4334. Cable: TANACARRO. Telex: 0232-5059. (SEE ADVERTISEMENT)
 Chappell KK, see Intersong.
 Cherry Lane Music Ltd., Harajuku Piazza Bldg., 4-26-18 Jingumae, Shibuya-ku, Tokyo.
 Home office: (USA).
 Chuo Music Publ'g Co. Ltd., Shochiku Kaikan Bekkan, 1-12-16 Tsukiji, Chuo-ku, Tokyo 104. Tel. (03) 542-8857.
 Church Music Publ'g Society Japan, 1-41-12 Minami-Ogikubo, Suginami-ku, Tokyo 107. Tel. (03) 334-3247.
 Int'l firms represented: Concordia (USA), Novello (UK), Ricordi (Italy), Schirmer (USA), United (UK).
 Cleo Music Publ'rs, Santo Bldg., 4F, 2-15-13 Akasaka, Minato-ku, Tokyo 107. Tel. (03) 585-5021.
 Columbia Music Publ'g Co. Ltd., 4-14-14 Akasaka, Minato-ku, Tokyo 107. Tel. (03) 584-8111. Pres. Minoru Harada.
 Int'l firms represented: Adagio (Spain), Constant Defourny (Belgium), GP (USA), Garima (France), Charles E. King (USA), Ninth Ethereal (USA), Zzelesta (Spain).
 Int'l rep.: USA (GP Music).
 Crown Music Publ'r Inc., 2-10-8 Akasaka, Minato-ku, Tokyo 107. Tel. (03) 582-4741. Pres.: Taketsuna Kamei; Gen. Mgr. Tohru Hoshino.
 Int'l firms represented: Cadencia, Union Musical (both Spain).
 Walt Disney Ent's. of Japan Ltd., Horaiya Bldg., 5-2-1 Roppongi, Minato-ku, Tokyo 106. Tel. (03) 404-1815, 412-8218. Cable: MICKYMOUSE. Contact: Masuo Yokoyama.
 Int'l firms represented: Walt Disney Music (USA), Wonderland (USA).
 Doorknob Publ'g Ltd., Shibuya Sanshin Mansion, Suite 501, 29-33 Sakuragaoka-cho, Shibuya-ku, Tokyo 150. Tel. (03) 476-5837. Cable: DOORKEY. Telex: 27637. Pres. Yuki Watanabe; Contact: Masuo Yoshiaki.
 Eastern Music Publ'g Co. Ltd., Hirasawa Bldg., 34 Kotohira-cho, Shiba, Minato-ku, Tokyo 105. Tel. (03) 501-0344. Cable: EASTMUS.

**CREATIVE
 BUT
 AGGRESSIVE**

WE ARE THE NEWEST PUBLISHER IN JAPAN.

PUBLISHING/MERCHANDISING



Carrot MUSIC INC.

SHIRAISHI BLDG., 1-2 YOTSUYA, SHINJUKU-KU, TOKYO, JAPAN

TELEPHONE: 03-357-4334
 TELEX: 0232-5059 TANMAN J.
 CABLE: TANACARRO TOKYO

**WANT TO BE
 HAPPY IN JAPAN?**



For the most aggressive exploitation and promotion of your catalog, try, us!
 Our organization, enjoys the backing of TV ASAHI in JAPAN.
 You'll be happy, if you contact us today:

TV ASAHI MUSIC CO., LTD.

ADDRESS: 6-4-10 ROPPONGI, MINATO-KU TOKYO JAPAN
 PHONE: TOKYO 405-3194 TELEX: JAPAN22520 TV ASAHI
 PRESIDENT: EIZO NAKAGAWA CABLE: JOEXTVASAHI
 SENIOR EXECUTIVE DIRECTOR: KIYOKAZE MATSUBAYASHI
 EXECUTIVE DIRECTOR: ZENJIRO MORIYASU
 COPYRIGHT MANAGER: SHINICHIRO TAMURA

VICTOR/JVC

We can connect you with Japan in three big ways.

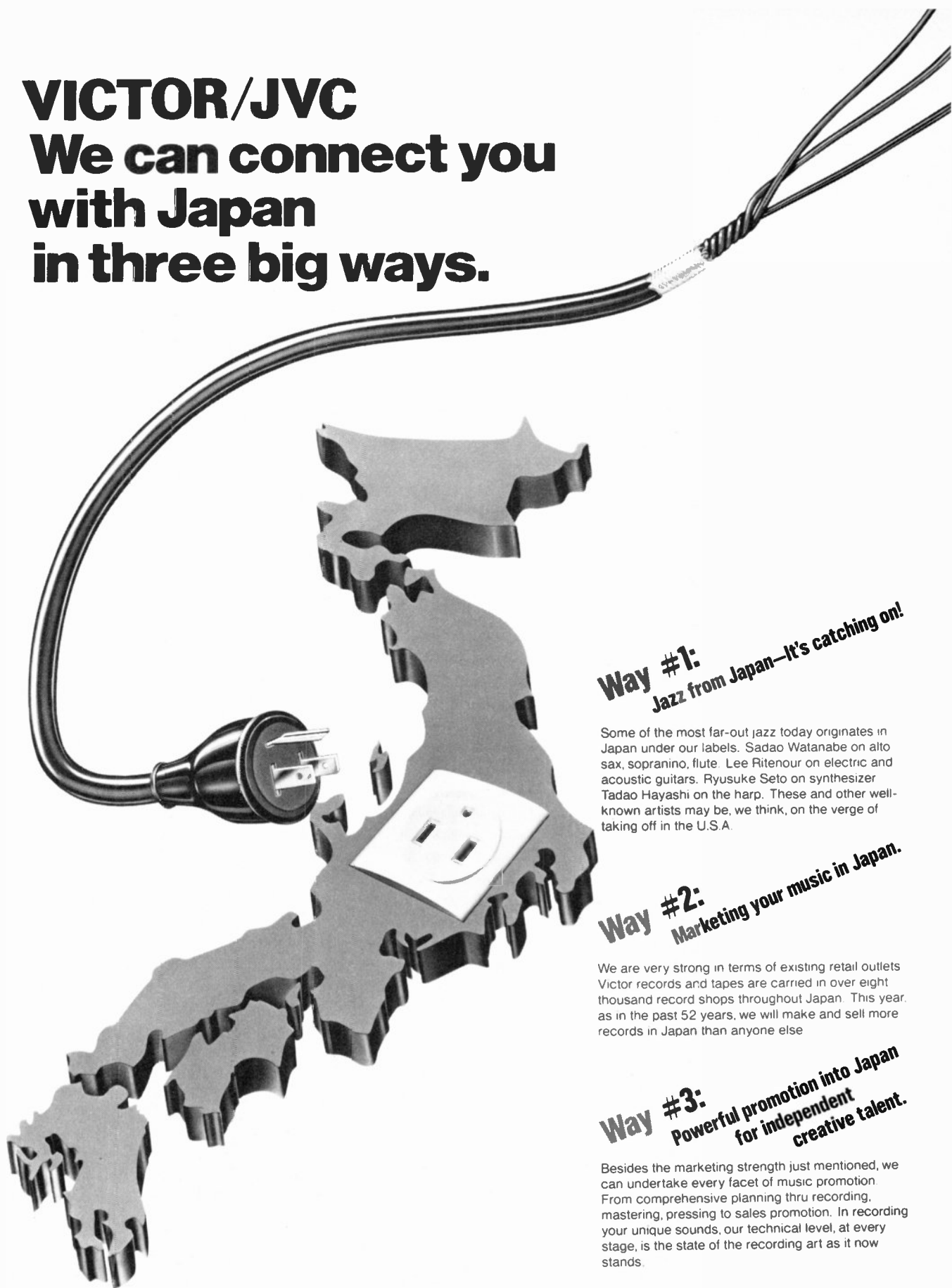

Way #1: Jazz from Japan—It's catching on!

Some of the most far-out jazz today originates in Japan under our labels. Sadao Watanabe on alto sax, soprano, flute. Lee Ritenour on electric and acoustic guitars. Ryusuke Seto on synthesizer. Tadao Hayashi on the harp. These and other well-known artists may be, we think, on the verge of taking off in the U.S.A.

Way #2: Marketing your music in Japan.

We are very strong in terms of existing retail outlets. Victor records and tapes are carried in over eight thousand record shops throughout Japan. This year, as in the past 52 years, we will make and sell more records in Japan than anyone else.

Way #3: Powerful promotion into Japan for independent creative talent.

Besides the marketing strength just mentioned, we can undertake every facet of music promotion. From comprehensive planning thru recording, mastering, pressing to sales promotion. In recording your unique sounds, our technical level, at every stage, is the state of the recording art as it now stands.

● **VICTOR MUSICAL INDUSTRIES, INC.**

26-18, 4-CHOME JINGUMAE, SHIBUYA-KU, TOKYO
150 JAPAN TEL. 405-1151
Cable: VICRECORD Tokyo Telex: VICREC J 242-4233

● **VICTOR MUSIC PUBLISHING, CO. INC.**

26-18, 4-CHOME JINGUMAE, SHIBUYA-KU, TOKYO
150 JAPAN TEL. 404-3201

● **VICTOR ARTISTS CORP. OF JAPAN**

26-18, 4-CHOME JINGUMAE, SHIBUYA-KU, TOKYO
150 JAPAN TEL. 402-8181

Essex, see TRO.
 Ever Green Music Publ'r Ltd. (Jasrac), see Nichion.
 Fuji Int'l Music Co. Ltd.—Pres.: Shimpei Matsuoka—see Zen-On.
 Fuji Telecasting Music Co. Ltd., c/o Fuji Telecasting Co. Ltd., 7 Kawada-cho Ichigaya, Shinjuku-ku, Tokyo 162 Tel (03) 359-6177, 357-7021.
 G P Music Corp. (Jasrac), Minami Bldg., Suite 202, 3-11-2 Sendagaya, Shibuya-ku, Tokyo 151. Tel (03) 404-2363. Cable JPNMANAGER Telex 27436 Pres. Daniel Nenishkis; VP & Gen. Mgr.: Knut Kraft
Int'l branch: USA
Int'l firms represented: Capability (USA), Crescent (Canada), Eiger (UK), Led Songs (UK), Little Tristan (USA), Lodge (UK), Andre Lutereau (France), Manhole (Canada), Naz (UK), On Stage (UK), Panache (UK), Round (UK), Stalom (Canada), Song of Tiffany (USA), Volatile (USA)
 Geier Music Publ'rs Co. Ltd., Nakamura Bldg., 3-13-13 Akasaka, Minato-ku, Tokyo 107 Tel (03) 584-0943
 Geion Music Publ'g Co. Ltd., Nakazawa Bldg., 1-58 Yoyogi, Shibuya-ku, Tokyo 151 Tel (03) 379-2266.
 General Music Japan Ltd., 2-6-4 Ginza, Chuo-ku, Tokyo 104 Tel (03) 562-0111. Cable TOWATOWA Pres. Nagamasa Kawakita; Gen. Mgr. Kazuo Ishii
Int'l firm represented: General (Italy).
 Giant Steps, see Zero.
 Global Music Publ'g Corp. (Jasrac), Asahi Seimer Bldg., 1-7-8 Shibuya, Shibuya-ku, Tokyo 150 Tel (03) 470-

4423. Cable RVCRCARECORD Telex 242-5162.
 Mng. Dir. Katsuma Kato
Int'l firms represented: Alvorada (Brazil), Associate (Australia), Bayamhan (Philippines), Beverly (Brazil), Brial (USA), Contempo (UK), Cyclus (Germany), Dunbar (Canada), EDIM (Mexico), 57th Street (USA), Give Me A Break (USA), Jaguaré (Brazil), Just Over The Bridge (USA), KBL (USA), Kidada (USA), Koppelman-Bandier (USA), Leme (Brazil), Meridional (Brazil), Metal Machine (USA), Oakfield Avenue (USA), RCA (France, Italy), Rashida (USA), 7 Notas (Brazil), Songs of Bandier-Koppelman (USA), Songs of Manhattan Island (USA), Sunbury (Canada, UK), Victor (Brazil), Yellow Brick Road (USA)
Int'l reps.: Australia (Associated), Brazil (Victor), Canada (Sunbury), France (RCA), Germany (Cyclus)
 Hands Music Publ'g Co. Ltd., Kyodo Bldg., 6F, 3-6-18 Kita-Aoyama, Minato-ku, Tokyo 107 Tel (03) 498-1756. Pres. Tatsu Nagashima, Exec. Dir. Akio Onodera.
 The Heibon Publ'g Co. Ltd., 3-13-7 Ginza, Chuo-ku, Tokyo 104. Tel (03) 541-3211.
 Herald Music Inc., Shimabashi-Ekimaie Bldg., No. 1, 2-20-15 Shimabashi, Minato-ku, Tokyo 105 Tel (03) 573-1281. Cable HERALDPICTURE Telex 23386
Int'l branches: France, Italy, USA
 High Note Publ'g Co. Ltd (Jasrac), Akasaka Makabe Bldg., 3-4-3 Akasaka, Minato-ku, Tokyo 107 Tel (03) 584-4711 Cable HIGHNOTE Telex 26610 Pres. Tsugi Sakagami

Int'l firms represented: Big Seven (USA), Bourne (USA), Burlington (UK, USA), Mietus Copyright (USA), Welk (USA).
 I B S, see Pacific.
 If Music Inc., Emerald Bldg., 4th fl., 12-7 Udagawa-cho, Shibuya-ku, Tokyo 150. Tel (03) 476-3215. Pres. Akio Onodera, Exec. VP. Ken Hosokawa.
 Inter Produce Inc., Haisei Bldg., 4F, 3-24-23 Nishi-Azabu, Minato-ku, Tokyo 106. Tel (03) 402-9191
 Intersong KK (Jasrac), Horiya Bldg., 5th fl., 5-2-1 Roppongi, Minato-ku, Tokyo 106 Tel (03) 405-5531. Pres. D. Bliersbach; Sr. Mng. Dir. H. Takashima, Mng. Dir. T. Sato.
Home office: Germany
Int'l firms represented: Carlin group (UK), Hill & Range (USA), Hudson Bay & Fort Knox group (USA), Intersong group (worldwide), Pickwick group (USA), RSO group (UK)
 Interworld Music (Far East) Ltd., c/o Taiyo Music Inc., Azabu PO Box 20, Tokyo 106. Tel (03) 585-3481. Cable TAIYOMUSIC. Rep. Dir. Tatsuji Nagashima
Int'l firms represented: Arch, Avco Embassy, BRC, Dandy Dittys, Connie Ducharme, Dunbar, East Hill, Charles Fries, GRT, Haymarket, Hog, Hollywood, Holmby, January, Joans Bones, Julio-Brian, Lorimar, Northridge, Powderhorn, Sealark, Larry Shayne, Six Continents, Southdale, Sunbury, Super Songs, Trans-Atlantic, Twinchris, World Song.
 J C M, see Japan Central Music.
 Dick James Music Japan Ltd (Jasrac), c/o Nichion Inc., Akasaka Makabe Bldg., 3-4-3 Akasaka, Minato-ku, Tokyo 107 Tel (03) 584-4711 Cable REVUEJAPAN Telex 26610.
Home office: England
 Japan Central Music Ltd (JCM), c/o Bunka Hoso, 1-5 Wakaba-cho, Shinjuku-ku, Tokyo 160 Tel (03) 359-7825 Cable JACENTRALMUSIC. Pres. Takae Minami, Gen. Mgr. Takaichi Motegi
Int'l firms represented: Bayamhan (Philippines), Scott-Wolfe (UK), Sunbury (UK)
Int'l reps.: UK (Watal Asanuma), USA (Creative Ent. Int'l) (SEE ADVERTISEMENT)
 Japan-Soviet Music Inc., Stork Bldg., 3-4 Hongoku-cho, Chuo-ku, Tokyo 103. Tel (03) 243-1601. Pres. Yoochi Noguchi
Int'l firm represented: VAAP—USSR copyright agency (USSR)
 Kanai Music Publ'rs, Takahisa Bldg., 2-8-8 Ebisunishi, Shibuya-ku, Tokyo 150. Tel (03) 462-1750.
 Kazan Music Publ'r, see Pacific
 Kitty Music Corp., Kobayashi Bldg., 7F, 1-14-11 Shibuya, Shibuya-ku, Tokyo 150. Tel (03) 499-4711 Telex 2425338. Pres. Hidenori Taga, Gen. Mgr.: Yoshihiro Kanda
 Kogakusha Music Publ'g Co. Ltd., 1-1-11 Misakicho, Chiyoda-ku, Tokyo 101. Tel (03) 291-4313 Cable GAKUSHA-MUSIC. Pres. Kanji Hara, Gen. Mgr. Ryukichi Hara.
 Kyuen Music Publ'g Co. Ltd., Hibiya Park Bldg., Rm 923, 1-8-1 Yuraku-cho, Chiyoda-ku, Tokyo 100. Tel: (03) 271-5861 Rep. Dir. Kenneth L Cole.
 Lee (Tokyo) KK, c/o Taiyo Music Inc., Azabu PO Box 20, Tokyo 106. Tel (03) 585-3481 Cable TAIYOMUSIC Telex 26512. Rep. Dir.: Hideo Nagashima (Administered by Taiyo Music)
Int'l firms represented: Chero (USA), Lee (USA), McCartney (UK), Morley (USA), Pic (USA), Rytvov (USA), Warock (USA).
 Lux Music Tokyo KK (Jasrac), 2-12 Ogawa-Machi, Kanda, Chiyoda-ku, Tokyo 101. Tel (03) 292-2865. Telex 25224. Co-Pres. Shoichi Kusano, Hubert Terheggen
Int'l firms represented: Apollo (Belgium), Celta (USA), Foycd Europe (Belgium), Louvigny Marquee (UK), Magazine (Germany), Radio Music (France, Luxembourg, Netherlands), Radio Pop (Spain), Radio Tele (Belgium, Germany, Netherlands), Radmus (USA).
 M C A Music KK (Jasrac), c/o Nichion Inc., Inc., Akasaka Makabe Bldg., 3-4-3 Akasaka, Minato-ku, Tokyo 107. Tel (03) 584-4711 Cable REVUEJAPAN Telex 26610 Pres. Salvatore T. Chiantia
Int'l firms represented: Leeds (UK), MAM (UK), MCA (USA).
Int'l reps.: UK (Leeds), USA (MCA).
 Manase Music Publ'g Co. Ltd., Mitoko Bldg., 6-2-4 Akasaka, Minato-ku, Tokyo 107. Tel (03) 584-5511
 Mister K Music Publ'rs Co. Ltd., see Saitani
 Ivan Mogull of Japan Inc., 2-12 Ogawa-Machi, Kanda, Chiyoda-ku, Tokyo 101 Tel (03) 292-2867 Telex 25224. Gen. Mgr. Shoochi Kusano.
 Musical Rights (Tokyo) KK, see Pacific
 Musica Nova, see Ongaku No Tomo Sha Corp
 Music Sales Corp., 4-26-22 Jingumae, Shibuya-ku, Tokyo 150 Tel (03) 470-5061.
 Music Tokyo Co., Wako Bldg., 4-8-5 Roppongi, Minato-ku, Tokyo 106 Tel (03) 401-9327. Cable MUSICATO. Telex: 2423224. Mng. Dir. Tadao Sekiguchi
Int'l firms represented: Buckhorn (USA), Televis (Italy)
 Myrica Music Publ'g Co. Ltd. (Jasrac), 1-1 Senrioka-kita, Suita, Osaka 565 Tel (06) 878-5141 Pres. Tadashi Amano; Gen. Mgr. Fumihiko Ito
Int'l firms represented: Mozart (Germany, UK, USA)
 N T V M, see Nippon Television Music
 N T V Music Co., see Yomi.
 Nagoya TV Music Inc., 2-9-18 Tachibana, Naka-ku, Nagoya-shi, Aichi-ken 460. Tel (052) 331-8111
 Nakayoshi Group Music Publ'rs, 5-41-1 Meiji Haim 201, Jingumae, Shibuya-ku, Tokyo. Tel (03) 406-0910.
 New Orient Music Inc., see All Staff.
 Nichion Inc (Jasrac), Akasaka Makabe Bldg., 3-4-3 Akasaka, Minato-ku, Tokyo 107. Tel: (03) 584-4711 Cable PUBLISHMUSIC Telex 26610 Pres. Shunsuke Kinoshita, Mng. Dir. Mamoru Murakami.
Int'l firms represented: Campbell Connelly (UK), Famous (USA), Robert Kingston (UK), Prophet (USA), Stonebridge (USA), Tallyrand (USA), Warner Bros (UK, USA) (SEE ADVERTISEMENT)
 Nipo-Americana Music Publ'g Co. Ltd., Central PO Box 250, Tokyo 101-91. Tel (03) 271-2170 Cable MATOSAN.
Int'l firms represented: Fermata (Argentina, Brazil), Hnos. Marquez (Mexico), Alfredo Perrotti (Argentina),

LOOKING FOR NEW!!



JAPAN CENTRAL MUSIC LTD.

J.C.M. has the EXPERIENCE, the STAFF and NATION-WIDERADIO NETWORK to help you find NEW OUTLET for Your music in JAPAN.

● A SUBSIDIARY OF BUNKAHOSO BROADCASTING INC.(JOQR)
 (BUNKAHOSO BROADCASTING INC. is Key Station of National Radio Network)
 ADDRESS : 5-1-CHOME WAKABA SHINJUKUKU TOKYO JAPAN
 PHONE : (03) 359-7825

● U.S.A. OFFICE
 ARIKO ACISHIHIMSKI
 ADDRESS 7060 HOLLYWOOD BLVD SUITE 510
 HOLLYWOOD CALIF 90028
 PHONE (213)463 9929

● ENGLAND OFFICE
 COCO ASANUMA (M)
 ADDRESS FLAT1, NEW HOUSE 65C
 MARLBOROUGH PLACE, LONDON N W 8
 PHONE (01)326 4641

WANTED

Small independent record company seeks licensing deals with same.
 Specializing in Soul, Blues, R & B, Reggae, Rock, but anything considered.
 Haven't you given up on the Majors.

Manufacturing, Distributing, Importing, Producing



VIVID SOUND CORPORATION

23-8, 2-CHOME, SHIMOMEGURO, MEGURO-KU, TOKYO 153, JAPAN. PHONE: 03-490-1070

The new 64:1 system is a pacesetter for high-speed duplicating. It's designed with the most sophisticated electronics and dependable transport mechanisms.

The pacesetting features include an 8MHz quartz bias oscillator in each slave, slanted loop-bin with an adjustable capacity and new transport design for improved tape path, built-in variable-frequency cue tone generator, all TTL control logic and plug-in electronics.

Behind the DP-7000 stands technology and reliability proven through a wide range of our professional sound equipment up to the 24-track recorder. For details, please contact your nearest Otari distributor.

OTARI

Japan: Otari Electric Co., Ltd.
4-29 18 Minami Ogikubo, Suginami-ku, Tokyo
167 Phone: (03) 333-9631
U.S.A.: Otari Corporation, 981 Industrial Road,
San Carlos, California 94070
Phone: (415) 593-1648
U.K.: Industrial Tape Applications, London
Phone: 724 2497
France: Reditec, Paris Phone: 300-9630
West Germany: RTW Radio-Technische
Werksstaetten Rudolf Twelker GmbH, Kohn
Phone: 0221-764035
Belgium: Trans European Music S.A., Brussels
Phone: 569 1823
Australia: Klarion Enterprises Proprietary Ltd.
South Melbourne Phone: 613801
Singapore: Otari Singapore Representative office
Phone: 640-250

Introducing the second-generation 64:1 duplicating system.

OTARI DP-7000



Pirovano (Argentina), Ricordi (Argentina), Tempo (Argentina).

Nippon Hoso Shuppan Kyokai (Japan Broadcast Publ'g Co. Ltd.), 41-1 Udagawa-cho, Shibuya-ku, Tokyo 150. Tel: (03) 464-7311.

Int'l firms represented: Agencia Autorska (Poland), Carvino (Italy), Seven Seas (New Zealand), Winter Hill (USA).

Int'l rep.: USA (Theodore Presser).

Nippon Television Music Corp. (NTVM) (Jasrac), NTV Yonbancho Annex 6-5, Chiyoda-ku, Tokyo 102. Tel: (03) 262-2221. Telex: 29410. Pres.: Toshiaki Kamiko; Gen. Mgr.: Masakazu Sunadoi.

Int'l firm represented: Satril (UK). (SEE ADVERTISEMENT)

Noel Music Publ'g Co. Ltd., c/o: Shinko Music Publ'g Co. Ltd., 2-12 Ogawa-Machi, Kanda, Chiyoda-ku, Tokyo 101. Tel: (03) 292-2868. Cable: SHINKOMUSIC. Pres.: Akio Onodera; Exec. Prod'r: Ken Hosokawa

Noguchi Music Publ'rs Corp., 1-2-21 Shimomoguro, Meguro-ku, Tokyo 153. Tel: (03) 493-1031.

Onagaku No Tomo Sha Corp., 6-30 Kagurazaka, Shinjuku-ku, Tokyo 162. Tel: (03) 268-6151, 260-6271. Cable: ONGAKUNOTOMO. Pres.: Sunao Asaka.

Int'l firms represented: Baerenreiter-Verlag (Germany), Theodore Presser (USA), B. Schott's Soehne (Germany), Universal Ed. (Austria).

Osaka Music Publ'ns Co. Ltd., 27 Umeda-cho, Kita-ku, Osaka 530. Tel: (06) 361-2288.

Overseas Music Publ'rs Co. Ltd., 25 Higashigoken-cho, Shinjuku-ku, Tokyo 162. Tel: (03) 260-5430. Pres.: Eijiro Shimada.

Int'l firms represented: Ludwig Doblinger (Austria), Nazionalemusic Org. (Italy), Shapiro Bernstein (USA), Sprint (Italy), Suvini Zerboni (Italy), Josef Weinberger (UK).

Pacific Music Publ'g Co. Ltd. (Jasrac), 6-5-9 Roppongi, Minato-ku, Tokyo 106. Tel: (03) 479-4101. Cable: PACIFICMUSE. Telex: 29240. Pres.: Akio Nakae; Gen. Mgr.: Ichiro Asatsuma.

Int'l firms represented: Albet, Alchemical, Alexscar, Alien, Alien Echo, Almo, Alrubby, Angelshell, Atomic, Back Road, Barometer, Barricade, Barton, Big Heart, Blue Monday, Bomass, Bossa Fataka, Braintree, Bright Moments, Brother, Brother Bill's, Brother Karl's, Buggerlugs, CAM-USA, Callee, Camex, Camino Real, Alan Cartee, Choral Art, Circus Tent, Copper Penny, Cortlandt, Cotton Pickin' Songs, Danor, Detus, Diamondback, Dimeola, Ding Dong, Dixie-John, Doors, Dump, EMP, Earmark, Elusive Sound, John Farrar, Fiction, Fireball, First Artists, Fish Scent, Fourth Floor, Sam Fox, Fram-Dee, Funky Nassau, Garrett, Gate, Goblet, good tunes, Bobby Goldsboro, Good Sam, David Gornston, Grand Teton, Grasshopper, Haida, Happy Tuesday, Heavy Gravy, Helf & Hager, Hobby Horse, Hollywood Songs, Hot Kitchen, House of Gold, House of Jones, Hungry Mountain, Icebag, Irving, Iska, I've Got the Music, Jelly Roll, Knee Trembler, Kradar, La Brea, Le Bill, Little Dragon, Low-Bam, Lowery, Low-Ja, Low-Rico,

Low-Sal, Low-Thom, Low-Twi, Lucky Pork, Lunatunes, Lunch, Maraville, Marbill, Bob Marley, Mary Beth, McKinley, Medicine Hat, Mercury Shoes, Milkman's Chivaree, Mr Music, Miyako, Mole, Montunes, Moppet, Mother Pearl, Movietone, Mulatto, Naked Snake, Nefertiti, Omega, Orange Tree, Paco, Pa-Giz, Pamjokeen, Peacock, Peso, Plurb-On, Plurkantz Fataka, Pods Pub, Porchester, Prairie League, Primus Artists, Pseudo Songs, Public Domain, Pure Songs, Quadraphonic, Red Setter, Remohj, Reynard, Ritchie, Rondor, Ronin, Rotgut, Rule One, Saga, St. Martin, Samfred, San Dino, Sands, Sattwa, Sawtooth, John Sebastian, Seeman & Mrijke, Seine, Senior, Eddie Shaw, Shiver & I, Shoals Music Mill, Sinatra Songs, Siren, Ski Cat, Skull, Songbirds of Paradise, Songs of Faith, Song Tailors, Sorn, Larry Spier, Stargen, Stillman Song, Stone Gold, Street People, Strong Box, Stygian, Sunflower, Swell Sounds, Tequila, Terri, Third Son, Tintagel, Trans, Unicorn, Uniprise, University of Miami, Vector, Weed High Nightmare, Wep, Wilder, Wilojatron, Wing Command, Wonder, Wooden Bear, Woolfongs, Yarone (all USA); Adonia, Air-Edel, Air Music, Air Pusic, Aitch, Ian Anderson, Bee Bee, Big Secret, Black Sheep, Blanedell, Blue Beard, Caesar, Casablanca, Chibell, Chrysalis, David Courtney, Crusty, Elf, Five Star, Flash, GOAL, Giffin, Grenyoco, Gull Songs, Gurusama, Hush, Longmanor, Macaulay, Mactive-Hive, Maision Rouge, Mintknoll, Mother Goose, Mulligan, New Acme, Our, PRP, Red Bus, Rockbottom, Rolarsol, St. Annes, Salamander & Son, Spaniel, Sparrowpit, Steeleye Span, THTH (all UK); Jonathan (Australia), Ralph Siegel (Germany). (SEE ADVERTISEMENT)

Pamper Music Japan Ltd.—Pres. Shimpei Matsuoka—see Zen-On.

People Music (Ed.) (Jasrac), 2-12 Ogawa-Machi, Kanda, Chiyoda-ku, Tokyo 101. Tel: (03) 292-0197. Cable: SHINKOMUSIC. Pres. Hiroaki Kaneko.

R F Music Publ'g Inc., Radio Kanto Tokyo Shisha-nai, 2-2-1 Azabudai, Minato-ku, Tokyo 106. Tel: (03) 585-6611.

Radio Kansai Music Publ'rs, 1-1-6 Miyuki-cho, Suma-ku, Kobe-shi, Hyogo-ken 654. Tel: (078) 735-5515.

Rhythm Music Publ'g Co. Ltd., Domi Palphan 201-202, 3-15-7 Roppongi, Minato-ku, Tokyo 106. Tel: (03) 586-8321.

River Music Publ'g Ltd. (Jasrac), see Nichion

Rokumonsen Music Publ'rs, Heights Taiyo 101, 1-21-10 Tomiyaga, Shibuya-ku, Tokyo 150. Tel: (03) 469-4911.

S T V Pack Co. Ltd., c/o Sapporo TV Bldg., N. 1, W. 8, Sapporo 060. Tel: (011) 241-1181 x 313.

Saitani Music Publ'rs Co. Ltd. (Jasrac), Casa-Mori 1F, 6 Iikura-Katamachi, Azabu, Minato-ku, Tokyo 106. Tel: (03) 585-7391. Cable: SAMUS.

Schott Japan Co. Ltd.—Co-Pres. Shimpei Matsuoka, Dr. Peter Hanser-Strecker—see Zen-On.

A. Schroeder Music (Far East) Ltd., Sumitomo Bldg., Rm. 832, 1-4-4 Marunouchi, Chiyoda-ku, Tokyo 100. Tel: (03) 281-6171.

Home office: USA.

Int'l firms represented: Aloud, Anim, Arbutus, Arch, Avaris, Bagimino, Bella Godiva, Boscoe, Burlac, Catch Fire, Cat Mother, Dandy Dittys, Dreams & Visions, Emm-Jay, Fitness King, Fool Killers, Fourvurs Survival, Kim Fowley, Golden Unlimited, Great Montana, Hedley Songs, Homecoming, Humdrum, January, Jenji, Joans Bones, Joint, LaLanne, Larbell, Lassie, Last Laugh, Lazy Canary, Magnanimous, Manistee, Mempro, Mile Wide River, Mother Hen, My Baby's, Next Stop, One Stop, Pierhead, Pitfield, Rebecca Raccoon, Re-Net, Rojnorth, Sa-Vette, Sea-Lark, Sepe, Skin, Stewart-Nims, Summer-tree, Super Songs, Tijuca, Va-Detta, Vancouver, Very Own, Wrathar, Yameta, Zekefield Follies.

Seihai Music Publ'n KK, 404 Akasaka Q. Bldg., 7-9-5 Akasaka, Minato-ku, Tokyo 107. Tel: (03) 583-8281.

Seven Seas Music Co. Ltd., 2-12-13 Otowa-cho, Bunkyo-ku, Tokyo 112. Tel: (03) 945-2111. Pres.: Kazumitsu Machijiri; Gen. Mgr.: Motohiko Takawa.

Int'l firms represented: Char-Liz (USA), Three Bros. (USA).

Shinko Music Publ'g Co. Ltd. (Jasrac), 2-12 Ogawa-Machi, Kanda, Chiyoda-ku, Tokyo 101. Tel: (03) 293-3791. Cable: SHINKOMUSIC. Telex: 25224. Pres.: Shoichi Kusano; Int'l. Joe Miyasaki (SEE ADVERTISEMENT)

Shogakukan Prod'n Co. Ltd., Shoko Bldg., 1-29-4 Kanda Jinbo-cho, Chiyoda-ku, Tokyo 101. Tel: (03) 262-7822. Pres.: Tetsuo Ohga; Gen. Mgr.: Michio Tamio.

Int'l firm represented: Tree (USA).

Southern Music Publ'g Co. Ltd. (Jasrac), Akasaka Makabe Bldg., 3-4-3 Akasaka, Minato-ku, Tokyo 107. Tel: (03) 584-4711. Cable: SOUTHMUSIC. Telex: 26610. Mgr.: Tsugi Sakagami.

Int'l firm represented: Peer-Southern (worldwide).

Standard Music Publ'g Inc. (Jasrac), see Nichion.

Stone Well Music Publ'rs, Fugetsudo Bldg., 6-6-1 Ginza, Chuo-ku, Tokyo 104. Tel: (03) 572-0355.

Street Music Ltd., see Doorknob.

Sugarmusic Japan, c/o Seven Seas Music Co. Ltd., 2-12-13 Otowa-cho, Bunkyo-ku, Tokyo 112. Tel: (03) 945-2181. Cable: SEVENMUSIC. Telex: 24963. Pres.: Kazumitsu Machijiri; Gen. Mgr.: Motohiko Takawa.

Int'l firms represented: ABR, ACE Adriatica, Apollo, Araldo, Canzoni Moderne, La Cicala, Clan, Cobra, Di Lazzaro, Fantasia, Fiera, Flaminia, Frank, Frasi d'Amore, GEA, Ivana, Liberty, Margherita, Mascheroni, Melodi, Menestrello, Panamusic, Rascel, Rias, Sofia, Successo, Sugar Music, Super sonic, Suvini Zerboni, Tender, Tiber (all Italy); Brut, Fab (both USA).

Suiseisha Music Publ'rs, Townhouse S, 3-3 Sanban-cho, Chiyoda-ku, Tokyo 102. Tel: (03) 265-1055. Cable: MUSICSUISEISHA. Telex: 28690. Pres.: Michiko Sekine Kinoshita.

Sunkyo Music Co. Ltd. (Jasrac), Yamagata Bldg., 1-14-7 Nishi-Shimbashi, Minato-ku, Tokyo 105. Tel: (03) 501-2667. Pres.: Ichiro Takeuchi.

Sun Music Publ'g Co. Ltd., Ohkido Bldg., 7F, 4-28 Yotsuya, Shinjuku-ku, Tokyo 160. Tel: (03) 354-8506. Chief



Thanks to
Everyone
For Helping
It Happen.

Pacific Music Publishing
Co., Ltd.

Roppongi 659 Building 6-5-9 Roppongi, Minato-ku,
Tokyo 106 JAPAN
TEL/03-479-4101 TELEX/J29240 PMP TOKYO

MUSIC LABO HOT 100 SINGLES
VOL. 10 NO. 31 (8/6)

8月第1週—1979—

順位	曲名	アーティスト	レーベル/曲名	順位	曲名	アーティスト	レーベル/曲名
1	☆ 125	☆ 125	☆ 125	1	☆ 125	☆ 125	☆ 125
2	☆ 3	☆ 3	☆ 3	2	☆ 3	☆ 3	☆ 3
3	☆ 16	☆ 16	☆ 16	3	☆ 16	☆ 16	☆ 16
4	☆ 10	☆ 10	☆ 10	4	☆ 10	☆ 10	☆ 10
5	☆ 1	☆ 1	☆ 1	5	☆ 1	☆ 1	☆ 1
6	☆ 4	☆ 4	☆ 4	6	☆ 4	☆ 4	☆ 4
7	☆ 11	☆ 11	☆ 11	7	☆ 11	☆ 11	☆ 11
8	☆ 12	☆ 12	☆ 12	8	☆ 12	☆ 12	☆ 12
9	☆ 6	☆ 6	☆ 6	9	☆ 6	☆ 6	☆ 6
10	☆ 7	☆ 7	☆ 7	10	☆ 7	☆ 7	☆ 7
11	☆ 8	☆ 8	☆ 8	11	☆ 8	☆ 8	☆ 8
12	☆ 10	☆ 10	☆ 10	12	☆ 10	☆ 10	☆ 10
13	☆ 14	☆ 14	☆ 14	13	☆ 14	☆ 14	☆ 14
14	☆ 16	☆ 16	☆ 16	14	☆ 16	☆ 16	☆ 16
15	☆ 17	☆ 17	☆ 17	15	☆ 17	☆ 17	☆ 17
16	☆ 19	☆ 19	☆ 19	16	☆ 19	☆ 19	☆ 19
17	☆ 19	☆ 19	☆ 19	17	☆ 19	☆ 19	☆ 19
18	☆ 14	☆ 14	☆ 14	18	☆ 14	☆ 14	☆ 14
19	☆ 16	☆ 16	☆ 16	19	☆ 16	☆ 16	☆ 16
20	☆ 17	☆ 17	☆ 17	20	☆ 17	☆ 17	☆ 17
21	☆ 21	☆ 21	☆ 21	21	☆ 21	☆ 21	☆ 21
22	☆ 21	☆ 21	☆ 21	22	☆ 21	☆ 21	☆ 21
23	☆ 18	☆ 18	☆ 18	23	☆ 18	☆ 18	☆ 18
24	☆ 27	☆ 27	☆ 27	24	☆ 27	☆ 27	☆ 27
25	☆ 41	☆ 41	☆ 41	25	☆ 41	☆ 41	☆ 41
26	☆ 24	☆ 24	☆ 24	26	☆ 24	☆ 24	☆ 24
27	☆ 20	☆ 20	☆ 20	27	☆ 20	☆ 20	☆ 20
28	☆ 23	☆ 23	☆ 23	28	☆ 23	☆ 23	☆ 23
29	☆ 25	☆ 25	☆ 25	29	☆ 25	☆ 25	☆ 25
30	☆ 22	☆ 22	☆ 22	30	☆ 22	☆ 22	☆ 22
31	☆ 20	☆ 20	☆ 20	31	☆ 20	☆ 20	☆ 20
32	☆ 30	☆ 30	☆ 30	32	☆ 30	☆ 30	☆ 30
33	☆ 11	☆ 11	☆ 11	33	☆ 11	☆ 11	☆ 11
34	☆ 38	☆ 38	☆ 38	34	☆ 38	☆ 38	☆ 38
35	☆ 34	☆ 34	☆ 34	35	☆ 34	☆ 34	☆ 34
36	☆ 37	☆ 37	☆ 37	36	☆ 37	☆ 37	☆ 37
37	☆ 42	☆ 42	☆ 42	37	☆ 42	☆ 42	☆ 42
38	☆ 31	☆ 31	☆ 31	38	☆ 31	☆ 31	☆ 31
39	☆ 13	☆ 13	☆ 13	39	☆ 13	☆ 13	☆ 13
40	☆ 33	☆ 33	☆ 33	40	☆ 33	☆ 33	☆ 33
41	☆ 39	☆ 39	☆ 39	41	☆ 39	☆ 39	☆ 39
42	☆ 40	☆ 40	☆ 40	42	☆ 40	☆ 40	☆ 40
43	☆ 69	☆ 69	☆ 69	43	☆ 69	☆ 69	☆ 69
44	☆ 10	☆ 10	☆ 10	44	☆ 10	☆ 10	☆ 10
45	☆ 28	☆ 28	☆ 28	45	☆ 28	☆ 28	☆ 28
46	☆ 35	☆ 35	☆ 35	46	☆ 35	☆ 35	☆ 35
47	☆ 32	☆ 32	☆ 32	47	☆ 32	☆ 32	☆ 32
48	☆ 36	☆ 36	☆ 36	48	☆ 36	☆ 36	☆ 36
49	☆ 43	☆ 43	☆ 43	49	☆ 43	☆ 43	☆ 43
50	☆ 11	☆ 11	☆ 11	50	☆ 11	☆ 11	☆ 11

Exec. Hideyoshi Aizawa; Gen. Mgr.: Tokio Fukuda.
Int'l firm represented: The Label (UK).
T R O Essex Japan Ltd. (Jasrac), 2-12 Ogawa-Machi, Kanda, Chiyoda-ku, Tokyo 101. Tel. (03) 292-2866. Telex: 25224. Pres.: Howard S. Richmond; Gen. Mgr.: Shoichi Kusano.
Int'l firms represented: Essex, TRO—The Richmond Org. (worldwide).
T V Asahi Music Co. Ltd., 6-4-10 Roppongi, Minato-ku, Tokyo 106. Tel. (03) 405-3194. Telex: 22520. Pres.: Eizo Nakagawa; Sr. Exec. Dir. Kiyokaze Matsubayashi; Exec. Dir. Zenjiro Moriyasu (SEE ADVERTISEMENT).
Taiyo Music Inc., Azabu PO Box 20, Tokyo 106. Tel. (03) 585-3481. Cable TAIYOMUSIC. Telex: 26512. Pres.: Tatsuji Nagashima.
Int'l firms represented: Ackee/UFO (USA), Alchemical/Doors (USA), Aljarreau (USA), Almighty (UK), Average (USA), Banco/Abilene (France), Bay City (UK), Big Hill (USA), Black Bull (USA), Blue Gum (UK), Blue Seas/JAC/New Hidden Valley (USA), Bulldog (USA), Bushka (USA), C'est Music/Quackenbush (USA), Clarkee (USA), Clear Air (UK), Cole-Arama (USA), Combine/Resaca (USA), Cram Renrah/Brew (USA), Curtis/Perkins (UK), Daksel (USA), Damont/Common Good/American Dream (USA), Dayn (UK), Eaton (UK), Fania/Vaya (USA), Feckless/Jump Tunes (USA), Floating (USA), Frank & Nancy (USA), Ganga (UK), Gear (USA), Gypsy Boy/Caleb (USA), Hansa (UK), Hobbitron (USA), Hollenbeck/India (USA), Hollow Point (USA), Ice Age/Golden Spread (USA), Island (UK), JE/Ripple (UK), Jasperilla (USA), Jobete (USA), Josley (UK), Joyride (USA), MPL (UK), Manticore (UK), Mauf Ke (USA), Minscene (UK), Musikram (Luxembourg), New Town (UK), No Exit/Rear Exit (USA), Owepar (USA), Paulanne (USA), Peterman (UK), Portolino (USA), Quite Right (UK), Rocket (UK), Rodra/Berna (USA), Sagfire/Hummit (USA), Boz Scaggs/Blue Street (USA), Shillelagh (USA), Shoe Shine (UK), Silver Dawn (USA), Skydiver/Combat (USA), Sky Harbor Seagrape (USA), Sparta Florida group (UK), Special (USA), Spooone/Cooga (USA), Sterling (USA), Superhype (USA), Tangerine/Racer (USA), Televis (Italy), Time (USA), Tonshire (UK), Trane (USA), Tremplin/Delphin (France), Tridex (USA), Tumbleweed (Australia), 20th Century/Fox Fanfare (USA), Uptall/Windfall (USA), Van Halen (USA), Vassar (USA), Virgin (UK), Wilsongs/ Know/ Primal Energy/ Fozzbass/Play My Music/Rosebud (USA), Wow & Flutter (USA), You You (France), Zargon (USA), Zevon/Polite (USA).
Tanabe Music Publ'g. Co. Ltd., see Nichion.
Teichiku Music Supply Co. Ltd. (Jasrac), 1-2 Nishi-Shimbashi, Minato-ku, Tokyo 105. Tel. (03) 502-6658. Pres.: Shigeji Nanko; Gen. Mgr. Manabu Okamoto.
Int'l firm represented: Belsize (UK).
Thunder Music Inc., Emerald Bldg., 4th fl., 12-7 Udagawacho, Shibuya-ku, Tokyo 150. Tel. (03) 496-0681. Chm.: Ken Hosokawa; Pres.: Akio Onodera.
Toa Music Co., 6-32 Kagurazaka, Shinjuku-ku, Tokyo 162. Tel. (03) 260-6271. Cable: TOA MUSICCO. Pres.: Sunao Asaka.

WE WANT TO MAKE AN AGREEMENT ON AN ARTIST BY ARTIST BASIS.



ABBA

POLAR MUSIC INTERNATIONAL AB Photo: OLA LAGER

discomate was launched in 1976 with a 2-million seller, "Beautiful Sunday" by Daniel Boone. Three years have passed and we are still flying, this time with "SUPER-ABBA"!

AKASAKA MAKABE BLDG. 2F, 3-4-3 AKASAKA, MINATO-KU, TOKYO 107, JAPAN



PRESIDENT	: Takayasu Yoshioka
VICE PRESIDENT	: Toshiro Hoshino
A & R PRODUCER	: 33 members
MEMBER OF EMPLOYEES	: Authorized Capital 350,000,000Yen
CAPITAL	: Paid-up Capital 100,000,000Yen
MAIN STOCKHOLDER	: TBS (Tokyo Broadcasting System, Inc.)
	: The Foremost Nationwide Radio and TV Network in Japan.
SALES NETWORK	: Victor Musical Industries, Inc.
TELEPHONE NUMBER	: (03)585-9111
TELEX NUMBER	: 02425228 DISCO-J
DISCOMATE STUDIO	: 702 VILLA GLORIA, 2-31-7 JINGUMAE, SHIBUYA-KU, TOKYO 150, JAPAN /PHONE: 03-470-2256

BIGGEST PLUS MOST ACTIVE IN JAPAN

NICHION

Music Publisher



- Subsidiary of, TBS, Tokyo Broadcasting System, Inc. (The Foremost Nationwide Radio & TV Network)
- Address: Akasaka Makabe Bldg. 5F, 4-3, Akasaka 3-chome, Minato-ku, Tokyo, 107, Japan.
- Cable: "PUBLISHMUSIC TOKYO"
- Telex: MUNICH J26610
- Phone: Tokyo(584)2771

Int'l firms represented: Belwin-Mills, E. B. Marks (both USA).
 Toho Music Publ'g Corp. (Jasrac), 1-2-1 Yuraku-cho, Chiyoda-ku, Tokyo. Tel (03) 591-1211
 Tokyo 12 Music Publ'g Co. Ltd. (Jasrac), 4-4-7 Shiba Park, Minato-ku, Tokyo 105. Tel (03) 433-4211 Telex 28475. Pres. Tatu Watanabe; Gen. Mgr. Takeshi Ishiguro.
Int'l firms represented: Rolf Budde (Germany).
 Top Music Publ'g Co. Ltd. (Jasrac), 1-2-5 Shimmoguro, Meguro-ku, Tokyo 153. Tel (03) 490-4621 Cable HORIPROMUSIC Telex 2468436 Pres. Takeo Hori, Gen. Mgrs. Hideharu Ubagai, Yasuo Noheji, Copyright Mgr. Michio Takahashi. (SEE ADVERTISEMENT)
 Toshiba EMI Music Publ'g Co. Ltd. (Jasrac), Makabe Bldg., 3-4-3 Akasaka, Minato-ku, Tokyo 107 Tel (03) 583-8701. Cable TOEMIPUBLISH Telex 29333 Pres Yoshitada Futara, Gen. Mgr. Sengo Fukukawa
Int'l firms represented: Accadia group (USA), Aisha (USA), Arc (USA), Atlantic (USA), Back Door (USA), Barn (UK), Beechwood group (USA), Bema/Ameb (USA), Big Ben (UK), Big Pig (UK), Bil-mar/Norway (USA), Chinnichap (UK), Cigum (USA), Colgems-EMI (USA), Conrad (USA), Consolidated (USA), Crabshaw (USA), Criterion (USA), Donna (UK), Dorsey Bros. (USA), EMI (worldwide), Embassy (USA), Fall River group (USA), B Feldman group (USA), Francis Day & Hunter group (UK), Glenwood (USA), Michael H Goldsen (USA), Granite (USA), Hancock (USA), Harrison (USA), Hustlers (USA), Jewel (USA), Jondora (USA), Kipahulu (USA), Kiss (USA), Lambert & Potter (USA), Peter Maurice group (UK), Natural Songs (USA), Orpheum (USA), Parker (USA), Prestige (USA), Promopub (UK), Keith Prowse (UK), Queen (UK), RAK (UK), Regent group (USA), Robbins group (UK), Rock Steady (USA), Sanga (USA), Screen Gems-EMI group (USA), Touch of Gold (USA), Tree (USA).
Int'l rep.: Worldwide (EMI)
 U-Sen Music Inc., 1-429 Nishi Ohkubo, Shinjuku-ku, Tokyo 160. Tel (03) 200-0226.
 Uni-Japan Music Inc. (Jasrac), see Nichion.
 Union Publ'rs Inc., Kurosaki Bldg., 4F, 4-1-4 Roppongi, Minato-ku, Tokyo 105. Tel (03) 586-8631.
 United Artists Music (Japan) Inc. see Taiyo.
 Valgroup Music (Japan) (Jasrac), Minami Bldg., Suite 202, 3-11-2 Sendagaya, Shibuya-ku, Tokyo 151. Tel (03) 404-2363 Cable: JPNMANAGER Telex 27436 Pres Daniel Nenishkis; VP & Gen. Mgr. Knut Kraft
Home office: England, Valentine Music Group Ltd.
Int'l firms represented: Arthur's Mother, Bettytunes, Bulldog, Burnt Ash, Cathy, Corner Stone, Crossdoor, Eden Studios, Golora, Allan Heather, Ladysmith, Latchmere, Lyndor-Martin, Maiden, Marathon, Middle Eight, Moffett-Dickinson, Monkton, Muggelfunkton, Nutmeg, Rainbow, Riding Light, Sally, Valentine (all UK), Mike Borchetta, CME, Jerry Chesnut, Chicago Times, Equator, Geronimo, Hallnote, Honeysuckle, Laurabob, Ojo, PBR, Passkey, Peglari, Pergee, Pickle, Rahman, Raymar, Rural Hill, Sicum, Silverhill,

Stallings, Ten-Hi, Thetatwins Valgroup, Veytig, Woodmont (all USA), North Country (Canada)
 Victor Music Publ'g Co Inc. (Jasrac), Harajuku-Piazza Bldg., 4-26-18 Jingumae, Shibuya-ku, Tokyo 150 Tel (03) 404-3201 Cable VICTPUBLISH Pres Tsuneo Nagavio, Mng Dir Masayuki Hashimoto
Int'l firms represented: Antasia (USA), Arista (USA), Irving Berlin (USA), Boca (USA), East Memphis (USA), Far Out (USA), Four Knights (USA), Jec-Fi (USA), Jowcol (USA), Kandalini (USA), Larball (USA), MJQ (USA), Rit Oj Habeas (USA)
Int'l rep.: USA (Transaction) (SEE ADVERTISEMENT)
 Watanabe Music Publ'g Corp (Jasrac), 1-8-10 Azabudai, Minato-ku, Tokyo 106 Tel (03) 585-1531 Cable WMUSICPUB Telex 2426848 Pres Misa Watanabe, Gen Mgr Haruo Matsushita, Int'l Mgr. Akiko Kato
Int'l firms represented: AA (France), ACO (France), After Dark (USA), Alessi (USA), Arlow (USA), Art (France), At Home (USA), BAT (UK), Bandora (USA), Bewlay Bros. (USA), Big Game (UK), Blue Chip (UK), Brand "X" (USA), British Rocket (USA), Bull Pen (USA), Ronald Carter (USA), Coal Miners (USA), Conducive (USA), Ear-Responsible (USA), Eau D'Yeah (USA), Family Affair (USA), Friday the 13th (USA), Goeland (France), Gwenaelle (France), Wayne Henderson (USA), Glen Hughes (UK), Interchange/Intersound (Canada), Jonalco (UK), KG (USA), Kahuku (USA), Ladysmith (UK), Land (USA), Louise Jack (USA), Marlu (USA), Mar Vista (USA), Modern Love Songs (USA), Mushroom (Canada), Musicways (USA), On Time (USA), Pasa Alta (USA), Pearlized (USA), Freddie Perren (USA), Perren-Vibes (USA), Playboy (USA), Relaxed (USA), Respect (USA), Rye Boy (USA), Spitfire (USA), State (UK), Sumac (USA), Sweet Harmony (USA), Tanday (France), Taurgo (USA), Thames Talent (USA), Tomake (USA), Transit (France), Tremor (USA), Tri-Song (USA), Artie Wayne (USA), Window (USA), **Purple Music Group**—Arabella, British Lion, Deep Purple, Ian Gillan, IGB, JDL, Owl, Purple (all UK), **Ricordi Group**—Fama, Fono Film, Iller, Jubal, Mondia, Pegaso, Radio Record RRR, Ritmi & Canzoni (all Italy) (SEE ADVERTISEMENT)
 Yamaha Music Foundation (Jasrac), 3-24-22 Shimmoguro, Meguro-ku, Tokyo 153 Tel (03) 719-3101 Cable WORLDFESTIVAL Telex 2466571 Mng Dir Akira Tamaari; Gen Mgr Yoshinori Umeiya, Prof Mgr Takashi Kamide.
Int'l firms represented: Dick James (USA), Morning Music (Canada), Pablo (USA)
Int'l reps.: Canada (Morning Music), USA (Dick James, Pablo) (SEE ADVERTISEMENT)
 Yellow Light Music, see Pacific
 Yomi Pack Corp., 4-15-13 Temma, Kita-ku, Osaka Tel (06) 353-8611 Chief Exec Genki Shibamura, Gen Mgr Eiichi Matsuzawa.
 Yui Music Publ'rs, 405 Olympia Annex, 6-31-21 Jingumae, Shibuya-ku, Tokyo 150 Tel (03) 406-6638. Pres. Yutaka Goto; Gen. Mgr. Shunichi Jinjama
 Zen-On Music Co. Ltd., 25 Higashigoken-cho, Shinjuku-ku, Tokyo 162. Tel (03) 267-4321 Pres Eijiro Shimada;

Mng Dirs Shachio Nishimura, Shmpei Matsuoka; Sales Mgr Nobuhiko Iwasawa
Int'l firms represented: Moeck (Germany), Schott (UK), B Schott's Soehne (Germany), Summy-Birchard (USA), Zero Music Publ'g Inc., 205 Shibuya Royal Mansion, 3-9-2 Shibuya, Shibuya-ku, Tokyo. Tel (03) 406-4714 Pres. Yusuke Tachibana

● **services**
ASSOCIATIONS & PROFESSIONAL ORGANIZATIONS
 All Band Directors Ass'n, c/o Senshu Co Ltd., 4-2-4 Kita Kudan, Chiyoda-ku, Tokyo 102. Tel (03) 261-8411
 All Japan Band Ass'n, c/o Asahi-Shimbun-Sha, 2-6-1 Yuraku-cho, Chiyoda-ku, Tokyo 100. Tel (03) 212-0131.
 All Japan Chorus League, c/o Asahi-Shimbun-Sha, 2-6-1 Yuraku-cho, Chiyoda-ku, Tokyo 100 Tel (03) 212-0131
 Council of Univ. Musical Dept., c/o Musashino Univ. of Music, 1-13 Hazawa, Nerima-ku, Tokyo 176. Tel (03) 992-1121.
 E I A J (Electronic Inds. Ass'n of Japan), Tokyo Shoko Kaigishi Bldg., 3-2-2 Marunouchi, Chiyoda-ku, Tokyo 100 Tel (03) 211-2765
 Japan Gustav Mahler Society, 5-23-3 Inamuragasaki, Kamakura City, Kanagawa-Ken 248 Tel (0467) 31-8243 Chief Exec Jack K Hirano.
 Japan Haydn Sociey, c/o Ochanomizu Univ., 2-1-1 Ohtsuka-cho, Bunkyo-ku, Tokyo 112. Tel (03) 943-3151.
 Japan Mozart Society, Nihonbashi-Chuo Bldg., No. 701, 4-8 Hasimoto-cho, Chuo-ku, Tokyo 103
 Japan Phonograph Rec Ass'n, Record Kaikan, 2-8-9 Tsukiji, Chuo-ku, Tokyo 104. Tel (03) 541-4411. Cable PHONOREC. Pres.: Saburo Watanabe; Gen. Mgr.: Jusaburo Kamei.
 Japan Smetana-Dvorak-Janacek Society, c/o Musashino Music Univ., 1-13 Hazawa, Nerima-ku, Tokyo 176 Tel (03) 922-1121
 Japan Society of Christian Music, 1-42-12 Minami-Ogikubo, Suginami-ku, Tokyo 107. Tel (03) 334-3247.
 Music Mgmt. Ass'n of Japan, Nakaginza Bldg., 8-11-9 Ginza, Chuo-ku, Tokyo 104 Tel (03) 572-2671
 Music Publ'rs Ass'n of Japan (MPA), Shuwa Akasaka Residential Hotel, No. 340, 9-1-7 Akasaka, Minato-ku, Tokyo 107. Tel (03) 478-4540, 401-1129. Bd. Chm.: Sunao Asaka, Gen. Mgr. Shigeru Kawabata; Secretariat Dir Takeji Kojima
 N C A (Nippon Conductors Ass'n), 4-18-20 Ogikubo, Suginami-ku, Tokyo 167 Tel (03) 392-0704.
 Nippon Geijutsuin (Japan Academy of Arts), 1-30 Ueno Kohen, Taiko-ku, Tokyo 110 Tel: (03) 821-7191.
 Twentieth Century Music Society, c/o Yamaha Hall, 7-9-14 Ginza, Chuo-ku, Tokyo 104 Tel. (03) 572-3111.

From Japan to the world.



TASHIKO AKIYOSHI

RVC
Corporation
RCA
Records and Tapes



ISAO TOMITA

Japan's Newest Creative Force

● RVC Corporation, affiliated with RCA and Japan Victor ● GLOBAL MUSIC PUBLISHING CORPORATION
 ADDRESS: 1-7-8, Shibuya, Shibuya-ku, Tokyo 150, Japan Telephone: (03) 499-3311 Cable: RVCRCR RECORD, Telex: 242-5162

YOUNG JAPAN

... is working hand in hand with other people in music activities in L. A., Seattle, N.Y., Nashville, London and Japan — see you at MIDEM 1980!

We Are: Artist Management; Record & Tape Production and Promotion; Music Publishing; Radio & Television Commercial Production and Promotion; Concert Booking & Promotion; Manufacture of Store Fixtures & Merchandising Aids; Theatrical Booking & Promotion

OUR COMPANIES:

YOUNG JAPAN INC.
 THUNDER MUSIC INC.
 IF MUSIC INC.
 NOEL MUSIC PUBLISHING CO., LTD.
 HANDS CO., LTD.
 HANDS MUSIC PUBLISHING CO., LTD.
 YOUNG JAPAN OSAKA INC.
 YOUNG JAPAN ENTERPRISE INC.
 YOUNG JAPAN PLANNING INC.
 ROCK CITY MUSIC INC.
 EPSTEIN MUSIC INC.
 I.M.O. MUSIC PUBLISHING

OUR ARTISTS: Management, Record Production & Publishing

Alice: Shinji Tanimura Takao Horiuchi Toru Yazawa	Signal Katsuhiko Miki Tomoharu Taki Yoshikazu Fukano Yukinobu Nakamura Takajin Yashiki Shyn Jitsukawa Yuji Yamamoto
Kaientai Akira Inaba Satoshi Kishida Hirofumi Bamba	

Record Production & Publishing:

The Tokyo Kid Brothers Bow Wow Gen Takayama Toru Oki & Blues Band	Mr. Slim Co. Shigeru Izumiya Miki Matsubara Brothers Four
--	--

Thanks to all of you who responded to our ad in the May 26 issue of **BILLBOARD**. We welcome your continuing interest in our objective of developing unsigned international artists in Japan, with hope of eventual distribution worldwide. Please write or call us at:

TOKYO HEAD OFFICE:

Ken Hosokawa, President
 Akio Onodera, Vice-President
 Emerald Building, 4th Floor
 12-7 Udagawa-cho, Shibuya-ku
 Tokyo 150, Japan
 (03) 496-0681

YOUNG JAPAN OSAKA, INC.:

Ekimae-daini Bldg. 1202
 1-2-2 Umeda Kita-ku Osaka-shi
 Osaka 530, Japan
 (06) 343-0541

U. S. OFFICE:

Robin Loggie
 P. O. Box 38754
 Hollywood, CA 90038
 (213) 464-8566



*KING RECORDS IS AN OLD RECORD COMPANY IN JAPAN
 BUT KING RECORDS IS ALWAYS A **NEW** RECORD COMPANY.*

KING RECORD COMPANY LIMITED

Kozumitsu Machijiri Shin Tamoda
vice chairman president

12, 2-chome, Otowa, Bunkyo-Ku, Tokyo, JAPAN
 telephone: (03)945-2131 ● telex: J24963



DESIGN & ARTWORK

P C C (KK), Shibuya Central Bldg., 5F, 3-14 Udagawa-cho, Shibuya-ku, Tokyo. Tel: (03) 464-6045. Pres.: Jyosuke Matsumoto.
 Teichiku Recs. Co. Ltd., 1-2 Nishi-Shimbashi, Minato-ku, Tokyo 105. Tel: (03) 502-7213. Pres.: Shigeji Nanko; Gen. Mgr. Ichiro Kinoue; Sales Mgr.: Minoru Ozaki.
 Toyo Kasei Co. Ltd., 2-5-5 Hirakawa-cho, Chiyoda-ku, Tokyo 102. Tel: (03) 264-3041. (Record only)

LICENSING ORGANIZATION, MUSIC

Jasrac (Japanese Society for Rights of Authors, Composers & Publ'rs), Jasrac House, 1-7-13 Nishishimbashi, Minato-ku, Tokyo 105. Tel: (03) 502-6551. Cable JASRAC. Chm.: Saburo Sakai; Pres.: Yoshio Katsu; Mng. Dirs.: Sadao Aoki, Masanori Morita, Kunio Yoshizato, Miyuki Ishimoto; Int'l Dept. Mgr.: Hiroaki Miyazawa.

PLANTING, PROCESSING & PRESSING PLANTS

Athene Rec. Ind'l Co. Ltd., 3-4-9 Ginza, Chuo-ku, Tokyo 104. Tel: (03) 542-6651. Cable: ATHENCORD. Pres.: Hiroshi Hirano.
 C B S/Sony Recs. Inc., 1561-2 Aikawa, Ohigawa-cho, Shida-gun, Shizuoka-ken 421-02. Tel: (05462) 2-1321. Pres.: Norio Ohga; Rep. Exec. Mng. Dir.: Tokio Sasaki.
 Japan Musicolor Co. Ltd., Kojimachi Royal Bldg., 4-7 Kojimachi, Chiyoda-ku, Tokyo 102. Tel: (03) 230-1611. Cable: SPIRITENTER. Telex: 23419. Pres.: Akio Tamura. (Pressing only)
 King Rec. Co. Ltd., 2-12-13 Otowa, Bunkyo-ku, Tokyo 112. Tel: (03) 945-2131. Telex: 24963. Pres.: Kazumitsu Machijiri; Mng. Dir.: Minoru Suzuki. (SEE ADVERTISEMENT)
 Nippon Columbia Co. Ltd., 4-14-14 Akasaka, Minato-ku, Tokyo 107. Tel: (03) 584-8111. Cable: NIPPON-COLUMBIA. Telex: 22591. Pres.: Takami Shobochi; Dir.: Toshio Kikutsugi. (SEE ADVERTISEMENT)
 Phonodisc KK, 1-8-4 Ohashi, Meguro-ku, Tokyo 153. Tel: (03) 462-5131. Pres.: J. Dieter Bliersbach; VP: Takao Yanagimoto.
 Teichiku Recs. Ltd., 1-2 Nishi-Shimbashi, Minato-ku, Tokyo 105. Tel: (03) 502-7213. Pres.: Shigeji Nanko; Gen. Mgr.: Ichiro Kinoue; Sales Mgr.: Minoru Ozaki.
 Toyo Kasei Co. Ltd., 2-5-5 Hirakawa-cho, Chiyoda-ku, Tokyo 102. Tel: (03) 264-3041.
 Victor Co. of Japan Ltd., 4-1 Nihonbashi-Honcho, Chuo-ku, Tokyo 103. Tel: (03) 241-7811. Cable: VICTOREX-PORT Telex: 26222.
 Int'l branches: Canada, England, USA (all JVC).

PRINTER & LITHOGRAPHER

Toyo Kasei Co. Ltd., 2-5-5 Hirakawa-cho, Chiyoda-ku, Tokyo 102. Tel: (03) 264-3041. (Record only)

RECORD PROMOTION

Aoyama Music Promo. Co. Ltd., Houraiya Bldg., 7F, 5-2-1 Roppongi, Minato-ku, Tokyo 106. Tel: (03) 404-9406
 Asahi Music Servs. Inc., c/o Asahi Broadcasting Corp., 2-2-48 Ohyo-do-Minami, Ohyo-do-ku, Osaka 531. Tel: (06) 458-5321. Cable: ASAHIHOSO OSAKA. Telex: 63680. Pres.: Kinkichi Kanbara; Gen. Mgr.: Kazuyuki Yagi; Sales Mgr.: Shuzo Asai.
 Branch: Tokyo, 2-6-3 Shiba Park, Minato-ku, Zone 105. Tel: (03) 436-5771. Cable: ASAHIHOSO TOKYO
 Inter Produce Inc., Hatsei Bldg., 4F, 3-24-23 Nishi-Azabu, Minato-ku, Tokyo 106. Tel: (03) 402-9191
 Ishii Music Promo., Fugetsudo Bldg., 6-6-1 Ginza, Chuo-ku, Tokyo 104. Tel: (03) 572-0351
 Kitty Ents. Inc., Kobayashi Bldg., 7th fl., 1-14-11 Shibuya, Shibuya-ku, Tokyo 150. Tel: (03) 499-4711. Telex: 2425338. Pres.: Harumi Ogawa; Gen. Mgr.: Yutaka Tanaka.
 Kyodo Tokyo Inc., Kyodo Bldg., 3-6-18 Kita-Aoyama, Minato-ku, Tokyo 112. Tel: (03) 407-8131. Cable: KYODO-TOTO.
 Spirit Ent. Inc., Kojimachi Royal Bldg., 4-7 Kojimachi, Chiyoda-ku, Tokyo 102. Tel: (03) 230-1611. Cable: SPIRITENTER. Telex: 23419. Pres.: Akio Tamura.
 Udo Artists Inc., Miyacho Bldg., Suite 2, Minami-Aoyama, Minato-ku, Tokyo. Tel: (03) 402-7561. Cable: UDOART.
 Universal Orient Promos. Inc., Oshoro Bldg., 4th fl., 3-15-3 Akasaka, Minato-ku, Tokyo. Tel: (03) 585-3045.
 Victor Artists Corp. of Japan, 4-26-18 Jingumae, Shibuya-ku, Tokyo 150. Tel: (03) 402-8181.
 Int'l branches: Canada, England, USA (all JVC)
 Young Japan Inc., Emerald Bldg., 4th fl., 12-7 Udagawa-cho, Shibuya-ku, Tokyo 150. Tel: (03) 496-0681. Pres.: Ken Hosokawa; Exec. VP: Akio Onodera.
 Branch: Osaka, Young Japan Osaka Inc., 1202 Ekimaedaini Bldg., 1-2-2 Umeda Kita-ku, Osaka-shi, Osaka 530. Tel: (06) 343-0541. Exec. Dir.: Yasuji Teramoto. (SEE ADVERTISEMENT)

TAPE CUSTOM DUPLICATORS

Apollon Music Ind'l Corp., 1-5 Wakaba-cho, Shinjuku-ku, Tokyo 160. Tel: (03) 353-0191.
 C B S/Sony Recs. Inc., 1561-2 Aikawa, Ohigawa-cho, Shida-gun, Shizuoka-ken 421-02. Tel: (05462) 2-1321. Pres.: Norio Ohga; Rep. Exec. Mng. Dir.: Tokio Sasaki.
 Audio: 8-tr., cassette.
 Eastern Sun Ents. Co. Ltd., Hirasawa Bldg., 34 Kotohira-cho, Shiba, Minato-ku, Tokyo 105. Tel: (03) 501-0344. Cable: EMP SUNUSERV.
 Audio: 8-tr., 8-tr. quadraphonic, cassette, open reel.
 Phonodisc KK, 1-8-4 Ohashi, Meguro-ku, Tokyo 153. Tel: (03) 462-5131. Pres.: J. Dieter Bliersbach; VP: Takao Yanagimoto.
 Audio: Cassette.
 Pony Inc., World Trade Center Bldg., 24F, 2-4-1 Hamamatsu-cho, Minato-ku, Tokyo 105. Tel: (03) 435-4925.

T B S Serv. Co. Ltd., 5-3-50 Akasaka, Minato-ku, Tokyo 107. Tel: (03) 584-7351.
 Audio: 8-tr., cassette.
 Video: 1" open reel.
 T D K Electronics Co. Ltd., 1-13-1 Nihonbashi, Chuo-ku, Tokyo 103. Tel: (03) 278-5111. Cable: TDKCORE. Pres.: Fukujiro Sono; Gen. Mgr.: Shohachi Okiyama; Sales Mgr.: Bud Barger.
 Audio: 8-tr., cassette, open reel.
 Video: 1/4" VHS & Beta cassette.
 Teichiku Recs. Co. Ltd., 1-2 Nishi-Shimbashi, Minato-ku, Tokyo 105. Tel: (03) 502-7213. Pres.: Shigeji Nanko; Gen. Mgr.: Ichiro Kinoue; Sales Mgr.: Minoru Ozaki.
 Audio: 8-tr., 8-tr. quadraphonic & cassette.
 Victor Co. of Japan Ltd., 4-1 Nihonbashi, Honcho, Chuo-ku, Tokyo 103. Tel: (03) 241-7811. Cable: VICTOREX-PORT. Telex: 26222.
 Int'l branches: Canada, England, USA (all JVC).
 Audio: 8-tr., 8-tr. quadraphonic, cassette, open reel, open reel quadraphonic.
 Video: 1" open reel.

● **supplies**

CARTRIDGE & CASSETTE PARTS

Magnadyne Corp., Royal Higashi Azabu Bldg., 2-23 Higashi Azabu, Minato-ku, Tokyo 106. Tel: (03) 583-8335.
 Home office: USA.

EMPTY CARTRIDGES, CASSETTES & REELS

Magnadyne Corp., Royal Higashi Azabu Bldg., 2-23 Higashi Azabu, Minato-ku, Tokyo 106. Tel: (03) 583-8335.
 Home office: USA.
 Audio: 8-tr.
 Sony Corp., PO Box 10, Airport PO, Tokyo 149; 6-7-35 Kita-Shinagawa, Shinagawa-ku, Tokyo 141. Tel: (03) 448-2111.
 Int'l branches: Brazil, Canada, England, Germany, Greece, Hong Kong, Panama, Singapore, South Africa, Switzerland, USA.
 Audio & Video: Reels.

JACKETS & SLEEVES

Magnadyne Corp., Royal Higashi Azabu Bldg., 2-23 Higashi Azabu, Minato-ku, Tokyo 106. Tel: (03) 583-8335. (Sleeves only)
 Home office: USA.

PROFESSIONAL TAPE SUPPLIES

Namiki Precision Jewel Co. Ltd., 3-8-22 Adachi-ku, Tokyo 123. Tel: (03) 919-0101. Pres.: Kazu Namiki; Sales Mgr.: M. Shimizu; Ass't Sales Mgr.: H. Narita.
 Int'l branch: USA.
 Product: Magnetic tape heads.

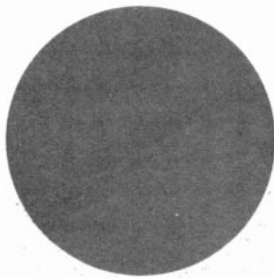

SHINKO

MUSIC PUBLISHING CO., LTD.

2-12, Ogawa-Machi, Kanda, Chiyoda-ku, Tokyo, Japan

tel: (293) 3791

telex: J25224 SHINKO

Cable Address

SHINKOMUSIC TOKYO

—ELECTORI—

It's an Opinion Leader of new technology
invented by the world foremost engineering.

GENERAL DISTRIBUTOR

AUDIO EQUIPMENT
ALTEC LANSING
SPEAKER SYSTEMS

ELECTROACUSTIC ELAC
SPEAKERS

Threshold
SPEAKERS

AEG-TELEFUNKEN
TAPE RECORDER

Eventide
STUDIO EQUIPMENT

quad/eight electronics
STUDIO EQUIPMENT

HIIH electronic
POWER AMP. AUDIO MIXER

IVIE ELECTRONICS INCORPORATED
AUDIO AMPLIFIER

RECORTEC, INC.
CASSETTE LOADER DUPLICATOR

URSA MAJOR
SPECIAL EFFECT DEVICES

EXR CORPORATION
ELECTRON

VIDEO EQUIPMENT

VITAL INDUSTRIES, INC.
SWITCHER

CVS
TAPES

BOSCH FERNSEH
AUDIO VHS RECORDERS

THOMSON-CSF LABORATORIES
SPEAKER

ELECTORI will go intensively introduce these new
techniques & products into Japanese Market.

ELECTORI CO., LTD.

● MAIN OFFICE: MONDO BLDG. 1-19-3 KAMIOCHIAI, SHINJUKU-KU, TOKYO, 161 JAPAN.
TELEPHONE: TOKYO (03) 950-6266 TELEX: 2723116



President
TAKEO HORI

PROUDLY ANNOUNCE THAT WE ARE THE OWNER OF
THE RIGHTS OF MASTERS AND COPYRIGHTS



Original Soundtrack Album

Dedicato al mare Egeo

Film Producer: ASAO KUMADA
Film Director: MASUO IKEDA
ComPoser & Arranger: Ennio MORRICONE
Ennio MORRICONE Orchestra
Violin Solist: YOKO SATO
Music Producer: MASAKATSU SUZUKI

Theme Song:

Dedicato al mare Egeo

Lyrics : MASUO IKEDA
Composer: Ennio MORRICONE
Arranger: Walter RIZZATI
Song : Ruggero GATTI

HORI GROUP

TOP MUSIC PUBLISHING CO., LTD.

One of the top five music publishers in Japan. Established in 1965.

HORI PRODUCTION, INC.

Talent management agency which constantly place 5-6 artists on local hit chart. Established in 1960.

HORI KIKAKU PRODUCTION, LTD.

One of the most well known film production companies in Japan. Established in 1969.

HORI GROUP HEADQUARTER, LTD.

Address: Hori Group Meguro Bldg., 2-5, 1-chome, Shimomeguro,

Meguro-ku, Tokyo 153 Telephone: (03) 490-4601

Cable Address: HORIPROMUSIC TOKYO

Telex: 2468436HORIGR J

IMPORT RECORDS SPECIALIST

Winners Records Shop

DISCO ★ SOUL ★ POP ★ ROCK ★ CROSSOVER JAZZ

ROPPONGI TOKYO JAPAN

〈ウィナーズレコードショップ六本木〉

ADDRESS: SHOP c/o SHIBATA BUILD. 3-13-8 ROPPONGI MINATOKU, TOKYO, JAPAN. CALL: 405-8190
OFFICE: c/o SANEHOUSE 505, SANEICHO 25, SHINJUKU KU, TOKYO, JAPAN. CALL: 341-1835
TELEX: 2324126 WINNERS

Watch out for our name!
Don't forget our name!
Keep on remember our name!

Specializing in Disco & Soul music, you believe or not, this is the truth.

We distribute import records to 95% of Tokyo's discos and 50% of our country's discos, as you've been already known by this magazine's Japan disco column.

We are very famous and popular to disco people (disco owners, DJs) of Japan.

★★★

FOR DISTRIBUTOR OF FOREIGN COUNTRIES.

We want your offer to sell records.

Send us your offer or catalogue, we'll try to contact with you. (U.S.A. U.K. CANADA. FRANCE. GERMANY. ITALY. NETHERLANDS and any other country) OK!

president T. KOHNO

★★★

FOR DOMESTIC.

ロック、ポップ、クロスオーバーはもとより、特に当店は日本のDISCO状況のビルボード取材の如く国内95%、国内50%のディスコ店と取り引き中。何かニューなものを求めましたらビルボード・ランクの各分野が揃う店、当店で新規加入ディスコ店、共々、お問い合わせ下さい。

〒106 港区六本木3-13-8 築田薬局ビル3F PM3:00
深夜営業 六本木交差点近く世田谷信用金庫となりAM2:00

Victor Co. Of Japan Ltd., 4-1 Nihonbashi-Honcho, Chuo-ku, Tokyo 103 Tel (03) 241-7811 Cable VICTOREX-PORT Telex 26222.

Int'l branches: Canada, England, USA (all JVC).

Audio: Test tape, heads, splicing & editing equip

Brand name: JVC

RECORD PROCESSING MACHINERY

Magnadyne Corp. Royal Higashi Azabu Bldg., 2-23 Higashi Azabu, Minato-ku, Tokyo 106 Tel (03) 583-8335

Home office: USA

Chief product: Shrink packaging

Namiki Precision Jewel Co. Ltd., 3-8-22 Adachi-ku, Tokyo 123 Tel (03) 919-0101 Pres. Kazu Namiki, Sales

Mgr. M. Shimizu, Ass't Sales Mgr. H. Narita

Int'l branch: USA

Product: Cutting styli.

Nippon Columbia Co. Ltd., 4-14-14 Akasaka, Minato-ku, Tokyo 107 Tel (03) 584-8111 Cable NIPPONCO-

LUMBIA. Telex 22591 Pres. Takami Shobochi, Dir.

Toshio Kikutsugi

Chief product: PCM

Brand name: Denon (SEE ADVERTISEMENT)

TAPE, BLANK LOADED & RAW

B A S F Japan Ltd., Tozan Bldg., 4-9 Nihonbashi-Honcho, Chuo-ku, Tokyo 103 Tel (03) 270-1461 Telex

2222130 Pres. Dr. Cantzler, Div. Mgr. H. Kreuels,

Sales Mgr. K. Suzuki, Adv. Mgr. D. Herzer

Audio: Blank—Cassette, open reel, raw—cassette

Video: Blank—1" open reel, 3/4" cassette, 1/2" open reel, 1/2" EIAJ cartridge

Fuji Photo Film Co. Ltd., 2-26-30, Nishi-Azabu, Minato-ku, Tokyo 106 Tel (03) 406-2409 Telex 24306 Pres.

Kusuo Hirata, Sales Mgr. Junichi Takahashi, Adv. Mgr. Shozo Masuda

Int'l branches: England, Germany, USA

Audio: 8-tr. cassette, open reel

Video: 1" open reel, 3/4" cassette, 1/2" EIAJ open reel, 1/2" EIAJ cartridge

Brand name: Fujifilm

Hitachi Maxell Ltd., Ginza Toho Seimei Bldg., 3-3-1 Ginza Chuo-ku, Tokyo 104 Tel (03) 567-6221 Cable MAX-

ELLELEC Telex 26391 Int'l Dept. Dir. Ken Kakura,

Sales Mgr. Tom Inoue, Ass't Sales Mgr. Bob Fujiwara (Blank only)

Int'l branches: Germany, Hong Kong, Kuwait, Singapore, USA

Audio: 8-tr. cassette, open reel

Video: 1" open reel, 3/4" cassette, 1/2" EIAJ open reel, 1/2" VHS cassette

Brand name: Maxell

J.V.C. see Victor

Magnadyne Corp., Royal Higashi Azabu Bldg., 2-23 Higashi Azabu, Minato-ku, Tokyo 106 Tel (03) 583-8335 (Blank only)

Home office: USA

Audio: 8-tr.

Matsushita Electric Ind'l Co. Ltd., PO Box 51, Osaka Central 530-91, 1006 Oaza Kadmoma, Kadoma-city 571 Tel (06) 908-1121 Cable MATSUDEN MORIGUCHI,

Telex 63426 Pres. Toshihiko Yamashita, (Blank only)

Int'l branches: Germany, USA

Audio: Cassette, open reel

Video: 3/4" cassette, 1/2" EIAJ open reel, 1/2" EIAJ cartridge, 1/2" VHS cassette, 1/2" VX

Brand names: National, Panasonic, Quasar, Technics, Maxell, see Hitachi

National, see Matsushita

Nippon Columbia Co. Ltd., 4-14-14 Akasaka, Minato-ku, Tokyo 107 Tel (03) 584-8111 Cable NIPPONCO-

LUMBIA Telex 22591 Pres. Takami Shobochi, Dir. Toshio Kikutsugi

Audio: Cassette, open reel (SEE ADVERTISEMENT)

Panasonic, see Matsushita

Quasar see Matsushita

Scotch see Sumitomo

Sony Corp., PO Box 10, Airport PO, Tokyo 149, 6-7-35 Kita-Shinagawa, Shinagawa-ku, Tokyo 141 Tel (03) 448-2111 (Blank only)

Int'l branches: Brazil, Canada, England, Germany, Greece, Hong Kong, Panama, Singapore, South Africa, Switzerland, USA

Audio: 8-tr. cassette, open reel

Video: 1" open reel, 3/4" cassette, 1/2" EIAJ open reel, 1/2" Beta cassette

Sumitomo 3M Ltd., 3M Bldg., 2-33-1 Tamagawa-dai, Setagaya-ku, Tokyo 158 Tel (03) 709-8493

Audio: Blank—cassette, open reel, raw—8-tr. cassette & open reel

Video: 1" open reel, 3/4" cassette, 1/2" EIAJ open reel

Brand name: Scotch

T D K Electronics Co. Ltd., 1-13-1 Nihonbashi, Chuo-ku, Tokyo 103 Tel (03) 278-5111 Cable TDKCORE

Pres. Fukujiro Sono, Gen. Mgr. Shohachi Okiyama, Sales Mgr. Bud Barger

Int'l branches: UK, USA

Audio: 8-tr. cassette, open reel

Video: 3/4" cassette, 1/2" EIAJ open reel, 1/2" EIAJ cartridge, 1/2" VHS & Beta cassette

Technics, see Matsushita

Victor Co. Of Japan Ltd., 4-1 Nihonbashi-Honcho, Chuo-ku, Tokyo 103 Tel (03) 241-7811 Cable VICTOREX-

PORT Telex 26222.

Int'l branches: Canada, England, USA (all JVC)

Brand name: JVC

TAPE DUPLICATING EQUIPMENT

Electro Co. Ltd., 1-19-3 Kamiochiai, Shinjuku, Tokyo 161 Tel (03) 950-6266 Cable KOHICHIIELECT Telex

2723116 Pres. Ike Ichiro Hattori, Consumer Sales H. Inaba, Commercial Sales: H. Higuchi, Int'l Dept. Mgr. Chris H. Koichibara

Audio: Cassette duplicators.

Brand name: Recortec (SEE ADVERTISEMENT)

Magnadyne Corp., Royal Higashi Azabu Bldg., 2-23 Higashi Azabu, Minato-ku, Tokyo 106 Tel (03) 583-8335

Home office: USA

Audio: 8-tr. duplicating equip

Matsushita Electric Ind'l Co. Ltd., PO Box 51, Osaka Central

530-91, 1006 Oaza Kadmoma, Kadoma-city 571 Tel (06) 908-1121 Cable MATSUDEN MORIGUCHI,

Telex 63426 Pres. Toshihiko Yamashita

Int'l branches: Germany, USA

Video: Duplicator

Brand name: National / Panasonic

Otari Electric Co. Ltd., 4-29-18 Minami Ogikubo, Suginami-ku, Tokyo 167 Tel (03) 333-9631 Cable OTARI-

DENKI Telex 26604 Pres. Masayuki Hosoda, Sales & Adv. Mgr. Takao Aoki

Audio: High speed tape duplicators (8x, 16x, 32x, 64x), rewinders

Video: Tape winders (SEE ADVERTISEMENT)

Sony Corp., PO Box 10, Airport PO, Tokyo 149, 6-7-35 Kita-Shinagawa, Shinagawa-ku, Tokyo 141 Tel (03) 448-2111

Int'l branches: Brazil, Canada, England, Germany, Greece, Hong Kong, Panama, Singapore, South Africa, Switzerland, USA

Audio & Video: Duplicators

TAPE PACKAGING & LABELING EQUIPMENT & SUPPLIES

Magnadyne Corp., Royal Higashi Azabu Bldg., 2-23 Higashi Azabu, Minato-ku, Tokyo 106 Tel (03) 583-8335

Home office: USA

Product: Shrink packaging

● accessories manufacturers

Akai Electric Co. Ltd., 2-12-14 Higashi-Kojima, Ohta-ku, Tokyo 144 Tel (03) 742-5111

Product: Head cleaners & demagnetizers

Clarion Co. Ltd., 1-22-10 Dogenzaka, Shibuya-ku, Tokyo 150 Tel (03) 463-6161

Int'l branches: Germany, Hong Kong, USA

Product: Carrying & storage cases, catalog servs

Hitachi Maxell Ltd., Ginza Toho Seimei Bldg., 3-3-1 Ginza Chuo-ku, Tokyo 104 Tel (03) 567-6221 Cable MAX-

ELLELEC Telex 26391 Int'l Dept. Dir. Ken Kakura,

Sales Mgr. Tom Inoue, Ass't Sales Mgr. Bob Fujiwara

Int'l branches: Germany, Hong Kong, Kuwait, Singapore, USA

Product: Head cleaners.

Magnadyne Corp., Royal Higashi Azabu Bldg., 2-23 Higashi Azabu, Minato-ku, Tokyo 106 Tel (03) 583-8335

Home office: USA

Product: Tape storage cases, cleaners, cloths & brushes, splicing tape

Nagaoka Seiki, 3-16-3 Kita-Otsuka, Toshima-ku, Tokyo 170

Product: Needles

Namiki Precision Jewel Co. Ltd., 3-8-22 Adachi-ku, Tokyo 123 Tel (03) 919-0101 Pres. Kazu Namiki, Sales

Mgr. M. Shimizu, Ass't Sales Mgr. H. Narita

Int'l branches: USA

Product: Needles (M)

Nippon Chikushin, 3-9-35 Tozuka-cho, Shinjuku-ku, Tokyo 160

Product: Needles

Nippon Columbia Co. Ltd., 4-14-14 Akasaka, Minato-ku, Tokyo 107 Tel (03) 584-8111 Cable NIPPONCO-

LUMBIA Telex 22591 Pres. Takami Shobochi, Dir. Toshio Kikutsugi

Product: Demagnetizers. (SEE ADVERTISEMENT)

Ogura Jewel Ind. Co. Ltd., 5-7-12 Omori Kita, Ota-ku, Tokyo 143 Tel (03) 763-3111 Telex 02466048 Pres

Kozaburo Ogura, Export/Import Mgr. Tadashi Takara

Product: Needles

Sharp Corp., 22-22 Nagaika-cho, Abeno-ku, Osaka 545 Tel (06) 621-1221 Cable LABOMET

Sony Corp., PO Box 10, Airport PO, Tokyo 149, 6-7-35 Kita-Shinagawa, Shinagawa-ku, Tokyo 141 Tel (03) 448-2111

Int'l branches: Brazil, Canada, England, Germany, Greece, Hong Kong, Panama, Singapore, South Africa, Switzerland, USA

Product: Head cleaners & demagnetizers, needles, splicing tape

Sumitomo 3M Ltd., 3M Bldg., 2-33-1 Tamagawa-dai, Setagaya-ku, Tokyo 158 Tel (03) 709-8493

Product: Tape catalog servs, leader & splicing tape

T D K Electronics Co. Ltd., 1-13-1 Nihonbashi, Chuo-ku, Tokyo 103 Tel (03) 278-5111 Cable TDKCORE

Pres. Fukujiro Sono, Gen. Mgr. Shohachi Okiyama, Sales Mgr. Bud Barger

Int'l branches: UK, USA

Product: Head cleaners & demagnetizers, leader & splicing tape

Tamradio, see Tamura

Tamura Seisakusho Co. Ltd., 433 Higashi-Oizumi, Nerima-ku, Tokyo 177 Tel (03) 925-1111 Pres. Itsuya Tamura, Sales Mgr. Junichi Noda

Product: Head demagnetizers (Tamradio)

Teac Corp., 3-7-3 Naka-cho, Musashino-shi, Tokyo 180 Tel (0422) 53-1111 Cable TEAC MITAKA Telex

2822551 Pres. Katsuma Tani, Gen. Mgr. Norio Tamura, Sales Mgr. Masao Morita

Int'l branches: Germany, Hong Kong, USA

Product: Head cleaners & demagnetizers

● store fixtures & merchandising aids manufacturers

Clarion Co. Ltd., 1-22-10 Dogenzaka, Shibuya-ku, Tokyo 150 Tel (03) 463-6161

Int'l branches: Germany, Hong Kong, USA

Product: Brower boxes, display racks

Young Japan Enterprise Inc., 5-F Emmerald Bldg., 12-7 Udagawa-cho, Shibuya-ku, Tokyo 150 Tel (03) 496-0681 Exec. Prod'r. Chikanori Kikuchi (SEE ADVERTISEMENT)

KENYA

Population: 13,850,000
 Rate of exchange: \$1 (US) = 7.82 shillings.
 Per capita income: \$209
 Holidays: January 1, Good Friday, Easter Monday, May 1, June 1, first Monday in August, October 20, December 12, 25, 26.

● record & tape manufacturers / distributors / importers

A I T Recs. (Kenya) Ltd (IFPI), PO Box 41152, Nairobi. Tel: 24725, 26732, 334-127 Cable: DREWSCO. Telex: 22366 Mng. Dir.: M.R. Andrews; Sales Dir.: R.J. Andrews
Labels: (Owned) AIT, Africa, Ba-Ba, Bana Beru, Do-7, King Kong, Lolwe, Moto Moto, Musiki du Zaire, Nyang Omaki, Owang Jaber, POK, Sungura. **(Licensed domestic)** Kung Fu. **(Licensed foreign)** Arista (USA), Capitol (USA), EMI (UK), Private Stock (USA), RCA (USA), Stax (worldwide), Teal (South Africa), United Artists (USA), WEA (worldwide).

Africa, see AIT.
 Ba-Ba, see AIT.
 Bana Beru, see AIT.
 Do-7, see AIT.
 Fontana, see Phonogram.
 King Kong, see AIT.
 Kung Fu, see AIT.
 Lolwe, see AIT.
 Mercury, see Phonogram.
 Moto Moto, see AIT.
 Musiki du Zaire, see AIT.
 Nyang Omaki, see AIT.
 Owang Jaber, see AIT.
 P O K, see AIT.
 Phonogram Ltd./East African Recs. Ltd. (IFPI), PO Box 43695, Nairobi. Tel: 557558, 557432. Cable: PHONREC. Telex: 22225 Mng. Dir.: J.H. Kinzl, Sales Mgr.: J. Costabir
Labels: (Owned) Fontana, Mercury, Phonogram group, Polydor group. **(Licensed)** A&M (USA) Bronze (UK), CBS (USA), Decca (UK), Fonior (Belgium, Zaire), Island (UK), Pye (UK).
 Int'l rep.: Worldwide (Polygram).
 Polydor, see Phonogram.
 Sungura, see AIT.

● music publisher

E I T Publ'g, PO Box 41152, Nairobi. Tel: 24725, 26732. Cable: DREWSCO. Telex: 22366 Mng. Dir.: M.R. Andrews.

● services

PLATING, PROCESSING & PRESSING PLANT

East African Recs. Ltd., PO Box 43695, Nairobi. Mng. Dir.: J.H. Kinzl; Factory Mgr.: G. Vieweger.

● accessories importer

A I T Recs. (Kenya) Ltd., PO Box 41152, Nairobi. Tel: 24725, 26732, 334127 Cable: DREWSCO. Telex: 22366 Mng. Dir.: M.R. Andrews; Sales Dir.: R.J. Andrews. (Importer)
Product: Cleaners, cloths, brushes, 45 rpm adaptors, head cleaners & demagnetizers, leader & splicing tape.

LEBANON

Population: 2,960,000.
 Rate of exchange: \$1 (US) = 3.25 pounds.
 Per capita income: \$786
 Holidays: January 1, March 30 (Moslem New Year), May 1 (Labor Day), May 6 (Martyr's Day), June 20 (Mohammed's Birthday), November 22 (Independence Day), December 25, Moslem & Christian religious holidays.

● record & tape manufacturers / distributors / importers

Arc, see Societe Mitri Murr & Fils.
 Archiv, see Philips Liban.
 A. Chahine & Fils, Hazmieh-Chiyah Blvd., Beirut. Tel: 452-750/563. Cable: CHAHINEMUSIQUE. Pres: Joseph A. Chahine; Gen. Mgr.: Bernard A. Chahine; Sales Mgrs.: Abdallah J. Chahine, Boutros Maroun, Joe Letayf.

Labels: (Owned) Voix de L'Orient; **(distributed—not licensed)** A&M (UK), Barclay (France), Bronze (UK), Capitol (UK), Carrere (France), DJM (UK), EMI (UK), EMI Int'l (UK), Fantasy (USA), Harvest (UK), His Master's Voice (UK), Island (UK), Motown (UK), Music For Pleasure (UK), Parlophone (UK), Pathe (France), Purple (UK), RAK (UK), Rocket (UK), Sonopresse (France), Tamla (UK), Trema (France), Tretaux (France).
 Int'l reps.: France (Pathe Marconi EMI), Greece (EMI).

D G, see Philips Liban.
 Empire, see Societe Libanaise du Disque.
 Fontana, see Philips Liban.
 Hamada, see Societe Libanaise du Disque.
 Heliodor, see Philips Liban.
 Romeo Lahoud Prod'ns, see Societe Libanaise du Disque.
 M G M, see Philips Liban.
 Melodisc, see Societe Libanaise du Disque.
 Mercury, see Philips Liban.
 Metrophon, see Societe Mitri Murr & Fils.
 Philips Liban Sal, Phonogram Dept., PO Box 670, Ave Sami Solh, Beirut. Tel: 382-300 Cable: PHILIBAN. Gen. Mgr.: E. Raben; Sales Mgr.: Roger Ghosn.
Labels: (Owned) Archiv, DG, Fontana, Heliodor, MGM, Mercury, Philips, Polydor, Polyphon, Triumph, Vertigo, Verve. **(Licensed)** Avco, All Platinum, B&C, Big Tree, Biram, Bus Stop, CTI, Capricorn, Carrere, Charisma, Clearlight, ECM, Ensign, Fresh Air, GM, GTO, Hispavox, Hot Foot, Jet, Just Sunshine, Kalan, Kalondour, Keltia, Kudu, Marzelle, Mooncrest, Mountain Oyster, Pablo, Passport, Pergola, Phil Spector, Power Exchange, RSO Ring O, Shelter, Sire, Sonopresse, Spring, State, Track, Transatlantic, Trojan, 20th Century, WWA, Zagora.
 Int'l reps.: Worldwide (Phonogram, Polydor).

Polydor, see Philips Liban.
 Polyphon, see Philips Liban.
 S L D, see Societe Libanaise du Disque.
 Societe Libanaise du Disque Sal (IFPI), PO Box 4758, Cinema Empire Bldg., Gouraud St., Beirut. Tel: 252222, 247209, 932787. Cable: CINEMPIRE. Telex: 21633. Pres. & Gen. Mgr.: Mario G. Haddad; Prod'n Mgr.: Joseph Tabet.
Labels: (Owned) Empire, Melodisc, SLD. **(Licensed)** Albatros (France), Ariola (Germany), Asylum (UK), Atco (USA), Atlantic (USA), CGD (Italy), Carabine (France), Cutom (USA), Dark Horse (France), Durium (Italy), Elektra (USA), Fleche (France), Hansa (Germany), Reprise (USA), Ri-Fi (Italy), Warner Bros. (USA). **(distributed—not licensed)** Disc'AZ (France), Ades (France), Barclay (France), Big Tree (France), Ember (UK), Erato (France), Eurodisc (France), Flamophone (France), Flarenasch (France), Hamada, Hungaraton (Hungary), Romeo Lahoud, Malignator (France), Manticore (France), Musidisc (France), Penny Farthing (UK), Pickwick (UK), Rolling Stones (USA), Swan Song (USA), Uniart, Westbound (USA), Whitfield (France).
 Int'l reps.: France (Sonodisc), USA (Monitor, Peters Int'l).



TRIO RECORDS

one of the most promising sons of ours

TRIO-KENWOOD CORPORATION

2-1, 5-chome, Roppongi, Minato-ku, Tokyo 106 JAPAN
 tel: 03-404-4391 tlx: 242-6776 TRIREC J cable: TRIODISC TOKYO

TRIO RECORDS, a division of TRIO-KENWOOD CORP.
 6-17, 3-chome, Aobadai, Meguro-ku, Tokyo 153 JAPAN

Societe Mitri Murr & Fils, PO Box 11-1211, Beirut. Tel. 24-46-20, 22-38-08.
Labels: (Owned) Arc, Metrophon. **(represented)** Chapter One (UK), Decca (UK), Deram (UK), London (UK), MAM (UK), Pink Elephant (Belgium), Rex (UK), Saout El-Hob (Egypt), Threshold (UK), UK (UK), Vega (France), Weekend (Belgium).
Int'l reps.: Belgium (Fonior), Egypt (Saout El-Hob), France (Societe Francaise du Son), UK (Decca).
 Triumph, see Philips Liban.
 Uniart, see Societe Libanaise du Disque.
 Vertigo, see Philips Liban.
 Verve, see Philips Liban.
 Voix de L'Orient, see A. Chahine & Fils.

MALAYSIA

Population: 12,264,345.
Rate of exchange: \$1 (US) = 2.13 ringgits.
Per capita income: \$748.
No. of homes with record players: 84,000
Holidays: Chinese New Year (2 days), Prophet Muhammad's Birthday, Labor Day, Vesak Day (Buddhist festival), King's Birthday, National Day, Hari Raya Puasa (Malay Fasting festival) (2 days), Deepavali (Hindu festival), Awal Muharram (Malay religious holiday), Hari Raya Haji (Malay New Year), Christmas.
RECORDS SOLD:
Records sold domestically including imports (retail value): LP's 1978—1,800,000 units, \$12,960,000, 1977—1,200,000 units, \$8,840,000.
Records imported from USA: 1978—90,000 units, 1977—78,000 units.
Records imported from countries other than USA: 1978—8470 units, 1977—3000 units.
Records exported to countries other than USA: 1978—2740 units, \$9416
Average retail price per record: Int'l LP's pressed locally—\$13.00.
Stereo sales: 99.99%.
Discounting: Frequent.
Type of distribution: The manufacturer-to-retailer system predominates with 80% of sales. Privately owned retail outlets account for the bulk of the retail business, with manufacturer-owned outlets having about 12%, and the rest going to mail order and direct imports.
Type of promotion: Newspaper and magazine reviews are the most used form, with advertising in these media also being popular. Television and radio stations allot 50% of music programming to MOR material. Videotape screenings are becoming popular. Stage shows by local artists also are boosters.

TAPE:

Pre-recorded tape sold domestically including imports: 8-tr 1978—700,000 units; 1977—640,000 units. Cassette 1978—2,800,000 units; 1977—2,200,000 units.
Market: While the 8-track market was slowly declining, the cassette market showed a 25% gain in 1978. Cassette equipment is readily available, with prices generally moderate. Having controlled the equipment market five years ago, 8-track units are now less popular.
Average retail price per tape: 8-tr.—\$15.50; cassette—\$14.00.

RADIO STATIONS

No. of government 1 (AM/FM).
Comment: Music accounts for about three-fourths of the airtime and is subject to government scrutiny. News, sports commentaries and documentaries make up the remainder of the airtime. FM, which is restricted to the Kuala Lumpur area, is 100% music. Popular music predominates, but classical and jazz are gaining. Live shows are sparse.

TELEVISION STATIONS:

No. of government channels 2 (2% PAL color)
Comment: Over two-fifths of the programs are locally produced, including news, documentaries, sports and plays. Imported music shows are limited to the MOR format.

IMPORT/EXPORT REGULATIONS:

All imports and exports are subject to tax duties of 10% + 5% + 5%. Although this is relatively high, both have shown yearly increases. **Christie Leo**

● record & tape manufacturers / distributors / importers

Ace of Clubs, see Decca.
 Ace of Diamonds, see Decca.
 Anca Musical Sdn. Bhd., 58 Jalan Midah 1, Taman Midah, Cheras, Kuala Lumpur. Tel: 612-031. Mng. Dir.: Wong Kim Leng.
 Angel, see EMI.
 Argo, see Decca.
 Baal Recs., 5115 Wisma Central, Jalan Ampang, Kuala Lumpur. Tel: 209-836.
Labels: (Owned) Baal, Best of Everything; (licensed) ABC, H&L (both USA).
 Beltona, see Decca.
 Best of Everything, see Baal.
 Capitol, see EMI.
 Chapter One, see Decca.
 Columbia, see EMI.
 D G G, see Phonogram.

Decca Orient (Pte.) Ltd., Kinta Hall Court, 20/34 Leboh Farquhar, Penang. Tel: 60-671. Mng. Dir.: Derrick J. Coupland; Dir.: H.K. Franklin; Mgr.: Lee Chin Har. **Local branch: Kuala Lumpur, Lee Rubber Bldg., 2nd fl., Rm. 2, 145 Jalan Bandar. Tel: 23-810. Mgr.: Encik Ismail Bin Haji Abdul Rahman.**
Reg'l headquarters: Singapore.
Labels: (Owned) Ace of Clubs, Ace of Diamonds, Argo, Beltona, Chapter One, Decca, Deram, Eclipse, Emerald, Greenwich, Gull, Headline, London, London Globe, Nova, L'Oiseau Lyre, Qualiton, Rex, Threshold, Vocalion, Vox, York; **(represented)** All Platinum (USA), Biogram (USA), Boot (USA), Capri (France), Coccinelle Varieties (France), Cynda (USA), Ember (UK), Fiesta (France), Horoscope (USA), London/ADA (USA), Maple (USA), O'Be (USA), Pye (UK), Spiral (UK), Stang (USA), Summus (USA), Sonet (UK), Sydney Thompson (UK), Turbo (USA), Vega (France).
Int'l reps.: Ceylon (Lewis Brown), China (Linfair), India (Gramophone), Japan (King), Korea (Sung Eum), Pakistan (EMI), Philippines (Super), Thailand (Kinnetex).

Deram, see Decca.
 Double Up, see EMI.
 E M I (Malaysia) Sdn Bhd. (IFPI), 1 Lorong Haji Taib Satu, Kuala Lumpur 02-07. Tel (03) 924133, 924261, 924392. Cable: EMITRON Telex 30682. Dir. & Gen. Mgr.: M. Comerford; Mktg. & Sales Mgr.: Ronald Cheong; Int'l A&R Mgr.: Connie Cheong; Domestic A&R Mgr.: S.P. Beh.
Home office: England.
Labels: (Owned) Angel, Capitol, Columbia, Double Up, EMI, HMV, Harvest, MFP, One Up, Parlophone, Pathe, Regal, Sonopresse, Sound Superb, Starline, (licensed) Arista (USA), Bronze (UK), CBS (USA), Disneyland (USA), Dyna (Philippines), Epic (USA), Island (UK), MAM (UK), Magnet (UK), Motown (USA), Passport (USA), Private Stock (USA), Purple (UK), RAK (UK), Rolling Stones (UK), Rare Earth (UK), Rocket (UK), Sherbet (Australia).
Int'l rep.: Worldwide (EMI).

Eclipse, see Decca.
 Elastic, see Musico.
 Emerald, see Decca.
 Fontana, see Phonogram.
 Golden Voice Musical Inds. Sendirian Berhad, Tasek Ind' Estate, Lot 11, Tasek Square, Ipoh, Perak Tel (05) 4-555.
 Greenwich, see Decca.
 Gull, see Decca.
 H M V, see EMI.
 Harvest, see EMI.
 Headline, see Decca.
 Hup Hup Sdn. Bhd., 66-68 Jalan Raja Chulan, Kuala Lumpur Tel: (03) 207-904/524. Mng. Dir.: C.H. Ng; Gen. Mgr.: A.W. Ng.
Label: (Distributed) Life.
 King Musical Inds. Sdn. Bhd., Lot 5, Jalan 13/2, Petaling Jaya, Selangor. Tel: (03) 52-118. Mng. Dir.: Ng Lian Chin; Gen. Mgr.: Ng Ay Vin.
 Life, see Hup Hup.
 London, see Decca.
 London Globe, see Decca.
 M F P, see EMI.
 Malaysia Recs. Sdn. Bhd., Lot 8244, Lorong 51A/222B, Kawasan Miel, Petaling Jaya, Selangor. Tel: (03) 773-685, 773-604. Cable: MAYRECH. Chm.: M.C. Brown; Factory Mgr.: Heng Yok Hong.
 Mercury, see Phonogram.
 Musico (Malaysia) Sdn. Bhd., China Insurance Bldg., Rm. 301, 174 Jalan Tuanku Abdul Rahman, Kuala Lumpur. Tel: 924-959. Mgr.: Khorjin Seong.
Labels: (Owned) Elastic; **(represented)** Barclay, Blue Note (USA), Casablanca, Fantasy (USA), JVC, King, Prestige (USA), United Artists (Germany, UK, USA).

Nova, see Decca.
 L'Oiseau Lyre, see Decca.
 One Up, see EMI.
 Parlophone, see EMI.
 Pathe, see EMI.
 Philips, see Phonogram.
 Phonogram Pte. Ltd., Jalan Bukit Bintang, 1st fl., No. 20, Kuala Lumpur. Tel: 422-747, 429-395.
Regional headquarters: Singapore.
Labels: (Owned) DGG, Fontana, Mercury, Philips, Polydor, RSO, Vertigo; **(represented)** A&M (USA), CTI (USA), Capricorn (USA), Charisma (UK), De-Lite (USA), GTO (UK), H&L (USA), Jupiter (Germany), MCA (USA), MGM, Monument, Pablo (Germany), Ring-O (UK), 20th Century (USA).
 Polydor, see Phonogram.
 Qualiton, see Decca.
 R S O, see Phonogram.
 Regal, see EMI.
 Rex, see Decca.
 Sonopresse, see EMI.
 Sound Superb, see EMI.
 Starline, see EMI.
 Threshold, see Decca.
 Vertigo, see Phonogram.
 Vocalion, see Decca.
 Vox, see Decca.
 York, see Decca.

● music publishers

Anca Musical Sdn. Bhd., 58 Jalan Midah 1, Taman Midah, Cheras, Kuala Lumpur. Tel: 612-031. Mng. Dir.: Wong Kim Leng.
 Burlington-Palace Music Orient Ltd. (div. of Decca Orient Pte. Ltd.), Kinta Hall Court, 20-34 Leboh Farquhar, Penang. Tel: 60-671. Mng. Dir.: Derrick J. Coupland; Dir.: H.K. Franklin. **Local branch: Kuala Lumpur, Lee Rubber Bldg., 2nd fl., Rm. 2, 145 Jalan Bandar. Tel: 23-810. Mgr.: Encik Ismail Bin Haji Abdul Rahman.**
Reg'l headquarters: Hong Kong.
 Pustaka Muzik EMI (Malaysia) Sdn. Bhd., 1 Lorong Haji Taib Satu, Kuala Lumpur 02-07. Tel (03) 924133, 924261, 924392. Cable: EMITRON, Telex: 30682. Mng. Dir.: Michael Comerford; Gen. Mgr.: S.P. Beh.

Int'l firm represented: EMI (Hong Kong).
 Int'l rep.: UK (EMI).

● services

DESIGN & ARTWORK

Golden Voice Musical Inds. Sendirian Berhad, Tasek Ind' Estate, Lot 11, Tasek Square, Ipoh, Perak Tel (05) 4-555.
 King Musical Inds. Sdn. Bhd., Lot 5, Jalan 13/2, Petaling Jaya, Selangor. Tel: (03) 52-118. Mng. Dir.: Ng Lian Chin; Gen. Mgr.: Ng Ay Vin.
 U N I Ent. Sdn. Bhd., 290 Jalan Raja Laut, Kuala Lumpur. Tel: (03) 923-252. Cable: UNIGOH. Telex: 31341. Mng. Dir.: S. S. Goh; Gen. Mgr.: Peter S.C. Goh; Sales Mgr.: Colin Edmonds; Office Mgr.: E.K. Su.

PLATING, PROCESSING & PRESSING PLANTS

Golden Voice Musical Inds. Sendirian Berhad, Tasek Ind' Estate, Lot 11, Tasek Square, Ipoh, Perak. Tel (05) 4-555.
 King Musical Inds. Sdn. Bhd., Lot 5, Jalan 13/2, Petaling Jaya, Selangor. Tel: (03) 52-118. Mng. Dir.: Ng Lian Chin; Gen. Mgr.: Ng Ay Vin.
 Malaysia Recs. Sdn. Bhd., Lot 8244, Lorong 51A/222B, Kawasan Miel, Petaling Jaya, Selangor. Tel: (03) 773-685, 773-604. Cable: MAYRECH. Chm.: M.C. Brown; Factory Mgr.: Heng Yok Hong. (Pressing only)

PRINTERS & LITHOGRAPHERS

Golden Voice Musical Inds. Sendirian Berhad, Tasek Ind' Estate, Lot 11, Tasek Square, Ipoh, Perak. Tel (05) 4-555.
 King Musical Inds. Sdn. Bhd., Lot 5, Jalan 13/2, Petaling Jaya, Selangor. Tel: (03) 52-118. Mng. Dir.: Ng Lian Chin; Gen. Mgr.: Ng Ay Vin. (Rec. only)
 Panda Inds. Sendirian Berhad, Kamunting Ind' Estate, Taiping, Perak. Tel: 822-246.
Int'l branch: USA, Spectrotape.
 U N I Ent. Sdn. Bhd., 290 Jalan Raja Laut, Kuala Lumpur. Tel: (03) 923-252. Cable: UNIGOH. Telex: 31341. Mng. Dir.: S.S. Goh; Gen. Mgr.: Peter S.C. Goh; Sales Mgr.: Colin Edmonds; Office Mgr.: E.K. Su.

TAPE CUSTOM DUPLICATORS TAPE PACKAGING & LABELING

Anca Musical Sdn. Bhd., 58 Jalan Midah 1, Taman Midah, Cheras, Kuala Lumpur. Tel: 612-031. Mng. Dir.: Wong Kim Leng.
 Emitape (Malaysia) Sdn. Bhd., 1 Lorong Haji Taib Satu, Kuala Lumpur 02-07. Tel: (03) 924133, 924261, 924392. Cable: EMITRON, Telex: 30682. Mng. Dir.: M. Comerford; Gen. Mgr.: Jenny Thong.
Audio: 8-tr., cassette.
 Golden Voice Musical Inds. Sendirian Berhad, Tasek Ind' Estate, Lot 11, Tasek Square, Ipoh, Perak. Tel (05) 4-555.
Audio: 8-tr., cassette & open reel.
 King Musical Inds. Sdn. Bhd., Lot 5, Jalan 13/2, Petaling Jaya, Selangor. Tel: (03) 52-118. Mng. Dir.: Ng Lian Chin; Gen. Mgr.: Ng Ay Vin.
 U N I Ent. Sdn. Bhd., 290 Jalan Raja Laut, Kuala Lumpur. Tel: (03) 923-252. Cable: UNIGOH. Telex: 31341. Mng. Dir.: S.S. Goh; Gen. Mgr.: Peter S.C. Goh; Sales Mgr.: Colin Edmonds; Office Mgr.: E.K. Su. (PKG)

● supplies

CARTRIDGE & CASSETTE PARTS

U N I Ent. Sdn. Bhd., 290 Jalan Raja Laut, Kuala Lumpur. Tel: (03) 923-252. Cable: UNIGOH. Telex: 31341. Mng. Dir.: S.S. Goh; Gen. Mgr.: Peter S.C. Goh; Sales Mgr.: Colin Edmonds; Office Mgr.: E.K. Su.
Audio: All plastic parts.

EMPTY CARTRIDGES, CASSETTES & REELS

Anca Musical Sdn. Bhd., 58 Jalan Midah 1, Taman Midah, Cheras, Kuala Lumpur. Tel: 612-031. Mng. Dir.: Wong Kim Leng.
 Panda Inds. Sendirian Berhad, Kamunting Ind' Estate, Taiping, West Malaysia. Tel: (05) 822-246, 823-499. Cable: PANDATAPE.
Int'l branch: USA, Spectrotape.
Audio: Cassette.
 U N I Ent. Sdn. Bhd., 290 Jalan Raja Laut, Kuala Lumpur. Tel: (03) 923-252. Cable: UNIGOH. Telex: 31341. Mng. Dir.: S.S. Goh; Gen. Mgr.: Peter S.C. Goh; Sales Mgr.: Colin Edmonds; Office Mgr.: E.K. Su.
Brand name: UNI-ET Mar.

JACKETS & SLEEVES LABELS

Golden Voice Musical Inds. Sendirian Berhad, Tasek Ind' Estate, Lot 11, Tasek Square, Ipoh, Perak. Tel (05) 4-555.
 King Musical Inds. Sdn. Bhd., Lot 5, Jalan 13/2, Petaling Jaya, Selangor. Tel: (03) 52-118. Mng. Dir.: Ng Lian Chin; Gen. Mgr.: Ng Ay Vin.
 U N I Ent. Sdn. Bhd., 290 Jalan Raja Laut, Kuala Lumpur. Tel: (03) 923-252. Cable: UNIGOH. Telex: 31341. Mng. Dir.: S.S. Goh; Gen. Mgr.: Peter S.C. Goh; Sales Mgr.: Colin Edmonds; Office Mgr.: E.K. Su. (Labels only)

POLYETHYLENE BAGS

Golden Voice Musical Inds. Sendirian Berhad, Tasek Ind' Estate, Lot 11, Tasek Square, Ipoh, Perak. Tel: (05) 4-555.

RECORD PROCESSING MACHINERY

U N I Ent. Sdn. Bhd., 290 Jalan Raja Laut, Kuala Lumpur. Tel: (03) 923-252. Cable: UNIGOH. Telex: 31341. Mng. Dir.: S.S. Goh; Gen. Mgr.: Peter S.C. Goh; Sales Mgr.: Colin Edmonds; Office Mgr.: E.K. Su.
Chief product: Presses.
Brand name: Finebit.

discomoda

YOUR WAY TO VENEZUELA

THE LARGEST AND MOST
EXPERIENCED RECORD
DISTRIBUTOR GIVES YOU NOW
ACCESS TO THE GROWING
VENEZUELAN MARKET.

A hand is shown pointing towards a green map of Venezuela. Below the map, several vinyl records are arranged in a curved path, leading from the bottom left towards the hand. The background is a solid blue color.

SEND YOUR CATALOGUE
AND SAMPLES TO:
DISCOMODA
Apartado Postal 3402
Caracas 101-Venezuela.

Tif: 497491
Cables: DISCOMODA

Licensees for:
AMPRO (USA), GAMMA
(México), HAPPY FACE
(U.K.), SATRIL (U.K.), PYE
(U.K.), RKM (Belgique),
PENNY FARTHING (U.K.)
and RIFI (Italy).

• CUTTING • PLATING • PRESSING • TAPE DUPLICATING
• DESIGN AND ARTWORK • PRINTING AND LITHOGRAPHY
• PROMOTION • DISTRIBUTION

• Branch office in Colombia:
DISCOMODA DE COLOMBIA LIMITADA
Av. Caracas, No. 4665, Bogotá, Colombia.



RIGO TOVAR

No. 1
en México

Distribuido por:
Discos y Cintas
Melody S. A.



TAPE, RAW & BLANK LOADED

Agfa Carat, see East Asiatic.
Agfa Stereochrom, see East Asiatic.
Agfa Videochrom, see East Asiatic.
Ampex, see Eastland.
Anca Musical Sdn. Bhd., 58 Jalan Midah 1, Taman Midah, Cheras, Kuala Lumpur. Tel 612-031 Mng Dir Wong Kim Leng.
Audiopak, see Emitape.
Capitolpak, see Emitape.
East Asiatic Co. Ltd., PO Box 354, 84 Jalan Ampang, Kuala Lumpur. Tel 25121 Telex 246.
Audio: Blank—compact-cassette, open reel, raw—cassette, broadcast, studio.
Video: Cassette, open reel.
Brand names: Agfa Carat, Agfa Stereochrom, Agfa Videochrom.
Eastland Trading Co., 301 Jalan Pekeliling, Kuala Lumpur 17-01. Tel: 25-302 Cable: EASTLAND. Sales Mgr: Wong Boon Sam. (Importer/Exporter)
Reg'l headquarters: Singapore.
Audio: Cassette, open reel.
Brand name: Ampex.
Emitape (Malaysia) Sdn. Bhd., 1 Lorong Haji Taib Satu, Kuala Lumpur 02-07. Tel (03) 924133, 924261, 924392 Cable EMITRON. Telex 30682 Mng Dir: M Comerford; Gen. Mgr.: Jenny Thong. (Blank only)
Audio: 8-tr., cassette.
Brand names: Audiopak, Capitolpak, Emitape.
Greencorp, see UNI.
Panda Inds. Sendirian Berhad, Kamunting Ind'l Estate, Taiping, West Malaysia. Tel (05) 822-246, 823-499. Cable PANDATAPE. (Blank only)
Int'l branch: USA, Spectrotape.
Audio: 8-tr. & cassette.
U N I Ent. Sdn. Bhd., 290 Jalan Raja Laut, Kuala Lumpur. Tel (03) 923-252 Cable: UNIGOH. Telex 31341. Mng. Dir.: S.S. Goh; Gen. Mgr.: Peter S.C. Goh; Sales Mgr.: Colin Edmonds; Office Mgr.: E.K. Su.
Audio: 8-tr., cassette.
Brand name: Greencorp.

TAPE DUPLICATING & PROCESSING EQUIPMENT

Eastland Trading Co., 301 Jalan Pekeliling, Kuala Lumpur 17-01. Tel: 25-302 Cable: EASTLAND. Sales Mgr: Wong Boon Sam. (Importer/Exporter)
Reg'l headquarters: Singapore.
Audio: Duplicators.
Brand names: Ampex, Pentagon.
U N I Ent. Sdn. Bhd., 290 Jalan Raja Laut, Kuala Lumpur. Tel (03) 923-252 Cable: UNIGOH. Telex 31341. Mng. Dir.: S.S. Goh; Gen. Mgr.: Peter S.C. Goh; Sales Mgr.: Colin Edmonds; Office Mgr.: E.K. Su.
Audio: Duplicators.
Brand name: Ed-Pic/Recordex.

TAPE PACKAGING & LABELING EQUIPMENT & SUPPLIES

U N I Ent. Sdn. Bhd., 290 Jalan Raja Laut, Kuala Lumpur. Tel (03) 923-252 Cable: UNIGOH. Telex 31341. Mng. Dir.: S.S. Goh; Gen. Mgr.: Peter S.C. Goh; Sales Mgr.: Colin Edmonds; Office Mgr.: E.K. Su.

● accessories manufacturers

Golden Voice Musical Inds. Sendirian Berhad, Tasek Ind'l Estate, Lot 11, Tasek Square, Ipoh, Perak. Tel (05) 4-555.
Product: Carrying & storage cases.
Panda Inds. Sendirian Berhad, Kamunting Ind'l Estate, Taiping, West Malaysia. Tel (05) 822-246, 823-499. Cable PANDATAPE.
Product: Head cleaners.
U N I Ent. Sdn. Bhd., 290 Jalan Raja Laut, Kuala Lumpur. Tel (03) 923-252 Cable: UNIGOH. Telex 31341. Mng. Dir.: S.S. Goh; Gen. Mgr.: Peter S.C. Goh; Sales Mgr.: Colin Edmonds; Office Mgr.: E.K. Su.
Product: Tape carrying & storage cases, cleaners, cloths & brushes, head cleaners & demagnetizers, leader & splicing tape.

● store fixtures & merchandising aids manufacturers

Panda Inds. Sendirian Berhad, Kamunting Ind'l Estate, Taiping, West Malaysia. Tel (05) 822-246, 823-499. Cable PANDATAPE.
Product: Tape display racks.
U N I Ent. Sdn. Bhd., 290 Jalan Raja Laut, Kuala Lumpur. Tel (03) 923-252 Cable: UNIGOH. Telex 31341. Mng. Dir.: S.S. Goh; Gen. Mgr.: Peter S.C. Goh; Sales Mgr.: Colin Edmonds; Office Mgr.: E.K. Su.
Product: Tape display racks.

MEXICO

Population: 69,500,000.
Rate of exchange: \$1 (US) 22.65 pesos.
No. of homes with record players: 3,500,000.
Holidays: January 1, February 5 (Promulgation of the Constitution), March 21 (Birthday of Benito Juarez), May 1 (Labor Day), May 5 (Cinco de Mayo), September 15 & 16 (Independence Day), October 12 (Columbus Day), November 20 (Anniversary of the Revolution), December 25.

RECORDS & TAPE:

Records & Pre-recorded tape sold domestically (retail value): 1978—\$250,000,000.

RECORDS:

Records, record blanks & pre-recorded media imported from USA: 1977—\$1,326,226.
Records exported to USA: LP's 1978—205,807 units. Singles EP's & blanks 1978—303,733 units.
Average retail price per record: LP's—\$3.00; EP's—\$1.25; singles—\$.75.
Stereo sales: 60% of total.
Quadraphonic sales: 3% of total.
Record club sales: 3% of total.
Discounting: Rare.
Type of distribution: Manufacturer-to-retailer system predominates. One rack jobber, 4 one stops & 1 club account for the remainder of the distribution.
Type of promotion: Radio & tv concerts are the most important.
Jukeboxes: 25,000.

TAPE:

Market: The cassette market continues to grow rapidly.
Average retail price per tape: 8-tr. & cassette—\$3.00.
Import sales: No pre-recorded tape is imported.

RADIO STATIONS:

No. of stations 908; 798 AM, 210 FM.

TELEVISION STATIONS:

No. of channels 25, 100% in color.

Marv Fisher

● record & tape manufacturers / distributors / importers

A C (Discos) (Central de Grabaciones), Mayorazgo 83, Col. General Anaya, Mexico, 13, D.F. Tel (905) 534-3370. Dir Gen. Carlos Gomez Barrera. Gen. Mgr.: Jose Antonio Zavala; Sales Mgr.: Rolando Islas; Admin. Dir.: Horacio Calderon.
Labels: (Owned) Clasica, Especial, Kabah, Palenque, Tulum.
A M S Recs. SA (Fabrica de Discos), Jerico 64, Mexico, D.F. Tel (905) 760-3441.
Acapulco, see Musart.
Accion, see Coro.
Allegria SA (Discos), Xochicalco 242-2, Mexico 12, D.F. Tel (905) 543-2470.
Int'l rep.: USA (Fama).
America (Discos), Av. Chapultepec 57, 2nd fl., Mexico, 7, D.F. Tel (905) 578-8022. Telex 1775799. Gen. Dir.: Jose Mantecón.
Angel, see EMI-Capitol.
Archiv, see Polydor.
Arcoris Musical, see Centro Musical de Tijuana.
Ariel, see Mexicanos.
Ariola, see Discolibro. (SEE ADVERTISEMENT)
Audioton SA (Discos), Allende 233, Mexico 16, D.F. Tel (905) 527-6478. (Licensed to Gas)
Labels: (Owned) Audioton, Beca.
Avon, see Coro.
Beca, see Audioton.
Belart, see Polydor.
C B S / Columbia Int'l SA, Av. 16 de Septiembre 784, Naucalpan. Tel (905) 576-0333. Cable: COLRECORD. Pres. Jose Manuel Villarreal P.; VP & Gen. Mgr.: Armando de Llano Arana; Sales Mgr.: Arturo Valdes de la Pena, Mktg. Mgr.: Raul Bejarano Teja. A&R Dir.: Manuel Montoya.
Labels: (Owned) CBS, Epic, Harmony, Okeh, Sultana; (licensed domestic) Dimeca; (licensed foreign) Bethlehem, Blue Sky, Buena Vista, Calla, Caribou, Fredy, Full Moon, Gamble, Hot Wax, Invictus, Memo, Monument, Mums, Nemperor, Philadelphia Int'l, Portrait, Ranch, Sound Stage 7, TK, T-Neck, TSOP, Zarape (all USA).
Int'l reps.: Worldwide (CBS Int'l) except USA (Caytronics).
Camden, see RCA.
Capitol, see EMI-Capitol.
Cara, see Grever.
Carlos SA (Discos), J. M. Correa 285-F, Esquina Coruna, Col. Viaducto-Piedad, Mexico 13, D.F. Tel (905) 526-1347.
Cash, see Grever.
Centro Musical de Tijuana SA, PO Box 292, San Ysidro, Calif. 92073, USA; 917 Constitucion Ave., Tijuana, B.C. Tel (903) 385-1322. Pres.: Luis B. Alonso, VP: Tessa Alonso; Sales Mgr.: Manuel Magdaleno C.
Labels: (Owned) Arcoris Musical, Rainbow Music; (distributed) Alhambra, Arcano, Arriba, Ariola, CBS, Capitol, Caytronics, Coco, Columbia, Fama, Fania Int'l, Fiesta, Fuentes, Gala, Gamma, Hispavox, Latin Int'l, Melody, Miami, Montilla, Musart, Nova Vox, Peerless, Polydor, Pronto, Raff, RCA, Safari, Sonido Int'l, Super Sonido.
Int'l rep.: USA (Fiesta).
Chain, see Guitarra.
Cisne Raff SA (Discos) (IFPI), Calle Carracci 64, Mexico 19, D.F. Tel (905) 563-2800. Pres.: Raul Fichai; Gen. Mgr.: Ramon Martinez Duran; Sales Mgr.: Ignacio Aguilar de la Torre; Promo. & Publ. Rafael Fachi Jr.
Int'l branch: USA, Raff Recs.
Labels: (Owned) Cisne, Diablo, Gaviota, Hot Rock, Raff; (licensed domestic) Cronos; (licensed foreign) Anahuac (USA), Dark (Venezuela), Disc Jockey (Argentina), Hurricane (USA), Mex Melody (USA), Moveplay (Spain), Nippon Columbia (Japan), Norteno (USA), Playboy (USA), Ric (USA), SISA (Nicaragua).
Int'l rep: Nicaragua (SISA).
Cladrjo SA (Discos), Miraflores 823, Mexico 13, D.F. Clasica, see AC.

Clave, see Gamma
 Colibri, see Sonomedios
 Corito, see Coro
 Coro SA (IFPI), SA, Bahia de Perula 80, Mexico 17, D.F. Tel. (905) 531-2900 Pres. Federico Riojas, Gen. Mgr. Gloria Oliveros, Pub. & Promo. Dir. Jaime Sanchez Rosalido
Labels: (Owned) Accion, Avon, Corito, Coro
Int'l reps.: Central America (Fonica in Guatemala), Argentina (Microfon), Bolivia (Heriba), Chile (Sochem-EMI), Colombia (Fuentes) Ecuador (IFESA), Guatemala (Fonica), Peru (Infopesa), USA (Safari), Uruguay (Renvar), Venezuela (BASF Discorona)
 Cronos SA (Discos), Av. Obregon 1824, Guadalajara, Jal. Tel. (9136) 18-63-84 (Licensed to Cisne)
 D C M, see Discos & Cintas Melody
 D E L A (Director de la Coordinacion & Explotacion de artista & repertorio para Latinoamerica), Av. Ejercito Nacional 209, 4th fl., Mexico 5 D.F. Tel. (905) 531-1524/7030 Cable GRAMMAPHON Telex. (017) 74520, 71227 Dir. Andre Toffel, (Liaison office for Polydor & Phonogram group of companies in Latin America)
 D G, see Polydor
 Diabolo, see Cisne
 Diana, see Gamma
 Dimeca, see CBS/Columbia
 Dimsa, see Mexicanos
 Discobolo, see Discos & Cintas Melody
 Discolibro SA (IFPI), Ave. de las Fuentes 41-A, 4th fl., Tecamachalco, Mexico, D.F. Tel. (905) 589-8400 Cable ARIOMEX Gen. Mgr. Fernando Hernandez, Sales Mgr. Hector Mendoza, Adv. & Promo. Mgr. Sergio Blanchet
Home office: Germany, Ariola Eurodisc
Labels: (Represented) Ariola America (USA), Ariola World, Belter (Spain), Bronze (UK), Eurodisc (France), Microfon (Argentina), Musiza (Germany), Sire (USA), Springboard (USA), Tomato (USA), Victoria (Colombia), Virgin (UK)
Int'l reps.: Central America (Dideca), Argentina (Microfon), Bolivia (Lauro), Colombia (Sonolux), Dominican Republic (Discomundo), Ecuador (Fadisa), Peru (FTA), USA (Caytronics), Uruguay (APSA), Venezuela (Cordica)
 Discos & Cartuchos de Mexico SA, see Discos & Cintas Melody
 Discos & Cintas Melody SA (IFPI), Lago Chalco 122, Mexico 17, D.F. Tel. (905) 250-1499 Cable MELMEX, Pres. Jose Ignacio Morales Perea, Gen. Mgr. Victor Marquez Mar., Sales Mgr. Antonio Maza Brito
Labels: (Owned) DCM, Discobolo, Melody (licensed) Durium (Italy), Fenix (Ecuador), Movieplay (Spain), Nova Vox (USA), Sonolux (Colombia), Vanguard (USA)
Int'l reps.: Central America (Dideca), Colombia (Sonolux), Spain (Movieplay), USA (Caytronics-Mericana), Venezuela (La Discoteca)
 El Dorado, see Producciones Musicales
 E M I-Capitol de Mexico SA de CV (IFPI), Rio Balsas 49, Mexico 5, D.F. Tel. (905) 525-1700 Cable CAPRECORDS

Gen. Dir. Roberto Lopez, Promo. & Pub. Rosa Maria Esquivel
Labels: (Owned) Angel, Capitol, EMI, Odeon, Seraphim, (licensed) A&M (USA), Arista (USA), Motown (USA), Private Stock (USA)
Int'l reps.: Worldwide (EMI group), Bolivia (Dueri), Central America (Dideca), Colombia (CBS), Ecuador (IFESA), Peru (IEMPSA), USA (Latin Int'l), Venezuela (Los Ruices)
 Eco, see Peerless
 Epic, see CBS/Columbia
 Erre, see Guitarra
 Especial, see AC
 F A (Discos), Revillagigedo 96-405, Mexico 1, D.F. Tel. (905) 510-2595
 Fiel, see Industria Disquera Mexicana
 Fiesta (Discos), Av. Antonio de Mendoza 1099, Mexico, B.C. Tel. (903) 8-13-88
Int'l rep.: USA (Fogata)
 Flama, see Gas
 Fonomex SA, Apdo. M-9496, Mexico 1, D.F. Tel. (905) 539-0961, 532-2083 Cable FONOMEX Dir. Miguel Moreno Franco, Gen. Mgr. Carlos E. Moreno, Sales Mgr. Esteban Alarcon
Labels: (Owned) Fonomex, Galaxia, Ja-Ja, Karma, Somma, Stereo Star, (licensed) Orbita (Colombia) Sideral (Germany), TR (USA)
Int'l reps.: Costa Rica, Guatemala, Honduras, Nicaragua, Panama, San Salvador (all Lyra), USA (TR), Venezuela (Suramericana)
 Fontana, see Polydor
 Galaxia, see Fonomex
 Gamma SA (IFPI), Apdo. 7762 Zone 1, Emerson 304, 1st fl., Mexico 5, D.F. Tel. (905) 545-6735 Cable GAMMADISC Telex 1772424, Pres. Jose M. Vidal Zapater, Gen. Mgr. Carlos J. Camacho, Int'l Luis M. Moyano
Labels: (Owned) Clave, Diana, Gamma, Golondrina, (represented) AVI (USA), Amadeo (Austria), Arion (France), Asylum (USA), Atlantic (USA), BWD (UK), Butterfly (USA), CTI (USA), Copacabana (Brazil), Delphine (France), Discomoda (Venezuela), Elektra (USA), Erato (France), Everest (USA), Fama (USA), Fantasy (USA), Golden Sands (USA), Hallmark (UK), Hispavox (Spain), Hungaroton (Hungary), JDC (USA), MM (France), Mastropiero (Argentina), Nonesuch (USA), Parachute (USA), Pausa (USA), Pickwick (USA), Pye (UK), RKM (Belgium), Reprise (USA), Supraphon (Czechoslovakia), Symphony Tone (Austria), Trova (Argentina), 20th Century (USA), Warner Bros. (USA), West Side (USA)
Int'l reps.: Argentina (Microfon), Australia (Festival), Bolivia (Lauro), Brazil (Gravacoes Eletricas), Central America (Dideca), Chile (Quatro), Colombia (Codiscos), Ecuador (IFESA), Peru (El Virrey), Spain (Hispavox), USA (West Side), Uruguay (Palacio de la Musica), Venezuela (Disco de Moda) (SEE ADVERTISEMENT)
 Gas-Norteno, see Gas
 Gas SA (Discos), Av. de los 100 Metros 1201, Mexico, D.F.

Tel. (905) 754-3403 Pres. Guillermo Acosta; VP Jesus Acosta; Promo. & Pub. Laura Acosta
Int'l branch: USA
Labels: (Owned) Flama, Gas, Gas-Norteno, Inter-Gas, (licensed domestic) Audioton, (licensed foreign) Beverly (Spain), Dicesa (El Salvador), Famoso (Ecuador), Gema (USA), Infopesa (Peru), Mundo (Dominican Republic), Orbe (Colombia), TK (Argentina), Velvet (Venezuela)
Int'l reps.: Brazil (Chantecler, Fermata), Peru (Infopesa), Venezuela (Velvet)
 Gaviota, see Cisne
 Golden, see Juventa
 Golondrina, see Gamma
 Gomez Dist., Apdo. 1395, Mexico 1, D.F. Contract Jorge Gomez Label (Represented) Stinson (USA)
 Grabaciones Mexicanas SA Veterinarios 16, Mexico 8, D.F. Tel. (905) 582-9362
Label: (Owned) Grabamex
 Grabamex, see Grabaciones Mexicanas
 Grever Producciones SA, Yauatepec 107, Mexico 11, D.F. Tel. (905) 286-0599 Cable GREVERINT Pres. Charles Grever, Gen. Mgr. Angel Hernandez
Home office: USA, A-Side Dist. g
Labels: (Owned) Cara, Cash, Lado A
 Guitarra SA (Discos), Nilo 50, Mexico 16, D.F. Tel. (905) 527-4549, Dir. Luis Alberto San Martin
Labels: (Owned) Erre, Guitarra, (licensed domestic) Chain, (licensed foreign) Ansonia (USA), Dial (Spain), Everest (USA), Musidisc (Brazil), Project 3 (USA), Sonet (Sweden)
Int'l reps.: Argentina (Parnaso), Guatemala (Dideca), Spain (Dial, Marfer), USA (Parnaso), Venezuela (Duplica)
 Harmony, see CBS/Columbia
 Heliodor, see Polydor
 Helix (Discos & Cintas), Olivar 29, Mexico 19, D.F. Tel. (905) 563-0100 Gen. Dir. Casimiro Flores, Promo. & Pub. Andrea Cordova
 Hot Rock, see Cisne
 I G L E, see Sonido y Ritmo
 Industria Disquera Mexicana SA, C. Central Sur 385, Mexico 15, D.F. Tel. (905) 355-0570
Labels: Fiel, Tono
 Inter-gas, see Gas
 Ja Ja, see Fonomex
 Juventa (Ed. Musical), Tonala 194-G, Mexico 7, D.F. Tel. (905) 574-1278 Pres. & Gen. Mgr. Rosamaria Gonzalez Romero, VP. Jorge Batalla Salgado, A&R Rafael de Paz Gonzalez
Labels: (Owned) Golden, Juventa, (represented) Ar-mex (USA)
 Kabah, see AC
 Karma, see Fonomex
 Karussell, see Polydor
 Lado-A, see Grever
 Libelula, see Sonomedios
 M G M, see Polydor

Discos musart



DISCOS MUSART, S. A.
 P. O. Box 17503 México, D. F. MEXICO
 TELS.: (905) 399-66-00 — 527-01-00
 TELEX: 17-71493

Magneto, see Sonomedios.
 Malibu (Discos), Palma Nte. 315-115, Mexico 1. D.F. Tel (905) 512-4202
Labels: (Owned) Malibu, Serape.
 Maya, see Mexicanos.
 Melody, see Discos & Cintas Melody. (SEE ADVERTISEMENT)
 Mercury, see Polydor
 Mexicanos (Discos) SA/Orfeon Videovox SA (IFPI), Alce Blanco 26, San Bartolo, Nautcalpan. Tel (905) 576-8300/1500. Pres. Rogerio Azcarraga.
Int'l branch: USA, Orfeon.
Labels: (Owned) Ariel, Dimsa, Maya, Orfeon, Premier, Studio. **(represented)** Carrere (France), Dalida (France), Fonografica Espanola (Spain), International Shows (France), Music Hall (Argentina), Pye (UK), Sabu (Argentina), Sonolux (Colombia).
Int'l reps.: Argentina (Music Hall), Central America (Indiana), Colombia (Sonolux), Japan (Teichiku), Peru (El Virrey), Spain (Movieplay), Venezuela (Dark).
 MUSA SA (Discos) (IFPI), Av. Cuitlahuac 2335, Mexico 16, D.F. Tel: (905) 527-0100/0020. Pres.: Eduardo L. Baptista; Gen. Mgr.: Eduardo A. Baptista; Admin. Dir.: Francisco J. Migoya; Int'l Mgr.: Andreas Baptista.
Labels: (Owned) Acapulco, Musart, Norteno, Oasis, Trebol; **(licensed)** Alshire Int'l (USA), Audio-Musik (Germany), Baby (Italy), Barclay (France), Bovema Negram (Netherlands), Buddha (USA), Can't Stop (USA), Carrere (France), Creole (UK), Crescendo (USA), DLI (USA), Dila (Guatemala), Durium (Italy), Egrem (Cuba), Elver (Belgium), Gapoca (USA), Golden Sands (USA), Jupiter (Germany), Marouani (France), Novola (Spain), Claude Pascal (France), Penny Farthing (UK), Petco Int'l (Peru), Prelude (USA), Ramex (USA), Riviera (France), Road Show (USA), Symphony Tone (Switzerland), This Record Co. (UK), Vogue (France), Zafiro (Spain) Zagora (France). **(distributed—not licensed)** DLV
Int'l reps.: Argentina (Sicamericana), Belgium (Vogue), Bolivia (Discolandia Dueri), Chile (EMI), Colombia (Codicodis, Discomoda), Dominican Republic (Distribuidora Dominicana), Ecuador (IFESA), France (Vogue), Guatemala (Dila), Luxembourg (Vogue), Netherlands (Vogue), Peru (IEMPSA), Spain (Zafiro), USA (Musical Recs. Dist. of America), Venezuela (La Discoteca). (SEE ADVERTISEMENT)
 Norteno, see Musart.
 Oasis, see Musart.
 Odeon, see EMI-Capitol.
 Okeh, see CBS/Columbia.
 Omega, see Son'Art.
 Orfeon, see Mexicanos.
 Patenque, see AC.
 Peerless SA (Fabrica de Discos) (IFPI), Laguna de Mayran 232, Mexico 17, D.F. Tel: (905) 531-3320, 545-7215. Cable: PEERLESS. Telex: (017) 77606. Exec. Pres.: Heinz Klinckwort; Gen. Dir.: Leo Porias; Gen. Mgr.: Peter Ulrich; Ass't Mgr.: Jurgen Ulrich; Sales Mgr.: Oscar Najera; Int'l Dir.: Frank J. P. Segura; Int'l Mgr.: Octavio Rubio; Promo. & Pub. Mgr.: Guillermo Arriaga
Labels: (Owned) Eco, Peerless; **(licensed)** Azteca

(USA), Decca (UK), Del Valle (USA), Direction (Canada), Fuentes (Colombia), IHP (France), London (USA), Onix (Ecuador), Palacio (Venezuela), Prism (USA), R&N (USA), Richmond (UK), Seeco (USA), Starbright (USA), Telefonken (Germany), Turnabout (USA), Virrey (Peru), Vox (USA), West End (USA).
Int'l reps.: Bolivia (Imperio), Chile (Philips), Colombia (Fuentes), Costa Rica (India), Dominican Republic (Guarachita), Ecuador (Fadisa), Peru (El Virrey), USA (Sunshine), Venezuela (Palacio de la Musica). (SEE ADVERTISEMENT)
 Philips, see Polydor.
 PolyGram SA de CV, Apdo 21-069, Av. Miguel Angel de Quevedo 531, Mexico 21, D.F. Tel (905) 554-1422. Cable: GRAMMOPHON. Telex: (017) 74520. Mng. Dir.: Klaus Petermann; Comm'l Mgr.: Reinhard Kruska; Promo. & Pub.: Herbe Pompeyo.
Home office: Germany
Labels: (Owned) Archiv, Belart, DG, Fontana, Heliodor, Karussell, MGM, Mercury, Philips, Polydor, Spectrum, Vertigo, Verve; **(represented)** Alhambra (Spain), Casablanca (USA), Chrysalis (UK), Egrem (Cuba), MCA (USA).
Int'l reps.: Chile (Philips), Colombia (Philips), Ecuador (Fadiscos), Guatemala (Dideca), USA (Velvet), Worldwide (Polygram group).
 Premier, see Mexicanos.
 Producciones Musicales SA, Xochicalco Nte. 38-1, Mexico 12, D.F. Tel (905) 530-6595.
Label: El Dorado.
 Promart SA, Angel Urzaa 428-3, Mexico 12, D.F. Tel: (905) 559-7524.
 Promofon (Promotora Fonografica), Calle de la Colima 25-B, Mexico 7, D.F. Tel (905) 514-7941. Owner Gabriel Gonzalez de la O.; Gen. Mgr.: Guillermina Lozano.
 R C A SA de CV, Av. de Cuitlahuac 2519, Col. Xochimanca, Mexico 16, D.F. Tel: (905) 527-6020. Pres. & Dir. Gen.: Louis Coultolenc; Gen. Mgr.: Guillermo Infante; Sales Mgr.: Jose Martin del Campo. Artistic & Creative Mgr.: Renato Lopez M.; Promo. Mgr.: Bernardo Garza.
Labels: (Owned) Camden, RCA; **(represented)** Casablanca (USA), Hansa (Germany), Mellow (Germany), Millennium (USA), Polar (Sweden), Roadshow (USA), Salsoul (USA), Talpro (USA), Windsong (USA).
Int'l reps.: Bolivia (Prodisco), Chile (IRT), Colombia (Sonolux), Costa Rica (Dicesa), Dominican Republic (Caribe), Ecuador (Fadisa), El Salvador (Dicesa), Guatemala (Dicesa), Honduras (Dicesa), Panama (Dicesa), Peru (Fabricantes Tecnicos Asociados), Trinidad (International Rec'g), Uruguay (American Prods.), Venezuela (Cordica).
 Raff, see Cisne.
 Rainbow Music, see Centro Musical de Tijuana.
 Regis, see Son'Art.
 Rex (Discos), Norte 75, No. 2537, Mexico 16, D.F. Tel: (905) 399-2779. Pres. & Gen. Mgr. Jorge Acosta
 Sasiain SA (Discos), Segovia 40, Col. Alamos, Mexico 13, D.F. Tel: (905) 530-5612, 538-4596.
 Serape, see Malibu.
 Seraphim, see EMI-Capitol.

Somma, see Fonomez.
 Son'Art SA (Discos), Lago Hielmar 26, Mexico 17, D.F. Tel (905) 531-8100. Pres. Teodoro Mantecon Olavarrieta; Comm'l Mgr.: Bernardo Gonzalez Bernaldez.
Labels: (Owned) Son'Art, Omega, Regis; **(represented)** Dinsa (Peru), Discophon (Spain), Flash (Spain), Fonica (Guatemala), Global (Argentina), Imperial (Venezuela), King (Japan), Kubaney (USA), Malveta (Argentina), Onda Nueva (Panama), Tal (Colombia), Tropical (Colombia), Vega (France).
Int'l reps.: Argentina (Global), Colombia (Tropical), Guatemala (Fono Industrial), Panama (Onda Nueva), Peru (DINSA), Spain (Flash), USA (Kubaney).
 Sonido Y Ritmo SA, Chiapas 31, Mexico 7, D.F. Tel: (905) 564-7211/6863. Gen. Dir.: Jorge Iglesias; Gen. Mgr.: Fernando Iglesias; Sales Mgr.: Pedro Baston; Admin. Mgr.: Rosamaria Manzano Silva
Labels: (Owned) IGLE; **(represented)** Alegre, Fania, International, Tico, Vaya (all USA) Carosello (Italy), Victor (Japan).
 Sono medios SA, Av. Vallarta 2590, Guadalajara, Jal. Tel (9136) 16-56-10. Gen. Dir.: Alejandro Diaz Romo; Gen. Mgr.: Robert A. Dubin West
Labels: (Owned) Colibri, Libelula, Magneto.
 Spectrum, see Polydor.
 Stereo Star, see Fonomez.
 Studio, see Mexicanos.
 Sultana, see CBS/Columbia.
 Tono, see Industria Disquera Mexicana.
 Trebol, see Musart.
 Tulum, see AC.
 Vertigo, see Polydor.
 Verve, see Polydor.
 Zodiaco SA (Discos), J.J. Herrera 98, Mexico 14, D.F. Tel (905) 577-8179.

● music publishers

Aberbach de Mexico SA, see Grever.
 Acapulco Music SA, see Edimusa
 Acuariana, see Intersong.
 Adriana (Ed.), see Intersong.
 Aguival, see Mexicana de Musica
 Alfa Music, Playa Tecoluitla 452, Col. Marte, Mexico, D.F. Tel (905) 579-7830/1211
 Alma Musical, see Intersong.
 Amac, see PHAM.
 America SA (Ed. Musical), Av. Chapultepec 57, 2nd fl., Mexico 7, D.F. Tel: (905) 578-8022. Telex: 1775799.
 Gen. Dir.: Jose Mantecon.
 Ana Musical SA, see Geminis.
 Arsa (Ed.), see Intersong
 Beechwood de Mexico SA de CV (SACM), Rio Balsas 49, Mexico 5, D.F. Tel: (905) 525-1700, 511-3742. Cable: BEECHMEX. Gen. Mgr.: Arq. Jose G. Cruz Ayala.
Int'l firms represented: ATV (UK, USA), Baboo (France), Big Pig (UK), Black Bull (USA), Continental (Peru), EMI group (worldwide), Flavius (USA), France Etoile (France), Intro/Hansa/Meisel (USA), Jobete (USA), Kiss (USA), Kipahulu (USA), Lupus (USA), MPL (UK), Naco (USA), Perren Vibes/Bull Pen (USA), Pink Floyd (UK), Queen (UK), RFT (USA), Red Bus/Our Music (UK), Rocca (USA), Rolling Stones (UK), Rondor group (UK, USA), Screen Gems/Colgems (USA), Tree Int'l (USA), World Copyright (UK).
Int'l reps.: Colombia (Ecomus), Peru (Continental), worldwide (EMI group).
 Blanco Musical, see Intersong.
 Bolero Musimex, see Mexicana de Musica
 Boni Collazo Eds. Musicales, Apdo. 9982, Administracion de Correos 1, Mexico 1, D.F.
 Brambila Musical Mexico SA, Av. Cuitlahuac 2305, Mexico 17, D.F. Tel: (905) 527-8383. Cable: MUSBRAM. Gen. Mgr.: Rogelio Brambila Pelayo, 2nd VP - J. Eleonor Alexander.
Int'l firms represented: Bourne (USA), Campbell Connelly (UK), Conedisa (Peru), Walt Disney (USA), Ecomus (Colombia), Notable (USA), Alfredo Perrotti (Argentina), Portable (USA), Andrew Scott/Helena (USA).
Int'l reps.: Argentina (Alfredo Perrotti), Colombia (Ecomus), Peru (Conedisa, SADRAM), Spain (Mendaur), USA (Songs of Mexico), Venezuela (Alfonso Sanchez Lopez).
 Buendia Musical, see Intersong.
 C S B/Mexico, c/o Ariola, Sierra Mojada 330, Mexico 10, D.F. Contact: Wolfgang Straub
Int'l firm represented: Copyright Serv. Bureau (USA).
 Cada Latinoamericano SA, see Mexicana de Musica.
 Camarena Musical SA, Laguna de Mayran 258, 2nd fl., Mexico 17, D.F.
 Campel SA, see Mexicana de Musica.
 Capricornio (Ed.), see Intersong.
 Cefuma SA, see Mexicana de Musica.
 Chapultepec Ed., see Rimo.
 Compositor de Cuba (Ed.), Regina 43, Rm. 201, Mexico 1, D.F. Tel: (905) 585-3163.
 Corsorcio Musical SA, see Mexicana de Musica.
 Coro SA (Ed.), Bahia de Perula 80, Mexico 17, D.F. Tel: (905) 531-2900. Dir. Federico Riojas.
 J. Cory de Mexico, see Intersong.
 Demetrio (Ed. Mus.), see Intersong.
 Discolibro SA, Ave. de las Fuentes 41-A, 4th fl., Tecamachalco, Mexico, D.F. Tel: (905) 589-8400. Cable: ARIOMEX.
 Discorama SA, see Edimusa.
 Do Mi Sol (Ed.), see Intersong.
 E M E X Publicidad Musical, see Hnos. Marquez.
 E M H A, see Intersong.
 E M L A S A (Ed. Musical Latino Americana SA), Guillermo Prieto 76, Mexico 4, D.F. Tel (905) 592-4966. Gen. Mgr.: Mario de Jesus
Int'l firms represented: Acuff-Rose (USA), Alvorada (Brazil), Apolo (Argentina), Arlequin (Brazil), Big Seven (USA), Big Three (USA), Bandom (USA), Burlington (UK), Champion (USA), Charing Cross (USA), Claridge (USA), Curci (Italy), Duchess (USA), Edimusica (Colombia), Leo Feist (USA), Glaser (USA), Hastings (USA), Hispavox (Spain), Interworld (USA), Irmaos Vitale (Bra-

THE FASTEST GROWING COMPANY IN MEXICO



WE RECOGNIZE OUR SUCCESS TO OUR SUPER-STARS

ESTELA NUÑEZ ROCIO DURCAL
 DENISE DE KALAFE EDNITA NAZARIO
 JUAN GABRIEL JOSE JOSE CARLOS LARA
 SOCIOS DEL RITMO LOS SEPULTUREROS
 CHICO CHE Y LA CRISIS
 AND OUR REPRESENTED CATALOGUES



- zil, Leeds (USA), MCA (USA), Metric (USA), Miller (USA), Morro (USA), Northern (USA), Orbe (Venezuela), Orbita (Argentina), Planetary Nom (USA), Ricordi (Italy), Robbins (USA), Shamley (USA), Spanka (USA), Sugar-music (Italy), Travis (USA), United Artists (USA), Val-group (USA), Vogue (USA).
- E M I** (Ed. Mexicana de Musica Int'l) SA, Mariano Escobedo 166, 1st & 2nd fls., Mexico 17, D.F. Tel: (905) 545-6940. Contact: Ramon Paz.
Int'l firms represented: Alpha, Ardmore, Artist, Audicon, Camarillo, Cedarwood, Continental, Crodcast, Cur-nar, Emily, Fox Gimbel, General, Malaco, Miyako, Peer-Southern, Porgie, Regent group, Romance & Ding Dong, Sheryl/Kimbel, Terrace, Vanle, Venice, Virginia, Warner Bros. group.
- E M R I S A** (Eds. Musicales & Representaciones Int'l SA), Xochicalco 242-2, Mexico 12, D.F. Tel: (905) 543-2470.
Int'l rep.: USA (LAFCAP)
- Edimusa** (Editora Musical Musart SA), Av. Cuatlahuac 2327, Mexico 16, D.F. Tel: (905) 399-3833 Cable MU-SART. Dir. Gen. Eduardo A. Baptista Lucio; Gen. Mgr.: Alberto Vega Aranda.
Int'l firms represented: Chrysalis (UK), Compass (UK), Discorama (Spain), Fermata (Brazil), Dick James group (UK), Ivan Mogull (USA), Morning (Canada), Notas Magicas (Spain), Prelude/Trumar-Phylmar (USA), Prodemus (Colombia), Stirling-McQueen (UK)
Int'l reps.: Argentina (Relay), Belgium (New Music), Brazil (RCA), Canada (Vander), Colombia (Prodemus), Spain (Discorama/Piramide), USA (Vander), Venezuela (Universal).
- Ed. Musical Latino Americana SA**, see EMLASA
Emroth SA, see Mexicana de Musica.
Estrada (Ed. Mus.), see Intersong.
Estrella Musical SA, see Edimusa.
Face (Promotora) (BMI), Revillagigedo 96-405, Mexico 1, D.F. Tel: (905) 510-2595
Fetuchni Music, see Intersong.
Fresa Mexicana (Ed.), see Intersong
Gamma SA (Eds. Musicales), Apdo. 7762, Zone 1, Emerson 304, Mexico 5, D.F. Tel: (905) 545-6735 Cable GAM-MADISC Telex (017) 72424 Admin. Mario de Jesus (Also see EMLASA).
Int'l firms represented: Ariston (Italy), CAM (Italy), CTI (USA), Callon-Love (USA), Delphine (France), Equinox (USA), Far Out (USA), Garrett (USA), Gesterne (USA), Hispavox (Spain), Intervox (Belgium), Jackson (USA), RKM (Belgium), Televis-Gabric (Italy), Valentine (Belgium)
Int'l reps.: Portugal & Spain (both Hispavox)
Gas Musical SA, see Intersong
Gemins Musical SA, Schiller 228-1, Col. Polanco, Mexico 5, D.F. Tel: (905) 250-7228, 545-4784 Gen. Dir. Enrique Marquez
Int'l firm represented: Parnaso (Argentina).
Gil, see Intersong
Grever Int'l, Yau-tepec 107, Col. Condesa, Mexico 11, D.F. Tel: (905) 286-0599. Pres.: Charles Grever.
Int'l firms represented: Handy Bros., T.B. Harms, MAM, Edward B. Marks, G. Schirmer, A. Schroeder (all USA).
Int'l reps.: Colombia (Exitos), Germany (Rudolf Slezak), Spain (Discoram), USA (Golden Sands Ent's.).
Guadalajara Musical SA, Av. Vallarta 2590, Guadalajara, Jal. Tel: (9136) 16-56-10. Pres.: Alejandro Diaz Romo; Gen. Mgr.: Alfredo Romo Barron.
Guitarra (Eds. Musicales), Nilo 50, Mexico 16, D.F. Tel: (905) 527-4549. Dir.: Luis Alberto San Martin.
I C (Ed.), see Intersong.
Impulsora Musical Bajacaliforniana, Av. Antonio De Mendoza 1099, Mexicali, B.C. Tel: (903) 8-13-88.
Intersong SA, Ejercito Nacional 209, 3rd fl., Col. Veronica Anzures, Mexico 5, D.F. Tel: (905) 531-7030 Gen. Mgr.: Alfonso Garcia Santillana.
Int'l firms represented: Artemis (Netherlands), Aurelius (USA), Chappell (UK), Clanort (Argentina), Egrem (Cuba), Intersong Int'l (Germany), Kece (USA), Leftover (USA), Leros (France), Up With People (USA), Will-anson (USA).
Int'l rep.: Worldwide (Intersong Int'l).
Juventa (Ed. Musical), Tonalá 194-G, Mexico 7, D.F. Tel: (905) 574-1278. Pres. & Gen. Mgr.: Rosamaria Gonzalez Romero.
Int'l firms represented: Canciones del Mundo (Spain), Korn (Argentina), Melodias (Ecuador), Nueva Ola (Panama), Rhyma (Colombia), Smart (Argentina), Susy (Italy), Tone (Japan), Unimusic (Japan)
Int'l reps.: Argentina (Korn), Colombia (Rhyma), Japan (Tone), Spain (SGAE).
Lagab (Eds. Musicales) SA, see Intersong
Latino Americana SA (Ed. Musical) see EMLASA.
Leo Musical SA, see EMLASA.
Liana Musical SA, see Gemins.
M U S A, see Melodias.
Mantram (Ed.), see Intersong.
Hnos. Marquez SA, Av. Chapultepec 48, Rm. 102, Mexico 1, D.F. Tel: (905) 588-0102/2516. (Affiliated with Edimusa).
Int'l reps.: Argentina (Korn), Colombia (Ecomus), Ecuador (SADRAM), USA (Golden Sands)
Mato (Ed. Mus.), see Intersong.
Melodias Universales SA (MUSA), Darwin 142, 3rd fl., Mexico 5, D.F. Tel: (905) 514-5977, 511-9821
Int'l firms represented: Airhond, Combine, Gambi, Ben Ghazi, Roger Miller, Peer-Southern, Resaca, Royal Oak (all USA).
Int'l rep.: USA (Melody Lane).
Mexicana de Musica SA de CV (Ed.) (Edim.) Poniente 48, No. 3902, Col. Xochimilca, Mexico 16, D.F. Tel: (905) 527-0320/8769. Cable MEXRCA Telex 00173867. Pres. Louis Coutoulen; Gen. Mgr. Juan del Rey y Lenero. Copyright Mgr.: Rafael Farias de la Torre; Int'l Dept. Jorge Enrique Perez Flores.
Int'l firms represented: Antisia (USA), CAM (USA), Cherry Lane (USA), Cherry Wood (USA), Clandatec (USA), Desert Moon (USA), EMP (USA), Editio Music (Hungary), Green Mountain (USA), Quincy Jones (USA), Kidada (USA), Ladysmith (USA), Ledacian (USA), Nick-O-Vat (USA), Oakfield (USA), Plein Soleil (France), Polar (Sweden), Rocket (UK), State (USA), Street (UK), Triple O (USA), Union Songs (Sweden), Yellow Brick Road (USA).
Int'l reps.: Argentina (Relay), Australia (Associated Music), Belgium (New Music), Bolivia (Boliviana), Brazil (RCA), Canada (Sunbury/Dunbar), Ecuador (ORAMA), El Salvador (Edicesa), France (RCA), Germany (Cyclus), Italy (RCA), Japan (Global), Peru (Prodemsa), Spain (RCA), UK (Sunbury), Venezuela (Unimusic).
Ivan Mogull Latina SA de RL, see Edimusa.
Moises (Ed.), see Intersong
Mundo Musical SA, Puebla 286, 1st fl., Mexico 7, D.F. Tel: (905) 533-2080. Pres.: Jose Manuel Villarreal; Gen. Mgr.: Manuel Cervantes Rivera.
Int'l firms represented: April/Blackwood (worldwide), Blue Seas/Jac (USA), Edimusa (Peru), Lowery (USA), Edward B. Marks (USA), Melograf (Argentina), Mundo Musical (Brazil), 20th Century (USA).
Int'l reps.: Argentina (Melograf), Brazil (Mundo Musical), Costa Rica (Mundo Musical), Ecuador (SADRAM), Peru (Edimusa), Venezuela (Mundo Musical), worldwide (April/Blackwood).
Musica de Mexico (BMI, SACM), Esteva 26A, Mexico 18, D.F. Tel: (905) 515-3590/6484. Pres. & Gen. Mgr.: Dario A. Zorzano.
Int'l reps.: Germany (Melodie der Welt), Japan (Unimusic), Spain (SGAE).
Musical del Bravo (Ed.), Otumba 342, Col. Mitras Centro, Monterrey, N.L. Tel: 48-00-38.
Musicales & Representaciones Int'l SA (Eds.), see EMRISA.
MusinoVA SA (Ed.), Calle Carracci 64, Mexico 19, D.F. Tel: (905) 563-2800
Int'l firms represented: Bleu Blanc Rouge (France), Dundee (USA), Mangione (Brazil), Petko (USA), Striking (USA).
Musirodo (Ed.), see Intersong.
N P A (Nueva Promotora Artistica), see Intersong
Orfeon SA (Ed.), Av. Universidad 1273, Mexico 12, D.F. Tel: (905) 534-6054/52
P H A M (Promotora Hispano Americana de Musica) SA, Mariano Escobedo 166, 2nd fl., Mexico 17, D.F. Tel: (905) 545-6855, 531-3190.
P I M (Productores Independientes de Mexico) SA, Insurgentes Sur 1722-1002, Mexico 21, D.F. Tel: (905) 534-4386. (Also see Mexicana de Musica).
Piscis Musical, see Intersong
Planeacion Musical SA, see Gemins.
Predisa, see Promociones & Ediciones.
Productores Independientes de Mexico, see PIM.
Promociones & Ediciones Int'l SA (Predisa), Mariano Escobedo 201, Mexico 17, D.F. Tel: (905) 545-7215. Cable: PEERLESS. Gen. Dir.: Heinz Klinckwort; Gen. Mgr.: Peter Ulrich.
Int'l reps.: Brazil (Euterpe), Colombia (Edimusa),

TIME IS MONEY IN MEXICO DON'T WASTE YOUR TIME



CONTACT: FABRICA DE DISCOS PEERLESS, S. A.

**250-60-38 531-33-20 545-72-15
TELEX 1777 606 FDPME**

Spain (Canciones del Mundo), USA (Golden Sands)
 Promusica, see Intersong
 Rampel, see Intersong
 Reyna Musical, see Intersong
 G. Ricordi & Co. Inc., Paseo de la Reforma 481-A, Mexico 5, D.F. Tel (905) 553-7506/7451
 Rimo SA (Eds. Musicales), Emerson 150, 4th fl., Mexico 5, D.F. Tel (905) 250-1196 Gen. Mgr. Humberto Rios.
 Int'l reprs.: Central America (Dimasi), Spain (Tracis), USA (Mexican Music Center).
 Roaga SA (Promociones & Eds.) Revillagigedo 96-202, Mexico 1, D.F. Tel (905) 518 4311
 Romantico Musical SA, see Geminis
 Rumont Musical, see Intersong
 Sagitiano Musical, see Intersong
 Selene (Ed.), see Intersong
 Sol Musical, see Intersong
 Son'Art SA, Lago Hielmar 26, Mexico 17, D.F. Tel (905) 531-8101 Pres. Teodoro Mantecon Olavarrrieta, Comm'l Mgr. Bernardo Gonzalez Bernaldez
 Sugar Music de Mexico SA, see EMLASA
 T R O-Essex de Mexico SA, see Melodias Universales
 Temas Musicales SA, Segovia 40, Col. Alamos, Mexico 13, D.F. Tel (905) 530-5612, 538-4596
 Tijuana Rose, see Intersong
 United Artists Music de Mexico SA, see EMLASA
 Wagner & Levin, see PHAM
 Yalis (Eds. Mus.) SA, see Mexicana de Musica
 Yoloxochitl (Ed. Mus.), see Intersong
 Z-19 Mexico, see Musica de Mexico
 Zariv Music, see Intersong

● services

ASSOCIATIONS & PROFESSIONAL ORGANIZATIONS

Amprofon (Asociacion Mexicana de Productores de Fonogramas A.C.), Guanajuato 65, Mexico 7, D.F. Tel (950) 574-7411
 Camara Nacional de la Industria de Radio & Television, Paseo de la Reforma 445, 9th fl., Mexico 5, D.F. Tel (905) 511-6186, 533-2528 Cable CAMINRA
 E M M A C (Ed. Mexicanos de Music A.C.), Melchor Ocampo 212, 3rd fl., Mexico 5, D.F. Tel (905) 546-4277 Pres. Alfonso Garcia S., Mgr. Dario Zorzano

DESIGN & ARTWORK

C B S / Columbia Int'l SA, Av. 16 de Septiembre 784, Naucalpan, Tel (905) 576-0333 Pres. Jose Manuel Villareal P., VP. Armando de Llano Arana
 Coro SA, Bahía de Perula 80, Mexico 17, D.F. Tel (905) 531-2900 Pres. Federico E. Riojas, Gen. Mgr. Gloria Oliveros
 Guitarra SA (Discos), Nilo 50, Mexico 16, D.F. Tel (905) 527-4549 Dir. Luis A. San Martin, Gen. Mgr. Marcelo Gorraez G., Gen. Admin'r. Eduardo Zarate
 Laminados & Acabados Especiales SA, Olivar 27, Colonia Al-

fonso XIII, Mexico 19, D.F. Tel (905) 563-9625 Pres. Rafael Ficachi Gonzalez, Admin. Mgr. Raul J. Castro, Prod'n Mgr. Marco Antonio Renteria, Sales Mgr. Alma Ficachi de Rivas
 Mexicanos SA (Discos)/Orfeon Videovox SA, Alce Blanco 26, San Bartolo, Naucalpan Tel (905) 576-4935 Pres. Rogelio Azcarraga
 Musart SA (Discos), Apdo. 17503, Zone 17, Av. Cuauhahuac 2335, Mexico 16, D.F. Tel (905) 527-0100/0020 Pres. Eduardo L. Baptista, Gen. Mgr. Eduardo A. Baptista, Sales Mgr. Francisco Llopis, Int'l Mgr. Andreas Baptista
 Promofon (Promotora Fonografica), Calle de la Colima 25-B, Mexico 7, D.F. Tel (905) 514-7941 Owner Gabriel Gonzalez de la O., Gen. Mgr. Guillermina Lozano
 R C A SA de CV, Av. Cuauhahuac 2519, Col. Xochimanca, Mexico 16, D.F. Tel (905) 527-6020 Pres. & Dir. Gen. Louis Couttolenc, Sales Mgr. Jose Martin del Campo, Promo Mgr. Bernardo Garza
 Sonomedios SA, Av. Vallarta 2590, Guadalajara, Jal. Tel (9136) 16-56-10 Pres. Alejandro Diaz, Gen. Mgr. Alfredo Romo, Sales Mgr. Enrique Corvera. (Record only)

LICENSING ORGANIZATIONS, MUSIC

Coro SA, Bahía de Perula 80, Mexico 17, D.F. Tel (905) 531-2900 Pres. Federico E. Riojas, Gen. Mgr. Gloria Oliveros
 S A C M (Sociedad de Autores & Compositores de Musica S de A), San Felipe 143, Colonia General Anaya, Mexico 13, D.F. Tel (905) 524-2104/2118 Cable COMPAS Pres. Consuelo Velazquez, Gen. Dir. Carlos Gomez Barrera, Int'l Dept. Head. Jose Luis Caballero (Performing rights)
 Sonomedios SA, Av. Vallarta 2590, Guadalajara, Jal. Tel (9136) 16-56-10 Pres. Alejandro Diaz, Gen. Mgr. Alfredo Romo, Sales Mgr. Enrique Corvera.

PLATING, PROCESSING & PRESSING PLANTS

C B S / Columbia Int'l SA, Av. 16 de Septiembre 784, Naucalpan Tel (905) 576-0333 Pres. Jose Manuel Villareal P., VP. Armando de Llano Arana
 Coro SA, Bahía de Perula 80, Mexico 17, D.F. Tel (905) 531-2900 Pres. Federico E. Riojas, Gen. Mgr. Gloria Oliveros
 E M I / Capitol de Mexico SA de CV, Rio Balsas 49, Mexico 5, D.F. Tel (905) 525-1700 Cable CAPRECORDS Gen. Dir. Roberto Lopez, Promo. & Pub. ROSA Maria Esquivel
 Guitarra SA (Discos), Nilo 50, Mexico 16, D.F. Tel (905) 527-4549 Dir. Luis A. San Martin, Gen. Mgr. Marcelo Gorraez G., Gen. Admin'r. Eduardo Zarate
 Helix (Discos & Cintas), Olivar 29, Mexico 19, D.F. Tel (905) 563-0110 Gen. Dir. Casimiro Flores, Promo. & Pub. Andrea Cordova (Pressing only)
 Laminados & Acabados Especiales SA, Olivar 27, Colonia Alfonso XIII, Mexico 19, D.F. Tel (905) 563-9625 Pres. Rafael Ficachi Gonzalez, Admin. Mgr. Raul J. Castro, Prod'n Mgr. Marco Antonio Renteria, Mgr. Raul J. Castro, Sales Mgr. Alma Ficachi de Rivas
 Matrices SA (Discos), Lago Chalco 122, Mexico 17, D.F. Tel (905) 250-1499 Cable MELMEX Pres. Jose Ignacio Morales Perea, Gen. Mgr. Enrique de Noriega S.
 Mexicanos (Discos) SA/Orfeon Videovox SA, Alce Blanco 26, San Bartolo, Naucalpan, Tel (905) 576-4935 Pres. Rogelio Azcarraga
 Musart SA (Discos), Apdo. 17503, Zone 17, Av. Cuauhahuac 2335, Mexico 16, D.F. Tel (905) 527-0100/0020 Pres. Eduardo L. Baptista, Gen. Mgr. Eduardo A. Baptista, Sales Mgr. Francisco Llopis, Int'l Mgr. Andreas Baptista
 Peerless SA (Fabrica de Discos), Laguna de Mayran 232, Mexico 17, D.F. Tel (905) 531-3320, 545-7215 Exec. Pres. Heinz Klinckwort, Gen. Dir. Leo Parias, Gen. Mgr. Peter Ulrich, Int'l Dir. Frank J.P. Segura, Int'l Mgr. Octavio Rubio
 Promofon (Promotora Fonografica), Calle de la Colima 25-B, Mexico 7, D.F. Tel (905) 514-7941 Owner Gabriel Gonzalez de la O., Gen. Mgr. Guillermina Lozano (Pressing only)
 R C A SA de CV, Av. Cuauhahuac 2519, Col. Xochimanca, Mexico 16, D.F. Tel (905) 527-6020 Pres. & Dir. Gen. Louis Couttolenc, Sales Mgr. Jose Martin del Campo, Promo. Mgr. Bernardo Garza

PRINTERS & LITHOGRAPHERS

C B S / Columbia Int'l SA, Av. 16 de Septiembre 784, Naucalpan Tel (905) 576-0333 Pres. Jose Manuel Villareal P., VP. Armando de Llano Arana
 Coro SA, Bahía de Perula 80, Mexico 17, D.F. Tel (905) 531-2900 Pres. Federico E. Riojas, Gen. Mgr. Gloria Oliveros
 Guitarra SA (Discos), Nilo 50, Mexico 16, D.F. Tel (905) 527-4549 Dir. Luis A. San Martin, Gen. Mgr. Marcelo Gorraez G., Gen. Admin'r. Eduardo Zarate
 I M Ed. SA, Sanctorum 86, Mexico 17, D.F.
 Laminados & Acabados Especiales SA, Olivar 27, Colonia Alfonso XIII, Mexico 19, D.F. Tel (905) 563-9625 Pres. Rafael Ficachi Gonzalez, Admin. Mgr. Raul J. Castro, Prod'n Mgr. Marco Antonio Renteria, Sales Mgr. Alma Ficachi de Rivas
 Mexicanos SA (Discos)/Orfeon Videovox SA, Alce Blanco 26, San Bartolo, Naucalpan Tel (905) 576-4935 Pres. Rogelio Azcarraga
 Musart SA (Discos), Apdo. 17503, Zone 17, Av. Cuauhahuac 2335, Mexico 16, D.F. Tel (905) 527-0100/0020 Pres. Eduardo L. Baptista, Gen. Mgr. Eduardo A. Baptista, Sales Mgr. Francisco Llopis, Int'l Mgr. Andreas Baptista
 Peerless SA (Fabrica de Discos), Laguna de Mayran 232, Mexico 17, D.F. Tel (905) 531-3320, 545-7215 Exec. Pres. Heinz Klinckwort, Gen. Dir. Leo Parias, Gen. Mgr. Peter Ulrich, Ass't Mgr. Jurgen Ulrich, Int'l Dir. Frank J.P. Segura, Int'l Mgr. Octavio Rubio
 R C A SA de CV, Av. Cuauhahuac 2519, Col. Xochimanca, Mexico 16, D.F. Tel (905) 527-6020 Pres. & Dir. Gen. Louis Couttolenc, Sales Mgr. Jose Martin del Campo, Promo. Mgr. Bernardo Garza. (Record only)

Stereo Jet de Mexico SA, Calle Dos 13-B, Naucalpan Tel (905) 576-6866 (Tape only)

RECORD PROMOTION

Promofon (Promotora Fonografica), Calle de la Colima 25-B, Mexico 7, D.F. Tel (905) 514-7941 Owner Gabriel Gonzalez de la O., Gen. Mgr. Guillermina Lozano
 Sonomedios SA, Av. Vallarta 2590, Guadalajara, Jal. Tel (9136) 16-56-10 Pres. Alejandro Diaz, Gen. Mgr. Alfredo Romo, Sales Mgr. Enrique Corvera.

TAPE CUSTOM DUPLICATORS
 TAPE PACKAGING & LABELING

The Audio and Video lines indicate the configurations which the firms duplicate. Companies which offer packaging and labeling of tape product are indicated by: (PKG) which appears after the main body of their respective listings.

A V Sistemas SA, Celaya 26, Mexico 11, D.F. Tel (905) 584-2044/3656 Gen. Mgr. Adolfo de la Huerta S., Ass't Mgr. Sergio Martinez M. (PKG)
 Audio: Cassette
 C B S / Columbia Int'l SA, Av. 16 de Septiembre 784, Naucalpan Tel (905) 576-0333 Pres. Jose Manuel Villareal P., VP. Armando de Llano Arana (PKG)
 Audio: 8-tr., cassette
 Coro SA, Bahía de Perula 80, Mexico 17, D.F. Tel (905) 531-2900 Pres. Federico E. Riojas, Gen. Mgr. Gloria Oliveros
 Audio: 8-tr., cassette
 Dupliscaset SA, Jose Vasconcelos 218, Mexico 11, D.F. Tel 553-12-06 286-14-97 Pres. Jose Ignacio Morales, Gen. Mgr. H. Eugenia de Betancourt, Sales Mgr. Robert J. Benitez
 Audio: 8-tr., 8-tr. quadraphonic
 E M I / Capitol de Mexico SA de CV, Rio Balsas 49, Mexico 5, D.F. Tel (905) 525-1700 Cable CAPRECORDS Gen. Dir. Roberto Lopez, Promo. & Pub. Rosa Maria Esquivel
 Audio: 8-tr., cassette
 Guitarra SA (Discos), Nilo 50, Mexico 16, D.F. Tel (905) 527-4549 Dir. Luis A. San Martin, Gen. Mgr. Marcelo Gorraez G., Gen. Admin'r. Eduardo Zarate
 Audio: Cassette
 Laminados & Acabados Especiales SA, Olivar 27, Colonia Alfonso XIII, Mexico 19, D.F. Tel (905) 563-9625 Pres. Rafael Ficachi Gonzalez, Admin. Mgr. Raul J. Castro, Prod'n Mgr. Marco Antonio Renteria, Sales Mgr. Alma Ficachi de Rivas
 Audio: Cassette
 Matrices SA (Discos), Lago Chalco 122, Mexico 17, D.F. Tel (905) 250-1499 Cable MELMEX Pres. Jose Ignacio Morales Perea, Gen. Mgr. Arturo Campero
 Audio: 8-tr., cassette
 Mexicanos SA (Discos)/Orfeon Videovox SA, Alce Blanco 26, San Bartolo, Naucalpan Tel (905) 576-4935 Pres. Rogelio Azcarraga
 Audio: 8-tr., cassette, open reel
 Musart SA (Discos), Apdo. 17503, Zone 17, Av. Cuauhahuac 2335, Mexico 16, D.F. Tel (905) 527-0100/0020 Pres. Eduardo L. Baptista, Gen. Mgr. Eduardo A. Baptista, Sales Mgr. Francisco Llopis, Int'l Mgr. Andreas Baptista
 Audio: 8-tr., cassette
 Peerless SA (Fabrica de Discos), Laguna de Mayran 232, Mexico 17, D.F. Tel (905) 531-3320, 545-7215 Exec. Pres. Heinz Klinckwort, Gen. Dir. Leo Parias, Gen. Mgr. Peter Ulrich, Ass't Mgr. Jurgen Ulrich, Int'l Dir. Frank J.P. Segura, Int'l Mgr. Octavio Rubio
 Promofon (Promotora Fonografica), Calle de la Colima 25-B, Mexico 7, D.F. Tel (905) 514-7941 Owner Gabriel Gonzalez de la O., Gen. Mgr. Guillermina Lozano
 Audio: Cassette
 Sonomedios SA, Av. Vallarta 2590, Guadalajara, Jal. Tel (9136) 16-56-10 Pres. Alejandro Diaz, Gen. Mgr. Alfredo Romo, Sales Mgr. Enrique Corvera.
 Audio: Cassette, open reel
 Sovi SA, Arquimedes 98, Mexico 5, D.F. Tel (905) 250-6000/6200 Dir. Gen. Oscar Rivero, Sales Mgr. Victor Hernandez Vieyra
 Audio: 8-tr., cassette, open reel
 Stereo Jet de Mexico SA, Calle Dos 13-B, Naucalpan Tel (905) 576-6866
 Audio: 8-tr., cassette, open reel

● supplies

EMPTY CARTRIDGES,

CASSETTES & REELS

Coro SA, Bahía de Perula 80, Mexico 17, D.F. Tel (905) 531-2900 Pres. Federico E. Riojas, Gen. Mgr. Gloria Oliveros
 Audio: 8-tr., cassette
 Brand names: Avon, Coro, Musik

JACKETS & SLEEVES
 LABELS

C B S / Columbia Int'l SA, Av. 16 de Septiembre 784, Naucalpan Tel (905) 576-0333 Pres. Jose Manuel Villareal P., VP. Armando de Llano Arana
 Coro SA, Bahía de Perula 80, Mexico 17, D.F. Tel (905) 531-2900 Pres. Federico E. Riojas, Gen. Mgr. Gloria Oliveros
 Mexicanos (Discos) SA/Orfeon Videovox SA, Alce Blanco 26, San Bartolo, Naucalpan Tel (905) 576-4935 Pres. Rogelio Azcarraga
 R C A SA de CV, Av. Cuauhahuac 2519, Col. Xochimanca, Mexico 16, D.F. Tel (905) 527-6020 Pres. & Dir. Gen. Louis Couttolenc, Sales Mgr. Jose Martin del Campo, Promo. Mgr. Bernardo Garza.

DISCOS GAMMA
 &
EDICIONES MUSICALES GAMMA

"most experienced company in promotion and distribution of international catalogs in Mexico"

P.O. Box 7762
 México 1, D.F.
 PHONE: 545-67-35
 CABLE: GAMMADISC
 TELEX:
 1772424 GAMMAME

RECORD PROCESSING MACHINERY

Mexicanos (Discos) SA/Orfeon Videovox SA, Alce Blanco 26, San Bartolo, Naucalpan, Tel. (905) 576-4935. Pres.: Rogelio Azcarra.

TAPE, BLANK LOADED & BULK RAW

Agfa-Gevaert de Mexico SA, Apdo. 7256, Mexico 1, D.F.; Ing. Zapadores 1, Naucalpan, Tel. 761-800. Telex: (017) 74479.

Audio: Blank—compact-cassette, open reel, raw—cassette, broadcast, studio.
Video: Cassette.
Brand names: Agfa Carat, Agfa Stereochrom, Agfa Videochrom.

Amplex de Mexico SA de CV, Div. Del Norte 1832, Col. Portales, Mexico 13, D.F. Tel. (905) 539-6870. Gen. Dir. Miguel A. Hernandez; Admin. Mgr.: Isaias Trujillo; Audio Prods. Sales Mgr.: M. Villela; Video Prods. Sales Mgr.: Oscar Luna; Tape Prods. Sales Mgr.: M. Santillana.

Audio: 8-tr., cassette, open reel.
Video: 1" open reel, 3/4" cassette, 1/2" EIAJ open reel, 1/2" EIAJ cartridge.

Aurex SA de CV, Calz. Tulyehualco 3370, Mexico 23, D.F. Tel. (905) 973-1233, 670-0277. Chm.: Federico Valdes. Gen. Mgr.: Ernesto Valdes; Sales Mgr.: Ramiro Gamboa.

Local branch: Av. Corona 181, Desp. 231, Tel. (903) 613-5474. Reg'l Mgr.: Ricardo de la Llave.
Audio: 8-tr., cassette, open reel.

Brand name: Amplex.

Avon, see Coro.
Coro SA, Bahia de Perula 80, Mexico 17, D.F. Tel. (905) 531-2900. Pres.: Federico E. Riojas; Gen. Mgr.: Gloria Oliveros. (Blank only)
Audio: 8-tr., cassette.

Brand names: Avon, Coro, In.

In, see Coro.
Montage Mexico SA, PO Box 244, Cuidad Ind'1 El Framboyan, Lotes 1, 2 & 3, Veracruz, Tel. 3-42-00. Gen. Mgr.: Raul Valenzuela Aguirre.
Audio: 8-tr., cassette, open reel.

Sovi SA, Arquimedes 98, Mexico 5, D.F. Tel. (905) 250-6000/6200. Dir. Gen.: Oscar Rivero; Sales Mgr.: Victor Hernandez Vieyra.
Audio: 8-tr., cassette, open reel.

TAPE DUPLICATING & PROCESSING EQUIPMENT

Amplex de Mexico SA de CV, Div. del Norte 1832, Col. Portales, Mexico 13, D.F. Tel. (905) 539-6870. Gen. Dir.: Miguel A. Hernandez; Admin. Mgr.: Isaias Trujillo; Audio Prods. Sales Mgr.: M. Villela; Video Prods. Sales Mgr.: Oscar Luna; Tape Prods. Sales Mgr.: M. Santillana.
Audio & Video: Recorders.

● accessories manufacturers

Amplex de Mexico SA de CV, Div. del Norte 1832, Col. Portales, Mexico 13, D.F. Tel. (905) 539-6870. Gen. Dir.: Miguel A. Hernandez; Admin. Mgr.: Isaias Trujillo; Audio Prods. Sales Mgr.: M. Villela; Video Prods. Sales Mgr.: Oscar Luna; Tape Prods. Sales Mgr.: M. Santillana.
Product: Head cleaners & demagnetizers, leader & splicing tape.

Aurex SA de CV, Calz. Tulyehualco 3370, Mexico 23, D.F. Tel. (905) 973-1233, 670-0277. Chm.: Federico Valdes. Gen. Mgr.: Ernesto Valdes; Sales Mgr.: Ramiro Gamboa.
Local branch: Av. Corona 181, Desp. 231, Tel. (903) 613-5474. Reg'l Mgr.: Ricardo de la Llave.
Product: Head cleaners & demagnetizers, leader tape.

Centro Musical de Tijuana SA, PO Box 292, San Ysidro, Calif. 92073, USA; 917 Constitution Ave., Tijuana, B.C. Tel. (903) 385-1322. Pres.: Luis B. Alonso, VP. Tessa Alonso, Sales Mgr.; Manuel Magdaleño C.
Product: Record & tape carrying & storage cases, cleaners, cloths, brushes, 45 rpm adapters, needles.

Coro SA, Bahia de Perula 80, Mexico 17, D.F. Tel. (905) 531-2900. Pres.: Federico E. Riojas; Gen. Mgr.: Gloria Oliveros.
Product: Tape carrying & storage cases, head cleaners & demagnetizers.

Sovi SA, Arquimedes 98, Mexico 5, D.F. Tel. (905) 250-6000/6200. Dir. Gen.: Oscar Rivero; Sales Mgr.: Victor Hernandez Vieyra.
Product: Leader tape.

● store fixtures & merchandising aids manufacturers

Coro SA, Bahia de Perula 80, Mexico 17, D.F. Tel. (905) 531-2900. Pres.: Federico E. Riojas; Gen. Mgr.: Gloria Oliveros.
Product: Record & tape display racks.

● jukebox manufacturers

Ami de Mexico SA, Calz. Tlatilco 239, Mexico 16, D.F. Tel. (905) 556-8611.
Fonografos Automaticos Evans SA, Via Dr. Gustavo Baz 49, Puente de Vigas, Mexico. Tel. 572-4744.

Industrias Nacionales de Sonido SA, Apdo. 22036, Calz. Mexico-Xochimilco 4861, Mexico 10, D.F. Tel. (905) 573-2413. Cable: ASTROINSSA. Telex: (017) 74282.
Local branch: La Feria SA, Rep. de Chile 7, Mexico 1, D.F. Tel. (905) 585-1311. (Importer only)
Brand name: Astrovox.
Manufacturera de Sinfonolas SA, Av. Jardin 330, Col. del Gas, Mexico 15, D.F. Tel. (905) 355-3199.
Sonata SA (Corp.), PO Box 22036, Mexico 22, Tel. (905) 573-2413. Pres.: David L. Romero Sr.; Gen. Mgr.: Raul C. Romero; Sales Mgr.: J. LaraValle.

NETHERLANDS

Population: 14,000,000.
Rate of exchange: \$1 (US) = 2 guilders.
Per capita income: \$5,345.
No. of homes with record players: 4,000,000.
Holidays: New Year's Day, Easter Monday, April 30 (Queen's Birthday), Ascension Day, Whitmonday, December 25 & 26.

RECORDS:

Records sold domestically including imports (retail value): LP's 1977—33,000,000 units, \$212,500,000; 1978—35,000,000 units, \$235,000,000; Singles 1977—11,000,000 units, \$27,500,000; 1978—14,000,000 units, \$35,000,000.
Average retail price per record: LP's—\$6.50; singles—\$2.50.

Stereo sales: 95% of total.
Quadraphonic sales: 0.1% of total.
Record club sales: 8% of total.
Discounting: Frequent.

Type of promotion: There are a few light programs on TV which are important to the promotion of records. The most important of these is the pop show TopPop, which plays the top 30 records weekly. Radio station Hilversum 3 is also important in promoting pop records.
Jukeboxes: 11,000.

TAPE:

Pre-recorded tape sold domestically including imports (retail value): Cassette 1977—4,500,000 units, \$35,000,000; 1978—5,500,000 units, \$40,000,000.

Market: Cassette sales continue to grow and cassettes are far more popular than 8-track cartridges.
Average retail price per tape: Cassette—\$7.75.

RADIO STATIONS:

No. of government 4.
Comment: Mi Amigo and Delmare operate offshore, outside Dutch territorial waters. Hilversum 1 has cultural programs & information; Hilversum 2, family-oriented programs; Hilversum 3, light & pop music; Hilversum 4, classical music only.

TELEVISION STATIONS:

No. of channels: 2 government, 95% color.
Comment: TV time is divided among 8 broadcasting companies with religious and cultural programming. Veronica, a former off-shore pop station, is the latest and smallest. The size of a company depends on the number of subscribing members.

MARKET ANALYSIS:

In terms of total sales, the industry in the Netherlands looks fine, with a 10 per cent growth over 1978. The problems lie in other areas, such as price stabilization and, of course, piracy, counterfeiting, and bootlegging—estimated to account for between 5 and 10 per cent of the overall turnover. Neither of the conventions of Rome and Geneva has been ratified, but STEMRA and NVPI, the Dutch branch of IFPI, conduct an impressive campaign to combat piracy, clean up the shops, and to bring as many cases to court as possible. We foresee a slight decrease in classical music sales, now around 12 per cent of the total, and an increase in sales of popular music from abroad—England, France, Germany, and the United States. It is becoming more and more difficult to produce, promote and sell local artists.

● record & tape manufacturers / distributors / importers

A R S I S, Steegstr. 18, 6041 EA Roermond, Tel. (04750) 1-36-98. (Record Distributor)

Ace of Clubs, see Decca.
Albersen & Co. BV (Muziekhandel), Gr. Hertoginnelaan 182, 4517 EV The Hague, Tel. (070) 45-60-00. Dir.: J. Albersen. (Distributor)
Alpa Recs., Tabaksweg 6, Elst, Tel. (08384) 17-34.

Arcade Recs. (Nederland) BV, Industrieweg 11, 4131 NK Vijan, Tel. (03473) 21-84. Telex: 40420. Gen. Mgr.: A. Seyssens; Adv. Mgr.: H. Luiten; Sales Mgr.: A.A. van Hoydonk.
Home office: England.
Labels: Arcade, Trent.

Archiv, see Polydor.
Argo, see Decca.
Ariola Benelux BV (IFPI), Kenastr. 1-3, 2011 MV Haarlem, Tel. (023) 31-92-90. Telex: 41385. Mng. Dir.: Wim Schipper; Deputy Mng. Dir.: Anton Witkamp; Sales Mgr.: Jaap Grooters.
Home office: Germany.
Labels: (Owned) Ariola, Baccarola Eurodisc. (distributed) Jupiter, Maritim, Veb; (licensed) ABC (USA), Al-

bion (UK), Anchor (UK), Blue Thumb (USA), Beserkley (UK, USA), Bronze (UK), Chiswick (UK), Chrysalis (UK, USA), Dot (USA), Fleet, Hansa, Impulse, (USA), Island (UK), Lifesong (USA), Manticore (UK), Shelter (USA), Tomato (USA), Virgin (UK), Westminster (USA).
Artone, see CBS.
Associated Artists Int'l BV, PO Box 37, Piet Heinstr. 4, Maarssen, Tel. (03465) 6-22-76. Gen. Mgr.: Joop Gerrets.
Asylum, see WEA Recs.
B E L Sound, Buurserstraat 356, Enschede, Tel. (053) 76-30-22.
B M G. Molenvlietsedijk, 23-25 Tholen, Tel. (01660) 3226.
Baccarola, see Ariola-Eurodisc.
Barclay Nederland NV (IFPI), Jacobus Pennweg 24, Hilversum, Tel. (035) 4-80-46. Telex: 43013. Dir.: B.R. Maassen. (Distributed by CNR).
Home office: France.
Labels: (Licensed) Barclay (France), Black & Blue (France), Blue Star (France), De-Lite (USA), Egg (France), Prelude (USA), Riviera (France).
Barrelhouse, see Martin A. van Olderen.
Basart Recs. Int'l BV (IFPI), PO Box 338, Flevolaan 41, Naarden, Tel. (02159) 4-62-66. Cable: EDITORAS. Telex: 43191. Mng. Dir.: Tony Berk, Bart Klimmert; Sales Mgr.: Bob Stoppelman, Label Mgrs.: Simon Mol, Vincent Klaus. Int'l Mgr.: Ton van den Bremer.
Int'l branch: Belgium.
Labels: (Owned) Goldstar, Groovy, Papillon, Park Polder, Redifusion, Tulip, (licensed) Acanta (Germany), Aura (UK), Butterfly (USA), Cantate (Germany), Durium (Italy), Fono (Germany), Lamb & Lion (USA), Project 3 (USA), Rainbow (UK), Request (USA), Sonet (UK), Turnabout (USA), Vox (USA).
Int'l rep.: Belgium (Inelco).
Herman Batalean Prods., Moerbeigarde 112, Zoetermeer, Tel. (070) 63-57-82. Gen. Mgr.: Herman Batalean; Sales Mgr.: Pieter I. Kieboom.
Labels: (Owned) Chapter 2, Esart.
Beltona, see Decca.
Benelux Music Inds., PO Box 70, 6000 AB Weert; Uilenweg 38, 6006 SK Weert, Tel. (04950) 3-56-40. Telex: 51285. Pres.: Johnny Hoes; Gen. Mgr.: Jacquie Hoes; Sales Mgr.: Adrian Hoes.
Labels: (Owned) Gnome, Kendari, Kilroy, Laudate, Lolre, Ojee, Starlet, Telstar, (distributed) Grand Gola, Mirasound, (represented) Beautiful Sunday (UK), Better Sounds (USA), Chart (USA), Hexagone (France), Hippo (Switzerland), Ronco (UK), Ronnex (Belgium), Shelby Singleton (USA), Spark (UK), Supertone (Germany), Starlet (Germany), Tempo (Germany), Wanted (UK).
Int'l reps.: Australia (Carinia), Austria (Turicophon), Brazil (Copacabana), Canada (Morning), Czechoslovakia (Supraphon), Germany (Ariola, EMI-Electrola, Polydor), Jamaica (Federal), Mexico (Polydor), Portugal (Rossil), Scandinavia (Euronett), South Africa (RPM), Spain (Belter), Switzerland (Turicophon), USA (Midland Int'l), Venezuela (Unimusic), Yugoslavia (Jugoton).
J Ph. Benson, PO Box 59, 7620 AB Borne, Tel. (05409) 41-24. Dir.: John Phillip Benson; Gen. Mgr.: A. Daphne Laanen.
Labels: (Licensed) Wim (USA), (distributed—not licensed) Avant (USA), Crystal (USA), Pandora (USA).
Bertus Distributie BV, Industrieweg 45-B, 2651 BC Berkel en Rodenrijs, Tel. (01891) 57-22. Telex: 26385 BETS. Dir.: Jan van der Linden; Gen. Mgr.: Bram Apon; Sales Mgr.: Almer Apon. (Distributor)
Blossom Recs., Valkenboslaan 180, The Hague, Tel. (070) 45-13-79.
Boem, see Durcco.
Boogie, see Martin A. van Olderen.
Born Free Prods., Albertus Perkestr. 35, Hilversum, Tel. (035) 4-77-49. Cable: PHONOGRAM. Mng. Dir.: Peter Koelewijn.
Bosheck Grammofoonplaten, PO Box 53, Aerdenhout, Tel. (035) 1-27-61. Owner: Willem Bosheck. Gen. Mgr.: H.R. Bosheck v.d. Laan.
Labels: (Owned) Kritos, Nevofoon, Onyx, Target, Traffic, (distributed) CPR, (represented) Alvorada (Portugal), Boosey & Hawkes (UK), Carioca (Portugal), Clave (Portugal), Copacabana (Portugal), Estudio (Portugal), Orfeu (Portugal), Rapsodia (Portugal), Roda (Portugal), Selected Sound (Germany), Telemusic (France), Unidisc (France).
Bovema Negram BV (IFPI), Bronsteweg 49, Heemstede, Tel. (023) 28-07-50. Telex: 41625. Dir.: Nico Geusebroek; Gen. Mgr.: Kees Baas.
Labels: (Owned) Bovema-Negram, His Master's Voice.
Brother Recs. Inc., Leidesgracht 49, Amsterdam 1013.
Home office: USA.
C B S Grammofoonplaten BV (IFPI), Stationsplein 82-84, Haarlem, Tel. (023) 31-94-10. Cable: COLRECORD. Telex: 41051. Gen. Mgr.: Allen Davis; Sales Mgr.: Will Nagel.
Home office: USA, CBS Int'l.
Labels: (Licensed domestic) Artone, (licensed foreign) A&M (USA), Arion (France), Bethlehem (USA), GTO (UK), CBS (USA), DJM (UK), Embassy (USA), Epic (USA), Inivictus (USA), Jet (USA), Monument (USA), Neighborhood (USA), Philadelphia Int'l (USA), Portrait (USA), TK (USA).
C C A, see Vista.
C I R, see PCMP.
C N R (BV Grammofoonplatenmaatschappij) (IFPI), Gouwezeenstr. 15, 1230 Weesp, Tel. (02940) 1-52-44. Cable: CENR. Telex: 12523. Gen. Mgr.: Ruud Wijenters; Repertory Dept.: Herman van der Zwan; Promo: Ron Mol.
Labels: (Owned) CNR, Injection, (licensed) AVI (USA), Acrobat (UK), Affinity (UK), Alte Werk (Germany), Aquarius (France), Barclay (France), Beggar's Banquet (UK), Black & Blue (France), Carrere (France), Casino (Canada), Deesse (France), De-Lite (USA), Egg (France), Melodia (USSR), Parsifal (Belgium) Prelude (USA), Riviera (France), Telefunken (Germany).
Int'l rep.: Germany (Teldec).
C P R, see Bosheck.
Canto di Vangelo, see Vista.
Capi (NV), Basisweg 38, Amsterdam, Tel. (020) 11-15-55.

- Labels: (Represented)** Musica Mundi, Musica Sacra. Capitol, see EMI-Bovema.
 Capri, see Durco.
 Carrere Holland BV, Gouwzeestr. 15, Weesp. Tel: (02940) 1-52-44. Telex: 12523. Mng. Dir.: Bart van de Laar; PR: Michel Damen. (Licensed to CNR)
 Chapter 2, see Herman Batelaan.
 Cinerec Supraphon-Holland NV, Frans Halslaan 2, Hilversum. Tel: (02150) 1-53-53, 4-94-38.
Label: (Licensed) Supraphon (Czechoslovakia).
 Circle, see Grammoservice.
 Collector Recs., PO Box 2296, 3000 CG Rotterdam. Tel: (010) 22-48-88.
Labels: (Owned) Collector, Unknown, White Label. Int'l reps.: Belgium (Monopole), France (Thonney), UK (Superdisc), USA (Down Home).
 Collector Series, see VIP.
 Commonwealth, see K-Tel.
 Condo, see Mike Vincent.
 Continental Sound, PO Box 81065, Rotterdam. Tel: (010) 21-10-98, 21-48-28. Pres.: Leen La Riviere; Gen. Mgr.: Mr. Zwarts; Sales Mgr.: Jan Daurlo.
Labels: (Owned) Free; (licensed) CS (USA), Catacombs (Canada) Janz Team (Germany); (distributed—not licensed) Abacus (Germany), Glory-Sound.
 Centre Point, see VIP.
 Coreco, see International Sound.
 D G, see Polydor.
 Dawn, see VIP.
 Decca Distributie BV (Hollandsche) (IFPI), PO Box 7104, Drenestr. 11, Amsterdam. Tel: (020) 44-08-88. Telex: 12038. Mng. Dir.: Bill Barents; Admin'r: Floor Wijngaard; Pop Prod. Mgr.: Jaap Hoitingh; Classical A&R: Hans Tecker; Mktg. Mgr.: Rob Edwards.
Labels: (Owned) Ace of Clubs, Argo, Baltona, Decca, Deram, Eclipse, London, L'Oiseau Lyre, Parrot, Rex, Rialto, Threshold; (licensed) Abkco, Big Sound, Brunswick, Commodore, Crossover, Hindsight, Jamie, Republic, Rumbleseat (all USA).
 Deram, see Decca.
 Desert-Moon, see VIP.
 Dial, see Diwa.
 Didi, see A.M. Girwar.
 Disco de Man-DDM Prods. BV, PO Box 214, 6190 AE Beek. Tel: (04402) 16-90. Dir.: Cees de Man.
Labels: (Owned) Golden Oldies Club, Klaver 4; (licensed foreign) Aristry (UK).
 Disco George, Termatistr. 17-3, Amsterdam. (Distributor)
 Disco Town, see Universe Prod'n.
 Disque Roermond BV, Hendriklaan 18, Roermond. Dir.: E. Kamzot. (Distributor)
 Diwa Recs., PO Box 612, 7550 AP Hengelo OV. Tel: (0540) 2-47-62. Dir.: Dick Waanders.
Labels: (Owned) Dial, Diwa; (licensed foreign) Folk Variety (Germany), Frog (UK), Lake Country (Switzerland), Olympic (USA), Rollin' Rock (USA), Route 66 (Sweden), Wix (USA); (distributed—not licensed) Baron (USA), Cowboy Carl (USA), Red Raven (Germany), Rockhouse (Netherlands), Sierra/Briar (USA), White Label (Netherlands).
 Doins, see Polydor.
 Dotan Recs., Rijnlanderweg 695, 2132 NK Hoofddorp. Tel: 1-32-85. Mng. Dir.: Micky Dotan. (Wholesaler).
 Double Pleais, see VIP.
 Durco (Dutch Rec. Co.) BV, Pampuslaan 45, 1380 AA Weesp. Tel: (02940) 1-53-21. Cable: RECMUS. Telex: 14409. Mng. Dir.: A.E. Palmans; A&R Mgr.: M.A.C. de Raaf; Mktg. Mgr.: A. van Nijffaten. Int'l Mgr.: C.V. Jansen.
 Branch: Hilversum, Luitgardeweg 20. Tel: (02150) 1-21-51.
Labels: (Owned) Boem, Capri, Durco, Elf Provincien, GIP, Halter, Scramble, Te Deum; (licensed) Audio Fidelity (USA), CTI (USA), Creole (UK), ECM (Germany), Gala (USA), Honeybee (USA), Immediate (UK), Japo (Germany), Joker (Italy), Kudu (USA), Music Control (France), Nems (UK), Penny Farthing (UK), Pilot (UK), Saar (Italy), Stiff (UK), Vega (France), Weekend (Belgium), Young Blood (UK), Zafiro (Spain).
 Int'l reps.: Austria (DGG), Belgium (Fonior), France (Sof-rassy), Germany (DGG), Luxembourg (Fonior), Switzerland (DGG).
 Evan Durlacher Audio-Visual Prod'n, Nagtglaslaan 18, Naarden. Tel: (02159) 4-27-60; Amsterdam Tel: (020) 24-37-81.
Labels: (Owned) Durlaphone, Obelisk, Pop Sound, Veronica.
 Durlaphone, see Evan Durlacher.
 Durob Audio, Grotestraat 18, 5437 AS Beers. Tel: (08850) 1-56-70. Telex: 41605. Pres.: Floortje van den Dungen.
Labels: ASI, American Gramophone, Century, Coherent Sound, Concord, EMI-Toshiba, Eastwind, Labyrinth, Merlin, Nautilus, Orinda, Philips, RVC, RCA, Romar, Salisbury, Sheffield Lab, Sonic Arts, Sound 80, Telarc, Trend, 2000 BC.
 Dutch Blues & Boogie Woogie Org., Maasdriehof 175, 1106 NG Amsterdam. Tel: (020) 96-11-11. Pres.: Martin van Olderen.
Labels: (Distributed—not licensed) Adelphi, Barrelhouse, Big Star, Blind Pig, Colt & Firmo, Lunar, Rounder, TK, Testament (all USA); JSP (UK).
 E & E, see International Rec. Dist'n.
 E M I Recs. Holland BV (IFPI), Bronsteweg 49, Heemstede. Tel: (023) 28-07-50. Telex: 41625. Mng. Dir.: Nico Geusebroek; Gen. Mgr.: Karen Hendriks; Sales Mgr.: Jan Gaasterlaad; Mktg. Mgr.: Richard Denekamp.
Labels: (Owned) Capitol, EMI; (licensed) Arista, Blue Note, Fantasy, Hispavox, Infinity, Intercord, Janus, Logo, MAM, MPS, MPS, Magnet, Motown, Passport, Private Stock, Purple, RAK, Rebel, Red Bus, Rocket, Rolling Stones, Savoy, Splash, Sunburst, Transatlantic, Triangle, Trojan, United Artists.
 E M I-EAR (European A&R, Prod'n-Mktg.-Promo.), PO Box 6106, Tulpenkade 1, Haarlem. Tel: (023) 31-95-18. Telex: 41902. Mng. Dir.: R. R. Kruijze; Gen. Mgr. & A&R Dir.: F.A.M. Jansen; Mktg. Mgr.: Dick Van Vliet.
 E M I Holland BV, Tulpenkade 1, Haarlem. Tel: (023) 31-93-80. Telex: 41257. Mng. Dirs.: B.J. van den Berg, Roel R. Kruijze; Ass't Dir. Mkts.: Kick Klimbie; Financial Dir.: L.A.P.A. Verhelst; Ass't Dir. Finances: J.C. La Grouw; Int'l Div. Mgr.: Theo Roos.
Note: EMI Holland BV is a holding company for the following firms: Anagon BV, Delta BV, EMI Recs. Holland BV, EMI Hifi BV, EMI-Holland Productie BV, Gramophonehouse BV, Bovema Negram BV.
 Eclipse, see Decca.
 Editio Laran, de Constant Rebecquest. 104, The Hague. Tel: (070) 45-89-17; Chief Exec.: Max Hallensleben; Sales Mgr.: C. H. Hallensleben.
Labels: (Owned) Editio Laran; (licensed domestic) Hallensleben.
 Int'l rep.: Germany (Mitur).
 Elektra, see WEA Recs.
 Elf Provincien, see Durco.
 Epigram Recs., v.d. Heimstr. 13, PO Box 3054, Delft. Tel: (015) 12-62-47.
 Esart, see Herman Batelaan.
 Eurodisc, see Ariola-Eurodisc & Sound-Prod's.
 Europeo Fono Club, 262 Singel, Amsterdam. Tel: (020) 23-71-95.
 Eurosound, see Vista.
 Festivo, see Vista.
 Fidelis, see Sound-Prod's.
 Flashlines BV, Catharinaland 11, The Hague. Tel: (070) 85-89-06. Telex: 31039. Mng. Dir.: Graham Neal. (Wholesaler/Importer/Exporter)
 Fleet Benelux, Kenastr. 3, Haarlem. Tel: (023) 31-35-43. Owners: Robert A. Aardse, Peter Meisel.
 Fontana, see Phonogram BV.
 Fountain Sound & Vision, Utrechtsestraat 105, Amsterdam. Telex: 33796. (Distributor)
 Free, see Continental Sound.
 G I P, see Durco.
 Gamtex, PO Box 10175, Raamsteeg 1, Amsterdam. Tel: (020) 24-71-90. (Importer)
 A. M. Girwar, Pieter Bureling, Didi Recs.
Labels: (Owned) Didi, Old Gold.
 Glory Sound, Thorbeckstr. 7, Veenoord. Tel: (05915) 1273. (Licensed to Vista).
 Gnome, see Benelux.
 Golden Guinea, see VIP.
 Golden Hour, see VIP.
 Golden Lion Recs. BV, PO Box 181, Peerlkamp 5, Hilversum. Tel: (02150) 1-59-53. Chief Exec.: D. De Vilder.
 Golden Oldies Club, see Disco de Man.
 Goldstar, see Basart.
 Gorilla Recs. BV, Lange Pot 15a, The Hague. Tel: (070) 64-21-73. Telex: 32240.
 Gospel Music Int'l, PO Box 210, 6880 AE Velp. Tel: (085) 64-68-15. Chief Execs.: A.M. Everaars, P.S. Groeneveld, L. Pool.
 Grammoservice BV (IFPI), Spaarndamseweg 410-414, 2022 EA Haarlem. Tel: (023) 25-85-21. Telex: 41062. Deputy Dir.: P.E. Hertog; Gen. Mgr.: J.W. Assman; Sales Mgr.: T.A. van Holten.
Label: (Owned) Circle.
 Grand Gala, see Intermedia & Benelux Music.
 Groovy, see Basart.
 Haast Grammofoonplaten BV, PO Box 3246920, 2e Oosterparkstr. 243, Amsterdam. Tel: (020) 35-15-07. (Record Distributor/Importer/Exporter)
 Hallensleben, see Editio Laran.
 Halter, see Durco.
 Harlekin Holland BV, Kerkdijk 11, Westbrook (U). Tel: (03469) 44-44-45. (Licensed to Polydor)
 Havo Int'l, PO Box 9702, The Hague. (Exporter).
 Hees BV, Choorstr. 1-3-7, Delft. Tel: (015) 12-41-83.
 Hekre, see Henk Kreeftmeyer.
 Heliodor, see Polydor.
 Hep, see K-Tel.
 His Master's Voice, see Bovema Negram.
 David Hofstede Ents., Van Baerlestr. 77, 1071 AS Amsterdam. Tel: (020) 72-08-82.
 Alberto de Hond Music Import-Export BV, Roetersstr. 18a, Amsterdam. Tel: (020) 24-12-25, 22-96-23. Pres.: Alberto de Hond; VP: Mrs. V.J. de Hond.
 Hosat (Holland South America Trading), Noordeinde 105a, The Hague. Tel: (070) 46-51-22. Dir.: H.J. da Silva; Sales Mgr.: M. de Jong.
Labels: (Licensed) Alvares (France), Astree (France), Audite (Germany), Bis (Sweden), Calig (Germany), Caliope/Arpege (France), Carus (Germany), Claves (Switzerland), Colosseum (Germany), Corona (Germany), Jercklin (Switzerland), SFP (France), Studio Monastere (France), Tangent (UK), Valois (France).
 Hotspot, see Universe.
 Idee Sound, Koningsweg 15, Alkmaar. Tel: (072) 1-08-19. Gen. Mgr.: J.V. Doorn. (Distributor/Importer)
 Int'l branch: Spain.
 Impact, see Phonogram BV.
 Inelco Recs. & Tapes BV (IFPI), Turfsteckerstraat 63, 1463 GD Aalsmeer. Tel: (02977) 2-88-55. Telex: 14683. Mng. Dir.: Wim Brandsteder; Deputy Mng. Dir. Sales: Jaap Beutler; Deputy Mng. Dir. A&R: Edo A.L. Peuk.
Labels: (Owned) Lark; (licensed) Fania (USA), Word (USA); (distributed—not licensed) Basart (Netherlands), RCA (USA), VIP (Netherlands), Varagram (Netherlands).
 Injection, see CNR.
 Intermedia NV, Nassaulaan 46a, Baarn. Tel: (02154) 37-12.
Labels: (Owned) Grand Gala, Studio 33; (represented) Fass (Germany).
 Intermusic BV, PO Box 312, Eikbosserweg 114, 1200 AH Hilversum. Tel: (035) 4-41-40. Telex: 43897. Mng. Dir.: Cees van Zijveld.
 International Rec. Dist'n Amsterdam (IRDA), PO Box 1525, 1000 BM Amsterdam. Tel: (020) 93-62-49. Gen. Mgr.: Peter Rensen; Sales Mgr.: Paul Rodenhuis.
Labels: Owned: E&E, Moonbase, Zen.
 International Sound Retail, Regentesseelaan 69, 2562 CV, The Hague. Tel: (070) 45-33-00. Telex: 33796. Owner: Andre J. Fontijn; Gen. Mgr.: Jorita Uuyk; Sales Mgr.: R. Allen Jones.
Labels: (Distributed—not licensed) All Ears (USA), Bomp (USA), Coreco (Netherlands), Haast (Netherlands), Improvising Artists (USA), Kilgaron (UK), PBR Int'l (USA), Payola (USA), Plurex (Netherlands), Ralph (USA), Rhino (USA).
 Ivory Tower Recs., Tusveld 55, Bornerbroek. Tel: (05408) 261. Dir.: Fred Rootvelde; Gen. Mgr.: Angie Rootveld.
Labels: (Owned) Ivory Tower, NL.
 J J, see Oldway-Windmill.
 Jojo, see Oldway-Windmill.
 Jox, see Henk Kreeftmeyer.
 Jubal, see Vista.
 Jupiter, see Ariola-Eurodisc.
 K-Tel (Holland) BV, Oude Schipholweg 885, 2143 CD Boe-singhelede. Tel: (02505) 683, 474. Telex: 41199. Gen. Mgr.: Peter Kloeth; Sales Mgr.: Fons Ronde.
Home office: USA.
Labels: (Owned) Commonwealth, Hep, K-Tel.
 Karussell, see Polydor.
 Kelrec BV, Reguliersbreest. 3, Amsterdam. Tel: (020) 23-37-50.
 Kendari, see Benelux Music.
 Killroy, see Benelux Music.
 Klaver 4, see Disco de Man.
 J. A. W. Koers, PO Box 1373, 9701 BJ Groningen. Tel: (050) 41-19-67. (Importer)
 Henk Kreeftmeyer Org., Abraham Bloemaertstr. 6, 3514 VP Utrecht. Tel: (030) 71-08-73. Telex: 40996. Dir.: Henk Kreeftmeyer; Int'l Sales Mgr.: John Wespord.
Labels: (Owned) Hekre, Jox, Pussycat; (licensed) Buck-board, Musicor, Springboard, Uprfont.
 Kritos, see Bosheck.
 Han Kuiper Ents., De Boelelaan 435, 1082 RJ Amsterdam. Tel: (020) 42-93-96. Gen. Mgr.: Wim Johan Kuiper.
 Lark, see Inelco.
 Laudate, see Benelux Music.
 Laurens, see Vista.
 Loisirs, see VIP.
 London, see Decca.
 Lorelei, see Benelux Music.
 Lowland Blues, see Martin A. van Olderen.
 M G M, see Polydor.
 Mamicha Music BV, Pettelaarseweg 25, 5126 BG 's-Hertogenbosch. Tel: (073) 14-73-34, 13-83-52. Pres.: Wilhelm Vermeulen Windsant; Dir.: Marijke Robberts-Vermeulen Windsant; Gen. Mgr.: Cees Vermeulen Windsant. (Distributed by Durco)
Labels: (Owned) Mamicha; (licensed foreign) Roses (Belgium).
 Maritim, see Ariola-Eurodisc.
 Mawogram, see Vista.
 Melba, see VIP.
 Mercury, see Phonogram BV.
 Metro, see Polydor.
 Miller Int'l Grammofoonplaten BV, Oud Blaricummerweg 25a, Laren NH. Tel: (02153) 8-30-36.
 Mirasound, Langestr. 51, 8130 AA Wijhe. Tel: (02153) 18-26.
 Money Tree BV, Streuvelaan 12, Roosendaal. Tel: (01650) 4-39-28. Contact: M.J. Kleijn.
Label: (Represented) Sirec (USA).
 Moon Base, see West World.
 Moonbase, see International Rec. Dist'n.
 Munich Recs. BV (VH B. Munnikendam's Groothandel NV), Albert Schweitzerlaan 9, 6721 AW Bennekom. Tel: (08389) 677-77. Pres.: Job C. Zomer; Gen. Mgr.: Huub Trautwein; Sales Mgr.: Wybo Baron.
Labels: (Owned) Munich, Oldie Blues, Stof; (distributed—not licensed) Advent (USA), Cadillac (UK), Cezame (France), Contemp (Germany), Evasion (Switzerland), Mulligan (Ireland), Musica (France), Muskadine (USA), Ogun (UK), Ornament (Germany), Red Rag (UK), SDNM (Greece), Shanachie (USA), Syntonic Research (USA), Topic (UK), Trix (USA).
 Int'l reps.: Belgium (Parsifal), France (Oiseau), Japan (Victor), Sweden (Amigo), Switzerland (Evasion), UK (Cadillac), USA (Shanachie).
 Musidor BV, Herengracht 566, 1017 CH Amsterdam. Tel: (02) 25-71-60. Telex: 16593. Mng. Dirs.: A.J. van der Marel, A.J.D. Wilkinson.
Label: (Owned) Rolling Stones.
 N A P, see Polydor.
 N L, see Ivory Tower.
 Nederlandse Boekenclub, Prinsevinckpark 2, The Hague. Tel: (070) 51-43-51. Gen. Dir.: P. Schreuder; Gen. Mgr.: J. Kasander. (Distributor/Importer).
 Negram BV, see Bovema Negram BV.
 Nevofoon, see Bosheck.
 New Entry Music, Burg. Lambooylaan 21, Hilversum. Tel: (035) 1-95-89. Gen. Mgr.: Marc de Raaf. (Licensed to Durco)
 Nixa, see VIP.
 Nonesuch, see WEA Recs.
 O R A, see Universe Prod'n.
 Obelisk, see Evan Durlacher.
 Octopus, Torenlaan 46, Blaricum. Tel: (02153) 7658.
 L'Oiseau Lyre, see Decca.
 Ojee, see Benelux Music.
 Martin A. van Olderen Oldie Blues Rec. Center, Moosdriehof 175, 1106 NG Amsterdam. Tel: (020) 96-11-11. Dir.: Martin A. van Olderen. (Distributed by Munich)
Labels: (Owned) Barrelhouse, Boogie, Lowland Blues, Oldie Blues; (distributed—not licensed) Big Town (USA), Blind Pig (USA).
 Old Gold, see A.M. Girwar.
 Oldie Blues, see Munich & Martin A. van Olderen.
 Oldway-Windmill Org., Oldway Studio, Streuvelaan 12, 4707 CH Roosendaal. Tel: (01650) 4-39-26. Telex: 74083. Artistic Dirs.: Jan Verbogt, Geoff Hardisty; Comm'l Dir.: Hans Jongmans; Admin. Dir.: Fon Verbogt.
Labels: (Owned) U.J. Jojo; (distributed—not licensed) Big Bear (UK), J.J., Free Reed (UK).
 Onyx, see Bosheck.
 Orange, see Universe Prod'n.
 P C M P Inc., PO Box 469, 3130 AL Vlaarding. Tel: (010) 35-71-20.
Labels: (Owned) CIR, Standard Folk Recs.
 Papillon, see Basart.
 Park, see Basart.
 Parrot, see Decca.
 Pastor Recs., Barteljorisstr. 42, Haarlem. Tel: (023) 31-08-65. Cable: PASREC. Telex: 41642. Dir.: K. Th. Pastor; Gen. Mgr.: C. Sieckerman; Sales Mgr.: M. Koelman. (Distributor/Importer)

Labels: (Represented) Atlas, Bahiaphone, Boussi-phon, Cairophone, Casaphone, Dounia, Duniaphone, El Feith, Fran, Koutoubiaphone, Lyra, Napiaphone, Oasis, Olympe, Sono Cairo, Soutelphon, Viking, Voix du Globe, Voix du Libanon, Voix du Stars; **(distributed—not licensed)** Lyricord, Monitor, Rounder (all USA)

Paviljoen, see Vista

Pegasus, Lodssestr. 25, Amsterdam. Tel: (020) 23-11-38, 23-13-94

Labels: (Represented) China, Dihavina, Topic

Pergola, see Phonogram BV

Philips, see Phonogram BV

Phonogram BV (IFPI), Drentestr. 11, Amsterdam-Buitenveldert Tel (020) 44-08-88 Telex 12038 Mng Dir. Bill Barents, Admin'r Floor Wijngaard; Nat'l A&R Otto Vriezenberg, Pop Prod. Mgr.: Jaap Hottingh; Mktg. Mgr.: Rob Edwards

Labels: (Owned) Fontana, Impact, Mercury, Pergola, Philips, Polystar, Simple Pee, Vertigo, **(licensed)** All Platinum (USA), Bus Stop (UK), Charisma (UK), Chess (USA), Criminal (UK), Decca (UK), Haven (USA), Plurex (Netherlands), Power Exchange (UK), Trema (France), 20th Century (USA)

Pico Recs, Ganzenhoef 28, Amsterdam. Tel (020) 99-47-36 Dir.: Hans Douw; Gen. Mgr.: Kees Kuiper; Sales Mgr.: Aima Ramchalaan; (Distributor/Importer)

Plurex, see International Sound & Phonogram

Poker, see Basart

Polydor BV, PO Box 129, Verrijn Stuaartaan 36, Rijswijk (Z-H) Tel (070) 90-76-00 Telex 31481 Mng. Dir.: Hans van den Broek; Deputy Mng. Dir.: Nico van Bie-men, Mktg. Mgr.: Bob Spits; Sales Mgr.: Joop Vaen; Nat'l A&R Mgr.: Harry Knipschild; Adv. Mgr.: George Cramer; PR Mgr.: Tom Sleenberger; Label Mgrs.: Henk Keuter, Jan Loman, Hans van Woerkens

Labels: (Owned) Archiv, DG, Heliodor, Karussell, MGM, Metro, NAP, Polydor, Verve, **(licensed domestic)** Doina, Harlekijn, **(licensed foreign)** Capricorn (USA), Cube (UK), EG (UK), Goldhawkie (UK), Karma (Germany), Oyster (USA), Pablo (USA), RSO (UK, USA), Spring (USA), Track (UK)

Polygram PO Box 23, 3740 AA Baarn; Gerrit van der Veenlaan 4, 3743 DN Baarn. Tel (02154) 1-99-11, Telex 43400 Pres. Coen Solleveld; Exec. VP's: Johannes van der Velden, Kurt Kinkle, Wolfgang Hux, Sr. VP: Hermann Franz, VP's: Pieter R. Schellevis, Werner Vogelsang, Heinz T. Voigt, Willem Zalsman, PR Dir.: Herbert Winter

Note: Polygram controls, among other companies, in the field of music: Phonogram Int'l, Baarn, and Polydor Int'l, Hamburg; in publishing: Chappell and Intersong Int'l, in TV-films: Polytel Int'l and Polymedia

Polystar, see Phonogram BV

Pop Music, see Evan Durlacher

Power Sound, see Mike Vincent

Purple Eye Prod'ns BV, Flevolaan 41, Naarden. Tel (02159) 4-62-66 Dir.: J. Brands

Pussycat, see Henk Kreeftmeyer

Pye, see VIP

RCA BV, Prins Hendriklaan 26, 1075 BD Amsterdam. Tel (020) 64-00-81 Telex 18063 Mng. Dir.: Cees Wessels; Comm'l Mgr.: Frank Leeman; Controller: Ben Haasdijs; Promo Mgr.: Tony Berk

Labels: (Licensed) BTM (UK), Crypto (France), EMG (UK), Ebony (UK), Erato (France), Free Light (USA), Gem Toby (UK), Gold Mind (USA), Grapevine (UK), Grunt (USA), Midsong (USA), Millennium (USA), Numero Uno (Italy), RCA (USA), Roadshow (USA), Salsoul (USA), Saravah (France), Seon (Germany), Solar (USA), Tom n Jerry (USA), Windsong (USA), Wooden Nickel (USA)

Radio Music Nederland, PO Box 338, Bussum. Tel 4-62-66 Dir.: Guus Jansen, Hubert Terheggen

Rec Track Nederland BV, PO Box 113, 3600 AC Maarsse. Tel (030) 43-11-44 Telex 40354 Dir.: Gen. & Sales Mgr.: M. C. Groeneveld; (Manufacturer/Distributor/Importer/Exporter)

Red Bullet Prod'ns, Alexanderlaan 2, Hilversum. Tel (035) 85-78-41 Dir.: Willem van Kooten

Redifusion, see Basart

Religioso, see Vista

Reprise, see WEA Recs

Rex, see Decca

Rialto, see Decca

Rockhouse Recs-de Platenboer BV, Stortenbekerstr. 5, 2421 ES Nieuwkoop. Tel (01725) 14-32. Dir.: Bert Rockhuizen; Gen. Mgr.: Frances Rockhuizen

Label: (Owned) Rockhouse

Int'l reps.: Austria (Bellaphon), Canada (Root), France (Sonopresse), Germany (Bellaphon), Scandinavia (Marilla), Spain (Auv), Switzerland (Bellaphon), UK (Charly)

Rubber Recs., NZ Voorburgwal 140, Amsterdam. Tel (020) 42-59-52

Rolling Stones, see Musidor

Rotogram, Van Ostadestr. 284, The Hague. Tel (070) 33-76-90, 29-34-87

S T B, see Vista

Scramble, see Dureco

Second Life Recs., A. J. Ernststr. 9, 1083 GP Amsterdam. Tel (020) 42-92-88 Cable SYLVAINSSHOW Dir.: Sylvain J. de Haas; Gen. Mgr.: Erna de Haas

Simple Pee, see Phonogram

Skyrocket, see Mike Vincent

Sonclair, see Vista

Sonopresse BV, PO Box 751, Stuwadoorstr. 106, Rotterdam. Tel (010) 84-47-10, 84-86-47 Telex 28862 Mng. Dir.: Leo Ritmeester

Sound-Prod's, Holland BV, Oud Loosdrechtseij 16a, Loosdrecht. Tel (02158) 51-01. Dir.: Gerald Vandermert

Labels: (Owned) Fidelio; **(licensed foreign)** Abbey (UK), GB (UK), Melodiya (USSR), Hed Arzi (Israel), Hungaroton (Hungary), Jecklin (Switzerland), Muza (Poland); **(distributed—not licensed)** Alpha (Belgium) CRD (UK), Cat Jazz (UK), Delta (Germany), Elite (Switzerland), Ensayo (Spain), Mulligan (UK), Nonesuch (USA), Plantlife (UK), Saga (UK), Sonodisc (France)

Int'l reps.: Germany (Delta), Switzerland (Tudor)

Space Prod'n, Finnmark 4, 3831 JG Leusden-C. Tel (033) 4-18-88 Dir.: John Russell

Standard Folk Recs., see PCMP

Starlet, see Benelux Music

Stoof, see Munich

Studio 33, see Intermedia

Supertone Holland BV, Amersfoortsestr. 130, Soesterberg. Tel (31) 1-53-41, Telex 47866 Pres. Hubert Tichelaar; Gen. Mgr.: John de Mol; Export Mgr.: Anton Tichelaar

Sure Shot, Udenseweg 29, Uden. Tel (04132) 6-88-23. Telex 50819 Gen. Mgr.: A.G. Conard; Sales Mgr.: R.B. Peters (Distributor)

Target, see Bosheck

Te Deum, see Dureco

Telstar, see Benelux Music

Threshold, see Decca

Timeless, see Wim Wigt

Traffic, see Bosheck

Trent, see Arcade

Tulip, see Basart

Tutor Country, see Mike Vincent

Twinkle Stars Prod'ns BV, PO Box 341, Schaloenstr. 36, Sittard. Tel (04490) 83-23 Cable MAASTRICHT; Gen. Mgr.: Rudolph de Nijs; Sales Mgr.: Roy Sinclair

Labels: (Distributed—not licensed) Flowers (Germany), Jolly (Italy), Picci (Italy)

Int'l reps.: Germany (BFC, Mersey, Stereotape), Italy (Interbeat)

U P, see Universe Prod'ns

Universe Prod'ns, Spanjaardslaan 33, Leeuwarden. Tel (05100) 2-01-94, 2-45-22 Pres. Wobbe van Seijen (Distributed by Phonogram)

Labels: (Owned) Disco Town, Hotspot, ORA Orange, UP, Universe; **(licensed)** EMI (Ireland), Mulligan (Ireland), Rockburgh (UK), Rounder (USA)

Unknown, see Collector

VIP Recs BV (IFPI), Turfstekestr. 61, 1431 GD Aalsmeer. Tel (02977) 2-89-91, Telex 18951 Dirs.: J. Leruth, W.S. Woyda; Gen. Mgr.: R.T. Lamers

Labels: (Owned) Collector Series, Contre Point, Dawn, Desert Moon, Double Plaisirs, Golden Guinea, Golden Hour, Loisirs, Melba Nixa, Pye, VIP, V-King, Virtuoso, Vogue; **(licensed)** Buddha (USA), Casablanca (USA), Chocolate City (USA), Contempo (UK), Crescendo (USA), Ember (UK), Parachute (USA), Pyramid (USA), Roulette (USA), Surprise (Belgium), Vanguard (UK)

V-King, see VIP

Van Leest BV, Pisanost 57, 5623 CB Eindhoven. Tel (040) 44-45-09 Telex 59078. Contact: K.L.H. Peters (Importer/Exporter)

Varamag, see Inlco

Veb, see Ariola-Eurodisc

Veronica, see Evan Durlacher

Vertigo, see Phonogram BV

Verve, see Polydor

Mike Vincent Prod'ns BV, Pettelaarseweg 25, 5216 BG s-Hertogenbosch. Tel (073) 14-73-34, 13-83-52 Telex 416 TEKOM Pres.: Wilhelm Vermeulen Wind-sant; (Distributed by Benelux Music)

Labels: (Owned) Condor, Power Music/Vliegende Hol-lander, Skyrocket, Tutor Country

Virtuoso, see VIP

Vista Recs., Flegelstr. 11, 5306 AW Brakel. Tel (04187) 18-85 Dir.: John A. Vis; Sales Mgr.: Fokke Antonides

Labels: (Owned) Canto di Vangelo, **(licensed domestic)** CCA, Editio Laran, Eurosound, Festivo, Glory Sound, Jubal, Laurens, Mawogram, Mirasound, Paviljoen, Religioso, STB, Sonclair, **(licensed foreign)** Abanori (Germany), Abbey (UK), Advent (USA), Berilton (Germany), Cathedral (UK), Cinesound (UK), Claudius (Germany), Credo (Sweden), Da Camera (Germany), Edo (Italy), Edici (France), Finlandia (Finland), GRC (USA), Gallo (Switzerland), Hed Arzi (Israel), Hibiscus (New Zealand), Impromptu (Germany), Lyricord (USA), Mixture (Germany), Motette (Germany), Organum (Finland), Pape Orgeldokumente (Germany), Pelca (Germany), Principal (Denmark), Proprius (Sweden), Psallite (Germany), Sasturphon (Germany), Stil (France), Telarc (USA), VDE (Switzerland), Vista (UK), Walcker (Germany) (SEE ADVERTISEMENT)

Vliegende Hollander, see Mike Vincent

Vogue, see V I P

WEA Recs. BV, Burg Lamboolaan 21, 1217 LB Hilversum. Tel (035) 1-54-53 Cable WEARC Mng. Dir.: Ben Bunders; Gen. Mgr.: Han Tonino; Sales Mgr.: Ger v.d. Meys; Controller: Anthony Vandermors

Home office: USA, WEA Int'l

Labels: (Owned) Asylum, Elektra, Nonesuch, Reprise, WEA, Warner Bros., **(licensed)** Bearsville (USA), Dark Horse (USA), Kluger (Belgium), Lightning (UK), Radar (UK), Sire (UK)

Warner Bros., see WEA Recs.

West World Recs., PO Box 633, Amsterdam. Tel (020) 93-62-49 Gen. Mgr.: Peter Rensen

Labels: (Owned) Moon Base, West World

Weton-Wesgram BV, Veerlaan 86-92, 3072 ZZ Rotterdam. Tel (010) 86-11-66 Telex 28798 Mng. Dir.: Albert de Vries

Labels: (Owned) PV, WSP

White Label, see Collection

Wim Wigt Prod'ns/Timeless Recs., PO Box 201, Roghorst 303, 6700 AE Wageningen. Tel (08370) 1-34-40 Telex 45991 Dir.: Wim Wigt

Labels: (Owned) Timeless, **(distributed—not licensed)** Black Saint (Italy), Circle (Germany), Horo (Italy), Steeplechase (Denmark)

Int'l reps.: Austria (Bellaphon), France (Musica), Germany (Bellaphon), Italy (Rif, Record Centre), Japan (Nippon Phonogram), Switzerland (Americasound), UK (Jazz Serv. Unlimited, Cadillac), USA (Muse)

Zen, see International Rec. Dist'n

Acorn Music, Tabaksweg 6, Elst. Tel (08346) 17-34

Actueel NV (Eds.), Baan 17, Haarlem. Tel (023) 31-77-73

Int'l firms represented: Altus (Germany), Capriole (Germany), Ho-Be! (Belgium), Literatoun (Germany), Montana (Germany), Wiener Boheme (Germany)

Alkema Music, see Universal Songs

Albersen & Co. BV (Muziekhandel), Gr. Hertoginnelaan 182, 4517 EV The Hague. Tel (070) 45-60-00 Dir.: J. Albersen

Alkema's Muziekhandel, PO Box 1174, O. Kijk in 't Jatstr. 46, Groningen. Tel (050) 12-05-13

All Rock Music Publ'rs, PO Box 2296, 3000 CG Rotterdam. Tel (010) 22-48-89 Gen. Mgr.: Cees Klop

Int'l firms represented: Ace, Banks, Bo-An, C. Brown, Charlie Roach, Linco, Prillman, (all USA)

Int'l rep.: Belgium (Monopole)

W. Alphenaar CV, Kruisweg 47-49, Haarlem. Tel (023) 32-02-44

Altona BV (Ed.), see Intersong-Basart

Anagon Music Publ'rs BV, see EMI Music Publ'g

Ananas, Flevolaan 41, Naarden. Tel (02159) 4-62-66 Chief Exec.: John Brands

April Music Holland BV, Stationsplein 82-84, Haarlem. Tel (023) 32-05-25 Cable COLRECORD Telex 41051 Gen. Mgr.: Allen Davis; Exec. Mgr.: Bas Mul

Int'l firms represented: Alotagood (USA), Albion (UK), April/Blackwood (worldwide), Bamboo Magic (USA), Batt (UK), Boom (USA), Bovina (USA), CBS Int'l (USA), Camp (USA), Clay (USA), Country Road (USA), Dave Mason (USA), Derringer (USA), Dickie Bird (USA), Double Diamond (USA), Dozier (USA), Flying Crown (USA), Fourteenth Hour (USA), Albert Hammond (USA), Hierophant (USA), Hudmar (USA), Indaba (USA), Joel (USA), Kool (USA), Little John/Twogether (USA), Mine (USA), Oceans Blue (USA), Petra (USA), Porcara (USA), Rocket (UK), Rock OM (UK), Sheefire (USA), Sherylly (USA), Silver Blue (USA), Silver Steed (USA), Strong Arm (USA), Sunlight (UK), Tuna Fish (USA), Weather Report (USA), Weedhigh-Nightmare (USA), Winter Blues (USA)

Int'l rep.: Worldwide (April/Blackwood)

Arabella Benelux (Eds.) CV, Oranje Nassaulaan 25, Amsterdam. Tel (020) 79-70-47 Telex 14475 Mng. Dir.: Wim Schipper; Gen. Mgr.: Wim Landman

Branch: Haarlem, Arabella Benelux BV, Kenaustr. 1, Tel (023) 31-92-90 Telex 41385

Int'l firms represented: Arabella (France, Germany, Spain, USA)

Int'l reps.: France, Germany, Spain (all Arabella)

Ariola Music Benelux BV, Lindenheuvel 3, 1217 JV Hilversum. Tel (035) 23-22-41. Telex 43639 Gen. Mgr.: Charles Ritton

Int'l firms represented: Arista/Careers, Fast Western, Minotaur, Pit, Tom Robinson

Ars Nova (Muziekuitgeverij), Oostsingel 92, Goes. Tel (01100) 1-58-16

Artemis Muziekuitgeverij BV, Gerrit van der Veenlaan 4, Baarn. Tel (02154) 1-95-99, 1-66-83 Cable MUZAR-TEM Telex: 43400 Pres.: Heinz T. Voigt; Gen. Mgr.: A. Smit

Int'l firms represented: Audistun, Argus, Arnakata, Barn, Baron, Betty Earland, Big Shorty, Blue Gum, Bob-Cor, Bregman Vocco & Conn, Broken Arrow, Bushka, Bruce Welch, CAM, CTA, Caesar's, Canopy, Carlin, Caseyem, Charlotte, Cherry, Clarke, Davray, Dijon, Doobies, Dough Boy, Dynatone, Ellis Clan, Fifth Floor, Fort Knox, Four Knights, Francis Dreyfus, Fuse, GH, Gumbo, Gento, Gwing Room, Gnosso, Golden Syrup, Good Morning, Guerilla, Hamilton Bohannon, Harbor, Heat/Levy, Hit & Run, Hudson Bay, Island, Jet, Jim-pire, Jiru, Josley, Kaskat, Kenya, Kolob, Leros, Lisha, Little Fugitive, Lois, Luckyu, Magnet, Man-Kan, Marson, Martin-Coulter, Matragn, Mayday, Midsong, Normal, Open End, Pickwick Int'l, Pocket Full of Tunes, Quick Mix, RSO, Razzle, Rock Rockhopper, Rodra Berna, Ruda, Ryan, Sailor, Sambo, Siquomb, Stevca, Sweet, TH, Ten East, Third Story, Times Square, Timtobe, Tone-shire, Trane, Trio, 20th Century, White Haven, Yellow Dog

Int'l rep.: USA (Jules Kurz)

(Also see Artemis, UK)

Atlantica Ed., s Heerenberg. Tel (08346) 14-36

Avia Music, see Home

Avion Music, see EMI Music Publ'g

B D Music, see Dutchy

B E L Sound, Buurserstr. 356, Enschede. Tel (053) 76-30-22

B L R Music, see Universal

for the Benelux:



UNIVERSAL SONGS

25 Oranje Nassaulaan
1075 AJ Amsterdam
Phone: 020-797047

BVP-Music, PO Box 181, Hilversum. Tel: (02150) 1-59-53.
Gen. Mgr.: Hans Pieters Jr.
Annie Bank (Ed.) BV, PO Box 60061, 1005 GB Amsterdam.
Anna Vondelstr. 13, 1054 GX Amsterdam. Tel: (020) 18-24-93. Dirs.: Annie Bank, H. Oostendorp.
Int'l firms represented: Austria (Doplinger).
Basart (Les Ed. Int'l) BV, see Intersong-Basart.
Belinda (Amsterdam) BV, see Intersong-Basart.
Benelux Music, see Tierolf.
Benelux Music Inds., PO Box 70, 6000 AB Weert: Uilenweg 38, 6006 SK Weert. Tel: (4950) 3-56-40. Telex: Dir.: Jacque Hoes; Gen. Mgr.: Anneke Janssen.
Int'l firms represented: Kirshner (USA), White (Germany).
J. Ph. Benson, PO Box 59, 7260 AB Borne. Tel: (05409) 41-24. Dir.: John Phillip Benson. Gen. Mgr.: A. Daphne Laanen.
Best Music, Crispynstr. 9, 5171 CH Kaatshoevel. Tel: (04167) 32-70. Mng. Dir.: Peter Best.
Big Shot Music, see PRP Int'l Music.
Binah Music, see EMI Music Publ'g.
Bingo Music, see EMI Music Publ'g.
Bird's Music, see Dutchy.
Black Night, see EMI Music Publ'g.
Black River Music, see Dutchy.
Black Tulip, see EMI Music Publ'g.
Blah Blah Music, see Soss.
Blow Music, see Actuel.
Blueball Music, see EMI Music Publ'g.
Boris Music, see April.
Bospel Music BV, see Dutchy.
Boy Scout Music, see EMI Music Publ'g.
Broekmans & Van Poppel, Van Baerlestr. 92-94, Amsterdam. Tel: (020) 72-80-84, 79-65-75, 79-61-26. Pres.: G. Ganzinotti, Sales Mgr.: P. J. A. Ganzinotti.
Int'l firms represented: Chester (UK), Forsyth Bros. (UK), Kultura (Hungary), Russian State Music (USSR), Warren & Philips (UK).
Int'l rep.: USA (Peters).
Brother Publ'g Co., Leidesgracht 49, Amsterdam 1013. Tel: (020) 23-90-47. Telex (844) 11209.
Home office: USA.
Buddle-Basart BV, see Intersong-Basart.
Buschmann, E. Meysterlaan 46, Utrecht. Tel: (030) 93-68-30.
Carnaby Music, see April.
Chappell & Co. Holland BV, PO Box 338, Bussum. Tel: (02159) 4-62-66. Mgr.: Jan De Winter.
Cheese Music, PO Box 53, 3750 GB Bunschoten/Spakenburg. Tel: (03499) 23-60, 23-70. Telex 41605 Tekom NL Spring.
Chinchilla Music, see Mamicha.
Choral Music, see Annie Bank.
Cloggy Music, see EMI Music Publ'g.
Clover Music, see EMI Music Publ'g.
Coehoon Music, see EMI Music Publ'g.
Commercial Controllers Publ'g Group, see Mamicha.
Connelly Basart BV, see Intersong-Basart.
Continental Sound, PO Box 81065, Rotterdam. Tel: (010) 21-10-98, 21-48-28. Dir.: Leen La Riviere.
Coolwine Music, Bosstr. 94, Soest. Tel: (035) 4-77-40. Dir.: Peter Koelewijn.
Corona Int'l, Margrietlaan 28, 1735 HE 't Veld. Tel: (02262) 21-34. Dir.: Jan C. Bujs.
Crappack Music, see EMI Music Publ'g.
Creyghton Musicology-Musica Antiqua, Lassuslaan 45, Bilthoven. Tel: (030) 78-37-14. Cable: MUSICANT.
Crusade Music, Stationweg 43, Hoogezaand. Tel: (05980) 9-26-35.
Cuckoo Music, Provincialeweg 47, 1561 KM Krommenie. Tel: (075) 21-50-21. Dir.: Joop Koekkoek.
Dali Press Studios BV, Leeuwenstr. 55, Hilversum. Tel: (02150) 1-48-50. Mng. Dir.: G. T. J. Hauer. Int'l Mgr.: Ralph de Waard van Gulik.
Dayglow-Snamyook Music, see Nada.
Dayglow-Tripper Music, see Nada.
In de Blockfluyt, Oude Gracht 305, Utrecht. Tel: (030) 31-20-51.
J. W. de Kruif, Rijksweg 191, Gaanderen. Tel: (08350) 4181.
De Centrale Muziekhandel, Albert Cuyppstr. 23, Amersfoort. Tel: (033) 1-60-70.
J. de Heer & Zn. BV., PO Box 3089, Rotterdam. Tel: (010) 66-18-71. Dir.: J. A. de Heer.
Delta Music, see EMI Music Publ'g.
Dennis Music, Paesteblookstr. 11/13, Genk. Tel: (011) 35-02-21. Telex 39071. Owner: Willem Bosheck. Gen. Mgr.: Ronny Bosheck van der Laan.
Int'l firms represented: Boosey & Hawkes, Cavendish, Creasound, Emihenco, Golden Ring, Happy, Impress, Magellan, Media Sound, Monophon, Neuilly, Selected Sound, Sirocco, Telemusic, Theme.
De Toorts (Muziekuitgeverij), PO Box 576, Nijverheidsweg 1, Haarlem. Tel: (023) 31-93-60.
Dirty River Prod'ns, Utrechtseweg 10a, Hilversum. Tel: (035) 4-03-34. Mng. Dir.: Ferry Wianne.
Dokkum Eds., PO Box 189, Gravestijn 33, 2804 GS Gouda. Tel: (01820) 1-83-14. Gen. Mgr.: W. L. Dokkum.
Double Dutch Music, see Sing-Along-Songs.
Dreissen-Basart BV, see Tierolf.
Driving Wheels Music, see EMI Music Publ'g.
Dukla Music, see Dutchy.
Dustbug Music, see Number One.
Dutch Rec. Centre Ltd., Oudegracht 305, Utrecht. Tel: (030) 31-20-51.
Dutchy Publ'g BV, Pampuslaan 45, 1380 AA Weesp. Tel: (02940) 1-00-00, 1-53-21. Cable: RECMUS. Telex: 14409. Mng. Dir.: Janine Bosmans; Gen. Mgr.: Frans Erkelens.
Int'l firms represented: AMT (France), Bens (Belgium), Bospel (Belgium), Chrysalis (UK, USA), Diamond (UK), Fonior (Belgium), Grande Avenue (France), Kassner (UK), Klaus Lorenzen (Germany), Meteorion (Germany), Polar (Sweden), Sutton-Miller (USA), Tres Jolie (UK), Union Songs (Sweden), Whitsett-Churchill (UK, USA), Wobble (UK).
E & E Music, PO Box 1525, Amsterdam. Tel: (020) 93-62-49. Gen. Mgr.: Peter Rensen.
E M I E A R Music BV, Tulpenkade 1, Haarlem. Tel: (023) 31-95-18. Telex 41902. Mng. Dir.: R. R. Kruize. Gen.

Mgr.: Frank A. M. Jansen.
E M I Music Publ'g Holland BV, PO Box 300, Coehoornstr. 71, Hilversum. Tel: (035) 83-18-04. Telex 73117. Mng. Dir.: Peter Schoonhoven; Gen. Mgr.: Pieter van Bodegraven.
Int'l firms represented: AVI (USA), Admiral One (UK), Alaska (UK), Alien (USA), Alkatraz Corner (USA), Antipodes (Australia), Arista (USA), Aristocrat (UK), Beechwood, Big Ben (UK), Big Heart (USA), Big Pig (UK), Big Sky (USA), Blackball (USA), Black Sheep (UK), Blue Street (USA), Bossu Fataka (USA), Caligula (USA), Careers (USA), Chibell (UK), Colgems (USA), Dawson's Cove (USA), Diamondback (USA), Walt Disney/Wonderland (USA), Dixie Bow (USA), Dump (USA), Dwarf (USA), ERM (UK), Eaton (UK), Emile (USA), Everblue (UK), Excellency (UK), Fish-scent (USA), Forty Love (USA), Francis Day, Frank & Nancy (USA), Al Gallico (USA), Garrett (USA), Goblet (USA), God Tunes (USA), Good Time (USA), Van Halen (USA), Heart's Delight (USA), Homefire, Hush (UK), Icebag (USA), Jackson (USA), Jobete (USA), Joyful Wisdom (USA), KPM (UK), Kipahula (USA), Charles Kippes (USA), Kiss (USA), Kongre (UK), Linda (USA), Little Dragon (USA), Little Switzerland (USA), Lucky 3 (USA), Lunatunes (USA), Mandina (USA), Mandy (USA), Manticore (UK), McDonald (USA), Medicine Hat (USA), Mole (USA), Mother Goose (UK), Mother Pearl (USA), New Acme (UK), New Town Sound (UK), Open Door (USA), Our Music (UK), Peacock (USA), Pink Floyd (UK), Pix-Russ, Plurkantz-Krundle (USA), Pods (USA), Polo Grounds (USA), Prodigal Son (USA), Pure Songs (USA), Queen (UK), Ram's Horn (USA), Rebel (UK), Red Bus, Remohj Music (USA), Robin (France), Rocksmith (USA), Rock Steady (USA), Ronin (USA), Rosy (USA), Saints (Australia), Salsoul (USA), Seafood (USA), Screen Gems, Box Scaggs (USA), Slik (UK), Sonet (Sweden, UK), Stainless (USA), Stone Gold (USA), Tradition (USA), Tree (USA), Trident (USA), Tumbleweed (Australia), United Artists, Venice (USA), Frank Zappa (USA).
Int'l rep.: Worldwide (EMI).
Ear Music, see EMI Music Publ'g.
Eaton Music, see EMI Music Publ'g.
Essex Muziek Holland BV (BUMA), Oranje Nassaulaan 25, Amsterdam. Tel: (020) 79-70-47, 79-63-48. Gen. Mgr.: Wim Landman, Prof. Mgr.: Bram Keizer.
Home office: England.
Int'l firms represented: Essex group (UK), TRO (USA).
F R P Music, see Dutchy.
Flame Music Publ'rs, Schipperstr. 5, Amsterdam. Tel: (020) 23-46-92.
Flevo Music, see April.
Francis Day, see EMI Music Publ'g.
Franchise Music, Stanjaardslaan 33, Leeuwarden. Tel: (05100) 2-01-94, 2-45-22. Pres.: Wobbe van Seijen.
Freetone Music BV, see Anagon.
G E Music, see Nada.
G M I Music, see Universal.
Gaba Music, see Intersong-Basart.
Gnome, see Benelux Music.
Gooi & Sticht BV, Vaartweg 51, Hilversum. Tel: (035) 4-81-46.
Granat Music, see Home.
Great Gull Music, Machineweg 8, Nederhorst den Berg. Tel: (02945) 1791.
Saul B. Groen BV, Ferd. Balstr. 6, Amsterdam. Tel: (020) 76-22-40. Dir.: S. B. Groen; Gen. Mgr.: M. de Heer.
Halifax Music, Flevoalaan 41, Naarden. Tel: (02159) 4-62-66. Telex 43191. Gen. Mgrs.: Ton van den Bremer, Frans de Wit.
Hammamet, see Mamicha.
Harmonia Uitgave, PO Box 126, Roeltjesweg 23, Hilversum. Tel: (035) 1-43-18.
Heartbreak Songs, see EMI Music Publ'g.
Hees BV, Choorstr. 1-3-7 Delft. Tel: (015) 12-41-83.
J. J. Heuwelmeijer & Zn., Weteringstr. 19, Amsterdam. Tel: (020) 22-62-08.
Hoax Music, Boveneind 86, Leed (GR). Tel: (05945) 2542.
J. Hofman, Tuinbouwstr. 59a, Groningen.
Hohner Nederland BV, PO Box 158, Alb. Perkstr. 16, Hilversum. Tel: (035) 4-24-83.
Holland Music BV (Peer-Southern Org.), Larenseweg 159, 1221 CL Hilversum. Tel: (035) 83-12-14.
Int'l firm represented: Peer-Southern (worldwide).
Home Music Ents. BV, Lindenheuvel 3, 1217 JV Hilversum. Tel: (035) 23-22-41. Telex 43639. Mng. Dir.: Charles Ritton.
Int'l firms represented: Beggar's Banquet, GH. Modern Love, C. Riva, Rye-Boy, Schwartz, Slezak.
Hondekap, see April.
I F O Music, see PRP Int'l Music.
Intersong-Basart Publ'g Group BV, PO Box 338, Bussum. Tel: (02159) 4-62-66. Dir.: John Brands. Gen. Mgr.: A. de Raaf.
Int'l firms represented: ABC/Dunhill, Aberbach, Bourne, Burlington, Carlin, Hal & Range, Edward B. Marks, Shelby Singleton, Warner Bros.
Intersong Muziekuitgeverij BV, see Artemis.
Intervorld Music BV (BUMA), see Universal Songs.
Dick James Music BV, see Intersong-Basart.
Jolio Music, Stationsplein 82-84, Haarlem. Tel: (023) 32-05-25. Telex: 41051 CBSR. Dir.: Bas Mul. Gen. Mgr.: Lion J. Swaab.
Jonegeneel (Uitgeverij), Gouwe 33, Gouda. Tel: (01820) 1-27-26.
Udo Juergens Music, see Mamicha.
Jungle Music, see Halifax.
Kartner Songs, see Dutchy.
Kassner Holland BV, see Dutchy.
Kayak Songs, see EMI Music Publ'g.
Klevec BV, Reguliersbreestraat 3, Amsterdam. Tel: (020) 23-37-50.
Keystone Music, see April.
Peter King Music, see PRP.
Kirshner Benelux, see Benelux.
Klavarskribo, PO Box 39, Benedenrijweg 355, 2983 GE Ridderkerk. Tel: (01804) 1-27-24. Gen. Mgr.: C. Kooyman.
Int'l rep.: UK (Klavarskribo Institute).
Kluger Holland, Meander 967, Amstelveen. Tel: (020) 45-88-87, 41-19-78. Telex 41115 Gen. Mgr.: Gerda Felleman.

Int'l firms represented: Acuff Rose, Bleu Blanc Rouge, Hansa/Fleet, House of Gold, I.M.C., Jean Kluger, Perren, Pi. Gem. R.K.M. Ramco, Paul Simon, Sugar Vibes.
Jean Kluger, see April.
Konefa Muziekuitgave BV, Stadhoudersring 17, Zoetermeer. Tel: (079) 16-55-61. Dir.: J. G. v. Eck.
Konez (Stichting Muziekuitgeverij), Spaubeeklaan 47, Gleen. Tel: (04944) 4-26-21.
Koy Koy Music, see Nada.
Krips Muziek, Thorbeckelaan 71, The Hague. Tel: (070) 68-96-55. Pres.: P. H. de Slegte.
Int'l firms represented: Apollo (Germany), Holzschuh (Germany), Le Mediator (France), Pressler (Germany), Ragotsky (Germany), Wild (Switzerland).
L E M/Basart, see Intersong-Basart.
Ladybird Music Eds., see Home.
Lady G Music, see Home.
Ladyvyn Music, De Wittenkade 118, Amsterdam 1014. Tel: (020) 18-71-38.
Leeds Muziek Holland BV, see Intersong-Basart.
W. F. Lichtenauer, Kruisplein 44, Rotterdam. Tel: (010) 11-82-53.
J. J. Lisset (BUMA), see Universal Songs.
Lim Eds., see Home.
Lotus Publ'ns, see April.
Lunar Music, see EMI Music Publ'g.
Lupa Music Holland, Utrechtseweg 10A, Hilversum. Tel: (035) 23-40-01.
Lux Songs, see EMI Music Publ'g.
M A M Music Publ'g BV, see Intersong-Basart.
M C A Holland BV, see Intersong-Basart.
M C R Publ'g, Tulpenkade 1, Haarlem. Chief Exec.: F. D. S. Sinnighe Damste; Gen. Mgr.: Peter Schoonhoven.
Malanda (Ed.), see April.
Mamicha Music Int'l BV, Pettelaarseweg 25, 5216 BG 's-Hertogenbosch. Tel: (073) 13-83-52, 14-73-34. Pres.: Wilhelm Vermeulen Windsant. Mgr.: Cees Vermeulen.
Int'l firms represented: Montana H. Beierlein (Germany), Carosello (Italy), Come il Vento (Italy), Hitburger (Germany), Udo Juergens (Switzerland), Melodie der Welt (Germany), Nido (Italy), Roses (Belgium), Sinus (Belgium), Talent (Norway).
Marathon Music Publ'g BV, Prins Hendriklaan 26, 1075 BD Amsterdam. Tel: (020) 64-00-81. Telex: 18063. Mng. Dir.: Cees Wessels; Gen. Mgr.: Tony Berk.
Marbella Music, see Ariola.
Charles Martin Music, A. J. Ernststr. 9, 1083 GP Amsterdam. Tel: (020) 42-92-88. Cable: SYLVAINSSHOW. Dir.: Sylvain J. de Haas; Gen. Mgr.: Erna de Haas.
Master Songs, see EMI Music Publ'g.
Mata Hari Music, see Universal Songs.
Matchpoint Music, see Home.
Jerry McEasels Music, see Mamicha.
Stef Meeder BV, 's-Gravenlandseweg 620, Schiedam. Tel: (010) 70-39-19.
Melodia Muziekuitgaven, Amstel 52, Amsterdam C. Tel: (020) 23-08-00; (035) 4-81-04. Pres.: Cor Smit Jr.; Sales Mgr.: Wim Eweg.
Metro Muziek, see Benelux Music.
Micron Music, see Number One.
Miller Music, Spanjaardslaan 33, Leeuwarden. Tel: (05100) 2-01-94, 2-45-22. Pres.: Wobbe van Seijen.
Minus Music, see Universal.
Mirasongs, see Universal.
Mixed Music, see EMI Music Publ'g.
Molenaar's Muziekcentrale NV, Industrieweg 23, Wormerveer. Tel: (075) 28-69-59. Pres.: Jan Molenaar; Gen. Mgr.: Bob Molenaar.
Int'l firms represented: Hal Leonard (USA), Martin (France), Studio PR (USA), Volk Union (USA).
Int'l reps.: Australia (Smith), Denmark (Hansen), France (Martin), Japan (Academia), Luxembourg (Pierre Wagner), New Zealand (Colliers), Norway (Tonika), Sweden (Sven Larssen), Switzerland (RUH), UK (Novello), USA (Studio PR).
Monkey Music, see EMI Music Publ'g.
Moonbase Music, see PRP Int'l.
Moonshine Music, see Universal Songs.
Munich Music, Albert Schweitzerlaan 9, 6721 AW Bennekom. Tel: (08389) 67-77. Pres.: Job C. Zomer; Gen. Mgr.: Huub Trautwein.
Music '73, Plantage Parklaan 12, 1018 ST Amsterdam. Tel: (020) 24-67-43, 23-54-29. Dirs.: Bob van Dam, Wim Hauer.
Musico, see Krips.
Music Tree, see Home.
N F M Publ'ns, see April.
Nada Music BV, Alexanderlaan 2, 1213 XS Hilversum. Tel: (035) 85-78-41. Telex 43956. Mng. Dir.: Willem van Kooten; Prof. Mgr.: Carl Bolger.
Int'l firms represented: ATV (UK), Barn (UK), Blackhill (UK), Blendingwell (USA), Bleu Disque (USA), Bron (UK), Casino (Canada), Curtis (UK), Ellisclan (UK), Fourth Floor (USA), Ganga (UK), Gear (USA), Robin Gibb (UK), Andrew Heath (UK), Hightree (USA), Hustler's (USA), Island (UK, USA), Teddy Jack (USA), Lambert & Potter (USA), Larball (USA), Lynn & Yarrak (USA), Macaulay (UK), Marksmen (UK), No Exit (USA), Painless (USA), Panache (UK), Planet (UK), Rock (UK), Rockin' (USA), Graham Sacher (UK), Sailor (USA), Satril (UK), Skyhill (USA), Bruce Springsteen (USA), State (UK), Stonebridge (USA), Street (UK), Tessa (USA), Three Hats (USA), Wilsongs (USA), Wow & Flutter (USA).
Int'l reps.: Belgium (Hans Kusters), USA (Dayglow, Nada). (SEE ADVERTISEMENT).
Nada-Winter Music, see Nada.
Negram Music, see EMI Music Publ'g.
New Dayglow BV, PO Box 231, Alexanderlaan 2, Hilversum. Tel: (035) 5-78 41. Telex 43956.
New Music Holland, see April.
New Sound, Rooseveltlaan 75, Amsterdam. Tel: (020) 46-00-58.
Number One Music Holland BV, Gallenkampsweg 31, Soest. Tel: (02155) 1-03-10. Owner: Eric Boom.
O K Music, see Nada.
Octave Music, see Universal.
Old Mill Music, Oldway Studio, Streuvelslaan 12, 4707 CH Roosendaal. Tel: (01650) 4-39-26. Telex 74083. Dirs.: Jan Verboogt, Geoff Hardisty.
Opus Music, see EMI Music Publ'g.

Ototo BV, s-Gravelandseweg 646, Schiedam Tel (010) 71-12-38

P C M P Inc Holland, PO Box 479, 3130 AL Vlaardingen, Tel (010) 35-71-20

P R P Int'l Music Publ'g, PO Box 3524, Amsterdam, Tel (020) 93-62-49

Palace Music Holland BV, see Intersong-Basart

Panda Prod'ns, Laan van Rijckevorsel 35, Lisse, Paris Publ'g, see Mamicha

Parrot Music, see Universal Songs

Pascal Music, see Universal

Penta Music Eds., Van Eedenlaan 26, 4707 LB Roosendaal, Tel (01650) 3-72-52, Dir. Jack de Nijs, Sales Mgr. Dick de Nijs

Picture Music, see April

John M. Pijlman, Cromme Camp 2, Amsterdam, Tel (020) 19-62-91

Piq Paq Music, see Mamicha

Planet Music, see Home

J. Poeltuyt, Deurlooster 18, 1028 JA Amsterdam, Tel (020) 72-28-27

Power Music, see Mamicha

Promobill BV, Herengracht 566, 1017 CH Amsterdam, Tel (020) 25-71-60, Telex 16593 Mng Dir. A.J. van der Marel, Gen. Mgr. A.J.D. Wilkinson

Pure Gold Music BV, Burg Hellenberg, Hubarlaan 7, Hilversum, Tel (035) 23-30-11

Question Mark Music, see Mamicha

Radio Music Nederland BV, see Intersong-Basart

Ready Music, see Universal

Reba Producties, PO Box 259, Sassenstr 52, Zwolle, Tel (05200) 1-50-04

Red Fox Music, see EMI Music Publ'g

Ren Music, see E & E

Rick's Music, see Home

Ring Eds. (CV), Orchideest 19a, Hilversum, Tel (02150) 4-38-41, Editorial Admin'r. Nette Kolb, Gen. Mgr. Theo de Vos

Roce Music, see EMI Music Publ'g

Rockhouse Music, Stortenbekerstr 5, 2421 ES Nieuwkoop, Tel (01725) 14-32-Telex 14475 Dir. Bert Rockhuizen, Gen. Mgr. Frances Rockhuizen

Russell's Music Inc., Finnmark 4, 3831 JG Leusden-C, Tel (033) 4-18-88, Dir. John Russell

A. V. D. Schaaf & Zn. BV, PO Box 1076, Parkweg 165, Enschede, Tel (053) 31-75-45

Schroon Muziekcentrale 6093 EA Heythuysen, Tel (04749) 19-89

Schweitzer Music, Allanstr. 55, 1551 RA Westzaan, Tel (075) 16-06-24, Gen. Mgr. Richard Schweitzer

Seagull Music, see EMI Music Publ'g

Seahorse, see Universal

Shark Music, see EMI Music Publ'g

Showunie Music, see PRP Int'l Music

Sight & Sound Int'l Inc., PO Box 125, Waalkwijk, Tel (04160) 3-84-88, Dir. Jan DeGraaf

Sikorski Basart, see Intersong-Basart

Sing-Along Songs, Oosterweg 9, 6229 XV Maastricht, Tel (043) 1-69-90, Gen. Dir. Harry Heltzel, Gen. Mgr. Rod Summers

Leo Smeets, Roelofstr 116, Heythuysen, Tel (070) 24-85-56

J. H. Smit, Keizersgracht 695, Amsterdam, Tel (020) 23-65-08

Cor B. Smit's Muziekhandel, Anstel 52, 1017 AB Amsterdam, Tel (020) 23-88-00, Gen. Mgr. W. Eweg

Solo Music, Statinstr 87, Deurne NB, Tel (04930) 25-43, Dir. & Gen. Mgr. Wim Berkens

Soss Music, Trekweg 8, 2516 ES, The Hague, Tel (070) 88-23-38, Pres. Dick Zwicker, Gen. Mgr. Aad Link

Int'l reps.: Austria (Intersong, Juicy), France (MCA), Germany (Intersong, Juicy), Switzerland (Intersong, Juicy), Switzerland (Intersong, Juicy), UK (Rocket)

Sparta Holland BV, see Intersong-Basart

Starshow Publ'ns, see April

Start, see Benelux Music

Step One Music BV, see Intersong-Basart

Taciturn, see Coolwine

Talita, see Universal

Teo Set Music, see EMI Music Publ'g

Tempo (Eds.), see Benelux Music Inds

Tierloff-Muziekcentrale BV, PO Box 18, Markt 90-92, 4700 AA Roosendaal, Tel (01650) 4-12-55, Pres. A.W.H. Vergouwen

Int'l firms represented: Georg Bauer (Germany), Champel (France), Musica (Belgium), Rubank (USA), Emil Ruh (Switzerland), Rundel (Germany), Scherzando (Belgium)

Int'l reps.: Belgium (Gasp), France (Champel), Norway (Tonika), Sweden (Tonika in Norway), Switzerland (Emil Ruh), USA (Elkan)

Timeless Music BV, Herfstlaan 22, Heemstede

Tipsy Music, see Mamicha

Topesa Music, see Dutchy

Gerard Tournier BV (Ed.), see Dutchy

Tower Eds., Oude Torenstr. 10, Hilversum, Tel (035) 1-43-05

Transistor Music, see Nada

Trident BV, see EMI Music Publ'g

Twinkle Stars, PO Box 341, Schaloenstr. 36, Sittard, Tel (04490) 83-23, Mgr. Rudolph de Nijs

Two Sherry's, see Coolwine

Unimil Music, see Universal & Franthea

Union Prod'ns, see Universal Songs

United Artists Music Nederland BV, see EMI Music Publ'g

Universal Songs BV (BUMA), Oranje Nassaulaan 25, Amsterdam 9, Tel (020) 79-70-47, 79-63-48, Cable UNISONG, Telex 14475 Mng. Dir. Wim Landman, Prof. Mgr. Bram Keizer

Int'l firms represented: J. Albert & Son (Australia), Antisa (USA), Belwin Mills (UK, USA), John T. Benson (USA), Blue Echo (USA), Blue Melody (USA), Fred Bock (USA), Brantree (USA), British Lion (UK), Chinnichap, RAK (UK), Clandale, Ledaclan (USA), Cookhouse Music (USA), Deep Purple (UK), Dunamis (USA), Dunbar (USA), 57th Street Entertainment (USA), Gaiter (USA), Gentry (USA), Hamblen (USA), Heathside (UK), Hope (USA), Jack (USA), Jando (USA), Janz (Germany), Kidada (USA), Lady Jane (USA), Latter Rain (USA), Lexicon (USA), Logo Music (UK), Maranatha Music (USA),

Ivan Mogull (USA), Morning (Canada), New Pax (USA), Nimbus 9 (Canada), Northern Songs (UK), Oakfield Ave. (USA), Paragon (USA), Angel Parker (UK), Parchester (USA), Purple (UK), Quarry (UK), RAK (UK), RCA (worldwide), Rodeheaver (USA), Rondor (UK, USA), Scott-Wolfe (UK), Shillelagh (UK), Swanell (UK), Strange (UK), Sunbury (UK, USA), Tembo (UK), 20th Century (USA), Virgim (UK), Lawrence Welk (USA), Woodwater (Jamaica), Word (UK, USA), Lawrence Wright (UK) (SEE ADVERTISEMENT)

Vabo Music, see Dutchy

Van Dam Music Co., Gen. Vetterstr. 66, Amsterdam, Tel (020) 22-75-18, Owner. Albert Van Dam

Van Rosmalen, see Tierloff

Van Teeseling Muziekuitgeverij, Broedestr. 138, 6543 ZX Nijmegen, Tel (080) 77-04-50, Dir. Bob van Teeseling

Int'l firms represented: Alpuerto (Spain), Doberman (Canada), Institute of Guitar & String Instruments (Germany), Reuter & Reuter (Sweden), Studio PR (USA)

Int'l rep.: Breitkopf & Haertel (UK)

Van 't-Hoens, Oostzeedijk 364, Rotterdam, Tel (010) 13-82-66

Veronica Music, see EMI Music Publ'g

Mike Vincent Music, see Mamicha

Volandam Music, see Home

Volita Music, see EMI Music Publ'g

W W Music, PO Box 201, Roghorst 303, 6700 RE Wageningen, Tel (08370) 1-34-40, Telex 45991, Dir. Wim Wigt

J. A. H. Wagenaar, Oudegracht 109, Utrecht, Tel (030) 31-04-09, 31-07-77

Warner Bros. Music Holland BV, Koninginneweg 49, Hilversum, Tel (035) 1-91-47, Mng. Dir. Ben Bunders, Gen. Mgr. Frans de Wit

Washington Music, see Benelux Music Inds

Weekend Music Int'l, see Ladyvyn

Weird Music, Amstelkade 15, Amsterdam, Tel (020) 76-20-96

P. J. Wiest, Hofstederstr 73b, Rotterdam, Tel (010) 25-48-84

J. C. Willemse, PO Box 79, Langestr. 72, Amersfoort, Tel (033) 1-62-25

Winter Music, see Nada

Witch Music, see EMI Music Publ'g

X Y Z (Muziekuitgeverij), Willemsparkweg 49, Amsterdam, Tel (020) 72-93-90

Xmusic, see April

Zen Music, see E & E

Herman Zengerink (Muziekuitgeverij), Urlusstr. 24, 3533 SN Utrecht, Tel (030) 93-06-85, Mng. Dir. Herman Zengerink

Int'l firms represented: Carrara (Italy), Edelweiss (Belgium), Paulus (Switzerland)

Zen Music, see E & E & PRP Int'l

Hartplein 23, Amsterdam, Tel (020) 79-15-11, 79-04-42, Chm., H.I. Kellerman, Mng. Dir. R.L. Woltz

Nederlandse Vereniging voor Grammofoonplaten Importeurs & Fabrikanten, see NVPI

Stichting Audiovisuele Manifestaties (SAM), Postbus 31, Huizen NH, Tel (02152) 5-44-55

Stichting CAP (Commercial Activities), PO Box 5259, Roelof Hartplein 23, Amsterdam, Tel (020) 79-15-11, 79-04-42, Chm., A.J. Felix

Stichting Contactoorgan Electronische Muziek (Contact Centre Foundation for Electronic Music), PO Box 30, Biltoven 5, Tel (0103130) 78-70-33

Stichting Nationale Platenbond (NBGD), Distributor of Record-Gift System, PO Box 5259, Roelof Hartplein 23, Amsterdam, Tel (020) 79-15-11, 79-04-42, Chm., R.L. Woltz

U N I M (Vereniging van Uitgevers van Nederlandse & Internationale Muziek), Amstel 52, Amsterdam, Tel (020) 23-88-00, Sec'y. C. Smit Jr.

Vereniging van Muziekhandelaren & Uitgevers in Nederland (Dutch Music Retailers & Music Publ'rs Ass'n), Amstel 52, Amsterdam, Tel (020) 23-88-00, Sec'y. C. Smit Jr.

Vereniging van Muziekinstrumentenhandelaren (Retailers of Musical Instruments Org.), Nieuwe Binnenweg 132, Rotterdam, Tel (010) 36-17-29, 36-19-29

Vereniging voor Nederlandse Muziekgeschiedenis (Society for Dutch Music History), Drift 21, 3512 BR Utrecht, Tel (030) 31-68-41, Pres.: Willem Elders, Gen. Mgr. Herman Zengerink

DESIGN & ARTWORK

Almere Printing BV, PO Box 45, Bedrijvenpark, De Vaart 1, 1300 AA Almere, Tel: (03240) 2-05-54, Telex 70442, Mng. Dir. Koert Bolhuis, Sales Mgr.: Wim Trouw

Benelux Music Inds., PO Box 70, 6000 AB Weert, Uilenweg 38, 6006 SK Weert, Tel (04950) 3-56-40, Telex 51285, Dir. Johnny Hoes, Gen. Mgr.: Sjayar Djamschidi, Sales Mgr. George Verbiest

C B S Grammofoonplaten BV, Nijverheidsweg 32-36, 2031 CP Haarlem, Tel (023) 31-94-10, Cable COLRECORD, Telex 41538, Gen. Mgr.: Peter P. Bouwens, Sales Mgr.: W.F. Ariens

Continental Sound, PO Box 81065, Rotterdam, Tel (010) 21-10-98, 21-48-28, Pres.-Dir. Gen.: Leen La Riviere, Dir. Nico Zwarts, Gen. Mgr. Kees Klaassen

E & E Prod'ns, PO Box 1525, Amsterdam, Tel (020) 93-62-49, Gen. Mgr.: Peter Rensen, Sales Mgr.: Paul Rodenhuis

E M I-Holland Productie BV, Industrielaan 24, 5406 XC Uden, Tel (04132) 6-81-55, Cable EMI HP, Telex 50477, Mng. Dir. J.H.G. Vossen

Ivory Tower Studio's, Tusseld 55, Bornerbrog, Tel (05408) 261, Dir. Fred Rootveld, Gen. Mgr.: Angie Rootveld, Eng. Jaap Hilbink

Nederlandse Normaal Drukkerij BV (Bramson Groep), PO Box 191, 3800-AD Amersfoort, Nijverheidsweg Noord 126-128, Amersfoort, Tel (033) 3-16-64, Telex: 79448

P C M P Inc Holland, PO Box 479, 3130 AL, Vlaardingen, Tel (010) 35-71-20

Polydor BV, Verrijn Stuurlaan 36, 2288 EL Rijswijk, Tel (070) 90-76-00, Telex: 31481, Mng. Dir.: Hans van den Broek, Sales Mgr.: Joop Veer

Ring Workshop BV, Orchideest 19a, Hilversum, Tel (02150) 4-38-41, Mng. Dir.: Niek Lucas, Gen. Mgr.: Theo de Vos, Sales Mgr. George Nissen; D&A Dept. Head. Letty Annokke

Universe Prod'ns, Spanjaardslaan 33, Leeuwarden, Tel: (05100) 2-01-94, 2-45-22, Pres.: Wobbe van Seijen; Sales Mgr.: Wim de Vries

Wax-Europe, Kattengat 2, 1012 SZ Amsterdam, Tel (020) 25-48-14, Pres.: Morton D. Wax, European Mgr.: Jules Farber

LICENSING ORGANIZATIONS, MUSIC

B U M A (Bureau Voor Muziek-Auteursrecht), Marius Bauerstr. 30, 1062 AR Amsterdam, Tel (020) 15-68-22 (Performing rights only)

S T E M R A, Marius Bauerstr. 30, 1062 AR Amsterdam, Tel (020) 15-68-22 (Mechanical rights only)

Vereniging Het Bureau voor Muziek-Auteursrecht (Composers' Rights Society), Marius Bauerstr. 30, 1062 AR Amsterdam, Tel (020) 15-68-22, Dir. J.H. Verhagen (Performing rights only)

PLATING, PROCESSING & PRESSING PLANTS

Algrammo, PO Box 7, Pettemerstr. 9, Alkmaar, Tel (072) 2-23-33 (Pressing only)

Benelux Music Inds., PO Box 70, 6000 AB Weert, Uilenweg 38, 6006 SK Weert, Tel (04950) 3-56-40, Telex 51285, Dir.: Johnny Hoes, Gen. Mgr. Sjayar Djamschidi, Sales Mgr. George Verbiest

C B S Grammofoonplaten BV, Dept. of Mfg. Opns., Nijverheidsweg 32-36, 2031 CP Haarlem, Tel: (023) 31-94-10, Cable COLRECORD, Telex 41538, Gen. Mgr. Peter P. Bouwens, Sales Mgr. W.F. Ariens

Cruquius BV, Biekersvaartweg 45, Heemstede, Tel (023) 28-25-12/23-53, Telex 41392, Gen. Mgr. Rien Duijsterhof

Dureco BV, Pampuslaan 45, 1380 AA Weesp, Tel (2940) 1-53-21, Cable RECMUS, Telex: 14409 Mng. Dir. A.E. Palmans, Factory Mgr.: H. Ridderikoff, Planning Mgr.: R. Ebbens, Customer Serv.: C.E. Stam (Pressing only)

E M I-Holland Productie BV, Industrielaan 24, 5406 XC Uden, Tel (04132) 6-81-55, Cable: EMI HP, Telex: 50477, Mng. Dir.: R. v.d. Berg

Interdisc BV/Interprint BV, Tulpenkade 1, Haarlem, Tel: (023) 31-93-80

P P I, Torenlaan 17, Baarn, Tel (02154) 1-99-11, Telex 43382

Roxs Handelsonderneming BV, PO Box 36, Grotestr. 69, Waalkwijk, Tel (04160) 3-25-81, Telex 35040 Chm.: Chris van Delft, Mgr.: Ron van den Beukel (Pressing only)

Sonclar Nederland, PO Box 1110, Hilversum, Tel: (035) 6-21-46

Sonopresse BV, PO Box 751, Stuwadoorstr. 106, Rotterdam, Tel (010) 84-47-10, 84-86-47, Telex: 28862

● **services**

ASSOCIATIONS & PROFESSIONAL ORGANIZATIONS

Amsterdam Arts Council, Town Hall, Rm. 133, O.Z. Voorburgwal 199, Amsterdam

Audiovisuele Beroepsver. (NBf), Keizersgracht 238, Amsterdam, Tel (020) 24-66-33

C G C (Foundation for Collective Gramophone Rec. Promo.), Oosteinde 23, Amsterdam, Tel (020) 24-10-32

Conamus (Foundation), Marius Bauerstr. 30, Amsterdam 1062, Tel (020) 15-68-22, Mgr. Henry Mildenberg, Ass't Mgr. Yvonne Andre

Documentatiecentrum voor Nederlandse Groepen & Artiesten, PO Box 3524, Amsterdam, Tel (020) 93-62-49

Donemus (Foundation) (Documentation of Netherlands Music), Paulus Potterstr 14, 1071 CZ Amsterdam, Tel (020) 76-44-36, Dir.: R. Starreveld; Promo Dir.: P. Herzberger

Dutch Guild of Songwriters (WTJ), Jacob Obrechtstr. 51, 1071 KJ Amsterdam, Tel (020) 79-21-52

Dutch Nat'l Group of EPPI, see NVPI

Gaudeamus Foundation (Promotion of Contemporary Music), PO Box 30, Biltoven 5, Tel (0103130) 78-70-33

Genootschap van Nederlandse Componisten (Society of Dutch Composers), Marius Bauerstr. 30, Amsterdam, Tel (020) 15-68-22

Jeugd & Muziek (Youth & Music), Roemer Visscherstr 42, Amsterdam W, Tel (020) 16-37-01, 16-43-54

Koninklijke Nederlandse Toonkunstenaars Vereniging (Royal Netherlands Musicians' Society), Vondelstr. 66, Amsterdam

Kunstenaarsorganisatie NVV, Passeerdersgracht 32, Amsterdam, Tel (020) 22-00-25, Chm.: Hans Boswinkel, Gen. Mgr.: Hans Verploeg

Music Papers Ass'n & Music Dealers Org., PO Box 338, Bussum, Tel (02159) 4-62-66

Muziek Informatie Burs, PO Box 1525, 1000 BM Amsterdam, Tel (020) 93-62-49, Gen. Mgr. Peter Bensen, PR Mgr.: Paul Rodenhuis

NTB, Herengracht 163, Amsterdam, Tel (020) 23-03-47

N V G D (Nederlandse Vereniging van Grammofoon Detailhandelaren), PO Box 5259, Roelof Hartplein 23, Amsterdam, Tel 79-04-42, 79-15-11

N V P I (Nederlandse Vereniging van Producenten & Importeurs van Beeld- & Geluidsdragers) (Dutch Nat'l Group of IFPI), PO Box 7000, Amsteldijk 166, Amsterdam, Tel (020) 44-41-29, Mng. Dir.: Leo Boudewijns

National Disc Jockey Org., PO Box 633, Amsterdam, Tel (020) 93-62-49

Nederlandse Bond van Piano & Orgelhandelaren & Fabrikanten (Piano Makers & Retailers Org.), Nieuwe Binnenweg 132, Rotterdam, Tel (010) 36-17-29, 36-19-29

Nederlandse Omroep Stichting (Radio & TV), PO Box 10, Hilversum, Tel (0103135) 77-91-11

Nederlandse Vereniging van Grammofoonplatenhandelaren, (Record Retailers' Ass'n), PO Box 5259, Roelof

Mng. Dir. Leo Ritmeester (Pressing only)
Sonorfix BV, Spaarnwouderstr. 72, Haarlem, Tel. (023) 32-10-15

PRINTERS & LITHOGRAPHERS

Almere Printing BV, PO Box 45, Bedrijvenpark, De Vaart 1, 1300 AA Almere, Tel. (03240) 2-05-54, Telex 70442
Mng. Dir. Koert Bolhuis, Sales Mgr. Wim Trouw
Amsterdam Drukkerij, N. Berchemstraat 1, Amsterdam, Tel. (020) 79-10-45

Benelux Music Inds., PO Box 70, 6000 AB Weert, Uilenweg 38, 6006 SK Weert, Tel. (04950) 3-56-40 Telex 51285 Dir. Johnny Hoes, Gen. Mgr. Sjayer Djamschidi, Sales Mgr. George Verbiest
Biljetdrukkerij Nederland, Binnenkant 40, Amsterdam, Tel. (020) 22-16-31

C B S Grammofoonplaten BV, Nijverheidsweg 32-36, 2031 CP Haarlem, Tel. (023) 31-94-10 Cable COLRECORD, Telex 41538 Gen. Mgr. Peter P. Bouwens, Sales Mgr. W. F. Ariens

Drukkerij van de Steeg BV, Hyacinthstr. 40B, Enschede, Tel. (053) 33-05-55 Chief Exec. J. W. van de Steeg, Gen. Mgr. H. H. Smit

E M I-Holland Produktie BV, Industrielaan 24, 5406 XC Uden, Tel. (04132) 68155 Cable EMI HP, Telex 50477 Mng. Dir. J. H. G. Vossen

Habo/Dacosta Grafische Industrie, Coloradodreef 18, Utrecht, Tel. (030) 61-68-21 Telex 47315
Interdisc BV/Interprint BV, Tulpenkade 1, Haarlem, Tel. (023) 31-93-80

Moonlight, Hurwenestr. 5, Rossum, Tel. (04182) 790, N N D, PO Box 191, Amerfoort, Tel. (033) 3-16-64

Nederlandse Normaal Drukkerij BV (Bramson Groep), PO Box 191, 3800 AD Amersfoort, Nijverheidsweg Noord 126-128, Amersfoort, Tel. (033) 3-16-64 Telex 79448

P C M P Inc. Holland, PO Box 479, 3130 AL, Vlaardingen, Tel. (010) 35-71-20

P P I, Torenlaan 17, Baarn, Tel. (02154) 1-99-11, Telex 43382

Polydor BV, Verrijn Stuurtaan 36, Rijswijk, Tel. (070) 90-76-00 Telex 31481 Mng. Dir. Hans van den Broek, Sales Mgr. Joop Veer

Sonclair Nederland, Postbus 1110, Hilversum, Tel. (035) 6-21-46

Arno van Orsouw BV, Oostenburgervoorstr. 71-73, Amsterdam, Tel. (020) 22-28-98, 25-21-13 Telex 13442, Chief Exec. Arno van Orsouw

PROFESSIONAL TAPE SUPPLIES

Nederlandse Normaal Drukkerij BV (Bramson Groep), PO Box 191, 3800 AD Amersfoort, Nijverheidsweg Noord 126-128, Amersfoort, Tel. (033) 3-16-64 Telex 79448
Audio: Inlays

RECORD PROMOTION

A K Prod'ns, Grunder 254, Bijlmermeer, Amsterdam, Tel. (020) 99-47-36, 98-38-47

Almere Printing BV, PO Box 45, Bedrijvenpark, De Vaart 1, 1300 AA Almere, Tel. (03240) 2-05-54 Telex 70442
Mng. Dir. Koert Bolhuis, Sales Mgr. Wim Trouw

Herman Batelaan Promos, Moerbeigaarde 112, Zoetermeer, Tel. (070) 63-57-82 Gen. Mgr. Herman Batelaan, Sales Mgr. Pieter J. Kieboom

Benelux Music Inds., PO Box 70, 6000 AB Weert, Uilenweg 38, 6006 SK Weert, Tel. (04950) 3-56-40 Telex 51285 Dir. Johnny Hoes, Gen. Mgr. Sjayer Djamschidi, Sales Mgr. George Verbiest

Black Snake Prod'ns, Schaeplanaan 22, Bloemendaal 1542, Tel. (023) 37-65-83

Louis Bolsius Theater & Organisatieburo BV, Nieuwlandstr. 20, 5038 SN Tilburg, Tel. (013) 32-30-77 Gen. Mgr. Louis Bolsius

Conamus (Foundation), Marius Bauerstr. 30, Amsterdam 1062, Tel. (020) 15-68-22 Gen. Mgr. Henry Mildeberg Ass't Mgr. Yvonne Andre

Continental Sound, PO Box 81065, Rotterdam, Tel. (010) 21-10-98, 21-48-28 Pres. Dir. Gen. Leen La Riviere, Dir. Nico Zwarts, Gen. Mgr. Kees Klaassen

Cosmos Prod'ns, PO Box 250, Kerkrade, Tel. (04445) 37-59

Disco Serv., PO Box 3524, Amsterdam, Tel. (020) 93-62-49

E & E Prod'ns, PO Box 1525, Amsterdam, Tel. (020) 93-62-49 Gen. Mgr. Peter Rensen, Sales Mgr. Paul Rodenhuis

Fleet Benelux, Kenastraat 3, Haarlem, Tel. (023) 31-35-43 Founders: Robert A. Aardse & Peter Meisel

Fonorama BV, PO Box 26, Koningin Wilhelminalaan 12, Amersfoort, Tel. (033) 3-45-14 Telex 79263 Gen. Mgr. Arnold van der Wees, Sales Mgr. Ben Vos
Holland Produktion, PO Box 146, Oudenoord 101 bis/a, Utrecht, Tel. (030) 31-36-76

Joop Koekkoek, Provincialweg 47, Kromme, Tel. (075) 21-50-21 Gen. & Sales Mgr. Joop Koekkoek

Han Kuiper Ents., De Boelelaan 435, 1082 RJ Amsterdam, Tel. (020) 42-93-96 Gen. Mgr. Wim Johan Kuiper

Lion Artists Mgmt. BV, Kerstant van de Bergelaan 38a, Rotterdam, Tel. (010) 22-52-22 Dir. H. van der Mey

Mazel Poppres Agency, Wassenaarseweg 89, The Hague, Tel. (070) 24-87-30

Mojo Concerts BV, PO Box 3035, Delft, Tel. (015) 12-19-80

Munich Recs. BV (VHB Munnikendam & Groothandel NV), Albert Schweitzerlaan 9, 6721 AW Bennekom, Tel. (08389) 67-77 Pres. Job C. Zomer, Gen. Mgr. Huub Trautwein, Sales Mgr. Judith Budding, Engs. Wil Hesen, Kees Hoepel

Muziek & Showbureau Jan Vis BV, Koninginnenlaan 7, s-Hertogenbosch, Tel. (073) 13-64-44 Mng. Dir. Jan Vis

National Promoting System, PO Box 1035, Veerhuis 156, 2302 BA Leiden, Tel. (071) 12-61-75 Gen. Mgr. Fred van Duiken, Sales Mgr. Bob Tasseron, Art-Designer H. A. Cee

Martin A. van Olderen Oldie Blues Rec. Center, Moosdriehod 175, 1106 NG Tel. (020) 96-11-11, Dir. Martin A. van Olderen

P C M P Inc. Holland, PO Box 479, 3130 AL, Vlaardingen, Tel. (010) 35-71-20

Pico, Ganzenhoef 28, Amsterdam, Dir. Hans Down, Gen. Mgr. K. Kuiper, Sales Mgr. A. Ramschalaan

Piq Pqg Music BV, PO Box 1229, Pettelaarseweg 25, 5216 BG s-Hertogenbosch, Tel. (073) 14-73-34, 13-83-52

Repar., PO Box 27, Coeverdoren, Tel. (05240) 37-79
Ring Workshop BV, Orchideestr. 19a, Hilversum, Tel. (02150) 4-38-41 Mng. Dir. Niek Lucas, Gen. Mgr. Theo de Vos, Sales Mgr. George Nissen

Sylvain's Show Prod'ns, A. J. Ernststr. 9, 1083 GP Amsterdam, Tel. (020) 42-92-88 Dir. Sylvain J. de Haas, Gen. Mgr. Erna de Haas

Topdog, Nieuwe Gracht, 49-51 Haarlem, Tel. (023) 32-26-70

Twinkle Stars Prod'ns BV, PO Box 341, Schaloenstr., Sittard, Tel. (04490) 83-23 Cable MAASTRICHT Gen. Mgr. Rudolph de Nijis, Sales Mgr. Roy Sinclair

Universe Prod'ns, Spanjaardslaan 33, Leeuwarden, Tel. (05100) 2-01-94, 2-45-22 Pres. Wobbe van Seijen, Sales Mgr. Wim de Vries

Aad van Holstein, Handellaan 176, 2671 VJ Naaldwijk, Tel. (01740) 2-57-61

Ben Vreeburg, Kometenlaan 12, De Bilt, Tel. (030) 76-27-55

Wax-Europe, Kattengat 2, 1012 SZ Amsterdam, Tel. (020) 25-48-14 Pres. Morton D. Wax, European Mgr. Jules Farber

Wim Wigt Prod'ns, PO Box 201, Roghorstr. 303, 6700 AE Wageningen, Tel. (08370) 1-34-40 Chief Exec. Wim Wigt

TAPE CUSTOM DUPLICATORS TAPE PACKAGING & LABELING

The Audio and Video lines indicate the configurations which the firms duplicate. Companies which offer packaging and labeling of tape product are indicated by: (PKG) which appears after the main body of their respective listings.

Audio Studio & Magnetronics BV, de Wetstr. 10-12, Arnhem, Tel. (085) 22-91-23 Telex 75037 Pres. Gert van der Garde, Gen. Mgr. Alfred van der Garde, Chief Eng. Charles van Cattenburch
Audio: Cassette, open reel

Benelux Music Inds., PO Box 70, 6000 AB Weert, Uilenweg 38, 6006 SK Weert, Tel. (04950) 3-56-40 Telex 51285 Dir. Johnny Hoes, Gen. Mgr. Sjayer Djamschidi, Sales Mgr. George Verbiest (PKG)
Audio: Cassette

C B S Grammofoonplaten BV, Nijverheidsweg 32-36, 2031 CP Haarlem, Tel. (023) 31-94-10 Cable COLRECORD, Telex 41538 Gen. Mgr. Peter P. Bouwens, Sales Mgr. W. F. Ariens
Audio: Cassette

E M I-Holland Produktie BV, Industrielaan 24, 5406 XC Uden, Tel. (04132) 68155 Cable EMI HP, Telex 50477 Mng. Dir. J. H. G. Vossen, Cassette Dept. Gen. Mgr. W. M. Klimkenbilj
Audio: Cassette

M C R Prod'ns BV, Hooglandseweg 62, 3813 AS Amersfoort, Tel. (033) 2-34-01 Telex 79388 Mng. Dir. Foppe Damste, Chief Eng., Ben Uytrens
Audio: Cassette

Polydor BV, Verrijn Stuurtaan 36, Rijswijk, Tel. (070) 90-76-00 Telex 31481 Mng. Dir. Hans van den Broek, Sales Mgr. Joop Veer
Audio: Cassette

Sonortape BV, PO Box 113, Dennaan 42, 3600 AC Maarssebroek, Tel. (030) 43-11-44 Telex 40354 Chief Exec. M. C. Groeneveld, Mgr. H. Dijkkamp
Audio: Cassette

van der Garde's Audio Studios BV, De Wetstr. 10-12, 6814-AP Arnhem, Tel. (0031) 85-22-91-23 Dir. Gert van der Garde
Audio: Cassette

● supplies

EMPTY CARTRIDGES, CASSETTES & REELS

Ampex BV, Zamenholdreef 65A, 2505 Utrecht, Tel. (030) 61-29-21 Telex 47856 Mgr. G. C. A. de Jong

Benelux Music Inds., PO Box 70, 6000 AB Weert, Uilenweg 38, 6006 SK Weert, Tel. (04950) 3-56-40 Telex 51285 Dir. Johnny Hoes, Gen. Mgr. Sjayer Djamschidi, Sales Mgr. George Verbiest

E & E Prod'ns, PO Box 1525, Amsterdam, Tel. (020) 93-62-49 Gen. Mgr. Peter Rensen, Sales Mgr. Paul Rodenhuis

ENVELOPES & MAILERS

E & E Prod'ns, PO Box 1525, Amsterdam, Tel. (020) 93-62-49 Gen. Mgr. Peter Rensen, Sales Mgr. Paul Rodenhuis

Nederlandse Normaal Drukkerij BV (Bramson Groep), PO Box 191, 3800 AD Amersfoort, Nijverheidsweg Noord 126-128, Amersfoort, Tel. (033) 3-16-64 Telex 79448

P C M P Inc. Holland, PO Box 479, 3130 AL, Vlaardingen, Tel. (010) 35-71-20

JACKETS & SLEEVES LABELS

Almere Printing BV, PO Box 45, Bedrijvenpark, De Vaart 1, 1300 AA Almere, Tel. (03240) 2-05-54 Telex 70442
Mng. Dir. Koert Bolhuis, Sales Mgr. Wim Trouw

Benelux Music Inds., PO Box 70, 6000 AB Weert, Uilenweg 38, 6006 SK Weert, Tel. (04950) 3-56-40 Telex 51285 Dir. Johnny Hoes, Gen. Mgr. Sjayer Djamschidi, Sales Mgr. George Verbiest (Labels only)

E M I-Holland Produktie BV, Industrielaan 24, 5406 XC Uden, Tel. (04132) 68155 Cable EMI HP, Telex 50477 Mng. Dir. J. H. G. Vossen

Magnetronics BV, De Wetstr. 12, Arnhem 6814 AP, Tel. (085) 22-91-23 Dir. Alfred van der Garde (Labels only)

Nederlandse Normaal Drukkerij BV (Bramson Groep), PO Box 191, 3800 AD Amersfoort, Nijverheidsweg Noord 126-128, Amersfoort, Tel. (033) 3-16-64 Telex 79448

P C M P Inc. Holland, PO Box 479, 3130 AL, Vlaardingen, Tel. (010) 35-71-20 (sleeves only)

Arno van Orsouw Uitgeverij BV, Oostenburgervoorstr. 71-73, Amsterdam, Tel. (020) 22-28-98 Telex 13442
Mng. Dir. Arno van Orsouw

TAPE DUPLICATING & PROCESSING EQUIPMENT

Ampex BV, Zamenholdreef 65A, 2505 Utrecht, Tel. (030) 61-29-21 Telex 47856 Mgr. G. C. A. de Jong

Audio Studio & Magnetronics BV, de Wetstr. 10-12, Arnhem, Tel. (085) 22-91-23 Telex 75037 Pres. Gert van der Garde, Gen. Mgr. Alfred van der Garde, Chief Eng. Charles van Cattenburch
Audio: Duplicators, loaders

Brand name: Telefunken
Telefunken, see Audio Studio & Magnetronics
Unaworld Corp., PO Box 6730, De Perponcherstr. 14, The Hague

Home office: USA
Audio: Duplicating heads

TAPE, RAW & BLANK LOADED

Agfa-Gevaert NV, Polakweg 10-11, Rijswijk, Tel. (070) 90-66-80 Mng. Dir. J. Davignon, Sales Mgr. D. van den Broek

Audio: Cassette, open reel
Video: 1" open reel, 1" cartridges, 3/4" cassette
Brand Names: Agfa-Carat, Agfa-Ferrocator, Agfa-Stereochrom, Agfa-Superchrom, Agfa-Superferro, Agfa-Videochrom

Ampex BV, Zamenholdreef 65A, 2505 Utrecht, Tel. (030) 61-29-21 Telex 47856 Mgr. G. C. A. de Jong
Audio: Blank—8-tr., cassette, open reel, raw—8-tr., cassette

Video: Blank—1" open reel, 1" cartridge, 3/4" cassette, 1/2" EIAJ open reel, 1/2" EIAJ cartridge, raw—1" open reel, 1" cartridge, 3/4" cassette, 1/2" EIAJ open reel, 1/2" EIAJ cartridge

Audio Studio & Magnetronics BV, de Wetstr. 10-12, Arnhem, Tel. (085) 22-91-23 Telex 75037 Pres. Gert van der Garde, Gen. Mgr. Alfred van der Garde, Chief Eng. Charles van Cattenburch
Audio: Cassette, open reel

Video: 1/2" EIAJ cartridge
B A S F Nederland BV, PO Box 1019, Kadest. 1, Tel. (085) 71-71-71 Telex 45111 Sales Mgr. Willem van Workum
Audio & video: Cassette & open reel

Chairos BV, Mensing 51, Amsterdam, Tel. (020) 44-13-77 Telex 18118 Pres. W. F. Harrems, Gen. Mgr. Mrs. B. Harrems (Blank only)
Audio: 8-tr. cassette

P C M P Inc. Holland, PO Box 479, 3130 AL, Vlaardingen, Tel. (010) 35-71-20 (Raw only)
Audio: Cassette, open reel

● accessories manufacturers

Almere Printing BV, PO Box 45, Bedrijvenpark, De Vaart 1, 1300 AA Almere, Tel. (03240) 2-05-54 Telex 70442
Mng. Dir. Koert Bolhuis, Sales Mgr. Wim Trouw
Product: Broswer boxes, dividers cards

Ampex BV, Zamenholdreef 65A, 2505 Utrecht, Tel. (030) 61-29-21 Telex 47856 Mgr. G. C. A. de Jong
Product: Head cleaners & demagnetizers

Audioscript BV, Postbus 80, Nieuw Loosdrechtsejdijk 107, Loosdrecht, Tel. (02158) 5104 Dirs. P. de Ruig, J. L. Cluysenaar
Product: Needles

Chairos BV, Mensing 51, Amsterdam, Tel. (020) 44-13-77 Telex 18118 Pres. W. F. Harrems, Gen. Mgr. Mrs. B. Harrems
Product: Tape carrying & storage cases, head cleaners & demagnetizers

Inelco Nederland BV, Turfstekerstr. 63, 1431 GD Aalsmeer, Tel. (02977) 28855 Cable INTELECT Telex 14168
Product: Needles (Pickering)

Munich Recs. BV (VHB Munnikendam & Groothandel NV), Albert Schweitzerlaan 9, 6721 AW Bennekom, Tel. (08389) 67-77 Cable MUREC Pres. Job C. Zomer, Gen. Mgr. Huub Trautwein, Sales Mgr. Judith Budding, Engs. Wil Hesen, Kees Hoepel
Product: Needles

P C M P Inc. Holland, PO Box 479, 3130 AL, Vlaardingen, Tel. (010) 35-71-20
Product: Needles, leader & splicing tape

Pico Recs., Ganzenhoef 28, Amsterdam, Tel. (020) 99-47-36 Dir. Hans Douw, Gen. Mgr. Kees Kuiper, Sales Mgr. Atma Ramchalaan
Product: Record carrying & storage cases, catalog servs., cleaners, cloths, brushes, 45 rpm adapters, needles

Polydor BV, Verrijn Stuurtaan 36, Rijswijk, Tel. (070) 90-76-00 Telex 31481 Mng. Dir. Hans van den Broek, Prod. Mgr. Nico van Biemen, Mktg. Mgr. Bob Spits, Sales Mgr. Joop Veer
Product: Record carrying & storage cases, cleaners, cloths, brushes, 45 rpm adapters

Twinkle Stars Prod'ns BV, PO Box 341, Schaloenstr. 36, Sittard, Tel. (04490) 83-23 Cable MAASTRICHT Gen. Mgr. Rudolph de Nijis, Sales Mgr. Roy Sinclair
Product: Record carrying & storage cases, leader tape

Weton-Wesgram BV, Veerlaan 86, 3072 ZZ Rotterdam, Tel. (010) 86-11-66 Telex 28798 Mng. Dir. Albert S. de Vries
Product: Record & tape carrying & storage cases, cloths, record & tape care products

● store fixtures & merchandising aids manufacturers

Chairos BV, Mensinge 51, Amsterdam. Tel: (020) 44-13-77. Telex: 18118. Pres.: W.F. Harrems; Gen. Mgr.: Mrs. B. Harrems.
Product: Tape display racks.
 Polydor BV, Verrijn Stuurtaan 36, Rijswijk. Tel: (070) 90-76-00. Telex: 31481. Mng. Dir.: Hans van den Broek; Prod. Mgr.: Nico van Biemen; Mktg. Mgr.: Bob Spits; Sales Mgr.: Joop Veen.
Product: Display racks.

NEW ZEALAND

Population: 3,148,000.
Rate of exchange: \$1 (US) = .99 NZ dollar.
Per capita income: \$3,943.
Holidays: January 1, April 25 (Anzac Day), Good Friday, Easter Monday, June 5 (Queen's Birthday), October 25, December 25, 26.

RECORDS:

Records, record blanks & pre-recorded media imported from USA: 1977—\$149,626.

● record & tape manufacturers / distributors / importers

Archiv, see Polygram.
 Asylum, see WEA.
 Atco, see WEA.
 Atlantic, see WEA.
 CBS Recs. (New Zealand) Ltd. (IFPI), 19 Falcon St., Parnell, Auckland. Tel: (09) 79-75-08. Cable: CBSREC. Gen. Mgr.: John McCready; Prod. Mgr.: Gaynor Crawford.
Labels: (Owned) CBS, Epic, Portrait; (Licensed—foreign) ARC (USA), Jet (UK), Nipper (USA), TK (USA).
 Capitol, see EMI.
 Columbia, see EMI.
 Concorde Prod'ns, c/o Henry B. Norcross Ltd., PO Box 21-101, Henderson, Auckland. (Distributor).
 D.G., see Polygram.
 Destiny, see Sacred.
 Direction Dists., see Sonoboy Gramophone.
 EMI (New Zealand) Ltd. (IFPI), PO Box 30849, 408 Hutt Rd., Lower Hutt, Wellington. Tel: 666-979. Cable: EMITRON. Telex: 3413. Mng. Dir.: P.N. Jamieson; Technical Dir.: D. Snell.
Branches: Auckland, PO Box 1931, 52 High St. Tel: 775-385. Telex: 21708. Cable: EMITRON—Christchurch, PO Box 2608, 77 Cashel St., Suite 5. Tel: 62735.
Labels: (Owned) Capitol, Columbia, EMI, HMV, Harvest; (Licensed) Arista (USA), BBC (UK), Decca (UK), Disneyland (USA), Magnet (UK), Motown (USA), Private Stock (USA), RAK (UK).
 Int'l rep.: Worldwide (EMI).
 Elektra, see WEA.
 Epic, see CBS.
 Festival Recs. (NZ) Ltd. (IFPI), 69 Carlton Gore Rd., Newmarket, Auckland 2. Tel: 33-885. Gen. Mgr.: Ray Porter; Sales Mgrs.: Chris Jackson, Ted Money; Nat'l Promos. Mgr.: Kevin Williams.
Home office: Australia.
Labels: (Owned) Festival, Interfusion; (Licensed domestic) Key; (Licensed foreign) A&M (USA), ATA (Australia), Ad-Rhythm (UK), Ariola-Eurodisc (Germany), Barclay (France), Beserkley (USA), Blue Note (USA), Chrysalis (UK), Clarion (Australia), DJM (UK), Daffodil (Canada), Eurovox (Belgium), Fantasy (USA), Festival (Worldwide), GNP Crescendo/Accent (USA), GRT (Canada), Good Ear (UK), Hispavox (Spain), Hot Wax (USA), Immediate (UK), Inivictus (USA), Island (UK, USA), King (Japan), Mainstream (USA), Milestone (USA), Monument (USA), Mushroom (Australia), Nems (UK), Pinnacle Storyteller (UK), Prestige (USA), Project 3 (USA), Ranwood (USA), Safari (USA) Shelby Singleton group (USA), Shelter (USA), Springboard (USA), Stanyan (USA), Steady (USA), Sydney Thompson (UK), United Artists (France, Germany, UK, USA), Viva (USA), Vogue (France), Wallis Original (USA).

Five Star, see Ode.
 Fontana, see Polygram.
 H M V, see EMI.
 Harvest, see EMI.
 Hibiscus, see Kiwi/Pacific.
 Houghton Hughes Ltd., see Music World.
 Inn, see Innovation.
 Innovation Ents. Ltd., PO Box 45-108, Te Atatu, Auckland 8. Tel: 44-444. Mng. Dir.: Errol J. Peters; Gen. Mgr.: Ginny Peters; Sales Mgr.: Austin Roberts.
Labels: (Owned) Inn, Innovation; (Licensed) Canary, E-Volve, Raven (all USA).
 Int'l rep.: USA (E-Volve).
 Interfusion, see Festival.
 K-tel Int'l (New Zealand) Ltd., PO Box 2614, 149 Victoria St., Auckland 1. Tel: 797-166.
Home office: USA.
 Key, see Zodiac & Festival.
 Kiddisc, see Music World.
 Kiwi, see Kiwi/Pacific.
 Kiwi/Pacific Recs. Ltd., 182 Wakefield St., Wellington. Tel: 849-981. Cable: KIWITONE. Mng. Dir.: Antony Vercoe.

Labels: (Owned) Hibiscus, Kiwi, Tartar; (represented) Folkways (USA), Free Reed (UK), Kiddy Kassettes (UK), Manuati (Tahiti), Melodiya (USSR).
 Int'l reps.: Pacific (W.H. Grove & Sons), Hawaii (Microphone).

M.G.M., see Polygram.
 Mandrill, see Polygram.
 Mercury, see Polygram.
 G.W. Moore Ltd., PO Box 29012, Greenwoods Corner, Auckland.

Label: (Licensed) Singcord (USA).
 Music For Millions, see Music World.
 Music World Ltd. (Houghton Hughes Ltd.) (IFPI), PO Box 7134, 75 Hawdon St., Christchurch Tel: 63-187. Cable: MASTERDISC. Telex: 4611. Mng. Dir.: Houghton Hughes, Sales Mgr.: R. Curry.

Labels: (Owned) Kiddisc, Music For Millions, Music World, Tee Vee; (Licensed) Arrowbats (UK), Astor (Australia), Barnaby (USA), Beatt (UK), Boot (Canada), Crest (Australia), Cyclone (USA), Damont (UK), Dyna House (Australia), EMS (Australia), Ember (UK), Emerald (UK), Enterprise (UK), Everest (USA), Fable (Australia), GRT-Janus (USA), Galaxy (UK), Gusto (USA), Hawk (Ireland), Image (Australia), J&B (Australia), Jupiter (Germany), Karma (Germany), Locomotive (France), Magnetic Video Corp. (USA), Mulligan (Ireland), Multiple Sound (UK), Paradiso (USA), Peter Pan (USA), Pickwick Int'l (UK), Rediffusion (UK), Release (Ireland), Scepter (USA), Sonet (Sweden), Specialty (USA), Sportsdisc (UK), Springboard (USA), Summit (Australia), Sutton-Miller (USA), Sydney Thompson (UK), Victor (Japan), W&G (Australia), Wand (USA).
 Int'l reps.: Australia (EMS, Image, J&B, W&G), Canada (V Recs), France (Locomotive), Ireland (Hawk), Philippines (Octo Arts), UK (Emerald, Multiple Sounds), South Africa (David Gresham), USA (Everest, Gillette-Madison, Magnetic Video, Request).

Ode Rec. Co. Ltd. (IFPI), 199 Karangahape Rd., Auckland. Tel: 370-007. Mng. Dir.: Terence P. O'Neill-Joyce; Gen. Mgr.: Robyn Kennerley; Sales Mgr.: Alan S. Nelson.

Reg'l branch: Fiji.
 Int'l branches: Australia, Cook Islands, PO Box 247, Raro Tonga.
Labels: (Owned) Five Star, Ode, Sonet, Thyme; (Licensed) Ariola-Eurodisc (Germany), Avan-Guard (Australia), EMI-Electrola (Germany), Fable (Australia), Fidelity Sound (USA), Stony Plain (Canada), Supraphon (Czechoslovakia), Vanguard (USA).
 Int'l reps.: Australia (Avan-Guard), South Africa (Sweet William), Tonga (Lemoto), USA (Fidelity Sound).

Peak, see Urwin.
 Philips, see Polygram.
 Polydor, see Polygram.
 Polygram Recs. Ltd. (IFPI), PO Box 3517, Wexford Rd., Miramar, Wellington. Tel: 888-080. Cable: ARGENTA. Telex: 3798. Mng. Dir.: J. Graham Broughton; Mktg. Mgr. (Polygram): Stuart H. Rubin; Mktg. Mgr. (Polydor): Nigel J.F. Sandiford.
Branches: Auckland, PO Box 37452, Parnell. Polygram House, 77 Grafton Rd. Tel: 775-663, 794-561. Telex: 2951 (Nat'l Sales & Mktg. Offices)—Christchurch, 77 Cashel St. Tel: 60-857. Telex: 4850.
Labels: (Owned) Archiv, DG, Fontana, MGM, Mercury, Philips, Polydor, Solid Gold, Vertigo, Verve; (Licensed domestic) Mandrill; (Licensed foreign) All Platinum (USA), Attic (Canada), B&C (UK), Bronze (UK), CTI (USA), Cadet (USA), Capricorn (USA), Casablanca (USA), Charisma (UK), Chess (USA), Cream (USA), ECM (Germany), EG (UK), Ensign (UK), Infinity (USA), MCA (USA), Mooncrest (UK), Neighborhood (USA), Pablo (USA), Pye (UK), RSO (USA), Rocket (UK), Roulette (USA), Saga (UK), Phil Spector (USA), Spring (USA), Stiff (UK), Track (UK).

The Sonoboy Gramophone Rec. Co. Ltd., 112 Albert St., Auckland. Tel: 362-295. Cable: DIRECTOR.
Labels: (Owned) Sonoboy Gramophone; (Licensed) CTI, Kudu, Lifesong (all USA).

Portrait, see CBS.
 RCA Ltd., 23 Norman Spencer Dr., Wiri, Auckland. Tel: POP 89-189. Telex: 791-2208. Label Mgr.: Dave Moulde.

R.T.C. (Record & Tape Co. of New Zealand) Ltd. (IFPI), PO Box 3825, 497 Parnell Rd., Parnell, Auckland. Tel: 799-963. Mng. Dir.: Brian Pitts; Nat'l Promos. & Sales Mgr.: Kama Fitzgerald; Finance Dir.: Patrick O'Sullivan.

Labels: (Full-Price) (Owned) RTC; (Licensed domestic) Viking; (Licensed foreign) Acrobat (UK), Activ (Switzerland), Alaska (UK), Barn (UK), Calendar (UK), DRG (USA), Frontline (UK), Garden (Australia), Gull (UK), Jupiter (West Germany), Logo (UK), Metronome (West Germany), Multiple Sound Dists. (UK), Panache (UK), Pinnacle (UK), Rockburgh (UK), Rubber (UK), Satril (UK), Scotia (UK), Sonet (UK), Transatlantic (UK), Versatile (USA), Virgin (UK), Warwick (UK), West End (USA); (distributed—not licensed) Century (USA), Sheffield (USA); (Mid-Price Racking) (Owned) RTC; (Licensed domestic) Solid Gold; (Licensed foreign) Ampro, Golden Hour, MCA, MGM, MSD, Mercury, Montax, Mountain, Philips, Polydor, Pye, Saga; (distributed—not licensed) CBS, Epic, Festival.

Reader's Digest Ass'n (NZ) Ltd., PO Box 37073, Parnell, Auckland 1. Tel: 770-339. Cable: READIGEST.
Home office: USA.

Reprise, see WEA.
 Sacred Recs (NZ) Ltd. (IFPI), Oxford St., Levin. Tel: (069) 84-005. Cable: SACORDS. Mng. Dir.: Peter R. Harris; Customer Servs. Mgr.: L.M. Lancaster.

Labels: (Owned) Destiny, Sacred; (Licensed) Canaan (USA), Dayspring (USA), Good News (USA), Image 7 (Canada), Lamb & Lion (USA), Light (USA), Myrrh (USA), New Pax (USA), New Song (USA), Paragon (USA), Sacred (USA), Seed (USA), Solid Rock (USA), Word (Canada, UK, USA).

Salem, see Viking Sevenses.
 Solid Gold, see Polygram.
 Sonet, see Ode.
 Tartar, see Kiwi/Pacific.
 Tee Vee, see Music World.
 Thyme, see Ode.
 Urwin Int'l Mktg. Ltd. (IFPI), 72 Riccarton Rd., Christchurch

4. Tel: 487-009. Cable: URLMARK.
Labels: (Owned) Peak; (represented) Artistes Francais Associes (France), Delmark (UK), Everest (USA), Societe Francaise de Prod'ns Phonographiques (France), Starlight (UK).

Vertigo, see Polygram.
 Verve, see Polygram.
 Viking Sevenses Ltd. (IFPI), 5-9 Tory St., Wellington. Tel: 859-759. Cable: VIKSEVEN. Mng. Dir.: Murdoch Riley; Gen. Mgr.: Keith Southern.

Int'l branches: Australia, Viking Pty. Ltd.; England, Viking Sevenses (UK) Ltd.
Labels: (Owned) Salem, Viking; (Licensed) Argo (UK), CMS (USA), Carinia (Australia), M-7 (Australia), Telefunken (Germany), Vox/Turnabout (USA).

Int'l reps.: Australia (Carinia), USA (Fiesta).
 WEA Recs. Ltd. (IFPI), PO Box 2915, 14-18 Lower Federal St., Auckland. Tel: 771-699. Telex: 2839. Mng. Dir.: Tim Murdoch.

Labels: (Owned) Asylum, Atco, Atlantic, Elektra, Reprise, Warner Bros.; (Licensed) Big Tree (USA), Rolling Stones (UK).

Warner Bros., see WEA.
 Zodiac Recs. Ltd. (IFPI), 108-110 Jervois Rd., Auckland 2. Tel: 761-218, 762-426. Mng. Dir.: E.C. Stebbing; Sales Mgr.: E. MacCallum.

Labels: (Owned) Key, Zodiac; (Licensed) Carinia (Australia), Telefunken (Germany).

● music publishers

Anton's Songs, 75 Hawdon St., Christchurch. Tel: 63-187. Cable: MASTERDISC. Mng. Dir.: Houghton Hughes.
Int'l firms represented: Morning Music Group (Canada).
Int'l reps.: Canada (Morning Music), Ireland (Squirrel Music).

Boom Boom Music Ltd. (APRA), PO Box 3825, 487 Parnell Rd., Parnell, Auckland. Tel: 799-964. Mng. Dir.: Brian Pitts; Gen. Mgr.: Patrick O'Sullivan.

Int'l firms represented: Allegro (UK), Frank Chacksfield (UK), Eiger (UK), Eros (UK), Medway (UK), Nazsongs (UK), Panache (UK), Strange (UK), Virgin (UK).

Chappell & Co. Ltd., Nimmo's Bldg., 2nd fl., 89 Willis, Wellington C1.

Home office: USA.
 Ephraim Music, 87 Wilson St., Hawera, Taranaki, New Zealand. Tel: 7537.

Int'l branch: Australia.
 Inn Publ'g (APRA), see Innovation.

Innovation Music Ltd. (APRA), 27 Bayside Ave., Te Atatu, Auckland 8. Tel: 44-444. Mng. Dir.: Errol J. Peters; Gen. Mgr.: Ginny Peters.

Int'l firms represented: Billy O (Australia), Swan Sea (USA).

Int'l rep.: Australia (Essex).
 Kiwi Music, 182 Wakefield St., Wellington. Tel: 849-981. Cable: KIWITONE. Mng. Dir.: Antony Vercoe.

Ode Music, 199 Karangahape Rd., Auckland. Tel: 370-007. Mng. Dir.: Terence P. O'Neill-Joyce.

Int'l firms represented: Flying Dutchman, Sweet William (both South Africa), Shwee Gee (Canada).

Sonoboy Gramophone, 112 Albert St., Auckland. Tel: 362-295.

Sandy Music Co. Ltd. (APRA), 5-7 Tory St., Wellington. Tel: 859-759. Cable: VIKSEVEN. Mgr.: Murdoch Riley.

Home office: Australia, Sevenses Publ'g Pty. Ltd. Sevenses Publ'g Pty. Ltd., see Sandy.

Southern Music Publ'g Co. (Australasia) Pty. Ltd., PO Box 656, 12 Security Bldg., 198 Queen St., Auckland C1. Tel: 23-851. Cable: SOUTHMUSIC.

Home office: USA, Peer-Southern Org.
Int'l firm represented: Sam Fox (USA).
 Word Music (ASCAP), Oxford St., Levin. Tel: (069) 84-005. Cable: SACORDS. Mng. Dir.: P.R. Harris.

Int'l firms represented: Canaanland, Lexicon, Rodeheaver, Word (all USA).
Int'l rep.: USA (Word).

● services

ASSOCIATIONS & PROFESSIONAL ORGANIZATIONS

New Zealand Radio & Television Mfrs. Federation, PO Box 9130, Wellington.

Recording Ind. Ass'n of New Zealand Inc., PO Box 9241, Wellington. Tel: 843-523. Cable: PHONOGRAPH. Mgr.: F.W. Smith.

DESIGN & ARTWORK

Video Pacific Communications Ltd., 199 Karangahape Rd., Auckland. Tel: 370-007. Mng. Dir.: Terence P. O'Neill-Joyce.

Whitcoulls Ltd., 76 Kent Terr., Wellington C3. Tel: 721-921. Cable: PRINTPAC. Telex: 3579. Prod. Div. Reg'l Mgr.: D.A. Pemberton; Sales Mgr.: B.H. Smith.

LICENSING ORGANIZATIONS, MUSIC

A.P.R.A. (Australasian Performing Right Ass'n Ltd.), BNSW Bldg., 318-324 Lambton Quay, Wellington. Tel: 724-430 (Performing rights only).

Home office: Australia.
 Phonographic Performances (New Zealand) Ltd., PO Box 9241, Wellington. Tel: 843-523. (Performing rights only)

PLATING, PROCESSING & PRESSING PLANTS

EMI Mfg. Ltd., 408 Hutt Rd., Lower Hutt, Wellington. Tel: 666-979. Cable: EMITRON. Mng. Dir.: P.N. Jamieson; Technical Dir.: D. Snell.

Music Carriers (NZ) Ltd. (div. of Polygram Recs. Ltd.), PO Box 14128, Wexford Rd., Miramar, Wellington. Tel: 888-080. Cable: PHONOCASS.

PRINTERS & LITHOGRAPHERS

Cello-Kraft Ltd., 61 Ira St., Wellington 3. Tel: 886-831. Mng. Dir.: R.C. Murray; Mgr.: E.L. Verrall.
 Music Carriers (NZ) Ltd. (div. of Polygram Recs. Ltd.), PO Box 14128, Wexford Rd., Miramar, Wellington. Tel: 888-080. Cable: PHONOCAST.
 Rotowax Ltd., 90-100 Hanson St., Wellington. Tel: 894-095.
 Whitcoulls Ltd., 76 Kent Terr., Wellington C3. Tel: 721-921. Cable: PRINTPAC. Telex: 3579. Prod. Div. Reg'l Mgr.: D.A. Pemberton; Sales Mgr.: B.H. Smith.

RECORD PROMOTION

Record Publ'ns Ltd., PO Box 9241, Wellington. Tel: 843-523.
 Word (NZ) Ltd., Oxford St., Levin. Tel: (069) 84-005. Cable: SACORDS. Mng. Dir.: P.R. Harris.

TAPE CUSTOM DUPLICATORS

EMI Mfg. Ltd., 408 Hutt Rd., Lower Hutt, Wellington. Tel: 666-979. Cable: EMITRON. Mng. Dir.: P.N. Jamieson; Technical Dir.: D. Snell.
Audio: Cassette
 Music Carriers (NZ) Ltd. (div. of Polygram Recs. Ltd.), PO Box 14128, Wexford Rd., Miramar, Wellington. Tel: 888-080. Cable: PHONOCAST.
Audio: Cassette
 Tape Transcriptions Ltd., PO Box 8665, Symond St., Auckland. Tel: 798-734. Mng. Dir.: Ross McEwan.
Audio: Cassette.

supplies

EMPTY CARTRIDGES, CASSETTES & REELS

EMI Mfg. Ltd., 408 Hutt Rd., Lower Hutt, Wellington. Tel: 666-979. Cable: EMITRON. Mng. Dir.: P.N. Jamieson; Technical Dir.: D. Snell.
 Music Carriers (NZ) Ltd. (div. of Polygram Recs. Ltd.), PO Box 14128, Wexford Rd., Miramar, Wellington. Tel: 888-080. Cable: PHONOCAST.
Audio: Cassette.

ENVELOPES & MAILERS

Whitcoulls Ltd., 76 Kent Terr., Wellington C3. Tel: 721-921. Cable: PRINTPAC. Telex: 3579. Prod. Div. Reg'l Mgr.: D.A. Pemberton; Sales Mgr.: B.H. Smith.

JACKETS & SLEEVES

Cello-Kraft Ltd., 61 Ira St., Wellington 3. Tel: 886-831. Mng. Dir.: R.C. Murray; Mgr.: E.L. Verrall.
 Rotowax Ltd., 90-100 Hanson St., Wellington. Tel: 894-095.
 Whitcoulls Ltd., 76 Kent Terr., Wellington C3. Tel: 721-921. Cable: PRINTPAC. Telex: 3579. Prod. Div. Reg'l Mgr.: D.A. Pemberton; Sales Mgr.: B.H. Smith.
 Word (NZ) Ltd., Oxford St., Levin. Tel: 84-005. Cable: SACORDS. Mng. Dir.: P.R. Harris.

LABELS

EMI Mfg. Ltd., 408 Hutt Rd., Lower Hutt, Wellington. Tel: 666-979. Cable: EMITRON. Mng. Dir.: P.N. Jamieson; Technical Dir.: D. Snell.
 Music Carriers (NZ) Ltd. (div. of Polygram Recs. Ltd.), PO Box 14128, Wexford Rd., Miramar, Wellington. Tel: 888-080. Cable: PHONOCAST.
 Whitcoulls Ltd., 76 Kent Terr., Wellington C3. Tel: 721-921. Cable: PRINTPAC. Telex: 3579. Prod. Div. Reg'l Mgr.: D.A. Pemberton; Sales Mgr.: B.H. Smith.

POLYETHYLENE BAGS

Whitcoulls Ltd., 76 Kent Terr., Wellington C3. Tel: 721-921. Cable: PRINTPAC. Telex: 3579. Prod. Div. Reg'l Mgr.: D.A. Pemberton; Sales Mgr.: B.H. Smith.

TAPE, RAW & BLANK LOADED

Agfa Carat, see Agfa-Gevaert.
 Agfa-Gevaert (New Zealand) Ltd., GPO Box 215, Shroff's Bldg., 99-101 Hobson St., Auckland 1. Tel: 34-743/717. Telex: 2934.
Audio: Blank—compact-cassette, open reel; raw—cassette, broadcast, studio.
Video: Cassette, open reel.
Brand names: Agfa Carat, Agfa Stereochrom, Agfa Videochrom.
 Agfa Stereochrom, see Agfa-Gevaert.
 Agfa Videochrom, see Agfa-Gevaert.
 Capitol, see EMI.
 DuPont, see Magnetic Prods.
 EMI Mfg. Ltd., 408 Hutt Rd., Lower Hutt, Wellington. Tel: 666-979. Cable: EMITRON. Mng. Dir.: P.N. Jamieson; Technical Dir.: D. Snell. (Blank only)
Audio: Cassette.
Brand names: EMI, Capitol.
 Fuji, see Magnetic Prods.
 Magnetic Prods. Ltd., 108-110 Jervois Rd., Auckland 2. Tel: 760-607. Gen. Mgr.: G.M. Watson.
Audio: Blank—cassette, open reel; raw—cassette.
Video: Blank—2" broadcast, 1" open reel, 3/4" cassette, 1/2" EIAJ open reel, 1/2" EIAJ cartridge, 1/4" cassette.
Brand names: DuPont, Fuji, Pyral.
 Music Carriers (NZ) Ltd. (div. of Polygram Recs. Ltd.), PO Box 14128, Wexford Rd., Miramar, Wellington. Tel: 888-080. Cable: PHONOCAST. (Blank only)
Audio: Cassette.
Brand name: Philips.
 Music World Ltd. (Hoghton Hughes Ltd.), PO Box 7134, 75 Hawdon St., Christchurch. Tel: 63-187. Cable: MASTERDISC. Mng. Dir.: Hoghton Hughes; Sales Mgr.: R. Curry. (Blank only)
Audio: Cassette.
 Philips, see Music Carriers.
 Pyral, see Magnetic Prods.

● accessories manufacturers

Music World Ltd. (Hoghton Hughes Ltd.), PO Box 7134, 75 Hawdon St., Christchurch. Tel: 63-187. Cable: MASTERDISC. Mng. Dir.: Hoghton Hughes; Sales Mgr.: R. Curry.
Product: Head cleaners & demagnetizers, record & cassette storage racks.
 Record Publ'ns Ltd., PO Box 9241, Wellington. Tel: 843-523.
Product: Record catalog services.
 Whitcoulls Ltd., 76 Kent Terr., Wellington C3. Tel: 721-921. Cable: PRINTPAC. Telex: 3579. Prod. Div. Reg'l Mgr.: D.A. Pemberton; Sales Mgr.: B.H. Smith.
Product: Carrying & storage cases, catalog servs.

NICARAGUA

Population: 2,230,000.
Rate of exchange: \$1 (US) = 7 cordoba.
Per capita income: \$633.
Holidays: January 1, Easter Week, May 1 (Labor Day), May 27 (Army Day), July 14 (National Day), September 14 (Battle of San Jacinto), September 15 (Independence Day), October 12 (Columbus Day), November 1, December 8, 25.

● record & tape manufacturers / distributors / importers

Dicesa (Discos Centroamericanos SA), Edif. de la Galeria de Arte Contemporaneo, Reparto Nva. Reforma, 100 Varas al S. del Rest. Rincon Espanol, Managua. Tel: 26123.
Home office: El Salvador (see for labels).
 Dideca (Discos de Centroamerica SA), Apartado Postal 2144, Managua. Tel: 23915. Cable: ARDELI.
Home office: Guatemala (see for labels).
 Indica (Nicaragua) SA, Apdo. 2622, Managua. Tel: 81523. Sales Mgr.: Vela Rocha.
Home office: Costa Rica (see for labels).

NIGERIA

Rate of exchange: \$1 (US) = 0.64 naira.
Per capita income: \$201.
Holidays: January 1, July 1 (Birth of Prophet), October 1 (Independence Day), December 26 (Boxing Day), traditional Moslem & Christian holidays.
Records, record blanks and pre-recorded media imported from USA: 1977—\$3,716,356.

● record & tape manufacturers / distributors / importers

Afrosidia, see Decca.
 Bridge, see Record Market.
 Capitol, see EMI.
 Cinterdisc, see Record Market.
 Coconut, see Phonogram.
 D G, see Phonogram.
 Decca (West Africa) Ltd. (IFPI), PO Box 412, 4 Faramobi Ajike St., Ikorodu Rd., Lagos. Cable: DECCAWA. Mng. Dir.: Robert Oeges; Mgr.: David G. Bennett. Mktg. Mgr.: Titus I. Olorunyomi; Int'l Label Exec.: Victor O. Nwogwugu.
Labels: (Owned) Afrosidia, Decca; (licensed) Deram (UK), London (UK), Trojan (UK), UK (UK).
Int'l reps.: France (Sofrason), UK (Decca).
 EMI (Nigeria) Ltd. (IFPI), PO Box 417, 7 Wharf Rd., Apapa, Lagos. Tel: (08) 45-164. Cable: EMITRON. Mng. Dir.: G.A. Beyering; Deputy Mng. Dir.: O.A. Akinyemi; Sales Mgr.: Femi Dairo.
Branches: Onitsha, 30 Old Market Rd. Contact: G.K. Ofor—Benin, Block 12B Sapele Rd. Contact: C.U. Nwaigbo—Kaduna, 5 Alli Akilu Rd. Contact: Mallam M. Shehu.
Labels (Owned) Capitol, EMI, HMV, Harvest, Parlophone, United Artists; (represented) Arista (USA), UK, Ballistic (UK), Creole (UK), Dynamic Sounds (Jamaica), Fantasy/Stax (USA), Ice (UK), Magna (UK), Motown (USA), RAK (UK), Red Bus (UK), WEA (USA).
Int'l reps.: Worldwide (EMI).
 H M V, see EMI.
 Harvest, see EMI.
 M G M, see Phonogram.
 Mercury, see Phonogram.
 Parlophone, see EMI.
 Philips, see Phonogram.
 Phonogram Ltd. (IFPI), PO Box 2997, 6 Ijora Causeway, Lagos. Tel: 44-837. Cable: PHILREC. Telex: 961-21297. Mng. Dir.: Peter Bond.
Labels: (Owned) Coconut, D.G. MGM, Mercury, Philips, Polydor, Vertigo; (licensed) All Platinum (USA), Atlantic (USA), Bronze (UK), Buddah (USA), Elektra (USA), H&L (USA), Island (UK), Pye (UK), RSO (UK), Reprise (USA), 20th Century (USA), Warner Bros. (USA).

Polydor, see Phonogram.
 Record Market (Nigeria) Ltd., PO Box 6371, 89 Bamgbose St., Lagos. Tel: 57-945. Cable: RODPUB. (Manufacturer/Distributor/One-Stop/Rack Jobber/Importer)
Int'l branch: Ivory Coast, Cinterdisc.
Labels: (Owned) Bridge, Cinterdisc; (licensed) EMI-Nigeria
 Senn-Sound (West Africa) Ltd., PM Bag 3135, 37 Adeniran Ogunsanya St., Surulere, Lagos. Tel: 48-337. Pres. Kaye Abraham Sr.; Gen. Mgr.: Mrs. Y.A. Abraham; Sales Mgr.: C.N. Ohajuba. (Distributor/Importer)
 United Artists, see EMI.
 Vertigo, see Phonogram.

● services

PLATING, PROCESSING & PRESSING PLANTS

Decca (West Africa) Ltd., PO Box 412, 4 Faramobi Ajike St., Ikorodu Rd., Lagos. Cable: DECCAWA. Mng. Dir.: Robert Oeges; Mgr.: David G. Bennett.
 EMI (Nigeria) Ltd., PO Box 417, 7 Wharf Rd., Apapa, Lagos. Tel: (08) 45-164. Cable: EMITRON. Mng. Dir.: G.A. Beyering; Deputy Mng. Dir.: O.A. Akinyemi; Sales Mgr.: Femi Dairo.
 Phonogram Ltd., PO Box 2997, 6 Ijora Causeway, Lagos. Tel: 44-837. Cable: PHILREC. Telex: 961-21297. Mng. Dir.: Peter Bond.

TAPE CUSTOM DUPLICATORS

EMI (Nigeria) Ltd., PO Box 417, 7 Wharf Rd., Apapa, Lagos. Tel: (08) 45-164. Cable: EMITRON. Mng. Dir.: G.A. Beyering; Deputy Mng. Dir.: O.A. Akinyemi; Sales Mgr.: Femi Dairo.
Audio: 8-tr.

● supplies

JACKETS & SLEEVES

LABELS

EMI (Nigeria) Ltd., PO Box 417, 7 Wharf Rd., Apapa, Lagos. Tel: (08) 45-164. Cable: EMITRON. Mng. Dir.: G.A. Beyering; Deputy Mng. Dir.: O.A. Akinyemi; Sales Mgr.: Femi Dairo.

TAPE, BLANK LOADED & RAW

Deekay & Sons, PO Box 2065, 18 Ereko St., Lagos.
Audio: 8-tr., cassette, open reel.
Brand name: Audio Magnetics.
 EMI (Nigeria) Ltd., PO Box 417, 7 Wharf Rd., Apapa, Lagos. Tel: (08) 45-164. Cable: EMITRON. Mng. Dir.: G.A. Beyering; Deputy Mng. Dir.: O.A. Akinyemi; Sales Mgr.: Femi Dairo. (Blank only)
Audio: Cassette, open reel.
Brand name: EMI, Emistar.
 Senn-Sound (West Africa) Ltd., PM Bag 3135, 37 Adeniran Ogunsanya St., Surulere, Lagos. Tel: 48-337. Pres. Kaye Abraham EIAJ Gen. Mgr.: Mrs. Y.A. Abraham; Sales Mgr.: C.N. Ohajuba.
Audio: Blank—8-tr., cassette; raw—8-tr., cassette, open reel.
Video: Blank—3/4" cassette.

● accessories manufacturer

Senn-Sound (West Africa) Ltd., PM Bag 3135, 37 Adeniran Ogunsanya St., Surulere, Lagos. Tel: 48-337. Pres. Kaye Abraham Sr.; Gen. Mgr.: Mrs. Y.A. Abraham; Sales Mgr.: C.N. Ohajuba.
Product: Head cleaners & demagnetizers, needles.

● store fixtures & merchandising aids manufacturer

Senn-Sound (West Africa) Ltd., PM Bag 3135, 37 Adeniran Ogunsanya St., Surulere, Lagos. Tel: 48-337. Pres. Kaye Abraham Sr.; Gen. Mgr.: Mrs. Y.A. Abraham; Sales Mgr.: C.N. Ohajuba.
Product: Browser boxes, display racks, record divider cards.

NORWAY

Population: 4,000,000.
Rate of exchange: \$1 (US) = 5.19 krone.
Per capita income: \$5,144.
No. of homes with record players: 850,000.
Holidays: January 1, Easter (Holy Thursday through Easter Monday), May 1 (Labor Day), May 17 (Constitution Day), Whitmonday, December 25, 26.

NOTE:

All figures reported are for IFPI members. Non-IFPI turnover and direct imports are estimated to be an additional 10%.

RECORDS:

Records sold domestically including imports: LP's 1978—4,200,000 units, \$33,300,000, 1977—3,600,000 units, \$27,200,000. Singles 1978—350,000 units, \$700,000; 1977—370,000 units, \$670,000.

Records, record blanks & pre-recorded media imported from USA: 1977—\$958,636

Average retail price per record: LP \$—\$7.90, Singles—\$2.03

Stereo sales: 99% of total

Record club sales: 6-7% of total

Discounting: Rare

Type of distribution: Manufacturer-to-retailer system predominates. There are two major rack jobbers, one of which is owned by the Norwegian record industry. Specially shops account for 70-75% of consumer sales.

Type of promotion: Television is the most important medium, followed by radio (one channel each). Most of Norway's 160 newspapers have album reviews, and some have a weekly music page. There are three music newspapers with limited circulation. Some important weekly magazines have music columns.

Jukeboxes: 1500

TAPE:

Comment: The tape market is growing but solely for cassettes, both blank and pre-recorded. Within a few years the cassette turnover may reach or exceed the LP turnover. Cassette deck sales have increased rapidly the last four years.

Pre-recorded tape sold domestically including imports: Cassette 1978—3,510,000 units, \$30,800,000; 1977—3,200,000 units, \$24,400,000.

Average retail price per tape: Cassette—\$8.78

RADIO STATIONS:

No. of government: 1

Comment: Programming is a mixture of cultural, political, educational, entertainment, news and sports features. About 60% of the music programming is pre-recorded & 40% is broadcast live. The ratio of classical music to popular is approximately 44/56

TELEVISION STATIONS:

No. of channels: 1 government, 85% color.

Comment: Norwegian television programming is similar to that for radio except for less music.

MARKET ANALYSIS:

Three 1978 releases broke the historic barrier of selling more than 200,000 albums each (including cassettes): "Abba The Album" by Abba, the soundtrack from "Grease" (double album), and "I Smurfelanc" by Geir Boerresen (the local version of Father Abraham). There is a trend showing a minor increase for singles in 1979 after years of marked decreases.

● record & tape manufacturers / distributors / importers

Akkompagnementsplaten. see Norsk Grammofonkompani.
Archiv. see Polydor.
Arctic Recs. Brattorgaten 5, N-7000 Trondheim. Tel. (075) 21-1-90 Mng Dir. Kolbjørn Alstad. Gen. Mgr. Gunnar Hordvik. Label Mgr.: Svein Strugstad. (Distributed by Polydor)

Aria. see EMI

Barneplaten. see Norsk Grammofonkompani.
Arne Bendiksen A/S (IFPI), Osterdalsgaten 1, Oslo 6. Tel. (02) 67-67-90 Cable BENDIKMUSIC, Telex (856) 19689 Pres. Arne Bendiksen. Gen. Mgr. Pal Skar. Sales Mgr. John Norman. Int'l Mgr. Terje Engen.
Labels: (Owned) Flora, Flower, Forum, Sonet Norsk, Triola, (licensed domestic) Tambourne, (licensed foreign) ABC/Dunhill (USA), Anchor (UK), Berserkey (UK), Bronze (UK), Chiswick (UK), Chrysalis (UK), Cube/Electric (UK), Island (UK), Logo (UK), Megafon (Sweden), Pye (UK), Red Star (UK), Sonet (Denmark, Sweden, UK), Sun (USA), Transatlantic (UK), Vanguard (USA), Virgin (UK), Vox (USA).
Int'l reps.: Japan (Teichiku), Spain (Discophon)

CBS Recs. A/S (IFPI), Ostrer Akervei 19, Okern, Oslo 5. Tel. (02) 15-29-00 Telex (856) 19356 Mng. Dir.: Per A. Jenssen. Local A&R Mgr.: Kristian Lindeman.

Labels: (Owned) CBS, Embassy, Epic, GTO, Portrait; (licensed) A&M (Europe, USA), ARC (USA), Bang (USA), Blue Sky (USA), Caribou (USA), Channel (USA), Invictus (USA), Jet (USA), Kirshner (USA), Lifesong (USA), Monument (USA), Nemperor (USA), Philadelphia Int'l (USA), Sam (USA), TK (USA), T-Neck (USA), Tabu (USA), Unlimited Gold (USA) (distributed—not licensed) Cupol (Sweden), dB (Norway), Frya Skilling (Sweden), Glendisc (Sweden), Round-Up (Sweden).
Int'l rep.: Worldwide (CBS)

Camel. see EMI & Pep-Wal

Camp. see Polydor

Canticum Novum A/S (Musikkelskapet), Torggaten 10, Oslo 1. Tel. (02) 20-00-89, 33-52-11. Dir.: Terje Strom-Olsen

Labels: (Licensed foreign) Bis (Sweden), Claves (Switzerland)

Cantor Corp A/S, Postboks 16, N-1315 Nesoya Pres. Per C Dahlstrom. Gen. Mgr. Finn Stokkland (Record & tape exporter—cutouts)

Capitol. see EMI

Classics for Pleasure. see EMI

Columbia. see EMI

Compendium, G Skogen & Co., (IFPI), PO Box 8285, Hammersborg, Mariboesgt 9, Oslo 1. Tel. (02) 11-59-89/58-84 Mng Dir. Frode Holm. Gen. Mgr.: Gunnar Skogen. Promo Mgr.: Sjur P. Johansen.

Label: (Owned) Compendium
Int'l reps.: Austria (Bellaphon), France (Phonogram), Germany (Bellaphon), Italy (Hi-Fi), Japan (Teichiku), Sweden (Sam), Switzerland (Bellaphon), UK (Selecta), USA (JEM)

Continental Recs. A/S, Sundbyjordet 4, N-2050 Jessheim. Tel. (02) 97-10-20 Cable PABAMA, Telex: 19341. Pres. & Gen. Mgr. Barry Matheson.

Labels: (Licensed) CRSM, CRST, Continental, MFA (all UK)

Int'l rep.: Sweden (Svenska Musikingen)
dB Recs., Oscarsgt 15, Oslo 3 Tel. (02) 60-76-13. Gen. Mgr. Ole A. Soerli. (Distributed by CBS)

D G, see Polydor

DaCapo. see EMI

Disco A/S (IFPI), Postboks 38, Ostrer Akervei 19, Okern, Oslo 5 Tel. (02) 15-27-90 Cable MUSICA, Telex 17079 Gen. Mgr.: Odd Roennings-Arnesen, Deputy Gen. Mgr.: Harald M. Kristiansen.

Labels: (Owned) Musica, (licensed) Ariola (Germany), Aura (UK), Black & White, (France), Bluebird (USA), Champion (USA), Ebony (UK), Erato (France), Flying Dutchman (USA), Free Flight (USA), Gem (UK), Grunt (USA), Hansa (Germany), Intercord (Germany), Jupiter (Germany), Logo (UK), Masters (France), Millennium (USA), Pickwick (UK), Playboy (USA), RCA (France, Germany, UK, USA), Roadshow (USA), Salsoul (USA), Solar (UK, USA), SteepleChase (Denmark), Supraphon (Czechoslovakia), Swedish Society Discifol (Sweden), Telefunken (Germany), Telestar (Sweden), Tomato (USA), Viking (Sweden), Windsong (USA), Wooden Nickel (USA), (distributed—not licensed) Tonop (Norway)

Double Up. see EMI

EMI Norsk A/S (IFPI), Postboks 42, Korsvoll, Frysjaveien 33, Oslo 8 Tel. (02) 23-14-88 Cable EMIGRAM, Telex (856) 16294 Mng Dir. Hans Ro. A&R Mgr.: Rolf Syversen, Mktg. Mgr.: Fredrik Mueller, Sales Mgr.: Frode Skulstad

Labels: (Owned) Capitol, Classics for Pleasure, Columbia, DaCapo, Double Up, EMI, EMI-EAR, EMI America, EMI Int'l, Electrola, Emidisc, Encore, HMV, Harvest, Hoeruz, Imperial, Music for Pleasure, Odeon, One Up, Parlophone, Pathe, Regal, Regal Starline, Regal Zonophone, Seraphim, Sideshow, Starline, Stateside, Studio Two, Talisman, Tower, Volkplatte, Waverley, Wings, World Rec. Club, (licensed) Apple, Arista, Artists House, Ballistic, Barclay, Blue Note, Plue Star, Bohus, Carrere, Casablanca, Chocolate City, Classic, EMG, Egg, Ember, Fantasy, Flam, Galaxy, Gordy, Hilltop, Hungaroton, Ju-par, Koster, Kultura, MAM, MPS, Magnet, Mariann, Melodyland, Milestone, Motown, Mowest, Oasis, Pacific Jazz, Passport, Pickwick (USA), Platina, Prestige, Private Stock, Prudigal, Purple, Qualiton, RAK, Rare Earth, Rebel, Rediffusion, Retreat, Rolling Stones, Scantia, Solid State, Soul, Stax, Strata-East, Sunset, Svensk American, T. Rex, Tamlia, Tor, Tylon, United Artists, Warrior, Wizard, (distributed—not licensed) Aria, Camel, Skandinaviske Artist Prod'n

Electrola. see EMI

Jorg-Fr. Ellertsen A/S (IFPI), Jernbanetorget 4, Oslo 1. Tel. (02) 425883 Cable TROLLMUSIC, Telex: 19871. Dir. Jorg-Fr. Ellertsen. (Distributed by Polygram)

Label: (Owned) Troll

Embassy. see CBS

Emidisc. see EMI

Encore. see EMI

Epic. see CBS

Euronett Norsk A/S, Ensjoeveien 5, Oslo 6. Tel. (02) 67-75-80 Telex 19010. Gen. Mgr.: O.R. Ernoe, A&R Mgr.: L. Hemmingsen

Labels: (Owned) Euronett, Nett; (licensed) Buddha (USA), Kama Sutra (USA), Moon-Disc (Sweden), T-Bone (Sweden); (distributed—not licensed) Ariola (Germany), Eurodisc (Germany), Hansa (Germany), Jupiter (Germany), Manticore (UK), Melodiya (USSR)

Int'l reps.: Finland (Polarov), Sweden (Toniton)

Euroton A/S, Manglerud Gard, Oslo 6. Tel. (02) 26-78-46, 26-99-97

Labels: (Owned) Euroton, Volt; (represented) Darris (USA), Eurovox (Belgium), Polyband (Germany), Polymax (Denmark, Finland, Germany, Sweden, UK).
Int'l reps.: Denmark, Finland, Germany, Sweden, UK (all Polymax)

Eventyrplaten. see Norsk Grammofonkompani.
Filadelfiaforlaget A/S, Box 6757, St. Olavsplass, Oslo 1. Tel. (02) 11-13-10

Labels: (Owned) Joy, Klango

Flora. see Arne Bendiksen
Flower. see Arne Bendiksen
Fontana. see Phonogram
Forum. see Arne Bendiksen
G T O, see CBS
H M V, see EMI

Harmoni. see Norsk Grammofonkompani

Harvest. see EMI

Helgeland's Imports, Postboks 120, 5501 Haugesund

Label: (Represented) Philo (USA)

Heliodor. see Polydor

Hoeruz. see EMI

Imperial. see EMI
Joy. see Filadelfiaforlaget

Karussell. see Polydor

Klango. see Filadelfiaforlaget

M G M, see Polydor

Mayco Agentur, PO Box 22, Kjelsas, Oslo 4

Label: (Represented) Sheffield Lab (USA)

Mercury. see Phonogram

Metrone. see Polydor

Montax A/S, Brynsengveien 5, Oslo 6. Tel. (02) 42-08-87

Mng Dir. Finn Erik Eian, Prod. Mgr.: Stein Ingebrigtsen (Distributor)

Musica. see Disco

Music for Pleasure. see EMI

Musikk-Distribution A/S, Rosenborggaten 19, Oslo 3. Tel. (02) 69-59-02, 46-39-52. Gen. Mgr.: Mr. Doornbos

N K F, see Polydor

Narvesen Spisevognselskapet A/S, B. Narvesensvei 2, Oslo

Tel. (02) 19-40-20. Prod. Mgr.: Rune Johannessen (Distributor/Importer)

Nett. see Euronett

Nor-Disc. see Polydor

Norsk Grammofonkompani A/S (IFPI), Fagerhoeveien 2, N-1324 Lysaker. Tel. (02) 53-34-72. Gen. Mgr.: O. Knudsen

Labels: (Owned) Akkompagnementsplaten, Barn-eplaten, Eventyrplaten, Harmoni; (distributed—not licensed) Music Minus One (USA)

Odeon. see EMI

On. see Phonogram

One Up. see EMI

Parlophone. see EMI

Pathe. see EMI

Pep-Wal Recs. & Camel Consultants, Postboks 45, Skovena-sen, Oslo 6. Tel. (02) 11-31-88, 28-76-97. Pres.: Jerry Pepper, VP: Ragnar Ridder-Neilsen, Gen. & Sales Mgr.: Peter Walker

Labels: (Owned) Camel (dist. by EMI), Pep-Wal, (li-censed) Laurie (USA)

Philips. see Phonogram

Phonogram (div. of Polygram A/S) (IFPI), Postboks 4352, Marcus Thranesgaten 2, Oslo 4. Tel. (02) 15-51-90. Mng. Dir.: Totto Johannessen; Gen. Mgr.: Michael Aas; Sales Mgr.: Lars Lysell; Rec. G.: Audun Tylden

Labels: (Owned) Fontana, Mercury, On, Philips, Ver-tigo, (licensed) Amadeo (Austria), Charisma (UK), DJM (UK), Decca (UK), Polar (Sweden), Stiff (UK)
Int'l rep.: Worldwide (Phonogram)

Pilot Music A/S, Postboks 32, N-1342 Jar.

Home office: Sweden

Labels: (Owned) Pilot; (licensed) Green Tree, Heart Warming, Impact, Lamb & Lion (all USA); (distrib-uted—not licensed) Manna (USA)

Play Music A/S, Kjelsasveien 174, Oslo 8. Tel. (02) 23-57-80. Mng. Dir.: Ake H. Wilke; Chief Buyer: Ms. Unni Weng (Distributor/Importer)

Labels: (Distributed) all Norwegian labels

Polydor A/S (div. of Polygram A/S) (IFPI), Marcus Thranesgaten 2, Oslo 4. Tel. (02) 15-51-90 Telex 18521. Mng. Dir.: Sigurd Johannessen; Gen. Mgr.: Joern Johnsen, Classical A&R: Sverre Dahl, RSO & Third-Parties Label Mgr.: Kari Sorknes; Jazz & Polydor Label Mgr.: Ellen Christensen, WEA Prod. Mgr.: Mats Nilsson, Promo Mgr.: Unni Saether

Labels: (Owned) Archiv, DG, Heliodor, Karussell, MGM, NKF, Nor-Disc, Polydor, Verve; (licensed) Asy-lum (USA), Atco (USA), Atlantic (USA), Capricorn (USA), DiscReet (USA), Elektra (USA), MCA (USA), Met-ronome (Germany & Sweden), Reprise (USA), Riva (UK), Rolling Stones (USA), Swan Song (USA), Warner Bros. (USA); (distributed—not licensed) Arctic (Nor-way), Camp (Norway), Ex Libris (Denmark)

Portrait. see CBS

Olaf T. Ranum A/S, Whsle. Dept., Olav Tryggvasonsgaten 18, N-7000 Trondheim. Tel. (075) 28-355, 27-729, 22-902 Cable MUSIKRANUM. Gen. Mgr.: Olaf T. Ra-num; Sales Mgr.: Sverre Granholt

Labels: (Owned) TKK, (represented) Oryx (UK)

Regal. see EMI

Regal Starline. see EMI

Regal Zonophone. see EMI

Rikajo Agentur & Handel, Postboks 147, Paradis, Bergen. Tel. 27-12-72. Mgr.: John Kolbeinsen. (Importer/ Ex-porter)

St. Olav Bokhandel A/S, Akersveien 5, Oslo 1. Mgr.: Sidsel Aasrud. (Importer)

Label: (Distributed—not licensed) Christophorus (Ger-many), Proprius (Sweden), SM (France), Schwann (Ger-many)

Scanax. see CBS

Seraphim. see EMI

Sidewalk. see EMI

Sinar Musik A/S, Tollbugaten 4, Oslo 1. Tel. (02) 41-29-16. Chief Exec.: Amund Hoff Berge. Gen. Mgr.: L.Y. Da-liot (Distributor/Importer)

Labels: (Distributed—not licensed) Caprice (Sweden), Everest (USA), Free Reed (UK), Hed Arzi (Israel), Roun-der (USA), Tangent (UK), Topic (UK)

Skandinaviske Artist Prod'n, Torggt. 7, Oslo 1. Tel. (02) 41-88-85. Dir.: Leif Hemmingsen; A&R: George Keller. (Distributed by EMI)

Labels: (Owned) Snowflake; (licensed foreign) SOS (Sweden), T-Bone (Sweden)

Int'l reps.: Denmark (EMI), Sweden (EMI)

Snowflake. see Skandinaviske

Sonet Norsk. see Arne Bendiksen

Starline. see EMI

Stateside. see EMI

Strawberry. see Dag Werner

Studio Two. see EMI

T K K, see Olaf T. Ranum

Talent Produksjon A/S (IFPI), Kjoelberggaten 29, Oslo 6. Tel. (02) 67-95-40. Pres.: Arve Sigvaldsen; Sales Mgr.: Arid Lund; A&R Mgr.: Ola Johansen

Labels: (Owned) Talent, Tinde

Int'l reps.: Denmark (Sun), Sweden (Electra)

Talisman. see EMI

Tambourne. see Arne Bendiksen

Tinde. see Talent

Toba Import, Postboks 252, N-5401 Stord. Tel. 1-48-41. Mgr.: Jon Endal. (Importer/Exporter)

Tonep. see Disco

Tower. see EMI

Triola. see Arne Bendiksen

Troll. see Jorg-Fr. Ellertsen

Vertigo. see Phonogram

Verve. see Polydor

Volksplatte. see EMI

Volt. see Euroton

Waverley. see EMI

Dag Werner Prod'ns/Strawberry Recs., Dronningensgate 13, Oslo 1. Tel. (472) 11-16-97 Telex 18507 Chief Exec.: Dag Werner; Ass't H. Nedal Jr.

Labels: (Owned) Strawberry; (distributed—not li-censed) Big Bear (UK), Cherry Red (UK), Dharmia (USA), Escape (USA), Galaxy (UK), Great American (USA), Ille-gal (UK), Music Is Medicine (USA), Sky (Germany), Springboard (USA), 3rd World (UK)

Wings. see EMI

World Rec. Club. see EMI

● music publishers

Arctic Songs, Brattorgaten 5, N-7000 Trondheim. Tel. (075) 21-1-90. Mng. Dir.: Kolbjørn Alstad. Gen. Mgr.: Gun-nar Hordvik. (Administered by Norsk Musikkforlag)

Billboard 1979-1980 International Buyer's Guide

Hit Power. see El Virrey

I E M P S A (Industrias Electricas & Musicales Peruanas SA) (IFPI), Av. Guillermo Dansey 1247, Lima. Tel. 32-40-05, 31-81-12 Cable IEMPSA Telex 25570 Mng Dir.: Augusto Sarría Salas, Ass't Mgr.: Rodolfo Canseco Torres

Labels: (Owned) IEMPSA, Lider; (licensed) A&M (USA), Arista (USA), Butterfly (USA), Capitol (Mexico, USA), Codiscos (Colombia), Decca group (UK), EMI (UK), Musart (Mexico), Private Stock (USA), Salsoul

Int'l firms represented: Brincos (Spain), Campeí (Mexico), Discomodá (Colombia), Ecomus (Colombia), Edifremex (Mexico), Edim (Mexico), Emroth (Mexico), Gramophone (USA), Hall of Fame (USA), Jaguar (Brazil), Leme (Brazil), Maranta (USA), Orama (Ecuador), Orbemusa (Venezuela), Parnaso (Argentina), PIM (Mexico), Prodemus (Colombia), RCA (Brazil), RCA Espanola (Spain), Relay (Argentina), Sono Inter (Colombia), Unimúsica (Venezuela), Universal (Spain), Victor (Brazil)

JACKETS & SLEEVES LABELS

I E M P S A (Industrias Electricas & Musicales Peruanas SA), Av. Guillermo Dansey 1247, Lima. Tel. 32-40-05, 31-81-12. Cable IEMPSA Telex 25570. Mng. Dir.: Augusto Sarría Salas; Ass't Mgr.: Rodolfo Canseco Torres.
El Virrey Industrias Musicales SA, Av. Republica de Panama 3551, San Isidro, Lima 27. Tel. 40-46-00. Cable VIR. Telex (354) 20276. Gen. Mgr.: Alejandro Parodi.

Arne Bendiksen A/S, Osterdalsgaten 1, Oslo 6. Tel: (02) 67-67-90. Cable: BENDIKMUSIC. Telex: 196889. Dir. Arne Bendiksen; Gen. Mgr.: Philip A. Kruse. **Int'l firms represented:** Black Sheep (UK), Cherry (UK), EMI (Denmark), Noel Gay (UK), Jobete (USA), Imudico (Denmark, Sweden), Magellan (USA), Multitone (Sweden), Reuter & Reuter (Sweden), Sonet (Sweden), Southern (Sweden), Stonebridge (USA). Brodr. Hals Forlag, see Norsk Musikforlag.

Phonogram (div. of Polygram A/S), Marcus Thranesgaten 2 Oslo 4. Tel: (02) 15-51-90. Gen. Mgr. Michael Aas; Sales Mgr.: Lars Lysell.

PRINTERS & LITHOGRAPHERS

Musikindustri (div. of Polygram A/S), Sagveien 11, Oslo 4 Tel: (02) 37-99-44. Gen. Mgr. Peter Kaatee.

RECORD PROMOTION

Cannon, see Empire.
Cap, see Alpha.
Cerveza, see A&W.
Chipack, see Offspring.
Chi Reet, see Offspring.
Circle, see Empire.
Contex, see Entertainment Mgmt.
Continental Artists, see Video Vision.
Cotillon, see WEA.
Countryside, see WEA.
Crystal, see JEM.
Current, see Grandeur.
Cycle, see Alpha.
Dimension, see Video Vision.
Disc Corp. of the Philippines, Maya Bldg., Suite 1, 678 E. De Los Santos Ave., Cubao, Quezon D-3001. Tel: 98-69-40, 96-81-91, 96-82-21. Cable: DISCOPHIL Manila. Exec. VP & Gen. Mgr. Danilo P. Olivares. Admin. Officer & Comptroller: Malov V. Chipeco. **Labels:** (Licensed foreign) Ariola (Germany), Buddha (USA), Casablanca (USA), Hansa-Oasis (Germany), Interglobal Music (Canada), Janus-GRT (USA), Jupiter (Canada), Salsoul (USA), Springboard (USA).

Dyna-Parlophone, see Dyna.
Dyna Prods. Inc. (IFPI), 135 Second Ave., Grace Park, Caloocan City, Manila. Tel: 23-23-62/67-35, 40-51-21. Cable: DYPRO Telex 0361. Pres. Albert Tan; Exec. VP James G. Dy, Gen. Mgr.: Tan Huy Bin, Sales Mgr. Vicente Ty. **Labels:** (Owned) Dyna, Dyna-Parlophone, Himig, Jive, Sinamar; (Licensed) A&M (USA), Angel (USA), Arista (USA), Audio Fidelity (USA), Capitol (USA), Chrysalis (UK), DG (Germany), DJM (UK), DM (USA), EMI (UK), Festival (Australia), GTO (UK), MAM (UK), Music for Pleasure (UK), Parlophone (UK), Pausa (USA), Pickwick (UK), Playboy (USA), Polydor (Germany), Private Stock (UK), Project 3 (USA), Pye (UK), RSO (UK), Rocket (UK), Telefunken (Germany), United Artists (USA).

Elektra, see WEA.
Empire Entertainment Corp., PO Box 967, Dynasty Cinema Bldg., 827-B31 Rizal Ave., Santa Cruz, Manila. Tel: 27-34-71. Cable: EMPINT. **Labels:** (Owned) Admiral, American Artists, Cannon, Circle, Fanfare, Masterpiece, Movietone, Quadrant, Soundtracks; (Licensed) Arcade (USA), Avenue (USA), Design (USA), Encounter, Europa (Germany), Europa Exquisit (Germany), Forest, GSF, Golden Ear, Happy Time (USA), Hilltop (USA), Hit (Ireland), Instant Learning Series (USA), Iris, Killroy (USA), Mr. Pickwick (USA), Mode (France), Mondiomusic (France), PIP (USA), Pacific, Peter Rabbit (USA), Pickwick Int'l (USA), Play (USA), Playhour (USA), R&R (USA), Release (Ireland), Showcase (USA), Somerset (Germany), Sonic (Germany), Stereo Plus 3, Swing, Telstar (Belgium), Vogue (France).
Entertainment Mgmt. & Mktg. Inc., Dynasty Super Cinema Bldg., Rizal Ave., Manila. Tel: 27-34-72. **Labels:** (Owned) Allied Artists, Arlo, Contex, Hit Sound, Quad, Ten; (represented) AU (USA), Avenue (UK), Boss (USA), Cherry (USA), Jade (USA), Love (USA), Mongo (USA), MusicDisc (USA), National (USA), Olga (Sweden), Pop (USA), Royal (USA), Venus (USA), Young America (USA), Zel (UK).

Everstar, see Video Vision.
Express, see VMI.
Fama, see Alpha.
Fame, see Alpha.
Fanfare, see Empire.
Fastbreak, see Offspring.
Filipinas Rec. Corp., 131 Del Monte Ave., Quezon City 3010. Tel: 35-45-20. Cable: FILRECO.

Gayle, see Grandeur.
Grandeur Music Corp., JLB Bldg., 2nd fl., Ronquillo & P. Gomez Sts., Quiapo, Manila. Tel: 48-97-14, 40-63-21. **Labels:** (Owned) Blue Jay, Current, Gayle, Grandeur, Grandsound, Luzvimin.
Grandsound, see Grandeur.
Guestar, see Video Vision.
Hidcor, see Home Inds.
Himig, see Dyna Prods.
Hit 100, see VMI.
Hit Sound, see Entertainment Mgmt.
Home Inds. Development Corp. (IFPI), PO Box 4140, Manila. Tel: 50-86-61. Cable: HOMID Telex: 7420409. Pres. Alfredo M. Lustre; Gen. Mgr. Antonio U. Lustre. **Labels:** (Owned) Hidcor; (Licensed foreign) Ariola (USA), Hi/Cream (USA), Infinity (USA), MCA (USA), Magnet (UK), Parachute (USA), Prelude (USA).

Honey, see Mareco.
Ikluvia, see Offspring.
JEM Rec'g Co. Inc., 160 20 Ave., Cubao, Quezon City. Tel: 78-15-27, 77-24-11, 78-48-67. Pres. & Gen. Mgr. Wilfrido B. Cruz; VP & Pressing Plant Mgr. Wigberto Gonzalez. Domestic A&R Mgr. Jaime M. Paredes, Int'l A&R Mgr. Margot M. Gallardo; Controller Rudy Jane Villanueva; Visayas & Mindanao Sales & Promos. Mgr.: Versim Enad. **Labels:** (Owned) Crystal, JEM; (Licensed foreign) CTI (USA).

Jive, see Dyna Prods.
Jonal, see Alpha.
Kinaham, see Alpha.
Lady Lynn Rec. Center, 533 Evangelista, Quiapo, Manila. Tel: 48-82-21, 40-65-96. Gen. Mgr.: Erlinda F. De Vera; Sales Mgr.: Relita P. Torres. (Distributor) **Labels:** (Distributed) Alpha group.
Luzvimin, see Grandeur.
Mabuhay, see Mareco.
Mango, see A&W & Mareco.
Manok, see Offspring.
Mareco Inc., 131 Del Monte Ave., Quezon City 3010. Tel: 35-45-26. Cable: VILMARECO. Telex: 7337577. **Labels:** (Owned) Action, Honey, Mabuhay, Mango, Superstar, Villar; (represented) GNP Crescendo, Monitor, Ranwood (all USA); Hispavox (Spain).
Masterpiece, see Empire.
Mayon, see Alpha.
Metro, see Alpha.

Skandinavisk Elektronik A/S, Ostre Akerveit 99, Oslo 5. Tel: 15-00-90.

Product: Needles
Brand name: Pickering.

store fixtures & merchandising aids

MGMitten, see Video Vision.
Mico Inds. Inc., PO Box 2364, Mico Tower Bldg., Sales & Ronquillo Sts., Santa Cruz, Manila. Tel: 49-57-80. Cable: MICOINDUST. **Label:** (Owned) Mico.
Movietone, see Empire.
Musika, see Alpha.
Nonesuch, see WEA.
Northern, see Alpha.
Number 1, see Video Vision.
Octo Arts Int'l, see Vicor.
Offspring Recs. Int'l, PO Box AC 468, Cubao, Quezon City. Tel: (632) 78-06-06. Cable: SPRINGPROD. Pres. Dane Samonte, Exec. VP Brooks Samonte, VP Mdsq. Fair Daban; VP Music Henry Toribio, VP Int'l Mike Enriquez; Gen. Mgr. Freddie Dandan, Sales Mgr. P. F. Sibal.

Labels: (Owned) Chipack, Fastbreak, Ikluvia, Manok, Offspring, Pay-Half, (Licensed domestic) Booma, Chi Reet, Soundtrack, Sungkit, (Licensed foreign) Delvecchio (Italy), Kusnilia (India), La Vacara (USA), Pong (Japan), Sho-Paw (Taiwan), Silat (Thailand). **Int'l reps.:** Hong Kong (Piao See), Japan (Po Pong), Thailand (Apurahan), UK (Bricks), USA (La Vacara).

Pay-Half, see Offspring.
Pearl, see Video Vision.
Pioneer, see Vicor.
Plaka Ilocano, see VMI.
Plaka Manila, see Blackgold.
Plaka Pilipino, see Vicor.
PopHits, see Video Vision.
PopMachines, see Video Vision.
PopTunes, see Video Vision.
President, see Video Vision.
Quad, see Entertainment Mgmt.
Quadrant, see Empire.
Red White & Blue, see Video Vision.
Reprise, see WEA.
Sagittarius, see A & W.
Saturday, see Video Vision.
Sinamar, see Dyna Prods.
Soundtrack, see Offspring.
Soundtracks, see Empire.
Stars & Stripes, see Video Vision.
Sungkit, see Offspring.
Sunshine, see Vicor.
Superstar, see Mareco.
Target, see Video Vision.
Ten, see Entertainment Mgmt.
V A, see VMI.
V I P, see Alpha.

VMI Music Corp., PO Box 4042, Manila, 77 D Tuazon St., Corner Sen. M. Cuenco St., Quezon City. Manila. Tel: 610-663, 623-588, 625-805. Bldg. Chm. Lim Han Eng. Pres. & Gen. Mgr.: Victor Que, VP Accounting Annette Que; VP Labels Liberto Quefichu; VP Finance Conchita Chua; VP Legal: George Bangayan; Sales Mgr. Ramon T. Lao; A&R: Kendrick Timothy, Adv. & Promo.: Constancia Mazon; Special Projects Yulo Go. Davao Sales: Rosie Hao; Cebu Sales: John Dy. Luzon Sales: Jun Cu.

Labels: (Owned) Bobby Recs., Express, Hit 100, Plaka Ilocano, VA, VMI, VMI Gold; (Licensed) Disco (Italy), MC group (Germany), Vanguard (USA).
Vicor Music Corp., PO Box AC270, Vicor Bldg., 782 Aurora Bldg., Cubao, Quezon City. Tel: 70-40-81. Cable: VIMUSCO. Telex: 7422056. Pres. & Chief Exec. Officer: Vicente del Rosario Jr.; Ass't to the Pres. Celso G. Delos Angeles, Exec. VP: Antonio M. Ocampo, Sr. VP Treas.: Teresita R. Cruz, Sr. VP Controller Danilo Principe; Sr. VP Sales & Mfg. Edgardo Alcanzare, VP Int'l A&R: Ricardo R. del Rosario, VP Prod'n Domestic A&R: Vicente Sotto III; VP Adv. & Promos. Felicitio R. Bautista; VP Finance Celso Sulit; AVP Prod'n (Pioneer, Plaka Pilipino Div.) Philip Maninang, Special Projects Dir. Ferdinand A. Paz; Foreign Bus. Affairs Mgr. Priscilla A. dela Cruz, PR Mgr. Norma Japitana.

Labels: (Owned) Pioneer, Plaka Pilipino, Sunshine, (distributed) Ace Music Prods., Octo Arts Int'l, Wilear's; (represented) ABC (USA), Alshire (USA), Cream (USA), De-Lite (USA), Disneyland (USA), Fania (USA), Fantasy (USA), Island (UK), Milestone (USA), Motown (USA), Novola (Spain), Prestige (USA), RCA (USA), Victor (Japan), Vista (USA), Zafiro (Spain).

Video Vision Inc., Dynasty Super Cinema Bldg., Rizal Ave., Manila. Tel: (2) 27-34-73. Cable: DIMENSION. **Labels:** (Owned) Asco, Dimension, MGMitten, Pearl, Saturday, Vivi, (distributed) Continental Artists, Everstar, Grand, Guestar, Number 1, PopHits, PopMachines, PopTunes, President, Red White & Blue, Stars & Stripes, Target, Winston.
Villar, see Mareco & A&W.
Vivi, see Video Vision.

WEA Recs., Manufacturers' Bank Bldg., Mezzanine fl., Plaza Santa Cruz, Manila 2805. Tel: 47-73-81. Cable: WEAREC. Pres. James G. Dy, Gen. Mgr. Ramon Chuaing. **Labels:** (Owned) Asylum, Atco, Atlantic, Cotillon, Countryside, Elektra, Nonesuch, Reprise, Warner Bros.; (Licensed) Bearsville, Big Tree, Brother, Curtop, DiscReet, Finnadar, Gemigo, Little David, Nemperor, Paradise, Rolling Stones, Slipped Disc, Swan Song, Warner Bros., Whitefield, Wing & A Prayer (all USA).

Warner Corp., see WEA.
Wilear's Recs., 51 Aurullo St., Mandaluyong, Rizal. Tel: 70-03-14. (Distributed by Vicor).
Winston, see Video Vision.
Wonderland Recs., 1835 F.B. Harrison, Pasay City. Tel: 59-05-31. Pres. & Gen. Mgr.: Alice Cabahug; Exec. Ass't: Yvette Ledesma.

music publishers

BAMI (Bayanhan Music Philippines Inc.), PO Box AC270, Blackgold Bldg., 770 Aurora Blvd., Cubao, Quezon City. Tel: 70-75-06. Cable: VIMUSCO. Telex: 7422056. Vicor PM. Pres. & Chief Exec. Officer: Vicente del Rosario Jr.; Exec. VP: Antonio M. Ocampo; Ass't: VP-

TAPE, RAW & BLANK LOADED

Estemac Peruana SA, Av. Petit Thouars 4620, Lima 18. Tel: 45-55-30, 45-65-87. Cable: ESTEMAC. Telex: 25385. Mng. Dir. H.O. Schleusner; Gen. Mgr.: Oswaldo Garcia. **Audio:** Cassette, open reel. **Video:** Blank—cassette, open reel. **Brand names:** Audio—Agfa, Eslabel, Royal; video—Agfa Videochrom.

TAPE DUPLICATING & PROCESSING EQUIPMENT

TAPE PACKAGING & LABELING EQUIPMENT & SUPPLIES

Estemac Peruana SA, Av. Petit Thouars 4620, Lima 18. Tel: 45-55-30, 45-65-87. Cable: ESTEMAC. Telex: 25385. Pres.: H.O. Schleusner; Gen. Mgr.: Oswaldo Garcia. **Audio:** Cassette, open reel. **Brand names:** Lyrec, Otari.

accessories manufacturer

Estemac Peruana SA, Av. Petit Thouars 4620, Lima 18. Tel: 45-55-30, 45-65-87. Cable: ESTEMAC. Telex: 25385. Pres.: H.O. Schleusner; Gen. Mgr.: Oswaldo Garcia. **Video:** Tape carrying & storage cases, head cleaners & demagnetizers, leader & splicing tape.

PHILIPPINES

Population: 43,750,000.
Rate of exchange: \$1 (US) = 7.35 pesos.
Per Capita Income: \$325.

Holidays: January 1 (New Year's), January 21, Holy Thursday, Good Friday, April 9 (Bataan Day), March 22, May 1 (Labor Day), June 12 (Independence Day), July 4 (Philippine-American Friendship Day), November 30 (Bonifacio Day), December 25 (Christmas), December 30 (Rizal Day), December 31.

record & tape manufacturers / distributors / importers

A & W Recs. Int'l, Vergel de Dios Bldg., 2nd fl., 530 Evangelista, Quiapo, Manila. Tel: 40-54-51, 48-46-46. Cable: AWREC. Pres. & Gen. Mgr. Allan J. Villar; VP Int'l: Willie J. Villar. **Labels:** (Owned) A&W, A&W Horizon, Cerveza, Sagittarius; (Licensed domestic) Mango, Villar; (Licensed foreign) AVI (USA), Everest group (USA), Penny Farthing (UK), Ranwood (USA).

Ace Music Prods., see Vicor.
Action, see Mareco.
Admiral, see Empire.
Allied Artists, see Entertainment Mgmt.
Alpha Recs. Corp., JLB Bldg., 3rd fl., Ronquillo, Quiapo, Manila. Tel: 47-12-47, 40-91-47. Pres. & Gen. Mgr.: Buddy O. De Vera; VP & Int'l Dir. Reynaldo O. De Vera; VP Special Projects: Reynaldo R. Cruz Jr.; Treas.: Erlinda F. De Vera; Musical Dir. & A&R: Gil Cruz; Local A&R: Marte De La Paz; Promo. Supervisor: Danny Mario; Creative Dir.: Rudy Retanan; Sales Mgr. Menchu O. Salazar; Greater Manila Sales Mgr. Quintin Mendoza; Luzon Sales Reps: Danny Torres, Manny Gaspard; Visayas Sales Mgr.: Sergio Cuyos; Mindanao Sales Mgr.: Jose Ramos. (Distributed by Arc Recs. & Lady Lynn). **Labels:** (Owned) Alpha, Arc, Bicolandia, Cap, Cycle, Fama, Fame, Jonal, Kinaham, Mayon, Metro, Musika, Northern, VIP; (Licensed) Arrow, International Artists, Solid Gold, Top Twenty, Windmill (all UK); Aquarius, Gamma (both Canada); Countdown (Germany). **Int'l rep.:** Germany (Countdown).

American Artists, see Empire Int'l.
Arc Rec. Sales (formerly Fortune Rec. Sales), JLB Bldg., 5th fl., Ronquillo, Quiapo, Manila. Tel: 40-91-47. Chm. & Pres.: Buddy O. De Vera; Gen. Mgr.: Reynaldo O. De Vera; Sales Mgr.: Quintin Mendoza. **Labels:** (Distributed—not licensed domestic) Alpha, Arc, Bicolandia, Cap, Cycle, Fama, Fame, Jonal, Kinaham, Mayon, Musika, Northern, VIP; (distributed—not licensed foreign) Arrow, Countdown, Gamma, Good Vibrations, International Artists, Solid Gold, Spire, Top Twenty, Warwick, Windmill.

Arlo, see Entertainment Mgmt.
Asco, see Video Vision.
Asylum, see WEA.
Atco, see WEA.
Atlantic, see WEA.
Bicolandia, see Alpha.
Blackgold Recs. Corp., PO Box AC270, Blackgold Bldg., 770 Aurora Blvd., Cubao, Quezon City. Tel: 70-75-06. Cable: VIMUSCO. Telex: 7422056. Vicor PM. Pres. & Chief Exec. Officer: Vicente del Rosario Jr.; Ass't to the Pres.: Celso G. Delos Angeles; Exec. VP & Gen. Mgr.: Benjamin F. Aniceto; VP Int'l A&R: Victor C. Jose; VP Domestic A&R: Lamberto de Leon, VP Mfg. & Sales: Edgardo Alcanzare; Ass't Sales Dir.: Alberto Munzon; Admin. Mgr.: Celso Sunga; Foreign Bus. Affairs Mgr.: Priscilla A. dela Cruz. **Labels:** (Owned) Blackgold, Plaka Manila.
Blue Jay, see Grandeur.
Bobby, see VMI.
Booma, see Offspring.

Linda Marqueses, Foreign Bus. Affairs Mgr. Priscilla A. dela Cruz, Technical Consultant; Simplicio Suarez
FAMI (Fil-Am Music Inc.), Calvo Bldg., Rm. 220, Escolta, Manila Tel: 40-35-05. Cable: FAMI
JEM Rec'g Co. Inc., 160 20 Ave., Cubao, Quezon City, Tel: 78-15-27, 77-24-11, 78-48-67. Pres. & Gen. Mgr.: Wilfrido B. Cruz
Lustre Music Publ'g Corp., PO Box 4140, Manila. Cable: HOMID Telex 7420409
Mareco Inc (FAMI), 131 Del Monte Ave., Quezon City, Tel: 35-45-26. Cable: VILMARECO
Int'l rep.: USA (L.I. Witkof)
Metro Music Masters Inc., JLB Bldg., 5th fl., Ronquillo, Quiapo, Manila Tel: 40-63-21. Pres.: Buddy O. De Vera
Mexicana de Musica (Ed.), see FAMI.
Sound Music House, Dynasty Super Cinema Bldg. Rizal Ave., Manila Tel: 27-34-73
Wonderland Recs. (Filscap), 1835 F.B. Harrison, Pasay City Tel: 59-05-31. Pres. & Gen. Mgr.: Alice Cabahug, Exec. Ass't Yvette Ledesma
Int'l rep.: Australia (Jonathan)

● **services**

ASSOCIATIONS & PROFESSIONAL ORGANIZATIONS

Artists Guild of the Philippines, c/o College of the Holy Spirit, 163 E. Mendiola St., Manila
Cultural Foundation of the Philippines, San Luis Terraces, Rm. 502, T.M. Kalaw St., Ermita, Manila Tel: 40-46-12
League of Filipino Composers, 1665 Taft Ave., Manila
Manila Symphony Society, PO Box 664, Elks Club Bldg., Roxas Blvd., Manila Tel: 70-73-13. Cable: SYMPHONY
Music Promotion Foundation of the Philippines Ysmael Bldg., 1845 Taft Ave., Manila Cable: MUSIPROM
National Band Ass'n of the Philippines, 70 Boston St., Cubao, Quezon City, Tel: 70-34-94
National Music Council of the Philippines, c/o UNESCO Nat'l Commission, 1580 Taft Ave., Manila. Cable: UNACOM
P.A.R.A.S. (Philippine Academy of Rec'g Arts & Sciences), c/o Oskar Salazar, PO Box 3739, Manila 2800. Tel: 60-48-44
R.I.A.P. (Record Ind. Ass'ns of the Philippines), c/o Manuel P. Villar, Calvo Bldg., Escolta, Manila Tel: 47-11-83, 40-10-81

DESIGN & ARTWORK

JEM Rec'g Co. Inc., 160 20 Ave., Cubao, Quezon City, Tel: 78-15-27, 77-24-11, 78-48-67. Pres. & Gen. Mgr.: Wilfrido B. Cruz
Mareco Inc., 131 Del Monte Ave., Quezon City 3010. Tel: 35-45-26. Cable: VILMARECO
Oskar Salazar Int'l Agency, PO Box 3739, Manila 2800. Tel: 60-48-44. Cable: RAZALAS. Exec. Dir.: Oskar Salazar
VMI Music Corp., 77 D. Tuazon St., Corner Sen. M. Cuenco St., Quezon City, Manila Tel: 610-663, 623-588, 625-805. Pres.: Victor Que; Sales Mgr.: Ramon T. Lao
Vicor Music Corp., PO Box AC270, Vicor Bldg., 782 Aurora Blvd., Cubao, Quezon City, Tel: 70-40-81. Cable: VIMUSCO Telex 7422056. Pres. & Chief Exec. Officer: Vicente del Rosario Jr.

LICENSING ORGANIZATIONS, MUSIC

BAMI (Bayanihan Music Philippines Inc.), 772 Aurora Blvd., Cubao, Quezon City, Pres. & Chief Exec. Officer: Vicente del Rosario Jr., Exec. VP: Antonio M. Ocampo; Ass't VP: Linda Marqueses; Technical Consultant: Simplicio Suarez
FAMI (Fil-Am Music Inc.), Calvo Bldg., Rm. 220, Escolta, Manila Tel: 40-35-05. Cable: FAMI. (Represents SESAC mechanical rights)
Filscap (Filipino Society of Composers, Authors & Publishers), Republic Supermarket Bldg., Rm. 243, Rizal Ave., Santa Cruz, Manila, Tel: 49-27-88. Pres.: Felipe P. de Leona; Exec. Dir. & Corp. Sec'y: Simplicio U. Suarez. (Performing rights only)
Oskar Salazar Int'l Agency, PO Box 3739, Manila 2800. Tel: 60-48-44. Cable: RAZALAS. Exec. Dir.: Oskar Salazar. (Mechanical rights rep.)

PLATING, PROCESSING & PRESSING PLANTS

Atlas Rec'g Co., 35 F. Josef St., Concepcion, Marikina, Metro Manila, Tel: 697-2056. Gen. Mgr.: Roger O. De Vera; Plant Mgr.: Noli O. Orteza (Pressing only)
Dyna Prods. Inc., 135 Second Ave., Grace Park, Caloocan City, Manila Tel: 23-23-62/67-35, 40-51-21. Cable: DYPRO. Telex: 0361. Pres.: Albert Tan; Exec. VP: James G. Dy; Gen. Mgr.: Tan Huy Bin; Sales Mgr.: Vicente Ty
Filipinas Rec. Corp., 131 Del Monte Ave., Quezon City 3010. Tel: 35-45-20. Cable: FILRECO
Home Inds. Development Corp., PO Box 4140, Manila. Cable: HOMID Telex 7420409
JEM Rec'g Co. Inc., 160 20 Ave., Cubao, Quezon City, Tel: 78-15-27, 77-24-11, 78-48-67. Pres. & Gen. Mgr.: Wilfrido B. Cruz. Pressing Plant Mgr.: Wigberto Gonzalez
Mareco Inc., 131 Del Monte Ave., Quezon City 3010. Tel: 35-45-26. Cable: VILMARECO
VMI Music Corp., 77 D. Tuazon St., Corner Sen. M. Cuenco St., Quezon City, Manila Tel: 610-663, 623-588, 625-805. Pres.: Victor Que; Sales Mgr.: Ramon T. Lao (Pressing only)
Vicor Music Corp., PO Box AC270, Vicor Bldg., 782 Aurora Blvd., Cubao, Quezon City, Tel: 70-40-81. Cable: VIMUSCO Telex: 7422056. Pres. & Chief Exec. Officer: Vicente del Rosario Jr.; Sr. VP Sales & Mfg.: Edgardo Alcanzare
WEA Recs., Manufacturers' Bank Bldg., Mezzanine fl., Plaza Santa Cruz, Manila 2805. Tel: 47-73-81. Cable: WEAREC. Pres. James G. Dy; Gen. Mgr.: Ramon Chuayang. (Pressing only)

Billboard 1979-1980 International Buyer's Guide

Conselheiro Fernando de Sousa 29 Av. D. Liberti, Tel: 656094.
Labels: (Owned) Diapasao, Guilda da Musica; (distributed) Ofir, (represented) Amadeo (Austria), ESP

Billboard 1979-1980 International Buyer's Guide

PRINTERS & LITHOGRAPHERS

Filipinas Rec. Corp., 131 Del Monte Ave., Quezon City 3010. Tel: 35-45-20. Cable: FILRECO
Home Inds. Development Corp., PO Box 4140, Manila. Cable: HOMID. Telex: 7420409
Mareco Inc., 131 Del Monte Ave., Quezon City 3010. Tel: 35-45-26. Cable: VILMARECO
VMI Music Corp., 77 D. Tuazon St., Corner Sen. M. Cuenco St., Quezon City, Manila Tel: 62-58-05 62-35-88 61-06-63. Pres.: Victor Que; Sales Mgr.: Ramon Lao
Vicor Music Corp., PO Box AC270, Vicor Bldg., 782 Aurora Blvd., Cubao, Quezon City, Tel: 70-40-81. Cable: VIMUSCO Telex: 7422056. Pres. & Chief Exec. Officer: Vicente del Rosario Jr.

RECORD PROMOTION

Dimads, c/o Sound Int'l, PO Box 967, Manila
Entertainment Mgmt. & Mktg. Inc., c/o Red, White & Blue Cinemas, 878-D Aurora Blvd., Cubao, Quezon City, Tel: 78-52-31
Fil-Am Music Inc., Calvo Bldg., Rm. 220, Escolta, Manila. Tel: 40-35-05. Cable: FAMI
JEM Rec'g Co. Inc., 160 20 Ave., Cubao, Quezon City, Tel: 78-15-27, 77-24-11, 78-48-67. Pres. & Gen. Mgr.: Wilfrido B. Cruz
Oskar Salazar Int'l Agency, PO Box 3739, Manila 2800. Tel: 60-48-44. Cable: RAZALAS. Exec. Dir.: Oskar Salazar
Soundtrack Studios, Philand Bldg., 3rd fl., Santillan St., Makati. Tel: (632) 828-8475. Cable: SOUNDTRACKEAST. Pres.: Greg Garcia III; Gen. Mgr.: Dan Samonte; Sales Mgr.: Robert Bariwang; Chief Eng.: Oscar Aquino III
VMI Music Corp., 77 D. Tuazon St., Corner Sen. M. Cuenco St., Quezon City, Manila Tel: 62-58-05, 62-35-88, 61-06-63. Pres.: Victor Que; Sales Mgr.: Ramon Lao
Vicor Entertainment Corp., PO Box AC270, Vicor Bldg., 782 Aurora Blvd., Cubao, Quezon City, Tel: 70-40-81. Cable: VIMUSCO Telex: 7422056. Pres. & Chief Exec. Officer: Vicente del Rosario Jr.; Foreign Bus. Affairs Mgr.: Priscilla A. dela Cruz

TAPE CUSTOM DUPLICATORS TAPE PACKAGING & LABELING

Dyna Prods. Inc., 135 Second Ave., Grace Park, Caloocan City, Manila, Tel: 23-23-62/67-35, 40-51-21. Cable: DYPRO. Telex: 0361. Pres.: Albert Tan; Exec. VP: James G. Dy; Gen. Mgr.: Tan Huy Bin; Sales Mgr.: Vicente Ty
Empire Electronics Corp., 20-A Magdalena Hemady St., corner Aurora Blvd., Quezon City, Tel: 70-16-66, 70-05-88. Cable: SOUND Manila Pres.: Gerardo S. Limlingan; Gen. Mgr.: Cesar S. Salazar; Sales Mgr.: Jacobo M. Serina; Prod. Group Mgr.: Leonida S. Rabe
Audio: Cassette, open reel
Video: Blank—1" open reel, 1/2" EIAJ open reel
Brand names: Ampex, Teac
3 M Philippines Inc., 3M House, Yabut Bldg., E. De Los Santos Ave., Makati, Rizal, Tel: 86-70-61. Cable: TRIM-INCO Mng. Dir.: R. L. Deschane; Group Sales Mgr.: Eduardo Z. Pinangang
Audio: Blank—Cassette & open reel, raw—Cassette
Video: Blank—1" open reel, 1/2" cassette, 1/2" EIAJ open reel, 1/2" EIAJ cartridge
Brand name: Scotch
VMI Music Corp., 77 D. Tuazon St., Corner Sen. M. Cuenco St., Quezon City, Manila Tel: 610-663, 623-588, 625-805. Pres.: Victor Que; Sales Mgr.: Ramon T. Lao (Blank only)
Audio: Cassette

Empire Electronics Corp., 20-A Magdalena Hemady St., corner Aurora Blvd., Quezon City, Tel: 70-16-66, 70-05-88. Cable: SOUND Manila Pres.: Gerardo S. Limlingan; Gen. Mgr.: Cesar S. Salazar; Sales Mgr.: Jacobo M. Serina; Prod. Group Mgr.: Leonida S. Rabe
Audio: Cassette, open reel
Video: Blank—1" open reel, 1/2" EIAJ open reel
Brand name: Scotch
VMI Music Corp., 77 D. Tuazon St., Corner Sen. M. Cuenco St., Quezon City, Manila Tel: 610-663, 623-588, 625-805. Pres.: Victor Que; Sales Mgr.: Ramon T. Lao (Blank only)
Audio: Cassette

Filipinas Rec. Corp., 131 Del Monte Ave., Quezon City 3010. Tel: 35-45-20. Cable: FILRECO
Home Inds. Development Corp., PO Box 4140, Manila. Cable: HOMID. Telex: 7420409
Audio: Cassette
JEM Rec'g Co. Inc., 160 20 Ave., Cubao, Quezon City, Tel: 78-15-27, 77-24-11, 78-48-67. Pres. & Gen. Mgr.: Wilfrido B. Cruz
Mareco Inc., 131 Del Monte Ave., Quezon City 3010. Tel: 35-45-26. Cable: VILMARECO
VMI Music Corp., 77 D. Tuazon St., Corner Sen. M. Cuenco St., Quezon City, Manila Tel: 62-58-05, 62-35-88, 61-06-63. Pres.: Victor Que; Sales Mgr.: Ramon Lao (PKG)
Audio: Cassette, open reel
Vicor Music Corp., PO Box AC270, Vicor Bldg., 782 Aurora Blvd., Cubao, Quezon City, Tel: 70-40-81. Cable: VIMUSCO. Telex: 7422056. Pres. & Chief Exec. Officer: Vicente del Rosario Jr.; Sr. VP Sales & Mfg.: Edgardo Alcanzare (PKG)

Empire Electronics Corp., 20-A Magdalena Hemady St., corner Aurora Blvd., Quezon City, Tel: 70-16-66, 70-05-88. Cable: SOUND Manila Pres.: Gerardo S. Limlingan; Gen. Mgr.: Cesar S. Salazar; Sales Mgr.: Jacobo M. Serina; Prod. Group Mgr.: Leonida S. Rabe (Distributor/Importer)
Product: Head cleaners & demagnetizers, needles
3 M Philippines Inc., 3M House, Yabut Bldg., E. De Los Santos Ave., Makati, Rizal, Tel: 86-70-61. Cable: TRIM-INCO Mng. Dir.: R. L. Deschane; Group Sales Mgr.: Eduardo Z. Pinangang
Product: Head cleaners, & demagnetizers, leader & splicing tape
VMI Music Corp., 77 D. Tuazon St., Corner Sen. M. Cuenco St., Quezon City, Manila Tel: 610-663, 623-588, 625-805. Pres.: Victor Que; Sales Mgr.: Ramon T. Lao
Product: Cleaners, cloths & brushes, needles, leader & splicing tape
Vicor Music Corp., PO Box AC270, Vicor Bldg., 782 Aurora Blvd., Cubao, Quezon City, Tel: 70-40-81. Cable: VIMUSCO. Telex: 7422056. Pres. & Chief Exec. Officer: Vicente del Rosario Jr.; Sr. VP Sales & Mfg.: Edgardo Alcanzare
Product: Catalog servs., cleaners, cloths, brushes, 45 rpm adapters

EMPTY CARTRIDGES, CASSETTES & REELS

Empire Electronics Corp., 20-A Magdalena Hemady St., corner Aurora Blvd., Quezon City, Tel: 70-16-66, 70-05-88. Cable: SOUND Manila Pres.: Gerardo S. Limlingan; Gen. Mgr.: Cesar S. Salazar; Sales Mgr.: Jacobo M. Serina; Prod. Group Mgr.: Leonida S. Rabe (Distributor/Importer)
Audio: Reel, broadcast cartridge
Video: Open reel
Brand names: Ampex, Fidelipac
3 M Philippines Inc., 3M House, Yabut Bldg., E. De Los Santos Ave., Makati, Rizal, Tel: 86-70-61. Cable: TRIM-INCO Mng. Dir.: R. L. Deschane; Group Sales Mgr.: Eduardo Z. Pinangang
Audio & Video: Cassette, open reel
Brand name: Scotch
Vicor Music Corp., PO Box AC270, Vicor Bldg., 782 Aurora Blvd., Cubao, Quezon City, Tel: 70-40-81. Cable: VIMUSCO. Telex: 7422056. Pres.: Vicente del Rosario Jr.; Sr. VP Sales & Mfg.: Edgardo Alcanzare

ENVELOPES & MAILERS

Mareco Inc., 131 Del Monte Ave., Quezon City 3010. Tel: 35-45-26. Cable: VILMARECO
VMI Music Corp., 77 D. Tuazon St., Corner Sen. M. Cuenco St., Quezon City, Manila Tel: 610-663, 623-588, 625-805. Pres.: Victor Que; Sales Mgr.: Ramon T. Lao
Vicor Music Corp., P.O. Box AC 270, Vicor Bldg., 782 Aurora Blvd., Cubao, Quezon City, Tel: 70-40-81. Cable: VIMUSCO Telex: 7422056. Pres. & Chief Exec. Officer: Vicente del Rosario Jr.; Sr. VP Sales & Mfg.: Edgardo Alcanzare

JACKETS & SLEEVES LABELS

Home Inds. Development Corp., PO Box 4140, Manila. Cable: HOMID. Telex: 7420409
JEM Rec'g Co. Inc., 160 20 Ave., Cubao, Quezon City, Tel: 78-15-27, 77-24-11, 78-48-67. Pres. & Gen. Mgr.: Wilfrido B. Cruz

Mareco Inc., 131 Del Monte Ave., Quezon City 3010. Tel: 35-45-26. Cable: VILMARECO
VMI Music Corp., 77 D. Tuazon St., Corner Sen. M. Cuenco St., Quezon City, Manila Tel: 62-58-05, 62-35-88, 61-06-63. Pres.: Victor Que; Sales Mgr.: Ramon Lao
Vicor Music Corp., PO Box AC270, Vicor Bldg., 782 Aurora Blvd., Cubao, Quezon City, Tel: 70-40-81. Cable: VIMUSCO Telex 7422056. Pres. & Chief Exec. Officer: Vicente del Rosario Jr.; Sr. VP Sales & Mfg.: Edgardo Alcanzare

POLYETHYLENE BAGS

Mareco Inc., 131 Del Monte Ave., Quezon City 3010. Tel: 35-45-26. Cable: VILMARECO
VMI Music Corp., 77 D. Tuazon St., Corner Sen. M. Cuenco St., Quezon City, Manila Tel: 610-663, 623-588, 625-805. Pres.: Victor Que; Sales Mgr.: Ramon T. Lao

RECORD PROCESSING MACHINERY

Empire Electronics Corp., 20-A Magdalena Hemady St., corner Aurora Blvd., Quezon City, Tel: 70-16-66, 70-05-88. Cable: SOUND Manila Pres.: Gerardo S. Limlingan; Gen. Mgr.: Cesar S. Salazar; Sales Mgr.: Jacobo M. Serina; Prod. Group Mgr.: Leonida S. Rabe (Distributor/Importer)
Chief product: Disk-cutting equipment
Brand name: Neumann

TAPE, RAW & BLANK LOADED

Empire Electronics Corp., 20-A Magdalena Hemady St., corner Aurora Blvd., Quezon City, Tel: 70-16-66, 70-05-88. Cable: SOUND Manila Pres.: Gerardo S. Limlingan; Gen. Mgr.: Cesar S. Salazar; Sales Mgr.: Jacobo M. Serina; Prod. Group Mgr.: Leonida S. Rabe (Distributor/Importer)
Audio: Blank—Cassette, open reel, raw—open reel
Video: Blank—1" open reel, 1/2" EIAJ open reel
Brand names: Ampex, Teac
3 M Philippines Inc., 3M House, Yabut Bldg., E. De Los Santos Ave., Makati, Rizal, Tel: 86-70-61. Cable: TRIM-INCO Mng. Dir.: R. L. Deschane; Group Sales Mgr.: Eduardo Z. Pinangang
Audio: Blank—Cassette & open reel, raw—Cassette
Video: Blank—1" open reel, 1/2" cassette, 1/2" EIAJ open reel, 1/2" EIAJ cartridge
Brand name: Scotch
VMI Music Corp., 77 D. Tuazon St., Corner Sen. M. Cuenco St., Quezon City, Manila Tel: 610-663, 623-588, 625-805. Pres.: Victor Que; Sales Mgr.: Ramon T. Lao (Blank only)
Audio: Cassette

Empire Electronics Corp., 20-A Magdalena Hemady St., corner Aurora Blvd., Quezon City, Tel: 70-16-66, 70-05-88. Cable: SOUND Manila Pres.: Gerardo S. Limlingan; Gen. Mgr.: Cesar S. Salazar; Sales Mgr.: Jacobo M. Serina; Prod. Group Mgr.: Leonida S. Rabe (Distributor/Importer)
Audio: High-speed duplicators
Brand name: Pentagon

Empire Electronics Corp., 20-A Magdalena Hemady St., corner Aurora Blvd., Quezon City, Tel: 70-16-66, 70-05-88. Cable: SOUND Manila Pres.: Gerardo S. Limlingan; Gen. Mgr.: Cesar S. Salazar; Sales Mgr.: Jacobo M. Serina; Prod. Group Mgr.: Leonida S. Rabe (Distributor/Importer)
Audio: Blank—Cassette & open reel, raw—Cassette
Video: Blank—1" open reel, 1/2" cassette, 1/2" EIAJ open reel, 1/2" EIAJ cartridge
Brand name: Scotch
VMI Music Corp., 77 D. Tuazon St., Corner Sen. M. Cuenco St., Quezon City, Manila Tel: 610-663, 623-588, 625-805. Pres.: Victor Que; Sales Mgr.: Ramon T. Lao (Blank only)
Audio: Cassette

Empire Electronics Corp., 20-A Magdalena Hemady St., corner Aurora Blvd., Quezon City, Tel: 70-16-66, 70-05-88. Cable: SOUND Manila Pres.: Gerardo S. Limlingan; Gen. Mgr.: Cesar S. Salazar; Sales Mgr.: Jacobo M. Serina; Prod. Group Mgr.: Leonida S. Rabe (Distributor/Importer)
Audio: High-speed duplicators
Brand name: Pentagon

TAPE DUPLICATING EQUIPMENT

Empire Electronics Corp., 20-A Magdalena Hemady St., corner Aurora Blvd., Quezon City, Tel: 70-16-66, 70-05-88. Cable: SOUND Manila Pres.: Gerardo S. Limlingan; Gen. Mgr.: Cesar S. Salazar; Sales Mgr.: Jacobo M. Serina; Prod. Group Mgr.: Leonida S. Rabe (Distributor/Importer)
Audio: High-speed duplicators
Brand name: Pentagon

TAPE PACKAGING & LABELING EQUIPMENT & SUPPLIES

VMI Music Corp., 77 D. Tuazon St., Corner Sen. M. Cuenco St., Quezon City, Manila Tel: 610-663, 623-588, 625-805. Pres.: Victor Que; Sales Mgr.: Ramon T. Lao

● **accessories manufacturers**

Empire Electronics Corp., 20-A Magdalena Hemady St., corner Aurora Blvd., Quezon City, Tel: 70-16-66, 70-05-88. Cable: SOUND Manila Pres.: Gerardo S. Limlingan; Gen. Mgr.: Cesar S. Salazar; Sales Mgr.: Jacobo M. Serina; Prod. Group Mgr.: Leonida S. Rabe (Distributor/Importer)
Product: Head cleaners & demagnetizers, needles
3 M Philippines Inc., 3M House, Yabut Bldg., E. De Los Santos Ave., Makati, Rizal, Tel: 86-70-61. Cable: TRIM-INCO Mng. Dir.: R. L. Deschane; Group Sales Mgr.: Eduardo Z. Pinangang
Product: Head cleaners, & demagnetizers, leader & splicing tape
VMI Music Corp., 77 D. Tuazon St., Corner Sen. M. Cuenco St., Quezon City, Manila Tel: 610-663, 623-588, 625-805. Pres.: Victor Que; Sales Mgr.: Ramon T. Lao
Product: Cleaners, cloths & brushes, needles, leader & splicing tape
Vicor Music Corp., PO Box AC270, Vicor Bldg., 782 Aurora Blvd., Cubao, Quezon City, Tel: 70-40-81. Cable: VIMUSCO. Telex: 7422056. Pres. & Chief Exec. Officer: Vicente del Rosario Jr.; Sr. VP Sales & Mfg.: Edgardo Alcanzare
Product: Catalog servs., cleaners, cloths, brushes, 45 rpm adapters

● **store fixtures & merchandising aids manufacturers**

Empire Electronics Corp., 20-A Magdalena Hemady St., corner Aurora Blvd., Quezon City, Tel: 70-16-66, 70-05-88. Cable: SOUND Manila Pres.: Gerardo S. Limlingan; Gen. Mgr.: Cesar S. Salazar; Sales Mgr.: Jacobo M. Serina; Prod. Group Mgr.: Leonida S. Rabe (Distributor/Importer)
Product: Tape display racks
VMI Music Corp., 77 D. Tuazon St., Corner Sen. M. Cuenco St., Quezon City, Manila Tel: 610-663, 623-588, 625-805. Pres.: Victor Que; Sales Mgr.: Ramon T. Lao
Product: Record & tape display racks, divider cards

Population: 21,900,000
Rate of exchange: \$1 (US) = 12 lei
Per capita income: \$1,200

Victor Music Corp., PO Box AC270, Victor Bldg., 782 Aurora Blvd., Cubao, Quezon City, Tel: 70-40-81, Cable: VI-

● music publishers

RADIO STATIONS:

Holidays: January 1, May 1 & 2 (Labor Day & Youth Day), August 23 (Liberation Day)
No. of homes with record players: 900,000.

RECORDS:

Records manufactured: 1978-5,300,000; 1977-5,118,000.

Stereo sales: 50% of total.

Type of distribution: Every three months, Electrecord representatives have contract talks and meetings with commerce representatives, who decide how many copies of each record will be pressed.

Type of promotion: Radio (especially) and TV are the most important means of promotion. TV is dominated by MOR and classical music. Electrecord publishes **Diacul** magazine every three months, presenting the latest records. A few magazines, such as **Saptamina** and **Flacara**, have permanent columns dedicated to records.

Comment: Music issued by Electrecord is 60% folklorical, 30% MOR, rock, folk and jazz, and 10% classical.

Jukeboxes: 50.

TAPE:

Comment: 8-tr. is not yet used. Cassettes are very popular, especially since cassette players are now manufactured in Romania. Blank open reel tapes are imported from the German Democratic and Federal Republics, and cassettes are imported from German Democratic and Federal Republics, Hungary, Switzerland and Israel.

RADIO STATIONS:

Comment: 40% of programming is MOR, rock, jazz and folk music, 40% is classical and 20% is folklorical. There are Hungarian, German and Serbian language programs, in addition to Romanian language programs. There also are programs for abroad in 13 languages: Arabian, English, French, German, Greek, Iranian, Italian, Portuguese, Romanian, Russian, Serbian, Spanish and Turkish. There also are programs for sailors, including "Radio Holiday" in Mamaia on the Black Sea coast from May 15 to October 1.

TELEVISION STATIONS:

Comment: Romania does not yet have color TV, but there is a color mobile unit for exporting color programs. Classical music is the most popular.

IMPORT/EXPORT REGULATIONS:

Importing and exporting is done by ILEXIM, which imports only from Socialist countries (including licenses) and from Dum-Dum in India. Electrecord licenses for Western Music.

● record & tape manufacturers / distributors / importers

Electrecord, Str. Luigi Cazzavilla 14-16, Bucharest. Tel: 13 97 57. Telex: (011) 191 Music Dept. Chief: Dr. Edgar Elian, Chief Eng.: Ing. Grigore Petreanu.
Labels: (Owned) Electrecord, (licensed) B&J (UK), CBS (France), CBS-Sugar (Italy), Juan Vallori (Spain), Metro-nome (Germany), Montana (Germany), PIPS (Switzerland), Philips (UK), Stop (Italy), Studio 33 (Netherlands), Transworld (Switzerland), Trilogy (USA).
Int'l reps.: Canada (Archambault), Germany (Bellaphon, Delta), Japan (Victor), Netherlands (Basart), USA (Moni-
tor).

I L E X I M, Str. 13 Decembrie nr. 3, Bucharest (Importer / Exporter)

● services

ASSOCIATIONS & PROFESSIONAL ORGANIZATIONS

A R I A (Romanian Agency for Artists' Mgmt.), Str. 16 Ienachita Vacarescu, 70528 Bucharest. Tel: (90) 13 70 08. Telex: 10139. Mgr.: Florea Vasile; Ass't Mgr.: Gheorghe Ravas; Musicologist: Vasile Donose.

A T M (Association of Artists from Theatrical & Musical Institutions), Str. Schitu Magureanu, Nr. 1, 7000 Bucharest. Tel: 13 41 72/44 99. Pres.: Costache Antoniu, VP: Dina Cocea, Sec'y: Ana Toboșaru.

Composers' Union (Uniunea Compozitorilor), Str. 2 Constantin Esarcu, Bucharest. Tel: (90) 16-37-47. Pres.: Petre Brancusi; VP's: Zeno Vancea, Romeo Ghircioasiu; Sec'y's: Dr. Vasile Tomescu, Theodor Grigoriu, Laurentiu Profeta, Wilhelm Berger.

Musical Publ'g House of the Composers' Union (Editura Muzicala a Ununii Compozitorilor), Str. 13 Decembrie 24, Bucharest. Tel: 13 57 75.

Socialist Culture & Education Council (Consiliul Culturii și Educatiei Socialiste), Casa Scintei, Piata Scintei 1, Bucharest. Tel: 17 60 10/20. Music Mgr.: Nicolae Calinciu.

● supplies

TAPE, RAW & BLANK LOADED

Reprezentanta tehnica-comerciala, Str. Giuseppe Garibaldi 14, Bucharest 1. Tel: 79-62-10/35. Telex: 11695. Brand name: BASF.

SINGAPORE

Population: 2,280,000.
Rate of exchange: 1 (US) = 2.16 Singapore dollars.

Per capita income: \$2,200.

Holidays: New Year's Day, Hari Raya Puasa (2 days—Malay Religious New Year), Chinese New Year (2 days), Thaipusam (Tamil New Year), Hari Raya Haji (Malay New Year), Labor Day (May 1), National Day (August 9), Vesak Day (Buddhist Festival), Christmas Day.
Records, record blanks & pre-recorded media imported from USA: 1977—\$327,416.

● record & tape manufacturers / distributors / importers

Ace of Clubs, see Decca.
Ace of Diamonds, see Decca.
Aim, see Alshire.
Alshire (Singapore) Pte. Ltd., OG Bldg., 703 Upper Cross St., Singapore 2. Tel: 914-794.

Labels: (Owned) Alshire, Aim, (represented) Vox (USA).

Angel, see EMI.

Argo, see Decca.

Baal Recs. Pte. Ltd. (IFPI), 1101 Marina House, Shenton Way, Singapore 2. Tel: 221-5484. Cable: BAALPROD. Dir.: Balrom Shotam.

Regional branches: China, Hong Kong, Malaysia.

Int'l branch: England.

Labels: (Owned) Baal, Best of Everything, (licensed) ABC, H&L (both USA).

Beltona, see Decca.

Best of Everything, see Baal.

Borneo Co. (Singapore) Pte. Ltd., Crosby House, 71/73 Robinson Rd., Singapore 1. Tel: 79-457, 91-5973. (Importer)

Capitol, see EMI.

Chapter One, see Decca.

Chiang Huat Co. Pte. Ltd., 195/199 Outram Park, Singapore 3. Tel: 220-3444, 222-2973. Cable: CHIPMUNKS. Chm.: Piekak Chang; Mgr.: T.T. Quek; Sales Mgr.: Koh Kok Thy.

Labels: (Owned) Echo, Elastic, (represented) Blue Note, Fantasy, Liberty, Prestige, United Artists (all USA).

Cogent, see Unisong.

Columbia, see EMI.

Contempo, see Decca.

Cosdel (Singapore) Pte. Ltd. (IFPI), Units 1C-5C, Block 11, 3rd fl., Kallang Bahru, Kallang Basin Ind'l Estate, Singapore 12. Tel: 258-9944. Cable: COSDEL. Chm.: Kenneth L. Cole; Mng. Dir.: S.P. Sim; Sales Mgr.: Willie Lim. (Distributor/Importer)

Reg'l headquarters: Hong Kong.

Labels: (Licensed) Durium (Italy), Festival (Australia), Pickwick (USA), RCA group (USA), Ranwood (USA).

D. G., see Polygram.

Decca Orient (Pte.) Ltd. (sub. of Decca Rec. Co. Ltd., UK) (IFPI), E6 MacDonald House, Orchard Rd., Singapore 9. Tel: 320-537, 327-071, 361-196. Mng. Dir.: Derrick J. Coupland; Reg'l Sales Mgr.: Esther Lim.

Regional branches: Hong Kong, Malaysia.

Labels: (Owned) Ace of Clubs, Ace of Diamonds, Argo, Beltona, Chapter One, Contempo, Decca, Deram, Eclipse, Emerald, Greenwish, Gull, Headline, London, London/AAO, Nova, L'Oiseau Lyre, Qualiton, Threshold, Vocalion, York; (represented) All Platinum (USA), Ariola-Eurodisc (Germany), Biograph (UK), Boot (USA), Brunswick (USA), Capri (France), Coccinelle Varieties (France), Cynda (USA), Ember (UK), Fiesta (France), Horoscope (USA), Maple (USA), O'be (USA), Pye (UK), Rex (UK), Spiral (UK), Sonet (UK), Stang (USA), Summus (USA), Turbo (USA), Vega (France), Vox (UK).

Int'l reps.: Ceylon (Lewis Brown), China (Linfair), India (Gramophone), Japan (King), Korea (Sung Eum), Macao (Universal Agencies), Pakistan (EMI), Philippines (Super), Thailand (Kinetex).

Deram, see Decca.

Double Up, see EMI.

EMI (Singapore) Pte. Ltd. (IFPI), PO Box 182, MacDonald House, 3rd fl., Orchard Rd., Singapore 9. Tel: 327-686. Cable: EMITRON. Mng. Dir.: John Forrest.

Home office: England.

Labels: (Owned) Angel, Capitol, Columbia, Double Up, EMI, Encore, HMV, Harvest, MFP (Music for Pleasure), One Up, Parlophone, Pathe, Regal, Regal Zonophone, Sounds Superb, Talisman, Waverley, (represented) Arista (USA), Bronze (UK), CBS/Sony (Japan), Disneyland (USA), Island (UK), Motown (USA), Private Stock (USA), RAK (UK), Rocket (UK).

Int'l rep.: Worldwide (EMI).

Eagle, see Teo Kwan.

Echo, see Chiang Huat.

Eclipse, see Decca.

Elastic, see Chiang Huat.

Emerald, see Decca.

Encore, see EMI.

Fontana, see Polygram.

Greenwich, see Decca.

Gull, see Decca.

H M V, see EMI.

Harvest, see EMI.

Headline, see Decca.

Hup Hup Sdn. Bhd., 5 Lorong Tukang Lima, Jurong Town, Singapore 22. Tel: 65-0137/1333. Cable: HUPHONIC. Mng. Dir.: Ng Lian Chin; Dirs.: Ms. Ng Ay Vin, Ms. Ng Ay Na. (Distributor)

Local branch: Singapore 8, 232 Serangoon Rd. Tel: 293-0129, 293-3404.

Home office: Malaysia.

Label: (Distributed) Life.

E. S. Isaac & Co. Pte. Ltd., 35-A Hongkong St., Singapore 1. Tel: 438-460/466. Cable: ISAACNCO. (Distributor)

Labels: (Distributed—not licensed) Accent (USA), Angel (India), Columbia (India), Crescendo (USA), Everest (USA), HMV (India), Hi Fi (USA), Odeon (India), Parlophone (India), Telefunken (Germany), Vogue (France).

Int'l reps.: France (Vogue), Germany (Teldec), India (Gramophone).
Island Music Dist., Golden Mile Shopping Centre, 7th fl., Suite 5817, Beach Rd., Singapore 7. Tel: 221-9210/9325. Telex: 25466. (Distributor)

Kwang Sia Pte. Ltd., Colombo Court, Rm. 308, 3rd fl., N. Bridge Rd., Singapore 6. Tel: 34501, 332-154. Cable: KWANGSIACO. Dir.: K.H. Ang; Mng. Dir.: Keng Seah Ang; Sales Mgr.: Rockie Lim. Local branches: Singapore 6, G3 Capitol Shopping Centre, N. Bridge Rd. Tel: 335-659—Singapore 6, 87/8 Colombo Court, N. Bridge Rd. Tel: 34 013—Singapore 9, International Bldg., 360 Orchard Rd., Ground fl., Rm. 7. Tel: 372-649—Singapore 12, Golden Wall Flatted Factory, 6th fl., No. 8F, Jalan Raja. (Importer)

Life Rec. Inds. (Pte.) Ltd., 5 Lorong Tukang Lima, Jurong Town, Singapore 22. Tel: 65-0137/1333/1187. Cable: LIFERECORD. (Distributed by Hup Hup)

London, see Decca.

London/AAO, see Decca.

M F P, see EMI.

Mercury, see Polygram.

Music for Pleasure, see EMI.

Nova, see Decca.

L'Oiseau Lyre, see Decca.

One Up, see EMI.

Parlophone, see EMI.

Pathe, see EMI.

Philips, see Polygram.

Polydor, see Polygram.

Polygram Recs. Pte. Ltd. (IFPI), 6 Joo Koon Circle, Tuas Jurong, Singapore 22. Tel: 268-1255. Cable: PHONRECORD. Telex: 24829. Mng. Dir.: Norman Cheng; Gen. Mgr.: Johnny Sng Chin Watt.

Reg'l branch: Malaysia.

Labels: (Owned) DG, Fontana, Mercury, Philips, Polydor, RSO, (represented) A&M, CTI (USA), Capricorn (USA), Charisma (UK), De-Lite (USA), H&L (USA), Jupiter (Germany), MCA (USA), MGM, Metronome, Monument, Pablo (Germany), Rocket, 20th Century (USA), Vertigo, Verve.

Int'l reps.: Worldwide (Phonogram, Polydor).

Qualiton, see Decca.

R S O, see Polygram.

Regal, see EMI.

Regal Zonophone, see EMI.

Scripture Union Christian Book Centre, 36H Prinsep St., Singapore 7. Gen. Mgr.: Winston Yap.

Labels: (Distributed—not licensed) Pilgrim (UK), Word (USA).

Singapore Audio, 225 Plaza Singapura, 2nd fl., Orchard Rd., Singapore 9.

Label: (Represented) Sheffield Lab (USA).

Sounds Superb, see EMI.

Talisman, see EMI.

Teo Kwan Electric Recs. Co., 17 Dhoby Ghaut, Singapore 9. Tel: 360-402, 328-265. Cable: KWANGELECT.

Label: (Owned) Eagle.

Threshold, see Decca.

Tony, see Tony Wong.

Unisong Pte. Ltd., Shaw Towers, No. 125, Beach Rd., Singapore 7. Tel: 293-4379. Gen. Mgr.: Kuek Soi Tee; Sales Mgr.: Tay Chor Huan.

Labels: (Owned) Cogent, Unisong.

Vocalion, see Decca.

Waverley, see EMI.

Tony Wong Co. (Pte.) Ltd. (IFPI), 16F, Block 9, Kallang Pl., Singapore 12. Tel: (65) 235-3847. Cable: AUDIOTAPE. Telex: 23252. Mng. Dir.: Tony C.K. Wong. Gen. Mgr.: Chow Yue Teng. Sales Mgr.: Eddy Chew.

Label: (Owned) Tony.

Int'l reps.: Hong Kong (Sun Hing Panasonic), Indonesia (P.T. Padang), Thailand (Lepso).

York, see Decca.

● music publishers

Baal Music, 1101 Marina House, Shenton Way, Singapore 2. Tel: 221-5484. Cable: BAALPROD. Dir.: Balram Shotam.

Int'l reps.: France (EPOC), Germany (Accord), Japan (Shinko), Latin America (Fermata).

Burlington-Palace Music Orient Ltd. (div. of Decca Orient Pte. Ltd.) E6 MacDonald House, Orchard Rd., Singapore 9. Tel: 327-071, 361-196. Mng. Dir.: Derrick J. Coupland; Dir.: H.K. Franklin; Far East Mgr.: Esther Lim.

Reg'l headquarters: Hong Kong (see for int'l firms represented).

Intersong Far East Pte. Ltd., 6 Joo Koon Circle, Tuas, Jurong, Singapore 22. Tel: 268-1255. Cable: PHONRECORD. Telex: 24829. Mng. Dir.: Norman Cheng; Gen. Mgr.: Johnny Sng Chin Watt.

Int'l firms represented: Acuff Rose, Ascherberg Hopwood & Crew, Balloon Head, Bena, Irving Berlin, Canopy, Chappell, Ensign, Famous, Fox Fanfare, Albert Hammond, Hot Cha, Lowery, Mayday, E.H. Morris, Osmond, Pilot, RSO, Ranger, Fred Rose, Saggifre, Robert Stigwood Group, Subiddu, Unichappell, White Cloud (all UK).

Int'l reps.: Worldwide (Intersong), Netherlands (Artemis).

Pathe Publ'ns (Far East) Pte. Ltd., PO Box 182, MacDonald House, 3rd fl., Orchard Rd., Singapore 9. Tel: 327-686. Cable: EMITRON. Mng. Dir.: John Forrest.

Regional headquarters: Hong Kong.

Int'l firms represented: See listing for reg'l headquarters in Hong Kong.

Tony Wong Co. (Pte.) Ltd., 16F, Block 9, Kallang Pl., Singapore 12. Tel: (65) 235-3847. Cable: AUDIOTAPE. Telex: 23252. Mng. Dir.: Tony C.K. Wong.

● services

DESIGN & ARTWORK

Craft Print Pte. Ltd., PSA Multi Storey Complex, Unit 513.

517, Block 3, 5th fl., PSA Pasir Panjang Rd., Singapore 5. Tel: 275-1816. Dir.: Dora Ong. Gen. Mgr.: Charlie Chan.
 Showstar Pte. Ltd., 506 Colombo Court, 5th fl., Singapore 6. Mng. Dir.: Wilson David.

● **services**

PLATING, PROCESSING & PRESSING PLANTS

E M I (Singapore) Pte. Ltd., 6 Wan Lee Rd., Jurong Town, Singapore 22. Tel: 650-544/183, 652-092. Mng. Dir.: John Forrest. Technical Mgr.: Lee Tuck Ming. Factory Admin. Mgr.: Wee Tiong Wah.
 Hardie Trading (Servs.) Pte. Ltd., 603 Shaw House, 6th fl., Orchard Rd., Singapore 9. Tel: 235-2394/2210. Telex: 21203 Mgr. D.P. Crainean.
 Life Rec. Inds. Pte. Ltd., 5 Lorong Tukang Lima, Jurong Town, Singapore 22. Tel: 65-1137/1333/1187. Mng. Dir.: Ng Lian Chin.
 Polygram Recs. Pte. Ltd., 6 Joo Koon Circle, Tuas, Jurong, Singapore 22. Tel: 268-1255. Cable: PHONRECORD. Telex: 24829 Mng. Dir.: Norman Cheng. Gen. Mgr.: Johnny Sng Chin Watt.
 Unique Art Record Ind'l Ent's Pte. Ltd., 1-E, Lot 16, Section 2, Lorong Tukang Lima, Jurong Town, Singapore 22. Tel: 651-981/982. Cable: SANKEICORD. Telex: 23380 Dir. S.T. Tsai.

PRINTERS & LITHOGRAPHERS

Craft Print Pte. Ltd., PSA Multi Storey Complex, Unit 513-517, Block 3, 5th fl., Pasir Panjang Rd., Singapore 5. Tel: 275-1816. Dir.: Dora Ong. Gen. Mgr.: Charlie Chan.
 Showstar Pte. Ltd., 506 Colombo Court, 5th fl., Singapore 6. Mng. Dir.: Wilson David.

RECORD PROMOTION

Baal Recs. Pte. Ltd., 1101 Marina House, Shenton Way, Singapore 2. Tel: 221-5484. Cable: BALLPROD. Dir.: Balram Shotam.
 Gabco Pte. Ltd., 22 Jalan Hitam Manis, Singapore 10. Tel: 633-005. Cable: GABBY. Telex: 25800 Chm. Philip C.M. Seow.
 Rediffusion (Singapore) Pte. Ltd., PO Box 608, 182 Clemenceau Ave., Singapore 9. Tel: 362-211. Cable: REDIFFUSE. Contact: Ong Su Tow.

TAPE CUSTOM DUPLICATORS

E M I (Singapore) Pte. Ltd., 6 Wan Lee Rd., Jurong Town, Singapore 22. Tel: 650-544/183, 652-092. Mng. Dir.: John Forrest. Technical Mgr.: Lee Tuck Ming. Factory Admin. Mgr.: Wee Tiong Wah.
 Otari Nampo Electronic & Sound Inds. (Pte.) Ltd., Redhill Ind'l Estate, 3809D, Block 1, Jalan Bukit Merah, Singapore 3. Tel: 272-2751/3776. Mng. Dir.: Hee Chin Sit, VP. Masayuki Hosoda, Sales Mgr.: Wong Luck.
 Audio: 8-tr. cassette.
 Polygram Recs. Pte. Ltd., 6 Joo Koon Circle, Tuas, Jurong, Singapore 22. Tel: 268-1255. Cable: PHONRECORD. Telex: 24829 Mng. Dir.: Norman Cheng. Gen. Mgr.: Johnny Sng Chin Watt.
 Rediffusion Servs. (Singapore) Pte. Ltd., 1 Jalan Selanting, Singapore 21. Tel: 671-144. Cable: REDIFFUSE. Telex: 24114.
 Audio: Cassette, open reel.
 Video: 1" open reel, 3/4" cassette.
 Unimagnetic Pte. Ltd., 1-D, Lot 16, Section 2, Lorong Tukang Lima, Jurong Town, Singapore 22. Tel: 268-4230, 651-981/982. Cable: SANKEICORD. Telex: 23380 Dir. S.T. Tsai.
 Tony Wong Co. (Pte.) Ltd., 16 F, Block 9, Kallang Pl., Singapore 12. Tel: (65) 235-3847. Cable: AUDIOTAPE. Telex: 23252. Mng. Dir.: Tony C.K. Wong.
 Audio: 8-tr., 8-tr. quadraphonic, cassette.

● **supplies**

CARTRIDGE & CASSETTE PARTS

Unigoh (Singapore) Pte. Ltd., 67 Jalan Jambu Ayer, Hock Seng Garden, Bukit Timah, Singapore 21. Tel: 667-027. Mng. Dir.: S.S. Goh. Gen. Mgr.: Samuel Chong. Home office: Malaysia, UNI.
 Audio: All plastic parts.
 Tony Wong Co. (Pte.) Ltd., 16F, Block 9, Kallang Pl., Singapore 12. Tel: (65) 235-3847. Cable: AUDIOTAPE. Telex: 23252. Mng. Dir.: Tony C.K. Wong.
 Audio: All 8-tr. & cassette parts.

EMPTY CARTRIDGES, CASSETTES & REELS

Kwang Sia Pte. Ltd., Colombo Court, Rm. 308, 3rd fl., N. Bridge Rd., Singapore 6. Tel: 34501/332154. Cable: KWANGSIACO. Dir.: K.H. Ang. Mng. Dir.: Keng Seah Ang. Sales Mgr.: Rockie Lim. (Importer).
 Otari Nampo Electronic & Sound Inds. (Pte.) Ltd., Redhill Ind'l Estate, 3809D, Block 1, Jalan Bukit Merah, Singapore 3. Tel: 272-2751/3776. Mng. Dir.: Hee Chin Sit, VP. Masayuki Hosoda, Sales Mgr.: Wong Luck.
 Audio: 8-tr. & cassette.
 Unigoh (Singapore) Pte. Ltd., 67 Jalan Jambu Ayer, Hock Seng Garden, Bukit Timah, Singapore 21. Tel: 667-027. Mng. Dir.: S.S. Goh. Gen. Mgr.: Samuel Chong. Home office: Malaysia, UNI.
 Brand name: UNI-EI Mar.
 Tony Wong Co. (Pte.) Ltd., 16F, Block 9, Kallang Pl., Singapore 12. Tel: (65) 235-3847. Cable: AUDIOTAPE. Telex: 23252. Mng. Dir.: Tony C.K. Wong.
 Audio: 8-tr., cassette.
 Brand name: Tony.

JACKETS & SLEEVES LABELS

Craft Print Pte. Ltd., PSA Multi Storey Complex, Unit 513-517, Block 3, 5th fl., Pasir Panjang Rd., Singapore 5. Tel: 275-1816. Dir.: Dora Ong. Gen. Mgr.: Charlie Chan.
 Unigoh (Singapore) Pte. Ltd., 67 Jalan Jambu Ayer, Hock Seng Garden, Bukit Timah, Singapore 21. Tel: 667-027. Mng. Dir.: S.S. Goh. Gen. Mgr.: Samuel Chong. Home office: Malaysia, UNI. (Labels only).

RECORD PROCESSING MACHINERY

Hardie Trading (Servs.) Pte. Ltd., 603 Shaw House, 6th fl., Orchard Rd., Singapore 9. Tel: 235-2394/2210. Telex: 21203 Mgr. D.P. Crainean (Importer).
 Product: Transco master recording blanks.
 Unigoh (Singapore) Pte. Ltd., 67 Jalan Jambu Ayer, Hock Seng Garden, Bukit Timah, Singapore 21. Tel: 667-027. Mng. Dir.: S.S. Goh. Gen. Mgr.: Samuel Chong. Home office: Malaysia, UNI.
 Brand name: Finebit.

TAPE, RAW & BLANK LOADED

Agfa Carat, see East Asiatic.
 Agfa Stereochrom, see East Asiatic.
 Agfa Videochrom, see East Asiatic.
 Ampex, see Eastland.
 B A S F, see Jebens & Jessen.
 E M I (Singapore) Pte. Ltd., 6 Wan Lee Rd., Jurong Town, Singapore 22. Tel: 650-544/183, 652-092. Mng. Dir.: John Forrest. Technical Mgr.: Lee Tuck Ming. Factory Admin. Mgr.: Wee Tiong Wah.
 Brand name: Emitape.
 East Asiatic Co. Pte. Ltd., Agfa-Gevaert Dept., Finlayson House, 1st fl., Raffles Quay, Singapore 1. Tel: 981201. Telex: 21234. Agfa-Gevaert Dept. Dir.: Andrew Heng Seng Par.
 Audio: Blank—compact-cassette, open reel, raw—cassette, broadcast, studio.
 Video: Cassette, open reel.
 Brand names: Agfa Carat, Agfa Stereochrom, Agfa Videochrom.
 Eastland Trading Co., GPO Box 1128, 271A & 283A Selegie Shopping & Office Complex, 1st fl., Selegie Rd., Singapore 7. Tel: 321-021. Cable: EASTLAND. Telex: 21014. Pres. T.S. Quek, Gen. Mgr.: Awa Wong. Sales Mgr.: Chen Wee. (raw only).
 Audio: Cassette, open reel.
 Brand name: Ampex.
 Emitape, see EMI.
 Greencorp, see Unigoh.
 Hardie Trading (Servs.) Pte. Ltd., 603 Shaw House, 6th fl., Orchard Rd., Singapore 9. Tel: 235-2394/2210. Telex: 21203 Mgr. D.P. Crainean (Importer). (Raw only).
 Jebens & Jessen (Singapore) Ltd., PO Box 2444, Supreme House, 10th fl., Penang Rd., Singapore 9. Tel: 32-8361. Cable: JEBJESSEN. Telex: 21487. Dir.: A. Pons.
 Audio & Video: Cassette, open reel.
 Brand name: BASF.
 Kwang Sia Pte. Ltd., Colombo Court, Rm. 308, 3rd fl., N. Bridge Rd., Singapore 6. Tel: 34501/332154. Cable: KWANGSIACO. Dir.: K.H. Ang. Mng. Dir.: Keng Seah Ang. Sales Mgr.: Rockie Lim. (Importer). (Blank only).
 Audio: Cassette.
 Otari Nampo Electronic & Sound Inds. (Pte.) Ltd., Redhill Ind'l Estate, 3809D, Block 1, Jalan Bukit Merah, Singapore 3. Tel: 272-2751/3776. Mng. Dir.: Hee Chin Sit, VP. Masayuki Hosoda, Sales Mgr.: Wong Luck.
 Audio: 8-tr. & cassette.

Tony, see Tony Wong.
 Unigoh (Singapore) Pte. Ltd., 67 Jalan Jambu Ayer, Hock Seng Garden, Bukit Timah, Singapore 21. Tel: 667-027. Mng. Dir.: S.S. Goh. Gen. Mgr.: Samuel Chong. Home office: Malaysia, UNI.
 Audio: 8-tr. cassette.
 Brand name: Greencorp.
 Unimagnetic Pte. Ltd., 1-D, Lot 16, Section 2, Lorong Tukang Lima, Jurong Town, Singapore 22. Tel: 268-4230, 651-981/982. Cable: SANKEICORD. Telex: 23380 Dir. S.T. Tsai. (Blank only).
 Tony Wong Co. (Pte.) Ltd., 16F, Block 9, Kallang Pl., Singapore 12. Tel: (65) 235-3847. Cable: AUDIOTAPE. Telex: 23252. Mng. Dir.: Tony C.K. Wong.
 Audio: 8-tr., cassette.
 Brand name: Tony.

TAPE DUPLICATING & PROCESSING EQUIPMENT

Eastland Trading Co., GPO Box 1128, 271A & 283A Selegie Shopping & Office Complex, 1st fl., Selegie Rd., Singapore 7. Tel: 321-021. Cable: EASTLAND. Telex: 21014. Pres. T.S. Quek, Gen. Mgr.: Awa Wong. Sales Mgr.: Chen Wee.
 Audio: Duplicators.
 Brand names: Ampex, Pentagon.
 Jebens & Jessen (Singapore) Ltd., PO Box 2444, Supreme House, 10th fl., Penang Rd., Singapore 9. Tel: 32-8361. Cable: JEBJESSEN. Telex: 21487. Dir.: A. Pons.
 Audio: Pancakes.
 Brand name: BASF.
 Unigoh (Singapore) Pte. Ltd., 67 Jalan Jambu Ayer, Hock Seng Garden, Bukit Timah, Singapore 21. Tel: 667-027. Mng. Dir.: S.S. Goh. Gen. Mgr.: Samuel Chong. Home office: Malaysia, UNI.
 Audio: Duplicators.
 Brand name: Ed-Pic/Recordex.

● **accessories**

Kwang Sia Pte. Ltd., Colombo Court, Rm. 308, 3rd fl., N. Bridge Rd., Singapore 6. Tel: 34501/332154. Cable: KWANGSIACO. Dir.: K.H. Ang. Mng. Dir.: Keng Seah Ang. Sales Mgr.: Rockie Lim. (Importer).
 Product: Cleaners, cloths, brushes, head cleaners &

demagnetizers, needles, splicing tape.
 Unigoh (Singapore) Pte. Ltd., 67 Jalan Jambu Ayer, Hock Seng Garden, Bukit Timah, Singapore 21. Tel: 667-027. Mng. Dir.: S.S. Goh. Gen. Mgr.: Samuel Chong. Home office: Malaysia, UNI.
 Product: Tape carrying & storage cases, cleaners, cloths, brushes, head cleaners, demagnetizers, leader & splicing tape.

● **store fixtures & merchandising aids**

Unigoh (Singapore) Pte. Ltd., 67 Jalan Jambu Ayer, Hock Seng Garden, Bukit Timah, Singapore 21. Tel: 667-027. Mng. Dir.: S.S. Goh. Gen. Mgr.: Samuel Chong. Home office: Malaysia, UNI.
 Product: Tape display racks.

SOUTH AFRICA, REPUBLIC OF

Population: 24,512,000.
 Rate of exchange: \$1 (US) = 0.84 rand.
 Per capita income: \$2641.
 No. of homes with record players: 1,250,000.
 Holidays: January 1, May 31 (Republic Day), First Monday in September (Settler's Day), October 10 (Kruger's Day), December 16 (Day of the Covenant) and all traditional Christian holidays.

RECORDS:

Records sold domestically including imports (retail value): LP's 1978—3,583,534 units, \$23,391,159; 1977—4,305,600 units, \$24,474,969; Singles 1978—6,060,738 units, \$10,893,651; 1977—6,091,659 units, \$9,293,696.
 Records imported from USA (factory value—CIF): 1978—188,431 units, \$335,701; 1977—230,768 units, \$354,139.
 Records imported from countries other than USA (factory value—CIF): 1978—199,075 units, \$515,953; 1977—374,585 units, \$610,036.
 Average retail price per record: (Excluding sales duty of 8.62%) LP's—\$6.53, singles—\$1.80.
 Stereo sales: 100% of total.
 Quadraphonic sales: None.
 Record club sales: None.
 Discounting: Frequent.
 Type of distribution: Manufacturer-to-retailer.
 Type of promotion: Radio and TV are the main promotional media. Springbok Radio features a weekly Top 20 (singles) program and Radio 5 has its own Top 20 and Disco 10 programs. TV includes a weekly "Pop Shop" program with film clips of international and local artists. Discotheques are important promotional outlets. The English language service features the Top 50 LP's in its "Audiomix" program. Two independent publications—"Music Maker" and "Film & Entertainment"—cover the record scene, and some newspapers have regular supplements on all aspects of the entertainment industry. Springbok Radio and the record industry combine to organize an annual contest to find the top South African artists and songwriters of the year. Winners are awarded gold SARIE trophies at a theater presentation, which is broadcast on radio and TV.
 Jukeboxes: 500.

TAPE:

Market: The swing from 8-track to cassette continues, the latter now being 94% of tape sales. The combined 8-track and cassette sales are about 14% in units and 22% in retail sales value of the total record and tape market. Cassette and radio cassette recording & playback equipment are extensively available in a wide price range.
 Pre-recorded tape sold domestically—including imports (retail value): 8-tr. 1978—100,590 units, \$556,674; 1977—193,561 units, \$852,609. Cassette 1978—1,454,747 units, \$8,859,227; 1977—1,622,596 units, \$8,022,115.
 Pre-recorded tape imported from USA (CIF): 1978—\$1,898, 1977—\$76,134.
 Pre-recorded tape imported from countries other than USA (CIF): 1978—\$118,422, 1977—\$123,940.
 Average retail price per tape: 8-tr.—\$5.53; cassette—\$6.09.

RADIO STATIONS:

No. of commercial 6 (all FM).
 Comment: The South African Broadcasting Corp. uses records to provide a substantial part of its radio services. These are the English and Afrikaans language non-commercial services and the commercial advertising services of Springbok Radio and Radio 5, and the regional music stations known as Radio Port Natal, Radio Highveld, Radio Good Hope and Radio Bantu broadcasting in seven African languages.

TELEVISION STATIONS:

No. of channels: 1 commercial, 100% color (PAL).
 Comment: The single channel national color service was inaugurated four years ago and introduced spot advertising on January 1, 1978. Program content covers popular and classical music, opera, ballet, drama, variety shows, detective, fiction, topical events, sports and shows for children.

IMPORT/EXPORT REGULATIONS:

Import permit is required for records. Custom duty is 10% on FOB and 20% excise duty. Import permit is not required for pre-recorded tapes. Custom duty is 20% on FOB, 20% excise duty and 7½% surcharge. Exporters arrange for irrevocable documentary credit to be opened in their favor by the importers' bankers for the amounts to be paid by draft payable at sight or at a future date. Usual shipping documents are required. Export credit insurance and forward exchange cover are available.

MARKET ANALYSIS:

Highlights in the South African record industry have included the great success of the movies "Saturday Night Fever" and "Grease" and the substantial sales of the films' albums. Other artists featured in the top of the album charts through many weeks are Abba, Soul Brothers, Disco Rock Machine, Gerry Rafferty, Commodores, Boney M and "Sgt. Pepper's Lonely Hearts Club Band" (Bee Gees and Peter Frampton).

Disco product continues to get stronger and many more discotheques have been established in the major centers. There is an upswing in the appreciation of jazz, particularly by the black population. Black artists, both local and international, are gaining popularity with all sections of the population.

Television and the somewhat low level of economic growth have had a restrictive effect on the record and entertainment industries in the past four years. The initial impact of television is now over and, with a mild improvement in the economic outlook, there is hope of a revival in the industry—barring unfavorable international events. Sales over the 1978 Christmas season showed an upward trend compared with 1977.

Home copying of records continues to be a major problem. A new copyright law came into effect on January 1, 1979 and makes provision for the appointment of a standing advisory committee and sub-committee on sound recordings, cinematography and broadcasting. The advisory committee may, from time to time, make recommendations to the government for amendments to the law.

The record industry will try, through the committees, to obtain some form of royalty on the sale of blank tapes and hardware to compensate for the loss of sales of pre-recorded tapes and disk records. Representation will also be made in respect of broadcasting rights in records and pre-recorded tapes.

William Ford Fraser

● record & tape manufacturers / distributors / importers

A V C Rec. & Tape Co. Pty. Ltd., AVC House, 3rd fl., Corner of Goud & Fox Sts., Johannesburg, Tel. (011) 37-3457. Mng. Dir.: Norman Greenberg; Mktg. Dir.: C.E.A. von Keyserlingk (Distributor).

Africa, see WEA

Akulalwa, see EMI-Brigadiers

Angel, see EMI-Brigadiers

Asylum, see WEA

Atco, see WEA

Atlantic, see WEA

Atlas City, see Teal

Awendo Rakedo, see Teal

Baba, see Teal

Bayete, see Teal

Beat City, see WEA

Berg & Boom, see Teal

Bet-El Book Room, Box 30154, Pretoria 00038, Tel. (12) 75-4287. (Distributor)

Black Belt, see Teal

Black Cherry, see EMI-Brigadiers

Black Music, see CCP

Blue Nile, see Teal

Brigadiers, see EMI-Brigadiers

Buffalo, see David Gresham

Bullet, see CCP

Butterfly, see Gramophone

C B S, see Gramophone

C C P Rec. Co. (Pty.) Ltd., Auction House, 2nd fl., 111 Fox St., Johannesburg 2001, Tel. (11) 833-1486. Cable SOUNDBOX. Telex: 8-7406. Gen. Mgrs.: Peter Vee, Howard Ipp.

Labels: (Owned) Black Music, Bullet, Horse, Intuhuko, Lake Victoria, Mabob City, Reggae, Spes Bona, Yashingoma, Zimbabwe, (licensed) Creole (UK), De-Lite (USA), Gang (USA), Jama (UK), Salsoul (USA), Virgin (USA).

Capitol, see EMI-Brigadiers

Cherry, see EMI-Brigadiers

Church, see Teal

City Late, see Teal

City Special, see Teal

Coast Disco, see Teal

Columbia, see EMI-Brigadiers

Contempo, see EMI-Brigadiers

Cool Blue, see EMI-Brigadiers

Date, see Gramophone

Double-Up, see EMI-Brigadiers

E M I, see EMI-Brigadiers

E M I America, see EMI-Brigadiers

E M I-Brigadiers (Pty.) Ltd. (IFPI), 32 Steele St., Steeldale, Johannesburg 2001, Tel. (11) 618-3900. Telex: 8-7409. Cable SOUNDBOX. Mng. Dir.: C. R. Kelly; Mktg. & Repertoire Dir.: Allan McInnes.

Labels (Owned) Akulalwa, Angel, Brigadiers, Capitol, Columbia, Contempo, Cool Blue, Double-Up, EMI, EMI America, EMI Int'l, Goli, Gull, HMV, Harvest, Jamloti, Kaya-Lami, Listen to the Wild, Molelo, N'Kanyazi, Odeon, One-up, Oz, Parlophone, Regal-Zonophone, Ring, Safari, Shona Langa, Side Walk, Starline, Stateside, Swinger, Umsakazo, Zodiac, (licensed foreign) Arista (USA), BBC (UK), Chiswick (UK), MAM (UK), Passport (USA), Purple (UK), RAK (UK), Rock Bottom

(UK), Savoy (USA); (distributed—not licensed) Black Cherry, Cherry, Sunshine, Trac.

E M I Int'l, see EMI-Brigadiers.

E M I Music for Pleasure (Pty.) Ltd. (IFPI), 32 Steele St., Steeldale, Johannesburg, Tel. (11) 618-3900. Cable SOUNDBOX. Telex: 87409. Mng. Dir.: Neville Blignaut, Sales Mgr.: Barry Bothma; Mktg. Mgr.: Johan du Plooy.

Labels: (Owned) Flame, Mellow Mood, Skyline; (licensed foreign) Classics for Pleasure, Music for Pleasure, Music Way, Sounds Superb (all UK).

Elektra, see WEA

Embassy, see Gramophone

Emdubane, see Gramophone

Epic, see Gramophone

Epidemic, see RPM

Explosion, see Contagious & RPM

Ezomdabu, see Gallo

F G B, see Gallo

Fast Move, see RPM

Flame, see EMI Music for Pleasure

Fun Time Int'l, see RMC

G R C, see Gramophone

Gallo (Africa) Ltd., PO Box 6216, 130 Kerk St., Johannesburg 2000, Tel. (11) 28-2400. Cable: GALLOTONE. Telex: 80153. Mng. Dir.: Peter Gallo; Creative Dir.: Peter Lotis, Sales Dir.: Fred Bugnato; A&R & Promo. Dir.: Ivor Haarburger.

Labels: (Owned) Ezomdabu, FGB, Gallo, Gumba Gumba, Inkonkoni, MIW, Mashalashala, Mavuthela, Motella, PG Super, Smanje Manje, Soul Jazz, Soul Jazz Pop, Ziyaluma, Zobo, (licensed domestic) Star Rays, The Sun; (licensed foreign) Audio Fidelity (USA), B&C (UK), Beserkley (USA), Bronze (UK), Butterfly (USA), CTI (USA), Capricorn (USA), Chrysalis (UK), Concord (USA), DJM (UK), Decca (UK), Disneyland (USA), Fonior (Belgium), Goldisk (Netherlands), Gull (UK), Hansa (Germany), Hispavox (Spain), MCA (USA), Mellow (Netherlands), Mushroom (USA), Parachute (USA), Rocket (UK), Shelter (USA), Sherbet (Australia), Springboard (USA), 20th Century (USA), Virgin (UK).

Int'l rep.: Worldwide (Decca).

Go-Go, see Teal

Goli, see EMI-Brigadiers

Good as Gold, see Reveille

Gramophone Rec. Co. (Pty.) Ltd. (GRC) (IFPI), PO Box 2445, 132 Kerk St., Johannesburg, Tel. (11) 37-2827. Cable: AFRICORD. Telex: 8-0153. Mng. Dir.: Percy Golembok; Gen. Mgr.: Hilton Rosenthal; Sales Mgr.: John De Beer; E/P/A Label Mgr.: Albie Jooste.

Labels: (Owned) Butterfly, CBS, Date, Embassy, Emdubane, Epic, GRC, HVN, Harmony, Imbongi, Intuhuko, Jive, Marabi, Masterpiece, Portrait, Soul Train; (licensed) Caribou, GTO, Kirshner, Lifesong, Monument, Ode, Philadelphia Int'l, Prelude, TK, T-Neck, Tappan Zee (all USA).

David Gresham Prod'n (Pty.) Ltd., PO Box 626, Zone 2000, 30 Eloff St., Johannesburg 2001, Tel. (11) 21-5029/5041. Cable: DAVEGRESH. Telex: 8-3645. Chm. & Mng. Dir.: D. Gresham; Gen. Mgr.: Allan Goldswain; A&R Mgr.: Dennis East; Promos. Dir.: Stephanie Mitchell; Prod'n Mgr.: Julian Laxton. (Also see Teal)

Labels: (Owned) Buffalo, Mpumelelo, NTU, Nitty Gritty, (licensed foreign) Ember (UK), PBR Int'l (USA), Splash (UK), State (UK).

Int'l rep.: USA (David Gresham).

Groove, see Jo'Burg

Gull, see EMI-Brigadiers

Gumba Gumba, see Gallo

H M V, see EMI-Brigadiers

H V N, see Gramophone

Harmony, see Gramophone

Harvest, see EMI-Brigadiers

Highway Soul, see WEA

Horse, see CCP

Hot Beat, see RPM

Hub, see Teal

Imbongi, see Gramophone

Inkonkoni, see Gallo

Intercontinental, see Teal

Intuhuko, see CCP & Gramophone

Ipi Tombi, see Teal

Jamloti, see EMI-Brigadiers

Jive, see Gramophone

Jo'Burg Recs. & Music Publ'g (Pty.) Ltd., PO Box 93005, Yeoville, 2143 Johannesburg, Tel. (011) 648-1244.

Chief Exec.: Stan Cohen

Labels: Groove, Jo'Burg, Jo'Burg Import, King, RSA, Sounds of Soul, Soweto.

Jo'Burg Import, see Jo'Burg

Jumbo Jet, see Teal

Kalahari, see Teal

Kanindo, see Teal

Kaya-Lami, see EMI-Brigadiers

King, see Jo'Burg

King Kong, see Teal

Knockout, see RPM

Koth Kiyombi, see Teal

Kung Fu, see Teal

Lake Victoria, see CCP

Listen to the Wild, see EMI-Brigadiers

Lolwe, see Teal

Love Love, see Teal

Luister, see Teal

M I W see Gallo

M v N, see Teal

Mabob City, see CCP

Ma Ma, see Teal

Maphuta, see Teal

Marabi, see Gramophone

Mashalashala, see Gallo

Masterpiece, see Gramophone

Mavuthela, see Gallo

Mellow Mood, see EMI Music for Pleasure

Molelo, see EMI-Brigadiers

Mosaic, see Teal

Motella, see Gallo

Moto Moto, see Teal

Mpumelelo, see David Gresham

Mumsie, see Teal

Music for Pleasure, see EMI Music for Pleasure

Musiki du Zaire, see Teal

N T U, see David Gresham & Teal

Nitty Gritty, see David Gresham & Teal

N Kanyazi, see EMI-Brigadiers

Nonesuch, see WEA

Nyang Amaki, see Teal

Odeon, see EMI-Brigadiers

One-up, see EMI-Brigadiers

One Way, see Reveille

Oz, see EMI-Brigadiers

P G Super, see Gallo

Parlophone, see EMI-Brigadiers

Phonogram, see Trutone

Pirate, see Teal

Plastic, see Teal

Plum, see Teal

Polydor, see Trutone

Portrait, see Gramophone

President, see Teal

R M C Video (Pty.) Ltd., PO Box 23, Parow Valley, Cape Town

7503, Tel. (21) 93-5187. Cable: JAGPLA. Telex: 576029

Label: (Owned) Fun Time Int'l.

R P M Rec. Co. Pty. Ltd. (IFPI), Craftsman Centre, 288 Commissioner St., Johannesburg, Tel. (11) 614-2262. Cable: PHONOSOUND. Telex: 8-0859. Chm. & Mng. Dir.: Matt Mann, Gen. Mgr. Ivor Schlosberg; Sales Mgr.: Peter Cooke, Musical Dir. Dan Hill

Labels: (Owned) Epidemic, Explosion, Fast Move, Hot Beat, Knockout, RPM, Shumba; (licensed) ABC (USA), A&M (USA), Blue Note (USA), Horizon (USA), Impulse (USA), Magnet (UK), Rampage (UK), United Artists (USA)

R S A, see Jo'Burg

Rave, see Trutone

Regal-Zonophone, see EMI-Brigadiers

Reggae, see CCP

Reprise, see WEA

Rev, see Reveille

Reveille Recs. (Pty.) Ltd., PO Box 9062, Zone 2000; Silvern

Centre, 3rd fl., Corner of Nugget & Market Sts., Johannesburg 2001, Tel. 23-5276/1866. Telex: 8-4075

Mng. Dir.: Audrey Smith, A&R Mgr.: Chris Voigt.

Labels (Owned) Good as Gold, One Way, Rev, Reveille; (licensed foreign) Argon Prod'n (USA), K-tel Int'l (Canada), Karavan (USA), Key Seven (Canada), Pinnacle (UK).

Ring, see EMI-Brigadiers

Robroy Music, 315 Mentz St., Muckleneuk, Pretoria 0002.

Tel. (012) 44-4290. Pres. Roy Bulkin; Gen. Mgr. Robert Schroeder; Sales Mgr. Clark McKay, Sec'y Pat Schroeder.

Safari, see EMI-Brigadiers

Shona Langa, see EMI-Brigadiers

Shumba, see RPM

Shungu, see Teal

Side Walk, see EMI-Brigadiers

Six Mabone, see Teal

Skyline, see EMI Music for Pleasure

Smanje Manje, see Gallo

Sondela, see WEA

Soul Jazz, see Gallo

Soul Jazz Pop, see Gallo

Soul Soul, see Teal

Soul Train, see Gramophone

Sounds of Soul, see Jo'Burg

Soweto, see Jo'Burg

Spes Bona, see CCP

Splash, see Teal

Star Black, see Teal

Starline, see EMI-Brigadiers

Star Rays, see Gallo

Stateside, see EMI-Brigadiers

The Sun, see Gallo

Sungura, see Teal

Sunshine Recs. (Pty.) Ltd., 480 Cork Ave., Ferndale,

Randburg, 2194 Transvaal, Tel. (011) 793-2913

Cable: BREAKAWAY. Mng. Dir. Graham Beggs, Gen.

Mgr. Christine Beggs. (Distributed by EMI-Brigadiers)

Super Black, see Trutone

Super Soul, see Trutone

Swinger, see EMI-Brigadiers

Symphonia Studio Pty., Helvetia House, Greenvale Rd., Bedfordview 2008.

Label: (Represented) Sheffield Lab (USA)

Teal Rec. Co. Ltd. (IFPI), PO Box 4105, Johannesburg 2000.

Tel. (011) 618-4113. Cable: TEALREC. Chm. & Mng.

Dir.: A.G.J. McGrath; Gen. Mgr.: I. Nathan; Sales Mgr.:

A.H. Marshall; Mktg. & Promos. Mgr.: J.B. Smithers;

Prod'n Mgr.: H.R. Friedman.

Labels (Owned) Atlas City, Awendo Rakedo, Baba, Ba-

bayete, Berg & Boom, Black Belt, Blue Nile, Church, City

Late, City Special, Coast Disco, Go Go, Hub, Inter-

continental, Ipi Tombi, Jumbo Jet, Kalahari, Kanindo,

King Kong, Koth Kiyombi, Kung Fu, Lolwe, Love Love,

Luister, MvN, Ma Ma, Maphuta, Mosaic, Moto Moto,

Mumsie, Musiki du Zaire, Nyang Amaki, Pirate, Plastic,

Plum, President, Shungu, Six Mabone, Soul Soul, Star

Black, Sungura, Up Up, World, Zambesi; (licensed)

Ariola (Germany), Barclay (France), Buddha (USA),

Casablanca (USA), Durium (Italy), Fantasy (USA),

Golden Hour (UK), Milestone (USA), Prestige (USA),

Pye (UK), RCA (USA), Rare Earth (USA), Stax (USA),

Vanguard (USA), Vogue (France); (distributed-not li-

icensed) Buffalo, NTU, Nitty Gritty, Splash.

Int'l rep.: USA (Arrow, Edelstein, Gross & Margolis).

Trac, see EMI-Brigadiers.

Trutone (Pty.) Ltd. (IFPI), 132 Kerk St., 5th fl., Johannesburg

2001, Tel. (11) 23-0791. Telex: 8-0153. Mng

(Germany), Nems (UK), Pablo (USA), Philips (Netherlands), Polydor (Germany), Power Exchange (UK), Privilege (Germany), Pyramid (USA), RSO (UK), Roulette (USA), Phil Spector Int'l (USA), Spoken Arts (USA), Spring (USA), Track (UK), Turnabout, Vertigo (UK), Verve (USA), Vox (USA).

Int'l reps.: Worldwide (Phonogram & Polydor)
The Turntable (Pty.) Ltd. (IFPI), Upper OK Mall, Carlton Centre, Johannesburg 2001. Tel (11) 21-1477. Telex: 8-3919 Pres Sol Marks, Gen Mgr. Bea Marks; Sales Mgr. K.H. Marks (Distributor/Importer)

Umsakazo, see EMI-Brigadiers
Up Up, see Teal.

WEA Recs. (Pty.) Ltd. (IFPI), 16 St. Andrews Rd., Parktown, Johannesburg, Tel 643-3141 Telex: 89413. Mng. Dir. Derek Hannan; Financial Controller Mike Oldfield
Home office: USA, WEA, Int'l

Labels: (Owned) Africa, Asylum, Atco, Atlantic, Beat City, Elektra, Highway Soul, Nonesech, Reprise, Sonda, Warner Bros.; (licensed) Big Tree, Dark Horse, DiscReet, Little David, Manticore, Swan Song (all USA); Dynamic Sounds (West Indies), Luapula (Zambia), Oyeyo Ringo (Kenya), Shungu (Rhodesia); (distributed—not licensed) Grace (USA), Jo'Burg, Roots, Stanyan (USA), Third Ear.
Int'l rep.: USA (WEA Int'l).

Warner Bros., see WEA

World of Life Whistle, PO Box 698, Florida 17.
Label: (Represented) Singcord (USA).

Yashingoma, see CCP

Zambesi, see Teal.

Zimbabwe, see CCP

Ziyaluma, see Gallo.

Zobo, see Gallo.

Zodiac, see EMI-Brigadiers.

● music publishers

A G Music, see Contagious

Acuff-Rose (SA) (Pty.) Ltd., see Reveille.

Angela Music Publ'g Co. (Pty.) Ltd., 4 Goudvis Rd., Melrose N., Johannesburg Tel (11) 788-6094/2613 Mng. Dir. Terry Dempsey; Gen. Mgr. Carrie Dempsey.
Int'l firm represented: Sesame Songs (UK).

Int'l reps.: Hong Kong (Decca), Sweden (Sweden Music), UK (Sesame Songs).

April Music Co. Pty. Ltd., see Gallo

Artalant Exports, see Musicpiece

Anwin Music of South Africa Pty. Ltd., see Gallo

Belwin-Mills (South Africa) Pty. Ltd., see Leeds.

Breakaway Music Co. (Pty.) Ltd., 480 Cork Ave., Ferndale, Randburg, 2194 Transvaal, Tel. (011) 793-2913. Cable: BREAKAWAY Mng. Dir. Grahame M. Beggs; Gen. Mgr. Christine E. Beggs.

Int'l firms represented: Barn (UK), Polar (Sweden)

Carstens de Waal Music (Pty.) Ltd., see Gallo.

Cherry Lane Music Co. (Pty.) Ltd., PO Box 379, 239 Alfeskor Bldg., 32 Third Ave., Wynberg Sandton, Bergville 2012. Gen. Mgr. Anton Alberts

Home office: USA.

Clan Music Publ'g Co. (Pty.) Ltd., Craftsman Centre, 288 Commissioner St., Johannesburg Tel (11) 614-2262

Cable PHONOSOUND, Telex 8-0859. Chm & Mng. Dir.: Matt Mann; Gen. Mgr.: Robbie Kallenbach.

Int'l firms represented: Antisa (USA), Combine (USA), Leo Feist (USA), Interworld (USA), Magnet (UK), Miller (USA), Page Full of Hits (UK), Resaca (USA), Robbins (USA), United Artists (USA).

Int'l reps.: Australia (Festival), Belgium (Gnome, New Music), Germany (Global, Intersong, Roba), UK (Carlin), USA (Ivan Mogull).

Contagious Music (Pty.) Ltd. (SAMRO), PO Box 33430, 2043 Jeppetown, Tel (11) 614-2262. Telex 8-0859. Mng. Dir.: Chris Kritzinger.

Int'l firms represented: Image (Australia), Radar/Vanilla (UK), Superwoop (UK)

De Phon Music (Pty.) Ltd., see Jo'Burg.

E M I-Brigadiers Music (Pty.) Ltd. (SAMRO), 32 Steele St., Steeledale, Johannesburg 2001. Tel (11) 618-3900. Cable ABEEMUSIC. Telex 87409. Mng. Dirs. Albie S. J. Venter, Clive Kelly; Gen. Mgr.: Andre Viljoen, Prof. Mgr.: Jee Nofal

Int'l firms represented: J. Albert & Son (Australia), Bay City (UK), Big Secret (UK), Capitol Prod'n (USA), Chibell (UK), Crusty (UK), Gold Hill (USA), Martin-Coulter (UK), Media (USA), Mews (UK), Mother Goose (UK), Our (UK), Owepar (USA), Red Bus (UK), Silver Dagger (USA), Stephen Stills (USA), Velvet Apple (USA).

Int'l rep.: Worldwide (EMI).

E M I Music Publ'g (South Africa), (Pty.) Ltd. (SAMRO), 32 Steele St., Steeledale, Johannesburg 2001. Tel (11) 618-3900. Cable ABEEMUSIC. Telex 87409. Mng. Dir.: Clive Kelly, Gen. Mgr.: Andre Viljoen.

Int'l firms represented: Big Pig (UK), Colgems-EMI (USA), Cross Keys (USA), Dawson's Cove (USA), Dix Ltd., Donna Music, EMI Music, Leo Feist, B. Feldman, Francis Day & Hunter, Good Time (USA), Hearts Delight (USA), Hermisc, Kennedy Street, Kipahula (USA), Manchester Music, Open Door (USA), Owens Capey & Plumb, Queen (UK), Rebel (UK), Roar Music, Robbins Music, Rolling Stones (UK), Sanah (UK), Saturday (USA), Screen Gems-EMI, Sun Music, Tree (USA), Young Music.

Int'l rep.: Worldwide (EMI).

Essex Music Group (Pty.) Ltd., PO Box 6857, 16 St. Andrews Rd., Parktown, 2193 Johannesburg. Tel (11) 643-3141. Cable SEXMUS. Mng. Dir.: Kevin J. O'Hara.

Flying Dutchman (Pty.) Ltd., see Jo'Burg.

Francis Day SA (Pty.) Ltd. (SAMRO, SARRAL), PO Box 10013, Johannesburg. Tel (11) 23-4492. Mng. Dir.: G.R. Hardie.

Gallo Music (Music Publ'g Co. of Africa Pty. Ltd.) (SAMRO), PO Box 6216, 130 Kerk St., Johannesburg 2000. Tel (11) 28-2400. Cable MUSIPUB. Telex 8-0153. Mng. Dir.: Peter Gallo; Gen. Mgr.: John Edmond.

Int'l firms represented: Braitree (USA), Briarpatch (USA), Brew (USA), Burlington-Palace (UK), Caymen (USA), Charliz (USA), Chinnichap (UK), Chrysalis (UK),

Cissi (USA), Compass (USA), Damit (USA), Danor (USA), Walt Disney (USA), Doors (USA), East Memphis (USA), Island (UK), Jasperilla (USA), Lady Jane (USA), Heath Levy (UK), Little Dickens (USA), Louvigny-Marquee (UK), McCartney (UK), Marksman (UK), Mews/Martin-Coulter (UK), Johnny Nash (USA), Newtown Sound (UK), No Exit/Rear Exit (USA), Pink Floyd (UK), RAK (UK), Rondor (USA), Cyril Shane (UK), Shillelagh (USA), Skyhill (USA), Spitfire (USA), 20th Century (USA).

Golden Music, see Laetrec

Goldrush Music, see Angela

Gwongsongs (Pty.) Ltd., see Jo'Burg.

Impala Music Co., see Gallo.

Intersong (Pty.) Ltd., PO Box 10678, 130 Kerk St., Johannesburg 2000. Tel (11) 37-6480 Cable BELINDSONG. Telex 8-0153. Dir. T. Rooney, Gen. Mgr. Art Heatle.

Int'l firms represented: Abigail (Australia), CAM (USA), Chappell (worldwide), Hill & Range (USA), Intersong group (worldwide), Kamikaze (USA), Penjane (Australia), RSO (UK, USA), Saggifire (USA).

Int'l reps.: Worldwide (Chappell, Intersong).

Jill Music (Pty.) Ltd., see Contagious

Jo'Burg Recs & Music Publ'g (Pty.) Ltd. (SAMRO), PO Box 93005, Yeoville, 2143 Johannesburg. Tel (011) 648-1244. Chief Exec.: Stan Cohen.

Int'l firm represented: Music Shoals Sound (USA).

Joint Music (Pty.) Ltd., see Jo'Burg.

Laetrec Music Ltd., Gallo Centre, 2nd fl., 130 Kerk St., 2001. Tel (11) 28-2400. Dir.: Peter Gallo; Gen. Mgr.: John Edmond.

Int'l firms represented: ABC/Dunhill Music Inc. (USA), American Broadcasting Music (USA), Blue Ribbon/Tristan group (UK), Blue Seas (USA), Broken Arrow/Silver Fiddle (USA), Canopy (USA), Casa David (USA), C'est (USA), Charing Cross (USA), Cirrus (USA), Crazy Crow (USA), De Schufflin (USA), EMP (Canada), Giving Room/Thin Ice (USA), Bobby Goldsboro (USA), Gopam (USA), Guerrilla/Staysail (USA), House of Gold (USA), Hungry Mountain (USA), Jac (USA), Jobete (USA), Keca (USA), Kirshner (USA), Kiss (USA), Lambert & Potter (USA), Joni Mitchell (USA), Morning (Canada, USA), Natural Songs (USA), Nimbus Nine (USA), One of a Kind (USA), Pattern (UK), Prophet (USA), Quackenbush (USA), Paul Simon (UK), Siquomb (USA), Stonebridge (USA), Tallyrand (USA), White Oak Songs (USA).

Int'l reps.: Worldwide (Arrow, Edelstein, Gross & Margolis) except Australia (Associated), Canada (Morning).

Leeds Music (Africa) (Pty.) Ltd., PO Box 6216, Gallo Centre, Kerk & Goud Sts., Johannesburg 2000. Tel (11) 28-2400. Telex 8-0153. Pres. Eric Gallo; Gen. Mgr.: Lisa Hogarth; Personal Ass't: Sandra Smith.

Int'l firms represented: ATV, Cuckoo Music, Tony Hiller, Dick James, Leeds, MAM, MCA, Northern Songs, Tic Toc.

Lions Head Music Pty. Ltd., see Gallo.

Little Monster Music (Pty.) Ltd. (SAMRO), PO Box 626, Johannesburg 2000. Tel: (011) 21-5029. Telex 8-3645. Mng. Dir.: Dennis East.

Magie Music, see Laetrec

Magpie Music, see Contagious

Mavuthela Music Co. (Pty.) Ltd., see Gallo

Mellin Music (Pty.) Ltd., 32 Steele St., Steeledale, Johannesburg 2001. Tel (11) 618-3900. Cable ABEEMUSIC. Telex 87409. Dir.: B. Papert; Gen. Mgr.: Andre Viljoen.

Int'l firms represented: Robert Mellin, Sherwin (both UK)

Melody Music (Pty.) Ltd., see Gallo.

Ivan Mogull Music (South Africa) (Pty.) Ltd., PO Box 6857, 16 St. Andrews Rd., Parktown, 2193 Johannesburg. Tel: (11) 643-3141. Cable SEXMUS. Mng. Dir.: Kevin J. O'Hara.

Mpumelelo Music, see WEA.

Musicpiece Publ'rs (Pty.) Ltd. (NORM, SAMRO), Auction House, 2nd Fl., 111 Fox St., Johannesburg 2001. Tel: (11) 833-1486. Cable SAGITTARIUS. Mng. Dir.: Clive Calder; Dirs.: Ralph Simon, Nat Bregman, Ron Schiff, Peter Vee; Gen. Mgr.: Pat Challis.

Int'l firms represented: Black Sheep (USA), Cam-Al (USA), Creole (USA), Gambi Ben Ghazi (USA), Grade & Lynton (USA), Heathside/Logo (USA), Hush (UK), Jama (USA), Ladysmith (UK), M&M (UK), Macauley (UK), Nada (Netherlands), New Acme (Canada), New Dayglow (Netherlands), Noel Gay (UK), PPX (USA), Panache (UK), Sunflower (UK), Three Hats (Canada), Virgin (USA).

Int'l rep.: Switzerland & UK (Zomba Corp.).

Music Publ'g Co. of Africa (Pty.) Ltd., see Gallo.

Planetary-Nom (Africa) Pty. Ltd., see Gallo

Plymouth Music (Pty.) Ltd. (SAMRO), 32 Steele St., Steeledale, Johannesburg 2001. Tel: (11) 618-3900. Cable ABEEMUSIC. Telex 87409. Dir.: B. Papert; Gen. Mgr.: Andre Viljoen.

Int'l firms represented: Allegro Holdings (UK), Berry (UK), Bron (UK), Campbell Connelly (UK), Chacksfield (UK), Eros (UK), Lermel (UK), L'illustration Musicales (France), Andre Lutereau (France), Manette (UK), Mason (UK), Medway (UK), Osibisa (UK), Osibisounds (UK), Rimusic (UK), Senlak (UK), Sforzando (France), Sheila (USA), Sonoton (Germany), Tonarchiv (Germany).

Reveille Music (Pty.) Ltd., PO Box 9062, Zone: 2000; Silvern Centre, 3rd fl., Corner Nugget & Market Sts., Johannesburg 2001. Tel: 23-5276/1866 Telex 84075. Mng. Dir.: Audrey Smith; A&R Mgr.: Chris Voigt.

Int'l firms represented: ATV (USA), Joe Allen (Canada), Bel Canto (USA), Big Heart (USA), Big Sky (USA), Blue Band (Canada), Blue Echo (Canada), Blue Melody (Canada), Brougham Hall (USA), Buckhorn (USA), Candle Bra (USA), Co-Jac (USA), Comet (USA), Enoree (Canada), Equinox (USA), Foresythe (USA), Fourth House (USA), JSH (USA), Lady Casey (USA), Mandina (USA), Mavid (USA), Meredith (USA), Mermaid (USA), Ram's Horn (USA), Return (USA), Rocksmith (USA), Simtec (USA), Special Rider (USA), Sweco (USA), Silverstar (Canada), Starburst (USA), War Drum (USA), Whole Wheat (USA), Jerry Williams (USA), Wooden Bear (USA).

Int'l rep.: Worldwide (Ralph L. Seltzer).

Robroy Music, c/o Gallo Music, 130 Kerk St., Johannes-

burg 2000. Tel: (011) 28-2400. Pres.: Robert Schroeder, Gen. Mgr.: Roy Bulkin.

Brian Rohan Int'l (SA), see Reveille.

Southern Music Publ'g Co. (SA) (Pty.) Ltd., 62 St. Patrick's Rd., Houghton, Johannesburg 2198. Tel: 43-6053. Cable SOUTHMUSIC. Dir.: Glyn Taylor.

Home office: USA, Peer-Southern Org.

Firms represented: Edward Kassner (UK), Snider Kruse, Sun Pacific (UK).

Southern Sky Music (Pty.) Ltd., see Contagious.

Special Rider Music (Pty.) Ltd., see Reveille.

Sudekruse Musikuitgewer Maatskappy, see Southern. Teal Music, see Laetrec.

Tradellus, PO Box 3159, Durban 4000. Tel (031) 69137. Cable: ACCORDIO. Telex: 6-0389. Pres.: H. Tradellus; Int'l Div. Dir.: E. Rasch.

Int'l firms represented: Alfred (USA), Almo (USA), Ashley (USA), Big 3 (USA), Chappell (UK, USA), Cherry Lane (USA), Columbia Pictures (USA), Hal Leonard (USA), Melbay (USA), Music Sales (UK, USA), W. Smith (USA), Warner Bros. (USA).

Tree Music (South Africa) Pty. Ltd., see Leeds.

Valentine Music (SA) Co., see Reveille.

WEA Music (Pty.) Ltd., 16 St. Andrews Rd., Parktown, Johannesburg 2001. Tel 643-3141. Telex 89413. Mng. Dir.: Derek Hannan.

Int'l rep.: USA (Warner Bros. Music).

Warner Bros. Music (South Africa) (Pty.) Ltd., 16 St. Andrews Rd., Parktown, 2193 Johannesburg. Tel: (11) 643-3141. Cable: WEARECORSA. Dirs.: Kevin J. O'Hara, Derek Hannan, Ed Silvers, Leonard Golove.

Yackamo Music (SAMRO), PO Box 626, Johannesburg 2000. Tel (11) 21-5029. Cable: DAVEGRESH. Telex: 8-3645. Chm. & Mng. Dir.: David Gresham; Dir. & Gen. Mgr.: Allan Goldswain.

Int'l firms represented: Belsize (UK), State (UK).

Int'l reps.: Canada (Goldgrish in USA), Europe (State in UK), USA (Goldgrish).

● sheet music jobber/supplier

Tradellus, PO Box 3159, Durban 4000. Tel (031) 69137. Cable: ACCORDIO. Telex: 60389. Pres.: H. Tradellus; Int'l Div. Dir.: E. Rasch.

● services

ASSOCIATIONS & PROFESSIONAL ORGANIZATIONS

Association of the Southern African Phonographic Ind. (ASAPI), PO Box 5411, Johannesburg. Tel: (11) 618-3900. Sec'y-Treas.: W.F. Fraser.

Southern African Record & Tape Distrib. Ass'n, PO Box 8213, Johannesburg 2000. Tel: (11) 618-3900. Telex: 87409. Chm.: C.R. Kelly; Sec'y-Treas.: W.F. Fraser.

DESIGN & ARTWORK

Space & Design, Scotch Corner, 1st fl., Rokeby St., Bellevue, Johannesburg. Tel 648-1244. Cable: ESPACEDES. Mng. Dir.: Charles Coetzee.

The Turntable (Pty.) Ltd., Upper OK Mall, Carlton Centre, Johannesburg 2001. Tel: (11) 21-1471. Telex: 83919. Pres.: Sol Marks; Gen. Mgr.: Bea Marks; Sales Mgr.: K.H. Marks.

LICENSING ORGANIZATIONS, MUSIC

N O R M (National Org. for Reproduction Rights in Music in Southern Africa Ltd.), PO Box 4378, Johannesburg 2000. Tel: (11) 23-8757. Chm.: George Hardie; Sec'y: Kathleen Webb.

S A M R O (South Africa Music Rights Org. Ltd.), PO Box 9292, SAMRO House, De Beer & Juta Sts., Braamfontein, Johannesburg. Tel: 725-1425. Cable: ACISUM. Mng. Dir.: Gideon Roos. (Performing rights only).

S A R R A L (South African Rec. Rights Ass'n Ltd.), PO Box 4378, Johannesburg. Tel: (11) 23-8757. Mng. Dir.: G.R. Hardie. (Mechanical rights only).

PLATING, PROCESSING & PRESSING PLANTS

E M I Inds. (South Africa) Pty. Ltd., 32 Steele St., Steeledale, Johannesburg 2001. Tel: (11) 618-3900. Cable: SOUNDBOX. Dir. & Gen. Mgr.: E. Cumings.

Gallo (Africa) Ltd., PO Box 6216, Gallo Centre, Kerk & Goud Sts., Johannesburg 2000. Tel (11) 28-2400. Cable: GALLOTONE. Mng. Dir.: Gerald McGrath. (Pressing only).

PRINTERS & LITHOGRAPHERS

E M I Inds. (South Africa) Pty. Ltd., 32 Steele St., Steeledale, Johannesburg 2001. Tel: (11) 618-3900. Cable: SOUNDBOX. Dir. & Gen. Mgr.: E. Cumings.

Interpak (Pty.) Ltd., 34 Barbara Rd., Elandsfontein, Transvaal 1406. Tel: (011) 58-8900. Cable: INPAKOR. Opns. Dir.: R.C. Horwitz; Sales Dir.: D. Sandler.

RECORD PROMOTION

Entertainment Mktg Mgmt (Pty.) Ltd., Auction House, 2nd fl., 111 Fox St., Johannesburg 2001. Tel: (11) 833-1486. Cable: SAGITTARIUS. Mng. Dir.: Clive Calder; Dirs.: Ralph Simon, Nat Bregman, Ron Schiff, Dir. & Gen. Mgr.: Peter Snyman.

The Turntable (Pty.) Ltd., Upper OK Mall, Carlton Centre, Johannesburg 2001. Tel (11) 21-1471. Telex: 8-3919. Pres.: Sol Marks; Gen. Mgr.: Bea Marks; Sales Mgr.: K.H. Marks.

TAPE CUSTOM DUPLICATORS

E M I Inds. (South Africa) Pty. Ltd., 32 Steele St., Steeledale, Johannesburg 2001. Tel: (11) 618-3900. Cable: SOUNDBOX. Dir. & Gen. Mgr.: E. Cumings.

Gallo (Africa) Ltd., PO Box 6216, Gallo Centre, Kerk & Goud Sts., Johannesburg 2000. Tel: (11) 28-2400. Cable:

GALLOTONE, Mng. Dir. Gerald McGrath.
Audio: 8-tr., cassette.

Magnetic Duplicating Servs., PO Box 302, Somerset West 7130. Tel: (024) 25839. Chief Exec.: Geoff Carman.
Audio: Cassette.

Newtronics (Pty.) Ltd., PO Box 23, Parow Valley, Cape Town 7503. Tel: (21) 93-5187. Cable: JAGPLA. Telex: 576029.

Audio: Cassette.
Video: 1" open reel, 3/4" cassette, 1/2" EIAJ cartridge, 1/2" VCR cassette.

Trutone Inds. (Pty.) Ltd., 24 Steele St., Steeple Dale, Johannesburg. Tel: (11) 869-1321. Telex: 8-0153. Mng. Dir. David G. Fine; Gen. Mgr.: Michael Davimes.
Audio: Cassette.

● supplies

CARTRIDGE & CASSETTE PARTS

Magnetic Duplicating Servs., PO Box 302, Somerset West 7130. Tel: (024) 25839. Chief Exec.: Geoff Carman.
Audio: Cassette cushion foils.

Newtronics (Pty.) Ltd., PO Box 23, Parow Valley, Cape Town 7503. Tel: (21) 93-5187. Cable: JAGPLA. Telex: 576029.

Audio: Cassette.
Trutone Inds. (Pty.) Ltd., 24 Steele St., Steeple Dale, Johannesburg. Tel: 869-1321. Mng. Dir. David G. Fine; Gen. Mgr.: Michael Davimes.
Audio: Cassette boxes, lids & halves.

EMPTY CARTRIDGES, CASSETTES & REELS

Magnetic Duplicating Servs., PO Box 302, Somerset West 7130. Tel: (024) 25839. Chief Exec.: Geoff Carman.
Audio: Cassette.

Newtronics (Pty.) Ltd., PO Box 23, Parow Valley, Cape Town 7503. Tel: (21) 93-5187. Cable: JAGPLA. Telex: 576029.

Audio: Cassette.
Brand name: FTI.
Trutone Inds. (Pty.) Ltd., 24 Steele St., Steeple Dale, Johannesburg. Tel: 869-1321. Mng. Dir. David G. Fine; Gen. Mgr.: Michael Davimes.
Audio: Cassette.

JACKETS & SLEEVES LABELS

Interpak (Pty.) Ltd., 34 Barbara Rd., Elandsfontein, Transvaal 1406. Tel: (011) 58-8900. Cable: INPAKOR. Opns. Dir.: R.C. Horwitz; Sales Dir.: D. Sandler.

TAPE, RAW & BLANK LOADED

Agfa-Photo (Pty.) Ltd., PO Box 1366, Johannesburg; Wrench Rd., Isando. Tel: 36-2811. Telex: 437936.

Audio: Blank cassette open reel; Raw—open reel.
Video: Blank—3/4" cassette, U-Matic, Beta, VHS.
Brand names: Agfa, Agfa Videochrome, Carat, Ferrocolor, SFD, Stereochrome.

B A S F South Africa (Pty.) Ltd., PO Box 11337, 68 Fifth St., Albertville 1, Johannesburg 2000. Tel: 673-3040. Cable: SABASF. Telex: 80304. Sales Mgr.: Mr. Mueller.

Audio: Cassette, open reel.
Video: Blank—1" open reel, 3/4" cassette, Philips VC; Raw—1" open reel.

Magnetic Duplicating Servs., PO Box 302, Somerset West 7130. Tel: (024) 25839. Chief Exec.: Geoff Carman.
Audio: Cassette.

Brand name: Fun Time Int'l.
Newtronics (Pty.) Ltd., PO Box 23, Parow Valley, Cape Town 7503. Tel: (21) 93-5187. Cable: JAGPLA. Telex: 576029.

Audio: Cassette.
Video: 1/2" VCR cassette, 3/4" cassette.
Brand name: FTI.

● accessories distributors

Newtronics (Pty.) Ltd., PO Box 23, Parow Valley, Cape Town 7503. Tel: (21) 93-5187. Cable: JAGPLA. Telex: 576029.

Product: Tape carrying & storage cases, leader & splicing tape.

The Turntable (Pty.) Ltd., Upper OK Mall, Carlton Centre, Johannesburg 2001. Tel: (11) 21-1471. Telex: 8-3919. Pres.: Sol Marks; Gen. Mgr.: Bea Marks; Sales Mgr.: K.H. Marks.

Product: Carrying & storage cases, catalog servs., cleaners, cloths, brushes, 45 rpm adapters, needles.

● store fixtures & merchandising aids manufacturer

The Turntable (Pty.) Ltd., Upper OK Mall, Carlton Centre, Johannesburg 2001. Tel: (11) 21-1471. Telex: 8-3919. Pres.: Sol Marks; Gen. Mgr.: Bea Marks; Sales Mgr.: K.H. Marks.

Product: Record & tape divider cards.

Per capita income: \$3,200.

No. of homes with record players: 2,450,000.

Holidays: January 1 (Circumcision of the Lord), January 6 (Epiphany), May 1 (Labor Day), June 24 (St. John's Day), July 25 (St. James Day), August 15 (Assumption), October 12 (Columbus Day), November 1 (All Saints' Day), December 8 (Immaculate Conception), December 25 (Christmas), other Christian holidays.

RECORDS:

Records sold domestically including imports (retail value): LP's: 1978—10,800,000 units, \$53,300,000; 1977—11,600,000 units, \$49,375,000. Singles: 1978—11,000,000 units, \$15,700,000; 1977—13,000,000 units, \$19,500,000.

Records, record blanks & pre-recorded media imported from USA: 1977—\$760,130.
Average retail price per record: LP's—\$2.70-\$9.30, singles—\$1.70-\$2.30.

Stereo sales: 99% of total.
Record club sales: 9% of total.
Discounting: Rare.

Type of distribution: Manufacturer-to-wholesaler-to-retailer (20%), manufacturer-to-retailer (75%); rack jobbing (4%), mail (1%).

Type of promotion: Promotion is made through the press (5%), radio (55%), television (35%), discotheques (14%), other (1%).

Jukeboxes: 16,500.

TAPE:

Market: Due to increased sales of car cassette units and a line of low-priced cassettes, the cassette market is widening its lead over LP's in both unit and dollar volume. 8-tr. is declining due to expensive equipment and the difficulty of purchasing cartridges.

Pre-recorded tape sold domestically including imports (retail value): 8-tr. 1978—290,000 units, \$1,000,000; 1977—300,000 units, \$1,250,000. Cassette 1978—22,000,000 units, \$100,000,000; 1977—16,500,000 units, \$60,000,000.

Average retail price per tape: 8-tr. \$5.00-\$9.30; cassette—\$2.10-\$9.40.

RADIO STATIONS:

No. of commercial 338; no. of government 63; no. of AM 181; no. of FM 220.

Comment: Programming is broken down into music (40%), news (20%), amusing (20%), cultural (12%), publicity (8%). Music programming is further broken down into pop (75%), folk and flamenco (18%), classical (6%) and jazz (1%), with 97% recorded and 3% live.

TELEVISION STATIONS:

No. of channels 2.
Comment: Programming is broken down into films and telefilms (40%), news (20%), amusing (10%), cultural (10%), sports (10%), children's (6%), music (4%).

IMPORT/EXPORT REGULATIONS:

Record & tape exportation is free. Record importation requires special import licenses. Therefore, it is cheaper to manufacture than to import, as the special import licenses involve high customs taxes.

Rafael Revert

● record & tape manufacturers / distributors / importers

Abanico, see Difesco.
Accion, see Productora de Grabaciones.

Afrodita, Pintor Murillo 31, Alicante.
Alfid, Tres Senoras 1-5, Barcelona 24.
Alhambra, see Columbia.

Alondra, see Ekipo.
Als 4 Vents, Trafalgar 78, 1st fl., Barcelona 10. Tel: (93) 317-42-63. Gen. Dir. Angel Fabregues Morla.
Labels: (Owned) Als 4 Vents, Barlovento, Cactus, Diabolo, Dido, Ette, Tic.

Ambar, see Gramusic.
Apolo Recs., Mascaro 23, Barcelona 32. Tel: (91) 236-6169. Chief Exec.: Angel Fabregues Morla.
Labels: Drips, Pardal.

Archiv, see Polydor.
Arco Iris, see Mayo.

Aries, Discos de Canarias, San Vicente Ferrer 73, Santa Cruz de Tenerife, Canary Islands. Tel: (922) 27-65-63.
Cable: DISCOSARIES. Chief Exec.: Carmen Garcia Santos; Gen. Mgr.: Luis Gutierrez Solano.

Labels: (Owned) Aries, Canary, Five Disc, Oro.
Aries Musical SA, Provenza 332, Barcelona 37.

Aniela, see Ariola-Eurodisc.
Ariola-Eurodisc SA (IFPI), Calle Aragon 204, 4th fl., Barcelona 11. Tel: (93) 254-9805. Cable: HISPARIOLA. Telex: 52771. Mng. Dirs. Alberto Serra, Ramon Secura, Sales Mgr. Antonio R. Ibanez, Promo Dir. Luciano Fuentes, Admin. Dir. Emilio Perez, Co-ord. Helmut Neuhaus, Int'l Div. Jose Eduardo Lerao.

Branch: Madrid 10, General Martinez Compos 9, 1st fl. Tel: (91) 447-4026. Telex: 23537.

Labels: (Owned) Aniela, Baccarola, Eurodisc, Vergara, (licensed) Ariola America (USA), Bronze (UK), Chrysalis (UK), Island (UK), Manticore (UK), Mericana (USA), Motown (USA), Ricordi (Italy), Shelter (USA), Tomato (USA), Virgin (UK).

Int'l reps.: Argentina (RCA), Bolivia (Lauro & Cia), Central America (Dideca), Colombia (Sonolux), Dominican Republic (Discomundo), Ecuador (Fadisa), Mexico (Discolibro), Peru (FTA), Portugal (Phonogram), Uruguay (APSA), USA (Ariola America, Mericana).

Arte & Ciencia, Ygentea 2, San Sebastian.
Arryphon, see Discophon.

Ataio Ingenieros SA, Enrique Larreta 10 & 12, Madrid 16.
Label: (Represented) Sheffield Lab. (USA).

Audiens, see CIMASA.

Audiomundo, see Portadores.
Audio & Video SA, Vallehermoso 32, Madrid. Tel: (91) 448-0955. Accounts Dir. Gen. Fidel Perez Hernandez.

Labels: Audio, Azar, Boa, CD, Fase, Iris, Jack, Magnetic, Mirinda, Off, Spot, UCD.

Auvi SA (Ed. de Audio/Visuales SA), Ronda General Mitre 233, Barcelona 23. Tel: (93) 217-7906. Dir.: Alfonso R. Serra, Sales Mgr.: Joaquin Gomez, Accounting Mgr.: Juan Planas.

Labels: (Owned) Auvi, Gala, Liceo, Tipi, (licensed) Charly (UK), Deesse (France), Rockhouse (Netherlands), Splash (UK), (distributed—not licensed) Baby (Italy), Gicipi (Switzerland), Hansa (Germany), Michael Holm (Germany), Hans Kusters (Belgium), MPA (Switzerland), Mouse (Belgium), Starbox (Denmark), Victor (Japan).

Azar, see Audio & Video.
B & F Ents., Jose Martinez Velasco 8, Madrid 30. Tel: (91) 273-2467. Mng. Dir. Mr. Platon; Export Div. Mgr. Miguel Fernandez (Importer/Exporter).

Baccarola, see Ariola-Eurodisc.
Barlovento, see Als 4 Vents.

Barnafon, see Zafiro.
Bass-Drums, see Satosa.

Belter SA (Discos) (IFPI), Calle Gomis 1, Barcelona 23. Tel: (93) 211-5500. Cable: BELTERDISC. Telex: 51259. Mng. Dir.: Francisco Roses; Dir.: Gabriel Orfila; Int'l Dir.: Antonio Figueiredo; Int'l Mgr.: Danielle Jahnke.

Branch: Madrid, Arroyo Teatinos 40, Poligon Ind'l Costada Tel: (91) 671-4716/4650. Cable: BELDISCO. Telex: 42065.

Int'l branch: Portugal.
Labels: (Owned) Belter, Impacto, Ocre, Olivo, Olymco, Saucedo Int'l, (licensed) Durium (Italy), PPK Int'l (USA), Peerless (Mexico), Penny Farthing (UK), Pickwick Int'l (UK), Pye (UK); (distributed—not licensed) Ensayo.

Int'l reps.: Argentina (Sicamericana), Australia (Carnaria), Chile (Quatro), Colombia (CBS—Belter, Copicos—Impact & Olymco), Ecuador (Coprodisa), Mexico (Ariola Disco-Libro—Belter, Peerless—Olymco), Nicaragua (Sonido), Panama (Fonodiscos), Peru (IEMPSA), Switzerland (Finsterwald & Cantacuzene), Turkey (Z Plakilik), UK (Continental), USA (Alhambra), Venezuela (Suramericana). (SEE ADVERTISEMENT)

Benzo Recs., Esparteros, Madrid 12. Tel: (91) 221 55 56.
Beverly, Cea Bermudez 53, Madrid 3. Tel: (91) 243-0800.

Pres.: Antonio Navarro; Gen. Mgr.: Jose Garcia Fraile; Artistic Dir.: Javier Iturralde.

Labels: (Licensed) Akanta, Contagious Time, Gas, Show-Caxa, Pickwick.

Bilbao Trading SA Import-Export, Marques del Puerto 9, Bilbao 8. Tel: (94) 415-5255. Cable: VELLIDOMUSIK. Telex: 31351. Gen. Mgr. Ramon A. Rodamilans. Sales Mgr.: Jose A. del Campo (Distributor/Importer/Exporter).

Label: (Distributed—not licensed) Music Minus One (USA).

Boa, see Audio & Video.
Boccaccio, see Compania Fonografica Espanola & Zafiro.

C A M Espana SA, Calle Emilio Mario 8, Madrid 2. Tel: (91) 416-7558/7612/7654. Telex: 23955. Mng. Dir.: Giuseppe Lulli.

Home office: Italy.
C B S SA (Discos), Av. del Generalísimo 25, 9th fl. Madrid 16. Tel: (91) 455-3845/4026. Cable: COLCORED. Gen. Mgr.: Tomas Munoz; Sales Mgr.: Roberto Navarro.

Branch: Barcelona, Tuset 19-21, 2nd fl. Tel: (93) 227-31-43.

Labels: (Owned) CBS, (licensed) Blue Sky (USA), CGD (Italy), Lifesong (USA).

Int'l reps.: Worldwide (CBS Int'l).

C D, see Audio & Video.
C I M A S A (Compania Industrial de Materiales Acusticos SA), Vallehermoso 14, Madrid 15. Tel: (91) 448-22-00/04/08.

Label: (Owned) Audiens.

Cabra, see Edigsa.
Cactus, see Als 4 Vents.

Camden, see RCA.
Canary, see Aries.

Cancela Tape, see Zafiro.
Cango, see Sayton.

Capitol, see EMI-Decca.
Carillon, see Eutepe.

Carnaby, see Columbia.
Caudal, see Difesco & Zafiro.

Chapa, see Zafiro.
Circulo del Cassette SA, Valencia 70, 2nd fl., Barcelona 15. Tel: (93) 243-8394. Admin'r.: Pablo Lopez Balada.

Circulo de Lectores (Club de Discos) SA, Valencia 344, Barcelona 9. Tel: (93) 258-76-00. Cable: CILEC. Dir.: Juan Mayo.

Labels: (Owned) Orlador, Pergola.
Clave, see Hispavox.

Clavel, see Portadores.
Cobra, see Difesco.

Cofasa (Columbia Phonogram Asociadas SA) (IFPI), Av. de America & Hernandez de Tejada, Madrid 27. Tel: (91) 267-4200. Gen. Mgr.: Kees Ton.

Columbia SA (Discos), Apdo. 2299, Av. de los Madroños 27, Parque Conde de Orgaz, Madrid 33. Tel: (91) 200-8040. Cable: DISCOLUMBIA. Telex: 44316. Pres.: Aurora Inurrieta; Mng. Dir.: Enrique Inurrieta; Gen. Mgr.: Enrique M. Garea, A&R Mgr.: Manuel de la Calva; Musical Dir.: Jose Luis Navarro; Mktg. Mgr.: Antonio Martinez; Export/Import Mgr.: Ramon Fernandez; Financial Mgr.: Antonio Fernandez-Peinado; Technical Mgr.: Manuel Pascual; Int'l Repertoire: Jose Manuel Gonzalez Cuevas; Press Promo: Vicente de Juan; Radio Promo Dir.: Gabriel Gonzalez; Int'l Mgr.: Gerhard Haltermann.

Branches: Barcelona 37, Gerona 176. Tel: (93) 257-9007. Mgr.: Rafael Olive; Sales Mgr.: Manuel Cespedes; Promo: Romy Felu; Classical Repertoire Mgr.: Juan Arnau—Seville 10, Constanza 18. Tel: (954) 45-60-59.

Int'l branch: Italy, Las Palmas de Gran Canaria.
Labels: (Owned) Alhambra, Carnaby, Columbia, Iberia, (distributed) Ace of Diamonds (UK), Argo (UK), Aris (Italy), Buddha (USA), Copacabana (Brazil), Decca (UK), London (USA), Ri-Fi (Italy), Som (Brazil), Stiff (UK), Tele-

SPAIN

Population: 36,949,000.
Rate of exchange: \$1 (US) = 70 pesetas.

funken (Germany).
Int'l reps.: Australia (EMI), Austria (Melodia, WEA), Belgium (Fonior), Bolivia (Lauror), Brazil (Som Industria & Comercio), Canada (London), Chile (Sochem), Colombia (Philips), Costa Rica (Discos Latinoamericanos), Ecuador (Famoso), Finland (Finnylve), France (Sofrason), Germany (DGG, Phonogram, Teldec, WEA), Greece (Music-Box, Minos Matsas, Polygram), Guatemala (Discos Latinoamericanos), Israel (CBS), Italy (Aris, Ri-Fi), Japan (King), Mexico (Phonogram), Netherlands (Dureco, Phonogram), Nicaragua (Discos Latinoamericanos), Norway (Phonogram), Panama (Discos Latinoamericanos), Portugal (Vadeca), Sweden (Phonogram), Switzerland (Musikvertrieb), UK (Decca), USA (Alhambra, London), Uruguay (Sondor), Venezuela (Grabaciones Mundiales).
 Compania Fonografica Espanola (IFPI), Augusto Figueroa 39, Madrid 4, Tel (91) 222-7474. Cable MILDISC. Gen Mgr. Carlos Perez Alvaro; A&R Mgr.: Jose Manuel Yanes; Guimbarda Mgr. Manuel Dominguez.
Labels: (Owned) Boccaccio, Explosion, Guimbarda, Poplandia, (licensed foreign) Ballon Noir (France), Cezame (France), L'Escargot (France), Everest (USA), Hexagone (France), Keltia III (France), Logo (UK), Orfeu (Portugal), Paredon (USA), Revolum (France), Rounder (USA), Transatlantic (UK), Trema (France), Ventadorn (France), Wanted (UK).
 R Cuxart (Eds) (IFPI), Montecasino 2, Barcelona 6, Tel (93) 212-5150, 200-9341. Chief Exec. Raimon Cuxart; Gen Mgr.: Ricardo Cabeceran; Sales Mgr. Ramon Villar.
Labels: (Owned) Eda, Stereo 4a Dimension.
 D D C, see Discophon.
 D G, see Polydor.
 D P M, see Distribuidora de Productos Magneticos.
 Dem, see Euromusic.
 Diabolo, see Als 4 Vents.
 Diada, see Dial.
 Dial Discos SA, Av. Generalisimo 165, Madrid 16, Tel (91) 733-5243. Gen. Mgr. Laurentino Ramos; Prod'n Mgr.: Jaime Munoz; Sales Mgr.: Carlos Fernandez; Int'l Mgr.: Inma Ruiz.
Labels: (Owned) Diada, Diamante, Diapason, Limoeiro, Nevada, (licensed) A-S (USA), Ansonia (USA), Audiomasters (USA), Basart (Netherlands), Born Free (Netherlands), Circle Line (Argentina), Everest (USA), Folkways (USA), Garzon (France), Guitarra (Mexico), Magnet (Germany), E Musicali Video (Italy), Orion (USA), RCU (Colombia), Swan Song (Belgium), Tapearc (Brazil), Top Tape (Brazil).
Int'l reps.: Argentina (Circle Line), Chile (Sonidos), Luxembourg (Geopress Int'l), Mexico (Guitarra), Panama (Liberia Ruby).
 Diamante, see Dial.
 Diapason, see Dial.
 Dido, see Als 4 Vents.
 Difesco (IFPI), Fernando Agullo 24, Barcelona 6, Tel (93) 209-3979/3733 Telex 54144. Mng. Dir.: Pedro Siguero; Gen. & Sales Mgr. Santiago Siguero; Accts. Dept. Mgr. Federico Cortes Flores.
Labels: (Owned) Abanico, Caudal, Cobra.
 Dimension, see Ekipo.
 Diplo, see Phonic.
 Discobal SA, C. Felipe de Paz, 4, Barcelona 28, Tel (93) 339-2776. Mgr. Jose Gallego; Art Dir. Jose Manuel Gonzales. (Tape Manufacturer/Distributor).
Labels: (Owned) Discobal, Sira, Sueve.
 Discobro, Pl. Gala Placidia 2, Barcelona 6.
 Discophon SA, Calle Valencia 288, Barcelona 7, Tel (93) 215-3848. Cable DISCOPHON. Gen. & Admin. Mgr. Manuel Alavedra; Gen. & Artistic Mgr. Francisco S. Ortega; Sales Mgr. Antonio Serra.
Branch: Madrid, Calle Antonio Arias 7, Tel (91) 273-9701.
Labels: (Owned) Artyphon, DDC, Discophon, Inici, Top Hits, (licensed) Alegre (USA), Arrow (UK), Basart (Belgium), Best Music (Argentina), Carabine (France), Cine Vox (Italy), Coco (USA), ESP (USA), Ember (UK), Fania (USA), Freedom (UK), GNP Crescendo (USA), International Artists (UK), Laif (USA), Nippon Columbia (Japan), Palacio de la Musica (Venezuela), Phonoco (UK), Purple Eye (Netherlands), Ranwood (USA), SFPP (France), Sonet (Denmark, Norway, Sweden, UK), Specialty (USA), Storyville (Denmark), Supraphon (Czechoslovakia), Swedisc (Sweden), Tico (USA), Triola (Norway), Vaya (USA).
 Distribuidora de Productos Magneticos SA, Gustavo Fernandez Balbuena 26, Madrid 2, Tel (91) 415-44-40. Mgr.: Pedro Mengibar Ortiz; Sales Mgr.: Ismael de Lera Mancenido.
Labels: (Owned) DPM, (represented) Europa (Germany), Joker (Italy), Symphony Tone (Switzerland).
 Documento, see Phonic.
 Drops, see Apolo.
 Duende, see Ekipo.
 E M I-Odeon SA (IFPI), Via Augusta 2 bis, 4th fl., Barcelona 6, Tel (93) 217-0500. Cable GRAMOFONO Telex 52497. Pres. Luis Sagi-Vela; Gen. Mgr. Pierre Maget; Deputy Mgr. Alberto Cardona; EMI-Odeon Div. Opns. Mgr. Rafael Gil; Capitol Div. Mgr. Salvador Perez.
Branch: Madrid 13, Plaza de Ramales 2, Tel (91) 242-5207.
Labels: (Owned) Capitol, EMI, Emidisc, Harvest, MFP, Odeon, Pathe, Regal, United Artists, La Voz de Su Amo, (licensed) Apple (UK), Arista (USA), Baby (Italy), Deutsche Harmonia Mundi (Germany), Discos Top-Hits (USA), La Discoteca (USA), MAM (UK), MPS (Germany), Magnet (UK), McCartney Music (UK), Melodyiva (UK), Oz (Australia), PDU (Italy), Pink Floyd (UK), Private Sound (USA), Purple (UK), RAK (UK), RKM (Belgium), Red Bus (UK), Rolling Stones, Savoy Jazz, Valentim de Carvalho (Portugal).
 Ebano, see Phonic.
 Eda, see R Cuxart.
 Edigsa (Ed General SA) (IFPI), Av. Jose Antonio 654, Barcelona 10, Tel (93) 302-2816. Gen. Mgr. Claudi Martí Pla.
Labels: (Owned) Als 4 Vents, Cabra Edigsa Oliba Pebrots, Xistral, Zeleste, (licensed) Balkanton (Bulgaria), Le Chant du Monde (France), Folkways (USA), Harmonia Mundi (France), Panton (Czechoslovakia).

Int'l reps.: France (Le Chant du Monde, Harmonia Mundi).
 Edi-Master, Berlin 95-97, Entlo A, Barcelona, Tel (93) 250-3907. Dir. Gen. Manuel Catalan Gil; Gen. Mgr. P. Ruiz; Sales Mgr. R. Cartana.
Labels: (Owned) Serie Jobbing, (licensed foreign) Michel Laguens (France), Locomotive (France).
 Ekipo SA, Rosellon 79, Barcelona 15, Tel (93) 321 02 50, 230.30.37.
Branches: Alicante, Italia 14, Tel 22 27 77—**Bilbao,** Ledesma 6, Tel 21 78 93—**Madrid,** P. de la Habana 64, Tel (91) 250 21 89—**Oviedo,** M. Alvarez 4, Tel 22 07 18—**Seville,** Padre Damian 3, Tel (954) 27 92 01—**Valencia,** Garrigues 1, Tel (963) 21 33 96.
Labels: (Owned) Alondra, Ekipo, Exit, Subur, (distributed) Dimension, Duende, Trebol, Unic (represented) Audio Fidelity (USA), Bia-Bla (Italy), Elite Special (Switzerland), Redifusion (UK), Star (Switzerland), Vogue (Belgium).
Int'l reps.: Austria, Germany, Switzerland (Turicaphon).
 Emidisc, see EMI-Odeon.
 Ensayo (Discos) SA (IFPI), Zaragoza 16-3-5, Barcelona 6, Tel (93) 217-5580. Gen. Dir. Antonio Armet (Distributed by Belter).
Int'l reps.: France (Arabella), Italy (Carosello), Japan (Phonogram Int'l), Netherlands (Sound Prods.), Switzerland (SADE), USA (Desmar, HNH).
 Epic SA (Discos) (IFPI), Generalisimo 25, Madrid 16, Tel (91) 455-3845. Gen. Mgr. Tomas Munoz; Mgr. Ramon Crespo; Sales Mgr. Roberto Navarro.
Labels: (Owned) Epic, (licensed) GTO (UK); A&M, Caribou, Cleveland, Full Moon, GTO, Gala, Heriba, Horizon, Invictus, Kirshner, Monument, Nemporer, Ode, Philadelphia, Portrait, Sweet City, TK, T-Neck, Tomato (all USA).
 Ette, see Als 4 Vents.
 Eufonic, La Fuente 16, Abrera (Barcelona).
 Eurodisc, see Arlora-Eurodisc.
 Euromusic, Capitan Blanco Argibay 139, Madrid 29, Tel (91) 215-7300/15/41. Gen. Mgr. Juan Vilches; Comm'l Mgr.: Jose Rodriguez Bononato; Promos. Dir. Emilio Bueno; Int'l Mgr. Francisco Pastor.
Labels: (Owned) Dem, Euromusic, (licensed) Dureco, PPX, Poker, SAM, Tropical.
 Euterpe, Eresma 12, Colonia El Viso, Madrid Tel (91) 261-8172. Gen. Mgr.: Laureano Irazazabal; Comm'l Mgr.: Carlos Urteaga.
Labels: (Owned) Carillon, Euterpe.
 Exit, see Ekipo.
 Explosion, see Compania Fonografica Espanola & Zafiro.
 Fase, see Audio & Video.
 Fash Tape/Fash Rec., Occidente 82, Hospitalet de Llobregat, Barcelona.
 Jorge Arque Ferrari, Ganduxer 5, Local 13, Barcelona 21, Ficlo Mktg., Plaza Cardona 11, Barcelona 6, Tel (93) 251 95 77 (Distributor).
 Fidiyas SA, Claudio Coello 76, Madrid 1, Tel (91) 226 45 63.
 Five Disc, see Aries.
 Flyson SA (Flash), Praga 25, Barcelona 24.
 Fono-2 Recs., Appdo 22022, Nueva Zelanda 50, Madrid 35, Tel (91) 216-4652. Chief Exec. Jose Luis Alvarez Sanchez.
Labels: (Owned) JLA, (licensed) Stereo Tape (Germany).
Int'l rep.: Germany (Stereo Tape).
 Fonogram SA (IFPI), Av. de America & Hernandez de Tejada s/n, Madrid 27, Tel (91) 267-4200 Telex 22849. Mng. Dir. Mariano de Zuniga.
Branch: Barcelona 9, Calle Bruch 136, Tel (93) 258-3484. Mgr. Ruperto Castro.
Labels: (Owned) Fontana, Mercury, Philips, Vertigo, (licensed) All Platinum (USA), Charisma (UK), Ensign (UK), H&L (USA), MCA (USA), Mountain (UK), Power Exchange (UK), Utopia (UK).
 Fontana, see Fonogram.
 Forma Grafica SA, Tomas Breton 51, Naves 4 & 6, Madrid 7, Tel (91) 227 91 15, 239.88.32. Dir.: Javier Campollo; Pres. Vicente Baez.
 G M A Recs., Fuencarral 5, Madrid 4, Tel (91) 232.27.74, 231.02.20.
Labels: (Represented) Gas (Mexico), Gema (USA), Infopesa (Peru), Rex (Mexico), Velvet (Venezuela).
Int'l reps.: Mexico (Gas, Rex), Peru (Infopesa), Portugal (Radio Triunfo, Roda), USA (Gema), Venezuela (Velvet).
 Gala, see Auvi.
 Gaviota, see Hispavox.
 Gold, see Satsosa.
 Gomez & Luis, Eusebio Navarro 60, Las Palmas de Gran Canaria, Canary Islands.
 Gong, see Movieplay.
 Grabaciones Alvarez Guedes SL, Fuencarral 5, Madrid 4, Tel (91) 232 27 74.
 Graficas Foco SA (IFPI), Av. de America & Hernandez de Tejada, Madrid 27, Tel (91) 267-4200. Gen. Mgr. Kees Ton.
 Gramusic SA, Tierra de Barros 4, Poligono Ind'l Coslada, Madrid Tel (91) 671-4512. Gen. Mgr.: Juan Santabaya.
Labels: (Owned) Ambar, Gramusic.
Int'l rep.: Portugal (Movieplay).
 Guimbarda, see Compania Fonografica Espanola.
 Happyband, see Sayton.
 Harvest, see EMI-Odeon.
 Heliodor, see Polydor.
 Hispavox SA (IFPI), Torrelaguna 64, Madrid 27, Tel (91) 415-2304. Cable VOX. Telex: 22931. Pres.: Jose Manuel Vidal Zapater, Counsel-Delegate Luis Vidal Zapater, Mng. Dir. Jose Luis Gil Rodriguez; A&R Mgr.: Rafael Trubuchelli; Mktg & Promo. Mgr.: Carlos Sanmartin; Int'l Mgr.: Luis Calvo; Int'l Promo. Mgr.: Marcial Elgueta.
Branch: Barcelona 13, Calle Marina 291, Tel (93) 235-2390 Telex 52599.
Labels: (Owned) Clave, Gaviota, Hispavox, (licensed) AVI (USA), Alvorada (Portugal), Amadeo (Austria), Arion (France), Ariston (Italy), Asylum (USA), Atlantic (USA), Baby (Italy), Beserkyly (USA), Big Tree (USA), Butterfly (USA), CTI (USA), Chant du Monde (France), Copacabana (Brazil), D&M Sound (USA), Damont (UK), Dark

Horse (USA), Delphine (France), Disneyland (USA), Elektra (USA), Erato (France), Fantasy (USA), Gamma (Mexico), Hungaroton (Hungary), Milestone, Nonesuch (USA), Prestige, Reprise (USA), Sire (USA), Stax (USA), Swan Song (UK), Vanguard (USA), Vogue (France), Vox (USA), Warner Bros (USA), Wergo (Germany).
Int'l reps.: Algeria (Siemens), Angola (Radio Triunfo), Argentina (Microfon), Australia (Festival), Austria (Polydor), Belgium (Polydor), Bolivia (Lauror), Brazil (Gravacoes Electricas), Canada (Polydor, Warner Bros.), Central America (Didaca), Chile (Quatro), Colombia (Codiscos), Dominican Republic (Mozart), Ecuador (IFESA), France (Arion, Erato, Polydor), Germany (Polydor), Ghana (Phonogram), Greece (Music Box), Israel (Hatakit), Indonesia (Muscarema), India (Polydor), Jamaica (Dynamic Sounds), Japan (Nippon Columbia, Victor), Korea (Sung Eum), Lebanon (Philips), Morocco (Siemens), Mexico (Gamma), Netherlands (EMI-Holland), New Zealand (Festival), Nigeria (Phonogram), Peru (El Virrey), Portugal (Radio Triunfo), Turkey (Grunberg Ticaret), Scandinavian (Polydor), Singapore (Phonogram), South Africa (Gallo), Switzerland (Finsterwald & Cantacuzen), UK (Warner Bros.), USA (Alhambra, Musical Heritage, Sire, Warner Bros., West Side Latino, Vox, etc), USSR (Melodiya), Uruguay (Palacio de la Musica), Venezuela (All Stars), Yugoslavia (RTB), Zaire (Phonogram) (SEE ADVERTISEMENT).
 Iberia, see Columbia.
 Iberca del Sonido, Principe 12, Madria.
 Impacto, see Belter.
 Inici, see Discophon.
 Iris, see Audio & Video.
 Rafael Izquierdo, Carrero Blanco 5, Chiclana de la Frontera (Cadiz).
 J L A, see Fono-2.
 Jack, see Audio & Video.
 K-tel, Velazquez 101, Madrid 6, Tel (91) 411-2613.
 Kardantxa, see Movieplay.
 Liceo, see Auvi.
 Lmoeiro, see Dial.
 Lord Pop, Ferrer del Rio 33, Madrid 28.
 Lova (Discos) SA, Pl. Maragall, 15, Entl. Barcelona 27.
 M F P, see EMI.
 M G M, see Polydor.
 Magnetic, see Audio & Video.
 Maller SA, Vicente Juan Rosello 22, Palma de Mallorca.
 Marler SA (IFPI), Paseo de la Virgen del Puerto 7, Madrid 5, Tel (91) 265-7800. Gen. Mgr. Emilio Fernandez; Antonio Martinez; Sales Mgr.: Vicente Jimenez; Int'l Mgr.: Jose L. de Andres.
Labels: (Owned) Marfer, Succes, Trama, Turquesa, (licensed) Arrowbats (UK), Everest (USA), Pyramid (USA), Record Serv (Italy), Roulette (USA), Springboard (USA), Turicaphon (Switzerland), Vox (USA).
Int'l reps.: Colombia (Republic Distribudora Dominicana), Dominican Republic (Distribudora Dominicana), Germany (Bellaphon), USA (Godel), Venezuela (Discorona).
 Mayo Fonografica SA, Rosellon 77, Barcelona 15, Tel (93) 321 02 50, 250.45.00. Cable MAYOFON.
Branches: Alicante, Italia 14, Tel 22 27 77—**Bilbao,** Ledesma 6, Tel 21 78 93—**Madrid,** P. de la Habana 64, Tel (91) 250 21 89—**Oviedo,** M. Alvarez 4, Tel 22 07 18—**Seville,** Padre Damian 3, Tel (954) 27 92 01—**Valencia,** Garrigues 1, Tel (963) 21 33 96.
Labels: (Owned) Arco Iris, Mavo, Selection, Temple, (represented) King (Japan), Vogue (Belgium).
 Mediterraneo SA, Tierra de Barros 4, Poligono Ind'l de Coslada, Madrid Tel (91) 671-4512. Gen. Mgr. Juan Santabaya.
Branch: Barcelona 6, Tuset 34, Tel (93) 227-1493.
Labels: (Owned) Mediterraneo, (licensed) ABC (USA), ABC/Blue Thumb (USA), ABC/Command (USA), ABC/Impulse (USA), ABC/Westminster (USA), Anchor (UK), Gull (UK), Hexagone (France), Nems (UK), Shelter (USA).
Int'l rep.: Portugal (Movieplay).
 Mercurio Discos, Molinda 7, Madrid.
 Mercury, see Fonogram.
 Metodos Vivos SA, Muntaner 479, Barcelona 21.
 Mirinda, see Audio & Video.
 Montilla, see Zafiro.
 Movieplay SA (IFPI), Tierra de Barros 4, Poligono Ind'l de Coslada, Madrid, Tel (91) 671-4512. Gen. Mgr. Juan Santabaya; Ass't Gen. Julio Fernandez-Cueto; Sales Mgr.: Rafael Monillo; A&R Mgr.: Alvaro Nieto; Promo & Pub. Mgr.: Carlos Casale; Int'l Mgr.: Juan C. Cifuentes.
Branch: Barcelona 6, Tuset 34, Tel (93) 227-1493.
Int'l branch: Portugal.
Labels: (Owned) Gong, Kardantxa, Movieplay, Xeira, Yupy, (licensed) Alshire (USA), Areito (Cuba), Barclay (France), Chiswick (UK), Condor/Dicap (France), Egg (France), Everest (USA), Guide Int'l Du Disque (France), Hemisferio (Argentina), Intercord (Germany), Joker (Italy), Melody (Mexico), Orfeon (Mexico), Sær (Italy), 20th Century (USA).
Int'l reps.: Argentina (CBS), Australia (Festival), Austria (Intercord), Canada (Caytronics), Costa Rica (Didaca), Dominican Republic (Alhambra), El Salvador (Didaca), France (Barclay, Chant du Monde, Sofrason), Germany (Intercord), Guatemala (Didaca), Honduras (Didaca), Italy (Durium, FMA), Japan (Toshiba), Mexico (Melody), Netherlands (CNR, Phonogram), Nicaragua (Didaca), Switzerland (Evasion), Turkey (Ozerman), Uruguay (CBS), USA (Alhambra, Caytronics), Venezuela (Grabaciones Mundiales).
 Nevada, see Dial.
 Novola, see Zafiro.
 Ocre, see Belter.
 Odeon, see EMI-Odeon.
 Off, see Audio & Video.
 Oliba, see Edigsa.
 Olivo, see Belter.
 Olympo, see Belter.
 Opalo, see Productora de Grabaciones.
 Orlado, see Circulo de Lectores.
 Oro, see Aries.
 Ots, Narrica 31, Lasarte, San Sebastian.
 P D S, see Portadores de Sonido.

- Palobal SA, Ingenieros Hermanos Granda 30, Madrid 22. Tel: (91) 205.07.91. Pres.: Pablo Lopez Balada; Mng. Dir.: Mari Carmen Cunado; Gen. Mgr.: Juan Salva Valls; Sales Mgr.: Julio Lopez Betrian.
- Pardal, see Apollo.
- Pathe, see EMI-Odeon.
- Pax (IFPI), Enrique Jardiel Poncela 4, Madrid 16. Tel: (91) 250-5310. Cable: DISCOPAX. Dir.: Jose M. Burgos Gonzalez; Dir.: Catalina Jaume.
- Pazo SA, Enamorados 34, Barcelona 13.
- Pebrots, see Ediga.
- Percasa, Via Carpetana 71, Madrid 19.
- Pergola, see Circulo de Lectores.
- Philips, see Fonogram.
- Phonic SA, Calle Madrastro 14, 3rd fl., Barcelona 6. Tel: (93) 228-0905. Gen. Mgr.: Jorge Doncos; Sales Mgr.: Angel Torner; Promo. Mgr.: Luis Quintana.
- Labels: (Owned)** Diplo, Documento, Ebano, Selector, Sound, Streak; **(licensed)** Arrowtats (UK), Beatt Int'l (UK), Creole (UK), Locomotive (France), Versatile (USA).
- Phonorecord, Cuesta de Santo Domingo, Madrid 11. Tel: (91) 241-0509 / 0580. Dir.: Maximino Baratas.
- Pleno, Eduardo Dato 21, Madrid 10. Tel: (91) 410.08.36.
- Polydor SA (IFPI), Agastia s/n, corner of Av. de America, Madrid 27. Tel: (91) 407-3100. Telex: 22849. Mng. Dir.: Mariano de Zuniga; Gen. Mgr.: Saul Tagarro.
- Branch: Barcelona 9, Bruch 136. Tel: (93) 207-0739.** Contact: Antonio Rovira.
- Labels: (Owned)** Archiv, DGG, Heliodor, MGM, Polydor, Polyphon, Triumph, Verve; **(licensed)** Capricorn (USA), Cube (UK), EG (UK), MN (France), Oyster (USA), Pablo (USA), RSO (USA), Spring (USA).
- Polyphon, see Polydor.
- Poplandia, see Compania Fonografica Espanola & Zafiro.
- Portadores de Sonido SA, Hortaleza 118, Madrid 4. Tel: (91) 419.94.72. Gen. Mgr.: J.M. Estebanz Mansilla.
- Labels: (Owned)** Audiomundo, Clavel, PDS; **(licensed)** Beatt (UK), Charly (France), Magnet (Switzerland).
- Practiphone, Flora 1, Madrid 13.
- Presa, Av. del Generalissimo Franco 463 bis, Barcelona 11. Tel: (93) 321.72.41.
- Productora de Grabaciones SA, Jorge Juan 21, Madrid 1. Tel: (91) 275.52.17.
- Labels: (Owned)** Accion, Opalo.
- Puput, see Zafiro.
- Puzzle, see Zafiro.
- Quality, see Satosa.
- RCA SA, Dr. Fleming 43, Madrid 16. Tel: (91) 457-4600. Gen. Mgr.: Alberto Galtes; A&R & Int'l Liaison: Ernesto Duarte.
- Branches:** Barcelona, Bilbao, Seville, Valencia.
- Labels: (Owned)** Camden, RCA, RCA Red Seal, Victrola, Vik; **(licensed)** CAM, Especial, Fonol, PDS, GMA, GTA, Microfon, Musimar.
- Int'l reps.:** Worldwide (RCA). (SEE ADVERTISEMENT)
- Regal, see EMI-Odeon.
- Ronald SA, Padilla 386, Barcelona 13.
- Satosa, Consejo de Ciento 83, Barcelona 15. Tel: (93) 325-9500. Gen. Mgr.: Jose Ma. Sanvisens; Sales Mgr.: Jose Ma. Collado.
- Labels: (Owned)** Gold, Quality, Satosa, **(licensed domestic)** Bass-Drums, **(licensed foreign)** Big-Bear (UK), Euro (Italy), Mandarin (France), Tapacar (Brazil), Turicaphon (Switzerland), Village (France).
- Sauce Int'l, see Belter.
- Sayton SA, Gran Via de Carlos III 17-19, Barcelona 14. Tel: (93) 230.31.04.
- Labels: (Owned)** Canigo, Happyband, Sayton.
- Selection, see Mayo.
- Selector, see Phonic.
- Serie Jobbing, see Edi-Master.
- Seven 7, Fuente del Coll 15, Barcelona 23.
- Singleton Prod'ns, Via Augusta 59, Desp. 805, Barcelona 6. Tel: (93) 228-3800. Telex: 54015. Owner: William H. Singleton; Sales Mgr.: Manuel Marti.
- Label: (Owned)** Vampire.
- Sintonia SA (IFPI), Vallehermoso 32, Madrid 15. Tel: (91) 445-8678/6465. Gen. Mgr.: Bartolome Espadale.
- Sira, see Discobal.
- Sonitec, Gomis 46, Barcelona 23.
- Sound, see Phonic.
- Spiral, Gomis 42, Barcelona 6. Tel: (93) 211.22.04.
- Spot, see Audio & Video.
- Stereo 4a Dimension, see R. Cuxart.
- Streak, see Phonic.
- Subur, see Ekipo.
- Success, see Marfer.
- Sueve, see Discobal.
- Temple, see Mayo.
- Tic, see Als 4 Vents.
- Tic-Tac, Amaya 14, Pamplona (Navarra).
- Tipi, see Auvu.
- Top Hits, see Discophon.
- Trama, see Marfer.
- Trebol, see Ekipo.
- Triton Eds., Lepanto 392, Barcelona 25.
- Triumph, see Polydor.
- Trova Rees SA, Isla de Java 60-62, Madrid 34. Tel: (91) 734-1212/1262. Pres.: Manuel Paz; A&R Dir.: Alberto Nunez Palacio; Sales Mgr.: Juan Jose Barroso; Int'l Mgr.: Jose Manuel Martin de la Plaza.
- Labels: (Owned)** Trova, **(licensed foreign)** Acanta (Germany), Audiofidelity (USA), Casino (Canada), Chiarocuro (USA), Image (USA), Improv (USA); **(distributed—not licensed)** Orinda (USA).
- Int'l reps.:** Costa Rica, El Salvador, Guatemala, Honduras, Nicaragua, Panama (all Dicesa); Colombia (Disco-teca), Venezuela (Disco-teca).
- Turquesa, see Marfer.
- U C D, see Audio & Video.
- Unic, see Ekipo.
- United Artists, see EMI-Odeon.
- Vampire, see Singleton.
- Vergara, see Ariola-Eurodisc.
- Vertigo, see Fonogram.
- Verve, see Polydor.
- Victoria, Larrat 34, Barcelona 24.
- Victrola, see RCA.
- Vik, see RCA.
- La Voz de Su Amo, see EMI-Odeon.
- Wah-Wah Producciones Discograficas, Saliente, A. Madrid 30. Tel: (91) 274-3208. Telex: 43241. Pres.: Ricardo Manzanares. (Importer/Exporter)
- Xeira, see Movieplay.
- Xistral, see Ediga.
- Yup, see Movieplay.
- Zafiro SA (IFPI), Apdo. 14177, Av. de Cantabria 2-4 & 6, Madrid 22. Tel: (91) 742-1261. Cable: ZAFIRO. Telex: 22690. Mng. Dir.: Esteban Garcia Sorens; Gen. Mgr.: Antonio Ortega; Sales Mgr.: Jose Mago-Vela; Int'l Mgr.: Angel Prieto; Int'l Co-ord. Sec'y: Aida Genta.
- Labels: (Owned)** Barafon, Cancela Tape, Caudal, Chapa, Difesco, Montilla, Novola, Puput, Puzzle, Zafiro; **(licensed)** Cetra (Italy), DJM (UK), Far Out (USA), Forit (Italy), Janus (USA), Mezkhkiga (USSR), Musart (Mexico), PWM (Poland), Prelude (USA), Slovart (Czechoslovakia); **(distributed—not licensed)** Boccaccio, Explosion, Guimbarda, Logo, Poplandia, Transatlantic (UK).
- Int'l reps.:** Argentina (Phonogram), Bolivia (Lauro), Colombia (Orbe), Ecuador (Fadisa), El Salvador (Discos Centroamericanos), Mexico (Musart), Panama (Prom-disc), Peru (FTA), Uruguay (Maloa), USA (Coco), Venezuela (Polydor).
- Zartos (Eds.), San Elias 11, Desp. 104, Barcelona 6. Tel: (93) 218-8891. Chief Exec.: Mercedes Mozart; Gen. Mgr.: Pilar Matos. (Distributor)
- Zelete, see Ediga.
- Zzelesta SA, Pedro Muguruza 8, 5th fl., Madrid 16. Tel: (91) 250.37.11. Gen. Mgr.: Rafael Martos.

● music publishers

- Aberbach (Madrid) SA, see Canciones del Mundo.
- Acropol (SGAE), Av. Jose Antonio 68, Madrid 13. Tel: (91) 248.31.80, 247.61.15.
- Adagio Eds. Musicales (SGAE), see Quiroga.
- Alier (Ed.), Carmen 27, Madrid 13. Tel: (91) 221.97.71.
- Amancer Ed. Musicales (SGAE), see Quiroga.
- April Music (SGAE), Av. Generalissimo 25, 9th fl., Madrid 16. Tel: (91) 455-3845. Cable: COLRECORD MADRID. Telex: (831) 22890. Gen. Mgr.: Antonio Perez Solis.
- Int'l firms represented:** April (worldwide).
- Int'l reps.:** Worldwide (April).
- Arabella Eds. Musicales SA, Calle Aragon 204, 4th fl., Barcelona 11. Tel: (93) 254-9805. Cable: HISPARIOLA. Telex: 52771. Gen. Mgrs.: Alberto Serra, Ramon J. Segura.
- Home office:** Germany.
- Int'l firms represented:** Arabella (Germany, Mexico), Chrysalis (UK).
- Int'l reps.:** Argentina (Relay), Colombia (Sono-Inter), Mexico (Arabella), Peru (Prodema), Venezuela (Unimusic).
- Astare Europa, Espanoleto 16, Madrid 4. Tel: (91) 223.49.87.
- Audiens (Ed.), Vallehermoso 14, Madrid 15. Tel: (91) 448-2200/04.08.
- Balmes, Duran & Bas 9, Barcelona 2.
- Barna, Via Layetana 158, Bajos, Barcelona 9. Tel: (93) 228.69.67.
- Belter SL (Eds. Musicales) (SGAE), Arroyo Teatinos 40, Poligono Ind'c Coslada, Madrid. Tel: (91) 671-4716. Cable: BELDISC. Edice. 42065. Dir.: Manuel Cubedo.
- Int'l firms represented:** CAM-USA (USA), Larry Douglas (USA), RKM (Belgium), Siegel (Germany), Synchron (France).
- Int'l reps.:** Belgium (Roland Kluger), Germany (Ralf Arnie, Intro, Minerva), USA (CAM-USA).
- Boccaccio Eds. Musicales (SGAE), Recoletos 11-2C, Madrid 1. Tel: (91) 276-9230. Cable: EDIMONT. Gen. Mgr.: Margarita Tamames.
- Int'l firms represented:** Robinsong (France), Superwop (UK).
- Bricos SA, see RCA.
- Burlington Music Espanola SA, see Notas Magicas.
- C A M Espana Eds. Musicales SA, Calle Emilio Mario 8, Madrid 2. Tel: (91) 416.7558/7512/7654. Telex: 23955. Mng. Dir.: Giuseppe Lulli.
- CPI Compania Fonografica, Av. del Generalissimo 4, Madrid, Tel: (91) 262.41.66.
- Cadencia (Eds.) (SGAE), Virgen de Aranzazu 23, Local F, Madrid 34. Tel: (91) 734-7651. Pres.: Carmen Macicior Jadrake; Mng. Dir.: Federico Moreno-Torroba Larregla.
- Int'l firms represented:** Five Continents (USA), New Music (Belgium).
- Int'l reps.:** Benelux (Mendaur in Belgium), Colombia (Brambila), France (Caravelle), Japan (Zen-on), Mexico (Brambila), North America except Mexico (Casa Latina), South America except Colombia & Venezuela (Casa Latina), UK (Casa Latina), Venezuela (Brambila).
- Calypso (Eds. Musicales) (SGAE), see Quiroga.
- Canciones del Mundo SA, Magallanes 25, Madrid 3. Tel: (91) 448-2350. Gen. Mgr.: Luis Regatero.
- Branch: Barcelona 9, Bruch 136-138. Tel: (93) 258-3484.**
- Int'l firms represented:** Canciones del Mundo SA—Big Seven, Blue Seas, Colgems, Leo Feist, Fox Fanfare, Hastings, Planetary, Planetary-Nom, Robbins, Screen Gems/Colombia, Shelby Singleton, Tree, Twentieth Century (all USA); **Robert Mellin Iberica SA—Robert Mellin (UK USA); Eds. Musicales Sympathy SA—Maraquani (France).**
- Carcelle SA (SGAE), Ronda San Pablo 11, Barcelona 15. Tel: (93) 242-5410.
- Chappell Iberica SA, Magallanes 25, Madrid 3. Tel: (91) 448.23.50. Gen. Mgr.: Luis Regatero.
- Home office:** USA.
- Int'l firms represented:** Acuff-Rose (USA), Irving Berlin (USA), Chappell (France, UK), Chappell-Morris (UK, USA), Famous (USA).
- Clan Eds. Musicales (SGAE), see Quiroga.
- Clave (Eds. Musicales) (SGAE), see Quiroga.
- Clipper's (Grupo Ed.) (SGAE), Rambla de Catalunya 10, 3rd fl., Barcelona 7. Tel: (93) 317-4686/90. Telex: 51539. Chief Exec.: Julio Guiu Clara; Dirs.: Julio Guiu Arbelo, Vinuesa Gimenez.
- Int'l firms represented:** ATV (UK, USA), Arc (USA), Barn (UK), Bluetunes (UK), Broken Arrow (USA),
- Campbell Connelly (UK), Crazy Crow (USA), DeShufflin (USA), Eaton (UK), Robin Gibb (UK), Giving Room (USA), Gold Hill (USA), Guerrilla (USA), Heath Levy (UK), Tony Hiller (UK), Island (UK), Kamakazi (USA), Keca (USA), Don Kirshner (USA), Kirshner Songs (USA), Ladysmith (UK), Lupus (UK), Joni Mitchell (USA), Nimbus 9 (Canada), Northern Songs (UK), Regent (USA), Ricordi (Italy), Rock (UK), Paul Simon (USA), Silver Fiddle (USA), Siquomb (USA), Staysail (USA), Thin Ice (USA), Warner Bros. group (USA), Lawrence Wright (UK).
- Coculla, Torrega lindo 5, Madrid 16. Tel: (91) 250-2330.
- Curci de Espana SL, see Canciones del Mundo.
- Daimon, Provensa 284, Barcelona 8. Tel: (93) 288.99.28. Cable: EDIDAIMON.
- Dial Discos Ed. Musicales SA, Av. Generalissimo 165, Madrid 16. Tel: (91) 733-5243. Cable: DIALDISCO MADRID. Gen. Mgr.: Laurentino Ramos; Int'l Mgr.: Inma Ruiz.
- Dim (Eds. Musicales), see Astare.
- Discorama Eds. Musicales, Av. de Jose Antonio 62, Madrid 13. Tel: (91) 248-0403. Telex: 226908. Mng. Dir.: Eduardo Bartrina de Caso.
- Int'l firms represented:** Airs Graces, Compass, Fast Western, Andrew Heath, Honey Hill, Hush, Dick James Music, Purple (all UK); Janus (USA).
- Ducal SL (Ed. Musicales), Calle Valencia 288, Barcelona 7. Tel: (93) 215-1370. Gen. Mgrs.: Manuel Alavedra, Francisco S. Ortega.
- Int'l firms represented:** Fania (USA), Sonet (Sweden, UK), Stainless (USA), Vaya (USA).
- E G O Musical SA, Via Augusta 2 bis, 4th fl., Barcelona 6. Tel: (93) 217-0500. Telex: 52497. Pres.: Luis Sagivela; Gen. Mgr.: Pierre Maget; Mgr.: Juan Canal.
- Int'l firms represented:** Alkatraz Corner (USA), Big Pig (UK), Black Bull (USA), Chinnichap (UK), Dawson's Cove (USA), Deep Purple (UK), EMI group (worldwide), EMP (Canada), Francis-Day (France), Heart's Delight (USA), Jobete (USA), Kipahula (USA), Roland Kluger (Belgium), LEM (France), MPL (UK), Queen (UK), RAK (UK), Rebel (UK), Red Bus (UK), Rocket (UK), Rolling Stones (UK), Rondor group (UK, USA), Screen Gems/EMI (UK, USA), Sumac (USA), Tree.
- E M E C (Ed. de Musica Espanola Contemporanea) (SGAE), see Quiroga.
- Essex Espanola SA (Eds.) (SGAE), Diputacion 337, Barcelona 9. Tel: (93) 225-8489. Cable: SEXMUS. Telex: 54040. Gen. Mgr.: Manuel G. Salinger.
- Branch: Madrid 16, Encina 36. Tel: (91) 221-3650.**
- Int'l firms represented:** Essex group (UK), TRO group (USA).
- Euromusic SA, Capitan Blanco Argibay 141, Madrid 29. Tel: (91) 215.73.00/15. Dir. Gen.: Rafael Martinez Lopez; Mng. Dir.: Juan Vilches Garcia; Press Officer: Rafael Martinez Escudero.
- Fiesta en Triana (Ed.), Virgen de Lujan 47, 2nd fl., Barcelona. Tel: (93) 27.92.84.
- Fontana SA (Eds. Musicales), Magallanes 25, Madrid 3. Tel: (91) 448.23.50. Cable: EDIFON. Gen. Mgr.: Luis Regatero.
- Int'l firms represented:** Abigail (UK), P.E. Baker (UK), Bizarre (USA), Buddha (USA), Dynatone (USA), Hudson Bay (USA), Kama Sutra (USA), Kama Rippa (USA), Pocket Full of Tunes (USA), RSO (UK), St. George (UK), Third Story (USA), Frank Zappa (USA).
- Grupo Profesional SA, Rosellon 79, Barcelona 15. Tel: (93) 250.51.04. Dir.: Mateo Fortuny.
- Hispania (Eds.), Av. Jose Antonio 31, Madrid 13. Tel: (91) 231.26.33. Pres. & Gen. Mgr.: Julian-Mario Suarez; Sales Mgr.: Mario S. Ruiz.
- Int'l firms represented:** Kassner (UK), SESAC (USA).
- Int'l rep.:** USA (SESAC).
- Hispanovox SA (Eds. Musicales), Torrelaguna 64, Madrid 27. Tel: (91) 415-2304. Cable: EDIVOX. Telex: 22931. Gen. Mgr.: Amado Regueiro.
- Int'l firms represented:** Emlasa (Mexico), Fleetwood (UK), Gamma (Mexico), Hastings (USA), Morro (USA), No Exit (USA), Rear Exit (USA), Robbins (USA), United Artists (USA), Walt Disney (USA), Warner Bros. (UK), Wonderland (USA).
- Int'l reps.:** Mexico (Gamma), Portugal (Radio Triunfo), USA (Barnegat). (SEE ADVERTISEMENT)
- I F I, Marques del Duero 106, Barcelona 15.
- Joya, Apdo. Correos 14-435, Concepcion Arenal 5, Madrid 13.
- Kama Music, see RCA.
- Kardantax Eds. Musicales (SGAE), see Quiroga.
- Kazan (Eds.), see RCA.
- Hal Leonard de Espana SA, Tallers 9, Pral. A, Barcelona 1. Tel: (93) 302-2744/2592. Cable: LEONARD. Gen. Mgr.: Gabriel Lara Cano.
- Int'l firms represented:** Almo (USA), Big Belis (USA), Big 3 (USA), Cherry Lane (USA), EMI (UK), Music Sales (UK), Warner Bros. (USA).
- Madrid (Eds. Musicales) (SGAE), Mayor 27, Madrid 13.
- Madrid No. 2 (Eds. Musicales) (SGAE), see Cadencia.
- Manoir (Ed.), Berlin 95-97, Entlo. A, Barcelona. Tel: (93) 250-3907. Dir.: Alberto Ros Blasco; Gen. Mgr.: Manolo Catalan Gili.
- Marfer SA (Eds. Musicales), Paseo de la Virgen del Puerto 7, Madrid 5. Tel: (91) 265.78.00. Gen. Mgrs.: Emilio Fernandez, Antonio Martinez.
- Int'l firms represented:** Demail, MAJ (Both USA).
- J. Mari (Eds.), Gomis 42, Barcelona 23. Tel: (93) 212-6295. Gen. Mgr.: Jorge Marti Huget.
- Robert Mellin Iberica SA, Magallanes 25, Madrid 15. Tel: (91) 448-2350. Gen. Mgr.: Luis Regatero.
- Int'l firms represented:** Robert Mellin (UK, USA).
- Mendaur (Eds. Musicales) (SGAE), Virgen de Aranzazu 23, Local F, Madrid 34. Tel: (91) 734-7651. Pres.: Carmen Macicior Jadrake; Mng. Dir.: Federico Moreno-Torroba Larregla.
- Int'l branch:** Belgium.
- Int'l firms represented:** Abacus (USA), Artistic (USA), Bolero Musimex (Mexico), Brambila (Mexico), Ramos Brambila (Brazil), Caravelle (France), Casa Latina (USA).
- Int'l reps.:** Colombia (Brambila), France (Caravelle), Japan (Zen-on), Mexico (Brambila), North America except Mexico (Casa Latina), South America except Colombia & Venezuela (Casa Latina), UK (Casa Latina), Venezuela (Brambila).

Mills Music Espanola (SGAE), see Quiroga.
 Ivan Mogull Espanola SA, see Notas Magicas.
 Montserrat (Eds. Musicales) (SGAE), Recoletos 11-2C, Madrid 1. Tel: (91) 276-9230. Cable EDIMONT Gen. Mgr. Margarita Tamames.
Int'l firms represented: Greenwich (USA), Morning (Canada), USA, Tabitha (UK), Venice (USA).
 Mundo de Ritmos (Ed.) (SGAE), see Quiroga.
 Musical Emporium, Ramba Canaletes 129, Barcelona 2.
 Musica Moderna (Ed.) (SGAE), Marques de Cubas 6, Madrid 14. Tel: (91) 221-5593. Ed. & Gen. Mgr. Antonio Carmona.
 Mycos SA, see Discorama.
 New Music Espana (SGAE), see Cadencia.
 Notas Magicas SA (Grupo Ed.) (SGAE), Calle Requeros 8, Madrid 4. Tel: (91) 419-1406/8591. Cable EDIMAGICAS. Pres. Enrique Inurrieta. Gen. Mgr. Enrique Garea. Prof. Mgr. Fernando Mitjavila.
Int'l reps.: Canada (Ivan Mogull), Germany (Magazine, Hans Sikorski), Mexico (Ivan Mogull Latina), UK (Burlington), USA (Ivan Mogull).
 Nuesch Publ' Co. (SUISA), Via Augusta 59, Desp. 805, Barcelona 6. Tel: (93) 228-3800. Telex: 54015. Chief Exec. & Gen. Mgr. Madlen E. Singleton.
 Opern Music, Rosellon 77, Barcelona 15. Tel: (93) 321-02-58.
 Otilia Music SA, see Canciones del Mundo.
 P A I Music (SGAE), Ganduxer 5/15, Local 13, Barcelona 21. Tel: (93) 211-6558. Gen. Mgr. Jordi M. Arque.
 Paulinas (Eds.), Protasio Gomez 15, Madrid 27. Tel: (91) 742-0511.
 Pax (Ed. Musicales), Enrique Jardiel Poncela 4, Madrid 16. Tel: (91) 250-5310. Cable DISCOPAX. Dir.: Jose M. Burgos Gonzalez.
 Penta-Music SA (SGAE), Tierra de Barros 4, Poligono Ind'l de Coslada, Madrid. Tel: (91) 671-45-12. Gen. Mgr.: Manuel Sancho, Mgr. Valentin Rodriguez.
 Pipa SA (Eds.), see Discorama.
 Piramide, see Discorama.
 Quiroga (Eds.) (SGAE), Alcalá 70, Madrid 9. Tel: (91) 276-3950/66. Cable QUIROGAMUSIC. Pres. Manuel Lopez-Quiroga. Gen. Mgr. Carlos P. Cancio. Prof. Mgr.: Manuel Lopez-Quiroga Jr.
Branch: Barcelona 2, Canada 45. Tel: (93) 318-6049. Gen. Mgr. Jose Cruells Solbes.
Int'l firms represented: ABC/Dunhill (USA), Alshire (USA), American Broadcasting (USA), Belwin-Mills (UK, USA), Bron (UK), Carish (Italy), Ecomus (Colombia), Hans Gerig (Germany), Gopam (USA), Intune (UK), Lady Jane (USA), Edward B. Marks (USA), Musicabana (Cuba), Eds. Musicales (Cuba), Orbe (Venezuela), Prodemus (Colombia), Rockin' (UK), B. Schott's Soehne (Germany), Andrew Scott (USA), Suvini Zerboni (Italy), Tonos (Germany).
Int'l reps.: Canada, UK, USA (all Belwin-Mills), Chile (Equus), Colombia (Ecomus).
 R C A Espanola SA (Eds. Musicales), Dr. Fleming 43, Madrid 16. Tel: (91) 457-4600/7818. Telex 22460. Pres.: Alberto Galtés, Dir.: Antonio Martinez.
Int'l firms represented: Angel (UK), Annie (UK), Antisia (USA), Associated (Australia), Average (USA), Barton (UK), Big Sky (USA), Brial (USA), Bubba (UK), CAM (USA), Campel (Mexico), Clandaee (UK), Clave (Brazil), Cyclus (Germany), Ding Dong (UK), Dunbar (Canada), Dwarf (USA), Edim (Mexico), Ellislan (UK), 57 Street Entertainment (USA), Give Me A Break (USA), Gloucester (UK), Hal (UK), Quincy Jones (USA), Just Over The Bridge (USA), KBL (USA), Kidada (USA), Koppelman-Bandier (USA), Ledacian (USA), Loraine (UK), Maraville (UK), Mark (UK), Memory Lane (USA), Metal Machine (USA), Metropole (UK), Midwood (UK), Mr. Music (UK), Mood (UK), Monshana (UK), Monster (Brazil, France, Italy), RCA Jagure (Brazil), RCA Leme (Brazil), Ramblin' Rose (UK), Ram's Horn (USA), Rashida (USA), Relay (Argentina), Sharon (UK), Eddie Shaw (UK), Show Biz (UK), Songs of Bandier-Koppelman (USA), Songs of Manhattan Island (USA), Sono Inter (Colombia), Soul (UK), Sparta Florida group (UK), Larry Spier (USA), Stillman (USA), Street (UK), Sunbury (Canada, UK), Thornwood (USA), Totem Pole (UK), Trans Music (UK), Vignoble (UK), Victor (Brazil), Scott Wolfe (UK), Woodshed (UK), Yellow Brick Road (USA), Faron Young co. (UK) (SEE ADVERTISEMENT).
Int'l rep.: Australia (Associated).
 Radio Musica, see Discorama.
 Radio Pop Music—Dirs.: Esteban Morencos, Hubert Terheggen—see Discorama.
 Real Musical SA, Carlos III, No. 1, Madrid 13. Tel: (91) 248-0924, 247-6365. Dir. Gen.: Ramon Jimenez Barrado; Gen. & Sales Mgr.: Jose Antonio Jimenez Barrado.
Int'l firms represented: Billaudot (France), Bre tkopf & Haertel (Germany), Deutscher (Germany), Henle (Germany), Heugel (Germany), Hofmeister (Germany), Edwin F. Kalmus (USA), Musica Budapest (Hungary), PWM (Poland), Peters (Germany), Le Pupitre (France), Suvini Zerboni (Italy), Universal (Austria).
 Ri-Fi Espanola, see Notas Magicas.
 Ritmo & Melodia (SGAE), Villarroel 18, Barcelona 11. Tel: (93) 224.44.33.
 Sagitario SA (Eds. Musicales)—Pres. Augusto Alguero—see Canciones del Mundo.
 Sikorski Espanola, see Notas Magicas.
 Sintonia SA Eds. Musicales, Calle Vallehermoso 32, Madrid 15. Tel: (91) 445-8678/6465. Gen. Mgr.: Bartolome Espadale.
Int'l firms represented: De Wolfe (UK), Hudson (UK), Mozart (Germany, UK), Raphaelae (Germany), Rouge (UK), Sylvester (UK).
 Southern Music Espanola SA (SGAE), Diputacion 337, Barcelona 9. Tel: (93) 225-6197. Cable: SOUTHMUSIC. Telex: 54040. Mgr.: Jose Carreras Moysi. Consultant: Manuel G. Salinger.
Branches: Madrid 4, Hortaieza 18. Tel: (91) 231-0661—Valencia 5, Arzobispo Melo 3. Tel: (960) 33 19 35.
Home office: USA, Southern Music Publ' Co. Inc.
Int'l firms represented: Leeds (UK, USA), MAM group (UK), MCA (USA), Southern-Peer group (worldwide).

Sympathy SA (Eds. Musicales), see Canciones del Mundo.
 Talisman-Ronald SA, see EGO.
 Total Music, Av. del America 22, Madrid. Tel: (91) 245 46.00, 246 02.05.
 Traca Eds. Musicales (SGAE), see Quiroga.
 Union Musical Espanola SA (SGAE), Carrera de San Jeronimo 26, Madrid 14. Tel: (91) 221-4612.
 Universal SA (Eds. Musicales), see RCA.
 Valentine, see Discorama.
 Viva la Musica SA, see EGO.
 World Music Espanola (SGAE), Diputacion 337, Barcelona 9. Tel: (93) 225-6197. Gen. Mgr.: Manuel G. Salinger.
Branch: Madrid 4, Hortaieza 18. Tel: (91) 231-0661.
 Zafiro (Eds. Musicales), see Discorama.
 Zzelestia (Eds. Musicales), Pedro Muguruza 8, 5th fl., Madrid 16. Tel: (91) 250.37.11.

Branch: Barcelona 14, Juan Guell 135-137. Tel: (93) 250.91.00.
 Ediciones Deportivas ALG, San Raimundo, Madrid.
 Edigsa (Ed. General SA), Av. Jose Antonio 654, Barcelona 10. Tel: (93) 302-2816. Gen. Mgr.: Claudio Marti Pla; Sales Mgr.: Santiago Desongles, Int'l Promo Mgr.: Ricard Canbra.
 Grupo Profesional SA, Rosellon 79, Barcelona 15. Tel: (93) 250.51.04. Dir.: Matto Fortuny.
 Iberofon SA, Av. Fuentemmar 35, Poligono Ind'l Coslada, Madrid. Tel: (91) 671-2200. Telex 42797.
 Melodix, Pedro Muguruza 8, 5th fl., Madrid 16. Tel: (91) 250.37.11.
 Real Musical SA, Carlos III, No. 1, Madrid 13. Tel: (91) 248-0924, 247-6365. Dir. Gen.: Ramon Jimenez Barrado; Gen. & Sales Mgr.: Jose Antonio Jimenez Barrado.

● services

ASSOCIATIONS & PROFESSIONAL ORGANIZATIONS

A N A I P (Asociacion Espanola de Industriales de Plasticos), Raimundo Fernandez Villaverde 45, Madrid 3. Tel: (91) 234-7697. Pres. Ramon M. Azcue; Gen. Mgr.: Jose M. Cavanillas.
 A N E R S (Asociacion Nacional de Empresas de Registro de Sonido), Cincá 25, Madrid 2. Exec. Sec. y: Jose Luis Uguet de Resayre.
 Agrupacion de Empresas de Produccion de Fonogramas, Castello 18, Madrid 1.
 Asociacion Espanola de Editores de Musica, San Jeronimo 29, Madrid 14.
 Direccion General de la Musica, Ministerio de Cultura, Av. Generalisimo 34, Madrid 16.
 International Music Council, Nat'l Committee, Martin de los Heros 56, Madrid 8. Tel: 241-5841.
 International Society for Contemporary Music, Nat'l Section, Martin de los Heros 56, Madrid 8. Tel: 241-5841.
 Juventudes Musicales (Jeunesses Musicales), Via Layetana 139, 4th fl., Barcelona 9. Tel: (93) 215 36 57.
 Organizaciones Artisticas Centano, Rosellon 366, Barcelona 25. Tel: (93) 258 08 68. Chief Exec.: Antonio Centano; Gen. Mgr.: Luis Centano.
 Sindicato Nacional del Espectaculo, Castello 18, Madrid 1.
 Sindicato Nacional del Papel & Artes Graficas, Fernandez de la Hoz 12, Madrid 4. Tel: 419 17 50.

DESIGN & ARTWORK

Ediciones Deportivas ALG, San Raimundo, Madrid.
 Edigsa (Ed. General SA), Av. Jose Antonio 654, Barcelona 10. Tel: (93) 302-2816. Gen. Mgr.: Claudio Marti Pla; Sales Mgr.: Santiago Desongles, Int'l Promo Mgr.: Ricard Canbra.
 Graficas Caro, Isabelita Usera 69, Madrid.
 Iberofon SA, Av. Fuentemmar 35, Poligono Ind'l Coslada, Madrid. Tel: (91) 671-2200. Telex 42797.
 Portadores de Sonido SA, Hortaieza 118, Madrid 4. Tel: (91) 410-3130. Gen. Mgr.: J.M. Estebanz Mansilla.
 S A I C Graficas Aramar, Juan de Austria 70, Barcelona. Tel: (93) 309 79 87.

LICENSING ORGANIZATION, MUSIC

S G A E (Sociedad General de Autores de Espana), Fernando VI 4, Madrid 4. Tel: (91) 419.21.00.

PLATING, PROCESSING & PRESSING PLANTS

Barnafon SA, Av. de la Fama 16, Cornella de Llobregat, Barcelona. Tel: (93) 377.15.63. Telex 54144. (Pressing only).
 C G O S A E, Carretera del Aeropuerto a Barcelona, Prat de Llobregat, Barcelona.
 Colasa (Columbia Fonogram Asociadas SA), Av. de America & Hernandez de Tejada, Madrid 27. Tel: (91) 267-4200. Gen. Mgr.: Kees Ton.
 D A F S A (Difusora Audio Grafica), Pallars 76, Barcelona. (Pressing only).
 E M I-Odeon SA, Poligono Manso Mateu, Prat de Llobregat, Barcelona. Tel: (93) 379-0508. Telex 52497. Factory Mgr.: S. Matamoros. (Pressing only).
 Hispavox SA, Torrelaguna 64, Madrid 27. Tel: (91) 415 23 04. Telex 22931. Cable VOX. Mng. Dir.: Jose Luis Gil; Special Projects: Gonzalo Llodra.
 Iberofon SA, Av. Fuentemmar 35, Poligono Ind'l Coslada, Madrid. Tel: (91) 671-2200. Telex 42797.
 Sonopresse, Torrelaguna 64, Madrid 27. Tel: (91) 415 23 04. Cable VOX. Telex 22931. Gen. Mgr.: Luis Vidal Zapater. (Plating & processing only).
 Vergara, General Mola 9, Barcelona 9. Tel: (93) 257 94 05. (Pressing only).

PRINTERS & LITHOGRAPHERS

Forma Grafica SA, Tomas Breton 51, Naves 4 & 6, Madrid 7. Tel: (91) 227.91.15, 239.88.32. Dir.: Javier Campollo; Pres. Vicente Baez.
 Graficas Foco SA, Av. de America & Hernandez de Tejada, Madrid 27. Tel: (91) 467-4200. Gen. Mgr.: Kees Ton; Admin'r: Pedro Checa.
 Hispavox SA, Torrelaguna 64, Madrid 27. Tel: (91) 415 23 04. Mng. Dir.: Jose Luis Gil; Special Projects: Gonzalo Llodra.
 Iberofon SA, Av. Fuentemmar 35, Poligono Ind'l Coslada, Madrid. Tel: (91) 671-2200. Telex 42797.
 Imprenta en el Acto, Conde Valle Suchil 13, Madrid 7. Tel: (91) 223 15 36.
 Portadores de Sonido SA, Hortaieza 118, Madrid 4. Tel: (91) 410-3130. Gen. Mgr.: J.M. Estebanz Mansilla.
 Repro Royal, Mendez Alvaro 63, Madrid 7. Tel: (91) 230 66 73.
 S A I C Graficas Aramar, Juan de Austria 70, Barcelona. Tel: (93) 309 79 87.

RECORD PROMOTION

Donnelley Espanola SA, Av. del Generalisimo 43, Madrid 20. Tel: (91) 270.24.90.

TAPE CUSTOM DUPLICATORS

Bias SA—Registro del Sonido, Fabregas 37, Esplugas de Llobregat, Barcelona. Tel: 317-6400/6050. Gen. Mgr.: Enrique Villalta.
Audio: 8-tr., cassette.
 C E C S A (Compania de Electronica & Comunicaciones SA), Trovador 5, Barcelona 13. Tel: (93) 255-1307. Telex 54536. Gen. Mgr.: Joan Planas.
Audio: 8 tr., 8-tr. quadraphonic, cassette, open reel.
 C I M A S A (Compania Industrial de Materiales Acusticos SA), Vallehermoso 14, Madrid 15. Tel: (91) 448.22.00/04/08.
 Colasa (Columbia Fonogram Asociadas SA), Av. de America & Hernandez Tejada, Madrid 27. Tel: (91) 267-4200. Gen. Mgr.: Kees Ton.
Audio: Cassette.
 Dumag SL, Gustavo Fernandez Balbuena 26, Madrid 2. Tel: (91) 4155388/1559. Chief Exec.: Pedro Mengibar; Gen. Mgr.: Ricardo Idiazabal.
Audio: Cassette, open reel.
Video: 1" open reel, 3/4" cassette, 1/2" EIAJ cartridge.
 E M I-Odeon SA, Poligono Manso Mateu, Prat de Llobregat, Barcelona. Tel: (93) 379-0508. Telex 52497. Factory Mgr.: S. Matamoros.
Audio: Cassette.
 Hispavox SA, Torrelaguna 64, Madrid 27. Tel: (91) 415 23 04. Telex 22931. Cable VOX. Mng. Dir.: Jose Luis Gil; Special Projects: Gonzalo Llodra. (PKG)
Audio: Cassette.
 Iberofon SA, Av. Fuentemmar 35, Poligono Ind'l Coslada, Madrid. Tel: (91) 671-2200. Telex 42797. (PKG)
Audio: 8-tr., 8-tr. quadraphonic, cassette.
 Person Iberica SA, Torre de Vidale 42-44, Barcelona 12. Tel: (93) 219-0612. Mng. Dir.: Olegario Godo; Gen. Mgr.: Jaime Gratacos.
 Portadores de Sonido SA, Hortaieza 118, Madrid 4. Tel: (91) 410-3130. Gen. Mgr.: J.M. Estebanz Mansilla.
Audio: 8-tr., 8-tr. quadraphonic, cassette, open reel.
 Sintonia SA, Vallehermoso 32, Madrid 15. Tel: (91) 445-8678/6465. Gen. Mgr.: Bartolome Espadale.
Audio: 8-tr., 8-tr. quadraphonic, cassette, open reel, open reel quadraphonic.

● supplies

CARTRIDGE & CASSETTE PARTS

Fonoplast SA, Av. Jose Antonio 142-5a Planta, Esplugas de Llobregat, Barcelona. Tel: (93) 371 60 16, 371 64 00. Gen. Mgr.: Joan Andres Berenquer.
 Iberofon SA, Av. Fuentemmar 35, Poligono Ind'l Coslada, Madrid. Tel: (91) 671-2200. Telex 42797.
 Person Iberica SA, Torre de Vidale 42-44, Barcelona 12. Tel: (93) 219-0612. Mng. Dir.: Olegario Godo; Gen. Mgr.: Jaime Gratacos.
 Jose-Maria Sala Elementos Audiovisuales, Ronda San Antonio 21, Barcelona. Tel: (93) 243-6207. Mgr.: Jose-Maria Sala.

EMPTY CARTRIDGES, CASSETTES & REELS

Audio Magnetics, see Portadores.
 C E C S A (Compania de Electronica & Comunicaciones SA), Trovador 5, Barcelona 13. Tel: (93) 255-1307. Telex 54536. Gen. Mgr.: Joan Planas.
Audio: 8-tr., cassette, open reel.
 Fonoplast SA, Av. Jose Antonio 142-5a Planta, Esplugas de Llobregat, Barcelona. Tel: (93) 371 60 16, 371 64 00. Gen. Mgr.: Joan Andres Berenquer.
 Iberofon SA, Av. Fuentemmar 35, Poligono Ind'l Coslada, Madrid. Tel: (91) 671-2200. Telex 42797.
 Person Iberica SA, Torre de Vidale 42-44, Barcelona 12. Tel: (93) 219-0612. Mng. Dir.: Olegario Godo; Gen. Mgr.: Jaime Gratacos.
Audio: Cassette.
 Portadores de Sonido SA, Hortaieza 118, Madrid 4. Tel: (91) 410-3130. Gen. Mgr.: J.M. Estebanz Mansilla.
Audio: 8-tr., 8-tr. quadraphonic & cassette.
Brand name: Audio Magnetics.

ENVELOPES & MAILERS

Iberofon SA, Av. Fuentemmar 35, Poligono Ind'l Coslada, Madrid. Tel: (91) 671-2200. Telex 42797.

JACKETS & SLEEVES

Artigrafia, Tucan 12, Madrid 19. Tel: (91) 228.92.09. (Jackets only).
 Forma Grafica SA, Tomas Breton 51, Naves 4 & 6, Madrid 7. Tel: (91) 227.91.15, 239.88.32. Dir.: Javier Campollo; Pres. Vicente Baez.
 Graficas Foco SA, Av. de America & Hernandez de Tejada, Madrid 27. Tel: (91) 467-4200. Gen. Mgr.: Kees Ton.
 Hispavox SA, Torrelaguna 64, Madrid 27. Tel: (91) 415 23 04. Telex 22931. Cable VOX. Mng. Dir.: Jose Luis Gil; Special Projects: Gonzalo Llodra. (Jackets only).
 Hostench SA (Talleres Graficos), Corcega 231-233, Barcelona 11. Tel: (93) 230 55 37. Cable FERHOSVILA. (Jackets only).
 Iberofon SA, Av. Fuentemmar 35, Poligono Ind'l Coslada, Madrid. Tel: (91) 671-2200. Telex 42797.

Martin (Graficas), Anafil 5, Madrid 19. (Jackets only)
Ofset ALG, San Raimundo 31, Madrid 20. (Jackets only)
Selecolor SA, Julian Tamarillo 53, Madrid. Tel: (91)
204.21.64. (Jackets only)

LABELS
POLYETHYLENE BAGS

Forma Grafica SA, Tomas Breton 51, Naves 4 & 6, Madrid 7.
Tel: (91) 227.91.15, 239.88.32. Dir.: Javier
Campollo. Pres. Vicente Baez
Graficas Foco SA, Av. de America & Hernandez de Tejada,
Madrid 27. Tel: (91) 267-4200. Gen. Mgr. Kees Ton.
(Labels only)
Hispafox SA, Torrelaguna 64, Madrid 27. Tel: (91)
415.23.04. Telex: 22931. Cable: VOX. Mng. Dir.: Jose
Luis Gil; Special Projects Gonzalo Llodra
Iberofon SA, Av. Fuentemar 35, Poligono Ind'l Coslada,
Madrid. Tel: (91) 671-2200 Telex 42797. (Labels
only)

TAPE, BLANK LOADED & RAW

Agfa-Gevaert SA, Paseo de Gracia 111, Barcelona 8. Tel:
(93) 227-3002. Telex. 52644. Mng. Dir.: E. Carton.
Audio: Blank—compact-cassette, open reel; raw—
cassette, broadcast, studio.
Video: Cassette, open reel.
Brand names: Agfa Carat, Agfa Stereochrom, Agfa
Videochrom
Audio Magnetics, see Redim.
B A S F Espanola, Paseo de Gracia 99, Barcelona 8. Tel: (93)
215-1354. Audio-Video Prods. Mgr.: Jorge Guardia.
Sales Mgr. Carlos Wuest. (Blank only)
C E C S A (Compania de Electronica & Comunicaciones SA),
Trovador 5, Barcelona 13. Tel: (93) 255-1307 Telex
54536. Gen. Mgr. Joan Planas. (Blank only)
Audio: 8-tr., cassette, open reel.
Fonoplast SA, Av. Jose Antonio 142-5a Planta, Esplugues de
Llobregat, Barcelona. Tel: (93) 371.60.16, 371.64.00.
Gen. Mgr. Joan Andres Berenquer. (Blank only)
Iberofon SA, Av. Fuentemar 35, Poligono Ind'l Coslada,
Madrid. Tel: (91) 671-2200 Telex 42797.
Audio: 8-tr., cassette.

Palobal SA, Ingenieros Hermanos Granda 30, Madrid 22.
Tel: (91) 205.07.91. Pres.: Pablo Lopez Balada; Mng.
Dir. Mari Carmen Cunado; Gen. Mgr.: Juan Salva Valls;
Sales Mgr. Julio Lopez Betrian. (Blank only)
Audio: 8-tr., cassette.
Portadores de Sonido SA, Hortaleza 118, Madrid 4. Tel: (91)
410-3130. Gen. Mgr.: J.M. Estebarez Mansilla.
(Blank only)
Audio: 8-tr., cassette.
Redim, Comandante Zorita 6, Madrid.
Audio: 8-tr., cassette, open reel.
Brand name: Audio Magnetics.
Scotch, see 3M.
3 M Espana SA, Josefa Valcarcel 31, Madrid 27. Tel: (91)
742.00.12. Telex: 27499. Mng. Dir.: G.J. Partington;
Gen. Mgr.: Esteban Lopez; Sales Mgr.: Antonino
Vergara; Mktg. Mgr.: Manuel de Martin-Barbadillo.
Audio: 8-tr., cassette, open reel.
Video: Blank—1" open reel, 1" cartridge, 3/4" cassette,
1/2" EIAJ open reel, 1/2" EIAJ cartridge, Beta & VHS
cassette.
Brand name: Scotch.

● accessories
manufacturers

Audio SA, La Granada 34, Barcelona 6. Tel: (93) 217-1554.
Telex: 54293. Gen. Mgr.: Carlos Pueyo; Sales Mgr.:
Antonio Colome.
Product: Needles.
Brand name: Pickering.
Forma Grafica SA, Tomas Breton 51, Naves 4 & 6, Madrid 7.
Tel: (91) 227.91.15, 239.88.32. Dir.: Javier
Campollo. Pres. Vicente Baez.
Product: Catalog servs.
Iberofon SA, Av. Fuentemar 35, Poligono Ind'l Coslada,
Madrid. Tel: (91) 671-2200 Telex 42797.
Product: Carrying & storage cases, catalog servs., 45
rpm adapters, leader tape.
Mabel, Calle Ripollés 84, Barcelona 13. Tel: (93) 235-4000.
Product: Needles.
Brand name: Stanton.
Portadores de Sonido SA, Hortaleza 118, Madrid 4. Tel: (91)
410-3130. Gen. Mgr.: J.M. Estebarez Mansilla.
Product: Head cleaners.
3 M Espana SA, Josefa Valcarcel 31, Madrid 27. Tel: (91)
742.00.12. Telex: 27499. Mng. Dir.: G.J. Partington;
Gen. Mgr.: Esteban Lopez; Sales Mgr.: Antonino
Vergara; Mktg. Mgr.: Manuel de Martin-Barbadillo.
Product: Head cleaners, demagnetizers, leader &
splicing tape.

SUDAN

Population: 17,760,000.
Rate of exchange: \$1 (US) = 0.35 Sudan pound.
Per capita income: \$143.
Holidays: January 1, May 25, October 21, December 25,
and various Mohammedan religious holidays.

● record & tape
manufacturer /
importer / distributor

Munspphone Rec'g Co., PO Box 2380, Khartoum. Tel:
73355, 81388, 73990.

Labels: (Owned) Munspphone: (represented) Chahat-
phone (Chad), Sono Cairo (Egypt), Sout el Phan (Egypt,
Greece).
Int'l reps.: Chad (Chahtaphone), Egypt (Sono Cairo),
Ethiopia (Impex Radio, Yared Music Shop), Libya (El Fe-
zani).

● services

DESIGN & ARTWORK (rec. only)
PRINTER & LITHOGRAPHER (rec. only)
RECORD PROMOTION

Munspphone Rec'g Co., PO Box 2380, Khartoum. Tel:
73355, 73990, 81388.

● accessories
manufacturer
store fixtures &
merchandising
aids manufacturer

Munspphone Rec'g Co., PO Box 2380, Khartoum. Tel:
73355, 81388, 73990.

Product: Record carrying & storage cases, rec. catalog
servs., cleaners, cloths, brushes, 45 rpm adapters, need-
les, rec. browser boxes, rec. display racks, rec. divider
cards.

SURINAM

Population: 447,000.
Per capita income: \$970.
Holidays: January 1, Good Friday, April 30, Ascension Day,
Whit Monday, July 1, December 25, 26.
Records, record blanks & pre-recorded media imported
from USA: 1977—\$267,797.

● record & tape
manufacturers /
distributors / importers

Didi Recs., PO Box 183, 2420 Paramaribo, Malebatrumstr.
4, 2438 Paramaribo. Tel: 76398.
Int'l branch: Netherlands, A. M. Girwar.
Labels: (Owned) Didi, Old Gold.
Dyna Concept Studios, PO Box 1776, Paramaribo. Tel:
72095. Exec. Dir.: Wilfred Amstelveen; Mng. Dir.:
(USA) Julian Reyna.
Labels: (Owned) Bluegrass, Catharsis, Graffiti.

● services

DESIGN & ARTWORK
RECORD PROMOTION

Didi Recs., PO Box 183, 2420 Paramaribo, Malebatrumstr.
4, 2438 Paramaribo. Tel: 76398.

SWEDEN

Population: 8,300,000.
Rate of exchange: \$1 (US) = 4.40 krona.
Per capita income: \$7,557.
Holidays: January 1, Epiphany, Good Friday, Easter
Monday, May 1, Ascension Day, Whit Monday, Mid-
Summer Day, November 5 (All Saints Day), December
25, 26.

RECORDS

Records sold domestically: LP's 1978—16,000,000 units,
\$127,220,000; 1977—16,100,000 units,
\$114,780,000. Singles 1978—1,600,000 units,
\$4,000,000; 1977—1,400,000 units, \$3,040,000.
Average retail price per record: LP's—\$7.80, singles—
\$2.50.

Stereo sales: 100% of total.
Record club sales: 10% of total.

Discounting: Frequent.

Type of distribution: Manufacturer-to-retailer system pre-
dominates. There are two major rack jobbers. Grammo-
rack, which is owned by the industry and Playmusic AB,
which together comprise about 20% of the market. Direct
importing is frequent.

Type of promotion: Government-controlled and non-com-
mercial radio and TV are the prime media for the promo-
tion of records. The major daily evening newspapers are
important for advertisements and reviews. Discoteques
are also significant, as are in-store video presentations.
Jukeboxes: 1,000.

TAPE:

Market: Cassette sales have now stagnated, with 1978 sales
somewhat lower than those of 1977. About 14 million
blanks were sold in 1978, a factor influencing the cas-
sette sales decline. A large number of playback equip-
ment in use points to frequent home duplication which
affects the pre-recorded LP and tape market.

Pre-recorded tape sold domestically: Cassette 1978—
2,900,000 units, \$25,450,000, 1977—3,300,000
units, \$26,520,000.
Average retail price per tape: Cassette—\$8.60.

RADIO STATIONS

No. of government 4.
Comment: One channel plays primarily recorded music 24
hours daily, although the percentage has lowered in the
last year. 24 local radio stations are now in operation.

TELEVISION STATIONS:

No. of channels 2 (government).
Comment: There are few programs featuring pop music.
Most of the shows are imported from the USA. The two
non-commercial channels each transmit about 40 hours
per week.
Leif Schulman

● record & tape
manufacturers /
distributors / importers

Abata Handels AB, Vanadisplan 5, S-113 31 Stockholm. Tel:
(08) 33-75-48. (Distributor)
Ad Lib Dist'n AB, PO Box 52, Skattegaerdsvaegen 49, S-162
11 Vaellingby. Tel: (08) 739-26-50/22-08. Exec. Ivan
Sundberg. (Distributor/Importer)

Labels: (Distributed—not licensed) Audio Fidelity,
CBS, Chiaroscuro, Choice, Classic Jazz, Improv, Inner
City, Master Jazz, Monmouth-Evergreen, Progressive
(all USA), Black & Blue (France), Dragon (Sweden), Fer-
mat (Sweden), Out (Sweden).

Amigo Musik AB (IFPI), PO Box 6058, Norra Stationsgatan
91-93, S-102 31 Stockholm 6. Tel: (08) 34-01-95.
Cable: GEODAH. Telex: 17840. Pres. Per-Anders
Boquist; A&R Mgr. Jan Boquist; Sales Mgr. Hans An-
derson.

Labels: (Owned) Amigo. (distributed—not licensed)
Advent (USA), Albatross (Italy), Anatolia (Sweden),
Baerenreiter (Germany), Beehive (USA), Black Saint
(Italy), Cassandra (USA), Celler (Switzerland), Chant du
Monde (France), Contemporary (USA), Deesse (France),
Delmark (USA), Dollar (Sweden), ECM (Germany), ENJA
(Germany), FMP (Germany), Folkways (USA), Free Reed
(UK), Gael Linn (Ireland), IAI (USA), Jefferson (Sweden),
Joliet (USA), Malvina Reynolds (USA), Movieplay
(Spain), Musidisc (France), Nessa (USA), Nighthawk
(USA), Ocora (France), Paredon (USA), Plaene (Ger-
many), Roldex (Sweden), Shandar (France), Sonodisc
(France), Spottite (UK), Supraphon (Czechoslovakia),
TAX (Sweden), Team (Sweden), Vedette (Italy), Vogue
(France), World Jazz (USA).

Anatolia, see Amigo
Anette, see Lido-Prod'n.
Angel, see EMI.
Arrival, see Polydor.
Arrival, see K-tel.
Arrow Recs., PO Box 295, Aegatan 28, S-580 01 Lin-
koping. Tel: (013) 114-923/933. Gen. Mgr.: B.
Roger Fransson; Sales Mgr.: Benny Lindell; Label Mgr.:
Chris Sorerman.

Artist, see Nordiska
Asylum, see WEA Metronome.
Atco, see WEA Metronome.
Atlantic, see WEA Metronome
Attack Recs. (Scandinavia) (IFPI), Dalagatan 12, Stockholm.
Tel: (08) 30-44-60. Dirs. Sanji D. Tandani, Cyril Hynes,
Hans Kjell; Disco Contact: Fredrick van Rosen.
Labels: (Owned) Attack, Magic, Pool, Tandani; (li-
censed foreign) Blue (UK), Kingpack (UK).
Int'l reps.: UK (Blue), USA (Record Haven).

Aubergine Grammofonproduktion AB (IFPI), Vikingagatan
22, S-113 42 Stockholm. Tel: (08) 32-36-00. Pres.:
Ove Hansson; Prod'r. Curt Peterson.
Branch: S-411 29 Goetoberg, Landalabergen 20. Tel:
(031) 16-26-90.

B A S F Svenska AB, Kungsporsavengens 31-35, S-411 36
Goberg. Tel: (031) 31-32-30 Telex: 2327.
Barnprod., see Nordiska.

Bastun Studio AB, Bastugatan 39, S-117 25 Stockholm. Tel:
(08) 84-18-75. Pres.: Peter Olsson; A&R Dir.: Anders
Larsson.

Labels: (Owned) SWS (distributed by EMI, Scandinavia
Music Dist'n), YTF (distributed by Scandinavian Music
Dist'n)

Bill Recs. AB, PO Box 953, Blommenbergsvaegen 140,
S-126 09 Hagersten 1. Tel: (08) 18-18-44.
Arne Bill Prod'n AB, Groendalsvaegen 18, S-147 00 Tumba.
Tel: 379-00, 317-91.

Labels: (Owned) Bill, Butler.

Blitz, see Sweetco.
Bohus AB (Grammofon) (IFPI), PO Box 24, S-442 01 Kun-
gaevle. Tel: (0303) 109-90, 168-71. Mng. Dir.: Bjarne
Lundqvist; Gen. Mgr.: Gert Lengstrand. (Distributed by
Mariann)

Labels: (Owned) Bohus; (licensed) EMI (Norway).

Boogie, see Scrinta
Bourre, see Skandinavisk Musikstjanst.

Bra Musik/Skandinavisk Press AB, PO Box 811, S-201 80
Malmo. Tel: (040) 10-18-30. Telex: 32575. Mktg.
Mgr. Rolf Nilstam; Prod. Mgr.: Hans-Ingvarg Hansson.

Bums, see EMI.

Butler, see Arne Bill.
C A M Scandinavia AB, Wibomsvaeg 7 BV, S-171 60 Solna.
Tel: 82-44-01. Telex: 21411. (Distributed by Mariann)

Home office: Italy.
C B S Recs. AB, PO Box 20037, Mariehallsvaegen 40,
S-161 20 Bromma. Tel: (08) 98-02-50. Cable: COLRE-
CORD. Telex: 17736. Mng. Dir. Sten af Klinteberg; Fi-
nancial Mgr.: Ingmar Ostberg; Mktg. Mgr. Lennart
Backman.

Labels: (Owned) CBS, Cupol, Date, Embassy, Epic, Har-
mony, Portrait; (distributed) Fyra Skilling, Glendisc; (li-
censed) A&M (USA), Ariola (Germany), GTO (UK), Jet
(USA), Monument (USA), Philadelphia Int'l (USA), TK
(USA), T-Neck (USA).

Int'l rep.: Worldwide (CBS).
 California Sweden Grammfolon Co., PO Box 117, S-721 05 Vasteras. Tel (021) 13-12-11, 35-66-10 Mng. Dir Sture Redin.
Labels: (Owned) California, Centy, Memphis, Montana, Omega, RR, Record, Sunrise, Swede, Sweden, WMP
 Capitol, see EMI
 Centy, see California
 Cewe, see Epok
 Chart, see Sonet
 Cirrus, see Sonet
 Cisco, see Country Korral
 Clanta Grammfolon, Normalstorg 18, S-111 46 Stockholm Tel (08) 21-90-19
 Walter Cohn, Bromsvagen 25, S-125 30 Alvsjo. Tel (08) 47-35-46 (Distributor)
 Columbia, see EMI
 Country Music Center, Maria Skolgata 38, S-116 62 Stockholm.
Label: (Represented) Sierra/Briar (USA).
 Cotillon, see WEA Metronome
 Crystal, see EMI
 Cupol, see CBS
 D G, see Polydor
 D J M, see Phonogram
 D J Special, see W-Sign
 D N, see Play
 Dacapo, see EMI
 Dance-record, see Marilla
 Date, see CBS
 Discolor Svenska AB, Vinbarsvagen 27, S-161 52 Bromma. Tel (08) 87-41-39.
 Dollar, see Amigo
 Double Up, see EMI
 Dragon Recs./Westin & Wallgren, Lovbergavagen 9, S-132 00 Saltsjo-Boo. Tel (08) 747-9332. Gen Mgr.: Lars Westin, Sales Mgr. Jan Wallgren (Distributed by Ad Lab)
 Dux, see Phonogram.
 EMI Svenska AB, Tritonvaegen 17, Fack, S-171 19 Solna 1. Tel (08) 730-0060. Cable. EMIGRAM. Telex 10046 Mng. Dir. Rolf Nygren; Mktg. Mgr. Peder Hedstrand, Sales Mgr.: Hans Ohlin; Promo. Mgr.: Kjell Ahlqvist, Int'l A&R Mgr. Lars Bremer.
Labels: (Owned) Angel, Capitol, Columbia, Crystal, Dacapo, Double Up, EMI, EMI America, EMI Int'l, Electrola, Emidisc, Encore, HMV, Harvest, Music for Pleasures, Odeon, One Up, Oz, Parlophone, Pathe, Regal, Regal Zonophone, Rondo, Seraphim, Sidewalk, Souvenir, Starline, Stateside, Talisman, Tower, Waveley; (licensed) AVI (USA), Arista (USA), Artist House (USA), Ballistic (UK), Barclay (France), Bell (UK), Black & Blue (France), Blue Note (USA), Carrere (France), Casablanca (USA), Chi-Sound (USA), Chocolate City (USA), Classic, Cowpie (UK), Delta, Deutsche Harmonia Mundi (Germany), Dolton (USA), Egg (France), Ember (UK), Fantasy (USA), GRP (USA), Gordy (USA), Hilltop (USA), Liberty (USA), MAM (UK), MPS (Germany), Magnet (UK), Mile-

stone (USA), Motown (USA), Passport (USA), Pickwick (USA), Prestige (USA), Private Stock (USA), Prodigal (USA), Purple (UK), RAK (UK), Rare Earth (USA), Record (Italy), Riviera (France), Rocket (UK), Soul (USA), Springboard (USA), Stax (USA), Sunset (USA), United Artists (USA), World Rec Club (UK), Zoom (UK); (distributed—not licensed) Bums, Flam, Four Leaf Clover, Glenn Music, Nugget, Pang, Platina, Royal, SR, Scranta, Ters.
 Edler, see Marilla
 Efel, see Europa-Produktion.
 Electra AB (Grammfolon) (IFPI), PO Box 1178, Ankdammsgatan 5, S-171 23 Solna 1. Tel: (08) 82-04-80, Cable ELECTRAGRAMMO STOCKHOLM. Telex 19561. Pres. Sixten Eriksson; Mng. Dir. Hans-Ove Eriksson; A&R Mgr. Carl-Eric Hjelm; Sales Mgr. Hans Lindqvist; Press Officer Lennart Anderson; Decca group Label Mgr. Dan Ekbaeck; RCA group Label Mgr. Klas Burling.
Labels: (Owned) Musica, Swedish Society Discofil, Telestar, Viking; (licensed) ABC, Ace of Clubs (UK), Ace of Diamonds (UK), Das Alte Werke (Germany), Argo (UK), Arnon (Italy), Aura (UK), Buddah (USA), Decca (UK), Emerald (UK), Erato (France), Grunt (USA), Inter-cord (Germany), Janus (USA), Logo (UK), London (UK, USA), Melodiya (USSR), Millennium (USA), Nova (Germany), Pickwick (UK), Playboy (USA), Prom (Germany), RCA (USA), Salsoul (USA), Supraphon (Czechoslovakia), Telefunken (Germany), Turnabout (UK), Wind-song (USA).
 Electrola, see EMI.
 Elektra, see WEA Metronome.
 Embassy, see CBS.
 Emidisc, see EMI.
 Encore, see EMI.
 Epic, see CBS.
 Epok Skivforlag, Vintergatan 10B, Ornskoldsvik. Tel (0660) 300-52.
Labels: (Owned) Cewe, Epok.
 Christer T. Eriksson & Son AB, PO Box 317, S-181 03 Lidinge. Tel: (08) 766-0290. Telex: 10155. Mng. Dir.: Christer T. Eriksson; Sales Mgr. Claes Eriksson. (Distributor/Importer/Exporter)
 Sven Eriksson (Ingenjorsfirma), PO Box 834, S-121 08 Johanneshov. Tel: (08) 19-90-50. Telex 13210. Owner Sven Eriksson.
Label: (Represented) Sheffield Lab (USA).
 Ess-Rosling (AB), Luntmakargatan 59, S-113 58 Stockholm. Tel: (08) 34-64-01. Telex 12080. Dir. Brian Shack (Distributor)
 Europa-Film, see Sonet.
 Europa-Produktion AB, Rasundavagen 45, S-171 52 Solna Tel: (08) 83-31-05.
Labels: (Owned) Efel, Olga.
 Fermat, see Ad Lib
 Filadelfia Forlaget, see Prim.
 Fixtra AB, PO Box 49021, Kungsholmsstrand 169, S-100 28 Stockholm 49. Tel: (08) 54-81-07. (Distributor)

Fjedur, see Sonet.
 Flam, see EMI.
 Flop, see Sonet.
 Fontana, see Phonogram.
 Four Leaf Clover, Jaernvaegsgatan 70, S-172 35 Sundyberg. Tel: (08) 98-28-08/55 Exec.: Lars Samuelson. (Distributed by EMI)
 Fralsningsarmens Handelsavdelning, PO Box 5090, Ostermalmsgatan 71, S-102 42 Stockholm 5. Tel: (08) 63-17-00 (Distributor)
 Frituna Produktion AB, Vaertavaegen 15, S-115 28 Stockholm. Tel: (08) 63-13-45, Telex 12328. Pres. Goeran Waltnr, Gen. & A&R Mgr. Claes af Geijerstam. (Distributed by GDC & Sonet)
Int'l branch: France
Int'l reps.: Denmark (Sonet), Finland (EMI), Norway (Arne Bendiksen)
 Fyra Skilling, see CBS
 G D C (Grammfolonbolagens Distributionscentral) AB, Dalva-gen 4, Solna. Tel: (08) 730-0720. Pres. Goran Stenberg; Sales Mgrs.: P-A Lindholm, Stig Stahl, Hans Kronwall (Distributor)
 G D K, see Sound of Scandinavia.
 Galaxy, see Scranta
 Gamla Stenkor, see Record Trading.
 Gavotte, see Skandinavisk Musiktjanst.
 Gazel, see Sonet.
 Glendisc, Vallvagen 2, S-182 75 Stocksund. Tel: (08) 85-68-00. (Distributed by CBS)
Int'l rep.: Worldwide (CBS).
 Glenn Music, see EMI.
 Globe, see Strike.
 Grammfoplast AB, Rorstrandsgatan 37, S-113 40 Stockholm. Tel: (08) 30-30-70.
 Grammotonverket, see Sonet.
 Grand Prix, see Sonet.
 Gump, see WEA Metronome.
 H M V, see EMI.
 Habima Grammfolon AB, PO Box 286, Nygatan 18, S-701 04 Orebro. Chm.: Alex Rojal; Mgr. Bo Rehnberg.
 Haparanda Budget Line Recs., Selmedalsvagen 22, S-166 55 Hagersten. Tel: (08) 46-15-11.
 Harmony, see CBS.
 Harvest, see EMI.
 Heavy Sound, Regeringsgatan 89, S-111 39 Stockholm. Tel: (08) 10-45-35. Cable: HEAVY. Telex: 14339. Mng. Dir. Torbjorn Hullegaard.
Labels: (Owned) Heavy Sound; (distributed—not licensed) Aquarius (Canada), Bourbon (Japan), Force One (Canada), Jelly (USA).
Int'l rep.: Japan (GP).
 Heliodor, see Polydor.
 Hemmets Haerold, see Prim.
 Hemmets Journal AB, Fack, S-200 22 Malmoe 3. Tel: (040) 934560, Telex 32449. Mng. Dir. Jan Morch.
 Hendrix Music, see Safir.
 Impact, see K-tel.
 Imperial, see K-tel.

ARE YOUR PRODUCTS REPRESENTED IN THE IMPORTANT SCANDINAVIAN MARKET? WE ARE THE COMPANY FOR YOU!



The greatest scandinavian act for years!



is still available for:
 USA, France, Brazil, Israel, Italy, Mexico, New Zealand, Ireland, Portugal, South Africa

Sound of Scandinavia and Recording AB is one of the few independent scandinavian companys that covers the whole chain from production to marketing and distribution, as well as publishing.

Give us your offers and let us offer you our products.

 Sound of Scandinavia & Recording AB Box 1108 S-141 23 Huddinge Sweden Phone 46-08-774 07 80 Telex 12601 SOSREC-S

Inter-Disc, see Record Trading.
 Iver Rec'g Co. AB, Grev Turegatan 38, S-114 38 Stockholm.
 Tel: (08) 67-99-10 Cable SOUTHMUSIC.
 Label: (represented) Spark (UK)
 Int'l rep.: Worldwide (Peer-Southern).
 Jefferson, see Scandinavian Blues Ass'n & Amigo.
 Jockey, see Record Trading.
 Joker, see Polydor.
 K B Rec AB/Shushu Rec. Ltd., PO Box 4153, S-203 12 Malmö. Tel: (040) 329-96. Dir. Ken Brown, Gen. & Sales Mgr. Ulla Nilsson.
 Labels: (Owned) KB, Shushu.
 K-tel Int'l (Sweden) AB, Fack, S-104 60 Stockholm. Tel: (08) 743-05-40. Telex: 12070. Gen. Mgr.: G. Soederman, Controller: A. Alm.
 Labels: (Owned) Arrival, Chart, Impact, Imperial, K-tel, Lotus; (licensed foreign) Can't Stop (USA), Ibis (USA), Prelude (USA).
 Karussell, see Polydor.
 Kenneth, see Polydor.
 Knappupp, see Sonet.
 Kontra Punkt, see Record Trading.
 Koster, see Mariann.
 Kountry Korral Prod'ns, PO Box 8014, S-720 08 Vasteras 8. Tel: (021) 18-86-20/90. Pres.: Lillies Ohlsson.
 Labels: (Owned) Cisco, Kountry Korral.
 L.P-Fyndet AB, PO Box 70, S-815 01 Tierp. Tel: (0293) 131-65. Telex 81126. Gen. Mgr.: Karl-David Kilstrom; Sales Mgrs. Kjell Gronberg, Nils-Erik Kilstrom. (Distributor/Importer)
 Lido-Prod'n, Fack 131, S-531 01 Lidköping. Tel: (0510) 231-25.
 Label: (Owned) Anette.
 Lilla Huset Musik AB, Stationsgatan 4, S-827 00 Ljusdal. Tel: (0651) 157-00. Chief Exec. Boerje Bergstrom.
 Label: (Owned) Wigwam.
 Ljudspar, see Sonet.
 Lotus, see K-tel.
 M G M see Polydor.
 M N W, see Musiknätet Waxholm.
 Magic, see Attack.
 Mallwax, see WEA Metronome.
 Marcus Music AB (IFPI), Raesundavaegen 45, S-171 52 Solna. Tel: (08) 730-0400. Dir.: Margaretha Andersson, Gen. Mgr. Christer Berg, Sales Mgr. Ann-Birgitt Carlsson, Chief Eng. Lars Rosin.
 Mariann Dist'n AB, PO Box 148, S-532 01 Skara. Tel: (0511) 161-50. Chief Exec.: Bert Karlson; Gen. Mgr. Kjell Jansson.
 Labels: (Owned) Mariann; (distributed—not licensed) Bohus, CAM, Koster, Planet, Rainbow, Signatur, Sirius, Solist, Zeaphone (all Sweden); Cream (USA), Gull (UK), Hi (USA), Warwick (UK), Xanadu (USA).
 Int'l reps.: Denmark, Finland, Norway (all EMI).
 Marilla Grammofon AB (IFPI), Parmmaatargatan 9, S-112 24 Stockholm. Tel: (08) 54-18-30. Telex: 10625. Pres.: Hans Edler; Gen. Mgr. Thord Edler; Sales Mgr. Gunner Karlstrom, Label Mgr. Robert Boerjhammar.
 Labels: (Owned) Dance-record, Edler, Marilla; (licensed) Disc'AZ (France), Charly (UK), Elver (Belgium), Image (Australia), RKM (Belgium), Rockoko (Germany). (distributed—not licensed) Polarovox (Finland), Sunset (France).
 Int'l reps.: Finland (Polarovox), France (Sunset), Norway (Royal Hogueus).
 Memphis, see California.
 Mercury, see Phonogram.
 Metro, see Polydor.
 Metronome, see WEA Metronome.
 Midnight Sun, see Sonet.
 Montana, see California.
 Montax AB, Klockaregatan 27, Falkenberg S-311 00. Tel: (0346) 81060.
 Moondisc, see Sound of Scandinavia.
 Mudist, see Scandinavian Music Dist'n.
 Musica, see Electra.
 Music Consult AB, Oestgoetagatan 17, S-116 25 Stockholm. Tel: (08) 44-03-80. Telex 12597. Import Mgr.: Johan Greholt. (Distributor/Importer)
 Music Explosion, see Pop Int'l.
 Music for Pleasure, see EMI.
 Musikfabriken, Stambanevagen 34, S-141 43 Huddinge. Tel: (08) 711-0894.
 Musiknätet Waxholm AB (MNW), Fack, S-185 00 Vaxholm. Tel: (0764) 323-45/29. Gen. Mgr.: Jan-Olof Schill; Sales Mgr. Johanna Lindstrom; Studio Mgr. Curt Ake Stefan; Admin. Lizzy Jorgensen. (Distributed by SAM).
 Label: (Owned) MNW.
 Nonesuch, see WEA Metronome.
 Nordiska Musikforlaget AB (IFPI), PO Box 745, Drottninggatan 37, S-101 30 Stockholm 1. Tel: (08) 24-94-30 Cable MUSICALIA. Telex 11859. Pres. Bengt Edvardsson; Sales Mgr. Tony Lonn.
 Labels: (Owned) Artist, Barnparaden; (licensed) Acanta (Germany), All Stars (France), BASF/Acanta (Germany), Claves (Switzerland), Montparnasse 2000 (France), Music Minus One (USA), Selected Sound (Germany).
 Int'l reps.: Denmark (Wilhelm Hansen), Finland (Scandia-Musikki), Norway (Norsk).
 Nugget, see EMI.
 Odeon, see EMI.
 Olga, see Europa-Produktion.
 Omega, see California.
 One Up, see EMI.
 Onskesagan, see Record Trading.
 Out, see Ad Lib.
 Oz, see EMI.
 Pz, see EMI.
 Parlophone, see EMI.
 Pathe, see EMI.
 Philips, see Phonogram.
 Phonogram AB, PO Box 3083, Dalvaegen 4, S-171 03 Solna 3. Tel: (08) 730-0260. Cable PHONOGRAMAB. Telex: 10750. Mng. Dir.: Bo Gyllenpalm; A&R Mgr.: Nicolai Wohrmann-Hill; Int'l A&R Mgr.: Robert Hulman; Pub. Mgr.: Ingvar Erikson; Int'l Pub. Mgr.: Elisabeth Johansson.
 Labels: (Owned) Dux, Fontana, Mercury, Philips, Smash, Sonata, Sonora, Vertigo; (licensed) All Platinum (USA), Biograph (USA), Charisma (UK), Chess (USA),

Ensign (UK), H&L (USA), Haven (USA), Manhattan (USA), Mountain (UK), Power Exchange (UK), Shelter (USA), Sire-Passport (USA), Stiff (UK), 20th Century (USA), Utopia (UK), (distributed—not licensed) DJM, Svenska Ljud.
 Phonograph, see W-Sign.
 Pike Music, see Saffir.
 Pilot Music AB, Fack, S-171 19 Solna. Tel: (08) 730-0810. Pres.: Kjell Samuelson; Gen. Mgr. Rolf Samuelson, Sales Mgr. Bertil Lindholm.
 Int'l branches: Denmark, Forlaget Royal, Faroe Islands, Finland, Finn-Gospel Oly, Iceland, Boka-og Bladautgavan, Norway.
 Labels: (Owned) Pilot; (licensed) Green Tree, Heart Warming, Impact, Lamb & Lion (all USA), (distributed—not licensed) Manna (USA).
 Planet Recs. & Music, Frannaesbacken 12, S-171 42 Solna. Tel: (08) 83-73-00. Cable PLANREC Telex 14392. Pres. & Mng. Dir. Mats Olsson; Ass't Birgitta Aehgren. (Distributed by Mariann).
 Labels: (Owned) Planet; (licensed foreign) Cream (USA), Gull (UK), Hi (USA), Xanadu (USA); (distributed—not licensed) CAM (Italy).
 Platina Recs AB, St. Arodsatan 29, H. Backa, S-422 43 Gothenburg. Tel: (031) 52-66-50. Pres. Evert Jakobsen. (Distributed by EMI).
 Int'l rep.: Norway (EMI).
 Playback Inspelningar AB, Gustav Adolfs Torg 10, S-211 39 Malmö. Gen. Mgr. Lennart Christiansson.
 Label: (Owned) Playback.
 Play Music AB, PO Box 751, S-131 24 Nacka. Tel: (08) 98-52-50. Cable SELJLAG Telex 17914. Mng. Dir. Ake Wilke; Chief Buyer Gunnar Bothen.
 Int'l branch: Norway.
 Labels: (Owned) Play; (distributed) CBS, DN, EMI, GDC, Metronome, Phonogram, Polar, Polydor, Sonet.
 Polar Music Int'l AB, PO Box 26072, Baldersgatan 1, S-100 41 Stockholm. Tel: (08) 14-30-20. Cable: SWE-DEMUSIC. Telex 11959. Pres. & Gen. Mgr. Stig Anderson. Ass't to Pres. Goerel Johnsen, Label Mgr. Hans Bergkvist.
 Label: (Owned) Polar.
 Polydor AB (IFPI), PO Box 3093, Dalvaegen 4, S-171 03 Solna. Tel: (08) 730-0940. Cable POLYDORAB. Telex 10466. Mng. Dir. Ivan Nordstrom; Gen. Mgr. Per-Arne Lindholm; A&R, Pub. & Promo Mgr. Kjellace Carlsson; Sales Mgr. Rolf Hellenius.
 Labels: (Owned) Archiv, DG, Heliodor, Joker, Karussell, MCM, Metro, Polydor, Polyphon, Tip, Verve, (licensed) Barn (UK), Bran (Germany), Capricorn (USA), Coral (USA), Disneyland (USA), MCA (USA), MPS (Germany), Pablo (USA), Phil Spector (USA), RSO (UK), Red Bull (Netherlands), Spring (USA), Track (UK); (distributed—not licensed) Kenneth, Proprius.
 Polyphon, see Polydor.
 Pool, see Attack.
 Pop Int'l, Sigtunag 16, S-113 22 Stockholm. Tel: (08) 30-31-10. Mgr. & Prod'r Lennart Pettersson.
 Labels: (Owned) Music Explosion; (represented) Bullet, Camel, Crab, Economy, Escort, Fonit-Cetra, New Beat, Ocean, Pama, Punch, Supreme, Unity.
 Portrait, see CBS.
 Prim Recs (IFPI), Dagenhuset, S-105 36 Stockholm. Tel: (08) 13-03-40. Pres.: Sverre Larsson; Gen. Mgr. Lars Eric Janson; Sales Mgr. David Edstrom, Prod'r Lennart Sjoeholm, Swante Bengtsson.
 Labels: (Owned) Hemmets Haerold, Prim; (licensed foreign) Birdwing, Dayspring, Good News, Lamb & Lion, Light, Maranatha!, Myrrh, Solid Rock, Sparrow, Spirit (all USA); Vord (UK, USA).
 Int'l reps.: Finland (Taboroerlaget), Norway (Prim/Filadelfiaerlaget).
 Proprius, see Polydor.
 R R, see California.
 Rainbow, see Mariann.
 Record, see California.
 Record Trading AB, Fack, S-191 20 Sollentuna. Tel: (08) 96-01-95. Pres. Kurt Westman.
 Labels: (Owned) Gamla Stenkakor, Inter-Disc, Jockey, Kontra Punkt, Onskesagan, Super-Sound, (distributed—not licensed) Alshire (USA), Audiomaster (USA), Opus (Czechoslovakia), Power (UK), Supraphon (Czechoslovakia).
 Regal, see EMI.
 Regal Zonophone, see EMI.
 Reprise, see WEA Metronome.
 Rock & Country Recs., PO Box 83, S-310 58 Vessigebo. Tel: (0346) 206-57. Gen. Mgr. Christer Malmstedt; Sales Mgr. Bertil Jansson.
 Labels: (Owned) Rock & Country; (licensed foreign) Cha Cha (USA), Showay (USA).
 Roldex, see Amigo.
 Rollis Grammofonskivor AB, PO Box 17120, S-200 10 Malmö 17. Tel: (040) 336-33. Mng. Dir. Hans Ingvar Hansson, Pres. Lennart Carlsson, Sales Mgrs U. Andersson, J. Eriksson (Wholesaler/Importer/Exporter).
 Rondo, see EMI.
 Ronny's Music, PO Box 4297, S-203 14 Malmö. Tel: (040) 12-89-12. Pres.: Ronnie Hall. (Importer of oldies singles).
 Royal, see EMI.
 S A M Dist'n Music AB, Fack, S-185 00 Vaxholm. Tel: (0764) 315-90. Chief Exec. Annette Guner, Sales Mgr. Goeran Pettersson; Info & PR Mgr. Haevan Lager (Distributor).
 Int'l reps.: Denmark (Demos), Finland (Musik & Foto), Norway (Ma).
 S O S, see Sound of Scandinavia (SEE ADVERTISEMENT).
 S R, see EMI & Sveriges Radio.
 S W S, see Bastun & Scandinavian Music Dist'n.
 Saffir Music of Sweden, PO Box 228, S-124 02 Bandhagen. Tel: (08) 99-1191. Gen. Mgr.: Stefan Nordin; Financial Dir. Haekan Carlen.
 Labels: (Owned) Hendrix Music, Pike Music, Saffir; (licensed) CMH (USA), Casino (Canada), Change (Canada), Laser (Australia), Third World (UK).
 Int'l reps.: Australia (Laser), Canada (Change), USA (Cherry).

Scandinavian Blues Ass'n, Talkkrogsvaegen 8, S-122 33 Enskede. Tel: (08) 59-54-43. Pres. Joergen Sandin (Distributed by Amigo).
 Label: (Owned) Jefferson.
 Int'l rep.: Worldwide (Amigo in Sweden).
 Scandinavian Music Dist'n AB, PO Box 6084, Prostgatan 2, S-200 11 Malmö. Tel: (040) 23-90-60, 23-90-70 Telex 32181. Pres.: Christer Gardsby; Sales Mgr. Mats Bodestedt; A&R Ronnie Klinteberg.
 Labels: (Owned) Mudist, YTF, (licensed) SWS (Sweden, USA); (distributed—not licensed) Coop-Climc (Sweden), EMI/Capitol (Sweden, UK, USA), Pickwick Int'l (USA).
 Int'l rep.: USA (SWS).
 Scan-Disc, see Sonet.
 Scratia Grammofon, PO Box 2037, Haesaengsvaegen 3, S-691 02 Karlskoga. Tel: (0586) 534-49. Mng. Dir. Ebbe Nilsson, Gen. Mgr. Per Nilsson; Sales Mgr. Sten Nilsson; Studio Mgr. Ake Svensson (Distributed by EMI).
 Labels: (Owned) Boogie, Galaxy, Scratia.
 Int'l reps.: Denmark (Sun), Norway (EMI).
 Seraphim, see EMI.
 ShuShu, see KB.
 Sidwalk, see EMI.
 Sidspar, see Sonet.
 Signatur, see Svenska Missionsforbundets & Mariann.
 Sirius, see Svenska Missionsforbundets & Mariann.
 Skandinavisk Musikförlag, Sandbackegatan 4, S-116 21 Stockholm. Tel: (08) 43-88-85.
 Labels: (Owned) Bourre, Gavotte.
 Smash, see Phonogram.
 Smile Recs., Storgatan 39, S-211 42 Malmö. Tel: (040) 97-60-62. Telex 33290. Mng. Dir. Lars Hansson, Gen. Mgr. Susanne Lind.
 Int'l branch: England.
 Labels: (Owned) Smile, (distributed—not licensed) BBC (UK), Peerless (UK), Schwann (Germany).
 Smokestack Rec. Sales, PO Box 29005, S-100 52 Stockholm. Tel: (08) 62-77-22. Mgrs. Hans Schweitz, Hans Andreasson. (Distributor/Importer/Exporter).
 Labels: (Distributed—not licensed) Blues Connoisseur (USA), Bluesmaker (Australia), Flashback (USA), Flyright (UK), Herwin (USA), Magpie (UK), Marmish (USA), Messaround (USA), Red Lightnitr' (UK), Trix (USA).
 Snap, see Strike.
 Snurr, see WEA Metronome.
 Solist, see Svenska Missionsforbundets & Mariann.
 Sonata, see Phonogram.
 Sonet Grammofon AB (IFPI), Atlasvaegen 1, S-181 20 Lidköping. Tel: (08) 767-0150. Cable SONETMUSIC. Telex 10037. Pres. Gunnar Bergstrom, Gen. Mgr. Dag Haeggqvist; Dir.: Sven Lindholm; PR Mgr. Lars-Olof Helen.
 Int'l branch: England.
 Labels: (Owned) Cirkus, Europa-Film, Fjedur, Flop, Gazel, Grammotonverket, Grand Prix, Knappupp, Ljudspar, Midnight Sun, Scan-Disc, Sidspar, Sonet, Spotlight, Storyville; (distributed) Frida, Splash (UK), Tylon, Vanity Fair; (licensed) Abra Cadabra (Denmark), Air (UK), Alligator (USA), Arhoolie (USA), Berserky (USA), Black Lion (UK), Blue Goose (USA), Blues Classics (USA), Bradley's (UK), Bronze (UK), Caroline (UK), Chiswick (UK), Chrystal (USA), Collectors Classics (Denmark), Criminal (UK), Cube (UK), Dawn (UK), Electric (UK), Elite (Switzerland), Excello (USA), Exlibris (Denmark), Flora (Norway), Flower (Norway), Flying Fish (USA), Freedom (UK), Front Line (UK), GNP Crescendo (USA), Golden Hour (UK), Gryphon (USA), Island (UK), JCOA (USA), Jazz Piano (Denmark), Jazz Unlimited (Denmark), Kicking Mule (USA), Medley (Denmark), Muse (USA), Nashboro (USA), Old Timey (USA), Oval (UK), Plantation (USA), Pye (UK), Red Star (USA), Rockhouse (Netherlands), Rough Trade (UK), Roulette (USA), Rounder (USA), SSS Int'l (USA), Safari (UK), Savoy (USA), Shanachie (USA), Specialty (USA), Speedball (UK), Starbox (Denmark), Stiff (USA), Sun (USA), Takoma (USA), Transatlantic (UK), Triola (Norway), Vanguard (USA), Virgin (UK), Xtra (UK), Yazoo (USA), Zarepta (Norway).
 Int'l reps.: Denmark (Sonet/Dansk), Finland (Scandia), Norway (Arne Bendiksen).
 Sonora, see Phonogram.
 Sound of Scandinavia & Rec'g AB (IFPI), PO Box 1108, Storaengsvaegen 22, S-141 23 Huddinge. Tel: (08) 774-0780. Cable SOSREC. Telex 12601. Pres. Leif Bigert, Mktg Mgr. Jan Bjørkerlund, Special Prods. Sales Mgr.: Bo Olander.
 Labels: (Owned) Moondisc, SOS, T-bone, (licensed) Butterfly (USA); (distributed—not licensed) Attack (UK), B&C (UK), Dragon (UK), Eurodisc (Germany), GDK (Sweden), Goldisc (Finland), Horse (UK), M&T (Finland), Maritim (Germany), Melodia Classic (Germany), Mooncrest (UK), Triola (Norway), Trojan (UK).
 Int'l reps.: Finland (PSO), Norway (Skandinavisk Artist). (SEE ADVERTISEMENT).
 Souvenir, see EMI.
 Space Recs. AB, PO Box 40103, S-103 43 Stockholm. Tel: (08) 21-22-28. Telex 13161. Sales Mgr. A. Hassbrink (Licensed to W-Sign).
 Spotlight, see Sonet.
 Starline, see EMI.
 Stateside, see EMI.
 Storyville Recs. AB (IFPI), Atlasvaegen 1, S-181 20 Lidköping. Tel: (08) 767-0150. Cable SONETMUSIC. Stockholm. Telex 10037. Mng. Dir.: Dag Haeggqvist; Dir.: Karl-Emil Knudsen (Also see Sonet).
 Int'l reps.: Canada (Moss), Denmark (Sonet), Finland (Scandia), France (Musidisc), Germany (Teldec), Japan (Teichiku), Netherlands (Sound Prods.), Norway (Arne Bendiksen), Spain (Discophon), USA (Moss).
 Strike of Sweden AB, Karlsbodavagen 14, S-161 70 Bromma. Tel: (08) 98-51-70. Telex 13366. Chief Exec. Leif Malmberg; Gen. Mgr. Lars Holm.
 Int'l branch: Denmark.
 Labels: (Owned) Globe, Snap, Strike.
 Sunrise, see California.
 Super-Sound, see Record Trading.

Svenska Ljud, see Phonogram.
 Svenska Missionsforbundets Forlag, PO Box 6302, Tegnergatan 8, S-113 81 Stockholm. Tel: (08) 15-18-30
Labels: (Owned) Signatur, Sirius, Solist
 Sveriges Radio AB (Swedish Broadcasting Corp.), Oxenstiernsgatan 20, S-105 10 Stockholm Tel: (08) 784-00-00. Cable BROADCAST STHLM. Dir.: Oerjan Wallqvist, Gen Mgr Allan B. Janzon. (Distributed by EMI)
Label: (Owned) SR
Int'l reps.: Denmark (EMI), France (Pathe Marconi EMI), Germany (EMI Electrola), Norway (EMI), UK (EMI), USA (Musical Heritage Society)
 Swecord Recs. AB, PO Box 347, Gamla Brogatan 32, S-101 24 Stockholm Tel: (08) 21-67-69. Telex 12481
 Owner Wolfgang Jedliczka (Importer/Exporter)
Labels: (Owned) Blitz; (licensed) Skydog (France); (distributed—not licensed) Brain, Sky (both Germany); (represented) Texas Re-Cord (USA).
 Swede, see California.
 Sweden, see California.
 Swedisc AB, Rasundavagen 106, S-171 37 Solna. Tel: (08) 83-33-78. Pres.: Roland Feinberg.
 Swedish Society Discofil, see Electra
 Swerco AB, Fack, S-121 06 Johanneshov 6. Tel: (08) 39-32-00. Cable SWEGRAMO. (Distributor/Importer)
 T A X, see Amigo.
 T B S Recs., Luetzengatan 12, S-115 23 Stockholm. Tel: (08) 62-01-79, 62-01-09. Pres. C.G. Lagenskoeld, Mktg. Dir. Ulf Zwedberg. (Importer/Exporter)
 T-bone, see Sound of Scandinavia.
 Tab Recs., PO Box 210, S-732 00 Arboga Tel: (0589) 103-50. Gen. Mgr. Harry Holm.
 Talsman, see EMI
 Tandans, see Attack
 Tape-Center AB, PO Box 7202, S-103 84 Stockholm Tel: (08) 10-83-38. Gen. Mgr.: Carsten Meijer
 Team, see Amigo
 Telestar, see Electra
 Ters, see EMI
 Tip, see Polydor
 Torenco Automotfabrik AB, Erstgatan 29, Stockholm Tel: (08) 41-66-99/31-42. (Distributor)
 Tor Grammolon AB, PO Box 40, S-360 71 Noteback Tel: (0474) 409-02
 Tower, see EMI
 Tyfon, see Sonet.
 Tyfon Recs., PO Box 7045, S-161 07 Bromma. Tel: (08) 87-93-75
 Vanity Fair, see Sonet.
 Vertigo, see Phonogram
 Verve, see Polydor.
 Viking, see Electra.
 W E A Metronome Recs. AB (IFPI), Storaengsvaegen 27, S-115 34 Stockholm. Tel: (08) 61-06-16. Cable METROREC Telex: 19022. Mng Dirs Boerje Ekberg, Anders Burman.
Labels: (Owned) Asylum, Atco, Atlantic, Cotillion, Elektra, Gump, Mall wax, Metronome, Nonesuch, Reprise, Snurr, Warner Bros. (licensed foreign)
 Bearsville, Big Tree, C.T.I., Curtom, Dark Horse, DiscReet, Embryo, Finnadar, Little David, Nemperor, Paradise, Planet, RFC, Rolling Stones, Scotti Brothers, Swan Song, WMOT, Whitfield, Wing & A Prayer (all USA).
 W M P, see California
 W-Sign Mktg. AB, Pontonjaergatan 32, S-112 37 Stockholm. Tel: (08) 51-39-73. Telex 13161. Chief Exec C Wendel
Labels: (Owned) DJ Special, Phonograph; (licensed) Space; (distributed) cut-outs & overstocks
Int'l rep.: USA (JRB)
 Warner Bros., see WEA Metronome
 Waverley, see EMI.
 Wigwam, see Lilla Huset
 Y T F, see Bastun & Scandinavian Music Dist'n
 Zeaphone, see Mariann.

● music publishers

Acclaim Music Inc., see Sweden Music—Palace.
 Ahlins Musikforlag, see Sweden Music
 Air Music Scandinavia AB, PO Box 27234, Oxenstiernsgatan 37, S-102 53 Stockholm Tel: (08) 63-07-20. Telex: 12335. Pres. Sture Borgedahl; Gen. Mgr. Lars Wiggman
Int'l firms represented: ATV (USA), Air (UK), Air & Graces (UK), J. Albert & Son (Australia), Ian Anderson (UK), Andustin (USA), Antisia (USA), Barn (UK), Earl Barton (USA), Bay City (UK), Beautiful Sunday (UK), Big Bang (USA), Big Secret (UK), Big Sky (USA), Black Coffee (USA), Black Sheep (UK), Blanedel (UK), Blendingwell (USA), Blue Beard (UK), Blue Seas/ Jac (USA), Brown Sound (USA), Caesar (UK), Callee (USA), Cam-al (UK), Alan Cartee (USA), Ronald Carter (USA), C'est (USA), Cheap Thrills (USA), Cherry Lane (USA), Chicken Key (USA), Chrys-A-Lee (UK), Chrysalis (UK), Claire (UK), Cladalee (USA), Cod (UK), Combine (USA), Comet (UK), Core (Canada), Cram Renruff (USA), Cuckoo (UK), Curtis/ Perkins (UK), Danor (USA), Dayn (UK), Dirty Tricks (UK), Dwarf (USA), ERP (UK), Earmark (USA), Eaton (UK), Fast Western (UK), Fennario (USA), Fiction (USA), Fiddler (UK), 57th Street Entertainment (USA), Firesign (UK), Fourth Floor (USA), Frank & Nancy (USA), Freshwater (UK), Ganga (USA), Gannet (UK), Gem (UK), Genesis (UK), Golden Syrup (USA), Grade & Lynton (UK), Grasshopper (USA), Great Honesty (USA), Gull Songs (UK), Harrisongs (USA), Andrew Heath (UK), Heavy (USA), Hightree (USA), Tony Hiller (UK), Hobbitor (USA), Horse Hairs (USA), Hush (UK), Indian Brande (UK), J&H (USA), Jobete (USA), Johi (USA), Jolly Cheeks (USA), Juniper (UK), Kamakazi (USA), Kidada (USA), Knee Trembler (USA), Knollwood (USA), Koopelman-Bandier (USA), Ladysmith (UK), Lambert & Potter (USA), Light (USA), Little Dickens (USA), Lornhol (USA), Lucky Three (USA), Lunch (USA), Macaulay (UK), Macver Hine (UK), Maison Rouge (UK), Mandina (USA), Mary Beth (USA), Barry Mason (UK), Maotglade (UK), McCartney (UK), Metal Machine

(USA), Micache (USA), Modo-Revolution (USA), Montunes (USA), Music Mill (USA), Musicways (USA), Naked Snake (USA), New Acme (UK), New Hidden Valley (USA), Northern Songs (UK), Notebest (UK), Oakfield Ave (USA), Ohio River Valley Songs (USA), Ozone/Paddlewheel (USA), PRP (UK), Page Full of Hits (UK), Pants Down (USA), Peterman (UK), Petra (USA), Plurb On (USA), Poco (USA), Prophecy (USA) Public Domain Foundation (USA), Quarry (UK), Quartet (UK), Quatermass (UK), Ram's Horn (USA), Resaca (USA), Rocket (UK), Rootyarn (UK), Rosebridge (USA), Ryerson (USA), SWS (USA), Sailor (USA), St. Anne's (UK), Saints (Australia), Salsoul (USA), Shoe Shine (UK), Silver Cloud (UK), Small Faces (UK), Songbirds of Paradise (USA), Sorn (USA), Space Opera (USA), Spaniel (UK), Sparrowpit (UK), State (UK), Steeleye Span (UK), Sterling (UK), Stevka (UK), Stirling McQueen (UK), Stone Diamond (USA), Strange (UK), Stratsong (UK), Strawberry (USA), Street People Songs (USA), Strong Arm (USA), Sunlight (USA), Sunshine (UK), Synergistic (USA), Tessa (USA), Thursday (USA), Tintagl (USA), Titanic (UK), Tone (UK), Toneshire (UK), Train (UK), Tres Jolie (USA), Triangle (USA), Tumbleweed (Australia), Valentine (UK), Wax (USA), R.P. Winkelman Tunes (USA), Wobble (UK), Yaronne (USA).

American Songs AB, see Intersong-Foerlagen.
 Amigo Musik AB, PO Box 6058, Norra Stationsgatan 91-93, S-102 31 Stockholm 6 Tel: (08) 34-01-95 Telex: 17840. Pres. Jan Boquist.
 April Music AB, PO Box 20037, Mariehallsvagen 40, S-161 20 Bromma. Tel: (08) 98-02-50. Cable COLRECORD Telex (854) 17736 Publ'g Mgr. Rolf Persson
Int'l rep.: Worldwide (April)
 Athens Music, see Sweden Music—Ivan Mogull
 Aubergine Music, see Mustang.
 Belinda (Scandinavia) AB, see Intersong-Foerlagen.
 Belwin-Mills Nordiska AB, see Ehrlingforlagen.
 Blitz Publ'g, PO Box 347, Gamla Brogatan 32, S-101 24 Stockholm Tel: (08) 21-67-69. Telex 12481 Mgr.: Wolfgang Jedliczka.
 Bocephus Music, see Sweden Music—Palace
 Bohus Music, PO Box 274, S-442 01 Kungaev. Tel: (0303) 109-90, 157-00 Gen. Mgr. Gert Lengstrand
 Brut Music (USA), see Sweden Music—Sugarmusic.
 Burlington Music Co., see Sweden Music—Palace.
 Hans Busch Musikforlag AB, Stubbstigen 3, S-181 46 Lindgoe Tel: (08) 765-1230
 J. F. Busch's Musikverlag (Der Musikus), see Hans Busch.
 C A M Scandinavia AB, Wibomsvaeg 7 BV, S-171 60 Solna. Tel: 82-44-01. Telex: 21411. Mng Dir. Gunnar Gunnrup
Home office: Italy
Int'l firms represented: CAM (Australia, Japan, Spain), Campana, Pema
 Camp Music Corp. AB, Jaervnaegsgatan 70, S-172 35 Sundryberg. Tel: (08) 98-28-08/55. Exec Lars Samuelson.
Int'l firm represented: Jump (Italy)
 Cedarwood (Scandinavia) AB, see Intersong-Foerlagen.
 Champion Music Corp., see Sweden Music—MCA
 Chappell Nordiska AB, see Intersong-Foerlagen.
 Cintercor Music, see Sweden Music—MCA
 Con Brio Music, see Sweden Music—Palace
 Concorde Music, see Sweden Music—Palace
 Duchess Music Corp., see Sweden Music—MCA
 E M A/Telstar AB, see Sonet.
 E M I Music Publ'g (Sweden) AB, Ynglingagatan 17, S-113 47 Stockholm Tel: (08) 23-66-80. Cable: TURNTABLE Telex 12587 Mng Dir Bengt Sundstom; Prof Mgr.: Tommy Hallden.
Int'l branch: Denmark
Int'l firms represented: Accord (Germany), Aiadin (USA), Algee (USA), Ambleside (UK), Ardmore & Beechwood (Belgium, Mexico, South Africa, UK), Ashtar (USA), Avant Garde (USA), Beechwood (Canada, USA), Belcas (New Zealand), Belwin-Mills (UK), Big Ben (UK), Big Pig (UK), Black Swan (UK), Blendingwell (USA), Blue Horizon (USA), Bowling Green (UK), Britten (UK), Buddha (USA), Kate Bush (UK), Cable Car (USA), Johnny Carter (UK), Johnny Cash (USA), Castle (Australia), Central Songs (USA), Champs-Elysees (France), Chanklin (UK), Charsy (USA), Chu Fin (USA), Colgems (USA), Columbia (Austria), Commodore (USA), Conquistador (USA), Coppa (UK), Coronado (UK), Cross Keys (USA), Francis Day & Hunter (France, Germany, Scandinavia, UK), Dean Street (UK), Deep Fork (USA), Dobo (USA), Dominion (USA), Donna (UK), Double R (USA), Dreamers (UK), EGO (Spain), EMI (Greece, Netherlands, Southeast Asia, Switzerland, UK), EMI-Brigadiers (South Africa), Easy Listening (USA), Elstree (UK), Episode (UK), Equator (UK), Family of Man (USA), Leo Feist (USA), B Feldman (UK), Ferris (UK), First Floor (UK), Sam Fox (UK), Gaetana (USA), Gallagher & Lyle (UK), Galleon (USA), Al Gallico (USA), Genius (USA), Giant (USA), Glasco (USA), Glenwood (USA), Golden Torch (USA), Gold Horizon (USA), Good Time (USA), Grand Canyon (USA), Groovesville (USA), Har Bock (USA), Hastings (USA), Heart's Delight (USA), Hec (UK), Neal Hefti (USA), Hip Trip (USA), Homecoming (USA), House of Cash (USA), How About (UK), Immediate (UK), Initial (UK), Interior (USA), Itaipu (Brazil), Jet (USA), KPM group (UK), Bert Kaempfert (USA), Kama Rippa (USA), Kama Sutra (UK, USA), Kennedy Street (UK), Kentree (USA), Kipahulu (UK), Kipper Songs (UK), Koppelman-Rubin (USA), Lonzo & Oscar (USA), MAI (Argentina), Mabrak (UK), Macmelodies (UK), Makamillion (USA), Makarint (USA), Man (UK), Manhattan (UK), Marchar (UK), Marouani (France), Martin Cooper (USA), Metric (USA), Metromedia (UK), Miles (UK), Miller (USA), Mmta (USA), Mortimer (UK), Mutual (UK), Mysongs (UK), Neverbreak (USA), New York Times (USA), Nightingale (UK), Obie (USA), Odeon (Argentina), Open Door (USA), Parasound (USA), Pathe (Far East), Pathe Marconi (France), Pedro (UK), Pepe (UK), Petal (UK), Post (USA), Powder (USA), Press (USA), Prima Donna (USA), Keith Prowse (UK), Queen (UK), Reynolds (UK), Robbins (UK, USA), Tom Robinson (UK), Rock Steady (USA), Rolling Stones (UK), Roosevelt (USA), Ruler (USA), Saffron

(UK), Sahara (UK), Sanah (UK), Sand B (USA), Sansu (USA), Saturday (USA), Savoy (USA), Sawgrass (USA), Scratchwood (UK), Screen Gems (UK, USA), Cyril Shane (UK), Shanfidd (UK), Shanklin (UK), Sheldon (UK, USA), Sochem (Chile), Solar Plexus (USA), Southtown (USA), Spectrum VII (USA), Stairway (USA), Stallion (USA), Sugartown (UK), Summerhill (USA), Summertree (USA), Sunbeam (USA), Sunlight (UK), Supersongs (UK), Survivor (USA), Tata Grande (USA), Telescope (UK), Tempo (USA), Tip Top (UK), Tomcat (USA), Tomorrows Tunes (USA), Too Rock (USA), Toshiba-EMI (Japan), Travis (USA), Tree (USA), Trident (UK), Triba (UK), Twitty Bird (USA), Conway Twitty (USA), Unart (USA), Uncanny (USA), United Artists (France, Germany, UK, USA), Univista (UK), Valentim de Carvalho (Portugal), Varda (UK), Vassar's (USA), Voce del Padrone (Italy), W&R (UK), Warhawk (USA), Larry Weiss (UK), West Coast (USA), Willow Way (USA), Bobby Womack (USA), World Wide (UK).

Int'l reps.: Argentina (MAI), Australia (Castle), Austria (Columbia), Belgium (Ardmore & Beechwood), Brazil (ITAIPU), Canada (Beechwood), Chile (Sochem), Far East (Pathe), France (Francis Day & Hunter, Pathe Marconi), Germany (Accord, Francis Day & Hunter), Greece (EMI), Hong Kong (EMI), Italy (Voce del Padrone), Japan (Toshiba-EMI), Mexico (Beechwood), Netherlands (EMI), New Zealand (Belcas), South Africa (Ardmore & Beechwood), Spain (EGO), Switzerland (EMI), UK (EMI), USA (Beechwood).

Hans Edler Music AB, Parmmaertargatan 9, S-112 24 Stockholm. Tel: (08) 52-31-00 Telex: 10625. Pres.: Hans Edler.

Elthae Publ'g, Storgatan 39, S-211 42 Malmoe. Tel: (040) 97-60-62. Telex: 33290 Chief Exec.: Lars Hansson; Gen. Mgr. Susanne Lind

Int'l reps.: Germany (Schwann), UK (Buk/Honeybee, Coomb), USA (Muscle Shoals).

Ehrlingforlagen AB, PO Box 5268, Linnegatan 9/11, S-102 45 Stockholm. Tel: (08) 63-07-60. Cable: EHRLINGMUSIK. Pres. Thore Ehrling; Gen. Mgr.: Staffan Ehrling; Professional Mgr.: Bo-Goran Edling.

Ehrling & Lovenheim AB, see Nordiska.
 Thore Ehrling Music AB, see Ehrlingforlagen.

Elbomo Music, see Sweden Music—Ivan Mogull

Ere Music, see Sweden Music—MCA.

Essex AB (Musikforlaget) (STIM), PO Box 27234, S-102 53 Stockholm. Tel: (08) 63-07-20. Cable: AIRMUSIC. Telex: 12335. Pres. & Gen. Mgr.: Sture Borgedahl.

Int'l firms represented: Essex group (UK), TRO (USA).

Int'l reps.: UK (Essex), USA (TRO).

Evita Music, see Sweden Music—MCA.

Felsted Music Corp., see Sweden Music—Palace.

Filadelfia Foerlaget AB (STIM/NCB), Dagenhuset, S-105 36 Stockholm. Tel: (08) 13-03-40. Pres.: Sverre Larsson; Gen. Mgr.: Larseric Jonson.

Int'l branch: Norway.

Int'l firms represented: Manna, Maranatha (both USA).

Lenco moulding

The swiss quality



Lenco-Moulding SA

ru de l'Industrie
 CH-1781 Courtaman
 tél. 037 34 19 15

Flames of Albion Music, see Sweden Music—MCA
 Flamingo Music Publ'g AB, c/o Air Music, Oxenstiernsgatan 37, S-102 53 Stockholm. Tel (08) 63-07-20. Pres. Sture Borgedal, Gen. Mgr. Roland Ferneberg.
Int'l firm represented: Nippon Flamingo (Japan).
Int'l rep.: Japan (Nippon Flamingo)
 Flam Music, see EMI.
 Fontaine Music Corp., see Sweden Music—MCA.
 Four Star Music group, see Sweden Music—Palace.
 Futuna Produktion AB (STIM), Vaeravaggen 15, S-115 28 Stockholm. Tel (08) 63-13-45 Telex 12328. Pres. Goeran Walther, Gen. Mgr. Claes af Geijerstam
 G-Produktion, Passvaegen 7, S-147 00 Tumba. Tel (0753) 349-56
 Gavotte Music, c/o Skandinavisk Musiktjanst, Sandbacksgatan 4, S-116 21 Stockholm. Tel (08) 43-88-85
 Carl Gehрман, PO Box 505, S-101 26 Stockholm. Tel (08) 10-30-04. Cable: MUSIKGEHRMAN.
 Getra Music Inc., see Sweden Music—MCA.
 Glensang AB, Vallvagen 2, S-182 75 Stockund. Tel (08) 85-68-00
Int'l rep.: Worldwide (April).
 Goal Music, see Sweden Music—MCA.
 Gredge Music, see Sweden Music—MCA.
 Groovesville/Conquistador, see EMI—Screen Gems-EMI.
 Wilhelm Hansen Stockholm (Ed.), see Nordiska.
 Hargrove Music, see Sweden Music—Ivan Mogull.
 Hawaii Music Inc., see Sweden Music—MCA.
 Hendrix Musikforlag, see Safir.
 Intersong-Foerlagen AB, PO Box 3094, Dalvagen 4, S-171 03 Solna. Tel (08) 83-08-90 Cable: SONORA Telex 12383. Pres.: Olle Bergman; Professional Mgr.: Sten Petri.
Int'l firms represented: American Songs—Allied, Arc, Conrad, Downey, East West, English, Ghana, Gladstone, Green Bros & Knight, Harman, Hot Point, Jewel, Lyco, Robert Lyons, Merrimac, Ralston, Red Seal, Regent, Reico, Sunflower. **Belinda**—Aberbach group, Ashree Holdings, Blue Gum, Buddha, Carlin group, Elvis, Hudson Bay, Jeff Lynne, Kama Ripka, Kama Sutra, Peterman, Pickwick, Quartet, Sweet, Trio, US Songs, White Haven, Xanadu Xongs, Yellow Dog. **Chappell**—A&R, Aznavour, Antique, Ascherberg Hopwood & Crew, Anzavour, BDM, Irving Berlin, Boston Butler, Bregman Vocco & Conn, Bundin, Canadiana, Charisma, Clara, Clondyke, Cortab, Cosmic Echoes, D&J Arlon, Dobbins, Diplomat, EFDs, Early Morning Prod'n, Ensign, Era, Erle, Famous Finger, Gershwin, Halmel, Charles Hansen, T.B. Harms, Honky Tonk, Hummit Ironside, Ivanhoe, J.P. Julie, Kaiser, Kander & Ebb, Ken-Glen, Keyboard Pendulum, Kiss Songs, Michel LeGrand, MRC, Magic Mouth, Music Machine, Leeds, Omar, Para-Thumb, Pillow, Pilot, Pippin the Friendly Ranger, Please, Promoco, Red Anchor, Revelation, Rhineland, Road, Saggifire, Douglas Sahm, Sarah, Scotia Songs, Shari, Subiddu, Tebo, Thank You, Think Big, Tom Tom, Top Hat, Unichappell, Universal Songs, Wardo, Williamson.
Intersong—Abigail, Ajay, Albet, Argus, Balloon, Bear Brown, John Beland, Big Apple, Big Seven, Stephen Bishop, Bizarre, Blue Disque, Bob-Cor, Boomtown Rats, Bovina, Brain Drain, Breeze, Brightwater, Broken Arrow, Bushka, Bygosh, CAM, Caesar's, Callee, Canopy, Cape Ann, Caribou, Caseyem, Caspat, Cedarwood, Celestial, Charlotte, Chicago, Clarkee, Stanley Clarke, Clifone, Common Good, Contagious, Coral Rock, Crazy Cow, Crited, Mike Curb, Daksel, Damont, Diagonal, Dijon, Dog Soldier, Donna, Double Exposure, Dough Boy, Down Town, Dreatleaf, Francis Dreyfus, Dwarf, Betty Earland, Eldorado, Elliscan, Eric, Every Little Tune, Fabul, Fairfield Fifth Floor, Fifth Star, Flat Lizard, Fleadleedle, Fleetwood Mac, Four Knights, Frozen Nose, Fuse, Peter Gabriel, Ganja, Gentoo, Getaway, Gibb Bros., Gnossons, Gone Fishing, Good Morning, Richard Gotteher & Jiru, Guys 'N' Dolls, Hamilton, Hands Together, Hanseatic, Happy, Harbar, Hardcore, Harlene, Heavy Metal, Hensley, Herold Square, High Class, Hillard, Hit & Run, Hustlers, Iza, Irod, Intersong Int'l, Intersong Ltd., Intersong USA, Jam, Jimpire, Jiru, Justin Case, Kaskat, Kenya, Kings Point, Kolob, Kongrnde, Kurlay, Laurel Canyon, Leo Leandro, Leross, Litha, Little Fugitive, Little Lasso, Lois, Lollipop & Lambda, Lucky, Magnet, Marks, Martin-Coulter, Matragun, Maybe, Mews, Michael, Midland, Midsong, Milk Money, Milmarsch, Joni Mitchell, Mobbetta, Montagu, Moonhill, Gayle Moran group, Nelson, New Sound, New York Times, Nineteen Eighty Foe, NoHem, Noodle Tunes, Normal, Omnipotent, Open End, Oyster, Pal Dog, Norrie Paramor, Angel Parker, Graham Parker, Peyott, Phonopub, Piedmont, Pinson, Pit, Pocket Full of Tunes, Poite, Polypub, Progressive, Quark, Quick Mix, RSD, Rare Blue/Monster Island, Peter Rice, Ricochet, Rock, Rockfish, Rockhopper, Rodra-Berna, Roosevelt, Ru-Da, St George, Samba, Samos, Seabreeze, Seagrave, Shukster, Silver Challice, Silver Fiddle, Siquomb, Sky Forest, Sky Harbor, Snug, Song, Soquel, Bruce Springsteen, Street, Strobe Light, Studio PR, Sunbeam, TH, Taurip Tunes, Tembo, Thalian, Third Story, Timtobe, Time/Redwal, Times Square, Toneshire, Top of the Town, Torbain, Trane, Triple Three, Tunessmith, UFO, Valando, Wednesday Morning, Welsh Witch, White Oak, Windecor, Winds & Dragons, Zevon; **Dick James**—Alto, Ammo-James, Argee, Bailey, Casanova, Cookaway, Edward Cox, Crest, Crystal, Spencer Davis, Debonaire, Dee Mac, Dee Tee, Filmusic, Golden Egg, Grallo, Gwyneth, Intune, Jamsham, Josid, Lords, Love Songs, Maribus, Medallion, Nuova, Pall Mall, Santa Ponsa, Shair, Tic Toc, Together, Tudor, Uptopia, Vri-Jon, Wonder, Zoom; **Mellin Musical Rights**—Algonquin, Anglia Television, Ansur, Big Leaf, Big Tree, Blackberry, Franklyn Boyd, Crow, Elmwin, Flying D, Franco-London, Great North American, Great Sterling, In-Sync, Lloyd Logan, Mellin Corp., Robert Mellin, Music Makers, Ed Neapolis, Pamco, Penthouse, Popo, Pumpkin, Rosnique, Sherwin, Trans Gulf—E.H. Morris—Anvil, Arden, BNP, Big B, Big H, Big L, Burke & Van Heusen, Country, Degar, Donna, Gear, Guard, Hall of Fame, Harlene, Harwin, Holly-Vine, Hulla-Balloo, Meridian, Edwin H.

Morris, Motion Picture, New Christy, Patricia, Quail, Don Robertson, Rondell, South Mountain, Sparrow, Thunderbird, Harry von Tilzer, Warman, Wren
 Intreco AB, see Sonet.
 Dick James Music AB, see Intersong-Foerlagen
 Jec Music Corp., see Sweden Music—Palace
 John's Music, see Sonet
 Johnsgons, see Sweden Music—MCA
 Justunes, see Sweden Music—MCA
 Key Music Prod'n, PO Box 2037, S-691 02 Karlskoga Tel (0586) 392-80 Mng. Dir. Per Nilsson.
Int'l firm represented: Sun (Denmark)
 Don Kirshner (Scandinavia) AB, see Sweden Music
 Kountry Korral Prod'ns, PO Box 8014, S-720 08 Vasteras 8 Tel (021) 18-86-20/90. Pres. Lillies Ohlsson
 Lappland Music, see Sonet
 Leeds Music Corp., see Sweden Music—MCA
 Leeds Music Ltd., see Sweden Music—MCA
 Liberty AB (Ed.), PO Box 1178, Ankdamsgatan 5, S-171 23 Solna. Tel (08) 82-04-80 Cable: ELECTRAGRANNO Telex 19561
Int'l firms represented: Ainos (USA), Dunbar (Canada USA), Erva (USA), Kimlyn (USA), Sunbar (USA), Sunbury (Canada, UK USA)
Int'l rep.: UK (Sunbury)
 Lilla Huset Musikproduktion, Stationsgatan 4, S-827 00 Ljusdal. Tel (0651) 157-00 Chief Exec. Boerje Bergstrom
 Lunapark Ed. Mus. Srl, see Sweden Music—Sugarmusic.
 Abr. Lundquist Musikforlag AB, Katarina Bangata 17, S-116 25 Stockholm. Tel (08) 43-67-67 Cable: LUNDROND. Pres. Helge Roundquist, Sales Mgr. Anders Roundquist.
Int'l rep.: Norway (Musikk-Huset)
 M A M Music AB, see Sweden Music
 M C A Music Svenska AB, see Sweden Music
 Marcus Music-Imudico, Raesundsvaegen 45, S-171 52 Solna. Tel (08) 730-0400 Pres. Marcus Oesterdahl, Gen. Mgr. Bengt Sundstrom
 Melanie Music Ltd., see Sweden Music—MAM
 Mellin Musical Rights AB, see Intersong-Foerlagen
 Robert Mellin (Scandinavia) AB, see Intersong-Foerlagen
 Midnight Sun Music AB, see Sonet
 Mikim Music, see Sweden Music—Palace
 Mimosa Music, see Sonet
 Modern Music AB, see Sweden Music
 Ivan Mogull Music Assocs., see Sweden Music
 Morganstjernans Forlag, see Sweden Music
 Eivind Nordiska AB, see Intersong-Foerlagen
 Multitone AB, Storaengsvaegen 27, S-115 34 Stockholm. Tel (08) 61-13-16 Cable: METROREC Telex 19022 Pres. Boerje Ekberg, Gen. Mgr. Sven-Olov Bagge
Int'l firms represented: Char-Liz, Fox-Gimble, Giving Room/Thin Ice, Gold Hill, Guerilla/Staysail, March Hare, No Exit, Rear Exit, Story Songs, Three Brothers, Artie Wayne (all USA); Fleetwood (UK).
Musikatnet Waxholm AB (MNW) Fax: S-185 00 Vaxholm Tel (0764) 323-45
 Mustang Music AB, Vikingagatan 22, S-113 42 Stockholm Tel (08) 32-36-00 Pres. Ove Hansson
Branch: S-411 29 Goateborg, Landalaberg 20, Tel (031) 16-26-90
 Natural Avenue Music, see Sweden Music—MCA
 Nils-Georgs Musikforlags AB, see Ehringforlagen
 Ninandy Music Co., see Sweden Music—Ivan Mogull
 Nordic Songs AB, PO Box 745, Drottninggatan 37, S-101 30 Stockholm 1. Tel (08) 24-94-30 Cable: MUSICALIA Telex 11859 Pres. Bengt Edwardsson, Prof. Mgr. Tony Lonn
Int'l firms represented: Average (USA), Barton (UK), Far Out (USA), Sparta Florida group (UK)
Int'l reps.: Denmark (Wilhelm Hansen), Norway (Norsk)
 Nordiska Musikforlaget AB, PO Box 745, Drottninggatan 37, S-101 30 Stockholm 1. Tel (08) 24-94-30 Cable: MUSICALIA Telex 11859 Pres. Bengt Edwardsson, Prof. Mgr. Tony Lonn
Int'l firms represented: J & W Chester (UK), Wilhelm Hansen (Denmark), Impala (France), Nicky James (UK), Montparnasse 2000 (France), Norsk (Norway), Selected Sound (Germany), Hans Sikorski (Germany), Union (Spain), Walton (USA), Wilhelmiana (Germany)
Int'l reps.: Denmark (Wilhelm Hansen), Germany (Wilhelmiana), Norway (Norsk), UK (J & W Chester), USA (Alexander Broude, Magna, G Schirmer, Walton)
 Normans Forlag (STIM/NCB), see Filadelfia
 Northern Music Corp., see Sweden Music—MCA
 Notservice AB, see Intersong-Foerlagen
 Open Road Music, see Sweden Music—Palace
 Ozone Music, see Sweden Music—Ivan Mogull
 Palace Music (Sweden) AB, see Sweden Music
 Palace Music Co., see Sweden Music—Palace
 Passkey Music Inc., see Sweden Music—Palace
 Peel, see Sonet
 Pickwick Music Ltd., see Sweden Music—MCA
 Pilot Music AB, Fack. S-171 19 Solna Tel (08) 730-0810 Pres. Kjell Samuelson, Gen. Mgr. Olle Samuelson
Int'l firms represented: John T. Benson, Daystar, Dimension Goldline, Heart Warming Impact Journey, Manna, Rambo, Silverline (all USA)
 Planet Music, Framnaesbacken 12, S-171 42 Solna Tel (08) 93-73-00 Telex 14392 Pres. & Mng. Dir. Mats Olsson
 Platina Musikforlag, St. Arodsagan 29, H. Backa, S-422 43 Gothenburg Tel (031) 52-66-50 Pres. Evert Jakobsson
 Play Music, PO Box 751, S-131 24 Nacka Tel (08) 98-52-50 Mng. Dir. Ake Wilke.
 Polar Music AB, see Sweden Music
 Ramlight Music, see Sweden Music—MCA
 Ranbach Music, see EMI—Screen Gems-EMI
 Red Bus Music (Scandinavia), see Sonet
 Mary Reeves Music, see Sweden Music—Palace
 Reuter & Reuter Forlags AB—Pres. Lennart Reuter-skold, Gen. Mgr. Kerstin Selling—see Sweden Music
 Mae Rich Music, see Sweden Music—MCA
 S B A Music, see Sonet
 Safir Musikforlag, PO Box 228, S-124 02 Bandhagen Tel (08) 99-1191 Gen. Mgr. Stefan Nordin
Int'l firms represented: Bixio (Italy), Casino (Canada),

House of Bryant (USA), Interchange (Canada), Intermusic (Netherlands), MMS (Switzerland), Olofsson (UK), Publicare (USA), Showcase (UK), Silverhill (USA), Sudden Rush (USA)
Int'l reps.: Australia (Laser), Brazil (RGE-Fermata), Canada (Interchange), Germany (Arabella), Italy (Durium), USA (Publicare)
 Scala Musikforlag AB (STIM/NCB), see Sweden Music—Reuter & Reuter
 A Schroeder Musikforlags AB, see Intersong-Foerlagen
 Shaftesbury Music Co. Ltd., see Sweden Music—MAM
 Sole Survivors Music, see Sweden Music—MCA
 Solstice Music, see Sweden Music—MCA
 Sonet Music AB (STIM/NCB), Atlasvaegen 1, S-181 20 Lidingoe. Tel (08) 767-0150 Telex 10037 Gen. Mgr. Dag Haeggqvist; Prof. Mgr. Ola Hakansson
Int'l branches: England, Netherlands
Int'l firms represented: Ackee (USA), Akila (USA), Alcatraz Corner (USA), And Son (UK), Angle (UK), Arabella (UK), Arends (Germany), Arista (USA), Audigram (USA), Bad Boy (USA), Big Game (UK), Blue Mountain (UK), Bron (UK), Canaan, Careers (USA), Carrera (Germany), Charing Cross (USA), Cibell (UK), Coal Miners (USA), Collins (UK), Copper Basin (USA), Deep Purple (UK), DeShufflin (USA), Diamond Touch (USA), Earthly (UK), Emile (USA), Eyeball (USA), Fantasy Songs (UK), Floating (UK), Flying Fish (USA), Food (USA), Ricky Gardiner (UK), Robin Gibb (UK), Ian Gillan (UK), Global (Germany), Glove (UK), Go (UK), Half (UK), Hara-Kiri (UK), John Hartford (USA), Hit Songs (UK), Hoodlog (USA), House of Dreams (UK), Glenn Hughes (UK), Hurriganes (Finland), IGB (UK), Inkwell (UK), Island (UK), USA, JDL (UK), Jayman (UK), Jonan (USA), Joyful Wisdom (USA), Keepers Cottage (UK), Keep on Trucking (UK), Kicking Mule (USA), King Coal (USA), King Street (USA), Lifegrade (UK), Lupus (UK), Mama Gail (UK), Mann (UK), Marklon (UK), McDonald (USA), Modest (USA), Morrison (UK), Mother Goose (UK), Neil (USA), Number 11 (USA), Oakshire (USA), Osibisa (UK), Osibosounds (UK), Owl (UK), Pal (UK), Penelope (UK), Plangent Visions (UK), Porpore (UK), Prince Street (USA), Purple group (UK), Radar (UK), Rafferty Songs (UK), Robertson Brown (UK), Rock (UK), Brian Rothen & Assocs. (USA), SP (UK), Savgos (USA), Scott-Wolfe (UK), Seaford (USA), Seven Brothers (USA), Paul Simon (USA), Skyhill (USA), Skyview (USA), Socks (UK), Sonet (UK), Stainless (USA), Sugar Daddy (USA), Sunbury (UK), Sweet Nana (USA), Tannen (USA), Tarka (USA), Tempest (UK), Toad Hall (UK), Tradition (USA), Two Knight (UK), UFO (USA), Umble Tunes (UK), Vanilla (UK), Venice (USA), Warlock (UK), Wayward (USA), White Line (USA), Winsack (UK), Wishbone (USA), Wizard (USA)
Int'l reps.: Canada (Stainless), France (Louis III), Italy (Tiber), Spain (Ducal), Switzerland (Satin) USA (Stainless)
 Sonora Musikforlags AB, see Intersong-Foerlagen
 Sound Of Scandinavia & Rec'g AB, PO Box 1108, Storaengsvaegen 22, S-141 23 Huddinge Tel (08) 774-0780 Cable: SOSREC Telex 12601 Pres. Leif Bigert (SEE ADVERTISEMENT)
 Southern Music AB (STIM, NCB), Grev Turegatan 38, S-114 38 Stockholm. Tel (08) 67-99-10. Cable: SOUTHMUSIC Mgr. Mrs. D. Sjogren
Home office: USA, Per-Southern Org.
 Spanka Music Ltd., see Sweden Music—MAM
 Starton AB, see April
 Stevenson Music, see Sweden Music—Palace
 Stockholms Musikproduktion, see Sweden Music
 Succemelodier (AB), see Sweden Music
 Sugarmusic (Scandinavia) AB, see Sweden Music
 Sweden Music AB, Baldersgatan 1, Fack. S-100 41 Stockholm 26 Tel (08) 24-59-90 Telex 11959 Pres. & Gen. Mgr. Stig Anderson, Gen. Prof. Mgr. Anders Moren
Int'l firms represented: ATV (UK), Ahab (USA), Alchemical (USA), All Seasons (USA), Andalusian (USA), Ariola America (USA), Arnakata (UK), Bill Black (USA), Blackbyrd (USA), Boca, Raton (USA), Braitre (USA), Briarpatch (USA), Butterfly (Germany), Carlew (UK), Chandos (USA), Chinnichap (UK), Cirrus (Canada), DeByrd (USA), Desert Moon (USA), Doors (USA), Equinox (USA), Everblue (UK), Garrett (USA), Gas Songs (UK), Geoff & Eddie (USA), Golden Withers (USA), Bobby Goldsboro (USA), Gypsy-Boy (USA), St. Clement (USA), Heath Levy (UK, USA), Hillgreen (USA), House of Gold (USA), Hungry Mountain (USA), Interworld (USA), Intro (Germany), Jack & Bill (USA), Jarak (USA), Jasperilla (USA), Kinky (USA), Lady Jane (USA), Lazy Lizard (UK), Louvigny (UK), Love-Zager-Lowery (USA), Lynam (USA), Lyn-Lou (USA), Maplehill (USA), Music Equity (USA), My Mama's (USA), Willie Nelson (USA), Newkeys (USA), New Seasons (USA), Partner (USA), Pennine (UK), Perren Vines (USA), Ben Peters (USA), Pi-Gem (USA), Probovis (USA), Porchester (USA), RAK (UK), Razzle (UK), Remohj (USA), Roadshow (USA), Rondor group (USA), St. Annes (UK), John Sebastian (USA), Shillelagh (USA), Shelby Singleton (USA), Slow Dancing (USA), Sumac (USA), Sylvia's Mother's (USA), Threshold (UK), Tomake (USA), TriSong (USA), US Arabella (USA), Valley (UK), Bruce Welch (UK), Wherefore (USA), Don Williams (USA), Window (USA), Whittsett, Churchill (UK), Wind & Sand (USA), Wishbone (USA), Lawrence Wright (UK), Xavier (USA) **Reuter & Reuter Forlags AB**—Black Bull (USA), Ca, USA, Consolidated (USA), Dorsey Bros (USA), Jack Elliott (USA), Embassy (USA), Evergreen (USA), Hamilton S. Gordon (USA), G Henle (Germany), Lowell (USA), Mecca (USA), Monogram (USA), Prophet (USA), Raw (USA), J. J. Robbins & Sons (USA), G Schirmer (USA), Sentinel (USA), 62 Revue (USA), Stonebridge (USA), Tallyrand (USA), H. B. Webman group (USA), Yankee (USA), Zargon (USA)
Int'l rep.: UK (Bocu)
 Sylvain AB (Ed.), see Ehringforlagen
 Tab Music/Textab Musikforlag, PO Box 210, S-732 00 Arboga Tel (0589) 103-50 Contact Harry Holm
 Target Music AB, Arkitektvaegen 24, Fack. S-161 09 Bromma Tel (08) 80-30-95 Mng. Dir. Tue Stiby, Gen. Mgr. Ragnar Blomstrom

Int'l firms represented: Crabshaw, Siren Sounds (both USA).

Tomeja Music, see Sweden Music—Ivan Mogull.

Tomo's Tunes, see Sweden Music—MCA.

Toniton AB, PO Box 1122, Forradsvagen 10, S-141 23 Huddinge. Tel: (08) 774-0290. Telex: 11260. Mng. Dir. Leif Bigert.

Tuckahoe Music, see Sweden Music—Palace.

Two Beat Music Corp., see Sweden Music—MCA.

Union Songs AB, see Sweden Music.

Universalmusik Forlags AB (STIB/NCB), see Sweden Music—Reuter & Reuter.

Vector Music Corp., see Sweden Music—MCA.

Warner Bros. Music (Scandinavia) AB, PO Box 4082, Hoeglidsvaegen 28, S-182 04 Enebyberg. Tel: (08) 768-7150/4844. Telex 12812. Pres.: Lennart Desmond; Prof. Mgr. Hans Desmond.

Int'l firms represented: Advanced, Carmine Appice, Aria, Athwarn, Atlas, Attraction, Auntie Gravity, Ayton, Baby Monica, Badco, Benchmark, Beverly Hills, Big Bang, Bil-Mar, Blue Jeans, Blue Street, B'O' Cult Songs, Bridgeport, Brown's Mill, Burbank, Burda, Caledonia Soul, Camad, Canasta, Cass County, Castle Hill, Chic, Chi-Sound, Chinmoy, Cinco, David Allan Coe, Companion, Cool Springs, Cotillion, Cricket, Curtom, Darkroom, Devalbo, Dgiga, Diamond Mine, Douglas, Elektra, Ezra, Fleckless, Ferguson, Fingers, First Artists, Four Jays, Freyda, Fry King, Gamble Hinged, Gava Dima, Gear, Golden Spread, Good Friends, Good High, Grand National Songs, Grey Dog, Gringo, Hallway, Harbo, Harms, High Wave, Hippiedayle, Holmes Line, Hombre, Ice Age, Ice Nine, Inherit, Inherit-Todd/Mark, Inner Earth, Jakmax, Jalyne, Jazz Bird, Jump Tunes, Katja, Howard Kenny, Kicking Bear, Kitty Hawk, Klancey, Kru, Kumba, Likely Story, Loma Alto, Longdog, Ludmila, Mansfield, Marsaint, May 12th, Van McCoy, Lonette McKee, Medicine Hat, Mercury Bird, Midnight Hour, Mississippi Mud, Nebraska, New World, Randy Newman, Nino, Niehah, Nina, Nine Star, Nipper, Norway, Oakland, Old Canyon, Open Love, Ordina, Pain-American, Paradox, Peabo, Pepamar, Precedent, Pronto, Pud, Radio, Red Cloud, Remick, Road Canon, Rodart, Rosy, Saloon Songs, Sanctum, Boz Scaggs, Seethalakshmi, Sergeant, Showfor, Shubert, Siesta, Skol, Southfield, Space Songs, Speed, Stone Canyon, Superhype, Sure Enough Tunes, Swallow Turn, Sweet Harmony, Sweet Pea, Taco Tunes, Teatime, Ten Speed, Terra Firma, Tidewater, Tonopah, Topographic, Trampler Devon, Upward Spiral, Vera Cruz, Viva, Walden, Warner Bros., Warner-Seventars, Warner-Tamerlane, Widescreen, Wine 'N' Dine, M. Witmark & Sons, Wow & Flutter, Xamol, Zapata (all USA); AHA, Alted, Anastasia, Autumn, Collins, GH, Glitterbest, Kinney, London Town, Mainspring, Marsam, Moggie, Nineden, PPR, Pendulum, Rare, Riva, Sky, Skylark, Slim Chance, Stutter, Tchaikovsky, Peter Walsh, Warner Bros, Winterfold (all UK); PECF, You You (both France), Klaatoons (Canada), MUZ (Germany), Warner Bros. (Australia, Italy, Netherlands, South Africa).

Int'l reps.: Australia, Italy, Netherlands, South Africa, UK, USA (all Warner Bros.), France (PECF), Germany (MUZ).

Wijex Music, see Sweden Music—Palace.

Wooden Horse Music Publ'g AB, see Flamingo.

Young Music of Scandinavia AB, PO Box 9019, S-750 09 Uppsala. Tel: (018) 35-23-10. Chief Exec Goran Hellsten, Gen. Mgr. Ingemar Nilsson.

● **services**

ASSOCIATIONS & PROFESSIONAL ORGANIZATIONS

F S T (Foereningen Svenska Tonsaettare) (Society of Swedish Composers), PO Box 5091, S-102 42 Stockholm 5. Tel: (08) 24-29-50.

National Committee of the International Music Council, c/o Royal Academy of Music, Blasieholmstorg 8, S-111 48 Stockholm.

National Section of the International Society for Contemporary Music, Prastigatan 28, Stockholm.

S K A P (Society of Swedish Popular Composers & Authors), PO Box 5091, S-102 42 Stockholm 5. Tel: (08) 24-29-50. Pres.: Bo-Goeran Edling.

Scandinavian Blues Ass'n, Tallkrovsvaegen 8, S-122 33 Enskede Tel: (08) 59-54-43. Pres. Joergen Sandin.

Society of Swedish Composers, see FST.

Society of Swedish Music Ass'n (Svenska Musikfoerlaeggarefoereningen Upa), Hoeglandstorg 2, S-161 40 Bromma Tel: (08) 25-07-99. Pres. Kettil Skarby; Gen. Mgr.: Christian Sylvan.

Society of Swedish Popular Composers & Authors, see SKAP.

Swedish Music Information Centre, PO Box 5091, S-102 42 Stockholm 5. Birger Jarlsgatan 66, Stockholm.

DESIGN & ARTWORK

Bohus Studio, PO Box 24, S-442 01 Kungaelv Tel: (0303) 109-90, 168-71. Gen. Mgr. Gert Lengstrand, Chief Eng. Olle Ramm.

Filadelfia Forlaget AB, Dagenhuset, S-105 36 Stockholm. Tel: (08) 13-03-40.

Interpromco PR, c/o Skandinavisk Musiktjänst, Sandbacksgatan 4, S-116 21 Stockholm. Tel: (08) 43-88-85.

Studioland AB, PO Box 2161, Kungsgatan 29, S-103 14 Stockholm 2. Tel: (08) 20-51-61. Mng. Dir. Thure O. Aberg.

W-Sign Mktg. AB, Pontonjærgatan 32, S-112 37 Stockholm. Tel: (08) 51-39-73. Telex: 13161. Mgr.: C. Wendel.

LICENSING ORGANIZATION, MUSIC

S T I M (Svenska Tonsaettare Int'l la Musikbyrå—Swedish Performing Rights Society), PO Box 1539, S-111 85 Stockholm. Tel: (08) 24-29-50. Pres.: Ove Rainer; Gen. Mgr.: Hans Nordmark. (Performing rights only).

PLATING, PROCESSING & PRESSING PLANTS

Europa Film, Rec. Plating Div., PO Box 20065, S-161 20 Bromma 20. Tel: (08) 28-28-00. Cable EUROPAS-TUD. Telex: 17656. Pres. Torbjorn Sjoeborg; Gen. Mgr. Bengt Runsten; Sales Mgr. Eric Augustsson. (Plating & processing only).

Grammoplast AB, Rorstrandsgatan 37, S-113 40 Stockholm. Tel: (08) 30-30-70. (Pressing only).

Heger Plastics AB, Stallarholmen Tel: (0152) 405-85.

Home office: Norway.

Skandinaviska Grammophon AB, PO Box 148, Industrigatan 12, S-662 00 Aemaal. Tel: (0532) 12-290. Telex: 5390. Mng. Dir.: Sven Samuelsson. Sales Mgr.: Carl-Gerhard Waellgren.

Svensk Grammofonindustri (AB), Sveavagen 17, S-111 57 Stockholm. Tel: (08) 10-63-67. Mng. Dir.: Tage Andersson; Sales Mgr.: Stefan Andersson.

Toolex Alpha AB, Esplanaden 10, S-172 31 Sundbyberg. Tel: (08) 28-90-30. Telex: 13378. Mng. Dir.: Osten Nilsson.

Ulvex, Vasavagen 4, S-172 31 Sundbyberg. Tel: (08) 26-25-60. (Pressing only).

PRINTERS & LITHOGRAPHERS

Filadelfia Forlaget AB, Dagenhuset, S-105 36 Stockholm. Tel: (08) 13-03-40.

Skoevde Offsettryck AB, PO Box 246, S-541 00 Skoevde. Tel: (0500) 34015. Gen. Mgr.: Bo Meijer.

W-Sign Mktg. AB, Pontonjærgatan 32, S-112 37 Stockholm. Tel: (08) 51-39-73. Telex: 13161. Mgr.: C. Wendel.

RECORD PROMOTION

E M A Telstar AB, PO Box 9127, S-102 72 Stockholm. Tel: (08) 68-02-50. Telex: 12234. Contact Thomas Johansson.

Int'l branch: Denmark, Knud Thorbjornsen.

Folkparkernas Artistformidling, Swedenborgsgatan 1, S-116 48 Stockholm. Tel: (08) 44-01-20.

Lars Olof Helen, Torsviksvangen 7a, S-181 05 Lidingöe 5. Tel: (08) 767-0150.

Interpromco PR, c/o Skandinavisk Musiktjänst, Sandbacksgatan 4, S-116 21 Stockholm. Tel: (08) 43-88-85.

K B Rec. AB/ShuShu Rec. Ltd., Box 4153, S-203 12 Malmö. Tel: (040) 329-96. Dir.: Ken Brown; Gen. & Sales Mgr.: Ulla Nilsson.

Marcus Music AB, Raesundavaegen 45, S-171 52 Solna. Pres.: Marcus Oesterdahl; Gen. Mgr.: Christer Berg; Sales Mgr.: Ann-Birgitt Carlsson.

Studioland AB, PO Box 2161, Kungsgatan 29, S-103 14 Stockholm 2. Tel: (08) 20-51-61. Mng. Dir.: Thure O. Aberg.

Telstar Konsertbureau AB, Frosaträbacken 24, S-127 37 Skarholmen. Tel: (08) 46-25-75.

W-Sign Mktg. AB, Pontonjærgatan 32, S-112 37 Stockholm. Tel: (08) 51-39-73. Telex: 13161. Mgr.: C. Wendel.

Svante Widen Agencies, Snoedroppsgrand 15, S-162 41 Vällingby. Tel: (08) 38-18-37. Mgr.: Svante Widen.

TAPE CUSTOM DUPLICATORS TAPE PACKAGING & LABELING

The Audio and Video lines indicate the configurations which the firms duplicate. Companies which offer packaging and labeling of tape product are indicated by: (PKG) which appears after the main body of their respective listings.

Marcus Music AB, Raesundavaegen 45, S-171 52 Solna. Tel: (08) 730-0400. Pres.: Marcus Oesterdahl; Gen. Mgr.: Christer Berg; Sales Mgr.: Ann-Birgitt Carlsson; Chief Eng.: Tony Wallenrud. (PKG)

Audio: Cassette

Playback Inspelningen AB, Gustav Adolfs Torg 10, S-211 39 Malmö. Gen. Mgr.: Lennart Christiansson.

Audio: Cassette, open reel.

Skandinaviska Grammophon AB, PO Box 148, Industrigatan 12, S-662 00 Aemaal. Tel: (0532) 12-290. Telex: 5390. Mng. Dir.: Sven Samuelsson. Sales Mgr.: Carl-Gerhard Waellgren.

Audio: Cassette

Svensk Grammofonindustri (AB), Sveavagen 17, S-111 57 Stockholm. Tel: (08) 10-63-67. Mng. Dir.: Tage Andersson; Sales Mgr.: Stefan Andersson.

Audio: Cassette.

T B S Corp., Luettzengatan 12, S-115 23 Stockholm. Tel: (08) 62-01-79, 62-01-09. Pres.: C.G. Langenskiöld; Mktg. & Sales Dir.: Ulf Zwedberg.

Audio: Cassette, open reel.

Toolex Alpha AB, Esplanaden 10, S-172 31 Sundbyberg. Tel: (08) 28-90-30. Telex: 13378. Mng. Dir.: Osten Nilsson.

Audio: Cassette.

● **supplies**

EMPTY CARTRIDGES, CASSETTES & REELS

Ampex AB, Rissneleden 8, S-172 07 Sundbyberg. Tel: (08) 28-29-10. Cable: VIDEOTAPE. Telex: 10867. Gen. Mgr.: Gerd Baumhof.

Audio: Cassette tapes.

PROFESSIONAL TAPE SUPPLIES

Ampex AB, Rissneleden 8, S-172 07 Sundbyberg. Tel: (08) 28-29-10. Cable: VIDEOTAPE. Telex: 10867. Gen. Mgr.: Gerd Baumhof.

RECORD PROCESSING MACHINERY

Alpha, see Toolex.

Europa Film AB, PO Box 20065, S-161 20 Bromma. Tel: (08) 28-28-00. Cable: EUROPASTUD. Telex: 17656. Pres. Torbjorn Sjoeborg; Gen. Mgr.: Bengt Runsten; Sales Mgr.: Eric Augustsson.

Chief product: Plating equip.

Svensk Grammofonindustri (AB), Sveavagen 17, S-111 57 Stockholm. Tel: (08) 10-63-67. Mng. Dir.: Tage Andersson; Sales Mgr.: Stefan Andersson.

Chief product: Vinyl.

Toolex Alpha AB, Esplanaden 10, S-172 31 Sundbyberg. Tel: (08) 28-90-30. Telex: 13378. Mng. Dir.: Osten Nilsson.

Chief product: Automatic presses, high speed moulds, pneumatic punch presses, presses for pre-forming of matrices, hot-knife trimmers, extruders & hot-air pre-heaters, granulating mills, hydraulic pump units, etc. (Alpha).

TAPE, BLANK LOADED & BULK RAW

Agfa-Gevaert AB, Oesthammsgatan 70, S-115 28 Stockholm. Tel: (08) 63-58-40. Telex: 1687. Mng. Dir.: Van Roosbroeck; Sales Mgr.: L. Karsbrink.

Audio: Cassette, open reel.

Video: Blank—1" open reel, ¾" cassette, ½" EIAJ cartridge.

Brand names: Agfa Carat, Agfa Stereochrom, Agfa Videochrom.

Ampex AB, Rissneleden 8, S-172 07 Sundbyberg. Tel: (08) 28-29-10. Cable: VIDEOTAPE. Telex: 10867. Gen. Mgr.: Gerd Baumhof.

Audio: 8-tr., cassette, open reel.

Video: 1" open reel, ¾" cassette, ½" EIAJ open reel, Beta, VHS.

B A S F Svenska AB, PO Box 53008, Kungsportsavenyen 31-35, S-400 14 Goeteborg 53. Tel: (031) 81-32-60. Cable: BASIMPORT. Telex: 2327. Sales Mgr.: Bo Hartzell.

Audio & Video: Cassette, open reel.

Ekman & Co. AB, Stora Nygatan 29, S-401 23 Goeteborg. **Audio:** 8-tr., cassette, open reel.

Brand name: Audio Magnetics.

Toniton AB, PO Box 1122, Forradsvagen 10, S-141 23 Huddinge. Tel: (08) 774-0290. Telex: 11260. Mng. Dir.: Leif Bigert; Domestic Sales Mgr.: Albertus Klaassen. (Blank only).

TAPE DUPLICATING & PROCESSING EQUIPMENT

Ampex AB, Rissneleden 8, S-172 07 Sundbyberg. Tel: (08) 28-29-10. Cable: VIDEOTAPE. Telex: 10867. Gen. Mgr.: Gerd Baumhof.

Audio: Duplicators.

● **accessories manufacturers**

Amigo Musik AB, PO Box 6058, Norra Stationsgatan 91-93, S-102 31 Stockholm 6. Tel: (08) 34-01-95. Telex: 17840. Pres.: Per-Anders Boquist; Sales Mgr.: Jorgen Adolfsso.

Product: 45 rpm adapters.

Ampex AB, Rissneleden 8, S-172 07 Sundbyberg. Tel: (08) 28-29-10. Telex: 10867. Gen. Mgr.: Gerd Baumhof.

Product: Head cleaners & demagnetizers.

Georg Dahlberg AB, PO Box 6058, Norra Stationsgatan 91-93, S-102 31 Stockholm 6. Tel: (08) 34-01-95. Cable: GEODAH. Telex: 17840. Pres.: Per-Anders Boquist.

Product: Tape carrying & storage cases, head cleaners & demagnetizers, needles.

Elfa Radio & Television AB, Industrivagen 23, S-171 17 Solna. Tel: (08) 730-0700. Telex: 10479. Mng. Dir.: Gunnar Roth; Sales Mgr.: Arne Ununger.

Product: Cleaners, cloths, brushes, head cleaners, demagnetizers, needles, leader & splicing tape.

Sven Eriksson Audio, PO Box 834, S-121 08 Johanneshov. Tel: (080) 19-90-50. Telex: 13210. Owner: Sven Eriksson; Sales Mgr.: Gunnar Silins. (Importer)

Product: Cleaners, cloths, brushes, head cleaners, demagnetizers, needles.

N A S A B, Chalmerströmgatan 27a, S-411 35 Goeteborg. Tel: (031) 18-86-20.

Product: Needles.

Brand name: Pickering.

Toniton AB, PO Box 1122, Forradsvagen 10, S-141 23 Huddinge. Tel: (08) 774-0290. Telex: 11260. Mng. Dir.: Leif Bigert; Domestic Sales Mgr.: Albertus Klaassen.

Product: Carrying & storage cases, cleaners, cloths, brushes, head cleaners & demagnetizers.

W-Sign Mktg. AB, Pontonjærgatan 32, S-112-37 Stockholm. Tel: (08) 51-39-73. Telex: 13161. Mgr.: C. Wendel.

Product: Carrying & storage cases, plastic record covers, catalog servs.

● **store fixtures & merchandising aids manufacturers**

Amigo Musik AB, PO Box 6058, Norra Stationsgatan 91-93, S-102 31 Stockholm 6. Tel: (08) 34-01-95. Telex: 17840. Pres.: Per-Anders Boquist; Sales Mgr.: Jorgen Adolfsso.

Product: Record divider cards.

Georg Dahlberg AB, PO Box 6058, Norra Stationsgatan 91-93, S-102 31 Stockholm 6. Tel: (08) 34-01-95. Cable: GEODAH. Telex: 17840. Pres.: Per-Anders Boquist.

Product: Tape display racks.

Fors & Fors AB, PO Box 1. S-170 11 Drottningholm. Tel: (08) 759-0090. Mng. Dir.: Haekan Fors; Sales Mgr.: Ingrid Windkilde.

Product: Record & tape display racks.

SWITZERLAND

Population: 6,350,000.

Rate of exchange: \$1 (US) = 1.92 francs.

Per capita income: \$7,810.

Holidays: January 1 & 2, Good Friday, Easter Monday, Ascension Day, Whit Monday, August 1 (Anniversary of the Founding of the Swiss Confederation), December 25 & 26, plus a number of local holidays.

No. of homes with record players: 72%.

RECORDS:

Records sold domestically including imports (retail value): LP's 1977—9,540,000 units, \$84,467,160. EP's 1977—19,000 units, \$89,053. Singles 1977—4,475,000 units, \$12,118,300.

Records, record blanks & pre-recorded media imported from USA: 1977—\$1,775,480.

Records exported to USA: 1977—11,720 units, \$103,768.

Average retail price per record: LP's—\$8.85; EP's—\$4.69; singles \$2.71.

Stereo sales: 98% of total.

Quadraphonic sales: 5% of total.

Record club sales: 12% of total.

Discounting: Frequent.

Type of distribution: Rack jobbing is growing steadily, especially in smaller communities. The most important method of distribution is manufacturer-to-retailer through the local branches of all major worldwide companies. Direct imports are estimated to account for 15-35% of total sales.

Type of promotion: Promotion through TV, radio & concerts, respectively, are the most important. Newspapers are less important, as they are unfriendly towards the record industry.

Jukeboxes: 17,000

TAPE:

Pre-recorded tape sold domestically including imports (retail value): 8-tr. 1977—15,000 units, \$163,950. Cassette 1977—2,358,000 units, \$22,106,250.

Average retail price per tape: 8-tr.—\$10.93, cassette—\$9.38.

Market: The 8-tr. market is practically dead, most dealers do not stock them anymore. Blank tape market is booming due to "rock-bottom" prices. Large scale duplication is suspected.

RADIO STATIONS:

No. of government: 3 AM/FM.

Comment: Most musical programs feature recorded music. Almost all the live music aired is performed by the three big bands under contract to national radio and television. Programming of cover versions is more frequent than that of the original versions.

TELEVISION STATIONS:

No. of channels: 3 government, 100% color.

Comment: Programming is regarded as above average. Good possibilities exist for music industry to promote its better acts.

IMPORT/EXPORT REGULATIONS:

Since 1977 there have been no customs; taxes still must be paid.—Beat Hirt

● record & tape manufacturers / distributors / importers

A J R, see Barclay.

A R A, see Metronome.

Activ-Recs. AG (S.A. Ltd.), Chruwezweg 4, CH-8852 Altdorf. Tel: (055) 63.37.22. Telex: 75145. Co-Pres.: Jakob Baumgartner, Fritz Frischknecht.

Labels: (Owned) Activ, Activ Special, Creativ.

Air, see Musicland.

Aktuell, see Musicland.

Aktuell, see Pick.

Alain Recs., Barclay.

Alpina, see Electromusic.

America Sound, Scheuchzerstr. 35, CH-8022 Zurich. Tel: (01) 28.01.82. Telex: 57666. Owner & Gen. Mgr.: Kaethi Hirzel; Sales Mgr.: Peter Schnyder (Distributor/Importer).

Labels: (Licensed domestic) Hat Hut, Willisau Live, (licensed foreign) Andrew's Music (USA), CJR (USA), EGO (Germany), Emanem (USA), IAI (USA), ICP (Netherlands), IPS (USA), Ictus (Italy), Incus (UK), India Navigation (USA), Mood (Germany), Ogun (UK), Philips (Brazil), Ring (Germany), Sackville (Canada), Steam (UK), Timeless (Netherlands), World Artists (USA).

Angel, see EMI.

AnnoMusic, see Bellaphon.

Arcane, see Barclay.

Archiv, see Polydor.

Ariola-Eurodisc AG (IFPI), Letziggraben 89, CH-8047 Zurich. Tel: (01) 54.53.90. Telex: 53436. Mng. Dir.: Ludwig Schmucki; Deputy Mng. Dir. & A&R Mgr.: Bruno Huber; Mktg. & Promo Mgr.: Marco Zanotta. (Distributed by Musikvertrieb)

Labels: (Owned) Ariola, Baccarola, Eurodisc, Vergara; (licensed domestic) Memory; (licensed foreign) Athena (Germany), Baby (Italy), Bronze (UK), Clan Celentano (Italy), Hansa (Germany), Island (UK), Joy (UK), Jupiter (Germany), Lifesong (USA), Manticore (UK), Maritim (Germany), Melodiya (USSR), Musiza (Italy), Oasis (Germany), PBR Int'l (USA), Palmbeach (UK), Pandora (Germany), President (UK), Red Star (USA), Shelter (USA), Sire (USA), Supraphon (Czechoslovakia), Tomato (USA), Virgin (UK).

Arifphon, see Turicaphon & Musikvertrieb.

Asmahan, see Turicaphon.

Asylum, see WEA.

Atco, see WEA.

Atlantic, see WEA.

Baccarola, see Ariola-Eurodisc.

Bacillus, see Bellaphon.

Baidaphon, see Turicaphon.

Barclay Recs. SA (IFPI), Rue du Roveray 14, CH-1207 Geneva. Tel: (022) 36.56.80. Cable: BARCLAYDISC. Telex: 23368. Gen. Mgr.: Claude Aubert.

Home office: France.

Labels: (Owned) Barclay, Riviera, Rei Veira; (distributed domestic—not licensed) AJR, Alain, Arcane, Discotel, IDM, KBL, M-Recs., Mad, NGD, Rainbow, Sade, Stamy, Tourel; (distributed foreign—not licensed) AZ, Alvares, Albatross, BAM, Big Box, Black & Blue, Blue Star, CAM, CMF, Candide, Can't Stop, Carabine, Carla, Cereste, Cornelia, Delphine, Do It, Duetto, EDO, EM, Egg, Erato, FY, Far Out, Fiori Musicali, Gama, Ineditis ORTF, Jazz Odyssey, Kuklos, Locomotive, MCM, MUB, Mahogany, Malypense, Marouani, Monteil, Mouche, Mouloudji, Nuages, Okapi, Opera du Rhin, Orlando, Panda, Pastel, Pema, Perides, SM, Sex Pistols, Sonopresse, Sylvestre, Temporel, Trianon. (all France).

Basilisk, see Electromusic.

Bellaphon AG (IFPI), Farbhofstr. 21, CH-8048 Zurich. Tel: (01) 62.74.02. Chief Exec.: B. Zivanovic; Gen. Mgr.: Ernst Feller.

Home office: German Federal Republic.

Labels: (Owned) Bacillus, Bellaphon, Pfiffikus; (licensed domestic) AnnoMusic, (licensed foreign) Stax (USA), (distributed—not licensed) Aristocare (France), Audiodelity (USA), BASF (Germany), Blues Beacon (Germany), Casablanca (USA), Charly (UK), Chelsea (USA), Chiaroscuro (USA), Concord Jazz (USA), Disneyland (Germany), Enja (Germany), Exhibit (USA), Fantasy (USA), Finger (Germany), Free Music Prod'ns (Germany), Galaxy (USA), Goodear (UK), Milestone (USA), Panoptikum (Germany), Penny Farthing (UK), Plantation (USA), President (France), Prestige (USA), Riverside (Japan), SSS (USA), Sun (USA).

Bimbo, see Metronome.

Bro Recs. AG, Adlibogenstr. 18, CH-8155 Niederhasli. Tel: (01) 850.42.88. Pres. & Gen. Mgr.: Ingo Schlotte. (Importer/Exporter/Mail Order)

Brunswick, see Polydor.

C B S Schallplatten AG (IFPI), Unter Altstadt 10, CH-6301 Zug. Tel: (042) 21.62.22. Telex: 78874. Mng. Dir.: Norman D. Block; Sales Mgr.: Achille Koelliker; Mktg. Mgr.: Edith Jakob.

Home office: USA, CBS Recs. Int'l.

Labels: (Owned) CBS, Embassy, Epic, GTO, Harmony, Odyssey, Portrait; (licensed) A&M (USA), Bethlehem (USA), Blue Sky (USA), CGD (Italy), Caribou (USA), Channel (USA), Cleveland Int'l (USA), Clouds (USA), Dyno (USA), Gateway (USA), Horizon (USA), Invictus (USA), Jet Recs. (UK), Kirshner (USA), Marlin (USA), Meys (France), Monument (USA), Philadelphia Int'l (USA), Record Bazaar (Italy), Rim (USA), TK (USA), T-Neck (USA), TSOP (USA), Tabu (USA), Unlimited Gold (USA), Versailles (France), Who's Who in Jazz (USA).

C C T (Compact Cassettes Trading AG), Birmensdorferstr. 55, CH-8036 Zurich. Tel: (01) 241.47.11. Telex: 58975. Pres. Hugo von Blumenthal; Gen. Mgr. Aldo Steiner.

Int'l branches: Austria, Germany.

Labels: (Owned) Galaxy, Toka.

C P S A (Cie. de Prod'ns Sonores & Audiovisuelles), Place du Grand Mont, CH-1052 Le Mont/Lausanne. Chief Exec.: Aurel Trost; Gen. Mgr.: Pierre-Henri Dumont. (Distributor/Importer)

Labels: (distributed—not licensed) Movieplay (Spain), Pye (UK), RKM (Belgium), Roulette (USA), Vogue (France).

Capitol, see EMI.

Carex, see Euxec.

Carsound, see Turicaphon.

Cellier, see Disques-Office & Phonag.

Charis, see Musicland.

Classic Pick, see Pick.

Collector's, see IRC.

Coloraphon, see Finsterwald & Cantacuzene.

Columbia, see EMI.

Core SA, Rue Gambaetta 22, CH-1815 Clarens-Montreux.

Label: (Represented) Latin Percussion Ventures (USA).

Cotillon, see WEA.

Creativ, see Activ-Recs.

Crypto, see Phonogram.

Custom, see Metronome.

D G, see Polydor.

Discofon, see Metronome.

Disc-Import, Seebahnstr. 111, CH-8003 Zurich. (Distributor)

Label: (Distributed—not licensed) DRG (USA).

Discotel, see Barclay.

Disques-Office (IFPI), Rte. de la Glane 35, CH-1700 Fribourg. Tel: (037) 24.62.61. Telex: 36424. Gen. Mgr.: Jean-Claude Vial; Sales Mgr.: Bernard Chassot.

Labels: (Owned) Cellier, Disques-Office, Frontier, Lazer, Via Music; (represented) Adele, Ades (France), America (France), Arflok, Arhoolie (USA), Arion, Ballon Noir, Biograph (USA), CT—Charles Talar (France), Canetti (France), Cavalier, Cezame (France), Club du Disque Arabe, Cobra, Debs, Deesse (France), Disneyland (France), Edici, Elver, Encyclopedie Sonore, Festival, GT—Gerard Tournier (France), Hexagone (France), Jazz Anthology, Kebec Disc, Musidisc (Belgium), Ocora, Petit Menestrel (France), President (France), Riti (Italy), Rigolo (France), Saravah, Serp, Sono Cairo, Sonodisc, Supradidac, Trema, Vista (USA); Carrere Group—Apollo, Boona, Fleche, Formula No. 1, Frederic, Heloise, Ibach, Norbert Aleman.

Int'l reps.: Belgium (Musidisc), Canada (Gamma, Presqu'ile), France (Musidisc), Germany (Bellaphon), Italy (Ducalle), Japan (RCA).

E M I America, see EMI Recs.

E M I Recs. (Switzerland) AG (IFPI), Badenerstr. 567, CH-8048 Zurich. Tel: (01) 54.00.10. Telex: 55695. Mng. Dir.: Guy Deluz; NCO Div. Gen. Mgr.: Peter Mampelli.

A&R Mgr.: Laico H. Burkhalter; Sales Mgr.: Max Trostel. Labels: (Owned) Angel, Capitol, Columbia, EMI, EMI America, Electrola group, Emidisc, HMV, Harvest, MFP, Odeon, Parlophone, Pathe, Punch, Regal, Regal Zonophone, Trianon, (licensed) AVI (USA), Aladin (Germany), Apple (UK), Arista (USA), Butterfly (USA), Contemporary (USA), Good Time Jazz (USA), Harmonia Mundi (Germany), MAM (UK), Magnet (UK), Motown (USA), Passport (USA), Private Stock (USA), Purple (UK), RAK (UK), Rebel (UK), Safari (UK), Savoy Jazz (USA).

Brunner, E S P, see Turicaphon & Musikvertrieb.

88 Upright, see IRC.

Einhorn, see Metronome.

Electrola group, see EMI.

Electromusic Ltd. (IFPI), Baslerstr. 9, CH-4102 Binningen 1. Tel: (061) 47.75.50. Cable: EMAG. Telex: 63754. Prod'r: Otto Aebi.

Labels: (Owned) Alpina, Tell; (distributed) Basilisk, Swiss, Swiss Hit, Tempo (Germany).

Elektra, see WEA.

Elite Special, see Turicaphon & Musikvertrieb.

Embassy, see CBS.

Emidisc, see EMI.

Epic, see CBS.

Ere du Verseau, PO Box 90, CH-1211 Geneva 1. Cable: REGORINT. Chief Exec.: M. Regor; Press: Regine Villars.

Labels: (Owned) Ere du Verseau; (represented) ALA (Italy), Alors Raconte (France), Caprice (Sweden), Chorafox (France), Corelia (France), Disque de Paris (France), Expo Norr (Sweden), Hebra (Belgium), Iris (France), KIF (France), Jump (Italy), Monde Melody (Belgium), Music Scene (Italy), Rusty (Italy), Shark (Italy), Sunshine (Germany), VIP (Italy), Warm (UK).

Eurex Recs., Hochstr. 152, CH-8330 Pfäfers-Zurich. Tel: (01) 950.22.31. Gen. & Sales Mgr.: Hans Rudolf Buechi. (Distributed by Finsterwald & Cantacuzene)

Labels: (Owned) Eurex, Carex (8-tr.), Lunarex (4-tr.).

Eurodisc, see Ariola-Eurodisc.

Evasion Sarl, Place du Grand Mont, CH-1052 Le Mont/Lausanne. Tel: (021) 33.33.55. Dirs.: Pierre-Henri Dumont, Francois Vautier, Gaston Schaefer.

Labels: (Owned) Evasion, Pavo; (distributed—not licensed) Auvidis (France), Black Lion (UK), Escargot (France), Freedom (UK), Moshe Naim (France), Munich Recs. (Netherlands), Oiseau Musicien (France), Playa Sound (France), Punch (France), Request (USA), Rounder (USA), SFPP (France), Topic (UK), Unidisc (France), Vendemiare (France).

Exclusiv, see Phonogram.

F & C, see Finsterwald & Cantacuzene.

Fass, see Phonogram.

Favorit, see John Lay.

Finsterwald & Cantacuzene (IFPI), 70 Ave. des Alpes, Montreux. Tel: (021) 62.45.55. Cable: DISQUES. Telex: 24686. Admin'r: Jean-Jacques Finsterwald; Gen. Mgr.: Ivan Cantacuzene.

Labels: (Owned) F&C; (distributed) Coloraphon, Eurex, Star; (represented) Aira (Germany), Amati (Germany), Arrow (U.K.), Belter (Spain), Cash (Germany), Cetra Opera (USA), Charade (France), Cigala (Italy), Circus (Italy), Clave (Spain), Collector (UK), Colledge (Italy), Comedie Francaise (USA), Concert Disc (USA), Counterpoint-Esoteric (USA), Coup (Germany), DOM (France), Delta (Germany), Design (USA), Discophon (Spain), Durium (Italy), Echo (Germany), Eden Roc (France), Equipe (Italy), Everest (USA), Freedom (Italy), Gaviota (Spain), Hebra (Belgium), Hispavox (Spain), Impacto (Spain), Joker (Italy), Jolly (Italy), Legacy (USA), Little (Italy), Main (Germany), Megaphonie (France), Musart (Mexico), Music (Italy), Olympic (USA), Olympo (Spain), Omnia (Italy), Period (USA), Pickwick (USA), Primaphon (Germany), RIS (France, Italy), Royal (Italy), Scala (USA), Signal (Italy), Song (Germany), Spotlight (Germany), Sprint (Italy), Start (France), Stella (Italy), Tradition (USA), Welt Melodie (Germany), Zafiro (Spain).

Fono GmbH, Seidenhofstr. 14, CH-6002 Lucerne. Tel: (041) 22.22.88. Contacts: Henriette & Dr. Paul Cron.

Fontana, see Phonogram.

Foraton, see Musicland.

Frontier, see Disques-Office.

Galaxy, see CCT.

Gallo, see VDE & Barclay.

Gnome, see Phonogram.

Gold Recs., Mythenquai 383, CH-8038 Zurich. Tel: (01) 43.69.30. Owner: Bernard Henrion. (Distributed in Switzerland by Metronome).

Label: (Owned) Gold.

Int'l reps.: Austria (Armadeo), Germany (Teldec).

Golden-Jet, see Metronome.

Gong, see Metronome.

Grossman, see Phonogram.

H M V, see EMI.

Hallelujah, see Phonag.

Harmony, see CBS.

Harvest, see EMI.

Hat Hut, see America Sound.

Hazyland, see Mabel.

Heco, see Phonogram.

Heliodor, see Polydor.

Helvetia, see Phonag.

Hot Pick, see Pick.

Hug, Lindenhofstr. 16, CH-4000 Basel. Tel: (061) 35.10.77.

Hurricane, see Metronome.

I D M, see Barclay.

I R C (International Rec. Center), PO Box 131, CH-8029 Zurich. Tel: (01) 55.07.27. Dir.: Theo Zwicky.

Labels: (Owned) Collector's, 88 Upright, Star Performance; (licensed) Caracol (France), (distributed—not licensed) Arcadia (USA), Black Jack (Germany), Cat (Netherlands), Dawn Club (Germany), Delmark (USA), Fat Cat's Jazz (USA), IAJRC (USA), Jackson (Germany), Jazum (USA), Jazz Club (France), Rarities (UK), Roots (Austria), Sackville (Canada), Swingfan (Germany), Vintage Jazz Mart—VJM (UK).

Impact, see Phonogram.

Indian, see Metronome.

Inter-Handel Recs. AG, Tribtschenstr. 13, CH-6005 Lucerne. Tel: (041) 44.44.50. Telex: 65209. Dir.: Hanns Hanneken.

International Pick, see Pick.
 International Rec. Center, see IRC.
 Intertape Ltd., Spinnereistr., CH-8753 Mollis. Tel: (058) 34.31.34. Telex: 75162. Gen. Mgr.: Peter Baumgartner. (Distributor)
 Intimus, see Turicaphon & Musikvertrieb.
 Iramac, Burgerstr. 17, CH-6000 Lucerne.
 Home office: France.
 Jacklin & Co., Raemistr. 30 & 42, CH-8024 Zurich. Tel: (01) 47.35.20. Cable: JECKLINCO. Telex: 58507. Chief Exec.: Hans Jacklin.
 Jona-Disc, see Metronome.
 Jubila, see Metronome.
 K B L, see Barclay.
 Karussell, see Polydor.
 Lake County Recs., Fritz Courvoisier 15, CH-2300 La Chaux-de-Fonds. Tel: (039) 22.63.03. Owner: Michel Cattin; Gen. & Sales Mgr.: Eliane Cattin.
 Labels: (Owned) Lake County; (distributed—not licensed) major labels.
 Int'l reps.: Australia (Bunnyip), France (Rock 'n' Roll Promos.), Germany (Bear Family, Dieter Beck), Netherlands (DlWA), Sweden (Kountry Korral, Rock & Country), UK (Swift), USA (Ville Platte, Wix).
 John Lay, Bundesstr. 9-13, CH-6003 Lucerne. Tel: (041) 23.44.55. Telex: 78610. Chief Exec.: John Lay; Mng. Dir.: Manfred S. Lay; Gen. Mgr.: Kurt S. Lay.
 Sales office: CH-6002 Zurich; Seestr. 45. Tel: (01) 36.67.10.
 Labels: Favorit, Layola.
 Layola, see John Lay.
 Lazer, see Disques-Office.
 La Librairie Nouvelle, Rue de Carouge 18, CH-1200 Geneva. Tel: (022) 25.98.76.
 Labels: (Represented) Le Chant du Monde (France).
 Lunarex, see Euxec.
 M-Recs., see Barclay.
 M C H, see Metronome.
 M F P, see EMI.
 M P A, see Metronome.
 M P V, see Musicland.
 Mabel Recs., Im Koller 17, CH-8706 Feldmeilen. Tel: (01) 923.49.17. Telex: 75437. Pres.: R. Hazy Osterwald; Gen. Mgr.: G. Sunny Lang; Sales Mgr.: Rino Bortolin; Promo.: Barbara Leuenberger. (Licensed to Phonag).
 Labels: (Owned) Mabel, Hazyland; (licensed foreign) Arabella (France), Chart (USA), Mounted (USA); (distributed—not licensed) Arca, Hazohr (both Canada).
 Int'l reps.: Australia (Quarint), Austria (Amadeo, Earl), Belgium (Anvers Radio, Supreme), Brazil (Central Tape), Canada (Arca, Select), France (Polydor), Germany (DCM, Metronome), Italy (Saar), South Africa (Teal), USA (Soul Vista).
 Mad, see Barclay.
 Mandolino, see Turicaphon.
 Marex SA, Via Generoso 6, CH-6900 Lugano. Tel: (091) 54.87.53. Telex: 73208. (Distributor/Importer/Exporter).
 Max, see Metronome.
 Maxli, see Metronome.
 Memory Music, Chruzewzies 4, CH-8852 Altendorf. Tel: (055) 63.38.92. Telex: 75145. Co-Pres.: Jakob Baumgartner, Fritz Frischknecht. (Licensed to Ariola, Distributed by Musikvertrieb).
 Mercury, see Phonogram.
 Meteor, see Metronome.
 Metronome Recs. AG (IFPI), Toedistr. 68, CH-8810 Horgen 1. Tel: (01) 725.36.83. Telex: 52941. Pres.: Juerg Zehnder; Gen. Mgr.: Bruno Moschin; Sales Mgr.: Max Gfeller; Custom Labels Div. Mgr.: Reinhard Frey.
 Labels: (Owned) ARA, Custom, Discolor, Golden-Jet, Gong, Jubila, MCH, Max, Maxli, Meteor, Metronome, Mustang, Pony, Top-Disc, Top Disc Gold; (licensed) Acorn (UK), Amadeo (Austria), Atom (Austria), Big Bear (UK), Big T (UK), Brain (Germany), CH-Recs. (Switzerland), CTI (USA), Carosello (Italy), Carplay (Germany), Chiswick (UK), Cinevox (Italy), DJM (Germany, UK), Einhorn (Switzerland), Flying Fish (Sweden, UK), Folk (UK), Frog (Italy), Gryphon (USA), Hallmark (UK), Kicking Mule (Sweden, UK), Kudu (USA), Lax (Germany, UK), Leader & Trailer (UK), Logo (UK), MPS (Germany), Metronome (Germany), Nature (Germany), Orizonte (Italy), PMC (Germany), Produttore Associati (Italy), Psycho (UK), Pyramid (Italy), Ricordi (Italy), Rubber (UK), Salvation (USA), Sky (Germany), Sonet (Sweden, UK), Specialty (Sweden, UK), Sussex (USA), Tangent (UK), Top-Class (Germany), Transatlantic (UK), 2001/2002 (Germany), Xtra (UK), Zebra (Germany); (distributed—not licensed) Atlanta, Atoll (France), Bere, Brmbo, Calig (Germany), Calliope (UK), Carabine (France), Champ (Austria), Contour (UK), Crystal (Germany), DSC (Netherlands), Dynamic (France), Emidisc (Germany), Figaro, GRT (Canada), Gold, Hurricane, Indian, Jona-Disc, Lotus (Italy), MC-Recs., MFP (Germany), MPA, Oxford Univ. Press (UK), PSM, Pickwick (UK, USA), Symphonica (UK), Tyrolis (Austria), Westwood (UK).
 Musexport Ltd., Clos Belmont 12, CH-1211 Geneva 6. Contact: Norbert Ayer. (Importer/Exporter)
 Musicland AG, Althardstr. 224, CH-8105 Regensdorf/Zurich. Tel: (01) 840.60.40. Telex: 56359. Pres. & Gen. Mgr.: Gian Carlo Astore; Domestic Sales Mgr.: Hans Vetterli; Sales Dir.: Fredy P. Frei; R&D Dir.: Richard Steiner.
 Int'l branch: Austria.
 Labels: (Owned) Air, Aktuell, Charis, Foraton, MPV, Musicland, S-3000, Vega 2000.
 Int'l reps.: Austria (Musicland), Germany (All-Music), Norway (Sanitas AIs), Sweden (Agenturfirman Tobiasson).
 Music Radio Promos., PO Box 1134, CH-8047 Zurich. Dir.: Alex Pfund.
 Int'l firm represented: Music Radio Promos (UK).
 Musikverlag zum Pelikan, Hadlaubstr. 63, CH-8044 Zurich. Tel: (01) 60.19.85.
 Labels: (Owned) Pelca; (represented) Camarata (Germany), Harmonia Mundi (France), Lyrichord (USA), MMO (USA), Monitor (USA).
 Int'l rep.: Germany (Disco Center).
 Musikvertrieb AG (IFPI), Badenerstr. 555/557, CH-8048 Zurich. Tel: (01) 54.97.54. Cable: MUSIKVERTRIEB.

Pres.: Dr. Jack Dimenstein; Rec. Dept. Gen. Mgr.: Lucien Monnerat; Gen. Label Mgr.: Marc Laeng; Promo. & Sales Mgr.: Juerg Hoffman. (Distributor/Importer)
 Labels: (licensed domestic) Artiphon, ESP, Elite Special, Intimus, Patria, Swiss Jazz, Triola; (licensed foreign) Apollo (Italy), Ariston (Italy), Asylum (USA), Atco (USA), Atlantic (USA), BTM (USA), Bearsville (USA), Berserkeley (USA), Big Mouth, Blue Note (USA), Buddha (USA), CAM (Italy), Crossover (USA), Dark Horse (USA), Decca (UK), DiscReet (USA), Elektra (USA), Eloise (France), GRT (USA), Gem (USA), Grunt (USA), Hed-Arzi (Israel), Janus (USA), Lollipop, London (UK), Millennium (USA), Nonesuch (USA), Nova (UK), Numero Uno (Italy), Pinball, Planet (Germany), RCA (USA), Radar, Reprise (USA), Road Show (USA), Salsoul, Swan Song (USA), Stiff (USA), Storyville (Germany), Strand (USA), Telefunken (Germany), Threshold (UK), Trojan (UK), United Artists, Vinyl, WEA Int'l (USA), Warner Bros. (USA), Windsong; (distributed—not licensed) Ariola (Germany), Athena (Germany), Baccarola (Germany), Blue Mountain, Bronze (UK), Clan Celentano (Italy), Eurodisc (Germany), H&L (USA), Hansa (Germany), Island, Jupiter (Germany), Manticores (UK), Melodia, Memory, President (UK), Red Star, Shelter, Speedball, Supraphon (Czechoslovakia), Vergara (Spain), Virgin (UK).
 Mustang, see Metronome.
 N G D, see Barclay.
 Nonesuch, see WEA.
 Odeon, see EMI.
 Odyssey, see CBS.
 Orchestrola, see Turicaphon.
 Oversea Recs. AG, Zuercherstr. 35, CH-8154 Oberglatt/Zurich. Tel: (01) 850.32.39. Cable: OVERSEAREC. Pres.: Michel Liber; Ass't: Alice Liber.
 Int'l branch: Germany, Deutsche Oversea.
 Labels: (Owned) Oversea; (represented) Athenee (Greece), Avenue (UK), Black Tulip (Netherlands), Diskosan (Turkey), Garnet (Germany), Luxembourg Sound (Luxembourg), Maietti (Italy), Melody (Greece), Moon Disc (Netherlands), Palobal (Spain), Said (Italy), Sayton (Spain), Sonor (Italy), Togo (Italy), Zephyr (Italy).
 P D U Ed. Discografiche & Musicali SA (IFPI), Via Generoso 6, CH-6900 Lugano. Tel: (091) 54.86.81, 54.87.51. Telex: 73208. Admin'r: Alberto Colleberg.
 Int'l branch: Italy.
 Int'l reps.: Worldwide (EMI), excluding Colombia (CBS).
 P S M, see Metronome.
 Parlophone, see EMI.
 Paroles, see VDE.
 Pathe, see EMI.
 Patria, see Musikvertrieb.
 Pavo, see Evasion.
 Pelca, see Musikverlag zum Pelikan.
 Pfiffikus, see Bellaphon.
 Philips, see Phonogram.
 Phonag Schallplatten AG (IFPI), Wartstr. 6, CH-8400 Winterthur. Tel: (052) 23.62.31. Cable: PHONAG Telex: 76281. Gen. Mgr.: Helmut Bischof.
 Labels: (Owned) Hallelujah, Helvetia, Phonag; (licensed domestic) Cellier, Mabel; (licensed foreign) Aves (Germany), Arcade (Germany), ECM (Germany), Fonit-Cetra (Italy), Gull (UK), Intercord (Germany), SteepleChase (Denmark), Vanguard (USA), Vedette (Italy).
 Phonogram AG (IFPI), Bahnhofstr. 6, CH-8952 Schlieren. Tel: (01) 730.52.00. Telex: 55530. Mng. Dir.: Wolfgang Zimmermann; Sales Mgr.: Ernst Anderegg; Pop Mgr.: Peter Frei, Classical Mgr.: Werner Seyboth; Adv. Mgr.: K.H. Fahrni.
 Labels: (Owned) Fass, Fontana, Impact, Mercury, Philips, Polystar, Rothkruetz, Spectrum, Star-Club, Vertigo; (distributed) Crypto, Exclusiv, Gnome, Grossman, Heco, Schnoutz; (represented) All Platinum (USA), Biograph (USA), Bus Stop (UK), Charisma (UK), Chess (USA), Chrysalis (UK), Cramps (France), De Lite (USA), Disques H (France), Edd-Music (France), Ember (UK), Ensign (UK), Garima (France), Hot Foot (Germany), Kalondour (France), Kelenn (France), Les 3 Oranges Bleues (France), Love (Italy), MM Recs. (France), Marzelle (France), Monty (France), Mountain (UK), OK Prod'ns (Italy), Paramount (USA), Power Exchange (UK), Rocket (UK), Sides (USA), Thelme (France), 20th Century (USA), Yona Disques (France), Zagora (France).
 Pick Recs. Switzerland (IFPI), Brunnenenstr. 26, CH-8049 Zurich. Tel: (01) 56.44.40. Cable: MUSIKCENTER. Pres. & Gen. Mgr.: Jane Peterer; Mgr.: Guido C. Capocchi.
 Labels: (Owned) Aktuell, Classic Pick, Hot Pick, International Pick, Pick, Swiss Made; (distributed—not licensed) Inner City (USA), MMO (USA), Mariphon (Germany), Maritim (Germany), Studio PR (USA), Sydney Thompson (UK).
 Int'l rep.: Germany (Gruner & Jahr).
 Poly, see Polydor.
 Polydor AG (IFPI), Bahnhofstr. 6, CH-8952 Schlieren. Tel: (01) 730.52.00. Telex: 55530. Gen. Mgr.: Dr. Juerg M. Schwarz; Sales Mgr.: H. U. Ruetschi; Label Mgr.: Manfred Wipfli; Prod'r: Rene Prod'r: Rene Wicky, Victor Pelli.
 Labels: (Owned) Archiv, Brunswick, DG, Heliolor, Karussell, Poly, Polydor, Polyfar, Polystar, Powerplay, Rotation, Schwann, Swiss Gold; (licensed) Barn (UK), Capcorn (USA), Coral (USA), EG (UK), HS (France), Infinity (USA), JMB (France), Karma (Germany), MCA (USA), MGM (USA), Midsong Int'l (USA), Pablo (USA), Pablo Live (USA), Polar (Sweden), Phil Spector Int'l (UK, USA), RSO (UK), Sirocco (France), Track (UK), Verve (USA).
 Polyfar, see Polydor.
 Polystar, see Phonogram & Polydor.
 Pony, see Metronome.
 Pophlight Recs. (Witschi & Co.), PO Box 4070, Sennweg 6, CH-3001 Berne. Tel: (031) 23.71.72. Telex: 33967. Dir.: Max Witschi. (Distributor)
 Portrait, see CBS.
 Powerplay, see Polydor.
 Punch, see EMI.
 R B Mktg., Waldstr. 8, CH-9008 St. Gallen. Tel: (071) 24.14.46. (Importer).

Rainbow, see Barclay.
 Regal, see EMI.
 Regal Zonophone, see EMI.
 Rei Veira, see Barclay.
 Reprise, see WEA.
 Riviera, see Barclay.
 Rotation, see Polydor.
 Rotkruetz, see Phonogram.
 S-3000, see Musicland.
 Alfred Sacher, Oetlingerstr. 39, CH-4000 Basel. Tel: (061) 33.94.48. (Importer).
 Label: (Represented) Music Minus One (USA).
 Sade, see Barclay.
 Friedrich Schait, Via Industria 1, CH-6900 Lugano. Tel: (091) 3.88.66, 3.47.55. Dir.: Friedrich Schait. (Wholesaler/Importer—tape).
 Schnoutz, see Phonogram.
 Schwann, see Polydor.
 Sonographic Rec'g Co. AG, Kampstr. 16, CH-8952 Schlieren. Tel: (01) 730.22.29. Pres.: R. Egli; Gen. Mgr.: W.A. Wettler; Sales Mgr.: A. Brand.
 Label: (Owned) Sonographic.
 Soundsexpress, Zuercherstr. 143, CH-4052 Basel. Tel: (061) 41.04.46. Dir.: Christian Wehrli, Enrico Cenci.
 Spectrum, see Phonogram.
 Stamy, see Barclay.
 Star Recs., PO Box 25, CH-7270 Davos 2. Tel: (083) 3.54.38. Gen. Mgr.: B. Bestgen.
 Labels: (Owned) Star, Swiss Sound.
 Star-Club, see Phonogram.
 Star Performance, see IRC.
 Stereo Tape AG, Kasernenstr. 50, CH-3013 Bern. Tel: (040) 48.10.74, 43.31.17, 24.07.30.
 Home office: Germany.
 Swiss, see Electromusic.
 Swiss Gold, see Polydor.
 Swiss Hit, see Electromusic.
 Swiss Jazz, see Turicaphon & Musikvertrieb.
 Swiss Made, see Pick.
 Swiss Sound, see Star.
 Tacoun SA, Rue St. Pierre 26, CH-1700 Fribourg. Tel: (021) 62.45.55.
 Teldec Musikvertrieb, Badenerstr. 555, Zurich. Tel: 54.97.57. Mng. Dir.: Jack Dimenstein; Mktg. Mgr.: Mr. Monnerat; Promo. Mgr.: Mr. Hoffman.
 Tell, see Electromusic.
 Toka, see CCT.
 Top-Disc, see Metronome.
 Top-Disc Gold, see Metronome.
 Tourel, see Barclay.
 Trianon, see EMI.
 Triola, see Musikvertrieb.
 Turicaphon AG Schweizer Schallplattenfabrik, CH-8611 Riedikon/Zurich. Tel: (01) 941.13.11. Telex: 52645. Cable: TURICAPHON RIEDIKON. Gen. Mgr.: Hans Oestreicher Sr.; Sales Mgr.: Hans Oestreicher Jr.
 Labels: (Owned) Ariphon, ESP, Elite Special, Intimus, Swiss Jazz (licensed to Musikvertrieb) Carsound, Mandolino, Orchestra; (distributed) Asmahan, Baidaphon (both Lebanon).
 Int'l reps.: Argentina (Surco), Australia (Carinia), Austria (Amadeo), Belgium (Anvers Radio), Brazil (Gravicoes Electricas), Denmark (Sonet-Starbox), Finland (Pohjoismainen), France (Sophotest), Germany (Deutsche Austrophon), Italy (Pilegio), Japan (Victor), Netherlands (Sound), Norway (A. Bendiksen), Spain (Marfer), Sweden (Sonet), USA (Fiesta/Peters), Yugoslavia (Yugoton).
 V D E (Disques), Rue de l'Alé 46, CH-1003 Lausanne. Tel: (021) 22.80.24. Gen. Mgr.: Olivier Buttex; Ass't Mgr.: Francois Queloz; Prod'n Mgr.: Francois Magnenat; Sales Mgr.: Andre Cortessis. (Distributed by Vogue-Evasion).
 Labels: (Owned) Gallo, Paroles, VDE.
 Int'l reps.: Australia (World Rec. Int'l), Austria (Mixture), Belgium (Edibon), Finland (Fuga), Germany (Mixture), Luxembourg (Edibon), Netherlands (Vista), New Zealand (World Rec. Int'l), Sweden (Sterling).
 Vega 2000, see Musicland.
 Vergara, see Ariola-Eurodisc.
 Vertigo, see Phonogram.
 Via Music, see Disques-Office.
 Visadis Record Communications SA, Via al Forte 2, CH-6901 Lugano. Tel: (091) 22.82.82. (Distributor/Importer/Exporter).
 Vogue, Place du Grand Mont, CH-1052 Le Mont/Lausanne. Tel: 33.33.55. Commercial Dir.: Pierre Henry Dumont; Admin. Dir.: Aurel Trost.
 W E A Int'l (European artists relations office & audio/video planning div.), Chillon 16, CH-1820 Montreux. Tel: (021) 61.64.31, 61.29.51. Cable: MONTREUXSOUNDS. Telex: 25796. European Artist Relations Dir.: Claude Nobs; Exec. Ass't: Jaqueline Ledent-Vilain. (Distributed by Musikvertrieb)
 Home office: USA.
 Labels: (Owned) Asylum, Atco, Atlantic, Cotillion, Elektra, Nonesuch, Reprise, Warner Bros.; (licensed) Big Tree (USA), Little David (USA), Swan Song (UK), Warner Curb (USA), Westbound (USA), Whitfield (USA); (distributed—not licensed) Bearsville, Dark Horse, Planet (all USA).
 Warner Bros., see WEA.
 Willisau Live, see America Sound.
 Young Electronics, 24-26 Ave de la Gare Des Eaux-Vives, CH-1211 Geneve 6.
 Label: (Represented) Sheffield Lab (USA).

● music publishers

Aberbach (Alpina) GmbH, see Turicaphon.
 Acuff-Rose Verlag AG, see Edifo.
 Amanda Music, see IMPACT.
 Freddy J. Angstmann Publ'g (SUISA), PO Box 28, CH-8050 Zurich. Tel: (01) 51.21.33/56. Telex: 55217.
 Annabella (Ed.) GmbH, see Turicaphon.
 Arena Musikverlag GmbH, see Turicaphon.
 Artillery Music, see IMPACT.
 Ascona Music, see Wintasco-Music.
 Bane Music, see Finsterwald & Cantacuzene.

Bellelulpe SA, see Fanfan.
 Belmont SA (Ed. Musicales), see Finsterwald & Cantacuzene.
 Bestgen Musikverlage (SUISA), Postfach 25, CH-7270 Davos 2, Tel: (083) 3.54.38
 Breeze Music Switzerland, Via Serodine 17, CH-6612 Ascona, Tel: (93) 35.32.51. Owner & Dir.: Corina Dierks-Fortman; Gen. Mgr.: Fred Hoock.
Home office: Germany
Int'l reps.: Germany (Meisel), USA (Summer Breeze).
 Campana, see Fanfan.
 Cantata Music, see IMPACT.
 Cecil-Music, see Oversea.
 Chicago Music, see IMPACT.
 Chrysa SA (Ed.), see Coda.
 Coda (Ed.), Brunnwiesenstr. 26, CH-8049 Zurich, Tel: (01) 56.44.40. (Affiliated with Jane Peterer)
Int'l firms represented: Meisel Prod'ns, Montana (both Germany).
Int'l reps.: Austria (Melodie), Germany (M. Hohner), Netherlands (De Eeste Muziek Centrale)
 Cron (Ed.), Seidenhofstr. 14, CH-6002 Lucerne, Tel: (041) 23.43.25. Gen. Mgr.: Dr. Paul Cron
Int'l firms represented: A. Boehm (Germany), Styria (Austria).
 Dueyees Music, see IMPACT.
 E M I Music Publ'g (Switzerland) SA, Badenerstr. 567, CH-8048 Zurich, Tel: (01) 54.00.10. Telex: 55695. Mng. Dir.: Guy Deluz
 Edifo SA, Badenerstr. 555, CH-8048 Zurich, Tel: (01) 54.97.54. Pres.: Dr. Veit Wyler; Gen. Mgr.: Sarah Dimenstein.
Int'l firms represented: Acuff Rose Music (USA), Melodie der Welt (Germany).
 Edition Musikproduktionen (ML, SUISA) c/o Metronome Recs. AG, Toedistr. 68, CH-8810 Horgen 1, Tel: (01) 725.36.83. Telex: 52941. Pres.: Juerg Zehnder; Gen. Mgr.: Bruno Moschin.
Int'l firms represented: Abramo Allione (Italy), Associati (Italy), Rolf Budde Musikverlag KG (Germany), Eurovox (Belgium), Farran Musica (Spain), Intervox (Belgium), Nobile (Germany), Peterman & Co. Ltd. (UK), Real (Italy), Royal (Germany), Swington (Ed.) (Germany), Valentine (Belgium)
Int'l rep.: Germany (Royal).
 Ere du Verseau, PO Box 90, CH-1211 Geneva 1. Chief Exec.: Mr. Regor.
 Estella Music, see IMPACT.
 Evasion Ed., Rue Dr. Cesar-Roux 28, CH-1005 Lausanne, Tel: (021) 22.81.34. Dirs.: Pierre-Henri Dumont, Gaston Schaefer, Francois Vautier
 Fanfan Music H. & B. Liechti & Cie. (SUISA/ML), Rue de Hesse 8-10, CH-1211 Geneva 11, Tel: (022) 21.77.66. Telex: 28657. Mng. Dir.: Heinz Liechti; Gen. Mgr.: Bertrand Liechti.
Int'l firms represented: CAM (Italy), Fermata Group (Brazil), Gerig (Germany), Goodman Group (USA), Roland Kluger (Belgium), Mills (USA).
 Finsterwald & Cantacuzene Eds. Musicales, Av. des Alpes 70 CH-1820 Montreux, Tel: (021) 62.45.55. Pres.: Jean-Jacques Finsterwald; Gen. Mgr.: Ivan Cantacuzene.
Int'l firms represented: Belmont (Germany), Durium (Italy), Fiumara (Italy), Maas (Italy), Pharaon (France), Saar (Italy), Sonet (Sweden, UK).
 Flora Musikverlag GmbH, see Turicaphon.
 Forever Music, see Hazyville.
 Francis-Day-Prod'n Switzerland, see Coda.
 Friedrich's Prod'ns, 13 rue Marignac, CH-1206 Geneva, Tel: 47.68.10/27. Pres.: Jean-Claude Friedrich.
 Giljan AG, see Jane Peterer.
 Gismonti Eds. Musicales, see Fanfan.
 Gold Recs., Mythenquai 383, CH-8038 Zurich, Tel: (01) 43.69.30. Owner: Bernard Henrion.
 Good Tunes Music, see Fanfan.
 Bill Grauer, see IMPACT.
 Hazyville (Ed.), Im Koller 17, CH-8706 Feldmeilen, Tel: (01) 923.49.18. Cable: OSTERWALDMUSIC. Telex: 75437. Pres.: R. Hazy Osterwald. Gen. Mgr.: G. Sunny Lang.
Int'l firms represented: Allround (Austria), Arabella (France), Paul C.R. Arends (Germany), Hazyland (Germany), Eugene McDaniels (USA), Moon Shadow Music (Germany), Peach (USA), Shirley (Germany), Trumpf (Germany), Yonah (USA).
Int'l reps.: Austria (Allround), Belgium (Frankie, Virgo), Canada (Arca), Germany (Paul C.R. Arends), South Africa (Laetec).
 Helbling & Co., Pfaffenkerstr. 6, CH-8604 Volketswil, Tel: (01) 945.43.93. Cable: HELBLINGMUSIC.
 Henn Eds., see Fanfan.
 I M P A C T (International Music Publ'rs & Composers Trust) SA, Box 10, Via del Tiglio 11, CH-6900 Cassarate/Lugano, Tel: (091) 51.80.71
Int'l firms represented: Jana, Mongo.
 International Melodies Geneve, see Fanfan.
 Jazz Standard Music, see IMPACT.
 Jeans Music, see Fanfan.
 Jury Music, see IMPACT.
 K B L, 22, Av. de Miremont, CH-1206 Geneva, Tel: (022) 36.70.61.
 L M N, see Fanfan.
 Lchif SA, see Fanfan.
 Louvin Music (ML), Rue de la Serre 61, C-2301 La Chaux-de-Fonds, Tel: (039) 22.16.19. Telex: 35383.
Int'l firms represented: Design (France), Durium (Italy), Frankie (Belgium), Tutti (France).
Int'l reps.: Belgium (Frankie), France (Chappell-Design, PES, Tutti), Italy (Durium), UK (Emerald, Sharcha).
 Lucy Music, Eden Roc 1, La Clai aux Moines, CH-1073 Savigny, Tel: (021) 97.18.94. Dir.: Gino Guds; Promo: Raymond Bailly; Int'l Prod.: Albert van Hoogten.
 Mediterranean Publ'g Prod'ns, 10 Chemin de Normandie, CH-1206 Geneva, Tel: 46.24.59. Gen. Mgr.: Vanda Chuard.
Int'l branch: Greece.
 Meisel-Prod'n der Ed. Coda, see Coda.
 Melodie (Ed.), see Jane Peterer.
 Mondiamusic SarL, see Fanfan.
 Music Club Verlag, PO Box 4, Im Baerenmoos 13, CH-8942 Oberrieden, Tel: (01) 43.69.30. Owner: Bernard Henrion.

Musicland AG, Althardstr. 224, CH-8105 Regensdorf/Zurich, Tel: (01) 840.60.40. Telex: 56359. Chief Exec.: Gian Carlo Astore.
 Music Today SA, Baarerstr. 57, CH-6301 Zug, Tel: (042) 21.07.45.
 Musikum Musikverlag GmbH, see Turicaphon.
 Musikverlag zum Pelikan, Hadlaubstr. 63, CH-8044 Zurich, Tel: (01) 60.19.85.
Int'l firms represented: G. Henle, Moeck, Moeseler, Sikorski, Stella, Volk (all Germany).
Int'l rep.: Germany (Baerenreiter).
 Musikvertrieb AG, Badenerstr. 555, CH-8048 Zurich, Tel: (01) 54.97.54. Telex: 52740. Pres.: Dr. Jack Dimenstein; Mgr.: Sarah Dimenstein.
Int'l firms represented: Burlington Music (UK), Melodie der Welt (Germany), Ivan Mogull (USA), Valentine Music Group Ltd. (UK).
 Nikto (Eds.), Av. de la Grenade 6, CH-1207 Geneva, Tel: (022) 35.17.62. Cable: NIKTOPRESS.
 Nova GmbH (Ed.), see Helbling.
 Nuesch Publ'g Co., Postfach 176, CH-9230 Flawil.
Int'l branch: Spain.
 Oeil Music, see Finsterwald & Cantacuzene.
 Onyx Music, see IMPACT.
 Orma Verlag, Chruzewicz 4, CH-8852 Altendorf, Tel: (055) 63.37.22. Telex: 75145. Pres.: J. Baumgartner; Gen. Mgr.: R. Henzi.
 Oversea Music, Zurcherstr. 35, CH-8154 Oberriggli, Tel: (01) 850.32.39. Telex: 56479. Pres.: Michel Liber.
 P D U Eds. Discografiche & Musicali SA, Via Generoso 6, CH-6900 Lugano, el: (091) 54.86.81, 54.87.51. Telex: 73208. Admin'r: Alberto Collembert.
Int'l branch: Italy.
 Jane Peterer Publ'g, Brunnwiesenstr. 26, CH-8049 Zurich, Tel: (01) 56.44.40. Cable: MUSIKCENTER. Pres.: Jane Peterer.
Int'l firms represented: Melodie (ed.)—United Artists Group (Germany, USA).
Int'l reps.: Austria (Melodie), France (Hohner), Germany (M. Hohner), Latin America (Columbia Pictures), Netherlands (De eerste Muziekcentrale), USA (Studio PR).
 Pool Music, see Hazyville.
 Prix Music, see IMPACT.
 Rinco Music Co., Spitalgasse 9, CH-8025 Zurich, Tel: (01) 47.92.40. Telex: 54565. Gen. Mgr.: Walter Schelling.
 Satin Music, see Finsterwald & Cantacuzene.
 Say Yes Music AG, Seestr. 12, CH-6072 Sachseln, Tel: (4141) 66.30.06. Telex: 45138. Gen. Mgr.: Dr. Hermann Stern.
Int'l rep.: Germany (Edition Intro).
 Sebring Music, see IMPACT.
 Sidem SA, see Fanfan.
 Sparta Florida Switzerland, see Coda.
 Turicaphon (Ed.) AG, Winterthurerstr. 40, CH-8610 Uster/Zurich, Tel: (01) 941.13.11/14.34. Gen. Dir.: Hans Oestreicher Sr.
 Violinada Musik Verlag, Postfach 47, CH-8105 Regensdorf, Tel: (01) 840.41.59. Pres. & Gen. Mgr.: Eugene Tiel.
 Wamjud Music, see IMPACT.
 Willin Music, see IMPACT.
 Wintaco-Music, PO Box 412, CH-8040 Zurich, Tel: (01) 241.27.04. Mgr.: Renate Burkhalter.
 Zomba Corp., Alpenstr. 14, CH-6300 Zug, Tel: (042) 21.14.66. Cable: IURZO. Telex: 78867. Dir.: Dr. Karel Zoller.
Int'l reps.: Austria (Robal), Belgium (Nada), Canada (Morning), Germany (Roba), Ireland (Zomba), Netherlands (Nada), South Africa (Musicpiece), UK (Zomba), USA (Athlone).

Prex/Vaud, Tel: (021) 76.10.26. Gen. Mgr.: Lea Manhart. (Performing rights only)
Home office: Austria.

PLATING, PROCESSING & PRESSING PLANTS
PRINTERS & LITHOGRAPHERS
 M C S (Music & Cassette Supply Ltd.), Schufelistr., CH-8863 Buttikon SZ, (055) 67.14.14. Telex: 75144. Pres.: Werner Weber; Gen. Mgr.: Mario Taravella; Sales Mgr.: Ulrich Plocher.
 Sonographic Rec'g Co. AG, Kampstr. 16, CH-8952 Schlieren, Tel: (01) 730.22.29. Pres.: R. Egli; Gen. Mgr.: W.A. Wettler; Sales Mgr.: A. Brand.
 Turicaphon AG Schweizer Schallplattenfabrik, CH-8611 Riedikon/Zurich, Tel: (01) 941.13.11.

RECORD PROMOTION
 Music Radio Promos, PO Box 1134, CH-8047 Zurich, Tel: (01) 748.26.97. Dir.: Alex Pfund.

TAPE CUSTOM DUPLICATORS
 Atlantida SA, Chemin Moise-Duboule 49, CH-1211 Geneva 28, Tel: (022) 98.33.22. Cable: ASAINTER.
 Intertape Ltd. (International Tape Org.), Spinnerstr. 21, CH-8753 Mollis, Tel: (058) 34.31.34. Telex: 75162. Gen. Mgr.: Peter Baumgartner; Sales Mgr.: Louis Bischof.
Audio: 8-tr., cassette, open reel.
Video: 1" open reel, 3/4" cassette, 1/2" cassette.
 M C S (Music & Cassette Supply Ltd.), Schufelistr., CH-8863 Buttikon SZ, Tel: (055) 67.14.14. Telex: 75144. Pres.: Werner Weber; Gen. Mgr.: Mario Taravella; Sales Mgr.: Ulrich Plocher.
Int'l branch: Germany.
Audio: 8-tr., cassette, open reel.
 Musicland AG, Althardstr. 224, CH-8105 Regensdorf/Zurich, Tel: (01) 840.60.40. Telex: 56359. Pres. & Gen. Mgr.: Gian Carlo Astore; Domestic Sales Mgr.: Hans Vetterli; Sales Dir.: Freddy P. Frei; R&D Dir.: Richard Steiner.
Audio: 8-tr., 8-tr. quadraphonic, cassette, open reel.
 Ruba, Beerli & Co./Arthcoq Ch. E. Beerli, PO Box 300, Claragraben 78, CH-4000 Basel, Tel: (061) 33.23.94.
 Union Studios E. Heers, Schulstr. 56, CH-8105 Regensdorf.

● supplies

CARTRIDGE & CASSETTE PARTS
 Alchemco AG, Althardstr. 224, CH-8105 Regensdorf/Zurich, Tel: (01) 840.66.06. Telex: 56359. Pres. & Gen. Mgr.: Gian Carlo Astore; Domestic Sales Mgr.: Hans Vetterli; Sales Dir.: Freddy P. Frei; R&D Dir.: Richard Steiner.
Audio: Cassette bodies, hubs, rolls, foils, pads, shields, all cartridge plastic parts, library cases.
 C C T (Compact Cassettes Trading AG), Birmensdorferstr. 55, CH-8036 Zurich, Tel: (01) 241.47.11. Telex: 58975. Pres.: Hugo von Blumenthal; Gen. Mgr.: Aldo Steiner.
Int'l branches: Austria, CCT; Germany, CCM.
 I C M Cassette Mdsrs. Ltd., Muehlebachstr. 27, CH-8800 Thalwil, Tel: (01) 720.29.42. Telex: 53759. Pres.: Werner Weber; Gen. Mgr.: Andy Baur; Sales Mgr.: Rolf Sager. (SEE ADVERTISEMENT)
 Lake County Recs., Bois-Noir 39, CH-2300 La Chaux-de-Fonds, Tel: (039) 26.93.60. Chief Exec.: Michel Cattin; Gen. & Sales Mgr.: Eliane Cattin.
 Lenco Moulding SA, rue de l'Industrie, CH-1781 Courmaman, Tel: (037) 34.19.15. Gen. Mgr.: Gerard Koeberle; Sales Mgr.: Zita Koeberle. (SEE ADVERTISEMENT)
 Toka AG, see CCT.
 Werner Weber Kunststoffwerk AG, Soodstr. 52, CH-8134 Adliswil, Tel: (01) 710.40.51. Pres.: Werner Weber; Ass't to Pres.: Mario Taravella.
Int'l branch: Germany.

EMPTY CARTRIDGES, CASSETTES, & REELS
 Alchemco AG, Althardstr. 224, CH-8105 Regensdorf/Zurich, Tel: (01) 840.66.06. Telex: 56359. Pres. & Gen. Mgr.: Gian Carlo Astore; Domestic Sales Mgr.: Hans Vetterli; Sales Dir.: Freddy P. Frei; R&D Dir.: Richard Steiner.
Audio: C-O cassette, cartridges, digital cassettes.
 C C T (Compact Cassettes Trading AG), Birmensdorferstr. 55, CH-8036 Zurich, Tel: (01) 241.47.11. Telex: 58975. Pres.: Hugo von Blumenthal; Gen. Mgr.: Aldo Steiner.
Int'l branches: Austria, CCT; Germany, CCM.
 I C M Cassette Mdsrs. Ltd., Muehlebachstr. 27, CH-8800 Thalwil, Tel: (01) 720.29.42. Telex: 53759. Pres.: Werner Weber; Gen. Mgr.: Andy Baur; Sales Mgr.: Rolf Sager. (SEE ADVERTISEMENT)
 Lake County Recs., Bois-Noir 39, CH-2300 La Chaux-de-Fonds, Tel: (039) 26.93.60. Chief Exec.: Michel Cattin; Gen. & Sales Mgr.: Eliane Cattin.
 Lenco Moulding SA, rue de l'Industrie, CH-1781 Courmaman, Tel: (037) 34.19.15. Gen. Mgr.: Gerard Koeberle; Sales Mgr.: Zita Koeberle.
Audio: C-O cassettes. (SEE ADVERTISEMENT)
 Musicland AG, Althardstr. 224, CH-8105 Regensdorf/Zurich, Tel: (01) 840.60.40. Telex: 56359. Pres. & Gen. Mgr.: Gian Carlo Astore; Domestic Sales Mgr.: Hans Vetterli; Sales Dir.: Freddy P. Frei; R&D Dir.: Richard Steiner.
 Toka AG, see CCT.
 Werner Weber Kunststoffwerk AG, Soodstr. 52, CH-8134 Adliswil, Tel: (01) 710.40.51. Pres.: Werner Weber; Ass't to Pres.: Mario Taravella.
Int'l branch: Germany.

ENVELOPES & MAILERS
 Turicaphon AG Schweizer Schallplattenfabrik, CH-8611 Riedikon/Zurich, Tel: (01) 941.13.11.

JACKETS & SLEEVES LABELS

Sonographic Rec'g Co AG, Kampstr 16, CH-8952 Schlieren Tel (01) 730.22 29 Pres R Egl. Gen. Mgr. W.A. Wettler, Sales Mgr. A. Brand. (Jackets & labels only)
 Turcaphon AG Schweizer Schallplattenfabrik CH-8611 Riedikon/Zurch Tel (01) 941.43.11. (Jackets & sleeves only)

POLYETHYLENE BAGS

Sonographic Rec'g Co AG, Kampstr 16, CH-8952 Schlieren Tel (01) 730.22 29 Pres R Egl. Gen. Mgr. W.A. Wettler Sales Mgr A Brand

PROFESSIONAL TAPE SUPPLIES

Audio Magnetics SA Geneva, PO Box 54, 2 Rte. des Acacias, CH-1227 Geneva, Tel: (022) 43 51.15. Telex 27152. Gen Mgr Jean-Pierre Murbach; Sales Mgr Werner Meier, Mktg. Mgr Jean-Jacques Eschenmoser
Int'l subsidiaries: England, France, Germany, Portugal (All Audio Magnetics)
Audio: 8-tr & cassette duplication tapes on NAB hubs

TAPE, RAW & BLANK LOADED

Agfa-Gevaert AG/SA, Steitbachstr 7, CH-8600 Duebendorf Tel Zurich 821 02 40 Telex 56961 Zurich Mng Dir R Klett, Sales Mgr U Buehring
Audio: Blank—Compact-cassette, open reel, raw—cassette, broadcast, studio.
Video: Cassette, open reel.
Brand names: Agfa Carat, Agfa Stereochrom, Agfa Videochrom.

Alchemco AG, Althardstr 224 CH-8105 Regensdorf/Zurich Tel (01) 840 66 06 Telex 56359 Pres & Gen Mgr. Gian Carlo Astore, Domestic Sales Mgr. Hans Vetterli, Sales Dir. Fredy P. Frei, R&D Dir.: Richard Steiner
Audio: Raw—8-tr., cassette, open reel, blank—8-tr., cassette
**Audio-Electronic AG, Raffelstr. 25 CH-8045 Zurich Tel (01) 66.26.90 Telex 56556 Chm. Manfred Frank; Sales Mgr. Ed Isenring, (Importer) (Blank only)
Audio: Cassette, open reel.
Brand name: Fuji**

Audio Magnetics SA Geneva, 2 Rte. des Acacias, CH-1217 Geneva 24, Tel (022) 43 51 15 Telex 27 52 Gen. Mgr. Jean-Pierre Murbach, Sales Mgr. Werner Meier, Mktg. Mgr. Jean-Jacques Eschenmoser.
Int'l subsidiaries: England, France, Germany, Portugal (All Audio Magnetics)
Audio: 8-tr., cassette & open reel
 B A S F (Switzerland) AG, Soestr 40, CH-8802 Kilchberg Tel (07) 15 19 21 Telex. 52396. Sales Mgr. Ueli Schori.
Home office: Germany
Audio: Cassette, open reel
Video: Cassette, open reel

C C T (Compact Cassettes Trading AG), Birmendorferstr 55, CH-8036 Zurich Tel (01) 241.47.11. Telex 58975 Chief Exec Hugo von Blumenthal Gen Mgr Peter Wurz.
Audio: Cassette
Brand Name: Toka/Galaxy.
 Fuji, see Audio-Electronic
 I C M, see MCA. (SEE ADVERTISEMENT)
 Intertape Ltd. (International Tape Org), Spinnerstr 21, CH-8753 Mollis, Tel (058) 34 31 34, Telex 75162. Gen Mgr., Peter Baumgartner; Sales Mgr. Louis Bischof. (Audio & Video).

Lenco Moulding SA, rue de l'Industrie, CH-1781 Courtaman, Tel (037) 34 19 15 Gen. Mgr. Gerard Koeberle; Sales Mgr. Zita Koeberle. (Blank only)
Audio: Cassette (SEE ADVERTISEMENT)

M C S (Music & Cassettes Supply Ltd.), Schufelistr., CH-8863 Buttikon SZ, Tel (055) 67.14.14, Telex 75144. Pres. Werner Weber; Gen. Mgr. Mario Taravella; Sales Mgr. Ulrich Plocher
Audio: 8-tr., cassette
Brand name: ICM

MagneTec Inc., Schwarztorstr 36, CH-3007 Berne. (Consulting & Engineering)

Musiland AG, Althardstr. 224, CH-8105 Regensdorf/Zurich, Tel (01) 840.60.40 Telex 56359 Pres. & Gen. Mgr. Gian Carlo Astore, Domestic Sales Mgr., Hans Vetterli, Sales Dir. Fredy P. Frei, R&D Dir. Richard Steiner

Audio: 8-tr., cassette, open reel
 Pyral (Produits) SA, 3 Rue Beau-Site, CH-1211 Geneva, Tel: 44 65 50, Telex 23756. (Blank only)
Home office: France.

Revox-ELA AG, Althardstr 146, CH-8105 Regensdorf, Tel (01) 840.26 71 Pres., Willi Studer, Gen. Mgr. Michel Ray (Blank only)
Audio: Open reel

Sony Overseas SA, Baarerstr. 59, CH-6301 Zug, Tel: (042) 23 31 21. (Blank only)
Audio: Cassette, open reel.
Video: 1" open reel, 3/4" cassette, 1/2" EIAJ cartridge.

Toka/Galaxy, see CCT
 Werner Weber Kunststoffwerk AG, Soodstr. 52, CH-8134 Adliswil, Tel (01) 710.40.51. Pres. Werner Weber; Ass't to Pres. Mario Taravella.
Int'l branch: Germany.
Audio: Blank—8-tr., cassette & open reel, raw—cassette & open reel

TAPE DUPLICATING EQUIPMENT

Alchemco AG, Althardstr. 224, CH-8105 Regensdorf/Zurich, Tel (01) 840 66 06 Telex 56359, Pres. & Gen. Mgr. Gian Carlo Astore, Domestic Sales Mgr. Hans Vetterli, Sales Dir. Fredy P. Frei, R&D Dir. Richard Steiner
Audio: Quality control equipment for CC production, cassette winders, audio acoustical equipment.
 Audio Magnetics SA Geneva, PO Box 54, 2 Rte. des Acacias, CH-1227 Geneva, Tel: (022) 43.51.15. Telex 27152.

Gen. Mgr. Jean-Pierre Murbach, Sales Mgr. Werner Meier, Mktg. Mgr. Jean-Jacques Eschenmoser
Int'l subsidiaries: England, France, Germany, Portugal (All Audio Magnetics)
Audio: 8-tr., cassette & open reel copiers & duplicators.
Brand name: Pentagon
 Intertechnika (div of Nichibe Technical Consultants Ltd.), Case Postale 475, 4 Rue Ami-Lullin, CH-1211 Geneva 3
Audio: Design & implementation of facilities
 Sony Overseas SA, Baarerstr. 59, CH-6300 Zug, Tel (042) 23.31.21

● accessories manufacturers

Alchemco AG, Althardstr 224, CH-8105 Regensdorf/Zurich, Tel: (01) 840 66 06. Telex 56359. Pres. & Gen. Mgr. Gian Carlo Astore; Domestic Sales Mgr. Hans Vetterli, Sales Dir. Fredy P. Frei, R&D Dir. Richard Steiner
Product: Carrying & storage cases, headd cleaners, demagnetizers, leader & splicing tape.
 Dynavox Electronics, route de Villars 105, CH-1700 Fribourg, Tel (037) 24 55.30.
Product: Needles, stereo cartridges
Brand name: Pickering

I C M Cassette Mdsrs. Ltd., Muehlebachstr 27, CH-8800 Thalwil, Tel (01) 720 29 42 Telex 53759 Pres. Werner Weber; Gen. Mgr. Andy Baur, Sales Dir.: Rolf Sager.
Product: Tape carrying & storage cases, splicing tape (SEE ADVERTISEMENT)

Lake County Recs., Bois Noir 39, CH-2300 La Chaux-de-Fonds Tel (039) 26 93 60 Owner Michel Cattin, Gen. & Sales Mgr. Eliane Cattin.
Product: 45 RPM adaptors, needles.

M C S (Music & Cassette Supply Ltd.), Schufelistr., CH-8863 Buttikon SZ Tel (055) 67 14.14, Telex 75144. Pres.: Werner Weber; Gen. Mgr. Mario Taravella, Sales Mgr. Ulrich Plocher
Int'l branch: Germany
Product: Head cleaners

Musiland AG, Althardstr 224, CH-8105 Regensdorf/Zurich, Tel: (01) 840.60.40. Telex: 56359. Pres. & Gen. Mgr. Gian Carlo Astore; Domestic Sales Mgr. Hans Vetterli; Sales Dir. Fredy P. Frei, R & D Dir. Richard Steiner.
Product: Carrying & storage cases, head cleaners & demagnetizers

Revox-ELA AG, Althardstr. 146, CH-8105 Regensdorf, Tel. (01) 840.26 71. Pres. Willi Studer; Gen. Mgr. Michel Ray
Product: Tape carrying & storage cases, head cleaners & demagnetizers.

E. Schweizer Design AG, Spalentorweg 54, CH-4051 Basel, Tel: (061) 22.17.65. Telex 63403. Gen. Mgr.: Peter Krummenacher

Int'l branches: Germany, USA
Product: Carrying & storage cases, cleaners, cloths, & brushes, head cleaners

Thorens-Franz AG, Hardstr 41, CH-5430 Wettingen, Tel (056) 26.28.61. Mng. Dir. Remy A Thorens; Sales Dir. Armin Graf.
Product: 45 rpm adaptors, needles

● store fixtures & merchandising aids manufacturers

Alchemco AG, Althardstr. 224, CH-8105 Regensdorf/Zurich Tel (01) 840.66.06. Telex 56359. Pres. & Gen. Mgr., Gian Carlo Astore; Domestic Sales Mgr. Hans Vetterli; Sales Dir.: Fredy P. Frei, R&D Dir.: Richard Steiner
Product: Tape display racks

Musiland AG, Althardstr. 224, CH-8105 Regensdorf/Zurich, Tel (01) 840.60.40 Telex 56359 Pres. & Gen. Mgr. Gian Carlo Astore; Domestic Sales Mgr. Hans Vetterli; Sales Dir. Fredy P. Frei, R&D Dir. Richard Steiner.
Product: Tape display racks.

E. Schweizer Design AG, Spalentorweg 54, Ch-4051 Basel, Tel (061) 22.17.65. Telex 63403 Gen Mgr. Peter Krummenacher.

Int'l branches: Germany, USA.
Product: Browser boxes, display racks.

THAILAND

Population: 42,960,000
Rate of exchange: \$1 (US) = 20 41 baht
Per capita income: \$318
Holidays: January 1, February 13 (Makha Bua), April 6, May 5 (Coronation Day), May 10, July 1, August 12 (Queen's Birthday), December 5 (King's Birthday), December 10 (Constitution Day), December 31 & all Buddhist holidays.
Records, record blanks & pre-recorded media imported from USA: 1977—\$146,329.

● record & tape manufacturers / distributors / importers

Black & White Co. Ltd., PO Box 335, Thai Lai Thong Bldg.,

52/4-6 Surawongse Rd., Bangkok. Tel. 31-939, 33-720, 31-241. **Local branch:** 900 Mahachai Rd. Capitol, see EMI.

Ching Thai Regd. Ord. Partnership, Burapa Palace, 669-671 Chakrapet Rd., Bangkok 2, Tel: 221-4471/4241. Cable CHINTAICOM. Pres. Maitri Boondiskulchok; Gen. Mgr.: Kavee Boondiskulchok; Sales Mgr.: Kamol Boondiskulchok. (Distributor/Importer from UK & USA)

Labels: (Distributed foreign—not licensed)
 Amsterdam, Atlantic, Capitol, Columbia, Command, Dolton, Dunhill, Elektra, Epic, Liberty, London, MCA, MGM, Mercury, Motown, Nonesuch, Pride, RCA, United Artists, Warner Bros. (all USA).

E M I (Thailand) Ltd., 522 Prasumain Rd., Bangkok Tel: 281-7089/7582/7377. Cable EMITRON. Mng Dir.: Neil Sarsfield; Sales Mgr.: Thaveechai Jariya-lam-Udom; Comm'l Dir. Pramahn Boodsakorn.
Labels: (Owned) Capitol, EMI, EMI (Thailand); (licensed) Arista (USA), Bronze (UK), CBS (USA), Island (UK), MAM (UK), Magnet (UK), Motown (USA), Philips (Netherlands), Polydor (Germany), Private Stock (USA), RAK (UK), Sherbet (Australia), United Artists (USA)

K S, see Thai Phonograph.
 Sri Krung Phonograph Rec. Co. Ltd., 129 Sukumvit 21, Bangkok, Tel (3) 920-208, 918-380, Cable: VASUVAT. Owner Manit Vasuvat; Gen. Mgr.: Chaichan Vasuvat; Sales Mgr. Pomphan Vasuvat.
Labels: (Owned) MV-Master Voice, SKS-Sri Krung, SPC-Sri Krung, Solina, Sona Tape
Int'l rep.: Germany (Asona), USA (RCA Int'l).

M V-Master Voice, see Sri Krung.
 S K S, see Sri Krung.
 S P C, see Sri Krung.
 Solina, see Sri Krung.
 Sona Tape, see Sri Krung
 Thai Phonograph Rec. Co. Ltd., 857 Mahachai Rd., Bangkok, Tel 286-1648. Mng. Dir.: Sukit Pachimsawat; Gen. Mgr.: Tian Chunsiripong
Label: (Owned) KS.

● music publisher

Kamol Sukosol Co. Ltd., 857 Mahachai Rd., Bangkok. Tel: 222-5131 Mng. Dir. Sukit Pachimsawat; Gen. Mgr.: Tian Chunsiripong.

● services

DESIGN & ARTWORK PLATING, PROCESSING & PRESSING PLANTS

Sri Krung Phonograph Rec. Co. Ltd., 129 Sukumvit 21, Bangkok Tel: 920-208. Cable: VASUVAT. Owner: Manit Vasuvat; Gen. Mgr.: Chaichan Vasuvat, Sales Mgr. Pomphan Vasuvat.

Thai Phonograph Rec. Co. Ltd., 857 Mahachai Rd., Bangkok, Tel 286-1648. Mng. Dir. Sukit Pachimsawat; Gen. Mgr.: Tian Chunsiripong.

PRINTER & LITHOGRAPHER RECORD PROMOTION

Sri Krung Phonograph Rec. Co. Ltd., 129 Sukumvit 21, Bangkok Tel: (3) 920-208. Cable: VASUVAT. Owner: Manit Vasuvat; Gen. Mgr.: Chaichan Vasuvat; Sales Mgr. Pomphan Vasuvat.

TAPE CUSTOM DUPLICATORS TAPE DUPLICATOR / MARKETERS

Sri Krung Phonograph Rec. Co. Ltd., 129 Sukumvit 21, Bangkok, Tel: 920-208. Cable: VASUVAT. Owner: Manit Vasuvat; Gen. Mgr.: Chaichan Vasuvat; Sales Mgr.: Pomphan Vasuvat
Audio: Cassette.

Thai Phonograph Rec Co Ltd., 857 Mahachai Rd., Bangkok Tel 286-1648 Mng. Dir. Sukit Pachimsawat; Gen. Mgr.: Tian Chunsiripong.
Audio: Cassette, open reel, open reel quadraphonic.

● supplies

CARTRIDGE & CASSETTE PARTS EMPTY CARTRIDGES, CASSETTES & REELS

BLANK LOADED TAPE

Sri Krung Phonograph Record Co. Ltd., 129 Sukumvit 21, Bangkok, Tel 920-208, 918-380 Cable: VASUVAT. Owner: Manit Vasuvat; Gen. Mgr. Chaichan Vasuvat; Sales Mgr.: Pomphan Vasuvat.
Product: Cassette parts & blank loaded tape, empty cassettes & reels, sleeves & processing equip.
Brand names: MV, Solina, Vasuvat.

● accessories manufacturer

Sri Krung Phonograph Rec. Co. Ltd., 129 Sukumvit 21, Bangkok, Tel: 920-208. Cable: VASUVAT. Owner: Manit Vasuvat; Gen. Mgr.: Chaichan Vasuvat; Sales Mgr.: Pomphan Vasuvat.
Product: Carrying & storage cases, catalog services, head cleaners & demagnetizers, leader & splicing tape.

TRINIDAD & TOBAGO

Population: 1,080,000.
Rate of exchange: \$1 (US) = 2.38 Trinidad & Tobago dollars
Per capita income: \$1,400.
Holidays: January 1, Good Friday, Easter Monday, Whitmonday, Corpus Christi, May 1, June 19, August 7 (Discovery Day), August 31 (Independence Day), Eid Ul Fitr Divali, December 25, 26.
Records, record blanks & pre-recorded media imported from USA: 1977—\$247,056

RADIO STATIONS

No. of commercial 1, government 1.
Comment: The commercial station transmits in both AM & FM. The government owned transmits in AM, FM and FM stereo.

TELEVISION

Comment: There is one government owned station transmitting two channels in black & white.

● record & tape manufacturers / distributors / importers

C L O, see Record Specialists.
 C S S, see Caribbean.
 Caribbean Rec'g Co. Ltd., Maingot & Gordon Sts., Mount Hope, Port-of-Spain, Trinidad, Tel. (638) 3354.
Labels: (Owned) CSS, Village, (distributed) Helen Disc, Hewanorra, Mamwa, Miraflores, Simpet, Suriname, Telco, (represented) Camille, Casa Grande (both USA).
Int'l rep.: Barbados (WIRL).

Catelli, see Record Specialists.
 D D S, see Record Specialists.
 Helen Disc, see Caribbean.
 Hewanorra, see Caribbean.
 K H Recs. Ltd., see Record Specialists.
 Kaimit, see Record Specialists.
 Kalaloo, see Record Specialists.
 Kalinda, see Record Specialists.
 Mamwa, see Caribbean.
 Miraflores, see Caribbean.

Record Specialists (Trinidad) Ltd / KH Recs. Ltd. (IFPI), 4 Milling Ave., Sea Lots, Port-of-Spain, Trinidad Tel. (62) 31092, 36435, 37789. Cable HEATSINK Mng Dir.: Kerry Richards.
Labels: (Owned) Kaimit, Kalaloo, Kalinda, (licensed domestic) CLO, Catelli, DDS, Ritchies, SH, Trinidad, (licensed foreign) Arrow (Montserrat).
Int'l reps.: Africa, Europe, UK (all Tackle), USA (Charlie).

Hilton D. Rhyner, 54 Prince St., Port-of-Spain, Trinidad, Tel. (62) 35673. Gen. Mgr.: Hilton D. Rhyner, Sales Mgr.: Cleve Calderon. (Importer)
 Ritchies, see Record Specialists.
 S H, see Record Specialists.
 Simpet, see Caribbean.
 Suriname, see Caribbean.
 Telco, see Caribbean.
 Trinidad Recs., see Record Specialists.
 Village, see Caribbean.

● music publishers

Cucumba Music Publ'g Co. Ltd. (BMI), 90 Frederick St., Port-of-Spain, Trinidad.
 K H Music, 4 Milling Ave., Sea Lots, Port-of-Spain, Tel. (62) 36435, 31092, 37789. Cable HEATSINK Mng. Dir.: Kerry Richards.
Int'l reps: France (Bagatelle), UK (PRS).
 Witelco Music Co., High St., Siparia, Trinidad, Tel. (649) 2415.

● services

DESIGN & ARTWORK PLATING, PROCESSING & PRESSING PLANT

Record Specialists (Trinidad) Ltd., 4 Milling Ave., Sea Lots, Port-of-Spain, Trinidad, Tel. (62) 31092, 36435, 37789. Cable: HEATSINK Mng. Dir.: Kerry Richards.

TAPE CUSTOM DUPLICATORS TAPE PACKAGING & LABELING

The Audio and Video lines indicate the configurations which the firms duplicate. Companies which offer packaging and labeling of tape product are indicated by: (PKG) which appears after the main body of their respective listings.

Record Specialists (Trinidad) Ltd., 4 Milling Ave., Sea Lots, Port-of-Spain, Trinidad, Tel. (62) 31092, 36435, 37789. Cable: HEATSINK Mng. Dir.: Kerry Richards. (PKG—audio only)
Audio: Cassette.

● supplies

LABELS

Record Specialists (Trinidad) Ltd., 4 Milling Ave., Sea Lots,

Port-of-Spain, Trinidad, Tel. (62) 31092, 36435, 37789. Cable HEATSINK Mng. Dir.: Kerry Richards.

● accessories importer

Hilton D. Rhyner, 54 Prince St., Port-of-Spain, Trinidad, Tel. (62) 35673. Gen. Mgr.: Hilton D. Rhyner, Sales Mgr.: Cleve Calderon.
Product: Cleaners, cloths, brushes, 45 rpm adapters, needles, head cleaners & demagnetizers.

TURKEY

Population: 40,160,000.
Rate of exchange: \$1 (US) = 47 liras
Per capita income: \$553
Holidays: January 1, April 23 (National Sovereignty Day), May 1 (Spring Day), May 19 (Youth & Sports Day), May 26, 27 (Freedom & Constitution Day), August (Victory Day), October 29, 30 (Republic Day), & important religious holidays.

● record & tape manufacturers / distributors / importers

A S, see Metronom.
 Aras, see Kent.
 Balet, see Gruenberg.
 Bobo, see Metronom.
 Evren, see Metronom.

Gruenberg Ticaret AS (IFPI), PO Box 533, Rızapasa Yokusu, Milas Han, Istanbul, Tel. (92) 26-32-60. Cable ODEON Telex 22219. Pres. Leon Gruenberg. Gen. Mgr. Benno Merovich, A&R Mgr.: Yesil Giresonlu, Sales Mgr.: Baruh Pinto.
Labels: (Owned) Balet, (represented) Apple (UK), CBS (USA), Columbia (UK), DG (Germany), Dureco (Netherlands), EMI (UK), Haven (USA), Odeon (UK), Parlophone (UK), Phonogram (Netherlands), Polydor (Germany), Stateside (UK).
Int'l reps.: Germany (Polydor), Netherlands (Phonogram), UK (EMI), USA (CBS).

H O P, see Yanki.
 I No Plakçılık, see Yanki.
 Jet, see Metronom.

Kent Müzik Ticaret ve Pazarlama Ltd., PO Box 24, IMC Blok 6, No. 6328, Unkapanı, Istanbul, Tel. (11) 26-34-65. Gen. Mgr.: Umit Guner, Sales Mgr.: Omer Borazancı.
Labels: (Owned) Aras, Kent, (licensed) Agumamanda (Italy), BMI (Netherlands), Carosello (Italy), Dureco (Netherlands), EMI (Netherlands), Marfer (Spain), Motors (France), Regal (EMI UK), Sonet (Sweden), Trema (France), Zafiro (Spain).
Int'l reps.: Germany (Yilmal Exp.)

Melodi Rec'g & Sound Ind. (IFPI), 348 Istiklal Caddesi, Istanbul, Tel. (92) 44-26-36. Cable MELODI. Gen. Sec'y: Faruk Ergokmen. Gen. Mgr.: Kayihan Çağlayan, Sales Mgr.: Turgut Çağlayan, A&R Mgr.: Vahe Dilacar.
Labels: (Owned) Melodi, (licensed foreign) Atlantic (USA), Baby (Italy), Bronze (UK), Discos Columbia (Spain), DJM (UK), Decca (UK), Elektra / Asylum (USA), Infinity (USA), London (USA), MCA (USA), Motown / Gordy / Tamla (USA), RCA (USA), WEA Int'l (USA), Warner Bros. (USA), (distributed—not licensed) Bo vema Negram (Netherlands), Fonior (Belgium), Killory (Netherlands), Victor Music (Japan).

Metronom Ltd., PO Box 66, IMC Blok 6, No. 6430, Unkapanı, Istanbul, Tel. 26-54-59. Gen. Mgr.: Nazmi Senel, Sales Mgr.: Tunay Akdeniz, Comm'l Mgr.: Akif Senbaobaoglu.
Labels: (Owned) Metronom, (licensed) AS, Evren, Senel, (distributed—not licensed) Bobo, Jet, Satellite, West, ZE, Zenith.
Int'l reps.: Austria (Super Corp.), Belgium (Ronnex), Italy (Carosello), Netherlands (Dureco), UK (Music World).

Satellite, see Metronom.
 Senel, see Metronom.
 West, see Metronom.
 Yanki Ltd. Rec. Mfg. & Dist'g Co. (IFPI), IMC Blok 6, No. 6437, Unkapanı, Istanbul, Tel. 22-07-15. Pres.: Atilla Cilanbol, Gen. Mgr.: Kadir A. Demirturk, Sales Mgr.: Ali Ihsan Oral, Contract Mgr.: Yasef Alguadis.
Labels: (Licensed) Durium (Italy), Hansa Int'l (Germany), (distributed—not licensed) Ariola Eurodisc (Germany), Barclay (France), Cyclon (France), HOP, I No Plakçılık, Int'l Show (France), Pye (UK), Saar (Italy).
Int'l reps.: France (Dalida, Cyclon, Orlando, Show Int'l), Germany (Ariola Eurodisc, Hansa), Italy (Durium, Saar), UK (Pye).

Z E, see Metronom.
 Zenith, see Metronom.

● music publishers

Kent Music Edisyon, Ankara Caddesi, No. 74 / 509, Sirkeci, Istanbul, Tel. 26-54-59. Chief Exec.: Nazmi Senel, Gen. Mgr.: Mrs. Beyhan Pastumaz.
 Kent Music Ltd., PO Box 24, IMC Blok 6, No. 6328, Unkapanı, Istanbul, Tel. (11) 26-34-65. Gen. Mgr.: Umit Guner.
 Odeon Ticaret TAO, PO Box 533, Rızapasa Yokusu, Milas Han, Istanbul, Tel. (92) 26-32-60. Chm.: Leon Gruenberg, Gen. Mgr.: Benno Merovich.

● services

ASSOCIATION & PROFESSIONAL ORGANIZATION

Association of Phonograph Music Prod'rs (Fono Müzik Pro-

duktorleri Derneği), Halkali Caddesi 85, Yesilkoy-Istanbul.

DESIGN & ARTWORK

Muzikservis, PO Box 66, IMC Blok 6, No. 6430, Unkapanı, Istanbul, Tel. 26-54-59. Pres.: Nazmi Senel, Gen. Mgr.: Nihan Goymen, Sales Mgr.: Erdogan Kalyoncu.

LICENSING ORGANIZATION, MUSIC

Muzikservis, PO Box 66, IMC Blok 6, No. 6430, Unkapanı, Istanbul, Tel. 26-54-59. Pres.: Nazmi Senel, Gen. Mgr.: Nihan Goymen, Sales Mgr.: Erdogan Kalyoncu (Mechanical rights only).

PLATING, PROCESSING & PRESSING PLANTS

Melodi Rec'g & Sound Ind., 348 Istiklal Caddesi, Istanbul, Tel. (92) 44-26-36. Cable MELODI. Gen. Sec'y: Faruk Ergokmen, Gen. Mgr.: Kayihan Çağlayan, Sales Mgr.: Turgut Çağlayan.
 Plaksan Plak Sanayi AS, Bağcılar Yolu, Marmara Cad., No. 12, Gungoren, Istanbul, Tel. 71-67-34. Cable SAN-PLAK Chm.: Leon Gruenberg, Gen. Mgr.: Engin Tunasar.

PRINTER & LITHOGRAPHER

Muzikservis, PO Box 66, IMC Blok 6, No. 6430, Unkapanı, Istanbul, Tel. 26-54-59. Pres.: Nazmi Senel, Gen. Mgr.: Nihan Goymen, Sales Mgr.: Erdogan Kalyoncu.

RECORD PROMOTION

Kent Müzik Ticaret ve Pazarlama Ltd., PO Box 24, IMC Blok 6, No. 6328, Unkapanı, Istanbul, Tel. (11) 26-34-65. Gen. Mgr.: Umit Guner, Sales Mgr.: Omer Borazancı.
 Muzikservis, PO Box 66, IMC Blok 6, No. 6430, Unkapanı, Istanbul, Tel. 26-54-59. Pres.: Nazmi Senel, Gen. Mgr.: Nihan Goymen, Sales Mgr.: Erdogan Kalyoncu.

TAPE CUSTOM DUPLICATORS TAPE PACKAGING & LABELING

The Audio and Video lines indicate the configurations which the firms duplicate. Companies which offer packaging and labeling of tape product are indicated by: (PKG) which appears after the main body of their respective listings.

Kent Müzik Ticaret ve Pazarlama Ltd., PO Box 24, IMC Blok 6, No. 6328, Unkapanı, Istanbul, Tel. (11) 26-34-65. Gen. Mgr.: Umit Guner, Sales Mgr.: Omer Borazancı. (PKG)

Audio: 8-tr. cassette.
 Melodi Rec'g & Sound Ind., 348 Istiklal Caddesi, Istanbul, Tel. (92) 44-26-36. Cable MELODI. Gen. Sec'y: Faruk Ergokmen, Gen. Mgr.: Kayihan Çağlayan, Sales Mgr.: Turgut Çağlayan.

Audio: 8-tr. cassette.
 Muzikservis, PO Box 66, IMC Blok 6, No. 6430, Unkapanı, Istanbul, Tel. 26-54-59. Pres.: Nazmi Senel, Gen. Mgr.: Nihan Goymen, Sales Mgr.: Erdogan Kalyoncu.

Audio: Cassette.
Video: 1/4" cassette, 1/2" EIAJ cartridge.
 Plaksan Plak Sanayi AS, Bağcılar Yolu, Marmara Cad., No. 12, Gungoren, Istanbul, Tel. 71-67-34. Cable SAN-PLAK Chm.: Leon Gruenberg, Gen. Mgr.: Engin Tunasar.
Audio: Cassette.

● supplies

CARTRIDGE & CASSETTE PARTS EMPTY CARTRIDGES, CASSETTES & REELS

Edvard I. Palacı, PO Box 515, 58 / 407 Cumhuriyet Blvd., Izmir, Tel. (51) 14-18-26. Cable PALACI. Telex: 52562. Mng. Dir.: Edvard I. Palacı, Gen. Mgr.: Robert Palacı, Sales Mgr.: Albert Sarfatı, Export Sec'y: Rose Palacı. (Empty Only) (Distributor / Importer / Exporter)
Audio: Cassette.

Plaksan Plak Sanayi AS, Bağcılar Yolu, Marmara Cad., No. 12, Gungoren, Istanbul, Tel. 71-67-34. Cable SAN-PLAK Chm.: Leon Gruenberg, Gen. Mgr.: Engin Tunasar.
Audio: Cassette.

TAPE, RAW & BLANK LOADED

Gantenbein Ticaret, Meclisi Mebusan Caddesi 147, Tutun Han 4, Istanbul, Tel. 43-28-00. Telex: 23441. Mng. Dir.: H. Koch, Technical Mgr.: K. Demiriz.
Audio: Blank—compact-cassette, open reel; raw—cassette, broadcast, studio.
Video: Cassette, open reel.
Brand names: Agfa Carat, Agfa Stereochrom, Agfa Videochrom.

Edvard I. Palacı, PO Box 515, 58 / 407 Cumhuriyet Blvd., Izmir, Tel. (51) 14-18-26. Cable PALACI. Telex: 52562. Mng. Dir.: Edvard I. Palacı, Gen. Mgr.: Robert Palacı, Sales Mgr.: Albert Sarfatı, Export Sec'y: Rose Palacı. (Distributor / Importer / Exporter)
Audio: Blank—8-tr., cassette, open reel; raw—cassette.
Video: Blank—1/2" EIAJ cartridge.
Brand names: Brand Five, CBS, G-Tape, Sonoramic, Standard, TDK (VHS & Beta formats).

TAPE DUPLICATING & PROCESSING EQUIPMENT

Edvard I. Palacı, PO Box 515, 58 / 407 Cumhuriyet Blvd., Izmir, Tel. (51) 14-18-26. Cable PALACI. Telex: 52562. Mng. Dir.: Edvard I. Palacı, Gen. Mgr.: Robert Palacı;

Sales Mgr.: Albert Sarfati, Export Sec'y: Rose Palaci (Distributor/Importer/Exporter)
 Audio: Cassette, pancakes.

PROFESSIONAL TAPE SUPPLIES

Edvard I. Palaci, PO Box 515, 58/407 Cumhuriyet Blvd., Izmir. Tel: (51) 14-18-26. Cable: PALACI. Telex: 52526. Mng. Dir.: Edvard I. Palaci; Gen. Mgr.: Robert Palaci; Sales Mgr.: Albert Sarfati; Export Sec'y: Rose Palaci (Distributor/Importer/Exporter)
 Audio: Test & alignment tape.
 Brand name: TDK.

● **accessories manufacturers**

Melodi Records & Sound Ind., 348 Istiklal Caddesi, Istanbul. Tel (92) 44-26-36. Cable: MELODI. Gen. Sec'y: Faruk Ergokmen; Gen. Mgr.: Kayihan Caglayan; Sales Mgr.: Turgut Caglayan.
 Product: Carrying & storage cases.
 Edvard I. Palaci, PO Box 515, 58/407 Cumhuriyet Blvd., Izmir. Tel: (51) 14-18-26. Cable: PALACI. Telex: 52526. Mng. Dir.: Edvard I. Palaci; Gen. Mgr.: Robert Palaci; Sales Mgr.: Albert Sarfati; Export Sec'y: Rose Palaci (Distributor/Importer/Exporter)
 Product: Tape carrying & storage cases, head cleaners & demagnetizers.

USSR

Population: 262,442,000.
 Rate of exchange: \$1 (US) = .66 rubles.
 Per capita income: \$2.010
 Holidays: January 1, March 8 (Int'l Women's Day), May 1, 2 (May Day), May 9 (VE Day), October 7 (Soviet Constitution), November 7, 8 (October Revolution).

RECORDS:

Record production: 1978—204,000,000 units (65,000,000 flexibles)
 Records imported from Eastern Europe & Cuba: 1978—700,000 units.
 Average retail price per record: Pop & jazz stereo LP's—\$3.25 & \$4.50, classical stereo LP's—\$2.19; mono & stereo singles (with 3 or 4 songs)—\$1.28, flexible mono singles—\$.90.
 Stereo sales: 40-45% of total pop sales, 100% of classical sales.
 Record club sales: None.
 Discounting: Rare, although clearance sales at extremely low prices have been recently effected by some outlets.

Type of distribution: Manufacturer-to-wholesaler-to-retailer is the major form of distribution. Wholesaler-to-customer distribution exists only in the form of mail order service. Nationwide retailing through newsstands has been in effect since 1969. There is no rack jobbing or one stopping in the usual form.

Need for specialized record shops (retail outlets) operated by Melodiya is apparent. Until now, all retail outlets have been operated by Ministry of Trade organizations. Certain quantities of records are retained by Soyuzpetchat (press distribution agency) through its newsstands.

Type of promotion: The government controls all airways, and there are no charts of best selling records. However, Melodiya promotes new recordings through handbills and through a program broadcast weekly by Mayak Radio on long and medium wavelengths. It also will publish a special record/tape monthly magazine, with a catalog-bulletin format, aimed at the general record collector and buyer. New releases are also advertised in "Soviet Culture," in the bi-weekly "Musical Life," and in some local newspapers and periodicals. Radio and television programs featuring recorded music are also a valuable means of promotion, as are sales exhibitions held periodically by East European companies in the major cities.
 "Muzykalny Kiosk" ("Musical Newsstand"), a weekly 30 minute program on the Central TV, which promotes mainly new classical releases and some pop, jazz, easy listening and folk. There are also various radio & TV programs in Estonia, Latvia and Tbilisi dealing with promotion and record reviewing. Klub, national bi-weekly magazines, runs "New Disks" column, in which most of the new Melodiya releases (classical, pop, jazz, folk, literature) are reviewed by music critics and journalists, with some cover-sleeves reproduced.

Jukeboxes: 15,000-20,000

TAPE:

Market: Since the pre-recorded cassette was introduced in 1971, it has become the dominant configuration, with almost no industrial production of pre-recorded open reel and no production of 8-track cartridge. The playback equipment market is steadily developing with a trend toward introducing more sophisticated, up-to-date quality products with a stronger emphasis on cassette units. The first high quality cassette unit is due on the market soon.

Average retail price per tape: Cassette—\$6.81.

RADIO STATIONS:

No. of government 222
 Comment: All radio stations are government owned. Most cities have access to cable broadcasting. There are over 30 FM stations. Radio Leningrad transmits for about 40 hours each week in FM stereo, programming classical (20 hours), pop and easy listening (12-13 hours) and literature. The news and music format of Mayak Radio is widely listened to. There is a trend toward the launching of more FM stations with a large percentage of stereo broadcasting as the national companies introduce more stereo tuners and radios.

TELEVISION STATIONS:

Comment: All television stations are government owned. Moscow has four channels, one of which is Central (nationwide). Most cities have their own stations, and the Central program is received everywhere; thus there is two-channel television in most of the USSR. The Central channel is fully color; other channels are partially color. SECAM type of color system is used. Both classical and easy listening music are utilized by television stations nationally. In 1978, up to 83% of the overall population in the USSR could see national television programs.

IMPORT/EXPORT REGULATIONS:

All import/export of records is controlled through Mezhdunarodnaya Kniga in Moscow. The quota for records received privately from abroad, excepting East European nations, is one unit. A customs duty of 5 rubles is charged for each additional unit enclosed. The same regulation applies to promotion copies mailed to private persons.

MARKET ANALYSIS:

In 1978, Melodiya Records reached its highest yearly output level—204 million units, including over 60 million flexible mono singles featuring national and international pop songs. Melodiya officials believe that in several years its production of flexibles will be finished (with the exception of study, promotional and advertising disks). The company has also expanded its line of licensed LP's, having released 45 licensed LP's (23 classical and 22 pop and jazz) in 1978 from licensees CBS, EMI, Polydor, Hispavox, ABC, among others.

Melodiya has considerably improved the quality of its releases, including cover sleeves, art design, comments on the material, and the A&R presentation. Last year it established a new facility—the Gramzapis pressing plant, which is involved with experimental and research problems in the development of recording studio equipment, the new technology of recording and pressing processes, the improvement of software quality, and the development of quadradisks and videodisks. Melodiya's three major pressing factories in Aprelevka (Moscow), Leningrad and Tashkent are being reconstructed and modernized.

There are plans to build a giant record production complex in Moscow. Upon completion, it will be the largest and most powerful record manufacturing enterprise in the world. Construction reportedly will begin in 1980, soon after the Olympic games are over. Meanwhile, the forging and pressing equipment enterprise in Odessa is completing the designing of the first Russia-made record pressing equipment. The pilot presses were tested in April and May of 1979.

The tape market is steadily developing but is far behind the record market. Melodiya produces fewer than three million cassettes.

Vadim D. Yurchenkov

● **record & tape manufacturers/distributors/importers**

Melodiya, 24 Tverskoi Blvd., Moscow K-9. Tel. 229-9248. Cable: MOSCVA. Dir. Gen. P.I. Shabanov.
 Mezhdunarodnaya Kniga (V/O), 32/34 Smolenskaya-Sennaya Pl., Moscow 121200. Tel. 244-1022. Cable: MEZHKNIGA. Pres. Youri B. Leonov; Gen. Mgr.: Mikhail P. Shmelov.
 Labels (Owned) Melodiya, (licensed foreign) ABC (USA), Ariola (Germany), CBS (USA), CNR (Netherlands), Chant du Monde (France), Chrysalis (UK), EMI (UK), Hispavox (Spain), Motown (USA), Polar (Sweden), Polydor (Germany), United Artists (UK), Zafiro (Spain).
 Int'l reps: Germany (Ariola, Polydor), Japan (Victor), Netherlands (Sound Prods.), UK (EMI, United Artists), USA (ABC, CBS, Pickwick Int'l).

● **music publishers**

Muzychna Ukraina, Ul. Pushkinskaya 32, Kiev. Tel. 25-2104.
 Soviet Composer Publ'rs, Moris Torez Embankment 30, Moscow V-35.
 Branch: Leningrad, Pr. Gaza 44. Tel. 52-34-62.
 State Publ'rs Music, Neglinnaya 14, Moscow K-45.

● **services**

ASSOCIATIONS & PROFESSIONAL ORGANIZATIONS

Kontora Gramplastinok, Ministry of Foreign Trade, Smolenskaja Square, Moscow G-200.
 Muzfond, Ul. Gotvalda 10, Moscow A-47.
 National Committee of the International Music Council, c/o Union of Composers of the USSR, Ul. Nyezhdanovi 8, Moscow K-9.
 State Committee of Broadcasting & Television, Ul. Pyatnitskaya 25, Moscow. Tel. 233-6356. Cable: MOSKVA-RADIO.
 Union of Composers of the USSR, Ul. Nyezhdanovi 8, Moscow K-9. Tel. 229-5444/4893.
 Branch: Leningrad, Ul. Gertzena 45. Tel. 12-16-23.

LICENSING ORGANIZATION, MUSIC

V A P (All-Union Agency of Copyright), Bolshaya-Bronnaya 6A, 103104 Moscow K-104. Tel. 203-4599. Cable: AVTOR. Telex 7627. Chm. Boris D. Pankin.
 Branch: Leningrad 191025 Vladimirovsky pr. 2. Tel. 1215-9237. Dir.: Nina Kramarova.

PRESSING PLANT

V S G (Vsesoyuznaya Studiya Gramzapis), Ul. Stankevitcha 8, Moscow K-9.

Branches: Leningrad, Ul. Tzvetochnaya 6—Moscow region, Aprelevsky, St. Aprelevska—Riga, Ul. Kalntziema 40—Tashkent, Ul. Druzhba Narodov 4.

RECORD PROMOTION

Gosconcert Agency, Neglinnaya 15, Moscow. Cable: MOSKVA GOSCONCERT.

● **supplies**

TAPE, RAW & BLANK LOADED

Melodiya, Tiivase 12, Tallin 16. (Blank only)
 Audio: Cassette
 Pereslavl-Zaleski Chemical Plant, Pereslavl-Zaleski, Yaroslavl Obl.
 Audio: Open reel.
 Shostka Chemical Plant, Shostka, Sumskaya Obl.
 Audio: Open reel.
 Vertretung der BASF, Ul. Lunatscharkogo 7, 121002 Moscow. Tel. 241-75-09. Cable: BASF. Telex: 7767.
 Brand name: BASF.

UNITED KINGDOM

Population: 55,900,000.
 Rate of exchange: 1 pound = \$2.22.
 Per capita income: \$44.00
 Holidays: January 1, Good Friday, Easter Monday, First Monday in May, Last Monday in May, Last Monday in August, December 25, December 26 (Boxing Day).
 No. of homes with record players: 16,200,000.

RECORDS:

Records sold domestically: LP's 1978—85,500,000 units, \$491,000,000; 1977—81,500,000 units, \$364,000,000. EP's 1977—2,000,000 units, \$5,000,000. Singles 1978—87,900,000 units, \$117,000,000; 1977—62,100,000 units, \$69,000,000.

Records imported from USA (factory value, CIF): 1978—1,000,000 units, \$8,000,000; 1977—1,500,000 units, \$8,000,000.

Records exported to USA (factory value, FOB): 1978—5,000,000 units, \$11,000,000; 1977—5,000,000 units, \$8,000,000.

Records imported from countries other than USA (factory value, CIF): 1978—7,000,000 units, \$10,000,000; 1977—4,000,000 units, \$9,000,000.

Records exported to countries other than USA (factory value, FOB): 1978—18,000,000 units, \$44,000,000; 1977—18,000,000 units, \$34,000,000.

Typical retail price per record: LPs—\$11.00; singles—2.20.

Stereo sales: 95% of total.

Record club sales: 8% of total.

Discounting: Frequent.

Type of distribution: The manufacturer-to-retailer system predominates with about 60% of the market; racked outlets account for 18% of sales; one-stops have about 7%, and mail order and clubs the remaining 15%.

Type of promotion: Radio and television are thought to be the most important media but there is some evidence that airplay is not vital to success. About 25% of LP sales are stimulated by TV advertising. Press coverage is good.

Jukeboxes: 65,000.

TAPE:

Market: Cassette is the only significant tape medium. While sales of top line product are decreasing, budget lines sales are increasing. Music centres are the most popular equipment for new purchasers.

Pre-recorded tape sold domestically including imports (retail value): 8-tr. 1978—600,000 units, \$400,000; 1977—1,100,000 units, \$6,000,000. Cassette 1978—20,500,000 units, \$129,000,000; 1977—18,500,000 units, \$94,000,000.

Pre-recorded tape exported to USA (factory value, FOB): 1978—500,000 units, \$2,000,000; 1977—500,000 units, \$2,000,000.

Pre-recorded tape imported from countries other than USA (factory value, CIF): 1978—400,000 units, \$2,000,000; 1977—300,000 units, \$1,000,000.

Pre-recorded tape exported to countries other than USA (factory value, FOB): 1978—2,000,000 units, \$6,500,000; 1977—2,500,000 units, \$5,000,000.

Typical retail price per tape: 8-tr.—\$7.70, cassette—\$11.50.

RADIO STATIONS

No. of commercial: 22 local; No. of government: 4 national & 20 local.

Comment: All stations transmit both AM and FM. Only two stations are non-music-based.

TELEVISION STATIONS

No. of channels: 2 government, 1 commercial (65% color).

IMPORT/EXPORT REGULATIONS

There are no tariff or quota restrictions. Imports are subject to a 15% VAT.

● **record & tape manufacturers/distributors/importers**

A I M Music Ltd., 43 Queen Anne St., Dunfermline, Scot-

- land. Tel: (0382) 28464. Gen. Mgr.: A.I. Muir; Sales Mgr.: B. Muir. (Distributed by Virgin)
Label: (Owned) No Bad Recs
Int'l rep.: Worldwide (Virgin).
- A K Recs., 26-28 Queen St., Manchester M2 5HX. Tel: (061) 834-2221. Gen. & Sales Mgr.: Dennis Baxter; Rec'g Mgr.: Keith Twort. (Distributed by Jazz Servs. Unlimited)
- A & M Recs. Ltd., A&M House, 136-140 New Kings Rd., London SW6 4LZ. Tel: (01) 736-3311. Cable: ALPER-MOSS Telex 916342. Mng. Dir.: Derek Green; Deputy Mng. Dir.: Glenn Simmons; Mktg. Dir.: John Cokell; Sales Mgr.: Bill Groves; Prod. Mgr.: Jim Chambers; Promo. Dir.: Tony Burfield. (Distributed by CBS).
Home office: USA
- Abbey Folk, see Abbey
- Abbey Recs., 1 Abbey St., Eynsham, Oxon. OX8 1HR. Tel: (0865) 880-240. Mng. Dir.: Harry F. Mudd; Sales Mgr.: John Walton. (Distributed by Selecta)
Labels: (Owned) Abbey, Abbey Folk, Abbey Street, Alpha
Abbey Street, see Abbey
- Able Label Prod'ns, 17 Berkeley St., London W1. Tel: (01) 409-1401. Chief Exec.: Veronica Hall.
- Acanthus, see Nimbus
- Ace of Clubs, see Decca
- Ace of Diamonds, see Decca
- Acorn Recs. Ltd., Church Rd., Stonesfield, Oxford OX7 2PS. Tel: (099 389) 324. Dirs.: Colin Sanders, R.J. Pennells. (Distributed by Audio Impact & Jazz Servs.).
Label: (Owned) Acorn
- Acrobat Recs. Ltd., 37 Harley House, Marylebone Rd., London W1. Tel: (01) 486-6744. Mng. Dir.: Chris Youle. (Licensed to Arista)
- Action, see B&C
- Acuff-Rose Music Ltd., 14 St. George St., London W1. Tel: (01) 629-0392. Gen. Mgr.: Tony Peters.
Home office: USA
Labels: (Owned) Hickory, TRX
- Ad-Rhythm Recs., 13 Denham Way, Rickmansworth, Herts. Tel: (01) 998-0911. Cable: SCARLETT GREENFORD. Telex 888889. Chief Exec.: Michael J. Collins; Mng. Dir.: Wendy Collins; Gen. Mgr.: John E. Jennings. (Distributor/Importer)
- Air Recs. Ltd., 12 Stratford Pl., London. Tel: (01) 408-2355. Cable: CHRYSALIS. Chm.: George Martin; Gen. Mgr.: John Burgess. (Distributed by Chrysalis)
Label: (Owned) Air
- Airborne, see Noel Brown
- Alaska Recs. Ltd., 12 The Quadrangle, Cambridge Square, London W2. Tel: (01) 402-4550, 723-0783. Mng. Dir.: John Schroeder; Gen. Mgr.: Ian Stevenson.
Labels: (Owned) Alaska, Black Bear
Int'l reps.: Benelux (Fleet Benelux), Argentina (Tape-car), Austria (Bellaphon), Brazil (Tape-car), France (Barclay), Germany (Bellaphon), Switzerland (Bellaphon)
- Alba Recs., 21A Grosvenor St., Edinburgh, Scotland. Tel: (031) 225-1066. Chief Exec.: John Mackinnon
Labels: (Owned) Alba, Stag
- Albion Recs., 147 Oxford St., London W1. Tel: (01) 734-9072. Telex 8954780. Dirs.: Dai Davies, Derek Savage. (Licensed to Arista)
Int'l reps.: Germany (Ariola), Netherlands (Ariola), Scandinavia (Phonogram), Spain (Ariola)
- Alcatraz, see Beserkley
- Alice Recs., 9 Cavendish Square, London W1M 0DU. Tel: (01) 995-1191. Prod'r: Graham Soudbourne.
- Alley Cat, see Humber
- Alpha, see Abbey
- Amber Recs., Wyastone Leys, Monmouth NP5 3SR. Tel: (0600) 890 682. Dirs.: N. Libin, M. & G. Reynolds. (Distributed by Nimbus)
- Amberlee Recs. Ltd., Amberlee House, 387 Harrow Rd., London W9. Tel: (01) 866-7748. Mng. Dir.: John Peters. (Distributed by Lugton, H.R. Taylor)
Labels: (Owned) Amberlee, Eyemark, (represented) Doric (USA)
Int'l rep.: (USA) (Doric).
- Amon Ra, see Saydisc
- Anemone Sound Facilities Ltd., 10A Poland St., London W1. Tel: (01) 439-9611. Telex 8812286. Mng. Dir.: Aaron Gershfield; Gen. Mgr.: Derek Hanlon; Sales Mgr.: Simon Patrick.
Labels: (Owned) Anemone Special Sound, Childsplay Tapes, D-Arblay Sound Studio Workshop, History Alive, Literature Alive, Singing Alive, Yoga For Health; (licensed) Breakthrough Tapes; (distributed—not licensed) Time To Listen.
- Anglo Recs., 30 Limekiln Ln., Bridlington, North Humberside YO16 5TH. Tel: (0262) 76388. Dir. & Prod'r.: Robert Fisher
- Antic, see WEA
- Apollo Sound, 32 Ellerdale Rd., London NW3. Tel: (01) 435-5255. Pres. & Gen. Mgr.: H. Herschmann. (Distributed by Rare Rec'd Eds., One Stop & Non Stop.)
Int'l reps.: Europe (Claves), Germany (Musia), Switzerland (Claves, Eulenburg).
- Aquarius, see President
- Aquarius Music Ents., 28 Dalrymple Crescent, Edinburgh, Scotland EH9 2NX. Tel: (031) 667-3633. Cable: MUSAQUA. Chief Exec.: Andy Petersen; Gen. Mgr.: Helen Douglas
Labels: (Owned) Helios, Wildtrack
Int'l reps.: Canada (Morning), USA (Worldwide Music Serv.)
- Arcade Recs. (UK) Ltd., 36/38 Willesden Ln., London NW6 7ST. Tel: (01) 328-1911. Telex 27140. Dirs.: Michael & Larry Levene, Laurence Myers, Promo. Mgr.: Bert Herman; A&R Co-ord.: Mrs. S. Curd.
Int'l branches: Germany, Netherlands.
- Archduke, see Derek Lawson
- Archiv, see Polydor
- Argo, see Decca
- Ariola Eurodisc UK Ltd., 48 Maddox St., London W1. Tel: (01) 408-1262. Mng. Dir.: Robin Blanchflower; Mktg. Dir.: Andrew Pryor; Int'l Mgr.: Sue Crockatt. (Distributed by Pye)
Labels: (Owned) Ariola, (licensed) Ariola-Hansa
Int'l reps.: Austria (Ariola), Belgium (Ariola Eurodisc), France (Arabella), Germany (Ariola Eurodisc), Mexico (Disco Libro), Netherlands (Ariola Eurodisc), Spain (Ariola Eurodisc), Switzerland (Ariola), USA (Ariola America)
- Ariola-Hansa, see Ariola Eurodisc, Hansa & Pye
- Arista Recs. (FPI), 49 Upper Brook St., London W1Y 2BT. Tel: (01) 491-3870. Telex 28370. Mng. Dir.: Charles Levison; Sales Mgr.: Peter Battershill; Mktg. Dir.: Denis Knowles; Int'l Mgr.: Allan Watson. (Distributed by Phonodisc)
Labels: (Owned) Arista, Bell; (licensed domestic) Acrobat, Albion, Zoom; (licensed foreign) Novus, Savoy (both USA)
Int'l reps.: Worldwide (EMI) excluding Japan (Nippon Phonogram), USA
Arrival, see K-tel
- Arrowlabs Ltd., Humber Rd., London NW2 6EP. Tel: (01) 450-2411. Cable: ARROWTABS Telex 923034. Mng. Dir.: M.D. Mindel; Gen. Mgr.: R.J. Bartholomew; Sales Mgr.: Alex Murray; Prod. Mgr.: P. Onslow.
Labels: (Owned) Aim, Arrow, International Artists.
- Artium, see BBC
- Asylum, see WEA
- Attack, see B&C
- Attrix Recs., 43 Buckingham Pl., Brighton, Sussex. Tel: (0273) 27181. Chief Execs.: Rick & Julie Blair; Prod'r: Terry Newbery.
- Audio Wholesale, 115B Trafalgar Rd., Greenwich, London SE10. Tel: (01) 853-0797. (Distributor)
- Aura Recs. Ltd., 1 Kendall Pl., London W1H 3AG. Tel: (01) 486-5288. Telex 24224. Ref. 3145. Mng. Dir.: Aaron Sixx. (Distributed by Pye)
Int'l reps.: Australia (7), Denmark (Hede Nielsen), Finland (Discophon), France (Motors), Italy (RCA), Japan (Victor), Norway (Disco A/S), Portugal (Teletra), Spain (RCA), Sweden (Electra), Switzerland (DL)
- Aurora, see Rediffusion
- Automatic Rec Co. Ltd., 5 Avery Row, London W1. Tel: (01) 493-9744. Mng. Dir.: Nick Mobbs.
- Avenue Recs. Ltd., 205 Chingford Mount Rd., London E4. Tel: (01) 524-1341.
- B B C Recs. & Tapes, The Langham, Portland Pl., London W1A 1AA. Tel: (01) 580-4468. Cable: BROADCASTS. Telex 265781. Chief Exec.: Alan Bilyard; A&R Mgr.: Mike Harding; Sales & Mktg. Mgr.: James Fleming; Bus Affairs Mgr.: Mehmet Arman. (Distributed by Pye)
Labels: (Owned) Artium, BBC, Beeb
Int'l reps.: Australia (Phonogram), Denmark (Vilfort), Germany (Intercord), Italy (Fonti-Cetra), Japan (Teichiku), Netherlands (Sound Prods.), New Zealand (EMI), South Africa (EMI-Brigadiers)
- B & C Recs. Ltd., 326 Kensal Rd., London W10 5BL. Tel: (01) 969-6651. Cable: MUSICALITY. Telex 261500. Mng. Dir.: Marcel Rodd. (Distributed by CBS).
Affiliated firm: Saga Recs. Ltd.
Labels: (Owned) Action, Attack, B&C, Horse, Lowbite, Mooncrest, Trojan
Int'l reps.: Austria (Musica), Belgium (International Bestsellers), Canada (Almada), France (Pathe Marconi EMI) Germany (Teldec), Ireland (Irish Rec. Factors), Italy (Ri-Fi), Japan (Trio), Netherlands (EMI-Holland) Nigeria (Decca), Scandinavia (Sound of Scandinavia), South Africa (Gallo), Switzerland (Musikvertrieb)
- B C O, see JBC
- B J, see Faulty
- B G S Prods. Ltd., Lethame Rd., Strathaven, Lanarkshire, Scotland Tel: (0357) 21130. Dir.: W.B. Garden. Sales Mgr.: Dougie Stevenson.
Labels: (Owned) BGS Chord, Country House
- B T W Rec'd Music Library, 125 Myddleton Rd., Wood Green, London N11 4NG. Tel: (01) 888-6655. Dirs.: John Ross Borthwick, R.J.T. Borthwick
- Baal Recs. Ltd. (FPI), 62 Gloucester Pl., London W1. Tel: (01) 486-1486. Cable: BAALON LDN W2. Telex 25836. Mng. Dir.: Colin J. Brain; A&R: Jay Shotam. (Distributed by Pye)
Labels: (Owned) Baal, Best of Everything, Roots
- Bach Collectors, see Oryx
- Bag Music Ltd., 6 Ludgate Square, London EC4M 7AS. Tel: (01) 248-3836. Chief Exec.: Eric James
Label: (Owned) Bag Music
- Ballistic, see Liberty-United
- Bamboo, see Storm
- Bancrupt, see Flyover
- Banners & Bonnets, see Word
- Barak, see President
- Bargain Recs. & Tapes, Hopewell Terr., Kippax, Leeds. Tel: (0532) 871-122. Mng. Dir.: Ian Wallace
- Barn Recs. Ltd., 35 Portland Pl., London W1. Tel: (01) 637-2111. Cable: BARNEMUS. Telex: 25929. Chm.: Charles Chandler; Mng. Dir.: Mike Hales. (Distributed by Pinnacle)
- Bedtime, see Metropolitan Communications
- Beeb, see BBC
- Beeswing, see Broadside
- Beggars Banquet Ltd., 8 Hogarth Rd., Earl's Court, London SW5. Tel: (01) 370-6175. Telex 915733. Dirs.: M.C. Mills, N. Austin
- Bell, see Arista
- Belsize, see Splash
- Beltona, see Decca
- Ivan Berg Assocs. (Audio Publ'g) Ltd., 35A Broadhurst Gardens, London NW6 3QT. Tel: (01) 624-7785. Mng. Dir.: Ivan Berg. (Distributed by Spartan)
Labels: (Owned) Chiron, Ivan Berg
Int'l rep.: USA (Communication Institute)
- Beserkley Recs., 97 Kingston Hill, Kingston-on-Thames, Surrey. Tel: 549-9366. (Distributed by Phonodisc)
Labels: Alcatraz, Beserkley, Home Of The Hits, Huge, Zilch
- Best of Everything, see Baal
- Big Bear Recs., 190 Monument Rd., Birmingham B16 8UU. Tel: (021) 454-7020. Cable: BEARSONGS. Mng. Dir.: Jim Simpson; Gen. Mgr.: Steve Marks; Sales Mgr.: Steve Simpson; Pub.: Kate Munn
Labels: (Owned) Big Bear, Grandstand
Int'l reps.: Australia (Wizard), Austria (Amadeo), Belgium (IBC), Germany (Intercord), Italy (CGD), Netherlands (Windmill), New Zealand (Wizard), South Africa (Gresham), Switzerland (Metronome)
- Big Ben, see Tangent
- Big Cock, see Hit
- Biabel, 3 Speedwell Close, Chandlersford Ind'l Estate, Eastleigh, Hants. Tel: (04215) 63434. Mng. Dir.: Roy Dickey; Gen. Mgr. & Mktg. Dir.: Malcolm Paton; Sales Mgr.: Martin Bennett. (Distributor)
- Billy Goat Recs., 71 Benhurst Gardens, Selsdon, South Croydon, Surrey CR2 8NY. Tel: (01) 657-3560. Mng. Dir.: Terry Parker. (Distributed by Billy Goat & Lightning)
Labels: (Owned) Billy Goat, Toadstool, (distributed—not licensed) Crazy Rhythm, Red Hot, Yorkie, (distributed—not licensed-foreign) Rock & Country (Sweden), Wix (USA)
Int'l rep.: Sweden (Rock & Country)
- Birds Nest, see Happy Face
- Black Bear, see Alaska
- Black Gold Rec. Prod'ns Ltd., Solsgirth Studios, Langmuir Rd., Kirkintilloch, Glasgow, Scotland. Tel: (041) 776-7572. Mng. Dir.: Ian C. McCredie
- Black Lion, see Logo
- Black Mountain Recs., PO Box 207, Mumbles, Swansea, Wales. Tel: (0792) 61234. Owner: M.D. Evans
- Black Music National Dist'n., 44 Cloudestraße, Tooting, London SW17. Tel: (01) 675-0850. Chm.: Oscar Carroll. (Distributor)
- Terry Blood, Federation Rd., Unit 4, Burslem, Stoke-on-Trent. Tel: (0782) 814-211. (Distributor/Importer)
- Bludgeon Rifola, see MSB
- Blue Bag, see Plastic Fantastic
- Blue Band, see Scarlet Band
- Blue Chip Recs., 2/3 Golden Square, London W1R 4BS. Tel: (01) 437-7544. Telex 918728. Mng. Dir.: Ivor Schlosberg
- Blue Inc. Recs. Ltd., 155 Church St., London W2 1NA. Tel: (01) 723-9090. Mng. Dirs.: Billy Russell, Billy Carruthers. (Distributed by Pinnacle & WEA)
- Blue Jean, see Spark
- Blue Note, see Liberty-United
- Blueport Recs., 81 Osborne Rd., Jesmond, Newcastle-on-Tyne NE2 2AN. Tel: (0682) 816-855. Co-Ord.: Maurice Roxoff; Gen. Mgr.: M.G. Maurice Sales Mgr.: Antoinette Le Grice
Int'l reps.: Germany (Rock-O-Rama), Japan (P-Vine), Netherlands (Rockhouse), USA (BOMP, JEM, Rollin Rock)
- Boa, see The Label
- Bonaparte Recs. Ltd., 101 George St., Croydon, Surrey. Tel: (01) 681-3062/1490. Telex 943763. Gen. Mgr.: Steve Melhuish
- Boom, see Kingsley
- Boring Recs., 23 Dalkeith Ave., Bishopbriggs, Glasgow, Scotland. Tel: (041) 772-2290. Mng. Dir.: Graham Scott; Dirs.: Stan Workman, Dougie Burns. (Distributed by Rough Trade)
- Boulevard, see Saga
- Bradley's Recs. Ltd., 24 Bruton St., London W1. Tel: (01) 409-2211. Telex 28526. Dir. & Gen. Mgr.: Stuart Slater. Dir.: Len Beadle.
- Breakthrough Tapes, see Anemone
- Breeze, see Pinnacle
- Bridge House Recs. Ltd., 23 Barking Rd., Canning Town, London E16. Tel: (01) 476-2889. Pres.: Chris Thompson; Gen. Mgr.: Terence Murphy; Sales Mgr.: Colin Brown; Admin. Mgr.: John McGeady
- Broadcast Recs. Ltd., 5 Silverthorne Rd., London SW8 3AD. Tel: (01) 622-8834. Mng. Dir.: H. Cow; Gen. Mgr.: Nick Hobbs. (Distributed by Recommended)
Int'l reps.: France (LTM), Italy (L'Orchestra), Sweden (SAM), USA (Bayer, Random Radar)
- Broadside Recs., Studley House, Limes Rd., Tettenhall, Wolverhampton WY6 8RB. Founder: Jon Raven. (Distributed by Selecta)
Labels: (Owned) Beeswing, Jester's Court
- Bronze Recs. Ltd., 100 Chalk Farm Rd., London NW1 8EH. Tel: (01) 267-4499. Cable: HITMUSIC. Telex 261653. Mng. Dir.: Gerry Bron; Gen. Mgr.: Robert Lemon; Int'l Dir.: Lilian Bron; Int'l Mgr.: Gordon Simpson. (Licensed to EMI)
Int'l reps.: Argentina (RCA), Australia (Festival), Austria (Ariola Schallplatten), Belgium (Ariola Benelux), Brazil (RCA Electronica), Canada (Chrysalis), China (EMI), Denmark (Sonet-Starbox APS), Finland (Scandia-Musikk), France (WEA Filipacchi), Germany (Ariola Eurodisc), Greece (Emial), Hong Kong (EMI), India (Gramophone Co. of India), Ireland (EMI), Italy (Ricordi), Japan (Toshiba-EMI), Kenya (Phonogram), Malaysia (EMI), Mexico (Disco Libro), Netherlands (Ariola Eurodisc), New Zealand (Polygram), Nigeria (Phonogram), Norway (Arne Bendiksen), Philippines (EMI), Portugal (Ariola), Singapore (EMI), South Africa (Gallo Africa), Spain (Ariola Eurodisc), Sweden (Sonet), Switzerland (Ariola Eurodisc), Thailand (EMI), Turkey (Melodi), Uruguay (APSA), USA (Chrysalis), Venezuela (Polydor), Yugoslavia (Jugoton), Zambia (Teal)
- Noel Brown Prod'ns Ltd. (NBP), 16 Bracklesham Close, Farnborough, Hants. GU14 8LR. Tel: (0252) 511-333. Mng. Dir. & Gen. Mgr.: Noel Brown; Dir.: Vic Evans.
Label: (Owned) Airborne
- Bruce's Rec. Shop, 45 Shandwick Pl., Edinburgh, Scotland EH2 4RG. Tel: (031) 229-3689. Telex 777493. Mng. Dirs.: Brian Findlay, Roy Lake. (Importer) (Exporter as Brian Findlay Exports)
- Harvey Buat, 84 Church St., London NW8. Tel: (01) 723-1011, 724-3711. Dir.: Alan Taub. (Distributor)
- Buena Vista, see Walt Disney
- Buffalo, see Dawn Anglian Soul Club & East Anglian Soul Club
- Bulldog, see President
- Bullseye Recs., A/R House, Spennymoor, Co. Durham. Tel: (0388) 814-632. Chief Execs.: Colin Pearson, John

ZOMBA ENTERPRISES INC.
Suite 7J,
330 West 58th St.,
New York, N.Y. 10019,
U.S.A.

Tel: (212) 265-2520
Tx: 237316 ZOMBA UR

ZOMBA CORPORATION
Alpenstrasse 14,
6300 Zug,
Switzerland

Tx: 78867 IURZO

Associate offices in
Holland and South Africa

**ZOMBA MANAGEMENT AND
PUBLISHERS LIMITED**
Basement Apartment,
8 Roland Gardens,
London SW7 3PE
England

Tel: 01-370-2929/2956
Tx: 919884 ZOMBA



Our Personal Management and Business Management division
represents such successful artists and producers as
CITY BOY, CLOUT (in association with Grahame Beggs),
GRAHAME BEGGS, ROBERT JOHN LANGE,
TIM FRIESE-GREENE, TONY CLARKE

Our Music Publishing division
represents such successful artists and writers as
AC/DC, THE BOOMTOWN RATS, CITY BOY, CLOUT, THE RITCHIE FAMILY,
ROBERT JOHN LANGE, SCORPIONS, TYCOON and VILLAGE PEOPLE.

Our associate Music Publishing company
STREET MUSIC LIMITED (co-owned with Dave Robinson)
represents such successful artists and writers as
GRAHAM PARKER, JONA LEWIE, LARRY WALLIS, LIAM STERNBERG,
THE RUMOUR and WRECKLESS ERIC.

All of this in only 2½ years watch us grow into the 80's.

- Wray, Gen. Mgr. Lloyd Smith; Sales Mgr. A.P. Blackett.
- CBS Recs. (IFPI)**, 17/19 Soho Square, London W1V 6HE. Tel. (01) 734-8181. Cable COLRECORD. Telex: 24203. Mng. Dir. Maurice L. Oberstein; Sr. Dir. Norman S. Stollman; Admin. Dir. John Brooks; A&R Exec. Dir. Dan Loggins; Comm'l. Dir. Jack Florey; Finance Dir. John Field; Mktg. Dir. Tony Woolcott; Sales Dir. John Mair; Int'l A&R Dir. Peter Robinson; Domestic A&R Dir. Muff Winwood; Bus. Affairs Dir. Paul Rodwell; Sec'y Veisi Avni.
- Labels:** (Owned) CBS, Epic, Embassy, Harmony, Portrait, (licensed) Blue Sky, Caribou, Full Moon, Kirshner, Monument, Mums, Ode, Philadelphia Int'l, TK, (distributed—not licensed) A&M, Anchor/ABC, Creole, DJM, GTO, Galaxy, Jet, Saga, Virgin, Warwick.
- Int'l rep.:** Worldwide (CBS).
- C C Recs. (Export) Ltd.**, 404/406 Brockley Rd., Croydon Park, London SE4 Tel. (01) 699-9350, 291-1518. Mng. Dir. B.S. Garland; Gen. Mgr. & Sales Mgr.: Mongi Eltaief. (Distributor)
- C M C Recs. Ltd.**, 14 New Burlington St., London W1X 2LR. Tel. (01) 734-3251. Cable CARLSONG. Telex: 267488. Dirs.: Frederick & Miriam Bienstock; R. Derek Knibb, Mike Collier.
- C R C**, see Outlet.
- Cactus**, see Creole.
- Cadenza**, see Liberty-United.
- Cadillac Music & Recs.**, 180 Shaftesbury Ave., London WC2H 8SJ Tel. (01) 836-3646. Mng. Partner John Jack.
- Labels:** (Owned) Cadillac, (distributed—not licensed) Adelphi, Advent, Albatros, Amigo, Bead, Beehive, Bvhaast, Cicalla, Circle, Concord, Dawn Club, Delmark, Dragon, ENJA, Ego, Esquire, Europhon, FMP, Fluid, Fourleaf Clover, Hat Hut, Hefty Jazz, Hep, Horo, ICP, IPS, Ictus, Incus, India Navigation, Jazzcraft, Joker, Khama, Larrikin, Lee Lambert, Livia, Matchless, Melodic, Mosaic, Nessa, NoLa, Ogun, Oldie Blues, Open, Original, Owl, PDU, PM, Palm, Parachute, Philly Jazz, Phoenix, Plant Life, PoToRich, Pumpkin, Quartz, Queendisc, Rarities, Red, Red Light'n'g, Ring/Moers Music, Route 66, SFA, SFF, Seventyseven, Stash, Steam.
- Calendar Recs. Ltd.**, 89 Chiswick High Rd., London W4. Tel. (01) 995-3682. Cable SUNARTISTS. Mng. Dir.: Don Lawson; Gen. Mgr.: C. Lawson; Sales Mgr.: Ann McDonald, PR Roger St. Pierre. (Distributed by Selecta).
- Labels:** (Owned) Calendar, Seven Sun, Sun American; (licensed) Harmony, Saar, UP.
- Int'l reps.:** Australia (EMI), Austria (Teldec), Canada (Unidisc), Finland (Euronet), Germany (Teldec), Italy (Saar), Jamaica (Total Sound), Sweden (Toniton), Switzerland (Teldec).
- Cambrian**, see Decca.
- Cambridge Classical Recs.**, 5 King's Parade, Cambridge, CB2 1SJ Tel. (0223) 350-565. Mng. Dir.: Edward Turner; Dir.: Christopher Hills.
- Cameo Classics**, see Indigo.
- Cameo Recs. Ltd.**, 5 Hampton Court Parade, East Molesey, Surrey. Tel. (01) 941-3983. Telex 8813485. Mng. Dir. John Dickinson; Dir.: Paulene Dickinson.
- Camp**, see Mettle.
- Canaan**, see Word.
- Candhaven**, see Metropolitan Communications.
- Canolfan**, see Oryx.
- Can't Eat Recs.**, 24 Chiswick High Rd., London. Tel. (01) 941-0356. Dirs.: D.P. Williams, Mark Rye.
- Capitol**, see EMI.
- Dave Carey**, 1b Mitcham Ln., Streatham, London SW16. (Distributor/Importer)
- Carmel Music Ltd.**, 4 Cliff Ave., Westcliff-on-Sea, Essex SS0 7AJ. Tel. (0702) 338-593. Mng. Dir.: Peter Eden; Sec'y Glynis Eden. (Distributed by Lugton, H.R. Taylor.)
- Carnaby Recs. (div. of Mervyn Conn Org.)**, Chandos House, 45/46 Chandos Pl., London WC2. Tel. (01) 836-7255/9970. Cable PROMDISC. Mng. Dir.: Mervyn Conn.
- Labels:** (Owned) Carnaby, Nashville Int'l, Ocean.
- Int'l reps.:** Belgium (Mervyn/Benelux), Germany (Glo-bal).
- Caroline**, see Virgin.
- Caroline Exports**, 56 Standard Rd., London NW10. Tel. (01) 961-2919. Cable BUMBLEBEE. Telex 22164. Mng. Dir.: Christopher Stylianou; Gen. Mgr. Adrian T. Rose; Sales Mgr. Brian Leafe; Projects Program Mgr.: Roar Eitman. (Distributor/Exporter)
- Carrere Recs. UK (IFPI)**, 22 Queen St., Mayfair, London W1. Tel. (01) 493-7406. Telex: 8953657. Mng. Dir.: Freddy Cannon, Promo Dir.: Oliver Smallman, A&R Mgr.: Peter Hinton. (Distributed by WEA).
- Label:** (Owned) Carrere
- Int'l reps.:** Austria (Polydor), Germany (Polydor), Italy (Fonti-Cetra), Netherlands (CNR), Scandinavia (EMI), Spain (CBS).
- Carrot**, see NoLa.
- Casino Classics**, see Robert Kingston.
- Cassette Developments (Audiocons) Ltd.**, Micra House, 138 Lower Montlake Rd., Richmond, Surrey TW9 2JZ. Tel. (01) 940-8186. Cable: MICRONETIC. Telex: 8813481. Mng. Dir. D. Dixon.
- Labels:** (Owned) Coronet, Coronet Philharmonic.
- Castle**, see LE.
- Castle Recs.**, The Castle, 93 Castle Hill Rd., Hindley, Wigan, Lancs. WN2 4BH. (0942) 58777. Chief Exec.: B. Gibbs; Gen. Mgr.: S.P. Millard.
- Labels:** Castle, Nelson.
- Catalyst Ltd.**, 6 Narcissus Rd., London NW6 1TH. Tel. (01) 794-7640. Telex: 21879. Mng. Dir.: Peter Knight Jr.
- Labels:** (Licensed foreign) Fabie (Australia), GMG (Germany), Nippon Columbia (Japan), RTC (New Zealand).
- Celebration Servs. (Post Green) Ltd.**, 57 Dorchester Rd., Lytchett Minster, Poole, Dorset BH16 6JE. Tel. (0202) 623-651. Cable CELSERV POOLE. Mng. Dir.: Philip Bradshaw; Gen. Mgr. Robert Ellis; Sales Mgr.: Debbie Thorpe; Prod'n Mgr.: Richard Foxley.
- Labels:** (Owned) Celebration; (licensed) Mustard Seed.
- Int'l reps.:** Australia (Spotlight), Canada (Praise), New Zealand (Osborne), South Africa (In Magazine), Sweden (Toniala), USA (Star Song).
- Central Recs. Suppliers**, 86/87 Wilton Rd., London SW1V 1DN. Tel. (01) 834-9506. Dir.: S. Howard. (Importer of recs. & tapes from Spain).
- Chameleon Recs.**, 19 S. Molton St., London W1. Tel. (01) 629-9719. Telex: 261805. Mng. Dir.: Mike Loveday; Gen. & Sales Dir.: Richard Fearn.
- Chapter One**, see Les Reed.
- Charisma Recs. Ltd. (IFPI)**, 90 Wardour St., London W1. Tel. (01) 434-1351. Chm. Tony Stratton-Smith; Mng. Dir.: Brian C.A. Gibbon. (Distributed by Phonogram).
- Int'l reps.:** Worldwide (Phonogram Int'l) excluding Canada (GRT), Ireland, UK, USA (Polydor).
- Charly Music Ltd.**, 9 Beadon Rd., London W6 0EA. Tel. (01) 741-0011. Cable CONFIDAD. Telex 934386. Chm.: John-Luc Young; Mng. Dir.: Joop Visser; Press & Promos. Mgr. Max Needham. (Distributed by Pye).
- Labels:** (Owned) Affinity, Charly, Smack, (licensed foreign) Plantation (USA), SSS-Int'l (USA), Sun (USA).
- Int'l reps.:** Argentina (Sicamericana), Austria (Bellaphon), Benelux (CNR), Finland (Marilla), France (Motors), Germany (Bellaphon), Greece (Lenogram), Italy (Arlstor), Japan (RCA), Norway (Marilla), Spain (Auviv), Sweden (Marilla), Switzerland (Bellaphon), Yugoslavia (Jugoton).
- Charmdale Rec. Dist. Ltd.**, 182 Acton Ln., Harlesden, London NW10 6NF. Tel. (01) 961-3133. Telex 8813067. Mng. Dirs.: Mike Campbell, Terry Winsor; Sales Dir.: Brian J. Smith.
- Labels:** (Owned) Charmdale; (distributed—not licensed) Pickwick, Rockbrook.
- Checkmate Recs. Ltd.**, 56 Northbrook St., Newbury, Berks. RG13 1AN. Tel. (0635) 45313. Mng. Dir.: Graham E. Rowe; Gen. Mgr. Phil Martindale; Sales Mgr. Sue Rowe. (Exporter as Western Gramophone Ltd.).
- Labels:** (Owned) Checkmate; (licensed foreign) Midland (USA).
- Cherry Red Recs. Ltd. (IFPI)**, 199 Kingdon Rd., London SW19. Tel. (01) 540-6831. Mng. Dir.: Ian McNay; Gen. Mgr.: Richard Jones; Special Projects: Oliver Mills. (Distributed by Spartak).
- Labels:** (Owned) Cherry Red; (licensed) Heartbeat.
- Int'l reps.:** Canada (Change), USA (Gem).
- Chevron**, see Multiple Sound.
- Childsplay Tapes**, see Anemone.
- Chipping Norton Recs. Ltd.**, 4 Kings Head Mews, Chipping Norton, Oxon. Tel. (0608) 2684. Dir.: Richard Vernon.
- Chiron**, see Ivan Berg.
- Chiswick Recs.**, 3 Kentish Town Rd., Camden, London NW1. Tel. (01) 267-5192. Telex 298634. Mng. Dirs. D.J.P. Carroll, T.A.J. Churchill; Creative Dir.: Roger Armstrong. (Distributed by EMI, Pinnacle, Chiswick).
- Labels:** (Owned) Chiswick, Thrust, (distributed—not licensed) Redwood (Canada).
- Int'l reps.:** Austria (Metronome), Benelux (Ariola), France (Sonopresse), Germany (Metronome), Ireland (Solomon & Peres), Italy (RCA), Japan (Nippon Columbia), Scandinavia (Sonet), South Africa (EMI-Brigadiers), Spain (Movieplay), Switzerland (Metronome).
- Chopper Recs.**, 9-11 Richmond Bldgs., Dean St., London W1V 5AH. Tel. (01) 439-3058. Dir.: Geoff Morrow; Gen. Mgr.: Philip Foster. (Distributed by Selecta).
- Chrysalis Recs. Ltd. (IFPI)**, 12 Stratford Place, London W1. Tel. (01) 408-2355. Telex 21753. Joint Chm.: Chris Wright, Terry Ellis; Mng. Dir.: Doug D'Arcy; Dir.: Terry Connolly, A&R Dir.: Roy Eldridge; Financial Dir.: Nigel Butterfield; Int'l Dir.: Des Brown. (Distributed by Tandem, Phonodisc).
- Int'l branch:** USA.
- Int'l reps.:** Australia (Festival), Austria (Phonogram), Benelux (Ariola), France (Phonogram), Germany (Phonogram), Italy (Phonogram), Japan (Toshiba/EMI), Scandinavia (Sonet), South America (Phonogram), Spain (Ariola), Switzerland (Phonogram), USA (Chrysalis).
- Cine Lingual Sound**, 27-29 Berwick St., London W1. Tel. (01) 437-0136. Mng. Dir.: Tony Anscombe.
- City Rec. Prod'n**, 45 Beauchamp Pl., London SW3 1NX. Tel. (01) 584-7584, 581-0978. Chief Exec.: Philip Scott.
- Classical Pops**, see Rediffusion.
- Classics**, see Indigo.
- Classics For Pleasure**, see Music For Pleasure.
- Clyde Factors (Electrical) Ltd.**, 79 Washington St., Glasgow G3 8BD. Tel. (041) 221-9844. Chm. & Mng. Dir.: Edward Woolfson; Dir.: Michael Woolfson.
- Labels:** (Distributed) A&M, Arcade, Arrowtails, BBC, CBS, Caldeania, Clay, Demese, Denver, EMI, Emblem, Emerald, Grampan, Howlandwest, Island, K-tel, LBJ, Linguaphone, Lismor, Lugton, Nevis, Outlet, Park Films, Peerless, Philips, Pickwick, Pilgrim, Polydor, President, RCA, REL, Ronco, Spectrum, Springthyme, SuperSonic, Sweet Folk All, Sydney Thompson, Symphonia, Thistle, Topic, United Artists, Virgin, WEA, Westwood, Word.
- Coast Recs.**, 30 Baker St., London W1M 2DS. Tel. (01) 445-4957, 486-5353. Mng. Dir.: Kevin Wyatt-Lown. (Distributed by Lightning).
- Collins Int'l**, 1 Fern Court, Hendon Ln., London N3 5F1. Tel. (01) 349-1388. Telex: 266393. Sales Mgr.: Jeffrey Collins. (Distributor)
- Colortone Rec. Co. Ltd.**, The Studio, 69 Dukes Ave., New Malden, Surrey. Tel. (01) 942-1347. Mng. Dir.: Siggy Jackson; Gen. Mgr.: David Brown; Sales Mgr.: Michael Fletcher.
- Labels:** (Owned) Colortone, Spectrum.
- Columbia**, see EMI.
- Concert Hall Rec. Club**, Concert Hall House, London SW18 2LU. Tel. (01) 874-0441. Cable: COHALLCLUB. Mng. Dir.: Leonard Joseph. (Also see Leisure Arts).
- Label:** (Owned) Concert Hall.
- Conifer Recs. (John G. Deacon Ltd.) (IFPI)**, Horton Rd., West Drayton, Middx. UB7 8NP. Tel. (08954) 48531. Telex: 27492. Mng. Dir.: John G. Deacon; Finance Dir.: R.C. Ropner; Sales Mgr.: Paul T. Shephard.
- Labels:** (Licensed foreign) Baidophon (Lebanon), Buzaidphon (Kuwait), Byblos (Lebanon), Carophon (Lebanon), Club Du Disque Arabe (Algeria, Morocco, Tunisia), Duniaphon (Lebanon), EMI-Voice Of The Orient (Leba-
- non), Moriphon (Egypt), Recordings of the Holy Koran, Sono Cairo (Egypt), Sound & Picture (Kuwait), Sout El Hob (Egypt), Soutelphan (Egypt), Union (Koranic) (Syria), Voice of Lebanon (Lebanon), Voice of Stars (Lebanon), (distributed—not licensed) Arion (France), Cellier (Switzerland), Lyra & Minerva (Greece), Polygram (Greece), Sonodisc (France).
- Conquest**, see World Recs.
- Contour**, see Pickwick.
- Cool Rockers**, see Greensleaves.
- Cornish Legend Music**, Bawdens Farm, Tremodrett, Roche, St. Austell, Cornwall PL2. Tel. (072689) 507. Mng. Dir.: Martin Griffin; Bus. Mgr. N. Strachan; Prod'r S. Fraser. (Distributed by Lightning).
- Labels:** (Owned) Cornish Legend, Jingle Singles, Roach, Roche.
- Coronet**, see Cassette Developments.
- Coronet Philharmonic**, see Cassette Developments.
- Cosmic Debris**, 33 Dollis Ave., London N3 1BY. Tel. (01) 542-1939. Cable: MICRODISC. Owner: Peter N. Lemer.
- Cosmopolitan**, see Oryx.
- Country House**, see BGS.
- Creole Recs. Ltd.**, 91-93 High St., Harlesden, London NW10. Tel. (01) 965-9223. Cable: CREMUS. Telex 28905. Dirs.: Bruce D. White, John A. Bautista. (Distributed by CBS).
- Labels:** (Owned) Cactus, Creole, PVK, Savannah.
- Crescent Recs.**, 29 Belvedere, Bath, Avon BA1 5HY. Tel. (0225) 312-082. Owners & Dirs.: David Lord, Brian Preston.
- Criminal Recs. Ltd.**, 498-500 Harrow Rd., London W9. Tel. (01) 960-5577. Mng. Dirs.: Max Hole, Geoff Jukes. (Distributed by Selecta).
- Crownium Recs.**, 15 Trafalgar Dr., Walton-on-Thames, Surrey KT12 1MY. Tel. (073-784) 3932, (09322) 42160. Chm.: Jim Grahame; Gen. & Sales Mgr.: Raphael Wise.
- Crystal**, see President.
- Cube**, see Electric.
- Custom**, see Zero.
- D G**, see Polydor.
- D I Ltd. (IFPI)**, 36 John Dalton St., Manchester M2 6LE. Tel. (061) 834-7292. Cable IMDISC. Mng. Dir.: Irving Wilson; Gen. Mgr.: Johan Levy; Sales Mgr.: Alan Wilson. (Distributed by Pye).
- Labels:** (Owned) Euroson; (licensed) Beat (Italy), Pentaphon (Italy); Pony (Italy); (distributed—not licensed) Duse (Italy).
- Int'l reps.:** Australia (EMI), Brazil (Companhia Industrial de Discos), Germany (Phon Und Ton), Japan (Techiku), Scandinavia (Music Hoy), USA (Bobbie, Everest).
- D J M Recs. Ltd. (IFPI)**, James House, 5 Theobalds Rd., London WC1X 8AE. Tel. (01) 242-6886. Cable: DEJMAUS. Telex 27135. Mng. Dir.: Stephen M. James; Dir.: Richard L. James; Group Bus. Affairs Coord.: Paul M. Davis; Financial Controller: Robert H. Lake. (Distributed by CBS).
- Int'l branches:** France, Dick James Music France SaRL, USA, Dick James Music Inc.
- Int'l reps.:** Argentina (Fermata), Australia (Festival), Belgium (CBS), Bolivia (Fermata), Brazil (Fermata), Canada (GRT), Colombia (Fermata), Denmark (Phonogram), Ecuador (Fermata), Finland (Finnyle), France (CBS), Greece (EMI), Guatemala (Dideca), Hong Kong (Studer-Revox), Iceland (Falkinn), India (EMI), Ireland (CBS), Italy (CGD), Jamaica (Record Specialists), Japan (CBS Sony), Kenya (EMI), Mexico (Musart), Netherlands (CBS), New Zealand (Festival), Nigeria (Phonogram), Norway (Phonogram), Peru (Reunidas), Philippines (Dyna), Portugal (Valentim de Carvalho), South Africa (Gallo), Spain (Zafiro), Sweden (Phonogram), Turkey (Melodi), Venezuela (Fermata), Yugoslavia (Jugoton).
- D R G Recs. (UK) Ltd.**, 28 Bolton St., London W3. Tel. (01) 491-3966. Pres.: Hugh Fordin; Gen. Mgr.: Gill Pembury. (Distributed by EMI, RCA, EMI Imports).
- Labels:** (Owned) DRG, DRG Archive, Stet; (licensed foreign) MGM.
- Int'l reps.:** Canada (Trend), Finland (Polarvox), France (Pemasusic), Japan (Nippon Phonogram), Switzerland (Disc Imports), USA (City Hall, Picks), Worldwide (RCA).
- D T P Inc./Vanessa Music & Recs.**, 86 St. Bernard's Rd., East Ham, London E6 1PE. Tel. (01) 472-9682. Mng. Dir.: Don Todd; Sr. Eng.: Peter Copeland.
- Label:** (Owned) Vanessa.
- Int'l rep.:** USA (Evelyn).
- Daffodil**, see Decca.
- Damont Recs. Ltd. (IFPI)**, Blyth Rd., Hayes, Middx. Tel. (01) 573-5122. Telex: 934076. Mng. Dir.: Monty Presky; Gen. Mgr.: Frank Pearce. (Licensed to WEA).
- Labels:** (Owned) Happy House, Stereo Gold Award.
- Dara**, see Pan-Audio.
- D'Arbly Sound Studio Workshop**, see Anemone.
- Dart**, see President.
- Christopher Davies (Publ'rs) Ltd.**, 52 Manse! St., Swansea SA1 5EL, Wales. Tel. (0792) 41933. Dirs.: Christopher Talfan Davies, John M. Phillips, Gen. Mgr.: John M. Phillips.
- Label:** (Owned) Wren.
- Dawn**, see Pye.
- Dawn Anglian Soul Club (Stamford) Ltd.**, 186 Casterton Rd., Stamford, Lincs. Tel. (0780) 51736. Chm. & Mng. Dir.: Ken Cox; Gen. Mgr.: W.A. Cox; Sales Mgr.: Mrs. D. King. (Distributed by SpAan).
- Labels:** (Owned) Buffalo, Pixie.
- Dayspring**, see Word.
- The Decca Record Co. Ltd.**, Decca House, 9 Albert Embankment, London SE1 7SW. Tel. (01) 735-8111. Cable: DECCORD. Telex: 28588. Chm.: Sir Edward Lewis; Dirs.: A.E. Cullis, Sir Martin Flett, A.C.W. Haddy, W.W. Townsley; Mktg. Dir.: P. Goodchild; MOR Prod. Mktg. Mgr.: C. Borland; Tape Prod. Mktg. Mgr.: A. Lomas; Classical Prod. Mktg. & Promo. Mgr.: D. Rickerby; Decca Classical Recs. Dir.: R. Minshull; Pub. & Adv. Mgr.: P. Knapp-Fisher; Int'l Mgr.: K.G. Thorne; Int'l Prod. & Promo. Mgr.: M. Stellman.
- Branches:** London W1V 2BL, 18 Great Marlborough St. Tel. (01) 439-9521—London SW3 6RR, Argo Recs., 115 Fulham Rd. Tel. (01) 589-5293. Dir.: H. Usill.
- Int'l branches:** Canada (London), Germany (Teldec

Telefunken-Decca), Ireland (Irish Rec Factors), Italy (Decca Dischi), Nigeria (Decca), Singapore (Decca Orient), USA (London)

Labels: (Owned) Ace of Clubs, Ace of Diamonds, Argo, Beltona, Daffodil, Decca, Decca Phase 4, Decca West Africa, Deram, Eclipse, London, L'Oiseau Lyre, Qualiton (Wales), Rex, Threshold, Vocalion (**distributed**) Cambrian Emerald, Emerald Gen., Great Bands, Mint, Turnabout, Vox (**represented**) Abiko (Cameo-Parkway), Commodore, Crossover, Jamie, Republic, Rumbleseat Shannon (all USA)

Int'l reps.: Argentina (EMI-Odeon), Australia (EMI), Austria (Musica Schallplatten) Barbados (WIRL), Belgium (Fonior) Bolivia (Discolandia Dueri), Brazil (Odeon), Canada (London), Chile (Odeon) Colombia (Daro), Costa Rica (Indica), Denmark (Nordisk Polyphon), Dominican Republic (La Guarachita) Ecuador (Emporio Musical) El Salvador (Indica in Costa Rica), Finland (Finnlevy Sound Centre—Turnabout only) France (Societe Francaise du Son)—Germany (Teldec) Greece (Music Box) Guatemala (Indica in Costa Rica) Honduras (Indica in Costa Rica) Hungary (Kultura) India (Gramophone) Iran (CBS) Ireland (Irish Rec Factors) Solomon & Peres Israel (Symphonia), Italy (Decca) Jamaica (WIRL, Barbados) Japan (King) Kenya (Phonogram), Korea (Sung Eum) Mexico (Peerless) Netherlands (Phonogram) New Zealand (EMI Viking Sevenses—Argo only) Nicaragua (Indica in Costa Rica) Nigeria (Decca) Norway (Phonogram, Arne Bendiksen—Turnabout only) Pakistan (EMI), Panama (Indica in Costa Rica) Peru (IFM), Philippines (Super) Portugal (Valentim de Carvalho) Singapore (Decca Orient) South Africa (Gallo), Spain (Comolumbia) Sweden (Grammofon), Switzerland (Musikvertrieb), Taiwan (Linfair), Turkey (Melodi), Uruguay (Clave), Venezuela (Palacio de la Musica), Yugoslavia (Jugoton)

Decca Phase 4, see Decca
Decca West Africa, see Decca
December Songs 42 Park View Rd., Neasden London NW10 1AL Tel (01) 450-5987 Gen Mgr Todd Luterod
Deep Soul, see Right On!
Delos Music, 182 Lansbury Dr., Hayes, Middx Tel 573-6299 Dir Pat Lynn, Gen Mgr Richard Benjamin
Delyse, see Symphonica
Dema Directions Ltd., 18 West Mall, Clifton, Bristol BB 4BQ
Chief Exec Dennis Ackerman, Gen Mgr Shirley Ackerman
Labels: (Owned) Firebrand, Great Western
Denver Recs., 87 Carlton Ave W., North Wembley, Middx HA0 3RB Tel (01) 908-0187 Owner John McCauley

Deptford Fun City, see Faulty
Deram, see Decca
Derry, see Outlet
Deutsche Grammophon, see Polydor
Deutsche Harmonia Mundi, see Harmonia Mundi
Dial Music Ltd, 73 Grosvenor St., London W1X 0DU Tel (01) 493-8505 Mng Dir Harry Paton Evans
Different Recs 11/12 Dover St., London Tel (01) 408-0868 Chief Execs Lynton Guest Angela Hopwood Steven Cook (Distributed by Selecta)
Dingle's Recs Ltd 322 Whitechurch Ln Canons Park, Edware Middx Tel (01) 952 3551 Chief Exec R L Holt Gen Mgr R N Slater (Distributed by Spartan)
Direct Tapes Cassettes & Cartridges Ltd., Direct House Torre Ln, Leeds LS9 6JW Tel (0532) 485-537 Mng Dir Ian Wallace Sales Dir George Hurst (Distributor)
Disco Dream, see Wake Up
Discourses Ltd 32 High St Royal, Tunbridge Wells, Kent TN1 2LZ Tel (0892) 26397 Mng Dir Robert F Hardcastle
Discovery Recs 91 Kington St Michael Chippenham Wilts Tel (024975) 537 Mng Dir & Gen Mgr M S Cox Sales Co-ord J J Ward (Importer)
Labels: (Distributed—not licensed) CBS, Deesse Jazz Legacy Musdisc, Vogue (all France)

Disneyland, see Walt Disney
Walt Disney Prods Ltd 68 Pall Mall London SW1Y 5EX Tel (01) 839-8010 Telex 21532 Chief Exec Keith Bales (Distributed by EMI Pickwick Int'l, Readers Digest Ronco)
Labels: (Owned) Buena Vista Disneyland
Do It Recs 48A Friarste Rd Richmond, Surrey TW10 6NQ Tel (01) 940-6161 Mng Dir Max Tregoning
Domino, see Tabitha
Dorian, see Emblem
Double Gold, see President
Double Up, see EMI
Dove, see Kingsway

Downing Recs 45 47 London Rd., Liverpool 3 Tel (051) 207-7218 Chief Exec R K Downing, Gen Mgr L Roberts, Sales Mgr L Symms
Labels: (Owned) Downing (**licensed domestic**) Liverpool Sounds, Spider Stag
Dynamite Recs Ltd, Parkgate House, 33 Parkgate Rd., London SW11 4NP Tel (01) 223-7547/1966/1943 Telex 917463 Chm Harry Lee, Mng Dir Seymour Fisher (Wholesalers/Exporters—Major TV Products & Budget Labels)

E A R, see EMI
E D S S, see The Folk Shop
E G Recs Ltd, 63A Kings Rd, London SW3 4NT Tel (01) 730-2162 Telex 919205 Dirs Samuel G Alder, Mark A Fenwick
Int'l branch: USA

EMI America, see Liberty-United
EMI Music Operations, 30 Gloucester Pl., London W1A 1ES Tel (01) 486-6022 Cable EMIGREAT Telex 8953682 Chm & Chief Exec Bhaskar Menon, Joint Mng Dirs Ken East, Leslie F Hill, Finance Dir Tony Todman, Business Affairs & Copyright Dir Guy C Marriott, Mfg & Dist Resources Dir Roy Matthews, Technical Resources Dir Wally Rand, Royalties Dir Alex Mears, Pub Dir Bob Hart, Int'l Licensee Controller Ken Butcher, Int'l Repertoire Controller Ron Harris, Personnel Dir Allen Harford
EMI Recs (UK) Int'l Imports (IFPI), 80 Blyth Rd., Hayes, Middx Tel (01) 848-7536 Cable EMIGRAM Telex

932161 Chief Exec P Watts, Gen Mgr P D Lloyd Deputy Mgr R Steggals

Labels: (Distributed—not licensed) Biograph (USA), CTI (USA), DRG (USA), DSC (Netherlands), Disneyland (USA), Galaxy (USA), Gryphon (USA), MPS (Germany), Pre ser (Austria), Sydney Thompson

EMI Recs Ltd (IFPI), 20 Manchester Square, London W1A 1ES Tel (01) 486-4488 Cable EMIRECORD Telex 22643 Mng Dir R Lopez, Group Repertoire Div Mng Dir R A Mercer, Licensed Repertoire Div Mng Dir A Kaupé Prod'n & Dist'n Dir R E Matthews Finance Controller N Payne, Bus Affairs Mgr L J Hall, Bus Planning Mgr W Judd, Pub Exec B D Southall, Group Repertoire A&R Gen Mgr B Shepherd, Licensed Repertoire A&R Mgr A Squire Group Repertoire Pop Gen Mgr Peter Buckleigh Group Repertoire MOR Gen Mgr Vic Lanza EMI Classical Gen Mgr John Patrick, Licensed Labels Gen Mgr Colin Burn, M Harvey, Rec'g Studio Mgr K Townsend, Int'l Div Gen Mgr Paul Watts

Branches: Sales Admin. Group Repertoire Div., Manchester Square, London W1—**Licensed Repertoire Div.** Heron Pl, 9 Thayer St, London W1A—**Int'l Sales,** Seymour Mews House, Seymour Mews, London W1—**Classical Div.,** Seymour Mews House, Seymour Mews, London W1

Labels: (Owned) Capitol, Columbia, Double Up, EAR (European Artist & Repertoire), EMI, EMI America, EMI Greensleeves, EMI Int'l, Encore Executive HMV, Harvest, Note, Nut, One Up, Parlophone, Regal Zonophone, Sidewalk, Starline, Stateside, Talisman, Waverley, United Artists Group, (**licensed**) Bronze Fantasy, Island group, MAM, Motown, Prodigal, Purple, RAK, Red Bus, Rolling Stones, Salsoul, Stax, Tammi, (**distributed**) MFP, Magnet, World

Earth Prods Ltd 47 Cross Ln, Farnley, Leeds LS12 5AA Mng Dir Martin Ashe, Press & Pub Paul Greenwood East Anglian Soul Club (Stamford) Ltd, 186 Casterton Rd, Stamford Tel (0780) 51736 Telex 377494 Mng Dir K M Cox, Gen Mgr W A Cox, Sales Mgr V Ryan (Distributed by Spartan)

Labels: (Owned) Buffalo, Pixie, Soul-Stop, (**distributed—not licensed**) Axe (Canada)
Ebony Recs., 25 Newman St., London W1 Tel (01) 637-9586

Eclipse, see Decca
Electric Recs., Essex House, 19/20 Poland St., London W1V 3DD Tel (01) 734-8121 Telex 22701 Mng Dir David Platz (Distributed by Pye).
Labels: (Owned) Cube, Electric

Elektra, see WEA
Embassy, see CBS
Ember Recs Ltd (IFPI), Carlton Tower Pl., Suite 4, Sloane St., London SW1X 9PZ, Tel (01) 235-8243 Cable EMBERTONS Telex 896795 Chm. Jeffrey S Kruger, Mng Dir J L Horton Deputy Mng Dir Leslie Lewis
Int'l branch: USA
Labels: (Owned) Ember (licensed to Pye), Ember

Classics, Great Voices of the Century, Specialty, (**licensed foreign**) Bareback (USA)

Int'l reps.: Argentina (Sicamericana), Australia (M7), Austria (Ariola-Eurodisc), Belgium (Vogue), Brazil (Compania Ind'l de Discos, Som), Canada (Quality), Costa Rica (Lyra), Cyprus (Electroacoustic), Czechoslovakia (Opus), Denmark (EMI), Finland (EMI), France (Ariola), Germany (Ariola-Eurodisc) Greece (Mynos Matsas), Hong Kong (Decca), Iceland (Hyddtaerahus Rejkaurkur), Israel (CBS), Italy (Ri-Fi), Jamaica (Federal), Japan (Tokuma), Kenya (EMI), Netherlands (VIP), New Zealand (Music World) Nigeria (Phonogram), Norway (EMI) Philippines (Disco Corp.), Singapore (Decca), South Africa (David Gresham), Spain (Discophon), Sweden (EMI) Switzerland (Phonogram), USA (Peters Int'l), Venezuela (El Palacio) Yugoslavia (RTB)

Emblem Recs Ltd, 15 Main St., Strathaven Stathclyde, Scotland ML10 6AJ Tel (0357) 20369 Mng Dir & Gen Mgr John McClary Sales Mgr J Houston Fyfe
Labels: (Owned) Doran Emblem London

Emerald Recs (IFPI) 120 Coach Rd Templepatrick, Ballyclare, County Antrim Northern Ireland BT39 0HB Tel (08494) 32711 Telex 747293 Mng Dir Mervyn Solomon Gen Mgr Les R Paterson, Sales Mgr Noel Spiller (Distributed by Clyde Factors, Irish Recs Factors, Lightning, Lugton, President Record Entis, Scotia, Selecta Wynd Up)
Labels: (Owned) Emerald Great Bands Mint, Mint-Julep, Rip-Off

Int'l reps.: Australia (Image) Benelux (Dureco in Netherlands), Canada (Morning, Quality) France (Jacky), Italy (Ariston), Japan (Polydory), New Zealand (Music World, Viking), USA (County-Int'l, Gillette-Madison, Tradition)

Encore see EMI
Enigma, see WEA
Enigma Recs Ltd, Horton Rd., West Drayton Middx Tel West Drayton 48531 Telex 27492 Mng Dir John Boyden, Mktg Dir Peter Whiteside, Rec g Mgr Tony Faulkner (Also see WEA)

Label: (Owned) Enigma Classics, Variation Two
Ensign Recs Ltd, 44 Seymour Pl, London W1 Tel (01) 723-8464 Telex 299612 Mng Dir Nigel Grange, Gen Mgr Doreen Loader, A&R Consultant, Chris Hill (Distributed by Phonodisc)

Int'l rep.: Netherlands (Phonogram Int'l)
Enterprise Recs Ltd, Unit 18, 2 Faraday Way, Westminster Ind'l Estate, Woolwich SE 18 Tel (01) 855-3421 Cable KASSMUSIC Mng Dir Edward Kassner
Labels: (See President)

Epic, see CBS
Esquire Recs Talent Ltd (IFPI), 76 Bedford Court Mansions, Bedford Ave., London WC1B 3AE Tel (01) 636-1810 Gen Mgr Greta Kraemer (Distributed by Cadillac, Jazz Servs Unlimited, Swift, H R Taylor, Chris Wellard)
Labels: (Owned) Esquire, Starlite, (**represented**) Delmark (USA)

**OPTICAL INSTRUMENTS
AND
EQUIPMENT
FOR THE RECORD AND TAPE
INDUSTRY**

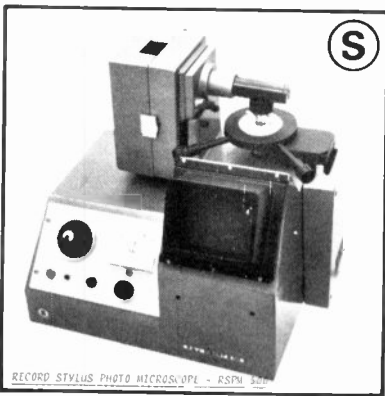
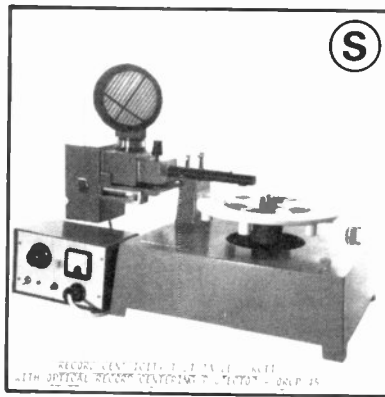

P & J SIBERT & CO
161 FINBOROUGH ROAD
LONDON SW10 9AP
ENGLAND
TEL 01 373 8508/01 330 0770

Tel (01) 969-5255 Telex 927813 Chm Raymond M Laren, Mng Dir Norman Mandell (Distributor)

Laser, see WEA

Lasgo Exports, 105-109 Oxford St., London W1 Tel (01) 439-8766 Telex 8953053 Mng Dir Warren Goldberg, Sales Dir Peter Lassman (Exporter)

Derek Lawson Recs 287 Kenton Ln., Harrow, Middx HA3 8RR Tel (01) 907-8721 (0403) 752-373 Cable DELAREC Telex London 8951688 Mng Dir Derek Lawson Gen Mgr John Butcher (Distributor/Importer/Exporter)

Labels: (Owned) Archduke

Leader Sound Ltd., 209 Rochdale Rd., Greetland, Halifax, West Yorks HX4 8JE Tel (0422) 76161 Mng Dir Bill Leader

Labels: (Owned) Hill & Dale Leader Trailer

Legend, see Redifusion

Leisure Arts, 18 St Anne's Crescent London SW18 2LY Tel (01) 874-0441 Telex 25881 Mng Dir Leonard Joseph, Rec Div Mgr Tony Owttrim

Label: (Owned) Concert Hall

Liberty, see Liberty-United

Liberty-United Recs Ltd (IFPI), Mortimer House, 37 41 Mortimer St London W1A 2JL Tel (01) 636-1655 Mng Dir Cliff Busby Sales Mgr Mike Edwards Mktg Mgr Howard Berman (Distributed by EMI)

Labels: (Owned) Blue Note Cadenza, EMI America, Liberty, Sunset United Artists (licensed) Ballistic, Pepper

Int'l reps.: Argentina (EMI-Odeon), Australia (Festival), Austria (EMI-Columbia) Belgium (EMI), Bolivia (Discolandia Dueri) Brazil (EMI-Odeon), Canada (Capitol) Chile (Industria IRT EMI-Odeon), Colombia (CBS), Cyprus (CBS), Denmark (EMI), Dominican Republic (Julio Tonos), Ecuador (Industria Fonografica), Finland (EMI), France (Sonopresse), Germany (EMI-Electrola), Ghana (Phonogram), Greece (Columbia EMI), Guatemala (Discos de Centroamerica), Hong Kong (EMI), India (Gramophone), Iran (CBS), Ireland (EMI), Israel (CBS), Italy (Ricordi/EMI Italiana), Japan (King), Kenya (AIT), Korea (Oasis), Malaysia (EMI), Mexico (EMI-Capitol), Netherlands (EMI), New Zealand (Festival), Nigeria (EMI), Norway (EMI), Pakistan (EMI), Panama (Sono Mundi), Peru (EMI), Philippines (Dyna), Portugal (Valentim de Carvalho), Singapore (EMI), South Africa (RPM EMI), Spain (EMI-Capitol), Sweden (EMI), Switzerland (Musikvertrieb), Thailand (EMI), Turkey (Grunberg Ticaret), Uruguay (Palacio de la Musica) USA (EMI America USA), Venezuela (Corporation Los Ruices), West Indies (West Indies), Yugoslavia (Jugoton), Zambia (Teal)

Lifesong, see GTO

Lightning Recs Ltd (IFPI), 841 Harrow Rd., Harlesden, London NW10 5NH Tel (01) 969-5255/7155 Telex 927813 Mng Dir Raymond M Laren, Financial Dir Norman Mandell, Mktg & Adv Dir Keith Yershon, Comm & Adm Dir Syed Reza, UK Sales Mgr Martin Wickham (Distributed by WEA)

Labels: (Owned) Lightning, Old Gold, Revival, Scope (distributed—not licensed) Rock Star, Rollin Rock (USA)

Int'l rep.: Worldwide (WEA)

Line Recs Ltd., 10 12 Yukon Rd., London SW12 9PU Tel (01) 673-8633 Mng Dir J H Gretney

Lingaphone Institute Ltd., 207 Regents St., London W1R 8AU Tel (01) 734-1633 Telex 266181

Lismor, see Peter Hamilton

Lismor Budget, see Peter Hamilton

Lismor Deluxe, see Peter Hamilton

Listen For Pleasure, see Music For Pleasure

Literature Alive, see Anemone

Little Pilgrim, see Pilgrim

Live & Love, see Third World

Liverpool Sounds, see Downing

Live Wire Recs Ltd 114 Maytree Close Oliver's Battery, Winchester Hants SO22 4JF Tel (0962) 62554 Mng Dir Chris Denning Sec'y A W Denning

Logo Recs (IFPI), 86 Marylebone High St London W1M 4AY Tel (01) 486-4353 Cable TRADISC Telex 25532 Mng Dir Geoff Hannington Sales Mgr Peter Mission Mktg Mgr Keith Peacock A&R Mgr John Briley (Licensed to RCA)

Labels: (Owned) Logo Transatlantic, Xtra, (licensed) Barclay (France) Black Lion Freedom (USA) (distributed—not licensed) Brain (Germany)

Int'l reps.: Australia (EMI M7) Austria (Metronome), Belgium (IBC) Denmark (Electra), Finland (Electra), France (Sonopresse) Germany (Metronome), Italy (Ricordi), Japan (Nippon Columbia) Netherlands (Negram), New Zealand (RTC), Norway (Electra), Spain (CFE) Sweden (Electra) Switzerland (Metronome)

London, see Decca

Look Recs Ltd September Sound Studios, 38 Knowl Rd., Golcar, Huddersfield, West Yorks Tel (0484) 658895 Mng Dir Steve Goddard, Gen Mgr Bob Whiteley, Sec'y Denis Gallivan (Distributed by Jazz Servs Unlimited)

Labels: (Owned) Look, September Sound

Lotus, see K-tel

Loudon, see Emblem

Lout, see Relay

Lowbte, see B&C

Lucky Recs, 3 Havenwood, Wembley, Middx HA9 9AR Tel (01) 904-2556 Mng Dir Colin Brown, Gen Mgr R Luckhurst, Sales Mgr R West

Lugton Co Ltd., PO Box 182, Cross Ln., Hornsey, London N8 7SB Tel (01) 348-9122/9129 Cable MAXITONE Telex 25618 Mng Dir Walter Ficker, Recs Dir Walter Collins, Hardware Div Gen Mgr John Sully (Distributor)

Labels: (Distributed—not licensed) AJP, Action Man, Ad-Rhythm, Affection, Affinity All About Music, Amberlee, Aquarius, Atlas, Attack, Audio Impact, Audio Spectrum, Avenue BBC Banners & Bonnets, Barak, Belmont, Big Bear, Big Ben, Boulevard, Bulldog, Burning Sounds, C&J, C.J.M.O. CMS, Cadillac, Caedmon, Cetra, Charly, Chew, Contour, Cosmopolitan, Count Shelly, Crystal, Crystal Clear, Dansan, Dart, Denver, Desmar, Desto, Discourses, Doric, Double Gold, Ebonite, Empire, Enterprise, Everest, Excelsius,

Exploring the World of Music, Fab, Flightstream, Galaxy, Gemini, Gold, Gold Star, Grosvenor, Halcyon, Hallmark, Howell & West, Ice, Ikon Impact, In Line, Invetia, Island, JVC, Jackson, Jamatel, Jay Boy, Joy, Justice, Justice, K-Tel, Kidiecraft, Kiddy Kassettes Klub, LBA, Lamb & Lion, Les Treteux, Light, Line, Lingaphone, Lismor, Live & Love, Lotus, Marble Arch Melodic, Melodiya, Military Music, Mint, Mr Pickwick Musac, Muse, Mushroom, Myra, Nautlius, Neptune Nesta, Nevis, New Key, New World, Night Owl, Observer, Olympic, Orbitone, Paradise, Peerless Penguin, Pickwick, Pitkin, Prelude, President, Prince Buster, Prism, Proms, Psycho, Quality Prods, RCA Camden, RCA Camden Classics, REL, RIM, Ray Redifusion, Rhapsody, Richards, Rollercoaster, Ronco, SRT Sacred, Seasharp, Seville, Sheffield Labs, Shell Bird, Shure Test Recs, Silver Dollar, Sky, Smack Sonodisc, Spiral, Sportsdisc, Staveley Makepiece, SteepleChase, Sticky, Strictly, Sun, Sunshine, Sunstar Superbad, Supraphon, Supreme, Survival Tackle, Tangent, Taylor Sound Stores, Tella Story, Thames Third World, Sydney Thompson, Three Centuries of Music, Thunderbird, Torpedo, Tradition, Trave Cassetts, Unicorn, VFM, Velvet, Viking, Virgin

Lyrita Rec'd Edition, (IFPI), 99 Green Ln., Burnham, Slough SL1 8EG Tel (06286) 4208 Owner A R Iiter (Distributed by Selecta)

Label: (Owned) Lyrita

Int'l reps.: Australia (World Rec Club), USA (HNH)

M A M Recs Ltd., 24 25 New Bond St. London W1 Tel (01) 629-9255 Cable MAMARTISTE Telex 27867 Mng Dir Geoffrey Everett (Licensed to EMI)

Int'l reps.: Worldwide (EMI) excluding Canada & USA (CBS)

M C A Int'l Dist'n Ltd (IFPI), 1 Great Pulteney St., London W1R 3FW Tel (01) 439-9951 Telex 27782 Mng Dir Roy Featherstone, Sales Mgr John Porter, Gen Mktg Mgr Stuart Watson (Licensed to CBS)

Labels: (Licensed) Infanity (USA), MCA (UK, USA), MCA Coral (UK, USA)

M C B C, see Recommended

M F P, see Music for Pleasure & EMI

M G M, see Polydor

M S B, 19 S Gallery, Exchange St, Sheffield, Tel (0742) 23366 Co-Pres Peter Martin, Frank Stuart-Brown

Labels: (Owned) MSB, (distributed—not licensed) Bludgeon Riffola

M W M, see Mawson Wareham & Transatlantic

Magcassettes—The Sounds of Magic, 77 Bolingbroke Rd, London W14 0AA Tel (01) 602-2795 Mng Dir Martin Breese

Magnephone Rec'g Co Ltd., 8 Hanway St., London W1 PDL Tel (01) 323-0880 Gen Mgr Victor L Leslie (Tape only)

Magnet Recs Ltd (IFPI), Magnet House, 22 York St, London W1H 1FD Tel (01) 486-8151 Cable MAGLONDON Telex 25537 Chm & Mng Dir Michael A Levy, A&R Dir Brian Reza, Sales & Mktg Mgr Graham Mabbutt, Promo Mgr Barry Johnson Int'l Sarah Jones, Financial Controller Tom Bradley (Distributed by EMI)

Int'l reps.: Worldwide (EMI) excluding Canada (CBS United Artists), Israel (Hatalkit), Philippines (Home Inds.), South Africa (RPM), USA (United Artists)

Magnus, see Quadramail

Magpie, see Flyright

Mainspring Recs., 2 Derby Crescent, Sunbury-On-Thames Middx Tel (76) 82358 Dirs Eric Woolfson, Bob Britton

Maquis, see Faulty

Mike Mansfield Ents Ltd., Gatehouse, 4 Ellerton Rd Wimbeldon SW20, Tel (01) 437-5125 6613 Prod & Dir Mike Mansfield

Marble Arch, see Pye

March, see Rutland

March Music Folktales, see Rutland

Marshall, Morgan & Scott Publ's Ltd., see Pilgrim

Matchbox, see Saydisc

Maudeella Patterns Co Ltd., Rec Div., 39/41 Chapel St Bradford, West Yorks BD1 5BZ Tel (0274) 21-498 Mng Dir E G Dunsford (Distributor—Yorks)

Labels: (Distributed) K-tel, Pickwick group Ronco Warwick

Mawson Wareham (Music) Ltd., Heath House, 11 Blakett St., Newcastle-upon-Tyne Tel (0632) 26461 (Distributed by Selecta)

Labels: (Owned) MWM Rubber

Melodic Recs Ltd., Avon Estate, Block 6, Avonmore Rd London W14 Tel (01) 602-0182 Mng Dir Emile E Shalit, Mgr Peter Staig

Merco, see Multiple Sound

Mercury, see Phonogram

Meridian Recs., PO Box 317, Eltham, London SE9 4SF Tel (01) 850-7268 Gen Mgr Edward Perry, Tech Mgr John Shuttleworth (Distributed by Selecta)

Int'l reps.: Australia (Avan-Guard), Canada (Magic Notes)

Metro, see Polydor

Metropolitan Communications & Belmont Recs Ltd., 8a Frogna Gardens, Hampstead, London NW3 Tel (01) 435-8803 Mng Dir Mark R F Hanau, Sales Mgr A Carson

Labels: Bedtime, Candhaven, Metropolitan, SF Original, Talkie Tapes, Venus

Metrosound Audio Prods. Ltd., 4/10 North Rd., London N7 9HN Tel (01) 607-8141 Telex 264773 Mng Dir David Mason, Sales Mgr Ian Levene

Labels: (Licensed foreign) ASI, Coherent Sound, Crystal Clear, Nautlius, Sound 80 (all USA), SteepleChase (Denmark).

Mettle Recs., 10 Barley Mow Passage, Chiswick, London W4 4PH Tel (01) 994-6477 Mng Dir Joseph R Stanley, Gen Mgr Mike A Carter

Labels: (Owned) Camp, Mettle

Midland Rec Co Ltd., Chase Rd., Brownhills, West Midlands WS8 6JT Tel (05433) 3083, 78222 Telex 919-249 (Distributor—cutouts/Importer/Exporter)

Branch: (Licensed) London W3 8HQ, 115 Gunnersbury Ln Tel (01) 993-2134

Mike's Country Music Room, 18 Hilton Ave., Hilton

Aberdeen, Scotland AB2 3RE Tel (0224) 44776 Chief Exec Mike Craig, Gen Mgr Angela Craig (Distributor/Importer)

Labels: (Distributed—not licensed) Arhoole (USA), County (USA), Davis Unlimited (USA), Folk Variety (Germany), Larrink (Australia), Old Homestead (USA), Revonah (USA), Ridgerunner (USA), Rounder (USA), Shiloh (USA), Sierra/Briar (USA), Sugar Hill (USA)

Mint, see Emerald, Solomon & Peres & Decca

Mint-Julep, see Emerald

Miracle, see Gull

Mr Pickwick, see Pickwick

Mojo Dist'n, 55 Boscombe Rd., London W12 9HT Tel (01) 743-2138 Contacts M & Pete Clardige, Steve Hillier (Distributor)

Mooncrest, see B&C

Morven, see Grampan

Moss Music, 6 Allhalland St Biddeford, Devon Tel Biddeford 5994 (Importer One Stop)

Mother Earth Recs., 27 Brookfield Rd., London W4 1DE Tel (01) 995-6842 (Distributed by Charmdale)

Motor Recs., 346A Farnham Rd., Slough, Bucks Tel (75) 29628

Motown Recs Ltd., 16 Curzon St London W1 Tel (01) 493-1603 Telex 8811658 VP Int'l Optrs Peter Prince Gen Mgr James Fisher (Licensed to EMI)

Home office: USA

Labels: (Owned) Motown Mowest, Prodigal, Rare Earth

Mountain Recs Ltd (IFPI), 49 Mount St., London W1Y 5RE Tel (01) 491-2904 Telex 269398 Chm & Mng Dir Derek Nicol, Gen Mgr Jim White (Distributed by Phonogram)

Int'l rep.: Worldwide excluding Canada & USA (Phonogram)

Mowest, see Motown

Mulligan Recs., Dryden Chambers, 119 Oxford St., London W1 Tel (01) 580-0885 Contact Gabrielle Goodchild (Distributor)

Multicord Recs., 52 Briardene Close, Sunderland, SR3 3RU Tel (0783) 282-353 Mng Dir Ken McKenzie

Labels: (Owned) Multicord, Porage

Multiple Sound Dists. Ltd., 79 Blythe Rd., London W14 OHP Tel (01) 602-3483 Cable MULTISOUND Telex 914382 Chm & Mng Dir Ian F Miles, Gen Mgr John S Coats, Mktg Dir Anne Miles, Sales Mgr Paul Hillwell

Labels: (Owned) Chevron, Merco, Spire, Tempo, Warwick, Windmill

Int'l reps.: Worldwide (CBS), excluding Canada (Ahed), Germany (Ariola), New Zealand (Music World)

Musac (Scotland) Ltd., Baltic Chambers, 50 Wellington St., Glasgow, Scotland G2 6HJ Tel (041) 221-1948 Mng Dir Angus Ian McDonald Sales Mgr Douglas MacLeod

Labels: Klub OK

Music for Pleasure Ltd (IFPI), 80 Blyth Rd., Hayes, Middx Tel (01) 561-3125 Telex 22417 Mng Dir R N Baldwin, Financial Controller G McDade, Sales & Mktg Dir E J Harris (Distributed by EMI & Original), **Labels: (Owned) Classics for Pleasure, Listen For Pleasure, Music for Pleasure**

Int'l reps.: Worldwide (EMI Int'l) excluding Australia (EMI—Listen for Pleasure only), USA (Motown—Listen for Pleasure only)

Music Machine, The Midway Colours, Holbeton, Plymouth, Devon PL8 1NA Dirs John K Dryden, John Greenslade

Music Radio Promos Ltd., PO Box 400, Kings Langley, Herts Tel (09277) 67660 Mng Dir & Gen Mgr Mike Baron

Mustard Seed, see Celebration

Myrrh, see Word

N Y J O Recs., 11 Victor Rd., Harrow, Middx HA2 6PT Tel (01) 863-2717 Mng Dir W Ashton (Distributed by Selecta)

Nashville Int'l, see Carnaby

Neat, see Impulse

Nelson, see Castle

Nems Recs Ltd., 31 Kings Rd., London SW3 Tel (01) 730-9461 Chief Exec Patrick Meehan Gen Mgr Peter Parkinson, Sales Mgr Ian Atkins, Promos Mgr Bruno Dean

Labels: (Owned) Immediate, Nemes

Int'l reps.: Australia (Festival), Benelus (Dureco), Brazil (RGE/Fermata), France (Arabella), Italy (RCA) South Africa (Trutone), Spain (Mediterraneo)

Neon Hearts Recs., Studley House, 63 Lames Rd Tettenhall Wolverhampton Tel (0902) 758-047

Neptune, see Peter Hamilton

Newhall Rec's Gs Ltd., 36 Regent Pl., Birmingham B1 3NJ Dir R W Brotherton

New World, see President

Nighthawk, see Faulty

Nimbus Recs Ltd., Wyastone Leys, Monmouth NP5 3SR Tel (0600) 890682 Telex 49378, 498378 Dirs N Libin, M & G Reynolds

Label: (Owned) Acanthus, Amber, Flame, Hermes, Nimbus, RNR, Sphinx

No Bad Recs., see AIM

NoLa Recs., 16 Clement Close, Purley, Surrey CR2 4BY Tel (01) 668-6772, Chief Exec Thomas N Staggs (Distributed by Cadillac, Jazz Servs Unlimited, NoLa, VJM, Chris Wellard)

Labels: (Owned) Carrot, NoLa

Int'l rep.: USA (Gentilly)

Non Stop Recs Ltd 11-15 William Rd., London NW1 3ES Tel (01) 388-4831 Telex 27371 Mng Dir Michael Ashwell (Exporter)

Nonesuch, see WEA

Novus, see Arista

Note, see EMI

Nut, see EMI

O C R, see Orbach & Chambers

O K, see Klub & Musac

O K I Wave, see Old New Wave

O U P, see Oxford Univ Press

Observer, see Third World

Ocean, see Carnaby

Ogun Rec'g Ltd., 75 Haverstock Hill, London NW3 Tel (01)

722-8960. Chm. Keith Beal; Co. Sec'y: Hazel Miller (Distributed by Cadillac, Jazz Servs. Unlimited)
Int'l reps.: Austria (Bellaphoni), France (Freebird), Germany (Bellaphoni), Italy (Hi-Fi), Scandinavia (SAM), Sweden (SAM), Switzerland (Phonag), USA (JEM)

L Oiseau Lyre, see Decca
 Old Gold, see Lightning
 Oldies Unlimited, 6/12 Stafford St., St. Georges, Telford, Shropshire TF2 9JQ. Tel (0952) 612244. Chief Exec.: A. J. Lewis. (Distributor/Importer—excess stock, cutouts—single)
 Old New Wave Recs., c/o The Victory Cafe, 54 Eversholt St., Somers Town, London NW1 Tel (01) 387-0694. Sales Mgr. Julian Hall, Co-ords. Keith Armstrong, Richard & Julian Hall. (Distributed by Company, Lightning, Rough Trade, Small Wonder)
Labels: (Owned) OK! Wave. Old New Wave.
 Olga Recs., 30 George St., London W1 Tel (01) 499-5561. 1 Stop Dist'n (Recs. & Tapes) Ltd., 11/15 William Rd., London NW1 3ES. Tel: (01) 388-0137. Telex 23731.
 One Up, see EMI
 Onslow Recs., 61 Kingswood Rd., London SW2 4JN. Tel: (01) 674-0705. Hoddesdon 62528. Gen. Mgr. E. Onslow.
 Opus, see Saga
 Orange Recs., 3/4 New Compton St., London WC2. Tel: (01) 836-7811. Pres. Ken Cooper. Mng. Dir.: Cliff Cooper
 Orbach & Chambers Ltd., 74 Long Ln., London EC1. Tel: (01) 606-9373. Mng. Dir.: Michael Chambers.
Label: (Owned) OCR
 Orel/Welsh Arts Council, 53 Charles St., Cardiff, Wales Tel (0222) 395-548. Dir. A.M. Thomas; Gen. Mgr.: Meic Stephens; Sales Mgr.: Peter Finch.
 Original Recs., 38 Long Acre, London WC2. Tel (01) 748-8489
 Oryx Rec's Ltd., 281 Snowdon Quay, Porthmadog, Gwynedd, Wales
Labels: Bach Collectors, Canolfan, Cosmopolitan, Excelsius, Exploring the World of Music, Oryx, 3 Centuries of Music
 Outlet Rec'g Co. Ltd. (IFPI), Outlet House, 48 Smithfield Square W., Belfast, Northern Ireland BT1 1JD. Tel (0232) 22826. Mng. Dir. William M.A. McBurney, Gen. Mgr. James Gough, Sales Mgr. Ray McGugan, Accounts Dir. Ann Collin
Labels: (Owned) CRC, Derry, Folk, Foyle, Homespun, Inset, Outlet Praise, R&O, Soccer, Ulster, Zip. (distributed—not licensed) ARA, Aisling, Bar, Blackbird, Bonus, Claddagh, Denver, Dolphin, EMI, Free Reed, Gael Linn, Glenside, Harp, Hawk, Horslip, Isle, ID, Leaf, Lsmor, Misty, Mulligan, Oats, Olympic, Play, Poor Genius, RMI, Release, Resistance, Ruby, Shamrock, Sharp, Silver Hill, Solo, Star, Tap, Tara, Topic, Top Spin, Tralee, Tribune, Triskel, Velvet.
 Oval Recs. Ltd., 11 Liston Rd., London SW4 ODG. Tel: (01) 622-0111. Dirs. Charlie Gillett, Gordon Nelki
Label: (Owned) Oval. (licensed foreign) Jin-Swallow (USA).
 Oxford Univ. Press, 44 Conduit St., London W1 Tel: (01) 734-5364. Cable: FULSCORE (Distributed by CRD)
Label: (Owned) OUP
 P. H., see LE
 P. V. K., see Creole
 Pacific Recs. Ltd., 51 Islip St., Kentish Town, London NW5. Tel (01) 267-2917. Telex 261478. Mng. Dirs. John Camp, Simon Goodman, Prom'l Mgr. Peter Macklin, Import Sales Rick French. (Distributor/Importer/Exporter)
 Pama Recs. Ltd., 78 Craven Park Rd., London NW10 4AE. Tel (01) 965-2267
 Pan-Audio Ltd. (IFPI), 4 Forth St., Edinburgh, Scotland EH1 3LD. Tel (031) 557-0181. Telex 72465. Chm. & Mng. Dir. John Mackinnon; Gen. Mgr. Alan Spence, Sales Mgr. Forbes Fordyce, Studio Mgr. Colin Nicolson. (Distributed by Pan-Audio, CML, Shannon)
Labels: (Owned) Dara, Pan-Audio
 Panda Recs., 2 Catherine St., Seaside, Llanelli, Dyfed SA15 2PA. Tel (05542) 52490, 58913. Chief Exec. Paul Adams. Gen. Mgr. A. Phillips
 Paradise, see Third World
 Paragon Int'l Prods., 19 Smithfield, Belfast, Northern Ireland Tel (0232) 656959. Dir. John O.P. McCourt; Gen. Mgr. Anne Heaps; Sales Mgr. Edwina Heaps
Labels: (Owned) Paragon. (represented) American Heritage, Atteram, County, Crown, Custom, Davis Unlimited, Dominion, Down Home, Dyer-Bennett, Flying Fish, Folk Legacy, Folkways, Green Mountain, Kanawha, Kiamichi, King Bluegrass, Lark, Lemco, Magnitron, Melody, Michigan Bluegrass, Minstrel, Music Minus One, Old Dominion, Old Homestead, Palomino, Philo, Pine Mountain, Pine Tree, Rebel, Rem, Revonah, Ridge Runner, Rome, Rounder, Rural Rhythm, Stoneway, Traditional, Vetco, Wheeling (all USA); CMH (Germany), Dominion (Canada), Folk Variety (Germany), Red Clay (Japan)
 Parke Rec. Dist., 55C Mortimer St., London. Tel (01) 636-6378/6531. Mng. Dir. L.A. Parker, Sales Mgr. R.J.E. North (Importer)
 Parolophone, see EMI
 Passport Recs., 51/53 Islip St., Kentish Town, London NW5. Tel (01) 257-2967
 Pavilion Recs. Ltd., 48 High St., Pembury, Tunbridge Wells, Kent Tel 2042. Pres. Gen. & Sales Mgr. Charles Haynes
Labels: (Owned) Pavilion, Pearl
Int'l reps.: Canada (Almada), USA (Qualiton)
 Pear Recs., 7 Woodside Grove, Hartburn, Cleveland. Mng. Dir. Alan Cole. Gen. Mgr. Andrew Ormston, Sales Mgr. Chris Andrews
 Pearsons, 29 Rawson Pl., Bradford, West Yorks BD1 3QL. Tel (0274) 27845 (Distributor/One Stop)
 Pearl, see Pavilion
 Peeping Tom, see Horizon
 Peerless Rec. Co. Ltd. (IFPI), Gunshot Farm House, Gunshot Common, Wisborough Green, Sussex RH14 0AQ. Tel: (0403) 752-373. Mng. Dir. Derek Lawson
Labels: (Owned) Oryx, Peerless, Proms, (licensed) CMS (USA), Desto (USA).
 Pendulum Music Ltd., 11 Cross Keys Close, London W1M

5FY. Tel (01) 486-0596, 935-3762. Telex 23733. Mng. Dir.: John Stirling
 Penguin, see Third World
 Penny Farthing Recs. Ltd., 4 Tiney St., Park Ln., Mayfair, London W1Y 5LE. Tel: (01) 493-8873. Cable: PENSONG. Telex 25238. Mng. Dir.: Larry Page; Dir.: Terry Fenn
 Penthouse, see Stage One
 Pepper, see Liberty-United
 Pepper, National House, 60-66 Wardour St., London W1. Tel: (01) 439-7849. Chm. Mike Dufficy
 Phase 4, see Decca
 Philadelphia Disco, see Soulville
 Philips, see Phonogram
 Phonodisc Ltd., Clyde Works, Grove Rd., Chadwell Heath, Romford, Essex RM6 4QR. Tel (01) 590-6088. Telex: 896556. Mng. Dir.: W.W. Bryant; Comm'l/Dist'n Mgr. B.W. Dean; Factory Mgr. V. Gowland. (Distributor)
Labels: (Distributed) Air, All Platinum, Archive, Arista, Avco, Bang, Barn, Bell, Big Ben, CTI, Capricorn, Charisma, Checker, Chess, Chrysalis, Class, G.D. Debut, EG, Ensign, Fontana, Fresh Air, H&L, Heliodor, Janus, Kudu, MGM, Mercury, Metro, Mountain, Obscure, Oyster, Pablo, Passport, Philips, Phonogram, Polydor, Privilege, RSO, Ring O. Rocket, Sire, Solo Classics, Phil Spector, Spring, Tangent, Track, Unverslo, Urgent, Vertigo, Verve, Vulcan.
 Phonogram Int'l, 16 St. George St., London W1A 2BR. Tel: (01) 493-0475. Telex 268403. (Pop Int'l Office)
 Phonogram Ltd. (IFPI), 129 Park St., London W1Y 3FA. Tel: (01) 491-4600. Telex: (851) 261583. Mng. Dir. Ken Maliphant; Finance & Comm'l Dir.: Glyn Williams; Bus. Affairs Dir. David Baker
Labels: (Owned) Fontana, Mercury, Philips, Vertigo. (licensed domestic) Ensign, Mountain, Utopia. (licensed foreign) All Platinum, Bang, Chess, De-Lite, H&L (all USA), Lollipop (Germany); (distributed—not licensed) Charisma.
Int'l rep.: Worldwide (Phonogram)
 Phonograph Recs., 150 Portland Rd., South Norwood, London SE25. Tel (01) 656-4070. Dirs.: Janet Smith, Terry Gregory, Alex Sarda. (One Stop/Importer)
 Pic-A-Tape, 290 Blackpool Rd., Preston PR2 3EE. Tel: (0772) 718238. (Tape Wholesaler/Importer)
 Pickwick Rec. Dist. Ltd., The Hyde Ind'l Estate, The Hyde, London NW9 6JU. Tel (01) 200-7000. Cable: PICKREC. Telex 922170. Chief Exec. Stephen Lewis; Buying & Mktg. Tony Harding
 Pickwick Int'l Inc. (GB) Ltd. (IFPI), The Hyde Ind'l Estate, The Hyde, London NW9 6JU. Tel: (01) 200-7000. Cable: PICKREC. Telex 922170. Mng. Dir. Montague Lewis; Gen. Mgr.: A.W. Freedman; Sales Mgr. Alan Friedlander; Export Mgrs. Fred Jackson, Patrick Perraud
Labels: (Owned) Hallmark, Mr. Pickwick, Pickwick; (licensed) Contour, Disneyland, Hallmark/ Marble Arch, RCA Camden.
Int'l reps.: Argentina (EMI), Brazil (RCA), Chile (Banglad), Mexico (Gamma), Spain (Belter)
 Pilgrim Recs./Marshall Morgan & Scott Publ'ns Ltd., 1 Bath St., London EC1V 9LB. Tel (01) 251-2925. Cable: GRAPHO. Telex 262364. Chief Exec. David Payne; Mng. Dir. Peter Lardi; Sales Dir.: Noel Halsey
Branch: Belfast, Northern Ireland BT1 6FD, 48 Upper Queen St. Tel: (0232) 21576. Gen. Mgr. Dennis Milligan
Labels: (Owned) Grapevine, Little Pilgrim, Pilgrim, Pilgrim Praise, Sharon.
 Pilgrim Praise, see Pilgrim
 Pilot Music Prod'ns, 16 Gull Close, Roundshaw Estate, Wellington, Surrey. Tel: (01) 857-6189.
 Pinnacle Recs., 9 Dean St., London W1V 5RL. Tel (01) 734-4543. Telex: 896141. Chm. & Mng. Dir. Terry Scully; Sales Mgr. George Stone, Mktg. & Dist. Mgr. Tony Berry
Labels: (Owned) Breeze, Firebird, Pinnacle; (distributed—not licensed) Ace/Chiswick, Barn, Hobo, Rediffusion, Robot
Int'l reps.: Germany (Teldec), Israel (CBS), Japan (Victor)
 Pipeline Recs., 11 Roslyn Court, St. John's Rd., Woking, Surrey. Tel. Woking 66555. Telex: 859549. (Distributor/Importer/Exporter)
 Pixie, see Dawn Anglian Soul Club & East Anglian Soul Club.
 Plant Life Recs. Ltd. (IFPI), Edison Chambers, 109 Bancroft, Herts. Tel (0462) 58555 (Distributed by JSU & Projection)
Labels: (Owned) Plant Life, Plant Life Jazz.
Int'l rep.: Benelux (Sound Prods.)
 Plant Music Ltd., 60 St. James' St., London SW1 1LE. Tel: (01) 499-4341. Cable: PLANTAX. Chief Exec. A.H. Yadgaroff; Financial Dir.: Stephen Rowe; Label Mgr. Angela M. Yadgaroff.
 Plastic Fantastic Recs., 22 Tavistock St., London WC2. Tel: (01) 240-1032. Mng. Dirs. Tony Randolph, Paul Rodriguez, Ethnic Prod. Dir. Tyrone Patterson
Labels: (Owned) Plastic Fantastic, Ultra; (distributed—not licensed) Albatross, Anansi, Black Jack, Blue Bag, December, D-Roy, Dover, Heart & Soul, Inner City, JAK, U.K. Manic, Natty Congo, Night Owl, Pearl, Record Mart, Red Lightnin', Soul Breaker, Spade/Thunder, Sun Starr, Warm.
 Pogo, see WEA
 Polydor Ltd., 17/19 Stratford Pl., London W1N 0BL. Tel: (01) 499-8686. Telex: (851) 27133. Mng. Dir. A. J. Morris, Deputy Mng. Dir. Tom Parkinson; A&R Dir. Jim Cook, Financial Dir. John Crane, Sales Mgr. Ray Jenks, Pop Prod. Mgr. George McManus, Promo. Mgr. Tony Bramwell, Press & PR Roger Easterby
Labels: (Owned) Archiv, Deutsche Grammophon, Heliodor, MGM, Metro, Polydor, Privilege, RSO, Verve; (licensed foreign) Beserkly, CTI, Capricorn, Kudu, Midland Int'l, Pablo, Phil Spector Int'l, Spring (all USA).
 Polygram, Leisure Ltd., 15 St. George St., London W1A 2BR. Tel: (01) 499-3751. Cable: SYMPHONY. Telex: 268403. Chm. S.L.G. Gottlieb; Mng. Dir. D.G. Fine; Dirs. K.N. Maliphant, A.J. Morris, W. Poldervaart, P.R. Schellevis, D. Gideon Thomson; Group PR Mary Jennings.

Porage, see Multicard.
 Portrait, see CBS.
 Power Exchange Int'l Ltd. (IFPI), 474 Harrow Rd., London W9 3RU. Tel: (01) 289-1036. Cable: POWREC. Telex: 299649. Chm.: Paul Robinson; Pres.: Jimmy Bishop; Gen. Mgr.: Richard Marven; Sales Mgr.: Tony Collins.
Labels: (Owned) Power Exchange (dist. by Decca/Selecta), (licensed foreign) Omni (USA).
 Praise, see Outlet.
 President Recs. Ltd. (IFPI), Broadmead House, 21 Panton St., London SW1. Tel: (01) 839-4672. Cable: KASSMUSIC. Telex: 24158. Mng. Dir.: Edward Kassner; Gen. & Sales Mgr. David Kassner; Financial Mgr.: Brian M.D. Seed. (Distributed by Clyde Factors, Lugton, Solomon & Peres, H.R. Taylor, Wynd Up)
Labels: (Owned) Aquarius (France), Barak, Crystal, Dart, Double Gold, Enterprize, Gemini, Jay Boy, Joy, New World, President, Rhapsody, Seville, Sky, Spiral, Sticky, Thunderbird, Torpedo; (licensed) Bulldog. Int'l repps: Australia (M7), Belgium (Fonior), France (Arabella), Germany (Ariola), Netherlands (Dureco)
 Privilege, see Polydor.
 Prodigal, see Motown & EMI.
 Projection Recs., 9 Grove End, Rectory Grove, Leigh-on-Sea, Essex. Tel: (0702) 72281. Dirs.: Dave Hatfield, Dave Lawrence; Gen. Mgr.: Dave Hatfield; Sales Mgr.: Dave Lawrence. (Distributor/Importer/Exporter)
Labels: (Distributed—not licensed) Adelphi (USA), Arhoolie (USA), Artists House (USA), Bead, Black Saint (Italy), Blues Classics (USA), Blue Goose (USA), Breakdown, Circle (Germany), EDC (Italy), Folklyric (USA), Folkways (USA), Green Linnet (USA), Herwin (USA), Improvising Artists (USA), India Navigation (USA), Mosaic, Nessa (USA), Ogun, Old Timey (USA), Philo (USA), Plant Life, Ring (Germany), Rounder (USA), Rubber, SRI—Spectrum (USA), Shandar (France), Shiloh (USA), Sierra/Briar (USA), Sky (Germany), Vinyl (USA), Wergo (Germany), Yazoo (USA)
 Proms, see Peerless.
 Purple, see EMI.
 Pye Big Deal, see Pye.
 Pye File, see Pye.
 Pye Recs. Ltd. (IFPI), ATV House, 17 Great Cumberland Pl., London W1A 1AG. Tel (01) 262-5502. Cable: PYREC. Telex 28259. Chm.: Louis Benjamin; Joint Mng. Dirs.: Walter S. Woyda (Int'l), Derek Honey (UK); Sales Mgr.: Trevor Eyles; Sec'y & Contracts Mgr.: Madeline R. Hawkward.
Int'l branches: Netherlands, VIP: USA, ATV.
Labels: (Owned) Dawn, Flashback, Golden Guinea, Golden Hour, Marble Arch, Pye Big Deal, Pye Chartbusters, Pye Collector, Pye Disco Demand, Pye 4D, Pye File, Pye Int'l, Pye Nixa, Pye Popular, Pye Special, Pye Top Brass, Pye Virtuoso; (licensed domestic) Ariola, Ariola-Hansa, Aura, Cube, Electric, Ember, Klub, Ronnie Scott; (licensed foreign) Ampro Prod'ns (USA), Attarack-Heller (USA), Buddha (USA), Casablanca (USA), Cream-Hi (USA), GNP Crescendo (USA), Inphason (USA), Kama Sutra (USA), Parachute (USA),

SONET



SONET
SONET

SONET

Leaders in Records and Publishing in Scandinavia.

Denmark: SONET DANSK GRAMMOFON
 Finland: SCANDIA MUSIC LTD
 Norway: ARNE BENDIKSEN A S
 Sweden: SONET GRAMMOFON AB

and in England:
SONET MUSIC & PUBLISHING
 121 Ledbury Road

- Pyramid (USA), Roulette (USA), 20th Century (USA), Vanguard (USA), Vogue (France); **(distributed—not licensed)** Affinity, BBC, Baal, Birds Nest, Charly, Gull, Kicking Mule, RK, Response, Safari, Sonet, Spark, Specialty
- Int'l reps.:** Central America (Discos Centroamericanos), Argentina (Sicamericana), Australia (Astor), Austria (Ariola), Belgium (Vogue), Brazil (Gravocoes Eletricas), Canada (Phonodisc), Cyprus (Electroacoustic Supply), Denmark (Sonet), Finland (Scandia), France (Vogue), Germany (Ariola), Ghana (Phonogram), Greece (Music Box), Hong Kong (Decca), India (Gramophone Co.), Ireland (Polydor), Israel (Hatakit), Italy (Ricordi), Japan (Teichiku), Kenya (Phonogram), Lebanon (Melody), Malaysia (Decca), Mexico (Gamma), New Zealand (Phonogram), Nigeria (Phonogram), Norway (Arne Bendiksen), Peru (FTA), Philippines (Super), Sierra Leone (Phonogram), Singapore (Decca), South Africa (Teal), Sweden (Sonet), Switzerland (Vogue), Tanzania (Phonogram), Uganda (Phonogram), Uruguay (Clave), Venezuela (Disco de Moda), West Indies (WIRL), Zambia (Disque Centre)
- Quadramail Ltd., 10 Green End Rd., Sawtry, Huntingdon, Cambs. PE17 5UX. Tel: (0487) 831451. Mng. Dir.: Jon Soyka; Sales Mgr.: Gary Lipman
- Labels: (Owned) Magnus; (distributed—not licensed) A&M (Canada), Century (USA), Direct Disk (USA), East Wind (Japan), JVC (Japan), Merlin (UK), Miller & Kreisel (USA), Negative Noise (USA), Nimbus (UK), Orinda (USA), Ortofon (Denmark), Philips (Japan), Sheffield Lab (USA), Telarc (USA), Umbrella (Canada).**
- Qualton (Wales), see Decca
- Quality Rec's Ltd., 43 Victoria Ave., Romford, Essex RM1 2DD. Tel: Romford 28413. Dir.: D.J. Davies. (Distributed by Lugton)
- R A K Recs. Ltd., 42-48 Charlbert St., London NW8. Tel: (01) 586-2012. Mng. Dir.: Mickie Most; Dir.: David Most; Gen. Mgr.: Ron Madison; Sales Mgr.: Dave Crowe. (Licensed to EMI)
- Int'l reps.:** Worldwide except Canada & USA (EMI).
- R C A Camden, see Pickwick
- R C A Ltd., Rec. Div., 1 Bedford Ave., London WC1B 3DT. Tel: (01) 499-4100. Telex: 266579. Mng. Dir.: Ken Glancy; UK Sales: John Howes; European Sales: Brian Hall; A&R Dir.: Derek Everett
- Labels: (Owned) Gold Seal, Red Seal, Starcall, UK Victor, Victrola; (licensed domestic) Gem, Logo; (licensed foreign) Erato (France), Grapevine, Grunt (USA), Midsong, Milestone (USA), Millennium, Prestige (USA), Solar (USA), Windsong (USA)**
- R E L Recs. Ltd. (IFPI), 10 Atholl Pl., Edinburgh, Scotland EH3 8HP. Tel: (031) 228-6344. Mng. Dir.: Neil Ross; Mktg. Dir.: Mel Benton
- Labels: (Owned) Housewives Choice, REL**
- Int'l reps.:** Canada (CBS Canada), New Zealand (Reed Pacific), USA (CBS Canada)
- R K, see Robert Kingston & Pye
- R K L, see Zodiac
- R M, see Record Mart
- R N R, see Nimbus
- R & O, see Outlet
- R O K, see The Label
- R S O Recs. Ltd., 67 Brook St., London W1. Tel: (01) 629-9121. Cable: STIGWOOD. Telex: 264267 VP & Mng. Dir.: RSO Recs. Int'l: Mike Hutson; Promos. Mgr.: Arthur Sheriff; Creative Servs. Mgr.: Ashley Newton; Press Officer: Helen Walters; Int'l Co-ord.: Linda Ghirardani; A&R Admin.: Alexander Sinclair. (Distributed by Polygram)
- Labels: (Owned) RSO; (licensed foreign) Curton (USA)**
- Int'l rep.:** Worldwide (Polygram)
- Rabid Recs., 20 Cotton Ln., Withington, Manchester 20. Tel: (061) 445-2661. Mng. Dir.: Lawrence Beedle; Gen. Mgr.: Tosh Ryan; Sales Mgr.: Martin Hannett
- Radar Recs., 60 Parker St., London WC2 B5PZ. Tel: (01) 404-5832. Telex: 27362. Mng. Dir.: Martin Davis; A & R Dir.: Andrew Leader; Sales & Mktg. Dir.: Tim Reed. (Distributed by WEA)
- Int'l reps.:** Worldwide (WEA), excluding Canada (Polydor), USA (Polydor)
- Rainbow, see Satril
- Rainbow Recs., 103 Hillside Grove, Chelmsford, Essex. Tel: (0245) 60853. Mng. Dir.: Terry Gisborne; Gen. Mgr.: Ken Porter; Sales Mgr.: Bill Jiggins; Finance Mgr.: Phil Marriage
- Rampage Recs. Ltd., 4 Tilney St., London W1Y 5LE. Tel: (01) 493-8873. Cable: PENSON. Telex: 25238. Mng. Dir.: Larry Page; Dir.: Terry Fenn. (Distributed by Selecta)
- Rare Earth, see Motown
- Rare Rec'd Eds., 54 Lymington Rd., London NW6. Tel: (01) 435-1476. Chief Exec.: Michael G. Thomas
- Rare Recs. Ltd., 36 John Dalton St., Manchester M2 6LE. Tel: (061) 832-7344. Mng. Dir.: Irving Wilson; Gen. Mgr.: Lesley Thompson; Sales Mgr.: E.S. Scrivings. (Distributor/Importer)
- Rather Recs., Meadowbank, Hall Ln., Harbury, near Leamington Spa, Warwickshire. Tel: (0926) 612089. Chief Exec.: A.N. Godfrey. (Distributed by Rough Trade)
- Raw Recs. (Rixcroft Ltd.), 48 King St., Cambridge, Cambs. Tel: (0223) 54697. Chief Exec.: Lee Wood; Gen. Mgr.: Dave Stephens. (Distributed by Selecta)
- Re Recs. Ltd., 5 Silverthorne Rd., London SW8 3AD. Tel: (01) 622-8834. Cable: REDFOX. Mng. Dir.: Chris Cutler; Gen. Mgr.: Fred Frith. (Distributed by Recommended)
- Int'l reps.:** France (LTM), Sweden (SAM), USA (Ralph. Random Radar)
- Reader's Digest Ass'n Ltd., 25 Berkeley Square, London W1X 6AB. Tel: (01) 629-8144. Cable: READIGEST. Rec., Tape & Equip. Mgr.: Ian Wright; Mktg. Mgr.: Derek Holder
- Home office: USA**
- Real, see Sire & WEA
- Reality, see Great Jazz
- Rebel Recs. Ltd., Rebel House, 67 Wigmore St., London W1. Tel: (01) 935-7587. Telex: 24224. Mng. Dirs.: G.W. Dare, D.A. Howman
- Recommended Recs., 5 Silverthorne Rd., London SW8 3AD. Tel: (01) 622-8834. Cable: REDFOX. Dirs. Chris Cutler, Nick Hobbs; Sales Mgr.: Rod Iverson
- Int'l branches:** France, Germany, Japan, Switzerland
- Labels: (Owned) Recommended; (distributed—not licensed domestic) Broadcast, MCCC, Re, Rft; (distributed—not licensed foreign) Atem (France), Frigo (France) HP (USA), L Orchestra (Italy), LTM (France), 9H17 (France), Ralph (USA), Random Radar (USA), SCOPA (France), Say Day-Bew (USA), Silence (Sweden), Transmusic (USA)**
- Record Corner, 27 Bedford Hill, Batham SW12 9EX. London. Tel: (01) 673-1066/6130. Buyer: Dave Hastings; Salesman: Terry Davis. (One Stop/Importer)
- Record Ents. Ltd., 244A Bath St., Glasgow, Scotland G2. Tel: (041) 332-0628. Dir.: A.J. Berman. Sec'y Patricia J. Berman. (Distributor)
- Record Mart, 16 London Hill, Rayleigh, Essex SS6 7HP. Tel: (0268) 776-555. Dir.: Frank K. Bailey. Gen. Mgr.: D.R. Glenister
- Labels: (Owned) RM; (licensed foreign) Olympic (USA), Ruby (USA); (distributed—not licensed) Erwin, Fortune, Glenn, Goldband, Hi-Q, Mar-Vel, Money, Ponie, Specialty, Strate 8, Tab, Yucca (all USA)**
- Record Mdsrs. Ltd., Crown Works, Clayton Rd., Hayes, Middx. UB3 1HS. Tel: (01) 848-7511. Telex: 934027. Mng. Dir.: S. H. Akhtar; Sales Mgr.: Max Mansfield; Comm'l Dir.: D.R. Hammond. (Record & Tape Rack Jobber)
- Red Bus Recs. (Int'l), 34 Salisbury St., London NW8. Tel: (01) 402-9111. Dirs. Elliot M. Cohen, Ellis Elias, Leslie Grade. (Licensed to EMI)
- Int'l reps.:** Australia (EMI), Austria (EMI Electrola), Belgium (EMI), Canada (Distribution de Musique Tempo), France (Pathe Marconi), Germany (EMI Electrola), Italy (EMI), Mexico (EMI), Middle East (EMI), Netherlands (Negram), Portugal (Valentim de Carvalho), Scandinavia (EMI), South Africa (EMI), South America (EMI), Spain (Odeon), Switzerland (EMI Electrola)
- Rediffusion Recs., 19 Ramillies Pl., London W1V 1DG. Tel: (01) 734-1483. Telex: 27950 Mono Ref. 1006. Chief Exec.: Ron Smith; Mktg. Mgr.: Mike Weston. Classical Mgr.: Norman Austin
- Labels: (Owned) Aurora, Classical Pops, Fusion, Legend, Rim; (represented) Harmonia Mundi (France), Opus (Czechoslovakia), Panton (Czechoslovakia), Supraphon (Czechoslovakia)**
- Int'l reps.:** Australia (Message), Belgium (Baltic), Czechoslovakia (Aria), Hong Kong (Studer-Revox), Netherlands (Basart, Sound Prods.), USA (Qualiton)
- Red Lightnin' Recs., The White House, The Street, Northnham, Diss, Norfolk. Tel: (037) 988-693. Dir.: Peter Shertzer; Gen. Mgr.: Brett Housego; Sales Mgr.: Bruce Simmons. (Distributed by Cadillac, Jazz Recs. Unlimited, Non Stop, Swift)
- Int'l reps.:** Germany (Teldec), USA (City Hall, Servo People)
- Red Rag Recs., 39 St. James Rd., Kingston, Surrey KT1 2AU. Tel: (01) 549-9181/5298. Chief Exec.: Alan Robinson
- Labels: (Owned) Red Rag**
- Red Seal, see RCA
- The Les Reed Org., 35 Soho Square, London W1. Tel: (01) 439-1755
- Label: (Owned) Chapter One**
- Reflection Recs., 26 Eastbourne Ave., Acton, London W3. Tel: (01) 560-0079. Gen. Mgr.: Derek J. Smith; Mktg. Mgr.: Rob Cox
- Labels: (Owned) Reflection, Reflection Workshop**
- Int'l reps.:** Australia (Move), USA (Morehouse-Barlow)
- Reflection Workshop, see Reflection
- Regal Zonophone, see EMI
- Regent Acoustics, Carrington House, 130 Regent St., London W1R 6BR. Tel: (01) 437-1997
- Label: (Represented): Sheffield Lab (USA)**
- Reggamite, see Soulvile
- Regis Recs., 174 Biscot Rd. Luton, Beds. Tel: (0582) 25906. Mng. Dir.: R.E. Harris
- Relay Recs. Ltd., Elthorne House, 9 Cherington Rd., London W7. Tel: (01) 579-6125/4249. Mng. Dir.: Tony Hamlin; Gen. Mgr.: Len Shilling; Sales & Mktg. Dir.: John Winnert; Sales Mgr.: Ken Hillier. (Distributor)
- Labels: (Owned) Lou; (distributed—not licensed) Arcade, CBS, EMI, K-Tel, Phonogram, Polydor, Pye, RCA, Ronco, Simons, WEA, Warwick**
- Release Recs., 325 Sauchiehall St., Glasgow, Scotland G3. Tel: (041) 332-8108
- Reprise, see WEA
- Response Music Ltd., 3 Dennis Rd., East Molesey, Surrey. Tel: 941-4767. Chief Exec.: Mike Claire. (Distributed by Pye)
- Retrieval Recs., 48 Eversley Ave., Barnehurst, Kent DA7 6BB. Tel: Erith 33875. Joint Partners: Norman Stevens, Ron Jewson, John R.T. Davies. (Distributed by Jazz Music, Jazz Servs. Unlimited, Retrieval, Swift, VJM, Chris Wellard)
- Labels: (Owned) Fountain, Retrieval**
- Int'l reps.:** USA (City Hall, Zim)
- Retrospect, see World
- Revival, see Lightning
- Rex, see Decca
- Rhapsody, see President
- Rialto Recs. Ltd., 4 Yeomans Row, London SW3. Tel: (01) 942-7373. Chief Execs.: Nick & Tim Heath
- Int'l rep.:** Worldwide (Decca)
- Rift Recs. Ltd., 5 Silverthorne Rd., London SW8 3AD. Tel: (01) 622-8834. Cable: REDFOX. Mng. Dir.: Fred Frith. (Distributed by Recommended)
- Int'l reps.:** France (LTM), Sweden (SAM), USA (Bayer)
- Right On! Recs. Ltd., c/o Westholme, Church Ln., Lincoln LN2 1OJ. Tel: (0522) 29160. Chief Exec.: Dave Godin; Gen. Mgr.: Alf Billingham
- Labels: Deep Soul, Right On!, Soul City**
- Rim, see Rediffusion
- Ring O'Recs., 17 Berkeley St., London W1X 5AE. Tel: (01) 409-1401. Telex: 23288. Mng. Dir.: Terry Condon. (Distributed by Phonodisc)
- Rip-Off, see Emerald & Solomon & Peres
- Ritual Prod'n's Ltd., 59 Draycot Pl., London SW3. Tel: (01) 589-4164. Dir.: Hilary Mark-Levings
- Riva Recs. (IFPI), 2 New Kings Rd., London SW6 4SA. Tel: (01) 731-4131. Telex: 28781. Chm.: William Gaff; Mng. Dir.: Mike Gill; Dir.: Bill Stonebridge. (Distributed by WEA)
- Riverline Ltd., 107 High St., Evesham, Worcs. Tel: (0386) 47766. Contact: Harry Dixon. (Distributor)
- Label: (Distributed) Umbrella**
- Roach, see Cornish Legend
- Robinson's Recs., 26 Blackfriars St., Manchester, Lancs. M3 5BP. Tel: (061) 832-2701. Telex: 666355. Dirs.: A. Robinson, E. Robinson; Whsle Mgr.: Richard Cooper; Gen. Mgr.: K. Roberts. (Distributor/Importer/Exporter)
- Labels: (Distributed—not licensed) Boa, Column One (USA), Inferno, Jazz Greats (USA), Rough Trade, T.J.M., The Label**
- Robot Recs., 49 Mount St., London W1. Tel: (01) 491-2904. Dirs.: Lee Gopthal, Jim Flynn
- Labels: (Owned) Kingston, Robot**
- Roche, see Cornish Legend
- Rock Bottom Recs., 8 Commerce Way, Croydon, Surrey CR0 4XA. Tel: (01) 680-4533. Telex: 8813340. Chief Exec.: L.J. Adams
- Rockburgh Recs. Ltd., PO Box 283, London SW6 2JU. Tel: (01) 731-3144. Mng. Dir.: Sandy Robertson; Ass't: Beverley Thompson
- Rocket Group of Cos., 40 S. Audley St., Mayfair, London W1Y 5DR. Tel: (01) 491-2777. Telex: 265870. Chm.: John Reid; Dir.: Elton John; Mng. Dir.: David Croker
- Int'l reps.:** Worldwide (Phonogram Int'l), excluding Canada (RCA), South Africa, USA (RCA)
- Rocking Horse, see Sweet Folk All
- Rockville, see Soulvile
- Rollercoaster Recs., 41 Elm Rd., New Malden, Surrey KT3 3HD. Tel: (01) 942-7235. Cable: CHIRPING. Chessington. Chief Exec.: John Beecher; Gen. Mgr.: Peter Eden; Press, Promo. & Sales Mgr.: Yvonne Tregrove
- Labels: (Owned) Rollercoaster; (licensed foreign) Arzee (USA)**
- Rolling Stones, see EMI
- Ronco Teleprods. (UK) Ltd., 111 Mortlake Rd., Kew, Richmond, Surrey TW9 4AB. Tel: (01) 903-4753. Telex: 923175. Mng. Dir.: Barry L. Collier; Sales Mgr.: Patricia A. Dennehy; Prod'n Mgr.: Gordon Smith; Label Mgr.: Ian McNay
- Rondercrest Ltd., 17 Queensway, Dunstable. Tel: (0582) 62325. Mng. Dir.: Keith Grainger. Sales Mgr.: Pam Grainger. (Distributed by Pinnacle)
- Roots, see Baal
- Rosalind, see S.R. White
- Jan Roseman Prod'n's Int'l, 8 Poland St., London W1. Tel: (01) 439-8241. Dir.: Michael Freeman
- Rough Trade, 202 Kensington Park Rd., London W11. (Distributor/Importer)
- Rox Rec'g Co. Ltd., 255 Liscard Rd., Wallasey, Merseyside. Tel: (051) 639-9270. Mng. Dir.: David Crosby. (Distributed by Scotia, Spartan)
- Rubber, see Mawson Wareham
- Rumours Whsle., 3 Lockwood Walk, Romford, Essex. Tel: (70) 24038. Dir.: Clive Spelman. (Distributor/Importer)
- Rutland Recs., 71 Rutland Rd., Chesterfield, Derbys. S40 1ND. Tel: (0246) 79976. Cable: HEDLEY. Chm. & Mng. Dir.: A. Hedley; Dirs.: D.J. & E. Hedley. (Distributed by Banshee)
- Labels: (Owned) Hedley, March, March Music, Folkpapes, Rutland, Wigwam**
- Ryemuse, see Spot
- S F Original, see Metropolitan Communications
- S P & S Recs. (London) Ltd., Wharf Rd., Stratford E15 2SU. Tel: (01) 555-4321. Telex: 8951427. Chm.: George Harris; Mng. Dir.: Peter Harris; Dir.: Terry Hanks; Sales Dir.: John Harris; Export Mgr.: Peter Stack. (Distributor/Importer/Exporter—cut-outs)
- Branch: Manchester M4 6AF, Glamour House, 47 Bengal St. Tel: (061) 228-6655. Telex: 666300. Mgrs.: Mike Nolan, Ron Willens**
- S R T Prod'n's Ltd., Priory House, Priory Ln., St. Neots., Cambs. Tel: (0480) 212-711. Chief Exec.: George Bellamy; Gen. Mgr.: J. Townsend. (Distributed by SRT, Lugton, H.R. Taylor)
- Sales office: London N12 8QA, 987 High Rd., Finchley. Tel: (01) 446-3218. Sales Mgr.: Dave Richardson**
- Labels: (Owned) SRT; (distributed—not licensed) Big-V, Denman, Robin**
- S R W, see S.R. White
- Sacred, see World
- Safari Recs., 42 Manchester St., London W1M 5PE. Tel: (01) 486-6141. Dirs.: Anthony Edwards, John A. Craig, Andreas Budde. (Distributed by Pye)
- Int'l reps.:** Australasia (Festival), Austria (EMI-Crystal), Belgium (Vogue), Denmark (Sonet), Finland (Sonet), France (Vogue), Germany (EMI-Crystal), Iceland (Sonet), Italy (G. Ricordi), Japan (Polydor), Netherlands (Vogue), Norway (Sonet), Sweden (Sonet), Switzerland (EMI-Crystal)
- Saga Recs. Ltd., 326 Kensal Rd., London W10 5BL. Tel: (01) 969-6651. Cable: MUSICALITY. Telex: 261500. Mng. Dir.: Marcel Rodd; Export Mgr.: Edward Royce
- Affiliated firm: B & C Recs Ltd. (Distributed by CBS)**
- Labels: (Owned) Boulevard, Opus, Saga**
- Int'l reps.:** Australia (Summit), Austria (Musica), Belgium (International Besiteller), Canada (Almada), Denmark (CSA), Finland (PSO), Germany (Teldec), Ireland (Dolphin), Italy (Ri-Fi), Netherlands (Sound-Prod.), Switzerland (Musikvertrieb), USA (CMS)
- Sain (Recordia) Cyl., Ffordd Llanyllynfi, Penygroes, Caernarfon, Gwynedd, Wales. Tel: (028681) 732. Mng. Dir.: Huw Jones; Gen. Mgr.: Gareth Mitford; Sales Mgr.: Ianwy Rhisiart
- Labels: (Owned) Sain, Tryfan, Ty Ar Y Graig, Welsh Teldisc**
- Salsoul, see EMI
- Sandiacre, Allstock, Knutsford, Cheshire. Tel: (056) 581-2781
- Satril Recs. Ltd. (IFPI) (div. of Henry Hadaway Org.), Satril House, 444 Finchley Rd., London NW2 2HY. Tel: (01) 435-8063. Telex: 261331. Mng. Dir.: Henry Hadaway

A&R Mgr.: Paul Jenkins; Bus. Affairs Mgr.: Peter Wells; Disco Promo. Mgr.: Greg Buccheri.
Labels: (Owned) Rainbow, Satril.
Int'l reps.: Austria (Jupiter), Benelux (Inelco), Brazil (Top Tape), Canada (London), Germany (Jupiter), Greece (Music Box), Israel (CBS), Italy (Fonit-Cetra), Japan (Satril/Nippon Television Music/Nippon Columbia), Philippines (Otoarts), Portugal (Rossil), Scandinavian (Sonet), Spain (Zafiro), Switzerland (Jupiter), Venezuela (Discomoda).
 Savannah, see Creole.
 Saydisc Recs., The Barton, Inglestone Common, Badminton, Glos. GL9 1BX. Tel: (045) 424-266. Chief Exec.: Gef Lucena; Sales Mgr.: Genny Lucena. (Distributed by H.R. Taylor Ltd.)
Labels: (Owned) Amon Ra, Matchbox, Saydisc, Village Thing.
 Scarlet Band Recs. Ltd., 61 Bideford Ave., Perivale, Middx. Tel: (01) 998-0911. Cable: SCARBAND Greenford. Gen. Mgr.: Garry Franks; Sales Dir.: Jeffrey Collins; Financial Dir.: Michael J. Collins.
Labels: (Owned) Blue Band, Gold Band, Scarlet Band.
 Scope, see Lightning & WEA.
 Scot Disc Ltd., Exchange House, Lochpark Pl., Denny, Stirlingshire, Scotland FK6 5AA. Tel: (0324) 823-625. Mng. Dir.: Roger Hickman; Gen. Mgr.: Norma Findlay; Sales Mgr.: Gordon Lothian. (Distributor/Importer).
 Scotia Dist'n, 33/37 Jeffrey St., Edinburgh, Scotland EH1 1DW. Tel: (031) 557-0029. Telex: 727507. Partners: Phil West, Derrick Wrenn; Sales Mgr.: John Allan. (Distributor/Importer).
 Robbie Scott, see Pye.
 Seabreeze Prod'n Ltd., 25 Newman St., London W1. Tel: (01) 637-2586. Dirs.: John Coletta, Andrew Tribe.
 Sea Horse Recs., 3 Lambolle Pl., London NW3. Tel: (01) 435-7765. Dirs.: Teddy A. Ruster, Aidan Austin. (Distributed by Spartan).
 Selecta (div. of The Decca Rec. Co. Ltd.), 125/127 Lee High Rd., Lewisham, London SE13 5NX. Tel: (01) 852-9171. Telex: 896029. Gen. Mgr.: J.D. Roberts; Sales Mgr.: R. Smedley; Dist'd Labels Mgr.: A.K. Scott. (Distributor/Importer).
Branch: Manchester M35 OBL, GPO Box 4, Selecta House, Morton St., Failsworth. Tel: 4071 Cable: DIAGRAM. Telex: 66289.
Labels: (Distributed—not licensed) Ace of Clubs, Ace of Diamonds, Argo, Beltona, Blossom, Broadside, Brunswick, Calendar, Cambrian, Canon, Chopper, Criminal, Christy, Curson Sounds, Decca, Denver, Different, Eclipse, Emerald, Free Reed, Headline, Hungaroton (Hungary), Keyboard, Lee-Lambert, London, Lyrita, M&M, Mawson & Wareham, Nova, L'Oiseau Lyre, Qualiton, RCA Black & White (France), Rampage, Rediffusion, Rex, Rubber, Saga, 77, Spotlite, Telefunken (Germany), Telefunken, Threshold, Topic, Turnabout, UK, Vocalion.
 Semp (UK) Ltd., 684 Fulham Rd., London SW6 5SA. Tel: (01) 736-5877. Dirs.: Nicolas Smith, Julian Beauchamp.
 Sensible Recs., Lennie Mauns, Cammo Rd., Edinburgh 12. Tel: (031) 334-2520. Chief Exec.: Lenny Love.
 Sentinel Recs. (Cornwall) Ltd., Paul, Penzance, Cornwall. Tel: (0736) 73246. Telex: 456087. Tel: 111. Chief Exec. & Gen. Mgr.: Job Morris; Sec'y: Irene Morris.
 September Sound, see Look.
 Seven Sun, see Calendar.
 77 Recs., 77 Charing Cross Rd., London WC2H 0AB. Tel: (01) 437-3075/4197.
Labels: (Owned) Folklore, 77, Swift.
Int'l rep.: Worldwide (Agate).
 Seville, see President.
 Sharon, see Pilgrim.
 Sharrowsmead Ltd., 37a Maida Vale, London W9 1TW. Tel: (01) 286-0115. Telex: 25247. Mng. Dir.: Graham Neal. (Exporter).
 Sidewalk, see EMI & Red Rag.
 Silver Dollar Recs. Ltd., Wherstead, Cannon Ln., Maidenhead. Tel: (062) 882-3582.
 Simons Recs. Ltd., 335 Barking Rd., East Ham, London E6. Tel: (01) 552-5211. Joint Mng. Dirs.: Warren Goldberg, Paul Feldman; Sales Mgr.: Jerome Wight. (Wholesaler/Importer).
 Simons Sales Stores Ltd., 16-20 Ripple Rd., Barking, Essex. Tel: (01) 594-9631. Mng. Dir.: Simon Goldberg; Dir.: Warren Goldberg. (Rack Jobber).
 Simurg Ltd., Stanhope House, Stanhope Pl., London W2 2HH. Tel: (01) 262-7788. Telex: 261583. Dir.: T. Matt Royds.
 Singing Alive, see Anemone.
 Sir, see Westwood.
 Sire Recs. Ltd. (IFPI), 39 Floral St., London WC2. Tel: (01) 379-6363. Cable: SIRECORD. Gen. Mgr.: Paul McNally; Promo.: Andy Ferguson. (Licensed to WEA).
Label: (Owned) Real.
Int'l reps.: Australia (WEA), Belgium (WEA), Denmark (Metronome), France (Pathe Marconi), Germany (Ariola), Italy (RCA), Japan (Nippon Phonogram), Netherlands (WEA), New Zealand (WEA), Spain (Hisavox), Sweden (Phonogram), USA (Warner Bros.), Yugoslavia (Yugoton).
 Sky, see President.
 Smack, see Charly.
 Small Wonder Recs. Ltd., 162 Hoe St., London E17. Tel: (01) 520-2727. Chief Execs.: Pete & Mari Stennett. (Distributed by Rough Trade, Small Wonder, Spartan).
 Smile, see Wakefield.
 Sniff, see Faulty.
 Soccer, see Humber.
 Soccer, see Outlet Rec'g.
 Soho Recs., 39 Hereford Rd., London W2. Tel: (01) 229-8911. Mng. Dirs.: S. Brennan, P. Gaston. (Distributed by Bonaparte, Lightning, Rough Trade, Small Wonder, Vinyl Solution, Virgin).
 Solid Gold Recs. Ltd., 14 New Burlington St., London W1X 2LR. Tel: (01) 734-3251. Chief Exec.: Mike Collier; Prods.: Chris Rae, Frank McDonald.
 Solomon & Peres Ltd., 120 Coach Rd., Templepatrick, Ballyclare, Antrim, Northern Ireland BT39 0HB. Tel: (08494) 32711. Telex: 747293. Mng. Dir.: Mervyn A.

Solomon, Gen. Mgr.: Les Paterson; Sales Mgr.: Noel A. Spiller. (Distributor).
Int'l branch: Ireland.
Labels: (Owned) Emerald, Mint, Rip-Off (distributed) A&M, Anchor, Arcade, Arista, Beserkley, CBS, Chrysalis, Creole, DJM, Decca, K-Tel, Logo, Multiple Sound, Phonogram, Precision Tracks, Pye, RCA, Rampage, Ronco, Virgin, WEA.
 Sonet Recs. & Publ'g Ltd. (IFPI), 121 Ledbury Rd., London W11 2AQ. Tel: (01) 229-7267. Telex: 25793. Mng. Dir.: Rodney Buckle; Gen. Mgr.: Alan Whaley; Sales Mgr.: Alexander Sneddon. (Distributed by Pye & Sonet).
Home office: Sweden.
Labels: (Owned) Kicking Mule, Sonet; (co-owned) Specialty; (licensed) Alligator (USA), Flying Fish (USA), Gazell (Sweden), Grand Prix (Sweden), Takoma (USA).
Int'l reps.: Australia (Larrikin), Austria (Amadeo), Belgium (Vogue), Brazil (Fermata), Denmark (Sonet), Finland (Scandia), France (Vogue), Germany (Metronome), Italy (Ricordi), Netherlands (Inelco), Norway (Arne Bendiksen), Spain (Discophon), Sweden (Sonet), Switzerland (Metronome). (SEE ADVERTISEMENT)
 Soul City, see Right On!
 Soul Stop, see East Anglian Soul Club.
 Soulville Recs., 44 Cloudestdale Rd., Tooting, London SW17. Tel: (01) 675-0850. Mng. Dir.: Oscar Carrol Jr.; VP: C.J.W. Lusack; Press & Creative Dir.: Gordon Branch.
Labels: (Owned) Philadelphia Disco, Reggamite, Rockville, Soulvie.
 Sound Conception, 85 Ashley Rd., Montpelier, Bristol 6. Tel: (0272) 554-721. Gen. Mgr.: Kenny Wheeler; Sales Mgr.: Andy Leighton; Studio Mgr.: Chris David.
Labels: (Owned) Fried Egg (distributed—not licensed) Warped.
 Sound Mail Supplies, 287 Kenton Ln., Harrow, Middx. HA3 8RR. Tel: (01) 907-8721, (0403) 752-373. Telex: London 8951688. Mng. Dir.: Derek Lawson. Gen. Mgr.: John Butcher. (Also see Derek Lawson Recs.).
 Soundpost, see Folktracks.
 Sounds Ahead Ltd., 8 Commerce Way, Croydon, Surrey CRO 4XA. Tel: (01) 680-4533. Telex: 8813340. Chief Exec.: L.J. Adams; Export Mgr.: M. Tanner. (Distributor/Importer).
 Sounds Express Int'l Ltd., 115 Gunnersbury Ln., Acton, London W3 8HQ. Tel: (01) 993-2248. Cable: SOUNDXPRESZ. Telex: 934885. Chief Exec.: M.J. Stearn; Sales Mgr.: M.L. How. (Importer/Exporter).
 Sound Stories, see H.R. Taylor.
 Sovereign Recs., 18 Lancaster Mews, London W2 3QE. Tel: (01) 723-4499. Telex: 923400. Mng. Dir.: Ben Nisbet.
 Spaceward Ltd., 19 Victoria St., Cambridge CB1 1JP. Tel: (0223) 64263. Mng. Dir.: Gary Lucas; Dir.: Michael J. Kemp. (Distributed by Rough Trade).
 Spade Recs. (sub. of P.M. Chalmers Recs.), 7 Mill Cottages, Bucks Green, Nr. Rudgwick, West Sussex. Tel: Rudgwick 2829. Chief Exec.: P.M. Chalmers; Gen. Mgr.: F.J. Chalmers; Sales Mgr.: D.E.C. Chalmers. (Distributed by Plastic Fantastic).
Labels: (Owned) Spade; (distributed—not licensed) Thunder (USA).
 Spark Recs. Ltd., 8 Denmark St., London WC2H 8LT. Tel: (01) 836-4524. Cable: SOUTHMUSIC. Dirs.: T.F. Ward, Monique & Ralph (I) Peer. (Distributed by Pye).
Int'l branch: Italy.
Labels: (Owned) Blue Jean, Spark.
 Spartan Recs., 3 Sevenex Parade, London Rd., Wembley, Middx. Tel: (01) 903-4753. Telex: 923175. Label Mgr.: Ian McNay. (Distributor).
 Specialty, see Ember, Pye & Sonet.
 Spectrum, see Colortone.
 Sphinx, see Nimbus.
 Spider, see Downing.
 Spiral, see President.
 Spire, see Multiple Sound.
 Splash Recs. Ltd., 38 North Row, London W1. Tel: (01) 409-0287. Telex: 23840. Mng. Dir.: Charles Peate; Dirs.: Clive Scott, Iris Giebler; Gen. Mgr.: Des Dyer.
Labels: (Owned) Belsize, Splash.
Int'l reps.: Australia (EMI), Austria (Deutsche Grammophon), Belgium (Barclay), Brazil (K-Tel), France (Musidisc), Germany (Deutsche Grammophon), Greece (Phonogram), Italy (Saar), Japan (Teichiku), Netherlands (Negram), New Zealand (EMI), South Africa (David Gresham), Spain (Auvvi), Switzerland (Deutsche Grammophon).
 Spot Recs. Ltd., 64 S. Molton St., London W1. Tel: (01) 499-7173. Gen. & Studio Mgr.: Kate Hudson.
Labels: (Owned) Ryemuse, Spot.
 Spotlite Recs., 103 London Rd., Sawbridgeworth, Herts. CM21 9JJ. Tel: (0279) 725-863. 724-572. Owner: Tony Williams; Sales Mgr.: Cine Williams. (Distributed by Cadillac Music, Jazz Servs. Unlimited, Selecta, Spotlite).
Int'l reps.: Australia (Jazz Down Under), Benelux (Nuis), Canada (Coda, Trend, WDA), Denmark (SteepleChase), France (Dam), Germany (Bellaphon), Italy (Hi Fi), Japan (Stateside), Spain (Bol Recs.), Sweden (Amigo), USA (Rick Ballard, Record People).
 Springthyme Recs., Balmalcolm House, Balmalcolm, Kingskettle, Fife, Scotland KV7 7TJ. Tel: (0337) Ladybank 30773. Dir.: Peter Shephard. (Distributed by CML Cadillac Recs., Clyde Factors, Non-Stop, Solomon & Peres).
 Stag, see Alba & Downing.
 Stage One Prod'ns, 22 Madeira Grove, Woodford Green, Essex. Tel: (01) 505-5221. Chief Exec.: John Bassett.
Labels: (Owned) Penthouse, Stage One.
 Stage One (Recs.) Ltd., Parshire House, 2 Kings Rd., Haslemere, Surrey GU27 2QA. Tel: (0428) 53953. Telex: 858226. Current Prod. Contact: Nick Anstey; Export Inquiries: Trudy Hunt; US Sales: Terry Shand. (Distributor/Importer/Exporter).
 Stagestruck (Recs.) Ltd., 57 Duke St., Grosvenor Square, London W1. Tel: (01) 493-5015. Cable: STAGESTRUCK. Chm. & Mng. Dir.: Simon Caplan; Dirs.: Terry James, Neil Sheshtobal.
 Stainer & Bell Ltd., 82 High Rd., London N2 9PW. Tel: (01) 444-9135. Mng. Dir.: B.A. Braley.
Label: (Owned) Galiard.

Stairway Recs., 9 Victoria House, S. Lambeth Rd., London SW8. Tel: (01) 735-6032. Telex: 27806. Mng. Dir.: Jon Samuel; Consultant: Peter Knight.
 Stallion Recs. Ltd., 87 Brewer St., London W1. Tel: (01) 439-6881, 834-4502. Mng. Dir.: Johnny Toogood; European Mgr.: Joe Napoli. (Distributed by Pye).
Int'l reps.: France (Polydor), Germany (Ariola), Italy (CBS), Netherlands (Ariola), Poland (Tonepress).
 Starcall, see RCA.
 Starline, see EMI.
 Starlite, see Esquire.
 State Recs. Ltd. (IFPI), Speen House, Porter St., Baker St., London W1M 1HY. Tel: (01) 487-5031. Telex: 25740. Chm. & Mng. Dir.: Wayne Bickerton; Dirs.: Tony Waddington, Financial Dir.: John Doe. (Distributed by WEA).
 Stateside, see EMI.
 Henry Stave & Co. (div. of Rediffusion Int'l Music Ltd.), 11 Great Marlborough St., London W1V 1DE. Tel: (01) 734-0343. Telex: 27950 Mono Ref. 1006. (Importer/Exporter).
Labels: (Represented) CTS (Switzerland), Colosseum (Germany), Da Camera (Germany), Discopaedia (Canada), Poseidon (USA), Sterling (Sweden).
 Stax, see EMI.
 Step-Forward, see Faulty.
 Stereo Gold Award, see Damont.
 Stet, see DRG.
 Sticky, see President.
 Stiff Recs., 28 Alexander St., London W2 4NU. Tel: (01) 229-7146. Telex: 299894. Mng. Dir.: Dave Robinson; Gen. Mgrs.: Alan Cowderoy, Paul Conroy; Press Officer: Andy Murray.
Int'l reps.: Australia (Festival), Austria (Musikvertrieb), Belgium (Barclay), Canada (Capitol), Denmark (Dandelion), Finland (Love), France (Barclay), Germany (Teldec), Greece (Phonogram), Iceland (Steinar), Ireland (Solomon & Peres), Israel (K-Tel), Italy (RCA), Netherlands (Dureco), New Zealand (Polygram), Norway (Phonogram), South Africa (CCP), Sweden (Phonogram), Switzerland (Musikvertrieb), USA (Arista), Yugoslavia (Jugoton).
 Storm Recs., 133 Park Rd., Blackpool. Tel: (0253) 23095. Mng. Dir.: Wayne Paulo; Gen. Mgr.: Lenny Harris, A&R Dir.: Estelle Paulo.
Labels: (Owned) Bamboo, Storm.
 Strathclyde Sound & Video Ltd., Central Chambers, 93 Hope St., Glasgow G2 6LD, Scotland. Tel: (041) 221-2244/2222. Telex: 777283. Mng. Dir.: Raymond E. Orr. Presentation/Prod'n Mgr.: P.R. Black.
Label: (Owned) Strathclyde Sounds.
 Street Light, see Trafalgar.
 String, see Topic.
 Studio G, 195 Wardour St., London W1. Tel: (01) 734-5784.
 Sun American, see Calendar.
 Sunburst Recs. Ltd., 25 Newman St., London W1. Tel: (01) 323-1272. Dirs.: John Coletta, Andrew Tribe.
 Sun Island Music Ltd., 3 Pres de la Mer, Greve D'Azette, 12 Hill St., Jersey, C.I. Tel: Central 35269; London (01) 965-6673. Dirs.: Neville Harris, Maurice Goldring. (Distributor).
Label: (Distributed) Pickwick.
 Sunlight Recs. Ltd., 51 Maida Vale, London W9 1SJ. Tel: (01) 289-3366. Dir.: Jimmy Duncan; Gen. Mgr.: M. Dahlmann.
 Sun-Pacific, PO Box 78, London SE19. Tel: (01) 653-8457. Cable: TREBLIG.
Labels: (Represented) Express, Moonstone Int'l (both USA).
 Sunset, see Liberty-United.
 Swan Song Recs., 484 Kings Rd., Chelsea, London SW10 0LF. Tel: (01) 351-4151. Telex: 919735. (Licensed to WEA).
 Sweet Folk All Rec's Ltd., 74 Shrewsbury Ln., Shooters Hill, London SE18. Tel: (01) 854-4014. Dir. & Gen. Mgr.: Joe Stead. (Distributed by Wynd-Up).
Labels: (Owned) Rocking Horse, Sweet Folk & Country.
 Swift, see 77 Recs.
 Swift Rec. Dists., 20 Endwell Rd., Bexhill-on-Sea, East Sussex TN39 3EP. Tel: (0424) 220028. Telex: 957082. Gen. Mgr.: Robin L. Gosden; Sales Mgr.: Dave Carter; Order/Dispatch Mgr.: Peter Stacey. (Distributor/Importer).
 Swift Rec. Exports, 20 Endwell Rd., Bexhill-on-Sea, East Sussex TN39 3EP. Tel: (0424) 220028. Gen. Mgr.: Simon Napier; Sales Mgr.: Diana Casselden. (Exporter).
 Symphola Recs. Ltd., 47/49 Fountain St., Belfast, Northern Ireland. Tel: (0232) 23306. Chief Exec.: Bart McCormick; Promos: Gerry Lang.
Labels: (Distributed—not licensed) A&M, Abbey, CBS, DJM, EMI, GTO, Island, Lismore, Phonogram, Pilgrim, Polydor, RCA, Tandem, United Artists, WEA, Word.
 Symphonica Music Ltd. (IFPI), 11 Heron Pl., 3 George St., London W1V 5PA. Tel: (01) 486-3650, 609-4294. Telex: 898209. Chief Execs.: Isabella Wallich (Rec'g & Prod'n), John Porter (Dist'n); Sales Mgr.: Harry Williams.
Labels: (Owned) Symphonica; (distributed—not licensed) Abbey, Caliope (France), Delyse, iPG (France), Oxford Univ. Press.
Int'l reps.: Denmark (EMI), France (WEA Filipacchi), Germany (Electrola), Japan (Victor), Norway (EMI), South Africa (Recordia), Sweden (Metronome), Switzerland (Metronome), USA (Peters Int'l).
 T D S, see Target.
 T R X, see Acuff-Rose.
 Tabitha Music Ltd., 39 Cordery Rd., St. Thomas, Exeter, Devon EX2 9DJ. Tel: (0392) 79914. Mng. Dir.: Graham Scalter; A&R & Sales: Denise Scalter.
Labels: (Owned) Domino, Tabitha.
Int'l reps.: Belgium (Barclay), Netherlands (CNR).
 Talisman, see EMI.
 Talkie Tapes, see Metropolitan Communications.
 Tamm, see EMI.
 Tandy's Recs. Ltd., Anderson Rd., Warley, West Midlands B66 4BB. Tel: (021) 429-6441. Telex: 338459. Mng.

Dir.: F. J. Tandy; Purchasing Mgr.: Dave Jones; Export Sales Mgr.: Mike Webster. (Distributor/Exporter).
Tangent Recs. Ltd. (IFPI), 176A Holland Rd., London W14 8AH. Tel: (01) 603-0893. Mng. Dir.: Mike Steyn. (Distributed by Jazz Servs. Unlimited, Lugton, Spartan, H.R. Taylor.)
Labels: (Owned) Big Ben, Tangent.
Int'l reps.: Belgium (Parsifal), Canada (Almada), Denmark (Mac's), France (SFPP), Germany (DGG), Ireland (Irish Rec. Factors), Netherlands (Hosat), Norway (Sinar), Sweden (SAM), Switzerland (Metronome), USA (Rounder).
Tank Recs., 4 Welton Rd., Wedgcock Estate, Warwick CV34 5YA. Tel: (0926) 45123. Owner: S.L. Bird; Gen. Mgr.: D. Rawlings; Sales Mgr.: D. Sheriff; Transport Mgr.: T. Arton.
Target Recs. Ltd., 28 Mount St. London W1. Tel: (01) 493-6439. Dirs.: Roger Greenaway, Harry Barter.
Labels: (Owned) TDS, Target.
H. R. Taylor (Birmingham) Ltd., 139 Bromsgrove St., Birmingham B5 6RG. Tel: (021) 622-2377. (Distributor).
Labels: (Owned) Sound Stories.
Teakfield Ltd., 1 Westmead, Farnborough, Hants. GU14 7RU. Tel: (0252) 519221. Cable: GOWSAX. Telex: 858623. Mng. Dir.: N. Farrow; Dirs.: M.J. Hanrahan, G. Cyriax.
Label: (Represented) Caedmon Spoken Word (USA).
Telemark Recs. Ltd., 16 Mile Oak Rd., Southwick, Brighton, Sussex BN4 4QE. Tel: (0273) 593-603. Mng. Dir.: Arthur J. Cook; Gen. Mgr.: Brenda M. Cook.
Int'l branch: USA.
Tembo Recs. Ltd., 50 Regents Park Rd., London NW1 7SX. Telex: 299220. Tel: (01) 586-5591. Gen. Mgrs.: Roger Whittaker, Irene Collins.
Tempo, see Multiple Sound.
Third World Rec'g Co. Ltd., 261 High Rd., Tottenham, London N15. Tel: (01) 802-0146. Telex: 299870. Mng. Dir.: E.A. Barrett; Gen. Mgr.: A.W. Hill. (Distributed by Lugton).
Labels: (Owned) Jamatal, Justice, Live & Love, Paradise, Penguin, Third World, (licensed) Observer.
Thistle Recs., 65 Berkeley St., Glasgow, Scotland G3 7DX. Tel: (041) 248-2791. Gen. Mgr.: John Cutler. (Distributed by Clyde Factors).
Sydney Thompson Recs., Eastcote Point, Pinner, Middx. HA5 2AL. Tel: (01) 866-8310. Dir.: Sydney Thompson. (Distributed by EMI Recs. Int'l)
Label: (Owned) Invicta.
Thor Recs., 201 St. Vincent St., Glasgow, Scotland G46 6HL. Tel: (041) 221-9407.
3 Centuries of Music, see Oryx.
Threshold Recs., 53/55 High St., Cobham, Surrey. Tel: (01) 266-4142. Gen. Mgr.: Norman Taylor.
Thrust, see Chiswick.
Thunderbird, see President.
Toadstool, see Billy Goat.
Topaz Leisure Ltd., 67 High St., Great Missenden, Bucks. Tel: (02406) 4161. Cable: ROSCO. Mng. Dir.: Colin Rose; Sales Mgr.: Liz Lupton.
Int'l rep.: USA (Topaz).
Topic Recs. Ltd., 27 Nassington Rd., Hampstead, London NW3 2TX. Tel: (01) 435-9983. Mng. Dir.: Tony Engle; PR: Tony Russell.
Labels: (Owned) Impact, String, Topic, Topic/Free Reed.
Int'l reps: Australia (Larrikin), Benelux (Parsifal), Canada (Almada), France (Edwards), Germany (Folk Werkstatt), Ireland (Irish Rec. Factors), Norway (Sinar), Sweden (Sam), Switzerland (Evasion), USA (Rounder).
Top Hat, see Humber.
Torpedo, see President.
Trafalger Recs. (IFPI), 8 Eglantine Close, Cowplain, Portsmouth PO8 9BO. Tel: (0705) 592500. Owner: Terry Moss; Gen. Mgr.: Wendy Moss.
Labels: (Owned) Carousel, KO, Street Light, Trafalger.
Trailer, see Leader.
Transacord Ltd., 115 Fulham Rd., London SW3 6RR. Tel: (01) 589-5293. Cable: ARGORECORD. Mng. Dir.: Peter Handford. (Distributed by Decca—Argo Div.)
Labels: (Owned) Transacord, World of Railways, World of Steam.
Int'l rep.: Worldwide (Decca—Argo Div.)
Transatlantic, see Logo.
Transdisc Ltd., 30 Danbury St., London N1. Tel: (01) 359-1139. Telex: 27950 Ref. 1607. Mng. Dir.: Stephen Jacques. (Distributor/Importer/Exporter)
Trojan, see B&C.
Tryfan, see Sain.
Turnabout, see Vox & Decca.
21st Century Leisure Ltd., 41 Cotswold Gardens, London NW2 1QT. Tel: (01) 458-8991. Mng. Dir.: Martin Lewis.
Ty Ar Y Graig, see Sain.
U K Recs., 48 Grafton Way, London W1P 5LB. Tel: (01) 387-5851. Pres.: Jonathan King.
Int'l branch: USA.
Labels: (Owned) UK, UK American.
Ulster, see Outlet.
Ultimate Music Ltd., 41 Lady Lodge Dr., Peterborough PE2 OES. Tel: (0406) 22044. Chief Exec.: R.N. Slater; Gen. Mgr.: A.P. Knight. (Distributed by Spartan)
Ultra, see Plastic Fantastic.
Unicorn Recs. Ltd., The Manor House, Markfield, Leicester LE6 0UN. Tel: (05305) 3138. Mng. Dir.: John C. Goldsmith; Export Dir.: Nigel J. Brandt.
Int'l reps.: Australia (Janda), Belgium (PMP), Canada (HNN), Denmark (EMI), Hong Kong (Studer Revox), Japan (Toshiba), Netherlands (Sound Prods.), Sweden (Sound Doctor), USA (HNN).
Unigram Recs. Ltd., 35-37 Wadour St., Piccadilly, London W1. Tel: (01) 734-7195. Mng. Dir.: Des Dolan.
United Artists, see EMI & Liberty-United.
Universal Rec. Co., 5 Doricote Rd., London SW18. Tel: (01) 870-5831. Pres.: Pierre Tubbs; Gen. Mgr.: Rick Steele.
Labels: (Owned) The Universal Record Co., Urco.
Urco, see Universal.
Utopia, see Phonogram.
V J M S (Vintage Jazz Music Society) Recs., 12 Slough Ln., London NW9 8QL. Tel: (01) 205-2587. Chief Exec.:

Steve Lane; Sales Mgr.: Kaye Sear. (Distributed by JSU, Lugton, Swift, Chris Wellard).
Labels (Owned) Halcyon, VJM; (distributed—not licensed domestic) Fountain, Hefty Jazz, Hep, NoLa, Retrieval, Sunshine; (distributed—not licensed foreign) Arcadia (USA), Cat Jazz (Netherlands).
Int'l reps.: Canada (Coda), Italy (Hi-Fi), USA (Zim).
V R D, see Vixen.
Vandisc Sales Ltd., 3 Dale End, Birmingham B4 7LN. Tel: (021) 236-9201/5493. Dirs.: Brian Harris, Keith Thornton; Gen. Mgr.: Ray Shepherd; Sales Mgr.: Peter Elliot. (Distributor/Importer)
Labels: (Distributed—not licensed) Fast, Faulty, Illegal, Mute, Rough Trade, Small Wonder.
Vanessa, see DTP.
Variation Two, see Enigma.
Venus, see Metropolitan Communications.
Vertigo, see Phonogram.
Verve, see Polydor.
Victor, see RCA.
Victrola, see RCA.
Viking Sevenses Ltd., Caroly House, 9th fl., Dingwell Rd., Croydon, Surrey CR9 2PL. Mng. Dir.: Keith Southern; Sec'y: W. J. Vooght.
Home office: New Zealand.
Village Thing, see Saydisc.
Vintage Jazz Music Society, see VJMS.
Virgin Recs. (Retail) Ltd., 32/34 Avon Trading Estate, Avonmore Rd., London W14. Tel: (01) 603-4588. Chief Buyer: Colin Walkden. (Distributor/Importer—cut-outs).
Virgin Recs. Ltd. (IFPI), 2/4 Vernon Yard, Portobello Rd., London W11. Tel: (01) 727-8070. Telex: 22542. Chm.: Richard Branson; Mng. Dir.: Simon Draper; Dirs.: Nik Powell, Ken Berry; Mktg. & Adv. Mgr.: Charlie Dimont; Sales Mgr.: Ann Kelly. (Distributed by CBS).
Labels: (Owned) Caroline, Front Line, Virgin; (licensed foreign) JCOA (USA), Watt (USA), (distributed—not licensed) ECM, JAPO (both Germany).
Int'l reps.: Argentina (Phonogram), Australia (Festival), Austria (Ariola), Belgium (Ariola-Eurodisc), Bolivia (Discolandia), Brazil (Phonogram), Canada (Polydor), Chile (Philips), Colombia (Philips), Denmark (Sonet/Starbox), Dominican Republic (Salon de Estudios Mozart), Ecuador (Fedisos), Finland (Polarvox), France (Polydor), Germany (Ariola-Eurodisc), Greece (Phonogram), Guatemala (Dideca), Hong Kong (Studer Revox), Ireland (CBS), Israel (General), Italy (Ricordi), Japan (Victor), Mexico (Libro), Netherlands (Ariola-Eurodisc), New Zealand (Record & Tape Co.), Norway (Arne Bendiksen), Panama (Sonomundi), Peru (El Virrey), South Africa (Gallo), Spain (Ariola-Eurodisc), Sweden (Sonet), Switzerland (Ariola-Eurodisc), USA (Atlantic), Uruguay (Edisa), Venezuela (Polydor), Yugoslavia (Jugoton).
Vista Recs. Ltd. (IFPI), 64A Lansdowne Rd., London W11 2LR. Tel: (01) 727-0432. Mng. Dir.: Michael Smythe; Gen. Mgr.: Robert Angles. (Distributed by Continental)
Int'l rep.: USA (German News Servs.).
Vixen Rec. Dist. Ltd. (VRD)/Vixen Rec. (Exports) Ltd., 34-44 Station Rd., West Croydon, Surrey CR0 2RB. Tel: (01) 686-0973. (Distributor/Importer/Exporter).
Vocalion, see Decca.
Vox Prod'n's (GB) Ltd. (IFPI), 11 Elgood House, Wellington Rd., London NW8 9TG. Tel: (01) 722-1208. Mng. Dir.: P. Fejer. (Distributed by Decca).
Home office: USA.
Labels: (Owned) Turnabout, Vox.
Voyage Int'l Recs., 264 Lavender Hill, Battersea, London SW11. Tel: (01) 223-6543. Dir.: Reg McLean.
W E A Recs. Ltd., 20 Broadwick St., London W1V 2BH. Tel: (01) 434-3232. Telex: 261425. Mng. Dir.: John Fruin; Deputy Mng. Dir.: Richard Robinson; Finance & Admin. Dir.: Ed Byrnes; Creative Servs. Dir.: David Cliphams; Promo. Dir.: Bill Fowler; Press Dir.: Moira Bellas; Sec'y: Bill Tierney; A&R Dir.: Dave Dee; Mng. Dir. Mfg. & Dist'n: Tony Muxlow.
Distribution branch: Wembley, Middx. HA0 1FJ, Alpertown Ln. Tel: (01) 998-8844. Opns. Dir.: Mike Hitches; Financial Controller: John Clarke.
Manufacturing branch: West Drayton, Middx. UB7 8NP, Horton Rd. Tel: (81) 48531. Telex: 27492. Opns. Dir.: Clive Hudson.
Home office: USA, WEA Int'l.
Labels: (Owned) Antic, Asylum, Atlantic, Elektra, Enigma, Nonesuch, Pogo, Reprise, Warner Bros.; (licensed domestic) Blue Inc., Damont, Hurricane, Laser, Lightning, Radar, Real, Riva, Scope, Sire; (licensed foreign) Automatic, Big Tree, Carriere, Cottillon, Dark Horse, DiscReet, Elektra/Curb, Finnadar, Little David, Manticore, Ork, Planet, Scott Bros., Swan Song, WEA, Warner/Curb, Warner/RFC, Warner/Tattoo, Whitefield (all USA); (distributed—not licensed) Rarity.
Wakefield Rec. Bar Ltd., 21 Upper Kirkgate, Wakefield, Yorks. Tel: (0942) 76399.
Label: (Owned) Smile.
Wake Up Recs. (sub. of Electronic Dream Plant), Red Gables, Stoneshill Rd., Combe, Oxford OX7 2ER. Tel: (099389) 8136. 296. Mng. Dir.: A.J. Wagner; Gen. Mgr.: C.J. Hamilton; Art Dir.: R.J. Vass.
Labels: (Owned) Disco Dream, Wake Up.
Int'l reps.: France (Ibach), Netherlands (Sound Prods).
Warm Recs. (IFPI), Warm House, 40 Gunter Grove, London SW10. Tel: (01) 352-2886. Mng. Dir.: Rui de Castro; Gen. Mgr.: Leo Pennant; Sales Mgr.: R. Cardoso. (Distributed by Plastic Fantastic, Spartan).
Labels: (Owned) Warm; (licensed foreign) Nova (Portugal).
Int'l reps.: Portugal (Nova), Switzerland (Ere Nouvelle).
Wanted Recs. (div. of Music Farm Ltd.), (IFPI), 72 Newman St., London W1. Tel: (01) 636-9251. Cable: MUSICFARM. Dirs.: Craig Baguley, Dave McAleer. (Distributed by Selecta).
Warner Bros., see WEA.
Warrens Recs. Ltd., 16-18 Hollen St., London W1. Tel: (01) 734-6822. Mng. Dir.: Warren Goldberg; Sales Dir.: Robert Shooman; Mdsgr. Dir.: Malcolm Sharp. (Distributor)
Warwick, see CBS & Multiple Sound.

Waverley, see EMI.
Wedge Publ'g/J.P. Prod'n's, 63 Grosvenor St., London W1. Tel: (01) 492-7831. Cable: WEDGE. Mng. Dir.: A.M. Gordon; Prod'r: Jimmy Pursey. (Distributed by Polydor)
Label: (Owned) JP.
Weekend Recs., 21 Poland St., London W1. Tel: (01) 437-2402. Telex: 22701. Mng. Dir.: John Blyton; Gen. Mgr.: Glyn Evans.
Chris Wellard-Independent Rec. Sales, 110 Eltham Hill, Eltham, London SE9 5EF. Tel: (01) 850-3161. Owner: Chris Wellard. (Distributor/Importer)
Labels: (Distributed—not licensed) Alamo, Bead, Beppo, Big Band Int'l, Black Bear, Blue Bag, Blue Parrot, Carrot, Checkmate, Classic Jazz Masters (Sweden), Collectors Items, Delmark, Esquire, Falcon, Firebrand, First Heard, Folklore, Fountain, GI, G&W, Giants of Jazz, Greenwich Village, H&E, Halcyon, Hefty Jazz, Hep, Inchechron, Jaguar, Jam, Jazz Society (Sweden), Jezabel (USA), Land O' Jazz, Lee Lambert, Live, M&C Jazz, Mosaic, Next, NoLa, Oldie Blues, Phonostick, Pixie, Plant Life, Polish Jazz, Rarities, Regis, 77, Shamrock, Shanachie, Small, Standing Room Only, Steam, Sweet Folk & Country, Swift, Swing Classics, Swing House, Swing World, Tax (Sweden), VJM, Vantage, Vortex, Wone, Whoopee, World Jazz.
Welsh Teldisc, see Sain.
Wessco Recs., 16 Granton Close, Brislington, Bristol BS4 4NA. Tel: (0272) 779-189. Co-Owners & Dirs.: Ian Gane, Gerry Mansfield.
Westward Gramophone Ltd., 56 Northbrook St., Newbury, Berks RG13 1AN. Tel: (0635) 45313. Mng. Dir.: Graham E. Rowe; Sales Mgr.: Sue Rowe. (Exporter).
Westwood Recs Ltd., Montgomery, Powys, Wales SY15 6LU. Tel: (0686881) 427. Mng. Dir.: Gordon R. Davies; Gen. & Sales Mgr.: George B. Pryce. (Distributed by Jazz Servs. Unlimited).
Labels: (Owned) Sir, Westwood.
Whitmore Music Ltd., 86 Turnham Green Terr., London W4. Tel: (01) 994-4895. Dir.: Norton York. (Distributed by Spartan).
S. R. White, 57 Stanley St., Rothwell, Kettering, Northants NN14 2EA. Chief Exec.: S.R. White.
Labels: (Owned) Rosalind, SRW; (represented) Concert Rec'g (USA), Pagoda (Australia).
Whoopie Rec. Prod'n Co. Ltd., PO Box 743, Putney, London SW15 1TE. Tel: (01) 789-4169. Cable: WHOOPIE MUSIC. Telex: 923591. Chief Exec.: Bob Kerr; Gen. Mgr.: Charlotte Crofton-Sleigh.
Wigwag, see Rutland.
Wildtrack, see Aquarius.
Windmill, see Multiple Sound.
Windsong Rec. (Exports) Ltd., Station Approach, Tweedy Rd., Bromley, Kent. Tel: (01) 464-3198. Telex: 896218. Mng. Dir.: Steve Mason; Sales Mgr.: Mike Chapman. (Exporter) (SEE ADVERTISEMENT)
Word (UK) Ltd. (IFPI), Northbridge Rd., Berkhamsted, Herts. HP4 1EH. Tel: (04427) 74711. Mng. Dir.: Ian Hamilton; Gen. Mgr.: John Trimmer; A&R & Promos. Mgr.: Norman Miller; Mktg. Mgr.: Anne Casey; Sales Mgr.: Dave Bruce.
Labels: (Owned) Canna, Dayspring, Myrrh, Sacred, Word; (licensed domestic) Banners & Bonnets, (licensed foreign) Birdwing (USA), Good News (USA), Lamb & Lion (USA), Light (USA), Maranatha (USA), New Song (USA), Seed (USA), Solid Rock (USA), Sparrow (USA), Spirit.
Int'l rep.: Australia (Sacred), Benelux (GMI), Canada (Word), Germany (Blue Rose), New Zealand (Sacred), Nigeria (Challenge), South Africa (Grace), Sweden (Kings Rock), Switzerland (Prim), West Indies (Record Specialists).
Word of Mouth Recs., 57A Wimpole St., London. Tel: (01) 699-2134.
World Jazz Recs. Ltd., 35 Great Russell St., London WC1B 3PP. Chm.: John B. Hickox; Gen. Mgr.: Gerry Finningley.
Home office: USA.
Int'l rep.: Scandinavia (Amigo).
World of Railways, see Transacord.
World of Steam, see Transacord.
World Recs. Ltd., Parkbridge House, Little Green, Richmond, Surrey. Tel: (01) 940-8331. Mng. Dir.: Austin Bennett. (Distributed by EMI).
Labels: (Owned) Conquest, Retrospect, World.
World Wide Rec. Exports, 8 Commerce Way, Croydon, Surrey CR0 4XA. Tel: (01) 680-4533. Telex: 8813340. Chief Exec.: L.J. Adams; Export Mgr.: M. Tanner. (Exporter)
Wren, see Christopher Davies.
Wudwink, see The Impulse Org.
Wynd Up Recs. Ltd., Greengate Ln., Prestwich, Manchester. Tel: (061) 798-9252/0533. Telex: 667985. Mng. Dir.: Colin Reilly; Gen. Mgr.: B. Patchett; Sales Mgr.: L. O'Meara; Purchasing Dir.: N.K. Raggatt; Warehouse Mgr.: B. Moore.
Labels: (Distributed—not licensed) A&M, Arcade, CBS, Chrysalis, DJM, Damont, Decca, EMI, 5th Ave., Folk Heritage, Island, Kingsway, K-Tel, MCA, MFP, Philips, Pickwick, Polydor, President, Pye, RCA, Release, Ronco, Saga, Spartan, Sweet Folk All, Sydney Thompson, Trojan, UA, Virgin, WEA, Warwick, Word.
Xtra, see Logo.
Yoga For Health, see Anemone.
Young Blood Recs., 138 New Bond St., London W1Y 9FB. Tel: (01) 493-9681. Cable: YUNGBLOOD. Mng. Dir.: Gerry Black.
Zel-la Recs. (Birmingham) Ltd., Walker Hall, Ampton Rd., Edgbaston, Birmingham B15 2UJ. Tel: (021) 455-0645. Mng. Dir.: William Johnny Haynes.
Zero Rec'g & Publ'g, 36 Pemberton Rd., Telford, Salop TF5 0BL. Tel: (0952) 3490. Chief Exec.: Phil Summers.
Labels: (Owned) Custom, Zero.
Zeus Rec'g Co. Ltd., 52 Montagu Square, London W1. Tel: (01) 723-1808/1938. Dir.: Zouina H. Gibsons.
Zilch Recs. Ltd., 97 Kingston Hill, Kingston-upon-Thames, Surrey. Tel: (01) 546-6664. Cable: ZILCH. Mng. Dir.: Fred Cantrell. (Distributed by Beserkley)
Zip, see Outlet.
Zodiac Prod'n's, 59 Dean St., London W1V 5TH. Tel: (01) 439-1827.

Zodiac Rec. Dist., 1099A Finchley Rd., London NW11. Tel: (01) 455-6620. Chief Exec. J. Rhyder Scott; Gen. Mgr.: Herb W. Wilcox; Sales Mgr.: M. Fyson.
Labels: Golden Era, RKL, Zodiac.
Zooom Recs., 45 Shandwick Place, Edinburgh, Scotland. Tel: (031) 229-3533. Mng. Dir.: Bruce R. Findlay; Mktg. & Press: Brian Hogg. (Distributed by Arista)

● music publishers

A J Music Ltd., see Kassner.
A L Music, see Metropolitan.
A M E Ltd., see Leosong.
A M P., see Carlin.
A & R Music, see EMI.
A & R Publ'g Ltd., see Chappell.
A T V Music Ltd., 24 Bruton St., Mayfair, London W1X 7DA. Tel: (01) 409-2211. Cable: SUGAR. Telex: 28526. Mng. Dir.: Peter Phillips; Creative Mgr.: Eric Hall.
Int'l branch: USA
Int'l firms represented: ATV, Ahab, Algee, All Seasons, Altam, Angel Wing, Big Heart, Briarpath, Brougham Hall, Bullpen, Cliffhouse, Comet, Cumberland, Cycus, Debdave, First Artists, Frog King, Bobby Goldsboro, Harmony & Grits, Hungry Mountain, Klaatoons, Lady Casey, Lambert & Potter, Larball, Lucky Three, Mandina, Mister Dogg, My Mamma's Music, Natural Songs, Oceans Blue, Peach Cobblers, Prophet, Proud Bird, Return, Paul Richey, Rocksmith, Salsoul, Sandstorm, Seine, Sigler Street, Silver Blue, Skydiver, Sound of Memphis, Sound of Nolan, Ray Stevens, Stonebridge, Strong Box, Swamp Dogg, Tallyrand, Taurus, Touch of Gold, Tri-Song, UPE, Welbeck, Jerry Williams, Windchime, Yisgav (all USA); Allo (France), Evans Gudinski (Australia), Leros (France), Northern Light & Sound (Canada), Pondwater (Canada), Saints (Australia), Smile (Canada).
Int'l reps.: Africa (Leeds), Australia (ATV/Northern Songs, Castle), Austria (Intro), Belgium (Hans Kusters), Central & South America excluding Mexico (Artemis), China (Pathe), France (Allo), Germany (Intro), Greece (Blackwood), Hong Kong (Pathe), Israel (Ilanot), Italy (Ricordi), Japan (Shinko), Luxembourg (Hans Kusters), Netherlands (Nada), New Zealand (ATV/Northern Songs, Castle), Portugal (Armonico Clippers), Scandinavia (Sweden), South Africa (Leeds), Spain (Armonico Clippers), Switzerland (Music Today), USA (ATV).
A-Z Music, c/o Vineyard Rec'g Studios, Sanctuary St., London SE1. Tel: (01) 403-0007. Mng. Dir.: Annette Marie Barrett.
Abacus, see Carlin.
Abesongs Ltd., see Rocket.
Abigail Music (London) Ltd., see Chappell & RSO.
Accolade Music Ltd., see Shapiro, Bernstein.
Ace Spec Music, see Leosong.
Acton Green Music Ltd. (Leosong/PRS), 15 Great Western Rd., London W9. Tel: (01) 289-1021. Telex: 299611. Dir.: Wayne P. Bardell.
Act One Music Co. Inc., see Leosong.
Acuff-Rose Music Ltd., 14 St. George St., London W1. Tel: (01) 629-0392. Gen. Mgr.: Tony Peters. (Affiliated with Chappell)
Home office: USA
Ad-Chorel Music Ltd. (PRS/MPA), 10 Atholl Pl., Edinburgh, Scotland EH3 8HP. Tel: (031) 229-9651. Mng. Dir.: Neil Ross; Prod'n Dir.: Alison Service.
Larry Adler Music Ltd., see Chappell.
Admiral One Music Ltd., see Margaret Brace.
Admiration Music Ltd., see Robert Mellin.
Aeolian Music Ltd., see Bourne.
Aerco Prod'n Ltd. (MCPS), 27 Chobham Rd., Woking, Surrey GU21 1JD. Tel: (04862) 64082. Chief Exec.: Steve C. Smith.
Afiat Music, see Leosong.
Agra Music, 4 Welton Rd., Wedgcock Estate, Warwick CV34 5YA. Tel: (0926) 45123. Owner: Sheila L. Bird; Gen. Mgr.: David Rawlings.
Aggro Music, see Margaret Brace.
Aha Ltd., see Warner Bros.
Airborne Music Ltd., 16 Bracklesham Close, Farnborough, Hants GU14 8LR. Tel: (0252) 511-333. Gen. Mgr.: Noel A. Brown.
Air Edel Assocs. Ltd., see Chrysalis.
Air Music Ltd., 12 Stratford Pl., London. Tel: (01) 408-2355. Cable: CHRYSALIS. Chm. George Martin. (Affiliated with Chrysalis)
Int'l firm represented: Air (Sweden)
Airs & Graces Music (PRS), 4D Oxford & Cambridge Mansions, Old Marylebone Rd., London NW1. Tel: (01) 723-2454. Mng. Dir.: Martin Hall.
Int'l reps.: Australia (Matthews), France (Francis Dreyfus), Germany (April), Italy (Crisler), Netherlands (Intermusic), Scandinavia (Air), South America (Intersong Int'l), Spain (Discorama).
Alaska Music Ltd., 12 The Quadrangle, Cambridge Square, London W2. Tel: (01) 402-4550. Mng. Dir.: John Schroeder.
Int'l reps.: Australia (Associated), France (Barclay), Germany (Global).
Alba Recs., 21A Grosvenor St., Edinburgh, Scotland EH12 5ED. Tel: (031) 225-1066. Chief Exec. & Gen. Mgr.: John Mackinnon.
Albert Bridge Music, 10 Haunch of Venison Yard, Brook St., London W1. Tel: (01) 499-9491. Telex: 24605. Chm.: Don Joy; Gen. Mgrs.: Jonathan Peel, Des Cox.
Int'l rep.: Worldwide (Chappell).
Albert Gate Court Music Ltd.—Drs.: Jonathan & Gunilla Rowlands—see Hush.
Albion Music Ltd., 147 Oxford St., London W1. Tel: (01) 734-9072. Mgr.: John Teller. (Affiliated with April)
Int'l rep.: USA (Irving-Almo).
Alexandria House, see Singpiration.
Alexis Music Ltd., see Carlin.
Harry L. Allford Music, see Leosong.
Algeo Music Co., 17 Palace Gate, London W8 5LS. Tel: (01) 589-6472. Mng. Dir. & Gen. Mgr.: George Erick.

Alice Music Ltd., 9 Cavendish Square, London W1M ODU. Tel: (01) 995-1191.
Allegro Holdings (Ireland) Ltd., see Frank Chacksfield.
Alliance Music Publ'g Co. Ltd., see Chappell.
Allways Music, 5 Staple Inn, London WC1.
Almanac Music, see Performance.
Almighty Music, see T-Bone.
Alona Music, see Leosong.
Alpadon Music Ltd., see Paul Rodriguez.
Alpane Music Co., see Leosong.
Alsax Music Ltd., see Paul Rodriguez.
Alted Music, 30 Baker St., London W1M 2DS. Tel: (01) 486-5353. Chief Execs.: Alex Hughes, Ted Lemow. (Affiliated with Warner Bros.)
Alto Music Ltd., see Dick James.
Amani Music Co., see Leosong.
Ambassador Music Ltd., 22 Denmark St., London WC2. Tel: (01) 437-7053. Cable: AMBAMUSIC. Pres.: George Pincus.
Home office: USA, Gil Music.
Ambleside Music Ltd., see EMI.
Amen, see Carlin.
Amicus Music, see Big Secret.
Ammo-James Music Ltd., see Dick James.
Amphonic Music Ltd., see Neophonic.
Anatom Music, see Leosong.
Ian Anderson Music Ltd., see Chrysalis.
And Son Music Ltd. (PRS), see Lupus.
Andrewella, see Carlin.
Angel Face Music, see Music Farm.
Angel Music Inc., see Leosong.
Angle Music, see Round.
Angle Music, Toftrees, Church Rd., Woldingham, Surrey. Tel: Woldingham 2386. Mng. Dir.: David Mackay; Gen. Mgr.: Peter Parr-Head.
Int'l reps.: USA (David Mackay, Sabre).
Anglia (Television) Music Ltd., see Robert Mellin.
Anglo-Soviet Music Press, see Boosey & Hawkes.
Anita, see Carlin.
Anna Music Ltd., see Miriamusic.
Annubus Music, see Leosong.
Apex Music Ltd., 12 Elgin Mansions, Elgin Ave., London W9. Tel: (01) 794-7191.
Apple Pie Music Ltd., Hurworth Cottage, Croft Rd., Hurworth, Darlington, Durham. Tel: (0325) 721-143, 720-792. Mng. Dirs.: Elaine Safer, Gary Wilson. (Also see Saffred)
April Music Ltd., 54 Greek St., London. Tel: (01) 439-1845. Cable: APRIMUSIC. Telex: 24203. Mng. Dir.: Len Beadle; Prof. Mgr.: Paul Bessell.
Int'l firms represented: Back Road, Bruiser, Carol Nan, Chesyl, Clay, Country Road, Coyote, Derringer, Dickiebird, Dijon, Donna, Double Diamond, Dozier, Drunken Boat, Ether, Ethnic, Gello Cheby, Fullness, Albert Hammond, Harlene, Hierophant, Ian Hunter, Jerry Lyn, Joelsongs, Lazy Libra, Manhattan, Mine, Mott, Novalene, Oceans Blue, Power Exchange, RSVP, Ragmop, Saybrook, Scorpicon, Sheryln, Silver Blue, Silver Steed, Siren Songs, Singsinger, Tradition, Tuna Fish, Venox, Stan Vincent, Weather Report, Westbrook, Winter Blues, Winter Wind (all USA); Wetwater, Woodwater (both Jamaica).
Int'l reps.: Argentina (Melograf), Australia (April), Austria (Wien Melodie), Belgium (April), Brazil (Mundo Musica), Canada (April/Blackwood), Central America (Mundo Musica), Chile (Melograf), Costa Rica (Mundo Musica), France (April), Germany (April), Greece (Blackwood), Israel (April), Italy (April), Japan (April), Luxembourg (April), Mexico (Mundo Musica), Netherlands (April), New Zealand (April), Norway (Arne Bendiksen), South Africa (April), Spain (April, Sweden (April), USA (April Blackwood), Uruguay (Melograf).
Aqua Music, see April.
Aquarius, 102-104 Gloucester Pl., London W1H 3PN. Tel: (01) 486-6040. Telex: 298995. Mng. Dir.: Don Arden.
Arabella Music Ltd., see Purple.
Arcades Music, 33 Pearson St., London SW1. Tel: (01) 622-8834. Cable: REDFOX. Dir.: Chris Cutler.
Arcadia Music Publ'g Co. Ltd. (MCPS), PO Box 1, Rickmansworth, Herts. WD3 3AZ. Tel: (01) 584-6671. Mng. Dir.: John Wallington.
Ardmore & Beechwood Ltd., see EMI.
Ardo Music Corp., see Leosong.
Arelia Music Co., see Leosong.
Arf Arf, see Carlin.
Ariol Music Co., see Valentine.
Argel Music, see Music Sales.
Arista Music Publ'g Group, 12 Stratford Pl., London W1. Tel: (01) 408-2355. Pres.: Billy Meshel; Gen. Mgr.: Tony Lytle. (Affiliated with Chrysalis/AIR).
Aristocrat Music Ltd., see Terry King.
Arnakata Music Ltd. (RPS), 74/78 Seymour Pl., London W1H 5DB. Tel: (01) 723-8424. Cable: ARNAKATA. Telex: 24996. Dirs.: Lloyd Beiny, Mike Dolan.
Int'l firms represented: Bleu Disques, Damit, Good Fortune (all USA).
Int'l reps.: South America (Intersong), Belgium (Universal Songs), France (Francis Dreyfus), Germany (Budde), Japan (Intersong), Netherlands (Intersong), Scandinavia (Sweden), USA (Horizon).
Arretta Music Ltd., Electron House, Cray Ave., St. Mary Cray, Orpington, Kent BR5 3QJ. Tel: (0689) 27099. Cable: HALLELECTRIC. Telex: 896141. Chm. & Mng. Dir.: Terry Scully; Gen. Mgr.: Laurie MacGregor.
Int'l rep.: Worldwide (Heath Levy).
Arsenal Music Ltd., see United Artists.
Artsmusic, see Astra.
Artiff Publ'g Inc., see Leosong.
Arthur's Mother Music Ltd., see Valentine.
Ascherberg Hopwood & Crew Ltd., see Chappell.
Edwin Ashdown Ltd., 275-281 Cricklewood Broadway, London NW2 6QR. Tel: (01) 450-5237. Mng. Dir.: S.E. Ashdown; Dir. & Sec'y: J.R. Sharpe; Dir.: L.H. Clark.
Int'l firms represented: Enoch (France).
Int'l rep.: Canada (Boosey & Hawkes).
Ashley-Fields Music Ltd., see Roncom.
Ashtree Holdings (Eire) Ltd., 223 Regent St., London W1R 8TD. Tel: (01) 734-9768. Telex: 24170. Dir.: Philip R. Dir.: Philip R. Solomon. (Administered by Margaret Brace)

Int'l firms represented: Impact (South Africa).
Int'l rep.: South Africa (Impact).

As-Shams, see Leosong.
Assinbourne Music Co., see Leosong.
Associated Board of the Royal Schools of Music, 14 Bedford Square, London WC1B 3JG. Tel: (01) 636-9085/4478. Cable: MUSEXAM.
Asterisk Music, 41 Elm Rd., New Malden, Surrey KT3 3HD. Tel: (01) 942-7235. Cable: CHIRPING Chessington. Chief Execs.: John Beecher, Tony Atkins; Gen. Mgr.: Yvonne Tregrove.
Astra Int'l Entertainments, Thornley St., Wolverhampton. Tel: (0902) 26628, 28084. Mng. Dir.: Tony Perry; Dirs.: Alan Clayton, George Maddocks.
Atholl Music, see Ad-Chorel.
Atoka Publ'g, see Leosong.
Atwater Music Co., see Leosong.
Aura Music Ltd., 1 Kendall Pl., London W1H 3AG. Tel: (01) 486-0958. Telex: 24222 Ref. 3145. Mng. Dir.: Aaron Sixx. (Also see RMO).
The Automatic Music Co. Ltd., 5 Avery Row, London W1X 9HA. Tel: (01) 493-9744. Mng. Dir.: N.A. Mobbs.
Autumn Music, see Warner Bros.
Aviation Music, 102-104 Gloucester Pl., London W1H 3PN. Tel: (01) 486-0997. Telex: 298995. Mng. Dir.: Peter Felstead; Gen. Mgr.: Eric Holland.
Aviator Music, 64 Tranquil Vale, London SE3. Tel: (01) 852-0114. Mng. Dir.: Harry Maloney. (Affiliated with Chappell)
Aviva Music Ltd., see Shapiro, Bernstein.
Avocet Music Ltd., see Chappell.
Axle Ents. Ltd., 27 Arkwright Rd., Hampstead, London NW3 6BJ. Tel: (01) 435-9601. Dir.: Ken Howard.
Roy Ayers Ubiquity, see Leosong.
Aza Music Co., 652 Finchley Rd., London NW11. Tel: (01) 458-7288. Dir.: Morris Aza.
B A M Music, see Chappell.
B A T Music Ltd., 47 Fulham Broadway, London SW6 1AE. Tel: (01) 381-2464. Mng. Dir.: Bernard Theobald.
B B Music, see EMI.
B D M Music/Chappell Music, 100 Westgate Rd., Newcastle-upon-Tyne. Tel: (0632) 24449, 20971. Telex: 537486. Mng. Dir.: Barry McKay.
Int'l reps.: Worldwide (Chappell).
B-flat Music, see Leosong.
B K M Ltd., 27 Curzon St., London W1. Tel: (01) 491-7645. Cable: KROWNED.
B S Music Ltd., see Carlin.
B T W (Music) Ltd., 125 Myddleton Rd., Wood Green, London N22. Tel: (01) 888-6655. Co-Dirs.: John Ross Borthwick, R.J.T. Borthwick.
B V F Anglo Continental Music Co. Ltd., see Bron.
B W D Music Co. Ltd., see Margaret Brace.
Baal Recs. Music, 62 Gloucester Pl., London W1. Tel: (01) 486-1486. Cable: BAALON. Telex: 25836. Mng. Dir.: Colin J. Brain; Gen. Mgr.: Jay Shotam.
Backbenchers Music, see Music Farm.
Background Music Publ'rs Ltd., see Josef Weinberger.
Badfinger Music Co., see Leosong.
Bag Music Ltd. (MPA), 6 Ludgate Square, London EC4M 7AS. Tel: (01) 248-3836. Chief Exec.: Eric James.
P. E. Baker Music Ltd., see Chappell & RSO.
Balthasar Publ'g, see Leosong.
Bandlin Music Ltd., see Carlin.
Band of Joy Music Ltd., see Sara Bee.
Banff Music Publ'g Co., see Leosong.
Bankrupt Music, see Leosong.
Anthony Banks Ltd., see Hit & Run.
Banks Music Publ'ns, 139 Holgate Rd., York. Tel: (0904) 21818. Owner: Ramsay Silver.
Banner Music Ltd., see Chappell.
Barber Picone Music Co., see Leosong.
Bardell-Smith Publ'g, see Acton Green & Leosong.
Peter Bardens Songs, see Leosong.
Barenreiter London Ltd., 17-18 Bucklersbury, Hitchin, Herts. SG5 1BB.
Barn Publ'g Ltd., 35 Portland Pl., London W1. Tel: (01) 637-2111. Cable: BARNEMUS. Telex: 25929. Chm.: Chas Chandler; Mng. Dir.: Sam Mortimer; Prof. Mgr.: John Bright.
Int'l firm represented: Olde Grog (USA).
Int'l reps.: Australasia (Chappell), Austria (Rudolf Slezak in Germany), Belgium (Hans Kusters), Brazil (Intersong), Canada (Melville), Eastern Europe (Rudolf Slezak in Germany), France Radio Europe No. 1, Radio Luxembourg & SACEM territories (Allo), Germany (Rudolf Slezak), Greece (Intersong Hellas), Hong Kong (Intersong in Singapore), India (Intersong in Singapore), Israel (Litratone), Italy (Senza Fine), Japan (Toshiba), Malaysia (Intersong in Singapore), Mexico (Intersong), Netherlands (Dayglow), New Zealand (Chappell in Australia), Pakistan (Intersong in Singapore), Portugal (Armonico in Spain), Scandinavia (Air in Sweden), Singapore (Intersong), South America excluding Brazil (Korn-Intersong in Argentina), South Africa (Breakaway), Spain (Armonico), Switzerland (Rudolf Slezak in Germany), USA (Barn).
Barstool Music Ltd., see ATV.
Bass Goldstein Inc., see Leosong.
Batt Songs, see April.
Beacon Music Ltd., see EMI.
Beaumont Music, 20-24 Beaumont Rd., Chiswick, London W4. Tel: (01) 995-5432. Chief Execs.: Piers Ford-Crush, Philip Love.
Bearsongs (PRS), 190 Monument Rd., Birmingham B16 8UU. Tel: (021) 454-7020. Mng. Dir.: Kate Munn; Gen. Mgr.: Brian Walker.
Int'l rep.: Germany (Roba).
Beautiful Music Ltd., see Kassner.
Beautiful Sunday Music Ltd., Flemington House, Gollanfield, By Inverness, Scotland. Tel: (06676) 2304. Telex: 75209. Mng. Dir.: Rod McQueen; Gen. Mgr.: Eva Balfe.
Int'l reps.: Australia (Albert & Son), Germany (Hansa), Scandinavia (Air).
Bedrock Prod'n Ltd., 20 Chiddingstone St., London SW6. Tel: (01) 736-1719. Dirs.: Michael & Sheena Latimer.
Bee Bee Music Ltd., PO Box 472, London SW7 2QB. Tel:

(01) 373-3269. Cable: JOLUSTIG. Telex: 21879. Mng. Dir.: Jo Lustig; Gen. Mgr.: Dee Lustig.

Sara Bee Music Ltd., 17 Ronneby Close, Weybridge, Surrey. Tel: Walton-on-Thames 42689. Dir.: Shirley Selwood; Gen. Mgr.: Clive Selwood.

Bees Knees Music Ltd. (PRS, MPA), 64 The Drive, Alwoodley, Leeds, Yorks. LS17 7QQ. Tel: (0532) 674-039. Gen. Mgr.: Geoff Menzer. (Administered by Margaret Brace).

Beggars Banquet Ltd., 8 Hogarth Rd., Earl's Court, London SW5. Tel: (01) 370-6175. Telex: 915733. Mng. Dir.: Martin Mills. (Also see Andrew Heath).

Bello Music Ltd., see Leosong.

Bel Mar Music, see Leosong.

Belsize Music Ltd., 38 North Row, London W1. Tel: (01) 491-3175. Mng. Dir.: Charles Peate; Gen. Mgr.: Iris Giebler.

Int'l reps.: Canada (Belsize), Scandinavia (Air), USA (Belsize).

Belwin-Mills Music Ltd., 250 Purley Way, Croydon, Surrey CR9 4QD. Tel: (01) 881-0855. Cable: BELMILMUS. Mng. Dir.: Cyril Gee.

Home office: USA.

Benday, see Carlin.

Anton J. Benjamin Ltd., see Richard Schauer.

Benny Bird Co., see Leosong.

Benson Co. Publ'g Ltd., Alliance House, 29/30 High Holborn, London WC1V 6AZ. Tel: (01) 242-9609. Mgr.: Harold Purvis.

Home office: USA.

Irving Berlin (England) Music, see Chappell.

Bernettia Music Co., see Leosong.

Bernice Music Inc., see Leosong.

Berry Music, see Campbell Connelly.

Berry Music Co. Ltd., see EMI.

Berserkley, 97 Kingston Hill, Kingston-Upon-Thames, Surrey. Tel: (01) 549-9366. Telex: 8751771. Cable: BESERK.

Besco Music, see Leosong.

Bestat Music, see Leosong.

Betterbron Music Ltd., see Bron Org.

Bettytunes Music Co., see Valentine.

Bev Bev, see Carlin.

Beverly Culver Music, see Leosong.

Bewalk Music, see Leosong.

Big Ben Music Ltd., 18 Lancaster Mews, London W2 3QE. Tel: (01) 723-4499. Dir.: Ben Nisbet. (Administered by Margaret Brace).

Big Ear Music, see Satril.

Big Ears Music Inc., see Leosong.

Big Five Music Inc., see Leosong.

Big Game Music, 42 Manchester St., London W1. Tel: (01) 486-6141. Dirs.: John Craig, Tony Edwards, Andrew Budde.

Big Jim Music Ltd., see Big Ben.

Big Mike Music, c/o Westholme, Church Ln., Lincoln LN2 1QJ. Tel: (0522) 29160. Chief Exec.: Dave Godin; Gen. Mgr.: Alf Billingham.

Big Pig Music Ltd., see Rocket.

Big Secret Music Ltd., 184 Regent St., London W1R. Tel: (01) 439-7731. Cable: LOVESONGS. Telex: 896691. Joint Chm.: Guy Fletcher, Doug Flett.

Int'l reps.: Australia (Phil Matthews), Austria (Melodie der Welt), Belgium (Hans Kusters), Canada (Big Secret), France (Intersong), Germany (Melodie der Welt), Japan (Pacific), Luxembourg (Intersong), Netherlands (Intersong), Scandinavia (Air), South Africa (EMI-Brigadiers), Switzerland (Melodie der Welt), USA (Big Secret).

Big Spliff Music, The White House, The Street, Diss, Norfolk. Tel: (037988) 693. Owner & Dir.: Peter Shertzer; Gen. Mgr.: Brett Housego; Sales Mgr.: Bruce Simmons. (Affiliated with Paul Rodriguez)

Big 3 Music Ltd., see United Artists.

Billy Goat Music, 71 Benhurst Gardens, Seisdon, South Croydon, Surrey CR2 8NY. Tel: (01) 657-3560. Mng. Dir.: Terry Parker.

Bird Music, see Intersong.

Bird's Nest Music, see Happy Face.

Birdseye Music, see Leosong.

Birth Music Ltd., see Olofson & Young Blood.

Biscuit Music Ltd., 17 Ronneby Close, Weybridge, Surrey KT13 9SB. Tel: (98) 42689. Mng. Dir.: Clive Selwood; Gen. Mgr.: S. Selwood. (Affiliated with Sara Bee)

Bishop Music, see EMI.

Bishop Music, 12 Hill Rd., St. Johns Wood, London NWB. Tel: (01) 286-4025. Telex: 23322. Mng. Dir.: Ann Bishop; Gen. Mgr.: Karen Davies.

Bitchin' Guy UK, see Asterisk.

Bitter Wind Music, see Leosong.

Bizet Music, 10 Gray's Inn Square, London WC1 5JJ. Tel: (01) 242-5582.

Blackbird Music, Badgers Wood, Cadbury Camp Ln., Clapton-In-Gordano, Bristol BS20 9SB. Tel: (02755) 6770. Dirs.: J. Miles, P. Budd, T. Baylis, T. Banner.

Black Gold Music (PRS, MPA), Solisgrind Studios, Langmuir Rd., Kirkintilloch, Glasgow, Scotland. Tel: (041) 776-7572. Mng. Dir.: Ian C. McCredie; Gen. Mgr.: Sylvia Meadows.

Black Friar Publ'g Co., see Leosong.

Black Neon Ltd., 4D Oxford & Cambridge Mansions, Old Marylebone Rd., London NW1. Tel: (01) 723-2454. Mng. Dir.: Nigel Haines; Gen. Mgr.: Martin Hall.

Black Sheep Music (MCP), Fulmer Gardens House, Fulmer, Bucks. Tel: 395-2143. Telex: 849208. Mng. Dir.: Ben Findon; Gen. Mgr.: Linda Findon.

Black Swan Music (London) Ltd., see EMI.

Black & White Music Co., see Leosong.

Blair Music, see Leosong.

Blanedell Ltd., see Compass.

Blank Music, see EMI.

Blitzongs Music Ltd., see Leosong.

Bloated Dormouse Music, see Music Farm.

Bloomsbury Music Publ'g Co. Ltd., 12/13 Greek St., London W1V 5LE. Tel: (01) 437-7064. Mng. Dir.: Iain McCarthy; Gen. Mgr.: Barbara Allen.

Karl Blore Music, see Chappell.

Blossom Dearie Music, see Louvigny.

Blubber Music, see Leosong.

Blue Ace Music, see Leosong.

Bluebell Music, see Peter Hamilton.

Bluebird Music Co., see EMI.

Bluebird Music Ltd., 155 Church St., London W2 1NA. Tel: (01) 723-6561/9090. Chief Execs.: Billy Russell, Billy Carruthers.

Bluebird Music Ltd., see RAK.

Blue Chip Music, 2/3 Golden Sq., London W1 4BS. Tel: (01) 437-7544. Cable: BLUECHIP. Mng. Dir.: Ivor Schlosberg.

Int'l firms represented: Clan, Contagious (both South Africa).

Int'l reps.: Germany (Global), Japan (Watanabe), South Africa (Clan).

Blue Eyes Music, see RAK.

Blue Gum Music Ltd., see Bruce Welch.

Blue Mountain Music, see Island.

Blue Rock Music, see Leosong.

Blues Man Music, see Leosong.

Blueytones Music Ltd., see ATV.

Bob Cor Music, see Leosong.

Bob The Dog Music Ltd., 24 Chiswick High Rd., London W4. Tel: (01) 941-0356. Mng. Dir.: Mark Rye. (Affiliated with Intersong)

Int'l firm represented: Bob The Dog (USA).

Int'l reps.: Australasia (ATV), Ireland (Intersong), South Africa (EMI Brigadiers), UK (Intersong), GASS (Francis Day & Hunter).

Bocu Music Ltd., 48 Grafton Way, London W1. Tel: (01) 388-7653. Cable: MARQUIMUS. Telex: 298976. Mng. Dir.: John Spalding; Gen. Mgr.: Carole Broughton.

Int'l firms represented: Barthel, Bill Black, Equinox, Good Flavour, Jarak, Lynam, Lyn Lou, Nelltone, Willie Nelson, Partner, Slow Dancing, Songtailors, Wimot, Window (all USA); Polar, Sweden, Union Songs (all Scandinavia).

Bog Music, see OK.

Boldex Ents. Inc., see Leosong.

Bomac Publ'g Inc., see Leosong.

Ronnie Bond Music, see Andrew Heath.

Bonney Music Ltd., see Kassner.

Boogie Music, see Beautiful Sunday.

Boon Music, see EMI.

Boosey & Co. Ltd., see Boosey & Hawkes.

Boosey & Hawkes Music Publ'rs Ltd., 295 Regent St., London W1R 8JH. Tel: (01) 580-2060. Cable: SONOROUS. Mng. Dir.: R.A. Fell.

Int'l branches: Australia, Canada, France, Germany, South Africa, Sweden, USA.

Int'l firms represented: Barry (South America), Ed. Musica Budapest (Hungary) Carl Fischer (USA), Luverne (USA), Suvini Zerboni (Italy), VAAP (USSR)

Int'l reps.: Austria (Erich), Denmark (Wilhelm Hansen), Finland (Musik Fazer), Italy (Carisch), Japan (Academia, Nippon Gakkai), Netherlands (Albersen), Norway (Norsk), South America (Barry), Spain (Vidal Limona), Sweden (Carl Gehrman).

Bootleg Publ'g Co. (PRS, MCP), 500 Chesham House, 150 Regent St., London W1R 5FA. Tel: (01) 734-3501. Telex: 261426. Dir.: David G. Rose; Gen. Mgr.: Brian Crook.

Botop Music, see Magnet.

Bottom Dollar Music, see Million Dollar.

Bourne Music Ltd., 34/36 Maddox St., London W1R 9PD. Tel: (01) 493-6412/6583. Gen. Mgr.: Alan Paramor.

Home office: USA.

'Bout Time Music, see Leosong.

Franklyn Boyd Music Ltd. (PRS), 24 Parkside, Knightsbridge, London SW1. Tel: (01) 245-9026. Chief Exec.: Robert Mellin; Gen. Mgr.: David Read.

Int'l reps.: Belgium (Music Rights Society), France (Robert Mellin); Germany (Robert Mellin), Italy (Neapolis), Netherlands (Timeless), Scandinavia (Mellin), Spain (Robert Mellin), USA (Robert Mellin).

Margaret Brace Copyright Bureau Ltd., 9 Dean St., 3rd fl., London W1A 4QD. Tel: (01) 437-3711. Mng. Dir.: Margaret Brace; Gen. Mgr.: Sandra Cackett.

Bradbury Wood Ltd., see Chappell.

Brampton Music Ltd., see Fresh Air.

Brand New Music, 1 Derby St., London W1Y 7HD. Tel: (01) 493-9637. Mng. Dir.: Mike Vernon.

Bress/Wind Educational Supplies & Co., see Belwin-Mills.

Breakaway Songs, see ATV & Desert Songs.

Breitkopf & Haertel (London) Ltd., 20 Earham St., London WC2H 9LN. Tel: (01) 836-3066. Mng. Dir.: Larry Fenton.

Int'l firms represented: Berben (Italy), Breitkopf & Haertel (East & West Germany), Alexander Broude (USA), Columbia (USA), Deutscher Verlag fuer Musik (East Germany), Friedrich Hofmeister (East & West Germany), Neil A. Kjos (USA), Neue (East Germany), Pro Musica (East Germany), Van Teeseling (Netherlands).

Int'l reps.: Austria (Breitkopf & Haertel), Canada (Alexander Broude), Germany (Breitkopf & Haertel), Mexico (Alexander Broude), Switzerland (Breitkopf & Haertel), USA (Alexander Broude).

Bridge House Music Ltd., 23 Barking Rd., Canning Town, London E16. Tel: (01) 476-2889. Pres.: Chris Thompson; Gen. Mgr.: Terence Murphy. (Affiliated with Mews)

Int'l rep.: Worldwide (Martin-Coulter).

Briggsville-Taylor Town, see Leosong.

Bright Music Ltd., 34 Maddox St., London W1. Tel: (01) 437-7138. Chief Execs.: Martin Wyatt, Charlie Crane. (Affiliated with Warner Bros.)

Brigitte Music Ltd., see ATV.

British & Continental Music Agencies, see EMI.

British Lion Music Ltd., see Purple.

Cliff Brittle Music Ltd., Longbridge Hayes Ind'l Estate, Newcastle, Stoke-on-Trent. Tel: (0782) 811-731. Mng. Dir.: Cliff Brittle.

Broken Soul Music Co., see Leosong.

Bron Org. Ltd., 100 Chalk Farm Rd., London NW1 8EH. Tel: (01) 267-4499. Cable: HITMUSIC. Telex: 261653. Dirs.: Sydney & Gerry Bron; Gen. Mgr.: Rod Duncombe.

Int'l firms represented: Munchin, Frank Zappa (both USA).

Int'l reps.: Australia (J. Albert), Austria (Intro Gebr. Meisel), Belgium (Hans Kuster), Brazil (Fermata), Canada (Warner Bros.), Far East (Pathe), Finland (Sonet

in Sweden), France (Bagatelle), Germany (Intro Gebr. Meisel), Greece (EMI), Iceland (Sonet in Sweden), Italy (Metron), Japan (Shinko), Mexico (Arabella), Netherlands (New Dayglow), Portugal (Quorra), Scandinavia (Sonet in Sweden), South Africa (Plymouth), Spain (Quorra), Switzerland (Intro Gebr. Meisel), USA (Warner Bros.).

Sydney Bron Music Co. Ltd., see Bron

Brons Music & Books, see Hansen

Brookside Music, see Asterisk

Brouhaha Music Inc., see Leosong

Roberton Brown Assocs., 47 British Grove, London W4.

Bruce Music Ltd., see Chappell & RSO

Brused Oranges, see Leosong

C. Brull Ltd., 26 West St., London WC2 Tel: (01) 836-1724. Chief Exec.: K. Schick

Int'l branch: France

The Brunad Music Publ'g Co. Ltd., 5 Denmark St., London. Tel: (01) 836-0947/0717

Bruno Music Ltd., see Kennedy

Brunswick Music Publ'g Co. Ltd., see Margaret Brace

Brunton Music Ltd., see ATV

Budanco Publ'g, see Leosong

Budgie Music Ltd., see Rondor

Buff Music (PRS), see Bright

Buffalo Music Ltd., see Intersong

Buk Music Ltd., see Leosong

Bulk Music Ltd., Baltic Chamber, 50 Wellington St., Glasgow, Scotland. Tel: (041) 221-1948. Mng. Dir.: Peter Shipton. (Affiliated with Mews)

Buildog Music Co., see Valentine

Bullseye Music, AIR House, Spennymoor, Co. Durham. Tel: (0388) 814-632. Chief Execs.: Colin Pearson, John Wray. Gen. Mgr.: A.P. Blackett

Bumper Songs, see Magnet

Burgher Music, see Robert Kingston

Burlington Music Co. Ltd., 9 Albert Embankment, London SE1 7SW. Tel: (01) 735-8111. Cable: BURLMUSIC. Dirs.: W.W. Townsley, P.J. Frankcom, M.L. Steliman; Gen. Mgr.: Leslie Lowe

Int'l affiliates: Australia (Palace), Austria (Burlington in Germany), Benelux (Palace in Netherlands), Canada (Burlington), Far East (Burlington-Palace in Hong Kong), France (Palace), Germany (Burlington), Italy (Palace), Portugal (Burlington in Spain), Scandinavia (Palace in Sweden), Spain (Burlington), Switzerland (Palace), USA (Burlington)

Int'l reps.: Argentina (MAI), Brazil (Fermata), Chile (MAI), Czechoslovakia (Supraphon), Greece (Grecophon), Japan (High Note), Rhodesia (Music Publ'g Co.), South Africa (Music Publ'g Co.), Uruguay (MAI), West Indies (Woodwater)

Burning Sounds Ltd., 379 Harrow Rd., London W9 3QF. Tel: (01) 960-7131. Gen. Mgr.: Robert Hill

Burnt Ash Music Co., see Valentine

Bustongs Ltd., see Sunbury

Byroom Music (MPA), see Happy Face

Bytown Music, see Leosong

C. S. Music, see Philip P. Roberge

C. S. Publ'g, see RAK

C. M. P. Ltd., see Robert Mellin

C. P. Music, see GGA

C. T. A. Music Ltd., 31 Park Crescent Mews W., London W1N 3PG. Tel: (01) 580-5250. Mng. Dir.: William Jackson Utley; Gen. Mgr.: David Chapman. (Affiliated with Carlin)

Cachand Music Co., see Leosong

Cadillac Music, 180 Shaftesbury Ave., London WC2H 8SJ. Tel: (01) 836-3646

Cadogan Music Ltd., see Eaton

Caesar Music Ltd., 19 London St., London W2. Tel: (01) 262-4321. Dirs.: Barry Murray, Harry Simmonds.

Int'l rep.: Worldwide (Chrysalis in UK)

Calendar Music, 89 Chiswick High Rd., London W4. Tel: (01) 995-3682. Cable: SUNARTISTE. Mng. Dir.: Don Lawson; Gen. Mgr.: Curlah Lawson.

Int'l reps.: Australia (Chappell), Austria (Aberbach), Canada (Morning), Germany (Aberbach), Switzerland (Aberbach)

Calua Music Co., see Leosong

California Music Press, see Leosong

Camad, see Carlin

Campbell Connelly & Co. Ltd. (PRS), 37 Soho Sq., London W1V 5DG. Tel: (01) 439-9181. Dir.: Roy Berry

CanCon Music Co., see Valentine

Candle Music, see EMI

Canned Rock Music Ltd., see Barn

Cap Quist Music, see Leosong

Capricorn Music Co., see Leosong

Captain Beaky Music—Dir.: Jonathan Rowlands—see Hush

Captain Billy's Music Ltd., see Margaret Brace

Car-Deb Music Co., see Leosong

Cardinal, see Carlin

Caribbean Music Co., see Leosong

Carlin Music Corp., 14 New Burlington St., London W1X 2LR. Tel: (01) 734-3251. Cable: CARLSONG. Telex: 267488. Pres.: Frederick S. Bienstock; Dirs.: Miriam Bienstock, Mike Collier; Exec. VP: R. Derek Knibb; VP & Int'l Mgr.: Paul Rich; Creative Mgr.: Paul Barber.

Int'l branch: USA, Carbert Music Inc.

Carmel Music Ltd., 4 Cliff Ave., Westcliff-on-Sea, Essex SSO 7AJ. Tel: (0702) 338593. Mng. Dir.: Peter Eden.

Carnaby Music Ltd., see Chappell

Carousel Music, see Trafalgar

Carren/Woolsongs, see Woolsongs

Carrie Music Ltd., see Bron

Alan Carree Music, see Leosong

John Carter Music Ltd., see Noon

Carter-Lewis, see Southern

L. J. Cary & Co. Ltd., see Chappell

Casanova Music Ltd., see Dick James

Casino Music, see Satril

Castle Hill Music, 34 Lake Terr., Hunslet, Leeds, Yorks. LS10 2JG. Tel: (0532) 700-010. Mng. Dir.: Ian R. Smith; Gen. Mgr.: A.M. Cain

Castrator Music, 40 Gunter Grove, London SW10 0UJ. Tel: (01) 352-2886. Owner: Rui De Castro

Int'l firm represented: Ertzmusic (Germany)

Int'l rep.: Switzerland (Blz Nouvelle)

Catalyst (Music Publ'g) Ltd. (PRS), 6 Narcissus Rd., London

NW6 1TH. Tel: (01) 794-7640. Telex: 21879. Mng. Dir.: Peter Knight Jr.
Int'l firm represented: Global (Germany).
 Cathy Music, September Sound Studios, 38 Knowl Rd., Colcar, Huddersfield. Tel: (0484) 657-054. Chief Exec.: Mike Storey. (Affiliated with Valentine)
 Cat's Eye Music, see State.
 Cavalcade Music Ltd., 138 New Bond St., London W1. Tel: (01) 493-9681. Telex: 8954791. Dirs.: J.A. Fogarty, R.A. Liversage. Gen. Mgr.: R.A. Liversage.
Int'l firms represented: ABC/Dunhill, American Broadcasting, Hav-A-Tune, Horse Creek/Don Williams, Len Lon Music (all USA).
 Cavendish Music Co., see Boosey & Hawkes.
 Cedarwood, see Southern.
 Cee Cee Music, see Asterisk.
 Celebration Servs. (Post Green) Ltd., 57 Dorchester Rd., Lytchett Minster, Poole, Dorset BH16 6JE. Tel: (0202) 623651. Cable: CELSERV Mng. Dir.: Philip Bradshaw; Gen. Mgr.: Robert Ellis.
Int'l rep.: USA (Redeemer Books).
 Cellar Music Ltd., see ATV.
 Central Music Co., see EMI.
 Capcor Ltd., see Chappell.
 Cesta Music, see Leosong.
 Frank Chacksfield Music Ltd., Allegro, Elm Walk, Farnborough Park, Orpington, Kent BR6 8LX. Tel: Farnborough 55509. Cable: GOLDISCS. Mng. Dir.: Frank Chacksfield.
 Chad Music, see EMI.
 Chameleon Publ'g, 19 S. Molton St., London W1. Tel: (01) 629-9719. Telex: 261805. Mng. Dir.: Mike Loveday; Gen. Mgr.: Richard Fearo.
 Chandos Music Ltd., 41 Charing Cross Rd., London WC2. Tel: (01) 437-1448/5512. Mng. Dir.: Brian Couzens.
 Chandos (Rec'gs) Ltd., see Chandos Music.
 Channel Music Ltd., see Rock Artistes.
 Chantelle Music Ltd. (PRS, MCPS), 3a Ashfield Parade, Southgate, London N14. Tel: (01) 886-6236. Dir. & Gen. Mgr.: Riss Chantelle.
 Chanter Music Ltd., see Chappell.
 Chappell Music Ltd., 50 New Bond St., London W1A 2BR. Tel: (01) 629-7600. Cable: SYMPHONY. Telex: 258403. Chm.: S.L.G. Gottlieb; Dir. & Gen. Mgr.: J.J. King; Creative Dir.: T. Roberts; Financial Dir.: J.J. King; Publ'ns Dir.: Gen. Mgr.: Robin Wood; Rec'g Studio Mgr.: R. Golding; Chappell Int'l Music Publ'rs Ltd., N.L.D. Firth; Chappell Music Centres Ltd. Dir. & Gen. Mgr.: D. Brown; Pub. Mgr.: Mary Jennings.
 Chappell & Co. Overseas Holdings Ltd., see Chappell.
 Chappell/Aznavour Ltd., see Chappell.
 Chappell/Bay Music, see Chappell.
 Chappell Int'l Music Publ'rs Ltd., see Chappell.
 Chappell Morris Ltd., see Chappell.
 Chappell/One West, see Chappell.
 Chappell/Pillow, see Chappell.
 Chappell/QTS, see Chappell.
 Chappell/R&R, see Chappell.
 Chappell/Robinson, see Chappell.
 Chappell/Scorpio, see Chappell.
 Chappell/Simpson, see Chappell.
 Chappell/Sparkle, see Chappell.
 Chapter One Music & Artists Ltd., see The Les Reed Org.
 Charisma Music Publ'g Co. Ltd., 90 Wardour St., London W1. Tel: (01) 434-1351. Dirs.: Brian C.A. Gibbon, Tony Stratton-Smith. (Affiliated with Chappell)
Int'l reps.: Worldwide (Chappell) excluding Canada (GRT), USA (Hudson Bay).
 Char Joel Music Co., see Leosong.
 Charlotte Music Ltd., 9 Bryanston Mews West, London W1. Tel: (01) 723-8416. Chief Exec.: Terry Sylvester; Dir.: Robin Britten. (Affiliated with Intersong)
 Charly Music (PRS), 9 Beadon Rd., London W6. Tel: (01) 741-0011. Cable: CONFIDAD. Telex: 934386.
 Charnwood Music Publ'g Co., 5 University Rd., Leicester LE1 7RA. Tel: (0533) 23345.
Int'l firm represented: Josef Preissler (Germany)
 Chatawa Music, see Leosong.
 Cheezburger Music Inc., see Leosong.
 Cherry Music Ltd., 49 Greek St., London W1. Tel: (01) 437-7418. Chm.: David Mindel; Gen. Mgr.: David Seys.
Int'l reps.: Belgium (Intersong), France (Intersong), Germany (Intersong), Netherlands (Intersong), North America (Famous), Scandinavia (Arne Bendiksen), South America (Intersong), Switzerland (Intersong).
 Cherry Red Music, 199 Kingston Rd., London SW19. Tel: (01) 540-6831. Mng. Dir.: Iain McNay; Gen. Mgr.: Richard Jones.
Int'l firm represented: Megalo (USA).
Int'l rep.: Canada (Change).
 Cherrysongs, 22 Wood Rd., Camberley, Surrey GU15 2RL. Tel: (0276) 26688. Chief Exec.: Jeff Cherrington.
 J. & W. Chester/Ed. Wilhelm Hansen London Ltd., 7 Eagle Court, London EC1M 5QD. Tel: (01) 253-6947/6276. Cable: GUARNERIUS.
Int'l firms represented: Wilhelm Hansen group (Denmark, Germany, Norway, Sweden), Silver Burdett (USA).
Int'l rep.: USA (Magna).
 Chevron Music Publ'g Ltd., Television Centre, Leeds LS3 1JS. Tel: (0532) 38283.
 Chibell Music Ltd., see Red Bus.
 Chinga Music Ltd., see Leosong.
 Chinnichap Publ'g Ltd. (PRS), 5 Clarges St., London W1Y 7PH. Tel: (01) 493-1409, 629-9516. Mng. Dir.: Nicky Chinn.
 Chiglow Music, see Lightning & Asterisk.
 Chipping Norton Music Ltd., 4 Kings Head Mews, Chipping Norton, Oxon. Tel: (0608) 2684. Mng. Dir.: Richard Vernon.
 Chiswick Music Ltd., see St. Thomas More.
 Chocolate Music, see RAK.
 Chorale Music, 33 Devonshire St., Suite 2, London W1. Tel: (01) 486-2362. Chief Exec.: Robert Howes; Gen. Mgr.: Barbara Courtney-King.
Int'l reps.: Benelux, Denmark, France, Germany, Italy, Norway, Portugal, Spain, Sweden (all United European).
 Christabel Music Ltd., see ERM/Robert Kingston.
 Chrysa-Lee Music Ltd., see Chrysalis.
 Chrysalis Music Ltd., 12 Stratford Place, London W1N 9AF.

Tel: (01) 408-2355. Telex: 21753. Joint Chm. Chris Wright, Terry Ellis. Gen. Mgr.: Chris Stone.
Domestic firms represented internationally: Blanedell, Bluebeard, Caesar, Fivestars, Longmanor, Rockbottom, Salamander, Seafood, Spaniel, Steeleley Span.
Int'l firms represented: Alkatraz Corner, Budd, Artie Wayne (all USA).
Int'l reps.: Australia (Festival), Austria (Roba), Belgium (Dutchy), Central America (Fermata in Brazil), France (Claude Pascal), Germany (Roba), Iceland (Air), Italy (Ricordi), Japan (Pacific), Mexico (Fermata in Brazil), Netherlands (Dutchy), New Zealand (Festival), Scandinavia (Air), South Africa (Gallo), South America (Fermata in Brazil), Spain (Arabella), Switzerland (Roba), USA (Chrysalis, Moth).
 Cinephonic, see Campbell Connelly.
 Cintercor Music Co., see Leeds.
 Cissi Music Inc., see Leosong.
 City Boy (Music) Ltd., see Chappell.
 Clarity Music Inc., see Leosong.
 Classic Editions, 36 John Dalton St., Manchester M2 6LE. Tel: (061) 834-7292. Cable: EUROBEAT. Mng. Dir.: Irving Wilson; Gen. Mgr.: Alan Wilson.
Int'l firms represented: Beat, Curci (both Italy).
Int'l rep.: Italy (Beat).
 Clifford Essex Music Ltd., see Music Sales.
 Clifton Music, see St. Thomas More.
 Clinton Music Co., Kraal, Woodside Hill, Chalfont St. Peter, Bucks. Tel: Gerrards Cross 83351.
 Clifone Ltd., see Hit & Run.
 Clondyke Music Ltd., see Chappell.
 Cloud Cuckoo Songs Ltd., see Chappell.
 Clover Conway Music Co., see Noel Jay.
 Clowns Music Ltd.—Contact: Ed Welch—see United Artists.
 Coaxle Prods. Ltd., see Margaret Brace.
 Coconut Airways, c/o Morgan Studios, 169/171 High Rd., London NW10. Tel: (01) 459-7244. Dirs. Gerant Hughes, Jeffrey Calvert.
 Cog Music, see Leosong.
 Cole-Arama Music, see Leosong.
 College Music, see EMI.
 Collegiate Music Publ'ns Ltd. (div. of Josef Weinberger group), 10/16 Rathbone St., London W1P 2BJ. Tel: (01) 580-2827. Cable: OPERETTA.
Int'l firm represented: Curci (Italy).
 Barry Collings Music, 15 Claremont Rd., Westcliff-on-Sea, Essex SS0 7DX. Tel: (0702) 43464, 47343. Mng. Dir.: Barry Collings.
 Collins Music Co., Townsend House, Flat 2, 22/25 Dean St., London W1V 5AL. Tel: (01) 437-0189. Chief Exec.: Peter Collins.
Int'l reps.: Scandinavia (Warner Bros.).
 Philip Collins Ltd., see Hit & Run.
 Column Music Co., see Leosong.
 Combine Music Ltd., see EMI.
 Commair-Chappell Music Ltd., see Chappell.
 Comma Music, see Intersong & Paul Rodriguez.
 Commercial Music Co. Ltd., 91 Gatliff Close, Gatliff Rd., London SW1. Tel: (01) 730-2343.
 Compass Music Ltd. (PRS), Alembic House, 12th fl., 93 Albert Embankment, London SE1. Tel: (01) 735-9291. Cable: COMP MUSIC.
 Compatible Rec'g & Publ'g Ltd., 87 Third Cross Rd., Twickenham, Middx. Tel: (01) 898-4095, 986-6904. Mng. Dir.: Derek Bailey; Gen. Mgr.: Evan Parker.
 Concord, see Essex.
 Consortway Music Ltd., 42 Priory Ave., London W4. Tel: (01) 995-7470. Dir.: K.E. Kaye; Gen. Mgr.: Boz Bosley.
Int'l rep.: Worldwide (United Artists).
 Consume Music, see Leosong.
 Contemporary Music Publ'g Ltd., see Jet.
 Cookaway Music Ltd., see Dick James.
 Coombe Music Ltd., 162 Coombe Ln. W., Kingston-upon-Thames, Surrey KT2 7DE. Tel: (01) 942-6240. Telex: 22914. Mng. Dir.: Gray Jones.
 Cooper Music Ltd., see EMI.
 Coppa Music Ltd., see EMI.
 Coquette Music, see Leosong.
 Corat Music, see Minimus.
 Corner Stone Music Ltd., see Valentine.
 Cornish Legend Music, Bawdens Farm, Tremodrett, Roche, St. Austell, Cornwall PL2. Tel: (072689) 507. Chief Exec.: Martin Griffin; Gen. Mgr.: N. Strachan.
 Coronet, see Carlin.
 Corries (Music) Ltd., West Buccleuch Near Hawick, Roxburghshire, Scotland. Tel: Etrick Valley 230. Dirs.: R.G. Browne, R.M.B. Williamson.
 Cortab Ltd., see Chappell.
 Corus Music, see Louigny.
 Covina High Music, 1-C Durham Terr., London W2. Tel: (01) 221-6250. European Opns. Dir.: Nancy Gayer.
 Edward Cox Music Ltd., see Dick James.
 Crackin Music Co., see Leosong.
 Craighall Music, 68 Craighall Rd., Edinburgh EH6 4RL, Scotland. Tel: (031) 552-3685.
 J. B. Cramer & Co. Ltd., 99 St. Martin's Ln., London WC2N 4AZ. Tel: (01) 240-1612. Gen. Mgr.: S.P. Pinning.
 Crater Music, see Paul Rodriguez.
 Craudian Music, see EMI.
 Crazy Music, The Tanners Arms Office, New Bridge St., Newcastle-upon-Tyne. Tel: (0632) 24052, 24062. Mng. Dir.: Barry McKay; Gen. Mgr.: Chris Cox. (Affiliated with Chappell)
Int'l rep.: Worldwide excluding Canada & USA (Chappell).
 Crazy Viking Ltd., see Olofson.
 Creedsan Music, see Trafalgar.
 Creek Publ'g Ltd., see Rondor.
 Crema Music Co., see Leosong.
 Creole Music Ltd., 91-93 High St., Harlesden, London NW10. Tel: (01) 965-9223. Cable: CREMUS. Telex: 28905.
 Crezent Music Ltd. (PRS), see GH.
 Cricklewood Music Ltd., Hyde Ind'l Estate, The Hyde, London NW9 6JU. Tel: (01) 205-5456. Mng. Dir.: Monty Lewis.
 Cromwell, see Essex.
 Cross, see Campbell Connelly.
 Crossdoor Music Co., see Valentine.

Crotchet Music Ltd., Devonshire Works, Barley Mow Passage, London W1.
 Crow Publ'g Ltd., 24 Parkside, Knightsbridge, London SW1. Tel: (01) 245-9026.
Int'l firm represented: Locomotive (USA).
 Crown Aztec Music, see Leosong.
 Crown Black Music, see Leosong.
 Crown Royal Music, see Leosong.
 Crunchy Grenola Music, see Leosong.
 Crusty Music, see Big Secret.
 Crystal Music Publ'g Co. Ltd., see Dick James.
 Cube Ents. Ltd., see Essex.
 Cuckoo Music Ltd., see ATV.
 Curb Carlin Music, see Carlin.
 J. Curwen & Son Ltd., see Faber & G. Schirmer.
 Cuzerzio Music Publ'g, see Leosong.
 Cyanide Music, see Sarah.
 Cyhoeddiadau Sain, Ffordd Llanllyfni, Penygroes, Caernarfon, Gwynedd, Wales. Mng. Dir.: Huw Jones; Gen. Mgr.: G. Mitford.
 Cymande Music Ltd., see Alaska.
 D I G I T, see Young Blood.
 D & J Arlon Ents. Ltd., see Chappell.
 D J Music, 76 Roebuck House, Victoria, London SW1. Tel: (01) 834-4502. Dirs.: Johnny Toogood, Danny Kamara; Gen. Mgr.: Joe Napoli.
 Dabe Music Ltd., see Carlin & Konkwest.
 Miki Dallou Music, see Pilot & Young Blood.
 Damil Music, Blythe Rd., Hayes, Middx. Tel: (01) 573-5122.
 Dancik to Disc Inc., see Leosong.
 Dan-Sar Music Ltd., 18 Ambleside Ave., York YO1 3RX. Tel: (0904) 34051. Mng. Dir.: Peter Hawkins.
 Dante Music, see EMI.
 Danver Music Ltd., 12 The Shrubberies, George Ln., South Woodford, London E18. Tel: (01) 504-2820.
 Herman Darewski Music Publ'g Co., see EMI.
 Dartsongs, 3 Grove Wood Hill, Coulsdon, Surrey. Tel: (01) 660-2311. Admin'r: Iain Thomson. (Affiliated with Asterisk)
 Dash, see Campbell Connelly.
 Spencer Davis Music Ltd., see Dick James.
 Davray Music Ltd., see Konkwest & Carlin.
 Dayn Music Ltd., see Carlin.
 Dayray Music Ltd., see Carlin.
 Daytime Music Ltd., see Carlin.
 Dazzle Songs Ltd., see RAK.
 Dean Street Music Co., see EMI.
 Blossom Dearie Music, see Louigny-Marquee.
 Deaver Ents., see Intersong.
 Debnar Publ'g Co. Ltd., see Bron.
 Debonaire Music Ltd., see Dick James.
 December Songs (PRS, MCPS), 42 Park View Rd., Neasden, London NW10 1AL. Tel: (01) 450-5987. Gen. Mgr.: Todd Lutterodt.
 Deep Purple Music, see Purple.
 Deep Purple Music (Overseas) Ltd., see Purple.
 Defrantz Monique Music, see Leosong.
 Dehany Music, see Leosong.
 Deke Music, see Leosong.
 Delfont Music Ltd., see Chappell.
 Delicate Music Ltd. (PRS), see Rondor.
 Delmount Ltd., see RSO.
 Delos Music, 182 Lansbury Dr., Hayes, Middx. Tel: 573-6299. Dir.: Pat Lynn; Gen. Mgr.: Richard Benjamin.
 Delphi Music Ltd., see Barn.
 Delta Artists Music Ltd., 7 Chiswick High Rd., London W4. Tel: (01) 995-8087. Mng. Dir.: Del Taylor; Gen. Mgr.: P. Padun. (Affiliated with Chappell)
Int'l rep.: Worldwide (Chappell).
 Dema Music (PRS), 18 West Mall, Clifton, Bristol BS8 4BQ. Tel: (0272) 35994, 35867. Chief Exec.: D.W. Ackerman; Gen. Mgr.: Mrs. S.A. Ackerman.
 Demain Music, see Leosong.
 Demark Music, see Paul Rodriguez.
 Denker Music, see Kassner.
 Chris Denning Ltd. (MCPS, PRS), 114 Maytree Close, Oliver's Battery, Winchester, Hants. SO22 4JF. Tel: (0962) 62554. Mng. Dir.: Chris Denning.
 Deoc Music Ltd., see Carlin.
 Deptford Songs, see Rondor.
 Desert Songs/Breakaway Songs, 216 Randolph Ave., The Basement, London W9. Tel: (01) 624-8252/5224/3717. Cable: SUGARSUGAR. Chief Exec.: Julian Spear, Clive Banks, Terry O'Neil. (Affiliated with ATV)
 Design, see Carlin.
 Destiny, see Carlin.
 Johnny Devlin, see Carlin.
 Dew Music Co., see Leosong.
 De Wolfe Ltd. (MCPS), 80/88 Wardour St., London W1V 3LF. Tel: (01) 439-8481. Cable: MUSICALL. Dir.: James Sylvester de Wolfe.
 Dial Publ'g, 73 Grosvenor St., London W1. Tel: (01) 493-8505. Mng. Dir.: Harry Paton Evans; Gen. Mgr.: B.G. Moss.
 Max Diamond, see Campbell Connelly.
 Diamond Music Co., see Gabriel.
 Diamond Touch Music, see Leosong.
 Dice Music, see Tabitha.
 Dickinsons, see Bloomsbury.
 Different Music, 11/12 Dover St., London. Tel: (01) 408-0868. Chief Execs.: Lynton Guest, Angela Hopwood; Gen. Mgr.: Steven Cook.
 Dig It Music Ltd., see Olofson.
 A. Dimartino Music Ltd., see Valentine.
 Dinosaur Music, see Asterisk.
 Diplomat Music Ltd., see Chappell.
 Dirty Deal Music Publ'g Inc., see Leosong.
 Discount Inter Shopping Co. Ltd., 11 Heronslea Dr., Stanmore, Middx. Tel: (01) 958-4197. Mng. Dir.: Johnny Franks.
 Discourses Ltd., 32 High St., Tunbridge Wells, Kent. Tel: (0892) 26397. Mng. Dir.: Robert F. Hardcastle.
 Walt Disney Prods. Ltd., 68 Pall Mall, London SW1Y 5EX. Tel: (01) 839-8010. Telex: 21532. Chief Exec.: Keith S. Bales.
Home office: USA
 Dix Ltd., see EMI.
 Dizzy Heights Music Publ'g, 44 Seymour Pl., London W1. Chief Execs.: N. Grainge, C. Hill.
 Des Dolan Music, see Leosong.

- Dolly Music, see EMI.
 Domax Music Inc., see Leosong.
 Domestic Music Co., see Leosong.
 Dominic Music Ltd., see Dick James.
 Dominion Music Co. Ltd., see United Artists.
 Domino Music, see Tabitha.
 Donna Music Ltd., see EMI & The Les Reed Org.
 Donovan, see Southern.
 Dormant Music Ltd., see Rondor.
 Dorsey Bros. Music Ltd., see Music Sales.
 Double W Music, see Logo.
 Dove Music Ltd., see Barn.
 Downside Music Co., 134 Seaford Ave., New Malden Surrey KT3 6JN. Tel: (01) 942-1412, 399-6201. Partners: John S. Astor, Peter Mitchell. Gen. Mgr.: John S. Astor.
 Dratleaf Music Ltd., see Chappell & RSO.
 Dream City Music, see Leosong.
 Dreamers Music Co., see EMI.
 Dreamway Ltd., see Intersong.
 Dreyfuse Music Ltd., see Fuse.
 Druid Music, see EMI.
 Duant Music, 76 Muswell Hill Rd., London N10. Tel: (01) 883-7656. Mng. Dir.: Jim McClean. (Administered by Margaret Brace)
 Dukelodge Ents. Ltd.—Administered by Carlin—see Dukelodge (FM).
 Dukelodge (FM) Ltd., 132 Gloucester Ave., London NW1. Tel: (01) 722-4306/8213. Mng. Dir.: John Gilbert.
 Dump Music Ltd., see Andrew Heath.
 Dunmo, see Southern.
 Dunster Music, see Eaton.
 Dupree Music, see EMI.
 Durham, see Essex.
 Dyna Music Ltd., see United 2.
 Dynamic Cat Music Ltd. (PRS), 19 New Bond St., London W1Y 9DE. Tel: (01) 408-1788. Mng. Dir.: Peter Barnes.
 E F D S Publ'ns Ltd., see Chappell.
 E G Music Ltd., 63A Kings Rd., London SW3 4NT. Tel: (01) 730-2162. Dirs.: Mark Fanwick, Sam Alder. Int'l reps.: Canada, USA (both EG in USA).
 E M I Film & Theatre Music, see EMI.
 E M I Music Publ'g Ltd., 138-140 Charing Cross Rd., London WC2H 0LD. Tel: (01) 836-6699. Cable: EMIMUS. Telex: 269189. Mng. Dir.: Ron White. Admin. Dir.: Peter Smits; Creative Dir.: Terry Slater; Financial Dir.: David Gray; Prof. Dir. & Gen. Mgr.: Roy Tempest; MOR Dir. & Gen. Mgr.: Kay O'Dwyer; Screen Gems Dir. & Gen. Mgr.: Brian Hopkins; Publ'ns & Overseas Co-Ord. Dir.: Pat Howgill.
 Int'l firms represented: Audigam, BRS Prod'ns, Black Sheep, Bandora, Jeff Barry, Bomass, Bowling Green, Combine, Daniel N. Crewe, Forty Love, Fascotti, Al Gallico, Gold Forever, Gopam, Hearty's Delight, Jiru Music, Kipahulu, Charles Kippis, Kiss Songs, Mabrak Inc., Neighbourhood, Open-Door, RFT, Red Robin/Seven Figure, Eddie Reeves, Quixotic, Resca, Rip/Keka, Rock Steady, Saturday, Shelby Singleton, Special group, Top Sail, Trachelle, Tree, Twitty Bird, Larry Weiss (all USA); J. Albert & Son (Australia), Marouani (France), Tumbleweed (Australia), VAAAP (USSR).
 E R M (Elson Rossiter Meadows) Int'l (Music) Ltd. (MCPS, PRS), 39a Gloucester Pl., London W1H 3PD. Tel: (01) 935-3753. Dirs.: Keith Rossiter, Steve Elson, Sylvia Meadows. Gen. Mgr.: Sylvia Meadows.
 Early Bird, see Carlin.
 Earthly Music Ltd., see Bron.
 Ear Wizard Music Pub., see Leosong.
 East End Music, see Leosong.
 Easy Music SA, c/o Heath Levy Music, 184/186 Regent St., London W1R 5DF. Tel: (01) 439-7731. Chief Exec.: Steve Guston.
 Eaton Music Ltd., 8 W. Eaton Pl., Belgravia, London SW1. Tel: (01) 235-8357. Mng. Dir.: Terry Oates; Dir.: Mrs. M. Oates.
 Int'l firms represented: Canopy, Fergell, Elliott Ferguson, Golden Syrup, Stage & Screen, Sunset Plaza, Taradam, White Oak (all USA).
 Int'l reps.: Australasia, Austria, Benelux, Canada, France, Germany, Italy, Japan, Portugal, Scandinavia, Spain, Switzerland, USA (all Eaton); Central & South America (Beechwood), South Africa (Gallo).
 Ecosse Music, see Sunset.
 Eden, see Essex.
 Eden Studios Music Publ'g Co., see Valentine.
 John Edward Music Ltd., 38/40 Upper Clapton Rd., London E5 8BQ. Tel: (01) 806-1121. Dir.: John Edward.
 Edwards Coletta Music, see EMI.
 Eeeg Music, see Leosong.
 Eez-Er-Gorn Music, see Music Farm.
 Kevin Eggers, see Carlin.
 Eiger Music Ltd., see Panache.
 Ekapa Music, see Leosong.
 Elbow Music, see EMI.
 Elcien Music Ltd., see Noel Gay.
 Eleonora Music, see Leosong.
 Elephant Five Music, see Leosong.
 Eleventh Avenue Theatricals Inc., see Leosong.
 Ellisclan Ltd. (PRS), see Street.
 Elman Music Publ'g Co., 22 Denmark St., London WC2. Tel: (01) 836-1783. Chief Exec.: Ralph Elman.
 Ember Music, see Sparta Florida.
 Emerald Music Ltd. (PRS), 120 Coach Rd., Templepatrick, Ballyclare, County Antrim BT39 0HB, Northern Ireland. Tel: (08494) 32711. Mng. Dir.: Mervyn A. Solomon. Gen. Mgr.: L.R. Paterson. (Administered by Margaret Brace)
 Int'l firms represented: Aesop's Fables (USA), Bospel (Netherlands), Helping Hand (Canada), Jumping Jack (USA), SPR (USA).
 Int'l reps.: Australia (Loeds), Canada (Quality), France (OK Music), Netherlands (Bospel), South Africa (Intersong), USA (Odyssey).
 Emerson Ed. (allied with June Emerson-Wind Music) Windmill Farm, High St., Ampleforth, Yorks. Tel: (04393) 324. Chief Exec.: Geoffrey Emerson.
 Int'l firms represented: Robert King, Music for Brass, Swift-Dorr, Woodwind World (all USA); Daiei/Muramatsu (Japan).
 Int'l reps.: USA (Robert King), Western Europe (G Schirmer).
 Emison Music, see EMI.
 Empire Consul Music Ltd., see Chappell.
 Engel Songs, see Carlin.
 Ennismore Music Ltd., see Rondor.
 Enoch & Sons, see Edwin Ashdown.
 Episode Music Ltd., see EMI.
 Equator Music, see EMI.
 Enquiry, see Carlin.
 Era Music Ltd., see Chappell.
 Erigena Eds. (PRS, MCPS), see Scotus.
 Erie Music Ltd., see Chappell.
 Eros Music Ltd., see Frank Chacksfield.
 Esoteric Music Ltd., 3/21 Hyde Park Square, London W2 2JR. Tel: (01) 299-0329. Mng. Dir.: Steve Royal; Gen. Mgr.: Don White.
 Esquire Music Co., 76 Bedford Court Mansions, Bedford Ave., London WC1B 3AE. Tel: (01) 636-1810. Owner & Gen. Mgr.: Greta Krahrmer.
 Clifford Essex Music, see Music Sales.
 The Essex Music Group, Essex House, 19/20 Poland St., London W1V 3DD. Tel: (01) 734-8121. Cable: SEXMUS. Telex: 22701. Mng. Dir.: David Platz.
 Estimated Time of Arrival, see Leosong.
 Estimated Time of Departure, see Leosong.
 Etude Music, see Leosong.
 Eudamonic Publ'g Co., see Leosong.
 Eugene Music Ltd., see Leeds.
 Eurobeat Ltd., 36 John Dalton St., Manchester M2 6LE. Tel: (061) 834-7292. Mng. Dir.: Irving Wilson; Gen. Mgr.: Johann Levy.
 Int'l firms represented: Beat, Cromo, Curci, Edizioni "71", Gemelli, Giraffa, Nazionale, Picci, Pinciana, Prima, Radio Music, Unifunq. West (all Italy).
 Int'l rep.: Italy (Beat).
 European Music Ltd., see Chappell.
 European North American Music Ltd., see Leosong.
 Evergreen, see Campbell Connelly.
 Evita Music Ltd., see Leeds.
 Evolution Music, Evolution House, 9 George St., London W1. Tel: (01) 486-8361. Telex: 24264. Chief Exec.: Tony Garland; Gen. Mgr.: Joan Michel.
 Exaggeration Music, see Andrew Heath.
 Excellency Music Ltd., see Nems.
 Express Music (London) Ltd., The Studio, 69 Dukes Ave., New Malden, Surrey. Tel: (01) 942-1347. Cable: EXMUSE. Mng. Dir.: Siggy Jackson; Gen. Mgr.: Adrian Jankowski.
 Int'l branch: USA.
 Faber Music Ltd., 3 Queen Square, London WC1N 3AU. Tel: (01) 278-6881. Cable: FABBAF. Telex: 299633.
 Int'l reps.: Australia (Boosey & Hawkes), Austria (Baerenreiter), Belgium (Heugel), Canada (Boosey & Hawkes), Denmark (Wilhelm Hansen), Finland (Fazer), France (Heugel), Germany (Baerenreiter), Hong Kong (Excelsior), Italy (Carisch), Japan (Nippon Gakki), Netherlands (Alberson), New Zealand (Price Milburn), Norway (Norsk), South Africa (Boosey & Hawkes), Sweden (Reimers), USA (G. Schirmer).
 Fabulous, see Essex.
 Face Music Co., see Leosong.
 Fadders Music, see Martin-Coulter.
 Fair Music Ltd., 9 Royal Parade, London SE3 0TL. Tel: (01) 852-4743. Dir.: Chris Williams. (Affiliated with Rondor)
 Int'l rep.: USA (Irving/Almo).
 Fair World Ltd. (PRS), see Rondor.
 Fair World Music, see Rondor.
 Faith Music Ltd., see Island.
 Falcon Music, see EMI.
 Famous Chappell, see Chappell.
 Fancy That Music, see Leosong.
 Fanfare Music Co. Ltd., 27 Forest Dr., Keston, Kent. Tel: (689) 54491, (01) 200-7000. Cable: ATMUS. BROMLEY. Mng. Dir.: Fred Jackson.
 Int'l firms represented: Five Continents (USA), Le Bill (USA).
 Int'l rep.: Germany (Fanfare).
 Fania Publ'g Co., see Leosong.
 Fantasy Songs Ltd., see Island.
 Farlitz Music, see Leosong.
 Fast Western Ltd., 2 York House, Upper Montagu St., London W1. Tel: (01) 723-9559. Mng. Dir.: Richard Lee; Gen. Mgr.: Diana Singh.
 Int'l reps.: Australia (Festival), Benelux (Ariola), Germany (Siegel), Scandinavia (Air), Spain (Discorama), Feldman (trading as Jade), 162 Coombe Ln. W., Kingston-on-Thames, Surrey KT2 7DE. Tel: (01) 942-6240. Telex: 22914. Mng. Dir.: Gray Jones; Gen. Mgr.: Martin Moritz.
 B. Feldman & Co. Ltd., see EMI Music.
 Julie Felix Music Ltd., see RAK.
 Femme Music Inc., see Leosong.
 Fenette Music, see Breitkopf & Haertel.
 Fontone Music, see Breitkopf & Haertel.
 Douglas Ferguson, see Leosong.
 Ferris Music Ltd., see EMI.
 Curtis Fields Music, see Leosong.
 Fernlea Music Ltd., see Chandos.
 Fiddler's Music Ltd., see Barn.
 Fiesta, see Carlin.
 Film Music, see EMI.
 Filmscores Ltd., see Chandos.
 Fireside Music, see Leosong.
 Firesign Music Ltd., see Andrew Heath.
 First Floor Music Ltd., see EMI.
 First Music, see Kassner.
 Fisher & Lane Music, 30 Limekiln Ln., Bridlington, North Humberside YO16 5TH. Tel: (0262) 76388. Dir. & Gen. Mgr.: Robert Fisher.
 Fish Music Publ'g, see Margaret Brace.
 Five Arts Music, see Leosong.
 Five Brothers Music, see Good Move.
 Flam Music Ltd., see Crotchet.
 Flam Music Ltd., see Chappell & RSO.
 Flash Music Ltd., 20 Chatterton Rd., London W10. Tel: (01) 960-4355. Mng. Dir.: Paul K. Walden. (Affiliated with Virgin)
 Fle Music, see Leosong.
 Fleur Music, see Sue Manning.
 Flip Flop Music, see Asterisk.
 Floating Music Ltd., 15 Dawson Pl., London W2 4TH. Tel: (01) 221-5602. Mng. Dir.: G. Lawson.
 Florida Music, see Sparta Florida.
 Fluke, see Carlin.
 Flying D Music Ltd., see Robert Mellin.
 Flying Duck Music Ltd., 69 New Bond St., London SW1. Tel: (01) 408-1606. Chief Exec.: J. F. Townley; Gen. Mgr.: A. J. Gournvish.
 Flying Dutchman Music, see Leosong.
 Flyright Music, 18 Endwell Rd., Bexhill-on-Sea, East Sussex. Tel: (0424) 214-390. Gen. Mgr.: Simon A. Napier.
 Folktracks & Soundpost Publ'ns, Grapevine House, Harborton, Totnes, Devon. Tel: (0803) 863-616. Dir.: Peter Kennedy.
 Folkworld Inc., see Leosong.
 Forestful of Music Ltd., see Chappell.
 Forever Music Ltd., see Noel Gay.
 Formula Music, see Leosong.
 Forrest Hills Music Ltd., see EMI.
 Forsyth Bros. Ltd., 126 Deansgate, Manchester M3 2GR. Tel: (061) 834-3281. Mng. Dir.: D.R. Loat.
 Int'l reps.: Austria (P.J. Tonger), Germany (P.J. Tonger), Netherlands (Broekmans & Van Poppel), New Zealand (Musical Import), South Africa (SA Music Dist.), Switzerland (P.J. Tonger).
 Fortel Music, see Leosong.
 Fourth House Music, see Leosong.
 Four Score Music Co., see EMI.
 Sam Fox Publ'g Co. (London) Ltd., see EMI.
 Francis Day & Hunter Ltd., see EMI Music.
 Franco-London, see Robert Mellin.
 Frank Music & Co. Ltd., see Chappell.
 Freedom Songs Ltd., see Chappell & Island.
 H. Freeman & Co., see EMI.
 Free Enterprise Music, see Leosong.
 Free Reed Music—Old Baptist Chapel, Bridge St., Belper Derby. Tel: (077382) 6264. Mng. Dir.: Neil Wayne.
 Fresh Air Music Ltd. (div. of Tony Hall Group of Cos.), 9 Carnaby St., London W1V 1PG. Tel: (01) 437-1958. Cable: TASTES. Mng. Dir.: Tony Hall.
 Int'l firm represented: Come Il Vento (Italy).
 Freshscape Music, see Barrose.
 Freshwater Music Ltd., see BKM & Island.
 Friday Music Ltd., see Chappell.
 Friday's Child Music, see Leosong.
 Friends Music Ltd., see Carlin.
 Frog Music, 24 Haig Rd., Stanmore, Middx. Tel: (01) 954-0959. Mng. Dir.: Bob Clifford.
 Frontier Music Ltd., 240A/242A Kilburn High Rd., London NW6. Tel: (01) 624-8137.
 Fugal, see Carlin.
 Funway Prod'ns, see Leosong.
 Fuse Music Ltd. (PRS), 4D Oxford & Cambridge Mansions, Old Marylebone Rd., London NW1. Tel: (01) 723-2454. Telex: 847777. Mng. Dir.: Nigel Haines; Gen. Mgr.: Martin Hall.
 Int'l reps.: Canada (Warner Bros.), France (Francis Dreyfus), South Africa (Breakaway), USA (Warner Bros.), rest of world (Intersong).
 Fyne Music, 2 Chester Ave., Southport, Lancs. PR9 7ET. Tel: (0704) 24666. Dirs.: Lou & Gwen Fyne.
 Fynest Music, see EMI.
 G & A Music Ltd., 132 Gloucester Ave., London NW1. Tel: (01) 722-4306/8213. Mng. Dirs.: John D. Gilbert, Neil S. Aspinall. (Administered by EMI).
 G & A Music, 10A Cheval Pl., Knightsbridge, London SW7 1ES. Tel: (01) 584-5622. Dirs.: Geoff Gill, David Beale. Int'l rep.: Worldwide (Dick James).
 G & G Music Ltd., see Intersong.
 G H Music Ltd. (PRS), 2 New Kings Rd., London NW6. Tel: (01) 731-4131. Mng. Dir.: Michael B. Gill; Gen. Mgr.: Dennis P. Collopy.
 Int'l firms represented: Gaff, HG, Riva (all USA), BRM (Australia).
 Int'l reps.: Australia (Rondor), Benelux (Schmolzi & Slezak), Canada (Riva/HG), France (Panache), Germany (Schmolzi & Slezak), Italy (Heath Levy), Japan (Heath Levy), Orient (Burlington-Palace), Scandinavia (Schmolzi & Slezak), South Africa (Heath Levy), Spain (Heath Levy), USA (Riva/HG).
 G L H Music Ltd., see Kassner.
 G-Mac Music, see GGA.
 Gabby Music Co., see EMI.
 Gaberfunzie Music, see Margaret Brace.
 Gabriel Music Co. (PRS), London Pavilion Chambers, Great Windmill St., London W1V BDR. Tel: (01) 734-3424. Cable: SHOWBIZ. Dir.: Philip Hindin; Gen. Mgr.: Eddie Calvert.
 Peter Gabriel Ltd., see Hit & Run.
 Gailtancy Music, see Leosong.
 Gale Music Ltd., 126 Wigmore St., London W1H 0JJ. Tel: (01) 486-7677. Telex: 298455. Dir.: Alan Williams.
 Galerie Music Ltd., see Purple.
 Gallagher & Lyle Music, see EMI.
 Gamble-Huff, see Carlin.
 Gamut Publ'ns Ltd., All Saints' Passage, Cambridge CB2 3LT. Tel: (0223) 51766.
 Garnett Music Ltd., see EMI.
 Garron Music, Kirkland Park Studios, Lethame Rd., Strathaven, Scotland. Tel: (0357) 21130. Dir.: W. B. Garden.
 Gavel Music Co. Ltd., see Noel Gay.
 Felicia Gay Music Co. Ltd., see Noel Gay.
 Noel Gay Music Co. Ltd., 24 Denmark St., London WC2H 8NJ. Tel: (01) 836-3941. Telex: 21760. Mng. Dir.: Richard Armitage; Gen. Mgr. Charles Armitage; Financial Dir.: Ralph Walker.
 Int'l firm represented: Midsong (USA).
 Int'l reps.: Australasia (Rango), France (Claude Pascal), Japan (Shinko), Netherlands (Gaba), Scandinavia (Arne Bendiksen), South Africa (Musicpiece), USA (Noel Gay, Midsong).
 Gee Whiz Music, see Leosong.
 Geirning Ltd., see Hit & Run.
 Generic Music, see Leosong.
 Genesis Music Ltd., see Carlin.
 Geobell Music Co. Ltd., 987 High Rd., Finchley, London N12. Tel: (01) 446-3218. Mng. Dir.: George Bellamy; Dirs.: Dave Richardson, P.R. Johnson.
 Flip Flop Music, see Asterisk.
 Floating Music Ltd., 15 Dawson Pl., London W2 4TH. Tel: (01) 221-5602. Mng. Dir.: G. Lawson.
 Florida Music, see Sparta Florida.
 Fluke, see Carlin.
 Flying D Music Ltd., see Robert Mellin.
 Flying Duck Music Ltd., 69 New Bond St., London SW1. Tel: (01) 408-1606. Chief Exec.: J. F. Townley; Gen. Mgr.: A. J. Gournvish.
 Flying Dutchman Music, see Leosong.
 Flyright Music, 18 Endwell Rd., Bexhill-on-Sea, East Sussex. Tel: (0424) 214-390. Gen. Mgr.: Simon A. Napier.
 Folktracks & Soundpost Publ'ns, Grapevine House, Harborton, Totnes, Devon. Tel: (0803) 863-616. Dir.: Peter Kennedy.
 Folkworld Inc., see Leosong.
 Forestful of Music Ltd., see Chappell.
 Forever Music Ltd., see Noel Gay.
 Formula Music, see Leosong.
 Forrest Hills Music Ltd., see EMI.
 Forsyth Bros. Ltd., 126 Deansgate, Manchester M3 2GR. Tel: (061) 834-3281. Mng. Dir.: D.R. Loat.
 Int'l reps.: Austria (P.J. Tonger), Germany (P.J. Tonger), Netherlands (Broekmans & Van Poppel), New Zealand (Musical Import), South Africa (SA Music Dist.), Switzerland (P.J. Tonger).
 Fortel Music, see Leosong.
 Fourth House Music, see Leosong.
 Four Score Music Co., see EMI.
 Sam Fox Publ'g Co. (London) Ltd., see EMI.
 Francis Day & Hunter Ltd., see EMI Music.
 Franco-London, see Robert Mellin.
 Frank Music & Co. Ltd., see Chappell.
 Freedom Songs Ltd., see Chappell & Island.
 H. Freeman & Co., see EMI.
 Free Enterprise Music, see Leosong.
 Free Reed Music—Old Baptist Chapel, Bridge St., Belper Derby. Tel: (077382) 6264. Mng. Dir.: Neil Wayne.
 Fresh Air Music Ltd. (div. of Tony Hall Group of Cos.), 9 Carnaby St., London W1V 1PG. Tel: (01) 437-1958. Cable: TASTES. Mng. Dir.: Tony Hall.
 Int'l firm represented: Come Il Vento (Italy).
 Freshscape Music, see Barrose.
 Freshwater Music Ltd., see BKM & Island.
 Friday Music Ltd., see Chappell.
 Friday's Child Music, see Leosong.
 Friends Music Ltd., see Carlin.
 Frog Music, 24 Haig Rd., Stanmore, Middx. Tel: (01) 954-0959. Mng. Dir.: Bob Clifford.
 Frontier Music Ltd., 240A/242A Kilburn High Rd., London NW6. Tel: (01) 624-8137.
 Fugal, see Carlin.
 Funway Prod'ns, see Leosong.
 Fuse Music Ltd. (PRS), 4D Oxford & Cambridge Mansions, Old Marylebone Rd., London NW1. Tel: (01) 723-2454. Telex: 847777. Mng. Dir.: Nigel Haines; Gen. Mgr.: Martin Hall.
 Int'l reps.: Canada (Warner Bros.), France (Francis Dreyfus), South Africa (Breakaway), USA (Warner Bros.), rest of world (Intersong).
 Fyne Music, 2 Chester Ave., Southport, Lancs. PR9 7ET. Tel: (0704) 24666. Dirs.: Lou & Gwen Fyne.
 Fynest Music, see EMI.
 G & A Music Ltd., 132 Gloucester Ave., London NW1. Tel: (01) 722-4306/8213. Mng. Dirs.: John D. Gilbert, Neil S. Aspinall. (Administered by EMI).
 G & A Music, 10A Cheval Pl., Knightsbridge, London SW7 1ES. Tel: (01) 584-5622. Dirs.: Geoff Gill, David Beale. Int'l rep.: Worldwide (Dick James).
 G & G Music Ltd., see Intersong.
 G H Music Ltd. (PRS), 2 New Kings Rd., London NW6. Tel: (01) 731-4131. Mng. Dir.: Michael B. Gill; Gen. Mgr.: Dennis P. Collopy.
 Int'l firms represented: Gaff, HG, Riva (all USA), BRM (Australia).
 Int'l reps.: Australia (Rondor), Benelux (Schmolzi & Slezak), Canada (Riva/HG), France (Panache), Germany (Schmolzi & Slezak), Italy (Heath Levy), Japan (Heath Levy), Orient (Burlington-Palace), Scandinavia (Schmolzi & Slezak), South Africa (Heath Levy), Spain (Heath Levy), USA (Riva/HG).
 G L H Music Ltd., see Kassner.
 G-Mac Music, see GGA.
 Gabby Music Co., see EMI.
 Gaberfunzie Music, see Margaret Brace.
 Gabriel Music Co. (PRS), London Pavilion Chambers, Great Windmill St., London W1V BDR. Tel: (01) 734-3424. Cable: SHOWBIZ. Dir.: Philip Hindin; Gen. Mgr.: Eddie Calvert.
 Peter Gabriel Ltd., see Hit & Run.
 Gailtancy Music, see Leosong.
 Gale Music Ltd., 126 Wigmore St., London W1H 0JJ. Tel: (01) 486-7677. Telex: 298455. Dir.: Alan Williams.
 Galerie Music Ltd., see Purple.
 Gallagher & Lyle Music, see EMI.
 Gamble-Huff, see Carlin.
 Gamut Publ'ns Ltd., All Saints' Passage, Cambridge CB2 3LT. Tel: (0223) 51766.
 Garnett Music Ltd., see EMI.
 Garron Music, Kirkland Park Studios, Lethame Rd., Strathaven, Scotland. Tel: (0357) 21130. Dir.: W. B. Garden.
 Gavel Music Co. Ltd., see Noel Gay.
 Felicia Gay Music Co. Ltd., see Noel Gay.
 Noel Gay Music Co. Ltd., 24 Denmark St., London WC2H 8NJ. Tel: (01) 836-3941. Telex: 21760. Mng. Dir.: Richard Armitage; Gen. Mgr. Charles Armitage; Financial Dir.: Ralph Walker.
 Int'l firm represented: Midsong (USA).
 Int'l reps.: Australasia (Rango), France (Claude Pascal), Japan (Shinko), Netherlands (Gaba), Scandinavia (Arne Bendiksen), South Africa (Musicpiece), USA (Noel Gay, Midsong).
 Gee Whiz Music, see Leosong.
 Geirning Ltd., see Hit & Run.
 Generic Music, see Leosong.
 Genesis Music Ltd., see Carlin.
 Geobell Music Co. Ltd., 987 High Rd., Finchley, London N12. Tel: (01) 446-3218. Mng. Dir.: George Bellamy; Dirs.: Dave Richardson, P.R. Johnson.

Geronimo Music Ltd., see Rondor.
 Gerrard Music, see EMI.
 Getaway, see Carlin.
 Giant Music Publ'g Ltd., see Terry King.
 Robin Gibb Publ'g Ltd. (PRS), see Lupus.
 Gigolo Music Co., see Leosong.
 Ian Gillan Music Ltd., see Purple.
 Glad Music Ltd., see Shapiro, Bernstein.
 Glendale, see Campbell Connelly.
 Glitterbest Ltd., see Warner Bros.
 Glocken Verlag Ltd., 10/16 Rathbone St., London W1P 2BJ. Tel: (01) 580-2827. Dirs.: Dr. O. Blau, R.M. Toeman, S. Buchman.
 Gloria, see Carlin.
 Gloucester Music, see Sparta Florida.
 Glove Music Ltd., see Purple.
 Go Ahead Music Ltd., see Amphonic.
 Gold Disc, see Carlin.
 Golden Egg Music, see Dick James Music Ltd.
 Goldsmith Music, see Castle Hill.
 Golora Music Co., see Valentine.
 Gonzales, see Woolfsongs.
 Jack Good, see Carlin.
 Good Child Music, see Leosong.
 Good Move Music, 27 Spedan Close, Branch Hill, London NW3. Tel: (01) 435-5302. Mng. Dir.: Phil Simmonds.
 Good Music Ltd., 10 Gray's Inn Square, London WC1R 5JJ. Tel: (01) 242-5582. See Cyril Shane).
 Goodsongs, see April.
 Goombay Music, see Leosong.
 Gouda Music, see Leosong.
 Grade & Lynton Music Ltd., 24 Bruton St., London W1. Tel: (01) 499-0673. Telex: 28526. Chm.: Paul Grade; Mng. Dir.: Paul Lynton.
 Grade One Music Ltd., see Red Bus.
 Graduate Music, 1 Union St., Dudley, W. Midlands. Tel: (0384) 59048. Owner: David Vire.
 Graphle Music Ltd., see Chappell.
 Gralto Music Ltd., see Dick James.
 Grandma Annie Music, see Leosong.
 Grant Music Ltd., see Marco.
 Grape Time Ltd., see Bloomsbury.
 Grapevine Music, see Leosong.
 Grater Music Co., see EMI.
 Great Sterling Music Ltd., see Robert Mellin.
 Gredge Music, see Leeds.
 Greene Music Inc., see Leosong.
 Greene-Stone Music, see Leosong.
 Greesco Music, see Leosong.
 Greensleeves Publ'g, 44 Uxbridge Rd., Shepherds Bush, London W12. Tel: (01) 749-3277. Mng. Dir.: Chris Sedgwick.
 Greenwish, see Essex.
 Greenwich Gramophone Publ'g Co., see The Les Reed Org.
 Greenwood Music Ltd., see Margaret Brace.
 Grigg Music, see Trafalgar.
 Grob-Chappell Music Co. Ltd., see Chappell.
 Guest & Edwards Music, see Metropolitan.
 Gull Songs, 169 High Rd., Willesden, London NW10. Tel: (01) 459-8657. Telex: 24224 Ref. 2275. Mng. Dir.: David Howells.
 Int'l reps.: Austria (Melodie der Welt), France (Panache), Germany (Melodie Der Welt), Japan (Pacific), New Zealand (Boom Boom), Portugal (Intersong), Scandinavia (Air), South Africa (Intersong), Spain (Intersong), Switzerland (Melodie Der Welt), USA (Heath Levy).
 A. Gutheil (Ed.), see Boosey & Hawkes.
 Gwyneth Music Ltd., see Dick James.
 H G Music, see GH.
 Hagen Music Ltd., see Compass.
 Halcyon Music Ltd., 126 Wigmore St., London W1H DJJ. Tel: (01) 486-7676. Telex: 298455. Dirs.: Alan Williams, John Richardson.
 Halmusic Ltd., see Sparta Florida.
 Peter Hamilton Music Ltd., 42 Kilmarnock Rd., Glasgow, Scotland G41. Tel: (041) 632-9269. Mng. Dir.: Peter Hamilton; Gen. Mgr.: Robert Stewart.
 Handle Music, 1 Derby St., London W1. Tel: (01) 493-9637. Mng. Dir.: Cathi Gibson; Dir.: David Walker. (Also see Brand New Music).
 Int'l reps.: Worldwide excluding UK & Ireland (Handle—Chappell, Sweet—Intersong).
 Hansa Prod'n Ltd., 12 Bruton St., London W1X 7AH. Tel: (01) 493-9766. Telex: 298777. Mng. Dir.: Peter Meisel.
 Charles Hansen Music & Books, see Hansen.
 Charles H. Hansen Music Corp., see Leosong.
 Hansen House (London) Ltd., 64 Dean St., London W1V 5HU. Tel: (01) 437-7288. Chief Exec.: Charles H. Hansen; Gen. Mgr.: Barbara Bevis.
 Happy Face Music Publ'g Co. (MPA), The Old Smithy, Post Office Ln., Kempsey, Worcs. WR5 3NS. Tel: (0905) 820-659. Chief Exec.: Muff Murfin; Gen. Mgr.: V.B. Murfin.
 Hara Kiri Music Ltd., see Island.
 Eddie Hardin Music Ltd., see Chappell.
 Hardor Music Co., see Valentine.
 Hardwick Music, see Hedley.
 Harmarlane Music Ltd., see Eaton.
 Harmer Music Co., see Studio Music.
 Harmonic Music Publ'g Co. Ltd., see C. Brull.
 Harmony, see Essex.
 Harriet Music Ltd., see Robert Mellin.
 Frederick Harris Music Co. Ltd., see Alfred Lengnick.
 Harrison, see Campbell Connelly.
 Harvard Music Ltd., see Noel Gay.
 Hawkana Music, see Arnakata.
 Hawkes & Son (London) Ltd., see Boosey & Hawkes.
 Haystack Music Ltd., see ATV.
 Hazelmere Music Ltd., see Noel Gay.
 Lee Hazelwood, see Carlin.
 Hazy Music Ltd., 9 Ravenscroft Ave., London NW11 0SA. Tel: (01) 455-4556. Mng. Dir.: Barbara M. Hayes.
 Hazzard Music Ltd., see Bron.
 Head Music Ltd., see Leosong.
 Headpean Ltd., see ATV.
 Heartbeat, see Cherry Red.
 Andrew Heath Music Ltd., 81 Harley House, Marylebone

Rd., London NW1. Tel: (01) 487-5587. Telex: 298415. Mng. Dir.: Andrew Heath.
 Heath Levy Music Co. Ltd., 184/186 Regent St., London W1R 5DF. Tel: (01) 439-7731. Telex: 27557. Mng. Dirs.: Geoffrey Heath, Edward Levy; Financial Dir.: M. Iqbal.
 Heath Music, see Warner Bros.
 Allan Heather Music, see Valentine.
 Heathside Music, see Logo.
 Hec Music, see EMI.
 Hedley Music, 71 Rutland Rd., Chesterfield, Derbys. S40 1ND. Tel: (0246) 79976. Mng. Dir.: Tony Hedley; Gen. Mgr.: Malcolm Perkins.
 Int'l branch: USA.
 Hena Publ'g, see Leosong.
 Henderson, see Bloomsbury.
 Henny Music, see Sparta Florida.
 Henrees Music Co., see EMI.
 Hensley Music Publ'g Co. Ltd., 29 Clarendon Rd., London W11. Tel: (01) 727-5118. Mng. Dir.: Tony Evers. (Affiliated with Intersong).
 Int'l firms represented: Midnight Sun (Sweden), Televis (Italy).
 Int'l rep.: Worldwide (Intersong).
 Hercules, see Carlin.
 Hermusic Ltd., see EMI.
 Hero Music Ltd., see Peter Rice.
 Heruxuti Prod'ns Ltd., see Leosong.
 Hey Look Music Co., see EMI.
 Highland Music Co. Ltd., see Beautiful Sunday.
 Highway Publ'g, see Leosong.
 Hilda Music, see Barry Collings.
 Hillcrest Music Ltd., see Robert Mellin.
 Tony Hiller Music Ltd., 24 Bruton St., London W1X 7DA. Tel: (01) 409-2211. Cable: TONYMUSIC. Chm.: Tony Hiller. (Affiliated with ATV).
 Int'l reps.: Canada (Attic), France (Vogue), Germany (Discont), USA (Silver Blue).
 Hillrent Music Ltd., 11 Albemarle St., London W1. Tel: (01) 493-3651.
 Int'l firms represented: Berkeley Square, Church Lane (both USA).
 Hi-Man Music Ltd., see Fuse.
 Hi-Time Music Ltd., see ATV.
 Hit & Run Music Publ'g Ltd., 55-59 Shaftesbury Ave., London W1V 7AA. Tel: (01) 439-8451. Telex: 8952998. Chm.: John Anthony Smith; Gen. Mgr.: Gareth J. Perkins.
 Int'l firms represented: Run It (USA), Venerable (USA).
 Int'l reps.: Worldwide (Intersong) excluding Canada (Run It), Ireland, Japan (Shinko), USA (Run It).
 Hit Songs Ltd., see Bron.
 M. Hohner Ltd., 39/45 Coldharbour Ln., London SE5 9NR. Tel: (01) 733-4411.
 Int'l firm represented: M. Hohner (Germany).
 Hollywood Music, see John Edward.
 Homemade Music Ltd. (PRS), 97 Rosebery Rd., Muswell Hill, London N10. Tel: (01) 444-9440. Mng. Dir.: Donny Marchand; Gen. Mgr.: John Levy.
 Honest Injun Music, see Panache.
 Honest Pleasure Prod'ns, see Budd.
 Honey Music Co. Ltd., see Rock Music.
 Honeyhill Music Ltd., see ATV.
 Honeywell Music Ltd., see ATV.
 Horizon Music Publ'g, Horizon House, Warwick Rd., Coventry. Tel: (0203) 21000. Telex: 312135. Chief Exec.: Barry H. Thomas; Gen. Mgr. & Eng.: K.T. Holmes.
 Hournew, see Campbell Connelly.
 Howlin' Music, 114 Lower Park Rd., Loughton, Essex. Tel: (01) 508-4564. Air Call (01) 828-5621 Code 1970. Chief Exec.: Howard Marks.
 Hud Songs Ltd., see Chappell.
 Hudson Music Co. Ltd., see De Wolfe.
 Hugg Music Ltd., see Intersong.
 Humber Music Ltd., see Carlin.
 Hunkey Dorey Music, see Leosong.
 Hurricane Music, see EMI.
 Hush-A-Bye Music SA, see The Les Reed Org.
 Hush Music Ltd., 8 Albert Gate Court, 124 Knightsbridge, London SW1. Tel: (01) 589-6293. Dirs.: Jonathan Rowlands, Judy London.
 I G B Music, see Purple.
 Ilona Music, see April.
 Imagination Music Ltd., 1-2 Berners St., London W1P 3A6. Tel: (01) 622-1874. Mng. Dir.: Stephen Bankler-Jukes; Gen. Mgr.: Fred Parsons.
 Imagine Music Ltd., see Rocket.
 Indigo, 72-74 Garside St., Manchester M3 3EL. Tel: (061) 834-7001. Mng. Dir.: David Kent-Watson.
 Industrial Recs. Ltd. (PRS), 10 Martello St., London E8. Tel: (01) 254-9178. Mng. Dir.: Peter Christopherson; Gen. Mgr.: Chris Carter.
 Int'l reps.: France (Celluloid/Decibel), USA (Independent Rec'g Syndicate).
 Initial Music Ltd., see EMI.
 Injun, 7 Mill Cottages, Bucks Green, West Sussex. Tel: Rudgwick 2829. Chief Exec.: P. M. Chalmers; Gen. Mgr.: F.J. Chalmers.
 Int'l firms represented: Grandweath, Showay, Westport (all USA).
 Inkwell Music Ltd. (PRS), 69 New Bond St., London W1Y 9DE. Tel: (01) 408-1788. Mng. Dir.: Peter Barnes.
 Instant Music, see John Edward.
 In-Sync Music Ltd., see Robert Mellin.
 Inter-Art Co. Ltd., see Josef Weinberger.
 Internationale Musik Produktion, 28 Alloo Rd., Goodmayes, Ilford, Essex.
 Home office: USA.
 Interplay Music, see Leosong.
 Intersong Music Ltd., 50 New Bond St., London W1. Tel: (01) 499-0067. Dir.: Bruno Kretschmar.
 Int'l firms represented: Affinitia, Ajay, Belikat, Big Apple, Bohannon, Bullhorn, Cafe Americana, Cape Ann, Cape May, Clarkee, Downtown, Dynatone, Fifth Floor, Jiru, Kaskat, Kenya, Kings Point, Kurlay, Laurel Canyon, Little Lasso, Maybe, Moonhill, Noodle Tunes, Pinpong, Quark, Quick Mix, Ricks, Sambo, Skunkster, Snugeflat Lizard, Soquel, Strobe Light, Tauripin Tunes, Three Cheers, Top Of The Town, Two One Two, Wescraft,

Windecor, Zevon (all USA); Hanseatic/Happy (Germany).
 Int'l reps.: Australia (Intersong), Austria (Aberbach), Belgium (Intersong Primavera), Brazil (Intersong), Canada (Belinda/Intersong), Denmark (Intersong), France (Intersong Continental, Intersong Pigalle, Intersong Paris), Germany (Aberbach, Artemis, Intersong Int'l), Greece (Intersong Hellas), Japan (Intersong), Mexico (Intersong), Netherlands (Artemis, Intersong Basart), Singapore (Intersong), South Africa (Intersong), Spain (Canciones del Mundo, Ed. Fontana), Sweden (Intersong), Switzerland (Aberbach, Arena), USA (Belinda/Intersong).
 Intersong Int'l Musikverlag GmbH, 13 St. George St., London W1R 9DE. Tel: (01) 629-7600. Pres.: Heinz T. Voigt; Gen. Mgr.: Ron R.C. Sollefeld.
 Int'l firms represented: (See Artemis in the Netherlands).
 Int'l reps.: (See Intersong Int'l in Germany).
 Interworld Music Ltd., 15 Berkeley St., 6th fl., London W1. Tel: (01) 491-3401. Cable: INTERMUSIC. Dir.: John Valasco; Gen. Mgr.: Laxley Duncan.
 Int'l firms represented: Interworld, Six Continents, World Song.
 Int'l reps.: Australia (Associated), Brazil (Victor), France (LEM), Germany (UFA Discoton), Italy (RCA), Japan (Taiyo), Mexico (EMLASA), Netherlands (Universal), South Africa (Cian), Sweden (Sweden).
 Intune Music Ltd., see Dick James.
 Ipanema Music Ltd., see Chappell.
 Isa Music, see Peter Hamilton.
 Island Music Ltd., 22 St. Peters Square, London W12. Tel: (01) 741-1511 Cable: ACKEE. Mng. Dir.: Peter Cornish; Creative Mgr.: Keith Aspden.
 Int'l firms represented: Ackee, Average, Berna, Canaan, Chicago, Island, Kedrick, Rodra (all USA).
 Int'l reps.: Australia (Festival), Austria (Melodie der Welt), Belgium (Hans Kuster), Canada (Island/Ackee), Far East (Burlington-Palace), France (Panache), Germany (Melodie der Welt), Greece (Intersong), Italy (Fama), Japan (Taiyo), Netherlands (Nada), New Zealand (Festival), Portugal (Armonico-Clipper's), Scandinavia (Sonet), South Africa (Music Publ'g Co.), South America (Artemis), Spain (Armonico-Clipper's), Switzerland (Melodie Der Welt), USA (Island/Ackee).
 Ivy, see Campbell Connelly.
 Iwo Music Inc., see Leosong.
 J B Music, see Margaret Brace.
 J D L Music, see Purple.
 J & E Music Ltd., see Leosong.
 J P Music Ltd., see Chappell.
 Jackson Music Ltd., see ATV & EMI.
 Jackson Rec'g Co. Ltd., The Studios, Rickmansworth, Herts. Tel: (09237) 72351. Cable: JACMUSIC. Telex: 26228A.
 Jade Music, see EMI.
 Jade Ring Music Co., see Leosong.
 Jaf Music, see Paul Rodriguez.
 Jalew Music, see Leosong.
 Jama Music, 1 Brixton Station Rd., Brixton, London SW9. Tel: (01) 737-3557. Owner: Euel Johnson; Gen. Mgr.: L. Scarlett.
 Jamaica Publ'g, see Leosong.
 Dick James Music Ltd., James House, 5 Theobalds Rd., London WC1X 8SE. Tel: (01) 242-6886. Cable: DEJAMUS. Telex: 27135. Chm. & Mng. Dir.: Richard L. James; Dir.: Stephen M. James; Group Bus. Affairs Co-ord.: Paul M. Davis; Financial Controller: Robert H. Lake; Gen. Mgr.: David Ions.
 Int'l branches: Australia, France, Germany, Italy, Japan, Netherlands, Scandinavia, Switzerland, USA.
 Int'l firm represented: Tic Toc (Switzerland).
 Int'l reps.: Brazil (Fernata), Far East (Pathe), Greece (Arion), Mexico (Musart), South Africa (Leeds), Spain (Discorama).
 Nicky James Music Ltd., see Peter Rice.
 Jamitin Music Co., see Leosong.
 Jammy Music Pub's Ltd., Inchbarn House, 957 Dumbarton Rd., Glasgow, Scotland G14 9UF. Tel: (041) 334-9722. Mng. Dir.: John MacCalman; Gen. Mgr.: Andrew Harvey.
 Jamsham Music Ltd., see Dick James.
 Jangle Music, see Leosong.
 Janna Music Ltd., 6 Brasslands Dr., Portlady-by-Sea, Sussex. Tel: (0273) 419441. Mng. Dir.: John MacLeod.
 Jano Music Ltd., see Olofson.
 Janus Music, see Forsyth Bros.
 Jardiniere Music, see Intersong.
 Jarrow Music Ltd., see ATV & EMI.
 Jasan Prod'ns Ltd., see Janna.
 Jasper Music Publ'g Co., see Leosong.
 Jayman Music Ltd., see Sunbury.
 Jeeves Music Ltd., see Leeds.
 Jelly Music Ltd., see Nems.
 Jelly Publ'g Ltd., see Nems.
 Jenevieve Music, see Panache.
 Alfred Jenkins, see Leosong.
 Caesar Jenkins, see Leosong.
 Jeremy Rose Music, see EMI.
 Jet Music Inc., 102-104 Gloucester Pl., London W1. Tel: (01) 486-6040. Telex: 298995. Chm. & Mng. Dir.: Don Arden.
 Jetstar, see Carlin.
 Jewel Music Publ'g Co. Ltd., see Chappell.
 Jig-Saw Music Ltd., 115 Old Lodge Ln., Purley, Surrey. Tel: (01) 868-3457. Dirs.: Dave & Sue Williams.
 Jigsaw Music, see RMO.
 Jill Music Ltd., see Collins & RAK.
 Jitney Jane Songs, see Leosong.
 Jiving Brothers, see R. Smith.
 Jo-Al Music Co., see Leosong.
 Joaneline, see Carlin.
 Joani Brightarp, see Leosong.
 Jobete Music (UK) Ltd., 16 Curzon St., London W1. Tel: (01) 493-1603. Telex: 8811658. Mng. Dir.: Peter Prince; Gen. Mgr.: James Fisher.
 Jody Boye Music, see Leosong.
 John Songs, see Leeds.
 Jonali Music Inc., see Leosong.

- Jonathan Music Ltd., see Nems.
 Jonjo Music Co. Ltd., see Marquis.
 Jory Music Co., see EMI.
 Josid Music Ltd., see Dick James.
 Josley Music, see Carlin.
 Josomo Music Co., see Leosong.
 Junic Prod'ns Ltd., 684 Fulham Rd., London SW6 5SA. Tel (01) 736-5877. Dir.: Julian Beauchamp. Gen. Mgr. Nicolas Smith.
Int'l firms represented: Music Control (France), Semp (Trinidad).
 Justunes (PRS), see Bright & Leeds.
 K Songs Ltd., see Page Full of Hits.
 K P M Music Group, see EMI.
 K P M Sound Studios, see EMI.
 Kadence Music Co., see EMI.
 Kalmann, see Carlin.
 Alfred A. Kalmus Ltd., 2/3 Fareham St. (Dean St.), London W1V 4DU. Tel. (01) 437-5203. Cable ALKAMUS.
 Dirs.: J. Palmer, M. Herrmann, W.M. Collieran, A. Schlee (Austrian), S. G. Harpner (Austrian).
 Kama Sutra Music Ltd., see United Artists.
 Kamakazi Music Corp., see Chappell.
 Kamikazi Music, see Carlin.
 Kassner Assoc'd Publ'rs, Broadmead House, 21 Panton St., London SW1. Tel. (01) 839-4672. Cable KASSMUSIC. Telex: 24158. Mng. Dir.: Edward Kassner. Gen. Mgr. David Kassner.
Int'l reps: Australia (Castle), Japan (Victor), South Africa (Southern), USA (Copyright Serv. Bureau).
 Edward Kassner Music Ltd., see Kassner.
 Katie Music, see Sue Manning.
 Keepers Cottage Music Ltd., see Island.
 Kelso Herston Music, see Leosong.
 Kenbill Music (PRS, MCPS), 16 Hampstead Gardens, Golders Green, London NW11. Tel. (01) 340-3598. Owner: Bill Crompton.
 Kenmar Music Co., 9 Dean St., 3rd fl., London W1A 4QD. Tel. (01) 437-3711. Owner: Margaret Brace; Gen. Mgr. Sandra Cackett. (Also see Margaret Brace & Marrow).
Int'l rep: Australia (Castle).
 Kennedy Music, 22 Park Crescent, Suite 55, London W1. Tel. (01) 637-8112. Mng. Dir.: Edward Kennedy; Gen. Mgr. William J. Kennedy.
 Kennedy St. Music Ltd., see EMI.
 Kennel Music, 20 Cotton Ln., Withington, Manchester 20. Tel. (061) 445-2661. Gen. Mgr.: Lawrence Beedle.
 Kennett Music Co., see Leosong.
 Kennick Music Ltd., 50 Cadogan Square, Flat 3, London SW1X 0JW. Tel. (01) 589-7711/8861. Telex: 268048. Gen. Mgr.: Nicola Merton.
 Kensington, see Essex.
 Kent Music, see EMI.
 Kernel Music, see Ad-Chorel.
 Ketch-Up Music Co., see Leosong.
 Kevin Music, see EMI & The Les Reed Org.
 Kewpie Music, see Leosong.
 Key, see Essex.
 Keyboard-Pendulum Music Ltd., see Pendulum.
 Keyhole Music Ltd., see EMI.
 Keymen Music, see Leosong.
 Kicking Mule Music, see Sonet.
 Kids Music Ltd., see RAK.
 Kieron, see Carlin.
 Terry King Assocs., 9-11 Monmouth St., London WC2. Tel. (01) 836-4761. Mng. Dir.: Terry King.
 Kingscourt Music, see Gabriel.
 Kingsize Songs Ltd., see Cyril Shane.
 Kingsley Music, see EMI.
 Robert Kingston Music Ltd., 34 Windmill St., London W1P 1HH. Tel. (01) 636-9242. Chm.: Robert Charles Kingston.
Int'l firms represented: Bolero Musimex (Mexico), Brambila (Mexico), Musicways/Real Fine Songs (USA), Nichion (Japan), September (USA).
Int'l reps: Mexico (Bolero Musimex), USA (September).
 Kissoun Music, see State.
 Kirzo Music, see Leosong.
 Klub Music Ltd., see Martin-Coulter.
 Klynch Music Ltd., see Fanfare.
 Knox, see Carlin.
 Konkwest Music Ltd., 84/86 Tottenham Ln., Hornsey, London N8 7EE. Tel. (01) 340-7873/4757. Dirs.: Ray & Dave Davies.
 Alexis Korner Music, see Philip P. Roberge.
 Korvaline Music, see EMI.
 Krandon Music Co., see Leosong.
 Kristannar Music Ltd., 33 Park Chase, Wembley, Middx. Tel. (01) 902-2024. Mng. Dir.: Eddie Stevens.
 L E Music, Nelson House, Castle Hill Rd., Hindley, Wigan, Lancs. WN2 4BH. Tel. (0942) 55871. Telex: 62594. Chief Exec.: W. Leyland; Gen. Mgr.: D. Larbey.
 L O E Music, 28 Lexington St., London W1R 3HR. Tel. (01) 734-3443. Mng. Dir.: Hiroshi Kato; Gen. Mgr.: Jim Russell.
Int'l firm represented: Music Boutique (Japan).
 Lad Music Ltd., see Peter Rice.
 Ladysmith Music, see State.
 J. R. Laffeur & Son Ltd., see Boosey & Hawkes.
 Lakeview, see Essex.
 Lamaja Music Publ'g, see Leosong.
 Lee Lambert Music Ltd. (PRS), 506-508 Kingsbury Rd., London NW9. Tel. (01) 204-9422. Cable LAMMETALS. Mng. Dirs.: Bill Lee, Howard Lambert.
 Lancia Music, see EMI.
 Landester Music Ltd., see Intersong.
 Lark, see Carlin.
 Larkworth Ltd., see Panache.
 J. H. Larway, see Edwin Ashdown.
 Latchmere Music Co., see Valentine.
 Latimer Music, see Leosong.
 Latin American, see Southern.
 Derek Lawrence Music Co. Ltd., see EMI.
 Leading Music Ltd., see Jet.
 Leading Note Ltd., 209 Rochdale Rd., Greetland, Halifax, West Yorks. HX4 8JE. Tel. (0422) 76161. Mng. Dir.: Bill Leader. (Also see Logo).
 Le Bill Music Ltd., 27 Forest Dr., Keston, Kent. Tel. 200-7000. (Administered by Fanfare).
Home office: USA.
 Leblon Music Corp., see Leosong.
 Led Songs, see Panache.
 Leeds Music Ltd., 138 Piccadilly, London W1V 9FH. Tel. (01) 629-7211. Cable LEEDSMUSIC. Telex: 22409. 22219. Mng. Dir.: Cyril Simons; Dirs.: Robert Lamont, Ray Webb; Copyright Mgr.: Robert Lamont; Co. Sec'y: Ray Webb; Exploitation Mgr.: Alma Warren.
Int'l firms represented: Far Out, Rawlou, Spooone, Vector (USA).
Int'l reps: Argentina (Korn), Australia (Leeds), Belgium (MCA), Brazil (MCA), Canada (Leeds), France (MCA), Germany (MCA), Italy (Pickwick), Japan (MCA), Netherlands (MCA), South Africa (Leeds), Spain (Southern), Sweden (MCA), USA (MCA).
 Legion Theatre Prod'ns, 23-24 Greek St., London W1. Tel. (01) 437-3066. Chm.: Stephen Baron Bentinck. Mng. Dir.: Christos Demetriou.
 Leiber-Stoller, see Carlin.
 Lemmel Music Ltd., 9 Dean St., London W1V 5RL. Tel. (01) 734-4543. Cable RIMUSIC. Telex: 28905 RF 580. Chm.: R.F.G. Dennis; Exec. Dir.: Charles Berlan.
Int'l firm represented: Plymouth (South Africa).
Int'l reps: Australia (Castle), Belgium (Baltic), Netherlands (Basart), New Zealand (Castle Music), South Africa (Plymouth).
 Alfred Lengnick & Co. Ltd., Purley Oaks Studio, 421a Brighton Rd., South Croydon, Surrey CR2 6YR. Tel. (01) 660-7646. Mng. Dir.: C.R.L. Avenell; Gen. Mgr.: Mrs. L. Jackson.
Int'l firms represented: CeBeDeM (Belgium), Frederick Harris (Canada), Icelandic Music (Iceland).
Int'l reps: Canada (Frederick Harris), Germany (A. Benjamin), South Africa (SA Music Dists.), Switzerland (A. Benjamin), USA (Frederick Harris).
 Lemon Music, see April.
 Cecil Lennox Ltd., see Kassner.
 Leonard, Gould & Boltier, see J.B. Cramer.
 Hal Leonard Publ'g, 18 Claridge House, 32 Davies St., London W1Y 1LG. Tel. (01) 499-2742. Telex: 261415. Int'l Opns. Dir.: Robert Hirschman; Sales Rep.: Steven Wilson.
Int'l rep: Spain (Music Distribution).
 Leosong Copyright Serv. Bureau Ltd., 28 Bolton St., London W1Y 8HB. Tel. (01) 491-3966. Mng. Dir.: David A. Simmons; Gen. Mgr.: Ray S. Ellis.
Int'l reps: Canada (Copyright Serv. Bureau), France (CSB), Germany (CSB), Japan (CSB Ltd./Hara Int'l), South America (CSB), USA (Copyright Serv. Bureau).
 Lespedeza Music, see Leosong.
 Leton Music, see Leosong.
 Leviathan Music, see Music Farm.
 Le Vien Music Ltd., see Chappell.
 Jerry Lee Lewis Music, see Leosong.
 Liber-Southern, see Southern.
 Libra Music Ltd., 22 St. Peters Square, London W6. Tel. (01) 731-3144. Chief Exec.: Sandy Robertson (Affiliated with Island).
 Liftglow Music Ltd., see ATV.
 Light Music Ltd., 33 Bryanston Square, Suite 18, London W1H 7LR. Tel. (01) 402-4810. Mng. Dir.: Trevor Lyttleton.
 Lightning Music Ltd., 841 Harrow Rd., Harlesden, London NW10 5NH. Tel. (01) 969-5255/7155. Telex: 927813. Chm.: Raymond Laren; Gen. Mgr.: Norman M. Mandell.
Int'l reps: Worldwide (Heath Levy, Asterisk for Chippglow).
 Lillian Music, see Mervyn.
 Limbridge Music Ltd., see Compass.
 Line Music, see EMI.
 Lingasong Ltd., see Leosong.
 Linvoy, see Carlin.
 Lissauer Music Ltd., see Chappell.
 Lit Cal Music, see Leosong.
 Littlechap Music, see Jeff Wayne.
 Little Feather Music Ltd., see Chappell.
 Lloyd & Logan Music Inc., see Leosong.
 Lobek Music, see Leosong.
 LoBo Music Ltd., see Fuse.
 Lodge Music Ltd., Manor Lodge, Vale of Health, London NW3. Tel. (01) 435-6111. (Also see Panache).
 Logo Music, 86 Marylebone High St., London W1M 4AY. Tel. (01) 486-4353. Cable TRADISC. Telex: 25532. Mng. Dir.: Geoff Hannington; Gen. Mgr.: Rob Gold.
Int'l firms represented: Char-Liz (USA), Intermusic (Netherlands), Kitchen Table (Canada), Linda (USA), Rodeo (USA), Rosebud (USA), VIP New Bag (USA).
Int'l reps: Far East (Heathside—Burlington-Palace), South America (Fermata), Austria (Slezak), Belgium (Universal), Canada (Heathside—BJC), France (Heathside—Francis O'Neill), Germany (Slezak), Italy (Heathside—Armando, Logo—Ricordi), Japan (Heathside—TRO-Exsex), Mexico (Heathside—Consortio), Netherlands (Universal), South Africa (Heathside—Musicipiece), Spain (Heathside—Southern), Sweden (Sonet).
 London Tree Music Ltd., see Leeds.
 London Tunemith Ltd., Pavilion House, 6 Sherlock Mews, London W1M 3RH. Tel. (01) 486-3883. Telex: 21626. Mng. Dir.: Michael Weston; Gen. Mgr.: Norma King.
 Long & Short Music, see Leosong.
 Looking Glass Music, 498-500 Harrow Rd., London W9. Tel. (01) 960-5577. Mng. Dirs.: Max Hole, Geoff Jukes, David Simmons. (Affiliated with Plant Life & Leosong).
Int'l firm represented: Pigs Whisker (USA).
 Loose Music, 296 Chiswick High Rd., London W4 1PA. Tel. (01) 995-6755. Mng. Dir.: Andrew J. Titcombe.
 Loraine Music, see Sparta Florida.
 Lords Music Co. Ltd., see Dick James.
 Lorjory Music, see Leosong.
 Louvigny Music Co. Ltd., 38 Hertford St., London W1Y 8BA. Tel. (01) 493-5961. Cable RADLUXADVE. Telex: 263912. Mng. Dir.: Alan Ken; Prof. Mgr.: John G. Reed.
Int'l reps: Australia (Festival), Belgium (Radio Tele), Luxembourg (Radio Music), Scandinavia (Sweden), South Africa (Gallo).
 Lovehouse Music, see Leosong.
 Lowery-Chappell Music, see Chappell.
 Lowgate Music, see Pan Audio.
 Lucy Music, see Sue Manning.
 Ludix, see Carlin.
 Lupus Music Co. Ltd. (PRS), 1 Hyde Park Pl., London W2 2LH. Tel. (01) 262-5326. Cable BRYMO. Chief Exec.: Bryan Morrison.
 Luxury Music Ltd., 13 Buckingham Mansions, West End Ln., London NW6. Tel. (01) 435-3731. Owners: David Stark, David Kent.
 Kenny Lynch, see Carlin.
 Lynda Songs, see Leosong.
 Lyndor-Martin Publ'g Co., see Valentine.
 Lynkin, see Jeff Wayne.
 Lynx Music Ltd., see Intersong.
 Lyrical World Co., see Leosong.
 M A M (Music Publ'g) Ltd., 24/25 New Bond St., London W1. Tel. (01) 629-9255. Cable MAMARTISTE. Telex: 27867. Gen. Mgr.: Roy L. Smith.
 M C Music, see Mervyn.
 M D K Musicas Ltda., see Leosong.
 M E Publ'g Ltd., see Chappell.
 M F Music Inc., see Leosong.
 M G P (Musical Graphic Publ'g) (PRS), 10 Clifton Terr., Winchester SO22 5BJ. Tel. (0962) 64755. Dir. & Gen. Mgr.: Clifford J. Bevan.
 M K M Music, see DJ.
 M & M Music Ltd., 23 Southacre, Hyde Park Crescent, London W2. Tel. (01) 262-5432. Cable JACKTONE. Dirs.: Jackie Trent, Leslie Burgess; Gen. Mgr.: Leslie Burgess.
Int'l reps: Canada (Jacktone/MCA), USA (Jacktone/MCA).
 M O Music, see Happy Face.
 M P L Communications Ltd., 1 Soho Square, London W1V 6BQ.
 M R E Publ'g, see Leosong.
 M R I Corp., see Leosong.
 Mac Melodies, see EMI.
 Macaulay Music Ltd., see Noel Gay.
 MacFarlane Music, see Performance.
 Macgint Music, see Island.
 Machetta Ltd., 7 Chiswick High Rd., London W4 2ND. Tel. (01) 995-8087. Mng. Dir.: Del Taylor. (Affiliated with Chappell & Delta).
 David Mackay Ents., see Round.
 Maestro Music Co. Ltd., 1 Cumberland Pl., Hinchley Wood, Surrey. Tel. (01) 398-3494.
 Magdalen Music, see Pendulum.
 Magic Music Ltd., see Chappell.
 Magna Entertainments Ltd., see Noel Gay.
 Magnet Music Ltd., Magnet House, 22 York St., London W1H 1FD. Tel. (01) 486 8151. Cable MAGLONDON. Telex: 25537. Mng. Dir.: Michael A. Levy; Gen. Mgr.: Fraser Macintosh.
Int'l firm represented: Butterfly (Germany).
Int'l reps: Worldwide (Intersong) excluding Australia (Castle), South Africa (Gallo), South America (Ivan Mogull), USA (Interworld).
 Magnificat Music, see St. Thomas More.
 Magnolia Music, see EMI.
 Magnum Music, 415 Oxford St., London W1.
 Maiden Music Ltd., see Valentine.
 Mainspring Music Ltd., see Warner Bros.
 Mainstreet Music, see United 2.
 Maj Music, see Leosong.
 Major Music Ltd., see Noel Gay.
 Majuba Music Ltd., see State.
 Makin Music, see Pan-Audio.
 Mallows Music, see Chevron.
 Malone Music Centre Ltd., 31 Malone Rd., Belfast BY9 6RU, Northern Ireland. Tel. 666361. Dir.: M. Ruderman; Gen. Mgr.: H.A. Ruderman.
 Malpas Music Ltd., see ATV.
 Mancha Music, see Leosong.
 Manchester Music Ltd., see EMI.
 Mander Music Ltd., see Chappell.
 Mandus Music Ltd., see Eaton.
 Manhattan Music Ltd., see EMI.
 Mann Music Publ'rs Ltd., see Bron.
 Sue Manning Music Publ'g Ltd., 21 Dering St., London W1. Tel. (01) 637-9748. 352-5634. Mng. Dir.: Sue Manning; Gen. Mgr.: Janet Bassett.
 Manor, see Carlin.
 Mansem Music, 36 John Dalton St., Manchester M2 6LE. Tel. (061) 834-7293. Cable IMDISC. Mng. Dir.: Irving Wilson.
Int'l firm represented: Eds 23 (Italy).
 Mansion Music Publ'ns, see Chappell.
 Manthula Music Ltd., see Rondor.
 Marathon Music, see Valentine.
 March Music Ltd., see Hedley.
 Marchbank Music, 34 Marchbank Dr., Balerno, Midlothian EH14 7ER. Tel. (031) 449-4709. Exec.: Duncan Brown.
 Marco Music Ltd., 81 Osbaldeston Rd., London N16. Tel. (01) 806-3252. Chm.: Eddy Grant; Gen. Mgr.: S. J. Blackburn.
 Mardanza Music, see Leosong.
 Janie Marden, see Musicus.
 Maribus Music Ltd., see Dick James.
 Mark Music Publ'g Co., see Sparta Florida.
 Marklon Music Ltd., see Bron.
 Marks Music Ltd., see Intersong.
 Marksman Music Publ'rs Ltd. (PRS), 12 Kingly St., London W1R 5LD. Tel. (01) 734-3691. Mng. Dir.: Hedley Leyton.
Int'l reps: Australia (Mathews), France (Francis Day), Germany (Cyclos), Netherlands (Nada/Dayglow).
 Marlboro Music Ltd., see EMI.
 Marlyn, see Carlin.
 Marmaduke Music, see Leosong.
 Marmalade Music Ltd., see Chappell & RSO.
 Marnell Music Co., see Leosong.
 Marmoney Music Co. Inc., see Leosong.
 Marquis Music Co. Ltd. (PRS), 48 Grafton Way, London W1P 5LB. Tel. (01) 388-7653. Cable MARQUIMUS. Telex: 298976. Dirs.: E.M. Roncoroni, Ken Jones; Gen. Mgr.: Carole Broughton.
Int'l reps: USA (Mainspring, Mainstay).
 Marrow Music (MCPS, PRS), 39 Harmer St., Gravesend,

- Kent Tel (0474) 65687. Dir. John W. Oram; Gen. Mgr. Margaret Shears.
 Marsh Music, see Leosong
 Marshall, Morgan & Scott Publ'g Ltd., 1 Bath St., London EC1V 9LB. Tel: (01) 251-2925. Cable: GRAPHO Telex: 262364. Mng. Dir. Peter J. Lardi; Gen. Mgr. David Payne
Int'l firm represented: Singspiration (USA)
 Martin-Coulter Music Ltd., Alembic House, 11th fl., 93 Albert Embankment, London SE1 7TY. Tel: (01) 582-7622. Telex 8814567. Dirs. Bill Martin, Bernard Brown.
Int'l branches: Australasia, Belgium, Canada, France, USA.
Int'l reps.: Austria, Germany, Switzerland & Eastern Europe (Melodie der Welt); rest of world excluding Ireland, Luxembourg & South Africa (Intersong)
 David Martin Music Ltd., High Holborn House, 52/54 High Holborn, London WC1E. Tel: (01) 242-9642. Dirs. Lionel Martin, Alan David. (Affiliated with Heath Levy)
 Passell Martin Publ'g, see Trafalger.
 Marylebone Music, 57 Green St., Flat H, London W1. Tel: (01) 409-0968. Telex: 896691. Dirs. Bob & J.T. Newby
 Mashy Music, see Chevron
 Barry Mason Music, see Marksmen
 Mason Music Ltd., see Lemmel.
 Matador Music Publ'g Co. Inc., see Leosong
 Matchbox Music, see Saydisc.
 Mato Dusco Music, see Leosong.
 Matrix Music, see Metropolitan.
 Peter Maurice Music Co. Ltd., see EMI.
 Mautoglade Music Ltd., 22 Denmark St., London WC2. Tel: (01) 836-5996. Chief Execs. Stuart Reid, Frank Coachworth; Dir. Patsy Reid
Int'l firms represented: Anglo Pic, Blue Ribbon, Blue Seas, De Shufflin, Jac, Pattern, Tristan.
 Mavid Music Inc., see Leosong
 Mawson & Wareham Music Ltd., Heath House 11, Blackett St., Newcastle upon Tyne NE1 5BS. Tel: (0632) 26461. Mng. Dir. Brian Mawson; Gen. Mgr. Geoff Heslop.
 Max Fil Music Co., see Leosong.
 Maycroft, see Carlin.
 May Music Ltd., see EMI.
 Mayoham Music Co., see Leosong.
 Maypole Music Ltd., see Hazy.
 Mazel Music, see Barry McKay.
 McCartney Music, 1 Soho Square, London W1V 6BQ. Tel: (01) 439-6621. Telex 21294.
 McElveen Music, see Leosong.
 Barry McKay Int'l Music (UK) Ltd., 100 Westgate Rd., Newcastle upon Tyne. Tel: (0632) 24449, 20971, 23030. Telex 537486. Mng. Dir.: Barry McKay; Gen. Mgr. Mary Robinson.
 Medusa Music Ltd., see EMI.
 Mediant Music Ltd., see Kassner.
 Medway Music Ltd., see Frank Chacksfield
 Melanie Music Ltd., see MAM
 Robert Mellin Ltd. (PRS), 24 Parkside, Knightsbridge, London SW1. Tel: (01) 245-9026. Cable MELLINMUS. Chief Exec. Robert Mellin; Gen. Mgr. David Reid.
Home office: USA.
Int'l firms represented: Ampco (USA), Big Leaf (USA), Robert Mellin (France), Neapolis (Italy), Pamco (USA), Sherwin (USA).
Int'l reps.: Australasia (Robert Mellin in Australia), Belgium (Music Rights Society), Canada (Robert Mellin in USA), France (Robert Mellin), Germany (Robert Mellin), Greece (Blackwood), Israel (Ilanot), Italy (Neapolis), Japan (Musical Rights Society), Netherlands (Timeless), Portugal (Robert Mellin in Spain), Scandinavia (Mellin in Sweden), South Africa (Robert Mellin), Spain (Robert Mellin), Sweden (Mellin).
 Melody Music, 56 Windermere Rd., Muswell Hill, London N10 2RG. Tel: (01) 833-3216. Chief Exec.: B. Zacharias; Gen. Mgr. S. Zacharias.
 Melwyn Music Ltd., see Robert Mellin.
 Memory Lane Music Ltd., Gray's Inn, 6 Raymond Bldgs., London WC1R 5BZ. Tel: (01) 242-8404. Telex: 21143. Mng. Dir.: Larry Spier. (Administered by Carlin).
Int'l branch: USA.
Int'l firms represented: Memory Lane, Joseph Meyer, Larry Spier, Stillman (all USA).
 Men of Progress Music, see Leosong
 Meridian, see Southern.
 Merlin Assocs. NV, see Chappell
 Merlin Music, see EMI.
 Mervyn Music (div. of Mervyn Conn Org.), Chandos House, 45/46 Chandos Pl., London WC2. Tel: (01) 836-7255. Mng. Dir. Mervyn Conn.
 Meteor, see Southern.
 Metro Music Ltd., see ATV.
 Metropole Music, see Sparta Florida.
 Metropolitan Music, 8a Frognal Gardens, Hampstead, London NW3. Tel: (01) 435-8803. Mng. Dir.: Mark R. F. Hanau; Gen. Mgr. Paul Rodriguez.
 Mettle Music (Publ'g), 10 Barley Mow Passage, Chiswick, London W4 4PH. Tel: (01) 994-6477. Cable: METTLEMUSIC. Mng. Dir.: Joseph R. Stanley; Gen. Mgr. Mike A. Carter.
 Mews Music Ltd., see Bulk & Martin-Coulter.
 Michigan Music Publ'g Corp., see Leosong.
 Midas Music Ltd., see Chappell.
 Middle Eight Music Ltd., see Valentine.
 Middle Road Music, Solgirth Studios, Langmuir Rd., Kirkintilloch, Glasgow, Scotland. Tel: (041) 776-7572. Admn.: Sylvia Meadows.
 Middle Road Publ'g Ltd. (PRS, MPA), see Black Gold.
 Mighty Music, see RAK.
 Mighty Oak Music Ltd., see Essex.
 Miles Music, see EMI.
 Miliz Music, see Leosong.
 Million Dollar Music, 12 Praed Mews, London W2. Tel: (01) 402-1261/4. Mng. Dir. Byron Godfrey; Musical Dir.: Tony King.
 Millmerran Publ'g Co. Ltd., see Bloomsbury.
 Mills Music Ltd., see Belwin-Mills.
 Mingard Music Ltd., 38 Hamilton Square, Birkenhead, Merseyside L41 5BP. Tel: (051) 647-4576. Chm.: Mike Mingard; Mng. Dir.: Chris Mellor.
 Mingles, 49 Greek St., London W1. Tel: (01) 437-7418. (Affiliated with Cherry Music & Intersong)
 Minimus Ltd., 1 Great Windmill St., London W1. Tel: (01) 437-8357. Cable: SEGWAY. Dir.: John Shakespeare.
 Miracle Songs, see Carlin.
 Miriamusic Ltd. (formerly Zack Laurence Music Ltd.), 1 Gleam Rd., Stanmore, Middx. HA7 4NW. Tel: (01) 954-2025. Gen. Mgr.: Zack Laurence.
 Mirror, see Southern.
 Mishagos Music, see Leosong
 Mister Mellow Music, see Music Farm.
 Mr. Sam (Music) Ltd., 169-171 High Rd., Willesden, London NW10. Tel: (01) 459-7244.
 Mistletoe Melodies Ltd., see Marquis.
 Mockbeag Music, 24 Beresford Rd., Wallasey, Cheshire L45 0JJ. Tel: (051) 639-2265.
 Moffett-Dickinson Publ'g Co., see Valentine.
 Moggie Music Ltd., 101 Hazelwood Ln., Palmers Green, London N13 5HQ. Tel: (01) 886-2801. Mng. Dir. & Gen. Mgr.: Hal Carter. (Affiliated with Warner Bros.)
 Ivan Mogull, see Essex.
 Mole Music Ltd., see Leosong & Looking Glass.
 Molecule Music (PRS), see Bright.
 Mo-Mar Music, see Leosong.
 Momentbest Ltd., see April.
 Moments Music Ltd./Spectrum Music, 4 Yarcombe, Adelaide Rd., Surbiton, Surrey. Tel: (01) 399-7043. Chief Exec.: Al Dickinson.
 Mo Music (MPA), see Happy Face.
 Mongo Music Inc., see Leosong.
 Monique, see Southern.
 Monkton Music Ltd., see Valentine.
 Monshana Music, see Sparta Florida.
 Monster Music Ltd. (PRS), see Bright.
 Vincent Montana Jr. Music Inc., see Leosong.
 Monclare, see Campbell Connelly.
 Mood Music, see Sparta Florida.
 Moon Beam Music, see Happy Face.
 Moonbird Music Co., see Leosong.
 Moondance Music Ltd., see Rondor.
 Moon Publ'g Co. Ltd., see Musicus.
 Moonsong Publ'g Co., see Leosong.
 Bryan Morrison Music Ltd. (PRS), see Lupus.
 Mortimer Music Ltd., see United Artists.
 Mosaic Music, see EMI.
 Herbert H. Moss Publ'g Co., see Leosong.
 Moss-Rose Music Ltd., see EMI.
 Most, see Southern.
 Mother Goose Music Ltd., see Red Bus.
 Mother Mistro Music Ltd., see Robert Mellin.
 Motive Music Int'l Ltd., see Leosong.
 Motor Music Ltd., see Acton Green & Leosong.
 Motpurs Music, see Downside.
 Mount Kisco Music Ltd., see Leosong.
 Mozart Ed. (Great Britain) Ltd. (PRS), 199 Wardour St., London W1V 3FA. Tel: (01) 734-3711. Dir.: Dr. G. Zagler. Mng. Dir.: H. Frankel.
Int'l branches: Germany, USA.
Int'l firms represented: Biwa (USA), Mozart (Germany), Raphaela (Germany).
Int'l reps.: Germany (Mozart, Raphaela), USA (Biwa).
 Mugglefunktion Music Group, see Valentine.
 Multicord Music, 52 Briardene Close, Sunderland SR3 3RU. Tel: (0783) 282-353. Dir.: Ken McKenzie.
 Multimood Music Ltd., see Belwin-Mills.
 Multiple Music, 79 Blythe Rd., London W14 0HP. Tel: (01) 602-3483. Cable: MULTISOUND. Telex: 914382. Chm. Ian F. Miles; Gen. Mgr.: Anne Miles.
 Mum & Dad Music Ltd., see Nems.
 Muscadine Music, see Leosong.
 Muscle Shoals Sound Publ'g Co., see Leosong.
 Music Assocs. Ltd., see Noel Gay.
 Musical Comedy Prod'ns, see Essex.
 Musical, Film & TV Ent's. Ltd., see C. Brull.
 Musical Publ'rs Ltd., 136 Fellows Rd., London NW3 3JH. Tel: (01) 722-9027. Dir.: E. A. Agouti; Gen. Mgr.: R.A. Agouti.
 Music Angel, see Leosong.
 Musica Viva (MCPS, PRS), 558 Galleywood Rd., Chelmsford. Essex CM2 8BX. (Affiliated with Scotus)
 Music Farm Ltd. (PRS), 72 Newman St., London W1. Tel: (01) 636-9251. Dirs.: Craig Baguley, Dave McAleer.
 Music Machine, The Midway Colours, Holbeton, Plymouth, Devon PL8 1NA. Dirs.: John K. Dryden, John Greenslade. (Affiliated with Chappell)
 Music Music, see Paul Rodriguez.
 Music of Today Inc., see Hansen & Leosong.
 Music Publ'rs of Ireland, see State.
 Music Sales Ltd., 78 Newman St., London W1P 3LA. Tel: (01) 636-9033. Telex 21892. Mng. Dir.: Robert Wise; Gen. Mgr.: Frank Johnson.
Int'l branches: Australia, USA.
Int'l reps.: Australia, Germany, Japan, USA (Music Sales Corp.).
 Music Sales/Alfred Music, see Music Sales Ltd.
 Musicus Ltd., 74 Newman St., London W1. Tel: (01) 580-0074.
 Musikverlag "City", see Richard Schauer.
 Mutual Music Co. Ltd., see EMI.
 N W R Music Publ'g Co. Ltd., see Noel Gay.
 Nab Songs Ltd., see Margaret Brace.
 Naimad Laine Songs Ltd., see Leosong.
 Namara Music, see Noel Gay.
 Nankip Music, see Noel Gay.
 Johnny Nash Music Inc., see Leosong.
 Natural Avenue Music Ltd., see Leeds.
 Nayland Music Co., see Leosong.
 Naz Songs, see Panache.
 Neat Music, 71 High St. E., Wallsend NE28 7RJ, Tyne & Wear. Tel: (0632) 624999. Chief Exec.: David Wood; Gen. Mgr.: Judith Wood.
 Neems Music, see Leosong.
 Nems Publ'g Ltd., 3 Hill St., London W1. Tel: (01) 629-6341. Cable: NEMSENT. Telex: 21716. Gen. Mgr.: Tony Chapman.
 Neophonic Music Ltd., Kercherers, Waterhouse Ln., Kingswood, Surrey. Tel: Mogador 2837. Chief Exec.: Syd Dale.
 Nervous Publ'g, see Asterisk.
 Nevis Prod'ns, see Duart.
 New Acme Music Co. (UK) Ltd.—Dirs.: Jonathan Rowlands, Judy London—see Hush.
 New Ikon, see Essex.
 New Malden Music Co., see Valentine.
 New Music, see EMI.
 New Town Sound Ltd., 326 Kensal Rd., London W10 5BL. Tel: (01) 969-8651. Cable: MUSICALITY. Telex: 261500. Mng. Dir.: Marcel Rodd.
Int'l reps.: Austria (Rolf Budde), Belgium (Ardmore & Beechwood), France (Francis O'Neill), Germany (Rolf Buddle), Italy (Settebello), Japan (Taiyo), Netherlands (EMI), South Africa (Gallo), Switzerland (Ardmore & Beechwood).
 Nickelodeon, see Intersong.
 Nineden Music Ltd. (PRS), see GH.
 Nirvana Music Co., see Leosong.
 Nisbet & Beck—Drs. Ben Nisbet, Ronnie Beck—see Big Ben.
 Noakes Music, see BAT.
 Nodlew Music, see Leosong.
 Noise Unlimited, see Andrew Heath.
 Noon Music Ltd., 29 Maddox St., London W1R 9LD. Tel: (01) 409-2924/2619. Mng. Dir.: Terry Noon; Gen. Mgr.: Vicki Masters.
 Noon-Scott Music Ltd.—Mng. Dirs.: Terry Noon, John Scott—see Noon.
 Northern Songs Ltd., see ATV.
 Ian North Music, see Leosong
 Novello & Co. Ltd., Borough Green, Sevenoaks, Kent TN15 8DT. Tel: (0732) 883-261. Cable: NOVELLOS. Mng. Dir.: George Rizza; Gen. Mgr.: John Braund; Sales Mgr.: Spencer W. Freeman.
Int'l firms represented: G. Henle, C.F. Kahnt, Kistner & Siegel, F.E.C. Leuckart, Moseler, Willy Muller, Wilhelm Zimmermann (all Germany), Molenaar's Muziekcentrale (Netherlands), Ricordi (Argentina, Brazil, Germany, Italy, Mexico), Rubank (USA).
Int'l rep.: USA (Novello).
 Now Music, see Leosong.
 Nuova Music Ltd., see Dick James.
 Nutmeg Ltd., see Valentine.
 O K Wave Music, c/o The Victory Cafe, 54 Eversholt St., Somers Town, London NW1. Tel: (01) 387-0694. Records: Keith Armstrong, Richard & Julian Hall.
 Oaktree, see Carlin.
 Obelisk Music (PRS), 32 Ellerdale Rd., London NW3. Tel: (01) 435-5255. Pres. & Gen. Mgr.: Heinz Herschmann.
Int'l firms represented: Adastramusik, Eulenburger, Melo-Music (all Switzerland).
Int'l rep.: Worldwide (Eulenburger in Switzerland) excluding Germany (Musia).
 Obie Music Co., see Leosong.
 Object D'Art, see Leosong.
 Object Music Ltd., Little Birchwood, Cock Clarks, Chelmsford, Essex. Tel: Purleigh 441.
 Occasional Music, see EMI.
 October, see Carlin.
 Oddsock Music Co., see ATV.
 Ogun Publ'g Co., 75 Haverstock Hill, London NW3. Tel: (01) 722-8960. Chm.: Keith Beal; Gen. Mgr.: Hazel Miller.
 Trisha O'Keefe Music Ltd., 19 Acree Ln., London SW2 5RS. Tel: (01) 274-0164. Dir.: Trisha O'Keefe.
 Old Sock Music, see Leosong.
 Oliver's Music Prod'ns Ltd., see Sunlight.
 Olofson Music, 6 Heath Close, London W5. Tel: (01) 99N-6266. Cable: BLUEYES. Chief Exec.: Jan Olofsson.
Int'l reps.: Denmark (Safir), Finland (Safir), France (Carrera), Germany (Intersong), Netherlands (Basart), Sweden (Safir).
 Omnibus Music, see April.
 Omy Music Co., see Leosong.
 One Note Music, see Asterisk.
 Onhisown Music, see Leosong.
 Onna Music, see Leosong.
 On Stage Music, see Panache.
 On Yer Bike Publ'g, see Asterisk.
 Open Door Music, see Hazy.
 Oracle Music Ltd., 120 Kings Rd., Fleet, Hants. Tel: (02514) 20053. Telex: 858893. Mng. Dir.: Patrick Smith.
 Orange Music Ltd., see RAK.
 Orange Publ'g, 22 Denmark St., London WC2. Tel: (01) 836-5229. Telex: 21397. Mgr.: Dennis R. Sinnott.
 Orbach & Chambers Ltd., 74 Long Ln., London EC1. Tel: (01) 606-9373. Mng. Dir.: Michael Chambers.
 Orchard Street Music Ltd., see Paul Robinson.
 Orchidia Music, see Leosong.
 Orco Publ'g, see Leosong.
 O'Rourke Music, see Performance.
 Oscar Music, see Arnakata.
 Original Music, 38 Long Acre, London WC2. Tel: (01) 748-8489.
 Osibisa Music Ltd., see Bron.
 Osibisounds Ltd., see Bron.
 Otis Publ'g, see Leosong.
 Our Music Ltd., see Red Bus.
 Our Songs Ltd., see Chappell.
 Oval Music Ltd., 11 Liston Rd., London SW4 0DG. Tel: (01) 622-0111. Cable: OVALDISCS. Dirs.: Charlie Gillett, Gordon Nelki.
Int'l rep.: Worldwide (Rondor).
 Owl Music Ltd., see Purple.
 Oxford Music, 1 Abbey St., Eynsham, Oxon. Tel: (0865) 880-240.
 Oxford Univ. Press (Music Dept.), 44 Conduit St., London W1. Tel: (01) 734-5364. Cable: FULLSCORE.
Int'l reps.: South Africa (Boosey & Hawkes), USA (Oxford Univ. Press).
 P C Music, see Margaret Brace.
 P D A Music Inc., see Leosong.
 P H A B (Philip H.A. Bailey), 12 Milton Rd., Walton-on-Thames, Surrey. Tel: (98) 27087. Dir.: Philip H.A. Bailey.
 P K Music Ltd., see Chappell.
 P M Music, see Handle.
 P & P Music, 33 Dollis Ave., London N3 1BY. Tel: (01) 542-1939. Cable: MICRODISC. Chief Exec.: Peter N. Lemer.
 P P R Music, see Warner Bros.
 P P X Publ'g, see Leosong.
 P R S Musical Mgmt., see LE.

- P S Music Ltd., see United Artists.
 Pageant Music Ltd., see Dick James.
 Page Full of Hits Ltd., 4 Tilney St., Park Ln., London W1Y 5LE. Tel: (01) 493-8873. Cable: PENSONG. Telex: 25238. Mng. Dir.: Larry Page. Dir.: Terry Fenn.
 Palace Music Co. Ltd., see Burlington.
 Pal Music, see Purple.
 Pam Cal Music, see Leosong.
 Panama Music, see Leosong.
 Panache Music Ltd. (PRS), 49 Mount St., London W1Y 5RE. Tel: (01) 491-2904. Telex: 269398. Dirs.: Malcolm Forrester, Derek Nicol.
Int'l firms represented: Andante, Avid, Castle, Celestial Harmonies, Coryell, Dizlo, Dex, John Doe, Dock of the Bay, Free Jazz, Gillian, Grimes Creek, Hancock, Chris Hills, Jon Mark, Josco, Joyride, Lauralee, Little Bros., Lupe, Mayflower, Millet, Mouson, Elvena Mouson, Music Mgmt., Ondine, On Strike, Other, Phrase Text, Pologrounds, Powerplay, Rohm, Royalty Control, Sanasu, Simbora, Smith, Tarik, Thames Talent, Trumar, Unit Core, Utom, Wah Watson, Whitetarr, You Call This Music, Zid (all USA), Can (Germany), Cerrone/Don Ray (France), Panache (France).
Int'l reps: Australia (Boom Boom), Austria (Melodie Der Welt), Belgium (Hans Kusters), Botswana (Musicpiece), Canada (B.C.) Central America (Fermata in Brazil), Far East (Burlington-Palace), France (Panache), Germany (Melodie Der Welt), Italy (Franton), Japan (GP), Lesotho (Musicpiece), Luxembourg (Hans Kuster), Netherlands (Nada), New Zealand (Boom Boom), Rhodesia (Musicpiece), Scandinavia (Kleinerts), South Africa (Musicpiece), South West Africa (Musicpiece), South America (Fermata in Brazil), Swaziland (Musicpiece) Switzerland (Melodie Der Welt), USA (Panache, MTB, Jenevie).
 Pan-Audio Ltd., 4 Forth St., Edinburgh, Scotland. Tel: (031) 557-0181. Telex: 72465. Mng. Dir.: John Mackinnon. Gen. Mgr.: Alan Spence.
 Pan Musik, see Kassner.
 Pantry Songs, see Carlin.
 Paradise Music Ltd., see Belwin-Mills.
 Paragon Music Co. Ltd., see Preston-Stevens.
 Paragon Publ'g, 19 Smithfield, Belfast, Northern Ireland. Tel: (0232) 656-959. Chief Exec.: J.O.P. McCourt. Gen. Mgr.: M.A. Heaps.
Int'l firms represented: Prairie, Royal Flair (both USA).
Int'l rep.: USA (Royal Flair).
 Parbeach Music Ltd., see Kassner.
 Parish Music Ltd., see St. Thomas More.
 Park Lane Music Co. Ltd., see Carlin.
 Angel Parker Music Ltd., see Andrew Heath.
 Tom Parker Music, see Andrew Heath.
 Parnes Music Ltd., see United Artists.
 Pasa Alta Publ'g, see Leosong.
 Pasco Music, see Margaret Brace.
 Andy Patch Music, see Margaret Brace.
 Patricia Music Ltd., see Chappell.
 Philip Patrick Music, see Philip P. Roberge.
 Peanuts Music Inc., see Leosong.
 Pear Music, 7 Woodside Grove, Hartburn, Cleveland. Mng. Dir.: Alan Cole. Gen. Mgr.: Andrew Ormston.
 Pearl Music, see Margaret Brace.
 Pebble Music Ltd., 46 Maddox St., London W1. Tel: (01) 629-3266. Telex: 25247. Mng. Dir.: James Pollard.
Int'l firm represented: Sound & Picture Co. (Kuwait).
 Pedro Music Ltd., see Cyril Shane.
 Peer-Int'l Library Ltd., see Southern.
 Peers Music Ltd., 6 Denmark Pl., London WC2. Tel: (01) 836-6699. Dir.: Kay O'Dwyer.
 Pendulum Music Ltd., see Chappell.
 Pennant Music, see Castrator.
 Pennine Songs, see Marksmen.
 Pentangle Ltd., see Hazy.
 Penthouse Music Ltd., see Robert Mellin.
 Peony Music, 95 Oakley St., London SW3 5NR. Tel: (01) 727-9215. Dir.: Sue Elliston.
 Pepe Music Ltd., see EMI.
 Percival Music, see Leosong.
 Perfection In Music Publ'g, see Leosong.
 Performance Music Ltd., Shepperton Studio Centre, Shepperton, Middx. Tel: (09328) 66531. Telex: 929416. Mng. Dir.: David Paramor. Gen. Mgr.: Brian Adams.
 Curtis Perkins Music, see Carlin.
 Peterbern Music, see EMI.
 Peterma Music Co., see Leosong.
 Peterman, see Carlin.
 Peter Maurice Music Co. Ltd., see EMI.
 Peters Ed. Ltd., 10 Baches St., London N1 6DN. Tel: (01) 253-1638. Cable: MUSIPETERS. Gen. Mgr.: Jonson Dyer. Local branch: 119 Wardour St., London W1V 4DW. Tel: (01) 437-1456.
Int'l firms represented: Beliaeff (Germany), Carisch (Italy), de Santis (Italy), Forberg (Germany), Heinrichshofen (Germany), Hug & Co. (Switzerland), Israeli Music Publ'ns (Israel), Kneusslin (Switzerland), Lienu-Schlesinger (Germany), Litloff (Germany), C.F. Peters (Germany, USA), Zanibon (Italy).
 Anthony Phillips Prods' Ltd., see Hit & Run.
 Photoplay Ltd., see State.
 Physco Music, Tanners Arms, Newbridge St., Newcastle-upon-Tyne NE1 2NS. Tel: (0632) 24052, 24062. Dir.: Simon Cow. Gen. Mgr.: Barry McKay.
 Pickle Music Co., see Valentine.
 Pierhill Music Co., see Leosong.
 Pig Shoot Music, see Leosong.
 Pilot Music Ltd., Culross Manor, Faygate, West Sussex. Tel: (029383) 331. (Affiliated with Chappell).
 Pinball Music, Bond Street House, 14 Clifford St., London W1. Tel: (01) 499-2933. Telex: 24224. Mng. Dir.: D.J. Vaughan.
 Pindrop Music Ltd., see Robert Kingston.
 Pineapple Music, 8 Nursery Rd., Prestwich, Manchester M25 7DN. Tel: (061) 773-8914, 766-5303. Dir.: Lionel Levine. Gen. Mgr.: Sid Gore. (Affiliated with Chappell).
 Pinetree Music Ltd., see Object.
 Pink Floyd Music Publ'rs Ltd. (PRS), 69 New Bond St., London W1Y 9DE. Tel: (01) 408-1788. Telex: 268279. Mng. Dir.: Peter Barnes.
 Pippin The Friendly Ranger Music Ltd., 52 Dean St., London W1. Tel: (01) 734-9734. (Also see Chappell).
 Pitman Hart & Co. Ltd., see J.B. Cramer.
 Pitney Music Ltd., see Bron.
 Pixie Music Co. Ltd., 186 Casterton Rd., Stamford, Lincs. Tel: (0780) 51736. Telex: 377494. Mng. Dir.: K.M. Cox. Gen. Mgr.: W.A. Cox.
 PlantengVisions Music Ltd. (PRS), 69 New Bond St., London W1Y 9DE. Tel: (01) 408-1788. Mng. Dir.: Peter Barnes.
 Plantagenet Music Co. Ltd., see Noel Gay.
 Plantation Music, see Paul Rodriguez.
 Plant Life Music Ltd., Edison Chambers, 109 Bancroft, Hitchen, Herts. Tel: (0462) 58555. (See Looking Glass).
Int'l reps: Worldwide (Copyright Bureau of America, Leosongs).
 Plaza Music Publ'g Co., see Chappell.
 Plex Music, see Leosong.
 Pocono Publ'g Co. Inc., see Leosong.
 Point Music Ltd., The Point, 9 Eccleston St., London SW1. Tel: (01) 730-4201/9777. Mng. Dir.: Rupert Merton.
 Polar Music, see Leosong.
 Polyphone Music Co. Ltd., see Arcadia.
 Polyphonic Reproductions Ltd., see Studio Music.
 Pooh Bear Music Co., see Leosong.
 Pop Gun Music, see Louvigny.
 Poppy Pub, see BKM.
 Popular Hollow Music, see Leosong.
 Porpoise Music, see Island.
 George Porter Music, see Margaret Brace.
 Portsmouth Publ'ns, see St. Thomas More.
 Posse Music, see RMO.
 Powe Music, see Leosong.
 Power Music Prods'ns, 64 S. Molton St., London W1. Tel: (01) 499-7173. Mng. Dirs.: John & Kate Hudson. (Affiliated with Heath Levy).
Int'l rep.: Worldwide (Heath Levy).
 Poz Music, see Leosong.
 Prestige Music Ltd., 48 Grafton Way, London W1P 5LB. Tel: (01) 388-7653. Cable: MARQUIMUS. Telex: 298976. Mng. Dir.: John Spalding. Gen. Mgr.: Carole Broughton. Prof. Mgrs.: Howard Huntridge, Ian Titchener.
Int'l firms represented: Aisha, Cireco, Johen, Jondora, Mumbi, Myrtle Monroe, Orpheum, Parker, Prestige, Tru-Sound (all USA).
 Preston-Stevens Music Co. Ltd., Lansdowne House, Lansdowne Rd., London W11. Tel: (01) 727-0041. Pres.: Denis Preston. Mng. Dir.: Lionel G. Stevens.
Int'l rep.: Austria, Germany, Switzerland (all Schmolzi & Siezak in Germany).
 Alan Price Music Ltd., see Carlin.
 Lloyd Price Music, see Leosong.
 Production Music, 127 High Rd., East Finchley, London N2. Tel: (01) 883-9849. Mng. Dir.: Len Carrington.
 Programme Music Ltd., see Josef Weinberger.
 Projection Publ'g Co., 74 High St., Old Leigh, Leigh-On-Sea, Essex. Dirs.: Richie Bull, Dave Hatfield, Dave Lawrence. Gen. Mgr.: Richie Bull.
 Promus, see Production.
 Proud Prods'ns Ltd., see United Artists.
 Purl Publ'g, see Leosong.
 Publicare Publ'g, see Leosong.
 The Publisher's (MCPS), 106 Dawes Rd., Fulham, London SW6 7EG. Tel: (01) 385-5660. Mng. Dir.: Caruzo Fuller. Gen. Mgr.: Tony Mathias.
Int'l rep.: Japan (Sun).
 Puffin Prod'ns Inc., see Leosong.
 Pulsar, see Carlin.
 Pumpkin Music, see DJ.
 Pure Noise Ltd., see Chappell.
 Pyramid Music, see EMI.
 Quarry Music Ltd., see Andrew Heath.
 Quarter Gale Music, see Island.
 Quartet, see Carlin.
 Quicksilver Music Corp., see Leosong.
 Quiston Music Co., see Leosong.
 R A K Publ'g Ltd., 42-48 Charlbert St., London NW8. Tel: (01) 586-2012. Dir.: David Most. Gen. Mgr.: Ron Maddison.
Int'l reps: Argentina (Melograf), Australia (Castle), Czechoslovakia (Supraphon), France (Baboo), Germany (Melodie der Welt), Hong Kong (Burlington Palace), Israel (April), Italy (Ed. Musicali Melodie), Japan (Toshiba), South Africa (Music Publ'g Co.), Spain (EGO), Sweden (Sweden Music), USA (Finchley).
 R A M Music Ltd., see The Les Reed Org.
 R J Music, 'The Return', 89 Clifford Rd., Barnet, Herts. EN5 5NZ. Tel: (01) 440-9788. Mng. Dir.: Roger James. Gen. Mgr.: Christine Sparks.
 R M O Music Co., 3 Alfred Pl., 3rd fl., London WC1E 7EE. Tel: (01) 580-6830. Telex: 261507. Ref. 3252. Gen. Mgr.: Ron McCreight.
Int'l reps: Australia (Rondor), Benelux (Intersong Basart), Germany (Global), Japan (Pacific), Scandinavia (Frost).
 R S O (The Robert Stigwood Group Ltd.) Publ'g Ltd., 67 Brook St., London W1Y 1YD. Tel: (01) 629-9121. Cable: STIGWOOD. Chm.: Robert C. Stigwood. Dir.: Alexander M. Sinclair. (Also see Chappell).
Int'l firms represented: Brothers Gibb (Netherlands), Casserole (USA), Red Cow (USA), Stigwood (USA).
 R T Music, see Asterisk.
 R T L Music, 111 Mortlake Rd., Kew, Richmond, Surrey TW9 4AB. Tel: (01) 876-8682. Telex: 928215. Mng. Dir.: Barry L. Collier.
 R 2 Music, 29 Gloucester Place Mews, London W1. Tel: (01) 935-2750. Mng. Dir. & Gen. Mgr.: Robb Eden. Sales Mgr.: Harvey Cazaly. (Administered by Louvigny).
 Radar Music, see ATV.
 Radarscope Music Ltd., 60 Parker St., London WC2. Tel: (01) 404-5832. Mng. Dir.: Martin Davis.
 Radio Luxembourg Publ'g, 58 West St., Harrow-on-the-Hill, Middx. Tel: (01) 864-5207. Mng. Dir.: Ernie Garside. Dirs.: Cliff Corbett, Neil Lancaster.
 D. Rahter, see Richard Schauer.
 Ramshack Music, see EMI.
 Tony Randolph Music, see Paul Rodriguez.
 Rapid Fire Music, see Music Farm.
 Rapscap Music, see Leosong.
 Rawlou Music Ltd., see Leeds.
 Raymar Music Co., see Valentine.
 Razamat, see Intersong.
 Rebel Music, 67 Wigmore St., London W1. Tel: (01) 935-7587. Telex: 24224. Mng. Dirs.: D.A. Howman, Gavin Dare.
 Red Bus Music (Int'l) Ltd., 34 Salisbury St., London NW8. Tel: (01) 402-9111. Dirs.: Eliot M. Cohen, Ellis Elias, Leslie Grade. Copyright Mgr.: Sandra Maylam.
Int'l reps: Argentina (MAI), Australia (Castle), Austria (Ralph Siegel), Belgium (Ardmore & Beechwood), Brazil (ITAIPU), Far East (Pathe), Germany (Ralph Siegel), Greece (EMI), Italy (La Voce del Padrone), Japan (Toshiba), Mexico (Beechwood), Netherlands (Anagon, New Dayglow), New Zealand (Castle), Peru (Perumusic), Portugal (Valentim de Carvalho), South Africa (EMI-Brigadiers), Spain (EGO), Switzerland (Ralph Siegel).
 Rediffusion Int'l Music Ltd., see Belwin-Mills.
 Red Pajamas Music Inc., see Leosong.
 Redmays Music Co., see EMI.
 Redrock Music, see Chappell.
 Redwood Music Ltd., see Carlin & Satril.
 The Les Reed Org., 35 Soho Square, London W1. Tel: (01) 439-1755.
 Regal Music Ltd., see Noel Gay.
 Regency Music Ltd., see ATV.
 Renaissance Music Ltd., see EMI.
 Dave Reinhardt Music, see Paul Rodriguez.
 Response Music Ltd., 3 Dennis Rd., East Molesey, Surrey. Tel: 941-4767. Chief Exec.: Mike Claire.
 Reynolds Music, see EMI.
 Peter Rice Music Ltd., 147 Wardour St., 2nd fl. Suite, London W1V 3TB. Tel: (01) 437-7061.
 Richcourt Music Ltd. (PRS), 17 Boltons Court, 216 Old Brompton Rd., London SW5. Tel: (01) 370-2919. Telex: 912881. Mng. Dir.: Barry Alexander. Gen. Mgr.: John B. House.
Int'l reps: Australia (Castle), Germany (Accord), Mexico (Beechwood), South Africa (EMI-Brigadiers).
 Richmond Music Ltd., see Paul Rodriguez.
 Richrick Music Co., see Valentine.
 Ricochet Music Ltd., 12a St. George St., London W1. Tel: (01) 493-1141.
 G. Ricordi & Co. (London) Ltd., see Belwin-Mills.
 Riding Light Music Co., see Valentine.
 Rimusic, see Lemmel.
 Rio Cartel Music, see April.
 Ritual Prods'ns Ltd., 59 Draycott Pl., London SW3. Tel: (01) 589-4164. Dir.: Hilary Mark-Levinge.
 Riva Music Ltd., 2 New Kings Rd., London SW6. Tel: (01) 731-4131. Telex: 28781. Dirs.: Mike Gill, W. Stonebridge. Gen. Mgr.: Dennis Collopy. (Also see GH).
 River Music Ltd., see Robert Kingston.
 Roar Music Ltd., see EMI.
 Robbins Music Corp. Ltd., see EMI Music.
 Philip P. Roberge Assoc. Inc., 16 Dunraven St., Mayfair, London W1Y 3FE. Tel: (01) 499-0671. Cable: TOM-TOM. Pres. & Mng. Dir.: Philip P. Roberge.
 Robertson Publ'ns, The Windmill, Wendover, Aylesbury, Bucks. HP22 6JJ. Tel: (0296) 623107. Co-Owner: Kenneth Robertson.
Int'l firms represented: Charles Colin (USA), Lawson-Gould (USA), Leslie (Canada), Paul Price (USA), Waterloo (Canada).
Int'l reps: Australia (Allans), Canada (Boosey & Hawkes), USA (Theodore Presser).
 Roberts Music Ltd., see EMI.
 Rock Artistes Music Publ'g Ltd., 2 Unwin Mansion, Queens Club Gardens, London W14 9TH. Tel: (01) 385-3759. Cable: RAM. Telex: 25584. Gen. Mgr.: Michael Walsh.
Int'l reps: Australia (Albert & Son), Austria (Intersong), Belgium (Hans Kusters), Canada (April Blackwood), Europe (April Blackwood), Germany (Intersong), Italy (Ariston), Japan (April Blackwood), Luxembourg (Hans Kusters), Netherlands (New Dayglow), New Zealand (Albert & Son), Switzerland (Intersong), USA (April Blackwood), rest of world (April Blackwood).
 Rockbottom Music Ltd., Sawmills, Golant, Fowey, Cornwall PL23 1LP. Tel: (072683) 3337. Dir.: Tony Cox.
Int'l rep.: Worldwide (Chrysalis).
 Rock City Music, see Performance.
 Rocket Publ'g, 4 Audley Square, London W1Y 5DR. Tel: (01) 499-9714. Telex: 265870. Dirs.: Elton John, John Reid. Mng. Dir.: Kevin Eade. Gen. Mgr.: Jim Doyle.
Int'l firms represented: British Rocket, Jordell, Newton House, Rocket Songs (all USA).
 Rockin' Music, 3 Kentish Town Rd., London NW1. Tel: (01) 267-5192. Telex: 298634. Mng. Dirs.: Trevor Churchill, Ted Carroll.
Int'l firms represented: Artrec Publ'rs (USA), Florentine/Vernon Wray (USA).
Int'l reps: Benelux (Nada), Austria (April), France (Francis Dreyfus), Germany (April), Italy (Franton), Japan (Pacific), Scandinavia (Sonet), Spain (Quirrogapenta), Switzerland (April).
 Rock Music Co. Ltd. (PRS), 69 New Bond St., London W1Y 9DE. Tel: (01) 408-1788. Mng. Dir.: Peter Barnes.
 Rock-On Music, see April.
 Rodeo Music, see Leosong.
 Paul Rodriguez Music (MCPS, PRS), 22 Tavistock St., London WC2. Tel: (01) 240-1032. Cable: MUSICCOMP. Mng. Dir.: Paul Rodriguez. Gen. Mgr.: Arabella Bedini.
Int'l firms represented: Deaver (USA), Ultra (Jamaica).
Int'l reps: Alsax Music Ltd. & Virginia Music Ltd. — Australia (Associated), Austria (Siegel), Belgium (Intersong-Paris), France (Intersong-Paris), Germany (Siegel), Switzerland (Siegel), Comma Music — Belgium, Luxembourg, Netherlands (all Bospel).
 Rogers Music Ltd., see United Artists.
 Winthrop Rogers Ed., see Boosey & Hawkes.
 Rojo, 22 York House, Upper Montagu St., London W1. Tel: (01) 723-1935. Dirs.: Jon Pope, Rob Boughton.
 Roker Music Ltd., see Rondor.
 Rokir Music Corp., see Leosong.
 Rollercoaster Music, see Asterisk.
 Rollerjoint Music, see Nems.
 Romney, see Essex.
 Roncom Music Ltd., 61 Frith St., London W1. Tel: (01) 734-

7462 Cable: FIELDMUS. Chief Exec.: Harold C. Fields. Gen. Mgr. Norman Nodel.

Int'l firms represented: Ashley Dealers, Century-Heritage, Joe Goldfeder, Music Exploitation.

Rondan Music Ltd., see State.

Rondercrest, 17 Queensway, Dunstable, Beds. LU5 4ET. Tel. (0582) 62325.

Rondor Music (London) Ltd., Rondor House, 10a Parsons Green, London SW6 4TW. Tel. (01) 731-4161. Cable: RONDORLON Telex 8951674 Mng Dir: Bob Grace.

Home office: USA.

Int'l firms represented: Alessi, Almo, Arnas, Back Road, David Batteau, Bigboro, Braintree, Doors, Dovan, Hollenbeck, India Music Ink, Irving, Jasperilla, Jeffmar, Jowcol, Lady Jane, Magic Land, Miles Ahead, Porchester, Saggifire, Shillelagh, Tangerine, Tower of Power, Walkin' Fish.

Int'l reps.: Australia (Rondor), Belgium (Universal), Brazil (ITAIPI), Canada (Irving/Almo), Chile (Sochem), Czechoslovakia (Opus), France (Pathe Marconi), Germany (Global), Greece (Blackwood), Hong Kong (Pathe), Italy (RCA), Japan (Pacific), Mexico (Beechwood), Netherlands (Universal), South Africa (Music Publ'g Co.), Spain (EGO), Sweden (Sweden Music), USA (Irving/Almo).

Jeremy Rose Music, see EMI.

Rosemary Music, Barn Cottage, Lower Church St., Cuddington, Bucks Tel (0844) 291-617. Dir. Bob Graham.

Rosey Music Ltd., see Tincabell.

Ross Music, see EMI.

Rouge Music Ltd., 84 Wardour St., London W1V 3LF. Tel. (01) 734-1310.

Round Music Co. Ltd., Toftrees, Church Rd., Woldingham, Surrey. Tel. 2386. Mng. Dir. David Mackay; Gen. Mgr. Michael Chalis.

Round Music Ltd., see Panache.

Roundabout Music Ltd., 9 Hillgate St., London W8 7SP. Tel. (01) 727-2791. Telex 25728. Chief Exec. Pat Farley.

Ro West Music Co., see Leosong.

Roxborough Music Ltd., see Robert Mellin.

Ruise de Musique (Ed.), see Boosey & Hawkes.

Michael Rutherford Ltd., see Hit & Run.

Rutland, see Essex.

Ryan Music Ltd., see Intersong.

Rybar Music, see Paul Rodriguez.

S F Original Sounds, see Metropolitan.

S P Music, see Purple.

Sackerson Music, see Leosong.

Sad Music Ltd., see Chappell.

Saffred Music Ltd., Hunworth Cottage, Hunworth, Darlington, Durham. Tel. (0325) 721-143, 720-792. Mng. Dir. & Gen. Mgr. Elaine Salfer.

Saguenay Music Ltd., see Crow.

St Annes Music, Kennedy House, 2 Swinbourne Grove, Withington, Manchester M20 9PP. Tel. (061) 434-3461. Cable: KENTESH. Dirs.: Danny Betesh, Harvey Lisberg, Ric Dixon.

Int'l firms represented: Razzle Dazzle Music (USA), Teddy Randazzo (USA).

Int'l reps.: Albania, Austria, Bulgaria, Czechoslovakia, Germany, Greece, Hungary, Poland, Romania, Switzerland, Turkey, USSR (all Francis Day & Hunter in Germany); Australia, New Zealand, British Solomon Islands, Christmas Island, Ellice Island, Fiji Islands, Gilbert Island, Nauru, New Guinea, New Hebrides, Norfolk Island, Tonga Island, Western Samoa (all Essex in Australia); Belgium (Intersong Primavera), Canada (Man-Ken), France (Allo), Japan (Pacific), Luxembourg (Intersong Primavera in Belgium), Netherlands (Intersong Basart), Scandinavia (Sweden), USA (Man-Ken).

St George Music Ltd., see Chappell & RSO.

St Gregory Publ'g Co., 64 Pineheath Rd., High Kelling, Holt, Norfolk NR25 6RH. Tel. Holt 2288.

St Mary's Press, The Convent, Wantage, Oxon. OX12 9DJ. Tel. Wantage 3141 Contact Sister Alison Julian. (Plainchant music only).

St Thomas More Centre for Pastoral Liturgy, 9/11 Henry Rd., London N4 2LH. Tel. (01) 802-1485/9874. Dir. Rev. Harold E. Winstone, Gen. Mgr. Paul Inwood.

Sally Music Co. Ltd., see Valentine.

Sam Fox Publ'g Co., see EMI.

Sammy Music Co., see EMI.

Sam Songs, see Carlin.

Sams Music, 78 Durham Rd., London SW20. Tel. (01) 947-9000 Mng Dir Max Wright; Gen Mgr Barry Wright.

Sandclock Music Inc., see Leosong.

Santa Ponsa Music Ltd., see Dick James.

Sapphire Music Ltd., see State.

Sarabee Music—Mng. Dir Shirley Selwood—see Biscuit.

Sarah Music, 9A Hallcroft Ln., Copman Thorpe, York Tel. (0904) 703-401, 797-090. Mng. Dir. Mal Spence. Gen. Mgr. Dave Leaper. (Affiliated with Chappell).

Int'l rep.: Worldwide (Chappell).

Sarm Songs, 9-13 Osborn House, Osborn St., London E1 Tel. (01) 247-1311.

Satellite Music Ltd., see Robert Mellin.

Satril Music Ltd. (div. of Henry Hadaway Org.), Satril House, 444 Finchley Rd., London NW2 2HY. Tel. (01) 435-8063 Cable SATRIL Telex 261331. Mng. Dir. Henry Hadaway, A&R Dir. Paul Jenkins; Bus Affairs Mgr. Peter Wells; Copyright Admin. Sheila Roberts.

Int'l reps.: Australasia (Leeds), Austria (Discoton), Belgium (Claude Pascal), Brazil (Top Tape), France (Claude Pascal), Germany (Discoton), Israel (April), Japan (NTVM), Luxembourg (Claude Pascal), Netherlands (Nada), Spain (Discomoda), Sweden (Sonet), Switzerland (Discoton).

Sauna Music, see Cherry Music.

Sava Music, see Satril.

Saydisc Recs., The Barton, Inglestone Common, Badminton, Glos GL9 1BX. Tel. (045424) 266. Chief Execs. Gef & Genny Lucena.

Schaeffers Kassner Music Ltd., see Kassner.

Schauer & May, see Richard Schauer.

Richard Schauer (PRS), Lyra House, 67 Belsize Ln., London NW3 5AX. Tel. (01) 794-8038. Mng. Dir.: Irene Retford.

Int'l firms represented: Musicus, E.C. Schirmer (both USA).

Int'l rep.: USA (Associated Music Publ'rs).

G. Schirmer Ltd. (MCPS, PRS), 140 Strand, London WC2R 1HH. Tel. (01) 836-4011. Chief Exec. & Gen. Mgr.: Julian Mitchell-Dawson.

Int'l firms represented: Associated (USA), Bote & Bock (Germany), Broude Bros. (USA), De Camera (USA), G&C—Morton Gould rental only (USA), General (USA), Joshua (USA), Margun (USA), Ronweng (USA), G. Schirmer (USA), Schroeder & Gunther (USA).

Int'l rep.: USA (G. Schirmer).

Schott & Co. Ltd., 48 Great Marlborough St., London W1V 2BN. Tel. (01) 437-1246. Cable: SHOTANCO. Telex: 298738. Mng. Dir.: P.W. Makings.

Schwartz Music Ltd., see Robert Mellin.

Scorpio Music, see Hazy.

Scotus Music Publ'ns Ltd. (PRS, MCPS), 28 Dalrymple Crescent, Edinburgh, Scotland EH9 2NX. Tel. (031) 667-3633. Cable: MUSICA VIVA. Mng. Dir.: James Douglas; Gen. Mgr.: Kevin Anderson.

Int'l firms represented: AA, PWM (both Poland).

Int'l reps.: Canada (Morning), Europe (G. Schirmer, Scotus), Greece (Hannelore), USA (Worldwide).

Scratchwood Music, see EMI.

Screen Gems-EMI Music Ltd., see EMI.

Scuzzy Chicken Music, see Leosong.

Seabreeze Music Ltd., 25 Newman St., London W1P 3HA. Tel. (01) 637-2586. Dirs. John Coletta, Andrew Tribe.

Seaside Publ'g Co., see Leosong.

Sea-Shanty, see Pendulum.

See Saw, see Southern.

Sega Publ'g Co., see Leosong.

Sidney A. Seidenberg Music, see Carlin.

Semprini, see Carlin.

Sentac Music Ltd., see Frank Chacksfield.

Sensible Songs, Lennie Mains, Cammo Rd., Edinburgh. Tel. (031) 334-2520. Chief Exec. Lenny Love. (Affiliated with EMI).

Sentinel Music, Paul, Penzance, Cornwall. Tel. (0736) 73246. Telex: 45608 Ref. 111. Chief Exec. & Gen. Mgr. Job Morris; Sec'y Irene Morris.

September Music Ltd. (MCPS), 209 Denby Dale Rd., Wakefield, Yorks. WF2 7AJ. Tel. (0924) 79589. Chm.: James Fowley.

Sequence Music, see EMI.

77 Music, 77 Charing Cross Rd., London WC2H OAB. Tel. (01) 437-4197. Owner: D.A. Dobell.

Seven Winds Prod'ns, see Leosong.

Seven Seven Music Ltd., see Chandos.

Sevengal Music, see Leosong.

Seysongs, see Cherry Music.

Shaboodle Music, 148 Charing Cross Rd., London WC2H OLL. Tel. (01) 836-0108. Mng. Dir. Trisha O'Keefe.

Shadamm, see Carlin.

Shadows, see Carlin.

Shafesbury Music Co. Ltd., see MAM.

Shair Music Ltd., see Dick James.

Shakin Music, see Leosong.

Cyril Shane Org., 14 New Burlington St., London W1X 2LR. Tel. (01) 734-3251. Telex 267488. Pres. Cyril Shane.

Int'l firms represented: Aliben, Boca, Broude/Bregman, Cashew, Fat Zach, Fix Int'l, Hexachord, House of Sham, Hubtones, Jadbber, New Pax, Raton, Ruzamu, Skunny Zach, Spiral, Stevarim, Stonehenge, Thunderclap, Wedge (all USA).

Int'l reps.: Australasia (Chappell), Austria (Melodie der Welt), Far East (Pathe), Germany (Melodie der Welt), Scandinavia (EMI), South Africa (Gallo), Switzerland (Melodie der Welt).

Shapiro, Bernstein & Co. Ltd., 184/186 Regent St., London W1R 5DF. Tel. (01) 439-7731. Cable: BERNSTEIN.

Int'l reps.: Australasia (Wallaby), USA (Ivan Mogull).

Shap Music Ltd., Abbott House, 1/2 Hanover St., London W1R 9WB. Tel. (01) 734-4742. Dirs. Helen & Ronnie Shapiro, Tony Barrow, Bess Coleman.

Shark Music, see Leosong.

Sharon Music, see Sparta Florida.

Shattinger Publ'ns Inc., see Leosong.

Shaw C. Music, see Leosong.

Shawbury Music Ltd., see Eaton.

Shelley Music Ltd., 3 Regents Dr., Keston, Kent. BR2 6BU. Tel. (0689) (66 from London) 59976. Chief Exec.: Peter Shelley.

Shere (Surrey), see Campbell Connelly.

Sherlyn Music, see April.

Sherwin Music Co., see Robert Mellin.

Sherwood Music Co., see Leosong.

Shetland Music Ltd., see Chappell.

Shirley Music, see Margaret Brace.

Shoestring Music Corp., see Leosong.

Shoestring Prod'ns, 13 Silverthorne Rd., Clapham, London SW8. Chief Exec. Mike Spenser.

Shoot Music, see EMI.

Show, see Campbell Connelly.

Showcase Music of London Ltd., 111 Uxendon Hill, Wembley, Middx HA9 9SH. Tel. (01) 904-3653.

Shownuff Music Publ'g Ltd., 22 Tavistock St., London WC2. Tel. (01) 836-7608. Chief Exec.: Marsha Abson; Sales Mgr. Neville Wills.

Int'l firm represented: Slum (USA).

Int'l rep.: USA (Morton Levine).

Sikorski, see Campbell Connelly.

Silent Music, see Hazy.

Silk Purse Music, see Louvigny.

Silly Billy Music Ltd., 36 Baker St., London W1M 1DG. Tel. (01) 935-5920.

Silhouette Music Corp., see Hansen & Leosong.

Silver Cloud Music Ltd., see Barn.

Silver Dawn Music, see Leosong.

Silver Stevens Music Inc., see Leosong.

Silver Thevis Music, see Leosong.

N. Simrock, see Richard Schauer.

Since Music Publ'g Co., see Leosong.

Sinclair Music, see Leosong.

Sing & Win Music, see Shaboodle.

Singature Publ'g, 63 Grosvenor St., London W1. Tel. (01) 493-7831. Cable: WEDGE. Mng. Dir.: A.M. Gordon.

Singspiration Inc., 28 George IV Bridge, Edinburgh 1,

Scotland. Tel. (031) 225-4816. Partner: T.C. Danson-Smith.

Singular Music Ltd., see Robert Mellin.

Sirod Music, see Leosong.

Siska Music (MCPS, PRS), 312 Addison House, Grove End Rd., London NW8. Dir.: Bill Barclay.

Skerryrock Ltd., see Island.

Skidmore Music Ltd., see Shapiro, Bernstein.

Skylark Music, 69 New Bond St., London SW1. Tel. (01) 408-1606. Mng. Dirs.: A.J. Gourvish, P.A.L.J. Goding.

Slamina, see Carlin.

Sledge Music Ltd., see Carlin.

Sleeping Bunny Music Ltd., see Sparta Florida.

Sleepy Dumping Music Ltd., see Martin-Coulter.

Slim Music Ltd., see RAK.

Sly, see Asterisk.

Small Wonder Music Ltd., 162 Hoe St., London E17. Tel. (01) 520-2727. Chief Execs.: Pete & Mari Stennett.

Smash Bros., see Island.

Smash Music, see Light.

Ethel Smith Music Corp., see Hansen & Leosong.

R. Smith & Co. Ltd., PO Box 210, Watford, Herts. WD2 4YG. Tel. (92) 34146.

Smooth, see Carlin.

Snibo Music Ltd., see Chappell & Delta.

Snob Music, see EMI.

Snorby Music Inc., see Leosong.

Socks Music, see Island.

Soho Recs., 39 Hereford Rd., London W2. Tel. (01) 229-8911. Mng. Dirs.: S. Brennan, P. Gaston.

Sol-Doon Music Publ'g Ltd., Astral House, 396 Leabridge Rd., London E10. Tel. (01) 539-3232, 556-1228. Mng. Dir.: Roger Mealey; Gen. Mgr.: Graham James.

Solid Gold Music, see Intersong.

Solid State Music, see Leosong.

Solstice Music, see Leeds.

Sonet Prod'ns Ltd., 121 Ledbury Rd., London W11 2AQ. Tel. (01) 229-7267. Cable: SONETMUSIC. Telex: 25793. Mng. Dir.: Rodney Buckle; Gen. Mgr.: Alan Whaley.

Int'l firms represented: Eyeball, Flying Fish, Greenwich, John Hartford, Hodolog, Stainless, Stone County, Tortoise, (all USA); Louis III (France), Satin (Switzerland), Sonet (Scandinavia), Tiber (Italy).

Int'l reps.: Austria (Satin), France (Louis III), Germany (Satin), Italy (Tiber), Netherlands (Sonet), Scandinavia (Sonet), Spain (Ducal), Switzerland (Satin), USA (Emile, Stainless).

The Song Factory, see Bedrock.

Songs For Alice, see Airs & Graces.

Soul Music, see Sparta Florida.

Soulville Music, 62 Lucien Rd., Tooting, London SW17. Tel. (01) 540-3775.

Sound of Scandinavia, see Tabitha.

Sound of Silk, see Leosong.

Soundpost Inc., see Leosong.

South Eastern, see Southern.

Southern Library of Rec'd Music, see Southern.

Southern Monarch, see Southern.

Southern Music Publ'g Co. Ltd., 8 Denmark St., London WC2H 8LT. Tel. (01) 836-4524. Cable: SOUTH-MUSIC. Dirs.: T.F. Ward, Monique & Ralph (II) Peer, D.R. King; Prof. Mgr.: Marjorie Murray.

Home office: USA, Southern Music Publ'g Co. Inc.

Southstrand Music Ltd., 10 Greek St., London W1. Tel. (01) 437-1450. Mng. Dir.: Paul K. Walden. (Also see Flash & Heath-Levy).

Int'l rep.: Worldwide (Heath-Levy).

Space Music Ltd., see Chappell.

Spaceward, see Spriguns.

Spade, see Injun.

Spane Music, see Leosong.

Spaniel Music Ltd., Dockens Water, Blashford, Ringwood, Hamps. Tel. (04254) 2645. Dir.: P. Goodhand-Tait.

Int'l firm represented: Coburn (New Zealand).

Int'l reps.: Australia (Coburn/Sundowner), Austria (Siegel), Benelux (Universal Songs), France (Chappell), Germany (Siegel), Italy (Chappell), Japan (Chappell), New Zealand (Coburn/Sundowner), Scandinavia (Chappell), Switzerland (Siegel), USA (Chappell).

Spanka Music, see MAM.

Sparerib Music, see Leosong.

The Sparta Florida Music Group Ltd., Carlton Tower Pl., Suite 4, Sloane St., London SW1X 9PZ. Tel. (01) 235-0168. Cable: HALMUSIC. Telex: 896795. Mng. Dir.: Hal Shaper; Gen. Mgr.: Mike Berry.

Int'l firms represented: Bareback, Barton, Glen Campbell, Faron Young (all USA).

Int'l reps.: Australia (J. Albert), Belgium (Sparta Florida), Germany (Hans Wewerka), Israel (Subar), Netherlands (Sparta Florida), Singapore (Decca), South Africa (Francis Day), Scandinavia (Nordic), South America (Sparta Florida), Spain (RCA), Switzerland (Sparta Florida).

Specs Music Ltd., see ATV.

Spectrum, see Moments.

Sphemasations, 12 Northfield Rd., Onehouse, Stowmarket, Suffolk IP14 3HF. Tel. (04492) 3388.

Spice Music, see Margaret Brace.

Spider Music, see Margaret Brace.

Spilt Beans, see Kennel Music.

Spin Publ'ns, see Mockbeggar.

Spindrift Music Ltd., see Chappell.

Spool Publ'g Co. Ltd., see United 2.

Spoone Music Ltd., see Leeds.

Sporn Music, see Leosong.

Spriguns Music Ltd., 34/35 Clarendon St., Cambridge. Tel. (0223) 646243. Mng. Dir.: Mandy Morton; Gen. Mgr.: Mike Morton.

Springfield Music Ltd., see Chappell.

Springpark Music Ltd., 5 Marston Close, Swiss Cottage, London NW6 4EV. Tel. (01) 328-7676. Mng. Dir.: Ray Davies.

Int'l reps.: Benelux (Kluger Int'l), Canada (Franklyn Boyd), Germany (Melodie Der Welt), USA (Franklyn Boyd).

Springthyme Music, Balmalcolm House, Balmalcolm, Kingskettle, Fife KY7 7TJ. Tel. (0337) Ladybank 30773. Dir.: Peter Shephard.

Spring Time Music, see Leosong.
 Stable Music, 4 Chalcot Rd., London NW1.
 Stade Music Co., see Leosong.
 Stage One Music (PRS), 22 Madeira Grove, Woodford Green, Essex. Tel: (01) 505-5221. Chief Exec.: John Bassett.
 Stagestruck (Music Publ'g) Ltd., 57 Duke St., Grosvenor Square, London W1. Tel: (01) 493-5015. Cable: STAGESTRUCK. Chm. & Mng. Dir.: Simon Caplan; Dirs.: Terry James, Neil Shestobal. (Also see Leosong)
Int'l reps.: Australia (Mathews Copyright Bureau), Brazil (Copyright Serv. Bureau), USA (Copyright Serv. Bureau.)
 Stallion Music, 10 Haunch of Venison Yard, Brook St., London W1. Tel: (01) 499-9491. Mng. Dir.: J. Toogood.
 Standard, see Essex.
 Stanhope Music Ltd., see Intersong.
 Stanmore Music, see Margaret Brace.
 State Music Ltd., Speen House, Porter St., Baker St., London W1M 1HY. Tel: (01) 487-5031. Telex: 25740. Mng. Dir.: Wayne Bickerton; Deputy Mng. Dir.: Brian Oliver.
 Statis Music Ltd., see Charisma.
 Status Quo Publ'g Co. Ltd., see Eaton.
 Stave & Nickelodeon Music Ltd., 51 Kilmaree Rd., London SW6. Tel: (01) 385-2470. Mng. Dir.: Nichola Martin; Prof. Mgr.: Steve Glen. (Affiliated with Intersong)
Int'l reps.: Austria, Germany & Switzerland (April); rest of world (Intersong).
 Steampower Music Ltd., see Chappell.
 John Stedman Music Publ'g (MCPS, PRS), 112 Sunny Gardens Rd., London NW4. Tel: (01) 203-1324. Mng. Dir.: John Stedman.
Int'l firms represented: Goodie Train, Prolific, Rogerman, Sundown (all USA).
 Miriam Rose Stern Agency Inc., 14 New Burlington St., London W1X 2LR. Tel: (01) 734-3251.
Home office: USA.
Note: Corporation representing heirs of songwriters, administering reversionary rights emanating from United Kingdom, Canada, Australasia, Ireland, Republic of South Africa.
 Sticks Music Ltd., see United Artists.
 Stink Horn, see Asterisk.
 Stirling-McQueen Ltd., see Page Full of Hits.
 Stone-Greene Music, see Leosong.
 Rosetta Stone Publ'g Ltd., see Calvacade.
 Storm Music, 133 Park Rd., Blackpool FY1 4ET. Tel: (0253) 23095, 27357. Mng. Dir.: Wayne Paulo.
 Straitjacket Songs Ltd., see Rondor.
 Strange Music Ltd., see Andrew Heath & GH.
 Stratford Music Ltd., see Chappell.
 Stratsong, see Carlin.
 Street Music Ltd. (PRS), 8 Roland Gardens, Basement Apt., London SW7 3PE. Tel: (01) 370-2929/2956. Dirs.: Clive Calder, Dave Robinson.
Int'l reps.: Central & South America (RCA), Australia (Mushroom), Austria (Melodie Der Welt), Belgium (Nada), Canada (Morning), France (Intersong), Germany (Melodie Der Welt), Italy (RCA), Japan (Door Knob), Mexico (RCA), Netherlands (Nada), New Zealand (Mushroom), Scandinavia (Intersong), South Africa (Musicpiece), Spain (RCA), Switzerland (Melodie Der Welt), USA (Athlone).
 Striped Music, see Trisha O'Keefe.
 Studio G (PRS/MCPS), 145 Wardour St., London W1. Tel: (01) 734-5784. Mng. Dir.: John Gale; Gen. Mgr.: Peter Dunkley.
 Studio Music Co., 77/79 Dudden Hill Ln., London NW10 1BD. Tel: (01) 459-6194. Owner: Stan Kitchen.
 Stylus Music Ltd., see Janna.
 Subar Music Ltd., see Robert Mellin.
 Subiddu Music Ltd., see Chappell.
 Success Music Ltd., see Kassner.
 Suede Music Inc., see Leosong.
 Summerland Music, see Annakata.
 Summit Music Ltd., 38 North Row, London W1. Tel: (01) 499-2014. Mng. Dir.: Charles Peate; Gen. Mgr.: Clive Scott.
Int'l reps.: Canada (Gong Dimension), Scandinavia (Air), USA (Gong Dimension).
 Sunburst Recs. Ltd., 25 Newman St., London W1. Tel: (01) 323-1272. Dirs.: John Coletta, Andrew Tribe.
 Sunbury Music Ltd. (PRS), 155-157 Oxford St., London W1. Tel: (01) 437-2468. Mng. Dir.: John Merritt; Prof. Mgr.: Jon Rose.
Int'l firms represented: Andustin (USA), Antisia (USA), Associated (Australia), Chess Music Inc. (USA), Cyclus (Germany), EDIM (Mexico), Global (Japan), Kidada/Rashida Music Inc. (USA), Koppelman-Bandier (USA), Metal Machine, Oakfield Avenue, Pi-Gem Music Inc. (USA), Roz-Tense Music Inc., RCA (Brazil, France, Italy, Mexico, Spain), Relay (Argentina), Sunbury Dunbar (Canada).
Int'l reps.: Argentina (Relay), Australia (Associated), Belgium (Universal Songs), Brazil (RCA-Victor), Canada (Sunbury Dunbar), France (RCA), Germany (Cyclus), Hong Kong (Burlington-Palace), Italy (RCA), Japan (Global), Mexico (EDIM), Netherlands (Universal Songs), Scandinavia (Sonet), Singapore (Burlington-Palace), South Africa (Gallo), Spain (RCA).
 Sunderland Music Ltd., see Eaton.
 Sunlight Music Prod'ns Ltd., 51 Maida Vale, London W9 1SJ. Tel: (01) 289-3366. Chief Exec.: Jimmy Duncan; Gen. Mgr.: Monique Dahmann.
 Sun-Pacific Music (London) Ltd. (MCPS), PO Box 78, London SE19. Tel: (01) 653-8457. Cable: TREBLIG. Mng. Dir.: Gilbert Gibson; Gen. Mgr.: Borek Nemecek.
Int'l firms represented: Black Stave (USA), Gold Stave (USA), Main Stave (USA), Master Measure (South Africa), Mir Song (USA), Sun Pacific (South Africa).
Int'l reps.: Australia (Associated), Benelux (Southern), Europe (Chappell), Germany (Intersong), Italy (Chappell), Scandinavia (Sweden Music), USA (Main Stave).
 Sunset Music, 30 Baker St. London W1M 2DS. Tel: (01) 445-4957, 486-5353. Mng. Dir.: K. Wyatt-Lown.
 Sunshine Music Ltd., see Sunlight.
 Sunstone Music, see Music Farm.
 Supermusic Ltd., see Sarah & Chappell.

Supersongs Ltd., see Cyril Shane.
 Superstar Music Ltd., see Chappell & RSO.
 Surrey Music Co. Ltd., see Valentine.
 Sutton Sound Ltd. (MCPS), 80 Queensway, London W2 3RL. Tel: (01) 262-9066. Chm. Ivan Sutton; Gen. Mgr. Mark Sutton.
 Suwal Music Co. Inc., see Leosong.
 Swan & Co. Music Publ'rs Ltd., see Arcadia.
 Swansong, see Carlin.
 Sweet Publ'g Ltd., see Handle.
 Swiggeroux Music Ltd., see Warner Bros.
 Swingbest Ltd., see Chappell.
 Sydo Music, see Leosong.
 Sylvester Music Co. Ltd., see De Wolfe.
 Symetric Music, 1 Melville Rd., Edgbaston, Birmingham 16. Tel: (021) 454-4666. Dir.: Karel Beer; Gen. Mgr. Eugen Beer.
 Sympathy Music Ltd., see Carlin.
 Syndicore Music Inc., see Leosong.
 T-Bone Music (PRS), 18 Claridge House, 32 Davies St., London W1Y 1LG. Tel: (01) 499-2742. Telex: 261415. Owner: Robert Hirschman.
 T H Music Ltd., see Intersong.
 T M, see Carlin.
 T R O, see Essex.
 Tabitha Music Ltd., 39 Cordery Rd., St. Thomas, Exeter EX2 9DJ. Tel: (0392) 79914. Mng. Dir.: Graham Sclater; Gen. Mgr.: Denise Sclater.
Int'l firm represented: Sound of Scandinavia (Sweden).
Int'l rep.: Spain (Monserrat).
 Tad Music Publ'g Co., see Leosong.
 Tairi Music, see Leosong.
 Tangent Music Ltd., 176a Holland Rd., London W14 8AH. Tel: (01) 603-0893.
 Tanspan, see Asterisk.
 Tape Leasing & Music (UK) Ltd., c/o SRT Prod'ns Ltd., 987 High Rd., Finchley, London N12. Tel: (01) 446-3218. Dirs.: George Bellamy, Dave Richardson, Keith Herd, Roy Neave.
 Tapestry, see Essex.
 Tara Music, see Leosong.
 Tarik Music Co., see Leosong.
 Tartan Music Ltd. (PRS), see GH.
 Tashman Music Ltd., see Leosong.
 Tatham Music, see Margaret Brace.
 Taurus Music Ltd., see Chappell.
 Taya Music, see Leosong.
 Tchaikovsky Music, see Warner Bros.
 Teleny Music Ltd., see Miriamusic.
 Telespin Music Ltd., 16 Mike Oak Rd., Southwick, Brighton, Sussex BN4 4QE. Tel: (0273) 593603. Mng. Dir.: Arthur J. Cook.
Int'l branch: USA.
 Tellurian Music Inc., see Leosong.
 Tembo Music, 50 Regents Park Rd., London NW1 7SX. Tel: (01) 586-5591. Telex: 299220. Gen. Mgrs.: Roger Whittaker, Irene Collins. (Also see Roncom).
 Tempest (MCPS/PRS), see Studio G.
 Tempest Music Ltd., see Bron.
 Tempest Music, 145 Wardour St., London W1V 3TB. Tel: (01) 734-5784. Dir.: John Gale.
 Alan Tew (Music) Ltd. (MCPS), Busby, Tye Green, Cressing, Braintree, Essex. Tel: (0376) 23860. Chief Exec.: Alan Tew.
 Thames Music Ltd., 39/41 New Bond St., London W1Y 0JL. Tel: (01) 499-5961. Dir.: C.W. Adams; Gen. Mgr.: Stella Walters. (Also see EMI).
 Thames Publ'g, 14 Barby Rd., London W10 6AR. Tel: (01) 969-3579. Publ'g Mgr.: John Bishop.
 Thank You Music, Lotbridge Drive, Eastbourne, E Sussex. Tel: (0323) 22454. Mng. Dir.: Geoffrey Ronald Shearn.
 That Music UK, 4 Yarrowcombe, Adelaide Rd., Surbiton, Surrey. Tel: (01) 399-7043/9491. Chief Execs.: Al Dickinson, Paul Karas.
Int'l firms represented: Holland (Netherlands), Peer-Southern.
Int'l rep.: Benelux (Fons Helkens-Jo Jo).
 Theofilm Music Corp., see Leosong.
 There Music Co., see Leosong.
 Third Man Music, 1-B Broughton St., London SW8. Tel: (01) 622-5421. Mng. Dir.: Peter Johnson.
 Third Power Music, see Leosong.
 Third World Music, see Paul Rodriguez.
 Thorup Music, see Philip P. Roberge.
 Threshold Music Ltd., see Leeds.
 Throat Music Ltd., see Chappell & RSO.
 Thud Music, see Philip P. Roberge & RAK.
 Tic-Toc Music (UK) Ltd., 27 Soho Square, London W1V 6AY. Tel: (01) 437-9985.
 Tiffany Prod'ns Ltd./Mecca Agency Int'l Ltd., see Robert Mellin.
 Tim Music, see Leosong.
 Timtobe, see Intersong.
 Tincabell Music Ltd., 17 Barlow Pl., Bruton St., London W1X 7AE. Tel: (01) 629-8816. Mng. Dir.: Dick Leahy; Gen. Mgr.: Colin Hadley; Prof. Mgr.: Leslie Turnbull.
 Tin Lid Music Ltd., see Rondor.
 Tin Pan Alley Music Co. Ltd., see Fantare.
 Tippy Music Co., see Leosong.
 Tired Iron Publ'g, see Leosong.
 Titanicus Ltd., see Carlin.
 Tito Music Ltd., see Intersong.
 Toad Tunes, see Campbell Connelly.
 Tollak, see Carlin.
 Tollie, see Carlin.
 Tomo's Tunes, see Leeds.
 Tomorrow Morning Music, see Leosong.
 Tom Tom Ltd., see Chappell.
 Tonob Music Publ'g, see Leosong.
 Tone Music Ltd., see Carlin.
 Toneshire Ltd., see Carlin.
 Top Hat Music Ltd., see Chappell.
 Torban Music Ltd., see Margaret Brace.
 Torill Music, see Satril.
 Total Video Music Ltd., see ATV.
 Totem Pole Music Ltd., see Sparta Florida.
 Touchstone Music Inc., see Leosong.
 Gerard Tournier Inc., see Leosong.
 Tower Bridge Music Ltd., 1 Gledwood Dr., Hayes, Middx. Tel: (01) 573-8744. Chief Exec.: Stuart Johnson.

Track Music Ltd., see Compass.
 Tracs Music, see Kikk.
 Trafalger Publ'g, Trafalger House, 8 Eglantine Close, Cowplain, Portsmouth PO8 9BO. Tel: (0705) 592-5000. Owner: T.F. Moss.
Int'l firm represented: Le Mans (France).
Int'l rep.: France (Claude Debret).
 Train Publ'g Plan Ltd., see Carlin.
 Transatlantic Music, see Chappell.
 Tres Jolie Music, 17 Berkeley St., Mezzanine II, London W1X 5AE. Tel: (01) 409-1401. Telex: 23288. Dir.: Bruce Grakal.
 Eddie Tre-Vett, see Carlin.
 Tribune Music Ltd., see EMI.
 Trident Music, see Leosong.
 Trident Music, see EMI.
 Trigram Music Mgmt. Ltd., see RAK.
 Trio, see Carlin.
 Trippington Music Publ'g Corp., see Leosong.
 True Note Music Publ'g, see Leosong.
 Tudor Music Ltd., see Dick James.
 Tukama Music, see Cyril Shane.
 Tulip Music, see Paul Rodriguez.
 Turp Tunes, see Leosong.
 Tuxedo Music, see Leosong.
 Twangy Music Ltd., see Shapiro, Bernstein.
 Two Bunch Music Ltd., see Leosong.
 21st Century Leisure Ltd., 41 Cotswold Gardens, London NW2 1QT. Tel: (01) 458-8991. Mng. Dir.: Martin Lewis.
 Two Four Music Publ'rs Ltd., see Noel Gay.
 Two World Leisure Time Corp., see Leosong.
 Tyler, see Essex.
 Tyne Publ'g, see EMI.
 U K Music Ltd., see Chappell.
 Ucronia Music, see Chappell.
 Ultimate Music Ltd. (PRS), 21 Lady Lodge Dr., Peterborough PE2 0ES. Tel: (0406) 22044. Chief Exec.: R.N. Slater; Gen. Mgr.: A.P. Knight.
 Umble Tunes Ltd., see Bron.
 Unicorn Ltd., see Leosong.
 Unit Music, see Kassner.
 United Artists Music Ltd., Mortimer House, 37/41 Mortimer St., London W1A 2JL. Tel: (01) 636-1655. Cable: UNARTISCO. Telex: 261818. Gen. Mgr.: Robin Taylor; Prof. Mgr.: William McElroy.
Home office: USA.
Int'l firms represented: Bar-Thel, Frandell, Liz-Bet, Primebeat, Rich-Car, Tempo, UA Music Int'l, Unart (all USA).
Int'l reps.: Argentina (United Artists), Australia (United Artists), Austria (United Artists), Brazil (Irmaos Vitale), France (United Artists), Germany (United Artists), Hong Kong (Pathe), Israel (Subar), Italy (United Artists), Japan (United Artists), Mexico (Ed. Musical Latino Americana), Netherlands (United Artists), South Africa (United Artists), Spain (Hispanovox), Sweden (United Artists), Switzerland (United Artists).
 United Music Publ'rs Ltd., 1 Montague St., Russell Square, London WC1B 5BS. Tel: (01) 636-5171. Cable: MUSIKNOTEN. Dirs.: Jutta Avaly, E.A. Roseman. (Also see United 2).
Int'l firms represented: Amphon (France), G. Billaudot (France), Bornemann (France), Chant du Monde (France), Choudens (France), Combre (France), Costallat (France), A. Cranz (Belgium, Germany), Durand (France), EFM (France), Elkan Vogel (USA), Enoch—orchestral catalog (France), Hamelle (France), Henn (Switzerland), Heugel (France), J. Jobert (France), Alphonse Leduc (France), H. Lemoine (France), L'Oiseau-Lyre (France), Rideau-Rouge (France), Transatlantiques (France), Union Musical Espanola (Spain).
Int'l reps.: France (Alphonse Leduc), Scandinavia (Wilhelm Hansen), USA (Theodore Presser).
 United 2 Music Ltd., 1 Montague St., Russell Square, London WC1B 5BS. Tel: (01) 636-5171. Cable: MUSIKNOTEN. (Also see United Music).
 Universal Ed. Ltd., see Alfred A. Kalmus.
 Universal Songs Ltd., 49 S. Molton St., London W1. Tel: (01) 870-5831. Mng. Dir.: Pierre Tubbs. (Affiliated with Famous Chappell).
Int'l reps.: Europe (Famous Chappell), USA (Famous).
 University of Wales Press, 6 Gwynneth St., Cathays, Cardiff CF2 4YD, Wales. Tel: (0222) 31919. Dir.: John Rhys.
 Upswing Music Corp., see Leosong.
 Urovenus Ltd., see Warner Bros.
 Valentine Music Group Ltd., 7 Garrick St., London WC2E 9AR. Tel: (01) 240-1628. Cable: VALGROUP. Mng. Dir.: John Nice; Gen. Mgr.: Pat Seward; Promo. Mgr.: Martin Grimham.
Int'l firms represented: BBP, Bear Claw, Buckhorn, CME, Chesdel, Jerry Chesnut, Chicago Times, Cordova, Daval, Derry, Donna Lee, Equator, Geronimo, Hallnote, Honeysuckle, Imagination, Jimmy's Music, Laurabob, Marjoh, Meredith, Ojo, PBR, Passkey, Peglar, Pergee, Rahman, Rural Hill, St. Francis, Shifty, Felfar, Scum, Silverhill, Solt, Stallings, Ten-Hi, Valgroup, Valsvift, Veytig, War Drum, Woodmont (all USA), BJC, CanCon, Maxess, Pig-Weed, Waldheim (all Canada).
Int'l reps.: Argentina (Valgroup), Australia (Valentine), Belgium (Basar-Belgium), Brazil (Valgroup), Canada (Valgroup), France (Valentine), Germany (Valentine), Greece (Valentine), Hong Kong (Valentine), Ireland (Valentine), Italy (Valentine), Japan (Valgroup), Mexico (Valgroup), Netherlands (Valentine), Scandinavia (Air), Singapore (Valentine), South Africa (Valentine), Spain (Valentine), Switzerland (Valentine), USA (Valgroup).
 Valgroup Music (London) Co., see Valentine.
 Valley Music Ltd., see Leeds.
 Vandisc Sales, 3 Dale End, Birmingham B4 7LN. Tel: (021) 236-9201.
 Vanessa Music & Recs., 86 St. Bernard's Rd., East Ham, London E6 1PE. Tel: (01) 472-9682. Mng. Dir.: Don Todd; Gen. Mgr.: Helen Keen.
Int'l firm represented: Evelyn (USA).
Int'l rep.: USA (Evelyn).
 Vanilla Music Ltd., see ATV.
 Vapour Music Ltd., see Leosong.
 Varda Music Ltd., see EMI.
 Vasko Music, see December Songs.

Vehicle Music, see Hedley.
 Velvet Music Ltd., see RAK.
 Venice Music Ltd., see Sonet.
 Venus Music, see Metropolitan.
 Verge Music, see Asterisk.
 Vern Music, see EMI.
 Veronica Music Ltd., see Shapiro, Bernstein.
 Verulam Music Co. Ltd., see Marquis.
 Vicglobe Ltd. (PRS), see Street.
 Vicki, see Carlin.
 Viewcrest Music Inc., see Leosong.
 Village Thing Music Ltd., see Saydisc.
 Vinco, see Campbell Connelly.
 Viola d'Amore Society-Ed., 1 Parkside Ave., London SW19 5ES. Tel: (01) 946-9222.
 Virgin Music (Publishers) Ltd., 2/4 Vernon Yard, 119 Portobello Rd., London W11. Tel: (01) 727-8070. Telex: 22542. Dirs.: Richard Branson, Nik Powell, Simon Draper, Mng. Dir.: Carol Wilson.

Int'l firms represented: Bleu Disque, Heartbreakers, James Osterberg, UBU (all USA).
Int'l reps.: Australia (Mushroom), Austria (Discoton), Belgium (Universal Songs), Brazil (Fermata), France (Clouseau), Germany (Discoton), Greece (EMI), Italy (Avant Garde, France), Japan (Taiyo), Luxembourg (Discoton), Netherlands (Universal Songs), New Zealand (Boom Boom), South Africa (Music Prece), Switzerland (Discoton).

Virginia Music Ltd., see Paul Rodriguez.
 Visual & Musical Entertainment Co. LTD. (PRS), see Richmond.

Viva Camaro Music, 49 Duke Rd. Ave., Hove, Sussex.
 Waif Music, No. 1 The Elms, Vine Rd., Barnes, London SW13. Tel: (01) 878-4229. Contact Carolyn Smyth. (Also see ATV).

Walnut Music & Mgmt., 90 Victoria Mansions, S. Lambeth Rd., London SW8. Tel: (01) 735-4596. Mng. Dir.: Emmonn Sherlock, Gen. Mgr.: Philippa J. Brown.

Walton Music Ltd., see Chappell.

Wantu Music, see Leosong.

Ward Music, see Leosong.

Warhorse Music Publ'g, see Leosong.

Warland, see Carlin.

Warlock Music Ltd., see Island.

Warne Marsh, see Leosong.

Warner Bros. Music Ltd., 17 Berners St., London W1P 3DD. Tel: (01) 637-3775. Cable: WANGLOSAX. Telex: 25522. Mng. Dir.: Robert Dickens.

Home office: USA.

Int'l firms represented: Broken Arrow, Broken Bird, Bug, C'Est, Chic, Cotillon, Crazy Crow, Double Exposure, Earmark, Evansongs Somerset, Feckless/Jump Tunes, Fifth Star, Fourth Floor, Fry King, Giving Room, Gnossons, Gold Hill, Guerilla, Ice Age, Ice Nine, Justincase, Luckyu, Medicine Hat, Joni Mitchell, Modern Love, Naked Snake, Normal, Overdrive, Painless, Pink Flower/Fleedleedle, Quakenbush, Raydiola, Boz Scaggs, Seagrade, Silver Fiddle, Squibb, Superhype, Tessa, Van Halen, WB, Wow & Flutter (all USA).

Int'l reps.: Australia (Warner Bros.), Brazil (Warner Bros.), France (PECF), Germany (Warner Bros.), Hong Kong (EMI), Italy (Warner Bros.), Japan (Nichion), Netherlands (Warner Bros.), South Africa (WEA), Spain (Hispavox), Sweden (Warner Bros.), USA (Warner Bros.).

Warren & Philips Ltd., see Forsyth Bros.
 Watanabe Prod'ns-Europe, 185 Pavilion Rd., London SW1. Tel: (01) 235-0525. Telex: 8812808. Gen. Mgr.: Akira Nakamura.

Home office: Japan.

Watch It Music Prod'ns, see Hazy.

Waterloo, see Carlin.

Jeff Wayne Music Ltd., Oliver House, 8/9 Ivor Pl., London NW1. Tel: (01) 402-9244. Mng. Dir.: Jeff Wayne.

Weather Report, see April.

Joel D. Webster Music, see Leosong.

Wedge Music, see Chappell.

Wednesday Music Ltd., see Noel Gay.

Josef Weinberger Ltd. (PRS), 10/16 Rathbone St., London W1P 2BJ. Tel: (01) 580-2827. Cable: OPERETTA. Dir.: Richard M. Toeman.

Int'l firms represented: Chappell Rec'd Music Library, Storzando (France), Telemusic (France).

Int'l reps.: Mood Music Library—Australia (Chappell), Austria (Wien Melodie), Belgium (Intersong), Canada (Morning), France (Storzando), Germany (Ring), Italy (Nazionalmusic), Netherlands (Chappell), South Africa (Bandstand), Spain (Harmony), USA (Musicus). **Stage Catalog**—Australia (Boosey & Hawkes), Austria (Josef Weinberger), Belgium (Almo), Canada (Boosey & Hawkes), France (Mario Bois), Germany (Josef Weinberger), Italy (Curci), Netherlands (Almo), Scandinavia (Wilhelm Hansen), South America (Conciertos Gerard), Spain (Vidal Llimona), Switzerland (Walter Lederer), USA (Boosey & Hawkes).

Bruce Welch Music Ltd. (PRS), 7 Ince Rd., Burwood Park, Walton-on-Thames, Surrey, Tel: (98) 43470. Chief Exec.: Bruce Welch.

Int'l rep.: USA (Bruce Welch).

Welstro Music Co., see Leosong.

Wembit Music, see Leosong.

Wensley Music Ltd., see Leosong.

Weston Music, see Leosong.

Westwood Music (PRS, MCPS), Montgomery, Powys SY15 6LU, Wales. Tel: (068681) 427. Dir.: Gordon R. Davies.

Wetwater Music, see April.

Wheeljam Music Ltd., see Intersong.

Whispering Wind Music, see Leosong.

White Cloud Music, 55 Bold St., Ground & 1st fl. Suites, Liverpool L1 4EU. Tel: 709-3952. Dirs.: Kevin O'Brien, Tommy Murray, Norman Smeddles.

White Don Music, see Leosong.

Edward White (Compositions) Ltd., see Musicus.

Edward White Orchestras, see Musicus.

White Hart Music Ltd., see Hazy.

White Lie Music Ltd., see Chappell & Delta.

White Light Music, see Leosong.

Whiterose Music Ltd. (PRS), 86 Turnham Green Terr., London W4. Tel: (01) 994-4895. Dir.: Norton York.

Whitesnake Music, see Seabreeze.

Whitewood Music Inc., see Leosong.

Whitfield Music Inc., see Leosong.

Whitsett Churchhill Music (PRS), 6 London St., London W2. Tel: (01) 402-8425. (0491) 680-176. Telex: 27659. Dirs.: Tim Whitsett, Chick Churchhill.

Int'l firms represented: Ace, Anderson Bros., Auravions, Coal Oil Johnny, Dirt Dobber, High Horse, Quixotic Gestures, Whitchurch, Whitsett Churchhill (all USA).

Int'l reps.: Australia (Rondor), Austria (Global), Benelux (Dutchy), Canada (Whitsett Churchhill), Germany (Global), New Zealand (Rondor), Scandinavia (Sweden), Switzerland (Global), USA (Whitsett Churchhill).

Wicked Fly Music, see Music Farm.

Wide-A-Wake Songs, see EMI.

Widowmaker Music Ltd., see Carlin.

Wilco Publ'g Inc., see Leosong.

Wildtrack (PRS, MCPS), see Scotus.

Wildwood, see Essex.

Williamson Music Ltd., see Chappell.

Will Need Music, 36 John Dalton St., Manchester M2 6LE. Tel: (061) 836-7293. Cable: IMDISC. Mng. Dir.: Irving Wilson; Gen. Mgr.: John Needham.

Wilson Eds., 36 John Dalton St., Manchester M2 6LE. Tel: (061) 834-7293. Cable: IMDISC. Mng. Dir.: Irving Wilson; Gen. Mgr.: Johann Levy.

Int'l firms represented: Agil (Germany), Archambault (Canada), Argyle (USA), Arne Bendiksen (Norway), Phil Bennett (USA), Central Park (Brazil), Malcolm Ford (USA), Polish Authors Agency (Poland), Jimmy Pratt/Juicy People (Germany), Spina (USA), Sunset (France).

Wim Wam Music, see April.

Windmill Music Ltd., see Chappell.

Window Music, 125B Sumatra Rd., West Hempstead, London. Tel: (01) 435-5128. Contact: Mike Sutcliffe.

Enno Winkler Musikvertrieb, 122 Sandford Rd., Birmingham 13. Tel: 449-3246.

Home office: Germany.

Witzend Music Ltd., see Eaton.

Wombat Music, see Chappell.

Wonderland Music Co. Inc., see Walt Disney.

Woods Music Ltd., see Intersong.

Woolfongs Ltd., 62 Pont St. Mews, London SW1X 0EF. Tel: (01) 584-0654. Chm.: Eric Woolfson; Mng. Dir.: Bob Britton.

Word Music (UK) (MCPS, PRS), Park Ln., Hemel Hempstead, Herts. HP2 4TD. Tel: (0442) 50132. Mng. Dir.: William T. Hamilton.

Home office: USA.

Int'l firms represented: Birdwing, Canaanland, Candle, Norman J. Clayton, Crouch, Dayspring, First Monday, His Eye, Journey, Latter Rain, Lexicon, Libris, Luminar, Promiseland, Rodeheaver, Sacred Songs, Sparrow, Word (all USA).

Int'l reps.: Benelux (Universal Songs), Germany (Hansler), Scandinavia (Prim), South Africa (Grace, WEA).

World Copyrights Ltd., see EMI.

Lawrence Wright Music Co. Ltd., see ATV.

Writers Workshop, see Essex.

Wrytree Music Ltd., see Leosong & Looking Glass.

Wumpa Music Ltd., see Miriamusic.

Wye Music Publ'ns, see Emerson.

Xaigon Music, see Leosong.

Xanadu Music, 1 Hawthorne Way, Edmonton, London N9. Tel: (01) 531-6445. Mng. Dir.: Steve Carroll; Gen. Mgr.: Don Morrison.

Int'l rep.: Austria, Germany, Switzerland (all Siegel).

Yahweh Tunes Inc., see Leosong.

Yale Music Corp. Ltd., see Bron.

Yankee Dog Music, see Leosong.

Yankee Ingenuity, see Leosong.

Yarcombe Music, see Bloomsbury.

Yardbirds Music Co., see EMI.

Yellow Springs Music, see EMI.

Yellowtail Music, see Leosong.

York Music, see Whiterose.

Norton York Music, see Whiterose.

Young Artists Ltd., see Dick James.

Young Blood Music Ltd., 138 New Bond St., London W1Y 9FB. Tel: (01) 493-9681. Cable: YUNGBLOOD. Telex: 268048. Mng. Dir.: Gerry Black.

Young Music Ents. Ltd., see EMI.

Your Music Ltd., 39 Leyton Rd., Harpenden, Herts. Tel: (05827) 5098. Mng. Dir.: David Blaylock; Gen. Mgr.: John Beecher.

Yukon Music Ltd., see Kassner.

Zama Music, see State.

Zan, see Carlin.

Zebra Music Ltd., see ATV.

Zengeist Music Publ'g, 53 Downside Rd., Glasgow G12 9DW, Scotland. Tel: (041) 339-1092.

Zel-la Music Co. (MCPS), Walker Hill, Ampton Rd., Edgbaston, Birmingham B15 2UJ. Tel: (021) 455-0645. Dir.: William Johnny Haynes; Gen. Mgr.: A.J. Haynes.

Zel Music Ltd., 63 Old Compton St., London W1A 4NB. Tel: (01) 734-5156.

Zelkova Prod'ns (PRS), see GH.

Zero Publ'g, 36 Pemberton Rd., Telford, Salop TF5 0BL. Tel: (0952) 3490. Chief Exec.: Phil Summers.

Zilch Music Ltd., 97 Kingston Hill, Kingston-upon-Thames, Surrey. Tel: (01) 546-6664. Mng. Dir.: Fred Cantrell.

Zomba Mgmt. & Publ'rs Ltd., 8 Roland Gardens, Basement Apt., London SW7 3PE. Tel: (01) 370-2929. Telex: 919884. Dirs.: Clive Calder, Ralph Simon.

Int'l firms represented: Artalex Exports (South Africa), Musicpiece (South Africa), Scorpio (France), Zomba (Switzerland), City Boy (UK), Athlone, Can't Stop (USA).

Int'l reps.: Worldwide (Zomba) excluding Austria (Roba), Belgium (Hans Kubista), Canada (Morning), Germany (Roba), Netherlands (Nada), South Africa (Musicpiece), USA (Athlone). (SEE ADVERTISEMENT)

Zoom Ents. Ltd., see Dick James.

Zum Music, 45 Shandwick Pl., Edinburgh, Scotland. Tel: (031) 229-3533. Mng. Dir.: Bruce R. Findlay; Gen. Mgr.: Brian Hoog.

Zum Publ'g, see Martin-Coulter.

● sheet music distributor/publisher

Music Sales Ltd., 78 Newman St., London W1P 3LA. Tel: (01) 636-9033. Telex: 21892. Mng. Dir.: Robert Wise; Gen. Mgr.: Frank Johnson.

● services

ASSOCIATIONS & PROFESSIONAL ORGANIZATIONS

A I R C, 5/11 Mortimer St., London W1. Tel: (01) 637-4961. Sec'y: Cecilia Garnett.

A P R S (Association of Professional Rec'g Studios Ltd.), 23 Chestnut Ave., Chorleywood, Herts. WD3 4HA. Tel: (09237) 72907. Sec'y: Edward L. Masek.

Amusement Trade Ass'n (ATA), see British Amusement Catering Trades.

Arts Council of Great Britain, 105 Piccadilly, London W1V 0AU. Tel: (01) 629-9495.

Associated Musical Entertainments, Orchestras & Artists, 39 Wardour St., London W1V 3HA. Tel: (01) 734-4550/6130/0813. Telex: 268312 Wescom G/Attn: Warrenorch. Dir.: Hubert Warren; Sec'y: Veronica Macfarlane.

Associated Trade Publ'ns Ltd., 259 Grays Inn Rd., London WC1. Tel: (01) 837-3311.

Association of British Orchestras, 11 Little Britain, London EC1A 7BX. Tel: (01) 606-1507. Sec'y: John May.

Association of Cinematograph Television & Allied Technicians (ACTT), 2 Soho Square, London N1.

Association of Exhibition Organisers, 10 Manchester Square, London W1M 5AB. Tel: (01) 486-1951. Dir.: G.A.M. Ritson.

Association of Musical Instrument Inds., 62 Park View, Hatch End, Pinner, Middx. HA5 4LN. Tel: (01) 428-4700.

Association of Sound & Communications Eng's. Ltd., 47 Windsor Rd., Slough, Berks. SL1 2EE. Tel: (0753) 39455. Chief Exec. & Sec'y: Douglas W. Joyce.

Association of Touring & Producing Managers, 18 Charing Cross Rd., London WC2. Tel: (01) 836-2133.

B I R S, see British Institute of Rec'd Sound.

B P I, see British Phonographic Ind.

B R T D C, see British Rec'd Tape Development Committee.

British Actor's Equity Ass'n, 8 Harley St., London W1N 2AB. Tel: (01) 636-6367.

British Amusement Catering Trades Ass'n, 122 Clapham, Common North Side, London SW4 9SP. Tel: (01) 228-4107. (incorporating Amusement Caterers Ass'n, Amusement Trades Ass'n, Phonograph Operators Ass'n, & Ass'n of Prize Bingo Operators)

British Audio Promos. Ltd., 414A Edgware Rd., London W2 1ED. Tel: (01) 402-9145.

British Copyright Council, 29/33 Berners St., London W1P 4AA. Tel: (01) 580-5544.

British Country Music Ass'n, PO Box 2, Newton Abbot, Devon. Chm.: Jim Marshall; Vice Chm.: Mike Stobert; Sec'y: Eddy Edwards.

British Federation of Music Festivals, 106 Gloucester Pl., London W1H 3DB. Tel: (01) 935-6371.

British Institute of Rec'd Sound (BIRS), 29 Exhibition Rd., London SW7. Tel: (01) 589-6603. Dir.: Dr. A. King.

British Music Information Centre, 10 Stratford Pl. London W1N 9AE. Tel: (01) 499-8567. Librarian: Roger W. Wright.

British Phonographic Ind. (BPI), 33 Thurloe Pl., London SW7 2HQ. Tel: (01) 581-3522. Dir.: John Deacon.

British Phonographic Ind. Copyright Ass'n, Corner House, Albert Rd., New Malden, Surrey. Tel: (01) 942-2488 x 330. Hon. Sec'y: P.H. Driscoll.

British Radio Equip. Mfrs. Ass'n (BREMA), Twentieth Century House, 31 Soho Square, London W1V 5DG. Tel: (01) 734-7471. Telex: 27869. Dir.: O.P. Sutton; Sec'y: R.B.S. Purdy.

British Rec'd Tape Development Committee (BRTDC), 33 Thurloe Pl., London SW7 2HQ. Chm.: John Deacon.

British Tape Ind. Ass'n, see European Tape Ind. Ass'n.

Campaign for Independent Broadcasting, 13 Ashwood House, London NW4. Tel: (01) 203-0861. Gen. Sec'y: J.W. Wyndham-Kaye; Hon. Press & PR: Martin Rosen.

Composers' Guild of Great Britain, 10 Stratford Pl., London W1N 9AE. Tel: (01) 499-8567. Gen. Sec'y: E. Yeoman.

Country Music Ass'n (Great Britain), PO Box 2LG, London W1H 1A5. Tel: (01) 935-0413. Chm.: Tony Byworth; Vice-Chm.: David Sandison; Pres.: Mervyn Conn; Treas.: Jeff Forrest. Sec'y: Mike Hutson.

The Disc Jockey Federation of Great Britain, 1 Low Farm Cottage, Drayton, Norwich NR8 6RR. Tel: (0603) 860-241. Chm.: Theo Lyola.

Distributive Ind. Training Board (DITB), Maclaren House, Talbot Rd., Stretford, Manchester M32 0FP. Tel: (061) 872-2494. Information Dir.: Harold Webb.

E M C (European Music Consultants), Harlowbury, Old Harlow, Essex CM17 0HZ. Tel: (0279) 416-721. Dir.: Don Morris.

The English Folk Dance & Song Society, Cecil Sharp House, 2 Regents Park Rd., London NW1 7AY. Tel: (01) 485-2206.

Entertainment Agents' Ass'n, 18 Charing Cross Rd., London WC2H 0HR. Tel: (01) 240-1724.

European Tape Ind. Ass'n, 8 St. Bride St., London EC4A 4DA. Tel: (01) 353-3020. Cable: REDNIBFAR. Telex: 24276.

Federation of British Artists, 17 Carlton House Terr., London SW1. Tel: (01) 935-9791.

Federation of British Audio, Federation Offices, Twentieth Century House, 31 Soho Square, London W1V 5DG. Tel: (01) 734-7471. Chm.: Gisela Burg.

Gramophone Rec. Retailers' Committee of the Music Trades Ass'n, 5 Denmark St., London WC2H 8LP. Tel: (01) 836-2059. Sec'y: Harry Tipple.

I F P I (International Federation of Prod'rs of Phonograms & Videograms) Ltd., 123 Pall Mall, London SW1Y 5EA.

Mary Harrison-Goudie BA, 40 Gunter Grove, London SW10. Tel: (01) 352-2886. Chief Exec.: Mary Harrison-Goudie.

John Harwood-Bee Assocs., The Maltings, 63 High St., Ware, Herts. Tel: (0920) 66310. Telex: 299929. Mng. Dir.: John Harwood-Bee.

Hazell-Smith, 36-37 Malden Ln., London WC2. Tel: (01) 240-3284. Mng. Dir.: Peter Hazell-Smith.

Heavy Pub., 498-500 Harrow Rd., London W9. Tel: (01) 960-0955. Telex: 62571. Chief Execs.: Joe O'Neil, Mick Wall, Richard Ogden.

The Howlin' Promo. Co., 114 Lower Park Rd. Loughton, Essex. Tel: (01) 508-4564. Air Call (01) 828-5621. Contact: Howard Marks.

Humberside Studios, Grimsby Rd., Laceby, Grimsby, South Humberside. Tel: (0472) 40152, 71582. Chief Exec.: L.A. Johnson; Gen. Mgr.: S.C. Johnson.

Independent Rec. Co., 39 Harmer St., Gravesend, Kent. Tel: (0474) 65687. Chief Exec.: J.W. Oram.

J & H Prod'ns, 1 Hyde Park Square, Rm. 12, London W2 2JZ. Tel: (01) 402-9855. Chief Exec.: Roger Howard.

Andrea Jackson Promos., 15 Alders Rd., Edgware, Middx. HA8 9QG. Tel: (01) 959-2452.

Jazistance, 142 London Rd., Rayleigh, Essex. Tel: (0268) 772-178.

T. Richard Johnson Ltd. Advertising (TRJ), 47/48 Bond St., London W1Y 0HE. Tel: (01) 493-6371. Mng. Dir.: Terry Johnson; Creative Dir.: Keith Milligan; Account Dir.: Barry Hodgetts.

Junic Prod'ns Ltd., 684 Fulham Rd., London SW6 5SA. Tel: (01) 736-5877. Dirs.: Julian Beauchamp, Nicolas Smith.

Kay Gee Publicity Consultants, 7 Denmark St., London WC2H 8LS. Tel: (01) 836-5067, 240-1641. Mng. Dir.: Keith Goodwin; Gen. Mgr.: John Dalton; Office Mgr.: Natalie Gordon.

L E Advertising, Nelson House, Castle Hill Rd., Hindley, Wigan WN2 4BH. Tel: (0942) 58555. Cable: LE HINDLEY. Dir.: Steve Brennan; Gen. Mgr.: Doug Larbey.

L O E Entertainment Ltd., 28 Lexington St., London W1R 3HR. Tel: (01) 734-3443. Cable: LOEGROUP. Telex: 24224 Ref. 2203. Mng. Dir.: Hiroshi Kato; Gen. Mgr.: Jim Russell. (Promotion for Japan).

Steve Lane Musical & Publicity Servs., 12 Slough Ln., Kingsbury, London NW9 8QL. Tel: (01) 205-2587. Owner: Steve Lane.

Lightning Recs. Ltd., 841 Harrow Rd., Harlesden, London NW10 5NH. Tel: (01) 969-7195/5255. Telex: 927813. Mng. Dir.: Raymond Laren; Mktg. Dir.: Keith Yershon; Financial & Admin. Dir.: Norman Mandell.

Listen Fine Ltd., 15 Dawson Pl., London W2 4TH. Tel: (01) 840-3444 x 12. Chief Exec.: G. Lawson.

M I F Rec. Promo., 44 Earham St., London WC2. Tel: (01) 240-3731. Dir.: Garrell Redfean.

Mama Concerts UK Ltd., 27 Curzon Pl., London W1. Mgr.: Carl Miller.

McKinley Mktg. Consultants Ltd., 601 Grand Bldgs., Trafalgar Square, London WC2N 5HN. Tel: (01) 930-0341. Contacts: Ivan Alter, Colin Hadley.

Monster Movies Ltd., Gatehouse, 4 Ellerton Rd., Wimbledon SW20. Tel: (01) 437-5125/6613. Prod'r & Dir.: Mike Mansfield.

Modern Pub., 147 Oxford St., London W1. Tel: (01) 437-9353. Owner: Alan Edwards.

Mushroom Studios, 18 W. Mall, Clifton, Bristol BS8 4BG. Tel: (0272) 35994, 35867. Chief Exec.: D. Ackerman; Gen. Mgr.: S.A. Ackerman.

Music Radio Promos., PO Box 400, Kings Langley, Herts. Tel: (09277) 64014. Mng. Dir. & Gen. Mgr.: Mike Baron; Sales Mgr.: Peter Duncan; Publ'g Dir.: Nik Oakley.

Nelson Rec'g Studio, Nelson House, 93 Castle Hill Rd., Hindley, Wigan, Lancs. WN2 4BH. Tel: (0942) 58777. Contacts: S.M. Millard, W. Leyland.

Newton Prod'ns, 33 Castelnau, Barnes, London SW13 9RS. Tel: (01) 748-2939. Chief Exec.: R.N. Lawson.

Northern Disco Promo. Servs., 116 Churchgate, Southport, Merseyside. Tel: (0704) 212-505. Chief Exec.: Ron Ellis.

Kay O'Dwyer Publicity Ltd., 6 Denmark Pl., London WC2. Tel: (01) 836-6699. Dir.: Kay O'Dwyer.

Old Smyth Rec'g Studio, Old Smyth Post Office Ln., Kempsey, Worcs. Tel: (0905) 820659. Chief Exec.: Muff Murfin; Gen. Mgr.: Val Biddle; Engs.: Colin Owain, Brad Davis.

Panda Recs., 11 Old Castle Rd., Llanelli, Dyfed, South Wales. Tel: (05542) 58913, 52490. Chief Exec.: Paul Adams; Gen. Mgr.: Alan Phillips.

Pan-Graphics (Edinburgh) Ltd., 21A Grosvenor St., Edinburgh, Scotland EH12 5ED. Tel: (031) 225-9502. Mng. Dir.: John Mackinnon; Gen. Mgr.: Colin Moore; Sales Mgr.: Jonathan Field.

Paragon Int'l Prods., 16 Holmes St., Belfast, Northern Ireland. Tel: (0232) 48260. Dir.: John O.P. McCourt; Gen. Mgr.: Anne Heaps; Sales Mgr.: Edwina Heaps.

Leslie Perrin Assocs. Ltd., Dumbarton House, 68 Oxford St., London W1N 9LA. Tel: (01) 636-7122.

Pilsner Pub., 1 Milville Rd., Edgbaston, Birmingham 16. Tel: (021) 454-4666.

Pinnacle Recs., 9 Dean St., London W1V 5RL. Tel: (01) 734-4345. Telex: 896141 Orpington. Chm. & Mng. Dir.: Terry Scully; Mng. Dir.: Jack Bass; Gen. Mgr.: G.F. Stone; Sales Mgr.: Ray Phillips.

Porter & Pocock Assocs. Ltd., 72 Westfields Ave., London SW13 0AU. Tel: (01) 878-4366/2595. Mng. Dir.: R. Alexander Porter.

Purple Recs. Ltd., 25 Newman St., London W1P 3HA. Tel: (01) 637-2586. Telex: 28288.

Rainbow Sound Servs., 1A St. Andrew St., Plymouth, Devon. Tel: (0752) 25781 (day), 774381 (night). Chief Exec.: Phil E.R. Simonds.

Rank Leisure Servs., 439/445 Godstone Rd., Whyteleafe, Surrey CR3 0YG. Tel: (820) 3355. Mng. Dir.: L. Small; Gen. Mgr.: C.D. Spruce; Sales Mgr.: W. Macgregor.

Realmeath Ltd., 15/23 Porteus Rd., London W2. Tel: (01) 723-8495. Dir.: Bryan Whitman.

Record Sales, 72 Newman St., London W1. Tel: (01) 636-9251. Telex: 8812733. Dirs.: Richard Jakubowski, Alan Wade.

Red Shadow Music Co. Ltd., 216 Randolph Ave., The Basement, London W9. Tel: (01) 624-8252/5224/3717. Dirs.: Clive Banks, Terry O'Neil, Julian Spear.

Rime Ents. Ltd., 3 Paddington St., London W1M 3LA. Tel: (01) 486-9695/6230. Mng. Dir.: Allan James; PA: Sue Sian.

Richard Robson Assocs. Ltd., 19 Orley Farm Rd., Harrow-on-the-Hill, Middx. Tel: (01) 864-3634/3367. Mng. Dir.: Richard Robson; Gen. Mgr.: Marjorie Robson.

Rogers & Cowan Inc., 27 Albemarle St., London W1X 3FA. Tel: (01) 499-0691. Telex: 25571. Pres. Int'l Div.: Margaret Gardner; Int'l Div. Music Dept. Dir.: Philip Symes.

Rougecrest Ltd., 10 Barley Mow Passage, Chiswick, London W4 4PH. Tel: (01) 994-6477. Mng. Dir.: Joseph R. Stanley; Gen. Mgr.: Mike A. Carter.

Saffrey Music Ltd., Hurworth Cottage, Croft Rd., Hurworth, Darlington, Durham. Tel: (0325) 721-143/720-792. Mng. Dir.: Elaine Saffer; Gen. Mgr.: C. Morris.

St. Pierre Pub., 24 Beauval Rd., Dulwich, London SE22 8JQ. Tel: (01) 693-6463. Exec.: Robert St. Pierre.

Sea Cruise Prod'ns (UK), 35 Great Russell St., London WC1. Tel: (01) 636-3925. Gen. Mgr.: Terry Wagborne.

Home office: USA

Shabodeo Promos., 148 Charing Cross Rd., London WC2H 0LH. Tel: (01) 836-0108. Mng. Dir.: Trisha O'Keefe.

Solomon & Peres Ltd., 120 Coach Rd., Templepatrick, Ballyclare, County Antrim, Northern Ireland BT39 0HB. Tel: (08494) 32711. Telex: 747293. Mng. Dir.: Mervyn A. Solomon; Gen. Mgr.: Les Paterson; Sales Mgr.: Noel A. Spiller; Country Music Sales Co-ord.: Betty Monteith.

T R J, see T. Richard Johnson.

21st Century Leisure Ltd., 41 Cotswold Gardens, London NW2 1QT. Tel: (01) 458-8991. Mng. Dir.: Martin Lewis.

Frances van Staden Publicity, 60 Fordwych Rd. London NW2. Tel: (01) 452-7509. Dir.: Frances van Staden.

Walnut Music & Mgmt., 90 Victoria Mansions, S. Lambeth Rd., London SW8 1QU. Tel: (01) 735-4596.

Wardour Motion Picture Co. Ltd., 11 Wardour Mews, London W1. Tel: (01) 439-4313. Dir.: M.J. Sutton; Gen. & Sales Mgr.: Christie Gillingham.

Waxie Maxie Publicity, 284 Dennton Rd., London SW17. Tel: (01) 672-6918. Mng. Dir.: Max Needham.

Wildie Rock Promos. Co. Ltd., 110 Clarendon Rd., London W11. Tel: (01) 221-3010. Chief Exec.: Jeremy MacKenzie; Gen. Mgr.: John Chance.

Int'l branch: Germany, Jumbo Prod'ns.

Wizard Recs. Ltd., 111A Westbourne Grove, London W2 4UW. Tel: (01) 229-7236. Chm.: Tony Secunda; Dir.: Sid Walker.

**TAPE CUSTOM DUPLICATORS
TAPE PACKAGING & LABELING**

The Audio and Video lines indicate the configurations which the firms duplicate. Companies which offer packaging and labeling of tape product are indicated by: (PKG) which appears after the main body of their respective listings.

Aardvark Design & Publicity, 145 Croydon Rd., Beckenham, Kent BR3 3RB. Tel: (01) 658-4386. Mng. Dir.: Paul Smith. (PKG)

Amberley Recs. Ltd., 387 Harrow Rd., London W9. Tel: (01) 969-2315. Mng. Dir.: John Peters; Gen. Mgr.: Orlean Lamas. (PKG)

Audio: Cassette, open reel.

Anemone Sound Facilities Ltd., 10A Poland St., London W1. Tel: (01) 439-9611. Telex: 8812286. Mng. Dir.: Aaron Gershfield; Gen. Mgr.: Derek Hanlon; Sales Mgr.: Simon Patrick. (PKG—audio only)

Audio: 8-tr., cassette.

Audicord Recs., 387 Harrow Rd., London W9. Tel: (01) 866-7748. Chief Exec. & Gen. Mgr.: K. Meller. (PKG—audio only)

Audio: 8-tr., cassette, open reel.

Audiogenic Ltd., 34-36 Crown St., Reading, Berks. RG1 2SN. Tel: (0734) 595647. Dir.: Martin Maynard; Gen. Mgr.: Moira Farrell; Sales Mgr.: Henry Smithson. (PKG)

Audio: Cassette.

Audio + Video Ltd., Video House, 48 Charlotte St., London W1P 1LX. Tel: (01) 580-7161. Telex: 22345 AYYEE G. Mng. Dir.: I.C. Pannaman; Sales Mgr.: N. Foley; Adv. Mgr.: D. Ubsdell.

Video: Cartridge, Cassette.

Avcom Systems Ltd., Stanlake Mews, London W12 7HJ. Tel: (01) 749-2201. Cable: CINEPRO. Mng. Dir.: Eric R. Bastin; Gen. Mgr.: Marc Hull; Sales Dir.: Nick Gillieron.

Audio: Cassette.

Ivan Berg Assocs. (Audio Publ'g) Ltd., 35A Broadhurst Gardens, London NW6. Tel: (01) 624-7785. Mng. Dir.: Ivan Berg. (PKG)

Audio: Cassette.

Bibi Magnetics Ltd., 101/105 Plough Rd., London SW11 2BJ. Tel: (01) 223-5955. Telex: 917732. Dir.: K. H. Bourke-Borrowes; Gen. Mgr.: M. Shepherd.

Audio: Cassette.

Bird Sound Studios, Welton Rd., Wedgwood Estate, Warwick CV34 5YA. Tel: (0926) 45213. Owner: Sheila L. Bird; Gen. Mgr.: David Rawlings; Sales Mgr.: Dave Sheriff.

Audio: Cassette, open reel.

C B S Mfg (div. of CBS (UK) Ltd.), 17/19 Soho Square, London W1V 6HE. Tel: (01) 734-8181. Cable: COLCREMAN. Telex: 24203. Mng. Dir.: George Ridnell (PKG)

Audio: 8-tr., cassette.

Caroline Exports Ltd., 56 Standard Rd., London NW10. Tel: (01) 961-2919. Gen. Mgr.: Steve Sparks; Projects Programs: Roger Elliman. (PKG only)

Cassette Developments (Audioconic) Ltd., Micra House, 138 Lower Mortlake Rd., Richmond, Surrey TW9 2JZ. Tel:

(01) 940-8186. Cable: MICRONETICS. Telex: 8813481. Gen. Mgr.: D. Dixon. (PKG)

Audio: Cassette.

Castle Studio, 93 Castle Hill Rd., Hindley, Wigan, Lancs. WN2 4BH. Tel: (0942) 58777. Chief Exec.: D. Larbey; Sales Mgr.: W. Leyland.

Video: VHS.

D T P Inc., 3 Alfred St., Weston-Super-Mare, Avon BS23 1PZ. Tel: (0934) 21932. Mng. Dir.: Don Todd.

Audio: Cassette, open reel.

Video: 1" open reel.

Decca Rec. Co. Ltd., Decca House, 9 Albert Embankment, London SE1 7SW. Tel: (01) 753-8111.

Factory: Bridgnorth, Shrops., Pale Meadow Works, Hospital St. Tel: 5721.

Discourses Ltd., 36 Crescent Rd., Tunbridge Wells, Kent TN1 2LZ. Tel: (0892) 26397. Mng. Dir.: Robert F. Hardcastle; Gen. Mgr.: Anthony James.

Audio: Cassette.

Duplitape, 1/7 Harewood Ave., London NW1. Tel: (01) 724-2497. Telex: 21879. Chief Exec.: R. Jackson Moore; Gen. & Sales Mgr.: B.R. Lambden.

Audio: Cassette. (PKG—audio only)

E M I Recs. Ltd., 1/3 Uxbridge Rd., Hayes, Middx. UB4 0SY. Tel: (01) 561-8722. Dir.: R.E. Matthews; Special Projects Mgr.: D.L. Watson.

Audio: Cassette.

Fifth Ave. Rec'g Co. (UK) Ltd., Avenue House, River Way, Templefields, Harlow, Essex CM20 2DN. Tel: (0279) 39256. Mng. Dir.: Len Collins; Gen. Mgr.: Bert Hamilton; Prod'ns Mgr.: Mike Stancevic.

Audio: Cassette.

Fraser-Peacock Assocs. Ltd., 94 High St., Wimbledon Village, London SW19 5EG. Tel: (01) 947-7551. Dir.: David R. Tuckman.

Audio: Cassette.

Gramplan Recs. Ltd., Airport Ind'l Estate, Wick-Caithness, Scotland. Tel: (0955) 2787. Dir.: J. Johnston; Mgr.: John Hunter. (PKG)

Audio: Cassette, open reel.

H & R, 255 Liscard Rd., Wallasey, Merseyside. Tel: (051) 639-9270. Mng. Dir.: David Crosby; Gen. Mgr.: Roger Baskeyfield; Ass't Gen. Mgr.: Peter Coleman. (PKG—audio only)

Audio: Cassette.

Happy Face Music, The Old Smithy, Post Office Ln., Kempsey, Worcs. WR5 3NS. Tel: (0905) 820-659, 820-566. Cable: SMITHYSOUND. Chief Exec.: Muff Murfin; Gen. Mgr.: V.B. Murfin.

Audio: Cassette, open reel.

Video: VHS.

Humberside Studios, Grimsby Rd., Laceby, Grimsby, South Humberside. Tel: (0472) 40152, 71582. Chief Exec.: L.A. Johnson; Gen. Mgr.: S.C. Johnson.

Audio: Cassette, open reel.

I B C Sound Rec'g Studios Ltd., 35 Portland Pl., London W1N 3AG. Tel: (01) 637-2111. Telex: 264413. Mng. Dir.: John D. Tucker; Technical Dir.: Dennis King; Studio Mgr.: Michael Claydon. (PKG)

Audio: Cassette, open reel.

Immediate Sound Servs. Ltd., 6 Orsman Rd., London N1 5QJ. Tel: (01) 739-9672. Telex: 262284. Chm.: Richard Clark; Mng. Dir.: Colin Johnson; Tape Mgr.: Malcolm Shepherd.

Audio: 8-tr., cassette.

Independent Rec. Co., 39 Harmer St., Gravesend, Kent. Tel: (0474) 65687. Chief Exec.: J.W. Oram.

Audio: 8-tr., cassette, open reel.

Industrial Recs. Ltd., 10 Mantello St., London E8. Tel: (01) 254-9178. Mng. Dir.: Peter Christopherson; Gen. Mgr.: Casey P. Orridge; Sales Mgr.: David Brooks.

Audio: Cassette.

S. Kempner Ltd., 61 Markfield Rd., London N15 4RA. Tel: (01) 801-6222. Telex: 21400. Gen. Mgr.: Paul R.S. Rogers; Technical Mgr.: Barry Heath. (PKG only)

L T S, see London Transcription Servs.

Steve Lane Musical & Publicity Servs., 12 Slough Ln., Kingsbury, London NW9 8QL. Tel: (01) 205-2587. Owner: Steve Lane.

Audio: Cassette.

Leader Sound Ltd., 209 Rochdale Rd., Greetland, Halifax, West Yorks. HX4 8JE. Tel: (0422) 76161. Mng. Dir.: Bill Leader; Dir.: Helen Leader.

Audio: Open reel.

Lee Eng'g Ltd., Napier House, Bridge St., Walton-on-Thames, Surrey KT12 1AP. Tel: 43124. Cable: LEETECH. Telex: 928475. Mng. Dir.: Thomas Lee; Gen. Mgr.: Chris Welsh; Sr. Sales Eng.: R.J. White. (PKG)

Audio: 8-tr., 8-tr. quadraphonic, cassette, open reel.

Linguaphone Institute Ltd., Trading Estate, 252/253 Argyll Ave., Slough, Berks. SL1 4HA. Tel: Slough 23200. Div. Mgr.: John King.

Audio: Cassette.

London Transcription Servs., 23 Denmark Pl., London WC2H 8NL. Tel: (01) 836-7148.

Audio: Cassette, open reel.

Metropolitan Communications, 8a Froggnal Gardens, London NW3 6UX. Tel: (01) 435-8803. Mng. Dir.: Mark R.F. Hanau; Gen. Mgr.: R. Perrott.

Audio: Cassette.

Mushroom Studios, 18 W. Mall, Clifton, Bristol BS8 4BG. Tel: (0272) 35994, 35867. Chief Exec.: D. Ackerman; Gen. Mgr.: S.A. Ackerman.

Audio: 8-tr., cassette.

National Panasonic (UK) Ltd., 107/109 Whitby Rd., Slough, Berks. SL1 3DR. Tel: (0753) 27516. Cable: PANASICO. Telex: 848761. Mng. Dir.: A. Imura; Sales Mgr.: J. Aoki; Adv. Mgr.: Ron Fry.

Branch: Staunton, Leeds, Skelton Grange Rd. Tel: (0532) 702541. Reg'l Sales Dir.: Tony Nishigaki.

Video: 1/2" EIAJ cartridge.

Nelson Rec'g Studio, Nelson House, 93 Castle Hill Rd., Hindley, Wigan, Lancs. WN2 4BH. Tel: (0942) 58777. Contacts: S.M. Millard, W. Leyland.

Audio: Cassette.

Video: 1/2" cassette, 1/2" VHS cassette.

Panda Recs., 11 Old Castle Rd., Llanelli, Dyfed, South Wales. Tel: (05542) 58913, 52490. Chief Exec.: Paul Adams; Gen. Mgr.: Alan Phillips. (PKG—audio only)

Audio: Cassette, open reel.

Pebble Recs Ltd., 46 Maddox St., London W1 Tel (01) 629-3266, 491-4140. Telex 25247 Mng Dir. James Pollard, Gen. Mgr. Julia Slocombe.
Audio: 8-tr. cassette, open reel
 Phonodisc Ltd., Walthamstow Ave., London E4 8SZ. Tel (01) 527-2256. Telex 896383. Mng. Dir. W. Bryant, Factory Mgr. V. Gowland; Tape Prods. Mfg. Mgr. F.W. Street. (PKG)
Audio: Cassette.

Phonogram Ltd., Stanhope House, Stanhope Pl., London W2 2HH Tel: (01) 262-7788. Cable PHONREC Telex 261583. Mng. Dir. A.J. Morris; Mktg. Mgr. K.N. Maliphant; Sales Mgr. F.R. Towers.
Audio: Cassette.

Pinnacle Electronics Ltd., Electron House, Cray Ave., St. Marys Cray, Orpington., Kent BR5 3QJ. Tel (66) 27099. Telex 896141. Chm. & Mng. Dir. Terry Scully, Mng. Dir. Jack Bass, Gen. Mgr. G.F. Stone, Sales Mgr. Ray Phillips (PKG)

Plant Life Recs Ltd., Edison Chambers, 109A Bancroft, Hitchin, Herts. Tel (0462) 58555. (PKG—Audio only)
 Portland Rec'g Studio Ltd., 35 Portland Pl., London W1 Tel (01) 637-2111. Cable: BARNEMUS. Telex 25929. Chm. Charles Chandler, Tape Copying Gen. Mgr. Brian Carroll
Audio: Cassette, open reel

Precision Tapes Ltd., ATV House, 17 Great Cumberland Pl., London W1A 1AG Tel (01) 262-5502 Cable PYREC LONDON Telex 28259 Mng. Dir. Walter S. Woyda (PKG)
Audio: 8-tr., 8-tr. quadrasonic, cassette

Production Express Int'l., 15 Britten Lodge, Fair Acres, Bromley, Kent Tel (01) 464-3249 Telex 912881 Mng. Dir. Bobbie Dahdi.
Audio: Cassette

Racal-Zonal Ltd., Station Hill, Pound Hill, Crawley, Sussex RH10 4AZ Tel (0293) 34982 Cable CASSETTES CRAWLEY Telex 87651 Mng. Dir. D.S. Worman; Gen. Sales Mgr. John Rooke, A/V Sales Mgr. Eric Mould.
Audio: Cassette

Rainbow Sound Servs., 1A St. Andrew St., Plymouth, Devon. Tel (0752) 25781 (day), 774381 (night). Chief Exec. Phil E.R. Simonds. (PKG only)
 Real Custom, The Camp, Montgomery, Powys SY15 6LU Tel (068681) 427. Mgr. G.R. Davies.
Audio: Cassette.

Rougecrest Ltd., 10 Barley Mow Passage, Chiswick, London W4 4PH Tel (01) 994-6477 Mng. Dir. Joseph R. Stanley, Gen. Mgr. Mike A. Carter.
Video: 1" cartridge, 3/4" cassette, 1/2" EIAJ cartridge.

S R T Rec. Prod'ns Ltd., 987 High Rd., Finchley, London N12. Tel: (01) 446-3218 Mng. Dir. George Bellamy, Gen. Mgr. J. Townsend, Sales Mgr. Dave Richardson.
Audio: Cassette

Sentinel Recs (Cornwall) Ltd., Paul, Penzance, Cornwall Tel (0736) 73246 Telex 45608 Chief Exec. & Gen. Mgr. Job Morris
Audio: Cassette

Simon Stable Promos., Inglenook, West End, Launton, Oxfordshire Tel (08692) 2831. Mng. Dir. Count S.C. de la Bedoyere, Gen. Mgr. Judy Dyble, Sales Mgr. Simon Stable, Dupl'r Daniel de la Bedoyere
Audio: Cassette

Soundpost Studios, Grapevine House, Harberton, Totnes, Devon. Tel (0803) 863616. Dir. Peter Kennedy
Audio: Cassette.

Spot Recs. Ltd., 64 S. Molton St., London W1 Tel (01) 499-7173 Gen. & Studio Mgr. Kate Hudson.
Audio: Cassette, open reel
Video: 1" cartridge

Strathclyde Sound & Video Ltd., Central Chambers, 93 Hope St., Glasgow, Scotland G2 6LD Tel (041) 221-2244. Mng. Dir. P. Grant
Audio: 8-tr., cassette, open reel.

T D Rec'gs., 1 Cleveland Park Crescent, Waltham Forest, London E17 Tel (01) 520-0414

T R A D Electronics Sales Ltd., 149B St. Albans Rd., Watford, Herts WD2 5BB Tel (92) 47988. Telex 262741 Mng. Dir. J.E. Southard
Audio: Cassette

The Tape Dupl'g Co. (GB) Ltd., Freedex House, 4-10 North Rd., Islington, London N7 9HN Tel (01) 609-0087 Telex 264773 Pres. Mark Myers, Mng. Dir. Peter Robey, Sales Mgr. Bob Hill (PKG)
Audio: 8-tr., 8-tr. quadrasonic, cassette

Theatre Projects Servs. Rec'g Studio, 11/13 Neals Rd., Monmouth St., London WC2 Tel (01) 836-1168. Cable THEATRELIT Telex 27522 Mng. Dir. John Ball; Studio Mgr. Roger Norwood
Audio: Open reel

Trident Audio Developments Ltd., 112/114 Wardour St., London W1V 3AW Tel (01) 734-9901 Telex 27782 Mng. Dir. Malcolm Toft, Sales Mgrs. Mike Rogers, Derek Fox (PKG)
Audio: 8-tr., cassette

Wardour Motion Picture Co. Ltd., 11 Wardour Mews, London W1 Tel (01) 439-4313. Dir. M.J. Sutton, Gen. & Sales Mgr. Christie Gillingham (PKG)
 James Yorke Ltd., Oak House, Northleach, Gloucestershire GL54 3ET. Tel (04516) 509 Chief Exec. J. Scarlett, Sales Mgr. Peter Fanshawe, Technical Mgr. Mike McClaron, Studio Mgr. Peter Rinnie (PKG)
Audio: Cassette

TAPE DUPLICATOR/MARKETERS

Metropolitan Communications, 8A Frogna Gardens, London NW3 6UX Tel (01) 435-8803 Mng. Dir. Mark R.F. Hanau, Gen. Mgr. R. Fry, Sales Mgr. R. Hanau, Admin. A. Lohmeyer
Labels: Bedside, Belmont, Talkie Tapes, Venus

Pebble Recs Ltd., 46 Maddox St., London W1. Tel (01) 629-3266, 491-4140 Telex 25247 Mng. Dir. James Pollard, Gen. Mgr. Julia Slocombe
Label: Sound & Picture (Kuwait)

Precision Tapes Ltd., ATV House, 17 Great Cumberland Pl., London W1A 1AG Tel (01) 262-5502 Cable PYREC LONDON. Telex 28259. Mng. Dir. Walter S. Woyda; Gen. Mgr. Gary Mann, Sales Mgr. Trevor Eyles
Labels: Ad-Rhythm, Ariola, Ariola-Hansa, Bradleys.

Buddah, Buena Vista, Cactus, Casablanca, Charly, Chartbusters, Chiswick, Conquest, Creole, Cube, Dawn, Daybreak, Dragon, Electric, Ember, Ensayo, Everest, Golden Hour, Gull, Hit & Run, Horse, Immediate, Karma Sutra, Magnet, Marble Arch, Nashville, Nixa, Nonesuch, PBR Int'l., Parachute, Precision Sound Guides, Precision Tapes, Private Stock, Pye, Pye Chartbusters, Pye Classical, Pye 4D, Pye Int'l., Pye Special, Redwood, Ronnie Scotts, SRT, Shell-Sound Guides, Small Talk, Spark, Sportsdisc, Stax, Sun, 20th Century, Vanguard, Virtuoso, Visaphone, Vogue, World, Xtra.

● supplies

CARTRIDGE & CASSETTE PARTS

Ampex Great Britain Ltd., Acre Rd., Reading, Berks RG2 0QR Tel (0734) 85200 Cable AMPEX READING Telex 847611 Gen. Mgr. W. Scullion, Mktg. Servs. Supervisor C. Murphy-O'Connor, Sales Mgr. J. Cripps, Adv. Mgr. P. Vaughan

C S B Ltd., 5/7 Carnaby St., London W1V 1PG Tel (01) 439-9281 Telex 896691 Mng. Dir. Mafalda Hall, Dir. & Prod'n Mgr. Mike Shaw, Sales Mgr. Paul Cumming, Int'l. Caroline Lacy-Thompson

Cosmocord Ltd., Eleanor Cross Rd., Waltham Cross, Herts EN8 7NX, Tel. Lea Valley 716-666 Cable ACOS WALTHAM CROSS Telex 24294 Mng. Dir. V.J. Sivyver, Sales & Mktg. Dir. G.E. Brewin

E M I Tape Ltd., Tape House, Dawley Rd., Hayes, Middx UB3 1BT Tel (01) 573-3888. Cable EMITAPE LONDON Telex 932161. Mng. Dir. E.A. Naef, Comm'l. Controller P.K. Mitchell, Gen. Sales Mgr. P. Sollitt, Mktg. Mgr. M.W. Cross
Audio: Cassette parts

Landmark (Precision Mouldings) Ltd., 2 Albion Way, Langford Rd., Biggleswade, Beds. Tel (0767) 314-231. Telex 23384 Mng. Dir. David Ritchie, Prod'n Dir. George Jardine, Works Dir. Don Pearson
Branch: Potters Bar, Herts., Deneway House, Darkes Ln

Audio: Plastic molded parts
 Musonic, see Ziphurst

Pyral Magnetics Ltd., Airport House, Purley Way, Croydon, Surrey CR0 0XZ Tel (01) 681-2272 Telex 946670 Mng. Dir. H.J. Hutchings, Sales Mgr. John P. Thurley
Factory: Eastbourne, Sussex, Courtlands Rd Tel (0323) 638-965

Racal-Zonal Ltd., Station Hill, Pound Hill, Crawley, Sussex RH10 4AZ Tel (0293) 34982 Cable CASSETTES CRAWLEY Telex 87651 Mng. Dir. D.S. Worman, Gen. Sales Mgr. John Rooke, A/V Sales Mgr. Eric Mould
Audio: All cassette components

S & B Trading, Stylus House, 34/38 Verulam Rd., St. Albans, Herts. AL3 4DF Tel (0727) 50611. Mng. Dir. P.H. Grant, Prod'n Dir. S.H. Blank, Sales Dir. B. Blank, Dir. D.N. Lever
Audio: Cassette parts

Thorn Consumer Electronics Ltd., 284 Southbury Rd., Enfield, Middx. EN1 1TJ Tel (01) 366-1155. Telex. 263201 Mng. Dir. R.E. Norman, Sales Dir. J. Ross, Adv. Mgr. M.L. Doman
Audio: Cassette mechanisms

Ziphurst Ltd., Stylus House, 34/38 Verulam Rd., St. Albans Herts AL3 4DF Tel (0727) 50611 Telex 28675 Mng. Dir. P.H. Blank, Gen. Dir. D.N. Lever, Sales Dir. B. Blank, Prod'n Dir. S.H. Blank
Audio: Cassette parts

EMPTY CARTRIDGES, CASSETTES & REELS

Ampex Great Britain Ltd., Acre Rd., Reading, Berks RG2 0QR Tel (0734) 85200 Cable AMPEX READING Telex 847611 Gen. Mgr. W. Scullion, Mktg. Servs. Supervisor C. Murphy-O'Connor, Sales Mgr. J. Cripps, Adv. Mgr. P. Vaughan
Audio: All configurations
 Audio Devices, see Lee

B A S F UK Ltd., Haddon House, 2/4 Fitzroy St., London W1P 5AD Tel (01) 637-8971 Telex 28649 Div. Mgr. H.C. Pattinson, Prof. Prods. Mgr. R.M. Hine
Audio: Cassette
Video: 1 1/2" open reel, cassette.

C S B Ltd., 5/7 Carnaby St., London W1V 1PG Tel (01) 439-9281 Telex 896691 Mng. Dir. Mafalda Hall, Dir. & Prod'n Mgr. Mike Shaw, Sales Mgr. Paul Cumming, Int'l. Caroline Lacy-Thompson

Copel, see Cosmocord
 Cosmocord Ltd., Eleanor Cross Rd., Waltham Cross, Herts EN8 7NX Tel. Lea Valley 716-666 Cable ACOS WALTHAM CROSS Telex 24294 Mng. Dir. V.J. Sivyver, Sales & Mktg. Dir. G.E. Brewin
Audio: 8-tr., cassette, open reel
Brand name: Copel

E M I Tape Ltd., Tape House, Dawley Rd., Hayes, Middx UB3 1BT Tel (01) 573-3888. Cable EMITAPE LONDON Telex 932161. Mng. Dir. E.A. Naef, Comm'l. Controller P.K. Mitchell, Gen. Sales Mgr. P. Sollitt, Mktg. Mgr. M.W. Cross
Audio: Cassette, open reel
 Fidelipac, see SIS

Landmark (Precision Mouldings) Ltd., 2 Albion Way, Langford Rd., Biggleswade, Beds. Tel (0767) 314-231 Telex 23384 Mng. Dir. David Ritchie; Prod'n Dir. George Jardine; Works Dir. Don Pearson
Branch: Potters Bar, Herts., Deneway House, Darkes Ln
Audio: 8-tr., cassette

Lee Eng g Ltd., Napier House, Bridge St., Walton-on-Thames, Surrey KT12 1AP Tel. Walton-on-Thames 43124 Cable LEETECH. Telex 928475 Mng. Dir. Thomas Lee; Gen. Mgr. Chris Welsh, Sr. Sales Eng. R.J. White
Audio: NAB
Brand name: Audio Devices

Musonic, see S&B Trading & Ziphurst
 National Panasonic (UK) Ltd., 107/109 Whitby Rd.,

Slough, Berks SL1 3DR. Tel: (0753) 27516. Cable: PANASONIC. Telex: 848761. Mng. Dir.: A. Imura; Sales Mgr.: J. Aoki; Adv. Mgr.: Ron Fry.
Branch: Stourton, Leeds, Skelton Grange Rd. Tel: (0532) 702541 Reg'l Sales Dir.: Tony Nishigaki.
Video: 1/2" EIAJ open reel, 1/2" EIAJ cartridge.
Brand name: National.

Professional Tapes Ltd., Cassette House, 329 Hunslet Rd., Leeds LS10 1NJ. Tel (0532) 706066. Telex: 55293. Mng. Dir. Raymond Linton; Gen. Mgr.: Joseph Nurgat; Sales Mgr. Bert Hamilton.
Audio: Cassette.

Racal-Zonal Ltd., Station Hill, Pound Hill, Crawley, Sussex RH10 4AZ Tel (0293) 34982 Cable CASSETTES CRAWLEY Telex 87651. Mng. Dir.: D.S. Worman; Gen. Sales Mgr.: John Rooke; A/V Sales Mgr.: Eric Mould.
Audio: Cassette.

S & B Trading, Stylus House, 34/38 Verulam Rd., St. Albans, Herts. AL3 4DF. Tel: (0727) 50611. Mng. Dir.: P.H. Grant, Prod'n Dir.: S.H. Blank; Sales Dir.: B. Blank; Dir. D.N. Lever.
Audio: 8-tr., cassette
Brand name: Musonic.

S I S Ltd., 57 St. Andrews Rd., Northampton NN1 2PB Tel (0604) 32965, 30559 Mng. Dir.: D.P.D. Mitchell; Sales Mgr.: I. Brown.
Audio: NAB "A" & "C"
Brand name: Fidelipac.

Scotch, see 3M
 Tandberg (UK) Ltd., 81 Kirkstall Rd., Leeds, Yorks. LS3 1HR. Tel (0532) 35111 Cable: TANBERG LEEDS. Telex: 557611 Mng. Dir. John Farnell; Dir. & Sales Dir.: W.R. Harrison; Adv. Mgr.: M.R. Cowing.
Audio: Cassette.

The Tape Dupl'g Co. (GB) Ltd., Freedex House, 4-10 North Rd., Islington, London N7 9HN. Tel (01) 609-0087. Telex 264773. Pres. Mark Myers; Mng. Dir.: Peter Robey, Sales Mgr. Bob Hill.
Audio: Cassette

3 M United Kingdom Ltd., PO Box 1, 3M House, Bracknell, Berks. RG12 1JU Tel (0344) 26726. Telex: 8499371. Mng. Dir. Donn Osmon; Dir. Div. P.G. Hutchings; Sales & Mktg. Mgr.: C. Hobbs; Pkg. Co-ord.: P.A. Stockwell-Jones.
Reg'l sales offices: Belfast BT1 5JE, Northern Ireland, 11 Donegal Square S. Tel: (0232) 42811, 42926—Birmingham B3 3EL, Edmond House, 12-22 Newhall St. Tel: (021) 236-5077—Glasgow G4 0AY, Scotland, 3M House, 9 Canal St. Tel: (041) 332-9622—London SE20 7TR, PO Box 38, Yeoman House, 63 Croydon Rd., Penge. Tel (01) 659-2323—Manchester M15 4PA, 3M House, 28 Great Jackson St. Tel (061) 236-8500
Audio: 8-tr., cassette & open reel
Video: Open reel, cassette.
Brand name: Scotch.

Ziphurst Ltd., Stylus House, 34/38 Verulam Rd., St. Albans, Herts AL3 4DF Tel (0727) 50611. Telex 28675. Mng. Dir. P.H. Blank; Gen. Dir.: D.N. Lever; Sales Dir.: B. Blank, Prod'n Dir.: S.H. Blank.
Audio: 8-tr., cassette
Brand name: Musonic.

ENVELOPES & MAILERS
 Ballantine Advertising Ltd., 8 Chestow Pl., London W2. Tel: (01) 229-6071. Mng. Dir.: A.N. Gill; Gen. Mgr.: Max Arnold.
 Barrester Music Co. Ltd., 23/5 Wilton Way, London E8 3EE. Tel (01) 254-3652. Mng. Dir.: John Barratt.

C S B Ltd., 5/7 Carnaby St., London W1V 1PG. Tel (01) 439-9281 Telex 896691. Mng. Dir. Mafalda Hall; Dir. & Prod'n Mgr. Mike Shaw; Sales Mgr. Paul Cumming; Int'l. Caroline Lacy-Thompson

Clout & Baker Ltd., Chalkin Works, Parkwood Ind'l Estate, Bircholt Rd., Maidstone, Kent. Tel (0622) 673261. Chm. D.P. Chalkin; Sales Dir.: John Benoy; Works Dir.: Robin Burr.

Rainbow Sound Servs., 1A St. Andrew St., Plymouth, Devon. Tel (0752) 25781 (day), 774381 (night). Chief Exec. Phil E.R. Simonds

Sound for Industry Ltd. (div. of MacNeil Press Ltd.), Newhams Row, 175 Bermondsey St., London SE1 3UW. Tel (01) 403-0044 Cable SFI Telex 883177. Dir.: John E. Moon, Gen. Mgr.: W. Maciejewski

Robert Stace & Co. Ltd., Chalkin Works, Longfield Rd., Tunbridge Wells, Kent. Tel (0892) 24225. Cable 95577. Chm & Mng. Dir. D.P. Chalkin; Ass't Mng. Dir.: A.G. Long, Sales Dir.: C.H. Garrett

James Upton Ltd., 67 Rosman St., London EC1. Tel (01) 278-2916 Cable TINROBOR. Sales Dir. W.G.A. Howe; Sales Mgr. C.J. Bennett

JACKETS & SLEEVES
 A M C (Associated Mktg. Co.), Harlow, Essex. Tel (0279) 416-721. Contacts: Don Morris, Janet Verdon

Album Graphics (UK) Ltd., 2 Goodwin's Court, 55 St. Martin's Ln., London WC2. Tel: (01) 240-1319. Telex: 21879, 25247 UK Rep.: Linda Halpin.
Home office: USA, Chicago, Ill.

John V. Armstrong Ltd., 142 Charing Cross Rd., London WC2 Tel (01) 836-8121. (Sleeves only)
 Artist Partners Ltd., 14 Ham Yard, Great Windmill St., London W1. Tel (01) 734-7991. (Sleeves only)
 Ballantine Advertising Ltd., 8 Chestow Pl., London W2. Tel: (01) 229-6071 Mng. Dir.: A.N. Gill, Gen. Mgr.: Max Arnold (Jackets only)

G. Bamford, 18 Gatesden, Cromer St., London WC1. Tel: (01) 837-8660. (Sleeves only)
 Bird Sound Studios, Welton Rd., Wedgwood Estate, Warwick CV34 5YA. Tel (0926) 45123. Owner S.L. Bird; Gen. Mgr. D. Rawlings, Sales Mgrs.: S. Riddell, T. Arton.

C S B Ltd., 5/7 Carnaby St., London W1V 1PG. Tel (01) 439-9281 Telex 896691. Mng. Dir. Mafalda Hall; Dir. & Prod'n Mgr. Mike Shaw; Sales Mgr. Paul Cumming, Int'l. Caroline Lacy-Thompson

Cassette & Rec. Servs., Eastcotts Rd., Bedford. Tel: (0234)

56317. Telex 825067 Contacts R. Denges, J. Norbury
Branch: Aylesbury, Bucks., Rabans Ln., Unit II, Tel: (0296) 20961. Contacts: P. Medcalf, M.J. Batchelor.
 Clout & Baker Ltd., Chalkin Works, Parkwood Ind'l Estate, Bircholt Rd., Maidstone, Kent, Tel: (0622) 673261, Chm.: D.P. Chalkin, Sales Dir.: John Benoy; Works Dir.: Robin Burr (Sleeves only)
 Ernest J. Day & Co. Ltd., 3 Olaf St., Freston Rd., London W11 4AX, Tel: (01) 229-3499
 Delga Press Ltd., Dingwall House, 8 Marlborough Rd., Bromley, Kent BR2 9NH, Tel: (01) 460-0112 Telex 8951346. Mng. Dir.: R.E. Edwards; Gen. Dir.: R.N. Roadnight, Dir.: R.G. Froment; Sales Mgr.: P.H. Grey (Sleeves only)
 E.C.G. (EC Graphics Ltd.), 67 Rosoman St., London EC1 Tel: (01) 278-8054 Telex 267985 Mng. Dir.: R. Vickers, Sales Mgr.: T.D. Stevens
 Garrod & Lofthouse Ltd., 6 Langley St., London WC2H 9JG, Tel: (01) 240-3322 Telex 262554. Chm. & Mng. Dir.: Norman J. Garrod
 Gothic Press Ltd., Hainault St., New Eltham SE9 2EQ, Tel: (01) 850-2266 Mng. Dir.: A.H. Harvey, Gen. Mgr.: M.E. Hughes, Sales Mgr.: R. Jeffery (Sleeves only)
 E Hannibal & Co. Ltd., Pinfold Rd., Thurleston, Leicester Tel: (0533) 695413 Telex 34627 Mng. Dir.: Chris Hetherington, Ass't Mng. Dir.: Roger Stewart, Music Div. Sales Dir.: Derek Deighton (Sleeves only)
 House Of Wizzard, 155/7 Oxford St., London W1R 1TB, Tel: (01) 734-6372 Mng. Dir.: David Myers (Sleeves only)
 K B P Litho Ltd., 88 Brewery Rd., London N7
 M L T Mktg. Assocs., 76 Neal St., London WC2H 9PA, Tel: (01) 240-5326. Creative Dir.: Mike Liddel-Taylor (Sleeves only)
 Frank S. Manley (Printers) Ltd., 22 Monson Rd., London NW10, Tel: (01) 965-7326 (Sleeves only)
 Musonic Ltd., 34/38 Verulam Rd., St. Albans, Herts. AL3 4DF, Tel: (0727) 50611 Telex 28675 Mng. Dir.: P.H. Blank, Sales Mgr.: Stephen H. Blank, Export Dir.: Brian Blank (Sleeves only)
 P T T Developments Ltd., 63 High St., Ware, Herts. SG12 9AD, Tel: (0920) 66242 Chief Exec.: R.C. Bayes (Sleeves only)
 Pan-Graphics (Edinburgh) Ltd., 21A Grosvenor St., Edinburgh, Scotland EH12 5ED, Tel: (031) 225-9502 Mng. Dir.: John Mackinnon, Gen. Mgr.: Colin Moore, Sales Mgr.: Jonathan Field (Sleeves only)
 Plastic Sales Leicester Ltd., 10/12 Dartford Rd., Leicester LE2 7PQ, Tel: (0533) 833-691, Chief Exec.: T.H. Winfield, Gen. Mgr.: Mrs. B.E. Flude (Sleeves only)
 The Presto Copying Serv., The Studio, Gatesden Flats, Cromer St., London WC1, Tel: (01) 837-8660 (Sleeves only)
 Production Express Int'l., 15 Britten Lodge, Fair Acres, Bromley, Kent, Tel: (01) 464-3249 Telex 912881 Mng. Dir.: Bobbie Dahdi
 Purpax Plastics Ltd., Longbank Works, Alva, Clackmannanshire, Scotland, Tel: (0259) 60307 Mng. Dir.: J.M. Fuller, Sales Mgr.: M. Pink, Prod'n Dir.: R.B. Dunbar (Sleeves only)
 Rainbow Sound Servs., 1A St. Andrew St., Plymouth, Devon, Tel: (0752) 25781 (day), 774381 (night), Chief Exec.: Phil E.R. Simonds
 Real Custom Prod'ns, The Camp, Montgomery, Powys SY15 6LU, Tel: (068681) 427 Chief Exec.: Richard G. Davies, Sales Mgr.: George B. Pryce (Sleeves only)
 S R T Rec. Prod'ns Ltd., 987 High Rd., Finchley, London N12, Tel: (01) 446-3218 Mng. Dir.: George Bellamy, Gen. Mgr.: J. Townsend, Sales Mgr.: Dave Richardson (Sleeves only)
 Senal Printing Ltd., 4 Hardwicke Way, London SW18 4AJ, Tel: (01) 874-5775 Mng. Dir.: M.M. Gunn
 Shannon Dist'n Ltd., 30 Holloway Rd., London N7, Tel: (01) 607-8544/3838 (Sleeves only)
 Shorewood Packaging Co. Ltd., College Rd., Aston Clinton, Bucks HP2 5EZ, Tel: (0296) 630421 Cable SHORE-PAK ASTON CLINTON Telex 83495 Gen. Mgr.: Denis Rex, Sales Mgr.: Lionel G. Rose, Works Mgr.: Reg Ward
Home office: USA, New York, N.Y.
 Sound for Industry Ltd. (div of MacNeill Press Ltd.), Newhams Row, 175 Bermondsey St., London SE1 3UW, Tel: (01) 403-0044 Cable SFI Telex 883177 Dir.: John E. Moon, Gen. Mgr.: W. Maciejewski
 Robert Stace & Co. Ltd., Chalkin Works, Longfield Rd., Tunbridge Wells, Kent, Tel: (0892) 24225 Telex 95577 Chm. & Mng. Dir.: D.P. Chalkin, Ass't Mng. Dir.: A.G. Long, Sales Dir.: C.H. Garrett
 Storm Rec'g Studios, 186 North Promenade, Blackpool, Tel: (0253) 23095, 27357 Dirs.: Wayne Paulo, Lenny Harris (Sleeves only)
 Studio G, 195 Wardour St., London W1, Tel: (01) 734-5784 (Sleeves only)
 Sutherland Studios, 85 Sutherland Ave., London W9 2HG, Tel: (01) 289-1875 Mgr.: Colin Burns
 Tinsley-Robor Group Ltd., Churchill Ind'l Estate, Lancing, Sussex BN15 8TX, Tel: (09063) 5381 Telex: 877171 Group Mng. Dir.: John Rose; Group Sales Dir.: Roy Joyner
 James Upton Ltd., 67 Rosoman St., London EC1, Tel: (01) 278-2916 Cable TINROBOR Sales Dir.: W.G.A. Howe, Sales Mgr.: C.J. Bennett (Sleeves only)
 Vintage Jazz Music Society Recs., 12 Slough Ln., Kingsbury, London NW9 8QL, Tel: (01) 205-2587 Owner: Steve Lane
 Wardour Motion Picture Co. Ltd., 11 Wardour Mews, London W1, Tel: (01) 439-4313 Dir.: M.J. Sutton, Gen. & Sales Mgr.: Christie Gillingham
 West Bros. Printers Ltd., 212 Durnsford Rd., London SW19 8DR, Tel: (01) 947-2106 Telex 25694 Mng. Dir.: Peter G. West, Gen. Mgr.: H.E.V. Pinnell, Sales Mgr.: Derek Higgs
 P.G. Wood & Son (Printers) Ltd., 32 Church St., Dagenham, Essex RM10 9UU, Tel: (01) 595-5115 Telex 897417 Mng. Dir.: Peter Wood, Gen. Mgr.: Chris Sanford, Sales Mgr.: Phil Douglas, Works Mgr.: Greg Bell (Sleeves only)
 Ziphurst Ltd., Stylus House, 34/38 Verulam Rd., St. Albans, Herts. AL3 4DF, Tel: (0727) 50611 Telex 28675

Mng. Dir.: P.H. Blank, Gen. Dir.: D.N. Lever, Sales Dir.: B. Blank, Prod'n Dir.: S.H. Blank (Sleeves only)
LABELS
 A M C (Associated Mktg Co.) Harlowbury Old Harlow, Essex CM17 0HZ, Tel: (0279) 416-721 Contacts: Don Morris, Janet Verdon
 John V. Armstrong Ltd., 142 Charing Cross Rd., London WC2, Tel: (01) 836-8121
 Ballantine Advertising Ltd., 8 Chepstow Pl., London W2, Tel: (01) 229-6071 Mng. Dir.: A.N. Gill, Gen. Mgr.: Max Arnold
 G. Bamford, 18 Gatesden, Cromer St., London WC1, Tel: (01) 837-8660
 Bird Sound Studios, Welton Rd., Wedgcock Estate, Warwick CV34 5YA, Tel: (0926) 45123, Owner: S.L. Bird, Gen. Mgr.: D. Rawlings, Sales Mgrs.: S. Riddell, T. Arton
 C S B Ltd., 5/7 Carnaby St., London W1V 1PG, Tel: (01) 439-9281 Telex 896691, Mng. Dir.: Mafalda Hall, Dir. & Prod'n Mgr.: Mike Shaw, Sales Mgr.: Paul Cumming, Int'l. Caroline Lacy-Thompson
 Cassette & Rec. Servs., Eastcoats Rd., Bedford, Tel: (0234) 56317 Chief Exec.: P. J. Norbury, Gen. Mgr.: P. Moore
 L. A. Cousins & Co. Ltd., 26 Grandens Ave., Hackney, London E8, Tel: (01) 985-4211 Owner: L.A. Cousins, Gen. Mgr.: S. Franks
 Garrod & Lofthouse Ltd., 6 Langley St., London WC2H 9JG, Tel: (01) 240-3322 Telex 262554 Chm. & Mng. Dir.: Norman J. Garrod
 Gothic Press Ltd., Hainault St., New Eltham SE9 2EQ, Tel: (01) 850-2266 Mng. Dir.: A.H. Harvey, Gen. Mgr.: M.E. Hughes, Sales Mgr.: R. Jeffery
 E. Hannibal & Co. Ltd., Pinfold Rd., Thurleston, Leicester LE4 8AP, Tel: (0533) 695413 Telex 34627 Mng. Dir.: Chris Hetherington, Ass't Mng. Dir.: Roger Stewart, Music Div. Sales Dir.: Derek Deighton
 Harrison & Sons (London) Ltd., Printing House Ln., Hayes, Middx UB3 1HQ, Tel: (01) 573-3828 Telex 23744, Mng. Dir.: R.A. Boxall, Works Dir.: B.L. Hibbald, Sales Dir.: D.S. Robinson, Prod. Mgr.: M.S. Fitzgerald
 House Of Wizzard, 155/7 Oxford St., London W1R 1TB, Tel: (01) 734-6372 Mng. Dir.: David Myers
 K B P Litho Ltd., 88 Brewery Rd., London N7
 K K Mktg., Ashurst Lodge 14, Liverpool Gardens, Worthing, Sussex BN11 1BR, Tel: (0903) 205053 Dir.: John Dean, Sales Dir.: Anthony Card
 Labeltech, 162B Dalston Ln., London E8, Tel: (01) 254-2483
 M L T Mktg. Assocs., 76 Neal St., London WC2H 9PA, Tel: (01) 240-5326 Creative Dir.: Mike Liddel-Taylor
 Frank S. Manley (Printers) Ltd., 22 Monson Rd., London NW10, Tel: (01) 965-7326
 I. Markovits Ltd., 1/2/3 Cobbold Mews, London W12, Tel: (01) 743-1131 Cable NAMEPLATE Mng. Dir.: I. Markovits, Dir.: T.P. Johnstone
 Pan-Graphics (Edinburgh) Ltd., 21A Grosvenor St., Edinburgh, Scotland EH12 5ED, Tel: (031) 225-9502 Mng. Dir.: John Mackinnon, Gen. Mgr.: Colin Moore, Sales Mgr.: Jonathan Field
 The Presto Copying Serv., The Studio, Gatesden Flats, Cromer St., London WC1, Tel: (01) 837-8660
 Production Express Int'l., 15 Britten Lodge, Fair Acres, Bromley, Kent, Tel: (01) 464-3249 Telex 912881 Mng. Dir.: Bobbie Dahdi
 Rainbow Sound Servs., 1A St. Andrew St., Plymouth, Devon, Tel: (0752) 25781 (day), 774381 (night), Chief Exec.: Phil E.R. Simonds
 Real Custom Prod'ns, The Camp, Montgomery, Powys SY15 6LU, Tel: (068681) 427 Chief Exec.: Richard G. Davies, Sales Mgr.: George B. Pryce
 S R T Rec. Prod'ns Ltd., 987 High Rd., Finchley, London N12, Tel: (01) 446-3218 Mng. Dir.: George Bellamy, Gen. Mgr.: J. Townsend, Sales Mgr.: Dave Richardson
 The Shaftford Press Ltd., 85b Bradford St., Braintree, Essex CM7 6AU, Tel: Braintree 21125 Mng. Dir.: R. Capon
 Shannon Dist'n Ltd., 30 Holloway Rd., London N7, Tel: (01) 607-8544/3828
 Shorewood Packaging Co. Ltd., College Rd., Aston Clinton, Bucks HP2 5EZ, Tel: (0296) 630421 Cable SHORE-PAK ASTON CLINTON Telex 83495 Gen. Mgr.: Denis Rex, Sales Mgr.: Lionel G. Rose, Works Mgr.: Reg Ward
 Smith Press (Raynes Park) Ltd., 36 W. Brnes Ln., London SW20, Tel: (01) 946-8781
 Sound for Industry Ltd. (div of MacNeill Press Ltd.), Newhams Row, 175 Bermondsey St., London SE1 3UW, Tel: (01) 403-0044 Cable SFI Telex 883177 Dir.: John E. Moon, Gen. Mgr.: W. Maciejewski
 Robert Stace & Co. Ltd., Chalkin Works, Longfield Rd., Tunbridge Wells, Kent, Tel: (0892) 24225 Telex 95577 Chm. & Mng. Dir.: D.P. Chalkin, Ass't Mng. Dir.: A.G. Long, Sales Dir.: C.H. Garrett
 Storm Rec'g Studios, 186 North Promenade, Blackpool, Tel: (0253) 23095, 27357 Dirs.: Wayne Paulo, Lenny Harris
 Vintage Jazz Music Society Recs., 12 Slough Ln., Kingsbury, London NW9 8QL, Tel: (01) 205-2587 Owner: Steve Lane
 West Bros. Printers Ltd., 212 Durnsford Rd., London SW19 8DR, Tel: (01) 947-2106 Telex 25694 Mng. Dir.: Peter G. West, Mng. Dir.: H.E.V. Pinnell, Sales Mgr.: Derek Higgs
 P.G. Wood & Son (Printers) Ltd., 32 Church St., Dagenham, Essex RM10 9UU, Tel: (01) 595-5115 Telex 897417 Mng. Dir.: Peter Wood, Gen. Mgr.: Chris Sanford, Sales Mgr.: Phil Douglas, Works Mgr.: Greg Bell

POLYETHYLENE BAGS

C S B Ltd., 5/7 Carnaby St., London W1V 1PG, Tel: (01) 439-9281 Telex 896691 Mng. Dir.: Mafalda Hall, Dir. & Prod'n Mgr.: Mike Shaw, Sales Mgr.: Paul Cumming, Int'l. Caroline Lacy-Thompson
 Crosswinds Pkg. Co., Pardia House, Cadmore Ln., Cheshunt, Herts, Tel: Waltham Cross 38141
 M & G Packaging (Essex) Ltd., 53 Pavilion Dr., Leigh-on-Sea, Essex, Tel: (0702) 712-381 Mng. Dir.: M.H. Goldring
 Musonic Ltd., 34/38 Verulam Rd., St. Albans, Herts AL3 4DF, Tel: (0727) 50611 Telex 28675 Mng. Dir.: P.H. Blank, Sales Mgr.: Stephen H. Blank, Export Dir.: Brian Blank

Plastic Sales Leicester Ltd., 10/12 Dartford Rd., Leicester, Tel: (0533) 833-691, Chief Exec.: T.H. Winfield; Gen. Mgr.: Mrs. B.E. Flude
 Rainbow Sound Servs., 1A St. Andrew St., Plymouth, Devon, Tel: (0752) 25781 (day), 774381 (night), Chief Exec.: Phil E.R. Simonds
 Shannon Dist'n Ltd., 30 Holloway Rd., London N7, Tel: (01) 607-8544-3828
 Robert Stace & Co. Ltd., Chalkin Works, Longfield Rd., Tunbridge Wells, Kent, Tel: (0892) 24225 Telex 95577 Chm. & Mng. Dir.: D.P. Chalkin, Ass't Mng. Dir.: A.G. Long, Sales Dir.: C.H. Garrett
 Ziphurst Ltd., Stylus House, 34/38 Verulam Rd., St. Albans, Herts AL3 4DF, Tel: (0727) 50611 Telex 28675 Mng. Dir.: P.H. Blank, Gen. Dir.: D.N. Lever, Sales Dir.: B. Blank, Prod'n Dir.: S.H. Blank

PROFESSIONAL TAPE SUPPLIES

A T (Associated Tape) Ltd., 214 Bowes Rd., Southgate, London N11, Tel: (01) 368-2309 (Importer)
Audio: Automatic 8-tr changer
Brand name: Telex
 Agfa-Gevaert Ltd., Unity House, 27 Great West Rd., Brentford, Middx, Tel: (01) 560-2131 Cable ARTOVEG Telex 28154 Mng. Dir.: G. Ahrens, Div. Mgr.: E.J. Drew, Sales Mgr.: E.A. Bowden
Product: Broadcast & studio tape, magnetic film, video tape & cassette, cassette bulk tape
Brand name: Agfa Videochrom
 Amos of Exeter Ltd., Weircliffe Court, Exwick, Exeter, Devon EX4 2AG, Tel: (0392) 72-132 Telex 42786 Mng. Dir.: R.E. Amos
Audio & Video: Bulk tape erasers
Brand name: Weircliffe
 Ampex Great Britain Ltd., Acce Rd., Reading, Berks RG2 0QR, Tel: (0734) 85200 Cable AMPEX READING Telex 847611 Gen. Mgr.: W. Scullion, Mktg. Servs. Supervisor: C. Murphy, O'Connor, Sales Mgr.: J. Cripps, Adv. Mgr.: P. Vaughan
Audio: Studio mastering tape
Video: 2" broadcast, 1" broadcast, & U-matic tape.
 Audiotope, see Lee
 Audua, see TDK
 B A S F (UK) Ltd., 2/4 Fitzroy St., London W1P 5AD, Tel: (01) 637-8791 Telex 28649 Chief Exec.: H.C. Pattinson, Prof. Prods. Mgr.: R.M. Hine
Product: Cassette duplicating tape
 Chroma 90, see Memorex
 E M I Tape Ltd., Tape House, Dawley Rd., Hayes, Middx UB3 1BT, Tel: (01) 573-3888 Cable EMITAPE LONDON Telex 932161 Mng. Dir.: E.A. Naef, Comm'l. Controller: P.K. Mitchell, Sales Mgr.: P. Sollitt, Mktg. Mgr.: M.W. Cross
Audio: Standard & long-play professional tape
 Editall, see Scenic Sound Equip
 A. C. Farnell Ltd., Kenyon Ltd., Sheffield S1 4BD, Tel: (0742) 78901
Product: Bulk erasers
 Lee Eng'g Ltd., Napier House, Bridge St., Walton-on-Thames, Surrey KT12 1AP, Tel: Walton-on-Thames 43124 Cable LEETECH Telex 928475 Mng. Dir.: Thomas Lee, Gen. Mgr.: Chris Welsh, Sr. Sales Eng.: R.J. White
Audio: Tape
Brand name: Audiotope
 Memorex UK Ltd., Hoechst House, 50 Salisbury Rd., Hounslow, West Middx, TW4 6JN, Tel: (01) 570-7716 Cable MRXLON Telex 935013 Mng. Dir.: J.E.M. Kitching, Audio Prods. Sales Mgr.: G. Creach, Video Prods. Sales Mgr.: G. Worthington
Video: 1 broadcast
 Racal-Zonal Ltd., Station Hill, Pound Hill, Crawley, Sussex RH10 4AZ, Tel: (0293) 34982 Cable CASSETTES CRAWLEY Telex 87651 Mng. Dir.: D.S. Worman, Gen. Sales Mgr.: John Rooke, A/V Sales Mgr.: Eric Mould
Audio: 2", 1", 1/2" & 1/4" tape
Brand name: Triple Three, Triple Six, Triple Eight
 S S E, see Scenic Sound Equip
 Scenic Sounds Equip, 97-99 Dean St., London W1, Tel: (01) 734-2812 Telex 27939 Mng. Dir.: David Hawkins
Audio: Splicing & editing equip
Brand name: Editall, SSEE
 Scotch, see 3M
 T D K Tape Dist. (UK) Ltd., 341 Brighton Rd., South Croydon, Surrey CR2 6EQ, Tel: (01) 688-7372 Telex 946727 Mng. Dir.: John C. Buchan, Sales Mgr.: Derek Huthwaite
Brand name: Audua
 Telex, see AT
 3 M United Kingdom Ltd., PO Box 1, 3M House, Bracknell, Berks RG12 1JU, Tel: (0344) 26726 Telex 849371 Mng. Dir.: Donn Osmon, Div. Dir.: P.G. Hutchings, Sales & Mktg. Mgr.: C. Hobbs, Mktg. Co-ord.: P.A. Stockwell-Jones
Reg'l sales offices: Belfast BT1 5JE, Northern Ireland, 11 Donegal Square S, Tel: (0232) 42811, 42926—Birmingham B3 3EL, Edmund House, 12-22 Newhall St., Tel: (021) 236-5077—Glasgow G4 0AY, Scotland, 3M House, 9 Canal St., Tel: (041) 332-9622—London SE20 7TR, PO Box 38, Yeoman House, 63 Croydon Rd., Penge, Tel: (01) 659-2323—Manchester M15 4PA, 3M House, 28 Great Jackson St., Tel: (061) 236-8500
Audio: 2", 1", 1/2" & 1/4" professional rec'g tapes
Video: Broadcast & helical scan tapes
Brand name: Scotch
 Triple Three, see Racal-Zonal
 Triple Six, see Racal-Zonal
 Triple Eight, see Racal-Zonal
 Weircliffe, see Amos of Exeter

RECORD PROCESSING MACHINERY

R Kempner Ltd., 61 Markfield Rd., London N15 4RA, Tel: (01) 801-6222 Telex 21400 Gen. Mgr.: Paul R.S. Rogers, Technical Mgr.: Barry Heath
Product: Shrink wrap machinery & material
 Lened, see Professional Tape

Professional Tape Mktg Assocs Ltd., Cassette House, 57 Manor Park Crescent, Edgware, Middx Tel (01) 951-0488 Telex 945309 Mng Dir Ray Linton, Gen Mgr Roger Morley.
Chief product: Automatic presses
Brand name: Lened
 P & J Sibert & Co., 161 Finborough Rd., West Brompton, London SW10 9AP Tel (01) 373-9509, (i-sales) 330-0770 Technical Sales Alan & Paul Sibert.
Chief product: Optical automatic center press, eccentricity testing equipment (stampers & pressings), record stylus & groove inspection equipment
Brand name: Optical Auto Record Center Press, Optical Record Centricity Test Table, Record Stylus Photo Microscope, Record Pressing Centricity Tester (SEE ADVERTISEMENT)

TAPE, BLANK LOADED & BULK RAW

Acoustic Dynamic, see TDK
 Adasta Electronics Ltd., Cricklewood Trading Estate, Unit N22 Claremont Rd., London NW2 1TU Tel (01) 452-6288 Cable WESTQUIP Mng Dir Michael Leaver; Gen. & Sales Mgr J. Boyce. (Blank only)
Audio: Cassette, open reel
Brand name: Synccassette, Synchrotape
 Agfa-Gevaert Ltd., Unity House, 27 Great West Rd., Brentford, Middx, Tel (01) 560-2131 Cable ARTOVEG. Telex 28154 Mng Dir G. Ahrens, Sales Mgr.: Ted Bowden; Adv Mgr P. Miller
Home office: Germany
Audio: Cassette, open reel
Video: 1" open reel, 1/2" cassette.
Brand names: Agfa Carat, Agfa Stereochrom, Agfa Videochrom
 Air Check, see Sound
 Aiwa Sales & Serv (UK) Ltd., 30/32 Concord Rd., Westwood Park Trading Estate, Western Ave., London W3 0TH. Tel (01) 993-1672 Telex 936239. Mng Dir. S.R. Chorley; Sales Mgr. D.J. Wright; Adv. & Press Officer T.D. Spiro.
 Ampex Great Britain Ltd., Acre Rd., Reading, Berks. RG2 0QR. Tel (0734) 85200. Cable AMPXEN READING. Telex 847611 Gen. Mgr W. Scullion, Mktg Servs. Supervisor C. Murphy-O'Connor, Sales Mgr. J. Cripps; Adv. Mgr. P. Vaughan.
Audio: 8-tr. cassette, open reel
Video: 2" broadcast, 1" open reel, 3/4" cassette, 1/2" EIAJ open reel, 1/2" EIAJ cartridge.
 Audiogenic Ltd., 34-36 Crown St., Reading, Berks RG1 2SN Tel (0734) 595647 Dir. Martin Maynard; Gen. Mgr. Moira Farrell, Sales Mgr. Henry Smithson (Blank only)
Audio: Cassette
 Audio Magnetics Inc. (UK) Ltd., 121 Loverock Rd., Reading, Berks. RG3 1JZ. Tel (0734) 598036 Telex. 849113. Mng Dir Nigel W. Bryden, Reg'l Sales Mgrs. Scott Murdoch (South), Hugh Smith (North), Export Mgr.: Ian Swash
Audio: 8-tr., cassette, open reel
 Audiosonic, see Cassette Developments
 Audiotope, see Lee Eng'g
 Audua, see TDK
 Avcom Systems Ltd., Newton Works, Stanlake Mews, London W12 7HJ Tel (01) 749-2201 Cable: CINEPRO LONDON Telex 896691 Mng Dir Eric R. Bastin; Gen. Mgr. Marc Hull; Sales Dir. Nick Gillieron
Audio: Cassette
 B A S F UK Ltd., Haddon House, 2/4 Fitzroy St., London W1F 5AD Tel (01) 637-8971. Telex 28649. Div. Mgr. H.C. Pattinson, Prof. Prods Mgr. R.M. Hine.
Audio: Cassette, open reel
Video: Blank—1" open reel, 3/4" cassette.
 F. W. O. Bauch Ltd., 49 Theobald St., Boreham Wood, Herts Tel (01) 953-0091 Telex 27502. Mng Dir.: John Bauch; Sales Mgr. Stephen Holmes, Press Officer David Neal
Brand name: Revox
 Bibi Magnetics Ltd., 101/105 Plough Rd., London SW11 2BJ. Tel: (01) 223-5955 Telex 917732. Dir. K. H. Bourke-Borrowes, Gen. Mgr. M. Shepherd.
Audio: Cassette
 Capitol Magnetics (div. of EMI Tape Ltd.), Tape House, Dawley Rd., Hayes, Middx. UB3 1BT Tel (01) 573-7860 Cable EMITAPE LONDON Telex 932161. Mng Dir.: E.A. Naef, Gen. Mgr. P. Sollitt.
Audio: 8-tr., Cassette, open reel
Brand name: Blank—The Master Tape; raw—Capitol.
 Cassette Developments (Audiosonic) Ltd., Micra House, 138 Lower Mortlake Rd., Richmond, Surrey TW9 2JZ Tel (01) 940-8186 Cable MICRONETICS Telex 8813481 Gen. Mgr. D. Dixon
Audio: Cassette
Brand name: Audiosonic
 Certron, see Lalex
 D & B Tape Servs., 23 Croydon Rd., Reigate, Surrey RH2 0LY Tel 49505 Owner E.G. Dowley
Audio: 8-tr., cassette, broadcast
 Decca, see Selecta
 Duplitate, 1/7 Harewood Ave., London NW11. Tel (01) 724-2497 Telex 21879 Chief Exec. R. Jackson Moore, Gen. & Sales Mgr. B.R. Lambden. (Blank only)
Audio: Cassette
Brand name: ITD
 Dynamic, see TDK
 E M I Tape Ltd., Tape House, Dawley Rd., Hayes, Middx. UB3 1BT Tel (01) 573-3888 Cable EMITAPE LONDON Telex 932161 Mng Dir. E.A. Naef, Comm'l. Controller P.K. Mitchell; Gen. Sales Mgr. P. Sollitt, Mktg. Mgr. M.W. Cross.
Audio: Cassette, open reel
Video: VHS cassette.
 E P S (Educational Publ'g Servs.), 75 Holloway Rd., London N7 8JZ Tel (01) 607-6059/3755 Telex 21120. Ref 2106. Pres. David Cavalier. (Blank only)
Audio: Cassette, open reel
Brand name: Leda, Tape 7
 Ferratope, see North East Audio
 Fidelipac, see SIS Rec'g
 Fifth Ave. Rec'g Co. (UK) Ltd., Avenue House, River Way,

Templefields, Harlow, Essex CM20 2DN. Tel (0279) 39256. Mng. Dir. Harold Leonard Collins; Gen. Mgr.: Bert Hamilton; Prod'ns Mgr. Mike Stancevic (Blank only)
Audio: Cassette
 Fuji Photo, see Pysier
 Goiding Audio Ltd., 26 Hyde Quay, Colchester, Essex. Tel: (0206) 77224 Mng. Dir. A.B. Goiding; Dir. D.P. Goiding; Gen. Mgr.: P. Walsh; Sales Mgr. R.K. Goiding (Blank only)
Audio: 8-tr., cassette.
 Gramplan Recs Ltd., Airport Ind'l Estate, Wick-Caithness, Scotland Tel (0955) 2787 Dir. J. Johnston, Mgr.: John Hunter. (Blank only)
Audio: Cassette
 I T D, see Duplitate.
 International Video Corp (UK) Ltd., 10 Portman Rd., Reading, Berks. RG3 1JR Tel (0734) 585421 Telex 847579 Cable INTERVIDEO. Mng. Dir. John D. Jeffery.
Video: 2" & 1" Professional
 J V C (UK) Ltd., Eldonwall Trading Estate, 6-8 Priestley Way, London NW2 7AF Tel (01) 450-2621 Mng Dir Kurt Lowy, Sales Mgr. A. Nishina, Adv. & Press Officer: Geoff Fleming
Video: 1/2" VHS cassette
 Lalex & Co. Ltd., Lalex House, 1 Canal St., Manchester M60 4AX Tel: (061) 236-8186 Cable ALMIGHTY. Telex 669431. Dirs. R.J. Mulchand, K.C. Bhavnani. (Blank only)
Audio: Cassette.
Brand names: Certron, Monatone, Wintronics.
 Leda, see EPS.
 Lee Eng'g Ltd., Napier House, Bridge St., Walton-on-Thames, Surrey KT12 1AP Tel: Walton-on-Thames 43124. Cable LEETECH Telex 928475 Mng Dir.: Thomas Lee, Gen. Mgr. Chris Welsh; Sr. Sales Eng.: R.J. White
Audio: NAB
Brand name: Auditotape
 The Master Tape, see Capitol.
 Maxell, see Natural Sounds
 Media Sound, see Metropolitan Communications.
 Memorex (UK) Ltd., Hoehst House, 50 Salisbury Rd., Hounslow, West Middx. TW4 6JN Tel (01) 570-7716. Cable MRXLON Telex. 935013. Mng. Dir.: J.E.M. Kitching, Audio Prods. Sales Mgr. G. Creach; Video Prods. Sales Mgr. G. Worthington. (Blank only)
Audio: Cassette
Video: 1" open reel, 3/4" cassette, 1/2" EIAJ open reel.
 Metropolitan Communications, 8a Frogal Gardens, London NW3 6UX Tel (01) 435-8803 Mng. Dir. Mark R.F. Hanau (Blank only)
Audio: Cassette.
Brand name: Media Sound.
 Monatone, see Lalex.
 Musonic, see S&B Trading & Ziphurst
 National Panasonic (UK) Ltd., 107/109 Whitby Rd., Slough, Berks SL1 3DR Tel (0753) 27516 Cable: PANASONIC. Telex: 848761 Mng. Dir.: A. Imura; Sales Mgr. J. Aoki; Adv. Mgr.: Ron Fry. (Blank only)
Branch: Stourton, Leeds, Skelton Grange Rd Tel (0532) 702541. Reg'l Sales Dir.: Tony Nishigaki.
Audio: Cassette.
Video: 1/2" EIAJ open reel, 1/2" EIAJ cartridge.
Brand name: National, National Panasonic, Technics.
 Natural Sound Systems, 10 Byron Rd., Wealdstone, Harrow, Middx Tel (01) 863-8622. Telex 922573. Sales Dir.: Malcolm Kays, Maxell Prod. Mgr. Mike Crawshaw. (Blank only)
Audio: Cassette, open reel
Brand name: Maxell
 North East Audio Ltd., Simonside Works, South Shields, Tyne & Wear NE34 9NX Tel (0632) 566321 Mng. Dir. A.J. Helliwell; Sales Mgr.: J. Sparrow.
Brand name: Ferratope.
 P T L/Mayfair, see Professional Tapes
 Paragon Int'l Prods., 16 Holmes St., Belfast, Northern Ireland Tel (0232) 48260. Dir. John O.P. McCourt; Gen. Mgr.: Anne Heaps. Sales Mgr.: Edwina Heaps
Audio: Cassette, open reel.
 Pebble Recs Ltd., 46 Maddox St., London W1 Tel (01) 629-3266, 491-4140. Telex 25247 Mng Dir.: James Pollard, Gen. Mgr. Julia Slcombe.
Audio: 8-tr., cassette
 Philips Electrical Ltd., City House, London Rd., Croydon, Surrey Tel (01) 689-2166. Telex. 946169
Audio: Cassette, open reel.
Video: 1/2" EIAJ open reel, VCR
 Products 2000, The Maltings, 63 High St., Ware, Herts. SG12 9AD. Tel (0920) 66242 Mng. Dir. R.C. Bayes; Gen. Mgr. C.W. Bayes. (Blank only)
Audio: Cassette.
Brand name: Sonorex/Audiogramm
 Professional Tapes Ltd., Cassette House, 329 Hunslet Rd., Leeds LS10 1NJ Tel (0532) 706066 Telex 55293. Mng. Dir. Raymond Linton; Gen. Mgr.: Joseph Nurgat; Sales Mgr. Bert Hamilton
Audio: Cassette
Video: 1/2" EIAJ cartridge.
Brand name: PTL/Mayfair.
 Pyral Magnetics Ltd., Airport House, Purley Way, Croydon, Surrey CR0 0XZ Tel (01) 681-2272. Telex 946670. Mng. Dir. H.J. Hutchings; Sales Mgr. John P. Thurley.
Branch: Eastbourne, Sussex, Courtlands Rd. Tel: (0323) 638-965
Audio: Cassette, open reel
 Pysier Ltd., Fircroft Way, Edenbridge, Kent TN8 6HA Tel (0732) 864111. Telex 95527. Mng. Dir. J.P. Tilt; Sales Dir. J.R. Carpenter
Branch: Harrow, Middx. 102 College Rd Tel (01) 427-2278.
Audio: 8-tr., cassette, open reel
Brand name: Fuji Photo
 Racial-Zonal Ltd., Station Hill, Pound Hill, Crawley, Sussex RH10 4AZ. Tel (0293) 34982 Cable CASSETTES CRAWLEY Telex 87651. Mng. Dir.: D.S. Worman; Gen. Sales Mgr. John Rooke; A/V Sales Mgr. Eric Mould
Audio: Cassette, open reel.

Brand name: Triple Three, Triple Six, Triple Eight.
 Revox, see F.W.O. Bauch.
 Ross Electronics, 32 Rathbone Pl., London W1P 1AD. Tel (01) 580-7112. Cable: ROSSILECT. Telex: 22747. Pres. Ross I.L. Marks; Gen. & Sales Mgr. A.C. Murphy. (Blank only)
Audio: 8-tr., cassette.
 S & B Trading, Stylus House, 34/38 Verulam Rd., St. Albans, Herts. AL3 4DF. Tel (0727) 50611 Mng. Dir.: P.H. Grant; Prod'n Dir.: S.H. Blank; Sales Dir. B. Blank; Dir.: D.N. Lever.
Audio: 8-tr., cassette.
Brand name: Musonic.
 SIS Ltd., 57 St. Andrews Rd., Northampton NN1 2PB Tel (0604) 32965, 30559 Mng. Dir. D.P.D. Mitchell. Sales Mgr.: I. Brown.
Audio: NAB "A" & "C"
Brand name: Fidelipac
 S R T Prod'ns Ltd., 987 High Rd., Finchley, London N12. Tel: (01) 446-3218 Mng. Dir. George Bellamy; Dir.: David Richardson.
Audio: Cassette.
 Scotch, see 3M
 Selecta (London) (div. of Decca Rec. Co. Ltd.), 125/127 Lee High Rd., Lewisham, London SE13 5NX Tel (01) 852-9171/9191 Telex 896029 Gen. Mgr.: J.D. Roberts; Sales Mgr.: D. Barsby; Sales Co-ord. E. Packham. (Blank only)
Audio: Cassette.
Brand name: Decca
 Sonorex/Audiogramm, see Products 2000
 Sony (UK) Ltd., Pyrene House, Sunbury Cross, Sunbury-on-Thames, Middx. Tel (76) 87644. Telex: 266371 London.
Video: 3/4" U-matic cassette, 1/2" EIAJ open reel
 Sound, 1 Odgershaw Mews, Maidenhead, Berks Tel: (0628) 33011. Mng. Dir.: S.M. Webb; Sales Mgr. M. Lloyd; Adv. Mgr.: C. McVie. (Audio only)
Brand name: Air Check
 Soundrider, see James Yorke
 Strathclyde Sound & Video Ltd., Central Chambers, 93 Hope St., Glasgow, Scotland G2 6LD Tel (041) 221-2244. Telex 777283. Mng. Dir.: Raymond E. Orr. Sec'y Pat R. Black.
Audio: 8-tr., cassette, open reel.
 Super Avilyn, see TDK.
 Synccassette, see Adasta.
 Synchrotape, see Adasta.
 T D K Tape Dist. (UK) Ltd., 341 Brighton Rd., South Croydon, Surrey CR2 6EQ. Tel: 688-7372 Telex 946727. Mng. Dir.: J.C. Buchan; Sales Mgr.: Derek Huthwaite.
Audio: Blank—8-tr., cassette, open reel; raw—cassette.
Brand names: Acoustic Dynamic, Audua, Dynamic, Super Avilyn.
 T R A D Electronics Sales Ltd., 149B St. Albans Rd., Watford, Herts. WD2 5BB. Tel: (92) 47988. Telex: 262741 Mng. Dir. J.E. Southard.
Audio: Cassette, open reel.
 The Tape Dupl'g Co. (GB) Ltd., Freedex House, 4-10 North Rd., Islington, London N7 9HN. Tel (01) 609-0087. Telex 264773. Pres. Mark Myers; Mng. Dir. Peter Robey, Sales Mgr.: Bob Hill. (Blank only)
Audio: 8-tr., cassette.
 Tape 7, see EPS.
 Technics, see National Panasonic.
 3 M United Kingdom Ltd., PO Box 1, 3M House, Bracknell, Berks RG12 1JU Tel (0344) 26726. Telex 849371. Mng. Dir.: Donn Osmon; Div. Dir.: P.G. Hutchings; Sales & Mktg. Mgr.: C. Hobbs; Mktg. Co-ord. P.A. Stockwell-Jones.
Reg'l sales offices: Belfast BT1 5JE, Northern Ireland, 11 Donegall Square S Tel: (0232) 42811, 42926—Birmingham B3 3EL, Edmund House, 12-22 Newhall St. Tel: (021) 236-5077—Glasgow G4 0AY, Scotland, 3M House, 9 Canal St. Tel: (041) 332-9622—London SE20 7TR, PO Box 38, Yeoman House, 63 Croydon Rd., Penge. Tel: (01) 659-2323—Manchester M15 4PA, 3M House, 28 Great Jackson St. Tel: (061) 236-8500
Audio: 8-tr., cassette, open reel.
Video: 1" open reel, 1" cartridge, 3/4" cassette, 1/2" EIAJ open reel, 1/2" EIAJ cartridge, 1/2" 1/2" open reel.
Brand name: Scotch
 Trident Audio Developments Ltd., 112/114 Wardour St., London W1V 3AU. Tel (01) 734-9901 Telex: 27782. Mng. Dir.: Malcolm Toft. Sales Mgrs.: Mike Rogers, Derek Fox.
Audio: 8-tr., cassette
 Triple Three, see Racial-Zonal.
 Triple Six, see Racial-Zonal.
 Triple Eight, see Racial-Zonal.
 Wintronics, see Lalex.
 James Yorke Ltd., Oak House, Northleach, Gloucestershire GL54 3ET Tel: (04516) 509. Chief Exec. J. Scarlett; Sales Mgr.: Peter Fanshawe; Technical Mgr. Mike McClarron; Studio Mgr.: Peter Rinnie. (Blank only)
Audio: 8-tr., cassette
Brand names: Soundrider, James Yorke
 Ziphurst Ltd., Stylus House, 34/38 Verulam Rd., St. Albans, Herts. AL3 4DF. Tel (0727) 50611. Telex 28675. Mng. Dir.: P.H. Blank; Gen. Dir.: D.N. Lever; Sales Dir.: B. Blank; Prod'n Dir.: S.H. Blank
Audio: 8-tr., cassette
Brand name: Musonic.

TAPE DUPLICATING & PROCESSING EQUIPMENT

Ampex Great Britain Ltd., Acre Rd., Reading, Berks. RG2 0QR. Tel (0734) 85200. Cable: AMPXEN READING. Telex: 847611. Gen. Mgr.: W. Scullion; Mktg. Servs. Supervisor C. Murphy-O'Connor; Sales Mgr. J. Cripps; Adv. Mgr. P. Vaughan.
Audio: Professional tape duplicators.
 Avuis-Asona, see Lennard.
 Avcom Systems Ltd., Newton Works, Stanlake Mews, London W12 7HJ. Tel: (01) 749-2201 Cable CINEPRO LONDON. Telex: 896691. Mng. Dir.: Eric R. Bastin; Gen. Mgr. Marc Hull; Sales Dir.: Nick Gillieron.

Audio: Cassette duplicators & high-speed copiers
Brand name: Telex.
 Cetec Int'l Ltd., Sapphire House, 16 Uxbridge Rd., Ealing London W5 2BP. Tel: (01) 579-9145 Telex 935847 Mng. Dir.: Brian C.A. Willis; Sales Mgr.: Michael J. Cotter
 Audio: High-speed duplicators.
Brand name: Gauss
 Cintron Group, Grove House, 551 London Rd., Isleworth, Middx. TW7 4DS. Tel: (01) 568-0131 Telex 935054 Sales Dir.: Bernard G. Rawson (Audio only)
Brand name: Pentagon (USA), Telex (USA), Wollensak (USA)
 Duplitape, 1/7 Harewood Ave., London NW1 Tel: (01) 724-2497. Telex: 21879 Chief Exec.: R. Jackson Moore; Gen. & Sales Mgr.: B.R. Lambden.
 Audio: Duplicators & loaders
Brand name: Otari (Japan)
 Gauss, see Cetec
 Hayden Labs. Ltd., Hayden House, Churchfield Rd., Chalfont St. Peter, Bucks SL9 9EW. Tel: (02813) 88447 Telex 849469 Chm.: K.E. Owens; Mng. Dir.: E.J. Barrett.
 Sales Mgr.: P. Harwood; Technical Mgr.: J. Rudling; Adv.: Mrs. A.C. Sandrey
Branch: London NW1 6SN, 6 Bendall Mews, Bell St. Tel: (01) 723-4441. Mgr.: P. Ferris; Serv. Mgr.: G. Davis.
 Audio: Cassette duplicators & loaders
Brand name: Telefunken
 Industrial Tape Applications, 1/7 Harewood Ave., London NW1 Tel: (01) 724-2497. Telex: 21879 Dir.: M. Parmiter; Gen. Mgr.: B. Lambden; Sales Mgr.: P. Leader.
 Audio: Cassette duplicators
Brand name: Otari (Japan)
 Lee Eng'g Ltd., Napier House, Bridge St., Walton-on-Thames, Surrey KT12 1AP. Tel: Walton-on-Thames 43124. Cable: LEETECH. Telex: 928475. Mng. Dir.: Thomas Lee; Gen. Mgr.: Chris Welsh; Sr. Sales Eng.: R.J. White.
 Audio: Duplicators, loaders, printers.
 Leavers-Rich Equip. Ltd., 319 Trinity Rd., Wandsworth, London SW19 3SL. Tel: (01) 874-9054. Cable: LEEMAG. Telex: 923455. Mng. Dir.: R.C. Blearsd; Gen. Mgr.: W.A. Costello; Sales Mgr.: J. Robinson.
 Audio: Bulk erasers.
 Lennard Developments Ltd., 206 Chase Side, Enfield, Middx. EN2 0QX. Tel: (01) 363-8238. Cable: LENNARD ENFIELD. Mng. Dir.: E.G. Lennard.
 Audio: Cassette loaders
Brand name: Auviss-Asona
 B. H. Morris & Co. (Radio) Ltd., Precision Centre, Heather Park Dr., Wembley, Middx. HA0 1SU. Tel: (01) 902-9422. Telex: 922131. Mng. Dir.: K. Lasky; Mktg. Mgr.: B.T. Cockram; Sales Dir.: A. Allenstein.
Brand name: Trio
 National Panasonic (UK) Ltd., 107/109 Whitby Rd., Slough, Berks. SL1 3DR. Tel: (0753) 27516. Cable: PANASONIC. Telex: 848761. Mng. Dir.: A. Imura; Sales Mgr.: J. Aoki; Adv. Mgr.: Ron Fry
Branch: Stourton, Leeds, Skelton Grange Rd. Tel: (0532) 702541. Reg'l Sales Dir.: Tony Nishigaki
 Video: High speed 1/2" cartridge duplicator (VTP)
Brand name: National
 Otari, see Duplitape. C.D. Hammond & Industrial Tape Pentagon, see Cintron
 Philips Electrical Ltd., City House, London Rd., Croydon, Surrey. Tel: (01) 689-2166. Telex: 946169
 Audio: Cassette duplicators
 Video: VCR duplicators
 Scotch, see 3M
 P & J Sibert & Co., 161 Finborough Rd., West Brompton, London SW10 9AP. Tel: (01) 373-9509, (sales) 330-0770. Technical Sales: Alan & Paul Sibert
 Chief Product: Tape head inspection & photographing equipment.
Brand name: Tape Photo Microscope. (SEE ADVERTISEMENT)
 Sony (UK) Ltd., Pyrene House, Sunbury Cross, Sunbury-on-Thames, Middx. Tel: (76) 87644. Telex: 266371 London. (Video only)
 Telefunken see Hayden.
 Telex, see Avcom & Cintron.
 3 M United Kingdom Ltd., PO Box 1, 3M House, Bracknell, Berks. RG12 1JU. Tel: (0344) 26726. Telex: 849371. Mng. Dir.: Donn Osmon; Div. Dir.: P.G. Hutchings; Sales & Mktg. Mgr.: C. Hobbs; Mktg. Co-Ord.: P.A. Stockwell-Jones.
Reg'l sales offices: Belfast, BT1 5JE, Northern Ireland, 11 Donegall Square S. Tel: (0232) 42811, 42926—Birmingham B3 3EL, Edmund House, 12-22 Newhall St. Tel: (021) 236-5077—Glasgow G4 0AY, Scotland, 3M House, 9 Canal St. Tel: (041) 332-9622—London SE20 7TR, PO Box 38, Yeoman House, 63 Croydon Rd., Penge Tel: (01) 659-2323—Manchester M15 4PA, 3M House, 28 Great Jackson St. Tel: (061) 236-8500.
 Audio: Cassette patchcaks.
Brand name: Scotch.
 Trio, see B.H. Morris.
 Wollensak, see Cintron.

TAPE PACKAGING & LABELING EQUIPMENT & SUPPLIES

Garrod & Lofthouse Ltd., 6 Langley St., London WC2H 9JA. Tel: (01) 240-3322. Telex: 262554. Chm. & Mng. Dir.: Norman J. Garrod.
 E. Hannibal & Co. Ltd., Pinfold Rd., Thurmaston, Leicester LE4 8AP. Tel: (0533) 695413. Telex: 34627. Mng. Dir.: Chris Hetherington; Ass't Mng. Dir.: Roger Stewart; Music Div. Sales Dir.: Derek Deighton; Sales Dir.: N.L. Cartwright.
 Product: Cartridge & cassette labels, inlay cards.
 S. Kemper Ltd., 61 Markfield Rd., London N15 4RA. Tel: (01) 801-6222. Telex: 21400. Gen. Mgr.: Paul R.S. Rogers; Technical Mgr.: Barry Heath.
 Lennard Developments Ltd., 206 Chase Side, Enfield, Middx. EN2 0QX. Tel: (01) 363-8238. Cable: LENNARD ENFIELD. Mng. Dir.: E.G. Lennard.
 Product: Cassette labelling machines (Auviss-Asona).

Professional Tapes Ltd., Cassette House, 329 Hunslet Rd., Leeds LS10 1NJ. Tel: (0532) 706066 Telex 55293 Mng. Dir.: Raymond Linton. Gen. Mgr.: Joseph Nurgat. Sales Mgr.: Bert Hamilton
 Product: Cassette labelling machines

● accessories manufacturers

Adastra Electronics Ltd., Cricklewood Trading Estate, Unit N22, Claremont Rd., London NW2 1TU. Tel: (01) 452-6288. Cable: WESTQUIP LONDON NW2. Mng. Dir.: Michael Leaver. Gen. & Sales Mgr.: J. Boyce
 Product: Carrying & storage cases, cleaners, head cleaners & demagnetizers.
 Agfa-Gevaert Ltd., Unity House, 27 Great West Rd., Brentford, Middx. Tel: (01) 560-2131. Cable: ARTOVEG. Telex: 28154. Mng. Dir.: G. Ahrens; Div. Mgr.: E.J. Drew; Sales Mgr.: E.A. Bowden
 Home office: Germany
 Product: Splicing & editing equip.
 Ampex Great Britain Ltd., Acce Rd., Reading, Berks. RG2 0QR. Tel: (0734) 85200. Cable: AMPEX READING. Telex: 847611. Gen. Mgr.: W. Scullion; Mktg. Servs. Supervisor: C. Murphy-O'Connor; Sales Mgr.: J. Cripps; Adv. Mgr.: P. Vaughan
 Product: Head cleaners & demagnetizers, leader & splicing tape.
 Francis Antony Ltd., Trenance Mill, Blowinghouse Hill, St. Austell, Cornwall PL25 5AH. Tel: (0726) 3476, 61264
 Product: Catalog servs
 Arrowtaps Ltd., Humber Rd., London NW2 6EP. Tel: (01) 450-2411. Telex: 923034. Mng. Dir.: Maurice Mindel; Sales Mgr.: Alex Murray; Prod. Mgr.: Paul Rinne.
 Product: Tape carrying & storage cases, cleaners, brushes, head cleaners, demagnetizers, leader & splicing tape.
 Audio Magnetics Inc (UK) Ltd., 121 Loverock Rd., Reading, Berks RG3 1JZ. Tel: (0734) 598036 Telex: 849113. Mng. Dir.: Nigel W. Bryden; Reg'l Sales Mgrs.: Scott Murdoch (South), Hugo Smith (North), Export Mgr.: Ian Swash.
 Audio: Cassette hubs
 B A S F UK Ltd., Haddon House, 2/4 Fitzroy St., London W1P 5AD. Tel: (01) 637-8971. Telex: 28649. Div. Mgr.: H.C. Pattinson; Prof. Prods. Mgr.: R.M. Hine
 Product: Cleaners, cloths, brushes, head cleaners & demagnetizers, leader & splicing tape, test tape
 Barrester Music Co. Ltd., 23/5 Wilton Way, London E8 3EE. Tel: (01) 254-3652. Mng. Dir.: John Barratt.
 Product: Record & tape carrying & storage cases, cleaners, cloths & brushes.
 F. W. O. Bauch Ltd., 49 Theobald St., Boreham Wood, Herts. Tel: (01) 953-0091. Telex: 27502. Mng. Dir.: John Bauch; Sales Mgr.: Stephen Holmes; Press Officer: David Neal
 Products: Heads, splicing & editing equip., test tape.
Brand name: Revox
 Bib Hi-Fi Accessories Ltd., Kelsey House, Wood Ln. End, Hemel Hempstead, Herts HP2 4RQ. Tel: (0442) 61291. Telex: 826437. Chm. & Mng. Dir.: P.B. Arbib; UK Sales Dir.: J. Embley; Int'l Sales Dir.: R.G. Everett.
 Product: Tape carrying & storage cases, cleaners, cloths, brushes, head cleaners, demagnetizers, splicing tape.
 Bibi Magnetics Ltd., 101/105 Plough Rd., London SW11 2BJ. Tel: (01) 223-5955. Telex: 917732. Dir.: K.H. Bourke-Borrowes; Gen. Mgr.: M. Shepherd.
 Product: Head cleaners & demagnetizers.
 Bradleys Tapemaster Tape Directory, Kempsey, Worcs. WR5 3PN. Tel: (0905) 820-137, 352-131. Ed. & Compiler: James Bradley; Research: Kathleen Bradley.
 Product: Tape catalog servs
 Cassette Developments (Audioisonic) Ltd., Micra House, 138 Lower Mortlake Rd., Richmond, Surrey TW9 2JZ. Tel: (01) 940-8186. Cable: MICRONETICS. Telex: 8813481. Gen. Mgr.: D. Dixon.
 Product: Head cleaners & demagnetizers.
 Cintron Group, Grove House, 551 London Rd., Isleworth, Middx. TW7 4DS. Tel: (01) 568-0131. Telex: 935054. Sales Dir.: Bernard G. Rawson.
 Product: Head cleaners & demagnetizers.
 Clendisc (Mail Order), Ltd., 7 Trinity Court, Grays Inn Rd., London WC1 Tel: (01) 837-9088. Pres.: Erna Smith; Gen. Mgr.: Beatrice Parker
 Product: Cleaners & cloths
 Colclene, see Future Film.
 Condor Electronics Ltd., 100 Coombe Ln., London SW20 0AY. Tel: (01) 946-0033. Cable: CONDORELECSW20. Telex: 928502. Mng. Dir.: C.A. Wolff; Sales Mgr.: L. Alley.
 Product: Catalog servs., cleaners, cloths, brushes, head cleaners & demagnetizers, needles.
 Cosmocord Ltd., Eleanor Cross Rd., Waltham Cross, Herts. EN8 7NX. Tel: Lea Valley 716-666. Cable: ACOS. Telex: 24294. Mng. Dir.: V.J. Sivyer; Sales & Mktg. Dir.: G.E. Brewin.
 Product: Tape carrying & storage cases, cleaners, cloths, brushes, 45 rpm adapters, head cleaners & demagnetizers, needles.
 Crown Arrow Co., 8 Gateolodge Close, Round Spinney, Northampton NN3 4RJ. Tel: (0604) 48744. Telex: 311165. Owner: Robert J. Parfitt.
 Product: Record & tape carrying & storage cases.
 Crown Merton, see T.I. Crown Merton.
 D & B Tape Servs., 23 Croydon Rd., Reigate, Surrey RH2 0LY. Tel: 49505. Owner: E.G. Dowley.
 Product: Head cleaners & demagnetizers.
 Discleaner, see Vac-O-Rec.
 E M I Recs. Ltd., Shopfittling & Supplies Div., 1/2 Uxbridge Rd., Hayes, Middx. 48H OSY. Tel: (01) 561-8722. Dir.: R.E. Matthews; Special Projects Mgr.: D.L. Watson.
 Product: Carrying & storage cases, cleaners, cloths & brushes.
 E M I Tape Ltd., Tape House, Dawley Rd., Hayes, Middx. UB3 1BT. Tel: (01) 573-3888. Cable: EMITAPE LONDON. Telex: 932161. Mng. Dir.: E.A. Nael;

Comm'l Controller P.K. Mitchell, Gen. Sales Mgr.: P. Sollitt; Mktg. Mgr.: M.W. Cross
 Product: Cleaners, cloths, brushes, head cleaners, demagnetizers, leader & splicing tape.
 Eagle Int'l, Precision Centre, Heather Park Dr., Wembley, Middx. HA0 1SU. Tel: (01) 902-8832. Cable: EAGLINT. Telex: 922131. Mng. Dir.: K. Lasky; Sales & Mktg.: J.P. Simon
 Product: Bulk erasers, head demagnetizers, needles.
 Edtall, see Soenic Sounds
 Elcon Magnetek, see Pro-Bel
 Emerald Recs. Ltd., 120 Coach Rd., Templepatrick, Ballyclare, Co. Antrim, Northern Ireland BT39 0HB. Tel: (08494) 32711. Telex: 747293. Mng. Dir.: Mervyn Solomon; Gen. Mgr.: Les R. Paterson; Sales Mgr.: Noel A. Spiller.
 Product: Needles
 Entre, see Lentek
 Ferroglyph, see North East Audio
 N & S.B. Field & Co. Ltd./Record Housing, 17-A Newham Rd., Wood Green N22. Tel: (01) 888-7487. Chm.: N. Field; Gen. Mgr.: F. Davis; Sales Mgr.: J. Edwards; Promo. Dir.: M.L. Field.
 Product: Carrying & storage cases.
 Fittall Prods. Ltd., Coastguard Rd., Larne, Northern Ireland. Tel: (0574) 3015. Telex: 747386. Mng. Dir.: C. Rumble.
 Product: Tape storage cases
 Future Film Developments (Allotrope Ltd.), 36/38 Lexington St., London W1R 3HR. Tel: (01) 437-1892. Cable: ALLOTROPE LONDON W1. Telex: 21624. Dirs.: C.S. Young, Tim Blackham; Sales Mgr.: John Dent.
 Product: Head cleaners (Colclene)
 Golding Audio Ltd., 26 Hythe Quay, Colchester, Essex. Tel: (0206) 77224. Mng. Dir.: A.B. Golding; Dir.: D.P. Golding; Gen. Mgr.: P. Walsh; Sales Mgr.: R.K. Golding.
 Product: Tape carrying & storage cases, head cleaners & demagnetizers
 C E Hammond & Co. Ltd., 105/109 Oyster Ln., Byfleet, Surrey KT14 7JH. Tel: (09323) 51051. Telex: 262525. Mng. Dir.: Peter M. Hammond; Sales Mgr.: Tony Smith; Co. Sec'y: Edgar A. Thomson.
 Product: Record & tape storage cases.
 John Harwood-Bee Assocs., The Maltings, 63 High St., Ware, Herts. Tel: (0920) 66310. Telex: 299929. Mng. Dir.: John Harwood-Bee.
 Product: Record & tape carrying & storage cases
 Hi-Fi Pro, 22/24 Buckingham Palace Rd., London SW1. Tel: (01) 834-9382. Telex: 926679. Dir.: Ms. M.H. Ling; Gen. Mgr.: Jeff Hill.
 Product: 45 rpm adapters, head cleaners, demagnetizers, needles, leader & splicing tape.
 Highgate Acoustics, 38 Jamestown Rd., London NW1 7EJ. Tel: (01) 267-4936
 Product: Needles
 K-tel Int'l (UK) Ltd., 620 Western Ave., London W3 Tel: (01) 992-8000. Cable: KAYTELE. Telex: 934195. Mng. Dir.: Tony Johnson; Sales Mgr.: Colin Ashby
 Product: Record & Tape carrying & storage cases.
 L G R Prods., 105 Eastern Esplanade, Southend-on-Sea, Essex. Tel: (0702) 65695. Owner: L.G. Raven.
 Product: Carrying & storage cases
 Landmark (Precision Mouldings) Ltd., 2 Albane Way, Langford Rd., Biggleswade, Beds. Tel: (0767) 314-231. Telex: 233384. Mng. Dir.: David Ritchie; Works Dir.: Don Pearson; Prod'n Dir.: George Jardine.
 Branch: Potters Bar, Herts., Deneway House, Darkes Ln.
 Product: Head cleaners & demagnetizers, cassette library cases.
 Lee Eng'g Ltd., Napier House, Bridge St., Walton-on-Thames, Surrey KT12 1AP. Tel: 43124. Cable: LEETECH. Telex: 928475. Mng. Dir.: Thomas Lee; Gen. Mgr.: Chris Welsh; Sr. Sales Eng.: R.J. White.
 Product: Tape carrying & storage cases, head cleaners, demagnetizers, splicing tape (Nortronics)
 Lennard Developments Ltd., 206 Chase Side, Enfield, Middx. EN2 0QX. Tel: (01) 363-8238. Cable: LENNARD ENFIELD. Mng. Dir.: E.G. Lennard.
 Product: Tape carrying & storage cases, cleaners, cloths, brushes, 45 rpm adapters, head cleaners, demagnetizers, needles, splicing tape.
 Lentek Audio Ltd., Ind'l Estate, Edison Rd., St. Ives, Huntingdon, Cambs. PE17 4LF. Tel: (0480) 62225. Telex: 32303. Dir.: P.M. Swift.
 Product: Needles (Entre)
 Lightning Recs. Ltd., 839 Harrow Rd., Harlesden, London NW10 5NH. Tel: (01) 969-7155/5255. Telex: 927813. Mng. Dir.: Raymond Lenton; Mktg. Dir.: Keith Yershon; Financial & Admin. Dir.: Norman Mandell.
 Product: Catalog servs., 45 rpm adapters.
 Lugton & Co. Ltd., PO Box 182, Cross Ln., Hornsey, London N8 7SB. Tel: (01) 348-8211. Mng. Dir.: Walter Ficker; Gen. & Sales Mgr.: John Sully.
 Product: Record & tape carrying & storage cases, cleaners, clothes, brushes, head cleaners, demagnetizers, needles, leader & splicing tape.
 Metrosound Audio Prods. Ltd., Freedex House, 4-10 North Rd., Islington, London N7 9HN. Tel: (01) 607-8141. Cable: METROS. Telex: 264773. Mng. Dir.: David Mason; Sales Mgr.: Ian Levene.
 Product: Carrying & storage cases, cleaners, cloths, brushes, 45 rpm adapters, head cleaners, demagnetizers, needles, leader & splicing tape.
 Multiple Sound Pressings Ltd., Deacon St., Leicester. Tel: (0533) 56608. Telex: 914382. Mng. Dir.: Ian F. Miles; Gen. Mgr.: John S. Coats; Sales Mgr.: J. Colgrove; Chief Eng.: D. Anderson.
 Product: Record carrying & storage cases, cleaners, cloths, brushes.
 Musac (Scotland) Ltd., Baltic Chambers, 50 Wellington St., Glasgow, Scotland G2 6HJ. Tel: (041) 221-1948. Mng. Dir.: Angus McDonald; Sales Mgr.: Douglas MacLeod.
 Product: Record & tape carrying & storage cases, catalog servs., head cleaners, demagnetizers, needles.
 Musiceas Ltd., Camberwell Ind'l Estate, Unit 6, Denmark Rd., London SE5. Tel: (01) 737-0480. Mng. Dir.: John Hardman; Prod'n Mgr.: Martyn Ward.

Product: Record & tape carrying & storage cases, cleaners, cloths, brushes, head cleaners & demagnetizers

Music Master, Music House, 1 de Cham Ave., Hastings, Sussex, Tel: (0424) 440104. Publ'r & Ed. John Humphries, Adv Mgr. Colin Parker, Prices & Company News Ed. Verena Couchman, Classical Ed. John Bath, Pop Ed. Michael Preston.
Product: Catalog servs.

Musonic, see Ziphurst.

North East Audio Ltd., Simonside Works, South Shields Tyne & Wear NE34 9NX Tel: (0632) 566321. Mng Dir. A. J. Helliwell, Sales Mgr. J. Sparrow.
Product: Head demagnetizers, test tapes (Ferrograph)

Nortronics, see Lee.

Osmabel Ltd., 46 Kenilworth Rd., Edgware, Middx HA8 8YG Tel: 958-9314. Mng Dir. O. Greenlick.
Product: Bulk erasers & head demagnetizers.

P T T Developments Ltd., 63 High St., Ware, Herts SG12 9AD Tel: (0920) 66242. Chief Exec. R.C. Bayes.
Product: Record & tape carrying & storage cases.

Paragon Int'l Prods., 16 Holmes St., Belfast, Northern Ireland Tel: (0232) 48260. Dir. John O.P. McCourt, Gen. Mgr. Anne Heaps, Sales Mgr. Edwina Heaps.
Product: Catalog servs.

Philips Electrical Ltd., City House, London Rd., Croydon, Surrey Tel: (01) 689-2166 Telex 946169.
Product: Cassette head cleaning tape, leader & splicing tape.

Pinnacle Recs., 9 Dean St., London, W1V 5RL Tel: (01) 734-4345. Telex 896141 Orpington Chm & Mng Dir. Terry Scully, Mng Dir. Jack Bass, Gen. Mgr. G.F. Stone, Sales Mgr. Ray Phillips.
Product: Carrying & storage cases, cleaners, cloths, brushes, head cleaners, demagnetizers, needles, leader & splicing tape.

Plastic Sales Leicester Ltd., 10/12 Darford Rd., Leicester LE2 7PQ Tel: (0533) 833691. Chief Exec. T.H. Winfield, Gen. Mgr. Mrs. B.E. Flude.
Product: Carrying & storage cases.

Pro-Bel Ltd., Terrace Rd., Binfield, Bracknell, Berks. Tel: (0344) 56969. Telex 848314. Mng Dir. Derek Owen, Press Officer K. Bryan.
Product: 2" & 1" tape cleaner/profiler (Elcon Magnetek).

Professional Tapes Ltd., Cassette House, 329 Hunslet Rd., Leeds LS10 1NJ. Tel: (0532) 706066. Telex 55293. Mng Dir. Raymond Linton, Gen. Mgr. Joseph Nurgat, Sales Mgr. Bert Hamilton.
Product: Head cleaners, demagnetizers, splicing tape.

Purpax Plastics Ltd., Longbank Works, Alva, Clackmannanshire, Scotland Tel: (0259) 60307. Mng Dir. J.M. Fuller, Sales Mgr. M. Pink, Prod'n Dir. R.B. Dunbar.
Product: Carrying & storage cases.

Pyrax Magnetics Ltd., Airport House, Purley Way, Croydon, Surrey CR0 0XZ Tel: (01) 681-2272. Telex: 946670. Mng Dir. H.J. Hutchings, Sales Mgr. John P. Thurlay, Factory: Eastbourne, Sussex, Courtlands Rd. Tel: (0323) 638-965.
Product: Carrying & storage cases, head cleaners & demagnetizers, leader & splicing tape.

Pyser Ltd., Fircroft Way, Edenbridge, Kent Tel: (073271) 864111. Telex 95527. Mng Dir. J.P. Tilt, Sales Dir. Malcolm Blockley.
Branch: Harrow, Middx, 102 College Rd. Tel: (01) 427-2278.
Product: Record preservative (Sound Guard), head cleaners & demagnetizers.

Quality Audio Supplies, Wollaton Rd., Beeston, Notts. Tel: (0602) 25-22-22.
Product: Head cleaners.

R A Audio, Kernick Rd., Penryn, Cornwall TR10 9DQ. Tel: (0326) 72753. Cable: RIMICRON. Mng Dir. M.A. Lee.
Product: Groovac antistatic vacuum record cleaners.

Racal-Zonal Ltd., Station Hill, Pound Hill, Crawley, Sussex RH10 4AZ. Tel: (0293) 34982. Cable: CASSETTES CRAWLEY. Telex: 87651. Mng Dir. D.S. Worman, Gen. Sales Mgr. John Rooke, A/V Sales Mgr. Eric Mould.
Product: Head cleaners, demagnetizers, leader tape.

Rainbow Sound Servs., 1A St. Andrew St., Plymouth, Devon Tel: (0752) 25781 (day), 774381 (night). Chief Exec. Phil E.R. Simonds.
Product: Record catalog servs.

Record Holding Soundmaster, 17A Newnham Rd., Wood Green N22. Tel: (01) 889-0139. Co-Chm. M.L. Field, Gen. Mgr. J. Cohen, Sales Mgr. J. Devan, Prod'n Buyer F. Davis.
Product: Rec. & tape carrying & storage cases, storage racks, cabinets, trolleys.

Record Housing, see N. & S.B. Field.

Revex, see F.W.O. Bauch.

Ross Electronics, 32 Rathbone Pl., London W1P 1AD. Tel: (01) 580-7112. Cable: ROSSILECT. Telex 22747. Pres. Ross L.L. Marks, Gen. & Sales Mgr. A.C. Murphy.
Product: Cleaners, cloths, brushes, head cleaners & demagnetizers.

S & B Trading, Stylus House, 34-38 Verulam Rd., St. Albans, Herts AL3 4DF. Tel: (0727) 50611. Telex: 28675. Mng Dir. P.H. Blank, Prod'n Dir. S.H. Blank, Sales Dir. B. Blank, Dir. D.N. Lever.
Product: Carrying & storage cases, catalog servs., cleaners, cloths, brushes, 45 rpm adapters, head cleaners, demagnetizers, needles, leader & splicing tape.

Scenic Sounds Equip. Ltd., 97-99 Dean St., London W1V 5RA. Tel: (01) 734-2812. Telex 27939. Owner David Hawkins.
Product: Splicing & Editing Equip (Editall)

Sculthorp Plastics Ltd., The Barge Walk, East Molesey, Surrey KT8 9AZ. Tel: (01) 941-2929. Mng Dir. R.H. Sculthorp.
Product: Carrying & storage cases.

Securette Ltd., 25 Bluebridge Ind'l Estate, Halsestead, Essex CO9 2EX. Tel: (07874) 5912. Mng Dir. Bruce T. Samson, Dir. Mary B. Valentine.
Product: Tape carrying & storage cases.

Selecta (London) (div. of Decca Rec. Co. Ltd.), 125/127 Lee High Rd., Lewisham, London SE13 5NX. Tel: (01) 852-9171/9191. Telex 896029. Gen. Mgr. J.D. Roberts, Sales Mgr. D. Barsby, Sales Co-ord. E. Packham.
Product: Record & tape carrying & storage cases, cleaners, cloths, brushes, 45 rpm adapters, head cleaners, demagnetizers, needles.

P & J Sibert & Co., 161 Finborough Rd., West Brompton, London SW10 9AP. Tel: (01) 373-9509. Technical Sales Alan & Paul Sibert.
Product: Record stylus & tape head inspection equip.

Solomon & Peres Ltd., 120 Coach Rd., Templepatrick, Ballyclare, Co. Antrim, Northern Ireland BT39 0HB Tel: (08494) 32711. Telex 747293. Mng Dir. Mervyn A. Solomon, Gen. Mgr. Les Paterson, Rec./Tape Mgr. Michael H. Ross, Sales Mgr. Noel A. Spiller.
Product: Record carrying & storage cases, cleaners, cloths, brushes, head cleaners & demagnetizers, needles.

Sound Guard, see Pyser.

Stanton, see Wilmex.

T D K Tape Dist (UK) Ltd., 341 Brighton Rd., South Croydon, Surrey CR2 6EQ. Tel: (01) 688-7372. Telex 946727. Mng Dir. J.C. Buchan, Sales Mgr. Derek Huthwaite.
Product: Head cleaners & demagnetizers.

T. I. Crown Merton Ltd., Trafalgar Works, Station Rd., Merton Abbey, London SW19 2NJ. Tel: (01) 542-1012. Sales Mgr. John Pengilly.
Product: Injection-molded plastic & wire record & cassette storage racks (Crown Merton).

Tapemaster Publ'ns, Kempsey, Worcs WR5 3PN. Tel: (0905) 82-01-37, 35-21-31. Compilation Ed. James Bradley, Research. Kathleen Bradley.
Product: Tapemaster classical cassette catalogue.

3 M United Kingdom Ltd., PO Box 1, 3M House, Bracknell, Berks RG12 1JU. Tel: (0344) 26726. Telex: 849371. Mng Dir. Donn Osman, Div. Dir. P.G. Hutchings, Sales & Mktg Mgr. C. Hobbs, Mktg Co-ord. P.A. Stockwell-Jones.
Reg'l sales offices: Belfast BT1 5JE, Northern Ireland, 11 Donegal Square S. Tel: (0232) 42811, 42926—Birmingham B3 3EL, Edmund House, 12-22 Newhall St. Tel: (021) 236 5077—Glasgow G4 0AY, Scotland, 3M House, 9 Canal St. Tel: (041) 332-9622—London SE20 7TR, PO Box 38, Yeoman House, 63 Croydon Rd., Penge. Tel: (01) 659-2323—Manchester M15 4PA, 3M House, 28 Great Jackson St. Tel: (061) 238-8500.
Product: Head cleaners, leader & splicing tape, antistatic turntable mats.

Trident Audio Developments Ltd., 112/114 Wardour St., London W1V 3AW. Tel: (01) 734-9901. Telex 27782. Mng Dir. Malcolm Toft, Sales Mgrs. Mike Rogers, Derek Fox.
Product: Library cases.

James Upton Ltd., Tinsley House, 67 Rosoman St., London EC1 Tel: (01) 278-2916. Cable: TINROBOR. Sales Mgr. W.G.A. Howe.
Product: Catalog servs.

V O R Int'l, Unit 16F, Randles Rd., Knowsley, Merseyside L34 9EZ. Tel: (051) 548-7400. Telex 627791. Mng Dir. Jim Thornton.
Product: Record care prods. (Discleaner, Vac-O-Rec) Vac-O-Rec, see VOR.

Cecil E. Waits Ltd., Darby House, Lower Hampton Rd., Sunbury-on-Thames, Middx. Tel: Sunbury 83252. Cable: DUSTBUG. Telex: 27750. Mng Dir. Mrs. A.H. Waits, Gen. & Sales Mgr. D.W. Luxford-Waits.
Product: Record maintenance equip. Dust Bug, Disc Preener, Manual Parastat, Hi-Fi Parastat, stylus cleaner, Humid Mop.

Wilmex Ltd., Compton House, New Malden, Surrey KT3 4DE. Tel: (01) 949-2545.
Product: Needle (Stanton).

Wynd Up Recs. Ltd., Greengate Ln., Prestwich, Manchester. Tel: (061) 798-9252/0533. Mng Dir. Colin Reilly, Gen. Mgr. B. Patchett, Purchasing Dir. N.K. Raggett, Sales Dir. L.J. O'Meara.
Product: Carrying & storage cases, catalog servs., cleaners, cloths, brushes, 45 rpm adapters, head cleaners, demagnetizers, needles, leader & splicing tape.

M. Young & Co., Industrial Estate, Southgate Ave., Mildenhall, Suffolk IP28 7AT. Tel: Mildenhall 712553. Partner M. Young.
Product: Polythene lined covers, master bags, cardboard record covers, cassette master bags.

Zeepa Instruments Ltd., 15 Richmond Grove, Surbiton, Surrey KT6 6AH. Tel: (01) 399-0966. Cable: ZEEPA SURBITON. Telex 929679. Mng Dir. W. Ling, Sales Mgr. R.S. English.
Audio: Carrying & storage cases, record cleaners, cloths, brushes, tape head spray demagnetizers, bulk erasers, needles.

Zerostat Components Ltd., Edison Road Ind'l Estate, St. Ives, Huntingdon, Cambs. Tel: (0480) 62225. Telex 32303. Dir. L.W.W. Scofield.
Product: Cleaners, cloths, brushes.

Ziphurst Ltd., Stylus House, 34/38 Verulam Rd., St. Albans, Herts AL3 4DF. Tel: (0727) 50611. Telex: 28675. Mng Dir. P.H. Blank, Gen. Dir. D.N. Lever, Sales Dir. B. Blank, Prod'n Dir. S.H. Blank.
Product: Carrying & storage cases, cleaners, cloths, brushes, 45 rpm adapters, head cleaners, demagnetizers, needles, leader & splicing tape (Musonic).

East Sussex BN27 2ER. Tel: (0323) 843191. Gen. Mgr. G.J. Willamowski, Sales Mgr. K.W. French.
Product: Record & tape browser boxes, tape display racks.

Ballantine Advertising Ltd., 8 Chepstow Pl., London W2. Tel: (01) 229-6071. Mng Dir. A.N. Gill, Gen. Mgr.: Max Arnold.
Product: Record divider cards.

Bilabel, 3 Speedwell Close, Chandlersford Ind'l Estate, Eastleigh, Hants. Tel: (04215) 63434. Gen. Mgr. & Mktg. Dir. Malcolm Paton, Sales Mgr. Martin Bennett.
Product: Browser boxes, display racks, divider cards.

Broomhall Joinery Co. Ltd., 222 High St., Uxbridge, Middx. Tel: 37311. Mng Dir. S.J. Hurley, Gen. Mgr.: R.F. Allen.
Product: Record browser boxes, record display racks.

Caroline, 56 Standard Rd., London NW10. Tel: (01) 961-2919. Telex: 22164. Mng. Dir.: C. Stylianou, Studio/ Electronics Exec. Roger Eilman.
Product: Browser boxes, displays racks, divider cards.

Crown Merton, see T.I. Crown Merton.

Decor Shoplifting Servs. Ltd., Horton Bank Top Mills, Cooper Ln., Bradford. Tel: 76109.
Branch: Cupar, Fife, Scotland, G. Walker-Audio, The Studio, South Bridge. Tel: 2400.

E M I Recs. Ltd., Shopfitting & Supplies Div. 1/3 Uxbridge Rd., Hayes, Middx. 48H OSY. Tel: (01) 561-8722. Dir. R.E. Matthews, Special Projects Mgr. D.L. Watson.
Product: Browser boxes, display racks.

E M I Tape Ltd., Tape House, Dawley Rd., Hayes, Middx. UB3 1BT. Tel: (01) 573-3888. Cable: EMITAPE LONDON. Telex: 932161. Mng. Dir.: E.A. Naef, Comm'l Controller. P.K. Mitchell, Gen. Sales Mgr. P. Sollitt, Mktg. Mgr.: M.W. Cross.
Product: Tape display racks.

Film & Television Prod'n Servs., Pinewood Studios, Iver Heath, Bucks.
Product: Tape display racks.

Fittall Prods. Ltd., Coastguard Rd., Larne, Northern Ireland. Tel: (0574) 3015. Telex: 747386. Mng. Dir.: C. Rumble.
Product: Tape display racks.

E Hannibal & Co. Ltd., Pinfold Rd., Thurmaston, Leicester. Tel: (0533) 695413. Telex 34627. Mng. Dir.: Chris Hetherington, Ass't Mng. Dir.: Roger Stewart, Music Div. Sales Dir.: Derek Deighton.
Product: Browser boxes, divider cards.

John Harwood-Bee Assocs., The Maltings, 63 High St., Ware, Herts. Tel: (0920) 66310. Telex: 299929. Mng. Dir. John Harwood-Bee.
Product: Record & tape browser boxes.

Hunt-Leigh (Showcard & Display Co.), 119 Alterburg Gardens, London SW11 1JQ.

Lightning Recs. Ltd., 841 Harrow Rd., Harlesden, London NW10 5NH. Tel: (01) 969-7155/5255. Telex: 927813. Mng. Dir.: Raymond Laren; Mktg. Dir.: Keith Yershon, Financial & Admin. Dir.: Norman Mandell.
Product: Display racks, browser boxes.

Lugton & Co. Ltd., Cross Ln., Hornsey, London N8 7SB. Tel: (01) 348-8211. Mng. Dir.: Walter Ficker, Gen. & Sales Mgr. John Sully.
Product: Record browser boxes, tape display racks.

Metropolitan Communications, 29-33 Park Ln., London W1. Tel: (01) 435-8803. Mng. Dir. Mark R.F. Hanau, Gen. Mgr.: R. Fry, Sales Mgr.: R. Hanau, Admin.: A. Lohmeyer.
Product: Tape display racks, audio sampler.

Metrosound Audio Prods. Ltd., Freedex House, 4-10 North Rd., Islington, London N7 9HN. Tel: (01) 607-8141. Cable: METROS. Telex: 264773. Mng. Dir.: David Mason, Sales Mgr.: Ian Levene.
Product: Display racks.

Musonic, see Ziphurst.

Natural Sound Systems, 10 Byron Rd., Wealdstone, Harrow, Middx. Tel: (01) 863-8622. Telex: 922573. Sales Dir.: Malcolm Kays.
Product: Display racks, divider cards.

Pinnacle Recs., 9 Dean St., London W1V 5RL. Tel: (01) 734-4345. Telex 896141 Orpington Chm & Mng Dir. Terry Scully, Mng Dir. Jack Bass, Gen. Mgr. G.F. Stone, Sales Mgr. Ray Phillips.
Product: Record browser boxes, display racks, divider cards.

Plastic Sales Leicester Ltd., 10/12 Darford Rd., Leicester LE2 7PQ. Tel: (0533) 833691. Chief Exec.: T.H. Winfield, Gen. Mgr. Mrs. B.E. Flude.
Product: Record & tape divider cards.

Realmeath Ltd., 15/23 Porteus Rd., London W2. Tel: (01) 723-8495. Dir. Bryan Whitman.
Product: Browser boxes, display racks, divider cards.

S & B Trading, Stylus House, 34/38 Verulam Rd., St. Albans, Herts AL3 4DF. Tel: (0727) 50611. Mng Dir. P.H. Grant, Prod'n Dir. S.H. Blank, Sales Dir. B. Blank, Dir. D.N. Lever.
Product: Browser boxes, display racks, divider cards.

Securette Ltd., 25 Bluebridge Ind'l Estate, Halstead, Essex CO9 2EX. Tel: (07874) 5912. Mng Dir. Bruce T. Samson, Dir. Mary B. Valentine.
Product: Tape display racks (Serrette).

Securivision Ltd., Rectory Ln., Prestwich, Manchester. Tel: (061) 236-8757.
Product: Closed circuit television.

Selecta (London) (div. of Decca Rec. Co. Ltd.), 125/127 Lee High Rd., Lewisham, London SE13 5NX. Tel: (01) 852-9171/9191. Telex: 896029. Gen. Mgr. J.D. Roberts, Sales Mgr. D. Barsby, Sales Co-ord. E. Packham.
Product: Record divider cards.

T D K Tape Dist (UK) Ltd., 341 Brighton Rd., South Croydon, Surrey CR2 6EQ. Tel: (01) 688-7372. Telex: 946727. Mng. Dir.: J.C. Buchan, Sales Mgr.: Derek Huthwaite.
Product: Display racks.

T. I. Crown Merton Ltd., Trafalgar Works, Station Rd., Merton Abbey, London SW19 2NJ. Tel: (01) 542-1012. Sales Mgr. John Pengilly.
Product: Cassette display racks (Crown Merton).

Trade Distributors Northern, 400 Great Horton Rd., Bradford, West Yorks. Tel: (0274) 76809.
Product: Browser Boxes.

● **store fixtures & merchandising aids manufacturers**

Amazing Exhibitionists Ltd., 20 Gloucester Place Mews, London W1H 3PD. Tel: (01) 486-3977. Dirs. Arastou Azar, Lawrence Miller, Sales Mgr. Janet Lamport.
Product: Browser boxes, display racks, divider cards.

Ateka & Co., Industrial Estate, 23 Station Rd., Hailsham,

Wynd Up Recs. Ltd., Greengate Ln., Prestwich, Manchester. Tel. (061) 798-9252/0533. Mng. Dir. Colin Reilly, Gen. Mgr.: B. Patchett, Purchasing Dir.: N.K. Raggett, Sales Dir.: L. J. O'Meara
Product: Browser boxes, display racks, divider cards.
 Ziphurst Ltd., Stylus House, 34/38 Verulam Rd., St. Albans, Herts. AL3 4DF. Tel. (0727) 50611. Telex 28675. Mng. Dir.: P.H. Blank, Gen. Dir.: D.N. Lever, Sales Dir.: B. Blank, Prod'n Dir.: S.H. Blank
Product: Browser boxes, display racks, divider cards (Musonic).

URUGUAY

Population: 3,150,000.
 Rate of exchange: \$1 (US) = 7.29 new pesos.
 Per capita income: \$1,480.

Holidays: January 1, January 6 (Holy Kings' Day), February (Monday & Tuesday of Carnival), March (Holy or Tourism Week), April 19 (Landing of the 33), May 1 (Workers Day), May 18 (Battle of Las Piedras), June 19 (Birth of Artigas), July 18 (First Constitution Day), August 25 (Independence Day), October 12 (Columbus Day), November 2 (All Souls Day), December 8 (Blessing of the Waters), December 25.

RECORDS:

Records sold domestically including imports: LP's 1978—477,363 units, \$2,443,791; 1977—523,520 units, \$2,042,040. Classical LP's 1978—16,571 units, \$93,390; 1977—39,181 units, \$167,473. Singles & EP's 1978—57,707 units, \$84,950; 1977—66,270 units, \$84,056.
Average retail price per record: Pop LP's—\$5.12; Classical LP's—\$5.63; singles & EP's—\$1.47.

Discounting: Frequent

Type of distribution: Manufacturer-to-retailer, with a 30% mark-up. Large manufacturers own retail shops, which sell product from all companies. The month of June has many specialty promoted discount sales, and many retailers also keep a permanent discount desk.

Type of promotion: Manufacturers send free sample records to radio and TV stations and newspapers as well as large Montevideo discotheques. They also advertise in a free monthly magazine ("Hit"), which has commentaries on artists and new releases. TV keeps gaining in importance as a medium for advertising records, followed by radio, although publicity prices are relatively high, considering the dimensions and tendencies of the market.

TAPE:

Pre-recorded tape sold domestically including imports: Cassette 1978—92,461 units, \$571,039; 1977—42,638 units, \$211,918.

Market: 1979 cassette sales showed a dramatic increase of 108% over 1977 sales. Most of the best selling product is released initially as both records and cassettes, but the cassette market is still somewhat different from the album market. Another important pre-recorded tape product is instrumental music, including light classics and folk.

Average retail price per tape: Cassette—\$5.00.

RADIO STATIONS:

No. of commercial 88; no. of government 5, 89 AM, 4 FM.
Comment: International pop music, mainly sung in Spanish, predominates on commercial stations. Some of these, located in Montevideo, promote almost exclusively English-sung songs, in most cases through imported product. The "Tropical Music" fad has a few specialized programs on secondary stations. Local and Latin-American folk song programs are increasing in importance.

TELEVISION STATIONS:

No. of channels 17; 16 commercial, 1 government, no color.
Comment: TV stations keep a daily eight-hour programming schedule. Almost all programs are foreign-produced films and serials, mainly from Argentina and the US. International pop music, through films, and local folk and "tropical," have gained programming time.

IMPORT/EXPORT REGULATIONS:

Prohibitive taxes make importing impractical. Nevertheless, in 1978 APSA imported Red Seal titles from the United States, with some response. This attempt was made considering the recent development of a social sector with important acquisitive power, and followed a trend of high-priced software imports.

MARKET ANALYSIS:

As almost everywhere in the Occident, 1978 in Uruguay was a "Saturday Night Fever" year. The soundtrack album was not only the overall best seller for the year, but also in many years. It attained the number one spot on the album charts almost within a week of its release even though the film was premiered after the end of the football (soccer) World Championship held in Argentina in June. Tied in with the phenomenon, which included dancing competitions and much promotion on almost all media, were the big hits of John Travolta, Olivia Newton-John, the "Grease" and "Sgt. Pepper" soundtracks, and Andy Gibb, not to mention all the Bee Gees' discography. As a fact that involved mainly dancers, the "Tropical" music market weakened a little in both club attendance and record sales, though it still can be considered strong.

Television promotion was supplied by a new company, Renvar, which has links with Montecarlo Channel 4, with significant responses to many of its titles. Other companies tried campaigns on certain records, but record sales in general declined, with the sole exception of pre-recorded cassettes.

General trends in record sales showed few changes, espe-

cially in Montevideo with about one-half the market. Sales were divided almost equally between Spanish and English product. Best selling albums included "various artists" albums, mostly locally produced with foreign product. The greatest sales decline was in the classical musical area.

Local folk music, including "new" folk, "pop" folk, and folk-rock, increased in importance on shows and on records. Many new young artists joined the names known from the earlier years of the "seventies generation," which follows the tradition of the 1968 folk boom. Shows were often presented in small theaters, and they also were held in large sports gymnasiums and stadiums, thus attracting, for the first time in many years, thousands of fans.

Carlos Alberto Martins

● record & tape manufacturers / distributors / importers

A P S A (American Prods. SA) (IFPI), Av. Italia 4230, Montevideo, Tel. 59-42-17. Dirs.: Isaac & David Wegbraut; Gen. Mgr.: Norman Arlin; Sales Mgr.: Eduardo Castro.
Labels: (Owned) Citrus; (licensed) Ariola (Spain), Barclay (France), Bronze (UK), Can't Stop (USA), Disco Libro (Mexico), Grunt (USA), Hansa (Germany), IRT (Chile), Millennium (USA), Polar (Sweden), RCA (worldwide), Ricordi (Italy), Roadshow (USA), Sigla (Brazil), Solar (USA), TK (Argentina, USA), Vanilla (Italy).
Int'l rep.: Worldwide (RCA Int'l).

Ayui, see Tacuabe.

Citrus, see APSA.

Clave (IEMSA) (IFPI), La Paz 2243, Montevideo Tel. 4-5065, 41-4020. Cable: CLALIM. Mng. Dir.: Leon Jurburg; Gen. Mgr.: Juan Carlos Luaces; A&R Mgr.: Luis A. Lema.

Labels: (Owned) Clave; (licensed) Beverly (Brazil), Copacabana (Brazil), Decca (UK), Discomoda (Venezuela), London (UK), Pye (UK), Seeco (USA), Threshold (UK), Trova (Argentina), WEA group.

Daisy, see EDISA.

EDISA (IFPI), Nueva York 1176, Montevideo, Tel. 91-20-61. Mng. Dir.: Juan Carlos Garcia; Gen. & A&R Mgr.: Alberto Gambetta.

Labels: (Owned) Daisy; (licensed) Charisma (UK), Chrysalis (UK), DGG (Germany), Fontana, H&L (USA), Island (UK), MCA (USA), MGM, Microfon (Argentina), Philips, Phonogram group, Polydor (worldwide), RSO (UK), Rocket (UK), 20th Century (USA).

I E M S A, see Clave.

Macondo Ltda., Ituzaingo 1324, Escritorio 203, Montevideo, Tel. 90-0337. Pres.: Luis Orlando Onel Hidalgo; Gen. Mgr.: Luis Orlando Onel Riviezzo; Promo. Mgr.: Werther Brito; Sales Mgr.: Ruben Lema.
Labels: (Owned) Macondo; (licensed) Qualiton (Argentina), Rower-Arfon (Argentina).
Int'l reps.: Argentina (Fonema, Rower-Arfon).

Maloa Recs. Ltd., Carlos Roxlo 1476, Montevideo, Tel. 49-8944. Mng. Dir.: Graciela Eugenia de Silva; Admin. Dir.: Mario Lopez Azagra; A & R Dir.: Alberto Trunfo.

Labels: (Owned) Maloa; (licensed) Arfon (Argentina), Cabal (Argentina), Chantecler (Brazil), Martin Meyer (Argentina), Tennessee (Argentina), Zafiro-Novola (Spain).

Melody, see Renew Variety.

Orfeo, see Palacio.

Palacio de la Musica Ricardo & Rodolfo Gioscia SA (IFPI), Av. 18 de Julio 1100, Montevideo, Tel. 90-01-13/48-25/84-31, 91-74-40/65-85, 98-61-21. Cable: GIOSPIANO. Pres.: Ricardo Gioscia Zamalvea; Sales Mgr.: Alfredo Aiviotti Robido.
Labels: (Owned) Orfeo; (licensed) ABC/Dunhill (USA), A&M (USA), Angel (UK), Apple (UK), Arista (USA), Capitol (USA), EMI group (UK), Hispavox (Spain), Magnet (UK), Odeon (UK), Pampa (Argentina), Private Stock (UK), United Artists (USA).

Palma, see Tacuabe.

Renew Variety Recs. SA, Av. 18 de Julio 1224, 2nd fl., Montevideo, Tel. 98-56-89, 91-21-82. Cable: MONTECARLO TV. Dirs.: Hugo & Daniel Romay Salvo; Gen. Mgr.: Cr. Pedro Mino, Sales Mgr.: Ernesto Averbug; A&R Dir.: Alfredo Leiros.

Labels: (Owned) Melody, Renew Variety; (licensed) Basart (Netherlands), Chantecler (Brazil), Continental (Brazil), Ri-Fi (Italy).

Renvar SA, Avda. 18 de Julio 1224, 2nd fl., Montevideo, Tel. 98-39-87, 98-56-89. Telex 834. Dir.: Gen. Daniel Romay Salvo; Gen. Mgr.: Cr. Pedro Mino, Artistic Dir.: Alfredo Leiros.

Label: (Licensed) Continental (Brazil).
Sondor SA (IFPI), Nicaragua 1478, Montevideo, Tel. 29-75-30. Cable: SONDRORADA. Pres.: Enrique Abal Salvo; VP: Pablo Echevarria; Gen. Mgr.: Enrique Abal Oliu; Sales Mgr.: Omar Montano.

Labels: (Owned) Sondor; (licensed) CBS Int'l (USA), Disc Jockey (Argentina), Epic (USA), Surco (Argentina), Telefunken (Germany).

Int'l rep.: Worldwide (CBS).

Tacuabe (Eds.), Treinta & Tres 1483, Escritorio 15, Montevideo, Tel. 91-10-65, 98-41-40, A&R Dir.: Corun Aharonian; Sales Mgr.: Myriam de Campos, Musical Advisor: Graciela Paraskevaidis.

Labels: (Owned) Ayui, Palma, Tacuabe; (licensed) Le Chant du Monde (France), La Cornamusa (Argentina), Edigsa (Spain), Moshe Naim (France).

Int'l reps.: Argentina (La Cornamusa), France (Le Chant du Monde), Spain (Edigsa).

● music publishers

Circle Line Eds Int'l's, Cooper 2101, Montevideo, Tel. 39-6475. Gen. Dir.: J. Olszewicki Fried; Gen. Mgr.: Mario Grandat.

Int'l firms represented: Paul Beuscher, Bretagne, Claude Carriere, Isabelle, Sforzando, Tremplin (all France), Elypeyrot (Europe).

Int'l rep.: Europe (Elypeyrot).

Tacuabe (Eds.) (AGADU), Treinta & Tres 1483, Escritorio 15, Montevideo, Tel. 91-10-65, 98-41-40, A&R Dir.: Corun Aharonian.

Tacuara (Ed.) (AGADU), Nicaragua 1478, Montevideo, Tel. 29-7530. Dir.: Enrique Abal Oliu.

● services

ASSOCIATIONS & PROFESSIONAL ORGANIZATIONS

Asociacion de Educadores Musicales, Montevideo. Pres.: Nilda Gonzalez Genta.

Asociacion Estudiantes de Musica (AEMUS), Colonia 1065, Montevideo. Pres.: Zulma Harambure; VP: Enrique Visca; Sec'y: Susana Prunes.

Asociacion Uruguaya de Musicos, Maldonado 983, Montevideo, Tel. 98-73-70. Pres.: Roberto Garcia Devita; Sec'y: Romeo Cernuschi, Treas.: Guillermo Aguirre.

Camara Uruguaya del Disco, Canelones 1974, Montevideo, Tel. 4-30-52. Pres.: Norman Arlin; VP: Ricardo Gioscia Zamalvea; Exec. Sec'y: Dr. Plinio Borggio; Sec'y: Juan Carlos Garcia; Treas.: Enrique Abal.

Centro Cultural de Musica, Av. 18 de Julio 1006, 6th fl., Montevideo.

Juventudes Musicales del Uruguay, Rio Negro 1228, Montevideo, Tel. 90-55-75. Pres.: Hugo Balzo; Sec'y: Maria Tania Siver.

Sociedad Uruguaya de Interpretes (SUDEI), Canelones 1090, Montevideo. Pres.: Orlando Romanelli; VP: Rogelio Coll; Sec'y: Jose Maria Lorenzo; Treas.: Guillermo Aguirre.

Sociedad Uruguaya de Musica Contemporanea, Casilla de Correo 1328, Montevideo. Pres.: Hector A. Tosar; Sec'y: Corun Aharonian.

DESIGN & ARTWORK

Artegraf Ltda., Florida 1477, Montevideo, Tel. 98-60-38. (Record only)

Estudio 3, Rio Branco 1320, Of. 302, Montevideo, Tel. 98-25-24. Gen. Mgr.: Juan Jose Gatto.

Imprenta AS, PO Box 1600, Rincon 387, Montevideo, Tel. 91-45-76, 98-56-68. Telex: Artega UY737. Pres. & Gen. Mgr.: Jorge de Artega; Sales Mgr.: Eduardo Diaz.

Imprenta Garcia SA, Rio Branco 1481-83, Montevideo, Tel. 90-51-75. Rec. Ind. Serv. Mgr.: Israel Garcia Aturaola.

LICENSING ORGANIZATION, MUSIC

A G A D U (Asociacion Gen. de Autores del Uruguay) Canelones 1130, Montevideo, Tel. 90-31-88. Pres.: Antonio Italiano; Gen. Mgr.: Rodolfo M. Cosentino; Sec'y: Luis Eduardo Echegonzelay. (Mechanical & performing rights.)

PLATING, PROCESSING & PRESSING PLANTS

A P S A (American Prods. SA), Av. Italia 4230, Montevideo, Tel. 59-42-17. Dirs.: Isaac & David Wegbraut; Gen. Mgr.: Norman Arlin; Sales Mgr.: Eduardo Castro.

Clave (IEMSA), La Paz 2243, Montevideo, Tel. 4-5065, 41-4020. Cable: CLALIM. Mng. Dir.: Leon Jurburg.

F I M S A (Fabrica de Instrumentos Musicales & Afines SA), Nueva York 1176, Montevideo, Tel. 91-60-74. Pres.: Jose Pedro Lopez Vidaur.

Sondor SA, Nicaragua 1478, Montevideo, Tel. 29-75-30. Cable: SONDRORADA. Pres.: Enrique Abal Salvo; VP: Pablo Echevarria; Gen. Mgr.: Enrique Abal Oliu; Sales Mgr.: Omar Montano.

PRINTERS & LITHOGRAPHERS

Artegraf Ltda., Florida 1477, Montevideo, Tel. 98-60-38. (Record only)

Pablo Cardellino—Publigraf, Magallanes 1240, Montevideo, Tel. 41-41-13. Pres.: Pablo Cardellino.

Imprenta AS, PO Box 1600, Rincon 387, Montevideo, Tel. 91-45-76, 98-56-68. Telex: Artega UY737. Pres. & Gen. Mgr.: Jorge de Artega; Sales Mgr.: Eduardo Diaz.

Imprenta Cervantes (Socolovsky SA), Calle Durazno 939, Montevideo, Tel. 98-24-35, 91-72-32. Pres. & Gen. Mgr.: Jaime Socolovsky.

Imprenta Garcia SA, Rio Branco 1481-83, Montevideo, Tel. 90-51-75. Rec. Ind. Serv. Mgr.: Israel Garcia Aturaola.

Lagomarsino SA, Sarandi 429, Montevideo, Tel. 90-23-45. Pres.: Daniel Lagomarsino; Gen. Mgr.: Alberto Lagomarsino.

RECORD PROMOTION

Imprenta AS, PO Box 1600, Rincon 387, Montevideo, Tel. 91-45-76, 98-56-68. Telex: Artega UY737. Pres. & Gen. Mgr.: Jorge de Artega; Sales Mgr.: Eduardo Diaz.

Imprenta Garcia SA, Rio Branco 1481-83, Montevideo, Tel. 90-51-75. Rec. Ind. Serv. Mgr.: Israel Garcia Aturaola.

TAPE CUSTOM DUPLICATORS

A P S A (American Prods. SA), Av. Italia 4230, Montevideo, Tel. 59-42-17. Dirs.: Isaac & David Wegbraut; Gen. Mgr.: Norman Arlin; Sales Mgr.: Eduardo Castro.

Audio: Cassette.

Sondor SA, Nicaragua 1478, Montevideo, Tel. 29-75-30. Cable: SONDRORADA. Pres.: Enrique Abal Salvo; VP: Pablo Echevarria; Gen. Mgr.: Enrique Abal Oliu; Sales Mgr.: Omar Montano.

Audio: Cassette.

● supplies

TAPE, BLANK LOADED

A P S A (American Prods. SA), Av. Italia 4230, Montevideo, Tel. 59-42-17. Dirs.: Isaac & David Wegbraut; Gen. Mgr.: Norman Arlin; Sales Mgr.: Eduardo Castro.

Audio: Cassette.

ENVELOPES & MAILERS

Imprenta Garcia SA, Rio Branco 1481-83, Montevideo, Tel. 90-51-75. Rec. Ind. Serv. Mgr.: Israel Garcia Aturaola.

JACKETS & SLEEVES

Artegraf Ltda., Florida 1477, Montevideo. Tel: 98-60-38. (Jackets only)
 Imprenta AS, PO Box 1600, Rincon 387, Montevideo. Tel: 91-45-76, 98-56-68. Telex: Artegra UY737. Pres. & Gen. Mgr.: Jorge de Arteaga; Sales Mgr.: Eduardo Diaz (Jackets only)
 Imprenta Cervantes (Socolovsky SA), Calle Durazno 939, Montevideo. Tel: 98-24-35, 91-72-32. Pres. & Gen. Mgr.: Jaime Socolovsky (Jackets only)
 Imprenta Garcia SA, Rio Branco 1481-83, Montevideo. Tel: 90-51-75. Rec. Ind. Serv. Mgr. Israel Garcia Aturaola.
 Lagomarsino SA, Sarandi 429, Montevideo. Tel: 90-23-45. Pres.: Daniel Lagomarsino; Gen. Mgr.: Alberto Lagomarsino.

LABELS

Imprenta Garcia SA, Rio Branco 1481-83, Montevideo. Tel: 90-51-75. Rec. Ind. Serv. Mgr. Israel Garcia Aturaola.
 Lagomarsino SA, Sarandi 429, Montevideo. Tel: 90-23-45. Pres.: Daniel Lagomarsino; Gen. Mgr.: Alberto Lagomarsino.

● accessories manufacturers

Clave (IEMSA), La Paz 2243, Montevideo. Tel: 4-5065, 41-4020. Cable: CLALIM. Mng. Dir. Leon Jurburg.
Product: Cleaners, cloths & brushes
 Sondor SA, Nicaragua 1478, Montevideo. Tel: 29-75-30. Cable: SONDORADA. Pres.: Enrique Abal Salvo; VP: Pablo Echevarria; Gen. Mgr.: Enrique Abal Oliu; Sales Mgr.: Omar Montano.
Product: 45 rpm adapters.

VENEZUELA

Population: 13,500,000
Rate of exchange: \$1 (US) = 4.29 bolivars.
Per capita income: \$2035

Holidays: January 1, January 6 (Epiphany), Carnival, March 10 (Vargas' Day—port of La Guaira only), March 19 (St. Joseph's Day—port of Puerto Cabello only), Ash Wednesday (half day), Holy Thursday, Good Friday, Holy Saturday, April 19 (Declaration of Independence), May 1 (Labor Day), Ascension, Corpus Christi, June 24 (Battle of Carabobo—all ports closed, businesses open elsewhere), June 29 (Sts. Peter & Paul), July 5 (Independence Day), July 24 (Simon Bolivar's Birthday), August 15 (Assumption), October 12 (Columbus Day), November 1 (All Saints' Day), December 24 (half day), December 25, December 31 (half day).

Records, record blanks & pre-recorded media imported from USA: 1977—\$92,969.

● record & tape manufacturers / distributors / importers

Allum's Maracaibo Import CA, Treceera Av. Los Palos Grandes Centro, Comercial El Parque, Caracas 106. Tel: (02) 283-8031/8913/5708. Cable: STEREO. (Importer)
 Andino, see San Sebastian de Oro.
 Archiv, see Polydor
 Guillermo J. Arnal, Apdo. 62185, Chacao, Caracas. (Importer)
 B A S F Venezolana SA (IFPI), Edificio BASF, Calle Milan, Urb. Ind'l Los Ruices Sur, Caracas 107. Tel: (02) 22-72-22. Cable: BASF. Pres.: Roland Schamp; Gen. Mgr. Hans Albrecht; Sales Dir.: Peter Lind; Sales Mgr.: Rafael Beneditto.
Labels: (Owned) BASF, (licensed) Arrowtaps (UK), CID (Brazil), Disneyland (USA), Durium (Italy), Egreff/Produfon (Cuba), Fonit-Cetra (Italy), MPC (USA), PPX (USA), Trova (Argentina).
Int'l reps.: Argentina (Cabal, Microfon, Prodisa, Trova), Brazil (CID), Italy (Durium, Fonit-Cetra), Mexico (Coro), UK (Arrowtaps), USA (Disneyland, PPX, Project 3).
 Billo, see Top Hits.
 C B S Columbia CA, Edif. Los Hermanos, 10th fl. Av. Principal Los Cortijos de Lourdes, Caracas. Tel: (02) 239-92-22. Cable: COLRECORD. Gen. Mgr. Victor M. Oliver M.; Sales Mgr. Gonzalo Pena; Artist Mgr. Mike Tellechea.
Labels: (Owned) CBS, CBS associated labels, Epic; (licensed) Astarte (Spain), Salsoul (USA), Sono-Radio (Peru).
Int'l rep.: USA (Columbia).
 C L R, see Los Ruices.
 Cachilapo, see Fonodisco.
 Color, see Top Hits.
 Cordica (Corp. Latinoamericana del Disco CA) (IFPI), Apdo 70232, Edificio La Discoteca, 3rd fl., Calle Milan, Urbanizacion Los Ruices Sur, Caracas 107. Tel: (02) 22-64-22. Cable: CORDIS. Comm'l Mgr. Sussy M. de Von Schwedler; Sales Mgr. Hector Gonzalez.
Labels: (Owned) Cordis; (represented) Anola (Spain), RCA Victor (USA).
 Cordis, see Cordica.
 Corona, see Fonodisco.
 D G, see Polydor.
 Debut, see Fonodisco.
 El Disco de Moda CA (IFPI), Apdo. 3402, 4a Calle Urbanizacion Ind'l Carapa, No. 40, Caracas 101. Tel: (02) 49-74-91. Cable: DISCOMODA. Pres.: Cesar Roldan; Gen. Co-ord.: Alfonso Ramirez; Sales Mgr.: Quilitano Molina; Int'l Div. Mgr.: Peter Cernik-Sindinger.

Int'l branch: Colombia, Discomoda de Colombia Ltda. **Labels: (Owned)** Discomoda, Jukebox, OK, Orbe. **(licensed foreign) ABC group (USA), Ampro (USA), BBC (UK), Discolando (USA), GRT group (USA), Gamma (Mexico), Greedy (USA), Garry Face (UK), Mustiron (USA), Penny Farthing (UK), Pye (UK), RKM (Benelux), Ri-Fi (Italy), Satril (UK), TK (Argentina)**
Int'l reps.: Argentina (EMI-Odeon), Bolivia (Discolandia Dueri), Chile (EMI-Odeon), Costa Rica (Sonido), Ecuador (Fedisos), El Salvador (Sonido), Guatemala (Sonido), Honduras (Sonido), Mexico (Gamma), Nicaragua (Sonido), Panama (Continental de Discos), Peru (IEMPSA), Spain (Amanecer 76), USA (Discolando), Uruguay (Clave). (SEE ADVERTISEMENT)

Discomoda, see El Disco de Moda.
 La Discoteca CA, Apdo. 70498, Edificio La Discoteca, Calle Milan 402, Urbanizacion Los Ruices Sur, Caracas 107. Tel: (02) 22-64-22. Cable: LADICOTECA. Pres. Wilhelm Ricken; Mgr.: Carlos A. Vidal C.; Comm'l Mgr. Genaro Fallu.

Labels: (Owned) Lad, Sonus; (represented) Ansonia (USA), Bambuco (Colombia), Borrique (USA), Cisner-Raff (Mexico), Codiscos (Colombia), Daro (Colombia), Marveta (USA), Melody (Mexico), Musart (Mexico), Orbe (Colombia), Panart (USA)
Int'l reps.: Colombia (Orbe), Costa Rica (Indica), Dominican Republic (La Guarachita), Ecuador (Famoso), Mexico (Musart), Peru (IEMPSA), Spain (EMI-Odeon), USA (TH).

Epic, see CBS
 Evesol, see Fonodisco.
 Fonodisco CA (IFPI), Apdo. 8316, Rio A. Puente Soublette, Caracas. Tel: (02) 42-73-30. Pres. Evelio Alvarez Cortez; Int'l Mgr. Gloria Alvarez Cortes.
Labels: (Owned) Corona, Evesol, Fonodisco; (licensed domestic) Cachilapo, Debut, Sonibell; (licensed foreign) Accion (Mexico), Condor (Ecuador), Fadisa (Ecuador), Falcon (Mexico), Gas (Mexico), INS (Colombia), Marfer (Spain), Mate Discolor (USA), Preludio (Colombia), Starbright (USA), Studio (Portugal), Tecla (Portugal), Trama (Spain), Tropical (Colombia), Vogue (France).

Fontana, see Polydor
 G M, see Grabaciones Mundiales.
 Grabaciones Mundiales CA, Apdo. 3637, Edif. Misamac, Local A, Tablitas a Venado, Caracas. Tel: (02) 441-99-10/5032. Cable: PAMUSICA. Telex 26232. Pres. Arlindo Andrade Silva; VP: Ernesto Aue; Sales Mgr. Armenio Sabena.
Labels: (Owned) GM; (licensed foreign) Alhambra (Spain), Aris (Italy), Atlantic/Atco (USA), Beverly (Brazil), Copacabana (Brazil), Elektra/Asylum (USA), Libra (USA), Movieplay (Spain), Nonesuch (USA), Orfeu (Portugal), Reprise (USA), Telefunken (Germany), Warner Bros. (USA)

Gramsa, see El Palacio de la Musica
 H B, see El Palacio de la Musica.
 Heliodor, see Polydor.
 Jukebox, see El Disco de Moda
 Karussell, see Polydor
 Lad, see La Discoteca
 Latino, see Suramericana
 Latinoamericana del Disco CA (Corp.), see Cordica
 M G M, see Polydor
 Mercury, see Polydor
 O K, see El Disco de Moda.
 Orbe, see El Disco de Moda.
 El Palacio de la Musica SA (IFPI), Apdo 3637, Guayabal a Venado 4-1, Caracas 101. Tel: (02) 45-10-46, 45-48-48, 45-19-39. Cable: PAMUSICA. Telex 26232. Pres. Ernesto Aue; VP: Herbert Venjakob; Gen. Mgr. Miguel Angel Pina; Sales Mgr. Carlos von Enem
Labels: (Owned) Gramsa, HB, Palacico, Solex; (licensed) AVI (USA), Alegre (USA), Buddha (USA), Cotique (USA), Decca (UK), Delphine (France), Fania (USA), Inca (USA), International (USA), London (USA), Mardi Gras (USA), Motown (USA), Peerless (Mexico), Seeco (USA), Tico (USA), United Artists (USA), Vaya (USA), West Side Latino (USA)
Int'l reps.: Central America (Indica), Colombia (Fuentes), Ecuador (Famoso), Mexico (Peerless), USA (West Side), rest of world (Polydor).

Philips, see Polydor
 Polydor SA, Apdo. 5458, Edificio Avo, 2nd fl., Calle Milan, California Sur, Caracas. Tel: (02) 22-49-45/37-09/68-98. Cable: POLYDOR. Telex 24235. Gen. Mgr. Harry Alex; Finance & Admin. Mgr. Freerk Abma; A&R Polydor & licensed labels: Helga Moslener, A&R Phonogram & licensed labels: Paul Ehrlich; A&R Nat'l Repertoire: Carlos Vila; A&R Nat'l Folklore & Latin Prod. Jose Bello.
Labels: (Owned) Archiv, DG, Fontana, Heliodor, Karussell, MGM, Mercury, Philips, Polydor, Tip, Vertigo, Verve; (licensed) Bronze (UK), Capricorn (USA), Casablanca (USA), Chrysalis (UK), De-Lite (USA), Infinity (USA), Island (UK), MCA (USA), Manhattan (USA), RSO (UK), Rocket (UK), 20th Century (USA), Virgin (UK), Zafiro (Spain)

R P M Discos, CA Edif. Rovessi, 3rd fl., No. 5, Cipreces a Santa Teresa. Tel: 45-43-81. Pres.: Robert Buckley, Promo Mgr. Cesar Esquivia; PR: Carlos Alamo; Int'l Mgr. Leon Ras.
Labels: (Owned) RPM, (represented) National, Prelude, Red Greg (all USA). (SEE ADVERTISEMENT)
 Los Ruices SA (Corp.), Apdo. 70251, Calle Milan 402, Urbanizacion Los Ruices Sur, Caracas 107. Tel: (02) 22-64-22. Cable: ODEONSA. Pres. Wilhelm Ricken; Mgr. Carlos A. Vidal C.; Sales & Promo. Mgr.: Armando Calderon.

Labels: (Owned) CLR; (licensed) A&M (USA), Arista (USA), Capitol (USA), Dicap (Luxemburg), EMI (worldwide), EMI-America (USA), Harvest (UK), MAM (UK), Magnet (UK), Pausa (USA), Private Stock (USA), Purple (UK), Rocket (UK).
 San Sebastian de Oro (Fundacion), Calle 5 & Av. Oriental, Urbanizacion Merida-Qta. Zunimar, San Cristobal. Tel: (076) 2-74-55, 3-60-05 (Distributor/Importer).
Labels: (Distributed—not licensed) Andino; (represented) Ambuco (Colombia), Sonolux (Colombia).

Solex, see El Palacio de la Musica.
 Sonibell, see Fonodisco.
 Sonografica Venezolana CA (Dist.), Apdo. 2057, Barcanas A Rio, Caracas 101. Tel: (02) 483-1527. Cable: CORAVEN. Telex: 21221. Pres. Peter Boltoime; Gen. Mgr.: Gerardo Rodriguez Yebrá.
 Sonus, see La Discoteca.
 Suramericana del Disco SrL (IFPI), Esq. Puente Restaurador, Mezzanina, Caracas. Tel: (02) 441-4444/4233. Cable: SURADISCO. Pres.: Antonio Jose Segura Gomez; VP: Hernando Izquierdo Fonseca; Promo. Dir.: Jorge Garcia.
Labels: (Owned) Latino, Venus, Yare, (licensed) Alshire (USA), Barclay (France), Belter (Spain), Famoso (Ecuador), Fonobosa (Colombia), Fonomex (Mexico), Santana (Colombia), Vergara (Colombia), Victoria (Colombia).

Int'l reps.: Colombia (Victoria), Ecuador (Famoso), Guatemala (Dideca), Panama (Dideca), Peru (FTA).
 Tip, see Polydor.
 Top Hits CA (Discos), Apdo. 70498, Edificio Continmca, Calle Milan 402, Urbanizacion Los Ruices Sur, Caracas 107. Tel: (02) 22-64-22. Cable: LADICOTECA. Pres.: Wilhelm Ricken; Mgr.: Carlos A. Vidal C.; Comm'l Mgr.: Oscar Serfaty.
Labels: (Owned) Billo, Color, Top Hits.
Int'l reps.: Central America (Indica), Argentina (CBS), Chile (EMI-Odeon), Colombia (Orbe), Dominican Republic (La Guarachita), Ecuador (Famoso), Mexico (Musart), Peru (IEMPSA), Spain (EMI-Odeon), USA (TH).

Velvet de Venezuela SA, Apdo. 19134, Edificio Andrea Doria, Of. 11, Rio a Puente Soublette, Caracas 101. Tel: (02) 41-40-62, 42-20-19. Cable: VELVESA. Pres.: Jose Page Barrios; Admin. Mgr.: Antonio Vallencia, Prod'n Mgr.: Luis Rivero Bruzual; Sales Mgr.: Luis F. Mendoza; Int'l Affairs Mgr.: Carlos Raybans.
Int'l branch: USA.
Labels: (Licensed) Ariola America (USA), Butterfly (USA), CTI (USA), Carosello (Italy), Casablanca (USA), Coco (USA), Gas (Mexico), Gema (USA), Gull (UK), H&L (USA), Infopesa (Peru), Microfon (Argentina), Versatile (USA), (distributed—not licensed) Alfa (Canada), Can 1 Stop Prod'ns (USA), Oasis (Germany), Roadshow (USA).

Int'l rep.: USA (Velvet).
 Venus, see Suramericana.
 Vertigo, see Polydor.
 Verve, see Polydor
 Yare, see Suramericana.

● music publishers

Mundo Musical, Edit. Los Hermanos, 10th fl., Av. Principal Los Cortijos de Lourdes, Caracas. Tel: (02) 239-92-22. Cable: COLRECORD.
Int'l firm represented: April (USA)
Int'l rep.: Mexico (Mundo Musical).
 Orbe Eds. Musicales, PO Box 3402, 4a Calle Urbanizacion Ind'l Carapa, No. 40, Caracas 101. Tel: (02) 49-74-91. Cable: ORBEMUSA. Pres.: Cesar Roldan; Gen. Mgr.: Ligia de Garcia.
Int'l firms represented: Amanecer 76 (Spain), Marfer (Spain), Morro (USA), Musicol (Colombia), Pamsco (Argentina), Prodema (Peru), SADRAM (Ecuador)
Int'l reps.: Argentina (Pamsco), Canada (Morro), Central America (EMLASA), Colombia (Discomoda), Ecuador (SADRAM), Mexico (EMLASA), Peru (Prodema), Spain (Amanecer 76), USA (Morro).
 San Sebastian de Oro (Fundacion), Calle 5 & Av. Oriental, Urbanizacion Merida-Qta. Zunimar, San Cristobal. Tel: (076) 2-74-55.
 Suramericana Musica (Ed.), Esq. Puente Restaurador, Mezzanina, Caracas. Tel: (02) 45-10-24, 45-20-53. Cable: SURADISCO.
 Universal Music Publ'rs CA (Unimusic), Apdo. 70419, Av. Milan 402, Urbanizacion Los Ruices Sur, Caracas 107. Tel: (02) 22-64-22. Cable: UNIMUSICA. Pres.: Wilhelm Ricken; Comm'l Mgr.: Ciro Vega Aguilera.

● services

DESIGN & ARTWORK

Orbemusa, Apdo. 3402, 4a Calle Urbanizacion Ind'l Carapa, No. 40, Caracas 101. Tel: (02) 49-74-91. Cable: FAVEDICA. Pres.: Cesar Roldan; Gen. Co-ord.: Alfonso Ramirez; Opns. Mgr.: Pedro Sepulveda; Maintenance Mgr.: Alvaro Rodriguez.
 San Sebastian de Oro (Fundacion), Calle 5 & Av. Oriental, Urbanizacion Merida-Qta. Zunimar, San Cristobal. Tel: (076) 2-74-55, 3-60-05

LICENSING ORGANIZATION, MUSIC

S A C V E N (Sociedad de Autores & Compositores de Venezuela), Edif. VAM, 9th fl., Torre Oeste, Av. Andres Bello, Caracas. Tel: (02) 574-0455/0477/0949. (Mechanical & performing rights).

PLATING, PROCESSING & PRESSING PLANTS

Audio Matrices de Venezuela CA, Rio a Puente Soublette, Edif. Andrea Doria, Of. 3, Caracas. Tel: (02) 41-01-23. Chief Exec. Jose Page Barrios; Gen. Mgr.: Humberto Torrealba (Disk mastering only)
 Crodisca (Productora Criolla de Discos CA), Apdo. 70498, Edificio La Discoteca, Calle Milan 402, Urbanizacion Los Ruices Sur, Caracas 107. Tel: (02) 22-64-22. Cable: LADICOTECA. Pres.: Wilhelm Ricken; Mgr.: Dr. Klaus Koller.
 Dark CA (Fabrica de Discos), Avda. Intercomunal de Antimano 60, La Yaguara, Caracas 101. Tel: (02) 49-49-09. Pres.: Jose Page Barrios; Gen. Mgr.: Julio Gonzalez. (Pressing only)
 Favedica (Fabrica Venezolana de Discos CA), Apdo. 3402, 4a Calle Urbanizacion Ind'l Carapa, No. 40, Caracas 101. Tel: (02) 49-74-91. Cable: FAVEDICA. Pres.: Cesar Roldan; Gen. Co-ord.: Alfonso Ramirez; Opns. Mgr.: Manuel Perez; Maintenance Mgr.: Alvaro Rodriguez.

Gramsa (Grabaciones de America SA), Piedras a Pte. Res-taurador 128, Caracas 101. Tel: (02) 41-54-22. Cable: PAMUSICA. Telex: 26232. Pres.: Gladys de Aponte; VP: Herbert Venjakob.
 Sonografica Venezolana CA (Ind'l), Apdo. 2057, Barcnas A Rio, Caracas 101. Tel: (02) 483-1527. Cable: CORA-VEN. Telex: 21221. Pres.: Peter Boltome; Gen. Mgr.: Gerardo Rodriguez Yebrá. (Pressing only)

PRINTERS & LITHOGRAPHERS

Criodisca (Productora Criolla de Discos CA), Apdo. 70498, Edificio La Discoteca. Calle Milan 402, Urbanizacion Los Ruices Sur, Caracas 107. Tel: (02) 22-64-22. Cable: LADICOTECA. Pres.: Wilhelm Ricken; Mgr.: Dr. Klaus Koller.
 Favédica (Fabrica Venezolana de Discos CA), Apdo. 3402, 4a Calle Urbanizacion Ind'l Carapa, No. 40, Caracas 101. Tel: (02) 49-74-91. Cable: FAVEDICA. Pres.: Cesar Roldan; Gen. Co-ord.: Alfonso Ramirez; Opns. Mgr.: Manuel Perez; Maintenance Mgr.: Alvaro Rodriguez.
 Orbemusa, Apdo. 3402, 4a Calle Urbanizacion Ind'l Carapa, No. 40, Caracas 101. Tel: (02) 49-74-91. Cable: FAVEDICA. Pres.: Cesar Roldan; Gen. Co-ord.: Alfonso Ramirez; Opns. Mgr.: Pedro Sepulveda; Maintenance Mgr.: Alvaro Rodriguez

RECORD PROMOTION

San Sebastian de Oro (Fundacion), Calle 5 & Av. Oriental, Urbanizacion Merida-Ota: Zunimar, San Cristobal. Tel: (076) 2-74-55, 3-60-05.

**TAPE CUSTOM DUPLICATORS
TAPE PACKAGING & LABELING**

The Audio and Video lines indicate the configurations which the firms duplicate. Companies which offer packaging and labeling of tape product are indicated by: (PKG) which appears after the main body of their respective listings.

Favédica (Fabrica Venezolana de Discos CA), Apdo. 3402, 4a Calle Urbanizacion Ind'l Carapa, No. 40, Caracas 101. Tel: (02) 49-74-91. Cable: FAVEDICA. Pres.: Cesar Roldan; Gen. Co-ord.: Alfonso Ramirez; Opns. Mgr.:

Manuel Perez; Maintenance Mgr.: Alvaro Rodriguez (PKG)
Audio: Cassette.
 Lider Multicassette CA, Rio a Puente Soublette, Edif. Andrea Doria, Of. 2, Caracas. Tel: (02) 42-26-27. Chief Exec.: Jose Page Barrios; Gen. Mgr.: Lijia Diaz.
Audio: 8-tr., cassette
 Polydor SA, Apdo. 5458, Edificio Avo, 2nd fl., Calle Milan, California Sur, Caracas. Tel: (02) 22-49-45/37-09/68-98. Cable: POLYDOR. Telex: 24235. Gen. Mgr.: Harry Alex.
 Sonografica Venezolana CA (Ind'l), Apdo. 2057, Barcnas A Rio, Caracas 101. Tel: (02) 483-1527. Cable: CORA-VEN. Telex: 21221. Pres.: Peter Boltome; Gen. Mgr.: Gerardo Rodriguez Yebrá.
 Sonus Electronics CA, Apdo. 70380, Edificio La Discoteca, Urbanizacion Los Ruices Sur, Caracas 107. Tel: (02) 22-64-22
Audio: 8-tr., cassette, open reel.

● **supplies**

**CARTRIDGE & CASSETTE PARTS
EMPTY CARTRIDGES, CASSETTES & REELS**

B A S F Venezolana SA, Edificio BASF, Calle Milan, Urb. Ind'l Los Ruices Sur, Caracas 107. Tel: (02) 22-72-22. Cable: BASF. Pres.: Roland Schempf; Gen. Mgr.: Hans Albrecht; Sales Dir.: Peter Lind; Sales Mgr.: Rafael Benedetti
Audio: Cassette.

**JACKETS & SLEEVES
LABELS**

Favédica (Fabrica Venezolana de Discos CA), Apdo. 3402, 4a Calle Urbanizacion Ind'l Carapa, No. 40, Caracas 101. Tel: (02) 49-74-91. Cable: FAVEDICA. Pres.: Cesar Roldan; Gen. Co-ord.: Alfonso Ramirez; Opns. Mgr.: Manuel Perez; Maintenance Mgr.: Alvaro Rodriguez.

TAPE, BLANK LOADED & RAW

B A S F Venezolana SA, Apdo. Edificio BASF, Calle Milan, Urb. Ind'l Los Ruices Sur, Caracas 107. Tel: (02) 22-72-22. Cable: BASF. Pres.: Roland Schempf; Gen. Mgr.: Hans Albrecht; Sales Dir.: Peter Lind; Sales Mgr.: Rafael Benedetti. (Blank only)
Audio: Cassette.
 Favédica (Fabrica Venezolana de Discos CA), Apdo. 3402, 4a Calle Urbanizacion Ind'l Carapa, No. 40, Caracas 101. Tel: (02) 49-74-91. Cable: FAVEDICA. Pres.: Cesar Roldan; Gen. Co-ord.: Alfonso Ramirez; Opns. Mgr.: Manuel Perez; Maintenance Mgr.: Alvaro Rodriguez.
Audio: Cassette.
Brand name: Discomoda (DCM)

VIRGIN ISLANDS (U.S.)

Population: 100,000.

● **record & tape
manufacturers /
distributors / importers**

Conrad (of St. Thomas) Ltd., PO Box 3187, Kronprindsens Gade Sta., St. Thomas 00801. Tel: (809) 774-2433. (Distributor)
Branch: USA
 Westindy Music Co. Inc., PO Box 2896, 86 Main St., St. Thomas 00801. Tel: (809) 774-4488. Pres.: Wilbur La Motta; Gen. Mgr.: Leroy A. La Motta
Labels: (Owned) Cultural Dimensions, Westindy.
Int'l reps.: Barbados (WIRL), Jamaica (Dynamic), Trinidad (Record Specialists), USA (Pickwick).

● **music publisher**

Westindy Music Co. Inc. (ASCAP), PO Box 2896, 86 Main St., St. Thomas 00801. Tel: (809) 774-4488. Cable: WESTINDY. Pres.: Wilbur La Motta.

YUGOSLAVIA

Population: 22,107,000
 Rate of exchange: \$1 (US) = 18.83 new dinars.
 Per capita income: \$1,620.
 Holidays: January 1, 2, May 1, 2, July 4, November 29, 30.

RECORDS:

Stereo sales: 90% of total.
 Discounting: Rare.

Type of distribution: Manufacturer-to-retailer through warehouse chainstores are significant sales points.
Type of promotion: Radio programs, TV programs and commercials, newspaper and magazine advertising and National song festivals are the main sources of promotion.

TAPE:

Market: Cassettes are the major tape configuration. Blank open reel is purchased by the serious music lover.

RADIO STATIONS:

No. of government: 19, both AM & FM. There are about 200 smaller local independent stations.

TELEVISION STATIONS:

No. of channels: 2, 50% in color.
 Comment: There is a national TV network and, in most areas, a second channel with local programs.

IMPORT/EXPORT REGULATIONS:

Balance-of-payment has temporarily forced a stiff import licensing policy on all trade organizations.

● **record & tape
manufacturers /
distributors / importers**

Alta Muzicak Produkcija, Ave. Borisa Kidrica 2, Zagreb. Tel: (041) 522-611/456. Dir.: Drago Diklic; Sales Mgr.: Zeljko Duric.
 Beograd Disk, Ljubica 15, Belgrade. Tel: 440-786.
 Diskoton Produkcija Gramofonskih Ploca & Kazeta, Hasana Brkica 58a, 71000 Sarajevo. Tel: (071) 33-613, 33-583. Dir.: Milosevic Vajo; Gen. Mgr.: Celjo Suljo; Sales Mgr.: Haveric Asim; Musical Mgr.: Vujovic Slobodan.
Label: (Owned) Diskoton.
Int'l reps.: USA (Motown).
 Helidon Tovarna Gramofonskih Plosc, Vodnikova 42, 61000 Ljubljana. Tel: (061) 55-179. Gen. Mgr.: Dusan Drolc; Sales Mgr.: Jozse Kosar; Prod'r: Vilko Ovsenik. (Distributed by Suzy).
Labels: (Owned) Helidon; (represented) Decca, Telefunken (West Germany).
 Jugoslovenska Kniga, Obilicev Venac 24, Belgrade. Tel: 623-799. (Importer/Exporter).
 Jugoton, Niska bb, 41040 Zagreb. Tel: (041) 251-155, 644-729/341/522. Telex: 21857. Gen. Mgr.: Slavko Kopun; Int'l Mgr.: Stanko Mrgic; Repertoire Dept. Head: Dubravko Majnaric; Label Mgr.: Veljko Despot; A&R Vojno Kundic; Classical Div.: Vida Ramuscak; Folk Repertoire: Mirko Gavrilovic; Childrens Editor: Ljerka Markovic.
Labels: (Owned) Jugoton; (licensed) ABC (USA), Arista (USA), Bronze (UK), Capitol (USA), Casablanca (USA), Chrysalis (UK), DJM (UK), Decca (UK), Deutsche (East Germany), EMI (UK), Elite Special (Switzerland), Fantasy (USA), Island (UK), Magnet (UK), Milestone (USA), Prestige (USA), Purple (UK), RAK (UK), RCA (USA), Rocket (UK), Supraphon (Czechoslovakia), Vogue (France); (distributed—not licensed) MCA (USA).
Int'l reps.: Czechoslovakia (Supraphon), East Germany (Deutsche).
 Prosveta, PO Box 555, Terazije 16, 11001 Belgrade. Tel: 20-566. Telex: 11609. Dir.: Slavko Kalaba. (Importer/Exporter).
 R T B, see Record Prod'n
 R T V Ljubljana Recs. & Tapes, Tavcarjeva 17, 61000 Ljubljana. Tel: (061) 313-039. Telex: 31118. Mng. Dir.: Jure Robeznik; Ass't Mng. Dir.: Int'l: Dusan Velkaverh.
Labels: (Owned) R T V Ljubljana; (licensed) Chrysalis (UK), Ricordi (Italy).
 Record Prod'n of Radio-Television Belgrade (IFPI), Makedonska St. 21, 11000 Belgrade. Tel: 320-277. Cable: RTB RECORDS. Telex: 12030. Gen. Mgr.: Stanko Terzic; Comm'l & Mktg. Mgr.: Milan Cirkovic; Int'l Relations: Miroslava Glisic.
Labels: (Owned) RTB; (licensed) ABC (USA), A&M Int'l (UK, USA), Ariola Int'l (Austria, France, Germany, Spain), BASF (West Germany), Bellaphon (West Germany), CNR (Netherlands), Carosello (Italy), Hispavox (Spain), Jupiter (USA), Philips Int'l (Netherlands), Polar (Sweden), Polydor Int'l (West Germany), 20th Century (USA).
Int'l reps.: Netherlands (Phonogram), Spain (Ariola), USA (Everest).
 Studio B. Produkcija Gramofonskih Ploca, (Radiodifuzna Org.), PO Box 10, Masarikova 5, 11000 Belgrade. Tel: (011) 684-798. Dir.: Dragan Markovic; Gen. Mgr.: Dragan Vidak; Sales Mgr.: Zorica Mladenovic; Musical Editor: Slobodan Konjovic.
Labels: (Owned) Studio B; (licensed) EMI (UK), Pye (UK).
 Sumadija—Produkcija Ploca, Batocian kod Krugujevca. Tel: (034) 81-187.
 Suzy Recs. (div. of Zalozba Obzorja Maribor), PO Box 729, Gruska 10, 41000 Zagreb. Tel: (041) 519-955. Cable: PGP SUZYZGB.
Labels: (Owned) Suzy, (distributed) Helidon; (licensed) CBS Rolling Stones, WEA Int'l (both USA).
Int'l reps.: USA (CBS, Rolling Stones, WEA Int'l).
Int'l firm represented: CBS (USA).
 Vuk Karadzic, Kraljevica Marka 9, Belgrade.
Labels: (Represented) Disneyland (USA), Vista (USA).

● **music publishers**

Alta Music, Ave. Borisa Kidrica 2, 41000 Zagreb. Tel: (041) 522-611/456. Dir.: Drago Diklic.

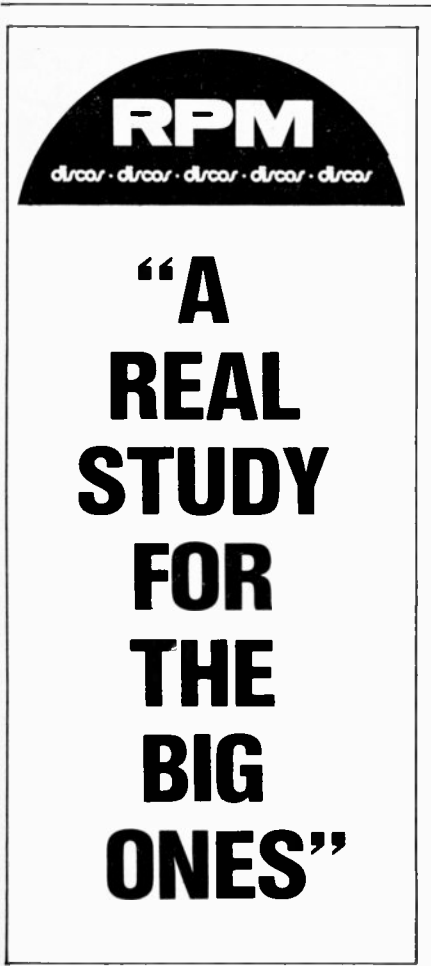

RPM
 discor · discor · discor · discor · discor

**“A
 REAL
 STUDY
 FOR
 THE
 BIG
 ONES”**

Favorite Music, PO Box 729, Gruska 10, 41000 Zagreb. Tel. (041) 519-955. Cable: PGP SUZYZGB
 Interfest, see Favorite
 Jugoton Eds. Musicales—JEM, Niska bb, 41040 Zagreb. Tel. (041) 251-155. 644-729/341/522. Telex 21857. Gen. Mgr. Sinisa Skarica
 Kinel Music (Eds. Musicales), Vinogradska 3, 41000 Zagreb. Tel. (041) 573-462. Pres. & Gen. Mgr. Mario Kinel.
Int'l firms represented: Accord (West Germany), Bruzia (Australia), Curci (Italy), Devega (Italy), Mascotte (Italy), Musica & Dischi (Italy), Sonoton (West Germany), Union (Sweden), Weltmusik (Austria)
Int'l rep.: Italy (Musica & Dischi), West Germany (Accord)
 Metronome (SOKOJ), Ruzveltova 19, Belgrade. Tel. 28-010
 R T V Ljubljana, Tavcarjeva 17, 61000 Ljubljana. Tel. (061) 313-039. Telex 31118. Mng. Dir. Jure Robeznik
 Dragan Schmitzanic, PO Box 543, Marticeva 21-11, 41000 Zagreb
Int'l firm represented: April Blackwood (USA)
 Zabavne Melodije, Berislaviceva 9, 41000 Zagreb. Tel. (041) 442-084

● **services**

ASSOCIATIONS & PROFESSIONAL ORGANIZATIONS

Association of Croatian Composers, Berislaviceva 9, 41000 Zagreb. Tel. (041) 440-025
 Association of Jazz & Light Music Musicians, Dusanova St. 96, Belgrade. Tel. 333-627
 F I D O F (Federation Int'l des Organisateur des Festivals), PO Box 370, 58000 Split. Tel. (058) 514-014. Pres. Augusto Alguero. Sec'y Gen. Armando Moreno. Ambassador Les Reed
 Jugoslovenska Radiotelevizija (Radio & TV), Borisa Kidrica 70/1, Belgrade. Tel. 433-647, 433-693. Cable: JURATE. Telex. (063) 11469
 National Committee of the Int'l Music Council, Misarska 12-14, Belgrade. Tel. (011) 334-771
 National Section of the Int'l Society for Contemporary Music, Remetinacka 75, Zagreb
 Union of Yugoslav Composers, Misarska 12-14, 11000 Belgrade. Tel. (011) 334-771. Cable SOKOJ. Exec. Bd. Pres. Slavko Zlatic. Pres. Bojan Adamic
 Union of Yugoslav Performing Artists, Terazije 26, Belgrade. Tel. (011) 322-732

LICENSING ORGANIZATIONS, MUSIC

S O K O J (Savez Organizacija Kompozitora Jugoslavije), Misarska 12-14, 11000 Belgrade. Tel. (011) 334-771. Exec. Bd. Pres. Slavko Zlatic. Pres. Bojan Adamic. (Mechanical & performing rights)
 Zavod za zastitu autorskih malih prava (Performing & Mechanical Rights Society), Misarska 12, Belgrade

PLATING, PROCESSING & PRESSING PLANTS

Helidon Tovarna Gramofonskih Plosc, Vodnikova 42, 61000 Ljubljana. Tel. (061) 55-179. Gen. Mgr. Dusan Drolc. Sales Mgr. Jozse Kosar. Prod'r. Vilko Ovsenik. (Pressing plant only)
 Jugoton Recs., Niska bb, 41040 Zagreb. Tel. (041) 251-155, 644-729/341/522. Telex 21857. Gen. Mgr. Slavko Kopun.

RECORD PROMOTION

R T V Ljubljana Recs. & Tapes, Tavcarjeva 17, 61000 Ljubljana. Tel. (061) 313-039. Telex 31118. Mng. Dir. Jure Robeznik. Ass't Mng. Dir. Int'l: Dusan Velkaverh

**TAPE CUSTOM DUPLICATORS
TAPE PACKAGING & LABELING**

The Audio and Video lines indicate the configurations which the firms duplicate. Companies which offer packaging and labeling of tape product are indicated by: (PKG) which appears after the main body of their respective listings.

Jugoton Recs., Niska bb, 41040 Zagreb. Tel. (041) 251-155, 644-729/341/522. Telex 21857. Gen. Mgr. Slavko Kopun.
Audio: Cassette
 R T V Ljubljana Recs. & Tapes, Tavcarjeva 17, 61000 Ljubljana. Tel. (061) 313-039. Telex 31118. Mng. Dir. Jure Robeznik. Ass't Mng. Dir. Int'l: Dusan Velkaverh. (PKG)
Audio: Cassette.

● **supplies**

TAPE, RAW & BLANK LOADED

Progres Direkcija BASF, PO Box 527, Knez Mihajlova 27, YU-11000 Belgrade. Tel. 624-222. Cable: JUGOPROGRES. Telex 11109, 11325.
Brand name: BASF.

● **accessories manufacturer**

Jugoton Recs., Niska bb, 41040 Zagreb. Tel. (041) 251-155, 644-729/341/522. Telex 21857. Gen. Mgr. Slavko Kopun.
Product: 45 rpm adapters.

IT TAKES 2 KINDS OF PEOPLE TO MAKE UNITED WAY WORK. THE BIG HEARTED AND THE HARD HEADED.



Thanks to a lot of generous people in your town, the United Way supports a wide range of human services for people who really need them.

A lot of ordinary people with extraordinary dedication devote long hours looking at budgets and community needs to determine how the money you give can be used to your community's best advantage. That's how United Way works. And why.



Thanks to you, it works. For all of us. **United Way**

Ad Council A Public Service of This Magazine & The Advertising Council

WHOLESALE

Continued from page 137

- Labels:** Alligator, Ameraba, Blind Pig, Blue Canyon, Caedmon, Channel, Cherry, Creative World, Deutsche Classische, Discovery, Dobre, Fiesta, Firegign, IPM, JDC, Mark 56, Philo, Prism, Produktion Deutschmark, Rhino, Rounder, SMI, Sonic Arts, TEC, Taxi, Trend, West End (SEE ADVERTISEMENT)
- Record Dist'g Serv. Inc., 2039 Antoine, Zip: 77055 Tel: 683-7171. Mgr.: Russ Reeder, Singles, Albums & Tape Buyer. **Jane Reeder (Rec. & Tape D & OS)**
- Labels:** Arctic, Astro, Crazy Cajun, Dapno, GMC, Hillside, House of Orange, Little Darlin', Nationwide Sound, Plantation, Raven Mad, South Breeze, Sun, TMS, Whiskey River.
- Record Specialty's Co., 14528 Hempstead Hwy. Zip: 77040. Tel: 939-1031. Owner: H.V. Hood. Mgr. & Buyer: Marjorie Menendez. **(Rec. & Tape RJ)**
- Sound Rec'g Co., see Eden Recs.
- South Texas Whsle. Recs. & Tapes Inc., 8566 Katy Fwy., No. 123. Zip: 77024. Tel: 464-6507. Mgr.: R.W. Powers. Buyer: D.F. Hagan. **(Rec. & Tape OS & RJ)**
- Home office: San Antonio, Tex.
- United Rec. Dist. Co., 1613 St. Emanuel St. Zip: 77003. Tel: 228-8151. Owner: Jack Kirby. Mgr.: G. Saldana. Buyers: Singles, Leatha Lundstrom, Albums, Gary Barnard. Tape: Chris Chapin. **(Rec. & Tape OS)**
- Warner/Elektra/Atlantic Corp., 5750 Bintliff. Zip: 77036. Tel: 789-5920. Sales Mgr.: John Quinn. **(Rec. & Tape D)**
- Rec. labels:** Asylum, Atco, Atlantic, Bearsville, Beserkley, Big Tree, Cotillion, Custom, Dark Horse, DiscReet, ECM, Elektra, Embryo, Famous Charisma, Finnadar, Little David, Loma, Manticore, Nonesuch, Nonesuch, Pacific, Paradise, Reprise, Rolling Stones, SHE, Sire, Slipped Disc, Swan Song, WMOT, Warner Bros., Warner/Curb, Warner Specter, Westbound, Whitfield, Wing & a Prayer, Zephyr
- Tape lines:** Same as rec. labels
- Western Mdsrs. Inc., PO Box 2384, 1233 N. Post Oak Rd. Zip: 77001. Tel: 688-7783. Mgr.: John Sobieski. Buyer: Pat C. Deckard. **(Rec. & Tape OS & RJ)**
- Home office: Amarillo, Tex.

LUBBOCK (Area Code 806)

Recordland USA Inc., PO Box 10112. Zip: 79408; 3111 34 St. Zip: 79410. Tel: 792-3277. Owner: Allan Rosen; Buyer: Carl Keel. **(Rec. & Tape OS)**

McALLEN (Area Code 512)

A R V Rec. Sales, see House of Falcon.

Alamo Rec. Dist. Inc., 1412 Beaumont. Zip: 78501. Mgr.: Nelson Balido. **(Rec. & Tape RJ)**

Home office: San Antonio, Tex.

House of Falcon Inc./ARV Rec. Sales, 821 N. 23. Zip: 78501. Tel: 686-5851. Mgr. & Buyer: Ramiro Perez. **(Rec. & Tape D, OS & RJ)**

Branch: Los Angeles, Calif. **(Rec. & Tape D)**

Labels: ARV Int'l, Falcon, Ric.

SAN ANTONIO (Area Code 512)

Alamo Rec. Dist. Inc., 1900 Fredericksburg Rd. Zip: 78201. Tel: 736-4391. Owner: Carlos M. Balido; Mgr.: Ruben Mella. **(Rec. & Tape RJ)**

Branch: McAllen, Tex.

Bromo Dist. of San Antonio Inc., 6522 San Pedro. Zip: 78216. Tel: 828-9991. Mgr.: Joe Malone; Buyer: James Cooper. **(Rec. OS)**

Home office: Dallas, Tex.

Cayre Dists. of Texas Inc., 722 San Pedro. Zip: 78212. Tel: 222-0106. Mgr. & Buyer: Charles McDonald. **(Rec. & Tape D)**

Home office: New York, N.Y. Caytronics Corp. **(Rec. & Tape D, OS, RJ, I & E)** (See for prod. distributed)

E & R One Stop, 301 S. Main Ave. Zip: 78204. Tel: 222-0911. Owner: Ethel Schram; Mgr. & Buyer: Pete Bustamante. **(Rec. & Tape OS)**

Marsal Prod'ns Inc., 1735 Castrovilla Rd. Zip: 78237. Tel: 433-9351. Pres.: Antonio J. Menendez; Gen. Mgr.: Pat Alvarado. Sales Mgr.: Chano Elizondo. **(Rec. & Tape D, OS, I & E)**

Branches: Los Angeles, Calif.; New York, N.Y.; TS Recs. & Tapes

Rec. labels: Del Rio, Del Topo, Dominante, Magda, Marsal, Tex Mex.

Tape lines: Del Rio, Del Topo, Dominante, Magda, Marsal, Super Mex, Taco, Tex Mex, West Mex.

Musical Recs. Co./Musical Tapes Inc., 135 Braniff Dr. Zip: 78216. Tel: 342-2621. Mgr.: Ruben Espinosa. **(Rec. & Tape D)**

Home office: Miami, Fla.

Rec. labels: Bueno, Dila, Discuba, Eco, Musart, Musidisc, Peerless.

Tape lines: Same as rec. labels.

Musical Tapes Inc., see Musical Recs. Co./Musical Tapes Inc.

Musical Merchants Inc., 310 W. Nakoma Dr. Zip: 78216. Tel: 349-1267. Owners: Bill McGehee, John Gonzales, Albums & Tape Buyer: Irmgard McGehee. **(Rec. & Tape OS)**

Rangel Music Co. Inc., PO Box 5524, 809 Fredericksburg Rd. Zip: 78201. Tel: 735-6111. Mgr.: Manuel E. Rangel. **(Rec. D, OS & RJ; Tape D)**

Rec. labels: Big Star, ARV, BSR, Cara, De La Rosa, Dina, Falcon, Fama, Fireball, Freddie, GC, Joey, Keloc, LRC, Nuevo, Uniko, Yuriko

Tape lines: ARV, BSR, Big Star, Cara, De La Rosa, Dina,

Falcon, Fama, Fireball, Freddie, GC, Joey, Keloc, LRC, Nuevo, Uniko, Yuriko

South Texas Whsle. Recs. & Tapes Inc., 724 Lexington. Zip: 78212. Tel: 224-0754. Mgr.: R.W. Powers, Singles, Albums & Tape Buyer: R.G. Guillerman. **Rec. & Tape OS & RJ)**

Branch: Houston, Tex.

Accessories: Le-Bo

SAN BENITO (Area Code 512)

Rio Grande Music Co., PO Box 861, 119 S. Sam Houston Blvd. Zip: 78586. Tel: 399-5377. Owner: Lionel C. Betancourt; Mgr. & Buyer: John F. Phillips. **(Rec. & Tape D & OS)**

Rec. labels: Akron, Alfa, Alhambra, Arcano, Bego, Bernal, Bronco, Buena Suerte, CR, CRC, Caliente, Capri, Carno, Caytronics, Chelmar, Chico, Coast, Cobra, Colonial, Columbia, Corona, DLB, DLV, De La Rosa, Del Sur, Del Valle, Del West, Discolando, Dominante, Do-Re-Mi, E-Z, East Band, Escorpion, Falcon, Fama, Fireball, Firma, Flecha, Freddie, GC, GCP, Gabe, Gapoca, Gas, Hino, Hurricane, Ideal, JC, Jilguero, Joey, Jo-Vi, Keyloc, Latino Int'l, Latin Soul, Lira, Magda, Marsal, Mex-Melody, Miami, Mister G, Musart, Musi-Mex, Norco, Norteno, Nova Vox, Nuevo, Orfeon, Oro, Parnaso, El Pato, Peerless, Popular, Primero, Pronto, RCA, RN, Raff, Ramez, Real, Relampago, Ric, Roca, Rosina, Rovi, Sombrero, Sonido Int'l, Starlite, Sunglow, Tear-drop, Tex-Mex, UA Latino, Unico, Valmon, ZAAO, El Zape.

Tape lines: ARV, Alhambra, Arcano, Bego, Bernal, Buena Suerte, CBS Latin, CR, CRC, Caliente, Capri, Carino, Caytronics, Chico, Columbia, DLB, Del Rio, Del Sur, Del Valle, Dominante, Falcon, Fama, Freddie, Fuego, GCP, Gas, Ideal, Impacto, JC, Keyloc, Latino Int'l, Mr. G, Magda, Marsal, Mex-Melody, Musart, Musart-Norteno, Musi-Mex, Nova Vox, Nuevo, Oro, Parnaso, Primero, RCA, RN, Raff, Reloj, Ric, Rovi, Super-Mex, Teardrop, Tex Mex, Torres, UA Latino, Unico, West-Mex, El Zape.

Playback equip.: Marantz, Pioneer, RCA, Sony, Zenith

Accessories: Blank tape, head cleaners, leader tape, splicing tape (BSAF, Scotch).

SNYDER (Area Code 915)

Corrales Ents./Corrales Music World, PO Box 664. Zip: 79549. Tel: 573-8566/7585. Owner: Ricardo L. Corrales; Mgrs.: Manuel & Arturo Corrales; Buyer: Ricardo L. Corrales. Local branch: Estampas Mexicanas, 1910 1/2 25 St. Zip: 79549. Tel: 573-8567. Mgr.: Arturo Corrales. **(Rec. & Tape OS & RJ)**

TAYLOR (Area Code 512)

Trackdown Rec. Dists., PO Box 763, 502 Booth St. Zip: 76574. **(Rec. D, OS, RJ, I & E)**

Home office: Chicago, Ill. (See for prod. distributed)

UTAH

SALT LAKE CITY (Area Code 801)

Alta Dist'g, 2270 Bridger Rd. Zip: 84125. Tel: 972-3800. Mgr.: Joe Sasich; Buyers: Singles, Alice Hale. Albums: Steve Middleton; Tape: Nick Sasich. **(Rec. & Tape OS & RJ)**

Accessories: Le-Bo, Maxell, Memorex, Scotch.

Cordova's Importers & Dists., PO Box 16065, 543 W. 400 North. Zip: 84116. Tel: 355-1914. Owner & Mgr.: Carl C. Cordova. **(Rec. & Tape D & I)**

Rec. labels: Bego, Buena Suerte, CR, Caytronics, Columbia (Mexico), Cristy, Del Rio, Disneylandia, Dominante, Eco, Estereo Fono, Freddie, Hurricane, Keyloc, Magda, Marsal, Musart, Musimex, Orfeon, Peerless, RJJ, Topo Chico, Torres, El Zape.

Tape lines: Bego, Bernal, Buena Suerte, CR, Caytronics, Columbia, Cristy, Del Rio, Dominante, Falcon, Freddie, Hurricane, Magda, Marsal, Musart, Orfeon, Peerless, Rovi, El Zape.

Western Toy & Hobby Inc., 327 W. Second South. Zip: 84101. Tel: 364-6593. **(Rec. D & RJ)**

Branch: Denver, Colo., Twirl Town Toys.

Rec. labels: Disneyland, Gusto-Alto

Tape lines: Pickwick

Phonographs: LJM.

VERMONT

BURLINGTON AREA (Area Code 802)

Almor Playtime Co. Inc., Dorset St., South Burlington 05401. Tel: 864-4087. **(Rec. & Tape D, OS & RJ)**

Home office: Amsterdam, N.Y. (See for prod. distributed)

Altec Dist'g Co. Inc., 36 Church St. Zip: 05401. Tel: 864-5777. Pres.: Martin Gold; Mgr.: Paul Schulman; Buyers: Singles & Tape, Kenneth Freestone; Albums, Paul Schulman. **(Rec. & Tape OS, RJ, I & E)**

RUTLAND (Area Code 802)

Record Shack of New England, 138 West St. Zip: 05701. Tel: 775-1933. Mgr.: Dennis Centofranchi. **(Rec. & Tape OS, I & E)**

Home office: Woodside (New York Metropolitan Area), N.Y., Record Shack of New York City Inc.

WATERBURY (Area Code 802)

Silo Inc., Box 82, RD.2, Zip: 05676. Tel: 244-8657. Owner: Mgr., Singles, Albums & Tape Buyer: Joan Pelton. **(Rec. D, OS & I; Tape D)**

Rec. labels: Adelphi, Arhoolie, Avoca, Bay, Bert & I, Biograph, Blarney Castle, Blue Goose, CMH, Cassandra, Celeste, Chelsea House, County Crest, Droll Yankee, Flying Fish, Flying High, Folk Legacy, Folk Lyrac, Folkways, Fretless, Front Hall, Gae-Linn, Galaxia, Grass Mountain, Green Mountain, Innisfree/Green Linnet, Jorral, June Appal, Kaleidoscope, Kicking Mule, Lady of Carlisle, Leader/Trailer, Living Folk, Mineral River, Minstrel, Monks of the Weston Priory, Mountain Railroad, Mulligan, Nessa, Newworld, Olivia, Pacific Cascade, Paraclete, Philo, Physical, Pleiades, Rebel, Redwood, Revonah, Ridge Runner, Sea Friends, Shanachie, Sierra/Briar, String, Sugar Hill, Topic, Troubadour, Voyager, Wyalton, Windham Hill, Wise Women.

Rec. labels imported: BBC (folk prod. only), Banff (Canada), CCBP (Canada), Celtic (Canada), Columbia (Canada), Fogarty's Cave (Canada), Glencoe (Canada), London (Canada), MCA (Canada)

Tape lines: Bert & I, CMH, Fretless, Monks of the Weston Priory, Pacific Cascade, Philo, Pleiades, Rebel.

VIRGINIA

ARLINGTON (Area Code 703)

Giant Music Whslns. Inc., 2615 Columbia Pike. Zip: 22204. Tel: 920-5420. Mgr.: Jeff Williams. **(Rec. & Tape OS)**

Home office: Falls Church, Va.

FAIRFAX (Area Code 703)

Giant Music Whslns. Inc., 9416 Main St. Zip: 22030. Tel: 591-4528. Mgr.: Bob Ballard. **(Rec. & Tape OS)**

Home office: Falls Church, Va.

FALLS CHURCH (Area Code 703)

Giant Music Whslns. Inc., 133 S. Washington St. Zip: 22046. Tel: 532-8116. Owner: Jack Shaver; Mgr. & Buyer: Mike Head. **(Rec. & Tape OS)**

Branches: Arlington, Fairfax, Va.

FLOYD (Area Code 703)

Record Depot Dists., PO Box 191, Zip: 24091. Tel: 745-2001. Owner: David Freeman; Mgr.: Chet Rhodes; Buyers: Albums, Barry Poss; Tape: David Freeman. **(Rec. & Tape D)**

Rec. labels: Adelphi, American Heritage, Atteiram, CMH, County, Flying Fish, Front Hall, Grassound, June Appal, Kicking Mule, Leather, Mountain, Old Homestead, Outlet, Philo, Puritan, Rebel, Revonah, Ridge Runner, Rounder, Shanachie, Shiloh, Sierra/Briar, Sonatone, Starday/King, Sugar Hill, Troubadour, Vetco, Wango.

Tape lines: CMH, County, Grassound, Old Homestead, Outlet, Rebel, Rounder, Starday/King, Sugar Hill.

McLEAN (Area Code 703)

Telemark Dance Recs., PO Box 55, Zip: 22101. Tel: 356-9113. Owners & Mgrs.: Dick & Sheila Mason. **(Rec. & Tape D, I & E)**

Rec. labels: Dance Along, Hootor, Al Pierson, Roper, Telemark

Rec. labels imported: Abeille, Dansan, Eric Winstone, Franco-Elite, Gold Star (UK), IDR, IDTA, Joys, Manibelle, Philips, Polydor, Redifusion (UK), Rencontre, Silver Dollar, Starlite, Sydney Thompson. Telemark (UK).

Tape line: Roper.

Tape lines imported: Philips (West Germany), Sydney Thompson (UK).

NORFOLK (Area Code 804)

Contact Norfolk Inc., 1011 W. 25 St. Zip: 23517. Tel: 625-7801.

Accessories: Le-Bo.

Scott Dist'g Corp., 3418 Azalea Garden Rd. Zip: 23513. Tel: 855-0188. Mgr.: Robert Kruglick. **(Rec. & Tape D—military sales, promotional recs. & tapes for civilian dist'n)**

Home office: Island Park, N.Y.

Accessories: Blank tape

Tidewater One Stop, 1910 Granby St. Zip: 23517. Tel: 622-8663. Mgr.: Jack Caputo. **(Rec. & Tape OS)**

Home office: Washington, D.C., Schwartz Bros. Inc. **(Rec. & Tape D)** (SEE ADVERTISEMENT)

RICHMOND (Area Code 804)

Dean's One Stop Ltd., PO Box 26205. Zip: 23260. Tel: 321-7515. Pres.: Dean Hogue, VP: Robert Marshall, Mgr.: Richard Brooks; Buyers: Dean Hogue, Robert Marshall, Richard Brooks. **(Rec. & Tape OS & RJ)**

Trackdown Rec. Dists., PO Box 7552. Zip: 23231. **(Rec. D, OS, RJ, I & E)**

Home office: Chicago, Ill. (See for prod. distributed)

ROANOKE (Area Code 703)

Turner Candy Co., 516 Rorer Ave. SW. Zip: 24008. Tel: 342-0500. Owner, Mgr. & Buyer: A.L. Turner Jr. **(Rec. & Tape RJ)**

ROCKY MOUNT (Area Code 703)

Outlet Rec. Dists., Box 594, 118 Main St. Zip: 24151. Tel: 483-0689. Owner: Rod Shively. **(Rec. & Tape D)**

Labels: American Heritage, CMH, County, Goldtone, Heritage, Mountain, Old Homestead, Outlet, Power Pak, Rebel, Ridge Runner, Rounder, Starday/King.

WASHINGTON

● BELLINGHAM (Area Code 206)

Praise Recs., 1515 W. North St Zip 98225 Tel 671-9562 (Rec. & Tape D)
Int'l branches: Canada—Vancouver, B.C.; Toronto, Ont
Rec. labels: Faith, Fisher Folk, Harold, Horizon Little People, Maranatha, New Born, New Life, Praise, Sunrise, StarSong
Tape lines: Same as rec labels

● SEATTLE AREA (Area Code 206)

C B S Recs., 1051 Andover Park E., Tukwila 98188 Tel 575-0931 Branch Mgr Joe Yoppolo (Rec. & Tape D)
Rec. labels: Arc, Bang, Blue Sky, CBS, Caribou, Columbia, Epic, Jet, Kirshner, Melodiya/Columbia, Nempor, Odyssey, Philadelphia Int'l, Portrait, Starlite, Stiff, T-Neck, Tabu, Tappan Zee, Unlimited Gold
Tape lines: Same as rec labels

California Rec Dists Inc, 6011 S Roxbury Zip 98118 Tel 723-0900 Sales Mgr George Bigley, Promo Mgr Ted Higashioka (Rec. D)
Home office: Glendale (Los Angeles Metropolitan Area), Calif

Labels: Abattoir, Advent, Arcane, Archive of Folk & Jazz, Archive of Piano Music, Artist House, Ashtree, Audio Fidelity, Audio Rarities, Bean, Big Band Int'l, Big Town, CRD, Caedmon, Candide, Century, Chiaroscuro, Coco, Columbia Special Prods., Concert Disc, Concord, Corinthian, Counterpoint, Creative World, Criterion, Demand, Discus, Dooto, Electric Lemon, Everest, First Heard, Folkways, Fremont, Gala, Giants of Jazz, Glendale, Golden Age, Golden Era, Graffiti, Granite, Green-tree, HNH, Harlequin, Hawaii Calls, History in Sound, IRDA, Jazz Treasury, King, Legacy, Los Angeles, Mark 56, Muskadine, Nessa, New Orleans Jazz, Nostalgia, Nostalgia Lane, Old Homestead, Olympic, Orion, Palm, Period, Plantation, Polaris, RGB, RVL-RDC, Radiola, Republic, Request, Retrospect, Revelation, Ridge Runner, Roper, Rounder, Sackville, Sandcastle, Scala, Semaphore, Shoestring, Sounds, Sountrak, Standing Room Only, Stanyan, Starday, Slash, Sun, Sunbeam, Survival, Syntonic Research, Tahiti, Taz-Jaz, Telarc, Testament, Tradition, Trix, Turnabout, Umbrella, Unicorn, Varese, Vox, Vox Box, World Jazz, Zafiro (SEE ADVERTISEMENT)

City Hall Recs., 1427 Calhoun E Zip 98112 Tel 329-5715 District Sales Mgr George Romansic (Rec. D, I & E; Tape D)
Home office: San Francisco, Calif (See for prod distributed)

Disc City One Stop (Record Sales & Serv. Inc.), PO Box 24701, Zip 98124, 1540 Fourth Ave S Zip 98134 Tel 622-4005 Owner Larry Dolgoff, Buyers Singles, Bill Dolgoff, Albums, Richard Levondovski, (Rec. & Tape OS)

General Rec. Serv. Inc., 6565 Seventh Ave S Zip 98108 Tel 767-7444 Pres & Gen Mgr Paul H Portteus, Mgr Russ Portteus, Buyers Singles, Steve Brown, Albums & Tape, Russ Portteus (Rec. & Tape RJ)

Handelman Co., 1207 Andover Park W., Tukwila 98188 Tel 575-0400 Mgr Alan Olson, Buyers Alan Olson, Frank Brandon, Lisa Jordan, (Rec. & Tape RJ)
Home office: Clawson (Detroit Metropolitan Area), Mich

Kiner Dist'g Co., PO Box 724, Redmond 98052 Owrer & Buyer Larry F Kiner (Rec. I)
Labels imported: Aircheck, Radio Archives, Spokane, Totem

M C A Dist'g Corp., 2633 Eastlake Ave E., No 301 Zip 98102 Tel 322-3100 Branch Mgr: Dan Wedlock (Rec. & Tape D)

Rec. labels: Backstreet, Butterfly, Coral, Infinity, LAX, MCA, Songbird, Source, Vocalion
Tape lines: Same as rec labels

Major Dists. Inc., 18292 Andover Park W., Tukwila 98188 Tel 575-0081, Owner R.G. Anderson; VP Rec Div. Gary Clark, Buyers Singles, Inge Wood, Albums, Jim Nickle, Monica Moore, Tape, Gary Davis (Rec. & Tape D & RJ)

Branches: Livermore (San Francisco & Bay Area), Calif., Honolulu, Hawaii
Rec. labels: Alshire, Camden, Disneyland, Pickwick, Stoneway
Tape line: GRT
Phonographs: BSR

Playback equip.: Hitachi, Mitsubishi, Panasonic
Accessories: Batteries (Duracell), blank tape (Ampex, BASF, Memorex, Scotch), needles (Transcriber), Le-Bo, Vanco prods.

P J L Corp., 1041 Industry Dr., Tukwila 98188 Tel 575-0675, Mgr Mike Boyle, Buyer Bill Green (Rec. & Tape OS)

Home office: Denver, Colo., Danjay Music Inc
Pacific Rec. & Tape Dists. Inc., 522 Industry Dr Zip 98188 Tel 575-3100 (Rec. & Tape D)

Home office: Emeryville (San Francisco & Bay Area), Calif

Labels: APA, AVI, Ala, Alston, Barnaby, Beserkley, Blues Spectrum, Canaan, Cat, Channel, Charlie Parker, Chimneyville, Clouds, Cream, Dash, Dial, Drive, Fantasy, Flying Fish, Galaxy, Glades, Good News, Gospel Roots, Gospel Truth, Hi, Janus, Jewel, Juana, Kayvette, LA, LRC, LS, Laff, Lamb & Lion, Light, Mainstream, Malaco, Maranatha, Marlin, Milestone, Mountain Railroad, Myrrh, New Pax, New Song, Paragon, Prelude, Prestige, Ranwood, Riverside, Ronn, Shadybrook, Shield, Silver Blue, Specialty, Stax, TK, Theresa, Tomato, Vanguard, Versatile, Wee, Weird World, Wolf, Wolf, Xanadu

Pacific Rec. Serv., 678 Industry Dr., Tukwila 98188, Tel 575-3110, Pres. Jim Huffine, Sales, Denny Vaughn

(Rec. & Tape D—cutouts). (Also see Western Rec. Sales, Emeryville (San Francisco & Bay Area, Calif.)
Pickwick Int'l Inc., Rack Servs Div., 18260 40 Ave S Zip 98118 Tel 725-2500 Opns. Mgr. Fred Stewart; Sales Mgr. Al Zangrillo, Buyer Kathy Doolin (Rec. & Tape OS & RJ)
Home office: Minneapolis, Minn

PolyGram Dist'n Inc., 1018 Industry Dr Zip 98188 Tel 575-3830 Mgr Gerry Kopecky (Rec. & Tape D)
Home office: New York, N.Y.

Rec. labels: American Int'l, Archiv, Capricorn, Casablanca, Charisma, Chocolate City, DJM, De-Lite, Deutsche Grammophon, Emarcy, Festivo, Fontana, Limglight, MGM, Mercury, Monument, Oasis, Parachute, Philips, Polydor, Polydor/BGO, Polydor/Harem, Polydor/Kolob, Polydor/MVP, Polydor/Mankan, Privilege, RSO, RSO/Curtom, Riva, Smash, Soundstage Seven, Spring, Vertigo, Verve, Zappa
Tape lines: Same as rec labels

R C A & A&M & Assoc'd Labels, PO Box 88239, 576 Industry Dr., Tukwila 98188 Tel: 575-1410 Sales Mgr.: Bonnie McCassy (Rec. & Tape D)

Rec. labels: A&M, Bluebird, Free Flight, Gold Seal, Grunt, Hologram, Millennium, NY Int'l, Pablo, Pablo Live, Pure Gold, RCA, Red Seal, Roadshow, Rocket, Salsoul, Solar, Tortoise, 20th Century, Victrola, Windsong
Tape lines: Same as rec labels

Record Sales & Serv. Inc., see Disc City One Stop
Roundup Music Dists., 18300 Midvale Ave. N. Zip 98133, Tel 542-7551 Mgrs. Lou Lavinthal, Stan Jaffe, Buyer Chuck Blacksmith (Rec. & Tape RJ)

Sound Recs. & Tapes (div. of Gull Inds.), 725 S Fidalgo Zip 98108 Tel 767-4580 VP Ed Richter, Opns Dir. Ray Watson, Buyers D & OS Singles, Diane Penney; D Albums & Tape, Michael Adelsherm, OS Albums & Tape, Sandy Blake (Rec. & Tape D), (Rec. & Tape OS as Super Sound One Stop)

Rec. labels: APA, ASI, Abkco, Accent, Alexander Street, Alston, Ananda, Argo, Arista, Arth, Ashtree, At Home, Audio Fidelity, Audio Rarities, Aural Explorer, Bach Guild, Barnaby, Big Sound, Big Town, Birthright, Blue Seagull, Buddha, Burdette, CTL, Candide, Cardinal, Cat, Century, Century 21, Chantrelle, Chiaroscuro, Children's Recs of America, Chimneyville, Chrystalis, Churchill, Cime, Classic Jazz, Clouds, Con Brio Concord Jazz, Conduco, Cream, Crescendo, Dana, Dash, Deluxe, Deram, Dial, Direct to Disc, Disneyland, Drive, ENJA, Echoes of an Era, Edge, Everyman, Fantasy, First American, First Component, Fona, GRP, GRT, Freckle, Galaxy, Glades, Good Sounds, Gordy, Gospel Roots, Great Northwest, Grecoophon, Gryphon, Gusto, HI, H&L, Harlequin, Hartley, Heart Warming, IRDA, Image, Impact, Improv, Inergy, Inner City, Inphasion, JDC, Janus, Juana, Kayvette, King, Koko, Kudu, LRC, LS, Label 21, Laurie, Le Joint, Living Language, L'Oiseau Lyre, London, MRC, M2WB, Malaco, Marlin, Midsong, Milestone, Motown, Muse, Mushroom, Music Is Medicine, Novus, Ode, Ovation, PBR, Pacific Arts, Parrot, Passport, Picadilly, Potato, Power Pak, Prelude, Prestige, Prodigal, Radiola, Ranwood, Rare Earth, Reid's World, Republic, Richmond, Ripcord, Riverside, Roots, Roulette, Royal Flush, SMI, SRI, Salvation, Sandcastle, Savoy, Scorpion, SeaWest, Shadybrook, Shield, Silver Blue, Soul, Sound Bird, Starbolt, Starday, Stax, Stereo Treasury, Stiff, Stony Plain, Sun, Sunnyvale, Sunshine Sound, TK, Talisman, Tamla, Telefunken, Threshold, Timeless, Turnabout, UK, Vanguard, Venture, Versatile, Visa, Vista, Vox, Wanderick, Watermelon, West End, Whid Isle, Weird World, Win, Wolf, Xanadu
Tape lines: Same as rec labels

Accessories: Fidelitone, Le-Bo, Maxell, Memorex, Sony, Sound Guard
Supersound One-Stop (Rec. & Tape OS), see Sound Recs. & Tapes

Warner/Elektra/Atlantic Corp., 1156 Industry Dr., Tukwila 98188 Tel 575-0190 Sales Mgr. Jack Shue (Rec. & Tape D)

Rec. labels: Asylum, Atco, Atlantic, Bearsville, Beserkley, Big Tree, Cotillion, Curtom, Dark Horse, Disc-Reet, ECM, Elektra, Embryo, Famous Charisma, Finnadar, Little David, Loma, Mantecore, Nempor, Nonesuch, Pacific, Paradise, Reprise, Rolling Stones, SHE, Sire, Shipped Disc, Swan Song, WMOT, Warner Bros., Warner/Curb, Warner Spector, Westbound, Whitfield, Wing & a Prayer, Zephyr
Tape lines: Same as rec labels

● VANCOUVER (Area Code 206)

Crown Prods. Inc., 1405 NE 88 St, Zip 98665 Tel: 574-5331 Owner, Mgr & Buyer Vernon H. Haas (Rec. & Tape D)

Rec. labels: Avant Garde, Benson, Calvary, Capitol, Columbia, Discovery, Hope, KCP, Lillenas, Manna, New Life, Pickwick, RCA, Ranwood, Singcord, Skylite, Sparrow, Star Song, Tempo, Word
Tape lines: Same as rec labels

WEST VIRGINIA

● CHARLESTON (Area Code 304)

Elkins Rec Shop, 1127 Central Ave, Zip 25302, Tel: 343-7833 (Rec. OS)

3-D Electronics Inc., 3126 Seventh Ave, Zip 25312, Tel 744-4701 Pres. Dave Ferrell; Mgr. Roger Fishers, Buyers: Singles, Tanus McClanahan; Albums & Tape, Richard Fisher (Rec. & Tape D & RJ)

Rec. labels: A&M, CMH, Capitol, Capricorn, Casablanca, Columbia, Country, GRT, Heart Warming, Jrm, King, Bluegrass, MCA, Mercury, Pickwick, Polygram, RCA, RSO, Rebel, Salsoul, Sire, 20th Century, WEA, Word
Tape lines: Same as rec labels
Phonographs: BSR, Garrard, Marantz

Playback equip.: Emerson, Marantz, Pioneer of America, Superscope
Accessories: Arista, Le-Bo, Memorex, Philmore

● HUNTINGTON AREA (Area Code 304)

Dr. Feelgood's Inc., 6349 Rt. 60 E., Barboursville 25504, Tel 736-1515 Owner: Jon Courts, Mgr.: J. Paul Hogg; Buyers Steve Blankenship, Connie Barbour, Marjane Valentine, Local branch: Dr. Feelgood's Rec Emporium, 3150 Rt. 60 E., Barboursville 25504, Tel 736-5971 Mgr. Johnnie E. Courts; Buyers Jane Culp, Ray Courts, Steve Neumeyer (Rec. D, OS, RJ & I)
Labels: Dr. Feelgood, Loveline, Ruby Tuesday
Labels imported: Charly, MCF, Phil Spector Int'l, Transatlantic
Phonographs: Akai, Pioneer, Superscope, Technics
Accessories: Le-Bo, Memorex, Recoton, Rec-O-Vac, Sound Saver, Watts

Music Man Inc., 2519 Fourth Ave, Zip 25703 Tel 522-9011, Pres.: Thomas M. Sheets; Buyers Singles, Sid Clark; Albums & Tape, Dale Rowe, Gospel, Tim Effingham (Rec. & Tape OS)

WISCONSIN

● BURLINGTON (Area Code 414)

The Music Mart, 164 E. Washington, Zip 53105 Tel 763-3361, Owner: Rollin J. Ruedebusch; Mgr. Lucille Waardenburg, Buyer: Anne Ruedebusch (Rec. & Tape OS)

● MADISON (Area Code 608)

Rapid Sales Co. Inc. (Rec. RJ, Tape D & RJ), see TMD Inc.
TMD Inc., 1019 Jonathan Dr, Zip 53713 Tel 271-2661 Pres. Rolf V. Voegel; Buyer: Lois Lawrence (Rec. D), (Rec. RJ, Tape D & RJ as Rapid Sales Co. Inc.)
Rec. labels: Accent, Dearborn, Disneyland, GNP Crescendo, Golden, Ranwood, Tell, Thunderbird, Vista, Vox, Word
Tape lines: All major lines

● MILWAUKEE (Area Code 414)

Audie's One-Stop, 2204 W. North Ave, Zip 53205 Tel 342-4636, 931-8015 Owner & Mgr. Autacraga Dotson, Buyers: Singles, Sheila L. Woods, Larry K. Myles, Albums & Tape, Larry K. Myles, Local branch: Audie's Recs., 2239 W. Capitol Dr, Zip 53206 Tel 445-2420 Mgr & Buyer: George Johnson (Rec. & Tape OS)

Good Vibrations Inc., 5825 N. 96 St, Tel: 462-8030 Mgr: Nick Pozmanski; Buyers: Singles, Pat Sindberg, Albums, Richard Grieb, (Rec. & Tape OS)

Music Man One Stop Inc., 5510 W. Florist Ave, Zip 53218, Tel: 353-0666, Pres.: Alan Dulberger, VP: James Bertram; Opns. Head: Jim Howard; Buyers: Albums, Jim Howard; Tape: Bonnie Beigel (Rec. & Tape OS)

Northwest Territory, 1983 N. Summit, No. 24, Zip 53202 Tel 271-2805 Pres. Ed Heinzelman, Warehouse: 630 N. Broadway, Zip 53202, (Rec. D)

Labels: Adelphi, Philo, Ramblin', Rounder, Tool Room
Radio Doctors & Recs. Ltd., 240 W. Wells St, Zip 53203 Tel: 276-6422 Pres.: Stuart Glassman, Mgr. Michael Mowers; Tape Mgr.: Bob Gumz; Buyers: John Janowski, Mary Singleton, Cebron Rollins, Berline Barnes, Kathryn Jachowicz, Mark Andree, Bartley Cooper, Caryn Gumz, Kathy Ludwig, Sandra Yelverton (Rec. & Tape OS)

● STEVENS POINT (Area Code 715)

Record Rack Corp., 901 Clark St, Zip 54481, Tel 341-8445 (Rec. & Tape OS)

Playback equip.: Craig, Clarion, Electrographic, Emerson, Panasonic, Pioneer of America, Sanyo
Accessories: GC Electronics, Maxell, Pickwick, Recoton, Scotch

Q: What's the grandstand capacity at the Wisconsin State Fair?

A: Find out from wherever you're sitting by checking the "U.S. Fairs" section of ITD: Billboard's International Talent Directory. Your #1 guide to the world's top talent.

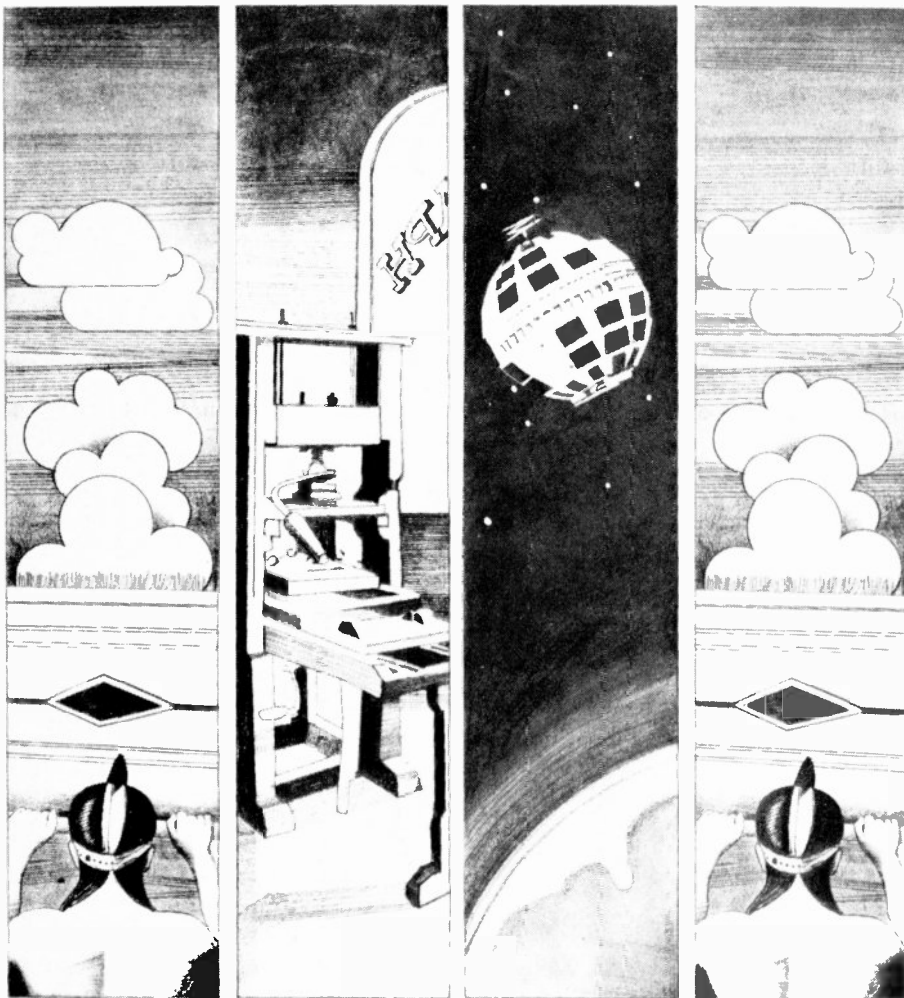

We can't afford to run out of ideas.

How many ideas do you suppose it took to develop human communications from smoke signals that covered a few miles to satellites and laser beams that reach from here to the moon? Most of those ideas came from college-trained minds and college-based laboratories. Now these vital sources of ideas are threatened—by shortages of money that are forcing colleges to curtail programs, reduce faculty, limit laboratory work, cut down on book purchases for libraries. We must not let this deterioration continue. We can't afford to run out of ideas. Or we may all be back to smoke signals again before we realize it.

**Make America smarter.
Give to the college of your choice.**

Council for Financial Aid to Education, Inc.
680 Fifth Avenue New York N.Y. 10019
A Public Service of This Magazine
& The Advertising Council



ACCESSORIES

• Continued from page 218

Zip 99502 Tel (907) 276-2363—**Burbank, Calif.**, 126 W Elm Court Zip 91502 Tel (213) 848-5534—**Los Angeles, Calif.**, 6023 S Garfield Ave Zip 90040 Tel (213) 726-6300—**South San Francisco, Calif.**, 320 Shaw Rd Zip 94080 Tel (415) 589-2663—**Washington, D.C.**, 1101 15 St NW Zip 20005 Tel (202) 331-6900—**Atlanta, Ga.**, 2860 Bankers Ind'l Dr Zip 30360 Tel (404) 447-7000—**Honolulu, Hawaii**, 2880 Ualena St Zip 96819 Tel (808) 841-0147—**Argo, Ill.**, 6850 S Harlem Ave. Zip 60501 Tel (312) 496-6500—**Needham Heights, Mass.**, 155 Fourth Ave Zip 02194 Tel (617) 449-0300—**Farmingington, Mich.**, 23923 Research Dr Zip 48024 Tel (313) 477-5000—**Eagan, Minn.**, PO Box 3211, St Paul 55133, 3130 Lexington Ave S Zip 55121 Tel (612) 733-3300—**St. Louis, Mo.**, PO Box 510, 10725 Baur Blvd Zip 63166 Tel (314) 991-1320—**West Caldwell, N.J.**, PO Box 76, 15 Henderson Dr Zip 07006 Tel (201) 575-2000—**Cincinnati, Ohio**, 4835 Para Dr Zip 45237 Tel (513) 242-2313—**Cleveland, Ohio**, 12200 Brookpark Rd Zip 44130 Tel (216) 267-1800—**Philadelphia, Pa.**, 5698 Rising Sun Ave Zip 19120 Tel (215) 728-5300—**Dallas, Tex.**, 2121 Santa Ana Ave. Zip 75228 Tel (214) 324-3100—**Seattle, Wash.**, Andover Ind'l Park, 100 Andover Park W Zip 98188 Tel (206) 244-7200.
Product: Tape carrying & storage cases, head cleaners, leader & splicing tape (Scotch) (M) (SEE ADVERTISE-
MENT)

Toyota, see Electronic Homes.

Trade Serv Publ's Inc., 2720 Beverly Blvd., Los Angeles, Calif. 90057. Tel (213) 385-4211 Pres J A Simpson, VP W.A. Mundy

Product: Record information serv (Phonolog), tape information serv (List-O-Tapes)

Trans Continental Eng'g, 503 N Central Ave., Kent, Wash. 98031 Tel (206) 854-4478 Pres Jack V Ritter, 1st VP & Adv Mgr. Capry Ricks, VP Sales John Cowen.

Branch: Summer, Wash., PO Box 127 Zip 98390.

Product: 8-tr & cassette repair kits, head cleaners, record care kit, splicing kit, tape deck lubricating & cleaning kit (The Sound Bug) (M)

Transcriber Co Inc., PO Box 478, Attleboro, Mass 02703 Tel (617) 222-3525 VP John Sheagreen, Nat'l Sales Mgr John McDonald

Product: Cleaners, cloths, brushes 45 rpm adaptors, head cleaners, demagnetizers, needles, leader & splicing tape

U T C, see Universal Tape

Ultra Specialty Inc., 20700 Belshaw Ave., Carson, Calif. 90746 Tel (213) 979-0338. Cable ULTRASPEC Telex 194566 Ultraspec Crsn Pres Don Wong, Pres Ultraspec Int'l Gary Lyle, VP Mktg Bill Dawson

Product: Ultrasonic film splicer (SEE ADVERTISE-
MENT)

Universal Tape Corp. Inc., 821 E Artesia Blvd., Carson, Calif 90746 Tel (213) 327-3203 Pres Edward O Praeger

Product: Head cleaners, demagnetizers, leader & splicing tape (A/V Paragon, UTC, Universal) (M)

Utopia Ultra-Sound, 38-40 S First St., Newark, Ohio 43055 Tel (614) 345-9426 Owner Robert H Kirk Jr

Product: Head cleaners (MD)

Victory Press Inc., 600 SW 10, Suite 502, Portland, Ore. 97205 Tel (503) 222-6138 Pres Dan E Gordon; Sales Mgr J E Gordon, Adv Mgr S R Gordon

Product: Tape carrying & storage cases.

Videotape Club of America, 311 Sunny Isles Blvd., North Miami Beach, Fla 33160 Tel (305) 944-3929 Pres & Sales Mgr Gary Zwerin

Product: Videocassette storage unit (VHS or Beta formats)

Vizi Co., 1-Box 283, Ellijay, Ga 30540 Tel (404) 635-7481

Product: Cassette carrying & storage cases

Vulcan Binder & Cover (div of EBSCO Inds Inc.), PO Box 29, Vincent, Ala 35178 Tel (205) 672-2241 VP R Denison Parker; Sales Mgr Dudley Pendleton III, Adv Mgr B R Cummings

Product: Tape carrying & storage cases (M)

W R E, see Wide Range Electronics

Walco-Linck Corp., 1234 Hwy 46, Clifton, N.J 07015 Tel (201) 471-1070 Pres J Lynam Sales Mgr A.W. Brill, Adv Mgr. E.T Spirko

Product: Needles (M)

Watts, see Empire

Watts Recordcare, see Elpa.

Webtek Corp., 4326 W Pico Blvd., Los Angeles, Calif 90019 Tel (213) 937-3511 Pres Joseph Klein, VP & Prod Mgr. John A Pace, Sales Mgr Ken George

Branch: Northfield, Ill., 778 Frontage Rd., Suite 115 Zip 60093. Tel (312) 446-6046

Product: Leader & splicing tape. (M) (SEE ADVERTISE-
MENT)

Wide Range Electronics Corp., 2119 Schuetz Rd., St. Louis, Mo. 63141. Tel (314) 567-5366

Product: Bulk erasers, magnetic erasing pencil (WRE)

Zerostat, see Discwasher

PREVENT
BIRTH DEFECTS
March of Dimes

Index to Advertisers

Listed Alphabetically

Advertisers	Page
A	
A-1 RECORD SALES	121
ABC PUBLISHING	57
ACTION MUSIC	129
A.E.G. TELEFUNKEN	279
AGFA—GEVAERT	181
ALCO RECORDS	147
AL—LEN CUTTING	220
ALL RECORD DIST.	124
ALPHA DIST CORP.	117
ALTERNATIVE MUSIC DIST INC	92
AMARAY INT CORP	218
AMERICAN ALBUM & TAPE CO.	118
AMERICAN MUSIC MKTG.	89
AMERICAN RECORD SALES	113
AMERICAN TAPE CORP.	157
AMPRO DESIGN PRODUCTIONS	215
AMPRO PRODUCTIONS	79
APRIL BLACKWOOD	53
ARIOLA EURODISC	297
ARIOLA MEXICO	350
ASR RECORDING SERVICES INC.	206
ATB S.P.A.	323
ATHENA INDUSTRIES, INC.	198
ATLAS RECORDS	321
AUDIO INDUSTRIES	194
AUDIO MAGNETICS	175
AUDIOGRAM	314
AUDIOMATIC CORP.	173
AUDIOMATIC CORP.	192, 193
AUDIOMATIC CORP.	203
AJMUN RECORDS	55
AUVIS ASONA KG	286
B	
BABY RECORDS SRL	311
BACKSTREET RECORDS	15
BACON, KENNETH A. ASSOC.	215
BALL CORP.	212
BEACHES RECORDS & TAPE DIST.	244
BELWIN—MILLS PUBL.	65
BENSON CO.	31
BERKLY AIR SERVICES	138
BLUES INTERACTIONS	332
BONDED SERVICES	138
BOURNE CO.	82
BRADLEY PUBL.	55
BRASILIA RECORDS & TAPE CORP.	116
BUTTERFLY RECORDS	27
C	
C.A.M.	71
CBS RECORDS INT.	223
CBS SONGS	51
C & M DIST.	104
CALIFORNIA MUSIC	90
CALIFORNIA RECORD DIST.	93
CANDY STRIPE RECORDS	428
CARDINAL EXPORT CORP.	119
CAROSELLO S.R.L.	322
CARROT MUSIC	334
CASH ONE STOP	243
CASSETTE PRODUCTIONS INC.	155
CETEC	186, 187
CHAPMAN DIST.	93
CHIPS DIST. CORP.	132
CLAY PAKY	316
COLDWELL—BANKER	23
COLUMBIA PICTURES PUBL.	86
COOKE, FRANK ENT.	90
COOPER, NORMAN D. CO.	127
COUNTRYWIDE RECORDS & TAPE DIST.	114
CREATIVE STORE EQUIPMENT	221

Advertisers	Page
CUSTOM CARTRIDGE	190
CUT CORNERS DIST.	114
D	
DARO EXPORTS	118
DATA PACKAGING CORP.	165
DATA PKG/DYNASOUND INC.	216
DAVE MUSIC	267
DISC TRADING CO.	128
DISCO MATE RECORDS	339
DISCO-SOUL INT.	233
DISCOMODA	347
DISCWASHER	214
DISCMAKERS INC.	143
DIXON CORP.	204
DONNAK IND.	202
DUNN, CHET ASSOC.	168
DURIUM S.P.A.	326
E	
ERH SALES CORP.	140
ERH SALES CORP.	146
ERH SALES CORP.	156
EV/GAME INC.	210
ECOFINA	325
EDITORIALE SCIASCIA	312
ELECTORI	343
EL MAR PLASTICS	167
EL MAR PLASTICS	168
EL MAR PLASTICS	169
ELTRON EXPORT	118
ENTERTAINMENT CO.	49
ESKIN, DAVID	122
EVA—TONE	67-68
EXTRUDA PRODUCTS INC.	145
F	
FAMOUS MUSIC PUBL.	73
FATHERS & SONS	101
FESTIVAL RECORDS	229
G	
GALGANO DIST.	99
GAMMA DISCOS	352
GERIG HAN MUSIK VERLAG	299
GERSH, RICHARD ASSOC.	152
GIL MUSIC CORP.	78
GLOBAL MUSIC GROUP	285
GOLD BAND RECORDS	103
GOLDEN MEMORIES	100
GOPHER PRODUCTS	220
GRANDY	200
GREAT ATLANTIC & PACIFIC MUSIC	110
GREENWORLD RECORDS LTD.	89
H	
H.R.C. PRINTING	151
HAMILTON FIXTURE	219
HAMILTON MFG.	146
HARBOR REC. EXPORT CORP.	93
HARTZELL CUSTOM PROD.	213
HEINO ILSEMANN	293, 294
HORI PROD.	343
HOUSE DIST.	110
HUBERT, DAVID ASSOC.	70
I	
ICM LTD.	144, 164
IPS	170
INFINITY RECORDS	2
INFONICS	189
INTERMAGNETICS CORP.	207
INTERWORLD MUSIC	63
IS MUSIC	103

The publisher does not assume liability for errors or omissions.

Advertisers	Page
J	
J & R MUSIC WORLD	124
J.S.J. TAPE DIST.	100
JAMIE/GUYDEN REC.	37
JAPAN CENTRAL MUSIC	336
JEM RECORDS INC.	111
JULIANNA HOP	298
K	
KANDAMERICA INC.	91
K-DISC	150
KESTER MKTG	90
KEYSTONE PRINTED SPECIALTIES	139
KING INSTRUMENT CORP.	185
KING KAROL	125
KING RECORDS	341
KLEINERTS MUSIK VERLAG	259
KULTURA—HUNGARIAN TRADING CO.	304
L	
LSJ CASSETTE CORP.	201
LEBO PRODUCTS	211
LENCO COMPANY	200
LENCO MOULDING	379
LENED INT. CORP.	25
LEONARD, HAL PUBL.	74
LIEBERMAN ENT.	108
LORANGER ENTERTAINMENT PRODUCTS	169
LOWERY GROUP	75
M	
MCA	5
MCA	15
MCA	27
MCA/INFINITY	2
MJS ENTERTAINMENT CORP.	97
MTI CORP.	197
MAGNETIC MARKETING CORP.	194
MALVERNE DIST.	123
MASTRO INDUSTRIES	178
MATTHEWS INT. CORP.	21
MELODY DISCOS	348
MEMOREX	19
MET RICHMOND	122
MICROPOINT	144
MIGHTY THREE MUSIC	47
MOGULL, IVAN	72
MORNING MUSIC	245
MUSART DISCOS	349
MUSHROOM RECORDS P/L	226
MUSIC BROKERS	91
MUSICCONTACT	295
MUSICANZA	116
MUSIC STREAMS INC.	125
MUSILCVERLAG, HANGERIG	292
MYLES, LEE ASSOC.	33
N	
NTV MUSIC PUBL.	330
NADA MUSIK	258
NATIONAL CUSTOM PRESSING	146
NEW LIGHT DIST.	102
NICHION	339
NIPPON COLUMBIA	329
NIPPON PHONOGRAM	332
NOSTALGIA LANE REC.	41
NOTEX—OFFSET A.S.	261
NUOVA SIAT	319



Specialty Sound Effects Records

18 Volumes of Authentic Sound Effects attractively packaged in color-coded albums help you offer a complete service for the audiophile. Buy direct from the manufacturer who pioneered Sound Effects on records. Send for catalog and price information listing these and 15 other specialty records such as "Silent Movie Music," "Calliope," "Carousel," "Music Box," and more.

Write to:

Thomas J. Valentino Inc.

Dept B • 151 West 46th St., NY, NY 10036
or call (212) 246-4675

"I thought it was out."



A Public Service of This Magazine
& The Advertising Council

Index to Advertisers

Listed Alphabetically

Advertisers	Page	Advertisers	Page
O			
ONE WAY RECORDS INC.	129	SONET U.K.	395
ONE WAY RECORDS OF OHIO	127	SONO DISC	269
OTARI ELECTRIC	337	SOUND PRO	180
OVATION RECORDS	29	SOUTHERN MACHINE & TOOL	174
OVERLAND PRODUCTS	167	SPECIALTY RECORDS MFG.	149
P			
P & G RECORDS	130	SPIRAL REC CORP & MUSIC PUBL	80
PACIFIC MUSIC PUBL	338	STAN'S DIST.	103
PAK WIK CORP.	202	STANTON MAGNETICS	209
PANARECORD S.P.A.	315	STAR TITLE STRIP CO.	88
PARAMOUNT RECORDS INC.	127	START INC.	309
PASSAVANT CORP.	195	STUDER REVOX	188
PASSAVANT CORP.	202	SUDDEN RUSH	83
PAULI PRODUCTS	184	SUN PLASTICS	144
PEDERSEN LABEL PRINTING	218	SURPLUS RECORD & TAPE DIST.	112
PEER SOUTHERN	81	SUTTON RECORDS	113
PEERLESS DISCOS	351	T	
PENTAGON INDUSTRIES	191	3M SCOTCH TAPE	179
PERFORMANCE RECORD & TAPE DIST.	111	TDK ELECTRONICS	183
PFANSTIEHL	208	T.R.O./ESSEX	61
PICKWICK INT.	109	TALBOT, JOE & ASSOC.	147
POLYGRAM	34-35	TANAKA MGMT	330
POLYLINE CORP.	167	TAPE KING	126
POLYMATRIX CORP.	205	TAPECOM INC.	156
PRESSWELL RECORDS MFG. CO.	148	TAPEMATIC	313
PRICE RITE RECORDS	115	TAUNUS TON TECHNIK	283
PROGRESSIVE LABEL & LITHO CO.	172	TENNECO CHEMICAL CORP.	182
PROMO RECORD DIST CO.	112	TKL DI F. MAGA	318
Q			
QCA CUSTOM PRESSING	148	TONE DIST.	95
R			
RCA INT.	17	TONE EXPORT	96
RCA RECORDS	427	TOWN HALL	120
RGH RECORD MFG. CO.	147	TRACKMASTER INC.	196
RPM DISCOS	420	TRACY-VAL CO.	148
RVC CORP.	340	TRANS-AM IND.	198
RABBITT DIST.	136	TRANSO PRODUCTS CORP.	151
RAINBOW RECORDS GMBH	287	TRI-STATE MUSIC TOWN DIST.	135
RAVEN/IMPORTANT REC.	121	TRIO RECORDS	345
RECORD HAVEN	118	TROY HILL MFG. CORP.	196
RECORD MERCHANDISING	88	TV ASAHU MUSIC PUBL.	334
RECORD RACK	92	U	
RECORD SHACK	120	U.F.A. PUBL.	292
RECORTEC	190	ULTRA SPECIALTY INC.	176
RECORTEC	191	ULTRA SPECIALTY, INC.	222
REGO IRISH REC & TAPES	116	UNIVERSAL RECORD DIST.	131
RIFI RECORDS	317	UNIVERSAL RECORDS & TAPES	132
RIMPO RECORDS & TAPE	281	UNIVERSAL SONGS/BELGIUM	235
ROBERTS, ALEX S. ASSOC. INC.	114	UNIVERSAL SONGS/NETHERLANDS	355
ROBLAN DIST.	242	V	
ROSENTHAL, A.I. ASSOC.	134	VALENTINO, THOMAS J. INC.	426
ROUNDER RECORDS CORP.	105	VALLEY EXPORTS INT.	150
S			
S.E.S.A.C.	77	VICTOR MUSICAL IND.	335
S.O.S.A.B.	377	VINTAGE RECORDS INC.	133
SCANDIA PKG. MACHINERY CO.	199	VINYL VENDORS	106
SCHWARTZ BROS.	94	VISTA RECORDS	260
SCORPIO DIST.	131	VIVID SOUNDS	336
SENTRY INDUSTRIES INC.	217	VOGUE MUSIC	59
SESAME ST. REC.	39	W	
SHAPE INC.	177	WAMID	123
SHEFFIELD LAB DIST.	92	WATANABE MUSIC PUBL.	331
SHINKO MUSIC PUBL.	342	WAX, MORTON D. ASSOC.	153
SHULZ, ALBERT	126	WEBTEK	166
SIBERT, P.J. & CO.	391	WIN RECORDS	121
SIDET, ED S.R.L.	320	WINDSONG RECORDS	393
SLEZAK MUSIC VERLAG	291	WINNERS	344
SLUIS, M.	116	Y	
SOMMERS, HENRY J.	76	YAMAHA MUSIC FOUNDATION	333
T			
U			
V			
W			
X			
Y			
Z			
ZAMOISKI CO.	104		
ZOMBA MGMT. & PUBL.	389		

The 1979-80 Directory of Hits

From
RCA



DAVID BOWIE "Lodger"
AQLI-3254

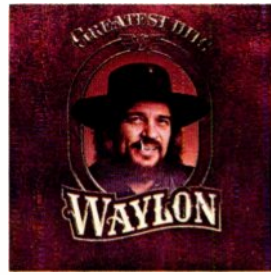

WAYLON JENNINGS
"Greatest Hits" AHLI-3378



TRIUMPH "Just A Game"
AFLI-3224

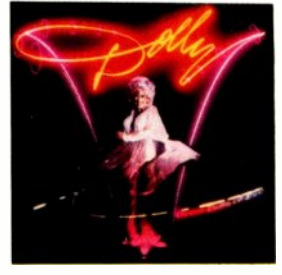

DOLLY PARTON
"Great Balls Of Fire" AHLI-3361



EVELYN "CHAMPAGNE" KING
"Music Box" AFLI-3033

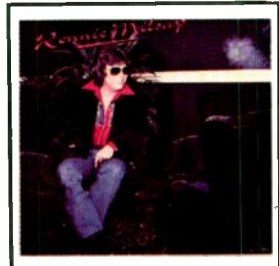

RONNIE MILSAP
"Images" AHLI-3346

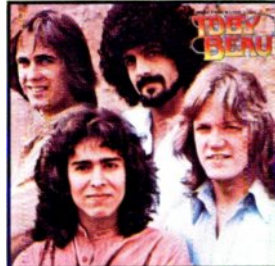

TOBY BEAU
"More Than A Love Song"
AFLI-3119



ELVIS
"Our Memories of Elvis,
Volume 2"
AQLI-3448



"SWEENEY TODD" CBL2-3379

And Associated Labels.



STEPHANIE MILLS "What Cha
Gonna Do With My Lovin'"
20th Century-Fox Records



THE WHISPERS
"Whisper In Your Ear"
Solar Records



MAXINE NIGHTINGALE
"Lead Me On" Windsong Records



ENCHANTMENT "Journey To
The Land Of Enchantment"
Roadshow Records/Nature's Music, Inc.



MACHINE Hologram Records



GENE CHANDLER
"When You're #1"
20th Century-Fox/Chi-Sound Records



BARRY WHITE
"I Love To Sing The Songs I Sing"
20th Century-Fox Records



CORY DAYE "Cory And Me"
New York International Records

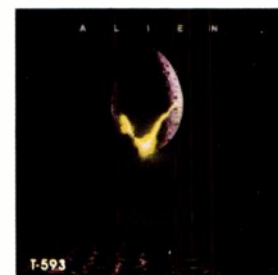

"ALIEN" 20th Century-Fox Records



FCC
"Baby I Want You"
Free Flight Records



Columbia Victrola

Sesame Street
AND MANY,
MANY MORE

FREE NEW 54 PAGE
DELUXE CATALOG
Listing 6,500 Current Major Labels,
LP & Tape Titles

LP PRICES FROM \$1.89
(Most Under \$2.00)



maxell
CASSETTE TAPES

UDXLI • UDXLII

TDK
SUPER AVILYN
VIDEO CASSETTES

CARRYING CASES
By
SALOY

CANDY STRIPE RECORDS, INC.
371 So. Main St., Freeport, N.Y. 11520 - U.S.A.

N.Y. PHONE (212) 895-3930 • L.I. PHONE (516) 379-5151 • (800) 645-3747-8

TELEX 126851 CAN STRIPE - FREE Toll Free (Outside N.Y. State)

NEW YORK'S MOST COMPLETE ONE-STOP DISTRIBUTOR FOR RECORDS, CUT OUTS, BLANK TAPES, VIDEO,
TAPE CARRYING CASES, HOME STORAGE UNITS AND ALL OTHER ACCESSORIES. SUPPLIERS TO THE WORLD!