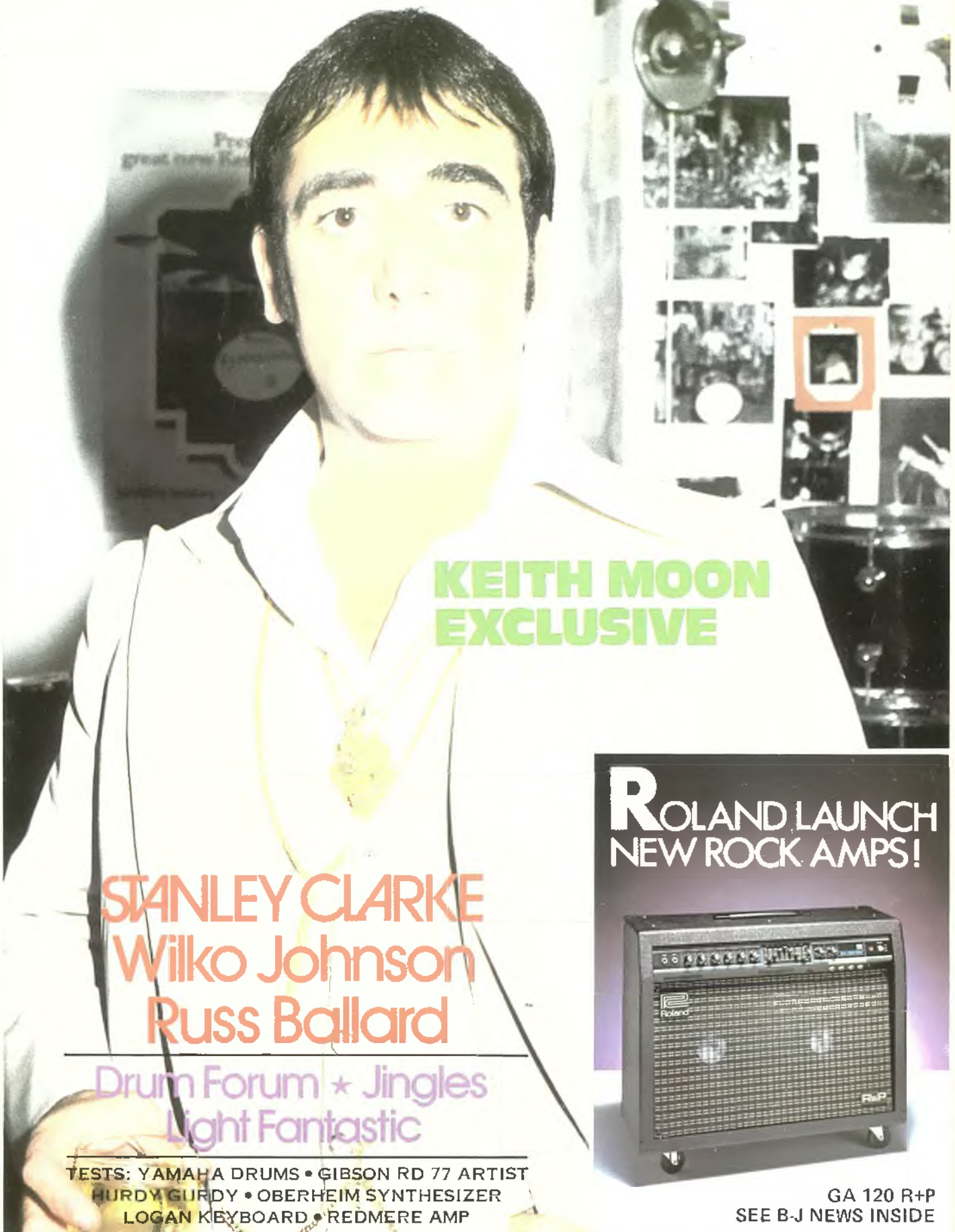


INTERNATIONAL Musician AND RECORDING WORLD

September 1978 50p



**KEITH MOON
EXCLUSIVE**

**STANLEY CLARKE
Wilko Johnson
Russ Ballard**

**Drum Forum * Jingles
Light Fantastic**

TESTS: YAMAHA DRUMS • GIBSON RD 77 ARTIST
HURDY GURDY • OBERHEIM SYNTHESIZER
LOGAN KEYBOARD • REDMERE AMP

ROLAND LAUNCH
NEW ROCK AMPS!



GA 120 R+P
SEE B-J NEWS INSIDE



Kramer™

SOLID BODY ELECTRIC GUITARS AND BASSES

Sole U.K. distributors:
BRODR JORGENSEN (U.K.) LTD.,
GREAT WEST TRADING ESTATE,
983 GREAT WEST ROAD,
BRENTFORD,
MIDDX. TW8 9DN.
TELEX 988 941.

You'll like the sound of this offer!

NEW

SOLTON TWIN-JET 200



This fantastic two channel speaker system has 2 x 100 watt amplifiers to meet all the requirements of both the group organist and solo artist.

ROTARY ORGAN SECTION

With a special 12" organ speaker. The lower frequencies are handled by the 15" bass speaker. Two inputs with Volume, Treble & Bass controls, also Reverb from Hammond type unit. Remote control for tremolo-chorale-stationary. High frequencies are acoustically projected through the Rotor system.

MAIN CHANNEL

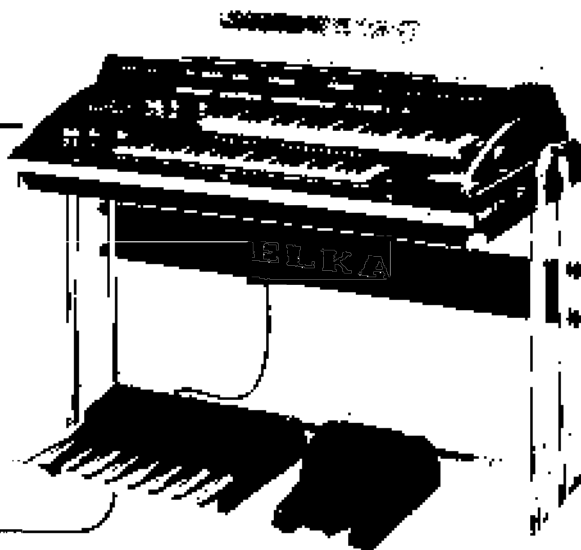
Five inputs with volume, Treble & Bass controls also reverb. 15" speaker plus Piezo treble speaker assure superb reproduction of any electronic instrument e.g. Piano, Strings, Rhythm Unit, Bass etc. DIMENSIONS h78 x b57 x d41cm.

The Solton Twin Jet 200 is particularly suitable for ANY 2 CHANNEL ORGAN. Such as the Hammond B2 Portable, Farfisa Pro 110, Cavendish Portable II, Welton Imperative, etc. **CHINGFORD ORGAN STUDIOS** are the sole UK Distributors of SOLTON Speaker Cabinets and as a **SPECIAL INTRODUCTORY OFFER** we are selling the TWIN JET 200 together with

THE ELKA X705

The most exciting Portable Organ Available today!

Twin Channels, 2 x 4 octave keyboards, draw bars on both manuals, strings and piano on both manuals. 3 organ pre-sets, 2 brass pre-sets, 1 variable synthesized voices, sustain on both keyboards and pedal plus automatic rhythm auto chord, bass patterns, all with memory plus other exciting features.



LIST PRICE of ELKA X705 . . . £2,420

LIST PRICE of TWIN JET 200 . . £ 695

£3,115



SPECIAL DOUBLE OFFER

Only

£2595

INC. VAT.

CHINGFORD ORGAN STUDIOS LTD

230 Chingford Mount Rd., London E4
38 Ballards Lane, Finchley, London N3
35 Horseshoe Street, Northampton
6/7 Station Road, Portslade, Sussex

Telephone: 01-524 1446/7/8
Telephone: 01-346 3059/8948
Telephone: 0604 22936/7
Telephone: 0273 412877

GROUP GEAR

242 Chingford Mount Rd., London E4

Telephone: 01-524 1446/7/8

INTERNATIONAL
MUSICIAN
 AND RECORDING WORLD
CONTENTS

Editorial Director Ray Hammond
Advertisement Director Richard Desmond
Promotion Director Malcolm Green

UK

Editor Bill Stephen
Assistant Editor David Lawrenson
Features Editor Eamonn Percival
Copywriter Adam Sweeting

Art Director Mervyn King
Assistant Art Director Chris May
Artists Fiona Beecham, Tom Fawcett,
 Beverley Bennett

Type Composer Janice Brown

Photographer Mike Valente

Production Manager Andrea Bearman
Production Team Jennet Ward, Alan King

Consultants: Robin Lumley
 Mark A. Sawicki M.Sc. (Eng.),
 C. Eng., MIEE, MAES
 Stephen Delft MIMIT
 Dave Mattacks
 Ken Dibble MIOA
 Alan Holmes

ADVERTISING

Assistant Advertising Manager Allan Andersson
Advertising Art Director Rick Alexander

USA

General Manager Julius Graifman
Assistant General Manager Maurisa Solomon
Contributing Editors Jon Tiven, Gary
 Graifman, Steve Rosen

LONDON

International Musician & Recording World is published monthly by Cover Publications Ltd., 7a Bayham Street, London NW1 0EY. TELEX No: 24676. TELEPHONE: 01-388 2011. Distributed in Great Britain by Independent Magazines Ltd., Bridge House, 181 Queen Victoria Street, London EC4V 4DD. Tel: 01-248 3482 (10 lines). Printed by Carlisle Web Offset, Carlisle, Cumbria, England. International Musician & Recording World is a trademark of Cover Publications Ltd. All rights reserved © Cover Publications Ltd., 1978. Whilst every care is taken in the publication of the magazine, the publishers cannot be held responsible for any results arising from the contents thereof. Subscriptions, 12 months only: U.K. £10.50. Worldwide (surface mail), £12.00. U.S. (includes 12 issues, shipping charges to New York, N.Y. and mailing costs from N.Y.) \$20. Second class postage paid at New York, N.Y. and at additional mailing offices. Air mail rates Europe, £17.00; S. America and S. Africa, £25.00; Australia and Japan, £31.00.

NEW YORK

Executive Offices:
 The Gulf & Western Building, 15 Columbus Circle, N.Y. 10023 U.S.A. Tel: (212).
Editorial & Advertisement Offices:
 277 Old Nyack Turnpike P.O. Box 414,
 Spring Valley, New York, N.Y. 10917, U.S.A.
 Tel: (914) 356 6797. Telex: 131566
POSTMASTER: if undelivered, please send form 3579 to International Musician and Recording World, PO Box 414, Spring Valley, New York 10977.

Sole International Distribution Agents:

**Gordon Gotch (Canada) Ltd., 65 York Street,
 Toronto, Ontario, M5J 1S4, Canada.**
**Gordon & Gotch (Australia) Ltd.,
 Melbourne, Sydney, Brisbane, Adelaide, Perth.**
**Gordon & Gotch (NZ) Ltd.
 Wellington, Auckland, Christchurch, Dunedin.**
Central News Agency Ltd., South Africa.

Regular Features

6 Letters

Readers' enquiries, comments and views.

86 Steel Works

Ace pedal steel player Dave Hayward begins a series on the ups and downs of levers and pedals

119 PLAYING: Paul Brett

This month, Paul gives a few hints and tips on how to get the best out of your acoustic guitar with transducers, bugs and other insects.

121 PLAYING: Mick Abrahams

Big Mick delves even deeper into open chord tunings

48 Albums

Tarney/Spencer, Steel Pulse, Russ Ballard, Dire Straits and a very dangerous live Thin Lizzy album are among this month's reviews

112 Build a Solid Guitar

At last, Part 21 in which Stephen Delft concludes this long-running serial on building your own electric guitar. The film rights have now been sold.

165 Studio Of The Month

This month, IM travels up to Womble-land to check out the brand new RG Jones recording studio in Wimbledon

Test Section

36 SAWICKI'S SOUNDCHECK

Mark Sawicki takes a close look at three amps in one -- the new Redmere Soloist

39 SIMMONS' SYNTHCHECK

For synthesizer players who are prone to bouts of amnesia, Dave Simmons checks out the new Oberheim OB-1 with its special programmable memory.

40 LUMLEY'S KEYBOARDCHECK

Robin Lumley finds a wealth of goodies packed into the Caravelle T249 portable organ from Logan

43 DELFT'S GUITARCHECK I

Stephen Delft reviews the latest innovation from Gibson -- the RD77 electric guitar, designed in conjunction with Dr. Moog

45 DELFT'S GUITARCHECK II

You may be forgiven for never having heard of a Hurdy Gurdy but Stephen enlightens us all

52 MATTACKS' DRUMCHECK

Ex-Fairport Dave Mattacks gives a fair report on the new Yamaha S222 WT drum kit

55 IN BRIEF

A Kelsey acoustic guitar bug and the new Bell Electrolabs ADT unit get the once-over.

180 DIBBLE'S SPEAKERCHECK

Four more pages on horns this month, this time the high-frequency ranges.



Special Features



20 The Keith Moon Exclusive

There can't be many drummers who have had such an influence on rock drumming as Keith Moon. Eamonn Percival speaks to the Wild One.

34 Buzz

The low-down on up-and-coming bands plus a chance to make a name for yourself with Hansa productions.

60 Drum Forum

A unique discussion on various aspects of drums and drumming. Tony Newman and Chris Millar are among those taking part.

68 Bowie's M.D.

No, not an interview with the Thin White Duke's thin white doctor, but a rare insight into the workings of Bowie's guitarist/arranger Carlos Alomar.

74 Behind the Eardrum

Pacific Eardrum's keyboardist talks to Ian White about the acoustic pianist going electric and vice versa

76 A Shot Of Rhythm 'n' Blues

Ex-Dr. Feelgood Wilko Johnson tells Eamonn Percival how Mick Green set him straight

92 Rock 'n' Roll Ballard

A man of many talents, Russ Ballard speaks to a very overworked Eamonn Percival

96 Forever The Bassman

Steve Rosen talks to everybody's favourite bassist, Stanley Clarke.

104 Taking Care of Business Part 7: Jingle Belle

Alan Holmes finds out about the intricacies of writing and marketing 30-second hits

126 Cymbal Sense

All you wanted to know about choosing the right cymbal for the right job. Bob Henrit imparts some of his not inconsiderable knowledge on the subject

132 Light Fantastic

An illuminating look at what's available in lighting and where to get it

140 Mouthpieces

Alan Holmes, expert in all things brass, gives the low-down on choosing the correct mouthpiece

152 Understanding Synthesizers: Part 4

Baffled by oscillators, waveforms and pulse widths? Tony Horsman takes us on a guided tour of a synthesizer

167 Meet Your Engineer

A further insight into recording as we meet the men behind the mixers

Editorial

On page six of this issue is a plea for help. Not an uncommon situation but an unusual set of circumstances. A man is in prison and wants to make music. To do that he needs equipment or, as he puts it, your "odds and sods".

Although a drumkit would suit his needs the request goes beyond the personal. Borstals, housing estates and institutions throughout the country find themselves confronted with the same problem: access to musical instruments. People want to make music and all they need is the tools of the trade.

And so we provide an open invitation to manufacturers, dealers, bands and individuals that can help by donating gear. Cast offs, seconds, gear that you may think has long since passed its usefulness can be a prize to someone with nothing.

We'll provide the communication if you'll provide the gear. The process is simple. Those in prison or in other institutions needing gear should send us a letter stating their needs. We'll publish all letters and help make the connection between those with the gear and those without.

Help out. The gratitude you'll receive for your donation will be well worth the effort.



VOL. 4 NO. 9
SEPTEMBER 1978 (UK)
OCTOBER 1978 (USA)

Within These Walls

Dear Editor: Congratulations on your success. I feel you do a lot to lift the veil of pseudo-mystique which the posers and chancers were drawing around the rock music culture. Being on the perimeter of something worthwhile these people realise that their only hope of holding on is to be the security guard — hence the coy and oblique attitude we so often meet, but you are succeeding in breaking that stranglehold, an action long overdue.

Token flattery aside, the crux of this communiqué is to request through your columns that your readers and advertisers have a browse through their odds and sods with a view to donating whatever they could to the rock nurseries — by that I mean young local bands, youth clubs, boys' homes, Borstals, young offenders' institutions, community centres and prisons. Any of these "organisations" would be glad of cast-offs from bands or from equipment and record companies. In a prison situation it is particularly difficult to acquire equipment, especially a drum kit, amps and cabinets and I feel that by neglecting these areas we desert the inmates on a humanitarian level and also miss a golden opportunity to stock the rock culture, Britain's finest export, with fresh blood and new energy. A number of years in an institution (prison, housing estate), although an unfortunate aspect of social control, is a learning opportunity, the potential of which I'm sure we can all recognise, but how much more productive if some tools and encouragement are given? Thus may I momentarily separate the concerned music heads from the parasitical bread heads and ask the former to consider investing a little time, effort and material in what is, after all, our future.

Perhaps your contribution as a communication device could be to publish details of bona-fide needs, described on headed note-paper?

Thank you for your time and space.

Keep it dirty and dancln'.

B. Robertson,

H.M. Prison Edinburgh.

P.S. Our particular need is for a drum kit, should there be any friendly response.

Mouthpiece Misery

Dear Alan Holmes: After reading your excellent articles in the recent editions of International Musician I am writing in the hope that you can help me in my choice of mouthpiece. At present I am using a Selmer Jazzmaster D mouthpiece coupled with a Rico Royal 2½-3 reed on a Mk VI tenor saxophone. I have been using this mouthpiece for about two years but still haven't acquired the ease of blowing I would like. I find the bottom bell notes especially difficult to control and also the notes on the 'break' between concert A and concert D.

Consequently I would like to try a new mouthpiece but not having access to other mouthpieces I want to be sure I have the right one before I buy it. The sort of sound I want is a modern one very much like that of Wilton Felder of the Crusaders which I would describe as a hard bright sound, but would also like to be able to get a breathy sound in the bottom register. If by any chance you know what sort of sax and mouthpiece he uses could you let me know or how I could find out. I hope you can help me with this and I will look forward to hearing from you.

Martin P. Long

Cheltenham, Gloucestershire.

Before you blame a mouthpiece for any playing fault, make sure that the saxophone is in perfect working order. The difficulty with

the bottom notes is nearly always due to leaky pads so check all the pads carefully for splitting and cuts particularly the top 'side lever' keys; the top 'F' pad will need replacing quite frequently, as often as twice a year.

The difficulty with the 'break' from A to middle D does sound like a mouthpiece fault; two years of playing should have cured this sort of problem by now but another mouthpiece could just be the answer.

Wilton Felder uses a metal Berg Larsen but at the moment I am working with the factory to try to get these near to the original design; so until these are ready try the ebonite Larsen as these seem to be OK and I recommend them in the first part of my mouthpiece survey. Leslie Evans of 275 Colney Hatch Lane, London N11, tel: (01) 368 4137, operates a seven days trial against receipt of the money. Try an Ebonite 95/1/M and, for added edge, La Voz medium reeds. Wilton uses a King Super 20 sax which are quite rare in England but new ones can be obtained from Barratts of Manchester for around £900.

If you are not happy with the sound of the Ebonite Larsen then by all means try the Steel. You might be lucky and get a good one.

Two other Ebonite mouthpieces which did very well in the tests contained in the May issue of IM are the H. Couf JB S marketed by the Vincent Bach Co. of America and the Beechler S7S obtainable from Elmer Beechler, Box 15, Encino, California, USA.

One of these will definitely solve your problem. Don't hesitate to ask if there are any other points you need help with.

Bassist baffled by bins

Dear Sir: I am a bass player, and in an effort to economise on speakers, I have built my own enclosure. At the moment I am using an infinite baffle cabinet, but have recently tried various bass bins (including the new Altec 816A) and have been most impressed.

I wonder if you could possibly give me any information on building my own bin (of any suitable type). If not, do you know of any firms which could give me information on building bass bins?

Thanks for your time and for your excellent magazine.

Christopher Boast,
Alton, Hants.

I suggest that you try writing to some of the speaker manufacturers and ask for plans. JBL are sometimes prepared to issue plans for some of their bins, but you may have to write to their head office in California, USA to get them although it is probably worth a letter to Tannoy (who are the UK distributors) first. Electro-Voice also publish enclosure designs but again, you will probably have to write to their head office in Michigan, USA. I have recently learnt that Goodmans have a range of enclosure designs for their Audiomax range of units and I suggest that you write to them, marking your letter for the attention of Mr. N. Bain. Addresses for these manufacturers can be found from the advertisements in this magazine.

Finally, I suggest that you try to get a copy of a book entitled 'How to Build Speaker Enclosures' by Badmaieff & Davis. Although originally published in the States, a UK edition was published in 1967 by W. Foulsham & Co. of Slough and it might be worth a letter to them. Alternatively, you might find a copy in your local library. Besides containing a good deal of useful advice on speaker building, this book also includes complete working drawings for several enclosures, one of which is the Altec 'Voice of the Theatre' bin.

PA Choice

Dear Sir: I would be extremely grateful if you could give me some advice on the choice of PA bins and horns I am thinking of buying.

The system I have at present consists of: one H/H MA100 PA amp and one H/H 100 watt slave plus two Peavey 215 HT vocal projectors containing 2 15" speakers, 2 hyperbolic horns and 2 piezo tweeters in each.

I want to keep the amps and get rid of the Peaveys because they just do not seem to perform all that well. I am not in a very loud band and in order for my vocals to get over the top, I find that the Peavey cabs begin to sound very muffled, even though the H/H amps are not even on half volume.

I had both amps and cabs checked over and the verdict was everything is working correctly but the Peavey cabs just aren't powerful enough although they are rated at 150 watts each.

The cabinets I am thinking of replacing them with are JBL 45/60 bins (one each side) with either a JBL 150 watt K140 speaker in each or a Gauss 5840 200 watt speaker in each. To go with them I am thinking of getting a pair of Grove power horns with RCF TW101 100 watt drivers on each horn.

I really wanted to know what you think of the above equipment and if they will give me an improved sound over the Peavey cabs.

There is not much difference in price between using the JBL speaker and the above horn which will give me a total of 250 watts each side or the Gauss speaker with the same horn which will give me 300 watts each side.

The prices I have been quoted are around £580 which is really my limit, and that price also includes a passive high pass filter or some thing.

As I said, I would be extremely grateful if you could tell me what you think of the equipment I've mentioned as I have to replace the Peavey cabs as soon as possible.

M. Mitchell

Plumstead

Ken Dibble replies: Before getting rid of your Peavey cabs, I suggest that you try to borrow or hire a really powerful slave amp — something like an Amcron DC300, or a Turner, feed this from the 'slave out' socket on the H/H MA100 and drive both Peaveys from the high power amp, leaving the speaker jacks on the H/H unused. It is possible that your 'mushy' sound is due simply to clipping of the two H/H amplifiers — not that there is anything wrong with H/H amps, but under certain matching conditions, you could possibly only have 70 watts coming out of each and this is unlikely to be sufficient to get the best out of the Peavey cabs. You ought to have between three and four hundred watts of power behind these cabinets.

If that does not solve your problem, then I would say that you are on the right track with the 4560 bins. I entirely agree with your horn selection, but why not look at the RCF 15" bass drivers? (See Speakercheck, p.132, April '78 issue). In particular, the RCF L15P/06 is particularly suited to this bin, and will save you about £40 on each unit. I do not recommend the use of a simple passive high pass filter for this application — you will need a proper quarter or half section two way crossover if you intend using passive components, and these can be obtained from RCF or from Vitavox. In fact, the Vitavox 500Hz crossover is particularly recommended, and although designed for 15 ohm systems, it will also work at 8 ohms with a small insertion loss.

Having built your new speakers, I still think that you will need a bigger amplifier to



LUDWIG®

We're playing together again.

Buddy Rich is playing Ludwig drums. And, we're telling drummers everywhere with 4-color ads and posters. Because when the greatest name in drums gets together with the greatest drummer, everyone should hear about it!

**Just what
the world doesn't
need.**

**Another
15" loudspeaker.**

How many 15" loudspeakers have you listened to lately?

Every major manufacturer seems to have one nowadays. Some of these companies have been producing them for years. And understandably some of them have produced loudspeakers of the highest quality. Loudspeakers you would be proud to use and recommend.

With all this competition around it would take a very special speaker to break into the current market.

That's where we come in. We've been making quite good speakers for some years now. First came the 12" drive unit. Originally designed by us to cope with the same problems that confront traditional 15" units but in a more compact package. Sensible enough it seemed to impress groups like Supertramp and Tangerine Dream. And give them that little extra others have never achieved.

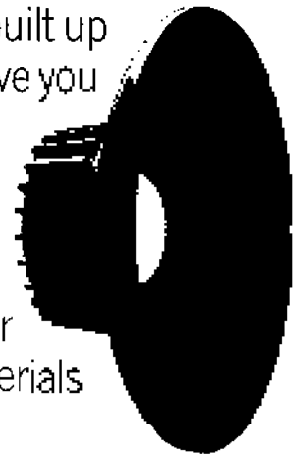
Impressive enough to beat the entire field which included many of the big name American models in the recent International Musician awards.

Then came the 9" drive unit. Smaller again, while others were trying to be bigger, and designed especially to give more power than most of the bigger units.

Over the years our reputation has gradually been built up through technical excellence and now we are ready to give you our latest offering. A new 15".

We applied the same design criteria as with the 12". The same advanced cone technology has given us the same lower distortion characteristics. The same advanced voice coil technology has given us even greater power handling. Our uncompromising approach to materials and tolerances has given us even greater efficiency.

So if you're thinking. What does the world need with another 15" loudspeaker, we think we might just have the answer.



ATS

Acoustic Engineers, Pier House Laundry, Strand-on-the-Green, London W4.
Telephone 01-995 3654

Distribution to the Retail Trade: Mick Johnson music tel: 01 788 3491. Represented internationally by: Australia, Robert Woodman tel: (54) 436099. Canada, Guy Berzsford tel: 416: 264 2340/7. Denmark, Paul Sauerberg tel: (01) 767500. Germany, Gerd Kuhn tel: 0521 513 30. Sweden, George Meals tel: (08) 40 63 93. Switzerland, Tony Patsch tel: (01) 284462. USA, Kenny Berger tel: (617) 9262574.

Sounds like a good thing

Not only do we have an extremely wide range of driver units and horns to suit every sound requirement, we also complete the range with an acoustic lens.

So no matter what kind of speaker installation you're building, you can get every component from a single supplier. A single manufacturer.

And you can be sure that every part is designed specifically to work with every other part.

Giving you a perfectly balanced system... Sound like a good thing? We think it sounds like the best.

From the people who Know.

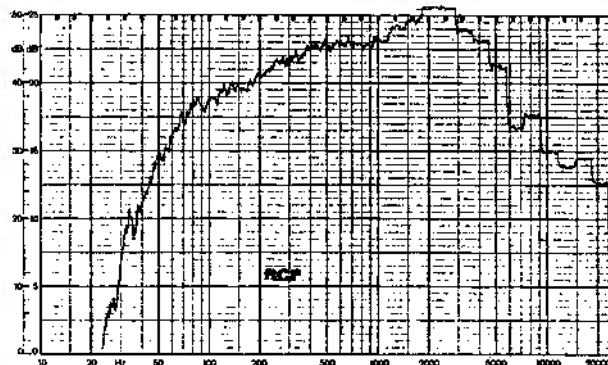
RCF
Covema Ltd

Sole U.K. Distributors

Dunchurch Trading Estate, London Road, Dunchurch, Rugby CV23 9LL.
Telephone: Rugby 815020.



RCF	L15P/100A	RRP incl. VAT E96
Parameter	Manufacturer's Rating	Test Result
Power	150w RMS	Just confirmed
Distortion	Not stated	8% @ 150w
Sensitivity	Not stated	103db @ 1w @ 1m
Resonance	45Hz free air	80Hz in 90 ltr 1B encl.
Impedance	8 ohm nominal	7.5 - 12 ohms
Useful Frequency Response	45Hz - 10KHz unqualified	45Hz - 18KHz @ -20db See Graph



This loudspeaker is to all intents and purposes, an exact replica of the JBL K130. The nicely finished cast alloy chassis is adequately strengthened to carry the weight of the magnet structure and is fitted with a light, shallow cone assembly with dural centre dome and doped linen suspension. In effect, it is a larger version of the L12P/11 reviewed last month. Like so many other units tested, the L15P/100A again only just scrapes through on the makers' power rating figure on account of a high second harmonic distortion of 6%, but in all other respects, it performed impeccably by returning the highest sensitivity figure of any loudspeaker yet tested of 103db.

Note also the amazingly wide frequency response for a unit of this type and the exceptionally linear impedance characteristic. I begin to wonder whether RCF have somehow cracked the problem of designing a constant impedance transducer, as the only other unit to contain its impedance range within reasonable limits was another RCF unit, the L12/31 reviewed in the February issue - although to be fair, the Goodmans Audiomax 15AX included in this report is also a good deal better than most in this respect. This loudspeaker was again delivered bolted to a hardboard panel and adequately boxed to ensure delivery in one piece after shipping from Italy. This is another very nice product from this manufacturer, especially so at this price.



Marshall Marshall

NEW

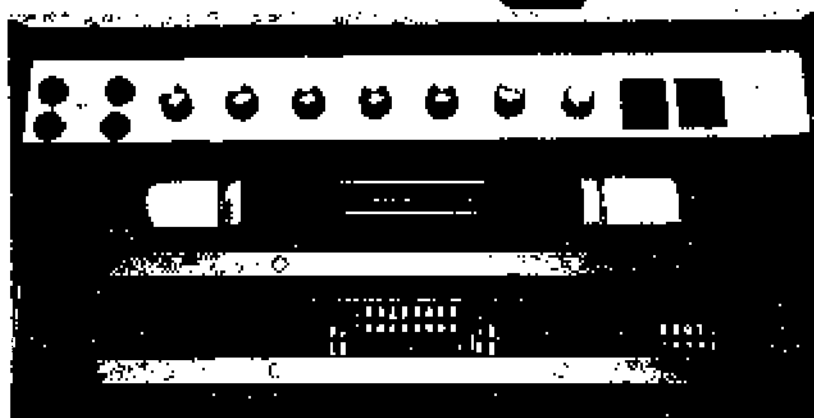


Rock 'N' Roll Baby

The definitive 'Baby Marshall'. The brand new Marshall 2150 is the smallest, most powerful Marshall combo ever. Many musicians need the power and sound of a stack but in a compact unit. The 2150 does the job!

The unit is small but the sound is BIG. A full 100 watts of Marshall power is delivered into a specially commissioned Marshall 12" driver which really projects your sound, enough for the biggest gig.

The amplifier is a pure valve unit so that famous Marshall raunch is still very much in evidence. Wind it up and it sounds like a full Marshall stack in a crowded club. Wind it down and it can be clean or dirty at a volume level barely above a whisper! Slightly different from the Marshall



100 watt heads, the amplifier is four input, two channel but with the added extra of a Master Volume control. With the Marshall E.O. circuit - Bass, Middle, Treble and Presence - and this special Master Volume, you have many sounds at your fingertips plus you can link the two channels and control the overall volume.

The speaker is a very special type of Celestion driver, exclusive to Marshall. It is easily capable of handling the output from the power amp, often well in excess of the 100 watts RMS rating. The sheer power that this compact combo produces is amazing. If you need a Marshall in a small package, look no further than the brand new 2150.

Rose-Morris
Marshall

MS-20 Monophonic Synthesizer

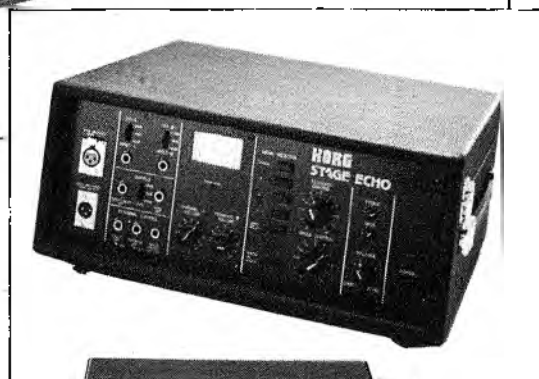
The MS-20 is a new addition to the Korg range. It has a host of features: a C-C 37-key keyboard, two VCFs, two VCOs and sweep filters. Two envelopes generators give independent hold, delay and attack times. The MS-20 has a patching panel with facilities that give envelope generator patching, and inputs for patching in an external signal. Compatible with the SQ10 Sequencer.

KORG



SE-500 Stage Echo

The SE-500 is an echo unit which obtains its effect through a tape loop. The unit has facilities to vary the rate and volume of the echo effect with extra feedback controls and LED level indicators together with extensive input and output routing and switching including balanced XLR in and outputs.



Korg is one of the fastest rising names in the synthesizer business, and over the past 12 months the company have really made their mark by launching products for musicians at all levels, from the pub band to the top professionals.

Korg's proud boast is that they have destroyed the "never in tune synthesizer" image, thanks to the circuitry which guarantees accurate tone pitch. Their constant innovations and new additions to the range keep pace with the most demanding requirements of today's musicians.

The prime example of Korg expertise and technical achievement can be seen in the PS3300 polyphonic synthesizer. This incredible instrument actually incorporates three polyphonic synthesizer systems plus signal mixers and battery of controls which can produce any sound imaginable, letting the musician really be creative.

From the same keyboard you can play the three polyphonic systems independently by using the Keyboard Volume Balance controls. An X-Y

control stick is included among the manual controls on the PS3300 keyboard unit to give the maximum range of effects.

The PS3100, whilst retaining many of the new features of the PS3300, is not quite so sophisticated. It features specifically developed integrated circuitry for every note of the keyboard, and one of its most practical benefits when used live is the rapid access to a large number of pre-patched sounds.

Another aid for playing live is the synthesizer's flow chart system and rationally designed patching panel which makes setting up a specific patch simple. Thanks to the unique control panel layout and dependable circuitry the PS3100 allows for consistently reliable operation without sacrificing any creative freedom.

These two instruments serve to illustrate one of the best features of all the Korg keyboard products in that they have "hidden" powers. Their capabilities are infinitely more than their uncomplicated keyboard layout would suggest. This characteristic is true of all the famous Korg products and also of the new instruments which have been added to their already extensive range.



EM-570 Echo Mixer

The EM-570 is another addition to the Korg range and enables the user to link in echo with any other signal source such as from a microphone, guitar, or any other electric instrument as well as tape decks and record players. The echo controls give control over the rate of echo and repeat trade. Rear panel inputs are: Phono, Aux 1-1-2 (for connection of tape decks) and outlets for speaker and external amplifiers. The EM-570 has four channels with independent tone and volume controls.

Rose-Morris
KORG

A UNIVERSE OF SOUND



VC-10 Vocoder

The Korg Vocoder is one of the most original breakthroughs to emerge in the short history of synthesizers. The Vocoder is a synthesizer which enables the human voice to be a source into the synth and altered through the playing of the keyboard. You can speak and at the same time accompany yourself on the keyboard and the synth functions will synthesize the pitch of your voice according to the settings you choose, altering the pitch of your voice as if you were a choir singing. Some of the effects you can get include: vibrato, octave changes, chorus effects and a myriad of other sounds which will enable you to make your voice do incredible things.



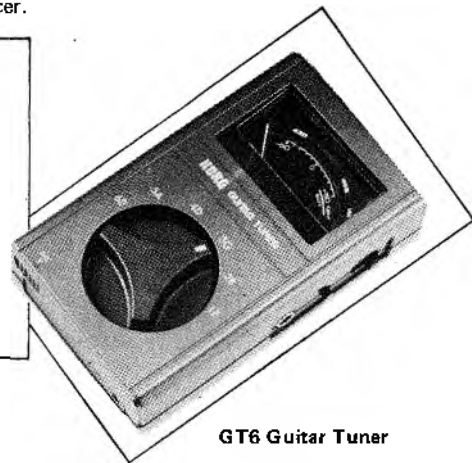
MS-10 Monophonic Synthesizer

The MS-10 is a 32-key synthesizer, equipped with envelope generator, VCO, and Low Pass Filter. A patching panel has a pink noise and white noise output. Portamento control and adjustment of external signal level are just two of the many features of the MS-10. The synthesizer also has a modulation generator controlling the wave form and frequency. Compatible with the SQ-10 Sequencer.



SQ-10 Analog Sequencer

Using the SQ-10 means you can vary the sound the synth makes according to prior selection of pitch, tone and colour. The SQ-10 is a 12-step, 3-channel, 6-mode sequencer. It enables you to select up to 24-steps and a built-in analog mixer lets you mix output voltages from each channel and connect more than one sequencer. Full facilities mean complete control over the mode of sequence, monitored by LEDs which give a visual indication of the channels and steps in a sequence.



GT-6 Guitar Tuner

One of the most frustrating and time consuming things for any guitarist is tuning his instrument. To eliminate this problem Korg have designed the GT-6 guitar tuner for instant, accurate tuning. Small enough to be used with either electric or acoustic guitars, it features both an input jack and built-in microphone. Other features of this remarkable accessory include a built-in meter light for use in dim lighting situations and an output socket which permits audible as well as visual tuning when connected to an amp.

Rose-Morris
KORG

NEW

Marshall Marshall



Marshall go Country

In a totally new departure Marshall, the acknowledged leader in rock amplification, have developed a valve amp specifically for Country, Jazz and general club work. Far from being a variation on an existing theme the 4140 is a new design from the chassis up.

Development time for the new model has been over 2 years and many top Country and Jazz players, both in the U.K. and America, have made important contributions at various stages. The amp offers all the features you would expect — and a few you wouldn't.

There are two channels, with two inputs per channel; each channel having separate equalisation. Channel 1 is mainly intended for instrument inputs such as guitar or pedal steel and has full

Hammond reverb, bass, middle and treble controls, bright and boost switches and a channel volume control, Channel 2 is intended mainly for microphone inputs and has bass, middle and treble and channel volume. A master volume control operates on both channels together.

The amp is all valve for both pre-amp and power stages and delivers a minimum of 100w RMS. Speaker design was one of the more difficult development areas, and it took some time before Marshall were satisfied with the twin 12" 80w speakers. Reverb and boost are both controllable by a double footswitch from the back panel.

Visually the combo also breaks new ground for Marshall. Unusually for a valve amp Marshall have engineered the control panel to be on the front of the

amplifier which is the most convenient design for club work. The finish is also unique: brown oak leathercloth covering for the cabinet with a straw coloured speaker cloth. The portability of the combo is ensured by new-style castors, two recessed side handles and a strap-type top handle.

So much for the design and engineering — but what about the sound? How do you describe a sound? Simply that the combo out performs everything that America produces for Country and Jazz musicians — what else would you expect from Marshall?

Rose-Morris
Marshall

The unique TEAC range from ITA

Only ITA offer such a wide range of models—always in stock.

TASCAM 80-8

This 8 track recorder is available with or without DBX noise reduction.

Immediate delivery.



A2340 SXH

All the advantages of 15 ips operation now available on this model. Outstanding value among 4 channel recorders.

Exclusive to ITA.



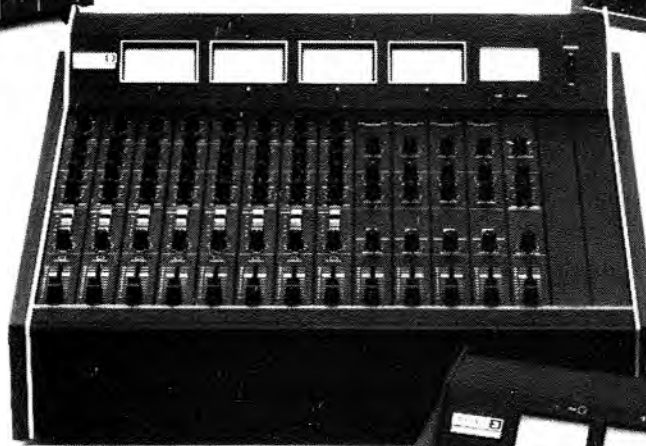
A3340S Industrial

This upgraded version of the A3340S standard model features 63dB signal to noise ratio.

Exclusive to ITA.

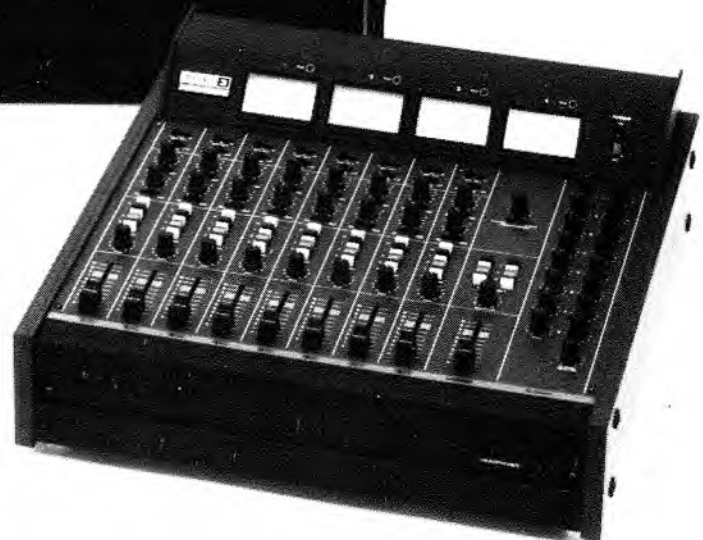
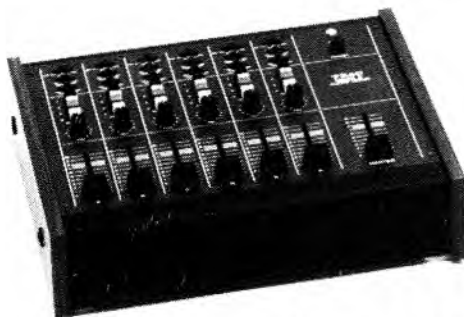


We hold the largest stock of TEAC in the UK for immediate delivery. Visit our new showrooms for a demonstration.



MIXERS

The Tascam Series Model 3 and Model 5. In stock, and available for demonstration



ITA

1-7 Harewood Avenue,
Marylebone Road, London NW1.
Tel: 01-724 2497
Telex: 21879

drive them and would suggest that you take a serious look at the H/H S500. This will give you about 200 watts per channel in the two channel mode, or about 600 watts if switched to the 'bridge' mono mode, and is a reasonable price.

So, try a much more powerful amplifier first — you may well find the Peavey cabs OK and save yourself a lot of time and money.

Blowing in the Wind

Dear Mr. Holmes: I recently read your article in International Musician called "Blowing In The Wind", and as I am having virtually the same basic problems such as the ones you pointed out, your article made very interesting reading.

I have been playing the alto sax for some years now and I am still not pleased with the tone, the ease of blowing and the fact that my front teeth leave a painful dent across the inside of my top lip. The bass notes are easy enough but only with considerable air pressure, which in my case entails an increase in volume. The midrange is OK, but the highs need a lot of "bite" on the reed. The tone is very breathy and "frying up" is a common occurrence. On the whole the sound produced is a very woolly parp! and it takes a great deal of control to get a better sound.

I am pretty sure my problems occur with a bad match of mouthpiece to my mouth, and mouthpiece to reed etc. which is an ebonite Selmer F and usually a Rico Royal 2½.

I own a Buffet crampton alto which I bought in an excellent re-conditioned state from George Clays of Birmingham. I don't think my problem then occurs from a faulty instrument.

As I am aiming my sights at becoming a capable professional saxophonist (it seems pointless to claim otherwise although it sounds bigheaded) I would be grateful for your professional advice as regards my problem. As I wish to continue to play the sax full-time I want to be at ease with my sound, style and capabilities which, as far as I can see, can only be achieved with the correct combination and mouthpiece.

You mentioned Leslie Evans at the end of your article, I wrote to him first. Amongst the 'Syllabus of Saxophone Tuition' by Leslie Evans, the prices of re-lacquering etc., various book lists and assorted leaflets of Salesmanship, I found a tabulation chart and price list and a very self-centred letter. He seemed to be blowing his own trumpet a little too much and seemed very biased around topics such as: teaching, impressing naive saxophonists, and the sax sound of days gone by. Although I don't condemn his obvious knowledge, and with all due respect to Mr. Evans, his approach to my immediate problem was not quite as desired. So after reading a good many of your articles (and I hope more in the future) it is to you I turn as you have the approach and knowledge that seems to be more on my wavelength.

So could you please give me your advice, or at least some guide line towards getting the desired mouthpiece.

Adam Broome,
Kineton, Warwickshire.

P.S. I play my sax through a Peavey Classic with a Barcus-Berry (which I know does destroy some of the sax's initial tone, but I have written about what my sax sounds like acoustically more than that of an amplified sound. The sound I would like to produce is bright but still

sonorous.

My taste is centred around the blues. A sound something like that of Randall Bramlett's on the Greg Allman tour album is what I would like to produce — within reason!

From what you say it seems you have a serious problem with the way you are blowing. The top front teeth rest directly on the top surface of the mouthpiece, the top lip just seals the air. No wonder your sound is woolly as you can't apply enough pressure without biting through your lip. Stick one or two layers of plastic insulating tape across where your front teeth bite. This will deaden the vibrations going up into your head, which some players find uncomfortable.

Next try some La Voz 2½ reeds, these will be brighter and edgier than the Rico Royal. If after a month with the new way of blowing and after plenty of high, long note practice to strengthen the muscles, the sound is still not bright enough, try a Beechler S53 plastic mouthpiece by first writing to: Elmer Beechler, Box 15, Encino, California, USA, asking how much to send. This mouthpiece is very bright and resonant. (See 'Blowing in the Wind', page 140 this issue, for more details on mouthpieces.)

For your live sound the Barcus-Berry pickup is too dull. Try putting your amp in front of you and using a Shure or AKG mike. Borrow one first to see if you like the effect. In the last analysis your sound is a very personal thing which only you will know when it matches what you hear in your head.

If, after changing the way you blow, reed and mouthpiece you are still not happy, you will need some lessons from a professional player to put you back on the right track. On the subject of lessons in general it is not advisable to stick with the same teacher for more than a year as no one player will know as much as two or three. Plus, a different approach will help you eventually to develop your own style.

These suggestions will definitely solve your problems but if you have any more queries don't hesitate to write again as you might still be marking time instead of improving.

Heady Problem

Dear Sir: I have recently decided to spend the money on some new, good quality drum heads, only to find that they are unobtainable in pre-international sizes. After extensive enquiry, I discovered that there is only one head available in these sizes, and that was not a very good one.

However, 'Eddie Ryans' told me that they had had a lot of enquiries about pre-international heads and were thinking of either making or ordering some in a few years' time. I think there are plenty of drummers who have pre-international kits (12" and 16" drums are the ones affected) and if there were enough response it would possibly provoke quicker action.

Alternatively, if there is anyone reading who is somehow involved in making heads, maybe they would be interested? Therefore would either drummers with the same problem, or anybody interested in making pre-international size heads, contact me at:

Nick Pretzel
270 Haggerston Road
London E8 4EP.
Tel: 01-254 3140.

Search for wood

Dear Stephen Delft: This letter is a plea for help. I've been trying to get hold of maple and rosewood (even sycamore and lime) but nobody could sell any reasonable quality of wood.

As you've probably guessed, I (and a few friends) intend to build a guitar. What we need is to be told where we can get the materials.

The guitar we intend to build is a copy of the Rickenbacker 4007 and as we have a problem with woods, we decided to make it a two piece construction. But, if so, could you suggest an appropriate joint (if you are familiar with the 4007 you may understand our problem).

Lastly, could you tell us dimensions of the neck and fret positions along the fingerboard.

William Gammage

West Haddon

Northants.

Stephen Delft replies: You should be able to obtain Maple and Lime from North Higham Sawmills, Paddock Street, Norwich or from Ritchett and Woollacot, Popham Street, Nottingham. You might also try Henry Venables Ltd, Doxey Road, Stafford.

I regret that the pressure of my own work prevents me from supplying detailed measurements on specific instruments which you may wish to reproduce. You might consider borrowing the instrument which appeals to you, or even hiring one for a day. If you can be very patient I hope to have a book and/or a series of articles out some time next year on the subject of making bass guitars. This will deal with constructional methods. Meanwhile I would not, in general, advise making a copy with a separate neck. The original design leaves little space for a neck joint.

Following last month's feature on "Recording Acoustic Guitar" with Tom Newman, we received this letter from Electro-Voice. Dear Mr. Newman: I have read your article in the July edition of International Musician on the subject of recording acoustic guitar. I note your usage of our electret condenser, the PL76 made by us.

I would like to reassure you that the electret capsule is made in the US and is not imported from Japan. We have found in the past that Japanese capsules did not live-up to the demands that we had put on electrets and to that extent we were forced to develop our own electret capsule which, as I am sure you are aware, includes a very complicated process of charging the electret diaphragm. This unique charging process has enabled us to produce electret capsules that are essentially immune to temperature and humidity variations, a definite weakness of early electrets.

L.R. Frandsen
Managing Director

We're gonna do it all over again!

Remember the hot, heady rockin' days of the 50's and 60's? Remember Hofner... the name that raised the roof in the music revolution of our times?

Well, we're back in the U.K. with new sounds for the 70's rock revival. 18 great guitars for the new rock era... we're gonna do it all over again!

You can create the sensational new Hofner sound in music stores all over the country. Or post off the coupon below for your own free collection of the latest full colour Hofner Catalogues and up to the minute price details.

Yes, good times are comin' back again... make the most of them with Hofner.



Hofner

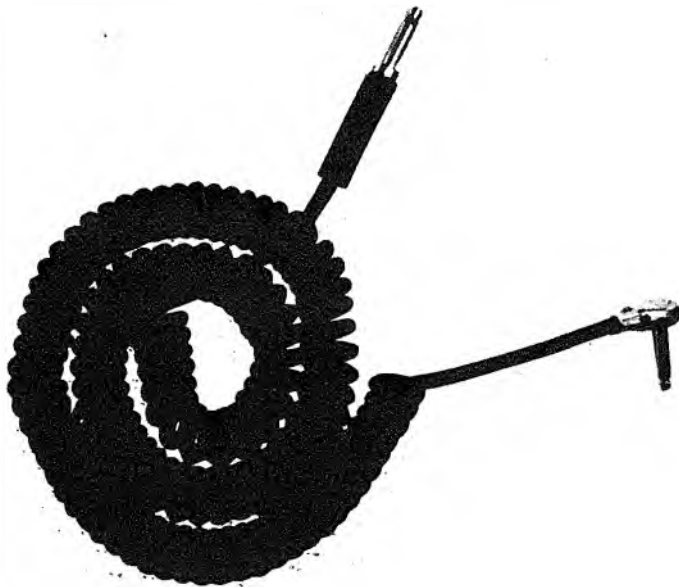
FREE!

Barratts of Manchester Ltd. Wholesale Division,
(Sole U.K. Distributors of Hofner Musical Instruments)
Tel: 061-872 0713

To: Barratts of Manchester Ltd 652 Chester Road,
Old Trafford, Manchester, M16 0RX.
Please send me full colour details of the complete
new Hofner collection—FREE.

Name _____
Address _____

SILENT PERFORMANCE



Cobra.

The first totally noise-free retractile guitar cord. Thick, heavy coils of tough cured neoprene cover a double-shielded cable manufactured by Belden to our exacting specifications. Tipped with rugged, strain relief phone jacks (your choice of solid brass military or standard steel Switchcraft plugs), Cobra comes with a full two year guarantee you'll never have to use. Your dealer has a complete selection of Cobra and other solid connections from Whirlwind Music, so get your Cobra from him.

It'll be one less guitar cord you'll have to replace one of these days.

whirlwind

P.O. Box 1075 • Rochester, N.Y. 14603 USA • (716) 663-8820

HERE NOW!

Guild B-301.

The Great New Long Scale Bass!

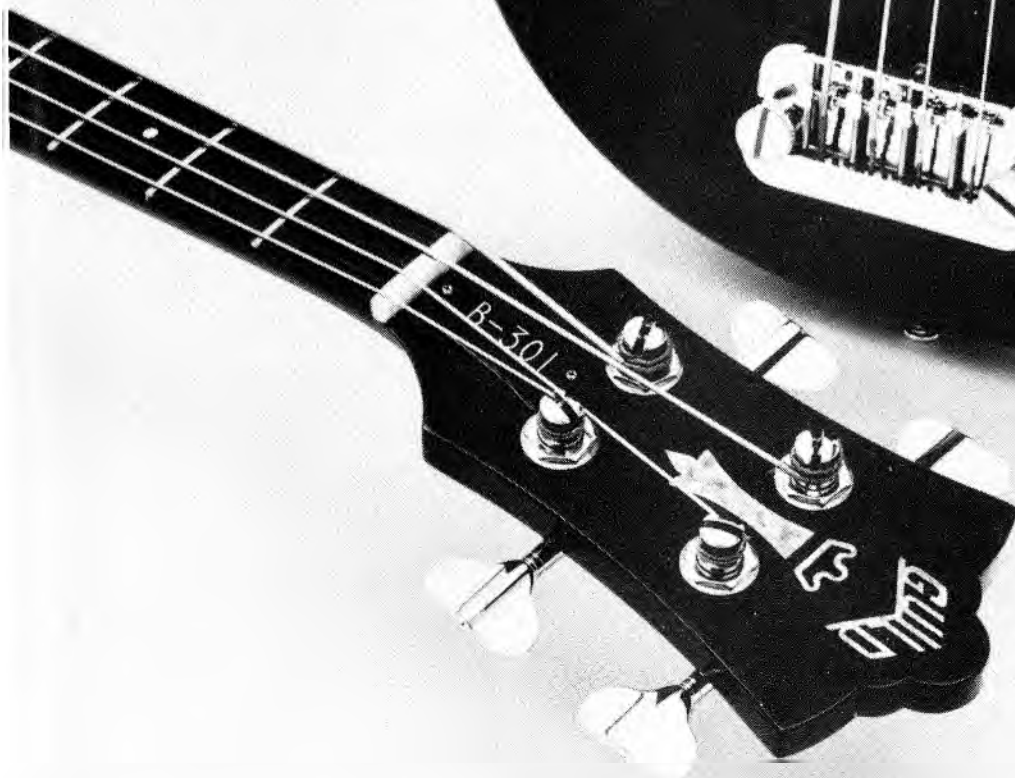
Throw away your ideas of what a bass should be like, because this is the one for now! Wide frets, curved fingerboard, Schaller M-4 machines, new pick-up, new solid brass bridge/tailpiece that gives you perfect intonation. Available fretless at no extra charge.

Guild B-301: More than just a pretty bass. It's the first in a whole new generation of solid bodies by Guild.

With 2 pick-ups: B-302.

Guild

MADE IN U.S.A.



Guild Guitars (U.K.) Ltd.
151 Portland Road, Hove, East Sussex.

In U.S.A., address:
Guild Guitars, 225 West Grand Street,
Elizabeth, New Jersey 07202.

Send Electrics Catalog 8402-EE.

Name _____ Age _____

Address _____

IN U.S.A.: PHONES—(201) 351-3002 · (212) 227-5390.
TELEX 138711 GUILD ELIZ A Division of Avnet, Inc.

In U.K., enclose large S.A.E. In U.S.A.,
for catalog and price list. include Zip.



The Keith Moon Exclusive

by Eamonn Percival

Since International Musician last spoke to Keith Moon two years ago, a lot has happened to him and The Who. This year the band celebrate 15 years together and have just released a new album, "Who Are You". With the purchase of a large part of Shepperton Studios, The Who are finding new creative directions while remaining very active. Their reported decision not to tour again has caused a great deal of controversy. I.M. recently spoke to Moon about drumming and the future of The Who.

Is there anything new in drums which interests you?

Yeah, the new synthesized drums. There's a company called Syndrum who make a set which comes with a sort of small computer. You can get bird calls and all different sorts of sounds. It's very good. Obviously, it's not like the real thing but the effects are quite startling if you use it set up next to a straight drum kit. It's great to go from one to the other, playing the same pattern, because the way it's reproduced through the Syndrum gives it a really different dimension.

Have you used them on record?

Yes, only experimentally, really. On the new album, they're in there somewhere. They're quite easy to control. When you set them up, you've got a chart which you work from. You set the decay and the rest and it's basically like a small Moog but connected to the drums instead of a keyboard. It can be a bit of a hassle if you're playing as it can be difficult to turn round and readjust the controls. They're

still experimental, for onstage use at least.

I don't really see a full synthesized kit. But they're great to add colour and that's important. I've got 16 drums in my kit and on every song I use a different set of four or five so eventually I've used all 16 drums. Sometimes I use the timpani, sometimes the timbale, sometimes I do runs that'll go right around eight drums and sometimes I'll just use bass drum, snare drum and hi-hat. I've got everything I need there. I can cover from a roar with the timpani right up to the smallest timbale which is about 6". That's why I have so many drums onstage because, with The Who, there's Pete who plays a lot of chords and John who plays very intricate bass figures that I work with and we have this empathy between us.

How much of the interplay between yourself and John Entwistle is worked out and how much is spontaneous?

Well, we rehearse the length of the song, whether it's verse, solo, middle-eight, verse, solo and then ad lib ending or whatever. We don't sit down and work out fills. Each of us works out our own part and then, when we put it all together and start to play, it comes out extremely powerful. You can't really work things out too much. We do certain things, certain build-ups and things but you can run into a danger of becoming an automaton if you do everything exactly the same each night. You just stop thinking and it ends up the same every bloody night but, with us, it's different. Sometimes I'll build up with timpani, sometimes I'll build up on cymbal or with a roll around

the kit. There are so many variations on each effect.

Your use of cymbals has always interested me. Quite often you will start a break on cymbals alone without the bass drum behind it, which is something alien to most drummers.

That gives me absolute top. If you hit the bass drum as well, you bring in some bottom; the cymbal gives you top and with both, you get something in between which is neither fully cymbal nor fully bass drum. Sometimes I do a single-stroke roll on cymbals for a "whoosh" effect. Again, we get back to colour. I believe very positively in colour in drumming. You know, there's so many drummers that can go through the routine but they don't add colour anywhere. They don't paint with the kit. That's what I like doing. I like painting, adding colour and effects and shocking people. Constantly, while I'm playing, I'm thinking two bars ahead. That gives me a chance to, if I'm in the middle of a roll, to do something I've already thought out so I can get out of the roll and into whatever I was already thinking about. Then when I'm there, I'm thinking another two bars ahead.

Having played certain songs for 14 years, do you find it difficult to actually think of new fills and breaks?

No, if I thought about it, I'd be in trouble. There are some parts that just naturally happen and I'll think of a figure that I'll put in at a particular point. A lot of them are very unconscious. Sometimes I'll think of a pattern and immediately forget it and store it subconsciously and then two bars later, I find myself playing it. Sometimes when we

go on tour, there might be a number where there is just a guitar and drum pattern or fill and it would be very easy to do the same thing every night but it doesn't work that way because the atmosphere is different at every place you play and the atmosphere on stage is different so you get different fills happening. I'm very adventurous with things like that, I don't like to remain static. I know when I've played a certain figure before so I try something else.

How much do you rehearse?

Well, as you know, I don't practice on my own. When we're going out on tour, we usually rehearse for three or four weeks and that's about three days a week, so we probably have about eight or nine rehearsals spread over a period. If you rehearse every day, you start getting cliched and you end up like an automaton, you can rehearse it to death. As far as we go, as long as we have the bare bones of a song, that's the way we rehearse. It's just to get the bones - the verses, solos and the general framework of the song. Then, within that framework, we're free to experiment and we all experiment. It's rather like plasticine, you've got the thing there but it's malleable. You can actually shape it and stretch it but you're still left with what you started out with.

Do you tune your drums yourself?

Yeah, I do. I work very closely with Bill, my roadie. I'll go round and tune the drums and then go out front while Bill plays them. I just tell him, "use the blunt end and whack it as hard as you can". I get the tuning right and if we have three or four dates

and we can't get to the hall in time for a soundcheck - I can't really walk on stage in front of the audience and start tuning the bloody things up - Bill knows how it should be tuned and he tunes it for me. After a show sometimes when the crew are breaking everything down, I occasionally go up and have a look around the kit and see if any heads need changing or anything. That happens quite a lot. We change the heads on every second show because I play very hard. What happens is the skin itself tends to lose its resonance after a couple of shows. You've thrashed the life out of it and it just gives up, really. We don't change all 16 drums, only the tom toms, snare drum, bass drum and one of the floor toms that I use a lot. The timbale are usually OK, but I suppose no skin stays on for longer than a week. They do lose their tone after a while and I do tend to hit them hard.

Do you have to work hard to keep fit?

Yes. I've just joined a health club because basically it's a question of keeping your stamina. You have to psych yourself up to it. I used to belong to a health club when I lived in Beverley Hills and I'd go there for a sauna and ride bikes and do press-ups and things. It is important to keep the muscles going. You need a lot of stamina to keep up a two-hour show. A drummer has to use more parts of his body than anyone else. I mean, it's not so important for John Entwistle to keep in top physical form because he just sort of stands there and basically just uses his hands. *(laughs)* He does a lot of hand exercises - a lot of wristwork!

The Keith Moon Exclusive

Your kit has grown since last time I spoke to you. How and why has it got bigger?

Well, I added some timbale. The kit changes really as the act changes. When we're doing some stuff from Tommy, there are some really big heavy drum breaks where I bring in timpani and the big floor toms and some timbale for light and shade, so you're not confronted by a big rumble. That can sound very dull, so I use the timbale mainly for accents. You have to hit them hard but then I hit all the drums pretty hard anyway. They're miked up through the PA anyway and, as long as I've got the kit sounding good, it's OK. I have my own PA system virtually so I have to check the sound that comes out of the drum PA. Bill will go round the kit and I'll listen and see what has to go up or down. So, it's not that important to whack 'em hard although I do whack 'em hard. I'm a very physical drummer. In fact, we have to use special mikes for the drums because the amount of air, from hitting it so hard, would produce this "popping" sound — like someone blowing into a mike. So they put windshields on and that helps the tonal reproduction.

Is there a nucleus of the whole kit that you tend to work from?

Yeah. It's obviously the bass drum, tom toms, snare and hi-hat. You see, with double bass drums, I have the hi-hat locked in a half-open position so you get a "swoosh". I don't actually use it as a hi-hat. Both my feet are on the bass drums. So, basically I get a good ride, hi-hat sound. They just bring in the crowbars! Everything is tightened down and nailed and strengthened with extra screws drilled in. Everything is double braced so I can get up, as we do at the end of the act, and actually stand on the kit without breaking the fittings or ripping them away

from the wood. Inside each drum I have a metal plate to support them so I can actually stand on top of the kit. The whole thing is solid as a rock.

What other drummers have you been listening to recently, or do you listen to other drummers?

Not really, I've been down to a couple of places like the Vortex and the Marquee and it's very odd because I see a lot of myself reflected in their styles. A lot of the atmosphere and a lot of the things they play. It's a bit brash, which I love. I think it's great, just thrashing away, but a lot of the drummers have not developed a definite style. That's something that comes from years of playing, I've picked up bits of Elvin Jones, Krupa, Philly Joe Jones — they were the sort of people I listened to for drumming.

The whole big band scene?

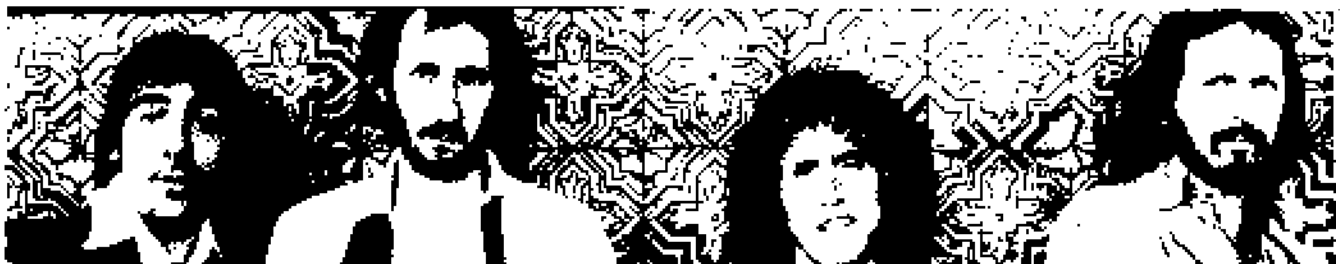
Yeah, mostly big band drummers. They're very dynamic, really wild.

Do you listen to the super-technicians like Cobham, etc.?

No, I'm not really into technical drumming. I don't play a technical drum at all. That Billy Cobham kind of control and discipline is incredible, beautiful but it just isn't me. Then again, I'd be lousy at playing what he does and he'd be lousy at playing what I do. I don't really get off on being able to do so many paradiddles. It doesn't impress me too much. I feel much more at home being very brash and spontaneous.

A few years ago Chris Welch said you deserved an award for "revolutionising rock drumming"

Well, you see, the drummer was always at the back and was very rarely noticed. He was the least photographed, the least interviewed. When The Who started, I began playing a constant drum solo throughout the act and Chris Welch saw us and probably



thought "I've noticed the drummer for the first time". In that era, nobody ever took any notice of the drummer. It was all guitars and singers. When I started twirling the sticks and standing up and those kind of things, nobody else did that kind of thing in rock. I'm a total extrovert, I love to be involved. I don't like this great big kit in front of me and the audience. I envy the guitarist who can go over and get that much closer to the audience. I can't do that, I have to sit at the back, so I acted in a different way and started to draw attention to the drums in a different way by acrobatics and all the tricks. So, a lot of people used to say "God, look at the drummer!" so I suppose there was a certain amount of revolutionising the drummer's role. Actually bringing the drummer out as an integral part of the group. The group wasn't just made up of a singer and a lead guitarist. You used to watch pop shows on TV, and they'd just show the singer, the rest of the band being just a backup group and nothing else.

When I started showing off a bit, the directors would notice. There were two great directors, Mike Lindsay-Hogg and Mike Mansfield and they started getting the camera on the drums. "Ready, Steady, Go" and "Top Of The Pops" really treated the band as a whole and, up until then, it was just Billy Fury and his group or Adam Faith and his group. Most of the TV in those days was only a couple of cameras, one trained on the front of the singer and the other getting a side shot of the singer and they never bothered with the rest of the group. They were always there as part of the furniture. It wasn't until Townshend started smashing guitars and I started smashing up the drums that the producers of the shows began to realise that

there was more than the singer in a band. They'd actually line up a camera for the drums, which was a first. People started to actually notice the drummer.

What's in the future for you and The Who?

Well, films basically. We've just finished "The Kids Are Alright", thank God! We've been working on that for two years. We've already started pre-production of "Quadrophenia", the casting and that kind of thing and we've got the money for it at last. That's the biggest headache — getting the money to do the picture. Roger's doing the McVicar film which will be done down at Shepperton and Pete's been working on the Lifehouse project for quite a while. There will also be soundtrack albums from these plus the studio albums. I often get asked about when The Who will be going on the road and the simple answer is, I just don't know.

Do you miss going on the road?

Not really, because I'm still involved in so much Who. Everything I do is still all to do with The Who. I enjoy going out on the road. I still get up now and again, and sit in with bands and play but as to putting together another road show and going out on a big tour . . . we've been doing that for 15 years and you can get a bit bored, especially when there are so many new directions opening up for us. We've toured and we've done our bit as regards live tours. I mean, let's not count it out but let's not put it too high on the agenda. There are no plans at the moment for a live gig. You have to look at it very carefully. If we do one here, we get insulting letters from America saying "You do one in London but you won't come to New York. We're just as big fans here as they are there!" You've got to be fair and go to New York,

you can't just do one-offs.

The Who, unfortunately or fortunately, attract a big audience and, unfortunately, once you decide to go on the road, you're committed to doing everywhere. If we were to do it, it would mean rehearsals, a new act, and we've got such a lot on our plate at the moment, it's impossible. For years, all we did was tour and now we've got the opportunity to turn Shepperton into a real working project with films, commercials, video theatres, rehearsal stages, our own production companies and all of that. That's as exciting for me as being on the road. I love playing drums but there is more that I can do. Playing drums got me in the position where I can now do other things but to go on the road again, I don't see it as being viable for quite a while.

Can The Who exist without live gigs?

Oh, yes. Very much so. The Who are still working but we're working in a different way. It's very difficult. You spend a lot of time on the road and people start screaming for a new record, you spend time in the studio on a record and people start screaming for a tour — you just can't win. You asked me last time about couldn't The Who do small clubs unannounced and the fact remains that it wouldn't work for us; if we went back on the road, we'd go back as THE WHO. It wouldn't be fair to the fans to do a small gig. I think you should do a gig in a venue where everyone can see you. You should give all the Who fans the same chance and not go to some out of the way place. You'd get people saying, "Bastards, what's special about that place?" I don't want that kind of criticism. You can see why it's so difficult. We've just got so much to do first.

WE ARE HERE



300-303 London Road (A13)
Hadleigh, Essex, England.

Large selection of secondhand gear at sensible prices.

GUITARS & BASSES

1958 Fender Strat, recent neck, tremolo, yellow finish	£325	sunburst	£139
1960 Gibson 330, original cherry finish, v. good condition	£275	Hayman 4040 bass, humbucking pick-ups, black maple neck	£110
1968 Gibson 330, dark sunburst finish, Schaller machines	£225	Vox organ guitar, 100% original - enough said	£150
Gibson Grabber II bass, natural finish, as new condition	£198	Ibanez 175 copy, 2 months old, immaculate with case	£210
Gibson EB3 bass, only 3 months old, cherry finish	£225	Antoria 175 copy, beautiful natural finish with Bigsby	£149
Gibson Les Paul Deluxe, v. good condition, cherry s/burst	£325	Antoria Telecaster Deluxe, humbuckers, walnut, maple neck	£210
Gibson Les Paul Custom, tobacco brown sunburst, DiMarzio's	£395	Burns Flyde, original but not the best respray job	£99
Gibson SG Special, 1974, walnut, excellent condition	£195	Harmony Meteor guitar, Bigsby, all original hardware	£39
Gibson SG Standard, 1975, cherry, Bigsby tail piece	£245	Hofner Violin bass, not the best, but look at the price	£29
Fender Telecaster blonde with rosewood neck, 1975	£165	Hofner/Burns 1960's bass, unusual but nice condition	£45
Fender Mustang bass, 1969, original candy with stripes	£135	Burns Vistasonic bass, all original with "Wild Dog" sound	£85
Fender Precision bass, sunburst with rosewood neck, original	£185	Framus Stratocaster, beech neck, maple fingerboard, excellent	£75
Fender Jazz bass, sunburst with rosewood neck, excellent	£225	Framus semi-acoustic, an oldie but goodie, sunburst	£35
Fender Jazz bass, 1974, maple neck on sunburst body	£239	Vox Precision bass, long scale, sound but tatty	£39
Gretsch Country Club, immaculate, gold fittings, s/burst	£295	Epiphone medium scale bass, "Nippon Origin" but a good buy at	£69
Gretsch Broadcaster, new condition, s/burst finish, fitted case	£295	Antoria long scale jazz bass, sunburst, nice condition	£69
Hayman 5050 bass (Jim Rodford recommended), cherry		Kimbara long scale jazz bass, immaculate maple finish	£99

DRUM KITS & PERCUSSION

1965 Ludwig 5-drums, oyster blue, excellent	£365
Gretsch 5-drums, rosewood, 24" bass drum	£395
Gretsch 5-drums, ebony finish, big sizes	£425
Premier 5-drums, pre-lock fast, blue pearl finish	£169
Premier 5-drums, lock fast stands and fittings, excellent	£225
Premier 4-drums, chrome snare, with stands etc.	£135
Sonor 4-drums, 7 ply shells, excellent condition	£195
Hayman 5-drum Showman kit, silver finish	£225
Hayman 3-drums, 26 inch BD, 14 inch and 18 inch toms	£139
Maxwin Stage 705 kit, all stands, red finish	£210
Rogers (English) 4-drums, excellent buy at this price	£110
Beverly 5-drums with stands, white pearl	£165
Olympic 4-drums, blue pearl, immaculate	£135
Olympic 4-drums, tatty, but so is the price	£75
Broadway 4 drums, old but well kept	£85
Just arrived - Rogers Londoner Five kit, swivomatic	£275
Stratford-Benson (who?) 4-drums, fablon finish, but	£59
Natal congas, set of three including stands	£165
Hondo wood congas, nice stand, wood shells	£29

Mexican tunable wood bongoes	£14
Pear Timbales with stand and cow bell, as new	£78
Rogers super ten snare drum, as new	£45
Ludwig 400, chromework sound	£49
Premier 2000 snare drum, immaculate	£39
Hayman chrome metal snare, rare	£45
Hayman Vibrasonic, wood shell choice of silver, black	£32
Maxwin chrome snare drums	£24
Several 20 inch bass drums, various makes and colours, from	£15
Carlton military chrome snare, lous	£29
Carroll's Bell Tree with case	£45
Large selection of secondhand cymbals always in stock; also stands, pedals, cases, percussion, equipment and accessories.	

NEW AMPLIFICATION

Ampeg V2 100 stack	£595
Ampeg VT40 comb0	£395
Ampeg VT22 comb0	£435
Custom Trucker lead	£98
Custom Trucker bass	£110
Custom Twin comb0	£129
Fender Twin Reverb 135w	£339
Fender Pro Reverb 70w	£279
Fender Super Reverb	£295
Fender Bassman 10 comb0	£245
Fender Bassman 135 top	£210
Fender Bassman 70 top	£179
Fender Bassman 135 cab	£199
Maine Musician comb0	£269
Maine 70 watt comb0	£179
Maine Standard top	£149
Maine Artist Reverb top	£189
Maine Altec bin	£245
Maine JBL bin	£225
MM Intermusic comb0	£199
MM Intermusic reverb comb0	£219
Organ Omeac 150 top	£139
Orange Omeac Reverb top	£159
Orange Omeac Deluxe top	£189
Roland JC120 comb0	£375
Roland JC80 comb0	£315
Roland JC60 comb0	£289
Vox AC30 valve	£210
Vox AC30 transistor	£125
Yamaha 100 lead comb0	£249
Yamaha 100 bass comb0	£295
Yamaha 50 bass comb0	£220
Yamaha 50 lead comb0	£175
Marshall - special offers for August	
Marshall 100 M/V top	£189
Marshall 50 M/V top	£145
Marshall 100 bass top	£189
Marshall 50 bass top	£145
Marshall 50 normal top	£145
Marshall 100 M/V comb0	£325
Marshall 50 M/V comb0	£225
Marshall 30 M/V comb0	£145
Marshall 4x12 100 watt	£155
Marshall 4x12 120 watt	£175
Marshall 2x12 100 watt	£110
Marshall 8x10 100 watt	£159
Marshall Superbins, pair	£199
Marshall Superbins + horns	£285
Marshall Mini Mixers	£65

NEW GUITARS

Fender Stratocaster	£255
Fender Stratocaster M/N	£279
Fender Stratocaster M/N trem	£295
Fender Telecaster	£219
Fender telecaster M/N	£239
Fender Telecaster Custom	£255
Fender Telecaster Deluxe	£289
Fender Precision bass	£239
Fender Precision bass M/N	£259
Fender Jazz bass	£275
Fender Jazz bass M/N	£295
Fender Mustang bass	£169
Fender Music Master bass	£110
Fender Music Master guitar	£99
Fender Bronco guitar	£125
Gibson Pro Deluxe	£495
Gibson Les Paul Custom	£495
Gibson Les Paul Standard	£465
Gibson Les Paul Deluxe	£395
Gibson Les Paul '55	£395
Gibson Melody Maker	£375
Gibson Explorer	£395
Gibson RD Artist	£545
Gibson RD Standard	£425
Gibson RD bass, Artist	£445
Kramer 350 guitar	£245
Kramer 350 bass	£295
Kramer 450 guitar	£349
Kramer 450 bass	£395
Kramer DMZ 1000 guitar	£425
Kramer DMZ 2000 guitar	£439
Music Man Stingray guitar	£345
Music Man Stingray bass	£365
Ovation Breadwinner	£325
Ovation Viper	£325
Rickenbacker 12-string	£395
Rickenbacker 480 guitar	£259
Rickenbacker 4001 bass	£395
Yamaha SG500	£295
Yamaha SG1000	£395
Yamaha SG1500	£395
Yamaha SG2000	£465
Yamaha SF500	£225
Yamaha SF700	£265
Yamaha SF1000	£295
Yamaha SB500 bass	£285
Yamaha SB700 bass	£325
Last but not least	
Peck leader guitar	£550

NEW DRUMS

Staccato 6-drums, white	£695
Staccato Concert tom-toms	£365
Ludwig Rock Machine, Steel	£875
Ludwig Big Beat, Bistalite	£750
Ludwig Power Factory, black	£985
Gretsch Blackhawk kit	£465
Gretsch Nameband kit	£395
Rogers Londoner Five	£525
Rogers Londoner Four	£398
Rogers Starlighter Four	£325
Autotune single headed kit	£395
Autotune 5-drum kit	£475
Premier 5-drums	£395
Premier 5, single-headed	£345
Premier 5 drums & stand	£425
Premier D717 7-drums	£495
Premier D717 with stands	£645
Pearl Rock kit	£495
Pearl Egyptian kit	£539
Maxwin Stage 705	£245
Maxwin Stage 405	£225
Maxwin 8+10 toms, stand	£45
Maxwin 12+13 toms, stand	£65
Maxwin 14+16 toms, stand	£89
Maxwin Timbales, stand	£59
Paiste cymbals always in stock	
404, 13 inch hi-hats	£26
404, 14 inch hi-hats	£29
404, 16 inch crash	£25
404, 18 inch ride	£28
404, 20 inch ride	£32
2002, 16 inch crash	£40
2002, 18 inch crash	£49
2002, 20 inch ride	£55
2002, 18 inch china	£69
2002, 14 inch hi-hats	£59
2002, 14 inch heavy rock	£69
602, 16 inch crash	£49
602, 18 inch crash	£59
602, 20 inch ride	£75
602, 18 inch flat ride	£59
602, 14 inch sound edge	£98
Also Zildjian and super Zyn cymbals	
Professional stands by Ludwig	
Professional stands by Pearl	
Professional stands by Rogers	
Special offer for August	
Rogers Dynasonic snare drums	£79

NEW KEYBOARDS

Fender Stage '73, new type	£645
Wurlitzer with stool	£445
Yamaha CP30 suitcase	£795
Yamaha SY1 synth S/S	£475
Roland EP30 suitcase	£425
Roland SH2000 synth	£595
Roland RS202 strings	£495
Solina string synthesizer	£495
Elka string synthesizer	£495
Elka string synthesizer	£325
Hohner K4 strings	£265
Vox electric pianos	£225
Korg micro preset synth	£265
Korg 700S synthesizer	£365
Korg poly 1000 synth	£625
Elgam Snoopy piano	£125
Echos and Effects	
Roland Space Echo	£345
Roland Boss Chorus	£85
Roland Boss Driver	£39
Roland Boss Flanger	£69
Roland AP2 Phaser	£45
Roland Sustainer	£25
WEM Copical Echo	£85
Memtree Computer Echo	£79
Melos Echo Units	£59
MXR Beve Box	£45
MXR Dynacomp	£59
MXR Phase 90	£65
MXR Phase 100	£89
MXR Noise Gate	£55
MXR Envelope Filter	£55
MXR Flanger S/S	£135
MXR Graphic Equaliser	£59
Resounder I Echo	£55
Resounder II Flanger	£55
Bell ADT unit mains	£85
Bell Flanger mains	£49
Bell Phaser mains	£39
Bell Fuzz mains	£28
Bell Sustain mains	£34
Bell power supply unit	£25
Vox Wah-Wahs	£16
Electric Mistress mains flanger	£65
Pulsar 2250 S-T-L unit	£25
Fender Volume Pedal	£29
Fender Blender	£45
Fender Phaser mains	£49
Korg guitar tuner	£38
Korg tuning standard	£79

CHASE
MUSICIANS

Buy Direct &
Save Money
Tel. 01-387-7449

An Open Invitation to a Night with **The Stars!**

**Every month throughout the year
top Musicians will demonstrate their
talent on the newest products
that make today's music.
And you can be there!**

DATE:	PRODUCT	DEMONSTRATOR
<i>Mon. September 4</i>	<i>ARP</i>	<i>Alan Townsend</i>
<i>Tues. September 5</i>	<i>Moog</i>	<i>Val Podlasinski</i>
<i>Wed. September 6</i>	<i>Roland</i>	<i>Adrian Lee</i>
<i>Thur. September 7</i>	<i>Yamaha</i>	<i>Pat Archer</i>

**Doors will open at 1 pm for general
display of products, formal show starts at 7.30**

All shows to be held at the

The Society Suite, Hotel New Ambassador, Upper Woburn Place, London WC1.
(Two minutes walk from Euston Station. Admission free. Refreshments available).

LONDON SYNTHESISER CENTRE
22 CHALTON STREET, LONDON NW1
(Off Euston Road, next to Shaw Theatre)

01-387 7449

LONDON AMPLIFICATION CENTRE
88 CHALTON STREET, LONDON NW1
(Off Euston Road, next to Shaw Theatre)

01-388 4094

CHASE MUSICIANS

Buy Direct &
Save Money
Tel. 01-387-7449

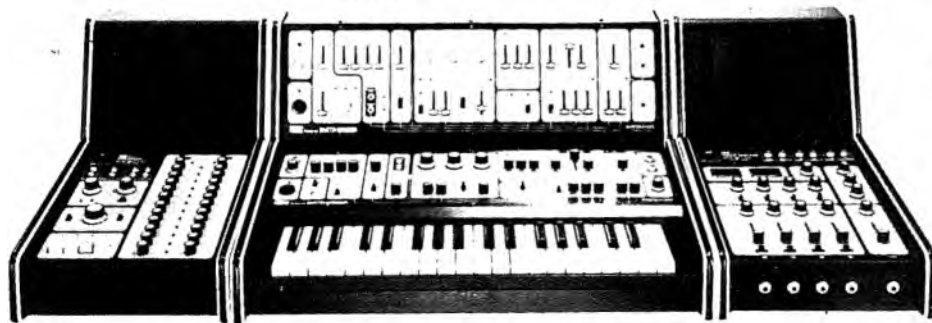
The London Synthesiser Centre present ROLAND



The Polyphonic Profit
Jupiter 4



Paraphonic 505



System 100



SH-1

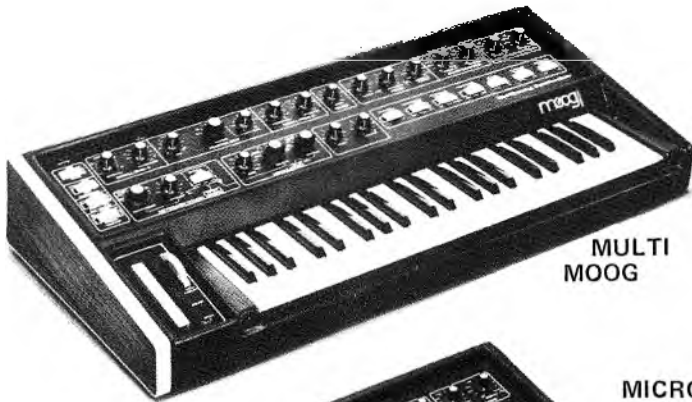
CHECK THIS LIST FOR COMPLETE RANGE

<p>Please check appropriate box</p> <p><input type="checkbox"/> Roland Synths</p> <p><input type="checkbox"/> Roland Strings</p> <p><input type="checkbox"/> Roland Electric Pianos</p> <p><input type="checkbox"/> Roland Amplification</p> <p><input type="checkbox"/> Roland Effects</p> <p>Other</p>	<p>Enclosed is £1 for a T-shirt/ £3 for a sweat shirt.</p> <p>T-shirt/sweat shirt</p> <p><input type="checkbox"/> Small</p> <p><input type="checkbox"/> Medium <input type="checkbox"/> Large</p>	<p><i>Dear Chase Musicians</i> 22/88 Chalton Street, London NW1. Off Euston Road</p> <p>Please send me details on items checked.</p> <p>Name</p> <p>Address</p>
--	--	--

CHASE MUSICIANS

Buy Direct &
Save Money
Tel. 01-387-7449

The London Synthesiser Centre present **MOOG**



MULTI
MOOG



POLYMOOG
KEYBOARD



MICRO
MOOG



MINI MOOG

CHECK THIS LIST FOR COMPLETE RANGE

Please check appropriate box

- Polymoog
- Polymoog Keyboard
- Mini Moog
- Micro Moog
- Multi Moog

Other

Enclosed is £1 for a T-shirt/
£3 for a sweat shirt.

T-shirt/sweat shirt

- Small
- Medium Large

Dear Chase Musicians

22/88 Chalton Street, London NW1.

Off Euston Road

Please send me details on items checked.

Name

Address

CHASE MUSICIANS

Buy Direct &
Save Money
Tel. 01-387-7449

The London Synthesiser Centre present YAMAHA



CS-50
Polyphonic Synth



CS-80
Polyphonic Synth



CS-60
Polyphonic Synth



CS-30
Synth



CS-30L
Synth

CHECK THIS LIST FOR COMPLETE RANGE

<p>Please check appropriate box</p> <p><input type="checkbox"/> Yamaha Synths</p> <p><input type="checkbox"/> Yamaha Electric Pianos</p> <p><input type="checkbox"/> Yamaha Strings</p> <p><input type="checkbox"/> Yamaha Amps</p> <p>Other</p>	<p>Enclosed is £1 for a T-shirt/ £3 for a sweat shirt. T-shirt/sweat shirt</p> <p><input type="checkbox"/> Small</p> <p><input type="checkbox"/> Medium <input type="checkbox"/> Large</p>	<p><i>Dear Chase Musicians</i> 22/88 Chalton Street, London NW1. Off Euston Road</p> <p>Please send me details on items checked.</p> <p>Name</p> <p>Address</p>
--	---	--

CHASE MUSICIANS

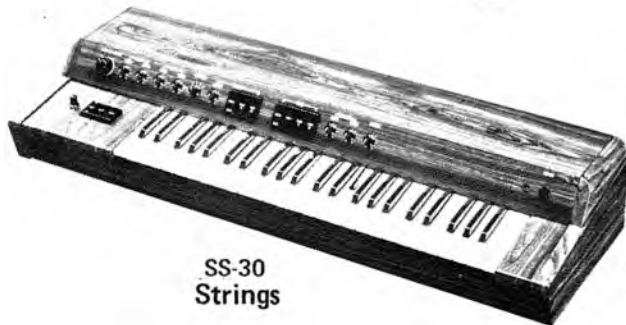
Buy Direct &
Save Money
Tel. 01-387-7449



CP-20
Elec-Piano



CP-70B
Elec-Grand Piano



SS-30
Strings



CP-30
Elec-Stereo Piano

YAMAHA AMPS



B212 Combo



CHASE MUSICIANS

Buy Direct &
Save Money
Tel. 01-387-7449

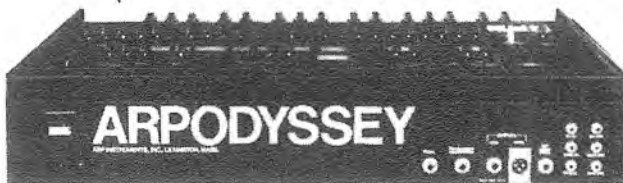
The London Synthesiser Centre present ARP



ARP 'AVATAR'



ARP 'AXXE'



ARP 'ODYSSEY'



ARP 'OMNI'

CHECK THIS LIST FOR COMPLETE RANGE

Please check appropriate box

- ARP "Avatar"
- ARP "Axxe"
- ARP "Odyssey"
- ARP Sequencer
- ARP "Omni"
- ARP 2600
- ARP PRO-DTX

Other

Enclosed is £1 for a T-shirt/
£3 for a sweat shirt.
T-shirt/sweat shirt

- Small
- Medium Large

Dear Chase Musicians
22/88 Chalton Street, London NW1.
Off Euston Road

Please send me details on items checked.

Name

Address

CHASE MUSICIANS

Buy Direct &
Save Money
Tel. 01-388-4094

The London Amplification Centre present **PEAVEY**



Peavey TNT



Peavey Classic



Peavey Session 400



Peavey Pacer



Peavey Backstage 30

CHECK THIS LIST FOR COMPLETE RANGE

Please check appropriate box

- Peavey Combos
- Peavey Heads
- Peavey Club P.A. Systems
- Peavey Guitar Cabinets
- Peavey Bass Cabinets

Other

Enclosed is £1 for a T-shirt/
£3 for a sweat shirt.
T-shirt/sweat shirt

- Small
- Medium
- Large

Dear Chase Musicians

22/88 Chalton Street, London, NW1.
Off Euston Road

Please send me details on items checked.

Name

Address

New London Synthesiser Centre Demo Evenings

As part of their steady programme to bring synthesisers within accessible reach of musicians, the London Synthesiser Centre is launching a comprehensive series of demonstration evenings.

Each month the LSC will host displays and demonstrations of keyboards from the major manufacturers. The first series of events take place in September when new ARP, Moog, Yamaha and Roland products will be shown on separate evenings.

The accent is to show off new equipment not yet available to musicians at large. The demo evenings begin on September 4 at the Society Suite of the New Ambassador Hotel in Woburn Place, London WC1. The sessions start at 1pm when there will be a general display of keyboards. At 7.30pm, demonstrators from each of the participating manufacturers will put products through their places.

ARP kick off the series of London Synthesiser Centre evenings when Alan Townshend will be playing both ARP and Peavey equipment. The next night, Moog demonstrator Val Podlasinski will be putting Moog gear through its paces. This will be followed the next day by Roland's Adrian Lee getting to grips with Roland equipment. To round off the first series of evenings, Pat Archer will be showing the versatility of Yamaha equipment.

The evenings will be free of charge and allow the chance for prospective customers to cross examine the experts on equipment as well as allowing the opportunity for musicians to try before they buy. Naturally, refreshments will be available.

All the participating manufacturers have promised that their latest models will be available for demonstration and inspection.

On the ARP front, Alan Townshend will go through the complete new range of synthesisers from ARP. These will include the Mark 11 versions of the Axse, Odyssey, 2600, Sequencer, Pro DGX and Avatar guitar synthesiser. He will also be demonstrating Peavey equipment and it is likely that the new Peavey guitar will be available for inspection.

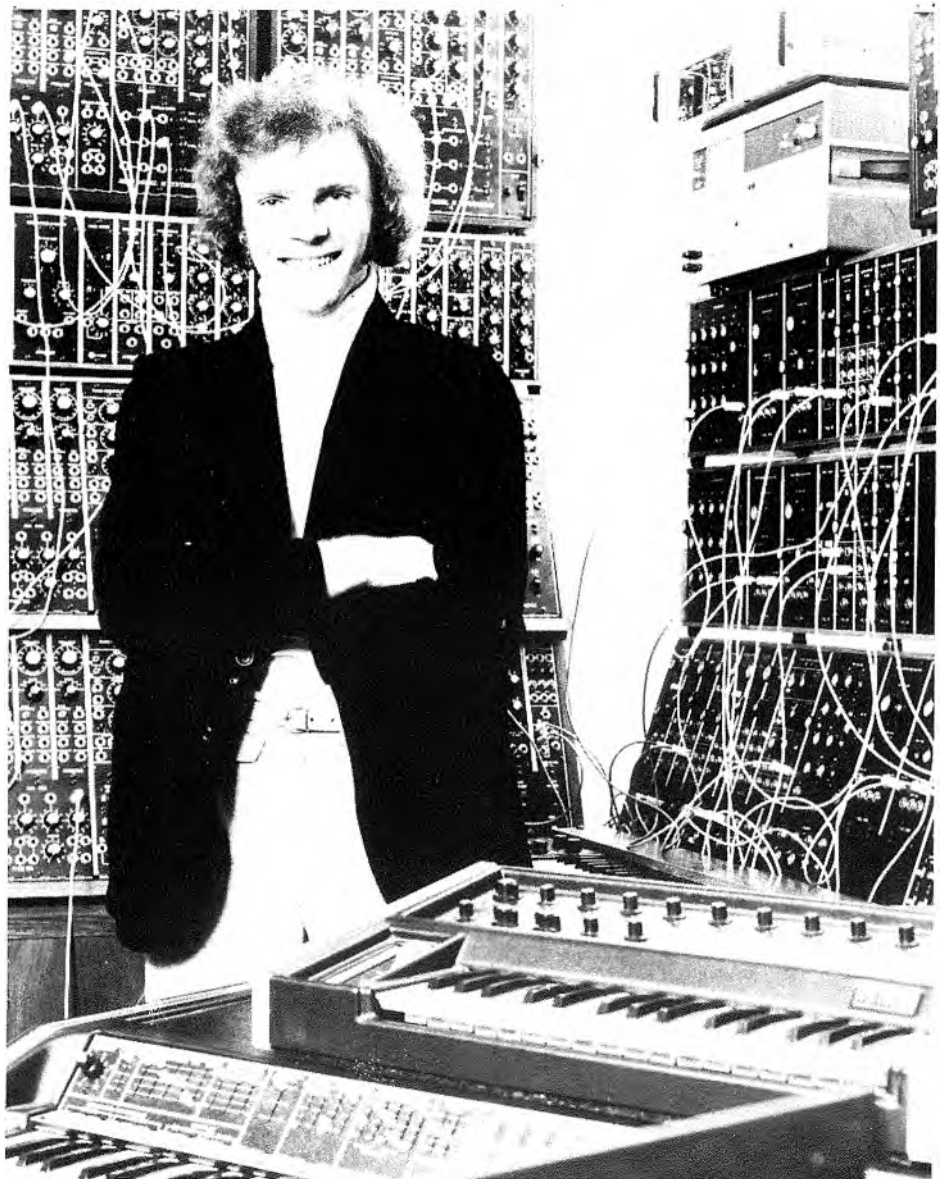
Keyboard and synthesizer expert Val Podlasinski will be on hand the next night to demonstrate the latest Moogs including the new Multi-Moog and Polymoog. Also on show will be the Micro Moog and Mini-Moog.

Roland fans will definitely not want to miss the Roland evening at the New Ambassador when Adrian Lee will be putting several new exciting pieces of Roland equipment through their turns. These will include keyboards like the SH1 and SH7 as well as the incredible Polyphonic Jupiter synthesiser which is equipped with no less than eight memory banks.

The RS5D5 string machine is guaranteed to create a lot of interest. Roland haven't lost sight of the fact that their established instruments are still in demand and, as such, the SH2000 and System 100 synthesizers will be seen and heard along with the now famous G500 Guitar Synthesizer.

Pat Archer is already well-known

from his previous demonstration evenings with the London Synthesiser Centre and Yamaha. He will be showing off new Yamaha keyboards such as the ultimate polyphonic synthesizer, the CS80. For those with less ambitious budgets, the CS60 and CS50 synthesizers will be checked out by Pat as well as the new CP70B electric grand piano and CP30 and CP20 keyboards. Yamaha have recently brought out a new string machine, the SS30, and this will be played by Pat along with the new Yamaha generation of synthesizers, the CS10, CS30 and CS30L. This is the first time these new products will be on open show to the public and represent an opportunity not to be missed.



Moog demonstrator Val Podlasinski

WARNING! You will become addicted to Crumar's T2 Organiser



Once you play a Crumar T2 you will become hooked. This is both a promise and a warning!

Crumar have packed every conceivable sound into the highly portable Organizer T2. This fabulous portable organ at last offers the professional and semi-professional musician the chance to carry with him an entire range of tones needed to fill out and fill in every group sound ever imagined. In the old days musicians would saw bulky concert organs in half and attempt to achieve merely a fraction of the sounds that appear

on this model. In addition the Organizer T2 features many sounds only possible through the use of solid state electronic. And, most importantly, full drawbar control has been maintained.

Breakdown and setting up time has been reduced to the minimum and from the twin 61 note keyboards every specification is built to professional standards.

Features include 9 flute drawbars, pitched at 16ft, 5thirdft, 8ft, 4ft, 2two thirds ft, 2', 1 three fifthsft, 1 third ft, and 1'. Percussion at the same footage, a decay

time drawbar and a percussion volume drawbar and four preset voices. An 18 note pedal board is provided (C12F2) and the organ swell pedal is also housed in this unit. Pitch adjustment is provided, the overall weight is only 94.61lbs.

Please rush me details of the T2 Portable
Name

Address

.....
.....

Trevor Daniels & Co., 65 Langdale Rd.,
Dunstable, Beds. LU6 3BX

BUZZ + BUZZ + BUZZ +

+ BUZZ + BUZZ + BUZZ



On the road with No Junction

No Junction are a young five piece band (their average age is 20) who specialise in playing raw funk. They formed just a year ago and the line up comprises Chris Squelch (vocals/percussion), Al Stirling (guitars), Kevin Flynn (guitars/vocals), Alan Hope (drums) and Neil Flynn (bass).

All their material is original and so far their gigs have been restricted to streets, parties and pubs in London, although they recently played Upstairs at Ronnie Scott's, where they played an excellent set. The band now have management, but are still looking for gigs so anyone looking for a really powerful funky band ring Graham on 01-499 3464 or Paddy on 01-439 8655.

Words on the Nurds

It seems that somebody down in Portsmouth has been watching too much of "Happy Days" by naming their band The Nurds. The line up is Martin Jacks (bass/vocals), Pete Rossi (guitar/vocals), Pete Sawyer (lead vocals/rhythm guitar) and Tim Nowell (drums).

They have been together about a year and drummer Tim says the music is a combination of R&B standards, blues and their own style New Wave material. Gigs would be greatly appreciated, if you can help ring Martin Jacks on Cosham 8787.

Smartie people

Do you remember Pub Rock, the forerunner of punk which spawned such top acts as Graham Parker, The Rods and Dr. Feelgood? Well one of the many excellent bands who didn't make it were Buster Crabbe.

The nucleus of that group have now resurfaced under the name of Smarties and are hoping to succeed where the Crabs failed. The original line up of Steve Bonnett (lead guitar/vocals), Neil Brockbank (bass/vocals), Mike Gaffey (drums/vocals) have been joined by Glen Skinner (guitar/vocals).

The music is deeply influenced by early Seventies pop, particularly Chairman of the Board, and they have a single out on the Wanted record label called "Saturday Night", one of their popular live numbers. The band will be doing a variety of gigs in and around London and they are definitely worth catching.

Smarties



O.K.

No Junction



Samson

It's always nice to hear of bands who have been mentioned in this column doing well and Paul Samson rang us up recently to tell us about the progress of his band. Named simply Samson, we featured them some time ago and since then they have been gigging regularly all over the country and now have their first single out called "Telephone". Paul says that the band will be concentrating on gigs outside London.

Talent Search

Peter Meisel of Hansa Productions, Ray Williams of Gas Songs, and Geoffrey Heath and Eddie Levy of Heath Levy Music are uniting in an extensive search of Great Britain and Ireland for young talent.

They are on the look out for fresh new talent, whether it be in the form of male or female solo artistes or groups. They are prepared to search the country high and low, and auditions will be held in major areas over the next few months.

Anyone who feels that they have a future as a recording artist is invited to send tapes to Ray Williams, 184 Regent Street, London W1, or by phoning him on 01-439 7731.

Every tape received will be listened to and selected acts will be recorded and their show videoed before a final decision is made.

Jazz is OK

Jazz groups are something of a rarity these days, good ones are even rarer which is why you should look out for OK playing down your way. They are based in North London and comprise Diana Wood (vocals/perc/alto sax), Joy Askew (piano/vocals/tenor sax), Henry Thomas (bass), Mark Wood (guitar) and Rovis Jared (drums/perc).

The feel is American with much soloing but they also possess two powerful female vocalists who are just as happy scatting be-bop lines over a Charlie Parker number or belting out a Ray Charles blues. In their set you're likely to hear influences ranging from Billie Holiday to Herbie Hancock by way of Charlie Mingus, Dave Brubeck and Ella Fitzgerald.

The band have had many well known jazzers in with them including John Ethridge, Steve York and Dick Hechtall-Smith. They are currently lining up gigs for autumn although they are regulars at the Dublin Castle pub in Parkway, Camden, NW1.

Expanding the Boundaries of Creativity

New levels of musical imagination present themselves to the creative musician with the application of the MXR Digital Delay. The diverse effects offered by the Digital Delay, when used with individual instruments, vocals, PA and recording mixes, offer a whole new range of musical creativity.

The MXR Digital Delay gives the musician a tool for creative application that is unparalleled in versatility, precision and ease of operation. The MXR Digital Delay is designed for a wide variety of applications including; amplified musical instruments, vocals, PA and recording mixes. The basic unit delays a sound between 0.08 milliseconds and 320 milliseconds, fully variable while retaining the dynamic range of the program source. The delay range is expandable to 1280 milliseconds in increments of 320 milliseconds by means of up to three additional plug-in memory boards. These boards are available from MXR and may be installed by the user.

Effects that can be obtained with fixed time delays include echo, vocal doubling and hard reverberation. The MXR Digital Delay contains sweep circuitry which allows additional effects such as flanging, vibrato, pitch bending and frequency modulation. The MXR Digital Delay is also capable of repeat hold (infinite non deteriorating regeneration).

Rack mountable for sound studio installation, it is also available with an optional road case for onstage use or location recording mixes.

MXR's Digital Delay can lead the way to new possibilities in creative sound at a price considerably lower than any comparable delay.

For more information see your MXR dealer.

Atlantex Music Ltd.,
16 High Street,
Graveley, Hertfordshire.
Telephone: 0438 50113.

MXR Professional Products Group





sawicki's SOUNDCHECK

Mark Sawicki is an M.Sc. (Eng.) consultant in electronics who also designs and builds electronic equipment.



TEST ON: The Redmere Soloist Combination Amplifier

DATE: September 1978

PRICE: (excl. VAT) £499 (combo); £410 (head)

Introduction

The Redmere Soloist is a very special instrument amplifier. In fact, until now, there has been no similar piece of equipment on the musical market – it is more like a Sound Multiprocessor than just an advanced conception of contemporary musicians' amplifiers. For example: three completely different tonal channels, with musicians' amplifiers. For example: three completely different tone channels each with three band equalisation and volume/master controls, a five band graphic EQ, Hammond-type spring Reverb, a Flanger, a Chorus and a Sustain/Compressor/Wah-Wah circuit with an effective noise gate which is a type of automatic volume control and noise reduction control system. Click-free touch switches have been used for both the channel selection and for the effects section. Other facilities include outputs marked Auxilliary/Slave and 600 ohms direct injection.

"The Soloist" is a combination amplifier and uses a pair of 12" Celestion drivers (15 ohms each), and also has the facility for adding extension speakers if more power output is required.

Construction

The whole system's subcircuits are basically designed as separate entities on nine medium sized fibre glass PCB's. Four

inputs are provided – two normal and two bright, with "LO" inputs being both less sensitive and of lower impedance. All three channels possess specially developed tone controls distortion circuits (see the Performance Table), simulating as Redmere claims:

"Channel 1 – Very well known American Valve amplifier usually bought in 'twin reverb' form.

Channel 2 – One of the most famous makes of British valve amplifiers, used by many rock bands.

Channel 3 – Another type of early British valve amplifier and usually found in a 30-20 watt combo form."

Channel 1 offers a very clean sound with an abundance of treble boost and comprehensive tone controls. This should be ideal for country music and most keyboard instruments. Channel 2 is relatively clean up to about 30 watts but progressively gets more distorted when it goes up to 100 watts. At high volume, this channel gives the raunchy bluesy sound which has dominated rock and heavy metal music since the early Sixties.

Channel 3 provides extra attack and distortion occurring at odd numbered harmonics similar to old valve combos whose actual power output was not really very large but whose sound projection capabilities were excellent. Redmere claims that at low volume, this channel gives a very lively sound with plenty of top and a funky bass response; at high volume, the distortion increases together with an exceptional amount of treble projection and powerful deep bass.

The power amplifier section will

deliver around 200 watts RMS into 4 ohms speaker loads. Operations under impedances of less than 4 ohm conditions are restricted and not recommended. The output stage power transistors are four RCA 2N 6254's mounted on large black anodised aluminium heatsink, and the whole power stage is connected to the rest of the system through a 12-pin strip connector.

Most of the in/out signal connections are of a high quality screened cable and the power supply transformer is separated from the other subassemblies, screened by two metal sheets. Protection on the supply side consists of a mains 3A/220-240v or 5A/125-110V fuse link and a pair of 3A/1" glass fuses are fitted internally on the DC side, smoothed by two large 6800uF/63VDC electrolytics.

Reverberation uses the Accutronics 3-spring module, controlled by one horizontally mounted slider level potentiometer and a touch switch. The graphic EQ covers the most useful part of the frequency spectrum for instruments ranging from 80Hz to approx. 6 KHz with centre frequencies at 80Hz, 240Hz, 700Hz, 2 KHz, 6 KHz plus about 15 dB of boost and cut. Four "touch" switches with on/off LED lights are situated on the right of the control panel.

The Flanger circuit is controlled by rotary potentiometers i.e. speed and depth, calibrated 0-10 and a 48mm regeneration slider. Apart from flanging, a lot of other effects are available: to name just a few – Vibrato, Rotary sound/Leslie effect, Doppler effect, etc. The Chorus "box" contains similar speed and depth

PARAMETER	RESULT	TEST CONDITION	COMMENTS
Specific power o/p WATTS (RMS) Ref. 1 KHz	Ch.1		
	210.25 W RMS	Onset of clipping into 4 ohms	The Redmere Soloist is equipped with 2x12" Celestion speakers wired internally for 8 ohms operations. The power amplifier stage is equipped with four RCA 2N 6254 devices mounted on a large black anodised aluminium heatsink. Operations with an external speaker (1/4" jack on rear panel) are possible, however not recommended below 4 ohms total impedance.
	136.12 W RMS	Onset of clipping into 8 ohms	
	68.76 W RMS	Onset of clipping into 16 ohms	
	Ch.2		
	162.25 W RMS	Onset of clipping into 4 ohms	
	105.12 W RMS	Onset of clipping into 8 ohms	
	58.56 W RMS	Onset of clipping into 16 ohms	
	Ch.3		
98.25 W RMS	Onset of clipping into 4 ohms		
101.53 W RMS	Onset of clipping into 8 ohms		
39.06 W RMS	Onset of clipping into 16 ohms		
Total Harmonic Distortions THD% Ref. 1 KHz	Ch.1 %		THD as well as Tone Control circuit in the Soloist are derived as described earlier from three well known valve constructions being widely accepted as "valve quality" in musicians and trade standards. Basically Ch.1 offers low distortions suitable for clean playing. Ch.2 - mild 2nd harmonic distortions and extra treble, Ch.3 - provides at high levels quite a heavy sound, extra bass and funky sounds.
	1.25	@ 120 W RMS into 8 ohms	
	0.95	@ 100 W RMS Ref. 1 KHz	
	0.65	@ 70 W RMS	
	0.61	@ 50 W RMS	
	0.49	@ 20 W RMS	
	0.40	@ 10 W RMS	
	Ch.2 %		
	8.25	@ 100 W RMS into 8 ohms	
	7.15	@ 70 W RMS Ref. 1 KHz	
	6.93	@ 50 W RMS	
	6.30	@ 20 W RMS	
	5.78	@ 10 W RMS	
	5.61	@ 5 W RMS	
	Ch.3 %		
17.98	@ 100 W RMS into 8 ohms		
15.03	@ 70 W RMS Ref. 1 KHz		
11.50	@ 50 W RMS		
2.41	@ 20 W RMS		
2.41	@ 10 W RMS		
2.38	@ 5 W RMS		
Input Sensitivity -mV (RMS) Ref. 1 KHz into 8 Ohms	Ch.1 "Normal"		The Soloist is equipped with 4x 1/4" jacks on both Normal & Bright channels where each of them possess High and Low sub-input in addition.
	28.3 mV RMS	Ref. Hi I/P	
	56.2 mV RMS	Ref. Lo I/P	
	Ch.1 "Bright"		
	19.1 mV RMS	Ref. Hi I/P	
	41.1 mV RMS	Ref. Lo I/P	
	Ch.2		
	Ch.2 "Normal"		
	6.3 mV RMS	Ref. Hi I/P	
	12.5 mV RMS	Ref. Lo I/P	
	"Bright"		
	5.1 mV RMS	Ref. Hi I/P	
9.4 mV RMS	Ref. Lo I/P		
Ch.3			
Ch.3 "Normal"			
27.6 mV RMS	Ref. Hi I/P		
55.8 mV RMS	Ref. Lo I/P		
Ch.3 "Bright"			
20.3 mV RMS	Ref. Hi I/P		
43.5 mV RMS	Ref. Lo I/P		
Tone Controls Range Swing in (dB)	Ch.1 "Bright"		The design of the Soloist tone control circuits (in all 3 instrument channels) is a logical consequence of the simulation of the corresponding valve amp tone circuit. The accuracy of the simulation is fairly good as it nearly works as well as the original networks. This applies also to the interactions between the particular controls.
	15.2 dB swing	Bass @ 50 Hz; Middle, Treble - flat	
	27.8 dB swing	Middle @ 1 KHz; Treble, Bass - flat	
	39.3 dB swing	Treble @ 10 KHz; Bass - flat, Middle - Min	
	Ch.2 "Bright"		
	14.7 dB swing	Bass - 50 Hz Middle, Treble - flat	
	9.8 dB swing	Middle @ 700 Hz, Bass, Treble - flat	
	43.1 dB swing	Treble @ 10 KHz, Bass, Middle - flat	
	Ch.3 "Bright"		
	22.5 dB swing	Bass @ 100 Hz, Middle - Min, Treble - Max	
	13.2 dB swing	Middle @ 1 KHz, Treble, Bass - flat	
	30.1 dB swing	Treble @ 10 KHz, Bass - flat, Middle - Min.	
Graphic EQ swing in (dB)	28.7 dB swing	@ 80 Hz EQ Band No. 1	The 5 band graphic EQ covers the most useful part of the frequency spectrum for the majority of popular musical instruments. Manufacturer claims ± 15 dB which is absolutely sufficient to modify characteristics of an instrument. Nice & ideally symmetrical.
	27.5 dB swing	@ 240 Hz EQ Band No. 2	
	27.6 dB swing	@ 700 Hz EQ Band No. 3	
	25.3 dB swing	@ 2 KHz EQ Band No. 4	
	29.1 dB swing	@ 6 KHz EQ Band No. 5	
Capacitive Load Test	OK	2uF + 8 ohms dummy load	Very good stability margin
	Open Circuit Stability Test	OK	Volume/Master - max
		T/C - max, Dummy load removed	
Short Circuit Test	30 seconds	Short circuit at full drive on Channel 1	Did not blow fuse and worked normally after short circuit was removed
Effects:	A) Reverb	subjective test only "Accutronic" 3 spring delay line unit	Very good reverb effect with slider level control.
	B) Sustain/Compressor	subjective test only Tested with Fender Rhodes piano	Very useful facility. The colour control acts as fixed wah wah effect and boosts certain frequencies.
	C) Flanger	subjective test only "Reticon" (Bucket Brigade based design)	Extremely good flanger. Gives a very nice "skying" effect and is very close to studio flanging
	D) Chorus	subjective test only Tested with electric guitar only	Beautiful effect which enhances any instrument. Good simulated 12-string sound available.

controls and an effect slide, while a stereo output is available on the back panel. A ¼" jack socket allows connection to a twin-channel slave set-up which will then simulate a "two instrument" sound coming from two different sources.

Finally, a Sustain/Compressor box with colour and effect controls is incorporated and acts as a fixed Wah-Wah type pedal, boosting certain frequencies before the sustained circuit. When "Colour" is set at maximum, it has very little or no effect, as the operational instructions state. Also on the far right, above the illuminated ON/OFF rocker switch, is the Noise Gate box. This device virtually switches off the effects units by dramatically reducing their gain when no signal is passing through the amplifier preamplifier section. This cuts out any unwanted background noise from the effects section which may be noticeable when the main music signal is not being amplified. The

Conclusion

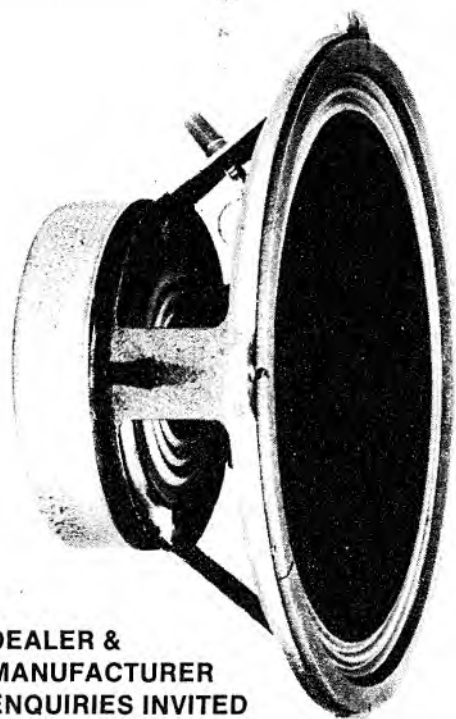
The amplifier is carefully designed and its control panel looks more like the front side of a synthesizer than an amplifier. The "touch" plates are made of brushed stainless steel with a red state LED indicator. The whole cabinet looks robust and sturdy and is made from top quality materials.

One practical point is that all effects can be programmed by a remote 3-button, 7-way footswitch unit which plugs in via a multicore cable into a special 9-way RS socket on the back panel and the footswitch over-rides the front panel touch switches.

I feel there is quite a big market for an amplifier like The Soloist with such advanced sound multiprocessor functions and high power levels. Redmere can be proud of this. Amongst the "Bucket Brigade" based effects, one or two small points could be slightly improved or

extended. On the flanger side, with slow speeds but relatively high depth control settings, a comb-filter response at high regeneration settings is available, which produces the familiar "skying" effect. Perhaps it would be more practical to increase the flanger range at high frequency for better "skying" and thus minimise the low frequency, which is used less frequently. This should improve the Bucket Brigade clocking noise performance, simultaneously reducing the overall noise of the unit. When testing the Soloist with my guitar, the tonal quality and wide range of sounds available surprised me. Who knows, maybe the Soloist will start a new trend in amplification gear - "multiprocessor amplifiers". The concept of giving you three different valve amplification simulation circuits in addition to many effects without the usual complex spaghetti network of wires/leads is really ingenious.

Richard Allan High Power Units



**DEALER &
MANUFACTURER
ENQUIRIES INVITED**

	HD12PS	HD12 (Illustrated)	HD12 SUPER
POWER HANDLING WATTS RMS CONTINUOUS			
	50	100	100
SENSITIVITY 1 WATT INPUT	99dB	96dB	97dB
FLUX DENSITY GAUSS	13,000	13,000	17,000
FREE AIR RESONANCE H2	30	55	55
RETAIL PRICE PLUS VAT	£15	£22	£29.50

ALSO AVAILABLE 50 WATTS 8" BEXTRENE
50 WATTS 10" PAPER
100 WATTS 15" PAPER

ALL AVAILABLE IN 8 OR 15 OHMS AND TWIN CONES
FOR FURTHER DETAILS WRITE OR PHONE:-

Richard Allan

Sales Office RICHARD ALLAN LTD, BRADFORD ROAD, GOMERSAL, CLECKHEATON, YORKS, BD19 4AZ, ENGLAND
TEL. CLECKHEATON STD (0274) 872442/3, CABLES "ACOUSTICS" BRADFORD, TELEX CON CAB 51112

Technical Advice D. J. PEERS ESQ, RICHARD ALLAN LTD, 559 BRADFORD ROAD, BIRKENS HAW,
BRADFORD, WEST YORKS, ENGLAND. BD11 2AQ. STD (0274) 683027

TEST ON: Oberheim OB-1

DATE: August 1978

PRICE: £1,240/\$2,500

simmons' SYNTHCHECK

The OB 1 is made in America by Oberheim Electronics Inc. and is one of the "new breed" of synthesizers which have memories i.e. a particular sound can be stored away, to be recalled instantly at the press of a button. This, to my mind, is the ideal type of synthesizer - fully variable but with a number of pre set sounds, each of which can be set up to the player's own taste. (You're not lumbered with someone else's idea of what a trumpet sounds like.) Apart from the memory, the synthesizer is fairly conventional, with two VCO's (Voltage Controlled Oscillators), two ADSR (Attack, Sustain, Release) envelope generators, one VCF (Voltage Controlled Filter) and one VCA (Voltage Controlled Amplifier).

Voltage Controlled Oscillators

The first thing that one notices when tuning the oscillators is that the frequency controls do not change the pitch of the oscillators smoothly. As the control is turned, the pitch changes in a series of "steps", each step being a fraction of a tone. This gives the memory precise voltage levels which can be stored and recalled from the memory section. (All the controls whose positions can be stored in the memory work in this way.) Precise tuning of the oscillators inside these steps is obtained by using the "fine tune" controls.

The oscillators can be tuned over four octaves and this range can be increased by use of the transpose control. The waveforms produced by the oscillators are (1) Pulse waves (the width of the pulse can be varied by the waveform control from a narrow pulse to a 50% square wave) and (2) Sawtooth (again, the shape of the sawtooth can be varied from triangle through to sawtooth).

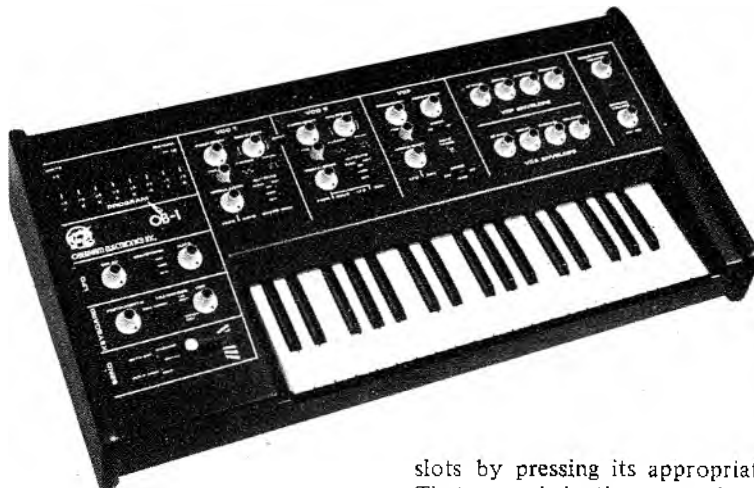
The pitch of VCO 1 can be modulated by the LFO (low frequency oscillator) to produce Vibrato, or the LFO can be switched to modulate the waveform (dynamic pulse) producing a "phasing" effect, similar to that of two oscillators being slightly out of tune. Pitch and waveform modulation of VCO 2 can be either by the LFO or by one of the ADSR generators.

Each oscillator produces a square wave an octave below its fundamental (on Moogs, this is called 'doubling') and this signal and the fundamental produced by the oscillator are fed into the VCF via two three-position switches marked ON, -3dB, OFF. This enables mixing of the various waveforms (albeit somewhat limited). VCO 1 can be "cross-modulated" by VCO 2 (the output of VCO2 is fed to the control input of VCO 1). The effect of this is similar to a ring modulator, producing gongs and bells.

VCO 2 can be "synched" to VCO 1, for perfect tuning, or when VCO 2 is forced out of tune (either manually or by modulation by the ADSR generator) it

Dave Simmons is an expert on synthesizers. He understands them both musically and technically and his background has made him uniquely qualified to be I.M.'s Synthesizer Consultant.

Dave's a musician and a technician. His musical achievements include playing in David Bedford's "Odyssey" and his technical background included a thorough training in practical and theoretical electronics.



produces a scanning of harmonics, which is very useful for guitar-like sounds and other "sweeping" effects.

Voltage Controlled Filter

The filter has four variable controls - cut-off frequency fine and coarse, resonance and modulation (modulation can be by the ADSR generator or the LFO) and can be used in two modes, '2-pole' or '4-pole'. The difference is that the 2-pole is harsher than the 4-pole which produces a cleaner, rounder sound. The keyboard control voltage can be fed into the filter so that the filter can be "played" as a third oscillator when the resonance control is at maximum (self-oscillation - producing a sine wave). Noise can be switched into the filter via a three position switch for wind or surf effects.

Envelope Generators and Voltage Controlled Amplifier

Two envelope generators of the ADSR type are supplied - VCF envelope (also used for modulation of VCO's) and VCA envelope. Attack, decay and release times are variable from zero to about eight seconds. The release time of both envelopes can be switched to zero (giving instant cut-off once a note is released) by a switch at the left hand side of the keyboard marked "Env Reset". The VCA envelope can be by-passed so that the synthesizer produces a constant tone.

Programming

All of the controls and functions that I have mentioned can be stored in one of the eight "memories". Loading the memory couldn't be simpler. Press the Manual button (all the programming buttons are of the non-mechanical "touch" type, and are accompanied by LED indicators to show which function has been selected), set up whatever sound you want with the front panel controls, press the "Write" button until the LED flashes and select one of the eight memory

slots by pressing its appropriate button. That sound is then stored away until recalled by pressing the button again.

Manual Controls

There are a few controls on the left hand side of the keyboard that cannot be stored in the memory - another good idea as it gives a certain amount of flexibility to the pre-set sounds - these are LFO speed and Delay (delayed vibrato etc.), LFO Shape (since, square and sample and hold), Portamento, Envelope re-set, Transpose, VCF frequency and bend controls. Pitch bending is achieved by a calibrated lever, pull towards you to bend up - push away to bend down. It returns to centre in the "hands off" situation and can be switched to control VCO 1 and 2 or VCO 2 only. The spread can be switched to bend a tone or octave at maximum, or it can be used to feed the LFO and noise to the oscillators (I would prefer it to be Bend Up in one direction and add Vibrato in the other direction).

Layout

The synthesizer has a three-octave (C to C) keyboard and the layout is great with all the controls one would need to get at quickly at the left hand side, apart from the output volume which, for some reason, is on the right hand side - a bit awkward to adjust whilst playing right-handed. The all-metal chassis is black with veneered end-panels and white lettering. On the back panel are all the normal interface connections you would expect to find enabling hook-ups with sequencers and other units.

Conclusion

Obviously the big "plus" for this machine is its programmable memory, enabling you to obtain the sounds of your choice quickly and easily from one machine. It does all that you would expect from a single voice, lead-line synthesizer and is not much more expensive than one without the memory.



Lumley's KEYBOARD CHECK

Robin Lumley is a record producer and keyboard player working mainly in London. His first major venture in the business was as keyboard man in Bowie's Spiders and he later formed a writing partnership with Jack Lancaster.



TEST ON: Caravelle T249 Portable Organ

DATE: August 1978

PRICE: £1,490 inc. VAT

Introduction

Logan Electronics are a brand new English company of distributors, based in Hampshire, and have started trading by introducing to our retail outlets a brand new range of electronic keyboards of Italian manufacture. The word organ,

however, is a little modest as far as an applicable noun is concerned with this instrument, because the designers have packed almost everything you can think of into this big black box, having forgotten only perhaps the swimming pool and indoor tennis court. The task for your reviewer was to sit for hours and play this machine to see how successful the design department were in packing the instrument with all its goodies, and to see how much of goodies all the features are. The only way I can present this review so you'll be able to understand it is to start

with a huge description of the features, and then examine them all one by one.

Layout

Sitting down at the beast, it all looks deceptively simple and uncomplicated; it is basically a two manual organ, with a standard staggered keyboard configuration, and with 49 notes for both the top and bottom boards. On the front panel, above the higher keyboard, resides a series of select tabs and buttons, which read from left to right as follows: Foot pedal controls, an on/off tab for sustain, and a tab which selects attack. Next

along are four lower manual tabs, trombone, viola, violin and "cancel flute" followed by a section controlling the effects (which will be described in full later).

The T249 carries a very comprehensive rhythm box as one of its features, and select buttons give you an idea by their names: Waltz, Tango, Beguine, March, Swing, Slow Rock, Cha Cha, Samba, Mambo, Bossa Nova, Shake, R&B, plus a red light down beat indicator, and tempo and volume controls. No matter what you might think of the labelling of these rhythms, and how much you might find the idea of a drum machine built into an organ amusing, the fact remains that rhythm boxes are an extremely useful tool when practising or writing by one's self. You can select any number of buttons on this one at the same time to provide yourself with the most bogglingly complex time signatures. I'm sure the manufacturers intended the drum machine to be an adjunct feature for live gigs in pubs or whatever, but they have nevertheless provided a useful device for home practice. It's surprising how good for you practising with a drum machine is. Improves your "time" no end.

Continuing ad extra, there follows a series of tabs controlling the percussion qualities of the organ sound, namely a five and one third foot, a four foot, a two and two thirds foot, a percussion repeat, and a soft percussion tab. Finally, there is a tab section for the top manual voicing and one can select clarinet, horn, trumpet, oboe, string, as well as cancelling the flute sound. All the sound select tabs for both the lower and higher manuals can be used individually or in any combination.

Operating the instrument purely as an organ, and not implementing all the members of the effects department (that we'll come to later), one finds that the sounds produced by the various selections are quite pleasing, but not particularly remarkable. This is not a slighting comment; it doesn't sound like a Hammond, but then it was never meant to. Using various percussion settings in conjunction with the sound select tabs makes the whole thing bigger in sound, and more impressive than the somewhat bland tone colours provided. One slight drawback in the design appears when playing the lower manual: the top manual, and the panel to its left overhang the lower keyboard in such a way as to cause the player's hand to clonk against the top keys; in other words, you can get your hand stuck! I don't think that I have got particularly big mitts, but they do bump against the top keyboard and thus become annoying.

On now to some of the built in toys. If there is one factor that could cause this

organ to be singled out for praise, it would be the wealth of additional gadgetry that the chassis carries. Not any one feature is in itself necessarily very impressive, it's just that no one's put them all together like this before. In fact, playing this review model was a bit like Christmas, discovering more new toys and fun and games with each new fader and knob twirled.

Firstly, there's an impersonation section, which allows the player to sound off with various piano colours or string machine effects. To the left of the lower manual is a panel carrying the following slider controls: Piano 16', Piano 8', Honkytonk, Harpsichord, Viola, Violin and Sustain and attack controls for the string sounds.

These voices are brought into play by push button selects mounted on yet another (and there's loads more to go!) panel immediately to the left of the lower keys. Any combination of piano types and/or strings may be played, and these sounds may in turn be combined with any organ sounds or simply heard on their own. The piano sounds are quite as good as any moderately priced *electronic* (rather than electric) pianos, and the strings, when carefully played and voiced, make not a bad string machine. Incidentally, the faders controlling the respective levels of these sounds operate under a reverse convention to, say, studio faders in that you pull them toward you for louder, rather than push away from you. In this respect they react like organ drawbars, and, being mounted on an organ, this makes for a nice, if subtle, design point.

On another part of this large lower-manual-left control panel are placed the synthesizer controls. Be it ever so basic, this is a true synthesizer and not a series of pre-select sounds. The source is a single oscillator, and its signal is passed through a very basic modification circuit that has the following controls: Depth, Attack/Decay, Sweep, Colour and Emphasis, plus an overall volume control, to help the player balance the synth-source sounds against other things he might have happening elsewhere on this instrument. Also, on button select, one has the choice of square or sawtooth waveforms, plus a built in wah-cum-phase effect, which can also be run automatically from yet another button. In itself, again, this synthesizer section is not particularly amazing, and couldn't really stand on its own, but it does enable the player to provide himself with the basic flavour of oscillator-source musical programme. I feel one should judge constantly against the whole of this instrument, rather than attempt to evaluate how good a string machine/piano/organ/synthesizer/drum

box it is. Because this Caravelle scores on its combination ability and its versatility; I suppose you could say Jack of all Trades and Master of None, but there is a certain market of purchasers who will find this instrument the answer to a prayer.

But there is yet one more department on this instrument to try, and this is the Cheats Department, perhaps, but nevertheless it is not really cheating anymore than a sequencer on a synth is cheating. To the right of the lower manual lurks a panel of sliders and buttons, but rather than let you doze off again while I reel off yet another list of functions, I'll attempt to describe what goes on over here in darkest lower-manual-right. Basically (a word beloved of reviewers, haven't you noticed?), this department is special accompaniment effect, operational on 20 notes (between C and G on the lower manual, and by selection, on the bass pedal board). By pressing the appropriate button, one can cause walking bass lines to occur, whose speed is governed by the rhythm box tempo, and the rhythm box plays along at the same time. The bass line is in key with the root note selected and held down on the lower manual, and changes basic chord whenever the player plays a new note. Further buttons cause whole chords (in differing inversions) to appear in the same way, and arpeggios of these chords will play in time with rhythm select if so desired. Another point about the chords is, that if the foot pedal is connected up (performing a volume control function), two additional wings on this pedal can be pressed with the foot to alter the selected chord into either a minor, or a seventh. This function occurs for the arpeggios as well. Rather neat. What's more, there are many interesting permutations of all these effects, all at the touch of a button or two.

Conclusion

To sum up this remarkable instrument, let me say firstly that it obviously may not be taken seriously by modern rock/jazz keyboard players who record and tour, nor even by those people who might aspire to such activities. But for the pub entertainer who may not be sure of whether his drummer will appear that night, or for the club musician who perhaps plays solo organ, and wants more colours tone wise, or more spectacular effects, then this instrument represents an important breakthrough for this select minority of players. The price is amazingly low; £1,490 including VAT. All right, to say that over a grand is a low price may seem weird, but for what is packed inside this extremely robust case, which incidentally is highly portable, breaking down into several easily carried parts, it is nothing short of Very Good.



delft's GUITARCHECK

Stephen Delft is a luthier and instrument repairer. He is also a solo performer and a member of the Institute of Musical Instrument Technology.



TEST ON: Gibson RD 77 Artist

DATE: August 1978

PRICE: £752 including case, incl. VAT
(\$958.50)

As I mentioned last month, this is a complex and unusual instrument. Even though I have spent rather longer than usual on this review, I suspect that several months, at least, would be required to do it justice. As I do not have several months of spare time at the moment (I do not even have several *days* in the foreseeable future), I must do the best I can in the time available. It is quite possible that someone might find an application for this guitar which I have not even considered in this review, and you would certainly need to play it for several hours if you want any understanding of what it can do.

The RD 77 looks like a fairly conventional guitar which combines the clean appearance and rounded profiles of Gibson's recent models, with a shape somewhere between an Explorer and a Firebird. The body and neck are of Maple, the fingerboard is Ebony, and there is a fair quantity of gold-plated metal and Mother of Pearl inlay, screwed on and inlaid, on various parts of the instrument. There are what appear to be two selector switches, but you would see nothing particularly unusual from the front. If you turned the guitar over, however, you might wonder why the RD 77 has one of the biggest back cover-plates in captivity, and the particularly observant might notice a small hole, neatly drilled in the main part of the plate. Why, you might ask, is there a hole drilled in the back plate? And why, for that matter, does this guitar have a wiring cavity in the back several times larger than normal?

The answer lies in an association between Norlin, who market Gibson guitars, and Dr. Moog, of Moog Synthesizer fame. Inside this guitar is an electronic control system, designed in conjunction with Dr. Moog, which provides compressor and expander functions, treble-boost equalisation, and also treble and bass controls, which can add to the signal as well as subtract from it. And the hole in the back plate? String gauges and playing techniques vary considerably and some adjustment to the "expander" control may be necessary. You could have another knob on the front of the guitar, but I am in favour of keeping front controls as few and as simple as possible. I am also in favour of guitars which do not require constant removal of the back panel to make internal adjustments. A screwdriver adjustment through a hole in the panel seems a reasonable compromise. I would suggest that, as some guitarists can be a bit heavy-handed with a screwdriver, the circuit board might be more firmly supported close to this adjustment, and that the slotted part of the control inside, might be made of metal, or of plastic considerably harder than the type used in this case.

Apart from this adjustment, all the electronic functions are selected by the controls on the front of the guitar. There is a volume control for each pickup, a conventional 3-way pickup selector switch, overall treble and bass controls which operate on the output signal whatever the setting of the other controls, and a second selector switch (the black one) for compression, expansion and treble-boost. I should make it clear that not all combinations of

these functions are available. In particular, compression only operates on the fingerboard-end pickup, or when both pickups are selected, the expansion only operates on the bridge pickup. Treble boost equalisation is available on either or both pickups, but not at the same time as compression or expansion.

In practice, this makes the switching arrangements rather confusing if you try to consider them logically. It is possible that many players do not think about switch functions in a logical way, but prefer to experiment more or less at random until they find interesting combinations. This is certainly possible on the RD 77, but the time required, to find and remember all possible interesting combinations, may take rather longer than usual.

As some people may not be familiar with compressors and expanders, I shall try to explain their functions in this guitar as simply as possible. (It is possible that you may encounter devices in studios which have the same names but which work in slightly different ways.) The compressor is intended to make any note, or group of notes, sustain for longer than usual without the obvious distortion associated with a fuzz-type sustain, or an overdriven amp. There is, with most simple compressors, a tendency for the general signal level to "dip" as each subsequent note is played. It is most audible if you sustain two or three notes on the top strings and then pick one of the bass strings relatively hard. This situation does arise quite frequently if you play complicated pieces with fingers and a pick. The result may be attractive or disconcerting, depending on the skill of the player, and the type of music.

A secondary effect of the compressor is to keep the maximum level of output from the guitar approximately constant. This may be of use in a home recording situation, but I would imagine that a professional studio would normally prefer to use their own compressors and/or limiters for this purpose, as the more complex ones have partly overcome the "dipping" problem. The nature of the signal from an electric guitar is a severe test for any compressor. Although separate pickups and separate compressors for each string would, in theory, have considerable advantages, both cost and drain on the batteries would probably be excessive.

If the compressor is intended to smooth out differences in level between notes, and to increase the guitar's sustain, the expander seems to do almost the opposite of this. It exaggerates the differences in loudness from picking hard on some notes and gently on others, and



it exaggerates the impulse at the beginning of each picked note. (This impulse is often described as the 'Starting Transient'.) Expansion increases the "punch" or "attack" of each note and makes it appear to die away more rapidly after the explosive beginning. This sort of effect would probably be of most use if you want to play groups of notes very rapidly and you want them to appear separate from each other, not blurred together. This is a feature which has not generally been available as a separate electronic "effect". My own opinion is that it is probably a useful effect, particularly if you want certain notes or phrases to stand out above the general sound, without resorting to brute force and a bigger amp. It may also be able to produce some unusual guitar sounds which are difficult to obtain in any other way. However, I find more than a few seconds of it rather a strain and I think it may be more effective and possibly more tasteful when used sparingly.

The so-called "Lead EQ" is a sort of treble boost device which, amongst other things, makes the guitar's sound rather more like the characteristic sound of Fender instruments. It is not an exact imitation, and I don't think it was intended to be, but it does produce a distinctive change in the guitar's sound. The result is useful, it doesn't cost much to include (when you already have a lot of electronics in the guitar) and it produces less "hiss" than many accessory treble-increasing devices.

The bass and treble controls work in a fairly obvious way except that, as they cut *and* boost each end of the spectrum, the arbitrary "flat" or inoperative position for each control is in the centre of rotation. On close examination, the knobs are numbered 0 in the centre, and 1 to 5 in each direction. You don't *have* to keep them in the central position, but this presumably will give what the designer intended as the basic sound of the guitar, and is a useful starting point.

As previously mentioned, this instrument is made almost entirely from Maple. The woodwork appears to be good, and the lacquer finish is smooth, glossy and almost faultless. The body is basically square-edged, with the corners rounded over, and some bevelling around the waist and the bottom corner for better playing comfort. The neck is a separate component, glued into the body, and both neck and body are made from several strips of wood, joined together. The outline of the body is pretty strange at first sight, but the same could be said of the Firebird and the Explorer, both of which have become collectors' items.

The only point which I feel is more than just a matter of taste, concerns the shaping of the back body edge where the neck joins on. For some reason, this part of the edge has been left quite square and un-rounded, even though there is room to continue the edge-rounding right across behind the neck joint. If I slide my hand up the neck, when my second finger is on the 17th fret, either the inside of my thumb or the palm of my hand is resting firmly on this square corner, which as far as I can see, need not be there at all. Gibson are one of the oldest American guitar companies, they have been making electric guitars since electric guitars were invented, and they have produced this "all-singing, all-dancing" wonder. Didn't anyone try playing up at the top of the neck before they sent it out?

While on the same sort of subject; it has a nice straight neck, a fine inlaid fingerboard, but the strings are much too high at the nut and the frets have not been polished. They are slightly rough, and the residual scratches are parallel to the strings, making string-bending rather a scratchy business. Now I know Gibson can polish frets, I have seen it done on a recent bass, and on an Artisan guitar. One instrument was cheaper than the RD 77 and one about the same, or perhaps a little more expensive. Also I know that some new Gibson guitars which I have had for review have had strings closer to the frets and fingerboard at the nut end. I wonder whether some models deliberately have a greater string clearance here, or whether this dimension is subject to rather wide tolerances.



As to the frets, one independent suggestion was that the same abrasive material is used for all or most fret-finishing jobs on certain guitars. When it is new and sharp, the frets come out rough, and when it is older and partly worn, they come out much smoother and, for most purposes, as good as if they had been polished by hand methods. Perhaps Norlin or their representatives would like to correct me if they can more accurately explain the variation in fret finishes. This is not a cheap guitar and its frets really should be better.

The fittings are all fairly conventional and all visible metal parts are gold-plated. The pickup covers appear, in addition, to be lacquered. This probably delays the deterioration of the plating underneath, but of course it will eventually wear through. Gold plating can be made to survive sweaty fingers for many years, but it requires a much thicker layer of gold than is usually on guitar fittings. The machine heads, although labelled Gibson, show every sign of having been made by Schaller. They all work well, and I would expect their gold plating to be a little more durable than the plating on the American fittings.

Although, as I have said, the frets are

a bit rough, they do seem to be level, and as the neck is firm and straight, it is not surprising that this sample will work happily with quite a low action. I find the strings a little worrying. They seem to be biased towards slightly "stiffer" trebles and relatively lower tension basses; the opposite of what I am used to.

It is not easy to have the strings changed on a guitar unless you have already bought it, or unless you happen to be on very good terms with your usual guitar shop. (All those who don't have a "usual" guitar shop and who buy each item where it is cheapest, can leave now.) With the present strings, one might be misled into thinking that the neck is in some way difficult. Not so. It is quite a good neck, if a little sharp at the corners: if anything is "difficult", it is the strings.

I am not going to try to describe the range of sounds available, as many of them can not easily be related to existing guitars. A very wide range of tonal and dynamic variations is possible by manipulation of guitar and amplifier controls. Incidentally, even though the compressor has been described as a sort of "distortionless" or "clean" sustain, it is still possible to use the guitar with the compressor function switched in, to drive a fuzz-type sustain unit, or an overdriven amp. The result is a sustain which is of course distorted, but in most cases, seems to be more even and to last longer before "cracking".

Conclusion

There probably have been guitars like this made before, but only the occasional one, made at least partly as an experiment. This is probably the first time you could just go out and buy one. Some people will undoubtedly buy it because of the electronic features, (which incidentally all run off one small 9-Volt battery) and I would not presume, in so short a time, to be able to assess how valuable these electronic features are.

With the "electronics" switched off, it is not a bad guitar, but I have seen better finished-off Gibsons than this sample, and I have seen them amongst recently-produced Gibsons. If the electronics are not to be seen as a gimmick, then the guitar must be as good as the electronics, and must play well before it reaches the customer. This one is good but could use another hour's work. I also think that the logistics of the switching arrangements could be made less confusing. I have not been able to find any setting of the controls which produces the same sort of sustain I get from the very best of "vintage" Les Paul models. Perhaps Dr. Moog could invent an answer for this, if anyone can manage to define precisely the right questions. Questions are much harder than answers.



delft's GUITARCHECK

Stephen Delft is a luthier and instrument repairer. He is also a solo performer and a member of the Institute of Musical Instrument Technology.

TEST ON: Hurdy-Gurdy.

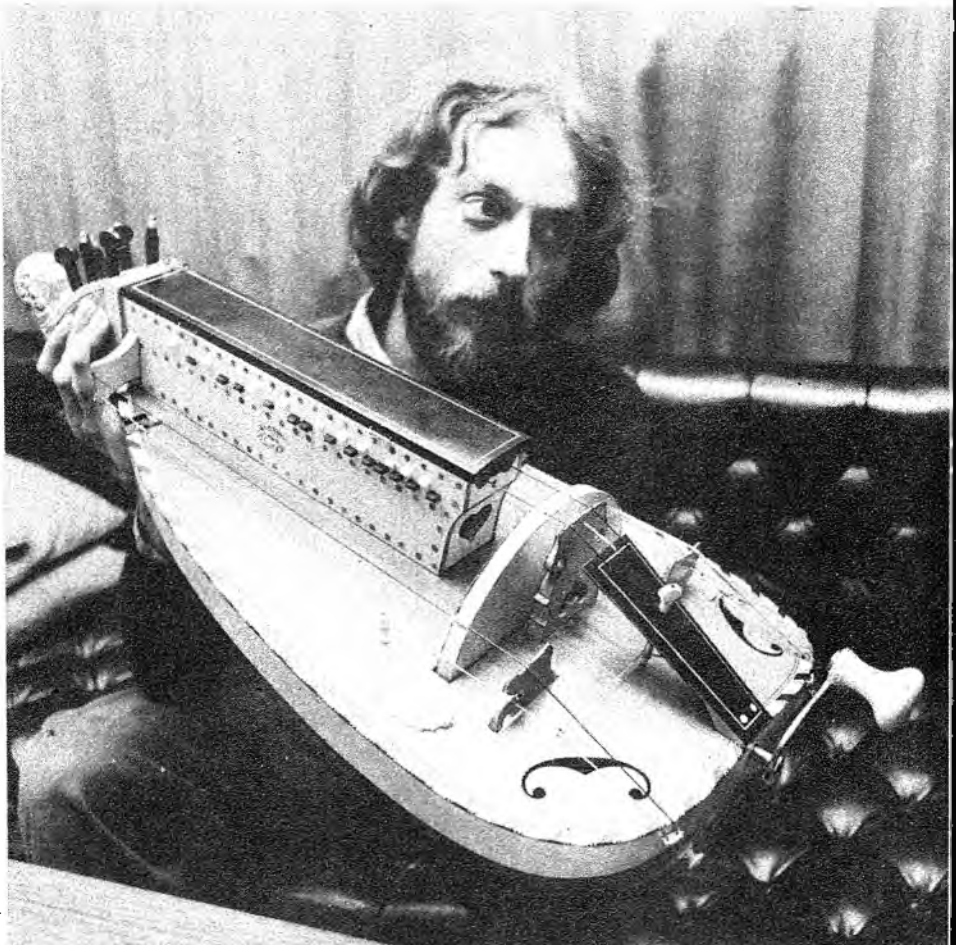
DATE: August 1978.

PRICE: £700 from maker.

Delft's Guitar Check . . . except that this one is not a guitar. Well what else can I call it?" Delft's Instrument Check" sounds like something out of a television 'Hospital' series and if I called it "Delft's Hurdy-Gurdy Check" half of you wouldn't understand it and the other half wouldn't believe it. Also, my Editor in his infinite wisdom, might feel that the strain of reviewing guitars had finally become too much for me, and that I should be transferred to reviewing re-issued soul albums. However, a Hurdy-Gurdy Check is what it is. The instrument in the photograph is not a perverse musical joke, but a perfectly workable musical instrument with a respectable pedigree, and a history of works written for it by Mozart, Vivaldi, Haydn and itinerant musicians all over Europe at some time or other.

Hurdy-Gurdys are also in regular use today, particularly in Brittany and parts of Southern France, as instruments for performing folk and popular music. The instrument may be ancient, but it is very far from dead. I should also emphasise that this is no 19th Century Golden Oldie, borrowed from a museum, nor is it the latest imported reproduction. It is entirely British-made, in a small workshop in East London, and more similar instruments should be available soon.

The Hurdy-Gurdy and this month's Gibson have one rather surprising feature in common. They both have power-assisted sustain! In some respects, the Hurdy-Gurdy is more sophisticated than the modern instrument. The Gibson requires a battery, and when the battery dies, so does the sustain. Also, in spite of all the electronics, you can only keep a note going for a minute or so, at most. A good Hurdy-Gurdy will keep its sustain going all night if necessary. Its only power requirement is a strong right arm to crank the handle on the end of the body. Apart from strings, the only equipment needed for regular maintenance, is a scrap of cotton thread, a pinch of powdered rosin, and some chalk and dry soap for adjusting the tuning pegs. Although the Hurdy-Gurdy uses a drone accompaniment, and much of the music



played on it resembles the modal tunes appropriate to bagpipes or dulcimer, the melody string of the Hurdy is fully chromatic, and all sharps and flats are available.

Within the limitation of a drone accompaniment, it can play in any key and can cope with modulations into related keys, usually without difficulty. Used as a solo instrument without the drones, it can play in any key or combination of keys, and can also be preset to play either in an equitempered scale, or in any of the modal scales. By comparison with this month's Gibson, the Hurdy has also the option of a "fuzzed" tone on one of the bass drones. This string and the distorted tone feature are both called the "Trompette". In unskilled hands the effect can appear as a tiresome rasp but, when properly set up, it is sensitive to the speed of rotation of the hand crank, and skilled players can use this feature to provide a rhythmic accompaniment while playing. Not only is the Hurdy-Gurdy organically grown and self sufficient, but it has touch-sensitive dynamics, a feature which has only recently been promoted as the last word in "home" keyboard instruments.

As it could (with some difficulty) be arranged to operate from windmill power, its future as a musical instrument would appear to be both fashionable and reasonably secure.

The principle of operation is a little complex and it may help if you refer to the illustrations. The usual form of Hurdy-Gurdy has a lightly-built wooden body, like that of a guitar or lute, having at one end a crank handle, and at the other, a short neck carrying a keyboard. The crank handle operates a large wooden wheel which appears through a gap in the front of the body close to the main bridge, and rubs on the strings—as it rotates. This works roughly in the same way as a violin bow. Any strings which have been set to touch the wheel, will sound for as long as the handle and wheel is turned. You should be able to see all these features in photo 1. Any strings which are required to be silent, can be pushed away from the wheel and held there by various notches and pegs.

The keyboard mechanism is concealed in the raised box fitted to the neck. Through this box pass the two high-pitched melody strings (one of which may be silenced by an ivory peg—inside

The Chappell Group Gear Centre is now open!

We now have probably the finest selection of professional guitars, amps and keyboards in the country at 52 Maddox St., London W1. Our new professional Centre is small and friendly – come and have a chat with Jack Plug and see if we have what you're looking for.

Alembic basses, Mesa Boogies – we have something different for you. If it sounds overwhelming – don't worry – we make time for everyone.

KEYBOARDS

come and compare them side by side.

Yamaha: CP70B Electric Grand
 Yamaha: CP70 Electric Grand
 Yamaha: CS80 Poly. synth.
 Yamaha: CS60 Poly. synth.
 Yamaha: CS50 Poly. synth.
 Yamaha: CP30 Electronic Piano
 ARP: Omni 2
 ARP: Odyssey
 ARP: Pro-DGX
 ARP: Axxe
 ARP: Avatar
 Korg: Poly ensemble 2
 Korg: 800DV synth.
 Korg: 700-S synth.
 Korg: Micro preset
 Korg: Vocoder
 Korg: Rhythm Boxes
 Korg: Tuning Devices
 Roland: RS202 Strings
 Roland: SH2000 Preset
 Roland: SH1000 Synth.
 Roland: System 100
 Roland: Jupiter 4
 Roland: RS505 Strings
 Roland: SH7
 Roland: SH5
 Roland: SH1
 Roland: EP30 Piano
 Roland: MP700 Stage 73
 Roland: Chorus Echos
 Roland: Space Echos
 Hohner: Duo-Clavinet & Pianet
 Hohner: Clavinet
 Hohner: Pianet
 Hohner: Hi-Piano with strings

Hohner: Strings
 Moog: Polymoog keyboard
 Moog: Polymoog
 Moog: Multimoog
 Moog: Micromoog
 Moog: Minimoog

ELECTRICS

all set up to your requirements.

Gibson: RD Custom
 Gibson: L.P. Customs
 Gibson: L.P. Standards
 Gibson: L.P. Deluxes
 Gibson: S.G. Standards
 Fender: Teles
 Fender: Strats
 Fender: Precisions
 Fender: Jazzers
 Kramer: DMZ4000 Bass
 Kramer: 650 Bass
 Kramer: 450 Bass
 Kramer: 350 Bass
 Kramer: DMZ 2000
 Kramer: 650 Guitar
 Kramer: 450 Guitar
 Ibanez: 2700 Artist E.Q.
 Ibanez: 2710 Artist
 Ibanez: 2622 Artist E.Q.
 Ibanez: 2619 Mahogany
 Ibanez: 2618 Plain
 Ibanez: 2617 Ash
 Ibanez: 2618 12-string
 Ibanez: George Bensons
 Ibanez: 2630 Semi-Ac.
 Ibanez: 2626 Basses
 Ibanez: Musicians
 Ibanez: Performers

Ibanez: Concerts
 Music Man: Stingray Basses
 Music Man: Stingray Guitars
 Yamaha: SG2000
 Yamaha: SG1500
 Yamaha: SF1000
 Yamaha: SF700
 Yamaha: SA2000 Semi-Ac.
 Guild: Artist Award
 Guild: B301 Bass
 Guild: S300AD
 ARP: Avatar
 Roland: Guitar Synth.

AMPLIFIERS

bring your axe and have a blast!

Mesa Boogies: when available
 Music Man: 1 x 12" 65w Dist.
 Music Man: 2 x 10" 65w
 Music Man: 1 x 12" 100w Dist.
 Music Man: 2 x 12" 130w
 Music Man: 65w Head
 Music Man: 130w Head
 Marshall: 100w Bass Head
 Marshall: 100w Lead Head
 Marshall: All cabinets
 Marshall: 100w Combo
 Marshall: 50w Combo
 Marshall: 30w Combo
 Roland: JC60 1 x 12"
 Roland: JC80 1 x 15"
 Roland: JC120 2 x 12"
 Roland: JC160 4 x 10"
 Roland: SB100 Bass
 Roland: GA120 2 x 12"
 Roland: GA60 1 x 12"
 Peavey: Deuce 120w
 Peavey: Classic 50w
 Peavey: Pacer 45w
 Peavey: Backstage 17w
 Peavey: TNT Bass
 Maine: 2 x 12" 120w
 Maine: PA. Heads
 Maine: Stage 70w
 Maine: Club 40w
 Randall: 120w 2 x 12"
 Randall: 300w 2 x 12"
 All Custom sound
 Fender: Super Twin
 Fender: Twin
 Fender: Princeton
 Fender: Vibro Champ
 Fender: Champ
 Vox: AC30
 All 'Lab' series
 Pignose: Gutsy
 Vox: Mains/Battery Escorts

* Electro Harmonix – Lowest prices in U.K. MXR, Boss, Copicats, E-Bows and hundreds of effects that you can actually try with no hassle.

* Last but not least: we hardly need to advertise the fact that we have the finest selection of Gurian, Ovation and Guild guitars (inc. Southpaw specials) in the country – the only problem is they can't make them fast enough.

Ed, Jack Plug, Funky Fingers, Percussion Pete and Southpaw Ian are waiting to help you! Give us a ring for our low prices – we are probably the cheapest – even in Bond Street.

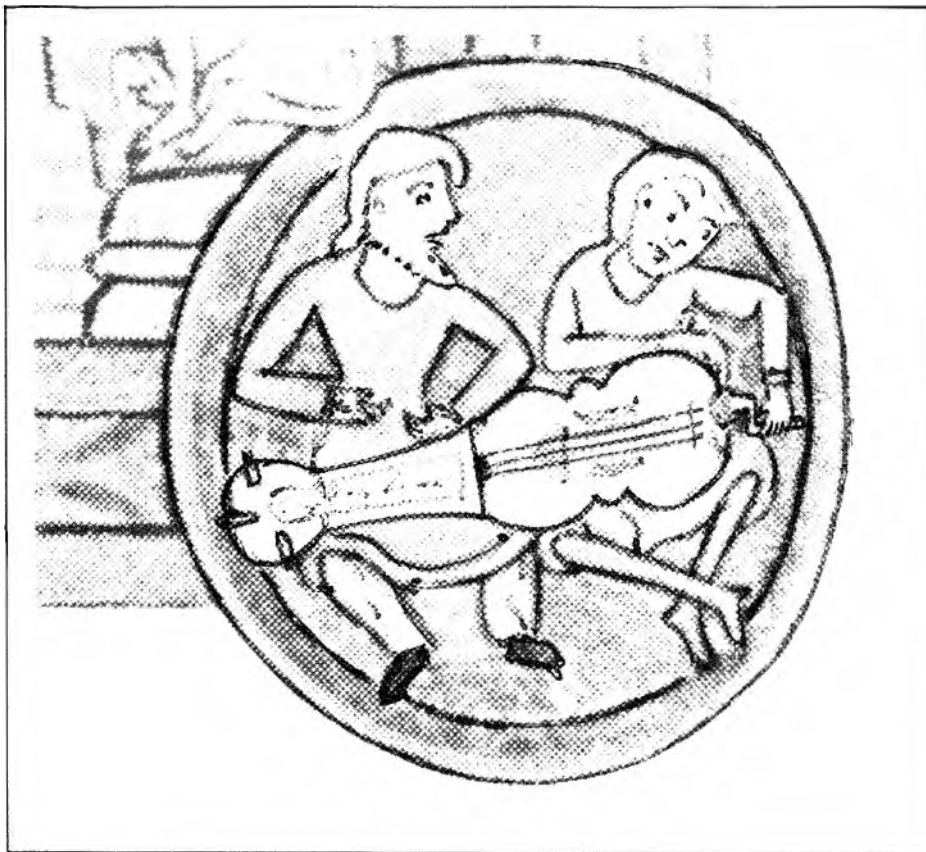


chappell

01-629 7600

London's musical department store

**50 New Bond Street, London W1.
 9.30-6 Mon-Fri. 10-5.30 Sat.
 (Free parking in Bond Street, after 1.30 Sats.)**



the box), and these strings are "fretted" by small wooden fingers or "tangents" on the inner end of the keys. As with some electronic organs, if you press more than one key, only the highest note sounds. The drone accompaniment strings pass outside the key-box and are not affected by the keys. They play continuously whatever note or notes are selected at the beginning of the piece, like the drones on a bagpipe, or the drone strings in traditional-style Dulcimer playing.

Early forms of Hurdy-Gurdy were fairly large, and playing them was a two-man job (Photo 2). Later instruments became portable (if only just - photo 3) although the difficulties of playing such a cumbersome instrument may have produced a less than enchanting musical result. (Also see photo 3 - lower right corner).

By the middle of the 18th Century, this strange mediaeval musical device had evolved into a graceful and sophisticated instrument. The example under review this month, by Sam Palmer of London, appears to be a fairly accurate reproduction of an instrument of this period from Provence, and unlike some other modern reproductions, can be made to play sweetly and fairly reliably, after only a few minutes instruction in the necessary adjustments. This example is made from Mahogany, Maple, Ebony, Boxwood and Ivory. As the spindle between the handle and the rotating wheel is not particularly accessible, it is of steel, running in bearings made from a very hard and oily wood called Lignum Vitae. Oil holes are provided in case they should be needed, but the principle of Lignum bearings was used successfully for many years in the propeller shaft bearings of large ships, and it seems a sensible precaution.

Although you can obtain special Hurdy Gurdy strings, the example which I played works well with carefully chosen

guitar and Cello strings, of the sort which should be available in most good music shops, supply fretted and bowed instruments. I do not foresee any unusual difficulties in finding suitable replacement strings.

The string called Trompette, sits on a smaller bridge which is deliberately made an unstable fit on the front of the instrument. The bridge and string are pulled to one side by a small string attached to a



single "tuning peg" fitted through the instrument's tailpiece. This can be seen in photo 1. According to the setting of this peg, the note from the Trompette string can be varied from a clean sound to a raucous buzz, quite similar to the effect of some early fuzz boxes. With care, this effect can be made sensitive to the speed of rotation of the wheel and used to provide a rhythmic underlay to the music, but the technique obviously requires much practice.

It is very difficult to comment on the workmanship and artistry involved in this

instrument. By comparison, even the better instruments reviewed previously appear uninspired and some of them, by comparison, seem to be graceless and made in a hurried and insensitive manner. Very few modern guitars could hold their own if put on exhibition in the same room as this Hurdy-Gurdy. It illustrates a point which often passes un-noticed because of poor communication, between people interested in *ancient* instruments and music, and people interested in *modern* instruments and music. Hidden in obscure corners all over England are makers of reproduction "old" instruments such as Lutes, Viols and of course Hurdy-Gurdies. In many cases the products of these makers exhibit a standard of workmanship which would put most of the better-known makes of imported guitars to shame. Most of these English makers have full order books, and a significant proportion of these orders are for export.

I would call this a considerable success, and a direct contradiction to the frequently-heard comments that imported products are "better". In some cases they are, and in some cases similar products are not made in England, or are only available at much higher prices. However, I think that really high quality hand-made musical instruments is one of the areas where items made in the U.K. frequently offer better value than similar imported ones. Imported instruments tend to be more widely, and possibly more efficiently, advertised and promoted. They are on display in shop windows, and they are available instantly, without a waiting list. These factors certainly make imported instruments more convenient, but they do not necessarily make them better, or better value for money. I have yet to see an American or Japanese electric guitar, for example, which can show anything like the care in design and construction found in this month's Hurdy-Gurdy, or in the products of several other makers in the U.K., some of whom make equally good acoustic and electric guitars.

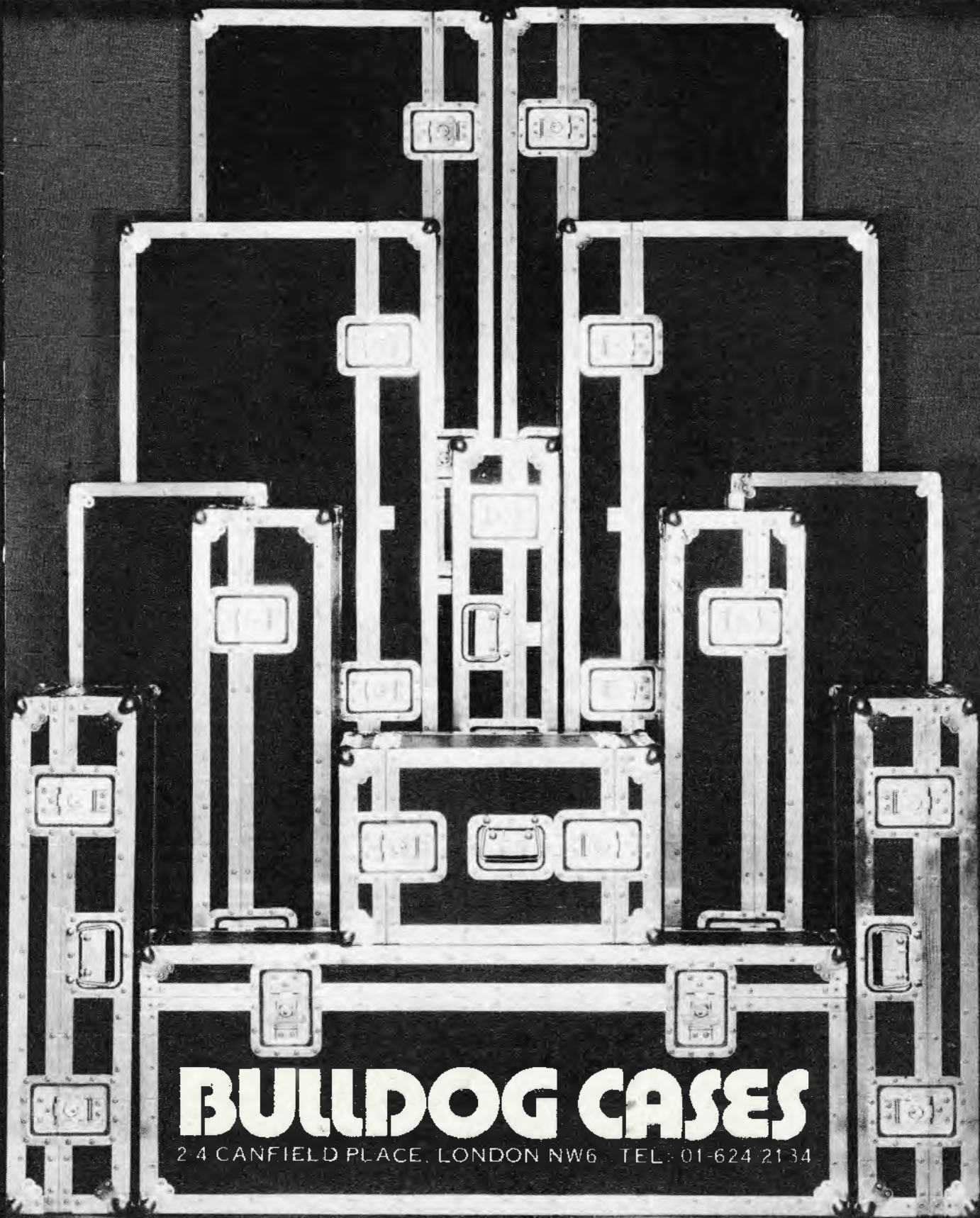
I try to be fair to American and Japanese guitars and basses, because many people in this country wish to buy them, and wish to know which ones generally offer the best value, or which ones have useful features. However, I really find it very difficult to place this instrument by Sam Palmer in the same league, even at the top of the same league (and there are other makers here who are equally good).

Conclusion

This is a beautiful instrument which I covet. If I thought I could find the time to learn to play it and to go over to the Breton Festival each year, I would probably order one for myself. It is a quite delightful instrument to play, and the price is a fair one, but £700 is still rather a lot of money.

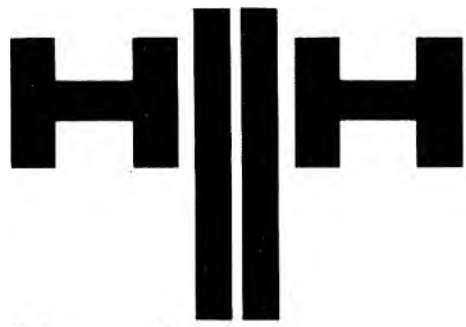
If I have any more instruments to review which exhibit the same quality as this one and the recent Lowden guitar, I shall have to find some other way of reviewing them. They are so much better than most of what I have to review, even at similar prices, that the present system can only barely encompass both kinds of instrument.

TOWER OF STRENGTH



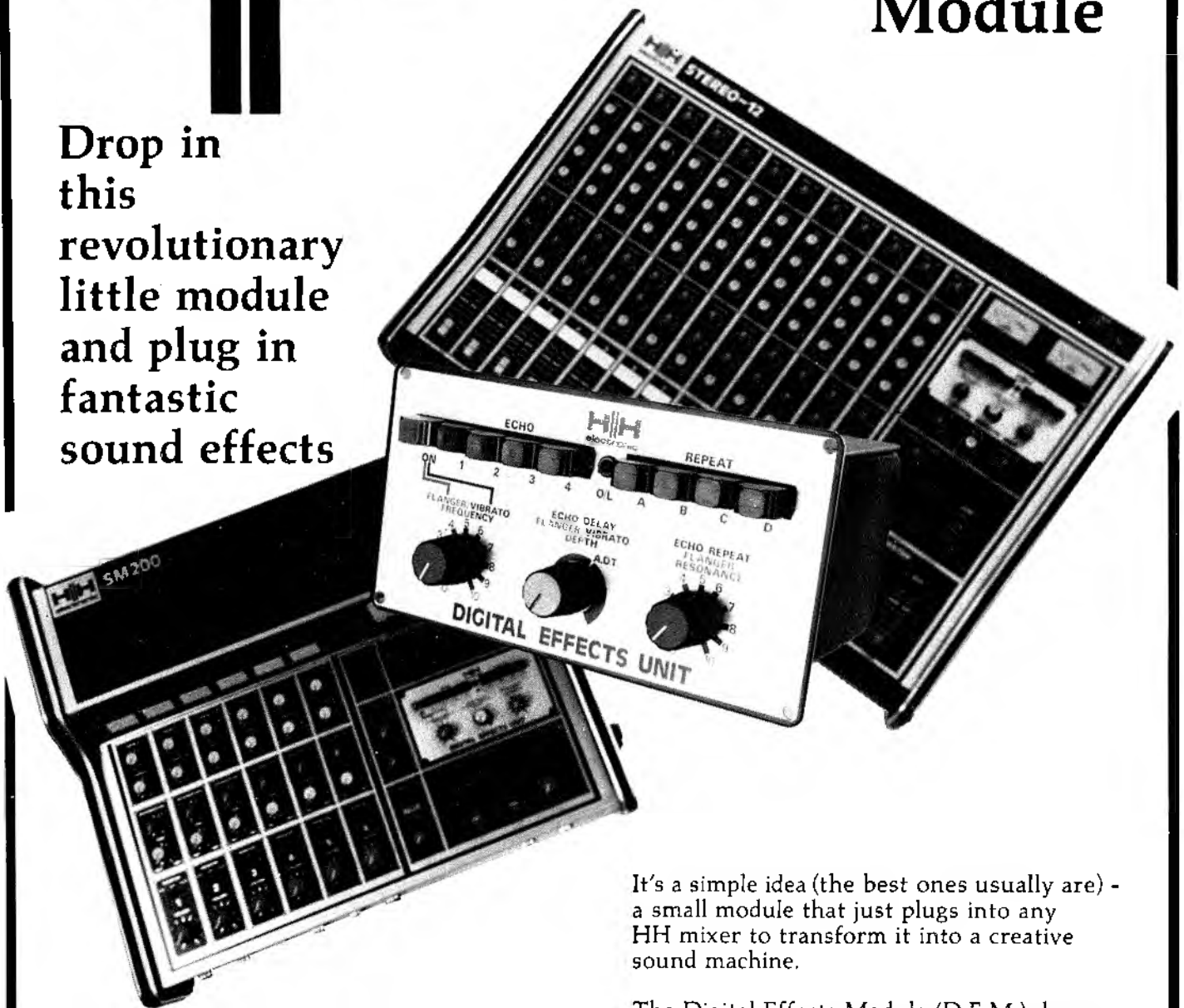
BULLDOG CASES

2 4 CANFIELD PLACE, LONDON NW6 TEL: 01-624 2134



Digital Effects Module

Drop in
this
revolutionary
little module
and plug in
fantastic
sound effects



It's a simple idea (the best ones usually are) - a small module that just plugs into any HH mixer to transform it into a creative sound machine.

The Digital Effects Module (D.E.M.) draws its power from the mixer's own power supply and is connected by a simple plug and socket, to form a permanent part of your HH mixer.

The D.E.M. will produce the following sound effects:

- A.D.T. Automatic Double Tracking. Essential for today's vocals.
- Echo A wide selection of echo sound with variable delay times and repeat combinations.
- Reverb Great reverb sound for adding the extra dimension to sound.
- Flanging Adds whirling spatial dimensions by means of a controlled pitch change.

Plug in a D.E.M. to your HH mixer and you will have up to 240 different sound effects at your fingertips - It's all easy and convenient - you are in control.

Please send me information on the Digital Effects Module

Name

Address

Tel. No



H. H. Electronic
Viking Way,
Bar Hill,
Cambridge CB3 8EL
Telephone: Crafts Hill (0954) 81140

frunt[®]

it sounds new — it looks new,
we make no comparisons, its upto
you! And you won't be dissappointed.

200 watt guitar
amp head



200L
£166 ex vat

just part of a complete new range
of band gear,
its with your frunt man now.

Send coupon for brochure and
nearest Frunt stockist

To:- Soundout Laboratories Ltd,
91, Ewell Road,
Surbiton, Surrey, England.
Telephone 01-399 3392 Telex 8951073/SNDOUT/G

Name

Address



Distributed in the U.K. and Ireland by:
STATESIDE ELECTRONICS LTD.

UNIT 8, NEW ROAD, RIDGEWOOD, UCKFIELD, SUSSEX, TN22 5SX.



mattacks' DRUMCHECK

Dave Mattacks is one of Britain's top session drummers who has worked extensively with dozens of top artists including Andy Fairweather Low, Kiki Dee, Brian Eno and Rick Wakeman. Although he works mainly freelance, Dave is a full time member of the Albion Band. He has been playing drums for 14 years and was with Fairport Convention between 1969 and 1974.



TEST ON: Yamaha YD-5222 WT

DATE: August 1978

PRICE: £385.00 incl. VAT

Yamaha's plans to thoroughly cover the drum market recently reached another stage with the introduction of their 5000 series. Top of their range is the excellent 9000 series, with the 7000 series offering a different shell type/construction and lighter hardware. The new kit from the 5000 series which I saw comprises a 14"x5" snare drum, 12"x8", 13"x9" and 16"x16" toms and a 22"x14" bass drum. The hardware (from the 7000 series) includes hi-hat, bass drum pedal, snare drum stand and one cymbal stand. I believe the exclusion of a second cymbal stand is connected with the attempt to price the kit under £400, putting it in the quality, middle-price range part of the market.

Sound

A few months back when I tried some drums in the 9000 series, it was obvious to me that I was seeing a quality kit, but my ears couldn't bring themselves to agree. The cause of this has now been remedied: Yamaha have owned up that their drum heads didn't make it and are now having them made by Remo (like

almost everybody else!). The 9000, 7000 and 5000 series (except for concert toms) all have Remo's fitted and they certainly enhanced the sound of the kit I tried. All toms were capable of either high tensioning with a ringing, penetrating sound — without getting "thin" — or could easily give the deader (now apparently unfashionable) "pudding" sound. The bass drum had only one head fitted (it does come with two, however) and with some padding inside the shell gave a solid sound. Slightly higher tensioning produced a rounder tone without losing impact or getting too resonant. I wasn't keen on the snare drum sound, but the excessive buzzing was undoubtedly caused by some rather mangled snares which presumably were damaged in transit. To compensate, I overtightened the snares and this gave a bright, if rather choked, response but the drum still tended to sound a bit "thin" even with the head at a lower tension. An unmangled set of snares will improve matters considerably! I personally would have preferred to have seen a matching wood shell snare drum, judging from the sound produced by the toms and bass drum, but as they aren't very popular, a metal shell drum is what you get.

Snare Drum

The 14"x5" snare drum has square-

headed tension rods (fitted throughout the kit), eight double-ended lugs and triple flange hoops. The rather slight alloy shell has three shallow ribs (as opposed to actual concave heads) around the middle of the shell underneath the lug and approximately 45 degree inverse flanges. A straightforward cam-action side-drop type snare release is fitted which stands proud of the shell and works perfectly. The snares themselves are 20-strand and are attached to strainer and butt by plastic strips. Remo ruff-coated heads are fitted to the snare drum and the toms and the bass drum on this kit. From a sound point of view, I found the snare the weakest link on the kit and, although it would adversely affect the price, I think that the sound produced by a more substantial shell would justify the increase.

Bass Drum

The bass drum has eight — not the more usual ten — lugs per head, "T"-shaped tensioners and rather cheap looking claws. The tensioners themselves are from the 7000 series and are very smart and functional. At the bottom of the back head where the bass drum pedal is attached, the two tensioners either side of the pedal have been replaced with long, square-headed rods. This is an excellent idea because, once the tension of each head is set one rarely alters it, compared to the number of times one fits and takes off the pedal. Before I fitted them to mine, I invariably found the handle of the tensioners getting in the way of the clamping mechanism of the pedal. It's little points like these — also height-marking collars — that individually can seem rather silly but collectively can take off four or five minutes of one's setting up time. The hoops are metal with a plastic inlay and a small rubber inset where the pedal is attached. When I first saw the disappearing spurs, I thought they entered the shell at 90 degrees but closer examination revealed the casting to be offset, so they point slightly downwards. A wing nut screws through the casting directly onto the spur — not ideal, but the offset angle plus a sharp point at the end of each rod helps efficiency.

The double tom-holder works very well. The receiver block sensibly mounted at the front of the bass drum has a large wing bolt which tightens indirectly onto the main tube. This tube has an indentation along its length and a small collar with a square-headed screw locates into the groove. The collar also has two small lugs protruding from it which fit into corresponding "steps" in the top of the

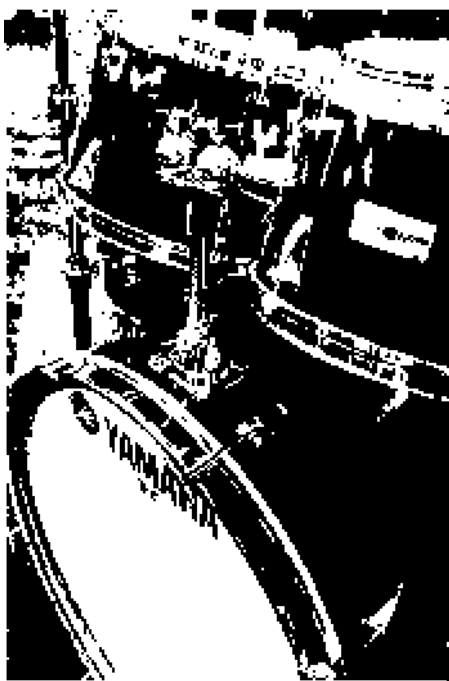
receiver block on the bass drum, thus marking the height and preventing the unit turning at the same time. At the top of the tube is a flat metal bar. At each end of the bar (for each tom) sits a hollow metal sphere cut horizontally in two. Inside each sphere is another hollowed-out metal ball with a hexagonal rod attached which protrudes through a slot cut in the outer sphere. A threaded rod passes vertically up through the end of the bar, the two halves of the sphere with the hollowed out ball inside, and a wing nut at the top clamps the whole thing down tight. Thus, the hexagonal arm can move on a horizontal axis as the sphere "sits" on the bar, and vertically through the slot cut into the two halves. The receiver blocks fitted to the toms have nylon inserts and, like the bass drum receiver unit, wing bolts which tighten indirectly onto the arm. A comparatively straightforward and efficient holder.

Toms

The 12" and 13" toms have six lugs per head; the 16" has eight per head. The cast lugs themselves -- a larger version is fitted to the bass drum -- are smart looking and have a similar shape to the Ludwig, without the vertical "ribs" on the outer casing. The lug nut is kept tightly in place by a special clip which, although preventing any movement of the nut, effectively eliminates rattling. The tom (and bass drum) shells are all made from Meranti wood (a form of mahogany) and are constructed using the Air-Seal system as used on the 7000 and 9000 series. The bass drum has a 7-ply construction, the toms 5-ply and the lamination joints are staggered at three places around the shell. I didn't think the finish was that good on the inside -- rather rough and unlacquered -- and I do think the rounded-off bearing edge could have had a slight flange at least, although I admit that a flat bearing edge is a personal preference. The toms (and the snare drum) are each fitted with one effective screw-up type damper; knurled knob, "V"-shaped spring steel and a large round felt. The floor tom has the usual wide-angle legs which fit into three blocks on the drum. Although the wing nut screws through the block directly onto the rod (rather than the preferred eye ring/wing nut type), it didn't feel quite so unsafe as some other brands I've tried with a similar method. Like the spurs, the machining and wing nuts feel just that bit better. All the toms have triple flange hoops.

Stands/Pedals

As I mentioned, the hardware is



mainly from the 7000 series, and very good it is too! The bass drum pedal reminded me of the Gretsch in appearance and feel. It has twin posts, a light but strong alloy two-piece footplate, a rather weedy-looking fibre/person-made strap, a hexagonal rotating shaft with a movable beater hub, adjustable expansion spring with helpful locking collars, a four-position cam and two small but effective adjustable spurs in its base. Apart from the strap -- very easy to replace with a leather or thicker fibre one -- this was very much "my" kind of pedal. Due to current playing styles, bass drum pedals have grown larger and more complex over the years and paradoxically have seemingly reached the state where the action has to be extremely efficient to compensate for the sheer bulk and weight of the pedal itself. They also seem to need small booklets on how to adjust and set them up. The 702 model I tried isn't the monstrosity one expects to see behind a drum kit these days, but if you aren't built like Guy the Gorilla (was), this could well be the smooth, uncluttered pedal you're after. I personally feel that the ideal compromise between strength, adjustment and action was reached with the Rogers Swiv-o-Matic, but outside of that preference I lean more towards simple, effective pedals like the 702 rather than heavier, more complicated ones.

The hi-hat pedal also has an excellent action. It has a wide-angle tripod base, a two piece footplate like the bass drum pedal and an adjustable compression spring. A solid plastic link between the footplate and the centre rod makes the centre-pull type mechanism very positive and there's a small adjustable spur at the bottom of the saddle unit, apparently a fairly standard item these days. The height adjustment/retention method for the upper tube is also used on the snare drum and cymbal stands. A large wing nut passes through a cast boss at the top of each section. Inside this boss is a plastic sleeve with a small piece of spring steel where the wing nut would touch it. Firm, indirect pressure squeezes the plastic sleeve around the tube. If necessary, the sleeve can easily be removed and replaced,

as can the small piece of spring steel which locates into a small recess in it. The whole thing works very well indeed. The upper tube has a wing nut operated clamp/collar which serves as a height marker and additional support, and a moulded plastic bottom cymbal tilter with a locking nut. The clutch assembles in a rather uncommon way -- from the bottom up. The bulk of the unit screws up into the main boss which has a large wing nut through it for attaching the whole thing to the centre rod. There are double locking nuts and felts and when assembled, it all feels secure and solid.

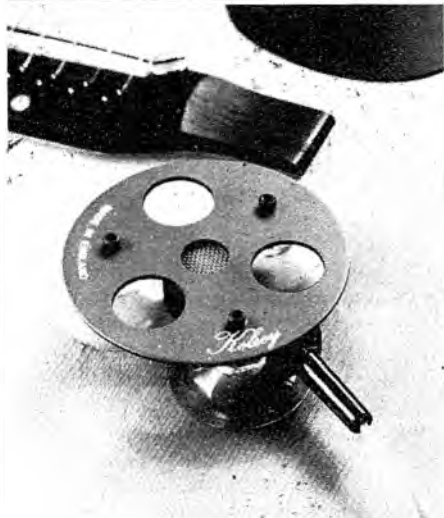
The snare drum stand has an almost flat, adjustable, tripod base and a comparatively short main stem which allows lower than usual positioning of the drum. The angle adjustment and clamping mechanism are basically the Buck Rogers type; a threaded rod with an attached wing nut up the centre tube of the basket for clamping the arms on the drum, and a coach bolt and "T"-shaped wing bolt for securing the angle. The three-tier cymbal stand has a wide-angle tripod base and employs the height adjustment method described earlier. The cast, anodised tilter is a wing nut locked splined ratchet type with a long rod. The idea of the extra-long rod is to enable cymbals to be played at severe angles without them tangling with the stand. A small point: there's a rubber washer underneath the bottom metal one to prevent rattling that can sometimes occur when, for instance, rolls are played quietly with mallets -- an affliction I've suffered from once or twice in the past.

Appearance/Summary

Apparently Kemble (Yamaha's distributor here) plan to market this set in only two colours -- plain black and one other as yet to be decided. This "Ford philosophy" obviously isn't a great idea, but I believe that the quality of the kit will be the deciding factor for buyers. My point is that as long as the other colour isn't something like Silky Purple -- though I bet Chris Millar would love it -- the kit will be bought because of the kit and prospective buyers won't be put off by a limited choice in the appearance. In my opinion, Yamaha are among the best of the Japanese-made drums and the day is certainly long gone when a statement such as that implied that Japanese drums still weren't up to the rest of the world's standards. This is a quality drum kit that can easily be added to (owing to the interchangeability of the hardware with the 7000 and 9000 series) and represents very good value for money.

IN BRIEF IN BRIEF

TEST ON: Kelsey acoustic guitar bug
DATE: September 1978
PRICE: £60



If you were at the Cambridge Folk Festival you will probably have heard this device in operation. It might be kinder to say as little as possible about at least one of the PA systems at this year's festival. What *should* be said, is that under very difficult conditions, one of these Kelsey mikes performed magnificently. It produced a realistic acoustic guitar sound, from a variety of different makes of instrument, and was more than able to hold its own with the vocal mikes. I have tested this mike, and I am not surprised that it is now being used and/or approved and/or sponsored by a substantial proportion of the guitarists who appeared at the festival.

It is my opinion that guitar microphones (and 'bugs'), like loudspeakers, each have their individual sound. None of them could be called perfect, indeed if one of them was perfect, it could only be so for one particular instrument under one set of circumstances. However, for most usual applications, some are very much better than others, particularly with respect to the sound level possible before feedback, and the subjective 'realism' of the resulting amplified sound.

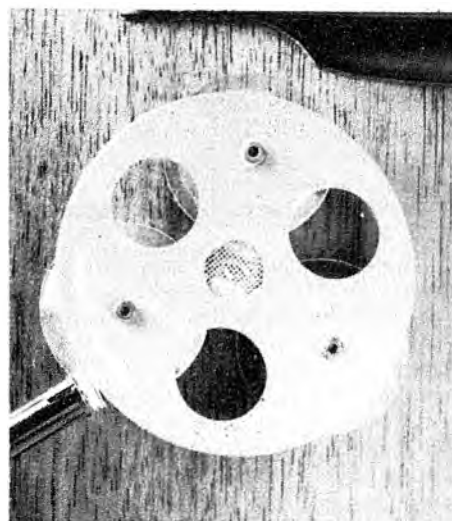
The Kelsey mike is definitely one of the better ones. Most 'bugs' work by sensing mechanical stresses or vibrations in some part of the instrument, usually in or near the bridge. A few are simply specialised microphones, usually clipped by the soundhole or inside the body. The Kelsey mike appears deceptively simple a mike on a metal disc, held onto the guitar with three plastic suckers. In fact, the sound conducting properties of the suckers and the microphone mounting are very important, as this unit is sensitive to sound waves coming from the front of the guitar and also to mechanical vibrations transmitted directly through the mounting suckers. It is probably this multiple method of operation which produces the superior sound quality.

As the Kelsey mike is intended to

operate into high quality PA systems it is supplied as standard, with a 'balanced' output on a twin-core and screen cable. This is fitted with a miniature jack on the mike end and may be supplied with a "Cannon" connector on the other. In this form it will plug directly into most stage boxes just like any high quality PA mike. Although in theory a matching transformer should be used for connecting this guitar mike to an unbalanced high impedance input, as found in guitar amps and the less expensive PA amps, I did not find it essential. I asked for a spare lead without the Cannon, connected a standard jack plug (red wire to centre, black wire and screen to case) and plugged in. On two different guitar amps, the Kelsey unit worked at least as well as the usual guitar bugs, without any matching transformer. It was necessary to turn the input gain control fairly well up, but there was sufficient gain available on both amps, and the result was quite loud enough for recording and club rock.

The appearance of this unit is rather 'modernistic' and it could hardly be called inconspicuous. Although changing the shape or size would probably alter the sound, I would prefer matt black to the present metallic blue finish. Also, while the cable is of good quality, it only fits the miniature plug with difficulty. I would expect some of the 'production' cables to be better connected than others. I would prefer to see a cable which is a little thinner, to allow for proper cable clamping, without being as fragile as the usual miniature cables which were never intended for on-stage conditions.

The "old established" firm of Kelsey have a winner here. I wish them every success.



TEST ON: Bell Electrolabs ADT unit
DATE: September 1978
PRICE: £115

A.D.T. means automatic double tracking and this is done electronically by delaying part of the signal and altering the pitch slightly to make a sound like two instruments from one. It is the

standard treatment for brass and vocals in the studio as it 'fattens up' a voice or sax to give a more impressive sound, particularly in solos where repetition of a complicated solo is impossible by normal overdubbing. For the first time the Bell Electrolabs A.D.T. makes available this studio type effect in pedal form at the very reasonable price of £115.00 retail.

From a guitarist's point of view this is an absolute bargain as it can turn a standard electric into a very convincing 12-string capable of passing a blindfold test. So an electric 12-string for £115 without having to struggle with a wide fretboard is going to be very much in demand.

This is not all the A.D.T. can do, however. It has a switchable program control for stereo vocal/mono vocal/mono instrument/stereo instrument. And a rotary knob for the degree of pitch deviation.

On stereo it can drive two amplifiers thus increasing the effect of two instruments as separate tones are possible for each amp. On 'vocal stereo' the delayed signal appears on amp one and the original on amp two. The delayed signal also has flanging so this setting is chorus flanging. On 'vocal mono' the effect just appears ready mixed on one amp. If you use one amp with the 'vocal stereo' setting but plug into the second stereo marked output just the delayed signal will appear. The most marked flanging also appears on the 'vocal mono' setting which can of course be used on guitar or other electric instruments too. The 'instrument mono' setting gives a greater delay than the vocal setting and is without flanging giving a more intensified double image. On 'instrument mono' again the delay appears on amp one and the original on amp two.

The deviation control is fairly critical in its position for the various effects. When rotated over to the left (anti-clockwise) slap back echo is possible and when rotated round to the right more deviation is applied until the note is rising and falling as much as a third (tone and a half) from its original pitch. This is extremely silly and should keep Brian Eno amused for hours to mention any other aspiring cosmic cowboys. The central position (12 o'clock) gives the optimum double effect and slight excursions to the right can produce some of the hard to explain Beatles guitar sounds.

On the pre-production model I tested a boost was noticeable when switching on to A.D.T. which was fine, and even desirable in electric instrument applications, but caused feedback on PA use. This boost did give the effect of another instrument joining the original but in the interests of the PA application has now been modified to give no appreciable level boost on the actual production models.

This PA application was just as important as the guitar useage as this

IN BRIEF IN BRIEF

pedal is really amazing in PA context. I used it with saxes and the straight A.D.T. instrument setting was really useful for playing tunes and filling out the single instrument switching it either off for straight solos or on to the vocal setting chorus flanging which really lifts a solo halfway through, and I am now addicted to this extra dimension so the Bell A.D.T. is now part of my equipment.

The A.D.T. is part of a complete range of effects by Bell and the range comprises in addition the A.D.T. Flanger, Phaser, Vibrato, Fuzz, Sustain, which all plug into the same Mother power supply unit which comes with the A.D.T. and without which it will not operate. All the effects plug together by means of a multi-pin connector on the side making a long pedal board. A very useful feature is the LED indicators to show when the unit is switched on. Most of the professional players I know have had their effects pedals modified to light an LED when in the on position; this is essential if you are not to begin a solo or tune with the effects from the last one still on, very often ruining the piece. You can look down at the Bell Electro Labs stuff and see exactly what its going to do before you start.

Another very good design feature is the internal wiring which is arranged so that when the unit is off the signal goes

straight through without anything in the way so that there is no loss at all in a series of six which would normally lead to a loss of volume and tone due to the electrical interference on most pedals in the 'off' position.

The use of very high impedance in the output circuit also means that it does not 'load' the instrument and allows more of the upper harmonics to come through

than when connected directly to an amp. So A.D.T., Chorus Flanging, Slap back echo (all in stereo if required), an instant conversion to 12-string for the guitarist and very silly pitch changing for the cosmic chaps would appear to be remarkable value and a worthwhile addition for all styles of musician whether they play or sing.

Alan Holmes



globetrotter



ELECTRONIC PORTABLE ORGAN

UPPER MANUAL - 49 keys C to C

6 drawbars: Flute 16', Flute 8', Flute 5 1/3', Flute 4', Flute 2 2/3', Flute 2'

Percussion: 3 push-buttons: 5 1/3', 2 2/3', LONG/SHORT

STRING SYNTHESIZER: 3 tabs: Cellos 16', Violins 8', 'Animazione'

BRASS SYNTHESIZER: 3 tabs: Horn 16', Trombone 16', Trumpet 8'

PRE SETS: 5 push-buttons: OFF, Full/Flute, Choral Organ, Jazz Organ 1, Jazz Organ 2

SPECIAL EFFECTS: 2 tabs: Piano Harpischord

LOWER MANUAL - 41 keys C to E

3 drawbars: Flute 8', Flute 4', Flute 2'

STRING SYNTHESIZER: 2 tabs: Violas 8', String 4'

ORBISOUND: 5 push-buttons: Lower Manual Flutes, Upper Manual Flutes, Upper Manual Brass, Upper Manual Special Effects, Slow/Fast

SUSTAIN: 2 push-buttons: Upper Manual Sustain, Lower Manual Sustain

GRAPHIC VOLUME CONTROLS: Brass Pedal Volume, Lower Manual Flutes Volume, String Synthesizer Volume, Upper Manual Flutes Volume, Upper Manual Percussion Volume, Brass Volume, Special Effects Volume

GENERAL: Pedalboard Input, Rhythm Unit Input, External Amplifier Input, Headphone Input, Pitch Control, External Electronics Instruments Input

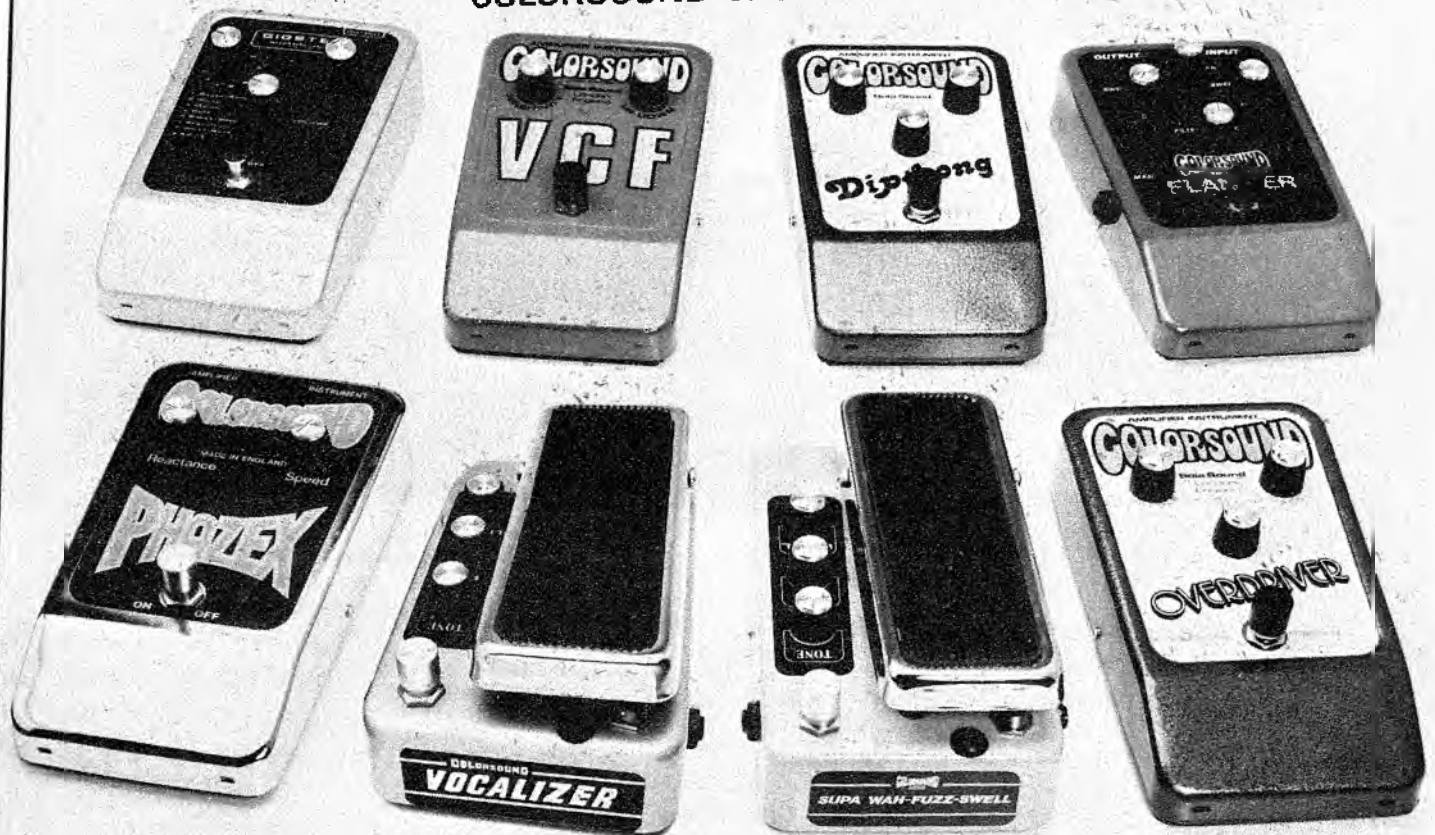
SOLE U.K. DISTRIBUTOR

WOODS (PIANOS & ORGANS) LTD.

15/17 Manchester Road, Bolton. Telephone: 0204 27171/2

A NEW WAVE OF PEDAL POWER

The latest additions to the ever-increasing range of **COLORSOUND** effects



GIGSTER

The Gigster pedal is a self contained rhythm unit – battery operated, it just plugs into most amplifiers. Up to ten different rhythms are available, including Bossa-Nova, Bossa-Rock, Swing, Waltz-Rock, etc.

THE V.C.F. UNIT

V.C.F. voltage control filter is triggered by the signal from the Guitar, the harder you play the more effect. A variety of interesting sounds include a staccato, a wah wah type and a funky 'shaft' tone.

DIPHTHONG

A new sound for Bass Guitar. The Dipthong is the first in a series developed for the Bassist. The device is triggered by a signal from the Bass or Guitar. It has three controls – Overdriver, Speed Depth, Filter Bias. Vowel sounds based on E-OO-AR can be produced in varying degrees.

FLANGER

The new Flanger produces sounds which are out of this world. The unit features automatic double tracking which gives all the usual flanging sounds, but with superb quality. With a total of four controls regulating speed, depth of sweep filter quality and ADT, the possibilities of this new unit are virtually limitless.

THE PHAZEX UNIT

Wide variety of effects including a rotating speaker type sound. A new reactance control enables the unit to scan the Phase circuit producing an arpeggio effect.

VOCALIZER

This is the unit that simply 'speaks for itself' the Vocalizer goes one step beyond the voice box. By merely pressing down the pedal it produces all the vowel sounds AEIOU. The

resonance control enables the player to get a totally different set of vowel sounds and so opens up a whole new world of effects.

WAH FUZZ SWELL

4 different effects. Wah Wah, Fuzz Swell, Wah Fuzz and swell pedal.

OVERDRIVER

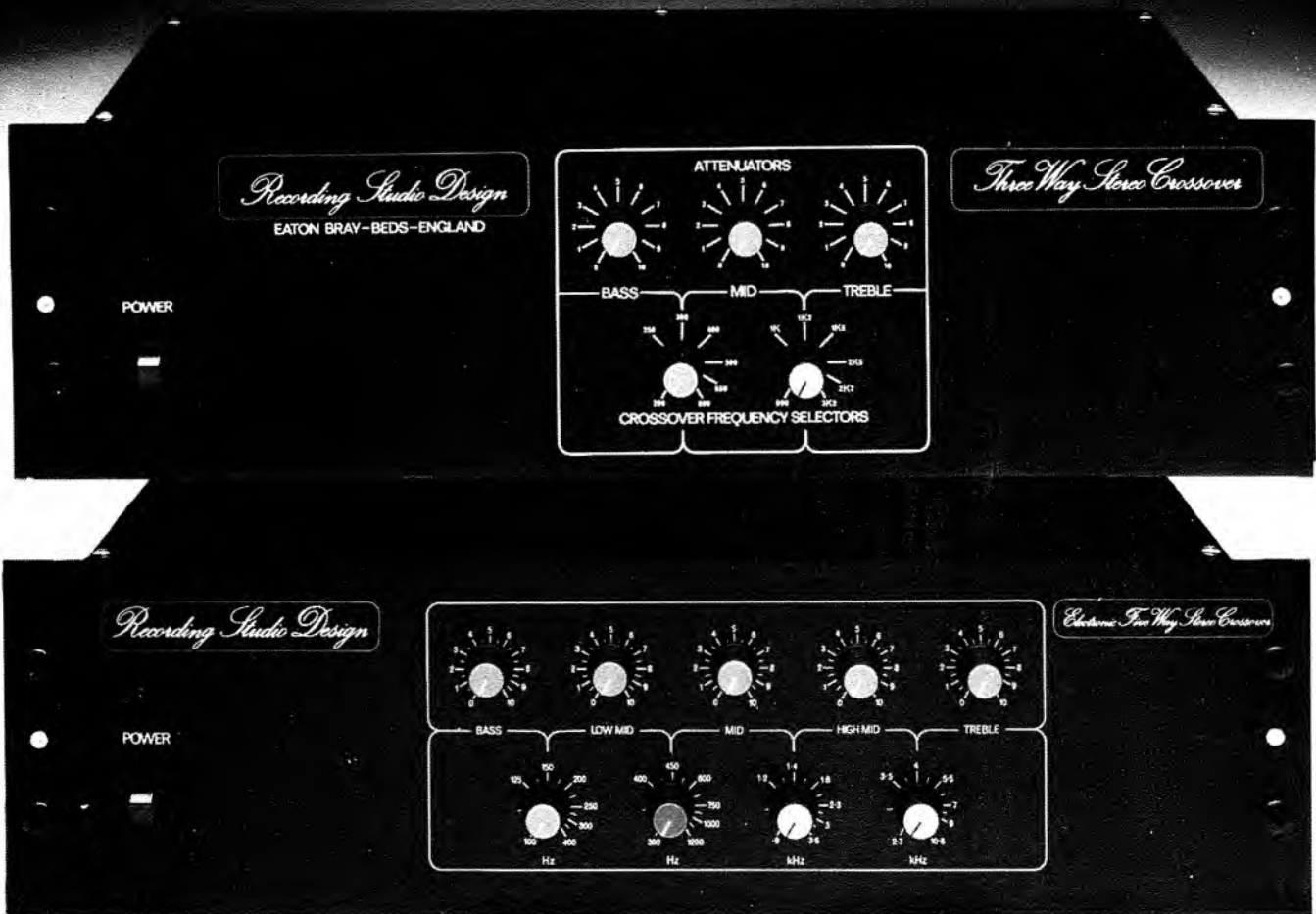
Gives an extra 'Boost' to an instrument which can overdrive to the extent of producing distortion.

COLORSOUND

TRY THIS NEW WAVE OF PEDALS NOW OR WRITE FOR DETAILS

VARIABLE 3WAY AND 5WAY ELECTRONIC STEREO CROSSOVERS

For your P.A./studio. With individual XLR connections and multicore connector (for our stage return multicore and stage box) on rear panel.

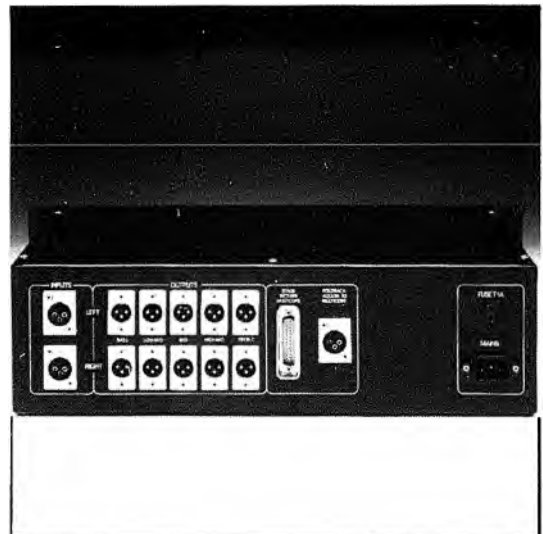


Recording Studio Design

Home Farm, Northall, Dunstable, Beds. Tel: Eaton Bray 221331

Distributors:

- Europe - ATC Ltd, London 01 995 3654
- England - Mick Johnson Music, London 01 788 3491
- London - ITA, London 01 724 2498
- Scotland - Westmill, Edinburgh 031 441 7926



TOMORROWS

Ibanez®

While most guitar companies are resting on their past accomplishments, there's a new name in guitars that has set its sights on the future — Ibanez. At Ibanez, it is our philosophy that guitarists should be able to enjoy the latest advancements in the guitarmaking art, without spending an exorbitant amount of money. We achieve this through a close relationship with many musicians, professional, amateur and in between, and by choosing features of honest value, not fad or flash. From this philosophy come the guitars on these pages — they're tomorrow's guitars as we see them today.

TRI-SOUND



Background: The top of the line Musician MC-500 — the ultimate solid body. The carved exotic wood body is a wonder to behold. The two Super 88 Tri-Sound pickups and EQ Tone System are a marvel to play. The Tri-Sound switches allow you to select either pickup as a humbucking, single coil, or reverse phased humbucking in any one of 15 combinations. The EQ Tone System gives you ± 15 db of gain in three frequency bands plus an overall boost of +15 db for nearly any sound you can imagine. This is a guitar you simply have to try.

The new Musician Series showcases our latest advancements. The maple and walnut neck runs the entire length of the instrument for rigidity and sustain. With optional extras like Super 88 Tri-Sound pickups and the exclusive Ibanez EQ Tone System, the Musician is the most versatile electronic guitar you can buy.

NAME IN GUITARS



SURE-GRIP KNOBS

The Ibanez Sure-Grip knobs feature a special contour and a ribbed rubber insert for no-slip performance even the going gets hot and sweaty.

GIBRALTAR BRIDGE AND TAILPIECE

After adjusting, the bridge and tailpiece can be locked rocksolid to the body for consistency of intonation and sustain.



The Ibanez Iceman is rock and roll. The bold body shape and Super 80 pickups make the Iceman hot in both looks and sound. Available in mahogany, maple or ash, the Iceman gives you more rock per buck than any guitar in its class.

The Concert Series is new and better balanced update of traditional concepts in a reasonably priced package. The body is mahogany with a carved rock maple top for great sustaining power and brilliance. The Super 80 pickups combine with the body construction to produce a bright, clear tone, rich in upper harmonics.



The Ibanez Performer Series offers a wide selection of features and finishes at a moderate cost. The Performers feature our famous Super 70 pickups and the Ibanez Gibraltar lock down bridge for starters and are available with Tri-Sound pickups and carved maple tops.

For a catalogue of the 1978 Ibanez electrics, clip this coupon and send 20p to:
Summerfield Saltmeadows Road, Gateshead, NE8 3AJ

Name

Address

City

Drum Forum



Gerry Evans

Drummers are still very much the poor relations when it comes to rock bands. True, there have been a few headline grabbers such as Ginger Baker and Keith Moon, but generally the drummers literally take a back seat and get on with the business of playing.

Over the past 10 years music technology has advanced at an incredible rate and although most of the innovations have been directed towards guitar and keyboards, the men in the drum chairs have not been entirely neglected.

Apart from the age-old problems of the mechanics of a kit, drummers must now come to terms with new technology such as synthesized drums, kits made from synthetic materials, single head drums etc.

So what are the problems facing drummers today? In what way has drumming changed over the years? Does new technology mean better drums, or is it still just as hard to get a tuning key when you turn up for a gig in Aberdeen?

These, and many more, are the type of questions which IM has been seeking the answers to via a special Drum Forum. We invited Tony Newman, one of the most famous session drummers around who has worked with hundreds of acts from Sounds Incorporated, through Jeff Beck and David Bowie, along with New Wave sticksman Chris Miller (a.k.a. Rat Scabies) who came to fame with The Damned and now has his own band the White Cats, for a discussion with Gerry Evans from Pearl drums and Malcom Ward of Premier.

The discussion covered a whole host of many and varied topics from techniques of playing to criticism of manufacturers. No punches were pulled, and the result is a fascinating discourse which will be of interest not just to drummers, but anyone who counts himself a musician.

The Forum kicked off with a run through of the drums used by Tony and Chris, and the reasons for their choice.

Tony Newman: I'm playing an Auto Tune kit now and I've got a 1958 Ludwig, a small session kit which is really nice. With the Ludwig I use Zildjian cymbals, but with the Auto Tune I use Paiste. I stay principally with the Auto Tune, I haven't been using the Ludwig that often, it's for small gigs.

I have been playing the Auto Tune for two years because they are really good drums and I like the idea of it because it saves a lot of aggro. The idea of a single lever to tune the kit really does work but it does have its drawbacks. When you have been using them for a while the gears wear out so you have got to replace them and you must use Ludwig heads, it's no use using any black spots because they are too shallow.

I've got the new kit now, which is wooden. It does make a difference, it's on stage where you notice it because you get the resonance on stage whereas in a studio you are dampening things down.

Chris Miller: I've got a Pearl kit which I've been playing for about three years, it is wood/fibreglass. Before that I had one which they call Maxwin which was a pure wooden kit.

I find that the fibreglass kits give you a lot harder sound, you can hear more of the hit and less of the note.

I.M.: *Do people in drums, like drum retailers, give you help or are they just a hindrance? Do you get what you want out of drum stores?*

CM: No, not all the time. Drum stores don't carry enough accessories. That's the main problem. Also the problem I had with Pearl was getting spares in the first place.

TN: I always take load of spares so I don't have that problem. If you triple up on everything, you'd be safe and you can get the spares if you're prepared to sweat it out.

Originally there was a problem with the Auto Tune because it was a brand new kit but now it's easy to get stuff. I did realise when I took it on the road that I would need a lot of spares.

Gerry Evans: You've got to think ahead. But if you're employing a roadie and tour managers it's more their job. If they know you are going on a six week tour of America then they should get the supplies.

To be fair to the manufacturers and the drum stores they never expect a roadie to come in and say 'look we're doing an American tour and we need this and that and the other'. That never happens. In real life, the guy dashes in, leaves the truck outside on a double yellow line and says 'I need this, get me this'. It's a lways a last minute panic.

CM: The point I'm making is that you're talking about tour managers and hanging around in big trucks. Let's talk about the other end where you can't afford to buy 37 bass drum brackets. Have you ever tried to get a square tuning key in Doncaster? I had to do it the other week and it's murder. It's down to the dealers because in somewhere like Doncaster there's only one music shop anyway.

IM: *Have you found in your experience that you can get spares for one kit easier than another and are the imported kits a lot harder?*

TN: The imported kits used to be harder, but I have to take care of myself so I always make sure that there are keys everywhere. I impress this on the roadie.

IM: *What policy have Premier got towards their dealers? Do they tell dealers they have to stock so many spares?*

Malcolm Ward: I think it's up to us as a manufacturer to try and educate the dealers, because it's a bit of a problem in a shop when you get the staff of the shop coming and going. Most guys who work in drum shops are drummers and they may be in there as a stop gap between gigs. They may stay three months or six months. It's very rare that they stay any longer.

We impress upon them that the after-sales service is most important because it is the thing that sells a great number of kits for us. It's not important that the Premier dealer concerned stocks spares, it doesn't always work. We don't insist on it, but what we do have are a series throughout the year of dealers' seminars where we invite a group of dealers to come round to the Premier factory. We show them around the plant then spend maybe three or four days with them and we try and educate them and get them into the frame of mind where they must realise that they need to have spare parts in the shop all the time.

GE: Pearl basically just do a franchise operation, Pearl Percussion Centres. Now they've cut it down to 40 so they can look after them.

IM: *That would sound like Pearl drummers like Chris have less chance to get what they want.*

GE: It would, but at the same time if you look at this country you have got at least 40 main centres so you find that the majority of drummers who are touring the country are going to the main places because it's got to be a decent place for them to play anyway. It means these 40 are going to do a better job.

CM: Looking at it from a practical side you only find something is wrong with the kit usually when you get to the



soundcheck, which is about 5.15, and most places are closed by half past.

What's been happening to mine lately is that bits are dropping off it, the lugs are the main thing.

TN: It might be because the kit is getting old, but you really need to service them. There's a hell of a lot of vibration and with your monitors as well there's those extra frequencies. I use monitors all the time and they add frequencies that I'd never had believed.

CM: I tried to get one normal screw for a tension rod from the normal drum shop. It's not a major problem it's just a silly little thing that you cannot get.

GE: I don't believe these things are dropping off through bad manufacture because we'd soon suss it out. I think that, either it's not been looked after or the kit has been played out because of the way it's been used or things haven't been replaced as they should have done.

MW: The only problem Premier have had on those lines was one of tension rods dropping out on parade drums. We solved that by putting a locking nut on. We've not had to do it on snare drums because we've not had any problems.

TN: When you go into drum shops in America that is the difference. You go into any drum shop there and the range of cymbals is outrageous and it is also a workshop. You see the guys in there repairing drums, turning new bits up, they really do do it there.

People couldn't give a shit here, they really couldn't. I think it's just the mood of the people, they are so lackadaisical. Also, the Avedis we get in here are terrible, we get seconds. I went with a guy from Rose-Morris to select, because they had a new batch coming along of 100. Do you know he rejected about 60 of them?

MW: The British dealer hasn't got the money to just put maybe a couple of thousand pounds worth of cymbals on the shop floor in the hope that somebody like you may walk in one afternoon and say 'that's the cymbal I want'.

GE: I think that is a myth because I have seen all different sides of it and as far as the manufacturer's point of view goes, they've no interest in selling faulty merchandise. They want to sell decent merchandise, they do hold a lot back, there is no reason why they should pinpoint a country and then say 'let's send all the crap there'.

CM: I used to buy Zyn because that would sound good for two weeks rather than buy Paiste for 12 times the amount that would only last me two months. It was cheaper for me to buy Zyn every two weeks.

If I go down and try five different Zyns, all 18", one of them will sound just right for what I want and the others will sound shit. It's the same with every other cymbal.

TN: What breaks my heart about Avedis is that you get what you like and it's beautiful. Then it gets knocked and cracked on the road. It does me in.

MW: In Boston at the Zildjian factory, believe it or not, there is a workforce of no more than 40 guys. There is one guy, Lenny Dimerzio, who knows more about cymbals than anybody else, and he personally tries every cymbal out. They would never dream of sending a bad batch out to one particular company.

GE: I do accept that manufacturers send out bad batches the same as we get crap cars. It happens all the time but no one intentionally does it, so what we have got to do is have more communication between the customers, dealers and distributors.

MW: The big problem with cymbals is what may sound great to you may sound terrible to someone else. I can quote you a perfect example of this when Frank Sinatra came over last year and brought his rhythm section. Irv Cotler, a fabulous drummer, came into's Foote's in London and he picked up some Zildjians. I asked him what he wanted and he said he was after an 18" crash, crash/ride. There must have been nine or 10 Avedis cymbals on the shelf. He picked up every one and hit it once and put it back on the shelf. Right at the end of the line there was a secondhand 10 year old Hayman cymbal, it was selling for about £9. He picked this thing up, hit it, and it sounded like a dustbin lid to me, and he said, "that's the one, that's fantastic, that's what I want".

He paid the £9 and walked out, and I went to see the show that night and I knew which cymbal it was because you could see it was a slightly different colour. When he hit it, it sounded fabulous it really did, it was just what he needed.

Drum Forum

Chris Millar

GE: We are very orientated to prices and margins, your cheaper stuff is, for amateurs going up through semi-pros, then your top stuff. Then you've got the punk thing coming forward and there is a lot of good kits, I mean those Olympic and Maxwin drum kits, if they are sorted out and they are played single headed say, they can sound great.

Then we got into the recording situation. How many times have you known or heard of people using ridiculous things in the studio to get a good sound, like playing the cases. From a drum manufacturer's point of view you can't just stop making drums and say just play the cases. You have got to have some common sense. We make drums and also supply the cases. If a guy wants to play the cases instead of the drums that's his choice.

IM: *Have drum sounds changed in 10 years? Have manufacturers done anything to change them?*

GE: What brought that home to me was my experience with Trixon. Trixon in the early days were really great, it was always Trixon against Premier. We somehow in the shop brought in a Trixon kit that had gone up in the loft and never been touched. Everyone used them; Bob Henrit, Phil Seaman even Tony, so we went down there and were all very excited, and we thrashed on this kit and it sounded terrible.

We said, "hang on, they sound better than that," so we were mucking about a bit and we got it to an average sound, but it slowly dawned on us that our ears between 1962 and 1978 had changed and so had the drum sounds. If you heard that sound now, going back 15 years, you'd be really disappointed.

TN: I always used to use plastic heads. On the bass drum I used to use a calf head so it lapped. It depends how you hear your drums, it took me years to understand that you have got to tune both heads.

I've now gone back to a double-headed kit, because I got fed up with the flat downbeat sound, it was just flat stick, there was no up beat so I put the bottom head on and you go up beat — you are playing drums again so you get away from that suitcase thing.

GE: That is what's definitely coming through, everyone's now going the single-headed concert tom thing and I can predict that that's going to carry on for a few more years. But slowly, the real pros are coming back to double-headed concert tom toms.

MW: Some producers are now beginning to appreciate at last the problems of a drummer in the studio. Glyn Johns never



uses more than four mikes. It doesn't matter if you are using 15 drums. He won't use more than four and he always gets a great sound.

TN: I know he does, because he leaves it up to the drummer. He does not dictate, he is not one of these guys who thinks because they have got a massive board in the studio he has to use it. For Christ's sake let's record drums flat, no EQ at all, let the guy go in and get a good sound and be happy, use a double head on the bass drum.

I get sick to death with this flat sound, this bass drum that is like in Australia, yet the rest of the kit is quite live. It's not a question of getting a good sound, we've got to get a better sound than we ever got before. It's not just a big whack, we've really got to improve our sound.

The States have the house kit everywhere, you just take your snare in and it's great for session, I love it. It still sounds like you because you are playing it, you'd be surprised. I have used a giant kit and a little Ludwig and the engineer told me he didn't have to EQ at all on both kits. He EQ'd the bass on the big kit and the little Ludwig, which was half the size, he didn't have to touch because it's your technique, it's going to sound like you whatever you do.

IM: *Can manufacturers like Malcom and Gerry do anything more to change drum sound? Are you waiting for brand new drum sounds to arrive, but you're not getting them?*

TN: They're coming in all the time, like Syn Drums now. I wanted to build an electronic kit, a complete one.

CM: The sound I'd like to get now is what Moon used to get with The Who, that awful, clanky, tin plate sound he used to get. I'd like to try and get that sound. But with today's studio sound — it would be that sound advanced.

MW: The kit that Moony's got at the moment is very similar to all the other kits he's had, it's got the Resonator shells that Premier do inside it instead of just

the plain shells. That's the only difference and he's been using Glyn Johns, as we were saying earlier, on the latest Who album.

GE: One thing I'd like to say, as far as endorsement artists are concerned, I think it's true to say, and we own up to it, is that every drum manufacturer gives away kits. English manufacturers don't necessarily get as involved as Americans do, where they give the drummers a salary as well and so the drummer actually joins the company. That's a bit heavy for us on our budgets.

I think that this whole thing is very important, because the guy who's reading the magazine and living in the middle of nowhere is going to say "It's all right for those guys, they get their drums for nothing". The point I want to make is that if you are a drummer with a well known group, or a name, all the big drum manufacturers are going to approach you and say, "why don't you look at our drums?". Quite honestly all the major makes of drums are all very high quality and basically the difference between them is just personal choice. There are no makes on the market which are absolute insults to drummers. There is nothing on the market which is absolute crap. So from a promotional point of view, the manufacturers have got to go on their plus features, like the Japanese might say, "we make all these different types of drum shells", then other people might say, "our chrome is better" or "we've got a spares service which is better", everybody's got their own thing that is the normal way of selling.

The point I want to make is that it doesn't matter — and this is what I want to say to the guy living in the middle of nowhere and is thinking, "he plays that drum kit because they gave it to him" — what he's got to realise is that when you're in the position that people come to your gig and say, "why don't you play our drums?", you still have to make the choice. Because the guy from Premier/Sonor/Tama/Pearl/Ludwig or whatever comes to you, you've still got to decide which ones you want to play.

I reckon the professional chooses more freely in fact because he's not worried about a drum kit because he's a professional. He's earning a lot of money and he's not worried about getting a free £400 drum kit.

MW: Following on from what Gerry says there, at one time, maybe 10 or 15 years ago, Premier used to have an agreement with endorsee drummers which was not a legal agreement but it was certainly a written agreement. Personally I feel, and



I go along with what Gerry says, that a professional drummer, if he's given a choice of 10 kits of different makes it doesn't matter. He will only play the kit that he wants to play, whether he's given it or not. You can't tie him down legally, you just couldn't do that.

CM: I don't agree with that endorsement thing anyway, because I've only ever had one kit free and that's the Maxwin one that I don't use. Any other kit I've had I've always paid for like the Pearl one I'm using now. I've been looking at other kits anyway, and another point is that I want to see what else is on the market. I think to myself, "OK, I like the white Pearl kit but maybe there is one better." I tried Sonor and Yamaha and didn't like them but nobody is giving drums away these days.

IM: *What about plastic drums?*

CM: A mate of mine ordered a Ludwig. He had them two weeks and had to have special hoops made to fit the ovalness of the bass drum, that was a while ago, I don't know what they are like now.

I tried the Pearl see-through on a session that we did and they worked really well on that session, but actually hearing them coming back at you, they're really clattering.

TN: I tried Fibes and they were exactly the same, they were great for studio work but on stage, nothing.

GE: The most important point is whether they are seamless or not. Basically, if you have a seam in the drum, which was the problem with the Ludwig Vistalite, then they go oval and also they shatter.

CM: What amazes me is the manufacturer's concept of a semi-pro kit or an amateur kit. Look at the Maxwin drums, the shells are great, I always get a good sound out of them, but the fittings are so useless. They just fall to bits. I think, for the sake of a bit extra, they could use better fittings because when you get things like the tom tom where the ball socket drops out because it's not spot-welded in properly, things like that. I don't see what difference professional or semi-professional makes to a drummer. The thing is, if I preferred the sound on that Maxwin kit, which I sometimes wouldn't mind using if the fittings would last longer.

GE: To be fair, they've got this Deluxe kit now, which is middle of the road, and there is a completely new range of Deluxe Maxwin fittings.

IM: *Do you think we are going into the age of the guy going into the shop and buying a kit and he uses all that kit with all the stands, bass drum pedal, hi-hat, cymbals, all in that make?*

TN: In reality it doesn't happen, any guy will tell you that, I feel like standing up and saying to these manufacturers, "OK, you might like to think that all your drummers use all your stands, and all your stuff, but they don't". The guy uses a Rogers hi-hat, different bass drum pedal — it's just personal choice.

CM: I think a lot of it is like the drummer with the group who were supporting us the other night. The kid's got a little Maxwin kit and he can't afford to buy anything else, consequently what is he getting? I think you're hampered from the beginning if you are using what YOU would class as semi-pro fittings and the kid's hampered. My bass drum work improved the second I got a Speed King pedal. What I'm saying is that the small things could make it so much better, but you say they have new fittings which is fine.

GE: I think it's important to get feedback from customers. What I do think is that it's not fair criticism if some of the roadies you've got are that type of low calibre roadie, just chucking them in the back of the van without cases. If they are being neglected like that then it's not fair. If it's a proper professional set up where you've got flight cases, good roadies etc. then OK.

TN: I'm glad you mentioned flight cases because they are so important, they will save so much time and money. I think your flight case, your tool box with your oil, your nut box, spare snare drum and all the rest are vital.

IM: *What about kits that light up?*

CM: The thing that I find with that is that you see it once and that's it. It doesn't matter who else does it, I mean even lighting yourself up from behind, all them old tricks. The average punter standing there will say, "Oh look, I don't care what gimmicks you come up with as regards the visual side of it".

TN: Let's be honest. When you go to a concert or see films of gigs, it is only drummers who notice drum kits and they only notice them if they sound good and that's down to the PA.

GE: I always found that the most out-

rageous drum kits always sounded the worst, and I always used to say they should be seen and not heard.

IM: *Who is the drummer you admire most?*

TN: Buddy Rich for his staying power, a man of 58. I saw him a month ago in Nashville and he was brilliant, absolutely brilliant. He's still as good as he ever was, his taste, his humour, his humour comes out in his playing. It's big band technique, his ability to drive along a big band is unique, a lot of other drummers say, "if you go and see Rich you go and see a sideshow." Perhaps that's partly true, but he always blows me away when I see him — he actually makes me laugh.

CM: The only one that I used to listen to was Moon, before he got fat. Phil Taylor, the drummer with Motorhead, plays some great things.

MW: Speaking personally, as a drummer, there are two guys who I really rate. One is Steve Gadd and the other guy is Steve Ferrone who plays with the Average White Band. I love listening to Louis Bellson because he's a very musical drummer; I admire Buddy Rich from a technical point of view but I think Louis Bellson is a very musical drummer and he has just produced a new album and his playing is great on that.

There are two guys I admire from Scotland who play pipe band drums; one of them, Jim Kilpatrick, is 21 years old and is a phenomenal technician. He does clinics for Premier and he can come out on stage with one drum, just a parade drum, and he'll go through all the licks, then he starts getting into this thing called backsticking, where he turns the sticks round and he also does a thing called clickety click where he puts the drum down and just plays two sticks together and he can play almost any rudiment on just two sticks, with the exception of a roll and a ruff.

GE: The guy I admire is Keith Moon; the best drummers I've ever seen have got to be the West Coast drummers, the Hal Blains, Steve Gadds, Harvey Masons. To me they are quality professional studio musicians. As regards admiring people, I admire Keith because from the age of 15 he knew what he wanted to do and went out and did it. The day he first hit a drum kit he has played like that, he has never put on any pretence, he never ever altered his style according to the type of music.

MW: To qualify that, it's fair to say that I answer all the consumer enquiries for Premier, and the one guy that we get more enquiries about than anybody else is Keith Moon.

TUBE SOUND WITHOUT TUBES.

PEARL "SG" SERIES GUITAR & BASS AMPLIFIERS.

"SG" Series.... A line of compact guitar amplifiers of highest quality at low cost.



The star of the "SG" series, with 100W power and original distortion effect.

This system employs a newly developed CNF circuit. The CNF circuit produces sounds which could not be achieved with previous transistor amplifiers. It provides clear tone quality — just like tube sound. Furthermore, the distortion depth can be controlled as desired with the over-drive circuit and by employing FET.

SPECIFICATIONS

OUTPUT: 100W RMS, 200W Music Power
SPEAKER: 30cm x 2, P30-50CT
SEMICONDUCTOR: 13 Transistors, 5 FET, 8 Diodes
CONSUMING POWER: 250W
DIMENSIONS: H525 x W670 x D250mm
WEIGHT: 22kg
ACCESSORIES: Foot Switch, Vinyl Cover

SG-101



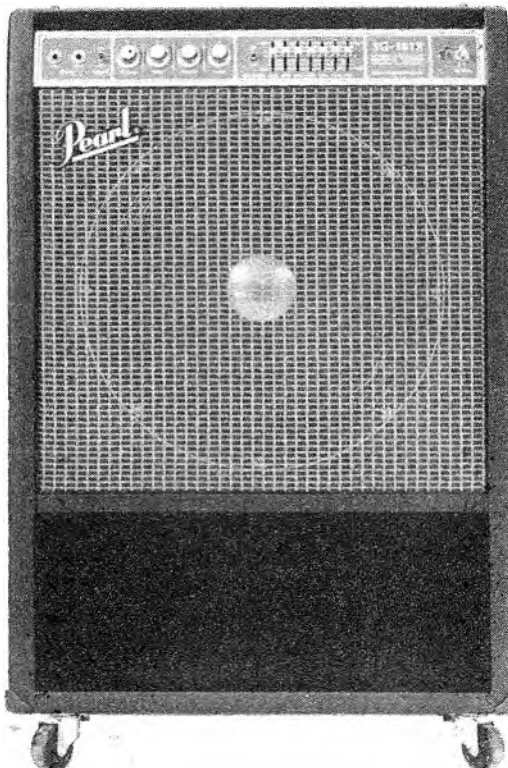
Pearl's newest compact amplifier (also suitable for use with headphones).

This amplifier embodies the best qualities of high-class guitar amplifiers in an extremely compact format. A special feature is the built-in hard distortion effect.

SPECIFICATIONS

OUTPUT: 30W RMS, 60W Music Power
SPEAKER: 30cm x 1, P30-35L
CONTROLS: Volume, Treble, Bass, Distortion
SEMICONDUCTOR: 8 Transistors, 7 Diodes
CONSUMING POWER: 50W
DIMENSIONS: H411 x W362 x D160mm
WEIGHT: 8kg
ACCESSORIES: Vinyl Cover

SG-031



New CNF circuit in a 100W bass amplifier mounted with a 15in speaker

The special CNF circuit built into this amplifier opens up many new possibilities. The new and exclusive 15in bass speaker offers impressive low frequency response coupled with superb high frequency performance. The speaker is of the back-loaded horn type.

SPECIFICATIONS

OUTPUT: 100W RMS, 200W Music Power
SPEAKER: 38cm x 1, P38-100B
CONTROLS: Volume, Treble, Middle, Bass, Equalizer Bright
SEMICONDUCTOR: 10 Transistors, 2 FET, 4 IC, 7 Diodes
CONSUMING POWER: 250W
DIMENSIONS: H820 x W535 x D335mm
WEIGHT: 33.5kg
ACCESSORIES: Vinyl Cover

SG-101B



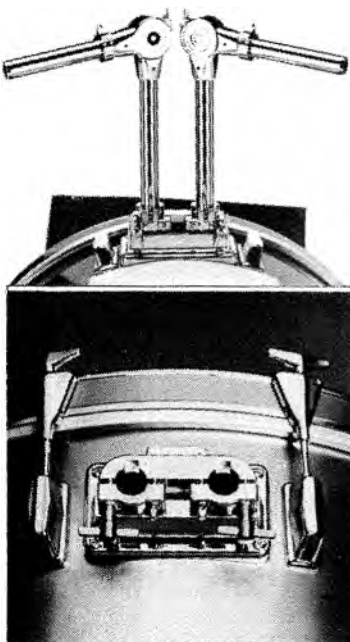
VARI SET SYSTEM

Many different settings are instantly possible
Designed for the professional drummer

Because drummers have many different requirements, Pearl has developed some very special accessories. The new tom-tom holders feature the VARI system. Very precise adjustments as well as full-range movements in all directions can be achieved. Using the lock-stopper, the unit is exceptionally stable and there is absolutely no vibration of the tom-tom. Once set, the system will always smoothly re-set.

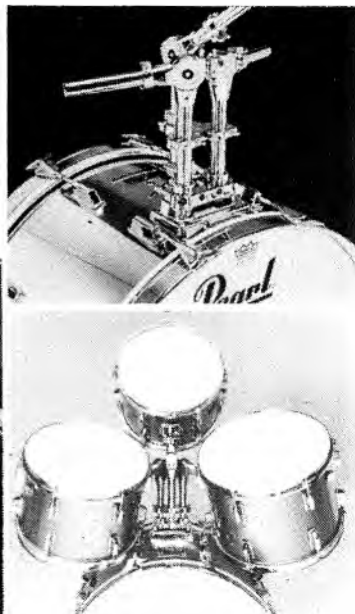


• TWIN TOM-TOM HOLDER



• TRIPLE TOM-TOMS

VARI System twin tom-tom holder
Adaptor



• TWIN TOM-TOM HOLDER WITH
UNIQUE CONCERT
TOM-TOM HOLDER

VARI System twin tom-tom holder
Adaptor
Concert tom-tom holder

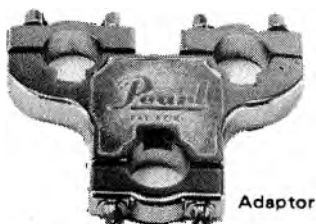


• TWIN TOM-TOM HOLDER WITH
CYMBAL HOLDER

VARI System twin tom-tom holder
Adaptor
Cymbal short boom holder



The adaptor of the VARI system and the stand in the New Pro 900 series comply with the same standard. With only a few stands, many Tom-Tom units and cymbals can be set up in a compact arrangement.



Adaptor

Pearl[®]
DRUMS
The Driving Force

viscount

Intercontinental Portables



The top selling professional portables for today's top keyboard players! Starting with the Synthdakota priced at £595 and providing not only an excellent organ specification but a built-in Synthesiser as well, the Intercontinental range then features the Imperial with Strings priced at £945. An amazingly versatile organ which now incorporates the superb Viscount Multi-String ensemble effect. And the superb Viscount Super (£1275 - illustrated) weighing only 77 lbs. must be the most portable professional portable on the market! 16'-1" Drawbars, Strings, Piano, 2nd and 3rd Harmonic Percussion, Key Click, Two Speed electronic doppler tremolo - the Imperial Super's got it all! Check out the Intercontinental Portables today at your nearest Viscount dealer or visit our special London Trade Fair Preview Exhibition.



**SPECIAL VISCOUNT
TRADE FAIR
PUBLIC PREVIEW DAY**

12 noon to 9.00 pm on Saturday 12th. August 1978
in The York Room, The Bonnington Hotel,
Southampton Row, London WC1
(Nearest Station - Russell Square)



VISCOUNT ORGANS LTD

Registered Office: 1 Clareville Street, London, SW7
Sales - Telephone: 01-427 2703
(01-370 3431 Answerphone)



Please send me details of the
Viscount range of Portable organs
and the name of my nearest Dealer.

Name _____

Address _____

Browns of Bristol

One of Bristol's leading musical specialists

We are area agents for

Premier

in Bristol

We also stock:-

Custom Sound Amplification, Avedis
Zildjian & Ufip Cymbals,
Shure Mics

In Our Guitar section we can offer
you
Eko, Epiphone, Yamaha and Crumar.

Come in and see us at
5 Union Street, Bristol.
Tel: (0272) 23646



NEWTONE MUSIC CENTRE

64 Market Street, Earlestown, Newton-le-Willows. Tel. 22514/5.

**Largest stockist of
Fender guitars in the area.**

Also in stock we have

Gibson
Epiphone
Eko
Hayman
Gretsch
Shaftesbury

Hagstrom
Yamaha
Shergold
Antoria
Avon
Columbus

Amplification
Marshall
Phoenix
Carlsbro
Yamaha

H & H
Custom Sound
W.E.M.
McGregor

Drums
Premier
Gretsch
Rogers
Sonor

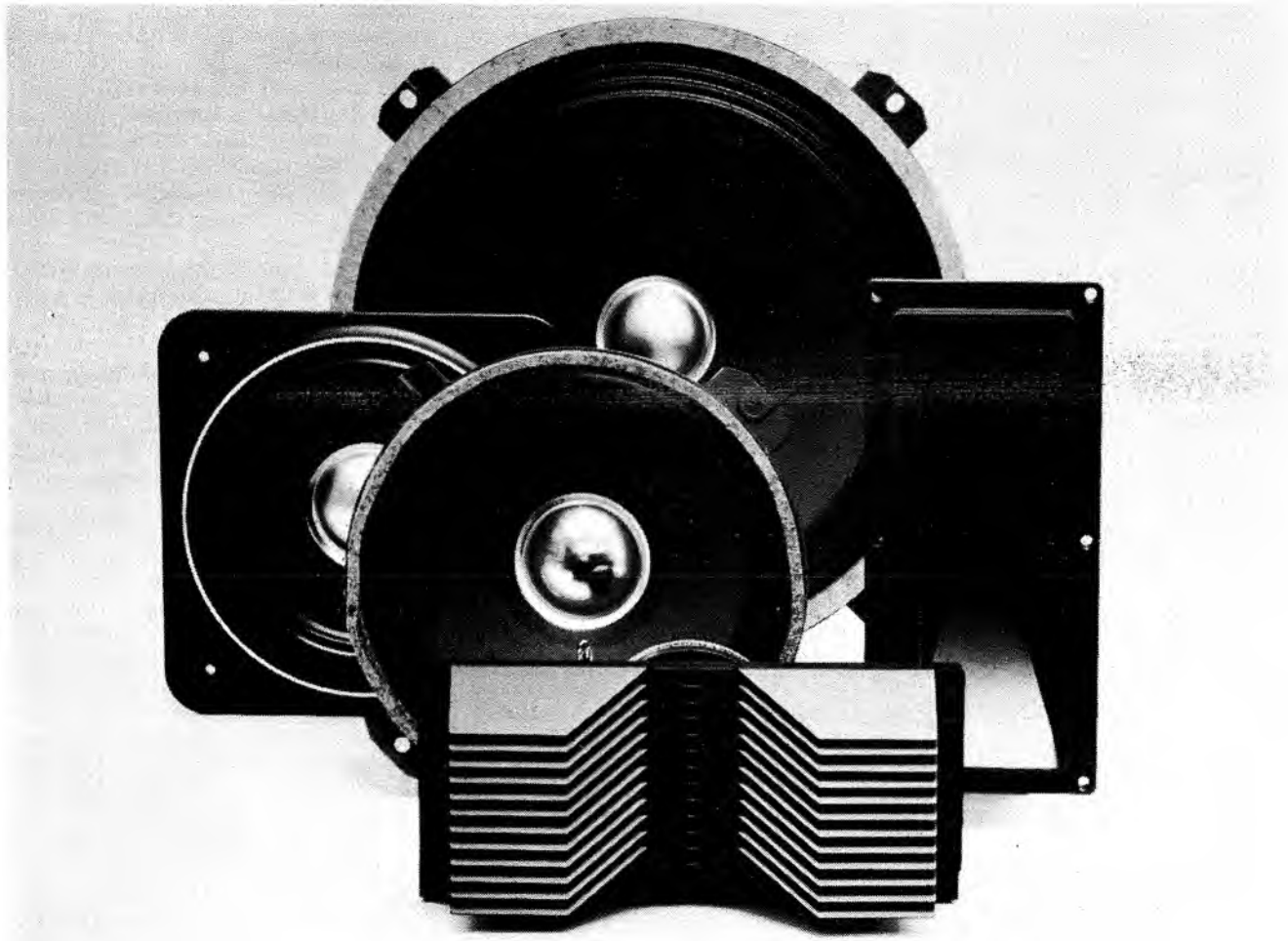
Yamaha
Ludwig
Olympic
Pearl

Keyboards
Korg
Moog

Hohner

Footpedals of all makes, mics of all makes,
Accessories to suit all demands.

New power drivers from **ISOPHON**



Isophon offer an extensive range of drive units including bass, mid-range and high frequency drivers.

Already renowned for their dome tweeters, Isophon have now introduced a number of high power bass units handling up to 200 watts RMS power.

Their new 30 page catalogue is now available and we invite you to write for your free copy. Please complete the coupon and post to us today.

Hayden Laboratories Ltd

HAYDEN

HAYDEN HOUSE, CHURCHFIELD ROAD
CHALFONT ST PETER, BUCKS, SL9 9EW
Telephone Gerrards Cross 88447

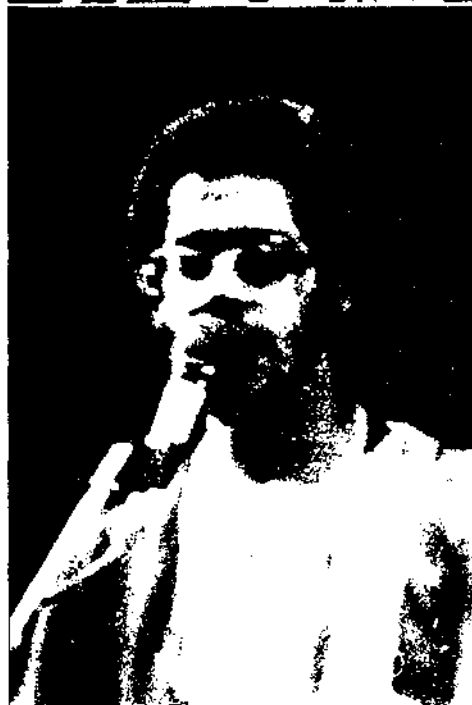
Please send me a free copy of the ISOPHON catalogue

Name _____

Company _____

Address _____

Code IM/978



The sight of Carlos Alomar striding to the front of the stage, baton in hand, to conduct David Bowie and his band would not seem to be normal practice for a rock guitarist. Then again, Carlos Alomar is no ordinary rock guitarist.

Since 1975 he has been Bowie's guitarist and general Musical Director, whose influence has spanned such albums as "Young Americans" right up to "Heroes" and included all of Bowie's live work for the past four years. Bowie's recent world tour has firmly established him as one of rock's genuine superstars and responsibility for translating his highly complex music into a stunning stage show has rested fairly and squarely on the shoulders of Mr. Alomar.

Carlos is a highly talented and respected musician who takes his profession very seriously. He is a professional in every sense of the word having learned his craft doing session work in New York with such people as Bette Midler, James Brown and Harry Belafonte as well as soul outfit "The Main Ingredient".

The man is about as far removed from the superstar, ego-tripping rock axeman as you can get. He reads and writes music, striving for perfection in everything he does and has such a wide knowledge of the various facets of the music scene that if there were a university for rock music, Carlos would be one of its most eminent professors. Music is his livelihood, and he has as much pride in it as any artist or sculptor.

Carlos first met David Bowie when the latter was working in America. "I was doing studio work with The Main Ingredient", he said, "and David was producing Lulu. I was doing some tracks for Lulu having been recommended by some of the guys in 'The Main Ingredient', and it was one of them, Tony Sylvester, who actually recommended me to David.

"So I went down to the studio, did the work and invited David over to my house for a home-cooked meal because he was really thin and just wanted to get away from "the road" and hotel rooms. He came over and we had a great time, and he asked me if I would go out on the road with him and I said 'yeah'.

"This was before 'Diamond Dogs', but when they were getting ready to do 'Diamond Dogs' I found that I couldn't do it so they got Earl Slick. Eventually they slipped back to Philadelphia to do the 'Young Americans' album and he called me up and said 'I'm doing an album in Philadelphia, do you want to come down?' I said 'Hell, yes' so I went

down to do that album.

"I was with The Main Ingredient for three or four years as their band leader, and so basically went from there to David. Although I was still doing studio work in New York, I have been band leader exclusively for those two. I've played on every album since 'Young Americans' and some of Iggy Pop's stuff which David produced. I did the whole of 'Lust for Life' with Iggy, which was nice."

As only to be expected with a master craftsman, Carlos is very particular about the tools of his trade. His main guitar is an Alembic, which he uses for all live work, and this specialist American company also furnish him with other equipment.

"The Alembic I have was made in California and I call it a Maverick. I have a rack (of effects) that I also had made in California by a guy named Steve Warren. The rack consists of an Alembic pre-amp, an equaliser, a Gain Brain, an MXR flanger, MXR phaser and a crossover. Everything is in stereo, but those are the only effects that I deliberately use on stage

"Although the Brain itself has the capabilities of having anything patched in, being a rhythm guitarist I leave all the effects out. This way, I can just have my clean sound. Then it goes through two Yamahas and one Crown, one Yamaha for the mids, one for the bass and the Crown for the highs. I have a JBL for the high, two Alembic 12's in a large cab and a big 18" Alembic for the bottom. I have two of them on each side so it's a lot of power.

"I like the Alembic for playing rhythm, but I also have a Gibson, a Strat and a Jaguar that I use at home and when I'm recording because I like to have as many different sounds as I can. I have the Alembic specifically for stage! If I'm doing 10 songs I try to have 10 different sounds and the Alembic is the only guitar I've found that gives me the ability to change the sound completely. I can get just about everything from that one guitar, from the super, super highs of a Telecaster all the way down to a 335 or I can get all the mids of a Strat.

"Alembic are very exclusive. Mine cost me about \$1,650 so they're pretty expensive but it gives you good clean sound. I can have the guitar completely turned up or the amplifier full out and you won't hear a thing - no hum because it has a hum cancellor. The only sound you hear is when I hit the guitar. It is a really transparent sound.

Carlos Alomar-

"You can turn up the guitar and have full wattage and yet not have any interfering noise. It gives you an actual brilliant sound. It has two pick-ups which are separated left and right and everything is Alembic pots, pre-amp, crossover and roll-off switch. The guitar also has a control on the back to enable it to be really souped up. If I want feedback and things like that I just turn it all the way up because it has a pre-amp and everything inside. If I did that, then I'd have a lead guitar — but I don't want a lead guitar."

Although Carlos is essentially a rhythm guitarist relying solely on his Alembic for live performances, studio work is somewhat different. You are likely to hear him playing some lead on albums and also using different instruments.

He explained: "I play rhythm on stage only, but on the albums I'm playing a lot of lead stuff. I have a 335 that I used on 'Station To Station' and on the things I play lead on. I prefer the 335 basically for the neck and for the sound. It's a lot dirtier. The Alembic is a bit too clean sometimes.

"I love rhythm guitar, I don't really want to play lead. A lead guitarist will come up to me and say 'play G and then A'. He'll play G and A and I'll have played 15 variations ranging from the simple G chord and he'll turn round and say 'No, no. Play G'. That's the whole knack of it, I can run all over the place and not get in the lead guitarist's way, yet fill up the sound. A lead guitarist on his own is just a lead guitarist. Put a strong rhythm with him and it will take him somewhere completely different."

"The strings I use vary. I used to use GHS but, out on the road, you can't always get them in the different places we play. I change my strings every other day while I'm on the road so the roadies have a real hard time. If my hands are dirty or anything like that, I change my strings — I love new strings. While I'm in London I have to use Ernie Ball, but I prefer not to. It's not that I don't like them, but I like the brilliance of another string, after two or three days they are just gone."

One of his biggest responsibilities is having to get the entire band together before the start of the tour and put together a show which has to be taken around the world and conform to Bowie's own high standards as well as the expectations of the thousands of fans for whom seeing Bowie live is such a rare and much anticipated event.

Carlos was contacted by Bowie a week before the tour was due to begin and asked to get everything ready. This meant him wrapping up work he was doing with his wife (singer Robin Clark) and getting the band ready to hit the road.

"I had to go to Dallas to meet a whole band that I'd never met before other than the two I already knew (drummer Dennis David and bass player George Murray)" he recalled. "Nobody knows anybody else and, as Musical Director, it entails setting up perfect vibrations so that everyone feels at ease and yet feels that there's someone there that they must listen to — which takes the anxiety away from them.

"It also means learning 32 songs in six days, giving out individual parts, writing out lead sheets, writing out music, getting everybody together and making them feel that they don't have to play this. It means not telling them what to play, it means direction, making them feel at ease and making sure they get everything they want. It also means giving them as much information as possible so they can do what they have to do.

"Being the MD means not knowing what Bowie wants but using intuition and having it all done so he can come along and say, 'OK let's drop 18 songs'. It just means doing everything in excess, again to give him a choice. Still it is fun, because if it is all done right — and Bowie makes sure of that because he has a great road manager in Eric Barrett, a great road crew and a great sound crew — then all the musicians have to do is enjoy themselves. It's a question of just getting on stage and plugging in, don't tune up, don't carry your instruments, don't do anything apart from walking from the hotel and walking out on stage."

With the band made up of musicians, the majority of whom had never played together, who come from different backgrounds and, in some instances, different countries, problems would seem inevitable. There is also the challenge of playing music taken from Bowie's entire career ranging from the straightforward rock of "Hunky Dory" and "Ziggy Stardust" through the soul of "Young Americans" to the New Music of "Low" and "Heroes".

"The English people in the band are Simon House and Sean Mayes, Roger (Powell) is from Woodstock, Dennis and George are from New York and Adrian (Belew) is from Kentucky but now living in Illinois. They are the only gifted people who are allowed to be themselves.

Their music is their life. If a musician's life is messed up, then it might relate to his music.

"As regards playing the stuff on stage it's easy, believe me. For myself, it's not that hard because, as it is, I overdub a lot of stuff so when I get to play it on stage I just have to listen to the album and decipher exactly what it was I played and which one of those lines I want to play. That's the difference between the studio and the stage. You'll hear it live and say 'Well damn, it sounds just like the record, but it sounds a lot better, a lot tighter.' It's not because we've actually changed the music, it's just that the mix is different, the parts that you are hearing are more exact, so you have a much cleaner sound.

"We've had to adapt everything to seven pieces which is a little different to the four pieces we had before and the five pieces before that. With seven pieces, we have a lot of sound that we have to take care of and duplicate and you can simulate a record pretty well. Seven pieces is a lot of parts but they don't get in the way because there's enough on the albums for everybody to get a little piece and walk away with it.

"The reason we recorded a live album from this tour is because there is so much power and punch on stage. When you do an album, it's flat, you can't get that fire that you get on stage. If you played the material as it is done on the albums it would just die. When you play it live, certain tempos have to come up, some come down and certain things have to be completely re-adapted, especially for seven pieces. 'Five Years' does not have seven pieces, so you've got to add everything in there and yet not make it sound as though everybody's playing all the time. It's not that hard to get everything done because the calibre of the musicians is excellent. We can play virtually anything Bowie wants."

Working with David Bowie must be one of the most challenging gigs in rock music, particularly as his music has changed so radically over the years. Carlos has gone through a number of phases with him since the "Young Americans" album which would seem radical to the listener but does it seem so to the musicians?

"Well it is and it isn't. George, Dennis and myself are the ones who do all the rhythm tracks and there's a lot of stuff that's overdubbed so it's not quite that different. What is different of course is that sometimes we'll listen to the album

Bowie's MD

By David Lawrenson

The Series IS, based on the world famous industry standard Series I. Unequalled features, technical sophistication and a modest price.

Input channels (12, 16 or 20)

Transformer balanced mic input with a 20dB pad. Variable gain mic amp. Insert send/return (line input). 120Hz high pass filter. Four band EQ, with the two mid band frequencies sweepable. Two monitor sends (post-EQ) and one echo send (post-fade). Automatic pre-fade Solo. LED peak indicator whose delay time indicates the relative size of the transient.

Five outputs

Left and right main, monitors A and B and master echo, each with two band EQ, solo and insert. Each output may be balanced by a plug-in transformer.

Meters

Two studio quality VU's and peak reading LED's display the main stereo output or any function soloed.

Communication

There's both talkback and intercom. The talkback mic can speak into the main output, monitors A or B, or into a ClearCom (or compatible) intercom system.

Specifications

Excellent, ie incredibly quiet and distortion-free.

Finally

Two echo returns, conductive plastic potentiometers throughout, socket for Shure lamp and, of course, the Soundcraft comprehensive 2-year warranty.

Encore.



The new EX4S studio quality 2, 3 or 4-way stereo electronic crossover.

Internal switching

The facilities for changing the crossover points, and for converting the unit to a 2, 3 or 4-way are inside, to provide maximum protection for P.A. systems, by avoiding accidental switching.

Front panel controls

Eight band-attenuators, eight LED peak indicators, and LED's to indicate 2, 3 or 4-way mode.

Circuitry

Bessel function filters (superior to Butterworth filters in other crossovers) give an ultimate slope of 24dB/octave, the most linear phase response and the best transient response. The result is, quite simply, a better sound.

And the rest

EX4S is built into an all extruded black anodised 19" case, tough enough to stand up to all the wear and tear of the road. XLR and multipin connectors on the back. Inputs are electronically balanced while outputs may be balanced by plug-in transformers. Of course, it's also covered by Soundcraft's comprehensive 2-year warranty.

Soundcraft Electronics Ltd., 5-8 Great Sutton Street, London EC1V 0BX. Telephone 01-251 3631. Telex 21198.

Soundcraft North America, PO Box 883, JFK Station, Jamaica, New York 11430, USA. Telephone (212) 528 8158. Telex 01-2203.

Début.

SOUNDCRAFT
ELECTRONICS LIMITED

after it's been done and say, 'we played that?'. You know the song because you played the rhythm tracks but then you start overdubbing and just keep bringing those rhythm tracks down until after a while you have a record and it sounds nothing like what you started with. Still, the musicians who have to overdub something don't have the anxieties of having to create a song. It's already there so all they have to do is embellish it.

"David has the ability to choose the right musicians, which is very important, and the right sound. The sound is what's so important. If he doesn't hear you and a particular sound, he has no way of putting you into his mind's 'ear'. When he heard Earl Slick, it was the sound that he went for. It becomes very easy for David to manipulate or specify exactly what he wants through the sound.

"There are two different ways in which David works. One is where he'll have something there, go to the piano, bang out a few chords and say 'let's play off this' and then we just start changing it. Once you have the chorus and the verse all you have to do is play it a few times until it actually falls into place. You make it a little slower or faster, perhaps a bit reggae, rock and roll or laid back, behind the tempo or in front of the tempo — that's all up to me. There's just three of us and we've been working together for a while and so we just start jamming. Once the jam is over, David can have a choice, and once he has a choice he can do whatever he wants.

"Some is premeditated — conceived, written and planned right there in the studio. 'Young Americans', for instance, was completely conceived in the studio; I mean the man walks in with nothing in his head and, out of the clear blue sky, he picks up a guitar and we jam. It's inspiring when you're there because you're completely at the disposal of David Bowie. You want to please him and get it done which means that any little idea can be taken to the limit."

Such is the way that Bowie works, that not only would Carlos and the rest of the rhythm section probably never hear the finished product until they had the album in their hands, but often they would not even meet other musicians whom Bowie had chosen to play on it.

The prime example of this would be guitarist Bob Fripp who has worked on Bowie's recent recordings. Carlos never met Fripp, and only realised he was on the album on receipt of the completed work. Still, Carlos has complete faith in



Bowie and feels completely happy with the arrangement.

One of the few occasions that he has to use his music reading and writing ability is when he is called upon to do a copyright sheet of David Bowie's albums — which does have its problems.

"I have a friend who helps me out when I'm in New York and he and I just sit down and listen to the record. Sometimes it is just ridiculous, I mean something like 'Weeping Wall' is really hard to do. Sometimes I take it on myself to just make something out of nothing, like on 'Warszawa'. Some words that he says basically aren't anything, but when I did the copyright I made them Latin words. If I can make something out of it which makes sense phonetically then I will try to, simply because I have pride in my work. Fans always come up and ask what things mean, so I can just tell them."

His taste in music is strictly classical, especially after spending so much time on the road touring. "When you tour for six months straight you're bobbing your head up and down every time you hear a record. As a Musical Director, I'm analysing every piece of music I hear and I get sick and tired of listening to rock

and roll, soul, disco, R&B, and punk. So when I get home, I turn on classical music and I don't bob my head up and down, I don't analyse it, I just go about my business.

"Of course I listen to guitarists, I do like Benson and Santana, but I tend to listen to so much stuff that I never get names. I listen to classical guitarists like John Williams, but I don't have a favourite player. I don't like everything Benson plays, or Segovia picks, although I'm inspired by Hendrix and I like Santana because I'm Latin and I love to hear guys playing Latin jazz."

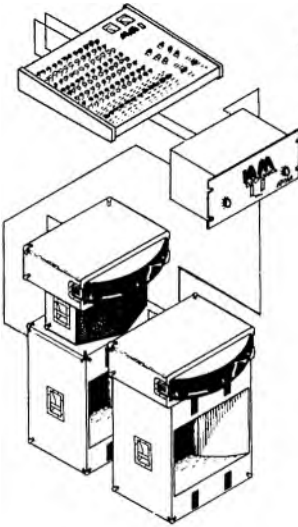
When the tour with Bowie is finished, Carlos will go back home and continue producing his wife's album. Producing is an area which attracts him and he has contributed to Bowie's work in this sphere — albeit without credits. However, despite his vast musical knowledge and reputation, he regards himself as a working musician who will continue to do sessions for whoever wants him and concludes, "I've done all kinds of work and I've never really turned down a gig. I'm a musician and I'm not about to say, 'No, I'm not going to play' unless I really have to."

Carlos Alomar

soundwave

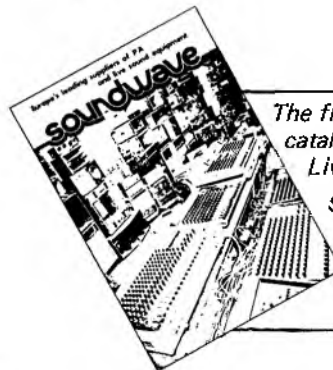
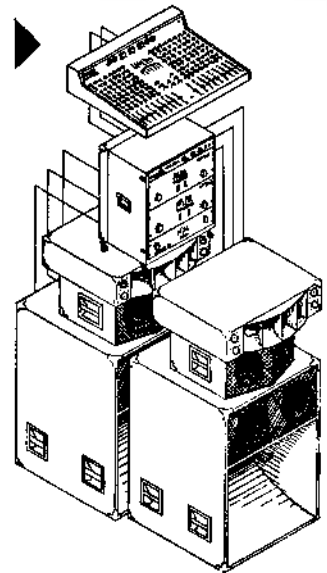
66 Victoria Rd, Romford,
Essex, England

Tel: Romford (0708) 25919



RIG 12/400
12-CHANNEL 400 WATT
STEREO PA SYSTEM—
Complete and ready to use
£985 inc vat
RIG 12/400M
As above but with the
addition of 2x12 mid cabs

RIG 16/1300
16-CHANNEL 1300 WATT
STEREO PA SYSTEM with
3-way electronic crossover—
Complete and ready to use
£3175 inc vat

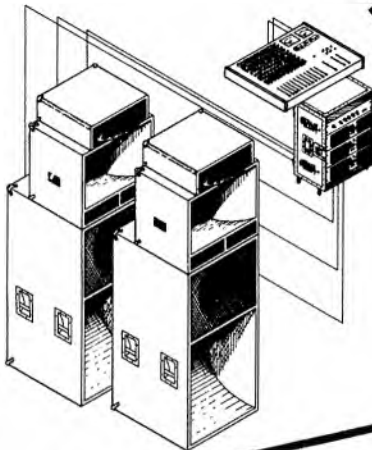


The first really comprehensive
catalogue exclusively of PA &
Live Sound equipment!

Send a large Stamped
Addressed Envelope (12½p
or 2 International Reply
Coupons) for your FREE
Catalogue and full up-to-
date price list

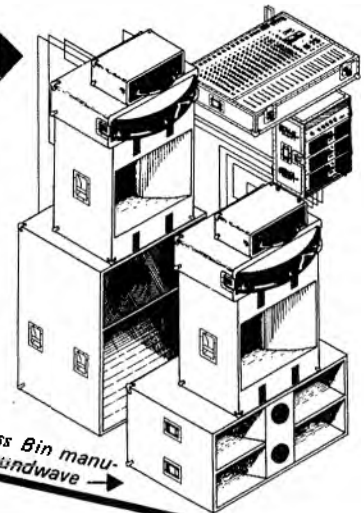
NEVER MIND THE KILOWOCKS! HERE'S THE SOUND PRESSURE LEVELS

These are two examples of our new series of High Efficiency rigs featuring JBL speakers and Trace Elliot amplification



RIG HE12/500
High Efficiency
12-Channel 500 watt
stereo PA system—
3-way electronic
crossover— JBL
drivers and Trace
Elliot amplification—
Complete and ready
to use
RIG 12/500S
As above but utilising
standard drivers and
MM amplification

RIG HE16/750
High Efficiency
16-Channel 750 watt
stereo PA system—
3-way electronic
crossover— optional
1x18 or 2x15 bass
bin— JBL drivers and
Trace Elliot
amplification—
Complete and ready
to use



JBL designed Ultra-low Bass Bin manu-
factured under licence by Soundwave

ABOVE ARE SHOWN FOUR OF OUR
OFF-THE-SHELF PA RIGS. WE ALSO SUPPLY
AND BUILD CUSTOM RIGS TO ANY
SPECIFICATION USING COMPONENTS FROM:

AKG, ALLEN & HEATH, ATC, ALTEC, BEYER, CANARY, CELESTION, CERWIN VEGA, ELECTRO-VOICE,
GAUSS, H H, JBL, MM, PACE, PEAVEY, RCF, RSD, SHURE, SOUNDCRAFT, VITAVOX AND MANY MORE

WE STOCK: BACKLINE AMPS AND CABS, DI BOXES, ECHOES, GRAPHIC EQUALIZERS, GUITARS, KEYBOARDS,
MIKES, MIXERS, MONITORS, MULTICORES, SPEAKERS AND MUCH MORE

ON PARLE FRANCAIS

EXPORT ENQUIRIES WELCOME

WIR SPRECHEN DEUTSCH

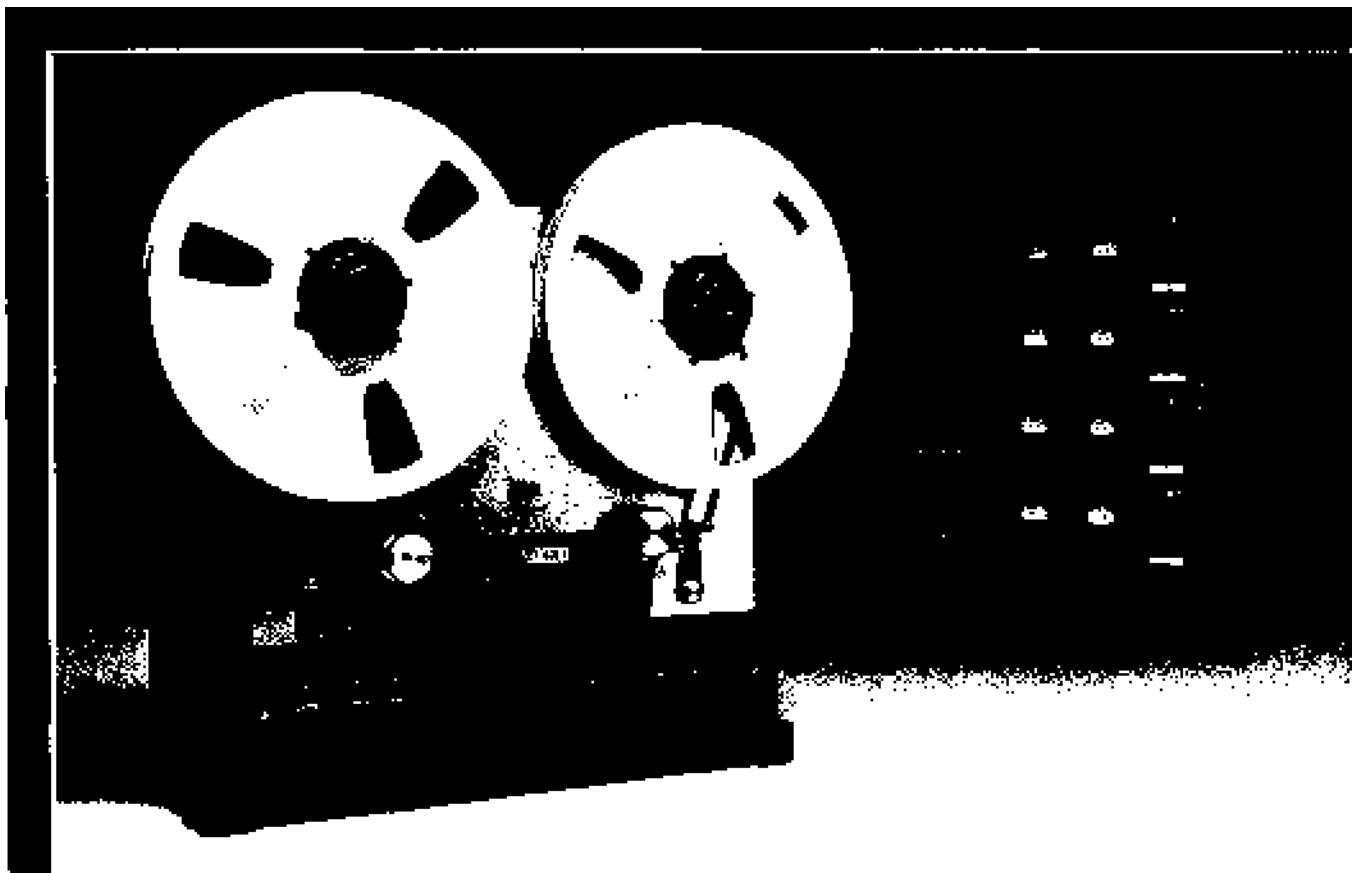
HP · PART EXCHANGE · BARCLAY & ACCESS CARDS · REPAIR SERVICE · SECOND HAND GEAR BOUGHT AND SOLD

WRITE NOW OR RING FOR DETAILS

OPENING HOURS: 9.30 to 6.00 MONDAY TO SATURDAY—CLOSED ALL DAY THURSDAY

OTARI

**The half-inch eight-track masterpiece.
Otari MX5050-8SD for discriminating recordists.**



If you have been thinking eight-track machines are bulky and costly, this 1/2" recorder will change your idea. It's exceptionally compact, yet comes with every feature critical professional applications require. DC-servo capstan motor for less than 0.05% wow/flutter, with $\pm 7\%$ pitch control. 63 dB S/N and greater-than-50 dB crosstalk. Selective reproduce on all eight tracks. Motion sensing control logic, front panel edit and adjustable cueing control for fast-mode monitoring. Front adjustable bias, record equalization and output level. 600 ohm

+4dBm fixed output with XLR connectors. And it comes with the latest plug-in card electronics. The compactness and performance make it ideal for live recording.

In short, the MX5050-8SD is an exception of eight-track professional recorders with performance, reliability and economy internationally proven in hundreds of applications producing high quality 15 and 7-1/2 ips masters. For the full story of this unique model, get in contact with your nearest Otari distributor.

**Please send me details on
MX5050-8SD**

Name _____

Company _____

Address _____

TM

Behind the Eardrum

with Dave Macrae

"New Zealanders are regarded as being terrific at rugby and sheep farming. They don't have that much of a reputation for being world-class musicians, which makes Dave Macrae something of an Australasian oddity.

Macrae, now living in London, is one of the most in-demand session keyboard players around, as well as being a respected producer and key member of the fusion band Pacific Eardrum which is comprised essentially of 'musicians' musicians.

Dave began his musical career back in the days of Bill Haley rock and roll pounding out chords in obscure bands in New Zealand. His musical progression soon led him to realise there was more to music and he began listening in earnest to the jazz keyboard greats like Art Tatum and Fats Waller and then later appreciating modern masters like Herbie Hancock, Chick Corea, Keith Jarrett and Joe Zawinul, now one of his favourite players.

He is mostly self-taught and his tuition largely came from listening to and talking to other keyboard players. Dave eventually moved to Australia becoming involved in Australian television and playing jazz clubs. One of his biggest breaks came when he moved to America and landed a gig with Buddy Rich.

"I'd been in Australia and put some money together so I thought I'd go to 'the land of music' and see what happens. I lived in LA and Rick Laird, a friend who used to play bass with Mahavishnu Orchestra, was with Rich and told me the piano chair was vacant, so I joined. We did all the world festivals. It was a wonderful thing to be thrown into the deep and working with the best jazz players about. Physically it was a very hard gig since you're doing one-nighters all the time. We did 48 in a row".

It was while working with Buddy Rich that Dave discovered his first electric piano — the Fender Rhodes. He was in the studio when Rich pointed to a Rhodes and said 'can you play that'. Dave, never having touched one before, naturally replied 'yes'. He played the instrument, liked it, and has been a Fender Rhodes fan ever since.

He soon latched on to synthesizers and now owns an ARP Odyssey as well as being familiar with the ARP 2600.

Like the majority of acoustic keyboard players who tackle the synthesizer, Dave had to rethink some of his musical ideas to a large extent.

"The key differences of a synthesizer to an electric piano are quite marked. The synthesizer keyboard is, in most cases a triggering device.

It has no particular feel to it. It makes no difference if you strike it hard or soft. The biggest difference is one of musical thinking. If you're playing a monophonic synthesizer you have to think in a different way; more like the guitar soloist or violin player. You're more in a solo position and you have to get the right emotional attitude towards that.

"If you can do that you can always find the sound that you're trying for. If you don't know what you're trying for you've really got troubles with a synthesizer. After you get familiar with the synthesizer keyboards, you realise they are meant for different things. If you have a selection of three keyboards and you hear something in your head, you'll automatically go to the right instrument to play it."

On stage his main instrument is the Yamaha electric grand to which he admits he has tuning problems. This is supported by a Hohner Clavinet, ARP Odyssey, Fender Rhodes and a Solina string machine which all go through a modified Allen and Heath mixer and finally out through two Yamaha custom cabs. In the studio his favourite piano is the Steinway Grand.

Of the Yamaha, Dave claims it is the closest electric piano to an acoustic instrument both for sound and feel. "Its biggest advantage is that, with correct monitoring, you can play fairly loud on stage and not get any feedback. It's relatively portable if you've got a couple of hefty friends. Unfortunately, it's expensive. If you're really getting into it and you start to play hard, the tuning can go and you have to be able to straighten it out yourself."

With Pacific Eardrum, Dave is now playing the music he thinks people will enjoy.

"We're trying to encompass more than perhaps the average band does. We try to fuse together aspects of our backgrounds and come out with things that people will find easy to relate to.

"An audience needs time to breath, musically speaking. Just like you do when you're playing. Some of us have been in bands where you play a 45 minute set straight through without a break. It's quite exhausting to play and it must be exhausting to listen to."

As well as his gigs with Pacific Eardrum, Dave has moved more and more into production. Indeed his last project was producing the new Walker Brothers album.

"I enjoy producing. Especially when it's someone else's music. I like to be involved in many different things. If you do the same thing

BY IAN WHITE



all the time you perhaps get a bit samey. I liked doing the Walker Brothers album because we had to do quite a lot of orchestration and I like working with large orchestras.

"I studied orchestration out of books but I learnt quite a lot in Australia doing orchestras for singles. Anyone who listens to the styles required can hopefully channel their head into the style that's required."

Nevertheless, Dave would not replace a string section with a synthesizer. On the Walkers' album the Yamaha CS80 was used on a few tracks but authentic strings have a definite sound as far as Dave is concerned.

"The best thing about the synthesizer is that, once you stop trying to get them to emulate other instruments, you get into what they are about which is a totally new thing.

"The best quality of any synthesizer is not trying to make it sound like a clarinet or an oboe but trying to get good synthesizer sounds." Dave says it is essential for synth players to have a technical understanding of what they are doing.

"You have to have a basic knowledge of what you are technically doing on a synthesizer. More so than on an acoustic instrument. In my opinion, I don't think that good music is made by technicians. It takes a good musician with a musician's knowledge to create good music.

"You get situations in America where people will come in and program instruments. But they specialise in the technicalities in getting good sounds out of synthesizers but then they go into the hands of musicians to play them."

He is quite keen on the new Fender Rhodes which has just come out which he thinks is a big improvement on the old one.

"I really think the Fender was an excellent instrument. It has a very identifiable sound. It's very warm and I like playing it. It's like an organ piano, a very long sustained ring which makes you play a special way."

Macrae is quite keen on the newer generation of synthesizers such as the CS80, which now have touch sensitive keyboards.

"The thing about the touch sensitive keyboard is that you can get expression or volume. I'm sure it's an advantage. I've seen Roland equipment but I've never delved into them".

He still has some way to go before he is fully conversant with all the facilities offered by an advanced synthesizer, such as the ARP 2600 because of the myriad of different patches that can be achieved on the instrument.

On stage he keeps well away from complicated patching manoeuvres. The Odyssey is used in about three songs but he rehearses his changes so that controls are manipulated quickly when the right musical moment comes.

"In one sense the ARP Odyssey is a little unwieldy, but I like its sound".

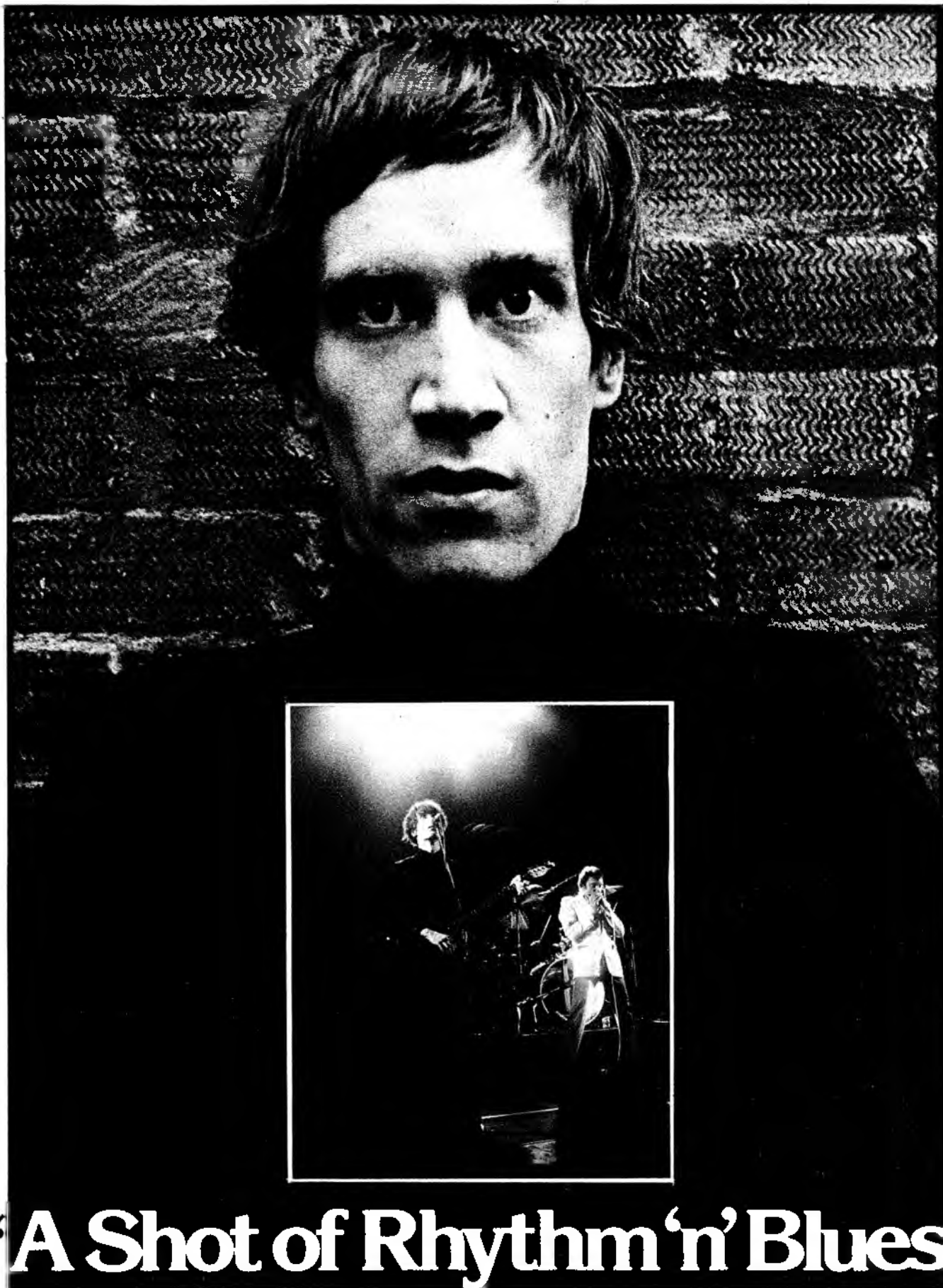
There is one area he would like to get more into. That is the world of film music, where he feels the synthesizer could be well used.

Meanwhile, Pacific Eardrum's new album is out about now and the band is well poised to undertake an extensive schedule of touring. You can be sure Dave Macrae's keyboard playing will be impressing a whole new audience.

Blake and the "Bizness"



"LIKE, WHERE DID WE GO WRONG?"



“A Shot of Rhythm ‘n’ Blues”

by Eamonn Percival

In the early Seventies, the live music scene in England was given a great boost when a now-legendary phenomenon took place. The "pub rock" boom seemed to explode overnight with many pubs booking bands on a regular basis, in most cases six or seven nights a week. Bands like Ducks Deluxe, Bees Make Honey, Ace and Kilburn and The High Roads began to attract large followings all over the country through appearances at these venues which had previously only booked discos for entertainment.

The boom started in London but ale houses all over the country soon found the idea of booking live bands attractive and most of the bands on this circuit eventually achieved nationwide popularity.

One of the most popular of these groups was Dr. Feelgood, a very tight four-piece from Canvey Island who specialised in no-nonsense, straight down the line R&B. They were a powerful unit with a clean and cutting sound. Attending a Dr. Feelgood gig was like stepping back into 1964, so authentic was their sound and execution.

The band eventually outgrew the pub circuit and went on to bigger and better things. They achieved a lot of success in the States and Europe but, while their PA system grew, their backline stayed the same and the band retained the energy and rawness necessary to the delivery of rhythm and blues.

About 18 months ago, Feelgood's guitarist Wilko Johnson split from the band. To many he *was* the band and it looked as though it was the end of the road for Dr. Feelgood. To their credit, however, they brought in John Mayo as replacement and still enjoy huge success.

But what of Wilko? After "being asked to leave" the band, he got together the Wilko Johnson Band, another four-piece in a similar vein to Dr. Feelgood. They recently changed their name to Wilko Johnson's Solid Senders, and look as though they are to emulate the success of Dr. Feelgood. The accent is on R&B naturally, as this type of music is Wilko's first love, and they have already completed four British tours, having just finished work on their debut album for Virgin.

Wilko would be the first to admit that his style owes a lot to Mick Green of The Pirates. That same clean, chopping, rhythm-and-lead-at-the-same-time guitar work is common to both. This fast right-hand technique may be due to the fact that, although he plays guitar "the right way round", Wilko is, in fact, left-handed.

"The first guitar I had was a left-handed Vox which I played for about a year", he recalls. "But I was a very slow learner and I only learnt a couple of

chords. When the following Christmas came around, I got a secondhand Watkins Rapiere which was a right-handed model. I thought I might as well learn to play right-handed as though I was starting from scratch, because I hadn't progressed much anyway."

It was soon after that when Wilko heard The Pirates on the radio and was bowled over by the guitar sound. It was something completely different for him and proved to be a mini-milestone in his musical career.

"The stuff I'd been playing was sort of basic rock and roll. The songs I was learning were songs that I'd just heard other local bands do. I didn't know where they came from. I hadn't any contact with the source of it and as soon as I heard "I'll Never Get Over You", I knew it was close to "it". Although it was a pop song, it just had that 'something'. From then on, I started digging out any Johnny Kidd and The Pirates records I could get hold of, following up on this guy and generally playing like him."

This coincided with the appearance of bands like The Rolling Stones and others who were playing R&B and Wilko began to hear more of this type of music.

"I just got totally committed to that kind of thing, listening to real R&B and getting the Pye R&B series and things like that. There were some excellent R&B groups in our area like The Paramounts, who later became Procol Harum. They had Gary Brooker on piano and Robin Trower on guitar and were playing some excellent R&B.

"R&B is the only sort of music I've ever wanted to play. When the blues boom happened in the late Sixties, I never really got into it. It wasn't people taking those influences and using them in their own kind of situations, they were just copying everything exactly what had been done. Obviously, you can't be as good as the people who invented it, so I've never been into blues. I love playing it, it's great to play blues but I'd be hesitant to get up on stage and play blues because the originals can do it so much better. I can play rock and roll or R&B or whatever you like to call it because I feel I'm doing it properly."

After leaving school, Wilko went to Newcastle University to study English Literature and actually stopped playing guitar for about five years. He picked the instrument up again in 1972 when he bumped into Feelgood singer Lee Brilleaux and decided to form a band.

"When I started playing again, I found I was a bit slow, obviously from lack of practice. At the same time, I found I was less inhibited starting again. We didn't take it too seriously. It was purely for enjoyment so I wasn't worried about what I was playing. I could just jump into

something without thinking about it. For one thing, we were the only ones playing that sort of thing when we started and I had a lot of confidence. We just wanted to play R&B but we had to play some chart numbers as well, just so we could get the gigs. I remember one rehearsal when Lee brought some records along and one of them was "My Babe" by Little Walter. I hadn't heard it for ages and as soon as I heard it again, I just thought 'Sod it! I don't want to play anything else but this'. We just carried on from there and we really started working seriously when we started playing the pubs in London. By that time, we were very much together and that was an advantage because we were totally unknown when we started to play in London but we were pretty tight. We had all the advantages of provincialism and then managed to get the advantages of playing in town".

From the time Dr. Feelgood began on the pub circuit, it didn't take long before they were a Big Name. Although they had played together for over two years around Canvey, in less than a year after working the London circuit they overtook their contemporaries in popularity. Were they prepared for this?

"Well, I had two attitudes to it. One was the obvious thrill you feel when you realise that what you're doing is getting somewhere. The other feeling was that I knew we'd be big because no-one was playing this kind of stuff and it is the greatest kind of music, so all you've got to do is get a half-decent group playing it and people will like it. It didn't seem surprising to me that it took off. The other thing is that, although it seems to happen very fast to people observing from the outside, it doesn't look that way from the inside because you can always see the next stage before you come to it. By the time you come to it, it's not like an overnight surprise. We also liked to keep a basic kind of cynicism about it. If it all falls through tomorrow, you've had the enjoyment out of it so you can't complain."

It transpires that the enjoyment didn't disappear from Dr. Feelgood before Wilko left, nor was the break-up due to the evergreen "musical differences". Quite simply, he was sacked. Of the split, he says: "Well, they fired me, you know. If they hadn't fired me, I'd still be with them. On the other hand, I can understand why they did it. There was an argument over one of the songs on the album and that turned into a confrontation in which no-one was going to back down. But then again, you don't get into that position out of nowhere. It's things that build up over a long time. Because I was the only one that was writing songs, it's pretty nerve-wracking when you've



This was **maine** at Frankfurt, 1978. Check out Europe's fastest-growing amplification at your **maine** dealer:

SCOTLAND

Aberdeen — Middleton Music
 Dundee — Wilkie's Music House
 Perth — Wilkie's Music House
 Falkirk — Forth Valley Music
 Dunfermline — Alexander Muir & Son

Edinburgh — James Grant Music
 Glasgow — McCormack's
 Glasgow — J.D. Cuthbertson
 Hamilton — Hamilton Music
 Melrose — Clinkscale Musical Instruments

Dumfries — Len Frobisher
 Paisley — J.D. Cuthbertson

NORTH-EAST

Newcastle — Rock City
 Newcastle — R.S. Kitchen
 Sunderland — White Sound
 Middlesbrough — Cleveland Music

NORTH-WEST

Workington — Northern Sounds
 Barrow-in-Furness — Northern Sounds

Lancaster — Hobbs Music
 Blackpool — Bee's Music
 Liverpool — Frank Hessay
 Wallasey — Rumbelows
 Manchester — A1 Music
 Warrington — Dawsons
 Stockport — Dawsons
 Wigan — Dawsons
 Chester — Dawsons
 Stoke-on-Trent — Chatfields
 Shrewsbury — Salop Music Centre

YORKSHIRE

Leeds — R.S. Kitchen
 Barnsley — R.S. Kitchen
 Bradford — R.S. Kitchen

Huddersfield — Dandelion
 Sheffield — Johnsons Sound Around
 Sheffield — Carlsbro Sound Centre
 Scarborough — Bernard Dean
 Hull — J.P. Cornell

LINCOLNSHIRE

Grimsby — Grimsby Music Centre
 Lincoln — Browns Musical

EAST MIDLANDS

Mansfield — Carlsbro Sound Centre
 Derby — Wisher
 Leicester — Sound Pad Music Centre
 Loughborough — Loughborough Music
 Peterborough — Live Music & Piano Centre

WEST MIDLANDS

Wolverhampton — Langdon Electric Music
 Birmingham — Woodroffe's
 Coventry — Coventry Music Centre
 Northampton — Funkshun Supersound

NORTH WALES

Bangor — Sound Centre
 Rhyl — Axe Music

SOUTH WALES

Swansea — John Ham Sound Centre
 Cardiff — Cardiff Sound Centre
 Newport — Sound Centre

WORCESTERSHIRE & HEREFORDSHIRE

Worcester — Worcester Music

Hereford — Buzz Music
 Ross-on-Wye — Ross Soundhouse

GLOUCESTERSHIRE

Gloucester — Gloucester Soundhouse

SOUTH WEST

Bristol — Biggles Music
 Bath — Assembly Music
 Weston-S-Mare — W.M. Organ Centre
 Swindon — Swindon Guitar Centre
 Salisbury — Mitchell Music
 Bournemouth — Coast Music
 Exeter — Bill Greenhalgh
 Truro — West Country Music

EAST ANGLIA & ESSEX

Norwich — Cookes Band Instruments
 Cambridge — Cambridge Rock
 Bury-St-Edmunds — Albert Balaam
 Ipswich — Albert Balaam
 Colchester — Axe Music
 Hadleigh — Honky Tonk Music
 Romford — Soundwave

KENT & SUSSEX

Margate — Pepper Music
 Hastings — Hastings Sound
 Worthing — Broadway Music
 Maidstone — Matthews Music
 Bromley — Wing Music

HANTS & SURREY

Fleet — Kingfisher Music
 Portsmouth — Bennett's
 Addlestone — ABC Music
 Kingston John King Sounds

HERTS BEDS BUCKS & OXON

Luton — Luton Music Centre
 Hemel Hempstead — Free 'N' Easy
 Watford — Hammonds
 Barnet — E.S.S.
 High Wycombe — Sun Music
 Aylesbury — Free 'N' Easy
 Windsor — Windsor Disco Centre
 Oxford — Free 'N' Easy

LONDON

Leytonstone E11 — Holiday Music
 Lewisham SE13 — Len Stiles
 Crouch Hill N8 — John Beeby's
 SW16 — Norbury Music Centre
 Ealing W5 — Dave Simms Music Centre
 Kilburn NW6 — Blanks Music Store
 W1 — Sounds
 W1 — Music City
 WC2 — Sho Bud Guitars
 WC2 — FD&H Music
 WC2 — Rod Argents Keyboards
 W1 — Chappell's

N. IRELAND

Newtonards — Modern Music
 Bangor — Modern Music
 Ballymena — Sports & Music

CHANNEL ISLANDS

Jersey St Helier — Regent Radio

ISLE-OF-MAN

Douglas — Island Music Centre
 Ramsey — Island Music Centre

ISLE-OF-WIGHT

Ryde — W. Teague's
 Newport — W. Teague's

REP OF IRELAND

Dublin — Music Circle Ltd

Please send me the information.

Name _____

Address _____

maine

Maine Electronics Ltd, Maine House, 193 Rickmansworth Road, Watford, Hertfordshire, England WD1 7JH. Tel. Watford 45388 and 43567

IM.9.78

got to make a record, because you have to write new songs and there was all this other madness going on. I was getting very isolated. When we were on the road, I would often be on my own. Little things like the fact that I don't drink and they do. That meant that I wouldn't be socialising with them because I don't enjoy going to bars and watching everyone getting drunk!

"I think, from their side, it looked like I was turning everything into my own trip or something. I don't know, I really don't know. We never really got to talk it over. There was an argument and the rest of it was just on the telephone between me and the manager. In the end, he told me I had to go! I've not seen them since and haven't had a chance to talk it over calmly."

It was a while before Wilko got together the Wilko Johnson Band as he admits he thought it was all over and he should quit. However, he met keyboardist John Potter and decided to form a band.

"I didn't know what to do. I knew I was in a real mess but I didn't have a clue what to do. I had an idea of what I wanted to do musically but it was all nebulous. The only way round it was just to get a group and start again. We had one attempt with some people that I thought were chums of mine and but, when we started trying to do something, I told them exactly the state of affairs and when they found out that I wasn't kidding and that I really didn't have a clue, they didn't want to know! Finally, it was friends that helped me out. Lemmy from Motorhead found a bass player for me and Dai Davies found me a drummer. We had a blow and as soon as we started playing, it was obvious that it was a group.

"Then we went into United Artists (Dr. Feelgood's record company) and I said 'I've got a group at last' and they said 'We want to have a word with you. We really feel you'd be better off elsewhere than on this label'. So that was all I needed! But I thought 'I'm not gonna let the swines stop me at this stage, so I had to finance the band for a long time until we got the deal with Virgin. It's good for me because it's sort of organised chaos at Virgin and that's what I believe in, in a way. I mean, I'm no fool, but I don't like to get too involved with the business side. It's like the way the band works. We've all got equal shares, I don't get any more than anyone else. There's nothing in the organisation of it that says I've got more say than anyone else."

Apart from the fact that the musicians are different, the lineup also includes keyboards, unlike the Feelgood lineup. Does that leave Wilko more space?

"It does. I mean, I still play basically in that style because it's the only one I'm really good at. But having keyboards means I've got a wider scope for solos. I can play solos on single notes whereas, before, I had to hit at least four at a time to keep it going! I can do a lot more with keyboards. I think this group is more

musical than Dr. Feelgood, if you know what I mean. Alan's drumming is much more fluid than Figure's. The way me and Figure used to play in Dr. Feelgood was very mechanical. This band is much more fluid, we're playing off one another rather than just keeping a steady thing going."

One thing that hasn't changed is Wilko's guitar. He still uses the same Telecaster with a HH combo fitted with two Gauss 12's, one of which he sometimes disconnects when recording. That's the only kind of distortion he likes.

"I just don't like effects. I settled on HH amps in the end because it's a pretty clean sound and what distortion there is occurs from just playing loud. I don't like any kind of artificial sustain. I never play at feedback level so the guitar won't feed back on its own. It's more attack than sustain. That's my whole outlook on rock and roll - very simple. It's like the three-chord twelve bar thing. The reason it comes up again and again is because it's the perfect form. If you work something good within that limitation then that's the achievement of doing it well. If you say there aren't any limitations, which is a perfectly valid way of looking at it, then you're going off into something else and I like to do whatever I can within those limitations.

"The reason why R&B tends to work out as short three-minute numbers is because it was orientated towards making singles and singles happened to be a certain length and the form came about because you have songs of a certain length like that. That sound that evolved around simple amplification is the best sound for me and it's like a parallel with the twelve-bar. The simplicity of it really is the beauty of it. If you can latch on to the simplicity of it and do something worthwhile within that, then you're doing something good musically. That's the way I look at it, I don't think I could do much musically worthwhile by straying out of it - there are others who could do it better. The thing that led me into music and the thing I see as the essence of it is that kind of simple thing."

In the early days of rock and roll when strings were of piano wire girth, guitarists never had the luxury of super-light gauge sets to work with. It comes as no surprise to find that Wilko prefers heavier than most in the string department.

"I use Rotosound strings. They go: 11, 13, 16, 28, 38 and 48. I remember when I used to play, after leaving school, Robin Trower told me how to do it. We used to use Clifford Essex strings and get a 1st, 2nd, 3rd, 4th and 5th and then put them down one and use a banjo string for the 1st. When I started playing again, they had these custom strings on the market and I got the lightest possible. I didn't realise how light they were because I hadn't played for so long - they were like fuse wire! It took me months before I sussed out I was losing a lot of power because the strings were so light. I didn't need strings that light for what I was doing. What I needed was a certain kind

of loudness so I started getting heavier and heavier in gauges until I arrived at the best set for me. I think what you should do is get as heavy a gauge as you can manage and work from there."

Contrary to what one would expect, Wilko doesn't use a plectrum at all. He picks with either his fingers or the thumb and forefinger nails.

"That goes back a long time. It was when I went to see an R&B band years ago and the guitarist was a bit of a jazzier and he was playing just with his fingers. It's just so impressive, I stopped using picks. It means that when I'm doing a rhythm part, I'm strumming the strings with the backs of my fingernails. I can't play with a pick now. I can't hold on to it, I just drop it after a few bars when I try to use one. Sometimes, if I'm doing a solo line, I'll either be plucking upwards with my fingers or using the thumb and forefinger together, as if I'm holding a pick. Also, in a solo, I'll be bashing across all six strings and pick out the solo line with the left hand by deadening the strings that aren't being played. So you might be hitting them all, but there might only be one line coming out."

In recent months, it's been obvious that there's a definite R&B "boom" starting to happen in the clubs and pubs with bands like Wilko's Solid Senders, The Bishops, Blast Furnace and The Heatwaves and The Pirates leading the field. It's also obvious that this is something that excites and pleases Wilko.

"When we started succeeding with Dr. Feelgood, I'd heard about a couple of bands like The Bishops and I was really glad because I thought it would lead to an R&B boom which I would dig anyway. If there's a general interest in that type of music, it means anyone playing that kind of music is looked upon a bit more seriously.

"There are a few people coming up now who are playing rhythm and blues and I'd really like to see it happen. It is a beautiful, simple music that anyone can start to play. One of the things I wanted to do with Dr. Feelgood is to show that you don't need laser beams and dry ice to make an exciting sound. I think if a boom happened, it would get a lot of people playing and that's got to be good."



"When I'm with Kustom, I have no problems."

Mixing it up with Red Roe, of the "Midnight Special".

When did you start with Midnight Special?

I was in on it from the beginning. I'm the only original engineer left on the show.

In fact you and producer Burt Sugarman are the only originals still with the show. What keeps it going on?

Burt's a down-to-earth cat who's got a whale of a TV show. I guess you could call it a success because there's a lot more people who care, from our end of it, than they do on other shows. People seem to pump out more. We do a lot together and we kinda keep each other loose.

The music ties all of you together?

Music is a helluva outlet. I really get pumped up on the show. It's cookin' on the natch, it really is.

Cookin' on the natch??

Natural high . . . it's the only way to go.

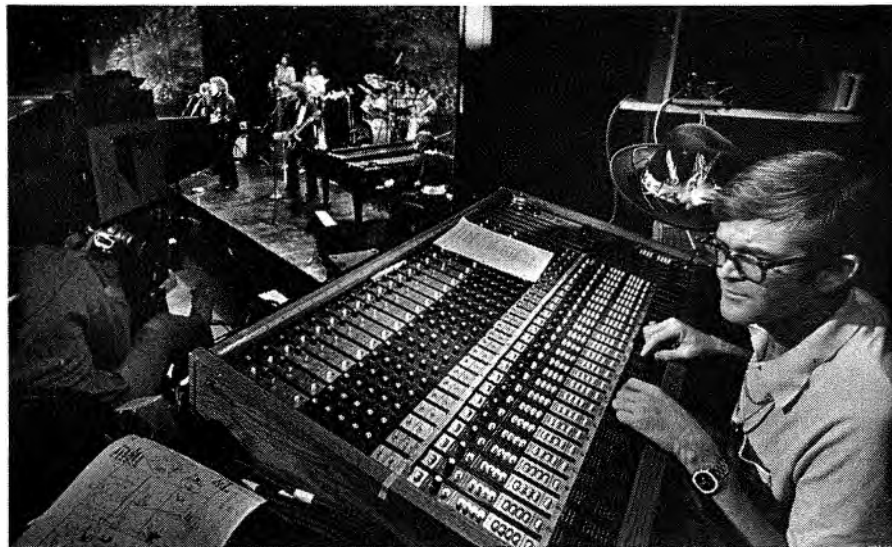
You've been using Kustom PA and mixing equipment on Midnight Special for three or four years now.

Any problems?

Technical problems? No. As a matter of fact, I'm a firm believer that Kustom does kick. It's good. And when it's good, you don't have to worry about it.



Red mixes sound for the Midnight Special with a Kustom SRM XX 24 in, 8 out. Stage set-up includes 8 each MF 1212 cabinets and MF 1012 horns, 4 XII Bi-Amp Slaves, and 8 sets of III Monitor Systems.



How about your Kustom mixer?

This is one helluva board. As a matter of fact, it's a better board than the main mixer on the show. That mixer was made for television and this board is made for music. It gives me what I need.

Did you ever use Kustom equipment before you came to the Midnight Special?

Oh yeah . . . in Texas . . . Oklahoma . . . back when I was a roadie . . . a go-fer in several of the PA houses in some of the towns I worked in.

Back in Kustom's roll and pleat days?

Yeah, Tijuana tuck 'n roll!

Are there any features you especially like about Kustom?

Sure, all of them . . . and that's the truth.

Is the music on Midnight Special your own kind of music?

I just like music. I love all kinds. Music speaks the language of the heart. All music does, but to me I understand country music more than I would understand Prokofiev or Tchaikovsky.

I don't feel out of place listening to the Juilliard String Quartet or the Oklahoma Symphony or any of that jazz.

It's just that I'd rather kick back with a cup of coffee and listen to a country western group any day.

You have to deal with a lot of different personalities on the show — the groups, the hosts, and so forth. How do you manage it?

When I let people know where I come from, that makes it a lot easier. As long as I'm honest with myself, that's all that counts. I say hello to myself every



morning. I have a sign over my mirror that says if I can't smile at this person, I can't smile at anybody.

But handling the sound for a show like Midnight Special is a great deal of responsibility. . .

It depends on how you look at it. I'm just a person who was put in a position, that's all. I'm a Group 2 engineer, like the guys down on the floor. I just kinda roll with the flow, that's all.



When sound is everything. . .

Chanute, Kansas 66720

LOGAN

LINE UP THEIR PROFESSIONALS

String
Orchestra
£570



T 242
RAM
£690



Already famous throughout the Music World for their reproduction of String Orchestral effects, Logan have created a range of professional keyboards designed by specialists for use by the most discerning of musicians.

Just look at the specification of the fabulous Caravelle T 249 Portable with its built-in String Melody, host of flute and orchestral voices, comprehensive Synthesis, Piano & Percussion section, intermixable rhythm patterns — to name only a few basic features — **Unbeatable Value at £1,490 R.R.P.**

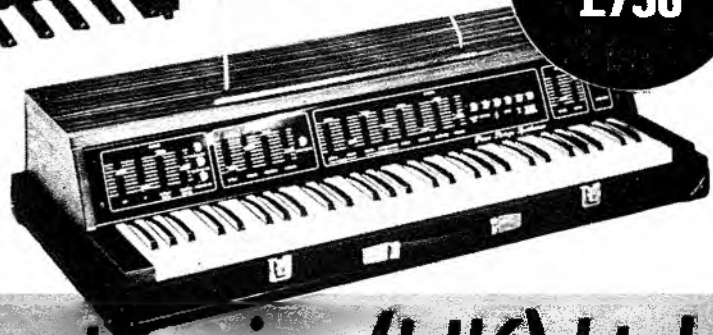
Why not ask your local Dealer NOW about the Logan Professionals or write to us for more information.



Caravelle
T 249
£1,490

*Recommended
retail prices
including VAT*

Piano
String Synths
£750



Logan Electronics (UK) Ltd


John M. Edgar, Managing Director, Logan Electronics (U.K.) Ltd.,
Unit 3, Queensway Industrial Estate, New Milton, Hants. BH25 5NN
Tel: (0425) 618220 Telex: 965649 Teleca G.

SOUND

Attack



Ibanez
Effects your Style

Distributed by  JAMES T COPPOCK (LEEDS) LTD Royds Lane Leeds LS126LJ

musicaid

SOLE IMPORTERS AND DISTRIBUTORS OF:

AMPEG AMPLIFIERS
LYRICON WIND SYNTHESIZERS
ASBA PERCUSSION
CAMBER CYMBALS
PICK POCKET GUITAR STRAPS

HAVE NOW ADDED

THE SIMMONS DRUM SYNTHESIZER

TO THIS PRESTIGE LIST

Dave Simmons – synthesizer specialist extraordinary – has designed and built (with a little help from Musicaid and The Premier Drum Company) the first British made drum synthesizer



FURTHER DETAILS ARE AVAILABLE FROM THE MANUFACTURERS:

musicaid (Arkay Sound Ltd.)

66 Radlett Road, St. Albans, Herts. Tel: Park Street (0727) 72829

A copy of the owner's manual is available
at the cost of £1.00 incl. post and packing.



Bass strings deserve to be straight.

Until now, all bass strings came coiled up in square envelopes. Unfortunately, coiling a sensitive, finely wound bass string can bend and damage the precision windings, making the string sound less than perfect. Nashville Straights, the first bass strings sold straight, are made of the finest nickel and steel alloys. Inside this long,

rigid package, the string set is hermetically sealed in plastic to prevent oxidation and promote brilliance and long life. String up a set of Nashville Straights and hear the difference. They're resonant, uncrashy, loud and together. If your dealer doesn't have them yet, write us. Dept. G, 1234 Sherman Ave., Evanston, Ill. 60202.

NASHVILLE STRAIGHTS

ACOUSTIC, ELECTRIC AND BASS GUITAR STRINGS

© 1976 by Fretted Industries, Inc.

Available through Ivan Rippley Music, 241 Canterbury Rd., Canterbury, VIC, Australia; Vainon Soiten, 40101 Jyvaskyla 10, Finland; A.H. Davidson, 4 Elib House, North End, Port Elizabeth, South Africa; Great West Imports, 788 Beaty St., Vancouver, Canada, and other fine distributors.

FANE ANNOUNCE ANOTHER OUTSTANDING DEVELOPMENT

The HF100 HIGH FREQUENCY HORN UNIT

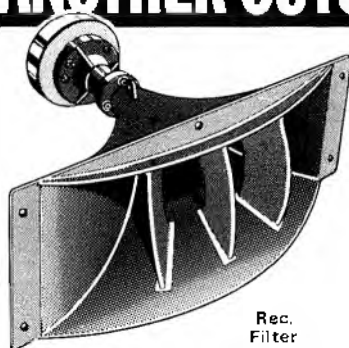
with a
**LIFETIME
GUARANTEE**

Average
Sensitivity
104 d/b

Also
available

OVER 60

BASIC MODEL CHASSIS SPEAKERS



Rec.
Filter
Point

Rec Retail Price
inc. V.A.T.

**DRIVE
UNIT £33.00**
**FLARED
HORN £33.00**

**FOR OUR ENGINEERS'
ANSWER TO THE BEST
WE COULD FIND**

**COMPARE THE HF100
CURVE WITH THAT OF
ANY SIMILAR UNIT
currently available**

USEFUL FREQUENCY RESPONSE

1 KHz - 15 KHz
HORN CUT-OFF 400 Hz
AVERAGE SOUND
PRESSURE LEVEL
at 1 metre for 1 watt input
104 db.
INPUT IMPEDANCE
8 - 15 ohms
POWER RATING
with 1,200 Hz Filter 100 watts
DIMENSIONS
Drive Unit: Diam. 6" (Thread 1 1/2")
Height overall 3.375"
Horn Flare: Overall width 17"
Overall height 8.7"

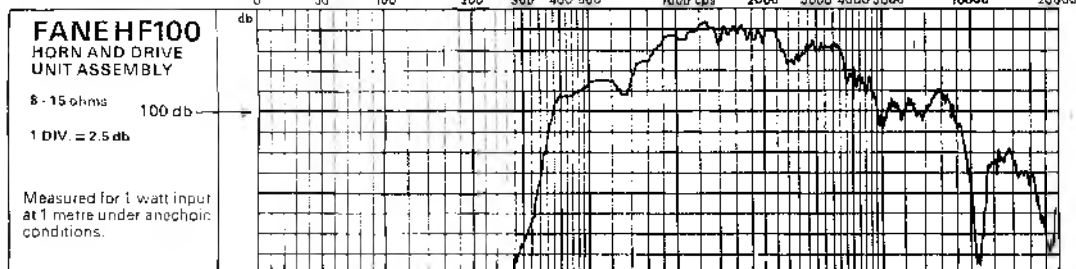
WEIGHTS:

Drive Unit 10lbs (4.5 Kg)
Horn 8lb 4oz (3.9 Kg)

'CROSS-OVERS'
HPX3A High Pass Filter
1200 Hz

HPX3B Low Pass Filter to be
used only with HPX3A
where FULL cross-
over at 1,200 Hz is
required.

Rec. Retail Price **£3.25** each
inc. V.A.T.



Manufacturers & Export Enquires to: **FANE ACOUSTICS LTD., Hick Lane, Batley, Yorkshire**

Tel: 947 6431 Telex: Chamcom
Hudds. 51458 for Fane

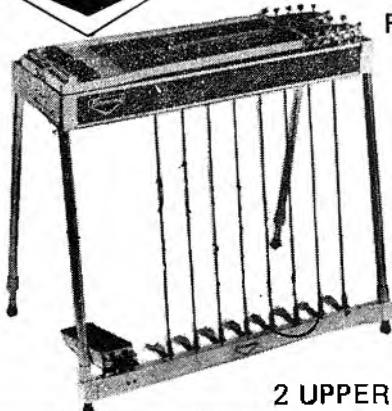
FANE LEADING SUPPLIERS OF HIGH POWER SPEAKERS to the U.K. MUSIC INDUSTRY

Emmons®

THE STEEL MILL

ZB custom

FOR EMMONS AND ZB CUSTOM GUITARS



STEEL GUITARS,
STEEL GUITAR ALBUMS
and all other Steel accessories

*
plus a large stock of
STRINGS, AMPS, TUTORS

*
For further information contact
us direct at:

THE STEEL MILL,
2 UPPER FANT RD. MAIDSTONE, KENT. (Tel: 673355)

Pat Chapman

Musical Instruments Ltd.

31/33 SIDCUP HILL, SIDCUP, KENT, 01 300 9668/3838
H.P./P. Ex. OPEN 10 - 6 1/2 Day THUR. Eves. (082 584)626

YAMAHA



HIWATT



Guild

Rose-Morris
Marshall

+ ORANGE, WEM, IBANEZ, MAYA, etc.

& a large selection of secondhand gear

P. Ex., H.P., ACCESS & BARCLAYCARD welcome

Premier

Percussions accordées et
batteries de tambours pourront
être obtenues à l'address suivante.

Chas. E. Foote Ltd.,
17 Golden Square, London W.1.
Tel. 01-437 1811.

FREEDMANS

THE ONLY MUSIC STORE WITH
GUARANTEED LOWEST PRICES!

Utter chaos in the Music Trade! Everywhere. Who knows what, when or where to buy best? Until now that is... Freedmans are making you an offer you can't refuse - our exclusive 'Lowest Price Pledge'. Simply, it means that if you find lower prices elsewhere at the time you purchase from us - we'll refund the difference. Everything marked with the LPP symbol applies - we guarantee it!

LOOK FOR FREEDMANS EXCLUSIVE GUARANTEE IF YOU FIND LOWER PRICES ELSEWHERE - WE'LL REFUND THE DIFFERENCE!

Get into **FREEDMANS** - Fast!

628, High Road, Leytonstone, E.11 D1 535-0288

Chandler

GITARS

present a range of deluxe customising hardware for electric guitars

- Replacement Strat-type bridge sections in solid brass, for improved sustain and ring. £12.00 per set inc. Allen wrench.
- Replacement solid brass nuts for yet more sustain. Gibson type £2.50 each. Fender type £2.00 each.
- Early 50's Tele-type scratch plates. Single layer black plastic. Puts years on any Tele! £4.50 each.
- Early 50's Fender-type dome top 'speed' knobs. Almost an ounce of solid brass. £1.00 each inc. Allen wrench.
- Tele-type control plates in polished brass. A hard-to-get spare. £4.00 each.
- Roadie proof jack plates in beautiful polished brass. £1.00 each.

Prices include VAT, p&p 25p extra

Remember, all our parts are engineered in the UK and there's lots more to come.

Chandler Guitars
199 Sandycombe Road, Kew, Richmond, Surrey
Telephone: 01-940 5874

STEEL WORKS

by Dave Hayward

PART ONE

Without doubt, Country & Western music is increasing in popularity in England and so is the use of pedal steel guitar. There is already a healthy country club circuit all over England and many fully professional bands are making a good living from this rapidly expanding circuit.

One of the most characteristic sounds in country music is the pedal steel guitar, a descendant of the early Hawaiian guitar albeit a little more complex. There are the American greats like Buddy Emmons, Sneaky Pete, Tom Brumley and Lloyd Green but England has only, so far, produced a handful of steel "stars" like B.J. Cole, Gordon Huntley, Gus York and Pete Willsher. However, more and more guitarists are turning onto the pedal steel guitar. Probably the same number, though, are put off when faced with what appears to be a baffling array of pedals, levers and strings with a complicated-looking mechanism underneath the body which, when plucked at random, seem to do nothing at all.

This month, Dave Hayward begins a series on how to play pedal steel guitar and aims to show that it's not impossible, nor do you need magical powers to be able to play steel.

Dave has been playing guitar for over ten years and, three years ago, fell in love with the sound of pedal steel. He decided to learn to play steel and, in this series of articles, will pass on some hints and tips to help would-be steelies. Since taking up steel guitar, Dave has been very busy with session work and is a member of a popular British Country & Western group, Del Stevens and a Touch of Country.

What gives the pedal steel its characteristic sound? What are the mysteries involved in playing one? These are the sort of questions I shall try to answer as we go along.

I'm not going to attempt to make this into a series of formal lessons on "How To Play The Pedal Steel Guitar"; there are teachers and tutor books available for this (albeit few and far between) and they are much better suited to it than a series of this kind. Nor is this to be, for the time being, a course of instruction for any but the newest of players (although if I know anything about "steelies", they'll read it anyway because they read everything they can get their hands on about pedal steel, and then pick it to pieces).

What I do hope to do with this series is to whet the appetite of anyone who is perhaps teetering on the brink of having a go at playing the instrument. Remember, if you are determined enough to play, then you will. This may seem a corny thing to say but I'm afraid it's true. If the sound of pedal steel guitar has already got to you then you'll almost certainly know it and feel compelled to take it up.

For those of you who have decided to take the plunge, I hope I can subsequently go on to provide some useful basic instruction. At the same time, all



this should furnish some interesting background information for musicians who don't actually play this instrument but who do like to keep a broad musical outlook. I also believe, and this is borne

out by some of the questions I'm often asked, that too little is known about the pedal steel guitar by the vast majority of people associated with the music business and I'd like to think I can help to put that right.

Tuning

So what notes are the strings of a pedal steel tuned to? Before we go into detail about this, there are a few points to sort out.

During the evolution of the instrument (and it's still continuing to evolve), two standard tunings have emerged along with their respective pedal arrangements. There are many variations and other tunings in use by individuals, but these are by no means widely used, being adaptations for personal preference of the players concerned. All such tunings have their own merits but, in an article of this sort, we must look at the standard method as used by the vast majority of players for the time being. Any adaption might perhaps take place later when a player has a fair bit of experience behind him.

The two standard tunings which I've mentioned are known as the 'C 6th' and the 'E 9th'. The C 6th is closely allied to some of the older Hawaiian tunings, of which there are a great many, and lends itself very well to that style of music and to jazz work due to its closely voiced tuning. However, just about every new player these days is using the E 9th tuning, which can be made to give those characteristic country-style licks and chords we are hearing more and more of. This is the one we will be concentrating on.

The standard E 9th tuning uses ten strings as follows:—

String No.1	F#	
" " 2	E♭	
" " 3	G#	
" " 4	E	← This 'E' is the same pitch as that on an ordinary guitar
" " 5	B	
" " 6	G#	
" " 7	F#	
" " 8	E	
" " 9	D	
" " 10	B	

This diagram applies to the instrument as it is viewed when you sit down at it. The lower pitch strings are those nearest to you. String no.3 (G sharp) is the highest in pitch, with strings 1 and 2 tuned lower than 3. The first and second are known as 'chromatic' strings because when they are sounded in the order 2, 4, 1, 3 (E flat, E, F sharp, G sharp), they form part of the chromatic scale of E.

Now we'll examine what the pedals and lever do. The basic arrangement for this tuning is three floor pedals, all operated by the left foot, plus one knee lever. The pitch of certain strings is varied by specific degrees, through increasing or decreasing tension on them by action on the pedals or lever. The three floor pedals we'll refer to as 'A', 'B' and 'C' and the knee lever as 'K'. This is how they operate:—

Pedal A raises both the 5th and 10th strings from B to C sharp.

Pedal B raises both the 3rd and 6th strings from G sharp to A.

Pedal C raises the 4th string from E to F sharp, and the 5th string from B to C sharp.

Knee lever K lowers both the 4th and 8th strings from E to E flat.

The pedal and tuning arrangement for any guitar is known as the co-pedant

and can be shown in chart form. The co-pedant for the arrangement we are dealing with is shown in the chart below.

Some steels are set up with pedals A, B and C reading from left to right and some have them reading from right to left. This may seem rather confusing on paper but, in practice, once you get used to the pedals in one particular position, as long as you stick to it there should be no problems. Determine and fix in your mind which pedal is which. The knee lever is usually situated on the left, and moves to the left, although this is not always the case, but as with the pedals, it doesn't really matter. The important thing is to know what each pedal and lever does. Incidentally, this whole set-up is the standard one for right-handed players which leads me to one question some readers may have, "what if I'm left-handed?"

It must be obvious to all who have ever seen a pedal steel that to change a standard model instrument over to left-hand is a major operation, if not impossible. They can be custom-made but almost certainly will be a lot more expensive. Some do exist but they are so rare that it's next to impossible to pick one up secondhand, at the same time if you did have one it would be very difficult to sell! So the best advice must be to learn on a standard instrument. There can't be many musical instruments around where you have to use both hands, both knees and both feet, so you might as well learn to play it right-handed from the start. Several top players have done it this way, incidentally.

If you are intending looking around for a pedal steel, it's worth mentioning that in my travels I've come across a few instruments (usually in instances where a music shop has perhaps only one in stock as an experiment or as a result of some part-exchange deal) which are so far out of tune and adjustment that they bear no resemblance to how they should sound. This is not necessarily a reflection on the shop staff as many probably don't know anyone who can set a steel up properly. But all the same this can be very misleading, so I'd advise you to watch it in cases like this. You can't do better than to visit one of the specialist dealers where you shouldn't come across problems such as this. But more of this later.

I hope, in this first article, I have provoked some interesting thoughts for the would-be beginner, cleared up some doubts, and answered a few of his questions. It might seem that, so far, there has been very little 'nitty gritty' and a lot of discussion but I make no apologies for this as, believe me, these are important aspects for the uninitiated. The decision to take up the pedal steel guitar is very often a difficult and protracted one, not least of all because a good deal of expense is involved.

In the next part we'll start looking at choosing a steel, tuning and adjusting your instrument, basic chord formations and a system of tablature.

Pedals →	A	B	C	K
F#				
E _b				
G#		+A		
E			+F#	-E _b
B	+C#		+C#	
G#		+A		
F#				
E				-E _b
D				
B	+C#			

CODAMUSIC

THE LARGEST STOCK OF DRUM KITS IN YORKSHIRE.

Agents for: **LUDWIG** and Slingerland

Large stocks of the following kits:

- Gretsch
- Rogers
- Beverley
- Tama
- Premier

*Musical Instruments · Sales · Hire · Tuition · Repairs
Recording and Video Studios*

28, Churchbank, Bradford
Tel: Bradford (0274) 307433

THE ORIGINAL SOUND OF THE SIXTIES

Hear for yourself the distinctive sound of the string with the 'black nylon' covering on electro magnetic wire. Available in all scale lengths.



James How's 1962 invention has often been imitated, but never duplicated. The original black nylon flatwound bass guitar string.

TRUBASSES



Kitchens Live Electric

MUSIC & SHOW

FREE ADMISSION

See and hear the world's finest
equipment played by top
demonstrators

at Kitchens of Bradford,
26 North Parade, Bradford.
From 2p.m. to 9.30p.m.
Wednesday and Thursday 13th and
14th September 1978.

Including – Gibson – Fender – Roland – Peavey
– ARP – Marshall – Yamaha – Korg – Lab series.
Moog – Premier – Maestro – Rhodes – MXR –
Antoria – Randall – Disco by Soundout – Haze –
Project

No entrance fee – No tickets required.

COUPON WORTH

£15

on every purchase of £100 and,
over or 10% discount on
purchases under £100

MUSEX



77

**NOW
RECOGNISED
AS THE....**

MUSICIAN'S EVENT OF THE YEAR

OVER 17,000 PEOPLE

ATTENDED MUSEX 77 SO MAKE
A DATE TO VISIT THE
HEART OF THE MUSIC WORLD

Continuous Demonstrations

THROUGHOUT THE 3 DAYS BY MANUFACTURERS
OF THE WIDEST RANGE OF GEAR AND
INSTRUMENTS

FREE TO ENTER COMPETITIONS AND GIVEAWAYS

Special Show Offers

ON GEAR AND INSTRUMENTS
PURCHASED FROM THE HESSY STAND

PARKING FOR 1000'S OF CARS

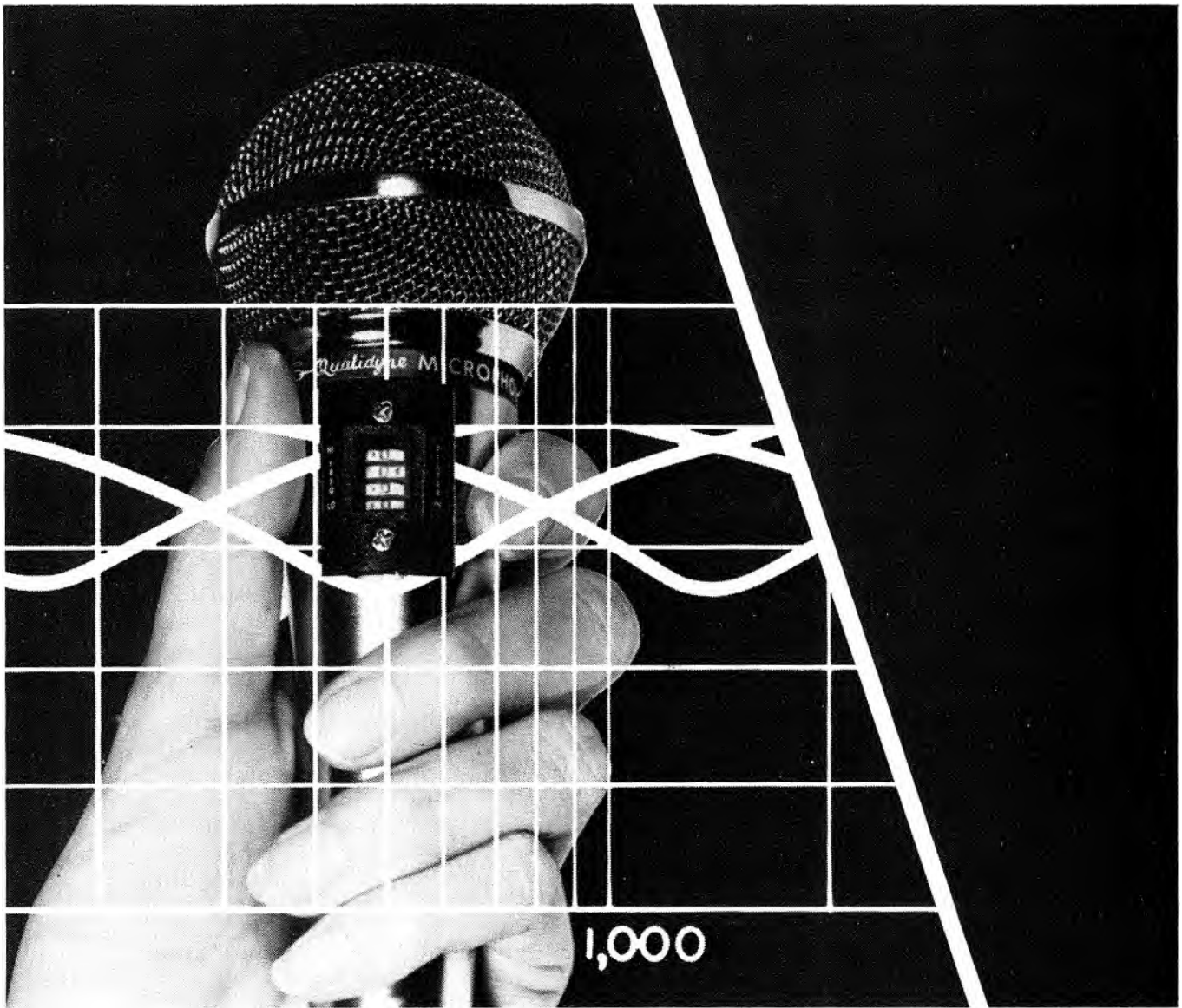
BARS OPEN



NOVEMBER
4th, 5th, 6th
HOLIDAY INN
PARADISE ST.
LIVERPOOL

MAKE SURE OF YOUR
FREE TICKET
IN NEXT ISSUE OF
**INTERNATIONAL
MUSICIAN**
Compliments of HESSY'S Music Centre

HESSY'S MUSIC CENTRE 62 STANLEY ST. LIVERPOOL L16AY Tel. 051-236 1418



Anti-Feedback & Equalization On the microphone!



Never before has a microphone put such absolute sound control into the palm of your hand. With Shure's new revolutionary PE5EQ E-Qualidyne Microphone, you simply preset any of four frequency switches *on the microphone* to minimize your Number One enemy—feedback. You can also select—on the spot—any one of 16 frequency response variations to tailor your performance to ANY stage: Sweeten the strings . . . enhance the better qualities of your voice . . . or eliminate close-up "boominess." Ideal where a single type of microphone will be used for different applications in the same act. Only the E-Qualidyne can offer such hand-held versatility. And only Shure has it!

Shure Electronics Limited
Eccleston Road, Maidstone ME15 6AU
Telephone: Maidstone (0622) 59881



Rock'n' Roll BALLAD

by Eamonn Percival

Russ Ballard has a long history in rock music. His first pro band was The Roulettes, Adam Faith's backing group in the early Sixties. Ace drummer Bob Henrit was also a member of the same band and the pair later went on to join Unit Four Plus Two, who really only had one hit record of note, "Concrete and Clay". When ex-Zombie Rod Argent decided to form his own band, he recruited Russ and Bob plus bassman Jim Rodford and Argent went on to become one of the top bands of the early Seventies. After four years with the band, Russ left to pursue a solo career and, in early 1975, released his first solo album on Epic. By this time he was already enjoying considerable success as a songwriter — his "gold-plated" song "Liar" reached the American Top Ten four successive times. Eight cover versions of songs from his second solo album "Winning" were recorded, selling over three and a half million units.

In addition, Ballard was also enjoying success as a producer, including production work for Leo Sayer and Roger Daltrey among others. In the last two years, over ten million units of Russ' songs have been sold.

His third solo album has just been released. Called "At The Third Stroke", he recorded it in the States under the guidance of producer Keith Olsen (of Fleetwood Mac and Foreigner fame). Russ also recruited the help of the cream of American sessioners including Jeff and Mike Porcaro, David Hungate, Tom Scott and David Paich along with Lee Sklar, Craig Doerge and Jim Horn who form part of The Section backing group for Jackson Browne, Steely Dan, Crosby, Stills and Nash and Linda Ronstadt.

"At The Third Stroke" is a very much more guitar-orientated album. The material is still very much typical melodic Ballard material but there is a distinct difference in his approach to arrangements. His guitar playing is more in evidence than on previous outings, and his guitar work is stronger and more forceful.

"It's harder, actually, trying to write vehicles for the guitar. It's not easy to write melodic songs and still feature guitar. It's easier to write a melodic thing but I've gotten into guitar a lot more now.

"A big problem for me is that I write most of the stuff on piano and, of course,

you find yourself ending up with something that's more of a vehicle for the piano. It just ends up being more a piano-type song. I've tried to get more away from that with this album as I want to get more of a rock thing. That's what I've been listening to for the last eighteen months and I've got more into the guitar again."

The fact that Russ tends to write most of his material on piano probably dates back to his early years when he learnt piano for five years after starting out as a drummer. He started taking piano lessons when he was nine years old.

"It was handy, that's where I learnt theory and stuff. I hated learning the sort of thing I was learning on piano and I used to sit at home and start playing Jerry Lee Lewis sort of things. If I could have found a teacher doing that sort of thing, I know I could have really gotten into it, but there was no-one around. In retrospect, though, it's helped me a lot. I can transpose things from piano to guitar and I can sort of see the notes I'm playing on the piano and see where they should go on the guitar. Sometimes you get really nice things on piano that you don't realise would also sound good on guitar. I took up guitar when I was about thirteen and stopped playing piano until I was about seventeen. I play more piano now because I tend to write on the piano."

Like many of us, Russ also finds that it's easier to write melodic material on piano and easier to write rockier songs on guitar.

"Yeah, and it's strange. I don't know what it is with guitar. It's a weird thing when you think about it. I get on guitar and tend to play rocky stuff but then it's the hardest thing in the world to write a good melodic rock song. It's so easy to fall into traps with rocky stuff where you use the same old chord progressions."

Russ' last two albums, while selling comfortably, didn't exactly elevate him to Frampton status. Was this the reason for recording in the States?

"It's always been in my mind to do something in the States but I wouldn't have gotten it together if Lenny Peatsey, who is head of A&R in America, came over here and asked if I'd like to record in the States because he'd played some of my songs to Keith Olsen. He liked the songs and wanted to produce me.

"I'd heard a lot about the musicians out there but until you do it for yourself you don't know what to believe. You hear people talk about LA and New York and how great the musicians are but you have to see for yourself. Luckily, I used who I think are the elite of the musicians over there. I don't know what it is. They seem to *live* music over there. It seems to be so much more important in their lives than it is here. I mean, for instance, Jeff Porcaro used to turn up to the mixes and it's not often you find a drummer who'll turn up to a mixing session! He was doing three sessions a day *and* finding time to turn up to the mixes. I thought it was great over there. I'm gonna do the next one over there."

Although Russ is a very prolific songwriter, he still feels he wants to spend more time writing so he has a wider choice of material to record.

"What I want to do is to get as many songs as possible written because that was always a danger in the past. Even with Argent, it was a danger as it is with most bands. You might write ten songs and then you go and record all ten and stick them on the album. The most obvious thing to do is to write about thirty and then pick the best ten. That way, you have the best songs and the songs with the most continuity. I've got about ten I could put down now, but I want to write a lot more for that reason."

Since leaving Argent, Russ hasn't really spent a lot of time on the road and he's never really had a permanent band with him. In fact, he has only appeared twice on a British stage since 1975. When I asked about the possibility of live work, there was a long pause and then a long sigh.

"Ah, well, I love being on the road and I really do miss it. Unless there's a demand and you can play to more than a couple of hundred people . . . there is a lot of expense involved being on the road. The bigger the demand, the more money you can earn for better musicians, bigger lights, a better sound system and that sort of thing. I went to the States and did about seven gigs and three dates at the Bottom Line but I lost money being away. I love being out there but I couldn't survive out there with a band without a hit record — that's what I'm waiting for. I ultimately want a hit album but a hit single is a kind of short cut to a hit album.

"It's just that feeling, you know? I really do miss it. When we did the gigs in the States, although we only did a few, I enjoyed it much more than I ever did with Argent because I was answering to myself. It was all my songs and if anything was wrong, it was down to me. Also, I tended to be a bit inhibited with Argent because there were a few songs I wanted to do and the band saw the songs in a different way, particularly Rod because he was going into an instrumental thing. I was much more into basic songs and because Rod was the featured instrumentalist, I was always a bit loathe to express myself on guitar but now I can do it. I can tailor the songs exactly the way I want them. It's always a bit of a compromise being in a band. It's much less of a compromise doing things for yourself. You write the song and you can make the guitar solo last as long as you want it to last. I wouldn't want to go back to what I was doing before, doing six or seven days a week on the road. I think everything suffers when you're on the road that long. It can become like a job and you don't have enough time to record or write or anything."

Over the years, Russ has remained faithful to his Fender Stratocaster. He bought a newer model recently and used it on the new album.

"I've still got the one with the holes cut in but I bought another Strat when I was in the States and I'm thinking of having that cut about a bit just to make it look different, but I really like Strats. I suppose it's what you get used to. I've tried Gibson, Gretsch and Rickenbacker but I always come back to the Strat. I'm thinking about sticking a humbucker on one of the Strats just to get a bit of a different sound. I was really pleased with the guitar sound on the new album but I think a lot of that was due to the Boogie amp I used, plus I used a sustain pedal with it."

Things have come a long way for Russ since the days of playing with the Roulettes and the way The Biz works has changed dramatically, but Russ has a lot of fond memories of those days.

"I was talking with one of the old band (Roulettes) the other day and he remembers lots of things I'd forgotten about. They were great days. Things like the old package tours were great. I remember one we did was with The

Undertakers, The Searchers, The Four Pennies, The Swinging Blue Jeans and Adam and us were topping the bill. It was ridiculous. In those days, we'd only get to play about twenty-minute sets and that was it.

"I thought the Roulettes were an incredible band live. We did a tour with The Paramounts and I thought we were very similar to them. They were in a very similar position because they were backing Sandie Shaw and they used to listen to very similar records to us and they had similar tastes. I think we both were very far ahead of the time and it sounds pompous but I think we were proved right. We covered "Tracks Of My Tears" by The Miracles as soon as we heard it and that was in 1965! It wasn't a hit here until much later. Then we did "Stubborn Kind Of Fellow" and Frankie Miller has just put that out."

Back to the present, Russ is still busy writing new material for his next album and, apart from that, has plans to work with Ringo on his next album.

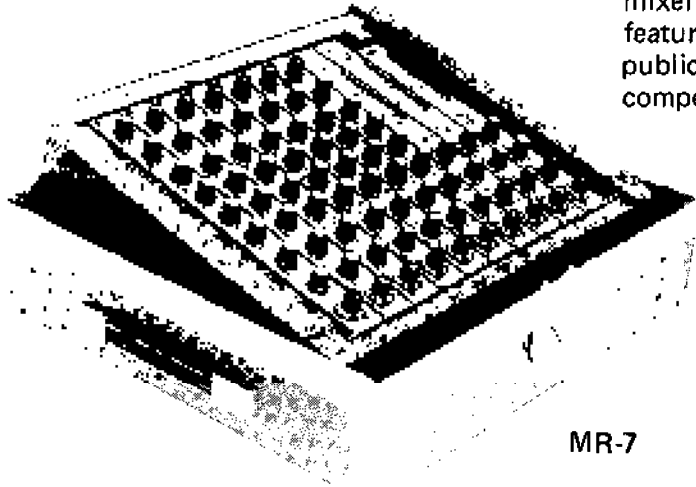
"Ringo's doing three of my songs and I think it's going to surprise a few people because it's new stuff for him. He lives in Monte Carlo now and he can't record over here so it looks like we're going to go to Paris, Holland or Germany to record it. It's something totally different. People expect him to do a certain type of song these days and I think that's his problem because he gives it to them. Apart from that, I've got the new album to do and that'll be recorded in Sound City again. It takes an album, really, to get to know people. I didn't know Keith before I even started the album so it's important to get to know each other. It can only improve.

"While I'm making better albums, and playing better guitar and writing better songs, I'll keep making albums. It depends on so many things — whether the next single will be a hit, whether the album sells well. That's what's so fascinating about the business. You never know what's going to happen. I mean, I never thought "Hold Your Head Up" would be a hit, so there you go!"



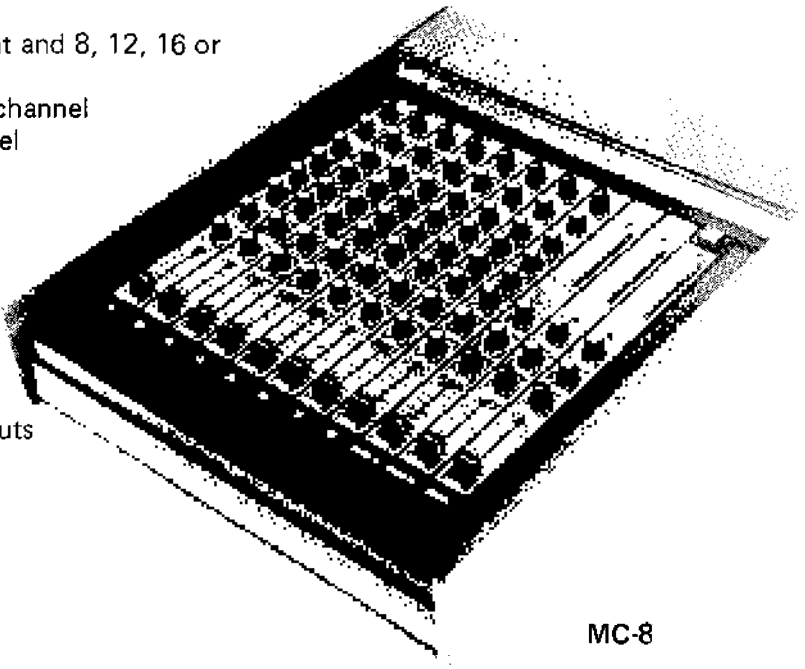
MARK 2 MIXERS

Peavey's new generation of professional quality mixers combine the latest studio performance features for all sound reinforcement and general public address applications — at prices our competition won't believe.



MR-7

- 7 channels, stereo rack mount and 8, 12, 16 or 24 channel consoles
- Led overload indicator each channel
- Pre-monitor send each channel
- 4-band EQ each channel
- Stereo pan each channel
- Led ladder displays on main and sum (40.0dB range)
- Stereo headphones selectable on main and sum
- Transformer balanced inputs and outputs
- + 20.0 dBm levels at all outputs
- Easy access to all busses



MC-8

Send large stamped addressed envelope for details of Peavey's New Generation of Commercial Sound Equipment to U.K. and Eire distributors:

PEAVEY ELECTRONICS (U.K.) LTD.

UNIT 8, NEW ROAD, RIDGEWOOD, UCKFIELD, SUSSEX. TN22 5SX.

POWER



At 60 pence* per watt!!



CS 800

* SUGGESTED RETAIL PRICE £480.50 + VAT

PEAVEY'S GIANT KILLER · 400 WATTS PER CHANNEL STEREO
19" RACK MOUNT POWER AMPLIFIER

specs

Frequency response:	-1 dB 5 Hz to 30 kHz @ 400 W, 4 ohms
Power @ clipping:	Typically: 280 W rms into 8 ohms 460 W rms into 4 ohms 250 W rms into 2 ohms 400 W rms into 4 ohms (both channels driven) 800 W rms into 8 ohms (in bridge mode)
Intermodulation distortion:	Less than 0.2% from 0.01 watt to 400 watts, typically .07%
Total harmonic distortion:	Less than 0.1% .01 watt - 400 watts, 20 Hz - 20 kHz, typically .04%
Hum & Noise:	100 dB below 400 watts rms output (20 Hz - 20 kHz)
Slew rate:	10 volts per micro-second
Load impedance:	4 ohms or greater (stable into any load configuration)
Damping factor:	Greater than 100 (1 kHz, 4 ohms)
Input sensitivity:	1.3 volts rms for 400 watts into 4 ohms
Input impedance:	25 k ohms (input overload protection)
Load protection:	Short, mismatch, open circuit proof voltage/current limiting instantaneous with no thumps or cutout. Long term overload may trip the thermal breaker resulting in temporary shutdown.
Speaker protection:	Instantaneous crowbar circuit clamps the output upon advent of amplifier failure
Dimensions:	7"H x 19"W x 13 1/2"D
Weight:	68 Lbs.
Power consumption:	1500 watts 120 VAC 50/60 Hz

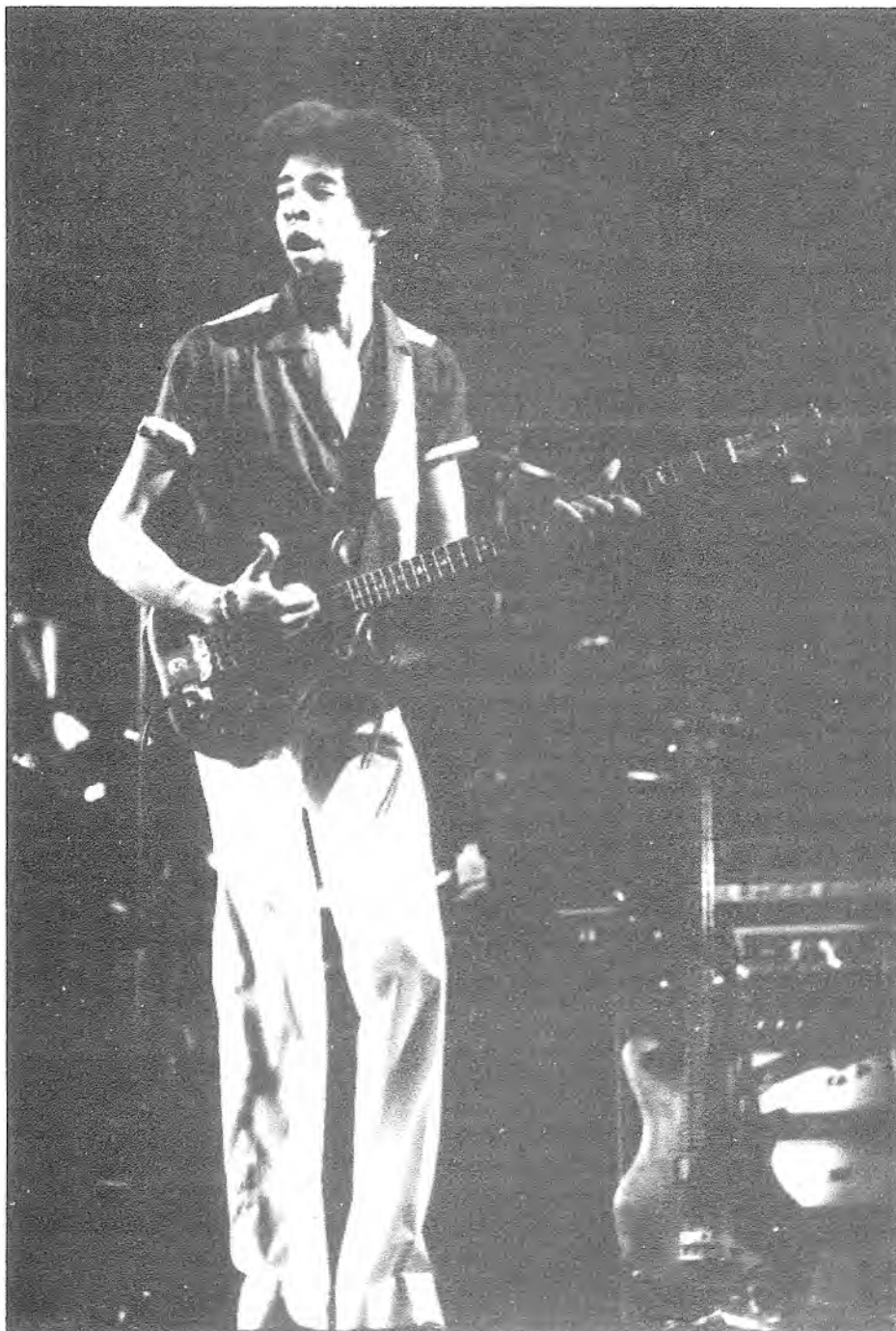
Distributed in the U.K. and Ireland by:
COMMERCIAL SOUND DIVISION,
PEAVEY ELECTRONICS (UK) LTD.,
UNIT 8, NEW ROAD,
RIDGEWOOD, UCKFIELD, SUSSEX, TN22 5SX.

Forever the Bass Man

Stanley Clarke talks to Steve Rosen

Stanley Clarke's musical progression has always been rapid. As a child, he quickly moved from violin to cello to double bass and, finally, to bass guitar as he proved both proficient and creative. Like most musicians, his success didn't come easy. After playing with local bands at the usual small time venues, he managed to enter the session world where his career moved into top gear after a session with top drummer Billy Cobham.

As a session musician, Clarke developed his own unique style and his music began to progress towards "free form". This development led to his joining Chic Corea's Return to Forever where his free jazz influence was brought to the fore. His solo work, too, was critically acclaimed, and his latest album, "Modern Man" sees him fusing jazz with disco and pushing the boundaries of the bass even further.



Did you take lessons?

Yeah, I took lessons for years. When I was living in Philadelphia I was always in some sort of band. I have a feeling that that is the most important thing. I think the thing that helped me the most was always playing with somebody because at a very young age I became very aware of what it's like to play with somebody. I know a lot of musicians who go through their whole life practicing in their rooms and all that and when they get out and play in front of a person they have problems applying what they've learned.

When did you get your first bass?

My first very own bass when I was about 15. That was an upright bass made in Czechoslovakia. I got my first electric bass at 16.

Once you started playing in bands were you playing electric bass all that time?

Yes. It's really interesting, I was playing in all sorts of bands. I used to play in bands that used to play the old 50's rock and roll, I'd play in acid rock bands and play electric bass, played in Country & Western bands and avant garde jazz bands when I played acoustic bass. So you feel as comfortable with the acoustic bass as with the electric bass?

Oh yeah, they're both equal I think, as far as my fingers, although I do prefer playing the electric bass when I'm playing with a band. The acoustic bass, if I play it, is usually just a solo instrument.

What is it about the Alembic that you like?

The Alembics I've had have all been handmade, and they just felt more like instruments to me. I have a lot of really old acoustic basses that are hundreds of years old that you can't even put a price on, that feel like instruments. You feel like a guy made the instrument for a person. That's what the Alembic bass feels like, made for a person. The Fender bass feels like it was made more for a body and you stick it on and play.

Do you think your style has changed since going to the Alembic?

Yes, definitely. I know I felt more like playing it when I got the Alembic. When I first started playing the electric bass, I wasn't so much into really playing, I was just taking the role of a bass player because it was such a boring type of thing, playing this instrument that sounded terrible. When I got the Alembic it started sounding like music to me, and then I really got involved and inspired to play it.

What type of amps were you using with Return to Forever?

I was using a Marshall for a little bit, I was using Acoustic 360s. I started out with 360s and I wanted to get smaller and used a couple either 215s or 410s, and a couple of 150s. I use Vega cabinets, actually the most recent thing is a speaker that is very similar to a Vega speaker. It's designed the same way.

What are all those pedals you use?

Well, I don't really use any pedals, but I use a harmonizer. I use it mainly for delay and also for certain solo stuff when I like to double the sound and I use a flanger for just a flanging sound and a couple of Alembic pre-amplifiers which just colour the sounds of the speaker, that's all, the Alembic input module which is basically like a direct box. Input modules are like a direct box for the bass. It's built specifically for the bass. I use a space echo that goes through a Yamaha mixer so I can bring in certain things and take out certain things. Do you tend to work from certain scales or certain runs when you play?

It really depends on what I'm playing. It could be a simple song and I'll just play simple, or it could be a complex song with lots of chords. It really depends on the song.

Do you use any special techniques, equipment techniques in the studio?

The last couple of years, I haven't really, but I'm starting to. The last couple of years, it's all been direct. But I'm starting to experi-

ment using certain types of amps. I have not totally got it yet, or gotten it to where I like it, but that's what I'm working on now. I just want to be able to get a fatter type of sound in the studio. I don't want it to be muddier or anything. You can throw out some amps with some mikes in front of them and it'll be fat. What kinds of things would you suggest to somebody to increase speed? Are there certain exercises or things they can work on?

Practice everything real slow and just keep getting quick about it. Just keep going over it again. And then there's another thing that really helps; playing with people who are always that much more advanced than you. It was something I always did, I always played with people who I considered gave me a challenge, where I really had to work. I never settled for someone who was worse than me. It always kept me on my toes and just kind of gives you another attitude.

You felt that way with Return to Forever?

Not so much with Return to Forever. The only guy in Return to Forever that I would look up to would be Chick and when Al DiMeola came into the band, he was just a kid. It was great to watch him. Al DiMeola's a very interesting guy to watch in a band because when he came in the band he couldn't really play the music. He was a young kid off the street, but he had this thing, like style. As the years went by we did more gigs.

When Al came in the band, the rhythm section was set. Chick, Lenny and I had been playing together for two years and we were set. We played very good together and Al was trying to fit in and he was having his problems like anyone would and as time went on, he started getting better and better and better, just from the challenge, which I think is great for any musician. I mean, not that he has to go out and look for challenges, because sometimes that can be negative, too. But just having the thing of playing with other guys and knowing that you have to stay on your toes is really something.

Did you enjoy playing with Lenny?

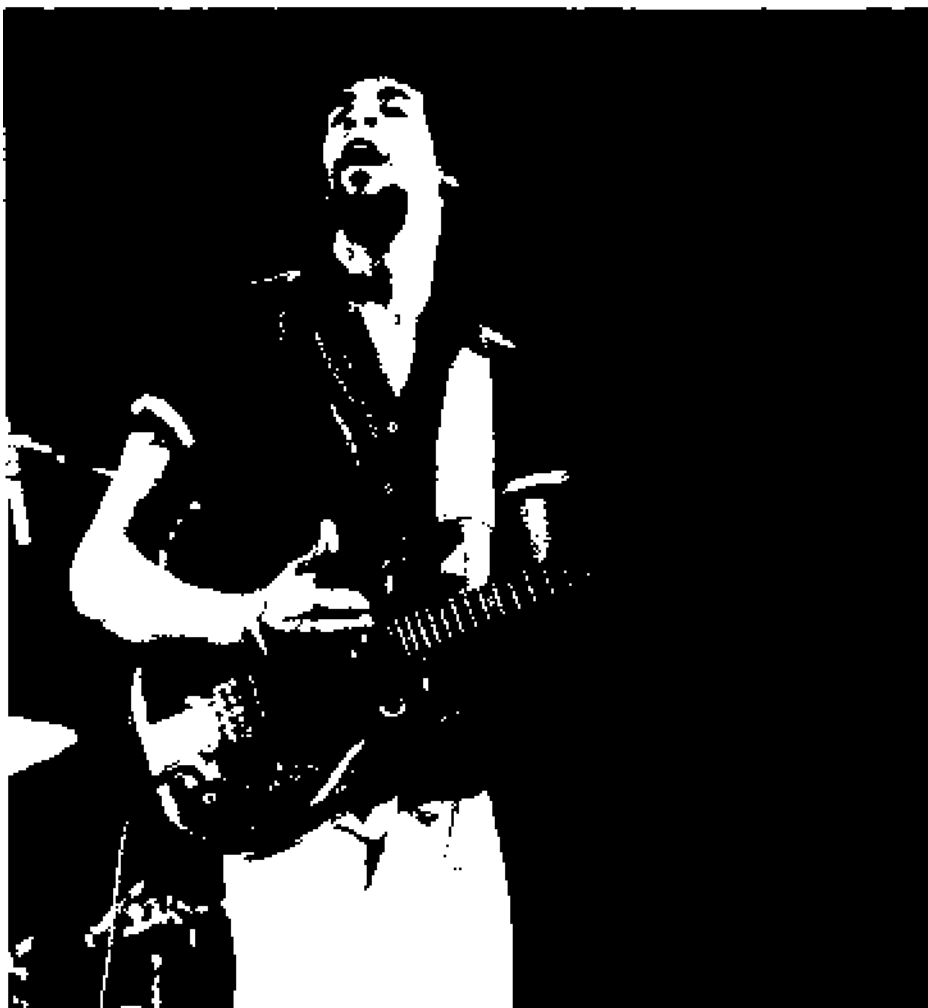
Oh yeah, Lenny's great. He's the type of drummer that I never have to worry about or anything. We go back years before Return to Forever. We used to play in New York in jazz bands and we were in groups that people had never even heard of, old be-bop bands. So we have a lot of stuff together.

What kinds of chords do you play?

I have a real simple attitude about the bass. It goes for any instrument. You've got an instrument and there's all these things that can be done on the instrument, so do it. It's as simple as that. I was never one for the standard. I think it was basically because, as a child into music, I always kept myself shut off from the world. The closest I got into being really plugged into the world was when I played basketball. I played with street guys on the street, and got into what they're into, which is basically nothing. I never had any fixed considerations that the bass had to be played this way or the drums had to go like this or the bass or the drums never played anything other than this or that a guitar player must play like that, must have sustain, must not have sustain or keyboard players can only play a Fender Rhodes. That would be the furthest thing from my mind. It never entered my mind. People say you must feel wierd about going around having your own group when you're a bass player. I feel fantastic, amazing. That's the basic concept behind chords, something I do on the bass.

Do you listen to other bass players?

The other night I went to the Roxy. The closest I've listened to another bass player was when I was at the Roxy the other night and a whole bunch of guys were in town that week-end; John McLaughlin's band, Billy Cobham's band, Lenny was here, Jeff was here, some people from Weather Report and we were all



hanging out because we decided that we never get a chance to see each other. I remember Jaco Pastorius, he was with Weather Report, and I hadn't seen him since way before Weather Report.

He used to come and see us when Return to Forever used to play in Florida, we'd hang out. So I saw him, and we said 'let's go out and do something.' Billy was playing at the Roxy, so we all went over there and I think on the second show one night, on the last tune, we all ran up on stage and started playing. This bass player that was with the band had about four basses, so there was me and Jaco and some other bass player and John McLaughlin, Jeff, Billy had two guitar players and this guy Raymond Gomez who plays really good.

Do you think Jaco is a good player?

Oh yeah. We kind of set up things and everyone started playing. All the guys were just setting up things, it was really nice. I like him. It's nice to hear somebody who can play that has some knowledge.

What kind of sound do you look for when you play live?

I look for a stage sound that has the full range, but with a special accent on low mids. This is probably only true of the Alembic bass. The one thing that's wrong with it is the way they make it. They're very weak in the mids areas. They have great lows, they go all the way down, it's open, it's not cut off.

Then the highs go straight up and with the mids there's not enough accent. I have a feeling that with any electric there's an accent on high mids and low mids, but this one doesn't, so it makes the low end sound real flabby. On stage, I add that and really accent it grossly and there's more distinction in it. You've won virtually every poll that there ever was. **What does that mean to you?**

It's nice to have those awards. I was looking around a couple of months ago, and there were quite a lot of awards. I always used to shy away from these guys, who'd have these sports cars, you go into their houses and they

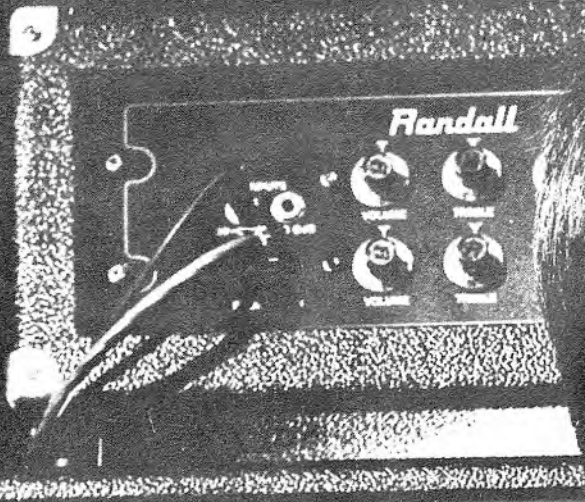
have these big trophies in the corner. You'd go in there, and they'd always stand by them. I have a lot of friends into sports and it's just something natural, they just go over to the trophies, so I figured that I don't like that sort of stuff. But then I was looking in my den the other day. I have all these things in this one area and it looks nice. It looks like a nice thing. I can understand what a guy can see in that, I wouldn't want to get pinned to it. Especially when you see all the numbers and the years, it kind of makes you look back on your life and see all the pictures of the things you did in that time.

How old are you?

Twenty-six.

It seems like you really had the chops down ten years ago and since then you've just been developing style.

Well, with chops I always practiced very hard when I was young. That's all I did. So I always had that down but I didn't always have the style down. That comes from playing with people, I think a person's style is like your personality. It has to do with the people you're playing with. If you play with some musicians that you dig as people, you'll expand quicker. If you play with some assholes that are just trying to take advantage of you or they don't really like you, and they don't give a shit about your own expansion, you'll never expand. It's as simple as that. I learned that is a very subtle thing, because I've seen guys get screwed as musicians because when they were real young, they played with some guys who didn't care about them. When I was younger, the musicians that I played with cared about me, they wanted me to get better and I wanted them to get better. It's like in any group, like a good football team, you care about the next guy. The quarterback definitely cares about the centre, or his ass is grass. So that's the kind of environment I grew up in and helped me a lot. It's amazing how dependent people are on other people. Sometimes it's not totally realised.



Randall

GARY PIHL
GUITARIST WITH
SAMMY HAGAR
CHOOSES RANDALL

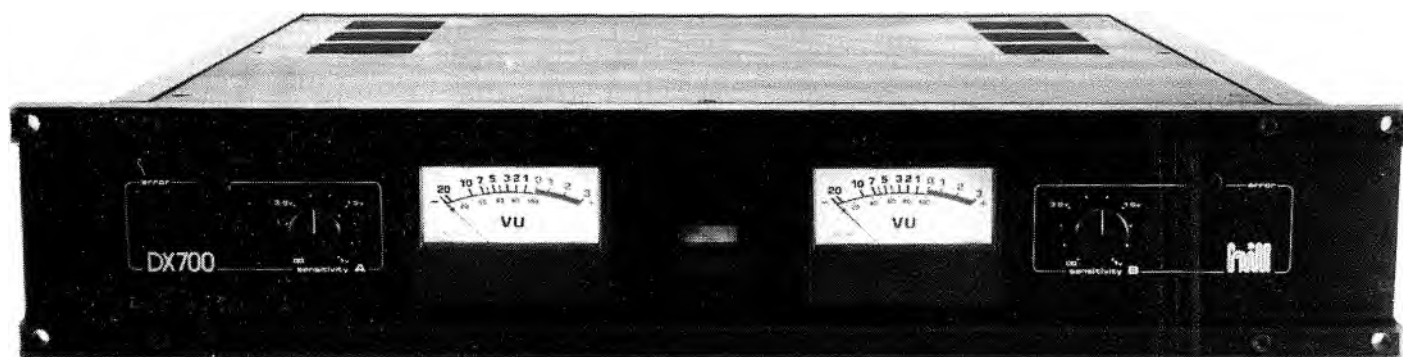
Randall

RANDALL INSTRUMENTS, INC.
1132 DURYEY, IRVINE, CALIF. 92705
P.O. BOX 10936, SANTA ANA, CALIF. 92711

OUTSTANDING NEW POWER AMPLIFIERS

DX 700

DX 140



POWER: DX700-800w (4ohms + 4 ohms) 1300w (2 ohms + 2 ohms) DX140-160w (8 ohms + 8 ohms) Rated R.M.S. Continuous. 260w (4 ohms + 4 ohms) MAX R.M.S. Continuous.

PERFORMANCE: THD less than 0.005% rated output, 1kHz; less than 0.04% at all levels up to rated output 20Hz-20kHz.

IMD less than 0.02% at all levels up to rated output, SMPTE 60Hz: 7kHz/4:1.

RELIABILITY: Total output device dissipation capability 6 times rated output power. High efficiency toroidal power supply. AC coupled driver stage.

ECONOMY: At rated output power, these amplifiers represent more than 2w per £1.



**Real Audio Transparency
Unconditionally Guaranteed for 5 years**



Ron Blechner, Sound Reinforcement, 6 Lillie Yard, 9 Lillie Road, London SW61UD, England. (01)- 381 3446

Peter Moody, Studio/Broadcast, 15 Greenfield Close, Stapleford, Cambridge. Shelford (02204) 2060. Cambridge (0223) 62392.

Malcolm Hill Associates, Head Office, Hollingbourne House, Hollingbourne, Kent, England. (062780)- 556

Gibson

as it was in
the beginning
is now and
ever shall be.



O.K. Show me what you're going to do with the next 25 years. Send me the new Gibson catalogue.

Name _____

Address _____

I'm also interested in receiving details of the following:

Moog®
Synthesisers

Pearl
drums

LabSeries
Amplifiers

Brass &
Woodwind

Gibson
is guitars

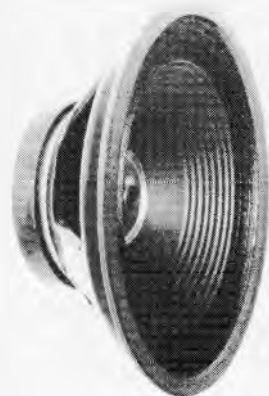


Norlin

Norlin Music (UK) Ltd. Woolpack Lane,
Braintree, Essex. Telephone: (0376) 21911.

IM

STAGESOUND COMPONENTS



ST1275GP A 12" 75 Watt general purpose Speaker
with a response from 40-8000 HZ
8 or 16 Ohm
Available around £26.50



ST15 A 15" 150 Watt Bass Speaker
with a response from 35-4000 HZ
Available around £60.00

From the

ALTEC

Distributors



ST1275TC A 12" 75 Watt Twin Cone Speaker
with a response from 40-15000 HZ
8 or 16 Ohm
Available around £27.50

ST10 A 10 Watt
Tweeter with a
response from
3000-20000 HZ
Available around
£17.50



**THEATRE
PROJECTS**

10 LONGACRE,
LONDON WC2

Tel: 01-240-5411

**'Watts' more
for your money with
Celestion Powercel**

The Celestion Powercel represents a great advance in loudspeaker technology.

It has been specially developed to give the finest possible sound reproduction of electronically amplified instruments and music.

Two models are available.

Powercel 12-150—150 watt RMS
14lb magnet system 12 inch chassis

Powercel 15-250—250 watt RMS
26lb magnet system 15 inch chassis

Both have heavy duty specification including die-cast aluminium chassis, cone with plasticised cambric surround and three inch copper wound voice coils with fatigue-resistant lead out wires. The massive magnet incorporates a specially engineered back pressure system to ensure top quality and reliability.

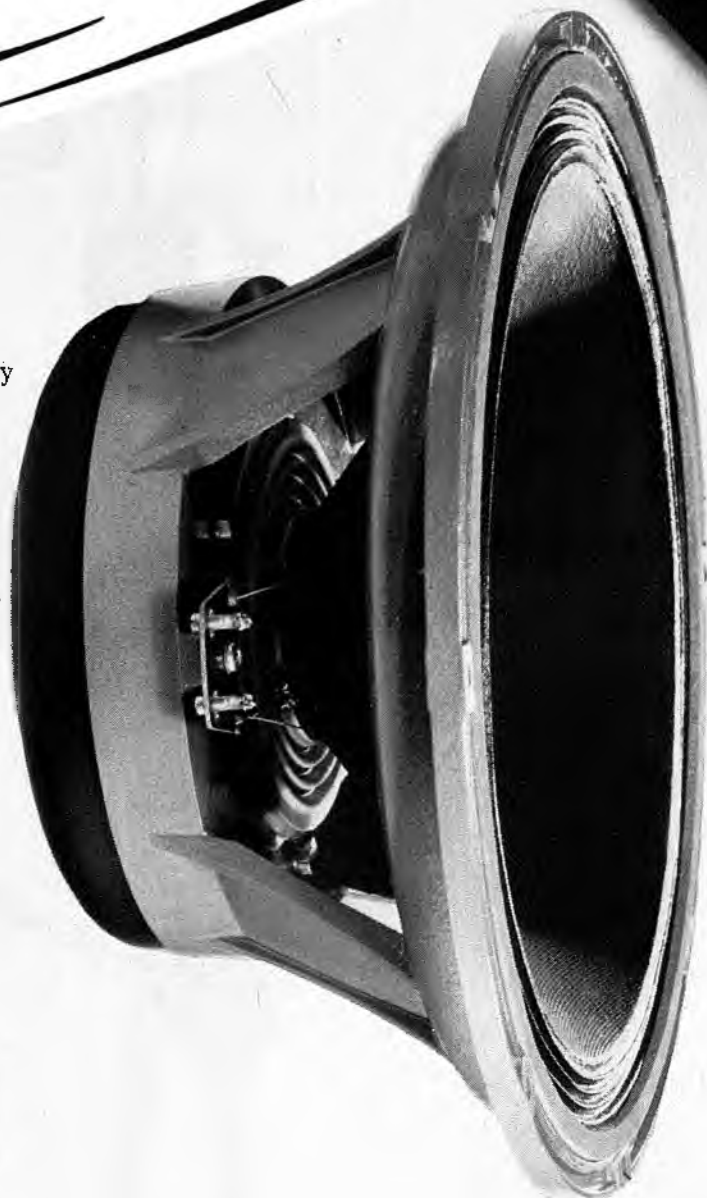
Choose Powercel for the highest quality amplification at a down to earth price.

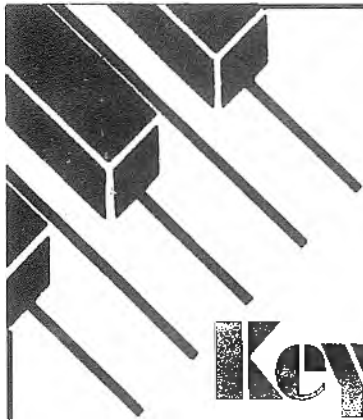
Principal Distributors to the trade:
A.C.Farnell Ltd., Sheffield, England.
Norman Rose (Electrical) Ltd., London,
Birmingham, Manchester, England.
Lugton & Co. Ltd., London, England.

Celestion



Rola Celestion Limited,
Ditton Works, Foxhall Road, Ipswich,
Suffolk IP3 8JP, England.
Tel: Ipswich (0473) 73131.
Cables: Voicecoil Ipswich. Telex: 98365.





*Rod
Argent's*

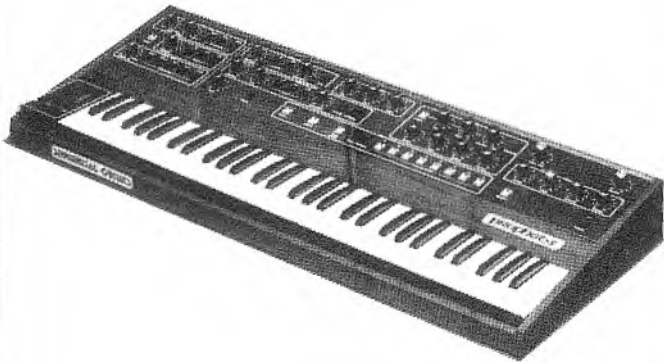
Keyboards

20 DENMARK STREET,
LONDON WC2A 8NA
TEL 01-240 0084/5

The only store offering the complete service to the discerning keyboard musician and the choice for the professional is now open.

Come and see the most comprehensive range of professional keyboards and ancillary equipment available in the United Kingdom including:-

SEPTEMBER IS THE MONTH FOR THE COMING OF THE PROPHET – the sensational Polyphonic Synthesizer from SEQUENTIAL CIRCUITS, U.S.A.



This amazing instrument must surely be the most versatile Polyphonic Synthesizer in existence offering as it does 40 completely programmable Memory Banks plus the onstage flexibility of both Pitch and Modulation wheels and is solely available from Rod Argents Keyboards. Call in for a demo any time . . .

CONTEMPORARY KEYBOARD MAGAZINE – Including all back issues is now in stock.

ROD ARGENTS – the choice for all professionals including you!

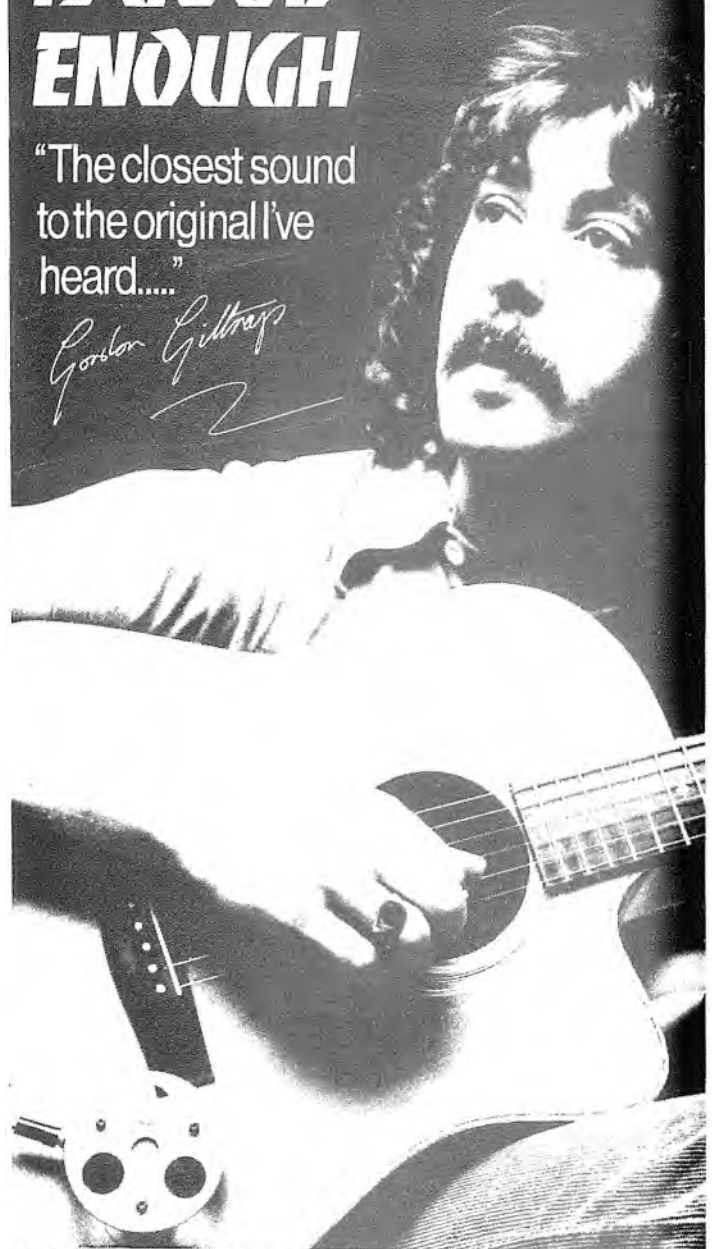
P.S. Don't forget our excellent repairs and modification service.

Rod Argent's
Keyboards

ONLY THE BEST IS GOOD ENOUGH

"The closest sound
to the original I've
heard...."

Garth Githtraps



The Kelsey Acoustic guitar microphone



Kelsey
Acoustics Ltd.,
28 Powis Terrace,
London W11.
727 1046

R.R.P.
£59.70
inc.VAT

Taking Care of Business

PART 7

BY ALAN HOLMES

Ever since the New Seekers had a number one hit with 'I'd Like To Teach The World To Sing', radio and TV jingles have become a major part of the music industry. The success of that song, which was originally a Coca-Cola advert, made a lot of people realise that the jingles field was a lucrative business. Other jingle-related hit singles have included "Jeans On" by David Dundas (Brutus), "Dancing Easy" by Danny Williams (Martini) and the awful "Smurf Song" by Father Abraham (National).

David Dundas, in fact, went on to become a successful recording star and has a new album coming out soon. The executive producer of his album, producer of "Jeans On" and winner of the top jingles producer award is Kate Hawthorne who has recently started her own company "Mothers and Masters" with Lisa Bown, after leaving Air Edel. At present she represents four writers including David Dundas and part of the offices is a four track demo studio where she works with the writers to create new jingles. The company is also involved in record production and music publishing.



Have you got any jingles on the air that people will be familiar with?

Whilst working for Air Edel I produced many jingles, several that are still on air, several that are very successful world wide:— Mary Quant, Boots make-up; I just recently finished one for Levis, Kiku, Thompson's Holidays, Crazy Curl, McEwans Beer, Spanish Tourist Board, Brutus Jeans, C&A and several for Europe. There's a great market in Europe which shouldn't be forgotten here. A lot of people still come to England. England has the best reputation throughout the world, coming up with the best commercials, both visually and musically. I personally have won several awards for radio. I won the Best Radio Campaign in 1976 for a track I produced for McEwans and I won the award for the Best Television Music Track for Brutus. Having left Air Edel, I've been commissioned to do several music tracks for substantial campaigns like British

Caledonian, a new after-shave for Boots, a new Birds trifle topping, which is on air at the moment, Dunlop Swingball, Skol lager and several others.

What is a jingle's purpose?

That's rather a broad question but, basically, music is one of the most emotive and immediate forms of getting through to people. Especially today, when the age of music is very strong and virtually everybody has some sound system. Television has now realised this and to heighten or to make advertising or commercials much stronger, music tracks are now in demand a lot more than they used to be in the past.

The purpose of a jingle? For example, I will go into an agency and they give me what is known as a brief or a story board or perhaps they have a final film. Depending on the product, it could be anything from a butter, a new bra, a new beer, an old beer, a coca-cola, I then sit down and talk with the creative team

Jingle Belle



which comprises an art director, an agency producer, a copywriter and several other people in an advertising agency or a film company according to who is commissioning me for the work. They will say to me, "this is the job, how can you heighten it with music?". I then look at the product objectively, try to understand what the product is, ask them what age group they're trying to reach, what market they're trying to reach and subsequently then sum up in my own mind what I think is the best mood the music should carry in order that this particular market can understand and relate to it. For example, if it was a chewing gum; obviously chewing gum is not chewed by everybody, so we've got quite a young age group here — anything ranging from 12 to 24, 25 in general, it's more of a young market. Here, I assess that you've got a male, female, young market. I then, through my experience in music, having worked in a record company for five years in A&R and press,

assess what sort of music is the best type or will express and project the correct mood in order to interest these youngsters. A chewing gum — that could be pop, that could be Eagles, it could be rock and roll. Punk would be too hard here because you also have people chewing chewing-gum who aren't necessarily of the punk ilk.

So we'd probably go for something on the middle of the road to the rock and roll side of things, in order to get the right listening audience. The purpose of a jingle is to get directly to your audience, your listening market, the mood to inspire them, something which actually appeals to them personally as well as helping the film along. Therefore the combination of the music and the film should be directly at that age group and the market and the mood and the jingle will be specifically worked about in order to do this.

For example, if someone was talking to me about producing some music or coming up with idea for a butter, I'd think of something like flutes, woodwind instruments of any kind really, maybe some violins, according to the picture. Something gentle but something quite happy. A child's toy, for instance. I'd then probably use some brass and some chirpy instruments, which would project or actually tune into children, something bright and young. Foods — these would take on different aspects according to which market the particular agency are trying to get to. If you're selling sound equipment of any substantial name, you'd then probably try to hit more of a rock and roll era because most of the people who buy the sound equipment are people interested in music of that sphere.

So a jingle's purpose is really to musically project what the film is trying to say. To give an idea to your audience and public that they're trying specifically to get a message for them. This can be done with music. Music is one of the most important things in everybody's life; it can especially highlight things, it can project things, it can say things which many other things can't say. It is also very immediate — you either like it or you don't like it. Jingle writing is a very hard thing to do, contrary to belief. The stigma that jingles once had — about people saying, "I don't like to write a jingle" is now gone because the market has increased so much. People are now aware that jingle writing has to have a lot more character, has to be a lot better than it used to be because the public are into music a lot more.

The production of a jingle is totally different from records. What are the most important differences?

It's a very good basis to be a music producer by starting off by being a jingle producer. You're called on to do every sort of music production, punk, funk

rock and roll, classical, popular music, middle of the road, any aspect of music is covered in jingles. You are under tremendous pressure because union laws and Equity rulings stipulate that musicians get very high rates. This also is quite good because you can usually dictate or manage to get hold of very good musicians to do the work. They get paid the same amount of money for doing a jingle for one hour only as they do for a three hour recording session. From this point of view, you can get very good musicians. Usually it's important for them to be able to read because of the time pressure. You've got to record a particular track — if it's a 30-second piece of music for television or a 60-second piece of music for television or cinema or for radio, you're under tremendous pressures.

I usually do one jingle in three hours. I put the rhythm section down in the first hour, the vocals in the second hour and I mix everything in the third hour. Also, you've got to remember that you're transferring to film what you're recording. You usually record it on mono, mix it mono, because transferred to film you get a better quality unless you're actually doing it for radio, in which case you would mix it in stereo. The actual recording differences and production differences are that, with jingles, you have to bring the vocals up front more than you would do on a record because one doesn't have sophisticated recording systems at home. You don't have the luxury of having headsets at home so, therefore, you have to mix your vocals up front, make sure they're very bright and the clarity of words is very important here. A lot of research is done in the market, a lot of time is spent on picking certain words which are important to particular briefs. It is essential that one picks the right set of words and therefore the agency spends a lot of time on research before they go ahead and either give you lyrics or ask you do do lyrics, giving you specific words to include. This is why the vocals have to be mixed up front.

This, again, is a difference between jingle recording and an album or a single recording. Nonetheless, it is a great stepping stone to single or album production; it also needs a certain production expertise which, in fact, is not so easy as it sounds. Simultaneously, it also needs a certain writer's expertise.

Singers also usually have to be highly qualified — there isn't a lot of time for them to be nervous, although obviously there are a lot of nervous singers. So you've got this other area which is quite difficult too. This should be borne in mind. Most singers can read. There are a lot of excellent high quality singers who do session work for jingles and it really is quite important that they can read and their confidence factor is important as

well, because of the short amount of time allowed and allotted to jingle production. **How do you choose a writer?**

I like to hear all writers' work. I go to recording sessions, other than my own. I listen to all writers' tapes and find that very important for me as a producer, just to make myself aware all the time, of changes and peoples' talents. I listen to a lot of records to keep myself on top of production. In picking the writers whom I shall represent, that's quite a difficult factor. I have a particular file that is full of different lyrics and briefs from agencies. I sit down with them, and we have a lot of famous people in this office, and explain the complications in writing a jingle. It has to be an immediate hit single, if you like.

You've got 28 seconds in general which is the time length for a 30-second television commercial, leaving 1½ seconds' silence at the front and a ½ second silence at the end for a 30-second commercial, making a total of 28 seconds for a jingle. The writers have to be able to have the ability to translate the mood and the market musically. It should have a beginning, a middle and a strong end within the 28 seconds giving the feeling of entirety, a complete feeling of a whole tune, but also having the immediate effect that a hit single does because it's put on television. There it is and people see it. It's got to come across with an impact and a writer has to have this ability. I don't expect writers to have the ability to be able to write within 28 seconds immediately as this is not easy. But after working with them at the piano, which I like to do, suggesting ideas, showing them different briefs, one can actually gather whether one is beginning to get into this market.



I would advise any writer who would like to get into the jingle field to actually pick a specific product, be it a toilet roll or a beer, try and identify, which isn't difficult for anybody, what sort of market and age group the particular product that he is trying to write about is, make up a set of lyrics for his own sake and try and actually write something within 28 seconds. On seeing this, he will see how it will scan musically, see how difficult the problem is, try and match it and see if he can actually do something constructive — the complete, entire 28 second track. If he can manage to do this, he is always winning before he actually arrives when he sees a production company or a jingle producer because what will happen is that he will see the difficulties. Rather than coming in and

seeing a production company and saying to them, "I want to write jingles," try and overcome their problems before you come and see them. Sit down at the piano or the guitar or sing and imagine you are doing one. Imagine the problems. Try and come up with an entire track. This is very impressive to a jingle producer. If someone has come in here and has taken the time and has actually tried to write something within that time limit, which to me has immediacy, which is complete, which sounds like a full song — even though it's only 28 seconds — I'm very impressed. Also, they've overcome the first step. They know that writing jingles is not as easy as it appears because, unfortunately, people still think that jingle writing is easy.

I can quote you a lot of people who have said to me, after a lot of time, "Katie, I'm finding it very hard to do. I thought it was a lot easier than it appeared". This is very important, I choose a writer by his imagination, his talents, his versatility, because obviously you get involved in all aspects. From a writer's point of view, it is extremely important. Writing jingles opens new doors for you as a writer. You sit down at the piano, you are given a brief, you are given a market, you are given a mood. You have to come out with something. It's not like sitting down and writing a song and you're scratching your head and thinking, "what shall I do?" Here you have a specific way, where you've got to write in a specific way, you've got to control yourself and approach it in a way which you normally wouldn't do. This can and does, as I've seen in many people, open new doors. You actually sit down at the piano or the guitar and you start writing something which you've been briefed by someone else and you come up and find that you've actually started writing in a way in which you wouldn't normally write yourself. This can be incredibly enlightening for a musician or a writer as he's found a new way of writing; new doors, which he wouldn't normally open himself and he will be very pleased. This can also lend itself to a very successful writing career.

How do you get clients to give you work?

This is built a lot on reputation, because jingles have only become increasingly more important in the last two or three years. The way to get clients to give you work is to be professional, be efficient, to have knowledge of their problems. People need to know that. I'm hired as a jingles producer because I'm aware of their problems. I can translate their problems to musicians and also sit down and sympathise and understand the musician's problems and logically work out a format for the musician, in order for him to get over the bridge, whereby he can relate back to the

client. Nobody expects a musician to understand advertising logic and terminology 100% and vice versa, which is why being a producer or working for a music production company is a very good thing. Basically, clients give people work on their track record. I have produced over two hundred jingles myself as a producer and, with the people I represent, we usually have a track record of coming up with the goods within the time limit, which is usually quite rushed, to come up with whatever they expect within that period. Therefore, I do get the work because of my track record, of the writers I represent, of the ability of the writers and myself to come up with the right style of music, market and mood within the client's specifications. It's very important, as it is with a recording artist.



It's a very hard industry to crack. The advertising industry is as hard as the record industry to break into. Having achieved the track record, one must respect the fact that they have to spend a lot of money on music and they wish to know that when they go into the studio they're going to come out with something that they do like. This is one of the reasons why you can persuade them that you can give them what they want. The best advice I can give to any writer or composer trying to get work is to get in with a production company. You'll find most of the jingle production companies are run by people who have a business ear and a musical ear. The combination of both don't usually go with writers, basically because they're either involved in albums or musical writing and they haven't got a background knowledge of the advertising industry. This I've accumulated through working through jingles, I also have an understanding of business through working in the record industry and the two make a perfect blend for the particular job which I have. **How does a writer get into the jingle business?**

Either he can find out who the top advertising agencies are and should approach the television producers within the advertising agencies. These people are exceptionally busy, they are television producers and are paid very well because they have an extreme knowledge of the best people to use around them, who can come up with good films, good jingle tracks and understand the nature of their business. They are given the choice of choosing the people whom they feel can come up with the goods for them. They have a tremendous responsibility and one

Jingle Belle

has to fulfill this. When one is suggesting to a writer to get into the business, he should have an understanding of this. He should understand the agency's problems. This is why a jingle production company is a good media because a writer can come, translate his problems to me. If I think he's good I can tell him why he won't be able to have any immediate success. However, if he has taken the trouble and come up and demo'd or recorded certain ideas for musical jingles, he will have much more of a chance to actually get into an advertising agency direct.

©
M.P.O.P.

The reason that this doesn't turn out to be so successful for most writers is because they do not want to devote 24 hours to the jingle industry because most composers are doing albums, arrangements or vocals so, in order to erase this problem or to support this problem, a music production company such as Mothers & Masters Limited, which is my company, comes into being. We find that I can then re-mix tracks if the writer happens to be in America, I can re-vocalise it, and suggest what the best sort of singer is to use on his session, what the best sort of arrangers are for his particular problems, pinpoint his particular need to translate his composition for the advertising agency's requirements and come up with ideas and also follow them through. This doesn't mean to say he has to sign a contract in jingles, I personally am very anti-contract signing. Most of my jobs are done on a one-off basis even though I do represent several writers exclusively.

It is a hard world, it is a difficult world, it means tolerance and understanding both from the film angle, the advertising industry's angle and the writer's angle. Most writers do not wish to spend their whole lives doing just jingles. Although I think it is excellent for most writers to try to write jingles because it opens up these new doors, it is not what writers want to do for most of their careers. A music production company that specialises in jingles would be the best way for a writer to get involved or to get writing for a jingle industry. They need immediacy; they don't have a lot of time, they're under extreme pressure. They do have a lot of money, it is a very lucrative industry, but they need expertise, professionalism and above all understanding of their requirements, their products, their needs and one should project this in the best way possible.

Having made the jingle, you then have to persuade the client that this is what they want, how do you do this?

Well, usually, if you are a successful music producer or a music jingle production company, you are commissioned first of all. You either do this by sending a particular writer's showreels around, with tracks composed by him, either in demo or final form, showing people how he is able to come up with jingles and understand their problems. When they commission you with a job, it usually means I, the producer, go in, sit down and talk about all the problems with the agency and discuss them. A lot of agencies have not been into recording studios as yet and they're expanding all the time. They're nervous about their lack of ability in the music industry. They shouldn't be ashamed of this, they are advertising people who are expert at their job. They have much more expertise at this than they do at music, much more so than I do in advertising or a composer does. A composer has much more talent than I do in writing a tune. It's nothing to be embarrassed about, yet they do feel embarrassed as I do when I have to try and produce certain things that I'm not sure about. One has to bear in mind all the different factors involved in one's producing.

B... GOLD

What usually happens is that a client will commission us to do a demo for a particular product. I then commission one of my writers, this depends on the talent required for the particular track that they're asking me for, depends on the availability of the writers, their expertise, the time factor involved. I then brief the writer who will come up with a demo track which can be just piano and voice, guitar and voice, just voice on its own. Once commissioned, I will take this to the agency, sit down with the agency people, try and express to them in their terms the form of final instrumentation that will be utilised at the studio which will actually take the demo track into the final mood with the orchestrations that they are looking for. This is quite difficult. It's not something that can be done in musical terms because you're talking to advertising and film people.

This is where the particular area of a music producer from a jingle company comes into being. One has to sit and discuss instrumentation. One shouldn't need to persuade a client. One should explain to the client clearly what the demo is going to be like when it's recorded into final, which is much easier for someone who is not a musician to translate.

Having approved that, I book the relevant musicians with the composer's approval, the arranger, the studio that the composer requires, engineer etc. and we go from there and I do what is known as a quote; which is made up according to Equity and union rulings. Once the client has accepted this, we go ahead into what is known as a final orchestration. This is one part of the problem. It can be anything from radio to television to cinema; different costs come into being for different media. Different costs come into being for different countries and different territories. It's a very complex system and one has to abide by Equity and the Musicians' Union. It's best to go to someone who does know the different stipulations and problems so they can actually look after that contractual side for you to make sure the musicians are repaid, should it go from television to radio, for example, whereby the musicians are due more money. All those sort of problems are very important in the jingle writing industry. Equity and MU have enough say to pull your commercial off the air if people have not received the right amount of money and quite rightly. Therefore, you should always make sure you go to someone who is aware of the problems and the rulings and all the different factors involved, which are not so simple.

What kind of rewards are there for a successful writer?

There are several different ways. If, for example, you happen to be a singer/songwriter, and you sing on your own commercial final track, you get what is known as repeat fees for singing. This is quite lucrative because if it is a big campaign and receives national airplay on television, you automatically receive quite substantial repeat fees. It's rather like an actor who appears in a commercial and receives repeat fees each time. If you are a good singer, you should better your voice and see several people; it's worth a lot of money to be good. Simultaneously, it's a lot of hard work and you need a lot of tolerance and expertise and you need to be able to read. It's very lucrative in the singer's way. It's very lucrative to the composer because of the time factor. The advertising people don't squander money, but there's a lot of time pressure involved.

Because of the difficulty of actually coming through with an immediate successful "single", if you like, which is a jingle, on television in 28 seconds, there are very few people who can do it. But if you can do it, the composition fees and the usage fees are quite lucrative. It is not an area which is so simple, and I must stress that; one must practise and try at home, before you bother the people involved who are usually very important.

REW Professional

We Will Beat Any Genuine Advertised Price

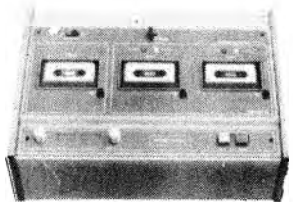
Europe's Largest Suppliers of Studio



EQUALIZERS SOUND CRAFTSMEN

Graphic EQ's.
AE Parametric EQ's.
VC SEA 10 (2 x 5 Band),
EA20 (2 x 7 Band)
TECHNICS SH9010 (2 x 5
 and), SH9090 (1 x 10 Band)
1XR (1 x 5 Band), (1 x 10
 and), (2 x 10 Band)
1M-Pace (2 x Band), SR271
 1 x 27 Band)

WOLLENSAK WOLLENSAK/West End Distributors



High Speed Duplicators.
 £1498.90 + VAT. New 2772A/V
 gives 2 stereo musicassettes in
 under 4 minutes. Call in for a
 demonstration.

UHER PORTABLE RECORDERS

As used by most
 Broadcasting Companies.
 All models in stock plus every
 accessory available.



Very low
 prices, e.g.
 4000IC £225
 + VAT.
 + SONY +
 NAKAMICHI
 + JVC +
 TECHNICS +
 TEAC.
 Portables all
 Off the Shelf.

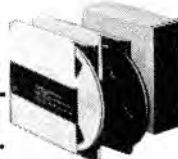
REVOX Incredible stocks at ridiculous prices!



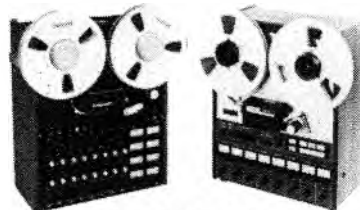
A77, B77, A700 Off the Shelf.
 High speed, low speed, vari-
 pitch + all accessories!
 Ring us now for the lowest price.

TAPE AT TRADE PRICES

Any quantity—
 same price $\frac{1}{4}$ "
 tape, 10 $\frac{1}{2}$ " reels.



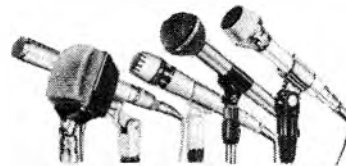
AGFA PEM368 Metal £10.06
 AGFA PEM368 Plastic £7.79
 SCOTCH 207 Metal £9.81
 SCOTCH 207 Plastic £8.03
 MAXELL UD180 Metal £8.89
 TDK AUDUA LB3600 Met £11.40
 TDK AUDUA L3600M Met £9.50
 SONY SLH-11-1100BL Met £10.00
 SONY SLH-740B Metal £6.89
 REVOX 601 Metal £11.80
 REVOX 601 Plastic £10.00
 All above prices exclusive of VAT.
 Also large stocks of 7" & 5" reels.



8 TRACKS $\frac{1}{2}$ " or 1"

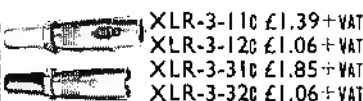
Both Tascam and Brenell
 Recorders in stock for immediate
 delivery.
 Plus complete range of 8 Track
 ancillaries.

MICS OVER 500 ALWAYS IN STOCK!



AKG We carry every model
 inc. capacitors
BEYER Most dynamic + ribbons.
CALREC 600 Range.
SENNHEISER Large stocks.
SONY All models.
NAKAMICHI All models.
E.V. Selected range.
SHURE Very large range.
NEUMANN All popular
 models.
 + Cables, Transformers, Stands,
 Connectors & Clips, Windshields,
 etc.

CANNON XLR'S ANY QUANTITY—SAME PRICE



XLR-3-11C £1.39 + VAT
 XLR-3-12C £1.06 + VAT
 XLR-3-31C £1.85 + VAT
 XLR-3-32C £1.06 + VAT

AMPLIFIERS

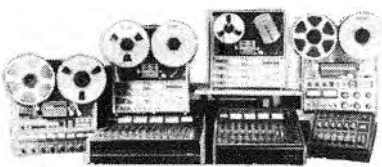
HH S500D, TPA, All stage
 amplifiers.
SAE From 2 x 50 watts to
 2 x 400 watts RMS.
QUAD 405, 303, 50E usually
 in stock.
JPS A fantastic range of budget
 studio amps.
AMCRON DC 300A, DI50A,
 D60. Trade prices.



TEAC-TASCAM CENTRE

Britain's Largest Stockists.

All Models on demo in our studio
 3340S 4 CH
 2340SX 4 CH
 3300SX2T 2 TR
 6100 2 TR
 7300 2T 2 TR
 TASCAM 80-8 8TR



MIXERS

The widest range under one
 roof!

From £35-£2500.
 Mixers in stock:
SOUNDCRAFT 16/2, 12/2,
 12/4 Series II.
HH 16/2, 12/2.
MM All models.

TEAC-TASCAM Models
 1, 2, 3, 5 + Accessories.
CANARY 10/2, 10/4.
HILL 16/2, 10/2.
SONY MX8, MX510, MX650.
 Plus **ALLEN & HEATH**,
JVC, **UHER**, **EAGLE**, etc.



Plus Echoe's, Phasers, Flangers,
 Limiters, Noise Reducers,
 Expanders, Mix-Downs, Mic
 Stands, Cable Drums, Disco
 Gear, Chassis Speakers, Studio
 Monitors, Headphones, Demags,
 Splicers, etc.

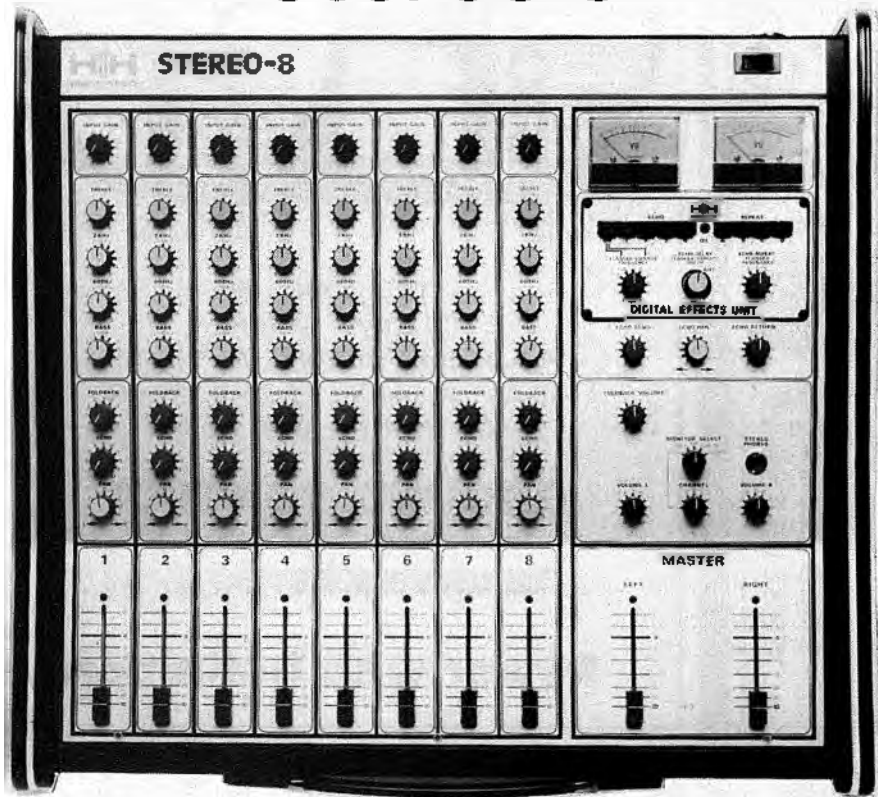
REW

PRO-AUDIO & DISCO: 146 Charing Cross Road, WC2 01-836 2372
VIDEO & HI-FI: 114-116 Charing Cross Road, WC2. Hi-Fi 01-240 3386 Video 01-240 3066
TAX-FREE EXPORT & EXPRESS MAIL ORDER: REW House, 10-12 High Street,
 Colliers Wood, SW19. 01-540 9684 ● Also at 230 Tottenham Court Road, W.1.

The Professional Everything Store

H.H. Superb So

Stereo-8



MULTICORE/STAGEBOX ACCESSORY

High quality remote connection system for your HH Mixer at an affordable price!

Stereo-12



DIGITAL EFFECTS MODULE - ACCESSORY

That unique HH wondrous ingredient - sound effects at your fingertips.

- A.D.T. • Echo • Reverb • Flanging

Sound Mixers....

Stereo-16



Designed for exact Sound Control

Operating your band's P.A. system to work as close as possible to that 'studio' sound at a live venue takes a soundman's skill, and more. You need a good HH Mixer.

HH Electronic's engineers, working closely with professional sound engineers and performers have created this versatile range of mixers sufficiently accurate for recording applications but precise and rugged enough to meet the needs of on-the-road performers.

SUPERB PERFORMANCE

Electronic performance is flawless - wide frequency response, low noise, low distortion with excellent precision controls: top quality electronic design is our standard.

FEATURES:

- Balanced inputs and output
- Four Band active equalization
- Stereo Pan, Echo Send, Foldback and Input Gain controls on each channel.
- Monitor Select switch and stereo headphone monitor facility. Additional Monitor V.U. meter on the Stereo-16.
- Illuminated V.U. Meters on each output.
- Foldback output group.
- Echo Send and Return with controls.
- Self-contained, fully regulated, fused power supply.
- Channel overload indicator.P.P.I. and Pre-Fade-Listen P.F.L. facility on Stereo-16.
- Multipin connector as standard on Stereo-16 only.
- Graphic Equalizer - seven band. Stereo-16 only.

ACCESSORIES:

- HH Digital Effects Module (D.E.M.)
- Full complement of Cannon-type connectors
- Flight Case
- Vinyl transport case
- Mixer Tripod stand
- Multipin connector for Multicore Stagebox
- Multicore/Stagebox

PLEASE SEND ME INFORMATION ON THE
HH SOUND MIXERS

NAME

ADDRESS

.....

.....

TEL No



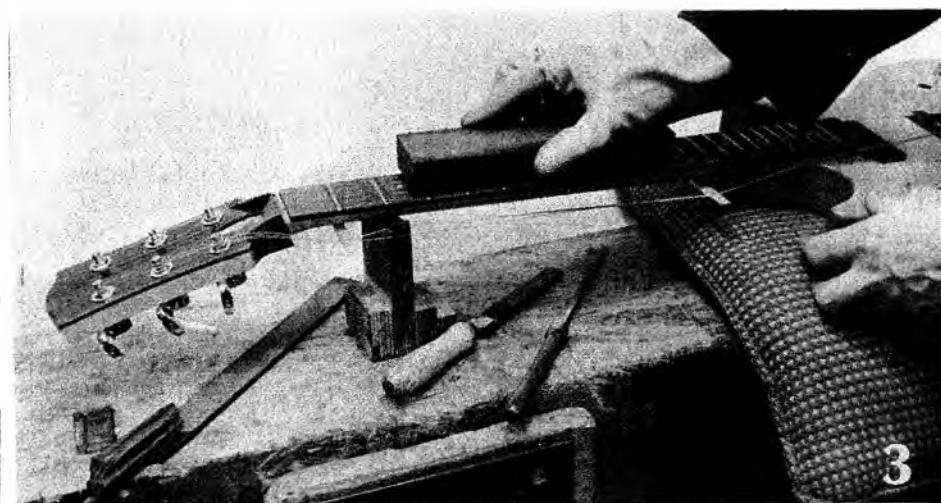
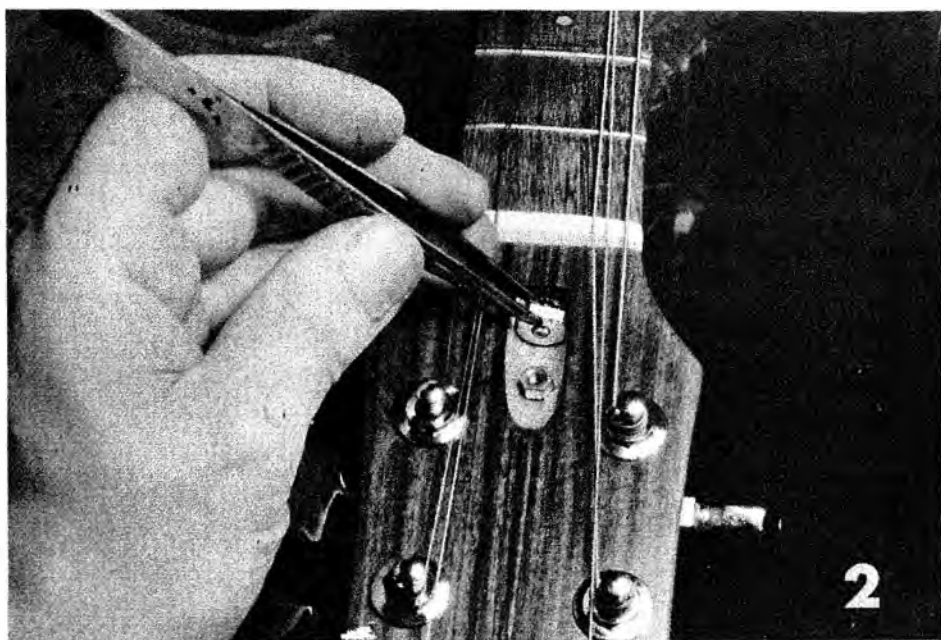
HH Electronic
Viking Way, Bar Hill, Cambridge CB3 8E
Telephone: Crafts Hill (0954) 81140
Telex: 817515 HH ELEC G

MAKING A SOLID GUITAR

Final Assembly Part 21

Stephen Delft

This chapter deals with the final assembly work on your instrument. After this, it is complete in its basic form. Although certain modifications such as phase-change switches or coil taps are certainly possible, I intend to cover these in future articles which will also deal with similar modifications to commercial production guitars. The wiring arrangement described in this chapter corresponds to the standard control system on the more common Les Paul guitars, and other similar instruments. It has certain limitations but the usual re-arrangements to overcome these limitations have problems of their own. I feel the original (and by now, classic) system is probably the most useful unless one is willing to be involved in quite sophisticated electronics. I shall be happy to describe several active mixing and tone control systems which I have found moderately successful, if there is a demand, but I feel this also is beyond the intended scope of the present DIY Guitar series.



Part 20 left the guitar strung up but without a truss-rod adjusting nut. This is quite intentional. I usually leave guitars (but not basses) in this state for a week or two before fitting and/or adjusting the truss-rod nut and washer. The neck usually pulls forward a little, giving the adjusting nut sufficient to work against, so that it will not shake loose, or need frequent re-adjustment. There is quite a large amount of fitting work required to complete the instrument. Most of it can be covered more efficiently with the help of a series of photographs. Photo 1 shows the completed guitar, needing only strap buttons and a cover plate for the truss rod adjustment on the head.

Photo 2 shows the truss rod adjustment nut and washer. The nut has been described earlier; it is an M4 by 0.7 full depth brass nut, filed down lightly on all six flats until it measures $\frac{1}{4}$ inch across opposite flats (or until it just fits a $\frac{1}{4}$ A.F. tubular spanner). It will then fit Guild and Rickenbacker neck adjusters. The washer is filed from a 2mm to 2.5mm slice cut from hard brass bar. It is roughly circular, with a flat, like a letter D, and has a 4.5mm hole for the truss rod. You will appreciate that this makes a very stiff washer. The usual kinds of shop-bought brass washers are unsuitable.

The neck will probably have about 1mm forward bow with strings tuned up, but no rod adjustment. You should reduce this to between $\frac{1}{3}$ and $\frac{1}{2}$ of 1mm. You can check the bow by holding first and/or third strings (under normal tension) onto the first and last frets. Observe the clearance between the string and the frets in the middle of the neck. During this process, adjust the bridge height as necessary to keep the string playing action at a reasonable

average figure. I would interpret this as 1.5mm clearance over the 12th fret for the top string, and 2.5mm for the bottom string. If the bridge and/or action is too high, it may pull the neck forward more than usual. This can be corrected by the truss rod but it would require re-adjustment if the bridge were lowered at a later stage.

Photo 3 shows the process of 'stoning' the frets, with a little oil and an accurate silicon carbide (Carborundum) sharpening stone.

Photo 4 shows a fine Swiss file being used for trimming the fret ends. There is no trick to this. It just requires very careful work trimming and rounding the ends, without nicking the edges of the fingerboard.

Photo 5 shows a final fret de-burring, and removal of bits of debris from the fingerboard. There are many ways of finishing a fingerboard. On lacquered ones, I use Superfine Scotchbrite abrasive plastic mesh. A similar product is sold for cleaning kitchenware, but it may be only 'fine' grade. It works as well, but leaves more obvious scratches in the finish. You can polish a lacquered fingerboard with the same mops and compounds used for the body. You will need help to hold the guitar firmly. It is easy to "catch" the fingerboard edge on the rotating mop.

For bare wood fingerboards, I prefer to use '000-grade' steel wool and 'Boogie Juice'. I would not recommend the use of Teak Oil, but I suppose you could use Raw Linseed Oil. I find that it tends to go a bit sticky after a while, unless you polish it off very carefully. 'Boogie Juice' penetrates the wood, and does not seem to leave a sticky residue, as long as you wipe off any obvious surplus. You should,

in any case, take care to remove all traces of steel wool. It is equally bad for fingers and pick-ups. Rubbing the steel wool along the length of the fingerboard is easier and gives a better appearance. Rubbing across the fingerboard sides of each fret gives a better playing feel.

The control cavity and back plate recess are painted with Condec H 104 screening paint (conductive paint). This is made by the Electrolube company in England. American readers may prefer to obtain screening kits from 'Stars Guitars'. The American paint is very good and dries faster, but it gives off unpleasant fumes. The English paint has the considerable advantage that if you spill any of it on the guitar's lacquer finish, it will usually just wipe off without damage. Also I would rather breathe water vapour than M.E.K. vapour. The Condec 104 which I have was supplied as a sample by Electrolube. If there is sufficient demand, I am sure the company would be happy to make it generally available to guitar makers. It is much simpler than using a foil lining and it seems to provide adequate screening.

Photo 6 shows the same screening paint applied to the pick-up recesses. The areas marked '5mm' are also painted, but have been covered with masking tape so as to show clearly on the photograph. You will only have to deepen the holes here, if you later find it difficult to lower the pick-ups enough to clear the strings adequately for the string action which you wish to use. (If you do remove any wood, you should make good the screening paint). When the paint is dry, you can fit the electrical controls and then the pick-ups. The jack socket will need a spiked washer inside the body and a smooth washer on the outside. The pots will need smooth washers and also a small SHALLOW hole on the inside of the body to take the projecting tab on the pot body. Take great care not to drill right through to the front of the guitar. I suggest a metal tube over the drill leaving only 2mm projecting. Alternatively, you could bend the tabs over and use spiked washers on the inside. A radio or amp repairman should be able to supply a few old washers from discarded worn-out pots. The switch can easily be held to prevent it from turning as you tighten the fixing nut, and will not need a spiked washer. In any case there is usually not enough thread to allow for fitting one. Hold the block with the solder-tags only, not the contact springs, which are easily bent out of alignment. Some switches have a stiff action. Apply just a smear of grease to the plastic operating lever between the ends of the contact springs. If the switch still does not work properly, take it back to the supplier for adjustment or replacement. Do not try to adjust it yourself unless you are willing to spoil one or two switches learning how to do the job. Some of these switches are fitted with a tubular, recessed nut for fixing to thick panels, but I have one sample which has only an ordinary nut and cannot be fitted to this guitar.

Alternative nuts should be obtainable, but in case anyone else has the same problem, I will describe the special nut which I made from a scrap of Light Alloy bar. You will need the use of a lathe and threading tools, or you could ask an engineer to make you one, together with a simple pin-spanner for turning it. The exact size of the thread on the switch is a little uncertain. I bored out the nut to 11mm and increased the depth of the internal 32 tpi thread until the switch screwed into it smoothly. Considering the small load and the depth of the thread, this seems satisfactory, although it would probably make any decent engineer wince. The end result both works and fits better than the commercial item. With either the home-made or the factory-made version, you should have no difficulty fitting the switch in place.

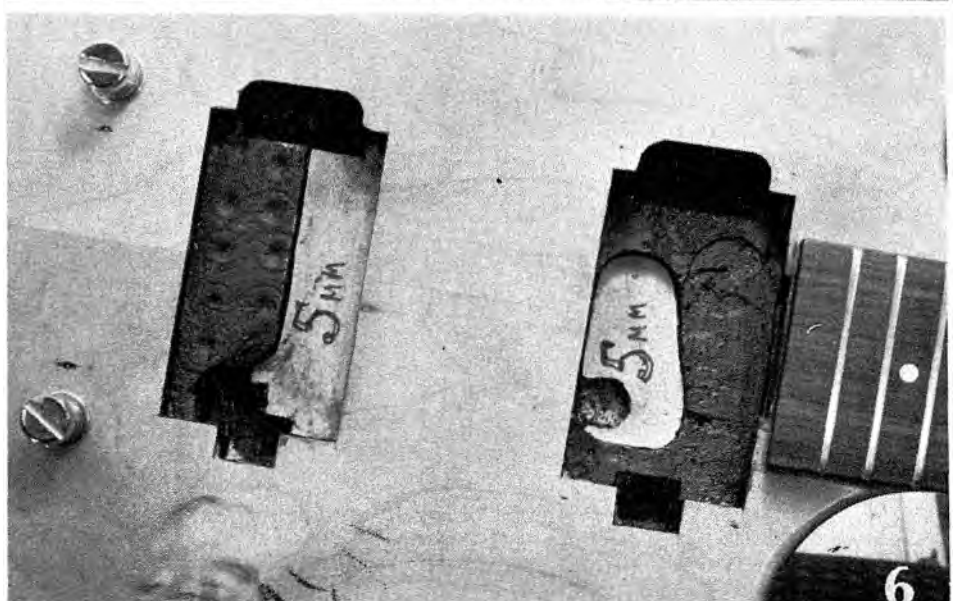
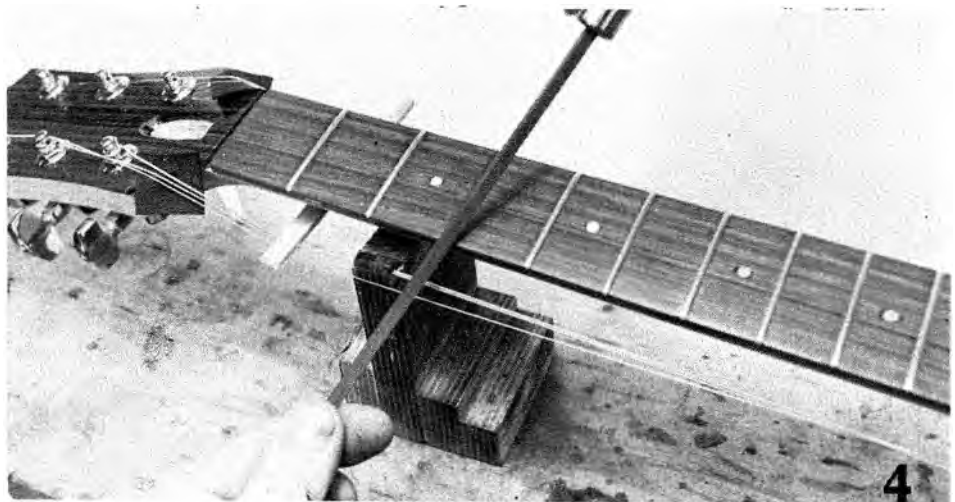
Photos 7 and 8 show stages in the wiring of the system which I have suggested. If you

prefer other arrangements, refer to Part 12 (Dec. 77 UK edition/Jan. 78 overseas, pages 118, 119) and/or wait for later articles on fancy wiring arrangements.

Photo 7 shows stage one. As the cavity is screened, you can use ordinary plastic insulated wire for the internal connections. All values of components and explanatory diagrams are in Part 12. The thick wire passing above the switch joins the bridge to the switch frame. This is also linked to the back of the nearest pot. Photo 8 shows stage two. I have covered most of stage one wiring with a piece of card, so that you can see better in the photograph. The numbers indicate the sequence of connecting wires. Wire number one is soldered first to the linked tags on the switch (see part 12, Dec. 77 UK). The other connections should be visible

from the photograph, but they are also detailed in part 12. Only the pick-up wires require screened cable because they pass through parts of the body not lined with screening paint.

Photo 9 shows the connections to the Guild pick-ups. Note the tops of the tags folded over and the cable soldered to the base of one tag on the fingerboard pick-up. It is not essential to do it this way, but it makes the cable point in the right direction for easy fitting of the pick-up. Other makes of pick-up may already have wires attached. Also the following fitting instructions may not exactly apply. Solder a thin copper wire to the switch frame or to the back of one of the pots. Loop it through the wiring channels, and fasten it to the surface of the screening paint in the two pick-up cavities with very small washers and



THE ECHO PEDAL

NEW



ECHO PEDAL

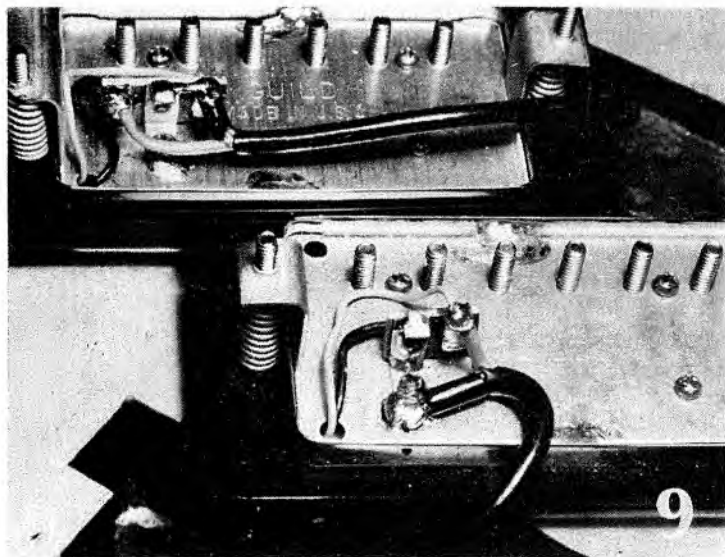
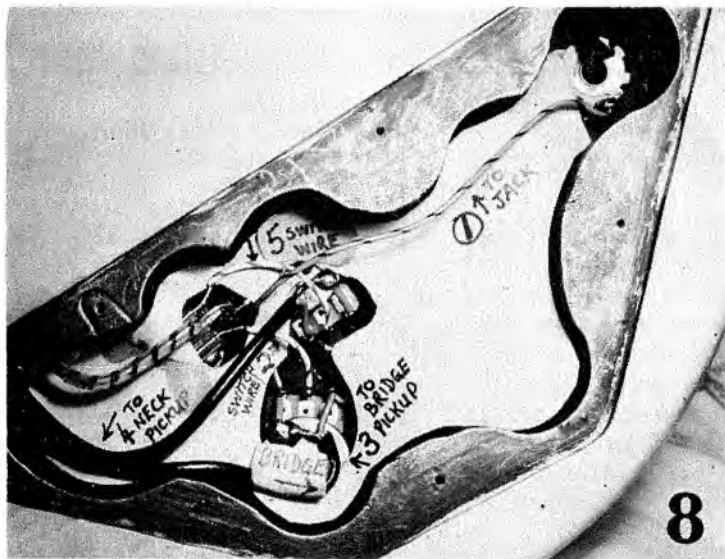
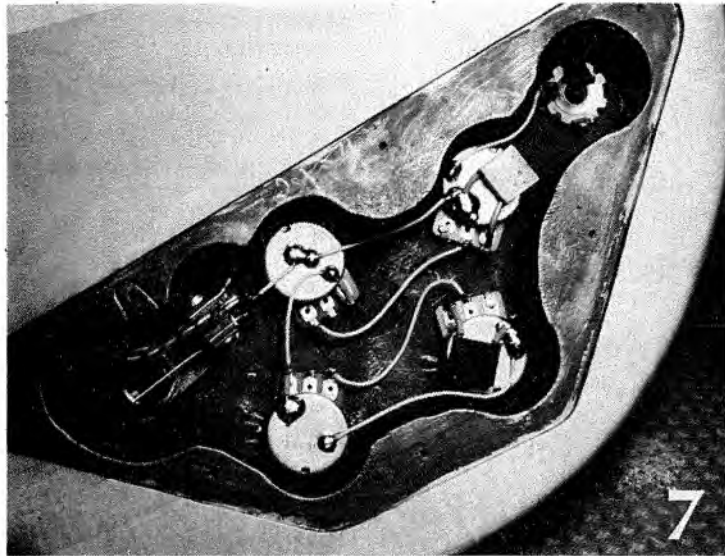
A mains powered solid state echo unit employing the latest charge transfer device for echo and ADT effects. Delay time is continuously variable from 20 mS to almost $\frac{1}{4}$ second. Features a built-in compander (compressor/expander circuit) for extremely low noise operation. The Carlsbro echo has rotary controls for mix, delay and swell plus two outputs – direct and mixed. Great value for money.

CARLSBRO electronics of the 80s

See these fantastic new effects units
now at your local dealer or write to
us for our new colour catalogue.

CARLSBRO (SALES) LTD.
Cross Drive,
Lowmoor Road Industrial Estate,
Kirkby-In-Ashfield,
Notts., England.
Telephone 0623 753902.

MAKING A SOLID GUITAR Cont...

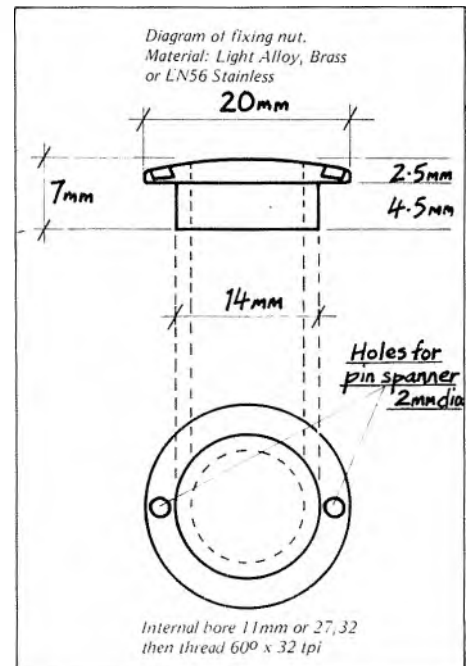


countersunk screws. Put a dab of paint over the top of each connection.

Before wiring in the pick-ups permanently, put them in their places, with the wires attached, and fed through to the control cavity. Adjust the strings to the 1.5/2.5mm action mentioned earlier, or lower if you prefer it. Lower the pick-ups in their surrounds until the pick-up covers clear the strings by about 1.5 to 2mm when the strings are fretted at the highest fret. If the pick-ups won't go low enough, check for obstructions or looped wires and, if necessary, deepen the recesses where indicated in photo 8. Replace screening paint and allow to dry. Re-fit pick-ups. Make sure the strings are lined up correctly at the bridge and nut. Set the pick-ups with their pole-screws under the strings, if necessary, favouring the top strings where screw spacing and string spacing do not quite agree. Prick through the surround mounting holes into the guitar front. Remove the pick-ups, drill proper pilot holes, and then screw the surrounds and pick-ups into place. Take care not to place the pick-ups on any important lacquered or polished surface, *even face down*. The mounting brackets and sometimes the pole screws have sharp burrs, which will scar a good finish. With the pick-ups in place, you can turn the guitar over, cut the ends of connecting wires to length, (leaving a generous surplus for possible re-connections at a later stage) and solder the connections. The screening braids go to the back of the volume pots or to the pot tags linked to the metal cases. You can use whichever is most convenient. The *centre* conductors of the pick-up wires go to the pot tags at the opposite end of each group of three (these tags are also connected to the tone controls, and the centre tags of the volume controls connect via short wires to the switch).

Your guitar should now be working. Cover the back plate with screening paint, or glue and metal foil. Let it dry, and screw in place. Make pilot holes for the screws if you have not already done so. You will also need to make a cover for the truss rod nut.

I hope you have enjoyed making this guitar, and that you will let us know if you have any outstanding successes or disasters. Fine adjustments to guitars are already covered in 'Improve a Copy Guitar' Parts 1, 2 and corrections. Photo-copies are available, price 30p per part.





ELIMINATE GUESSWORK



**KORG Guitar Tuner
GT-6**

**See The
Correct Pitch**

The days of guess work in guitar tuning are over. Whether you play a classical, folk or electric guitar, the compact, battery-operated KORG Guitar Tuner GT-6 permits visual tuning of individual strings and is also adaptable to string bass.

This scientifically-designed tuning instrument assures optimum precision in pitch measurement. Why be less than sure when the GT-6 can give you increased confidence in your playing. Open-string pitch readings can be taken directly through built-in microphone. Can also be inserted between electric guitar and amp to hear pitch while tuning, and if you don't need to hear the sound, you can see correct pitch in silence. Why guess? KORG Guitar Tuner GT-6 can give you the correct pitch, simply and precisely.

**KORG Tuning
Standard WT-10A
(Elder Brother of GT-6)**



**KORG Guitar Tuner
GT-6 Specifications**

NOTES E(82.41 Hz) A(110.00 Hz) D(146.83 Hz) G(196.00 Hz) B(246.94 Hz) E(329.63 Hz) MEASUREMENT RANGE 2-octaves above and 1-octave below each position. ACCURACY ± 3 cents DIMENSIONS 143(D) x 86(W) x 43(H) mm WEIGHT 275 grm BATTERY 006P 9V x 1

ERIKSON MUSIC REG'D. 7750 Trans Canada Hwy. St. Laurent, Que., H4T1A5, CANADA
GAMME 17, Rue Laperous, 93500 Pantin, FRANCE
G. MEYER KG. 3550 Marburg 1 WEST GERMANY
MILESTONE B.V. Energieveg 38 Vlaardingen, HOLLAND
ROSE MORRIS & CO. LTD. 32, Gordon House Road, London NW5 1NE ENGLAND
UNICORD, INC. 75 Frost Street, Westbury, New York, N.Y. 11590 USA
KEIO ELECTRONIC LABORATORY CORP., Tokyo, Japan



JBL PROFESSIONAL DEALERS
IN THE U.K.



**FORMULA SOUND
LIMITED**

FORMULA SOUND LIMITED
3 Waterloo Road
Stockport Cheshire
Telephone 061-480 3781

GRAHAMS

Graham's Electrical
86/88 Pentonville Road
London N1
Telephone 01-837 4412



P. A. Hire & Sales
Unit F New Crescent Works
Nicoll Road
London NW10 9AX
Telephone 01-961 3295

SIGMA SOUND ENTERPRISES

John Penn
12 Sandringham Drive
Bramcote Hills
Nottingham
Telephone 258625

Rear of Works
128 Hartley Road
Radford
Nottingham
Telephone 73306

soundwave

66 Victoria Road
Romford
Essex
Telephone 0708 25919

REW

REW Audio Visual
126 Charing Cross Rd.
London WC2
Telephone 01-836 2372/7851

For further information contact
Harman (Audio) U.K. Ltd.

St John's Road
Tylers Green
High Wycombe
Bucks HP10 8HR
Telephone
0494-815221



GET IT ALL

HEAR FROM US BEFORE YOU HEAR FROM THEM.

Today's broadcasting equipment and standards let you transmit things you never could before.

Like tape hiss, cue tone leakage and turntable rumble, to name a few.

And that's precisely why you need the JBL 4301 Broadcast Monitor.

It lets you hear everything you're transmitting. All the good stuff. And, all the bad. So you can detect the flaws before your listeners do.

The 4301 is super-compact, so it fits all EIA Standard racks. 19" h x 11½" d x 12¼" w.

And it's made by JBL. The recognized leader in professional sound equipment.

Just give us your name and address and we'll send you all the 4301's very impressive specs.

Along with the name of your nearest JBL Professional Products Dealer.

He'll tell you everything you need to hear.



JBL

GET IT ALL.





Rod Stewart joined our Ear Force before he even joined our country.

Long before he became an American citizen, Rod Stewart was flying with the Ampeg Ear Force—the tube amplifiers that can help take any sound to new heights.

After all, Ampeg tube amps have feature after feature you won't find in any other amps at any price. But what really convinced the Rod Stewart band to come on with all that Ampeg power was that unmistakable Ampeg sound—a full, rich, round sound that's the most imitated and sought-after in the world of music.

To find out more about it, contact Musicaid, 66 Radlett Road, St. Alban, Herts.

Join the people who've joined the Ear Force. Ask Rod Stewart. It's the only way to fly.

**Vincent
Bach
International**
Elkhart, Indiana U.S.A.

Rhanc Series

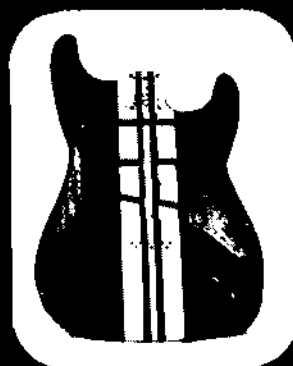
exotic wood bodies for
the discriminating
guitarist

crafted from fine Walnut and Hard Rock Maple

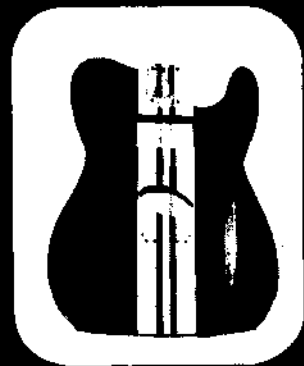
exclusively by

Kharna Bodies

Dept. MR
P. O. Box 82
W. Hempstead, N.Y. 11552
U. S. A.
(516) 489-2038



send 50¢ for info

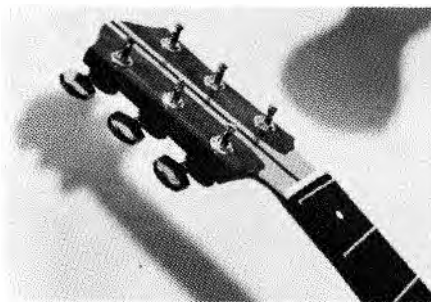


Dealer Inquiries

If you want your notes to hang in mid-air and
stay out there, play a

PETILLO "DOUBLE L" NECK

(Patent Applied For)



With these unique features:

- 7-piece laminations of exotic hardwoods adhered with stress-relieved aluminum angles, 1/3 the weight of any other metal neck with 40% more sustain and adapted for any stringed instrument.
- Petillo Precision Frets (Pat. #4,064,779), Perfect Intonation

**Convert your present guitar
into a guitar of the future**

Distributed exclusively by:
PHIL-LU INC.

1206 Herbert Ave.,
Ocean, N.J. 07712

(201) 531-6338 Telex: 79-1999

★ PLAYING ★

PAUL BRETT

Amplifying acoustic guitars is always a much talked-about subject among guitar players, especially with a view to reproducing the natural acoustic sound by electronic means. In my opinion, acoustic is acoustic, so what we really talk about is close facsimiles of the natural sound of the acoustic guitar. There are many ways of amplifying an acoustic guitar, mainly by the use of transducers (bugs), pickups, or by directly amplifying the guitar by use of a microphone through a PA system.

Barcus-Berry are probably the most famous acoustic guitar transducers and the one I use is supposed to be used in conjunction with a Barcus-Berry pre-amplifier, but I found it better, and more natural, to use it without the pre-amp. Plugged directly into a guitar amplifier for small venues or into a PA system via an MXR noise gate for large venues, I can project the sound of my guitar to a small or large capacity audience with great tone and clarity.

Fig.1 shows the position I use to attach my Barcus-Berry bug to the guitar bridge. A special adhesive is supplied with the "kit" for attaching the transducer if, like me, you don't want to screw the bug into the wood of the bridge.

Barcus-Berry also make a cheaper transducer, the Barcus-Berry Jr, which does not need a pre-amp. However, I found this to feed back more at a lower volume than the more expensive one and it also does not compare tonally. Again, for external fitting, the bridge is probably in the best position as in Fig.1.

For internal fitting, Barcus-Berry produce a tiny "Hot Dot" transducer. It fits into the bridge by drilling a hole through the bridge and then running the cable through the inside of the guitar.

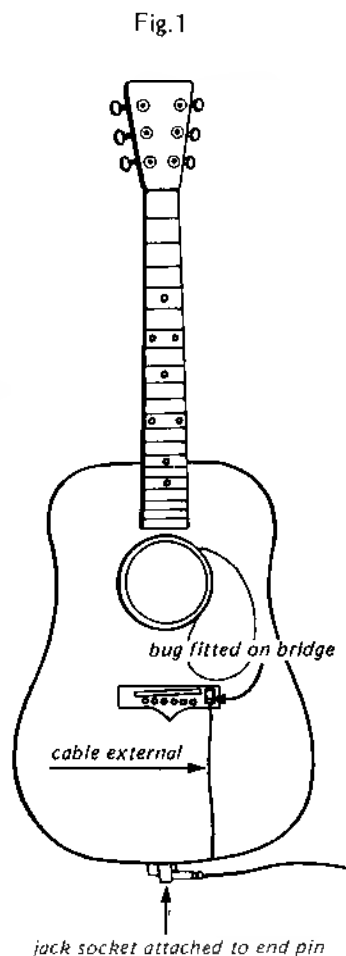


Fig.1

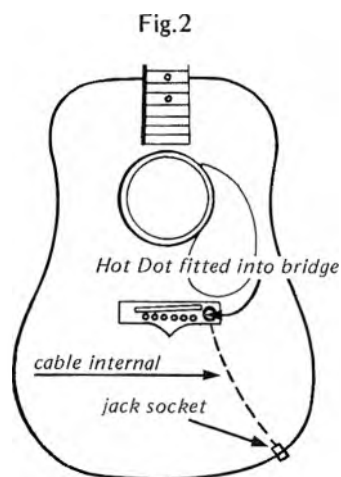


Fig.2

You then need to fit a jack socket to the side of the guitar. After fitting the "Dot" into the drilled hole, it is then held with putty and surrounded with a mother of pearl circle, for a professional finish (see Fig.2).

The Shadow is a German-made transducer. This time it is fitted under the bridge between the second and third treble strings and, like the "Hot Dot" the cable is passed internally and the jack-socket takes the place of the end-pin. In fact, you have to remove the end-pin and drill the hole larger to accommodate the socket (Fig.3). This transducer is best used in conjunction with a pre-amp.

In the pick-up range, I would recommend the DeArmond single pole pick-up for the six string guitar and the double pole pick-up for the 12-string. They have been established a long time and come with built-in volume

controls. They are designed to fit across the sound-hole of the guitar (Fig.4) and act in the same way as an ordinary guitar pick-up. The sound quality is good (better on 12-string) and the only drawback is their size.

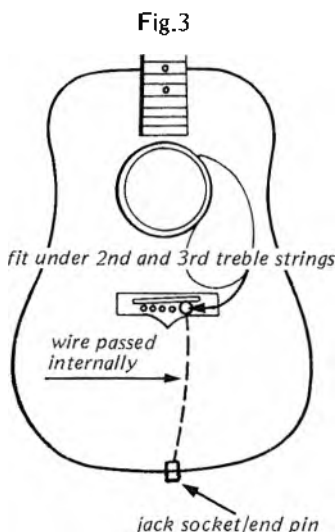


Fig.3

DiMarzio seem to have a large slice of the electric guitar pick-up market and their acoustic pick-up is no disgrace to their progress. Again it is attached, this time lengthways, to the sound-hole of the guitar and, apart from its good sound qualities, can be adjusted to suit the player's tonal requirements. Free-running on the two attachment rods, it can be set near the top of the sound-hole for bass response; in the middle of the sound-hole for bass/treble response; or towards the bridge-end of the sound-hole for treble response (Fig.5). A new, but very good pick-up.

There are also a few acoustic guitar microphones available for use with flat response systems i.e. PA systems. These are low impedance microphones and are

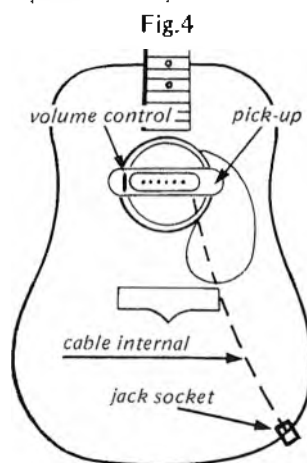


Fig.4

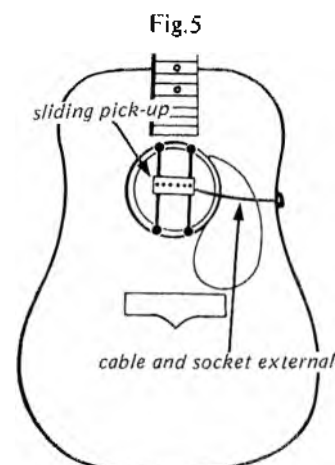


Fig.5

probably best suited to the professional player who relies upon the use of a sound-mixer to project his guitar to a large audience.

Apart from a few "cheap-and-nasties", the best is the newly developed Kelsey Acoustic Microphone (no. GM1). Kelsey are mainly known for their PA systems and have developed this microphone for use with similar systems. Although a little cumbersome, looking somewhat like a spaceship, it is attached to the guitar by means of three suction pads upon which is smeared

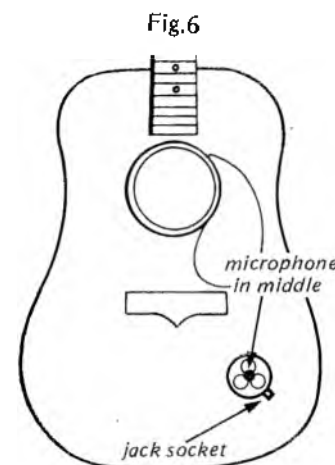


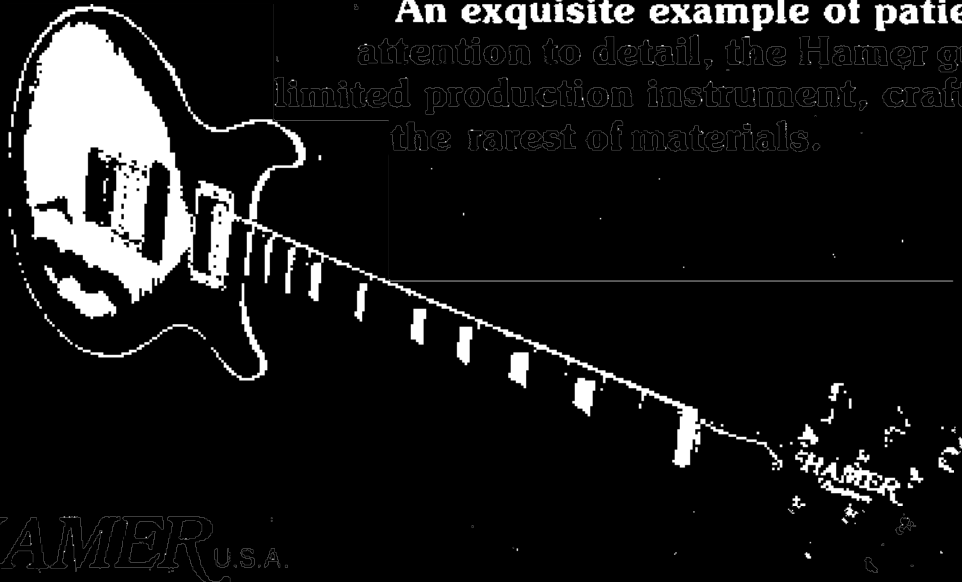
Fig.6

vaseline jelly and then pressed into position on the guitar table. I found the best position to be just below the bridge on the treble string side (Fig.6). But remember, in all cases it will differ (as will transducers and pick-ups) depending on the natural tone of your guitar. So you have to experiment and find the best position before permanent attachment. Kelsey also make a low to high impedance transformer for use with the GM1 so that the microphone may be used with normal guitar amplifiers.

However, many acoustic guitarists prefer just to sit down with a mike in front of their guitar and feed it straight into the PA system. In the end, it's just a matter of choice.

The Ultimate™

An exquisite example of patience and attention to detail, the Hamer guitar is a limited production instrument, crafted from the rarest of materials.



HAMER U.S.A.
GUITARS

U.K. Distributor John Hornby-Skewes & Co., Ltd.

RDG Production Company

3M M79 24 Tracks with autolocate 2 years old	£15,500
3M M79 24 Tracks 9 months old	£18,000
Studer A80 MK 2 16 Tracks pre-wired 24 1 year old	£16,500
MCI JH 10 24 Tracks with autolocate	£10,000
Ampex MM1100 16 Tracks with remote	£9,250
3M M56 16 Tracks with remote	£9,000
Studer A80 MK1 8 Tracks	£6,750
3M M79 stereo with autolocate (never used)	£4,800
Scully 8 Tracks	£3,200
Scully 8 Tracks	£3,000
3M M79 4 Tracks with stereo head-block	£4,500
Ampex AG 440 4 Tracks	£1,800
Cadac Serie "E" 32-24-24 as new. Bargain	£30,000
Cadac Serie "E" 28-16-24 as new	£22,000
Cadac Serie "E" 18-16-16 pre-wired 28-16-24 as new	£20,000
Neve 20-4-16 excellent condition	£14,000
Studer Model 189 18-8-8 very nice condition	£9,000
Trident "B" 16-8-16 excellent condition	£11,500
Allen & Heath Modular 2 16-8-16	£2,000
Allen & Heath Modular 2 16-8-16 as new	£2,200
Dolby A301 5 off each	£400
Amek 2000 20-16-16 as new	£9,500
JBL 4311 brand new, the pair	£520
RDG Fanger 19" rack mounting, brand new	£280
RDG Phaser 19" rack mounting, brand new	£270
RDG Compressor-Limiter 19" rack with inverse limit	£550
Neumann U87 used	£275
Neumann U67 used	P.O.A.
Neumann M49 used	P.O.A.
Revox A700 stereo machine	£600
Eventide Phaser	£175

WANTED: All studio equipment best prices offered.
Prices do not include VAT and are from Milton Keynes.

12 Hill View
Newport Pagnell
Buckinghamshire

Tel:
0908 613009

PLAYING

MICK ABRAHAM'S

Mick Abrahams was a founder member of Jethro Tull and later went on to form Blodwyn Pig with Jack Lancaster, Andy Pyle and Ron Berg. Mick has been writing and recording some new material and is soon to re-emerge as a solo artist. In this series of articles, he will be giving advice and tips on bottleneck and open tunings.

Last month I was talking about chord structure and exercises within the framework of a chord of D. This time I'd just like to talk about a few more actual chord tunings and run a brief analysis on as many as I can.

We're already been through the E major tuning, which is a fairly popular one for bottleneck, but a couple of ones that I use on various occasions are quite effective. The main one is a G or G7th chord, the other is an A

major.

Starting with the G major, the tuning is:

Concert or standard
E A D G B E
 ↓ ↓ ↓ ↓ ↓ ↓
G G D G B D

G Major

The same kind of technique for obtaining various chords within the framework of the dominant chord of G applies in exactly the same way as I

mentioned in my article on E tuning. The only difference here is that you have both the E and A strings tuned to the same note. If you practice around in the same method, you should obtain some very interesting effects. One number which I used that particular tuning on was "Dear Jill" on "Ahead Rings Out" by Blodwyn Pig on Island Records.

A G7th is useful too, for playing bottleneck over the E, B and G strings to produce a "train" sound. The chord is tuned exactly the same way as before but this time the G string is detuned to F. The whole chord then becomes

Concert or standard

E A D G B E
 ↓ ↓ ↓ ↓ ↓ ↓
G G D F B D

G7th

The A major is tuned thus:

Concert or standard

E A D G B E
 ↓ ↓ ↓ ↓ ↓ ↓
A A E A C[#] E

A Major

The A7th is the same but the G string is detuned to G.

The G and A chords, both in their Major and 7th tunings, can be very handy for country-ish picking numbers, i.e. dropping the

E string on the G tuning down to A and, on the A tuning, to a lower E.

Try this simple exercise to start with, but still retain the same method I've previously described to make the usual chord shapes. Start first with the guitar tuned to a major chord shape A or G, it doesn't matter which. First, in moderate straight 4/4 tempo, pick first the A string letting the middle finger pick out alternately on the top E and B strings. On each second beat, cross the rhythm to play the dropped octave note. After a while, experiment with different chords and, with some swapping around between the use of Majors and 7ths, you'll find some interesting patterns to use. This is useful for blues work especially and some varied basic picking patterns for country music.

Referring to the last three articles, some good players to listen to are: Earl Hooker, Elmore James, Ry Cooder, Alexis Korner, Sonny Terry and Brownie McGhee, Rev Gary Davies and, of course, one of the greatest contemporary exponents in the art of chord tuning and bottlenecking, Stefan Grossman. Read also Stefan's book on chord tuning and ragtime melodies. This has a lot of interesting information for the bottleneck enthusiast.

A LEGEND IN AMERICA!! A RUMOUR OVERSEAS...

THERE IS A COMPANY THAT SELLS THE VERY FINEST FRETTED INSTRUMENTS
EVER MADE

They sell:

Gibson Mandolins: 1900-1950
 Gibson Mastertone Banjos: 1925-1939
 C.F. Martin Guitars: 1850-1969
 Pre-War Gibson Guitars
 . . . And Banjos by turn-of-the-century companies like A.C. Fairbanks, S.S. Stewart, Vega, Cole's, Orpheum, Washburn, Paramount, Bacon & Day, Epiphone.

They Publish a Free Illustrated Stock and Price List
 And they Ship Instruments everywhere — All over the World.

THEIR NAME?

mandolin bros. Ltd.

"The largest Bluegrass Store"

629 FOREST AVENUE, STATEN ISLAND, NEW YORK 10310 USA.
 Telephone: 212 981-3226

They sell:

New C.F. Martin Guitars
 New Ovation Guitars
 New Guild Guitars
 New Dobro Guitars
 New Gibson Mastertone Guitars





It can be a rough business.

For the guitarist, but also for his equipment. Take guitar amplifiers. They get quite a hammering on the road, and they need tough components to stand up to it.

The M-OV KT77 Beam Tetrode Valve does just that. It has strengthened components in its construction for extra durability. It is built to withstand rough handling and perform brilliantly.

Many leading manufacturers are finding out for themselves with the KT77 right now.

If you'd like to join them, get in touch with M-OV for technical data and details of worldwide distribution.



EEV/M-OV

Members of GEC: turnover £2054 million



S 665

THE M-O VALVE CO LTD, HAMMERSMITH, LONDON, ENGLAND W6 7PE.
TELEPHONE 01-603 3431. TELEX 23435. GRAMS THERMIONIC LONDON

The NOVATRON



For the sounds of

REAL Strings, REAL Brass, REAL Choirs etc, etc.
NOT Simulated – NOT Generated – NOT Synthesized
BUT – THE REAL THING

Novatrons are now fitted with:

- Rock steady non-temperature sensitive speed control.
- Improved amplifier signal-to-noise ratio.
- Noise gate.

A SELECTION OF 40 TAPE SETS ARE AVAILABLE
CURRENT MODELS

Single Manual Model 400SM (in black or white)
Double Manual Mark 5 (in black vynide)

We thank visitors to the recent NAMM Expo in Chicago for their interest in the NOVATRON and assure them that all orders and enquiries will receive our prompt attention.

STREETLY ELECTRONICS LTD.

338 ALDRIDGE ROAD, STREETLY, SUTTON COLDFIELD,
B74 2DT, WEST MIDLANDS, UNITED KINGDOM
Telephone: 021 353 3171
Telex: 338024 Bircorn G (Prefix all messages STREL)



Dynacord

the technology of tomorrow

STAGE-STUDIO-SERIES

1978 Novelties

New appliances in the field of musical sound reinforcement and effects equipment which are setting a guide line for the future. The digital, analogue, and hybrid techniques of today determine the technology of new developments in the future. The results of our basic research work over many years enables us to show and offer you today the future of tomorrow. With these new products DYNACORD gives the user an equipment which is unequalled throughout the world and which enables him to produce studio quality sounds on stage.



DRS 78 DIGITAL ECHO & REVERBERATION SYSTEM

With this fully electronic digital echo/reverb system DYNACORD covers another gap in the field of echo machines for the most pretentious and demanding user.

It would take pages to enumerate the full range of possible echo and reverb effects. The unit contains approximately: 140 integrated circuits, a memory storage capacity of 100,000 bits, run-off control by program stores (5,000 bits capacity), calculating units with 250,000 additions and 375,000 divisions per second. Do not get confused by all this technical data. You will be greatly surprised how easy it is to operate this unit.

The essential advantages of this new product are: Completely shatter-free reverberation, very high Signal-to-Noise ratios of 75 dB on the original signal and 70 dB on the echo signal, far better quality in reproduction than tape echo machines, no maintenance of tape run, variable delay times up to 320 m.secs.

Frequency response:	Outputs:	
Original 20 Hz – 20 kHz	universal	220 mV
Inputs:	3-pin connector	1 V
universal	2 mV original stereo left/right	775 mV
3-pin connector	15 mV effects stereo left/right	775 mV
stereo connector left/right	775 mV original-effects stereo left/right	775 mV



TAM 19 TIME AXIS MANIPULATION SYSTEM

- Stereo flanging
- Stereo pitch changing
- Stereophonic double tracking
- Mono to stereo signal conversion
- Stereophonic spacesound simulation (simulation of rotating speakers)

Basis for all these producible effects in the so-called time axis manipulation. Expressed in more simple words the music in its course of time is being expanded and compressed alternatively and effects signals are being mixed with the original in different ways and manners. By mixing the manipulated effects signal with the direct signal a comb filter like response is obtained within the spectrum of music which changes in temporal respect and which produces extremely pleasing impressions of the sound.

For full details write to:

DYNACORD, Electronic und Geratebau GmbH & Co. KG
P.O. Box 68, D-8440 Straubing, West-Germany.

UK: Beyer Dynamic (G.B) LTD
1 Clair Road
Haywards Heath
Sussex

IRELAND: Joe O'Neill LTD
Glenamaddy
CO. Galway

**Martin,
the real
thing**

**Sigma,
almost
the real
thing**



When we designed the Sigma guitar back in 1970 we did it with the idea of offering a quality instrument in the Martin tradition. Not only good sound construction techniques, but good sound too. We don't claim a Sigma is as good as a Martin, but it's a great second choice. 24 models to choose from, each one imported and inspected by The CF Martin Organisation.

Sigma

From The CF Martin Organisation
Box 8968, S-40274 Gözeborg, Sweden

Levin

MASTER GUITARS

**are hand made of solid,
rare woods.**

Levin guitars are made by master craftsmen, guitar makers who know the art of charming the sound out of the wood. You benefit from this combination of master artisans and the use of solid, rare woods. They are the secret of how real Levin guitars are made.



LEVIN

**BOX 8968, S-402 74 GÖTEBORG, SWEDEN
HEAD OFFICE FOR
THE CF MARTIN EUROPEAN ORGANISATION**

THE
Zildjian
BAZAAR



1. Zildjian lighter by Zippo, U.S.A. The 'one-zip' wind proof lighter comes with the unique Zippo guarantee. Brushed stainless steel finish complete with Zildjian trademark engraved black and gold.
£2.50 + 18p P&P

2. Zildjian steel tape measure, inches and centimeters, by 'Park Avenue' U.S.A. Gold metal with black Zildjian trademark. Complete with makers guarantee.
£1.00 + 18p P&P

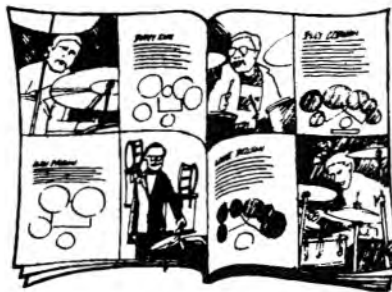


5. 'Ritepoint' retractable black felt marker. Red casing with black writing 'Avedis Zildjian Co.'
75p + 18p P&P



9. Zildjian all-purpose T-shirt. Size: small, medium and large. White trademark printed on black shirt.
£2.50 + 35p P&P

8. Zildjian baseball shirt. White with red ¾ length arms and red neck band. Zildjian trademark in black. Sizes: small, medium and large. **£3.50 + 35p P&P**



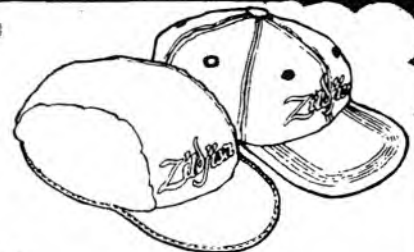
4. The Zildjian book of cymbal set-ups of famous drummers. Printed in brilliant colours with action photos and cymbal set-up diagrams of rock, jazz, studio and big band poll winners.
50p + 18p P&P



10. Satin banner. Contrasting white on black screen print. Billy Cobham, Buddy Rich or Louis Bellson. Hanging banner pole and tassels. Size 20" x 27"
£2.00 + 35p P&P

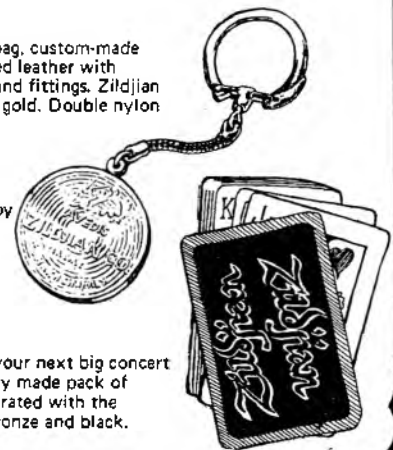
11. Deluxe cymbal bag, custom-made for Zildjian. Simulated leather with smart black handles and fittings. Zildjian trademark printed in gold. Double nylon stitched for long life.
£9.00 + 75p P&P

12. Zildjian key-tag. Bronze alloy cymbal replica bearing Zildjian trademark. **75p + 18p P&P**



3. American sports cap of a very high quality, for all weather, for always. The Zildjian logo is machine embroidered in white writing on navy blue cap.
£5.00 + 18p P&P

7. Zildjian all-purpose cotton drill cap - one size fits all. Yellow writing on black.
£1.50 + 18p P&P



13. Relax before your next big concert with this beautifully made pack of playing cards, decorated with the Zildjian name in bronze and black.
95p + 18p P&P

Please send me the following:

Quantity	Ref. No.	Item	Price	Total

Please enter total postage and packing:

I enclose cheque/postal order for

Name: _____

Address: _____

Post this coupon to: Zildjian, BCM 989, London WC1V 6XX

in favour of Zildjian

#

Are these superiorities of the **New Morley Pro Flanger (PFL)**

worth your \$220.00? **Yes.**

You're a musician making music for a living. Dedicated, hardworking, creative . . . in one of the world's fiercely competitive art forms.

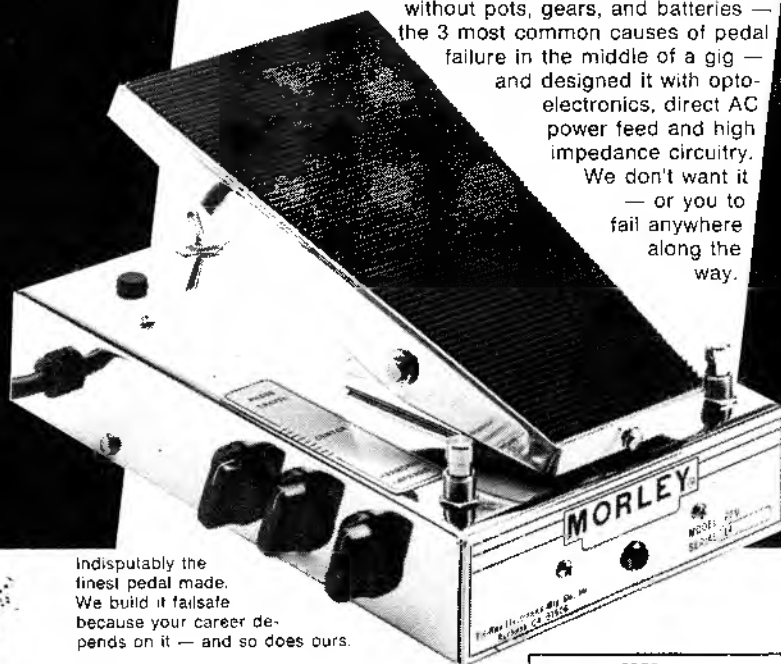
Unbelievable odds getting to the top of the charts — unbelievable rewards when you make it. Your creative ability requires complete freedom to get there.

Inaudible sounds — tumbling, weaving, spiraling through the creative chambers of your mind — become precisely audible expressed within the broad range and versatility of the only flanger capable of continually meeting your creative challenges on your way to the top of the chart.

Only Morley gives you a competitive edge by doing what you'd expect a high quality flanger to do — but does it better and offers more — like these unique features:

- * in the "Automatic" position the pedal pre-sets any selected sweep from .1 second to once every 25 seconds.
- * in the non-automatic position the sweep varies with the movement of your foot.
- * an indicator lamp reveals when you are in the flanging position and also oscillates at the flanging rate when on "Automatic".
- * odd/even harmonic emphasis switch.

That's not all. We made the Pro Flanger without pots, gears, and batteries — the 3 most common causes of pedal failure in the middle of a gig — and designed it with optoelectronics, direct AC power feed and high impedance circuitry. We don't want it — or you to fail anywhere along the way.



Indisputably the finest pedal made. We build it failsafe because your career depends on it — and so does ours.



MORLEY

6855 VINELAND AVE.
NO. HOLLYWOOD, CA. 91605
(213) 760-3140

FREE catalog and crazy bumper sticker

MORLEY

6855 VINELAND AVE.
NO. HOLLYWOOD, CA. 91605
(213) 760-3140

NAME _____
ADDRESS _____
CITY _____ ZIP _____

Dept. C-11

CYMBAL SENSE

For almost the past 20 years, or at least since the American Zildjian cymbals were available here (in England) in significant numbers, there has been a certain mystique or even, for some people, a pleasant agony surrounding cymbal selection. I propose, in this article, to explode, or at least go some way to defusing, this myth with a few well-chosen (dare I say) words on the subject. For the moment I'll confine myself solely to rock selection since this is (a) what I know about and (b) what statistics show most of you reading IM will be interested in. However for rock, read not only hard but jazz-rock, country rock, reggae, disco, soft rock, punk or whatever. In short, I'm not talking about jazz or any of its direct derivations — although personally I'm not convinced there's any difference in cymbal selection for any style of music.

Obviously, before you go into the shop, you will have made some decisions about what you're looking for. I don't mean what make of cymbal because this is always a matter of personal taste and sometimes a matter of personal economics. What I mean is, will the cymbal be used for Riding or Crashing? What type of music will you (and it) be playing? What size is the band in relation to the size of the cymbal?

The answer to the first question is relatively simple since there are only three alternatives, Crash, Ride or the compromise Crash/Ride. (Of course there are Pang and Swish too and China Type but I'll touch on these later). The second answer is a little more complex, especially if you want to be able to flexibly play several types of music on one set of cymbals, and it basically has to do with designation and construction viz. Thin Crash, Rock Crash, Medium Crash, Crash Ride (always Medium Thin these days apparently) etc.

Then there are the Ride designations: Medium, Mini-Cup, Ping, Rock, Heavy, etc. I realise there are more designations than this among all the manufacturers but, for the purposes of this article, I'll stick to these since they give the total picture anyway. We know that response is dependent upon thickness and mass, therefore the weight of the cymbal is important. A thin cymbal will speak i.e. reach its ultimate vibrations and volume more quickly than a heavy one. There's less metal to vibrate and vice versa. So, a Crash cymbal designed to speak immediately is thinner, and one designed to carry a sustained beat (Ride) is thicker.



The cymbal's overtones will be determined by the size of its cup — a small cup allows less ring and less overtones and gives a tighter sound; a large cup gives more ring and overtone. (No cup at all, as in the completely flat cymbals, cancels out a hefty percentage of the overtones to give a near-perfect Ride sound).

Crash cymbals have large cups to give a full fast-reacting body sound. Ride cymbals have various cup sizes shrinking from medium to mini. Whilst I'm on the subject, I might as well tell you that it's the bow (curve) or taper of the cymbal which determines the pitch. The more pronounced the curve the higher the pitch — a flat low curve results in a dark low sound.

The answer to the third question is simplicity itself. Anything over 20" (the norm for a Ride cymbal) will be loud and anything under will be (relatively) soft. Only noise is produced by overplaying a cymbal too small for the job.

Now for some Do's and Do Not's of cymbal selection.

Do take your own cymbals into the shop with you to compare since it's important that your new cymbal be compatible with your old. A good dealer shouldn't

mind this and will probably admire you for having given the project ample thought.

Do take into account the acoustic qualities of the shop and don't be put off by them. Take care not to miss a good buy because of them. If you have your own cymbals with you and you know how they normally sound, this should give you a comparison. If a cymbal sounds good under adverse conditions then obviously it will sound even better under more advantageous ones. How many of your gigs (or mine) have really good acoustics anyway?

Don't play Sixties modern jazz Ride cymbal patterns on your test instrument if you're a Seventies rocker and plan to use it for heavy Riding.

Don't try to Ride on a Crash cymbal and vice versa while you're testing since this won't prove a thing.

Do take someone with you whose judgement you trust (one of your band would be best) because it takes two pairs of ears to select a cymbal. You play the available alternatives (Zildjian recommend 20's then 18's then 22's if you are looking for Ride cymbals, 18's then 20's for Crash), and your colleague (or the dealer)

stands as far away as possible from you to simulate the audience. Once you settle on one which you *both* like, switch positions and *you* listen to it from a distance. Incidentally, have you ever heard your own cymbals (or drums) being played? I don't mean on record. Most drummers haven't and it's quite an education. Try it. The reason I advocate taking one of your band with you is that it's them who ultimately have to listen to the cymbal in closer proximity than anyone else; so it's reasonable to find one which doesn't offend *them* too much. I used to use a 22" Chinese with *Argent* which actually gave everyone a headache. It was a pretty powerful weapon!

Do clean your cymbals regularly, especially before buying new ones. It's an old wives' tale that cleaning cymbals harms them. Only freezing or heating a cymbal or using it wrongly will harm it. Therefore never clean them with a buffing wheel and be sure to clean around the cymbals, never across, to remove the dust from the grooves.

Do take your normal sticks with you to test. You'd be surprised how many drummers

don't do this -- and it's crucial.

Don't dampen your cymbal by tightening a felt on top. It's pointless to select a good instrument and then take away all its tone by not allowing it to breathe. If you need to dampen for a session or something use small pieces of sticky tape.

Don't have your top high-hat cymbal tight and let the pair of them breathe by leaving a big gap between and *do* angle the bottom one to let the air out.

Finally, *do* trust your dealer. Remember, *he* buys the cymbal before you do and is hardly likely to buy a load of old rubbish himself.

Now, I have a philosophy about cymbal sound which I thought I'd lay on you. We drummers know from bitter experience (whether we admit it or not) that it is always the higher pitched sounds which cut through the rest of the band. This is borne out by the fact that larger tom toms get lost or are at best indistinguishable in pitch in a modern band. Sometimes even when miked up. This brings me to my theory that invariably it's the high-pitched cymbals which cut and since modern drumming is all about keeping time be it 8's, 16's, 32's or even 18's and stressing the punctuation with crashes it's obviously important to be audible. So, the higher the pitch, the more audible the cymbal. Therefore, select the highest pitched cymbal in the size you want on offer. It's normally easy to ascertain. A higher pitched cymbal will take longer (in years) to get to its optimum tone since "playing-in" results in a slight pitch drop. I'm convinced this is the best and

easiest way to choose cymbals and some years ago picked out more than a dozen different-sized ones for myself using this method. I can honestly say I've been happy with every single one.

Hi-hat cymbals seem, on the face of it, more complicated instruments to select because you're choosing a pair and no two cymbals will react the same together. Any cymbal will interact with other cymbals in a completely different and invariably confusing way. It's because of this I feel there is very little (possibly nothing) to be gained from matching your own hi-hats. Mainly because the guy at the factory where I had the benefit of up cymbals not only has the benefit of a great deal more experience than anybody else -- he also has *hundreds* more cymbals to match from. I was once successful some time ago in matching a medium heavy 14" top cymbal with a heavy military bottom. Mind you, I was fortunate enough to be doing it at the factory where I had the benefit of expert advice and unlimited selection to choose from. Having said that, nowadays you *can* buy that sort of combination ideal for rock since it gives a deafening off-beat. The "rock hi-hat" from Zildjian fits the bill perfectly.

One question asked very frequently by drummers is whether the cymbal they are buying for live work will also be good for recording. The immediate answer is that any medium-sized, medium-weight Ride or Crash cymbal up to 20" diameter *should* work reasonably well when recorded. Obviously if you're in a Who/Zeppelein type band, you can use

what you like in the studio since a big crashy sound is part of their (your) recording sound. However, if you plan to be an all-round, studio-type drummer playing every sort of music, then it would pay you to invest in more contained, therefore lighter weight, quicker-speaking cymbals to use just for recording.

Perhaps I could encapsulate what I'm trying to say. The ideal session player not only plays well but has a drum set which the recording engineer can get a good sound on immediately because, in the studio, time is money. Half an hour spent getting a reasonably usable bass drum or even hi-hat sound is half an hour wasted as far as the producer is concerned. So the good drummer who has a good easily recordable kit sound is a better bet and will get more work than the very good player with a "difficult to record" sound. Ask any producer. As far as recording hi-hats are concerned, I still feel it's necessary to have thinnish cymbals, but engineers (and producers) seem to prefer a more "middle", more dirty sound. Medium New Beats should be ideal for this. As I said before, if you play for The Who, you can use your 16" heavy hi-hat cymbals and nobody will care.

While I'm here, I'll explain something which I'm often asked. What is the difference between a Swish and a Pang? No prizes for saying the Swish has rivets and the Pang hasn't since they can both be fitted with them. Even though both cymbals are "China types" the "Pang" is available only at 20" diameter whereas "Swish" are available in

18", 20" and 22". They both have an upturned edge and because of this, are the only hand-hammered cymbals produced today. They can't be random machine-hammered because their shape won't fit the machine. The "Pang" has a slightly smaller cup and is just a shade thinner than the "Swish". Either are ideally suited for the modern punctuation Crash sound but if you actually want to choose one to Ride on, I feel the Swish is the best bet since its more traditional sound gives less build-up and is just a bit more tasteful.

It's difficult for me to advise you from scratch what actual size cymbals to use in your set, but I was able to ascertain that the most popular ones sold today are 20" medium Ride, 18" thin Crash and 14" "new beat" or "sound edge" hi-hats. I've been through both the Zildjian and Paiste books of cymbal set-ups and they bear out my conclusions. (N.B. Most of the heavy rockers use 15" "sound edge" or "rock" hi-hats). So add to these, say, a 16" medium Crash and an 18 or 20" "Swish" and you have a pretty comprehensive set of cymbals.

Incidentally, if for some totally inexplicable and highly unlikely reason you haven't fully understood this article I know that both the Zildjian and Paiste companies would be only too pleased to send you further details since they have reams of literature available on the subject. Write to:

The Avedis Zildjian Company Ltd., P.O. Box 198, Accord, Mass. 02018, U.S.A.

Paiste Drummer Service, CH-6207 Nottwil, Switzerland.

Boogie Bass

Self Generating Bass Pedalboard

- PLUGS INTO ANY AMPLIFIER
- 16' AND 8' PITCH
- SINGLE TUNING CONTROL
- VARIABLE SUSTAIN
- ULTRA COMPACT TO FIT UNDER ELECTRIC PIANOS
- CAN BE USED WITH ORGANS + GUITARS + PIANO ACCORDIONS + SYNTHESIZERS

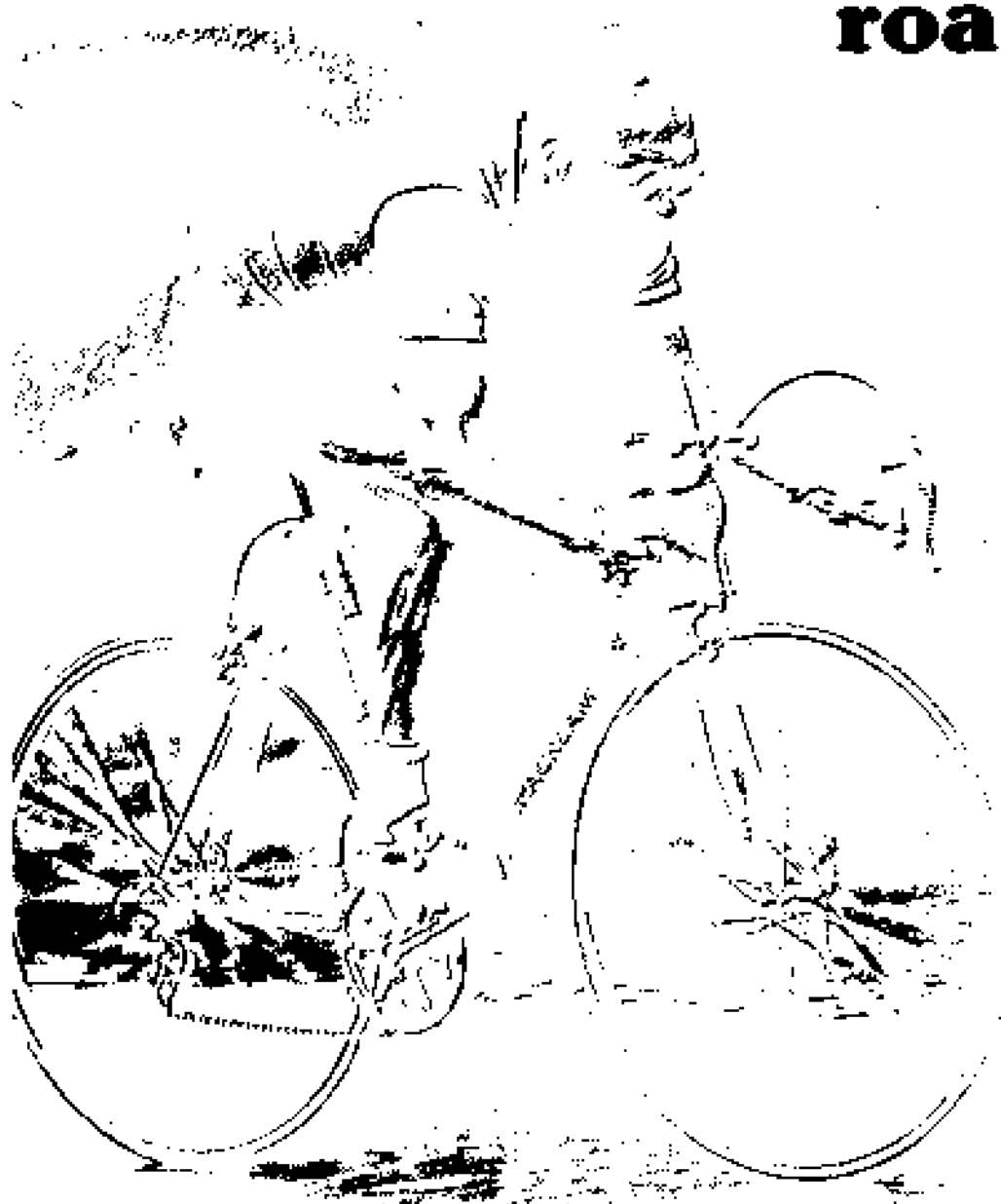


FREEDMANS — 629, High Road, Leytonstone, E.11 01-539-0288

MAKE CHEQUE PAYABLE TO FREEDMANS:-

CRUMAR

roadracer



RACING INTO A NEW ERA

with touch sensitivity

The new ROADRACER electronic piano from CRUMAR has touch sensitive keys. The harder you play the louder the sound – just the same as a mechanical piano.

Like its predecessors, the CRUMAR COMPAC PIANO and the ROADRUNNER, the ROADRACER has three distinct piano sounds and two octaves of bass notes at the push of a button.

NOW with the addition of a variable "CHORUS" effect, rich phasing sounds can be introduced.

the Crumar Roadracer a touch ahead of the bunch



Available from your local music store
or send a s.a.e. for a free leaflet, to-

UK TRADE DISTRIBUTORS

hornby skewes

JOHN HORNBY SKEWES & CO LTD
Salem House Garforth Leeds LS25 1 PX

THE MUSIC HOUSE

387-389 LINCOLN ROAD
PETERBOROUGH

Tel: PETERBOROUGH (0733) 51485

PUT YOURSELF IN THE SPOTLIGHT WITH LIGHTING FROM
THE EXPERTS. RIGS TO SUIT ALL GIGS FOR SALE OR HIRE AT
UNBEATABLE PRICES.

Suppliers include:

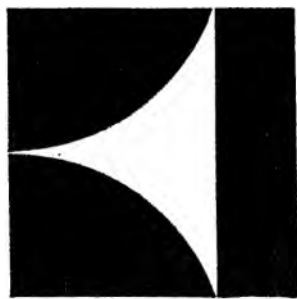
Rank Strand
Zero 88
Pulsar
Opticinetics
Lemaitre
Cobalt Blue
Pluto
Fenn
Rank Aldis

Also agents for:

Electrovoice
H/H
Carlsbro
Allen & Heath
Aria
Norlin
Ibanez
Premier
Plus many, many more.

PEAK SOUND & LIGHTING

12 Buxton Rd, Hazel Grove, Stockport



**DISCO, PA
& LIGHTING
EQUIPMENT**

PSL

150w – 5000w power all facilities.
Day or contract Hire. All quality
equipment used. Breakdown service.
24 hr callout.

IMPACT HIRE

TEL: (0224) 24256

- Complete Stage Lighting Service
- Hire & Sales
- British & European Gigs & Tours
- Genies, Dimmer Racks, Desks, Stands, C.S.I.'s, Rigging, Strouders, Flight Casing etc., etc.
- Operators & Crews supplied.
- Staging & casing designed & built.
- 24 hour service for very reasonable quotations.

ZENITH LIGHTING

HIRE AND DESIGN

LONDON

115-125 LAMBETH ROAD, LONDON S.E.1.
Tel: (01) 582 3717

NEW YORK

21-25 45th ROAD, LONG ISLAND CITY,
NEW YORK
Tel: 212 729 0600/0660

THIS IS IT

Multiphase 404

a lighting controller for the master class

see us at
DISCOTEK 78
Bloomsbury Centre Hotel
Sept 12-14

MULTIPHASE 404

Power, good looks and reliability.
Ideal for clubs, bands, roadshows & theatre.

for details contact
Multiform Electronics Limited
22 Portugal Road
Woking
Surrey GU21 5JE
Tel (04862) 70248

HW AUDIO
156 BRADSHAWGATE
BOLTON BL2 1BA
(0204) 26639

**LIGHTING & EFFECTS
SALE & HIRE**

Stage lighting, Followspots, U.V.,
Strobes & Pyrotechnics

CCT theatre lighting

LeMaitre Pyroflash

Cookes Band Instruments

AGENTS FOR

PULSAR

Cookes Band Instruments, 34 St. Benedict's Street,
Norwich NR2 4QA. Tel: Norwich (0603) 23563

Get it under control



Musicians have been improving their amplification systems for years; even local bands are into stacks of professional looking P.A. gear these days.

Pulsar can offer you something extra. We produce the finest range of stage lighting control systems available, that will give your gig the ultimate professional touch.

Our lighting control systems have been designed especially for gigging bands and a great deal of thought went into making the systems easy to operate and assemble.

Our super 12 channel Control Desk can be simply linked to one or several 12K.Watt Dimmer Packs, a Slave Unit and even our Modulator to create exciting sound to light effects.

Why don't you put your gig up in lights with Pulsar?



12 CHANNEL
CONTROL DESK
AND 6 x 2500 DIMMER PACK



CONTROLS THE LIGHTING PROFESSIONALS USE

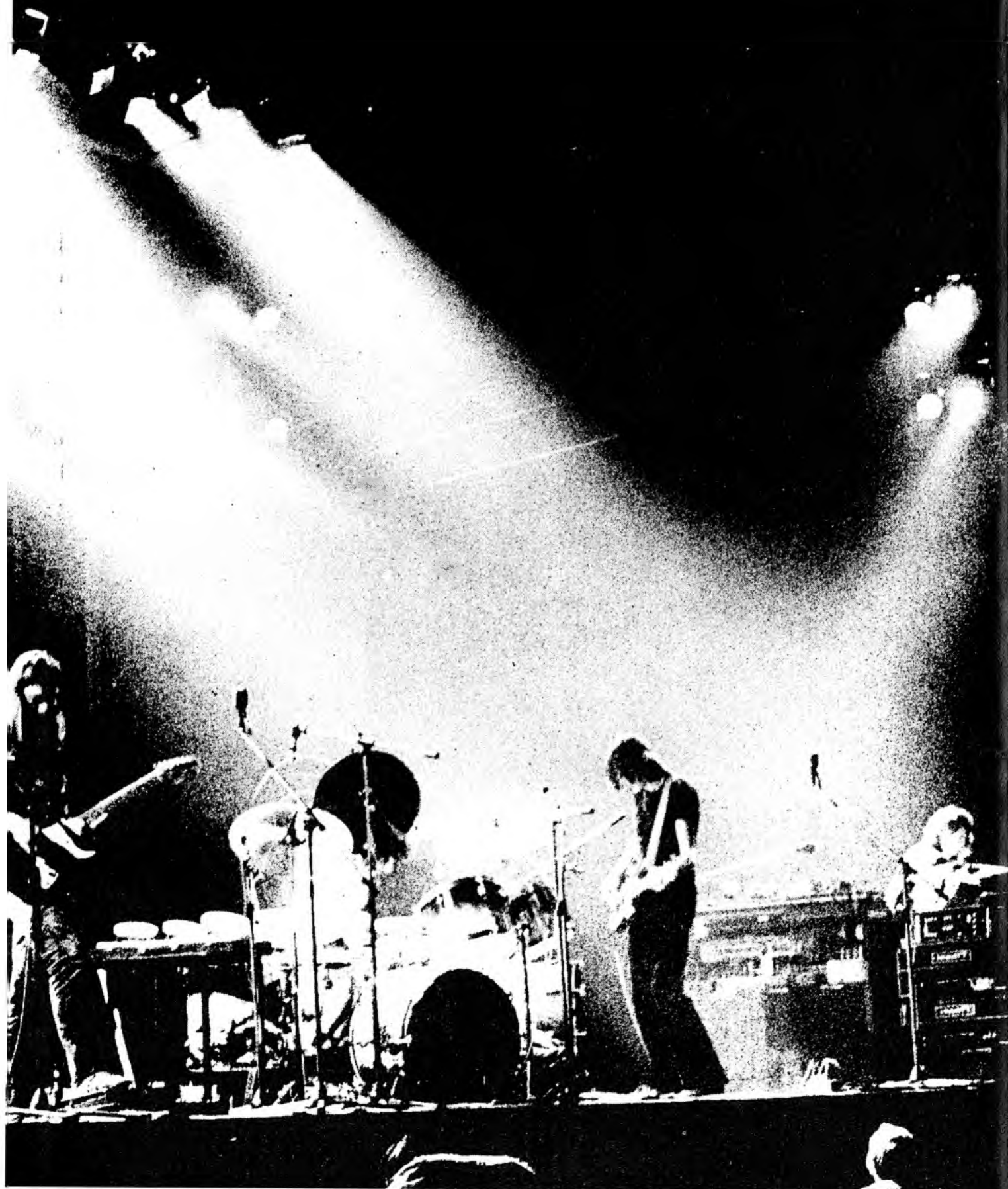
Find out more about our range of products by writing in for our catalogue or by telephoning Derek Saunders on (0223) 66798. Derek will be delighted to tell you about our lighting control systems.

Pulsar Light of Cambridge Limited
Henley Road, Cambridge, CB1 3EA
tel. (0223) 66798

Write for our catalogue or for more information
2000-1987
Name _____
Address _____
Tel. (0223) _____

“LIGHT FANTASTIC”

I.M. turns the spotlight on illumination



The story of the light show in rock music really began in the mid-Sixties with the advent of Psychedelia and Acid Rock. Prior to that, all you could expect in the way of lighting at a concert would be the usual spot lights and anything else that the house might have lying around.

Suddenly things began to change and as the music became more adventurous, groups began to see the potential in using lights to complement and enhance their performance. Undisputed leaders in this field were Pink Floyd whose use of lights, strobes, slides et al was quite revolutionary and paved the way for many bands to follow.

Soon, specialist lighting companies began to spring up and some of these became even more famous than the groups they were working with. In America, Bill Graham's legendary Fillmore West boasted Joe's Lights which became readily identifiable with audiences both there and in Britain when they were installed during the initial opening of the Rainbow theatre in London.

During the last 10 years, the lighting business has become more sophisticated and more spectacular with the supergroups trying to outdo each other in presentation. However, a good light show does not depend solely on having a whole gamut of special effects, some of the most impressive shows of late have featured simple lighting used imaginatively e.g. the black and white theme of both David Bowie's Earls Court shows and The Who's amazing laser display, engineered by John Woolf.

Of course, the use of lighting is not the sole prerogative of the Queens and Led Zeppelins of the music world. More and more up-and-coming bands are looking to lights to give their act that little boost which could secure them a record deal and a chance of the big league.

Many PA hire companies, whether large or small, usually carry some form of lighting for hire but there are companies who specialise solely in lighting. One such outfit is Zenith Lighting, one of the biggest companies around. Zenith, who are based in South East London, have been in business for six years and during that time have worked with literally hundreds of top acts.

Bruno from Zenith said: "We've done just about all the big halls you can think of such as Wembley, Bingley Hall to Madison Square Gardens (they have a rig in the States). A basic rig of a couple of towers with four or six lamps a side will cost about £40 a night then you can go up to £2,000 a night. There is really no limit.

"We do the whole lot; lighting, projectors, films and lasers. Lasers are one of the biggest new developments although, as yet, we have only scratched the surface of their potential. Over the past few years there has been a growth in special effects and, working with a touring band, you can really build up the whole thing. For a big tour, we usually send someone round to all the venues to suss out all the requirements of the different halls.

"The set-up is thoroughly professional and everything is done to the highest professional standards. All the equipment is road-boxed and we're using the new multi-pinned system. We have worked with literally hundreds of top names who recently have included Thin Lizzy, Manfred Mann, Bob Marley and Rory Gallagher."

Sandy McRobbie runs the Aberdeen-based Lamplight company specialising in lighting, but operations take in the whole of Britain. Sandy said: "We specialise in medium-size rigs usually with two Genie towers with 12 lights on each side of the stage and possibly a

few floor lanterns thrown in. The charge for this is about £250 a week with an operator which is calculated at four times the nightly rate. However, prices fluctuate according to how long a band wants a rig for.

"Knowing music and playing an instrument helps because you can anticipate the ends of bars and other musical dynamics," says Sandy. "There is a general agreement among lighting companies that they don't tread on each other's toes. Some companies stick to big concerts and others to smaller ones. We're finding now that record companies are putting lights among the priorities along with the PA in getting a band on the road."

As with many aspects of the music business, much is done on a personal basis and, if Sandy knows a band and trusts them, he will let them use a rig without an operator. Lamplight's recent customer have included Steel Pulse, Talking Heads and The Rezillos.

The general trend is towards more bands wanting to use lights which, according to Colin James, director of Chameleon Lighting in Chiswick, West London, is more reliable than PA gear. "It's safer and more reliable than sound equipment and at least, if a light fails, it won't stop the music — unlike a faulty cable in the PA.

"Basically, our operator sets everything up and fixes the lighting for the set, although if a band lays down specific requirements for what they want then we go along with that. The control equipment for lighting is getting more sophisticated with computerised desks giving you the facility for automatic sequencing of lights. What happens is you programme a series of what you want, and a manual push of the button controls it all.

"I've heard of some nasty accidents like towers falling down, but luckily we haven't had anything like that. The GLC (Greater London Council) have stringent safety measures and check out rigs both on paper and at the gig and insist on safety chains for each lamp, etc."

Chameleon only really cater for the big gigs, and will in fact recommend a band to go somewhere else if their requirements are too small for the company to deal with. They only rent with their own personnel operating the rigs and basically stick to tours. The cost works out at about £35 per week for a hoist, £150 a week with a 40ft truss and then £10 for each pair of lamps. Chameleon lights have recently been used by The Rich Kids, Frankie Miller, Alvin Lee and Steve Hillage.

Zero 88 were one of the first companies to realise the importance of professional lighting gear in the entertainment business. Formed by six Brunel University graduates in 1972, the St. Albans company deal solely in the manufacture of lighting. Sales Manager Peter Knifton explained that they were one of the first outfits to fuse the idea of lighting in the theatre situation with the way lights were being used in discos.

The result has been a highly successful company whose turnover has increased tenfold in just two-and-a-half years. Peter added: "We are in the up-market end of the business and do a lot of instalments in nightclubs. We recently installed a system at the Institute of Contemporary Arts in London which they seemed very pleased with.

About 50 per cent of the products are sold to bands with the rest to the rental companies, and the majority of their business is directed towards the export market.

Pulsar Lights of Cambridge are another company who deal with the business end of lighting. They specialise in electronic control equipment, although they do supply lamps. Ken Sewell is the company's founder director, and said: "Our lighting control systems have

been designed especially for gigging bands, and we specialise in dimmer packs and desks for semi-pro and up-and-coming professional bands to large custom desks for hire companies for a particular band.

"Lighting is a very specialist business and we are only just getting into the discount structure. About two thirds of our business is in the export market, and we work a lot with Cerebrum Lighting."

All of the Pulsar lighting control units, from the basic, low-cost Zero 2250 Soundlite to the Super 12-channel control desk and 12K dimmer pack can be simply linked together to build up larger systems.

One of the newer names on the hire scene is Music House of Peterborough who hire and sell everything in the music equipment field with particular emphasis on lighting. They will hire out anything from one FAL to a 10,000 watt rig, and hire charges start at an incredible £5 a night for a 2-3,000 watt set-up.

Chris Allen, Assistant Sales Manager, said: "We either send out our own engineers or show them how to work the gear. Most people who come in here know what they want and know how to work it. They see what other bands are using and have a pretty clear idea of what is going on.

"Probably the biggest innovation of the past few years have been lasers. They are expensive but, like most things, the price will eventually come down. The other thing is power-drive stands which are 15ft stands which can hold a spotlight."

Chris can personally vouch for the quality of the Music House gear because he plays keyboards in a local band called Gobblin who have just invested in a set of lights.

There are only a handful of specialist lighting companies in the country and it still tends to be an area which bands regard as a luxury, although this is changing, too. One company who have noted the changes has been PSL of Stockport which was started two years ago by partners Harry Demack, Sonja Gardener and Steve Bradbury.

Harry said: "It has been a long, hard slog because we do not have the gigs up here in the North of England like they do in London. Still more and more London bands are finding it cheaper to hire our stuff when they come up here now.

"The smaller bands find it difficult to hire lights because by the time they have paid out for PA etc. the just can't afford it. What they usually do is hire the lights if they want to put on a really good show for agents or managers.

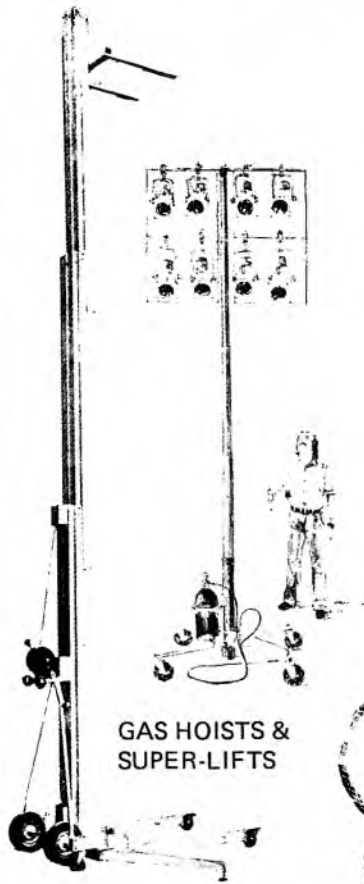
"We have done all the top Northern gigs, Manchester Free Trade Hall and Apollo, Liverpool Empire, Eric's etc. and cover the whole area including Yorkshire, going down to Birmingham and Bristol."

An average rig would be about 24K but they can go both smaller and bigger and usually send along two of their own crew. A 12K rig would cost about £30 a night, but the company are always willing to try and work something out for bands who come and explain what type of gig they are doing and exactly what they want.

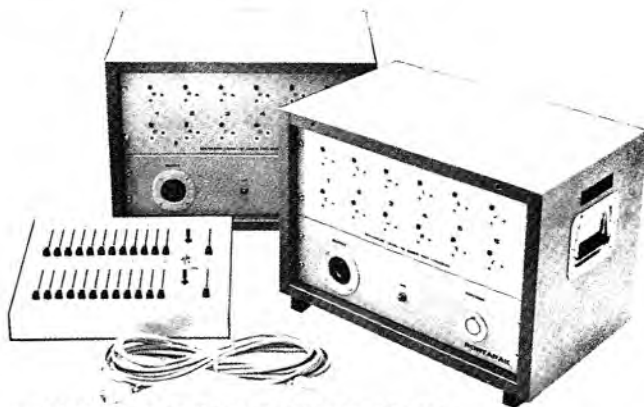
The whole lighting business has come a long way since the heady days of the Sixties, but it remains an aspect which, at its best, can be almost as important as the music. It is an area which is ripe for innovation and experimentation although already one new band, Brian James' Tanz Der Youth, have dipped into the past to utilise a light show which is reminiscent of early Pink Floyd and Hawkwind, to great effect. There is no doubt that the future in lighting will be equally as interesting and exciting as its past.

David Lawrenson

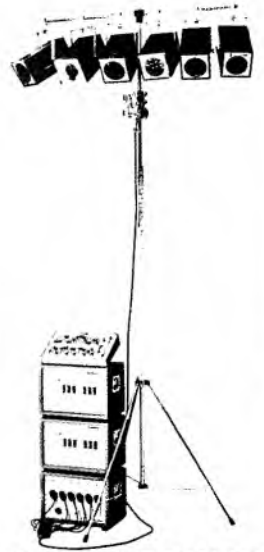
ANY BRIGHT IDEAS?



GAS HOISTS & SUPER-LIFTS



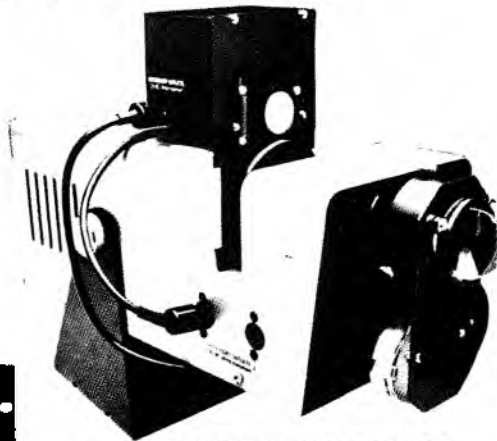
CONTROL DESKS & DIMMER RACKS



POWERDRIVE STANDS



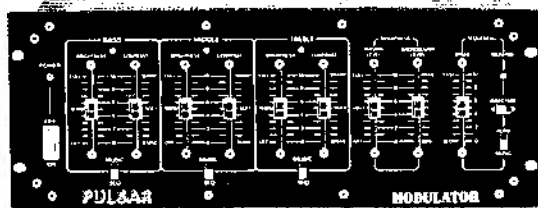
SPECIAL EFFECTS



EFFECTS PROJECTORS



FOLLOW SPOTS



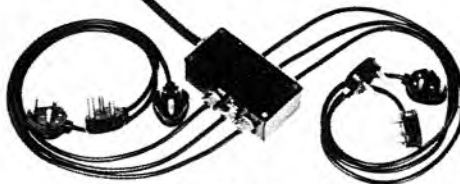
LIGHTING SEQUENCERS



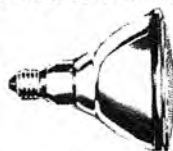
CABLES & CONNECTORS



300, 500 & 1,000 WATT SPOTLIGHTS



DISPLAY LAMPS



STROBES

Cerebrum Lighting (Sales & Hire) Ltd, 168 Chiltern Drive, Surbiton, Surrey KT5 8LS, England.

Telephone 01-390 0051

Retailers - Wholesalers - Export Distributors - Equipment Rentals



IM's Guide to Lighting

A SURVEY OF BRITISH COMPANIES INVOLVED IN THE LIGHTING BUSINESS

Entec, Shepperton Studio Centre, Squires Ridge Road, Shepperton, Middlesex. Tel: 093 28 66777

Entec are one of the big PA companies who also provide lighting systems as part of their comprehensive service. There is no limit to the size of the systems they can provide and Entec have worked with all the big rock acts including Uriah Heep, Patti Smith, Lou Reed and recently did the Reading Festival. The man to contact is John Denby.

Supermick Lights, 11a Sharples Hall Street, London NW1. Tel: 01 586 3848.

Supermick are the lighting division of Europa Concert Systems and, once again, there is really no limit to the lighting systems they hire out. The average price of a system for a London gig would be £100-£200, and recent clients have included Cliff Richard, The Stranglers, Boomtown Rats, Hot Chocolate, Elvis Costello and The Hollies. Contact Peter Clarke.

Andromeda Hire (Belfast), 1 Thirlmere Gardens, Belfast 15. Tel: 01 0232 772491.

One of Northern Ireland's biggest hire companies who offer a comprehensive lighting service. All prices are negotiable and so far this year they have worked with Tom Paxton, The Rods and Barbara Dickson. Contact John Connolly.

Colac, 212 Carlisle Lane, London SE1. Tel: 01 261 1705.

Colac specialise in lighting for big tours and festivals both in Britain and on the Continent. Price is negotiable depending on what the artist requires and their clients have included Black Sabbath, Dr. Hook and Lindisfarne. Contact Keith Davies.

Fringe Promotions (Swansea), 75-76 Mansel Street, Swansea, Wales. Tel: 0792 50968.

This is a new company recently formed out of John Ham's Swansea music shop to take care of the hire side of the business. They provide lighting for discos as well as local rock bands and are hoping to expand the lighting business in the near future.

R.D.E. Stage & Lighting Systems Ltd., 81 Leathermarket, London SE1. Tel: 01-403 1300

R.D.E. are specialists in providing custom rigs with professional crews and theatre trained lighting designers. Sets and properties are designed and built to specification in house. Specialists in lighting of all rock film presentations. Recent clients have included Tom Petty, Blondie, The Rods, John Miles, Mud, Suzi Quatro, City Boy, Gilbert O'Sullivan, Split Enz and The Kinks.

H.W. Audio, 156 Gradshaw Gate, Bolton, Manchester. Tel: 0204-26639.

This company has worked with the Dead End Kids, Flintlock and Goldie although they deal mainly with cabaret-type groups. They cover the whole spectrum of equipment providing everything from the smallest do-it-yourself lighting kit to a full rig. H.W. Audio will do full stage lighting providing any of the special effects you might desire. Prices for gear average between £1400 and £2000. Contact Chris Harfield.

Muscle Music, 74 Great Suffolk Street, London SE1. Tel: 01-928 6649.

Renting out full rigs, this company has provided lighting for Hawkwind, Robert Gordon and The Drifters as well as local bands. For an average rig, the price works out about £75. Contact Mark Hardy.

Playlight Hire Ltd., Sovereign Works, Church Lane, Lowton, near Warrington.

Providing whole lighting rigs and transport, they have worked with Heatwave, Liverpool Express, Alvin Stardust and Johnny Mathis, among others. Small and medium rig charges are about £400 per week which includes operators and transport. Contact Mike.

Electrasound, 11 Marshalsea Road, London Se1. Tel: 407 6781.

Working with such greats as Bob Dylan, Queen, Neil Diamond and Jefferson Starship, this company can provide a variety of lighting rigs. On a weekly basis, prices average between £1500-£2000.

Travelling Light (Birmingham) Ltd., 177 Rookery Road, Handsworth, Birmingham. Tel: 021 523 3297

Formed by Chris Osborn, Travelling Light do lighting for just about everything from rock bands through to films and TV work. Can cater for local club and pub gigs as well as the big concert halls and have recently worked with City Boy and Jasper Carrott. They cover the whole Midlands area, South Wales and London.

Multiform Electronics Ltd., 22 Portugal Road, Woking, Surrey. Tel: 04862 70248.

A manufacturing company who specialise in lighting controls for mobile disco use and rock bands. The two main Multiform units are the Multiphase 410 and the brand new Multiphase 405. The 405 comes in either four by 1kw per channel or four by 2kw per channel with both manual dimmers and flash buttons and is ideal for small band work. There are facilities for sequencer, sound sequencer, sound modulations and three-colour auto-fade, and the unit can be either panel mounted, rack mounted or housed in a portable steel case. The company supply mainly to the trade and hire companies like Cerebrum; all their units are available in 110v versions.

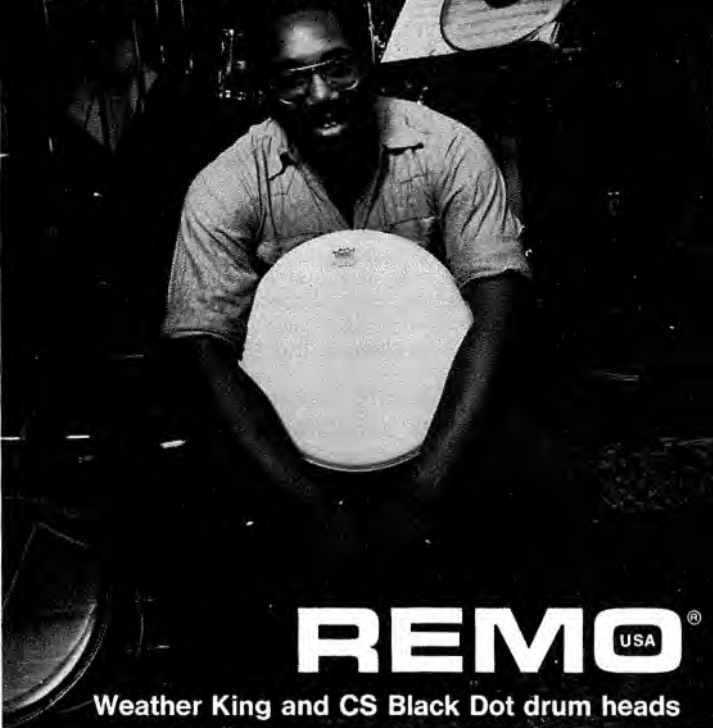
Lairhurst Prods, 7 Wood Close, London E2. Tel: 01-739 7543

Lairhurst deal exclusively in lighting and often have five rigs out at any time. They have serviced Genesis, Bowie, Be Bop Deluxe, Bad Company and Nazareth. Contact Christine Smith.



Lighting up with Queen

GILLY COBBHAM & FRIENDS



REMO USA

Weather King and CS Black Dot drum heads

REMO, INC. 12804 RAYMER ST., NO HOLLYWOOD, CA 91605 U.S.A.

HOHNER for Keyboards

The original Hohner keyboard sound has become legendary amongst rock groups and artists all over the world. The Hohner range includes the famous Hohner Clavinet and Pianet, Hohner International K1, K2 and K4. This fantastic range of keyboards has all the technical virtuosity that top keyboard players demand. Look for Hohner at your local music store - or post the coupon for full details.



To: M. Hohner Limited, 39-45 Coldharbour Lane, LONDON SE5 9NR
Please send me details of the famous Hohner Keyboard sound.

NAME _____

ADDRESS _____

 **HOHNER**

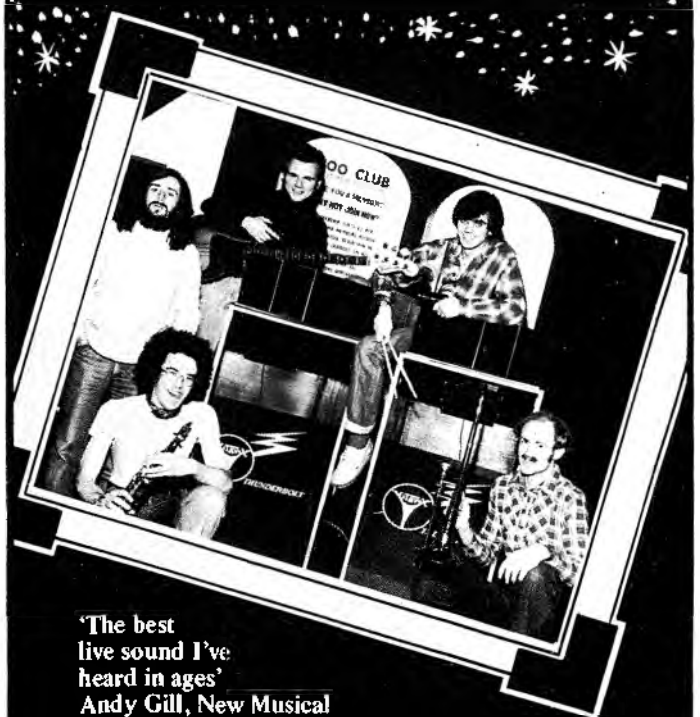
IM 9/78

THE ENID USE THUNDERBOLTS



After two tours of the UK and eighty trouble free gigs The Enid returned to London and a standing ovation at The Rainbow.

LANDSCAPE USE THUNDERBOLTS



'The best live sound I've heard in ages'
Andy Gill, New Musical Express, June 17th

'Their sound system, though not vast, is exceptionally clear and painlessly powerful!'
What's On in London, June 30th

Buying Thunderbolt contact:
Vitavox Ltd
Westmorland Rd
London
NW9 9RJ
Telephone
01-204 4234



Hiring Thunderbolt contact:
NSR Ltd
Parr Road
Stanmore
Middlesex
Telephone
01-951 0222





**SOUNDS
IMPOSSIBLE!!**

The \$249.95 sizzle machine from HONDO made possible by DIMARZIO.

That's right. Now for only \$249.95 you can have a super, fat sounding, great looking guitar that responds to your every need . . .
DIMARZIO POWERED HONDO IIs.

SOUNDS IMPOSSIBLE?

Well, see, play, and listen to one, then decide.

Write INTERNATIONAL MUSIC CORP. today for the dealer nearest you who features

HONDO IIs with DIMARZIOs

International
Music Corporation

P. O. BOX 2344 FORT WORTH, TEXAS 76101

CARLSBRO

SOUND CENTRE

**THE P.A. SPECIALISTS OF THE MIDLANDS
NOW IN STOCK, THE AMAZING**

S.S.E. P.A. SYSTEMS

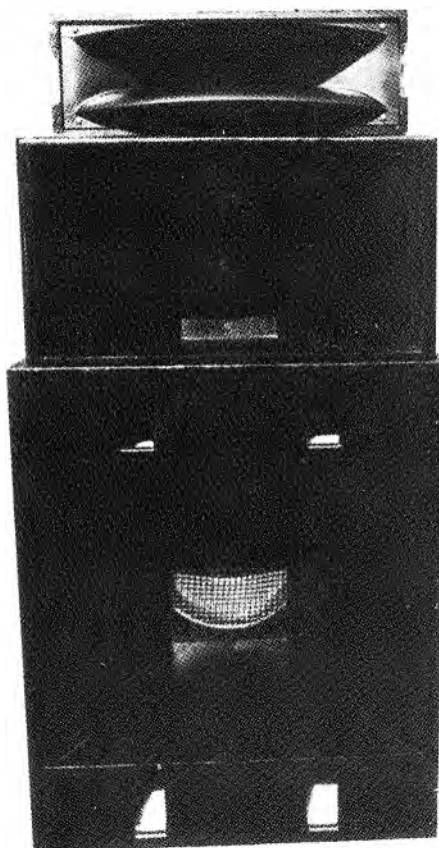
(SOLE AREA DISTRIBUTORS)

GROVEPOWER HORN

A.T.C. MID-RANGE CABINET

J.B.L. 4560

BASS BIN/R.C.F. SPEAKER



If you buy a basic system like the one shown you're making a genuine investment. It is modular and easily expandable, so you can build on to it without having to trade in. The 400W stack in our picture can be expanded to a 5000W stack, suitable for any major act in any venue. Because the system is fully modular it is available in different formats, utilising a variety of components, including A.T.C., J.B.L., R.C.F. and Electrovoice, which will suit your present budget, and which can be upgraded as your career progresses. The basic system has been designed for immediate use with the M.M. range of mixers, amplifiers and accessories, but for even greater performance, as your system expands, consideration should be given to professional units by T.A.C., R.S.D. and TURNER. The system has been fully tried and tested by our own hire company and is now available direct from S.S.E. or from our agents listed below.

**YOURS
FOR ONLY
£495** + VAT

Trade in your old P.A. Gear now for a truly professional P.A. Rig. High Part Exchange Allowances.
Credit available 10% deposit.

J.B.L. 4560 Bass bins also available with J.B.L. K140 Speakers (optional extra)

STOP PRESS ★ STOP PRESS ★ STOP PRESS ★ STOP PRESS
FABULOUS NEW RANGE OF H/H P.A. GEAR NOW IN STOCK-

182/184 CHESTERFIELD ROAD NORTH.

MANSFIELD

Tel: 0623 26199

13 BERKLEY PRECINCT SHEFFIELD.

SHEFFIELD

Tel: 0742 663862

PHONE FOR DETAILS.

Mail Order anywhere in the UK.
No extra charge for delivery.
Export enquiries welcome.
Credit facilities.
10% deposit up to 3 years to pay

STRINGS & THINGS

**PROUDLY PRESENT THEIR
EXCLUSIVE NEW
RANGE OF GUITARS**

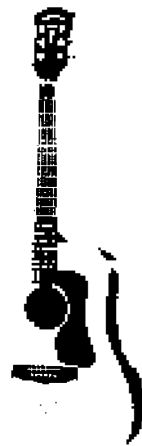
Write or phone now
for details
of the full range of

Nashville
ACOUSTIC
GUITARS



N-350D

Brown stained spruce (solid) top, mahogany back & side, rosewood fingerboard & bridge, fully adjustable mahogany neck, deluxe machine head.



N-40D

Solid spruce top, mahogany back/side, rosewood fingerboard, mahogany adjustable neck, chrome plated deluxe machine head, Guild M-450 strings.

N-40DS

As N-40D with sunburst top.



N-500J

Solid spruce top, maple back/side, mahogany adjustable neck, chrome plated deluxe machine head, black finish all way round.

STRINGS & THINGS LTD.

20 CHARTWELL ROAD, CHURCHILL INDUSTRIAL ESTATE,
LANCING, WEST SUSSEX BN15 8TU.
Tel: (09063) 65871. Telex: 87266.

PERFORMANCE
PERFORMANCE
PERFORMANCE

Malatchi Electronic Systems, Inc. introduces the Performer Mixers for Sound Reinforcement and Recording.



STEREO

- Master Section
- Effects Send
- REVERB With Pan
- Effects Return / Pan
- Monitor With Aux. Level
- Stereo LED OUTPUT METERS
- Seven Band Graphic Equalizer
- Left & Right Masters W. Aux. Inputs

STANDARD

- Master Section
- Seven Band Graphic Equalizer
- LED Output Level Meters
- Electronic Crossover
- Effect Controls

- Input Attenuator
- Channel Patching
- Two Effects Buses
- LED Overload Indicator
- Internal Reverberation
- Independent Monitor Send
- Four Band Graphic Equalizer
- Balanced Mic and Line Inputs

Available in six, twelve, eighteen and twenty-four standard and stereo.

International Inquiries Welcome

**MALATCHI
ELECTRONIC
SYSTEMS**

1368 C WEST BYERS DENVER, CO 80223 (303) 722-6775

Roger Squire's PRO-AUDIO

The specialist shop in St John's Wood

Full of MICS, MIXERS and MULT. TRACK

35 Charteris Street, London NW8 5.N. Tel. 01-722 8111

OPEN TUESDAY SATURDAY CLOSED MONDAYS LATE NIGHT WEDS 3PM

PROFESSIONAL DISCOUNTS · 2nd HAND BARGAINS · EASY TERMS

All prices inclusive of VAT

Shure UNIDYNE III
The musician's best friend

100's of microphones in stock including models from SHURE, BEYER, CALREC, AKG and NEUMANN.

RRP £62.00
SQUIRE'S PRICE £44.00

MIXERS

We have a huge range of on-the-road mixers from H/H, MM, A&H, SOUNDCRAFT, and HILL. Prices from around £220.00

FREE MIXER STAND WORTH £27.00 WITH EACH MIXER PURCHASED

H/H MA 100
The mixer amp used by the majority of small bands and groups. £189.00

REEL TO REEL Big Discounts

A minimum of 10% off on TEAC-TASCAM machines plus big professional user discounts on REVOX. Now in stock, the fabulous REVOX 877 Hi-Speed model.

BIG RANGE OF H/H ALWAYS IN STOCK

MAIL ORDERS COD · EXPORTS
Telex 298133

ALSO: 4 TRACK & 8 TRACK TEAC-TASCAM-BRENELL

We have a big range of 4 track and 8 track machines on continuous demonstration, also large stocks and professional discounts. Come up and try the equipment out for yourself!

FREE 60 page Catalogue. Send today No sale no required (UK)

Please send latest catalogue

Name








Address

Send to: Roger Squire's, Freepost, NW8 6YA.

PA:IM

BLOWING IN THE WIND...

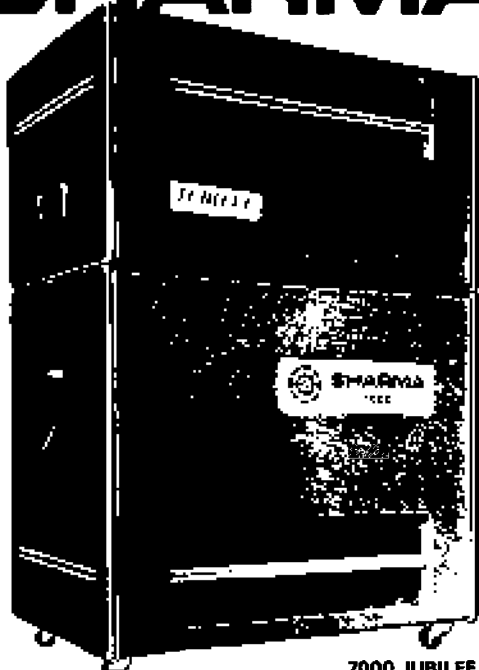
Alan Holmes tells you everything you'll want to know about mouthpieces in PART FOUR of his series

	MAKERS' MARKING	TIP OPENING MEASURED IN THOUS + -.002"		BORE SIZE
 <p>LARSEN 01</p>  <p>LARSEN 2</p>	80/0/M	80	7	.628 .590
	80/1/M	80	7	.633 .587
	80/1/SMS	78	7	
	80/2/M	80	7	.630 .581
 <p>MEYER</p>	7M Medium Lay Medium Chamber	83	7*	.632
 <p>BEECHLER</p>	S5S	80	7	.615
 <p>SELMER</p>	S80 E	75	6*	.635
 <p>COUF</p>	5* R Artist	82	7	.627
	4* R Special	72	6	.625
 <p>GREGORY</p>	5/18M	66	5*	.642 .629

EBONITE ALTO

LENGTH OF LAY	INTONATION KORG METER	PROJECTION	EDGE	TONE	PRICE	
.850	●●●	●●●●	●●●●	Thin		<p>The design has two different interior chambers, the "0" and "1" and the "2", which is less constricted. The "0" differs from the "1" by having a higher baffle which gives a slightly brighter sound. The "SMS" and "M" refer to the types of curve which are used in the lay. The "SMS" is slightly nasal compared to the "M". The length is the same in each case. I found the tone and tuning of the "2" preferable to the "0" and "1" which tended towards thinness. The 80/2/M is quite a nice mouthpiece and well worth trying, particularly as it represents very good value at £11.50 which also includes the ligature and cap which are not supplies with any of the other makes and would add £2 or £3 to the price.</p>
.850	●●●	●●●●	●●●●	Medium		
.925	●●●	●●●●	●●●●	Medium Nasal		
.850	●●●●	●●●●	●●●●	Full	£11.50	
.825	●●●●●	●●●●	●●●	Full Bright	\$30 approx.	<p>This is used by nearly all the top session players on both sides of the Atlantic as it combines excellent tuning with easy blowing and produces the accepted standard alto tone. Very nicely made and finished. Every alto player should have one in their collection. It is available in small and large chamber and long and short lay. The one I tested is my own and has medium lay and chamber which I recommend you try first. Obtainable from Mannys in New York.</p>
.800	●●●	●●●●●	●●●●●	Bright Cutting	\$24	<p>Made by Elmer Beechler, Box 15, Encino, California, and obtainable direct or from some US shops. An exceptionally loud, cutting tone makes this ideal for group work, although the intonation needs great care as the constricted chamber causes the upper range to be sharp if you are not careful. Available in a longer lay which is just \$5 and also in a more conventional chamber. Recommended.</p>
.800	●●●●●	●●●	●●●●	Full Slightly Hollow	£16.00	<p>The S80 is the replacement for the old "Soloist" model which is still used by many players. The S80 design uses a square tone chamber to produce a brighter sound than the old "Soloist". The tuning is excellent and, because of the short lay, is ideal for the beginner, as well as classical-style playing. A standard mouthpiece from the makers of the world's best saxophones.</p>
.875	●●●●●	●●●●	●●●	Full Round	NA	<p>This range is marketed by the Vincent Bach company of America, Box 310, Elkhart, Indiana, 46514. It is unique in offering tenor, alto and clarinet mouthpieces (especially for the doubling musician) which all have the same size bite and feel in the mouth. This is called the "S" model and they make one for Alto with the same interior as the "Artist". The "Special" is made of plastic and has a different interior which is constricted from the side like a clarinet mouthpiece in design. This produces a brighter, edgier sound and more volume and is recommended.</p>
.800	●●●●	●●●	●●●●	Bright Round	NA	
.850	●●●●●	●●●	●●●	Round Full	£21.85	<p>An example of the traditional "straight through" design which gives the straight classical tone. Perhaps a little dated by the Selmer in this respect which sets out to do the same thing but in a modern way which results in the Selmer being easier to blow. Well made with a brass ferrule around the end.</p>

SHARMA®



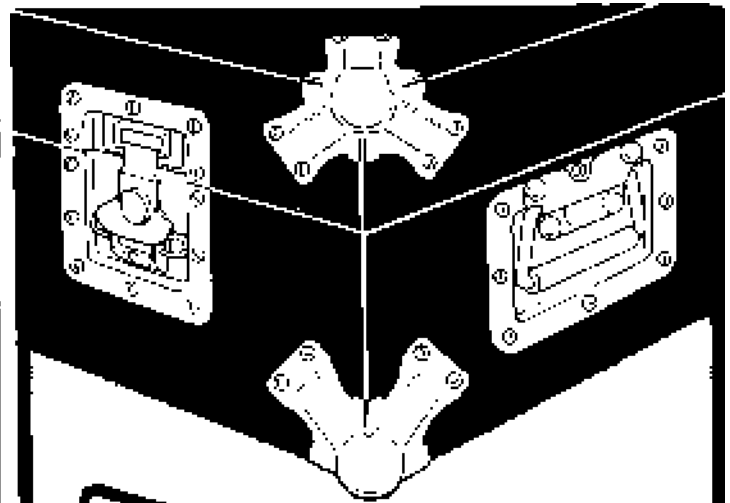
7000 JUBILEE
300 watts RMS fed to four specially developed
speakers with its own amplifier

Sound Around

SEND FOR A FREE
BROCHURE ON OUR
COMPLETE RANGE

KEITH HITCHCOCK & CO

THE MILL 13/9 LINCOLN ROAD WERRINGTON PETERBOROUGH
TEL (0733) 71913 CABLES HITCHCOCK PETERBOROUGH



Protex quick-release latches, handles, corner pieces and fasteners are used by some of the world's leading manufacturers because they are just right for the job.

protex FASTENERS LTD.

Arrow Road, Redditch, Worcs. Tel: Redditch 63231

NEW EXCITING 64-PAGE

GUITAR
and AMPLIFIER, DISCO
and LIGHTING

FREE
CATALOGUE

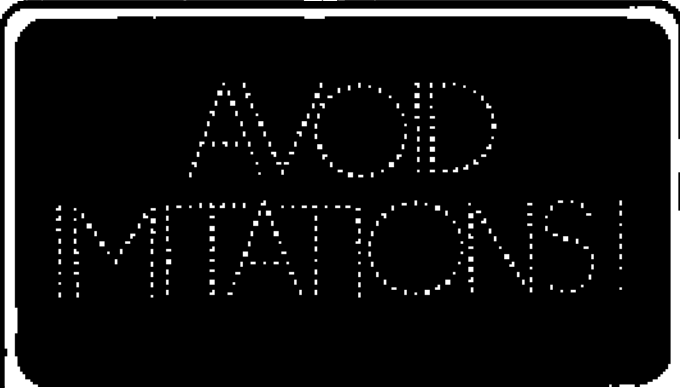
Hot off the press comes this new BELL Catalogue. Packed with exciting instruments and profusely illustrated with actual photographs. It contains absolutely the latest - model after model of all types and makes of Guitars, Pick-ups, Amplifiers, Echo Units, Microphones, Accessories, Disco Units, etc. Wonderful cash bargains or easy terms.

CALL OR WRITE
FOR YOUR
FREE
GUITAR CATALOGUE
TODAY!

BELL'S

MUSICAL INSTRUMENTS LTD.
(Dept 36) 157/159 EWELL ROAD
SURBITON, SURREY KT6 6AR

Callers Welcome.
Phone 01-399 1166.
Open all day Saturday.



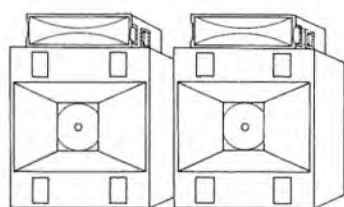
KINGFISHER MUSIC CO.,
20 KINGS ROAD, FLEET, HANTS.
TEL: 02514 21210

New range of acoustic amplification in stock now.

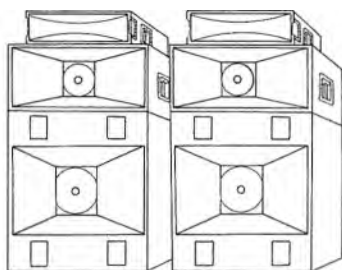
114	50w self contained w/2 x 10 inch Speaker	£260
116	50w Bass combo	£250
124	100w self contained w/4 x 10 inch Speaker	£399
125	100w self contained w/2 x 12 inch Speaker	£386
126	100w self contained bass amp	£375
220	125/160w bass amp	£275
230	125/160w guitar amp	£325
402	2 x 15 inch Speaker Cabinet	£215
406	2 x 15 inch Speaker Cabinet	£295
320	300w dual channel Bass amp	£395
408	Enclosure 4 x 14 inch Speakers	£429

ALL PRICES INC. VAT

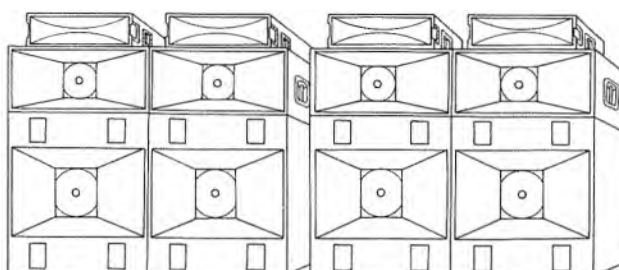
Everything new and Secondhand for the modern musician. Give us a ring for best prices.
Barclaycard/Access/H.P. welcome.



SYSTEM 1



SYSTEM 2



SYSTEM 3

SYSTEM 1A

2 Grovopower horns/RCR TW101 driver with 3k passive crossover
 2 JBL 4560/RCF 15" bass bins
 Total power handling 400 watts
 Suggested amplification:- 1 MM AP360

SYSTEM 2A

2 Grovopower horns/RCF TW101 driver with 3k passive crossover
 2 ATC 1 X 12 mid range units
 2 JBL 4560/RCF 15" bass bins
 Total power handling 600 watts
 Suggested amplification:- 1 MM AP360 or
 1 Turner B502 XLR or
 1 RSD 800B

SYSTEM 3A

4 Grovopower horns/RCF TW101 driver with 3k passive crossover
 4 ATC 1 X 12 mid units
 4 JBL 4560/RCF 15" speaker bass bins
 Total power handling 1200 watts
 Suggested amplification as in system 3B

SYSTEM 2B

As in system 2 but using
 2 Grovopower horns/Electrovoice 1B23M driver with 3k passive crossover
 2 ATC 1 X 12 mid range units
 2 JBL 4560/JBL K140 15" bass bins
 Total power handling 800 watts
 Suggested amplification:- as in system 2A

4 Grovopower horns/Electrovoice 1B23M driver with 3k passive crossover
 4 ATC 1 X 12 mid range units
 4 JBL 4560/JBL K140 15" speaker bass bins
 Total power handling 1500 watts
 Suggested amplification

	listed in connection with MM
2 MM AP360's	2 way 330Hz crossover:-
2 RSD 800B's	(total output 960 watts)
2 Turner B502's	(" " 1350 watts)
1 RSD 800B (bass) +	(" " 1350 watts)
1 MM AP360 (mid/top)	(" " 1150 watts)
1 Turner B502 (bass) +	(" " 1150 watts)
1 MM AP360 (mid/top)	(" " 1150 watts)

SYSTEM 2C

As in systems 2 and 3 but with the addition of a 2 way Electronic crossover crossing between bass and mid range at 330Hz.

The system then requires separate amplifiers for bass and mid frequencies:-

2 MM AP360's	(total output 600 watts)
2 RSD 800B's	(" " 880 watts)
2 Turner B502's	(" " 800 watts)
1 RSD 800B (bass) +	(" " 740 watts)
1 MM AP360 (mid/top)	(" " 680 watts)
1 Turner B502 (bass) +	(" " 680 watts)
1 MM AP360 (mid/top)	(" " 680 watts)

**'Standard' range
 Modular P.A.
 Units.**

SIGMA SOUND ENTERPRISES

Rear of: 128 Hartley Road, Radford, Nottingham 73306

**200w + 200w at £184.84 + vat
 (cabinet inc)**



ROOST

Sound Equipment Ltd.

Your Present Amplifier Is Obsolete

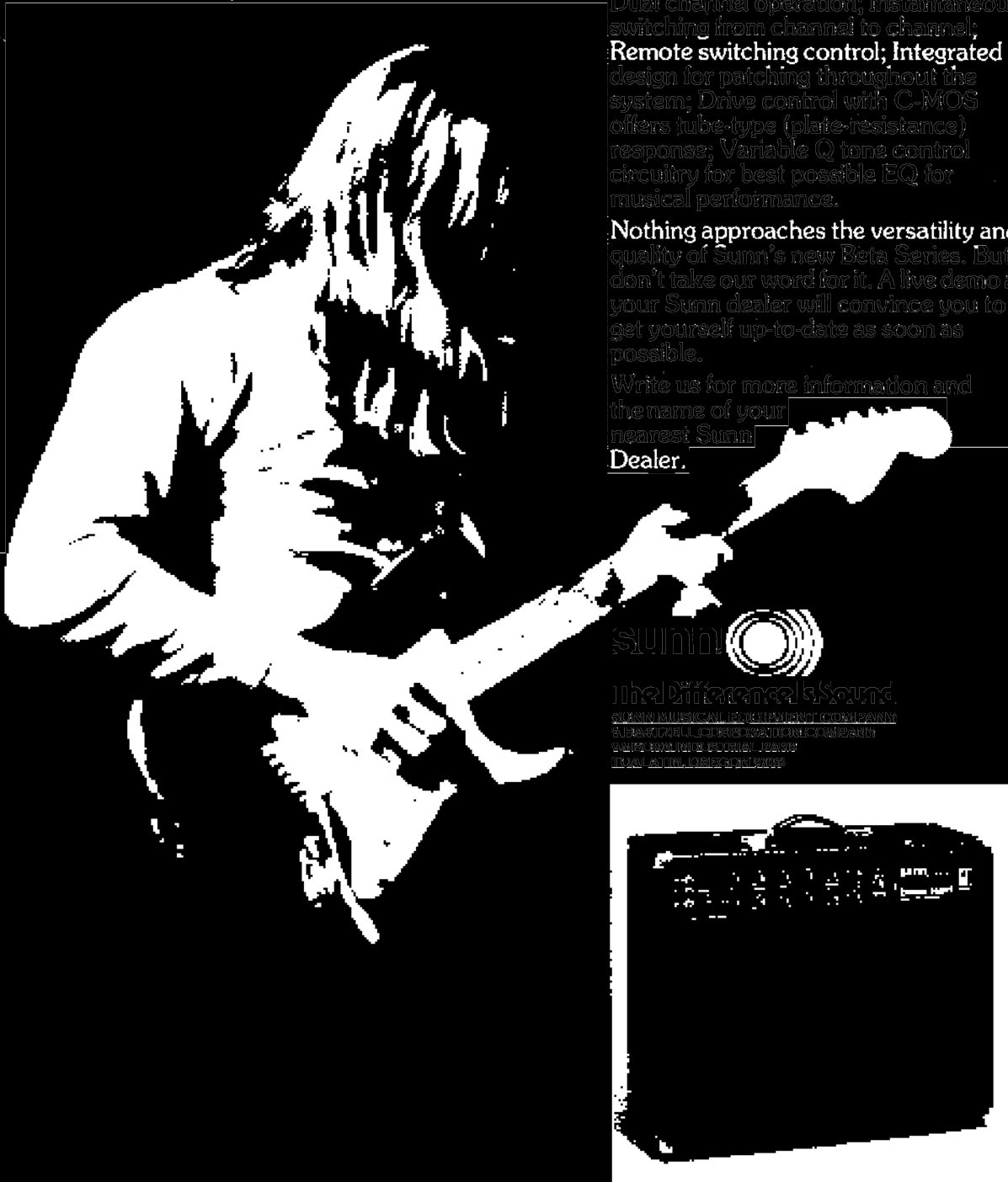
If you bought a new guitar or bass amp yesterday, it's already out of date! The reason is Sunn's new Beta Series – the most innovative amplifier yet developed for the musician.

The Beta Series' "Digital C-MOS Technology" offers musical benefits unmatched by any other amplifier in the world.

Dual channel operation; Instantaneous switching from channel to channel; Remote switching control; Integrated design for patching throughout the system; Drive control with C-MOS offers tube-type (plate-resistance) response; Variable Q tone control circuitry for best possible EQ for musical performance.

Nothing approaches the versatility and quality of Sunn's new Beta Series. But don't take our word for it. A live demo at your Sunn dealer will convince you to get yourself up-to-date as soon as possible.

Write us for more information and the name of your nearest Sunn Dealer.



SUNN 

The Different Sound

SUNN MUSICAL EQUIPMENT COMPANY
AUSTIN, TEXAS
A SUNN COMPANY
1101 E. 11th Street, Austin, Texas 78702



FREE SEX



Yeah ! O.K. so we know it's a corny eye catcher — but who needs FREE SEX anyhow when you can get the biggest discounts off the best gear at ANDERTONS — Cash or Credit — no matter where you live.

- * PAISTE
- * H'H'
- * MARSHALL
- * SHURE
- * HI-WATT
- * AMPEG
- * F.A.L.
- * WURLITZER
- * CAT
- * KORG
- * ROLAND
- * PEAVEY
- * W.E.M.
- * VOX
- * PHOENIX
- * FENDER
- * GIBSON
- * GUILD
- * YAMAHA
- * RICKENBACKER
- * PREMIER
- * LUDWIG
- * TAMA
- * PEARL
- * SLINGERLAND
- * MOOG
- * ELECTRO HARMONIX
- * CARLSBRO
- * MXR
- * ROGERS

PLUS MANY MORE !

CHECK US OUT NOW

Andertons
MUSIC SUPERSTORE

STOKE FIELDS, GUILDFORD,
SURREY



(0483) 38212
Guildford (6 lines)



Something for everyone at
**THE NORTH'S LARGEST
MUSICAL INSTRUMENT
SHOW**

HARROGATE EXHIBITION CENTRE
OCTOBER 7, 8, 9. (Admission: 50p Children 25p)

**SEE!
HEAR!
PLAY!**

A tremendous selection of quality musical instruments by the world's leading manufacturers.

DON'T MISS LIVE ON STAGE
THE INCOMPARABLE

PASADENA ROOF ORCHESTRA

PLUS THE **Bowles Brothers BAND**

SUNDAY OCTOBER 8, from 7.30pm
in the ROYAL HALL, HARROGATE
(Tickets from Booking Office
Tel. Harrogate 508649)
£3, £2.50, £2

(Arranged by Melody Maker/Larry Westland)

SAT. OCT. 7: 10am. to 9pm. SUN. OCT. 8: 10am. to 7pm.
MON. OCT. 9: 9pm. to 9pm.

GET BEHIND BGW PLAYERS



Nothing is more irritating than to have an amp fold on you in the middle of a gig. Experienced players know the problem. They also know the solution: BGW.

Behind BGW's much-imitated front panels lie serious electronics that the imitators have yet to rip off. Electronics that have made BGW the clean, reliable workhorse of professional musicians.

BGW's ruler-flat frequency response, phenomenal power and impeccable performance have won the respect of the most demanding engineers in the music industry. Sound quality is absolutely neutral right up to the limits of each model's extensive bandwidth... And beyond. Check it out for yourself. Hook a BGW amp to your heftiest, most reactive monitor speakers. Punch on the power. The silence will be deafening... Until you hit that first note.

BGW amps don't blow out. Crank one up to clipping for a day or two. If you trip the integrated circuit breaker, a simple flip of a front-panel switch will put you back in business: No fuses. No hassling.

The huge, high efficiency heat sinks on a BGW let you send your heaviest signals without worrying about a shutdown from thermal overload. Super-solid welded steel packaging (with the famous integrated rack handles) protects your BGW from the worst abuse amplifiers take in sessions, on stage and on the road.

Get behind a BGW and plug into some real power: the 30 watt MODEL 100, the 100 watt MODEL 250, or the new 225 watt 750 SERIES amplifiers.*

BGW amplifiers may set you back a few bucks. But they'll never let you down.

*All power specs are per channel into 8 ohms, 20 Hz-20kHz, with less than 0.1% THD.



BGW Systems, Inc., 13130 S. Yukon Ave., Hawthorne, CA 90250. Telex: 66-4494
In Canada: Omnimedia Corp., 9653 Cote de Liesse, Dorval, Quebec H9P 1A3

U.K., Webland International Ltd., 129 Walham Green Court Moore Park Rd., Unit F, London SW6 2TP.01 385-9478. Telex: 25570
International Inquiries please contact the factory.

Get Behind Us!



Electro-Voice So that professional music sounds absolutely true



Even among professionals,
Electro-Voice sets the standards

Whatever you play, whatever your combination, Electro-Voice interprets your pop, folk, rock, blues, jazz etc. exactly as your pop, folk, rock, blues, jazz etc. should sound. It renders faithfully and flawlessly what voice, guitar, bass, saxophone, piano, organ, flute, percussion and other instruments strive, individually and jointly, to express.

Why not send in the coupon and get detailed particulars on Electro-Voice microphones, loudspeakers, loudspeaker systems and other individual components? You will soon realize that Electro-Voice does not compromise on acoustic and technical quality.

None but the best should be good enough for professionals.

Primary Distributors:
 Thwaitescene Ltd., S.E.S., Sound & General Electronics,
 London WC2. Sheffield, Dublin 2, Eire.
 01-240 2115 07415-64585 711222-711064

COUPON

Please forward detailed particulars on the professional Electro-Voice programme.

Name _____

Address _____

Send to: *Electro-Voice Division
Gulton Europe Ltd.
Maple Works
Old Shoreham Road
Hove BN3 7EY*



Dire Straits: Dire Straits (Vertigo 9102021).

This is the debut album from a band which has been attracting a lot of attention in London over the past few months. They are now regarded by those with the power to say such things as the finest new band in the capital.

On the strength of this record there is no reason to doubt that claim. The Straits live are supposed to be red-hot and using their album as a taster I'd certainly recommend you see them if you get a chance.

The music is a mixture of JJ Cale meets Bob Dylan, joins up with Bruce Springsteen and then listens to Eagles records.

There is a distinct American feel to the music and the songs have prosaic lyrics which don't look so good written down but come across strong on the actual performance.

The most outstanding ingredient of Dire Straits music is the country-rock guitar playing of songwriter Mark Knopfler who has achieved one of the most distinctive Stratocaster sounds I've heard on record; thin and snappy without sounding tinny and weak. Credit to producer Muff Winwood for bringing this sound out.

The rest of the Straits are: David Knopfler (rhythm), John Illsley (bass), and Pick Withers (drums). They form an efficient, tight band which can move from candlelight rhythms to overdrive rock with ease.

The album is very immediate without sounding in the least trite and every song is a strong number. Dire Straits are making some good music that deserves to be heard in the current morass of disco-drek and New Wave blitzkrieg material that is commanding much of today's platter time.

Ian White
Recorded at Basing St. Studios,
Engineered by Rhett Davies, Produced by Muff Winwood.

Thin Lizzy: Live and Dangerous (Vertigo 6641 807)

For all Lizzy fans, this has been a long-awaited album. It's the first live material they have released and this double album, for me, captures fully the excitement and energy. As many live albums have shown, it's probably the most difficult thing to do. Atmosphere, feel, ambience and a thousand other nebulous factors come into it and you can count the number of successful live albums on one hand.

This one works really well. Lizzy have got one of the best live acts around and this set shows more subjectively that they also have one of the best sounds. The material is taken from two Lizzy tours - their "Johnny The Fox" tour in 1976 at the Hammersmith Odeon and the "Bad Reputation" tour in 1977 at Seneca College in Toronto.

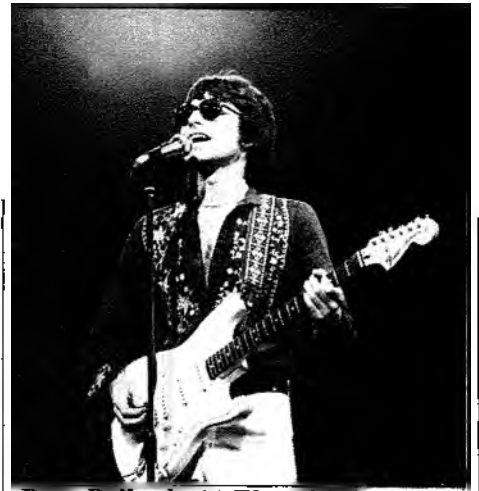
The two records feature all of Lizzy's best work including "Jailbreak", "Rosalie", "Dancing In The Moonlight", "The Boys Are Back In Town", "Don't Believe A Word" and "The Rocker". This last number was one of my favourite early Thin Lizzy singles. That was in the Eric Bell days and, since then, it's been re-worked and injected with new bass and guitar riffs which, for me, doesn't really work as well as the original form. Having said that, the rest of the material is faultless.

One of my favourite cuts is "Still In Love With You", a beautiful melodic love song with a particularly effective echoey guitar solo from, I think, Brian Robertson. Most of the songs are very Lizzy (The Rock Band and what more could you want? The overall balance and sound is amazing. The vocals cut through really well, so I would imagine a long time was spent mixing it.

The album cover and packaging was conceived by Thin Lizzy and Chalkie Davies and really deserves a special mention. The sleeve folds out to reveal some amazing colour shots of the band onstage. Each record has its own inner sleeve with a photo profile of each member of the band, again in colour. Quite simply, it's one of the best album covers I've seen.

Whether you're a Thin Lizzy fan or just a fan of good rock music, "Live and Dangerous" is well worth a listen. Lizzy are one of our best rock bands and this is one of the best live albums.

Eamonn Percival
Produced by Thin Lizzy and Tony Visconti. Recorded on Maison Rouge Mobile (England) and Record Plant Mobile (Toronto).



Russ Ballard: At The Third Stroke (EPC 82629)

This is Russ Ballard's third solo album since he left Argent and is the first one he's recorded in the States under the production of Keith Olsen of Fleetwood Mac production credit fame. The songs are all Ballard originals, but the 'feel' is distinctly American no doubt due to the presence of Jeff and Mike Porcaro (drums and bass), David Foster and David Paich (keyboards) and Tom Scott (horns) to name but a few.

The material is excellent and the playing superb throughout the album. All the songs have the Ballard 'trademark' of good melody, precision vocals and thoughtful arrangements. A good example and one of my favourite tracks is "Scorpio". A short instrumental section with strings and guitar introduce the track before the title is sung in acappella harmony leading into the main part of the number. The song has a very strong rhythm and a gutsy sound overall, interspersed with great guitarwork. The end of the number builds up with a dramatic string section following the theme of the number complete with excellent guitarwork.

It's hard to pick out 'best' tracks as they literally are all so good. "Dancer" is a very strong number complete with flamenco-style handclaps on the chorus while "Expressway To Your Heart" is a bit reminiscent of the Foundations' hits of the Sixties and would probably make a good single for Diana Ross. There is a lot of variety on the album but all the songs bear the Ballard stamp.

Eamonn Percival
Produced by Keith Olsen, engineered by David De Vore, recorded at Sound City, Van Nuys, Calif.



Steel Pulse: Handsworth Revolution (Island ILPS 9502)

To the unenlightened, Handsworth is a suburb of Birmingham, Britain's second city, and is an area with a high concentration of immigrants. Steel Pulse are from Handsworth, they are Britain's premier reggae band and this is their first album.

Over the past year they have established themselves as one of the most potent live acts on the circuit, and as expected "Handsworth Revolution" contains much of their familiar stage set. The album cover, a typical scene of a decaying slum, plus the title track serve to illustrate the source and inspiration of their music.

Their biggest musical influence would appear to be Bob Marley's "Catch a Fire" album, which really laid the foundations for the Jamaican superstar's success. The cuts on the Pulse album are all strong vehicles for the band who combine proficiency with a natural rhythmic feel for the music.

Lead guitarists Basil Gabbidon adopts a melodic approach to his playing using his Les Paul for understated lead lines behind the rhythm. The band score heavily in the vocal department with five of the seven members involved in harmonies.

One of the strongest tracks on the album is "Ku Klux Klan", and it would be hard to ignore the political message behind the song - not that one really should because of its powerful lyrics. It contains a really great rumbling bass line which leaves room for little fills from the rest of the band. "Prodigal Son" the other track which was released as a single has the same strong theme running through but perhaps with a more commercial feel. Not all the numbers are heavy and political and "Sound check" has the same easy going laid back feel as some of the current music coming out of Jamaica e.g. The Gladiators, Bob Marley.

One of the biggest objections to reggae by many people is the whole Rastafarian cult and the constant reference to "Jah" in their songs. True this can be a little wearing, but it should not be allowed to obscure good music which Steel Pulse undoubtedly make on this album.

David Lawrenson
Produced by Karl Pitterson, assistant engineer Godwin Logie, executive producer Pete King.

Tarney/Spencer Band: Three's a Crowd (A&M AMLH 68466)

This is Tarney/Spencer's first album for A&M and the first under the name The Tarney/Spencer Band. Their first album appeared on the now defunct Bradleys label and was credited Tarney and Spencer, but didn't exactly set the world alight.

Alan Tarney plays guitars, bass, keyboards and sings while Trevor Spencer handles drums and percussion. They have already had success as a songwriting team having written a few hits for Cliff Richard and also as session men, having played on hits by The New Seekers, The Real Thing and Bonnie Tyler.

This album can only be described as a good, classy pop album. The songs are superb, the delivery and arrangements excellent. Unlike their first album on which they did everything themselves, additional help is provided by members of the Climax Blues Band, Tony Rivers, John Perry and Stu Calver among others.

The album opens with a really strong track, "Bye Bye Now My Sweet Love". It's a driving number with a powerful sound and superb vocal harmonies on the hook-line. Towards the end, a great slide guitar appears, probably Climax's Pete Haycock. "Takin' Me Back" is another standout track with an effective harmony guitar line and a great drum sound.

One of my favourite tracks is a slow number called "Maybe I'm Right" which closes Side One. It starts with electric piano and vocal for the first verse and builds up from the second verse with beautiful swirling synthesizer and positively celestial vocal harmonies.

"Capital Shame" is another excellent song with a really strong arrangement. It starts with acoustic guitar and a cornet-type synth line laying the background for a plaintive melody before the rhythm section appears playing a nice, solid half-time against the acoustic guitar picking.

A lot of thought has obviously gone into the arrangements of the numbers, and some of the songs feature the best use of synthesizer I've heard in a long time. Synth lines appear at just the right times adding texture and not sounds for the sake of sounds. There's a lovely majestic brass sound on the chorus of "Capital Shame" and a subtle flute sound on "Easier For You".

Eamonn Percival
Produced by David Kershenbaum, engineered by Pete Swettenham, recorded at AIR, additional recording and mixing at Producers Workshop, L.A.

The Brothers Johnson: Blam (A&M AMLH 64714)

As with so many American funk/soul outfits, The Brothers Johnson mean far more in the USA than here in Britain. "Blam" is their third album, the first two having gone platinum on the other side of the Atlantic. Despite an excellent concert debut here a year ago, they have failed to meet with any significant chart success although the potential is obviously there.

The brothers are Louis Johnson, who plays bass, guitar and takes vocals, and George Johnson who plays lead guitar and does both lead and background vocals. They began their musical career playing with Billy Preston before working with Quincy Jones on his album "Mellow Madness". The influence of Quincy proved a major factor in the success of their first two albums, although the Brothers were using their own material.

For this their third album, he is once again in the production seat and his influence is such that "Blam" could well be tagged a "producer's album". The studio and its effects are used to full advantage to produce a depth and range of sound on every track which is quite something.

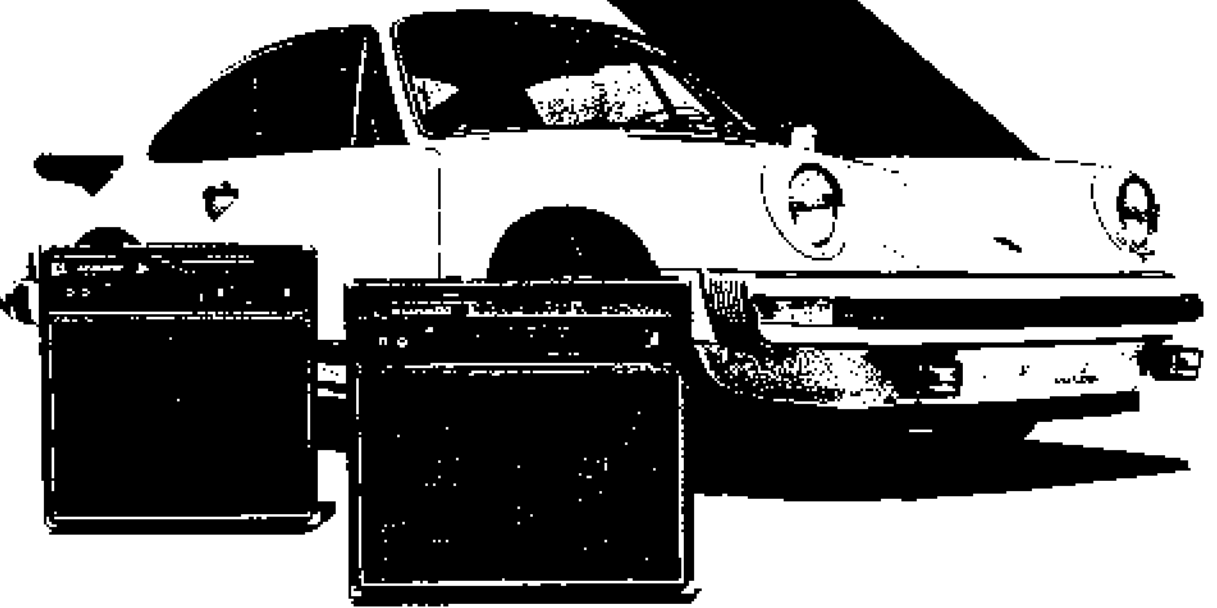
The album contains out-and-out funk numbers like "Ain't We Funkin' Now", to "Streetwave" which is a rich full-blooded instrumental. It also includes their first ever recorded ballad, "So Won't You Stay" which is reminiscent of those classic slow Commodores tracks. The playing throughout is excellent, the duo having relied on the musicians who backed them on tour rather than bringing in session guys.

I find the Brothers Johnson more accessible than many funk bands because their is much light and shade in their work. They write good songs which are melodic and don't rely on straight ahead souped up funk all the time. Thanks to their producer they are able to include many interesting ideas and techniques on virtually every track and seem always willing to experiment, as a result they never sound dull and in a rut.

A very listenable album, which should grow and grow the more it is played. I wish them every success and hopefully any success they have will lead to a re-issuing of "Strawberry Letter 23" - one of the best singles of 1977.

David Lawrenson
Recorded and Mixed by Bruce Swedien using the Acousonic Recording Process at Cherokee Recording Studios, Los Angeles
Produced by Quincy Jones, associate producer Tom Bahler.

“Small & hot”



For years professional musicians have been asking Acoustic for a small amp. Not a cheap beginner amp, but an amp hot enough for the club yet clean enough for the studio. Naturally they wanted all the performance and reliability they've enjoyed in their big Acoustic systems. Acoustic has responded with the 100 Series. We used the same pre-amp from our concert models and added a 50 Watt RMS power section for the Model 114 Guitar Amp, and a 75 Watt RMS section for the Model 116 Bass Amp. They both feature our internal effects loop (for superior accessory performance) and a solid 3/4" plywood cabinet using locked seam dado construction. In addition, the Model 114 with two heavy 10" speakers has our reverb and unique gain compensated master volume, controllable by a footswitch. The 116 Bass Amp has the "Power Boost" feature and drives it's 15" bass speaker in a carefully tuned-reflex enclosure reaching incredible levels. And of course Acoustic backs them all by offering their Exclusive Lifetime Protection Plan. So get to an Acoustic dealer soon and try our Hot New Small Amps!!!



professional sound equipment

7949 WOODLEY AVENUE • VAN NUYS • CALIFORNIA 91406

nobody was ever sorry . . . they bought the best!

HIT THE ROAD.



This is the HIT, WLM's portable combo organ weighing no more than some 70 kgs.



Its sturdy, though elegant cabinet easily withstands the rough life on the road.



The HIT folds open unbelievably quickly, in just ten seconds



Then you just start playing. And what a sound you've hit! Purely magnificent!



The HIT sound also contains consonants, not just vowels, which means an exciting and pleasing sound impression.



A light touch of your finger enables you to use seven fixed sound combinations.



And you just go on enjoying the distinctive sine-wave sound and the easiness of controlling it with the drawbars.



The HIT also folds neatly back after you've finished. Ready, steady, go!

Meet the HIT, WLM's impressive organ. Mail this coupon for our new brochure giving full details about the distinctive WLM Sound Concept.

Name _____

Address _____

Representative in the U.K.: Richard Brown Distribution, The Minster, Harbridges Lane, Long Buckby, Northants, England. • USA: UNICORD Inc, 75 Frost Street, Westbury, New York 11590. • Australia: The Music Distillery, 503 Pittwater Rd, Brookvale N.S.W.



Manufacturer: WLM-organ Oy, SF-03600 Karkkila, Finland

UNDERSTANDING SYNTHESIZERS

by Tony Horsman

PART 4

Introduction

In the first three parts of this series, I covered some of the more important terms used whenever synthesizers are described and introduced some of the very basic physics of sound synthesis. In this and future articles I will be writing about synthesizers themselves, taking the various parts (*modules*) of the synthesizer in turn.

Each module has its own role to play in the creation of the sound which finally emerges from the synthesizer. The most important modules of all are the *oscillators* which are the primary sources of sound in all synthesizers.

Oscillators

Synthesizer oscillators are of two kinds; both produce periodic (repetitive) voltage waveforms but their frequency ranges are different. *Low-frequency oscillators* (LFOs), which I will be describing next month, produce very slow, inaudible oscillations which are generally used to modulate (alter) other signals, producing effects such as "vibrato" and "tremolo" (see Part 1). *Audio-frequency oscillators* — or *audio-oscillators* for short — produce relatively fast oscillations in the audio-frequency band (20Hz to 20kHz; see Part 2).

Audio-oscillators

If you fed the output of an audio-oscillator directly into an amplifier and loudspeaker (see Fig.1; ignore the "control voltage" for the moment), you would be able to describe three different characteristics of the continuous sound you heard; its *pitch*, *loudness* and *tone*

quality. The frequency of the oscillator's output determines its pitch, and the amplitude determines its loudness (see Part 1). Although the pitch and loudness would be relatively easy to describe in familiar terms, describing the tone quality could present problems; musicians would, if possible, liken the sound to that of other instruments (e.g. flute-like, clarinet-like, string sound, etc.) while others might use words such as "harsh" or "hollow".

Some of this may seem rather obvious but it has allowed us to identify the features of an oscillator's output which need to be varied in order to produce music and musical sounds. First of all, we can forget the amplitude control, because synthesizer oscillators produce a constant output of fixed amplitude; audio-signal amplitudes are varied by other synthesizer modules (e.g. voltage-controlled amplifiers, VCAs) designed specifically for that purpose. However, we clearly need a means of altering the oscillator's pitch and, because most of our sound generation is going to be achieved by subtractive synthesis, the more basically different tone qualities available from each oscillator the better. In Part 3 last month, I explained that the tone quality of a continuous sound is determined by the relative strengths of the *harmonics* it contains, and how any periodic waveform is the sum of its harmonic components. Synthesizer oscillators provide us with the variety of basic tone qualities we need as a selection of output waveforms with different harmonic contents.

Oscillator waveforms

It is not difficult to see that, however many ways other modules in the synthesizer can modify the oscillator output waveform, the more choices of basic oscillator waveform there are, the greater the variety of sounds the synthesizer will be able to produce.

Fig.2 shows the shape and frequency spectrum (see Part 3) of five waveforms commonly available at the output of oscillators. Sometimes you can use only one at a time; on more flexible synthesizers, a combination of waveforms can be used simultaneously if necessary. Although the sine wave is often not available, it has been included to emphasise that this particular waveform contains no harmonics, just the fundamental; in fact, its total lack of harmonics is the reason why it is not very useful in subtractive synthesis. The triangular and square waveforms contain only the "odd" harmonics i.e. harmonics having frequencies 3x, 5x, 7x etc. the frequency of the fundamental. The amplitudes of the harmonics decrease rapidly in the frequency spectrum of the triangular wave, which has quite a smooth sound. You might have expected this from the shape of the waveform; the sine wave and triangular wave look (and sound) very similar. In the square wave the "even" harmonics are again totally absent but in contrast to the triangular wave the odd harmonics do not decrease in amplitude very rapidly. In the sawtooth wave, which has a rather harsh sound, all the harmonics are present. Finally, in the pulse wave, the harmonics are very strong in relation to the fundamental and give this waveform a very nasal, reedy sound.

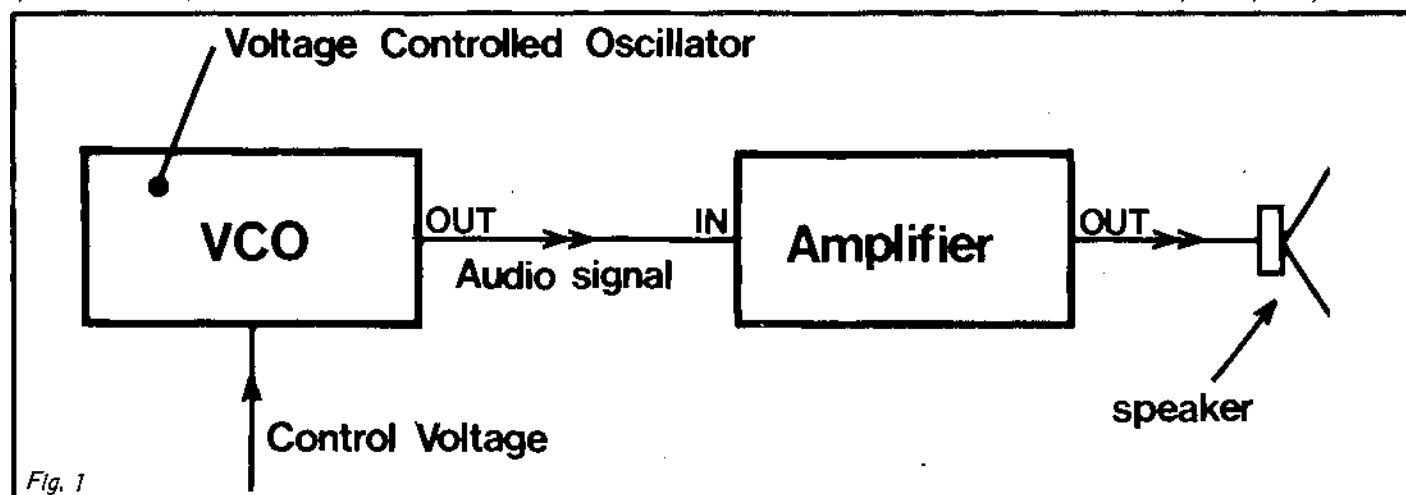


Fig. 1

Schematic diagram showing connection of a synthesizer oscillator to a conventional amplifier/speaker system.

Instrumental sounds

To put these oscillator waveforms in a musical context, I have listed in Table 1 some of the sounds which can be produced by subtractive synthesis from the different types of waveform. The sounds have been limited to familiar instrumental sounds; it would not help you very much to know that a Funny Cat sound is synthesized from a pulse wave, unless you're familiar with Funny Cats! It is clear from Table 1 that the sawtooth is a strong favourite for string and brass sounds. Incidentally, the reason why the clarinet sound is synthesized from a square wave is that the cylindrical bore of the clarinet body only allows the odd harmonics to be generated in the air column; the frequency spectrum of a sustained note on a clarinet is very similar to that of the square waveform shown in Fig. 2.

Pulse width

Due to its high harmonic content the pulse waveform is used very extensively in sound synthesis. The high part of the pulse waveform is called the *mark* and the gaps between the marks are called *spaces* (see Fig.3); the *duration* of the mark is called the *pulse width*. In some synthesizers, it is possible to alter the shape of the pulse wave both manually and electronically to produce some very exciting sounds. The pulse wave is altered by varying the relative lengths (durations) of the mark and space of each cycle but *keeping the total length constant* (otherwise the pitch would change). In the jargon of electronics, the "*mark/space ratio*" can be altered. With a bit of imagination, you can see that if the mark

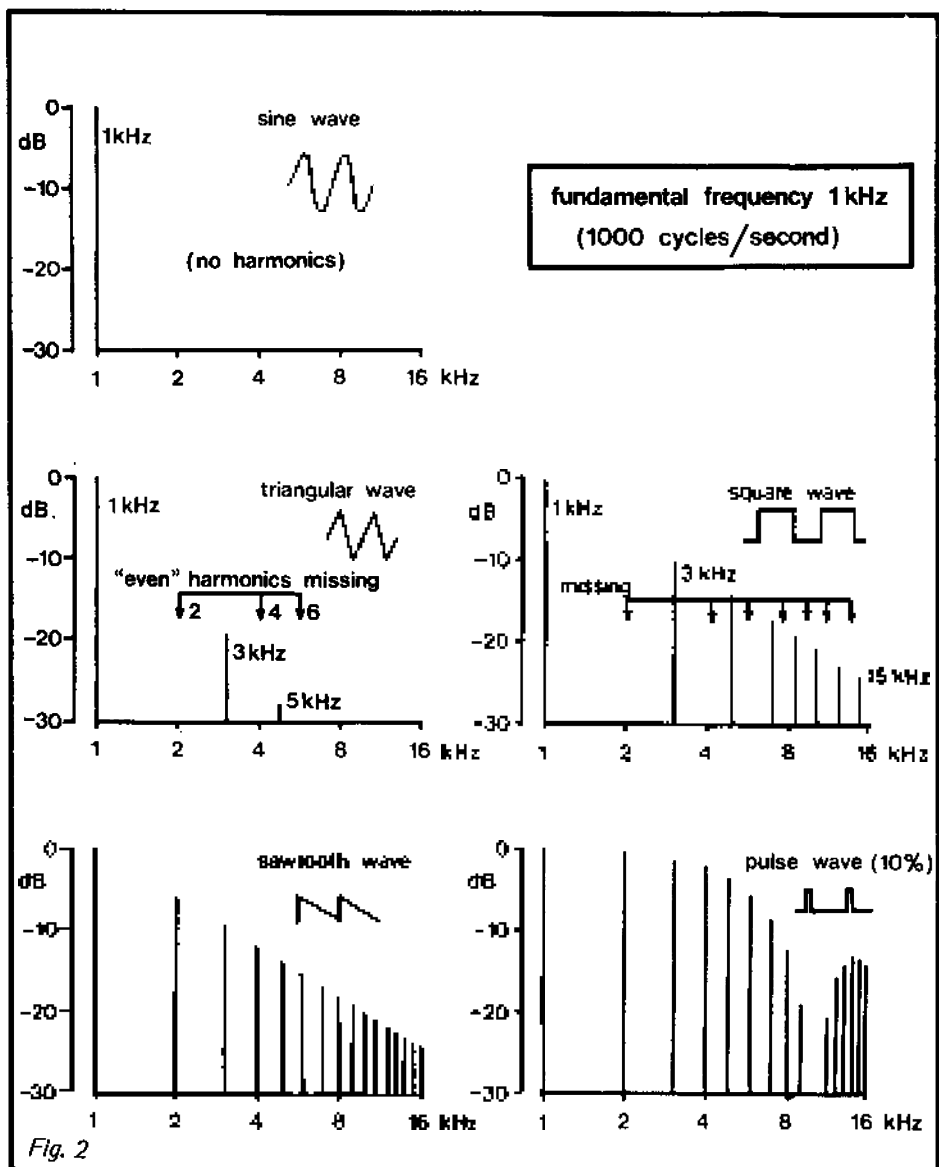


Fig. 2

Frequency spectra of five voltage waveforms commonly available at the output of synthesizer oscillators. Notice that the even harmonics are totally absent from both the triangular and square waves.

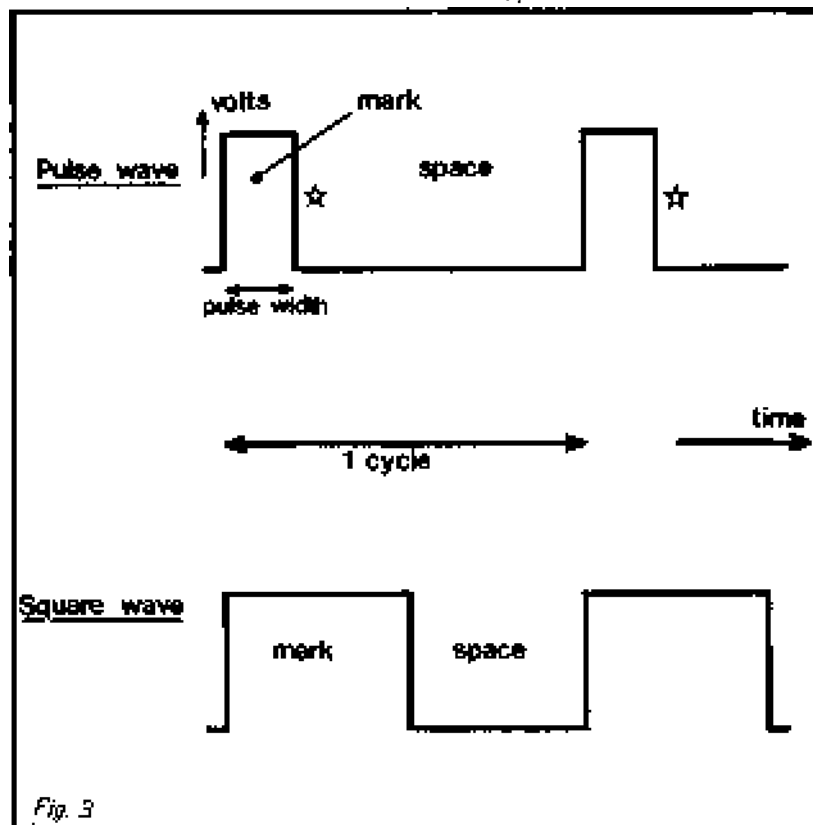


Fig. 3

Pulse and square waveforms. By moving the falling edge (*) of the mark to the right, the pulse wave eventually becomes a square wave.

Triangular 	Sawtooth
bass drum flute celeste vibraphone whistle -	'cello viola violin trombone horn -
Square 	Pulse
clarinet xylophone - - -	saxophone harpichord piano fuzz guitar oboe accordion

Table 1. Basic waveforms used in the synthesis of instrumental sounds. The most useful are the sawtooth waveform, for synthesizing string and brass sounds, and the pulse waveform which is used for the more harmonically rich sounds.

KING OF THE ROAD



Whether you're on that stage in front of thousands of people or dozens, you want equipment you can count on. No foul-ups or hassles. You want equipment that works and works well.

That's the reason why more and more musicians are switching to Peavey. Our track record speaks for itself. Quality. Dependability. Roadability. Because we want to make sure that we sound our best...when you're sounding your best.

38 SPECIAL, on the road with Peavey Sound gear



Peavey Electronics Corp. • Meridian, Miss. 39301

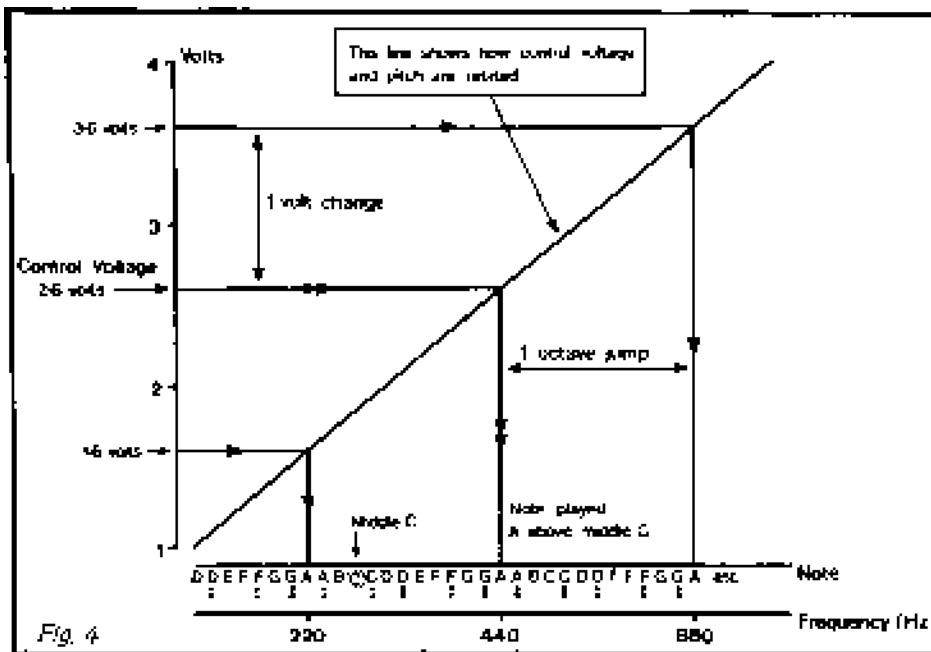


Fig. 4
Diagram showing how the note produced by a voltage-controlled oscillator (VCO) depends on the control voltage. Nowadays VCOs are usually designed so that a change in control voltage of 1 volt produces a pitch change of 1 octave.

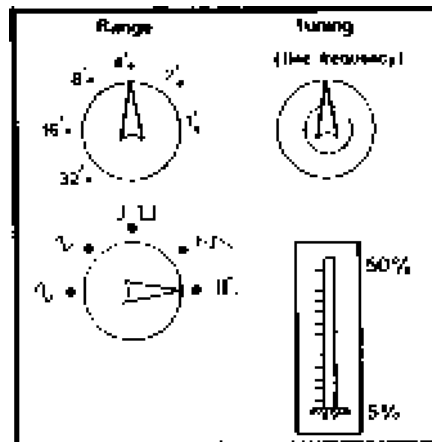
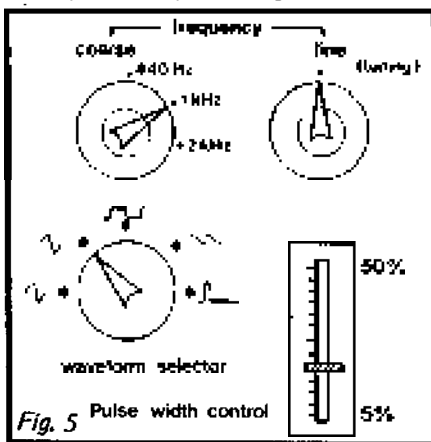


Fig. 5
Two typical oscillator panels. Left: continuously variable coarse and fine frequency controls. (top). The oscillator is set up to produce triangular waves with a frequency of about 1kHz. Right: frequency altered by range switch (marked in footages) and a tuning or fine frequency control. The oscillator is set up to produce pulse waves having a mark which occupies 5% of each cycle.

is lengthened and the space shortened, there comes a point at which the two are equal; the pulse wave eventually becomes a square wave (see Fig.3).

Remembering that the square wave contains only the odd numbered harmonics but that a narrow pulse wave contains almost all the harmonics (see Fig.2), it is clear that adjusting the mark/space ratio of a pulse wave **changes its frequency spectrum**. So the manual adjustment of "pulse width" (more correctly, mark/space ratio) allows you to find a basic waveform which produces just the sound quality you want, but of course once the control is set, the sound does not change.

You will often see a "pulse width" control marked 5% to 50%. This percentage is simply the fraction of each cycle occupied by the mark. The lower the percentage, the greater the strengths of the harmonics relative to the fundamental — so the 5% setting will produce the brightest sounds.

Voltage-controlled oscillators

The frequency of synthesizer audio-oscillators is governed by a voltage which

is an **input** to the oscillator (see Fig.1); this voltage is called a **control voltage** (CV). In the same way that the steam pressure in a whistling kettle determines the pitch of the whistle, so the control voltage determines the pitch or frequency of a **voltage-controlled oscillator** (VCO). It is becoming increasingly common for oscillators to be designed so that a 1 volt change in control voltage produces a change in pitch of one octave. If, for example, a control voltage of 2 volts produces middle C (262Hz), when the control voltage is raised to 3 volts the oscillator pitch will rise to the C one octave higher (new frequency = $2 \times 262\text{Hz} = 524\text{Hz}$). If the control voltage is increased by one more volt to 4 volts, the pitch will rise another octave to the C two octaves above middle C (new frequency = $4 \times 262\text{Hz} = 1048\text{Hz}$).

In Fig.4, I have illustrated this in a slightly unusual way; you would often find only one horizontal axis marked "frequency" but it is easier to think first of the actual **notes** produced as the control voltage changes. The figure shows how you can predict the note which will be produced by first choosing the control

voltage, looking horizontally across until you hit the line, then dropping your eye vertically downwards to the horizontal axis. In the example I have chosen, 2.6 volts produces the A above middle C. This note has a frequency of 440Hz (now have a look at the frequency scale). When the pitch falls one octave, the frequency halves (e.g. A below middle C = 220Hz) and when it rises one octave, the frequency doubles. You can see that if we make the **notes** equally spaced, as I have done in Fig.4, **the frequencies are not equally spaced**; it is as far on this diagram from 220 to 440Hz (a change of 220Hz) as it is from 440 to 880Hz (a change of 440Hz). You will often see these "non-linear" or "logarithmic" (!) frequency scales; you may have noticed I used them in Fig.2. This sort of scale makes musical sense because **equally spaced musical intervals are the same distance apart on the horizontal axis and are produced by equal changes in control voltage**.

On most VCOs, you will find either "coarse" and "fine" frequency controls or "range" and "tuning" controls. They all do the same thing — provide the VCO with a control voltage. On a VCO with "coarse" and "fine" frequency controls, the coarse control will shift the pitch over a very large range (probably seven octaves or more), so the fine control is necessary for exact tuning of the oscillator to the required pitch. On a VCO with "range" and "tuning" controls, the "range" control is usually a rotary switch marked in **footages** (e.g. 16', 8', 4', 2'). Instead of allowing you to vary the oscillator control voltage continuously, the switch provides fixed values — say 1, 2, 3 and 4 volts. Each position of the switch changes the pitch by one octave. The reason for indicating frequencies in terms of "footages" is that an organ pipe eight feet long plays one octave higher than one 16 feet long etc. — so the "footages" are a shorthand way of specifying the pitch the oscillator will produce. What's more, most keyboard players know what the different footages **do**, so this is more helpful to many people than indicating frequencies. On a synthesizer oscillator with a "range" switch, the "tuning" control will usually move the pitch over at least one octave so that the oscillator's frequency can be set to any value in the audio-frequency range.

Fig.5 shows two types of VCO layout, with the frequency controls at the top, the waveform selector switch and the pulse width slider below, which is effective only when the pulse waveform is selected. As I introduce more synthesizer modules, the VCO layout will become slightly more complicated but this diagram illustrates the features I have discussed so far.

Next month I will be introducing the low-frequency oscillator (LFO) and explaining how it is used to produce vibrato and to change the pulse width.

Hot and Cool

Maya
GUITARS

Join the professionals, and don't be fooled by the price, they aren't. Over twenty different superb models developed from famous American originals to bring you Maya performance and quality plus truly outstanding value.

Panophone & Cozzani SAXOPHONES, one of the fastest actions around with the power in the right place.

Stentor

Sole Distributors: Stentor Music Co. Ltd. Reigate, Surrey



SUPERB GUITARS!

from

F C N
music

To: Fletcher, Coppock & Newman, Morley Road, Tonbridge, Kent.

Please send me a catalogue of full range of Hagstrom Guitars.

Name _____

Address _____

Marcel Dadi picks with the best of 'em: D'Angelico Guitar Strings.



There's only one Number One. And professionals like France's Number One country guitarist won't settle for anything less. That's why Marcel Dadi insists on D'Angelico Guitar Strings. He

knows there is a difference and D'Angelico makes it. Next time, don't settle for second best. Select Number One and pick with the best of 'em:

D'Angelico
NEW YORK

The ultimate in Strings, none finer... perfect for pickin'.
D'Merle Guitars, Inc., PO Box 153, Huntington Station, N.Y. 11746.
D'Merle, successor to D'Angelico, New York.

Goodmans for lasting pleasure



Things have changed since the days of R & B, and the true players—15 years of leading the pack out of his Goodman's 15" and it still goes on working—giving pleasure.

When you next buy some new gear the first question to ask is: Does it have Goodman's speakers? Since they have changed but for over 30 years

Goodmans have maintained their lead in speaker technology.

Goodmans

power range



Goodmans

Goodmans Loudspeakers
Limited, Crowley Road,
Harlow, Essexshire
PO2 2NL, England

Goodmans Loudspeakers Limited, Crowley Road
Harlow, Essexshire PO2 2NL, England
New York
Atlanta

These black boxes reveal their secrets

H||H N



Ideal applications

quality sound reinforcement
portable P.A. Systems
theatre and club installations
reproduction of electronic keyboard
instruments

By the use of new materials and advanced technology, H.H. offer you, at realistic prices, an entirely new range of loudspeakers, for professional application, designed to a new high standard of performance.

ts...

NEW SOUND FORMULA - PRO-SERIES LOUDSPEAKERS

These entirely new, compact enclosures, with shatter-proof high density polythene edge mouldings - the H.H. built-in answer to expensive flight cases - will impress your audience by their individual, stylish appearance.



But what will really excite you is the power and high performance of our new Pro-Series loudspeakers - they match and exceed those of many expensive American systems.

At H.H. we demand the best - so, we fitted our "black boxes" with our new 1200 and 1500 drivers - a new generation of high efficiency speakers, researched, designed and manufactured by the H.H. team of sound engineers.

New, because H.H. pioneered the use of magnesium - the stiffest structural metal available - for the chassis. H.H. chassis will outlast the more delicate aluminium or pressed-steel units. Voice-coils capable of withstanding up to 260°C have been built using high temperature polyimide for the voice-coil former. The cone profile is carefully designed and calculated to generate better sound radiation and maximise transient performance. H.H. also perfected the magnet assembly so that the bond between the components is stronger than the magnet itself.

That's not all!

The Pro-Series Loudspeakers incorporate our new, revolutionary *HF 200 Bullet Radiator*: it reproduces and projects with clarity and power the harmonics and sibilants within the frequency range of 3.5 kHz to 20 kHz.

Please send me information on
the H.H. Pro-Series Loudspeakers

Name

Address

Tel. No.



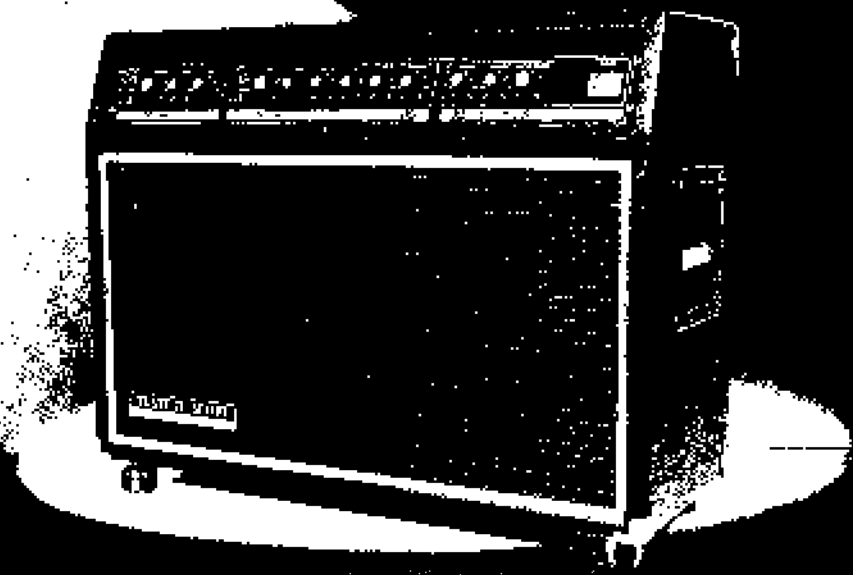
H. H. Electronics
Viking Way,
Bar Hill,
Cambridge CB3 8EL
Telephone: Crafts Hill (0954) 81140

The Custom Sound Model 705 combo has been developed to provide simply the best and most versatile sounds.

The secret is a carefully designed and developed pre-amplifier stage featuring incredibly versatile tone networks and the proven 'Overtone' circuits plus a master volume control as well as an input gain.

New sensitive 12" speakers have been specially developed for Custom Sound, resulting in a strong, penetrating yet tonally full sound.

Now the stage is set.



The Model 705, 100/150w
2x12" combination amplifier.

Channel One: Hi and Lo Inputs/Volume/
Bass/Treble/Reverb Selector.

Channel Two: Bright and Normal Inputs/Gain/
Bass/Lo-Mid/Hi-Mid/Treble/Overtone (with Foot-
switch Socket)/Reverb Selector.

Master Controls: Presence/Reverb (with
Footswitch Socket)/Volume.

Outputs: Headphone/Power Amp/Line
Speakers (2)/100 watt RMS into it's 2 x 12"
Speakers/150 watts RMS with further cabinets.



Custom House, Arthur St., Oswestry,
Salop. SY11 1JN.
Tel: Oswestry (0691) 59201/2.



Leslie[®]

SPEAKERS

When you want to hear more from your Electronic Organ

We know how great Leslie Speakers are. But then, that's to be expected. What is more important is that we want **you** to know how great they are.

Professional artists know and demand Leslie Speaker quality. They insist upon the original 'music in motion' design and engineering. For these perfectionists, Leslie Speakers are the sound of excellence.

Leslie rotating electro-mechanical speakers produce a 'live' sound that cannot be produced by ordinary speakers.

Leslie Speakers not only complement your electronic organ - they compliment you, too. No matter what music you play - or in what style, Leslie Speakers enhance your performances with a richness and quality unheard of by any other means of reproduction. In fact the total performance of the organ is elevated to a new level of truly magnificent sound.

Naturally you're proud of the way you play. Let your talent really come alive with Leslie Speakers. There are Leslie Speakers to meet every

requirement - at home, in church, at school, or for the musician on the move.

Write now for all the details, to:
Leslie Speakers Division,
Boosey & Hawkes (Electrosonics) Ltd.,
4 Brick Knoll Park,
Ashley Road,
St. Albans,
Herts AL1 5NX.

**DON'T SETTLE FOR ANYTHING
 LESS THAN LESLIE
 SPEAKERS**



Jon Hiseman: (Colosseum II) „Miking-up my drum kit”



These are the AKG MICROPHONES I recommend as a result of my experiments in miking-up my drum kit.

ONE D224: used overhead for cymbals and overall stereo picture of the kit.

TWO D12: one for each bass drum. The large diaphragm of this mike together with the built-in "bass-chamber" enables it to reproduce the sound of my 24-inch bass drums without distortion.



ONE D1200: with the EQ-switch in "M" or "S" position for snare drum gives progressive bass roll-off according to drum or hall acoustics.

FOUR D2000: with the EQ-switch in the "M" position for tom toms.

TWO D224: as a stereo picture for crotels and hi-hat.

THREE C451 with CK 1S capsules for my seven gongs.

AKG Acoustics Ltd. 191 The Vale, London W3 7QS, Telephone 01-749 2042 (5 lines), Telex 28938 (akgmic g)

frunt® power

an already successful power amplifier currently working with many studios & touring bands,

4005 slave amp



£245 ex vat

restyled for a new look to match its exceptional performance.

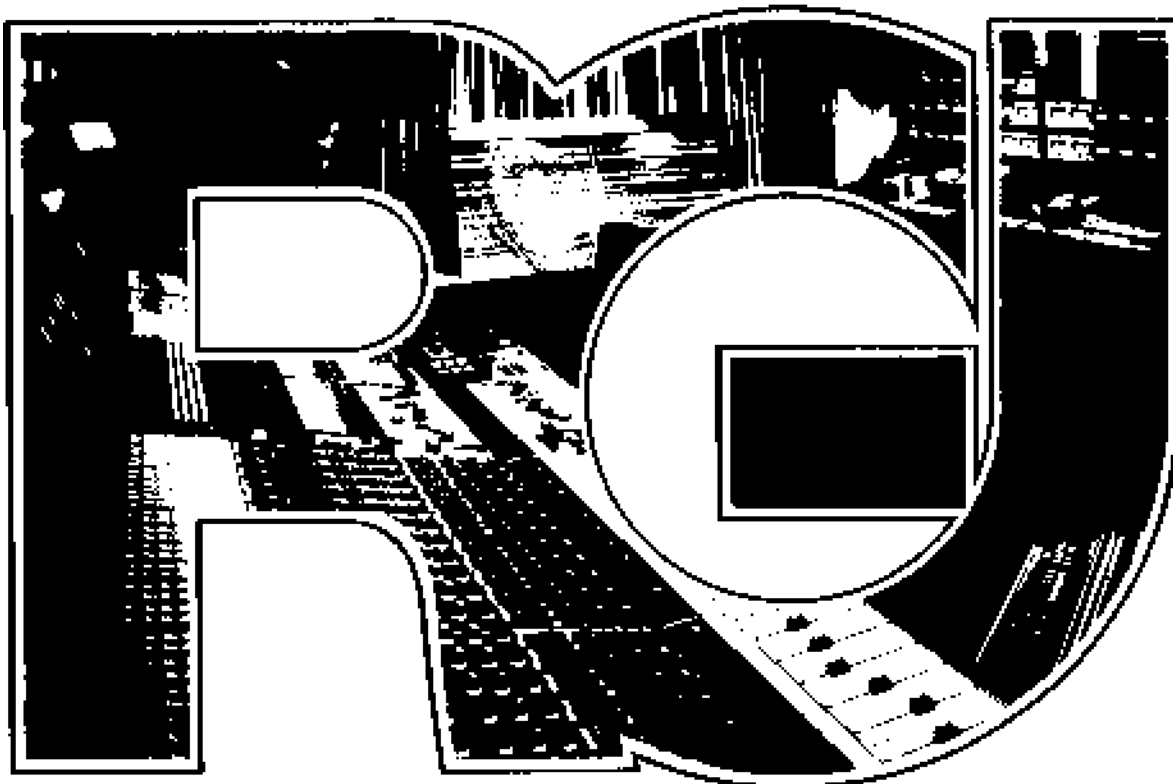
- 200 Watts r.m.s. per channel.
- Frequency response:- 6Hz-80Hz
- Distortion:- Less than 0.1% @ 1kHz
- Power band width:- 10Hz-28KHz
- Slew Rate:- 20v. μ sec.
- 'LED' Output meters:- 28dB + 8dB
- Fitted cannon connectors!
- 19" rack mounting.

Send coupon for brochure and nearest Frunt stockist

Name

Address

To:- Soundout Laboratories Ltd
91, Ewell Road,
Surbiton, Surrey, England.
Telephone 01-399 3392 Telex 8951073/SNDOUT/G



RG Jones

Recording Studios

It's ready! Ripped out, gutted and completely re-purpose built. All you ever looked for in a recording studio, but were never quite able to find. Choice of 24 or 16 track recording. Acoustics - superb! Equipment - space-age! Engineers - the cream!

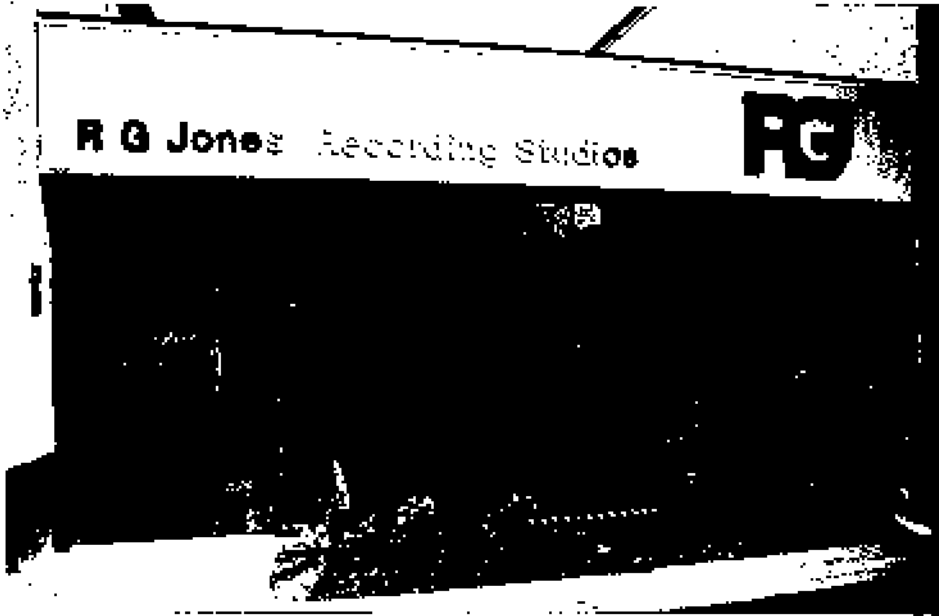
If you're familiar with our world-wide reputation for consistently super quality sound - you really ain't heard nuthin' yet. Bring a 35-piece orchestra and hear the separation we can achieve. Bring a solo cello and listen to the sharpness and clarity we can reproduce. Prices? Amazingly competitive, considering the quality. Ready for your next session? OK - let's Take One!

- Fully air conditioned studio and control room.
- E.M.T. & AKG Echo.
- Steinway 6' 11" model B Grand Piano.
- Rupert Neve Custom 32/16/24 Quadrophonic Console.
- 3M's—M79 Multitrack Recorders.
- Instrument hire arranged.
- Kepex Noise Gates, Allison Research Brain Gain, Neve Stereo Width Units, Neve and Audio Design Limiter Compressors.
- Studer mastering machines.
- Convenient parking and unloading.
- Dolby noise reduction.
- Special effects including Eventide Harmoniser, Marshall Time Modulator, Cooper Time Cube.
- 93M² (1,000 sq. ft.) Recording area.
- JBL 4350 monitor loudspeakers bi-amplified by Amcron Power amplifiers.
- 3 spacious isolation booths including a specially designed Drummer's booth.



R G JONES (Morden) LTD, Beulah Rd, Wimbledon, London, SW19 3SB. Tel: 01-540 9881 (5 Lines) Telex: 8814917

Keeping up with the JONES'



I suppose it's rather inevitable that mention of Wimbledon conjures up visions of tennis and the Wombles, but in music circles it is more likely to mean RG Jones Recording Studios.

This South West suburb of London has been the home of one of the capital's most popular recording set ups for almost 10 years, although RG Jones has been recording sound for near 40. The company was founded by Geoff Jones in the Thirties, who was an enthusiast working from his home in nearby Morden.

Sound recording became very much a family affair in the Jones household, with son Robin taking over the business which eventually transferred to its present premises in Beulah Road, Wimbledon in 1969. With Robin as Managing Director the studios really began to take off and became one of the most popular around.

Still, Robin Jones is a perfectionist and he decided that the premises were in need of a facelift so at the beginning of the year he closed the studios. For seven months the doors remained closed as the whole building was gutted and completely re-designed and re-built. Anyone who has seen the new studios will agree that the wait has been worthwhile.

It really has been a "top to bottom" operation from the smart facade and reception area through to the sympathetic layout and decor of the actual studio and control room which makes for a relaxed atmosphere. Robin explained that closing down the studio for refurbishment was a bit of a risk, but it has been one which

has paid off with a full booking schedule.

If the studio was good before, it is nothing short of superb now. One of the outstanding features of the new set up is the drum booth which is totally separate from the rest of the studio, although the large glass panel can be removed if the drummer feels too isolated from the rest of the studio.

"We are really concerned about getting a good drum sound," said Robin, "and we designed this booth ourselves. We reckoned that with our experience we knew just what we wanted to get the best sound." Adjoining the drum room is another separate room which can be used for either vocals or auxiliary percussion.

The main body of the studio, which is fully air conditioned, is big enough to accommodate a couple of dozen musicians, but still manages to retain a comfortable feel which is so important in a recording situation.

The nerve centre of the whole operation is of course the control room which boasts a line up of hardware second to none. The Rupert Neve custom built recording console is one of the largest ever built by the company. It comprises 32 inputs, 16 groups, 24 track monitoring, four equalised echo circuits, Kepex noise gates, Allison Research brain gain, Neve stereo width units, with Neve and Audio Design limiter compressors.

There are JBL 4350 monitor loudspeakers bi-amplified by Amcron power amps, EMT and AKG echo, 3M's - M79 Multitrack recorders, Studer mastering

A family affair

machines and varispeed, phasing and the usual line up of effects.

The list of people who have used the studio is as long as it is impressive, covering the whole music spectrum. An all day session with a Punk band followed by the Mike Sammes Singers recording nursery rhymes is nothing out of the ordinary at RG Jones and mention must be made of one of the studio's most famous and regular clients, producer Mike Batt. I suppose it's fitting that the producer of so many Wombles' record should record in Wimbledon!

Robin places great store by having a relaxed friendly atmosphere in the studio and this permeates right through the staff and inevitably to the clients. Chief engineer Gerry Kitchingham has been there for 12 years while studio manageress Paula Kannet has been there six.

The RG Jones company is not just limited to the Wimbledon studio, however, they cover just about every aspect of recording and projecting sound. At nearby Mitcham they have a depot, workshops, their own maintenance crew, a hire department and even another small studio.

The studios are ideally situated for anyone wanting to escape the pressures of central London, but still not having to travel too far away, the premises being a mere five minutes from Wimbledon railway station which itself is only 10 minutes from Waterloo.



A view of the studio



MCI 24 TRACK RECORDING

£475 per day

£3000 per week

***Inclusive of accomodation,
good food, tennis & swimming.***

Phone: DORKING 711202.

MEET YOUR ENGINEER

A further insight into the world of recording as we continue with our spotlight on the men behind the desks.

Gerald Kitchingham, RG Jones

Gerald has been working in RG Jones' Wimbledon studio for 12 years and it was his first job after leaving school. During this time he has worked with a wide variety of artists, but mainly pop groups who have recently included Flintlock, the RAH Band, Cleo Laine and Five Panny Piece.

The studio also do jingles and TV work and appropriately have worked with "Wombles" man Mike Batt. The premises have been closed for six months for rebuilding but that has now been completed and the set up is better than ever.

The studio equipment includes EMT and AKG echo, JBL 43/50 monitoring, Amcron power amps, Dolby A system and AKG and Neumann mikes. The new re-designed studio produces very live drum and guitar sounds, with improved strings and brass responses.

Calum Malcolm, Castle Sound

Calum Malcolm was one of the founders of Castle Sound Studios in Edinburgh four and a half years ago. He has been an engineer since the studio opened and has covered the whole spectrum of studio work from backing tracks for BBC television through to radio work and rock bands.

The music ranges from local punk bands through to folk music, and the Bay City Rollers did a lot of work at Castle Sound. The studio is 16 track, the desk is Amek and the mikes used are Neumann and AKG.

Dave Foster, Sabre

"Reels on Wheels" would be a more appropriate description of Dave Foster's set up at Sabre. Sabre is a mobile recording studio set up by Dave only a matter of months ago down at Poole in Dorset; previously he had spent two years at the Riverside Recording Studios in Chiswick working with artists like The Stranglers and other punk bands.

The studio is both 16 and eight track location recording facilities; this includes an Ampex 16 track, and much of the work involves local bands.

Bob Auger, Arrow Sound

Bob Auger began life as an engineer with the BBC 12 years ago before moving over to Manchester-based Granada television. In 1972 he decided to work for himself and set up Indigo Studios where he stayed for two years.

Bob then set up Arrow Sound which has since amalgamated with Indigo to become one of the most important studios in Manchester. Many of the local acts who are gaining national recognition have worked there including The Buzzcocks, Magazine, Skrewdriver and John Cooper-Clarke. Lindisfarne recorded their latest album there and Bob also does some work for the BBC and Granada.

The studio has an MCI 36, with an Ampex MM1200 24 track, AKG B620 reverb, six Audio Design compressors, noise filters, Studer or Crown power amps, Tannoy monitors in Lockwood cabinets, AMS phaser and GH400 desk with spectra view on its eight meter system. Mastering is done on Ampex two track machines.



Gerry Kitchingham (right) behind the desk at RG Jones studios, Wimbledon

Johnnie Haines, Zella Studios

Johnnie Haines has been working at Zella in Birmingham for 14 years as an engineer. The studio is quite a busy one considering it is located in the provinces and Johnnie has done a lot of work with City Boy as well as a wide variety of acts from all parts of the country.

The studio is eight track and has a Soundcraft Series Two desk with master room reverb, compressor and Revox, Monitor and Tannoy HPD's with quad 405 amps. Studio instruments include two grand pianos, Ludwig drum kit, Fender amps, Hammond and Natal congo drums.

They also have a mobile studio, and Zella specialises in a lot of Asian music as well as English.

Bjorn Noreen, EMI Stockholm

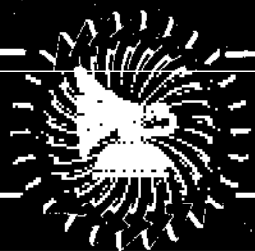
Bjorn Noreen has been working for EMI Stockholm for 25 years starting out as an engineer's assistant before becoming a fully fledged engineer in 1960. His work during that time has encompassed that whole music spectrum from classical to pop and MOR artists.

There are two studios in the EMI building, which is situated in a Stockholm suburb, although Number Two studio is mainly used for overdubbing. They have a 24 track Neve desk plus a 24 track Lyrec and Studer mix down equipment and the usual range of mikes and ancillary equipment.

Apart from many of the top Swedish stars who record there like Bjorn Skeff and Sven Bertil-Taube, the studio attracts many other artists from around Europe.



INDIGO



ARROW



061 832 8457 . 061 833 9417
21-25 Bootle Street, Manchester 2

The Studio in the North



September Sound Studios

- Ampex AG440 stereo machines.
- 16 TRACK LYREC with vari-speed and auto locate.
- Sound techniques desk.
- Eventide Flanger (phaser).
- Neve Stereo limiters/compressors
- EMT echo plate.
- Microphones by: A.K.G., Neumann, Sennheisser, S.T.C., Calrec.
- Beyer headphones.
- Tannoy monitoring.
- Crown amplifiers.
- Graphic equalizers.
- Mobile recording.

38, Knowl Road, Golcar,
Huddersfield.
Tel. (0484) 6558895/6

CUSTOM RECORD PRODUCTION

CASSETTE DUPLICATION



11 Dublin Street, Edinburgh EH1 3PG
031 556 8162

*"Atmosphere at Castle Sound
is essentially young, laid back
and with a professional bite—
just right in fact."*

October 77 Beat Instrumental

16 track recording from £90* a 14 hour day



We've recently had in the studio Toyah, Red Express, The Settlers, Funkshun, Riff Raff, June Tabor, Martin Simpson, Spriguns with Tim Hart, Graeme Taylor, The Outsiders, U.K. Subs, Flying Aces, Tubeway Army, Hamburger, Swell Maps ... Phone Gary for details and we'll make you a star too (well, almost).

*Includes discount. VAT extra.

Spaceward
19 Victoria St,
Cambridge.
(0223) 64263



SMILE

SMILE RECORDING STUDIOS, MANCHESTER
THE NORTH-WEST'S FRIENDLIEST

FROM AUG/SEPT **16 TRACK**
INTRODUCTORY OFFER **£10 per hr.**
ONLY
+ vat & tape

LARGE NEW PREMISES. FREE USE OF INSTRUMENTS
RECORD PRODUCTION. RESIDENT PRODUCER

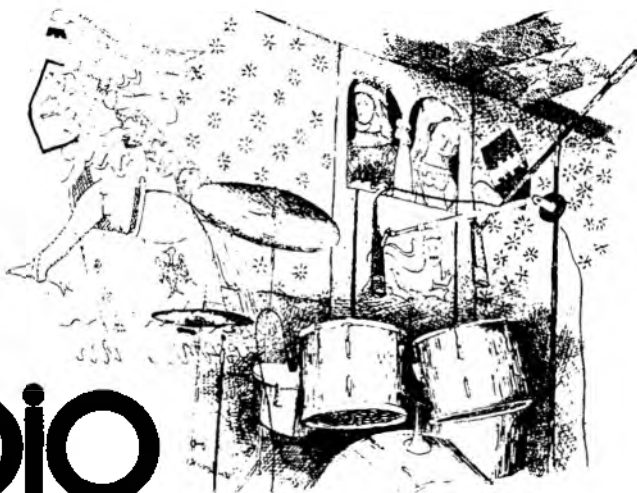
STEVE FOLEY 061-962 4399

HAVE YOU BEEN

HANDLED
WITH CARE AT
QUEST

When you're ready for the best in 8-Track recording
Phone: Luton 414297 (24 hour answering service)
721 WINDMILL ROAD, LUTON, BEDS.

THE REAL JAILHOUSE ROCK STUDIO



300 years ago Gothenburg city prison.
5 years ago converted into a studio.

Full facilities with 24/16 tracks.
MCI, DBX, JBL etc.
One of Scandinavias most
well-equipped studios.

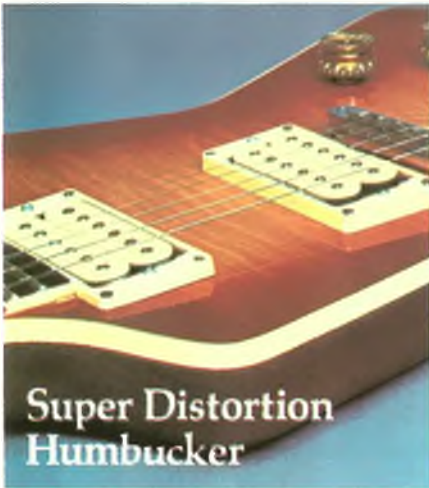
But still the old imprisoning charm.
Only 90 minutes from London.

TAL & TON

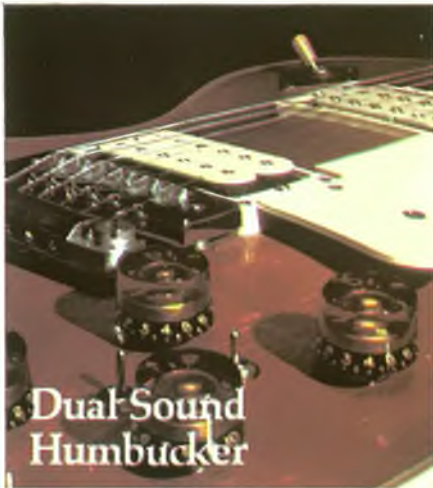
Kungsgatan 5
S-411 19 GOTHENBURG
SWEDEN

TELEPHONE
GOTHENBURG
13 02 05

Don't choose one of these for our sound. Choose one for yours.



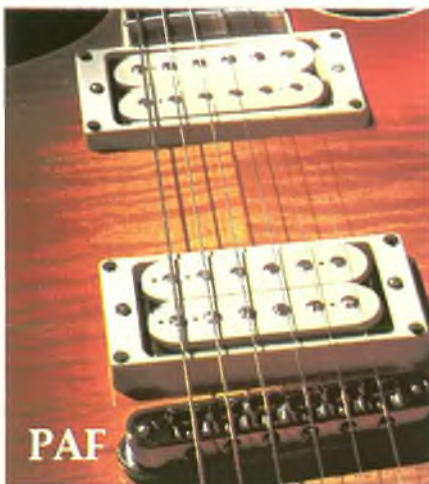
Super Distortion
Humbucker



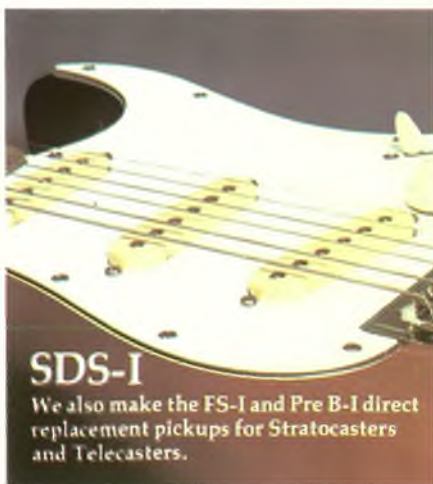
Dual-Sound
Humbucker



Super II

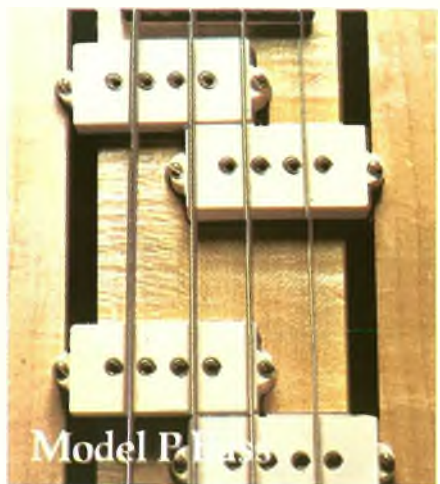


PAF



SDS-I

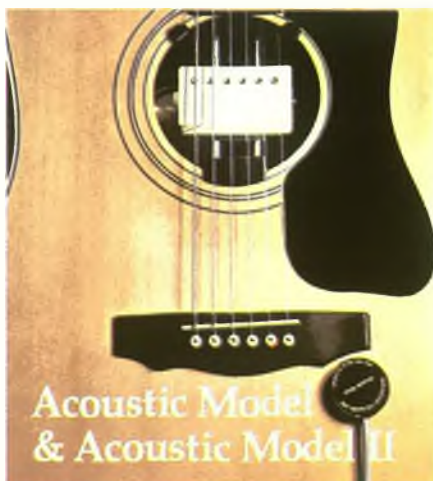
We also make the FS-I and Pre B-I direct
replacement pickups for Stratocasters
and Telecasters.



Model P



Model I Bass



Acoustic Model
& Acoustic Model II

For a full color catalog
on all our fine pickups,
send 75¢. Also, if you'd
like a poster of this ad,
send \$1.00 to cover
postage and handling.



DiMarzio
Musical Instrument Pickups, Inc.

1388 Richmond Terrace
Staten Island, N.Y. 10310
(212) 981-9286



If you could
play this page,
you'd hear what
great pickups
are all about.

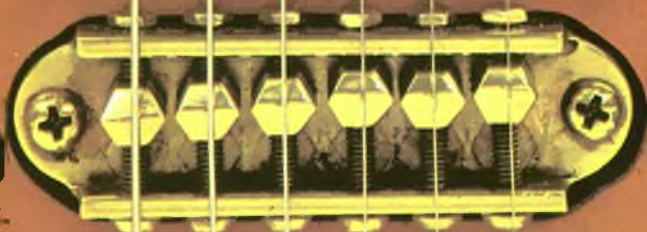


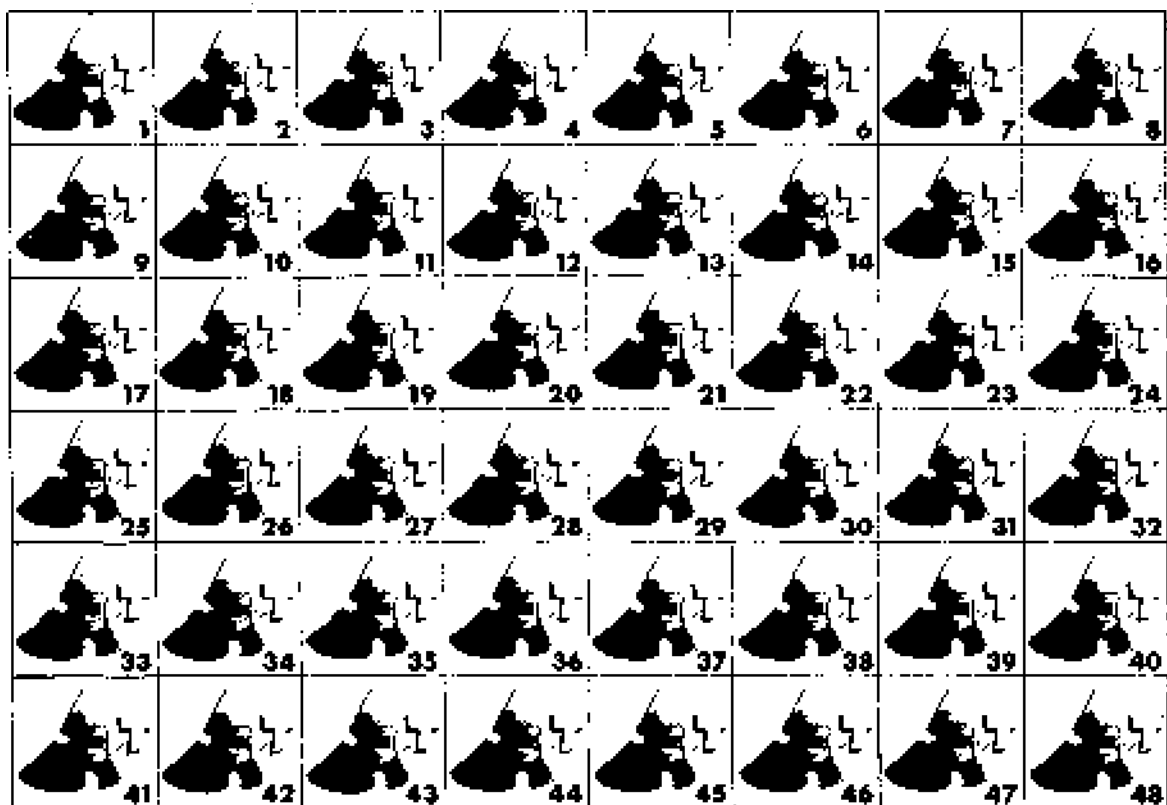
DiMarzio

Musical Instrument Pickups, Inc.

643 Bay St., Staten Island, N.Y. 10304

(212) 981-9286





~Speaks for itself... on 48 Tracks

TRIDENT RECORDING STUDIOS Ltd. 01-734 9901

TELECOMMS 8 Track Studios

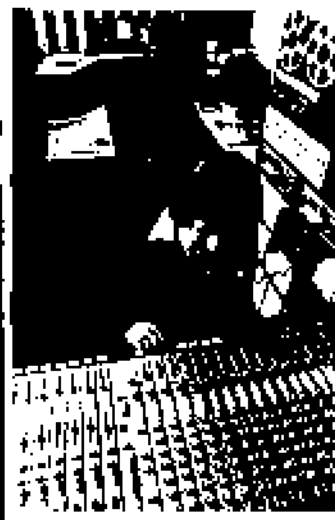
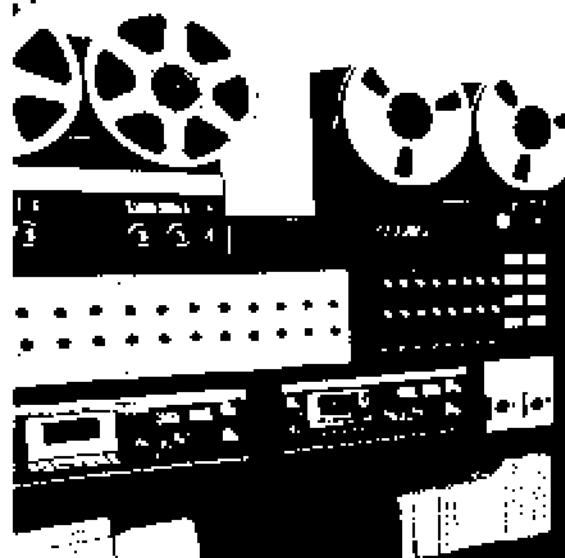
• **£9 per hour**

• **£58 per day**

• Fender Rhodes, Drums, Synthesisers
& Guitars available.

write or telephone for details
189 London Road, North End

**Portsmouth
(0705) 60036**



BIGGEST CHOICE

at the right prices

HIGHEST
P/Ex

plus... the best after-sales service in the business!

GREAT SELECTION OF SHURE MICS
AND MXR EFFECTS

TERMS
MAIL
ORDER
EXPORT

**ABC
MUSIC**

SURREY'S LIVE!est
Music Store

14-16 High Street, Addlestone, Surrey. Tel: Weybridge (0932) 40139/54877

96 High St., Esher, Surrey, Tel: Esher 66436 Pianos 85 High St., Esher, Tel: Esher 66195

BARP Avatar
Amazing guitar synthesiser spec.
try and buy only £1199

maine PA170
Amazing 200 watt PA amp with
graphic and reverb £269 £239
Maine Artist 200w Top £189 £169
Maine Standard
200w Top £189 £149
Maine Combo £269 £250

MM
12 into 2 Stereo mixer
8 into 2 Stereo mixer
AP 360 Slave £280
£220
£195

For the Limited Budget

FAL
50 watt top 4 channel
100 watt top 4 channel
Kestral 100 watt and Reverb £59
Kestral 100 watt and Reverb £77
Kestral 100 watt Bass Combo £89
Merlin 50 watt Bass Combo £169
ASAL 12 into 2 Stereo mixer £183
ALL GUARANTEED
Real value for money

H/H
Huge range from
stock. Some examples:-
MA 100 £130
VS Musician £180
VS Musician Combo £267
VS Bass Combo £145
VS Bass Top £120
DC 212 £200
4 x 12 Bl. £210
2 x 16 Bl. £210

Marshall
TRY THE SUPERB CAT
AND KITTEN SYNTHESISERS
100 watt Master £299 £199
volume valve £329 £100
100 watt valve £299 £250
50 watt valve £245
master volume combo £269 £135
100 watt Mixer PA Amp £269 £135
PA Supabin £499 £150
Always in selection of used Marshall
30 watt
Transistor Combo £499 £150

Carlsbro
Martin 130w PA £189 £165
Stingray Top £176 £159
Stingray Combo £249 £189
Stingray Bass £236 £176
Stingray Bass Combo £285 £229

WURLITZER PIANOS
Backstage 30 £-05 £ 85
Pacer 50w £185 £165
Classic 2x12 50w £267 £225
TNT Bass Combo £235 £199
PA Standard £245 £215
Bass and Automix £399 £299
Artist combo £289 £299

**ALWAYS A SELECTION
OF USED KEYBOARDS
FROM £150.00**

HORG
Micropreset £295 £275
7005 £479 £425
770 £479 £399
Pre-set £628 £445
Polyphonic £897 £695

YAMAHA Guitars
SG2000 £585 £450
SG1600 £485 £375
SG1000 £485 £375
SF 500 £225
SF 1000 £205

SECONDHAND BARGAINS
Marshall 200 W £150
Marshall 100 W £95
H/H IC 100 £99
H/H VS Bass Combo £195
JBL Copy Bins £350
H/H Echo £125
Suni Model T amp £195
GUITARS £178
Les Paul deluxe 1958 £345
Fender Telecaster £195
Fender Telecaster Deluxe £195
Fender Telecaster Custom £199
Fender Telecaster Thin Line £225
This is just a sample of our fantastic stock.
Phone us for details.
COMPLETE ARIA PRO RANGE IN STOCK.

Fender Guitars
Teles from £199
Strats from £220
Precision from £220

**Biggest Selection of used
Bargains**
Always a superb selection of
amps guitars and keyboards from
£30 to £1,000 STOCKS CHANGE
DAILY SO PHONE IN FOR AN
UP TO DATE STOCK CHECK.

MUSIC MAN
1x12 85 Combo £428 £375
2x10 85 Combo £471 £410
2x12 130 Combo £649 £599
65 Head £315 £275
1x15 Cab £267 £215
Stingray Guitar £433 £378
Stingray Bass £433 £378

Celestion



SENIOR DEVELOPMENT ENGINEER FOR MUSIC EQUIPMENT c. £5000

As leading manufacturers of drivers for sound-reinforcement equipment, we have a unique vacancy for a MUSICIAN/ENGINEER capable of strengthening the company's development team.

You should be aged 26-40, male or female, formally qualified in engineering subjects, have experience in the music industry and be a capable musician (preferably guitarist).

In addition to basic development work, you will be required to liaise with customers and demonstrate the product in their equipment. An attractive salary is negotiable and relocation expenses will be paid where appropriate. Apply in confidence, giving full details of career and qualifications to:-

The Managing Director,
ROLA-CELESTION LTD,
Foxhall Road,
Ipswich,
England.
1P3 8JP
(Telephone: 0473-73131)

NEW HAMMOND B-200

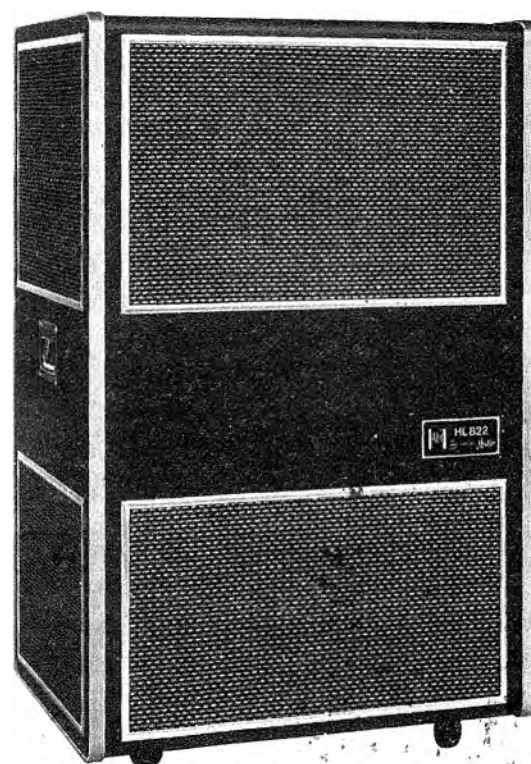
When the show is you-
show off with the Hammond B-200

The B-200 . . . Another reason why most pros won't settle for anything less than a Hammond. It features the famous 'Hammond Sound', copied by many but achieved by none. The B-200 is devoted to professionals who depend on superior performance and great sound.

It's portable with no sacrifice in features or tone of traditional Hammond Tonebar organs. There's also a new, custom high powered Leslie Speaker, the model HL 822, specially created for the B-200. The blending of the best, Hammond and Leslie.

You know what Hammond have done for electronic organs . . . play the B-200 to know what Hammond can do for you.

See your Hammond Dealer - NOW.

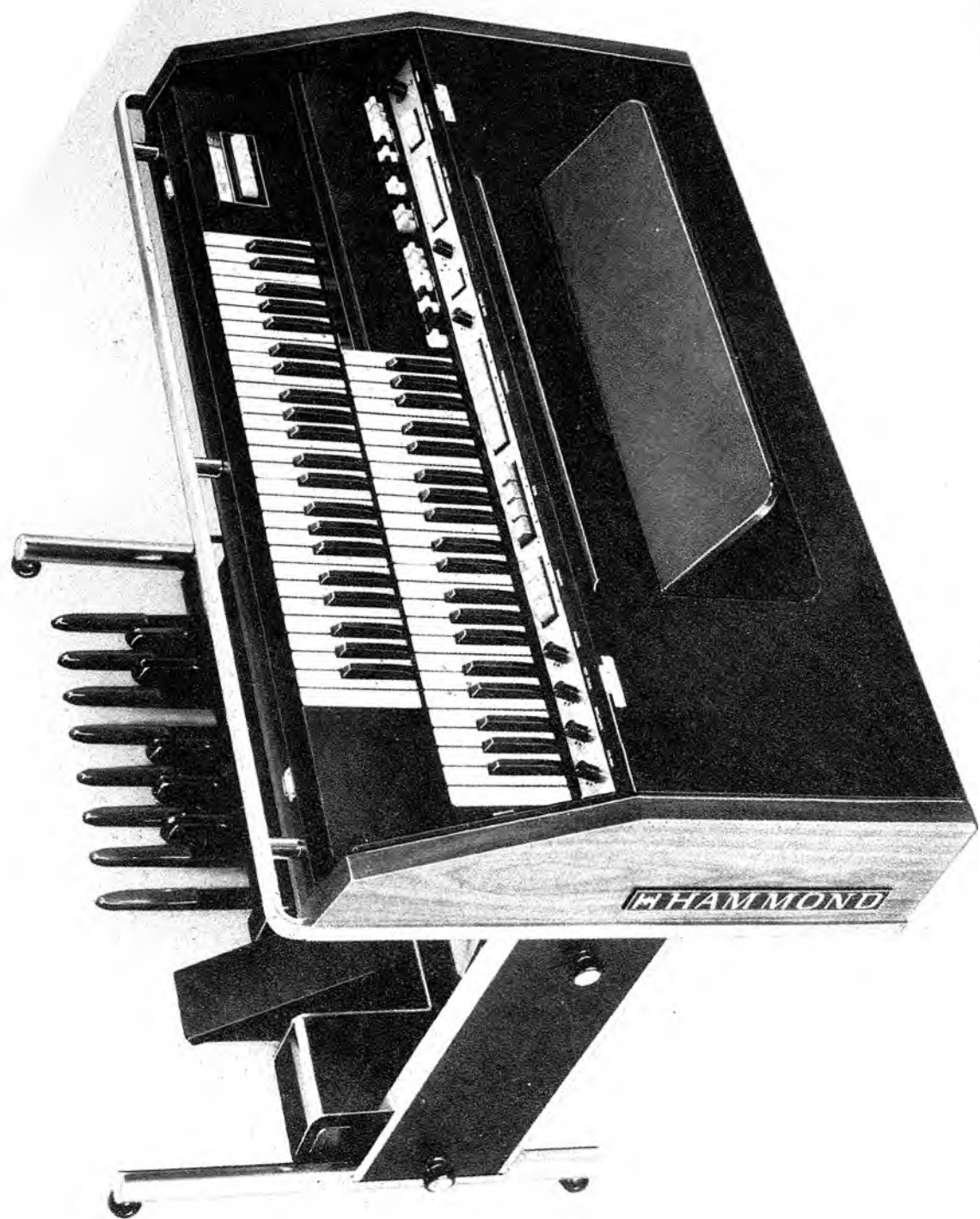


Leslie Speaker model HL822



HAMMOND ORGAN (UK) LIMITED

19 Denbigh Hall, Bletchley, Milton Keynes MK3 7QT
Telephone: Milton Keynes (STD 0908) 79561



**'We only use the finest
loudspeakers in the world'**



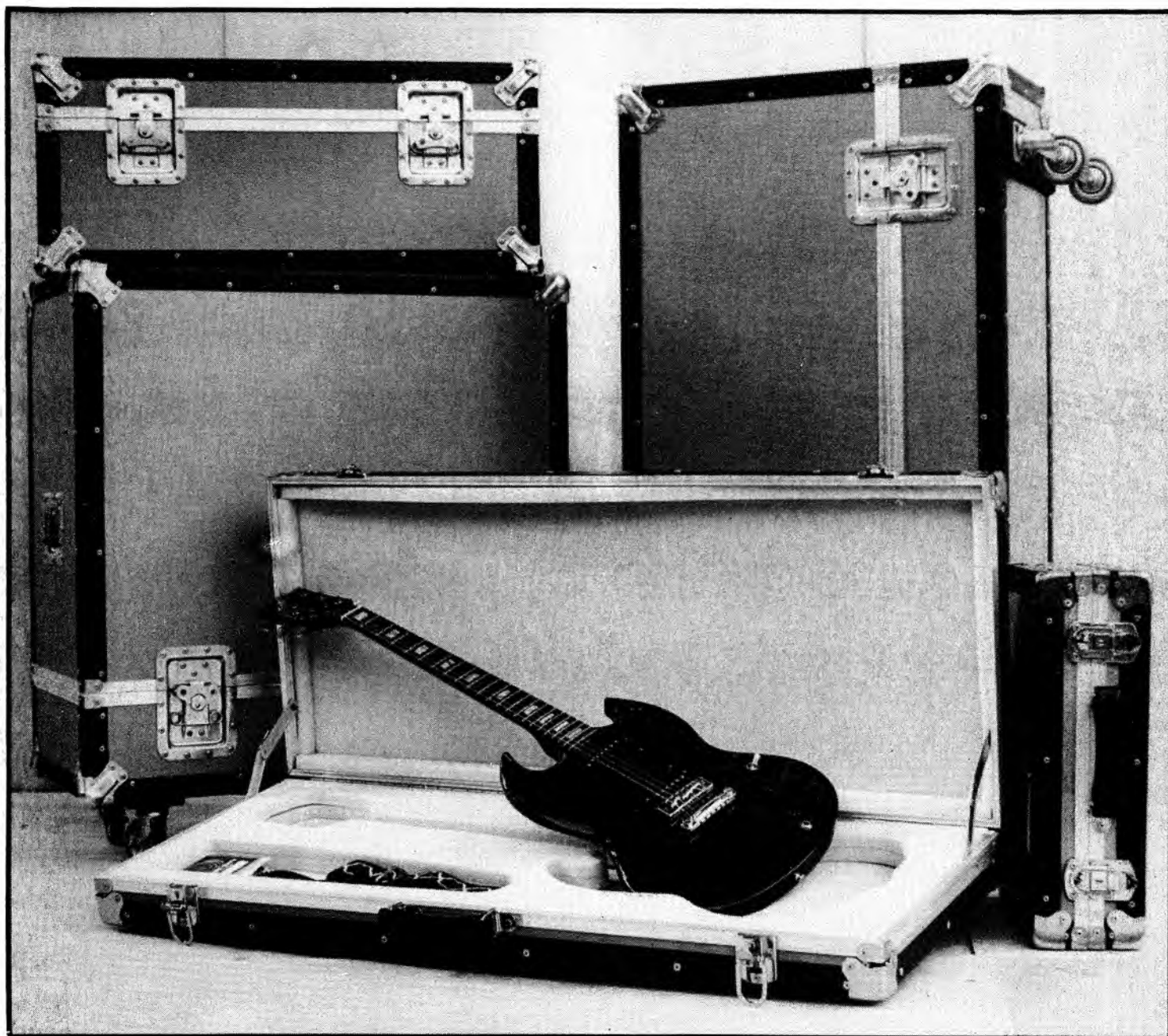
ATC

We wouldn't consider using any other, we're sure you wouldn't either. We have the full range of ATC loudspeakers in stock now, for immediate delivery.

So if you would like to hear more, simply sound us out or call Mick Johnson in London.

Westmill

Westmill Audio Ltd, West Mill Road, Colinton, Edinburgh. Tel: 031-441 7926.
Mick Johnson Music, 277 Putney Bridge Road, London. Tel: 01-788 3491.



A STRONG CASE FOR EQUIPMENT PROTECTION

When you've spent good money on quality equipment, you want it to last a long time. So treat it right—protect it in a top-quality, low cost flight case—a Bluebird case.

Bluebird Flight Cases are manufactured by the company who custom build for the professionals. They're light, rugged, and have tremendous impact absorption.

Bluebird



Flight Cases

So your precious equipment, inside, is protected against all the bumps and knocks of trucking.

Bluebird Flight Cases are carefully designed, good quality cases at prices which musicians can actually afford.

Write to us for a leaflet showing the Bluebird range, with all the details. We've got the cases you want—at surprisingly low prices.

MBE Amplification Ltd., 8 West Mill Road, Colinton, Edinburgh, EH13 0NX.

Feel free to phone 031-441 7474

THE MOST LES



Les Paul's silver anniversary is your golden opportunity.

Fifty years ago Les Paul broke into the music business and began breaking it wide open with his echo chambers, overdubs and hit records. Twenty-five years ago the Gibson Les Paul guitar began establishing its own records, becoming the world's greatest electric guitar. And today, both are still creating Grammy award winning music.

Gibson is honoring its twenty-five year association with Les Paul by introducing the 25th Anniversary Les Paul guitar. It's the kind of guitar they'll be talking about 25 years from now. But you have to order it by December 31st, 1978, because it's a limited edition model. In fact, each guitar will be serialized to make it a one-of-a-kind collector's item.

The 25th Anniversary Les Paul looks like a work of art. Its solid mahogany body has a beautiful maple top—two piece, book-matched and highly figured. For the fastest calibration and per-

fect intonation, Gibson designed the exclusive new fine-tuning tailpiece. There's a lot more brilliant Les Paul sustain because of the brass nut and the solid brass studs mounted under the tuneomatic bridge. We've added more power too with Gibson's new high output Series VII pickups. And there's even more sounds thanks to the coil tap switch that lets you flip from hum-bucking to non-humbucking modes. It's simply the most Les Paul guitar ever.

Invest in an anniversary present that'll mean more and more, year after year. But you must order by December 31st. The 25th Anniversary Les Paul guitar. It's your golden opportunity to play the most Les.

For information on the Anniversary Les Paul guitar and other Gibson instruments, send \$1.50 for postage and handling.



Gibson
Another quality
product from Norlin

7373 N. Cicero Ave., Lincolnwood, Illinois 60466
51 Nantucket Blvd., Scarborough, Ontario Canada



Aria Pro II ELECTRIC GUITARS *PE-1000*

UK distributor: Gigsville Limited, NMT House, Phoenix Way, Cranford Lane, Heston, Middlesex.

USA distributor: Music Distributors, Inc., 3400 Darby Avenue, Charlotte, N.C. 28216.

Canada distributor: Great West Imports Ltd., 788 Beatty Street, Vancouver, B.C.

Canada Music Supply Limited, B660 Jeanne-Mance, Montreal, Quebec.

(ILLUSTRATED PE1000)

(Send 25p for Catalogue)

SPEAKERCHECK

BY KEN DIBBLE

The horn loudspeakers to be reviewed this month are integrated units intended primarily to reproduce the high frequency band right at the upper end of the audio spectrum. Most of these would probably find application in a three-way crossed over system, where 12" or 15" units provide the low frequencies, a mid-range horn or cone unit provides the bite necessary in the middle register, and the components now under consideration would add the crispness and transient response at the very top end. Alternatively, many of these units would also find application in a two-way system, where the bass unit was designed to reproduce part of the mid-range as well — some of the twin cone or dual — concentric 12" units, or high power 10" or even 8" units would be suitable for such an application.

Such a horn would be fed from a suitable crossover network. This would be either a two or three-way network as appropriate and the crossover would be designed to perform four prime functions:—

1. To feed only low frequencies to the bass unit. These would be frequencies below the first crossover point and is termed the 'low pass' filter section of the crossover network.
2. To feed only the middle frequencies to the mid-frequency reproducer. These are the frequencies that lie between the two crossover points and is termed the 'band pass' section.
3. To feed only the upper frequencies to the high frequency or tweeter unit. These are the frequencies above the second, or upper, crossover point and is termed the 'high pass' filter.
4. To ensure that the amplifier is presented with a reasonably matched, reasonably constant load impedance, while all this crossing over is going on.

This is rather different from the action of the more simple high-pass filters discussed last month in conjunction with the general purpose horns, as these only serve to prevent the lower frequencies from being fed to the horn unit and therefore protect it from damage. In the more sophisticated situation now being considered, the objective is to ensure that frequencies that are too high, as well as frequencies that are too low, are prevented from reaching each trans-

ducer unit. Possible crossover points for such a network might be, say 800Hz as the first crossover point and, say, 3.5KHz as the second. The slope rate of the filters would be around 12dB/octave. This would imply that the bass unit received only frequencies below 800Hz, that the high-frequency unit received only frequencies above 3.5KHz and that the mid-range unit received only the range of frequencies between the two, i.e. between 800Hz and 3.5KHz. The actual selection of the crossover points can be critical as became very much apparent in last month's article and will be seen to retain its importance as we discuss the results of the tests that follow.

Besides sound quality, the other area of prime concern in high performance loudspeaker systems must be that of dispersion. A good many ordinary 12" loudspeakers will reproduce sounds right up into the treble register, but the output energy will be contained in a narrow beam of sound that will be lost in the audience. The distribution of high frequency energy over a wide listening area is one of the main problems that face loudspeaker designers and a good deal of the cost of some of the units now under review will be due to design features relating to this particular factor. Even with the general purpose horns, the best dispersion figures measured at 16KHz were about 26° or 28° off axis, representing an included angle of between 52° and 56° while, in the case of some of the specially designed high-frequency horns now under consideration, we find included angles as great as 110°. While on dispersion, it is probably as well to mention that, in the case of the circular horns included this month, it is only necessary to measure the polar response in one plane and, therefore, only one set of results is given in these instances.

I must admit to some concern over two sets of results obtained from these tests. Having been working with loudspeakers for a good many years, I find that it is usually possible to relate the actual sound obtained from a given loudspeaker unit or system to the results obtained under laboratory testing. Certain features emerge on the response plots which explain some particular quirk or characteristic of the loudspeaker's performance. It is in only a very few instances during these tests that I

have been really surprised at the response plots being churned out by the chart recorder at GEC-Hirst and on these occasions, we have stopped the test, checked that all is well with the equipment and with the test sample in the anechoic chamber, and re-run the test. However, in the case of the JBL 2402 (known in the trade as the 'bullet'), I am somewhat confused. Whenever I have heard a PA rig fitted with these units, I have been most impressed by the almost transparent clarity, apparent smoothness of response and freedom from colouration at the top end — and also, by the energy that they seem to be able to handle. Yet, here we are with this unit showing a dangerously high distortion peak in the 10KHz region at just 2w. sine wave input, and a particularly ragged frequency response! On the other hand, another HF horn which I have always liked, the Electro-Voice T350, gave a near perfect set of results. The JBL results are just not compatible with my experience with this unit, especially so in the case of its power handling capability — even allowing for its incredible sensitivity.

The other surprise came with the Vitavox S3 pressure unit coupled to the 4KHz diffraction horn. I had expected great things from this combination but as the results show, was somewhat disappointed — especially as Vitavox are just about the only manufacturers in this country still active in this market. Unfortunately, publication dates did not allow time for consultation with the manufacturers in these two instances, and so perhaps we will come back to these at a later date.

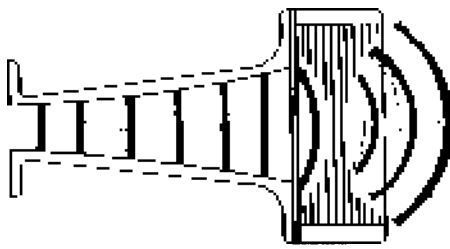
No 'league tables' this time. All the units tested have their individual merits and in any event, the price range covered is so wide that there are hardly two units competing in the same price bracket. I will, however, admit to some surprise at the performance of the little Fane J44 at under £17. I also rather liked the Isophon DKT11/C110/B at just over £24, and was most impressed by all three Electro-Voice units — especially the new ST350/A, which at £70 is a very nice unit at the professional end of the market.

Next month, we shall talk at some length about the workings and uses of acoustic lenses, and review a selection of these mysterious units from the few manufacturers active in this area.

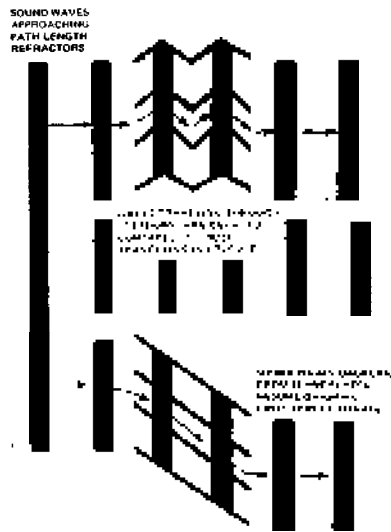


Fig. 2

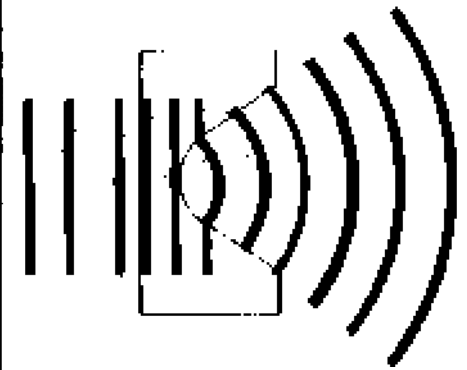
PERFORATED PLATE LENS



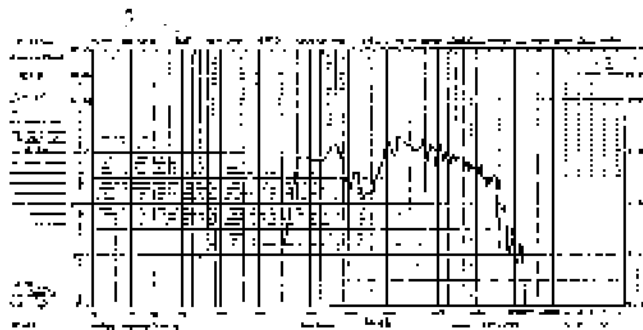
FOLDED & SLANT PLATE LENSES – END VIEW



FOLDED & SLANT PLATE LENSES – TOP VIEW



RCF TW/200
 Approx. dimensions:—
 800mm x 350mm external
 overall depth 530mm
 Retail price incl. VAT:—
 around £200



Parameter	Manufacturers' Rating	Test Result
Power	100 w. unqualified	Just confirmed at equivalent sine power of 10 w. RMS above 500 Hz
Distortion	Not stated	6% @ 10 w. as above
Sensitivity	Not stated	100 dB @ 1 w. @ 2 m. (equivalent to 106 dB @ 1 m.) averaged between 2 KHz & 10 KHz
Resonance	Not stated	850 Hz
Impedance	8 ohms nominal	9.5-21.5 ohms
Recommended c/o Frequency	2 KHz	Confirmed
Frequency response	1.5 KHz-20 KHz unqualified	1.5 KHz-15 KHz @ -8 dB — see graph
Polar response	Not stated	66°V x 70°H @ 2 KHz 50°V x 60°H @ 4 KHz 12°V x 63°H @ 8 KHz 8°V x 30°H @ 16 KHz

at -6 dB

This is a 32" slant-plate horn/lens assembly with an integral pressure unit. It is supplied in two parts, the large, cast alloy, elliptical horn flare and a pressure unit of substantial proportions comes as one sub-assembly, and the slant-plate lens assembly as another. The front flange of the horn flare is specially fitted with mounting holes and a sealing gasket to accommodate the lens assembly. The whole unit is finished in matt black, with a moulded black plastic cover over the pressure unit. The pressure unit can in fact be dis-mounted from the horn flare by means of four bolts, but the throat entry dimensions and bolt spacings are such that neither horn nor pressure unit can reasonably be used with other components without recourse to special, purpose-made

adaptors — which are not commercially available. Although mounting holes are provided in the same flange to which the lens assembly is fitted, care must be taken to ensure that the rear of the unit is also supported by means of a special bracket provided for the purpose.

It can be seen from the results table above that the unit gave a good overall account of itself under test, with good sensitivity figures, a wide frequency response and, although distortion was getting towards the high side, the unit did withstand a re-test at 20 w. sine wave without damage — although distortion increased to about 12% at this level.

Although the frequency response of the pressure unit extends well up the frequency spectrum, the lens assembly does not seem to

maintain the control over radiation that is evident further down the scale. It can be seen that at 16 KHz, dispersion is down to just 60°H x 16°V (included angle) and one should question the usefulness of the upper registers with a unit whose sole "raison d'être" is to control dispersion. Also, in comparison with other units tested, the wavefront shown on the polar plots from which our figures are taken, is somewhat ragged and irregular, although to all intents and purpose, it fulfils its purpose, and the spread of energy in the horizontal plane is far wider than can be expected from a conventional radial horn over most of its useful frequency range — probably to about 10 KHz. A nicely made unit giving very good overall performance at about one third of the cost of its major competition.

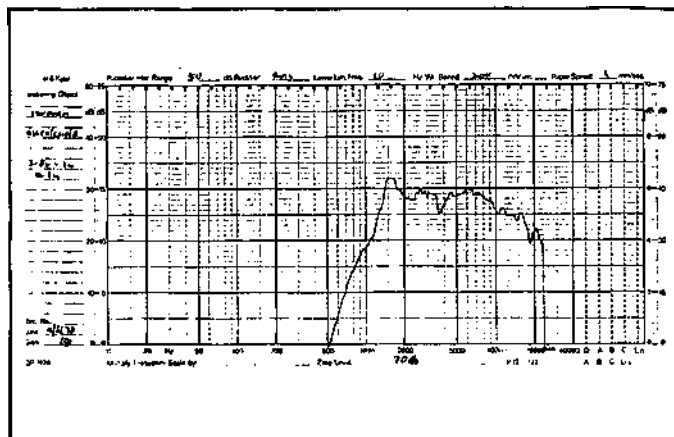
SPEAKERCHECK

ISOPHON DKT11/C110/8

RRP incl. VAT £24.30

Parameter	Manufacturers' Rating	Test Result
Power	Up to 50w DIN above 3KHz	Confirmed at equivalent sine wave power of 5w RMS and at 10w RMS above 2KHz.
Distortion	Not stated.	2% @ 5w RMS & 3% @ 10w RMS
Sensitivity	102dB average unqualified	98dB @ 1w @ 1m averaged between 2KHz & 15KHz.
Resonance	Not stated.	950Hz.
Impedance	8 ohms of nominal	8.5-11 ohms
Recommended c/o frequency	3KHz	3KHz
Frequency response	1KHz-20KHz	2KHz-22KHz @ -12dB
Polar response	Not stated.	65° @ 2KHz 55° @ 4KHz @ -6dB 18° @ 8KHz 20° @ 16KHz

A small, circular, high frequency horn, very nicely made and presented. The horn flare is of cast/fabricated alloy and is both mechanically reinforced and acoustically damped against ringing by six substantial ribs. For a unit of this type it is unusually solidly made with a large magnet assembly. Termination is by means of a pair of solder tags on the back plate and a phase corrected throat is employed. Again, front or rear mounting can be used without disturbing the radiation characteristics.



Like the Isophon mid-range horn reviewed last month, here again we find DIN power ratings in use but, from the results obtained in this particular instance, I would expect to find that this unit would be quite happy with a 50w RMS rated system at the crossover points recommended. As the results table shows, even on a 10w RMS sine wave test, equivalent to 100w of programme material, the distortion level still did not exceed 3%. In fact, the overall performance of this unit is very good indeed, with an adequate sensitivity figure and a particularly smooth and extended frequency response up to 22KHz.

This is a very nice loudspeaker indeed, from both constructional and performance aspects and although primarily designed as a high frequency reproducer for use with three-way loudspeaker systems, it could also be used in conjunction with a 10" or 12" bass unit in a two-way configuration. It is manufactured by a German company having a prestigious reputation on the continent of Europe as manufacturers of hi-fi equipment and it must be appreciated that this high frequency unit is not specifically intended for musical instrument application. A very nice unit indeed and highly recommended, especially at this price.

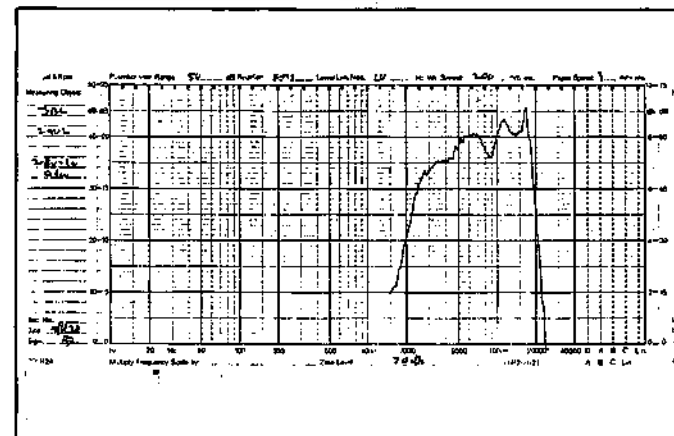
JBL 2402

RRP incl. VAT £97.20

Parameter	Manufacturers' Rating	Test Result
Power	20w continuous programme.	Confirmed at equivalent sine wave power of 2w RMS above 2KHz.
Distortion	Not stated.	3% average, rising to 10% @ between 9KHz & 12KHz @ 2w.
Sensitivity	110db @ 1w @ 1m averaged between 4KHz and 15KHz	109dB @ 1w @ 1m averaged between 4KHz & 20KHz.
Resonance	Not stated.	Below 1KHz.
Impedance	8 ohms nominal	7.5-11 ohms
Recommended c/o frequency	2.5KHz or higher	5KHz at 12dB/oct.
Frequency response	2.5KHz-15KHz Graph given	3KHz-20KHz @ -12dB - see graph
Polar response	40 conical @ 10KHz - graph given	53° @ 4KHz 32° @ 8KHz @ -6dB 20° @ 16KHz

The 2402 is the famous 'bullet' radiator seen atop many a large PA stack to reproduce and disperse the very high frequencies. By far the greater proportion of the substance of this superbly made transducer is the magnet assembly, to the front of which is fitted the familiar 'bullet and ring' horn - cast by the way in solid aluminium. The unit is designed to be mounted from the rear of the baffle panel and termination is by means of a pair of large spring-release terminals.

The actual power handling capability of this unit is not at all clearly defined. From our 10% sine wave tests, it would seem as though the unit just about met the 20w rating on a 2w RMS sine wave test and even then there



was a sharp peak between 9KHz and 12KHz, at which distortion rose to over 10% and for this reason, we did not try to increase the power input for fear of damaging the diaphragm. However, looking at the JBL catalogue, we find a pair of 2402's being used in the 4682 'strongbox' column with a system rating of 600w programme! I would have expected cone break-up due to fatigue in the 9KHz-12KHz region at these power levels although I will accept that distortion over such a narrow band is not likely to become audibly objectionable until very high levels of distortion are present.

The response is decidedly ragged and irregular and I would recommend that this unit is not crossed over below 5KHz for optimum performance. At 109 dB at 1w, the unit is very sensitive indeed and must rate among the most efficient units on the market. One of the manufacturer's great selling points with this product is the dispersion, or polar response, and it certainly complied with the maker's claims in this respect by exhibiting a tightly controlled radiation characteristic. A superbly made piece of engineering that obviously serves its purpose, but with a somewhat confusing set of results under test.

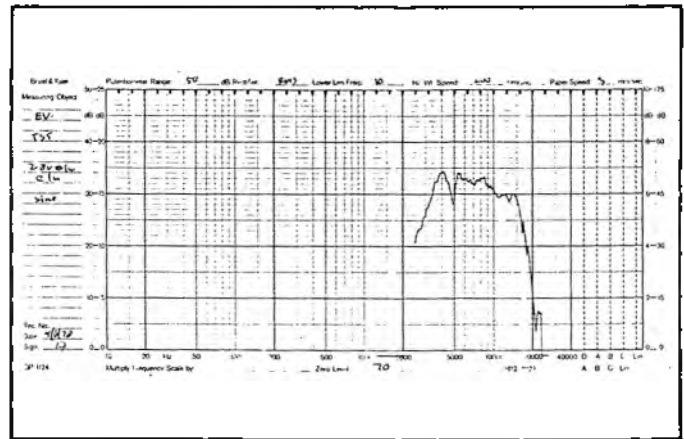
SPEAKERCHECK

ELECTROVOICE T35

RRP incl. VAT £37.80

Parameter	Manufacturers' Rating	Test Result
Power	20w programme 40w peak	Confirmed at equivalent sine wave power of 2w RMS above 3.5KHz
Distortion	Not stated.	3% @ 2w RMS above 5KHz rising to 10% below 5KHz.
Sensitivity	57dB EIA	100dB @ 1w @ 1m averaged between 3KHz & 17KHz
Resonance	Not stated	3KHz
Impedance	8 ohms nominal	7.5-8.5 ohms
Recommended c/o frequency	3.5KHz	5KHz @ 18dB/oct.
Frequency response	3.5KHz-20KHz unqualified	3KHz-17KHz @ -12dB - see graph
Polar response	Not stated.	65°V x 44°H @ 4KHz 44°V x 50°H @ 8KHz 30°V x 30°H @ 16KHz @ -6dB

The T35 is a superbly made, miniature, high-performance tweeter horn intended for use at frequencies above 3.5KHz. It has a special phase corrected throat operating on the diffraction principle which is an EV registered design and termed by them a 'Sonophase' throat. The particularly shallow, superbly cast, alloy



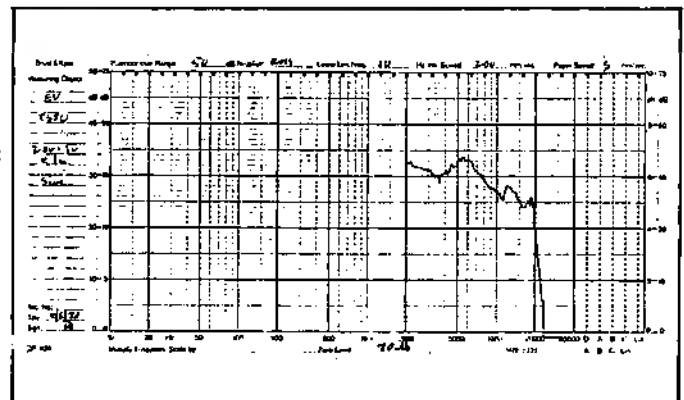
horn flare is anodised and polished on its external surfaces while the inner face is finished matt black, resulting in a very professional looking unit indeed. A large magnet assembly is fitted making the unit surprisingly heavy for its size and termination is by means of a pair of small, colour coded spring release terminals. The T350 is virtually an exact replica of the T35 on a larger scale — and is fitted with a particularly large magnet structure weighing some 7lbs. According to the maker's specifications, it has two and a half times the power handling capability, is several dB more sensitive and has an extended frequency response over the T35. Both horns are intended for similar applications — as a precision reproducer of high frequencies in a top quality two or three way system. The price alone, especially in the case of the T350, will confine application of these units to the professional end of the market.

ELECTROVOICE T350

RRP incl. VAT £81

Parameter	Manufacturers' Rating	Test Result
Power	5w RMS sine wave 50w programme 100w peak	Confirmed at 5w RMS sine wave above 3.5KHz
Distortion	Not stated.	2% @ 5w RMS as above.
Sensitivity	60dB EIA	100dB @ 1w @ 1m averaged between 2KHz & 20KHz
Resonance	Not stated.	1.7KHz
Impedance	8 ohms nominal	7-8 ohms
Recommended c/o frequency	3.5KHz	3.5KHz @ 12dB/oct.
Frequency response	3.5KHz-23KHz unqualified	2KHz-20KHz @ -12dB - see graph
Polar response	Not stated.	44°V x 60°H @ 4KHz 36°V x 52°H @ 8KHz 22°V x 28°H @ 16KHz @ -6dB

The T350 has probably returned the best overall results of all the horns submitted for test in this category. It is very efficient — although not the most efficient — it has almost a straight line frequency response and impedance curve and very low distortion. It easily complied with the makers' power rating and even at 10w sine wave, distortion did not rise above 3%. Although the dispersion at the higher frequencies is not by any means the best



measured, the actual polar plots show good control and forward propagation — often a desirable characteristic for many applications. As the table shows, the T35 also gave a good account of itself and almost equalled the sensitivity figure, but in the more restricted bandwidth over which the measurement was made.

One problem found with the T35, however, is again that of high distortion in the region of the makers' recommended crossover frequency. A study of the impedance curve (not published) shows that again, this is in the resonance region as was the case with the ST350/A from the same manufacturer. Therefore, we have disagreed with the makers' recommendation in this respect and recommended a higher crossover frequency — of at least 5KHz and for preference, at 18dB/oct slope to ensure a rapid cut-off. This applies only to the T35, as the resonant peak and attendant distortion is well down at 1.7KHz on the T350, where it can be disregarded from any practical aspect.

A pair of very nice horns, beautifully made and presented, both returning excellent results under test, is somewhat expensive on the UK market.

The Name To Drop



Namedrop the PA's at these ATC stockists:

A1
Manchester
ABC Music
Surrey
Ace Music
Cleckheaton, West Yorks
Andertons
Guildford, Surrey
Barratts
Manchester
John Beeby's Music Place
North London
Biggles Music
Bristol, Avon
Blackpool Sound Centre
Blackpool, Lancs
Blaze Sound Equipment
Torquay
Bristol Musical
Bristol, Avon
Buzz Music
Hereford
Cambridge Rock
Cambridge
Cannock Music Stop
Cannock, Staffs
Cascade Music
London
Chrom Audio
London
Custom Sound
Crewe, Cheshire
Stephen Delft
London
ESS
Barnet, North London
Bill Greenhalgh
Exeter
John Ham Sound Centre
Swansea, S. Wales
Hamilton Music Centre
Hamilton, Scotland
Hamilton's
Teesside
Holiday Music
Leytonstone, London
C. E. Hudson
Chesterfield & Sheffield
Jim 2
Bournemouth
JSG
Bingley, West Yorks
Kempster's
Swindon, Wilts
Kingfisher
Fleet, Hampshire
Magnum Sound
Wishaw, Scotland
Mary's Music
Accrington, Lancs
McCormacks
Glasgow
Dick Middleton
Guildford, Surrey
Music Circle
Dublin
Music Maker
South Shields, Tyne & Wear
Music Market
Altrincham, Cheshire
Pete Noble
Cardiff, S. Wales
Pandora's Box
Exeter
REW Audio Ltd
London
Rock City Music
Sunderland, Tyne & Wear
Reel Shop
Dudley, Yorks
Salop Music Centre
Shrewsbury, Salops
Sound Advice Installations
Lancs
Sound Services Swindon
Swindon
Soundwave
Romford, Essex
Southside Music
London
Sutton Music Centre
London
Tempo
Faling, London
Wigwam Acoustics
Heywood, Lancs
Woodruffes
Birmingham

ATC is available as 9, 12 and 15 inch speakers, and appears to be the name to drop now.

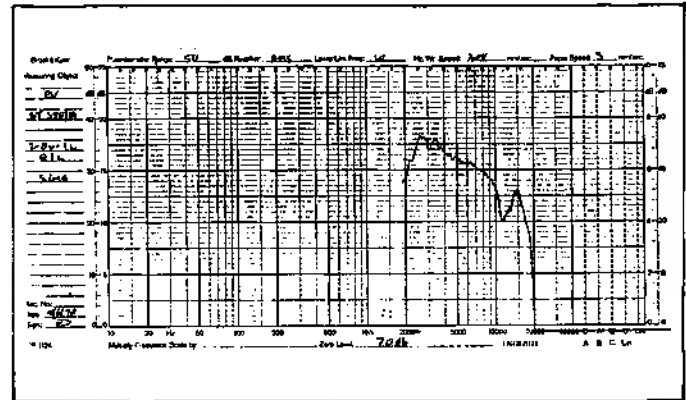
Manufactured by Acoustic Transducer Co. Ltd.
Pier House Laundry, Strand on the Green, London W4.
Telephone: 01-995 3654

Distributed by: Mick Johnson Music
277 Putney Bridge Road, London SW15.
Telephone: 01-788 3491

ELECTROVOICE ST350/A RRP incl. VAT £70.20

Parameter	Manufacturers' Rating	Test Result
Power	8w RMS sine wave above 8KHz. 4w RMS sine wave above 4KHz.	Confirmed as stated.
Distortion	Not stated.	3% @ 4w 5% @ 8w as above
Sensitivity	Graph given showing average sensitivity of 105dB above 2KHz @ 2v RMS input	102dB @ 1w @ 1m averaged between 4KHz & 16KHz
Resonance	Shown on impedance graph at 2.5KHz	3KHz
Impedance	Graph given showing range of 6.5-9 ohms	8-9 ohms
Recommended c/o frequency	3.5KHz or higher	5KHz @ 12dB/oct.
Frequency response	Useful from 3KHz to 16KHz graph given	2KHz-16KHz @ -12dB with 5KHz filter at 12 dB/oct.
Polar response	Graph given showing horizontal dispersion as varying between 90° @ 2KHz & 125° @ 10KHz and vertical varying between 100° @ 2KHz & 50° @ 13KHz.	52°V x 63°H @ 4KHz 37°V x 62°H @ 8KHz 25°V x 55°H @ 16KHz @ -6dB

This is another high frequency horn with a particularly high sensitivity, high order power handling, and wide dispersion at the upper frequencies. It is intended to be used as the high frequency reproducer in a high power three-way loudspeaker system for PA or monitoring



applications, or at reduced power in a two-way system. It is used by the manufacturers in their own Sentry IVA system for which purpose it was originally designed, but is now available as a separate component as well as being fitted to a variety of other EV systems. It is a very nicely made item and basically consists of a cast aluminium/zinc alloy sectoral horn flare coupled to a large integral driver unit. The whole assembly is finished in matt black paint and is of the usual EV standard of workmanship and presentation. Termination is by spring release terminals.

It can be seen from the response curve that the unit has a response peak at about 2.5KHz and that this falls away gradually as frequency rises, with a noticeable dip at about 11KHz. It is suggested that a more useful response would be obtained if the crossover frequency were raised to 5KHz, as this would have the effect of equalising this peak (see last month's review of general-purpose horns).

The sensitivity of 102dB is very good and its outstanding polar response, which shows an included dispersion angle of 110° at 16KHz, is very good indeed for situations in which side dispersions at high frequencies is required.

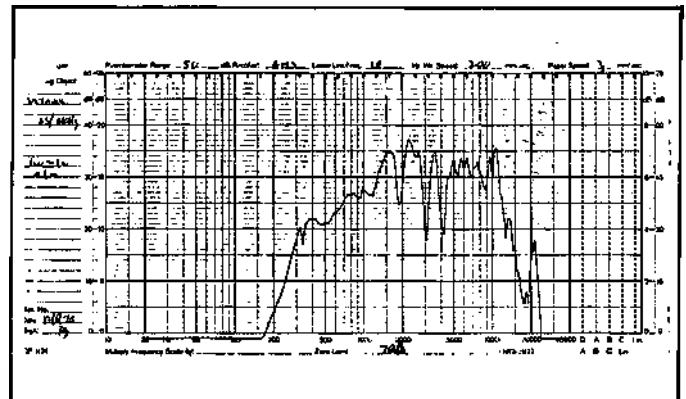
Altogether, a very nice unit. It is expensive but, for my money, is capable of a performance that justifies the expenditure.

VITAVOX S3/4KHz RRP incl. VAT (approx.) £190

Parameter	Manufacturers' Rating	Test Result
Power	100w music, 70w RMS qualified by notes on amplifier ratings etc.	Not confirmed
Distortion	Not stated	12% at equivalent sine wave power of 10w RMS above 4KHz.
Sensitivity	100dB @ 1.6w @ 2m	102dB @ 1w @ 1m averaged between 2KHz and 12KHz See text
Resonance	Not stated	
Impedance	15 ohms @ 400Hz	12.5-25 ohms over useful bandwidth.
Recommended c/o frequency	4KHz	4KHz @ 12dB/oct.
Frequency response	4KHz-15KHz unqualified	2KHz-12KHz @ -12dB - see graph.
Polar response	150°H x 30°V @ 12KHz assuming vertical orientation	64°V x 57°H @ 4KHz 55°V x 40°H @ 8KHz 46°V x 32°H @ 16KHz @ -6dB

Although not strictly an integrated horn, this assembly more nearly qualifies for the category of units now under review than for any of the product groups planned for the future.

The horn flare consists of a long, narrow 'slot' horn working on the diffraction principle, carried within a substantial mounting frame. To the rear of the frame is mounted a threaded ferrule, into which the pressure unit is fitted in the usual way. The horn is intended for use with the long dimension in the vertical plane and is considerably larger than any of the other horns submitted for test. The S3 pressure unit is also of substantial proportions and weight and care must be taken when mounting this assembly to allow for this. The horn flare



is specially coated to prevent ringing and is finished in hammer black. The S3 pressure unit is also finished in hammer black, over a moulded housing. Large screw terminals are provided and the overall standard of manufacture and finish is good. It is a functional piece of engineering with no frills and is certainly suitable for its intended purpose.

The distortion test showed a second harmonic content of between 10% and 15% right through the operating bandwidth at an input power of 10w RMS. Also, the frequency response curve is decidedly ragged and irregular and falls short of the makers' claim. The impedance curve showed a series of resonances which do not appear to be harmonically related, any of which could be the electrical resonance of the system, while the rest are almost certainly due to the fact that the pressure unit is virtually unloaded from an acoustical aspect at frequencies below about 2KHz. On the credit side, the sensitivity is good at 102dB and dispersion control is particularly good.

Similar tests were carried out (not for review purposes) with the S3 coupled to another type of horn and although some improvement resulted due to improved acoustic loading, the general pattern remained much the same. I suspect that the 4KHz horn is, in all probability, an excellent means of coupling a compression drive unit to the air, but that its full potential is not realised due to inherent shortcomings with the S3 unit.

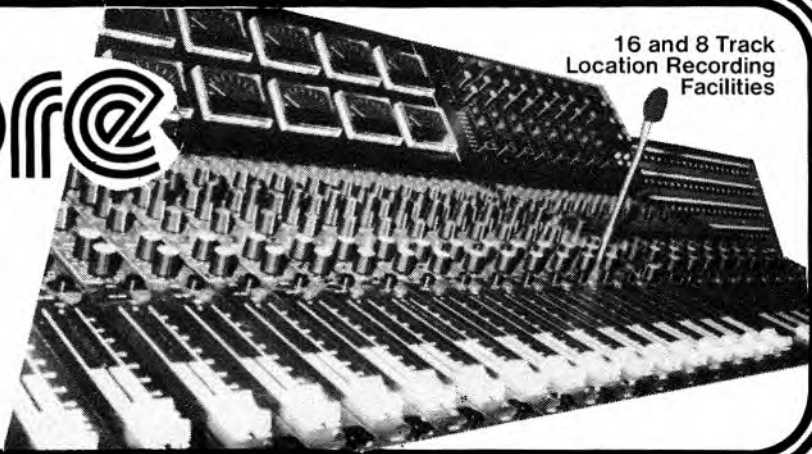


MOBILE RECORDING STUDIO

Contact Dave Foster

55 CLIFF DRIVE · CANFORD CLIFFS
POOLE · DORSET · BH13 7JG
TELEPHONE 0202 708303

16 and 8 Track
Location Recording
Facilities

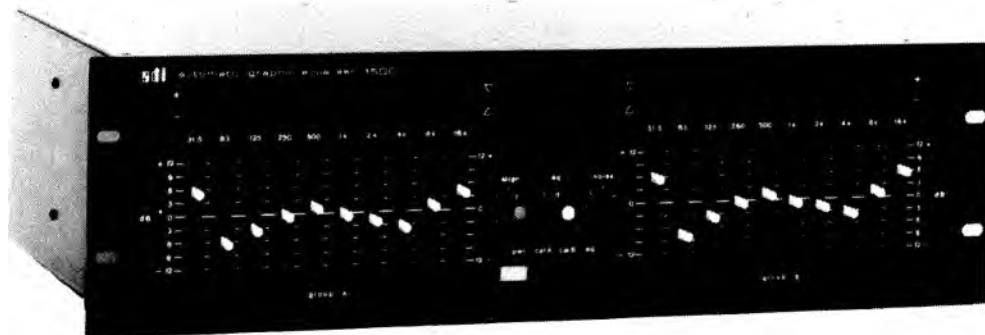


Fylde Acoustic Guitars

*are lovingly made by English craftsmen.
They are built out of the finest possible
solid materials, and we back up our faith
in our craftsmanship by giving each guitar
a lifetime guarantee. If you are an exacting
guitarist who demands the best, you should consider
the instrument that is played by all leading guitarists.*

See and play the Fylde guitar at one of
these carefully chosen dealers
London: Ivor Mairants, 56 Rathbone Place
Birmingham: Woodroffe's, Dale End
Manchester: Forsyth Bros., Deansgate
Leeds: Kitchen's 26 Queen Victoria Street
Newcastle: J.G. Windows, The Central Arcade
Edinburgh: Grant's Home Street
Stevenage: Counterpoint Music, Town Centre
Sudbury Music Centre
or find out more by writing to
Fylde Instruments Ltd., Progress Mill,
Orders Lane, Kirkham, Lancs.
Tel: Kirkham 684987
Export enquiries to Sound out Production,
Surbiton, Surrey.

adi 1500 automatic graphic equaliser



Features

- Fast, simple, and extremely accurate equalisation to $\pm 0.75\text{db}$ using easy-to-read red and green LED indicators
- Economical self-contained Auto-EQ (pat pend.) circuitry
- Double-tuned, minimal phase-shift, monolithic IC saturation-free active filters on standard ISO centres (leaves older "gyrator" design undesirable due to distortion and saturation)
- Low-noise with super-wide dynamic range
- Precision pink-noise generator
- Time-delay circuit for noiseless operation
- Full spectrum controls with $\pm 12\text{dB}$ boost and cut input level controls
- Low-noise, hydraulically-damped, silver-contact slide controls with centre detent
- Highest quality ADI design with rugged 19" rack mount construction

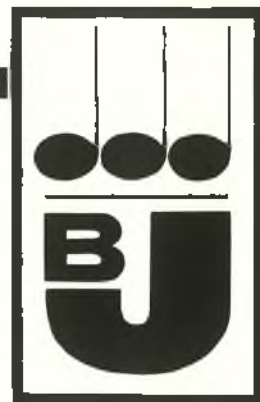
Applications

- Environmental equalisation for flat frequency response
- Utmost in simplicity of operation
- Speediest solution to feedback elimination
- Programme material processing and frequency optimisation
- Programme monitoring and visual indication of feedback frequencies
- Acoustic level balancing
- Elimination of all peripheral test gear

AUDIO DEVELOPMENTS INTERNATIONAL CORP.
644 Emerson St., Palo Alto, CA 94301 USA
tel: (415) 321-3035 telex: 470 464 ADIC UI

B·J NEWS

Brodr Jorgensen (UK) Ltd., Great West Trading Estate, 983 Great West Road, Brentford, Middx. TW8 9DN.
Telephone 01-568 4578 Telex 888941 Chamcom London.



POLYPHONIC PARADISE

Now you can own a polyphonic synthesizer. Roland have created a polyphonic four-voice instrument which sells at a price only made possible by the massive volume of Roland's world-wide production.

Until now instruments such as the new Jupiter 4 have sold for many thousands of pounds and they have been beyond the reach of most working musicians. Even well-paid professional musicians have balked at the idea of spending so much on one instrument.

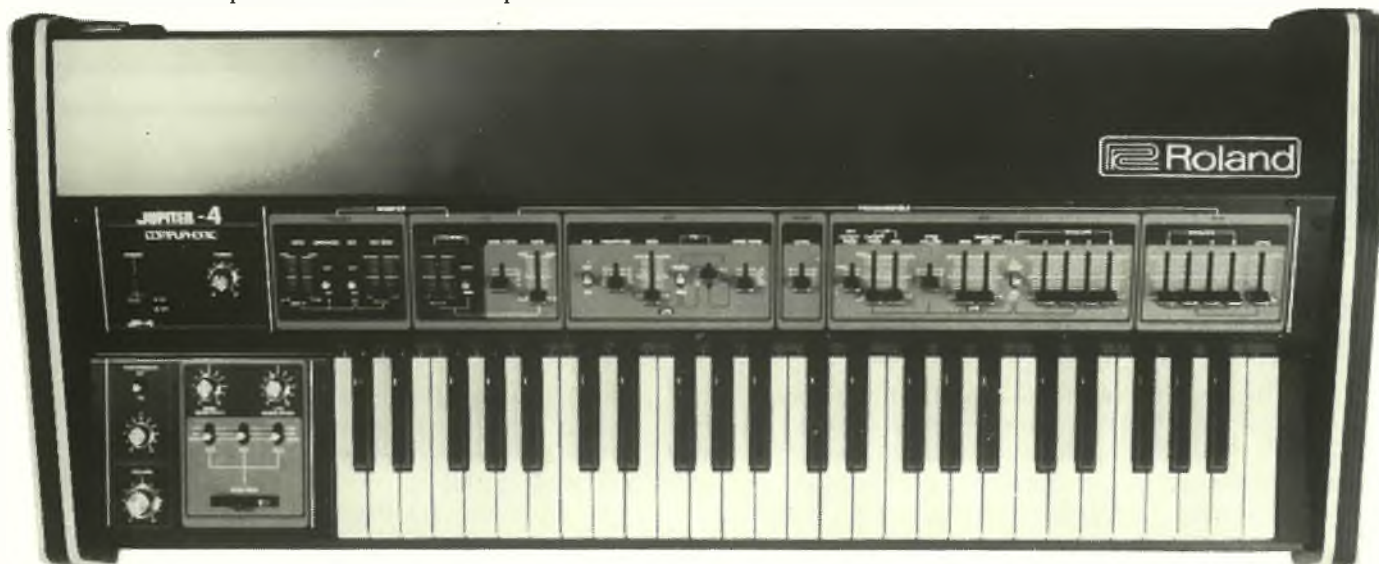
Now Roland have cut the price in half. They have built an entirely new synthesizer which is, in fact, *computer controlled*, and it is this feature that harnesses the difficult art of synthesis into something that is very useable on stage.

Until now keyboard players have been offered two synth options: 1. A pre-set synthesizer with a limited range of sounds that is easy to use on stage. 2. A "patched" synth that makes an infinite variety of sounds but which is virtually impossible to set up between numbers on stage.

Now Roland provide a built in computer which

solves this long-standing puzzle. The player can set up his own sounds and enter them into a built-in memory before he goes on stage. Then he can recall them at a touch of a switch just as he would use a pre-set. The method of using this system is to push the "write" button on the synth once the sound you want has been obtained. This enters that particular "patch" into the memory and up to eight different sounds can be entered in the memory at the same time. If you get bored with the sound you've entered into the memory you can push "write" again and erase one memory with a new sound. Simple isn't it? In addition there are 10 pre-set voices giving a total number of 18 voices. Add to this an arpeggio switch in four different modes which will play independently of what your hand is doing. In addition the arpeggio rate can be controlled directly by their new Computer Rhythm box CR68. Also there are two mono and two poly assign modes, pitch bend control and ensemble effect.

Roland have been solving problems for musicians for the past six years. In doing so they're helping you to be more creative.



THE JUPITER-4

ONLY £1,499

SH... YOU KNOW WHO

Two new major synthesizers have been launched in Britain by Brodr-Jorgensen (UK) Ltd. They are the Roland SH-1 and the Roland SH-7.

Both synths are performance designed allowing the right hand to play whilst the left operates the control panel.

The SH-1 is an amazing new synthesizer at the remarkable selling price of £529. A departure from their normal styling, Roland are using here an injection moulded body which is a complete dream for the service engineer. Jack sockets normally hidden around the back are freely available from above. Add to this the provision of a suboscillator and you have a power and depth normally associated with big synthesizers.

This synth doubles as either a complete synth or an expander module and in addition to audio outputs it also features audio inputs included both for control voltage and gate. This means that the synth will process another instrument, such as a guitar, through its filters and voltage controlled amplifier. You can also play the SH-1 by remote from another synth having a voltage control output. You can also interface any other monophonic or polyphonic keyboard instrument with the SH-1 and that instrument will not only be processed by the SH-1 but will trigger the SH-1's envelope generators.

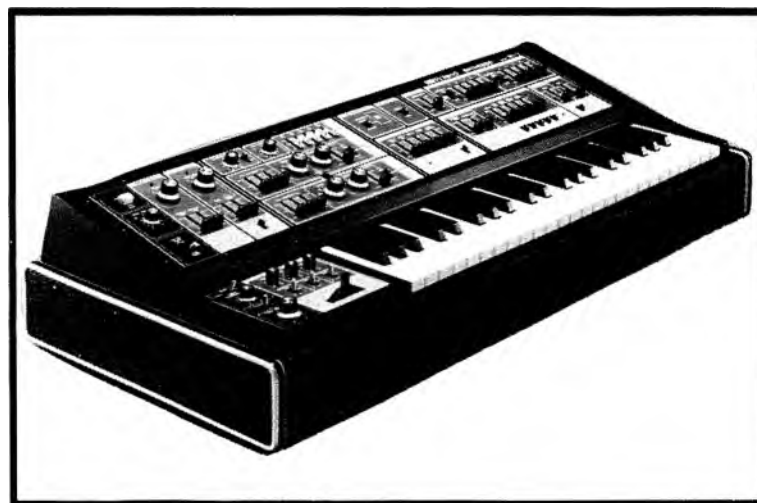
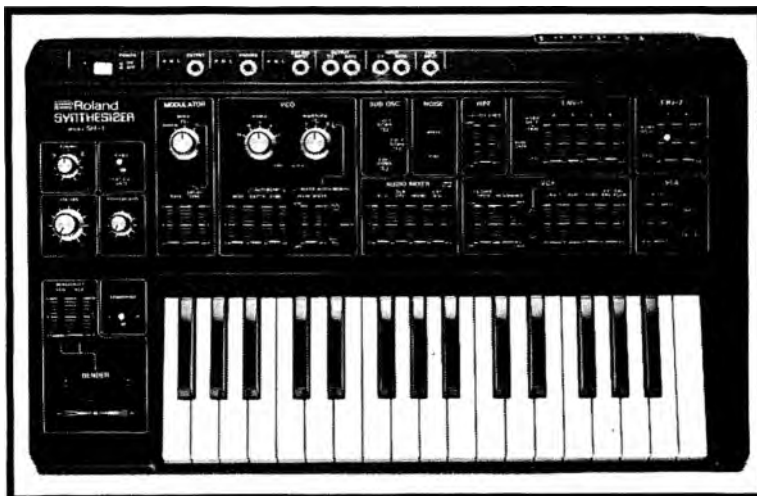
Because of a built-in transpose control the SH-1 has an effective five octave range and a built-in pitch-bender that automatically returns to zero.

The other new synth is the SH-7 and this is the "Big Brother" to the SH-1. As well as the same 24dB "super filter" big sound that is so impressive on the SH-1, the SH-7 has two voltage-controlled oscillators plus a sub-oscillator. Not only is the SH-7's keyboard duo-phonc, but it still sustains both notes after you release the keys.

The patching and interface characteristics of the SH-7 are the same as the SH-1's and the built-in pitch-bender controls the VCA as well as the VCO. Plus you can direct the LFO through

the pitch-bender to control the VCO, VCA and VCF, either separately or together.

These two synthesizers will rapidly change the fact of both "live" and recorded synth music.



AND NOW: A CANNED DRUMMER THAT'S HUMAN!

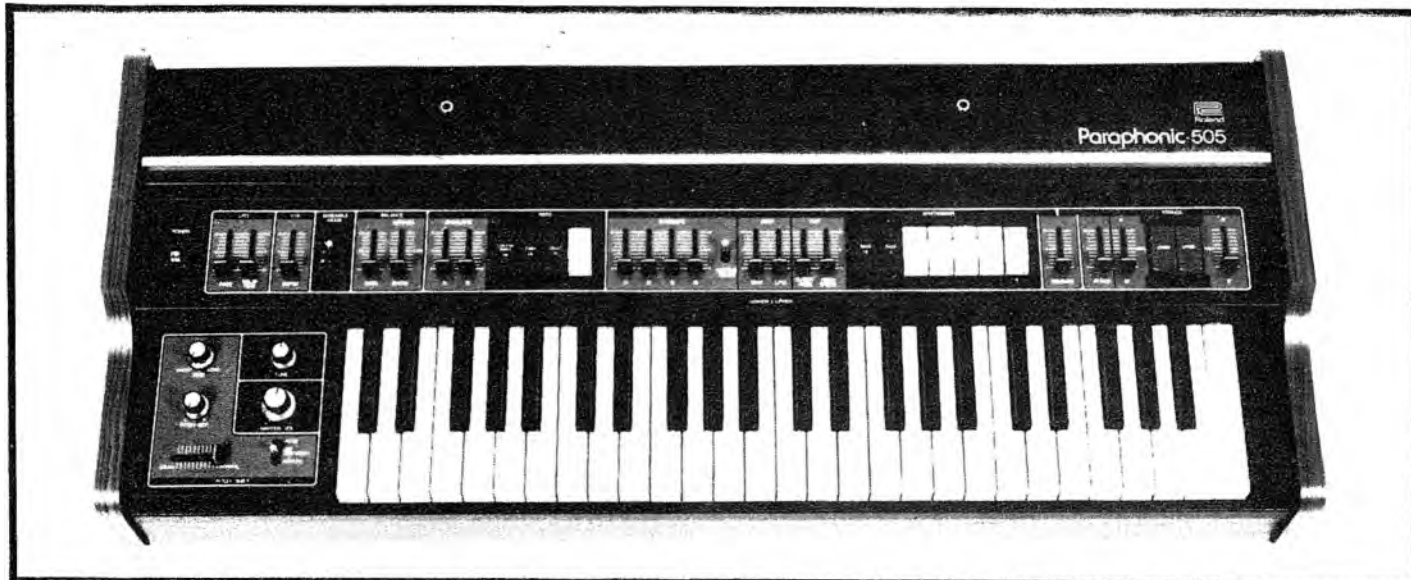
What's been wrong with automatic drum boxes up until now? They have sounded like automatic drum boxes. They have played monotonously and every one very quickly gets bored even with little breaks programmed to happen every few bars. Now ROLAND have come up with the answer.

The answer is called ACCENT. What it actually means is that the automatic rhythm box introduces varying intensity into the rhythm just as any human drummer would. This amount of intensity

(or Accent) is controllable and on a live gig you can increase "accent" to coincide with the way a real live drummer would be playing as he downed more and more pints!

At last the automatic drummer takes on human form in the new Roland Rhythm box called the CR68 (the CR stands for Computer Rhythm) and that's bad news for drummers and good news for the rest of us. It will of course also directly trigger the Jupiter 4 arpeggio rhythm.

THE "MANTOVANI" MACHINE



"And now the Mantovani strings will play . . ."

So there's you with a brand new RS505 from Roland. This is the ultimate in string machines and you can confidently expect it to provide any band or combo with the fullest string section sound imaginable.

It's only in the last few years that musicians have discovered how accurately electronics can produce string sounds. Today a four piece band that sounds like a 30 piece orchestra is not uncommon. Thanks to inventions like Roland string machines and guitar synthesizers. Volume, pitch, sustain and VCF can be controlled by pedals and foot switches.

Interfacing is possible just like its brother the RS 202. Split keyboard gives right or left hand lead line. Thus the illusion of a really big orchestra may be built up from this one small keyboard. One more small step by Roland, a giant step for keyboard players!

The big things about the new Roland 505 is that it is paraphonic. It is, of course, fully polyphonic to play, but paraphonic is a term that refers to the output section. On this instrument five different outputs maybe lead to five different amps. Each output is different. One may be a bass section, one maybe an envelope shape of the sound, one maybe the solo voice section and so on.

NEW ROLAND STAGE PIANO

Below a certain price level all electronic stage pianos are rubbish. Right?

Wrong. Or at least no longer right, but then you weren't to know.

Roland are proud to announce the MP600 stage piano, the world's first stage piano that plays right, feels right and sounds right for under £700 (in fact the suggested selling price in the UK is £639).

Roland are well aware why this price barrier has never been broken by other manufacturers in the world and it's only because of the major worldwide success of the MP700 stage piano that Roland have been able to create this little gem.

Using the same basic technology that provides the MP700 with touch sensitive keys and split outputs, Roland have built a slightly simplified version keeping all the basic ingredients of "playability" but giving the sound just that little twist of individuality that makes the MP600 a piano in it's own right rather than a plain version of big brother. 64 keys, piano soft/bright, clavichord, pitch and decay control plus a six band graphic equaliser complete the specification. plain version of big brother.

Bands will find the MP600's attack sharper, more clearly defined and with musicians now realising that

a piano is still the ideal base for almost all instrumental line-ups the MP600 seems assured of a long and successful life.



“NEW AMPS DESIGNED WITH THE ROCK GUITARIST IN MIND”

BRIAN NUNNEY, B.J

So you play rock 'n' roll guitar and you play it loud. So what else is new? You want it hard and fast and raunchy and the amp better not blow up or else. O.K.?

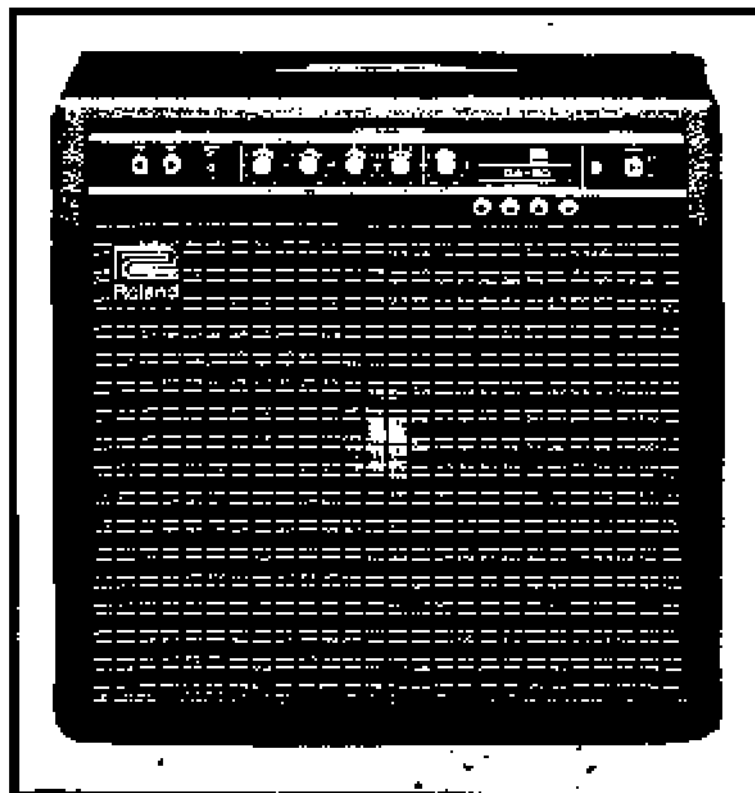
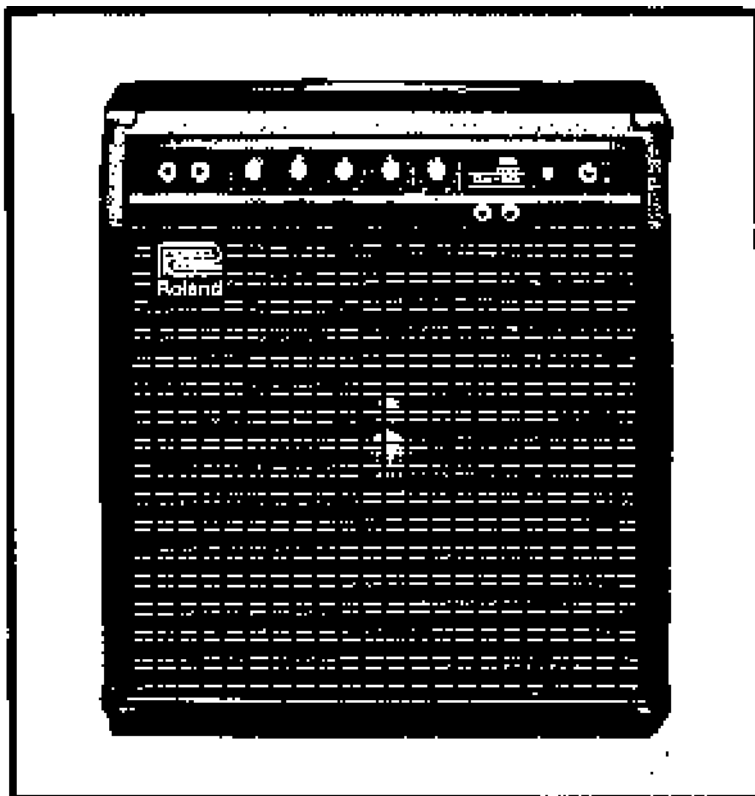
Meet the GA amps. GA stands for Guitar Amp. Simple isn't it? Roland have built them for guitarists.

You must have tried the fantastic JC range of Roland amps. Expensive? Well perhaps not as much as some American stuff. Loud? Yes, very. Sounding clean? Yes, definitely. Sounding raunchy? Weeell, perhaps not.

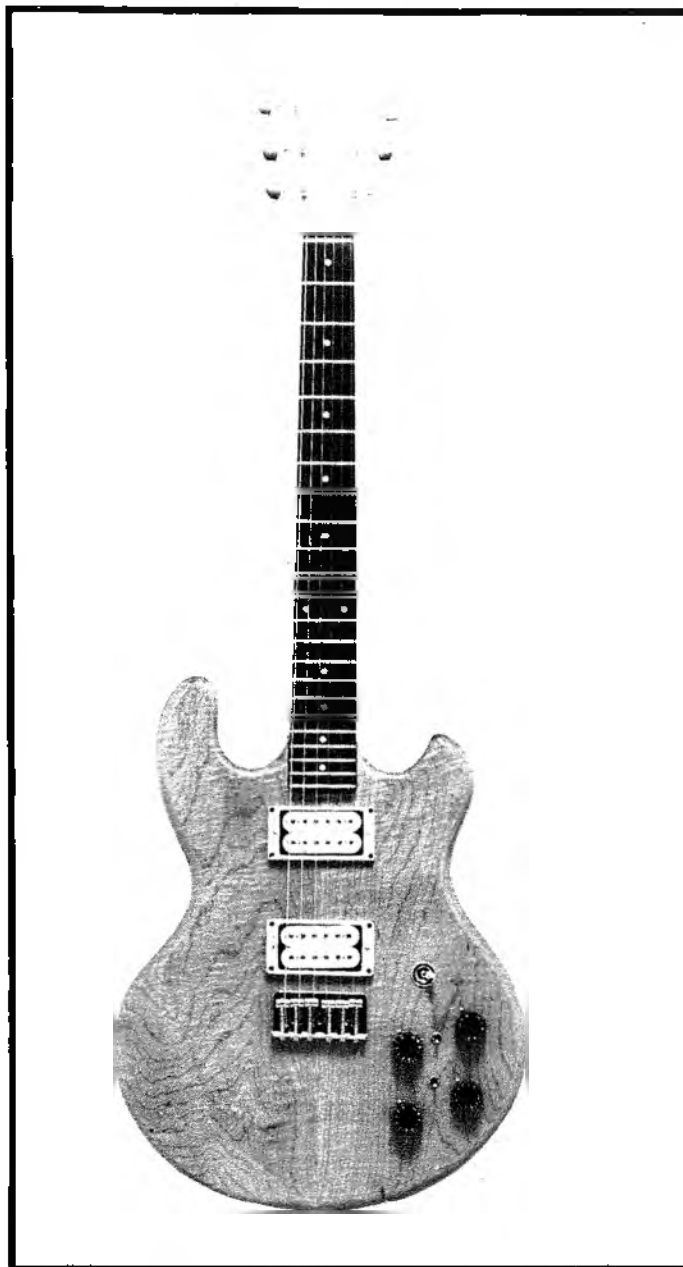
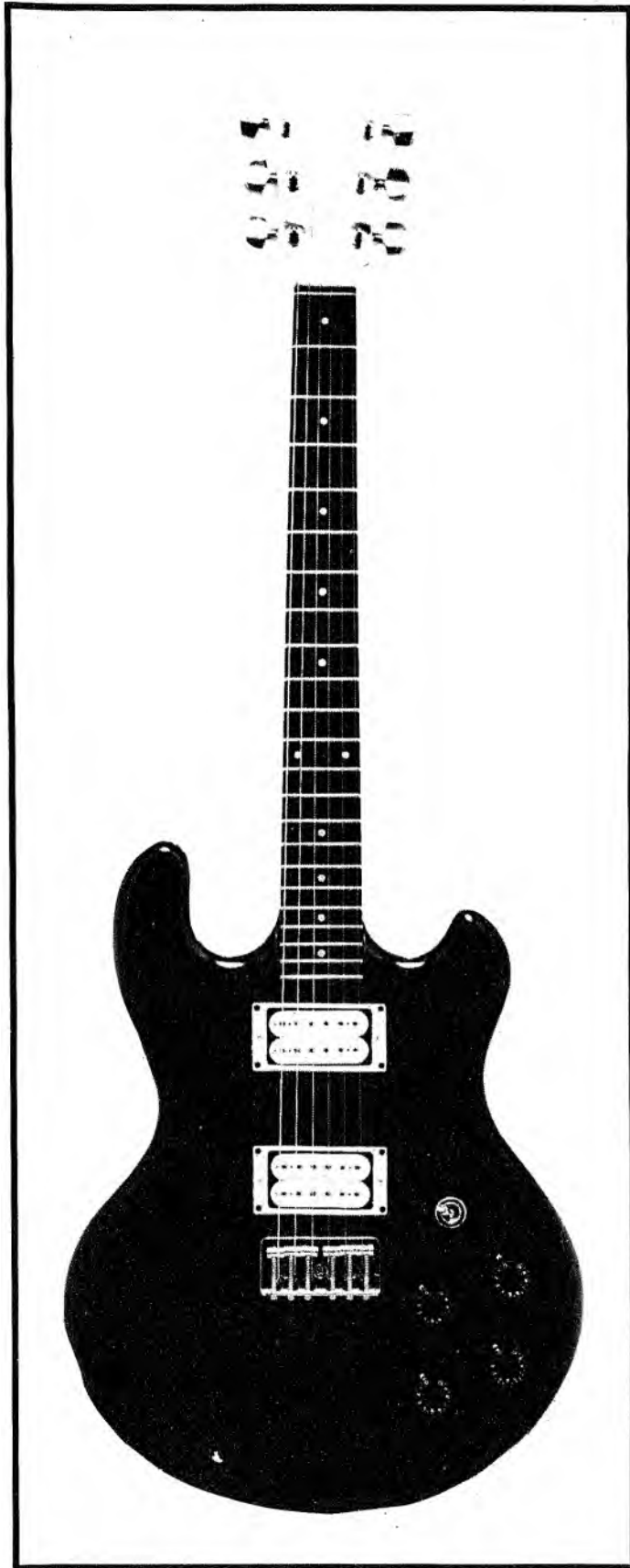
So Roland have built a guitar amp series for rock 'n' roll. You know they understand dirty music too and if that's your game you should know that you can get all the Roland qualities you know about (reliability, quality, volume - boring things until you haven't got them). Plus a sound that will hit you somewhere between your chest and your kneecaps with a sensation that really shouldn't be described in a family paper like this.

To be a bit monotonous we should explain that there are four amps available. They're all combos and they're rated at 30 watts, 50 watts, 60 watts and 120 watts. The suggested retail prices of the standard units are as follows: the GA 30 (yes, you've guessed it, that's 30 watts) sells for a suggested retail price of £187 (pretty good eh?). The 50 watt number is £231, the GA 60 watts gets a bit flashy with a built in graphic and compressor at £345 and the 120 very, very loud machine is £475.

Now if you really want to be something else and drive a T registration GA with a bit of class you can get the 60 and 120 watt versions with Pioneer speakers. If you've never played an amp with Pioneer speakers you haven't lived, so cancel all upcoming gigs whilst you check these out. You never get something for nothing (despite Roland's reputation of the maximum for the minimum) so the jobs with the Pioneers would set you back (£452 (60 watts) and £584 (120)). At this level you should make sure that your friendly music dealer is prepared to be your roadie free of charge for six weeks as part of the bargain; but you'll play like never before. In fact with a GA R+P (as they're called) we'd like to be your manager. For a consideration, of course! And for those who want the existing JC range with Pioneer speakers, they are catered for now too with the JC60 R&P and JC120 R&P.



KRAMER GET HOT WITH DMZ CUSTOM SERIES DIMARZIO



It's incredible but true! In just two years Kramer guitars have become world famous and they've proved that the right combination of metal and wood makes a guitar neck infinitely superior to old-fashioned styles. Now, there's some very special news from Kramer.

Four new models have been launched ALL FITTED WITH DIMARZIO PICK-UPS!

DiMarzio have become as important a name to guitarists as Kramer and since Larry DiMarzio started selling his very special, high output, units four years ago the name has become synonymous with all that is good about loud, searing rock.

Called the DMZ Custom Series, the range includes three guitars and one bass and they offer the ultimate in high output, sustain sounds built into a very high quality instruments.

Another piece of extremely important news from the B-J (UK) camp is that because Kramers have been so successful on a world-wide basis the price in Britain has actually been REDUCED!

How often does that happen these days? It's true, you can now own a new Kramer guitar with it's special metal and wood neck and the option of DiMarzio pick-ups for far less than in the past. If you've never played one, you should.

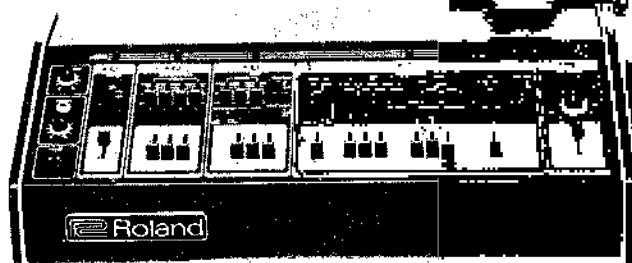
IF YOU WANT TO PRETEND YOU'RE AN ORCHESTRA, USE THE GUITAR SYNTHESIZER

Musicians are realising that the unique Roland Guitar Synthesizer announced last year is a far more versatile instrument than was at first thought.

Coupling up the many sounds available from the instrument with other Roland items like the Space Echo have provided truly monumental effects and it is literally possible for a solo guitarist to sound like a vast string section, or a brass section (or almost anything else) instantly.

The G500 Guitar synth has the peculiar advantage of a PARAPHONIC output capability and it is this flexible system which really allows interesting things to happen. For instance: the bass output of the control unit may be amplified via one amp system, the output of the string section via another and the output of the solo section via a third and so on. One, or all, of these may be treated to effects like echo or digital Chorus (if you haven't heard the Roland chorus "ADT" system, do so) and the effects can be breathtaking. The added facility of having the circuitry now containing a VCO has given even greater depth to the sounds possible from this amazing instrument. Many world famous players are now using the G500 and with it they are interfacing the SH5 or 100-102 expander. In other words amazing though the instrument is in itself it can be used as a base for even greater sounds by normal interfacing.

One wit recently remarked that the G500 could record the entire music to Star Wars in one take and that's not so far from the truth!



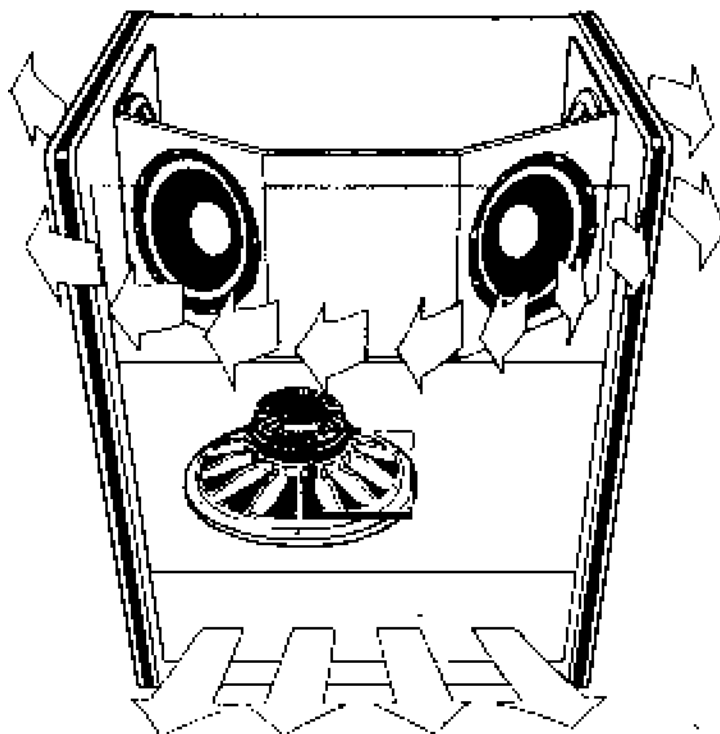
REVO GOES ROUND AND AROUND

Organists have made a startling discovery. Electronic organs prefer **ELECTRONIC TONE CABINETS**. When we say electronic organs we mean *electronic* organs and not the Heath Robinson affairs of tone wheels and valves.

The perfect mate for the old electro-mechanical organ was the old electro-mechanical tone cabinet. No doubt about that. But nearly all organs built today are solid state and they are far happier working with electronic tone cabs than noisy mechanical units.

Take the new Roland VK9 and VK6 portable organs. These superb professional organs were designed to mate perfectly with the fabulous Roland Revo rotary tone cabinet. In this unit speakers don't whirl about in mid-air, but the sound is "rotarised" electronically to produce a real, and deeply satisfying, doppler effect.

Many other brands of electronic organ are today mating more successfully with the Revo than with any other system. It does make sense, however, electronic organs play better through Revo.



IN THE MIDST OF CONFUSION ROLAND EFFECTS A SOLUTION

Effects pedals have come a long way since the first fuzz box crackled onto the scene in the mid-Sixties, but guitarists are often confused by the bewildering display of effects units now on offer. Some are big, some are small and some are good and many are bad. So just how does the careful player decide on which flanger is right? Or which compressor? Now we can reveal the truth, LOOK FOR BOSS.

The new BOSS COMPACT range of effects units is made by Roland and has been specifically designed to provide a well-matched, complementary range of units that will really have a very strong effect on whatever chain they are fitted in to.

When it comes down to it only one thing matters about an effects unit. "HOW much effect does it have?" Boss provides more than you can actually use and when they say "Phase" (for example) you can rely on the fact that the room seems to sway and you begin to feel dizzy if you push a BOSS phase control over to maximum.

In the new BOSS compact range the following units demand your attention: GE6 (six band foot-operated graphic) £52.15, the PHI phaser £49, the ODI Overdriver £89, the SPI, Spectrum Peaker £39, the TWI touch-wah box £43, the CSI, compressor/sustainer £39 and the DSIm distort/sustain at £36.

Don't forget, of course, that the technology used in the Boss range comes from the bigger league stuff that Roland produce: items like the DC10, analog echo at £239, the DC30 (similar) at £305 and, a very useful unit, the DMI, foot-operated delay unit at £158.

Last, but not least, Roland report that two new mixers are on the way (how they fit into this effects section we don't know!). They're the KM60 mixer at £199 and the KM40 mixer at £158.

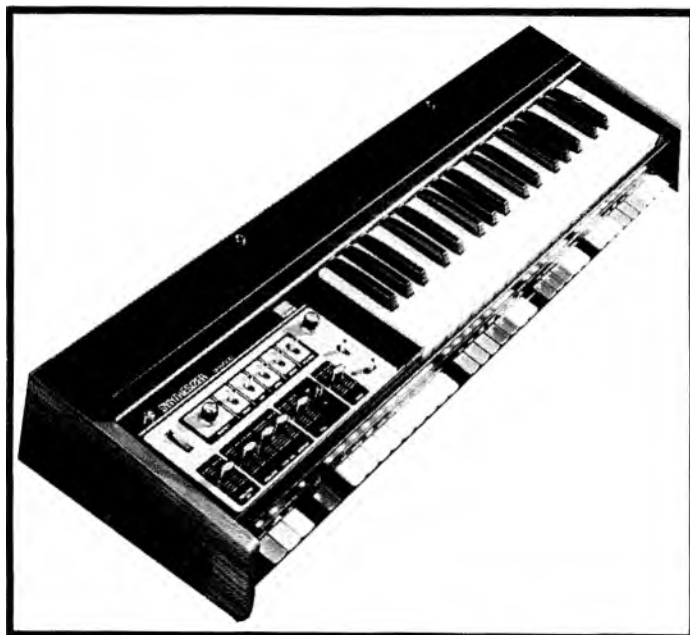


STILL THE WORLD'S MOST POPULAR PRE-SET SYNTH -THE ROLAND SH2000

What can you say to success. It's the argument that silences all criticism. You might not like a band, but a succession of number one albums proves you a minority, you might not like a film but a box-office smash finishes your argument. A similar No.1 is the Roland SH2000 pre-set synth, the most popular pre-set synth in the world! The only difference is that you're likely to agree with everybody that it really is a superbly flexible instrument.

Until Roland introduced the computer-controlled JP-4 (see page 1), the world's keyboard players were faced with the choice of a pre-set or programmable synth. Both had advantages and disadvantages and out of all the confusion in the musical market place came the clear winner, the Roland SH2000.

Hundreds of hit records owe something to the SH2000 and a million live gigs wouldn't have been as good without it. The design that the Roland team got so brilliantly right five years ago remains a world beater and if you want a value-for-money synth that sounds as good as it looks there's still nothing in the world to beat the Roland SH2000.

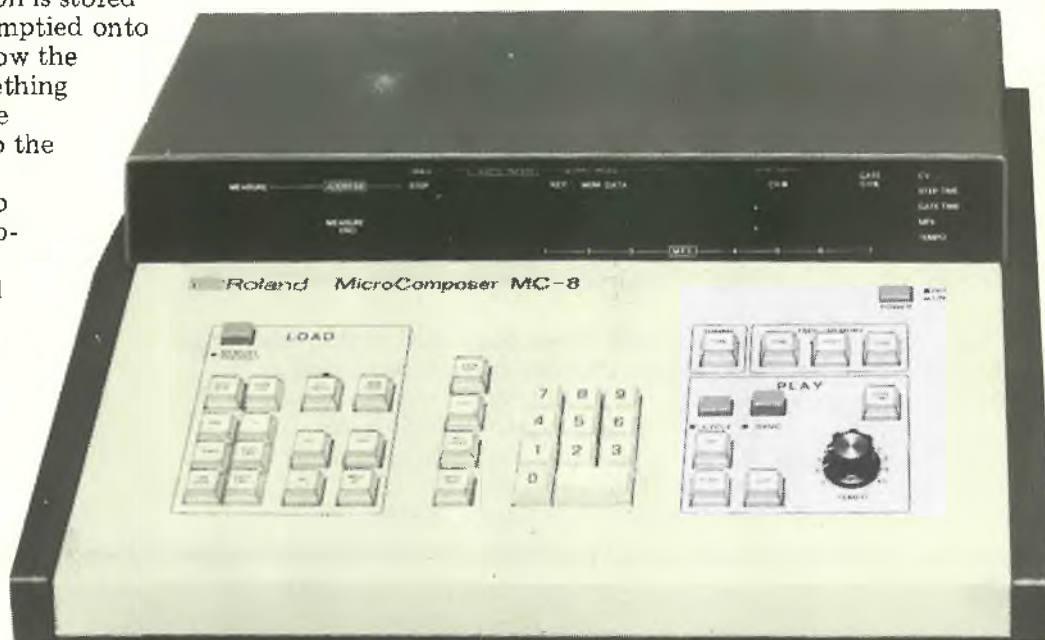


MEANWHILE, IN MUSICAL STATE-OF-THE-ART...

Despite the fact that you can buy a Roland product for under £40 (the new Boss Compact effects pedals), it is important to remember that these little units are merely spin-offs from the technology that Roland are pioneering for their "State-of-the-Art" musical products. The research and development work carried out by Roland into musical computers produces better and less expensive effects pedals. One item that is most certainly "State-of-the-Art" is the Roland Micro-Composer, the world's first and ONLY computer-sequencer for music.

The MC8 allows anybody who can hum a tune to play it using the MC8 and a synthesizer. The Micro-Composer (MC8) allows anyone with a working knowledge of written music to program up to eight melody lines at once. It will then play back those eight lines and allow the composer to change, add, delete any notes as he wishes. The information is stored in a memory which can be emptied onto a normal cassette tape to allow the memory to be used for something else. The information on the cassette can be put back into the memory when required.

Anyone can learn how to "write" music into the Micro-Composer within two days. The composer does not need to be fluent in musical theory and this device is now being used by composers the world over eliminating the need for instrumental technique (and in some instances session men).



A NEW, VERY POWERFUL AMP FROM ROLAND



If you need very high power coupled with reliability you need look no further. Roland have announced a brand new amp head to fill just this need. You will already know that when Roland say "100 watts" that means quite a bit more and their 100 watt amps will blast away all of the competition. So when we tell you that there's a new JC-200A WATT HEAD you'll know that it really is a powerful

beast!

The new amp contains all the features that have made the JC range so popular with a large number of musicians playing widely divergent music.

Bands like Genesis have majored on the JC amps and the new 200A head has been launched to provide that extra power for the large gig.

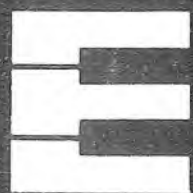
THE ELKA X705 PORTABLE...



TAKE IT AWAY!



For further details contact your nearest dealer or Nando Fabi at



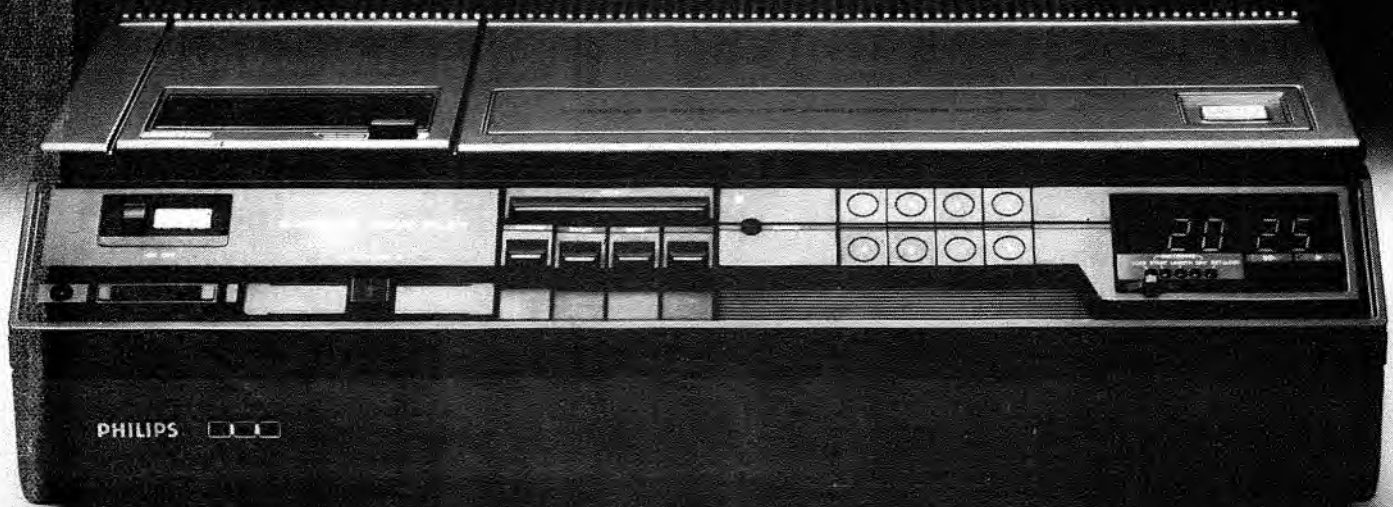
ELKA-ORLA
(U.K.) LTD

19 BLUEBRIDGE INDUSTRIAL ESTATE,
HALSTEAD, ESSEX TEL: 07874 5325/6





The Philips VCR. It lends a whole new meaning to the demo-tape.



The Philips N1700 2½ hour Video Cassette Recorder.

The more ambitious you are, the keener you'll be to improve. The Philips N1700 can help in two ways.

First, it gives you a chance to see your own act. Used with the new V100 mono video camera, with built-in microphone, it will record your whole performance so you can watch yourselves to see how you can improve.

When you're really happy with your act, you can send a VCR to recording companies.

That way, they can appreciate the full impact of your music and your staging.

Our new range of low-cost LVC Video Cassettes offers you up to 2½ hours recording time. And you can play them back whenever you like or, if you wish, they can be erased and re-used just like audio cassettes.

Of course, you can use the Philips VCR for pleasure as well as business. A unique three-day clock allows you to set the machine precisely to record programmes from your television while you're away and the set is switched off.

And because it can receive the three channels independently of your TV set, the N1700 will record one programme while you watch another.

The Philips N1700 is available now from your local VCR dealer. Call in, and he'll be pleased to play you a demo-cassette that will show you just what the N1700 could do for yours.



Simply years ahead

IN BRIEF IN BRIEF

**On Test: Philips V100 Camera
Rec. Retail Price — £450**

This review is really an extension of the feature we carried two issues ago on the use of video in rock music.

At that time one of the video machines reviewed was the new Philips N1700 2½ hour video cassette recorder. Despite the fact that this machine is sold primarily for domestic use — sitting beside televisions recording programmes whilst you are out or whilst you are watching another channel — it is important to realise that there are several other uses to which this versatile machine can be put.

This video camera designed by Philips for use with VCR machines, will become available later this year. It is relatively inexpensive and offers black and white pictures with perfectly synchronised sound which may be recorded directly onto a video cassette in the N1700.

As the cassette recorder cannot really be called portable (it is possible to carry it about rather like a television) Philips sensibly provide a very long cable with the V100 camera and this does offer the camera operator about 30 feet of movement from the video machine.

The uses of such a system for the musician are obvious. There is no better way for any performer to judge his or her

performance than by watching it on television. The differences that creep into an act once it can be viewed objectively are immediately noticeable and if you are in the fortunate position of being able to consider using such machinery you will find it almost invaluable in the aid it brings you.

The camera has a built in microphone which is extremely sensitive and of high quality but the automatic gain control circuit that is built into the camera produces some distortion of sound perspective and this brings a rather misleading sound quality to live music recording.

Unlike a normal "photographic" camera the video camera can see very well in quite low light conditions. The Philips V100 is particularly good at this and even in quite dingy venues it would be able to make a reasonable film. The camera is extremely simple to operate, requiring only fine focus adjustment and some aperture control. A zoom lens is provided which does allow a considerable degree of picture "cropping". After 15 minutes or so the camera does become a little heavy but using any sort of video camera over long periods is a technique that has to be learned.

The camera does not carry any remote control functions for controlling the tape in the machine, but I would have liked to have seen some sort of picture-break switch on the camera which would have allowed a clean start and finish to recordings.

The camera is ridiculously simple to hook up to the VTR, requiring only the

addition of a small power pack which converts the electrical output of the camera to the UHF transmission which, via a cable provided, feeds directly into the aerial socket of the video cassette recorder. One of the VCR's 8 channels is tuned to pick up this transmission and — bingo — you are recording!

Picture definition is excellent with this camera. Given a reasonable light and a subject not too demanding it would be difficult to distinguish between a recording made using this camera and a recording using a professional black and white camera, on the average household TV.

If the idea of performing, either singly or with your band, in front of your own video camera fills you with horror at your own egotism, you must remember just how much you can learn from watching yourself. Very quickly the novelty of just watching yourself on tape fades and it is possible to become very constructive and for the first time observe your performance objectively.

In Britain this Autumn, high street rental shops are beginning to offer video cassette recorders on rental terms. This brings the usage of such machines into the reach of many more homes and, consequently, into the reach of many more musicians. The Philips camera built to operate successfully with their machine is an inexpensive and extremely worthwhile tool. It may safely be claimed as a necessary tool for any performer's business and it really does make excellent home movies.

Ray Hammond

**Full range of equipment by PHILIPS (1700
2 hour machine) SONY (BETAMAX) JVC (VHS)
NATIONAL PANASONIC etc., backed-up with
a first-class advice and after-sales service.**



HIRE IT

Video recording, Play-
back & Projection
equipment.

Video recording is now one of the most advanced and economical audio visual information aids available, with applications virtually unlimited.

For the training of staff, students, for use at business conferences or seminars; public meetings, clubs, committees etc. or for use in industry and commerce.

Full range of video equipment for hire for any period.

**Sony U-Matic Systems
Philips Video Recorders
Large Screen Projection Units
Camera and Accessories
Fully equipped Studio available**

Suppliers to Ministry of Defence, Home Office, British Airways, Norwich Union, Fisons, Ciba-Geigy, Anglia Television etc.

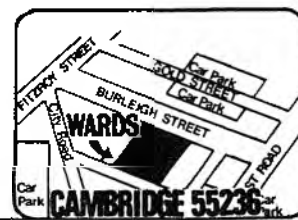
Whatever your requirements for recorded sound & visual impact consult —



WARDS

10 YEARS
EXPERIENCE
IN VIDEO
SYSTEMS

BURLEIGH STREET, CAMBRIDGE. Tel: 55236



**IF YOU MISSED IT
ON B.B.C. or I.T.V.
SEE IT ON VHS
VIDEO HOME SYSTEM**

**WE SELL
RENT
LEASE
SERVICE
REPAIR**

**LEADING MAKES OF VIDEO EQUIPMENT
YOU CAN RECORD T.V. PERFORMANCES* TO
HELP YOU TO COMPARE WITH OTHERS AND
IMPROVE YOUR OWN PERFORMANCE. AS A
BONUS, YOU CAN ENJOY REPLAYING YOUR
FAVOURITE TV PROGRAMS, IN COLOUR OR
BLACK AND WHITE. WHY NOT WRITE OR
TELEPHONE FOR DETAILS, WITHOUT
OBLIGATION.**

** RECORDING AND PLAYBACK OF MATERIAL
MAY REQUIRE CONSENT. SEE COPYRIGHT
ACT 1956 AND THE PERFORMERS
PROTECTION ACT 1958-1972.*



**10, MALMO CLOSE, TYNE TUNNEL TRADING
EST., NORTH SHIELDS, TYNE AND WEAR.
TEL: 089-45-79121.**

Santana Knows!

If he doesn't, who does?

Carlos Santana has brought the Latin sound to more people than anyone else in history

So, when this Giant of Music steps out it must be with top equipment — especially his Latin percussion instruments

The traveling this band does is considerable and the instruments he uses must not only sound the best, they must hold up

Do as this leader does, and

Trust the leader*

LATIN PERCUSSION

P.O. BOX 88 • DEPT RW PALISADES PARK, N.J. 07650



Distributed by CLEARSTONE MUSICAL INSTRUMENTS LTD,
7 DAWSON ROAD MOUNT FARM,
MILTON KEYNES MK1 1LH



Send 50¢ for catalog.

**AT LAST, A BASS DESIGNED
WITH YOUR BODY
IN MIND.**

Our NS-1 Bass Guitar is a hand crafted, limited production instrument, with a sculpted, contoured body for maximum comfort and balance. Some of its outstanding features are:

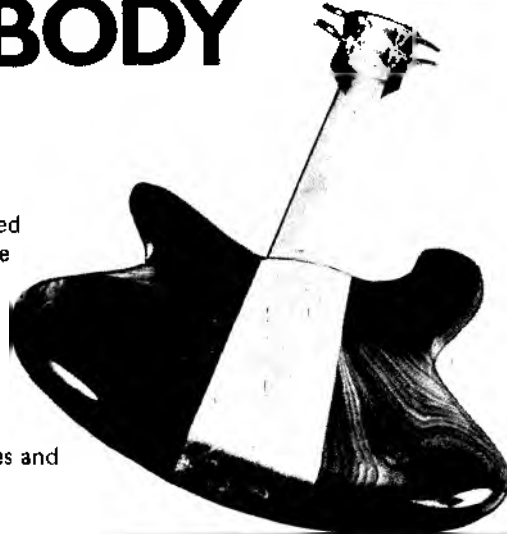
Series 1 Custom Design DiMarzio Pick-up

One piece neck, body construction

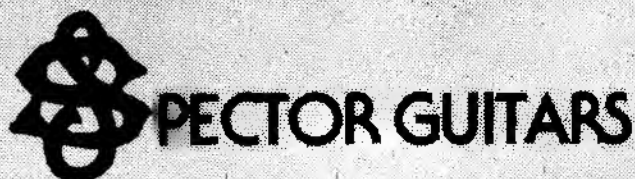
Gold plated Schaller Tuning Machines and
Badass Bridge

Low impedance electronic EQ system

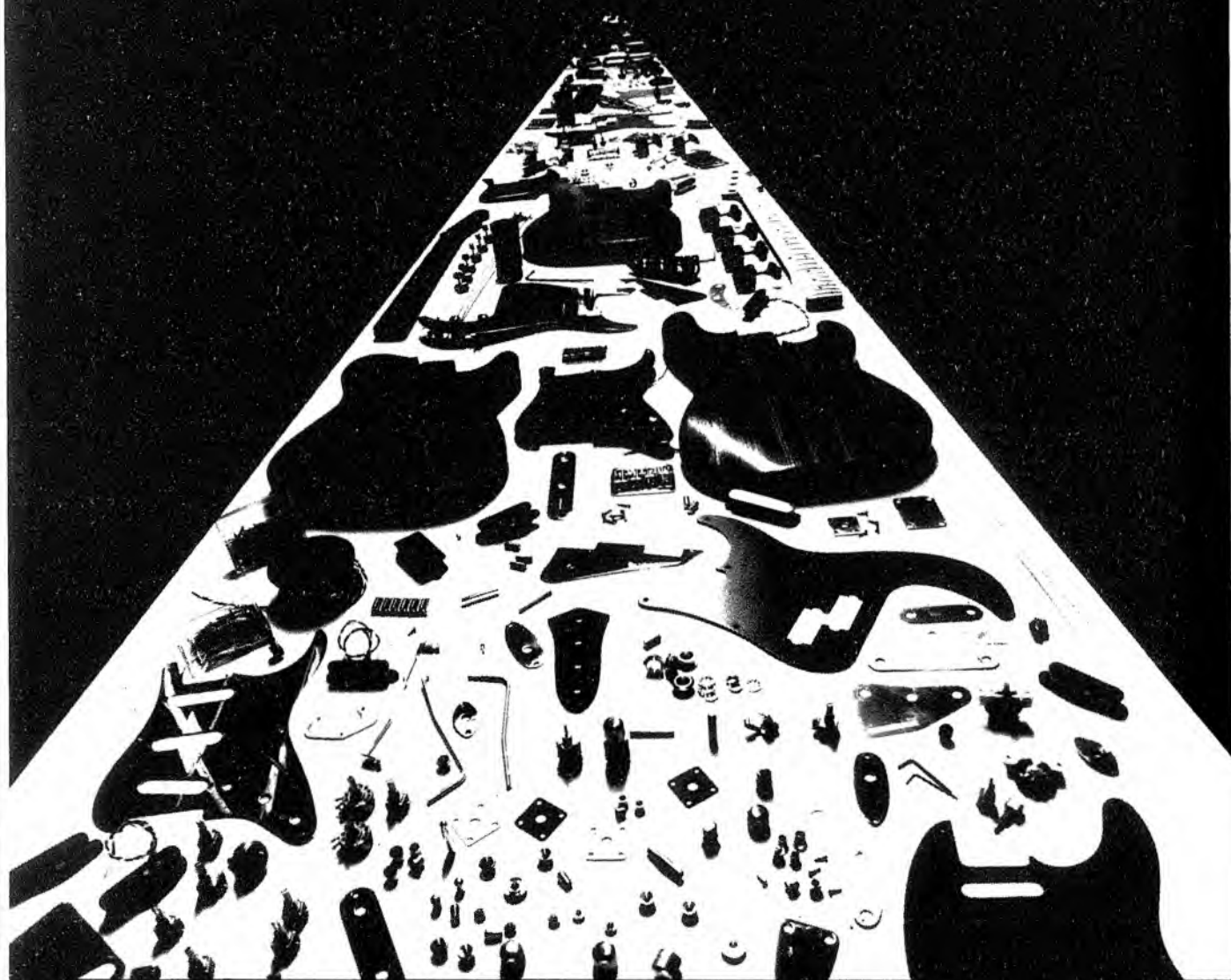
Play the bass that's as individual as your
sound. Write for more information. Dealer
inquiries invited.



444 12th Street
Brooklyn, N.Y. 11215
(212) 788-0483



SCHECTER GUITAR RESEARCH



our parts go on and on...

DISTRIBUTED BY:



ISA

INTERNATIONAL SALES ASSOCIATES

POST OFFICE BOX 9783 NORTH HOLLYWOOD, CA 91609 (213) 782-3202

For Our All New Complete 20 Page Catalog Send One Dollar For Postage & Handling. See Your Dealer Or Guitar Repair Shop.

WANT TO GET TO THE PARTS THE OTHER BEERS CAN'T REACH?

Well, how about a two octave Fretboard, you can actually PLAY, with no joints or lumps of wood getting in the way at the top? With the lowest, smoothest action you can imagine, and a range of 18 different pickups all guaranteed for any failure plus special tone controls to give you exactly the sound you want. Stereo — Mono — Antiphase is standard, there is a range of shapes, stylings and finishes you just wouldn't believe.

I've had ten years experience in building guitars for such people as Tony Iommi, Geezer, Brian May, Roy Wood, Ritchie Blackmore, Allan Holdsworth, Pat Travers, Roy Orbison, A/C D/C, City Boy, Horselips, Nectar, Hot Chocolate, Slade, Mud and many too numerous to mention. How about joining them? And remember — it takes up to 12 weeks to make a "Rolls" to order, to the same standards of excellence. And we can take about the same time. We do have a limited stock however. 2 x 11p stamps will get you all details of our guitars, repairing and customising. Trade enquiries welcomed.

Jb

JOHN BIRCH GUITARS LTD.
106 NEW ROAD, RUBERY
BIRMINGHAM B45 1JL ENGLAND
Tel (021) 453 5665

SOUNDER

electric guitar strings

Plain String

Unique 'Long Life' twist at ball end. Almost doubles strength at this weakest point, reducing breakage. Finest plated high tensile steel.

Wound String

Sounder covered strings are precision wound under a constant tension using a process which allows you to cut the string anywhere along its length without the spinning wire coming loose. So no problems because 'you did not take a turn around the peg'. Spun with silk at the ball end. Pure hard nickel wound.

Available in four superbly balanced sets, reference numbers as follows:

Superlight No IOS (.008) Extra Light No IOE (.009)
Light No IOL (.010) Light Wnd. 3rd No IOLW (.011)

Also full custom range.

valley MUSIC STRINGS
Treorchy Rhondda
CF42 6AA

BRISTOL'S OWN



**Build your own P.A.
— check these prices**

CROSSOVERS

RSD 3 Way	£165
MM 3 Way	£69
MM 2 Way	£59
RSD 12/2B (Same facilities as 16/4)	£625

MIXERS

MM 6/1	£95
MM 8/2	£220
MM 12/2	£265
MM 16/2	£330
RSD 12/2	£425
RSD 16/2	£595
RSD 16/4	£825

AMPS

MM 250W per channel	£185
MM 125W	£95
RSD 500W per channel	£525
Turner 340W per channel	£415
Turner 150W per channel	£275
JFS 100W per channel	£195
Quad 405	£175

SPEAKERS

Celestion	
18" 100W	£45
15" 100W	£35
15" Powercal 250W	£60
12" 75W (Guitar)	£19.95
12" D/Cone	£21.95
12" Soft Suspension (for monitors)	£20.95

A T C

9" standard	£68
12" standard	£78
12" L/Coil bass	£82
15" Standard	£135
15" L/Coil bass	£135

MICS

Shure Unidyne III	£54.50
AKG D190E	£49.50
Shure Unidyne B	£26.50
Shure SM 58	£78

Or have a ready made Biggles System

Systems from 800W inc. RSD desks, Mega PA Equipment custom built gear with multi cores & stage boxes from (Complete Systems) £2500

**Secondhand gear always in stock.
P.A. advisory service.**

BIGGLES MUSIC, 85 West St. Old Market,
Bristol 0272 552147

HAMLYNS THE MUSIC SHOP

20 OXFORD STREET, DOLPHIN SQUARE,
WESTON-SUPER-MARE. Tel: 0934 23788

Come to our new showrooms
to see one of the largest stocks of



amplification in the South West.

Also wide range of the leading makes of electronic organs (both new & second hand). Pianos — Baldwin & Kemble. All Maine makes of guitars both electric and acoustic, including accessories, and one of the best selections of album & sheet music.

**CREDIT TERMS ARRANGED AND
REPAIRS UNDERTAKEN**

HAMLYNS

ARE ALSO AT:

35-39 BRIDGE ST, TAUNTON, SOMERSET.
Tel: 5153

91 CORNWALL ST, PLYMOUTH, DEVON.
Tel: 25360

BIG ENOUGH TO COPE
SMALL ENOUGH TO CARE

ZEL-*LA*
RECORDS

RECORDING STUDIOS - RECORD PRESSINGS
RADIO/TV JINGLES - DEMO DISCS ETC.
WRITE OR PHONE FOR DETAILS

ZELLA RECORDING STUDIOS, WALKER HALL,
AMPTON ROAD, BIRMINGHAM B15 1UJ, ENGLAND.
Tel: 021-455-0645 (24 hour Answerphone service)

4BTW RECORDING STUDIO
TRACK IN **LONDON**
just £6.50 per hour

EQUIPMENT INCLUDES:- TEAC, REVOX ETC.
ARP ODYSSEY SYNTHESIZER, BECKSTEIN PIANO
FENDER JAZZ BASS AND EFFECTS AVAILABLE
BTW Recording Studio, 125 Myddleton Road,
Wood Green, London
TEL: **01-888-6655** N22 4NG.

WE ARE PLEASED TO
ANNOUNCE A LIMITED
NUMBER OF PACKLEADER
GUITARS AVAILABLE IN
BOTH ROSEWOOD AND
WALNUT

*WRITE FOR DETAILS:

PACKLEADER

P.O. BOX 22 BLACKPOOL
Tel: 27167

AT LAST



Complete 'All Risks' (inc. Transit) cover for
musical and P.A. equipment is our business
..... Amateur or Professional
..... U.K. or World Wide with the full
security of LLOYDS of LONDON.

Phone now for immediate cover

**BONDSCREST
LIMITED**

151 HIGH STREET HAMPTON HILL MIDDLESEX TW12 1NL
979 8261/2

A Member Of The

IIIA
INSTITUTION OF INSURANCE

Enquiries from abroad welcome

*Come and meet us at the
LONDON DISCO FAIR
Sept. 10-11-12*

BLACKPOOL SOUND CENTRE

NOW IN STOCK THE INCREDIBLE PACKLEADER
GUITARS, BOTH MODELS AVAILABLE,
ROSEWOOD AND WALNUT. COME AND TRY
THESE BEAUTIFUL HANDMADE ELECTRIC
GUITARS WITHOUT OBLIGATION.
YOU'LL BE DELIGHTED!

ALSO IN STOCK A COMPREHENSIVE RANGE OF
NEW AND USED GUITARS/AMPLIFICATION AT
VERY COMPETITIVE PRICES, eg. LES PAUL
CUSTOM C/W CASE AT £495. WE ALSO HAVE
A CONTINUOUS FLOW OF USED AMERICAN
GUITARS, USUALLY A CHOICE OF 80 PER
MONTH.

**BLACKPOOL SOUND
CENTRE,
7 COOKSON STREET,
Tel: 25544**

IF YOU CAN THE MICRO WILL PLAY



The Roland Micro-Composer does for the musician what the pocket calculator has done for the schoolboy. It is very, very simple to operate and it allows the operator to think of a tune, push the appropriate buttons and the Composer will make a synthesizer (or a whole group of synths) play that tune. The writer needn't even touch a musical keyboard!

Programming the Micro-Composer has deliberately been made easy. If you think of a tune that starts with (for example) C, E, G as the first three notes you punch in the code for C, E and G. The code is so simple you can understand it immediately and learn it by heart in a couple of days. To give you an idea how easy it is middle C is 24 (that's the code number you would push on the calculator-type panel) and because the notes are numbered to correspond with the notes on a keyboard the next note, E, is 28 because that's four semi-tones up. The C above middle C is 36 because that is exactly one octave higher which is 12 semi-tones. So you punch in 24 because you want the first note to be middle C. If you want it to be a crotchet (one beat) you punch in the crotchet code which is 32. Deciding how long you want the note to last is as easy as the pitch choice. A crotchet is 32, a minim is 64 and so on. The only thing you've got to decide now is how loud you want the note to sound. Naturally there's a code for loudness

Brodr Jorgensen Denmark,
Rygards Alle 104
2900 Hellerup
Denmark.
Tel. no. 010451297511
Telex 19603

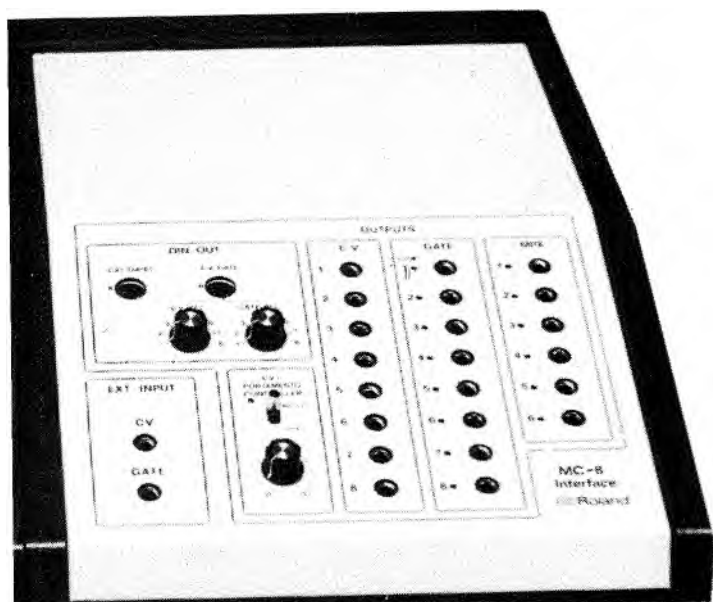
Brodr Jorgensen Musik A/F
Mossevein/Vinterbro
1400 Skj
Norway.
Tel. no. 010472871375

Brodr Jorgensen Musik A/G
Gerberstrasse 5
ch - 4410 Liestal
Switzerland.

Brodr Jorgensen Musik A/B
Hindbygarden
Ystadsvagen
213 63 Malmo
Sweden.
Tel. no. 0104640942080

Great West Imports Ltd.
55 Walter Street
Vancouver
British Columbia.
Tel. no. 684 5364
Telex 04-54527

HUM A TUNE, -COMPOSER IT FOR YOU!



(it starts at 100 and goes down to 30 for very soft). So by punching three numbers in, you've chosen a note, decided how long you want it to sound for and decided how loud it will be.

You can programme each note in about one and a half seconds. Having put in a complete passage, push the button and the synth that is hooked up to the Micro-Composer will immediately play what you have just written. If you don't like a note, or think any note is too loud or too soft, you can alter that without affecting anything else in the memory. There's no recording tape involved, all of the information is held in electronic memories. If you've written something in the memory you can transfer the information to an ordinary cassette tape in a cassette recorder and use the memory again. You can then put back the original piece by playing the cassette recorder back into the Micro-Composer.

Because the Micro-Composer has multi-channel output it can be used to control as many as eight independent voice lines at the same time.

If you will give yourself ten minutes with a Micro-Composer you will change the course of your creative life. See your local Roland dealer to arrange a demonstration.

Roland Corporation
7-13 Shinkitajima
3-Chome Suminoe-Ku
Osaka 559 Japan.
Tel. no. (06) 683 5001
Telex 5267368

Roland Corporation
2401 Saybrook Avenue
Los Angeles
CA 90040
U.S.A.
Tel. no. (213) 6855141

Roland Corporation (Australia) PTY Ltd
13 Chard Road
Brookvale 2100
New South Wales.
Tel. no. 9383911

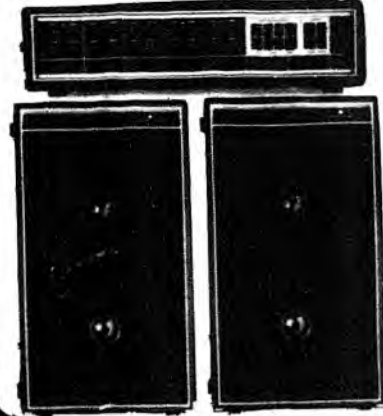
7-13 SHINKITHAIMA,
3 CHOME SUMINOE-KU
OSAKA 559,
JAPAN.



Roland

JOHN KING

the **maine** dealer
IN KINGSTON



IN STOCK NOW
P.A 170 200W SYSTEMS
WITH
GRAPHIC
EQUALIZATION
PIEZO CRYSTAL
HORNS
THERMAL
PROTECTION
AND
5yr GUARANTEE
AVAILABLE ON OUR
NO-DEPOSIT CREDIT
— JUST SEND YOUR
NAME, ADDRESS and
AGE
— WE'LL DO THE
REST

The best in the South West

The Drum Room

where the action is, and the drums are Gretsch, Ludwig, Premier, Olympic, Beverley, Pearl, Maxwin, Yamaha, plus the strong new name in drums and drum equipment.

TAMA

- SUPERSTAR
- FIBRESTAR
- IMPERIALSTAR

SEE'EM-TRY'EM -- FREE CASES WHEN YOU BUY'EM
ONLY AT

JOHN KING MUSIC LTD
8 RICHMOND ROAD
KINGSTON UPON THAMES
FROM WATERLOO 25 MINS
AND YOU'RE IN THE SHOP



DO YOURSELF A GOOD DEAL AND COME TO

Marcus

MUSICAL INSTRUMENTS

113 North St., Belfast. Tel. 22871/24956

PERSONAL LOANS AVAILABLE ON EASY TERMS TRADE-INS WELCOMED.

FULL RANGE OF H/H EQUIPMENT ALWAYS IN STOCK.

GROUP GEAR * DISCO EQUIPMENT * BRASS, WOODWIND, STRINGS AND
 PERCUSSION * ORCHESTRAL, EDUCATIONAL AND ALL TYPES OF MUSICAL
 INSTRUMENTS * HOME, CHURCH AND STAGE ORGANS

Curly Music Ltd

58 Stanley Street Liverpool L1 6AU Telephone 051 227 1919

Curly Music is a stockist of the best of . . .

Citronic, MM, Pace, Redmere, Yamaha, Marshall, HH, Carlsbro, Allen & Heath, Gibson, Fender, Optikinetics, Custom Sound, Electro-Harmonix, Morley, Music Man. A professional quotation for all your PA requirements is only a phone call away — 051-227-1919.

Melos Echo Units:—	A modern efficient clean echo unit incorporating a replaceable cassette. Only	£57.50 inc. postage & packing
Shure Microphones.—	All 25% off manufacturers list prices	
	515SA	£22.50
	588SA	£32.50
	545	£50.50
	SM58	P.O.A.

All Electro-Harmonix pedals. Phone for a quote.
Access, Barclaycard, cheques or postal orders only please.

REDMERE

Soloist

Tomorrow's amp today

The Redmere Soloist is an amp of very advanced design and concept. It has been produced only after the most extensive liaison between musicians and research engineers. The aim of Redmere in producing the amp was to give musicians all the advantages of transistor amplifiers and valve amps in one solid-state package. Now at last the great Valve or Transistor debate is over. Redmere have proved that correctly designed transistor amps can actually sound better than valves.

Now, after months of continual testing, redesigning, and rebuilding, the Soloist Superamp has arrived. Here is a list of features it contains: sustain/compressor with colour control, flanger, chorus, reverb, graphic equaliser, touch switches, direct injection socket, noise gate, foot switch, three independent channels.

Channel One of the Soloist simulates a familiar American valve amp usually bought in a "twin reverb" form. This amp is ideal for country music and keyboard instruments; the Soloist simulates the clean sound with controls for treble, bass and middle.

The second channel gives you the sound of the top British rock valve amp used by practically any big rock band you can think of. This channel gives the Soloist's rock sound. The sound is clean up until 25 watts and then distorts more and more. Once you reach a certain volume, the sound changes and distorts dramatically to give a familiar raunchy blues sound which you'll recognise as soon as you hear it.

If you were a fan of the Beatles, and who wasn't, you'll be familiar with the 30-watt combos they used. The Redmere Soloist gives you the sound of the Sixties Beat Boom with Channel Three. At low volume you get a lively sound with lots of top and bass but high volume increases the distortion giving amazing treble projection and powerful bass.

Having chosen your sound, you can modify it extensively with the collection of effects built into the amp. The Sustain/Compressor allows you to control the amount of distortion you get when you pick your guitar.

A special Colour Control acts like a manual wah-wah pedal and works by boosting certain frequencies before they reach the sustain circuit. You can adjust the level control which allows you

to get any sound you want at either high or low volume. These controls all give you any sound from a gentle distortion to an indefinite fuzz.

Flanging has become a very popular effect recently, and the Soloist gives you flanging at the touch of a switch with full control for speed and depth. If you combine a slow speed with a high depth setting you'll get the familiar "skying" effect. Different settings will give a rotating Leslie speaker effect.

The Soloist can also change a six-string guitar into a 12-string with a touch of the chorus control. This adds three extra signals to slightly different pitch and delay to create the sound of more than one instrument playing together. The Chorus can be modified for speed and depth. You can even hook up a slave amplifier via a stereo output on the Soloist and get the sound of two instruments from two sources even though you are only playing one guitar.

Reverb is a familiar enough effect. Naturally the Soloist's reverb will give you everything from slight depth to a big empty hall type of reverb.

Once you have selected your sound, the five-band graphic equaliser covers your final adjustment of sound by offering 15dB cut and boost which can change your Fender into a Gibson or vice versa. This means that your control of sound is practically infinite. You can go from clean country, rock and roll, or heavy-metal at the touch of a control.



In fact the Redmere Soloist is practically a studio built in to an amplifier. What other amp do you know has studio-type facilities like a 600 ohm direct injection socket and noise gate? The Noise Gate in particular is a useful feature. It cuts off the effect units when no signal is present and so removes hiss and noise generated by effects circuits. This means that if you have your flanger and chorus on there will be no unwanted white noise whilst not playing.

The switches alone are something out of the 21st century. Gone are clumsy mechanical buttons and knobs. To operate a function on the Soloist you merely touch the appropriate control section. There is nothing to wear out or get damaged so your Soloist switches will operate indefinitely.

We're living in the Space Age. Redmere are the first makers of music amplification equipment to really bring musicians into the 1980's with the Soloist.

REDMERE

Kneesworth Street, Royston, Herts.
Tel: 0763 45214

Canadian Distributor:—
Northern Audio Musical Enterprises,
953 Fraser Drive,
Burlington,
Ontario L7 L4X8,
Canada.

We hand-test *every* guitar string
La Bella makes.

Attila Zoller



Attila Zoller

You would expect nothing less from La Bella, which is also the only company to bring you the unique advantage of *perfectly balanced* strings. *Perfectly balanced* so that when a chord is played, all the strings vibrate for the same length of time. With no notes dropping out before the others. Plus, all the strings are heard equally, without one string louder than any other. And without undesired overtones. The result is a uniform sound character, with the same tension & same flexibility for each string. And being *perfectly balanced*, finger pressure can now be the same for all the strings.

La Bella makes the widest range of guitar strings on the market today: round, semi-round & flat wound, in gauges from extra light to heavy.

La Bella
Perfectly Balanced Strings
For Your Perfectly Balanced Hand

E. & O. Mari, Inc., 38-01 23rd Avenue, Long Island City, N.Y. 11105

La Bella strings distributed in the U.K. exclusively by: James T. Coppock (Leeds) Ltd., Royds Lane, Leeds S12 6JL, England.

Aria Competition Winners

The three lucky winners in IM's Aria Guitar competition gathered at The London Music Shop in Great Portland Street to receive their superb prizes. We received hundreds of entries for the competition which involved identifying the silhouettes of four top guitarists and stating why you would like to have an Aria guitar.

The first prize of an Aria PE800 was won by Tony Adams from Folkestone in Kent who plays in a local folk/rock band. Tony is in the habit of going in for competitions and went for a straightforward slogan after naming all the silhouettes. He had never played a PE800 before and was very impressed with the look of the instrument which he said he would be playing at the next gig of his group, Shadwater Weir.

Les Javan from Hebburn, Tyne and Wear, collected the second prize of an Aria LS450B electric and was accompanied by both his brother and cousin who all play in the Newcastle-based band, Freebird. It is the first competition Les has entered and he didn't really have any problems with the answers. His



Pictured at the Aria guitar presentation (left to right) Les Javan (second prize), Mr. Pete Tulett, Managing Director of Gigsville Ltd., distributors of Aria products, Tony Adams (first prize), Nith Kettanurak (third prize) and Mr. Malcolm Green, Promotions Director of International Musician.

band play the clubs around Newcastle and are trying to break out of that circuit but the main problem seems to be paying for new gear — which is where the Aria LS450B should come in handy.

Nith Kettanurak from Hamersmith in West London entered the competition when a friend asked him if he could identify the

guitarists silhouettes. His entry won him the third prize of an Aria 9210 acoustic guitar which will join his other two acoustics, a Martin and a Levin.

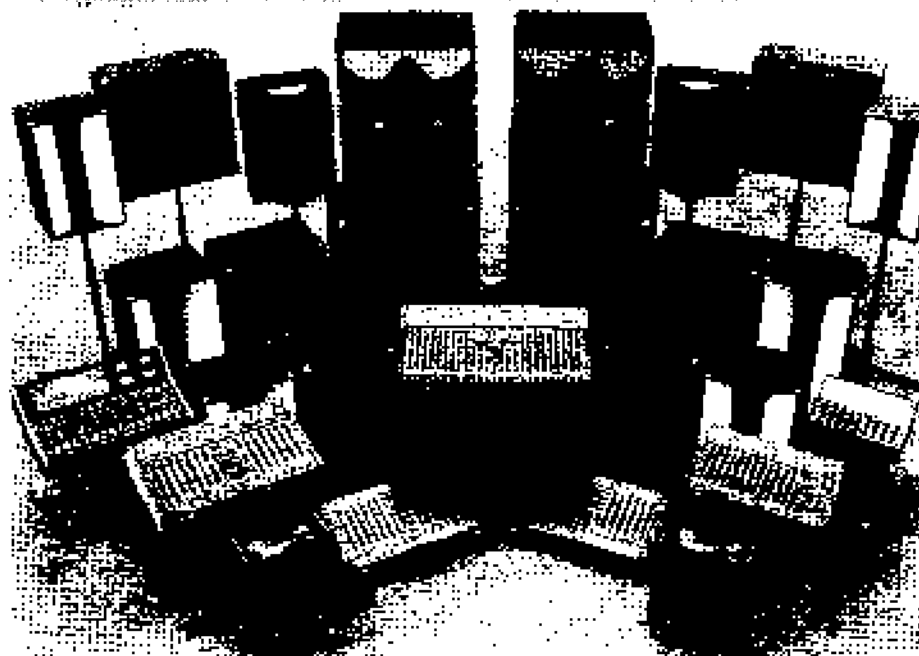
Nith, who is a student at Queen Elizabeth College in London studying food science and management, just plays for his own enjoyment and his tastes range from CSN&Y to Jimi

Hendrix.

The guitars, which all came with both a strap and a case, were presented to the winners by Mr. Pete Tulett, managing director of Gigsville Ltd., who are the UK distributors of Aria products. IM Promotions Director, Malcolm Green, and other members of the IM staff were on hand for the presentation.

FBT ELETTRONICA

THE LARGEST MANUFACTURERS OF AMPLIFIERS, AND P.A. SYSTEMS IN ITALY



DISTRIBUTED IN ENGLAND BY
THE CHAIRMAN
33 Old Compton Street
LONDON, W.1. Tel: 01-439 1842/3
Telex 298803

To: The Chairman 33 Old Compton Street London, W.1. England

Please send me details of FBT products

NAME

ADDRESS

.....

Simms

PROJECT AUGUST



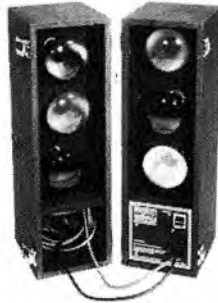
ATLANTIS STEREO DISCOS
WITH BUILT IN GRAPHIC EQUALISER



4 WAY-THEATRE
SPEAKER SYSTEM



PS 500 WATT SLAVE AMP



SOUNDLITE 6
UNIT



LIQUIDATOR EFFECTS PROJECTORS



THE AMAZING
LS808 LIGHT MIXER

SEE THEM AT THE
AMI Trade Show
RUSSELL HOTEL, Room 155

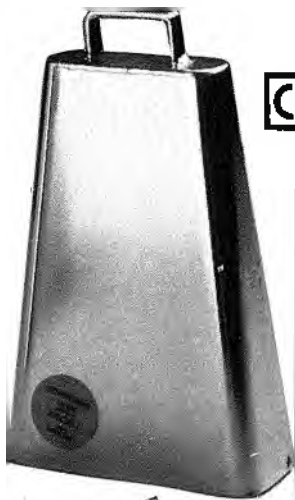
PROFESSIONAL DISCO, SOUND AND LIGHTING SYSTEMS

Project Electronics Ltd., Project House, 1-5 The Grove, Ealing, London W5 5DX. England. Tel: 01-567 0757

LATIN PERCUSSION

COWBELL PANORAMA

Trust the leader.

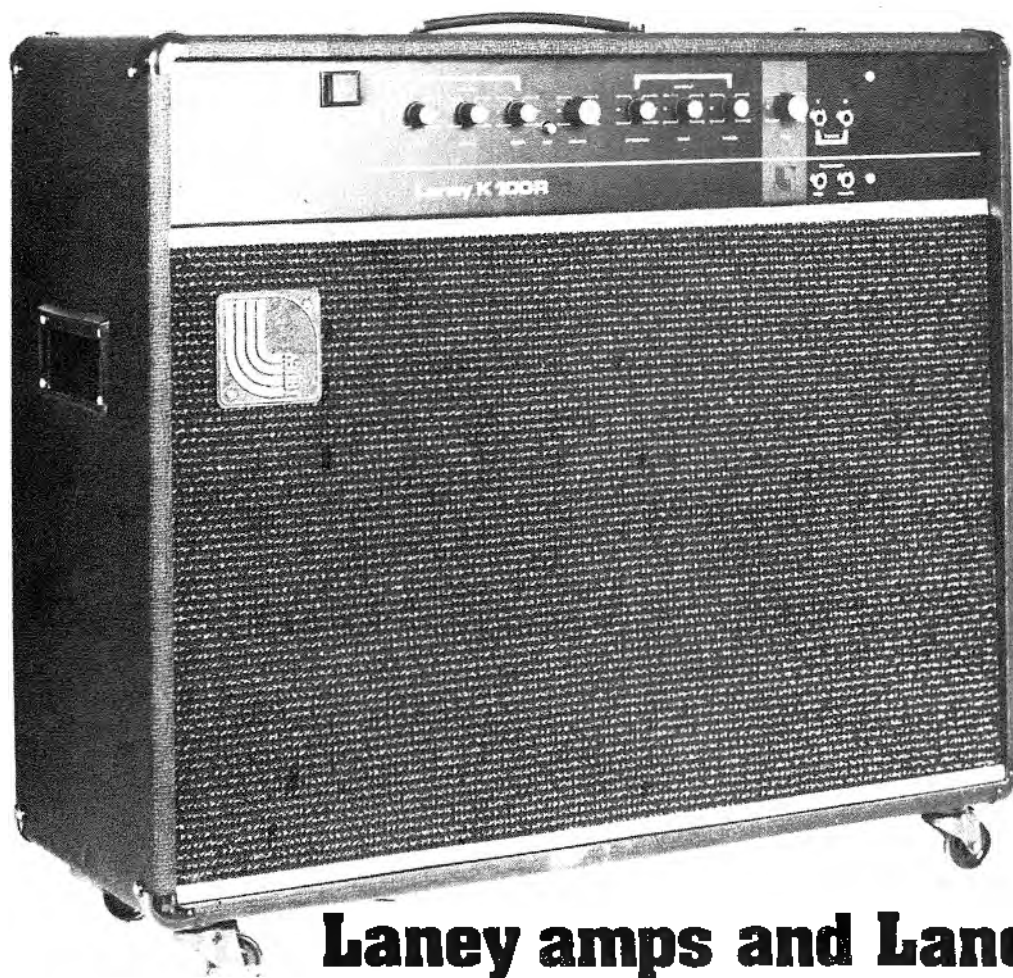


Cleartone M.I.Ltd.

7 DAWSON Rd. MOUNT FARM,
MILTON KEYNES. MK1 1LH
Phone 0908 71662



Have you played through our K100 Reverb Combo?



You haven't! Well we would strongly advise you to give it a blast at your local Laney dealer before you buy your next combo. The K100 Reverb Combo is a compact, powerful true 100 watts RMS combination amplifier with unique contour tone shaping circuits, Reverberation, Tremolo, Top Boost and the unique Klipp, controlled sustain circuit. We have even provided a headphone output for practising at home. Try it out at one of our dealers this weekend.

£120
inc. VAT!

Laney amps and Laney dealers make a great combination.

Ashford
Banbury
Barnstaple
Bath
Bedford
Beverley
Birmingham

Blackpool
Bolton
Bournemouth
Bracon
Brighton
Bristol
Burton
Bury St. Edmunds
Cambridge
Canterbury
Chastar
Chesterfield
Chiswick
Coventry
Corby
Crewa
Darby
Doncaster
Eastbourne
Exeter
Gateshead
Gillingham
Gloucester
Guildford
Harrow
Hemel Hempstead
Hereford

Arthur Sexton
Osbourne
Nekkins
Duck Son & Pinker
Mr. Music
Music Centre
Geo. Clay
Yardleys
Music Stores
Harker & Haworth
Jimz Music
The Music Shop
Southern Music
Biggles
Abbey Music
Albert Balaam
Guitar & Drum Centre
Socodi
Dawsons
Hudsons
Chiswick Music Centre
Sound Centre
Treasure Music
Custom Sound
Wishers
Music Ground
Cass Music
Greenhalgh
Bob Hall
Simpsons
Soundhouse
Amertins
Volume One
Free 'n' Easy
Mr. Music
Buzz Music

Hounslow
Huddersfield
Hull
Isle of Wight
Ipswich
Kettering
Kings Lynn
Kingston
Leamington
Leeds

Leicester

Lough
Lewisham
Leytonstone
Lowestoft
Maidstone
Manchester
Margate
Middlesbrough
Newcastle
Norwich

Nottingham

Oldham
Orpington
Oxford
Peterborough
Plymouth
Portsmouth
Reading
Redhill

Bano Centre
Organ Loft
Cornells
Ryde Guitar Centre
Albert Balaam
Treasure Music
John Savage
John King
Buzz Stop
Scherers
Stephens
Humbucker Music
Central Music
Cusack Music
Veloury Music
S. F. Entertainments
Iresimans
Merlings
Mathews
A1
Pepper Music
Cleveland Music
Rock City
Sound Systems
Kief Music
Cooles
Ken Neal
Clements Pianos
Rock Island
Derek Cudde
Free 'n' Easy
Treasure Music
Hamlyns
Courtney & Walker
Humblebees
Keyboard Harmony

Romford
Ross
Rushden
Sheffield
Sittingbourne
Southend
Stafford
Stockport

Stoke on Trent

Sunderland
Surbiton
Swinton
Taunton
Walsall

Warrington
Watford
Weston
Wigan
Winchester
Wolverhampton

Ireland
Dublin
Drogheda
Scotland
Glasgow

Edinburgh

Sound Wave
Sound House
Treasure Music
Johnson's Soundground
Simpsons
Tim Gentle
Music Centre
Dawsons
Rhythmic House
Chatfields
Music & Allied
Power Drive
White Sound
Arthur Bell
Guitar Centre
Hamlyns
Sound Centre
Music Shop
Dawsons
Hammonds
Hamlyns
Dawsons
Whitwatts
Langdon's
Band Box

McCullough & Piggott
The Music Shop

McCormacks
Ken Hughes
James Grant



If you would like further information please contact —
Electronic Manufacturing (Sales) Ltd.

Devonshire House, High Street, Deritend, Birmingham B12 0LP Tel. 021-772 7145/3669 Telex. 336409 Fiesta

Rockbottom

74 LONDON ROAD, WEST CROYDON, SURREY.

TEL: 01-680 1042 ALL PRICES INCLUDE VAT

FENDER SPEAKER SALE: ALL MODELS AVAILABLE FROM £15

FREE hard plush case. Fender Lead. Strap & personal setting up of every guitar bought from us if needed.

Limited offer.

Telecaster, any colour, R/W neck & case	£220.00
Telecaster, any colour, M/N neck & case	£230.00
Telecaster, any colour. Custom & case	£250.00
Telecaster, any colour. Deluxe & case	£290.00
Stratocaster, any colour, R/W neck & case	£235.00
Stratocaster, any colour, M/N neck & case	£255.00
Stratocaster, any colour, R/W neck & case & trem	£255.00
Stratocaster, any colour, M/N neck & case & trem	£270.00

BASSES

Precision, any colour, M/Neck & case	£235.00
Precision, any colour, R/neck & case	£225.00
Precision, any colour, M/neck & case	£255.00
Precision, any colour, R/neck & case, Fretless	£245.00
Jazz Bass, any colour, R/neck & Case	£275.00
Jazz Bass, any colour, M/N & case	£285.00

LOOK SPECIAL OFFER! For £5.00

Extra Fretless Jazzes. For all your Jacos Pastoriuses

Telecaster Bases, blond or black & case	£235.00
Mustang, any colour, R/W neck & case	£210.00
Mustang, any colour, M/neck & case	£190.00

OTHER NEW GUITARS

Gibson L/P Custom. Black & case	£450.00
Gibson L/P Custom. Cherry & case	£450.00
Gibson L/P Custom. Wine & case	£450.00
Gibson L/P natural & case	£420.00
Gibson L/P Standard, T/Brown & case	£435.00
Gibson L/P Deluxe T/brown & case	£420.00
Gibson Thunderbird & case	£430
Musiman Bass. White	£320.00
Rickenbacker	£365.00
Ovation Balla, Elec. & Ovation case	£420.00
Ovation Ballader	£275
Ovation Elec Glen Campbell 12 & case	£540
Guild D25 Acoustic	£220
Shergold Masquerader	£155
Shergold Meteor Deluxe	£135
Shergold Marathon Bass	£160
Maya Les Paul Black	£75
Maya Les Paul Sunburst	£85
Maya SG Bass Ebo Copy	£65
Maya Strat Copy Nat	£85
Maya Strat Copy White	£85
Maya Les Paul Custom Fixed neck	£120
Shaftesbury Rick Bass copy & case	£140
Shaftesbury EBZ Bass Copy	£95
Shaftesbury Gold Top Deluxe & case	£130
Hayman 10 10 Bass	£160
Hayman Semi Bass Medium Scale	£140

SECONDHAND

Gibson Thunderbird Bass 1963 & case	£600
Gibson 345 Stereo Cherry	£460
Gibson ES 325 Cherry	£250
Gibson Les Paul Special 1966	£470
Gibson SG Standard Cream	£285
Gibson EB2 Sunburst & Case	£140
Guild Starfire	£175
Fender Jaguar Immaculate	£200
Hayman 2020	£140
Antoria SG Junior Immaculate	£95
Hagstrom Les Paul Sparkle Blue	£95
Arbitor TV Special Copy Yellow	£85
Arbitor TV Special Copy Cream	£100
Grimshaw Les Paul Copy Sunburst	105
Hayman 1010 3 Pick Ups Sunburst	£100
Hayman 1010 3 Pick Ups Lime Green	£85
Jedson Les Paul Blonde	£85
Hondo Les Paul Maple Neck	£85
Kimbara Strat Copy Nat	£90
Saxon SG & Trem New	£95
Burns SG & Trem New	£95
Burns Jazz Split Sound	£100
Jazz Bass Copy Fretless	£65
Antoria Custom Sunburst	£105
Hoyer Les Paul TV Model	£100

NEW AMPS

Fender Twin Reverb	£300
Fender Twin Reverb & JBLs	£385
Fender Super Twin Reverb	£340
Fender Vibrolux	£195
Fender 6 Super reverb S/Soiled	£285
Fender Quad Reverb S/Soiled	£290
Fender PRO Reverb New	£250
Fender Bassman 10 Combo	£230
Fender Bassman 135 Top	£175
Fender Bassman 135 Cab	£185
Fender Bassman 70 Top	£145
Fender Bassman 70 CAB	£160
Fender Dual Showman D140 Cab	£230
Fender Dual Showman D130 Cab	£210
Fender Vibro Champ	£65
Fender Champ	£60
Fender Princeton Combo	£115
Marshall MV 100 Combo Valve	£300
Marshall MV 50 Combo Valve	£210
Marshall MV 30 Combo Tran	£135
Marshall MV 100 Amp Valve	£185
Marshall MV 50 Amp Valve	£160
Marshall Super Bass 100 Amp Valve	£185
Marshall 30 Lead-Bass Combo	£95
Marshall Lead Bass Trani MV 100 Amp	£95
Marshall 4 x 12 100W Cab	£140
Marshall 4 x 12 120W Cab	£165
Musiman 210 HD 130 W	£385
Musiman 212 HD 130 W	£500
Musiman 130 W Amp Top	£340
Peavey Backstage 30	£80
Peavey Pacer 45W	£150
Peavey Classic	£230
Peavey TNT Bass Unit	£190
Peavey Vintage	£300
Peavey 2 x 15 Bass Enc.	£170
Vox AC 30	£200
Vox AC 30 & Reverb	£220
Vox Escort Battery	£32
Vox Escort Mains/Battery	£37
Vox AC 120W Twin Valve	£220
Carlsbro Marlin PA Amp Top	£155
Carlsbro Stingray Bass Top 130W	125
Carlsbro 100W Slave	£85
Carlsbro Flare Bass Cab 2 x 12	£128
Carlsbro Hornet Combo	£85
Carlsbro Scorpion Combo	£140
Carlsbro Mini Bins	£250
Carlsbro 130W Bass Como M/M	£210
Equipment	£210
12/2 Mixer	£210
16/2 Mixer	£245
AP 350 Amp	£195

SECONDHAND AMPLIFICATION

Fender 100W PA Complete	£220
Fender Bassman 10 Combo	£200
Fender Super 6 Reverb	£250
Vox Supreme 100W Amp	£95
Vox UL 150W Amp	£110
Vox Foundation Bass 75W Unit	£150
Vox PA 200W Colls	£120
Yamaha 50 Combo	£185
Laney 30 Combo	£120
Davoli SS 500 100W Combo	£110
Impact 100 Amp Top	£85
Kelly 100 Amp Top	£90
Traynor Bass Bin	£150
Carlsbro 2 x 15 Bass Cab	£90
Orange PA 120	£125
Orange Slave	£80
HH 1C100 S Amp Top	£85
Arbitor 100W Amp Top	£85
Peavey Classic	£175
Traynor (a) MK3 100W Combo	£220
Traynor (1) MK 3 100W Combo	£220
Traynor (2) MK 3 100W Combo	£210
Wem A Colls 200W	£125
Sound City 200W PA New	£150
Marshall 4 x 10 Guitar Cab	£80
Davoli Bass Stack 200 Watts	£285

PERCUSSION KITS

Tama Imperial Star 5 Drum Kit	£285
Maxwin CB 700 Kit 5 Drum Kit	£210
Pearl Rock Kit 5 Drums	£300
Premier Kit Old	£150

KEYBOARDS

Fender Rhodes 73 Stage	£575
Wurlitzer EP 200	£485
Fender Rhodes 88 Stage	£650
Logan String melody	£385
Hohner Clavinet D6	£290
Crumar Roadrunner	£220
Logan Pianitone S/Hand	£110

EFFECTS UNITS

Electro Harmonix Small Stone	£27
Electro Harmonix Big Muff	£22
Electro Harmonix Doctor Q	£20
Electro Harmonix Soul Preacher	£28
Electro Harmonix Clone Theory	£38
Electro Harmonix De Luxe Big Muff	£34
Electro Harmonix Elec Mistress deluxe	£55
Electro Harmonix 10-Band Graphic	£48
Electro Harmonix Slap Back Echo	£26
Electro Harmonix Memory Man Echo	£57
Electro Harmonix Memory Man Deluxe	£78
Electro Harmonix Echo Flanger Chorus	£98
WEM Copicat Echo	£87
Roland Space Echo	£285
MXR Dyna Comp	£62
MXR Phase 100	£110
MXR Phase 90	£70
MXR Blue Box	£50
MXR Graphic	£70
MXR Flanger	£138
MXR Analogue delay	£150

PICK-UPS

Di Marzio Dual Sound	£28
Di Marzio PAF	£27
Di Marzio Super Distortion	£27
Di Marzio Super II	£24
Di Marzio Fat Strat	£23
Di Marzio pre BS Tone	£23

SEND THIS PAGE BACK FOR FREE DELIVERY ON ANY GOODS

P/X, Access, B/Card, Mail Order, Speedy H.P. Terms available and pay up to 12 months, 24 months, 36 months, or up to 4 years in a hospital of your own choice, if you don't pay at all. (Loss of limbs arranged)

Moon Meets IM Premier Winner

Rob Stubbs, 25, from Plymouth was the lucky man who won the fabulous Premier Resonator kit in our recent giant Premier Competition. Rob is seen here being presented with his prize by none other than Keith Moon.

The presentation took place at Henrit's Drumstore in London where Simon Everett from Premier and Bob Henrit were also on hand to congratulate him.

"I was delighted," he told us, "it was like winning the pools as far as I'm concerned. The most I've ever won in a competition was a pair of cinema tickets!"

Rob has been playing drums for about ten years and is a member of a five-piece rock band called Quarry who gig regularly around the Plymouth area. His band are nearing completion of an EP of their own material, recorded at Roach Studios, and he is looking forward to using his new Premier drums for the final sessions.



Musical Supplies

Eccleshall

GUITAR STRINGS FOR THE PROFESSIONAL

CRAFTSMAN
MADE
GUITARS

Eccleshall
GUITARS

Hide
GUITAR
RARE

A KEITH HAND PRODUCT

BY
Gherson

A KEITH HAND PRODUCT

REGAL PRO-STIX

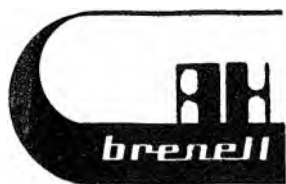
**THE CHOICE OF
PROFESSIONALS**

A KEITH HAND PRODUCT

PRO-STIX

A KEITH HAND PRODUCT

for **BROCHURES & TRADE ENQUIRES** contact: Keith Hand Musical Supplies,
71 Onslow Rd., Richmond, Surrey. Tel: 01 940 5254



ALLEN & HEATH BRENELL products now available in the north of England, from Cathedral Sounds Limited, manufacturers and specialist suppliers of studio equipment

Special Offer for a limited period only. SAVE over £750 on AHB professional studio package consisting of:

- MOD II Console, 16 x 8
- Heavy Duty power supply
- Brenell Mini 8 one inch 8 track recorder.
- Pro Limiter.
- Digital Tape Counter.
- Electronic Variespeed unit, plus-free of charge, Cathedral CL4 Quad Comp. Limiter.

Finance available. Write or telephone for details:

Cathedral Sounds Ltd., Fourways, Morris Lane, Halsall, Ormskirk, Lancs., L39 8SX Tel: Halsall (0704) 840328



CATHEDRAL SOUNDS LTD

REW

PRO-AUDIO & DISCO:
146 Charing Cross Road, WC2 01-836 2372
VIDEO & HI-FI: 114-116 Charing Cross Road, WC2.
Hi-Fi 01-240 3386 Video 01-240 3066



ALLEN AND HEATH BRENELL LTD.

TAX-FREE EXPORT & EXPRESS MAIL ORDER: REW House, 14-12 High Street, Colliers Wood, SW19. 01-540 9684 • Also at 230 Tottenham Court Road, W.1.

soundwave

AHB

ALLEN AND HEATH BRENELL LTD

66 VICTORIA ROAD,
ROMFORD, ESSEX
TEL: 25919

H. W. AUDIO



ALLEN AND HEATH BRENELL LTD.

158 Bradshawgate, Bolton, Lancs.
Tel: (0204) 26639

SOUND SERVICES

AHB

ALLEN AND HEATH BRENELL LTD

9, Tweed Close, Swindon, Wilts.
Tel: 0793 31616

Retail Music Services (U.K.) Ltd



ALLEN AND HEATH BRENELL LTD.

Music House, 387/389 Lincoln Rd. Peterborough.
Tel: 0733 61830

Roger Squire's

PRO-AUDIO

BRITAIN'S LEADING SUPPLIERS OF PROFESSIONAL AUDIO EQUIPMENT

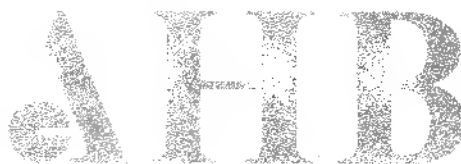
AHB

ALLEN AND HEATH BRENELL LTD

Branch Manager: Cliff Lake
Sales Engineer: Dave Whitaker
Roger Squire's PRO-AUDIO
11 Chalfont St., London NW2, 6JN
Telephone: 01-221 8111 Telex: 221 111

Specialist in... Tuesday - Saturday 10.00 am - 6.00 pm
Lunch 12.00 - 1.30 and 8.00 pm
11-12, Tottenham Court Road, London W.1
EXPRESS UK AND EXPORT DELIVERY SERVICE

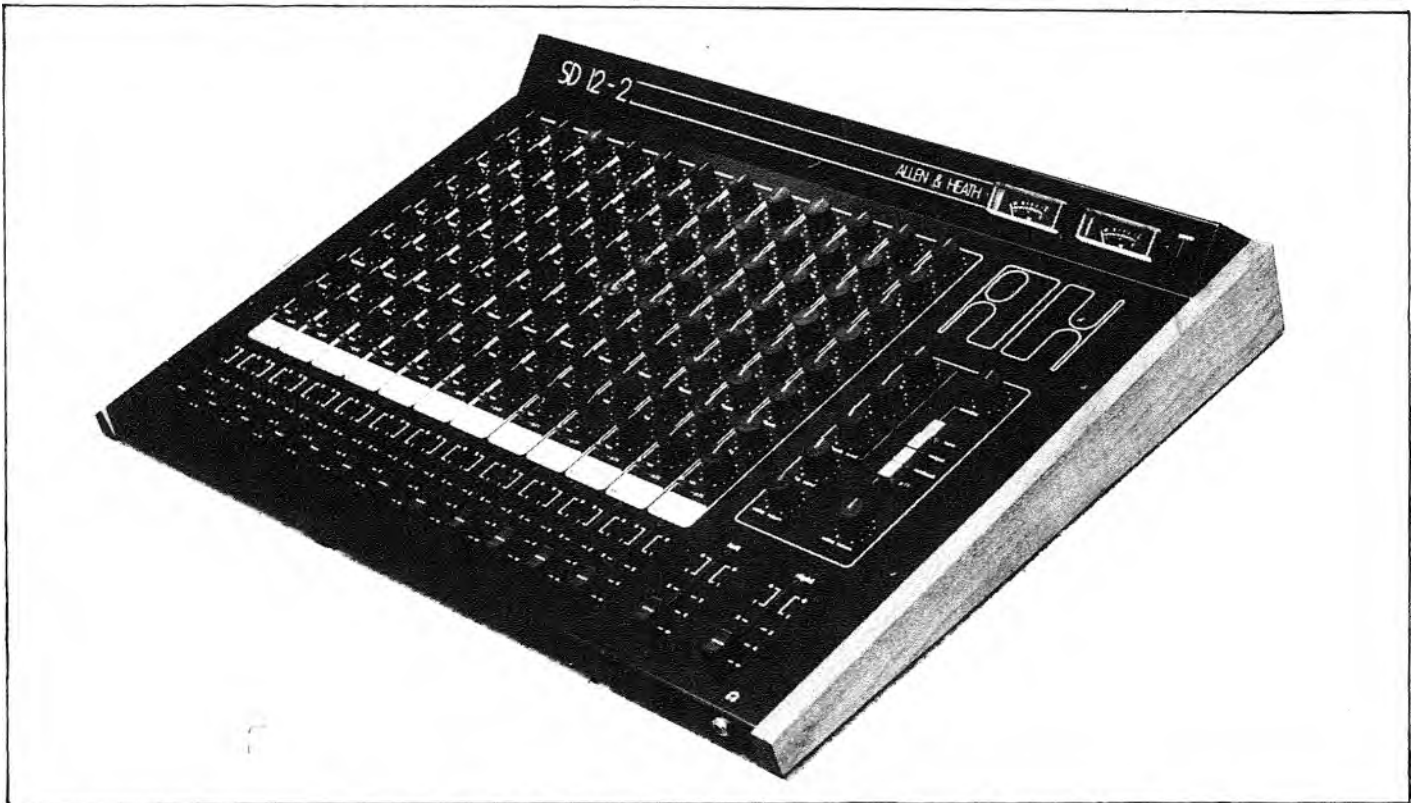
TURNKEY



ALLEN AND HEATH BRENELL LTD.

8, East Barnet Road, New Barnet, Herts.
01-440 9221

MIXING WITH ALLEN & HEATH LIMITED



At last a 12-2 that isn't a toy

The recording and mixing of sound has developed into an exacting science on all levels over the past few years. Bands who were once content to turn on their amps and balance everything themselves are now looking to mix their sound as the big pro performers do.

It is for the up-and-coming groups new to having their own mixing facilities that the Allen & Heath SD 12-2 stereo mixing console has been produced.

For the price of a top quality guitar, the SD 12-2 offers club bands a full range of features that have only been available on the big, and pricey, range of mixers.

Each of the input sections has a XLR balanced inputs. Along with the regular treble and bass controls, the SD 12-2 has two mid-range controls, one to give boost to vocals, guitar and snare harmonics

with a second lower mid-range pot to cover all voices and instruments at their fundamental frequency.

The SD 12-2 also has one of the most comprehensive monitoring sections to be found on a mixer of its size and price.

A special array of monitoring pushbuttons gives the sound engineer the opportunity to listen in stereo to either the tape output (when recording), the main mix, foldback mix or individual channels without interfering with the main output. Whichever signal is selected is displayed on the twin VU meters.

Each of the 12 channels is equipped with its own direct line output and input insertion point, which facilitates the use of special effects on individual signals. The entire mixer is semi-modular which makes for rapid and easy servicing even while under performing conditions.

Operating the SD 12-2 is simplicity itself even for a relative beginner. Careful design has ensured that all controls have a logical format. You can easily link the mixer to an external echo or reverb unit and adjust the amount of echo intensity individually for each channel.

To protect all this precision hardware from damage under touring conditions, Allen and Heath have built a special heavy-duty flight case, which affords the mixer maximum cushioning from major impacts and knocking.

The SD 12-2 facilities makes possible a total of 48 different interfaces with sound and recording systems. Indeed it is the ideal mixer to serve an up-and-coming band both on the stage and as an essential foundation for four-track recording.

Taking the SR20

Far too often, the sound engineer's task is made difficult by his need to operate so many controls that he cannot devote time to concentrate on the creative aspect of obtaining the right sound.

With many desks there is the task of operating numerous faders and monitoring VU meters, and controlling tone. This means the engineer, producer or artist cannot concentrate solely on sound second by second.

The SR20 and SR28 from Allen and Heath minimise the physical task of the sound engineer by an ingenious system of sub-groups. For instance, if you have six mikes on the drum kit, the routing of those channels to a subgroup means you only have to control the kit from one fader.

Each channel can handle multiple special effects thanks to a total of ten echo returns which are provided for this purpose. This allows

a guitar to be played in one effect and then fed to another effect in mid-echo without the need for re-patching. Echo returns to foldback are also provided. On every input and output channel you'll find insertion points which facilitate the use of limiters and graphics where and when these are required. The addition of auxiliary sends lets the sound engineer choose different mixes for foldback and echo. Three auxiliary sends are attached to each input channel.

Both the SR20 and the SR28 are direct spin-offs from the Allen and Heath studio desk series. The transportable SR20 concert and theatre console has special transformer balanced XLR inputs which mean a very quiet threshold of noise.

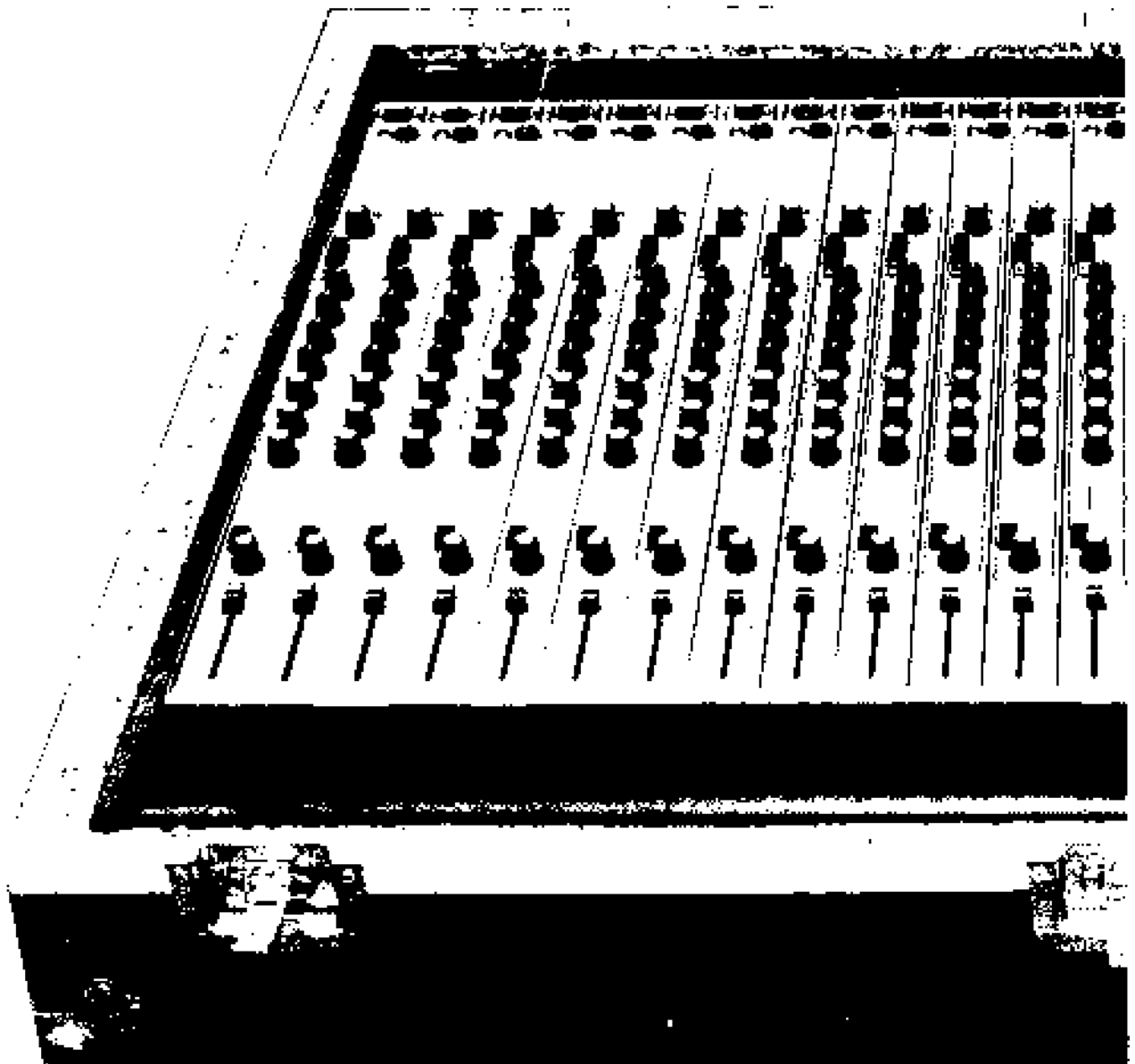
You would be very hard put to hear any difference in performance between these desks and the top studio consoles that Allen and Heath provide for the big studios.

The ingenious subgrouping of the desks is done through eight busses. Quite simply this means that each input can be fed to any one of eight sections. So adept are Allen and Heath at this design that Pink Floyd chose the company to build the band's first quadrophonic desk.

The SR20 and SR28 have another added plus. Three bank equalisation with a parametric mid-band means that the equalisation can be done to fit the vocalist or instrument rather than trying to squeeze the best sound out through pre-determined eq. The eq on the SR20 is not tied to preset frequencies and gives unmatched tone modification to fit any acoustic situation. It's also almost impossible to accidentally overload the mixer with an unintentional high signal.

Flexibility and fidelity are what the SR20 and SR 28 equipment is all about.

The meter system can be changed at the



on the road

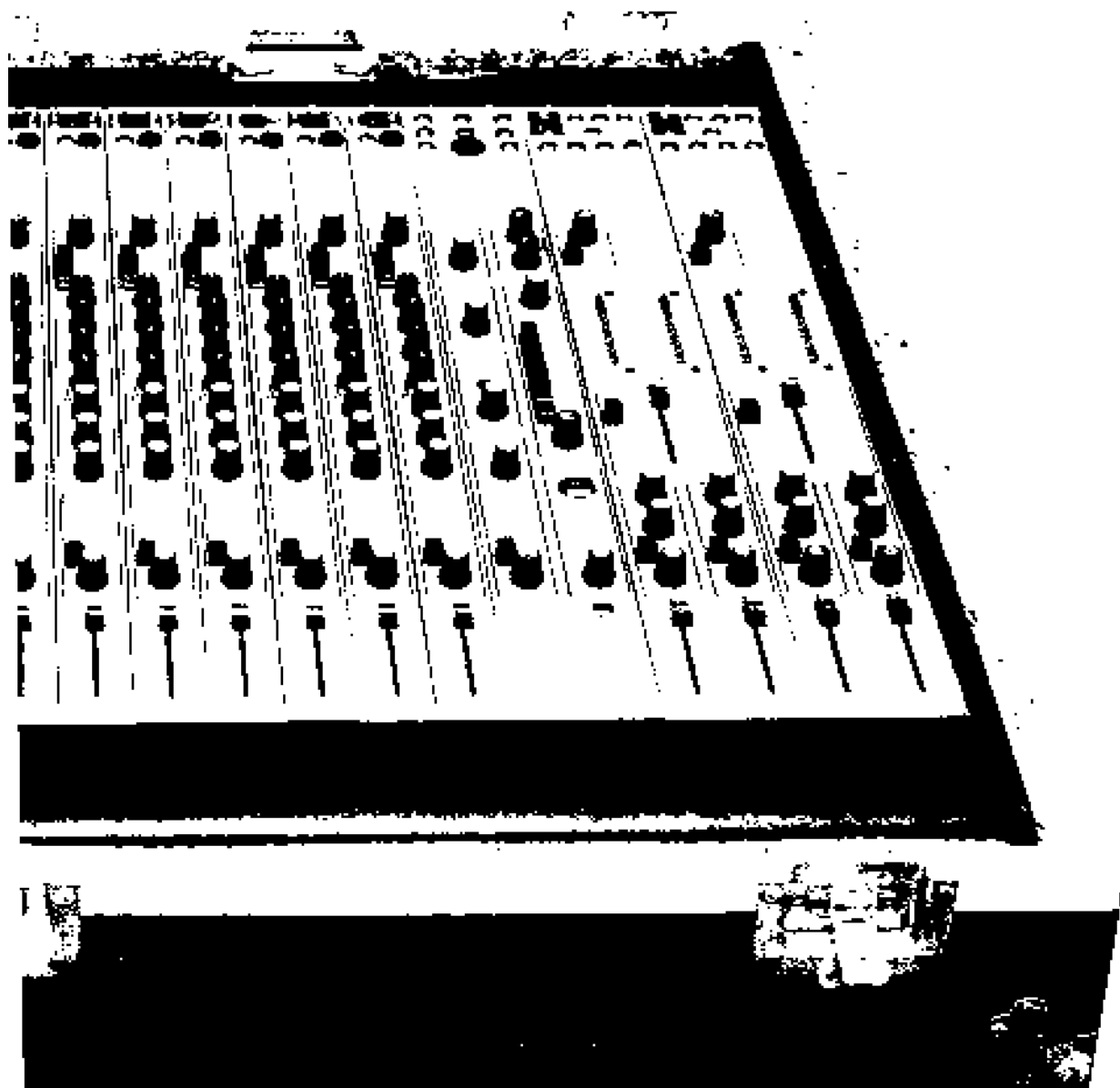
push of a button to give either the reading for the main sound, or each of the individual signals coming in off the four sub-groups. A special master control module allows the engineer to monitor all the signals in the console without affecting the main mix.

If, in the unlikely event of anything failing in the consoles, modular design means faults can be rectified within seconds. All the operator has to do is take out the module containing the faulty component or circuit and replace it with a working module. Thus performances need never be brought to unplanned halts and the mixer need not lie useless in the repairer's workshop.

The specifications and design of the SR20 and SR28 console series means any concert hall or theatre can become a studio. Let your ears, and not your hands, do the work with this A&H equipment.

SR 20 and 28 – Technical Specification

Format	SR 20 20-4-2	SR 28: 28-4-2
Equivalent Input Noise	-126dB	
Sensitivity	-80dB	
Maximum Output	+18dBm	
Noise	Better than -75dB overall	
Frequency Response	30Hz to 20kHz + 1dB	
Output Operating Level	0dBm including insertion points	
Equalization	±16dB at 10kHz ±16dB at 100Hz ±18dB at 1.8kHz to 7.5kHz cont. variable	

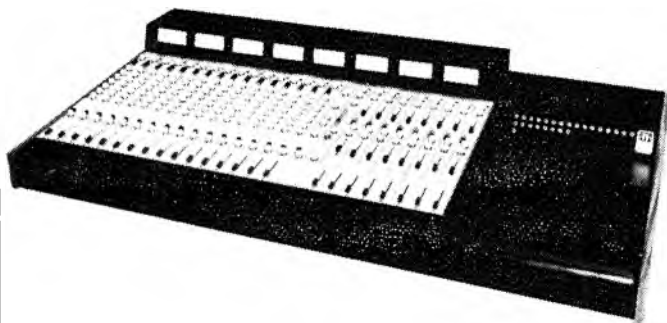


MIXING

WITH ALLEN & HEATH LIMITED

Allen and Heath-Brenell manufacture a unique professional studio package which enables musicians and engineers to produce master tapes without permanent brain (or bank) damage.

Consisting of the Mini 8 and Mod II with the option of limiters and A.D.T. unit, the AHB package is now available at an extremely advantageous price through specialist AHB dealers and worldwide agents.



PACKAGE FEATURES

Mini 8

- Professional 25mm tape format giving 63dB signal to noise ratio (A weighted ref 320nwb/m) enabling track bouncing without noise reduction.
- Powerful three motor transport with full logic control
- Fully modular electronic with front panel alignment
- Ultra silent Drop-In and Sync monitoring
- Digital tape counter, remote control and vari-speed

Mod II

- Fully modular desk electronics with integral patch bay
- Sweep frequency equalization as standard (± 18 dB)
- Expandable from 4 to 16 track without additional wiring

For further details contact Andy Munro at:
Allen and Heath-Brenell Ltd.,
Pembroke House,
Campsbourne Road,
Hornsey,
London N8

Telephone: 01-340 3291
Telex: 267727 BATGRP G

AHB Dealers

Allen & Heath dealers show a professionalism that comes from both knowing the practical side of the business while being knowledgeable of the sophisticated electronics of their equipment. In today's music world, simply knowing about musical instruments is no qualification for judging the merits of a mic pre-amp or routing system. That is why A&H dealers have been carefully chosen.

For instance, if recording equipment is your need then Telecomms, Radford and Turnkey have their own eight track demo facilities as does Roger Squires. And few people know more about mixing consoles than Cathedral Sound, Photo-Acoustics or SES. When it comes to production studios and club installations then F&M Wilson, Sound Services, MBA and Seen & Heard have the answers to all the problems.

Of course the SD12/2 and SR20 are available in London from Roger Squires, ITA, REW, SES and Grahams as is other A&H equipment along with our successful 8-track Studio Package. And Trad and Turnkey have become the first stockists of Syncon, a state of the art mixer for 16 and 24 track recording.

Upcoming in the autumn you can look forward to an exhibition put on by SuperFi which Allen & Heath will be actively supporting.

Photo-Acoustics Ltd
255a St. Albans Road
Watford, Herts.

Soundwave
66 Victoria Road
Romford, Essex

Epicentrum
Fox House
Moor Road
Langham
Colchester, Essex.

Telecomms
189 London Road
North End,
Portsmouth, Hants.

Maldwyn Bowden Associates Ltd
168 Edward Street
Brighton, Sussex.

Radford
52-54 Gloucester Road
Bristol, Avon.

Cathedral Sound
Fourways
Morris Lane
Haisall
Ormskirk, Lancs.

Audio Services
25 South Meadway
High Lane
Stockport, Cheshire

Curly Music
58 Stanley Road
Liverpool

Rushworths Music House Ltd
Whitechapel
Liverpool

H.W. Audio
158 Bradshawgate
Bolton, Lancs.

Tractor Music
Kenion Street, off Drake Street
Rochdale, Lancs.

F&M Wilson
20 Market Avenue
Ashton-under-Lyne, Lancs.

Retail Music Services (UK) Ltd
Music House
387-389 Lincoln Road,
Peterborough, Northants.

Super Fi
15 Market Street,
Nottingham, Notts.

I.T.A.
Harewood Road
London NW1

Studio Equipment Services
Studio Shop,
Oxgate Farm
Coles Green Road,
London NW2

REW Professional
146 Charing Cross Road
London WC2

Grahams Professional Ltd
86-88 Pentonville Road
London N1

Roger Squires Pro Audio
55 Charlbert Street,
London NW8

Turnkey
8 East Barnet Road
New Barnet, Herts.

Trad Electronic Sales Ltd
149B St. Albans Road
Watford, Herts.

Sound Services
9 Tweed Close
Swindon, Wilts.

Audio Visual Seen & Heard Ltd
38 Half Moon Lane
Gateshead, Tyne & Wear

supplying of news, notices, the
 completeding notices and
 governmental departments etc.
 including a full range of products
 Gram, Rev, & Neel Quad, JBL, Phase
 Linear, Fairchild, Teac, DEN
 AKG, Shure, Tascam, Beyer, and
 many more.

Address:
 117, West Street, Brighton, Sussex
 Telephone: 0273 607384

**PRO-WORKSHOP AND
 MOBILE SERVICE FACILITIES**



**studio
 equipment
 services**

117
 WEST
 STREET
 BRIGHTON
 SUSSEX
 BN2 2JB

maldwyn bowden associates limited

FOR THE COMMUNICATORS

WE SUPPLY, DESIGN AND INSTALL
 PROFESSIONAL SOUND AND LIGHTING
 EQUIPMENT FOR CLUBS / DISCOS,
 THEATRES AND STUDIOS

168 Edward Street, Brighton Sussex, BN2 2JB
 Tel: 0273 607 384



THE FACILITY AHB

ALLEN AND HEATH BRENELL LTD

THE FACILITY, RADFORD HI-FI LIMITED,
 52-54 GLOUCESTER ROAD, BRISTOL
 BS7 8BH.

Telephone: (0272) 422709 Telex: 449315

SALES & SERVICE
 to studios, broadcasting,
 education and governmental
 departments, everything
 for the Pro user.
EXPORT FACILITIES

AHB

ALLEN AND HEATH BRENELL LTD

also REVOX, NEAL UHER
 AKG, BEYER, QUAD, TEAC
 + Signal Processors, Monitors
 and a full range of accessories

THE
 STUDIO
 SHOP
 Oxgate Farm
 Coles Green Rd,
 London NW2 7EY
 Ring 01-452 1979



**studio
 equipment
 services**

East Midlands HI-FI Exhibition

29th 30th September and 1st October.
 Albany Hotel, Nottingham

29th 30th September and 1st October.
 ALBANY HOTEL, NOTTINGHAM.
 See the Allen & Heath SD 12/2, SR 20
 and Mini 8 at the SUPERFI Show in
 Nottingham. Try the finest range of
 today's Hi Fi and Pro Audio.

**Superfi
 commercial**

15 Market Street, Nottingham NG1 6HY. Telephone 0602 412137/8
 34/36 Queen Victoria Street, Telephone: 0532 449075

PA Sales & Fine

MIXERS FROM **AHB** NOW AVAILABLE
ALLEN AND HEATH BRENELL LTD

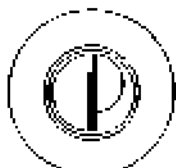
TRACTOR MUSIC

KENTON ST., OFF DRAKE ST., ROCHDALE, LANCS.

TEL.: 0706 56287

Mix with the
 right people...

AHB



**GRAHAMS
 PROFESSIONAL**

86-88 Tottenham Road London, N1.
 Tel 01 837 44171 or 410 1466 Telex 299446

THE AHB

ALLEN AND HEATH BRENELL LTD.

DEALERS IN
 STOCKPORT

25 SOUTH MEADWAY STOCKPORT' CHESHIRE
 Phone: (06632) 2442

DEALERS

AVON

ASSEMBLY MUSIC.
25 Claverton Buildings, Widcombe, Bath.
0225 22894
12 The Promenade Gloucester Road, Bristol.
0272 425245
EC. IR. MA. RS. Spec. ERS. EK. G. A. D. B. W.
H. Ac. SFI. PA. PSG. S/hnd. M. RC. CB.
Premier. Traynor. Sonor. Carlsbro. Gibson
Tama.

BEDFORDSHIRE

BEDFORD MUSICAL INDUSTRIES
59 Midland Road, Bedford.
0234 58142
EC. IR. G. A. D. S. S/hnd. MA. RS. Spec.
ER. L. H. M. RC. PA. CB. Di.

BOOGALOO BASEMENT
17 Bridge St., Leighton Buzzard, Beds.
05253 66622
G. A. D. B. W. S. Dr. R. S. Gibson Star Dealer

MILTON KEYNES MUSIC LTD
17 Bridge St., Leighton Buzzard, Beds.
05253 66622
ER. RCn. O. IR. SYN. G. A. D. S. S/hnd
MA. RS. ERS. EK. K. B. W. L. H. T. M. RC.
SM. PA. Di.

MR MUSIC
St. John Street, Bedford.
Bedford 50861/2
A. EC. O. IR. SYN. G. A. D. S. S/hnd. RS. K.
ERS. EK. B. W. L. H. Ac. SFI. SM. PA.
PSG. CB. Di.



CENTRE Ltd
114 Leagrave Road, Luton, Beds.
Tel. Luton 26826
Part Exchange Credit and Cash
G. K. A. D. B. W. S. & EC. O. IR. SYN. S/hnd.
MA. RS. Spec. ERS. EK. L. H. Ac. SFI. T. M.
RC. SM. PA. PSG. CB.

BIRMINGHAM

RUMBELOWS MUSIC.
138/141 Friar Street, Reading.
Reading 65361
EC. O. SYN. G. A. D. S. S/hnd. RS. SPEC.
ERS. EK. K. L. AC. T. M. SM. PA. Di.

BIRMINGHAM

MICHAEL PECK-THE SHEET MUSIC SPECIALISTS
1478 Pershore Road, Stinchley, Birmingham
B30.
Tel: 021 458 6460
K. EK. Syn. RS. S. ERS. S/hnd. A. G. S.
(Gibson. Rotasound Spec.) J. T. (D.K.G.) Ac.
SM. PA.

YARDLEYS
Snow Hill, Birmingham.
21 Colmore Row, Birmingham B3
021 236 7441
G. A. D. B. W. S. Di. PA. RS.

JONES & CROSSLAND LTD.
6-8 Smallbrook, Queensway, Birmingham.
021 643 4655/6/7.
CB. RCn. O. IR. SYN. G. A. D. S. S/hnd.
RS. ERS. EK. B. W. Ac. M. SM. PA.



WOODNOTES
100 Old Road, Birmingham
021 236 9823

BRISTOL

BIGGLES MUSIC
85 West Street, Old Market, Bristol.
0272 552147
A. G. S. RCn. IR. S/hnd. MA. RS.
ERS. EK. M. PA. CB. T. HP & PX.

BROWNS OF BRISTOL
5 Union Street, Bristol
0272 23646
Wem Copycat EC. RC. IR. G. A. (MA Custom
Sound) Di (Premier MA) S. S/hnd. RS. ERS.
BIMA Conn) W. SFI (Mandolins,
bouzoukies). M. PA.

BUCKINGHAMSHIRE

HAMMOND MUSIC & ORGAN CENTRE
43a Buckingham St., Aylesbury, Bucks.
0296 3131
G. A. D. K. B. W. S. EC. Di. L. Ac. Syn.
RS. EK. SM. RC.

ORGAN WISE LTD.
48 Aylesbury Street, Bletchley, Milton
Keynes.
0908 70955
O. K. Spec. RES. EK. S. A. G. SYN. IR. EC. B.
W. Ac. T. M. RC. SM. PA. CB.

YEOMAN MUSIC LTD.
33 Cambridge Street, Aylesbury, Bucks.
Aylesbury 85549
O. W. K. Ac. SFI. T. M. RC. SM. ERS. EK.
G. A. S. CB. MA. S/hnd.

CAMBRIDGESHIRE

CAMBRIDGE ROCK
44 Newnham Road, Cambridge.
0223 65093
EC. RCn. IR. G. A. S. S/hnd. MA. RS.
ERS. H. M. RC. PA. CB. PA.

DRUM AND GUITAR CENTRE
4 Norfolk Street, Cambridge.
0223-64410
D. G. A. ERS. EC. S.

CHESHIRE

CUSTOM AMPLIFICATION
45 Nantwich Road, Crewe
0270 4779
46 Hope Street, Hanley
Stoke-on-Trent
0272 266897
G. A. D. K. S. Di. L.

THE ORGAN CENTRE
(J.G. Flatly & C.R. Durran)
26 Edleston Road, Crewe.
G. A. D. K. B. W. S. P. M.

JONES MUSIC STORE
5 Queen Victoria St., Macclesfield.
0625 22677
G. A. D. K. W. S. B.

RUMBELOWS/STROTHERS
Coronation Bldgs., Wallasey Rd., Wallasey.
051 638 3622/9871
G. A. D. K. W. S.

CLEVELAND

CLEVELAND MUSIC
19-21 Cleveland Sq., Middlesborough.
0642 210889
G. A. D. K. S. Di. ERS. S/hnd. Fender.
S/House.

COVENTRY

COVENTRY MUSIC CENTRE
3-4 Whitefriars St., Coventry.
0203 58571
(EC. RCn. O.) Syn. G. A. D. S. S/hnd. MA. RS.
Spec. ERS. EK. K. B. L. H. T. M. RC. SM. PA.
CB. Di.

CORNWALL

WEST COUNTRY MUSIC
New Bridge Street, Truro, Cornwall.
Truro 78501
EC. O. IR. SYN. G. A. D. S. S/hnd.
MA. EK. B. W. M. SM.

CUMBRIA

J.P. DIAS (CARLISLE) LTD.
149-153 Botchergate, Carlisle.
0228 22369/28700
EC. O. Syn. G. A. D. K. B. W. S. Di
Ac. PA. RS. ERS. EK. T. M. S. M. P.

NORTHERN SOUNDS
41 Jane Street, Workington
0900 4797
113 Duke Street, Barrow in Furness
0228 27100
G. A. D. K. RS. T. M. SM. Di. SYN. B. M. RC.
EC. RCn. CB. MA. MAINE

DEVON

MOSS MUSIC
6 Allalland Street, Bideford, North Devon.
Bideford 5994
G. A. O. RS. ERS. B. W. T. S. SM. MA.
SYN. S/hnd. M. PSG.

MUSIC MARQUEE
47 Notte St., Plymouth PL1 2AG.
0752 63559
G. A. D. K. Di. L. RS.

O. NICKLINS & SONS LTD.
45 High Street, Barnstable, Devon.
0271-2006
A. K. G. W. S. S/hnd. SM. D. RS.

THE DAVID VANE MUSIC CENTRE
47 Exeter Rd., Exmouth, Devon.
03952 75246
A. O. D. Di. S/hnd. S. M. ERS.
Spec. G. T. G. K.

DORSET

COAST MUSIC
129A Hankinson Road, Charminster,
Bournemouth 0202 522613
Spec. American Guitars.
G. A. D. S. MA. RS. M. PA. CB. Ek. S/hnd.



JIMZ
83 Bishops, Christchurch
Bournemouth
02015 71270
EC. RCn. G. A. D. S.
S/hnd. RS. Spec. ERS. EK. WL. H. SFI. M. RC. PA. Di.

GLOUCESTER



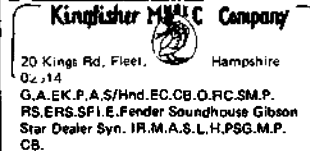
Ray's
287 High Street, Exeter, Devon, EX1 1JH

HAMPSHIRE

BECKETTS MUSIC.
2/3 Gibbs Road,
(Side of ABC Cinema),
Southampton.
0703 24827
G. A. D. S. S/hnd. RS. B. W. Ac. M. SM.

TELECOMMS
189 London Road, North End, Portsmouth.
0705 60036
S/hnd. MA. RS. EK. K. I. R. SYN.
G. A. D. S. M. PA. Di.

U-NAME-IT
8 Arundel Way,
Arundel Street,
Portsmouth, Hants.
Portsmouth 21165
Everything music at super discount



Kingfisher Music Company
20 Kings Rd, Fleet, Hampshire
023 214
G. A. EK. P. A. S/hnd. EC. CB. O. RC. SM. P.
RS. ERS. SFI. E. Fender Soundhouse Gibson
Star Dealer Syn. IR. M. A. S. L. H. PSG. M. P.
CB.

HEREFORD

BUZZ MUSIC.
65 Widemarsh St., Hereford.
0432 55961
G. A. S. S/hnd. RS. H. PA. M.
EC. MA. Maine, Altoc. MM. Amek.

HEREFORD SOUND CENTRE LTD.
7 Bridge St., Hereford.
Hereford 58550
EC. G. A. D. S. S/hnd. MA. P. RS. Spec.
L. H. M. PA. Di.

HERTFORDSHIRE

HERMITAGE ORGAN CENTRE LTD.
35-37 Hermitage Road, Hitchin, Herts.
Hitchin 59925
O. G. D. EC. RCn. IR. SYN. A. S. S/hnd.
MA. RS. Spec. ERS. EK. K. B. W. L. T.
M. RC. SM. PA. Di.

MR MUSIC
24 Bridge Street, Hemel Hempstead, Herts.
Herts 61812/3
A. Ec. O. IR. SYN. G. D. S. S/hnd. RS. K.
ERS. EK. B. W. L. H. Ac. SFI. SM. PA.
PSG. CB. Di.



Ware Music Ltd
9 Baldock St., Ware, Herts. 0920-5939
G. A. K. EK. B. W. S. T. M. RC. SM. P. ERS. O.
S/hnd.

HUMBERSIDE



JOHNNY PAT'S MUSIC PLACE
188 Holmestone Road,
Hull HU8 2EA
Hull 23782
New + S/H Group Gear Plus
Repair Service - Main Agents

IRELAND



AUDIO
13 Upper Street, Dublin 2
Concerts, Theatre Shows, Festivals,
Clubbing

THE BAND CENTRE
9 Harcourt Road, Dublin 2
0001 75 2663
G. A. K. PA. Spec. H. PA.

MODERN MUSIC CENTRES
Wright's Arcade, Newtownards,
46 Gray's Hill, Bangor, Northern Ireland.
0247 51292
EC. IR. SYN. G. A. D. S. S/hnd. RS.
ERS. B. W. L. Ac. T. M. RC.
SM. PA. PSG. CB. Di.

CRYMBLES (IRELAND)
67-71 Dublin Street Belfast.
0232 26818
G. A. D. K. B. W. S. Di. Ac. RS. SM.



Evans Musical
53 Bridge Street, Lurgan 0282 2011
ERS. EK. K. L. H. Ac. T. M. RC. PA. PSG. Di.
EC. RCn. O. IR. SYN. G. A. O. S. S/hnd. M. Spec.

SPORTS & MUSIC CENTRE
73-75 Broughshane Street, Ballymena.
0266 41792
1/3 The Strand, Coleraine.
0265 51665
G. A. D. K. PA. S. PSG. M. ERS. MA. W.
Ac. T.
Session Music, 169 Spencer Road,
Londonderry.

ISLE OF MAN

ISLAND MUSIC CENTRE
2 Market Hill, Ramsey.
0624-813688
52 Duke St., Douglas.
0624 6752
O. SYN. G. A. D. S. p/x. RS. SFI. T. M.
JVC. Spec. SM. PA. Di. Sole Agents: Lowrey,
Thomas, Welson, Wurlitzer, O. Service,
Educ. Records.

KENT

PAT CHAPMAN
31-33 Sidcup Hill, Sidcup, Kent.
01-300 3838/9668
EC. SYN. G. A. D. S. S/hnd. MA. RS. CB.
Spec. ERS. K. B. W. Ac. SFI. M. RC. SM.



Demand Percussion
31 Leadmill Road, Dartford
0203 24349



KENNARDS
86 St Northgate, Canterbury, Kent
0227 84231
EC. O. IR. SYN. G. A. O. S. S/hnd. RS. Sun. LHS
EK. K. B. W. L. H. Ac. T. M. RC. SM. PA. Di. 24
Hour internet priced service

PEPPER MUSIC
86 Northdown Road, Margate.
0843 23205
G. A. D. PA. RS. PA. Hire

MOSS MUSIC LTD.
67 Canterbury St., Gillingham.
Medway (0634) 576381
G. A. D. S. RS. ERS. PA. B. W. T. M. Di.

WING MUSIC
15-15A London Road, Bromley, Kent.
01-464-3190
EC. RCn. O. IR. SYN. G. A. D. S. SYN. MA.
RS. Spec. ERS. EK. K. L. H. M. RC. PA. CB. Di.

LANCASHIRE

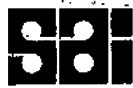
BARRATTS
1 Meadow Street, Preston
0772 55628
IR. SYN. RS. ERS. EK. G. A. D. B. W.
S. Di. L. H. PA. M. P.

FLAME AMPLIFICATION
100 Eastbank St., Southport, Lancs.
0704 37050
G. A. EC. RCW. S. Di. L. PA. S/hnd.
M. RC. CB for Cab's and PA Systems.

HOBBS MUSIC
3/5/7 Mary Street, Lancaster.
Lancaster B0740
EC. O. IR. SYN. G. A. D. S. S./Hnd. MA.
RS. ERS. EK. K. B. W. L. H. Ac.
SFI. M. RC. SM. PA. CB. Di.

HW AUDIO
156 Bradshawgate, Bolton BL2 1BA
0204 26639
PA. Di. L. MA. A. M. CB. H. RS.

PALL MALL MUSIC
58 Pall Mall, Chorley, Lancs.
025 72 71124
G. A. S. Di. EK. M. P. A. S./Hnd. ERS. CB.



S. A. I
Regent St Showrooms,
Regent St., Coppull,
Chorley, Lancs.
0257 791845,
G. A. D. Di. L. PA. RS

WOODS PIANOS & ORGANS
1a-b Manchester Rd., Burnley.
0282 33709
SYN. G. A. D. K. B. W. S. Ac. PA. RS.
ERS. EK. M. RC. SM. T. EC. O.
IR. S/Hnd. P.

WOODS PIANOS & ORGANS
84 Church St. Preston.
0772 52865
SYN. G. A. D. K. B. W. S. Ac. PA. RS. ERS.
EK. M. RC. SM. T. EC. O. IR. S/Hnd. P.

WOODS PIANOS & ORGANS
15-17 Manchester Rd., Bolton
0204 27171
SYN. G. A. D. K. B. W. S. Ac. PA. RS. ERS.
EK. M. RC. SM. T. EC. O. IR. S/Hnd. P.

LEEDS

KEYBOARDS of LEEDS

53 The Headrow, Leeds.
Tel: 0532-468939
351 Otley Road, Leeds 16.
Tel: 0532-788466
O. M. Syn. G. A. S/Hnd. MA. Yamaha Farfisa Gramer
RS Spec. ERS. EK. F. Ac. T. SY.

SCHREERERS
8 Merrian Centre, Leeds 2
0532 449592
G. EC. A. WB. S. D. ERS. RS. HH Agents

STEPHENS MUSICAL
70 New Briggate, Leeds LS1
0532 34710

LEICESTERSHIRE

CENTRAL MUSIC LTD.
12 New Bond Street, Leicester.
0533 538681
EC. O. R. I. RS. E. K. ERS. F. A. D. B.
W. Di. S/Hnd. T

CUSACK'S MUSIC
33 Braunstone Gate,
Leicester
0533 548517
CB. PA. G. A. ERS. Di. H

HUMBUCKER MUSIC CENTRE.
124C, Green Lane Road, Leicester.
0533 769318
EC. O. IR. SYN. G. A. S S/Hnd. MA (Laney).
RS Spec. ERS. EK. K. L. H. Ac. T (Bass). M.
RC. PA. CB. Di (Manufacturers of Sound to
Light, P. A. Speakers and Bins).

LOUGHBOROUGH MUSIC CENTRE.
18 The Rushes, Loughborough, Leicester.
0509 30398
EC. O. IR. SYN. G. A. D. S. S/Hnd. MA. RS.
ERS. EK. K. B. W. L. H. Ac. T. M. SM. Di.

SOUNDPAD MUSIC CENTRE
64 London Road, Leicester
0533 20760
G. A. K. Di. L. IR. SI. PA. Peavey Powerhouse,
Gibson Star Dealer, Pearl, HH and Carlbro.

SUPERMOUSE MUSIC.
233 Matton Road, Leicester
0533 63830
IR. SYN. G. A. D. S. S/Hnd. MA. RS. Spec.
ERS. EK. K. B. L. H. T. M. RC. SM. PA. CB. Di.

LIVERPOOL

**HESSY'S
MUSIC CENTRE**
62 Stanley St., Liverpool 1
051-236-1418
G. A. D. K. B. W. Di. L. RS.

LONDON

J.V. BOURDON LTD.,
21-22 High Street, Shoreditch, London E1
01 247-8063
(500 yards from Liverpool Street Station)
G. A. D. S. S/Hnd. RS. B. W. M. RC.

CACOPHONY
110 Churchfield Road, Acton W.3.
01 993 2910
EC. G. A. D. S. S/Hnd. MA. Elec. Guitar RS.
ERS. Peavey. Traynor. Marshall Spec. M. RC.
Electric Guitar + Amplification CB.

CITY OF LONDON MUSIC STORE.
17 Eldon Street, E.C.2.
01 588-4649
EC. SYN. G. A. D. S. S/Hnd. B. W. Ac. SFI.
PSG. RS. ERS. M. SM (Albums). PA.

STEPHEN DELFT
242 Cable Street, E1
01 790 7028
G. A. SFI. CB. 24 Hrs. RS.

F D & H MUSIC
138 - 140 Charing Cross Road, London
WC2H 0LD
Tel: 01 836 4766
EC. Syn. G. A. S. S/Hnd. MA. (HH. Maine,
Ibanez, Peavey, Music Man, Guild, Gibson,
Electroharmoni). RS. Spec. ERS. EK. K. B.
W. SFI. T. M. RC. SM. PA. PSG. Di.

GRANGWOOD ORGANS (J80)
445/7 High Street, North, Manor Park,
London E12
01 472-5107/4690
EC. SYN. D. S. S/Hnd. MA. RS. ERS. EK. K. L.
T. M. PA. Di. Spec. A. O. G.

HERNIM'S DRUM STORE
111 Tottenham Court Road, London W1P
01 253 4444
Specialists in all types of drums, cymbals,
percussion, amplifiers, tuners, mutes, etc.
Tel: 01 253 4444

Holiday Music LTD.
111 Tottenham Court Road, London W1P
01 253 4444
Specialists in all types of drums, cymbals,
percussion, amplifiers, tuners, mutes, etc.
Tel: 01 253 4444

**LONDON
SYNTHESIZER
CENTRE**
111 Tottenham Court Road, London W1P
01 253 4444
Specialists in all types of drums, cymbals,
percussion, amplifiers, tuners, mutes, etc.
Tel: 01 253 4444

maconix
111 Tottenham Court Road, London W1P
01 253 4444
Specialists in all types of drums, cymbals,
percussion, amplifiers, tuners, mutes, etc.
Tel: 01 253 4444

Monterey Music Co.
111 Tottenham Court Road, London W1P
01 253 4444
Specialists in all types of drums, cymbals,
percussion, amplifiers, tuners, mutes, etc.
Tel: 01 253 4444

MAURICE PLACQUET
358-360 Uxbridge Rd.,
Shepherds Bush W12
01 749 1204
G. A. D. B. W. S. Ac. PA. RS. P.

MUSIC HOUSE (S.E. ENT)
375-377 Lewisham High St., SE13
01 690 2205
G. A. D. K. S. Di. L. PA. RS. Spec.

PRO-DRUM PRODUCTS
112, 114 Gardner Street
London W. 1.
01 437 1836
Distributors of staccato fibre glass concert
tom toms and the drumstore multi purpose
drum key. Call John Vernon any time

SESSION MUSIC LTD.
163 Mitcham Rd., Tooting SW17
01 672 3413
G. A. D. S. S/Hnd. RS. ERS. L. M. SM.
PA. Di.

DAVE SIMMS MUSIC CENTRE
1-5 The Grove, Ealing W5.
01 560 0520
Spec. G. A. PA. S/Hnd. Di. L. D.

SOUNDS
124 Shaftesbury Ave. London W1
01 437 2458
G. A. D. EC. S. S/hnd.

**ST. GILES MUSIC
CENTRE**

16-18 St. Giles High St., London WC2 1TL 01 836 2888-2358-4090
G. A. D. B. W. RS. IR. R. H. M. Strategic. Among. Peavey. Guit.

THE SUPREME DRUM COMPANY
208 Forest Road, Walthamstow, London
E17.
Tel: 01 520 3873
43 The Broadway, Stratford, London E15.
Tel: 01 534 1680
Acrylic Drums Manufacturer. 9 Ply Birch
Shell 6" - 24". Full Recovering Service.

TOP GEAR
5 Denmark Street, WC2H BLP.
01 240 2118
Spec. G. A. D. PA. EC. Ac. CB. M. RC.
P. MA. RS. PSG. S/Hnd.

WESTERN MUSIC CO. LTD.
50 The Broadway, Wimbledon SW19.
01 540 0494
O. Syn. G. A. D. S. S/Hnd. MA. (Lowrey,
Farfisa, Yamaha). SPEC (Keyboards). ERS.
EK. K. B. W. AC. SFI. T. M. SM.

WESTERN MUSIC CO. LTD.
130-132 King St.,
Hammersmith W6.
01 748 5824
O. Syn. G. A. D. S. S/Hnd. MA. (Lowrey,
Farfisa, Yamaha). SPEC (Keyboards). ERS.
EK. K. B. W. AC. SFI. T. M. SM.

MANCHESTER

AL. MUSIC
80 OXFORD STREET, MANCHESTER 1
061 236 0340
SYN. G. A. D. K. ERS. ERS. ERS.
EK. L. SFI. PA. S. Hnd. M. RC. P. CB. SPEC.
MAIN AGENTS: OMEGA 1, HIRSHLAND
MUSIC, MAY PROJECT LIGHTING, MARTIN GUITARS,
PEARL, AMPS, STRAP, ETHNIC, USCOS
CONTACT: QUAM AND ANNE FOR DESIGNER SERVICE

BARRATTS
8a Oxford Street, Manchester M15 0QA.
061 236 0542
IR. RS. B. W. H. SM.

BARRATTS
72-74 Oxford Street, Manchester
061 236 0052
IR. SYN. RS. ERS. EK. G. A. D. K. Di.
L. H. SFI. PSG. P.

MIDDLESEX

BAND CENTRE
53 Bell Road, Hounslow, Middlesex.
Tel: 01 570 7821
(Only 4 miles from London Airport)
G. A. S. S/Hnd. Spec. ERS. EK. K. H. M. PA.
CB.

NEWCASTLE-UPON-TYNE

BARRATTS
168 Newbridge St., Newcastle-upon-Tyne.
0632 22331
IR. SYN. RS. ERS. EK. G. A. D. B. W. S.
Di. L. H. PA. M. P.

LEWIS MUSIC
16 Bedeburn Road, Jarrow.
Jarrow 897784
D. P. Sp. MAP. SCB.
EC. G. A. S/Hnd. RS. H. T. M. R. C. PA.

ROCK CITY
48 Cloth Market, Newcastle-upon-Tyne.
Newcastle-upon-Tyne 78068
G. A. D. EC. RC. IR. O. SYN. S. MA. RS.
ERS. EK. B. W. L. H. M. SM. CB. Di.

NORFOLK

**Cockes Band
Instruments**
34 St. Benedicts Street, Norwich NR1 2PB
G. A. D. S. D. RS. EC. IR. SYN. MA. ERS. EK. G. B. W. PA. M. P.

NORWICH SOUND SYSTEMS
80 Prince of Wales Road, Norwich
Norwich 611989
H. E. RS. RS. S/Hnd. S. D. A. G. SYN.
EC. Di. PSG. AC. PA. M. MA. - Traynor Pearl.
Gibson. Star Dealer. Yamaha and Disco
Sound (in MA).

JOHN SAVAGE MUSIC CENTRE
71-72 Norfolk Street, Kings Lynn, Norfolk.
0553-4026
G. A. D. S. SM. S/Hnd. EC. SYN. RS. T.

JACK WHITE ORGANS
48-50 St. Benedicts Street, Norwich.
0603 613678
Pro. Keyboard Centre.

NORTHAMPTONSHIRE

FUNKSHUN
168-186 Wellingborough Road,
Northampton.
(0604) 34100
RCn. O. IR. SYN. G. A. D. S. S/Hnd. MA. RS. Spec.
ERS. EK. K. L. H. M. RC. SM. PA. CB. Di.

MIDLAND MUSIC CENTRE
6 Cowper St., Northampton.
0604 36832
G. A. D. K. B. W. S. Di. RS. T. IR.

NOTTINGHAMSHIRE

CLEMENTS' PIANOS LTD.
21-23 Derby Road, Nottingham
0602 47912
G. A. D. P. B. W. S. SM. RS.

**Farnsworth
Music**
134 Radford Boulevard,
Nottingham (0602) 76510
Syn. G. A. S/Hnd. RS. ERS. K. D. W. H. T.
M. SM. PA.

HARDY SMITH MUSIC CENTRE
2a Outram St., Sutton-in-Ashfield, Notts.
Mansfield 56242
G. A. D. K. B. W. S. RS. SM.

JACK BRENTNALL
Premier Music House,
3 Market Street,
Nottingham.
0602 47166
G. A. EC. IR. D. S. RS. B. ERS. W.

NOHPONEX LTD.
c/o Flat 1, 1 Shirley Road, Mapperley Park,
Nottingham.
0602 624666
4T. £4.50 p/h. £39 p/d. Cap 8.
TF. CP. R. R. R. C. D. T. M. S. Ka. DBX. AC.
SM & DC ba.
Various instruments and amplification both
available and/or by arrangement
Fully Professional Recording Equipment
and Accessories.

SCOTLAND

BRADLEYS MUSIC LTD
68a West Regent St., Glasgow
041 332 1830
EC. RCN. MA. RS. Spec. G. A. D. B. S.
PA. S/Hnd. T. M. P.

Charnley
109 High Street, Walsley
05829 20899 G. A. D. B. W. S.

FVM FORTH VALLEY MUSIC
100 High Street, Perth
Tel: 0534 9447
PA. S/Hnd. T. M. P.

JERRY ALLEN MUSIC
25 Titchfield Street, Kilmarnock
0563 28450
G. A. D. K. Di.

C. B. MILLER & CO. LTD.
2 Queengate Arcade, Inverness, Scotland
Inverness 33374
G. A. D. S. EC. O. IR. S/Hnd. RS. ERS. EK. K.
B. W. Di. M. T. Ac.

THE MUSIC BOX
7-9 Whitburn Road, Bathgate
0606 52893
G. A. D. K. B. W. S. RS. SM.

WILKINSON'S MUSIC.
71 Stirling Street, Airdrie
02366 60873
G. (Yamaha, Ibanez, Antoria, Hagstrom,
Gibson, Fender) EC. O. MA. (WEM,
Carlbro, Marshall etc.) D. (Tama)
S. S/Hnd. A. SM. PA. M. ERS. EK. B.
W. AC. SFI. T arranged.

SHROPSHIRE

GEAR CELLAR
100 Market Street, Shrewsbury
Tel: 0534 9447
PA. S/Hnd. T. M. P.

SALOP MUSIC CENTRE
Unit 1, Town Walls, Shrewsbury
0743 84111
EC. IR. SYN. G. A. D. S. S/Hnd. MA.
RS. Spec. ERS. EK. K. B. W. L. H. T. SFI.
M. SM. PA. CB. Di.

STAFFORDSHIRE

THE ABBEY MUSIC CO.
5-6 Market Place, Burton-on-Trent.
0283 68404
G. A. K. B. W. RS. T. Spec. D.

LANCASHIRE & NORTH MUSIC
 17 Millers' Lane, Wigan, Lancashire
 0902 22211
 1. H.C. R.C. A. D. S. S. Hnd. PA. RS. L. PA.
 1. Pianos, Organ, Amps, Music, Custom USA
 Synthesizers, etc.

NORMANS MUSICAL INSTRUMENTS LTD
 1 Lichfield St., Burton-on-Trent.
 0283 42401/61528
 G.A.D.K.B.W.S.RS. Gibson, Star Dealer.
 H/M. Boosey & Hawkes, Premier. SM.
 Pianos.

JOHNSONS MUSIC CENTRE
 37 Station Street,
 Burton-on-Trent, Staffs.
 0283-44536
 Brass and woodwind. Parade band
 equipment.

SUFFOLK
MORLINGS LTD.
 House of Music,
 149-151 London Road North,
 Lowestoft, Suffolk.
 Lowestoft, 05491-713143
 EC.O.IR.SYN.G.D.S.S/Hnd.MA.
 RS.ERS.K.B.W.L.H.AC.SFI.SM.
 P.SG.DI.

SURREY
ABC MUSIC
 14/16 High Street, Addlestone, Surrey.
 0832 40139/54897
 96 High Street, Esher.
 78 66436
 EC.RCn.O.IR.Syn.G.A.D.S.S/Hnd.
 MA.RS. Spec.ERS.EK.K.B.W.L.H.
 Ac.SFI.T.M.RC.SM.PA.PSG.CB.Di

JOHN KING SOUNDS
 8 Richmond Road, Kingston
 01 546-9100/9124
 O.IR.SYN.G.A.D.S.S/Hnd.MA(HH).RS.
 Spec.EK.B.W.L.H.Ac.T.M.RC.PA.Di

CROYDON MUSIC STUDIOS
 40 Station Road, West Croydon, Surrey.
 01 688 0628
 G.A.D.S.S/Hnd.RS.B.W.Ac.SFI.
 M.SM.MA. (Premier, MXR)

DICK MIDDLETON MUSICAL INSTRUMENTS.
 51 Quarry Street, Guildford.
 0483 34537
 EC.O.IR.SYN.G.A.D.S.S/Hnd.RS.ERS.
 EK.K.H.Ac.SFI.M.RC.PA.PSG.CB.

KEYBOARD HARMONY
 82 High Street,
 Redhill, Surrey
 01-68821
 EC.RCn.O.IR.Syn.G.A.D.S.S/Hnd.MA.RS.
 Spec.ER.EK.K.B.W.L.H.SFI.T.M.HC.SM
 PA.CB.Di

Redhibition
 81 and 83rd Street, Croydon, Surrey, 01 688 1907
 125 High Street, Sutton, Surrey, 01 661 1167

WESTERN MUSIC CO.LTD.
 53-59 High Street, Croydon.
 01 688 1248
 O.Syn.G.A.D.S.S/Hnd.(Lowery, Farfisa,
 Yamaha).SPEC(Keyboards).ERS.EK.K.B.
 W.AC.SFI.T.M.SM.
WESTERN MUSIC CO. LTD.
 125 High Street, Sutton, Surrey.
 01 661 1167
 O.Syn.G.A.D.S.S/Hnd.MA.(Lowery,
 Farfisa, Yamaha).SPEC(Keyboards).ERS.
 EK.K.B.W.AC.SFI.T.M.SM.

SUSSEX
CASSMUSIC
 29 South Street, Eastbourne, Sussex.
 0323 37273
 EC.G.A.D.S.S/Hnd.MA.RS.Spec.ERS.
 EK.K.B.W.SFI.M.RC.SM.PA.CB.

Hartings sound
 37 Kings Road St Leonards on Sea
 0424 428970

SOUTHERN MUSIC
 34 Waterloo Street,
 Hove, Sussex
 0273 733387/774536
 EC.RCn.O.IR.Syn.G.A.S.Hnd.WA.RS
 Spec.(G.A.)ERS.EK.L.H.SFI.M.RC
 PA.CB.Di

JOHN HAM MUSIC CENTRE
 48 Clothmarket Newcastle
 Tel: (0632) 24175
 THE NORTH'S BEST
 FOR GUITARS, AMPS & CABS
 KEYBOARDS, EFFECTS, DISCO,
 PERCUSSION, REPAIRS.
 Mail Order, H.P. Available.

WHITE SOUND EQUIPMENT
 3 Albion Close,
 Sunderland, Tyne & Wear 0783 78058
 Spec.RS.EC.O.IR.Syn.G.D.S/Hnd.
 ERS.EK.K.B.W.L.H.SFI.M.RC.Sm.
 PA.PSG.CB.D.MA: (Peavey, Marshall, Pearl,
 Amcion, Carlsbro, Fender, Rodgers, Ludwig,
 DJ Electronics, SAI, Gibson, Music Man).

WALES
JOHN HAM
 75-76 Mansel St., Swansea, Wales.
 0792 50968
 G.A.D.K.B.W.Di.RS.SM.Tape Demo
 Gear
PETER NOBLE LTD.
 11 Station Road, Llanishan, Cardiff.
 0222 753911
 EC.SYN.G.K.B.D.P.W.S.Di.L.S/Hnd.
 M.Spec.PA.ERS.
 Yamaha and Pearl pro centre.

MUSIC CENTRE ABERDARE
 13c Canon Street, Aberdare, Mid
 Glamorgan.
 Aberdare 874141
 O.G.A.RS.S.SM.M.K.SYN.ERS.

GWENT MUSIC CO.
 Kingsway Centre,
 Newport, Gwent.
 0633 57505
 EC.O.IR.SYN.G.A.D.S.S/Hnd.MA.RS.
 Spec.ERS.EK.K.B.W.Ac.M.SM.PA.Di.

SOUND CENTRE
 129 High Street, Bangor.
 0248 53320
 A.Di.L.RS.SFI.H.SM.Spec.G.D.O.

BERT VEALE (MUSICAL) LTD.
 8 New St., Neath, Glam.
 Neath 2825
 EC.RCn.O.SYN.MA.RS.MA.RS.Spec.
 EK.G.A.D.K.B.W.S.Di.L.Ac.SFI.PA.
 PSG.S/Hnd.T.M.SM.P.

SOUNDWAVE MUSIC CENTRE
 51 Gwent Square, Cwmbran, Gwent, Wales.
 06333 2501
 SFI.T.M.RC.SM.PA.CB.Di.EC.O.IR.
 SYN.G.A.D.S.S/Hnd.RS.ERS.EK.B.
 H.Ac.MA. Music Man, Gibson, Star Dealer.
 John Birch.

RHYL SOUND CENTRE
 25 Vale Road, Rhyl, Nth. Wales.
 Rhyl 51436
 G.A.RS.Di.E.O.SYN.D.S.S/hnd.
 ERS.K.EK.L.M.SM.

Mitchell Music & Electronics
 1 Queen St., Sarnbury, Wilt.
 0742 21829

WILTSHIRE
BUZZ STOP
 24 Market Street,
 Ludlow, Shropshire, 0507 32214
 125 G.A.D.S.S/Hnd.MA.RS.EK.B.W.
 SFI.M.RC.

CENTERSOUND
 11 Castle Street, Rugby, Warwickshire.
 0788 74566
 RCN.O.IR.S6n.G.A.D.S.S/Hnd.MA.
 RS.ERS.EK.L.H.M.RC.SM.PA.Di

WARWICKSHIRE
ALBERT HIND
 16-18 Waterhouse Street, Halifax, Yorks.
 0422 53879
 A.G.P.O.D.S.W.SM.

YORKSHIRE
ALBERT HIND
 16-18 Waterhouse Street, Halifax, Yorks.
 0422 53879
 A.G.P.O.D.S.W.SM.

I.S.G. MUSICAL SERVICES

KEYBOARDS
 54-58 The Headrow, Leeds
 251 Otley Road, Leeds 16
 0532 468938
 O.H.SYN.A.MA.Yamaha Farfisa Crumar.
 RS.Spec.ERS.EK.E.Acc.T.SM.

MUSIC GROUND
 Station Road, Stamford, Doncaster, South
 Yorkshire.
 0302 843037
 EC.RCn.O.Syn.MA.RS.G&A Spec.
 ERS.EX.D.K.PSG.S/Hnd.T.M.RC.P.

PROFESSIONAL MUSIC CENTRE
 13 Netherhall Rd., Doncaster.
 0302 68157
 G.A.B.W.K.T.
 EC.RCn.O.IR.Syn.D.S.S/Hnd.MA.
 RS.Spec-organs.perc.ERS.EK.
 M.H.RC.PA.

JIGSAW SOUND CENTRE
 2 Station Road,
 Ossett, W. Yorks
 (0924) 277981
 Fender, Gibson, Vox, Carlsbro, Orange,
 WEM, Custom, Pearl, Rodgers, Area agents
 for MVX equipment

OSUPDGUIDE

BEDFORDSHIRE
PIPER SOUND STUDIOS
 50 Cheapside, Luton Beds.
 0582 605875/27195/26693
 8T £8 p/h 16T 10 p/h incl. tape Cap 10 R-R
 C-D, DBX, Comps/Lims Sm, tf, CP, Ac/ba I.
 A. Ampex Mastering Echo Plates, TV.

QUEST STUDIO
 721 Windmill Road, Luton, Bedfordshire.
 0582 414297/36950
 8T Cap 8, from £6.00 p/h. p/d ba D. tf. R-R.
 CP, R-C, Dc, Ba, d-t, Piano, M.S. Ac. ba. SM.
 Eventide effects

ROLLING THUNDER STUDIO
 21A Bridge Street, Leighton Buzzard, Beds.
 05253 71622
 16 Track Master Recording Studio £12 p/h.

BIRMINGHAM
GROSVENOR RECORDING STUDIO
 (Hollick & Taylor Recording Co)
 16 Grosvenor Road, Handsworthwood,
 Birmingham, B20 3NP.
 021 356 9636
 Studio 1 16T Cap 35, £27 p/h
 Studio 2 2T Cap 10, £18 p/h
 tf. R-R. CP. Ka. RC. Dc. d-t. M.S. fcl. SM.

ZELLA RECORDING STUDIOS
 Walker Hall, Ampton Road, Edgbaston,
 Birmingham B15 2UJ
 021 456 0645
 8T £15 p/h (10am-10pm after 10pm and
 Sundays £20 p/h) Cap 35. f. R.

BRISTOL
MUSHROOM STUDIOS
 18 West Mall, Clifton, Bristol.
 0272 35994
 8T £10.50 p/h Cap 17. R-R-C-Cr CP DBX D
 Ka Disc Pressing, Accommodation 6
 bedrooms, self catering.

SOUND CONCEPTION
 85 Ashley Road, Montpellier, Bristol 6
 0272 554721
 BT £9p/h. £75p/d. Cap 10. tf. R-R. R-C. d-t
 CP. Ka. (Bechstein Grand Piano) SM

BUCKINGHAMSHIRE
MAURICE PLACQUET
 Pinewood Ltd., Pinewood Film Studio,
 Pinewood Road, Iver, Bucks.
 0753 654 571/0753 651 700
 Cap 60 when touring ring Iver 654571 for
 the following, Rehearsals, Sound
 Recordings, Promotional Filming.
 Instruments available including
 amplification, PA System, Steinway Grand
 Piano Hammond B3 & C3 Organs Ac/ba.
 Sm.

KEY FOR DEALER GUIDE

EC	Echo Chamber
RCn	Re-Coning
O	Organs
IR	Instrument Rental
SYN	Synthesizers
G	Guitars
A	Amplifiers
D	Drums
S	Strings
S/Hnd	Second Hand
MA	Main Agents
RS	Repair Service
Spec.	Specialists
ERS	Electronic Repairs
EK	Electric Keyboards
K	Keyboards
B	Brass
W	Woodwind
L	Lighting
H	Hire
Ac	Accordions
SFI	Special Fretted Inst.
T	Tuition
M	Mikes
RC	Reconditioning
SM	Sheet Music
PA	Public Address
PSG	Pedal Steel Guitars
CB	Custom Building
Di	Disco

OSUPDGUIDE

CAMBRIDGESHIRE
SPACEWARD RECORDING STUDIOS
 19 Victoria Street Cambridge
 0223 64263 24 hours
 from 10am to 2am with 2 hours breaks,
 includes use of 2" tape and free 1/4" tapez.
 Phone Gary for details of full technical
 facilities and services.

CHESHIRE
STRAWBERRY RECORDING STUDIO (UK) LTD.
 3 Waterloo Rd., Stockport Cheshire.
 061 480 9711
 24T £30 p/h 16T £35 p/h 8T £18 p/h. 2T
 Stereo & Mono £15 p/h Cap 35. tf. D. R-R,
 R-C

COVENTRY
HORIZON STUDIOS
 Now 16T. The rates are applicable for 16T.
 and for 8T.
 Horizon House, Coventry CV3 6QS
 0203 21000
 16T £19 p/h 8T £14 p/h 4T £10 p/h 2T £6
 p/h Cap 20 Dc/ba R-R-C Ka SM/ba Special
 rate day bookings.

DEVON
WEST OF ENGLAND SOUND LTD.
 14 Swan St., Torquay, Devon
 080 428 276
 Studio 1 8T £8 p/h Cap 30
 Studio 2 8T £8 p/h Cap 10
 R-R-C-Cr CP Pro PA Equipment for hire.

ESSEX
PENTHOUSE STUDIO
 22 Maderia Grove, Woodford Green, Essex.
 01 505 5221/1110
 8T and 4T, 8T £8p/h. 4T £5p/h. Cap 6, R-R,
 R-C. R-Cr. d-t. CP. Ka. Dc. M.S. AC. SM.

GLOUCESTERSHIRE
WINDRUSH RECORDING STUDIO
 (Between Oxford and Gloucester)
 High Street, Bourton-on-the-Water,
 Gloucestershire.
 0451 20172
 4T £4.00 p/h £35.00 p/d Cap 7. tf. R-R, R-C,
 d-t. CP. (K.A.G.D.ba) Ac ba M.S.SM.ba.

HEREFORD
CHAPEL LANE STUDIOS
 Hampton Bishop, Hereford.
 0432 73430/65198
 16T £16 p/h 8T £8 p/h Cap up to 18
 musicians. tf. R-R. R-C. No OTC. CP. MS.
 Good AC ba. all SM ba. bass, drums guitars
 etc. Free use of Fender-Rhodes grand pno.
 Fender amps, string synth etc.

HUDDERSFIELD

SEPTEMBER SOUND STUDIOS
38 Knowl Road, Golcar, Huddersfield,
HD7 4AN.
0484-658895/6
16T. Cap 45 £15.00 p/h, p/d ba D, R-R, C-Cr,
R-C ba CP, M.S. vs Ac ba. SM. ba Oba. Ka
Drums

N. HUMBERSIDE

FAIRVIEW MUSIC
Willerby, Hull, N. Humberside
0482 653116
8T £8.50 p/h p/d neg. Cap 10. tf. R-R CP.
Ka. R-C. d-t. M.S. SM.

KENT

ESCAPE STUDIOS
Island Farm, Edgerton, Kent.
023 578259
16T £350p/d Cap 10 D Ac

INDEPENDENT RECORDING STUDIOS
39 Harmer Street, Gravesend, Kent.
0474-65687
8T Cap 20 From £10 p/h or £70 p/d.
D. All d R-R. CP. Kba. (Grand Upright String
Synth) Dc. No OTC. M. S. SM. (all types) by
arr. Acc by arr. Food and drink avail on
premises.

LEICESTERSHIRE

PHOENIX THEATRE
Upper Brown Street, Leicester.
0533 57589
2T £3.00 p/h £30.00 p/d (12 hrs) Cap 16 tf
R-C Ka Ma S SM ba No setting up time
charge.

LIVERPOOL

AMAZON RECORDING STUDIO.
Music House, 1 S.D. Stoppage Lane,
Simonswood, Liverpool 33
051-546 6444/0434
8T Cap 20 £10 p/h R-R. CP. Ka. R-C. Dc d-t
OTC. £24p/h M.S. Ac/ba. SM.
24T Cap 30 £35 p/h D. tf. R-R. CP. Ka. R-C.
d-t. OTC. £38 p/h Ac/ba. SM.
Steinway Concert Piano, Hammond C3.

AUGUST SOUND STUDIOS
16 Benson Street, Liverpool 1.
051 708 0006
16T p/d neg. 8T £10.50 £86 p/d (inc spool &
tape) Cap 8. tf. R-R. R-C. CP. Ka. (Bechstein
Piano, Hammond organ, Moog Synth.) NO
OTC M-S. AC ba. SM.

LONDON

ABBEY ROAD STUDIOS (EMI)
3 Abbey Road, St John's Wood, NW8 9AY
01 286-1161
24T £48 p/h 16T £46 p/h 8 or 4T £44 p/h 2T
£42 p/d neg Cap 120 tf. R-R. R-C. CP. Ka. DC
(Playback Lacquers) d-t. Q OTC M.S.
(Custom Disc Pressing, Electronic process,
Mono to Stereo. 2 Mobile recording units
operating in any country).

ALVIC STUDIO
13 All Saints Road, Wimbledon, SW19.
01-542 5696
4 T Cap. 8 £6.00 p/h. ba. tf. R-R. CP R-C
Piano, M.S. SM. ba. Drums. Amps

ANEMONE SOUND FACILITIES LTD.
D'Arby House, 10 Poland Street, London
W1V3DE
01 439 9611/2
8T rates negotiable Cap 10 KA Synthesiser
and amps. D & DBX CP R-R. C-d-t D & DBX
M.S. cassette high-speed duplication.

BASING ST. STUDIOS (ISLAND)
8-10 Basing St., London W11.
01 229 1229
Studio 1 24T £48 p/h up to 6pm after 6pm,
weekends and holidays £65 p/h Cap 80
Studio 2 24T £48 p/h up to 6pm after 6pm,
weekends and holidays £55 p/h p 20
R-R-C-Cr. £10 p/h D. OTC.

BERWICK STREET RECORDINGS
8 Berwick Street, London W1.
01-734 1888/5750
24T Cap 16 £40 p/h D. tf. R-R. CP. Ka. R-c-d-t.
M. S.

B.T.W. RECORDING STUDIO
125 Myddleton Road, Wood Green,
London N22.
01-888 6655
4T Cap 10 £6.50 p/h tf. R-R. Ka. dt. M. S. SM.

CBS RECORDING STUDIO
31-37 Whitfield St., London W1
01 636 3434
Studio 1 £48 p/h 24T Cap 75
Studio 2 £48 p/h 24T Cap 25 & automated
desk
Studio 3 £45 p/h 24T Cap 12
DC. R-R-C-Cr. D All studios multi-track

CENTRAL RECORDERS LTD
9 Denmark Street, London WC2H 8LP.
01-836 6061
24T Cap 20 £32 p/h D. tf. R-R. CP. Ka. R-c. dt.
OTC £5 p/h. M. S. Ac/BA. SM.

CHALK FARM STUDIOS.
1A Belmont Street, London NW1
01 485 5798
16T. Cap. 15. £18 p/h. D. TF. R-R. C.P. Ka.
R-C. DC. D-T. OTC. £3 p/h. M.S. SM

DECIBEL STUDIOS
19 Stamford Hill, London N16
01 802-7868
24T £27 p/h. p/d neg. Cap 20 D. tf (1 Ampex
1 Studer) R-R. CP. Ka (Yamaha Grand and
Synth). R-C. d-t. Q. OTC. £2. M. S. fcf. Ac ba.
SM.

ELEPHANT RECORDING STUDIOS
181A Long Lane, London SE1
01 403-3505
8T £6 + £5 1" Tape hire. £30 per 6 hours. Cap
8. tf. (Breneil) 8 track - Revox 2T. R-R. CP. Ka.
(Piano, Organ). R-C. OTC (after 11pm £2.00
p/h) M.S. SM ba.

FOREST STUDIO
189 Hainault Road, Leytonstone, E11.
01 558 3344
24T £18p/h. 16T £16p/h. 8T £10p/h. (Block
Bookings - more than 10hrs. neg). tf. R-R.
R-C. Cap 25. CP. Ka. (2 Organs.
Synthesizers, Pipe Organ, Piano etc.). DC. ba.
NO OTC. M. S. AC. SM.

FREE RANGE STUDIO
22 Tavistock Street, London WC2
01-836 7608
16T £15 p/h neg p/d Cap 30 tf. R-R. CP. Ka
(Grand Piano) No OTC. MS. fcf. VS. SM.

GOOSEBERRY STUDIOS
19 Gerrard Street, London W1
01-437 6255, 01-734 2257
16T £16 p/h (discounts available on sliding
scale). 8T £13 p/h Cap 8 D. tf. R-R. CP. Ka
Hammond L100, Roland SH2000, Fender
Rhodes) R-C. d-t. OTC. M.S. SM ba

R.G. JONES
Beulah Road, Wimbledon SW19
01 540 9881
24T £40 p/h 16T £35 p/h Cap 40 R-R-C-D
OTC. Studio 2 - Stereo only £7 p/h.

KINGSWAY RECORDERS LTD.
129 Kingsway, London WC2
01 242 7245
24T £38 p/h Cap 35
16T £34 p/h Dc/ba D

KPM STUDIOS
21 Denmark Street, WC2.
01 836 6699
16 Track £28p/h. Cap 18. Copyshop
£12p/h.

MARGRITTE MUSIC
15 Holloway Lane, Harmondsworth, West
Drayton.
01 897 9670
16T £20 p/h 8T £10 p/h. Cap 12.
DC/ba. tf. DBX. SM. Ka. R-R-C all rates
negotiable. Fender, Marshall and more
available.

MAJESTIC RECORDING STUDIO
145 Clapham High St., London SW4
01 622 1228/9
24T £28 p/h Cap 50 R-R-C DBX CP OTC £5
p/h

MARQUEE STUDIOS
10 Richmond Mews, Dean Street, W1
437 6731/2
24T/16T £44p/h. p/d neg. Cap 35. D. tf.
R-R. R-C. d-t. CP. Ka (Steinway). £8p/h.
OTC. MS. S (Remix & Studio with MC1 500
series automated consoles. Live recording
facilities to adjoining Marquee Club).

MILNER SOUND LTD
117c Fulham Road, London SW3
01 589 6477
8T Cap 14 £14 p/h tf. R-R. CP. Ka. R-C. Dc.
d-t. M. S.

PATHWAY STUDIOS
2A Grosvenor Avenue, London N5
01 359 0970
8T £8 p/h, Cap 6. R-R. CP. R-C d-t.

RADIO LUXEMBOURG STUDIOS
18 Hatford Street, W1.
01 493 5961
Studio 1. 8T £14p/h. Cap 8. D. tf. R-R. R-C.
R-Cr. d-t. CP. Ka. (Steinway grand, ARP 2600
Synth). OTC. £4p/h. (6.00am-9.30pm.
Weekends & Bank Holidays). M. S. SM. ba.
Studio 2. Self op. £12p/h. Radio productions
and commercials

RAMPORT ENTERPRISES LTD.
115 Thessaly Road, London SW8
01 720 5066
Cap 40 8am-12noon 12T & 24T £30 p/h.
12noon-6pm 16T £35 p/h 24T £40 p/h
6pm-8am next day flat rate w/ends Bank
Hols. 16 T £40 p/h 24T £45 p/h £12 p/h
editing copying D & DBX Bosendorfer,
Rhodes, Hammond 83 Q.M.S. tf. R-R. R-C.
R-C. R-Cr. d-t. SM. ba

REDWOOD RECORDING STUDIOS
15 Neals Yard, WC2.
01 240 0568
8T £18p/h. Cap 8. tf. R-R. R-C. R-Cr. d-t. CP.
Ka. (Rhodes, ARP Odyssey, Roland String
Synth, Daneman Piano). Q. OTC. (+25% of
hourly rate) M. S. SM.

REGENT SOUND STUDIOS
4 Denmark St., London WC2
01 836 6769
16T £16 p/h Cap 20 R-R-C OTC. Sound
Techniques Desk 18 x 16

RIVERSIDE RECORDINGS
78 Church Path, Fletcher Road, Chiswick,
London W4
01 994 3142
16T £16 p/h Reductions on block bookings
8T £14p/h. OTC £2 p/h. tf. R-RCP. Kba. R-C.
R-C. d-t 8T Mobile Bechstein Session
Musicians.

ROCK STAR RECORDING STUDIO
63 Charlotte Street, London W1
01-637 0999
16T £16 p/h Cap 15 D. tf. R-R. (Revox,
Ampex) R-C. No OTC. M.S. AC. ba. SM
(Drummers, Guitarists).

ROX BOX STUDIO
92 Devonshire Road, Chiswick, W4.
01 995 2648
4T. £5p/h. p/d. neg. Cap 7. tf. R-R. R-C. CP.
M. S. SM. ba. (Fender, Marshall, HH, Amps).
Rehearsal Studios £2.00 p/h.

SARM STUDIOS
Osborn Hse., 9-13 Osborn St., London E1
247 1311
24T £42 p/h 16T £42 p/h RECORDING &
mixing Cap 30 R-R-C-Cr. D Dbx (NO OTC)

SAV STUDIOS
34 Cricklewood Broadway, NW2.
01 450 4455
8T (1") £16p/h. Cap 5. DBX. tf. R-R. R-C.
R-Cr. d-t. CP. Ka. (Piano) DC. OTC. M. S. SM.

THE SOUND SUITE RECORDING STUDIOS.
92 Camden Mews, London NW1
01-486 4881
16T £16.15 p/h 8T £10 p/h. 15% discount
for settlement within 10 days. tf. R-R. R-C.
d-t. CP. S. No OTC. JBL monitoring (graphic
equalised). SM. ba Master room
Fender-Rhodes Suitcase 88. Tama drumkit.
Fender Jazz bass. Grand piano.

THEATRE PROJECTS SERVICES LTD.
11-13 Neals Yard, Monmouth St., London
WC2
01 836 1168
Studio A 8T £12 p/h and piano Cap 15 (demo
tape)
Studio B M.S. £12 p/h Cap 6 (voice overs)
R-R-C OTC.

T.M.C. RECORDING STUDIO
118 Mitcham Road, Tooting, London SW17
01-672 4108/8488
16T Cap 40 £20 p/h D. tf. R-R. CP. Ka. R-C.
d-t. M. S. OTC. SM. Steinway Piano. Scamp
System ADT.

UNDERHILL STUDIO
178 Newcross Road, London SE14
01-639 3090
16T £25 p/h Block bookings neg. Cap 25 (30
RPS). tf. R-R. R-C. CP. Ka (grand pianos,
string machine, Mellotron) d-t. No OTC. M.S.
SM.

MANCHESTER

ARROW SOUNDS LTD.
6-10 Jacksons Row, Manchester 2
061 833 9417/832 8457
24T £35 p/h £225p/d. 16T Cap 35 £25 p/h
p/d ba D. R-R. CP. R-C. R-Cr. d-t. Ka. O. OTC.
after 9.00pm MS. SM.

PLUTO STUDIOS
36 Granby Row, Manchester 1
061-228 2022
16T £28 p/h 8T £25 p/h Cap 35. tf. R-R. CP
R-C. d-t.

MIDDLESEX

LANE STUDIO
87 Deans Lane, Edgware, Middlesex.
01 959 6369
4T £4p/h. 2T £2p/h. Cap 8. tf. R-R. R-C ba.
M. S. SM./ba. NO OTC. (Drums & Guitars
available. No extra charge).

VILLAGE WAY STUDIO
228 Imperial Drive, Rayners Lane,
North Harrow.
01-888 2073
16T £18 p/h fully Dolby tf. R-R. R-C. No OTC.
+ S. CP. Overdubbing. Bechstein
Summerfield grand Roland SM by
arrangement Scamp rack.

NOTTINGHAMSHIRE

ELECTRIC CAT RECORDING STUDIO
31 Cedar Road, Sherwood Rise, Nottingham.
0602-608955
4T £8 p/h Cap 10
TF. R-R. CP. RC. SM. M.S. KA. Bechstein,
Rhodes, Hammond, ARP, Drums Amps

RAINBOW SOUND LTD.
Pearson Buildings, 26/28 St. James Street,
Nottingham.
0602 412749
8T £9.50 p/h. p/d. ba. Cap 6 R-R. R-C. Ka.
d-t. No OTC. M.S. Ac. ba. SM ba. Rock
specialists.

OXFORDSHIRE

MANOR STUDIO
Shipton Manor, Shipton-on-Cherwell,
Kidlington, Oxford.
08675 2128
24T £800 per day. Quad. Cap 20. D
Accommodation: 8 bedrooms & resident
chef.

PORTSMOUTH

TELECOMMS RECORDING STUDIOS
189 London Road, North End, Portsmouth.
0705 60036
8T £9.00 p/h £48 p/d Cap 8 tf. R-R. CP.
(Cassette + 1/4") Ka (Rhodes, ARP OMNI,
Korg, Preset, Cat) R-C. R-Cr. d-t. M.S. Ac. ba.
SM.

SCOTLAND

CRAIGHILL RECORDING STUDIOS
68 Craighill Road, Edinburgh, EH6 4RL.
031 552 3685
16T £22p/h. p/d neg. D. tf. R-R. R-C. CP. Ka.
(Steinway grand, Haven organ) d-t. Q. OTC
(+25% on basic after 6.00pm or Saturdays
and Sundays). M. S. SM ba Ac ba. (8T
Mobile available. Prices on request.)

SURREY

**RIDGE FARM (MOBILE RECORDING
STUDIO)**
Capel, Nr. Dorking, Surrey
0306 711202
£40 p/d. No OTC (Steinway Grand, Gibson
Les Paul) 60" x 22" AC (12 Persons. £12 p/d.
p/p. 3 meals per day. £6 p/d per person self
catering). Block Bookings Neg.

SURREY SOUND STUDIO
70 Kingston Road, Leatherhead.
53 79444
MCI 24T £25 p/h. £250 p/d. (12hrs). 16T
£22 50p/h. Automated CAP 40 No OTC. 4 to
8/16 R-R. R-C. CP. Grand Piano other K by
prior arrangement. d-t. MS. AC. ba. SM. Any
Catering Facilities.

E. SUSSEX

BLUEBELL STUDIOS
Bluebell Farm East Sussex.
058083 635
16T £15p/h. (Over 10hrs £10p/h.) Cap 5 tf.
R-R. R-C. R-Cr. d-t. CP. Ka. NO OTC. M. S. SM
ba.

W. SUSSEX

OBIDEC RECORDING STUDIOS.
Dorvic Building, Quarry Lane, Chichester,
West Sussex.
0243 83265
8T £8 p/h £65 p/d (10 hr.) £250 p/wk. Cap
16 tf. R-R. R-C. d-t. CP. M. S. Ka
Dc/Ac/Sm/ba.

TYNE & WEAR

IMPULSE RECORDING STUDIO
71 High Street East, Wallsend NE28 7AJ
Tyne & Wear
0632 824999
BT Cap £12 p/h DBX f R-R CP Ka R-C d-t
OTC SM

MORTON SOUND.
13-16 Carrileal Square,
Newcastle-upon-Tyne.
0632 28902
BT £5 p/h Cap 10 DC R-R-C Cr.

WALES

BBC WALES
Stacey Road Studio, c/o Broadcasting
House, Llanfair Road, Cardiff.
Tel: 0222 493053
16T £20 p/h. 6T £10 p/h. (Block bookings
neg.) CAP 40. D. f. R-R. R-C. d-t. CP. Ka
(Bechstein Baby Grand, Yamaha Electric
Piano, Poland String Synth, Drum Kit,
Electric Organ), Q/ba. OTC "25%. M.S. fcf.
VS. AC/ba. SM. (Also 22T facility available).

FOEL STUDIO LTD
Foel Llanfair Cae-rainion Powys's Wales
083 882 754573
16T Cap 10 £175 p/d t. R-R. CP. Ka. R-C. DC.
M. S. AC/ba. SM.

ROCKFIELD STUDIOS
Amberley Court, Rockfield Rd., Monmouth
0600 2449/3625
Studios 1 & 2, 24T, 40 Channel Custom Built
Mixer, Natural Acoustic Echo Room,
Auxiliary equip. to cover all eventualities.
ALSO Acoustically Insulated Rehearsal
Studio in 10 Bedroom country house. 1 1/2
miles of fishing available. ALL prices on
application only.

WARWICKSHIRE

BIRD SOUND STUDIOS
Wedgnock Industrial Estate, Warwick
0926-46123/4
BT £12 p/h Cap. 20 DC/ba. R-R. CDBX OTC
£14 p/h

WORCESTERSHIRE

THE OLD SMITHY RECORDING STUDIO
The Old Smithy,
1 Post Office Lane, Kempsey, Worcester
0905 820666
16T £20 p/h p/d ba. Cap. 35 D. f. R-R R-C
DC. CP. Ka. No OTC. M.S. VS. Ac. SM

W. YORKSHIRE

LEADER SOUND
209 Rochdale Road, Greetland, Halifax, W
Yorks.
04227 6181
BT £75 p/d Cap 8 D. DBX. R-R. R-C. CP. Ka
(Piano), Dc ba. M.S. Ac. SM ba.

**SOUND COMMUNICATION (PUBLISHERS)
LTD.**
Dewsbury, W. Yorkshire.
0924 469436
Loop-bin cassette copying and R-R copying
Dolby A & D facilities. Blank cassettes of any
length supplied.

KEY FOR STUDIO GUIDE

- T Track
- Cap Capacity
- p/h per hour
- p/d per day
- D Dolby
- f Transfer facilities
- R-R Reel to Reel
- CP Copying
- tba to be advised
- Ka Keyboards available
- R-C Reel to Cassette
- R-Cr Reel to Cartridge
- Dc Disc Cutting
- d-t Disc to tape
- Q Quad
- OTC Overtime charge
- M Mono
- S Stereo
- fcf Fully coated film
- VS Video Studio
- AC Accommodation
- ba by arrangement
- SM Session Musicians

HIRE GUIDE

A. C. LIGHTING
57 The Cresom, Tottenham, High Wycombe,
Bucks.
For enquiries please ring 06285 28522
SL. T & C. Di. CM. PA. Mr Leggett.

ACME P. A. HIRE
Willow Bank, Leeds Road, Otley, Yorkshire.
09434 2281
P.A. 1,000 watts. T&C 16 CM. Di.

ANDROMEDA
1 Thirlmere Gardens, Belfast. BT1 55EF
0232 772491
P.A. 25cm. SL. Sc. T&C. ME

BAN MANAGEMENT
89/97 St. John Street. EC1 M4AB.
01 253 9410
ME T & C. RHR. SL Ba. St. R. CM. (24 or 16) P.
A.

CASCADE MUSIC & HIRE
42-44 Upper Tooting Road,
Tooting, SW17
01 672 3997
ME T&C. ba. SL. Sc. Di. CM. PA.

CERWIN VEGA UK
281 Balmoral Drive, Hayes, Middlesex
01 573 1566
ME. T & C. CM. P.A.

**COLAC SOUND & LIGHTING EQUIPMENT
RENTALS.**
212 Carlisle Lane, London SE. 7LH
261-1706
Midas Martin PA System SL. T&C

COUNTERPOINT STEVENAGE
5, Queensway, Stevenage, Herts.
Stevenage SG8 15 Day
Machin 35717 Evenings only
ME. Di. CM. PA.
Full repair service. Not evenings.

C. P. HIRE.
Pier House, Strand on the Green, Chiswick,
London W4
01-994-7135
Flight Case Hire & Staging Hire

CUSACK'S MUSIC.
33 Braunstone Gate, Leicester.
0533 548517
ME. SL. Di. CM. PA. Competitive Rates

**EUROPA CONCERT SYSTEMS
EUROPA CONCERT SOUND LTD.**
11A Sharpleshall Street, London NW1
01 596 3848
PA Mixers. T & C CTM.

H. W. AUDIO
156 Bradshawgate, Bolton. BL2 1BA
0204 26639
D.I.Y. or T & C. Instrument Amps P.A. and Di.
S.L. and Di. L

JULIAN'S J. R. LTD.
2 Churchill Road, London NW2
459 7294/5
M.E. Demo room, repair workshop

KELSEY ACOUSTIC HIRE
1 Alfa Place, London W11
01 727 1046
ME T & C CM. CTM. PA.

MAURICE PLACQUET HIRE
69 Jeddou Rd., London W12
01 749 1204
PA. ME. T & C. RHR. Di. Cm. CTM

MITREX
961 Oldham Road, Newton Heath,
Manchester M10 6FE
061-205 8093
ME. T + C. Di. 12 CM. PA 2 miles from city
centre

THE P. A. COMPANY
7-9 Market Road, London N7
01-607 0067/8
ME. PA. T & C. RHR. Sc. CM. Spec in Yamaha
Equip..

PILEDRIVER EQUIPMENT HIRE
9 West Richmond Street, Edinburgh.
031 668 2444
ME. T & C. SL. Di. PA. 16T Channel Mixer

RIG HIRE
20A Russell Parade, Golders Green Road,
London NW11
01-458 5807
T + C. SL. ba. 30 into 8CM (Main Desk) 20
into 6 Monitoring PA.

STANDISH LIGHT & SOUND HIRE CO
358 Preston Rd, Standish, Wigan
0257 421603
PA to 3,000 Wats Di. T & C SL

SUTTON MUSIC CENTRE
64 Heddon Road, Sutton
01 642 2838
G. A. D. B. W. S. SM. RS. H. Di

TELECOMMS
189 London Road, North End, Portsmouth,
Hants.
Portsmouth 60036 Ask for Mike
ME Di T&C PA CM

WHALE AUDIO VISUAL
28 Belmont Park Road, Maidenhead, Berks
0628 21696
Hill-Martin 20CM PA 36Kilowatt SL T & C
Di

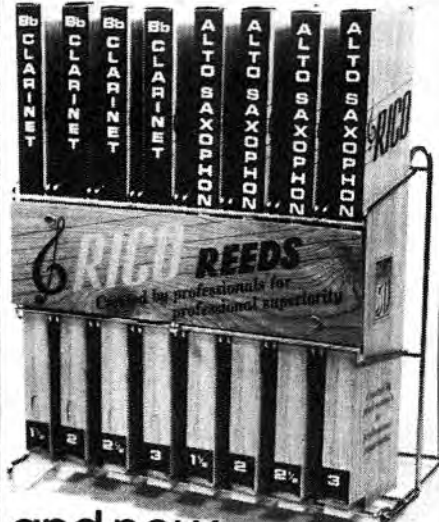
WIGWAM ACOUSTICS
St Annes House, Ryecroft Avenue
Heywood, Lancashire
0706 68766 Contact Mike Spratt
ME T & C SL 24 CM. CTM. R PA to 5000
Watts

KEY FOR HIRE COMPANIES

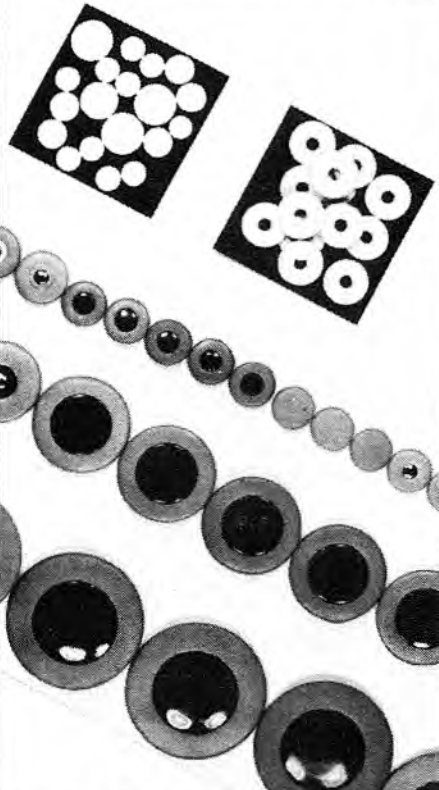
- ME Musical Equipment
- T & C Transport & Crew
- RhR Rehearsal Rooms
- SL Stage Lighting
- Sc Security
- Di Disco
- CM Channel Mixer
- CTM Concert Tour Management
- PA Public Address
- ST Storage
- R Repairs



RICO
Reeds



and now...
**THE NEW
RICO PADS**



NOVA
REED CORPORATION
P.O. Box 661
Sun Valley, California 91352, U.S.A.
Contact Your Rico Distributor
For Rico Pads and Rico Reeds.
U.K. Exclusive Distributors:
Boosey & Hawkes, Ltd.
Rose-Morris & Co., Ltd.

★ CLASSIFIED ★

SONGWRITERS

SONGWRITERS

Songwriter Magazine explains copyright, royalties, publishing etc., and interviews famous songwriters. Free copy from INTERNATIONAL SONGWRITERS ASSOCIATION LTD. (IMRW), Limerick City, Ireland

MANUFACTURERS AIDS & GUITAR PATENTS

GUITAR MAKERS:

Our 1978 catalogue includes everything for the professional and Amateur Luthier. Spruce and Cedar, Rosewood, Maple, Ebony, Walnut, Ash, Etc. Also Pearl, Abalone, Ivory, Sheet plastics, Truss Rods, Bindings, Glues and Finishes.
NEW: Reproduction Solid Bodies in Ash, Maple and Alder — ideal for repairs.
NEW: Largest range of Banjo/Mandolin parts outside U.S.A.
 Send today! 50p postal order appreciated to: Strings 'N' Things, 63 Far Gosford Street, Coventry CV1 5DZ.

ROKA ACOUSTIC SERVICES

AMPLIFIER: Repairs & Servicing to all leading makes. Modifying and Customising
GUITAR: Repairs, Refrets, Reploys, Rewinds to Pick-ups, Setting up, Lowering Action etc.
RHODES: Tuning and Repairing, Lightening Action Fitting Preamps etc. Full range of Accessories and Spares for the above always available.
 Flight Cases Custom Made.
 57 Endell Street, London WC2H 9AJ. 01 250 2610 Oper. 10.5 weekdays 10.4 Saturday

CHRIS Eccleshall GUITARS

Established Hand Builders of the finest acoustic and electrical guitars, mandolins and dulcimers
17c-18b, Station Parade, Uxbridge Road, Ealing Common, London W.5.
 Tel: 01-992 4741 . 020-488 6860

D.I.Y. Cabinet Makers

Give your cabs the professional finish with

HAMILTONS CABINET FITTINGS

Get our fully illustrated catalogue now. Vynides, Fret Cloths, Handles, Feet, Adhesive, Paint, Catches, Castors, Edging, Trim, Connectors, Switches... The lot! Huge Stock -



HAMILTONS OF TEESIDE

26 Newport Road, Middlesborough.. Cleveland. (0642) 247314

Standard range
 £350-£650.

Lowden

Fine handmade acoustic steel string guitars.

Custom instruments also made to your requirements.

Enq: George Lowden, 6a High St., Bangor, Co. Down, N. Ireland. Tel: (0247) 62981.

RECORDS

RECORD & TAPE EXCHANGE

LP's and Tapes of every kind bought, sold and exchanged
 40 Notting Hill Gate, London W.11,
 28 Pembridge Road, Notting Hill Gate, W.11,
 90 Goldhawk Road, Shepherd's Bush, W.12
 TELEPHONE: 01-749 2930

DISC CUTTING

Stereo/Mono Masters and Cassettes cut on our Scully lathe with ME/76/uk Cutterhead. Masters sent to any pressing plant. Free helpful advice regarding pressing and record production. SAE for details to:
COUNTY RECORDING SERVICE
 London Rd. Binfield, Bracknell Berks. Tel: Bracknell (0344) 34933
DOLBY A, DOLBY B AND DBX NOISE REDUCTION

D.I.Y. RECORDS

133, Park Road
 Blackpool FY1 4ET
 Eng: (0253) 23095. (Studio)



SRT RECORD MANUFACTURING 01-446 3218

Top quality Pressing 12-inch and 7-inch
 Also Sleeve Printing, Mastering, etc., provided to pressing customers.

Cassette manufacturing



AERCO PRODUCTIONS LIMITED

The Professional Record Pressing Service. Send S.A.E. or ring
 Aerco Productions Ltd.,
 27 Chobham Road, Woking, Surrey. 04862-64032.

BRANCH MANAGER

WE are the world's leading designers, manufacturers, and distributors of electronic devices for musicians.

WE are a dynamic, expanding company, headquartered in New York City.

WE need a high-calibre individual to organize our London office and set up a distribution and service center capable of expanding our extensive European business.

WE offer fantastic future growth opportunities in New York, London, Toronto, Tokyo, and other international locations.

YOU must be ambitious, responsible, hard-working, self-starting, and organized.

YOU must have related experience in business administration and an interest in rock & roll music.

YOU must be ready, willing, and able to develop and operate a high-volume branch office, managing all office, administrative, sales, importing, distribution, and service work from bottom to top.

Send resume and salary requirements to:
 Faye Levine, Assistant to President

electro-harmonix

27 WEST 23RD STREET, NEW YORK, NY 10010

SOWTER TRANSFORMERS

WITH 37 YEARS' EXPERIENCE
we have the expertise to design and manufacture
ANY TYPE OF AUDIO TRANSFORMERS AT THE
RIGHT PRICE

Whilst we specialise in every kind of transformer for audio control decks and mixers, demands are increasing for **LOUDSPEAKER TRANSFORMERS** and **100 VOLT LINE AUDIO OUTPUT TRANSFORMERS** for most kinds of amplifier from 30 watts to 500 watts output.

We have standard designs for AMCRON and BOSE amplifiers and can also supply **Multi-output transformers** for **COLUMN LOUDSPEAKERS** in a wide variety of powers. A recent tendency is the demand for **OUTPUT TRANSFORMERS FOR ULTRA LINEAR VALVE AMPLIFIERS** using KT88 BEAM TETRODES and for these we have standard designs with exceptional performance.

Many of our output transformers for loudspeakers have been installed in Theatres, Television Studios, Lecture and Concert Halls, Churches and Outdoor Arenas whilst others are in constant use for high quality portable Public Address Systems.

We will supply single transformers, or any quantity, with short delivery times and, without obligation on your part, will quote price and exact dispatch on receipt of your requirements.

KINDLY NOTE OUR NEW ADDRESS AND TELEPHONE NUMBER: E.A. SOWTER LTD., Transformer manufacturers and designers, P.O. BOX No. 36, IPSWICH IP1 2EL, ENGLAND. Tel: Ipswich (0473) 52794-219390.

REHEARSAL STUDIOS

**EAR
REHEARSAL STUDIOS
HOLLAND PARK**
Fully equipped AKG Turner
JBL PA. Full backline included
Keyboards, Acoustics etc.
Excellent access parking.
01-727 2900

**ALLAN-GORDON
STUDIOS
WALTHAMSTOW**
Special weekday 10-6 and Saturday
evenings £4.50. Weekend 10-6 £7.50
Evenings 6.30-11.00 £6.00. FULLY
EQUIPPED room available at approx-
imately double the above rates.
01-520 3706/8642

EASYSTREET STUDIOS

Has two very comfortable
rehearsal rooms, plus 4 track
recording facilities; equipment
hire per hour. P.A. inclusive with
room and free refreshments.
Tel: 01-739 1451

BRAGGER STUDIOS
Central London
Large Rehearsal Studios
P.A. available - storage
Easy access and parking
From £2.00 per hour
01-231 3200
WHARF MUSIC

MISCELLANEOUS

FREELANCE

State of the Art for the Artist

BOOKS by John Amaral (Berklee Instructor)
Guitar Major and Tonal Improvising
Guitar Pentatonic Improvising
Guitar Jazz-Rock Fusion Improvising
Guitar Chordology
Guitar Technique
Guitar Rhythms and Fingerpicking Solos
Electric Guitar Classical Solos
Basic Electronics: Pedals, Effects for Working Musicians
Music Synthesizer Electronics for Working Musicians
Amplifier and Guitar Circuit Modifications \$8 EACH

COMPLETE ALBUM Joe Pass Virtuoso
TRANSCRIPTIONS George Benson Body Talk
\$20 EACH
TYM MACHINE Analog - Digital Echo Reverb
Balancing Doubling \$350
HOCKEY PUCK Acoustic Pickup - Flat from
10 to 10 1/2 Hz \$50

Freelance Music, 18 Haviland, Boston 02115.
0617-266-0001

DRUM TUITION

by

JOEL ROTHMAN

Well known writer and teacher
All styles taught.
01-373 7140

Fake Books & Music FREE Big Catalog

Jazz-Pop-Improvising-Combos, etc.
Greatest & Biggest Collection of
Best Music Books Ever Published.

Write: Box 66 - F. N.Y., N.Y. 10022 U.S.A.

Black/White and Colour
Video equipment available for
hire with or without operator.

Competitive rates.

Tel: 01-952 9543
CLEAR SOUND VIDEO

★ CLASSIFIED ★

To advertise in the classified section
Telephone: 01-388 2011

REPAIRS

Eddie Ryan
DRUM RENOVATIONS
5 Langley Street, Covent Garden,
London WC2. Tel: 836 4941
Best sounding drums made. Made from finest
selected beech and mahogany (not plywood)
Own design not boxes, legs, spurs, etc. Sizes
from 6 in. to 26 in.
Drums recovered and repaired by experts
All work guaranteed - no job too small

JBL ALTEC ELECTRO VOICE GAUSS FENDER RCF KEF VOIT
GODMAN CELESTION FANE PEERLESS ELAC WHARFEDALE RICHARD ALLEN EMINENCE BAKER LEAK
**QUALITY
SPEAKER**
Individual Customizing service
for Power Rating - Frequency
and Performance.
REPAIRS
JOHNSON & JONES
66 Dalston Lane, London E8 3AH
Phone 01-254-9331

**ANDY'S
GUITAR WORKSHOP**
Secondhand guitars guaranteed
1 year
Fast professional repairs and
resprays
27 DENMARK ST. WC2
Tel: 01-836 0899
Open 10am-7pm inc. Saturdays

**CONTACT THE EXPERTS
for service on Revox, Neal
Ferrograph, Uher & Tanberg**
Photo Acoustics Ltd., 255A St.
Albans Road, Watford. Tel:
Watford 32006.
The Studio, Sherrington. Tel:
Newport Pagnell 610625

**PERCUSSION
& DRUM
ACCESSORIES**

**ES PRACTICE
DRUM KIT**
WHY HAVE NOISE PROBLEMS?
5 drum complete practice units: Excellent
drumkit feel Fully adjustable - £40. Send
stamp to: Bill Sanders, 84 Cornwall Ave.,
Southall, Middx. Personal attention
01-578-2909 (evenings). **SOLD DIRECT**
EST. 1973

ACCESSORIES

TOOTLEBUG
FOR
WOODWIND & BRASS
BUGS
OCTAVE DIVIDERS
A. R. TOOTELL
9 Mendip Close
ST. ALBANS
HERTS
Tel: 60525

TASCO
FOR SALE
Limited amount of JBL
copies Metal Castings
2350 Mid Horn Flares 90°
Radial (require acoustic
damping) £66.57
2350 Mid-Horn Flare 90°
Radial (coated) £86.57
2328 Throat adaptor £21.54
ALL PRICES EXCLUSIVE
OF V.A.T.
Phone TASCO (01) 582 3020
Ask for Bill, Euan or Keith

RECORDING STUDIOS

ELLIE JAY RECORDS
For all your RECORD MANUFACTURING and SLEEVE DESIGN/PRINTING requirements.
Please note our telephone
number - 01-388-5771

Percussion recording of superior
quality.
Write:
Percussion Dept. RW,
P.O. Box 88,
Palisades Park,
N.J. 07650,
U.S.A.

SEND THIS PAGE BACK

OUR ADVERTISERS

SEPTEMBER UK/OCTOBER USA 1978

ABC	175	Dawsons	M.26	Kustom	80	Randall	98
Acoustic Control	150	Bernard Dean	M.26	Lamplight Hire	130	RDG	120
Acoustic Kingfisher	142	DiMarzio	170/171	Laney	209	Rea	M.31
AKG	162	D'Merle	157	Langdons	M.21	Redmere	205
R. Allen	38	Dynacord	122	Latini Percussion	M.29/198	Remo	136
Allan & Heath	212-215	Electrovoice	147	Levin	123	REW	108-109
Ampeg	118	Elka Orla	195	Ljvè Music Centre	M.27	Ridge Farm	166
Andertons	145	ESS	M.30	Loughborough MC	M.26	Rockbottom	201
Rod Argent	103	Fane	84	Macari	56/226	Rola Celestion	102,175
Aria	179	FBT	207	Maine	78	Roland	202-203, M.6
Arrow Sound	168	FCN	DBC 125	Ivor Mairants	M.31	Roost	143
Ashely Pangbourne	M.30	Flame	M.30	Malatchi	139	Sabre	186
ATC	B.9	Chas. E. Foote	85	Mandolin Bros.	121	September Sound Studio	168
Axe	M.31	Freedmans	85, 127	Marcus	204	Session Music	M.29
Albert Baalam	M.28	Free 'n Easy	M.13 M.20	E & O Mari	206	Sharma	142
Ernie Ball	M.8/M.9	Fretted Industries	84	MBE	177	Shure	91
Barratts	17	Fyde	186	McCormacks	M.26	Dave Simms	M.27
John Beaby	M.27	Gardeners	M.31	Mega	M.9	Smile	169
Bees	M.27	GEC	122	Metro Tapes	M.29	Soundcraft	70
Bell	142	Gigsounds	M.32	Middleton	M.21	Soundout	50, 164
BGW	146	Gigsville	M.12	Mitchell Music	M.27	Soundshop	M.31
Biggles	200	Goodmans	157	Modern Music	M.29	Soundwave	72
John Birch	200	Grant	M.26	Morley	125	Spaceward	169
BKL	IFC	Ground Control	109	Multiform	130	Roger Squires	130
Blackpool	201	Guild	19, M.19	A. Muir	M.25	SSE	143
Bondcrest	201	John Ham	M.21	Music Aid	83	Stateside	51
Boosey & Hawkes	161	Hamar	120	Music Circle	M.28	The Steel Mill	85
Brodr Jorgensen	187/194	Hamiltons	M.25	Music Ground	M.3	Stentor	156
Browns	66	Harrlyns	200	Music House	129	Streetly	122
BTW	201	Hammonds	174, 175	Music Man	18C	Summerfield	58/59
Bulldog Cases	68	Hammonds of Watford	M.28	MXR	35	Sunn	144
Buzz Music	M.28	Keith Hand	211	Nashville Guitars	139	Tal & Ton	169
Carlsbro S.C.	148	Harman	116	Nashville Music Strings	M.5 M.30	Teagues	M.29
Carlsbro SE	114	Hayden Labs	67	Newton	66	Telecomms	172
Castle Sounds	168	Frank Hessy	90	Norlin	101	Theatre Projects	100
Cathedral Sounds	M.31	HH	49/110-111/158-159	Northern Publications	145	Trident	172
Cerebrum	134	Malcolm Hill	99	Northern Sounds	M.25	Turners	198
Chandler	84	Hobbs	M.25	Nova	222	Vitavox	136
Pat Chapman	85	Hohner	109, 136	Otari	73	Viscount	66
Chappells	46	Honkytonk	24	Packleader	201	Wards	197
Chase	28-33	Hornby Skewes	128	Peak Sound & Lighting	129	Westmill Audio	176
Chingford	3	James How	88	Pearl	64-65	Whale Audio	M.32
Cleartone	208	H'W' Audio	130	Peavey UK	94/95	Whirlwind	18
Cleveland Music	M.26	Intermusic	M.2	Peavey USA	154	Whitesound	M.5
Clinkscale	M.29	International Music Corp.	137	Pector	198	Windsor Disco	M.27
Code Music	87	ISA	199	Pettillo	118	WLM	151
Cookes	130	JBL	117	Phillips	196	Woods	55
Cookes	M.28	Mick Johnson	184	Premier	M.11	Worcester Music Centre	M.27
J.T. Coppock	82	R.G. Jones	164	Project Electronics	208	Yamaha	M.10
J.P. Cornell	M.28	Keio	116	Protex Fastners	142	Zella	201
Covemain	10	Kelsey Acoustics	103	Pulsar	131	Zenith	130
Curly Music	204	Kharma	118	Quest	169	Zildjian	124
Custom Sound	160	John King	204	Ram Systems	M.32		
Trevor Daniels	33	Kitchens	89				

Use this page to get more information about the products advertised in this issue. Place a tick against any advertiser from whom you would like to get catalogues, brochures, price lists etc. and we'll make sure that the advertisers forward the information to you. (Block Capitals please)

Name Address

..... Please return to Cover Publications Ltd., 7a Bayham St. London, NW1.

JOHN SHAW OF GLASGOW HAS WON A FREE YEAR'S SUBSCRIPTION TO IM. HE SPOTTED THE DELIBERATE MISTAKE IN LAST MONTH'S MAGAZINE-THE REVERSAL OF THE PICTURES ON PAGES 46 AND 60.

The MACARI CHRONICLE

No. 4

New Dipthonzers give bass players a chance

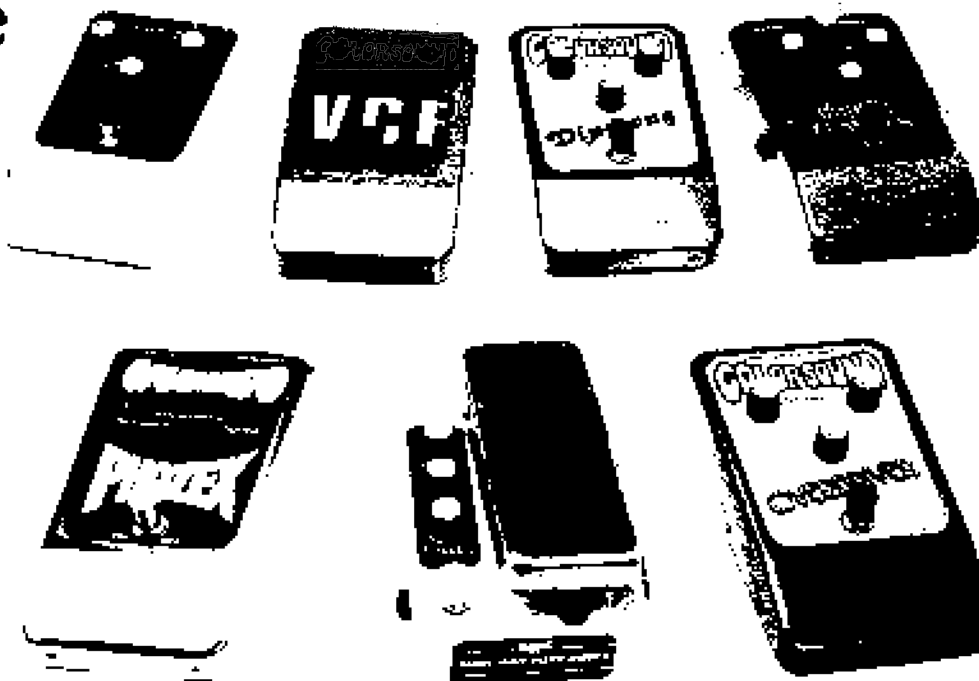
Bass players are always ignored. Ever since the double bass kept players at the back of the band, the bass player has quietly done his own thing without anyone taking much notice. But now things have changed.

The "Dipthonzers" is an effects unit especially developed for the bass guitar. The bass Dipthong parts of speech have been captured in a tiny micro-chip used in an exclusive way by Colorsound and coaxed to produce a most amazing effect for bass players.

"Talking bass" becomes a reality and bass players can now solo using the Dipthonzers and really do something interesting. Controls governing the shape of sound are fitted and the player can choose to use as much or as little of the effect he desires.

Like all Colorsound effects units, the Dipthonzers is housed in a solid metal case and it's built to withstand all the hard treatment life on the road can dish out.

You can try the Dipthonzers at either of the famous Macari retail stores in London's Charing Cross Road, or ask your own local dealer about the range of Colorsound pedals, the latest of which is the amazing Dipthonzers.



Part of the new Colorsound range.

The Effects Centre of London

There's a certain time in every electric musician's life when he realises that his sound is not everything he wanted. It doesn't matter whether he plays guitar, bass, keyboard or electric nose flute, the instrument-amplifier set-up alone cannot provide that little extra something. That's when he needs to visit one of the world-famous Macari music shops in London's "music mile", Charing Cross Road.

Macari's is owned by Larry and Joe Macari — the famous show-biz brothers — they've made a speciality of producing and selling unique sound effects units.

Their involvement in sound modifiers is historical as it was in Larry's shop in Denmark Street that the world's very first fuzz-box was born in the early 1960's. This was a development of an item called a "buzz-box". Produced by the pioneering brothers, it later became the Tone Bender and was used on the Yardbirds hit, "Over, Under, Sideways,

Down".

From that moment on, development never stopped in the search to build better and more interesting effects units. Under the brand name Colorsound and, more recently, Eurotec, the Macari brothers have been responsible for supplying many of the world's musicians with their effects pedals. The units are effective, reliable and inexpensive and it's that combination of qualities that first pushed the Macaris into the wholesale business.

Today, both Macari shops — at 102 and 122 Charing Cross Road — have a huge display of effects units. These now range from the original Tone-Bender used by Jeff Beck so long ago (and still used by him to this day) to solid-state delay, vocalizers, reverb units and flangers.

The key to Eurotec and Colorsound success remains the same — good products produced reliably for reasonable cost. You can see the entire range at Macari's in Charing Cross Road.



The new Dipthonzers.

More Black Magic ...



Introducing a new series of power tube guitar amplifiers featuring foot-switchable distortion, built-in phasers, line in-line out jacks for effects accessories and provision for remote master volume control. This family includes four 112 models — two with built-in phasers and two with foot-switchable distortion. They are available with either 65 watts output R.M.S. or 100 watts R.M.S. The 100 watt models are equipped with Electro-Voice EVM[®] speakers. There is also a 115-100-EVM model with a 15 inch Electro-Voice speaker, built-in phaser and remote master volume jack.



MUSIC MAN, INC.

The experience people.

P.O. Box 4589
Anaheim, CA 92803
Telex 692-397

UK and Eire Distributors

Music Man Division
STRINGS & THINGS Ltd. 20 Chartwell Rd.
Churchill Industrial Estate
Lancing, W. Sussex BN15 8TU

NEW!

Columbus CONSTELLATION

Columbus, a word of discovery — explore the new Columbus Constellation range for yourself.



For full details of this and all our other superb guitars ask your dealer now or write to



FLETCHER COPPOCK & NEWMAN LTD
MORLEY ROAD, TONBRIDGE, KENT TN9 1RA
Telephone: 0732 365271

To: Fletcher, Coppock & Newman, Morley Road,
Tonbridge, Kent.

Please send me details of your Guitars.

Name _____
Address _____
