

RECORD WORLD

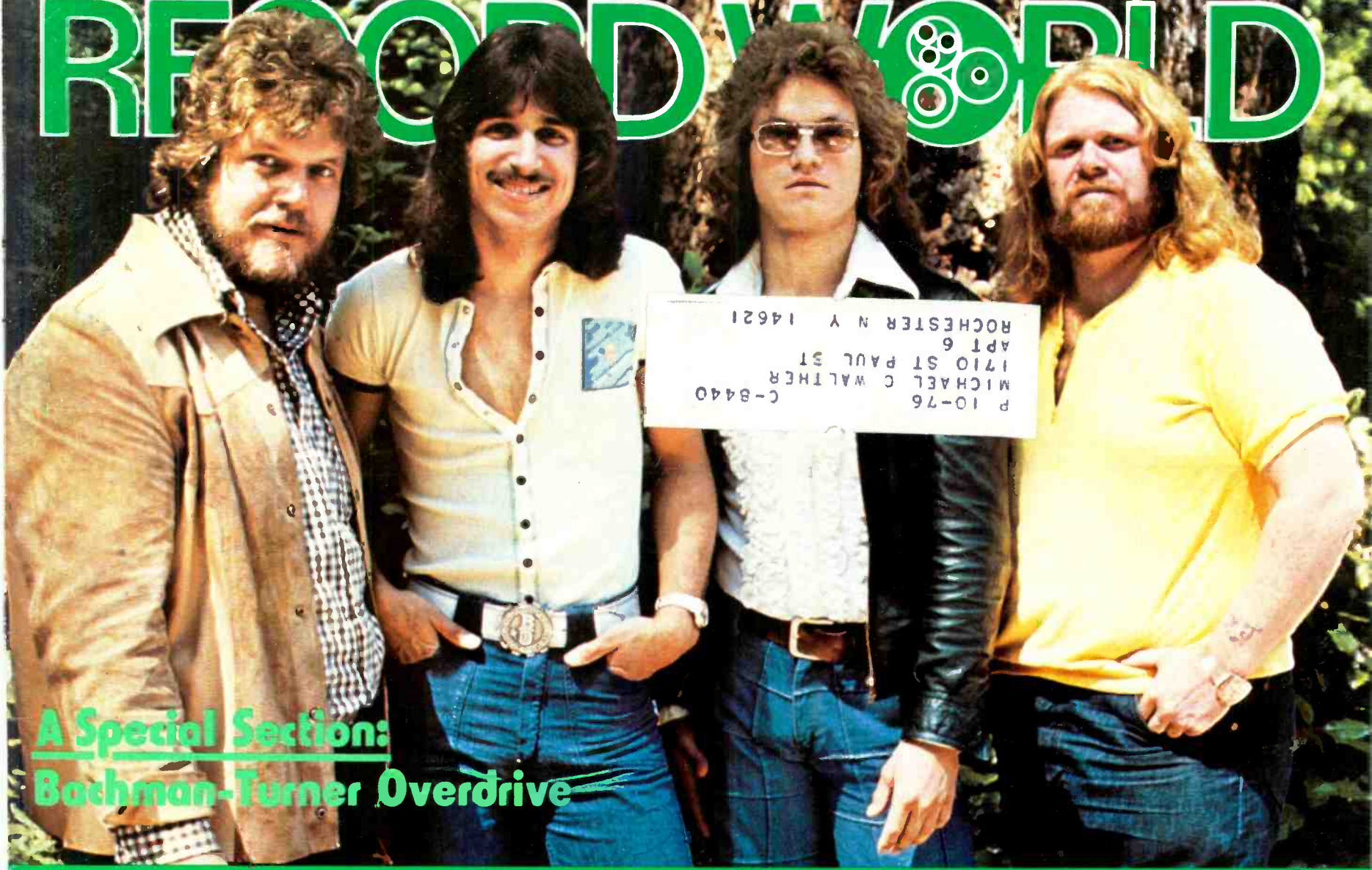

A Special Section: Bachman-Turner Overdrive

HITS OF THE WEEK

SINGLES

HELEN REDDY, "SOMEWHERE IN THE NIGHT" (prod. by Joe Wissert) (Almo, BMI; Irving, ASCAP). Helen offers a moving vocal performance of the Jim Kerr—Will Jennings song, which combined with this exquisite Nick DeCaro arrangement, makes for one of her finest musical moments. An excellent follow to "No Way To Treat A Lady." Capitol P 4192.

JEFFERSON STARSHIP, "PLAY ON LOVE" (prod. by Jefferson Starship & Larry Cox) (Ronin/Alien, BMI). The release of the "Red Octopus" lp and the group's "Miracles" single rekindled interest in the group. This rocker is a choice album track with Grace taking the lead vocal and maneuvering the Starship to still higher plateaus. Grunt JH 10456 (RCA).

BACHMAN-TURNER OVERDRIVE, "DOWN TO THE LINE" (prod. by Randy Bachman) (Ranbach/Top Soil, BMI). BTO stand to continue their string of successes with this Randy Bachman rocker. Marked by a handclapping rhythm and a thrust of power chording, this new effort shows that they're still one of the country's premier rock bands. Mercury 73724.

THE CHARLIE DANIELS BAND, "BIRMINGHAM BLUES" (prod. by Paul Hornsby) (Kama Sutra/Rada Dara, BMI). Wailing guitars and double drummers laying down twice the rhythm that most are capable of, and Charlie makes it abundantly clear that he's got his sights fixed on the upper reaches of the charts. Kama Sutra KA 606 (Buddah).

SLEEPERS

GREG LAKE, "I BELIEVE IN FATHER CHRISTMAS" (prod. by G. Lake & P. Sinfield) (Manticore Music Ltd.). This is not your run of the mill Xmas song, but a thoughtful plea in which Lake remarks, "The Christmas we get we deserve." Co-written with the ELP man's old King Crimson cohort, the ballad develops into a full wall of sound production. Atlantic 3305.

JOHN FOGERTY, "ALMOST SATURDAY NIGHT" (prod. by John Fogerty) (Greasy King, ASCAP). John tops his last one man band outing with a spirited Saturday night feeling. Punctuated by his gravelly vocals and a distinctly Creedence Clearwater sound, he is in top form producing, arranging, and doing just about everything here. Asylum 45291 (Elektra).

WILSON PICKETT, "THE BEST PART OF A MAN" (prod. by Brad Shapiro) (Sherlyn, BMI). No introduction is necessary for the newest member of the TK stable. The "Wicked" Pickett and long time producer Brad Shapiro team up once again for one of their best single efforts in years. Pickett, sounding sharper than ever, really lets loose. Wicked 8101 (TK).

JIM CAPALDI, "LOVE HURTS" (prod. by Steve Smith) (Acutt-Rose, BMI). This cover of the Boudleaux Bryant song which is currently on the RW charts in its version by Nazareth, is Capaldi's strongest effort as a solo artist. The tempo has been speeded up with the rhythms emphasized for dancing while Capaldi gives a happy-go-lucky reading. Island IS 045.

ALBUMS

"CHICAGO'S GREATEST HITS." From the onset, with classics "Beginnings" and "Does Anybody Really Know What Time It Is?" and onward to gems "Make Me Smile," "Just You 'N' Me" and "Wishing You Were Here," the coupling of big band smoothness and potent harmonies has been undisputably hit provoking. Now all are joined for one happy holiday set. Col PC 33900 (6.98).

THE O'JAYS, "FAMILY REUNION." Thematically programmed to warm the cockles of the collective family heart, these Philadelphia vocal masters provide a soul stirring set, whether to a disco beat ("I Love Music" and "Unity") or with a moving ballad ("You and Me" and the title tune). Family fun and sales 'cause it's O'Jay okay! Phila. Intl. PZ 33807 (Col) (6.98).

NEIL YOUNG, "ZUMA." Another distinct Young set, this time reverting back to well-remembered "After the Goldrush" and "Everyone Knows This Is Nowhere" days. A childlike reality emerges on a variety of levels—from lyrics to vocals to graphics—and endears as well. Crosby, Stills and Nash lend their skills on "Through My Sails." Reprise MS 2242 (WB) (6.98).

"DAN HILL." A Canadian folk-styled singer/songwriter with a pen not unlike Harry Chapin's (except the songs are shorter). Each of the tracks examines a different stage of an individual's development through the perspective of a well-tempered optimist. "Growing Up," "People" and "Fountain" are good introductions to this fine new artist. 20th Century T-500 (6.98).

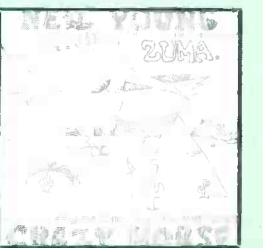
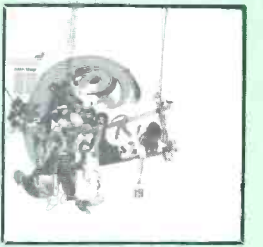

JAZZ IS ON THE
Horizon

"...a series of records intended to capture important new music..."

Horizon is jazz.

Horizon is a new venture from A&M Records dedicated to improvisational music and the artists who create it.

Horizon will present a series of records intended to capture important new music for those interested in the remarkable and unpredictable evolution of jazz.

All Horizon album covers will be gatefold and, in most cases, will contain extensive liner notes, along with transcribed solos, a lead sheet of a selected composition, a diagram of the stereo mix of one of the selections, a graphic score of one selection (what instrument is playing when), artists' comments, and photographs.

All Horizon pressings will be of the highest quality available to ensure the ultimate sonic experience. Each record will be packaged in a plastic lined inner sleeve.

All Horizon albums will be available at a list price of \$5.98, instead of the usual \$6.98. And all tapes will be \$6.98 instead of \$7.98.

We welcome your opinions.

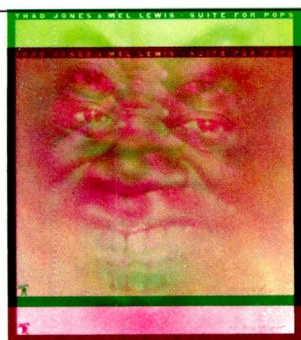

THAD JONES & MEL LEWIS
 SUITE FOR POPS SP 701

Thad Jones and Mel Lewis have been leading one of the most exciting big bands in the world for the last ten years. Their Monday night gigs at New York's Village Vanguard are legendary. This album is Thad & Mel & Co. in a musical tribute to Louis Armstrong.

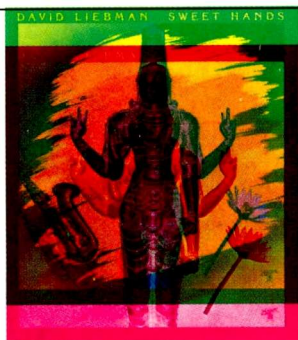

DAVE LIEBMAN SP 702
 SWEET HANDS

One of the rising stars of contemporary instrumental music, Dave is a former Miles Davis reed player who's also recorded with Mahavishnu John McLaughlin and Elvin Jones. He plays all saxes and flutes and is featured with his quintet. Lookout Farm: Richie Beirach on keyboards, Badal Roy on tabla, Jeff Williams on drums, and Frank Tusa on bass.

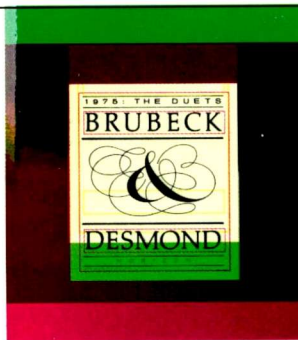

DAVE BRUBECK & PAUL DESMOND
 1975: THE DUETS SP 703

Brubeck and Desmond first played duets aboard the S.S. Rotterdam Jazz Cruise earlier this year. This album marks a special moment in jazz history: their first duet recording in over twenty years of performing together. It all started 2000 miles out at sea and it's all here. Definitely a vintage set.

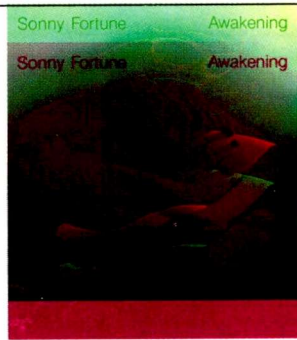

SONNY FORTUNE SP 704
 AWAKENING

Former Miles Davis reedman Sonny Fortune has also played and recorded with Mongo Santamaria, McCoy Tyner, and Buddy Rich. His multi-textured Horizon debut includes: Chip Lyles and Billy Hart on drums, Wayne Dockery and Reggie Workman on bass, Kenny Barron on piano, and Charles Sullivan on trumpet.

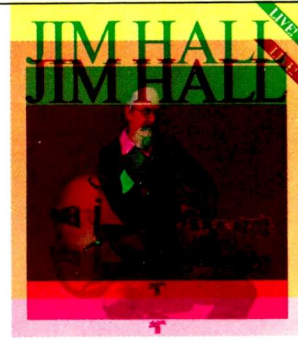

JIM HALL SP 705
 LIVE!

Preeminent among contemporary jazz guitarists, Jim Hall shares equal space with the two generally acknowledged masters — Django Reinhardt and Charlie Christian. This album is the best of his recent "live" performances — accompanied by Don Thompson on bass and Terry Clarke on drums.



A JAZZ SERIES ON A&M RECORDS & TAPES

RECORD WORLD

MCA Plans Automation For Pressing Plants

By ELIOT SEKULER

■ LOS ANGELES—MCA Records is moving towards the automation of its two domestic pressing plants located at Pinckneyville, Illinois and Gloversville, New York. According to the company's vice president of operations, George Jones, the automated process, expected to be implemented in the near future, was planned to reduce payroll costs and allow for production on a 24-hour, 7 days a week basis when such need arises. Production capacity, currently estimated at 150,000 albums and 130,000 singles daily, will not be altered by the introduction of automation.

In addition to the automation of record pressing operations, (Continued on page 88)

NEA Budget-Boosting System Proposed

By MICHAEL SHAIN

■ WASHINGTON, D.C.—A freshman Congressman from Brooklyn has an idea that could push the budget of the National Endowment for the Arts to 10 times its present level. The new money—conceivably more than \$1 billion—would come from a check-off system using the U.S. income tax form. The arts check-off idea would generate money for the support of composers, symphonies, performances and education.

The present NEA budget—already at an all-time high level due to recent increases by Congress for Bicentennial year projects—stands at around \$75 million. The check-off system, which would authorize the Treasury to forward a portion of an individual's tax refund to either NEA or

the National Endowment for the Humanities, could explode NEA's budget to upwards of \$1 billion, according to some estimates.

The arts check-off plan is the brainchild of Rep. Fred Richmond (D-NY), a former New York City Councilman who led the fight to save Carnegie Hall from demolition in the late 1950s and was soon after made chairman of its board of directors. He was also a member of the board of the New York State Council on the Arts.

Rep. Richmond introduced a bill to create the new check-off and subsidy system last June. The bill (H.R. 8274) was referred to the Ways and Means Committee at that time, but to date no action has been taken on it. The first step in consideration of the idea will be hearings before the Ways and Means Subcommittee on Public Assistance chaired by Rep. Richard Fulton (D-Tenn).

If approved, the system will work thusly:

The Internal Revenue Service will be directed to incorporate onto the front page of personal tax forms a box including the arts/humanities check-off. If taxpayers elect to make a contribution, they will specify the amount of their gifts—to be subtracted from their refund or added to their tax payment if they still owe IRS tax money—in a blank space. Then the contributors will have the

option of checking one of three boxes directing that the money be given to either NEA, the Humanities Endowment, or divided equally between both.

According to a Harris poll conducted last year, 64 percent of those adults surveyed are willing to pay \$5 annually for support of the arts. Nearly 50 percent claimed to be willing to pay \$25 a year and 36 percent said they would contribute as much as \$50 yearly.

Projecting the survey figures over the more than 80 million U.S. taxpayers, the check-offs would create a fund in excess of \$1.7 billion, the Harris organization found. The study was sponsored by the National Research Center of the Arts. The Richmond bill would prevent the endow-

(Continued on page 86)

'Hits' Compilations Show Chart Strength

By DAVID MCGEE

■ NEW YORK—With the holiday buying season beginning in earnest, manufacturers are coming forth with a spate of "Greatest Hits" albums, and the wisdom of their actions is reflected on this week's Album Chart and Retail Report.

Chartmaker of the Week this week is "Barry White's Greatest Hits," which comes on at a bulleted 51. Last week's Chartmaker, Seals and Crofts' "Greatest Hits," zooms from a bulleted 81 to a bulleted 17 this week. "Greatest Hits" packages by America and Gordon Lightfoot have entered the charts at, respectively, bulleted 58 and bulleted 120. John Lennon's "Shaved Fish" continues strong, moving from a bulleted 61 to a bulleted 48 position this week. Renewed interest in "Simon and Garfunkel's Greatest Hits" has resulted in that package jumping from a non-bulleted 128 position to a bulleted 117.

Of the older "Greatest Hits" packages still on the Album Chart, "John Denver's Greatest Hits" is exhibiting the most resiliency. On the chart for 102 weeks thus far, the Denver collection retains its unbulleted 49 position from the previous week. "Elton John's Greatest Hits," which in the long run may equal Denver's for staying power, re-

mains at an unbulleted 26 position after 53 weeks on the chart. A year ago Elton's album entered the chart as Chartmaker of the Week at a bulleted 39 and eventually topped the chart for eight consecutive weeks. The number one album from November 2, 1974, Jim Croce's "Photographs and Memories," moved up one notch this week, from 162 to 161 (no bullet).

(Continued on page 91)

Tribute to Tony & Dawn



After filming a 90 minute tribute to Tony Orlando & Dawn on the Dinah Shore Show in honor of their 5th anniversary, a group of radio & record executives toasted the group. Pictured, from left are: Bill Drake, K-100; David Geffen, chairman of Elektra/Asylum/Nonesuch Records; Charley Van Dyke, KHJ; Paul Drew, RKO Broadcasting; Tony & Elaine Orlando; Tim Sullivan, KHJ; Joyce Vincent Wilson; Jerry Sharell and Freddy DeMann, Elektra/Asylum Records.

Songwriters Hall Sets Headquarters

■ NEW YORK — Established in 1968, the Songwriters' Hall of Fame found its first permanent home on Thursday (13) when papers for a three-year lease at One Times Square, New York City, were signed.

Alex Parker, realtor and owner of the building that housed the New York Times for so many years, signed a lease granting the Hall of Fame three years free tenancy on the eighth floor. Academy Award winning lyricist

(Continued on page 24)

AMC Yetnikoff Dinner Stirs Industry Interest

■ NEW YORK — The Humanitarian Award Dinner given by the American Medical Center to honor Walter Yetnikoff, president, CBS Records Group, is attracting a great deal of industry interest. More than 1000 people are now expected to attend the dinner, which takes place on December 14, 1975 in the Grand Ballroom of the New York Hilton Hotel. The award is being presented to Yetnikoff by the board of trustees of the American Medical Center for his active support of the AMC and his outstanding contributions to other humanitarian pursuits.

(Continued on page 91)

Tony King Named Rocket Records VP

■ LOS ANGELES — John Reid, president of Rocket Records, has announced the appointment of Tony King as executive vice president of the label.

Prior to joining Rocket Records, King acted as general manager of Apple Records in the USA and label manager of Apple Records in the United Kingdom. In addition to his five-year association with Apple Records and The Beatles, King has worked with The Rolling Stones/Andrew Oldham, Decca Records, London and A.I.R., London.

In his new position, King will report directly to John Reid and will oversee the a&r, product coordination and administrative budgeting activities of the label.

Dennis Morgan remains general manager of Rocket Records, serving as liaison between Rocket and MCA Records.



Tony King

Papale Exiting Chrysalis Post

■ LOS ANGELES—Michael Papale, national sales and promotion director, is leaving Chrysalis Records as of December 1. He has been with the company for three years. Papale started as national promotion director in 1972 when Chrysalis Records began its American operation (distributed by Warner Bros. Records). A year later he was promoted to national sales and promotion director.

Papale, a twelve year veteran of the music business, said he will announce plans shortly.

RCA Names Moseley To Head R&B A&R

■ NEW YORK—Ronald G. Moseley has been named division vice president, rhythm and blues artists & repertoire, at RCA Records. Effective immediately, Moseley assumes full responsibility for rhythm and blues music at the company.

The announcement was made by RCA Records president Ken Glancy, to whom Moseley will report.

In his most recent positions in the industry, at Polydor, Inc. during 1975 and at Sussex Records for the previous five years, Moseley worked closely with such artists as Bill Withers, Zulema, Faith, Hope & Charity and Creative Source. At Polydor, he functioned as east coast a&r director and as national promotion manager, as well. He was co-founder and vice president of Sussex, where he directed all a&r, promotion and marketing activities, reporting directly to the president of the company. While at Sussex, he brought Bill Withers to the label, helped establish Faith, Hope & Charity, and encouraged Zulema



Ronald Moseley

to leave that group and begin her career as a solo artist.

Prior to his tenure at Sussex, Moseley was director of rhythm and blues at Capitol Records where, from 1968 to 1969, he coordinated promotion and marketing for all r&b product. From '67 to '68, he served as national pop singles promotion manager for ABC/Dunhill Records and all its affiliate labels. For Warner Brothers Records and Loma Records, he worked in national r&b promotion and special products, from '66 through '67. Moseley also served as regional promotion manager for MGM Records in 1965.

Chalice Adds Renzetti

■ LOS ANGELES — Joe Renzetti has been signed to an exclusive co-production agreement by Chalice principals David Chackler and Lee Lasseff. Chalice will represent Renzetti in all his endeavors in the production field.

Renzetti will operate from the organization's headquarters office in Los Angeles, at 8467 Beverly Blvd.

Renzetti has been involved creatively, either as a producer or arranger, with songs and artists such as Barry Manilow, including the "Mandy" and "Could This Be Magic" singles and the "I" and "II" albums; Gary Glitter, Cashman & West, Spanky and Our Gang, Wayne Newton, Al Hirt, Tony Orlando & Dawn. As an arranger, Renzetti is currently represented by the David Geddes Big Tree single, "Blind Man In the Bleachers."

Belwin-Mills Names Litwin Vice President

■ NEW YORK—Burton L. Litwin has been named to the post of vice president of Belwin-Mills Publishing Corp. by Martin Winkler, president and chief executive officer of Belwin-Mills. In this position, Litwin will direct the New York office operations as chief operating officer of the pop and serious music divisions, and will also serve as the business affairs officer of all divisions of the company.



Burton Litwin

Litwin had recently been named general manager of the New York division, after serving Belwin-Mills as director of business affairs since the merger of Belwin and Mills Music in 1969. Prior to the merger he had been general counsel and vice president of Mills, and previously had been in private law practice specializing in the entertainment industry.



1700 Broadway, New York, N.Y. 10019
Phone: (212) 765-5020

PUBLISHER **BOB AUSTIN**
EDITOR IN CHIEF **SID PARNES**
VP & MANAGING EDITOR **MIKE SIGMAN**

LENNY BEER/DIRECTOR OF MARKETING
HOWARD LEVITT/ASSOCIATE EDITOR
MITCHELL KANNER/CREATIVE SERVICES
TONI PROFERA/RESEARCH EDITOR
Roberta Skopp/Assistant Editor
Ira Mayer/Assistant Editor
David McGee/Assistant Editor
Barry Taylor/Assistant Editor
Howard Newman/Assistant Editor
Mike Vallone/Assistant Research Editor
Dede Dabney/R&B Editor
Michael Schanzer/Associate Art Director
John Czajkowski/Assistant Art Director
Randy Eichler/Production
Speight Jenkins/Classical Editor
Vince Aletti/Discotheque Editor
Michael Shain/Washington Correspondent
Irene Johnson Ware/Gospel Editor

Stan Soifer/Advertising Sales

WEST COAST

SPENCE BERLAND

VICE PRESIDENT

WEST COAST MANAGER

Eliot Sekuler/West Coast Editor

Ben Edmonds/Assistant Editor

Linda Nelson/Production

6290 Sunset Blvd., Hollywood, Calif. 90028
Phone: (213) 465-6126

NASHVILLE

JOHN STURDIVANT

VICE PRESIDENT

SOUTHEASTERN MANAGER

Don Cusic/Southeastern Editor

Marie Ratliff/Research

Red O'Donnell/Nashville Report

806 16th Ave. So., Nashville, Tenn. 37203
Phone: (615) 244-1820

LATIN AMERICAN OFFICE

TOMAS FUNDORA

VICE PRESIDENT

LATIN AMERICAN MANAGER

Carlos Marrero/Assistant Manager

3140 W. 8th Ave.

Hialeah, Fla. 33012

(305) 823-8491

(305) 821-1230 (night)

ENGLAND

NOEL GAY ORGANISATION

24 Denmark St.

London, W.C.2, England

Phone: 836-3941

JAPAN

ORIGINAL CONFIDENCE

CBON Queen Building

18-12 Roppongi 7-chome

Minato-ku, Tokyo

GERMANY

PAUL SIEGEL

EUROPEAN EDITOR

Tauntzienstrasse 16, 1 Berlin 30, Germany
Phone: Berlin 2115914

FRANCE

GILLES PETARD

8, Quai de Stalingrad,

Boulogne 92, France

Phone: 520-79-67

CANADA

LARRY LE BLANC

9 Craig Crescent

Toronto M4G2N2, Canada

Phone: (416) 482-3125

SUBSCRIPTIONS: ONE YEAR (52 ISSUES) U.S. AND CANADA—\$50; AIR MAIL—\$85; FOREIGN AIR MAIL—\$90. SECOND CLASS POSTAGE PAID AT NEW YORK, N.Y. AND AT ADDITIONAL MAILING OFFICES. DEADLINE: NEGATIVES AND COPY MUST BE IN NEW YORK BY 12 NOON FRIDAY.

Copyright © 1975 by

RECORD WORLD PUBLISHING CO., INC.

VOL 31, No. 1483

Powerhouse Picks

(Due to airplay and sales in projectable markets, these records exhibit top five potential)

Sweet (Capitol) "Fox On The Run."

Showing upward moves in markets where already aired and backed by strong sell-through. The record receives an added push via new additions at several key stations.

Barry Manilow (Arista) "I Write The Songs."

Flying up the charts in Memphis (top 15) and Philadelphia (top 20), the record's growth continues this week with adds at major stations. Good national sales have accompanied the record from the outset.

1st. TIME EVER

BESERKLEY

RECORDS

AVAILABLE

NATIONWIDE!



"Jonathan Richman is here now with a good 'life in the city love song' and an edge in his voice that lets you feel this isn't the six millionth time he's sung it."

—Judy Nylon,
New Musical Express

JONATHAN RICHMAN

"Government Center is Jonathan Richman at his sharpest"
—Boston Real Paper

GREG KIHN

"Sleeper of this super-charged LP Greg Kihn... Both his original songs slay me, and Kihn is the one meant to sing them."

—Rose Bimler, Dundalk Shopping News.



RUBINOOS



"...a bubblegum garage band that would turn any junior high school dance upside down."

—John Morthland



distributed by
PLAYBOY RECORDS

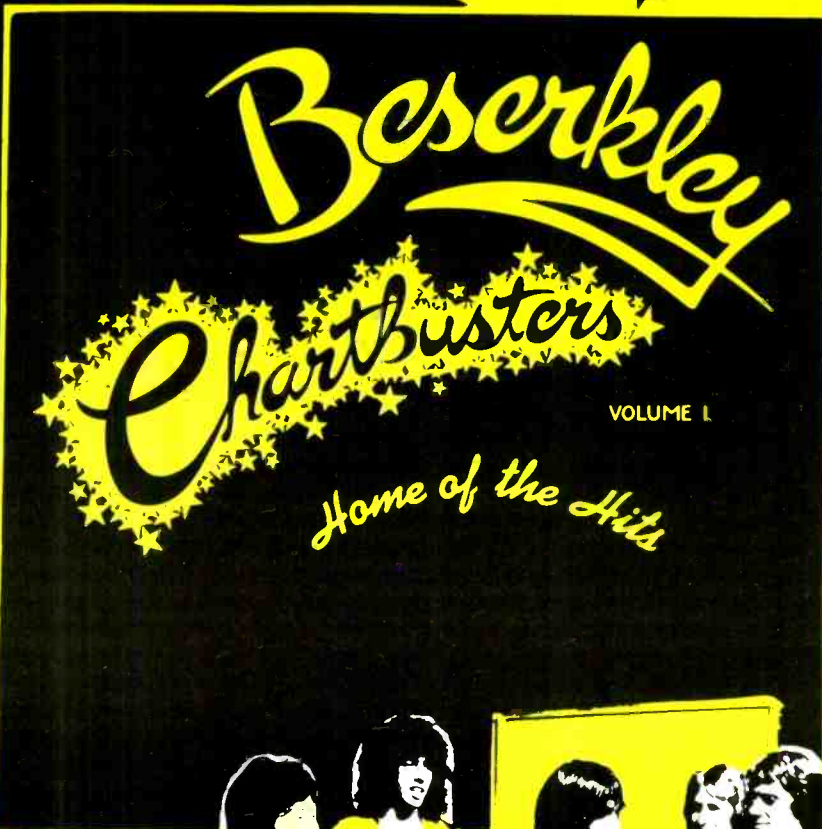

"For my money, Earth Quake is one of the most dynamic pop bands extant today."
—Greg Shaw, *Phonograph Record*

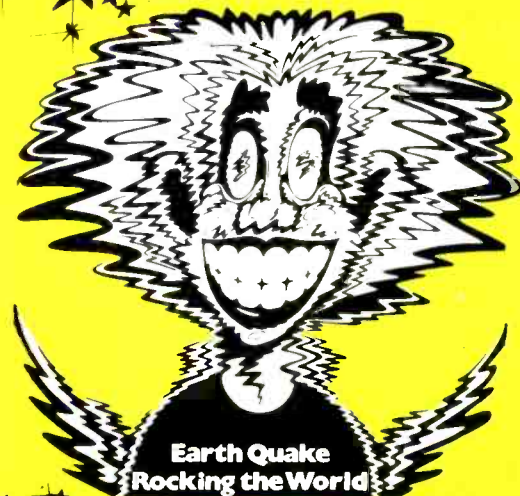

"Rockin' The World captures the East Bay quintet in its natural millieu—a gutsy, explosive performance in Berkeley. The crude power of the live tracks is overwhelming."
—Joel Selvin, *San Francisco Chronicle*

© 1975 BESERKLEY

Radio Vital to Springsteen Success

By BARRY TAYLOR

■ NEW YORK — Columbia Records' efforts in the promotion of Bruce Springsteen were, according to Stan Monteiro, vice president, national promotion, "assisted greatly by radio play and helped by good timing and luck."

During a period of more than a year between the release of his second album, "The Wild, The Innocent and the E Street Shuffle," and "Born To Run," radio stations in key markets were responsible for keeping Springsteen's music exposed to the public.

Progressive Belief

"Progressive stations such as WBCN, Boston; WNEW, New York; WMMR, Philadelphia; WMMS, Cleveland; WHFS, Washington; and KLOL, Houston really believed in him and stayed with Bruce long before he broke," said Monteiro.

"Before he started his famous tour, excitement was building in these markets. Bruce's first two albums were re-serviced and we worked with the radio and newsprint in those markets to the point where we were cooking all over again with his first two albums three to four months before the release of 'Born To Run.'"

Who Tour Sell-Outs Force Added Dates

■ NEW YORK — Even as tickets went on sale for the first time in some venues, Part I of The Who's 1975-76 tour of the United States is virtually sold-out in every date where tickets went on sale Nov. 1 and thereafter, and some of these cities will be revisited by the British rock group this summer in Part III of their tour.

Houston Opener

The Who's tour begins Nov. 20 in Houston at the city's new \$18 million facility, The Summit, and inaugurates rock into the ultra-modern multi-use arena. Tickets officially went on sale in Houston on Oct. 31; all 18,000 seats sold out in 2 hours and 45 minutes.

According to Sir Productions, The Who's management, Houston will be one of the cities the group will return to this summer—although the itinerary for Part III is only 20 percent penciled in at the time and several dates in Part II are still to be finalized.

Sell-Out Cities

Other sold-out dates include Chicago, Cleveland, Toronto, Atlanta, Providence, Springfield (Mass.) and Philadelphia.

The Who ended their current tour of the U.K. and Europe on Nov. 9 in Frankfurt, West Germany, and arrived in New York on Nov. 18 to change planes for rehearsals in Houston.

In addition, a preview tape of the "Born To Run" title track was distributed to various stations. The tape began to pick up considerable airplay and generated much of the excitement that preceded the release of the lp.

When "Born To Run" was released during the first week of September, Columbia took advantage of the momentum that was built with an advertising campaign geared to the cities where Springsteen had nearly been a fixture on the airwaves.

"We didn't spend disproportionately," Monteiro pointed out. "By the time 'Born To Run' was released, the groundwork had been laid and Bruce just exploded. We did the same thing we would do for any other artist. This time, it just stuck." Monteiro also pointed to the AM stations that had gone on "Born To Run" before it had been singled out of the album: "We got some very early play from top 40's such as WPGC in Washington, WFIL and WIBG in Philadelphia, and WCAL in Baltimore which was a very encouraging sign."

A Little Bit Of Luck

Luck was another factor in the success of "Born To Run," which topped Record World's Album Chart in its third week of release, according to Monteiro. "The difference between a good company and one that's not too good is in how they take advantage of luck. If you're with a company that knows how to do it, then you're in a good position."

Crosby and Nash Gold

■ LOS ANGELES—ABC recording artists Crosby and Nash have qualified for an RIAA gold award for their debut lp for the label, "Wind on the Water."

Lone Star Soiree



Columbia Records recently announced an agreement calling for the release of all Willie Nelson Lone Star productions on the Columbia label. The deal involves artists discovered by Nelson and produced by his Lone Star company. The first records to be issued under the arrangement are singles by Billy C. and Milton Carroll. Shown at the Columbia-Lone Star press party in Houston are, from left: Billy C.; Carroll; Nelson; Bruce Lundvall, vice president and general manager, Columbia Records; Neil Reshen, Nelson's manager.

Lifesong Holds Promo Meets



Terry Cashman and Tommy West of Lifesong Records recently met with the promotion men from their network of independent distributors to play new product. The meetings were chaired by Barry Gross and Marty Kupps, vice presidents, sales and promotion, Lifesong. Shown at the Chicago meeting, held at the Regency Hyatt O'Hare are (front, from left): Butch Cordell, Record Sales, Memphis; Mike Hicks, Daily, Houston; Tommy West; Ken Marrs, Big State, Dallas; Lenny Zdanowitz, All South, New Orleans; (back row) Skip Pope, MS, Chicago; Frank Juliano, MS, Chicago; Scott Kranzburg, Commercial, St. Louis; Terry Cashman; Gary Diamond, Heilicher, Minneapolis; Craig Lambert, AMI, Detroit; Marty Kupps, Barry Gross.

Fantasy Taps Sunday

■ BERKELEY — Michael Sunday has been appointed director of a&r administration at Fantasy/Prestige/Milestone. The announcement was made by Ralph Kaffel, president of the labels. In his new position, which he starts immediately, Sunday will be responsible for overseeing the administration of all recording activity.

Before coming to Fantasy, Michael was director of contemporary product at Epic in L.A. for three years. Earlier, he was a producer/a&r at Capitol in L.A. for two years, a disc jockey at KSAN-FM under Tom Donahue in San Francisco for a year, and producer/a&r at Vanguard in New York for two years.

Foghat Gets Gold

■ LOS ANGELES—Foghat's first Bearsville album, "Foghat," has been certified gold by the RIAA.

Sterling Music Formed By Howe and Ahlert

■ LOS ANGELES — Formation of The Sterling Music Company in Los Angeles has been announced by producer Bones Howe and publisher Fred Ahlert, Jr., who will jointly head the new organization. Sterling will headquarter at 9165 Sunset Blvd., Ste. 300, Los Angeles 90069; phone (213) 273-7261.

Variety Of Areas

The company will operate in a variety of areas within the music industry, according to Ahlert and Howe, with special concentration on production and publishing ventures. Sterling's active catalogues will include Sterling (AS-CAP) and Gold Sovereign Music (BMI), along with others.

Duties

While Ahlert will direct this operation, Howe will supervise record production, including projects he personally undertakes, production by producers signed to the Sterling Music Company, and with independent producers through special arrangement with the company.

■ Helen Reddy has been having chart success for five years, not three years, as was reported in last week's issue.

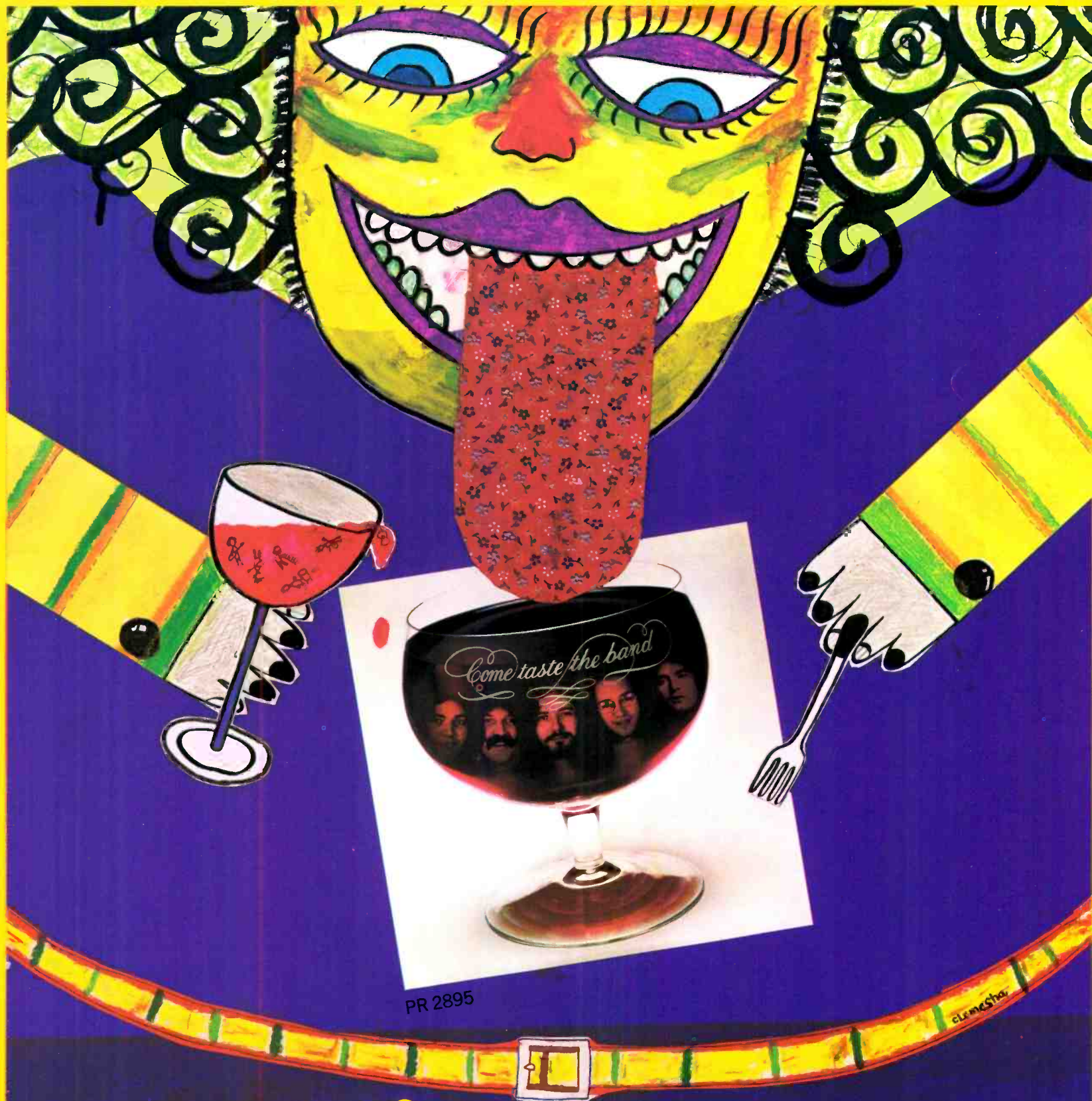

Dig Deep.

**DEEP PURPLE
COME TASTE THE BAND**

ON WARNER BROS. RECORDS AND TAPES.

By BEN EDMONDS



■ **PATTI SMITH: HEARTS ON LEATHER:** The armies of poetry and rock & roll have never really been able to find mutually satisfactory ground on which to consolidate their forces. Up until now, the most significant mediamixes have come to us by way of **Bob Dylan** and **Jim Morrison**. Dylan's amphetamine spew of the "Highway 61 Revisited" and "Blonde On Blonde" period elevated him from topical songwriter to poet; his words were judged as poetry because they showed a truly creative

intelligence being applied to rock & roll in a way that people hadn't heard before. They were also considered to be poetry because people had no idea what in the hell he was singing about most of that time, and whenever people don't understand words they invariably call it poetry. When Bobby reverted to simple rhymes and sentiments (in the wake of his motorcycle accident) that people thought they could understand, they stopped considering him as a poet and he was back on the street as a topical songwriter. Jim Morrison considered himself to be a poet. Most of the kids who came to see the **Doors**, however, didn't; they politely tolerated the "Celebration Of The Lizard" to get to "Light My Fire" and the other hits. He died before any meaningful redefinition of character could be explored. At the time of his death, Morrison was involved in plans to put together a poetry-oriented album that would've speeded that process; the vocal tracks, sans music, are aging quietly in Elektra's vaults. The poetry of Dylan and Morrison wasn't really poetry at all, just superior lyrics. They were hailed as poets by people who'd never for one second consider buying a volume of poetry when the same money could get them a rock & roll album; the trad poetry element chose not to hail them at all. It was "alternative poetry" at best. To **Patti Smith**, sitting at home in Jersey and Philadelphia, Dylan and Morrison's kind of alternative poetry made sense. When Dylan said that **Smokey Robinson** was America's greatest living poet, she understood that, too. From the earliest solo poetry readings that got the buzz about her going in New York, it was obvious that Patti Smith was more than just a poet. For starters, she was the only poet in town whose work screamed for a band to back it up. She published collections of poetry, but wrote for rock magazines as well. When she finally got her band, it didn't comprise her poetry, it consummated her very special relationship with the form. When she was signed to Arista and people began to talk about her as if she was a prize painting hanging in somebody's gallery, it didn't mean that Patti had changed; it just meant that she was allowing people to think they'd discovered her. What Patti Smith does now is what she's always done. A little better, perhaps, with her continuing stage experience and the ever-evolving capabilities of her band, but certainly no difference from what she set out to do. The phrase "set out to do" might be misleading, because Patti doesn't try to be anything; she is. And what she is, for those who need black & white definition, is the first genuine fusion of poetry and rock & roll. She's a tough chick, as tough as rock & roll. But it's not the desperate, unfulfilled sort that was **Janis Joplin**, nor is it the kind of cheap magazine dykishness that's usually attached by implication to any woman performer who doesn't come on like cheerleader material. She's tough because rock is tough, and anybody who loves rock is tough (or at least wants to be). All of her rock & roll fire and strut is filtered through her primary person as a poet. Poetry is letters written to yourself late at night when you're naked and there's nobody around to talk to. It's vulnerability, and it's this quality in conspiracy with her rock attitude that makes her unlike anything else presently available. Her poetry comes out of a sensibility that read **Rimbaud** and listened to the **Rolling Stones** at the same time. Her first album, out this week, is that and nothing more. Her label (Arista) and her producer (**John Cale**) judiciously stepped aside and let Patti be, and the result is sometimes crude, often rough and, most of all, real. Her band, expanded and much improved since their engagement here at the Whisky last year, still has plenty of room for further improvement, but their limitations serve to reinforce her passionate reality. Patti Smith may not be for everybody, but there's no denying that the genuine talent at work here offers exciting and boundless possibilities. Those who were vaguely disappointed in **Bruce Springsteen** because they expected him to be something completely new and unique will undoubtedly find what they were looking for in Patti Smith. LA area residents will have the opportunity to find that something when she takes over the Roxy on November 28 and 29. Discovery is still the best part of the rock and roll experience.

Davis, Grierson Named to New Capitol Posts

■ **LOS ANGELES** — Dan Davis, Capitol Records' director of creative services/press & publicity, has been assigned additional corporate responsibilities and reporting to him, effective immediately, will be the merchandising and advertising departments, announced Don Zimmermann, CRI's senior vice president, marketing.

Don Grierson, formerly Capitol's manager, international a&r/

promotion, has been named national merchandising manager and will report directly to Davis.

Valery Smith, creative director, merchandising and Mickey Diage, national advertising manager will report to Grierson.

Davis' Responsibilities

In addition to his new duties, Davis will continue to be responsible for the art, press, pre-recorded tape, and copy departments.

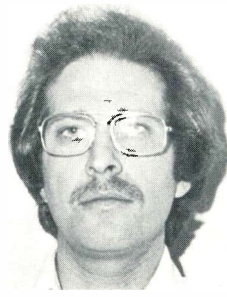

Dan Davis



Don Grierson

New Joni Mitchell LP

■ **LOS ANGELES** — Elektra/Asylum Records has set "The Hissing Of Summer Lawns," the new Asylum album from Joni Mitchell, for national release this week. Major sales, merchandising, advertising and promotion programs are underway in support of the set, the artist's first studio album in nearly two years.

"The Hissing Of Summer Lawns" is the first collection of new Mitchell songs since "Court And Spark" was released early in 1974; that album reached the number one position on **Record World's** chart and earned both gold and platinum record awards. Recorded in Los Angeles, the new album features musical support from members of the L.A. Express and the Crusaders, James Taylor, David Crosby, Graham Nash and veteran jazz musicians Bud Shank and Victor Feldman. Mitchell plays guitar, piano and synthesizers, and designed the cover art.

Columbia Signs Return to Forever, Al DiMieola

■ **NEW YORK** — Irwin Segelstein, president, CBS Records, has announced the signing of Return to Forever, and of the group's guitarist, Al DiMieola, who will record separately as a solo artist for the label. The other three members of Return to Forever are Chick Corea, keyboards; Stanley Clarke, bass; and Lenny White, drums, all of whom also record individually.

Return to Forever, a group concept started by Corea in 1972 with different personnel (except for Clarke), developed into a permanent quartet.

Fania Announces Price Increase

■ **NEW YORK** — Fania Records has announced that due to increased costs of production, upgraded vinyl quality, and a higher grade of artwork, the Fania family of labels will be raising the cost of some albums to \$6.98 in 1976.

The first four albums released at the new price will be Ismael Miranda's "Este Es Ismael Miranada," Larry Harlow's "El Judio Maravilloso," Mon Rivera and Willie Colon's "There Goes The Neighborhood," and Johnny Pacheco's "El Maestro."

Marshall Tucker Gold

■ **LOS ANGELES** — The Marshall Tucker Band's Capricorn album "Where We All Belong" has been certified gold by the RIAA.

Pompadur Honored



I. Martin Pompadur, vice president and assistant to the president, American Broadcasting Companies, Inc., receives a citation honoring him as the United Jewish Appeal-Federation of Jewish Philanthropies-Music Industry Division "Man of the Year" from Morris Levy, dinner chairman and president of Roulette Records. The dinner honoring Pompadur, held November 1 at the New York Hilton, drew more than 1,000 people.

They discovered Bruce Springsteen:

The radio stations, retailers and people of New York, Boston, Philadelphia, Washington/Baltimore, Houston, Cleveland, Phoenix and Hartford were the true discoverers of Bruce Springsteen.

All along, they knew who he was, and who he would become.

**Thanks
from Columbia Records.**

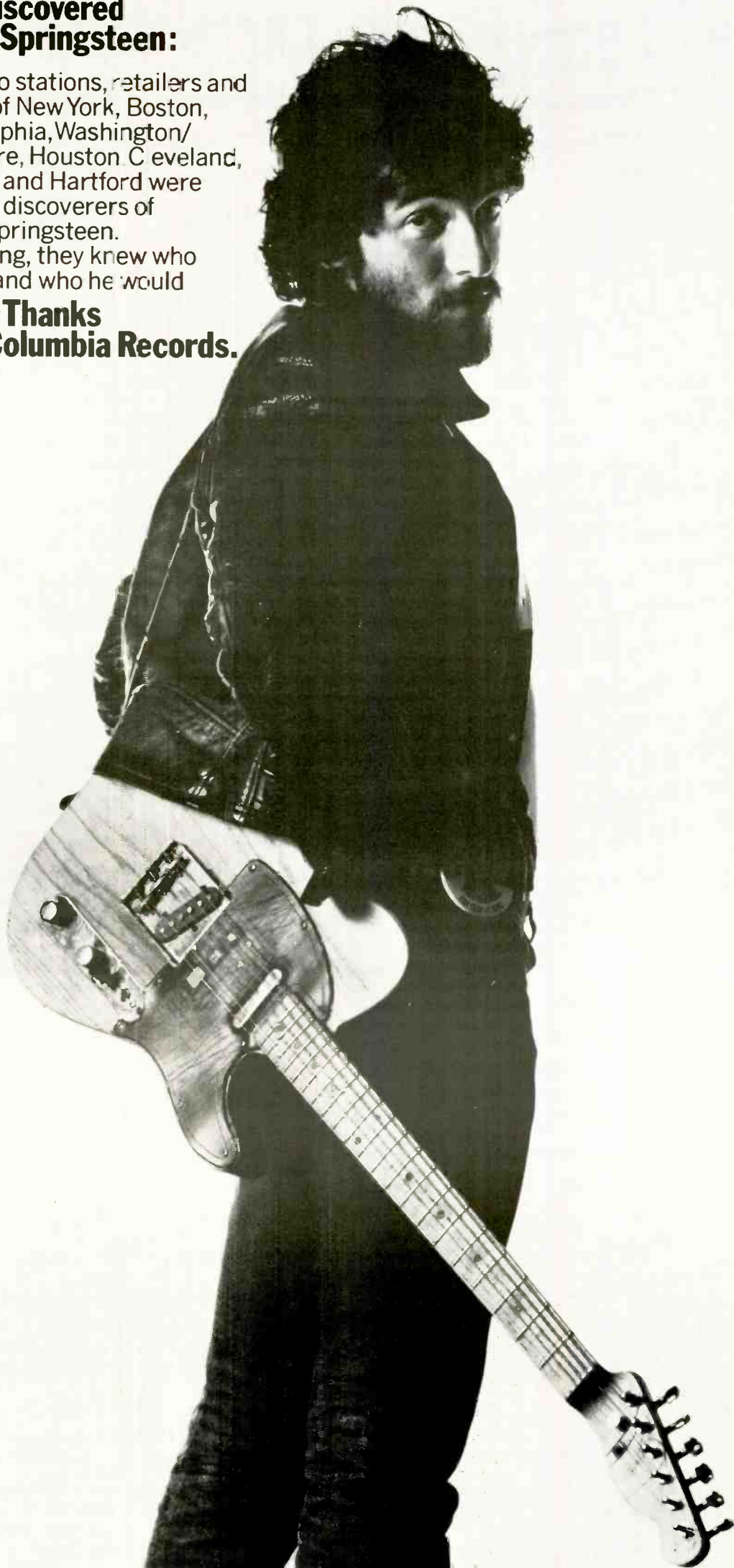

10cc—Mercury 73725

ART FOR ART'S SAKE (prod. by 10cc)
(Man-Ken, BMI)

The group's follow up to "I'm Not In Love" is a spirited tour-de-force of vocal and production technique with an irresistible hook. A great sound.

TERRY GARTHWAITE—Arista 0164

ANGEL OF LOVE (prod. by David Rubinson)
(Winds & Dragons, BMI)

Terry sings and swings along with a sassy brass section on a song written by her former Joy Of Cooking partner, Toni Brown. A great solo bow!

MAJOR HARRIS—Atlantic 3303

I GOT OVER LOVE (prod. by S. Bernstein, A. Rubens & M. Harris) (WIMOT/Sacred Pen, BMI)

Harris, a disco sensation with his "Love Won't Let Me Wait" stands to repeat his success with this teary ballad. A strong vocal outing that could go all the way.

THE DUDES—Columbia 3 10259

DANCIN' SHOES (prod. by Mark Spector) (North American Flyers, BMI)

A brisk pop sound that owes to the Doobies in its rhythms, but is purely the Dudes in its delivery. These Canadian rockers are headed chartward!

LOVE CHILD'S AFRO CUBAN BLUES BAND—Roulette 7180

BLACK SKIN BLUE EYED BOYS (prod. by J. Love & M. Zager) (Picadilly, BMI)

From their "Out Among 'Em" lp, the group sports an aggressive sound ignited by cascading stringed rhythms and a brisk percussion break.

BLACK BLOOD—Mainstream MRL 5574

CHICANO (prod. by Ralph Benatar & Jean Kluger)
(September, ASCAP)

African percussion provides the underlining pulse while exotic vocals color the song with its own distinct flavor. A much requested disco item.

AEROSMITH—Columbia 3 10253

YOU SEE ME CRYING (prod. by Jack Douglas)
(Daksel, BMI)

These Beantown rockers flex their vocal cords and guitars on a track culled from the "Toys In The Attic" lp. The sound of the quintet remains as vital as ever.

KING ARTHUR—Soundscape 400 352

HEY BABY (prod. by McArthur Belin)
(Alakazam, BMI)

A memorable debut from a singer whose voice swells with emotion and sincerity. A brassy arrangement provides a colorful backup and a steady beat.

THE DOOBIE BROTHERS—WB 8161

I CHEAT THE HANGMAN (prod. by Ted Templeman)
(Lansdowne/Warners, ASCAP)

AM favorites though they remain on par with FM tastes, the Doobies stretch out with a searing ballad that relies on a strong vocal harmony sound.

THE TRAMMPS—Buddah BDA 507

HOLD BACK THE NIGHT (prod. by R. Baker, N. Harris & E. Young) (Golden Fleece, BMI)

The group who are veritable superstars on the disco circuit have created another immaculate dance record. Vocally and instrumentally, a superb disc.

BETTY WRIGHT—Alston 3718 (TK)

SLIP AND DO IT (prod. by Willie Clarke) (Coachland, BMI)

Few female singers can deliver a song with the emotion and urgency of Betty. Here, she sings about satisfying her man and sounds like she knows how to do it.

BILL CODAY—Epic 8 50167

I DON'T WANT TO PLAY THIS GAME (prod. by David Johnson) (Interior, BMI)

A talented singer with a voice reminiscent of Wilson Pickett, Bill drives this tune by sheer energy and enthusiasm. A big production and a great record.

ARCHIE BELL & THE DRELLS—TSOP ZS8 4774 (Epic)

THE SOUL CITY WALK (prod. by J. Whitehead, G. McFadden, V. Crastarphen) (Mighty Three, BMI)

These disco swingers have invented a new dance and provide the music to move and groove to it. A great up-tempo party record and a refreshing sound.

THE CHARLES RANDOLPH GREAN SOUNDE—Ranwood R 1044

STAR TREK (prod. by Charles R. Grean) (Bruin, ASCAP)

A theme song that should be easily identifiable to anyone who owns a TV, it's injected with a shot of disco. A sound that could be big in several markets.

CY COLEMAN—RCA PB 10440

CHLOE (prod. by Cy Coleman, Mike Berniker & Mike Lipskin) (Robbins, ASCAP)

Tune from his "Party's On Me" lp is a haunting latin-tinged arrangement. A song that should appeal to pop, jazz, or MOR tastes. Pick up on it.

SPANKY & OUR GANG—Epic 8 50170

I WON'T BRAND YOU (prod. by Chip Young)
(Youngun, BMI)

Group that told us that "Sunday Will Never Be The Same" in the '60s makes a comeback with a country-tinged ballad spiced by a warm vocal from Spanky.

GINO CUNICO—Arista 0162

FANNY (BE TENDER WITH MY LOVE) (prod. by Vini Poncia) (Casserole, BMI)

A singer with an engaging vocal style, Gino instills flair into this tune from the Bee Gees' "Main Course" lp. Fine arrangement enhances its emotional depth.

ANDY WILLIAMS—Columbia 3 10263

TELL IT LIKE IT IS (prod. by Rick Hall) (Conrad/Olrap, BMI)

Andy recorded this version of Aaron Neville's 1966 hit in Muscle Shoals, and as a result, is given a steady back up to bolster his smooth delivery.

BILL WITHERS—Columbia 3 10255

MAKE LOVE TO YOUR MIND (prod. by Bill Withers & Larry Nash) (Golden Withers, BMI)

Bill Withers lays it straight on the line with a track from his "Makin' Music" lp. A percussive instrumental backing underpins his flexible voice.

KATHE GREEN—Motown M 1372F

BEAUTIFUL CHANGES (prod. by Frank Wilson)
(Jobete, ASCAP; Tally, BMI)

Kathe's sweet, senuous vocal is enhanced by a sparse, enchanting arrangement that allows her voice to hit and take hold! A record headed for crossover success.

LONNIE LISTON SMITH & THE COSMIC ECHOES—Flying Dutchman JB 10392

A CHANCE FOR PEACE (prod. by B. Thiele & L. Liston Smith) (Cosmic Echoes, BMI)

Lonnie defies categorization with this outing from his "Visions" lp. Singer Donald Smith's velvet smooth vocals set the record's optimistic tone.

RONNIE McNEIR—Prodigal PLP 0620F

SAGGITARIAN AFFAIR (prod. by Ronnie McNeir)
(Crishelle/Mac West, BM)

Ronnie puts it all together with an astrological message and a smooth, silken vocal with a breezy arrangement. A good crossover shot.

ELVIN BISHOP—Capricorn CPS 0248
(Warner Bros.)

SILENT NIGHT (prod. by Bill Szymczyk & Allan Blazek) (Crabshaw, ASCAP)

Surely to be one of this year's most bizarre Christmas records, Elvin infuses the classic with his Southern humor.

BOBBY HEBB—Laurie LR 3638

SUNNY '76 (prod. by Marty Sheridan & Joe Renzetti)
(Portable, BMI)

Bobby secured a niche for himself in the pop annals with this 1966 hit. This bright, disco re-recording of it is a timely re-entry about due for a chart resurgence.

Millie Jackson's "Loving Arms" SPR 161 has the D.J.s flipping.

"Loving Arms" was the flip side of Millie's breakaway single from that explosive concept album, "Still Caught Up." "Loving Arms" is where the action is. This new side of Millie is coming on strong, fast and soulful straight across the country.

Look where "Loving Arms" has the D.J.'s flipping: WIGO—Atlanta WBLS—N.Y. WWRL—N.Y. WOOK—Washington WCHB—Detroit KDIA—San Francisco WWIN—Baltimore KKDA—Dallas

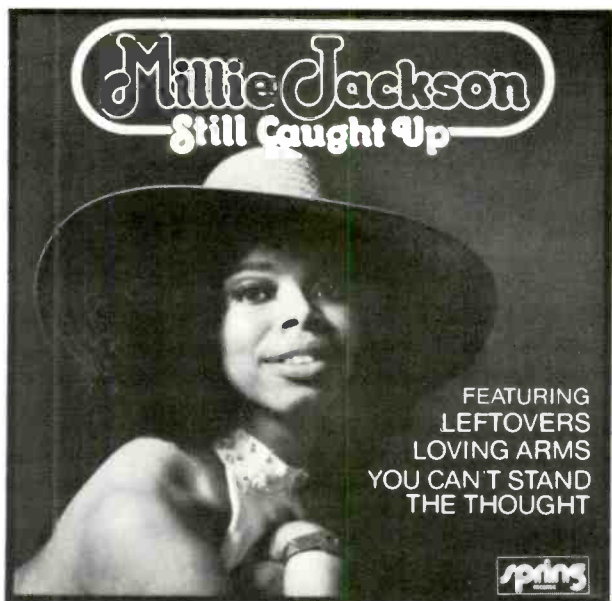

The Album: "Still Caught Up" SPR 6708
8-Track: 8F 6708 Cassette: CF 6708



Manufactured and Distributed by Polydor Incorporated
A Polygram Company





Z88 3577

Distributed by CBS Records.

O'JAYS TO THE PEOPLE

The hottest of the hot. The new O'Jays album titled "Family Reunion," featuring "I Love Music," already a monster top 40 and R&B hit.

Accompanying the release is a campaign that includes multi-artist TV spots, bag stuffers, ads in major black publications, a radio blitz, window streamers, artist posters and cover blow-ups. Now that's getting to the People.

"Family Reunion," featuring "I Love Music." The Earthquake goes on! Nothing like it anywhere. On Philadelphia International Records and Tapes.



FOR THE FIRST TIME

STEPHANIE MILLS—Motown M6-85951 (6.98)
Tremendous teaming of talents as the star of "The Wiz" emerges with a disc comprised of Bacharach/David selections and produced by same. Accessible for MOR, top 40, FM and r&b formats, the most playable platters are "Loneliness Remembers (What Happiness Forgets)" and "This Empty Place."



RADIO ACTIVITY

KRAFTWERK—Capitol ST-11457 (6.98)
Those same elements that boosted "Autobahn" to a noteworthy chart position are present on the German band's latest disc, too. The electronic base works much in the same manner, providing an alternative to the disco-directed trend on the airwaves. The title track's the winner.

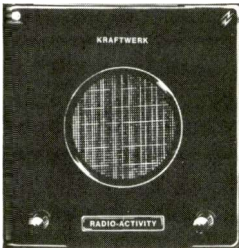

WHO'S TO BLESS AND WHO'S TO BLAME

KRIS KRISTOFFERSON—Monument PZ 34379 (Col) (6.98)
That rockin' country & western twang is sharply pronounced here, with Kristofferson being one of the masters of that particular coupling. Humor ("Rocket to Stardom"), emotional intensity ("Easy, Come On") and lyrical ingenuity ("The Year 2000 Minus 25") merge to yield one of his best.



WHO LOVES YOU

FOUR SEASONS—Warner Bros. BS 2900 (6.98)
With a former top 5 single title tune and commercial Bob Gaudio production setting the pace, you can be sure that this all-encompassing disc will be a fast chart-climber. The title hit leads the way of winners, with "Harmony's Perfect Harmony" and "December 1963 (Oh, What A Night)" coming up fast.



SUBTLE AS A FLYING MALLET

DAVE EDMUNDS—RCA LPL1-5003 (6.98)
Edmunds' first album in five years spotlights him in a series of masterful performances, playing just about every instrument, producing and arranging and engineering. Edmunds is best at his recreations of the Phil Spector "wall of sound," which is effectively worked here on "Maybe," and "Baby I Love You."



SHAME ON THE WORLD

MAIN INGREDIENT—RCA APL1-1003 (6.98)
Trio's been r&b staples for quite some time now, making stronger pop inroads with each release. "Let Me Prove My Love to You," "Jamaica (Let Me Go Home)" and "If I'm Gonna Be Sad" are ample displays of their versatility. No shame here.

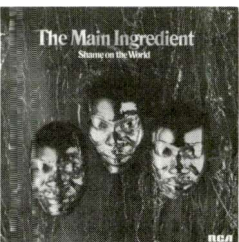

CHANGE

SPANKY & OUR GANG—Epic PE 33580 (6.98)
Get yourself a strong musical base, sprinkle with equal amounts of rousing rock and country charm and what you'll probably come up with is a new set from Spanky & Our Gang. Ms. McFarlane's vocals are as warm 'n wonderful as ever; try "Since You've Gone," "L.A. Freeway" and the single, "I Won't Brand You."

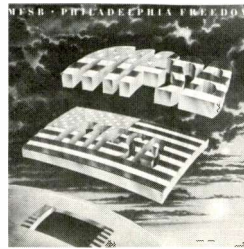

PHILADELPHIA FREEDOM

MFSB—Phila. Intl. PZ 3T845 (Col) (6.98)
Instrumental savvy propelled this City of Brotherly Love conglomerate to the fore and that same savvy keeps 'em here. The arrangements and performances sparkle with an irresistible life spirit that makes an offer that's hard to refuse. "When Your Love Is Gone" and "Zip" (the single) top.

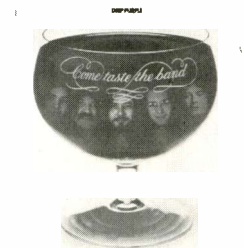

COME TASTE THE BAND

DEEP PURPLE—Warner Bros. PR 2895 (6.98)
Deep Purple Mark IV, in which guitarist Tommy Bolin replaces Ritchie Blackmore, finds the Anglo-American group kicking up a heavy metal storm, with Bolin's pyrotechnic style brought to the fore. The menu is full of hard rockin' delights like "Comin' Home" and "Lady Luck."



CRACK THE SKY

LIFESONG LS 6000 (6.98)
Metal weight's kept intact with smooth production, instrumental expertise and flowing harmonies—making this band's debut a noteworthy one. The sounds are accessible for both progressive and top 40 formats, as witnessed by "Robots for Ronnie," "Mind Baby," "Ice" and "Hold On."

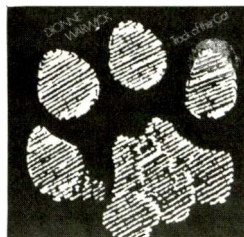

TRACK OF THE CAT

DIONNE WARWICK—Warner Bros. BS 2893 (6.98)
With Bell/Creed authored selections, Mr. Bell's production capabilities, backing from MFSB and Ms. Warwick's appealing vocals leading the way, how can this album be anything but a mover? Her finest in quite some time is topped by "Once You Hit the Road" and "Love Me One More Time."



HELP ME MAKE IT (TO MY ROCKIN' CHAIR)

B.J. THOMAS—ABC ABCDP-912 (6.98)
From "Raindrops Keep Fallin' On My Head" to more his recent success of "Another Somebody Done Somebody Wrong Song," B.J.'s proven himself as a steadfast hitmaker—this disc being no exception. His vocal capabilities are high calibre, and the Nashville production suits well. Try "Ballyhoo Days" and "Lyn' Again."

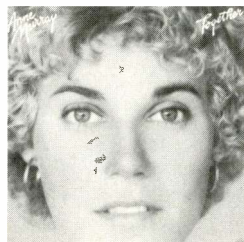

TOGETHER

ANNE MURRAY—Capitol ST-11433 (6.98)
Clear voiced and finely produced (by Tom Catalano), Ms. Murray has chosen some works from several of today's top writers (David Gates, Mark James, Peter Allen and Bobby Russell) to make this lp a superfine vocal vehicle. Check out "Sunday Sunrise," "Part Time Love" and "Player In the Band."

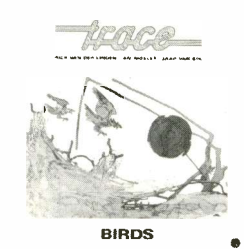

BIRDS

TRACE—Sire SASD-7514 (ABC) (6.98)
Sophisticated electronic effects gel to yield a progressive effort sure to get exposure on that format and elsewhere. The sounds are heavy metal without being overpowering—a feat not easily accomplished. Best bets include "King Bird," "Bourree" and "Penny." Get your wings ready!

Record World
in cooperation with John Reid Enterprises and MCA Records
presents

A TRIBUTE TO ELTON JOHN



Photo: Terry O'Neill

A spectacular in the truest sense of the word. This tribute to the premier rock star of the '70s will be available, through a special, increased press run, at the 1976 MIDEM Convention for distribution throughout the world.

ISSUE DATE: January 31, 1976
AD & EDITORIAL DEADLINE: December 31, 1975

For further information, contact one of our marketing specialists:

New York
Stan Soifer
(212) 765-5020

Los Angeles
Spence Berland
(213) 465-6126

Nashville
John Sturdivant
(615) 244-1820

London
Noel Gay Organisation
24 Denmark St.
London, W.C. 2, England

Screen Gems-Columbia Publications Unveils New Miami Headquarters

■ NEW YORK — Screen Gems-Columbia Publications is moving into a modern and expanded 50,000 square foot facility recently constructed for it in Miami (Hialeah, Florida), it was announced by Frank J. Hackinson, vice president and head of the music print division of Columbia Pictures Industries, Inc.

Department Headquarters

The new complex will house all departments, personnel and equipment for the division. In addition to the executive offices, the modern facility will be headquarters for the following departments: licensing and acquisitions; creative; design and reproduction; arrangements; engraving; advertising and marketing; sales; customer service coordination

Casablanca Reports Strong October Sales

■ LOS ANGELES — Neil Bogart, president of Casablanca Records, has announced that October sales far exceeded their first million dollar month of September.

Major contributing factors to the success, according to the label, were Kiss' two-record, live set; Donna Summer's "Love To Love You Baby," the first lp release from the Casablanca distributed Oasis Records of Germany; and the initial release of Angel, on Casablanca.

Phonogram Promotes Taylor to Assistant Promotion Manager

■ CHICAGO — Stan Bly, vice president/national promotion for Phonogram, Inc./Mercury Records, has announced the appointment of Jim Taylor to the newly created post of assistant national promotion manager. The appointment is effective immediately.

In his position, Taylor will coordinate the various divisions of the promotion department (r&b, country, FM and college) in addition to working with top 40 radio. He will also prepare the "Taylor-Made Record Report," a weekly status recap sheet on key albums and singles, for the Mercury national and field staffs.

Before assuming the position of assistant national promotion manager, Taylor was local promotion manager in the Ohio Valley and Indianapolis territories for Phonogram/Mercury. Prior to joining the firm, he worked upstate New York promotion for A&M Records, and is veteran of six years in radio, including a stint as program director of WHFM in Rochester, N.Y.

and shipping; type setting; business affairs; and computerized accounting and royalties payable. It also incorporates a printing plant, designed to handle small-quantity orders. Nearby is a full-sized, four-color facility operating 24 hours a day.

Screen Gems-Columbia Publications has been holding a series of audio/visual presentations in the last few months designed to showcase the growth of the music print division and to unveil the new facility in Florida. Presentations have taken place in Los Angeles, Nashville and New York.

Asylum Signs Clarke

■ LOS ANGELES — Allan Clarke has been signed to an exclusive recording contract with Elektra/Asylum Records; he will record on the Asylum label for the U. S. and Canada.

As lead singer and, with Graham Nash and Tony Hicks, founding member of The Hollies, Clarke has been featured on over 30 international hit records during the past 12 years, among them "He Ain't Heavy, He's My Brother," "The Air That I Breathe," "Bus Stop" and "Long Cool Woman In A Black Dress." He also collaborated in writing such Hollies' standards as "On A Carousel," "Carrie-Anne" and "Stop, Stop, Stop."

Allan Clarke will begin recording his Asylum debut album in Los Angeles this month, with Spencer Proffer producing.

Yakus VP At Record Plant

■ NEW YORK — Roy Cicala has announced that Shelly Yakus has been appointed VP and director of recording at the Record Plant.

NAMI Signs John & Carl Bellante

■ SCRANTON, PA.—North American Music Industries has announced the signing of John and Carl Bellante to a long term recording contract. In addition, they have been appointed a&r directors for the NAMI retail label. John and Carl will screen new product available on a master purchase basis, along with auditioning new artists and writers. They will operate out of NAMI's home office, 300 Brook Street, Scranton, Pennsylvania, as well as their office in Manhattan, (212) 734-2436.

The twin brothers graduated from Amherst College in 1973. For the past two years Carl and John have been collaborating on both the music and lyrics of their

Phila. Intl. Sets Seven Album Release

■ NEW YORK — Philadelphia International has announced seven major album releases, plus a gospel album on the TSOP subsidiary, aimed for the holiday buying season. Included are packages by Philadelphia International artists the O'Jays, Harold Melvin and the Blue Notes, MFSB, the Three Degrees and Billy Paul, in addition to label debuts by Archie Bell and the Drells and DeeDee Sharp.

The albums being released are: The O'Jays "Family Reunion;" Harold Melvin and the Blue Notes' "Wake Up Everybody;" MFSB's "Philadelphia Freedom;" "The Three Degrees Live;" and "When Love Is New" by Billy Paul.

Archie Bell and the Drells' lp is titled "Dance Your Troubles Away," and "Happy 'Bout the Whole Thing" is DeeDee Sharp's return to recording after an absence of some years.

On their TSOP label, Kenneth Gamble and Leon Huff are making their first venture into the gospel field with "I'm Going On a Journey," a collection of contemporary gospel performances by

Ted Wortham and Company, Brockington Ensemble and the Dandridge Choral Ensemble.

The Philadelphia International releases are being supported by the CBS Custom Labels' two-month Soul Campaign that includes radio and TV advertising. A 30-second television multi-spot will run in selected markets, and ads will appear in various publications and on r&b and progressive black stations in major markets. Extensive in-store promotion will also be used to call attention to the new releases.

ASCAP Taps Cushman

■ LOS ANGELES—Nancy Cushman has been appointed as membership representative for ASCAP on the west coast, it was announced by Stanley Adams, president.

A native of Miami, Florida, Ms. Cushman was graduated from Florida State University. She comes to ASCAP from Shelter Records, where she was assistant GM of Shelter-Vision.

Renaissance at the Roxy



When Renaissance came to Los Angeles' Roxy Theater recently they were greeted by an enthusiastic audience and by a party hosted by Sire and ABC Records. Pictured backstage from left are Terry Sullivan of Renaissance; group manager and president of B.T.M. Miles Copeland; ABC's Corb Donohue; Seymour Stein, president of Sire Records; and Renaissance members Annie Haslam, John Tout, John Camp and Mick Dunford.



John & Carl Bellante

own songs. Scheduled for an immediate release on NAMI is one of their latest compositions, "Amy When She's Sleeping," backed with "I'll Be Home."

Subscribe to Record World

Swan Tours Europe

■ NASHVILLE — Monument Recording artist Billy Swan, in conjunction with CBS Records International, is currently launching a four-week multi-date tour of Europe to promote his current release "Everything's The Same (Ain't Nothin' Changed)." The tour includes France, Holland, Belgium, Switzerland, England, Austria, Germany, and Spain.

Radio & TV

Before the tour is complete, Swan will have taped major radio and television appearances in virtually every major city in those countries.

Upon his return to the United States, Swan will begin touring engagements with his newly-formed band.

ZUMA



The new album from
Neil Young
With Crazy Horse



On Reprise records and tapes

MS 2242

DIALOGUE

THE VIEWPOINTS OF THE INDUSTRY

Terry Ellis: Artist Orientation Comes First

By ELIOT SEKULER

■ Since forming *Chrysalis* in partnership with Chris Wright in 1967, Terry Ellis has moved rapidly through every area of the music business. From booking agency to personal management and finally, to record manufacturer and publisher, *Chrysalis* has scored notable successes with such acts as Procol Harum, Jethro Tull, Robin Trower, Ten Years After, Steeleye Span and Leo Sayer. In addition, Ellis has interests in the publishing of David Bowie and the personal management of Jethro Tull



Terry Ellis

and the Carpenters. Having recently relocated himself to Los Angeles on a more-or-less full-time basis, Ellis discusses the relationship between the American and English markets as well as the interrelationship of his various interests in this *RW Dialogue*.

Record World: How has the record business changed since you first became involved in the early sixties?

Terry Ellis: We came into the industry at a time when record companies molded their artists. They'd say, "Here's a talented kid we can do this or that with; we'll give him an image, a song and bring in this producer." The artist really wasn't a part of the decision-making process.

RW: What era are you describing?

Ellis: I'm talking about the pre-Beatles era. After the Beatles, things changed. The artist became more and more important and that's when we happened along. We were booking for an agency and became involved with Ten Years After and Jethro Tull, both of whom asked us to manage them because we seemed to have more interest in their careers than anybody else at the time. We found them very exciting and very talented and wanted to see that everything would be right for them. Later, we got into the record business because I, as a manager, couldn't find any record company that was excited about Jethro Tull. They'd all say "Yeah, O.K.," but nobody was leaping up and down in the air, and we saw Jethro Tull as a very special thing, something that had to be done in a very special way. We ended up by saying that we wouldn't just let them churn out Jethro Tull albums and went into the studio by ourselves. So the record business has become far more artist-oriented since we first became involved.

RW: How necessary was the establishment of your own label to developing the acts that you were working with?

Ellis: Record companies are the greatest vehicles for developing artists' careers; after all, almost everything is done through the record company in terms of how an artist is presented to the public. The promotional campaigns, the radio ads, print ads and so on have to be done in the way that the artist wants to come across and what we try to do is to present the artist as he wants to be known by the public. For example, somebody designed a mobile for Robin Trower that consisted of a combination of a guitar and rocket ship. It was foul and I wouldn't let it go because that wasn't Robin Trower. It might have been alright for a hard rock band who were trying to project a "fuck-rock" image, but Robin Trower's is more of a head music, a music of feelings and emotions. The mobile didn't represent where Robin Trower was at and that's what music marketing is all about.

What you try to do as a record company is to build the interest in the artist to the point where people come in and buy their records; that's your job. The basic thing is the record itself. In the ideal situation, the record gets played on the air, somebody hears it, likes it and runs out to buy it. If that happened all the time, there wouldn't be any need for record companies. Some people are harder to sell than others, but if you really believe in the record, you have to try to reach the people out there who you think would like it and that's a matter of presenting the artist properly. You have to think in terms of an

audience that doesn't necessarily want to be sold to. There's the person out there who is not thinking about buying a Robin Trower album or any album and you think, "How can I motivate that person, get across to him the desirability of buying this record?" So maybe they'll hear the record on the radio and it will half-register; they'll see a store display, a print ad or hear a spot on the radio. Inside their head, they have a picture building of Robin Trower and if that sort of music is what they're into, the combination of elements may become a record sale. So the presentation of an artist can be very important.

RW: Does your background in Great Britain, where the possibilities of obtaining airplay are more limited, make you more aware of merchandising?

Ellis: I would say so. It's far more important to present images there because, as you say, you don't have the same opportunity for airplay that you have in America. That's very upsetting because by and large, if you don't get your record played on the BBC and your artist on "Top Of The Pops," you can't sell anything. There are exceptions to that.

RW: Didn't Jethro Tull sell without substantial British airplay?

Ellis: No, that's not true. They were very successful early on and had a number of big hit singles. Their second album went to number one on the charts about the first week out and stayed there for two months. Unfortunately, the media in England tend to breed a certain amount of contempt for successful artists, and particularly when those artists spend a lot of time in America. Mentioning no names, I think it's true throughout the media in England. I can understand it to a certain extent. One year an artist is rubbing shoulders with them at the pub and a year later, when they call for an interview they're told, "Sorry, he's in America." I can see where they might resent that, and what happens is that the media fosters the concept of English acts going to America to reap huge rewards while forsaking their original audience. The unfortunate truth about it is that if it weren't for the American market, the English market wouldn't exist. Nobody makes that much money in England and that's a simple economic fact. The English market can't finance the music industry.

“People have asked me how I can negotiate for our own act with our own record company and the only answer is that it's a question of honesty.”

RW: What is the relationship between *Chrysalis Records* and your agency and management operations?

Ellis: What we found was that the two operations—the agency and management interests and the record company — weren't always working for their mutual benefit. It's difficult for us, and a bit dishonest, to tell an artist we're signing to the label that we want them to be booked by *Chrysalis*. Booking is a personal thing just as the involvement on the record company level is personal; we can't expect the agency to believe in all the same artists that we believe in. We might sign somebody because they write and sing beautiful songs but maybe they're not the kind of stage attraction that the agency feels they can do the job with.

We're in the business because of artists and we can only represent an artist if we really like what they do; it's a similar situation with the agency. If we're not that involved with what an artist is doing, if we don't really feel it, then the artist shouldn't be represented by us. We've sometimes said, "Hey, they'll probably make it, but just not with us." And we've had difficult situations where an artist on our label has had a falling out with the agency, and whatever the reason may be, we find it embarrassing to be in the middle. So we try to avoid any conflict of interest. So Kenny Bell and Richie Cowley have moved out—very amicably—and started their own company. We still maintain links; they carry on with some of our artists and we're very happy with the job they're doing. We'll still present artists to them that we'd like them to represent just as any other record company would do. If they want to represent them, fine; if they don't, they don't have to.

(Continued on page 32)

Here's one for the racks.

OK. You've earned it. A Roxy Music album that can be displayed up front, where it belongs.

The new Roxy Music album, "Siren." But we're not making any promises about the next one...

Roxy Music. "Siren."

(SD 36-127)

Produced by Chris Thomas for E.G. Records Ltd.

On Atco Records and Tapes

**THE GREAT
ATCO
COP-OUT**



NAB, RAB Host Radio Conventions

■ WASHINGTON, D.C.—The last of six two-day regional radio conventions sponsored by the National Association of Broadcasters and the Radio Advertising Bureau will be held in San Francisco November 20-21 at the Fairmont Hotel. In addition, NAB will hold a separate, concurrent seminar for radio program directors the first day.

The conventions are designed

to provide radio executives with an over-all look at every aspect of day-to-day radio station operation: general management, legal matters, sales, programming, publicity, promotion, public relations and government relations.

Hypothetical Station

At their seminar, the program directors will program a hypothetical radio station and will hear from prominent management/

program director teams on how they have made their stations successful in highly competitive markets.

Program

On the first day there will be a luncheon address by motivationalist Hugh Finnerty, and commissioner Benjamin L. Hooks of the Federal Communications Commission will speak at the closing day luncheon.

On the second day there will be a four-hour session with top FCC personnel. Participants will be Ashton Hardy, general counsel; William B. Ray, chief, complaints and compliance; Richard Shiben, chief, renewals and transfers; Lionel J. Monagas, chief, industry equal employment opportunity; Martin Levy, chief, broadcast facilities; and Phyll Horne, chief, field operations.

mediasound chart hits

Artist	Recording	Producer	Record Co.	1 Recorded 2 Mixed 3 Mastered
AVERAGE WHITE BAND	CUT THE CAKE	ARIF MARDIN	Atlantic	mediasound 1 2
JIMMY CASTOR	KING KONG Part 1 & 2	JIMMY CASTOR JOHN PRUITT	Atlantic	mediasound 1 2 3
JIMMY CASTOR	BUTT OF COURSE	JIMMY CASTOR JOHN PRUITT	Atlantic	mediasound 1 2 3
CLIMAX BLUES BAND	SENSE OF DIRECTION	RICHIE GOTTEREHER	Sire	mediasound 1 2 3
	STAMP ALBUM	RICHIE GOTTEREHER	Sire	mediasound 1 2 3
CROWN HEIGHTS AFFAIR	DREAMING A DREAM	FRIEDA NERANGIS	Delite	mediasound 1 2 3
	EVERY BEAT OF MY HEART	BRITT BRITTON	Delite	mediasound 1 2 3
FAITH, HOPE & CHARITY	TO EACH HIS OWN	VAN McCOY	RCA	mediasound 2 3
GLORIA GAYNOR 1	NEVER CAN SAY GOODBYE	TONY BONGIOVI	MGM	mediasound 1 2 3
GLORIA GAYNOR 2	EXPERIENCE	MECO MENDARDO	MGM	mediasound 1 2 3
JIMI HENDRIX	CRASH LANDING	ALAN DOUGLAS	Warner Bros.	mediasound 1 2 3
JIMI HENDRIX	MIDNIGHT LIGHTNING	TONY BONGIOVI	Warner Bros.	mediasound 1 2 3
RUPERT HOLMES 1	WIDE SCREEN	JEFFREY LESSER	Epic	mediasound 1 2
RUPERT HOLMES 2	RUPERT HOLMES	JEFFREY LESSER	Epic	mediasound 1 2
BEN E. KING	SUPERNATURAL	BERT DE COTEAUX	Atlantic	mediasound 1 2
PETER NERO	EMANUELLE	TONY SILVESTER	Arista	mediasound 1 2 3
KOOL & THE GANG	SPIRIT OF THE BOOGIE	RON BELL	Delite	mediasound 1 2 3
KOOL & THE GANG	LIGHT OF THE WORLDS	AND KOOL & THE GANG	Delite	mediasound 1 2 3
KOOL & THE GANG	WILD & PEACEFUL	AND KOOL & THE GANG	Delite	mediasound 1 2 3
KOOL & THE GANG	CARIBBEAN FESTIVAL	AND KOOL & THE GANG	Delite	mediasound 1 2 3
BARRY MANILOW 3	I WRITE THE SONGS	RON DANTE	Arista	mediasound 1 2
BARRY MANILOW 2	MANDY • IT'S A MIRACLE	BARRY MANILOW	Arista	mediasound 1 2
BARRY MANILOW 1	COULD IT BE MAGIC	BARRY MANILOW	Arista	mediasound 1 2
HERBIE MANN	WATERBED	HERBIE MANN	Atlantic	mediasound 1 2 3
VAN McCOY	DISCO BABY—THE HUSTLE	HUGO & LUIGI	Avco	mediasound 1 2
VAN McCOY	FROM DISCO TO LOVE	VAN McCOY	Buddah	mediasound 3
VAN McCOY	THE DISCO KID	HUGO & LUIGI	Avco	mediasound 1 2 3
TODD RUNDGREN	EUTOPIA	TODD RUNDGREN	Bearsville	mediasound 1
TOM RUSH	LADIES LOVE OUTLAWS	MARK SPECTOR	Columbia	mediasound 1 2
DAVID RUFFIN	WALK AWAY FROM LOVE	VAN McCOY	Metown	mediasound 1 2 3
JOE SIMON	GET DOWN GET DOWN	RAY GERALD	Spring	mediasound 1 2
JOE SIMON	MUSIC IN MY BONES	JOE SIMON	Spring	mediasound 1 2 3
SISTER SLEDGE	LOVE NO CHANGES ON ME	TONY SILVESTER	Atlantic	mediasound 1 2
SISTER SLEDGE	LOVE HAS FOUND ME	BERT DE COTEAUX	Atlantic	mediasound 1 2
CAT STEVENS	TWO FINE PEOPLE	CAT STEVENS	A & M	mediasound 1
STYLISTICS	THANK YOU BABY	HUGO & LUIGI	Avco	mediasound 1 2
STYLISTICS	LET'S PUT IT ALL TOGETHER	HUGO & LUIGI	Avco	mediasound 1 2
STYLISTICS	HEAVY YOU ARE BEAUTIFUL	HUGO & LUIGI	Avco	mediasound 1 2
SYNERGY	SYNERGY/L. FAST	MARTY SCOTT	Passport	mediasound 2
FRANKIE VALLI	MY EYES ADORED YOU	BOB CREWE	Pvt. Slack	mediasound 1 2
FRANKIE VALLI	SWEARIN' TO GOD	BOB CREWE	Pvt. Slack	mediasound 1 2
STEVIE WONDER	INNERVISIONS	STEVIE WONDER	Metown	mediasound 1 2
STEVIE WONDER	FULLFILLINGNESS	STEVIE WONDER	Metown	mediasound 1

mediasound

311 West 57th St. • New York, N.Y. 10019 • Telephone 212-765-4700
 † Once a Church, Now 4 Great Recording Studios †

COUNTRY RADIO

By CHARLIE DOUGLAS

■ Got a letter from **Jim Walton**, PD of WITL (Lansing, Michigan). He sent along the top 101 country songs as voted on by the WITL listeners, tally completed during the last of October. These things are always interesting in that they will show a complexion in a particular market, and that complexion will be totally changed six months from now. There are 60 acts represented on the top 101: **Conway Twitty** got a total of eight mentions when you include the duets, five without the duets; **Cash, Haggard, Denver and Hall** had four each; **Fender, Tucker, Wynette, Conway and Loretta**, and **Parton** had three each; **Rich, Pride, Faron, Horton, Lynn, Swan, Gilley, Statlers, Rodriguez, Ray Price and Roy Acuff** all had two each. 34 of the titles mentioned are less than six months old and the only two in the top 10 that have been around long enough to make you think they might qualify as "classics" are "Behind Closed Doors" and "Kiss An Angel Good Morning." Interesting stuff—and Walton has a most effective programming guide for his station for the next six months or so.

Gary Michaels is looking for a couple of first tickets folk at KFVY (Arroyo Grande, Cal.) . . . The WYDE news department in Birmingham, Ala. has kicked off a series of programs called "The Last Puff." **Bob Rowe** spent a year researching the project and is presenting a step-by-step program to help you quit smoking. The features are 90 seconds in length and will be aired three times daily. If you want full details, contact **Borden Black** at 322-4511.

Lee Sherwood at WMAQ is still looking for a weekender, and at the salary range indicated one would think the applications would be pouring in . . . **KIKK** (Houston) is in need of an AM personality . . . Already it's time to start writing in some dates on your calendar for 1976. For those who are serious about exchanging ideas and getting into nose to nose conversation about country radio, the Nashville Radio Seminar will be held on the 12th and 13th of March, 1976 at the Airport Hilton. This annual gathering is sponsored by Nashville record promotion men and the monies collected over and above costs have been escrowed for the purpose of scholarship funding.

Rolling On with Ann-Margret



With the Bay City Rollers (Arista) is Ann-Margret, pictured above filling out a Roller outfit as she greets her guest stars for the recent London taping of NBC-TV's "Ann-Margret Smith" special which will air on Thursday, November 20 at 9:00 p.m.

“Bellavia”
is a “beautiful way”
to hear
Chuck Mangione.



“Bellavia” means “beautiful way.”
“Mangione” means great music on A&M Records and Tapes.

SP 4557

BTO Takes Atlanta Hands Down



In the grand tradition of Hollywood stars, Bachman-Turner Overdrive members put their hands and feet into a cement display in the shape of the BTO logo, outside Peaches' Atlanta store. Pictured are, from left: J. J. Jackson of WQXI, Randy Bachman, Fred Turner, Blair Thornton and Robbie Bachman of the group, Roger Sayles of Mercury Records and Peaches store manager Lee Barman.

Island Names Stark Production Manager

■ LOS ANGELES — Charles Nuccio, president, Island Records, Inc., has announced the appointment of Penny Stark to the position of production manager for Island Records. Ms. Stark will be based in the newly opened Island offices in New York and will report directly to Herb Corsack, vice president, Island Records.

In her new capacity, Ms. Stark will be responsible for the coordination of the release of all Island Records' albums, singles and tapes. She will oversee the purchasing of all materials for the manufacturing of Island product and the maintenance of inventory. In addition, she will be responsible for the traffic of all Island product while tracking inventory and production operations throughout the United States.

Ms. Stark first entered the record industry in 1970 when she was the assistant to the president of Bang Records. In the summer of 1971, she assumed the position of album production manager for Atlantic Records, a post she held for three years prior to her new appointment.

★★ GENERAL MANAGER ★★ V.P. OF MARKETING

N.Y. based record company seeking individual to handle all phases of the record business. A knowledge of the major independent distributors, as well as a proven track record within the record industry is a must. Good starting salary plus fringes.

Write: **Box 1020**
Record World
1700 Bdwy,
N.Y., N.Y., 10019

Epic Names Two to Merch. Posts

■ NEW YORK—Bruce Harris, director, product management, Epic and CBS Custom Labels, has announced two appointments in the merchandising department on the west coast for the Epic and Custom Labels. Steve Slutzah has been appointed associate director, artist development and product management, Epic and CBS Custom Labels, and Mark Hartley has been moved up to the position of product manager, west coast, Epic and CBS Custom Labels.

Tour Coordination

In his new capacity, Slutzah will be responsible for the coordination of artists' personal appearance tours, maintaining ongoing contacts with key club managers, concert promoters, programmers, key press and radio personnel, TV show producers and talent coordinators throughout the western region. He will also be involved in the planning and execution of various merchandising programs on behalf of Epic and CBS Custom Label artists. He will report directly to Harris.

In his new position, Hartley will also be involved in the planning and execution of merchandising efforts on behalf of Epic and CBS Custom Label artists on the west coast. He will work closely with the advertising, sales, promotion and art departments in developing advertising/image approaches and cover art for assigned Epic/Custom recording artists. He will report directly to Harris.

Prior to moving to Los Angeles, Slutzah operated out of New York as manager, national album and FM promotion, Epic and CBS

London Names Three to Promo Dept.

■ NEW YORK—London Records has announced three appointments to its promotion department. Joshua Blardo has been named assistant national promotion manager, Kathy Henke promotion coordinator and Arnie Handwerger local New York promotion manager.

Duties

As assistant national promotion manager, Blardo will be responsible for FM and secondary AM promotion and the coordination of all field personnel. He will assist Herb Gordon, national promotion manager, on all levels. Blardo comes to London from the George Daly Organization where he was vice president. Prior to that, he was the national promotion director of Grateful Dead Records, and national promotion coordinator for Commander Cody. He began his

music industry career 10 years ago as an on-the-air personality at KMPX-FM in San Francisco.

Kathy Henke's duties as promotion coordinator include the coordination of all national airplay, via tracking sheets and promotion releases. Prior to her London appointment, she was promotion coordinator for Arista Records. She began her industry career in the promotion department of Atlantic Records. Both Henke and Blardo will report directly to Herb Gordon.

Most recently Arnie Handwerger was manager of CBS Records' college program, serving before that as assistant editor of College Radio Report. In his current position as local New York promotion manager, he will be responsible for servicing New York radio stations and retail stores.

DJM Signs Kirwan

■ LONDON—DJM Records has recently concluded a worldwide deal for artist Danny Kirwan, formerly of Fleetwood Mac. Kirwan was signed to DJM Records in England by the label's managing director, Stephen James, who has created a major sales campaign for the artist in the U.K.

Kirwan's first single, "Ram Jam City," is being released this week in the U.S., with an album entitled "Second Chapter" to follow in about one week, according to Ron Kramer, manager, DJM Records in Los Angeles.

O'Connell Speaks At B'nai B'rith

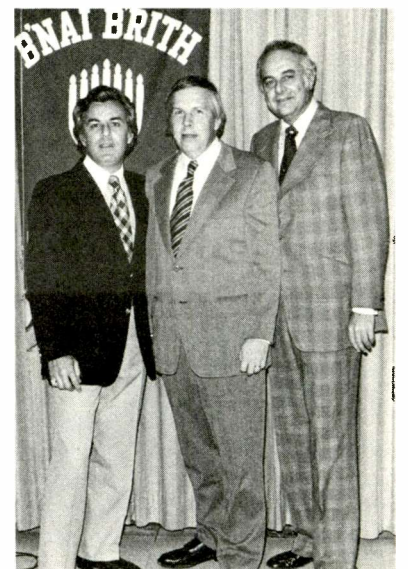

David O'Connell, president of Phonodisc, Inc. is shown flanked by the Music and Performing Arts Lodge of B'nai B'rith president Toby Pieniek of RCA (left), and former lodge president Cy Leslie of Pickwick International. O'Connell was the guest speaker in the "An Evening with . . ." series at the lodge's November meeting.

Custom Labels. Before assuming that post in early 1973, he was coordinator of product placement for CBS Records for approximately three years. Prior to joining the CBS Records staff in New York, Slutzah was a college representative for the company at the University of Florida.

Hartley comes to the Epic/Custom Labels after working for more than three years on the Columbia Records promotion team. For the past 14 months, he was the local promotion manager for Columbia in San Francisco and, before that, served as the local promotion manager for Columbia at the Denver branch.

Basil To Choreograph Bette Midler Shows

■ NEW YORK — Toni Basil will choreograph the production for Bette Midler's forthcoming 20-city/80-performance concert tour which kicks off Dec. 10 in Seattle, Washington, and features a six-day stand at Los Angeles' Dorothy Chandler Pavilion Dec. 26 through New Year's Eve, it was announced by Aaron Russo, Bette's personal manager and producer of the cross-country swing.

Miss Basil is the dance director of and a performer with The Lockers, the rock dance ensemble which has appeared on such television shows as "The Tonight Show" and "Midnight Special" and has performed on-stage with Frank Sinatra and Bill Cosby.

For Midler, she will arrange and direct the dance numbers which will accompany the songstress's performances.

The Hottest Record In England

Love Hurts (IS045)

**Now Released
In America**

**Jim
Capaldi's
New Hit
Single**



Island records inc.
los angeles, california 90006

Produced by Steve Smith

"NEVERTHELESS"

CPS 0246



ON CAPRICORN RECORDS, MACON, GA.

An ace-of-a-single from their album "Win, Lose or Draw."

Produced by Johnny Sandlin and the Allman Brothers Band for Capricorn Records, Inc., by special arrangement with Phil Walden and Associates, Inc.

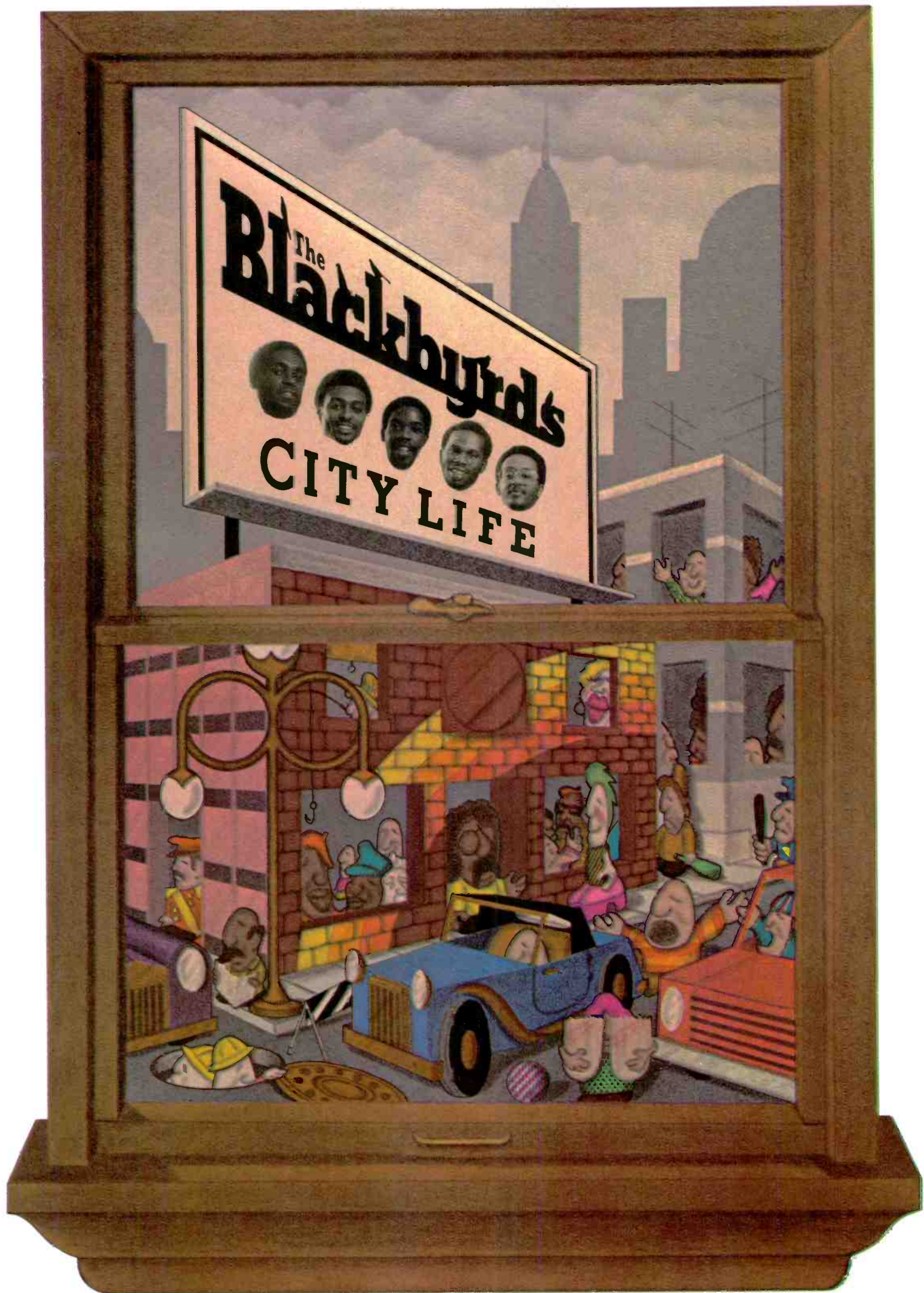

THE BLACKBYRDS "CITY LIFE"

Produced by Donald Byrd for Blackbyrd Productions, Inc.

City Life • Flying High • Thankful 'bout Yourself • Love So Fine
Rock Creek Park • All I Ask • Happy Music • Hash and Eggs



Fantasy F-9490



SOMEWHERE
IN
THE
NIGHT
(4192)



HELEN
REDDY'S
NEW
SINGLE

from her album,
No Way To Treat A Lady
(ST-11418)





THE SINGLES CHART

TITLE, ARTIST, Label, Number, (Distributing Label)
NOV. 22 NOV. 15

WKS. ON CHART

1	1	ISLAND GIRL ELTON JOHN MCA 40461		7
2	12	THAT'S THE WAY (I LIKE IT) KC & THE SUNSHINE BAND/ TK 1015		6
3	11	FLY, ROBIN, FLY SILVER CONVENTION/Midland Intl. MB 10339 (RCA)		7
4	7	THE WAY I WANT TO TOUCH YOU CAPTAIN & TENNILLE/ A&M 1725		10
5	4	FEELINGS MORRIS ALBERT/RCA PB 10279		19
6	6	HEAT WAVE/LOVE IS A ROSE LINDA RONSTADT/ Asylum 45282		12
7	8	LOW RIDER WAR/United Artists XW706 Y		9
8	9	THIS WILL BE NATALIE COLE/Capitol 4111		16
9	2	MIRACLES JEFFERSON STARSHIP/Grunt FB 10367 (RCA)		14
10	10	S O S ABBA/Atlantic 4265		15
11	14	NIGHTS ON BROADWAY BEE GEES/RSO 515 (Atlantic)		8
12	21	LET'S DO IT AGAIN STAPLE SINGERS/Curtom 0109 (WB)		6
13	16	SKY HIGH JIGSAW/Chelsea 3022		13
14	5	WHO LOVES YOU FOUR SEASONS/Warner Bros.-Curb 8122		14
15	3	LYIN' EYES /Asylum E 45279		11
16	19	MY LITTLE TOWN SIMON & GARFUNKEL/Columbia 3 10230		6
17	18	I ONLY HAVE EYES FOR YOU ART GARFUNKEL/Columbia 3 10190		14
18	26	SATURDAY NIGHT BAY CITY ROLLERS/Arista 0149		6
19	22	EIGHTEEN WITH A BULLET PETE WINGFIELD/Island 0261		12
20	13	THEY JUST CAN'T STOP IT (THE GAMES PEOPLE PLAY) SPINNERS/Atlantic 1284		15
21	15	BAD BLOOD NEIL SEDAKA/Rocket 40460 (MCA)		11
22	17	LADY BLUE LEON RUSSELL/Shelter 40379 (MCA)		16
23	24	BLUE EYES CRYING IN THE RAIN WILLIE NELSON/ Columbia 3 10176		13
24	28	OPERATOR MANHATTAN TRANSFER/Atlantic 3292		8
25	25	I WANT'A DO SOMETHING FREAKY TO YOU LEON HAYWOOD/20th Century 2228		11
26	20	I'M SORRY/CALYPSO JOHN DENVER/RCA PB 10353		16
27	23	IT ONLY TAKES A MINUTE TAVARES/Capitol 4111		17
28	34	OUR DAY WILL COME FRANKIE VALLI/Private Stock 043		6
29	27	MR. JAWS DICKIE GOODMAN/Cash 451 (Private Stock)		13
30	31	SOMETHING BETTER TO DO OLIVIA NEWTON-JOHN/ MCA 40429		10
31	29	BORN TO RUN BRUCE SPRINGSTEEN/Columbia 3 10209		11
32	30	FAME DAVID BOWIE/RCA PB 10320		21
33	38	VENUS AND MARS ROCK SHOW WINGS/Capitol 4175		4
34	32	DANCE WITH ME ORLEANS/Asylum 45261		19
35	55	LOVE ROLLERCOASTER OHIO PLAYERS/Mercury 73734		3
36	39	JUST TOO MANY PEOPLE MELISSA MANCHESTER/ Arista 0146		10
37	40	WELCOME TO MY NIGHTMARE ALICE COOPER/Atlantic 3298		5
38	54	I LOVE MUSIC (PART I) THE O'JAYS/Phila. Intl. ZS8 3577 (Col)		3
39	41	I'M ON FIRE 5000 VOLTS/Mercury 40801		6
40	52	I WRITE THE SONGS BARRY MANILOW/Arista 0157		3
41	60	FOX ON THE RUN SWEET/Capitol 4157		3
42	33	BALLROOM BLITZ SWEET/Capitol 4055		23
43	58	THEME FROM MAHOGANY (DO YOU KNOW WHERE YOU'RE GOING TO) DIANA ROSS/Motown M 1377F		4
44	51	SECRET LOVE FREDDY FENDER/ABC Dot DOA 17585		4
45	36	DO IT ANY WAY YOU WANNA PEOPLES CHOICE/ TSOP ZS8 4759 (Col)		15
46	59	THE LAST GAME OF THE SEASON (BLIND MAN IN THE BLEACHERS) DAVID GEDDES/Big Tree BT 16052 (Atlantic)		3
47	37	WHAT A DIFFERENCE A DAY MADE ESTHER PHILLIPS/ Kudu 925F (Motown)		15
48	43	CAROLINA IN THE PINES MICHAEL MURPHEY/Epic 8 20121		14
49	61	YOU SEXY THING HOT CHOCOLATE/Big Tree 16047 (Atlantic)		5

50	35	ROCKIN' ALL OVER THE WORLD JOHN FOGERTY/ Asylum 45274		12
51	42	ROCKY AUSTIN ROBERTS/Private Stock 020		18
52	62	PART TIME LOVE GLADYS KNIGHT & THE PIPS/Buddah BDA 513		4
53	57	PEACE PIPE B.T. EXPRESS/Roadshow 7003 (Scepter)		12
54	66	WALK AWAY FROM LOVE DAVID RUFFIN/Motown 1376		3
55	44	YOU GEORGE HARRISON/Apple 1884		10
56	45	RUN JOEY RUN DAVID GEDDES/Big Tree 16044 (Atlantic)		18
57	46	AIN'T NO WAY TO TREAT A LADY HELEN REDDY/ Capitol 4128		16
58	74	COUNTRY BOY (YOU GOT YOUR FEET IN L.A.) GLEN CAMPBELL/Capitol 4155		3
59	48	CHANGE WITH THE TIMES VAN McCOY/Avco 4660		8
60	49	KEEP ON TRYIN' POCO/ABC 12126		9
61	63	COME AND GET YOUR LOVE ROGER DALTRY/MCA 40453		6
62	64	SAILING ROD STEWART/Warner Bros. 8146		7
63	50	DIAMONDS AND RUST JOAN BAEZ/A&M 1717		8
64	67	WE ALL GOTTA STICK TOGETHER FOUR TOPS/ABC 12123		5
65	47	BRAZIL RITCHIE FAMILY/20th Century 2218		14
66	56	WASTED DAYS AND WASTED NIGHTS FREDDY FENDER/ ABC Dot DOA 17558		22
67	76	ROCK AND ROLL ALL NIGHT KISS/Casablanca NB 850		3
68	72	LONELY SCHOOL YEAR HUDSON BROS./Rocket PIG 40484 (MCA)		5
69	53	GET DOWN TONIGHT KC & THE SUNSHINE BAND/TK 1009		23
70	80	WAKE UP EVERYBODY (PART I) HAROLD MELVIN & THE BLUENOTES/Phila. Intl. ZS8 3579 (Col)		2
71	83	LET'S LIVE TOGETHER ROAD APPLES/Polydor 14285		2
72	73	LOVE POWER WILLIE HUTCH/Motown 13601		7
73	86	OVER MY HEAD FLEETWOOD MAC/Reprise RPS 1339		2
74	84	TIMES OF YOUR LIFE PAUL ANKA/United Artists XW737 Y		2
75	69	(HOW I SPENT MY SUMMER VACATION) OR A DAY AT THE BEACH WITH PEDRO & MAN—PART I CHEECH & CHONG/ Ode 66115 (A&M)		6
76	85	SCHOOL BOY CRUSH AWB/Atlantic 3304		2
77	71	MEXICO JAMES TAYLOR/Warner Bros. 8137		7
78	88	LOVE MACHINE, PART I MIRACLES/Tamla T 54262F (Motown)		2

CHARTMAKER OF THE WEEK

79	—	SING A SONG EARTH, WIND & FIRE Columbia 3 10251		1
----	---	--	--	---

80	81	VOLARE AL MARTINO/Capitol 4134		4
81	—	EVIL WOMAN ELECTRIC LIGHT ORCHESTRA/ United Artists XW 729 Y		1
82	92	HEY THERE LITTLE FIRE FLY FIRE FLY/A&M 1736		2
83	—	WINNERS AND LOSERS HAMILTON, JOE FRANK & REYNOLDS/Playboy P 6054		1
84	87	NEVER BEEN ANY REASON HEAD EAST/A&M 1718		6
85	91	CARIBBEAN FESTIVAL KOOL & THE GANG/Delite 1573 (PIP)		2
86	—	FULL OF FIRE AL GREEN/Hi 2300 (London)		1
87	98	FIRE ON THE MOUNTAIN MARSHALL TUCKER BAND/ Capricorn CPS 0224 (WB)		2
88	100	LOVE HURTS NAZARETH/A&M 1671		2
89	—	THIS OLD MAN PURPLE REIGN/Private Stock 052		1
90	—	FOR THE LOVE OF YOU (PART 1 & 2) ISLEY BROTHERS/ T-Neck ZS8 2259 (Col)		1
91	93	SINCE I MET YOU BABY FREDDY FENDER/GRT 031		3
92	96	I'M ON FIRE JIM GILSTRAP/Roxbury RB 2016		2
93	99	BYE BYE BABY US 1/Private Stock 045		2
94	—	CONVOY C. W. McCALL/MGM 14839		1
95	95	KING KONG—PART I JIMMY CASTOR BUNCH/Atlantic 3295		3
96	97	NO REBATE ON LOVE DRAMATICS/Mainstream MRL 5571		2
97	—	THEME FROM S.W.A.T. RHYTHM HERITAGE/ABC 12135		1
98	—	CARRY ME DAVID CROSBY/GRAHAM NASH/ABC 12140		1
99	—	PALOMA BLANCA GEORGE BAKER/Warner Bros. WBS 8115		1
100	—	SOUL TRAIN '75 SOUL TRAIN GANG/RCA SB 10400		1

FLASHMAKER



SIREN
ROXY MUSIC
Atco

MOST ACTIVE

- ROCK OF THE WESTIES**—Elton John—MCA
STILL CRAZY—Paul Simon—Col
WISH YOU WERE HERE—Pink Floyd—Col
BORN TO RUN—Bruce Springsteen—Col
FACE THE MUSIC—ELO—UA
FLEETWOOD MAC—Reprise
LAST RECORD ALBUM—Little Feat—WB
WHO BY NUMBERS—The Who—MCA

WNEW-FM/NEW YORK

- ADDS:**
BIRDS—Trace—Sire
FLIGHT—Capitol
HOLLYWOOD BE THY NAME—Dr. John—UA
MIDNIGHT LIGHTNING—Jimi Hendrix—Reprise
OWL CREEK INCIDENT—Prelude—Fye
RADIO-ACTIVITY—Kraftwerk—Capitol
SIREN—Roxy Music—Atco
SWANS AGAINST THE SUN—Michael Murphey—Epic
TERRY—Terry Garthwaite—Arista
ZUMA—Neil Young—Reprise
HEAVY ACTION (approximate airplay):
ANGEL—Casablanca
BORN TO RUN—Bruce Springsteen—Col
ERIC CARMEN—Arista
FACE THE MUSIC—ELO—UA
ROCK OF THE WESTIES—Elton John—MCA
STILL CRAZY—Paul Simon—Col
WHO BY NUMBERS—The Who—MCA
WIND ON THE WATER—Crosby & Nash—ABC
WISH YOU WERE HERE—Pink Floyd—Col
YELLOW FEVER—Hot Tuna—Grunt

WLIR-FM/LONG ISLAND

- ADDS:**
DAN HILL—20th Century
HIGH ENERGY—James Cotton—Buddah
HOLLYWOOD BE THY NAME—Dr. John—UA
KLONAKILTY COWBOYS—Noel Redding—RCA
LESLIE WEST BAND—Phantom
MIDNIGHT LIGHTNING—Jimi Hendrix—Reprise
OWL CREEK INCIDENT—Prelude—Pye
RADIO-ACTIVITY—Kraftwerk—Capitol
SIREN—Roxy Music—Atco
ZUMA—Neil Young—Reprise
HEAVY ACTION (airplay—in descending order):
ROCK OF THE WESTIES—Elton John—MCA
WHO BY NUMBERS—The Who—MCA
ELYSIAN ENCOUNTER—Baker-Gurvitz Army—Atco

- PARADISE**—Country Joe McDonald—Fantasy
VANCE OR TOWERS—A&M
LAST RECORD ALBUM—Little Feat—WB
TERRY—Terry Garthwaite—Arista
PICK UP—Brian Protheroe—Chrysalis
FLEETWOOD MAC—Reprise

WMMR-FM/PHILADELPHIA

- ADDS:**
AGAINST THE GRAIN—Rory Gallagher—Chrysalis
ALL AROUND MY HAT—Steeleye Span—Chrysalis
HOLLYWOOD BE THY NAME—Dr. John—UA
SAFETY ZONE—Bobby Womack—UA
SIREN—Roxy Music—Atco
YELLOW FEVER—Hot Tuna—Grunt
HEAVY ACTION (sales, phones, airplay):
ANGEL—Casablanca
HURRICANE (single)—Bob Dylan—Col
LAST RECORD ALBUM—Little Feat—WB
SIREN—Roxy Music—Atco
YELLOW FEVER—Hot Tuna—Grunt

WORJ-FM/ORLANDO

- ADDS:**
AGAINST THE GRAIN—Rory Gallagher—Chrysalis
ANGEL—Casablanca
DAN McCAFFERTY—A&M
HOLLYWOOD BE THY NAME—Dr. John—UA
LAST RECORD ALBUM—Little Feat—WB
TERRY—Terry Garthwaite—Arista
VENUSIAN SUMMER—Lenny White—Nemperor
YELLOW FEVER—Hot Tuna—Grunt
HEAVY ACTION (airplay, sales, requests—in descending order):
ROCK OF THE WESTIES—Elton John—MCA
WISH YOU WERE HERE—Pink Floyd—Col
STILL CRAZY—Paul Simon—Col
JOURNEY TO LOVE—Stanley Clarke—Nemperor
FLEETWOOD MAC—Reprise
BORN TO RUN—Bruce Springsteen—Col
FACE THE MUSIC—ELO—UA
ANOTHER YEAR—Leo Sayer—WB
FLAT AS A PANCAKE—Head East—A&M
RED HEADED STRANGER—Willie Nelson—Col

WSDM-FM/CHICAGO

- ADDS:**
ANDREW GOLD—Asylum
ANOTHER LIVE—Todd Rundgren's Utopia—Bearsville
CAR OVER THE LAKE ALBUM—Ozark Mt. Daredevils—A&M
FACE THE MUSIC—ELO—UA
HOME PLATE—Bonnie Raitt—WB
LAZY AFTERNOON—Barbra Streisand—Col
MAKING MUSIC—Bill Withers—Col
PARADISE—Country Joe McDonald—Fantasy
RUFUS FEATURING CHAKA KAHN—ABC
SON OF SPIRIT—Spirit—Mercury
HEAVY ACTION (approximate airplay):
BLUE GUITAR (single)—Hayward/Lodge—Threshold
BREAKAWAY—Art Garfunkel—Col
FLEETWOOD MAC—Reprise
HISTORY—America—WB
HURRICANE (single)—Bob Dylan—Col
SAVE ME—Silver Convention—Midland Intl.
SING A SONG (single)—Earth, Wind & Fire—Col

- STILL CRAZY**—Paul Simon—Col
WIND ON THE WATER—Crosby & Nash—ABC
WINNERS & LOSERS (single)—Hamilton, Joe Frank & Reynolds—Playboy

W-4/DETROIT

- ADDS:**
HOUSE PARTY—Temptations—Gordy
PRESSURE DROP—Robert Palmer—Island
RHINESTONES—20th Century
RUFUS FEATURING CHAKA KAHN—ABC
SIREN—Roxy Music—Atco
STAMP ALBUM—Climax Blues Band—Sire
ZUMA—Neil Young—Reprise
HEAVY ACTION (airplay, sales—in descending order):
KISS ALIVE—Casablanca
RED OCTOPUS—Jefferson Starship—Grunt
ROCK OF THE WESTIES—Elton John—MCA
BORN TO RUN—Bruce Springsteen—Col
ATLANTIC CROSSING—Rod Stewart—WB
DREAM WEAVER—Gary Wright—WB
WISH YOU WERE HERE—Pink Floyd—Col
PRISONER IN DISGUISE—Linda Ronstadt—Asylum
MINSTREL IN THE GALLERY—Jethro Tull—Chrysalis
JOURNEY TO LOVE—Stanley Clarke—Nemperor

KSHE-FM/ST. LOUIS

- ADDS:**
AGAINST THE GRAIN—Rory Gallagher—Chrysalis
MIND YOUR OWN BUSINESS—Henry McCullough—A&M
RADIO-ACTIVITY—Kraftwerk—Capitol
SIREN—Roxy Music—Atco
YELLOW FEVER—Hot Tuna—Grunt
HEAVY ACTION (airplay):
ANGEL—Casablanca
ANOTHER LIVE—Todd Rundgren's Utopia—Bearsville
ERIC CARMEN—Arista
FACE THE MUSIC—ELO—UA
LAST RECORD ALBUM—Little Feat—WB
LESLIE WEST BAND—Phantom
TED NUGENT—Epic

KMYR-FM/ALBUQUERQUE, N.M.

- ADDS:**
AGAINST THE GRAIN—Rory Gallagher—Chrysalis
ALL AROUND MY HAT—Steeleye Span—Chrysalis
ANOTHER LIVE—Todd Rundgren's Utopia—Bearsville
HURRICANE (single)—Bob Dylan—Col
OREGON LIVE—Vanguard
PRESSURE DROP—Robert Palmer—Island
SWANS AGAINST THE SUN—Michael Murphey—Epic
TOUCH—John Klemmer—ABC
YELLOW FEVER—Hot Tuna—Grunt
ZUMA—Neil Young—Reprise
HEAVY ACTION (sales, airplay, requests—in descending order):
RED OCTOPUS—Jefferson Starship—Grunt
ROCK OF THE WESTIES—Elton John—MCA
STILL CRAZY—Paul Simon—Col
PRISONER IN DISGUISE—Linda Ronstadt—Asylum
BREAKAWAY—Art Garfunkel—Col
WISH YOU WERE HERE—Pink Floyd—Col
BORN TO RUN—Bruce Springsteen—Col

- WHO BY NUMBERS**—The Who—MCA
WIND ON THE WATER—Crosby & Nash—ABC
NOMADNESS—Strawbs—A&M

KBPI-FM/DENVER

- ADDS:**
IT'S ONLY LOVE—Rita Coolidge—A&M
RADIO-ACTIVITY—Kraftwerk—Capitol
SWANS AGAINST THE SUN—Michael Murphey—Epic
ZUMA—Neil Young—Reprise
HEAVY ACTION (sales, airplay, requests—in descending order):
ROCK OF THE WESTIES—Elton John—MCA
CAR OVER THE LAKE ALBUM—Ozark Mt. Daredevils—A&M
ONE OF THESE NIGHTS—Eagles—Asylum
RED OCTOPUS—Jefferson Starship—Grunt
PRISONER IN DISGUISE—Linda Ronstadt—Asylum
STILL CRAZY—Paul Simon—Col

KPFT-FM/HOUSTON

- ADDS:**
AGAINST THE GRAIN—Rory Gallagher—Chrysalis
ANGEL—Casablanca
CITY LIGHTS—Blackbyrds—Fantasy
COPULATIN' BLUES—Various Artists—Stash
HARD TIMES IN THE COUNTRY—Happy & Artie Traum—Rounder
HOLLYWOOD BE THY NAME—Dr. John—UA
LOVE YOU'RE THE TEACHER—Linda Hargrove—Capitol
SUNSET GLOW—Julie Tippetts—Utopia
TERRY—Terry Garthwaite—Arista
YELLOW FEVER—Hot Tuna—Grunt
HEAVY ACTION (airplay—in descending order):
JOURNEY TO LOVE—Stanley Clarke—Nemperor
PLACES & SPACES—Donald Byrd—Blue Note
EYES OF AN ONLY CHILD—Tom Jans—Col
FANCY DANCER—Bobbi Humphrey—Blue Note
LAST RECORD ALBUM—Little Feat—WB
FROM SOUTH AFRICA TO SOUTH CAROLINA—Gil Scott-Heron—Arista
FIRST SEVEN DAYS—Jan Hammer—Nemperor
FUNKY THIDE OF SINGS—Billy Cobham—Atlantic
NIGHTHAWKS AT THE DINER—Tom Waits—Asylum
BUCKINGHAM NICKS—Polydor

SLEEPER



TERRY
TERRY GARTHWAITE
Arista

KMET-FM/LOS ANGELES

- ADDS:**
AGAINST THE GRAIN—Rory Gallagher—Chrysalis
CATE BROTHERS—Asylum

- ERIC CARMEN**—Arista
HOLLYWOOD BE THY NAME—Dr. John—UA
RADIO-ACTIVITY—Kraftwerk—Capitol
RUFUS FEATURING CHAKA KAHN—ABC
SAFETY ZONE—Bobby Womack—UA
SIREN—Roxy Music—Atco
WHO I AM—David Ruffin—Motown
YOU—Aretha Franklin—Atlantic

HEAVY ACTION (airplay, sales):

- ATLANTIC CROSSING**—Rod Stewart—WB
BORN TO RUN—Bruce Springsteen—Col
ERIC CARMEN—Arista
FLEETWOOD MAC—Reprise
OUTLAWS—Arista
PRISONER IN DISGUISE—Linda Ronstadt—Asylum
ROCK OF THE WESTIES—Elton John—MCA
STILL CRAZY—Paul Simon—Col
TERRY—Terry Garthwaite—Arista
WISH YOU WERE HERE—Pink Floyd—Col

KSAN-FM/SAN FRANCISCO

- ADDS:**
AGAINST THE GRAIN—Rory Gallagher—Chrysalis
ANDREW GOLD—Asylum
CATE BROTHERS—Asylum
HURRICANE (single)—Bob Dylan—Col
INDISCREET—Sparks—Island
SIREN—Roxy Music—Atco
YELLOW FEVER—Hot Tuna—Grunt
HEAVY ACTION (airplay—in descending order):
ZUMA—Neil Young—Reprise
PRESSURE DROP—Robert Palmer—Island
ANOTHER LIVE—Todd Rundgren's Utopia—Bearsville
FACE THE MUSIC—ELO—UA
WHO BY NUMBERS—The Who—MCA
TERRY—Terry Garthwaite—Arista
AGAINST THE GRAIN—Rory Gallagher—Chrysalis
LAST RECORD ALBUM—Little Feat—WB
STILL CRAZY—Paul Simon—Col
ANDREW GOLD—Asylum

CHUM-FM/TORONTO

- ADDS:**
BURN (single)—Bruce Cockburn—True North
FUNKY THIDE OF SINGS—Billy Cobham—Atlantic
HOLLYWOOD BE THY NAME—Dr. John—UA
JOURNEY TO LOVE—Stanley Clarke—Nemperor
LAST RECORD ALBUM—Little Feat—WB
OH, WHAT A MIGHTY TIME—NRPS—Col
PLACES & SPACES—Donald Byrd—Blue Note
SIREN—Roxy Music—Atco
SON OF SPIRIT—Spirit—Mercury
YOU—Aretha Franklin—Atlantic
HEAVY ACTION (sales, airplay):
CAR OVER THE LAKE ALBUM—Ozark Mt. Daredevils—A&M
FACE THE MUSIC—ELO—UA
FLEETWOOD MAC—Reprise
GORD'S GOLD—Gordon Lightfoot—Reprise
ONLY THE SILENCE REMAINS—Murray McLauchlan—True North
ROCK OF THE WESTIES—Elton John—MCA
SIREN—Roxy Music—Atco
STILL CRAZY—Paul Simon—Col
WHO BY NUMBERS—The Who—MCA
WISH YOU WERE HERE—Pink Floyd—Col



*jimi hendrix
midnight lightning*

CRASH LANDING was the first in a series of new Jimi Hendrix albums compiled from previously unreleased recordings produced by Alan Douglas.



MS 2229

Now, Reprise Records and Alan Douglas present the second album in that series, **MIDNIGHT LIGHTNING** — an album of blues-accented music that shows Jimi Hendrix' virtuosity in a new light.

AVAILABLE NOW ON REPRIZE RECORDS AND TAPES.

De-Lite Signs Genya Ravan



Fred Fioto, president of De-Lite Records, recently announced the signing of Genya Ravan as both artist and producer. Her first single for the label is "Feel The Need In Me" and was produced by the Golden Raven Company, a production firm headed by Raven and Harvey Goldberg. Seen here at the signing are (seated from left): Ravan; Fioto; Iris Irizarry, assistant to Jim Benci; (standing) Jim Benci, head of national pop promotion; Stan Price, head of national r&b promotion; Reggie Barnes, New York promotion and Gabe Vigorito, vice president.

J. A. McCarthy Dies

■ NEW YORK—Joseph Allan McCarthy, a writer and publisher member of the American Society of Composers, Authors and Publishers since 1948 died in New York City on November 7 after a long illness. He was 53 years old.

Educated at the Juilliard School of Music and New York University, McCarthy wrote for a number of Broadway revues including "John Murray Anderson's Almanac" (1953) and "Ziegfeld Follies" (1956) in collaboration with such composers as Cy Coleman and Marvin Fischer. He was the son of ASCAP lyricist Joseph McCarthy, who contributed to many major hits and Broadway successes. Survivors include his wife Susan and his children Joseph Rory, Jennifer Allan McCarthy Dell, Brion-James and Parnell.

UA Names Meis To Promo Post

■ LOS ANGELES—Ray Anderson, vice president, promotion, United Artists Records, has announced the appointment of Allen Meis to the post of midwest regional promotion manager. Meis will be headquartered in Cincinnati.

Prior to joining UA, Meis was employed in sales and promotion for Cleveland's Progress Record Distributors, working in Cincinnati as Southern Ohio promotion and marketing representative. He had previously been with United Artists Records in promotion, and had also been a radio personality.

Kinks LP, Tour

■ NEW YORK — RCA recording artists The Kinks, will kick off the release of their new RCA album, "Schoolboys in Disgrace," with a national concert tour which will open on November 21 in Bethlehem, Pennsylvania.

Shively to Prodigal

■ DETROIT — Gordon Prince, Prodigal Records vice president, has announced the appointment of Frank Shively to the post of national promotion director. Shively, a 12 year music industry veteran, has served as midwest regional director for London, Buddah and Polydor before joining the Prodigal group. Shively will be responsible for all Prodigal promotion. He will work out of the company's home base at 18465 James Couzens, Detroit, Michigan, (313) 864-5300. Steve Ales, promo manager, will report directly to Shively.

Shively's appointment coincides with the release of three albums, "Second Generation," Gaylor & Holiday, "Ronnie McNeir," Ronnie McNeir and "With A Little Help From My Friends," Shirley Alston and also a new single release by Ronnie McNeir, "Sagittarian Affair."

Atlantic Promotes Beth Rosengard

■ NEW YORK — Beth Rosengard has been appointed assistant national special projects coordinator for Atlantic/Atco Records, it was announced by Dick Kline, vice president of national pop promotion for Atlantic/Atco.

FM Duties

In her new post, Ms. Rosengard will be working directly with Tunc Erim, Atlantic/Atco's national special projects album coordinator. In this capacity, she will be involved in the promotion and coordination of all FM album airplay.

Ms. Rosengard originally came to the label in 1973 as assistant to Gunter Hauer, national director of college radio promotion.

Dialogue (Continued from page 18)

RW: Do you ever find a conflict of interest between your role as a manager and your involvement with Chrysalis Records?

Ellis: I don't think so. People have asked me how I can negotiate for our own act with our own record company and the only answer is that it's a question of honesty. You often end up in a ludicrous situation because you tell your artist, "we have to make a deal; this is what I would suggest." Then I advise him to take outside advice and to get some outside person to conduct the negotiations. That's where the problems often begin because all of a sudden, you have people representing your own artist against you on your own advice. I suppose, though, that it's a bit like democracy where two sides are fighting against each other in everybody's interest and eventually, you wind up walking somewhere down the middle. And although it can be difficult, all parties concerned usually know what area the deal should be made within, according to the strength of the artist. If you want to be together you'll be together.

RW: At this time, most Chrysalis acts are from England. Will you be acquiring more American acts?

Ellis: Bernie Proust was our first American signing. There will be other American signings announced within the coming months; we're here looking. It will probably take some time for people to realize that we're here and we're serious about being here in America. The truth of the matter is, though, that we're not an English record company with an American label but a full-time American record company. That's an important concept for us to establish because no intelligent manager is going to bring his artist to a company whose principals don't reside here and run the company. If you talk to a bright manager based in Los Angeles, he'll tell you that he can't do business with a record company based in New York. That's certainly going to be true with a record company based in London. When you make a deal with a record company, you make the deal with the head of the company; you have to have some kind of relationship with him, you have to be able to communicate. In our case, Chris Wright and I are the company; nobody is going to be bringing an artist to Chrysalis unless they feel that the company is being run by us personally and that they have access to us.

RW: How much time do you spend on the road?

Ellis: You'll find that a successful record company president spends an awful lot of time out of town. He's got to do it in order to fulfill his international responsibilities on behalf of his artists. Chris Wright and I function as co-chairmen. We work closely together and the titles and positions we have are very much administrative positions. We found early on that enormous problems were created if, when we were asked for an answer about any particular question, we would have to turn to each other before a decision was reached. As it stands now, we each make daily decisions while working closely together on the overall principles and theories of our operation. Both of us travel all of the time, but we communicate on a daily basis.

RW: Do you expect that Chrysalis will continue to be distributed by Warner Brothers or will you be taking a more independent direction?

Ellis: That's difficult to answer. First of all, any move we might take towards greater independence would automatically involve us in larger investment commitments and expenditures. One's ability or willingness to do that depends on (a) one's financial ability to take on a greater and the inherent expenditures and, (b) one's inclinations in that direction based on the state of the market. The judgment you arrive at has to be made according to how good the risks are. We've grown in the past years and have accordingly taken on greater responsibilities towards our artists because that's the way we think—in terms of people who rely on us to do a job for them, to guide their careers. Along the way, each decision we've made to expand or grow has not been based on arrogance or just a belief in ourselves, but on careful consideration of whether we're capable—in terms of our financial position, our organizational structure and our expertise—of taking on those responsibilities. I'd say that anybody who is now signed or who might be signed to Chrysalis can be sure that Chris and I will do the job properly for them no matter how many of the people who are working on their careers are paid by Chrysalis.

Our ultimate wish, though, is that everybody who works with our artists will be employed by Chrysalis; that's a goal we're working towards. Our basic belief is that the more things that are done by ourselves and our employees, the happier we are with what gets done. So we'll take on as many responsibilities as we can as we feel fit to do them, because that's the kind of record company that we are and the kind of people that we are. We like to be totally involved with our artists. ☺

Record World Presents



**A Tribute to
Bachman-Turner Overdrive**

WELCOME HOME



BACHMAN-TURNER OVERDRIVE

Marketed by Polydor



6000 Cote de Liesse, St. Laurent, Montreal, Quebec, Canada H4T 1E3 • Telex: 01-26546 TWX: 610-4213509 • Cable POLYDISC Tel.: (514) 739-2701

Record World Honors Bachman-Turner Overdrive



There are many points at which to begin praising Bachman-Turner Overdrive because, for the better part of its existence, the group has had a chain of support without a weak link in it. At the top of the chain are the group members themselves, whose talents are reflected in their meticulous recordings and powerful live performances. Bruce Allen has been their dedicated manager, always cognizant of what is best for the group in which he believes so passionately; Phonogram/Mercury has provided BTO with unlimited support and encouragement, and has been aggressive in promoting what is in their minds a quality act with few if any competitors; numerous concert promoters and radio personnel have been in BTO's corner since the "Blue Collar" days, and their enthusiasm has been an invaluable ingredient in the group's success. Behind all of this, largely unseen but hardly unacknowledged, are technical and road crews which rank among the finest anywhere.

No group or individual artist can please the public on a grand scale without the sort of coordinated support that has followed BTO. The group's success is a measure of the worth of those who have worked for or on behalf of it at any time, and this special issue is certainly a salute to their contributions.

But the spotlight is deservedly on Randy, Robbie, Fred and Blair, who together have created some great musical moments and have been justly rewarded for their efforts. In its own way, in the niche it occupies in the world of rock music, Bachman-Turner Overdrive is simply unbeatable.

Here's hoping we ain't seen nothin' yet.

phonogram, inc.

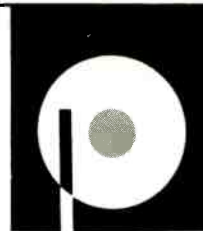

A POLYGRAM
COMPANY

IRWIN H. STEINBERG
President

November 3, 1975

Dear Randy, Robbie, Fred,
Blair and Bruce:

It has been five years since Charlie Fach and I first met with Randy in Edmonton, promising ourselves at that time to work with him in some way, sometime. Three years later Bachman-Turner Overdrive came to Mercury and the relationship since that signing in 1973 has been beautiful.

We have enjoyed being a part of your success and witnessing the public's enjoyment of your music.

We look forward to many more successful years with you.

Regards,

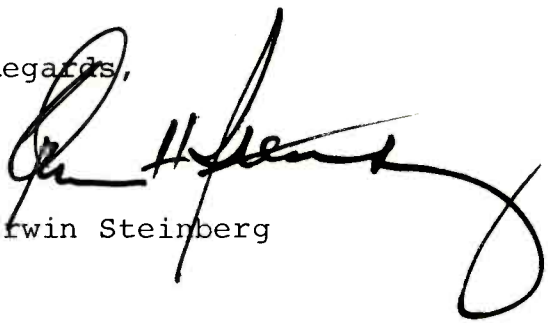
Irwin Steinberg



ONE IBM PLAZA/CHICAGO, ILLINOIS 60611/(312) 645-6200/CABLE ADDRESS: PHONOGRAM



products of Phonogram, Inc., one IBM Plaza, Chicago, Ill.
a Polygram Company



HEY YOU - B.T.O.,
THANKS FOR TAKIN' CARE
OF BUSINESS WITH YOUR
BIGGEST YEAR EVER.

REGARDS,
THE GANG AT
PHONOGRAM, INC. / MERCURY

P.S. WE KNOW WE AIN'T
SEEN NOTHIN YET!

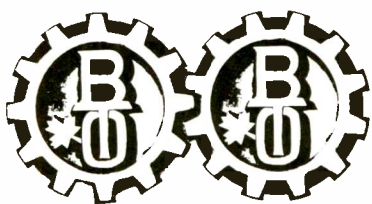

BACHMAN-TURNER OVERDRIVE

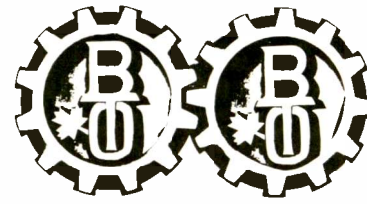

From Basement to Big Time: A Bachman-Turner Overview

By ROBERT ADELS

■ The ultimate people's poll—what happens out in the marketplace—clearly shows that no American rock band born into this decade has been able to top the impact of Bachman-Turner Overdrive.

Given your choice of yardstick, it all still measures out the same: Bachman-Turner Overdrive has become the proudest answer to the question: "Who new can rule rockdom on its own turf?" Sales just so happen to be a good place to start surveying BTO's rightful claim to the territory.

The record company who helped put them on top, Phonogram/Mercury, conservatively estimates that the rock quartet sold more than 5.3 million records in the United States during calendar 1974 alone. No album they've released is any less than gold and their string of top singles continues to reaffirm their acceptance with the top 40 audience.

In the two-year period since the release of their first lp, "Bachman-Turner Overdrive" (May 1973-May 1975), the official sales tally checks in at over 4 million albums and over 2.6 million singles. Small wonder then that in *Record World's* 1975 Directory and Annual Awards Issue, Bachman-Turner Overdrive walked away with top male group honors in both album and singles categories, in all-American style.

We use the term "America" in its most comprehensive geographic sense, covering and referring to the entire Western Hemisphere. BTO of course is a product of Canada, being that country's biggest recording/touring export on any side of its borders. Their conquering of the U.S. puts that broad definition of Columbus' discovery right on the band's doorstep.

Bachman-Turner's thrust into the U.S. market went a long way in making them an international phenomenon. But the group's summer '75 tour of the motherland showed them bringing it all back home, outdistancing as it did all previous Canadian tour gross milestones.

Bachman-Turner Overdrive as we know it today began with a bang-up 1973 and—as we have already documented—an almost unbelievable 1974. But their roots go all the way back to 1961, and the story of band founder Randy

Bachman.

The current producer/member of the proven success that is BTO can tell you how it didn't come in any sense automatically from his first big time group endeavor, The Guess Who. Randy Bachman was "braintrust" for this first internationally acclaimed Canadian rock band for nine years, through the early days and on to the fertile 1968-70 period which netted the act five gold singles and a pair of certified albums. Randy Bachman, who had taken on the role of business manager for the entourage while still a pivotal member, boasts performing and writing contributions that encompass the smashes "These Eyes," "Undun," "No Time," "American Woman" and "Laughin'."

Brave Belt

Gall bladder trouble caused Bachman to exit Guess Who in 1970. His operation and subsequent convalescence just did not mesh with a band whose commitments were so full.

Recovery led to a solo Bachman album, and then the desire to organize a new group. His dream became the genesis of BTO: Brave Belt, a group originally playing a rather unique style of country-rock of the honky tonk variety. But when original lead singer Chad Allen (another Guess Who vet) left the Belt, so too did the band's reason for sticking with music to struggle by.

The directional reorganization of Brave Belt came about to a large degree at a "pub night" series of dates during October of 1971 at Thunder Bay's Lakehead University. New member C. F. (Fred) Turner took to singing

as well as bass playing, finding himself an uncompromising rock musician leaving country tinges far behind. Robbie Bachman (Randy's brother) began to march to a more raw kind of different drummin'. In combination with mentor Randy and another brother Tim, what was to become the original BTO lineup was thrust into a trial-by-fire situation—and survived. The live environment was to prove to be BTO's main lifeline.

The year 1972 brought Brave Belt from Winnipeg to Vancouver, where Randy turned management chores over to Bruce Allen. Brave Belt was looking for a new name to cap off their newfound identity and discovered it during a road stop—in the title of a magazine called "Overdrive." The trucker's monthly linked itself with their last names in short order. C. F. Turner remembers the initial and lasting attractiveness of the new billing as having to do with "power barrelling along" at peak efficiency.

Fate could also have had a lot to do with this new development as well, for motorized musical monikers had popped up before in the lives of the BTO team. Nine years ago, Bruce Allen's first client had called itself Five Man Cargo; the most recent addition to BTO, Blair Thornton, came from a later Allen-managed force named Crosstown Bus.

Whatever the reason, the fact is that the name has worked as hard and as successfully as the band it represents. Informally shortened from Bachman-Turner Overdrive by press, trade and fans alike, "BTO" today is a rockin'

household word in either configuration.

Randy Bachman (RW's Top Artist-Producer in the aforementioned Awards Issue) is very much the leader (but not exclusively the spokesman) for the band. The voice as well as the pen of the group's founding father has been dually responsible for the act's biggest single to date—"You Ain't Seen Nothin' Yet"—while his lead guitar work never fails to rule triumphant.

Having moved to that instrument from the violin after seeing Elvis Presley on Tommy Dorsey's TV show at age 15, Bachman soon schooled himself towards the first electric in Winnipeg through a borrowed acoustic and an attic-discovered dobro. Today his customized Stratocaster has been self-designed to reflect some very personal demands on the music.

Elvis proved to be more of an initial inspiration than a specific influence on Randy Bachman, who has gone on record as having been greatly and most affected by the jazz/country styles of Lenny Breau and Chet Atkins, and collectively by those eternal British faves, The Who.

C. F. (Fred) Turner began as a guitar player with Vegas Lounge bands in 1968. Today he holds down both vocal and bass duties in BTO, labeling his instrumental contributions as "providing a solid undertow" to Randy Bachman's axe accomplishments. A car fanatic in his spare time, C. F. rolled into BTO prominence as lead vocalist on the first three singles from the band, including their first top 20 entry "Let It Ride." He also wrote all three, the last with Bachman—so Turner has been a multi-dimensional focal point of the act since its beginnings.

Robbie Bachman first tried his hands at a drum set during a Guess Who rehearsal some 10 years ago. Credited with "album design" honors for the initial BTO package—which debuted the group's maple-leafed Nash/Studebaker gear logo—he has collaborated as a writer from the first album and began adding vocal duties to his percussion expertise with the band's "Four Wheel Drive" set.

Second lead guitarist Blair Thornton, a self-described "veteran of Vancouver bar boogaloo,"

(Continued on page 24)



Bachman-Turner Overdrive; from left: Randy Bachman, Fred Turner, Robbie Bachman, Blair Thornton.

THANK YOU FOR ANOTHER GREAT YEAR

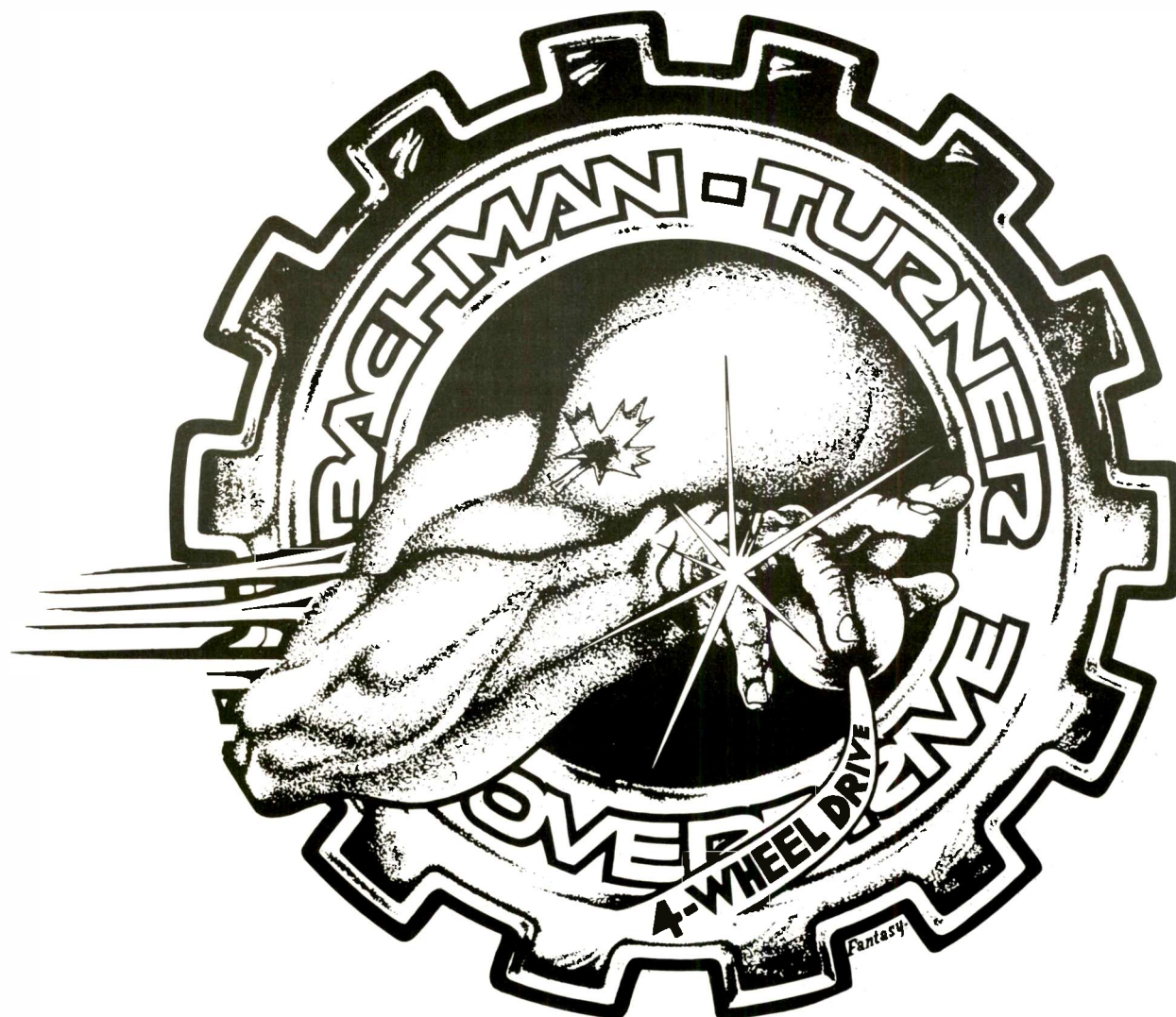

FROM EVERYONE AT BEAVER PRODUCTIONS

GEORGE

Robin

Ray

DON FOX

BARRY

CLAYTON

MONGO

DIALOGUE

THE VIEWPOINTS OF THE INDUSTRY

Randy Bachman: The Heart and Soul of BTO

By DAVID MCGEE

■ Randy Bachman's contribution to rock music, as a songwriter, (he wrote many of the Guess Who's early hits in addition to writing, with Fred Turner, all of BTO's hits), producer and musician, are extensive. He has been praised for bringing thunder back to rock, and he has been criticized for being too rudimentary in his approach to the music. All that aside, one need only look at the sales figures of BTO's records to realize that the group is enormously popular and is obviously saying something to a lot of people. In conversation, Bachman is low-keyed but not reticent; as the following Dialogue reveals, he is sure of himself and the principles by which he lives.



Randy Bachman

Record World: What were you doing just prior to joining the Guess Who?

Randy Bachman: I was with a band in Winnipeg on one side of the river and Gary Peterson, the Guess Who's drummer, was in my band and we'd always hear about this other band on the other side of the river and how great they were. They were called Allan and the Silvertones. They in turn were hearing how great we were doing just in high schools and community clubs. We had never got to meet them and they never got to meet us because we were always working on the same things. Finally I heard that they needed a rhythm guitar player, and my band was just not doing too terrific. I had to throw out the leader because he was not coming to practice on time and stuff like that—it was disintegrating. I went over and auditioned with them as *rhythm* guitar player, but the minute I auditioned I knew I was better than their lead guitarist, but I just wanted to get into the band. Chad Allan was playing lead at the time and after two days he said, "Why don't you play lead, you're better than me." In practicing with this band and working their weekend gigs, I saw that their drummer was weak compared to Gary Peterson and I said to the rest of the band—Jim Cale who was in Guess Who and Chad Allan—I said "You know, your drummer isn't bad but I have a guy who's terrific. He's Gene Krupa, he's everybody." So they wanted to hear him. This was at two o'clock in the morning and I went to his house and knocked on the door, I was so excited. His mom and dad got out of bed and woke him up; they were kind of a show business family so they didn't mind a whole band coming in and setting up. By now it was two-thirty or three o'clock in the morning. We played one song and stopped in the middle to let him do a drum solo and when he finished his solo, they just looked at me stunned and said "This guy is in the group, the old drummer leaves Friday." Peterson and I had been together about a year before that.

This band then changed its name to the Guess Who, which was just a gimmick for a record label, because the English invasion was just beginning with the Searchers, the Hollies, the Beatles and these groups coming in just after we got together. We incorporated all their songs into our repertoire and when we made a record of our own, someone at Quality Records thought that if we called ourselves Guess Who the programmers in Canada would not think we were Canadian, because early in that stage we had an English sound, we just didn't sound American because we had recorded in the basement of a TV station in mono, and we had a very English sound; that record was "Shakin' All Over" and it went to number one all across Canada. From then on we had ups and downs, many, many records over a period of four or five years. When Chad Allan left, I invited Burton Cummings to join the Guess Who. He was in a younger band in Winnipeg at the time. He came in and we spent a couple of years together and met Jack Richardson and recorded

the "Wheatfield Soul" album, which started a string of hits from "These Eyes" to "Laughing," "Undun," "No Time," "American Woman."

RW: What was the real turning point then for the Guess Who?

Bachman: Well, we had a lot of downs in that period of about eight years that I was with them; I think the turning point with most groups comes when you sit down and want to break up and another guy in the group wants to break up and you're so frustrated with trying to make it, but for some reason you don't break up; you keep going, you say "Let's overcome this." Now we never sat there and said "Let's overcome this"; we just didn't have any choice—there weren't any better musicians around to start a new band with in Winnipeg so we just stuck together, and that happened five or six times during those seven or eight years of development. I know everybody goes through that; that's just paying dues. I think the real turning point was coming back from a bum trip in England where we were \$18,000 or \$20,000 in the hole and we really should have broken up and I just told the rest of the group that I didn't want to sell shoes to pay off my share of the \$20,000; I wanted to play in the group. So we stuck together and had no bookings for months and months because we had cancelled everything to go to England. But when we got to England we met some undesirables there and we didn't want to sign up with them. We came home to four or five months of cancelled gigs and we couldn't get booked again. What we did get was a CBC television show and it saved us; it was a weekly show which ran 39 weeks from fall to spring and it was called "Music Hop" and was later called "Let's Go." We did that show for three years and it pulled us out of the hole. It was programmed to run at 4:30 every day, Monday to Friday, a show where the local groups go to do the hit parade stuff and it was

I think the turning point with most groups comes when you sit down and want to break up . . . but for some reason you don't break up, you keep going . . .

always from a different city. So Monday it was from Halifax and on that show they had Anne Murray, Gene MacLellan (who wrote "Snowbird") and a lot of other people who are in the business today. Then from Montreal they had people like Andy Kim and guys like that who are still around today. Then from the Toronto show they had Gordon Lightfoot and that type of artists. From Winnipeg they had the Guess Who doing the show and from Vancouver they had Terry and Susan Jacks doing the show, and guys called the Chessman who later were the Collectors who later became Chilliwack. So the people are still around today who were doing that show ten years ago and it just gave everybody money, which is what CBC does. It's a government station and they employ a lot of people and it really saved our necks. We did that show for three years and got out of the hole, consequently got a bank roll and our popularity across Canada was just right at the top because of this weekly show. And I suppose we thought our show was the best and Halifax thought their show was the best and everybody thought their show was the best, but it was a real ego thing for what were once punk Canadian local groups to have their own TV show, to be getting fan mail and suddenly all the groups began playing their own original material.

From Montreal and Toronto there was a group called the Stacattos and they later became the Five Man Electrical Band. We were asked by Coca Cola to do an album, with one side being the Guess Who and the other side being the Stacattos. It was just going to be sold with ten Coca Cola bottle caps and a dollar as a promotion item for Coca Cola. Coca Cola at the time was into those commercials where they had Ray Charles singing and the Supremes and everybody was singing these commercials, especially in Canada. So for us to do this was a great thing. They asked for five original songs from us and five from the Stacattos. That album today is a real

(Continued on page 20)

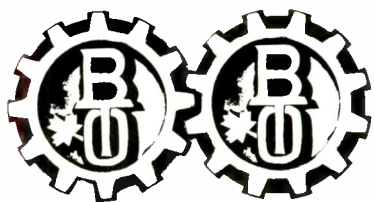

BACHMAN-TURNER OVERDRIVE

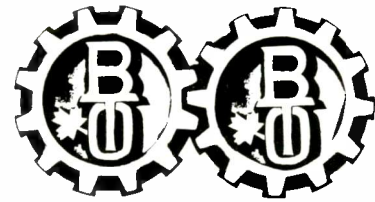

How BTO and Mercury Joined Hands

By IRWIN STEINBERG

(Irwin Steinberg is president of the Polygram Record Group)

■ How Bachman-Turner Overdrive and Mercury Records joined hands may be one of the great examples of how one mention from one person can lead to one of the success stories of the decade.

In 1970 Charlie Fach was in Chicago visiting the RCA studios where the Guess Who had done much of their recording. One of the engineers talked about a member of the group, Randy Bachman, and how he wanted to get more involved with production. Fach mentioned that to me, subsequently making contact with Randy. In June of 1970 Charlie and I flew up to Edmonton to visit Randy and Wes Dakus and although we didn't make a deal at that time, I told Charlie that we must get involved with Randy someday.



Irwin Steinberg

As you know, we got involved on the greatest level possible. It's safe to say that BTO is the most successful act, financially and otherwise, that has ever been signed to Mercury in its 27 year history.

It was almost three years after that visit to Edmonton that Charlie, who had kept in contact with Randy, discovered that someone in the New York office had turned down a tape Randy had submitted. I suspect Randy thought his career had come to a halt as

nearly every company in the business had passed on that tape; however, he re-mixed it and sent it to Charlie. At a subsequent a&r meeting in Los Angeles everyone loved the music and we acquired what became "Bachman-Turner Overdrive 1." Actually, we didn't sign the group immediately. Randy came to Chicago once for us to hear the tape and to discuss the band, but even then a contract wasn't signed. The signing date turned out to be March 28, 1973.

The association has not only been pleasant, to say the least, but there are aspects to this band and the group of people involved that often amaze me. Randy is the only Mormon in the group, contrary to popular belief, with the remaining members fully respecting his way of life and generally living in the same manner. Truthfully, it is a bit of a shock to go back stage after a concert and sit and have a Coke with a fellow

who just rocked 20,000 people into oblivion and find out he's not in oblivion with them. By the way, rocking people into oblivion is something I saw happen with BTO from the first time I witnessed one of their performances. I was taken with the simplicity of their music contrasted with the amount of feeling and power that evolved. In the beginning of their touring they worked as opening acts for many glitter bands and the contrast was stunning. On the one hand were four or five guys on stage with exotic make-up, 12 inch heeled shoes, leopard skinned pants and tassles and on the other hand there was BTO, dressed in football shirts, blue jeans and sneakers. But their music, exquisitely hard and driving, heavily impacted the audience.

Actually, they may have learned a few things from those glitter bands. One realization Bruce Al-
(Continued on page 30)



**WE REACHED
FOR THE STARS**

and got the

STARS

**THANKS
BTO!**

 **Pacific
National
Exhibition**

BACHMAN-TURNER OVERDRIVE

Bruce Allen: Guiding BTO To The Top

By DAVID MCGEE

■ BTO's manager is 30-year-old Bruce Allen, a Vancouver native who entered the music business after completing three years of study at the University of British Columbia where he majored in labor economics. "I wanted to be Jimmy Hoffa," he recalls. Fortunately for BTO he was dissuaded from that goal. In the following interview, Allen discusses his career and the managerial philosophies that contributed to BTO's rise to superstardom.

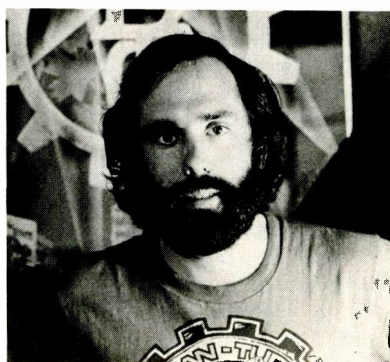

Bruce Allen

Record World: What was your first job in the music business?

Bruce Allen: My first job was with a booking agency. I opened a—actually I didn't even start a booking agency; I got hold of one local group in Vancouver that was very good and I worked with them in a management and booking capacity. I worked with them to the stage where they were bookable in any of the clubs in Vancouver. At the time they became probably the best club attraction in Vancouver. So whenever a club in Vancouver wanted them—and to this day Vancouver is still a big, big club market—I would say "Okay you can have the band for a couple of weeks, but now I want the booking rights to the club for a year." I still have about 20 clubs under exclusive booking rights that my office here handles.

RW: So you really plunged right into managing as your first job?

Allen: Managing at a local level was my first job, yes.

RW: Why did you think you were capable of being a manager? Did you know anything about the music business?

Allen: No, I don't think a manager at that level has to know too much. All he has to do is yell and scream and get the band some money. There's no career developing for a copy band or a juke box band or a bar band—all they have to do is get more money out of the venues that they play. The ultimate goal for a band like this is to make the Vegas circuit. The main thing at that time is just to get them the most money possible and of course just to keep them working.

RW: When did you start expanding and getting into more important things?

Allen: Well, when . . . due to the fact that we had the club circuit here tied up pretty well—my company, Bruce Allen Talent Promotion—I still only managed one or two local acts around and it got to the point where every Canadian touring act that came into British Columbia would work through my office for instance, we worked the Stampeders, groups like Fludd, April Wine—they all came through my office because I had the club market tied up. So they'd come in and work a couple of nights in clubs, and I'd also book them one-nighters and colleges at the same time. So Randy Bachman had his group Brave Belt on Warners, and because he had left the Guess Who and because the Guess Who was a very powerful outfit, Randy was basically being blacklisted in Toronto and his home province of Manitoba; there was so much bad flack about him and so many agents and managers and club owners owed allegiance to the Guess Who that they wouldn't work Randy. Randy came into my area and asked me if I could help him out because I didn't have any allegiance to the Guess Who whatsoever, so I brought Randy into town here to work the club circuit while he was doing the first album. I worked him here for about a year and a half solidly until one day a record deal was finally put together with Mercury and he walked into my office and said "Okay, we're looking for a manager and we've decided we want you to manage the band." And I said to him "I've managed groups on local levels, but you've been in the big time before and you know more about managing the group than I do." He said "Don't worry. Between the two of us we'll do it." That's when I said okay and I left the agency and moved strictly into the managing field with Bachman-Turner Overdrive.

The first personal goal that we had was to get the album on the charts. I can remember when it went on the charts at 189 without a bullet, and it was the biggest day of our career.

RW: So you actually worked with the group when it was Brave Belt.

Allen: Oh yeah. I worked with them in a booking capacity. I didn't believe a group at Brave Belt's level needed a manager. You need a manager when you've got a record happening and you need logistics and tours set up and transportation arranged and equipment set up. So many managers make a living off little bar groups or little local groups when actually a group shouldn't pick up a manager until they have something to manage. This is when Randy made his move.

RW: You mentioned Randy being blacklisted after the break with the Guess Who. Did you get any flack for helping him out?

Allen: No, there were no repercussions. I didn't owe anything to the Guess Who and they didn't owe anything to me. And I've always been a rebel anyway: I was never in the short-lived Canadian Music Federation; I've never been in the Canadian Management Federation. I've never been in any of those things; I don't believe in them. I've always been an outcast; by myself; an independent. So if there was any flack coming it would be no worse than the flack that was already there.

RW: Why don't you believe in those organizations?

Allen: I think a managerial organization thing is ridiculous, because of the Canadian managers there's only about three who know what they're doing, and I think I'm one of them, along with the manager of the Guess Who—and maybe the manager of Anne Murray. So what they're doing now, all the little managers in the country with little groups, they're sitting around picking my brain and what other brains that are there, for angles. Why should I set up a school, give my advice away free so that these guys might be able to get their groups up to a level where Bachman-Turner Overdrive is? Let's face it—it's a dog-eat-dog business out there, especially at our level. I'm not going to help anybody knock me off the charts.

RW: Do these organizations actively harass you for not joining them?

Allen: No. They all fold.

RW: When the group became BTO and you became their manager, what were the first things you had in mind as personal goals for the group? What did you want to do for them initially?

Allen: The first personal goal that we had was to get the album on the charts. I can remember when it went on the charts at 189 without a bullet, and it was the biggest day of our career. It still is to me, the biggest day that's ever been; I've never been so excited as when that album went on the charts at that level. The other goal, of course, was to get them work in the States, and thank God I met Paul Smith, who is a great agent and who worked his ass off for us when we had nothing but one album out there and had no booking or packaging power due to that fact that we were the only act at his agency. He cajoled and did whatever he had to do to get us on shows, and we got in front of the public, the public liked us and finally we broke an album onto the charts.

The reason we went with Paul Smith was because we had been rejected by all the agencies—nobody wanted to touch us in the United States. Every major agency passed; every major record label passed on us.

RW: Sounds like a discouraging time. Did you and the group ever consider packing it in and trying something different?

Allen: It was very close. Randy had carried the band financially from his cash reserves from the Guess Who. I think the band was into Randy for 90,000 dollars or something, just for salaries, clothes and it just

(Continued on page 32)

**The music
of Bachman-Turner
Overdrive is heard
around the world.**

**And we
represent it there.**



Screen Gems-Columbia Music, Inc./Colgems Music Corp.



Screen Gems-Columbia Publications

The Music Publishing and Music Print Division of Columbia Pictures Industries, Inc. 

BACHMAN-TURNER OVERDRIVE

Robbie Bachman: The Beat of Bachman-Turner Overdrive

By DAVID McGEE

■ Robbie Bachman is, aside from being Randy Bachman's brother, the drummer for BTO. Robbie has been with the group since its birth as Brave Belt, coming aboard after Randy asked him to play drums on a Chad Allan solo project that grew and eventually became Brave Belt's first album. In addition to his solid drumming, Robbie is best known for his impression of World War II.



Robbie Bachman

Record World: Your bio said that you first played drums 11 years ago at a rehearsal break of the Guess Who. Is that true?

Robbie Bachman: That would make me 11 right? When was "Hard Day's Night" out? Was it that long ago?

RW: 1964.

Bachman: So I was like 12 or 13 or so. I got my first set of drums at 16. I saw "Hard Day's Night" and saw Ringo playing drums and said "That looks real easy. He's not doing that tough of a thing." With his right hand he's hitting the high hat. I thought he was keeping time with the music like a conductor. I'm watching the movie and saying, "Boy that's really not hard" and it just sunk in my head and I thought of myself doing that every time I heard a record. The Guess Who were practicing in my parent's house right in the living room. While my Dad was building a rec room downstairs for them to practice in, they practiced right in the living room and when they had a break I was doing that. Always had that in my head, so I sat down and went boom boom and to me it's been there and I just did what my head was doing with my hands and everyone went "Hey I didn't know Robbie could play drums." Neither did I and it just went from there. Just constantly playing and having it in mind.

RW: Up to that point, had you ever played an instrument?

Bachman: No.

RW: Did you ever think that you wanted to be a professional musician?

Bachman: There was a time when I was about four years old and Randy played violin and my brother Gary played accordion and my brother Tim and I went around singing Everly Brothers songs and Elvis Presley songs and "Peggy Sue." And at that time it was cute thing—look at the cute little boy singing "Peggy Sue." And Tim played and I'd have a little tamborine and sometimes play a little cardboard drum. Then we quit because we weren't interested in it any more. It was just a cute thing to do for little kids at a Christmas party.

RW: Being a rock star was not your dream?

Bachman: No, I never thought about it. Randy was in the Guess Who and he was just my older brother who left town.

RW: Was he any influence at all? Do you think you were more interested because he was a musician?

Bachman: I was exposed to it more and interested in music more, but I wasn't a real music freak at 12 years old. He'd just say "Listen to the neat record I got from a group called The Who. They smash their instruments." What the hell is this? They're going crazy! I got to telling the kids at school and there were two or three friends of mine who would hear this stuff from England and they really weren't into that yet. Then Randy got a Beatles album. And he said, "Look at this group from England." He played it for my cousin and she said "These guys look weird with this hair and stuff." He was in a record club and they'd send him all this stuff about all the groups. I looked at it and said "It's a new group" and it didn't mean a thing to me. Then it caught on—like, it really caught on. I wouldn't say he was the first guy who knew about them, but he was among say, maybe the first 100,000 people in North America to know about them, and another one was Ed Sullivan. I was into a lot of groups like Herman's Hermits, the Animals and the Rolling Stones before other kids were.

He would pick up on this because they would influence him in his writing and playing on stage. I would sit in his room and listen to him.

RW: What was the first group that you played in then?

Bachman: It was a high school group with my brother Timmy. Randy said, "Let's get this guy a guitar, and this guy can play drums pretty good so let's get him a set of drums," and we practiced.

RW: Randy wasn't in this group?

Bachman: No, he was still in the Guess Who going on the road. He was my older brother who brought home gifts from Mexico and Texas. That's what it was. He would come and say "Hey I played with Three Dog Night and here's one of their songs." He would give us songs by Ten Years After. We'd play this thing at a high school dance and we'd be so different from everybody else because these guys hadn't heard the music yet. And here's Hendrix; people weren't into him yet and we were playing all this stuff. He was an influence when we needed it.

I played with Timmy for three years—two or three years—and I grew. We played sock hops and high school dances, community clubs.

RW: When you started with Brave Belt, you already had a chance to make a record. You didn't have to wait.

... I went through dues but not as much as anybody else. I just had an older brother who went through it all and I consider myself good enough to be with this group or else I wouldn't be here. (Randy) ain't carrying me.

Bachman: Yeah, I went through dues but not as much as anybody else. I just had an older brother who went through it all and I consider myself good enough to be with this group or else I wouldn't be here. He ain't carrying me. I mean he can listen to the album and hear that those are fairly good drums because he ain't in a position to carry somebody and say "The group's great but the drummer's not that great, but he's my brother." I myself don't feel I'm in the group because I'm Randy's brother. He taught me as I went along and now I know basically enough what's happening in the business, but I'm not ready yet to become a producer or record executive. I'm too young and I like this part of the business right here. I enjoy it.

RW: When Brave Belt started out, did you know of any specific goals the group had in mind, anything in particular they wanted to achieve as Brave Belt?

Bachman: That group wanted to play concerts. I didn't know what a concert was. I went to them, but I didn't know what it was like playing in one. I played dances and we really didn't have a goal in that. It was really that far away to reach. I didn't even think about it, but when we sold our record to Mercury, I realized we'd been playign our "Brave Belt III," or "BTO I," music for a year and kids were really getting off on it. This was before it was out anywhere, and we knew that kids would like the album when it came out. I knew we were good enough to make it, but we had to do the right things at the right time. I knew it was going to happen, but I knew it was going to take time.

RW: Were you consciously aware, when you were in Brave Belt, of striving for something, or were you just really playing and having a good time?

Bachman: I was just playing and having a good time, really; I wasn't striving for anything.

RW: Wasn't Randy's concept different from yours? Wasn't he actually striving for something more than you were?

Bachman: He and Fred were, but I had nothing else to worry about. I was living at home, 17 and 18 years old. Made \$150 a week, which is great when you're 17 or 18, driving a new Firebird and all this stuff, and it was great. I didn't know what else could be gained, but Randy

(Continued on page 37)

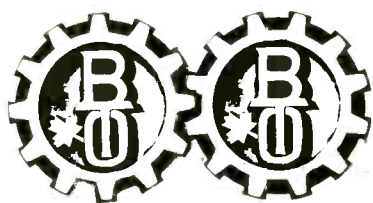

BACHMAN-TURNER OVERDRIVE



Charlie Fach:

BTO Will Be Around For a Long Time

By BARRY TAYLOR

NEW YORK — Charlie Fach, executive vice president/general manager, Phonogram Inc., and one of BTO's biggest supporters recalls a time when Mercury Records originally passed on the group. "Well," he says trying to hide a trace of embarrassment, "I was out of the country for two or three weeks, so the tape was reviewed by somebody else and he didn't dig it too much, so he sent it back. A week or so later when I got back, Randy called me and wanted to know what was wrong with the album."

Bachman offered to re-mix the tape and send it back to Fach, who was so excited when he heard the songs that he immediately forwarded the tape to his sales staff in Chicago.

"They went out of their minds with it," he said. "Everybody in

the company went crazy about it.

"As you can see, with BTO it was never one of those things where you throw it out and see what happens. Randy is a very together guy and the group always wanted to go out and work and do whatever had to be done. They've stood behind all of their promises too."

Fach believes that the single biggest factor in breaking BTO was the free concerts the group did for radio stations across the country. "At the time, there were four or five radio stations that would take BTO for nothing," he said. Sometimes, BTO was the only act out of several scheduled that would actually show, which immediately established a loyalty between the station and the group. "It was enough to create a name for them in these cities. When they'd play these dates,



Charlie Fach

we'd find that we would get re-orders and the group would keep returning until they were headliners in places like Detroit, St. Louis, Nashville, and New Orleans."

Fach says that the majority of the buyers of BTO product are male and fall into the 16-30 age category. Furthermore, he points

out that because of these statistics BTO's tape sales are "as strong as or better than anyone else's in the business including Elton John."

"You have to realize that if you take a guy in that age group, his big thing is his car. Even if he has a stereo at home, he's going to have an 8 track in his car. These people have oriented themselves to buying tapes and for reasons like that, 'BTO II' is currently selling more in its 8 track configuration than the lp. 'Four Wheel Drive' is running neck and neck.

"In the case of BTO, it was never a matter of the group being some fond hope of an a&r man," said Fach. "Everybody in the company believed in them from the start and I think we've just begun to scratch the surface with them. They are a group that will be around for a long time to come."

WE MOVE WELL TOGETHER

Mercury

phonogram

BTO

marketed by
phonogram

Phonogram Ltd., Stanhope House, Stanhope Place, London W2 2HH, England.

BACHMAN-TURNER OVERDRIVE

Blair Thornton: Coming to Terms with Stardom

By BARRY TAYLOR

■ Blair Thornton, the newest member of BTO, has been playing guitar with the group since "Let It Ride" catapulted them into national prominence. In this RW Dialogue, Thornton discusses the growth of BTO from the perspective of both an outsider and as an intrinsic member of the quartet. He talks about what his role in the group was when he first joined and what he expects it to be in the future.

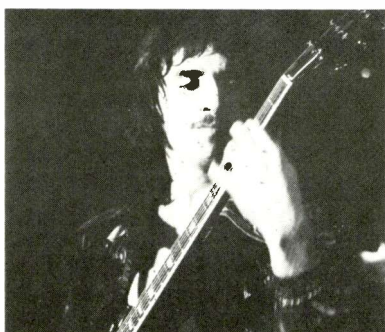

Blair Thornton

Record World: How did you first meet Bruce Allen and Randy Bachman?

Blair Thornton: I had fallen in with a local group which had an album out at the time. It was called "Cross Town Bus" and Bruce was managing them, but he was thinking bigger. When Brave Belt happened on the scene at the time, he went to see them and was taken on as their manager. As soon as they started touring, I went to see them because Randy was a local Canadian hero of sorts. He was on the wane, but there he was, and I hadn't seen too many heroes pass by. I wanted to get a chance to play guitar with him. It was a curious sort of thing because I wanted to be able to say, "Wow, I played with Randy Bachman." They were playing clubs like any other band at the time, playing everybody else's material. I came in and played a few songs with them. Just for 20 minutes. Randy and the rest of the band had seen me play and that was the end of that.

RW: When were you asked to join BTO?

Thornton: A year after I jammed with Brave Belt. They had already released the first BTO album on Mercury which was actually the third Brave Belt album, but Warners wasn't going to release it. Timmy was about to leave the group and they were going to have to find another guitar player. Well, because I jammed with them, I was the only person that Randy had seen play because he doesn't associate with anybody. So the logical choice was me. "Let It Ride" was just put out. "Blue Collar" was a minor success, but it was nothing gigantic; it was successful in certain areas. They had played for about six months as BTO but they were still bumbling around, nothing big had happened yet.

RW: How soon after you were asked to join BTO did you have to play with them in public?

Thornton: They phoned me up completely out of the blue and told me that they wanted me to try out for the band. I said, "Oh sure." I had a couple of practices with them and then I had to go to play an "In Concert" show. It was real quick. In fact, I had two remaining gigs with Cross Town Bus. I told the band that I've got to go out with these guys. It's a break. They said, "Oh well, that's tough, but go ahead." I played one last gig with them anyway. So I went up to Fort St. John which was 800 miles north of Vancouver up in the hinterlands of Canada and played this gig and the next day I flew down to Vancouver, got on another plane and flew down to Los Angeles with BTO for the In-Concert. I had only had these two short practices with the band, so it was a real freak. I was scared and said, "I can't do it, I can't do it." So we go to our dressing room and right besides us is this little name plate that says, "Loggins and Messina." This was too much for me. Somehow I survived it and then I went on a tour.

RW: Had you already known all their songs from the album?

Thornton: Oh, I knew all their songs. I knew all the stuff. I had actually learned it all when I was going to jam with Randy. I learned every one of their songs off their album because before the album was released I had an acetate of what Randy had mixed which Bruce gave me to listen to for an opinion. I was pretty well acquainted with the material and I was acquainted with their success because I was following it. I was seeing Bruce because he was also involved in Cross Town Bus, but now to a lesser degree. It was quite an easy sort of

“It's here now and I've gone through this unbelievable change; economically, status-wise and everything else . . .”

operation, but it was tough for me to adjust to playing "In Concert" and going in a limo and all this kind of stuff. At this time the band wasn't doing that much either. "Let It Ride" was just on the charts when I came into the band. So we were starting to do all right. I still wasn't on an album and I was an unknown face. Every time I came to a concert I felt really strange because people would look up and I knew they were going, "That's not the other guy, who is that?" That gave me an inferiority complex for a while.

RW: How did you feel when you suddenly found yourself playing those big halls for the first time? What it easy for you to adjust to being a showman, playing on bigger stages?

Thornton: Yeah that was really weird. The volume was weird and the fact that now I just couldn't stand still and play a song was weird. I had to get in there and do something. I had to find out what my appeal was going to be, what my part in the band should be and then play up on it, I didn't know, I was feeling my way out. I was insecure in that I didn't know for sure whether they really got off on what I was doing in the band. I didn't know if I was really in the band. I was a junior member. Like, I was not going to make as much money as these guys were going to make, but they didn't put me on salary. They gave me a very small percentage at first and said, "If it works out, we'll boost your percentage," which was fair because I walked into something. I didn't start from the beginning. So I had all these little insecurities there that got me. But in about four months I started to get into it. I started thinking, well yeah I'll get into this and by "Not Fragile" when it had been released, I got my first boost because then all of a sudden I would go on stage and somebody would yell out my name from the crowd. They'd yell, "Hey Blair!" or something and I went (sigh) that's me. Then it started to come together and I started feeling much more secure and I realized I was part of the band. From that point on it was smooth. But it was still hard to believe that we were rising. We just kept rising and it was happening very, very quick. It was just up, up. I've only been in the band since March of '74 and from where we've gotten for me in the band I'm telling you that's where it was in March '74, it wasn't that big. It's now here and I've gone through this unbelievable change; economically, status-wise, and everything else all hit me within the first eight months. It hit that hard. I had a real tough time with all my friends and my family because they couldn't relate and I couldn't relate. I would immediately come in and tell my friends after I had been out on the road for six weeks about all the neat things that happened and all the groups that I'd met and everything. And they'd go uh-huh. It didn't occur to me at first, but about two months later, I picked up on the fact that these guys weren't really getting off on what I was telling them because they weren't there. They wanted to be there and they weren't and I didn't know that I was shoving it down their throats saying hey look at this, it's great, with all this exuberance. I'm a hyper-active individual to begin with, so I was really pushing it down. I went through about six months of turmoil. It was pretty tough. I don't know about the rest of the guys, although I can tell you everybody seems to be into privacy. You get into this thing where you have to get away from it, divorce yourself and I never thought it would be like that. I always thought success would mean attaining goals, Eldorado, etc. You want to get there and attain your goal, but 90 percent of the fun is in getting there. I forgot that it was in getting there. Once you get there, all of a sudden there's no more challenge. Next, there's all the people that were with you that didn't rise with you. All your friends are still down there if you want to look at it in black and white terms. My musician friends are still playing dances that I was playing two years ago.

(Continued on page 36)

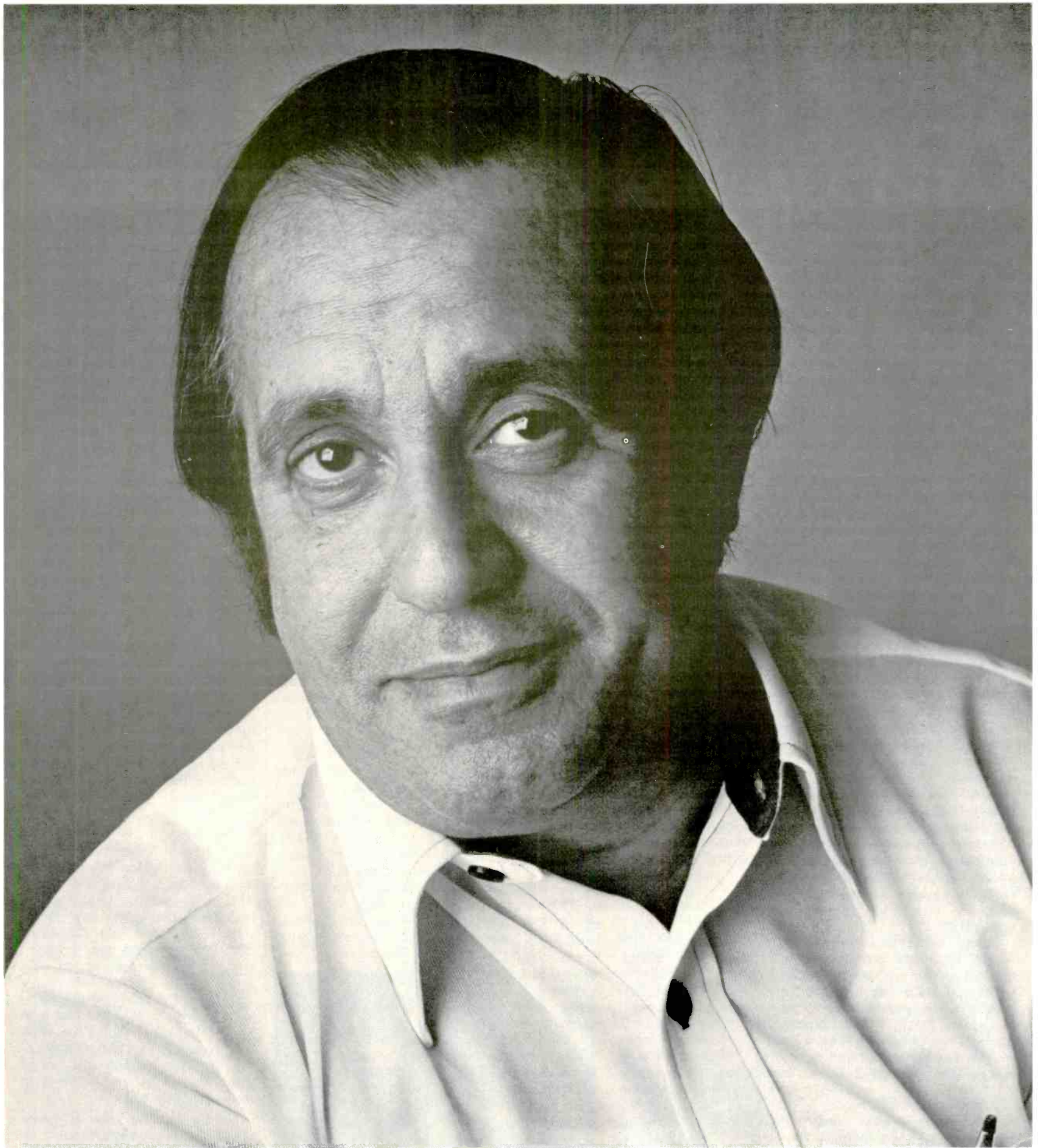

**TONY,
A BTO BIG WHEEL.**

HE MAKES THE PLATES, THAT PRINT THE BOARD,
THAT IS MADE INTO ALBUMS FOR...

BTO AT AGI.

THANK YOU, BTO AND PHONOGRAM INC.

BACHMAN-TURNER OVERDRIVE

Bachman-Turner Overdrive—The Best Around

By LARRY LeBLANC

■ TORONTO — Bachman-Turner Overdrive, which reaches a rock audience too young to remember The Beatles, is probably the best rock and roll band around. Their popularity verges on the phenomenal and, in only two years, the band has powered its way into rock's top 10 and onto the world's largest concert stages.

Their records, ironically, sell millions, while rock critics bad-mouth them. They say the band, in many ways, is filling the proletarian void left by the decline of Grand Funk Railroad. They criticize BTO for being repetitious, simple, hackneyed, derivative and too obvious. Such criticism is misdirected. The band can be all of those things (and occasionally proud of them) but delivers competent product to a specific audience, and does a good job of it.

Sound Synthesis

They've merged a hard-edged Memphis country/rock instrumental sound with sweaty 1956-57 rock and roll and the hardness of the earliest days of British Mod. Overall, it's an unabashedly commercial hardrock framework with little variety in vocals, hooks or riffs. All fuzz tones stomped into action. The guitars, bass and voice are distinct, but the drums stand out. Every last cymbal sizzle and harmonic is there: the bass drum thuds precisely against the chest when it is used and the snare is perfectly riveted to the melody instruments.

These days one can hardly blame BTO for being ecstatic about their current success. Three years ago, under the name Brave Belt, the band couldn't get a hit to save itself. Two albums bombed on Reprise. They kept plugging away, toured and finally signed with Mercury Records.

Initial Album

BTO's first album, recorded while the group was living in Vancouver and working as Brave Belt, was turned down by a large segment of the industry (including Mercury the first time around). "I flew back and forth from Los Angeles every week to try and sell it," says Randy Bachman. "I submitted it to a couple of Canadian labels but my main interest was worldwide and the United States. I went to A&M, Epic, Atlantic, Columbia, Asylum — you

name it. In a few weeks I'd get letters saying 'Dear Randy, We pass.' We're thinking of calling our greatest hits album 'We Pass' and printing all those refusals on the jacket. I've got 22 of them. David Geffen, Clive Davis, Ahmet Ertegun, Jac Holtzman—they all passed."

Bachman's turndown at Mercury Records occurred when Charlie Fach was in Europe attending MIDEM. A few months later when Fach heard that Bachman was shopping for a label he got in touch with him and asked to hear the album. Bachman said he'd already sent it and that Mercury had passed. Fach had never heard the album, found it in a pile of tapes in the a&r files and excitedly phoned Bachman a few days afterwards to offer a deal.

"Bachman-Turner Overdrive I" turned out to be a jukebox of dance songs for juice bars, after hours clubs and private dance parties. Hit singles just flew out of the jacket. It was one of the best albums of 1973. In a rock album, the producer's job is to hold you in his grip and keep squeezing you to react the way he wants you to, and Bachman, on this album, did his job efficiently, in fact, sensationally. Under his direction the quartet had finally hit on the right state of mind to start making that long string of hit records.

Appeal

"When a group does a first album," says Randy Bachman, "you've got to make it the most appealing thing you can. I had to



BTO's live presence is one of the most compelling things about the group.

look and put those songs together so some guy somewhere was going to like two out of the eight songs and say this is worth spending money on."

The most outstanding success in the record company practice of subsidizing a band's early tour efforts was Mercury's initial financing of BTO in the days of the band's first album.

"There's two ways to sell a product in this business," Randy says. "You go to a concert hall and the people come there or you can be hyped in publications. Every group wants full-page ads in Rolling Stone, Creem, Crawdaddy. We wanted the same. Mercury told us that wasn't the way to do it. They told us: 'When we take out full-page ads, people will know who you are and what your name is. The name will have

hit them in the face a couple of times—either by radio ads or in concerts or a visit to their station. The name will mean something.'

"Sometimes we'd play twice a night. We'd play a gig at 7 o'clock and fly somewhere and play at midnight. That way we'd get to more people. I can't even estimate the amount of money that they spent then. Every city that we played, and we must have played hundreds, they bought spots on the AM and FM outlets plugging the show and the album."

The constant touring and splitting bills with Edgar Winter, Cactus, Dr. Hook, Joe Walsh, Spirit and the Doobie Brothers forced BTO to revamp their act, which had been pretty low-key up 'til then. Explains Randy Bachman: "Every time we'd see a group where one guy really got moving and got it on with his instruments and got to the crowd, Bruce Allen would say to us 'Look at that guy. He's doing great stuff. Look what he's wearing, look what he's doing.' So we gradually got out of our blue jeans and started to move around."

When it came time to write songs for the band's second album Randy Bachman remembered the incident and wrote "Welcome Home," a nose thumb at Canadian nationalists who had panned the group during the time they were rolling in success after success in the U.S. "BTO II" also featured two breakout hits, "Let It Ride" and "Takin' Care Of Business." The album achieved platinum status.

(Continued on page 31)



Publicity photo of Brave Belt

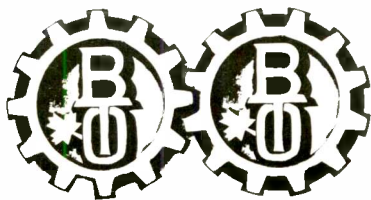

BACHMAN-TURNER OVERDRIVE

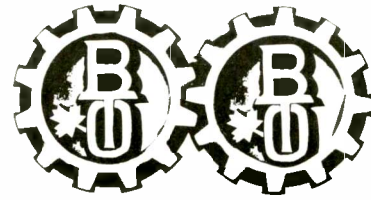

Werner Vogelsang:

BTO & the International Market

By IRA MAYER

■ NEW YORK — Polygram International president Werner Vogelsang describes his two meetings with Bachman-Turner Overdrive—the first as having been “theoretical,” the second “real.” When I took over Polygram International in October 1974,” explains Dr. Vogelsang, “I was aware of BTO’s successes, but a year ago they were not too well known in Europe. Irwin Steinberg asked me for an opinion and I saw a five-minute movie. That convinced me they were a world act.”

Dr. Vogelsang’s second meeting with the group came in the course of BTO’s spring ’75 tour, specifically when the band played the Nassau Coliseum on Long Island in May. At that time, he adds, the group came to his apartment for a home-cooked dinner including fresh pea soup and German style fried potatoes.



Werner Vogelsang

On the more formal side, Dr. Vogelsang points out the difficulties of breaking a group such as BTO in the European market, what with the far more limited radio outlets and the costs of transporting the group to Europe for live touring (as well as the difference between what they could earn in Europe and in North America). As two examples of the

radio situation, Dr. Vogelsang mentions Germany, where there are a total of 11 stations serving the 62-million-strong population, and France, where stations are not allowed to program more than 25 percent of their music by foreign composers and producers.

Thus, while the group has hopes of expanding its reputation in the European market—having even toured in some countries already—a string of number one hits would be a difficult accomplishment under present conditions. In time, of course, such problems work out, especially when the talent is as strong as BTO.

“The members of Bachman-Turner,” Dr. Vogelsang told *Record World* recently, “are very self-critical, which in their case is healthy. Their’s could have been success by chance, but that’s not the case. They’re all highly professional from the way they start an album to their overall outlook. We expect a long term career with them.”

Cees Wessels:

Helping BTO Worldwide

■ Cees Wessels, head of a&r for Phonogram International in Baarn, Holland, must be credited for much of BTO’s international renown. It was Wessels who handled the band’s European tour for the label; it was Wessels who was greatly responsible for breaking the band’s first European single success, “You Ain’t See Nothin’ Yet;” and it was Wessels who laid the groundwork that has helped establish Bachman-Turner Overdrive on the continent.

As Wessels explained in a recent interview, “After the first album was released we had to get the group known to the public in general, and that took a year of hard work. Each country involved with Phonogram is independent, so they can decide whether or not to release an album. If they choose to release the product, they really believe in the artist and they’re really committed.”

(Continued on page 30)



**CONGRATULATIONS
& THANK YOU!**
From
KEN KINNEAR

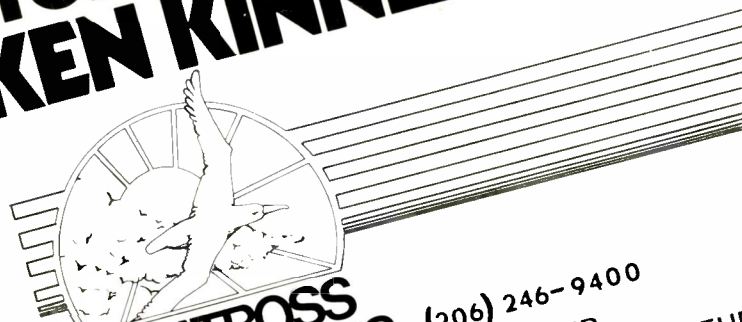

ALBATROSS PRODUCTIONS (206) 246-9400
SEE YOU IN: SALT LAKE DENVER
SALT PALACE DENVER COLISEUM
NOV. 25, 1975 NOV. 26, 1975
FARGO BISMARK
NDSU CIVIC ARENA
NOV. 28, 1975 NOV. 29, 1975



BACHMAN-TURNER OVERDRIVE



Randy Bachman (Continued from page 8)

collector's item. It sold 60,000 copies. I still have about ten of them here and kids really pay \$50 to \$100 for one. This album was produced by Coca Cola's producer, who was Jack Richardson. Suddenly the Guess Who had met a big time producer. He did all the commercials that came out of Toronto. When Jack Richardson heard how long we had been together and what we had been through he saw something binding us together through all our hard times; he saw, I guess, some talent in Burton Cummings and myself as songwriters. Suddenly we started to write very good songs and Jack mortgaged his house, started a record label called Nimbus Nine and then he cut an album with us. Then he proceeded to take that album to I don't know how many record labels and got turned down by a good dozen, and finally he made a deal with RCA and that was the "Wheatfield Soul" album, the one he cut first thing. From then on was our string of hits.

RW: Why did you leave the Guess Who?

Bachman: I had converted to Mormonism, and being a Mormon I didn't drink or smoke or do dope; and that left me out of a lot of parties and things that go on in the music business.

We just kind of grew apart in the way we wanted to live. That was underlying—you know it wasn't enough to make me quit. One day I had to go into the hospital—I had some gall bladder problems—and when I did go into the hospital I knew that it was really nice to be away from them and the pressures I had in trying to maintain my standards as opposed to theirs. I'm not putting their standards down because they were my standards at one time, but I just happened to get a different set of rules to live by. It was really tough to always be the odd man out; I became that all the time and it was very depressing. It depressed my spirits. I wasn't feeling up any

All of the Guess Who's 8½ years of rough, tough times were crammed into 2½ years for BTO. It just hit us all at once.

more, and when I did go into the hospital I knew it was time for me to go. On the other hand, the group felt the same way, because when I was in the hospital they felt the same relief. I'm sure they felt a great weight off their shoulders in not having me around, because I did turn into such an opposite—not musically, but just personality-wise. When I went back and talked to them we were both quite happy that the situation was ending and we were quite emotional; we had been together at that time ten and one-half years; we had come from being a basement group to being the biggest group ever to come out of Canada at that time. After it was over I rested and got better and found I was still very interested in music. It was really tough to give it up after playing every night. You know, I was really bored at night with nothing to do. I had this adrenalin in my system and I'd be awake at ten o'clock at night and I'd be up until two or three in the morning with no way to expend this energy that my body was used to putting out every night. So I just started out with another group and got people together and we evolved into Bachman-Turner Overdrive.

RW: Legend has it that after you formed Brave Belt and were looking for places to play, there was some sort of blacklisting going on among promoters who apparently had a vested interest in the Guess Who and this caused you problems getting good gigs. Did that really happen?

Bachman: That's basically true. If you asked me to prove it I could whip out about two dozen newspaper articles bad mouthing me and putting me down for leaving the Guess Who, and then the story came out that they threw me out of the group. You could narrow that bad press down to a couple of people. I don't want to name anyone because I don't want to get in any trouble, but it's generally known throughout Canada who they were. They shot their mouths off—"The Guess Who is terrific and Randy Bachman is in oblivion and everything he's doing is garbage and he'll never make it" and consequently there was a soured attitude on anything that had my name on it. We had a really tough time for three years. It was very frustrating; it was a brick wall that was very, very high and we kept banging our heads against it. Finally we asked "Why are we doing this? Let's go somewhere where there's not brick wall." And we moved to Vancouver.

We got a release from Warner Brothers because they didn't want to release our third album because they felt they had spent enough money on us and we weren't really happening. They didn't really sense the change in the group's direction, the evolution from a country rock band to a straight rock band. During this time when we weren't getting anywhere and not getting any work, we weren't making any money; but I had made money in the Guess Who. I was bankrolling the group, if you want to call it that; I was paying their salaries. When it came to the day that I sold the album to Mercury, to Charlie Fach, I had spent in the high forty thousands of my own money on the group. About 36,000 dollars on the album and the rest for about two years' salary to group members. I did it because I knew we had something; I knew we could make it and I didn't want, for example, Fred Turner to go and work in a car wash or sell shoes to pay his rent and not be available when things started happening. I wanted him there, so I was willing to pay his salary and I paid Robby's salary and this just went on and on. I paid Chad Allan a salary before he left, and I paid Timmy a salary. Here I was very close to 100,000 dollars out of my own pocket and feeling very depressed because "BTO 1" got refused by about 24 or 25 record labels. And I went to several of the labels two or three times because the upper crust of the jobs in the record industry is like musical chairs. The head of a&r from RCA will go to Columbia, this and that, and I would keep track of who refused my tapes; as he left the company I'd see who was brand new at that company and I'd send him the tape again.

(Continued on page 34)

**THANKS
BTO** Randy Bachman,
Bruce Allen &
Beaver Productions

for the
biggest back-to-back
gross ever—

Calgary,
Edmonton
Concerts
Summer '75



**BRIMSTONE
PRODUCTIONS**

912 — CANTABRIAN DR. S.W.,
CALGARY, ALBERTA, CANADA
Phone: (403) 281-2616

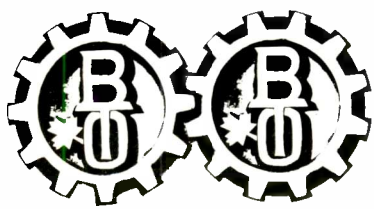

BACHMAN-TURNER OVERDRIVE

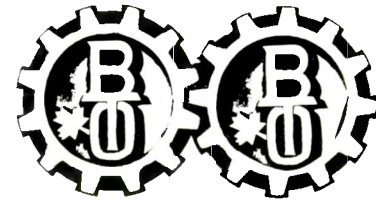

Jules Abramson:

Backing BTO from the Start

By ROBERTA SKOPP

■ NEW YORK — In discussing the marketing aspect of Bachman-Turner Overdrive's career, Jules Abramson, Phonogram senior vice president/marketing, was enthusiastic about the fact that, "The nice thing about their success is that now we know that when we spend money to market we get a return." But, even though that guarantee exists today, Phonogram's marketing force was behind the band long before such claims could be made. Perhaps that is an indication both of the importance the corporation places on the effectiveness of specialized marketing techniques and the professionalism and determination that BTO showed the firm right from the start.

Immediate Backing

"We were behind them just as soon as they came to the label," Abramson explained. "They were always out there working, out there performing, and as long as we have an act that'll do that, we want people to come and see them, and hopefully buy their records." Even prior to Bachman-Turner Overdrive's initial Mercury release and ensuing performances, individualized marketing techniques were employed. "The first time that we heard BTO product," Abramson continued, "was at the NARM Convention, in 1972, I think. We held a meeting and listened to a great deal of product and it was the BTO product that really stood out to us. And, when we released the first Bachman-Turner Overdrive album, or rather just prior to that release, we realized that Randy Bachman had built up quite a reputation for himself with the Guess Who, having written at least six or eight of that group's biggest songs.

Awareness

"It was about two weeks before the album's release and RCA came out with an album titled 'The Best of the Guess Who' and I sent copies of the Guess Who album to all the key dealers, all the key racks, all the key one stops and to just about everybody on our mailing list who's involved in merchandising. I sent a note asking that they take a look at Randy Bachman's credits on the album and said that we were



Jules Abramson

about to release an album by a group featuring Randy Bachman."

Anticipation

Abramson believes that this tool made all very aware, and that industry people were ready and looking for the arrival of this album. "It got a great deal of attention through this little maneuver," he explained. "At that time we were going through a corporate reorganization and were not forcing our distributors with any product. We sold very hard and we told them that this is what we have to offer. We were very sup-

Bly Flies High with Overdrive

By DAVID MCGEE

■ NEW YORK—Of no small significance in BTO's rise to superstardom has been the aggressive promotion given the group by Phonogram/Mercury. Stan Bly, the company's vice president of national promotion, credits "general promotion on the personal level" with being a significant factor in BTO's American success.

Promotional Aspects

"Promotionally," he said, "we tried to break BTO through concerts for radio stations and good 'rap' tours, because they're a dynamite group to talk to.

"I traveled with the group and I tried like hell to get people to let them play for benefits and for radio stations. That was the only way to get BTO off the ground. I knew the kids would like them; we just had to get the group in front of the kids. Radio stations helped us a lot. CKLW in Detroit played BTO's records from the beginning and WCFL in Chicago

portive and distributors bought as they saw fit. So, initially we got out about 5000 pieces. It wasn't really a rack item because nobody had ever heard of Bachman-Turner Overdrive as yet."

Advertising

The group worked constantly and the label supported all of the dates with advertising. Abramson stressed the fact that in the early stages virtually all of the money spent for BTO went to radio ads in conjunction with the band's performances, with Chicago, Minneapolis, St. Louis, Nashville, New Orleans, Detroit and Seattle being the first markets where BTO started to break while in the beginning phases of development. "Print advertising was basically a supplement after the name BTO had become known so that a visual of the product could be associated with the sound," Abramson said. "The second album moved quicker, and then one rack jobber in particular really believed that the group would make it and featured the disc in the chains and coupled with lots of advertising the album really sold."

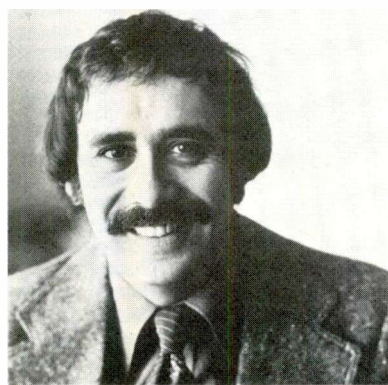

Stan Bly

played their first record before it was really a hit. Word got around and after a few shows a demand was built for the group and then it was our job to determine the best markets to attack."

Randy Bachman's association with the Guess Who was beneficial in gaining better exposure for BTO's records in the States, and Phonogram/Mercury capitalized on this natural advantage by offering incentive programs to its promotion personnel so that they

Steve Francis and BTO's Publishing

■ MIAMI—Steve Francis, license coordinator of Screen-Gems Columbia Publishing, in Miami, has been a booster of Bachman Turner-Overdrive since the beginning. Francis relates, "A couple of years ago I heard the first BTO single, 'Blue Collar,' and really dug it. At the time the group was playing at the University of Miami as a second act. I decided to check them out and heard that certain something, that gut level driving rock. They knocked me out, performance wise. After the show I went backstage to introduce myself to the band and Bruce Allen. We got to know each other and went out for a super Chinese meal."

The evening led to BTO's signing with Screen-Gems Publishing which now administers their music copyrights and prints all BTO songbooks and sheet music. Francis does the arrangements for the songbooks along with Randy Bachman, as well as helping with the layout and photo displays of the books. Francis says, "We have creative control, but the final say is the group's decision. There (Continued on page 39)

would "get behind the records and not take no for an answer." Bly explained that bonuses were offered to those who secured quick airplay or who got the most airplay for a record.

Intangibles

"It was a day to day, hour to hour effort by everyone in the promotion department," said Bly. "There's so many intangibles you have to deal with effectively in these situations. We had promotions that zeroed in on BTO product in an area over and above the normal push we had on it. The radio benefits were an enormous help; the stations that went with the group's records were very important in the group's success here. So many things must come together for a group not only to have a hit but to reach the level that BTO has reached."

All of Mercury's promotions were enhanced by BTO's total cooperation: the group worked when and where they needed to (Continued on page 38)

PHONOGRAM IN TOP GEAR



phonogram



FOR BTO - WORLDWIDE



***With Phonogram in the driving seat
of the fastest vehicle to success***

BTO, ON THE MERCURY LABEL, IS MARKETED BY PHONOGRAM ALL OVER THE WORLD, EXCLUDING CANADA

BACHMAN-TURNER OVERDRIVE

A Bachman-Turner Overview (Continued from page 6)

likens his "raised on rock" background to Randy's. But BTO is his first major group endeavor, having joined when Tim Bachman left for personal reasons just before the "Not Fragile" album. Rounding out the all-writing band, he can more often than not be found in rousin' riffs comin' from the right channel of your stereo system, as well as in backup vocals.

Together, these four men are plugged straight into rock consciousness on its most accessible level. How odd then to learn that after two unsuccessful Brave Belt studio efforts, some 20 labels could not hear the dawning of BTO in their third, which became the first Mercury package. At first, it seemed that despite Randy's prior accomplishments, his newly rock-infused second offering was in for more than its share of hard times.

Early on, booking agency ex-

gone into great detail in explaining BTO's road ethic to members of the press. While in Britain last spring, he elaborated in business-like fashion: "Even if there isn't a market, we'll try to create one . . . We really play out of the way places where fans come from a 500-mile radius . . . We'll go back to a town four times a year, building up the audience each time. It's just our policy to get out and do it no matter where we are, and it's paid off." (The last observation is a prime candidate for Understatement of the Year.)

From May '73 to May '75, the Bachman-Turner Overdrive machine made good on putting its pet theory into positive practice, appearing before some 2.5 million people at over 230 concerts in 130 cities. To accomplish all of this meant traveling some 700,000 miles in this two-year period.

zies to greet their arrival. An outdoor appearance for KSHE drew local TV news coverage in St. Louis; in-store appearances in Seattle were bringing out crowd control police along with the crowds.

Meanwhile, Phonogram's radio spots were supporting BTO in headliner fashion, even in markets where they were third or fourth on the bill. More tour backing came from the label when a \$14,000 loss—certainly not unusual in a formidable formative situation of such magnitude—threatened to mess with the band's momentum.

A glance at the first two years of BTO itinerary gives the outward impression of being one solid tour. It's now well documented that sales built city-by-city as Bachman-Turner Overdrive continued its non-stop road life. Yet for all the hectic elements of the

ian's cover sculpture became the motorin' mojo workin' right along with the hard-drivin' sound, as it rolled on through the U.S. live and over the airwaves.

When "Blue Collar" was pulled as the second single (8-8-73), Overdrive's record sales really saw an upward swing. Chalking up over 100,000 units on its own, the tune kept the album movin' on the charts and into the hearts of FM and college programmers. BTO consciousness was beginning to take shape. Their identity was being felt and appreciated.

With everything so concisely stated and working so well, the band abandoned its plans to call their second album "Adrenaline Rush" and settled for "Bachman-Turner Overdrive II," an even more successful example of what "1" had begun. Live shots of the group were most fittingly moved to the front cover of their packag-



BTO live power in action.

citement was also passing the band right by. It was Paul Smith of RPM that first showed outside-the-band enthusiasm needed for getting the act productive live work. And with the Bruce Allen and Phonogram components at last connected in three-way support of BTO itself, the band's current high-voltage success really began to flow. A total commitment to the road played a large part in Bachman-Turner's power surge from the onset of this teamwork.

All were in agreement that the key to breaking the act would be concert upon concert. Manager Bruce Allen has consistently been quoted as saying: "As long as there's a market, BTO will play there. They play the areas that are starved." This food for thought was echoed in Paul Smith's philosophy which RPM put into action: "Concerts are my first line of offense."

Guitarist Thornton has often

No one in the organization is exempt from the hard work. Randy Bachman spoke of Bruce Allen's commitment thusly: "Our manager comes with us on the road, and when we're tired, then he's just as tired."

Having generated geometrically increasing drawing power while others were crying "recession," BTO still holds onto its fervid allegiance to those towns considered "too small" by groups of lesser stature. Granted, their touring schedule is now in line with their status—a streamlined, consolidated itinerary better designed to keep their engines from overheating. But places like Raleigh and Chattanooga, part of the matrix of cities that made up their initial Southeastern "break-out" market, are still dates to be kept, as are others in Fargo or Sioux City. BTO remembers.

In July of 1973, their road habits were only a month old, but BTO was already causing concert fren-

pace, their dates received instant acclaim from promoters, local press and the local public.

Talking to promoters who have worked with BTO from the start sees certain key descriptive words pop up over and over again: "professional," "dependable," "business-oriented." On-the-spot enthusiasm from the band was never dampened by the Herculean demands of their schedule, nor was it ever affected by the size of the turnout. "They play to each audience as if it was the largest they ever saw" is how one promoter capsulized it.

Bachman-Turner Overdrive's first single, "Gimme Your Money Please" (5-1-73) deals with some "bad goin's on" in the Big Apple; this initial rough 'n tumble rock encounter led directly to the release of the album on which it became the first cut—"Bachman Turner Overdrive" (5-10-73). Impressive first effort chartings followed for both as Parviz Sadigh-

ing while the Seattle-recorded music hit hard from the first day of release (12-15-73). They greeted the new year with a single forced out by demand, one which went top 20 soon afterwards ("Let it Ride," 1-21-74).

The band's current lineup became firm, and so too did the group's international status. "You Ain't Seen Nothing Yet" not only was a U.S. and Canadian monster, but it garnered top 5 and gold attention for BTO throughout Europe and on into South Africa and Australia. "Roll On Down the Highway" (1-2-75) from "Not Fragile" provided a solid follow-up and the perfect bridge to that European tour and next pair of powerhouse chart items—the single "Hey You" released before "Four Wheel Drive" album.

Randy Bachman is indeed a striking combination of good Mormon and solid business tenets. He also runs a tight ship.

(Continued on page 35)

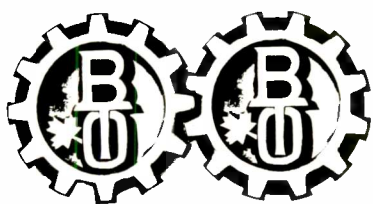

BACHMAN-TURNER OVERDRIVE

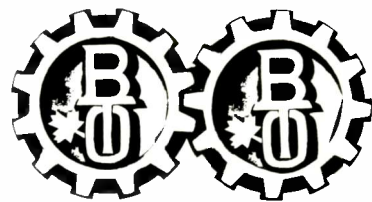

Publicity With a Purpose Aids BTO

By **MIKE GORMLEY**

(Mike Gormley is national director of publicity for Phonogram/Mercury)

■ With all the madness that can go on around rock groups, especially in the beginnings of their career, seldom do you get the chance to put together an organized publicity campaign designed to gain the greatest amount of print exposure for the artist. Well, we didn't get it with BTO either, at least not at first.

The obvious thing to start laying on all the great literary figures found in the world of rock & roll was the fact that Bachman-Turner Overdrive was lead by a man who had already met with great success. Randy Bachman had been leader, manager, co-writer and just about everything else for the Guess Who. Here he was on his way back to the top after illness and no success with a new group had kept him in the dark for



Mike Gormley

over two years. It would seem automatic for the various editors-in-the-know to slip into full speed and get down on paper what this musical stalwart had to say. Wrong—nobody at the national publications really cared. They were too busy at the time with The New York Dolls and Alice Cooper to worry much about this man from Canada. "Lumberjack," they called him. It all meant pos-

sible defeat for Mercury's publicity department, but they refused to give up.

It was time to sit back and see what we had. Randy Bachman had written some of the great rock tunes of the 1960s, including the classic "American Woman;" Randy was a Mormon yet a rock & roller, unlike the Osmond Brothers who looked at the time like they were headed for Las Vegas; BTO travelled constantly in small towns and large cities. Put all that together and the obvious move for the publicity crew was to hit every daily newspaper where the group performed. BTO agreed to do interviews wherever possible and they made it possible in just about every city. It wasn't long before clippings were flowing in from St. Louis, Nashville, Des Moines, and then the northwest with Seattle reporting in along with Portland; then the south followed with Richmond, Charlotte,

and up to Dayton. Story after story about "Randy's Mormon Rock" and "What Does BTO Do After A Concert—Watch TV or Sleep" occurred and we even got some mileage out of the fact that, while crossing from their hometown of Vancouver to the state of Washington, border guards decided these long-hairs definitely had something to hide. After an extensive search a nasty looking bag was found in the bottom of Robbie Bachman's luggage. The border guards gleamed with the knowledge they had another international drug bust on their hands and the old days of Jimi Hendrix flashed through their minds. The bag was dutifully opened and thoroughly searched, to find that bubble-gum freak Robbie was simply bringing his supplies along with him for the duration of one lengthy tour.

The daily newspapers did their
(Continued on page 30)

Thank You

B.T.O.

P&B Lighting
P.O. Box 303
Union, Mo.
63084

**We are pleased to be a part
of BTO's success through
the telecommunications expertise
provided to Phonogram, Inc.**

**Benton, Schneider & Associates
Management Services
Oak Brook, Illinois**

Congratulations BTO,

Bruce Allen and Paul Smith
on the magnitude of your
international acceptance
and success.

A toast to new licks in '76

Rick • Robert • Michael • Glenn • Doug
Kay • Fox • Tinik • Peacock • Banker

Brass Ring Productions
Plymouth, Michigan



BACHMAN-TURNER OVERDRIVE

Polydor Canada Execs Praise BTO's Canadian Strength

By LARRY LeBLANC

■ MONTREAL—If there had been any doubts about Bachman-Turner Overdrive's popularity in Canada they were smashed this summer with the band's incredible coast-to-coast Canadian tour.

Promoted by Beaver Productions' Don Fox and Donald Tarleton of Donald K. Donald, the 16 day tour was enormously profitable, earning an estimated \$1.5 million gross. Radio airplay for BTO was phenomenal with stations falling over each other to program tracks from the band's four Mercury albums. Advance press on the tour, aided by a press junket tour a half week prior to the beginning of the real tour, was ecstatic. What's more, Polydor Records of Canada, which distributes Mercury, was selling the entire BTO catalogue almost as quickly as copies came off the presses.

Says Polydor's new president Tim Harrold: "About the only thing I got involved with at the

company was this tour. It was a pretty big introduction to an enormously popular band. It was a tremendous start. I went to Halifax, which was the first proper date of the tour. I went, of course, to the Canadian National Exhibition which was the biggest date of all. I was very impressed. They're very professional."

Polydor's national promotion director Allan Katz, who has been responsible for BTO's massive promotional push for the tour, also feels that the Canadian National Exhibition date was the highlight of the tour. "I was surprised at the CNE. I never thought I'd see Toronto people rising and lighting bonfires."

The logistics of planning a marketing campaign fell upon Katz who met with BTO's manager Bruce Allen in Wichita, Kansas to work out strategy. It was decided, for example, that an advance show would be set up in Regina and that Polydor would host a press conference, bringing major writ-

ers in from across the country. It turned out to be a brilliant stratagem; it guaranteed BTO some earth-shaking, major press and gave them a chance to capture additional review press once they hit town.

"To me," Katz stresses, "the main issue in our campaign was to give an image to the tour, which I felt was the record company's job, and to sell records. The press conference, junketing people out to Regina, was a major thing in this country. It had never been done before. We were quite uncertain whether or not it could be done. It was a chance to sit down and have BTO direct their media.

"This tour was the first time I have said to myself that almost anything you do will pay off. As a marketing person that's the way I was thinking. The first thing we did was to commemorate the tour and commemorate the group by making up special medallions that were presented individually to the

band and then to the media.

"There was," Katz smiles, "also a horrendous amount of album and single airplay around this time. The CHUM chain had jumped on 'Quick Change Artist,' stations were pulling out album tracks and programming them almost as singles, and there were all those hits from the albums."

Some quarters, in the light of Mercury's dramatic approach of heavily promoting BTO from the start, argue that Polydor Canada has hung back on the band and waited for the U.S. reaction to set in. In all fairness, it should be pointed out that Mercury had the support of a band hitting the road constantly, playing anywhere anytime until the big breaks came. In Canada, on the other hand, BTO has done very few dates and this summer tour was its first prolonged tour. One wonders if the lack of touring here, has hurt them or just built up anticipation over the band.

(Continued on page 30)

Congratulations
and
best wishes
for continued
success
from your
friends at
Queens Litho



CONGRATULATIONS

and
thank you
for many hours
of easy listening

**A
COMPLETE
GRAPHICS
SERVICE**

GRAPHIC DESIGN
OFFSET & LETTERPRESS PRINTING
BINDERY/ENGRAVING
**WILMAR PRINTING
CORPORATION**
333 W. LAKE STREET
CHICAGO, ILLINOIS 60606 (312) 372-5544

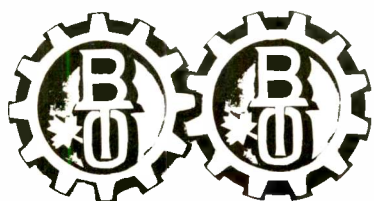

BACHMAN-TURNER OVERDRIVE

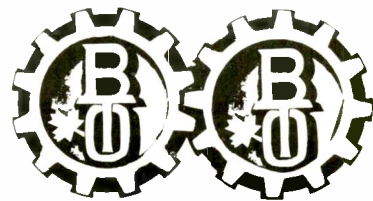

RPM's Paul Smith on Booking BTO

By ELIOT SEKULER

■ LOS ANGELES—Paul Smith has headed the rock division of RPM since the agency's inception about three years ago. His involvement with Bachman-Turner Overdrive began soon thereafter when manager Bruce Allen brought him a test pressing of the group's first lp and a proposal for the fledgling agency to handle the personal appearances of the then-unknown group. "I really liked the album and we put them on the road about three weeks after they signed with us," said Smith. "They did every kind of date, from clubs to one-nighters at \$200 a show, working as opening act for any-

Pat O'Day Praises BTO's Live Power

■ SEATTLE — Concerts West is involved in concert promotion on a nationwide basis, from the northwest to the deep south and most markets in between. The firm's Pat O'Day, who has worked closely with Bachman-Turner Overdrive over the past fourteen months, recently commented on the group's ascent to the top of the rock concert business.

"Bachman - Turner Overdrive's success has been the result of music that is very, very broad in appeal — extremely uncluttered, straight - ahead, uncomplicated rock & roll. We've done shows with them in Terre Haute, Indiana, Charlotte, North Carolina and Fort Worth, Texas and the same great response in every place they've played." The Fort Worth, Texas engagement has special significance to O'Day as the site of an imaginative go-kart party that was arranged for the group following their series of Texas dates. "We rented a go-kart track for them and everybody participated in a free-for-all go-kart race. I went through a cyclone fence and wound up in the hospital for two weeks," recounted O'Day.

O'Day looks forward to working with the band for some time to come. "They'll be successful for a long time because they're filling an important need; that's infectious, simple, driving rock & roll music and that's their secret. As long as they continue to produce that kind of music," he concluded, "they'll continue to produce the kind of success they've had."

body who happened to be on tour."

Concentrating on the northwest, Chicago, Detroit and other markets in the midwestern states, BTO built a following, according to Smith "faster than any act that

I've ever seen. They were so good that the local promoters knew the act would break and after a few months, some took a gamble and headlined them in maybe a 2000-seater." Smith credits Phonogram/Mercury with providing an

enormous amount of support for those crucial first headlining dates.

In their first year as Bachman-Turner Overdrive, the group worked as much as three months without a break, playing a dizzying succession of one-nighters until the first of what would be an almost unbroken string of hit singles became AM radio staples. "When the group broke into the AM market, we just kept going," said Smith. "From the 2000 and 3000-seaters, we went to 5,000 to 10,000 to a 50,000 outdoor date in Pittsburgh."

BTO's schedule is relatively more relaxed now, calling for an average of 10 to 12 successive dates each month. With the remainder of 1975 reserved for re-recording, RPM plans to arrange bookings beginning in January and for eastern and European tours may be scheduled for the group in 1976.



Randy and Blair work it out in concert.

Austin Keeps BTO's Show on the Go

■ When Bachman-Turner Overdrive takes to the road for a concert tour, the group members can rest easy as far as the care and handling of their equipment is concerned, knowing that the goods are in the more-than-capable hands of John Austin and his crew. Austin has been handling that aspect of BTO tours for some two and a half years now, and in that time has developed a reputation and expertise that are second to none.

Recently dubbed "Road Crew of the Year" by Performance magazine, Austin and his co-workers are in constant communication with each group member, dealing with such stumbling blocks as power problems, etc., and traveling one stop ahead of the band in order to ensure trouble-free, on-time gigs.

Schedule

The crew usually starts their work at any given tour stop at about one in the afternoon, and is ready for a sound check, if one is needed (a rare occurrence according to Austin) at about five. If any problems occur during the course of a show, Austin and the members of the group will sit down at the end of the evening to

(Continued on page 38)

SCHON

Congratulates

*"the Biggest, Baddest
and the Best,"*

BTO

Randy Levy

SCHON PRODUCTIONS

MINNEAPOLIS, MINNESOTA 55403

Congratulations

BTO

and

Phonogram, Inc.

Chicago Messenger Service

Coordination Is the Key at P&B

By HOWARD NEWMAN

■ Tom Pehle and Rich Bay of P&B Lighting have presented coordinated lighting effects for Bachman-Turner Overdrive since 1973. Coordination is the key to Tom and Rich's concept of their job. They work hand-in-hand with the members of the band, Bruce Allen and the Clair Bros. sound crew to achieve the maximum lighting creations necessary for a rock group of BTO's stature.

It is almost an accident that Pehle and Bay came to work for BTO in the first place. In early 1973 BTO was playing a date in the St. Louis area (P&B's home-ground) with REO Speedwagon. At the time Tom and Rich were involved with lighting for low-budgeted midwest regional bands and were interested in checking out the newly formed Bachman-Turner supergroup. They were incredibly impressed by what they saw and after the show went

over to road manager John Austin to give him their professional compliments and to introduce themselves on a business level. As fate would have it, Austin was stuck for a ride to Joplin, Missouri and the pair was able to provide him with a lift in their van. The opportunity was given Austin to become acquainted with P&B on a personal and professional level so when the first BTO tour was organized that spring, Tom and Rich hit the road with the group.

BTO is one of the hardest working road bands extant. They were travelling this entire summer, an incredible grind. The usual schedule is a little bit more sane but almost as hectic; seven-12 dates in a row, with two or three weeks off, then back on the road for another dozen engagements. Bay notes, "We're touring at least once a month." All this roadwork brings savvy to a smart technical crew. P&B has learned

to ease their burden by designing special packaging for their equipment. According to Pehle, the packaging design that they employ is unique in the industry, allowing for extra quick loading and unloading through a modular concept. All the lights are pre-mounted on steel frames and pre-wired. According to Pehle, "All that's involved in setting up our lights is fitting the racks and rolling them out. We've been able to set up in as little as an hour and 10 minutes." This gives the crew a great deal of added flexibility in an area that can be all too time consuming.

The basic lighting set-up for BTO does not change from hall to hall, but special consideration must be given to each concert date. The main thing that Rich advocates is "to check on the power availability in a particular hall and count the number of lights going into each circuit." If not enough power is available, the show can be done with half the lights and this occasionally happens. Pehle states that "We do all we can do in advance, but no matter how much preparation you do, you can never get all the problems worked out." An example is a BTO concert in Toronto where the group was roaring through their last number and suddenly the lights blew out. In retrospect, Pehle finds this incident amusing. "We were lucky. By this point in the show the audience was too into it to notice that the lights were gone," he explains, "but we took out half the power in the building."

P&B comes equipped with both industry standard and custom designed lighting apparatus. Their dimmers are all solid-state units made by the Colortron division of Berkey Photo. The stage lighting fixtures are manufactured by Altman and the spotlights are Strong Supertroopers. Aside from their uniquely designed packaging, P&B's own additions to the visual part of the BTO tour are a huge neon sign weighing about 800 pounds and featuring the BTO logo and a non-electric scenic backdrop. The sign was constructed by Tom in consultation with the group members and Bruce Allen. Tom is especially proud of the electric sign. He says, "When the sign is turned on at the right moment, when the

music is most intense, it will get the maximum possible reaction from the crowd."

All of P&B's efforts for BTO are aimed at one goal: achieving the maximum amount of excitement possible. Rich Bay stresses, "There are certain special effects, like the logo sign, that, if they are coordinated properly, can get as much an audience reaction as anything in the show. This is what we're aiming for." Working closely with the band to achieve the desired results has been easy for Bay and Pehle. They claim that although Bruce and the group are consulted before anything goes into the light presentation, the band likes what they do, and there have never been any major disagreements. "They're real easy people to work for," says Bay. "It's all a very coordinated show. We've been doing it so long, we know what we're going to need." Pehle, who actually operates the board in concert, adds, "You would be surprised how coordinated it is. If one of the guys in the group misses a part or overplays a part, I'm so attuned to what should be that it can throw me off, but it doesn't take long to recover and probably the only people to notice it are in the show. Bruce is in constant contact with us during the show, so he can have final say for on the spot decisions."

Work Frequency

The extraordinary frequency that BTO works has made them an all-inclusive gig for Pehle and Bay. They did a week engagement for Kansas earlier this year, but the demands of the Bachman-Turner tour have made regular outside work impossible. They are planning an expansion so they can get another crew out on the road while their personal time is spent with BTO. Although they cannot give other groups individual attention, P&B plans to get their approach to lighting to others by selling their unique packaging system to bands and complete lighting set-ups for clubs and discos. They are currently building a 100 lamp lighting system that is larger than the present set-up and could be used by BTO or any other group that they might become associated with in the future.

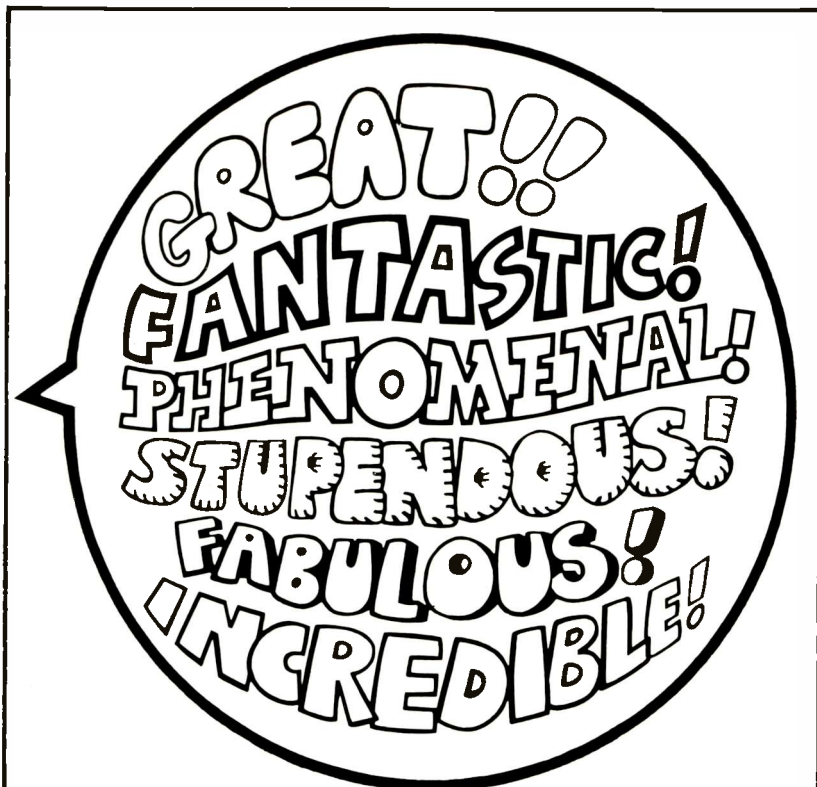

It's nice to know that no matter what you say in a BTO ad or commercial, you're not making an exaggerated advertising claim.

marvin h. frank & co., inc.
Advertising agency for Phonogram, Inc.

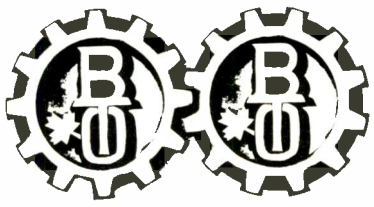

BACHMAN-TURNER OVERDRIVE

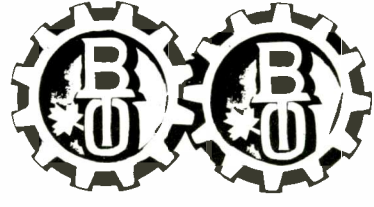

Business Mgr.:

Waymark Finds BTO Unique

■ LOS ANGELES — Graham Waymark is a chartered accountant and executive with the firm of Waymark & Reid, and has specialized in entertainment accounts for eight years now. He became involved with Bachman-Turner Overdrive through a previous business association with Bruce Allen, the group's manager.

"Randy came to me in March of 1973," Waymark recalled, "and at that time I told him I couldn't take him on as a client because I was in the midst of planning a year sabbatical. I went to Geneva, Switzerland for one year and took an assignment with the United Nations. So Randy went with one of my partners in the firm, and I told that partner not to worry about the situation because 'If the fellow's going to make it big, it will take him at least a year to do it, and by that time I'll be back.' After I'd been gone for about eight months, I started get-

ting calls in Switzerland saying, 'There's something wrong. The fellow's already getting things called gold records.' So I immediately came back to handle the account, and we've been together ever since."

Waymark finds working with the group quite different from other rock acts he's had occasion to be involved with. "Randy Bachman, in particular, has more knowledge of business and is more aware of the legalities and the accountabilities of the record industry than most producers and performers that I normally run across. It makes our working relationship a lot easier because I can then talk to him in more technical terms and explain to him the tax ramifications of the matters he gets into. He absorbs far more readily than your typical entertainer who's more concerned with day-to-day than with his future."

Jim Bodenheimer:

Making The BTO Show Happen

By HOWARD NEWMAN

■ Bachman-Turner Overdrive travels with between 15 and 20 tons of electronic equipment. That, in anybody's estimation, provides a logistical problem to move from city to city on a long tour of one night stands. The man who sees to it that BTO is ready to roll is Jim Bodenheimer of Ego Trips Inc. Ego Trips is a Philadelphia based outfit with offices in Los Angeles as well. They have been with BTO since May, 1974. Bodenheimer recalls that John Austin, technical manager for BTO, came to him with the request to coordinate the special moving problems that can occur with a major rock and roll act. The first tour that Bodenheimer had to provide transportation for covered 34 cities in six weeks. This rugged road stretched some 13,500 miles in the short period of time.

Bodenheimer sub-leases all the trucks for BTO. He does not own any of the equipment. BTO provides their own drivers, the chief driver being Brad Varney. Bodenheimer states: "One of our big features is our ability to bail people out of emergencies and if I owned the equipment we wouldn't have the substitute capability we have dealing with the major lease companies. This way if someone breaks down, we can come to the rescue. It's a lot more flexible. The idea is to make the show happen."

Make the show happen they do. Bodenheimer keeps BTO on the road for an average of six months out of the year. One time BTO had dates at opposite ends of the country in a days time. Bodenheimer resourcefully hired a charter cargo plane to make
(Continued on page 35)

Bravo to BTO
*Best Wishes for many
more spectacular successes*



EGO TRIPS
PHILADELPHIA, PA.
Transportation Consultants
(215) 732-4974

**THANKS FOR
EVERYTHING,
BTO, BRUCE & PAUL**

**FROM
RICH ENGLER
DICESARE-ENGLER PRODUCTIONS, INC.**

**The folks at Ye Olde Music Shoppe
Wish to congratulate BTO on their
current tour.**

Continued Success in the future

**Ye Olde Music Shoppe
Marissa, Illinois**



BACHMAN-TURNER OVERDRIVE

Irwin Steinberg

(Continued from page 9)

len, their manager, had was that some sort of stage show was needed. Suggestions were given to him by various people at Mercury on stage presentation and he took their advice, resynthesized it and soon BTO not only sounded fine but their staging also enhanced their performance.

The working relationship between Bruce Allen and Mercury has always been one of professionalism and cooperation. There was and still exists frequent contact between the company and Bruce correlating sales data and airplay information with play dates. Bruce and the group were always open to publicity and promotional activity. Stan Bly, as head of promotion for the company, had the band working many radio station sponsored shows, beginning with WMAK in Nashville. His work with Mike Gormley and the publicity staff has been so successful that BTO has never hired the services of an

outside publicity agency. They simply accept the fact that doing interviews and working with radio stations is as much part of the business as the music. The rapport between Bruce and Mercury has also extended to the financial side. He has studied our accounting and marketing data and procedures and has learned from them. We salute Bruce, whose work has played a major role in the band's success. In the early days he spent considerable time at booking agencies trying to get a foothold on touring. He knew travelling to towns large or small, was important and still lives by that philosophy. The band may only work 10 days a month now because they also believe in being with their families, but during those 10 days they hit places like Fargo, Laramie, and they recently played Lake Charles, La. In other words, they aren't just interested in the New York, Chicago, L.A. circuit, but want to play for everyone.

It is not difficult for me to go on about the virtues of BTO, Bruce and the many people involved. Simply said, it's the wish of every record company president and his staff to work with talented professional people such as BTO whose focus is to work with the record company in a way that has the success of both as its objective.

Mike Gormley

job, however. The editors and writers from national publications were starting to see the name of Bachman-Turner Overdrive wherever they travelled, and in August of 1973 "Bachman-Turner Overdrive I" entered the charts where it was to find a home for over a year, and the single, "Blue Collar," was being heard on the radio. Finally, the big break-through came from Circus Magazine. Jonathan Singer of Circus flew to some American midwest outpost to talk specifically with Randy, and BTO's first national print exposure came about. From that point on national publications such as Creem, Zoo World and eventually—are you ready—Rolling Stone decided these Canucks were worth checking out.

Where the group's itinerary helped considerably on one hand, it hindered on the other. The two major centers to get stories are New York and Los Angeles, and

Polydor Canada

(Continued from page 26)

"The catalogue has sold exceptionally well since the tour," asserts Tim Harrold. "We've noticed an enormous increase in sales. This is reflected in chart placing. All the albums are on the charts. The whole catalogue is moving. I think people who bought one album have gone out and bought the others. I think a lot of people in the U.S. who buy BTO albums are not aware that they are a Canadian group. I think the tour was a homecoming for BTO. They, in effect, had made it overseas and came back. I'm not saying we don't sell one hell of a lot of BTO albums in Canada but there really has been a marked increase since that tour."

"We are rather conscious that BTO is from Canada," Harrold says. "We now, of course, feel a responsibility of finding the BTOs of the future. And Charlie Fach deserves praise for the finding. I think, if you come down to it, the story of BTO has been an enormous success in another respect. American money has been invested into a Canadian act, enormous amounts of money have flowed back into Canada, and there's really no recognition of this in Canada."

Adds Tim Harrold, "I think Mercury has done a damn good job of things and we have benefited enormously from it. What can I say? Success proves it."

(Continued from page 25)

BTO seemed to consider those two cities some sort of "home of the plague." The fact is their entrance into New York didn't set the world on fire, and it wasn't until "You Ain't Seen Nothing Yet" that New York woke up to the workings of BTO and ironically it is now one of their strongholds, recently selling out Nassau Coliseum with plans to return to New York soon. L.A. had softened long before that and both coasts and down-the-middle U.S. were now BTO backers.

The press has since covered just about every aspect of BTO, from Randy's squabbles with Burton Cummings (which has been blown out of proportion) to Blair Thornton coming into the band as they recorded "Not Fragile" and debuting with the band in front of millions of people on "In Concert," the last TV show the group has done in the U.S. Most recently, Robbie and Blair visited

Cees Wessels

(Continued from page 19)

Wessels' job was to convince the label people throughout Europe that BTO had the potential to become a supergroup. And, most countries chose to release the band's second album.

"'You Ain't Seen Nothing Yet' was a hit," Wessels continued. "It was simply in the grooves. It really went over well in England, Germany, Holland, Sweden—most major European markets—and in New Zealand and Australia as well." Wessels feels that promotional films help a great deal in selling product in Europe and saw to it that all necessary exposure that could be generated via that technique was. "We made sure to get a promotional film of the group performing that song and offered it to the various television companies and such. The film really helped break the record in Germany and throughout Europe," Wessels expounded.

In addition, Wessels traveled with the band to the six or seven countries involved in their European tour, reporting particularly enthusiastic response in Germany and the Scandinavian countries.

"We very much rely on television," Wessels repeated. "They did no television while in Holland, Germany and Sweden. And we always offer the stations new films of the band. When a song is being released we automatically make a film of them doing the song." Through that television exposure, coupled with interest at the press level and top notch product, Wessels helped to get BTO's initial product top 40 play in Europe.

"What was really important," Wessels concluded, "was that they toured and made a strong impact as performers. That will keep Bachman-Turner Overdrive successful here in the lasting sense."

Roberta Skopp

New York where they spent three days talking to almost every publication, wire service and syndicated columnist in the country, and in March of this year BTO covered Europe completely.

A point of pride is that BTO has never had an outside public relations firm working for them. They didn't need it, not only because of what I feel is an extremely professional publicity staff at Mercury, but because of the professionalism of Bachman-Turner Overdrive, realizing talking about their craft is as important as producing it.



CONGRATULATIONS BACHMAN-TURNER OVERDRIVE!

STAN KYRI

JULES SIRBU ASSOCIATES

DON M. SCHNEIDER

CONGRATULATIONS BACHMAN-TURNER OVERDRIVE!

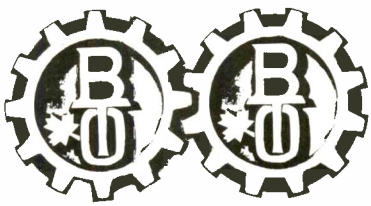

BACHMAN-TURNER OVERDRIVE

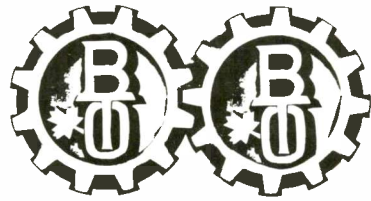

BTO—The Best Around (Continued from page 18)

It was at this point that Tim Bachman left the group and Blair Thornton, a two-set-a-night, six-nights-a-week musician in a local Vancouver band named Cross-town Bus joined up. His first performance with the group was at an "In Concert" taping. With Thornton in the lineup, and people clamoring for new BTO material, the group came up with . . . "B-b-b-baby, you ain't seen nothing yet . . ." and the track that the band thought of as a joke rocketed straight up to the top of the charts, as did the "Not Fragile" album.

Paralleling BTO's phenomenal recording successes were their concert dates (now being made on weekends) marked by record grosses and attendances. A European tour, consisting of 18 concerts in 23 days in this period, repeated their U.S. success and brought home the news that BTO had become a world power.

During their European visit Randy Bachman and engineer

Mark Smith completed mixing of the "Four Wheel Drive" album in London. It had been recorded a few months previously at Sounds Interchange in Toronto. It yielded three hit singles: "Hey You," "Quick Change Artist" and "Rolling Down The Highway."

A particularly rewarding triumph for BTO this summer was a 13-city Canadian tour which reportedly grossed the group \$1.5 million. Promoters of the package were Don Fox of New Orleans and Donald K. Donald in Montreal and Concept 376's Tom Wilson handled booking chores. In many ways it was BTO's flexing of power on home-ground. This was obvious on their first date in Regina, July 28 (a 12,000 sellout). Polydor's national promotion director Allan Katz and Ontario promotion rep Lori Brunor hosted a bevy of prominent Canadian journalists who flew to Regina for a BTO press conference.

A year ago Randy Bachman predicted that a group like BTO

probably had a lifespan of four to five years. It's a quote that was widely reported. I suspect he'd like to forget it because situations change. Asked at the conference if he still felt the same he answered: "I don't know. There are a lot of factors. In the business end, if you are really selling a lot of records and you're not making any money from those records because you have managers, agents, producers and so on taking a big share of the money,

some members will eventually leave. There are also personal differences within the members of the group as to the type of music that each member wants to play. You've all read stories about who left what group and for what reason—we don't really have any of those differences because we've kind of picked the music that we wanted to play, and we stayed with it. We haven't made any revolutionary changes. It's been a natural evolutionary thing."

Waymark, Reid & Co.

CHARTERED ACCOUNTANTS

626 Bute Street, Vancouver, British Columbia

V6E 3M1 (604) 683-3171

REPRESENTED IN PRINCIPAL CITIES THROUGHOUT NORTH AMERICA

It's a pleasure serving you.

Thrasher Leasing Corp.
Birmingham, Ala.

**From one Bockman
To another Bachman
Congratulations BTO**

Bockman Printing & Mailing Services
111 N. Canal St.
Chicago, Ill. 60606

**CONGRATULATIONS
on your continuing success**



**BACHMAN-TURNER
OVERDRIVE**

Thank You

**Bruce Allen, Paul Smith, Bill McPherson
RPM, Ltd., and the entire BTO Organization**

from

**DAVE LUCAS—JOE HALDERMAN—STEVE SYBESMA
SUNSHINE PROMOTIONS, INC.
Indianapolis, Indiana**

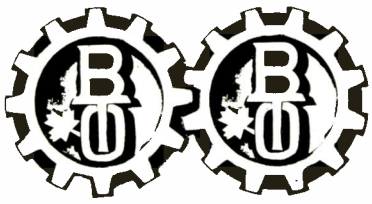

BACHMAN-TURNER OVERDRIVE

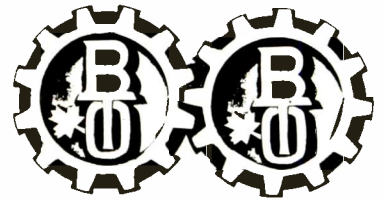

Bruce Allen (Continued from page 10)

got ridiculous. And when we'd been passed by everybody for the second time, Randy was getting very close to packing it in. You just can't go on and on; you've got to say, "Well that's over with. I'll try a new project." But Charlie Fach at Mercury Records jumped at the tape. They loved it after passing it once—the second time around they decided they loved it—and away we went.

RW: Did Mercury give you any reasons for passing the first time?

Allen: When we sent it to Charlie to hear he was at the MIDEM conference in Europe. I heard it went to one of his underlings and it was heard for him; so in reality the top brass at Mercury had never really heard it. So when Randy and Charlie bumped into each other, I think it was in Vancouver or something, Randy said "So you passed on the tape, Charlie?" And Charlie said "What do you mean passed? I never heard it. Send it to me." So Randy added a couple of songs to it, sent it to Charlie and as soon as Charlie heard it—he got halfway through "Give Me Your Money Please"—he said "Don't make any deals. We've got a deal here." And that was it. We flew to New York and put together the deal.

RW: After the deal was made and you had your contract, what did you do?

Allen: The next step was to fly to Mercury Records in Chicago and get trade ads, billboards, belt buckles, posters and all that, and we had our own ideas about how to market them. We thought we were going to be The Beatles. So we went in there to the Mercury offices and met Irwin Steinberg, Stan Bly, Lou Simon and all the big guys at Mercury and sat down with our list of demands and they were ready for us: they told us why our demands were wrong at the time and told us that they preferred to break the act by going out on the street. We listened to their philosophy about working in the States and going at it from a consumer level and it made sense to us. So we said, "Okay, Mercury, you have your idea how to promote us and you say we'll be a big act if we do this." So we immediately threw the ball in their court by doing it. I said to Randy, "Let's go out on the road; let's do the best we can; let's take every job we can get." So we went out on the road. The first date was June 8, 1973, in Nashville, Tennessee. We played for nothing for radio station WMAK, and we kept up the pace. We toured and toured—we went everywhere, playing every market three months at a time and none of them making any sense logistically. We'd drive 800 miles overnight, go coast to coast for a TV show if the record was starting to break out in Seattle and then fly to Cleveland; just going everywhere where the record was starting to get some action, and the label backed us all the way: They backed us at the street level, they backed us with the product in the stores, with displays in the stores, they backed us on the radio. They did everything, and finally the product started to move.

RW: What kept you going then? Just seeing that you were getting on the radio here and there, things like that?

Allen: That was keeping us going plus Randy's and mine American Express cards. And it finally came to a grinding halt when all of our American Express cards, Carte Blanche, everything, was cancelled. We'd run up huge bills and we had no short fall from Mercury. We went to Mercury and we said "Okay, we went out on the road like you guys said, but now we're broke. We can't go on. We know we've got no short fall but could you help us out?" They must have known that we were very very close, because Steinberg went into his office and came back with a check for all the money we'd lost, and that kept us going. Within a short period of time, bang! We exploded. We lived up to our part of the deal, Mercury lived up to its part of the deal and that's why we're a hit act.

RW: What was the audience response to that first show in Nashville?

Allen: Here's what happened. It was a free show and free shows are set up kind of Mickey Mouse. We were supposed to play with Foghat and Charlie Daniels and we were third on the bill and there was another act on the bill. Anyway, Foghat decided it was too Mickey Mouse for them to play; Charlie Daniels got up, played a couple of numbers and said the sound was too bland, then we went up there and played. And we played and played. We did two hours. Nashville and Scott Shannon, who at that time was program director at WMAK, have never forgotten it. While the other groups put down the kids,



Pictured from left are Bruce Allen, Blair Thornton, Charlie Fach, Robbie Bachman, Randy Bachman and Fred Turner with a "Not Fragile" gold record.

put down the station, put down Nashville in general and put down the guys who put on the date, we were out there and did the job and people always remember that. We did it in spite of everything and people went wild. They loved us.

RW: You were a complete unknown at that time?

Allen: We had nothing. Just an album with no single off of it.

RW: Do you actually consider that gig the group's biggest break in the U.S., or is there something else that you can single out as their biggest break?

Allen: Biggest break in the U.S. for us, I guess, was when Rosalie went on our record at CKLW and then it broke out of Detroit. Another one was when St. Louis went on the record. We did a free show in St. Louis and KSHE got behind the record, and those are two big breakout markets that happened for us. Those were our two biggest breaks.

RW: As the record started to break, what were you and the group conscious of doing once you saw stations picking up on the record and getting better response from the public?

Allen: As soon as we saw an area where a station had added the record, what was foremost in our mind was getting to that area—we had to get there because we knew from the way we were going over as a comparatively unknown band that if people saw the band they'd buy the album. We're a "come see" group; when people see us our album sales take off; they always do. So that was the main thing we tried to do. We tried to give the people 35 or 40 minutes of solid rock and roll, and we still try to do that. We grind out all our hits and there's no wasted time, no long, drawn-out guitar solos. We play the music on the album like it is on the album and the people love it because we don't change anything. We were never pretentious.

RW: What role do you play when the group goes into recording sessions? Do you get involved at all with the group musically?

Allen: I have never been in the studio in my life. I don't know what goes on in there, I don't want to know what goes on in there, I'm too hyper-active. I'd go in there and say "That sounds good, let's go on to the next one." I know I'm going to cause trouble in there because I'm not knowledgeable in that type of thing. I'm not a musician. I might go to one or two practices so they can play the stuff and just get my opinion on what I think of it, but I've never been in the studio to watch BTO record. That's strictly Randy's domain and he does all the production work and the band does all the playing and then they come out to me and I hear the rough tape. That's all.

RW: Do you keep up with what other rock groups are doing musically, so you can sort of keep track which way BTO is going in comparison with other rock groups?

Allen: Yeah. There's a few groups out there who go after our market. The Doobie Brothers are one; Chicago is another. They're out there, they're touring all the markets, they go after the same dollar that we

(Continued on page 36)

For Concert Promoter Rich Engler, BTO Has Solid Staying Power

■ NEW YORK — Promoter Rich Engler, who works primarily in the east, booked Bachman-Turner Overdrive's third date in this country, in June, 1973. It was a small club which he secured for the group in Pittsburgh on a friend's recommendation and started a relationship which has led up to the Engler-produced "World Series Of Rock" this past summer at Three Rivers Stadium before 52,000 fans.

Engler, who entered the music business in 1966, and ran his own booking firm, The Command Performance Agency, three years later, now puts on six shows a month. "I don't want to overextend myself or cut myself thin," he told **Record World**. "When I take on a show, I like to go 100 percent; I like to take my time

and work for the act. It's especially gratifying to work for groups like Bachman-Turner Overdrive who I personally believe in.

"I really enjoy working with them because they're great guys," Engler said. "They're just what the audience wants. They're heavy but at the same time they're commercial enough to pick up both AM and FM airplay. Any band who has that much can clean up. I guess the key to our relationship is that once they saw the job I did they believed in me like I believed in them."

Another important factor in BTO's success, according to Engler, is Bruce Allen's management. "I met Bruce the second time I did some dates for them. I think

that it's important for a group to have that kind of management."

'World Series'

Engler's most memorable BTO date was his "World Series Of Rock" concert which set attendance records in Pittsburgh by drawing 52,000 people for a \$437,000 gross. BTO headlined the event over Dave Mason, Foghat, Styx, Kansas, and Bonaroo.

"Bachman-Turner Overdrive should be around for a long time to come," said Engler, "with all they've got going for them, they won't ever have to worry about getting burned out."

Barry Taylor

**Subscribe to
Record World**

Albatross' Kinnear:

BTO Deserve All Their Success

■ NEW YORK—"I think that the success of Bachman-Turner Overdrive in the Seattle area and throughout the northwest is due to their basic grass roots following," observed Ken Kinnear of Albatross Productions, a promoter who has been instrumental in bringing BTO before increasingly large audiences in the northwest for the past two years.

First Encounter

Kinnear, who has been promoting regional concerts since 1972, originally saw Bachman-Turner Overdrive perform in a small club in Vancouver. "It was shortly after the first album was released in 1973 and I was really impressed," Kinnear said. "Unfortunately, there was nothing happening for them here. They weren't getting any airplay and they didn't have an agent; in fact, I couldn't get hold of them at all, at the time."

Kinnear, who owned a concert theater and a 600 seat club in Seattle, called Judge Roy Bean's, managed to get the group by September. "The show was a sell out and we recorded it for future broadcast on the local progressive radio station.

"The concert was a big success," Kinnear reflected. "In fact, the FMs started playing the album the next day."

Headline Dates

Kinnear brought BTO back to the area in November, opening for groups like Rare Earth and the Climax Blues Band. By early 1974, Kinnear was able to command headlining dates for them in cities like Portland, Seattle and Spokane.

"We started them headlining the 1200 seat halls. Then three months later it was 3000 seaters and three months after that, the group was breaking virtually every

attendance record set in places like the Dakotas, Montana, Laramie, Wyoming, Salt Lake City, Denver and Idaho. In Seattle, they (Continued on page 38)



Congratulations
B.T.O.
and
Phonogram, Inc.
on your huge success.

Photomatic Corporation, Chicago

ROCK IS THEIR LIFE... THIS IS THEIR BOOK

BACHMAN TURNER OVERDRIVE
ROCK IS MY LIFE THIS IS MY SONG



THE AUTHORIZED BIOGRAPHY BY
MARTIN MELHUISH

**THANK YOU
RANDY, FRED,
BLAIR, ROB
AND
BRUCE ALLEN**

Marty

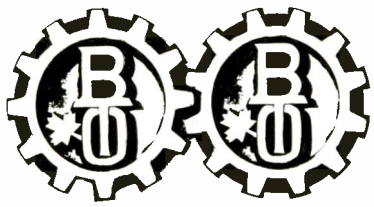

BACHMAN-TURNER OVERDRIVE

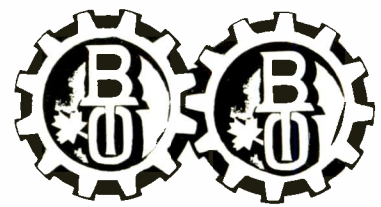

Randy Bachman *(Continued from page 20)*

I had about 24 or 25 rejections, all of which I saved and I've got them on the letterhead saying "We pass," and it's neat to have them now. It was not neat to get them three years ago. Then we made the deal with Mercury, with Charlie Fach, and at the same time I realized we needed a manager. Up to that point we didn't need a manager because there was nothing to manage.

We were being booked by Bruce Allen in Vancouver and I liked the way Bruce worked: if somebody needs to jump three feet in the air, he can yell loud enough to make them jump that high. He can get the job done. The way he acted was the way I thought big-time managers should act. I've been a friend of Neil Young's for 15, 16, 18 years and I used to visit Neil in L.A. He showed me how David Geffen and Elliot Roberts handled their artists and bang! I saw what managers should do. They would call the record label and scream for three hours until they got ads, radio support, T shirts and everything they wanted. A lot of guys don't know how to do that. But that's the way Bruce was dealing with people in Canada in selling his groups. I went in to Bruce's office one day and I said "Bruce, I really like the way you've been handling our group and I want you to manage it." He sat there stunned and he said "Well, you know more about the music business than I do." And I said, "We'll help each other because you can talk like I can't talk." I'm not really a heavy guy; I'm more mellow. I tend to say please to somebody instead of yelling at them to get them to do it. We shook hands on it and it really has worked out.

RW: When you were beginning as BTO and your album was starting to happen, did you establish any goals for the group to reach?

Bachman: Well, when I put BTO together I could have had super musicians from all over the world, but super musicians have age problems or dope problems or personality problems that obviously are not going to match with what I want to do with the other half of my life. So I got competent musicians with compatible personalities. That is, Turner and Robbie and myself and now Blair Thornton and Bruce Allen. We're all like brothers and that's how I think we made it through a lot of those tough times. All of the Guess Who's 8½ years of rough, tough times was crammed into 2½ years for BTO. It just hit us all at once. There were no ups; it was just all one great big down, one great big curve and gradually we stuck at it until we made it. But there was no up in the middle to keep us going like there was in the Guess Who.

I learned early to have a long-term objective, but I didn't want to tell anyone. What I've learned to do is to set several small goals that will get you to your ultimate goal. I cut the best album I could cut and that was my first goal—get really good rock and roll material and make it a good album that nobody can refuse. Everybody did for a while, but sooner or later it got to the people. I think part of the appeal of BTO is that the little 16- or 18-year-old guitar player thinks he can play it. So he buys our record and he comes to see us. There's that relationship. I used to say that about Chuck Berry and Bo Diddley and everybody I grew up with. So the first thing I wanted to do was cut that kind of musical album. Secondly was to get a label and thirdly was to get that label, the group and an agency working and working and working. When that finally happened we had a gold album and it was like a hit in the forehead with a sledge hammer. I was so busy getting it rolling, I didn't realize that all of a sudden it was starting to snowball way down the line; you can't keep track on how the country is reacting to you. Suddenly we were supposed to do a second album for Mercury 18 months after the first album; I got called four months after the first one was out from Charlie Fach. He told me the first album is doing great and that they'd like another one by Christmas, and I was knocked out. So we went ahead and did that and our career has just been step after step. The records have achieved great things saleswise all around the world and that was my ultimate goal—to be a world-wide success. But I think everybody has to have those kind of goals, those kind of daydreams, or you will settle for less.

RW: As the group has become more popular, how have your responsibilities as the leader of this group changed? Is it harder for you to control things now?

Bachman: Well, things get out of hand only slightly and we com-



Pictured from left: Mercury publicity head Mike Gormley, Bruce Allen, Randy Bachman, Burt Burdeen of WSDM, Blair Thornton (partially hidden), Robbie Bachman, Fred Turner and Irwin Steinberg. The occasion is the presentation of a plaque by Mercury to the group and Burt. Burt was (and is) the program director of WSDM, which first played "Blue Collar," the group's first single to make chart impact. The plaque was presented at a party at the Canadian Consulate in Chicago, early 1974.

municate with each other on a family level. Do you know what I mean? If you have a brother or sister, you can scream and yell at them over a problem and when it's over, you're suddenly brother and sister again. It's forgotten. It's the way you talk to each other. If we were complete strangers in the band we would try to be very polite and say "We've all taken a vote and our ears are bleeding because you're playing too loud." All we say is "Hey look you're playing so loud, man, I can't hear my own amp." We talk like brothers and sisters talk. When it's over there's no hard feelings. Things do get out of hand musically and personality-wise sometimes. Bruce Allen does a lot of intermediary refereeing, but we all know what we want. We all want the same thing, so there's no point arguing over it. If Fred has a red bass or a black bass and it doesn't match Blair's shoes, there's no point in arguing over it; it's trivial.

We have quite a good organization and I have certain responsibilities in getting the music together to record. I'm under a lot of pressure from the record label, a lot of pressure from the agency that wants more product out so they can book more gigs and get more money, and then from our manager—I'm under pressure from Bruce to get product out. But on the other hand, I have to feel the group out to see that I'm not writing sterile songs or putting pieces together that aren't falling together naturally.

RW: You're well-known for being a good businessman as well as a good musician. Why do you choose to be so interested in this side of the industry instead of just concentrating on the music.

Bachman: A lot of it is from self-defense. I've been in music now for 26, 27 years and out of that about 15 or 16 years professionally. I've seen several million dollars slip through the fingers of people I've been involved with and go to people that shouldn't have got it. I'm lucky enough and I was together enough to have a second career in music. A lot of guys don't get that and what I want to make sure of is that me and the rest of the guys in the group get what we deserve and the manager gets what he's supposed to get and the agent gets what he's supposed to get and the label gets what they are supposed to get. I've seen a lot of guys who weren't in good hands and now they're working in ice-cream parlors and garages when they could be contributing and making somebody happy somewhere with their music. Look at the guys in Jimi Hendrix' group. They're broke. I make mental notes of musicians from every kind of band in England, Europe and America and what happens to them after they leave the band. I know what Eric Burdon's doing; I know what Chas Chandler's doing. What are the other three guys from the old Animals doing? What are all the guys in the Searchers doing? What are they doing? And when I look at them I see them doing some depressing things. They at one time made great music and made a lot of people happy with that music, but they were taken advantage of monetarily and now they can't afford to be musicians. I see that all over the place and that's scared me into looking out for the dollars. What I'm doing is common sense.

(Continued on page 42)

A Bachman—Turner Overview

(Continued from page 24)

But early on, Randy explained that he was "religious, but no evangelist" and told an inquisitive Cincinnati reporter of his honest surprise that anyone would even be interested in his beliefs in this regard.

Randy will gladly talk about the fact that, yes, he is "in business." And then he'll go on to calmly explain how his "no" rules are really positive promoters of efficiency. Any super-lofty moral preachments were set to rest later when Bachman elaborated:

"None of the band members participate in any dangerous activities or sports . . . It's not fair to the band if one of us gets hurt on something unnecessarily dangerous . . . It's like we all have an insurance policy on each other."

With BTO so prepared to meet its audience with its "heavy duty rock" (the group's own label for their own music) in full working order, they're also prepared to talk straight for interviews. And when the philosophy of BTO becomes the topic of conversation, their music and their thoughts meld as one.

Randy Bachman has long held an instinctive feeling about what he's doing: "As fickle as the public is, they always want hard rock," he's maintained. And in relating that proposition to Bachman-Turner Overdrive's existence, he continues: "Rock 'n roll songs go on forever . . . we're just exploring."

The founding Bachman has been known to be even more realistic and personal on record. Take these lyrics from "Rock Is My Life" which were committed to vinyl in the "Not Fragile" lp: "You're only as good as your last record/Someday I know we will be gone."

With that very real sense of mortality in mind, BTO's music sets out to challenge reality. This is a group fully aware of the importance of making every moment count.

C. F. Turner has often used the word "accomplished" to describe the power of the band, a term not

typical of the "change for change's sake" brand of philosophy which takes a stand that progression must be the prime focal point of the new rock.

Blair Thornton has detailed this point down to a fine line: "We all like the music we play and don't want to change for the sake of progressing beyond our audience." It's clear that BTO listens to its audience, not to its critics.

In general, critical reaction to BTO's heavy duty rock has followed rather than led public opinion—a kind way of saying that Randy Bachman's quote "Who cares about critics?" is—at least for this band—right on target. BTO happened too fast for the printed word of rock to ever hope to catch up with it on a national level.

Local press corps members fortunate enough to have witnessed the early rise of BTO in 1973 forecasted what now can only be analyzed in glorious retrospect. Yet tastemakers of national prominence who normally won't get on a bandwagon once it's passed them by have seen fit to let loose with praise nevertheless.

John Rockwell of The New York Times described his BTO perspective thusly: "Their music could hardly be called subtle. But in its tough, infectious way, with thumping ostinatos that become compelling for the very repetitiousness, their songs are fun—and simple pleasure is hardly to be despised these days."

On the west coast, The Los Angeles Times' Richard Cromelin used the hindsight of public frenzy to light up his observation that BTO is "a primal, unadorned rock 'n roll beacon . . . which is true to both the letter and the spirit of rock's sweat-soaked constitution."

A literal constitution would no doubt proclaim in its preamble that above all else, if it doesn't roll people over, it really isn't and doesn't rock at all. And in the seventies, nobody is better geared up to send us all to heavy duty overdrive heaven than Bachman-Turner.

Jim Bodenheimer (Continued from page 29)

sure their intricate sound and lighting apparatus would be sitting on stage by showtime. For the more ordinary situation, Jim employs some extraordinary trucks. BTO's vans are two 1975 Ford 350 tractors, hooked up to 45 foot Dorsey trailers equipped with New Way air ride suspension. These are the biggest trailers allowed on the road.

Bodenheimer's working relationship with BTO is excellent.

"They're great people," raves Bodenheimer. "They're real crowd pleasers and know how to satisfy an audience." This is no light tribute coming from a man who currently works with the J. Geils Band, Leslie West, Peter Frampton, and Gary Wright, and has worked with, among others, Lynyrd Skynyrd, Ten Years After, Jeff Beck, the Mahavishnu Orchestra, Humble Pie, Stevie Wonder and the Rolling Stones.

CNE SALUTES

The world's largest
Annual Exhibition
Salutes
Bachman-Turner Overdrive
Canada's
Outstanding rock group

RANDY BACHMAN



FRED TURNER



ROB BACHMAN



BLAIR THORNTON

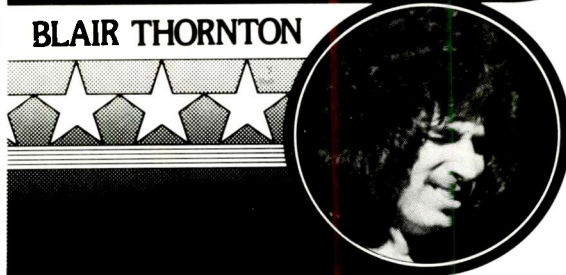

CANADIAN NATIONAL EXHIBITION, TORONTO, CANADA
1976 Dates-August 18 to September 6

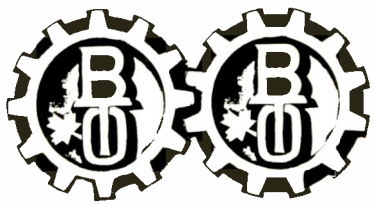

BACHMAN-TURNER OVERDRIVE

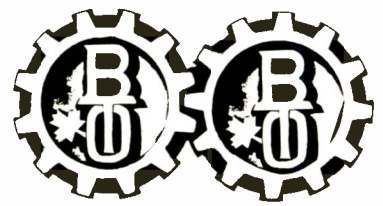

Blair Thornton *(Continued from page 16)*

making \$100 a week and playing somebody else's tunes and being very frustrated because they want to be creative and show their creativity to the world. I didn't realize these problems were in store for me until I started getting up, to this point, then bang, there they were. It took me about five or six months to adjust to that. First of all, I cut myself off from everybody. I didn't see anybody for a while. I'd sit in my apartment and watch TV, and then I said no, that's no good. I wasn't resorting to becoming a junkie or something like that, I was just sitting around saying, "what's wrong?" Then I sort of came out of that shell and went back and made light of everything I did. To all of my good close friends that I had been with before I'd just say, "well yeah, gold records on the wall—that's a joke," which it is in a sense. It's achievement, it's great, but it's a joke too because you kind of go, well all I did was the same thing I've been doing for the last 12 years except I've got a gold record now. So, in effect, there's really no big emphasis on it and that was something that I hadn't done before. I was putting emphasis on it, "this is great, this is great guys." So I realized that it was kind of like fame and fortune and everything was kind of an empty vessel. Now it's kind of like it's something to be achieved and it's nice to try to attain it, but when you get there, you'd better start being able to handle it or you're going to get screwed up.

RW: Was the "Not Fragile" album the first you recorded with BTO?

Thornton: "Not Fragile" came out in August of '74. We recorded it in August of '74 around there. It came out and "You Ain't Seen Nothing Yet" immediately jumped on the charts and just rocketed.

Bruce Allen *(Continued from page 32)*

go after. I can't compare ourselves with the Rolling Stones. I know the Rolling Stones are going to come in here and do a huge tour and make lots of money and sell out every day. We're aware of that. Like ourselves though, the Doobie Brothers and Chicago go all over the States, play everywhere and put out singles. I think these are the guys that I really watch. I'll buy all the Doobie Brothers stuff; I don't buy a lot of Chicago stuff because I don't like horn bands, but I keep tabs on what they are doing. I enjoy watching other acts come up. I enjoy watching an act like ZZ Top start to come up.

RW: How often do you actually see the guys in the group? Do you socialize or is it strictly a business arrangement?

Allen: The only guy in the group I socialize with is Blair, because I play racquetball with him and he also lives very close to me. Robbie lives way out in the country on a farm, Fred is way up in the mountains and Randy I see once a week or so when he comes into town, but I talk to Randy two or three times a day because he's the leader of BTO and he and I are partners in a record company. Randy and I are in very close communication. However, socially Randy and I do not socialize.

RW: At this point in time what is the best thing that you as their manager can do for BTO? What thing is right on top in your mind when you're working on behalf of a superstar international group?

Allen: The most important thing that I can do is make sure that nobody around me—whether it's promoters, the record company or the publicists—relax on BTO. Say, "Well, BTO has got it made now, we'll put out an album that will sell a million and I'll have this date." The promoter mustn't say, "Well, I've got a BTO date so I'll cut back on the advertising because it's going to sell out anyway." I have to keep everybody still enthused as if we were still coming up the ladder. I have to keep everybody enthused and pushing, including the group. The group can't sit back and say "Well, we don't need to work for a while, we're rich now. We don't have to work. We can take a year off and not put out an album." I have to keep everybody motivated. That's the key thing—to keep everybody motivated, and I believe that's what I'm doing. I believe Mercury is still hyped on BTO. BTO still wants to get their product out on the market, they're still writing, they're still enthusiastic; the promoters are still enthusiastic and are still spending the dollars to give us the best quality show. That's what I can do now. I still have to keep everybody interested because it's too easy to let down. Ⓜ

The album started to rocket like crazy and then it became #1. As I was saying before, it was then that I realized that there was something vastly wrong with my personal life. First of all, my parents couldn't understand it. For years they thought I should have another job. I was the black sheep of the family by my relatives because I was this long-haired crazy musician. All of a sudden I'd say hey we're really big now. Listen, I'm telling you we're going to make a lot of money. We're doing really good, people know who we are. "Yeah, sure, son, that's really good, I'm glad for you," they'd say. Then all of a sudden, they started seeing it. I bought them a gardener to take care of their lawns and stuff because my father and mother were getting a little older and it was becoming a hassle. I'd show up one day with this car. "A car, what are you doing? Are you sure you're doing this. You're not dealing in drugs are you?" That was not too hard to take care of. Your family is not too tough. Within five months, I solved the problem. Now I'm okay. I'm fine and happy, but it was a crisis. It's something I talk about because I'm sure I'm not the only person that went through it. I'm sure that athletes go through it. It can happen to a famous journalist or anything like that. Anywhere you reach a certain amount of prestige and success in this type of society, all of a sudden these things happen that you read about that you don't really think are going to happen. You don't think they'll happen to you. They just couldn't, oh come on. When you get there, you suddenly realize that you're there but all of your buddies aren't.

RW: What kind of image do you see BTO projecting?

Thornton: Well, when we came out, we were this heavy duty rock group. We got branded that, and we were sold that way so we had to stay that way. Now we have to scale ourselves down all the time and go four or five chords with a hook. Think about it. If you were to try and write a simple song, you'd see it was very tough limiting yourself to only a few chords. "Not Fragile" came out with a great formula on that album and it sold very well. "Four Wheel Drive" has not sold badly, but it was very reminiscent. It was unfortunate, but it was a rushed album, a bad scene. If "Not Fragile" had not been there, it would have been fine. We're a generation thing like the Stones or The Who. I am primarily a blues-rock oriented guitar player. I can play anything that any other blues or rock player in the world can play. Give me the record and I'll sit down and I'll play it like him too because I sort of think that way as well. Jimi Hendrix sounds like a strange guitar player right? I can sit down for four or five months and get into his mind how he plays and I'll do it because the ability is there.

RW: Where do you see BTO's music heading?

Thornton: We're not going to come out with a rock opera, we're not going to come out with a "Sgt. Pepper." This has been done and we can't do it in our framework. So we have to sort of play the same music that we've been playing—straightforward stomp, but we have to color it. We've got to record it differently. We've got to have a different sound on our instruments. One of the reasons "Not Fragile" and "Four Wheel Drive" sound the same besides similarities in certain songs is that the recording sounds the same. We've got to make sure that our songs don't sound exactly like a lot of other songs. That's the tough part. When you're working with five chords that's when it gets really tough, but more than that, we have to produce it a little differently and we have to make the juxtaposition of songs different when we put it on the album; do a whole bunch of other psychological things. Sort of appear to be a logical extension of BTO without having to resort to playing a lot of jazz or a lot of synthesizing music. We're really stuck because we're not like Elton John who has got this giant wide scope where he can go out and play "Saturday Night's All Right" and be a rocker or he can do "Someone Saved My Life Tonight" or a ballad or something. He can do that. We can't do that because if we do that, we've lost the image. I don't know how long it will last. It's really a tough question. What we're going to do is forge ahead with what we are. We're going to play the BTO things, we're going to try and do what little we can where we can do it, but we're not going to drastically change because we can't afford change. If the fans don't like us any more, then that's it; the logical end of Bachman-Turner Overdrive, it's gone.

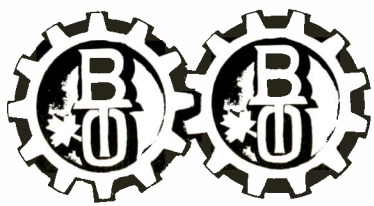

BACHMAN-TURNER OVERDRIVE

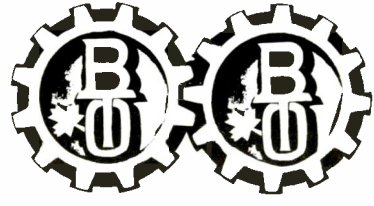

Robbie Bachman *(Continued from page 14)*

did. I never thought about it, because I wasn't pretending at that time that I was a professional musician. It wasn't time for that. As soon as we sold our tape to Mercury, I realized it was good and somebody was excited. I was older then and I knew much more about what could happen; so I just waited properly for it to happen.

RW: Then you were starting to think of the group in more concrete terms?

Bachman: Yeah, we went from playing clubs to playing concerts—it was that quick. And it was a big transition—like whoosh! That was it. But we still drove everywhere. I remember once driving through Toronto. In the back of our Brave Belt truck were Randy, Fred, myself and my brother Gary, who was our manager at the time. We drove from Winnipeg to Toronto through Minneapolis, Chicago and Detroit, because the highways are better than the ones in Canada, and we come up and we're going to enter the tunnel to go into Windsor. We drive by Cobo Hall and I see "Now appearing—Rod Stewart and the Faces—sold out." I'm driving and I'm looking at that sign and I said, "Some day I'm going to play in that place." I didn't tell anybody, I just said it to myself. That was my goal. Two years later we sold out Cobo Hall three days in a row. That's 73,000 kids total; 14,000 a night. I knew I was going to do it, but I don't go around predicting things. I just knew that we were good enough. I really had that feeling.

RW: Were you discouraged when you didn't have a recording contract?

Bachman: No, because there was no big downfall. I was still getting my money, still eating. There was no big worry. The albums were there somewhere. We just didn't stick with that same record company. Mercury said they were really going to work hard. "You guys work and we'll work." We had this agreement with Mercury and they told us—"you'll be a big group and in time you will sell albums; soon things will come, and there are certain things you go by; second album, third album, we do this; fourth album, we do that. By the fourth album, you might have a gold album." I looked at Timmy and I told him I wasn't gonna wait till the fourth album. I'm thinking the first album is going to go gold and I'm going to work toward it and I wanted the label to work toward it. Timmy said "Yeah, why put a deadline? Is there a law or a rule saying nothing will go gold before the fourth album?" They said no, so we worked hard and all of a sudden "BTO I" is on the charts for six months and they ask us to put out another album and the second album went gold, and then platinum, and the first one went gold; and I felt like taking the album and saying "Fourth album?" Now the fourth album is out and they are all platinum and gold already.

I didn't like that holdback. They had a set plan and set rules of what happened and when you got an ad on TV and when you got a big Rolling Stone thing. It's like you learn to walk, you learn to talk, you learn to drive a car, whatever. I said "Okay, I won't argue." But to Timmy I said, "That guy has no right to say that. I don't care if he's president, vice president, whatever. Those are his rules, but they ain't mine and we're just gonna do it and that's it." Everybody was as surprised as we were. I knew it was going to happen but not this soon. It was really fast, just sailing. But it's still hard work.

RW: What does rising to a superstar level do to a group? Do you ever get the feeling that maybe you can just serve up anything and the audience will accept it?

Bachman: Oh no. You really can't put crap out. Because you might just have your old fans and never get any new ones. There's got to be someone somewhere who hasn't heard of Elton John. Where in the hell, I have no idea. Because there's something like 250 million people in the United States and we're one of the top five groups nationally. Now we sell something like 14 or 16 million records in the world. Now, how small is that really? It's bigger than all the other groups, but how small? There's about 40 billion people in the world and of course someone doesn't know who I am. Elton John has sold 46 million and still there's 250 million people in the States. Right? And they are just all of a sudden going to hear this guy. Now if he comes up with crap, and says I can throw anything out, people will say it's crap. And they won't buy any of those other 20 albums or whatever else he has out and he won't get any new fans. His popularity won't

grow and his crowd will say, "Oh, well, he's not as good as he used to be." You're not going to keep getting new kids and the old ones won't stay with you either.

So I try to think that everytime we put an album out 2000 more kids have to buy it. Someone else is going to like that song. Someone else has to hear us now. And you keep growing and growing. If it's not good enough, you're going to grow, you're going to be there at a level for awhile and then fall down.

RW: Is it sometimes hard to concentrate as much as you need to? On your material? Or maintaining that level?

Bachman: No. Because I look where we are now and I know we're here because we worked hard. So I'm just going to continue to try harder. I don't want it to end. I just want to keep going. I don't want to stop doing this because I really like doing it. I like having fans jump all over me and come and see my concerts and buy my records.

RW: What do you want for yourself and for BTO in the future?

Bachman: I would like to continue like The Who and the Rolling Stones. And Elvis. Have a cult that would follow along and grow up with us. And, just continue to play. I'd like to go like The Who for 10 years.

And I would like to have a cult following—an age group. Like kids now that are 12 years old, when they're 16 they'll buy our records. When they're 18 they'll buy a new album. Like the Beach Boys, okay? So they can say "When I was 18, I did this, when I was 16 this, when I was 12, I bought my first BTO album when I was 10." I'd like to go for another five years. I certainly enjoy it, and I think everyone else really does. There's no doubt that we can do it.

When the music's over

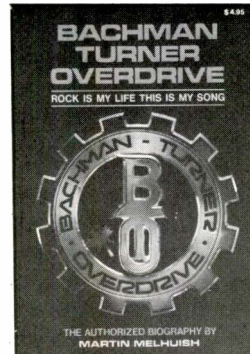

What is it like to be one of the most popular rock'n'roll bands of the mid-70s? Martin Melhuish tells this and much more in this biography of a top band of our time. \$4.95

Available at all Bookstores

Order from:
Methuen Publications
2330 Midland Avenue
Agincourt, Ontario
Canada M1S 1P7

U.S. orders only:
The Two Continents
Publishing Group Ltd.
5 South Union St., Lawrence, Mass. 01843

Best wishes
& continued success
in the future to
BTO.

Many thanks
for the prosperity
you passed on.

A.B.C. Litho-Chicago

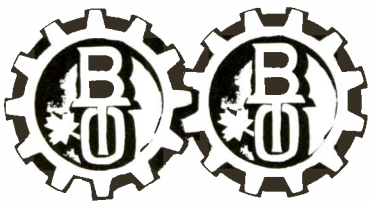

BACHMAN-TURNER OVERDRIVE

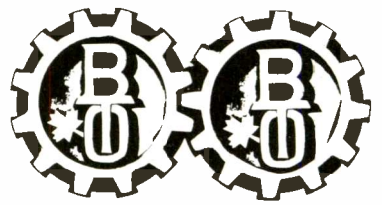

Stan Bly *(Continued from page 21)*

work and they were unrelenting in their drive to the top. Bly points to this when he reflects on

Kinnear

(Continued from page 30)
did the first midnight show ever when 12,000 seats for the first show sold out and another performance had to be added. In that one day, the group played two SRO shows before 24,000 people.

"This past July, we held an outdoor concert in Portland where the group set a new attendance record by drawing 25,000 people. The concert also set a record for the highest gross.

"I really feel that BTO deserves all the success," Kinnear stated without reservation. "In the beginning, they'd go out for 60 days at a time and play places that nobody ever heard of. That's why they have such a loyal following."

Barry Taylor

the reason for the group's success: "Total teamwork helped break BTO and the fact that the group members themselves were willing to do whatever was asked of them was a real plus. There's only so many spots on the playlists and when you're trying to break an act you go with whatever you can come up with to get them seen and heard. BTO certainly didn't hurt our efforts by going to all the markets—large and small—when its record started breaking."

Unlimited Future

As for the future, Bly said he will direct his efforts towards making BTO the top international rock group. "We're going to double our efforts," he stressed "and we're going to reach that plateau. BTO has the potential and talent to be around for a long, long time as the number one group and I'd like to see that happen. Their future is unlimited."

John Austin

(Continued from page 27)

iron them out and prevent their recurrence.

The road crew works on an extremely tight schedule, usually a "14 day basis—a week to two weeks a month" as Austin told **Record World**. They then go home for a well-needed two week rest, and then it's back on the road again.

"We all work together well," said Austin. "No one person just does sound and that's it. If somebody else has a problem, we all chip in and help."

When asked what qualifies a working team for "Road Crew of the Year" honors, Austin stated simply that "we create no hassles. Nobody power trips on anybody; if there's anything to be said, people comes to me and then I go to the promoter."

Austin sees the current success of Bachman-Turner Overdrive as a product of their "going out and working their butts off, playing to everybody and anybody. We did our first tour in 47 days—42 dates in 47 days; we covered 13,000 miles."

As for the future, Austin hopes to branch out within the industry, hopefully in the area of engineering (he already mixes one group at home in Vancouver). But at present, he's still the man that keeps the BTO show on the go.

Brad Varney:

Vehicular Virtuosity for BTO

■ Brad Varney has been driving the big rigs for BTO since their first major tour in May, 1974. One of the first assignments he recalls was getting the group's equipment from Chicago to Florida in two days, which is some truckin'. Brad remembers that first tour: "John Austin was such a hard worker, if it wasn't for his efforts in those days, BTO

wouldn't get there. It was hard for the road crew on a very difficult tour."

Brad didn't make every trip on the first tour; the chief driver then was John Mullin.

The experience of eight tours has straightened out some of the earlier difficulties. Brad stated. "The trucking is set up pretty well" *(Continued on page 41)*

Fred Turner *(Continued from page 12)*

RW: How do you feel about gigging? Do you enjoy it?

Turner: Yes, I do enjoy it. You get on the road, away from your family and friends and say "I've got to get home." But then you get home and you sit around for awhile, and you're ready to go again.

RW: Since the group has been so successful with commercial hard-rock, do you feel a pressure to continue in that same direction?

Turner: Oh, there's always pressure. For example, right now I'm in the process of moving. I've got about five different things going and we're pressured to do a single and an album right now. So I've been in and out of the studio. I've been getting up at seven in the morning to get things together and start packing and get enough time in the studio. The pressure's always there. Of course there are the outside pressures from friends and old acquaintances to listen to their music and try and do something for them.

RW: But what about pressure to continue in the direction that you've been headed for fear that if the direction changes the success will diminish?

Turner: I don't worry about that.

RW: Is there any desire to change musically?

Turner: Yes, there's a desire. For example, we went into the studio and cut three sides for a single that's going to be released very soon. We started off trying to change directions and get a little bit more intricate. We went into the studio, started to play, something came together, and then, during the playback, we started to simplify it. To us, it was just too cluttered and we got back to the same old thing again. That seems to be where we play our best together and where everything seems to gel for us. Everytime the music starts to get a little bit busy, we don't like it. It takes the heaviness away. We're trying to spread out a little bit but it's coming very, very slowly. We don't like what we hear.

RW: Do you think that the Canadian origin was a handicap in the band's rise to fame?

Turner: No, I don't think so. I think it's the radio here that's a handicap.

RW: How involved in the business aspect of things do you get?

Turner: I try to get as involved as I can so that I know what's happening. Sometimes it's very difficult because all the business is handled between Bruce (Allen) and Randy and what leaks through is what they want to leak through. It's just that way. If they were to phone everyone every time something happened, they'd be constantly on the phone. I try and stay as close to it as I can, and we're in communication all the time, but it is difficult.

RW: Is there any fear about not being able to sustain the success?

Turner: Oh I don't care. I don't let it bother me because if I could go out and get a job as a mechanic tomorrow, I'd still make music. I think my best days were days when I was roaming around Winnipeg and playing clubs with my buddies and having a good time. There was nothing really serious about it—we would just loosen up and play good music. And though I love it now, it has become a good, hard business, and that takes a lot of the romance out of it.

RW: Are you planning any solo projects?

Turner: The only time I would plan a solo project is when everybody says, "Well, I think I'm getting tired." I'll hang with these guys until the last curtain falls.

Wishing

BTO

Continued Success

—●—

The Stampede
&
Mel Shaw

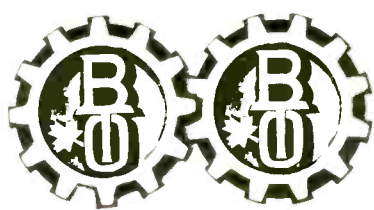

BACHMAN-TURNER OVERDRIVE

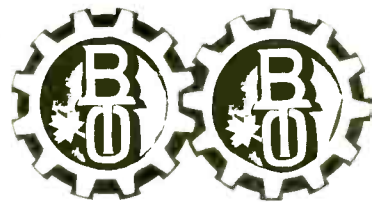

Peter Allies: Capturing BTO's Charisma on Film

■ Peter Allies, a Canadian-based filmmaker, is currently in the process of editing some 36 to 37 thousand feet of footage shot on Bachman-Turner Overdrive, with a small portion of shooting yet to be completed. Allies was approached by BTO less than a year ago, to do a film—a free form documentary — with BTO's main objective, at the moment, being a 60 minute special for television.

Allies has been involved with documentaries for about ten years now, with most of his work based on personality expression dealing primarily with Canadian sports figures and politicians. "You're involved with situations where you're trying to capture what's going on inside a bubble without interfering with the bubble," he explained. "You're moving around the bubble with a minimum amount of equipment, but as much as you need to get the job done." What Allies did, he said, was to come up with a series of suggestions based on the band's

schedule, and thus far he's been out on the road with them on three separate occasions.

"The first actual shooting date was held during a business meeting on February 20," Allies continued. "We have included all aspects of their operations. We have film on their personal lives—although we respect their privacy as much as anyone else. In the European tour I didn't concentrate on the travelogue aspect so much as I did on their personalities; where they are is not quite as important as what they're doing and their relationships. It was incredible fun to travel with them."

Allies is both producing and directing the documentary. He shot the eastern concert tour in the States and the concert in Vancouver, during the latter having used eight cameras. "One of the last places you make it is at home," he said, "their song 'Welcome Home' reflects that and it's really true that Vancouver was one of the last places to recognize

the success of the group." Allies also recalled one particular incident during the European tour that he felt captured much of their personalities: "We were traveling in an executive coach somewhere in the backwoods out of Rotterdam and all of a sudden, out of nowhere, there happened to be a Viennese waltz. Well, the next thing I knew these guys started making waltz sounds and it was just terrific. They just broke off into that—not because I was there—but because of who they are. As a matter of fact, I was thinking of the next shoot but when this happened I got my camera out and got it shot."

The film was shot in 16mm in color negative so that it can be blown up to 35mm with no problem. The film is for use in the States and in Canada (with Canadian airing first) and now there's talk of overseas use and the addition of a Japanese narration. According to Allies, the Canadian Broadcasting Corporation has al-

ready indicated interest and there have been several talks with music/television moguls here including Don Kirshner, Dick Clark and the Midnight Special folks.

Roberta Skopp

Steve Francis

(Continued from page 21)

haven't been any problems, though, because we have a good relationship." Francis calls BTO, "the nicest band I've met."

Aside from the personal friendship, Steve Francis has the greatest admiration for BTO's professionalism. He notes, "Randy Bachman knows this business. A lot of guys don't even know where their money is going." He also cites Bruce Allen as being, "instrumental in their success because he's thoroughly professional." Francis sums up: "the important relationships are the people who believed in you from the beginning. I think BTO appreciates this and doesn't forget who their friends are."

Howard Newman

**“B.T.O.
HEADLINES THE SEATTLE SUMMER JAM...
26,500 AND A RECORD.
THANK YOU.
CONCERTS WEST”**

BACHMAN-TURNER OVERDRIVE

Scott Shannon:

Recalling BTO's First U.S. Concert

By ROBERTA SKOPP

■ NEW YORK—Steeped in the traditions of rock & roll and powered with musical intensity and rhythmic drive, the sound of Bachman-Turner Overdrive offers something extraordinary to the radio programmer and the listening audience. As one New York programmer described, "What is so special about playing BTO on the air is that their music generates excitement within the programmer and the audience simultaneously." With that knowledge in hand, it seems not so unusual that the debut U.S. performance of BTO occurred in conjunction with a benefit sponsored by WMAK in Nashville. Scott Shannon, currently program director of WQXI in Atlanta, held a similar position at WMAK several years ago, when the event took place. The group's professionalism, determination and love for rock & roll triggered a respect in Shannon for BTI still in full bloom.



Scott Shannon

ance there was an equipment failure. It was at that point that Foghat decided they didn't want to go on. We had gotten everything into fairly good working condition but now we had a really big problem—The show had started at around 6 p.m. and was supposed to go on until around 11:00 p.m. and I just didn't know what to do."

Intermission

At that point Shannon said that he called an intermission, gave out about a thousand WMAK tee-shirts and used the intermission time to talk with Mercury's Stan Bly about his problem. Bly suggested that they go over and talk to the guys in BTO to see if something could be worked out. According to Shannon, the unanimous BTO response was, "We don't care how long you want us to play; we'll play for as long as you want us to."

"Those guys played for two and a half hours," Shannon explained, "and the crowd went beserk and really loved them. Before they went onstage we had discussed the controversy regarding the Guess Who, but those guys were very determined and very calm. The kids just loved them and gave them three huge ovations. At that time they were trying to break 'Blue Collar' but nothing much happened with that. As soon as the next release came out, 'Let It Ride,' we added it."

Independence

"You know," Shannon continued, "a lot of people don't like them because they're so independent but I respect them for that. They did something as human beings that they didn't have to do. I'll never forget it."

BTO's Ultimate Sound Equipment

By HOWARD NEWMAN

■ A rock group with the stature of Bachman-Turner Overdrive demands the ultimate in sound equipment. This is exactly what BTO gets from Clair Brothers Sound of Lititz, Pennsylvania. The details of Clair Brothers' association with BTO were put together in separate interviews with company members Stan Shaak and Tom Swan.

Clair Brothers Sound was founded by Roy and Gene Clair in 1968. In a period of seven years they have built a reputation of unparalleled excellence in the field of concert sound systems as indicated by their associations with such heavyweight bands as: The Rolling Stones, Chicago, Elton John and, of course, BTO.

BTO actually sought out the services of Clair Brothers this summer. They started using them on July 14, 1975. Tom Swan notes that it was his company's reputation and its new four-way system that attracted BTO to Clair Brothers.

A four-way sound system actually consists of four separate speakers systems, just as the two way speakers in your home stereo have a separate tweeter and woofer. Stan and Tom described the components of BTO's system: They use six W-Boxes with a folded horn bass cabinet containing two 15" JBL speakers for the low frequencies (25-250hz). "What we affectionately call the Roy Box is used for the midrange crossover from 250-1000hz," notes Tom. The "affection" goes to Roy Clair, the inventor of the Roy Box. BTO uses 12 of these units each consisting of two 12" JBL speakers in a horn loaded cabinet. The high-frequency duties are handled by 20 JBL 2482 drivers that are operative in the 1-7Khz range. The fourth way is provided by 24 separate super high-drivers which are JBL 075's and JBL 2420's. Stan notes that this equipment can produce sounds over 20 Khz, "but most people cannot hear past 16Khz."

An area of concert production that particularly interests Stan Shaak is stage monitors. A Clair Brothers sound crew consists of two people: the engineer who runs the console, and the stage man who handles the monitors. The tour that went from October 21 in St. Louis, to November 1 in Miami was the debut of Mike

Stahl as engineer and Eric Martell as stage man.

Both crew members work together on the stage set-up and equipment wiring. The engineer will be primarily responsible for the sound check before the show. Stan mentions that BTO is very concerned with the pre-concert preparations, especially getting their monitors to satisfaction. Stan continues, "BTO is loud on stage, so they need loud monitors. We use JBL's with custom built cabinets. With the loud monitors feedback becomes a problem because of the proximity of the mikes to the monitor itself. It's a hard job getting the sound the way each member of the group wants it, and at the same time satisfying the group as a whole."

One of the greatest problems that faces any road crew is fatigue brought on by both long hours and hard work. Clair Brothers crews can eliminate some of this trouble on the BTO tour because their equipment moving is taken care of by the group. Stan comments, "Also, our people travel in the BTO Greyhound bus, so they don't have to worry about being late." Tom states, "Generally speaking, the crew shows up around lunchtime, 11:00-1:00 o'clock. Then the two guys start setting up, which can take the better part of the afternoon. It's rough, but it's their job to work at peak efficiency on the road, and the guys are used to it."

AGI's Ladwig Gives BTO New Dimension

By HOWARD NEWMAN

■ If you have picked up a copy of either of BTO's latest albums, "Not Fragile" or "Four Wheel Drive," you will probably notice something right away; they're three-dimensional. The man responsible for this unusual and highly effective art direction is Jim Ladwig of Album Graphics Inc. Jim says, "We developed the tactile feel, giving the album package extra dimension by embossing. This is common in packaging, but fairly uncommon in record albums."

"The emphasis at Phonogram" according to Jim, "is to have a package that is distinctive for the band and having for the catalogue

(Continued on page 41)

A VERY SPECIAL THANKS TO BACHMAN-TURNER OVERDRIVE AND BRUCE ALLEN

From Dennis Erlandsen and the staff of TRAVELEX RICHMOND LTD., who handle all travel arrangements for BTO TRAVELEX RICHMOND LTD., 655 #3 Road Richmond, B.C., Can. V6Y 2B6 Phone: (604) 274-8844

Jim Ladwig *(Continued from page 40)*

a fresh look in a new package."

Jim describes a four-step process in the development of an album design for BTO. First the idea comes from the band of what they are trying to accomplish. Next,

Brad Varney

(Continued from page 38)

by Bruce Allen. He knows we can only do so many miles a night." The ultimate haul in any day is 700 miles or 14 hours on the road, but 3-500 miles is a practical distance to cover, according to Brad.

Brad's truck hauls the band and lighting equipment, while John Mullin carries the sound gear. They are scheduled to arrive at most destinations by noon, which gives them the day to unwind and get the white line out of their eyes.

Obviously a professional, Brad admires the professionalism of BTO. He comments, "I have a world of respect for Randy Bachman. He knows how to get things done. The band is a great bunch of guys. They're not into drugs or drink and that makes a big difference. I've seen great guys fall apart on the road due to drinking and not getting rest. Also, Bruce Allen knows the band and how to take care of them."

Howard Newman

Album Graphics will draw some rough sketches that reflect these ideas and present them to Charlie Fach, BTO's r&b representative from Phonogram and (up to the latest album) Phonogram's marketing chief, Lou Simon. Third, the comprehensives are developed which are more concrete and are fairly representative of the finished product. Last, after much consultation with the band and Phonogram executives, the final product is completed. It is shown in "proof" form for final approval. The covers are then manufactured at Album Graphics' headquarters in the Chicago suburb of Melrose Park, Illinois.

Jim told *Record World* his philosophy of album cover art: "The more the imagery is integrated into the band and the feeling about what they do, the more successful the cover. The album cover should speak for the band and its music. The BTO logo originally came from an idea by Rob Bachman. It conveys the feeling of strength and power you get from BTO's music. Synergism like this should be created with the artwork, not just the playing off on trends, like the '50s."

Of BTO, Jim says, "I really like them personally. They're up front and easy to work with, and besides that, they're fun to listen to."

Thank you

Randy

Robbie

Bruce

Fred

Blair

For paving the yellow brick road

Your eternal friends,

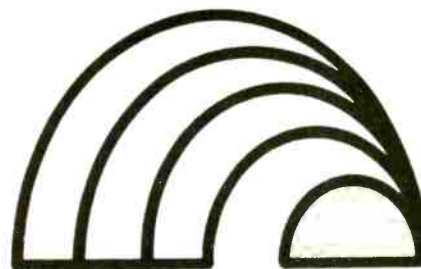

steve glantz productions

To: BTO

From: PHIL LASHINSKY

STEPHEN GUDIS

You made 1975 the best ever.

Looking forward to 1976

and on and on. . . .

ENTAM, LTD.
CHARLESTON, W. VA.



BACHMAN-TURNER OVERDRIVE



Randy Bachman *(Continued from page 34)*

RW: Going on to some of the things you're doing now. You're either in the process of making a new album or you have completed it.

Bachman: We're just beginning. We've got the songs written and if one of them is good enough, Mercury wants to release it as a single like "Junior's Farm," or "Philadelphia Freedom." You know, an in-between single just to put us back on the radio before Christmas and just before the album's out.

RW: Are you going to be making any musical departures on this album from your previous albums?

Bachman: Oh yeah. You know, somebody who won't admit to that is kind of to stay close to the top. I know we can't always be number one—that's impossible with heavies like Elton and Paul McCartney, and Eagles and everybody else. Everybody has a turn at being number one and we've had our turn—it might come up again but who knows. Just to be up there in the top ten is enough to strive for. But to stay there I think we've got to keep our fans fairly interested. And we've stayed within a basic BTO structure and that is songs that are really easy to dance to and really easy to sing. The only thing we're going to do is just stretch some of that out, but it's not going to be contrived. If I feel like doing a longer guitar solo somewhere they're all willing to let me do it. If Blair has a hot solo and if Robbie wants to do a drum solo, we'll let them. We usually just do whatever turns up the best. We don't like to copy anything that we've done other than the basic simple beats and sing-a-long words that everybody can get into.

RW: Could you reveal anything about the BTO movie?

Bachman: We ran into a film crew here in Vancouver and we rented a club and they filmed some songs that we did. We got to talk to these people who were doing our video taping and found out that they were really together people. I said to Bruce, "Instead of going and doing a movie with Dick X, where we have to go down there and do what they tell us to do, let's just see how much it's going to cost us to do our own movie. We won't have any guests; we won't have a lot of stage show. Let's just show what it's like to be part of this machinery. Let's show people what the truck drivers do, what the roadies do, what the light people do, what the manager does when he arguing, the fees, the talking to promoters, and then show what the band does at home and then show what the band does at the studio and what the band does on stage." So that's what we decided to do. It was a pretty heavy investment for the We've had the film crew now following us all over the world for the last six or seven months. We don't have a title for it yet—they're just putting together the sequencing now, but it's all coming together quite nicely. And it's very exciting and we've already sold it to CBC in Canada and we already have somebody marketing it in the United States.

RW: What's happening with your own label, Legend? Are you getting any new acts; is it taking you away from BTO?

Bachman: I can say when I first started, I started out producing a lot of other acts and I had to drop some of them because the initial BTO period was a lot of work. And now we've leveled off to quite a light work schedule. But I like to keep busy and I do it through music. That's what I do all the time. I'm either playing guitar, or playing tapes to listen to music. So it's a natural evolution. You know when we made it, I was what everyone called a hot producer, and Bruce Allen was a hot manager. We got offers from every label in the world for Bruce to handle groups and for me to produce groups. But I didn't want to be forced to work with people I didn't want to work with. So I turned down all the garbage and then I started to get offers to produce on what would be my own label. And the initial offer come from Phonogram/Mercury. So just to compare their deal I checked out some other offers and I happened to get a very good deal with MCA.

The first group I got was Trooper, which was a Vancouver bar band that I first ran into when I came here. They played one of the dances that I was running at church. And at that time my own label deal came through. So I went to them and said "I've got my own label, we don't have to worry about selling the tape. I've got a good budget. Let's just go and do it." So the album has come out and it's doing quite well. It's only been out I think, about a month and it's in the middle 40,000 in albums. And the single sold over 30,000. The single is a hit in Canada. The single didn't do that well in the States, but I expect to reach a point between the second and third albums where people will really want it. But I was very pleased with the initial album. The group wrote some really good songs, and I was pleased with my production. It's a good, super heavy album.

The next thing we have on line is Bill Wray, who is a phenomenon. He's producing his own album now in Denver and I'm going to fly there Saturday after I finish with Trooper in LA and I'm going to play on a couple of cuts on his album.

RW: Are you concerned that BTO be remembered after it's all over?

Bachman: Well, like I said, now that we're on the top, the goal is in the wrong business. You study history you read about Napoleon, Daniel Boone, Christopher Columbus . . . you always remember those names and what they did. We have something now that those guys didn't have and that's records, tapes, video tapes, that are going to be around. I was concerned, but I'm no longer concerned. I know we're going to be remembered by somebody; that millions of pieces of BTO product is going to stay in some homes somewhere. People that see us in concert will always remember us because we give them their money's worth in concert. Ⓢ

**Congratulations
Irwin & BTO
for your
phenomenal
success**

Nate Wortman
Ram Industries, Inc.
3510 N. Elston Ave.
Chicago, Ill. 60618

Congratulations Bachman-Turner Overdrive

Randy Bachman

Robbie Bachman

Fred Turner

Blair Thornton

Happy to be a part of the organization

RPM Ltd.

**400 So. Beverly Drive
Beverly Hills, Ca. 90212**

U. S. A.

(213) 277-6730

Robert Phillips
President

Paul Smith
Vice-President

I wish to express my thanks
to Randy Bachman, Fred Turner,
Robbie Bachman and Blair Thornton
Bachman-Turner Overdrive
for being given the opportunity to
become involved with your success.

Thank you.
Bruce Allen

New York, N. Y.

By IRA MAYER and ROBERTA SKOPP

■ **SING FOR YOUR SUPPER:** While this city's in need, who do we find coming to the fore and offering their services? Well, **Cashman & West** for one (or two). Seems their new Lifesong label got wind that several east coast stations had picked up on the last of four songs from their "American City Suite," released in '72 by ABC. The song's titled "A Friend Is Dying" and over the last two months their Madison Avenue offices have been hearing from friends, who, in turn, have been hearing it on the air. The artists/producers/label heads felt a re-release would be appropriate at this time, in view of the fact that the song is so relevant to the city's current situation. Well, ABC passed, so Lifesong issued on its own, all for a good cause, of course. Cashman & West are donating all artist royalties to the city of New York. The way they've got it figured, if they sell 80 billion records they can pay the city debt in full. With not quite as lofty aspirations, if they sell 400,000 copies they can pay a fireman or a policeman for a year. So do us a favor, please—buy a record . . . Attention New York-based firms: In a previous issue we mentioned a special program between high school students in the city and various companies, specifically WPIX-FM. We've learned more and think it deserves mention. There's a special program run by the Human Resources Administration in conjunction with the Board of Education. High school students eligible for the program apply for internships at various companies (otherwise referred to as the sponsor), are interviewed and satisfactory associations are made whereby the student works with the sponsor for four days a week (for free, folks) and a mutually beneficial situation occurs. The students get to work and learn and the sponsor enjoys his or her capabilities. The HRA is in need of more sponsors, so if you're interested you can contact either Leah Newman at (212) 883-6000 or Joan Brown at 553-6028.

AND THE REGGAE RHYTHMS ROLL: **The Wailers** have recorded two songs with **Joe Cocker** in Kingston for his forthcoming album . . . And, while we're there, the new **Bob Marley & the Wailers** set is expected to be completed at the end of January with a spring release tentatively scheduled . . . A busy Mr. Marley is also working with **Martha Velez** in Jamaica as well. "Aggravation" by Ms. Velez is currently being remixed (the song is from her two year-old "Matinee Weepers" set). Seems that ol' disco trend forced it out again . . . Seems several labels are interested in the solo services of **Joe Higgs**, former Wailer and current bandleader for **Jimmy Cliff**.

ALL AROUND THE TOWN: The Rainbow Collection has been signed to represent singer-composer-actor **Alan Price** in the States and Canada for recording management. Other news about the wonderful Mr. Price is that he's just completed an English tour with a 16-piece band is currently writing songs for a new album planned for release in early spring. Label negotiations are also currently underway. In addition, it looks like he'll take those February blahs away with a tour here to coincide with the album release. Hopefully, his film, "Alfie Darling" will be released here, as well . . . Showing up for **The Tubes** Bottom Line appearance, aside from lots of record industry dignitaries, were **Ian Hunter**, **Johnny Winter**, **Elliott Murphy**, **Ryan and Tatum O'Neal** (sorry Ben), **Tim Curry** and two **Labelle**-ers, **Nona Hendryx** and **Sarah Dash** . . . **Les McCann** involved with a series of jazz lectures at Harvard . . . **Orchestra Luna** is realigning with members **Rick Kinscherf**, **Peter Barrett**, and **Liz Gallagher** remaining. They gave their last performance in their original line-up at CBGB's last week . . . Lots of rumors on the street about **Alice Cooper**. First off is the word that he's readying a Las Vegas act. Secondly, we hear that he's got a film set for national release soon, but no one's sure whether it's "Billion Dollar Babies" or "Welcome to My Nightmare" . . . **Hudson Brother Bill** has been about with **Goldie Hawn**. Those brothers will be feted with "Hudson Brothers Day" in Wayne, New Jersey next week. It's in conjunction with a contest being run by WPIX-FM. The lucky winner gets a pizza party for 20 hosted by the Hudsons at MCA's New York office. Ain't show biz swell? . . . **Greg Lake's** Christmas single will be played as part of the holiday season music at Rockefeller Center and it's possible that it'll get played during the tree lighting ceremony . . . **Loudon Wainwright** and **Bill Graham** surfacing for **Terry Garthwaite's** opening at the Bottom Line . . . Midland International has a contract with another lead singer from **Silver Convention**, **Linda Thompson** who is due out with a single "Ooh What A Night" . . . Street word question's why **Little Feat's Lowell George** didn't want **Alex Harvey** to play on the same bill with him . . . Has **Anthony Quinn** been hanging around the Atlantic offices? . . . **Juggy Murray**, a long time record business personality, is back

(Continued on page 91)

Cain Is Able



Jonathan Cain recently signed a long term recording contract with the newly formed October label. His first release is entitled "Till It's Time To Say Goodbye." Pictured at the signing are, from left: Vic Catala, national a&r director, Claridge Records; Jim Tract, professional manager of Blue Lick Music; J. C. Phillips, vice president, October Records; Steve McCormick, president of October Records; Jonathan Cain; Frank Slay, president of Claridge Records; and KoKo, national promotion director, October Records.

Claridge Sets Holiday Promo

■ **LOS ANGELES**—Claridge Records has planned a special Christmas campaign for the next four weeks that will highlight both catalogue and new lp releases by Bo Kirkland, Jonathan Cain, Mike Boyd and Jerry Corbetta and Sugarloaf. The campaign was designed to focus on new artists Claridge will be promoting during the coming year and will be supported by extensive radio and print advertising.

Bo Kirkland's first lp for the label is titled "Grandfather Clock" after his current r&b single. Jonathan Cain's first October Records (distributed by Claridge) release is titled "Cain Was His Name" and features his new single "Till It's Time To Say

Goodbye." Mike Boyd's first country lp "The Houston Kid" also features his recently released single "Main Street Mission Home."

The label is also planning to repackaging Jerry Corbetta and Sugarloaf's "Don't Call Us, We'll Call You" lp which features his new single "I Got A Song."

Bowie Names Wartoke

■ **LOS ANGELES**—The Wartoke Concern has announced that they have been retained by Michael Lippman, attorney and advisor to David Bowie as exclusive press representatives for David Bowie and all of his professional activities.

Spinners Week in Detroit



The Spinners' Detroit homecoming performance at Olympia Stadium on Sunday evening, November 2, capped a week of festivities honoring the Atlantic Records group. A declaration of "Spinners Week in Detroit" by Michigan governor William Milliken was passed in the State Legislature. Shown are, from left: Spinner Henry Fambrough, governor's representative Roy Williams, and Spinners Pervis Jackson, Bobby Smith, Billy Henderson and Phillippe Wynn.

Farr Taps Dolinger

■ **LOS ANGELES** — Farr Music, Inc. has announced the appointment of Budd Dolinger as professional business manager.

ATTN! OVERSEAS IMPORTERS and U.S.A. EXPORTERS

We transport Records, Tapes, etc. from U.S.A. Offering: Great savings, low freight rates—New American Suppliers for buyers—Assemble various orders—Welcome you when you arrive in N.Y.

Contact:
BERKLEY AIR SERVICES, MARKETING
P.O. Box 665, JFK Airport
Jamaica, N.Y. 11430, U.S.A.

"A dynamic and explosive record that is a must for every rock record collection. Very strong sales throughout our chain of stores." Music Plus, Los Angeles, Calif.

"Initial retail activity was much stronger than we expected and two different re-orders were the result. Retail action is strong in every store." Licorice Pizza, Los Angeles, Calif.

"Ted Nugent is embarking on a journey to superstardom and super sales."

Mile Hi One-Stop, Denver, Colo.

"Ted Nugent is stormtrooping....Top 20 sales consistently in the last three weeks."

Music Menu Stores, Seattle, Tacoma, Spokane Wash.

"Retail reaction to the new Ted Nugent album has been fantastic."

Everybody's Records, Seattle, Wash.; Portland, Eugene, Ore.

"Nugent is definitely happening. We are getting good sell-off and are in a steady re-order pattern."

Eucalyptus Records, San Francisco Calif.

"A killer hard-rock album. Can't keep it in stock."

Banana Records, Terra Linda, Calif.

**Put Ted Nugent
in your store, and turn
up the volume.**

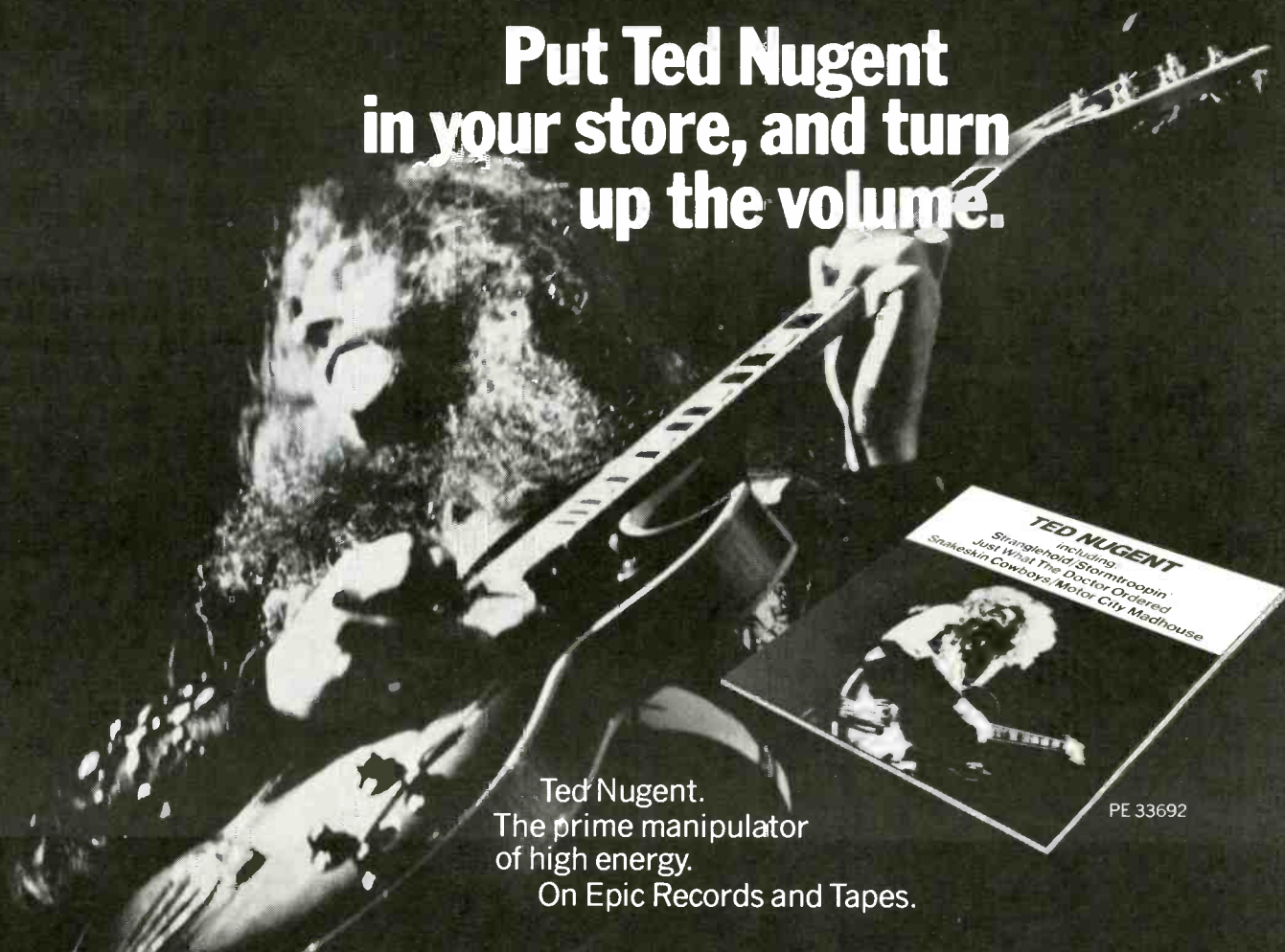

Ted Nugent.
The prime manipulator
of high energy.
On Epic Records and Tapes.

PE 33692

SALESMAKER OF THE WEEK



ROCK OF THE WESTIES
ELTON JOHN
MCA

TOP RETAIL SALES THIS WEEK

- ROCK OF THE WESTIES—Elton John—MCA
- FEELS SO GOOD—Grover Washington Jr.—Kudu
- GREATEST HITS—America—WB
- GREATEST HITS—Seals & Crofts—WB
- SHAVED FISH—John Lennon—Apple
- STILL CRAZY—Paul Simon—Col
- THE LAST RECORD ALBUM—Little Feat—WB

CAMELOT/NATIONAL

- BREAKAWAY—Art Garfunkel—Col
- GREATEST HITS—America—WB
- GREATEST HITS—Barry White—20th Century
- GREATEST HITS—Seals & Crofts—WB
- KISS ALIVE—Kiss—Casablanca
- LAZY AFTERNOON—Barbra Streisand—Col
- PRISONER IN DISGUISE—Linda Ronstadt—Asylum
- ROCK OF THE WESTIES—Elton John—MCA
- ROCKY MOUNTAIN CHRISTMAS—John Denver—RCA
- STILL CRAZY—Paul Simon—Col

MUSICLAND/NATIONAL

- BARRY WHITE'S GREATEST HITS—20th Century
- FEELINGS—Johnny Mathis—Col
- GREATEST HITS—Seals & Crofts—WB
- HIGH ON YOU—Sly Stone—Epic
- MOVIN' ON—Commodores—Motown
- ROCKY MOUNTAIN CHRISTMAS—John Denver—RCA
- SHAVED FISH—John Lennon—Apple
- THE CAR OVER THE LAKE ALBUM—Ozark Mountain Daredevils—A&M
- TRYIN' TO GET THE FEELING—Barry Manilow—Arista
- YOU ARE BEAUTIFUL—Stylistics—Avco

RECORD BAR/NATIONAL

- BY REQUEST—Walter Carlos—Col
- FEELS SO GOOD—Grover Washington Jr.—Kudu
- GREATEST HITS—America—WB
- GREATEST HITS—Barry White—20th Century
- GREATEST HITS—Seals & Crofts—WB
- HOUSE PARTY—Temptations—Gordy
- LAZY AFTERNOON—Barbra Streisand—Col
- LET'S DO IT AGAIN—Curtom (Soundtrack)
- ROCK OF THE WESTIES—Elton John—MCA
- THE LAST RECORD ALBUM—Little Feat—WB

KING KAROL/NEW YORK

- FACE THE MUSIC—Electric Light Orchestra—UA
- GREATEST HITS—America—WB
- HIGH ON YOU—Sly Stone—Epic
- MAN-CHILD—Herbie Hancock—Col
- PASS THE FEELIN' ON—Creative Source—Polydor
- ROCK OF THE WESTIES—Elton John—MCA
- SOLID SILVER—Quicksilver—Capitol
- TOUCH—John Klemmer—ABC

SAM GOODY/EAST COAST

- ERIC CARMEN—Arista
- FEELINGS—Morris Albert—RCA
- GOOD, BAD BUT BEAUTIFUL—Shirley Bassey—UA
- GORD'S GOLD—Gordon Lightfoot—Reprise
- PARADISE WITH AN OCEAN VIEW—Country Joe McDonald—Fantasy
- SHAVED FISH—John Lennon—Apple
- STILL CRAZY—Paul Simon—Col
- THE FACES I'VE BEEN—Jim Croce—Lifesong
- WINDSONG—John Denver—RCA
- YELLOW FEVER—Hot Tuna—Grunt

TWO GUYS/EAST COAST

- ARE YOU READY FOR FREDDY—Freddie Fender—ABC Dot
- BREAKAWAY—Art Garfunkel—Col
- DREAMING A DREAM—Crown Heights Affair—Delite
- FEELINGS—Morris Albert—RCA
- HUNGRY YEARS—Neil Sedaka—Rocket
- ROCK OF THE WESTIES—Elton John—MCA
- STILL CRAZY—Paul Simon—Col
- THE FACES I'VE BEEN—Jim Croce—Lifesong
- TRYIN' TO GET THE FEELING—Barry Manilow—Arista
- WINDSONG—John Denver—RCA

DISCOUNT RECORDS/CAMBRIDGE MASS.

- ABBA—Atlantic
- CITY LIFE—Blackbyrds—Fantasy
- HOUSE PARTY—Temptations—Gordy
- LOVE TO LOVE YOU BABY—Donna Summer—Oasis
- SECOND STEP—Aztec Two Step—RCA
- SHAVED FISH—John Lennon—Apple
- STILL CRAZY—Paul Simon—Col
- THE BAND PLAYS ON—Back Street Crawler—Atco
- THE LAST RECORD ALBUM—Little Feat—WB
- THE WHO BY NUMBERS—The Who—MCA

CUTLER'S/NEW HAVEN

- ALL AROUND MY HAT—Steeleye Span—Chrysalis
- CRUISIN'—Duke & the Drivers—ABC
- DISCO KID—Van McCoy—Avco
- FEELS SO GOOD—Grover Washington Jr.—Kudu
- GREATEST HITS—America—WB
- GREATEST HITS—Seals & Crofts—WB
- RHINESTONES—Just Sunshine
- ROCK OF THE WESTIES—Elton John—MCA
- SHAVED FISH—John Lennon—Apple
- YELLOW FEVER—Hot Tuna—Grunt

GARY'S/RICHMOND

- DARYL HALL & JOHN OATES—RCA
- FEELS SO GOOD—Grover Washington Jr.—Kudu
- HUNGRY YEARS—Neil Sedaka—Rocket
- KISS ALIVE—Kiss—Casablanca
- MOVIN' ON—Commodores—Motown
- THE FACES I'VE BEEN—Jim Croce—Lifesong
- THE LAST RECORD ALBUM—Little Feat—WB
- THE WHO BY NUMBERS—The Who—MCA
- TRYIN' TO GET THE FEELING—Barry Manilow—Arista
- WARNER BROS. PRESENTS MONTROSE—WB

FOR THE RECORD/BALTIMORE

- FANCY DANCER—Bobbi Humphrey—Blue Note
- FEELS SO GOOD—Grover Washington Jr.—Kudu
- HOUSE PARTY—Temptations—Gordy
- JOURNEY TO LOVE—Stanley Clarke—Nemperor
- LOVE TO LOVE YOU BABY—Donna Summer—Oasis
- MAKING MUSIC—Bill Withers—Col

- MOVIN' ON—Commodores—Motown
- PLACES & SPACES—Donald Byrd—Blue Note
- ROCK OF THE WESTIES—Elton John—MCA
- SUPERSOUND—Jimmy Castor Bunch—Atlantic

WAXIE MAXIE/WASH., D.C.

- FEELS SO GOOD—Grover Washington Jr.—Kudu
- FIRST CUCKOO—Deodato—MCA
- JOURNEY TO LOVE—Stanley Clarke—Nemperor
- LOVE ON DELIVERY—Reflections—Capitol
- LOVE TO LOVE YOU BABY—Donna Summer—Oasis
- MAKING MUSIC—Bill Withers—Col
- MOVIN' ON—Commodores—Motown
- SHAME ON THE WORLD—Main Ingredient—RCA
- SUPERSOUND—Jimmy Castor Bunch—Atlantic
- YOU—Aretha Franklin—Atlantic

NATL. RECORD MART/MIDWEST

- BARRY WHITE'S GREATEST HITS—20th Century
- BREAKAWAY—Art Garfunkel—Col
- GREATEST HITS—America—WB
- GREATEST HITS—Seals & Crofts—WB
- IMAGINATION QUOTA—David Werner—RCA
- REINFORCEMENTS—Brian Auger's Oblivion Express—RCA
- ROCK OF THE WESTIES—Elton John—MCA
- SPLIT COCONUT—Dave Mason—Col
- STILL CRAZY—Paul Simon—Col

HANDLEMAN/DETROIT

- BREAKAWAY—Art Garfunkel—Col
- DRAMA V—Dramatics—ABC
- ERIC CARMEN—Arista
- FACE THE MUSIC—Electric Light Orchestra—UA
- GREATEST HITS—Seals & Crofts—WB
- HAVE YOU EVER SEEN THE RAIN—Stanley Turrentine—Fantasy
- MAHOGANY—Motown (Soundtrack)
- ROCK OF THE WESTIES—Elton John—MCA
- RUFUS FEATURING CHAKA KAHN—ABC
- TRYIN' TO GET THE FEELING—Barry Manilow—Arista

ONE OCTAVE HIGHER/CHICAGO

- BREAKAWAY—Art Garfunkel—Col
- FEELS SO GOOD—Grover Washington Jr.—Kudu
- JOURNEY TO LOVE—Stanley Clarke—Nemperor
- KISS ALIVE—Kiss—Casablanca
- PLACES & SPACES—Donald Byrd—Blue Note
- STILL CRAZY—Paul Simon—Col
- THE LAST RECORD ALBUM—Little Feat—WB
- THE WHO BY NUMBERS—The Who—MCA
- WHO I AM—David Ruffin—Motown

RECORD ESTATE/CHICAGO

- FEELINGS—Morris Albert—RCA
- GREATEST HITS—America—WB
- LAZY AFTERNOON—Barbra Streisand—Col
- LOVE TO LOVE YOU BABY—Donna Summer—Oasis
- PRESSURE SENSITIVE—Ronnie Laws—Blue Note
- REDHEADED STRANGER—Willie Nelson—Columbia
- SHAVED FISH—John Lennon—Apple
- THE FACES I'VE BEEN—Jim Croce—Lifesong
- TRYIN' TO GET THE FEELING—Barry Manilow—Arista
- WARNER BROS. PRESENTS MONTROSE—WB

ROSE DISCOUNT/CHICAGO

- FACE THE MUSIC—Electric Light Orchestra—UA
- FEELINGS—Morris Albert—RCA

- GREATEST HITS—Barry White—20th Century
- LOVE TO LOVE YOU BABY—Donna Summer—Oasis
- PARADISE WITH AN OCEAN VIEW—Country Joe McDonald—Fantasy
- REINFORCEMENTS—Brian Auger's Oblivion Express—RCA
- ROCK OF THE WESTIES—Elton John—MCA
- STILL CRAZY—Paul Simon—Col
- TRYIN' TO GET THE FEELING—Barry Manilow—Arista
- X-RATED—Black Oak Arkansas—MCA

RECORD REVOLUTION/CLEVELAND

- AGAINST THE GRAIN—Rory Gallagher—Chrysalis
- ANOTHER LIVE—Todd Rundgren's Utopia—Bearsville
- BACKHAND—Keith Jarrett—ABC
- BRICKS—Hello People—ABC
- CRUISIN'—Duke & the Drivers—ABC
- FEELS SO GOOD—Grover Washington Jr.—Kudu
- IMAGINATION QUOTA—David Werner—RCA
- INDISCREET—Sparks—Island
- JOURNEY TO LOVE—Stanley Clarke—Nemperor
- RUFUS FEATURING CHAKA KAHN—ABC

PEACHES/FT. LAUDERDALE

- BREAKAWAY—Art Garfunkel—Col
- GREATEST HITS—America—WB
- GREATEST HITS—Barry White—20th Century
- GREATEST HITS—Seals & Crofts—WB
- HUNGRY YEARS—Neil Sedaka—Rocket
- LAZY AFTERNOON—Barbra Streisand—Col
- ROCK OF THE WESTIES—Elton John—MCA
- SPLIT COCONUT—Dave Mason—Col
- STILL CRAZY—Paul Simon—Col
- THE WHO BY NUMBERS—The Who—MCA

SPEC'S MUSIC/FLORIDA

- BELLAVIA—Chuck Mangione—A&M
- BRAZIL—Ritchie Family—20th Century
- BREAKAWAY—Art Garfunkel—Col
- FEELS SO GOOD—Grover Washington Jr.—Kudu
- LOVE TO LOVE YOU BABY—Donna Summer—Oasis
- MAHOGANY—Motown (Soundtrack)
- ROCK OF THE WESTIES—Elton John—MCA
- SHAVED FISH—John Lennon—Apple
- TRYIN' TO GET THE FEELING—Barry Manilow—Arista
- WHO I AM—David Ruffin—Motown

POPLAR TUNES/MEMPHIS

- AGAINST THE GRAIN—Rory Gallagher—Chrysalis
- BLACK BEAR ROAD—C.W. McCall—MGM
- FACE THE MUSIC—Electric Light Orchestra—UA
- FEELS SO GOOD—Grover Washington Jr.—Kudu
- GORD'S GOLD—Gordon Lightfoot—Reprise
- GREATEST HITS—America—WB
- HOUSE PARTY—Temptations—Gordy
- MAKING MUSIC—Bill Withers—Col
- THE LAST RECORD ALBUM—Little Feat—WB
- TRYIN' TO GET THE FEELING—Barry Manilow—Arista

MUSHROOM/NEW ORLEANS

- FACE THE MUSIC—Electric Light Orchestra—UA
- FEELS SO GOOD—Grover Washington Jr.—Kudu
- LET'S DO IT AGAIN—Curtom—(Soundtrack)
- MAN-CHILD—Herbie Hancock—Col
- MOVIN' ON—Commodores—Motown
- PRESSURE DROP—Robert Palmer—Island

- ROCK OF THE WESTIES—Elton John—MCA
- SHAVED FISH—John Lennon—Apple
- THE BAND PLAYS ON—Back Street Crawler—Atco
- THE LAST RECORD ALBUM—Little Feat—WB

CIRCLES/ARIZONA

- DRAMA V—Dramatics—ABC
- FEELS SO GOOD—Grover Washington Jr.—Kudu
- GREATEST HITS—Barry White—20th Century
- GREATEST HITS—Seals & Crofts—WB
- HOUSE PARTY—Temptations—Gordy
- LAZY AFTERNOON—Barbra Streisand—Col
- LOVE TO LOVE YOU BABY—Donna Summer—Oasis
- ROCK OF THE WESTIES—Elton John—MCA
- THE LAST RECORD ALBUM—Little Feat—WB
- TRYIN' TO GET THE FEELING—Barry Manilow—Arista

WHEREHOUSE/CALIFORNIA

- BELLAVIA—Chuck Mangione—A&M
- DRAMA V—Dramatics—ABC
- GREATEST HITS—Barry White—20th Century
- HIGH ON YOU—Sly Stone—Epic
- HOUSE PARTY—Temptations—Gordy
- SHAVED FISH—John Lennon—Apple
- SOLID SILVER—Quicksilver—Capitol
- TERRY—Terry Garthwaite—Arista
- TOUCH—John Klemmer—ABC
- WHO I AM—David Ruffin—Motown

LICORICE PIZZA/LOS ANGELES

- BREAKAWAY—Art Garfunkel—Col
- FACE THE MUSIC—Electric Light Orchestra—UA
- GREATEST HITS—Seals & Crofts—WB
- JOURNEY TO LOVE—Stanley Clarke—Nemperor
- MAN-CHILD—Herbie Hancock—Col
- ROCK OF THE WESTIES—Elton John—MCA
- SHAVED FISH—John Lennon—Apple
- STILL CRAZY—Paul Simon—Col
- THE LAST RECORD ALBUM—Little Feat—WB
- WIND ON THE WATER—David Crosby & Graham Nash—ABC

TOWER/LOS ANGELES

- BELLAVIA—Chuck Mangione—A&M
- GREATEST HITS—America—WB
- HOLLYWOOD BE THY NAME—Dr. John—UA
- HOUSE PARTY—Temptations—Gordy
- MAHOGANY—Motown (Soundtrack)
- MAN-CHILD—Herbie Hancock—Col
- SAFETY ZONE—Bobby Womack—UA
- TRYIN' TO GET THE FEELING—Barry Manilow—Arista
- WHO I AM—David Ruffin—Motown
- YOU—Aretha Franklin—Atlantic

EVERYBODY'S RECORDS/NORTHEAST

- FACE THE MUSIC—Electric Light Orchestra—UA
- FEELS SO GOOD—Grover Washington Jr.—Kudu
- FUNKY THIDE OF SINGS—Billy Cobham—Atlantic
- GORD'S GOLD—Gordon Lightfoot—Reprise
- GREATEST HITS—America—WB
- GREATEST HITS—Seals & Crofts—WB
- JOURNEY TO LOVE—Stanley Clarke—Nemperor
- OH WHAT A MIGHTY TIME—New Riders of the Purple Sage—Col
- SHAVED FISH—John Lennon—Apple
- THE LAST RECORD ALBUM—Little Feat—WB



THE ALBUM CHART

PRICE CODE
 E — 5.98 H — 9.98
 G — 7.98 J — 12.98
 I — 11.98 F — 6.98

TITLE, ARTIST, Label, Number (Distributing Label)

NOV. 22	NOV. 15				WKS. ON CHART	
1	1	ROCK OF THE WESTIES	ELTON JOHN	MCA 2163	(2nd Week)	3 F
2	2	WINDSONG	JOHN DENVER/RCA APL1 1183			8 F
3	3	RED OCTOPUS	JEFFERSON STARSHIP/Grunt BFL1 099 (RCA)			19 F
4	4	ONE OF THESE NIGHTS	EAGLES/Asylum 7E 1039			22 F
5	5	STILL CRAZY AFTER ALL THESE YEARS	PAUL SIMON/ Columbia PC 33540			5 F
6	6	CAPTAIN FANTASTIC AND THE BROWN DIRT COWBOY	ELTON JOHN/MCA 2142			25 F
7	8	PRISONER IN DISGUISE	LINDA RONSTADT/Asylum 7E 1045			8 F
8	7	WISH YOU WERE HERE	PINK FLOYD/Columbia PC 33453			9 F
9	10	WIND ON THE WATER	DAVID CROSBY & GRAHAM NASH/ ABC ABCD 902			7 F
10	9	CLEARLY LOVE	OLIVIA NEWTON-JOHN/MCA 2148			7 F
11	11	THE WHO BY NUMBERS	THE WHO/MCA 2161			5 F
12	14	BREAKAWAY	ART GARFUNKEL/Columbia PC 33700			5 F
13	12	BORN TO RUN	BRUCE SPRINGSTEEN/Columbia PC 33795			11 F
14	15	KISS ALIVE	KISS/Casablanca NBLP 7020			7 F
15	16	KC AND THE SUNSHINE BAND	/TK 603			16 F
16	13	EXTRA TEXTURE	GEORGE HARRISON/Apple SW 3420			7 F
17	81	GREATEST HITS	SEALS & CROFTS/Warner Bros. BS 2886			2 F
18	18	PICK OF THE LITTER	SPINNERS/Atlantic SD 18141			16 F
19	22	FACE THE MUSIC	ELECTRIC LIGHT ORCHESTRA/ United Artists LA546 G			5 F
20	19	WHY CAN'T WE BE FRIENDS?	WAR/United Artists LA441 F			20 F
21	21	GREATEST HITS	CAT STEVENS/A&M SP 4519			20 F
22	27	MAN-CHILD	HERBIE HANCOCK/Columbia PC 33812			6 F
23	23	HONEY OHIO PLAYERS	/Mercury SRM 1 1038			15 F
24	17	CAPTURED ANGEL	DAN FOGELBERG/Epic PE 33499			8 F
25	20	MINSTREL IN THE GALLERY	JETHRO TULL/Chrysalis CHR 1082 (WB)			9 F
26	26	GREATEST HITS	ELTON JOHN/MCA 2128			53 F
27	28	LOVE WILL KEEP US TOGETHER	CAPTAIN & TENNILLE/ A&M SP 3405			33 F
28	29	THE HUNGRY YEARS	NEIL SEDAKA/Rocket PIG 2157 (MCA)			7 F
29	24	SEARCHIN' FOR A RAINBOW	THE MARSHALL TUCKER BAND/ Capricorn CP 0161 (WB)			10 F
30	30	THE HEAT IS ON	ISLEY BROTHERS/T-Neck PZ 33536 (Col)			23 F
31	31	INSEPARABLE	NATALIE COLE/Capitol ST 11429			12 F
32	32	BAY CITY ROLLERS	/Arista 4049			7 F
33	35	FLEETWOOD MAC	/Reprise MS 2225			17 F
34	34	SAVE ME SILVER CONVENTION	/Midland Intl. BKL1 1129 (RCA)			12 F
35	33	SPLIT COCONUT	DAVE MASON/Columbia PC 33698			6 F
36	25	WIN, LOSE OR DRAW	ALLMAN BROTHERS BAND/ Capricorn CP 0156 (WB)			10 F
37	55	TRYIN' TO GET THE FEELING	BARRY MANILOW/Arista 4060			3 F
38	48	LAZY AFTERNOON	BARBRA STREISAND/Columbia KC 33815			4 F
39	38	ATLANTIC CROSSING	ROD STEWART/Warner Bros. BS 2875			12 F
40	39	WILL 'O THE WISP	LEON RUSSELL/Shelter 2138 (MCA)			17 F
41	43	BACK HOME AGAIN	JOHN DENVER/RCA CPL1 0548			64 F
42	42	IS IT SOMETHING I SAID?	RICHARD PRYOR/Reprise MS 2227			15 F
43	52	JOURNEY TO LOVE	STANLEY CLARKE/Nemperor NE 433 (Atlantic)			4 F
44	51	BEFORE THE NEXT TEARDROP FALLS	FREDDY FENDER/ ABC Dot DOA 2020			28 F
45	47	SEDAKA'S BACK	NEIL SEDAKA/Rocket 463 (MCA)			18 F
46	46	2ND ANNIVERSARY	GLADYS KNIGHT & THE PIPS/ Buddah BDS 5639			5 F
47	57	FEELS SO GOOD	GROVER WASHINGTON, JR./Kudu 24S1 (Motown)			3 F
48	61	SHAVED FISH	JOHN LENNON/Apple SW 3421			3 F
49	49	JOHN DENVER'S GREATEST HITS	/RCA APL1 0374			102 F
50	36	BETWEEN THE LINES	JANIS IAN/Columbia PC 33394			25 F



CHARTMAKER OF THE WEEK

51 — **BARRY WHITE'S GREATEST HITS**
 20th Century T 493



52	131	ROCKY MOUNTAIN CHRISTMAS	JOHN DENVER/RCA APL1 1201			1 F
53	64	THE FACES I'VE BEEN	JIM CROCE/Lifesong LS 900			3 H
54	37	NIGHTRIDER	THE CHARLIE DANIELS BAND/Kama Sutra KSBS 2607			9 F
55	70	HIGH ON YOU	SLY STONE/Epic PE 33835			3 F
56	63	LOVE TO LOVE YOU BABY	DONNA SUMMER/Oasis OCLP 5003 (Casablanca)			4 F
57	54	TOYS IN THE ATTIC	AEROSMITH/Columbia PC 33471			30 F
58	—	HISTORY/AMERICA'S GREATEST HITS	/Warner Bros. BS 2894			1 F
59	59	BARRY MANILOW I	/Arista 4007			13 F
60	40	DON'T IT FEEL GOOD	RAMSEY LEWIS/Columbia PC 33800			8 F
61	71	FEELINGS	MORRIS ALBERT/RCA APL1 1018			4 F
62	58	THAT'S THE WAY OF THE WORLD	EARTH, WIND & FIRE/ Columbia PC 33280			37 F
63	66	WARNER BROTHERS PRESENTS MONTROSE	/MONTROSE/ Warner Bros. BS 2892			5 F
64	77	MOVIN' ON	COMMODORES/Motown M6 838S1			3 F
65	67	PRESSURE SENSITIVE	RONNIE LAWS/Blue Note BN LA452 G (UA)			13 F
66	74	REDHEADED STRANGER	WILLIE NELSON/Columbia KC 33482			3 E
67	85	THE LAST RECORD ALBUM	LITTLE FEAT/Warner Bros. BS 2884			2 F
68	41	BLUES FOR ALLAH	GRATEFUL DEAD/Grateful Dead GD LA494 G (UA)			12 F
69	45	GREATEST HITS	TONY ORLANDO & DAWN/Arista 4045			19 F
70	65	CITY OF ANGELS	MIRACLES/Tamla T6 339S1 (Motown)			5 F
71	83	THE CAR OVER THE LAKE ALBUM	OZARK MOUNTAIN DAREDEVILS/A&M SP 4549			3 F
72	60	HEARTS AMERICA	/Warner Bros. BS 2852			33 F
73	50	FANDANGO	ZZ TOP/London PS 656			28 F
74	82	PARADISE WITH AN OCEAN VIEW	COUNTRY JOE McDONALD/Fantasy F 9495			3 F
75	78	ARE YOU READY FOR FREDDY?	FREDDY FENDER/ ABC Dot DOSD 2044			7 F
76	89	AN EVENING WITH WALLY LONDO FEATURING BILL SLASZO	GEORGE CARLIN/Little David LD 1008 (Atlantic)			2 F
77	76	DIAMONDS AND RUST	JOAN BAEZ/A&M SP 4527			24 F
78	73	VENUS AND MARS WINGS	/Capitol SMAS 11419			24 F
79	53	NITTY GRITTY DIRT BAND	/United Artists LA469 G			8 F
80	56	E.C. WAS HERE	ERIC CLAPTON/RSO SO 4809 (Atlantic)			12 F
81	62	FOOL FOR THE CITY	FOGHAT/Bearsville BR 6959 (WB)			6 F
82	44	OUTLAWS	/Arista 4042			17 F
83	84	DREAMING A DREAM	CROWN HEIGHTS AFFAIR/ Delite 2017 (PIP)			4 F
84	—	HOUSE PARTY	TEMPTATIONS/Gordy G6 973S1 (Motown)			1 F
85	97	LET'S DO IT AGAIN	ORIGINAL SOUNDTRACK/Curtom CU 5005 (WB)			2 F
86	68	BONGO FURY	FRANK ZAPPA/BEEFHEART/MOTHERS/ DiscReet DS 2234 (WB)			5 F
87	75	THE MANHATTAN TRANSFER	/Atlantic SD 18133			9 F
88	94	FUNKY KINGSTON	TOOTS & THE MAYTALS/Island ILPS 9330			2 F
89	92	RITCHIE BLACKMORE'S RAINBOW	/Polydor PD 6049			14 F
90	90	HOME PLATE	BONNIE RAITT/Warner Bros. BS 2864			7 F
91	72	HOT LINE J.	GEILS BAND/Atlantic SD 18147			9 F
92	93	MELLOW MADNESS	QUINCY JONES/A&M SP 4526			14 F
93	79	AL GREEN IS LOVE	AL GREEN/Hi SHL 32092 (London)			13 F
94	104	MAHOGANY (SOUNDTRACK)	/Motown M6 858S1			1 F
95	80	DESOLATION BOULEVARD	SWEET/Capitol ST 11369			14 F
96	98	ENDLESS SUMMER	BEACH BOYS/Capitol SVBB 11307			46 F
97	69	VISIONS OF A NEW WORLD	LONNIE LISTON-SMITH & THE COSMIC ECHOES/Flying Dutchman BDL1 1196 (RCA)			5 F
98	87	NO WAY TO TREAT A LADY	HELEN REDDY/Capitol ST 11481			18 F
99	88	YOUNG AMERICANS	DAVID BOWIE/RCA APL1 0998			36 F
100	91	IN THE SLOT TOWER OF POWER	/Warner Bros. BS 2880			4 F



Listen With Your



Dan Hill

*is saying something about people, about life, about love
He's saying something about You!*

Produced By Mathew McCandey & Fred Mullin

Now Available On

T-500

101 THE ALBUM CHART 150

NOVEMBER 22, 1975

NOV. 22	NOV. 15	
101	100	MAIN COURSE BEE GEES/RSO 4807 (Atlantic)
102	101	GORILLA JAMES TAYLOR/Warner Bros. BS 2866
103	103	BRAZIL RITCHIE FAMILY/20th Century T 498
104	102	HEART LIKE A WHEEL LINDA RONSTADT/Capitol ST 11358
105	99	PORTRAIT GALLERY HARRY CHAPIN/Elektra 7E 1041
106	116	DRAMA V DRAMATICS/ABC ABCD 916
107	95	THIRTEEN BLUE MAGIC LANE BLUE MAGIC/Atco SD 26120
108	96	LISTEN TO THE CITY TIM WEISBERG/A&M SP 4545
109	—	WHO I AM DAVID RUFFIN/Motown M6 848S1
110	120	A FUNKY THIDE OF SINGS BILLY COBHAM/Atlantic SD 18149
111	121	HAVE YOU EVER SEEN THE RAIN STANLEY TURRENTINE/ Fantasy F 9493
112	112	STRAIGHT SHOOTER BAD COMPANY/Swan Song SS 8413 (Atlantic)
113	86	CAUGHT IN THE ACT GRAND FUNK RAILROAD/ Capitol SAAB 11445
114	113	TOMMY SOUNDTRACK/Polydor PD 9502
115	130	PLACES AND SPACES DONALD BYRD/Blue Note BN LA549 G (UA)
116	118	SKYBIRD TONY ORLANDO & DAWN/Arista 4059
117	128	SIMON & GARFUNKEL'S GREATEST HITS/Columbia KC 31350
118	119	MELISSA MELISSA MANCHESTER/Arista 4031
119	123	GOOD, BAD, BUT BEAUTIFUL SHIRLEY BASSEY/ United Artists LA542 G
120	—	GORD'S GOLD GORDON LIGHTFOOT/Reprise 2RS 2237
121	122	WELCOME TO MY NIGHTMARE ALICE COOPER/Atlantic SD 18130
122	132	YOU ARETHA FRANKLIN/Atlantic SD 18151
123	124	REINFORCEMENTS BRIAN AUGER'S OBLIVION EXPRESS/ RCA APL1 1219
124	126	RETURN TO FOREVER CHICK COREA/ECM 1022 (Polydor)
125	137	MAKING MUSIC BILL WITHERS/Columbia PC 33704
126	127	HAVE YOU NEVER BEEN MELLOW OLIVIA NEWTON-JOHN/ MCA 2133
127	106	DARYL HALL & JOHN OATES/RCA APL1 1144
128	129	LED ZEPPELIN IV/Atlantic SD 7208
129	—	THE BAND PLAYS ON BACK STREET CRAWLER/Atco SD 26125
130	134	LUCILLE TALKS BACK B. B. KING/ABC ABCD 898
131	133	KICK OFF YOUR MUDDY BOOTS GRAEME EDGE BAND Featuring ADRIAN GURVITZ/Threshold THS 15 (London)
132	—	SOLID SILVER QUICKSILVER MESSENGER SERVICE/ Capitol ST 11462
133	135	YOU ARE BEAUTIFUL STYLISTICS/Avco AV 69010
134	105	THE DISCO KID VAN McCOY/Avco AV 69009
135	—	YELLOW FEVER HOT TUNA/Grunt BFL1 1238 (RCA)
136	136	ON THE BORDER EAGLES/Asylum 7E 1004
137	—	SUPERSOUND JIMMY CASTOR/Atlantic SD 18150
138	—	FROM SOUTH AFRICA TO SOUTH CAROLINA GIL SCOTT-HERON & BRIAN JACKSON/Arista 4044
139	107	FLAT AS A PANCAKE HEAD EAST/A&M SP 4537
140	140	SOUVENIRS DAN FOGELBERG/Epic KE 33137
141	108	CHAIN REACTION CRUSADERS/ABC Blue Thumb BTSD 6022
142	146	THE KOLN CONCERT KEITH JARRETT/ECM 1064/65 (Polydor)
143	109	RHINESTONE COWBOY GLEN CAMPBELL/Capitol SW 11430
144	110	LET THERE BE MUSIC ORLEANS/Asylum 7E 1029
145	148	X-RATED BLACK OAK ARKANSAS/MCA 2155
146	111	SO FINE LOGGINS & MESSINA/Columbia PC 33810
147	114	EXPERIENCE GLORIA GAYNOR/MGM M3G 4997
148	115	RIDIN' HIGH JERRY JEFF WALKER/MCA 2156
149	117	CHEWING PINE LEO KOTTKE/Capitol ST 1144
150	125	HORIZON CARPENTERS/A&M SP 4530

151-200 ALBUM CHART

151	FLYING AGAIN THE FLYING BURRITO BROS./Columbia PC 33817
152	LISZTOMANIA ORIGINAL SOUNDTRACK/A&M SP 4546
153	SECOND STEP AZTEC TWO STEP/ RCA APL1 1161
154	OH, WHAT A MIGHTY TIME NEW RIDERS OF THE PURPLE SAGE/Columbia PC 33688
155	ANOTHER LIVE TODD RUNDGREN'S UTOPIA/Bearsville BR 6961 (WB)
156	CRUISIN' DUKE AND DRIVERS/ABC ABCD 911
157	SATURDAY NIGHT SPECIAL NORMAN CONNORS/ Buddah 5634
158	DARK SIDE OF THE MOON PINK FLOYD/Harvest SMAS 11163 (Capitol)
159	BURNIN' BOB MARLEY & THE WAILERS/Island ILPS 0256
160	SAFETY ZONE BOBBY WOMACK/ United Artists LA544 G
161	PHOTOGRAPHS AND MEMORIES, HIS GREATEST HITS JIM CROCE/ ABC ABCD 835
162	IMAGINATION QUOTA DAVID WERNER/RCA AFL1 0922
163	LIVE THE SENSATIONAL ALEX HARVEY BAND/Atlantic SD 18148
164	PRESSURE DROP ROBERT PALMER/ Island ILPS 9372
165	DOG DAYS ATLANTA RHYTHM SECTION/Polydor PD 6041
166	BARRY MANILOW II/Bell 1314
167	ERIC CARMEN/Arista 4057
168	BELLAVIA CHUCK MANGIONE/ A&M SP 4557
169	ON THE TRACK LEON REDBONE/ Warner Bros. BS 2888
170	BACKHAND KEITH JARRETT/ Impulse ASD 9405 (ABC)
171	FANCY DANCER BOBBI HUMPHREY/ Blue Note BN LA550 G (UA)
172	TOUCH JOHN KLEMMER/ABC ABCD 922
173	INDISCREET SPARKS/Island ILPS 9345
174	TED NUGENT/Epic PE 33692
175	WIRE FIRE SAVOY BROWN/Parrot PS 659 (London)
176	HUSTLE TO SURVIVE LES McCANN/ Atlantic SD 1679
177	HIGHER THAN HIGH THE UNDISPUTED TRUTH/Gordy G6 972S1 (Motown)
178	CITY LIFE BLACKBYRDS/Fantasy F 9490
179	GET YOUR WINGS AEROSMITH/ Columbia KC 32847
180	IF YOU LOVE ME LET ME KNOW OLIVIA NEWTON-JOHN/MCA 411
181	PAUL HORN & NEXUS PAUL HORN/ Epic KE 33561
182	FEELINGS JOHNNY MATHIS/ Columbia PC 33887
183	AGAINST THE GRAIN RORY GALLAGHER/Chrysalis CHR 1098 (WB)
184	SUPER JAZZ AL HIRT/PETE FOUNTAIN/Monument PZG 33485 (Col)
185	NOMADNESS STRAWBS/A&M SP 4544
186	NASTY GAL BETTY DAVIS/Island ILFS 9329
187	PASS THE FEELIN' ON CREATIVE SOURCE/Polydor PD 6052
188	COKE COKE ESCOVEDO/Mercury SRM 1 1040
189	NIGHTHAWKS AT THE DINER TOM WAITS/Elektra 7E 2008
190	ANDREW GOLD/Asylum 7E 1047
191	EROGENEOUS MYSTIC MOODS/ Sound Bird SB 7509
192	THE TUBES/A&M SP 4534
193	BY REQUEST WALTER CARLOS/ Columbia XM 32088
194	CLAUDE BOLLING: SUITE FOR FLUTE & JAZZ PIANO RAMPAL/Columbia M 33233
195	HAIR OF THE DOG NAZARETH/ A&M SP 4511
196	GIVE 'EM HELL HARRY ORIGINAL SOUNDTRACK/United Artists LA504 H2
197	STARS JANIS IAN/Columbia KC 32857
198	DRESSED TO KILL KISS/Casablanca NBLP 7016
199	A QUIET STORM SMOKEY ROBINSON/Tamla T6 337S1 (Motown)
200	TAPESTRY CAROLE KING/Ode SP 77009 (A&M)

ALBUM CROSS REFERENCE

AEROSMITH	57	RONNIE LAWS	65
MORRIS ALBERT	61	LED ZEPPELIN	128
ALLMAN BROTHERS	36	JOHN LENNON	48
AMERICA	58, 72	RAMSEY LEWIS	60
BRIAN AUGER	123	GORDON LIGHTFOOT	120
BACK STREET CRAWLER	129	LONNIE LISTON-SMITH	97
BAD COMPANY	112	LITTLE FEAT	67
JOAN BAEZ	77	LOGGINS & MESSINA	146
SHIRLEY BASSEY	119	VAN McCOY	134
BAY CITY ROLLERS	32	COUNTRY JOE McDONALD	74
BEACH BOYS	96	MELISSA MANCHESTER	118
BEE GEES	101	MANHATTAN TRANSFER	87
RITCHIE BLACKMORE'S RAINBOW	89	BARRY MANILOW	37, 59
BLACK OAK ARKANSAS	145	MARSHALL TUCKER BAND	29
BLUE MAGIC	107	DAYE MASON	35
DAVID BOWIE	99	MONROSE	63
DONALD BYRD	115	MIRACLES	70
GLEN CAMPBELL	143	WILLIE NELSON	66
CAPTAIN & TENNILLE	27	NITTY GRITTY DIRT BAND	79
GEORGE CARLIN	76	OLIVIA NEWTON-JOHN	10, 126
CARPENTERS	150	OHIO PLAYERS	23
JIMMY CASTOR	137	ORIGINAL SOUNDTRACKS:	
HARRY CHAPIN	105	LET'S DO IT AGAIN	85
ERIC CLAPTON	80	MAHOGANY	94
STANLEY CLARKE	43	TOMMY	114
BILLY COBHAM	110	TONY ORLANDO & DAWN	69, 116
NATALIE COLE	31	ORLEANS	31
COMMODORES	64	OUTLAWS	144
ALICE COOPER	121	OZARK MT. DAREDEVILS	71
CHICK COREA	124	PINK FLOYD	8
J. CROCE	53	RICHARD PRYOR	42
DAVID CROSBY & GRAHAM NASH	9	QUICKSILVER MESSENGER SERVICE	132
CROWN HEIGHTS AFFAIR	83	BONNIE RAITT	90
CRUSADERS	141	HELEN REDDY	98
CHARLIE DANIELS BAND	54	RITCHIE FAMILY	103
JOHN DENVER	2, 41, 49, 52	LINDA RONSTADT	7, 104
DRAMATICS	106	DAVID RUFFIN	109
EAGLES	4, 136	LEON RUSSELL	40
EARTH, WIND & FIRE	62	SEALS & CROFTS	17
GRAEME EDGE	131	GIL SCOTT-HERON	138
ELECTRIC LIGHT ORCHESTRA	19	NEIL SEDAKA	28, 45
DAN FOGELBERG	24, 140	SILVER CONVENTION	34
FOGHAT	81	PAUL SIMON	5
FREDDY FENDER	44, 75	SIMON & GARFUNKEL	117
FLEETWOOD MAC	33	BRUCE SPRINGSTEEN	13
ARETHA FRANKLIN	122	SPINNERS	18
ART GARFUNKEL	12	ROD STEWART	39
GLORIA GAYNOR	147	CAT STEVENS	21
GRAND FUNK	113	SLY STONE	55
GRATEFUL DEAD	68	BARBRA STREISAND	38
AL GREEN	93	STYLISTICS	33
DARYL HALL & JOHN OATES	127	DONNA SUMMER	56
HERBIE HANCOCK	22	SWEET	95
GEORGE HARRISON	16	JAMES TAYLOR	102
HEAD EAST	139	TEMPTATIONS	84
HOT TUNA	135	TOOTS & THE MAYTALS	88
JANIS IAN	50	TOWER OF POWER	100
ISLEY BROTHERS	30	STANLEY TURRENTINE	111
KEITH JARRETT	142	JERRY JEEF WALKER	148
JEFFERSON STARSHIP	3	WAR	20
JETHRO TULL	25	GROVER WASHINGTON, JR.	47
J. GEILS BAND	91	TIM WEISBERG	108
ELTON JOHN	1, 6, 26	BARRY WHITE	51
QUINCY JONES	92	WHO	11
KC AND THE SUNSHINE BAND	15	WINGS	78
B. B. KING	130	8ILL WITHERS	125
KISS	14	FRANK ZAPPA	86
GLADYS KNIGHT & THE PIPS	46	ZZ TOP	73
LEO KOTTKE	149		

Some of Dionne Warwick's hits:

- "Walk On By"
- "A House Is Not A Home"
- "Alfie"
- "Do You Know the Way to San Jose"
- "Anyone Who Had a Heart"
- "Don't Make Me Over"
- "I Say a Little Prayer"
- "I'll Never Fall in Love Again"
- "Message to Michael"
- "Make It Easy on Yourself"
- "You'll Never Get to Heaven"
- "Then Came You" (with the Spinners)

Some of Thom Bell's hits:

- By the O'Jays
- "Back Stabbers"
- By the Delfonics**
- "La La Means I Love You"
- "Didn't I (Blow Your Mind This Time)"
- By the Stylistics***
- "Rockin' Roll Baby"
- "Stone in Love With You"
- "Let's Put It All Together"
- By the Spinners***
- "One of a Kind (Love Affair)"
- "I'm Coming Home"

"Love Don't Love Nobody"

"I'll Be Around"

"Games People Play"

"Then Came You" (with Dionne Warwick)

*arranged by Thom Bell

**co-produced and arranged by Thom Bell

***produced and arranged by Thom Bell

NOW, WARNER BROS. RECORDS PROUDLY PRESENTS DIONNE WARWICK AND THOM BELL'S GREATEST HIT:

ONCE YOU HIT THE ROAD (WBS 8154)

FROM THE NEW ALBUM

TRACK OF THE CAT

BY DIONNE WARWICK

PRODUCED BY THOM BELL

TWO TALENTS WHO BRING OUT THE BEST IN EACH OTHER



AVAILABLE NOW ON WARNER BROS. RECORDS AND TAPES



SOUL TRUTH

By DEDE DABNEY



■ **HOLLYWOOD:** Personal Pick: "Funky Weekend" — Stylistics (Avco). Van McCoy's golden ear for arranging definitely enhances this disc. A Hugo & Luigi original, it is one of the extractions from the group's recent album.

DEDE'S DITTIES TO WATCH: "Jesse James Is An Outlaw" — Jean Knight (Chelsea-UPT); "(Are You Ready) Do The Bus Stop" — Fatback Band (Event-UPT); "Far As We Felt Like Goin'" — Labelle (Epic-UPT).

Stan Watson of Philly Groove has completed a distribution deal with Warner Brothers, including artist development, producers and writer development. Just emerging from the studio is a new group known as the Quickest Way Out, which will issue a release entitled "Thank You Baby For Loving Me." On their way into the studio are those "Armed and Extremely Dangerous" girls, the First Choice. Also as the public demanded, the Delphonics are currently going over material to be recorded. Looks as though Philly Groove is on its way to new happenings with a transfusion of new creativity.

Another form of creative expansion is that of WMOT Productions, which marks with Blue Magic and Major Harris. It has been passed on to this editor that "3M," which is the title of a show produced by this company, will be opening at the Latin Casino in Cherry Hill, New Jersey, December 1st, complete with Margie Joseph.



From the lp cover to Record World comes the car used for the cover of Bobby Womack's contribution to the airwaves, "Safety Zone." Shown here is Record World's r&b editor DeDe Dabney talking to Womack about the initial reaction to his current product.

BE EAGER TO SEE EAGER

Brenda Lee Eager has been singing professionally 10 years in a little club in Mobile, Ala. This powerhouse of an artist moved to Chicago where she met Chuck Jackson, brother of Rev. Jesse Jackson, and they began writing together. The final outcome was the tune "It's Real What I Feel," recorded by Jerry Butler and Ms. Eager.

The duet of Eager and Butler made for a mellow and beautiful marriage when they recorded "Ain't

Understanding Mellow" and "Close To You," which was included in their album.

After a couple of years and many awards the couple split up to pursue single artist roles. To bring you up to date, Brenda Lee Eager is with Playboy Records with a heavy tune, "Old Fashioned Love."

Playboy showcased her some weeks ago to an audience that received her well. She sang some of the old and some of the new, doing quite well when tunes such as "Ain't Understanding Mellow" and "Close To You" were sung.

Brenda Lee Eager is a young lady worth watching — she has all the unique ingredients to become a huge star in '76.

Disco File (Continued from page 24)

Sisters," the most danceable; "Get Down with the Philly Sound;" "The Zip," already a single (and a Polaroid commercial); and a version of War's "Smile Happy." Stephanie Mills' first album for Motown, produced by Burt Bacharach and Hal David and containing her fine re-make of Dionne Warwick's "This Empty Place," is out now; the title: "For the First Time."

FEEDBACK: The instant-excitement import this week is the Biddu Orchestra's new British single, "I Could Have Danced All Night," a re-make of that standard, with a fabulous "Jump for Joy" which lives up to its title on the other side (Epic import). Desi, now playing at The Alley in Queens and one of the key people to introduce Biddu's imports to New York DJs, brought a copy by the office and put it on his top 10 list this week (it also popped on Bobby Guttadaro's list from the new, immediately popular Infinity in New York). Another import on Desi's list that's new to us is "Ha-Ri-Ah," an Italian record by a group called Son of Albatross (Decca) with a great African chant sound that could become very popular too . . . Penny McLean's "Lady Bump/The Lady Bumps On" (available on both the Jupiter and Columbia labels, depending on the country of origin) is shaping up as the most played import right now, probably because it picks up the Silver Convention sound everyone's still hot for (McLean is SC's lead singer and the group back her up here). American release is scheduled by Atlantic soon . . . Walter Gibbons, back at Galaxy 21, lists an advance copy of the first release on Casablanca's new Chocolate City label: "Find My Way" by a group now called Cameo (their original name, the Players, was changed so as not to conflict with the group currently riding the "Love Rollercoaster")—very Crown Heights Affair but that's one of the better things you can say about a record these days—and it grows on you. Out this week . . . "Nowhere" by Hokis Pokis has been picked up by TK for the people who haven't been able to find this particular record outside of a few New York stores. It'll be out on TK's Shield label within the week . . . Hottest new single: "Inside America Part 1" by Juggy Murray Jones (Jupiter), reviewed here last week and spreading like wildfire on the DJ grapevine. One of the most surprising and invigorating instrumentals this year.

Soultown Label is Reactivated

■ **LOS ANGELES** — Soultown Records has been reactivated here by Bobby Sanders, who has announced the signing of two artists to the label. Burt Ward will be represented in the company's first release by a single titled "I Got Love For My Baby" and Sweet Stuff will be featured on

"Freaky (To You), Parts I and II," an "answer record" to the recent Leon Haywood song, "I Wanna Do Something Freaky To You."

Also being released by the company is an lp featuring songs of the Young Hearts and various other artists titled "Heart Full of Memories."

R&B PICKS OF THE WEEK

SINGLE **MAJOR HARRIS, "I GOT OVER LOVE"** (WMOT Music, Sacred Pen Music, BMI). Haunting and penetrating, Major Harris has a perfect sequel to his mighty seller, "Love Won't Let Me Wait." He gets better with time as the pleading voice lends much to the disc. The first extraction from his soon to be released lp. Atlantic 45-3303.



SLEEPER **MICHAEL ZAGER'S MOON BAND FEATURING PEABO BRYSON, "DO IT WITH FEELING"** (Web IV Music, BMI/Louise/Jack, ASCAP). Heavy bass beat warrants plenty of all-around play. This cut should give this new group plenty of chart action. Recorded in Atlanta, the sound is funky, filled with strong rhythm. Bang B-720.



ALBUM **DIONNE WARWICK, "TRACK OF THE CAT."** Linda Creed's imaginative pen strikes once again. Together, she and Thom Bell have given Ms. Warwick a new boost to her singing career. Other superb writers who participated were Marshall, Wortham and Barrett; and Jefferson and Simmons. Highlights: "Track Of The Cat," "His House And Me," "World Of My Dreams," "Jealousy" and "Once You Hit The Road." Warner Brothers BS 2892.

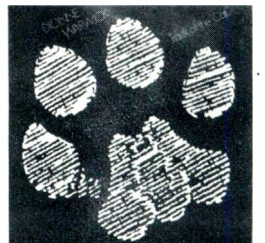

*Music
makes the
mind grow fonder.*

From the smash album
"Making Music,"
the new Bill Withers single,
"Make Love to Your Mind,"
3-10255

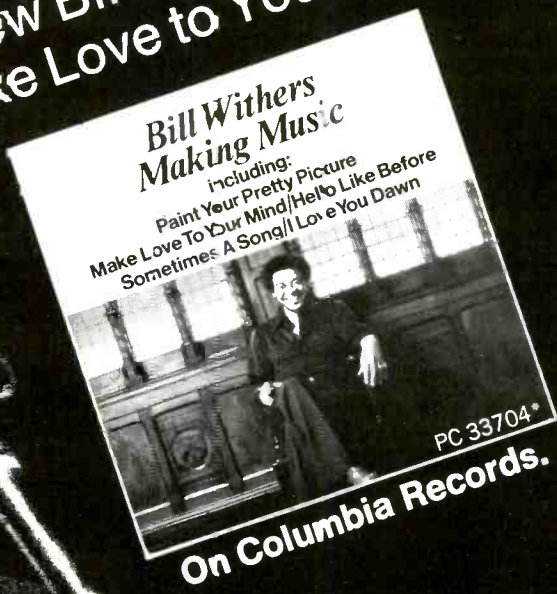

RECORD WORLD THE R&B SINGLES CHART

NOVEMBER 22, 1975

NOV. 22	NOV. 15	
1	2	LET'S DO IT AGAIN THE STAPLE SINGERS—Curtom 0109 (WB)
2	1	FLY, ROBIN, FLY SILVER CONVENTION —Midland Intl. MB 10339 (RCA)
3	3	LOW RIDER WAR —United Artists XW706 Y
4	8	THAT'S THE WAY (I LIKE IT) KC & THE SUNSHINE BAND—TK 1015
5	6	I LOVE MUSIC (PART I) THE O'JAYS—Phila. Intl. ZS8 3577 (Col)
6	4	THEY JUST CAN'T STOP IT (THE GAMES PEOPLE PLAY) SPINNERS—Atlantic 3284
7	7	THIS WILL BE NATALIE COLE —Capitol 4099
8	9	SAME THING IT TOOK IMPRESSIONS —Curtom CMS 0103 (WB)
9	5	I WANT HIS OWN FAITH, HOPE & CHARITY —RCA PB 10343
10	10	I WANT'A DO SOMETHING FREAKY TO YOU LEON HAYWOOD—20th Century 2228

11	11	DO IT ANY WAY YOU WANNA PEOPLES CHOICE—TSOP 47691 (Col)
12	12	LOVE POWER WILLIE HUTCH—Motown 1360
13	16	I'M ON FIRE JIM GILSTRAP—Roxbury 2016
14	13	SO IN LOVE CURTIS MAYFIELD—Curtom 0105 (WB)
15	14	THE AGONY AND THE ECSTASY SMOKEY ROBINSON—Tamlam 154251 (Motown)
16	15	(I'M GOING BY) THE STARS IN YOUR EYES RON BANKS & THE DRAMATICS—ABC 12125
17	20	NO REBATE ON LOVE DRAMATICS—Mainstream MRL 5571
18	31	PART TIME LOVE GLADYS KNIGHT & THE PIPS—Buddah 513
19	21	CHANGE WITH THE TIMES VAN McCoy—Avco 4660
20	24	SOUL TRAIN 75 SOUL TRAIN GANG—RCA SB 10400
21	22	WE ALL GOTTA STICK TOGETHER FOUR TOPS—ABC 12123
22	23	HAPPY EDDIE KENDRICKS—Tamlam 54263 (Motown)
23	29	CARIBBEAN FESTIVAL KOOL & THE GANG—Delite DEP 1573 (PIP)
24	17	I GET HIGH ON YOU SLY STONE—Epic 8 10135
25	18	LOVE DON'T COME NO STRONGER (THAN YOURS AND MINE) JEFF PERRY—Arista 0133
26	19	SWEET STICKY THING OHIO PLAYERS—Mercury 73713
27	40	FULL OF FIRE AL GREEN—Hi 2300 (London)
28	35	IS IT LOVE THAT WE'RE MISSING? QUINCY JONES—A&M 1743
29	30	KING KONG—PART I THE JIMMY CASTOR BUNCH—Atlantic 3295
30	42	LOVE MACHINE PT. I THE MIRACLES—Tamlam T 54262F (Motown)
31	34	GIVE ME YOUR HEART BLOODSTONE—London 5N 1062
32	44	LOVE ROLLERCOASTER OHIO PLAYERS—Mercury 73734
33	25	IT'S TIME FOR LOVE / HERE I AM THE CHI-LITES—Brunswick 55520
34	26	LOVE INSURANCE GWEN McCRAE—Capitol 1999 (TK)
35	27	THIS IS YOUR LIFE THE COMMODORES—Motown M 1361 F
36	36	LEFT OVERS/LOVING ARMS MILLIE JACKSON—Spring 161 (Polydor)
37	32	WHAT A DIFFERENCE A DAY MADE ESTHER PHILLIPS—Kudu 925 (Motown)
38	46	VALENTINE LOVE NORMAN CONNORS—Buddah 499
39	49	FOR THE LOVE OF YOU (PART 1 & 2) THE ISLEY BROTHERS—T-Neck ZS8 2259 (Columbia)
40	50	SUPER BAD, SUPER SLICK—PART I JAMES BROWN—Polydor 14295
41	33	FANCY LADY BILLY PRESTON—A&M 1735
42	51	YOU SEXY THING HOT CHOCOLATE—Big Tree BT 16047 (Atlantic)
43	28	I ONLY HAVE EYES FOR YOU SYL JOHNSON—Hi 2295 (London)

44	54	IT'S ALRIGHT GRAHAM CENTRAL STATION—Warner Bros. 8148
45	45	THE NAME OF THE GAME JONESES—Mercury 73719
46	48	EIGHTEEN WITH A BULLET PETE WINGFIELD—Island 026
47	37	MR. D.J. (5 FOR THE D.J.) ARETHA FRANKLIN—Atlantic 3289
48	55	WE GOT TO GET OUR THING TOGETHER THE DELLS—Mercury 435
49	62	WAKE UP EVERYBODY (PART I) HAROLD MELVIN & THE BLUENOTES—Phila. Intl. ZS8 3579 (Col)
50	56	WHOLE LOTTA LOVE TINA TURNER—United Artists XW 724 Y
51	59	WHAT'S COME OVER ME MARGIE JOSEPH & BLUE MAGIC—Atco 7030
52	52	DRIVE MY CAR GARY TOMS EMPIRE—PIP 6509 (Pickwick)
53	57	LOVE ON DELIVERY REFLECTIONS—Capitol 4137
54	60	CHANGE/MAKES YOU WANT TO HUSTLE (PART I) DONALD BYRD—Blue Note BN XW726 Y (UA)
55	58	I'M IN HEAVEN—PT. I TOUCH OF CLASS—Midland Intl. MB 10393
56	64	LET'S DO THE LATIN HUSTLE EDDIE DRENNON & BBS UNLIMITED—Friends & Co. T124
57	66	WALK AROUND FROM LOVE DAVID RUFFIN—Motown 1376
58	65	ONCE YOU HIT THE ROAD DIONNE WARWICKE—Warner Bros. 8154
59	53	HE CALLED ME BABY NANCY WILSON—Capitol 4117
60	67	ALL I DO IS THINK OF YOU JACKSON 5—Motown M 1356 F
61	71	I DON'T WANNA LEAVE YOU DEBBIE TAYLOR—Arista 0144
62	69	THEME FROM MAHOGANY (DO YOU KNOW WHERE YOU'RE GOING TO) DIANA ROSS—Motown M 1337 F
63	—	SING A SONG EARTH, WIND & FIRE—Columbia 3 10251
64	73	WE'RE ON THE RIGHT TRACK SOUTH SHORE COMMISSION—Wand 11291 (Scepter)
65	39	JOHANNESBURG GIL SCOTT-HERON—Arista 0152
66	—	WHERE THERE'S A WILL THERE'S A WAY BOBBY WOMACK—United Artists XW735 Y
67	—	IT'S ALRIGHT (THIS FEELING) NOTATIONS—Gemigo 0503 (WB)
68	—	(ARE YOU READY) DO THE BUS STOP FATBACK BAND—Event EV 227 (Polydor)
69	—	EVERY BEAT OF MY HEART CROWN HEIGHTS AFFAIR—Delite BEP 1575 (Pickwick)
70	—	HOLLYWOOD HATS 11th HOUR—20th Century TC 2215
71	72	I TAKE IT ON HOME BOBBY BLAND—ABC 12133
72	74	COME LIVE WITH ME ISAAC HAYES—ABC 12138
73	—	GOING DOWN SLOWLY THE POINTER SISTERS—Blue Thumb BTA 268 (ABC)
74	75	TONIGHT'S THE NIGHT SSO—Shady Brook 019
75	—	THEME FROM S.W.A.T. RHYTHM HERITAGE—ABC 12135

It's The Miracles



The Miracles recently descended upon RW's west coast office to deliver their latest lp, "City of Angels." Chaperones for the occasion were Motown's vice president, sales, Mike Lushka and single sales manager Miller London, who made sure that we mentioned that the single from the lp, "Love Machine, Part 1" is currently bulleted at 78 on The Singles Chart. Pictured from left are RW's Lenny Beer, Bill Griffin of the Miracles, RW's Eliot Sekuler, London, The Miracles' Pete Moore and Lushka.

PIP Inks Moonlion

■ NEW YORK—Bugs Bower, vice president of PIP Records, a division of Pickwick International, has announced the signing of the group Moonlion, whose first release is a disco-instrumental version of "The Little Drummer Boy."

Spinners Go Gold

■ NEW YORK—"They Just Can't Stop It (Games People Play)," the newest single on Atlantic Records by the Spinners, produced by Thom Bell, has been certified gold by the RIAA for sales in excess of 1,000,000 units, it was announced by Atlantic Records vice president Henry Allen.

NEA Budget (Continued from page 3)

ments from using any of the money generated by the check-offs for administrative purposes; all money would go to projects approved by the two organizations.

Presuming that NEA does not add any new categories for grants to its subsidy system—a presumption that may not hold true if the arts budget inflates by nearly 1000 percent—more money will be given to composers to write new works; to symphonies, chamber groups, ballet and opera companies to offset losses at the box office; to music schools and departments to subsidize musical education; and to community and regional organizations to fund single and series performances, as well as workshops, TV and radio programs, etc.

Also, NEA's new office of Folk, Jazz and Ethnic Music, which made its first awards last spring for, among other things, folk festivals, folk music research and even to support some folksong writers, could begin to commission more record projects. The folk office gave \$25,000 to the Library of Congress to produce a 15-record set of the American folk music in its vaults (RW, July 7, 1975). NEA funded a similar jazz record project by the Smithsonian Institution several years ago. There is a good possibility that with its greatly increased funding, the government will go deeper into these record-producing efforts. And there is nothing currently in the law that could prevent commercial record companies from applying for grants to produce and manufacture traditional music packages.

The federal government has traditionally shunned subsidiaries to the arts, the legacy of a free-market system. For 200 years, the strictures of American capitalism have made sure that whatever music survived was that music which was commercially viable. Now—in a time where more and more public officials are convinced that much art that is of value is disappearing because it cannot support itself—the government is approaching the realization that good art and commercially successful art are not at all times synonymous. "The U.S." Rep. Richmond wrote for the Congressional Record when he introduced his bill, "has permitted the arts . . . to deteriorate to the point where each day more and more time and energy is devoted not to the development or creative potential, but to the fight for financial survival." It's an "ironic" situation, he added, that the United States considers itself "the center of Western culture" while "our nation's artists scrounge for every penny."

Rep. Richmond and his staff are currently trying to generate support for the arts check-off idea around the cultural organizations across the country. The Ways and Means Committee has been tangled in tax-reform legislation almost since the beginning of the year. And, historically, it is not a committee which responds freely or swiftly to the urgencies of its junior members. Only a strong grass-roots lobbying effort, a Richmond aide said last week, will push Rep. Fulton to hold hearings on the measure some time next year.

**Coming Attraction
from Brunswick & Dakar**

BOHANNON'S NEW L.P.

**"THE
MIGHTY
BOHANNON"**

WATCH FOR IT!

BRUNSWICK

DAKAR

RECORD WORLD LP CHART

THE R&B LP CHART

NOVEMBER 22, 1975

- HONEY**
OHIO PLAYERS—Mercury SRM 1 1038
- KC & THE SUNSHINE BAND**
TK 603
- LET'S DO IT AGAIN**
ORIGINAL SOUNDTRACK—
Curton CU 5005 (WB)
- SAVE ME**
SILVER CONVENTION—
Midland Intl. BKLI 1129 (RCA)
- INSEPARABLE**
NATALIE COLE—Capitol ST 11429
- PICK OF THE LITTER**
SPINNERS—Atlantic SD 18141
- LOVE TO LOVE YOU BABY**
DONNA SUMMER—Oasis OCLP 5003
(Casablanca)
- FEELS SO GOOD**
GROVER WASHINGTON, JR.—
Kudu KU 2451 (Motown)
- YOU**
ARETHA FRANKLIN—Atlantic SD 18151
- 2ND ANNIVERSARY**
GLADYS KNIGHT & THE PIPS—
Buddah BDS 5639
- VISIONS OF A NEW WORLD**
LONNIE LISTON-SMITH & THE COSMIC
ECHOES—Flying Dutchman BDL1 1196
(RCA)
- THIRTEEN BLUE MAGIC LANE**
BLUE MAGIC—Atco SD 36120
- AIN'T NO 'BOUT-A-DOUBT-IT**
GRAHAM CENTRAL STATION—
Warner Bros. BS 2876
- IS IT SOMETHING I SAID?**
RICHARD PRYOR—Reprise MS 2227
- MOVIN' ON**
COMMODORES—Motown M6 84851
- HIGH ON YOU**
SLY STONE—Epic PE 33835
- YOU ARE SO BEAUTIFUL**
STYLISTICS—Avco AV 69010
- WHO I AM**
DAVID RUFFIN—Motown M6 84951
- MAKING MUSIC**
BILL WITHERS—Columbia PC 33704
- THE HEAT IS ON**
ISLEY BROTHERS—T-Neck PZ 33536 (Col)
- DRAMA V**
DRAMATICS—ABC ABCD 916
- DON'T IT FEEL GOOD**
RAMSEY LEWIS—Columbia PC 33800
- FANCY DANCER**
BOBBI HUMPHREY—
Blue Note BN LA550 G (UA)
- MAN-CHILD**
HERBIE HANCOCK—Columbia PC 33812
- PLACES AND SPACES**
DONALD BYRD—Blue Note BN LA549 G
(UA)
- JOURNEY TO LOVE**
STANLEY CLARKE—Nemperor NE 433
(Atlantic)
- FROM SOUTH AFRICA TO
SOUTH CAROLINA**
GIL SCOTT-HERON & BRIAN JACKSON—
Arista 4044
- WHY CAN'T WE BE FRIENDS?**
WAR—United Artists LA411 G
- SUPERSOUND**
JIMMY CASTOR—Atlantic SD 18150
- AL GREEN IS LOVE**
AL GREEN—Hi SHL 32092 (London)
- A FUNKY THIDE OF SINGS**
BILLY COBHAM—Atlantic SD 18149
- RUFUS** featuring **CHAKA KAHN**
ABC ABCD 909
- LUCILLE TALKS BACK**
B. B. KING—ABC ABCD 898
- HOUSE PARTY**
TEMPTATIONS—Gordy G6 97381
(Motown)
- ODE TO MY LADY**
WILLIE HUTCH—Motown M 83851
- BARRY WHITE'S GREATEST HITS**
20th Century T 493
- SAFETY ZONE**
BOBBY WOMACK—
United Artists LA544 G
- MAHOGANY** (Soundtrack)—
Motown M6 85851
- WE GOT TO GET OUR THING
TOGETHER**
DELLS—Mercury SRM 1 1059
- SATURDAY NIGHT SPECIAL**
NORMAN CONNORS—Buddah BDS 5643

CONCERT REVIEW

Music of Two Worlds United at Carnegie

■ NEW YORK—A scintillating cross-cultural concert occurred when Herbie Hancock (Columbia) and Hugh Masekela (Casablanca) brought their music to Carnegie Hall recently (7).

Opening the bill was Masekela and his new band, OJAH, comprised entirely of musicians from Ghana and Nigeria. OJAH is a blend of traditional African percussion, and western, electric guitar, bass and keyboards. They open the show with their "witch doctor" reciting a chant while accompanying themselves on African drums. The band slowly fills the stage and quickly the distinctive tones of Masekela's trumpet fill the hall. He performed his most popular hit from the sixties, "Grazin' In The Grass," with a few new twists supplied by OJAH. He also led the band through several spirited tunes from his Casablanca album, "The Boy's Doin' It." One chant, backed only by stark percussion, was breathtakingly effective as a vehicle for bringing true African music to a jazz concert.

Herbie Hancock has taken the original African rhythms and run

them through the technology of the twentieth century. In a recent interview with *RW*, Hancock said, "The only good music is music that benefits people." By this criteria alone, his appearance at Carnegie Hall would have to be judged a success. The audience greeted his updated version of "Watermelon Man" with total approval. Hancock then ran through the entire gamut of electronic keyboard gadgetry in presenting four tunes from his current "Man-Child" album; "Bubbles," "Steppin' In It," "Heart-beat" and "The Traitor." Backed by the Headhunters, a solo band in their own right, Hancock had the crowd screaming for more of his funky-electronic brew. He obliged with a version of "Chameleon" that explored the outer limits of synthesizer possibilities.

The contrast between Masekela and Hancock demonstrated the incredible distance that black music has traveled. Their complete acceptance here proved there is still room for the traditional in the electric world of jazz.

Howard Newman

MCA Plans Automation for Pressing Plants

(Continued from page 3)

such auxiliary functions as electroplating will also be streamlined and automated. Jones, reluctant to divulge the number of employees that will be eliminated from the payroll by the transition, said that the man-power savings will be "substantial."

The decision to automate the plants was actually made two years ago when MCA, one of four domestic labels that presses its own product, cut all custom pressing services, an area that had been a source of considerable profit to the company. "We made that decision for two reasons," Jones explained. "One was the vinyl shortage that was in effect at that time, but even more importantly, we had determined that the manufacturing division could best serve the company by being more immediately aware of the MCA requirements and not having to contend with third-party requirements."

In the wake of MCA's withdrawal from the custom pressing business, substantial work had to be turned down, according to Jones, in an effort to keep the plant flexible and responsive to the needs of MCA Records. "One of the secrets of the record business is controlling proper order-fill while maintaining an inventory turn in the market. Our inventory turns are substan-

tially better than those of most companies I know of in the business," Jones said. He attributed the flexibility of MCA's product flow to daily communication between branch offices and the product department, as well as to the ownership and exclusive services of its pressing facilities.

Flexibility Valuable

"When a record is played in say, Dallas, the promotion men are immediately advising the corporate headquarters here by telephone. That, in turn, is immediately relayed to my production planning people and they will make an estimate of what effect airplay will have in Dallas. We'll then review the existing stock in the Dallas branch plus what we have in the plant and that may trigger off a production schedule. In the case of an album, we'll not only check our stock, but we'll check our component inventory—the jackets, stickers, inserts, whatever," added Jones.

According to Jones, the flexibility afforded by MCA's in-house plants also allows for careful attention to the amount of product run off on the first pressing, since additional product could be more easily manufactured should that become necessary. Overruns and returns are diminished as a result.

RECORD WORLD LP CHART

THE JAZZ LP CHART

NOVEMBER 22, 1975

- FEELS SO GOOD**
GROVER WASHINGTON, JR.—
Kudu KU 2451 (Motown)
- JOURNEY TO LOVE**
STANLEY CLARKE—Nemperor NE 433
(Atlantic)
- MAN-CHILD**
HERBIE HANCOCK—Columbia PC 33812
- VISIONS OF A NEW WORLD**
LONNIE LISTON-SMITH & THE COSMIC
ECHOES—Flying Dutchman BDL1 1196
(RCA)
- MELLOW MADNESS**
QUINCY JONES—A&M SP 4526
- DON'T IT FEEL GOOD**
RAMSEY LEWIS—Columbia PC 33800
- PRESSURE SENSITIVE**
RONNIE LAWS—Blue Note BN LA452 G
(UA)
- CHAIN REACTION**
CRUSADERS—ABC Blue Thumb BTSD 6022
- FIRST CUCKOO**
DEODATO—MCA 491
- SATURDAY NIGHT SPECIAL**
NORMAN CONNORS—Buddah BDS 5643
- MISTER MAGIC**
GROVER WASHINGTON, JR.—
Kudu 2051 (Motown)
- BAD LUCK IS ALL I HAVE**
EDDIE HARRIS—Atlantic SD 1675
- PLACES AND SPACES**
DONALD BYRD—Blue Note BN LA549 G
(UA)
- WATERBED**
HERBIE MANN—Atlantic SD 1676
- A FUNKY THIDE OF SINGS**
BILLY COBHAM—Atlantic SD 18149
- LISTEN TO THE CITY**
TIM WEISBERG—A&M SP 4545
- HAVE YOU EVER SEEN THE RAIN**
STANLEY TURRENTINE—Fantasy F 9493
- FROM SOUTH AFRICA TO
SOUTH CAROLINA**
GIL SCOTT-HERON & BRIAN JACKSON—
Arista 4044
- KOLN CONCERT**
KEITH JARRETT—ECM 1064/1065
(Polydor)
- BAD BENSON**
GEORGE BENSON—CTI 6045S1 (Motown)
- REINFORCEMENTS**
BRIAN AUGER'S OBLIVION EXPRESS—
RCA APL1 1210
- BACKHAND**
KEITH JARRETT—Impulse ASD 9305
(ABC)
- RETURN TO FOREVER**
CHICK COREA—ECM 1022 (Polydor)
- TOUCH**
JOHN KLEMMER—ABC ABCD 922
- WHAT A DIFFERENCE A DAY MADE**
ESTHER PHILLIPS w. BECK—Kudu 2351
(Motown)
- THE BOY'S DOIN' IT**
HUGH MASEKELA—
Casablanca NBLP 7017
- SONG FOR MY LADY**
JON LUCIEN—Columbia PC 33544
- FANCY DANCER**
BOBBI HUMPHREY—
Blue Note BN LA550 G (UA)
- THE CHICAGO THEME**
HUBERT LEWIS—CTI 6058S1 (Motown)
- HUSTLE TO SURVIVE**
LES McCANN—Atlantic SD 1679
- TAKING OFF**
DAVID SANBORN—Warner Bros. 2873
- CITY LIFE**
BLACKBYRDS—Fantasy F 9490
- CANNONBALL ADDERLY PRESENTS
BIG MAN**
Fantasy F 79006
- BELLAVIA**
CHUCK MANGIONE—A&M SP 4557
- FIVE PIECES 1975**
ANTHONY BRAXTON—Arista 4064
- LIQUID LOVE**
FREDDIE HUBBARD—Columbia PC 33556
- COUNT BASIE JAM**
COUNT BASIE—Pablo 2310 712 (RCA)
- TWO**
BOB JAMES—CTI 6057S1 (Motown)
- COKE**
COKE ESCOVEDO—Mercury SRM 1 1040
- CHASE THE CLOUDS AWAY**
CHUCK MANGIONE—A&M SP 4518

*No one
tells it like
Ann Peebles.*

Come To Mama
I Don't Lend My Man
I Needed Somebody
Stand By Woman
It Was Jealousy
Doctor Love Power
You Can't Hold A Man
Beware
Put Yourself In My Place
Love Played A Game

ANN PEEBLES
TELLIN' IT

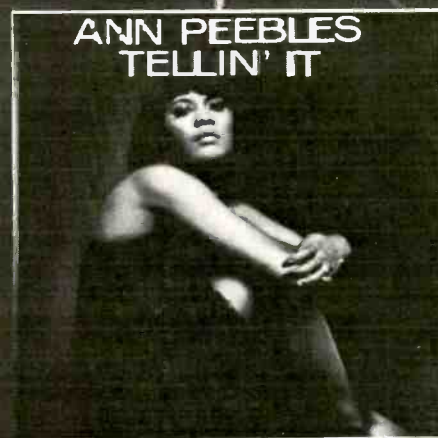

SHL3209

Hi IMPORTED BY **LONDON**

Produced by Willie Mitchell

Confidence Is Key to Garthwaite's Music

By HOWARD NEWMAN

■ NEW YORK—Terry Garthwaite, the former lead singer of Joy of Cooking, is embarking on a solo career with Arista Records. Her new album, "Terry," is a diverse blend of styles that her old fans will find familiar, as well as forms that are new for Ms. Garthwaite.

It has been two years since Joy of Cooking broke up, and Terry has used this time to build up her awareness and proficiency in a variety of musical molds. She teaches vocal and guitar music in her native Bay area, as well as studying music theory, which keeps her in touch with the basics. In an interview with *RW*, Ms. Garthwaite mentioned that, "I bring guitar books along on the road to give me ideas to turn on to. I got through the Mickey Baker book and," she continued humorously, "page one of Joe Pass."

Ms. Garthwaite also worked frequently with a traditional New Orleans jazz band in Oakland during the two year interim. With this group she gained a keener appreciation of traditional and classic be-bop music. She lists Ella Fitzgerald, Betty Carter and Anita O'Day as prime influences on her vocal approaches. Terry adds, "I've always been afraid of sounding like Billie Holiday. She's such a strong, distinctive artist and I have been afraid of



Terry Garthwaite

falling into someone else's style, but now I have more confidence. I don't try to imitate Ella in my scat-singing — that would take so much work. What does matter to me is soulful feeling in music, singing from the heart."

Heartfelt singing is exactly what Ms. Garthwaite delivered at her New York solo debut at the Bottom Line (12). She demonstrated an uncanny ability to improvise vocally through use of both rhythm and tone quality. The Billie Holiday comparisons must be made when she tackles Toni Brown's "Changing Colors" or Illinois Jacquet's "Robbins Nest," yet this is not a cheap imitation Billie but a real, vivid Terry who has the vocal range to make this another style that is wholly her own.

From the Bottom Line, Garthwaite and her band, featuring Willow Wray's backing vocals and exciting harmonies, will go on a two-month club tour that should re-introduce the rest of the country to Terry Garthwaite.

CLUB REVIEW

Phil Everly: At Home on His Own

■ LOS ANGELES — Phil Everly (Pye) is a man that's been in the music business all his life, but he's still got the jitters onstage—a quality that simply adds to the warmth and spontaneity of his show.

Headlining a two-night stand at the North Hollywood country landmark The Palomino, Phil worked tunes from his entire career, from "Bye Bye Love" and "Walk Right Back" from the Everly Brothers days to "Lion and the Lamb" and "Words In Your Eyes" from the new "Mystic Eyes" album. Spotlit, naturally, was a version of his two-time hit "When Will I Be Loved," and a rousing version of last year's "Invisible Man."

Everly sang alone in a high, clear, fluid voice that never reflected the nervousness that emerged in his rambling, unsure

CLUB REVIEW

Peggy Lee: Integrity & Resiliency

■ NEW YORK — Through all the changes in American popular music in the last 30 years, Peggy Lee (A&M) has exhibited a marvelous resiliency and integrity. Dozens of musical fads were committed to history while Ms. Lee was carving out a reputation as one of a handful of truly great popular singers, and more than anything else her career verifies the old saw that says a good song teamed with the right artist is an unbeatable combination in any era.

Ms. Lee's recent performance at the Empire Room of the Waldorf Astoria Hotel (22) was remarkable for what it revealed about the artist. Surely the temptation is great at this point to fall back on years of hits, but she refuses to do so; instead she remains unswervingly modern by tackling with undiminished vocal prowess, a completely new set of technically demanding Leiber-Stoller songs on her recent "Mirrors" album and in concert. She still challenges herself, takes chances and creates new magic.

At the Empire Room, Ms. Lee recreated the intriguing musical odyssey into one person's remembrances of the past that is the theme of "Mirrors." Her repertoire is best described as bitter-sweet, for beneath the surface happiness and jocularity of many of the songs (such as the set's opener, "I've Got Them Feeling Too Good Today Blues") is a desperate and pathetic situation that can hardly be ameliorated by pretending to ignore it or by making light of it. Why should anyone worry about feeling too good?

If all this sounds too heavy,

please note that Ms. Lee tempered the set with several romantic songs ("I've Got You Under My Skin," "Touch Me In The Morning," were two) which enhanced the effect of the ominous Leiber-Stoller material. In fact, lest the mood become too black, Ms. Lee employed what was surely a deliberate fast one-slow one pacing. Few singers could get away with it so easily, but Ms. Lee did because it is her method to bring out the essential truth residing in each song. As you get caught up in what she's doing, you forget about such mundane matters as pacing—there are new worlds to be explored here.

Final Numbers

The set wound down to its final numbers before Ms. Lee sang several of the songs for which she is justifiably famous: "Fever," "Why Don't You Do Right," "Is That All There Is" and the beautiful "I'll Be Seeing You." And it would be a major *faux pas* to ignore the accomplished instrumental support given Ms. Lee by the Bill Harrington Orchestra conducted by John Pisano (whose brief but pungent guitar solo during "Johnny Guitar" was the most effective of all comments on the doomed affair of the song's main character).

But with apologies to all those fine musicians, the real story was, and has been for years, Peggy Lee. Her unadorned voice, her unique phrasing, her *feel* for a song are what make her, in the words of English jazz critic Peter Clayton, "Quite simply the finest singer in the history of popular music."

David McGee

Diamond and Boyd Sign with Claridge

■ LOS ANGELES—Claridge Records has entered into the field of country and western music with the signing of two country artists, Dave Diamond and Mike Boyd, announced Vic Catala, Claridge Records national director of a&r.

Releases

Dave Diamond's first single release is titled "In The Heat Of A Kansas Night," which Diamond wrote and co-produced with Jay Lewis. Diamond was formerly a disc jockey in Nashville, Denver, St. Louis, San Francisco and Los Angeles over the last 10 years. Diamond has spent the last two years composing and producing tunes, many of which will appear on his first Claridge lp early next year. He is currently on a 40 city promotional tour for his new release.

Art Fein

Phila. Intl., Polaroid Plan 'Zip' Campaign

■ NEW YORK—Philadelphia International Records, distributed by CBS, and Polaroid are combining their promotion and marketing forces in support of "The Zip," which is the name of Polaroid's new camera and MFSB's new single. Kenneth Gamble and Leon Huff composed the MFSB track, which is being used as background for Polaroid TV and radio commercials, and an extensive joint publicity effort by the two companies is planned.

Among activities being planned are store invasions by high school students in "Jack the Zipper" caps giving away photos and singles; in-store tie-ins between photography and record departments; "It's the Zip" stickers with pictures of the camera placed on copies of MFSB's "Philadelphia Freedom" lp; and nationwide radio station giveaways and contests with the camera and/or records used as prizes.

Also, the products are linked graphically, with the camera available in optional red, white or blue colors, and the album cover art based on the American flag.

'Greatest Hits' Show Strong Sales

(Continued from page 3)

The Beach Boys "Endless Summer" collection, in its 46th week on the chart, moved up from 98 to 96. Cat Stevens' "Greatest Hits," in its 20th week on the charts, retains its number 21 position. "Greatest Hits" of Tony Orlando and Dawn didn't fare as well this week, as it fell from its 45 position but remained in the top 100 at 69.

The strength of the new "Greatest Hits" packages is also reflected on this week's Retail Report. The America, Seals and Crofts and John Lennon packages can be found in the Top Retail Sales box, and "Barry White's Greatest Hits" missed by the barest of margins. The White album, though Chart-maker of the Week, has yet to make its full impact at the retail level.

Of the 26 stores reporting to the Retail Report, half of them reported two or more "Greatest Hits" album as being among their top 10 new products, and only six stores failed to report a "Greatest Hits" album.

Manufacturers' future releases indicate that the deluge is far from over. Currently in release or

coming soon are packages by Helen Reddy, Chicago, Ringo Starr, the Four Seasons (under the title "The Four Seasons Story"), the Allman Brothers Band, Carly Simon, Sonny and Cher and Lobo.

Smolen Comments

Pete Smolen, head buyer for the 75 store Record Bar chain, reports three "Greatest Hits" albums in the chain's top 30 this week, including the Seals and Crofts package, which came in as the number two record, topped only by Elton's "Rock of the Westies." "This is the time of the year when you get people in the stores who are buying gifts but who don't know a lot about all the current hit product," Smolen told **Record World**, "so they buy something safe, like a 'Greatest Hits' album. Last year, during Christmas week, our chain's top album was 'Elton John's Greatest Hits;' its number three album was 'John Denver's Greatest Hits;' and its number four album was Jim Croce's 'Photographs and Memories.' Manufacturers took a look at this and realized they had a good thing, so they're capitalizing on it this year."

CLUB REVIEW

Edwin Leaves 'Em Starr—Struck

■ LOS ANGELES — Edwin Starr (Granite) has been teetering on the brink of r&b and pop stardom for years now, scoring breakaway writing and/or recording successes with such familiars as "War," "SOS" (Stop Her On Sight) "Agent Double-O Soul," and "Oh How Happy." All the while, Starr has vigorously pursued his career on the road, playing frequent dates here and abroad, building a loyal and enthusiastic following.

It was no surprise then that a swarm of those followers managed to be on hand as Starr opened at the club that bears his surname, and judging by both the quality of his performance and his audience's response, it just may be Starr's turn on the barrel as a major artist.

Variety of Material

Warming up the crowd with a sampling of his former hits and a Latin-styled treatment of the Ben E. King classic "Spanish Harlem," Starr proved to be a versatile stylist who transposes his own, strong musical personality over a wide variety of soul/pop material. Accompanied by what seemed like an army of musicians who jockeyed (some, unsuccessfully) for space to move on the Starwood's diminutive stage, Starr's gruff vocal qualities were strikingly complemented by effective brass arrangements. The

date was the first American gig performed by the band since the recording of their recent Granite album and the set was not without its awkward moments. The strength of Starr's material, though, and his talents as a showman and musician combined to off-set any opening night snafus.

Granite Material

The latter portion of Starr's set was devoted to his new Granite material, featured on this just-released lp "Free To Be Myself."

Standout songs included the occult-flavored "Absynnia Jones," presented with a suitably melodramatic prelude, and Starr's recent single, "Stay With Me."

Eliot Sekuler

Bruno to ABC Music

■ NEW YORK — Helaina Bruno has been appointed to the post of east coast professional manager of ABC Music publishing companies — American Broadcasting Music, Inc. (ASCAP) and ABC Dunhill Music, Inc. (BMI). The announcement was made by Gerald E. Teifer, vice president and general manager of ABC Music.

Teifer stated that Ms. Bruno's responsibilities will be the screening, casting and placement of new and existing song material and working with staff and independent writers.

Chappell Signs Sylvia Tyson



Canadian writer/artist Sylvia Tyson has signed an exclusive worldwide agreement between her Newtonville Music and Chappell & Co. Ltd. in New York to promote her new lp, "Woman's World," and forthcoming single, "Sleep On My Shoulder." She met with Chappell—New York's professional managers. Shown above (from left): Chappell's Ron Solleveld, Mitch Schoenbaum, Sylvia Tyson, Graham Thorp of Capitol Records/Canada and Tommy Mottola.

Yetnikoff Dinner (Continued from page 3)

Founded in 1904 and based in Denver, Colorado, the AMC is a world renowned hospital for cancer treatment, research and education. The center is non-sectarian and provides care for cancer patients regardless of their ability to pay. Its programs receive support almost entirely through charitable gifts, grants and contributions from individuals and organizations.

The Center, regarded as one of the top institutes in its field, annually presents the AMC Humanitarian Award, and last year's recipient, Paul B. Shore, will act as chairman for the Yetnikoff dinner. Seymour Leslie and Jack Grossman will be honorary and general chairmen, and Sheldon Wool will be executive dinner chairman. Additional honorary chairmen are Goddard Lieberman and Arthur Taylor.

Yetnikoff, in addition to his duties as president of the CBS Records Group, is also on the board of directors of CBS, Inc. and is a vice president of the corporation. He has been with

CBS since 1961, when he came to the company as an attorney after three years of private law practice. Yetnikoff was a Phi Beta Kappa graduate of Brooklyn College and received his Law degree at Columbia University, where he was an editor of the Columbia Law Review. In May of 1975 he was appointed president of the CBS Records Group following four years as president of the company's International Division. Previously he had been general attorney for the CBS Records Group and executive vice president of the CBS International Division. Among Yetnikoff's achievements during his presidency of CBS Records International was the conception and negotiation of the first agreement with the Soviet Union by an American recording company to market records under its own label in Russia.

Tickets for the black-tie affair are \$125 per person and will be available through the American Medical Center office at 516 Fifth Avenue, New York, N.Y. 10036; phone: (212) 697-1220.

New York, N. Y. (Continued from page 77)

in the biz again, after a four year hiatus. He's started Jupiter Records in Hollywood, and is out with a new single titled "Inside America, Pts. I and II." During a quick **RW** visit he told us it's a disco record that he co-wrote, produced and is now working . . . There's a record out with lots of songs about marijuana on it, called "Copulatin' Blues." It's stirred talk and we've heard that the disc can be secured by contacting Stash Records, 66 Green Street, New York (sorry, we couldn't get the zip). Phone number's (212) 226-7388 . . . **Rick Derringer's** collaborating his writing efforts with **Cynthia Weil** ("Up-town," "Soul & Inspiration," "We've Gotta Get Out of This Place" and "You've Lost That Lovin' Feelin'" just to name a few) in preparation for his new album to be produced by **Bill Symzyck** at Miami's Criterion Studios . . . **Susan Blond** and **Gary Kenton** are now "officially" engaged. They've decided to get married in '76 so they can celebrate their 25th in the year 2001 . . . Just thought you'd like to know that even as this is being written **Dylan** and entourage are performing in New Haven.

Record World en Mexico

By VILO ARIAS SILVA

■ MEXICO—Medio siglo de existencia, cumple la industria mexicana del disco. Y con ella, va un justo reconocimiento nacional, a caballerosa estampa del desaparecido don **Eduardo C. Baptista Covarrubias**, precursor de la industria fonográfica en México.

Los méritos de don Eduardo, se remontan al año 1925, cuando después de múltiples esfuerzos, logró la fabricación del primer disco. Nunca se imaginó don Eduardo, que en ese momento, nacía lo que en el futuro, vendría a ser una monstruosa y próspera industria. Los progresos fueron violentos, y al poco tiempo, recibía la primera satisfacción internacional; al obtener la medalla de plata en la Exposición Mundial de Sevilla, España, con la producción de "El Faisán."

La medalla al mérito, en el homenaje póstumo que le hacen todas las agrupaciones ligadas con el medio disquero, a don **Eduardo C. Baptista Covarrubias** "padre" del disco en México, será recibida por su hijo **Eduardo L. Baptista**, actual Presidente y

Director General de discos Musart. ¡Nos unimos a este digno y merecido homenaje, que le tributa la industria mexicana a don **Eduardo C. Baptista Covarrubias**, caballeroso luchador, que a pesar del tiempo, siempre vive en el pensamiento de todos los que aman este noble negocio del disco! . . . ¡Saludos para esa buena gente de Miami! Te agradezco **Tony Rivas** —talentoso director de programación de la vigorosa emisora latina WCMQ de Miami, Florida— tus palabras de bienvenida, en tu escuchado programa dominical.

Mi estancia fué fugaz, pero pude comprobar la forma tan aplastante en que **Morris Albert** retorna al primer lugar de popularidad y ventas con su cañonazo mundial "Dime" versión en castellano de "Feelings." Hasta las emisoras en inglés, lo están tocando en castellano, lo que significa un brillante triunfo . . . Continúa **Rigo Tovar** y su grupo **Costa Azul** (Mélody), acaparando el primer lugar de las
(Continued on page 94)

DESDE NUESTRO RINCON INTERNACIONAL

By TOMAS FUNDORA



■ Dentro de sus ya habituales características hubo de celebrarse el "Festival de la Canción y la Voz" en Puerto Rico. **Manoella Torres** viajó desde México para hacer triunfo en su voz la canción "El Río" de **Enrique Muñoz** y **Felipe Gil** con arreglos de **Pocho Pérez**. El segundo lugar en Canción pasó a "Chiuá" con arreglos de **Augusto Martelli**, de **Augusto Martelli** y por **Augusto Martelli**. El Tercer lugar pasó a "Mi Casita" de **René Romero** y por **René Romero**.

El Primer lugar como Voz resultó la cantante Yugoslavia **Radioka**, el segundo lo fué **Hector Pablo Leiva** de Republica Dominicana y **René Romero** de Venezuela en Tercer Lugar . . . La grabación de **Julio Iglesias** de "Manuela" realizada en portugués va tomando características de éxito en Brasil. . . **Martinha** está sonando fuerte en Brasil con su ultima grabación "Eu e Você," a tiempo en que inicia una tournee que la llevará por Venezuela al cuidado del Palacio de la Música de **Ernesto Aue** . . . **Marcos Roberto** va adelante en Brasil con el tema "Muito Obrigado" (Muchas Gracias) . . . **Izzy Sanabria**, "publisher" de la revista "Latin N.Y.," y miembros del "staff" **Tony Pabon**, **Aurora Florez** y **Pablo Figueroa** aparecieron como invitados en el Show Televisivo "Midday Live" que lanza al aire la

WNEW-TV de Nueva York. Dialogaron sobre el desarrollo de la música latina en la urbe neoyorkina . . . Confirmada la firma por Rico Records del **Conjunto Candela** de Nueva York . . . Gracias a las "discotecas" neoyorkinas, el número "Sunny" por el excelente grupo **Yambu** va tomando fuerza meteórica. **Yambu** es producción del sello Montuno de **Al Santiago** y aparece en casi todas las listas de éxitos de los centros neoyorkinos de baile. ¡Se merece amplio apoyo radial!



Manoella Torres

Producciones Susquehanna de Miami obtuvo sonado éxito con la radionovela "Papa Corazón" en interpretación de **Andrea del Boca** y **Pinina**, ya que logró ser radiada por varios países latianamericanos entre los cuales se contaba México. Ahora, Susquehanna está lanzando la radionovela "Esmeralda" de **Delia Fiallo**, en interpretación de **Lupita Ferrer** de Venezuela, bajo la dirección de **Raul Berrier** con Adaptación de **Mario Martín** y musicalización a cargo de **Roberto Ruiz Lavin**. Actúan **Julio Enrique Mendez** como Ingeniero de Sonido y **Mario Ruiz** como Operador de Efectos. Lo grandemente importante es que el tema de la radionovela en sus escenas románticas los constituye "Vuelve Conmigo Amor" de **Sam Malnati**, en producción brasilena del **Coro Angel**.

La exquisitez de este tema y su grabación no dejan dudas que ha de convertirse en un gran vendedor dondequiera la radionovela sea expuesta.



Mark y Taylor

Acaba de establecerse en Estados Unidos la American Musical Industries, productora de Discos y Películas que tendrá a su cargo la promoción de las producciones de Hara Internacional de Brasil (Musidisc America) cuyo productor **Nilo Pinto** se encuentra visitando las facilidades de su distribuidor en Estados Unidos, Parnaso Records. Musidisc producirá dirigidos al mercado norteamericano a sus artistas **Mark & Taylor** y al grupo **The Congregation** . . . **Cornelio Reyna** y **Ramón Ayala**, los afamados texanos **Los Relampagos del Norte**, separados por más de cuatro años, han vuelto a integrar su dueto. Han comenzado presentaciones en Texas, Chicago, California, Arizona y New Mexico . . . El amigo **Johnny González** de Zarape
(Continued on page 93)

FANIA

Este Es Ismael Miranda

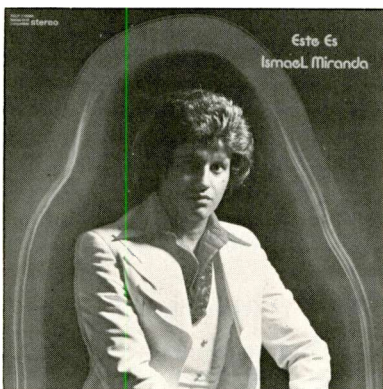

XSLP #00480 Compatible Stereo Series 0598
Available on Stereo 8 Track Cartridges & Cassettes

DISTRIBUTED BY FANIA RECORDS

DISTRIBUTORS

Doran Music, 538 So. Broadway, Los Angeles, Calif., (213) 628-6751
Musica Latina, 2360 West Pico Blvd., Los Angeles, Calif., (213) 385-2151
All West, 2952 West Pico Blvd., Los Angeles, Calif., (213) 734-4108
Eric Mainland, 1460 Park Ave., Emeryville, Calif., (415) 658-9287
Villaneuva Asturias Corp., 401 W. Girard Av., Phila., Pa., (215) 236-4544

LATIN AMERICAN HIT PARADE

Albums

Panama

By JOSE A. JIMENEZ

1. **DAMA DEL AMANECER**
JUAN BAU—Zapiro
2. **DANIEL**
JIMMY CASTOR BUNCH—Atlantic
3. **EXITOS CON ANGEL VOL. 4**
ANGEL GUTIERREZ—Padisco
4. **BRAZIL**
RITCHIE FAMILY—20th Century
5. **A MEXICO**
JULIO IGLESIAS—Alhambra
6. **THE HUSTLE**
VAN McCOY—Avco
7. **SWEARIN' TO GOD**
FRANKIE VALLI—Private Stock
8. **TIEMPO PARA AMAR**
CLAUDIA—CBS
9. **LO VOY A DIVIDIR**
LISSETTE—Borinquen
10. **UNIVERSAL LOVE**
MFSB—CBS

Mexico

By VILO ARIAS SILVA

1. **TE TENDRE QUE OLVIDAR**
RIGO TOVAR—Melody
2. **CHAMBACU**
AURITA CASTILLO—Peerless
3. **TIEMPO**
JOSE JOSE-M. A. MUNIZ—RCA
4. **MARIPOSAS LOCAS**
MIKE LAURE—Musart
5. **MENTIRA MENTIRA**
ROSALBA—Melody
6. **LAGRIMAS Y LLUVIA**
ESTELA NUNEZ—RCA
7. **QUE MAS DA**
RICARDO CERATTO—EMI Capitol
8. **LLUEVE SOBRE MOJADO**
CAMILO SESTO—Musart
9. **MI CORAZON LLORO**
KING CLAVE—Orfeon
10. **CUANDO MAS TE QUERIA**
LOS BABY'S—Peerless

Nuestro Rincon *(Continued from page 92)*

Records de Texas, acaba de lanzar una nueva grabación larga duración de su descubrimiento **Juan Antonio "El Remolino,"** bajo el título "Barrio Pobre," canción del compositor texano **Eligio Tovar de Irving.** Johnny planea una gran promoción a favor de este interprete de la onda chicana . . . A más de la ampliación de los estudios de grabación de La Discoteca en Venezuela (Caracas), se inaugurarán próximamente cuatro nuevos estudios de grabación . . . **Mario Cavagnaro,** el muy popular compositor de "La Primera Piedra" y otros grandes éxitos, regresó a su amado Perú . . . Hispavox concedió la distribución de su producto en Estados Unidos a la firma Caytronics y a Discomoda para Venezuela y Colombia . . . Discos Bambuco de Venezuela no representa más a Music Hall de Argentina . . . La Discoteca de Venezuela abre sucursal en Colombia . . . Inicia **Morris Albert** su "tournee" por Estados Unidos a finales de este mes, a tiempo en que su "Feelings" y "Dime" están vendiendo fuertemente en los mercados latinos y americanos de Estados Unidos. Hasta la ABC de Nueva York ha programado ambas interpretaciones en su habitual programación de éxitos . . . Y ahora . . . ¡Hasta la próxima!

"Festival of the Song and Voice" of Puerto Rico took place last week. Winners were "El Rio" from composers **Enrique Muñoz** and **Felipe Gil,** performed by **Manoella Torres** (arrangements by **Pocho Perez**). Second place went to "Chiuva" (Augusto Martelli) by **Augusto Martelli** and third place was won by "Mi Casita" (René Romero) by **Rene Romero.** Prizes on voices were awarded as follows: First, **Radoika,** Yugoslavian singer, second to **Hector Pablo Leiva** from the Dominican Republic and third to **Rene Romero** from Venezuela . . . **Julio Iglesias** recorded, in Portuguese, his hit "Manuela" (Manuel Alejandro), which is also becoming a success in Brazil in that language . . . **Martinha** is moving nicely in Brazil with her recording of "Eu e Voce" at the time in which she starts touring Venezuela, where Palacio de la Musica is heavily promoting her new album recorded in Spanish . . . **Marcos Roberto** is enjoying good air coverage in Brazil with "Muito Obrigado" ("Thank You") . . . **Izzy Sanabria,** publisher of Latin NY Magazine, and staff members **Tony Pabon,** **Aurora Florez** and **Pablo Figueroa,** appeared as guests on "Midday Live" on WNEW-TV (New York) on October 31. They talked about "Newyoricans" and Latin music . . . New York's very popular "salsoul" orchestra, **Conjunto Candela,** has signed with Rico Records . . . "Sunny" by **Yambú** produced by **Al Santiago,** is a smash hit on all discotheques in the New York area. The performance deserves the best of attention!

Susquehanna Productions from Miami (WQBA Radio) smashed several months ago with the radio drama "Papa Corazón" by **Andrea del Boca** and **Pinina.** The drama was aired by several stations in all of Latin America, including Mexico. Now they are releasing "Esmeralda" (Delia Fiallo) by actress **Lupita Martin.** Music was under the direction of **Roberto Ruiz Lavín** with **Julio Enrique Mendez** as sound engineer and special effects by **Mario Ruiz.** The important matter is that the love theme of the radio-drama is the song "Vuelve conmigo Amor," performed by **Angel Chorus** from Brazil. The song was composed by **Sam Malnati.** English lyrics are being prepared for this smash tune.

Nilo Pinto, owner of Musidisc (Brazil), established last week in Miami a new enterprise under the name of American Musical Indus-

(Continued on page 94)

Singles

Chile

By RICARDO GARCIA

1. **PALOMA BLANCA**
GEORGE BAKER—Asfona
2. **BELLA SIN ALMA**
RICARDO COCCIANTE—RCA
3. **TE HECHIZO**
CREEDENCE CLEARWATER REVIVAL—Banglad
4. **EL ANIMALITO**
LUEROS DEL VALLE—Sol de America
5. **LO MUCHO QUE TE QUIERO**
PATRICIO ESQUIVAL—Polydor
6. **CUANO TRISTE ESTES**
PATRICIO RENAN—Alba
7. **LOS HOMBRES NO DEBEN LLORAR**
KING CLAVE—Parnaso
8. **PEQUENA Y FRAGIL**
SABU—Alba
9. **LO QUE EL HOMBRE DIJO**
WINGS—EMI-Odeon
10. **EL EMPUJON**
VAN McCOY—Banglad

Mexico

By VILO ARIAS SILVA

1. **TE TENDRE QUE OLVIDAR**
RIGO TOVAR—Melody
2. **POR QUE NOS DIJIMOS ADIOS**
DAVE MACLEAN—RCA
GRUPO YNDIO—Polydor
3. **EL ALACRAN**
LA PANDILLA—Cisne RAFF
4. **LAGRIMAS Y LLUVIA**
JUAN GABRIEL—RCA
5. **MARIPOSA LOCAS**
MIKE LAURE—Musart
6. **CHAMBACU**
AURITA CASTILLO—Peerless
7. **MELINA**
CAMILO SESTO—Musart
8. **UNA VIEJA CANCION DE AMOR**
RAUL ABRAMZON—CBS
9. **COMO UN DUENDE**
LOS BABY'S—Peerless
10. **AMOR Y TIEMPO**
HECTOR MENESES—Melody

Panama

By ANTONIO JIMENEZ P.

1. **TO EACH HIS OWN**
FAITH, HOPE & CHARITY—RCA
2. **DAMA DEL AMANECER**
JUAN BAU—Zapiro
3. **WHO LOVES YOU**
FOUR SEASONS—Warner Bros.
4. **LO VOY A DIVIDIR**
LISSETTE—Borinquen
5. **AMADO NINO MIO**
TORMENTA—RCA
6. **NUNCA VOLVERE A QUERERTE**
EVANGELINA—Padisco
7. **GET IT UP FOR LOVE**
DAVID CASSIDY—RCA
8. **BRAZIL**
RITCHIE FAMILY—20th Century
9. **A TI MUJER**
JUAN CAMACHO—CBS
10. **WHAT A DIFFERENCE A DAY MADE**
ESTHER PHILIPS—Kudu

New York (Salsoul)

By JOE GAINES

1. **QUE BIEN TE VES**
CONJUNTO MELAO—T.R.
2. **LET'S DO THE LATIN HUSTLE**
EDDIES DRENNON & THE B.B.S.
UNLIMITED—Friends & Co.
3. **UN AMOR DE LA CALLE**
HECTOR LAVOE—Fania
4. **LEJOS DE TI**
SABOR—Alegre
5. **DE MI PARA PUERTO RICO**
JUSTO BETANCOURT—Fania
6. **TEMA DE B'WAY**
JOE QUIJANO—Coco
7. **LA MORAL**
BOBBY RODRIGUEZ—Vaya
8. **VAGABUNDO**
EL GRAN COMBO—EGC
9. **BAN BAN QUERE**
RAY BARRETTO—Fania
10. **SOY FELIZ**
ISMAEL RIVERA—Vaya

Record World en Chile

By RICARDO GARCIA

■ **Rosamel Araya,** el popular cantante chileno radicado en Argentina estuvo de paso en Chile para promocionar sus primeros discos grabados para Phonogram (Polydor en Chile).

Oswaldo Díaz será el cantante chileno que presente a nuestro país en el proximo festival de la OTI. **Oswaldo Díaz,** cuyas grabaciones para Philips le han puesto entre los favoritos de la juventud, presentara una canción compuesta especialmente por **Luis "Poncho" Venegas.**

Terminó el festival "Primavera una canción," organizado por Secretaria Nacional de la Juventud como motivo de las recientes fiestas estudiantiles de la primavera, tradicionales en nuestro país. El festival fue ganado por la compositora **Maria Angelica Ramirez,** ganadora de muchos otros festivales. la canción, titulada "Canta" fue presentada por **Sergio Lillo.**

La compositora **Scottie Scott,** productora de discos y fotografo profesional, lanza al mercado el primer disco del sello "Pucará," con el cantante nicaraguense **Hernaldo Zuñiga,** ganador de un reciente festival en Chiclayo,

Perú. El éxito ha sido la canción de **John Denver** "My sweet lady," muy bien interpretada por **Hernaldo.**

El sello Microfón, de Argentina, será distribuido en Chile por Quatro Ltda. Emi Odeon comenzó a distribuir los discos del sello Bell, antes distribuido por Philips en Chile.

Uno de los éxitos de venta en estos momentos lo constituye el disco producido por el compositor **Carlos Baeza** "Lo mucho que te quiero." La obra es recitada por **Patricia Esquivel,** popular locutor de radio Santiago.

Paolo Salvatore, otra popular figura chilena viajara próximamente a los festivales de Santo Domingo y Tokio, donde competirá llevando canciones de **Reinaldo Martinez** y **Luis Miguel Silva,** una pareja de autores que ha hecho una buena cantidad de éxitos locales.

Entre los artistas extranjeros que acaban de visitarnos con suficiente éxito han estado **Edmundo Rivero** y **Roberto Goyeneche.** **Enzo Viena,** popularísimo en Chile por la teleserie argentina "Nino," realizó una temporada

(Continued on page 94)

SALSOUL

THE SALSOUL ORCHESTRA—Salsoul SZS 5501

En producción de Vincent Montana, Jr., esta grabación instrumental llena de maestría refleja grandes ventas al momento de salir. Genial para discoteques. Influenciada por White, McCoy y el sonido del momento. Salsoul ha dado un paso en extremo adelante. "Salsoul Hustle" (V. Montana, Jr.), "Tangerine" (J. Mercer-V. Schertzinger), "Salsoul Rainbow" (V. Montana, Jr.), "Get Happy" (R. Baker) y "Love Letter" (V. Young-E. Heyman). Los arreglos de Vincent son espectaculares y la labor de los músicos muy encomiable.

■ This is it! The Salsoul Orchestra is making it big with this package. Arrangements and production by Vincent Montana, Jr. The today sound in a great way. All musicians really played their butts off. "Tangerine" (J. Mercer-V. Schertzinger), "Chicago Bus Stop" (V. Montana, Jr.), "Tale of Three Cities" (R. Baker) and "You're Just the Right Size." This is a big step forward for Salsoul.

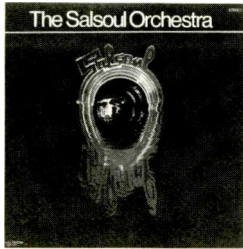

AL SANTIAGO PRESENTS

YAMBU—Montuno MLP 506

Rafy Fuente en las partes vocales, líder Ramon Rodriguez, director musical Milton Hamilton y producida por Al Santiago. Fuera de grupo en gran creación. Con "Sunny" (B. Hebb) vendiendo fuerte, esta grabación va adelante por méritos propios. Exitos de discoteques! "Caballo" (E. Rivera), "Movin' On" (M. Hamilton), "Dinamita" (M. Hamilton) y "Hippopotamus" (M. Hamilton). Otro paso adelante!

■ With Rafy Fuente taking care of the vocals, Ramon Rodriguez as leader, musical director Milton Hamilton and Al Santiago as producer, this automatically becomes a winner. Salsoul at its very best! Another great mixing job by Irv Breenbaum. On its own merits, this package is going ahead. Smash disco cut "Sunny" included. Also "A New Thing" (M. Hamilton), "Professor" (Hamilton), "Vecindad" (Hamilton-Puente) and "Cosas de Amor" (L. Davila).

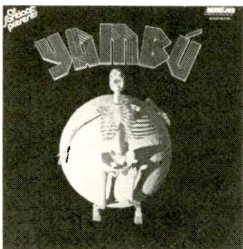

FELIZ NAVIDAD

ISMAEL RIVERA—Tico TSLP 1404

Ritmico y frenéticamenteailable este album de navidad por Ismael Rivera. Se lucen interprete y músicos en "Llegó Navidad" (J. Vasquez), "Mi Tia María" (B. Capó), "Bomba de Navidad" (L. Ramírez) y "Seis de Borinquen" (R. Muñiz).

■ Rhythmical and frenetically danceable package for Christmas by Ismael Rivera. Musicians are excellent. "Una Tarjeta Postal" (C. Alonso), "Venego del Campo" (J. Blanco) and "Navidad de Nuevo" (Spanish lyrics Sammy Ayala).



NAVIDADES JIBARAS

ALFONSO VELEZ—Velvet LPV 1501

Con su toque especialísimo, Alfonso Velez "Fua" brinda aquí música navideña que venderá fuerte en Puerto Rico y Nueva York. "Enditry contra Compay" (V. Valle), "Tus amigos intimos" (J.R. Candelario) y "Mi Vacilón" (T. Valentin). Acompaña Moncho Valle y su Conjunto.

■ With his special touch, Alfonso Velez "Fua" offers a superb Christmas repertoire that will sell strongly in Puerto Rico and New York. Backed by Moncho Valle and his Conjunto. "Le Traigo Alegría" (A. Velez), "El Tonto" (B. Lopez) and "Parranda Boricua" (T. Valentin).



En Chile

(Continued from page 93)

teatral en Santiago. También nos visitó la temporada de espectáculos en el Casino Municipal de Viña del Mar, la principal ciudad balneario de nuestro país.

'Alerce Producciones'

El sello T K, de Argentina será distribuido en Chile por "Alerce Producciones," nueva compañía discográfica que también distribuirá otros sellos extranjeros. la dirección postal de "Alerce" es P.O. Box 1032, Santiago, Chile. En el primer lanzamiento figuran discos de **Bovea y sus vallenatos** y de **Alexandra**, con su hit Palomita Blanca." El sello comenzará también su producción nacional en estos días con los conjuntos **Ortiga** (musica del altiplano) y **Chamal** dedicado a la música de la isla de Chiloé, que tiene muchos adeptos en Chile.

En Mexico (Continued from page 92)

listas de éxitos con su 'Te tendré que olvidar' . . . **Los Sonor's** (Peerless), ingresan también a la pelea con su reciente grabación "Bésame Morenita."

Mi gratitud, para el buen amigo **Genival Melo**. Tu postal desde Sao Paulo, Brasil, está llena de tantos buenos deseos, que los mantendré presentes . . . Muy bueno, el tema "Ya no hay rosas" que interpreta **Zoilita Flor** (Cisne RAFF), el cual acaba de aparecer con muchas posibilidades . . . Una nueva reorganización se deja sentir en Orfeón. Pronto tendremos novedades; ya que silenciosamente se disponen cambios en los departamentos de promoción, dirección artística y ventas . . . **Pépe Comacho**,

WEA/Discount Promo

■ LOS ANGELES — Vic Faraci, WEA's vice president, marketing, has announced that "Sounds For All Seasons," a holiday promotion specially designed for Discount Records, will run November 15 to December 31 and feature fourteen new releases from Warner Bros., Elektra/Asylum and Atlantic.

Point of Sale

Bob Moering, WEA's national product manager, and Linda Sloan, Discount Records' ad director, are coordinating their efforts to stress maximum product exposure at point of sale.

Moering has designed a kit of merchandising aids to support the "Sounds For All Seasons" radio and print advertising campaign: a custom-produced LP in-store sampler, posters, blow-ups, mobiles and banners.

eficiente titular de publicidad de EMI Capitol, de la mano con **Roberto Sánchez (Sandro)**, su nuevo artista, por las emisoras locales; los encontré visitando radio "Variedades," la radiodifusora de mayor "rating" en México.

Intensa labor promocional en Peerless por los nuevos valores. **Laura Alegría y Beatriz Adriana**, reciben fuerte apoyo de la radio y de la prensa . . . Dura pugna por la supremacía del tema "Por qué nos dijimos adiós." Tanto **Dave Maclean** (RCA), como el grupo **Yndio** (Polydor) logran sensacionales ventas, y ambas versiones van que vuelan al primer lugar de nuestro hit parade.

Nuestro Rincon (Continued from page 93)

tries, which will produce recordings and films. The distributor for the label in the States is Parnaso Records. Musidisc is producing their artists **Mark & Taylor** and **The Congregation**, directed to the English-speaking market . . . **Cornelio Reyna** and **Ramon Ayala**, members of the famous duo **Los Relampagos del Norte** from Texas, are together again after four years of performing as soloists. They are touring Texas, Chicago, California, Arizona and New Mexico . . . **Johnny Gonzalez**, from El Zarape Records, Texas, released a new album by his discovery, young performer **Juan Antonio "El Remolino."** The album is titled "Barrio Pobre" (Eligio Tovar de Irving). Johnny is planning a very heavy promotion campaign in favor of this artist in all the Chicano markets . . . La Discoteca (Venezuela) is improving their studio facilities. By the same token, four new recording studios will be opened shortly in Venezuela . . . **Mario Cavagnaro**, very popular musician and composer ("La Primera Piedra"), flew back to Lima, Peru, after several months absence . . . Hispavox granted the rights to release their product in the States to Caytronics Corporation. They also granted Discomoda the rights to release their productions in Venezuela and Colombia . . . Bambuco is no longer the distributor of Music Hall from Argentina in the Venezuelan territory . . . La Discoteca (Venezuela) is opening a branch in Colombia . . . **Morris Albert** will tour the States during late November and December . . . His performance of "Feelings" ("Dime") had been programmed in both Spanish and English by most American radio stations. And that's it for the time being!

CLASSICAL RETAIL REPORT

NOVEMBER 22, 1975

CLASSIC OF THE WEEK



KORNGOLD
DIE TOTE STADT
NEBLETT, KOLLO, LEINSDORF
RCA

BEST SELLERS OF THE WEEK

KORNGOLD: DIE TOTE STADT—
Neblett, Kollo, Leinsdorf—RCA
CARLOS BY REQUEST—Columbia
MASSENET: LA NAVARRAISE—
Horne, Domingo, Milnes, Lewis—
RCA
LUCIANO PAVAROTTI SINGS
FAVORITE TENOR ARIAS—London
SIBELIUS: SYMPHONIES NOS. 5, 7—
Davis—Philips

PEACHES/NATIONAL

BEETHOVEN: SYMPHONY NO. 5—
Kleiber—DG
BEETHOVEN: SYMPHONY NO. 9—
Solti—London
BEETHOVEN: COMPLETE SYMPHONIES—
Solti—London
FREIBURG: ORGAN CONCERTOS—Biggs—
Columbia
GERSHWIN: AMERICAN IN PARIS,
RHAPSODY IN BLUE—Davis, Maazel—
London
MASSENET: LA NAVARRAISE—Horne,
Domingo, Milnes, Lewis—RCA
LUCIANO PAVAROTTI AND JOAN
SUTHERLAND IN DUETS—London
STRAUSS: PIANO QUARTET—L.A. String
Trio—Desmar
TCHAIKOVSKY: SYMPHONY NO. 1—
Thomas—DG
TOMITA: SNOWFLAKES ARE DANCING—
RCA

SAM GOODY/EAST COAST

AFTER THE BALL—Morris, Bolcom—
Nonesuch
BEETHOVEN: SYMPHONY NO. 5—
Kleiber—DG
BERLIOZ: SYMPHONIE FANTASTIQUE—
Karajan—DG
BOLLING: SUITE FOR FLUTE AND JAZZ
PIANO—Rampal, Bolling—Columbia
CARLOS BY REQUEST—Columbia
KORNGOLD: DIE TOTE STADT—
Neblett, Kollo, Leinsdorf—RCA
MASSENET: LA NAVARRAISE—Horne,
Domingo, Milnes, Lewis—RCA
RAVEL: DAPHNIS ET CHLOE—Boulez—
Columbia
ROSSINI: SIEGE OF CORINTH—Sills,
Verrett, Schippers—Angel
SIBELIUS: SYMPHONIES NOS. 5, 7—
Davis—Philips

KING KAROL/N.Y.

MONTERRAT CABALLE SINGS ARIAS—
London
CARLOS BY REQUEST—Columbia

FOOTLIFTERS—Schuller—Columbia
KORNGOLD: DIE TOTE STADT—
Neblett, Kollo, Leinsdorf—RCA
LUCIANO PAVAROTTI SINGS FAVORITE
TENOR ARIAS—London
RAVEL: DAPHNIS ET CHLOE—Boulez—
Columbia
ROSSINI: IL BARBIERE DI SIVIGLIA—
Sills, Gedda, Milnes, Levine—Angel
SIBELIUS: SYMPHONIES NOS. 5, 7—
Davis—Philips
VERDI & PUCCINI DUETS WITH LEONTYNE
PRICE AND PLACIDO DOMINGO—RCA
WEBER: EURYANTHE—Norman, Hunter,
Gedda, Janowski—Angel

RECORD & TAPE COLLECTORS/ BALTIMORE

BERLIOZ: SYMPHONIE FANTASTIQUE—
Karajan—DG
BIRTHWHISTLE: THE TRIUMPH OF TIME—
Boulez—Argo
CARLOS BY REQUEST—Columbia
CARTER: DOUBLE CONCERTO—
Weisberg—Nonesuch
KORNGOLD: DIE TOTE STADT—
Neblett, Kollo, Leinsdorf—RCA
LUCIANO PAVAROTTI SINGS FAVORITE
TENOR ARIAS—London
MENDELSSOHN: SYMPHONY NO. 3—
Baltimore Symphony—Vox
ROSSINI: IL BARBIERE DI SIVIGLIA—
Sills, Gedda, Milnes, Levine—Angel
STRAVINSKY: CHAMBER MUSIC—
Baltimore Symphony Orchestra—DG
WORK: SONGS OF THE CIVIL WAR ERA—
Morris, Bolcom—Nonesuch

TOWER RECORDS/SAN FRAN.

BACH: LUTE MUSIC—Williams—Columbia
BACH: VIOLIN SONATAS AND PARTITAS
—Milstein—DG
GERSHWIN: AMERICAN IN PARIS,
RHAPSODY IN BLUE—Davis, Maazel—
London
GO FOR BAROQUE—RCA
KORNGOLD: DIE TOTE STADT—
Neblett, Kollo, Leinsdorf—RCA
MAHLER: SYMPHONY NO. 5,
KINDERTOTENLIEDER—Ludwig,
Karajan—DG
MASSENET: LA NAVARRAISE—Horne,
Domingo, Milnes, Lewis—RCA
LUCIANO PAVAROTTI SINGS FAVORITE
TENOR ARIAS—London
SIBELIUS: SYMPHONIES NOS. 5, 7—
Davis—Philips
WEBER: EURYANTHE—Norman, Hunter,
Gedda, Janowski—Angel

WHEREHOUSE/LOS ANGELES

BACH: BRANDENBURG CONCERTOS—
Harnoncourt—Telefunken
BACH: LUTE MUSIC—Williams—Columbia
KORNGOLD: DIE TOTE STADT—
Neblett, Kollo, Leinsdorf—RCA
MASSENET: LA NAVARRAISE—
Horne, Domingo, Milnes, Lewis—RCA
LUCIANO PAVAROTTI SINGS FAVORITE
TENOR ARIAS—London
LUCIANO PAVAROTTI AND JOAN
SUTHERLAND IN DUETS—London
RAVEL: DAPHNIS ET CHLOE—Boulez—
Columbia
RAVEL: FIREBIRD—Boulez—Columbia
TCHAIKOVSKY: EUGENE ONEGIN—
Kubiak, Burrows, Weikl, Solti—London
WAGNER: DER RING DES NIBELUNGEN—
Nilsson, Windgassen, Hotter, Solti—
London

London's Trio and RCA's Carmen

By SPEIGHT JENKINS

■ NEW YORK — London Records has just issued three records which should prove interesting Christmas gifts to those who want the established star in slightly off-beat repertory or a superlative version of a familiar piece. The three records, each outstandingly good in itself, are "Regine Crespin Sings Offenbach," Mozart's Concerto for Two and Three Pianos (K. 365, K. 242) with Daniel Barenboim, Vladimir Ashkenazy and Fou Ts'ong, and the third volume of "The Piano Music of Ravel" played by Pascal Roge. Miss Crespin also appears as an exciting Carmen in a gift-worthy recording for RCA.

The Roge record may be the best of the lot. The first two volumes of Ravel by this brilliant young pianist clearly demonstrates his feel for the style and his grasp of the nature of Ravel. To some, no doubt, the third volume will only accentuate a previous good impression. To this listener, however, the third volume which con-

tains the complete "Miroirs" and "Jeux D'Eau," marks a step forward in both interpretation and pianistic skill.

Roge adds to extremely supple fingerwork, a tremendous grasp of the variety of color, expressed through many different tones and moods, necessary for Ravel. "Un Barque sur l'Ocean" has the sense of the waves about it; were it not for Roge's clarity one might think it was Debussy. In "Alborada del gracioso" he manages to suggest Spain and France, a neat but important trick. As with Bizet, Ravel's Spanish music is not Spanish *per se* but Spanish as seen through the eyes of a Frenchman. Spain to Ravel and his older colleague was far more a land of orange groves and mystery than we are apt to think today. "Le Vallee des cloches," in first-class performance, always recalls Gray's "Elegy in a Country Churchyard," not because it is English, but because the rural magic of bells and a ver-

(Continued on page 97)

MASTERWORKS TWX... FROM COLUMBIA

A REMINDER... INCREASING FM AIRPLAY AND SUPER PRODUCING IN-STORE PLAY MOVING THE AMAZING RAMPAL/BOLLING SUITE FOR FLUTE & JAZZ PIANO OUT AT RETAIL IN MORE AND MORE AREAS... IF YOU HAVEN'T HEARD IT OR STOCKED IT SEE YOUR COLUMBIA MAN... AND, FROM CHICAGO COMES NEWS OF ALL KINDS OF FM (CLASSICAL, JAZZ, PROGRESSIVE, CONTEMPORARY) PLAY AND RETAIL ACTION ON RAMPAL'S ODYSSEY RELEMANN FANTASIA DISC... GET WITH RAMPAL "THE FLUTE KING"

IN HIS FIRST JAZZ RECORDING
JEAN-PIERRE RAMPAL, Flutist
SUITE FOR FLUTE
AND JAZZ PIANO
CLAUDE BOLLING,
Pianist/Composer
MARCEL SABIAN, DRUMS
MAX HEDIGUER, STRING BASS

M 33233

JEAN-PIERRE RAMPAL
TELEMANN
TWELVE FANTASIES
FOR FLUTE

Y 33200

© 1974 CBS Inc.

JAPAN

コンフィデンス

IN CONJUNCTION WITH ORIGINAL CONFIDENCE, JAPAN'S LEADING MUSIC TRADE PUBLICATION

Record production in Japan for August of 1975 was 14,247,985 copies, 5 percent more than the same month of the previous year and the same as the previous month, according to a report from the Japan Phonograph Record Association (JPR). This was 11,090,689,298 yen, 16 percent above the same month of the previous year and 2 percent below the previous month. The production of singles was 4 percent less than the previous month of the previous year and 6 percent more than the previous month, while that of lps was 18 percent more than the previous month of the previous year and 5 percent less than the previous month.

Victor Music Industries has recently acquired the selling rights to Fantasy Records in Japan. The first releases from Victor are **John Fogerty's** single, "Rockin' All Over The World," and the **Blackbyrds'** "Walking In Rhythm." The Fantasy label had been released here by Toshiba EMI.

Sha Na Na will make their first visit to Japan to perform several concerts at the end of November. Popular Japanese rock 'n roll group **Dawn Town Boogie Woogie Band** will perform as opening act at the Sha Na Na concerts. The American rock 'n roll band recorded the English version of Dawn Town's best selling single, "Smokin' Boogie," in New York. Nippon Columbia released the single on November 10 to welcome the band.

(Continued on page 97)

GERMANY

By PAUL SIEGEL



BERLIN — Germany's most successful record company is currently EMI-Electrola with 12 chart hits in the top 50 national sales. They are building a brand new pressing plant which can produce 130,000 albums and singles per day with the most modern machines available. Director **Wilfried Jung's** statistics show a yearly pressing of 24 million lps, 15 million singles and five million cassettes, with bigger figures predicted for the future.

Esther Phillips' recording of **Stanley Adams'** great standard "What A Difference A Day Made," on CTI, hit number 30 with a bullet . . . **Louis Benjamin's** British Pye has a hit in Germany with "Kiss Me, Kiss Your Baby," by **Brotherhood of Man**, released on Ariola here.

A hot album is Teldec's "Decca, 20 Golden Melodies," by Decca artists such as **Ted Heath**, **Werner Muller**, **Mantovani** and **George Melachrino** . . . Polydor released a good album by Israeli star **Daliah Lavi**.

The music world will be shocked to learn of the death of German music publisher **Rolf Budde**. Budde died of a heart attack in his Berlin home at the age of 62. He had many successes with **The Beatles** and **Frank Sinatra** . . . **Dr. Dieter Pröttel** of M Records is also the producer of television's "Rudi Carrell Show" . . . **Dr. Joe Bamburger** of UFA Music in Munich reports that one of his top composers, **Nico Dostals**, will receive the **Robert Stolz** Plaque in the Austrian city of Graz. Ariola director **Egmont Luftner** will present the award . . . Journalist **Dieter Liffers** of "Show" has surprised the industry with his lyrics for such artists as **Adam & Eve** and **Batta Illic** . . . United Artists' **Michael Stewart** visited the companies offices in Munich and set the UA German operation together with Ariola/Eurodisc for distribution, while retaining his German publisher. **Gaby Richt** will head up the publishing division . . . There has been a tendency in Germany in the '70s to create German product from German copyrights. This has been enhanced by the television networks, ARD and ZDF. Indications are that the public does not approve of this and prefers international entertainment.

ENGLAND

By RON McCREIGHT

LONDON—More than ever this year record company release schedules are bulging with seasonal releases, causing a queue for pressing facilities resulting in some companies reverting to European factories to avoid any delays. A&M is re-releasing the **Carpenters'** single, "Santa Claus Is Coming To Town;" going with a new **Supertramp** album, "Crisis What Crisis," which includes the single "Lady;" and **Elkie Brooks'** "Rich Man's Woman." Bell has a new Bay City Rollers album, "Wouldn't You Like It," and singles by **Showaddywaddy** ("Heavenly") and **Gary Glitter** ("Papa Oom Mow Mow"). CBS offers a special three album box set by the **Wombles**, the **Sutherland Brothers & Quiver's** "Reach For The Sky" album and **Sailor's** "Girls Girls Girls," with singles coming from all three albums along with new ones by **ABBA** ("Mama Mia"), **David Essex** ("If I Could") and **Mike Batt** ("The House Of The Clown"). Other big ones to watch are albums by **Gary Benson** ("Don't Throw It All Away"—State) and **Peter Shelley** ("Girls and Places"—Magnet), and singles by **Leo Sayer** who revives the **Beatle** classic "Let It Be" (Chrysalis), **Slade** ("In For A Penny"—Polydor), **Rod Stewart**, who launches the Riva label with "This Old Heart Of Mine," and **Kiki Dee** whose "Once A Fool" is the first on Rocket since their new deal with EMI.

Adding to this already impressive list is Anchor which issues **Ace's** new album, "Time For Another," to coincide with their current college tour. The new album will be exclusively previewed on Radio One's "John Peel Show" this week. Another Anchor band, **Stretch**, just breaking with a single, "Why Did You Do It," is also on tour of the universities.

The **Sensational Alex Harvey Band** is crossing the Atlantic for a tour of the east coast while their next single is issued here, "Gambling Bar-room Blues" (Vertigo), before they return for their special Christmas concerts. **Nazareth** is bound for Canada to cut a new album in Le Studios in Montreal, returning to open their tour at the Liverpool Empire on November 20th.

Phonogram hosted a special tribute lunch acknowledging 21 years in the industry for their staff producer/a&r manager **John Franz**. Among the personalities in attendance were some of the countless artists with whom he has enjoyed hit records, including **Peters & Lee**, **Marty Wilde**, **Harry Secombe** and **Ronnie Carroll**, while those sending their congratulations were **Dusty Springfield**, **Shirley Bassey** and **The Walker Brothers**.

Sparks' Ron Mael has written "Room For Two" for **Marianne Faithful** and brother **Russell** to record as a duo. Sessions take place in New York during Sparks' Stateside tour and two other Mael titles will be included.

CBS marketing director **Clive Selwood** has made two new appointments, promoting **Andrew Pryor** as pop product marketing manager, and bringing in **James Fleming** as creative marketing sales manager. A&R director **Dan Loggins** also makes an addition to his department by appointing **Lem Lubin** as an a&r manager, reporting to **Robin Blanchflower**. Chrysalis Publishing company is joined by **Colin Griffin**, formerly with **Cyril Shane**, and **Ann Munday** who leaves Rocket's Big Pig Music; **Bob Adcock** goes to the Deep Purple Organisation to represent their management division in the U.K. and Europe; and EMI makes two international appointments in **H.P. Beugger** (regional director, Latin America) and **John Forrest** (resident director, Iran).

Publishing deals concluded by April Music whose managing director **Brian Hutch** has announced that they now have exclusive U.K. rights to **Janis Ian's** titles through her Mine Music Company, including her current "At Seventeen" single. Already, new Ian titles have been cut by **Olivia Newton-John**, **Roberta Flack**, **Shirley Bassey** Music in the U.K., which handles titles by Epic artist **Michael Murphey**, Music in the U.K., which handles titles by Epic artist **Michael Murphy**, including his American hit single "Wildfire." The United European Publishing cooperative has secured representation of three American companies: Casablanca, Rosebridge and the Earl Barton Music Company, which has rights to **Austin Roberts'** "Rocky," now breaking in the U.K. following his American chart success.

London and RCA (Continued from page 95)

dant nineteenth-century landscape is so well conveyed. Roget quietly captures the sense. In "Jeux D'Eau" Roge gives full play to the piano's capacity to convey images of water, and of a fountain. His use of the pedal is exemplary, his dynamics vary within a wide and fascinating limit, and most of all there is an assurance about what he is doing that makes one realize what kind of a Ravel specialist he is. With Denise Roge, he plays the "Mother Goose Suite" for four hands. Here all the precision and love of clarity of the composer comes out. The whole record is extraordinary.

A Renaissance of Voice

Miss Crespin has just scored a huge success at the Metropolitan Opera as Carmen. A few weeks ago RCA issued her complete recording of the opera which allows us to hear the warmth and French quality of her version of Bizet's heroine. Miss Crespin, who made her Met debut as the Marschallin in 1962, spent a large part of her career singing German and Italian opera. Sieglinde, Senta, and several others vied with some of the Verdi heroines. Either because of heavy use or because it lacked a solid technique, her voice fell on evil days, and at the end of the sixties she had volume without beauty. It is wonderful to report that here is a renaissance of voice that does not seem artificial or manufactured and a look at a major French singer in her own tongue. Miss Crespin sings again with the creaminess and vocal allure that was once hers. If there is an occasional widely focused note above the staff, there always were some of those, but there is no quaver, no hardness—and as for charm! No singer before the public has more of that indefinable quality or more real sex appeal. In RCA's *Carmen* she shows conclusively that she understands the heroine to be French to her fingertips, whether Spanish or a slut.

Some feel that her interpretation onstage is too *haute Parisienne*; for this listener it casts a spell. She may not belong with a bunch of ragamuffin gypsies, but then did Carmen either? If she fitted, if she, was like the others,

Durango-Decini Names Talmadge

■ LOS ANGELES — Randy Talmadge has been appointed general manager of Durango-Decini Music Publishers, it was announced by David K. Mancini, president of the publishing firm and Devonshire Productions. Prior to joining Durango-Decini, Talmadge had worked independently and for Garrett Music.

why was she always the one called out wherever she went? But logical arguments do not and cannot work on stage. The crucial fact is that she is totally convincing as Carmen. The French sound, the wonderful voice and manner, the slimmed down yet, very voluptuous body: This is a Carmen. On RCA's record Miss Crespin has what she does not have in New York: a fine conductor. Alain Lombard, who left something to be desired when he was in residence at the Met, conducts *Carmen* with passion and electricity. It is splendid, colored and vigorous leadership. The Escamillo, Jose Van Dam, is also sensational—a black, passionate voice that can handle the highs and lows of this most ungrateful role. Ungrateful? Escamillo may have the most famous song in opera, but he has little else to sing and the tessitura is almost impossible for any one who has ever tried to sing it. Van Dam is excellent. If the listener can, he should overlook Gilbert Py's case.

On Sure Ground Again

For London, Miss Crespin is on sure ground again. She sings famous selections from Offenbach's *La Grande Duchesse de Gerolstein*, *La Belle Hélène*, *La Périchole*, *Ciboulette*, even *Phi-Phi*. What a joy to hear some of the best music of the century—and never forget that Offenbach was a major, important composer who wrote popular but extremely beautiful music—sung with such flair! Offenbach is also very, very difficult to perform; not only because he managed to capture perfectly the time and place of his era and so is hard to discover today, but because he asked a tremendous amount from his singers. His music looks easy but can fall on its face fast. With Miss Crespin the honeyed texture of her voice makes its points with wit, sex and suggestiveness. This is a record to play in the store; the music is delicious, not too well-known, and the sound is wonderful. Any customer interested in voice or singers will ask what it is and will surely be entranced.

Mozart's Concerto for Two Pianos and the one for three Pianos may not draw a huge retail audience, but both are splendidly performed. It is particularly interesting to hear two of the showiest performers of the time, Vladimir Ashkenazy and Daniel Barenboim unite in what are essentially ensemble pieces. But the essential style of both men, their aristocracy and individuality of playing, comes through strong even though they are in leash with each other. Barenboim conducts the English Chamber Orchestra with more than appropriate precision.

CANADA

By LARRY LeBLANC



■ TORONTO—RCA Canada will shortly announce the appointment of its vice president, **Bob Cook**, to head RCA operations in Australia. Replacing Cook will be **Ed Preston**, RCA's operations manager . . . Former *Everyday People* vocalist **Pam Marsh** at Sound Stage last week working on demos for a solo single . . . Capitol-EMI readying new lps by **Peter Donato** and **Suzanne Stevens** . . . Balmur Ltd. hosted a reception at the Ramada Inn for songstress **Dianne Brooks**, who's been recording with **Brian Ahern**. **Anne Murray** and **Bonnie Raitt** took part in the L.A. sessions.

For the second time this year **Copperpenny** has split up and everybody concerned agrees that lead singer **Rich Walmil** will now be billed as a solo artist. He appears on the new "Fuse" lp on Capitol . . . **Bachman-Turner Overdrive** now scheduled to record at Le Studio in Morin Heights next month . . . New **Myles and Lenny** lp, "It Isn't The Same," has been produced by **Marybeth Solomon** and **Mickey Erbe**.

First Quality Records release in the U.S. will be "Hit The Road Jack" by **The Stampeders**. The band is set to appear at The Great Crater Festival on Dec. 31st with Concept 376 handling the booking . . . Concept 376 recently has made exclusive booking agreements with **Shawne Jackson**, **Myles and Lenny**, **Dillinger** and **Patricia Dalquist** . . . **Small Wonder** now living in L.A. and working on its first lp for CBS . . . The long-awaited **Anne Mortifee** lp will be released by Capitol-EMI in January.

GRT launched the current **Moe Koffman** 'live' lp with a party where the set was recorded—George's . . . **Ken Tobias** turned up on "24 Hours" TV spot for a 12 minute interview and performance . . . New **Fludd** single is "I'm On My Way," produced by **Brian Pilling** . . . **Dudes** touring in the west Nov. 16 and the following seven weeks . . . **Mornington Drive** is reforming . . . **Marty Melhuish's** book on BTO due next week. Freelancer Melhuish is splitting his time between Toronto and Montreal these days. He's appearing on CHOM-FM and writing for The Montreal Star . . . **Mike Reed** has left his national promo post at Motown . . . London Records preparing to release debut **Sweeney Todd Folder** lp, produced by **Martin Shaer** at Timbre one.

Worldwide Release Set For New Manilow LP

■ NEW YORK—Aaron Sixx, director of international operations for Arista Records, has announced that "Tryin' To Get The Feeling," the new album from Barry Manilow, will receive a simultaneous release next month in more than a dozen major international territories.

Worldwide Pacts ASI

■ MEMPHIS — Worldwide Sound Distributors has announced the signing of an exclusive distributorship with ASI Records Incorporated of Norfolk, Virginia.

The first release will be by the duo Goolsby and Plante; the title of the song is "Life's a Bitch" backed with "Lover and Friend." The scheduled release date is November 17, 1975.

Japan (Continued from page 96)

Toshiba EMI released an album, "Hollywood—Yuya Meets the Ventures," by **Yuya Uchida** and the **Ventures**. Recorded at the United Studio, Toshiba-EMI Studio and Onkyo House Studio in Tokyo through April-July, 1975, the joint-effort album should be a memorial in the history of Japanese rock from the viewpoint that the Ventures, and Yuya as an originator of Japanese rock movement, have made a great contribution to the field.

On November 5, Toshiba released **Sadistic Mika Band's** new album, "Hot! Menu," produced by **Chris Thomas**. The group was the support act throughout **Roxy Music's** recent English concert tour. It is the first time a Japanese rock outfit has ever toured in England.

CBS/Sony released **Three Degrees'** new single, "Take Good Care Of Yourself," and an album, "Three Degrees Live In Japan," on November 1 to coincide with their visit to Japan. The group is staying here for a month till the end of November to promote the records and to make a recording of their new album. The album is to include songs composed by Japanese writers.

Seichi Kizu joined Shinko Music Publishing Co., Ltd. (president: **Shu Kusano**). Kizu began his career in the industry with Victor Records, where he dealt with foreign record promotion and later moved to the position of national a&r director. From there he went to Nippon Phonogram five years ago, and has been a chief in the charge of international repertoire until October 31, 1975.

The Stanky Brown Band Arrives...



Seymour Stein, managing director of Sire Records, has announced the signing of the Stanky Brown Band. The group is currently in the studio recording their first album for the label, produced by Ron Frangipone and Al Steckler. Seen at Sire Records' New York office at the signing are, from left: Jim Brown (Stanky Brown); Arthur Patsiner, their booking agent; Jerry Cordasco (Stanky Brown); John Scher, the group's manager; Jeff Leynor (Stanky Brown); Rich Bunkiewicz (Stanky Brown); Allan Ross (Stanky Brown), (seated) Seymour Stein, Sire Records.

Restraining Order In CBS-Tucker Suit

■ NEW YORK — Attorneys for Tanya Tucker were granted a temporary restraining order against CBS in U.S. District Court for the Southern District of New York on October 30.

The decision states that CBS is temporarily restrained from "Manufacturing, selling, distributing, or otherwise exploiting those recordings of Tanya Denise Tucker, an infant, which have been previously released for sale and distribution to the general public at prices, or configurations, or in any other manner not heretofore utilized in the sale and distribution and exploitation of such recordings; and

"Manufacturing, selling, distributing, or otherwise exploiting those recordings of Tanya Denise Tucker, an infant, which have not been previously released for sale and distribution to the general public."

CBS has until November 25 to show why the restraining order should not be entered.

ABC Releases Four

■ LOS ANGELES—ABC Records is preparing for release four new albums to be ready before the Christmas season is in full swing. The schedule includes Ace's "Time For Another" on Anchor Records, distributed by ABC; Bobby Vinton's "The Bobby Vinton Show" on ABC Records; The Mighty Clouds of Joy "Kickin'" on ABC Records; and Ray Price's "Say I Do" on ABC/Dot.

Billy Joel Gold

■ NEW YORK—Columbia recording artist Billy Joel has earned a gold album, certified by the RIAA, for his 1973 lp release "Piano Man."

Nonesuch Releases Five

■ NEW YORK — Nonesuch rounds out its 1975 schedule with a release of five albums.

Four Piano Sonatas by Joseph Haydn (Hob. XVI: Nos. 34, 32, 46, 51) are presented by Gilbert Kalish in his first solo appearance on Nonesuch. An album of instrumental works by Charles Wuorinen (all of them premiere recordings) presents several works by this contemporary/composer. The German art song is the subject of an unusual coupling of music by Franz Schubert and Arnold Schoenberg: mezzo-soprano Jan DeGaetani and pianist Gilbert Kalish offer nine Schubert "Lieder" and Schoenberg's "The Book of the Hanging Gardens."

In Nonesuch's Explorer Series, "Turkey/A Musical Journey" presents traditional songs, dances, and rituals, in an album produced in Istanbul by Aykut Sporel. Another Explorer Series album, entitled "The Bengal Minstrel/Music of the Bauls."

IRDA Pacts Three Labels

■ NASHVILLE—Mike Shepherd of International Record Distributing Associates has announced the completion of distribution deals between his company and Main Street Records of Atlanta, Georgia, Aerie Records of Santa Fe, New Mexico and American International Artists Records of Los Angeles.

The first Main Street single is "Music Matic" by a new group called Brick.

The first release on Aerie is a single called "Billy Farmer" by The Eagle and The Hawk."

American International is releasing a new single by Jewel Aken, entitled "When Something Is Wrong With My Baby."

Warners Ships Seven Albums

■ LOS ANGELES—Warner Bros. Records is presently shipping the major portion of its November release. In addition to those lps which shipped November 1 ("History — America's Greatest Hits" on Warners, Gordon Lightfoot's "Gord's Gold" on Reprise, and the Chrysalis packages, Steeleye Span's "All Around My Hat" and Rory Gallagher's "Against the Grain"), seven Warner/Reprise albums shipped this week.

"Track of The Cat" is Dionne Warwick's fourth album, produced entirely by Thom Bell and featuring the single "Once You Hit the Road." "Come Taste the Band" is the tenth Warners lp from Deep Purple; produced by Martin Birch and the group, it's the first Purple album to showcase the contributions of new guitarist - songwriter Tommy Bolin.

From the single of the same name comes "Who Loves You," the Four Seasons' Warners debut. Written and produced by veteran Season Bob Gaudio, the album spotlights the title track and seven other new tunes, including "Storybook Lovers" and "Slip Away."

Neil Young's "Zuma" is one of four November albums from Reprise, his ninth album with the label. The all-original set finds Young performing once again

Elektra Releases 'Best of Simon' LP

■ LOS ANGELES—Elektra/Asylum Records is releasing "The Best Of Carly Simon," an anthology of the best-known Elektra recordings by the artist. The album's national release is being supported by extensive merchandising, promotion and advertising programs.

Ultra-Sonic Rowans



Asylum recording artists, the Rowan Brothers, gave a live concert for WLIR-FM at the Ultra-Sonic Studios. Standing from left is Ultra Sonic's John Bradley, Elektra-Asylum rep Bruce Shindler, Rowans' manager Mike Love, Ultra-Sonic engineer Steve Goetz and WLIR's music director Gil Colquitt. Seated are Lorin, Peter and Chris Rowan.

with support from Crazy Horse. Richard Pryor is represented by "That Nigger's Crazy." Originally released on Partee Records well over a year ago, this Reprise re-release arrives on the heels of Pryor's most recent album, "Is It Something I Said."

"Midnight Lightning" is the latest collection of Jimi Hendrix performances taken from the Alan Douglas tapes. Rounding out the November release is the Reprise album, "Ray Wylie Hubbard & The Cowboy Twinkies," the debut of the Texas progressive-country group of the same name.

Kaye's New Single

■ Gloria Kaye, 19 year old Canadian songstress, has a new single release on RCA/Canada. "Dr. Love" features the disco sound, b/w "You are the Sweetest Song," an MOR ballad.

Whale of an Honor



David Crosby & Graham Nash were recently presented with individual award plaques from the Humane Society due to the attention their new ABC album, "Wind On the Water," has brought, regarding the plight of the whale. At a press conference following their performance in Atlanta, Corbin Benefield, president of the Atlanta Humane Society, presented the plaques which read: "To David Crosby & Graham Nash in recognition of their significant contributions to the humane movement." Pictured from left: Nash, Benefield and Crosby.

CLUB REVIEW

Faith, Hope & Charity: Disco Delights

■ NEW YORK — Faith (Brenda Hilliard), Hope (Albert Bailey) and Charity (Diane Destry) performed to an enthusiastic disco crowd at Barney Google's Saturday (25). The RCA recording trio's opener, "Let's Go to the Disco," couldn't have been more appropriate; the urge to get up and dance permeated the room, with only the utmost respect holding back the audience's flight to the dance floor.

Backed by a six-piece band, F, H and C (as they nick-named themselves) included most of their current album cuts in their act. A standout was the song "Mellow Me," which incorporated some nice harmonic counter lines during the non-lyrical break. These lines were particularly pleasing and reminiscent of the more intricate harmonies of the Fifth Dimension. "Little Bit of Love" featured Diane not only

as a vocalist, but as an enticing performer who displayed her abilities by actually visiting members of the audience — occasionally with a kiss. Though this procedure is not original, it still has the uncanny ability to get the people reacting to more than the music.

It's not surprising to find that one of the main people responsible for the material interpreted is none other than the "Disco Kid" himself, Van McCoy. In fact, F, H and C have the distinction of being very much involved in Van's solo records, which must account for their being so at home with this music.

The most excitement occurred when they "hustled" into their chart-topper "To Each His Own." It was the one we were all eagerly awaiting, and they "made it our business" to have an incredibly rhythmic evening.

Brian Gari

Phila. Intl. Re-Signs O'Jays



An intricate part of the sound of Philadelphia since 1968, The O'Jays have renewed their exclusive recording contract with Philadelphia International Records. The group's current single is "I Love Music," from their new "Family Reunion" lp. Gathered at the signing are from left: O'Jays, William Powell; personal manager, Barbara Kennedy; O'Jay, Eddie Levert; Kenneth Gamble, chairman of the board, Philadelphia International Records; O'Jay, Walter Williams; Jimmy Bishop, executive vice president/general manager, PIR; Leon Huff, co-chairman of the board, PIR.

CLUB REVIEW

D.J. Delivers At The Troubadour

■ LOS ANGELES —D.J. Rogers (RCA), broke in recently at the Troubadour. Playing before a tough, show-me audience, and experiencing technical difficulties in adjusting to the small, acoustically oriented room, he didn't quite get over opening night, although his abundant talent was obvious.

Looking like a cross between a Kansas City preacher and a chocolate leprechaun, he surrounded himself with a loose, entertaining menagerie of performers, including a red bearded drummer from Minneapolis, a guitarist with a unique ability to imitate his playing vocally, and an outrageous choral trio.

D.J. operated in a pleasantly, high-pitched voice that seemed

to come from his toes, exhorting the audience to involvement. He communicated through an upbeat blues medium about the resolution of hard times through lyrics from tunes like "A Little Love Will See You Through," which created a mood of contagious optimism. In the ballad "Say You Love Me," Rogers switched to acoustic piano and accompanied himself sweetly, with the choral group echoing and answering, imparting a lower-key feeling to an otherwise revival tent-like set.

The artist's eccentric prowess as a vocalist, along with an interesting and engaging repertoire, make Rogers an ideal cabaret performer, one whose recorded efforts translate well to a stage setting. Mike Wineland

GOSPEL TIME

By IRENE JOHNSON WARE



■ The first board meeting of The Gospel Evangelists, Musicians and Choral Association (International) will convene in St. Louis, Mo. December 3-5, at the Rodeway Inn Downtown, 2600 Market Street. All night services will be held at the Progressive Baptist Church, 3021 Franklin Ave., St. Louis, Missouri.

PURPOSE OF ORGANIZATION: The purpose of this organization is to promote, on a nationwide basis, the "Preaching the Gospel" as ordained in the Holy Bible, (Mark 16:15-18), and to provide a structured setting in which delegates can be taught how "Preaching directs and provides guidelines for governing other phases of church work."

GOALS OF THE ORGANIZATION: (1) To have each delegate who attends understand the importance of Preaching the Gospel, Personal Evangelism, Missionary Endeavor, and Musical Praise in Today's Church; (2) To have each delegate who attends understand the purpose of the church in relation to the ministry of the Gospel; (3) To have each delegate who attends to become cognizant of the character of music worship (Psalms 150): that music is an act of worship, not entertainment; and that the pulpit and music must be in accord if worship is to be gratifying and spiritually profitable; (4) To explore and provide conducive avenues through which the teaching ministry can be channeled to the entire world; (5) To promote Christian education and service in the area of evangelism and religious music; (6) To stimulate more life in Christian service in the area of missionary; (6) To stimulate more life in Christian service realize the importance of the leadership role of the Pastor in relation to the religious cultivation of his church and the spiritual welfare of the congregation; and to clearly understand that the Pastoral Office is the only divine appointment from God over His church; (8) To have each delegate be more knowledgeable upon departure from the convention than they were upon arrival at the convention.

OBJECTIVES OF THE ORGANIZATION: (1) To promulgate spiritual enrichment via preaching, teaching, praying and singing; (2) To organize courses for delegates that will emphasize the goals of GEMCA; (3) To utilize, on a daily basis, the talents of the preaching ministers by having a minimum of three sermons daily, and one midnight sermon; (4) To establish a Christian "Utopia" whereby ministers of the Gospel can effectively and harmoniously work together (regardless of denomination or religious belief) in emphasizing the importance of evangelism through the Word ministry (preaching and teaching), and the Ministry of Music (by singing and playing instruments); (5) To explore the pros and cons of community choirs or choruses; (6) To explore the pros and cons of the position of the Minister of Music as a supportive position working harmoniously with the Minister/Pastor; (7) To explore and emphasize the need for missionary endeavor in the church; (8) To explore the pros and cons of the appointment of trained or semi-trained counselors in the church; (9) To provide an avenue through which Gospel evangelism can be projected in its true perspective; that is, preaching and teaching the Word, praising God in song; and praising God with musical instruments; (10) To emphasize the importance of the music department and musicians role in effectively bringing about the return of gospel music or sacred music to the church auspices rather than in the present day structure of community choirs and community directors controlled primarily by civic leaders.

Note: The above stated goals and objectives are tentative and will be changed as necessary during the board meeting. It is desired that they be reviewed carefully, and recommendations for additions, deletions and/or changes be brought to the board meeting for consideration.

For additional information write to: Gospel Evangelists, Musicians, and Choral Association (Interdenominational), P.O. Box 14086, St. Louis, Missouri 63178; Rev. Dr. Joseph D. Linton, Founder; phone: (314) 869-7517, (314) 355-2160.

Send all gospel news to Irene J. Ware, P.O. Box 2261, Mobile, Alabama 36001; phone: (205) 457-8012 or 457-6771.

Light Orchestra Makes Heavy Music

By HOWARD NEWMAN

■ NEW YORK — The name of the Electric Light Orchestra (United Artists) is synonymous with progressive concepts in rock. From their first hit single in the U.S., featuring an inventive re-working of Beethoven's Fifth Symphony, to the critically acclaimed album "Eldorado," ELO has been in the forefront of musical ideas in the rock idiom.

ELO is led by former Move members Jeff Lynne and drummer Bev Bevan. Lynne and Bevan decided to form ELO about three years ago when Move self-admittedly, "dissipated." Lynne is lead guitarist and vocalist and is the author of most of the group's material. He is the force behind "Eldorado" and the great single from the album, "Can't Get You Out of My Head." Lynne states, "I work out the concepts almost totally in my head and arrange them for the recordings with our keyboardist Richard Tandy."

'Face The Music'

Although ELO has gained the reputation as a concept-oriented band, Lynne describes their new album, "Face The Music," as "a collection of tunes," the single "Evil Woman" being the tune gaining the most popularity. "Face The Music" is breaking faster than any of their previous records indicating a growing acceptance for ELO's advanced rock music.

Most of ELO's popularity is centered in the United States. Their frequent appearances on TV's "In Concert" and "Midnight Special" have certainly contributed to their American success. They have appeared on "Midnight Special" an unprecedented 14 times in the past two years. The opportunity for similar exposure does not exist in their native England due to the



Bevan, Newman, Lynne and Jet Music's Dave Arden.

tight formats imposed by the BBC. The few commercial outlets tend to stick to the same structure as the BBC. Bev Bevan adds, "Besides, England is going through a teeny-bopper and soul stage right now," categories ELO obviously does not fit into. The radio situation is not much better, so the group prefers the atmosphere on this side of the Atlantic.

ELO has not given up on the European market. They receive airplay on important Radio Luxembourg and will soon embark on a tour covering Holland and the Scandinavian countries. By the New Year they will be back in the States for an extensive

concert tour that will heavily feature material from "Face The Music." Even though they receive extensive television coverage, ELO fills American concert halls because of the excitement generated by their live act. Lynne notes, "The crowds seem to love the way our string players jump around like crazy." He added that all three musicians were classically trained, but now play by ear. They had to, to keep up with the free-wheeling demands of rock. Today ELO's complete musicianship coupled with unbridled spontaneity creates a total stage performance comparable to the most sophisticated groups extant.

CONCERT REVIEW

Frank Zappa: A Halloween Treat

■ NEW YORK—What would Halloween be without a Frank Zappa and the Mothers of Invention (DiscReet) concert? The mere prospect of the King of the Bizarre deserting his faithful followers on the night of nights is too frightening to dwell on. So

on to the festivities.

Zappa packed the Felt Forum for the crucial midnight show. First appeared the incredible apparition of the former University of Wyoming baton twirling champion dressed (?) in a silver lamé thong and doing bits with those whirling sticks that would make your head spin!

Ground Loop Dancers

Next came the Ground Loop Dance Troupe. Ostensibly roadies in leotards, these three gentlemen performed an interpretive dance revolving around the eternal themes of the mop, wash bucket and, of course, the devil. Realizing there wasn't much left to top that performance, Zappa and the Mothers arrived to "play some rock n' roll."

Zappa has always criticized the absurdities of our society by pointed exaggeration. Sometimes this technique can be sledgehammer, as in the presentation of "Dirty Love" where a Ground Loop Trouper comes out dressed as the infamous poodle "Frenchie" to take a bite out of the band members. Zappa's attack on traditional journalism in "The Illinois Enema Bandit" is far more

Couple Arrested In Piracy Case

■ LOS ANGELES — Shane and Janet Mason were arrested here following their indictment by a Federal Grand Jury charging them with violating the Federal Copyright Law by manufacturing and selling pirated versions of copyrighted sound recordings.

The two had been convicted in June, 1974, of copyright infringement. Mr. Mason was sentenced to 40 weekends in jail and was placed on probation for three years. Mrs. Mason was sentenced to three years' probation.

The new indictments, charging five counts of copyright infringement, mean that the Masons, if convicted, would be guilty of a felony subject to imprisonment of up to two years and/or a fine of up to \$50,000 on each count.

Authorities charged that sales of allegedly pirated recordings took place at the Diamond Bar in Pomona, Cal., and that the actual duplication was done at an undisclosed location in Pomona.

Harrison Gets Gold

■ HOLLYWOOD — "Extra Texture," the latest Capitol-distributed Apple album by George Harrison, has received RIAA gold certification announced Don Zimmermann, senior VP, marketing, Capitol Records, Inc.

Bunny Gets Gilded



Playboy Records and Hamilton, Joe Frank and Reynolds were understandably elated when their "Falling In Love" single was certified gold recently and members of the group recently visited RW's west coast offices to share their joy and gold records. RW's Spence Berland and Lenny Beer were presented with commemorative plaques and shown, from left, at those proceedings are the group's Alan Dennison, Berland, Dan Hamilton, Beer, Joe Frank Corolla, Joel Cohen of Kudo III management and Playboy Records' Jack Hakim.

subtle, although getting two members of the audience on stage for a simulated reconstruction of the deed was a bit much. When the object of Zappa's satire was clear in "Slime From Your Video," the audience reacted with total approval.

No matter how you view Zappa's commentary, there is no denying his complete mastery of rock guitar. He played inventive, extended solos on "Chunga's Revenge" and "Stinkfoot," where the theatre stopped and the music took over.

Theatrics are an integral part of the act and the Mothers are greatly enhanced by the presence of the perpetual motion machine named Napoleon Murphy Brock. Brock doesn't sing so much as act out every number, complete with costume changes. He also played some fine sax duets with guest musician Norma Bell. Rounded out by original Mother Roy Estrada on bass and screeching high vocals, Alfonso Lewis on keyboards, and drummer Terry Bozzio, the Mothers added strong support to Zappa's rock-culture concepts.

Howard Newman

RECORD WORLD COUNTRY SINGLES PUBLISHERS LIST

ALL AMERICAN MAN Billy Sherrill (Algee, BMI) 26	MAMAS, DON'T LET YOUR BABIES GROW UP TO BE COWBOYS Chuck Haines & Patsy Bruce (Tree/Sugarplum, BMI) 82
ALL OVER ME Billy Sherrill (Ben Peters and Charsy, BMI) 4	MAYBE TOMORROW Wesley Rose (Acuff-Rose, BMI) 91
ANOTHER WOMAN Crews, Gilmer & Browder (Dan Penn, BMI/Buzz Cason, ASCAP) 48	ME AND OLD C.B. E. Jimmy Key & Jack J. Key (Newkeys, BMI) 40
ARE YOU SURE HANK DONE IT THIS WAY/BOB WILLIS IS STILL THE KING Jack Clement & Waylon Jennings (Baron, BMI) 3	OUR MARRIAGE WAS A FAILURE Roy Dea (Hall-Clement, BMI) 41
BATTLE OF NEW ORLEANS None Listed (Warden, BMI) 44	OVERNIGHT SENSATION Eddie Kilroy (Hall-Clement, BMI) 70
BILLY GET ME A WOMAN Norro Wilson (Al Gallico/Algee, BMI) 13	PAPER LOVIN' Jim Vienneau (Jidobi, BMI) 50
BLACK BEAR ROAD Don Shears & Chip Davis (American Gramophone, SESAC) 49	PARADISE Glenn Sutton (Cotillion/Sour Grapes, BMI) 90
BLUE EYES CRYING IN THE RAIN Willie Nelson (Milene, BMI) 55	PLEDGING MY LOVE Jim Vienneau (Lion/Wemar, BMI) 61
CONVOY Don Sears & Chip Davis (American Gramophone, SESAC) 64	PIECES OF MY LIFE Prod. not listed (Danor, BMI) 36
COUNTRY BOY Dennis Lambert & Brian Potter (ABC/Dunhill/One of a Kind, BMI) 35	QUEEN OF THE SILVER DOLLAR Cecca Prod. (Evil Eye, BMI) 87
COWBOYS AND DADDYS Bill Rice & Bobby Bare (Wilber/Martin Cooper, ASCAP) 42	ROCKY Roy Dea and Dickey Lee (Strawberry Hill, ASCAP) 7
DANCE HER BY ME (ONE MORE TIME) Jerry Kennedy (LeBill, BMI) 74	ROLL YOU LIKE A WHEEL Eddie Kilroy (Acclaim, BMI) 34
EASY AS PIE Ron Chancey (Chappell & Co., ASCAP) 19	ROLY POLY Wesley Rose, (Milene, ASCAP) 97
EVERY ROAD LEADS BACK TO YOU Keith Potger & Barry Mason (Cherry Lane, ASCAP) 76	SAN ANTONIO STROLL Snuff Garrett (Unichappell, BMI) 23
EVERYTHING'S THE SAME (AIN'T NOTHING CHANGED) Chip Young & Billy Swan (Combine, BMI) 43	SAY I DO Larry Gordon (Dayspring, BMI) 77
FIRE AND RAIN Felton Jarvis (Blackwood/Country Road, BMI) 63	SECRET LOVE Huey P. Meaux (Warner Bros., ASCAP) 5
FLAT NATURAL BORN GOOD TIMIN' MAN Roy Dea (Forrest Hills, BMI) 32	SHAME ON ME Billy Sherrill (Regent/Fort Knox, ASCAP) 69
FROM WOMAN TO WOMAN Ricci Mareno (Ricci Mareno, SESAC) 25	SHE DESERVES MY VERY BEST Charlie Rich & Sy Rosenberg (Shelmer-Poe/Unichappell, BMI) 53
FUNNY HOW TIME SLIPS AWAY Johnny Morris (Tree, BMI) 45	SHE EVEN WOKE ME UP TO SAY GOODBYE Chips Moman (Acuff-Rose, BMI) 10
GEORGIA RAIN Joe Johnson (Four Tay, BMI) 72	SILVER WINGS AND GOLDEN RINGS Larry Butler (Almo/Peso, ASCAP) 52
GOOD MORNING LOVIN' Allen Reynolds (Owepar, BMI) 100	SINCE I MET YOU BABY Wayne Duncan (Unichappell, BMI) 17
GREENER THAN THE GRASS Billy Sherrill (Window, BMI) 60	SO FINE Norro Wilson (Eldorado/Wildcat, BMI) 96
HELP ME MAKE IT (TO MY ROCKIN' CHAIR) Chips Moman (Baby Chick, BMI) 38	SOMETHING BETTER TO DO John Farrar (ATV, BMI) 20
I LIKE BEER Jerry Kennedy (Hallnote, BMI) 1	STONED AT THE JUKEBOX Dick Glasser (Bocephus, BMI) 62
I SHOULD HAVE MARRIED YOU David Malloy (Briar Patch/Deb Dave, BMI) 22	SUGAR SUGAR Tommy Hill (Don Kirshner, BMI) 86
I STILL BELIEVE IN FAIRYTALES Billy Sherrill (Tree, BMI) 16	SUNDAY SUNRISE Tom Catalano (Screen Gems-Columbia/Sweet Glory, BMI) 73
I'D RATHER BE PICKED UP HERE Ron Chancey (Pi-Gem, BMI) 75	SWEET YESTERDAYS Ricci Mareno (Ricci Mareno, SESAC) 99
I'LL BE YOUR SAN ANTOINE ROSE Roy Dea (Sunbury, ASCAP) 84	TEXAS 1947 Charlie Bragg (Sunbury, ASCAP) 66
I'LL TAKE IT Mary Reeves & Bud Logan (Screen Gems-Columbia, BMI) 89	THE BLIND MAN IN THE BLEACHERS Snuffy Miller (Tree, BMI) 47
I'M A FOOL TO CARE Huey P. Meaux (Peer, Intl., BMI) 79	THE DOOR'S ALWAYS OPEN Jim Vienneau (Jack, BMI) 71
I'M SORRY Milt Okun (Cherry Lane, ASCAP) 9	THE GOOD LORD GIVETH AND UNCLE SAM TAKETH AWAY Shelby S. Singleton, Jr. (Brandywine, ASCAP) 80
INDIAN LOVE CALL Ray Stevens (Warner Bros., ASCAP) 30	THE LETTER THAT JOHNNY WALKER READ Tommy Allsup (Asleep At the Wheel & Black Coffee, BMI) 39
INDIAN CREEK Porter Wagoner (Owepar, BMI) 83	THE MAN ON PAGE 602 D. Corey & B. Fischer (Georgene, BMI) 56
IT'S ALL IN THE MOVIES/LIVIN' WITH THE SHADES PULLED DOWN Fuzzy Owen (Shade Tree, BMI) 2	THE SONG WE FELL IN LOVE TO Ray Baker (Acuff-Rose/Milene, ASCAP) 31
IT'S NOT FUNNY ANYMORE Bob Dean (Owolofus, ASCAP/Myownah, BMI) 65	THE WOMAN ON MY MIND Norro Wilson (Algee & Al Gallico, BMI) 58
IT'S SO NICE TO BE WITH YOU Earl Richards (Interior, BMI) 95	TODAY I STARTED LOVING YOU AGAIN Jim Malloy (Bluebook, BMI) 12
IT'S THE BIBLE AGAINST THE BOTTLE Nelson Larkin & Dick Heard (A-Gee-Jay & Blue Moon, ASCAP) 93	(TURN OUT THE LIGHTS AND) LOVE ME TONIGHT Don Williams (Hall-Clement, BMI) 54
I'VE BEEN AROUND ENOUGH TO KNOW Glen Keener (Hall-Clement, BMI) 81	WARM SIDE OF YOU Steve Stone (Hartline, BMI) 33
JASON'S FARM Walter Haynes (Pick-a-Hit, BMI) 29	WE USED TO Porter Wagoner (Owepar, BMI) 11
JUST IN CASE Tom Collins & Jack D. Johnson (Pi-Gem, BMI) 27	WESTERN MAN Norro Wilson (Al Gallico, BMI) 24
LAST OF THE OUTLAWS Eddie Kilroy (Tree, BMI) 85	WHATEVER I SAY Stan Silver (Prima Donna, BMI) 37
LOOKING FOR TOMORROW (AND FINDIN' YESTERDAYS) Jim Vienneau (Sawgrass, BMI) 46	WHAT'S HAPPENED TO BLUE EYES Ken Mansfield (Baron, BMI) 14
LOVESICK BLUES Bob Montgomery (Mills, ASCAP) 98	WHEN I STOP DREAMING Norro Wilson (Acuff-Rose, BMI) 94
LOVE IS A ROSE Peter Asher (Silver Fiddle, BMI) 6	WHEN THE TINGLE BECOMES A CHILL Owen Bradley (Wilderness, BMI) 51
LOVE PUT A SONG IN MY HEART Jerry Kennedy (Pi-Gem, BMI) 8	WHERE LOVE BEGINS Russ Reeder & Bob Webster (Blue Echo, ASCAP) 18
LOVE WAS Pete Drake (Beechwood/Window, BMI) 88	WHO WANTS A SLIGHTLY USED WOMAN Audie Ashworth (Boyce & Powers/Adventure, ASCAP) 92
LUST AFFAIR Dick Heard (Blue Moon, ASCAP) 28	WILL YOU LOVE ME TOMORROW Billy Sherrill (Screen Gems-Columbia, BMI) 67
LYIN' EYES Bill Szymczyk (Benchmark/Kicking Bear, ASCAP) 21	WOMAN, WOMAN Dick Glaser (Ensign, BMI) 68
MAKIN' LOVE Walter Haynes (Tree, BMI) 59	YOU RING MY BELL Ray Griff & Lee Hazen (Blue Echo, ASCAP) 15
	YOU'LL NEVER KNOW Chet Atkins (Brigman, Vocco & Conn, ASCAP) 78

CONCERT REVIEW

Country's Pride Comes to Gotham

NEW YORK—New York was treated to the best in country music when the Charley Pride Show (RCA) rolled into Felt Forum last Saturday (8). The scarcity of top-flight country acts in New York City made the evening especially attractive to civic groups and social clubs throughout the Metropolitan area. A group of 850 suburbanites came in on a "Country Music Special" Long Island Railroad train.

Although this was the New York debut of the Charley Pride Show, the crowd immediately warmed up to Charley and his supporting cast. Opening the bill of RCA artists was Dave and Sugar (Dave Rowland with Vickey Hackeman and Jackie Frantz), who performed covers of the year's country hits, including: "Day Dreams 'Bout Night Things," "When Will I Be Loved" and "Rhinestone Cowboy." Backed by The Pridemen, Dave and Sugar excell at tight country harmonies.

Former studio songwriter and Pridesman Gary Stewart got the crowd rocking with his up-tempo originals "Out of Hand" and "Honky Tonkin'." Stewart is in the rockabilly tradition of Carl Perkins, but had a terrific rapport with the big-city audience. His popular single, "She's Actin' Single, I'm Drinkin' Doubles," was greeted with familiarity, which put Stewart in the mood for a piano pounding encore of Jerry Lee Lewis' "Whole Lotta Shakin' Goin' On." Here's a performer to watch!

To cap the evening, Charley Pride arrived, accompanied by the Pridemen and the backing vocals of Dave and Sugar. Pride has an ease and warmth of performance based on his tremendous success and years of experience. From the opening number, "My Love is Deep, My Love is Wide," Pride had the audience in the palm of his hand. His is a smooth professional show that doesn't require requests from the

audience, simply because he knows what his public wants and delivers it to them during the course of the evening.

"Elijah" demonstrated the range of Pride's vocal styling, while "Crystal Chandelier" exhibits a social conscience in country music. The response to the medley of "Put Back My Ring On Your Hand," "Too Good To Be True" and "Is Anybody Goin' To San Antone" showed that New Yorkers have been listening to Charley Pride for many years.

Pride's hits are so extensive that it would be impossible for him to sing them all in one concert. However, when his set was over the audience clamored for more and Pride delivered the ballad "(I'm So) Afraid of Losing You," Hank Williams' classic "Love Sick Blues" and a rousing "Old Cotton Fields Back Home" that had people out of their seats.

Pride is a consummate entertainer in a field that has not been adequately explored in New York. Judging by the reaction to the concert, there will be a lot more "Country In New York" in the near future.

Howard Newman

Clark Golf Tourney Aids Medical Center

TULSA—The Children's Medical Center of Tulsa, Oklahoma has announced that substantial monies resulting from the first annual Roy Clark Celebrity Golf Classic have been directed to a general fund which helps to defray the Center's \$3 million annual operating expenses.

Tape Pirate Fined

LOS ANGELES — Stephen I. Stillman was sentenced in Federal District Court here to a fine of \$750 and placed on probation for one year after pleading guilty to one count of copyright infringement resulting from the sale of pirated sound recordings.

FBI agents had seized 300 tapes from Stillman's premises at 107 No. Euclid, Ontario, Cal.

MCA Promotes Two

LOS ANGELES — Sam Passamano, MCA vice president of sales, has announced that Glenn Horner has been promoted from sales manager in MCA's Miami office to the position of sales manager in Atlanta. Rod Tremblay, formerly a salesman working from the Miami office, has been promoted to take Horner's former position as sales manager in Miami.

Thunder Storm



On a recent studio date in New York to record her now current single, "Don't You Have Any Love In Your Heart," Margo Thunder was visited by Matt Parsons, national r&b promotion and sales director of Capitol Records. Margo records on Haven Records, distributed by Capitol.

UA Names Butler Vice President

■ NASHVILLE — Al Teller, president, United Artists Records, has announced the promotion of Larry Butler to the post of vice president and director of country product, United Artists Records.



Larry Butler

During his stint with UA, Butler has produced several top country singles, including Billie Jo Spears' "Blanket on the Ground" and Jean Shepard's "Slippin' Away," and has been instrumental in bringing such artists as Dave Dudley, Kenny Rogers, Sunday Sharpe, Calico and Ed Bruce to the label.

Butler has been with United Artists for a year and a half as director of country product for the label. Prior to joining UA, he was an independent producer, producing numerous acts.

Anderson To NARAS

■ NASHVILLE — Bob Thompson, president of the Nashville chapter of NARAS, has announced, on behalf of the board of governors, the appointment of Francine Anderson to the position of executive director of NARAS in Nashville.

Anderson comes to NARAS after several years as executive secretary of SESAC and most recently as promotion secretary for Avco Records.

Country Music Assoc. Elects New Officers

■ NASHVILLE—The Country Music Association officers for 1975-76 were elected last week, with Jim Foglesong, president, ABC Dot, elected chairman of the board of CMA, and Ron Bledsoe, director of Nashville operations, CBS, elected president.

Elected executive vice president is Irving Waugh, with Frank Jones first VP. Other VPs elected were Bob Wolfe, Bud Wendell, Dan McKinnon, Bill Anderson, Charley Pride and Bob Neal. Tom Collins was elected secretary and Ralph Peer II was elected assistant to the secretary. Elected treasurer was Hutch Carlock, with Mary Reeves Davis assistant treasurer. The sergeant-at-arms is Charlie Douglas.

The elections were held last Thursday (13) in Nashville by the CMA board.

Wise/Fox Agency Bows In Nashville

■ NASHVILLE — The Wise/Fox Agency, geared toward representing a wide variety of talent, has opened in Music City, according to an announcement made by general manager Noel Fox.

Fox, who founded the company in a partnership agreement with recording artist Mac Wiseman, was formerly a member of the Jim Halsey Agency.

Prior to his position with Halsey, Fox had worked two years as an agent for the Don Light Agency and initially began his career in the music business as bass singer for the Oak Ridge Boys.

Still in its infancy, the Wise/Fox Agency has already set over 90 festivals and concerts for next year on Mac Wiseman, as well as over 50 dates on The Second Generation.

ASCAP To House DJ Hall of Fame

■ NASHVILLE — The temporary home of the newly-founded Country Music Disc Jockey Hall of Fame will be the southern regional offices of ASCAP in Nashville.

Replicas of the bronze plaques given the first inductees will be on permanent display in the lobby of the ASCAP building. As more inductees are made into the Hall of Fame, plans are being made to display the plaques in one of the board rooms and call the room The Country Music Disc Jockey Hall of Fame Room.

RCA Signs Paxton



Singer / songwriter / producer / publisher Gary S. Paxton (left) is shown signing a contract to record for RCA Records. On the right is Chet Atkins, RCA's vice president of country music, who will produce Paxton for the label.

NASHVILLE REPORT

By RED O'DONNELL



■ Macy's 49th annual Thanksgiving Day parade in New York City could be the "bust" ever. Buxom **Dolly Parton** will be aboard a float singing "The Seeker" (it'll be aired by NBC-TV on the morning of Nov. 27) . . . **Roy Clark** guests on **Mac Davis'** NBC Christmas special Dec. 14 . . . WLMD (Laurel, Md.) DJ **Jim Fitzgerald** says he set a record when he played 45 RPMs on the air for 236 hours, 42 minutes & 30 seconds—with only stops for station breaks and pitches for a Multiple Sclerosis fund

raising campaign.

Folks at Mercury's local office are so excited about the voice of Pittsburgh Steeler quarterback **Terry Bradshaw**, they plan to release his first single "within two or three weeks." Bradshaw is being produced by **Jerry Kennedy** . . . **Dinah Shore** tagged her television company "Winchester Productions," a salute to her birthplace, Winchester, Tenn.

Top-of-the-charts "All Over Me," (recorded by **Charlie Rich**) and "Love Put A Song in My Heart" (cut by **Johnny Rodriguez**) were written by **Ben Peters** . . . There is a new Kristofferson singing professionally: 24-year-old **Sally Kristofferson** of Albuquerque, New Mexico, who is signed to the locally based Mecca label. **Paul Huffman**, president of the record company, in reply to a question, said: "Yes, that is her right name—and if she is related to Kris it is very distant."

Danny Davis & Nashville Brass did one-night stand at Atlanta's Federal prison. Ah, an inside job? . . . Of course you know that 20th Century disc artist **Margo Smith** wrote and recorded "There I Said It" and "Paper Lovin'," but did you know that her husband, **Ken Smith**, is vice president of a bank in their hometown of New Carlisle, Ohio, which isn't too far from Springfield?

Charlie Rich, via a letter to his fan club members, apologized for
(Continued on page 104)

COUNTRY PICKS OF THE WEEK

SINGLE **NARVEL FELTS**, "SOMEBODY HOLD ME (UNTIL SHE PASSES BY)" (Al Cartee/Ensign, BMI). This has got to be one of the strongest songs Narvel has ever recorded. With a song strong enough to match the emotion packed into his voice, it's a sure bet this ballad will take over the airwaves. Look for a monster with this. ABC Dot DOA-17598.

SLEEPER **STONEY EDWARDS**, "BLACKBIRD" (Blackwood/Back Road, BMI). One of the most insightful songs to come out this year as Stoney sings honestly about a black man growing up in the south, loving country music. Penned and produced by Chip Taylor, the possibilities here are endless. Stoney has stone country soul! Capitol P-4188.

ALBUM "REMEMBERING . . . THE GREATEST HITS OF LEFTY FRIZZELL." This album is truly a classic, containing the original versions of hits recorded on Columbia under Don Law by one of the greatest country singers to ever belt out a song. Included are "Always Late," "I Love You A Thousand Ways," "Mom and Dad's Waltz" and "Saginaw, Michigan." A most timely release, further establishing Lefty as a legend. Columbia KC 33882.

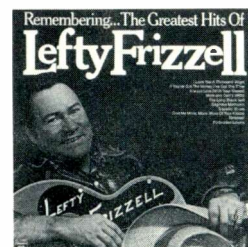

Sale Exits 4 Star; Forms Own Company

■ NASHVILLE — After 12 years with 4 Star Music Co., Inc. and affiliates, Peter Sale has resigned his position as general manager, effective this month, to commence his own company, Pete Sale Associates, at 45 Music Square West.

Sale's new enterprises will include the accounting and administration of music publishing companies whose owners wish to concentrate more on plugging songs and leave the chores of accounting and administration to someone more qualified. He will also initiate new publishing companies for those who require them.

On his agenda will be the financial management of artists who are too preoccupied with the creative side of the industry to keep a tight check on incoming cash. Pete Sale Associates services include: collecting all personal income; payment of all bills; maintaining bank accounts; providing budgetary counseling service; tax services by associate; insurance services by associate; investment counseling; and payroll taxes.

NSD Pacts Two

■ NASHVILLE—Nationwide Sound Distributors has announced the signing of distribution pacts with two country labels, Corona and Sunshine Country.

Corona's roster includes Ray Smith, who is scheduled for a single release in November. Sunshine Country debuts the new deal with Billy Parker's "Average Man" single and lp.

DJs of Distinction



Veteran radio personalities Grant Turner (seated, left) and Smilin' Eddie Hill (seated, right) are pictured during a reception following their induction into the Country Disc Jockey Hall of Fame. Standing are ASCAP's Ed Shea (left) and Chuck Chellman, trustee of the Country Disc Jockey Hall of Fame. Plaques honoring Turner, Hill, and deceased inductee Nelson King will be displayed in the ASCAP lobby on Music Row.

COUNTRY HOT LINE

By MARIE RATLIFF



■ **FEARLESS FORECAST:** Kenny Rogers takes his first Nashville-produced session on United Artists and aims it directly at the top of that country charts! "Love Lifted Me" has the lift it needs for a swift ascent — look out, Top Ten!

Jerry Jeff Walker is making commercial country waves for the first time — primarily in Texas and the southern markets with "Jaded Lover." Look for it to spread rapidly!

It's not what you'd expect, but Stoney Edwards' "Blackbird" has all the earmarks of a blockbuster! Stoney's new producer, Chip Taylor, gets a great sound that's showing initial growth at KENR and WHOO.

New duo about town: Bill Anderson teams up with Mary Lou Turner; and already "Sometimes" is being aired frequently at KFDI, WMC, WKDA, WWOK and WCMS.

The Oak Ridge Boys present a solid offering in "Heaven Bound;" doing extremely well at WINN, KCKC, KBUL and KCKN.

Vernon Oxford is drawing attention with "Shadows Of My Mind" in Atlanta, Kansas City, Nashville and Springfield.

Album Action: "Coin Machine" from Jerry Reed's

"Red Hot Picker" lp is the choice at WHK and KBUL; interest still heavy on Ronnie Milsap's "I'll Be There" at WSLR, WINN and KBUL.

The Queens are taking over! Dave & Sugar's "Queen of the Silver Dollar" continues to grow by leaps and bounds; Brian Collins' "Queen of Temptation" is taking off at KENR, KCKC, WINN and KCKN.

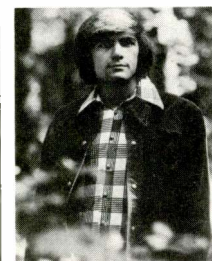

Brian Collins

Super Spinners: Ed Bruce, Dottsy, Ray Price, Chuck Price.

Linda Hargrove has her first heavy scorer in "Love Was," with good reports in from WSUN, KSOP, KVOO, WBAP, KWMT, KTTS and KFDI.

Crystal Gayle shows early response on "Somebody Love You" at KBOX, WIRE, KFDI, WWOK, WKDA and KCKC.

There's some indecision as to which way to go on the Loggins & Messina single. WMQM is going with "Lover's Question," KCKN chooses "Oh Lonesome Me" and WIRE is airing both!

A Bicentennial salute in the form of "200 Candles" by Curly Cook is taking off at both WMC and WMQM in Memphis!

(Cont. on page 104)

TV Appearances Set for Clark and Fender

■ NASHVILLE — The combined television appearances of two ABC/Dot artists, Roy Clark and Freddy Fender, will bring at least one of them before a network television audience nearly every week during November and December.

Clark will be seen Nov. 26 with "Tony Orlando and Dawn" on CBS; he will appear on CBS' "Country Music Hit Parade" Nov. 28, will host the "Tonight Show" Dec. 1 on NBC, and will guest on a Mac Davis special Dec. 14

on NBC. Earlier in November Clark was guest on "Howard Cosell Live" and "The Grand Ole Opry at 50," in addition to being a regular on the syndicated "Hee Haw" series.

Fender, who also was on "The Grand Ole Opry at 50," will join Clark again Nov. 28 for the "Country Music Hit Parade." In addition he will return to NBC's "Tonight Show" for the third time Dec. 8 and will join Dean Martin Dec. 14 for a Christmas Show on NBC.

A honey
of a NEW single...
**Country
Honey**



Stoney Edwards

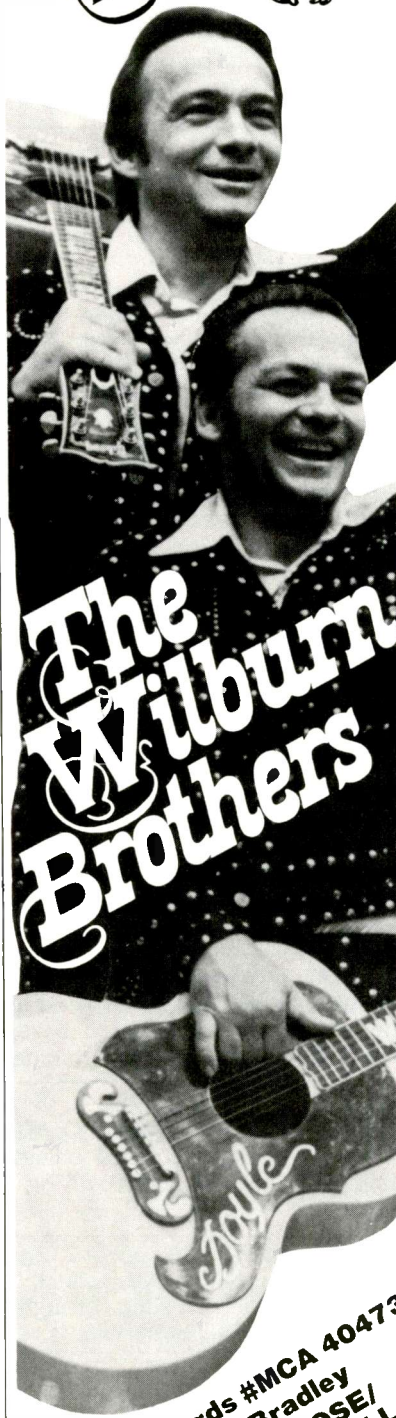

On MCA Records #MCA 40473
Producer: Owen Bradley
Publisher: ACUFF-ROSE/
UNICHAPPELL
Writers: Dallas Frazier/
A.L. "Doodle"
Owens

Bookings: Wil-Helm Agency
801 Music Square East, Nashville,
Tennessee 37203 (615) 244-1403

Public Relations: THE JAMES AGENCY,
971 N. LaCienega, Suite 204, Los Angeles,
California 91604 (213) 659-2386

Fan Club: Wilburn Brothers Clubs
International, Brenda Wade & Betty Jones,
P.O. Box 376, Fenton, Mo. 63026

COUNTRY SINGLE PICKS

COUNTRY SONG OF THE WEEK

AMAZING RHYTHM ACES—ABC ABC-12142

AMAZING GRACE (USED TO BE HER FAVORITE SONG)
(Fourth Floor, ASCAP)

The follow-up to "Third Rate Romance" is catchy and shows that this group will be around for a long time. Infectious melody and strong lyric will make this a popular request item.

C. W. McCALL—MGM M 14839

CONVOY (American Gramophone, SESAC)

The distinctive style of C.W. is right on here as he spins a tale about C.B.s and trucks. Another programmer's delight as he offers up a change of pace.

WILMA BURGESS—Shannon SH 839

A SATISFIED MAN (Jack & Bill, ASCAP)

A easy-flowing number that'll have Wilma on top of the charts in a hurry. She delivers the message here that you don't lose a satisfied man. Satisfaction guaranteed!

BILL ANDERSON AND MARY LOU TURNER—MCA MCA-40488

SOMETIMES (Stallion, BMI)

Bill and Mary Lou debut on a duet and the result is a sure-fire winner. Penned by Bill, it's a ballad that'll hit home in a hurry. All the time!

JEANNE PRUETT—MCA MCA-40490

MY BABY'S GONE (Central Songs, BMI)

Jeanne brings back this classic in hit fashion. A strong chorus and Jeanne's distinctive vocals will make this a hit all over again.

KENNY ROGERS—United Artists UA-XW746-Y

LOVE LIFTED ME (John T. Benson, ASCAP)

Kenny is back on the track making hit records, as this release will testify. A very positive song with a gospel feel makes this a sure winner.

AVA BARBER—Ranwood R-1043

THAT'S WHAT LOVE MEANS TO ME (Jack and Bill, ASCAP)

A star on the Lawrence Welk Show, Ava has a sweet, easy feeling in this number about all the good things that come from love.

TOM TALL—Scorpion SC-0501

DO THE WRONG AGAIN WITH ME (Newkeys, BMI)

Tom delivers the message to a lady here that if she's gonna cheat, do it with him. Great song for this new artist.

CHRIS GANTRY—ABC/Dot DOA-17594

SAYING GOODBYE WITHOUT SAYING HELLO (Ja-Len, ASCAP)

A very touching, sensitive ballad from one of Nashville's premier underground poets. Chris will hit big as an artist with this—just give it a listen.

VICKI LEHNING—Capitol P-4174

KILLER BARRACUDA (Buckhorn, BMI)

An old Kristofferson song, brought to life by a new songstress, has a haunting feel. This barracuda is ready to strike at the charts.

JIMMY LOUIS—Plantation PL-132

COUNTRY MUSIC IS COMING TO THE CITY (Shelby Singleton/
Friendly Finley, BMI)

A peppy, up-tempo number with the message that every country programmer will be delighted to put on the air. Country music is coming on strong!

LARRY G. HUDSON—Aquarian IRDA 118

SHOP AROUND (Jobete, ASCAP)

The old classic by the Miracles is brought back in country form by this Macon native. Get it on!

RANDY KNIGHT—Big Foot BF-711

THE FOOL (Malapi, BMI)

A hit from a few years back comes back strong again.

LEON RAUSCH—Derrick 45-DRC-105

THROUGH THE BOTTOM OF THE GLASS (Acuff-Rose, BMI)

A western swing-type number that'll gather airplay. Bottom's up!

Nashville Report *(Continued from page 102)*

"erratic behavior" the night of the nationally televised Country Music Association awards show here (Oct. 13).

"I wish I could undo it," Charlie wrote. "And from this dark hour will come my shining hour."

"There is an old saying that adversity builds character," he continued. "I intend to show you this is a true saying."

Rich said that on the night of the awards show—aired on CBS-TV—he had been taking pain-killing drugs for what he thought was a poisonous spider bite.

"It later proved to be a fractured foot—which I evidently suffered during a recent tour of Europe," he said.

Bobby Goldsboro as "semi-regular" on NBC-TV's Tonight show? "It's being talked about," says Goldsboro, who guests on the program Wednesday (19) for 21st time. "I may appear every three or four weeks, and be an occasional host," adds the writer-singer. Goldsboro has been composing an instrumental for **Burt Reynolds'** "Gator" movie, which recently completed shooting in Savannah, Ga.

"It's a ballad for love scenes in the picture," Bobby explained. "When I have it all on tape, Burt and some of the production staff will listen to it—and decide if it is what they want."

Goldsboro has scheduled no work for next month. "I am going to spend all of December with my family. I've been away from my wife and children too much this year."

The **Danny Davis and Nashville Brass** TV special produced at Cypress Gardens, Fla. has been completed and is scheduled to air "sometime in early 1976" either via network or syndication.

Roy Clark and singer-songwriter **Red Lane** bought a 1943 "Steerman" plane. The aircraft is an all red, 2-holer, open cockpit job; christened "The Ole R&R." All I can say about this enterprise is "Look out below!"

"Jimmy," a song about the missing labor leader **Jimmy Hoffa**, has been recorded for Warner Bros. by **Bob O'Donnell**, formerly of Utica, N.Y., a resident of Nashville for the past three years. O'Donnell co-wrote the lyrics with Capt. **Paul Godsey** of the Metro Nashville Detective Dept. The single was produced by **Huey Meaux**, who struck pay dirt with recordings by **Freddy Fender**. (Red's Note: Bob O'Donnell is not one of my Yankee cousins—or if he is he doesn't admit it.)

I do believe that **Jim Ed Brown** has had his hair "marcelled"? At any rate, his tresses now appear to be wavy & curly. Reckon what the homefolks back in Pine Bluff, Ark. think about that???

Jack Greene is performing through the remainder of this year without his featured singer **Jeannie Seely** for first time since the duo was formed in 1969. Jeannie & her husband **Hank Cochran** are aboard their yacht, "The Legend," sailing to gosh-knows-where.

Hot Line *(Continued from page 103)*

Sharon Vaughn is getting attention at KBOX, KENR, WUNI, WBAM and WENO on "You and Me."

SURE SHOTS

Amazing Rhythm Aces — "Amazing Grace"

C. W. McCall — "Convoy"

LEFT FIELDERS

Stoney Edwards — "Blackbird"

Nick Nixon — "She's Just An Old Love Turned Memory"

AREA ACTION

Kathy Barnes — "Be Honest With Me" (KRMD)

Ron Lowry — "I Wish I Had Someone To Love" (KJJJ)

Red Sovine — "The Old Fiddler" (KOYN)

Jeannie C. Riley — "Daddy's French Harp" (WCMS)

HOTLINE CHECKLIST

KBOX, Dallas	KTTS, Springfield	WIRE, Indianapolis
KBUL, Wichita	KVET, Austin	WJJD, Chicago
KCKC, San Bernardino	KVOO, Tulsa	WJQS, Jackson
KCKN, Kansas City	KWMT, Ft. Dodge	WKDA, Nashville
KENR, Houston	WAME, Charlotte	WMAQ, Chicago
KFDI, Wichita	WBAM, Montgomery	WMC, Memphis
KIKK, Houston	WBAP, Ft. Worth	WMQM, Memphis
KJJJ, Phoenix	WCMS, Norfolk	WPLO, Atlanta
KKYX, San Antonio	WENO, Nashville	WPNX, Columbus
KLAK, Denver	WGBG, Greensboro	WSDS, Detroit
KOYN, Billings	WHK, Cleveland	WSLR, Akron
KRAK, Sacramento	WHOO, Orlando	WSUN, St. Petersburg
KRMD, Shreveport	WIL, St. Louis	WUNI, Mobile
KSOP, Salt Lake City	WINN, Louisville	WWOK, Miami

NOVEMBER 22, 1975

NOV. 22	NOV. 15		WKS. ON CHART
1	2	REDHEADED STRANGER WILLIE NELSON—Columbia KC 33482	22
2	3	LOVE IN THE HOT AFTERNOON GENE WATSON—Capitol ST 11443	11
3	1	WINDSONG JOHN DENVER—RCA APL1 1183	7
4	4	RHINESTONE COWBOY GLEN CAMPBELL—Capitol SW 11430	14
5	15	ARE YOU READY FOR FREDDY FREDDY FENDER—ABC Dot DOSD 2044	4
6	7	TEXAS GOLD ASLEEP AT THE WHEEL—Capitol ST 11441	10
7	6	SAY FOREVER YOU'LL BE MINE PORTER & DOLLY—RCA APL 1 1116	12
8	5	BEST OF THE STATLER BROTHERS—Mercury SRM 1 1037	17
9	9	CLEARLY LOVE OLIVIA NEWTON-JOHN—MCA 2148	6
10	10	TOM T. HALL'S GREATEST HITS, VOL. 1—Mercury SRM 1 1044	6
11	11	STACKED DECK AMAZING RHYTHM ACES—ABC ABCD 913	6
12	14	PRISONER IN DISGUISE LINDA RONSTADT—Asylum 7E 1045	16
13	13	M-M-MEL MEL TILLIS—MGM M3G 5002	10
14	16	NARVEL FELTS GREATEST HITS, VOL. 1—ABC Dot DOSD 2036	7
15	17	DOLLY DOLLY PARTON—RCA APL 1 1221	16
16	20	WHAT CAN YOU DO TO ME NOW WILLIE NELSON—RCA APL 1 1234	17
17	19	A ROSE BY ANY OTHER NAME RONNIE MILSAP—Warner Brothers BS 2870	17
18	8	THE HIGH PRIEST OF COUNTRY MUSIC CONWAY TWITTY—MCA 2144	16
19	31	DON WILLIAMS GREATEST HITS—ABC Dot DOSD 2035	3
20	32	BLACK BEAR ROAD C. W. McCALL—MGM M3G 5008	4
21	26	THE FIRST TIME FREDDIE HART—Capitol ST 11449	5
22	29	SINCE I MET YOU BABY FREDDY FENDER—GRT 8005	4
23	30	ROCKY DICKEY LEE—RCA APL 1 1243	5
24	27	I STILL BELIEVE IN FAIRYTALES TAMMY WYNETTE—Epic KE 33582	6
25	47	NIGHT THINGS RONNIE MILSAP—RCA APL 1 1223	2
26	28	EVERYBODY'S COUNTRY DAVID WILLS—Epic KE 33548	7
27	12	BEST OF DOLLY PARTON—RCA APL 1 1117	16
28	25	WHATEVER I SAY MEANS I LOVE YOU DONNA FARGO—ABC Dot DOSD 2029	11
29	22	BEFORE THE NEXT TEARDROP FALLS FREDDY FENDER—ABC Dot DOSD 2020	32
30	21	DREAMING MY DREAMS WAYLON JENNINGS—RCA APL 1 1062	20
31	33	BILLY GET ME A WOMAN JOE STAMPLEY—Epic KE 33546	7
32	23	CHARLEY CHARLEY PRIDE—RCA APL 1 1058	20
33	18	HOME LORETTA LYNN—MCA 2146	13
34	24	ONCE UPON A RHYME DAVID ALLEN COE—Columbia KC 33508	15
35	40	HERE COMES JOHNNY RUSSELL—RCA APL 1 1211	3
36	39	MARGO SMITH—20th Century T 490	5
37	44	COUNTRY MALE ARTIST OF THE DECADE SONNY JAMES— Columbia KC 33846	3
38	36	PIECES OF THE SKY EMMYLOU HARRIS—Reprise 2213	34
39	56	RIDIN' HIGH JERRY JEFF WALKER—MCA 2156	2
40	37	ROY CLARK'S GREATEST HITS, VOL. 1—ABC Dot DOSD 2030	12
41	34	LOVIN' AND LOSIN' BILLY WALKER—RCA APL 1 1160	7
42	46	ROCK N' ROLL MOON BILLY SWAN—Monument PZ 33805	5
43	48	BILLIE JO BILLIE JO SPEARS—United Artists LA508 G	3
44	43	MEMORIES OF US GEORGE JONES—Epic KE 33547	7
45	35	I WANT TO HOLD YOU IN MY DREAMS TONIGHT STELLA PARTON— Soul Country and Blues LPN 6006	5
46	60	HEART TO HEART ROY CLARK—ABC Dot DOSD 2041	2
47	38	BANDY THE RODEO CLOWN MOE BANDY—GRC GA 10016	9
48	45	EVERYTIME YOU TOUCH ME (I GET HIGH) CHARLIE RICH— Epic PE 33455	22
49	55	WORLD'S GREATEST HONKY TONK BAND BILL BLACK'S COMBO— Hi SHL 32093	3
50	—	COUNTRY WILLIE WILLIE NELSON—United Artists LA510 G	1
51	42	CALICO—United Artists LA454 G	7
52	53	SOME DAYS ARE DIAMONDS DICK FELLER—Asylum 7E 1044	4
53	49	KEEP MOVIN' ON MERLE HAGGARD—Capitol ST 11365	28
54	41	I'VE NEVER LOVED ANYONE MORE LYNN ANDERSON— Columbia KC 33691	12
55	—	SEARCHIN' FOR A RAINBOW MARSHALL TUCKER BAND— Capricorn CP 0601	1
56	51	LOOK AT THEM BEANS JOHNNY CASH—Columbia KE 33814	6
57	—	UNCOMMONLY GOOD COUNTRY DAVE DUDLEY—United Artists LA512 G	1
58	—	THE NIGHT ATLANTA BURNED ATKINS STRING CO.—RCA APL 1 1233	1
59	58	EDDIE RABBIT—Elektra CM 3	16
60	57	I'M JESSI COLTER—Capitol ST 11363	37
61	—	DON'T STOP LOVIN' ME DON GIBSON—Hickory H3G 4524	1
62	52	THIS SIDE OF THE BIG RIVER CHIP TAYLOR—Warner Brothers BS 2882	9
63	59	FEELIN'S CONWAY & LORETTA—MCA 2143	21
64	—	RED HOT PICKER JERRY REED—RCA APL 1 1226	1
65	63	HEART LIKE A WHEEL LINDA RONSTADT—Capitol ST 11358	48
66	62	YOU'RE MY BEST FRIEND DON WILLIAMS—ABC Dot DOSD 2021	28
67	61	JUST GET UP AND CLOSE THE DOOR JOHNNY RODRIGUEZ— Mercury SRM 1 1032	26
68	66	AN EVENING WITH JOHN DENVER—RCA CPL 2 1765	37
69	67	BACK HOME AGAIN JOHN DENVER—RCA CPL 1 0548	69
70	54	OH HOW LOVE CHANGES DON GIBSON & SUE THOMPSON— Hickory H3G 4521	9
71	50	BURNIN' THING MAC DAVIS—Columbia PC 33551	18
72	65	MISTY RAY STEVENS—Barnaby BR 6012	22
73	68	TODAY ELVIS PRESLEY—RCA APL 1 1039	22
74	71	HAVE YOU NEVER BEEN MELLOW OLIVIA NEWTON-JOHN— MCA 2133	39
75	64	NARVEL FELTS—ABC Dot DOSD 2025	22

"Paradise" ■ 3-10243
And that's what it is with every song she sings.
 Lynn Anderson's new single, appropriately named "Paradise." Already picked by Gavin and jumping up play lists all over the country.
On Columbia Records.





THE COUNTRY SINGLES CHART

TITLE, ARTIST, Label, Number	NOV. 22	NOV. 15	WKS. ON CHART
1 2 I LIKE BEER TOM T. HALL Mercury 73704			12
2 5 IT'S ALL IN THE MOVIES/LIVIN' WITH THE SHADES PULLED DOWN MERLE HAGGARD/Capitol 4141			8
3 1 ARE YOU SURE HANK DONE IT THIS WAY/BOB WILLS IS STILL THE KING WAYLON JENNINGS/RCA PB 10379			12
4 4 ALL OVER ME CHARLIE RICH/Epic 8 50142			10
5 9 SECRET LOVE FREDDY FENDER/ABC Dot DOA 17585			6
6 6 LOVE IS A ROSE LINDA RONSTADT/Asylum 45271			12
7 3 ROCKY DICKEY LEE/RCA PB 10361			15
8 18 LOVE PUT A SONG IN MY HEART JOHNNY RODRIGUEZ/ Mercury 73715			8
9 8 I'M SORRY JOHN DENVER/RCA PB 10353			15
10 11 SHE EVEN WOKE ME UP TO SAY GOODBYE RONNIE MILSAP/Warner Bros. WBS 8127			10
11 15 WE USED TO DOLLY PARTON/RCA PB 10396			9
12 13 TODAY I STARTED LOVING YOU AGAIN SAMMI SMITH/ Mega MR 1236			12
13 14 BILLY GET ME A WOMAN JOE STAMPLEY/Epic 8 50147			11
14 7 WHAT HAPPENED TO BLUE EYES JESSI COLTER/Capitol 4087			14
15 17 YOU RING MY BELL RAY GRIFF/Capitol 4126			12
16 16 I STILL BELIEVE IN FAIRYTALES TAMMY WYNETTE/ Epic 8 50145			10
17 20 SINCE I MET YOU BABY FREDDY FENDER/GRT 031			7
18 23 WHERE LOVE BEGINS GENE WATSON/Capitol 4143			7
19 25 EASY AS PIE BILLY CRASH CRADDOCK/ABC Dot DOA 17584			6
20 22 SOMETHING BETTER TO DO OLIVIA NEWTON-JOHN/ MCA 40459			9
21 27 LYIN' EYES EAGLES/Asylum 45279			7
22 10 I SHOULD HAVE MARRIED YOU EDDIE RABBITT/Elektra 45269			14
23 12 SAN ANTONIO STROLL TANYA TUCKER/MCA 40444			14
24 29 WESTERN MAN LaCOSTA/Capitol 4139			8
25 31 FROM WOMAN TO WOMAN TOMMY OVERSTREET/ ABC Dot DOA 17580			8
26 26 ALL AMERICAN MAN JOHNNY PAYCHECK/Epic 8 50146			9
27 40 JUST IN CASE RONNIE MILSAP/RCA PB 10420			5
28 35 LUST AFFAIR MEL STREET/GRT 030			7
29 36 JASON'S FARM CAL SMITH/MCA 40467			6
30 30 INDIAN LOVE CALL RAY STEVENS/Barnaby 616			11
31 32 THE SONG WE FELL IN LOVE TO CONNIE SMITH/ Columbia 3 10210			8
32 38 FLAT NATURAL BORN GOOD TIMIN' MAN GARY STEWART/ RCA PB 10351			7
33 41 WARM SIDE OF YOU FREDDIE HART/Capitol 4152			6
34 42 ROLL YOU LIKE A WHEEL MICKEY GILLEY & BARBI BENTON/ Playboy 6045			6
35 46 COUNTRY BOY GLEN CAMPBELL/Capitol 4155			4
36 44 PIECES OF MY LIFE ELVIS PRESLEY/RCA PB 10401			6
37 39 WHATEVER I SAY DONNA FARGO/ABC Dot DOA 17579			7
38 37 HELP ME MAKE IT (TO MY ROCKIN' CHAIR) B.J. THOMAS/ ABC ABP 12121			9
39 21 THE LETTER THAT JOHNNY WALKER READ ASLEEP AT THE WHEEL/Capitol 4115			13
40 53 ME AND OLE C. B. DAVE DUDLEY/United Artists XW722 Y			5
41 58 OUR MARRIAGE WAS A FAILURE JOHNNY RUSSELL/ RCA PB 10403			8
42 49 COWBOYS AND DADDYS BOBBY BARE/RCA PB 10409			6
43 19 EVERYTHING'S THE SAME (AIN'T NOTHING CHANGED) BILLY SWAN/Monument ZS8 8661			14
44 45 BATTLE OF NEW ORLEANS BUCK OWENS/Capitol 4138			8
45 24 FUNNY HOW TIME SLIPS AWAY NARVEL FELTS/ ABC Dot DOA 17569			15
46 56 LOOKING FOR TOMORROW (AND FINDIN' YESTERDAYS) MEL TILLIS/MGM 14835			4
47 64 THE BLIND MAN IN THE BLEACHERS KENNY STARR/ MCA 40474			4
48 28 ANOTHER WOMAN T. G. SHEPPARD/Melodyland ME 6016			15
49 33 BLACK BEAR ROAD C. W. McCALL/MGM 14825			11
50 34 PAPER LOVIN' MARGO SMITH/20th Century TC 2222			11
51 70 WHEN THE TINGLE BECOMES A CHILL LORETTA LYNN/ MCA 40484			2



52 63 SILVER WINGS AND GOLDEN RINGS BILLIE JO SPEARS/ United Artists XW712 Y			4
53 61 SHE DESERVES MY VERY BEST DAVID WILLS/Epic 8 50154			5
54 52 (TURN OUT THE LIGHTS) AND LOVE ME TONIGHT DON WILLIAMS/ABC Dot 17568			15
55 54 BLUE EYES CRYING IN THE RAIN WILLIE NELSON/ Columbia 3 10176			19
56 67 THE MAN ON PAGE 602 ZOOT FENSTER/Antique IRDA 106			3
57 65 SOMETIMES I TALK IN MY SLEEP RANDY CORNOR/ ABC Dot DOA 17592			4
58 68 THE WOMAN ON MY MIND DAVID HOUSTON/ Epic 8 50156			4
60 74 GREENER THAN THE GRASS TANYA TUCKER/Columbia 3 10236			3
61 72 PLEDGING MY LOVE BILLY THUNDERCLOUD & THE CHIEFTONES/20th Century TC 2239			5
62 80 STONED AT THE JUKEBOX HANK WILLIAMS, JR./MGM 14833			3
63 82 FIRE AND RAIN WILLIE NELSON/RCA PB 10429			2

CHARTMAKER OF THE WEEK

64 — CONVOY C. W. McCALL MGM 14839			1
65 66 IT'S NOT FUNNY ANYMORE STELLA PARTON/Country Soul & Blues IRDA 088			8
66 79 TEXAS 1947 JOHNNY CASH/Columbia 3 10237			2
67 73 WILL YOU LOVE ME TOMORROW JODY MILLER/Epic 8 50158			3
68 86 WOMAN, WOMAN JIM GLASER/MGM 14834			3
69 55 SHAME ON ME BOB LUMAN/Epic 8 50136			12
70 — OVERNIGHT SENSATION MICKEY GILLEY/Playboy 6055			1
71 71 THE DOOR'S ALWAYS OPEN LOIS JOHNSON/ 20th Century TC 2242			7
72 76 GEORGIA RAIN JERRY WALLACE/MGM 14832			5
73 77 SUNDAY SUNRISE ANNE MURRAY/Capitol 4142			5
74 84 DANCE HER BY ME (ONE MORE TIME) JACKY WARD/ Mercury 73716			5
75 75 I'D RATHER BE PICKED UP HERE JERIS ROSS/ABC Dot DOA 17573			5
76 78 EVERY ROAD LEADS BACK TO YOU LEAPY LEE/MCA 40470			4
77 85 SAY I DO RAY PRICE/ABC Dot DOA 17588			2
78 89 YOU'LL NEVER KNOW JIM REEVES/RCA PB 10418			2
79 87 I'M A FOOL TO CARE DONNY KING/Warner Bros. WBS 8145			2
80 91 THE GOOD LORD GIVETH AND UNCLE SAM TAKETH AWAY WEBB PIERCE/Plantation 131			2
81 81 I'VE BEEN AROUND ENOUGH TO KNOW JOEL SONNIER/ Mercury 73702			7
82 92 MAMMAS, DON'T LET YOUR BABIES GROW UP TO BE COWBOYS ED BRUCE/United Artists XW732 Y			3
83 83 INDIAN CREEK PORTER WAGONER/RCA PB 10411			4
84 — I'LL BE YOUR SAN ANTOINE ROSE DOTTSY/RCA PB 10423			1
85 — LAST OF THE OUTLAWS CHUCK PRICE/Playboy 6052			1
86 88 SUGAR, SUGAR MIKE LUNSFORD/Starday GO 133			5
87 97 QUEEN OF THE SILVER DOLLAR DAVE & SUGAR/ RCA PB 10425			3
88 — LOVE WAS LINDA HARGROVE/Capitol 4153			1
89 93 I'LL TAKE IT ROY HEAD/Shannon 838			2
90 — PARADISE LYNN ANDERSON/Columbia 3 10240			1
91 95 MAYBE TOMORROW DON GIBSON & SUE THOMPSON/ Hickory 360			2
92 — WHO WANTS A SLIGHTLY USED WOMAN CONNIE CATO/ Capitol 4169			1
93 — IT'S THE BIBLE AGAINST THE BOTTLE EARL CONLEY/GRT 032			1
94 94 WHEN I STOP DREAMING DEBI HAWKINS/Warner Bros. WBS 8140			4
95 — IT'S SO NICE TO BE WITH YOU BOBBY LEWIS/ Ace of Hearts 7503			1
96 99 SO FINE CARMOL TAYLOR/Elektra 45277			2
97 100 ROLY POLY CARL SMITH/Hickory 357			2
98 — LOVESICK BLUES SONNY CURTIS/Capitol 4158			1
99 — SWEET YESTERDAYS COUNTRY CAVALEERS/Country Showcase America CSA 166			1
100 — GOOD MORNIN' LOVIN' LARRY KINGSTON/Warner Bros. WBS 8139			1



“CONVOY”^{M-14839} IS ROARING OUT OF C.W. McCALL'S “BLACK BEAR ROAD”



THE ALBUM: "BLACK BEAR ROAD" M3G-5008 8-TRACK: M8H-5008

"Convoy" is the track that exploded out of C.W. McCall's
"Black Bear Road" into a single that's unstoppable.

This week in Record World it's #64.

CHARTMAKER OF THE WEEK

64

— CONVOY

C. W. McCALL

MGM M-14839

MGM Records
Manufactured and Distributed by Polydor Incorporated
A Polygram Company

WHETHER YOUR STATION IS COUNTRY OR POP,
BILLY "CRASH" CRADDOCK'S "EASY AS PIE"
IS RIGHT UP YOUR ALLEY!



"EASY AS PIE," A BEAUTIFUL BALLAD, PROMISES TO BECOME A GIGANTIC CROSS-OVER HIT.
(DOA-17584)

Over 150,000 copies have already been sold, and key one-stops and retailers across the country report that demand continues to increase dramatically.

Written by Rory Bourke, Johnny Wilson, Gene Dobbins

 Exclusive Bookings
United Talent, Inc.
1907 DIVISION STREET - NASHVILLE, TENNESSEE 37203(615) 244-8112

Available on
 abc Dot Records

chappell music company  A POLYGRAM COMPANY