



# ANTIQUE RADIO CLASSIFIED



VOLUME 3

SEPTEMBER 1986

NUMBER 9

## A.W.A. ANNUAL CONFERENCE CANANDAIGUA, N.Y. SEPTEMBER 24-28

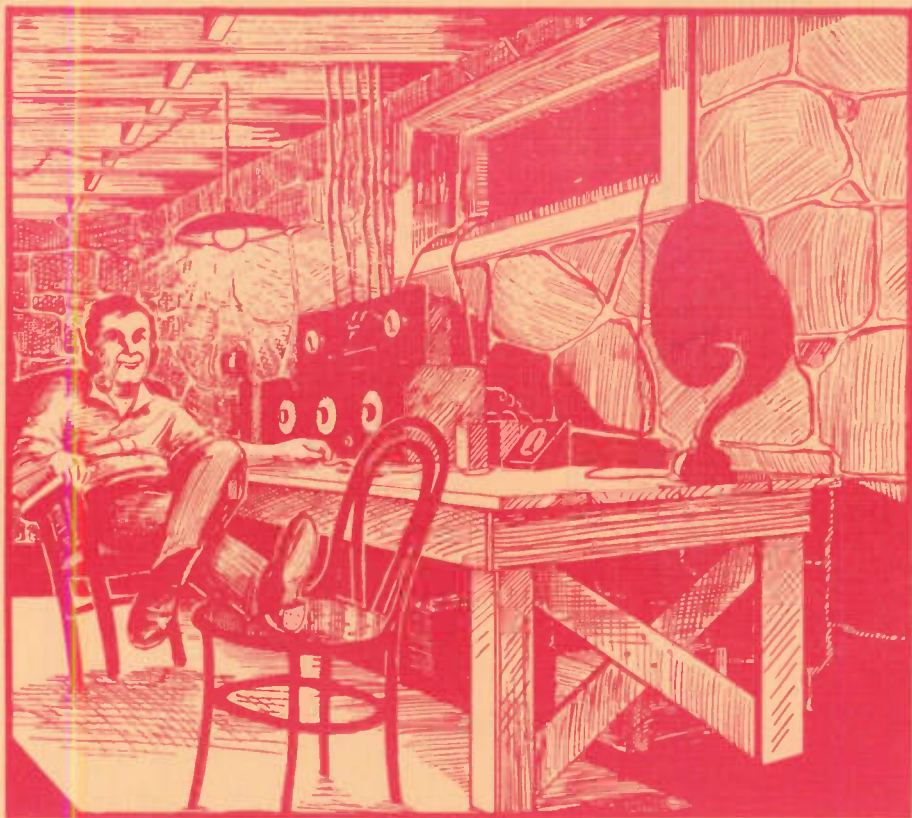

THE NATIONAL PUBLICATION FOR BUYERS AND SELLERS  
OF OLD RADIOS AND RELATED ITEMS - PUBLISHED MONTHLY

# ANTIQUE RADIO CLASSIFIED

## Publishing Details

Antique Radio Classified (USPS 735-090) is published monthly, 12 times yearly, at a subscription rate of \$18.00 per year Second Class and \$24.00 First Class mailing rates, by G.B.S. Enterprises, 9511 Sunrise Blvd., #J-23, Cleveland, Ohio 44133, (216) 582-3094.

Second-class postage paid at Cleveland, OH.

Publisher and Editor - Gary B. Schneider.

POSTMASTER: Send address changes to address above. Copyright 1986... Antique Radio Classified

## Purpose

Antique Radio Classified is published for people involved in the radio collecting hobby. Its purpose is to stimulate growth of the hobby thru the buying, selling and trading of radios and related items. In addition, there will be coverage of upcoming radio conventions, meets, flea markets, etc. Other items of interest to collectors will be included in issues as material or suggestions are received.

## Display Ad Rates

Antique Radio Classified accepts display advertising from companies that provide a product or service to the radio collecting hobby. As artwork is reduced 35% when printed, original should be 1.54 times the desired finished size and must be camera ready artwork. Original size areas are available as follows:

Full Page	10-1/2" H x 7-1/2" W	\$45.00
Half Page	5-1/4" H x 7-1/2" W	22.50
1/4 Page	5-1/4" H x 3-3/4" W	11.25
1/8 Page	2-5/8" H x 3-3/4" W	5.75
Business Card	1-5/8" H x 3-1/4" W	3.90

Full page ads may be vertical or horizontal format. Multiple insertions for 3 months qualify for a 10% discount.

All artwork must be received by the 1st of the month to be included in the following month's issue.

## Classified Ads

Each subscriber is entitled to one 20 word classified ad free of charge per issue. Additional words over the limit are 10¢ per word. Multiple insertions of same ad are discouraged. This is to allow for a varied ad content in each issue. Multiple insertion ads for more than 2 issues must be run as a display ad. All ads must be printed neatly and be received by the 8th of the month before next issue. See classified ad details elsewhere in this issue.

## Payment

All ads must be paid for in advance. Make checks payable to Antique Radio Classified.

## Subscription Rate

Subscriptions are available on a yearly basis, \$18.00 per year Second Class and \$24.00 First Class mailing rates. Sample issues: \$2.00.

## Submission of Material

Antique Radio Classified welcomes and solicits any information that pertains to the radio collecting hobby. This may include material such as upcoming radio events, meetings, radio books and publication reviews, new radio clubs and organizations, radio auctions and price reports, sources of old radio material and restoration supplies, and any other material that would be of interest to the hobby. All material submitted should be typewritten and verified for accuracy.

## Change of Address

Notification of change of address should be made well in advance to receive uninterrupted copies of Antique Radio Classified. Do not depend on the Post Office to let us know.

## Fine Print

The publisher is not responsible for any buying and selling transactions incurred by readers thru the content of this publication.

Antique Radio Classified subscription and ad rates subject to change, as well as frequency of publication, content, and size.

# Music Master

OUR PRICE

\$ **32**<sup>50</sup>  
Each

F. O. B. N. Y.

To Dealers only

IN LOTS OF SIX  
**\$30.00**

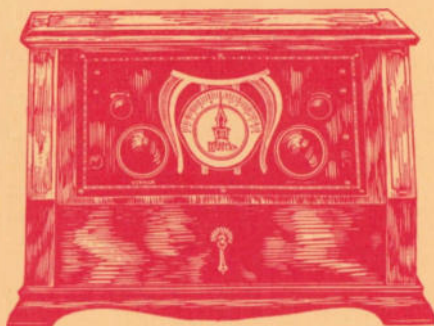

Illuminated Panel

ONE DIAL CONTROL  
**\$175.00 VALUE**

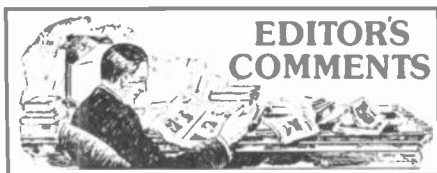

## EDITOR'S COMMENTS

Throughout the past two years Antique Radio Classified has grown from an unknown publication, with just a small gathering of loyal collectors who felt the hobby needed a monthly publication to serve their needs, to its present state as a more-or-less household word in the collector circles. This growth was the result of much hard work on my part as well as the faith and support of collectors all over the country.

However, as A.R.C. has grown so has the amount of work and financial stress of keeping A.R.C. a quality publication. It is with sad regret that I must say to my fellow subscribers that the resources needed to keep A.R.C. at its present level of excellence are no longer available to me.

Effective with the next issue, October 1986, A.R.C. will have a new publisher & editor. I would like everyone to welcome Mr. John Terrey of Carlisle, Massachusetts. Although most of you probably do not know much about him, I can say with confidence that he will do a splendid job of continuing A.R.C.'s commitment of providing a quality publication, with the aim to serve the needs of fellow collectors in all aspects of the hobby. Yes, there will be a few problems during the transition period, but given the support you have given me, I believe A.R.C. will continue to grow even more in the coming months and years.

I urge everyone to continue to support your new publisher in every way possible. A.R.C. is your publication and is here to serve your needs. With strength in unity, A.R.C.'s high number of subscribers can only lead to the day when every collector will be a part of A.R.C. - my number one goal upon my creation of A.R.C. 2½ years ago!

Although I will not be the owner of A.R.C. I am happy to announce that John has selected me to be the assistant editor and to be still active in the continuing process of publishing A.R.C. I hope each and every one of you have enjoyed A.R.C. since its introduction just two years ago - I just wish I had the resources to carry out my goal - A UNIFIED HOBBY! Thank you all - Gary B. Schneider



## COMMENTS FROM THE NEW EDITOR

I am honored to be the new publisher and editor of ANTIQUE RADIO CLASSIFIED and am excited about its future. Since Gary Schneider began A.R.C. in 1984, it has grown from a 16 page sample issue to a 28 page monthly publication. By August, 1986, the number of subscribers had grown to over 1800. A.R.C. is now the leading monthly publication in the radio collecting hobby.

My goal is to build upon the hard work that Gary has put into A.R.C. With your support as subscribers, contributors and advertisers, A.R.C. will continue to be a leading contributor to the radio collecting hobby.

A few words about who I am... My interest in radio goes back to 1954 when I received my ham license at the age of 13. W5DTQ has been my call ever since. My radio collecting began in 1962 with a Westinghouse RC set. After acquiring a few more sets, job and family prevailed until the late 1970's when I began collecting again. I now have a collection of over 200 old radios.

My work experience had been in electronics, computers, documentation and business. With this background plus my enthusiasm for old radios, I plan to establish a solid future for A.R.C.

I foresee no changes in A.R.C.'s policies. Subscription and advertising rates will remain the same as will the one free 20 word classified ad per issue. Gary will be working with me as an assistant editor so we expect the transition will be smooth.

Please write with your suggestions and comments on any aspect of ARC. I will be at the 1986 AWA Annual Conference in Canandaigua and hope to meet many of you there and talk with you about A.R.C. This is your magazine and its purpose is to be of maximum service to its subscribers.

The goal of A.R.C. will be to meet, or exceed, the high standard that Gary has set with A.R.C. over these past two-plus years. So, spread the word that A.R.C. is on a positive course, help find new subscribers, send in classified ads, advertise in the display ad pages, write articles, send pictures and I will do my part to put it all together and send the result to over 1800 enthusiastic radio collectors. Yours truly - John V. Terrey

**Has your subscription EXPIRED? If your mailing label reads "8609" or "8610" then this is your last issue! Renewal rates are: \$18.00 for Second Class or \$24.00 for First Class mail service. Send renewals to: A.R.C., P.O. Box 2, Carlisle, MA 01741**

# AMATEUR RECEIVERS

CONTRIBUTED BY: JEROME MUNDEL, WA7OHS, 7738 N. 40TH DR., PHOENIX, AZ 85051

## RESTORATION OF A CLASSIC

### The Hammarlund HQ-120-X

My new, old classic receiver is a Hammarlund HQ-120-X. I found this radio by scanning the Sunday classifieds as I usually do to see what old radios are for sale. A family was moving and the radio was part of a collection of old equipment being sold. The receiver was not working, and was covered with dirt, rust, and corrosion. However, it looked complete with all tubes and components. The chassis and cabinet were not dented or damaged and were complete with handles, dials, and all knobs.

Besides the radio, the speaker and speaker cabinet were part of the deal. The speaker was a ten inch permanent magnet type in a metal enclosure, the same style as the receiver. I bought them both and happily drove home.

There was no manual with the radio, but about two months later the family mailed me the original operating manual that had come with the set, new. It was in perfect condition and not even turning yellow as some manuals will do.

The radio was an HQ-120-X originally sold for the first time in December, 1938. My model was probably built in 1939 or 1940, judging from the serial number. I had always heard about Hammarlund receivers but did not know much about them, and had never even seen many of them. It is not as popular a "collector radio" as are Hallicrafters or Nationals.

The first thing I did when I got the receiver home was to take off the cabinet and remove the front panel. All knobs, handles, feet, and hardware were stored in Ziplock bags. Everything was taken in a box to a local gas station where I used the air hose to blow dust and dirt out of the chassis, the cabinet, and speaker enclosure. From the cloud of dust it appeared to be 20 years of dirt accumulation.

Back home I removed all 12 tubes and checked them on a tube tester. My tube tester is a Hickok model from the early 1950's. Only three of the tubes were bad and were replaced with new ones. The speaker was badly damaged and beyond anything that I could re-

pair. It was taken to a speaker repair shop because this is something many collectors can't do themselves.

The first step to restore the HQ-120-X was to obtain a schematic of the original circuit. Next, all of the capacitors and resistors were checked with a volt-ohmmeter. The resistors were all good and very close to the values in the schematic. The electrolytics in the power supply were shorted. Many of the tubular paper and wax capacitors checked out OK but looked charred and had a burned smell to them.

Rather than have trouble from bad capacitors one by one, I decided to replace the electrolytics and all of the tubular capacitors. Most of the tubular capacitors were .02mfd and .05mfd paper type. It was time consuming to replace all of these capacitors with new ones, but would save time in the future from old capacitors shorting. The mica capacitors were not replaced as they seemed to test OK, and they seldom go bad.

Now that all capacitors were replaced and all the tubes were good I plugged in the radio and turned it on. All of the tubes lit up, and no smoke came from the receiver, but there was no sound in the speaker, not even a hiss. At first glance it appeared to be out of alignment and some wiring was disconnected from where it should be. This turned out to be quite a job. All of the wiring had to be traced and the radio needed a complete realignment. This procedure took me about 4 months to complete, off and on during my spare time.

For signal tracing and realignment I used a Heath signal generator and a RCA VTVM. Both items of test equipment are from the early 1960's. During this step of radio restoration I learned more about servicing receivers because of the hands on testing and the reading that had to be done to follow proper procedures. Three books that were most helpful and necessary during restoration were:

Continue next page...

1. Operating Manual, Hammarlund HQ-120-X Communications Receiver
2. The Radio Amateur's Handbook, ARRL, 1940 edition
3. Elements of Radio Servicing, Marcus and Levy, 1947 edition

In past years I have restored old radios and have aligned them, but I had never restored a multi-band superheterodyne of this type. My background is not electronics, but with practical experience and following the above three books. The restoration of a communications receiver is not that difficult if you have the patience to take the restoration step by step.

Tracing the wiring was done to get the set to work so that it could be aligned. The schematic was followed in the usual way, from power supply backward to the RF section. I used a VOM to test voltage at various points and to test continuity in coils, resistors and transformers. The most troublesome area was around the 2nd AF tube, 6V6. This could be due to the high voltages and heat generated in this area. Figure 1. shows the 2nd AF and the 1st AF-Detector stages of the HQ-120-X. On testing it was found that C-103, the self-bias bypass capacitor, was shorted. This is a 47mfd, 450vdc electrolytic capacitor. This was replaced with a new one of like value. The volume control, R-113, was OK, as was R-114, 25K ohms. Capacitors C-115 and C-137 proved to be problems as they both were intermittent shorts. C-115 was a .01mfd mica, not the original paper type capacitor. C-137 was a 1,000mmf mica and may have been original. It is not true that mica's rarely go bad. They should be checked as carefully as paper ones.

C-115 was replaced with a .01mfd tubular and C-137 with a 1000mmf tubular. The 2nd AF stage then worked and a loud hiss could now be heard in the speaker. The wiring tracing continued in the usual procedure back to the 1st AF-Detector, 3rd AF, 2nd Af, 1st AF, converter and finally the RF section.

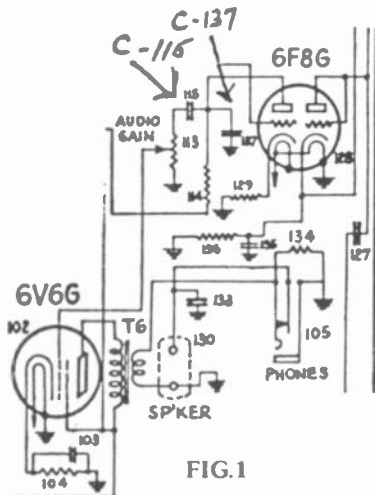
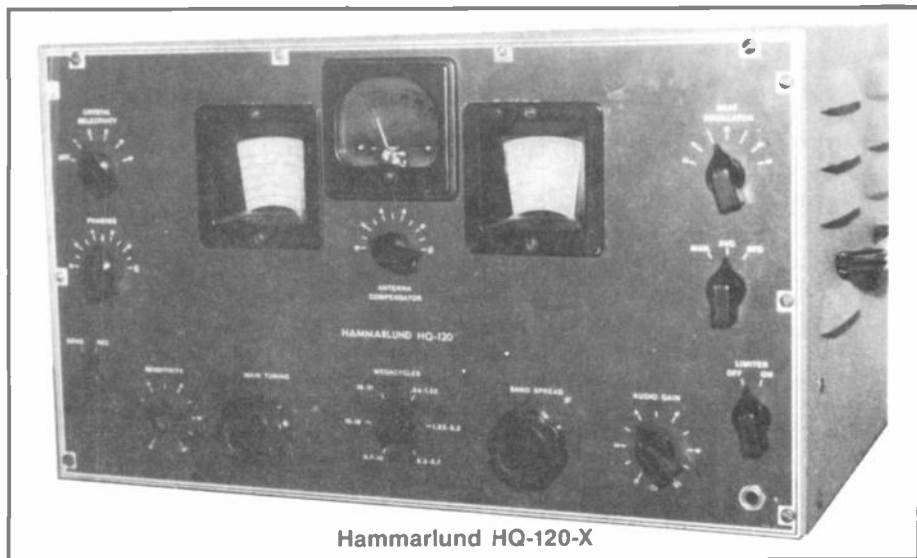

FIG.1

The RF tube had no high voltage on the plate. Plate voltage was zero. I traced back from the RF plate to the RF coil sections. There was no voltage on the RF coils. The RF coils receive high voltage through the send-receive switch directly from the output of the power supply. This is shown in Figure 2. A lead wire from the RF coil unit had broken off where it connected to the send-receive switch

Continued...



Hammarlund HQ-120-X

assembly and had been resoldered to the wrong lug on a terminal block. This took only a few minutes to correct. With the VOM I found which lug had high voltage when the send-receive switch was in the receive position. The wire was then resoldered to the correct lug on the terminal block. The receiver now came to life and loud static, hisses and squeals could be heard from the speaker.

The alignment of the IF section must be done first. The signal generator was connected to the converter input grid and set on high output at 455 KHz. **Figure 3.** shows a typical set up of connecting the signal generator and VTVM to the radio through .1mfd tubular capacitors. When a superhet like this is badly out of alignment there may be two frequencies where the output meter will peak. The correct setting of the IF is usually the stronger signal. Another way of checking the correct peak is to turn the slugs in the IF transformers in towards their center as far as possible. Then with an insulated tool back the slugs out slowly. The first peak that shows on the VTVM should be the correct IF setting. Do this on all the IF transformers and then go over the complete alignment again to fine tune all the IF transformers. A third way of tuning the IF is to precede after this step and go ahead and align the rest of the receiver. Then tune in a strong broadcast station, and using just the speaker as output carefully adjust the slugs of the IF transformers until the voice or music is as clear and sharp as possible. This should put the IF section on the correct 455 KHz peak.

The next step in the alignment is in the usual way of connecting the signal generator to the antenna input of the radio. The RF coils are adjusted first, the oscillator coils next, and the antenna coils last. For the HQ-120-X the low end of each band required inductance adjustments of the slug tuned coils. For the high end of the bands the trimmers were adjusted for proper capacitance. These adjustments are interacting and require going back over coil and trimmer several times until both high and low end of the bands are at their correct setting. I used the same method as was done in the IF section of turning the coils the way in and turning the trimmers until tight. Then turning coils and trimmers back out until the first peak, as shown on the VTVM, is reached. The first peak on the way back out is the proper setting.

Continue next page...

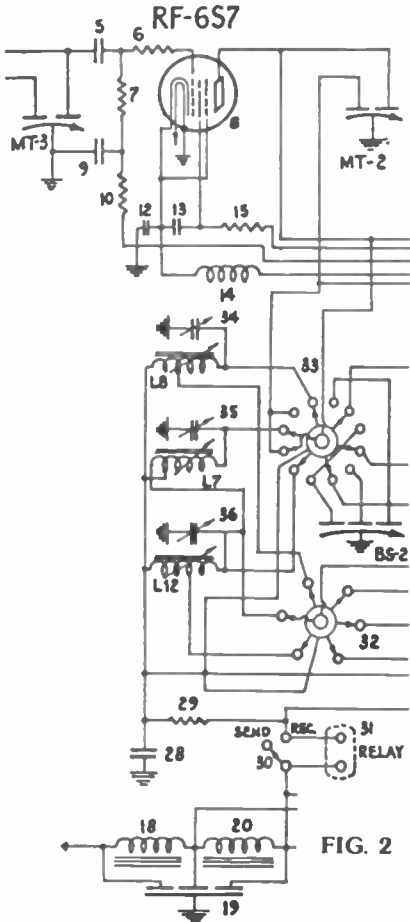

FIG. 2

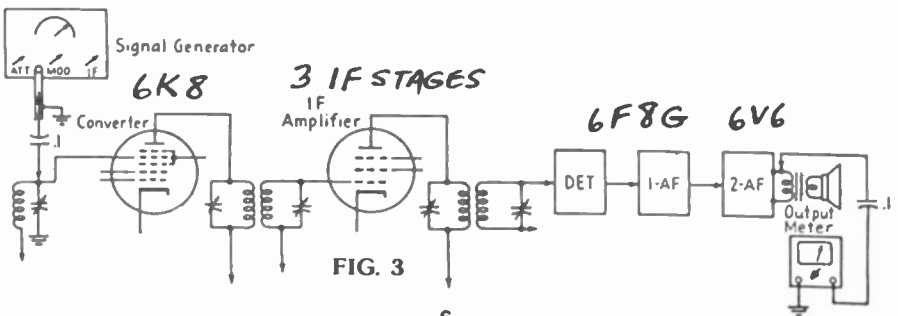

FIG. 3

# NEW "HQ-120-X" AMATEUR RECEIVER



THE NEW HAMMARLUND "HQ-120-X" meets the most critical demands of amateur and professional operators. Hammarlund engineers have gone beyond ordinary practice in designing this new and outstanding receiver. This ultra-modern 12-tube super-heterodyne covers a continuous range of from 31 to .54 mc. (97 to 555 meters) in six bands, taking in all important amateur, communication, and broadcast channels. The "HQ-120-X" is not to be confused with modified broadcast sets. Two years were required to develop it. This is a special receiver with special parts throughout. Every wave range is individual—that is, each range has its own individual coil and a tuning condenser of proper value for maximum efficiency; thus, including the broadcast band does not decrease efficiency at high frequencies. Besides having all the necessary features for perfect short wave reception, such as A.V.C., beat oscillator, send receive switch, phone jack and relay terminals, the "HQ-120-X" also includes a new and outstanding crystal filter circuit which is variable in 6 steps from full

band-width to razor edge selectivity. This permits the use of the crystal filter for the reception of both voice and music. It is no longer necessary to contend with serious heterodyne interference. These annoying disturbances can be phased out with the phasing control on the panel. Other features include a new and accurate "S" meter circuit for measuring incoming signal strength; antenna compensator to compensate for various antennas; and 310 degrees band-spread for each amateur band from 80 to 10 meters. The band spread dial is calibrated in megacycles for each of these amateur bands. The main tuning dial is calibrated in megacycles throughout the entire range of the receiver. Rack adapter \$6.00 extra.

#### Prices Include Speaker and Tubes

Code	Type	Tuning Range	Speaker	Net Price
HQ-120-X	Crystal	31 — .54 mc.	10" P.M. Dyn.	\$138.00
Speaker cabinet (metal) 12 1/4" x 12 1/4" x 7 inches				3.90

Special model finished in gray.....\$141.00 Net  
Speaker Cabinet, gray to match.....4.50 Net

#### Hammarlund HQ-120-X advertisement

Obtaining a copy of the original manual for the HQ-120-X was a big help. The alignment instructions were fairly good and did save quite a bit of time. Sensitivity is better than in many solid-state receivers. The selectivity is very good with the crystal filter and can be as narrow as single signal CW reception. Single sideband can be copied very clearly using the crystal filter on a narrow setting and using the BFO to fine tune the SSB signal. The AVC is excellent, the noise limiter does keep out ignition noise almost completely. The phasing control cuts out heterodynes and will separate two closely spaced stations. I now use the radio as my regular ham-shortwave-broadcast receiver and am very pleased with it.

The last step of restoration to an as-nearly-new appearance was refinishing the radio and speaker cabinets. Both were washed with a strong detergent solution to remove dirt, grime and grease. They were then given two coats of grey spray wrinkle paint. The grey wrinkle finish was as close to the original as possible.

The Hammarlund HQ-120-X now sits on my desk at home and is a very presentable old radio in my collection. It took a long time to restore, but when I turn it on and the dials and meter light up and all the tubes are glowing, I know that it was well worth it. (Jerry Mundel - Phoenix, AZ)

## SELDOM SEEN RADIOS...

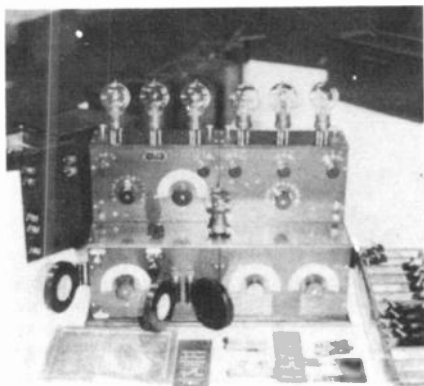

S.E. DUCRETET - a seven valve receiver manufactured in Paris around 1919 or 1920. The unit consist of four "standard" panels arranged to provide two stages of tuned RF, two stages of untuned RF, a regenerative detector and three switchable stages of AF. This receiver was discovered, along with the complete set of 14 plug-in coils (200 - 4000 meters), a handmade coil box and the original operators blueprint. Said to once belong to E.H. Armstrong, this receiver was found under a pile of junk in one of Harry Houck's storage barns. This receiver was in very poor condition and was completely restored by: Mike Katzdorn - Gaithersburg, MD



# PHOTO REVIEW



The "Photo Review" column is intended to present in pictorial form many of the radios, speakers, tubes, advertising, and other radio related items in the collections of other collectors. These photos are meant to help increase awareness of what's available in the radio collecting hobby. Photos are solicited from other collectors for use in future issues of A.R.C. Items desired are the more unusual radios and other items related to the hobby (covering the years 1900 to 1940's). Photos must be B&W (any size) and be sharp in detail, preferably with a light colored background. Please include a short description of each item submitted.



**WILCOX-GAY** - Made in Charlotte, Michigan, this cathedral is called the "Cardinal". It is a five tube superhet with airplane dial, standard broadcast and short wave. Made in 1935 it sold for \$28.50. It is built in a Mahogany cabinet and measures 12 x 14½ x 7 inches. (Karl Rommel - Lansing, MI)



**SPARTON** - Sparks-Withington Co., Jackson, Michigan. This neon sign is sitting atop the original wooden crate in which it was recently found. It was found in the attic of a man who had worked for Sparks-Withington for 37 years. The sign was to be sent (as the tag on crate reads) to the Sparton Radio display at the American Furniture Mart in Chicago, Illinois. But it was broken at the bottom of the "p" and discarded. The employee, rather than toss it out, took it home and it resided in his attic until this year (1985). The bottom portion, "Radios Richest Voice - 1926" works fine. (Karl Rommel - Lansing, MI)

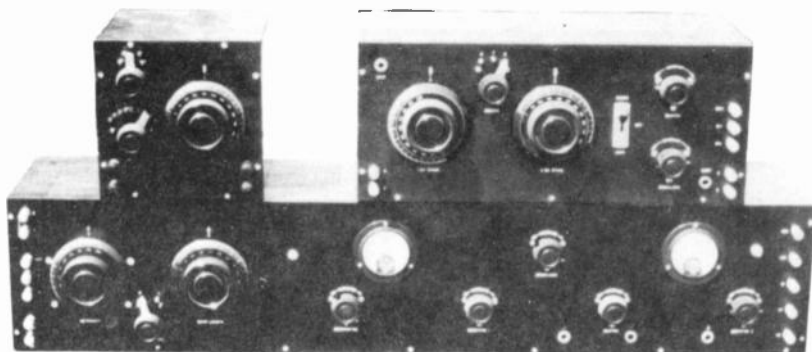

**LEUTZ** - On bottom is a Leutz model "C" Superhetrodyne receiver, top left is the Leutz model "K" antenna adapter and top right a Leutz model "J" R.F. Amplifier. The model "C" is an eight tube superhet designed to operate with a loop antenna. The model "K" antenna adapter enables the "C" to be operated with a long wire antenna. The model "J" is a two tube R.F. amplifier that enables the model "C" receiver to be operated with either a long wire antenna or loop. (Larry Wright - Lake In The Hills, IL)



---

## PHOTO REVIEW

---

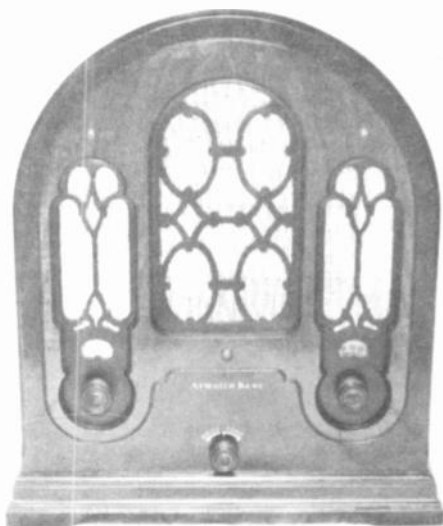

**ATWATER KENT** - Model 165, this five tube set came out around 1933 and sold for \$29.90. The same chassis is used in the Model 185, also a table radio but with a flat top and a "modern" design, similar to, but taller than the AK 275 pictured in *Flick of the Switch*. The intricate grill work is made of very thin wood and is easily damaged. Although a small and inexpensive set, it has a large speaker for a set this size and is a remarkably good performer. (John Miller - Lexington, KY)

---

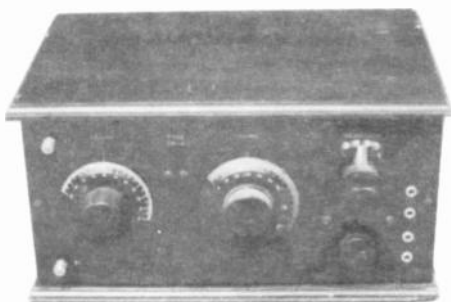

**CHELSEA RADIO CORP.** - Type ZR-4 Transcontinental, a 3 tube set, one stage regen. and two audio stages. It is 13" wide, 7" high and 8 1/2" deep. Rear of cabinet has 5 binding post for battery connections. Looks like 1923/24 vintage. (Bob Burick - Parma, OH)

---



**ARVIN** - Model 417, made in 1936, it is a 4 tube "Rhythm Baby". Covers two bands, 550 kc to 1.6 mc and 1.6 mc to 3.6 mc. It has been completely restored. (Ed Turner, Youngstown, OH)

---

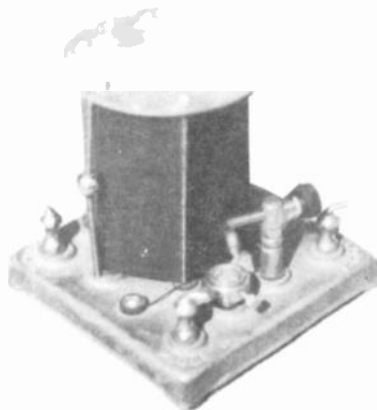

**MARTIAN SPECIAL** - A very nice crystal set manufactured in Newark, NJ. It sits on a 3 7/8 square metal base. Uses a "ball slider" for tuning and has 4 binding post for connections. Very similar to the Martian "Big 4" that is well known to collectors for its 3 tripod legs. (Bob Burick - Parma, OH)

---

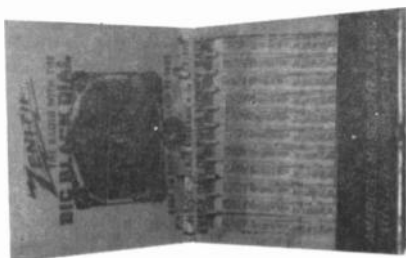

**ZENITH** - A pack of matches advertising the "Big Black Dial" Zenith radios (photo a little too dark). To collectors this type of item can be classified as a radio novelty item or promotional advertising item. (John Miller - Lexington, KY)

---



# TELEGRAPH KEY REVIEW

During the course of collecting and searching for radios, many collectors will have the opportunity to acquire telegraph keys and related items. In order to acquaint you to this collecting speciality and broaden your knowledge in this field, the accompanying photos of the Gil Schlehman, K9WDY, collection are presented to show the many types and variations you may encounter. Any questions regarding telegraph keys, please write in care of Antique Radio Classified.



**PUMP HANDLE KEY** - This key was made by the Foote-Pierson Co. from the design of the Shirley and Skirrow Co. It was made specifically for those long time telegraphers that developed "telegraphers paralysis", an occupational ailment that remained on the books until very recently. Made in about 1900, it is exquisitely made and decorated with hand painted flowers, reflecting the pride of workmanship that once was a part of our nation. The handle could be adjusted for up and down or sideways motion, or anywhere in between, at the discretion of the owner. This saved many a "burned out" telegrapher with a "glass arm". A truly fine instrument.

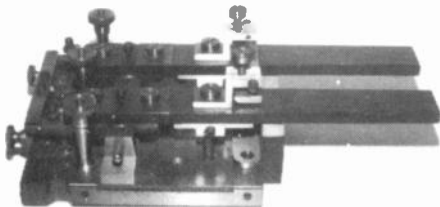

**CABLE KEY** - This is a Walters Electrical Mfg. Co. model 8K double pedal key used with the undersea cables around 1900. It is on a polished teak base, and rivals the best of American makers for quality of materials and workmanship. It measures a full ten inches long and works as well as it looks. *Courtesy T. Shedd, K4IWD.*

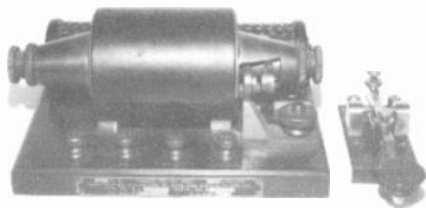

**KEYING RELAY** - This SE 137B relay was made for keying 5KW, and was used in conjunction with a smaller key to enable the operator to send CW on a high power spark station without a giant "rock-crusher" key of the era. It also isolated the operator from dangerous voltages present around early transmitters. It was made by Wireless Specialty Apparatus Co., and could be described as being of "solid" construction. It is typical of the monster keying mechanisms prevalent during this period. *Courtesy Ed Raser, W2ZI.*

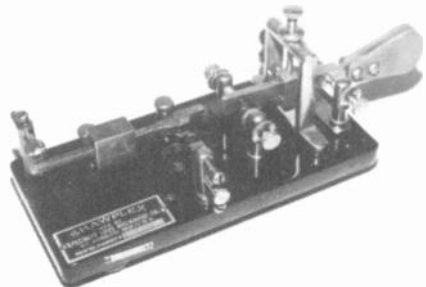

**THE SHAWPLEX** - This unusual bug (speed key) was made by the Specialty Shoe Machinery Co. of St. Joseph, Mo. about 1916. It was patented, but must have been in violation of the existing patents held by the Vibroplex Co. Notice the unusually looped dot contact springs that were used. This is certainly a unique piece, as not much is known about it. *Courtesy R.W. Reinke.*

# MANUFACTURER'S REVIEW

A friend of mine recently presented me with a radio trade magazine that I never heard of before. He had found it at an antique auto swap meet. It is *Radio-Television Retailer & Jobber* magazine, January 1932 issue, Vol. X, #9, published monthly in Brooklyn, New York, and was in its tenth year of publication.

Much information was given on the latest in radio happenings. Among the headlines were: Grigsby-Grunow and Columbia Phonograph Merge; Radio Inventories at Low Ebb as New Years Dawns; Perryman (Tube) Company Assets to be Sold at Public Auction, and RCA Settling Tube Litigations (having been sued by CeCo, DeForest, and other tube companies). There are a few ads for sets, though not as many as in *Radio Retailing* or *Radio-Music Merchant* magazines. There were small ads for DeWald-Pierce Airo, Crosley, and Freed-Eisemann and a big ad for RCA. Most interesting, however, was a full page, back cover, ad for Perry Radio Products Inc. of 152 West 22nd St., New York, N.Y.

I had passed up a Perry radio at the auction during the IHRS meet at Auburn a number of years ago. It was a 110 volt direct current mantel set using a half dozen or so 01A's. Being something odd it caught my interest but for some reason, most likely lack of money, I didn't make a bid on it, which I always regretted. I had never heard of one before or since till this advertisement. I am curious as to whether Perry was a manufacturer or if it is a private brand name set made elsewhere? It seems rather odd that a private brand set would take out a full page ad, but I have never seen the company listed anywhere. Does anyone have any additional information about this company or their products? (*Frank Heathcote, 1235 N. 3rd St., Logansport, IN 46947*)



**T**HE radio receivers illustrated are available in AC and DC models, in console sets as well as midget cabinets. 5 and 6 tube chassis employing Pentode, Variable Mu and all latest type tubes. Ultra-Sensitive Dynamic Speakers. Tone Control. Hum Control. Full-Vision Dial. Ball-Bearing Condensers. Chassis Cadmium Plated. Art-Grained American Walnut Cabinets. Compactness. All Latest Developments.

In addition the PERRY LINE includes an all-wave receiver, that has proved a revelation; a short-wave adapter that WORKS; and a complete TELEVISION model, now in the course of completion.



## PERRY PRODUCTS, INC.

*"First with the Latest"*

152 WEST 22nd ST.

NEW YORK, N. Y.



# HINTS & TIPS



**HINTS & TIPS** - Readers are encouraged to submit any "Hints & Tips" they have concerning restorations, repair & trouble-shooting, and other topics of interest to collectors.

---

**HINTS & TIPS** - *Hard Rubber* - When rubber is vulcanized at high temperature, with great pressure and with the use of comparatively large quantities of sulphur, it becomes very hard and strong, being called "Hard Rubber". Hard Rubber is jet black and takes a high gloss easily. The surface of rubber for use in decorative panels may be colored to represent natural woods or other ornamental designs.

From the standpoint of electrical properties Hard Rubber is one of the best of all available materials for use in insulators, brackets, supports, bases and panels of radio receivers. Hard Rubber has the disadvantage of changing its form under pressure or bending strain. Bolts and other fastenings which pass through hard rubber should be secured with lock washers because in time the rubber will give under the nuts or bolt heads and looseness will result.

Hard Rubber may be quite easily formed and bent into any desired shape by immersing it for a minute or two in boiling hot water. The rubber softens sufficiently to bend without cracking or breaking and if held in position until it cools the new shape will be retained. This is a very handy method for making special brackets and supports for receiver parts.

Good grades of hard rubber have a dielectric constant of 2.0 to 2.5. The dielectric strength is high, being from 1000 to over 2000 volts per thousandth of an inch thickness. It has very low dielectric losses when used in and near coils and condensers which are carrying radio frequency currents.

Hard Rubber deteriorates slowly with age, but if properly vulcanized in the first place and if protected from light it is not affected. This material softens to a noticeable extent at 150 degrees Fahrenheit. At the temperature of boiling water it bends easily, at 240 degrees it becomes leathery and may be cut easily with a knife, at 390 degrees it melts. (*Phil Weingarten - New York, NY*)

**HINTS & TIPS** - Handy source for radio tuning belts... Need a drive belt for the tuning capacitor or dial of the radio you are restoring? New old stock is difficult to obtain and can often be disappointing, especially if dry rot has set in. An easy alternative is to call *Projector-Recorder Belt Company* in Whitewater, Wisconsin. Have your credit card number handy before you dial their toll-free number (1-800-558-9572). They can often determine exactly which belt your radio needs just from the make and model number of the set, so have that information available when you call, too. The company will also make up special order belts for those it does not have in stock. (*Sorry - lost name of contributor of this Hint - GBS*)

---

**HINTS & TIPS** - Speaking of hints, how many of you collectors have yet to discover that the windings removed from a new Stancor A-53 & A-53C interstage audio, can be reassembled very neatly on the original core, case and contact header of those old Radiola open audios? It works equally well on other makes having the same 1/2" core dimensions, such as some of the Crosleys. The A-53's have a 3:1 turn ratio which may fall short of the original, but my experience has been that with few exceptions the set's performance seemed acceptable. Perhaps a little less audio gain. (*William Stuber - Woodward, IA*)

---

**HINTS & TIPS** - To clean an overly dirty, gummed-up variable condenser to like new condition, use a spray type carburetor cleaner with extension tube. Slope chassis into a metal pan to catch residue and to obtain a fast runoff. Do not get cleaner on varnished or lacquer surfaces. This cleaner will also restore sluggish mechanical typewriter keys to normal operation. (*Gene Johnson - Ovid, ID*)

---

**HINTS & TIPS** - A source for the rubber shock mounts in Radiola III, Federal and other receivers is the vacuum cleaner belts available in most appliance and super market stores. They come in varying sizes and thickness, one package does several sets. Also, a good substitute for condenser drive belts is the "O" rings available in auto supply stores. (*Jim Barrows - Bothell, WA*)

## COLLECTING ABROAD

### Collectors tune in to the sound waves.

A small but growing band of collectors are hunting through junk shops and in provincial salesrooms in search of vintage wireless sets. Specialist dealers are appearing although, as yet, there is only one specialist shop in London that is open every weekday.

Collectors are neatly divided between nostalgic buffs and the technical expert. The former remember the time barely 20 years ago when every British front room had as a focal point a large and cumbersome wireless. They and their younger companions who cannot remember this period go for the look of a vintage wireless set. For them Bakelite or the bizarre novelty sets of the 1920's hold a special appeal. The integrated or all-in-one box set that came in in the 1930's with its extremely ornate carved fretwork in front of the speaker is collected for similar reasons. Sets of this period were designed to appeal to the eye. People sat in front of them to listen as today we would a television.

The second group of collectors are the technicians. They are interested in the history of radio engineering and often confine themselves to a particular field of interest. Collectors from the technical category go for top-of-the-range models which means prices running into thousands of dollars.

The first generation of hand-made receivers are very expensive if in good condition, ranging from \$650-\$1500. The earliest of the integrated sets of the 1930's are much prized and

range from \$150-\$200. Early transistor sets of the 1960's are also now appealing to technically minded collectors, but again value is enhanced by first generation status.

Prices for vintage sets can vary over a wide range depending on technical details and on value added or possibly subtracted by restoration. In a provincial junk shop in Britain one might pick up a 1930's wireless for \$10 while a fully restored collectors' piece of the same model might cost \$450. Prices are still relatively modest when one considers the dizzy prices that good horn gramophones now command, but this is an expanding market and prices are expected to continue rising.

One of the sure signs of an expanding market is growing international interest. The Japanese have begun recently to collect avidly, fascinated as they are by the pre-history of communications. Dutch museums are also contenders in the market place. The Dutch nostalgia for old wireless sets is said to be triggered by memories of German Nazi occupation during World War II.

The British possess no national collection despite having been one of the early pioneers of radio engineering. The largest collection is in a private museum, the creation of Gerald Wells, a lifelong enthusiast and collector. The Vintage Wireless Museum, at 23 Rosendale Road, London SE21, can be visited by appointment only, as it is here where Mr. Wells lives and works surrounded by early television sets, gramophones and wirelesses. (Reprinted from *The Antique Trader Weekly*, Dubuque, Iowa.)

## MORE CLASSIFIED ADS

**WANTED:** G.E. "K" series of AC sets like K-60, K-63, K-52, K-80 and similar RCA sets. John Kern, RD#2 - Box 457, Quakertown, PA 18951 (215) 538-2128

**WANTED:** Klitzen Radio Mfg. Co. Model 500 Regenerative Amplifying Receiver made in Racine, Wisc. W.W. Runcorn, 216 Jefferson, Clayton, NM 88415

**FOR SALE:** Tubes - some oldies; books and magazines. Send wants and SASE. Glen Blizzard, 614 Hollywood Ave., Suffolk, VA 23434

**WANTED:** Mutual Conductance tube tester. T. Walker, 154 Intervale Rd., Mountain Lakes, NJ 07046

**WANTED:** Speaker for Philco 90 (good field coil); also Carborundum detector (cartridge). Jack Behrns, 4846 Lorraine Dr., San Diego, CA 92115

**WANTED:** Dual Victoreen Audio #112, at least one good section. Lou Lindauer, 43 Meadowrue Lane, East Northport, NY 11731

### SEND ALL ADS FOR OCTOBER ISSUE TO:

**Antique Radio Classified  
P.O. Box 2  
Carlisle, MA 01741**

### NOTICE

FOR SALE: We have acquired the Radio-Electricity section of the Franklin Institute Library and also the inventory of the late A.D. Santomasso. We are in the process of putting together a list of early Radio/Telegraph and Electrical books. We need your name and address along with your "Wants" for our file. Please send info to: NEW WIRELESS PIONEERS, 6270 CLINTON ST., ELMA, NY 14059

# CLASSIFIED ADVERTISEMENTS

**CLASSIFIED AD DETAILS:** Each subscriber is entitled to one free 20 word ad each issue. Additional words over the free limit are 10 cents per word. Enclose correct payment with ad, as we do not bill for ads. Ads must be received before the 10th of the month to appear in the following months issue. Late ads will be held for the following issue. Limit of two multiple insertions of same ad. Ads may be sent in advance, however each ad must be submitted on a separate sheet of paper, preferably a 3 x 5" index card. Publisher reserves the right to edit ads and is not responsible for errors due to illegibly written ads. **OPTIONS:** Shaded ads are available at a cost of 10 cents per word additional, including free words. Photo ads are \$5.00 each for half-tone charge. Allow extra time for processing of photos. B&W line-art drawings also accepted at a rate of \$1.50 per vertical inch, maximum width is 3 1/2 inches. Custom ads made to order, send sketch of your ideas for quote.

**WANTED:** Telegraph keys and bugs that are rare or unique. Have good traders. Gil Schlehman, 335 Indianapolis, Downers Grove, IL 60515

**WANTED:** Crosley plaster Pup; Grandfather clock radio; Model 141 Crosley Transistor radio, & Crosley book radios. Rcnnie Kaczmar, 5747 Williamson, Dearborn, MI 48126

**FOR SALE:** Beautiful 1925 Sonora all wood speaker - \$65; A.K. "30" - \$65; Philco "514" beautiful art deco radio and speaker - \$165; Crosley "75" beautiful art deco radio - \$200 (see A.R.C. May 1985); RCA Victor "R-8" excellent - \$95; RCA Victor "28-X" - \$65; Stewart Warner "9000-B" all chrome front - \$95; 1937 Hallicrafters "Super Skyrider" with speaker, excellent - \$135. All with tubes, postpaid. George Friedrich, 7162 Lake Jacqueline, Custer, WI 54423

**WANTED:** Bottom plate, coil compartment shields for Scott SLR-12-B; German Enigma code machine. Walter Sutton, 2530 Louisiana, Beaumont, TX 77702

**FOR SALE:** Unused and used tubes, have over 700 different types, some priced as low as 40 cents. Also electrolytic capacitors, cone speakers. C. Elmer Nelson, 11 S. Church St., Princeton, IL 61356

**WANTED:** Schematic, instructions & tube charts for Hickok 750 tube tester. Also any info on NORA radio GMBH-BLN - "CHARLOTTENBURG 4", tunes 16-50m. Uses odd tubes - DF11, DL11, DCH11, DAF11 & UY11. Mike Crain, RD 1 - Box 472, Harveys Lake, PA 18618

**FOR SALE:** R.C.A. Model 14BT2, tubes are 1A7, 1N5, & 3Q5. Doesn't play, nice wood case - \$35. Martin Kirk, 801 Washington Ave., Bakersfield, CA 93308

**WANTED:** Atwater Kent Models 24 Deluxe, Model 35 (SN around 715,000), Model 48 (SN around 600,000 to 900,000); "R" Supply; "R" horn. Raymond Thompson, 7422 Cherry Tree Dr., Fulton, MD 20759

**WANTED: SERIOUSLY NEEDED -** A restorable Radiola (Westinghouse) Model RS, or enough original parts to build up my own exact replica. Mainly the box with cover, panel, WD-11 sockets, tuning coils, audio xfmr, knobs, rheostat, etc. All replies answered. William H. Stuber, P.O. Box 153 (406 S. 1st Ave.), Woodward, IA 50276

**FOR SALE:** Crosley Pup, works - \$225; Federal Jr., works - \$225; RADA, untested - \$150; Radiola III, works - \$85. Rod Stidham (206) 854-4874

**WANTED:** Early radio advertising signs, promotional or display items. Jack Gray, 1162 Broadmoor Dr., Napa, CA 94558

**FOR SALE:** Parting out E.H. Scott sets - AW15 power supply, AW15 tuner parts, AW23 tuner parts, AW23 & Phantom tweeter sets, misc. N.S. Braithwaite (916) 246-4209



## Standard Radio Horn

Pat. Applied For

### Special Design

Will fit any receiver.  
Heavy material, no blast.  
Rubberoid Enamel finish.

Your Dealer can supply you

We figure on Special Horns  
for Manufacturers.

7" Bell, 19" High  
No. 17  
Price \$7.50

**FOR SALE:** Celestron cone speaker - \$30; A.K. 33 - you clean it up - \$30; Crosley 52 - \$90; send SASE for list. **WANTED:** Horn only for a Stromberg Carlson 1A speaker; one horn only for a Brandes Table Talker; one base for a Standard horn speaker (shown above), I have the horn & driver already; also need any cone speaker bases and drivers. Bob Barnes, 511 N. Chestnut, Monroe City, MO 63456 (314) 735-2945

---

**CLASSIFIED ADVERTISEMENTS**

---

**FOR SALE:** Riders volumes - one each of #6, 8, 9; two each of 10, 11, 12, 14, 15, 16 - weight 5 to 10 lbs each. One volume of RCA schematics for 1953-54-55-56 and 57 in Rider holder, 8 lbs. One volume of Zenith schematics #CM100 and CM199A in Rider holder, 7 lbs. Write for list of 1000's of radio & TV parts, tubes, and schematics, books and prices. G. Van Etten, P.O. Box 141, Texarkana, TX 75501

**FOR SALE: Coming off the presses - the Old Time Radio Services Directory. List suppliers of parts and services, a must for all collectors. Only \$2.00 Ppd. If you have a service you provide to the hobby, there is still time to get it listed - rush info immediately. Andrew Mooradian, 5 Priscilla Lane, Winchester, MA 01890**

**WANTED:** Dial lamp cover and '27 tube shield for Victor R-32 radio. Paul Bourbonin, 25 Greenview Ct., San Francisco, CA 94131

**FOR SALE: Quality cathedrals and battery sets - send SASE for new list. Jerry Finamore, P.O. Box 37, Budd Lake, NJ 07828**

**FOR SALE:** 8 volumes Edison Phonograph Monthly (exact reproductions by Wendell Moore) 1905 - 1910, exc. - \$100 Ppd; Audels Motor Guide, 1036 pgs, exc. - \$18 Ppd; Edison Blue Amberol Recordings Volume 2, 1915 - 1929, exc. - \$50 Ppd; 9 volumes Hawkins Electrical Guide, 2854 pgs, copyright 1917, gd \$25 Ppd. Ed Martin, 8816 Ansonia Ave., Cleveland, OH 44144 (216) 661-9999

**WANTED:** Need 3 spider web coils, please help. Hugo Castelli, 1406 E. 5th Ave., Joliet, IL 60433

**FOR SALE:** Tube collection - large SASE for list. Bill Thompson, 1095 N.W. 147 St., Miami, FL 33168 (305) 685-1993

**TRADE:** My AK-84 cathedral (F.O.S. pg 64) for working AK breadboard. Richard Arnold, (405) 657-3319 Oklahoma

**WANTED:** Cabinet for AK 33; dial for Philco 60 chassis; Riders 22 & 23; Sams 41-50 and 207 and up in bound volumes. Marc Ingenthron, 5814 Red Rock Circle, Enid, OK 73703

**FOR SALE:** Big AK 20 - \$15; small AK 20 - \$25; Kolster 6D battery set - \$10; Crosley Type E Dynacone speaker - \$25. **WANTED:** Elbow and bell for AK Type "M" horn. Francis Edwards, 516 Harter Ave., Mansfield, OH 44907 (419) 522-5343

**WANTED:** Loop antenna for Radiola 24 portable; name plate/tube cover for Radiola 26 portable. Jim Barrows, 15121 41st Ave. S.E., Bothell, WA 98012 (206) 337-4880

**WANTED:** Crosley Pup and other one tube factory sets. AK breadboards, and factory crystal sets. J.E. Young, 11 Willow Court, Totowa, NJ 07512

---

**CLASSIFIED ADVERTISEMENTS**

---

**FOR SALE:** Parts for radios of the early to mid 1930's: Five (5) new in box speaker cones - \$18; 220 fibre dial belts in individually marked envelopes including dial belt replacement manual and belt chart - \$25. Parts for battery sets: 30 used variable air tuning condensers - \$15; 44 used radio phone jacks - \$10. All plus postage. H. Fothe, 10 Jackson St., Sloatsburg, NY 10974 (914) 753-2090

**WANTED:** Collins, Drake SW receivers; MS-7 speaker. Levy, 8 Waterloo, Morris Plains, NJ 07950 (201) 455-4312

**FOR SALE/TRADE:** Philco Safari, Predicta's; magnifying lens for 7-8" sets. Sonny Clutter, 14330 NE. Fremont Ct., Portland, OR 97230 (503) 254-9296 or 233-5061 days.

**WANTED:** Schematic or info on Holmes Jordan Model 40 (made in St. Paul). Harry Pewowaruk, 1535 No. 8th Ave., St. Cloud, MN 56301

**FOR SALE:** Magnavox "J", good condition, with tubes - \$80; Magnavox R-4 horn, V.G. condition - \$75; AK20C, good condition with tubes, plus Model "L" horn - \$85. Dave Christensen, 362 Charlson Dr., Red Wing, MN 55066 (612) 388-3076

**WANTED:** Circuit diagrams 1960's Magnatone Amps - M-450, M-460, M-480, and M-20 (critical). G. Rhoads, 69 M Rockledge, Hartsdale, NY 10530 (914) 472-6839 (late)

**FOR SALE:** Several cathedrals; G.E. with "Pearl Look" cabinet; maroon "flocked" Karola; more. SASE to: Ed Ripley, 2276 Holloway Ave., Maplewood, MN 55109

**WANTED:** TV7-U tube tester with adapters; book for PACO T60 tube tester. Larry Johnson, 77 Ccountry Rd. E., Freetown, MA 02717



**WANTED:** Sears Silvertone 1930's bakelite or plastic radio shown in photo above - top price paid! Eric Brill, 115 River Road, Cos Cob, CT 06807 (203) 629-1756

## CLASSIFIED ADVERTISEMENTS

**WANTED:** King Am-Pli-Tone horn speaker, Rhamstine Adapt-O-Phone horn speaker, McElroy bugs; sideswiper key. Pat Stewart, 1404 Ruth, Walla Walla, WA 99362

**FOR SALE:** SAMS Photofact Folder Sets for early radios and television sets. Send SASE for sets I have and price for all sets. R. McGee, Route 4 - Box 406, Rogersville, AL 35652

**WANTED:** SCOTT SELECTONE TRANSFORMERS (RF, Osc., Ant. coils) types 610, 611, 612, 620, 630, 631, and 632 for SHIELD GRID NINE SCOTT; speaker/s for SCOTT SINGLE DIAL ALLWAVE TWELVE; power supply and speaker for SCOTT SIXTEEN (the power supply and speaker from an early PHANTOM AM would substitute); HOWARD 490 communications receiver, also home receiver models 500, 501, and 501 DELUXE; Kennedy radio using 66 series chassis such as: 266B, 366A, 366B, 766B, and 866B; KENNEDY SIXTEEN TUBE SUPER-HETERODYNE DELUXE. Will be at the VRPS/AWA meet in Dallas, in October. P.S. - Also want Scott single chassis SUPER XII, and 6-pin - 2.5 volt WUNDERLICH tubes. Thomas Peters, P.O. Box 3925, McAllen, TX 78502

**FOR SALE:** Three (3) AK Model 10 tuning condensers; three quack boxes; AK Model 44 radio (cheap). **WANTED:** Volume control parts for AK breadboard model 10. Russell Schoen, R#1 - Box 224, Clintonville, WI 54929 (715) 823-6744

## CLASSIFIED ADVERTISEMENTS

**FOR SALE:** Old radio tubes, new 2A3's, 45's, 50's, 845's, metal 6L6, 6V6; used W.E. 205-D, 242 A & C, 274-A. Will accept best offers on the tubes listed above. Also used 45's, 50's, 245's hundreds more (many of each). Please send large SASE. Reasonable prices, buyers pay P&H. Lynn Cinquegrana, 453 Cliff St., Fairview, NJ 07022

**WANTED:** The "Good Night Melody" which was the sign-off from EAQ in the 1930's from Madrid, Spain to the tune of "Taps". Would appreciate a tape or a copy or a recording so that we may run a copy of this sign-off. James H. Sullivan, M.D., 1021 Talbotton Rd., Columbus, GA 31904

**NEW ADDRESS:** Effective with the next issue, October, A.R.C. will have a new address. The new address is: **Antique Radio Classified, P.O. Box 2, Carlisle, MA 01741**

**WANTED:** Early semiconductors - want to trade. Need point-contact, CK703, CK721, 2N68, oldie diodes, literature. Have some NOS. SASE for list. Ludwell Sibley, 44 E. Main St., Flemington, NJ 08822 (201) 782-4894

**WANTED:** 1930's Silvertone black or brown thick plastic table radio, streamlined "Turbine" design with round tuning knobs at one end of the cylinder that forms the top of the radio. Very good price paid. Eric Brill, 115 River Road - #5 Riverlanding, Cos Cob, CT 06807 (203) 629-1756

## BOOKS FOR SALE

**New Wireless Pioneers, James and Felicia Kreuzer, have acquired the inventory of hundreds of radio and technical books from the late A.D. Santmasso. We have put together a list of rare and desirable books. If you want to get on our mailing list send a SASE for our soon to be published list. Here are just a few examples of what we have:**

*Signaling Thru Space Without Wires* by Oliver Lodge

*Commercial Broadcasting Pioneer - The WEA F Experiment 1922-26*

*The Marconi Yearbook of Wireless Telegraphy - 1917*

*Father of Radio - by Lee DeForest*

*Builder of Tomorrow - Fessenden - by Helen Fessenden*

*The Book of Practical Television - First Edition, 1935*

*Short Waves - by Leutz, First Edition, 1930*

*History of Radio to 1926 - by Gleason Archer*

**and many more hard-to-find titles!**



**New Wireless Pioneers, 6270 Clinton St., Elma, NY 14059 (716-681-3186)**



## CLASSIFIED ADVERTISEMENTS

**FOR SALE:** Crosley 52SD, 1924, vgd, inside needs a good cleaning, one bad audio (not original) - \$75; Philco 91B, 1931, refinished, cloth not original (but from a radio of this period), works - \$190; World receiver, 1926, vgd, one bad audio winding - \$75. Send large 2-stamp SASE for complete and up-to-date photo list. Ron Boucher, 376 Cilley Rd., Manchester, NH 03103 (603) 669-1698



**FOR SALE:** GALENA CRYSTALS - like Grandpa used in his crystal radio, all tested, guaranteed no duds. Prices: 1 to 10 - \$2.00 each, 11 to 20 - \$1.75 each; 21 to 30 - \$1.50 each; 31 to 40 - \$1.25 each; 41 to 50 - \$1.00 each. **FREE** - one copper Pyrite crystal with each order of 5 or more Galena Crystals. Charles Martin, 602 Duque Rd., Lutz, FL 33549

**FREE:** From Olde Tyme Radio Co. (for SASE) - NEW SUPER FLYER, completely revised, 4 pages of radios. Olde Tyme Radio Co., 2445 Lyttonville Rd., Silver Spring, MD 20910

**WANTED:** TV neon tube and early small round Television CRT's - have stuff for trade or will purchase. Sonny Clutter, 14330 NE. Fremont Ct., Portland, OR 97230

**WANTED:** Rheostat for AK 10 breadboard. Russ Schoen, R#1 - Box 224, Clintonville, WI 54929

**FOR SALE:** Unused tubes - 6AC7 - 10 cents, 6SH7, 1626 - 25 cents, 6AK5 - 50 cents, XXB - \$1.00 plus UPS. Five page list of more tubes and almost everything needed to restore AC sets. Sue Coulter, Box 11-A, 1000 West Columbus, Bakersfield, CA 93301

**WANTED:** Supreme test equipment - state price, model number, condition and price wanted. Also looking for Edison cylinder records. Gerald Weiss, N-89 W-16229 Main St., Menomonee Falls, WI 53051

**WANTED:** National Carbon Co. "Eveready" Model Series 50, must be intact and in restorable condition. E.J. Mondor, 121 Gateway Drive, Greenville, SC 29615

**FOR SALE:** Tell me your tube needs and I'll find them and quote. Many in stock. Ted Youngman, 2225 Vigo St., Lake Station, IN 46405

**WANTED:** Need Clapp-Eastham R-4 panel and tuning condenser; Federal 110 cabinet. Richard Jehlik, 8320 North 28th Ave. Omaha, NE 68112

**FOR SALE:** General Radio 726A VTVM - \$50. **WANTED:** Plastic front & pushbuttons from Zenith 6R40 Transoceanic. T. Wickstrom, 1664 E. Shore Dr., St. Paul, MN 55106

## CLASSIFIED ADVERTISEMENTS

**WANTED:** Philco Model 20 chassis and speaker; Philco 90 complete tuning condenser dial and all. Fred Geer, 6042 Brookridge Rd., Jacksonville, FL 32210 (904) 771-7828

**FOR SALE:** WD-11 (3), brass w/tip on top - \$20 each; WD-11 (12) with black bakelite base, no tip - \$15 each plus UPS. J. Wasiewicz, 229 Sarles Ln., Pleasantville, NY 10570

**WANTED:** I need sixteen (16) Cap Nuts for the binding post on the Westinghouse RC and the Aeriola Sr. The same nut fit both receivers. Paul D. Dilliard, 1313 East Wheeling St., Lancaster, Ohio 43130

**WANTED:** Cabinet, speaker, and escutcheon for PHILCO 20; PHILCO 91 cabinet w/wo front plate; four Radiola Model 60 feet; PHILCO 70 escutcheon. Henry Brown, 2 Central Ave., Morris Plains, NJ 07950 (201) 538-2014

**FOR SALE:** Riders Vol. 16 - \$15, Vol. 17 - \$18. Avery Baswell, 2603 Pentolope Dr., Huntsville, AL 35803 (205) 882-9513

**WANTED:** Early electric Phono and Radio/Phono combinations. Especially Victor Models 9-16, 9-18, REA-68, Electrolas and Brunswick Panatropes. Bob Molesworth, 53 Keeley Ave., New Britain, PA 18901 (215) 345-6358

## FOR SALE

1. Atwater Kent 84, vgd ..... \$175
2. Leutz Plio-6, mint w/manual ... 200
3. Atwater Kent 44, excellent ..... 45
4. Radiola 60, very good ..... 75
5. Peerless speaker, vgd. .... 30
6. Radiola 7-11 with manual .... 125
7. Crosley 148 cathedral, wrks ... 75
8. Crosley Gem Box with manual 40
9. Philco 513, very good ..... 45
10. Brandes wooden cabinet horn 35
11. Zenith plastic set, excellent ... 10
12. Zenith Model 11 ..... 60
13. Radiola 100A speaker, mint ... 30
14. Radiola Model 16 ..... 55
15. Radiola Model UZ-1325 bell only 10

## WANTED:

1. Speaker for Philco Model 91
2. Crosley Model 59 (Show Boy)
3. Celluloid horn speakers
4. Unusual cathedrals & horns
5. AK-12 and AK-558 radios

**Gary Hill**  
1507 Ridge Ave.  
New Castle, PA 16101  
412-656-0338

---

## CLASSIFIED ADVERTISEMENTS

---

**FOR SALE:** RCA B&W TV Model T100 (F.O.S. page 162); also Westinghouse Grandfather clock radio model WR12. Russ Schoen, R#1 - Box 224, Clintonville, WI 54929

**WANTED:** I need two Weston type 301 panel meters, both must fit thru 2 5/8 inch hole; 0 to 30 ma. D.C. and 0 to 8 volts D.C.; 2 Precise type 750 variable condensers; Bogen MPX adapter. Steven N. Raymer, 190 E. Island Ave., Minneapolis, MN 55401



**FOR SALE:** Electrocardiograph - early model, tube type, made by Sanborn Co. (since acquired by Hewlett Packard), excellent condition. Complete with all electrodes, cabling, spare stylus and dust cover. Mounted in a fine mahogany cabinet, it would be very suitable for display. Book, "Electrocardiography" included. Price - \$160 plus UPS cost. John McCoy, Box 86, Bradford, VT 05033 (802) 222-4614

**FOR SALE:** Philco Service Notes 1928-1937 - \$10; Radio Physics Course by Ghirardi - \$15; Meissner "How to Build Instruction Manual (1942) - \$12; Variable transformers - Ohmite 6 Amps, Powerstat 7.5 Amp, RCA (220-110V) 4 Amps - each \$30; Home-made crystal set slide coil bread board - \$65; assorted Weston large, old, panel meters, cast iron case, 6 1/2" dia. - each \$15; 1/2 pound #28 CCW spool wire - \$4.00; Howard Sams service folders #1 to #150 - \$3.00 each; Riders Vol #1 - \$50, #2 - \$40; #3 - \$30, plus others available. Crosley N.O.S. boxed tubes - \$4.00; Zenith N.O.S. boxed tubes - \$4.00; #46 dial bulbs - box of ten (10) for \$3.00; RCA UV877 tube - \$4.00; AK 40 Power Unit - \$27.50; Kleer Tone - \$4.00. Have other tubes, parts, service notes,, Riders, Howard Sams, RCA, Philco, G.E. plus more - list E-86 for large SASE. All items plus shipping, minimum order \$7.50. F. Krantz, 100 Osage Ave., Somerdale, NJ 08083

---

## CLASSIFIED ADVERTISEMENTS

---

**WANTED:** Two or three dial belts, GC #117 or JFD #80. Tod Prowell, 1073-15 Lancaster Blvd., Mechanicsburg, PA 17055

**WANTED:** G.E. A125 and other G.E. 1938-39 sets. Fred Geer, 6042 Brookridge Rd., Jacksonville, FL 32210 (904) 771-7828

**FOR SALE:** ABC power supply, all voltages - \$125. Rod Stidham (206) 854-4874

**WANTED:** Transistor Zenith Transoceanic, McIntosh stereo tube gear; German, English foreign sets; Pilot, Midwest; Cathedrals; tombstones; AK-558 cathedral; AK-328 tombstone. HAVE Deco radios to trade. Bill Moore, 5014 Rickwood Ct., Huntsville, AL 35810

**FOR SALE:** "60 year's" accumulation radio items from W2CUZ Estate - SASE, cannot ship large items. J. Wasiewicz, 229 Sarles Ln., Pleasantville, NY 10570

**WANTED:** Need for Crosley RFL 60 - 2 dial pointers and 1 tuning knob. Glen S. Lee, RR#2, Mt. Brydges, Ontario, Canada N0L-1W0

**FOR SALE:** Delco Model 1107 tombstone - \$150; Pla-Pal 300CL tombstone - \$150; Philco Jr. 81 cathedral - \$120; Philco 37-620 tombstone - \$150. All in excellent condition, plus shipping. Doris Hall, 1500 Turner St., Old Hickory, TN 37138

**WANTED:** Crosley Model 59 chassis or radio in any restorable condition to complete my Crosley Grandfather clock radio. Burnette Kerchner, 27 Willow St - Box 24, Lenhartsville, PA 19534

**WANTED:** Nameplate for W.S.A. IP501A receiver (made for RCA). Allen Jochem, 2205 Broadway, Quincy, IL 62301

**FOR SALE:** Large RCA 3-band 810T tombstone - \$25; Philco 66 tombstone - \$30; Arvin "Rhythm Baby" (F.O.S.) - \$30; Crosley "Fiver Jr." (F.O.S.) - \$25; Philco 38-38 (like 10 tube in F.O.S.) - \$20; Philco 46-420 (F.O.S.) - \$12; RCA 551 (F.O.S. pg 161) - \$10; Philco 49-1401 (F.O.S.) - \$15; Zenith A600 Transoceanic - \$8; tiny Germanium radio w/box, old - \$12; Philco Model 50T701 TV. (F.O.S. pg 301, R to L, third stack, 2nd from top) - \$45; 1920's homemade batt. set - \$20; Philco and Windsor 12" transistor cathedrals - \$20 each; Wilcox Gay Recordio - \$18; Quack Machine - \$10; Little Wonder Microphone w/box - \$13; 830B Radiotron tube w/box - \$4; two old cardboard Everyready 45V "B" Batt., large size (for display) - \$5 each; magazine reprint showing interior of radio retail store in Jan. 1933 full of cathedral and console radios - \$1 each Ppd; 15 "Elementary Electronics" magazines - \$12; large RCA tube caddy packed full of new electrolytic capacitors, diff. mfd's and voltages - \$45. Postage extra. Leroy Blalock, 1706 Chaffin Dr., Sanford, NC 27330 (919) 776-7592

## CLASSIFIED ADVERTISEMENTS

**FOR SALE:** Authentic reprints of operating instructions for Hopalong Cassidy radio - \$4.00 each. Ed Ripley, 2276 Holloway Ave., Maplewood, MN 55109

**HELP:** Looking for any information on (or schematics) for a Philco Model 133 radio made in England. Uses tubes EM81, ECH81, EBF89, EF86, EL84, and EZ80. James MacDonald, RR#1, Glendale, N.S., Canada B0E-3L0

**WANTED:** Fisher R-200-B tuner; McIntosh MR-55A AM/FM Tuner; dial glass for Philco 48-1274 or 48-1276. John Peterson, 4333 9th N.E.. #D, Seattle, WA 98105

**SWAP MEET:** Cincinnati, Ohio - A one day swap meet/show has been tentatively scheduled for mid-October. This event will be sponsored by several Cincinnati area collectors and dealers. Set up space will be available. See upcoming A.R.C. issue for time and location. All interested in participating should contact Tom Ducro (513) 271-0156 or Tim Kaiser (606) 581-8636

**FOR SALE:** Loop antenna for Radiola 25 - \$15.  
**WANTED:** Clapp Eastham Radak Type C-23 parts or complete set. Bryan Laughlin, P.O. Box 10081, Rochester, NY 14610 (716) 436-6716

**FOR SALE:** 60 radios - cathedrals, battery, tombstones, Stromberg Carlson #16 speaker, horns, consoles, tubes, earphones. List available November 1st, meanwhile send wants to: Ted रुपinski, 170 Cheshire Rd., Pittsfield, MA 01201

## CLASSIFIED ADVERTISEMENTS

**WANTED:** I have an AK "L" horn that needs a base - who can sell me one? Also have a dial-less Howe Xtal set - who can help? Got any knobs for a Philco 20? **FOR SALE:** Cabinet for Grimes 4DL and a Philco 39-6 radio-phono. D. Crocker, 6 Old Farm Rd., Duxbury, MA 02332

**WANTED:** Need operating instructions and/or circuit diagrams for early Supreme Instruments Model 592 Volt Ohmmeter with push buttons, need two small round dial plates (these fit over protruding shafts and are held on panel by shaft nut). Also need information on military model Meissner Signal Shifter. Wes Chatellier, 1950 Chevelle Dr., Baton Rouge, LA 70806

**FOR SALE:** Good RBO power trans. and two filter chokes, used, original parts - \$35; good Philco 13 inch, 1100 ohm field coil, speaker from 1940's - \$13; nice RCA 100A enclosure, rear cloth is torn, repairable - \$15. Please add UPS. **WANTED:** Peerless dynamic gothic spkr box. Julian Hoyt, 596 S. Edgewood Ave., Jacksonville, FL 32205

**WANTED:** Blueprints/Kit assembly instructions for PILOT SUPER WASP, battery Model K-110. Any Super Wasp ads/literature. Jim Miller, 5581 Einor Ave., Rockford, IL 61108

**WANTED:** B&K Model CR48 Test Socket Adapter Fred Emerson, 627 Illinois Ave, Elgin, IL 60120

**WANTED:** Information or equivalent charts on Muter brand ballast tubes, or old catalogs that may also list them. Anthony Jacobi, 8053 Maywood, Ralston, NE 68127 (402) 331-5480

## VINTAGE TV's

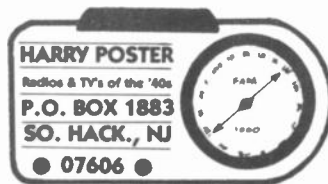

(201) 794-9606/956-6680

buy  
sell  
Repair

### PAYING:

Pre-WWII TV's..\$1200-\$4000      1946-1950's..\$25-\$500

### BUYING (These plus 100's more):

RCA: 621..\$350      630..\$100      721/730..\$100  
CT100(CTC1/CTC2)..\$350      Projection sets..\$100-200  
Dumont: RA 102 Clifton..\$350      RA-103..\$60  
Philco: 48-700..\$225      48-1000..\$150      48-1001..\$100  
Predictas: Remote..\$350      Consoles..\$250      Table tops..\$75-150  
Pilot: 3" Portable..\$120      Pilot Magnifier..\$60  
Color Wheels-complete..\$300  
Mid-50's Personal Sets..\$5-15

\*\*Call or write with make and model. I sold over 200 TV's in June!! I need all your sets-and I'll pay CASH!

\*\* (See you at AWA's Canandaigua meet in Sept. '86)

## CLASSIFIED ADVERTISEMENTS

**WANTED:** Quaker Oats crystal radio. **FOR SALE:** Have Merry-Go Sounds childs phonograph, and pay motel radio. Otto Niill, 192 Grant Ave., Islip, NY 11751

**FOR SALE:** Kennedy XV. **WANTED:** Nov. and Dec. 1923 "Popular Radio" magazine. I am collecting some tubes - oldies - what have you? Also Hallicrafters S-27 FM-AM, Hallicrafters HT-11, 8, 12, and other VHF & UHF equipment. Frank Brewster, 3rd & East Ave., Baxter Springs, KS 66713 (316) 856-3220

**WANTED:** Tube tester for 01A's, WD11's, etc; coil winding machine. Good base and driver for UZ-1325 speaker. Chuck Strozier, 24100 #E Avenida Rancheros, Diamond Bar, CA 91765 (714) 594-5922

**FOR SALE OR TRADE:** Scott Chippendale - \$200, needs work, pick up only. Rudy Hoffart, 19380 Newton Ave., Euclid, OH 44119 (216) 531-4697

**FOR SALE:** Radio News magazines - May, June & July 1938; Radio Craft Aug. 1941. Russ Schoen, R#1, Clintonville, WI 54929

**WANTED:** Early Crosley items: Harko Jr., Harko Sr., Detector, Two-Step, Crystal Set, Etc. Larry Wright, 131 Hilltop Dr., Lake in the Hills, IL 60102 (312) 658-5993

**FOR SALE:** Radio books, technical, juvenile, manuals, magazines, and catalogs. SASE for list. Serge Krauss, 141 Homan Ave., Elkhart, IN 46516

## CLASSIFIED ADVERTISEMENTS

**WANTED:** RCA Victor Service manuals (red books) Volume One (1923-1938) and Volume Two (1938-?). Contact: Brian Ruppel, 703 Maple St., Lawrenceville, IL 62439 (618) 943-3990

**FOR SALE:** Two G.E. mercury tungar bulbs, catalog 20X672, 5 amps, in original box, unused - \$5.00 each. Crystal cat whiskers and galenas \$1.00 each. L.W. Gardner, 458 Two Mile Creek, Tonawanda, NY 14150

**FOR SALE:** Send SASE for estate sale of old radio items. Paul Giganti, 2429 San Carlos Ave., San Carlos, CA 94070

**WANTED:** Reputable Deco collector paying up to \$5,000 for a Sparton floor model mirror glass radio. Let's talk - Ed Sage, 1781 Helene Ct., Benicia, CA 94510 (707) 746-5659

**FOR SALE:** Radio service manuals, Riders, Howard Sams, RCA, Philco plus others. Also tubes, parts, knobs, speakers, test equipment. SASE for list #2-86. Krantz, 100 Osage Ave., Somerdale, NJ 08083



**NEW ADDRESS:** Effective with the next issue, October, A.R.C. will have a new address. The new address is: **Antique Radio Classified, P.O. Box 2, Carlisle, MA 01741**

**WANTED:** Zenith chassis 1501, should be somewhat clean but need not work. Mike Simpson, 1345 Floyd Ave., Sunnyvale, CA 94087



# PUETT ELECTRONICS

P.O. BOX 28572 DALLAS TX 75228



GET THIS



**WORLD'S  
GREATEST  
RADIO  
CATALOG**

# NEW

RECEIVE A \$3.00 COUPON BY INCLUDING THIS CODE NUMBER:

## CATALOG NO. 7

ARC007-\$3 WITH CAT. ORDER.

## \$2.00 POSTPAID

ORDER YOUR COPY TODAY!!!!!!

OVER 770 BOOKS, INSTRUMENT MANUALS, COMMUNICATIONS RECEIVER MANUALS, SERVICE DATA BOOKS, CATALOGS, AND OTHER LITERATURE AVAILABLE. HUNDREDS OF OLD-TIME-RADIO PROGRAMS ON CASSETTES, SCHEMATICS & DATA ON NEARLY ANY RECEIVER, APPRAISALS, OVER 440 DIFFERENT TUBE TYPES WHICH ARE USED IN ANTIQUE RADIOS, TUBE MANUALS, RIDER MANUAL INDEXES, ETC.

CATALOG NO. 7 CONTAINS MANY NEW LISTINGS NEVER BEFORE OFFERED. PRICES ARE NOT INCREASED. ALL PRICES IN CATALOGS NO. 21 AND 22 ARE THE SAME. OUR LATEST LISTS OF NEW LITERATURE (MANUALS, ETC.) AND OUR LATEST LIST OF CLASSIC RADIO LITERATURE AND OLD-TIME-RADIO SHOWS IS INCLUDED.

---

**CLASSIFIED ADVERTISEMENTS**

---

**WANTED:** N.O.S. obsolete electronic parts: 1N1218, 1N1693, 1N1355, 2N1415, 2N241A, 2N270. Centralab pots - WW103, WW253. Electrolytic caps CDE Beaver - BR500-50, BR40-150, BR16-150, BR8-150 & Aerovox PRS1470, PRS1430, PRS1405. Please send price and quantity available to Richard Cannon, 585 W. Hazelwood Ave., Rahway, NJ 07065

**FOR SALE:** Riders 10, 12 & 13 - \$10 each F.O.B. Nashville. Larry Chambers, 5026 Suter Dr., Nashville, TN 37211

**FOR SALE:** Atwater Kent brown spray can, professionally duplicated from AK20 - \$8.00 Postpaid large can. John Drew, 28 Babcock Rd., North Stonington, CT 06359

---

Has your subscription EXPIRED? If your mailing label reads "8609" or "8610" then this is your last issue! Renewal rates are: \$18.00 for Second Class or \$24.00 for First Class mail service. Send renewals to: A.R.C., P.O. Box 2, Carlisle, MA 01741

---

**FOR SALE:** RCA B/W portable TV Model 8PT7034, mfg 1956 - \$45; Candlestick extension telephone with ringer - \$65; back issues of Radio-Electronics magazine 1954 to present - \$10 per year; Mercury Model 101 tube tester - \$10. Clark Trissell, 3530 Pawnee St., Lincoln, NE 68506 (402) 488-5263

**WANTED:** Top cabinet boards for Radiola 28 and 104 power unit. Base for Trinity horn speaker; need 8" speaker with 2500 ohm field coil, and early - light bulbs. **FOR SALE:** Heathkit capacitor tester - \$15 plus shipping; hundreds of tubes from 1930's to present - \$1.00 each - SASE for list. Bruce Harbeck, 13408 Westwood Ln., Omaha, NE 68144

**WANTED:** Early electric brass blade fans and lighted advertising clocks. Richard Cane, 8391 N.W. 21st St., Sunrise, FL 33322 (305) 741-6838

**WANTED:** Need 2 audio transformers for Crosley Trirdyne; 2 interstage audios 1:3 - old battery type, make unimportant, NOT enclosed, 1 1/2 x 2 inch mounting, specify make, price. W. Vanderlaan, 425 Major Andre Rd., Virginia Beach, VA 23462

**FOR SALE:** Volume and tone controls including rare "loudness" taps! Send set name and model number, part number, shaft type and length, resistance value & tap (if any). Indicate AC switch or no. Dual sections available for old stereo gear. Single section - \$7.00, duals - \$10, tapped sections add \$2 per section, add \$3.00 per AC switch, plus \$1.00 shipping per order (not per unit). Mark Opat, 167 Caster, Plymouth, MI 48170

**WANTED:** Schematic for Allied Radio, 1957, Knight Kit R100A receiver. Marvin Hess, 204 Queensway Rd., Elma, NY 14059

---

**CLASSIFIED ADVERTISEMENTS**

---

**FOR SALE:** Unusual Sylvania Color TV and slide projector sold as the Scanner Color Slide Theatre, working, best offer, you pick up. Charles R. Nichols - (518) 672-4677, Philmont, NY. Will trade on antique guns & swords or one cylinder gas engines.

**FOR SALE:** Nazi Kleinempfänger - \$225; Sentinel, marble plastic - \$125; DeForest Crosley 52 - \$150. A. Nolf, 539 Kastelic, Burlington, Ontario, Canada L7N-3R5

**WANTED:** Marathon Radio MR-2 schematic. Also Radio City Products Model 322 schematic/tube chart, copies OK - \$4.00 each set, all letters answered. Leonard Cartwright, 113 Sea Terrace Way, Aptos, CA 95003

**FOR SALE:** Zenith Model 4-R, 1922, fine - \$225 plus \$20 UPS; Steinite crystal set, 8 x 7 x 2 3/4 inches, fine, plays good - \$40 firm; Monarch crystal set by the Rippner Bros. Mfg Co. of Cleveland, OH, fine, plays, ex-good - \$85 firm; Zenith Radio Phonograph, about 2' x 2' x 12", brown bakelite, plays ex-good, ex-fine case, top raises up - \$60 plus \$25 packing & Greyhound; Crosley "Fiver" small tombstone, round dial, plays - \$55 plus \$7.00 UPS; Little Wonder Microphone in box by Little Wonder Specialties, Inc., Cleveland, Ohio, fine - \$25; Philmore Junior Microphone, Philmore Mfg. Co., New York City, mint in box with instructions - \$35; two 12 x 15 inch pictures from the Johnson family album with Jimmy Scribner who had 22 characters in male and female on WLW's and one De Main event - Peewee's Downs - consider offers; Motorola Aeroscope plastic maroon, 12 x 9 x 5 inches, gold color, metal grill 4 x 8", ex-fine, doesn't play - \$50; Zenith portable, maroon plastic, ECT-B, 8 x 5 x 6 inches, very heavy, chrome grill 4 x 5", fine, plays - \$85; Motorola portable Model 5A7A, ECT-B, 8 x 4 x 3 1/2 inches, metal painted maroon with plastic maroon front lid, chrome front with maroon plastic over speaker, no tubes, doesn't play - \$25; Admiral portable, 11 x 7 x 3 inches, red vinyl covering with 1 1/2" black around center, black plastic handle, chrome front and grill 4 1/2" x 9 1/2", black antenna 1 1/4 x 1 x 6 inches swings out under handle, model 215, fine, plays - \$125; Westinghouse Juke Box radio, gets one station - \$25; Silvertone, about 20 x 12 x 14 inches, round dial, left top rounded, fine, plays - \$35; Hallicrafters Model S77, fine, lights up, doesn't play - \$35; Silvertone wire recorder with mike, radio plays - \$75 plus packing UPS. Not too good at writing ads, so call for complete description on any items - thank you. Edison Mabry, 715 W. Longview Ave, Mansfield, OH 44906 (419) 526-1175

---

**CLASSIFIED ADVERTISEMENTS**

---

**FOR SALE:** Total approximately 1,200 radio magazines ranging from 1930 to 1967. Titles include Radio News, Radio Craft, Radio Electronics, Popular Electronics, QST, CQ, Electronics World, and some miscellaneous. Conditions good to poor. Send SASE for listing. Walter Friedrich, 19 Pine Circle, Doylestown, PA 18901

**WANTED:** Radio Amateur's Handbook before 1958 and radio magazines before 1950, especially "Popular Radio". Send asking price postpaid to Japan by surface mail. Minoru Wakasugi, 1-16-11 TokiWaDai, ToYoNoCho, Osaka, 563-01 Japan

**FOR SALE:** Hallicrafters - Models S-37 -\$137, S-27 -\$120, S38E -\$31. All mint cond. Ward Becht, 625 Tufts Ave., Burbank, CA 91504 (818) 842-3444

**WANTED:** Knob for FADA Neurolette with Off/Med/Loud on it. Leonard Arzuomanian, 12 DiFillippo Ct., North Providence, RI 02904

**FOR SALE:** Zenith 6000 series junker for parts - \$1750; Hallicrafter Model R46B speaker, mint - \$29.50; Cap/Resistor tester Model HC-1 by Hallicrafters - \$49.50; Bietman's service manuals - 7 for \$27.50. Chet Wisner, 1014 Main St., Dalton, MA 01226

### A.R.C.'s NEW ADDRESS...

**Antique Radio Classified  
P.O. Box 2  
Carlisle, MA 01741**

**WANTED:** To correspond with anyone owning or having used a Thompson Uni-Control receiver. James Chew, 900 N. 4th St., Jeannette, PA 15644

**FOR SALE:** Two volumes "Official Radio Service Manual" and all supplements - \$50. SASE for "Stan's Stuff", also repair service. Stan Lopes, 1201-74 Monument Blvd., Concord, CA 94520

**WANTED:** Phcto or diagram for restringing a Bodine basketweave loop aerial; 1W4 tubes, and 864/WD11 adapters. John Andrews, 2975 So. 600 East, Salt Lake City, UT 84106

**FOR SALE:** Riders 6 through 16 - \$8.00 each, Riders 3, 4, 5, 17 & 18 - \$20 each. **WANTED:** Radio and Lionel Train collections. Bill - (216) 871-4547 Ohio

**HELP:** Looking for a copy of manual for playing space controlled "Theremin" by J. Schillinger, Camden, NJ 1929. Also a Theremin any condition for parts, any information or literature. Floyd Engels, 8044 Davis Rd., Colden, NY 14033

**WANTED:** Maritime related radio items. Chief R/O Nygaard, SS Norway, 1265 South America Way, Miami, FL 33132

---

**CLASSIFIED ADVERTISEMENTS**

---

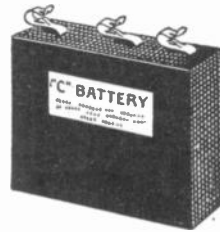

**WANTED:** Colorful and odd-ball "C" batteries for my collection. Does anyone else collect "C" batteries. Looking for style as shown above. Labels must be in very good condition. Gary Schneider, 9511-23 Sunrise Blvd., Cleveland, OH 44133

**COMING EVENT:** California Historical Radio Society swapmeet, September 20th at Foothill College. Contact C.H.R.S., P.O. Box 1147, Mountain View, CA 94041

**FOR SALE:** Old instrument, meters, parts - large SASE. Also GR-1802A Crystal Galvanometer w/probe & access. in wooden case. Presto Model K-8 portable recorder/player with 50 blank 10 inch transcription discs. WWII OAN Range Test Oscillator 190 - 2200 KHz; Signal Corps WWII TS-460 Impedance Bridge w/silver dials - mint. **WANTED:** Super Skyrider (Flick of Switch page 225), silver panel containing speaker; Harvey Transmitter Model FT-30 (F.O.S. page 257). Cash or trade choice items. Robt Enemark, Box 1607, Duxbury, MA 02331

**FOR SALE:** CRT's - 3BP1, 5BP1 (2), 5BP4, & 7BP7 - \$15 each plus UPS. Serge Krauss, 141 Homan, Elkhart, IN 46516

**WANTED:** Information and price on 1925 X Aeriola and 1926 Crain Craft Jr. crystal sets made by Crain Bros. Radio Shoppe. **FOR SALE/TRADE:** Many different speaker cones, spiders, and voice coils made by Carrone, Leotone, etc. Send wants or will sell all. Also schematics - \$2.50 for 2-sided page. Mike Crain, RD1 - Box 472, Harveys Lake PA 18618

**TUBE SALE:** New list each month. Send SASE to: Tracy Sands, 1520 W. Juno Ave. #C, Anaheim, CA 92802

**FOR SALE:** Zenith console, 1935, Model 8S154, fine condition. (601) 684-0241 Mississippi, Pat Robinson

**FOR TRADE:** DeForest Radio Training Course - 31 booklets in original binder with letter from the DeForest company. Ccvers spark to the 1930's. Michael Payne, Rt 5 - Box 796, Alvin, TX 77511

**WANTED:** Panel for Pilot Super Wasp; book - Modern Radio Reception by Leutz (1923-24). Ron McNeil, Box 472, Yorkton, Sask, Canada S3N-2W4

---

**CLASSIFIED ADVERTISEMENTS**

---

**YOUR AD MISSING FROM THIS ISSUE?:** As explained in the August issue, the deadline for this issue (Sept. issue) was August 6th. If your ad was received after this date then your ad will appear in the October issue. (GBS)

**FOR SALE:** Firestone Air Chief (battery) 4A24 - \$50; Knight SpanMaster 4-band - \$25; RCA 96T3 3-band, P-button - \$40; G.E. AM/FM T150B - \$35; Zenith G730W AM/FM - \$35; Grundic 4-band RE-250 - \$50; Zenith K-731 AM/FM - \$40; Airline 4-band, P-button 14BR913A - \$60; Philco console 41-285, original, 3-band, P-button - \$75 (All radios above working); RCA 18T, 3-band, P-button, tubes lite - \$50; Crosley 66T, 2-band, tubes lite - \$50; Galaxie FM203, 4-band, push button, made in Poland, tubes lite - \$60; Zenith chassis and speaker 7S363 - \$25. Don Nordboe, 3220 West Broadway, Council Bluffs, IA 51501

**WANTED:** Need some help, I acquired a Shamrock battery set - need any info and schematic for it. Made by Shamrock Mfg Co. of Newark, NJ. Uses 01A's and is 2 3/4 x 1 1/4 x 10 3/4 inches high with hinged lid. O.J. Carpenter, 7729 Doris Dr., Norfolk, VA 23505

**FOR SALE:** UZ-1325 horn speaker, bottom cover missing, works - \$75 or best offer. B. Kasindorf, 8 Maymont, Framingham, MA 01701 (617) 877-4947

**WANTED:** Space Rambler midget all-band radio, circa 1958; also RCA Monitor Tube Amp., type BA-4C. Mike Koval, 1012 Grand Ave., Cincinnati, OH 45204

**WANTED !**  
**VINTAGE 32 VOLT VACUUM CLEANERS**  
- MADE IN INDIANA -



- DUST BAGS & BEATER BRUSHES
- BLACK, ALUMINUM OR POLISHED MOTOR HOUSINGS
- WEST COAST VACUUM CLEANERS

**FRANK HEATHCOTE**  
(MEMBER A.C.R.R.)  
1235 N 3rd St.  
LOGANSPORT, IN. 46947

**FOR SALE:** Zenith 7S-363 console, works, cabinet rough, glass and bezel missing - \$35 plus shipping. George Moritz, 31 Hart, Woburn, MA 01801

**WANTED:** Xtal detector for Amrad Xtal set model 2575. Have one Grewol Xtal Det. to trade toward it. H.R. Harder, Box 95, W. Brookfield, MA 01585

**WANTED:** Murdock Loose Coupler and mounting yoke for RCA 77 Microphone. Mike Koval, 1012 Grand Ave., Cincinnati, OH 45204

**FOR SALE/TRADE:** RCA 45 RPM bakelite record players and lots of AC and Battery Radios. Sonny Clutter, 14330 NE. Fremont Ct., Portland, OR 97230

---

**CLASSIFIED ADVERTISEMENTS**

---

**FOR SALE:** Large Scott, 1946, chrome chassis, best offer, you pick up. Charles Nichols, Philmont, NY 12565 (518) 672-4677. Will trade on antique guns & swords and one cylinder gas engines.

**WANTED:** Ring type microphone stand for Western Electric or similar carbon microphones. Ralph Michelson, 19150 Portos Dr., Saratoga, CA 95070 (408) 867-2883

**WANTED:** Cash for ACE radios - models TRU, TTR, AVA, AVB, AVC, amps, etc. made by Precision Equipment Co. Craig Ball, 10101 Oak Hollow Cir., Austin, TX 78758 (512) 835-7292

**FOR SALE:** Ampex 4 channel 1/2" tape instrumentation recorder in rack cabinet - \$150, pick-up only - heavy! Doug Houston, 3441 Hadley Rd., Ortonville, MI 48462

**WANTED:** Books, catalogs and periodicals on telegraph and telegraph items wanted. Dick Randall, K6ARE, 1263 Lakehurst Rd., Livermore, CA 94550

**WANTED:** Keil Table for AK-60; Zenith radio knobs; battery switch for AK-10 - Part No. 4183. James Cole, 240 Gillespie Dr., Abingdon, VA 24210

**Will be at A.W.A. meet with many small parts for battery sets. Get your list of items needed - once-a-year chance to get many hard to find items. Gary Schneider, 9511-23 Sunrise Blvd., Cleveland, OH 44133 (216) 582-3094**

**WANTED:** Atwater Kent 90 chassis with or without speaker. M.B. Gaskins, 227 Risen Ave., Campbellsville, KY 42718

**WANTED:** Does anyone have parts for an AK 84? Will buy complete chassis, please write. Thomas Fuller, 96 Cocasset St., Foxboro, MA 02035

**WANTED:** Mint Hallicrafters S-38, SX62, SX42. Russ Reading, 253 Goodwater Ave., Brown Mills, NJ 08015

**WANTED:** Need schematic and/or on-off switch for Bush & Lane Piano Co. Model "N" TRF battery radio. Sidney Allen, Jr., 1908 Rosecrest Dr., Greensboro, NC 27408

**NOTICE:** Will be at Canandaigua with large inventory of radio related literature - technical, juvenile, biography, history, nostalgia, magazines, etc. Bring your want list. Jerry Simkin, 10 Avalon Lane, Matawan, NJ 07747

**WANTED:** Crank (female type) for wind-up phonograph. Tim Healy, 595 East 83rd St., Brooklyn, NY 11236

**FOR TRADE:** 1931 Silver Marshall Model "B" floor model radio, very unique. Michael Payne, Rt 5 - Box 796, Alvin, TX 77511



# DISPLAY ADVERTISEMENTS

## WANTED

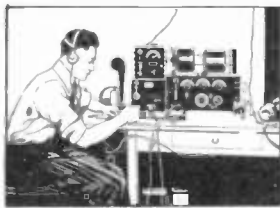
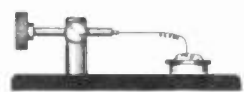

Radio and Wireless items - pre-1925:  
 Books, Magazines, Catalogs, Receivers,  
 Transmitters, Speakers, Crystal sets,  
 Detectors, Tubes, and Spark Gear.

Will buy entire collections! Qualified appraisals anytime, anywhere.  
 (References provided)

*New Wireless Pioneers*



*Jim Kreuzer, N2GHD, 6270 Clinton St., Elma, NY 14059 (716-681-3186)*

### RADIO COLLECTION APPRAISALS

- U.P.S. INSURANCE CLAIMS
- PARCEL POST CLAIMS
- INSURANCE PROTECTION
- COLLECTION VALUATION
- WILLS AND ESTATES

**RADIO COLLECTION APPRAISALS:**  
 We will do complete professional appraisals of your radio collection by mail or within reasonable driving distance of Buffalo, New York. **References** available upon request. For details write or call: James Kreuzer, 6270 Clinton St., Elma, NY 14059 (716) 681-3186



**WAVES**  
 ANTIQUES  
 EARLY RADIOS  
 &  
 PHONOGRAPHS  
 78 RECORDS  
 BOUGHT • SOLD  
 OPEN 12 • 6  
 CLOSED SUN & MON

32 EAST 13TH ST. NEW YORK, N Y 10003 212 989-9284  
 PROPRIETORS Bruce and Charlotte Mager

#### THIS MONTHS SPECIALS:

1. Philco Model A Radio Clock . . \$75
  2. Small chalk Victor dog, 1920's . . 35
  3. Philco hat (No Squat, No Stoop) 35
  4. Philco Model 20, working . . . . 200
  5. Mesco Spark Gap, 1915 . . . . . 55
  6. Omnigraph code machine 1915-2075
  7. Atwater Kent advertising whistle . 12
  8. Sparton Radio & TV display . . . 25
- ..SEE NEXT MONTHS LIST FOR MORE..





# BUSINESS CARD ADS - \$10.50 FOR 3 MONTHS

**BUSINESS CARD RATES:** Run your business card ad (or small display ad) here for only \$10.50 for 3 consecutive months. Artwork must be "camera ready" or a reproducible business card. Typesetting is available at additional cost. Maximum printable area is 1 5/8" high and 3 1/4" wide



**Antique Radio Service**

**REPAIR BUY RESTORE SELL**

RICHARD FOSTER  
12 SHAWMUT AVE  
COCHITUATE MA 01778

617 655 2056

Andrew Mooradian

Wanted Pre 1926 Radios by



Also Radio Parts, Accessories  
and Literature

Priscilla Lane, Winchester, MA 01890

30s MEMORIES 40s



ED SAGE - COLLECTOR

707-746-5659 1781 MELANE CT BENICIA, CA 94510

**Joseph Mullan**

W3RLR

ANTIQUE RADIO COLLECTOR

217 NORTHWAY BALTIMORE, MD 21218

TELEPHONE: (301) 467-3500

SCHEMATICS 1920-1960  
RADIO/TV/HAM/ETC.

FULL DESCRIPTION OF SET IN  
FIRST LETTER PLEASE - \$3.50 EA.

ALTON H. BOWMAN  
RD2 (CHAPIN VLG.)  
CANANDAIGUA, NY 14424

— WANTED —

Old Transmitting Tubes

Amateur or Commercial types  
FOR MUSEUM

Ye Olde Transmitting Tube Museum  
Post Office Box 97  
Crescent City, California 95531



**WANTED**

**RADIO — WIRELESS**

Pre-1925

**ELECTRICITY — TELEGRAPHY**

Pre-1900

Books Magazines Autographs Catalogs Ephemera  
One Item or Entire Collection

**New Wireless Pioneers**

6270 Clinton, Elma, NY 14059 USA  
(716) 681-3186

**Antique Radios**

David & Nancy Snow

6024 Leora Ln

Jackson, MI 49201

(517) 750-4992

We Buy, Sell, Repair

Custom Made Battery Eliminators



**REINKE & SONS**

Telegraph Items Bought & Sold  
Roger W. Reinke, Prop.

5301 Neville Court, Alexandria, Virginia 22310

**WANTED: Western Electric Equip:** Tubes, Amps, Drivers, Horns, Speakers, & Parts. Radio tubes - 2A3, 10, 45, 50, 80, 199, 211, 845. Old speakers, drivers, horns from Jensen, Altec, JBL, Trusonic, Tannoy. *David Yo, P.O. Box 832, Monterey Park, CA 91754 (818) 576-2642*

\$\$\$\$\$\$\$\$\$\$\$\$

SALES PARTS TRADES

**OLDE TYME RADIO COMPANY**

2445 Leesville Road  
Silver Spring, MD 20910

Business  
and Serv.  
5/16/1988

Howard W. Cranoff  
Telephone  
and Equip.  
16/16/88

Telephone  
and Equip.  
16/16/88

**IS YOUR  
BUSINESS  
CARD  
AD HERE???**



**PERMANENT WANTS:** Buying radio related novelties such as: radio banks, radio board games, puzzles, radio toys, sheet music & Va entines showing old radios on cover, promotional and advertising items & gimmicks, anything with the words **Radio** on them Gary Schneider, 9511-23 Sunrise Blvd., Cleveland, Ohio 44133 (216) 582-3094

# DISPLAY ADVERTISEMENTS



24 hrs. a day • 7 days a week  
FREE TO EVERYONE

National Broadcast Museum  
**SUPER STATION**



Music from  
1899-1949

Plus  
Old Time Radio Shows



TUNE TO: **SATCOM 4**  
HANKING COUNTY OF THE  
NOSTALGIA CHANNEL AUDIO 6.2  
TRANSPODER 21

*"The WORLD'S LARGEST BROADCAST MUSEUM"*

**2001 PLYMOUTH ROCK**  
RICHARDSON TEX. 75081 (214) 788-1112  
OPENING SOON IN A NEW LOCATION  
LISTEN FOR DETAILS...

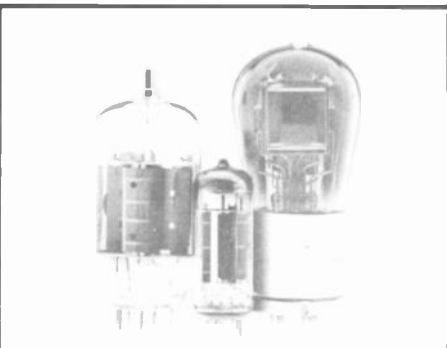

## TUBES — 2,000 TYPES DISCOUNT PRICES!

20-pg. wholesale catalog for the radio collector/hobbyist. Antique, hard-to-find and modern tubes. Also transformers, capacitors and parts for tube equipment, and books, etc.

**ANTIQUE ELECTRONIC SUPPLY**

688 W. First Street • Tempe, AZ 85281  
602/894-9503

### NOW AVAILABLE FOR RADIO RESTORERS - A HALF-WATT RESISTOR KIT

This kit of 5% tolerance, carbon film resistors, a total of 500, has been selected specifically for radio restoration. Both values and quantities have been chosen to follow as closely as possible those found in radios made from about 1926-1940, but are also useful for restoring newer radios.

#### CONTENTS OF THIS KIT

100---5	1.0K--15	10K--20	100K--20	1.0M--15
150---5	1.5K--10	15K--10	150K--10	2.0M---5
200--10	2.0K--15	20K--15	200K--15	
240--10	2.4K--15	24K--15	240K--20	
300--10	3.0K--10	30K--15	300K--10	
360---5	3.6K---5	36K---5	360K---5	
390---5	3.9K--10	39K--10	390K--10	
510--10	5.1K--15	51K--20	510K--20	
620---5	6.2K--10	62K--15	620K---5	
680---5	6.8K---5	68K---5	680K---5	
750---5	7.5K---5	75K--10	750K--10	
820---5	8.2K---5	82K---5	820K---5	



Kits are shipped U.P.S. for \$20.00 plus \$2.50 shipping and handling per kit. For orders of 5 or more kits sent to one address, we pay shipping. For 10 or more kits to one address, the cost is reduced to \$17.50 per kit. For 25 or more kits sent to one address, the price is \$15.00 per kit. Get a club order together! Make checks payable to Michael D. Lewis. Personal checks take two weeks to clear. Shipping will follow check clearance. Send orders to:

**RADIO FREQS - 6070 LINCOLN RD. - OREGON, WI 53575**



# DISPLAY ADVERTISEMENTS



## W A N T E D

\* ELECTRON TUBE ( ST SHAPE )

50,ST16 size,same as 2A3...\$16      50,ST19,large size.....\$20

\* ELECTRON TUBE ( ANTIQUE GLOBE SHAPE )

37/237.....\$5	42/242.....\$7	45/245/345/445...\$12
50/250/350/450..\$30	56/256.....\$5	80/280/380/480...\$9
565.....\$25	643.....\$7	10/210/310/410...\$11
UV201, RCF TIP...\$12	UV202, RCF TIP...\$20	UX 215/216B.....\$7

\* TRANSMITTING TUBES

211/VT4C.....\$10      645/7147.....\$22

\* WESTERN ELECTRIC TUBES

VT 1.....\$16      VT7/705 B.....\$30

101D/F/L.....\$6	102D/F.....\$6	104D.....\$8
101/102/104 (TENNIS BALL SHAPE) & D86326/D86327.....\$16		
205D/E (TENNIS BALL SHAPE ).....\$30	205F.....\$14	
211D/E.....\$30	216A.....\$15	217A.....\$15
242A/B/C.....\$22	244A.....\$6	247A.....\$6
252A.....\$100	262A.....\$12	262B.....\$8
271A.....\$20	274A/B.....\$30	275A.....\$15
276A.....\$22	284D.....\$60	300A.....\$100
300B.....\$70	301A.....\$10	310A(MESH PLATE)..\$7
339A.....\$12	345A.....\$8	347A.....\$8
348A.....\$8	349A.....\$6	350B.....\$24
VT 25/25A.....\$6	VT52.....\$10	

NOTE:ALL ABOVE PRICES ARE FOR "NEW,IN ORIGINAL BOX" TUBES,AS FOR "USED" TUBES,ASK DETAILS.

\* WESTERN ELECTRIC EQUIPMENTS. ( FOR THEATER & STUDIO )

DRIVERS & HORNS.....555(W),594(A),597A/P,22A,24A,25A & ETC.  
 SPEAKERS.....TA4151,4153,4181,4191 & ETC.  
 TRANSFORMERS.....171,197,618 & ETC, LIST AVAILABLE.  
 CARTRIDGE & ARMS.....1A,3A,4A,7A,9A,10A & ETC.

NOTE:WE EAGERLY LOOK FOR ABOVE W.E.THEATER & STUDIO EQUIPMENTS,WE PAY MUCH MORE THAN ANY DEALERS IN U.S.A.,INFORM US THEIR PRICES OR YOUR EXPECTED PRICES,WE WILL NEVER DISAPPOINT YOU.

\* G.E.VARIABLE RELUCTANCE CARTRIDGES....RFX 040/041/050,VR2,ETC..\$20  
 \* NEEDLES FOR ABOVE G.E.CARTRIDGES...for 33/45RPM..\$2    for 78RPM..\$4  
 \* TONE ARMS..FA 21A(G.E.),108B/206/208(GRAY) & for above cartridge..\$25  
 \* TUBE SOCKET...UX4PIN & UY5PIN,CERAMIC/MICANOL WITH MOUNT BASE TYPE.  
 AMPHENOL,JAMES-MILLEN & ETC.WANT LARGE QUANTITY.  
 PLEASE QUOTE FOR THEM,AND ASK DETAILS.

## TRIAL ELECTRIC PRODUCTS, INC.

409 YOTSUYA SUN HEIGHTS,6-1 YOTSUYA 4 CHOME,SHINJUKU,TOKYO 160 JAPAN



## ANTIQUE RADIO CLASSIFIED



A.R.C., 9511 SUNRISE BLVD., #J-23, CLEVELAND, OHIO 44133  
RETURN POSTAGE GUARANTEED

SECOND CLASS  
POSTAGE PAID  
at Cleveland, OH

# TO:

CLARENCE E. FILLEY  
1109 SOUTH 2ND  
HAMILTON

Z# 7 EXP: 8709  
MT 59840

CLASSIFIED AD

DEADLINE SEPT. 10TH

POSTMASTER: Deliver Promptly