

# audiocraft

for the **HIFI** hobbyist 25

JULY 1957

35 CENTS

**Tape music  
in your  
automobile**

**How to add  
a tweeter**

**Gadget box  
for  
tape recording**



**EICO 60-Watt Power Amplifier Kit**

these  
are the  
features

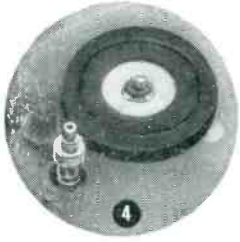

that have  
made it

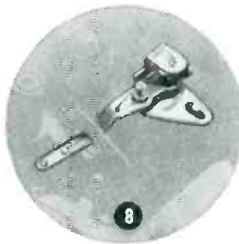
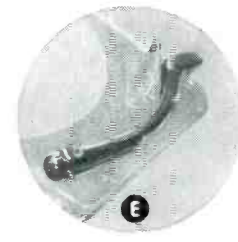
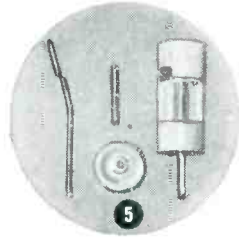

...and  
kept it

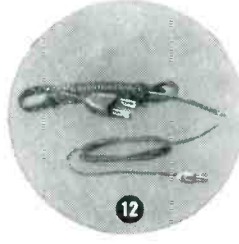
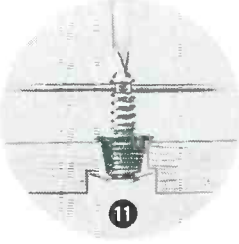
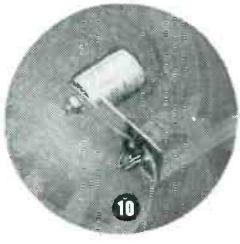

The  
WORLD'S  
FINEST!

1. 4-POLE SHADED "INDUCTION SURGE" MOTOR gives this changer constant speed with minimum vibration. Will not cause hum even with sensitive pickups. The rotor is dynamically balanced!
2. FULL MANUAL POSITION: Just touch the switch and tone arm is freed for manual play. Returns automatically to its rest at end of record.
3. ADVANCED GARRARD PUSHER PLATFORM: After twenty years still the only device insuring positive, gentle handling of all records, any diameter, thickness or condition of center hole.
4. PERFECTED TRUE-TURRET DRIVE operates directly off motor without belts. Combined with an oversized "soft tread" idler wheel, it gives you unflinching speed without wows or flutter.
5. INTERCHANGEABLE SPINDLES (Manual and Automatic) insert easily, remove instantly. Note that the Garrard one-piece spindle has no moving parts to nick or enlarge center holes.
6. EXCLUSIVE TRUE-TANGENT TONE ARM OF ALUMINUM plays better, provides rigidity, low mass and lightness ... It has the easiest stylus pressure adjustment on any changer.
7. HEAVY STEEL PRECISION TURN-TABLE with genuine rubber traction mat. A full inch high! Eliminates magnetic hum by strengthening motor shielding. Turns on silent, free-wheeling ball-bearing mount.
8. EXCLUSIVE SENSIMATIC TRIP MECHANISM gives you sure operation even with tone arm set at lowest tracking pressures. Automatic stop after last record.
9. INTERCHANGEABLE PLUG-IN HEADS accommodate your personal choice of high fidelity pickups, fit all cartridges ... magnetic, crystal or ceramic; turnover, twist or simple plug-in types.
10. REINFORCED AUTOMATIC MUTING SWITCH eliminates sound through speaker during record change cycle. Also, a special condenser-resistor network eliminates shut-off noise.
11. STEEL MONO-BUILT UNIT PLATE keeps changer permanently in line. Exclusive snap-mount springs permit you to mount changer instantly, level it from top with screwdriver.
12. CHANGER COMES READY FOR PLUG IN to any system of high fidelity components. Supplied with full 5 ft. U.L.-approved electrical line cord, and pick-up cable terminating in standard jack.

Model **RC88** *Triumph II*

# GARRARD

De Luxe Auto-Manual Record Changer

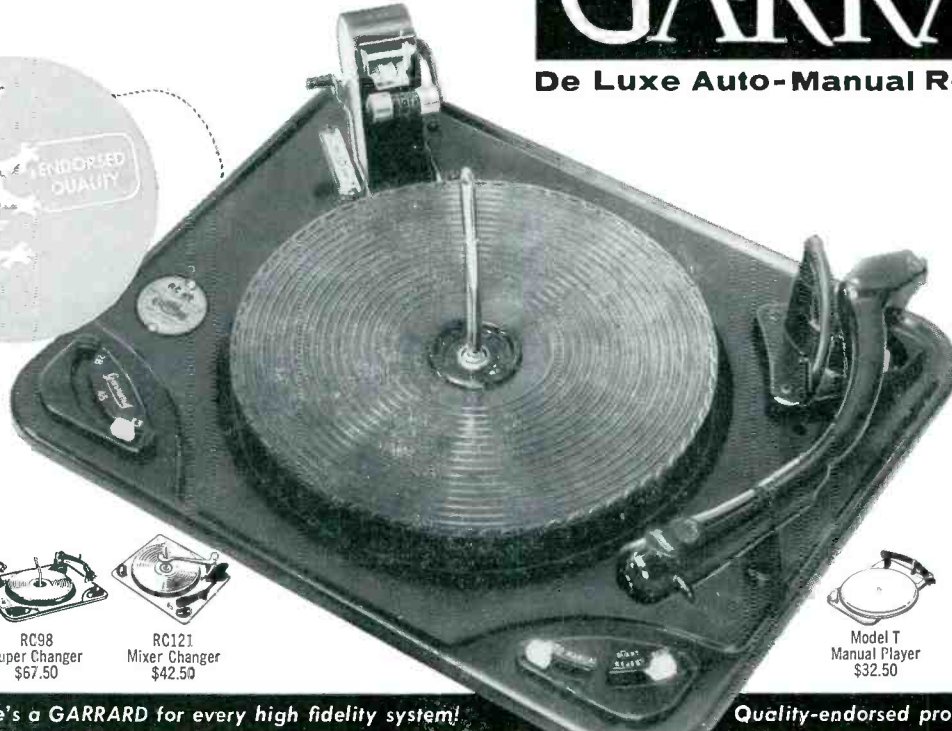

**\$54<sup>50</sup>** net  
less cartridge

-  301 Turntable \$89.00
-  RC98 Super Changer \$67.50
-  RC121 Mixer Changer \$42.50

 Model T Manual Player \$32.50

MAIL THIS COUPON for illustrated B.I.C. High Fidelity Plan Book.

Garrard Sales Corp., Dept. GG-97  
Port Washington, N. Y.

Send B.I.C. High Fidelity Plan Book.

Name.....

Address.....

City.....Zone.....State.....

Now there's a GARRARD for every high fidelity system! Quality-endorsed product of the B.I.C. Group

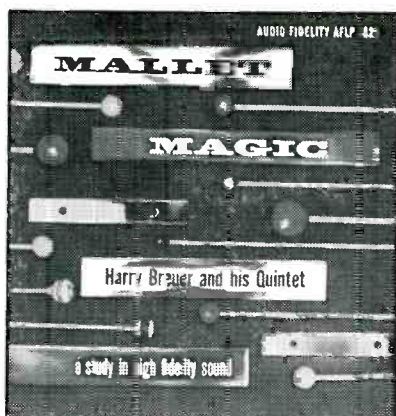
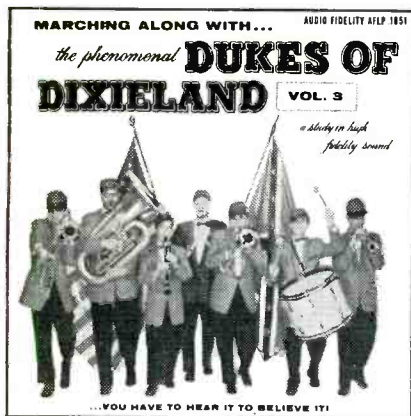

**MARCHING ALONG WITH** the phenomenal **DUKES OF DIXIELAND** Volume 3 It's real Rebel music... the kind you don't hardly hear no more! Dixieland Marches done in the Dukes own unique styling converts the ordinary to the unusual! Top honors go to When Johnny Comes Marching Home. AFLP 1851

**MALLETT MAGIC** Featuring Harry Brewer and his quintet. Exciting toe-tapping novelty tunes arranged for marimba, xylophone, glockenspiel and vibes — backed by a bass fiddle, organ, guitar, drums and assorted 'clap-trap' — make this a hi-fi musical extravaganza! The show stoppers — Mosquitos Parade and Bumble Bee Bolero. AFLP 1825

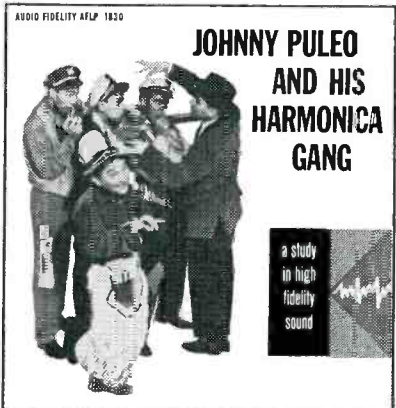
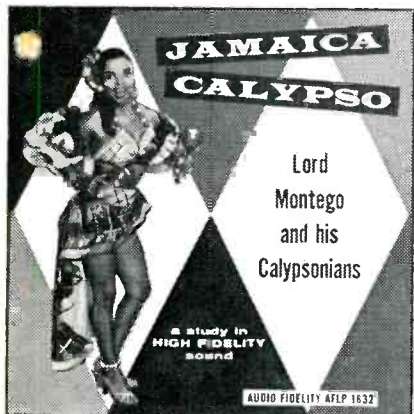

**JAMAICA CALYPSO** Plenty of Bongos... plenty of Rhythms... plenty of clever lyrics — some new, some old — by Lord Montego and his Calypsonians. Rum and Coca Cola, Down to the Islands, Is There a Land?, Run Joe, etc. Brilliant hi-fi. AFLP 1832

**JOHNNY PULEO** and his **HARMONICA GANG** World renowned as a wonderful little pantomimist with a harmonica — Johnny Puleo now rises to even greater heights as a virtuoso of the harmonica on this brilliant Hi-Fi recording. Magnificent tonal effects, never before recorded, add zest and sparkle to favorites as: Peg 'O My Heart, St. Louis Blues, It Had To Be You, etc. AFLP 1830

# EXCITING NEW RELEASES ON AUDIO FIDELITY

TOTAL FREQUENCY RANGE RECORDINGS

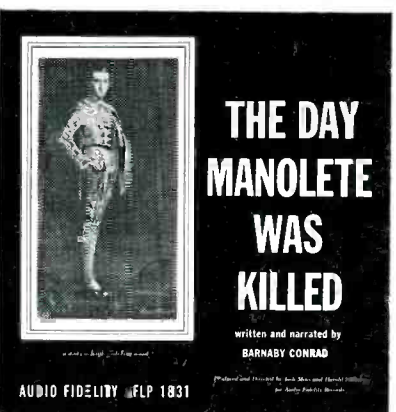

Brilliant Hi-Fi recordings for the lazy listener or hectic hep-cat... every record is a new listening thrill — a wonderful emotional experience!

**ROME WITH LOVE** Come wander thru Rome... down narrow picturesque streets, past little art shops and elegant palaces to the cafe at the Trevi Fountain... accompanied by Jo Basile, his accordion and orchestra. AFLP 1822

**THE DAY MANOLETE WAS KILLED** The dramatic and thrilling story of the life and death of the world's most famous Bullfighter — Manolete, narrated by the noted author on Bullfights — Barnaby Conrad. Recorded in Hi-Fi at the arena! AFLP 1831

**BAWDY SONGS** and **BACKROOM BALLADS** Vol. 3 Gather 'round you lovers of lusty lore... Oscar Brand has done it again! A complete new album of spicy musical folklore. AFLP 1824

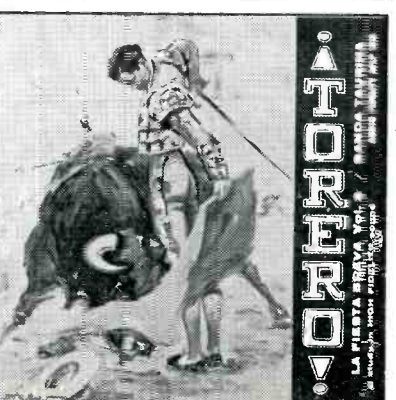
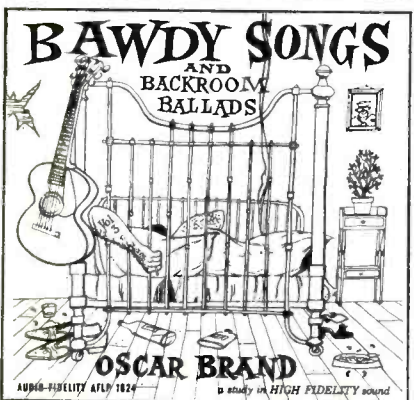

**TORERO! La Fiesta Brava! Vol. 3** Once again music by the Banda Taurina transports you to the bullfight arena to experience all the drama and emotional thrills. Luxuriously packaged with 50-page book, El Toreo. AFLP 1818

Only \$5.95 for each 12-inch LP. Attractively packaged, in individual polyethylene bag in four color jacket.

WRITE FOR FREE CATALOG



Nationally Distributed By **DAUNTLESS INTERNATIONAL** 750 Tenth Ave., N. Y. 19

Save yourself time and trouble  
by ordering your books directly from us.  
Just fill in the coupon below.

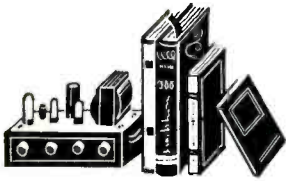

# audiophile's bookshelf

Three recent books by three experts

## HANDBOOK OF SOUND REPRODUCTION

By EDGAR VILLCHUR, inventor of AR loudspeaker systems and president of Acoustic Research, Inc.

Here is A-1 information about all aspects of sound reproduction, acoustics, and the necessary components. Written by one of the foremost authorities in the field, the book is organized in a way similar to home training courses. It fully covers a difficult technical subject in a manner which will provide pleasure and profit to the high-fidelity enthusiast. \$6.50 **249**

## HIGH FIDELITY: THE WHY AND HOW FOR AMATEURS

By G. A. BRIGGS, designer and manufacturer of Wharfedale loudspeakers.

"... holds something for everyone. For the amateur, for whom it was written, it holds a bit of everything, in suitably compressed form, and must inevitably leave him with a feeling that he has acquired a general working background to the whole subject. . . . It deserves a wide readership, and I am certain it will secure it."—HI-FI NEWS (England) \$2.95 **250**

## OLIN DOWNES ON MUSIC

Edited by IRENE DOWNES

A selection of over 170 of Olin Downes's reviews, Sunday columns, and other pieces, written between 1906 and 1955. \$5.00 **246**

"The general impression these (reprints) have left on me is that I have been in long and fruitful contact with a fine musical mind, a mind moreover, of fundamental sincerity and integrity."—Ernest Newman in THE NEW YORK TIMES BOOK REVIEW

Now available — the revised edition of Greene & Radcliffe's extremely popular

## THE NEW HIGH FIDELITY HANDBOOK

A complete, practical guide for the purchase, assembly, installation, maintenance, and enjoyment of high-fidelity music systems. Includes the latest information on equipment. 250 illustrations, diagrams, and plans. \$4.95 **251**

"... Messrs. Greene and Radcliffe, two gentlemen whose knowledge of hi-fi is only slightly less than awesome. Whoever said that 'reading maketh a full man' was right — at least as concerns this book. Read it through, and you will arise full of knowledge."—Deems Taylor

## WHAT TO LISTEN FOR IN MUSIC

By AARON COPLAND. The revised edition of a book which made it possible for thousands to increase their enjoyment of music through creative listening. \$3.95 **247**

## THE FORMS OF MUSIC

By SIR DONALD TOVEY. Written by one of the most literate and profound of modern interpreters of music, these essays are drawn from those articles which Tovey prepared for the *Encyclopaedia Britannica*. Paper, \$1.35 **239**

Book Department  
AUDIOCRAFT Magazine  
Great Barrington, Mass.

I enclose \$..... for which please send me, postpaid, the books indicated by circled numbers below. (No C.O.D.'s or charge orders, please.) Foreign orders sent at buyer's risk. Add 55¢ per book for postage on foreign orders except Canadian.

Binder 1 (holds 14 issues)	223	\$3.50	
Binder 2 (holds 12 issues)	245	\$3.00	
	201		245
NAME .....	223		246
	232		247
ADDRESS .....	233		249
	234		250
	237		251

Continuing best sellers

## HIGH FIDELITY RECORD ANNUAL: 1956

Edited by ROLAND GELATT. The second volume of *High Fidelity Record Annuals*. Included in this collection are reviews of classical and semiclassical music and the spoken word which appeared in HIGH FIDELITY Magazine from July 1955 through June 1956. Comparisons with recordings of previous years are emphasized. A performer index is included. \$4.50 **237**

HIGH FIDELITY RECORD ANNUAL: 1955 \$4.95 **201**

## MAINTAINING HI-FI EQUIPMENT

By JOSEPH MARSHALL. A much needed book on the specialized approach necessary to service high-fidelity equipment. The author discusses not only electronic faults, but the mechanical and acoustical defects which cause a hi-fi system to function less than perfectly. The book is clearly written and well indexed. Hard cover, \$5.00 **232** Soft, \$2.90 **233**

## HIGH FIDELITY: A PRACTICAL GUIDE

By CHARLES FOWLER, Publisher, AUDIOCRAFT Magazine

Whether your budget is small or large, whether you are a beginner or a devotee from way back, this complete and definitive guide can help you get the most enjoyment out of your high-fidelity system.

Here is the practical expert advice needed by everyone who has, or expects to have, a high-fidelity system. Starting with an introduction to sound, the author then describes the various links in the hi-fi chain, explaining their features and specifications so as to provide the most helpful criteria for evaluating, and for selecting and matching components. \$4.95 **234**

# audiocraft



Charles Fowler  
Publisher

Warren B. Syer  
Associate Publisher

Roy F. Allison  
Editor

Frank R. Wright  
Managing Editor

Eleanor B. Wright  
Editorial Assistant

Roy Lindstrom  
Art Director

Eleanor Gilchrist  
Art Assistant

Frances A. Newbury  
Manager, Book Division

R. D. Darrell  
J. Gordon Holt  
Joseph Marshall  
Contributing Editors

Claire Eddings  
Advertising Sales Manager

Arthur J. Griffin  
Circulation Manager

THE MAGAZINE FOR THE HI-FI HOBBYIST

JULY 1957

Volume 2 Number 7

<b>The Grounded Ear</b> <i>What's new in sound reproduction</i>	<b>4</b>	<i>Joseph Marshall</i>
<b>Book Reviews</b>	<b>8</b>	<i>Richard D. Keller</i>
<b>Audionews</b>	<b>10</b>	
<b>Editorial</b>	<b>13</b>	
<b>Readers' Forum</b>	<b>13</b>	
<b>Play Your Tapes at 60 mph</b> <i>Install a tape deck in your car</i>	<b>14</b>	<i>Joseph Rebbholz</i>
<b>Using Test Instruments</b> <i>The oscilloscope, part III</i>	<b>19</b>	<i>Donald Carl Hoefler</i>
<b>New British Audio Developments</b> <i>A special report on the London Audio Fair</i>	<b>20</b>	<i>Charles Fowler</i>
<b>EICO HF-60 Power Amplifier</b> <i>An AUDIOCRAFT kit report</i>	<b>22</b>	
<b>Inexpensive Turntable Base</b> <i>An attractive turntable base you can build</i>	<b>24</b>	<i>Abraham Wolfthal</i>
<b>How to Add a Tweeter, Part I</b> <i>How tweeters work</i>	<b>26</b>	<i>Edmond Ariessohn</i>
<b>Gadget Box for Tape Recording</b> <i>Tape news and views</i>	<b>28</b>	<i>J. Gordon Holt</i>
<b>Basic Electronics</b> <i>Chapter XVIIIa: Triodes</i>	<b>30</b>	<i>Roy F. Allison</i>
<b>The Right Wood for the Job</b> <i>Tips for the Woodcrafter</i>	<b>32</b>	<i>George Bowe</i>
<b>Audio Aids</b>	<b>34</b>	
<b>Sound-Fanciers' Guide</b> <i>Reviews of exceptional disc and tape records</i>	<b>35</b>	<i>R. D. Darrell</i>
<b>Advertising Index</b>	<b>48</b>	

### ADVERTISING

**Main Office** — Claire Eddings, The Publishing House, Great Barrington, Mass. Telephone: Great Barrington 1300.

**New York** — Frederick H. Wallin, 280 Madison Ave., New York, N.Y. Telephone: Murray Hill 3-4449, 3-4450.

**Chicago** — John R. Rutherford & Associates, Inc., 230 East Ohio St., Chicago, Ill. Telephone: Whitehall 4-6715.

**Los Angeles** — Brand & Brand, Inc., 6314 San Vicente Blvd., Los Angeles, Calif. Telephone: Webster 8-3971.

Audiocraft Magazine is published monthly by Audiocom, Inc., in Great Barrington, Mass. Telephone: Great Barrington 1300. Editorial, publication, and circulation offices at: The Publishing House, Great Barrington, Mass. Subscriptions: \$4.00 per year in the United States and Canada. Single copies: 35 cents each. Editorial contributions will be welcomed by the editor. Payment for articles accepted will be arranged prior to publication. Unsolicited manuscripts should be accompanied by return postage. Entered as second-class matter October 1, 1955, at the post office, Great Barrington, Mass., under the act of March 3, 1879. Additional entry at the post office, Pittsfield, Mass. Printed in the U. S. A. by the Ben Franklin Press, Pittsfield, Mass. Copyright 1957 by Audiocom, Inc. The cover design and contents of Audiocraft Magazine are fully protected by copyrights and must not be reproduced in any manner.

# The Grounded Ear



by Joseph Marshall

## Bogen DB115 Amplifier

Until about 18 months ago the audio engineer's ability to produce a low-priced high-fidelity amplifier was limited by the lack of a small tube with high power sensitivity, efficiency, and good linearity. The EL84 which, in push-pull, can deliver 18 watts with less than 300 volts on the plates and less than 15 volts of drive, has overcome that limitation. This summer in the show rooms of hi-fi dealers there are some fine examples of what audio engineers can do with this tube. The Bogen DB115 (Fig. 1), for example, at an audiophile net price of \$75, offers features which, as recently as a year ago, could not have been bought for \$125.

For one thing, it will deliver 15 watts with less than 0.5% harmonic and 1.5% IM distortion. A year ago, it took a pair of 807-KT66-5881's, with about 400 volts on the plates and 40 volts of drive, to deliver that much hi-fi output. The smaller tubes, the smaller power transformers made possible by lower voltages, and the simpler driving requirements not only save space, but money as well, and thus leave more room and more funds for refinements. One refinement is the excellent Bogen-type damping control which provides positive damping factors of from 0.1 to infinity and negative factors to -1.5.

Moreover, to make adjustments simple and safe, the circuit includes a "damping indicator" consisting of an NE 51 neon tube connected as a voltmeter across one of the output tubes. Instructions recommend setting the damping control for the most satisfying sound quality with a given speaker; however, the indicator provides insurance against setting the damping in the unstable region, for it will indicate either continuous or momentary oscillation. Incidentally, the damping control can be cut out completely, in which case the damping factor is about 10.

There are two other very handy refinements in the output stage. First, a switch provides a choice of 8- or 16-ohm speaker impedances (4 ohms are also available through a special hookup). Second, there is a three-position slide switch which permits the amplifier output to be fed to either or both of two speaker systems. The drive is supplied by a 6U8 pentode-triode, with the pentode as the voltage amplifier direct-coupled to the triode which acts as a split-load phase inverter.

The DB115 includes complete pre-amplifier and control facilities. There is a LOUDNESS control with a CONTOUR SELECTOR switch which provides a choice of no compensation at all, 10-db compensation, and 20-db compensation. The BASS and TREBLE controls

are of the excellent Baxendall type. Just ahead of the tone controls are a rumble filter and a high-frequency roll-off, both with 12-db slopes, and both with switches to disable their action. The effect of these is not so sharp as it is in the EICO preamp I analyzed a couple of months ago (AUDIOCRAFT, Apr. 1957, p. 4), but it is adequate to handle the rumble of modern changers and turntables, and the distortion of broadcast stations and overcut records.

The output to feed a tape recorder precedes tone controls and filters, and, since it comes from a cathode follower, has low impedance and permits long cables. The preamp is of the two-stage feedback type and equalizes modern 78-rpm records, old 78's, and modern RIAA LP's. There are inputs for a Ronette 284 crystal cartridge, for magnetic cartridges (100-K load), as well as a tuner and one additional source, such as a TV tuner or a tape recorder with a built-in preamp. However, the amplifier will also accept the input straight from the playback head of a tape deck and provide NARTB equalization for playback.

Hum levels are claimed to be -85 db for high-level (tuner or tape) inputs and -60 db for the phono or low-level tape inputs. To help achieve these low levels there is a hum-balancing control in the filament string, which is also biased by the amount of bias on the output tubes. Gain for the tuner and auxiliary channels is 80 db, 110 db for the phono channel, and 120 db for the direct tape channel. There is an AC outlet for a tuner or other equipment. Total power consumption is only 80 watts. The complete amplifier is 12 in. wide, 11½ in. deep, and a little over 4 in. high; it weighs only 13 lbs.

Although I was not able to give the DB115 a complete laboratory test, I was able to use one for most of a day before it was installed in a friend's home. I thought it delivered excellent quality and represented a big value for the money.

## Wing-Chair Stereo

While visiting the International Photo

*Continued on page 42*

Fig. 1. Bogen's moderately priced DB115 offers 15 watts of power, low distortion.

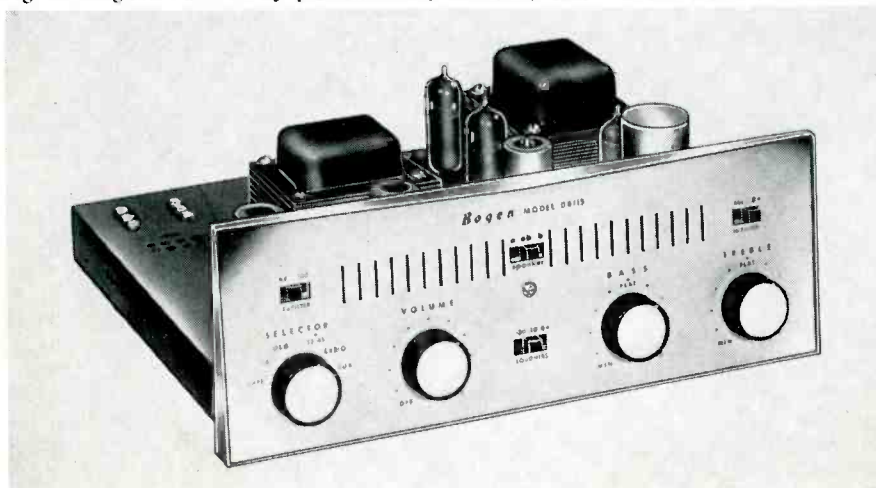

Courtesy David Bogen Co., Inc.

# "We're building a HEATHKIT<sup>®</sup>..."

BECAUSE IT'S SUCH GREAT FUN... AND BECAUSE WE GET SO MUCH MORE FOR OUR MONEY!"

Every day more and more people (just like you) are finding out why it's smart to "do-it-yourself" and save by building HEATHKIT high fidelity components. These people have discovered that they get high-quality electronic equipment at approximately one-half the usual cost by dealing directly with the manufacturer, and by doing their own assembly work. It's real fun—and it's real easy too! You don't need a fancy work shop, special tools or special knowledge to put a Heathkit together. You just assemble the individual parts according to complete step-by-step instructions and large picture-diagrams. Anyone can do it!

## Heathkit Model SS-1 Speaker System Kit

This high fidelity speaker system is designed to operate by itself, or with the range extending unit listed below. It covers the frequency range of 50 to 12,000 CPS within  $\pm 5$  db. Two high-quality Jensen speakers are employed. Impedance is 16 ohms, and power rating is 25 watts. Can be built in just one evening. **\$39<sup>95</sup>**  
Shpg. Wt. 30 lbs.

## Heathkit Model SS-1B Speaker System Kit

This high fidelity speaker system kit extends the range of the model SS-1 described above. It employs a 15" woofer and a super-tweeter to provide additional bass and treble response. Combined frequency response of both speaker systems is  $\pm 5$  db from 35 to 16,000 CPS. Impedance is 16 ohms, and power is 35 watts. Attractive styling matches SS-1. Shpg. Wt. **\$99<sup>95</sup>**  
80 lbs.

## HEATHKIT

### "LEGATO" SPEAKER SYSTEM KIT

Months of painstaking engineering by Heath and Altec-Lansing engineers has culminated in the design of the Legato, featuring "CP" (critical phasing) and "LB" (level balance). The result is a *new kind* of high fidelity sound, to satisfy even the most critical audio requirements. Two high-quality 15" theater-type speakers and a high-frequency driver with sectoral horn combine to cover 25 to 20,000 cycles without peaks or valleys. "CP" and "LB" assure you of the smooth, flat audio response so essential to faithful reproduction. Choice of two beautiful cabinet styles below.

### "Legato" Traditional Model HH-1-T

Styled in classic lines to blend with period furniture of all types. Doors attractively paneled. African mahogany for dark finishes unless you specify imported white birch for light finishes. Shpg. Wt. 246 lbs. **\$345<sup>00</sup>**

### "Legato" Contemporary Model HH-1-C

This fine cabinet features straightforward design to blend with your modern furnishings. Slim, tapered struts run vertically across the grille cloth to produce a strikingly attractive shadowline. Wood parts are pre-cut and pre-drilled for simple assembly. Supplied in African mahogany for dark finishes unless you specify imported white birch for light finishes. Shpg. Wt. **\$325<sup>00</sup>**  
231 lbs.



\$4.00 dwn.  
\$3.36 mo.

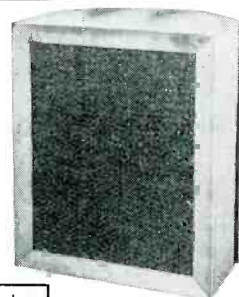

\$10.00 dwn.  
\$8.40 mo.



\$34.50 dwn.  
\$28.98 mo.

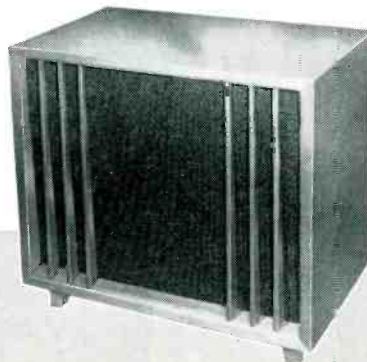

\$32.50 dwn.  
\$27.30 mo.



**HEATH COMPANY**

A Subsidiary of Daystrom, Inc.

BENTON HARBOR 18, MICHIGAN

# Make yours a **HEATHKIT**®

**It's Easy (and fun) to Plan Your Own Hi-Fi Installation  
By Choosing the Heathkit Components  
That Best Suit Your Particular Needs.**

As the world's largest manufacturer of electronic equipment in kit form, Heath Company can provide you with a maximum variety of units from which to choose. You can select just the amplifier you need from five different models, ranging in power from 7 watts to 25 watts, some with preamplifiers, and some requiring a separate preamplifier. You can pick your speaker system from four outstanding high fidelity units ranging in price from only \$39.95 to \$345.00. You can even select a fine Heathkit FM or AM Tuner! Should there be a question in your mind about the requirements of an audio system, or about planning your particular hi-fi installation, don't hesitate to contact us. We will be pleased to assist you.

### **MATCHING CABINETS . . .**

The Heath AM Tuner, FM Tuner and Preamplifier are housed in matching satin-gold finished cabinets to blend with any room decorating scheme. Can be stacked one over the other to create a central control unit for the complete high fidelity system.



MODEL FM-3A



MODEL BC-1



MODEL WA-P2



### **PRE-ALIGNED TUNERS . . .**

A unique feature of the Heathkit AM and FM Tuners is the fact that both units are pre-aligned. A signal generator is not necessary! IF and ratio transformers are pretuned at the factory, and some front-end components are preassembled and pretuned. Another "extra" to assure you of easy kit assembly.



## **HEATH COMPANY**

A Subsidiary of Daystrom, Inc.  
BENTON HARBOR 18, MICHIGAN

**EASY TIME PAYMENTS . . .** We invite you to take advantage of the Heath Time Payment Plan on any order amounting to \$90.00 or more. Just 10% down and the balance in twelve monthly payments. **WRITE FOR COMPLETE DETAILS.**

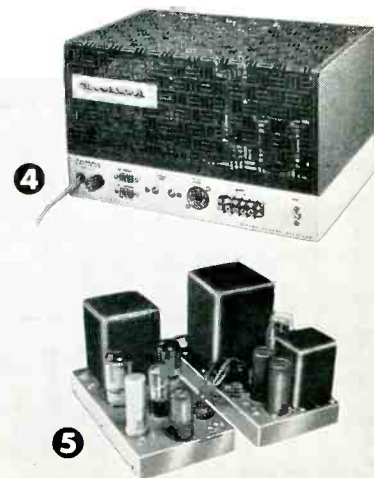



# HIGH FIDELITY SYSTEM

**1 HEATHKIT HIGH FIDELITY FM TUNER KIT** Features AGC and stabilized, temperature-compensated oscillator. Sensitivity is 10 microvolts for 20 db of quieting. Modern circuit covers standard FM band from 88 to 108 mc. Employs ratio detector for efficient hi-fi performance. Power supply is built in. Illuminated slide rule dial for easy tuning. Housed in compact satin-gold enamel cabinet. Features prealigned transformers and front end tuning unit. Shpg. Wt. 7 lbs.

MODEL FM-3A Incl. Excise Tax (with cab.)

**\$25<sup>95</sup>**

\$2.60 dwn., \$2.18 mo.

**2 HEATHKIT BROADBAND AM TUNER KIT** This fine AM Tuner was designed especially for use in high fidelity applications, and features broad bandwidth, high sensitivity and good selectivity. Employs special detector circuit using crystal diodes for minimum signal distortion, even at high levels. Covers 550 to 1600 kc. RF and IF coils are prealigned. Power supply is built in. Housed in attractive satin-gold enamel cabinet. Shpg. Wt. 8 lbs.

MODEL BC-1 Incl. Excise Tax (with cab.)

**\$25<sup>95</sup>**

\$2.60 dwn., \$2.18 mo.

**3 HEATHKIT HIGH FIDELITY PREAMPLIFIER KIT** This pre-amplifier meets or exceeds specifications for even the most rigorous high fidelity applications. It provides a total of 5 inputs, each with individual level controls. Hum and noise are extremely low, with special balance control for absolute minimum hum level. Tone controls provide 18 db boost and 12 db cut at 50 cps, and 15 db boost and 20 db cut at 15,000 cps. Four-position turn-over and four-position rolloff controls for "LP", "RIAA", "AES", and "early 78" equalization. Derives power from main amplifier, requiring only 6.3 VAC at 1A and 300 VDC at 10MA. Beautiful satin-gold enamel finish. Shpg. Wt. 7 lbs.

MODEL WA-P2 (with cab.)

**\$19<sup>75</sup>**

\$1.98 dwn., \$1.66 mo.

**4 HEATHKIT ADVANCED-DESIGN HI-FI AMPLIFIER KIT** This fine 25-watt high fidelity amplifier employs KT66 output tubes by Genalex and a Peerless output transformer for top performance. Frequency response  $\pm 1$  db from 5 to 160,000 cps at 1 watt. Harmonic distortion less than 1% at 25 watts, an IM distortion less than 1% at 20 watts. Hum and noise are 99 db below 25 watts. Output impedance is 4, 8 or 16 ohms. Extremely stable circuit with "extra" features.

MODEL W-5: Consists of W-5M plus WA-P2 Preamplifier

Shpg. Wt. 38 lbs. Express only **\$79.50** \$7.95 dwn. \$6.68 mo.

MODEL W-5M

**\$59<sup>75</sup>** \$5.98 dwn. \$5.02 mo.

Shpg. Wt. 31 lbs. Express only

**5 HEATHKIT DUAL-CHASSIS HI-FI AMPLIFIER KIT** This 20-watt Williamson-type amplifier employs the famous Acrosound model TO-300 output transformer, and uses 5881 tubes. Frequency response is  $\pm 1$  db from 6 cps to 150 kc at 1 watt. Harmonic distortion less than 1% at 21 watts, and IM distortion less than 1.3% at 20 watts. Output impedance is 4, 8 or 16 ohms. Hum and noise are 88 db below 20 watts.

MODEL W-3M

MODEL W-3: Consists of W-3M plus WA-P2 Preamplifier

Shpg. Wt. 37 lbs. Express only **\$69.50** \$6.95 dwn. \$5.84 mo.

**\$49<sup>75</sup>** \$4.98 dwn. \$4.18 mo.

Shpg. Wt. 29 lbs. Express only

**6 HEATHKIT SINGLE-CHASSIS HI-FI AMPLIFIER KIT** This 20-watt Williamson-type amplifier combines high performance with economy. Employs Chicago-Standard output transformer and 5881 tubes. Frequency response  $\pm 1$  db from 10 cps to 100 kc at 1 watt. Harmonic distortion less than 1.5% and IM distortion less than 2.7% at full output. Output 4, 8 or 16 ohms. Hum and noise—95 db below 20 watts.

MODEL W-4AM

MODEL W-4A: Consists of W-4AM plus WA-P2 Preamplifier

Shpg. Wt. 35 lbs. Express only **\$59.50** \$5.95 dwn. \$5.00 mo.

**\$39<sup>75</sup>** \$3.98 dwn. \$3.34 mo.

Shpg. Wt. 28 lbs. Express only

**7 HEATHKIT 20-WATT HIGH FIDELITY AMPLIFIER KIT** Features full 20 watt output using push-pull 6L6 tubes. Built-in preamplifier provides four separate inputs. Separate bass and treble controls. Output transformer tapped at 4, 8, 16 and 500 ohms. Designed for home use, but also fine for public address work. Response is  $\pm 1$  db from 20 to 20,000 cps. Harmonic distortion less than 1% at 3 db below rated output. Shpg. Wt. 23 lbs.

MODEL A-9B

\$3.55 dwn., \$2.98 mo.

**8 HEATHKIT ELECTRONIC CROSS-OVER KIT** This device separates high and low frequencies electronically, so they may be fed through two separate amplifiers driving separate speakers. Eliminates the need for conventional cross-over. Selectable cross-over frequencies are 100, 200, 400, 700, 1200, 2000 and 3500 cps. Separate level controls for high and low frequency channels. Attenuation 12 db per octave. Shpg. Wt. 6 lbs.

MODEL XO-1

**\$18<sup>95</sup>** \$1.90 dwn., \$1.59 mo.

**9 HEATHKIT 7-WATT ECONOMY AMPLIFIER KIT** Qualifies for high fidelity even though more limited in power than other Heathkit models. Frequency response is  $\pm 1\frac{1}{2}$  db from 20 to 20,000 cps. Push-pull output and separate bass and treble tone controls. Good high fidelity at minimum cost. Uses special tapped-screen output transformer.

MODEL A-7E: Same as A-7D except one more tube added for extra preamplification. Two inputs, RIAA compensation and extra gain.

Shpg. Wt. 10 lbs. Incl. Excise Tax **\$19.95** \$2.00 dwn. \$1.68 mo.

MODEL A-7D

**\$17<sup>95</sup>** \$1.80 dwn. \$1.51 mo.

Incl. Excise Tax Shpg. Wt. 10 lbs.

## HOW TO ORDER

Just identify kit by model number and send order to address below. Write for further details if you wish to budget your purchase on the HEATH TIME PAYMENT PLAN.

## HEATH COMPANY

A Subsidiary of Daystrom, Inc.  
BENTON HARBOR 18, MICHIGAN  
Please send Free HEATHKIT catalog.

Name \_\_\_\_\_  
Address \_\_\_\_\_  
City & Zone \_\_\_\_\_ State \_\_\_\_\_

Write for  
Free Catalog

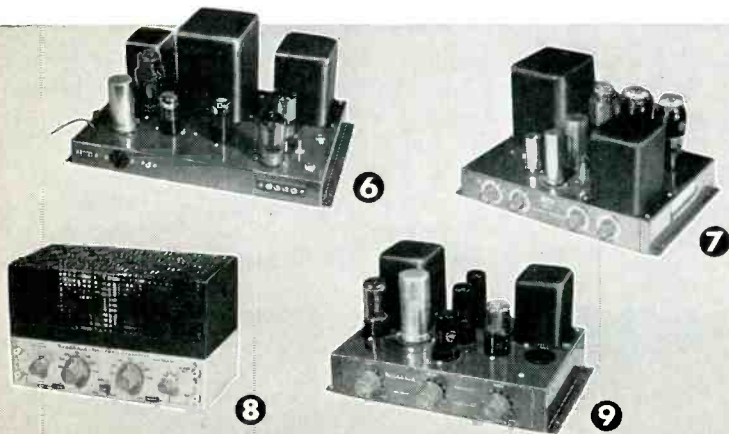

by RICHARD D. KELLER

# book reviews



## The New High Fidelity Handbook

Irving Greene and James Radcliffe; pub. by Crown Publishers, Inc., New York; 193 pages; \$4.95.

This large manual, with a foreword by Deems Taylor, was written primarily for the lay reader who has little knowledge of electronic technology. The music lover who wants the greater depth, expression, and realism that can be achieved from records and tapes played back on the superior equipment now available for his home will find it a practical guide. The purchase, installation, and maintenance of high-fidelity music systems are points taken into consideration.

A large portion of the book is devoted to how equipment may be fashionably housed in custom or do-it-yourself cabinetry. A section on interior decoration, with a gallery of pictures of tastefully designed home systems, is included. The amateur craftsman should find useful the discussion of furniture-making techniques and the detailed plans for cabinets. A glossary of hi-fi terms and a buyer's guide of high-fidelity equipment manufacturers and dealers throughout the nation serve to round out the manual.

Perhaps most interesting to me was the symposium on power-amplifier design, giving the candid views of the chief engineers of a number of the larger manufacturers in the field. Particular attention is given in the symposium to the "triode-vs.-pentode question."

## Transistor Engineering Reference Handbook

H. E. Marrows; pub. by John F. Rider Publisher, Inc., New York; 272 pages; \$9.95.

The influence of the transistor on the electronics industry continues to grow at a breathless pace—almost too fast for the printing presses to keep up. Although dated November 1956, the man-

ufacturers' specification sheets which make up the bulk (202 pages) of this book are already largely outdated or superseded. The 2N205 is the highest numbered transistor shown, but JETEC registrations are now (April) in the 2N340 area. Of course, transistor types included here are the stalwarts which have been responsible for the current upsurge of applications for these tiny, efficient devices.

The rest of the manual is devoted to a general survey of transistors, with a brief historical chronology; a short sur-

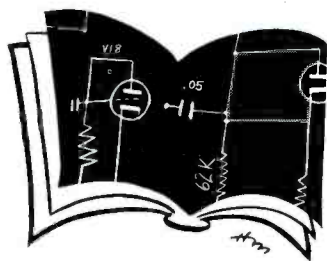

vey of fabrication techniques, circuit properties, and diagrams; a bibliography; and a directory of manufacturers. Reference data are given on miniature commercial transistor parts, such as transformers, batteries, capacitors and the like.

A lot of information is presented here, but the book would have been more helpful if it had included a consolidation of all transistor specifications, with, perhaps, some cross referencing between the various manufacturers' types (as is done in the new *General Electric Transistor Manual*, for example).

## Circuit Theory and Design

John L. Stewart; pub. by John Wiley & Sons, Inc., New York; 480 pages; \$9.50.

Strictly for the advanced engineer, this work applies modern network theory to the understanding of vacuum tubes and feedback systems.

Pole-zero design methods based on a pictorial representation are employed extensively. They are used in developing design methods for a variety of circuits, both with and without vacuum tubes, and for systems with and without feedback. In discussing feedback systems, the precision realization of a prescribed closed-loop transfer function is emphasized.

Examples relating to practical system design are given along with certain useful adjuncts, such as normalization, function design, and the use of ideal transformers. As you can see, this is a basically mathematical approach intended for the advanced student and circuit-design engineer.

## The Oscilloscope at Work

A. Haas and R. W. Hallows; pub. by Philosophical Library, Inc., New York; 171 pages; \$10.00.

Oscillograms—over 200 of them—portray the subject matter of this book. Originally a French volume and elaborated upon by an Englishman, *The Oscilloscope at Work* contains interpretations and ideas for using the oscilloscope in all sorts of RF, AF, pulse, rectifier, and oscillator circuits. Information on oscilloscope circuits, construction, and adjustment is given, although, of course, such information is based primarily upon British "valves" and European design practices. The line or mains voltage over there is 50 cps, rather than our 60 cps, and it's a bit shaky at times as evidenced in some of the pictures.

An interesting comparison might be made with the Heathkit Technical Application Bulletins published several years ago for only \$2.00. For truly helpful information in American terminology, these Bulletins are still hard to beat; and most of the essential information on scope-pattern interpretation is presented there in more condensed form than in this volume.



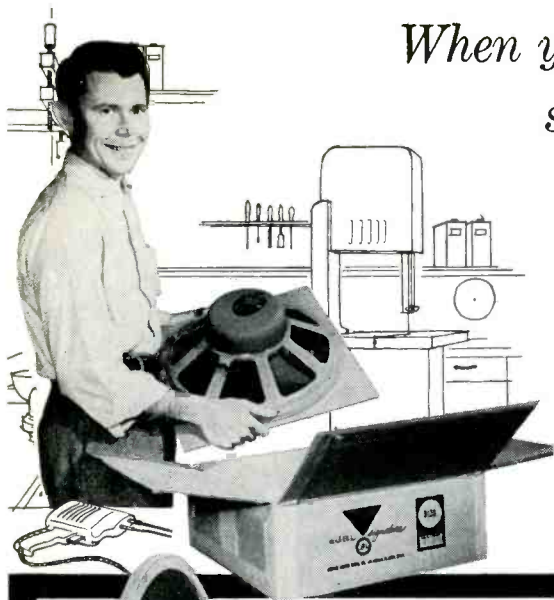

# When you build your High Fidelity sound system, use **THE VERY BEST** **LOUDSPEAKERS YOU CAN GET**

You are planning to build, or improve, your high fidelity sound system. Unstintingly, you will pour out your enthusiasm, time, and energy to get the finest music reproduction you can bring into your home. Get a loudspeaker that will do full credit to your handiwork... Install a JBL Signature Extended Range Loudspeaker, or two-way speaker system, in your enclosure.

JBL Signature Loudspeakers are made with the same careful craftsmanship, the same precision forming and fitting that you yourself would use if you set out to make the finest loudspeaker the world had ever heard. JBL Signature precision speakers are the most efficient loudspeakers made.

With a JBL Signature Loudspeaker in your high fidelity system, you can exhibit your components with pride, confident that those you have made yourself are being demonstrated in the most effective way possible.



**MODEL D130—15" extended range loudspeaker** The only 15" extended range speaker made with a 4" voice coil is the world-famous JBL Signature D130. The large voice coil stiffens the cone for crisp, clean bass; smooth, extended highs. Your basic speaker, the D130 works alone at first, later becomes a low frequency driver when you add a JBL Signature high frequency unit and dividing network to achieve the ultimate excellence of a JBL Signature two-way system.



**MODEL D208—8" extended range loudspeaker** A precision transducer in every sense of the word, the famed JBL Signature 8" D208 is made with the same care and precision as the larger units in the James B. Lansing Sound, Inc., line. If space and cost are major considerations, the D208, properly enclosed, provides the most lastingly satisfactory sound you can get. It is widely used in top quality systems where extension speakers are desired for areas other than the main listening room.



**MODEL D123—12" extended range loudspeaker** With outstanding "presence" and clean response throughout the entire audio spectrum, the D123 features an unusual shallow construction. Only 3 5/8" deep, it is designed to mount flush with the wall, between studding, in any standard wall or partition. Frequently, the D123 is used in multiples in "infinite baffle" wall installations. In this case the JBL Signature 075 is a logical high frequency unit to add when you advance to a two-way system.



**MODEL 175DLH high frequency assembly** The acoustical lens is only available on JBL Signature high frequency units. The 14 element lens on the 175DLH disperses sound within the listening area over a 90° solid angle, smoothly, with equal intensity regardless of frequency. The acoustical lens is the greatest contribution to lifelike high frequency reproduction in 20 years, and it was developed for use with high fidelity equipment by James B. Lansing Sound, Inc. In addition to the lens, the 175DLH consists of a high precision driver with complex phasing plug and a machined aluminum exponential horn. Designed for crossover at 1200 cycles with the JBL Signature N1200 Network.



**MODEL 075 high frequency unit** Another exclusive for James B. Lansing Sound, Inc. is the ring radiator in the JBL Signature 075 high frequency unit. A ring, rather than a diaphragm, radiates into the annular throat of an exponential horn. The result is high frequency reproduction of unmatched smoothness and clarity, absolutely free of resonances and strident peaks. The horn is beautifully machined from aluminum, the entire unit is a gratifying, solid piece of fine craftsmanship. Designed for crossover at 2500 cycles with the JBL Signature N2500 Network.

## JBL Signature two-way systems are available as kits

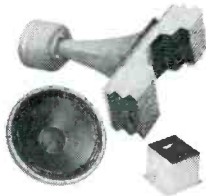

**086 KIT** This two-way system is made up of units which have been acclaimed by impartial authorities as the finest available anywhere today. Included in the kit are the 150-4C Low Frequency Driver, N500H Network, 375 High Frequency Driver, 537-509 Horn-Lens Assembly. These are the same units—including the serpentine acoustical lens—which are used in The Hartsfield... units designed originally for installation in the most modern theaters in the world.



**002 KIT** Including some of the newest speakers made, the JBL Signature 002 Kit includes a D123 for low frequency reproduction, N2500 Network, 075 High Frequency Unit. The 002 Kit is moderately priced, yet gives the user all the advantages of a two-way system made with independent drivers.



**001 KIT** Probably the most popular high quality two-way system on the market, the JBL Signature 001 system consists of a 130A Low Frequency Driver, N1200 Network, 175DLH High Frequency Assembly. The D130 may be substituted for the 130A without disturbing the balance or coverage of the system.

There are many more kits and loudspeakers in the JBL Signature line. Whatever your needs, you will find exactly the right unit or system in the complete JBL Signature catalog. Send for your free copy. A limited number of technical bulletins are also available. Please ask only for those in which you are vitally interested.



means  
**JAMES B. LANSING SOUND, INC.**  
2439 Fletcher Drive • Los Angeles 39, California

Please send me the following:

- Free Catalog of JBL Signature Products       Name and address of Authorized JBL Signature Audio Specialist in my community

TECHNICAL BULLETINS ON:

- D130    D123    D208    175DLH    075    130A    150-4C

Name \_\_\_\_\_

Address \_\_\_\_\_

City \_\_\_\_\_ Zone \_\_\_\_\_ State \_\_\_\_\_



# Audionews

## PERI 50-WATT AMPLIFIER

Printed Electronic Research, Inc., has announced an easy-to-assemble 50-watt high-fidelity amplifier kit. The kit utilizes a deep-etched photoelectronic circuit board which, it is claimed, can be assembled in 90 minutes or less without any special tools or equipment. The deep-etched copper circuit board replaces all wiring and forms the complete base

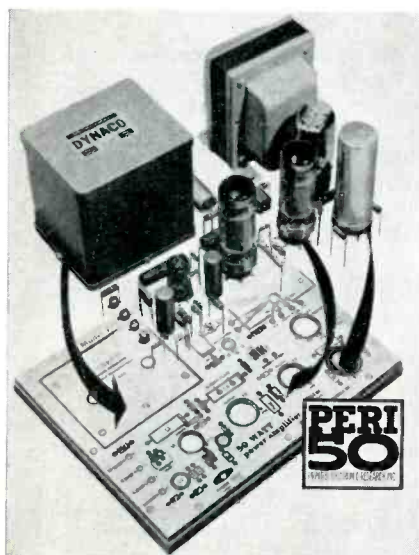

Amplifier kit with printed-circuit base.

of the PERI-50 amplifier. The kit is not only complete as to all components, including tubes, but even provides the necessary solder and soldering iron.

Power output is said to be 50 watts continuous, 100 watts peak. Intermodulation distortion is stated to be less than 1% at 50 watts, less than 0.25% at 35 watts. Frequency response from 6 to 60,000 cps is flat  $\pm 0.5$  db, according to the manufacturer's specifications.

The manufacturer offers a free illustrated brochure showing the complete unit and supplying full specifications and operating characteristics.

## STEREOPHONIC TAPES

A new line of stereophonic tapes has been introduced by Klipsch and Associates, manufacturers of Klipschorn and Shorthorn loudspeaker systems. Developed to meet the demands of high-quality stereo playback equipment, the tapes are recorded to be played at 15 ips.

*Klipschtapes* are recorded under the

technical supervision of Paul W. Klipsch, using Stephens capacitor microphones. Recordings are monitored immediately after recording so that they can be compared with the live sound source. All Klipschtapes are first-generation copies of the original master tapes, made directly from the original tape at the original recording speed.

A list of releases is available free on request.

## CROSSOVER NETWORK

The Racon Model CON-4M crossover network provides a wide choice of crossover points for use in two- or three-way speaker systems. In two-way systems, crossover may occur at 300, 600, 1,200, or 5,000 cps, depending on the cutoff of the upper-range speaker. In three-way systems, the middle-range speaker may cross over at 300, 600, or 1,200 cps, and the high-frequency speaker at 5,000

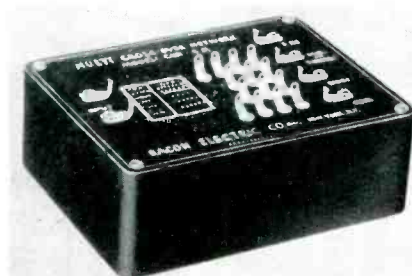

Racon multicrossover dividing network.

cps. Other combinations are possible. The network is of the full half-section type, with attenuation of 12 db per octave.

Selection of various crossover points is made by strapping terminals as shown by data stenciled on the panel and included in an instruction sheet furnished with every network. Price is \$28.50.

## MINIATURE RESISTORS

Workman TV Inc. has announced a new line of Model GM Miniature Globar Resistors. These resistors will be available at electronic-parts jobbers in the United States, Canada, and abroad.

The miniature resistors (1/4 in. long by 1/16 in. diameter) are specially designed for circuitry where space limitations demand the tiniest components. Capable of dissipating 1/5 watt of power continuously, these resistors are said to be very stable in value, even at temperatures as high as 125° C. They are

reported to have negligible reactance components at low and high frequencies. Globar Miniatures are especially suited for use in hearing aids, transistor radios, printed circuits, and laboratory work. Each resistor is RETMA color-coded for easy identification.

## SCOTT BOOKLET

A catalogue containing photographs and specifications of all new H. H. Scott high-fidelity components has been released by H. H. Scott, Inc., and will be furnished free on request. The catalogue contains a question-and-answer section in which some facets of high fidelity are discussed.

## CABINART ENCLOSURES

The Cabinart division of G & H Wood Products Company has announced a pair of matched cabinets, Models 30 and 31, for high-fidelity systems.

Model 30 is a lift-top equipment cabinet featuring two equipment compartments. The upper player compartment is 19½ in. wide and 14½ in. deep; height above player board is 6 in. The lower compartment, for tuner/amplifier, is 13 in. high, 19½ in. wide, and 14½ in. deep. The equipment panel may be removed and this compartment used for



Matched speaker and enclosure cabinets.

storage. The cabinet weighs 46 lbs., and costs \$39 net unfinished, or \$51 net finished in a choice of mahogany or korina finish on birch.

The matching bass-reflex enclosure, Model 31, has a 4.5-cubic-foot volume. Its shipping weight is 44 lbs., and it costs \$37.50 net unfinished, or \$45 net finished. Both cabinets stand 32 in. high, including legs. Each model is 21 in. wide and 16 in. deep.

## COMPLETE LINE OF ADAPTERS

Switchcraft, Inc., manufactures a complete line of adapters which have wide application in audio work. These adap-

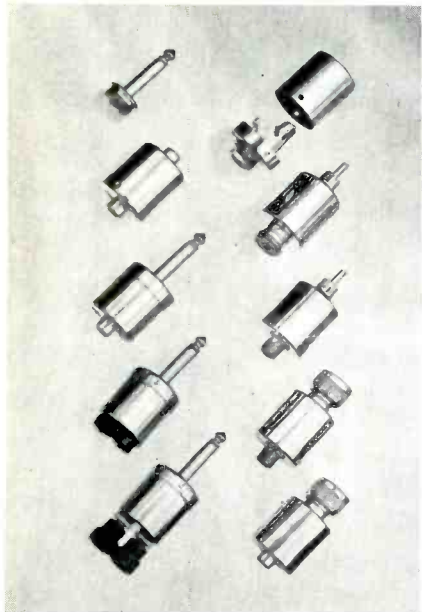

Some of the Switchcraft adapter units.

ters permit a plug of one type to be connected to a jack of another type.

In addition to adapters, Switchcraft manufactures connectors, phone jacks, phone plugs, switches, and other electronic components. These products are available from radio-parts distributors throughout the country.

A catalogue of Switchcraft products is available. Request Catalogue No. S-57A.

## TECH-MASTER 60-WATT AMPLIFIER

The Tech-Master Corporation has introduced a 60-watt high-fidelity amplifier system, Model 19. The Model 19 contains a low-distortion preamplifier-control section with a modern power-amplifier circuit in a single unit.

Intermodulation distortion of the unit is stated to be below 1% at 60 watts, and less than 0.25% at normal listen-



High-power amplifier and preamp unit.

ing levels. Frequency response is said to be flat from 10 to 50,000 cps.

Other features include direct inter-stage coupling; special 10 lb. output transformer with tapped primary for ultra-linear connection; and output matching for 16-, 8-, or 4-ohm speakers.

Equalizer positions are provided for RIAA, AES, NAB, orig. LP, and 78's.

The Model 19 Tech-Master amplifier system stands 14½ in. wide by 10¾ in. deep by 5¼ in. high, and it weighs 28 lbs. The price is \$129.95.

## FREE LAFAYETTE BROCHURE

This 16-page, illustrated brochure, compiled with the audiophile hobbyist in mind, offers a wide selection of speaker systems. Also included are the latest developments in tuners, amplifiers, and Lafayette's own sale-priced systems.

The HF-250 brochure can be obtained free at any of the six Lafayette hi-fi centers, or it will be mailed free on request.

## GARRARD 4-SPEED RECORD PLAYER

The well-known Garrard Model T manual record player has recently been replaced by the improved Garrard Model T Mk II. The Model T Mk II



Garrard Model T Mk II manual player.

is a 4-speed, single-record player of compact size. By eliminating automatic record-changing features, it has been possible to incorporate in the player the Garrard 4-pole shaded induction motor and the new belt-free True-Turret drive, while retaining the same nominal price category as the former Model T unit. The price is \$32.50, less cartridge.

The new player is furnished with UL-approved wiring; electric cord and pick-up cable are ready to be plugged in. It starts automatically with a simple movement of the tone arm, and shuts off automatically at the end of the record.

Additional information will be furnished on request.

*For more information about any of the products mentioned in Audio-News, we suggest that you make use of the Product Information Cards bound in at the back of the magazine. Simply fill out the card, giving the name of the product in which you're interested, the manufacturer's name, and the page reference. Be sure to put down your name and address too. Send the cards to us and we'll send them along to the manufacturers. Use this service; save postage and the trouble of making individual inquiries to a number of different addresses.*

## VISCOUS-DAMPED ARM

Argonne's new AR-600 12-inch viscous-damped transcription tone arm is licensed by the Columbia Broadcasting System. The damping fluid is factory installed and sealed to assure accuracy



Inexpensive viscous-damped tone arm.

of damping action and to prevent the possibility of leakage. Automatic stylus-force compensation is achieved by using individually designed cartridge adapters; no additional weights are required. The arm's three-point base-support design simplifies height and leveling adjustments. Cartridge is of the plug-in type.

The price of the AR-600 tone arm is \$19.50.

## ORCHESTRA BELL KIT

Now available in a new compact form, this modern version of the Glockenspiel can be connected to any organ console, piano, or accordion. Its crystal-clear tones are produced by metal solenoids striking 30 precision-ground bars.

Pitch ranges from G above middle C to the top of the standard organ keyboard. The Orchestra Bells can also be used for tuning organs, and are easily mounted in a hardwood box, speaker cabinet, or behind a tone opening.

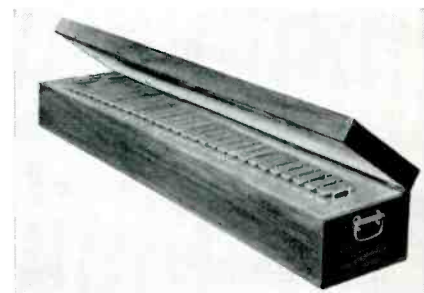

Orchestra bells are solenoid-operated.

Amplification can be added for large rooms or noisy locations. Kits are supplied with assembly instruction and drawings.

The Orchestra Bell Kit is manufactured by Electronic Organ Arts, Inc. Its price is \$110.

## PAMPHLET ON PRINCIPLES OF ACOUSTICAL RESISTANCE UNITS

A free pamphlet of reprints of articles on the basic principles of loudspeakers, Acoustical Resistance Units, and friction-loaded enclosures was announced recently by Rockbar Corp. Written for the hi-fi hobbyist, the articles previously appeared in several magazines and are reprinted with permission.

# THE FACTS OF LIFE ABOUT CANCER!

*alive today!*

*...like 400,000 other Americans*



*... who have had cancer and are well and happy today because of the progress that has been made in cancer control. In their faces you will find the message of hope that is the American Cancer Society's perennial inspiration and challenge.*

## your best cancer insurance

### lifetime policy:

See your doctor *every year* for a thorough checkup, no matter how well you may feel.

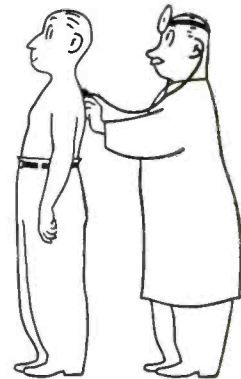

### day-to-day policy:

See your doctor *immediately* at the first sign of any of the seven danger signals that may mean cancer.

About 1 in 4 of us living today will develop cancer at some time in our lives.

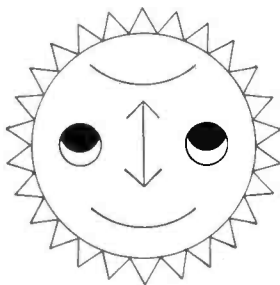

### LET'S LOOK

#### AT THE BRIGHTER SIDE

Cancer is much more curable than it was even 10 years ago. Approximately 150,000 Americans are being saved every year.

More and more people are going to their doctors *in time*. In fact, today one out of every three cancer patients is being saved annually. Formerly only one out of four was saved. This amounts to an additional 30,000 lives saved every year.

## MANY MORE THOUSANDS COULD BE SAVED

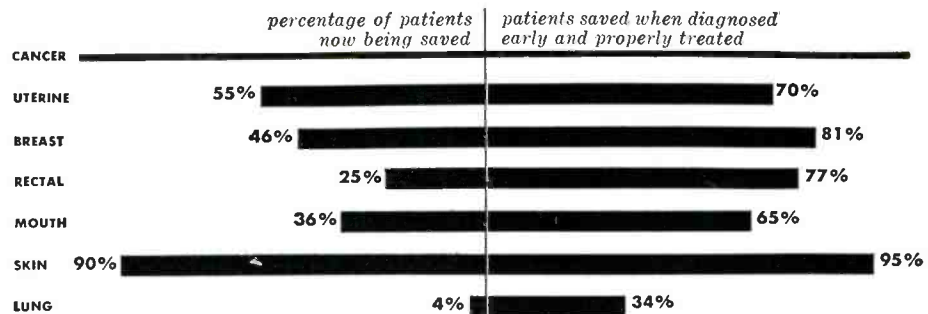

*(Estimates based on reports to the Third National Cancer Conference that included comprehensive data from the Connecticut State Department of Health, as well as the records of many hospitals, clinics, and other medical sources. The figures are believed to be sound estimates for most of the United States).*

### 7 "LIFE-SAVING" SIGNALS

These seven so-called "danger" signals of cancer have, in reality, been seven *life-saving* signals to hundreds of thousands of Americans who have gone to their doctors at the first sign of any one of these:

- 1 ANY SORE THAT DOES NOT HEAL
- 2 A LUMP OR THICKENING IN THE BREAST OR ELSEWHERE
- 3 UNUSUAL BLEEDING OR DISCHARGE
- 4 ANY CHANGE IN A WART OR MOLE
- 5 PERSISTENT INDIGESTION OR DIFFICULTY IN SWALLOWING
- 6 PERSISTENT HOARSENESS OR COUGH
- 7 ANY CHANGE IN NORMAL BOWEL HABITS

None is a *sure* sign of cancer, but only a doctor can tell.

AMERICAN  
CANCER  
SOCIETY



FOR MORE LIFE-SAVING FACTS ABOUT CANCER CALL THE AMERICAN CANCER SOCIETY OR WRITE TO "CANCER" IN CARE OF YOUR LOCAL POST OFFICE.



# EDITORIAL

Gentlemen:

Just received the May issue of AUDIO-CRAFT and, with the cover mentioning a complete up-to-date listing of the data on FM stations, how could I resist turning to page 38 first off?

I am sure you will get comments from other stations which find themselves either incorrectly listed or listed in a fashion that does not coincide with their opinions of themselves. It just so happens that we are pretty much satisfied with the way WCRB-FM is listed. We are an "outstanding" station.

Most recently we have been out standing around waiting for the FCC to come through with a license for WCRB-FM. It happened that when we applied to boost our power, through a minor error of a consulting engineer, we applied for 9.2 Kw power. After the job was done, we calculated what we had for power at 10.2 Kw ERP. Now, to compound the confusion, our new license wandered in the other day. It shows just plain 10 Kw. This is all of just statistical interest, because Mr. Inverse Square and his law will see to it that no practical listener can tell much difference among the three output powers.

Anyhow, there we are, and if you want to correct the record, we certainly won't object.

Richard L. Kaye  
Station Manager  
WCRB  
Boston, Mass.

Gentlemen:

What is the possibility of the leading manufacturers [of audio equipment] changing over to transistors in their units? I am interested in this because we are planning an expansion of our home music system. Should the change to transistors be near, I would hesitate to make too much of an investment and not have the latest designs.

James W. Riney  
St. Joseph, Mo.

*According to the best available sources of information, there will be a gradual — not an abrupt — changeover from tubes to transistors in audio equipment. This will be accomplished over several years, and will be so handled as to prevent obsolescence of any tube-operated equipment: that is, a transistorized pre-amplifier, for instance, will be usable with an all-vacuum-tube power amplifier.*

*Further, it is quite probable that there*

*Continued on page 48*

CERTAINLY one of the most, if not actually the most, significant of audio developments of the year, we believe, is the single-groove stereo disc recording and playback system demonstrated by A. R. Sugden & Co. (Engineers), Ltd. (Connoisseur turntables and pickups), at the recent London Audio Fair. This system, as explained in our special report on the Fair beginning on page 20, makes use of LP records standard in every respect except that the groove is modulated vertically (hill-and-dale) as well as laterally. The vertical cut carries information for one stereo channel, and the lateral cut is for the other channel. A single playback stylus is used, coupled to what are actually two playback cartridges in one; the stylus's lateral motion produces an output from one cartridge, and its vertical motion produces a simultaneous output from the other cartridge. Fed to two separate amplifier and speaker systems, these output signals provide genuine stereo sound from a single record groove. Sugden has disc cutters and playback cartridges for the system now in production, although, we understand, there is a waiting list several months long and there are still very few records available.

Vertical/lateral single-groove stereo is far from a new idea. It has been tried unsuccessfully so many times, in fact, that virtually everyone had given up on it — everyone except Sugden, apparently. The exceedingly difficult design problem that others had found insurmountable was taming the vicious cross modulation between the two channels that occurred both in cutting the disc master and in the playback system. Sugden has succeeded in obtaining a minimum of 25 db isolation between the channels. That this is sufficient is attested to by listeners at the Fair demonstration; one correspondent went so far as to say that it was the best stereo he had ever heard.

Anyone who has been buying stereo tapes on a fairly regular basis will appreciate the primary advantage of single-groove disc stereo: the far lower cost of source material. A 12-inch disc record, at \$4 or \$5, often contains more music than a stereo tape at \$13 to \$18, and just as much playing time is possible with a combination groove as with one cut laterally on a standard LP. There may be other economies as well in equipment needed to play these disc stereo records, particularly for the man who doesn't already own a tape machine.

There are only two difficulties that we can foresee in the commercial exploitation of the process; they are the reasons we hedged a bit in our opening sentence.

First is the matter of pickup design. It is an unfortunate but unavoidable fact that the effective moving mass of an LP stylus must be extremely low in order to avoid a high-frequency resonance within the audible range. It is necessary to avoid such resonance if the smoothest response over the entire range is desired, and if high-frequency wear on records is to be minimized. In present highest-quality pickup designs, nearly the ultimate reduction in moving mass has been achieved — and it is just about adequate for the purpose. If the stereo stylus must drive what is actually two cartridges simultaneously, and must be fitted with mechanical isolation devices to do this without vertical/lateral interaction, will not its mass of necessity be higher? Perhaps not, but the design problem here will be formidable.

The other problem is that, because the cartridge will be sensitive to vertical as well as lateral vibration, the rumble, flutter, and acoustic feedback will be intolerable unless a high-quality turntable, carefully mounted, is used. Even though this may not appear to be a serious limitation to hi-fiers, it is more important to them than the first problem, in an indirect way. If the stereo disc records cannot be played except on very good equipment, there isn't yet a mass market for them in the sense of the market for standard LP's. This means, probably, that the recorded repertory will be limited in the same way that recorded stereo tapes are limited in number and variety, and that the cost may be up because of the relatively small number sold.

We hope that some way can be found to overcome these potentially serious obstacles, because the advantages of the system are so attractive. As to the first problem, we have no suggestion, and will trust our pickup designers to find the answer. For the second, there is one idea that may be worth considering. It is said that most of the stereo effect is limited to middle and high frequencies. For the mass market, then, why not produce a stereo pickup in which the vertical response is attenuated sharply below 300 cps? That should subdue noises from changers in the cheapest table-model phonographs — and then we could all afford stereo. — R.A.



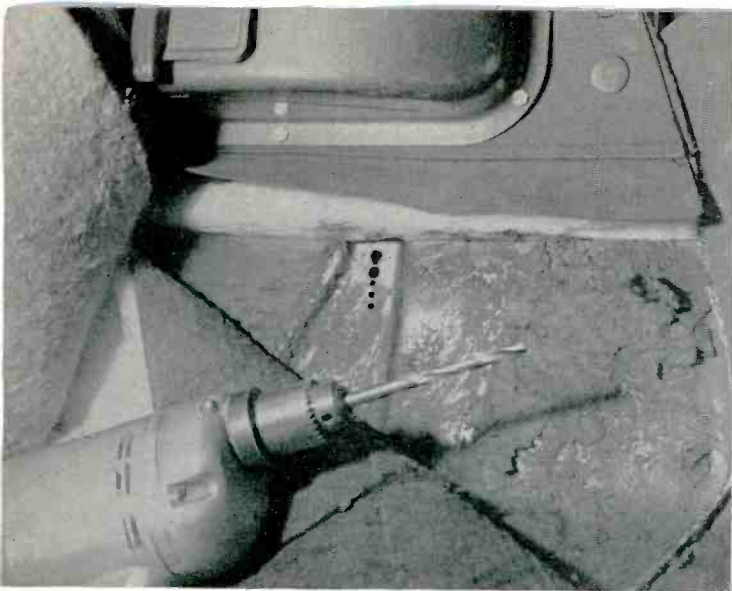

Cables from battery to power-supply inverter must pass through the automobile's fire wall. A slot is cut for the cables by filing away metal between drilled holes.

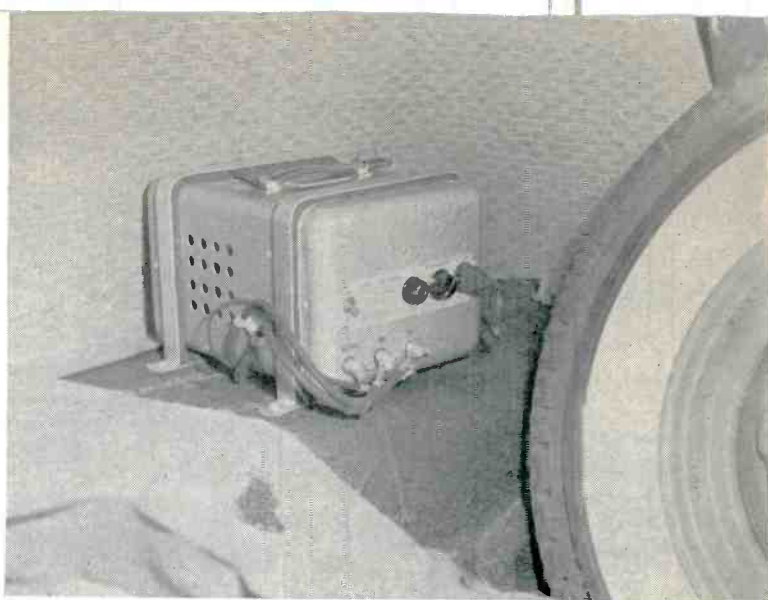

Best place for DC to AC inverter is trunk, forward of spare tire. Rubber-cushioned mounting brackets are held by sheet-metal screws into drilled floor holes.

## Play Your Tapes at 60 mph

by Joseph Rebholz

All photos by the author.

**M**USIC without commercials, fading, or static is not just something you may have in tomorrow's dream car, but a pleasure to be enjoyed today with pre-recorded magnetic music tapes.

Tape decks to play soothing music are inexpensive, light in weight, and easy to install. Two of the more popular makes are the Viking FF75, at \$59.95, and the Pentron TM-56, selling for \$69.95. Both were intended for custom installations in home music systems, but are completely adaptable for use in your automobile. Each accepts 7-inch (or

smaller) reels of tape for operation at either 3¾- or 7½-ips speed. They both use the dual-track system, with which you obtain double use from each roll of magnetic recording tape. Despite their low price, both the Viking and the Pentron decks offer full-fidelity reproduction of taped music.

The only difficulty is that their motors require 110 volts AC, since they are meant for use on house current. This calls for a gadget known as an *inverter*, which changes the DC automobile voltage to AC.

With the tape deck you will also need a playback preamplifier: a tiny amplifier that boosts the weak signal from the tape head to a level high enough to drive the power amplifier in your car radio. Both Viking and Pentron offer preamps. The Viking unit sells for only \$24.50, while the Pentron preamp costs slightly more than twice as much. With the Pentron system, you can record as well as play tapes; you can do so with the Viking also if you get more expensive tape deck and preamplifier models.

*Remote control unit for inverter turns it on and off, mounts under dash. AC power from inverter in trunk is carried by a cable to AC outlet in the control unit.*

*Smaller inverter can be plugged into receptacle for cigarette lighter. Cornell-Dubilier makes inverters also; Carter markets "Converter" motor-generators.*

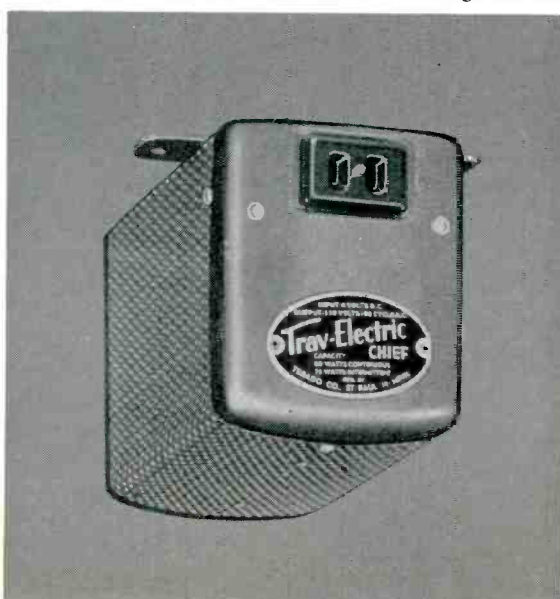
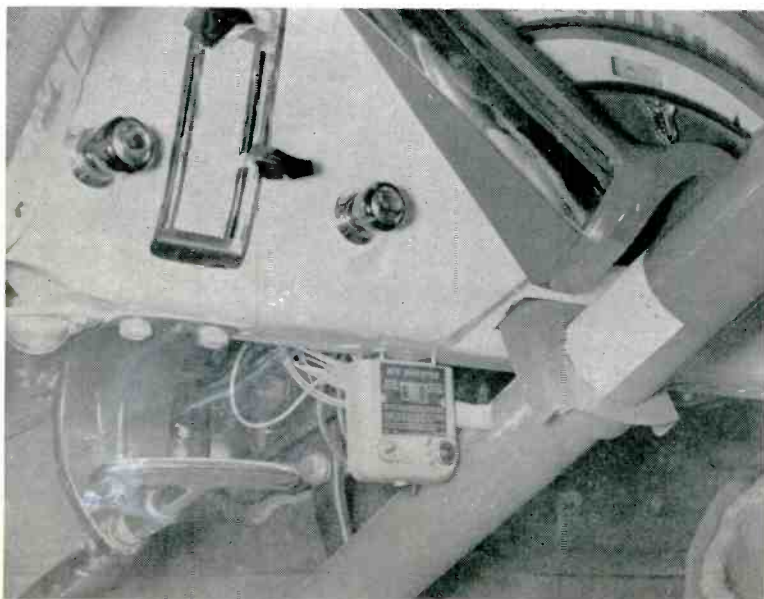



Fitting your car with 110-volt current is not the difficult job it might appear to be. Many manufacturers, such as American Television & Radio Company (ATR), the Terado Company, and Cornell-Dubilier, produce inverters. All these inverters are, basically, vibrator-driven transformers. The Carter Company makes what is known as a "Converter." This product is a DC motor (operating from the car battery) which spins an AC generator, producing the required 110 volts for your tape deck. Prices of these units range from \$40

to \$80, depending on the size and capacity required. An unusual feature of both inverters and converters is that they *must* be closely matched to the tape recorder you will use. This point is important enough to bear repeating. Don't buy just any inverter or converter. Select that unit which the manufacturer recommends for your particular recorder.

duce the tape signal into the radio at the same point as the radio's detector output is introduced into the radio's audio system. Cost of the single-input job will be around \$3.50 for labor and \$1.50 for parts. The double-input installation may run about a dollar more. While you're at the radio shop, buy 10 ft. of *shielded* single-conductor wire and four RCA-type phono plugs. The wire will be used to connect the tape deck, preamplifier, and radio together; the phono plugs fit standard sockets already on the equipment you will buy.

made in the rear package shelf near our previously installed speakers, in the back of a front seat, overhead in place of a sun visor, or in place of the glove box. Take your pick. It's well worth taking a bit of time just sitting in the car to select and reject sites for the tape deck. There's enough planning and work connected with this project so that it's worth while to make your installation a good one.

Installation of the inverter seems fairly easy, and adequate directions are given by the manufacturers. The invert-

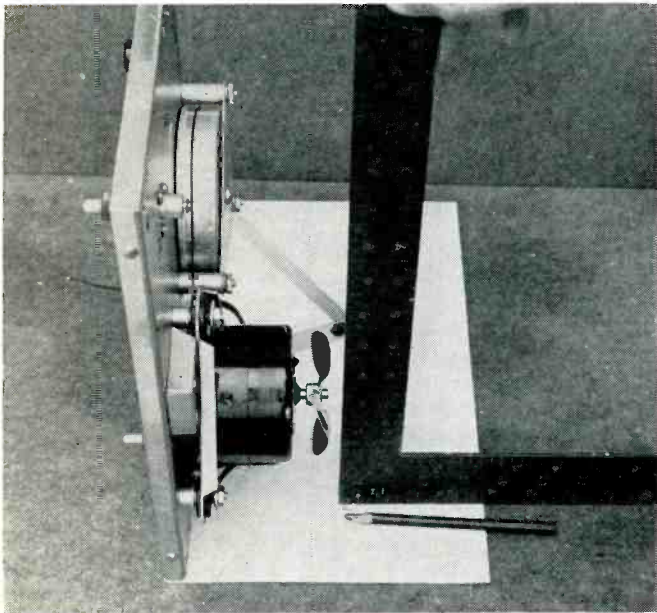

*When making a case for the tape deck, clearance must be furnished for the motor fan. Use framing square or other right-angle device when laying out side pieces.*

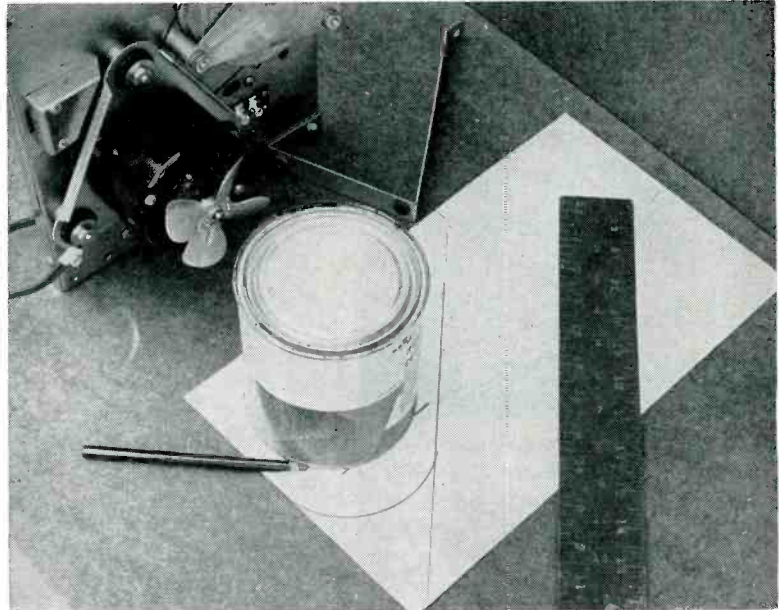

*If you don't have a compass, a paint can or any other round object can be used to form a suitable curve at the bottom of the case. Two side pieces are required.*

We've said that we'll use the audio amplifier in the car radio, and the automobile's speaker system. To do this, remove the radio chassis and deliver it to a competent auto-radio service shop. Ask the technician to install a phono-input socket controlled by a single-pole double-throw toggle switch. A wiring diagram (Fig. 1A) is given with this article for his information, or yours if radio is another of your hobbies. If you want to have both a tape deck and record changer play through the radio, have *two* phono-input sockets installed; they should be controlled by a lever-action or rotary switch with at least three positions, as shown in Fig. 1B.

These plugs and switches will intro-

duce the tape signal into the radio at the same point as the radio's detector output is introduced into the radio's audio system. Cost of the single-input job will be around \$3.50 for labor and \$1.50 for parts. The double-input installation may run about a dollar more. While you're at the radio shop, buy 10 ft. of *shielded* single-conductor wire and four RCA-type phono plugs. The wire will be used to connect the tape deck, preamplifier, and radio together; the phono plugs fit standard sockets already on the equipment you will buy.

You'll be doing a lot of work up under the dash panel anyway, so it might be a good idea to take the radio out now. Then you can shop around for tape decks and preamps, and install them while the radio is being altered. Space limitations in the average car severely limit the choice of locations for inverters and tape decks. Inverters are rather heavy (20 to 30 lbs.) and create a soft hum while in operation. Heat of the engine compartment is rough on electronic components, which leaves us only the trunk as suitable or available space.

Location of the tape deck is more of a problem. It has to be convenient for loading, out of the way of casual kicks and curious hands, and accessible for servicing. There seem to be only two places in the average car which come close to meeting these requirements. They are on the transmission hump between passenger and driver, and up underneath the dash panel. We chose the underdash location. Unusual, but perhaps usable, installations might be

er selected for our installation was the ATR inverter Model 6-RHF, which sells for \$79.95. This model takes in 6 volts DC, puts out 110-volt AC, and will handle a 100-watt load continuously or up to 125 watts intermittently. There is a voltage-regulator output switch with four positions, and provision for remote on-off control built right into the inverter. Instructions suggest that the voltage-regulator output switch be set to the lowest position that will provide proper operation of the recording equipment. In our case the tape deck, preamplifier, and record player drew a little over 100 watts, but operated satisfactorily with the switch set to the next-to-highest position. It is recommended that the inverter be turned on before starting any of the 110-volt equipment. Such planned switching increases the already long life of the inverter, and tends to reduce operating noises.

With our inverter we obtained a set of extension cables to permit mounting the unit in the car's trunk, rubber-cushioned mounting brackets to hold it

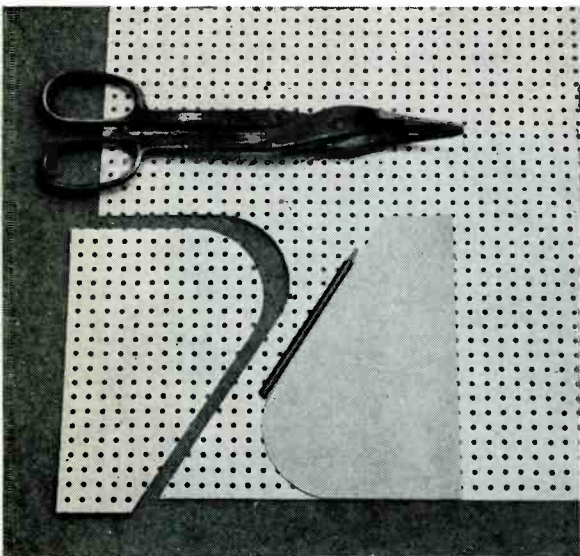

*After the pattern is traced on the soft aluminum sheet, ordinary scissors or a sharp knife can be used to cut it out if tin snips aren't available. Then angle stock is cut to fit sides (photo above).*

*Rectangular sheet of aluminum is formed to follow contour of side pieces. Rivet holes are drilled in the angle stock to match every second edge hole in panel.*

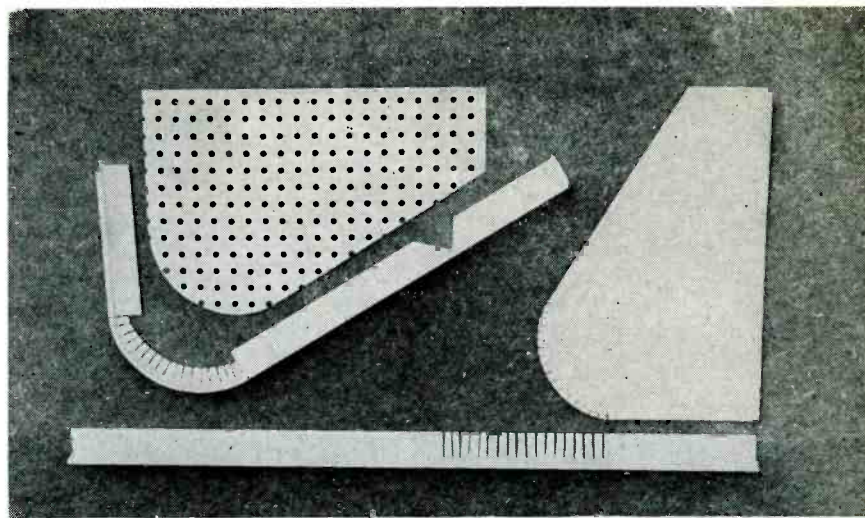
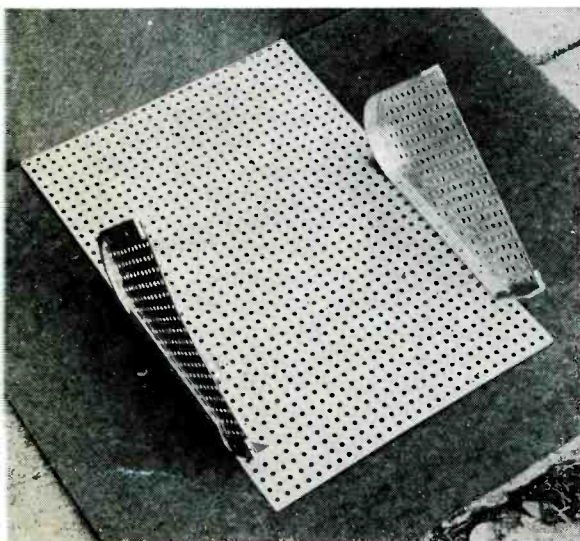

*Aluminum angle stock cut to the proper length is first notched as shown, then bent to fit around side pieces. Soft aluminum rivets hold assembly securely together.*

in place, and a remote-control unit. This device is a small switch and 110-volt extension receptacle which fastens to the car's dash panel. It switches the inverter on and off, and has a gleaming red light to warn you when it is on. Safe operation is assured by a built-in fuse, which will blow and prevent damage to the inverter from accidental overloads.

Before starting to install the inverter we tested it to be sure there had been no shipping damage. It was decided to run the extension cables under the floor mat along the drive-shaft tunnel. The upper right corner of the floor mat was pulled back and a group of holes drilled in the cowl. The 8-gauge battery connection cables are stranded copper wire; they bend, but only a very little. A narrow vertical slot was filed from the series of holes and the finished metal edges protected with several layers of electrician's tape. This method of passing wire through the cowl permitted it to lie smoothly on the floor pan, while running along the heater's cold-air intake pipe to the forward-mounted battery. To make sure we had no trouble with shorts, the extension cables were merely taped to the car body with enough extra length for future attachment to the battery terminals after the entire hookup was completed.

Next, the remote-control switch box was attached to the dash, just a bit left of the steering column. Both sets of wires from it (control and AC current) were carried up under the dash to the right side, then down under the floor mat where they joined the battery cables going back to the inverter. The three sets of conductors (battery, control, and current) were pushed or pulled under the carpets and through a frame hole where car wiring passed under the rear seat. After pulling them

tight, a pad of Fiberglas was stuffed around the battery cables where they passed through the cowl to seal out motor noise and fumes. The floor mats were replaced and brushed off. Finally, the three sets of conductors were pushed under the fiberboard panel separating the trunk compartment from the car body.

In most recent production cars the spare tire sits upright on either the right or left side of the trunk. Between the tire and the rear-seat partition is a normally unused space just large enough for the inverter, and this is where it went. The trunk mat was stripped back and holes were drilled in the metal floor pan to match the rubber-cushioned brackets. Sheet-metal screws, supplied with ATR brackets, were used to attach the whole works solidly to the car.

Both ends of the remote-control wires are marked, so there was no trouble encountered in attaching them to the proper terminals. The pair of AC current-carrying wires were already furnished with a standard extension plug which fitted into the inverter's 110-volt receptacle. The battery cables were not marked, however; yet the battery ground connection *must* be screwed to the inverter ground connection. If you have no voltmeter to check the cables, use the following method: attach one battery cable to the ungrounded, or hot, terminal of the car battery. Go back to the trunk and rub the terminal end of each battery cable against a metal part of the car body. That terminal which sparks is hot and should be attached to the hot terminal of the inverter. Forward, in the engine compartment, you can attach the grounded inverter cable to the battery ground terminal.

Use an electric lamp bulb of the same wattage as the rated output of your inverter to check its operation both at the trunk receptacle and at the dash-

mounted remote-control switch panel. If everything functions as it should, replace the mats and curl up excess wire under the rear seat. Check to be sure that braces of the rear seat cushion do not rest on the connecting wires.

Installing the tape deck underneath the dash panel is a bit more complicated, for it requires the construction of a case of some sort. The tape-deck motor is equipped with a tiny fan to cool the motor windings. If the fan is left exposed it could cause damage to the motor, curious fingers, or even someone's shoes. In this installation we wanted to slant the bottom of the case to leave a satisfactory amount of passenger foot room. Because no commercial cases of the proper shape were available locally, we decided to make one. The Viking deck was easy to measure, and, since it is shallower and lighter than the Pen-tron, it fitted our space better.

A trip to the village hardware store cost us \$8.64 for a large sheet of perforated Reynolds do-it-yourself aluminum, two lengths of aluminum angle

pattern, two pieces of perforated aluminum sheet were cut, and the edges sand-papered smooth. Then lengths of angle stock were cut off, slotted on the sides, and bent to follow the bottom contours of the end panels.

Tiny aluminum button-head rivets were used as fasteners, and they hold very well indeed. Soft rivets hold best if the end is peened over with a very light (2-ounce) hammer. If you try to drive them like a nail, the shank swells and you have no head to hold them in place. Use the round end of a ball-peen hammer, and tap the rivet end lightly many times.

After both end panels were completed, they were set over the ends of the Viking deck. A steel tape rule established the size of the cover sheet, which was easily trimmed from the stock of perforated metal. The cover sheet was formed around the end panels and riveted in place. A front stiffener was cut to length, notched to fit the trunk clasp, and both clasp and stiffener were then riveted to the front of the case. A

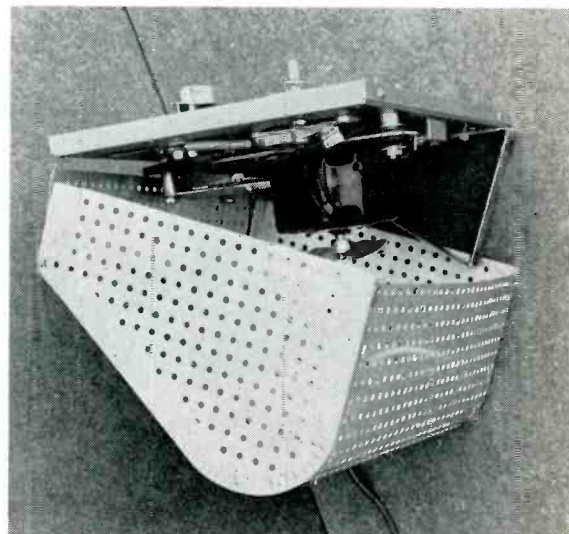

*Here the tape deck is being checked for fit in the case. At this time also the support-bracket locations were marked, and a hole cut in back for the cables.*

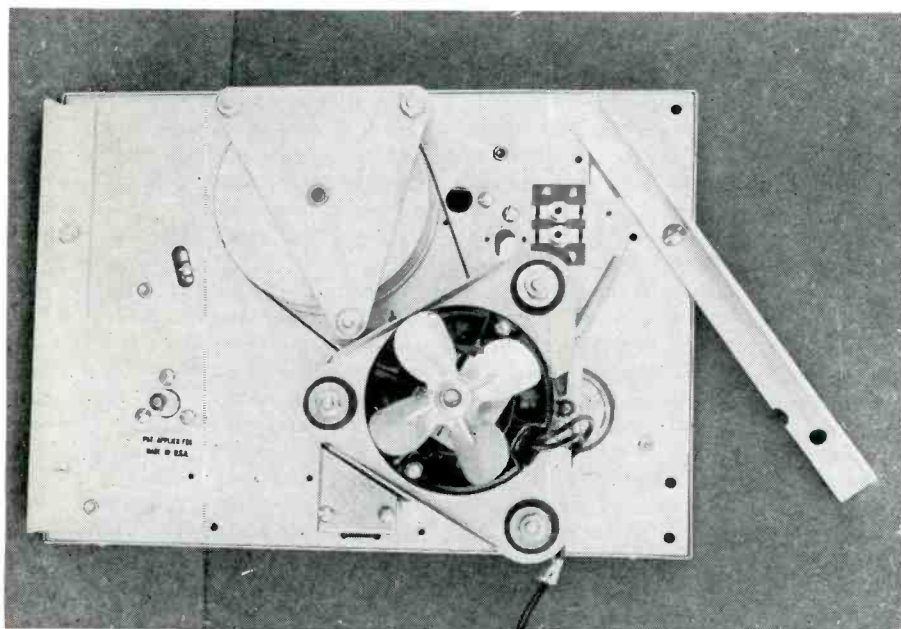

*Two other pieces of angle stock were used as brackets to secure the tape deck to side pieces of the case. Case was attached to brackets with sheet-metal screws.*

stock, a trunk clasp, 12 in. of chromed piano hinge, and two packages of soft aluminum rivets. The Reynolds metal would drive an aircraft mechanic crazy, but for this type of work it's wonderful. You can cut the sheet with scissors or a dull knife, and drill holes in the angle stock with simple woodworking tools.

First, a cardboard pattern of the desired contour was made for the Viking case. We wanted the bottom to be rounded to eliminate barked shins and still clear the motor's fan blades. The pattern for the right and left sides of the case was drawn to do this. From the

section of piano hinge was riveted to the back side to act both as a stiffener and as the hinge. Finally, an angle bracket was installed on each side of the tape deck, which supports the deck inside the case.

The metal case was primed and brush-finished in white enamel to match the car dash panel. While the paint was drying, an attachment rail was trimmed from a scrap of aluminum and fitted to the car's metal heater frame. The best method of attaching the hinge mount will vary considerably with different cars, and you may save a lot of

*Piano hinge riveted to back of case is a stiffening brace as well. Other hinge leaf is sheet-metal screwed to channel-shaped offset member, made from scrap aluminum and riveted to heater chamber.*

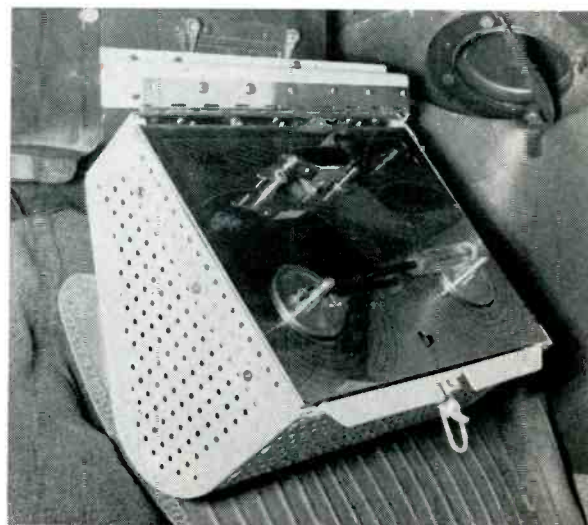

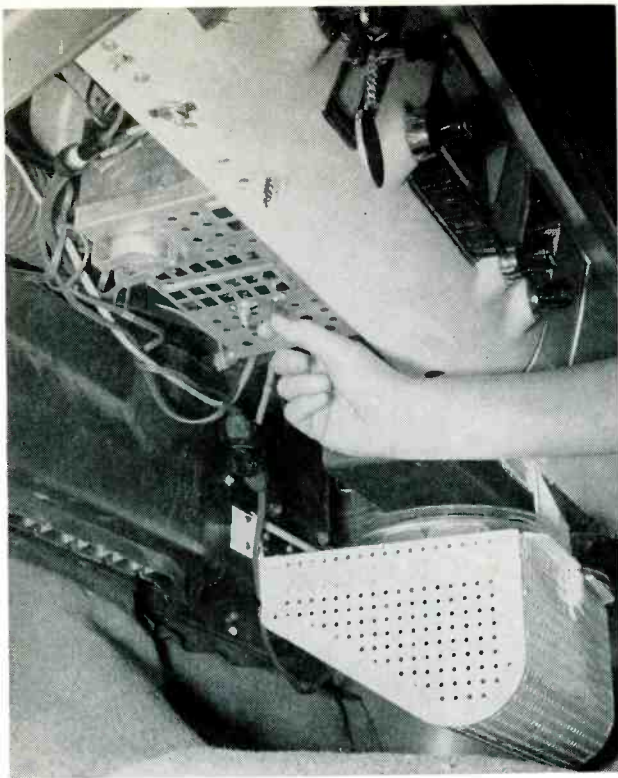

To use car radio's amplifier and speaker system for tape playback, audio input jack and selector switch are installed on bottom of radio as in diagram below.



Tape playback preamplifier and several reels of tape fit comfortably in the glove compartment. Under the tape deck, visible below dash, is adequate foot room.

trouble if this phase of the operation is well thought out before construction begins. After the attachment rail had been fitted and all the holes drilled (including a set in the wrong place), it also was painted white to match the car dash panel.

Although the trunk clasp was already riveted to the tape-deck case, no attempt was made to create a support for the upper catch until after the deck was installed. It would have been much too difficult to figure out exactly where the clasp should have met the support.

On the bottom of the Viking tape deck are two phono-plug sockets, one of which carries the output of the tape-playback head. One of the phono plugs was soldered to the shielded wire and plugged into the playback-head socket. The wire was not cut, nor was another plug soldered to the other end until

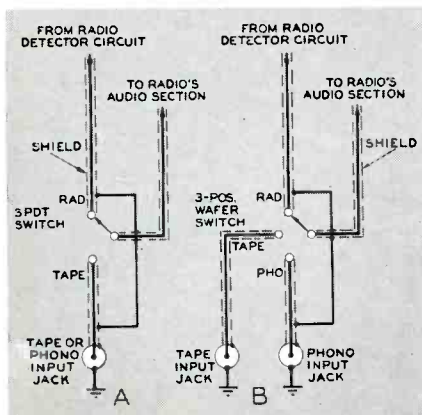

Fig. 1. How to modify auto radio so that one or two external signal sources can be fed through radio's audio amplifier.

installation of the deck was completed. This gave us an opportunity to conceal the shielded wire to best advantage, while stringing it to the preamplifier. The 110-volt power cord feeding the tape-deck motor was shortened so that only 15 in. of wire extended from the back of the tape case. Almost forgot to mention that we had cut a hole in the back of the tape-deck case for the various wires to pass through.

By the next day, our nice white enamel job was thoroughly dry. The tape deck was screwed into its new case and fitted tightly to the supporting brackets. The entire case-deck assembly was supported under the dash on a cardboard box while the piano hinge was screwed (with sheet-metal screws) to the attachment angle previously fitted to the heater frame. With the tape deck propped up to its proper location a section of aluminum angle was measured, cut, and riveted into a T bracket. The trunk-clasp catch was riveted to the leg of the T; then the assembly was screwed to the under lip of the car's dash panel with sheet-metal screws. More white enamel on the bracket, and touches of red enamel on the new screw heads, completed installation of the deck and supporting latch.

A Viking PB60 preamp was used with this installation because it offers complete control of the reproduced music at a very low cost. Our glove compartment proved to be an ideal place for the preamp, so, for the first time since the car was new, said glove compartment was cleaned out. The preamp was fastened to the bottom of the box,

with audio and current wires feeding through a small hole in the cardboard. There is still more than enough room in the compartment for recorded-music tapes, a spare reel, a map, and the customary can opener.

Now that everything was installed, we could hardly wait to connect up the components and listen to our new mobile music system. A hastily borrowed extension cord with a cube tap was pressed into service. The tape deck and preamp were plugged in, while the extension cord draped over the floor mat to reach the 110-volt socket on the ATR remote-control unit. An extra noisy reel of jazz music was installed on the tape spindles, threaded through the head, and the switch switched. The reels turned but there was no sound.

Our first check point was the preamp, but as volume had been turned up it should have been feeding music to the car radio. A second glance at the radio awarded us the dim-bulb medal. It had not been turned on. Buttons were stabbed and we sat back again to wait the few moments for tubes to warm up. Of course, the volume was full on, and the resulting blast nearly blew us out the windows. Turning it down to an intelligible level, we discovered that "corn was still a scarcity in Pakistan." Obviously, the phono switch on the bottom of the radio hadn't been flipped from the radio to tape input. It was forthwith flipped.

This was it. From the music system came some of the finest jazz our tired old ears have heard. It was so nice to

*Continued on page 48*

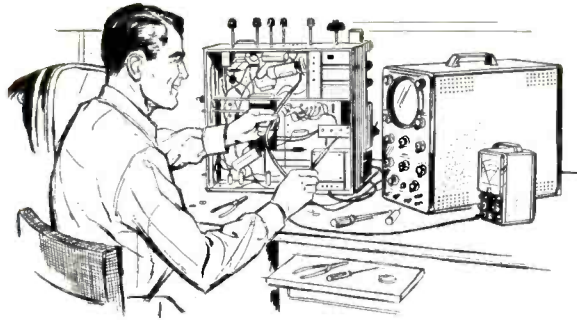

# Using Test Instruments

## The Oscilloscope, PART III

by DONALD CARL HOEFLER

IN previous discussions of the audio applications of oscilloscopes, we have assumed a linear time base provided by the sawtooth sweep voltage on the horizontal-deflection plates. But we have learned also that most scopes have provision for applying voltages to the horizontal plates from an external source, and from the 60-cps AC power line as well. Let's see now what effects we'll observe on the tube face under these conditions, and of what use they are.

The first pattern, Fig. 1, shows the geometrical development of a resultant trace *R*, when a sine wave *V* is applied to the vertical plates, and an identical sine wave *H* is applied to the horizontal plates, but with a phase displacement between *V* and *H* of exactly 90°. Under these conditions, *R* becomes a perfect circle. From this we infer that we might obtain information concerning both frequency and phase of voltages applied to the vertical and horizontal systems of scopes, provided we know how to interpret the patterns. These are often called Lissajous figures.

For a sawtooth sweep, when the horizontal sweep frequency equals the frequency of the voltage being applied to the vertical plates, exactly one full cycle will appear on the screen. But it is usually desirable to observe several cycles rather than just one. This is accomplished simply by adjusting the sweep frequency to 1/2, 1/3, or 1/4 the test frequency as desired, in which case we can observe 2, 3, or 4 complete cycles.

A similar effect will be noted in the case of Lissajous figures. When the ver-

tical signal is twice the frequency of the horizontal voltage, then a double pattern appears, and a triple one shows up for a 3:1 ratio, as shown in Fig. 1. Many other combinations are possible, a few of which are shown in Fig. 1, but they become progressively more complex and difficult to analyze.

To find the frequency ratio between two signals, first count the loops along either horizontal edge of the pattern. Then count the loops along either vertical edge. Now the loops along the horizontal edge correspond to the vertical frequency, while the loops along the vertical edge correspond to the horizontal frequency. Thus, the ratio of the number of horizontal loops to vertical loops gives the frequency ratio between the vertical and horizontal signals.

This is a little confusing to swallow at a single gulp, so let's take a practical example. Suppose you are working in a

recording studio, and are about to make master discs from a tape recorded in Europe, when you discover that there is a hum recorded on the tape. You have facilities for sharply filtering out this hum, but first you have to know its exact frequency.

You'll begin by switching the horizontal selector switch of the scope to the 60-cps position, and connecting the output of the tape signal to the vertical plates. Then play the tape at some quiet passage, usually before the performance begins, where only the hum can be heard and observed on the scope.

Suppose then that you see a pattern indicating a 5:3 ratio, similar to that shown in Fig. 1. Then you could easily calculate the unknown frequency by the following formula:

$$f_x = \frac{L_h \times f_h}{L_v}$$

Continued on page 40

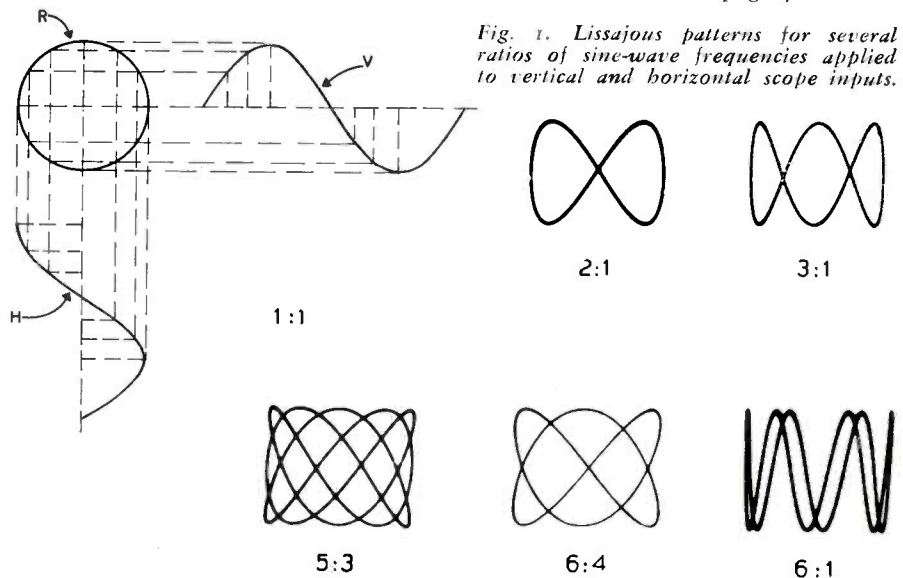
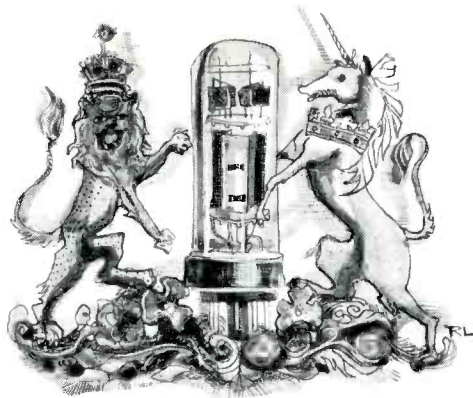

Fig. 1. Lissajous patterns for several ratios of sine-wave frequencies applied to vertical and horizontal scope inputs.



# New British Audio Developments

*A special report on the London Audio Fair*

by Charles Fowler

**F**OR the American visitor, accustomed to audio shows in New York, Chicago, Los Angeles, and where have you, there was a decided English accent to the London Audio Fair, held at the Waldorf Hotel in London from April 12 to 15.

Most noticeable difference was the demonstrations; many of the exhibitors remained behind closed doors and demonstrated their equipment at scheduled times to a series of captive audiences. Visitors to the Fair queued up in the hotel corridors, then filed in to take whatever seats were available. When the seats were all taken, the doors were closed, and the "demo" began. In general, it lasted 15 minutes.

Another major difference was the volume level. Not one exhibitor played his equipment at anything like the loudest levels reached at our shows; one or two reached what might be politely called our average audio-show level (thereby making conversation impossible), but most stayed in the home-listening range. Some demonstrations were at such a low level that one had to listen closely to catch soft passages. One exhibitor even went so far as to say, "Listen to how much of the music you can hear, even though it's soft." Such a statement in the United States would be considered sacrilegious! Of course, it is easier to keep down the sound level when demonstrating behind closed doors. There is no one across the corridor to lure the audience away with louder bangings—and the audience can't get out anyway.

There are some very definite and obvious advantages to the closed-door

technique. It is certainly a fine way to show off equipment, and hence is good from the exhibitor's point of view. The system doesn't work so well for the visitor, however. There simply isn't time enough to listen to each piece of equipment. Most visitors have an afternoon or an evening to devote to the show; some may have both. There were 52 exhibits at the London Audio Fair. It took at least half an hour to go through a queue and the demonstration that went with it. With half the exhibits behind closed doors, you can figure out how much the average visitor might have a chance to see. For example: Goodmans and Acoustical were two who had electrostatic tweeters. Waiting time for these exhibits ran better than an hour during peak rush periods.

Another bit of English accent was the "stand." In addition to the demonstration rooms, which were, as usual, hotel bedrooms on the third and fourth floors, each exhibitor had a stand in the hotel's

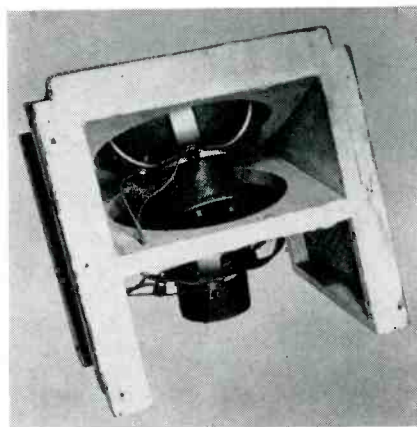

*Aperture between speakers is connected to enclosure cavity. These drivers are wired out of phase. Purpose of the unconventional drive is to reduce harmonic distortion at the low bass frequencies.*

main ballroom. All booths were the same size (quite small, as a matter of fact), and there each exhibitor could display his equipment and hand out free literature. No sound was permitted. At first, this seemed to us like a silly idea, because the purpose of an audio show is to let one hear the equipment. But after watching the crowds for four days, it was apparent that people wandered around the booths, talked about the equipment, did all the looking they needed to, and picked up whatever literature they wanted. Then, with this preliminary investigation completed, they could maximize their time in the demonstration rooms upstairs. Once upstairs, the primary objective was to *hear* selected items of equipment.

There was a wealth of equipment of all types: amplifiers by the dozens, a good many FM tuners, turntables, changers, speakers—much like a standard U.S. show, with perhaps less on the tape-recording side. Some of the equipment of particular interest included A. R. Sugden's demonstration of his single-groove, two-channel stereo record. This has been shown privately before, but had its first public demonstration at the Fair. Sugden (manufacturer of Connoisseur turntables and pickups) combined lateral and vertical recording techniques in the same groove. He has developed a cutting head (magnetic) which is capable of cutting masters, and he is making a few playback heads. These employ high-quality crystals. The sound range is said to be 12,000 to 13,000 cps. Certainly it was excellent to listen to, without noticeable cross talk between channels. In the recording cutter and playback cartridge, Sugden employs mechanical filtering to achieve a channel separation on the order of 25 db. As this system becomes available, hi-

fi enthusiasts will certainly devote much time to experimentation with it.

From the popular point of view, one stumbling block is extreme sensitivity to rumble and acoustic feedback. A very good turntable must be used, since any vertical motion will be translated by the pickup into sound, the pickup being sensitive to both vertical and lateral motion. Connoisseur has pressed some records and is reported to be discussing matters with some of the large record companies. Their playback pickup, by the way, is provisionally priced in England at £11.0.0 plus purchase tax (which is £5.0.0!). Less tax, that is almost exactly \$30.00—reasonable enough, since it includes a diamond stylus. Delivery is said to be at least four months away. Generally, this principle of stereophonic recording and reproduction on single-groove discs is to be watched closely. It is one of the chief methods propounded so far as a single-groove possibility. Sugden is to be commended for long experimental efforts and, at last—let us call them, for the time being—"precommercial" results.

Electrostatic loudspeakers had quite a field day. Acoustical, Leak, and Goodmans actively demonstrated their versions and stalled traffic in all directions around their exhibits. Acoustical and Goodmans were wide-range units, Goodmans baffling theirs to help the low end, Acoustical playing it straight, so to speak, with a panel-type model. Harold Leak routed the low end through a 15-inch woofer; the electrostatic was of approximately bookshelf size. Sound? Pretty hard to judge; we like to live with a speaker for a while. The middles and highs seemed to have the soundless quality which appears to characterize electrostatics, a dryness, perhaps. But this quality, carried down to the low-bass zone, made the sound lack conviction. We'd like to wait a bit before judging,

finally, the full-range electrostatic group. It is likely to be a while, anyway, before the English ones find their way to the States.

Speakers were used in a way new to us in the G.E.C. (General Electric Company, no relation to American GE) demonstration. G.E.C. is well known in Great Britain for its metal-cone 8-inch speakers. The advantage of the metal cone is said to be, among other things, a closer approach to the pure engineering concept of a piston; less cone breakup, etc. Anyway, G.E.C. took two speakers and mounted them as shown in the photographs: facing the same way, with one magnet more or less inside the cone of the second speaker. A pair of small baffles meet at one edge, to form a V; the sides of the V are closed in, and the top is connected to a large enclosure of bass-reflex air-column design. Then the speakers are wired together out of phase, so that when one cone moves in, the other moves out. The result is a bellows action, with low frequencies being pumped in and out of the cabinet. The two speakers are mounted in the bottom of the cabinet. Only the extreme bass pumps through the cabinet; the speakers are free to radiate sound directly into the room. There is a dividing network at 1,000 cps which diverts higher frequencies to small tweeters mounted in pairs on the front and side panels.

The sound from the G.E.C. system is normal except for the extreme bass, which is startling—particularly when you realize that the speaker system is essentially a pair of 8-inchers. If anything, there was too much bass! But this was a demonstration and presumably things could be brought into balance with a bit of experimentation. Sound was very clean; claims are made for very low harmonic distortion for the system, said to be a result of the push-pull effect of the two cones operating out of phase.

Garrard showed a new cartridge

(magnetic; very nice) and a dilly of a new arm. This arm does anything: the angle of the head can be changed (for minimum tracking error), the over-all length can be changed, and the stylus force can be scale-adjusted. Watch for the arm in mid-summer in the United States.

Philips startled quite a few people by showing OTL (output-transformerless) amplifiers. An unusual series/push-pull tube connection permits output impedances of 400 ohms, and some tricky manufacturing processes permit winding voice coils having 400-ohm impedances. The result is the elimination of output transformers, and this leads to all sorts of interesting possibilities, which show up on the specification sheet as frequency response of  $\pm 0.2$  db from 10 to 20,000 cps. The interesting part of that spec is the low end; not many amplifiers using transformers specify anything below 15 cps, and then the deviation figure is larger. Not that there is sound, of interest, down there; but engineers correlate amplifier stability and transient response with what happens at subaudible frequencies. Philips also had a very trim, sweet-sounding cartridge.

Passing notes: Collaro showed a four-headed tape deck. Two record-playback heads, two erase heads; one set each for upper and lower tracks. Unfortunately, it does not appear to be adaptable to stereo, since the heads are separated by more than the American staggered standard.—Truvox had a neat recorder, with a conversion kit so Continental tapes could be played. (Europe and Great Britain have not agreed on where track one goes: top or bottom half.)—Some familiar names make things we never hear about; did you know that Lowther makes amplifiers, tuners, pickups, and control units as well as speakers?

Speaking of tuners, Chapman makes

*Continued on page 44*

*Front view of the GEC system, showing tweeters on front and sides, and "bomb bay" below which holds pair of 8-inch units.*

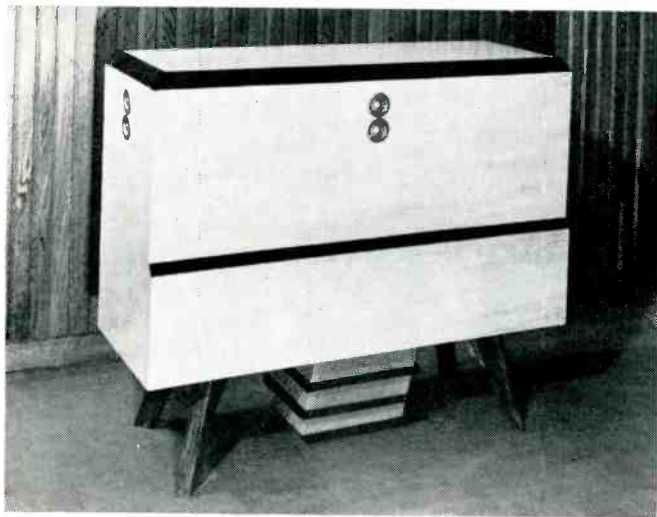

*View of the enclosure from the rear, with back panel removed. Cabinet serves simply as tunnel-port resonator for the bass.*

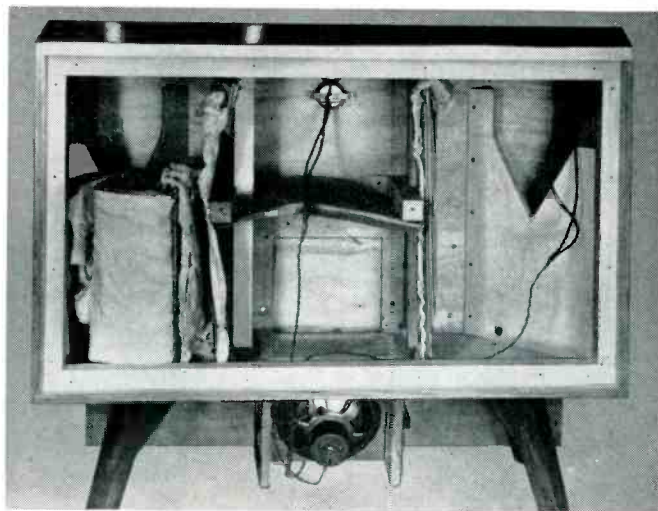

All photos courtesy The General Electric Co., Ltd.



# EICO HF-60 Power Amplifier

*An AUDIOCRAFT kit report*

THERE have been a great many advances recently in power-amplifier design: new tubes, new circuits, and new output transformers. The result is that amplifiers are simpler, less expensive, produce greater power, and are of higher quality than those of just a few years ago. They are so simple and stable now, in fact, that it is practical to produce them as kits which, when assembled by an inexperienced purchaser, are reliable and even less expensive. The EICO Model HF-60 is one of the best of these modern amplifiers.

Available completely wired at \$99.95, or as a complete kit at \$72.95, the HF-60 produces more than 60 stable, exceptionally clean watts over the full audio range. That approaches pretty closely a dollar per watt if you build the kit—and, for 15-cps watts, it is a remarkable buy. The HF-60 has an Acro TO-330 output transformer. Another version of this amplifier, the HF-50, differs in that an output transformer of another manufacture is used. Rated power of the HF-50 is 50 watts; its cost is \$87.95 wired, or \$57.95 as a kit. A metal cage cover for the chassis base of either model is available at \$4.50. For

this report we obtained an HF-60 without the cage cover, as the photographs show.

Fig. 1 is the schematic diagram of the amplifier. Both models are variants of a basic Mullard circuit. An input level control and an isolating resistor precede the input stage which utilizes a low-noise high-gain Z729 pentode. Both high- and low-frequency step networks, for feedback phase correction, are included in this stage. The output is directly coupled to a 6SN7 phase inverter of the cathode-coupled type\* which has, according to many proponents, the best combination of reasonably high gain, stability, and extended frequency balance of any inverter circuit. The output voltage-handling ability of this inverter, the high gain of the first two stages in combination, and the high power sensitivity of the ultra-linear connected EL34/6CA7 output tubes, eliminate the need for an intermediate drive stage. That, in turn, eliminates one high-frequency and one low-frequency

rolloff network within the feedback loop, which makes for a great improvement in amplifier stability.

Bias for the output stage is obtained from a separate negative voltage source in the power-supply circuit. The bias on both output tubes is adjustable simultaneously by means of the BIAS control, a screw-driver adjustment on top of the chassis. It can be decreased slightly on one output tube and increased slightly on the other, or vice versa, by adjusting the BALANCE control (also a screw-driver control on top of the chassis). The BALANCE control serves to compensate for slight inequalities in the output tubes. Output-stage cathodes are not grounded directly; there is a 10-ohm precision resistor in each cathode circuit, and voltages developed across these resistors serve two purposes: first, they permit accurate adjustment of DC balance; the BALANCE control is simply set so that voltage readings at the meter jacks are identical. Second, they permit accurate adjustment of the bias; the BIAS control is set (just as easily) for a voltage reading at either meter jack of 0.65 v DC, with no input signal. At that setting the current in

\*This circuit was discussed at length in "The Grounded Ear," by Joseph Marshall, AUDIOCRAFT, I (Nov. 1955), p. 10. See also "Phase Inverters for High Fidelity," by Mannie Horowitz, Radio and TV News, LVII (May 1957), p. 92.

*These photographs of the EICO Model HF-60 show the simplicity of construction of this well-designed power amplifier.*



Photographs by Warren Syer

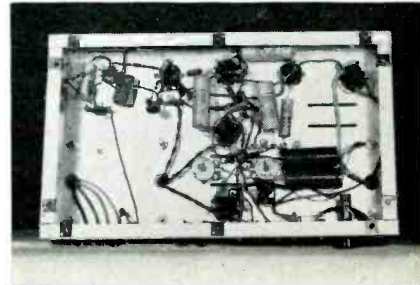



each output tube is exactly 65 ma, the correct value.

There is a small capacitor across one half of the output-transformer primary winding, to compensate for a residual phase-inverter imbalance at extremely high frequencies. The over-all feedback loop is rather complex, stemming from the 16- and 4-ohm secondary taps. It furnishes 21 db feedback with a claimed margin of 16 db—a fine accomplishment indeed, particularly since the feedback is fully effective over a very wide frequency range.

The power supply is fused, and has provision for furnishing power to a preamp-control unit. Leads in the AC primary circuit are brought to the preamp power socket, so that the amplifier can be switched on and off externally. A plug is supplied for this socket in case it is not used to furnish preamp power; the plug is wired to complete the primary AC circuit, and to ground one side of the filament supply (normally, in a preamp-control unit, the filament supply is grounded by the moving arm of a hum-adjustment potentiometer). Two auxiliary AC power outlets are furnished on the amplifier also, one of which is controlled by an external ON-OFF switch if it is used. No choke

is used in the B+ supply. The output-tube plates and screens are connected (through the output transformer, of course) directly to the top of the power-supply input capacitor; not even a series resistor is employed. Omission of a resistor or choke keeps the voltage across the electrolytic capacitors to a minimum, so as to prolong their operating span. This also reduces the cost of the amplifier substantially, but it makes accurate balancing necessary to reduce hum. Note that an indirectly heated cathode rectifier is used, and must be retained, in order to limit initial current surges when the amplifier is first turned on—again, to reduce the strain on the power-supply input capacitors.

Tolerance on all fixed-value resistors is 10%, 5%, or 1%; on all nonelectrolytic capacitors, 10%.

### Construction Notes

Every part is supplied in the EICO HF-60 kit, including a prepunched and lettered chassis base with bottom cover, hardware, colored wire and spaghetti sleeving, and all electronic components. All that the constructor must furnish are solder, tools, and the ability to follow very simple assembly instructions.

The instruction book is worthy of

special note. It is in two sections: the owner's manual and, stapled inside in a different color, the assembly instructions. Soldering directions, a list of required tools, parts-identification information, step-by-step assembly and wiring instructions, pictorial diagrams for several stages of construction, and final-setup information are given in the latter section. After the amplifier is completed, this section can be removed from the booklet and thrown away. The permanent section contains detailed specifications for the amplifier and a schematic diagram, a replacement parts list, installation instructions, a chart of normal voltage and resistance readings for all sections of the amplifier, and one of the most complete and elaborate guides to maintenance and service procedures we have seen from any manufacturer. It is a painstaking and elaborate piece of work, deserving of a hearty "well done!" for the valuable assistance it will be to owners of the HF-60.

We had no trouble in building the amplifier, and have only a few comments that may be helpful to the totally inexperienced:

Page 3C, step 8. There are three potentiometers used in the HF-60; in

*Continued on page 45*

Fig. 1. Schematic diagram of the EICO HF-60 power amplifier. This circuit is a variant of a basic Mullard design.

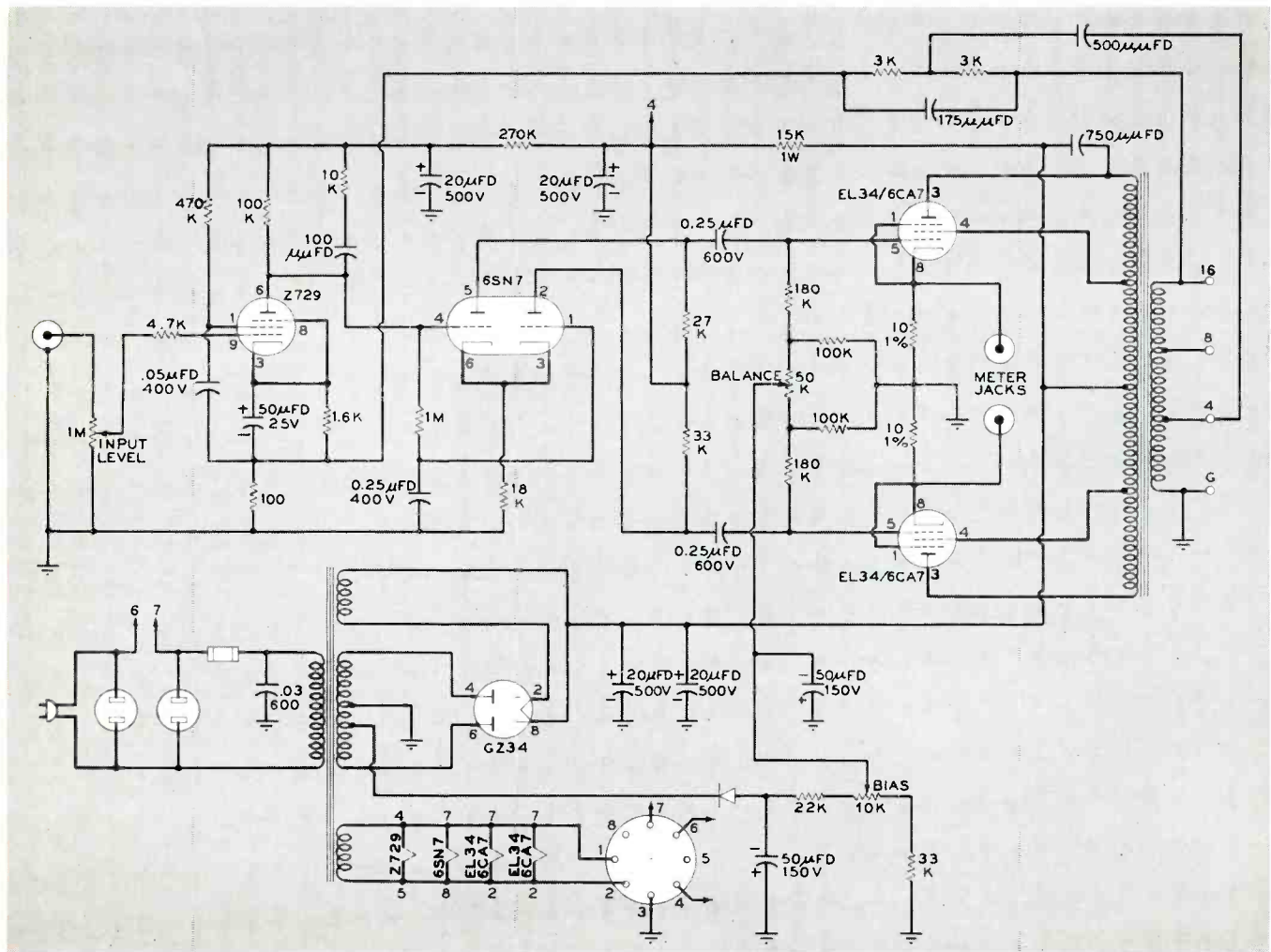

by ABRAHAM WOLFTHAL

## Inexpensive Turntable Base

THE problems of the audiophile don't end with the acquisition of components for a sound system. Furniture to house the equipment remains a matter of concern in any household, and not the least important is a good turntable base.

In this instance, a base was needed for a Rek-O-Kut Model L-37 turntable and Model 120 tone arm. Commercial bases of good quality are relatively costly — about \$25, and I felt that any money I could save by making the base myself could be used to advantage in purchasing a cartridge. Moreover, since my tolerant spouse was anxious to have a match with existing furniture, there was even more incentive for me to carry out the project successfully. That it was successful can be seen from Fig. 1, which shows the finished base.

A good turntable mounting arrangement should fill certain qualifications. Its construction should be sturdy and sufficiently heavy to isolate the pickup from extraneous noise. The mounting board should be warp-free, or as much so as possible; and its area should be large enough to mount both the turntable and the arm, with sufficient clearance for free motion of the arm. In addition, there should be a means for leveling the unit. With these qualifications in mind, it was determined that the outside-edge dimensions of the base were to be 16 in. by 18 in., and that construction would be of  $\frac{3}{4}$ -inch wood.

It was apparent that the lumber sizes involved were too small for profitable purchase at a lumber yard. A local custom cabinet shop furnished all the necessary wood from discard cuts for \$2.50,

with plenty of excess to permit trimming to exact size.

The mounting board was very carefully selected to be free from any warp. It appears that lumber-core birch plywood,  $\frac{3}{4}$  in. thick, is best in this respect. If the wood is carefully selected, there is no need to hide the edge grain; in this instance the edge grain was somewhat irregular, so it was concealed with birch woodtape applied with Weldwood contact cement. If ply-core wood is available and satisfies the requirement of being warp-free, it can be similarly treated to hide any objectionable edge grain. Remember that any warp in this board will be transmitted to the turntable mounting plate and make subsequent leveling virtually impossible.

The finishing scheme permitted selection of less expensive wood for the base —  $\frac{3}{4}$ -inch yellow pine, trimmed to 5-inch width and suitable lengths. These pieces were rabbet-jointed, glued, and clamped. Yellow pine 2-by-2-inch stock was then beveled (see detail drawing Fig. 2A), accurately squared and sanded smooth, and cut into 4-inch lengths. These were nailed and glued to form corner blocks at the inside of each of the four corners of the base section, placed so that they sat flush with the bottom edge of the base. This left one inch free below the top edge. The finished base is illustrated in Fig. 2B.

Hardwood (mahogany) glides of solid 1-by-1-inch stock were cut to sufficient length to make a complete frame for the underside of the mounting board, one inch inward from each edge. These were glued and screwed to the board (see Fig. 3A). Two purposes are served: 1) to form a mounting on the corner blocks of the base; 2) to inhibit warp of the mounting board. The bottom of the finished mounting board is shown in Fig. 3B.

To provide a means of leveling the



Fig. 1. Attractive homemade base for Rek-O-Kut L-37 turntable and 120 tone arm.

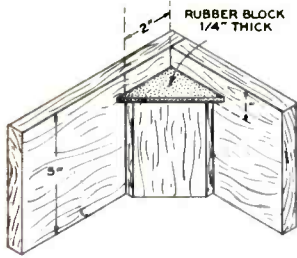

Figs. 2A, above, and 2B, right, show corner construction of base section. Note gum-rubber pads on corner blocks.

base, the Cabinart Levelor Kit ACC-3 was installed. This kit is readily available and sells for \$2.10. It consists of a circular level which is installed conveniently on the mounting board, and four rubber-tipped leveling screws. The leveling screws were mounted in the center of the bottom of each corner block, and a triangular rubber cushion was fitted to the top of each corner block. Medium-hard gum rubber, approximately  $\frac{1}{4}$  in. or  $\frac{3}{8}$  in. thick is suitable for the purpose. A 4-by-4-inch piece can be obtained for as little as 25¢. These blocks should not be glued in place until the finishing work is completed. The positions of the rubber turntable mounting cushions are shown in Fig. 2B.

Cutouts in the mounting board were then made in accordance with the manufacturer's templates. After that, the turntable was assembled for a trial run.

The final step in construction is the finishing. Wood finishing is an art that lends itself to a variety of techniques; many of these can be used successfully by the amateur. The following method is one which gives highly satisfactory results in the hands of the uninitiated. Products used are the Rez finishes, manufactured by the Monsanto Chemical Co. of St. Louis, Missouri.

It will be recalled that this project was to be finished to match existing furniture, finished in cinnamon and black. This scheme suggested that the base be black and the mounting board, cinnamon. The base was sanded smooth with No. 6-0 sandpaper, sponged with water, and allowed to dry for 24 hours. Then it was sanded again and stained with a hot solution of Nigrosine black in water, the stain being rubbed on with a piece of soft waste cloth. This tech-

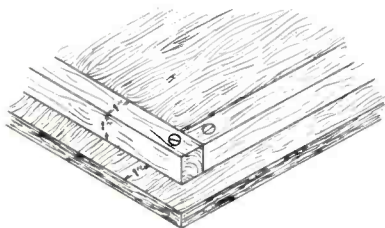

Figs. 3A, below, and 3B, right, show construction of frame on underside of mounting board. Frame rests on gum-rubber pads on corner blocks of base.

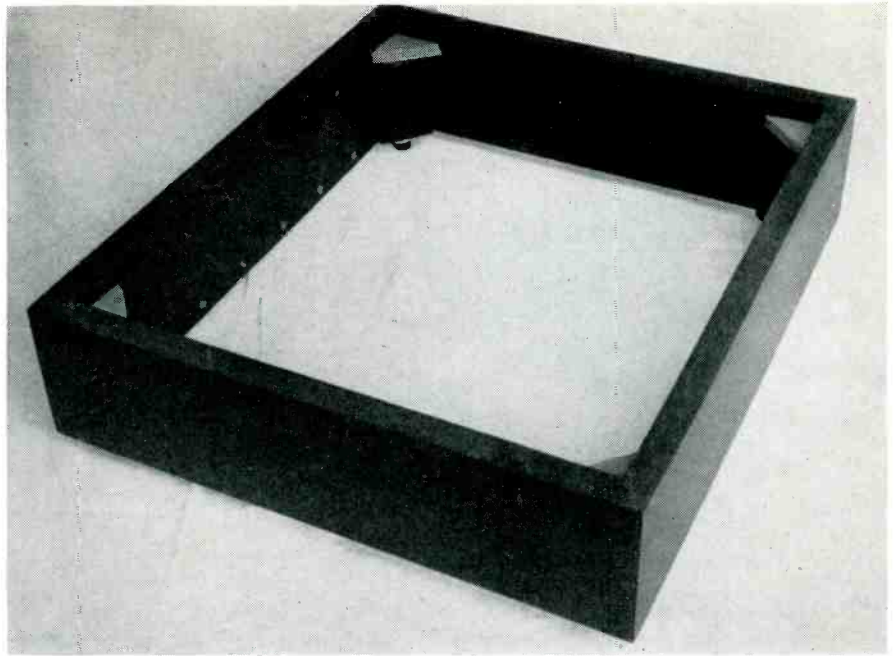

nique was selected because it provided a bodying color to any subsequent finishing and prevented any patchy appearance which would be especially unsightly in black. Water stains are easily applied and are resistant to bleaching by light. Nigrosine Black powder can be obtained at dye and chemical shops, but a common household black dye, such as Tintex or Rit, will suffice. A concentration of one level tablespoonful to a pint of boiling water makes a good wood stain. The initial sponging with clear water serves to raise the grain so that, when the water stain is applied, further raising of the wood grain is minimal.

After 24 hours of drying, the work should be sanded lightly with No. 8-0 sandpaper to remove any fuzz that may

have resulted from the staining process. This sanding should be done very carefully to avoid removing any stain. Then dust the work and apply a coat of Rez Charcoal primer-sealer; dry overnight and sand lightly. Apply three coats of Rez Satinwood, a low-gloss finish, dry-sanding lightly between coats with No. 400 wet and dry sandpaper. The final coat is rubbed with wet No. 400 and polished to a satin finish with wet No. 600 wet and dry sandpapers. When this surface is rubbed with a good liquid furniture wax, it takes on a soft luster.

The mounting board was sanded and treated with a coat of Rez Redwood primer-sealer, rubbed to the desired cinnamon color. Three coats of Rez Satinwood were then applied and fin-

*Continued on page 39*

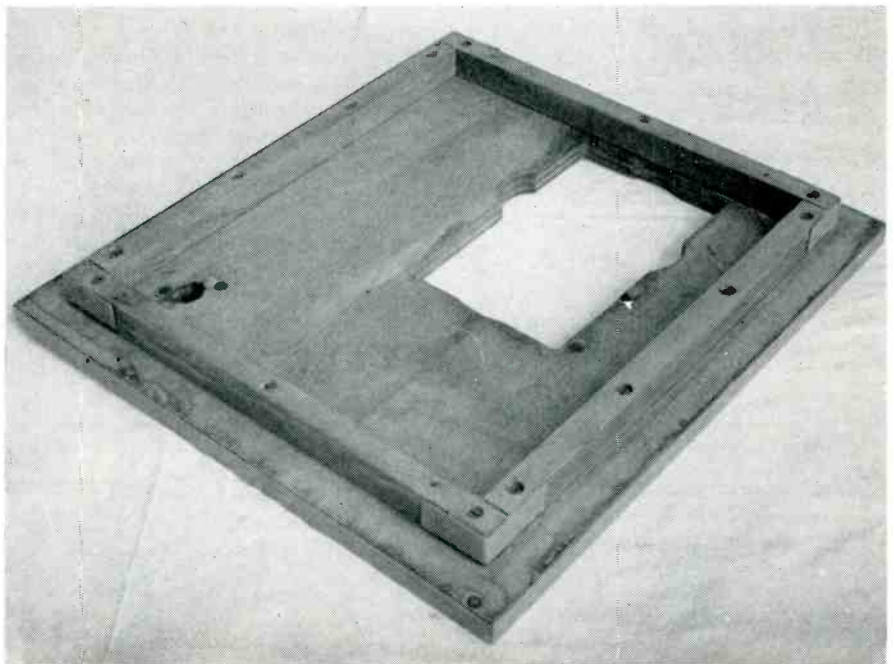



by EDMOND ARIESSOHN

# How to add a TWEETER

## Part I

THANKS to the ever-increasing interest in high-fidelity sound, the term "tweeter" no longer brings to mind the image of a canary. If the word has become common, however, a full appreciation of its implications has not. Every owner of a limited-range sound-reproducing system realizes that he can probably increase its high-frequency response by adding a tweeter, but let him once decide to do so, and he is immediately beset by perplexing problems. Shall he use a cone tweeter or a horn tweeter? Can he simply connect it to his existing system or must he have one of those "crossover networks"? Someone suggested a "high-pass filter"; wouldn't that serve just as well? What about the proper crossover frequency? The catalogue lists tweeters that have many different low-frequency cutoff points. And what about voice-coil impedance? Must the tweeter have any special type of enclosure? These are questions that must be answered, and it is the purpose of this article to provide such answers.

### Why Add a Tweeter?

The designer of a single-cone wide-range loudspeaker must make a series of compromises in order to produce a unit which meets high-fidelity standards. While these problems have been solved successfully by many manufacturers, and excellent wide-range speakers are in common use today, it will not be denied that a multiple-speaker system, whether

composed of individual units or of the popular integral design, offers certain advantages. Each reproducing unit of a multispeaker system (since its burden of performance is considerably lightened) can be designed to cover a restricted portion of the frequency spectrum with maximum efficiency. Reduction of intermodulation distortion is another important advantage in separation of the spectrum. But paramount in importance is the greatly increased flexibility which the multispeaker system offers. As shown in Fig. 1, individual control of each reproducing range is possible; the user can adjust the balance among highs, middles, and lows to suit his preferences and to compensate for atypical room acoustics. The three-way system is made up of the low-frequency woofer, the middle-range speaker, the high-frequency tweeter, appropriate electrical networks to guide the proper frequency bands to each speaker, and level or balance controls to adjust their output intensities.

It is apparent that the owner of a single general-purpose speaker may obtain these advantages by *expanding* his loudspeaker system. In some cases, the wide-range speaker suffers from lack of highs. The addition of a tweeter, then, is for many people the most logical beginning of this expansion program. As we shall also see, the tweeter entails no additional enclosure problems other than availability of reasonably modest space for its installation.

Fig. 1. Smoothed response curve of a wide-range speaker, left. At right, level controls on separate middle-range and high-frequency units permit adjustment of sound balance over a wide range according to taste and the acoustic environment.

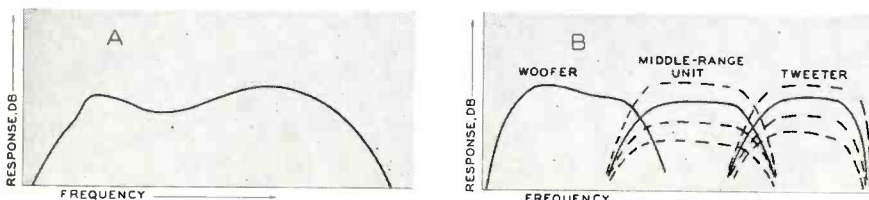

### How Tweeters Work

The tweeter, as we have noted, is a loudspeaker designed specifically to cover the high-frequency end of the audible spectrum in a two-way, three-way, or four-way multispeaker system. While tweeters differ in the frequency at which they take over from the low-frequency or middle-range speaker, they are all intended for unrestricted high-frequency reproduction. The two most common classes into which they fall are the cone-diaphragm type and the horn-loaded driver.<sup>1</sup>

A cone tweeter is simply an adaptation of the familiar paper-cone dia-

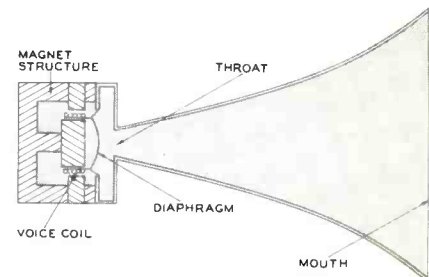

Fig. 2. Construction of a tweeter horn.

phragm loudspeaker, with many of the design parameters chosen to shift the maximum efficiency of its operation into the high-frequency range. The most apparent difference is the small size of the cone tweeter. While large dimensions and weighty construction are required for a cone speaker if it is to push the volume of air necessary for efficient low-frequency response, large cone mass is a disadvantage if the diaphragm must be called upon to move back and forth 10,000 or 20,000 times a second. Reduction in the mass of the cone tweeter is necessarily accomplished by reduc-

<sup>1</sup>There are tweeters that do not belong in either category, such as the electrostatic and ionized-air units. The two types discussed in this article are still used in the majority of speaker systems.

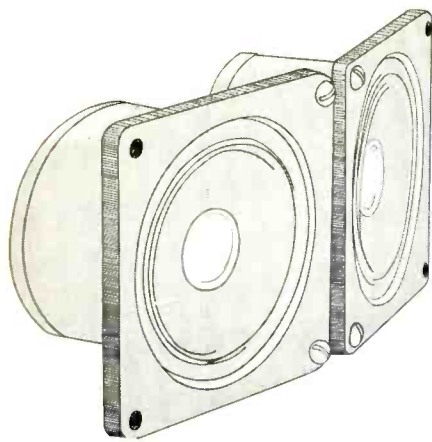

Fig. 3A. Multiple-cone tweeter assembly.

tion in the size of the cone. At the same time, a high resonant frequency is achieved by increasing the stiffness of the cone and the edge suspension. The same considerations hold true for the voice coil, and we find that miniaturization has been applied here as well. Fortunately for the tweeter designer, a relatively small amount of electrical power is required in this frequency range. Nevertheless, the tweeter must be capable of withstanding spurious oscillations generated by some amplifiers under certain conditions.

In the horn-loaded-driver type of tweeter, the same considerations of lightness and stiffness apply to the voice-coil design, but the method of imparting motion to the air is fundamentally different. The voice-coil assembly of a cone tweeter moves the relatively large paper cone diaphragm which, in turn, moves the air; but in the horn-loaded driver, the diaphragm is very little larger than the throat of the horn. This is shown in Fig. 2.

The horn itself acts in a fashion analogous to an electrical transformer. At the horn throat, a relatively large sound pressure moves a small mass of air. At the mouth, the pressure becomes small but moves a relatively large mass of air. Thus the horn performs a very important function: it acts as an impedance-matching device between the driver diaphragm and the air. It is a well-known fact that maximum power is delivered to a load from a generator when the load resistance is equal to the generator's resistance. For exactly the same reason, a greater amount of acoustic power is delivered to the air at the horn mouth by virtue of the horn's impedance-matching action. For that reason the horn-loaded tweeter is inherently a more efficient radiator than the cone: in the order of 35 to 45% efficiency, compared to 5 to 10% for the best cone tweeters.

One further general remark about horns before we discuss the various tweeter types. Any horn has a definite low-frequency cutoff, determined by the

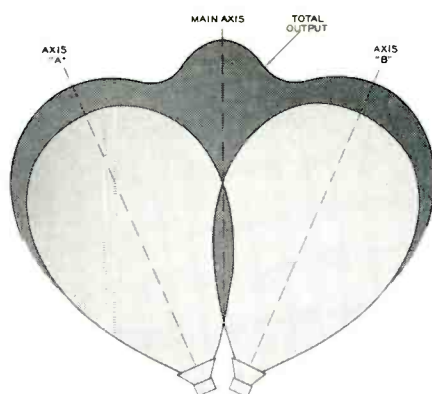

Fig. 3B. How the quite narrow radiation patterns from a properly offset pair of cones add to give wide-angle diffusion.

rate of flare and the mouth dimensions.<sup>2</sup> For a lower cutoff frequency, the horn flares less rapidly and has larger mouth dimensions. The horn, in its role as a device constraining the spread of the sound waves, is a baffle per se; no additional baffling or other special mounting is required with a horn-loaded tweeter.

### Tweeter Designs

Apart from the fundamental difference between cone and horn-loaded-driver tweeters, it may be said that all variations among tweeters are the result of designers' attempts to achieve wide angular distribution of the sound. It is an unfortunate characteristic of the cone speaker that, as the frequency of sound

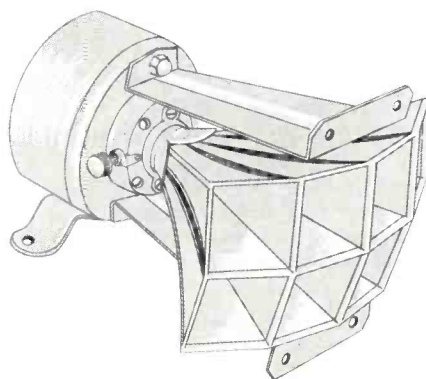

Fig. 4. A multicellular tweeter design.

increases, its directional characteristics become more and more pronounced until, at the frequency range in which tweeters are presumably operative, the beaming effect is quite drastic. In cone-type tweeters it is difficult to overcome this limitation; generally the problem is avoided, rather than met, by the use of two or more identical units arranged with their axes angled out to form a fan. As Fig. 3 shows, the individual sound beams point away from each other. If angled to give the proper amount of overlap, this will provide acceptable performance. Baffling is not

<sup>2</sup>Charles F. Baldwin, "Home-Built High-Frequency Horn"; *AUDIOCRAFT*, II (Apr. 1957), p. 28.

usually required for a cone-type tweeter, although the separation of front and rear radiation is not as effective as it is with a horn unit.

Among horn-loaded types there is a wide variety of horn configurations, all intended to widen the horizontal radiation pattern. The four types most commonly employed are the multicellular horn, the diffraction horn, the acoustic lens, and the reciprocating-flare horn.

The multicellular horn (Fig. 4) is based on a design philosophy similar to that of the cone-speaker array. The horn is, in fact, composed of a number of individual cells driven by a common diaphragm. Each cell has a sharply directional characteristic, but they are arranged in a bank to produce an over-all pattern of wide angular dispersion. This over-all characteristic is determined by the particular arrangement of the individual cells. As with the cone array, the smoothness of response is rather critically dependent on the correct overlap of the individual lobes. Since good horizontal coverage is usually the designer's goal, the multicellular horn appears most frequently as a rectangular array with the larger number of cells in the horizontal plane.

The diffraction horn, Fig. 5, employs a principle long familiar in the study of optics. This horn is dimensionally in the same order of magnitude relative to sound waves as the diffraction grating is with respect to light waves, and it performs the same function. It is by no means a recent discovery; the principle of sound diffraction from horns was treated as long ago as 1877 by Lord Rayleigh in his *Theory of Sound*. Sound emanating from a slit or aperture (whose width is small compared to the wave length of the sound) spreads out in a cylindrical pattern, with the aperture as the axis. Since the horn flare determines only the tweeter's cutoff frequency, this type of speaker should be mounted with the long dimension of the aperture vertical. The rapid rate of expansion in the vertical plane frequently leads an

*Continued on page 43*

Fig. 5. Diffraction-type horn tweeter.

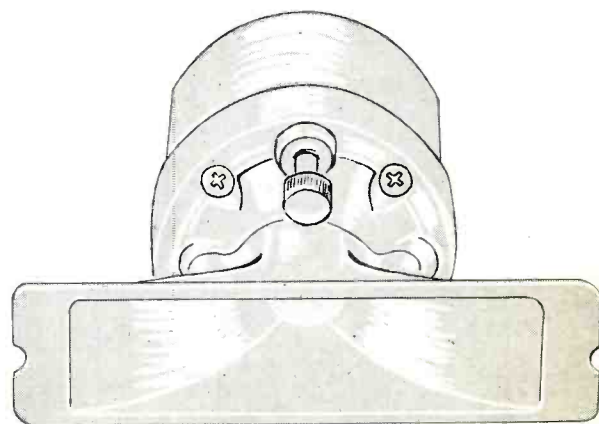

## Gadget Box for Tape Recording

A COUPLE of days ago I was digging through the old suitcase that serves as a catchall for my recording accessories, searching diligently but fruitlessly for an AC cube tap, when the idea struck me that I had simply accumulated too much junk. A house cleaning was due.

The battered old case was so full of rattling bits of miscellany that I decided I had to do some throwing out; things just couldn't go on this way. It had reached the stage where there were so many cables, plugs, adapters, bits of string, and bent pieces of wire that I couldn't find what I wanted when I wanted it, and wasn't even sure that it was in there amongst the confusion.

Carefully, I removed everything that was big enough to get hold of—the coiled cables, mike gooseneck extensions, and headphones—and then, rashly, I dumped the rest of the stuff on the floor, pulled a wastebasket within easy reach, and turned an evaluating eye on what came to light. I picked up each item, scrutinized it, analyzed its potential use in future recording ventures, made my decision, and laid it carefully aside or tossed it with abandon into the oval file (my wastebaskets aren't circular). At the end of this bout, I found I had relegated exactly 38 items to the "potentially useful" pile and 3 to the waste-

basket—an ineffectual purge, if ever there was one!

This may have been a result of the same provident philosophy that clutters the typical household cellar with empty tin cans and old hose nozzles, but it did serve to point up one observation about tape recording: you *can* make good tapes with nothing more than a recorder, a microphone, and enough cable to tie them together, but the road to minimal-effort, highest-quality recording is paved with gadgets. The more gadgets you own (assuming they are chosen with a modicum of discretion), the smoother will be the ride to hypothetical sonic perfection.

For instance, consider two apparently unrelated objects that were taking up valuable space in my gadget box: a 100-foot coil of laundry rope and a large roll of paper masking tape. Those are things that I rarely use, but on an occasion when I want to record a large choral group with organ, I can't do without them. A typical microphone stand is not nearly high enough to get the mike to an adequate height, but the laundry rope can be used either to suspend the mike from an overhead beam or between two wall fixtures at opposite sides of the auditorium. Where does the masking tape come into the picture? Well, if there doesn't happen to be a

ladder handy, or if you happen to share my acrophobia, getting up to attach the rope to a ceiling beam or a couple of high wall fixtures can be a problem—unless, of course, you tie one end of the rope to the roll of masking tape and pitch it up over the suspension member. The tape roll is heavy enough to carry the rope a long distance, yet is soft enough that it won't shatter a window or put dents into ornamental woodwork if you miss your mark. Then, when one end of the rope is hooked up and brought back to floor level (for tying to any convenient object), the masking tape can be used to attach the mike cable to the rope at intervals, so the cable won't be a free-hanging eyesore in the auditorium. Finally (if the mike is to be suspended from the middle of a horizontally hung rope), the other end of the rope is tied to the roll of masking tape and tossed over its wall support, bringing it back to near floor level where it can be pulled up tightly and then tied to anything within reach. If this sounds terribly complicated, Figs. 1 and 2 may help to clarify things.

This accounts for two of the potentially useful items; what about all the others? Most of them are also microphone accessories of various types, and adapters comprise the bulk of them. Few things in a recordist's life are more

Fig. 1, left, and Fig. 2. Cable is held to rope by masking tape. Tape roll was used as weight to get rope over rafter in Fig. 1.

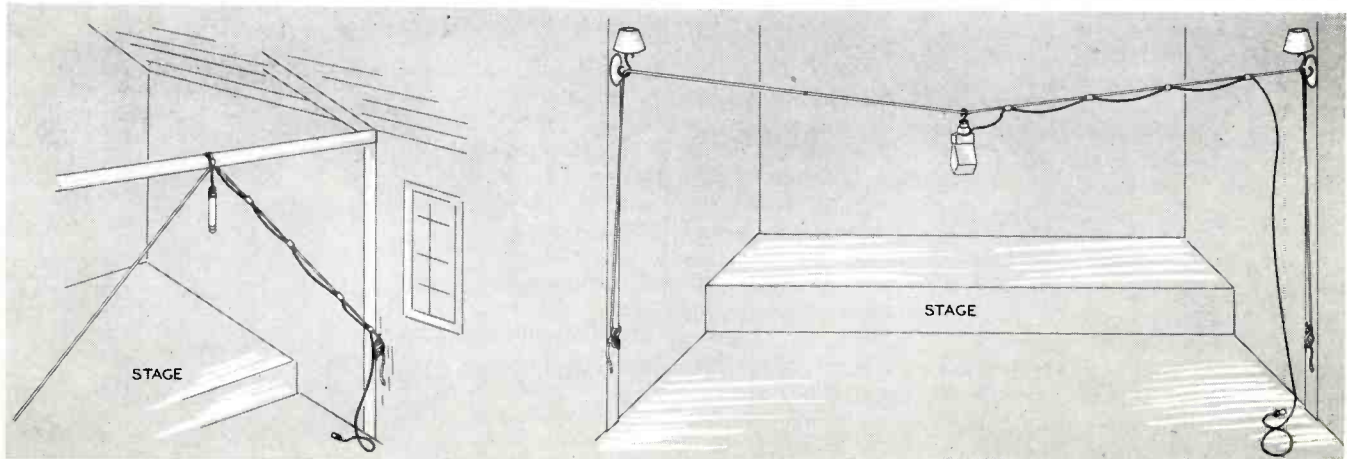

frustrating than having a signal source, something to feed the source into, and no means of interconnecting them. For this reason it is a good idea to make up as many adapters as you think you will ever need, using short (1 ft. is enough) lengths of cable with different kinds of plugs or identical sockets on both ends. These can be used as cable joiners in certain applications, or as a means of changing a plug to a socket (or vice versa) at the end of a long cable, so that, for instance, a male plug may be connected to a male chassis receptacle.

A third type of adapter that is sometimes quite useful is a  $\gamma$  junction (Fig. 3), in which a plug splits out to feed

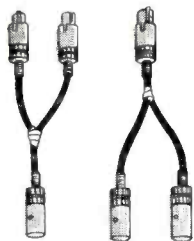

Fig. 3. The useful  $\gamma$ -junction adapter.

two sockets, so that two inputs can be fed from a single source. A note of caution about this, though: if this type of adapter is used with low-impedance lines, some correction will have to be made at either the source or the terminations to insure proper matching. A similar type of adapter, which we might call the  $\lambda$  adapter because it's the same thing in reverse, can be used to feed two sources into a single input. On low-Z lines, the above caution applies equally; and if both sources are equipped with independent volume controls, this device can also serve as a simple two-channel input mixer. One form of this device can be made up from three RCA-type chassis-mount receptacles soldered together to form a triangle, Fig. 4. This is likely to prove just as useful at times in a home hi-fi system as it will on recording ventures.

Then there are the stand adapters. The likelihood that you will someday have to borrow a microphone stand or a microphone whose mounting threads are nonstandard is rather remote, but, if it should happen, it will pay to have adapters on hand. These should be male-female types (microphones invariably have female threads, stands, male), and they are made by the Atlas Sound Corp. in sizes to match most mikes and stands.

Other handy devices include a microphone shock mount (Electro-Voice) to help isolate the mike from floor-borne vibrations traveling up a mike stand; flexible gooseneck stand extenders which allow a mike to be angled to one side in practically any position; and a microphone rope hanger. The last is useful

when suspending a microphone whose weight is likely to strain the cable-plug connections. Some microphones are light enough that they can safely be suspended by their cable alone, but a heavy microphone hung in this manner may short the leads inside the plug or may even break some of the internal connections. For this reason it is a good idea to support massive microphones (like the Western Electric-Altec 639 or the Telefunken) from a rope hanger that will take the load from the mike cord. One of these gadgets can be made from a short piece of wire coat hanger, the threaded cover from an Amphenol type-AA combination cable plug and jack, a fiber washer that fits snugly into the threaded cover, and a 1-inch-long piece of  $\frac{3}{8}$ -27 threaded pipe. Fig. 5 is self-explanatory, although it might help to point out that the loop at the bottom of the bent coat-hanger wire should fit snugly around the inner circumference of the threaded cover. Screwing the threaded pipe into the assembly will force the washer against the wire loop and prevent the hook from twisting around.

That about covers the microphone accessories, but we still haven't accounted for all the other gadgets that get in the way when you're looking for something else. One that should be cluttering up every recordist's gadget box is a head demagnetizer. Without going into details, we can safely state that a magnetized recorder head is a treacherous thing, and that a head that isn't demagnetized from time to time\* will become magnetized with use. A head degausser is also useful for demagnetizing scissors and razor blades that are to be used for editing, so they won't leave bleeps or clicks wherever they contact the tape.

Which brings us to another class of gadgets: splicing equipment. According to books on tape recording, tape can be spliced by hand, but anyone who

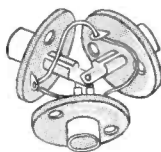

Fig. 4. Adapter of RCA-type receptacles.

has tried to do it this way will agree with me that there *must* be a better way. There is. There are about a half dozen or so devices that are quite an improvement over the manual-dexterity technique. They vary widely in their degree of automation, precision, and price. The most complex and automatic of the inexpensive home-type splicers is the Robins TS-4DLX which for about

\*Some recorders have built-in provision for automatically demagnetizing the record head, but if they have a separate playback head, this should be degaussed periodically.

\$8.50 gives you a tape clamp, a guided diagonal cutter, an edge-trim cutter, and a splicing-tape dispenser. Parallel in price and much less automatic is the EdiTall, by Tech Labs. This is a long block of aluminum with a shallow channel running the length of its top surface. The channel, which is slightly undercut to hold firmly a tape pressed into it, passes across a diagonal slot that is used to guide the cutting razor. It holds the tape precisely in line, and requires the use of a strip of splicing tape cut to a little less than  $\frac{1}{4}$  in. wide. Thus, there is no need to cut into the edges of the tape to trim off the splicing tape. Both of these splicers are very popular, and many others are available which do the same job with varying degrees of ease and precision. My personal preference is for the EdiTall, perhaps simply because I'm accustomed to using it and have never found any fault with it.

A bright-red china-marker grease pencil is about the best thing I've found



Fig. 5. Coat-hanger microphone support.

for marking tapes at the spot where they are to be cut for editing, and the grease pencil also comes in handy for labeling tape boxes and reels. The markings can be removed from boxes with an art gum eraser, or from the reels with Kleenex.

Finally, if you ever do any recording for broadcasting or discing, you should have a stop watch with a zero-return button. This can be useful on other occasions too, as a guide to how much tape is left on the reel.

These items are, as far as I'm concerned, about all that a recordist *needs* in his gadget box, but I'm certain that anyone with a little ingenuity will come up with plenty of original ideas with which to clutter up things still more. Other suggestions might include a small notebook and a pencil, for jotting down microphone placements and volume-control settings for future reference, and for listing the miscellany that comprises different sections of each reel of tape. Several 6-inch lengths of string are useful for tying up coils of wire so they won't get tangled between then and the next recording job, and if you want to cover yourself against all exigencies, you

Continued on page 47

# BASIC ELECTRONICS

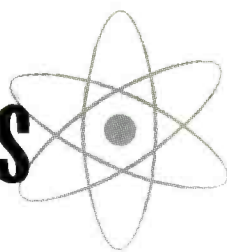

by Roy F. Allison

## XVIIIa: Triodes

**A** DIODE, as was discussed in previous chapters of this series, is a two-electrode device (often a vacuum tube) which conducts current freely in one direction, but not in the opposite direction. In the case of a vacuum tube, electrons travel easily from the cathode electrode to the plate electrode but not in the reverse direction, because the heated cathode can emit electrons from its surface while the plate cannot. If the plate is positive with respect to the cathode, current flows; and the more positive the plate potential, the greater the current, up to the point at which the current consists of all the electrons the cathode can possibly emit. Within the normal positive operating range of the tube, though, the current is reasonably proportional to the plate voltage. We can show this easily by a chart such as that in Fig. 1. The curve is called the *plate characteristic* of a diode; it shows how current through the tube (plate current) varies according to the voltage of the plate with respect to the cathode (plate voltage). For example, with 40 volts on the plate, the current is about 20 ma; with 60 volts, 40 ma. If the proportionality between plate voltage and current were exact, the curve would, of course, be a straight line.

Now suppose that we add another electrode to the tube, in the form of a fine wire grid of cylindrical shape, sur-

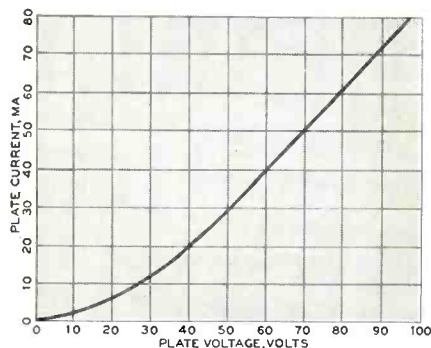

Fig. 1. How the current through a diode varies with the positive plate voltage.

rounding the cathode completely and close to but not touching it. This added element is known as the *control grid*, or simply the *grid*. Its presence makes the tube a triode. The physical construction of a typical receiving-tube tri-

ode is portrayed in Fig. 2A, and the corresponding schematic symbol in Fig. 2B. It should be noted that the heater is often omitted from the schematic symbol of a triode or other amplifying tube, and all heater connections shown together someplace else on the diagram.

The control grid is situated between the cathode and plate, so that any electrons reaching the plate must pass through the spaces between the grid wires. This they manage to do quite successfully; as a matter of fact, the physical presence of the grid is insignificant as an obstruction to electrons going from cathode to plate. The electrical effect of the grid on plate current, however, is a major one. To appreciate the significance of this, refer to Fig. 3 during the following discussion.

In Fig. 3 is shown a 6J5 tube, which is electrically similar to its versatile dual-triode derivatives, the 6SN7 and 12AU7. For the plate supply voltage a 500-volt source is used, and a potentiometer is connected across the source. The plate is connected to the potentiometer slider, so that by adjusting the slider the plate can be varied from 0 to 500 v positive with respect to the cathode. A similar source of negative DC voltage is furnished for the grid; the grid can be adjusted from 0 to 25 v negative with respect to the cathode. Assume, to start, that we set the plate voltage at 160 and the grid voltage at 0. We should find that quite a lot of current would flow from the cathode through the grid to the plate: about 20 ma. No current would flow from the grid to the plate, because the grid is not heated and does not emit electrons. No current would flow from cathode to grid because they are at the same electrical potential.

Now, suppose we adjust the grid voltage to  $-25$  v with respect to the cathode. (All voltages on vacuum-tube elements are assumed to be with respect to the cathode, even when the cathode is not at ground potential as it is in Fig. 3.) We find that the plate current ceases almost entirely, even though the plate is 160 v positive. The tube is "cut off" by the negative grid voltage. Note that the grid still doesn't conduct; being negative with respect to the cathode, it repels the electron cloud back

toward the cathode rather than attracting it. And, even though the grid isn't physically solid, the electrostatic field formed by the voltage on the grid wires extends in fairly uniform fashion over the entire cylindrical grid structure. It is this uniform electrostatic field that prevents electrons from the cathode getting through to the plate. No matter what the plate voltage, it is possible to prevent plate current flow by making the grid sufficiently negative.

If the grid voltage is reduced to  $-8$  v, with 160 v on the plate, the plate current is still small—less than 1 ma,

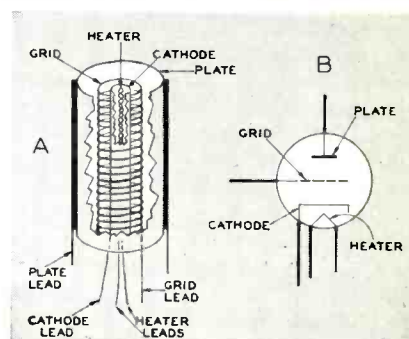

Fig. 2. A triode has a wire grid closely encircling but not touching the cathode.

as shown in Fig. 4. Decreasing the grid voltage even further, to  $-4$  v, permits an increase in plate current to about 7.7 ma. When the grid is returned to zero voltage, plate current increases to its original value, 20 ma. Thus the function of the grid is to *control the plate current*. Only in a few circuits, and then only incidentally, does it conduct current itself. If the grid is made negative, it reduces plate current; if it is made still more negative, it reduces plate current further; and so on down to cutoff. Driving the grid positive with respect to the cathode will usually increase plate current above the zero-grid level. At some fairly low positive grid potential, however, plate current reaches a maximum (determined by the emissive ability of the cathode), and this is called the saturation point of the tube. Between these two extremes—saturation and cutoff—the grid acts as a plate-current valve, which is open by an amount that depends on the grid voltage.

Evidently the grid voltage has a



marked effect on the plate current. But the plate voltage exercises some control on plate current too, just as it does in a diode. If we chart plate current vs. plate voltage for the circuit shown in Fig. 3, for various fixed values of grid voltage, we obtain the family of curves depicted in Fig. 5. These are the plate characteristic curves for the 6J5, 6SN7, and 12AU7 triodes. Each curve is for the marked value of grid voltage; it shows what value of plate current will flow for any given value of plate voltage. Looking at the  $-2$ -volt curve, for example, we can see that, with a grid voltage of  $-2$  v, 160 v on the plate will produce a plate current of slightly more than 13 ma, and that 120 v on the plate will produce a plate current of 8 ma. This curve, and the others in the family, have a marked resemblance to the diode plate characteristic (Fig. 1).

Let's examine the family of curves again. Suppose we adjust our potentiometer sliders to put 80 v on the plate and 0 v on the grid. According to the curve for zero grid voltage, this will

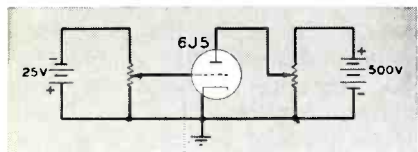

Fig. 3. A circuit for determining the operating characteristics of a triode.

produce a plate current of 8 ma. Now, keeping the plate voltage constant, we move the grid-voltage slider so as to put  $-2$  volts on the grid. That will move the operating point vertically down to the  $-2$ -volt curve; for 80 volts on the plate, the new plate current value is about 3.4 ma. A change of 2 v on the grid has caused a change of 4.6 ma in plate current. How much must the plate voltage be increased to compensate for the changed grid voltage? Following the  $-2$ -volt curve up to the original plate current value of 8 ma, we find the corresponding plate value to be 120 v. The plate voltage, then had to be increased 40 v to cause the same change in the plate current that a 2-volt change in grid voltage caused. Obviously, the closer proximity of the grid to the cathode makes it  $40/2 = 20$  times as effective as the plate in controlling plate current.

This greater efficacy of the grid is what makes it possible for the tube to function as a voltage amplifier, as we shall see. The ratio of the change in plate voltage necessary to counteract a change in grid voltage, to keep the plate current unchanged, is a measure of *how much greater* an effect on plate current a change in grid voltage has than a change in plate voltage. Accordingly, it is an indication of how much voltage amplification the tube can accomplish. This

ratio is called the amplification factor, and its symbol is  $\mu$ . The formula for  $\mu$  is simply an expression of the calculation carried out in the preceding paragraph:

$$\mu = \frac{\Delta e_p}{\Delta e_g} (i_p \text{ constant}),$$

where  $\mu$  is the amplification factor,  $\Delta e_p$  is a small change in plate voltage, and  $\Delta e_g$  is the corresponding change in grid voltage that will keep  $i_p$ , the plate current, at the same value. The value of  $\mu$  is relatively constant anywhere within the normal operating range of the tube. It is a simple numerical quantity, since it is a voltage divided by a voltage.

Two other quantities are needed to describe the tube characteristics. They are the transconductance, defined formulaically as follows:

$$g_m = \frac{\Delta i_p}{\Delta e_g} (e_p \text{ constant}),$$

where  $g_m$  is the transconductance,  $\Delta i_p$  is a small change in plate current, and  $\Delta e_g$  is the change in grid voltage necessary to produce that change in plate current while  $e_p$ , the plate voltage, is held constant. The transconductance is simply a measure of the degree to which changes in grid voltage affect plate current; that is, how *much* of a change in plate current a given change of grid voltage will produce.

Finally, there is the *plate resistance* of a tube. This is expressed by the following formula:

$$r_p = \frac{\Delta e_p}{\Delta i_p} (e_g \text{ constant}),$$

where  $r_p$  is the AC plate resistance of the tube, and  $\Delta e_p$  is a small change in plate voltage that produces a corresponding change in plate current,  $\Delta i_p$ , while the grid voltage  $e_g$  remains constant. The plate resistance is the actual resistance of the tube itself to an AC signal.

Transconductance is a figure of conductance (current divided by voltage),

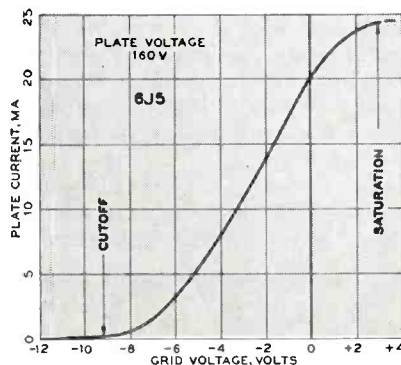

Fig. 4. How grid voltage affects triode plate current with fixed plate voltage.

so its units are inverse ohms, mhos, or micromhos. For a triode such as the 6J5, a typical transconductance value may be 3,000 micromhos; that is, a grid-voltage change of 2 v may produce a plate-current change of 6 ma. Plate resistance is expressed in ohms, since it

is a figure of voltage divided by current. A 6J5 triode's plate resistance may be around 7,000 ohms; for example, a change in plate voltage of 70 v will change the plate current by about 10 ma. Both transconductance and plate resistance can and do vary considerably within any tube's operating range.

If the reader cares to perform some substitutions among these three formulas, he will find that they are interrelated in the following way:

$$\mu = g_m r_p$$

That is, the amplification factor is the product of the transconductance and the

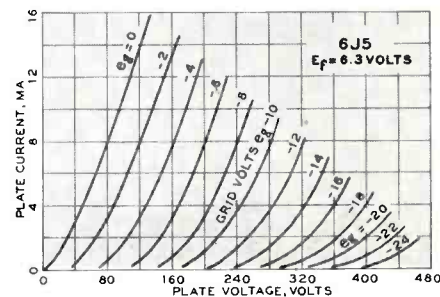

Fig. 5. Curves of triode plate current vs. plate voltage at 2-volt bias steps.

plate resistance. When any two are known, the other can be found by simple multiplication or division. It should be emphasized again that these are AC or dynamic quantities, not static ones; for example, dividing a given plate voltage by the plate current existing at that time will *not* give the plate resistance (except accidentally). Incremental values—*changes* from the static values—must be used to obtain valid results.

Now we are ready to tackle an actual voltage-amplifying stage, such as that shown in Fig. 6. Note that there is no negative voltage applied to the grid; there is only a resistor,  $R_g$ , from the grid to ground, and a capacitor,  $C_g$ , between the grid and the input-signal source. This combination is an AC coupling circuit. It will permit AC signals to reach the grid, but will keep the grid at zero DC potential with respect to ground. The incoming AC signal, then, will cause the grid to swing alternately positive and negative with respect to ground. Yet we've said that the grid shouldn't swing positive with respect to the cathode, for that would make the grid draw current and would cause serious distortion in a voltage-amplifying stage. Neither should the AC input swing the grid negative enough to cut off the stage; that would cause distortion also. If we want the stage to be able to handle the largest possible AC input signal, without having the positive swings make the grid positive with respect to the cathode, and without having the negative swings cut off the tube, then obviously we must make the grid's DC potential negative with respect to the cathode by an amount

Continued on page 46



## Tips for the woodcrafter

# The Right Wood for the Job

by George Bowe

**I**N an earlier issue (Apr. 1956), we hit some of the high spots of the lumber story as it concerns the home craftsman. Such a general article did not permit detailed discussion of many of the important points, and one of these points is the selection of the type and grade of wood that will give you a finished product to match the picture you've created in your mind's eye. Economy, too, can be served by a knowledge of wood classifications and characteristics; the most expensive grade of wood is not necessarily the best for your purpose.

One of the principal factors in determining the selection of a cabinet wood is the finish. In most cases the finish should show off the natural beauty of the wood, so the type of grain dictates the method of finishing. A wood finisher thinks of wood in terms of open-grained, medium open-grained, or close-grained, depending upon the coarseness or fineness of the pores of the wood. Here are some examples:

*Open-grained:* ash, chestnut, mahogany, oak, walnut.

*Medium open-grained:* butternut, cedar, gum, hickory, pine, poplar.

*Close-grained:* basswood, birch, cherry, holly, spruce.

For a smooth cabinet finish, woods with an open grain should be treated with a paste filler.

I have always felt that the grain of the wood should have priority over color in finishing cabinetwork. There are

many stains available to today's craftsman to bring out the tone he desires, but tone without grain is not very effective; a natural finish is only as good as the grain beneath it. Some woods have a monotonous grain that can never equal the grain pattern of a wood with unusual and beautiful figures. Lovely graining can be highlighted by proper staining that subtly accentuates the beauty of the wood; an example of a successful finish on good wood is shown in Fig. 1. Select the wood for the grain, then choose the stain.

Another consideration in the selection of cabinet wood is shrinkage and warpage. During seasoning, all woods shrink and sometimes warp (Fig. 2) — some more and some less than others. For instance, black walnut, cherry, and mahogany all have a beautiful grain with less tendency to shrink and warp than most other woods. Birch, maple, and red gum also have distinctive grains, but they have, as well, a weakness for shrinking and warping.

The use of screws and glue to straighten out a piece of wood that's either "green" or warped does not nec-

essarily dispose of the problems of splitting, checking, or loose joints. Never lose sight of the fact that Mother Nature cannot be restrained easily. A good friend of mine can attest to this fact through a recent experience. To fasten to the transom of a boat he was building, he needed a piece of oak to serve as reinforcement to hold the outboard motor. Having a warped piece of oak, he used an oldtime method to straighten it out. The oak was placed on a piece of wet newspaper on the flat surface of a concrete basement floor. The next day the wood was perfectly flat, and my friend attached it to the boat transom with waterproof glue and screws. However, normal exposure to atmospheric conditions brought on a series of "checks" (Fig. 3) in the oak — a natural reaction traceable to the original warping. A piece of cabinetwork or furniture can also suffer from unseasoned wood, especially if it is exposed to the high temperature of a nearby radiator. The finish of the piece may delay disaster, but cannot forestall it completely.

Hardness and strength are two other factors to consider in choosing a wood.

Fig. 2. Five kinds of warp: A) bow; B) crook; C) diamond; D) cup; and E) twist.

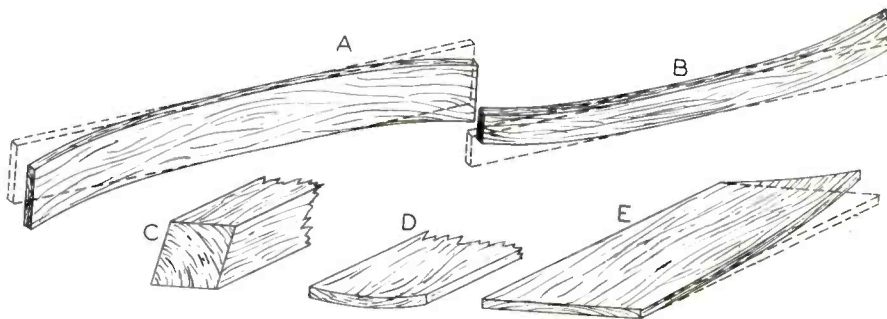

Usually, hardness and strength go together, although not all so-called "hardwoods" are really hard, nor all "softwoods" really soft. For instance, basswood, cottonwood, and poplar are really physically soft woods, although they are classified as hardwoods. Yellow pine, considered botanically to be a softwood, is really harder than many hardwoods. In working qualities such as nailing and machining, some of the so-called "softwoods" are tougher than "hardwoods." Generally speaking, the softwoods are cone-bearing trees, usually referred to as "conifers." The hardwoods, with few exceptions, are broadleaf trees. The woodworker frequently groups woods into three classifications: *hard*, *medium hard*, and *soft*. Typical are the following:

*Hardwoods*: ash, birch, ebony, hickory, maple, oak, rosewood.

*Medium hardwoods*: cherry, chestnut, mahogany, poplar, red gum, walnut.

*Softwoods*: balsa, basswood, cedar, fir, pine, redwood, spruce, sycamore.

Cabinet and furniture woods should

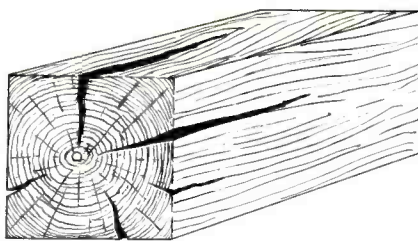

Fig. 3. Checks are splits on outside of timber. They form when the outside shrinks more than the interior.

be resistant to easy damage. In most cases, softwoods will not fill this requirement since they bruise and nick easily. Extremely hard woods are difficult to work with and they also dull tools. Thus, woods in the medium-hard class are more ideally suited to the home craftsman and his workshop.

Lumber is priced according to its grade, and softwoods and hardwoods have entirely different grading systems. In a lumber yard you will generally find the following classifications of lumber: *yard*, *shop*, and *structural*. Shop lumber

is used in school shops and in manufacturing; structural lumber is used in heavy construction and is graded by its strength. Since neither of these is of particular interest to the home craftsman, we shall concern ourselves with yard lumber which is cut to serve practically all purposes and is handled by all lumber yards.

Softwoods are divided into two classes — *select* and *common* — and, in general, are graded as follows:

*Grade A Select* is ideal for natural wood finishing, since it is clear.

*Grade B Select* can serve practically the same purpose as Grade A, even though it may have a few small defects.

*Grade C Select* may be almost perfect on one side. Typical flaws are small, loose knots; grain running in opposite directions; and minor blemishes. It can be stained or painted.

*Grade D Select* is the lowest grade suited to natural stain finishes. However, it will take a good natural finish and is adequate for some cabinet projects and

*Continued on page 47*

Fig. 1. The right wood for the job. This owner-designed cabinet was finished in rich walnut veneer by simple homecraft methods. Wood materials for the case cost \$25.52, with the appearance of solid walnut lumber achieved by the use of Industrial Woodtape edging on inexpensive plywood pieces. The cabinet contains a Heathkit FM tuner, preamplifier, and amplifier, with a Garrard changer. Ample additional space is provided for speaker system and record storage.

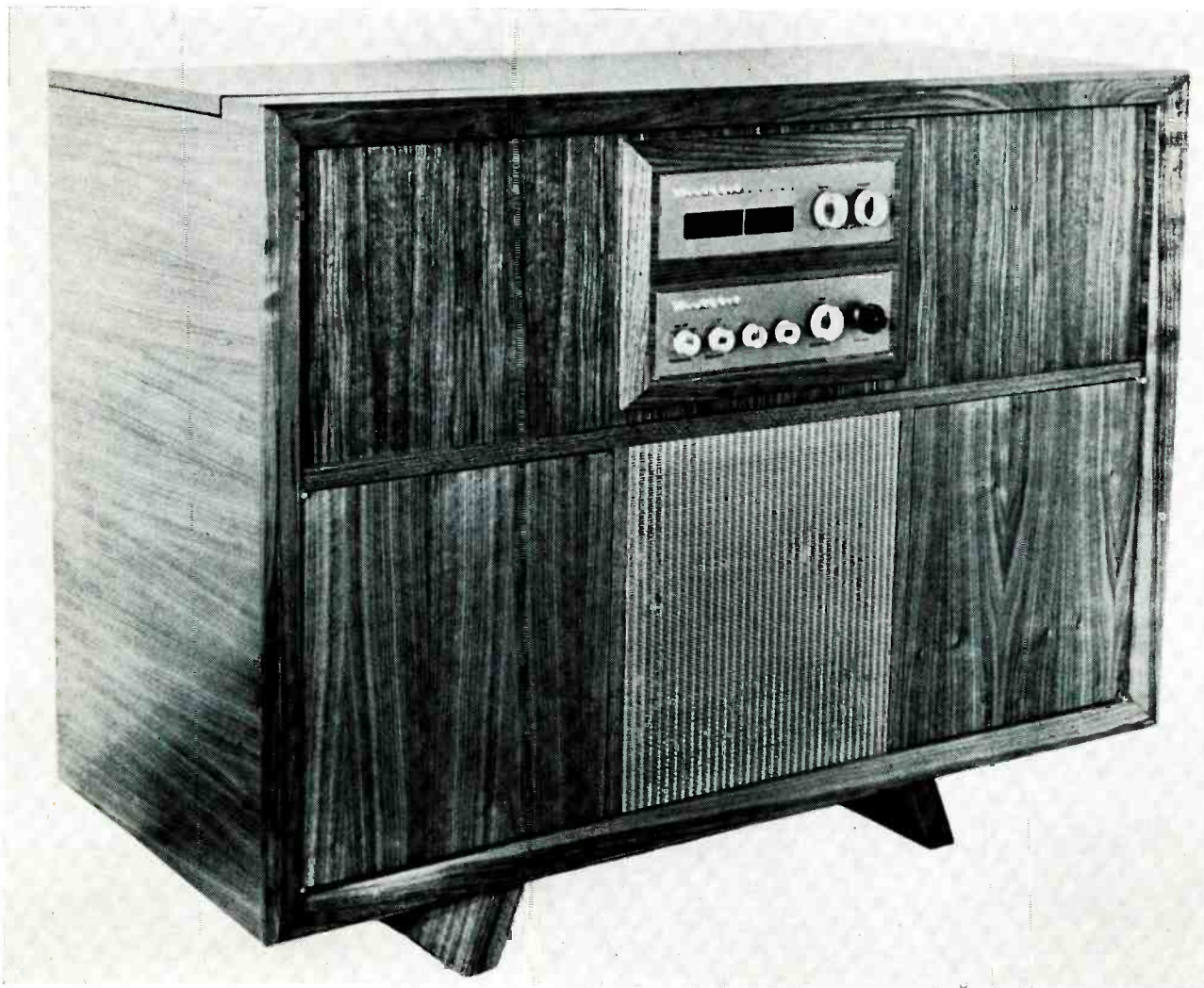

Courtesy Elliott Bay Lumber Co.



### Sheet-Metal Screws

Many pieces of new audio equipment are delivered to the customer without fully attached cages, bottom plates, or legs. Generally, these items are to be attached with sheet-metal screws driven into undersize holes in the chassis. When these screws are driven for the first time, a great deal of force is needed to tap the threads and enlarge the holes. Often the screw driver slips and scratched cabinets or slashed fingers result.

Most of us are familiar with the technique of soaping wood screws to ease their driving, but this idea is almost never applied to sheet-metal screws. I have found that the application of a small amount of soap or grease to the threads of a sheet-metal screw will reduce the amount of force needed to drive it.

Jeffry Wisnia  
Allston, Mass.

### Grounding Test Equipment

A major headache in taking precise measurements with vacuum-tube voltmeters and oscilloscopes is hum in the leads. Often, adequate grounding overcomes this difficulty. I have had good luck with the following system.

Connect heavy wire (No. 18) from a ground terminal on each piece of equipment (meters, scopes, generators, etc.) to a common point, and run a No. 16 or so wire from there to the nearest good ground. A water pipe is usually adequate, but sometimes these have hum induced on them from nearby electric wiring.

To use the equipment, run a ground wire to the equipment under test from the common ground point. Two or three spare wires from this point, with clips on the ends, are handy. Ground the chassis, and also the electrical ground if it is not connected to the chassis, but only at one point. Ground all other pieces of equipment if they are not already grounded by connecting cables. Be sure all chassis are grounded, but not grounded twice. If they are grounded twice, the resulting ground loops may cause trouble.

In injecting signals and taking meas-

urements, use shielded wire. On the instrument end, connect the shield to the instrument ground. At the probe end, make only one connection. Do not connect the grounds together again, as doing this will create a ground loop.

If necessary, the ground of any particular instrument can be removed independently of all the others.

It is sometimes helpful for the person making the measurements to ground himself — by touching either a test-lead shield or a chassis. However, when there is high voltage around, this practice is dangerous.

Beware of AC-DC equipment. Unless the AC line is completely isolated from the equipment ground (as it usually is on good hi-fi gear), it is possible to ground the ungrounded side of the 110-volt line, thus blowing a fuse.

Paul Penfield, Jr.  
Brookline, Mass.

### Rumble Reduction

After much experimenting, I was able to reduce rumble resulting from vibration in my turntable. The 4-pole induction motor with which the turntable was equipped was quiet, but it had a

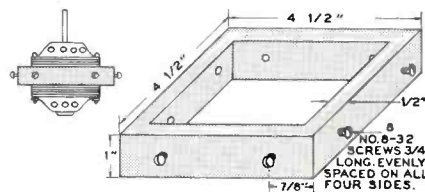

Assembly used to increase mass of motor.

small amount of vibration which was transmitted to the pickup. By increasing the mass of the motor, a measurable amount of vibration was eliminated.

To increase the mass of the motor, a wooden mold was made and a lead

#### AUDIO AIDS WANTED

*That's right — we'll pay \$5.00 or more for any short cut, suggestion, or new idea that may make life easier for other AUDIOCRAFT readers, and which gets published in our Audio Aids department. Entries should be at least 75 words in length, and addressed to the Audio Aids editor. No limit on the number of entries.*

weight cast in the form of a hollow square. Dimensions are shown in the drawing. Eight equally spaced holes were drilled and tapped for No. 8-32 screws, 3/4 in. long.

This assembly was slipped over the motor and rigidly fastened to the stator with eight setscrews. The results were remarkable.

B. V. Marcellus  
San Francisco, Calif.

### Record Storage Racks

The illustration shows a simple and inexpensive record storage rack. The basis for the rack is a cake rack, available from the five-and-ten for about 25¢. The size varies, but most racks are approximately 12 by 14 in. The outer frame is of 1/8-inch wire, and the 1/16-inch spacer wires are spot-welded to the outer frame. The racks are easily bent by placing them on the edge of a table with half of the rack projecting over the edge. Hold the rack on the table with one board while pressing the free end of the rack down with a second board. The angle of the bend should be 90°. If the rack has an intermediate cross

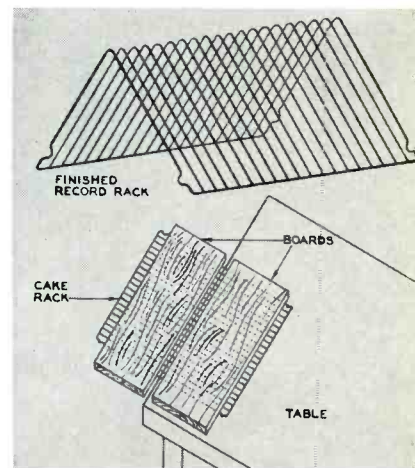

Record storage rack made from cake rack.

wire, it can be removed with wire cutters.

This type of storage rack can be used inside a record storage cabinet, as well as on top of a table or cabinet.

T. E. Adams  
Edmonton, Alta.

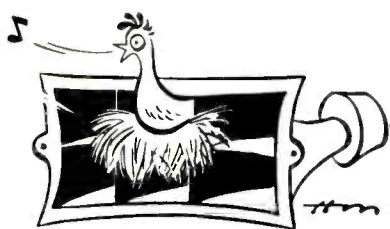

# Sound-Fanciers' Guide

by R. D. DARRELL

RETURNING to music on discs after last month's tape and test-record explorations, I've slid back into accustomed microgrooves with special avidity. In part, this extra listening zest was stimulated by some unusually novel program materials, but to an even greater extent by the opportunity of trying out a new pickup and arm—a rarer adventure for me than for many more restlessly experimental audiophiles, since I'm constitutionally reluctant to replace any component of a satisfactorily operating home system. Indeed, I've been using the same Pickering 190 (long) arm for some seven years now, and for the last half of that period I've seldom shifted from the same maker's D-240 (thumbnail) cartridge. I don't think that I'm too prejudiced by familiarity to deny that there are other designs probably just as good (perhaps even better); it's merely that I've had no real incentive to make a change—none, that is, until the present irresistible temptation to determine for myself whether my old friends in the Pickering labs are justified in their claims of making further advances in the Unipoise arm and Fluxvalve cartridge.

I won't attempt to draw any immediate hard-and-fast conclusions, for in both theory and practice a prime tenet of my audio philosophy stipulates that any component (or complete system, for that matter) can be fairly judged only by extended familiarity, in *casual* as well as analytical listening, and on the widest possible variety of program materials. It's enough to say now that, after some preliminary comparative shifting back and forth between the old and new setups, I soon found myself sticking happily with the new one. Perhaps even more significantly, I began to forget entirely about specific response characteristics and was able to concentrate on the musical performances. This in itself is a kind of basic test for anyone who believes that the ideal in sound reproduction is the closest possible approach to *transparency* of the reproducing system—that good equipment, like good children, should be seen and not heard—and that in the end it should be the program only which commands one's full attention.

## Latest LP Samplers

The first programs for such attention this month are disc extensions of last month's survey of tape samplers, with which they compare favorably indeed in their complete omission of spoken announcements or blurbs, and their generally more compatible choices of selections. The comparison is considerably less favorable on the basis of recording-quality uniformity. London's 7 *Great Operatic Voices* (MS 3, \$1.98) is notable as the first miscellany of this kind directed primarily at vocally minded listeners, for it presents seven authentic stars in characteristic virtuoso arias, sung and recorded with extreme brilliance (but with excessive closeness and ultrasonance in the case of Siepi's *Don Giovanni* excerpt and Del Monaco's scene from *Norma*). But Tebaldi's "Pace, pace" from *Il Forza del*

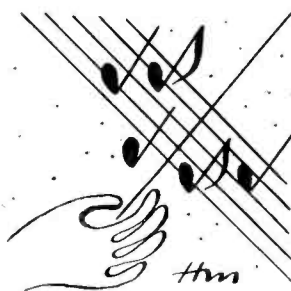

*Destino* alone would make this disc a not-to-be-missed musical as well as vocal treat.

The *Lyrichord Hi-Fi Sampler* (LLS 1, \$1.98) is another story, for, while the all-orchestral selections are certainly well off beaten programmatic paths, the recording qualities here are incredible unless they can be ascribed to faulty processing or as side effects of the atrocious performances themselves. I should mercifully pass this over in silence, since the Lyrichord catalogue includes a number of works (unrepresented here) which I have genuinely relished in the past. But, in the light of the record's claim to "hi fi," I can't forbear citing this as an almost ideal demonstration of everything that genuine high-fidelity recording is *not*. I can commend it only as a salutary reminder that, even in these days of generally high technical standards, it's

still possible to hear on occasion a complete travesty of instrumental sonorities.

On the other hand, the *Concert Hall Society Sampler* (CHS-SP-56, \$1.98) can be enthusiastically recommended, both for its far-ranging musical scope and, in at least two works (Vivaldi's blazing Concerto for Two Trumpets and Orchestra and the spirited Symphony No. 32 in G, K. 318, conducted by Ackermann and Bamberger respectively), for engineering which matches in every respect the artistry of the musicians themselves. Alexander Schreiner's Bach Toccata in F, S. 540, and Walter Goehr's Stravinsky *Firebird* Suite are also excellently recorded, but here the performances are more routine. The one real disappointment is the Franck *Symphonic Variations*; although the incredibly gifted young Philippe Entremont demonstrates again the virtuosity and delicacy which impressed me so powerfully in his recent Concert Hall stereo tapes, Bamberger's reading is awkwardly mannered and his Netherlands Orchestra is unpleasantly coarse-toned when not seemingly bodiless. Were it not for this mishap, the whole disc would rank close to the top of the sampler repertory to date; even with it, this is a brimful LP worth many times its bargain price.

## Opera for Nonoperagoers

In a kind of delayed double-take after mentioning the London demonstrator above, it suddenly struck me that, widely as my "sound fancies" may wander, they've seldom ventured into the favorite domain of innumerable listeners: the world of opera. This is partly a consequence of my own instrumentally oriented biases, of course, which in this respect at least are probably shared by most *sound* fanciers. I'm sure it also reflects the indisputable fact that opera recordings are infrequently used either to illustrate technical progress or to demonstrate the protean powers of the best home sound systems.

Opera fans may be able to advance some good reasons why this should not be so, but I'm afraid they'll find it difficult to counter the arguments that only exceptional recordings of complete operas are wholly successful, and that,

*Continued on page 37*

Why you need every feature of these

# NEW UNIVERSITY FOLDED-HORN ENCLOSURE KwiKits

Because... in performance, mechanical design, construction and ease of assembly, these new KwiKits are unquestionably the *very finest* enclosure kits—at any price!

KEN-12... for 12" speakers and systems

KEN-15... for 12" or 15" speakers and systems



MODEL KEN-12

## ROOM-BALANCED PERFORMANCE

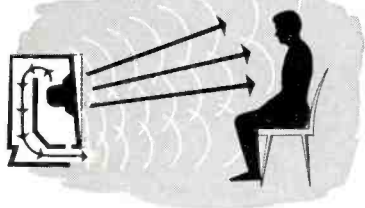

KwiKit acoustic design and tilted baffle combine direct speaker radiation and compensated rear horn loading in a way that blends bass, middle and treble ranges perfectly... for *uniform* response throughout the listening areas of a room.

## HEAVIER CONSTRUCTION

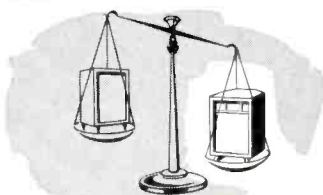

Heavy 3/4" first grade, fully cured lumber for top, bottom, sides and back... *not* flimsy 1/2" wood commonly used in "kits." Bigger, sturdier — *as much as 30% heavier* than others in the same price class. Eliminates spurious resonances so detrimental to achieving richer, cleaner bass reproduction.

## PRECISION MECHANICAL DESIGN

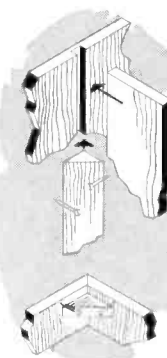

Exterior and interior elements, even the cleats, fit snugly with-in close tolerance "rabbeted" grooves. Gluing and screwing of each piece results in reliably air-tight, permanent joints. No nails used. No pencil markings necessary. Mitering and plenty of glue blocks and bracing for truly rigid construction.

## PLACE ANYWHERE IN ROOM

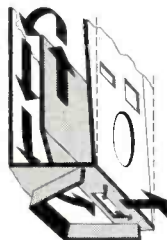

Underside view shows how advanced design, self-contained folded horn extends to the *front* of the cabinet, projecting low frequencies out into the room... not back into a corner, splashed against the walls. Small slot in base is resistively controlled vent which equalizes woofer diaphragm excursions in compression chamber. KwiKits

are therefore independent of room furnishings, shape or placement and can be used against a flat wall, in a corner... even up in the air!

## FOOLPROOF ASSEMBLY

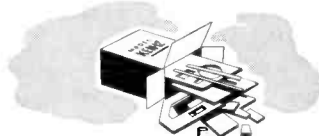

All pieces are pre-cut and pre-drilled... *engineered* to go together quickly. All you need is a screwdriver! Baffle board is pre-cut... blank plugs and adapters supplied for easy installation of additional components as your system expands.

Your KwiKit includes all required hardware, plastic wool, glue, sandpaper, Tufflex insulation, easy-to-follow instructions and... special attention is given to packaging of KwiKits to insure safe, intact delivery to your door.

## PROFESSIONAL RESULTS

### GENUINE KORINA VENEER

... for a luxurious finish in *any* desired color.

### DECORATIVE FRONT MOLDINGS

... designed to complement and enhance any decor.

### TEXTURED GRILLE FABRIC

... exquisite, and acoustically correct to prevent high frequency attenuation.

For any wide-range, coaxial, diffraxial or multi-speaker system... *if it's a kit that you want, it's KwiKit you need!*

LISTEN

University sounds better



KEN-12 15 1/2"D x 21 1/2"W x 29 1/2"H \$44.75 User Net  
KEN-15 18 1/2"D x 29 W x 35 1/4"H 59.50 User Net  
Adapter for mtg. 12" spkrs. in KEN-15 \$1.50 User Net

UNIVERSITY LOUDSPEAKERS, INC., 80 SOUTH KENSICO AVENUE, WHITE PLAINS, N. Y.

**KwiKits... the perfect complement for P.S.E.,**  
University's Progressive Speaker Expansion.

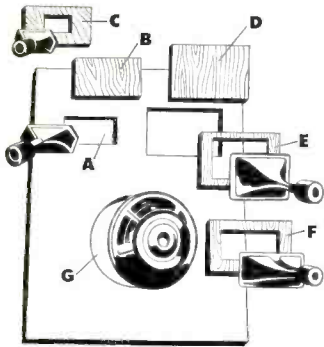

**MODEL KEN-12**

takes any 12" wide-range or woofer cone speaker and any tweeter or mid-range speakers

A—Hole cut out for HF-206. B—Blank plug supplied when tweeter isn't used. C—Adapter supplied cut out for UXT-5. D—Blank plug supplied. E—Adapter supplied cut out for 4409. F—Adapter supplied cut out for new H-600 horn. G—Takes 312, UXC-123, Diffusicone-12, UNC-122, Diffaxials, 6200, 6201 wide-range speakers and C-12W woofer.

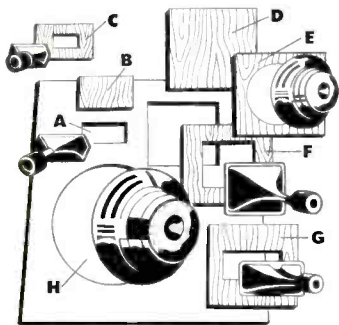

**MODEL KEN-15**

takes any 15" wide-range or woofer cone speaker and any tweeter or mid-range speakers

A—Hole cut out for HF-206. B—Blank plug supplied when tweeter isn't used. C—Adapter supplied cut out for UXT-5. D—Blank plug supplied. E—Adapter supplied cut out for C-8W or Diffusicone-8. F—Adapter supplied cut out for 4409. G—Adapter supplied cut out for new H-600 horn. H—Takes 315, 6303, Diffusicone-15 Diffaxials, and C-15W, C-63W, woofers.

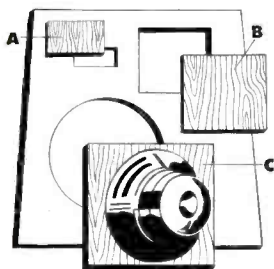

**MODEL KEN-15**

takes any 12" wide-range or woofer cone speaker when 12" adapter board (optional) is used

A and B—Blank plugs supplied. C—Takes 312, UXC-123, Diffusicone-12, UNC-122 Diffaxials, 6200, 6201 wide-range speakers and C-12W woofer.

**Remember... if you like to build your own and save money too, the KwiKit is made to order for you.**

**SEE YOUR DEALER TODAY!**

**SOUND FANCIER**

*Continued from page 35*

even in such rare instances, it is almost impossible to *isolate* suitable excerpts for sensationally effective display purposes. I first ran into the latter difficulty some years ago when I was preparing a program of outstanding recordings for an Audio Engineering Society section meeting. I had to pass up representing the finest all-round operatic release then available (and still one of the very best), Strauss's *Die Fledermaus* (London XLL-281/2). Any comparatively brief passage selected at random from it would be delightful to listen to, but that delight would be primarily musical, since the audio techniques involved are so completely self-effacing that they draw no special attention to themselves—a cause for the highest artistic praise, but hardly ideal for sheerly sonic impressiveness or system testing.

Now I've run into exactly the same problem with the superb current resurrection of Handel's almost forgotten Italian opera, *Sosarme* (Oiseau-Lyre OL 50091/2/3), which was recommended to me by a knowledgeable engineer-friend as the finest example of current recording excellence. After listening to it with unflawed delight throughout, I still wouldn't rate it that high technically, although it impresses me, too, as (within the limits of its material demands) technically perfect. I'd rather acclaim it as the finest current example of musical/technical *direction* than of recording per se. It's almost impossible to play in bits rather than as a whole, or for its sonic values alone, since the music and performance imperiously command one's full attention; the silkiness



of the little, mostly string, ensemble, the crispness of the harpsichord *continuo*, and the limpidity of the singing all are incidental, as it were. For sheer aesthetic pleasure this album is unsurpassed, but no entranced auditor ever will be able to listen specifically for technical details in either the recording or reproduction.

Fortunately, from the very selfish point of view of the sonic specialist, such matched artistic and technical triumphs are rare exceptions even in these days. Much more characteristic of normal operatic releases is Anton Paulik's Strauss *Gypsy Baron* (Vanguard VRS 486/7), which (as far as the score it-

self is concerned) is almost, if not quite, as musically attractive as *Die Fledermaus*, but which is sung here with merely routine Viennese vivacity and recorded with a bold clean strength, admirable enough in itself, but utterly lacking in the ingratiating warmth of the London *Die Fledermaus* LP's. So again the hi-fi fan, as such, is not likely to be particularly excited, even if he is sure to be haunted for weeks by the gay tunes themselves.

And unless he particularly fancies his own voice, he is hardly likely to listen more than a minute or two to the "do-it-yourself" Gilbert & Sullivan *H.M.S. Pinafore* excerpts (Concord 3001, with text and music booklet). The recording here is barely competent, and the Philharmonia Orchestra under Louis Shanks is far from that. Even the G & S amateur, for whom the disc is specifically intended, will be annoyed that the score is not more fully represented and (unless he is wholly incapable of carrying a tune) by the constant doubling of his own parts by a lugubrious bassoon, oboe, or horn "prompter." The basic notion of ready-made accompaniments is a good one, but Gilbert & Sullivan without gusto is a contradiction in terms.

**Oratorios, Cantatas, Folksongs**

I'm convinced that larger-scale, more frankly dramatic stage works than Handel's and Strauss's must wait for stereo for fully satisfactory recording or special sonic-demonstration effectiveness. This is true of oratorios too, or any works which call for big choral and orchestral ensembles, with or without soloists. Compare, for example, the 12 *Messiah* excerpts in Unicorn UNLP 1043 (drawn from the three-disc album UNS 1) with four of the same selections, plus two others, in the stereo tape BO 7-9 BN issued under the Boston label by Livingston. The former are fine by any ordinary standard, but how much they miss of the original Handel and Haydn Society (and Boston's Symphony Hall) sonorities can be realized only when one hears the difference stereo sound can make. I regret that the tape includes one unrepresentatively poor contralto solo and even more that it excludes the thrilling Gramm-Voisin "Trumpet Shall Sound," but both the soprano and tenor solos and the three choral sections (naturally including the "Hallelujah!" Chorus) are just about as electrifying as anything I've ever heard in home reproduction.

Yet even stereo can't work miracles. I strongly doubt that some future EMI tape of Sargent's misconception of the Handel *Israel in Egypt* (Angel 35386/7) can ever reconcile me either to his inexcusable cuts or tasteless tam-

*Continued on next page*

## SOUND FANCIER

*Continued from preceding page*

pering with the original scoring. The music itself—especially the double-chorus writing so characteristic of this particular oratorio—is Handel at his mightiest, but the typically British “devotional” performance here does it scant justice; even the best of single-channel recording can’t lighten its sonic murkiness, much less supply the magnificent breadth and weight it should have.

Where vocal LP’s are most satisfactory as a rule is in the less demanding repertoires for solo voice, with either small orchestral or single-instrument accompaniment. That this has been true for a long time is proved by two current reissues of older recordings which still sound admirable even to ears familiar with the finest present-day engineering achievements. Granted that the Archive processing of Fischer-Dieskau’s Bach Cantatas 56 and 82 (ARC 3058) is notably superior to the earlier Decca DL 9595 pressing, it’s still hard to believe that the original recording dates back to 1951, or that even today purer or sweeter justice could be done to the soloist’s eloquent baritone voice, the lilting oboe obbligatos, or Karl Ristenpart’s sensitive string and harpsichord accompaniments.

And in very different, earthier music, the oddly mannered, largely falsetto singing and the mountaineer-dulcimer strumming in *John Jacob Niles 50th Anniversary Album* (Camden CAL 330) hardly could be more authentically reproduced, despite the probability that this ballad and folksong miscellany dates from the 78 era. Certainly his earlier CAL 219 of *American Folk and Gambling Songs* does, for I still have most of its shellac originals packed away somewhere. If you’re unlucky enough never to have encountered this singular minstrel before, on or off discs, I suggest that you sample CAL 219 first, solely on the basis of its contents’ more piquant appeal. But unless you find his mannerisms intolerable (which some listeners do!), you’re likely to want both LP’s, and any other of Niles’s you can lay your hands on. You’ll never play them as sonic-display works, but for haunting entertainment they’re hard to beat.

### Orchestral Miscellanies...

Don’t worry; I’m not suddenly turning into an exclusively vocally oriented listener! But it’s good to get out of any aural rut at least occasionally, and I must concede that, for all my quibbling,

the best of the nonsymphonic, nondisplay works above may have temporarily dulled my taste for a batch of strictly instrumental grab-bag programs which in different listening sequences I might relish more than I do now. In each case, there’s little cause for criticism in the performances and no reservations to be drawn about the recordings. If something seems to be lacking, it must be that unanalyzable ability of some musicians to *project*—even via the long and heavily attenuating chain of intermediaries—a distinctive and magnetic personality.

In Felix Slatkin’s Hollywood Bowl Orchestra *España* (Capitol P 8357), an Iberian-flavored symphonic pops program including Ravel’s *Boléro* and *Alborado del gracioso*, Rimsky’s *Capriccio espagnol*, and the Albéniz-Arbós *Triana*, this seeming lack of personality probably is a result of the conductor’s leaning over backward to avoid the mannered idiosyncrasies which disfigure so many recorded interpretations of these war horses. Certainly the performances are extremely straightforward (for once Ravel will not turn in his grave over tempo accelerations or unsteadiness in the *Boléro*), while the recording is immaculately crisp and clean and bright.

In Joseph Levine’s Ballet Theatre versions of the Strauss-Dorati *Graduation Ball* and Meyerbeer-Lambert *Patineurs* ballets (Capital P 8360), equally well recorded if somewhat thinner in symphonic sonorities, the conductor seems more intent on playing for actual dancers than listeners whose toes can twinkle only in their imaginations. At any rate, his own personality contributes no further nuance to the kaleidoscopic scorings here.

In the fantastically misnamed *Light Music* Boyd Neel orchestral program (Unicorn UNLP 1038), we get some fine big massed-string sonorities (recorded by Peter Bartók in an unspecified Canadian auditorium) and an only too accurate impression of the conductor’s own skilled but too often characterless craftsmanship. However, his program materials are notably catholic, ranging from sentimentalities by Sibelius, Grieg, and Ole Bull (which I could easily skip), to the first recorded representation of the 18th century Johann Agrell, some lovely airs and dances by Arne, and some both novel and welcome bits of Handel’s seldom heard *Alcina* and *Faramondo*.

### ...And Instrumental Dittos

Yet, in general, I got much more of a kick out of the unabashed and oftentimes crude showmanship of another batch of instrumental *divertissements*,

in all of which the musical values are low-level at best, but to which the performers uninhibitedly communicate their own lusty zest, and the recording engineers no less gleefully let the decibels ring for all they’re worth. The most striking (and technically best controlled) of these is the hodgepodge program by the Coldstream Guards’ Regimental Band (Angel 35370), which not only features the expected fanfares and rousing marches, but also an amusing, if childish, piccolo solo and a Zez Confrey *Dizzy Fingers* floridly transcribed for massed clarinets, and even an incredibly lush Victorian Fantasia for bugle, organ, and band. Yet everything is played with verve and precision, while the recording itself has the same sensational brilliance and almost out-of-doors spacious clarity which bowled me over a year ago in the memorable Scots Guards Band debut disc (Angel 35271) that still serves as just about the finest all-around hi-fi LP “demonstrator” for stupifying unsuspecting visitors with the fully unleashed resources of my home sound system.

I have many more reservations about *Magoo in Hi-Fi* (RCA Victor LPM 1362), for here the brash recording strikes me as deliberately exaggerated, with probably boosted and certainly pretty shrill highs. Moreover, Dennis Farnon’s orchestra plays coarsely, as well as relying heavily on more often crude than ingenious “novelty” arrangements and sound effects. Much of the humor, too, is likely to be lost on anyone unfamiliar with the incomparable UPA film-cartoon misadventures of Magoo and his mother. Nevertheless, as a travesty on the errors and joys of many a blundering hi-fi novice, there are some very funny—as well as ear-searing—moments here.

The musical appeal of Joe Basile’s *Rome With Love* (Audio Fidelity AFLP 1822) is likely to be confined to accordion fanciers, and that of *The Dukes of Dixieland*, Vol. 2 (Audio Fidelity AFLP 1840), to not-too-discriminating Dixieland fanciers for whom energy is more important than subtlety. But if you want to study virtuoso accordion techniques or to check your system’s capacity for handling razor-sharp and explosive transients, you can hardly find anything more rigorously effective than *La Piccinina* and the other lively pieces in the former; while the fast-and-furious banjo scrabbling and tuba grunting in the latter’s *Dill Pickles*, *Mama Don’t ‘Low*, and *Ain’t She Sweet?* will give your ears, no less than your electronic equipment, the most bracing of spring workouts.

### Gold-Star Documentaries

Finally, a couple of sonic documents which impressed me as far transcending the usual one-play-only interest of most of their general kind. One is *The Auto-*





mobile: *Sounds of 50 Years* (Unicorn UDS 1) which is guaranteed to bring nostalgic tears to the eyes of old-car aficionados, both by its handsome pictures and fantastically diversified authentic sounds. Unlike the earlier Watkins Glen racing disc from Folkways, I found this consistently absorbing throughout — not least in its magnificent evocations of a Stutz "Bulldog's" brute power and the never matched excitements of setting out cross-country in that trackless locomotive, the Stanley Steamer. The old transient master, Peter Bartók, adds a few new technical laurels for his recordings here, and in addition reveals an unsuspected versatility in his engaging driver interviews.

The other is a unique sonic storybook recreating the legends, humor, and lore of the Mississippi: *Steamboat 'Round the Bend* (Folkways FP 74), which brings the noted author, Ben Lucien Burman, into one's living room to ramble on informally and delightfully in a session which surely must be the next thing to having been entertained by Mark Twain himself. Burman must share honors here with Eddie Manson's harmonica interludes and incidental aural scene settings, themselves poignant evocations of the Father of Waters's eternal magic and, as perfectly recorded here, the most convincing evidence I have ever heard of this too often misused and underestimated instrument's delicately poetic tonal qualities.

## TURNTABLE BASE

*Continued from page 25*

ished in the manner described above. After the rubber blocks were cemented to the tops of the corner blocks, the base and turntable were assembled and leveled for operation.

The design for this turntable base is simple, yet rugged enough to conform to the requirements of a transcription turntable. Extraneous noise is eliminated by the rubber-damped "floating mount," which also leaves space between the top of the base and the mounting board for escape of heat from the turntable motor. All the work can be done with hand tools. Mitered joints can be used at the corners of the base section, but were dispensed with in this instance because the black color concealed any edge grain. Exclusive of finishing materials, the total cost was less than \$5.00. This design is suitable for use with a tone arm for 16-inch records; it is merely necessary to increase the over-all dimensions to 18 in. by 20 in. With the variety of finishing techniques available, and the variety of woods that can be used, there is scarcely any limit to the aesthetic possibilities of a project like this.

# Look over the BEST BUYS in HI-FI ... from EICO®



HF60, HF50



HF61



HF20

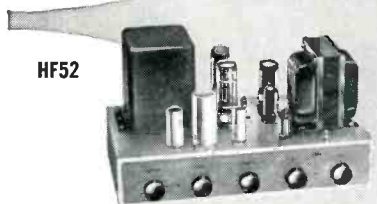

HF52



HF12



HF51

EICO is a pioneer (1945) in kit test equipment — leads the industry in distributor sales to trained and critical users.

EICO has achieved this acceptance because

- EICO engineering policy is to stress electrical and mechanical quality, soundness and functional completeness.
- EICO prices are low because they are justly related to costs and geared for volume sales.

The same engineering and price policy underlies all EICO high fidelity equipment. You can examine and compare EICO at any of the 1200 neighborhood distributors and hi-fi specialists throughout the U.S. Judge EICO's claims for yourself before you buy.

Write for FREE Catalog AC-7.

### HF61 Master Control PREAMPLIFIER

KIT \$24.95 WIRED \$37.95  
with Power Supply: KIT \$29.95 WIRED \$44.95

Does not add distortion or detract from wideband or transient response of finest power amplifiers at any control settings. High-quality feedback circuitry throughout & most complete control & switching facilities. Feedback scratch & rumble filters, equalizations, tone controls. Centralab Senior "Compentrol" loudness control, concentric level control. 4 hi-level, 2 lo-level switched inputs. Extremely flat wideband freq resp:  $\pm 0.3$  db 12-50,000 cps. Extremely sensitive. Negligible hum, noise, harmonic or IM distortion. 4-7/8" x 12-5/16" x 4-7/8". 8 lbs.

### HF60 60-WATT Ultra-Linear POWER AMPLIFIER with ACRO TO-330 Output Transformer

KIT \$72.95 WIRED \$99.95

EF86 volt ampl direct-coupled to 6SN7GTB K-coupled phase inverter driving two U/L-connected p-p EL34 output tubes. GZ34 extra-rugged rectifier. Rated output: 60 w (130 w pk). IM Distortion: less than 1% at 60 w; 0.5% at 50 w. Harmonic Distortion: less than 0.5% from 20-20,000 cps within 1 db of rated power. Sine Freq. Resp: at 1 w:  $\pm 0.1$  db 15-35,000 cps at any level from 1 mw to rated power. Square Wave Resp: excellent 20-25,000 cps; 3 usec rise-time; Sens: 0.52 v for 60 w. 7" x 14" x 8". 30 lbs. Matching Cover E-2, \$4.50.

### HF50 50-WATT Ultra-Linear POWER AMPLIFIER

KIT \$57.95 WIRED \$87.95

Extremely high quality output transformer with extensively interleaved windings, 4, 8, and 16-ohm speaker taps, grain-oriented steel, fully potted in seamless steel case. All other specs equivalent to HF60 but on 50 w level. Matching cover E-2, \$4.50.

### HF20 20-WATT Ultra-Linear Williamson-type INTEGRATED AMPLIFIER complete with Preamplifier, Equalizer & Control Section

KIT \$49.95 WIRED \$79.95

Sets a new standard of performance at the price, kit or wired. Rated Power Output: 20 w (34 w peak). IM Distortion: 1.3%. Max Harmonic Distortion: below 1%, 20-20,000 cps. within 1 db of 20 w. Power Resp (20 w):  $\pm 0.5$  db 20-20,000 cps; Freq Resp (1/4 w):  $\pm 0.5$  db 13-35,000 cps. 5 feedback equalizations. Low-distortion feedback tone controls. 4 hi-level & 2 lo-level inputs. Conservatively rated, fully potted output transformer: grain-oriented steel, interleaved windings. 8 1/2" x 15" x 10". 24 lbs. Matching Cover E-1, \$4.50.

### HF52 50-WATT Ultra-Linear INTEGRATED AMPLIFIER complete with Preamplifier, Equalizer & Control Section

KIT \$69.95 WIRED \$109.95

Power amplifier section essentially identical to HF50, including output transformer, GZ34 rectifier, etc. Includes all-feedback equalizations (5 pos.) & tone controls. Centralab loudness control & separate level control that does not affect response at any setting. Cathode follower output to tape. Correct input loading for new ceramics. Zero cross-talk Bi-amplification input & output facilities. 8 1/2" x 15" x 10". Matching Cover E-1, \$4.50.

### HF12 12-WATT Williamson-type INTEGRATED AMPLIFIER KIT \$34.95 WIRED \$57.95

Complete with Preamplifier, Equalizer & Control Section. Equalized direct tape head & magnetic phono inputs. Power Output: 12 w cont., 25 w pk. IM Dist.: 1.3% @ 12 w. Freq. Resp.: 1 w:  $\pm 0.5$  db 12-75,000 cps; 12 w:  $\pm 0.5$  db 25-20,000 cps. 2-EL84, 3-ECC83/12AX7, 1-EZ81.

### HF51 TWO-WAY SPEAKER SYSTEM \$39.95 Complete with FACTORY-BUILT CABINET

Jensen heavy-duty 8" woofer & matching Jensen compression-driver exponential horn tweeter. Smooth clean bass & crisp, extended natural highs. Overall response:  $\pm 6$  db 70-12,000 cps. Power-handling capacity: 25 w. Impedance: 8 ohms. Bookshelf size: 23" x 11" x 9". 25 lbs. Wiring Time: 15 min.

### EICO® Brooklyn 11, N. Y.

AC-7

Please send FREE catalog & name of neighborhood distributor or hi-fi specialist.

NAME .....

ADDRESS .....

CITY ..... ZONE ..... STATE .....

Prices 5% higher on West Coast

## TEST INSTRUMENTS

Continued from page 19

where  $f_x$  = the unknown frequency,  $f_h$  = the horizontal reference frequency,  $L_h$  = the number of horizontal loops, and  $L_v$  = the number of vertical loops.

Substituting the values given in the example, we find

$$f_x = \frac{5 \times 60}{3} = 100 \text{ cps}$$

Knowing this frequency, we could then easily tune a band-rejection filter to it and eliminate the hum.

Lissajous figures may also be used to calibrate an audio generator at the lower frequencies. Again, the use of the 60-cps reference standard is useful, because power companies are exceedingly particular in maintaining this frequency within very close tolerance. Most scopes have provision for switching the power frequency to the horizontal plates internally, but, for instruments not having this feature, the simple setup shown in Fig. 2 may be used. In this case a small isolation coil, such as a filament transformer, is used to apply the horizontal signal. A rheostat may also be necessary to step down the voltage even further.

In either arrangement, the audio generator output is connected to the vertical plates, and the Lissajous patterns noted as the generator frequency is varied. A number of check points can be noted on the generator dial as you swing through the various combinations. Since around eight loops is just about the useful maximum (above this, the number is too difficult to count accurately) the highest calibrated frequency possible with this method would be 480 cps, at the 8:1 ratio.

With a half dozen or so check points up to nearly 500 cps, though, it can usually be assumed that the rest of the generator range is fairly accurate. If a more precise check is desired, it can easily be obtained through the use of a second calibrated generator as a standard. In this case, the internal sweep would probably be used for horizontal deflection, while the calibrated generator would be connected to the vertical input. Then the generator is set to any desired frequency and the sweep adjusted for a convenient pattern, such as two or three complete cycles. The standard genera-

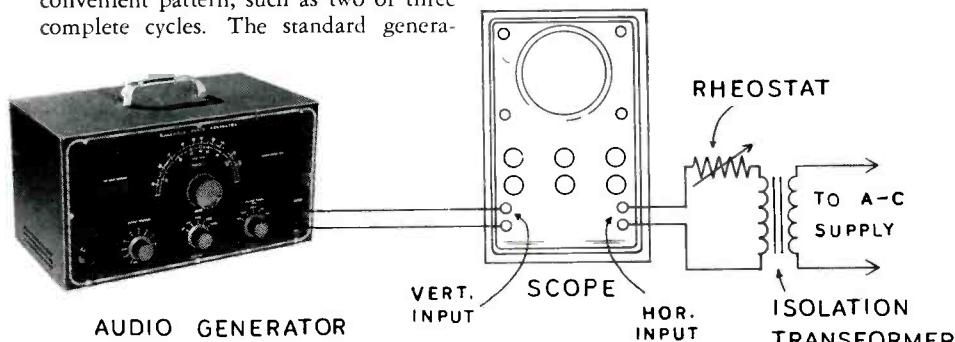

Fig. 2. Setup for calibration of audio oscillator by means of Lissajous patterns.

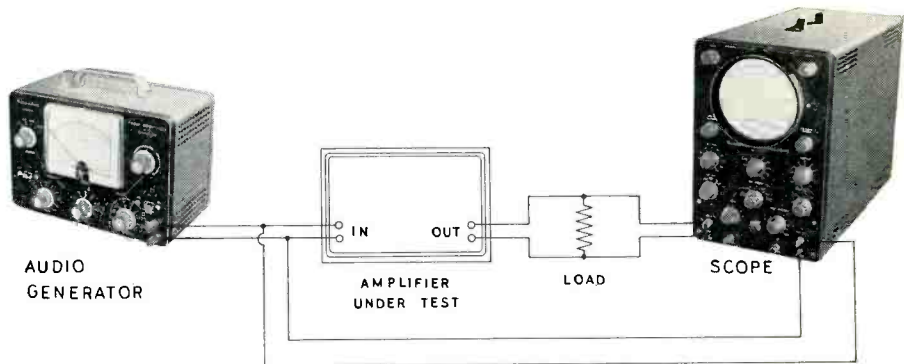

Fig. 3. In this arrangement, a sine-wave test signal applied to an amplifier is also used as a reference input to the scope's horizontal deflection plates. The amplifier's output, applied to the vertical plates, shows clearly any phase shift.

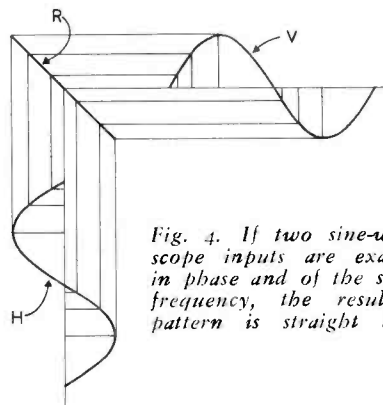

Fig. 4. If two sine-wave scope inputs are exactly in phase and of the same frequency, the resultant pattern is straight line.

tor is then disconnected from the vertical, and the generator being calibrated is connected in its place.

The latter instrument is then adjusted until the pattern on the scope is identical to that seen when the standard generator was in the circuit. At this point it is known that the second generator output is identical in frequency and voltage to that of the standard. By this method it is possible to run through the complete ranges of the instruments, verifying as many check points as desired.

The oscilloscope is also extremely useful in showing up phase distortion in an amplifier. It should be understood

first that phase distortion does not refer simply to the phase reversals that a signal goes through in passing through an amplifier. Rather, it refers to phase shifts which occur by differing amounts at various frequencies.

If we were to find, for example, that the output signal of a given amplifier was displaced from the input by, say,  $180^\circ$  at all frequencies, this would be of no great consequence and no phase distortion would be said to be present. But if we were to find, for example, that the phase angle is  $135^\circ$  at 60 cps,  $150^\circ$  at 120 cps, and  $160^\circ$  at 240 cps, then these lower frequencies either lead or lag one another, and phase distortion is definitely present.

You will recall that the circular scope pattern of Fig. 1 occurs when identical voltages are applied to each set of plates with a phase difference of  $90^\circ$  between them. Now let's see what happens when we apply identical voltages to each set of plates *without* any phase difference. The resultant under these conditions is developed geometrically in Fig. 4. We can see that this resultant is simply a straight diagonal.

Since a phase displacement of  $90^\circ$  develops a circular pattern, while a phase difference of  $0^\circ$  exhibits a diagonal line,



Fig. 5. Lissajous patterns for sine waves of same frequency and amplitude, with the phase relationships shown. These patterns can be used for rough estimates.

it is reasonable to assume that other phase angles between these two will produce patterns somewhere in between. This is actually the case, as shown by the typical examples in Fig. 5. Here we see that, except at the cardinal points of the compass, the pattern is an ellipse whose shape and direction are determined by the phase angle.

In an audio amplifier, phase shift is usually most troublesome at the lower frequencies. For this reason it is customary to start a phase-shift test at the upper end of the spectrum and work

down. We will use the Lissajous figures developed on the screen through the setup shown in Fig. 3. The frequency ratio is kept at 1:1 throughout the test, since the same signal is applied to both sets of plates.

The output of the audio generator is fed simultaneously to both the amplifier under test and to the horizontal input of the scope. The generator level is of course held low enough to avoid overload distortion in the amplifier. At the output of the amplifier is a dummy load, usually a resistor of the same number of ohms as the speaker impedance. Across this load are connected the vertical-input terminals of the scope. A graduated grid scale over the face of the tube will greatly enhance the accuracy of the measurements. With these preparations completed, the specific test procedure is as follows:

- 1) Allow adequate time for all three pieces of equipment to warm up.
- 2) With the generator output level turned down all the way, adjust the scope controls so that the spot is in the exact center of the screen.
- 3) Turn up the generator level to the usual input for the amplifier under test. Do not overdrive the amplifier.
- 4) With the HORIZONTAL GAIN set at zero, adjust the VERTICAL GAIN for a convenient pattern height, usually about half of the screen diameter.
- 5) Note the exact pattern height on the graduated scale, and note the dial setting of the VERTICAL GAIN control.
- 6) Turn the VERTICAL GAIN back to zero, and bring up the HORIZONTAL GAIN to give a pattern width the same as the height noted in step 5.
- 7) Turn the VERTICAL GAIN control back up to the setting noted in step 5.
- 8) Keeping the generator output at a constant level, vary its frequency from the top of the audio spectrum to the bottom frequency claimed for the amplifier, comparing the Lissajous figures with those in Fig. 5.

Remember that it is only the *change* in the shape of the pattern which indicates phase distortion. As long as the shape remains constant, you are assured that the phase difference between input and output is also constant. In this case it is not especially important what that phase difference is. And if the phase shift throughout the range never varies more than ten or fifteen degrees, the phase distortion can be regarded as negligible.

For a more accurate measurement of phase displacement than comparison with Fig. 5, a simple mathematical calculation is possible. Referring to Fig. 6, the distance *A* is measured on the grid screen from the horizontal axis to the intersection point of the pattern with the vertical axis. The distance *B* is the

*Continued on next page*



ON ONE COMPACT CHASSIS! FISHER FM-AM TUNER, AUDIO CONTROL AND 30-WATT AMPLIFIER!

**New!**

EVERYTHING YOU NEED!  
ON ONE SUPERB CHASSIS!

# THE FISHER "500"

THOUSANDS have asked us for it—and here it is! An extreme-sensitivity FM-AM tuner, a powerful 30-watt amplifier, and a Master Audio Control—all built on one compact chassis. Simply add a record changer and loudspeaker to the FISHER "500" and, as easily as that, you have a complete high fidelity system. Its quality—in the finest FISHER tradition. Its appearance—the timeless beauty of classic simplicity. Here is the most economical form in which you can own FISHER equipment.

Chassis Only, **\$249.50**  
Mahogany or Blonde Cabinet, **\$19.95**

### Outstanding Features of THE FISHER "500"

- Extreme sensitivity on FM and AM. Meter for micro-accurate tuning. ■ Full wide-band FM detector for maximum capture ratio. ■ Powerful, 30-watt amplifier; handles 60-watt peaks. ■ Uniform response, 16 to 32,000 cycles. ■ 4 inputs, including separate tape playback preamp-equalizer. ■ 4, 8 and 16-ohm outputs match all existing speakers. ■ Recorder output ahead of volume and tone controls. ■ 7 Controls, including 9-position Channel Selector (AM, FM, AES, RIAA, LP, NAB, TAPE, AUX 1 and AUX 2), Loudness Contour (4-position), Volume, Bass, Treble, AC-Power, Station Selector. ■ Beautiful, die-cast, brushed brass escutcheon and control panel. ■ Pin-point, channel indicator lights. ■ Smooth, flywheel tuning. ■ Largest, easy-to-read, slide-rule dial, with logging scale. ■ High efficiency FM and AM antennas supplied. ■ 14 tubes plus 2 matched germanium diodes. ■ SIZE: 13 7/16" w. x 12 3/4" d. (excluding knobs) x 6 1/2" high.

WRITE TODAY FOR COMPLETE SPECIFICATIONS

**FISHER RADIO CORP., 21-31 44th DRIVE • L. I. CITY • N. Y.**



The "King of Instruments"—an Aeolian-Skinner organ installation.

The sound of the organ is one of the most difficult to reproduce, because of its wide tonal and dynamic range, and because of the large amount of fundamental energy that appears at extreme bass frequencies.

At a recent public demonstration, staged by the Audio League at St. Mark's Church, Mt. Kisco, N. Y., the recorded sound of an Aeolian-Skinner organ (from stereo tape) was instantaneously alternated with that of the "live" instrument. The reproducing equipment selected included four AR-1 speaker systems. Here is some of the press comment on the event:

*The Saturday Review* (David Hebb)

"Competent listeners, with trained professional ears, were fooled into thinking that the live portions were recorded, and vice versa. . . . The extreme low notes were felt, rather than heard, without any 'loudspeaker' sound. . . ."

**AUDIO** (Julian D. Hirsch)

"Even where differences were detectable at changeover, it was usually not possible to determine which sound was live and which was recorded, without assistance from the signal lights. . . . facsimile recording and reproduction of the pipe organ in its original environment has been accomplished."

**audiocraft**

"It was such a negligible difference (between live and recorded sound) that, even when it was discerned, it was impossible to tell whether the organ or the sound system was playing!"

The price of an AR-1 two-way speaker system, including cabinet, is \$185.00 in mahogany or birch. Descriptive literature is available on request.

**ACOUSTIC RESEARCH, INC.** 24 Thorndike St., Cambridge 41, Mass.

## TEST INSTRUMENTS

*Continued from preceding page*

maximum height of the pattern above the horizontal axis. The axes of the ellipse must pass through point O. This condition will be met if step 2 of the procedure has been followed. With these definitions in mind, the formula for the calculation of the phase angle is:

$$\sin \theta = \frac{A}{B}$$

To try this out in practice, let's suppose that we observe an ellipse in which *A* equals 6 units on the calibrated screen,

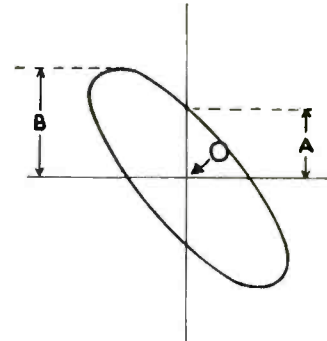

Fig. 6. How to determine exact amount of signal phase shift:  $\sin \theta = A/B$ .

while *B* measures 10 units. The fraction would then be 6/10, and the sine of the phase angle would be 0.6. Referring to a trigonometry table we find that the angle would equal approximately either 37° (or 322°) or 142° (or 217°). Referring to Fig. 5, we can immediately eliminate one pair of these numbers by observing the direction in which the pattern leans. If the top leans toward the left, the angle is either 37° or 322°. If it leans to the right, the angle is either 142° or 217°. It is not too important which of these two figures is taken as the correct one, for we are still interested only in the *change* in this angle with varying frequency.

Checking a little further, we can see that, in the case of the diagonal-line pattern, *A* would measure zero and *A/B* would likewise be zero. The trig tables tell us that a sine of zero corresponds to an angle of 0° or 180°, which confirms the patterns of Fig. 5. Similarly, in the case of the circular pattern, *A* would be identical to *B*, and *A/B* would equal 1. This is the sine of an angle of 90° or 270°, again as shown in Fig. 5.

Next month we'll conclude our discussion of oscilloscopes in audio work.

## GROUNDED EAR

*Continued from page 4*

Exhibition in Washington late in March, I found in the booth of the Irish Tape people a novelty which became quite an attraction and provoked considerable thought. This was a "Stereophonic Lis-



Fig. 2. The "Listening Chair" in action.

tening Chair"—a big wing chair with two oval speakers concealed in the ear-level wings (Fig. 2). The speakers were fed individually from the two tracks of stereophonic tapes, at very low volume levels, so low that sound was all but inaudible to anyone not sitting in the chair. Each speaker was 8 or 10 in. away from the ear of a person sitting in the chair. The quality was not first-class hi fi, since neither the speakers nor the associated amplifiers were up to hi-fi standards, but the stereo effect was very marked and, because of the close association of speakers to ears, far less subject to the shifting and crossing-over effects which may occur when the speakers are 8 ft. or more away from the listener.

The "Stereophonic Listening Chair" was designed by Mark Mooney, editor of *Hi-Fi Tape Recording*, and is going to be manufactured by the Chesapeake Stereo Products Company of Severna Park, Maryland.

The idea of a "Listening Chair" may sound like an amusing novelty, but it has been, for me, the subject of considerable cogitation. Our hearing is binaural, rather than stereophonic. It is possible to reproduce sound binaurally, and such reproduction gives an extremely high degree of realism. The Museum of Science & Industry in Chicago used to (and may still) have an exhibit demonstrating binaural reproduction with astonishing fidelity. In this exhibit small microphones are positioned in a dummy head at the ear positions, duplicating the

pickup of the ears. Unfortunately, binaural reproduction requires also that headphones be used to transfer the reproduced sound to the ear, and there is the rub; headphones are uncomfortable and very few people are willing to wear them for long periods. The Stereophonic Wing Chair is a way of reproducing binaural sound without headphones. Since a separate chair would be necessary for each listener, I shouldn't imagine that this method of binaural reproduction would have a very large market. It occurred to me, though, that the possibility might be worth investigating, and I pass the idea on to those who may be interested.

### ADD A TWEETER

*Continued from page 27*

inexperienced user to assume that the greatest energy distribution is in this direction. The reverse is actually the case.

Since a diffraction grating is a frequency-sensitive device, the *actual* dispersion angle of such a horn will vary with frequency. As the frequency of sound increases, its wave length decreases; and, as the wave length becomes shorter and shorter, it becomes an increasingly larger fraction of the diffracting slit. This reduces the efficacy of diffraction, and the dispersion angle decreases. It should be noted, however, that this type of horn avoids the irregularities of the multicellular type and gives relatively smooth response within its operating range.

In appearance and in theory of operation the acoustic lens is by far the most complex of the tweeter family. As Fig. 6 shows, the flared horn works into a

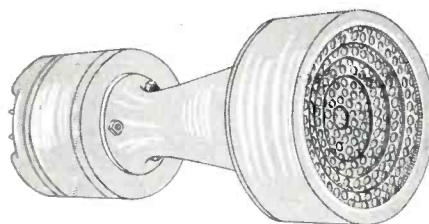

Fig. 6. Tweeter horn with acoustic lens.

chamber in which there are a number of perforated plates spaced one behind the other. Each plate has a larger hole that is cut in the center; these are graduated in size from back to front. To gain a physical appreciation of the way in which this tweeter operates, consider that the sound impinging upon the first perforated screen has a plane (flat) wave front. As the sound passes through each screen it does so only through the perforations, which are not aligned in successive screens, or through the central hole. If it goes through the perforations, it must make one or more reflections, which delay it in respect to sound at

*Continued on next page*

# AR-1

**W**HEN the AR-1 speaker system first made its appearance on the hi fi market, our published specifications were sometimes greeted with skepticism; for a speaker to perform as claimed, particularly in such a small enclosure, was contrary to audio tradition.

Now, two years later, the AR-1 is widely accepted as a bass reference standard in both musical and scientific circles. There is general understanding of the fact that, due to the patented acoustic suspension design, the small size of the AR-1 is accompanied by an advance in bass performance rather than by a compromise in quality.

# AR-2

The AR-2 is the first application of the acoustic suspension principle to a low-cost speaker system. Prices are \$89 in unfinished fir cabinet, \$96 in mahogany or birch, and \$102 in walnut.

We would like to suggest, as soberly as we invite comparison between the AR-1 and any existing bass reproducer, that you compare the AR-2 with conventional speaker systems which are several times higher in price. No allowances at all, of course, should be made for the AR-2's small size, which is here an advantage rather than a handicap from the point of view of reproducing quality.



Literature is available on request.

**ACOUSTIC RESEARCH, INC.**  
24 Thorndike St., Cambridge 41, Mass.

## ADD A TWEETER

*Continued from preceding page*

the center of the screen passing through the large hole unobstructed. The closer it is to the outside edge of the lens, the more screens a sound must go through to reach the front, and the more reflections it must make in doing so. Thus there is a progressively greater delay from the center to the edge; the plane wave is gradually transformed into a spherical wave. Since the design parameters of the acoustic lens are frequency-dependent, the energy distribution in the wave front will change with frequency. Since this type of lens is radially symmetrical, there is as much vertical as horizontal dispersion.

In the reciprocating-flare<sup>8</sup> horn, Fig. 7, wide-angle coverage is achieved by carefully controlling the *pressure gradient* within the horn. The reciprocating flare may be considered to consist of two flare sections at right angles following one another. In the first section there is a sharp flare in the vertical direction, but a narrow parallel-walled chamber in the horizontal direction. Hence high sound pressure is built up in the horizontal plane and diminishes rapidly in the vertical plane. About half-

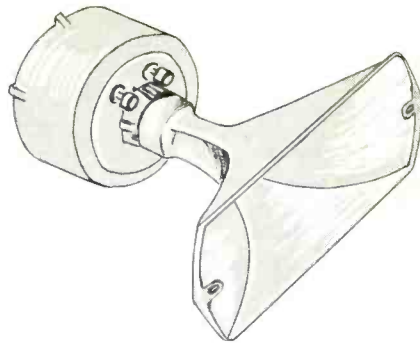

Fig. 7. Reciprocating-flare horn unit.

way down the total length of the horn, the process is completely reversed; there is little further expansion in the vertical plane, but the high side-pressure wave of the first section now expands freely in the horizontal direction. The mouth of the horn is intentionally made too wide in the vertical dimension to act as a diffraction aperture. This results in a concentration of energy in the horizontal plane, and increased useful efficiency of the tweeter. There is a uniformly wide angle of coverage over the entire high-frequency spectrum.

*Part 2 of this article will appear next month.*



<sup>8</sup>Abraham B. Cohen, "Wide-Angle Dispersion of High-Frequency Sound"; *Journal of the Audio Engineering Society*, IV (May 10, 1952).

## Send now for FREE NEW HIGH FIDELITY CATALOG:

Here's a *special* high fidelity catalog that you'll find particularly useful, because we have included *only* equipment which we at MusiCraft consider the best—from the standpoint of compatibility and stable operating efficiency—in every price range.

Page after page pictures the newest high fidelity equipment with detailed information about characteristics and specifications.

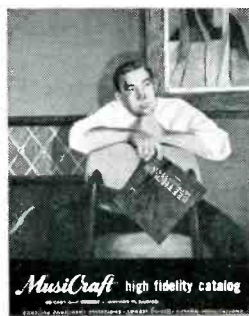

# MusiCraft

48-F East Oak St. • Chicago 11, Illinois • DELaware 7-4150

Lowest Prices • Largest Component Selections • Complete Custom Installation Service

## LONDON FAIR

*Continued from page 21*

a nice one which might be of some interest in the United States: Model S6BS. It is similar to the Model S5, which is now being imported, except that it does not include FM and does include two stages of IF for better sensitivity; also, it provides band-spread tuning on the major shortwave broadcast bands. Readers write us from time to time about such tuners.

More sidelights: G. A. Briggs, of Wharfedale fame, has now gone the complete circle. Having started loud-speaker life with open-backed cabinets, he became a strong proponent of the bass-reflex type. He still is, but what do you suppose he demonstrated at the Fair? An open-backed cabinet! The only hitch was that the sound was clean and smooth, with no trace of cabinet resonance. We asked Mr. Briggs how he was going to overcome the horror held by hi-fi enthusiasts for open-backed jobs, and why his system sounded so good. "There have been improvements," he said, "in amplifiers and speakers, since the early open-backed cabinets. Doesn't the sound prove it?"

Sound Sales, Ltd., makers of the Tri-Channel system, brought out a neat tape record-playback preamplifier which equalizes for either the CCIF or the NARTB/Ampex characteristic. It would be useful with several of the new tape decks. Incidentally, the Tri-Channel control unit has been modified to provide a better match with American pickups.

Two generalizations: most British control units provide high-frequency cutoff filters, some with variable activity or effectiveness. This apparently stems from the fact that there are still many 78-rpm records in England and in the countries to which it exports. And most British amplifiers are low-power units, compared to recent production in the States. Several manufacturers showed 5-watt amplifiers; 10 and 12 watts were common. Not many units went much above 20 watts. The emphasis is not on power but on stability and clean watts.

From the industry point of view, it would appear that the English public is beginning to feel in its veins the first stirrings of hi-fi fever. High fidelity has been a hobby in Great Britain for many years, but interest seems to have been limited to the dedicated enthusiast. Meantime, in the United States, the hobby came of age and became an industry and is approaching a way of life. This process is just starting in England, but there is no doubt that the public, the layman, is catching the fever. Last year's audio fair in London was a success; this year's was even better.

*Postscript:* for the final in fidelity we

attended a concert at the Royal Festival Hall. Much has already been written about this wonderful structure of lightness and beauty, so let this be only a reminder that no reader of AUDIOCRAFT, visiting London, should fail to experience the remarkable acoustics of this hall. One has the sensation of hearing into the music, of being able to pick out and examine each note of each instrument, in a way that is most unusual and exciting.

## EICO HF-60

*Continued from page 23*

our kit, only the 10-K unit was marked for value. Of the other two, the one with the blue plastic shaft was 50 K, and the one with the metal shaft was the 1-megohm input level control.

Page 5C, step 7. None of the nuts supplied with our kit fitted the output-transformer mounting bolts. We fretted for only a short time before we discovered that nuts were already on the mounting bolts, turned up tightly against the case! Simply remove them and there are your mounting nuts.

Page 11C, step 3. The 18-K resistor lead should be soldered to both XV2-3 and XV2-6.

It took us 9 hours for the job, from checking the parts against the parts list to the final adjustment. The amplifier worked perfectly the first time we turned it on, and has been working continuously for three weeks since then without failure, which would seem to indicate that no parts were defective. It is stated clearly in the instruction book that defective parts will be replaced if returned within 90 days; that service consultation by mail is available; and that, if all else fails, the amplifier will be repaired at the factory for a nominal charge (provided certain reasonable conditions are met).

### AUDIOCRAFT Test Results

Some of the more important manufacturer's specifications not stated previously are given below:

**IM distortion** (60 and 6,000 cps, 4:1). Below 1% at 60 watts; below 0.5% at 50 watts.

**Undistorted sinusoidal frequency response.**  $\pm 0.5$  db, 5 cps to 100 Kc, at 1 watt;  $\pm 0.1$  db, 15 cps to 35 Kc, at any level from 1 mw to 60 w; no peaking outside audio range.

**Sensitivity.** 0.52 v for 60 w.

**Hum.** 90 db below rated output.

**Damping factor.** Above 12 from 20 cps to 20 Kc.

**Size.** 7 in. high by 14 in. wide by 8 in. deep.

**Load impedances.** 4, 8, and 16 ohms.

Fig. 2 is a chart of IM distortion vs. power output for our HF-60. It should be noted that no attempt was made to

match, switch, or select tubes for minimum distortion; the tubes supplied were inserted in their sockets, BIAS and BALANCE controls were adjusted as directed in the instructions, and tests were made after two weeks of amplifier use. Our test frequencies were 60 and 7,000 cps, and our AC line voltage was 110 v, both tougher conditions than the specifications were prepared for. Yet the specs are clearly exceeded in our test, so far as IM is concerned. As a matter of fact, many amplifiers are rated at the 2% IM point—and that occurs at about 66 watts in our HF-60.

As far down and as far up as we are equipped to measure, the frequency-response specifications were met easily. Square-wave response was nearly perfect with any kind of load: resistive, inductive, or capacitive. The only way we

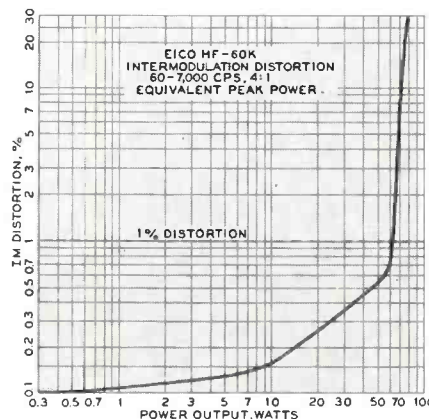
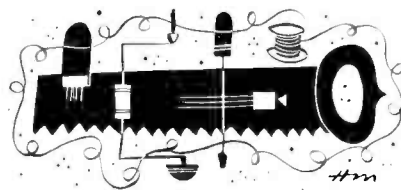

Fig. 2. IM distortion vs. power output for the EICO HF-60 power amplifier.

could make the amplifier show noticeable high-frequency ringing was to operate it with *no* load at all. Low-frequency stability was excellent also.

Our measured sensitivity was 0.50 v input for 60 w output. Hum and noise, with correct setting of the BALANCE control, was almost incredibly low: better than 100 db down from 60 w. We found the damping factor to vary between 13 and 19 over the range from 20 cps to 20 Kc.

Listening tests confirmed the fine instrument test results without question. Our HF-60 produced firm, well-defined bass and clear, sweet treble on the finest speaker systems available. It clipped momentary overloads very well and recovered quickly, and this gave listeners the impression of tremendous reserve power. In our opinion, it is one of the best-performing amplifiers extant; it is obviously an excellent buy.



# BUILD THE SUPERB PERI-50

50 WATT—  
100 WATT PEAK



**\$69.75**  
CALIF. RESIDENTS  
ADD 4% SALES TAX

*Now* YOU can re-create in your own home the breathtaking realism in sound that has been known only to design engineers!

The PERI-50 engineering is "built in" through the revolutionary new deep-etched copper circuit board—a development of Printed Electronic Research Inc.

The DEEP-ETCHED copper circuit board replaces all wiring and guarantees that every PERI-50 AMPLIFIER built will perform exactly like the laboratory original—whether built by amateur, audiophile or electronic engineer!

**EVERYTHING PROVIDED**—including an Ungar soldering iron and solder! All components literally "plug in" to the self-contained circuit board. No schematics to follow (although provided).

**ANYONE** can build and hear the laboratory realism of the PERI-50 AMPLIFIER in 90 minutes or less... utilizing the most advanced circuitry and the incomparable Dynaco Output Transformer for unsurpassed transient response and stability.

### GUARANTEED TO PERFORM TO THESE SPECIFICATIONS:

- POWER OUTPUT** 50 watts cont. — 100 watts peak.
- DISTORTION**—Intermodulation distortion less than 1.0% at 50 watts, less than 0.25% at 35 watts.
- FREQUENCY RESPONSE** 6 cps to 60,000 cps within  $\pm 0.5$  DB.  $\pm 0.1$  DB from 20 cps to 35,000 at any level from 1 milliwatt to 50 watts.
- POWER RESPONSE** less than 0.1% harmonic distortion at 50 watts from 20 cps to 25,000 cps and flat within 1 DB.
- SENSITIVITY** 50 watts output from 0.75 volt RMS input 100 watts output from 1.0 volt RMS input.
- SQUARE WAVE RESPONSE** essentially undistorted on speaker load at frequencies 20 cps to 35,000 cps. Damping Factor—15. Output impedances 8 ohm and 16 ohm.
- TUBE COMPLEMENT** Two EL-34, one 6AN8 one 5U4.

### ORDER DIRECT FROM PRINTED ELECTRONIC RESEARCH INC.

4212 LANKERSHIM BLVD. NO. HOLLYWOOD, CALIF.  
CHECK OR MONEY ORDER  COD.   
SEND FREE BROCHURE  DEPT. A-1

Name .....  
Address .....  
City ..... Zone ..... State .....

## BASIC ELECTRONICS

Continued from page 31

equal to about half the cutoff voltage. This fixed DC grid potential is called the *bias voltage*.

The most apparent method of applying bias to a stage is that shown in Fig. 3: leaving the cathode at zero, or ground potential, and making the grid negative. It is seldom convenient in an amplifier to provide a voltage negative with respect to ground, however, except for the power-output stage in some recent high-power amplifiers. An alternative and less costly method is that shown in Fig. 6: leaving the grid at zero DC voltage, and making the cathode *positive* with

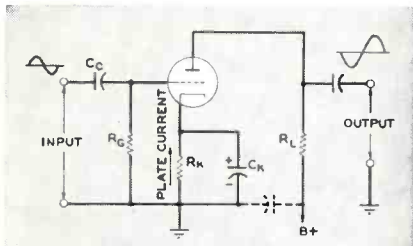

Fig. 6. Amplifier circuit for a triode.

respect to ground by the proper amount for bias. Then, effectively, the grid is at a *negative* bias potential with respect to the cathode. This is shown in Fig. 7; for this example it is assumed that cutoff occurs when the grid is at  $-8$  v with respect to the cathode. The proper bias is then 4 v. With the grid at DC ground, the cathode must be made 4 v positive. The incoming signal can swing the grid 4 v positive before making it positive with respect to the cathode, and 4 v negative before cutting off the tube (on the negative swing, the grid becomes 8 v negative with respect to the cathode).

The bias method for the circuit in Fig. 3 is known as *fixed bias*, and that for the circuit in Fig. 6, *cathode bias*.

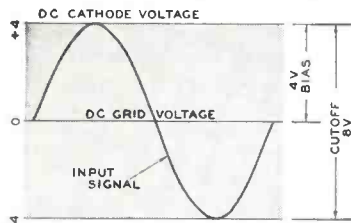

Fig. 7. Grid voltage with cathode bias.

Cathode bias is obtained by putting a resistor,  $R_k$ , between the cathode and ground. Current going through the tube from cathode to plate develops a positive potential across the resistor, making the cathode positive with respect to ground; the resistor value is chosen to provide the proper amount of bias.

As the input signal swings in the positive direction, however, the plate current increases, which would increase the positive voltage developed across  $R_k$ . That would reduce the *difference* in AC

voltage between the grid and the cathode, which would effectively reduce the amplitude of the input signal, and reduce the amplification of the stage. This is a form of negative feedback, and as such will be discussed at greater length later in this series. If the feedback is not desired, a large capacitor ( $C_k$ , Fig. 6) is connected across the cathode resistor to absorb the relatively fast changes in plate current caused by the input signal. It keeps the cathode at a constant DC bias potential regardless of the input-signal swings.

A resistor  $R_L$  is connected between the plate and the B+ voltage source also. This is the *load resistor*. Variations in plate current, caused by the AC signal on the grid, produce changes in the voltage drop across the load resistor; that is, the *output* signal is developed across this resistor.

Let us say that our triode is biased at 4 v, and that we want 160 v on the plate. Assume a B+ voltage of 360 v. Under these conditions, the plate current

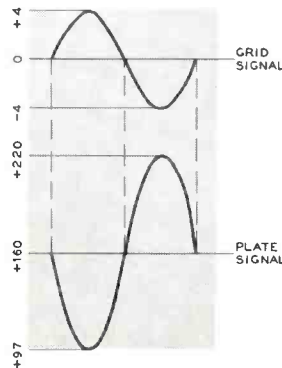

Fig. 8. How plate voltage varies with an input signal on the grid; see text.

with no input signal will be (according to Fig. 5) roughly 8 ma. The voltage drop in  $R_L$  under no-signal (quiescent) conditions must then be  $360 - 160$ , or 200 v. To drop 200 v at 8 ma requires a load resistor of  $200/.008$ , or 25K. Now, suppose that the input signal is 4 v peak, or 8 v peak-to-peak. As the input signal swings positive, plate current increases; therefore, the voltage drop across  $R_L$  increases, and the plate voltage goes *down*. At the peak of the positive input-signal swing, the plate current reaches about 10.5 ma. The voltage drop across the load resistor is then  $25,000 \times 0.0105$ , or 263 v. The plate voltage is  $360 - 263$ , or 97 v, as shown in Fig. 8. As the input signal swings back down to zero, the plate current decreases, the voltage drop across  $R_L$  decreases, and the plate voltage increases. When the input signal reaches its maximum negative swing, the plate current is reduced to about 5.6 ma. The voltage drop in  $R_L$  is then only  $25,000 \times .0056$ , or 140 v. Voltage at the plate has increased to  $360 - 140$ , or 220 v. As the input signal swings back to zero, plate current increases, voltage drop

across  $R_L$  increases, and the plate voltage drops back to its quiescent value, 160 v.

Fig. 8 shows that the output signal is an enlarged replica *in reverse* of the input signal. The total plate swing is from 97 to 220 v, which is 123 v peak-to-peak. Compared to the 8-volt peak-to-peak input signal, the tube shows a *voltage gain* of  $123/8$ , or just over 15. The coupling capacitor between the plate

## PROFESSIONAL DIRECTORY

### Artisan Build-It-Yourself

ELECTRONIC ORGANS  
Send \$1.00 for "Organ Builders Manual"  
ELECTRONIC ORGAN ARTS  
4878 Eagle Rock Blvd.  
Los Angeles 41, Calif.

SIX BRANDENBURG CONCERTOS

**BACH'S**  
greatest works  
in distinctive  
performances  
conducted by  
HERMANN SCHERCHEN  
exclusively  
on tape

**Omegatape**

**FM/Q**  
antenna systems

High gain broadband FM Antennae for max. tuner sensitivity to 72 or 300 ohm inputs. Provides optimum signal level for best recording of high fidelity broadcasts.

**APPARATUS DEVELOPMENT CO.**  
FM/Q Dept. Wethersfield 9, Conn

**GIBSON GIRL TAPE SPLICERS**

splices in a wink!  
NO SCISSORS!  
NO RAZOR BLADES!  
Diagonal cuts tape ends  
and trims splice edges

At Your Dealers

**ROBINS INDUSTRIES CORP.** Bayside 61, N. Y.

AUTOMATIC CHANGER NEEDLE BRUSH

**KLccNccDLE**

KLeeNeedLE automatically keeps record changer needles clean. It is designed to remove the familiar "dust-blob" from under the needle point. At Your Dealer

**ROBINS INDUSTRIES CORP.** Bayside 61, N. Y.

**AUD-O-FILE**  
An entirely new method for filing fine records

NO INDEXES!  
NO JACKETS!  
NO SLEEVES!  
NO ALBUMS!

**ROBINS INDUSTRIES CORP.**  
Bayside 61, N. Y.



and the output terminals would block the DC component of the plate voltage, and would pass only the AC plate swing; the voltage at the output would swing plus and minus 61.5 v.

This discussion will be continued in the next issue.

## GADGET BOX

*Continued from page 29*

might consider carrying a screw driver, soldering iron, solder, pliers, and a set of spare tubes. If you have a yen to smoke while on the job, you might even include a small ash tray for use on remote recording jobs where the house management fails to supply such necessary items.

Oh, and as an afterthought, don't forget a cube tap and an AC extension cord. Or are these really gadgets? Sometimes, yes, but if you need two AC supplies and have only one outlet, 30 ft. away from the recorder, they could better be classed as absolute necessities.

That, however, is another story.

## WOOD FOR THE JOB

*Continued from page 33*

built-ins. If desired, all defects can be concealed by paint. Less expensive than the better grades, Grade D Select is very popular with the average craftsman.

*No. 1 Common* is tight-knotted wood suitable for paneling and painting.

In *No. 2 Common*, knots may be larger and not so tight as in the previous grade. However, wood of this grade can be painted and serves as all-purpose lumber.

In *No. 3 Common*, there are often pitch and surface cracks. This grade is suitable for shelves, stairs, workshop cabinets, etc.

There are lower grades in the soft-

## TRADERS' MARKETPLACE

Here's the place to buy, swap, or sell audio equipment. Rates are only 20¢ a word (excluding name and address) and your advertisement will reach 20,000 to 35,000 readers. Remittance must accompany copy and insertion instructions.

DISCOVER our "SIX UNIQUE SERVICES" and rock bottom prices on hi-fi; stereo. Write the Silver Trumpet, 406C Walnut, Alexandria, Indiana.

TWEETER ENCLOSURE PLANS \$2. Used audio equipment at discounts to 50%. Price list with first order. Larry B. Turner, R-7, Spartanburg, S. C.

LEARN WHILE ASLEEP with your recorder. Amazing book gives full instructions. \$2.00. Guaranteed. Research Association, P. O. Box. 610-AC, Omaha, Nebr.

UNHAPPY WITH "HI" hi-fi prices? So alright already. . . . Write already to Key Electronics Co., 120 Liberty St., Ntw York 6, N. Y.

PICKERING FLUXVALVE 1957 Model Turnover Diamond-Sapphire Cartridge. Brand new, unable to use. Will sell for just \$33.00. Russell Forbes, 3 Mohawk Rd., Marblehead, Mass.

wood category, but they have no special use in cabinetwork.

While hardwoods are generally thought of as being more expensive than softwoods, it is interesting to note that the top grades of both types of wood are comparable in price. Here are a few of the hardwood grades:

*Grade FAS* means wood of firsts and seconds in quality. It is air dried and top commercial grade for hardwoods. The firsts run about 91% clear on both sides and the seconds about 83% clear.

*Grade No. 1* can be either select or common. It is kiln dried and contains more knots and defects than FAS.

*Grade No. 2* is a poorer grade with numerous defects, suitable only for small cuttings.

Air-dried (AD) lumber is stock that has been dried over a long period of time by being exposed to the weather. It has a moisture content of from 15% to 20%. Before using it for cabinetwork, let it season indoors for a month. On the other hand, kiln-dried (KD) lumber has gone through scientific artificial heating to reduce the moisture content to between 5% and 8%, which is ideal for cabinet construction. To maintain a good glue joint, lumber should contain not more than 10% moisture.

## Things to Remember

When buying wood for cabinetwork, remember that lumber defects decide the grading of the wood and certain defective characteristics should be avoided in your selection.

1) *Checks*: these are cracks usually found at the end of a board, and they should be trimmed off before the stock is cut to length.

2) *Decay*: do not use the area where a soft, rotted spot appears. Cut it off and use the wood on either side of it.

3) *Knots*: knots are irregular growths in the body of a tree. The fibers of the wood turn from their nor-

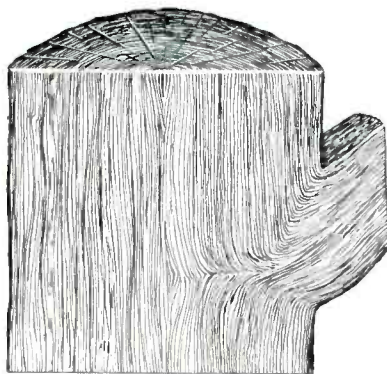

Fig. 4. How a knot is formed in wood.

mal course and grow around the knot at the point where a limb is being formed on a tree (Fig. 4). Cross grains, which cause the lumber to break easily,

*Continued on next page*



ENJOY ALL THAT  
HIGH-FIDELITY  
CAN GIVE YOU —  
WITH CENTRALAB  
COMPENTROL®

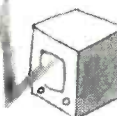

You bought your hi-fi to enjoy concert-hall realism. Are you actually getting it? You are for sure, if you use a Centralab Compentrol.

When an ordinary volume control is turned down, it not only lowers the sound—but cuts down both the high and low frequencies, leaving only the uninteresting middle range.

That's when you need a special control that bolsters frequencies otherwise lost.

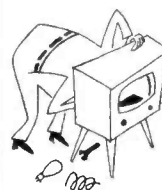

THAT'S WHERE  
COMPENTROL  
COMES IN

*with do-it-yourself fun!*

Compentrol is a COMPensated conTROL that provides tonal balance of the lows and highs—and does it automatically at any volume level. You hear the pleasing full range of the orchestral score.

It's easy to replace an ordinary volume control with Centralab Compentrol—in amplifiers, pre-amplifiers, radios, TV, tuners, tape recorders, and record players.

Buy a Compentrol from your Centralab distributor today.

Remember, only Centralab makes Compentrol

6 models  
from \$2.50

suggested  
net price

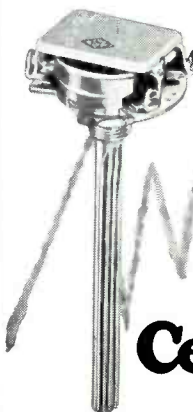

Send for Compentrol booklet. Write Centralab, Dept. 928G, Milwaukee 1, Wis.

**Centralab**

# SPEAKING OF speakers

always look  
for this  
symbol for  
sound. Then  
compare...  
when you  
listen...  
you'll always  
hear more  
from:



© STEPHENS TRUSONIC INC.  
8538 Warner Drive  
Culver City, California



## If you are interested in CONTEMPORARY MUSIC

... or would like to learn about it—

—this is your opportunity. Nowhere are the exciting sounds and brilliant techniques of modern composers reproduced and interpreted as they are in exclusive **FIRST EDITION RECORDS**. These are first recordings of newly commissioned symphonic works by the world's master composers—played superbly and flawlessly recorded in high-fidelity by the renowned

**LOUISVILLE ORCHESTRA**  
Robert Whitney, Conductor

These "collector's item" recordings are engineered by Columbia Masterworks technicians. All are *contemporary music*, with the composer working closely with the orchestra to achieve a true and sensitive interpretation. Available from *the Society only*, they represent a priceless collection of new, exciting music... the finest expressions of living composers the world over.

OFFER LIMITED—SEND TODAY FOR  
• • INFORMATION ON FREE TRIAL RECORDS • •

LOUISVILLE PHILHARMONIC SOCIETY  
Dept. D-5, 830 S. 4th St., Louisville 3, Ky.

Please send me free, complete information on exclusive First Edition Records and free record offer.

Name \_\_\_\_\_  
Address \_\_\_\_\_  
City \_\_\_\_\_ State \_\_\_\_\_

## WOOD FOR THE JOB

*Continued from preceding page*

are formed if the knot is large. Where knots are solid, they are fine for paneling and certain built-ins and cabinet work. For most cabinet construction, however, use stock with no knots.

4) *Warp*: warping manifests itself by twisting, cupping, or bowing the wood. To be sure of good results, don't use a warped piece of wood.

## READERS' FORUM

*Continued from page 13*

*will be intermediate hybrid-type equipment that will use both transistors (probably in earlier stages) and vacuum tubes (for power supplies and output stages).*

*In sum, we don't feel that it is necessary to wait for transistorized equipment. Even when it does come, which will be some time still, its main advantages will be those of compactness and reliability: performance will probably not be significantly better, if it is better at all. — ED.*

Gentlemen:

I am interested in obtaining a copy of the February and March 1956 issues of your magazine. Your Circulation Director, Mr. Griffin, informs me that these two issues are out of stock.

Could you place a note in your "Readers' Forum" column asking any of your subscribers who may have a copy of one or both of these issues to get in touch with me? Thank you.

Alfred Di Tizio  
2030 Emily St.  
Philadelphia 45, Pa.

## TAPES AT 60 MPH

*Continued from page 18*

listen — without interruption, static, or record changing. This tape stuff is really for us!

After the first bloom of pleasure had worn off, we completed wiring the units together with properly shortened lengths of wire. Friction tape was used liberally to tie every loose wire to a solid underdash assembly.

If you have followed us up to this point, it may be a good idea to begin checking for means to improve the quality of the music. With the tape deck playing back through the radio at very low volume, reverse the 110-volt power plugs of the tape deck and preamp several times. Select that position



for each plug which gives the least background noise. Mark the plugs with paint to make it easy to replace them properly every time. Another point to check is the voltage-regulator control on the inverter. Try setting it at other than the maximum setting to see if your deck will operate satisfactorily at a lower output level. With the Viking preamp are extensive grounding instructions. You may have to ignore these to some extent, because in some cars grounding the preamp or deck to the car frame produces a disturbing hum. If your deck installation is noisy, try cutting various ground connections until the noise is eliminated. The outside shield of a signal-connecting cord is the ground wire; this makes it easy to break the ground by pulling the phono plug a little out of its socket until the outside clip is free of the socket. The inside pin will still make a connection, so your unit will play.

And that's that. Recorded tapes now available have just about every desirable type of music on them. You can make your own long-play tapes by recording from phonograph records, AM-FM radio, or television programs. A plush touch would be a clock-controlled tape recorder at home, to record the programs missed while sitting in a movie. Transfer the tapes to your car and enjoy them while you drive.

## ADVERTISING INDEX

Key No.	Advertiser	Page
1	Acoustic Research, Inc.	42-43
2	American Cancer Society	12
3	Apparatus Development Corp.	46
4	Audio Fidelity Records	1
5	Audiophile's Bookshelf	2
6	British Industries Corp.	
	Inside Front Cover	
7	Centralab	47
4	Dauntless International	1
8	EICO	39
9	Electronic Organ Arts	46
10	Fisher Radio Corp.	41
6	Garrard Sales Corp.	
	Inside Front Cover	
11	Heath Co.	5-7
12	International Pacific Recording Corp.	46
13	Lansing, James B., Sound, Inc.	9
14	Louisville Philharmonic Society	48
15	MusiCraft	44
16	North American Philips Co.	1
	Back Cover	
12	Omegatape	46
17	Printed Electronic Research, Inc.	45
	Professional Directory	46
18	Robins Industries Corp.	46
19	Stephens Tru-Sonic, Inc.	48
	Traders' Marketplace	47
20	University Loudspeakers, Inc.	36-37
21	Viking of Minneapolis	
	Inside Back Cover	

## SPECIFICATIONS

### ALL VIKING DECKS

frequency response: 30 to 14,000 cps plus, at 7½ ips. 40 to 7,000 cps plus, at 3¾ ips.

signal-to-noise: 50 db or better.

flutter: 0.2 percent average.

long term speed regulation: ½ of 1.0 percent.

tape speed: 7½ ips (3¾ ips available by changing belt to smaller groove on motor pulley).

maximum reel size: 7"

record/playback head characteristics: track width .090 inch. Gap width .00015 inch. Impedance 2000 ohms at 1000 cycles. Double coil hum bucking winding. Mu-metal shielded. Output 2.5 mv.

recommended bias current: .8 ma. at 68 kc.

erase head characteristics: track width .125 inch, double gap (each .005 inch), inductance 53 mh. at 1 kc, erase 60 db at 68 kc.



# MORE PERFORMANCE PER DOLLAR

## THESE ARE THE REASONS WHY:

Ultra-linear transport . . . flutter and wow completely below audibility.

Short-gap record and/or playback heads for extended range . . . Double-coil (hum-bucking) record and playback heads for minimum hum. Double-gap erase heads for *dead quiet* erase.

The finest of bearings, and the ultimate in machining tolerances in capstan and drive members— *where precision counts.*

Rugged simplicity for enduring performance.

Physically independent amplifier components for increased flexibility and minimized hum pick-up

Very high erase-bias oscillator frequency permits extended range recording without bias intermodulation.

NARTB equalization. Physical separation of mechanical and amplifier components, plus clean design, eliminates need for roll-off of lower (*hum*) frequencies.

## SPECIFICATIONS

### RP51 SERIES PREAMPLIFIERS

frequency response, playback: 30 to 14,000 cps ± 2 db.

frequency response, record-playback cycle: 30 to 12,000 cps ± 3 db.

distortion (tapes recorded 12 db below saturation): less than 2% with n specified frequency range.

internal signal-to-noise ratio: 60 db minimum all units.

equalization: modified NART 3

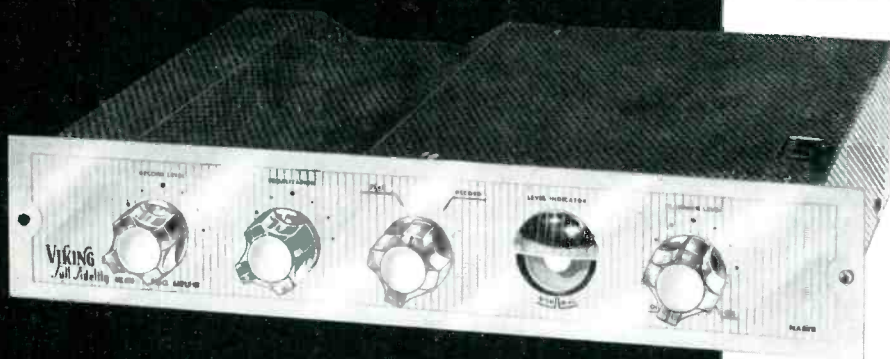

Ask your dealer for a Viking recording and playback demonstration before you buy any other recorder.

recording channel gain: low level input. Requires .002 volt rms at 400 cycles for recording level 8 db below saturation. (High level input, .3 volts rms.)

playback channel gain: 55 db

recording inputs: high impedance microphone (62 db overall gain) and high impedance radio or phono input (32 db gain).

bias frequency: 68 kc.

output: 1 volt, high impedance.

tube complement: 1-12AX7, 1-12AU7A, 1-12AV7, 1-6X4, 1-6E5 Indicator.

**Viking** OF MINNEAPOLIS  
9600 Aldrich Avenue South, Minneapolis 20, Minnesota

EXPORT DIVISION: 23 Warren Street, New York City 7, New York  
Cable: SIMONTRICE, NEW YORK (All Codes)

## You can have the finest sound reproduction throughout all frequency ranges without distortion

You will hear a remarkable difference in the clarity of Norelco \*Full Response Speakers. In a single speaker, twin-cones reproduce low frequencies, middle range, as well as the higher frequencies extending beyond the audible range—without distortion.

### WHY ARE NORELCO FRS SPEAKERS SO EXCEPTIONAL?

They have incorporated a number of technical refinements which are evident the moment you listen. The air gap has been made long so that the coil is completely enclosed in an even magnetic field at all times. A copper ring has been fitted into the deep air gap to keep the voice coil impedance constant over the whole frequency range; this avoids incorrect matching. High flux densities are obtained through the use of "Ticonal" magnet steel.

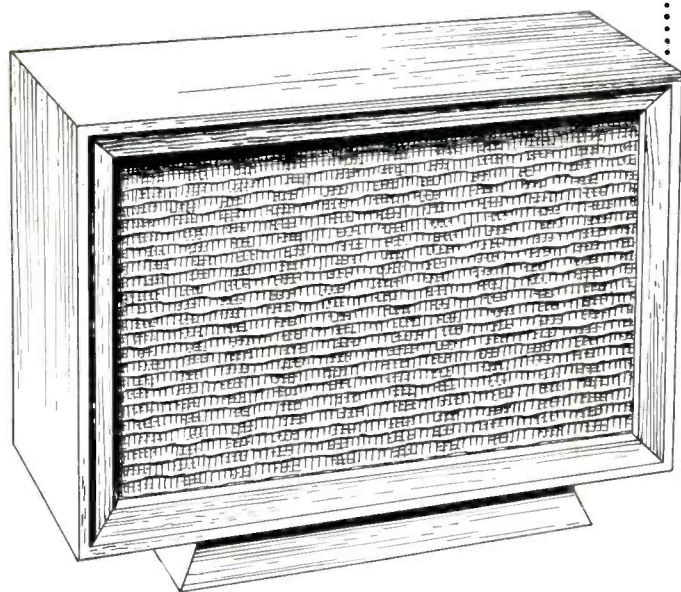
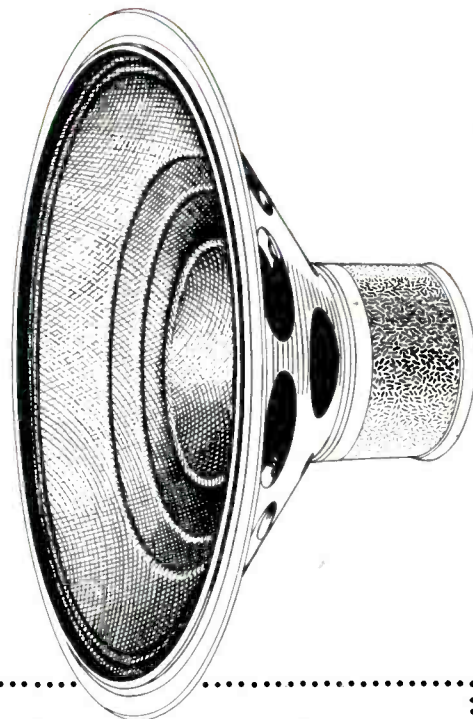

*Norelco FRS Improved Bass Reflex Enclosures are available in three sizes; FRS Enclosures I, II and III. Priced from \$33.75 to \$119.95.*

### *Norelco \*F.R.S.*

*speakers are available  
5", 8" or 12" sizes in standard impedances.  
Priced from \$6.75 to \$59.98  
Blue prints are available for the  
do-it-yourself enclosure builder.*

Norelco speaker-matched enclosures are scientifically designed acoustical boxes which enhance the exceptional tone qualities of FRS speakers; bringing out their true performance values.

Norelco FRS Speaker Enclosures are available in three sizes to match the characteristics of the speaker in use. Supplied in either mahogany or blond, these enclosures incorporate a removable base permitting the enclosures to be placed horizontally or vertically to suit any room arrangement or decor.



ADD TO...and improve any sound system with **Norelco®**  
\*FULL RESPONSE SPEAKERS

Write today to Dept. M7 for brochures and prices of these unique speakers.

NORTH AMERICAN PHILIPS CO., INC., 100 E. 42nd Street, New York 17, N.Y.