

A musical extravaganza of exciting toe-tapping novelty tunes. AFLP 1825

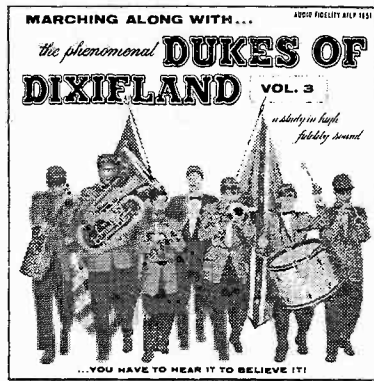

Dixieland Marches in the Dukes' unique styling converts the ordinary to the unusual! AFLP 1851

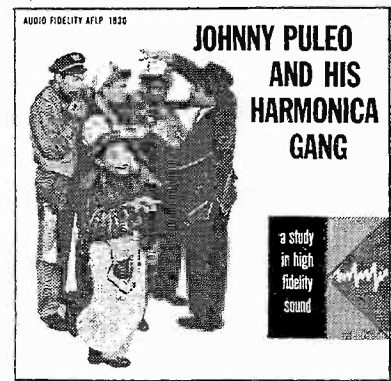

A lovable little guy, a zany group and a breath-taking display of harmonica mastery! AFLP 1830

the choice of High Fidelity Fans Everywhere...

# AUDIO FIDELITY

TOTAL FREQUENCY RANGE RECORDINGS

Here is the powerful and vital sensuous impact of sound in its purest and most natural form. This is true high fidelity as you always want it to sound! . . . not just records . . . each a Wonderful Emotional Experience!

recorded in brilliant High Fidelity Sound  
\$5.95 each 12 inch LP



Music from an afternoon at the Bull-fights. Luxuriously packaged with four color illustrated book of Bullfight scenes. Volume 4 AFLP 1835



Moon-drenched Cha Cha rhythms alive with the mystery of exotic Latin nights. AFLP 1837



Exotic, tantalizing music from the mysterious Middle East. AFLP 1833



Siruous Tango melodies from the land of the Gauchos. AFLP 1838



America's most famous marches brilliantly and excitingly performed by the BANDA TAURINA. AFLP 1836

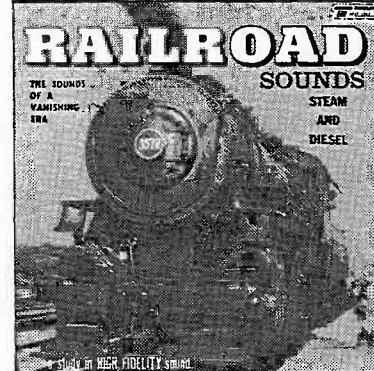

A documentary of the sounds of a vanishing era captured in dazzling Hi-Fi. AFLP 1843



"Pop" standards on the most brilliant Theatre Organ in the Western Hemisphere. AFLP 1829

 **AUDIO FIDELITY** 770 Eleventh Ave., New York 19, N. Y.

# Improve your own music system with a superb new ESL cartridge and arm

## ESL PROFESSIONAL SERIES ARM & CARTRIDGE

Breathtaking perfection of reproduction for the most critical broadcast, recording, and laboratory use is now made possible by this superlative reproducer. The ultimate in compromise-free design, plus matchless Danish hand craftsmanship. The precision machined, ball bearing arm fits this cartridge only.

Frequency response: 16-30,000+ cps • IM distortion: almost immeasurably small • Minimum compliance:  $6.8 \times 10^{-6}$  cm/dyne • Dynamic mass: .001 grams • Vertical force: 1-3 grams  
Output impedance: 1.5 ohms • Minimum output voltage: 2.0 mv (1 kc at 10 cm/sec)

ESL-310 arm (15 $\frac{3}{4}$ " ) without cartridge \$57

Diamond stylus: ESL-P1 (.001"), P2.5 (.0025"), P2.7 (.0027"), P3 (.003") \$49.50

Acknowledged as the world's finest

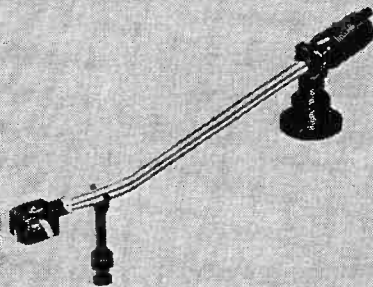

## ESL CONCERT SERIES CARTRIDGE

The most advanced electronic technology and mechanical skills have devised this magnificent instrument which can improve the finest music reproducing systems. Used for quality control by leading record manufacturers. It greatly prolongs record and stylus life, and will fit any standard mounting arrangement.

Frequency response: 16-30,000+ cps • IM distortion: almost immeasurably small • Minimum compliance:  $6.8 \times 10^{-6}$  cm/dyne • Dynamic mass: .001 grams • Vertical force: 2-6 grams  
Output impedance: 1.5 ohms • Minimum output voltage: 1.5 mv (1 kc at 10 cm/sec)

Diamond stylus: ESL-C1 (.001") or ESL-C3 (.003") \$35.95

For the audio connoisseur

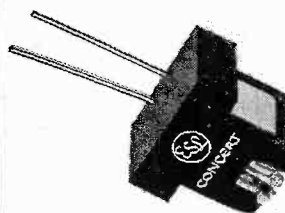

## ESL/BJ 'SUPER 90' TANGENTIAL ARM

Highly improved, studio model of the world-famous BJ tangential arm which overcomes tracking error, reduces distortion, and increases record life. Self-lubricating ball bearings insure friction-free movement; twin arms virtually cancel resonances. Complete with two plug-in heads accommodating almost all cartridges, including turnover and triple-play models. Counter-weights variable over 40-gram range. Calibrated pedestal permits instant selection of correct stylus overhang. Made in England under the personal supervision of its inventor.

ESL/BJ 'Super 90/12' (12 $\frac{3}{4}$ " ) \$33 • ESL/BJ 'Super 90/16' (14" ) \$36.50

Overcomes tracking error



## ESL TRANSFORMER ACCESSORIES

The ESL cartridge requires with some amplifiers a high quality ESL voltage step-up transformer (or ESL transistor amplifier): the 201 Series for low level magnetic inputs, 301 Series for low or high level magnetic inputs, or the 211 with insensitive amplifiers.

ESL-201 Shielded, unmounted transformer; 1:11 voltage step-up \$7.50

ESL-201M An ESL-201, mounted and wired for plug-in connection \$11

ESL-201F Same as 201M, plus supersonic filter and switch \$15

ESL-301 Shielded, unmounted transformer; 1:30 voltage step-up \$9

ESL-301M An ESL-301, mounted and wired for plug-in connection \$12.50

ESL-301F Same as 301M, plus supersonic filter and switch \$16.50

ESL-211 Shielded, unmounted transformer; 1:244 voltage step-up \$6.25

For flexibility of application

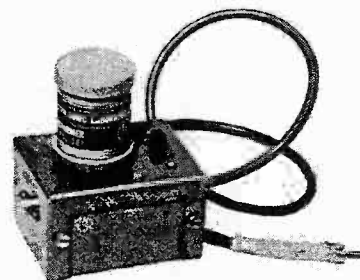

ESL-201F ESL-301F



FOR LISTENING AT ITS BEST

Electro-Sonic Laboratories, Inc.

Dept. C • 35-54 Thirty-sixth St • Long Island City 6, N.Y.

Additional information available  
free upon request to ESL

<b>Roy F. Allison</b> Editor	<b>Charles Fowler</b> Publisher
<b>Frank R. Wright</b> Managing Editor	<b>Warren B. Syer</b> Associate Publisher
<b>Philip C. Geraci</b> Editorial Associate	<b>Claire Eddings</b> Advertising Sales Manager
<b>Eleanore B. Wright</b> Editorial Assistant	<b>Arthur J. Griffin</b> Circulation Manager
<b>Roy Lindstrom</b> Art Director	<b>Frances A. Newbury</b> Manager, Book Division
<b>Eleanor Gilchrist</b> Art Assistant	
<b>R. D. Darrell</b> <b>J. Gordon Holt</b> <b>Joseph Marshall</b> Contributing Editors	



# audiocraft

THE MAGAZINE FOR THE HI-FI HOBBYIST

SEPTEMBER 1957

Volume 2 Number 9

<b>The Grounded Ear</b> <i>What's new in sound reproduction</i>	<b>4</b>	<i>Joseph Marshall</i>
<b>Audionews</b>	<b>10</b>	
<b>Book Reviews</b>	<b>12</b>	<i>Richard D. Keller</i>
<b>Editorial</b>	<b>15</b>	
<b>Readers' Forum</b>	<b>15</b>	
<b>Check List for High-Fidelity Systems</b> <i>How to evaluate hi-fi components</i>	<b>16</b>	<i>Norman H. Crowhurst</i>
<b>Bogen K-DB20DF Amplifier</b> <i>An AUDIOCRAFT kit report</i>	<b>18</b>	
<b>Pro and Con for Contour Controls</b> <i>The facts on a controversial subject</i>	<b>22</b>	<i>J. Gordon Holt</i>
<b>Weighting an Inexpensive Turntable</b> <i>How to improve a low-cost unit</i>	<b>24</b>	<i>Frank J. Bertolotti</i>
<b>Basic Electronics</b> <i>Chapter XIX: Tetrodes and pentodes</i>	<b>26</b>	<i>Roy F. Allison</i>
<b>Stereo Standards and Conversions</b> <i>Tape News and Views</i>	<b>28</b>	<i>J. Gordon Holt</i>
<b>Audio Aids</b>	<b>30</b>	
<b>Sound-Fanciers' Guide</b> <i>Reviews of exceptional disc and tape records</i>	<b>31</b>	<i>R. D. Darrell</i>
<b>Audiophile's Bookshelf</b>	<b>33</b>	
<b>Professional Directory</b>	<b>46</b>	
<b>Advertising Index</b>	<b>48</b>	

## ADVERTISING

**Main Office** — Claire Eddings, The Publishing House, Great Barrington, Mass. Telephone: Great Barrington 1300.

**New York** — Frederick H. Wallin, 280 Madison Ave., New York, N.Y. Telephone: Murray Hill 3-4449, 3-4450.

**Chicago** — John R. Rutherford & Associates, Inc., 230 East Ohio St., Chicago, Ill. Telephone: Whitehall 4-6715.

**Los Angeles** — Brand & Brand, Inc., 6314 San Vicente Blvd., Los Angeles, Calif. Telephone: Webster 8-3971.

**Audiocraft Magazine** is published monthly by Audiocom, Inc., in Great Barrington, Mass. Telephone: Great Barrington 1300. Editorial, publication, and circulation offices at: The Publishing House, Great Barrington, Mass. Subscriptions: \$4.00 per year in the United States and Canada. Single copies: 35 cents each. Editorial contributions will be welcomed by the editor. Payment for articles accepted will be arranged prior to publication. Unsolicited manuscripts should be accompanied by return postage. Entered as second-class matter October 1, 1955, at the post office, Great Barrington, Mass., under the act of March 3, 1879. Additional entry at the post office, Pittsfield, Mass. Printed in the U. S. A. by the Ben Franklin Press, Pittsfield, Mass. Copyright 1957 by Audiocom, Inc. The cover design and contents of Audiocraft Magazine are fully protected by copyrights and must not be reproduced in any manner.

# The Grounded Ear

by Joseph Marshall

## Heathkit 70-Watt Amplifier Kit

If I were in charge of handing out Oscars to the high-fidelity industry, I would award one to the Heath Company for setting what I hope will become a widely followed precedent with its new W-6M 70-watt amplifier kit (Fig. 1). The performance specifications and curves given in the instruction manual for this kit are the most complete and detailed I have ever seen; they include frequency and power-response curves, IM- and harmonic-distortion curves, phase curves, input-output curves, square-wave response, overload recovery traces, and stability traces with the amplifier operating without load and into speaker loads. I should like to see similar information in the manuals for other commercial equipment, not only as a matter of good salesmanship, but to help service technicians to keep the equipment operating at its maximum potential. Heath and others have made it possible for any serious technician to own the instruments needed to measure the essential characteristics of

audio equipment. What is lacking is the detailed information about performance needed to determine whether specifications are being met—information such as that given in the manual for this Heathkit. The quality of today's hi-fi equipment and quality control in manufacturing are good enough to allow most manufacturers to give detailed information without fear of exposing some fatal weakness in design or production. Providing such information would also be the best defense the industry could have against cheap and unscrupulous competition.

As for the new Heathkit amplifier, it will be a factor to be reckoned with in the present high-powered-amplifier sweepstakes. According to the performance curves, the amplifier will deliver 70 watts, within 0.25 db, over the audible range from 20 to 20,000 cps. The low-frequency power response is especially noteworthy, for the amplifier will not only deliver the full 70 watts at 20 cps, but 60 watts at 15 cps, 18 at 10, and 5 watts at 7 cps. Voltage response is flat at the  $\frac{1}{2}$ -watt level from

10 to 40,000 cps, and within 6 db from 2 to 200,000 cps. The distortion curves are especially complete; they indicate the percentage of distortion throughout the entire audio range at various output levels, and the available output at all frequencies at various distortion levels. The harmonic distortion is below 2% at full 70-watt output over the entire audible range, and 0.7% from about 22 to 7,000 cps at 70 watts (0.7% harmonic distortion is considered to be imperceptible even to critical ears). The distortion curves rise most steeply above 5 Kc, but even in this area 20 watts can be delivered with 0.7% harmonic distortion. There are few high-amplitude sounds in this region, so the available low-distortion output should be more than sufficient. IM distortion is less than 1% at all points below 70 watts, and less than 0.1% below 7 watts. Stability and overload recovery appear to be very good, according to the traces. All in all, the electrical characteristics will be hard to beat at any price.

The circuit of the amplifier portion of the W-6M is fairly conventional. The output tubes are a pair of 6550's in ultra-linear with fixed bias, direct-coupled to a 12BH7 cathode follower. A meter and switch are provided for reading the plate current of each output tube, and in the cathode-follower driver stage there are pots for adjusting the bias on each tube independently, thus obtaining exact balance as indicated on the meter. The front end is of the familiar Williamson type. There are two interrelated feedback loops: one for the usual voltage feedback, and the other for current feedback. The two feedbacks are controlled by ganged pots which vary the ratio of voltage-to-current feedback (and thus the damping factor), while the over-all feedback ratio remains constant. The feedback resistor is automatically changed as the output impedance tap is changed.

So far as I am aware, this is the first hi-fi amplifier of any type to use the new silicon rectifiers instead of vacuum-tube rectifiers. Four of these silicon rectifiers are used in a voltage-doubling circuit, fed by a 170-volt winding on the

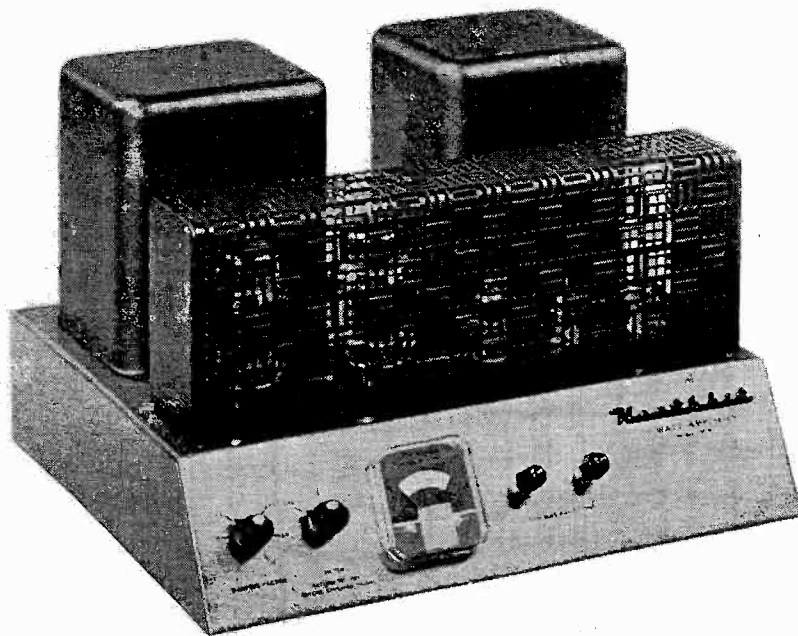

Fig. 1. The new W-6M Heathkit 70-watt amplifier is one of the most expensive amplifier kits on the market, but its outstanding performance justifies its price.

Continued on page 46

**FREE!**  
**LAFAYETTE**  
**CATALOG**

JUST OFF THE PRESS!



**NEW 180 PAGE ELECTRONIC CATALOG FEATURING THE BEST BUYS IN THE BUSINESS**

The newest and largest assortment of Electronic, Radio and TV parts, Hi-Fi and Public Address Components and systems, Test Equipment, tubes, Transistor Kits and miniaturized components for transistor circuitry, Ham Equipment, Builders Kits, Tools, Books, Microscopes, Binoculars, Telescopes, Cameras, and Drafting Equipment.—**ALL AT LOWEST PRICES**—Catering to the economy minded dealer, serviceman, engineer, technician, experimenter and hobbyist. **CRAMMED FULL OF MONEY SAVING BUYS. SEND FOR YOUR FREE COPY TODAY.**

**Lafayette Import Special!** **TRANSCRIPTION-TYPE MANUAL PLAYER**  
**Complete Turntable and Tone Arm Assembly at Lowest Price**

Here is a new manual player for the audiophile who wants noiseless, "wow-free" and rumble-free reproduction of recorded music at nominal cost. All the important features of professional transcription players have been incorporated in this precision turntable. The lightweight pickup arm is an integral part of the mounting plate. Player is equipped with a heavy duty, 4-pole, 3-speed motor for 78, 45 and 33 1/2 RPM records. An exclusive magnetic brake controlled by knob on the base plate, permits instantaneous fine adjustment of each speed. Stroboscope disc included with unit, checks speeds. Extremely smooth and quiet operation. No hum even with the most sensitive cartridges. Speed selector safety switch protects mechanism by making it necessary to pass through an OFF position when switching from one speed to another.

10" diameter, weighted cast turntable is supplied with a rubber traction mat for positive grip of record. Stylus pressure adjustment can be made easily and quickly with the conveniently located adjusting screw on the underside of the tone arm. Mounting plate is also equipped with pickup rest and ON-OFF switch. Dimensions of mounting plate: 12-15/16" left to right, and 10 7/8" front to rear. Requires 23 3/4" clearance below motor board and 2" above. Supplied with AC line cord, two plug-in heads, output cable for connection to amplifier and 45 RPM adapter. For 105-120 volts, 60 cycle AC. Shpg. wt., 12 lbs. (NOTE: For protection in shipping, tone arm is separate. Just fasten to mounting plate.)

PK-160 Manual Player Less cartridge. Net 25.95  
Wood base, cut out for PK-160 Manual Player. Top quality veneer attractively finished in mahogany or blonde (Specify).  
PK-162. Shpg. wt., 5 lbs. Net 3.95

**with TONE ARM and TWO PLUG-IN HEADS**

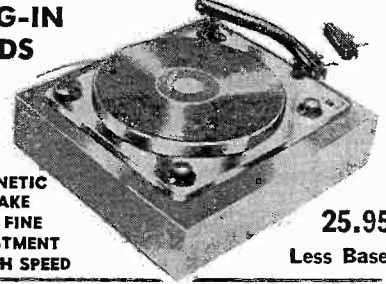

**MAGNETIC BRAKE FOR FINE ADJUSTMENT OF EACH SPEED**

**25.95**  
Less Base

**LAFAYETTE'S FM-AM TUNER KIT**

- SIMPLIFIED DETAILED INSTRUCTION MANUAL
- MEETS FCC REQUIREMENTS FOR RADIATION
- GROUNDED GRID TRIODE AMPLIFIER
- ARMSTRONG FM CIRCUIT WITH FOSTER-SEELEY DISCRIMINATOR
- AFC DEFEAT CIRCUIT WITH FRONT PANEL CONTROL

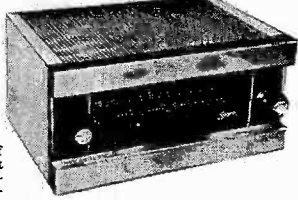

The excellence of its design and the quality of its components combine to provide this compact high-fidelity FM-AM tuner with superb characteristics normally found in units costing several times as much, and with performance unbelievable at this low price. Features Armstrong FM circuit with limiter and Foster-Seeley discriminator. Simplified tuning with slide-rule dial and flywheel counterweighted mechanism. AFC defeat circuit combined with tuning control. Attractive etched copper-plated and lacquered finish.

**SPECIFICATIONS**

**FREQUENCY RANGE:** FM, 88-108 MC; AM, 530-1650 KC. **ANTENNA INPUT:** FM, 300 ohms; AM, Ferrite loopstick and high impedance external antenna. **CONTROLS:** 2—2 function control for AM, FM, PHONO, TV and a tuning/AFC defeat control. **DISTORTION:** Less than 1% rated output; **FREQUENCY RESPONSE:** FM, ± 3 db 20 to 20,000 cps; AM, ± 3 db 20 to 5000 cps. **SENSITIVITY:** FM, 5 μv for 30 db quieting; AM, Loop sensitivity 80 μv/meter. **SELECTIVITY:** FM, 200 KC bandwidth, 6 db down—375 KC FM discriminator peak to peak separation; AM, 8 KC bandwidth, 6 db down. **IMAGE REJECTION:** 30 db minimum. **HUM LEVEL:** 60 db below 100% modulation. **TUBE COMPLIMENT:** 2-12AU6, 1-6BE6, 1-6BE5, 2-6AU6, 1-6AL5 plus 1-6X4 rectifier. **SIZE:** 5 1/2" high x 9 3/4" wide x 9 3/4" deep (excluding knobs). **CONSUMPTION:** 30 watts. For 110-120V 60 cycles AC. Less metal case. Shpg. wt., 9 lbs. **KT-100** kit, less cage. Net 34.95

ML-100—Metal cage for above, shpg. wt., 3 lbs. Net 5.00

**New!** **LAFAYETTE MASTER AUDIO CONTROL CENTER WITH BINAURAL CHANNEL AND DUAL VOLUME CONTROL**



**\$39.50**  
IN KIT FORM  
KT-300  
**\$59.50**  
WIRED & TESTED  
LT-30

**YEARS AHEAD OF EVERY OTHER PREAMPLIFIER CONTROL UNIT**

The Lafayette Master Audio Control Center is not only the finest high fidelity preamplifier, characterized by unmatched features, but it has been functionally designed to keep pace with the conversion of your present hi-fi system to binaural (Stereo) sound.

**FEATURES**

- Incorporates an extra channel and dual volume control for binaural reproduction.
- DC on all tube filaments for minimum hum, and negative feedback in every stage.
- IM distortion and harmonic distortion so low, it is practically unmeasurable at normal operating level. IM is below 0.05% at 1V; HM approximately 1/4 of 1% even at 5V.
- Dual cathode follower output stages.
- High gain for low level pickups.
- Separate turnover and roll-off controls —24 positions of equalization.
- Printed circuit construction.
- Tasteful styling, brilliantly executed.
- Designed for ease of installation and operation.

**SPECIFICATIONS**

**INPUTS:** 7 inputs accommodate every type of phono, tuner and tape. **CONTROLS:** 9 front and 2 rear panel controls make for utmost versatility. **FREQUENCY RESPONSE:** Uniformly flat frequency response over the entire audible spectrum. **TAPE EQUALIZATION:** Tape head playback equalization both NABTB and adjustable. **SENSITIVITY-GAIN:** 33db on magnetic input (2mv input produces 1V output); 14db on radio tape and auxiliary inputs (0.2V produces 1V output). **HUM & NOISE:** 80db below 3V output at full gain on radio, tape and auxiliary inputs; better than 60db below effective program level at full gain with 10mv input. **TUBES:** 3 premium type ECC83 tubes plus 2 selenium rectifiers. **POWER SOURCE:** 105-125V 50-60 cycles AC. **SIZE:** 12 3/4" L x 3 3/4" H x 9 3/4" D from front panel to rear jacks—knobs project 1". Shpg. wt., 10 1/4 lbs.

**FOR FURTHER DETAILS WRITE FOR BULLETIN ST-74.**

**NEW!** **IMPORTED 12" HI-FI COAX. SPEAKER**



- **FREQUENCY RANGE 30-15000 CPS**
- **HANDLES 20 WATTS OF POWER**
- **COMPLETE WITH LEVEL CONTROL**
- **POWERFUL TSK-5 MAGNETS**
- **SPECIAL SHEEPSKIN-EDGED CONE**

A Lafayette exclusive import and exceptional value. Consists of a 12" woofer, coaxially mounted 2 1/2" tweeter and a built-in crossover network. The specially processed fibre cone has a sheepskin edge to suppress unwanted nodal vibrations and insure beautiful tone quality. Highly efficient TSK-5 magnets. Level control provides variation to 6 db cut. Maximum input 20 watts. Impedance 8 ohms. Rugged all-metal frame. If made in this country, would cost at least \$49.50. Shpg. wt., 11 lbs. **SK-58** Net 29.50

Reg. Price **44.50**  
Net **29.50**

**LAFAYETTE HI-FI LP TEST RECORD**



Ideal for audiophile who is building a bass reflex speaker enclosure, or wants to check the components already in use. Two-side, 12" LP record covers cartridge and stylus test, turntable rumble test, average and minimum recording levels, stylus and tone arm resonance check, equalization checks, sound effects, tuning bass reflex enclosures, and a group of delightful music box selections. Specially recorded with painstaking care at 33 1/2 RPM, and master cut on a mechanism that produces the quietest grooves in the industry. Complete with instructions for use and colorful protective envelope. Shpg. wt., 1 lb. **PR-10** Hi-Fi Test Record Net 2.25

**Lafayette Radio** 165-08 LIBERTY AVE. JAMAICA 33, N. Y.  
DEPT AC-1

NAME \_\_\_\_\_  
ADDRESS \_\_\_\_\_  
CITY \_\_\_\_\_  
ZONE \_\_\_\_\_  
STATE \_\_\_\_\_

**SEND FREE LAFAYETTE CATALOG**

**CUT OUT AND MAIL TODAY!**

*treat your family  
to all the fun and enjoyment  
of fine high fidelity at  
one-half the price you  
would expect to pay*

**HERE'S ALL YOU NEED**

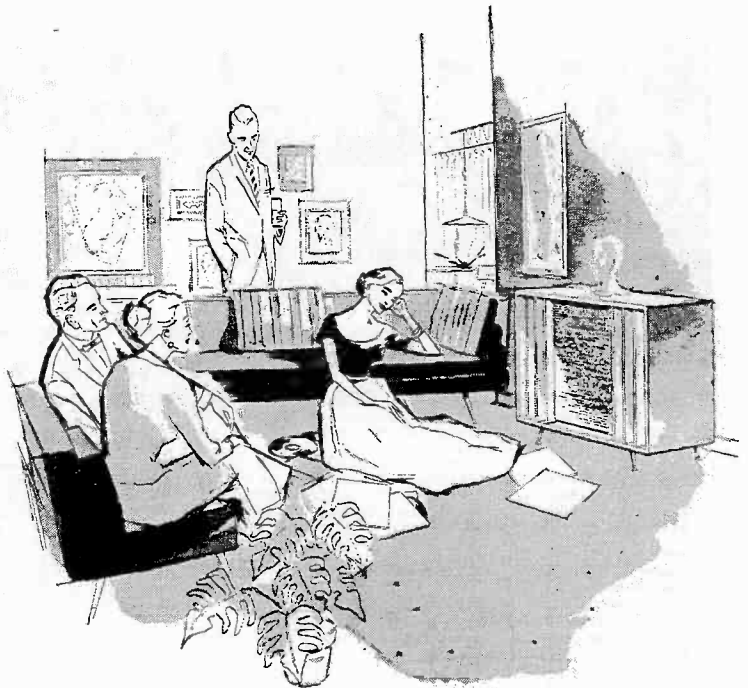
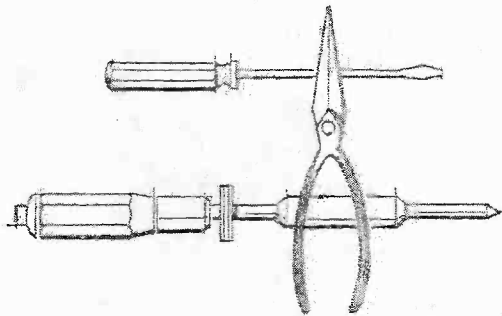

*to build your own*



**HI-FI**



FM TUNER

AM TUNER

PREAMPLIFIER

**HEATHKIT  
HIGH FIDELITY FM TUNER KIT**

This FM tuner is your least expensive source of high fidelity material! Stabilized oscillator circuit assures negligible drift after initial warmup. Broadband IF circuits assure full fidelity, and 10 microvolt sensitivity pulls in stations with full volume. High-gain cascode RF amplifier, and automatic gain control. Ratio detector gives high-efficiency demodulation. All tunable components prealigned. Edge-illuminated dial for easy tuning. Here is FM for your home at a price you can afford. Shpg. Wt. 7 lbs.

MODEL FM-3A \$25.95 (with cabinet)

**HEATHKIT  
BROADBAND AM TUNER KIT**

This tuner differs from an ordinary AM radio in that it has been designed especially for high fidelity. The detector uses crystal diodes, and the IF circuits are "broadbanded" for low signal distortion. Sensitivity and selectivity are excellent. Quiet performance is assured by 6 db signal-to-noise ratio at 2.5 uv. All tunable components prealigned. Incorporates AVC, two outputs, and two antenna inputs. Edge-lighted glass slide rule dial for easy tuning. Your "best buy" in an AM tuner. Shpg. Wt. 8 lbs.

MODEL BC-1A \$25.95 (with cabinet)

**HEATHKIT "MASTER CONTROL"  
PREAMPLIFIER KIT**

This unit is designed to operate as the "master control" for any of the Heathkit Williamson-type amplifiers, and includes features that will do justice to the finest program material. Frequency response within  $\pm 1\frac{1}{2}$  db from 15 to 35,000 CPS. Full equalization for LP, RIAA, AES, and early 78's. Five switch-selected inputs with separate level controls. Bass and treble control, and volume control, on front panel. Very attractively styled, and an exceptional dollar value. Shpg. Wt. 7 lbs.

MODEL WA-P2 \$19.75 (with cabinet)

**HEATHKIT "BASIC RANGE"  
HIGH FIDELITY SPEAKER SYSTEM KIT**

The very popular model SS-1 Speaker System provides amazing high fidelity performance for its size because it uses high-quality speakers, in an enclosure especially designed to receive them.

It features an 8" mid-range-woofer to cover from 50 to 1600 CPS, and a compression-type tweeter with flared horn to cover from 1600 to 12,000 CPS. Both speakers are by Jensen. The enclosure itself is a ducted-port bass-reflex unit, measuring 11½" H x 23" W x 11¼" D and is constructed of veneer-surfaced plywood, ½" thick. All parts are pre-cut and pre-drilled for quick assembly.

Total frequency range is 50 to 12,000 CPS, within ±5 db. Impedance is 16 ohms. Operates with the "Range Extending" (SS-1B) speaker system kit later, if greater frequency range is desired. Shpg. Wt. 30 lbs. **MODEL SS-1 \$39.95**

**HEATHKIT "RANGE EXTENDING"  
HIGH FIDELITY SPEAKER SYSTEM KIT**

The SS-1B uses a 15" woofer and a small super-tweeter to supply very high and very low frequencies and fill out the response of the "Basic" (SS-1) speaker system at each end of the audio spectrum. The SS-1 and SS-1B, combined, provide an overall response of ±5 db from 35 to 16,000 CPS. Kit includes circuit for crossover at 600, 1600 and 4000 CPS. Impedance is 16 ohms, and power rating is 35 watts. Measures 29" H x 23" W x 17¼" D, and is constructed of veneer-surfaced plywood, ¾" thick. Easy to build! Shpg. Wt. 80 lbs.

**MODEL SS-1B \$99.95**

*...and save!*

**HEATHKIT "LEGATO"  
HIGH FIDELITY SPEAKER SYSTEM KIT**

The fine quality of the Legato Speaker System Kit is matched only in the most expensive speaker systems available. The listening experience it can bring to you approaches the ultimate in esthetic satisfaction.

Frequency response is ±5 db 25 to 20,000 CPS. Two 15" theater-type Altec Lansing speakers cover 25 to 500 CPS, and an Altec Lansing high frequency driver with sectoral horn covers 500 to 20,000 CPS. A precise amount of phase shift in the crossover network brings the high-frequency channel into phase with the low-frequency channel to eliminate peaks or valleys at the crossover point. This is one reason for the mid-range "presence" so evident in this system design.

The attractively styled "contemporary" enclosure emphasizes simplicity of line and form to blend with all furnishings. Cabinet parts are pre-cut and pre-drilled from ¾" veneer-surfaced plywood for easy assembly at home. Impedance is 16 ohms. Power rating is 50 watts for program material. Full, smooth frequency response assures you of outstanding high fidelity performance, and an unforgettable listening experience. Order HH-1-C (birch) for light finishes, or HH-1-CM (mahogany) for dark finishes. Shpg. Wt. 195 lbs.

**MODELS HH-1-C or HH-1-CM \$325.00 each**



"BASIC" SPEAKER SYSTEM

RANGE EXTENDER

"LEGATO" SPEAKER SYSTEM

**HEATHKITS**  
*World's finest  
electronic equipment  
in kit form...*

*Pioneer in  
"do-it-yourself"  
electronics*

**HEATH COMPANY**

A subsidiary of Daystrom, Inc.  
Benton Harbor 18, Mich.

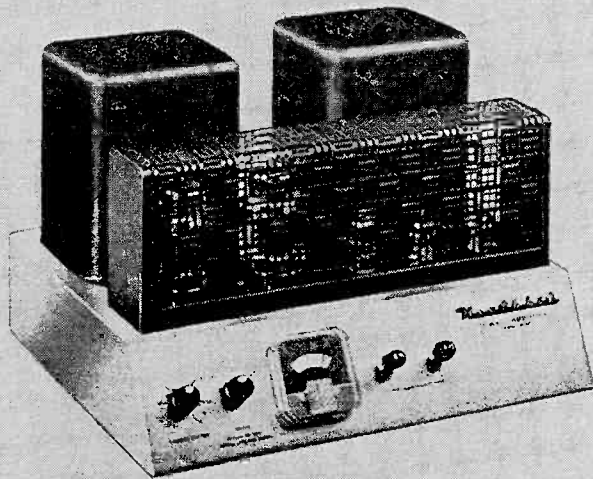

70-WATT AMPLIFIER

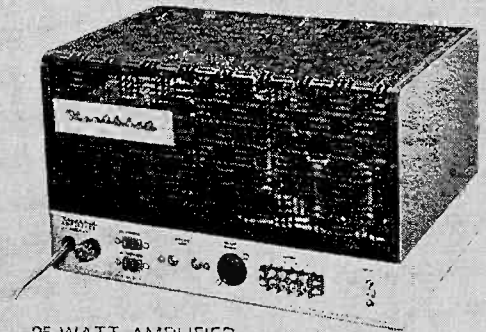

25-WATT AMPLIFIER

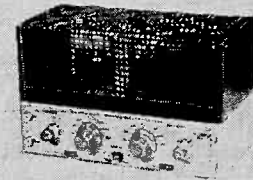

ELECTRONIC CROSS-OVER

*easy-to-build designs by*  *insure*

You get more comprehensive assembly instructions, higher quality circuit components, and more advanced design features, when you buy HEATH hi-fi!

**HEATHKIT 70-WATT HIGH FIDELITY AMPLIFIER KIT**

This new amplifier features extra power reserve, metered balance circuit, variable damping, and silicon-diode rectifiers, replacing vacuum tube rectifiers. A pair of 6550 tubes produce full 70-watt output with a special-design Peerless output transformer. A quick-change plug selects 4, 8 and 16 ohm or 70 volt output, and the correct feedback resistance. Variable damping optimizes performance for the speaker system of your choice. Frequency response at 1 watt is  $\pm 1$  db from 5 CPS to 80 KC with controlled HF rolloff above 100 KC. Harmonic distortion at full output less than 2%, 20 to 20,000 CPS, and intermodulation distortion below 1% at this same level. Hum and noise are 88 db below full output. Variable damping from .5 to 10. Designed to use WA-P2 preamplifier. Express only. Shpg. Wt. 50 lbs. **MODEL W-6M \$109.95**

**HEATHKIT 25-WATT HIGH FIDELITY AMPLIFIER KIT**

The 25-watt Heathkit model W-5M is rated "best buy" in its power class by independent critics! Faithful sound reproduction is assured with response of  $\pm 1$  db from 5 to 160,000 CPS at 1 watt, and harmonic distortion below 1% at 25 watts, and IM distortion below 1% at 20 watts. Hum and noise are 99 db below rated output, assuring quiet, hum-free operation. Output taps are 4, 8 and 16 ohms. Employs KT66 tubes and Peerless output transformer. Designed to use WA-P2 preamplifier. Express only. Shpg. Wt. 31 lbs. **MODEL W-5M \$59.75**

**HEATHKIT ELECTRONIC CROSS-OVER KIT**

This device separates high and low frequencies electronically, so they may be fed through two separate amplifiers driving separate speakers. The XO-1 is used between the preamplifier and the main amplifiers. Separate amplification of high and low frequencies minimizes IM distortion. Crossover frequencies are selectable at 100, 200, 400, 700, 1200, 2000, and 3500 CPS. Separate level controls for high and low frequency channels. Attenuation is 12 db per octave. Shpg. Wt. 6 lbs.

**MODEL XO-1 \$18.95**

**HEATHKIT W-3AM HIGH FIDELITY AMPLIFIER KIT**

Features of this fine Williamson-type amplifier include the famous Acrosound model TO-300 "ultralinear" transformer, and 5881 tubes for broad frequency response, low distortion, and low hum level. Response is  $\pm 1$  db from 6 CPS to 150 KC at 1 watt. Harmonic distortion is below 1% and IM distortion below 1.3% at 20 watts. Hum and noise are 88 db below 20 watts. Provides output taps of 4, 8 or 16 ohms impedance. Designed to use WA-P2 preamplifier. Shpg. Wt. 29 lbs. **MODEL W-3AM \$49.75**

**HEATHKIT W-4AM HIGH FIDELITY AMPLIFIER KIT**

A true Williamson-type circuit, featuring extended frequency response, low distortion, and low hum levels, this amplifier can give you fine listening enjoyment with a minimum investment. Uses 5881 tubes and a Chicago-standard output transformer. Frequency response is  $\pm 1$  db from 10 CPS to 100 KC at 1 watt. Less than 1.5% harmonic distortion and 2.7% intermodulation at full 20 watt output. Hum and noise are 95 db below full output. Transformer tapped at 4, 8 or 16 ohms. Designed to use WA-P2 preamplifier. Shipped express only. Shpg. Wt. 28 lbs. **MODEL W-4AM \$39.75**



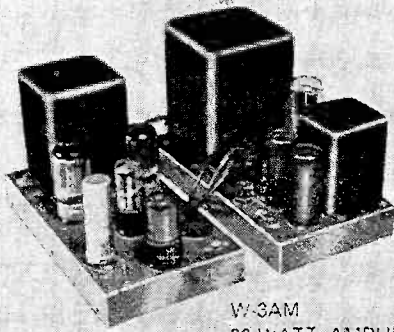

W-3AM  
20-WATT AMPLIFIER

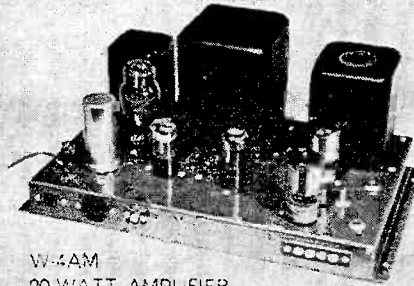

W-4AM  
20-WATT AMPLIFIER

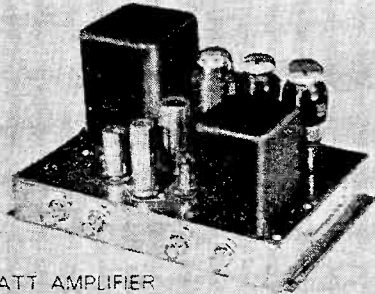

A-9C  
20-WATT AMPLIFIER

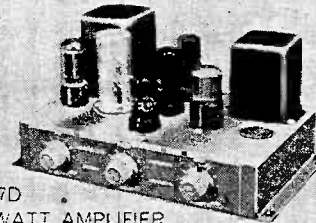

A-7D  
7-WATT AMPLIFIER

## HEATHKITS

*World's finest  
electronic equipment  
in kit form...*

*...top **HI-FI** performance*

### HEATHKIT A-9C HIGH FIDELITY AMPLIFIER KIT

This amplifier incorporates its own preamplifier for self-contained operation. Provides 20 watt output using push-pull 6L6 tubes. True high fidelity for the home, or for PA applications. Four separate inputs—separate bass and treble controls—and volume control. Covers 20 to 20,000 CPS within  $\pm 1$  db. Output transformer tapped at 4, 8, 16 and 500 ohms. Harmonic distortion less than 1% at 3 db below rated output. High quality sound at low cost! Shpg. Wt. 23 lbs. **MODEL A-9C \$35.50**

### HEATHKIT A-7D HIGH FIDELITY AMPLIFIER KIT

This is a true high fidelity amplifier even though its power is somewhat limited. Built-in preamplifier has separate bass and treble controls, and volume control. Frequency response is  $\pm 1\frac{1}{2}$  db from 20 to 20,000 CPS, and distortion is held to surprisingly low level. Output transformer tapped at 4, 8 or 16 ohms. Easy to build, and a fine 7-watt performer for one just becoming interested in high fidelity. Shpg. Wt. 10 lbs. **MODEL A-7D \$17.95**

**Model A-7E:** Same as the above except with extra tube stage for added preamplification. Two switch-selected inputs, RIAA compensation, and plenty of gain for low-level cartridges. Shpg. Wt. 10 lbs. **\$19.95**

#### HOW TO ORDER...

Just identify the kit you desire by its model number and send check or money order to address below. Don't hesitate to ask about HEATH TIME PAYMENT PLAN.

*Pioneer in  
"do-it-yourself"  
electronics.*

**HEATH COMPANY**

A subsidiary of Daystrom, Inc.  
Benton Harbor 18, Mich.

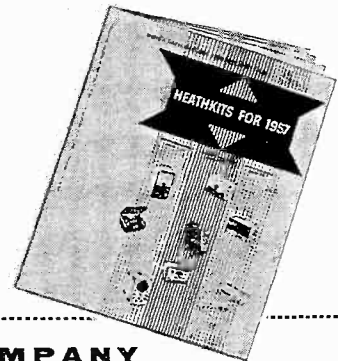

NAME \_\_\_\_\_

ADDRESS \_\_\_\_\_

CITY & STATE \_\_\_\_\_

*Please send **FREE** Heathkit Catalog*

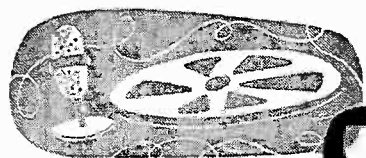

# Audionews

## KNIGHT KLIPSCH-DESIGNED ENCLOSURES

Allied Radio Corporation has announced the availability of a new, low-priced series of prefinished speaker enclosures in knocked-down form. The enclosures are of the Klipsch corner-horn type. All exposed wood panels of these enclosures are factory finished in mahogany or blond, and models are available for 12- or 15-inch speakers.

The new enclosures have been designated as the *Quick-Craft* series, and they are quickly assembled with only a screw driver. All parts are precision cut, and there is no need for sawing, sanding, gluing, or drilling.

The flexibility of Quick-Craft enclosures is heightened by the inclusion of an adapter panel which permits internal mounting of tweeter components. A plastic grille is supplied for covering the front panel.

Quick-Craft enclosures, prefinished in blond or mahogany, are priced at \$46.75 for 12-inch models, and \$54.75 for 15-

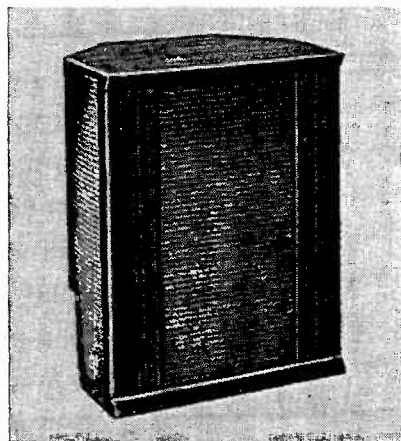

*Klipsch-designed Quick-Craft enclosure.*

inch models. Unfinished enclosures for 12- or 15-inch speakers are priced at \$34.95 and \$39.95 respectively. The enclosures are also offered prefinished and completely assembled at \$62.50 for the 12-inch models, and \$77.50 for the 15-inch models.

## BEAM-ECHO LINE

A demonstration of high-fidelity equipment manufactured by Beam-Echo of England was held recently in New York City. Among items demonstrated was

the Beam-Echo *Type AF9* nine-tube AM-FM tuner. This unit features a Foster-Seeley discriminator and is said by the manufacturer to have FM sensitivity of  $2 \mu\text{v}$  for 20 db quieting. The



*FM-AM tuner of English manufacture.*

tuner operates on 117-volt 60-cps AC. Its output is said to average 0.75 v into 0.5 MΩ. The AF9 is priced at \$149.95.

Also demonstrated was the Beam-Echo *PL-6 Super 21*, a combined preamplifier and power amplifier, with inputs for tuner, phono pickup, tape, and auxiliary. The loudspeaker outputs are two screw terminals with a selector switch giving 4, 8, and 16 ohms, with negative feedback adjusted automatically for each impedance.

The Super 21 is provided with a loudness compensator, and separate bass and treble tone controls. Power output is said to be 15 watts minimum from



*Beam-Echo Super 21 15-watt amplifier.*

30 cps to 20 Kc. IM distortion measured at 40 and 10,000 cps (4:1 ratio) is stated as 1% at 10 watts and 2% at 14 watts. Hum and noise are down 80 db at 10 watts, according to the manufacturer. Price of the Super 21 is \$149.95.

Other items of Beam-Echo high-fidelity equipment are the *Model PL12 Double 21* twin-channel stereophonic amplifier for \$239.95; the *Model DL7* 35-watt power amplifier and *Model PD-L7* preamplifier-control unit, priced at \$199.95 for the pair; the *Model BD10* stereophonic tape deck, \$150.95; the *Model BD20* stereophonic tape deck with twin-channel head amplifier and equalizer for \$225.95; the *Model LC31* 30-watt corner speaker system, including 12-inch high-flux woofer, crossover network, and tweeter, for \$195.95; and the *Model LE31* 30-watt square speaker

system, including 12-inch high-flux woofer, crossover network, and tweeter, for \$185.95.

All Beam-Echo high-fidelity equipment is distributed in the United States by Majestic International Sales Corp.

## MATCHED TRANSISTOR PAIRS

Specially selected, matched pairs of p-n-p and n-p-n transistors are now available from the General Transistor Corp. for use in complementary symmetry circuits. The pairs, labeled by General Transistor as its *SMP Series*, are matched in five contiguous categories, and have a wide variety of applications, especially in transformerless Class-B push-pull output stages, DC-coupled amplifiers, and balanced modulators.

A data sheet describing these transistors is available on request.

General Transistor has also placed on the market a kit of six all-n-p-n transistors for radio-circuit applications. The six-transistor complement consists of these types: one GT-792R, two GT-948R, one GT-949R, and two GT-905R.

## WRIST RADIO

Barlowe Electronics produces a wrist radio which is now available in kit form. Because of its small size, the radio can be worn on the wrist or carried in a shirt pocket. Total weight of the radio, including battery, is only  $2\frac{1}{2}$  oz.; dimensions of the plastic case are  $2\frac{3}{4}$  in. long by  $1\frac{3}{4}$  in. wide by  $\frac{3}{4}$  in. thick.

Assembly consists of dropping the leads of the components through the

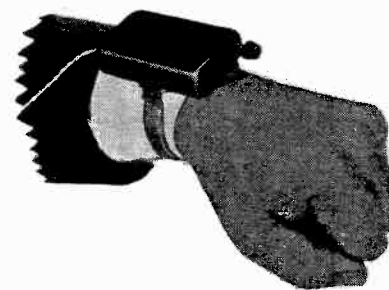

*Wrist radio is now available as a kit.*

holes in the printed-circuit board and soldering them on the underside. It is said that construction of the receiver can be completed in about half an hour by following the step-by-step instructions.

### MINIATURE TAPE RECORDER

A new portable tape recorder that weighs only 7½ lbs. is being introduced in North America by American Geloso Electronics, Inc. The recorder, known as the *Model G-255/S*, is manu-



*Miniature recorder imported from Italy.*

factured by Societa per Azioni Geloso, Milan. Its dimensions are only 9⅞ in. by 5¾ in. by 5½ in.

Among the operating features of the *G-255/S* are a choice of 3¾ ips or 1⅞ ips tape speed; dual-track recording; push-button control of recording, rewind, and playback; and a volume level indicator. The unit has outputs for headphones, external speaker, or power amplifier. The recorder operates on line voltages of from 110 to 220 volts. It uses standard 3-inch magnetic recording tape or Geloso 3¼-inch tape.

### HI-FI AND TAPE GLOSSARY

A glossary of 99 high-fidelity and tape-recording terms has been prepared by Minnesota Mining and Manufacturing Company. The glossary is free on request to Dept. M7-177, 900 Bush Street, St. Paul, Minn.

The 12-page glossary gives concise, easy-to-understand definitions of terms applying to magnetic recording tape as well as to tape recorders and hi fi generally.

### ERIE AMPLIFIER KIT

The Erie Resistor Corporation has designed a four-tube audio-amplifier kit. The kit includes an Erie "PAC" module of preassembled resistors and capacitors,

*Low-cost amplifier is easy to construct.*

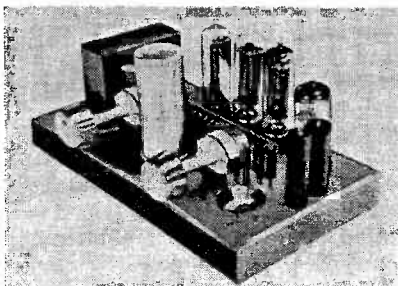

an Erie embossed wiring board, and additional plug-in components consisting of tubes, tube sockets, output transformer, filter capacitors, volume control and switch, and tone control. Complete instructions are provided with the kit.

### PARTS CATALOGUE

The J. W. Miller Company has recently published a new general catalogue, No. 58. The new catalogue lists nearly 1,000 different replacement coils for television sets, radios, and other equipment. Particularly noteworthy is a new series of transistor antenna rods, oscillator coils, and IF transformers.

### NEW SHURE MICROPHONE

Shure Brothers, Inc., manufacturer of microphones and electronic components, recently announced the introduction of a super-cardioid, unidirectional microphone, the *Model 330 Unitron*.

The manufacturer states that the Unitron has been designed for two specific



*New microphone by Shure, the Model 330 Unitron.*

markets: fine tape-recording applications and "celebrity-used" public-address systems where highest quality is needed to achieve good reproduction.

Further information about the Shure Model 330 microphone will be furnished on request.

### ELLIPTICAL CONE TWEETER

Sonotone Corporation has made available the *T-64 Linear Standard* elliptical cone tweeter for single or multiple use in separate two- or three-way hi-fi systems. The low price of the speaker

makes it ideal for multiple-speaker installations using several tweeters.

The *T-64* is the tweeter unit used in the Sonotone *CA-15 Linear Standard*



*Sonotone's T-64 elliptical tweeter.*

coaxial loudspeaker. The elliptical shape is said to give broad spatial coverage at high frequencies.

The price of the *T-64* is \$7.50 (\$8.50 in the Far West).

### C-SLOT TAPE REEL

A new reel for magnetic recording tape was announced recently by Audio Devices, Inc. Called the *C-Slot Reel*, the design features a curved groove in the hub for tape threading. Tape is slipped into this groove in the direction opposite that of reel rotation. No kinks or twists are made in the tape, and no tape ends are left sticking up. Since

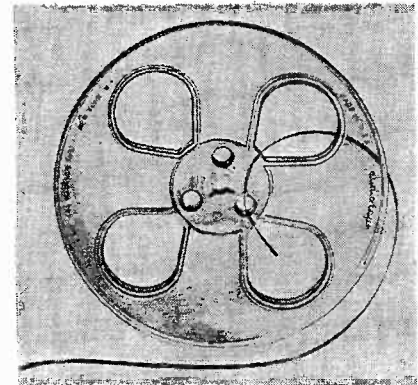

*New C-Slot reel offered by Audiotape.*

the C-Slot is self-locking, there is no need to turn the reel by hand.

All 7-inch reels of Audiotape are now being supplied on the C-Slot reel at no extra cost. It will also be standard for all 5-inch reels in the near future, according to the manufacturer.

### NEW CATALOGUE

A complete new catalogue of electronic products for high fidelity, PA, ham, industrial, and experimental applications has been released by Custom Electronics, Inc., of Dayton, Ohio. The catalogue contains 180 pages, of which 72 pages are devoted to PA and hi-fi products. It is available without charge on request.

*For more information about any of the products mentioned in Audiotape, we suggest that you make use of the Product Information Cards bound in at the back of the magazine. Simply fill out the card, giving the name of the product in which you're interested, the manufacturer's name, and the page reference. Be sure to put down your name and address too. Send the cards to us and we'll send them along to the manufacturers. Make use of this special service; save postage and the trouble of making individual inquiries to a number of different addresses.*

# COMPONENTS



JUNIOR and DUO-SPEED  
TURNTABLES ARE...

DOWN  
65 DB  
(SIGNAL TO NOISE RATIO)  
TODAY

DOWN  
65 DB  
TOMORROW

DOWN  
65 DB  
NEXT YEAR

AND  
BELT DRIVE  
DOES IT!



JUNIOR,  
\$39.50

DUO-SPEED,  
\$49.50

COMPONENTS  
CORPORATION

DENVILLE, NEW JERSEY

Department JD3

P.S. High Fidelity May TITH says, "The Duo-Speed's performance in the rumble, flutter, wow department is superb."



by RICHARD D. KELLER

## book reviews

### Frequency Modulation

Alexander Schure, ed.; pub. by John F. Rider Publisher, Inc., New York; 46 pages; \$.90, paper-bound.

The basic theory of frequency and phase modulation is given very brief, non-mathematical treatment in this book. The material is presented clearly and concisely and should help any beginner get a clearer understanding of the subject.

The book opens with a discussion of fundamental concepts, then proceeds to the production of FM and PM (phase modulation), and finally explains the propagation and reception of FM signals (omitting FM limiters and detectors, covered by another booklet in this series). Simple circuits, block diagrams, and graphical illustrations are used liberally throughout.

### FM Transmission and Reception

John F. Rider and Seymour D. Uslan; pub. by John F. Rider Publisher, Inc., New York; 426 pages; \$4.95.

This large volume should answer just about all of the many questions concerning FM that arise in the minds of technical people and engineers. It covers thoroughly the fundamental considerations and essentials of FM transmitters, giving detailed descriptions of a number of regular commercial units along with the various types of antennas which are used with them. In the second part of the book, FM receivers are described from the viewpoints of both design and servicing.

Narrow-band and wide-band FM are discussed, along with the many different fields — television, ham, aviation, marine, police, point-to-point, and mobile radio communications systems —

in which this type of radio propagation is utilized today. Both direct FM and indirect FM (PM) transmitters are discussed, with all the essential theory necessary for a thorough understanding of them both.

Mathematics is kept to the necessary minimum throughout the book. Illustrations, drawings, and schematics are liberally employed. Also, in this latest (9th) edition, questions have been added at the end of each chapter to make the book more useful to technical schools and to readers using the book for self-study.

### How to Service Tape Recorders

C. A. Tubbill; pub. by John F. Rider Publisher, Inc., New York; 154 pages; \$2.90, paper-bound.

The first third of this book gives a fairly good, nonmathematical explanation of the theory of magnetic recording and the general mechanics of present-day units. From there on, it consists of detailed discussions of particular recorders from the standpoint of mechanism, circuitry, maintenance, and repair. If your recorder is one of the 16 or so included, you may find it handy to keep this manual along with your machine's regular instructions. Otherwise, since recorders vary so much from one manufacturer to the next, the rest of the book is of doubtful value.

### Obtaining and Interpreting Test Scope Traces

John F. Rider; pub. by John F. Rider Publisher, Inc., New York; 186 pages; \$2.40, paper-bound.

This excellent little book is highly recommended to all who use an oscilloscope. Here at last is a reference that is at once more complete and more compact than the fine loose-leaf Heathkit Technical Bulletin series of several years ago.

It is liberally illustrated with actual scope pictures of wave forms which are likely to be encountered under a variety of servicing and laboratory conditions. In interpreting scope traces, particular emphasis is given to the causes underlying deteriorated or distorted wave forms. The manual also tells how to make many types of scope setups and controls for various displays.

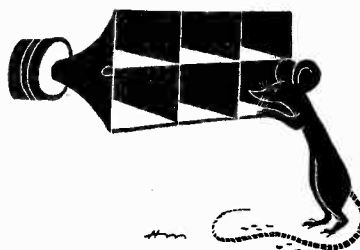



*the only fifteen-inch extended range speaker made with a 4" voice coil*



*the* **JBL SIGNATURE D130**

The four-inch voice coil in the JBL Signature D130 stiffens the speaker cone to form a rigid acoustic piston. Combined with suspension which permits long linear excursion, the D130 produces crisp, accurate bass. • The four-inch dural center dome is attached directly to the voice coil to form a large, effective high frequency radiator. The shallow curvilinear cone permits an excellent distribution of highs. • The large voice coil is made of edge-wound aluminum ribbon so that, with small mass, an unusually large amount of conductor is subjected to the lines of force in the gap of the precision-machined Alnico V magnet. • A pot structure of pure iron provides a low-reluctance return path for the magneto-motive force. Such extremely efficient use is made of the permanent magnet material that stray magnetic fields are virtually non-existent. • Tight electrical coupling and meticulous, close-tolerance workmanship combine to produce the most efficient extended range loudspeaker made anywhere. It is unsurpassed in its handling of transients. Bulletin number SB1002 describing the JBL Signature Model D130 will be sent to you free upon request.

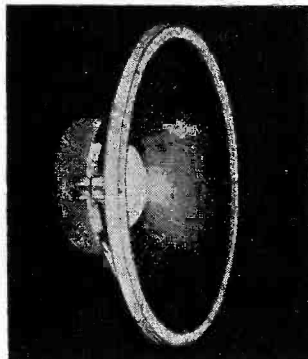

*specifications*

PHYSICAL DIMENSIONS • Voice coil diameter 4"  
Baffle hole diameter 13½" • Shipping weight 23 lbs.

ELECTRICAL • Power input 25 Watts • Impedance 16 Ohms  
Field—Permanent Alnico V Magnet  
Bl factor—1.7 x 10<sup>7</sup> Dynes per Abampere

ACOUSTICAL • Free air cone resonance 37 cps  
Frequency response, usable range, as a direct radiator,  
enclosed in an adequate baffle 30-17,000 cps

"JBL" means **JAMES B. LANSING SOUND, INC.** 3249 casitas avenue • los angeles 39, california

# Fleetwood<sup>®</sup> CUSTOM TELEVISION

## A New HIGH In FIDELITY...

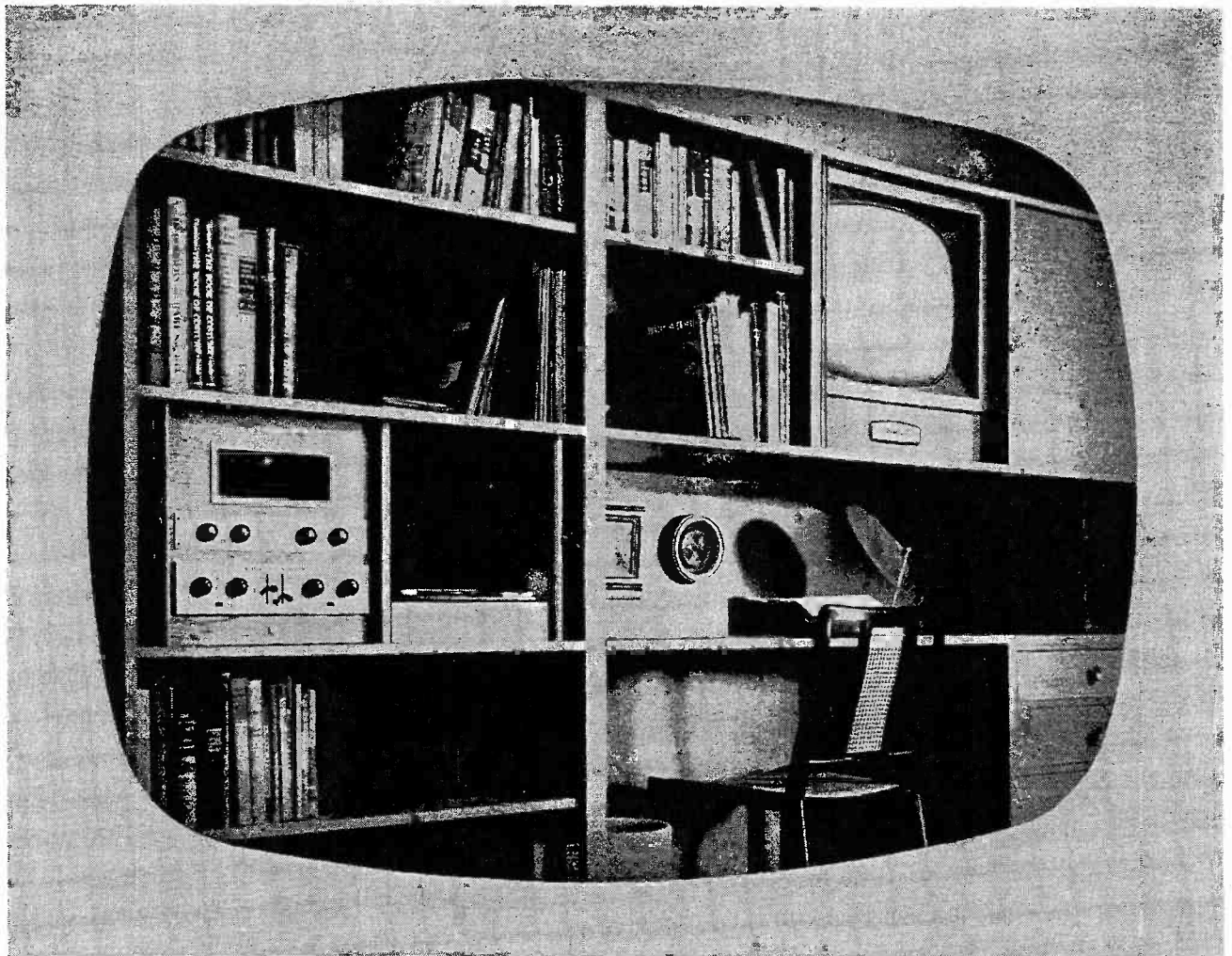

FLEETWOOD is the *monitor-standard* television system. Made to the same exacting standards as the professional telecast monitors Fleetwood makes for the major networks — Fleetwood is the television professional's choice for his home!

Fleetwood's fully electronic remote control provides not just channel selection and volume control — but contrast, brightness, volume, channel selection, fine tuning and the exclusive Definition Control that tailors picture texture to suit individual taste. Non-remote Fleetwoods are also

available. The Fleetwood receiver has four I.F. stages for full four megacycle bandpass—employs 27 tubes exclusive of the picture tube and will mount a 21", 24" or 27" rectangular picture tube. Fleetwood provides high and low impedance audio outputs that furnish your high fidelity system with distortion-free sound.

Wherever you want Fleetwood — *it belongs beautifully!* In a wall, room divider, bookcase, piece of valued heirloom furniture — in the living room, den, kitchen, bedroom, recreation room . . . installations are unlimited!

*For a free booklet of installation ideas, complete information and the name of your nearest dealer, write:*

# Fleetwood<sup>®</sup> CUSTOM TELEVISION

Crafted by CONRAC, INC. • Department G, Glendora, California

Export Division: Frazar & Hansen, Ltd., 301 Clay St., San Francisco, Calif.

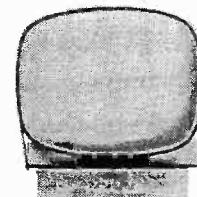

© Conrac, Inc. 1957



# EDITORIAL

Gentlemen:

I just finished reading the editorial in the June issue of AUDIOCRAFT and sat down to write before reading the magazine any further. Throughout the editorial I had the feeling that I just had to help you find the word you were searching for.

Since tape enthusiasm is a profession for some and a hobby for others (which includes work, study, and almost continual experimentation), it seems to me that there is only one word to describe the situation aptly and correctly: *tapeology*. The fancier is a *tapeologist*.

Since we are coining words, we have license to make up our own spelling. We can drop the *e* for the sake of brevity and simplicity if we choose, or we can leave it in.

If that terminology is too cumbersome, we might come down a peg or two and be punsters. Audiophiles, disc or tape, are always searching for *realism* in reproduced sound, and they therefore become sound *realists*. Substituting an *e* for the *a*, we seek *reelism* and become *reelists*! Or is that too painful a pun?

The term *tapeology*, or *tapology*, lends a little more dignity to the hobby. After all, it is a study, a continuing experiment in listening or producing home-grown tapes.

Henry S. Gordon  
Pampa, Tex.

Gentlemen:

Your June editorial comments on the lack of a suitable word for *tape recording*. May I suggest that a word of Greek origin might prove as suitable as *audiophile*, *philatelist*, or *numismatist*?

I would suggest some word based on *nema*, *nematos*—worm, or *tapeworm* (in some combinations); perhaps *thread* would be a good translation. Thus, *nematist* would refer to one who records, *nematism* or *nematios* would refer to the act of recording, and *nematology* would refer to the study of recording.

(The Rev.) D. G. Reid  
Sutherland, Nebr.

Gentlemen:

I'm glad you asked. Tape came of age long ago, and should be accorded the recognition it deserves by receiving a nomenclature derived from the Greek, as have the related photograph, phonograph, and others.

Tape recording is a process based on

*Continued on page 48*

ONCE in a while—and it is beginning to happen more and more often—I hear a very good sound system under just the right circumstances, in exactly the right room, playing a record or tape that is recorded and processed under precisely the right conditions; and it sounds like the real thing for a moment, or perhaps a little longer than a moment. If you don't think that remarkable you haven't done much critical listening to live music lately. Reproduction that is close enough to perfect to satisfy completely a listener whose habit is to listen attentively, even when it occurs for only a few bars, is rare enough to remark upon. And the fact that these magic intervals are becoming more frequent is, I believe, a reason for rejoicing in our good fortune as interested onlookers and participants in the current development of high fidelity. It is also warrant for a sincere tribute to the manufacturers of recording and reproducing equipment, and to their engineers, who have so far advanced this fascinating combination of art and science.

It is certainly true that we have come a long way in a few years. It is such a long way, in fact, that we may be dazzled into wondering how we can possibly go further; comparison of our finest equipment and recordings now with those of 1952 can be shocking.

But we should recall that we were pretty well satisfied with what we had in 1952, also, and were pleased and awed by the rate of progress during the preceding five years. This can be carried back as far as you want to go: in 1892, for example, a new phonograph was hailed as having reached "... a startling degree of perfection." We don't seem to have learned yet, as we should have, that a closer approach to perfection doesn't mean that the ultimate has been achieved; it merely means that we are a little closer to the goal. It furnishes a new standard of judgment, but we should realize that this "standard" is only temporary. There is a long way to go yet.

It is interesting to speculate on the direction that further major advances will take. We thought that amplifiers had been developed to a point at which no further improvement would be worthwhile until other audio components had caught up. Then it was proved that residual instability at both ends of the frequency range, when cleared up, made amplifiers sound better; that even when

higher power didn't seem to be theoretically necessary, it often improved the sound nevertheless; and that it paid to reduce distortion in preamplifiers far below the levels we had thought to be satisfactory. Now amplifiers are undoubtedly better, in general, than they were—but it would be silly to say that they can't be better still.

In the same vein, pickup cartridges are consistently improving. Tracking-force requirements are still going down, moving mass is being reduced bit by bit, and distortion is constantly being lowered. Gradual improvements are being made in microphones, tape machines, and in recorded tapes and discs. Even turntables are getting better.

These, however, represent simply refinements of existing types of equipment and techniques and, although we may find that this approach yields the greatest dividend in the long run, it is undeniably more exciting to think about more radical innovations that may come in the next five years. Stereo on tape isn't really new, but it hasn't yet been exploited as fully as it can be and will be. Potentially more practical, perhaps, is stereo on discs. We devoted an entire editorial recently to a most promising development in this line, so I won't say much about that now—except that if this method of disc stereo should for any reason not be adopted, another method will be, sooner or later.

As for loudspeakers, it seems inevitable that we shall have commercially practical full-range electrostatics not too long from now. Perhaps a way will be found to extend the operating range of ionized-air loudspeakers downward as well. There are persistent rumors of still another type of sound-reproducing device that will reach the market soon. We can't ignore the very strong probability of striking improvements in moving-coil loudspeakers and loading devices, either. And to conclude our list (but not to exhaust the possibilities, by any means), I believe that we shouldn't be surprised to find extensive work being done on devices to modify electronically the acoustic properties of listening rooms.

With many of these wonderful gadgets in developmental laboratories now, and others scheduled for early study, anyone can be pardoned an outlook of eager anticipation for what will come in the years between 1957 and 1962. They should be exciting ones for high-fidelity hobbyists.—R.A.



# CHECK LIST

## for High-Fidelity Systems

*A high-fidelity system consists of a number of components, whether these are bought separately or combined in a ready-to-hear system. Either way, these components should meet certain standards of performance. This check list will help determine whether the component you have in mind is a good buy, or if your present system is still up to par.*

### Pickup and Tone Arm

1) *Stylus Compliance and Tracking Force.* The important thing here is that the minimum of force should be necessary to keep the stylus in the groove and play records satisfactorily. With modern pickups it is possible to use a stylus force not greater than 1 or 2 grams, although some very good ones do run a little higher. Also, if you want a pickup for an automatic record changer you will probably have to select one with a much larger tracking force than this.

2) *Needle Talk.* Figures on stylus and tracking force really tell only part of the story. Something you can easily check for yourself is the needle talk, which reveals how much reaction the stylus gives to the groove when playing a record, and which is definitely connected with the amount of wear it will cause to the record. The pickup which plays most quietly when the amplifier's

volume control is turned off is likely to be the best one in this respect.

3) *Lateral Friction of Arm.* If you use a pickup with only 1 or 2 grams force to hold it in the record, the friction to lateral movement, whatever kind of arm you use, must be extremely low. It should not require a lateral force of more than a few milligrams to move the arm quite freely across the record; otherwise, the friction will cause undue side stress on the stylus, producing distortion.

4) *Balance of Arm.* Most modern pickup arms must be balanced in the vertical sense to produce just the required force on the stylus, but they are not necessarily balanced horizontally. This can be important in preventing vibration transmitted to the playing table (from people walking around the room, for example) from making the stylus jump a groove. A well-designed pickup arm will play the record even when the turntable is tilted to an angle of several degrees.

5) *Kinds of Distortion.* The four most important things to listen for in pickup and tone-arm performance are: (a) intermodulation distortion, producing a dithery effect in the middle and upper frequencies when a very low tone is played simultaneously (pipe organ music); (b) a low frequency buzz when higher tones are played (guitar solos); (c) low-frequency resonance, caused by the compliance of the pickup stylus resonating with tone-arm inertia, and producing an accentuated thump on low frequencies; (d) high-frequency resonance of the pickup mechanism, producing noticeable edginess or background hiss in the reproduction.

6) *Susceptibility to Hum.* Some pickups are overly sensitive to hum pickup and may produce considerable hum output when moved over a turntable or brought near the power transformer of an amplifier.

7) *Correct Matching to Preamp.* Make sure the output level and impedance of the pickup are suited to the available input circuit on the preamplifier. If the pickup does not produce sufficient output you will not be able to play the program as loudly as you wish. If it produces too much output, you can turn down the volume control on the pre-amplifier, but this may leave some distortion from overloaded input stages.

The input resistor in the preamplifier

Check your present  
or proposed system  
against this list

O.K.

Fair

Turn it off



should also suit the pickup maker's recommendation.

8) *Diamond Stylus.* It is generally recognized now that, to avoid excessive wear on LP records, a diamond stylus is an absolute necessity. If you don't play 78's very often, you can get away with a sapphire for them.

9) *Comfortable Handling.* A highly desirable feature of any tone arm and pickup combination is that you should be able to find, within a couple of grooves at most, any desired point in an LP record. Preferably, you should be able to see the stylus when lowering it onto the disc. If not, you should have a very clear indication of just where it is.

## Turntable or Record Changer

10) *Freedom of Tone-Arm Movement.* If you select a record changer, make sure that the action required for changing does not produce any restriction on the movement during the playing time (see check points 1 and 3).

11) *Available Speeds.* This naturally depends on what you want to play most. Probably you will require 33 $\frac{1}{3}$  rpm for LP's, and it is often nice to have 45 and 78 rpm to play those records too. But multispeed drive for tables makes them more expensive and also makes it more difficult to achieve uniformly high performance on all speeds. If you are only going to play LP's, you will probably get best performance at the price by buying a single-speed table.

12) *Speed Accuracy and Constancy.* Check the speed with a stroboscope for accuracy. If possible, also check the drive for constancy by using a Variac to change the voltage applied to the motor, between say 90 and 130 volts, watching its effect on speed constancy.

13) *Wow and Flutter.* These are short-term speed variations. Wow produces a slow fluctuation up and down in pitch, while flutter produces a more rapid fluctuation giving a dithery effect to the reproduction. Listen very carefully for these defects on a variety of program material; piano recordings are especially good for such tests.

14) *Rumble.* This is due to the transmission of mechanical vibration from the motor to the turntable. It is most noticeable, and can best be checked, when the stylus is lowered into a silent groove on the disc, such as a run-in or run-out groove.

15) *Acoustic Feedback.* Turn the gain control of the system all the way up to see whether the resilient mounting of the turntable is sufficient to prevent acoustic feedback from the loudspeaker to the pickup at a low frequency. Try this with a record playing, but turn it louder than you would ever want to listen.

16) *Hum Radiation.* Sometimes the turntable motor radiates hum to the pickup. This can be obviated by careful

placement of the tone arm so the pickup does not pass over the motor, but a well-designed table should not produce hum, however the tone arm and pickup are arranged.

## Preamplifier

17) *Available Input.* Check that the preamplifier is provided with inputs suitable for the pickup and tuner you intend to use, both as regards level and impedance.

18) *Available Output.* The preamplifier should also produce sufficient output to drive the main amplifier. If it produces much more than is necessary, hum and noise level may be excessive, particularly when the gain is turned down to a comfortable listening level. If it does not produce sufficient output, you obviously won't be able to use the full power of your amplifier.

If the output is much greater than necessary, and input level controls are furnished for each source, they should be turned down so that the main volume control will operate well beyond the halfway point for normal listening. If input level controls aren't furnished, have an attenuator inserted between the preamplifier and power amplifier.

Also check that the impedance of the connection between the preamplifier and power amplifier is suitable. The best arrangement is a preamplifier with cathode-follower output, feeding into a high-impedance amplifier input circuit.

19) *Hum and Noise Level.* This should be checked by connecting, and shielding, suitable resistor values to simulate the input sources (pickup and tuner) that will be used. With the preamplifier suitably coupled to the main amplifier (see check point 18) turn volume fully up. Hum should be inaudible, and hiss, at very low audible level.

20) *Power Supply.* Some preamp-control units do not have built-in power supplies, but are meant to obtain operating power via a cable and plug to the main amplifier. If you're considering one of these, be certain that the amplifier (and any amplifier you may buy in the future) has provision for furnishing preamp power, and that the plug pins correspond to the receptacle pins.

21) *Equalization Facilities.* The preamplifier should provide equalization facilities for all the records you intend to play. Most modern records, from both sides of the Atlantic, have RIAA characteristics. Some older ones, notably the London recordings, have the *ffrr* curve, while earlier American recordings employed a variety of different character-

istics too. If you are only now starting to collect records, the RIAA characteristic, built in without any alternative, should be adequate.

22) *Tone-Control Facilities.* To take care of your own room acoustics and variations in tonal quality of different recordings, you should have facilities to boost or roll off both the low frequencies and high frequencies. If you want to play old recordings, a variable low-pass filter, provided on some preamplifiers, is an asset.

23) *Loudness and/or Volume Control.* The best preamplifiers provide both these components, so that each can be used to serve its appropriate purpose. An economy in price may be effected by supplying only a loudness or volume control, and both are not vitally necessary if price is a serious factor in choosing.

24) *Distortion.* A preamplifier should produce less distortion than any other part of a high-fidelity system. If distortion shows, it is usually due to improper connection between the output of the preamplifier and the input of the power amplifier, or between the output of a tuner and the input of a preamplifier. Using a relatively high-level pickup into an input intended for lower-level types may also introduce distortion.

25) *Microphony.* This, in preamplifiers, is usually caused by microphonic tubes, particularly in the first stage. Test by tapping the preamplifier to see whether an undesirable "pong" is heard in the loudspeaker.

## Tuner

26) *AM, FM, or Both?* This is strictly a what-do-you-want-it-for-and-how-much-do-you-want-to-pay question. A tuner designed and aligned for AM or FM only will perform better than one designed for both services, on the average. But a well-designed combination tuner can still give excellent performance at a cost lower than two separate tuners.

27) *AFC Action.* With an FM tuner you can easily check the AFC (automatic frequency control) action by adjusting the tuning with the AFC switched to the "in" position, and seeing how far you can go either side of the correct tune point before the tuner flips off station.

28) *AGC Action.* Notice, as you de-tune either type of tuner, how well the AGC (automatic gain control) action holds the volume of the output constant (disregarding distortion or changes in frequency response). This will give you a good idea how close the AGC control is.

*Continued on page 39*



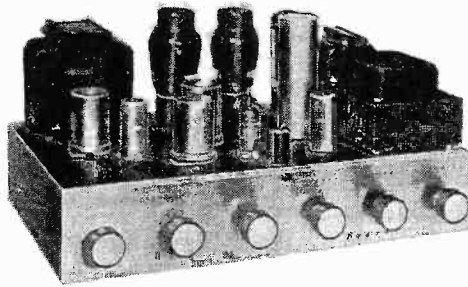

# Bogen K-DB20DF Amplifier

*An AUDIOCRAFT kit report.*

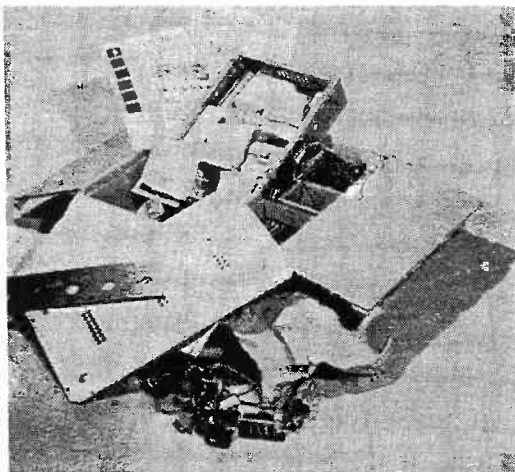
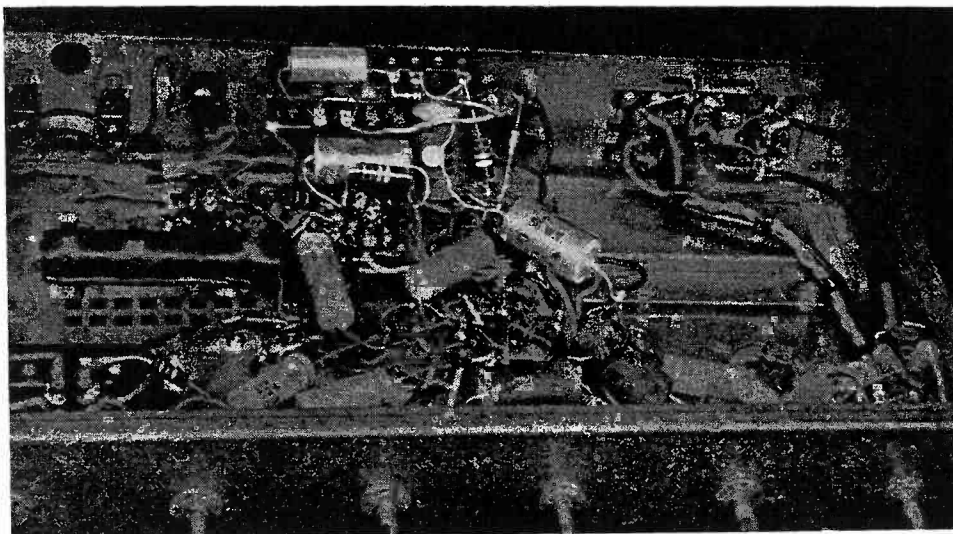

Fig. 2. Kit has parts for each stage of construction packed in individual paper bag. One bag is shown opened at front.

Fig. 3. One of the many FotoGram illustrations given in the assembly and wiring instruction manual. The parts shown in lighter shade are printed in red in the manual; they represent parts and wiring added during that particular stage.



**T**O many long-time admirers of the Bogen DB20DF amplifier, the news that it is available in kit form will probably seem too good to be true. True it is, though, and we've built one; here is the kit report.

It won't be necessary to describe the amplifier in great detail, since it is so well known. But for the benefit of any readers who may have spent the last ten years in the USUBF, a brief description follows:

The DB20DF is a complete preamplifier-equalizer-control unit combined with a 20-watt power amplifier. There are four input circuits, consisting of three high-level channels (marked TAPE, AUX, and RADIO), and a magnetic phono pickup channel with alternate receptacles for high-output and low-output cartridges. The selector switch has seven equalization positions for the phono input: LP,

AES, NAB, RIAA, EUROPEAN 78, AMERICAN 78, and POP. Feedback equalization is used in the phono preamplifier stages, and a rumble filter is provided that can be switched in or out of the circuit. Output for a tape recorder is taken off at the selector switch, which means that no other controls affect this output signal. A dual volume control is used to minimize noise and distortion, and the Bogen LOUDNESS CONTOUR switch is included. This provides fixed loudness compensation for five different sound-intensity levels. Bass and treble tone controls of the Baxendall feedback type are located in the circuit between the two sections of the volume control. The fine power-amplifier section is equipped with a variable damping-factor control that is adjustable from less than +2, through infinity, to below -2.5. Two switched AC power outlets are supplied on the rear chassis apron. This is one of the relatively few commercial amplifiers still utilizing a power-supply choke. DC is applied to the phono preamplifier filament, and the AC circuit for the other filaments has a hum-adjustment potentiometer.

It is a relatively complex circuit, as the schematic diagram in Fig. 1 (facing page) shows. Still, a kit should be constructible by anyone, so we assigned it to a staff member who had never built an electronic kit before. His comments are given in the next section.

## Construction Notes

"It's in the bag." These three words pretty well sum up construction of the Bogen STEPpak kit, K-DB20DF.

The immediately outstanding feature

*Text continued on page 20*



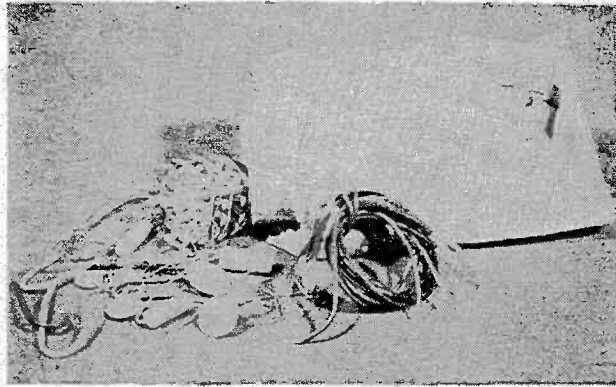

Fig. 4. Kit is built in easy, clearly defined stages of construction. This bag contained all parts and wires for stage 2, which involves wiring and installation of selector switch.

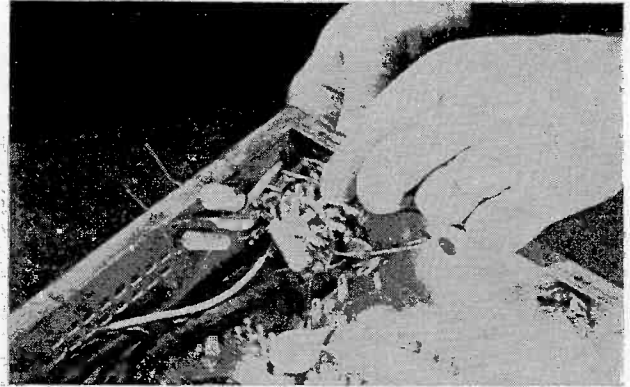

Fig. 6. Mounting the prewired selector switch. Switch has seven equalization positions for the magnetic phono channel; the three high-level input channels are also controlled here.

of the kit is its whole packaging concept. Sixteen separate bags contain the parts necessary to complete the K-DB20DF in its 17 construction stages. Fig. 2 shows the shipping carton with all component parts in view. The bottom plate, front plate, and construction and operating manuals were removed from their original position on top of the chassis, so that the packaging of the parts bags, transformers, and filter choke could be shown.

The container and the parts were received in excellent condition even after having been shipped a considerable distance twice: once by Railway Express and once by Parcel Post—a rugged test for any package containing delicate parts. (If, by chance, parts are damaged on arrival, the usual 90-day factory warranty applies.)

Once a kit is received by the builder, it must, of course, be built. The success or failure of the builder depends on the instructions for assembly provided by the manufacturer. Bogen has done an excellent job of writing and illustrating (in two colors) a clear, understandable set of instructions that should be quite easy to follow. Only in a few places

did I find that the instructions were not so clear as they could have been. However, this happened near the beginning of the construction project and a good deal of it was, undoubtedly, due to my own unfamiliarity with ordinary electronic terms. After reading over troublesome spots a couple of times the instructions will become clear—even to the most inexperienced builder.

The manual consists essentially of two parts:

*The introduction.* This part contains a complete discussion of the simple tools needed, parts-identification information, and clear instructions for wiring and soldering procedures.

*Construction directions.* This section of the manual contains step-by-step assembly directions. These instructions are in three parts for each stage: an inventory of parts contained in the particular bag for the stage being built; procedure for construction of that particular stage; and a checking FotoGram (Fig. 3) in two colors, so that the builder can compare the stage he has just completed with a picture showing how it should look. Note that these FotoGrams are actual photographs of a kit in the process

of being built, with the step just completed printed in red for easy identification.

From the very beginning, the kit was fun to build and really quite simple despite the apparent complexity of the equipment. The idea of building in stages originated with the production-line methods of manufacturing at Bogen, with one step following another in logical physical sequence—thus eliminating, to a large degree, any complications that might be encountered if the amplifier were built circuit by circuit. This method also eliminates the need for any knowledge of electronic theory. The STEPPak method has other obvious things in its favor: for example, it makes inventory an easy task, simply by not making the builder inventory all parts at once. Moreover, it permits the builder to go as fast or as slowly as he likes; the end of each construction stage makes a natural stopping point. Figs. 4, 5, and 6 show the construction of stage 2 from the loose parts to installation of the completed selector switch.

With the construction manual comes *Change Data Sheet #1*. On it are listed

Fig. 5. Parts and cables are attached to the selector switch before it is mounted on the chassis. This makes the job much easier, and is typical of thorough planning by manufacturer.

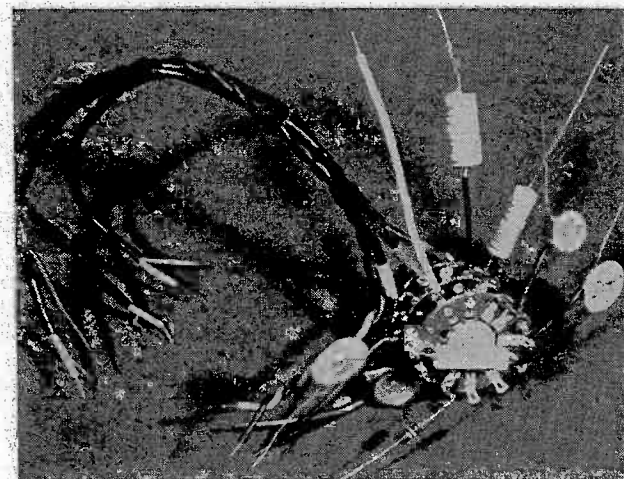
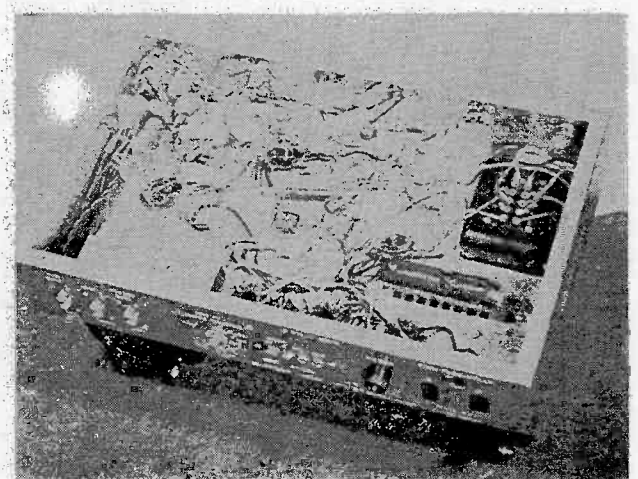

Fig. 7. Completed amplifier, identical to the production-line DB20DF. Stage-by stage wiring technique reduces the apparent complexity so that any beginner can do a good job on the kit.



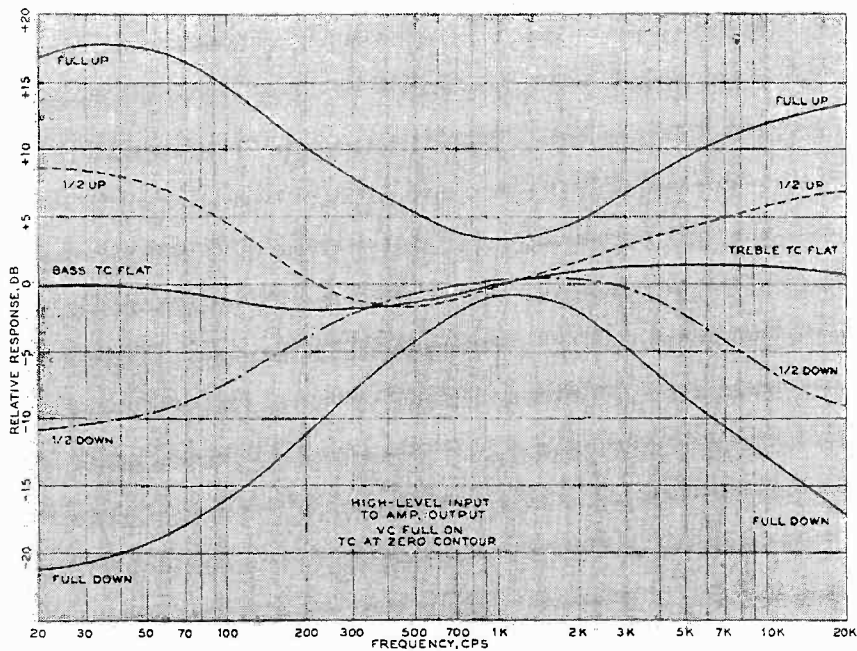

Fig. 8. Range of action for the bass and treble tone controls. Note that controls are of the sliding-turnover variety, which act on extremes of the frequency range at intermediate settings without affecting the middle range. Center curve shows over-all response of amplifier with all controls set at indicated flat positions.

corrections to be made in the manual. If you make the corrections in the manual before you start building, there won't be any chance of overlooking them.

Work on stage 2 (the input selector

switch) with particular care; follow all instructions accurately, and recheck thoroughly. The input selector switch is, in my opinion, the most difficult stage in the whole kit. After it is mounted on the chassis it is extremely

Fig. 9. Response from magnetic phono input to amplifier output, for all settings of equalization. RIAA curve is shown with and without rumble filter in circuit.

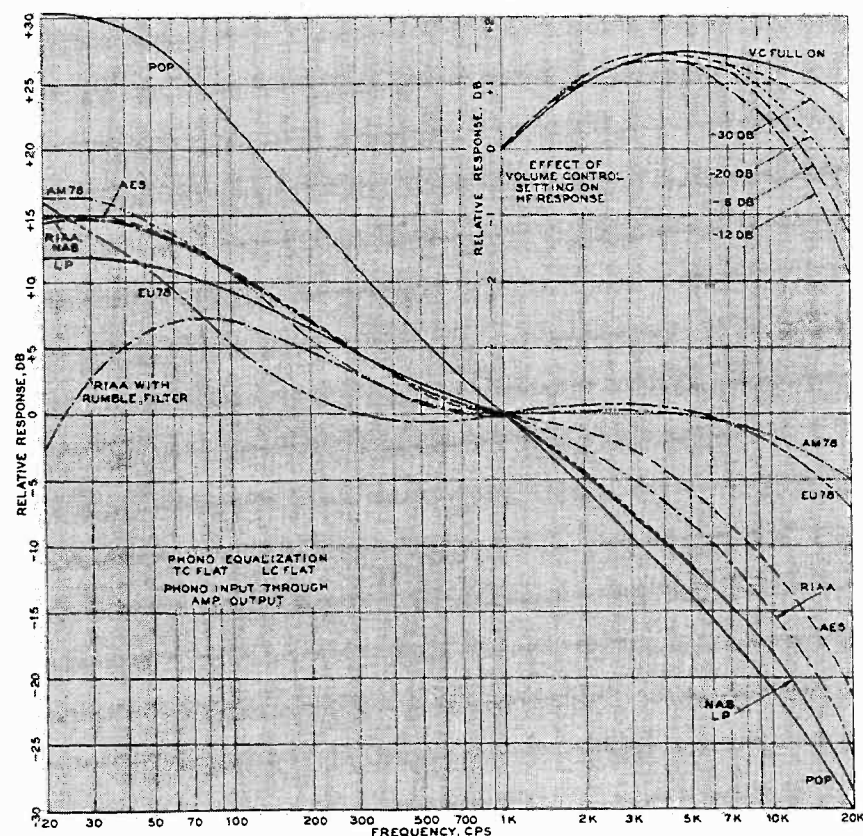

difficult to make corrections. In working on this stage I found that when you connect the three shielded wires from A8, A9, and A10 front, they should be marked as the instructions in paragraph 1 of stage four indicate. The reason for this is obvious. By looking at Fig. 5 you'll see that the shielded cables are bunched together and taped. After the switch is installed (Fig. 6) it is difficult to trace the cables and mark them.

Have a ruler handy when inventorying parts. Since the inventory lists do not have any color code for the precut wires, it is important to measure them. Many of them are of nearly the same length. To insure the proper wire in the proper place—measure!

To inventory resistors, it would be handy to have a chart of the resistance color code close at hand. Again, the colors, band by band, are not given. The proper color coding can be found in the procedure paragraphs for that step; however, this wastes a good deal of time in searching for the paragraph in which each particular resistor is mentioned.

When the procedure instructions indicate that you are to attach a lead to a center post of a tube, a pin, or to any lug and *not solder*, be sure to leave plenty of space. There are more leads coming to that spot. In a few places it gets very crowded.

Step 17 is, without a doubt, one of the most important stages of all. It tells you to go back to stage 1, and check for anything that you might have done wrong or have failed to do. Take your time and make sure everything is correct. Bottom view of the completed chassis is shown in Fig. 7. Plug your amplifier in and turn it on. The final step is to make all adjustments that are noted in the operator's manual.

In general, the sixteen hours I spent building the K-DB20DF kit were a pleasant experience. They can be for you too. If you read carefully and follow the instructions accurately, a few hours will convert your \$69.50 investment into many hours of listening pleasure.

### Audiocraft Test Results

When the completed K-DB20DF was returned to us for testing, it worked the first time it was turned on. These tests are based on results obtained without tube matching or any adjustments that a home builder would not be able to make himself, without test equipment. That such a relatively elaborate amplifier could be completed by a novice without mishap should be attributed not only to the care of the builder, but also to the meticulous care of the manufacturer in preparation of the kit and the instruction book. It is one of the best jobs we've seen. Indeed, the uniformly

*Continued on page 36*

# Pro

and

# Con

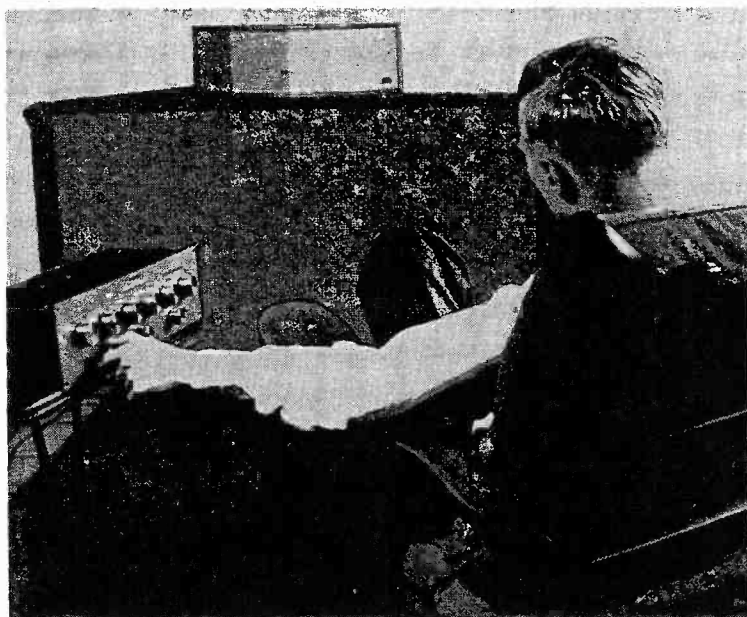

## *For Contour Controls*

by J. GORDON HOLT

ANYONE who has had the opportunity of rotating a volume control knows, without giving thought to the matter, that the *volume* of a sound is its degree of intensity. He knows that low volume means low intensity, high volume means high intensity, and medium volume is a sort of no man's land in between. But as soon as someone mentions the word *loudness* he is treading on disputed ground, because the loudness-control controversy is showing signs of becoming as acute as the triode-vs.-pentode fight that marked audio's infant years.

There are those who maintain doggedly that loudness controls are absolutely necessary; there are others who assert that loudness controls muddy up the bottom of the crystal pool of sound; and there are precious few who can truthfully claim to be indifferent about the matter. As is often the case, these opinions are actually formed by other factors than the validity of the loudness-compensation theory. There can be no question about that; it is based solidly on work done by Messrs. H. Fletcher

and W. A. Munson of the Bell Telephone Laboratories.

Twenty-four years ago, they collaborated on a paper rather pedantically entitled "Loudness, Its Definition, Measurement and Calculation," which was duly published in the *Journal of the Acoustical Society of America*. This work summarized a number of experiments indicating that the audible loudness of a tone is a function, not only of its intensity, but also of its frequency. In terms of the human listener, this means that no matter how linear the frequency response of the sound source, the ear acts as a tone control at low volume levels, introducing its own bass and treble attenuation.

If the ear were a linear transducer, it would perceive all equally intense tones with the same facility; that is, regardless of their frequency, all equally intense tones would be attributed the same loudness. Fletcher and Munson simply confused the issue by proving that the ear is *not* linear.

For their tests they chose a number of persons of average hearing capability,

and subjected each one to a 1,000-cps tone and then to other tones of different frequency. The tones were adjusted in intensity until they matched the 1,000-cps reference level in loudness; then the intensity levels thus obtained were plotted against frequency as an equal-loudness-contour curve. The reference tone was set at various levels from the threshold of feeling to the lower limit of audibility, and response curves were plotted throughout the listener's hearing range at each level. The resulting set of curves (Fig. 1) shows the average amount of volume correction or compensation that was needed at various frequencies to give the illusion of uniform loudness, for all reference levels.

Translating the Fletcher-Munson curves into high-fidelity terms, it would seem that the ear produces the original balance only for sounds reproduced at their original volume, because at lower volume levels, the ear automatically introduces progressively *greater* amounts of bass attenuation. Therefore, if recorded sound is played back at an intensity level lower than the original

sound, the balance is not the same: bass appears to be missing. This would apparently justify playing records at full, ear-shattering, orchestral level—but before you use this data to prove to your wife that you've been correct all along when you insisted your music didn't sound right unless it shook windows, I should point out that there's another less noisy solution to the problem: loudness compensation.

The loudness compensator, loudness control, or contour control (all common terms) is a device which introduces varying amounts of bass and treble boost to offset the ear's losses at reduced volume levels, thereby restoring the original balance. Two types of compensating control are most often used: the contour control, which adds fixed amounts of compensation without regard to the actual volume-control setting, and the loudness control or compensated volume control, which automatically adds its loudness compensation as the over-all volume is reduced. Both serve essentially the same function.

The equal-loudness contours in Fig. 1 show that the bass region requires very much more compensation at low levels than does the treble range. At the lowest indicated level, indicated bass boost amounts to almost 60 db at 30 cps. The frequency at which bass boost should begin increases as the average level is reduced, and so does the slope or sharpness of the boost curve. Treble curves are fairly uniform, being about 10 db up at 10,000 cps throughout most of the lower intensity ranges. (The upward turn on each of the curves was simply the result of hearing losses exhibited by some of the tested subjects. Since the curves are almost identical at the treble end for any loudness level, the treble loss is not significant in loudness-compensation calculations.)

A loudness compensator, then, must supply a great deal of bass boost, with simultaneously varying bass turnover and slope. A slight amount of treble boost is usually desirable also, although it is not justified theoretically. A treble tone control can give more than enough boost to cover whatever high-end compensation is needed, but how many bass controls will give more than 15 db of boost at 50 cps, with simultaneously varying slope and turnover? An ordinary bass control may provide an approximation of the needed compensation throughout part of the volume range, but full loudness compensation calls for middle-range attenuation of almost 60 db, which amounts to a stage gain reduction of close to 1,000! Even if we were to settle for 30 db compensation at 50 cps, we should still need additional amplifier gain of 32 to produce unity gain in the middle range. This would entail additional amplifying stages and attendant distortion. Thus it

would seem that the best place to add loudness compensation is at the volume control itself, where we can arrange our compensating network to give flat response with the control at or near its full-volume position, and can use the control to depress mostly the middle range. As the control is turned down, the middle range will drop rapidly, the treble range a little less rapidly, and the extreme bass range will change only slightly in volume. This is more like what we're after.

Since no one has yet proven Fletcher and Munson to be radically wrong, no one will quibble about the *theory* of loudness controls. The quibbling starts when we begin to investigate their *application*.

A large segment of audiophilia, many of whom possess indisputably golden ears, simply do not like what loudness compensation may do to reproduced sound. They maintain that the treble boost adds roughness and screech, and that the bass boost leads to muddiness and boom. On the other hand, there are those, about equal in numbers and aural acuity, who assert that the opposite is true: that loudness controls are absolutely necessary to maintain proper musical balance at low listening levels. As is usually the case, the truth of the matter lies roughly midway between the two extreme views, and is tied up with such touchy subjects as the philosophy of music reproduction and the deficiencies of some hi-fi components.

To begin with, Fletcher and Munson carried the upper volume extreme in their test almost to the threshold of feeling or pain; but the curves indicate that the ear is nearly linear (except for some slight treble loss) at any level

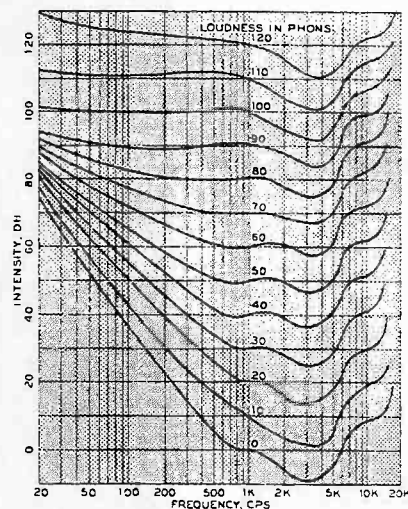

Fig. 1. The Fletcher-Munson curves of equal loudness. Below 90 phons, bass hearing loss becomes progressively more acute as the intensity level decreases. Compensation is for difference in loss between original and reproduced levels.

above 100 db. At levels below this, bass attenuation begins to appear, and increases steadily as the over-all level goes down. According to accepted standards of measurement, the threshold of pain is about 130 db above the lower limit of hearing, whereas the maximum output level from a 75-piece orchestra, heard from a fairly close vantage point, is usually measured at around 100 db. Now, the orchestra does not focus all its output power into a narrow beam and throw it at the listener; the sound spreads out in all directions throughout the auditorium, and as you get farther away from the source the level decreases. The conductor may experience sound levels of over 100 db above his hearing threshold, but by the time a concertgoer has moved back into row C, chances are that the sound intensity is below 100 db. Row M drops the level even lower; and although greater distances probably won't diminish it much more, the average live-orchestra patron is certainly getting less than the 100 db he paid for. So the Fletcher-Munson effect actually influences what we hear at a live concert, played at "original concert-hall volume," and right or wrong, this is what we are accustomed to hearing in the concert hall. Adding compensation à la Fletcher-Munson to what we hear in row M of Carnegie Hall would create a singularly disconcerting illusion of unreality. Our eyes and brains would tell us to expect a certain balance of sound (because of the orchestra's observed distance and audible volume), but our ears would perceive balance corresponding to a closer seat, along with echo and blending of a distant seat. Fortunately, this isn't something we're likely to experience.

A second point to consider is that the only time we hear live music at very low volume levels is when we are a long way from it, or when we hear it through closed doors. Then the ear is losing large amounts of bass (and some treble), but, again, years of listening experience tell us that this is how music should sound under these conditions.

This line of reasoning could well bid adieu to all forms of loudness compensation, were it not for the fact that live listening is *not* home listening.

One of the reasons why hundreds of thousands of Americans buy high-fidelity systems is that, when they buy a record with deep bass and clear overtones recorded on it, they want to be able to hear them. They know that a good record can sound realistic when "all the highs and all the lows" are reproduced, and many of them have found that these delights are best heard at volume levels which, although not higher than those in the concert hall, seem very high in the home.

The stumbling block between the

*Continued on page 44*

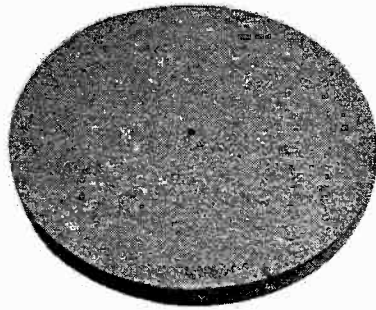

# WEIGHTING AN INEXPENSIVE TURNTABLE

by Frank Bertolotti

**A**FTER a good five-cent cigar, what this country probably needs most is a good low-priced turntable. For several years there has been on the market a turntable embodying many excellent features and a few shortcomings, selling for less than \$15. For the many audiophiles already possessing this turntable or to any contemplating its purchase, here is a simple, yet effective alteration for improving its weakest point, rumble, and coincidentally, its appearance.

The turntable in question is one made by General Industries in several models (depending on the combination of speeds desired), embodying, as its chief asset, a good four-pole motor. To meet a low price objective the manufacturer apparently preferred to skimp on the turntable proper rather than on the motor, which, incidentally, is the same type used to drive more expensive makes of turntables. An analysis of the General Industries turntable reveals it to be of low mass and therefore susceptible to the transmission (to the pickup) of any minute speed fluctuations generated in the drive system. Rumble, the most serious offender, can be detected in varying degrees, even in high-priced units. To reduce transmission of these speed fluctuations to a minimum, it is essential that the turntable be of sufficient mass to cause it to act as a flywheel. Although it can be argued that the greater the mass, the better the turntable, practical considerations, coupled with the law of diminishing returns, keep the weights of most "professional" turntables within reason.

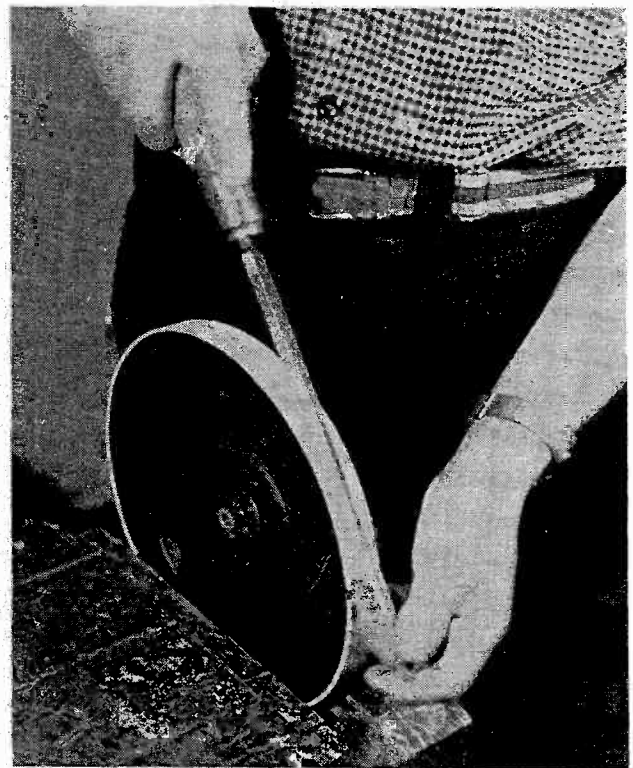

*To prepare turntable for weighting, a groove is filed in its rim. This groove provides a recess into which weighting material can flow and grip turntable. In this way, maximum benefit is derived from added weight, which is concentrated at turntable's outer edge and contributes to flywheel effect.*



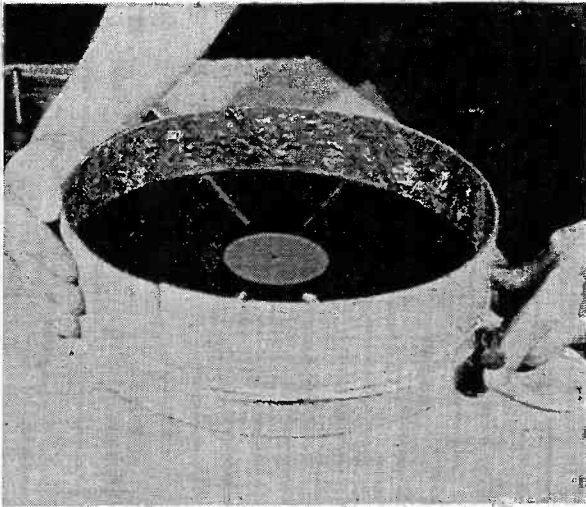

Mold, made of linoleum wrapped around an old record, is held by twine and turnbuckle arrangement.

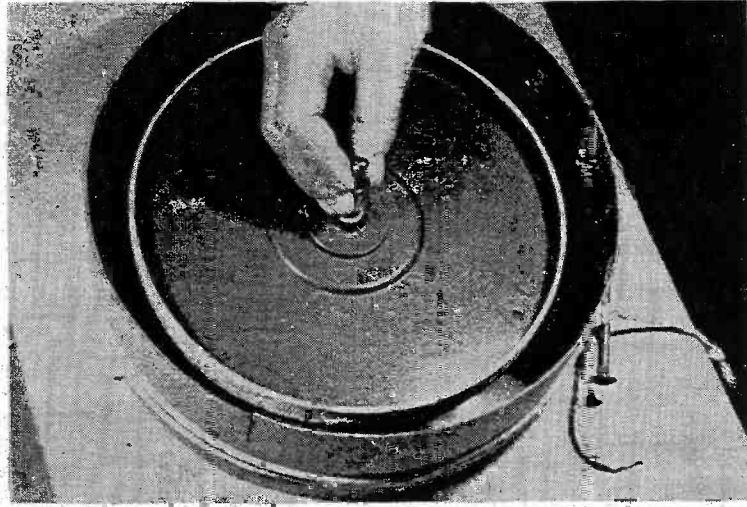

Turntable is placed in mold and centered by fitting the spindle through center hole of old record underneath. Spindle should then be withdrawn.

To increase the mass of the General Industries turntable, it was decided to add mass at its periphery, increasing the over-all diameter from 10 to 12 inches. The added weight would then be a function of the material used, varying from 1½ lbs. if an epoxy resin were used as the filler, to 13 lbs. if lead were poured around the rim. I decided to follow a conservative (and, I must confess, convenient) course, using a rich mixture of portland cement, sand, and water. This added more than 3 lbs. to the weight of the turntable. The added mass, being located at the periphery, is most effective in increasing the moment of inertia and, hence, the flywheel action of the turntable.

The illustrations show the procedure employed. A mold is easily made by wrapping a piece of linoleum around a stack of old 78-rpm records (the top record will be ruined in the process), not allowing the linoleum to overlap. The linoleum mold is held together by a rope tightened with a twisting rod acting as a turnbuckle. The turntable is prepared by filing a groove around its flange to provide a recess into which some of the cement will flow, thereby gripping the turntable. The turntable is centered with respect to the periphery of the mold. At this point, a word of caution: the whole operation should be conducted on a level table to insure that the cement filler will set flush with the turntable. The cement, after it is poured around the turntable flange, should be kept moist for the first few hours of set so that it will not crack. Once the cement has set, the unit can be removed from the mold, sandpapered, and coated with paint or shellac, avoiding, of course, the flange's inner surface which constitutes the rim drive. A corkprene mat cut to size (available from most rubber supply houses) gives the unit a \$50 look. Place the turntable back on its spindle and enjoy the \$50 performance.

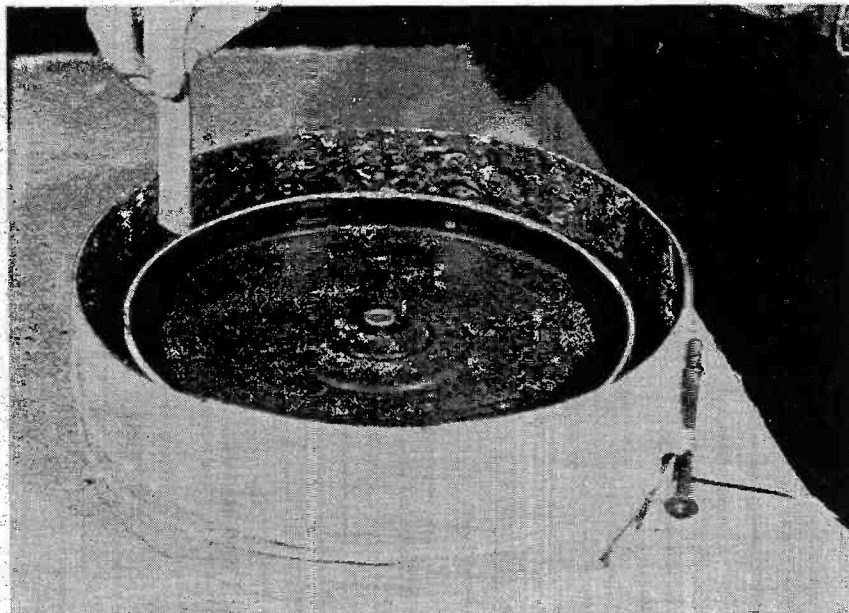

When it is not possible to use spindle, turntable can be centered by method shown in photo above. A shim, equal in width to half the difference between the diameters of mold and turntable, is used to adjust placement of turntable in mold. Picture below shows how cement filler is smoothed after it is poured around flange of turntable. Work must rest on a surface that is absolutely level while the filler sets.

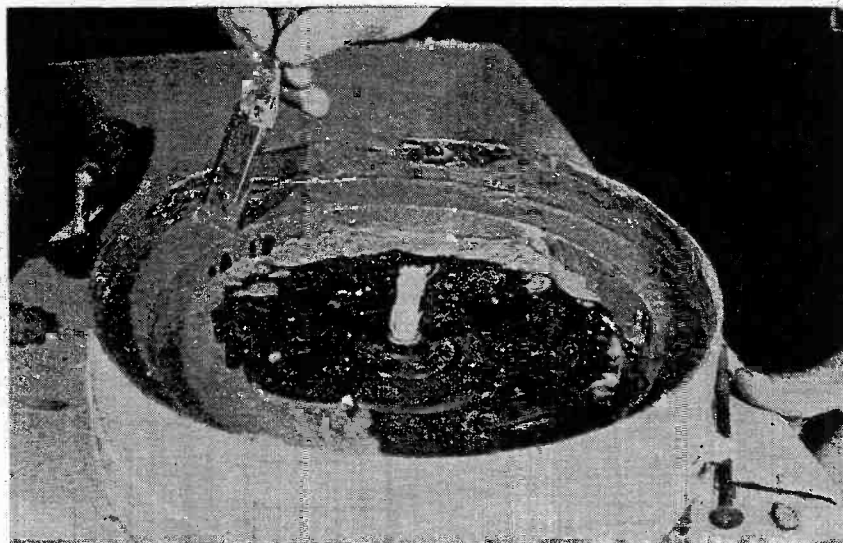

# BASIC ELECTRONICS

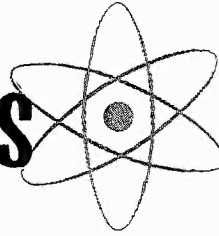

by Roy F. Allison

## XIX: Tetrodes and Pentodes

IN the preceding chapter on triode amplifying tubes it was emphasized that, although the grid voltage exercises primary control of plate current, plate voltage also has an appreciable effect on plate current. This is evident from the sharply sloped plate characteristic curves, which show plate current vs. plate voltage for various fixed values of grid voltage. If plate voltage had very little effect on plate current (within limits of the normal operating range of the tube), these curves would be nearly horizontal straight lines: that is, plate

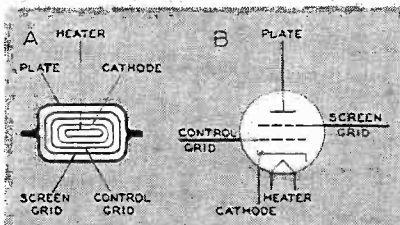

Fig. 1. Physical locations of elements in a tetrode, and the schematic symbol.

current would be about the same value for any plate voltage above zero.

It will be recalled that the amplification factor is determined by the relative effectiveness of plate voltage to grid voltage on the plate current. With nearly horizontal plate characteristic curves this ratio would be very high; above a reasonable value of plate voltage, the plate current would be virtually completely controlled by grid voltage, and the amplification factor  $\mu$  would be much higher. In a typical amplifier stage the voltage gain is given to a close approximation by

$$A = \frac{\mu R_T}{R_T + R_P}$$

where  $A$  is the voltage gain,  $R_T$  is the total AC load resistance, and  $R_P$  is the tube's plate resistance. Other factors remaining equal, the gain is directly proportional to the amplification factor. Thus we can generalize without serious error and say that, so long as the load remains constant in magnitude, stage gain increases as the plate characteristic curves become more nearly horizontal.

If we want increased gain, then, we

can get it by increasing the amplification factor—or by reducing the effect of the plate voltage on the plate current, which amounts to the same thing. This can be done by isolating the plate electrostatically: inserting an electrostatic shield between the plate and the grid-cathode assembly. In practice this takes the form of another wire grid similar in structure to the control grid, concentric with the other tube elements and situated between the control grid and the plate, as shown in Fig. 1A. This is known as the *screen grid* or simply the *screen*. Its presence increases the number of active tube electrodes to four (the heater isn't considered an active element), so the tube is called a *tetrode*. The schematic diagram of a tetrode appears in Fig. 1B; as with the triode, the heater symbol is often omitted or shown separately with heaters for other tubes in the circuit.

We have seen that the mechanical construction of the control grid—a fine wire spiral with relatively large spacing between turns—enables it to control current in the tube by virtue of a fairly uniform electrostatic field, without interfering physically with the passage of electrons through it. It acts much like an electrical valve, whose opening depends on the grid voltage. That is why the British term for vacuum tube is "valve." Now, the screen is made in the same way. Electrostatically, it re-

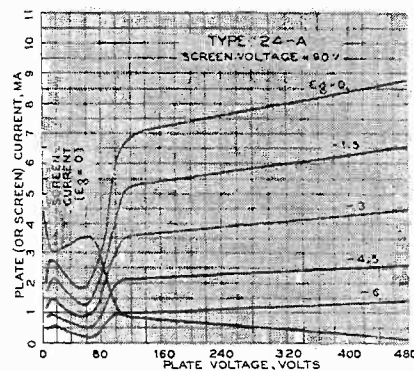

Fig. 2. Plate characteristic curves for a tetrode. Typical negative-resistance region is apparent between 15 and 60 v.

places the plate in attracting electrons from the cathode, and accordingly it must be supplied with a positive voltage of appreciable magnitude. But because of the open construction, relatively few of the electrons actually hit the screen; they fly through the interstices on to the

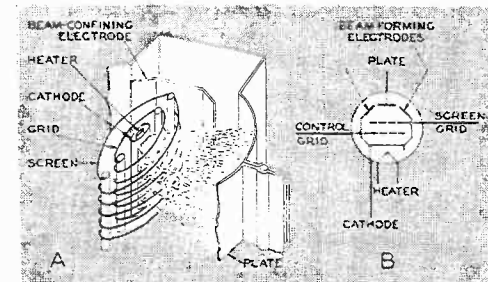

Fig. 3. A beam-power tetrode (courtesy RCA) and one of its schematic symbols.

plate, which is also positive and a solid physical barrier as well. The screen potential is normally kept at a constant DC level by a large capacitor so that it does not vary according to the signal input. Therefore, the effectiveness of the grid in controlling tube current is not reduced by the positive electrode (the plate in a triode) swinging in an opposite direction simultaneously, because of the AC voltage developed across the load. The plate of the tetrode swings in the same way, of course, but the effect of these swings on plate current is all but eliminated by the isolating action of the constant-potential screen.

Plate characteristic curves for a tetrode are shown in Fig. 2. Note that in the region to the right of about 100 v plate voltage, the curves are much more nearly horizontal than those for a triode, indicating greater independence of plate current from plate voltage. The amplification factor is correspondingly high: over 600 in this case. The realizable gain does not increase so much as the radical increase in amplification factor might indicate, however, for reasons that will be discussed later. For the moment, let us examine Fig. 2 more closely in the region to the left of 100 v plate voltage.

One of the ways in which electrons

can be freed from the surface of a conductor is by bombardment of the surface with high-energy electrons from an external source. This is secondary emission, as was explained in Chapter XVI. As soon as the plate in any tube becomes positive with respect to the cathode by a certain minimum voltage, it attracts electrons with enough force to cause secondary emission from the plate's surface. In a triode this effect isn't noticeable, for the electrons knocked loose are attracted back to the plate immediately; it is the only positive electrode in the vicinity. That is no longer true when a screen grid is added.

The curves in Fig. 2 are for a tetrode with a DC screen voltage of 90 v, and in this particular tube (a 24-A) secondary emission from the plate begins when the plate voltage reaches about 15 v. Up to 15 v, therefore, plate current increases with plate voltage, as it would be expected to. But above 15 v on the plate, secondary emission begins; and most of the secondary electrons go to the screen because that is substantially more positive than the plate. As the plate voltage increases still further, more and more secondary electrons are knocked off the plate and are lost to the screen, so that the plate current actually decreases. It decreases more and more as the plate voltage increases from 15 to 60 v. Above 60 v secondary emission still increases, but now the plate is positive enough to attract a good share of the

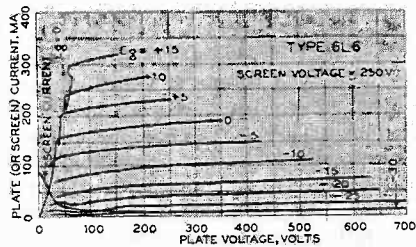

Fig. 4. Beam-power-tube characteristics show little negative-resistance effect.

secondary electrons back to itself. In the region between 60 and 120 v on the plate, plate current rises sharply and the screen current decreases abruptly to the normal operating values.

The significance of the abnormal region from 15 to 60 v is that, in this range, the tube acts as a negative resistance. It seems a ridiculous concept, but it is valid nevertheless: only a negative resistance could show a decrease in current as the voltage across it is increased, and vice versa. In certain applications such as oscillators the effect is put to good use, but it is usually a disadvantage. That is why tetrodes are rarely used except in modified form as power amplifiers, and never as voltage amplifiers.

To recapitulate the last few paragraphs: the undesirable negative-resistance effect occurs in tetrodes because

secondary electrons, emitted from the plate, are more attracted to the screen than to the plate when the screen voltage exceeds that of the plate. Secondary emission is not a problem in triodes because there is no electrode nearby that is positive, other than the plate itself; thus, even when the plate is only slightly positive, all the secondary electrons return to it. This suggests that, if the screen could be made to appear physically or electrostatically distant from the plate, it would attract few secondary electrons. Most of these electrons would then return to the plate, and the negative-resistance effect would be minimized.

There are definite narrow limits to the permissible spacing between screen and plate, however. Any appreciable great isolation between them must be accomplished by electrostatic means. It would do no good, obviously, to put a positive electrode between them; the new electrode would attract secondary electrons also. A region of minimum potential is required so that electrons knocked off the plate will face, toward the center of the tube, a repulsive force, and will return to the positive plate. There are two distinctly different ways in which this is achieved.

In the beam-power tube (Fig. 3A) the low-potential region is established by the electron stream itself. Turns of the screen grid are carefully wound in precise alignment outside corresponding turns of the control grid, so that as few electrons strike the screen as possible. This helps to obtain the maximum number of electrons traveling toward the plate. Density of the outward-traveling electron stream is further increased by confining it to two narrow beams by means of beam-forming electrodes operated at cathode potential. At low plate voltages (for which suppression of secondary emission is important) the electron stream is accelerated through the screen but, once beyond the screen, is not accelerated further by attraction to the plate. This produces an intense concentration of low-velocity electrons between screen and plate that constitutes a negative space charge. Secondary electrons from the plate, which would normally be attracted to the high-voltage screen, are repelled back toward the plate by this space charge. At higher plate voltages, of course, the space charge diminishes because the plate continues to accelerate the electron stream toward it after the stream passes through the screen; but at higher plate voltages isolation from the screen is no longer needed.

Fig. 3B is the schematic diagram for a beam-power tube. Note that the beam-forming electrodes are internally connected to the cathode in order to keep them at zero potential. They cannot possibly conduct current; they merely form a physical barrier to confine the stream. The success of this method for

eliminating the negative-resistance region is not complete, but nearly so, as is demonstrated in Fig. 4. This shows plate characteristic curves for a widely used beam-power tetrode, the 6L6.

Unfortunately, beam-tetrode construction isn't practical except for power-amplifier tubes such as the 6L6 and 6V6, because the plate current of a voltage-amplifier tube would be insufficient (even with severe beam constrict-

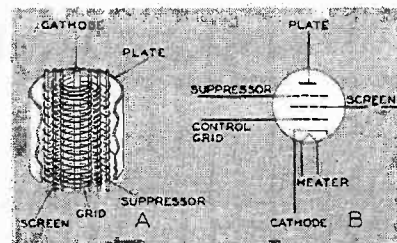

Fig. 5. Construction of pentode voltage amplifier (courtesy RCA), with symbol.

tion) to permit formation of the requisite space charge. For voltage amplifiers another spiral-grid electrode is added between screen and plate. This element is operated at zero potential or nearly so in order to establish the isolating electrostatic field between screen and plate. It serves the same purpose as the beam-power space charge in suppressing secondary electron travel to the screen, and is accordingly called the suppressor grid or, simply, the suppressor. This tube is a five-electrode device: a pentode. Its construction is shown in Fig. 5A, and its schematic symbol in Fig. 5B.

It should be explained here that the symbol for a beam-power tetrode is often drawn in the same way as that for a pentode. One way to distinguish be-

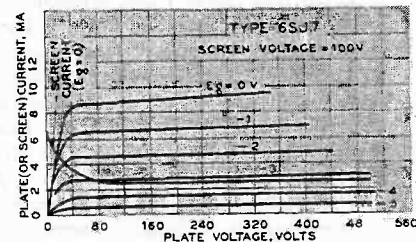

Fig. 6. Negative-resistance region is completely eliminated by the suppressor.

tween the two (although this is not an infallible guide) is that an internal connection is shown between cathode and beam-forming elements in the beam tetrode, while it is not usually shown for a pentode unless it is a power-amplifier pentode.

Addition of a suppressor grid can eliminate completely any negative-resistance tendency at low plate voltage. This is evident from Fig. 6, which shows the plate characteristic curves for a 6SJ7—a popular voltage-amplifier pentode.

Continued on page 38

## Stereo Standards and Conversions

**E**ARLY this summer, the audio avant-garde was jarred out of its preoccupation with 1-gram pickups and electrostatic tweeters by news from Great Britain about Sugden's single-groove stereophonic disc recordings. The general feeling about Sugden's coup was that it represented a veritable milestone in the forward march of fi.

The news came none too soon to suit many people. A lot of record collectors, surrounded by walls of LP records, had been eying the rise of stereo tape with the growing dread that, in a few years, their massive collections of LP's would be as outmoded as the 78's they had just finished palming off on relatives. The announcement of stereo discs somehow brightened their horizon, and renewed their fervent hope that discs were here to stay.

On the other hand, there must be many hi-fi enthusiasts who were not favorably impressed with the fruits of Sugden's ingenuity—those, for instance, who had sunk large amounts of money in stereo tape players and exorbitantly priced tapes to play on them. These people figured they had gone about as far as they could go with monaural sound, and had taken stereo tape for what it appeared to be—the next thing beyond discs—only to find that discs had moved up to share with tapes the title of perfectionists' program material.

According to informed sources, the stereo discs are supposed to be compatible, in the sense that the pickup which plays them will play monaural discs with equal facility. But stereo-tape converts are only too aware that this is not true of their medium. A monaural tape *will* play on a stereo tape player, but the player certainly isn't compatible with monaural discs.

So, for the benefit of those who have thus far missed the writing on the wall, I'm going to hold myself up as a prophet of things to come. The fact that I have never yet made an incorrect prediction may deeply impress anyone who is unaware that I've never made a prediction, but others may take my

ruminant speculations for what they are—guesses.

First, I think Sugden will succeed in perfecting his stereo recording to the point of commercial practicability. I don't think his crystal pickup will be popular in the U.S.A., though, for any longer than it takes some clever designer to add vertical pole pieces to a cantilever-type magnetic pickup. And I think stereo discs will stop the downward pricing trend in stereo tapes.

Mind you, I did not say that they'll kill stereo tapes, because I don't think they will. But I do believe they will curtail their popular acceptance, which everyone was hoping would bring the price down.

Today's hue and cry about stereo stresses its ultrarealism—it's ability to re-create a sense of roundness, depth, and perspective that is not obtainable from monaural sound. So stereo itself is considered the perfectionist's medium, and the idea of there being good stereo and bad stereo has not come into the picture at all. Neither has price, because everyone admits (while grumbling about it) that premium quality is usually synonymous with premium price. Stereo discs, though, are going to change all this, and will give the depth-conscious listener a price choice.

The average music listener may be willing to accept the minor inconven-

expensive. If both of the stereo media give equivalent audio quality, then I think most people are going to choose the discs.

But there, I believe, is where tapes will win out. Today's stereo tapes are not nearly so good as they could be: they don't utilize the potential dynamic range, they do not have the transparency and detail of a good original tape recording, and many of them are rather poorly miked. It is impossible to realize how tremendous is the actual volume range of a large symphony orchestra in performance until you've actually heard it reproduced intact. Listeners within range of good-music FM stations that broadcast original tape recordings will know what I'm talking about, but those accustomed to getting their music from records or recorded tapes will just have to take my word for it. There's nothing like it on any commercial recording I know of, but I've heard privately recorded tapes which prove that full dynamic range at low distortion *can* be tape recorded. Perhaps they could be disc'd, too, but there aren't many pickups that could track a full uncompressed orchestral crescendo.

At the present stage of technical development, tape is the only medium that could *commercially* handle full-dynamic-range recording, and permit frequent replaying without rapid wear. Stereo discs, however, will share the dynamic-range limitations of ordinary LP's, not necessarily because they are incapable of wider dynamics, but because the playback equipment will represent a perpetual stumbling block. Also, groove wear on monaural or stereo discs becomes increasingly serious as recorded velocity increases.

Recorded tape will certainly continue to hold its own in matters of expected life and freedom from clicks and pops. If it is to flourish in competition with stereo discs, all the same, it is going to have to get a lot better than it is now. This means that some of the commercial recording companies are going to have to re-evaluate their concepts of

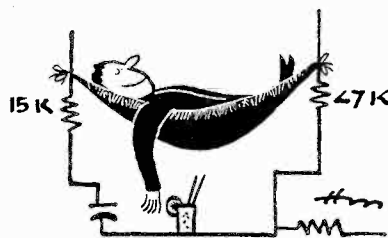

iences of the tape medium as long as it gives him better sound, but the fact remains, that discs are easier to handle than tape, they allow any selection to be picked out instantly from a recorded program, and they are notably less

what can and cannot be recorded, and it also means that tape duplicating equipment and techniques are going to have to be improved. These things will come about, I firmly believe, because nothing spurs technological advance like some healthy competition.

The long-range picture, then? Stereo discs will fill the gap between today's monaural LP's and stereo tapes. The discs will probably be as good as, or perhaps a little better than, today's stereo tapes, and they'll be priced about midway between current stereo tapes and classical LP's. They will share monaural discs' advantages and disadvantages, and may ultimately replace monaural records, but they won't make them obsolete so far as playback equipment is concerned.

Stereo tapes may come down in price some, but not much. They'll still be the perfectionist's medium, and as such they'll have to carry recorded sound the like of which you've never imagined.

Don't throw away your stereo player. And if you haven't already gone stereo, you may as well convert, because you aren't likely to be caught at a dead end. All of which brings us to the nominal topic of this month's column: converting to the Standards.

In the first issue of AUDIOCRAFT, this column decried the lack of standards in tape recorders, and pointed out the multiple hazards of recording tapes on one machine and then trying to play them on another. At that time, there were many different recording and playback curves in use, there were two different kinds of stereo head configuration, and there were several variations on the theme of monaural head configuration. I am pleased to be able to report at this time that two of these inconsistencies have been largely solved.

The stacked-vs.-staggered stereo head business is just about over and done with, as of the date of RCA Victor's welcome announcement that their staggered stereo releases were being discontinued. Of course, the fact that RCA chooses to take this step doesn't necessarily mean that stacked stereo has been established as the industry standard. But I dare say that, as the most powerful manufacturer of stereo tapes, RCA Victor is in about as good a position as anybody to establish trends. As for those tape users who own staggered-head playback machines — be not dismayed. Most tape recorder manufacturers are planning to make available stacked conversion kits; and Brush Electronics Company and Dynamu Magnetronics Corporation (to

mention two that I know of) now manufacture stacked stereo heads that can be installed in practically any recorder already equipped with staggered heads.

As a matter of fact, the conversion of a tape recorder having staggered stereo playback heads into one equipped for stacked stereo playback has interesting possibilities. The average home recorder of this type contains two separate amplifiers: one that doubles as a monaural

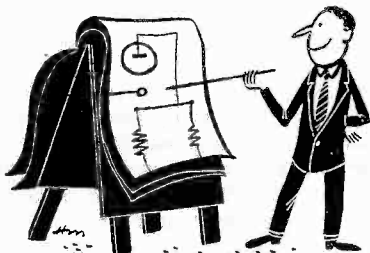

record amplifier and channel-1 stereo playback amplifier, and another that operates only for channel-2 stereo playback. Such a recorder contains three heads, for half-track erase, half-track record and playback (on the upper half of the tape), and half-track playback only, on the lower tape track. Replacing the third head with a stacked stereo head means that there are two signal-carrying heads serving the upper track — a circumstance which lends itself readily to playback monitoring *while recording* monaurally.

The best professional monaural tape recorders are equipped with three heads, for erasure, recording, and playback. Their record and playback amplifiers are separate, enabling the recordist to listen to the playback from the third head while the second head is recording. This gives him a positive guarantee that all is well in the recording operation, and that his tape sounds like the original signal going onto it. The three heads in the converted home recorder can be made to function similarly, by connecting the upper half of the new stereo head to the playback-only amplifier, and modifying the electronic switching if necessary to keep this amplifier connected in circuit at all times. The half-track record head and the lower half of the stereo head will then have to be rewired into the record-playback switch, so that the record head is connected to the output of its amplifier channel when recording, and the lower stereo head is connected to that channel's input when playing back. Additional frills might include the installation of a separate volume control in the top-track playback amplifier, to

enable the monitor (playback-only) amplifier to be set at comfortable listening level when the unit is recording at full modulation, and perhaps even an A-B switch to enable the headphones or monitor speaker to be switched from one channel to the other. If you're handy with cut-and-try circuit designing, this could be an intriguing and rewarding project; if you're not, you'd better stick with the simpler conversion. Don't expect perfection, though, when you compare B with A. Only professional-quality machines can produce a tape that sounds almost indistinguishable from the original. With most recorders, the monitoring facility will serve mainly to insure proper recording level and absence (or presence) of tape dropouts.

The second standardization that I referred to is the adoption of the NARTB tape playback curve for 7½-ips tapes. This is not actually an official 7½-ips standard, but is actually the 15-ips standard playback curve, which Ampex Corporation adopted for its 7½-ips speed. And since Ampex has thus far led the field in recorder manufacture, it was probably inevitable that its 7½-ips curve would become generally accepted. It is perhaps an unwise choice, because the very large amount of treble boost needed to record a 7½-ips tape to the optimal 15-ips playback curve causes more distortion at high frequencies than does, say, the European CCIR curve, or the early so-called Dubbing curve. Be that as it may, the recorded-tape manufacturers backed Ampex by swinging to the NARTB curve for their commercial tapes, and the combination of forces established the present "standard."

To play commercially recorded tapes, a playback machine equipped with a ¼-mil playback head requires about 30 db of bass boost, with a transition frequency of 3,000 cps. Other playback heads will require slightly different equalization, so, if in doubt, get hold of Ampex's No. 5563 test tape, run it through the machine, and tailor the equalization to give flat response. The necessary modification will probably involve changing the value of the attenuation resistor in the playback equalization circuit, to give a total of 30 db loss in the network, and then adjusting the equalization capacitor to give flat response.

Then, if the record characteristic in the machine need not be changed, a switch should be installed to allow the

*Continued on page 47*





### Electronic Bandpass Filter

The Heathkit Electronic Crossover XO-1 consists of two electronic filters, a high-pass and a low-pass unit with independently selected transitions at 100, 200, 400, 700, 1,200, 2,000, or 3,500 cps. The design affords a sharp "knee," 12-db-per-octave attenuation outside the passband, and negligible distortion or phase shift.

Normally, the input signal is divided into two channels and appears at the LOW and HIGH output jacks. A fourth jack and a slide switch are provided to bypass the input to some other circuit.

A simple interchange of two wires to the switch makes the units available separately, and, with the addition of a cable jumper, the circuit can function as a bandpass filter. At A in the illustration is shown a block diagram of

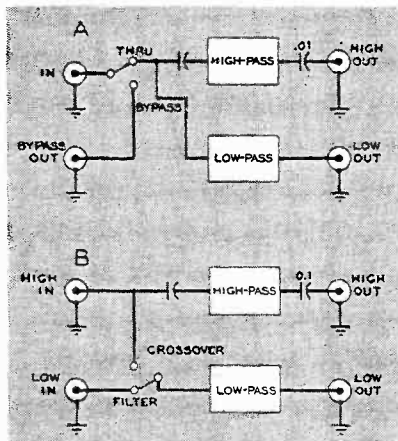

How to modify Heath Electronic Crossover so that filter sections are usable independently or in series connection.

the original circuit, and, at B, the modified connection and labels. With the switch in the former BYPASS position, the former BYPASS OUT jack becomes the input for the low-pass filter, and the two sections are independent. If a cable is run from LOW OUT to HIGH IN, then the two sections are in series and the output of the bandpass circuit appears at HIGH OUT. If it is desired to run the signal through the high-pass

filter first, which is more convenient if the circuit is normally used as a crossover unit, it is necessary to increase the output coupling capacitor of the HIGH channel from .01 to 0.1  $\mu$ fd or larger.

I devised this connection to permit raising the signal-to-noise ratio of portions of a tape recording which involved narration between musical movements. With the aid of this circuit and a mixer-fader, the narrator's voice volume could be raised and the noise and hum suppressed at the same time, and the transitions effected smoothly. When the technique had been worked out, a dubbing was made onto another tape.

Dr. John D. Seagrave  
Los Alamos, N. Mex.

### Behind the Grille Cloth

Whenever a speaker enclosure is built, the problem arises of how to prevent the speakers from showing through the grille cloth. Usually, the speakers are dull black, sometimes the tweeter is bright aluminum, while, on occasion, the horns may be gray.

To prevent the speakers from showing through the grille cloth, paint the outside of the speaker mounting board and the visible surfaces of the horns a flat black.

Insert a clean cloth deep inside the horns to prevent paint from running in and damaging the speakers. Cone speakers do not need painting, since they are always a dull black color.

Stanley L. Adams  
Detroit, Mich.

### Improved Pin Tips

While everyone agrees that the phono tips we use for connecting audio components are a trial and an abomination, no one has produced anything better at

the price. Until something better comes along, the situation can be improved somewhat by pushing a 2-inch length of  $\frac{1}{4}$ -inch I.D. Saran laboratory tubing up over the outer shell of the jack as



Plastic tubing makes phono pin-tip plug easier to handle, less likely to break.

shown in the illustration. This provides a hand grip, and prevents the short bends that break the ground connection. Just remember to thread the tubing onto the cable before the tip is soldered on.

Rubber tubing will work, but the Saran grips the shell better. It will push on more easily if the shell is warm from soldering.

R. L. Browning  
Texas City, Tex.

### B+ Test Points

Here is a simple expedient that provides convenient test points in B+ lines, and, at the same time, affords maximum protection to equipment components.

Drill a small hole through which a meter probe can be inserted through the plastic to the metal part of the thumb knob of a Littelfuse panel-mount fuse holder (see diagram). Adding the inexpensive fuse holder, drilled as shown, to a front or side panel of an amplifier allows a quick check of the B+ voltage while the unit is in operation. If a

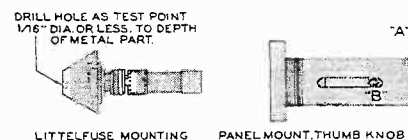

Hole drilled in fuse-holder cap serves as access point for a test-load probe.

failure should occur, a check at the fuse holder will indicate the particular B+ line that has blown.

The fuse should be wired with the front part, "B," on the load side, so that a zero voltage reading at this point indicates that the fuse is dead.

Albert J. Pezzo  
Troy, N.Y.

### AUDIO AIDS WANTED

That's right—we'll pay \$5.00 or more for any short cut, suggestion, or new idea that may make life easier for other AUDIOCRAFT readers, and which gets published in our Audio Aids department. Entries should be at least 75 words in length, and addressed to the Audio Aids editor. No limit on the number you can submit!

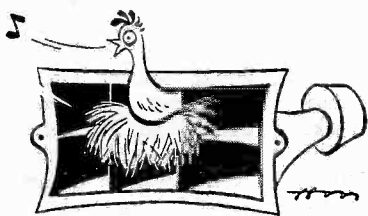

# Sound-Fanciers' Guide

by R. D. DARRELL

AFTER last month's preoccupation with contemporary—if not always aggressively “modern”—music, I hankered to go as far back as I could in history for other examples of sounds that are arrestingly strange to our ears, in some ways even stranger than those of the most advanced compositions of today. For, as Thomas Mann wrote in the prologue to his *Joseph* series, the “. . . further down into the lower world of the past we probe and press, the more do we find that the earliest foundations of humanity, its history and culture, reveal themselves unfathomable.”

Unfortunately, the earliest preserved European art music of any consequence (apart from some Gregorian and Byzantine chants) dates from relatively “recent” medieval times—not the so-called Dark Ages immediately following the fall of Rome, but the great Gothic Era (twelfth through fifteenth centuries) which preceded the Renaissance and in many ways was a comparably rich and exciting period of discoveries in the tonal as well as the other arts. A wonderful sonic documentation of the two main types of music new in the thirteenth century is provided by Safford Cape's *Pro Musica Antiqua* on Archive ARC 3051, one side of which includes 12 secular motets and troubadour *chansons*, and the other, two longer examples of the earliest types of sacred polyphony: *organum duplum* and *organum quadruplum* (i.e., singing together in two and four parts respectively) by the first great composers known by name, Leoninus and Perotinus of the *Ars Antiqua* school centered in the Cathedral of Notre-Dame at Paris.

The wondrously tender, fresh, and often humorous songs and rudimentary motets are the most readily appealing to present-day ears, especially the three or four enhanced in sonic interest by accompanying recorders, medieval “fiddles,” and lute; but it is the unaccompanied *organa*, based on Gregorian chants, which are the most impressive, if at times quite weird and interminably drawn out. Beautifully sung and recorded with the utmost purity (and processed on as immaculate surfaces as I've ever encountered on LP's), this disc is so well-nigh perfect of its kind

that only the most insatiable audiophile could ask for more. Yet I still wish that *all* of the songs had been accompanied, as surely must have been the custom of the time, and, even more, that the musical director had been daring enough to record the two *organa* in a big, highly reverberant cathedral (such as Notre-Dame itself), so we might have a more realistic notion of what they sounded like to the listeners of their own day.

(But perhaps I have been biased by the simultaneous reading of John Harvey's book, *The Gothic Age: 1100-1600*, Batsford, 1950, which, with its breath-taking pictures and descriptions of Gothic cathedrals, has whetted my aural appetite almost as much as Henry Adams's *Mont-Saint-Michel and Chartres* for an authentic personal experience of their unique acoustics.)

## Strings—Old, New, and Odd

At any rate, a similar curiosity about the actual sounds of prehistoric, medieval, and Renaissance stringed instruments has at last been satisfied by the latest release in the Vox Spotlight series (DL-320). This volume, of course, also features most of the best-known later stringed instruments, both plucked and

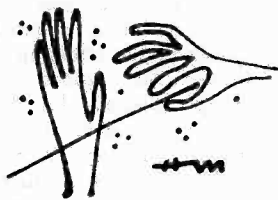

bowed, but from either the antiquarian or odd-sound point of view the most fascinating are such curios as the musical bow with gourd resonator, the three-stringed *rebec* with its pungently dark tone coloring, and the viols with sympathetic strings—not only the *viola d'amour*, but also the *barytone* for which Haydn wrote so many compositions. The strangest sounds, however, emanate from the ugliest monstrosity of all musical-instrument making: the *tromba marina*. After reading about it for years, I'm delighted to have heard it at last—once! The brief sample here

is conclusive proof that obsolescence of some ancient instruments is a proper as well as inevitable fate.

As may perhaps be gathered from between-the-lines reading of my accompanying booklet, I am not a whole-hearted fancier of the more orthodox bowed instruments. Indeed, for some of the successors to the viols (which enchant me) I often share the Choctaw-Indian prejudices expressed so ribaldly in my booklet quotation drawn from Vance Randolph's Ozark folk tales. But, despite myself, I was mightily intrigued by the direct comparisons (in the same music, with the same player and identical mike setup) of one modern and three classical violins: an Amati of 1674, a G. G. B. Guarnerius of 1706, the “Joachim” Strad of 1723, and a Haenel of 1956. For true violin fanciers these comparisons should be even more valuable, as indeed they are for any listener who prides himself on his ability—or chides himself for his supposed inability—to recognize quite subtle differentiations in timbre. Although my association as annotator with this project disqualifies me from making any impartial technical judgments on it, it may not be out of bounds to note that in general, as well as in this particular instance, it's far easier to evaluate such comparative qualities in record reproduction than it is in direct, live listening. I was conscious of many tonal distinctions when I attended the actual recording sessions, but, studying the record itself months later, I found anew that one's memory for sonic subtleties is treacherously fleeting, and that they can be dependably analyzed only under home-study conditions.

One also tends to be more critical then, too. Many performances of more familiar materials which might be unalloyed delight to hear in concert either lose much of their auditorium impact in one's living room or—perhaps more often—suffer by comparisons with what might be termed more “phonogenic” versions. An apt case in point (since it features two of the finest works ever written for massed strings) is the program by Boyd Neel Canadian recordings which includes Vaughan Williams's eloquent *Fantasia on a Theme by Tallis*, Dvorák's melodious *Serenade*, Op. 22,

and the former composer's *Greensleeves Fantasia*—with flutes and harp augmenting the strings (Unicorn UNLP 1044). Attractively played as all these are, the competent (but not exceptional) recording can't compensate for some failure in the line of communication between conductor and home listener, or for the fact that the experienced discophile will consciously or unconsciously contrast these somewhat characterless performances with others of more distinction.

In a quite different repertory and with no less differently constituted string orchestra, that of the Grand Curucaye of Trinidad in the British West Indies, it's entirely possible that the *Epilogue to the String Band Tradition* (Cook RR 5020) misses some of the atmosphere of the original performances, but only Emory Cook and his staff can testify to that. To this home listener the disc is a superb evocation of an on-the-spot recording session, for here the players do genuinely communicate their own infectious enthusiasm, and the sheer novelty of their materials is *hors concours* as far as most North American listeners are concerned. Ethnically, these materials (representing a dying tradition of old Venezuelan dance music) probably are extremely important, but for me even their brisk rhythms and underlying melodic nostalgia are less notable than the chattering, strumming tone qualities produced by three *cuatros* (a kind of guitar, I presume), *bandol* (Spanish mandolin), with regular guitar, violin (handled here mostly in an effective, if whining, fiddle style), cello, and bass, plus flute and piano.

### More Offbeat Sonic Qualities

The peripatetic Cook's tours of the Caribbean continue to produce other disc documentaries of unusual ethnic and sonic interest, among them *Danse Calypso* (1180) and *Castilianne* (10890). The Johnny Gomez Orchestra's pieces in the former are noteworthy only for their jauntiness, but the Brute Force Steel Band contributes some of its most liquidly bubbling playing in two selections, and "Small Island Pride" does a magnificent combined Calypso spiritual in *Going Down Jordan*. Moreover, "Lord Cristo" puts to shame most of the better-publicized Calypsonian singers I have ever heard, and the "Dictator" does a convulsing, even if largely unintelligible, take-off on Chinese singing in his *Chinese Cricket Match* (with a virtuoso *claves* player providing the crickets' parts). *Castilianne*, however, is probably the safest general recommendation of all the Cook Caribbean series, for it contains a bit of everything: three pieces drawn from the Grand Curucaye disc noted above, a couple of dances by Johnny Gomez's Orchestra, six even better ones (notably the instrumental ver-

sion of *Terra Seca*) by John Buddy Williams's Band, and a very strange and wonderful piece by the Girl Pat Steel Band, in which the astonishingly poetic oil-can drums share honors with a deftly handled *guiro* or scratcher.

Audio Fidelity is another outstanding contributor to the archives of both recorded local musical color and those of sounds fascinating for their own sake. One of the finest dual attractions of this kind is *Fiesta en España* (AFLP 1819), a collection of flamenco materials starring the guitarist Rafael Molero, the dancer Alberto Salicru, and—in a couple of songs each—the singers Esperanza La Macarena and Paco de Jaen. The latter two are perhaps too restrained and artistic to convey the wild abandon most characteristic of gypsy singing, but Molero and Salicru are both immensely dramatic and at times sensitively poetic. Best of all, from the audiophile point of view, not only the guitar transients but those of the dancer's incisive heel clicks and castanet clacks are recorded with a brilliance perhaps too sharp and strong to be entirely natural, but which is uncommonly effective.

I was disappointed, though, in the playing of *Johnny Puleo and His Harmonica Gang* (AFLP 1830), for it gives little notion of the mouth organ's potentialities as either a solo or ensemble instrument. Again the recording is excellent, but the arrangements of familiar



pop tunes (plus bits of Ravel and Offenbach) are crudely commercial with little if any attempt at phrasing or coloristic delicacies. Much more worthy of the engineers' technical skill—as well as infinitely more fun to listen to—is Eddie Barnes's *Honky Tonk Piano* (AFLP 1827), which is the Real McCoy as far as the beat-up instrument and its percussive accessories are concerned, while Barnes himself has just the right flair for rambunctious, all-out, old-time pianny pounding. After hearing his ribald, but divertingly catchy versions of *Humoresque* and the third *Liebesträum*, it'll be almost impossible ever to listen again to straight versions of these indestructible salon war horses!

How well Barnes has captured—and transcended—the varied sound effects of the one-time popular mechanical pianos and "orchestras" hardly can be fully appreciated until one has heard

what some of the playerless monsters actually sound like in the *Honky-Tonk in Hi-Fi* documentary (Sonotape SW 1053 or Westminster WP 6033.) featuring the "classic" nickelodeons preserved lovingly in the musical museum at Deansboro, N.Y. These include a Wurlitzer Piano, Seeburg Orchestral Piano and Orchestron, Link Piano with xylophone and mandolin "effects," and—most primitive and distinctive of all—a Nelson-Wiggen Orchestron; and the assorted buzzes, clanks, bangs, strums, and jangles caught here in sharply focused, high-level recording evoke a whole nostalgic era when the first step in reproduced music making was not lowering a pickup into a groove or punching a tape mechanism's start button, but simply dropping a nickel in the slot. The eventual triumph of jukeboxes and TV proves to have been a Pyrrhic victory!

There's another *Honky-Tonk* sweepstakes entry (Stereophony tape B 120), but it's strictly an anachronism of definite jukebox character. For while Bill Austin and his combo (featuring too much wheeze box for my taste) play with old-fashioned schmaltz and forced vivacity, this is far from the genuine honky-tonk tradition. The stereo recording, however, is first-rate, if often at an overpoweringly high level with a consequently overheavy bass, and I did get a kick out of the virtuoso banjoing in *Bye Bye Blues and Down South*.

### Popularized Percussion

Perhaps only the fanatical historian—and, of course, the equally fanatical and even more omnivorous and unshockable hi-fi specialist—can wholeheartedly accept completely authentic revivals of old instruments or styles, or uncompromising sonic documentations of completely offbeat tonal qualities. Yet these do arouse enough interest to prompt popularizers and commercializers into diluting and adapting some of these aural stimulations for tenderer ears. Perhaps nowhere is this tendency more evident than in the recent rush to capitalize on the new hi-fi-promoted vogue for percussive sounds of all kinds.

Two typical examples are Morton Gould's *Jungle Drums* (RCA Victor LM-1994) and Stanley Black's *Percussion Fantasy* played by the New Concert Orchestra under Nat Nyll (Cameo tape PMC-1012), both of which are somewhat misleadingly named, inasmuch as the primary appeal lies in the mostly light Latin-American or quasi-exotic musical materials, while the drums and various "kitchenware" noisemakers provide merely more-or-less appropriate top dressing. Of the two, I much prefer the former, for not only is the recording itself strongly clean and reverberantly big, but the music has considerable attractiveness, especially in the whole side

*Continued on page 34*



Save yourself time and trouble  
by ordering your books directly from us.  
Just fill in the coupon below.

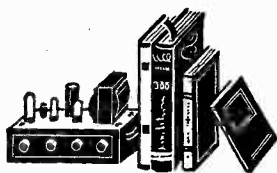

# audiophile's bookshelf

Three recent books by three experts

## HANDBOOK OF SOUND REPRODUCTION

By EDGAR VILLCHUR, inventor of AR loud-speaker systems and president of Acoustic Research, Inc.

Here is A-1 information about all aspects of sound reproduction, acoustics, and the necessary components. Written by one of the foremost authorities in the field, the book is organized in a way similar to home training courses. It fully covers a difficult technical subject in a manner which will provide pleasure and profit to the high-fidelity enthusiast. \$6.50 **249**

## HIGH FIDELITY: THE WHY AND HOW FOR AMATEURS

By G. A. BRIGGS, designer and manufacturer of Wharfedale loudspeakers.

"... holds something for everyone. For the amateur, for whom it was written, it holds a bit of everything, in suitably compressed form, and must inevitably leave him with a feeling that he has acquired a general working background to the whole subject. . . . It deserves a wide readership, and I am certain it will secure it." — HI-FI NEWS (England) \$2.95 **250**

## UNDERSTANDING HI-FI CIRCUITS

By NORMAN H. CROWHURST

Here the audiophile will find the answers to questions often confusing. The chapters are: special output stages, feedback, damping, inverter and driver stages, input stages, matching, equalization, speaker distribution and crossovers, loudness and volume controls, tone controls. Hard cover, \$5.00 **254**  
Soft cover, \$2.90 **255**

Now available — the revised edition of Greene & Radcliffe's extremely popular

## THE NEW HIGH FIDELITY HANDBOOK

A complete, practical guide for the purchase, assembly, installation, maintenance, and enjoyment of high-fidelity music systems. Includes the latest information on equipment. 250 illustrations, diagrams, and plans. \$4.95 **251**

"... Messrs. Greene and Radcliffe, two gentlemen whose knowledge of hi-fi is only slightly less than awesome. Whoever said that 'reading maketh a full man' was right — at least as concerns this book. Read it through, and you will arise full of knowledge." — Deems Taylor.

## WHAT TO LISTEN FOR IN MUSIC

By AARON COPLAND. The revised edition of a book which made it possible for thousands to increase their enjoyment of music through creative listening. \$3.95 **247**

## THE FORMS OF MUSIC

By SIR DONALD TOVEY. Written by one of the most literate and profound of modern interpreters of music, these essays are drawn from those articles which Tovey prepared for the *Encyclopaedia Britannica*. Paper, \$1.35 **239**

Book Department  
AUDIOCRAFT Magazine  
Great Barrington, Mass.

I enclose \$..... for which please send me, postpaid, the books indicated by circled numbers below. (No C.O.D.'s or charge orders, please.) Foreign orders sent at buyer's risk. Add 55¢ per book for postage on foreign orders except Canadian.

Binder 1 (holds 14 issues)	<b>223</b>	\$3.50	
Binder 2 (holds 12 issues)	<b>245</b>	\$3.00	
			<b>201 245</b>
			<b>223 247</b>
NAME .....			<b>232 249</b>
			<b>233 250</b>
ADDRESS .....			<b>234 251</b>
			<b>237 254</b>
			<b>239 255</b>

## Continuing best sellers

### HIGH FIDELITY RECORD ANNUAL: 1956

Edited by ROLAND GELATT. The second volume of *High Fidelity Record Annuals*. Included in this collection are reviews of classical and semiclassical music and the spoken word which appeared in HIGH FIDELITY Magazine from July 1955 through June 1956. Comparisons with recordings of previous years are emphasized. A performer index is included. \$4.50 **237**

HIGH FIDELITY RECORD ANNUAL: 1955 \$4.95 **201**

### MAINTAINING HI-FI EQUIPMENT

By JOSEPH MARSHALL. A much needed book on the specialized approach necessary to service high-fidelity equipment. The author discusses not only electronic faults, but the mechanical and acoustical defects which cause a hi-fi system to function less than perfectly. The book is clearly written and well indexed. Hard cover, \$5.00 **232** Soft, \$2.90 **233**

### HIGH FIDELITY: A PRACTICAL GUIDE

By CHARLES FOWLER, Publisher, AUDIOCRAFT Magazine

Whether your budget is small or large, whether you are a beginner or a devotee from way back, this complete and definitive guide can help you get the most enjoyment out of your high-fidelity system.

Here is the practical expert advice needed by everyone who has, or expects to have, a high-fidelity system. Starting with an introduction to sound, the author then describes the various links in the hi-fi chain, explaining their features and specifications so as to provide the most helpful criteria for evaluating, and for selecting and matching components. \$4.95 **234**

# The Most Advanced Master-Control Amplifier Available Today!

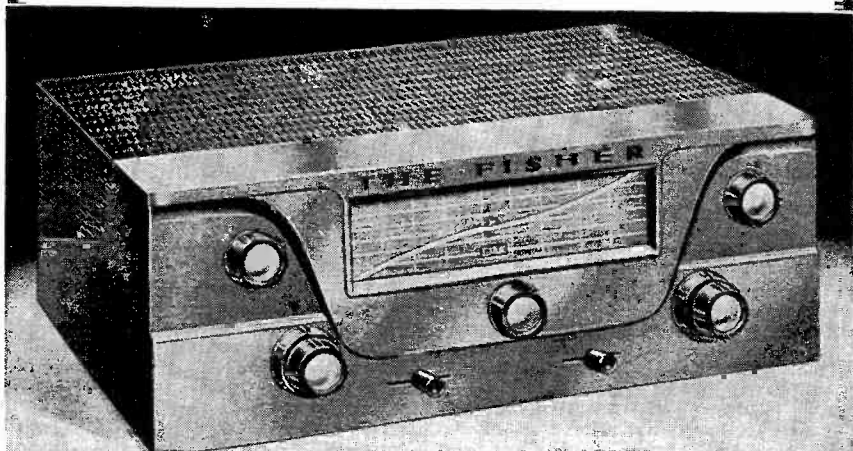

AUDIO CONTROLS AND AMPLIFIER, COMPLETE IN EVERY RESPECT—ON ONE COMPACT CHASSIS!

## THE FISHER Master Control-Amplifier Model CA-40

DESIGNED to satisfy the most critical requirements of the music connoisseur, as well as the professional engineer, THE FISHER Model CA-40 is, without a doubt, the most versatile unit of its type available today. On one compact chassis it offers the most advanced preamplifier with controls, as well as a powerful, 25-watt amplifier with less than 1% distortion at full output! The Model CA-40 has provisions for *six* inputs and offers complete equalization and preamplification facilities for *both records and tape*. An exclusive FISHER First-TONESCOPE, provides a graphic indication of Bass and Treble Tone Control settings. In every respect — flexibility, laboratory-quality performance, handsome two-tone styling — the MASTER CONTROL-AMPLIFIER reflects the creative engineering that has made THE FISHER world-renowned for two decades. Truly, the CA-40 will long serve as the ultimate standard of comparison for amplifiers with control facilities. SIZE: 12¾" x 10¼" x 5" h.

**\$139<sup>50</sup>**

Slightly Higher in the Far West

WRITE FOR COMPLETE SPECIFICATIONS

FISHER RADIO CORP. • 21-31 44th DRIVE • L. I. CITY 1, N. Y.

## SOUND FANCIER

Continued from page 32

of familiar and less familiar pieces by Ernesto Lecuona, and (in the overside miscellany) Falla's *Ritual Fire Dance* and Villa-Lobos's *Little Train Toccata* from the *Bachianas Brasileiras*, No. 2. The performances are spirited too, with a particularly fine, florid harp solo by Laura Newell in Lecuona's *Rapsodia negra*, but too many of the arrangements are extravagantly overfancy. The Black suite also tries to be so, but unsuccessfully, and this is a rare entry in the Cameo series which possesses minimal musical interest for all its lavish Latin-American sound-effects augmentations of conventional salon-orchestral resources. Even the otherwise bright and clean recording falls down in the silliest selection of all, *Dolly's Bed Time*, where "music-box" bells and chimes are grossly overamplified with the inevitable consequence of intolerably increased studio-background noise.

Somewhat less obviously popularized are Les Baxter's *Skins* (Capitol T-774) and *The Percussive Phil Kraus* (Golden Crest CR 3004), both of which are notable for the variety of instruments starred and their bright and crisp, if somewhat dry studio-type, recordings. Baxter has the more interesting and off-track musical materials, all well suited to his battery of bongos, timbales, guiro, cymbals, gong, etc., augmented at times by a surprisingly poetic electronic celeste and a fascinatingly jangly ancient Porto Seguro harpsichord-piano. Kraus plays more conventional, mostly pop pieces, heavily overdressed with novelty sound effects, but he does demonstrate remarkable versatility and virtuosity on the marimba, xylophone, vibes, celeste, etc. Most interesting, probably, to the sound fancier's ears are the soft-shoe qualities obtained by the use of slap mallets on the marimba (in *Nola*) and the novel finger cymbal, elephant- and camel-bell tingles which decorate the *March of the Siamese Children*.

The one complete failure in popularizing and dramatizing percussion comes from — of all people — my old hero, Duke Ellington, of whom it can be said, as of La Guardia, then when he does make a mistake, it's a beaut! Certainly he was completely misinspired and misadvised to attempt, in *A Drum Is a Woman* (Columbia CL 951), a TV spectacular masquerading as a history of jazz. In the few brief moments when he does give his orchestra a chance, it sounds as magnificent as ever; Ozzie Bailey does some good singing and Joya Sherrill copes bravely with her less tractable songs; but Margaret Tynes's pseudo arias sound merely silly emerging none too steadily from the depths of an echo chamber, and the Duke's own inter-

minable, pretentiously mannered narrations succeed in achieving a travesty of high-school pageantry. I'd willingly trade a hundred such counterfeits as this for just three minutes of an equally effective (technically) modern recording of one of the Duke's genuine masterpieces, say *Hot and Bothered* or *Day-break Express!*

### Jazzical Extremes

But that kind of jazz apparently just isn't being played today, and I find it hard to get excited by such currently popular big-band performances as those by Boyd Raeburn's Orchestra in *Fraternity Rush* (Columbia CL 957), even though the recording here (as in *A Drum Is a Woman*) is something we could only dream of in the old days. I like much better the fine variety in big- and small-band playing in Deane Kincaide's *Arranged for You* (Weathers w-5610). There is a wide range of styles here, but they all are handled authoritatively—at their best with jaunty lilt and drive—and for as versatily skilled an arranger as Kincaide proves himself to be, he is exceptionally careful to avoid inflated and exaggerated effects. Yet, for all such merits, it is definitely the engineers who steal top honors. I sneered a bit when I first saw the conspicuous stamp on the label, "Certified Perfect Fidelity," but after hearing the disc itself, with its superb transient response and adroit compromise between the extremes of ultrareverberance and ultradryness, I have to concede that, while perfection in sound reproduction still remains an unattainable ideal, the present recorders come as close to it as is possible with single-channel techniques.

For sheer musical pleasure, though, as well as an entirely fresh and distinctive exploration of "cool" music, I relished most of all *Le Jazz Trinidad* (Cook 10850), in which a hitherto un-honored Caribbean genius, Rupert Clemendore, establishes himself not only as an imaginative master of the vibes and drums (listen especially to the long solo in *Drummer's Mood*) and a curiously effective *sotto voce* vocalist (*Clem's Confusion* and *Mambo Chop Suey*), but also as a leader who can inspire a small combo to beautifully controlled yet lilting performances in both Latin-American and non-Latin styles. The recording here is less notable than that of the Weathers disc above, but it is transparent enough to give an authentically natural and attractive sound picture of the players' sonic subtleties—and it is these which make the present LP a true gem.

But if your taste runs to less polished jazzical diamonds-in-the-rough and to rowdy power rather than poetic delicacy, I recommend to you *Doc Evans Plays Dixie in Stereo* (Stereophony B 121)

*Continued on next page*

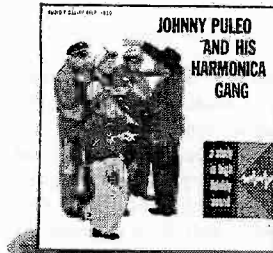

AFST 1820



AFST 1825

Introducing . . .

## AUDIO FIDELITY STEREO MASTER TAPE

A NEW DIMENSION IN SOUND

. . . for music lovers and sound enthusiasts who demand the ultimate in sound reproduction.

AUDIO FIDELITY, leader in the field of high fidelity recordings, introduces a new dimension in Stereo Sound . . .  
Tape equivalent to the original master!

Hear, for the first time, unsurpassed sound reproduction of the total recordable frequency spectrum • absolute, guaranteed distortion-free reproduction • maximum signal • maximum dynamics • perfect balance • purest definition • highest brilliance • startling realism • plus exciting entertainment!

7 1/2" Stereophonic Tape \$12.95

- Full color record-album style packaging with liner notes.
- Box and reel clearly labeled for immediate identification.
- Available for stacked or staggered heads. Specify when ordering.



AFST 1835



AFS 836

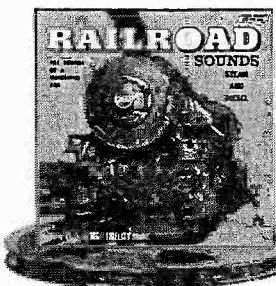

AFST 1843



AFST 1833



AFST 1838



**AUDIO FIDELITY**  
INCORPORATED

770 ELEVENTH AVE., NEW YORK 19, N. Y.

**NOW—**  
from the leader in sound...

# CAPITOL STEREO TAPE!

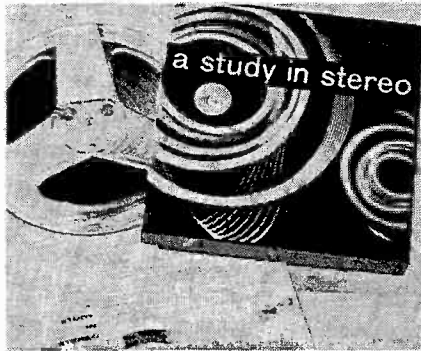

## A Study in Stereo

A breathtaking showcase of stereo's vast range featuring Capitol's big-name artists. 20-page booklet with introduction by Edward Tonnall Canby included. (ZH-2)

## Other "Full Dimensional Sound" stereo releases

### LEOPOLD STOKOWSKI:

*The Orchestra* (ZH-8)

### ROGER WAGNER CHORALE:

*House of the Lord* (ZF-9)

### WM. STEINBERG, PITTSBURGH SYMPHONY:

*Toch: Third Symphony* (ZF-7)

### HOLLYWOOD BOWL SYMPHONY ORCHESTRA:

*L'Italia* (ZF-3)

*Gypsy* (ZF-6)

*Symphonic Dances* (ZF-5)

*Bolero & Capriccio Espagnol* (ZF-4)

## Intro to Stereo

A narrated journey through the wonders of stereo — music and real-life sounds. (ZA-1)

## Top Stars in Stereo

### NAT "KING" COLE:

*Love is the Thing* (ZD-11)

### KENTON IN HI-FI (ZD-10)

GEORGE SHEARING: *Black Satin* (ZC-13)

FRED WARING & THE PENNSYLVANIANS  
IN HI-FI (ZD-12)



2 CHANNEL — 7½ IPS — FOR IN-LINE HEADS

## SOUND FANCIER

Continued from preceding page

and Kenny Clarke's *Goin' Crazy* drum improvisations (Cameo PMC-1011). In the former tape, the pieces are all (except for a helter-skelter adaptation of *Maryland, My Maryland*) standard Dixieland masterpieces, topped by *Oh, Didn't He Ramble*, and done throughout with a rowdy verve that well might seem frantic or raucous in single-channel recording, but which in the present big, open stereo sounds irresistibly exciting. So too, even without the benefits of an added dimensionality, are Clarke's long drum-and-traps solos, now happily detached from the rest of the *Spotlight on Percussion* materials (Vox DL-180 and Phontapes-Sonore PM-155). Gone too are "Jazzbo" Collins's blurby vocal annotations, leaving the astonishing varieties of virtuoso beating and banging to hold the stage by themselves.

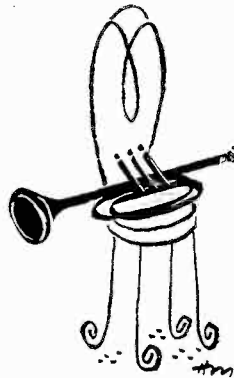

**W**HEW! From thirteenth-century France to today's Broadway, New Orleans, and the West Indies is a jump approximating the sonic equivalents of light-years and parsecs, but science fiction can't pre-echo the promised age of space and time travel as dramatically as audio adventures. The true sound fancier disdains all spatial and temporal boundaries!

## BOGEN K-DB20DF

Continued from page 21

high quality of kit packaging and instruction-book preparation is a source of recurrent amazement to us.

Now to the performance of our completed kit. Perhaps it is best to show the "normal" flat frequency response first — that is, the response from a high-level input to the amplifier output, with all controls set in their indicated flat positions — because the response deviations caused by manipulation of other controls will be added to this curve, and should be interpreted in that light. The center curve in Fig. 8 shows this reference response. Departures from perfectly flat do not exceed  $\pm 2$  db from

20 to 20,000 cps, and are introduced in the tone-control circuits. Note that the low point on the curve is at 200 cps, and the high point, 5,000 cps, which would tend to establish a slightly crisp balance as normal. The other curves in Fig. 8 show our measured response for full-up, ½-up, ½-down, and full-down positions of the bass and treble controls.

Curves for each of the phono equalization positions are shown in Fig. 9, with an extra curve showing the effect of the rumble filter on the RIAA bass compensation. Also in Fig. 9, in the upper right-hand corner and with a substantially spread-out db scale, the effect of volume-control setting on high-frequency response is shown. In the worst possible position of the control, response at 20 Kc is less than 2 db down from that at 1 Kc. This can be called negligible.

Curves for each of the five loudness-contour switch positions are given in Fig. 10. The switch positions are quite accurately labeled according to the amount of attenuation introduced at 1 Kc. No loudness compensation is supplied in the first position; progressively greater amounts of bass boost are furnished in the other positions. Treble boost is obtained in the last two positions only. These are fixed curves, incidentally, in that the volume-control setting has little effect on them. At the top of Fig. 10 is a curve of maximum amplifier power, for which data was obtained by measuring the power of sine-wave output signals just at the level before distortion became visible on an oscilloscope. Note that the full rated 20 watts was obtained down to 20 cps.

Fig. 11 shows IM distortion from a high-level input circuit to the amplifier

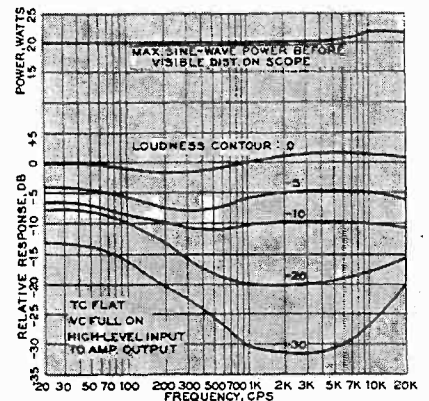

Fig. 10. Curves for loudness-contour switch, and maximum-power curve.

output, for four different volume-control settings: ¼ on, ½ on, ¾ on, and all the way up. These represent physical rotation points on the control, of course (attenuation is about 30 db at the halfway point). The ¾ and full-on positions produce curves very close together; IM is less than 1% at 10 watts,

and less than 2% at 20 watts, for both positions. In the 1/2-on setting of the control, however, 2% distortion is reached at less than 7 watts, and in the 1/4-on position, at 0.6 watts! Moral: except for very low-level listening, adjust input voltages so that the volume control is normally beyond the half-

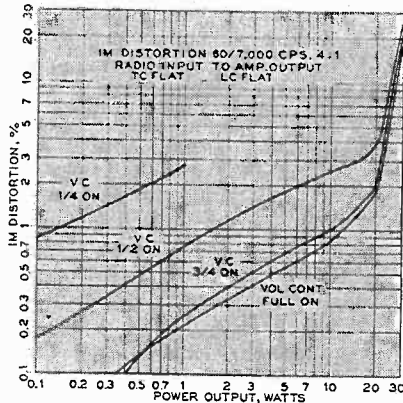

Fig. 11. Over-all amplifier distortion for various settings of volume control.

way point. These curves were run with the loudness-contour control in the zero position; lower settings would probably reduce distortion at low volume-control settings, so that in normal circumstances no precaution would be necessary.

Sensitivity of the amplifier is very high. At 1,000 cps, it required only 1.6 mv at the LOW MAG input to produce 20 watts output. However, the pre-amplifier section could handle better than 120 mv (LOW MAG) and 260 mv (HIGH MAG) input before visible distortion occurred at the preamp output. For an input of 15 mv (LOW MAG) the preamp section output was 220 mv, and, at the 3/4 volume-control position, 215 mv was required for 20 watts output. Thus it is extremely unlikely that excessive distortion could occur in the phono channel through any combination of circumstances. Again, these measurements were made with the loudness-compensation switch set at zero.

Signal-to-noise ratio on the phono channel, RIAA position, with the LOW MAG input shorted, loudness and tone controls at flat settings, and the volume control at 3/4-on setting, was measured at 57 db below 20 watts. High-frequency square waves looked very good, and bass stability was excellent except when the damping-factor control was turned too far into the negative region.

The DB20DF obviously deserves its fine reputation. Now, the K-DB20DF provides a method of obtaining one at a saving of nearly \$40.



# Look over the BEST BUYS in HI-FI ... from EICO®

HF60, HF50

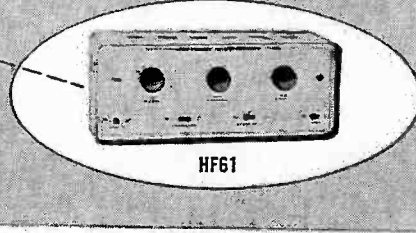
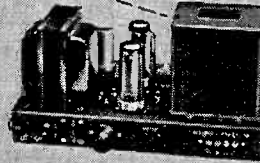

HF61

HF20

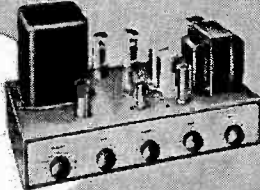

HF52

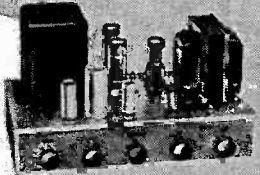

HF12



HF51

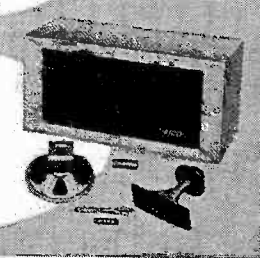

**HF52 50-WATT Ultra-Linear INTEGRATED AMPLIFIER** complete with Preamplifier, Equalizer & Control Section  
KIT \$69.95 WIRED \$109.95

Power amplifier section essentially identical to HF50, including output transformer, GZ34 rectifier, etc. Includes all-feedback equalizations (5 pos.) & tone controls. Centralab loudness control & separate level control that does not affect response at any setting. Cathode follower output to tape. Correct input loading for new ceramics. Zero cross-talk. Bi-amplification input & output facilities. 8 1/2" x 15" x 10". Matching Cover E-1, \$4.50.

**HF12 12-WATT Williamson-type INTEGRATED AMPLIFIER** KIT \$34.95 WIRED \$57.95  
Complete with Preamplifier, Equalizer & Control Section. Equalized direct tape head & magnetic phono inputs. Power Output: 12 w cont.; 25 w pk. IM Dist.: 1.3% @ 12 w. Freq. Resp.: 1 w: ±0.5 db 12-75,000 cps; 12 w: ±0.5 db 25-20,000 cps. 2-EL84, 3-ECC83/12AX7, 1-EZ81.

**HF51 TWO-WAY SPEAKER SYSTEM** \$39.95  
Complete with FACTORY-BUILT CABINET  
Jensen heavy-duty 8" woofer & matching Jensen compression-driver exponential horn tweeter. Smooth clean bass & crisp, extended natural highs. Overall response: ±6 db 70-12,000 cps. Power-handling capacity: 25 w. Impedance: 8 ohms. Bookshelf size: 23" x 11" x 9". 25 lbs. Wiring Time: 15 min.

EICO is a pioneer (1945) in kit test equipment — leads the industry in distributor sales to trained and critical users.

EICO has achieved this acceptance because

- EICO engineering policy is to stress electrical and mechanical quality, soundness and functional completeness.
- EICO prices are low because they are justly related to costs and geared for volume sales.

The same engineering and price policy underlies all EICO high fidelity equipment. You can examine and compare EICO at any of the 1200 neighborhood distributors and hi-fi specialists throughout the U.S. Judge EICO's claims for yourself before you buy.

Write for FREE Catalog AC-9.

**HF61 Master Control PREAMPLIFIER**

KIT \$24.95 WIRED \$37.95  
with Power Supply: KIT \$29.95 WIRED \$44.95

Does not add distortion or detract from wideband or transient response of finest power amplifiers at any control settings. High-quality feedback circuitry throughout & most complete control & switching facilities. Feedback scratch & rumble filters, equalizations, tone controls. Centralab Senior "Compentrol" loudness control, concentric level control. 4 hi-level, 2 lo-level switched inputs. Extremely flat wideband freq resp: ±0.3 db 12-50,000 cps. Extremely sensitive. Negligible hum, noise, harmonic or IM distortion. 4-7/8" x 12-5/16" x 4-7/8". 8 lbs.

**HF60 60-WATT Ultra-Linear POWER AMPLIFIER** with ACRO T0-330 Output Transformer  
KIT \$72.95 WIRED \$99.95

EF86 volt ampl direct-coupled to 6SN7GTB K-coupled phase inverter driving two U/L-connected p-p EL34 output tubes. GZ34 extra-rugged rectifier. Rated output: 60 w (130 w pk). IM Distortion: less than 1% at 60 w; 0.5% at 50 w. Harmonic Distortion: less than 0.5% from 20-20,000 cps within 1 db of rated power. Sine Freq. Resp: at 1 w: ±0.1 db 15-35,000 cps at any level from 1 mw to rated power. Square Wave Resp: excellent 20-25,000 cps; 3 usec rise-time; Sens: 0.52 v for 60 w. 7" x 14" x 8". 30 lbs. Matching Cover E-2, \$4.50.

**HF50 50-WATT Ultra-Linear POWER AMPLIFIER**  
KIT \$57.95 WIRED \$87.95

Extremely high quality output transformer with extensively interleaved windings, 4, 8, and 16-ohm speaker taps, grain-oriented steel, fully potted in seamless steel case. All other specs equivalent to HF60 but on 50 w level. Matching cover E-2, \$4.50.

**HF20 20-WATT Ultra-Linear Williamson-type INTEGRATED AMPLIFIER** complete with Preamplifier, Equalizer & Control Section  
KIT \$49.95 WIRED \$79.95

Sets a new standard of performance at the price, kit or wired. Rated Power Output: 20 w (34 w peak). IM Distortion: 1.3%. Max Harmonic Distortion: below 1%, 20-20,000 cps, within 1 db of 20 w. Power Resp (20 w): ±0.5 db 20-20,000 cps; Freq Resp (1/4 w): ±0.5 db 13-35,000 cps. 5 feedback equalizations. Low-distortion feedback tone controls. 4 hi-level & 2 lo-level inputs. Conservatively rated, fully potted output transformer; grain-oriented steel, interleaved windings. 8 1/2" x 15" x 10". 24 lbs. Matching Cover E-1, \$4.50.

EICO® 33-00 Northern Blvd., L.I.C. 1, N.Y. AC-9

Please send FREE catalog & name of neighborhood distributor or hi-fi specialist.

NAME.....  
ADDRESS.....  
CITY..... ZONE..... STATE.....  
Prices 5% higher on West Coast

## BASIC ELECTRONICS

Continued from page 27

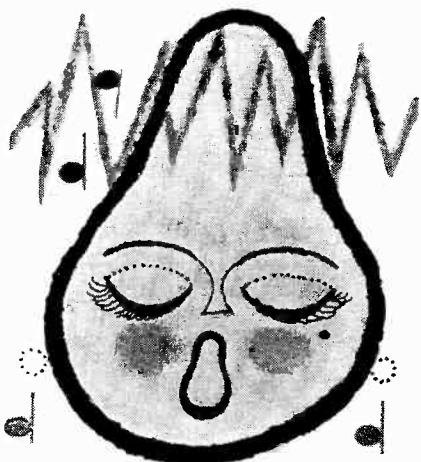

think pear-shaped tones are peachy?

**"PICK YOUR OWN" WITH A CENTRALAB COMPENTROL®**



Ever sit in front of your hi-fi speaker and wonder why you aren't getting concert-hall clarity?

You probably blame the equipment. "Lemon" is the usual expression! But you may just be experiencing the Fletcher-Munson effect — very-high and very-low actually sounding softer than the middle range.



**THAT'S WHEN YOU NEED A COMPENTROL®**  
Get out that soldering iron!

Compentrol is a loudness attenuator that boosts frequencies otherwise lost — and does it automatically at any volume level. You enjoy greater listening pleasure.

You can install a Compentrol in place of the ordinary volume control in amplifiers, pre-amplifiers, radios, TV, tuners, tape recorders, and record players.

Get a Compentrol from your Centralab distributor.



**6 MODELS from \$2.50**  
suggested net price

Send for Compentrol booklet. Write Centralab, Dept. 9281 Milwaukee 1, Wis.

**Centralab**

8-5637

A typical voltage-amplifier circuit for a pentode is shown in Fig. 7. Cathode bias is used, as with a triode, and a cathode bypass capacitor is added for the same reason. Note that the suppressor is connected externally to the cathode. The screen is supplied with its positive operating potential through a voltage-dropping resistor to  $B+$ ; this resistor is of such value that the screen current passing through it will develop a voltage drop across it equal to the difference between  $B+$  and the desired screen voltage. Since voltage-amplifier screen currents are only a few milliamperes,

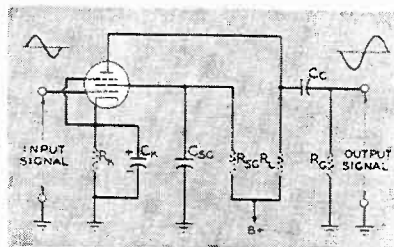

Fig. 7. Voltage-amplifier stage using a pentode. Circuit discussion is in text.

and optimal screen voltages, from 100 to 150 v or so, screen dropping resistors are usually high in value — from 250 K upward, sometimes well over 2 megohms. Accordingly, the screen decoupling capacitor ( $C_{SG}$ , Fig. 7) does not have to be very large. A typical value is .05  $\mu$ fd.

Load lines can be constructed on pentode characteristic charts just as for triode charts, and yield as much information. Generally higher load resistances are used for pentodes than for triodes; 100 K and 180 K are common values, and 470 K is not unusual. This means that the following grid resistor (normally 470 K or less) has a significant effect on the total value of AC load, and must be included in the calculation of  $R_T$ .

The simple gain formula,

$$A = \frac{\mu R_T}{R_p + R_T}$$

and the same equivalent circuit as for the triode apply to the pentode and tetrode as well. Note, however, that by reducing the effect of plate-voltage changes on the plate current, the AC plate resistance  $R_p$  has been increased radically along with the amplification factor. In the equivalent circuit the total voltage  $\mu e_o$  is developed across the plate resistance and the AC load in series; and even though  $\mu e_o$  is far greater for a pentode because of the great increase in  $\mu$ , a lesser part of the voltage is developed across the load because of the much greater magnitude of  $R_p$ . The net result is an increase in average gain,

but not so great an increase as a simple comparison of the relative values of  $\mu$  would imply. For voltage-amplifier pentodes, plate resistances of 1 megohm or slightly less are typical, as are voltage gains of 100 or a little more.

A striking difference between triodes and pentodes or tetrodes now becomes apparent: in a triode circuit, the AC load is usually several times the plate resistance in magnitude; in a pentode or tetrode circuit, the plate resistance is usually several times the AC load resistance. This difference has many important consequences, and we shall cover most of them in the future. But let us touch on only two now, referring to the AC equivalent circuit given in Chapter XVIIIb.

The load, we have said, is in series with the plate resistance across a voltage which is the product of  $\mu$  and the AC signal developed between grid and cathode. If the load is large with respect to the plate resistance (as it is in a triode), then changes in the load value over a reasonably wide range have relatively little effect on either the AC voltage developed across the load or on the voltage gain of the stage — since most of the voltage will appear across the load anyway, until it is reduced to a point at which it is comparable in magnitude to the plate resistance. Therefore, the triode appears to the load as a constant-voltage generator; changes in load value have little effect on the voltage output.

If the plate resistance is much larger than the load, however (as it is for a pentode or tetrode), then changing load values produce nearly proportional changes in the voltage developed across the load, and in the voltage gain of the stage, because the total resistance in the circuit is not changed much and the current remains fairly constant — up to the point at which the load becomes comparable in magnitude to the plate resistance. Within reasonable limits, therefore, the voltage gain can be varied at will by increasing or decreasing the load value. It follows also that a pen-

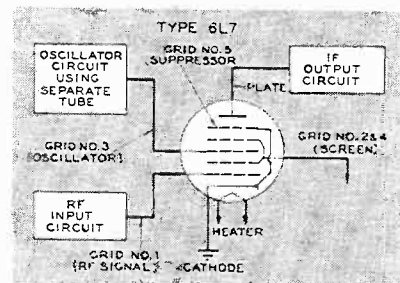

Fig. 8. One of the many special-purpose multielectrode tubes: a pentagrid mixer.

tode or tetrode appears to the load as a constant-current generator, for which variations in the load value produce appreciable changes in voltage output.

There are other tube types with up

to six grids that are used for special combination purposes, such as frequency converters (mixer-oscillators). A five-grid tube (pentagrid converter) of this type is shown in Fig. 8, with the function of each electrode indicated. Two or more standard tubes—diodes, triodes, pentodes, and multigrad types—are also available in various combinations within single tube envelopes. Especially numerous are dual-triode and triode-pentode combinations.

### CHECK LIST

*Continued from page 17*

29) *Stability of Tuning.* After a 10- or 15-minute warm-up period, a well-designed tuner should stay on tune, with either FM or AM reception, for an indefinite period. If the tuner can be adjusted to an appreciably better tuning point after, say, a couple of hours playing time, it is subject to drift and should be rejected.

30) *Sensitivity.* Tuners come in either high or low sensitivity. Pick one to suit your listening location. If you are near to the stations you wish to receive and have good signal strength, the low-sensitivity tuners will give the best performance. They have potentially the best frequency response and freedom from distortion and noise, and are not bothered by picking up all the unwanted kinds of interference that high-sensitivity tuners do. If you are living in a location a long way from the transmitter, you will need a high-sensitivity tuner. Pick one with the best quieting or noise elimination possible.

31) *Distortion.* The most important source of distortion in any tuner is the demodulation stage. But apart from this, a tuner can cause distortion if it is incorrectly operated. If the gain control following the demodulator is operated at maximum, and a preamplifier or amplifier gain control is used to adjust the volume, most probably the audio stages of the tuner will be causing unnecessary distortion. Adjust the respective gain controls so you get a satisfactory listening level without undue distortion.

32) *Hum and Noise.* The audio stages can also introduce hum by an opposite extreme to that in the previous answer, working with the preamplifier or main amplifier volume control fully on and using the tuner control to adjust volume. It is best to adjust the tuner control for the best combination of distortion and hum and use the preamplifier or main amplifier control to adjust listening loudness.

### Main Amplifier

33) *How Much Power?* The answer to this question will depend on three principal factors: (a) the size of the room and its furnishings; (b) the kind

*Continued on next page*

# spectacular...new Tape System Components PENTRON

• STEREO • MONAURAL

*Select* the Tape units to meet your needs

Pentron combines professional features and custom styling with building-block flexibility. You buy what you want and add to your system when you desire—from the simplest monaural system to the all inclusive stereo systems.

### PENTRON LEADERSHIP FEATURES

- Precision made and tested professional head assembly with Azmur-X spring loaded screw adjustment.
- Simple single rotary control.
- Four outputs plus two AC convenience outlets.
- Mounts VERTICALLY, horizontally, or at any angle.
- Speed change lever at front panel.
- Removable pole pieces in heads, as easy to change as a phono needle.
- Automatic self-energizing differential braking.

### basic specifications

#### TM series mechanisms

**COMBINATION HEAD:**  
Frequency response: 40-14,000 cps with proper equalization. Signal-to-Noise: 55 db with CA units; track width: .093"; gap width: 1/4 mil; impedance of record section: 6000 ohms; inductance of erase section: 60 mh • **STACKED HEAD:** track width: .080"; gap width: .15 mil; impedance: 3500 ohms • **FLUTTER:** under 0.4% at 7 1/2 ips; under 1% at 3 1/2 ips. • **CAPSTAN DRIVE:** Idler driven • **MOTOR:** 4 pole induction type, individually balanced • **OUTPUTS:** 4 standard pin jack outputs to accept shielded phono plug • **CONVENIENCE OUTLETS:** two auxiliary AC outlets controlled by mechanism power switch. Supplied with removable mounting brackets with shock mounts.

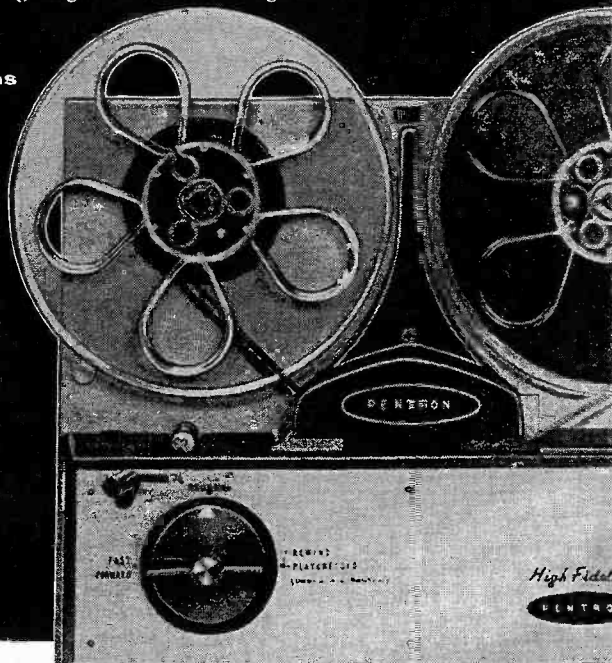

### preamplifiers



CA-11

Tape Playback only. Response: 20-20,000 cps. Signal-to-Noise: 55 db



CA-13

Tape playback preamp and record amplifier. Response: 20-20,000 cps. Signal-to-Noise: 55 db

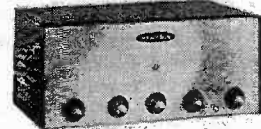

CA-15

Stereo dual channel playback. Response: 20-20,000 cps. Signal-to-Noise: 60 db

ALL CA UNITS HAVE SAME PHYSICAL DIMENSIONS AND REQUIRE SAME CUTOUT.

HEAR PENTAPE RECORDED TAPES—"GREATEST SOUND EVER FOUND"



786 S. Tripp Avenue  
Chicago 24, Illinois  
Canada: Atlas Radio Ltd. Toronto

Send brochure on tape components

Name \_\_\_\_\_

Address \_\_\_\_\_

City & State \_\_\_\_\_

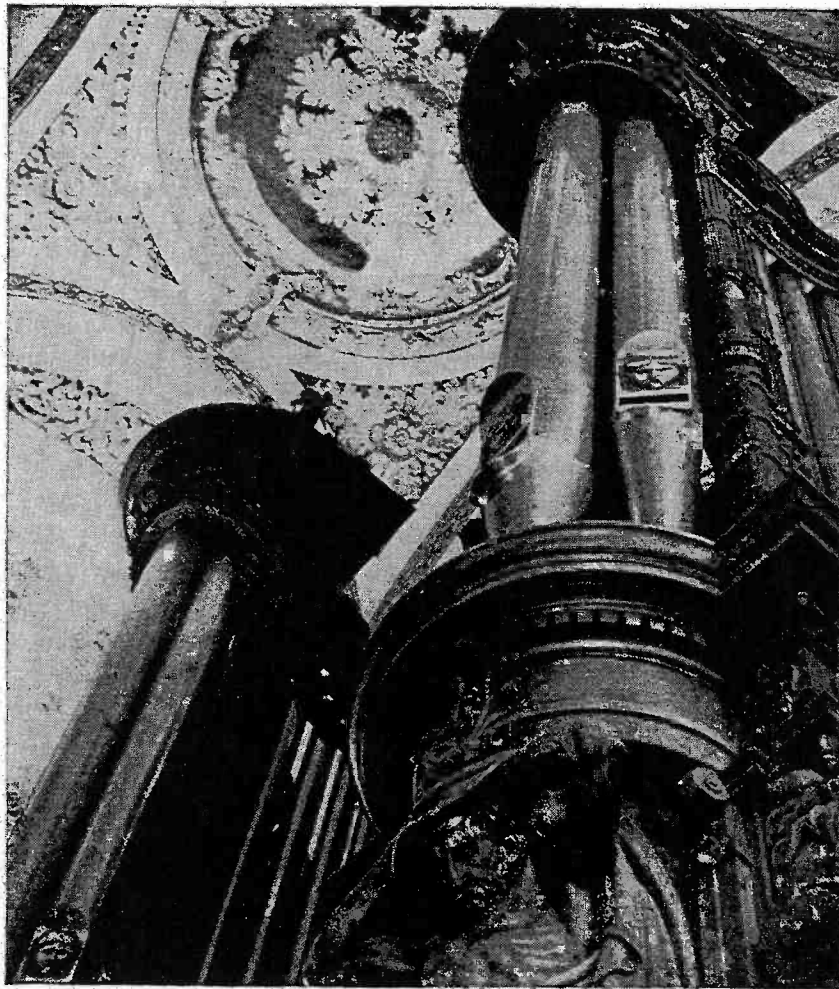

The "King of Instruments"—an Aeolian-Skinner organ installation.

The sound of the organ is one of the most difficult to reproduce, because of its wide tonal and dynamic range, and because of the large amount of fundamental energy that appears at extreme bass frequencies.

At a recent public demonstration, staged by the Audio League at St. Mark's Church, Mt. Kisco, N. Y., the recorded sound of an Aeolian-Skinner organ (from stereo tape) was instantaneously alternated with that of the "live" instrument. The reproducing equipment selected included four AR-1 speaker systems. Here is some of the press comment on the event:

*The Saturday Review* (David Hebb)

"Competent listeners, with trained professional ears, were fooled into thinking that the live portions were recorded, and vice versa. . . . The extreme low notes were felt, rather than heard, without any 'loudspeaker' sound. . . ."

**AUDIO** (Julian D. Hirsch)

"Even where differences were detectable at changeover, it was usually not possible to determine which sound was live and which was recorded, without assistance from the signal lights. . . . facsimile recording and reproduction of the pipe organ in its original environment has been accomplished."

**audiocraft**

"It was such a negligible difference (between live and recorded sound) that, even when it was discerned, it was impossible to tell whether the organ or the sound system was playing!"

The price of an AR-1 two-way speaker system, including cabinet, is \$185.00 in mahogany or birch. Descriptive literature is available on request.

**ACOUSTIC RESEARCH, INC.** 24 Thorndike St., Cambridge 41, Mass.

**CHECK LIST**

*Continued from preceding page*

of program you want to listen to; (c) the efficiency of your loudspeaker. The accompanying Table I shows how much power requirements can vary with these different classifications.

**Table I**

Room classification:	Peak watts required					
	A		B		C	
Program classification:	1	2	1	2	1	2
High-efficiency speaker:	0.25	1	1.5	6	5	20
Medium-efficiency speaker:	1	5	6	25	20	80
Low-efficiency speaker:	5	20	30	100	100	400

Room A is small and moderately furnished, or medium-size and lightly furnished, with a quiet background. Room B is medium-size and moderately furnished, or large and sparsely furnished, with medium suburban background. Room C is large and moderately furnished, or medium-size and well furnished, with fairly heavy city-noise background.

In the program specification, column 1 is for jazz or dance music, in which the fluctuation in peak dynamic level is not very great, while column 2 is for high-quality classical music with good dynamic range and requiring a minimum of distortion on peaks.

Three relative efficiencies of loudspeaker are given to cover the commercial range.

34) *Matching to Loudspeaker.* It is not always sufficient to check that the amplifier has, for example, a 16-ohm output and that the crossover network and loudspeaker unit also operate at 16 ohms. Some kinds of amplifier output circuits are critical of the kind of impedance into which they operate, as well as just the impedance rating, or value. Failure to check that an amplifier will work satisfactorily with the actual loudspeaker units to be used can result in unexpected distortion or harshness in reproduction.

35) *Frequency Response.* Most modern high-fidelity amplifiers, under the conditions used for testing their frequency response, give a performance whose deviation from perfect is a very small fraction of the smallest that could possibly be detected by ear. A response that is 3 db down at 40 cps and 15,000 cps could give quite acceptable practical performance. The fact remains that, under practical working conditions referred to in check point 34, some ampli-





fiers with a rating very much nearer than this to perfect do not behave according to rating when connected to the particular loudspeakers in question.

36) *Distortion*. Likewise, most of the amounts of harmonic or IM distortion quoted in amplifier specifications are quite inaudible. However, there are often differences in amplifier performance, as regards distortion, that can be noticed by listening. These are forms of distortion that do not show up under the measurement method used for the specification. Listen carefully on music containing: (a) a plucked double bass with other instruments playing at the same time; (b) a good clear solo on the horn, trumpet, or trombone; (c) a clear reproduction of a cymbal clash or the triangle.

37) *Hum and Noise*. Any main amplifier should have a hum and noise level which is completely inaudible in the loudspeaker before the preamplifier or tuner is connected, even if you put your ear quite close to the loudspeaker. If you can hear either hum or background hiss, reject the amplifier or see if a tube or electrolytic capacitor needs replacing.

### Loudspeaker Units

Since you may have one, two, or three of these and they may include a woofer, middle-range unit, and tweeter, separate headings would result in repetition. Therefore, the check points here are grouped under one heading, with comments that are applicable to separate units when necessary.

38) *Distortion*. The woofer unit is most likely to produce its distortion at the extreme low frequencies. Listen for intermodulation with an effect similar to that described for check point 5a.

In the middle-range and tweeter units distortion will usually produce an effect similar to a buzz—particularly when a minor chord higher in the frequency range is played. Select a piece of program material that gives this kind of test. For the middle-range unit a two-part solo violin recording (such as a Bach concerto for two violins) gives a good test, while for the tweeter, the triangle or high-pitched bell-like tones will often show up the effect you are looking for, by producing a jangling sound.

Don't forget, over the whole range, to listen for spurious buzzes due to mechanical defects—the diaphragm touching something, for example.

39) *Frequency Range*. Each loudspeaker unit should be capable of operating at least an octave beyond the crossover frequency chosen. If the low-to-middle-range crossover, for example, is at 500 cps, then the woofer should respond up to 1,000 and the middle-range down to 250 cps.

40) *Smooth, Level Response*. Listen

carefully to the reproduction of all the units for any evidence of overemphasis on a particular tone, showing that there is an undesirable resonance or breakup in the response. Use a variety of program material and vary your listening position.

41) *Sensitivity*. Compare the sensitivity or efficiency of the different units you propose to use together by playing them through a suitable crossover and see that they fall into consistent groupings of the table given in answer to check point 33; that is, ascertain that the disparity in sensitivity is not too great.

42) *Impedance*. It is well not to rely too much on the specified impedance rating of a loudspeaker unit. Impedance of any loudspeaker changes drastically according to the frequency it is reproducing; further, some manufacturers rate impedance in a different way than do others. So have the impedance of the loudspeaker units checked at a frequency about the middle of the range in which they are intended to play.

43) *Directionality*. This is particularly important in middle-range and tweeter

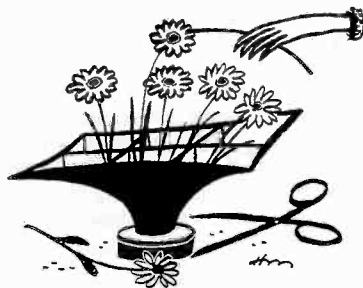

units. No woofer can be sensibly directional in its radiation of low frequencies. In most living rooms directionality should be neither extreme nor completely avoided. The kind of acoustic diffuser that aims at completely avoiding directionality is apt to make trumpets sound as if they were muted. Check this by listening to the proposed loudspeaker on a variety of program materials and moving around, noticing the distribution of the higher frequency components. If the general effect is a satisfactory degree of realism, your directionality is all right.

### Crossover Networks

Every loudspeaker system having any driver that is not intended to cover the entire audio range has a crossover network of some sort.

44) *Correct Loading for Amplifier*. A crossover network cannot modify the basic impedance of the loudspeaker units. It is not best practice to use an 8-ohm middle-range unit with a 16-ohm woofer and tweeter, for example (although this is sometimes done) because the crossover network cannot convert the 8 ohms to 16 ohms for uniform amplifier loading.

*Continued on next page*

# AR-1

**W**HEN the AR-1 speaker system first made its appearance on the hi fi market, our published specifications were sometimes greeted with skepticism; for a speaker to perform as claimed, particularly in such a small enclosure, was contrary to audio tradition.

Now, two years later, the AR-1 is widely accepted as a bass reference standard in both musical and scientific circles. There is general understanding of the fact that, due to the patented acoustic suspension design, the small size of the AR-1 is accompanied by an advance in bass performance rather than by a compromise in quality.

# AR-2

The AR-2 is the first application of the acoustic suspension principle to a low-cost speaker system. Prices are \$89 in unfinished fir cabinet, \$96 in mahogany or birch, and \$102 in walnut.

We would like to suggest, as soberly as we invite comparison between the AR-1 and any existing bass reproducer, that you compare the AR-2 with conventional speaker systems which are several times higher in price. No allowances at all, of course, should be made for the AR-2's small size, which is here an advantage rather than a handicap from the point of view of reproducing quality.

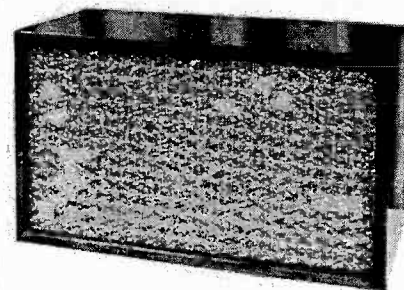

Literature is available on request.

**ACOUSTIC RESEARCH, INC.**  
24 Thorndike St., Cambridge 41, Mass.

Build with the Best —  
Build with  
**BOZAK**  
Quality  
Loudspeakers  
for  
Sustained Satisfaction

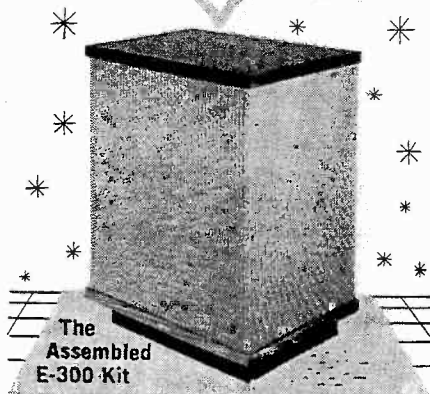

B-207A Two-Way Speaker System



B-209 Mid-Range Speaker



N-10102 Crossover Network

From the most modest to the largest, all Bozak Speaker Systems are formed from the same Bass, Mid-Range and Treble Speakers. All are unrivalled for realism and listening ease.

For instance: A Bozak B-207A two-way Speaker System and an E-300 Enclosure Kit\* assemble easily into a "Little Giant" that shames many a larger system. Now or later, add a Bozak B-209 Mid-Range and an N-10102 Crossover Network. You can use these same speakers for systematic growth into a Bozak B-305 or B-310.

Whether you assemble it yourself or buy it ready-made, each Bozak Speaker System, in its class, offers

#### The Very Best in Sound

\* — E-300 Kit \$42.50; slightly higher in the Deep South and Far West  
Export: Electronics Manufacturers' Export Co., Hicksville, N.Y.

The R. T. **BOZAK** Sales Co.

Box 966 • Darien • Connecticut

## CHECK LIST

Continued from preceding page

All the loudspeaker units should ideally have the same impedance, unless more than one unit is used to cover a range, in which case the combination should land up with the same impedance.

45) *Constant-Energy Curve.* This is another way of stating the requirement last mentioned. The difference is that this relates to the acoustic energy from the loudspeakers (assuming they have the same efficiency). If the crossover network delivers the same total energy to the two or three units over the whole frequency range, it will automatically satisfy the condition of correct amplifier loading.

46) *Correct Rate of Transfer.* There is a difference of opinion as to how rapidly the frequencies should transfer from one unit to another in the vicinity of crossover. In a well-designed system, the simplest kind of crossover, using only an inductor and capacitor for each transition, gives the most successful results. This ties in with the necessity for each unit to respond adequately about an octave beyond its rated range (see check point 39).

47) *Distortion.* There are two ways a crossover network can cause distortion. One is by using inductors with iron cores, which can produce distortion because of the nonlinear magnetizing current. In any well-designed crossover this possibility can be neglected.

The other possibility arises from the reactive impedance that can be reflected as a load to the amplifier. This can cause the amplifier to distort. If check point 44 has been satisfied, this distortion will not occur either.

48) *Balance Adjustment.* Because different living rooms have differing degrees of "liveness," any multiway system should have arrangements for balancing the amounts of energy fed to the loudspeaker units—particularly to the tweeter, and preferably to the middle-range unit as well. This also is a matter on which agreement is not unanimous.

### Enclosures

49) *Bass Loading and Coupling to the Room.* If possible, see what happens

to the diaphragm of the woofer unit under practical working conditions, mounted in the enclosure, and with the enclosure in its operating position in the room. When a powerful bass note of the lowest frequency desired, say 40 to 50 cps, is being radiated, the movement of the loudspeaker diaphragm should be just about visible. If it is more than this, it indicates that the enclosure does not adequately load the diaphragm for the low frequencies, nor does it couple these properly out into the room. [An important exception to this rule is infinite-baffle units, with drivers specifically designed for wide excursions.—ED.]

50) *Integration of Total Sound.* This is another matter related to the size of room in which you will listen. A loudspeaker that gives good integration of sound in a large room may sound completely "disintegrated" in a small room. Listen to the complete assembly in a room approximately the same size you intend to use. Listen on program material particularly requiring good integration: for example, a vocal solo.

51) *Smoothness of Response.* The enclosure can introduce peaks in the over-all response, because the output from the various drivers may not combine correctly at crossover frequencies. Listen particularly for the smoothness in these regions. If you need to, find out what the crossover frequencies sound like by means of an oscillator, or by striking a note of corresponding frequency on a piano or electric organ. Then listen acutely to frequencies within half an octave each side of this point in the reproduction.

52) *Freedom from Resonances.* Enclosures can also produce resonances in the response, from vibration of wooden panels or from acoustic cavities which may resonate. Panel resonances are readily identified by the sound, characteristic of the side of the cabinet vibrating at its own natural frequency. This you can often determine simply by tapping the panels and noticing whether a particular "woody" tone is produced in the low or middle-frequency region. Acoustic cavity resonances lend a sort of hollow effect to the reproduction, rather as if you spoke with your mouth directly over a vase.

53) *Driver Isolation.* Although each loudspeaker unit may be quite free from intermodulation distortion itself, it is possible for the enclosure to introduce some by causing interaction between units. For example, the back-wave pressure from the woofer may appreciably move the diaphragm of the middle-range unit, so that it produces intermodulation distortion.

If you notice this kind of distortion on the complete assembly, try connecting the woofer output from the crossover network to a dummy load (a resistor of the woofer's impedance value), so that



the woofer does not operate, and see if you still notice the dithery effect. If this removes it, then the distortion was occurring because of enclosure coupling. If not, of course, the distortion must be in the program material itself, or caused by the pickup cartridge or amplifier.

### Equipment Cabinet

54) *Utility and Accessibility.* The principal purpose of an equipment cabinet is to provide a decorative housing for all the equipment except the loud-speaker unit. This it should do in such a way as to make the necessary controls readily accessible, so that you don't have to bend double to operate them, nor lean over in a position where you cannot properly see (or feel) what you are doing.

55) *Avoiding Equipment Interaction.* The equipment cabinet can also cause unwanted effects such as hum, acoustic



feedback, and microphony. See that units radiating hum, such as power transformers, are not close to low-level input circuits; and that items liable to pick up vibration (which might produce acoustic feedback or microphony) are either mounted in a vibration-isolation assembly, with sponge rubber or suitable material, or else that the mounting is so rigid it cannot vibrate.

56) *Adequate Ventilation.* This is necessary to insure that the equipment does not overheat and cause unnecessary shortening of tube life. Particular attention should be given to ventilation for the output tubes in the main amplifier.

57) *Durability.* If the cabinet is adequately constructed to meet the demands of the preceding check points, it is undoubtedly durable.

58) *Is It Really Big Enough?* This is a good check question on the others. Often the troubles mentioned in the other check points are caused principally because of the desire to house equipment in the minimum possible space. Make sure that your equipment cabinet is big enough to house all the components you have, together with possible future additions, with adequate room to take care of all contingent requirements.

## IT'S NEW!

TV Tone gives your television dependable high fidelity sound.

TO YOUR  
HI-FIDELITY  
AMPLIFIER

PLUGS INTO A.C. OUTLET



NO ACTUAL  
CONNECTION...

PICKS UP SOUND  
FROM YOUR  
OWN T.V. SET

SMALL • COMPACT  
11" x 4" x 4 1/2"

Enjoy true fidelity television sound by adding TV Tone to your existing hi-fidelity system.

All you need is your television set, your own amplifier and hi-fidelity speaker . . . TV Tone does the rest . . . price \$69.95.

Excellent for tape recording favorite T.V. programs.

Ask your dealer or write to **TAPETONE, INC.**  
WEBSTER, MASS.

## GRAY'S NEW "MICRO-BALANCED" DUAL VISCOUS-DAMPED HIGH FIDELITY TONE ARM

. . . guarantees maximum tracking stability, because of sealed viscous-damping on BOTH vertical and horizontal pivots, and complete static balance around the vertical pivot.

The Gray "Micro-Balanced" arm offers a maximum of compliance and responsiveness with all popular cartridges, that is beyond the experience of most High-Fidelity enthusiasts. For details, please write.

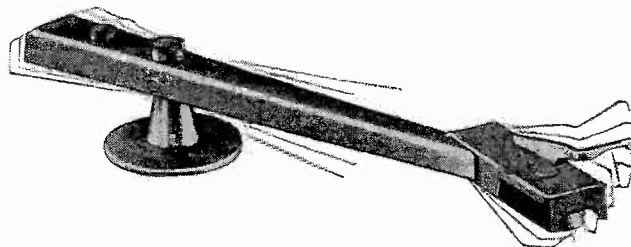

**THE GRAY MANUFACTURING CO.**  
ARBOR STREET • HARTFORD, CONN.

**"LIVING SOUND" IS THE LUXURY  
OF LISTENING TO REALISTIC REPRODUCTION  
THROUGH Norelco® TWIN FULL RESPONSE SPEAKERS**

Write today to Dept. M9 for brochures and attractive prices of these unique speakers.

NORTH AMERICAN PHILIPS CO., INC. • 230 Duffy Ave., Hicksville, L. I., N. Y.

**CONTOUR CONTROLS**

*Continued from page 23*

ideal and its realization is the fact that, whereas everybody in a concert hall wants to hear the music, many neighbors in suburbs and paper-walled apartments do not. And since there are enforceable laws against disturbing the peace or creating a public nuisance, high-fidelity enthusiasts are often obliged to play their records at less than original concert-hall volume. This, then, is where the loudness control comes in handy.

Proper loudness compensation can, at low volume levels, simulate high levels with surprising effectiveness. The ear still knows it is being fooled, but the deceit is intentional and the general effect is that of sound which is louder than it actually is. All the bass notes are heard in their proper perspective, the treble has its familiar bite, and if the loudness control is functioning properly, the over-all balance is much the same at low levels as when the system is opened up wide.

The ideal amount of loudness compensation for low-level listening is not, however, the same for all records, because they aren't all recorded at the same aural distance. Mercury Living-Presence records, for instance, are close-miked to give the illusion of row-A seating in the hall. When there is no restric-

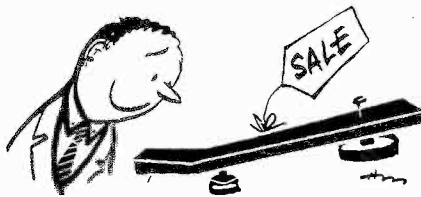

tion imposed on home listening levels, such recordings are most convincing when played at around 100-db peak level. Angel records, miked to sound like row-M concert seats, should be kept at lower levels. When circumstances demand reduced volume for all records, the listener will probably want to play Mercurys and Angels at the same volume; but at this level, the Angel will need less loudness compensation than will the Mercury.

This seems to make perfectly good sense, so whence the controversy? There are several reasons for it, not the least of which is the detrimental effect of loudness controls on mediocre hi-fi equipment.

Nearly all modern amplifiers will produce flat frequency response from at least 20 to 20,000 cps, at low power levels, but their ability to deliver full rated output at the frequency extremes is not so consistently outstanding. Many amplifiers — particularly medium- and low-cost ones — exhibit very poor low-

...the ultimate goal  
of the  
critical listener

**marantz**

*Audio Console*  
preamplifier, complete \$171\*

*Power Amplifier*  
\$198\*

*Electronic Cross-over*  
\$90\*

\*slightly higher west of  
the Mississippi

write for literature

**marantz company**

25-14 Broadway Long Island City 3, N. Y.

**FM BECOMES HI-FI  
WITH THE  
RIGHT ANTENNA**

**TACO**  
"do-it-yourself"  
**FM ANTENNAS**

Here's a powerful FM antenna that will provide the necessary signal-to-noise ratio essential for true Hi-Fi results . . .

The antenna is a twin-driven, 6-element yagi design providing 7 db gain throughout the FM band. It is packaged complete with mast, mount, stand-off insulators, transmission line and everything you need to make a beautiful FM installation, including complete, easy-to-follow instructions.

List price \$27.95

Write for complete details . . .

**TECHNICAL APPLIANCE  
CORPORATION**  
SHERBURNE, N.Y.

frequency power characteristics. In fact, it is not uncommon to find budget-priced units which, at 50 cps, will overload at half their rated power output. It is easy to see how such an amplifier would react to the tremendous bass boost required for Fletcher-Munson compensation. Its middle-range output would be much below overload level, but the bass range would still be driving to or beyond the amplifier's low-frequency power limit. Presto—the muddy bottom!

Amplifiers that are marginally unstable at the low end can also contribute to some weird and puzzling observations about loudness controls. If an amplifier is driven to near its maximum power capability, and has any tendency toward low-frequency instability (motorboating), it will begin to sound ponderous and boomy. At low levels, it may behave perfectly normally, but here we have the makings of a real paradox. The speaker system may give proper balance at high volume levels, or at low volume levels; but whichever way it tends, the sonic balance of such a system will change markedly as the volume is reduced. This is *not* the Fletcher-Munson effect at work, and even though a loudness control may seem to hold the system's balance on an even keel, it is obviously not the solution to the problem. The loudness control would be trying to compensate for the system *as well as for the ears*, and that is too much to expect of it.

The acoustics of your listening room can have much to do with your observations about loudness compensation, too, as can the speaker enclosure itself. A small room (15 ft. or less in length), and particularly a square small room, will almost invariably sound boomy if a speaker system is played loudly in it. A flimsy speaker enclosure, with thin or inadequately braced walls, will do the same thing as soon as its internal pressure becomes high enough to drive the walls into nonuniform sectional vibration. Depending on which combination of system defects may be present, a loudness control may or may not be preferred.

Now let's see what conditions might spawn a perfectly satisfied loudness-control user. He is fortunate enough to own a high-power, highly stabilized amplifier with excellent low-frequency power response, a speaker that is so efficient that it rarely taxes his amplifier, and a rectangular living room in which to house his system. His equipment and his room combine to produce much the same sonic balance at high levels as at low levels, so the only thing he has to worry about is his ears. If he never listens to music except at life-size volume, he won't care much one way or the other about a loudness control; but if by circumstance or choice he does much low-volume listening, he finds loudness compensation indispensable.

Finally, a strong criticism that is often aimed at some loudness controls is that they are *overly* effective, adding more compensation than is needed for a given reduction in volume. This flaw is often just a matter of misuse. A loudness control may be automatic in action but even the best ones can't think for themselves. The amount of compensation that they add depends entirely upon their rotational setting; if a particular hi-fi system has so much gain that "full room volume" finds its loudness control turned halfway down, it is going to add far too much compensation. For proper operation, any

loudness control should be at or near its full-on (or flat-response) position when the system is playing about as loudly as it will ever be played. Then, turning it down will (ideally) add no more compensation than is needed at any given setting. This is why the best control amplifiers are equipped with individual input level-set controls, or have separate front-panel controls for loudness and volume, enabling one function to be matched to the other.

### Summary

It would undoubtedly please many  
*Continued on next page*

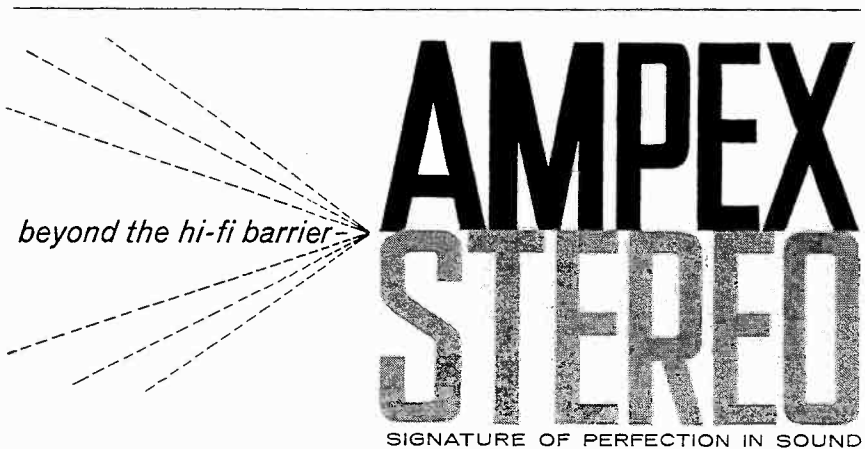

**AMPEX**  
**STEREO**  
SIGNATURE OF PERFECTION IN SOUND

*Here's the authentic story of authentic realism in sound—Ampex **true** Stereophonic Sound—written especially for you by the makers of America's most-wanted and best-engineered home music systems. Send the coupon today for free copy of the new full-color brochure, "**Ampex Stereophonic Sound.**"*

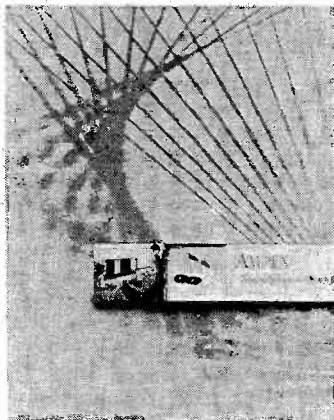

## AMPEX

CREATORS OF THE VIDEOTAPE TELEVISION RECORDER; MAKERS OF AMERICA'S BEST-ENGINEERED, MOST-WANTED AUDIO EQUIPMENT

### AMPEX AUDIO, INC.

1038 KIFER ROAD, SUNNYVALE, CALIFORNIA

Please rush my free copy of "Ampex Stereophonic Sound"

NAME \_\_\_\_\_

ADDRESS \_\_\_\_\_

CITY \_\_\_\_\_

COMING SOON  
NEW! NEW! NEW!

The GROMMES  
"Little Genie"

HIGH  
FIDELITY  
KITS

"So simple,  
it's just like magic"

Wait for the "Little Genie" before  
you build another kit. His way  
is . . . FASTER, EASIER and  
FOOLPROOF.

See your dealer or write . . .

Grommes  
BEST BUY IN HI-FI

NEW PG SERIES  
HI-FI AMPLIFIERS

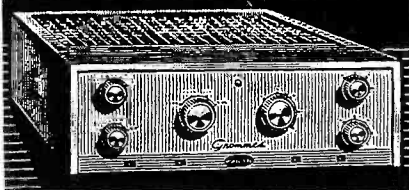

### 15PG 12 Watt Hi-Fi Amplifier

All new deluxe 15PG features the most advanced circuitry, the highest quality components and greater flexibility of controls. It provides feedback throughout, separate turn-over and roll-off record compensators, new loudness control, wide range bass and treble controls, rumble and scratch filters, and six inputs including tape head. Charcoal gray with brushed brass trim.

Net Price to user ..... 72.50

**10PG 10 Watt Hi-Fi Amplifier**—Here is new styling with a full set of controls providing exceptional flexibility. Cabinet Charcoal Gray and Brass. Net Price to user ..... 62.50

**20PG 20 Watt High Fidelity Amplifier**—An all new amplifier with all new features of the deluxe 15PG plus higher power in the output stage. Net Price to user ..... 89.50

See your High Fidelity Dealer or write

**Grommes** Div. of Precision Electronics, Inc.  
Dept. C-9, 9101 King Street, Franklin Park, Ill.

- Send details on "Little Genie" kits.  
 Send Free Hi-Fi Equipment Brochure.

Name .....  
Street .....  
City ..... Zone ..... State .....

## CONTOUR CONTROLS

Continued from preceding page

readers and antagonize many others if, at this point, I could utter a blanket pronouncement to the effect that loudness controls are or are not necessary. But there is no last word on the subject, and there won't be until all amplifiers, loudspeakers, and listening rooms are perfected beyond question. The Fletcher-Munson effect exists beyond mere theory; moreover, it has a practical bearing upon the illusion of realism in reproduced sound. But at the present state of technical development, loudness compensation can be a mixed blessing.

If you must do most of your listening at restricted volume levels, then loudness compensation is necessary—and an ordinary bass tone control won't take the place of a well-designed loudness control. If the amplifier won't handle the requisite compensation, then settle for thin bass, or compensate the bass and accept the distortion, or (best of all) replace the amplifier with a better one.

On the other hand, it must be understood that no loudness control can be expected to take the place of reproduction at natural levels. By "natural" I mean reproduction at the level you might hear in a good concert-hall seat, rather than the imagined 100 db of the Philadelphia Orchestra in your living room.

Actual loudness is bound to be more convincing than the *illusion* of loudness, but there are always (unfortunately) going to be cases when this is out of the question, as witness the urban beehive and the late-at-night listener. Loudness controls are necessary in these cases.

Choose your loudness control carefully, though, and use it properly. A poor one, or a good one that is misused, can turn out to be worse than the Fletcher-Munson effect.

## GROUNDING EAR

Continued from page 4

power transformer, to deliver 470 volts DC to the output tubes. The physical layout uses a well-thought-out combination of the vertical and the newer flat types, resulting in a surprisingly compact (approximately 11 by 14 by 9 in. high), though heavy (43 lb.), package for so powerful and complex a device. There is a socket to feed filament and plate voltages to the Heathkit preamplifier-control unit.

This is one of the most expensive amplifier kits on the market, but its performance should make it a bargain even so.

## Fairchild Turntable with Electronic Drive

Late in May, Fairchild introduced one

## PROFESSIONAL DIRECTORY

### Artisan Build-It-Yourself ELECTRONIC ORGANS

Send \$1.00 for "Organ Builders Manual"

ELECTRONIC ORGAN ARTS

4878 Eagle Rock Blvd.  
Los Angeles 41, Calif.

SIX BRANDENBURG  
CONCERTOS

**BACH's**  
greatest works  
in distinctive  
performances  
conducted by  
HERMANN SCHERCHEN  
exclusively  
on tape

**Omegatape**

### FM/Q antenna systems

High gain broadband FM Antennae for max tuner sensitivity to 72 or 300 ohm inputs. Provides optimum signal level for best recording of high fidelity broadcasts.

APPARATUS DEVELOPMENT CO.

FM/Q Dept. Wethersfield 9, Conn.

UNHAPPY  
WITH  
"HI"  
HI-FI  
PRICES?

Write us your Hi-Fi Needs:  
KEY ELECTRONICS CO  
120 LIBERTY ST.  
NEW YORK 6, N.Y.

## TRADERS' MARKETPLACE

Here's the place to buy, swap, or sell audio equipment. Rates are only 20¢ a word (excluding name and address) and your advertisement will reach 20,000 to 35,000 readers. Remittance must accompany copy and insertion instructions.

LEARN WHILE ASLEEP with your recorder. Amazing book gives you full instructions. \$2.00. Guaranteed. Research Association, P. O. Box 610-AC, Omaha, Nebr.

IF YOU LIKE TO COLLECT RECORDS you should send for our free catalog of Wrought Iron Record Cabinets holding over 250 Albums. Leslie Creations, Dept. C518, Lafayette Hill, Pa.

of the most novel turntables so far developed. It has long been known that the hysteresis-synchronous motor is the most desirable type for high-quality turntables or tape recorders because it is practically immune to speed variations caused by fluctuation of the power-line voltage. Though immune to voltage fluctuations, the hysteresis-synchronous motor responds to variations in frequency. Fairchild has exploited this characteristic in a four-speed turntable (Fig. 2) in which changes of speed can be

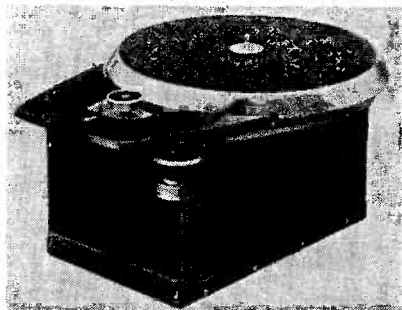

Fig. 2. Speed is changed electronically in the Fairchild Model 412-4 turntable.

achieved without any change in mechanical drive or coupling. This is done by driving the motor with a power source whose frequency can be changed to 30, 60, 81, or 141 cps. The power source consists of a very stable oscillator and a Class-B power amplifier. The frequency of oscillation can be any of these four frequencies modified with a vernier providing a  $\pm 3\%$  change to permit exact adjustment of the turntable speed to  $16\frac{2}{3}$ ,  $33\frac{1}{3}$ , 45, and 78 rpm. The drive from the motor to the turntable itself is a fixed, two-step, belt arrangement which remains constant at all speeds.

Aside from the simplicity of its method of changing speed and elimination of mechanical speed-changing devices which can wear and produce various aberrations, this system offers other advantages. For one thing, it operates with great accuracy of speed on line voltages which may fluctuate anywhere from 95 to 140 volts, and from 25 cps to almost any power-line frequency. Thus it can be used with no special changes here in the United States with 60-cps power lines, or on the Continent with 50-cps lines. Moreover, it will operate satisfactorily from gasoline-driven AC generators, or from a storage battery and vibrator or a rotary converter. It may be of special usefulness for hi-fi aboard ships, planes, and in vacation homes.

The Model 412-4 with this four-speed electronic drive has a price tag of \$159.95. Also available is the 412-1, a single-speed ( $33\frac{1}{3}$ -rpm) turntable for \$79.95. The electronic drive is available separately for addition to the single-speed model to convert it to four-speed operation.

## TAPE NEWS

Continued from page 29

NARTB curve or the unit's original curve to be selected as desired. Recording equalization should not be modified unless the manufacturer is willing to supply instructions applying to your particular recorder. Magnecord, Incorporated, is the first recorder manufacturer I know of that has come forward with an unsolicited offer to supply NARTB conversion instructions for its early recorders. Owners of PT-6 series recorders are advised to take the plunge.

Personally, I abhor blind conformity—but when it's a matter of equipment conformity, there are certain standards that it pays to adopt. These are two of them.

I hope there will be more.

### Last-Minute News Item

Several companies have just jumped into the stereo tape field with both feet. At this writing, Capitol has already pre-released 13 stereo tapes, most of them pops and light classics, while Mercury has brought out 12 preadvertised tapes, Vanguard 8, and Urania about 6. The Capitols are in reviewer Rob Dargell's hands by now, so keep an eye on future "Sound-Fanciers' Guide" pages.

Who's next? Columbia, London?

Better Results With  
ROBINS' AUDIO ACCESSORIES!

GIBSON GIRL® TAPE SPLICERS		
1. Semi-Pro	SP-4	\$ 3.50
2. Junior	TS-4JR	6.50
3. Standard	TS-4STD	8.50
4. De luxe	TS-4DLX	11.50
5. Industrial (5 sizes to 1")		(net) 55.00
ROBINS PHONO AND TAPE ACCESSORIES		
6. Splicing tape	ST-500	\$ .39
7. Jockey Cloth for Tapes	JCT-2	1.00
8. Tape Threader	TT-1	.98
9. AUD-O-FILE	AF-50 (net)	23.99
10. Changer Covers	CC-1, 2	2.00
11. Turntable Covers	CC-3	2.50
12. Disclosures	E10, 12 (pkg)	1.20
13. Jockey Cloth for Records	JC-1	1.00
14. KleeNeeDLE	NB-1	1.50
15. Phono-Cushion, 10", 12"	PC-10, 12	1.50
16. Atomic Jewel	SE-90	5.00

At Dealers Everywhere

**ROBINS INDUSTRIES CORP.**  
BAYSIDE 61, NEW YORK

# COMING to your city HIGH FIDELITY MUSIC SHOWS

See and hear the latest in HIGH FIDELITY from leading high fidelity manufacturers . . .

Don't miss these public showings of Hi-Fi Equipment . . . from the most economical units for the budget-minded to spectacular home music theatres . . . compare and enjoy them all. Components and complete systems will be displayed.

## THREE DAYS OF CONTINUOUS DEMONSTRATIONS 1 P.M. to 10 P.M.

Cincinnati	September 6, 7, 8	Sheraton-Gibson Hotel
Miami	October 18, 19, 20	McAllister Hotel
Seattle	November 8, 9, 10	New Washington Hotel
St. Louis	November 22, 23, 24	Statler Hotel

**Rigo Enterprises, Inc.** 500 North Dearborn Street, Chicago 10, Illinois

# SPEAKING OF speakers

always look  
for this  
symbol for  
sound. Then  
compare...  
when you  
listen...  
you'll always  
hear more  
from:



STEPHENS TRUSONIC INC.  
8538 Warner Drive  
Culver City, California

for everything in hi-fi  
GET THE MONEY-SAVING 1958  
ALLIED CATALOG

featuring the  
world's largest  
stocks of systems  
& components

**free!**  
SEND FOR IT

Here's your complete money-saving guide to Hi-Fi. Own a fine custom quality Hi-Fi music system at no more than the cost of an ordinary phonograph. See dozens of ALLIED-Recommended complete Hi-Fi systems, plus the world's largest selection of components (amplifiers, tuners, changers, speakers, enclosures and accessories). Want to build-your-own?—see our exclusive Hi-Fi KNIGHT-KITS. For everything in Hi-Fi—for everything in Electronics, get the FREE 1958 ALLIED Catalog.

**ALLIED RADIO** AMERICA'S HI-FI CENTER

ALLIED RADIO CORP. Dept. 89-J7  
100 N. Western Ave., Chicago 80, Ill.

Send FREE 1958 ALLIED Catalog

Name \_\_\_\_\_  
Address \_\_\_\_\_  
City \_\_\_\_\_ Zone \_\_\_\_\_ State \_\_\_\_\_

## READERS' FORUM

Continued from page 15

magnetism, exactly as photography is based on light (*photos* in Greek). The Greek word for the lodestone (magnetite, an iron ore) is *magnes*. The suffix *graphy*, of course, derives from the Greek *graphein*, to mark, draw, write.

*Magnetography* is the art of recording with magnetism (and, since the wire recorder is practically obsolete, this can refer only to tape). Prerecorded tape is, of course, a *magnetogram*. Blank tape, corresponding to photographic film, is called *magnetographic* tape. The operator of the machine is a *magnetographer*.

The difficulty is to make the public accept the new nomenclature. It wasn't easy in the case of photography either, I suppose, but at least there was no other term to compete with, except daguerreotype, which is an ugly hybrid. With the co-operation of the industry and of publications like yours, it should be possible to introduce this new concept.

John J. Stern, M.D.  
Utica, N.Y.

Gentlemen:

I just received my July issue of AUDIOCRAFT and read your article "Play Your Tapes at 60 mph" with a great deal of interest, since I had just finished a tape installation in my 1957 Plymouth.

I can go you one better though: my installation is completely separate from the car radio, and I used the Viking FF75SR stereophonic deck and built dual preamps and power amplifiers. The Plymouth four-door hardtop has three speaker openings behind the rear seat, so I used the two outer speaker holes to mount my two speakers. The deck is mounted on the hump over the transmission in the front seat—no room under the dash. The preamps and power amplifiers are in the trunk. My Trav-Electric converter is mounted under the hood on the right side of the car next to the radiator.

The sound of stereo in the car can't be explained in words; it must be heard. I'd put the stereo system I have in my home up against any combination of units I've heard, but it just doesn't give the intimate feeling that you get in the car. With the speakers behind you in the small area inside the car, you can feel the orchestra spread out in back of you. It's like sitting on the podium with your back to the orchestra.

Well, as you can see, I'm well satisfied with my tape at any speed, and would recommend this installation to anyone who has the desire for recorded music at its best.

Kenard A. Johnston  
Harper Woods, Mich.

## ADVERTISING INDEX

Key No.	Advertiser	Page
1	Acoustic Research, Inc.	40-41
2	Allied Radio Corp.	48
3	Ampex Corp.	45
4	Apparatus Development Co.	46
5	Audio Fidelity Records	1, 35
6	Audiophile's Bookshelf	33
7	Bozak, R. T., Sales Co.	42
8	British Industries Corp.	Inside Front Cover
9	Capitol Records	36
10	Centralab	38
11	Components Corp.	12
12	Conrac, Inc.	14
13	EICO	37
14	Electronic Organ Arts	46
15	Electro-Sonic Laboratories	2
16	Fisher Radio Corp.	34
17	Fleetwood	14
18	Garrard Sales Corp.	Inside Front Cover
17	Gray Research & Development Co.	43
18	Grommes	46
19	Heath Co.	6-9
20	International Pacific Recording Corp.	46
21	Key Electronics Co.	46
22	Lafayette Radio	5
23	Lansing, James B., Sound, Inc.	13
24	Marantz Co.	44
25	Minnesota Mining & Mfg. Co.	Back Cover
26	North American Philips Co.	44
20	Omegatape	46
27	Pentron Corp.	39
18	Precision Electronics, Inc.	46
	Professional Directory	46
28	Rigo Enterprises, Inc.	47
29	Robins Industries Corp.	47
30	Stephens Tru-Sonic, Inc.	48
31	Technical Appliance Corp.	44
32	Tapetone, Inc.	43
	Traders' Marketplace	46
33	Viking of Minneapolis	Inside Back Cover