

BroadcastEngineering®

FEBRUARY 2010

www.broadcastengineering.com

FACING MEDIA TRAFFIC CHALLENGES

A discussion on
IT switch performance
in media applications

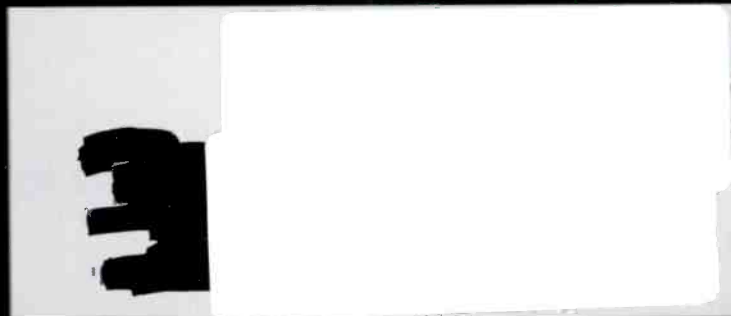

ALSO INSIDE:

THE FUTURE IS NOW

New approaches to
handling media

CHOOSING A RAID STORAGE SYSTEM

Select a secure and
reliable solution

STEREO MICROPHONES

Placement is key to good
stereo imaging

in a field of its own

Get an **\$800** rebate
with purchase.
Act now. Limited-time offer.



Shown with optional wireless mic receiver.

If you dream of shooting 10-bit 4:2:2 master quality but believe you can't afford it, the new AG-HPX300 P2 HD camcorder changes your dreams into reality. With a \$10,700 list price, the HPX300 is the world's first affordable 10-bit 4:2:2 camcorder. And there's nothing even close. With a standard 17X interchangeable lens and newly-developed three 1/3" 2.2 megapixel 3-MOS imagers, you can record 1080 and 720 HD as well as SD content using master-quality AVC-Intra, DVCPRO HD, DVCPRO50, DVCPRO and DV compression — all with the benefit of P2's faster, independent frame, file-based workflow. As rich in creative features as it is in style, the HPX300's innovative, low profile, shoulder-mount design lets you shoot freely through a beautiful, master-quality world. It's no longer a dream. The HPX300 is here.

Visit www.panasonic.com/p2hd.

when it counts

Panasonic ideas for life

P2HD **AVC INTRA**

DVCPRO HD

© 2010 Panasonic of North America

Gaps in Your Transmission?



▲ Represents simulated signal loss in transmission coverage.

THE LINEAR ADVANCED-TV™ GAP-FILLER SERIES

Improve DTV coverage in areas obstructed by terrain and buildings—or in areas where higher signal strength is needed for indoor reception—with gap-filling transmitters from LINEAR.

Our on-channel repeaters are the perfect solution to fill coverage holes and provide seamless DTV coverage for today's—and tomorrow's—transmission needs.

Features:

- ▲ DTV M/H ready
- ▲ Automatic power limit
- ▲ Automatic linear and non-linear precorrection
- ▲ Gain-margin monitoring
- ▲ Echo cancellation
- ▲ Automatic gain control
- ▲ Range of models and output power

KEY BENEFITS

- Cover shadows and extend to lost zones*
- Recoup lost audiences & ad revenue*
- No need for higher power Tx to reach lost customers*
- Prepare & increase density to deliver Mobile TV*



ATG20P™ 20W Gap-Filler

BroadcastEngineering®

FEATURES

36 The future is now

Broadcasters are using innovative approaches to keep pace with today's digital world.

42 Quality control

Understanding PQR, DMOS and PSNR measurements helps improve the quality of your content.

52 Facing media traffic challenges

The way the IT world characterizes and defines IP traffic must change to accommodate the demands of today's media.

BEYOND THE HEADLINES

DOWNLOAD

14 UGC goes mainstream

Technology is taking user-generated content to a new level, one broadcasters must embrace.

FCC UPDATE

18 End of over-the-air TV?

The wireless industry is honing in on TV spectrum.

DIGITAL HANDBOOK

TRANSITION TO DIGITAL

20 DTV reception solutions

Learn about techniques and tools to resolve station reception problems.

COMPUTERS & NETWORKS

26 Networking hardware

Understanding the fundamentals of networking hardware allows you to get more from your broadcast facility.

PRODUCTION CLIPS

28 Stereo mics

Improper placement can result in poor stereo imaging or even unusable sound.

continued on page 6

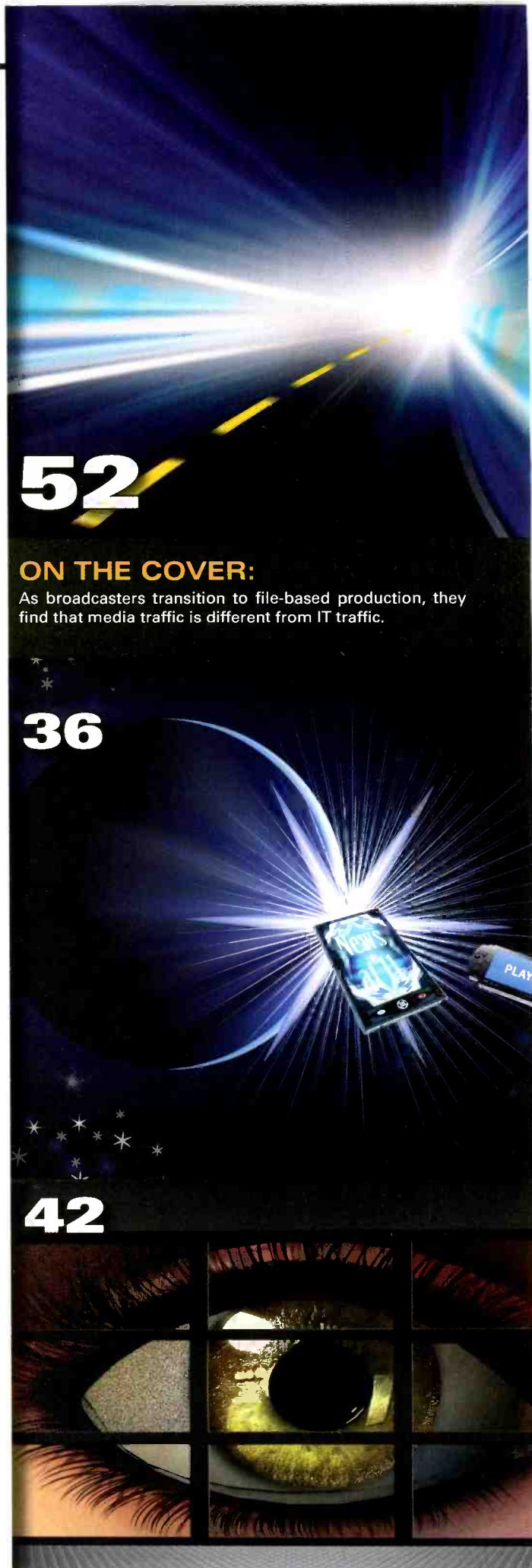

52

ON THE COVER:

As broadcasters transition to file-based production, they find that media traffic is different from IT traffic.

36

42



SDI to Analog
\$495



Analog to SDI
\$495



SDI to Audio
\$495

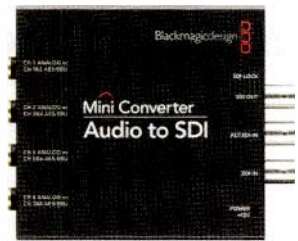

Audio to SDI
\$495



SDI to HDMI
\$495

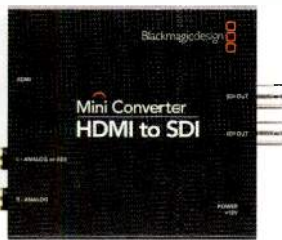

HDMI to SDI
\$495



Optical Fiber
\$495



Sync Generator
\$295

The most advanced 3 Gb/s converters for SD and HD that include AES/EBU and analog audio!

Build your studio with the world's most advanced converters. Only Mini Converters include auto SD/HD switching, redundant input, AES/EBU and analog audio on 1/4 inch jack connections, plus advanced 3 Gb/s SDI! There are 8 great models to choose from depending on the conversion you need!



Auto Switching SD and HD

Mini Converters instantly switch between all SD and HD formats, including NTSC, PAL, 1080i/59.94, 1080i/50, 1080PsF/23.98, 1080PsF/24, 720p/59.94, 720p/50. Updates can be loaded via USB.

Redundant SDI Input

Most Mini Converters feature a redundant input and loop through SDI output. Connect a redundant SDI cable to the second input, and if the main SDI input is lost, Mini Converters will automatically switch over in an instant. That's great for mission critical tasks such as live events.

Pro Analog and AES/EBU Audio

Standard 1/4 inch jacks are built in to most Mini Converters for professional balanced audio that switches between AES/EBU or analog. Unlike other converters you don't need expensive custom audio cables.



3 Gb/s SDI Technology

Mini Converters include the latest 3 Gb/s SDI technology, so you're always future proofed! 3 Gb/s SDI is also fully compatible with all your existing standard definition and high definition SDI equipment.

Broadcast Quality

Mini Converters are built to the highest quality standards with low SDI jitter, so you get the longest SDI cable lengths combined with ultra low noise broadcast quality analog video and audio. Mini Converters are the world's first converters to include 3 Gb/s SDI on all models!

Eight Exciting Models

Mini Converters include more new technologies than other converters, while every model is an affordable \$495. The Sync Generator model is only \$295!



Mini Converters
\$495
Sync Generator
\$295

Learn more today at www.blackmagic-design.com

SYSTEMS INTEGRATION

DIGITAL TUTORIAL

- 32** Choosing a RAID storage system
Secure storage has never been more affordable.

NEW PRODUCTS & REVIEWS

APPLIED TECHNOLOGIES

- 68** CoreEL's H.264 decoder
- 70** Deyan Automation's On Line MCR
- 72** Abit's Show^{it} automation

FIELD REPORTS

- 66** Dielectric's Symphony RF control system
- 74** JVC's HM100 and HM700 camcorders

TECHNOLOGY IN TRANSITION

- 76** A recording conundrum
The goal is achieving a standardized method of interchanging content between recording media.

NEW PRODUCTS

- 78** Linear Acoustic's PAMbDa-II and more ...

DEPARTMENTS

- 8** EDITORIAL
- 10** FEEDBACK
- 80** CLASSIFIEDS
- 81** ADVERTISERS INDEX
- 82** EOM

GET CONNECTED!

Have a burning question? Go to *Broadcast Engineering's* Forum and ask questions of fellow experts. Or join our online community on Facebook.

Learn more at <http://community.broadcastengineering.com/forums>

LATEST NEWS!

The Society of Motion Picture and Television Engineers (SMPTE) has selected Barbara Lange as its new executive director.

Learn more at www.broadcastengineering.com

72



74



76



8



Beauty on the outside. Beast on the inside.

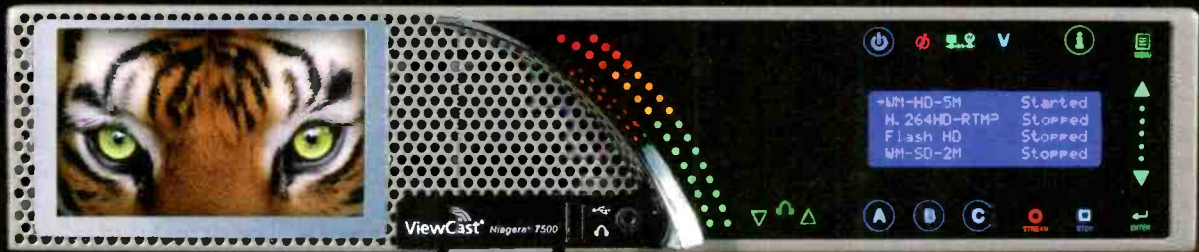

It's easy to be enticed by the alluring good looks of the Niagara® 7500 – the newest HD streaming solution from ViewCast. On the outside, its sleek, innovative design and responsive touch-control interface will excite you. Its brilliant high-resolution HD display will dazzle you. But on the inside, it's a beast.

The Niagara 7500 devours your HD video and easily transforms it into high-quality streams for delivery to IP and mobile networks. Its powerful video pre-processing features streamline and simplify your workflow. Inverse telecine, closed caption extraction and rendering, de-interlacing, scaling, cropping and bitmap overlay are just a few of its standard features.

You can switch on-the-fly between HD or SD video, and with ViewCast's SimulStream® technology, you've got the power to stream simultaneously in multiple formats, bit rates and resolutions from a single SDI video source.

The Niagara 7500 from ViewCast. Beauty on the outside... a beast on the inside.

Speak with one of our streaming experts today at **800-540-4119**, or visit us on the Web at viewcast.com/be to learn more.



ViewCast®

USA 800.540.4119 | Europe, Middle East, Africa +44 1256 345610

A stacked deck

Along with a continued spell of global warming — It's 4 degrees with a windchill of 20 below outside as I write this — the news of impending monumental changes to be imposed on local TV broadcasters is building. We ended 2009 with an FCC chairman who midyear suddenly discovered a "spectrum crisis." To resolve the crisis, Chairman Julius Genachowski assembled a staff of FCC appointees who seem to be as like-minded as agents Smith, Brown and Jones from "The Matrix." Genachowski and his squad of single-purpose, pro-government interventionists have launched an attack on broadcast spectrum unlike anything we've seen since the days of Motorola versus HDTV.



Let's look at just a few of last year's sign posts that might cause a legacy broadcaster to raise an eyebrow:

- Days prior to Genachowski's confirmation in June, acting FCC Chairman Michael Copps hired Blair Levin to oversee development of a nationwide broadband plan. Levin was part of President Barack Obama's transition team's technology policy group. Guess who else was on that technology group? His next boss, FCC Chairman Genachowski. Levin is an FCC insider and former chief of staff to previous FCC Chairman Reed Hundt.
- Genachowski, who served as Hundt's chief counsel, was then appointed FCC chairman. Genachowski attended Harvard Law School with (guess who?) Obama and was in charge of developing the president's technology and innovation agenda. (Notice a trend? Could this be Reed Hundt round two?)
- Shortly after Genachowski arrived, he announced a

"looming spectrum crisis." This crisis forms (in part) the basis of the new chairman's attack on broadcasters' "inefficient" use of spectrum.

- In late July, Genachowski announced the appointment of Mark Lloyd as the FCC's chief diversity officer. Lloyd has been criticized for his regulatory-focused and anti-commercial broadcaster viewpoints. Two of his most criticized writings include "The Structural Imbalance of Political Talk Radio" and "Prologue to a Farce: Communication and Democracy in America." (Can you spell Fairness Doctrine?)

- In December, Stuart Benjamin was appointed the FCC's distinguished scholar in residence. Benjamin wrote in his 2009 paper "Roasting the Pig to Burn Down the House: A Modest Proposal," "... society would benefit if the wireless frequencies currently devoted to broadcast could be used for other services."

Chairman Genachowski soon had most everything in place: a defined crisis and a team of like-minded, experienced bureaucrats. All he needed was something that appeared to be an impartial justification to reclaim broadcast spectrum.

That justification arrived Oct. 23 in the form of a CEA-backed study, "The Need for Additional Spectrum for Wireless Broadband: The Economic Benefits and Costs of Reallocations," written by Coleman Bazelon. Bazelon's paper started a firestorm. His solution to the crisis: pay broadcasters to give up their spectrum, kill (or severely restrict) OTA broadcasting and provide free cable or satellite to current OTA homes. Bazelon claims that recovering the broadcast spectrum will ultimately produce a consumer benefit of \$1.2 trillion.

More than a trillion dollars in supposed benefits?!

With that, Genachowski has drawn what might turn out to be the winning card.

BE

Broad Dish

EDITORIAL DIRECTOR

Send comments to: editor@broadcastengineering.com



Rethink automatic loudness control

Excessive loudness variation is probably the most common viewer complaint, and it's now something you can eliminate entirely. Our Automatic Loudness Control for our Densité interfaces is designed to address all typical loudness problems, including audio jumps between programs and commercials. To ensure effective loudness control without adversely impacting program content, we've incorporated the latest proven technologies from our partners, **Linear Acoustic** and **Jünger Audio**. It's time to rethink what's possible.



Rethink what's possible

ALC
AUTOMATIC
LOUDNESS
CONTROL

www.miranda.com/loudness

Lies, damned lies and the looming spectrum crisis

Dear editor:

Manmade global warming became all the rage a few years ago, and it led to absurd reactions. Lawmakers banned incandescent light bulbs, political enemies put aside differences and engaged in sofa-bound sloganeering to save the planet, and Congress created a global warming subcommittee poised to write legislation saving Earth from the onslaught of blast furnace-like temperatures.

The Nobel Committee even awarded its peace prize to the narrator of a really shoddy PowerPoint presentation that was later lampooned in "The Simpsons Movie."

Public warnings of saving humanity from a calamitous global meltdown became as kitschy as "Where's the beef?" "Bud-weis-er" and "Whassup!"

Thanks to a whistleblower at Britain's East Anglia University — the mecca of global warming studies — the world now knows that manmade global warming is a total fake, a fraud, a complete hoax. Everyone trusted the "experts" behind manmade global warming hysteria when they announced there was a scientific consensus.

However, the release of thousands of e-mails between those who shared in the accolades of the Nobel Peace Prize has revealed the "experts" corrupted data, twisted findings, withheld documents in Freedom of Information Act requests, and stonewalled on the facts in order to promote a political — and possibly business — agenda.

With this as the background, the public should be forewarned that the "looming spectrum crisis" is the new "manmade global warming." That's right. Just as the threat of manmade global warming burst on the scene coincidentally as Al Gore was trying to find a way to supplement his retirement income, we have been informed we face a "looming spectrum

crisis" by industry giants attempting to handcuff competition.

As recently as September, the nation had been planning its wireless future, completely ignorant that a crisis loomed. However, in an Oct. 7 speech to the wireless industry, the chairman of the FCC warned of a "looming spectrum crisis." The remarks of Julius Genachowski were the functional equivalent of firing a starter's pistol.



The national wireless companies were well-prepared. They began pumping out papers, studies and filings waving the "looming spectrum crisis" banner and warning they desperately need broadcasters' spectrum in order to survive. Just barely. Broadcasters must be banished from the airwaves to save the republic, they argue.

Pronouncements of "near unanimous agreement that current spectrum allocations will be insufficient to meet the explosive demand" appear to have been ripped from "the

science is settled" playbook of man-made global warming. The problem is that aside from the bumper sticker slogan campaign, no one has actually proved the claim that there is a "looming spectrum crisis." It sounds great, but not even the wireless companies can dance to it.

Sure, there may be occasions when iVideo Cocktails — just one of the more than 50,000 iPhone apps — bogs down, but does this really portend a spectrum crisis? (For the non-iPhone enthusiasts, iVideo Cocktails is a bartender's guide.)

More to the point, AT&T sued Verizon Wireless over an ad campaign pointing out that AT&T hasn't bothered to upgrade most of its network from 2.5G to 3G. Really, do wireless carriers that have neglected to modernize their oh-so-last-year networks need even more spectrum?

We have been lectured before that the spectrum sky is falling. Nearly a decade ago, the national wireless carriers warned there was insufficient spectrum and that they would be unable to launch 3G wireless services. In fact, there was, and they did (although, as Verizon Wireless has pointed out, some national wireless carriers have yet to fully upgrade to 3G even now). No drastic action was taken, and yet that spectrum crisis was averted.

Back then, regional wireless carriers alleged that the real motive behind the national wireless carriers' demand for more spectrum was to hoard it in order to prevent new entrants — and competitors — into the marketplace. The scheme appears to have worked.

The current issue has nothing to do with the contrived spectrum shortage claim but has plenty to do with old-fashioned competition. Television broadcasters are in the final stages of introducing mobile DTV on a widespread basis that is receivable on a variety of small and pocket-sized devices, including telephone handsets.



Finally, a **Tapeless HD Flash Memory System** that understands the pace of newsgathering.



Ikegami and Toshiba's GFseries optimizes HD workflow for news, sports, and entertainment.

Ikegami and Toshiba have teamed up for one incredible tapeless HD ENG system. The GF series features fast, innovative workflow, superb open-architecture HD quality, and Flash memory technology. These advantages provide broadcast HD news and digital media professionals with unprecedented file-based HD efficiencies from video capture, to fast editing, to instant IT networking, to content delivery. The GF series includes the rugged GFCAM™ HDS-V10 Tapeless Camcorder, the GFSTATION™ GFS-V10 Multi-Format Studio Recorder, and GFPAK™ high-capacity Flash media to record more than two hours of HD video. The race is on for affordable tapeless HD ENG solutions, and Ikegami leads the way.

Learn more about GF series at
www.ikegami.com/gf/

GF™ SERIES

TOSHIBA
Leading Innovation >>>

Ikegami Electronics (USA), Inc.
37 Brook Avenue, Maywood, NJ 07607
East Coast: (201) 368-9171 West Coast: (310) 297-1909
Southeast: (954) 735-2203 Southwest: (972) 869-2363
Midwest: (630) 834-9774 www.ikegami.com

Ikegami
Tapeless • Wireless • Seamless

A slew of new mobile DTV-capable devices are being introduced in the coming months. This does not sit well with wireless providers who would prefer consumers subscribe to their wireless applications. A typical laptop wide area service costs about \$60 a month and smart phone service about half that.

Anti-competitive behavior by the national wireless carriers is not new. Three years ago, the nation's rural and regional wireless carriers complained to the FCC that the national companies were charging the smaller companies 7X the rates for roaming charges they charged other national carriers and 4X what they charged their own retail customers. One can detect a trend to the national wireless companies' spectrum strategy.

Recent government policies of evicting one party in favor of another have ended poorly. In 2005, Susette Kelo and her neighbors had their Connecticut homes seized under eminent domain when New London city officials found a potentially higher tax-paying resident in the form of pharmaceutical giant Pfizer.

The homes have long since been bulldozed, but today the plots of land remain vacant after Pfizer lost interest and abandoned plans to develop the property.

The ignore-the-man-behind-the-curtain moment for the national wireless carriers is their own underdeveloped and underutilized spectrum. There is also the matter of the spectrum they are vacating as they transition from older 2G and 3G technologies (e.g. EVDO, GPRS) to 4G technologies such as LTE.

Broadcasters are comfortable with having an open and honest discussion on the use of spectrum. But don't try to tell us we are days away from being boiled alive during the snow-crusted month of December or that we face a "looming spectrum crisis" when the facts indicate otherwise.

Mark Hyman
Commentator and
all-around gunslinger
Sinclair Broadcast Group

No substitute for local TV news coverage

Dear editor:

If broadcast TV does not survive, local news reporting might not continue either. The FCC and other government leaders need to understand that the decline of newspapers together with an erosion of local news reporting on radio increases the importance of broadcast TV in providing this resource to the public.

If the Internet could provide the accuracy and viewership in this regard, it is likely that it would have already done so. Personal blogs and occasional public notices on Web sites are no substitute for local TV news coverage. Whatever your opinion of politics might be, please consider how much worse things would

be in your locale if local TV reporting simply disappeared, together with its ability to expose issues and keep voters informed.

Chris Zell
WETM-TV

Aspect ratio

Dear editor:

I'm writing in regard to your comment on aspect ratio in the "Did Apple goof on its name?" blog post. The widescreen aspect ratio was simply a gimmick that the movie industry came up with to fight the early TVs. Movies were roughly 4:3, and TV started with the same aspect ratio. Movies were afraid of audience loss and invented widescreen as a "feature" that TV couldn't copy. My use

of the word "gimmick" is appropriate because it added nothing of real value. Only extra background, as the real action was still confined to the 4:3 central area.

As for the iPod, if you look at it, you will quickly see that it is not easily possible to extend the screen sideways to a widescreen format while keeping its present height. The buttons would have to get smaller or be rearranged around the screen. So to make it 16:9, you would have to simply reduce the height. You would not have a larger screen, but a smaller one. Then older, 4:3 images, which make up the vast majority of all graphics composition outside of the movie houses and new production for TV, would have to be reduced to fit in the middle.

I fail to understand the TV industry's fascination with 16:9. The old movie folks must really be chuckling in their soup.

A word about my "vast majority of all graphics composition" statement above. Just look at almost all other forms of graphics. The most standard paper size is 8.5 x 11 for an aspect ratio of 4:3.09. Most paintings from the great masters to modern works are approximately 4:3. Magazines are themselves roughly 4:3, and almost every picture in them is roughly 4:3. Ditto for newspapers.

Outside of movies, television and the Internet, it is hard to find any form of graphics that is not roughly 4:3. The reason for this is simple: It works.

Paul

Converting video files

Dear Russell Brown:

In response to your Feb. 5 online article "Converting video files," I do miss the uncompressed file option. If video quality is really important, it would be good to know if there are possibilities to maintain the uncompressed video data in another wrapper. For the rest, your article is quite informative. Thanks!

Ramon



Discover the Kahunaverse™

Kahuna is more than just a production switcher – it's a whole range of solutions for fast paced, live production, ready to help you create the very best in live TV.

From Sports to News, Outside Broadcast to Studio, there's a Kahuna to suit every application and budget.

Easy to install, maintain and integrate with 3rd party equipment, Kahuna is at home in mission critical environments and easily handles the most demanding workflows.

Offering simultaneous SD/HD operation, a wealth of must-have creative tools, common control surfaces across the entire range, and a powerful feature set, Kahuna delivers the ultimate in flexibility and a future-proof investment.

Affordable and within your reach, take a look – there's a whole Kahunaverse out there.

snellgroup.com/kahunaverse

Routing
Modular Infrastructure
Conversion & Restoration
Production & Master Control Switching
Automation & Media Management

UGC goes mainstream

Technology is taking user-generated content to a new level, one broadcasters must embrace.

BY JIM MARTINOLICH

User-generated content (UGC) is not new to television, but it has never been so widely used. Many things have changed in the 46 years since Abraham Zapruder accidentally filmed the most important piece of UGC ever, but the powerful impact even the most shaky and blurry image can have remains the same. Because of the ubiquitous mobile phone, virtually everyone has a camera with them 24 hours a day. High-quality digital cameras, even HD camcorders, are cheap and easy to use, and even easier to share on the Web. Social networking Web sites have changed people's perception of media and created a desire to contribute and not just consume. There is virtually no breaking news story that can't be captured as it happens. When US Airways Flight 1549 crash-landed in the Hudson River, it's no surprise that the first pictures were posted to Twitter before the news crews got there.

Persuading viewers

How can broadcasters participate in this revolution? One must actively encourage viewers to contribute and to develop a workflow for managing that content efficiently all the way through to the control room. Getting those images to air is the easy

Social networking Web sites have changed people's perception of media and created a desire to contribute and not just consume.

part thanks to the convergence of consumer electronics, computer and broadcast technology.

A major factor in encouraging viewers to contribute is an active Web site. Only a small fraction of UGC will ever make it to air, so a Web site

becomes the forum for displaying the bulk of the viewer-contributed content. The Web site also develops into a platform for providing feedback to contributors, teaching basic reporting skills and securing terms-of-use agreements.

Some broadcasters are taking even more proactive steps to encourage viewers to contribute. Some broadcasters have given away "Flip" digital camcorders to local bloggers and feel it's well worth the little money spent. It may even be worth the expense to provide station staff members with camcorders so they can shoot videos and use their BlackBerrys to e-mail the videos back to the station if regular news crews are not on-site.

Managing images

Ideally, UGC should be treated like any other news graphic once in the newsroom. A MOS newsroom graphics system makes it easy for a producer to find the content, format it in a template and then drop it into the news rundown using familiar tools. User-generated content is based on a variety of consumer and telephony standards. The good news is that there are many powerful and easy-to-use software tools that can be creatively used to develop a smooth production workflow.

Maintaining useful metadata is central to the entire process and starts when the image is first contributed. The front-end Web site should harvest contact information and comments supplied by the contributor and other viewers. Consumer JPEG image files contain EXIF metadata (EXchangeable Image File format is the camera manufacturer's de facto standard for embedding metadata in image files), which time and date stamp the

FRAME GRAB *A look at the issues driving today's technology*

User-generated content is increasing

By 2013, there will be 114.5 million user-generated content creators.

U.S. user-generated content creators, by content type (millions)

	2008	2009	2010	2011	2012	2013
User-generated video	15.4	18.1	20.6	22.7	24.9	27.2
Social networking	71.3	79.7	87.7	94.7	100.1	105.3
Blogs	21.2	23.9	26.7	28.5	30.2	32.1
Virtual worlds	11.6	13.9	15.4	16.9	18.4	19.9
User-generated content creators	82.5	88.8	95.3	101.7	108.0	114.5

Source: eMarketer

www.emarketer.com

How loud is it? Know for sure.

 **DOLBY**

NEW Dolby® Media Meter 2 software

Now with added measurement options and digital audio workstation (DAW) compatibility



Accurate loudness measurement is vital to creating a quality viewer experience. And Dolby® Media Meter 2 makes it easy. It's an ideal tool for program creation and quality control, and perfect for optimizing broadcast and disc media.

Version 2 builds on the original software, adding new measurement algorithms, new plug-ins for popular DAWs, and new features that include level meters, a high-quality peak limiter, and real-time graphing.

For accuracy, flexibility, and ease of use, Dolby Media Meter 2 offers unbeatable value at **\$795 (MSRP)**. We also offer a paid upgrade for current owners.

Dolby Media Meter 2 Features

- Dialogue Intelligence™ technology
- ITU-R BS.1770-1, Leq(m), Leq(A), True Peak, and Dialogue Range
- Complete logging functions

MAC/WINDOWS

- Stand-alone application for file-based measurement
- Digidesign® and VST plug-ins

MAC OS

- Mac® AU plug-in for Apple® software

Dolby and the double-D symbol are registered trademarks of Dolby Laboratories. Dialogue Intelligence is a trademark of Dolby Laboratories. All other trademarks remain the property of their respective owners. © 2010 Dolby Laboratories, Inc. All rights reserved. 510/22413

image. 3G iPhones and GPS-enabled BlackBerrys can tag pictures with GPS coordinates as well. This metadata should be extracted and logged for immediate use in the production system using a variety of consumer, commercial and custom software. For long-term storage and reuse, metadata can be embedded in most UGC file formats using the eXtensible Metadata Platform (XMP) standard. Embedding metadata in the essence file means it will never get lost as the image is passed from one system to another and eventually archived. XMP, as the name suggests, is extensible so that it's possible to create new metadata containers to fit your need.

Finally, of course, the images and video need to get to air. Most user-generated image files will be in JPEG format. Resolutions vary from 640 x 480 pixels for a cell phone image to more than 4000 x 3000 pixels for digital cameras. Depending on the play-out device, the image may need to be scaled offline and enhanced and/or cropped for better presentation. Older still store and graphics devices may require fixed resolution files, but modern production equipment will usually reformat content with built-in image scaling and compositing.

Managing video

Managing user-contributed video can be a little more difficult. Non-standard frame rates and file formats have to be converted. Captured quality can vary from near broadcast quality from 1920 x 1080 consumer AVCHD cameras, to cell phone video captured at 176 x 144 pixels 25fps that conform to 3GPP and 3GPP2 standards. These video standards are named after the 3rd Generation Partnership Project, which specifies standards for phone systems based on GSM technology, and the 3rd Generation Partnership Project 2, which specifies standards for phone systems based on CDMA technology. Luckily, there are many video format conversion utilities available from professional quality to relatively low-cost shareware products. Fast-Forward

MPEG (FFmpeg) is popular and free under a GNU license.

There are two basic methods for getting computer-based images to air. The first is to use a scan converter, to play an image from a computer desktop directly to air (or tape). The advantage of this is that it will work with any Web- or file-based media. Another method is using a graphics compositing device to embed an image or movie file of any size and almost any format

to be deployed in the United States. Several third-party vendors — such as Qik, Ustream, Fring and Flixwagon — have live video streaming applications for popular 3G smart phones that look promising. These typically require 250Kb/s upload speed for acceptable video, and though this is on the edge for the best 3G connections, it is highly dependent on coverage area and network traffic. An alphabet soup of new 3.5G and 4G cellular

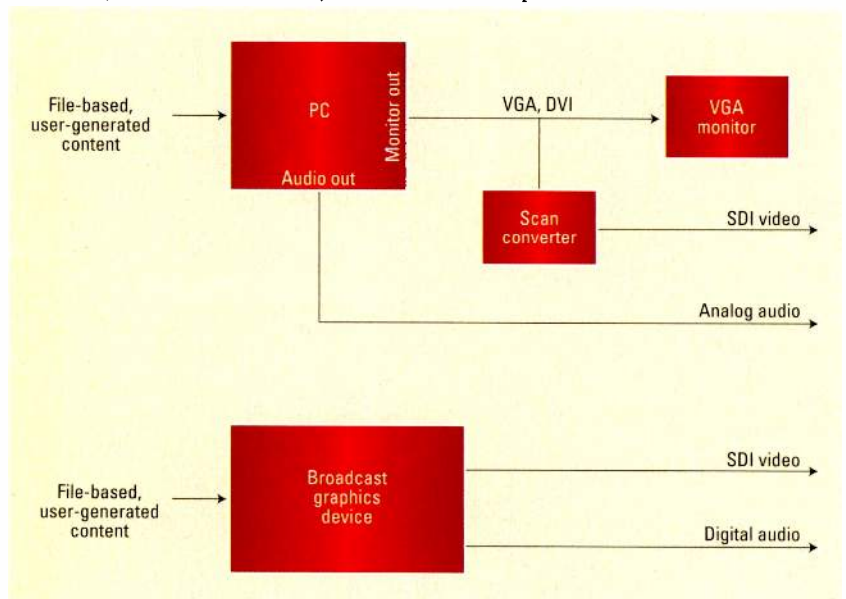

Figure 1. An AES-EBU digital output card improves audio quality, and a broadcast graphics play-out device should natively provide for embedded or discreet digital audio outputs.

into a graphics template for play to air. The latter method will be better integrated into the standard news production workflow, which is a benefit if you are using UGC frequently.

And don't forget the audio. Scan conversion systems don't generally process audio, so consider using an AES-UBU digital output card to improve audio quality. A broadcast graphics play-out device should natively provide for embedded or discreet digital audio outputs. (See Figure 1.)

The Holy Grail of user-generated content is live streaming from an on-location cell phone to air. Cell phone companies have been planning two-way video calling for years, but because of high bandwidth requirements and low demand, it is having limited success in Europe and has yet

technologies promise to increase that bandwidth a factor of 10 or more in the near future, so we are not far off. Meanwhile, citizen journalists can also connect to the hardwired Internet, WiMax and even municipal Wi-Fi to use more ubiquitous teleconferencing applications such as Skype for sending reports. While this lacks the potential immediacy of the cell-phone connection, it has significantly better quality and reliability.

As the role of UGC in media continues to grow, it is up to broadcasters to keep an open mind and embrace the opportunity and the variety of the new consumer and commercial technologies it is built on.

BE

Jim Martinolich is vice president of integration technologies for Chyron.

Imagination to Creation

www.for-a.com

- Head Office (Japan)
Tel: +81 (0)3-3446-3936
- USA Western (CA)
Tel: +1 714-894-3311
- USA Eastern & Midwest (NJ)
Tel: +1 201-944-1120
- USA Southern (FL)
Tel: +1 352-371-1505
- Latin America & Caribbean (FL)
Tel: +1 305-931-1700
- Canada (Toronto)
Tel: +1 416-977-0343
- UK (London)
Tel: +44 (0)20-8391-7979
- Italy (Milan)
Tel: +39 02-254-3635/6
- Korea (Seoul)
Tel: +82 (0)2-2637-0761
- China (Beijing)
Tel: +86 (0)10-5170-9870

FOR.A[®]
INNOVATIONS IN VIDEO
and AUDIO TECHNOLOGY



HVS-300HS: The New Standard in Small HD/SD Switchers!

Unrivalled Features, Unequaled Cost Performance

- Very compact main unit (1RU high)
- 4 types of control panels: standard panel, front panel, remote panel, and control GUI
- HD/SD-SDI 4 input/4 output standard. Max. 12 input/8 output
- Frame sync, re-sizing engine, and Proc Amp on each input
- Variety of I/O options: HD/SD-SDI, DVI-D, VGA, HD/SD analog component, and analog composite
- Built-in 16-split multiviewer, supporting 4, 10 or 16-split view with tally and title display
- Up-stream Keyer (with Chroma Key) and DSK both with 2D DVE
- Dual Picture-in-Picture function
- Various 2D and 3D DVE transitions
- Over 100 wipe patterns
- Two channels of still stores
- ANC data pass through
- Aux remote control (option)



Main Unit with HVS-300RU Remote Panel



Main Unit with HVS-300FP Front Panel



Main Unit with HVS-300U Operation Unit

Now FOR-A offers a complete line of switchers from our affordable 1M/E up to our new 3Gbps ready 4M/E model

End of over-the-air TV?

The wireless industry is honing in on TV spectrum.

BY HARRY C. MARTIN

Are we at the beginning of the end of over-the-air broadcast television? Some might argue that free-over-the-air broadcast TV has been on its way out as a result of the DTV conversion. But late last year, the FCC took a new turn toward accelerating television's demise by proposing to repurpose at least part of the spectrum currently used by television stations. This initiative took the form of notices of inquiry looking toward use of TV frequencies by wireless Internet providers and the migration of TV to the Internet. Specifically, new proceedings launched in December asked for data on current use of TV spectrum and ideas on how to encourage more video distribution via the Internet.

Spectrum use

The unusually short three-week time period allowed for comments on the major spectrum issues the FCC has raised begged the question as to

whether the agency has already made up its mind to support the wireless raid on broadcast spectrum. As evidence of this bias, the FCC spectrum inquiry notice referenced a joint letter from the heads of CTIA-The Wireless Association and the Consumer Electronics Association, urging the

The FCC, in effect, asks the broadcast industry to justify continued use of its spectrum.

commission to begin considering the TV spectrum for reassignment to the wireless industry.

In the context of its information gathering on spectrum use, the FCC asks, "What would be the impact to the U.S. economy if insufficient additional spectrum were made available for wireless broadband deployment, in terms of investments, jobs, consumer welfare, innovation and other indicators of global leadership?" Contrast that with the followup question: "What would be the impact to the U.S. economy and public welfare if the coverage of free over-the-air broadcast television was diminished to accommodate a repacking of stations to recover spectrum?"

There is no doubt where the FCC is going with this, and there should not be given the oft-stated goal of Julius Genachowski, the current chairman, to significantly improve broadband capabilities and make wireless Internet services universally available.

In its spectrum inquiry proceeding, the FCC notes that broadcast television is delivered to a vast majority of consumers via cable and satellite, not over the air. In an effort to appear even-handed, the FCC's in-

quiry then asks what impact the demise of broadcast TV might have on such things as "public awareness of emergency information, local news, political discourse and education?" One can only guess what the answers will be from broadcasters, but the issue the FCC's questions beg is why it would be seeking information it already has except to feign impartiality in the looming broadcaster vs. wireless battle that its new inquiry proceedings have spawned.

The FCC's bias in favor of broadband is further evidenced by the presumptions embodied in the spectrum inquiry proceeding. In the notice of inquiry on this subject the FCC, in effect, asks the broadcast industry to justify continued use of its spectrum, but includes no similar request for a justification from wireless providers — this in spite of the presence of considerable amounts of spam and pornography on current wireless networks, and in spite of underuse of some of its dedicated spectrum.

Video device deployment

The second of the FCC's notices of inquiry invited comments on how to incentivize video manufacturers to promote greater migration from broadcast TV to IP-delivered TV. While the commission seeks comments on how to best shape future device development to encourage the use of a single, portable screen for all personal video and Internet usage, the contemplated convergence involves creating an Internet-based parity among broadcasters and other video providers that does not currently exist.

BE

Harry C. Martin is a member of Fletcher, Heald and Hildreth, PLC.

Dateline

- For noncommercial TV stations in Texas, the biennial ownership report deadline is April 1. The biennial ownership reporting date for commercial TV, Class A TV and LPTV stations has been suspended pending improvements to the new FCC Form 323.
- April 1 is the deadline for TV stations in Texas to electronically file their broadcast EEO midterm reports (Form 397) with the FCC.
- April 1 is the deadline for TV stations licensed in the following states to place their annual EEO reports in their public files: Delaware, Indiana, Kentucky, Pennsylvania, Tennessee and Texas.

? Send questions and comments to: harry.martin@penton.com

Take YouTube™ to Air



BrightEye Mitto™ Scan Converter For Broadcasters

Do You Need to Broadcast Video Content from the Web?

BrightEye Mitto offers the best way to take computer video to air. Video that once seemed constrained by your computer desktop can now be used for the most demanding broadcast and display applications. Just use a mouse to select the video you want to output to air.

Superior Quality – For the Most Demanding Broadcast Applications

BrightEye Mitto* has the advantage of proprietary scaling technology and exclusive multi-tap filtering. The filters automatically adjust in accordance with the conversion being performed.

Bringing progressive images from the desktop into the interlaced world of video used to be a compromise between sharp details versus interfield flicker. Mitto's advanced filtering satisfies both of these seemingly contradictory requirements. The result is that the output looks as good, or better, than the original and passes the most stringent testing.

A broadcaster came to us and asked that we build an HD scan converter for them. When we brought the prototype to them for testing, they were ecstatic at how good the output looked.

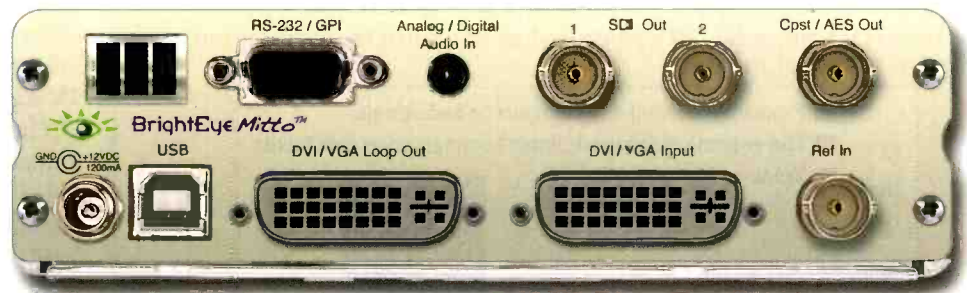

Easy-to-Use

The included Mac/PC application let's you simply use your mouse to click and drag over the specific portion of computer video that you want to output. We're all used to using a mouse – it's the easiest way to select exactly what you want to output. The region selected for output determines if Mitto acts as an upconverter or downconverter. Whether you output the entire screen or just a selected portion, you'll be able to see exactly what you are doing. And timing the video output into your system is easy, too.

*Purveyors of Fine Video Gear -
Loved By Engineers Worldwide*

* Mitto - the Latin root word for Transmit and Uncompromising

ENSEMBLE

DESIGNS
www.ensembledesigns.com

530.478.1830

DTV reception solutions

Learn about techniques and tools to resolve station reception problems.

BY ALDO CUGNINI

Digital broadcasting has now replaced high-powered analog television broadcasting in the United States. But is reliable over-the-air reception a given? The FCC planning factors for DTV were developed to replace analog broadcast with a similar digital footprint. Successful digital reception, however, is subject to a different set of conditions.

This month, we'll look at a number of methods being used to maximize digital reception quality. While some of these issues relate directly to the transmission side of broadcasting, some are a function of receiver technology. Nonetheless, broadcasters can do their part to improve the performance of receivers by participating in discussions when relevant standards or rules are revised, and as products are specified and developed.

Circular polarization

Recently, SPX Dielectric Corp. conducted a study into the reception characteristics of receivers, with the aim of investigating the use of circular polarization for mobile handheld televisions. Using simulation software to evaluate a sample device's RF reception characteristics at VHF and UHF frequencies, its conclusion was that the small antennas in a handheld phone essentially behave with the characteristics of the long dimension of the phone; the phone itself acts like a dipole, and the antenna's polarization is along the axis of the phone.

The company then conducted a field study of the impact of signal polarization on reception by a handheld device. The noise margin of the receivers was measured to determine any possible improvement of vertical and circular polarization over that of

horizontal polarization. According to the company, circular polarization offered a 5dB average improvement over horizontal polarization and a 7.5dB average improvement over vertical polarization. These results suggest that coverage area and/or reception reliability could be enhanced by the use of circular polarization. Of course, further studies into different sample cases should be carried out before embarking on the expense of a new antenna.

Continuing receiver improvement

Last October, the FCC Office of Engineering and Technology (OET) published a report on its testing program, conducted on behalf of the NTIA DTV converter box coupon program. While the report concentrated on lessons learned in testing converter boxes, the information is useful for assessing the state of the art of DTV reception technology (i.e., tuners and demodulators), which is independent of the final display device.

Historically, the spacing of UHF TV stations has been regulated by the FCC as a consequence of the technical limitations of TV receivers. These so-called UHF taboos are a function of various tuner mechanisms, including local oscillator (LO) radiation, intermediate frequency (IF) beat, IF image rejection, nonlinear distortions and out-of-band rejection. Receiver performance in the presence of interfering signals from adjacent channels ($N\pm 1$) and taboos ($N\pm 2, 3\dots 15$) is therefore critical to good reception in a crowded market.

The good news is that receiver performance continues to improve with time. According to the FCC report, taboo-channel rejection performance

FRAME GRAB

A look at tomorrow's technology

Consumer DTV reception and transition problems

After the DTV transition, 10.81 percent of consumers complained of a weak or spotty signal.

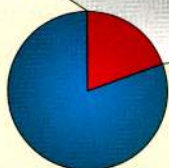
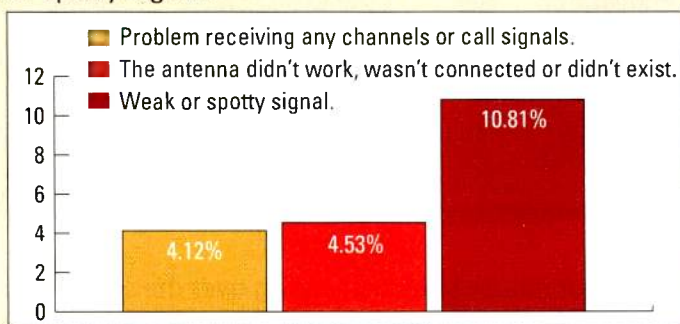

19.46% of consumers had reception and technical problems after the DTV transition

Source: FCC

www.dtv.gov



When you need **scalable capacity,**
bandwidth and **processing power**

MediaGrid™ **Performs.**



Grow your way to an optimized file-based workflow, with a storage system that lets you add both capacity and bandwidth. MediaGrid combines the bandwidth you need for collaborative editing with the resiliency you need for transmission operations. It even lets you transcode between production and delivery formats within the storage system. Whatever your workflow, isn't it time for your storage to play an active role? **Omneon MediaGrid – active storage for digital content.**

www.omneon.com

For details, go to www.omneon.com/MediaGridPerforms
or call us at 1-866-861-5690

 **OMNEON**®

Active Storage for Digital Content™

of the converter boxes showed significant improvements over the 2005 and 2006 DTV receivers that had previously been tested, with median performance of the converter boxes exceeding that of the earlier DTV receivers at every channel offset that produced a measurable result.

There have been concerns by some that the FCC DTV channel allocation process — which started more than 10 years ago — did not fully take into account the effect of multiple interferers in a coverage area, and this could challenge a receiver's intermodulation susceptibility. According to the FCC report, the converter boxes tested exhibited better rejection performance against paired interferers than the group of eight 2005 and 2006 DTV receivers that had previously been tested. In addition, the measured VHF and UHF sensitivities of converter boxes were

found to be about 2dB better than the minimum performance requirements recommended by the ATSC for all DTVs and required by the NTIA for coupon-eligible converter boxes.

DTV transmission can get a boost with gap fillers or repeaters that operate on-channel to extend or fill in coverage.

During the FCC channel allocation process, the commission used various propagation models to determine DTV broadcast coverage. The report also shows a receiver improvement in this area, with the median sensitivities of receivers about 4dB better than

the sensitivity assumed by the coverage model for VHF and 1dB better at UHF. The 10th percentile (near worst) performance on all tested channels was about 1dB better than the ATSC guidelines and NTIA requirements. Median sensitivities of the converter boxes were from 1dB to 3dB better than those of the 28 DTV receivers that the FCC tested in 2005, and 10th percentile performance in the high and low VHF bands was 4dB and 7dB, respectively — better than that of the DTV receivers from the 2005 tests.

Guidance on DTV antennas

The Consumer Electronics Association (CEA) and MSTV have issued various documents to help consumers maximize their DTV reception. CEA has published several standards, such as CEA-774-B, CEA-2032-A and CEA-2028-A, which help to match the correct antenna performance to

TRAINING DOESN'T COST, IT PAYS.



Leave the teaching to the experts, the consultants at *Broadcast Engineering*.

Is technology moving faster than your staff's skills? Do you have engineers and operators who aren't up-to-date on your latest equipment and systems? Have the demands of HD and handling multi-formats created workflow problems or caused on-air mistakes? These failures can cost you money.

Broadcast Engineering is excited to offer you an introductory series of training workshops targeted specifically to broadcast operations and engineering staffs.

All this is contained in a self-paced, complete program accessible from any computer.

Log on to www.broadcastengineering.com/webcast/best to learn more about the classes available, or to enroll.

BroadcastEngineering®
SPECIALIZED TRAINING

Zeus™
BROADCAST
An Obor Digital Company

a viewer's particular reception situation. These three documents specify general performance criteria, indoor receiving antenna performance and product color codes, respectively, and form the basis for a consistent marketplace consumer education program.

MSTV has published a set of consumer tips for VHF reception, as well as an advisory on indoor antennas. Both are intended to be used as tools for broadcasters to aid consumers experiencing difficult reception conditions. The consumer tips address some interesting factors that will not be obvious to many consumers, such as the fact that an antenna should not be placed near the TV itself (due to radiated electronic interference), and that amplified VHF antennas may increase the interference from other electrical devices in the home.

NAB sponsored a program last year to help develop smart antennas and a single-wire interface for them. (Smart antenna technology allows a DTV receiver to dynamically reconfigure an electronically adjustable antenna to optimize the reception performance across multiple stations. A new compatible receiver and antenna are needed; the two require a CEA-909A interface.) The NAB FASTROAD project had a number of interesting findings. Apparently, many currently available

CEA-909A enabled DTV converter boxes do not rigorously implement or conform to the CEA-909A specification, leading to implementation and crosscompatibility issues.

Also, while the firmware on most converter boxes will support a simple



CEA indoor antenna check mark. Image courtesy CEA.

antenna (e.g., a switched dipole), the support for advanced smart antennas varies widely. Since firmware functionality and compatibility are not defined in the current CEA-909A standard, success of the smart antenna technology in the marketplace may hinge on establishing compatibility standards. Sources tell us that a revision to the standard is in the works to address these issues.

DTV gap fillers

Good DTV reception at fixed locations is sometimes an issue due to geography (terrain) and a coverage pattern different from that of NTSC, potentially leading to holes in coverage. DTV transmission can get a boost in this respect with gap fillers or repeaters that operate on-channel to extend or fill in coverage. Last year, bills were floated in both houses of Congress, called the DTV Cliff Effect Assistance Act of 2009, which could help broadcasters deploy such equipment.

The bills call for establishing an assistance program for the construction of digital TV translators, with the Department of Commerce making payments of up to \$125 million in the aggregate, during fiscal years 2009 through 2012, from the Digital Television Transition and Public Safety Fund. The program would target local civil government bodies, which would receive funding for the construction and equipment of digital TV translators. At press time, the bills were referred to committees in both houses, and await debate. **BE**

Aldo Cugnini is a consultant in the digital television industry.

? Send questions and comments to: aldo.cugnini@penton.com

Curious? See you at NAB 2010, Booth C6747

RIEDEL
The Communications People

MEDIORNET – RE-DEFINING FIBRE-OPTIC NETWORKS

The Solution for World Class Events.

Riedel Communications Inc. • 1721 Victory Blvd • Glendale, CA 91201 • USA • www.riedel.net

Networking hardware

Understanding the fundamentals of networking hardware allows you to get more from your broadcast facility.

BY BRAD GILMER

Various claims can be found on the Internet regarding the earliest network implementation, but one thing is for sure: It was not long after computers were invented that people began hooking systems together. Early networking relied on serial ports and dial-up connections. But it was not until Ethernet and TCP/IP became dominant that networking really took off.

Hardware fundamentals

Broadcasters may be surprised to learn that the precursors to modern Ethernet networks ran over RG-8 coaxial cable. This early system, called thicknet, was standardized under the nomenclature 10BASE-5.

Figure 1 shows a typical vampire tap in a thicknet network. The tap gets its name because it “bites” through the RG-8 cable to make contact with the outer shield. The installer uses a special drill to cut away the shield and dielectric, and then threads a probe into the tap to make a connection to the inner conductor of the coax.

The tap is bolted to a medium access unit (MAU). Signals from the MAU are sent to an attachment unit interface (AUI) over a 15-conductor cable. Figure 1 shows the DB-15 AUI connector on the side of the tap. In PC applications, the AUI cable is plugged into an AUI card, which is installed in an expansion slot on the motherboard. Software drivers enable the computer to send and receive signals on the network.

10BASE-5 was not around long; the cable and the taps were heavy, hard to work with in an office environment and expensive. Yet, 10BASE-5 showed that computer networking was viable, even in electrically noisy factory environments. 10BASE-5 saw limited

deployment in broadcast facilities. I know of only a few systems that were built using this technology.

10BASE-2, also known as thinnet, was the next hardware advance. Thinnet uses fundamentally the same technology as 10BASE-5, but sends

1990s, most of this had been replaced by thinnet.

While RG-58 was much easier to work with, and while advances in technology allowed manufacturers to create inexpensive interface cards, the cable was still awkward to work



Figure 1. Illustrated here is a vampire tap transceiver showing the medium access unit and a DB-15 attachment unit interface connector, which connects the tap to the computer.

signals over RG-58 coaxial cable instead of RG-8. It was not long before manufacturers combined the MAU and AUI into a single device, known as the network interface controller

with in the office environment. It required a BNC T and a 50Ω terminator on the back of every card, and you had to shut down the network to install or remove computers from the

10BASE-T is the grandfather of all modern wired Ethernet technology.

(NIC). This arguably was the first mass-produced Ethernet card. If you have any old Ethernet cards lying around and wondered why they have a BNC connector, now you know the answer. Thinnet was the first technology widely deployed in the broadcast environment. While some early automation systems employed other networking technologies, by the mid-

network. Implementers, especially in the broadcast environment, needed a more flexible, less complex and more reliable solution that could be maintained on the fly.

10BASE-T and modern networking

10BASE-T is the grandfather of all modern wired Ethernet technology.



The Power To Brand & Control

When It Comes to Power and Control, Go With the Masters

The Utah Scientific MC family are the masters of master control systems. Proven in all types of television applications – from single channel management to commanding the complexities of large-scale, multichannel, multiformat operations – they handle SD, HD, or both simultaneously, while directing multiple mixed format audio sources if necessary.

Utah Master Control systems offer seamless integration with Utah's industry-leading routing systems, full compatibility with all major automation systems, and advanced intelligent handling of EAS alerts. Add to all of that its complete channel branding capability – including multiple keys, logos, squeeze-back and graphics – and you're not just in control, *you rule*.

Contact us at: info@utahscientific.com, or call (800) 453-8782.

The Best In The Business

www.utahscientific.com



US Utah Scientific

It established several important innovations that remain influential today. 10BASE-T was the first Ethernet standard that made use of unshielded twisted pair (UTP) cable. You probably have surmised that networks operate using transmission lines (thus the early use of RG-8 and RG-58 coax cable). But coax was always expensive and difficult to work with. It has been

today, is the use of the RJ-45 modular connector. This connector is actually designated the 8P8C connector, but consumers were already used to the telephone RJ-11 and RJ-45 connectors, and when the 8P8C connector came out with similar physical dimensions to the RJ-45, the name stuck. Although these connectors appear to be the same, broadcasters should

to the network requires a “home run” back to a centralized switch. At first, this was a significant obstacle to the adoption of 10BASE-T because hubs were expensive. But as demand increased, and as technology improved, the cost of hubs dropped to acceptable levels.

100BASE-T and 1000BASE-T, sometimes called Gigabit Ethernet (GigE), are evolutions that build upon the original 10BASE-T. The new technology is faster, smaller and less expensive than the original, and there have been many important technical innovations that have allowed broadcasters to access their networks at ever-increasing speeds. But 10BASE-T over UTP is the fuel that fired the networking revolution.

The advent of hubs brought to light a problem. But actually, this problem existed since the invention of Ethernet. The problem is that the hub, like the shared RG-58 and the RG-8 before, is a shared medium. In other words, every conversation happening on the network is transmitted to every computer on the network segment. Any message going into a hub is relayed to all the rest of the ports on the hub. (Note that switches do not behave this way.) This raises the obvious question: What happens when more than one device wants to talk at the same time?

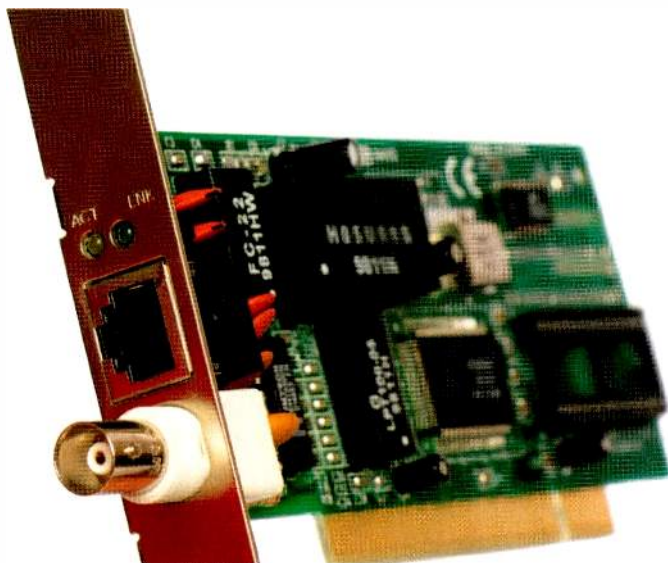

Shown here is a network interface card that supports both 10BASE-2 and 10BASE-T.

known for a long time that it is possible to create a transmission line by twisting two cables together using a uniform twist-per-foot. So designers knew that they could use twisted pair wire rather than coax. But the Ethernet standard requires two cable pairs — one for send and another for receive. Typically, this would require shielding between the two pairs to avoid cross-talk, increasing the complexity and cost of cabling. Engineers discovered that they could meet the signal isolation requirements of the standard by putting two twisted pairs in the same jacket as long as the two pairs were twisted in opposite directions — one pair with a left-hand twist and one pair with a right-hand twist. This eliminated the need for shielding and significantly reduced the cost of the cable.

The next major innovation in the 10BASE-T standard, which continues

pay special attention to the connectors, especially when using them at high network speeds. Old 10BASE-T connectors may not work.

10BASE-T and 10BASE-2 co-existed for quite some time, because broadcasters and many other users already had a large installed base of 10BASE-2. As the photo above shows, manufacturers addressed this situation by making NICs with both 10BASE-T and 10BASE-2 connectors.

The last major innovation from the 10BASE-T era that is still with us today is the advent of the network hub. Neither 10BASE-5 nor 10BASE-2 required central network equipment. All you had to do was to string cable between a group of networked computers, connect them, and you were ready to go. But 10BASE-T requires the use of a network hub. (Hubs are no longer in use; switches predominate now.) Every computer attached

10BASE-T over UTP is the fuel that fired the networking revolution.

The inventors of Ethernet anticipated this problem and came up with a solution as part of the original design. The solution is called Carrier Sense Multiple Access with Collision Detection (CSMA/CD). CSMA does just what it says; it allows multiple computers to access a network. NIC cards implement CSMA by listening before they send. Detecting a carrier on the network indicates that the

network is in use and that a collision would occur if the computer tried to send at that moment. When the NIC detects that the network is busy, it backs off for a random amount of time and then tries again.

Network collisions

CSMA/CD works amazingly well as long as the network is not too heavily loaded. But as users began to demand more from their networks, especially broadcast users moving very large files, CSMA began to show its limitations. If the network started to run much over 75 percent capacity, collisions would go up rapidly, and throughput would grind to a halt.

One way to visualize this is to think of a dinner party. If you have a few guests with important things to say, it is no problem for one person to wait for another to finish. But if you have a large dinner party and you played by

the same rules, it would not be long before a large number of people were waiting for their turn to talk. And if they had tried to talk but had to wait, tried to talk again but still found that others were talking, pretty soon they would get frustrated and leave. The

Moving, high-resolution video is one of the most demanding types of network traffic around.

same thing happens on heavily loaded computer networks.

This problem has continued to plague network users to this day. It can be dealt with through sound network

design, proper network segmentation, deployment and proper configuration of modern networking hardware, and vigilant monitoring of the network by trained engineers. Unfortunately, moving, high-resolution video is one of the most demanding types of network traffic around, and broadcasters need to pay special attention to all these factors if they want to have reliable networks in their facilities. **BE**

Brad Gilmer is president of Gilmer & Associates and executive director of the Advanced Media Workflow Association.



Send questions and comments to:
brad.gilmer@penton.com

STORAGE & NETWORKING ONESTOP

at www.broadcastengineering.com

For more news and articles on storage & networking, visit our Web site and click on the **Storage & Networking** link at the top of the page

Broadcast Time Zone Delay
Profanity Delay
Visually Lossless
HD-SDI Input and Output
HDMI Monitor Output
Simple Built-In GUI
All this, in just 2 RU!

High Definition Time Delay

360 Systems BROADCAST

MAXX-2470HC

Call now for more information: (818) 735-8221.

Stereo mics

Improper placement can result in poor stereo imaging or even unusable sound.

BY STEVE SAVANYI

Acquiring sound in stereo is more than just putting up a couple of microphones and designating one left and the other right. Because of the physics in how sound waves relate to one another and with the microphones within the acoustic space, improper techniques can result in poor stereo imaging or even unusable sound.

Stereo microphone techniques

Over the years, several techniques have been developed for capturing a stereo image using conventional



Proper use of mics can enhance the overall audio experience for listeners. Shown here is Audio-Technica's BP4025 mic used to capture Notre Dame's marching band in surround.

microphones. The three most common methods are spaced pair, coincident or X-Y, and mid-side (MS).

In a spaced pair arrangement, two microphones (usually omnidirectional) are spaced between 0.9m and 3m apart and panned left and right accordingly, resulting in a wide stereo image. The spacing distance is usually related to the size of the sound source, with smaller sound sources requiring a closer spacing to maintain a stereo image. Spaced pairs are also susceptible to phase-cancellation issues caused by the differences in sound ar-

rival time at the microphones. They do not collapse down to mono well and if spaced too far apart, they can leave a "hole-in-the-middle" in the stereo image.

The coincident or X-Y arrangement uses two cardioid microphones, with the capsules placed as close together as possible. For best results, the microphones should be identical models from the same manufacturer. The angle of the capsules can vary from 90 degrees to 135 degrees, depending on the size of the sound source and the width of the stereo image desired. The pair of microphones faces direct-



While some X-Y mics incorporate two physical capsules mounted on a handle, others, such as the one shown here, use proprietary engineering techniques to achieve an X-Y arrangement inside a more traditional headcase.

ly at the sound source, and the microphones are panned left and right. Because the microphone capsules are in close proximity to each other, phase cancellation issues are minimized. Stereo separation when using an X-Y pair is good but can be restricted on a wide sound source. Mono compatibility is fair to excellent depending on the spacing (near-coincident vs. coincident).

The mid-side technique uses a cardioid microphone to pick up the on-axis sound (mid) and a bidirec-

tional or figure-of-eight microphone oriented to face left and right to pick up off-axis sound (side). The two microphone outputs are connected to an MS matrix decoder, which allows for a variable controlled stereo image. By simply adjusting the level of the mid signal in relationship to the side signal, the stereo image can be made narrower or wider without moving the microphone.

What is a stereo mic?

Typically two microphones with appropriate mounts are used for stereo. In many broadcast applications, however, setting up stereo pairs can be cumbersome and time-consuming. Plus, pairs of mics don't always adapt well for camera mounting. A stereo mic is basically a single microphone body with two distinct capsules configured in one of the arrangements explained above. In its simplest form, a compact field interview recorder with two built-in microphones (one on each side of the device) is a basic spaced pair. More often, stereo microphones are built with their capsules configured for X-Y or MS. Some X-Y microphones incorporate two physical capsules mounted on a handle, whereas others use proprietary engineering techniques to achieve the X-Y arrangement inside a more traditional headcase.

A mid-side stereo microphone uses a common headcase to house its two capsules. This configuration allows for single-point (cardioid) or line-gradient (shotgun) versions. Some models include a built-in selectable MS decoder matrix, enabling users to choose from a wide or narrow stereo output along with discrete mid and side outputs to feed an external matrix.

One workflow. From Lens to Post.

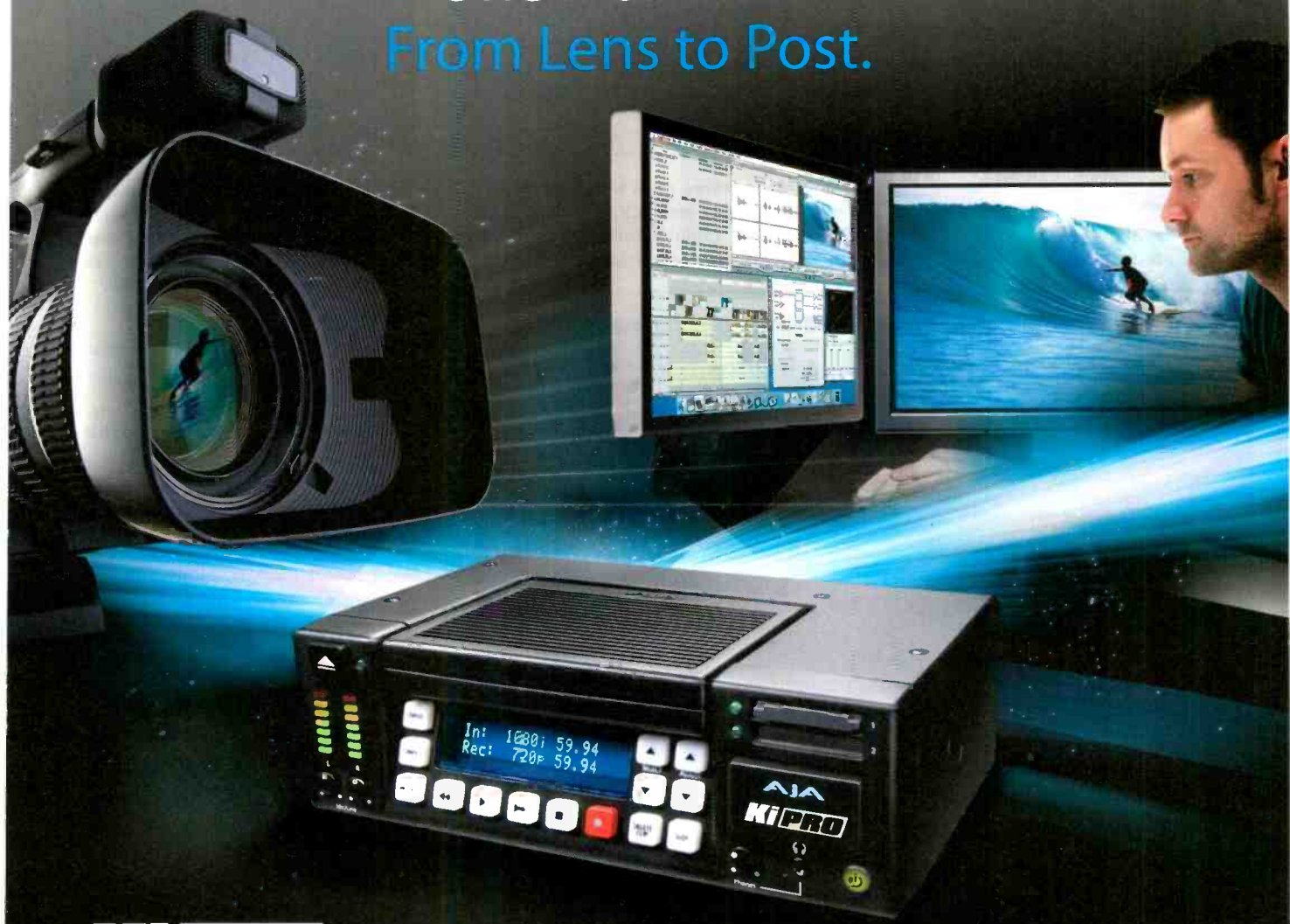

Ki Pro

Ki Pro is an all new way of connecting production and post. Finally, shoot on the same codec as you edit with, Apple ProRes 422, built natively into Ki Pro's stand-alone, portable hardware.

With its extensive analog and digital connectivity, virtually any video and audio source can be fed into Ki Pro. It also includes AJA's powerful 10-bit realtime up/down/cross-conversion, enabling instantaneous recording of SD or HD from any camera format.

Record pristine ProRes media to a removable Storage Module with built-in FireWire 800, or to 34mm ExpressCard Flash — both instantly mount on your OSX desktop for immediate editing and file access.

Ki Pro is tough and rugged, yet small and portable, designed for real production environments. Powered through an industry standard 4-pin XLR, you have flexible AC and battery options. Use Ki Pro on a table, or mate it between your camera and tripod via a bulletproof optional aluminum cage, complete with sliding baseplate and accommodation for 15mm rods.

Visit www.aja.com to discover the full details of how Ki Pro will change your world.

ProRes

Record natively to Apple's ProRes 422 codec for full raster 10-bit 4:2:2 HD and SD.

Record to a removable Storage Module with built-in FireWire 800 or 34mm ExpressCard Flash.

Built-in WiFi and Ethernet for complete control via a web-browser, or your iPhone.

Connect any digital camera via SDI or HDMI, or any analog camera. Convert in realtime from SD to HD, or 720 to/from 1080. Ki Pro is your hub for all types of sources, regardless of format or connectivity.

Ki Pro. Because it matters.

AJA

VIDEO SYSTEMS

Many stereo mics terminate in a five-pin XLR-type connector and include a fan-out cable terminating in three-pin XLRM-type connectors. It is often a good idea to have a spare fan-out cable in the production kit ... just in case.

Finally most stereo microphones are marked as to proper orientation.



Many stereo mics terminate in a 5-pin XLR-type connector and include a fan-out cable terminating in three-pin XLRM-type connectors.



This mic includes a built-in selectable MS decoder matrix, enabling users to choose from a wide or narrow stereo output along with discrete mid and side outputs to feed an external matrix.

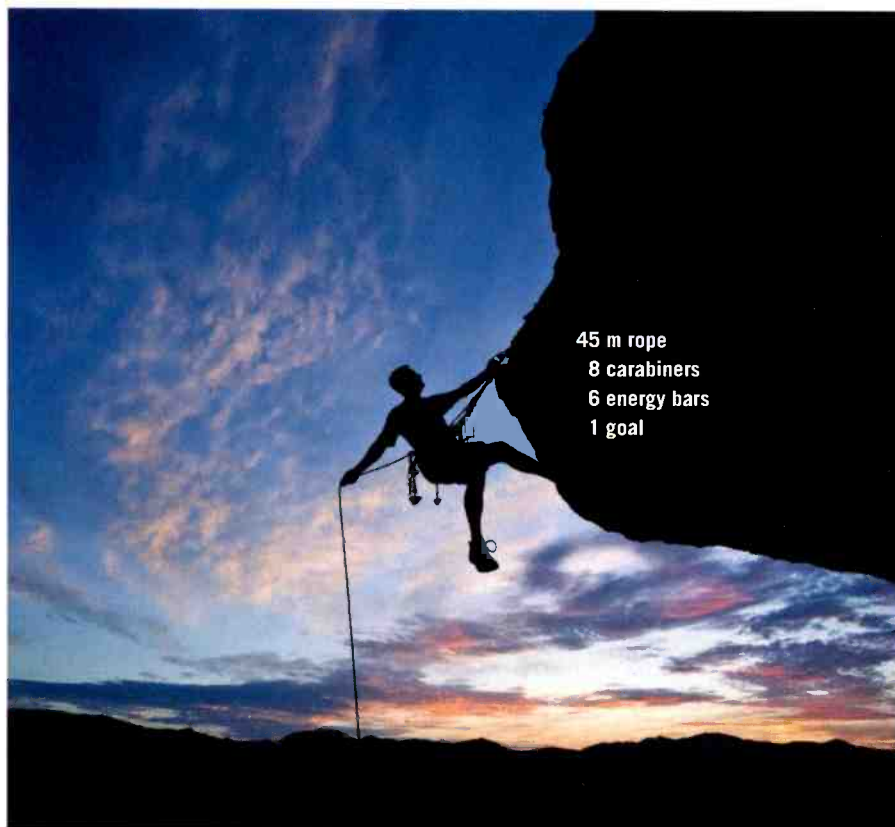

45 m rope
8 carabiners
6 energy bars
1 goal

Focus on functionality – the new mc²66.

Inspired by your needs — the new mc²66. Not only does this much developed mc²66 stand out with proven efficiency and outstanding functionality, but also with its new features, which once again make high tech equipment from Rastatt/Germany a worldwide standard for mixing consoles. Now you can benefit from the latest touch screen displays, a revised layout and totally reliable control computer redundancy. One of the best consoles available suddenly became even better. Only one thing has not changed: The mc²66's outstanding usability, which will continue to inspire audio engineers in OB trucks, studios and theaters. For more information visit www.lawo.de



Networking Audio Systems



See Us at NAB Booth #C2217

Making certain "this end is up" maintains the L-R perspective.

Stereo microphones in use

The most obvious use of these microphones is to provide a stereo point of view perspective. Often they are camera-mounted in sports or on a boom pole, or stand for other programs. Stereo mics positioned over the studio audience in a talk show can provide additional depth. In live programming or reality shows, using stereo microphones helps establish perspective and localization of sound sources. They can widen the sound field to make viewers feel as if they are in the midst of the action. MS mics enable sound engineers to vary the width of the stereo image, allowing them to narrow in on the close-up action and widen the sound field for establishing shots.

In sporting events, stereo mics are used to provide side-to-side perspective of the action (hockey, basketball, football, etc.), as well as localization of specific sound sources, such as coaches and players, to spread them out in the mix. Placing stereo mics on handheld cameras provides a visual reference to the stereo image.

However, be aware that if, for example, the camera pans toward the crowd, the overall stereo perspective changes, which can confuse the viewer. Using an MS microphone with its ability to be narrowed down to mono by sound mixers is a good choice for these situations.

When producing a music-based program, the audience is often shown from the musician's perspective, while the sound is presented from the



Most stereo mics are marked as to proper indication. Be sure that the proper end is up (left) in order to maintain L-R perspective (right).

audience perspective. To minimize the effects of a “reversed sound field,” stereo ambient microphones are used in conjunction with the normal close-miked vocal and instrument microphones. Thus, sound mixers can create a pleasing soundtrack that fits the visuals regardless of angle.

Stereo mics are often used when capturing sound effects for use in post production. Their ability to maintain L-R perspective adds depth to the effect. With their rugged construction and high sensitivity, a good stereo microphone is an indispensable tool in the location recordist’s bag of tricks.

Unique application

In one application, we needed to capture a college marching band in surround. Because of the band’s physical location, and because of the crowded space, it was nearly impossible to put mics up in front of the musicians. To accomplish this with a minimum number of microphones, we used two stereo mics, with one located on each side of the band. The individual outputs of each stereo microphone were routed in the console to provide Lf/Lr and Rf/Rr. The result enabled the A1 to position viewers in the midst of the band.

Like other audio tools, the proper use of stereo mics can enhance the overall audio experience for listeners or viewers. Try different placements and mic positions. Think outside the box, and don’t be afraid to experiment. However, always remember that somewhere, someone will be listening to the program in mono. Make certain that the technique used is verified for mono compatibility before going to air.

BE

Steve Savanyu is director of educational services for Audio-Technica.

AUDIOONESTOP
 at www.v.broadcastengineering.com
 For more news and articles on audio, visit our Web site and click on the Audio link at the top of the page

More Features and Better Specs for Less.



The ESE Family of DV Products

ESE’s economical SDI Distribution Amplifiers and HD/SD Sync Generators support 3G HD & SD, and offer automatic rate detection, reclocking & equalization, ASI compliance, and a variety of enclosures.



Visit www.eseweb.com to find the best DV products for less.



ESE, 142 Sierra Street, El Segundo, CA 90245 USA, Tel: (310) 322-2136

www.eseweb.com

See Us at NAB Booth #C6437

Choosing a RAID storage system

Secure storage has never been more affordable.

BY LUIS RODRIGUEZ

With so many different storage options today, users have access to exciting and powerful storage technologies previously reserved for the multimillion-dollar enterprise elite. Finding the right RAID solution can often prove to be a lengthy and dizzying process entailing months of research, conference calls to multiple storage vendors and endless budget meetings with management to justify the new investment. Making the wrong buying decision can often result in catastrophic data loss, unforeseen bandwidth bottlenecks, loss of man hours and precious company resources wasted on solving technical issues.

RAID storage usually makes most sense for users whose data plays a vital role in their operation. As storage systems develop and grow, more users find the need for large amounts of data to be stored and made accessible for future use. Combined with the rapid price drops for disk media, storage capacity and security have never been more affordable. The basic reasons for implementing a RAID array still remain the same: It provides a large storage capacity for a specific purpose or need, it complements and/or enhances system or application performance, and it protects and makes stored data easily available.

Internal PCI RAID storage

With the lowest cost, internal PCI RAID controllers remain a popular choice when compared with external RAID systems. PCI RAID entails a low deployment cost (ranging from several hundred dollars up to several thousand), delivers excellent performance and can offer high I/O capabilities.

However, the use of internal PCI RAID controllers creates a different set of problems when it comes to maintenance and availability of the stored data. Because there is no such thing as a “one size fits all” PCI RAID system, critical component decisions are often left to the user. This results in the selection of components that may reduce



Integrated storage servers often provide high performance, simplicity and scalability.

the overall integrity and performance of the RAID array — the very reason why the system was deployed in the first place. By using an internal PCI RAID controller, the storage becomes a part of the host computer system and eliminates the ability to perform

PCI RAID entails a low deployment cost and can offer high I/O capabilities.

quick system maintenance, while lowering data availability and increasing downtime. Choosing a prepackaged PCI RAID solution may offer better overall compatibility and support in the event of failure or disaster.

External host-independent RAID storage

External RAID offers the greatest flexibility, integrity and deployment options compared with PCI and

server-based RAID products. A host-independent RAID array is a storage appliance that has been designed with a specific purpose in mind: store and protect valuable data. Every component has been developed to perform a specific function, which increases the overall efficiency and reliability of the system. This type of system is

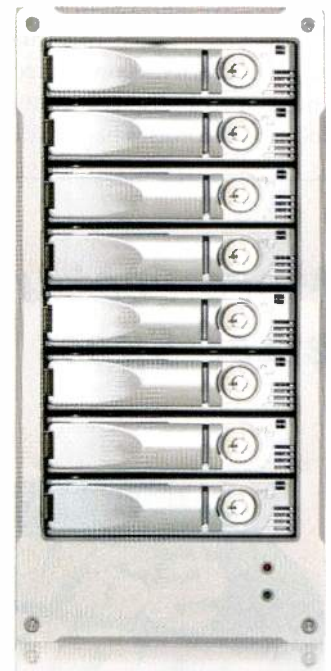

External RAID systems can be repurposed or relocated as storage needs change.

normally classified as an “enterprise” product due to its increased integrity, redundancy and appliance-type nature. Host-independent RAID storage exists autonomously and does not require a dedicated host server; in fact, most of today’s external RAID systems offer some form of high-speed network connectivity, eliminating the need for a host computer to be physically connected. Another advantage

Upgrade your broadcast infrastructure to HD, 3G and IP

Fiber solutions for
in-house broadcast
and campus networks

Do you need to upgrade your existing video broadcast infrastructure to HD, 3G or IP? With the limitations of physical coaxial or copper cable, the only feasible option is fiber. Nevion, formerly Network/VPG, has been developing innovative, quality-driven products for video transport for more than 15 years. We know video. And we know fiber.

With our modular, state-of-the-art technology, it's surprisingly easy to build fully redundant broadcast facility video architectures with full monitoring and control, and scalable solutions to maximize your ROI. Connect easily to external contribution networks with the same solution adapting to IP, SONET/SDH, or fiber overlay.

Discover what a customized solution from Nevion can do for your network.

www.nevion.com



+1 800 515 0811

Where video is moving

broadcast solutions • service provider solutions • routing • control & management

The **future** IS NOW!

BY STEVEN CANEPA

Broadcasters are using innovative approaches to keep pace with today's digital world.



Video on demand



As we enter the second decade of this new century, it is a time of tremendous change for the media and entertainment industry in general, and networks and broadcasters in particular. We have all witnessed the challenges presented by today's economic climate, migrations in audience consumption patterns and the movement from "dollar to dime" content.

What is required now, even more than ever, is a focus on new ways to enhance business models and to optimize and revitalize core operations in order to respond to a more complex marketplace. With an approach focused on three areas — open, standards-based platforms; streamlined workflows; and new business intelligence — the industry is addressing a rapidly changing market while pursuing new cost savings and revenue opportunities.

The challenge: Shifting consumption patterns

Consumers are adopting and using new multimedia devices at an accelerating pace. Based on recent IBM research, 30 percent of consumers now own a smartphone, 58 percent an HDTV, 54 percent a game console, 25 percent a portable game player and 45 percent a portable video player. Commensurate with this device adoption, new Web, mobile and on-demand video services are experiencing substantial growth. Our survey reports 38 percent of U.S. users have watched video on an ad-supported online site like Hulu, 25 percent do so at least a few times a month, and 40 percent have watched video on demand on their television. Close to 20 percent have watched video through a mobile phone or portable video device, and more than 40 percent of consumers desire the ability to port content from one device to another. All of this adds up to more content, more devices, scarce consumption time and the resulting audience fragmentation.

Industry players are in this battle for attention often supported by technology and hardened workflows that were optimized for an era when content was prepared for a single distribution topology and a broad audience. While this approach enabled and even propelled the analog age, it has left many firms with siloed, tightly-coupled and often inflexible custom systems that are costly to maintain and difficult to change. In the media industry's new reality — with its welter of devices, platforms and applications — standards-based IT can enable firms to more efficiently and cheaply connect to assets and services both inside and outside the organization. A smarter, more intelligent, instrumented and interconnected world of media is emerging.

One of the hallmarks of the new digital age is agility. To command audience attention, industry players have to understand ever-changing segments, usage patterns and device preferences. Content may still be king, but media firms now have

to respond to the context — where, when and how — in which consumers want content. Consumers are empowered to act as their own programmers and directors. Advertisers are also seeking value for their advertising spending. Changes in CPMs, audience size and cross channel reach are tilting the field against established business models.

In addressing this dynamic market, broadcasters are using a more open framework to improve flexibility while simultaneously reducing operating costs. They are deploying systems that can understand consumer behaviors and tools that can provide better control of and real-time views into business processes. This allows for more efficient deployment of scarce resources in order to seize opportunities as they arise.

The opportunity: Greater business flexibility

These trend lines all point toward a more horizontal architecture where information can flow bidirectionally

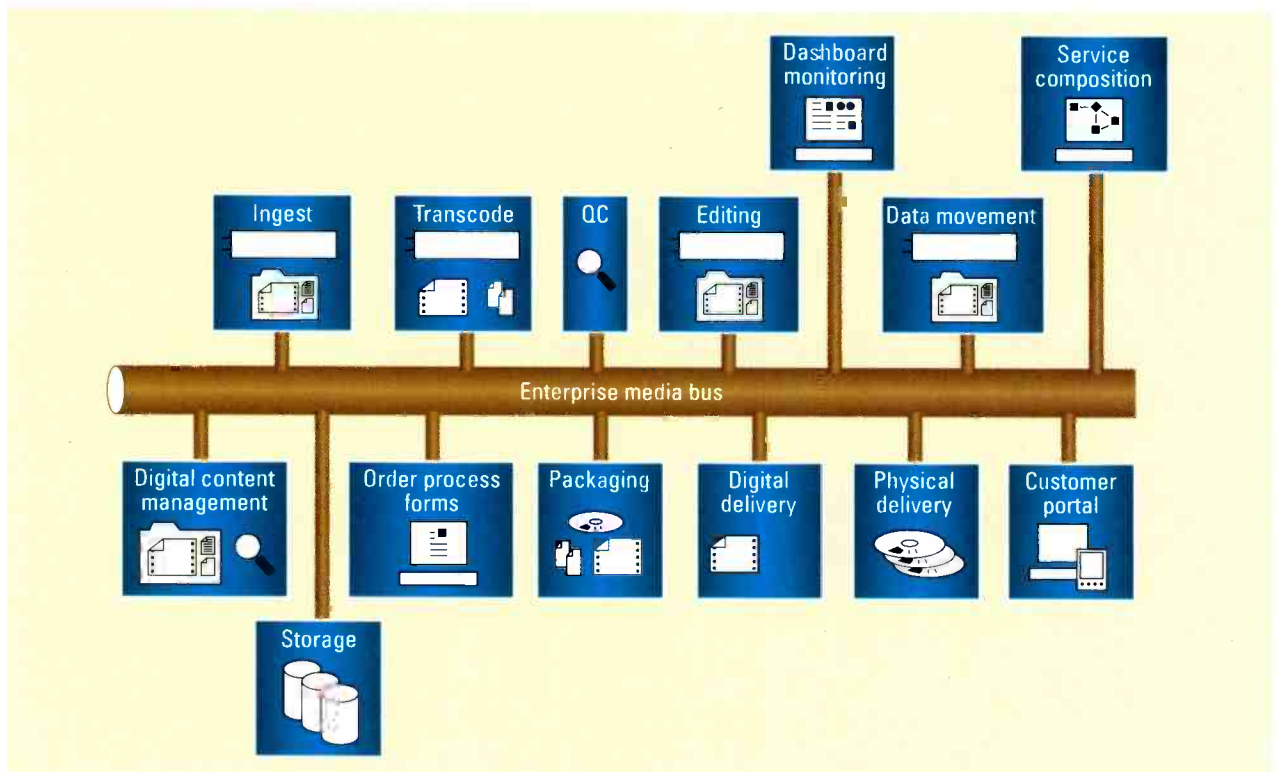

Figure 1. A media enterprise framework delivers the benefits of real-time automation and business process orchestration to the media and entertainment industry.

X ANYWHERE



The surprisingly affordable X50™ synchronizer/converter.

The latest member of the award-winning Harris family of 1RU video/audio processors, the versatile X50 fits any production environment — and even the tightest budget. Its industry-leading features include:

- SD/HD up/down/cross conversion
- Integrated color correction
- Fully adjustable aspect ratio converters
- 16-channel embedded audio processing
- Optional 3 Gb/s and fiber I/O

The X50 processor — the compact platform for any situation.

Learn more at broadcast.harris.com/X50 or contact your local Harris dealer.

ONE Company. ONE Direction. The Future.

HARRIS

assuredcommunications

Broadcast Communications • RF Communications • Government Communications Systems

www.harris.com

across business units and with business partners as well as consumers. In this enhanced enterprise architecture, data is not confined to a single destination or use but is harvested to inform the holistic organization. This approach can allow core production and distribution processes, back-office systems, and customer-facing content Web sites and platforms to work in a more integrated manner. And, importantly, it allows data, metadata and content to flow more efficiently among loosely-coupled applications that serve the various parts of the business. Additional benefits are being realized by deploying enterprise collaboration, analytics and reporting solutions to improve team communications, streamline workflows and provide more visibility into business processes.

An important step in this direction is deploying open standards-based software like service-oriented architecture (SOA) middleware. An SOA approach can abstract applications from the underlying server and storage infrastructure and make them capabilities, or business services, that are uncoupled from specific hardware architecture. This can allow firms to deploy new capabilities quicker and reduce the challenge of untangling custom systems. In this more open environment, companies are also benefiting from a broader set of application choices, enabling them to pick vendor applications and tools that best reflect their business model and specific workflow needs, and move away from a world where limited application choices often dictated format and function.

However, in order to achieve the value that SOA can deliver, the interface standards for these common media business services need to evolve. In response to this requirement, new open source standards are beginning to emerge. The goal is to reduce the integration effort required to assemble composite business processes by providing more standard Web service interfaces. Work is now

underway in both the Advanced Media Workflow Association and the EBU to support this approach. This will allow software vendors to have a set of interface standards akin to those used by broadcast hardware vendors. By adopting this standards-based, modular approach to workflow — and this abstraction of business services — media firms are gaining more flexibility, speed and adaptability to compete in today's challenging environment.

A related design requirement for this transformation is automation. To achieve the desired economics — expressed essentially as the average unit cost of production for a piece of content — we need to further

By adopting this standards-based, modular approach to workflow, media firms are gaining more flexibility, speed and adaptability.

streamline and automate production and distribution workflows. (See Figure 1 on page 38.) A media-intelligent architectural framework that understands data in three forms — transaction data, metadata and the content essence itself — is key. This can help deliver a more dynamic and flexible workflow that incorporates rules-based decision making with fewer manual interventions.

With today's technology, business rules can be created that let the architecture do much more of the work. Data on how efficiently processes are working can be harvested and published to dashboards that allow executives to see what's going on and determine where they stand at any moment across a number of fronts. They can receive instant status updates on campaign management, spot make-goods,

sales force leaders and laggards, and program availability. And, they can also determine whether infrastructure resources, like transcoding, are running at peak loads or sitting largely unused. Having access to this level of intelligence means they can use content and advertising more efficiently, and support movement across channels to optimize inventory on new channels like the Web and mobile.

Clearly, a transformation of this sort isn't only about technology. It's about culture, skills, union rules, personnel policies, individual responsibilities, dealings with partners and vendors, and much, much more. It's also, importantly, about a marketplace shift. The reality is that historically, the broadcast industry has largely been served by many specialty vendors whose R&D budgets were largely funded by the broadcast industry alone. As such, the rate of innovation of products and service offerings was gated by this limitation and the pace of transformation ultimately dependent on the collective broadcast industry spending.

However, with general-purpose technology now able to provide the requisite performance and robustness, the broadcast industry is availing itself of the best applicable technology from the much broader IT industry. We are seeing how this broader R&D spending is providing real advantages for broadcasters. The Linear Tape-Open (LTO) consortium is an example of a standards-based, multivendor approach to data tape storage. With the announcement of LTO 5 support for dual partition tape cartridges, workflows that have previously been restricted to disk or flash memory can now be extended to LTO. As the resolution and archiving demands of the industry grow, broadcasters can leverage the price, performance and density advancements that data tape storage provides without the complexity or proprietary encumbrances previously accompanying videotape-based approaches.

A three-faceted approach

Three key focus areas are emerging. First, optimizing operations and infrastructure to reduce costs (a shared, virtualized infrastructure of servers, storage and data tape — powered by fast file systems and orchestrated by systems management software) is allowing media firms to pool and deploy resources more efficiently. It is also allowing firms to select tools commensurate with the workflow, purpose and intent. An example is editing. Instead of a single editorial platform, broadcasters are capitalizing on multiple editing tools sharing a common infrastructure. This allows firms to use high-end resources for high-value content while optimizing more simplified tools for lower complexity workflows. This virtualized approach can also be extended to incorporate emerging capabilities like cloud computing — where the on-premise infrastructure is augmented by remote infrastructure and services delivered over the Internet.

The second focus area is the horizontal workflow capability engendered by SOA middleware. As already discussed, this allows for integration of workflows across the business. Most importantly, it allows applications

to be “snapped together” and, as needs change, to be unsnapped and reassembled into new forms. This unbundling of application functions is a key element of a more flexible media organization.

The third focus area involves using enhanced analytics and decision support tools to derive more insight. To achieve this, companies are extracting more data from workflows and cleansing and standardizing it so they can get a better view of what’s actually happening with content, advertising and more. Crucially, this allows for a more holistic view of operations such as licensing, business agreements, and how content may be used or exploited. This enhanced data flow is enabling executives to make more informed decisions sooner, and to get more out of their resources — both human and technology.

To continue this transformation, there are several steps that broadcasters are taking:

- Assessing legacy infrastructure, pooling assets and creating a roadmap for optimization. This often involves virtualization of resources and evolving infrastructures toward a more standards-based architecture. There are now many good marketplace ex-

amples of the benefits of end-to-end file-based workflow and using IT in lieu of specialized media platforms.

- Uncovering what workflow exists today and determining what the key inhibitors are to responding to evolving business requirements — costs, redundant format transforms, manual processes, rigid technologies, etc.
- Focusing on unique value. This includes achieving strategic objectives and serving multiple audiences across multiple channels while securing cost advantages and capitalizing on opportunities to differentiate.
- Outlining the path forward. Developing a roadmap can help broadcasters get to a more dynamic business framework with clear metrics of success and a focus on what internal transformations and external partners are required.

Clearly, the future is now.

BE

Steven Canepa is general manager, IBM Global Media and Entertainment Industry.

INFRASTRUCTUREONESTOP
 at www.broadcastengineering.com
 For more news and articles on infrastructure, visit our Web site and click on the **Infrastructure** link at the top of the page

Can It Be This Easy?

Quality Mobile Broadcasting

Yes! **GuideBuilder™ Mobile** allows broadcasters to introduce mobile ATSC services as an extension of their current operations. Integrated mobile DTV metadata management and generation enable transmission of required programming information to mobile ATSC receivers, allowing viewers to select and view channels.

- 1 Integrates smoothly with existing multiplexers, listing services, traffic systems, and automation
- 2 Supports centralized metadata generation for terrestrial and mobile broadcasting
- 3 Support for mobile signaling and ESG
- 4 Allows GuideBuilder users to repurpose existing investment in information and metadata management systems



GuideBuilder™



For a product demo visit us at booth SU3202
 To schedule a demo contact: sales@TriveniDigital.com

triveni
 DIGITAL

www.TriveniDigital.com

QUALITY

BY RICHARD DUVAL



Consumer picture quality expectations are higher than ever, creating intense pressure on video equipment manufacturers, broadcasters, network operators and content providers to verify that their devices, systems or processes have not introduced impairments in video content that will affect perceived picture qual-

ity. This has led to the development of new automated picture quality instruments capable of evaluating picture quality across the video supply chain without the need for slow and expensive human evaluators, while also improving repeatability.

Historically, organizations have used an informal method of subjective picture quality assessment that

relies on one person or a small group of people who demonstrate an ability to detect video quality impairments. These are the organization's "golden eyes." Subjective picture quality evaluations are fraught with error and expense, and often end up only approximating viewer opinion.

These factors have led organizations to alternatives for subjective

CONTROL

Understanding PQR, DMOS and PSNR measurements

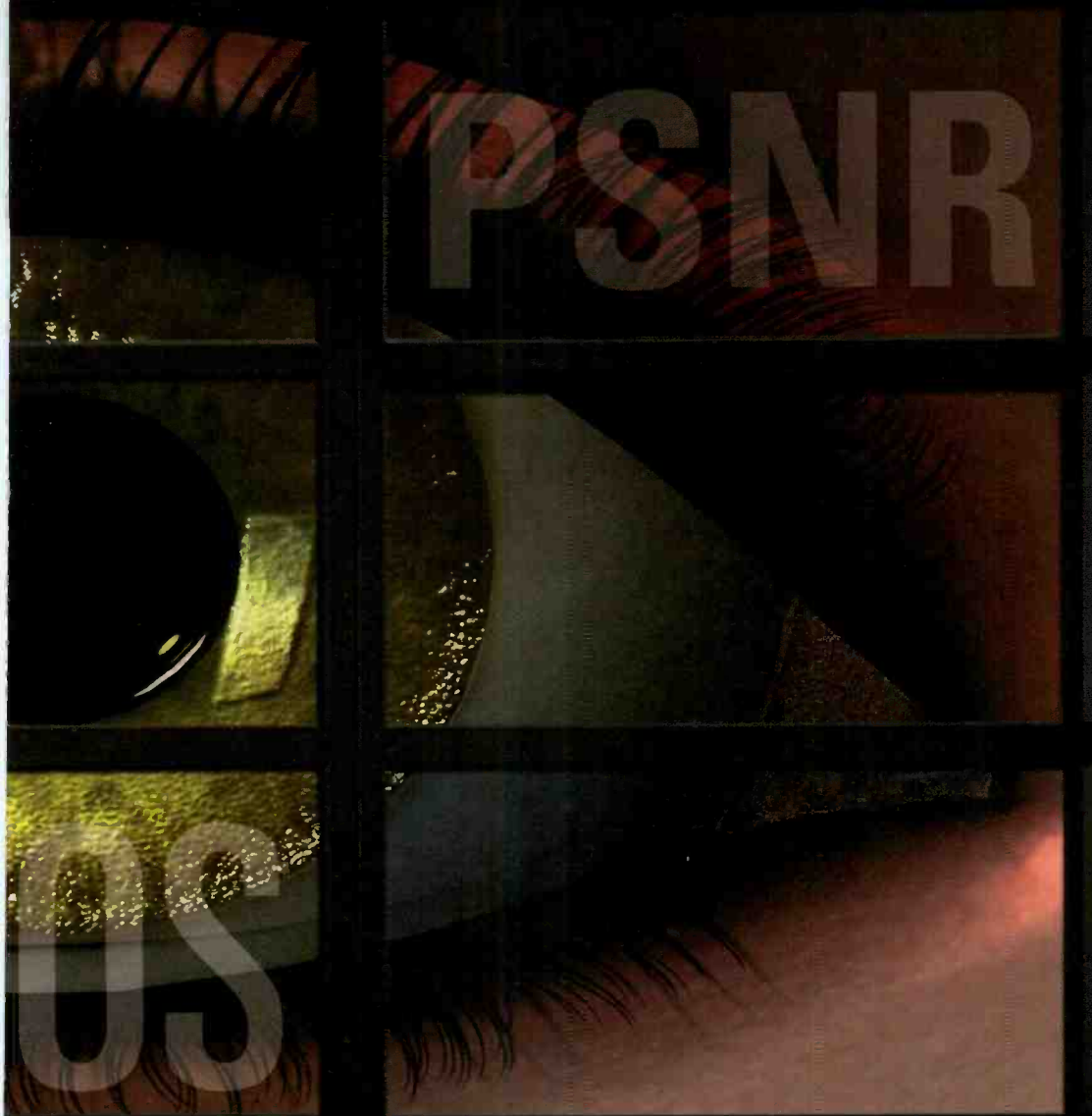

evaluation, such as the ITU-R BT.500 recommendation that describes several methods, along with requirements for selecting and configuring displays, determining reference and test video sequences, and selecting subjects for viewing audiences. Such subjective picture-quality assessments are expensive and time consuming.

Instead, engineering, maintenance

and quality assurance teams are starting to turn to a new class of instruments that use full-reference objective picture quality measurements. Using these instruments, teams can make accurate, reliable and repeatable picture quality measurements more rapidly and cost effectively than testing with actual viewers.

The tests used by instruments in-

clude Difference Mean Opinion Score (DMOS), Picture Quality Rating (PQR) and traditional Peak Signal-to-Noise Ratio (PSNR) measurements as a quick check for picture quality problems. This article explores key concepts associated with these measurements. It also provides tips and guidance for how teams can use these techniques in a variety of settings for their greatest advantage.

FEATURE

UNDERSTANDING PQR, DMOS AND PSNR MEASUREMENTS



Figure 1. The video frame shown in Figure 1.1 has greater mean squared error with respect to the original reference video than the video frame in Figure 1.2. However, because the error in Figure 1.1 has a high spatial frequency and the error in Figure 1.2 has a low spatial frequency, the human eye perceives Figure 1.2 as lower quality.

Subjective assessment and objective picture quality measurement

If people perceived all changes in video content equally, assessing picture quality would be much easier. A measurement instrument could simply compute the pixel-by-pixel differences between the original video content (the reference video) and the content derived from this reference video (the test video). It could then compute the Mean Squared Error (MSE) of these differences over each video frame and the entire video sequence.

However, people are not mechanical measuring devices. Many factors affect viewers' ability to perceive differences between the reference and test video. Figure 1 illustrates this situation. The video frame shown in Figure 1.1 has greater MSE with respect to the original reference video than the video frame in Figure 1.2.

However, the error in Figure 1.1 has high spatial frequency, while the error in Figure 1.2 consists of blocks containing much lower spatial frequencies. The human vision system has a stronger response to the lower

spatial frequencies in Figure 1.2 and less response at the higher spatial frequencies in Figure 1.1. Subjectively, Figure 1.2 is worse than Figure 1.1, even though the MSE measurement would assess Figure 1.1 as the poorer image.

Objective picture quality measurements that only measure the noise difference between the reference and test video sequences, e.g. PSNR, will not accurately and consistently match

Noise-based measurements compute the noise, or error, in the test video compared to a reference video. This form of PSNR measurement is helpful in diagnosing defects in video processing hardware and software. Changes in PSNR values also give a general indication of changes in picture quality.

Alternative versions of the PSNR measurements adjust the base measurement result to account for

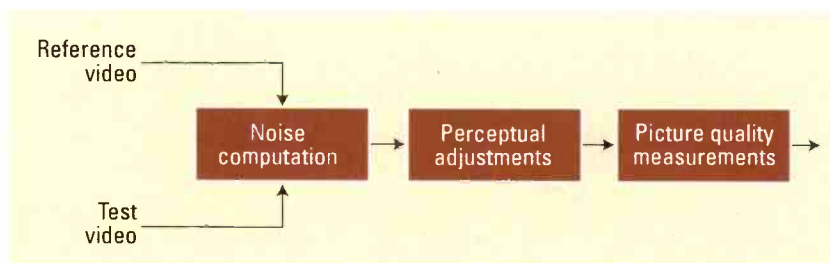

Figure 2. Noise-based objective picture quality measurements compute the noise, or error, in the test video compared to a reference video.

viewers' subjective ratings. To match subjective assessments, objective picture quality measurements need to account for human visual perception.

One of the two categories of full-reference objective picture quality measurements is shown in Figure 2.

perceptual factors and improve the match between the measurement results and subjective evaluations. Other noise-based picture quality measurements use different methods to determine noise and make perceptual adjustments.

Introducing ...

SR1 Audio Analyzer

- **-110 dB THD + N** (1 kHz, 2 V, 22 kHz BW)
- **± 0.008 dB flatness**
- **200 kHz system bandwidth**
- **24-bit / 192 kHz digital audio**
- **<600 ps residual jitter**
- **Cross-domain analysis**

SR1 ... \$6900 (U.S. list)

Introducing SR1 Dual-Domain Audio Analyzer
— AP 2700 class performance at \$6900.

SR1's outstanding specifications and rich suite of measurements make it ideal for analog, digital and cross-domain audio signal analysis.

Standard measurements include Level, THD + N, Harmonic Distortion, IMD, FFT, Frequency Response, Multi-Tone, Crosstalk, Histogram, Jitter Amplitude & Spectrum, and more. Hardware options include a digital audio carrier digitizer with full-color eye diagrams and carrier spectra, multi-channel I/O switchers, and an atomic rubidium system clock.

SR1 offers uncompromised performance at a fraction of the price of the competition.

Call us or visit our web site for further details.

thinkSRS.com

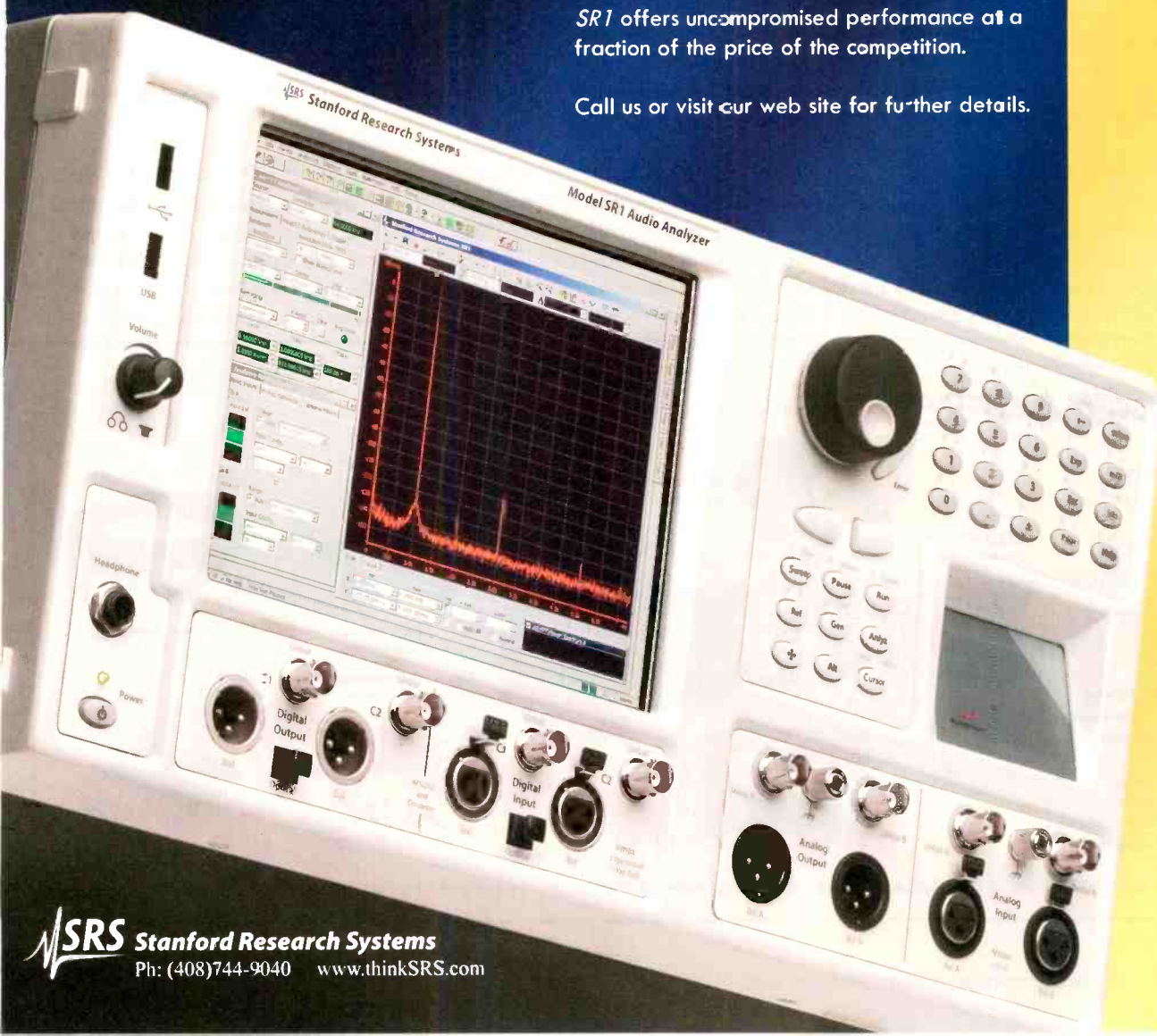

FEATURE

UNDERSTANDING PQR, DMOS AND PSNR MEASUREMENTS

A second category of full-reference objective picture quality measurements is illustrated in Figure 3. Perceptual-based measurements use human vision system models to determine the perceptual contrast of reference and test videos. Further processing accounts for several other perceptual characteristics. These include relationships between perceptual contrast and luminance and various masking behaviors in human vision.

picture quality measurements. With an accurate human vision model, picture quality measurements based on perceptual contrast differences match viewers' subjective evaluations.

Picture quality rating measurements

Picture quality rating measurements convert the perceptual contrast difference between the reference and test videos to a value representing

The concept of JND dates to the early 19th century and the work of E.H. Weber and Gustav Theodor Fechner on perceptual sensitivity. Measurements of perceptual sensitivity involve repeated measurements with a single test subject. A 1 JND difference corresponds to approximately 0.1 percent perceptual contrast difference between the reference and test videos. With this perceptual contrast difference, most viewers can barely distinguish the test

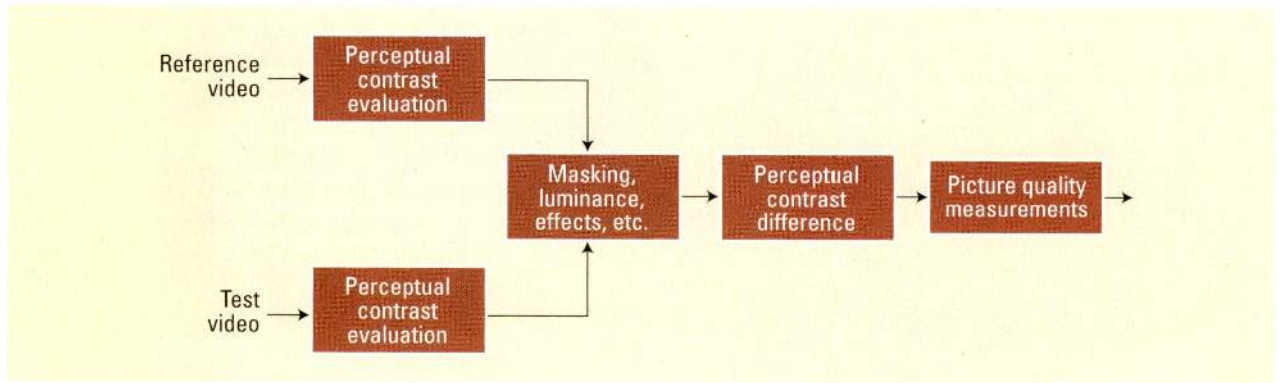

Figure 3. Perceptual-based objective picture quality measurements use human vision system models to determine the perceptual contrast of reference and test videos.

The measurement then computes the perceptual contrast difference between the reference and test videos rather than the noise difference. The perceptual contrast difference is used directly in making perceptual-based

viewers' ability to notice these differences between the videos. Perceptual sensitivity experiments measure the viewer's ability to notice differences in terms of Just Noticeable Differences (JNDs).

video from the reference video in the forced-choice pairwise comparison. At this, and at lower levels of perceptual contrast difference, viewers will perceive the test video as having essentially equal quality to the reference video.

CANARE digital interconnect technology

Hybrid Fiber-Optic Camera Connector Panels

Features

- SMPTE 311 Standard
- Integrated splice enclosure
- Easy maintenance and Installation
- Patented Design modular system
- Available in 2RU, 3RU and a variety of Configurations

Accessories

- Hybrid Camera Cable Checker
- Hybrid Camera Cable
- Optical Splice Box

Support 5-Directional Wiring Cabling Direction

Configuring PQR measurements

Like the actual human vision system, electronic human vision system models operate on light and must convert the data in the reference and test video files into light values. This conversion process introduces several factors that influence PQR and DMOS measurements.

In a subjective picture quality evaluation, the light reaching a viewer comes from a particular type of display. The display's properties affect the spatial, temporal and luminance characteristics of the video the viewer perceives. Viewing conditions also affect differences viewers perceive in a subjective evaluation. In particular, changes in the distance between the viewer and the display screen and changes in the ambient lighting conditions can affect test results. Taking this into account, instruments of-

fer built-in models for a range of CRT, LCD and DLP technologies and viewing conditions, or can be custom-configured.

Interpreting PQR measurements

The PQR scale uses data from perceptual sensitivity experiments to ensure that 1 PQR corresponded to one JND and that measurements around this visibility threshold match the perceptual sensitivity data. The following scale offers guidance in interpreting PQR measurement results:

- 0: The reference and test image are identical. The perceptual contrast difference map is completely black.
- <1: The perceptual contrast difference between the reference and test videos is less than 0.1 percent or less than one JND. Viewers cannot distinguish differences between videos. Video products or systems have some

amount of video quality "headroom." Viewers cannot distinguish subtle differences introduced by additional video processing, or by changes in display technology or viewing conditions. The amount of headroom decreases as the PQR value approaches 1.

- 1: The perceptual contrast difference between the reference and test videos equals approximately 0.1 percent or 1 JND. Viewers can barely distinguish differences between the videos. Video products or systems have no amount of video quality headroom. Viewers are likely to notice even slight differences introduced by additional video processing, or by changes in display technology or viewing conditions.
- 2-4: Viewers can distinguish differences between the reference and test videos. These are typical PQR values for high-bandwidth, high-quality MPEG encoders used in broadcast applications. This is generally recognized



THE NEXT GENERATION

Meet the newest member of the Stagetec digital console family: **CRESCENDO**. Designed for the Live and Broadcast markets where space for a mixing console is often a luxury, **CRESCENDO** is a compact yet fully loaded digital console that is a breeze to operate. It offers unsurpassed visual feedback, flexibility in console architecture and pristine workmanship. Being part of the Stagetec family, the **CRESCENDO** is a workhorse that will not let you down.

- FAILSAFE OPERATION:** Extremely reliable
- LOGIC CONTROL:** Console events and GPI/O
- POWERFUL PROCESSING:** 40 bit floating point processing
- SCALABILITY:** Up to 300 channel paths; max.128 buses
- FLEXIBLE DIGITAL I/O:** MADI, AES, DOLBY, 3GHD-SDI and more
- MULTI FORMAT:** Up to 5.1 Surround with up and down mixing capabilities
- SPEEDY RECALL:** Snapshot/Cue load time max 10ms
- BUILT-IN SAFETY:** Boot to "last known state" in less than 30 seconds
- TRUE CONFIDENCE:** Project load from RAM with no need for PC

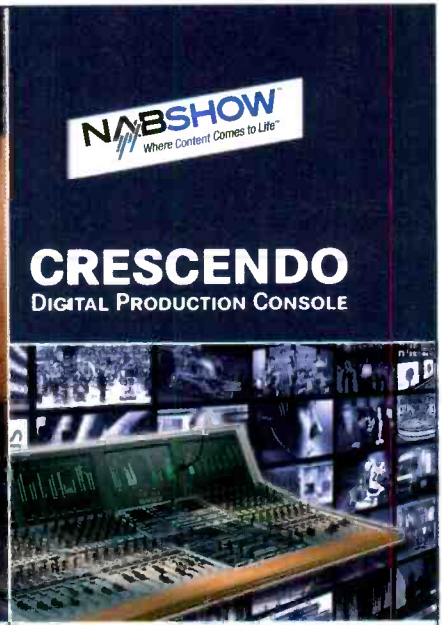

NABSHOW
Where Content Comes to Life™

CRESCENDO
DIGITAL PRODUCTION CONSOLE

STAGETEC DELIVERS



STAGETEC USA
Phone +1-888-782-4391
usa@stagetec.com
www.stagetec.com

FEATURE

UNDERSTANDING PQR, DMOS AND PSNR MEASUREMENTS

as excellent to good quality video.

- 5-9: Viewers can easily distinguish differences between the reference and test videos. These are typical PQR values for lower bandwidth MPEG encoders used in consumer-grade video devices. This is generally recognized as good to fair quality video.
- >10: Obvious differences between reference and test videos. This is generally recognized as poor to bad quality video.

Difference Mean Opinion Score measurements

The perceptual contrast difference map produced by an instrument's human vision system model contains information on differences viewers will perceive between reference and test videos. As a result, devices can predict how viewers would score the test videos if they evaluated the video content using methods described in ITU-R BT.500. In particular, predicted Difference Mean Opinion Score (DMOS) values for test videos can be generated. And, unlike testing with people, results can be produced for each frame in the test video sequence as well as the overall sequence.

ITU-R BT.500-11 describes several methods for the subjective assessment

of television picture quality. While they differ in the manner and order of presenting reference and test videos, they share characteristics for scoring video and analyzing results.

In methods that compare both reference and test videos, viewers grade the videos separately. They use a grading scale shown to collect opin-

ion scores from each viewer participating in a test. Subjective evaluations typically involve groups of around two dozen viewers. These scores are averaged to create the Mean Opinion Score (MOS) for the evaluated videos. The MOS for the reference video sequences is then subtracted from the MOS for the test video sequences. This generates a DMOS for each test sequence. The DMOS value for a particular test video sequence represents the subjective picture quality of the test video relative to the reference video used in the evaluation.

Before viewers evaluate any video, they are shown training video sequences that demonstrate the range and types of impairments they will assess in the test. ITU-R BT.500 recommends that these video sequences should be different than the video sequences used in the test, but of comparable sensitivity. Without

Devices can predict how viewers would score the test videos if they evaluated the video content using methods described in ITU-R BT.500.

the training session, viewers' assessments would vary widely and change during the test as they saw different quality videos.

Configuring predicted DMOS measurements

The considerations about display technologies also apply to configuring DMOS measurements. In addition, DMOS measurements also have a configuration parameter related to training sessions. The training session held before the actual subjective evaluations ensures con-

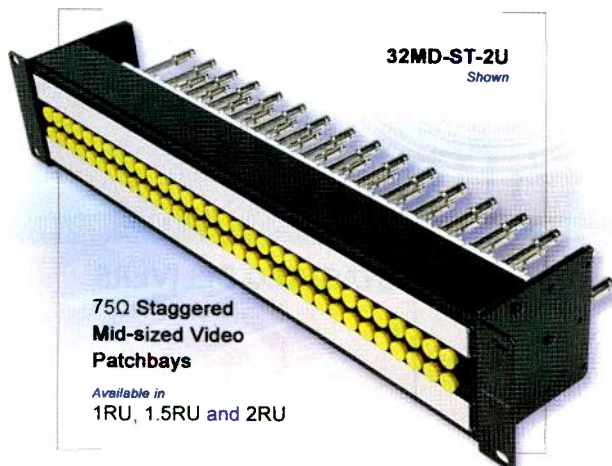

75Ω Staggered
Mid-sized Video
Patchbays

Available in
1RU, 1.5RU and 2RU

Mid-sized Video Patchbays

Features

- Superior isolation performance up to 3.0GHz
- Industry standard BNC plugs can be used
- 32 channels of I/O into 1RU and 2RU
- Canare original reliable rotary switch
- Lightweight
- Available in Normal & Straight Through Configurations

CANARE
digital interconnect technology

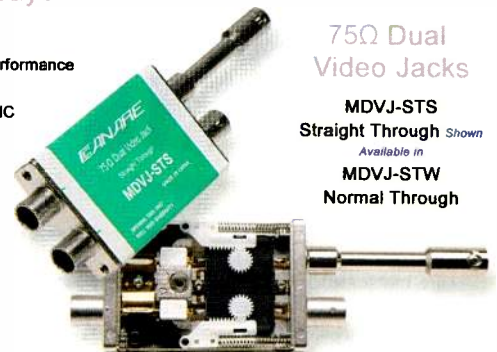

75Ω Dual Video Jacks

MDVJ-ST
Straight Through Shown
Available in
MDVJ-STW
Normal Through

Featuring Canare's Exclusive Rotary Switch Technology

canare.com 973.837.0070 | sales@canare.com hybrid fiber-optics & EO/OE | snake systems | connectors | cable reels | patchbays | cables

sistent scoring by aligning viewers on the “best case” and “worst case” video quality, establishing the range of perceptual contrast differences viewers will see in the evaluation. The worst case training sequence response configuration parameter performs the same function in a DMOS measurement.

This parameter is a generalized mean of the perceptual contrast differences between the best case and worst case training video sequences associated with the DMOS measurement. This generalized mean, called the Minkowski metric or k-Minkowski metric, was calculated by performing a perceptual-based picture quality measurement, either PQR or DMOS, using the best case video sequence as the reference video and the worst case video sequence as the test video in the measurement.

Instruments offer preconfigured DMOS measurements that contain different values for the worst case training sequence response parameter, determined by using video sequences appropriate for the measurement. These serve as templates for creating custom measurements that more precisely address a specific application’s characteristics and requirements for picture quality evaluation.

Interpreting DMOS measurements

Figure 4 shows a typical DMOS measurement. In the preconfigured DMOS measurements, values in the 0-20 range indicate test video that viewers would rate as excellent to good relative to the reference video. Results in the 21-40 range correspond to viewers’ subjective ratings of fair to poor quality video. DMOS values

above 40 indicate the test video has poor to bad quality relative to the reference video.

DMOS measurements predict the DMOS values viewers would give the reference and test videos used in the

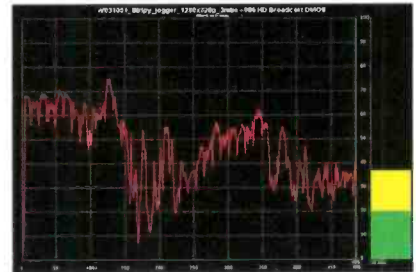

Figure 4. Shown here is a typical DMOS measurement result. Values in the 0-20 range indicate test video that viewers would rate as excellent to good relative to the reference video.

measurement if they evaluated these videos in a subjective evaluation conducted according to procedures

**Buy a truck,
get a truck.**



**Buy Streambox Live,
get everyone.**

VS.



Make your station a universal newsdesk.

For a fraction of the cost of an SNG truck deployment you can implement Streambox Live into your organization. Let Streambox Live give you the ability to broadcast news anytime, anywhere, by everyone.



Streambox LIVE

Find out more at www.streambox.com or call us today at (206) 956-0544

FEATURE

UNDERSTANDING PQR, DMOS AND PSNR MEASUREMENTS

defined in ITU-R BT.500.

The same test videos can receive different DMOS values from different viewer audiences. It depends on the video sequences used to train the view-

the associated ITU-R BT.500 subjective evaluation depend on the video sequences used to train the viewing audience. When comparing DMOS measurement results, evaluators need

the DMOS measurement by helping these teams determine if viewers can notice this difference, especially near the visibility threshold.

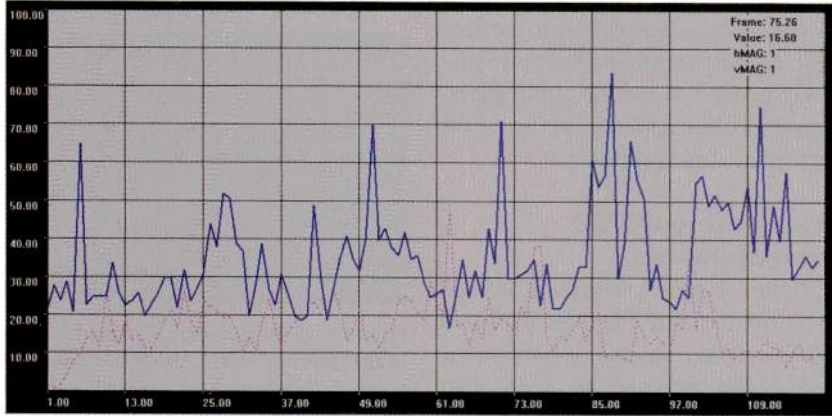

Figure 5. Shown here is a comparison of PSNR and DMOS measurements. The PSNR measurement (solid blue line) shows when differences occur between two video sequences, while the DMOS measurement (dotted magenta line) shows the perceptual impact of these differences.

ers. Similarly, DMOS measurements configured with the same display technology and viewing conditions can produce different results if they are also configured with different worst case training sequence responses.

In this sense, the DMOS measurement is a relative scale. The DMOS value depends on the worst case training sequence response used to configure the measurement, just as the results of

to verify that the measurements use the same display technologies, viewing conditions and worst case training sequence response parameters.

The DMOS measurement is an excellent choice for picture quality evaluation teams needing to understand and quantify how differences between a reference and test video degrade subjective video quality. The PQR measurement complements

PSNR measurements

To calculate a PSNR value, an instrument computes the root mean squared (RMS) difference between the reference and test video and divides this into the peak value. It computes the PSNR value for every frame in the test video and for the entire video sequence. In PSNR measurements, as the difference between the reference and test video increases, the PSNR measurement result decreases.

Combining PSNR measurements with the perceptual-based measurements offers unique insight into the impact of differences between the reference and test videos. Figure 5 shows a comparison of a PSNR measurement in Mean Absolute LSBs units (solid blue line) and a DMOS measurement (dotted magenta line). The PSNR measurement shows when differences occur between the two video sequences. The DMOS measurement shows the perceptual impact of these differences.

In these comparison graphs, evaluation teams can see how differences do, or do not, impact perceived quality. They can see how adaptation in the

CANARE digital interconnect technology

Canare Fiber Optics Systems

EO/OE Optical Converters.

Key Features & Benefits

- SMPTE 259M & 292M
- Multi-format HD-SDI, SD-SDI & DVB-ASI
- Mux/Demux enables 8/16Ch in one fiber
- Compact Design Power supply 16 modules within 1RU Frame
- Passive optical splitters
- FDM-2, FDM4

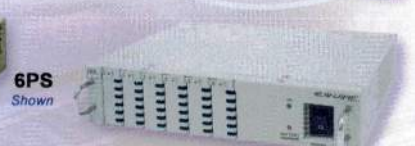

canare.com | 973.837.0070 | sales@canare.com | hybrid fiber-optics & EO/OE | snake systems | connectors | cable reels | patchbays | cables

visual system affects viewers' perception. For example, a large transition in average luminance during a scene change can mask differences. Comparing the difference map created in the PSNR measurement and the perceptual contrast difference map created in a PQR or DMOS measurement can reveal problem regions within the video field or frame. These comparisons can help engineers more easily map visual problems to hardware or software faults.

Conclusion

Engineering and quality assurance teams need to perform frequent, repeated and accurate picture quality assessments to diagnose picture quality problems; optimize product designs; qualify video equipment; optimize video system performance; and produce, distribute and repurpose

high-quality video content. They cannot afford the time and expense associated with recruiting viewers, configuring tests and conducting subjective viewer assessments. They need objective picture quality measurements that can make these assessments more quickly than subjective

fer results well matched to subjective evaluations. Over a wide range of impairments and conditions, DMOS measurements can help evaluation teams determine how differences between reference and test videos can affect subjective quality ratings. PQR measurements can help these teams

The perceptual-based DMOS and PQR measurements offer results well-matched to subjective evaluations.

evaluation and at a lower cost. However, these objective measurements should match subjective evaluations as closely as possible.

Full-reference objective picture quality measurements address these requirements. The perceptual-based DMOS and PQR measurements of-

determine to what extent viewers will notice these differences, especially for applications that place a premium on high-quality video. **BE**

Richard Duvall is the Americas video marketing manager for Tektronix.

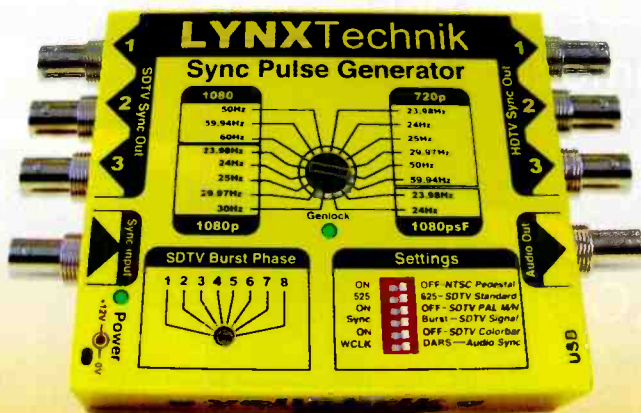

Sync problems?

- ✓ Need a stable HDTV, SDTV and audio sync source?
- ✓ Need HDTV sync locked to a NTSC or PAL reference?
- ✓ Need to cross-lock between all video standards?
- ✓ Need 2ppm temperature controlled accuracy?

we have the solution...

With a myriad of new HDTV formats and legacy NTSC and PAL formats to deal with, the **SPG 1707 yellobrik Sync Generator** solves a multitude of synchronization problems. Use as a stable standalone reference sync source, or slave to any reference signal with fully automatic format detection and cross-lock....

The **SPG 1707 yellobrik** has it all

\$679



LYNXTechnik AG
Broadcast Television Equipment

yellobrik™
Just the first of many..

See all the yellobriks at
www.yellobrik.com
infousa@lynx-technik.com

Facing **MEDIA TRAFFIC** CHALLENGES

The way the IT world characterizes and defines IP traffic must change to accommodate the demands of today's media.

BY LUC ANDRIES, MSC

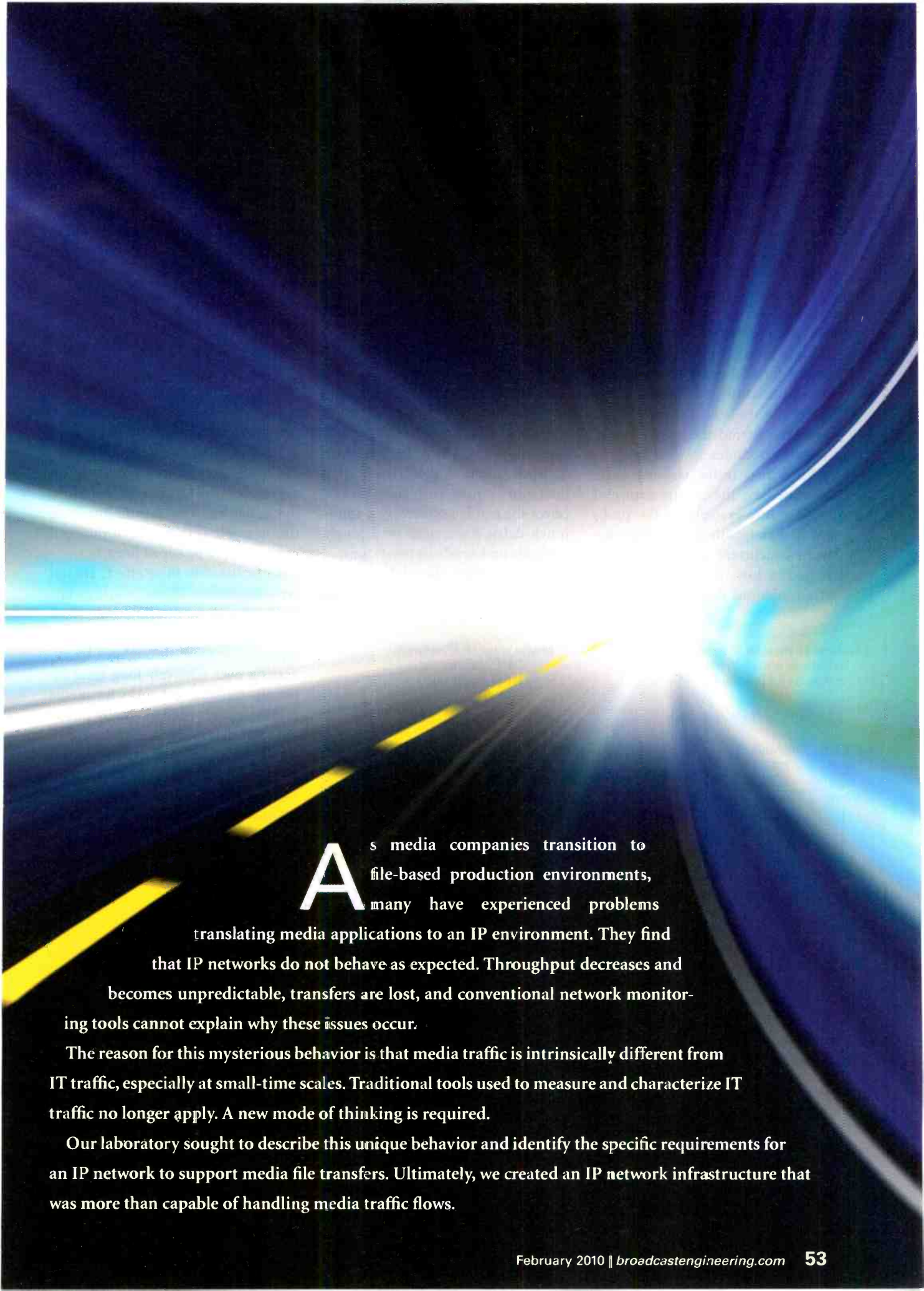

As media companies transition to file-based production environments, many have experienced problems translating media applications to an IP environment. They find that IP networks do not behave as expected. Throughput decreases and becomes unpredictable, transfers are lost, and conventional network monitoring tools cannot explain why these issues occur.

The reason for this mysterious behavior is that media traffic is intrinsically different from IT traffic, especially at small-time scales. Traditional tools used to measure and characterize IT traffic no longer apply. A new mode of thinking is required.

Our laboratory sought to describe this unique behavior and identify the specific requirements for an IP network to support media file transfers. Ultimately, we created an IP network infrastructure that was more than capable of handling media traffic flows.

Comparing IT and media traffic

IT traffic generally consists of short messages or small files, such as those generated by SAP or e-mail, which use the IP network for only relatively brief time periods. Transfer speed is not critical, and packet loss and resulting retransmission are acceptable. Media traffic, however, generally consists of large files (several gigabytes), which typically use the link for a longer time period and almost constantly try to use 100 percent of the available bandwidth. The longer this period, the more “bursty” the traffic becomes.

When two traffic streams share the same link, the unique nature of media traffic exacerbates the problem of bandwidth competition between concurrent transfers, leading to packet loss. Any required data retransmissions decrease the overall

To understand why this happens, consider an analogy of traffic traveling along a two-lane highway. (Figure 1.) Imagine two clients running standard IT services, sending traffic at a speed of 400Mb/s to a common file server. Since each car in the stream is relatively small, the two lanes of IT traffic

can merge (i.e., when they reach the network switch) and efficiently combine into a single lane. The server receives the traffic at 800Mb/s without much delay. Bandwidth or throughput adds up linearly in most cases. Now examine the right portion of Figure 1; it illustrates what hap-

pening when two traffic streams share the same link, the unique nature of media traffic exacerbates the problem of bandwidth competition between concurrent transfers, leading to packet loss. Any required data retransmissions decrease the overall efficiency of the transfers drastically and, if sustained, can lead to complete transfer interruption. This occurs even when the network has been designed (at least on the macroscopic scale) with sufficient bandwidth to accommodate both streams.

pening when large media files are being transported over the same network. Keeping with the transportation analogy, we see that the large media files actually behave more like trains approaching a junction than cars (i.e., long, continuous bursts of traf-

fic arriving back to back). Two clients sending large files to the same server at 400Mb/s no longer manage to get all the traffic through to the server without interference. If both trains (large media files) arrive at the (switch) junction simultaneously, they crash into each other; all traffic is stopped. Consequently, the receiving media server does not attain an aggregated throughput of 800Mb/s, but much less. The bottom line for this example is that data/throughput can no longer be added linearly. Unfortunately, these effects are not typically visible when applying classical network monitoring tools. Such tools are geared toward IT traffic and typically measure throughput by averaging over relatively long time intervals. Building networks for media traffic requires fundamentally different tools that can look at the network on a time scale several orders of magnitude smaller. At this scale, concepts such as average network throughput become meaningless. In these cases, a network link is loaded with a packet, or it is idle. There is no such thing as bandwidth percentage anymore.

When two traffic streams share the same link, the unique nature of media traffic exacerbates the problem of bandwidth competition between concurrent transfers.

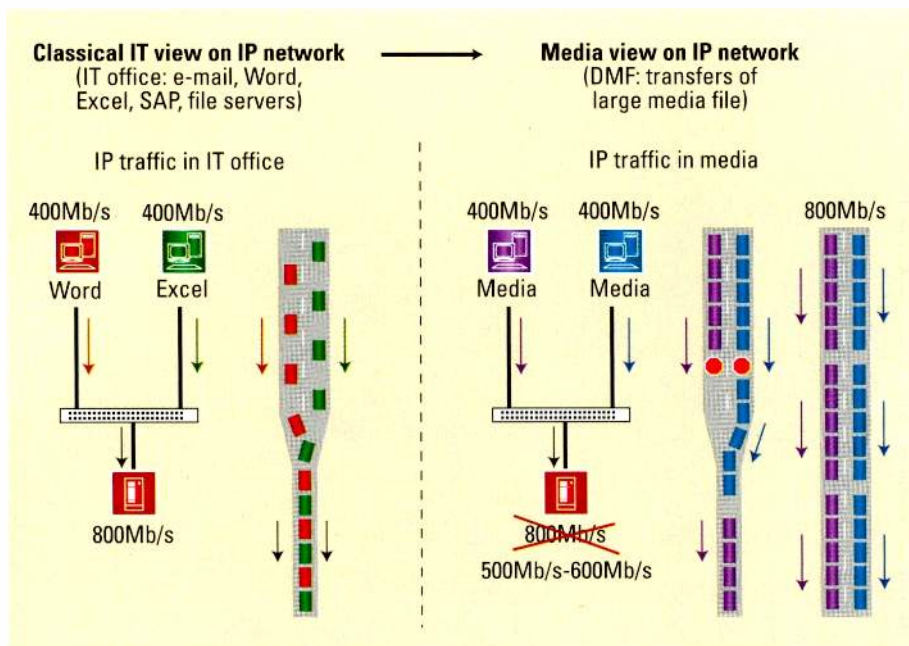

Figure 1. Large media files act more like trains than cars in IP network traffic, causing congestion.

Testing HD over IP networks

To demonstrate these effects, the VRT-medialab analyzed the IP network traffic generated by an editing client connected to a media storage cluster on different time scales. As a challenging test case, we used a set of Avid Media Composer editing clients using multiple streams of HD video, all connected to a generic media storage cluster architecture like that shown in Figure 2. The network used a Workhorse Application Raw Power (WARP) media storage cluster from VRT-medialab as a generic storage

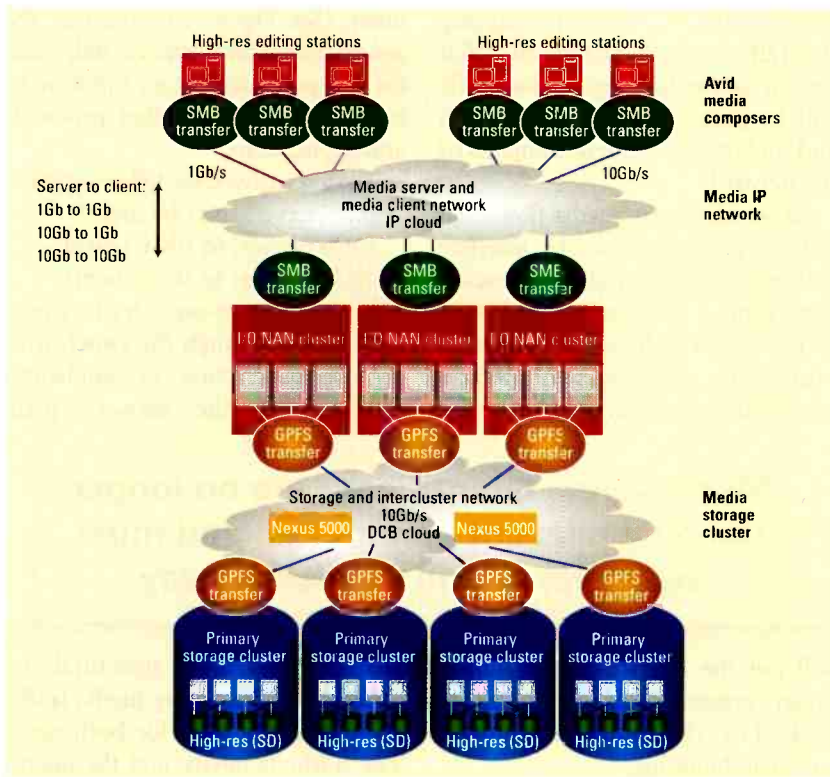

Figure 2. This test configuration used Avid editing clients providing multiple streams of video, all connected to a generic media storage cluster architecture.

platform. Cisco Nexus 5000 switches with lossless 10GE and Data Center Bridging functionality were used in the cluster network, providing a generic media storage solution with ample throughput for HD editing.

Several Avid Media composer editing clients were connected via a Cisco Nexus 7000 switch to the storage cluster using both 1Gb and 10Gb links. IP media traffic was transported via the SMB/CIFS (Server Message Block/Common Internet File System) protocol between the server and the client.

Analyzing media traffic

The analysis consisted of playing a single DNxHD 145Mb/s HD video stream with a frame rate of 29.97 frames per second over a single 1Gb connection. Figure 3 illustrates the traffic moving between the storage and client.

The left side of the figure displays the macroscopic time scale of seconds and measures an average bandwidth of around 150Mb/s. This corresponds nicely with the compression bandwidth of the DNxHD 145Mb/s

codec. The measured throughput is slightly higher than the codec specs, due to the header and protocol overhead in the TCP/IP packets. The first 1.6 seconds, the client is prefetching a number of video frames into its buf-

fers to overcome the eventual jitter of the storage and network. During this period, the measured macroscopic bandwidth is around 580Mb/s, 4X the codec spec, indicating the client is reading four times faster than the playout speed.

These results correspond to the specifications typically used by video engineers and media solution suppliers. Throughput is expressed on this macroscopic time scale, and network architectural designs are based solely on these values. However, zooming in on increasingly smaller time scales reveals a completely different story.

Now, examine the right side of Figure 3; the seemingly continuous throughput displayed on the left actually appears to consist of discrete blocks of five consecutive video frames. During the prefetch period, 37 groups of five video frames are sent over the network, almost back to back. In steady state, blocks of five video frames are interleaved with long periods of no traffic on the link. At the 10ms time scale, the network reaches an average bandwidth of around 600Mb/s during transmissions. This is slightly higher than the average throughput during the prefetch

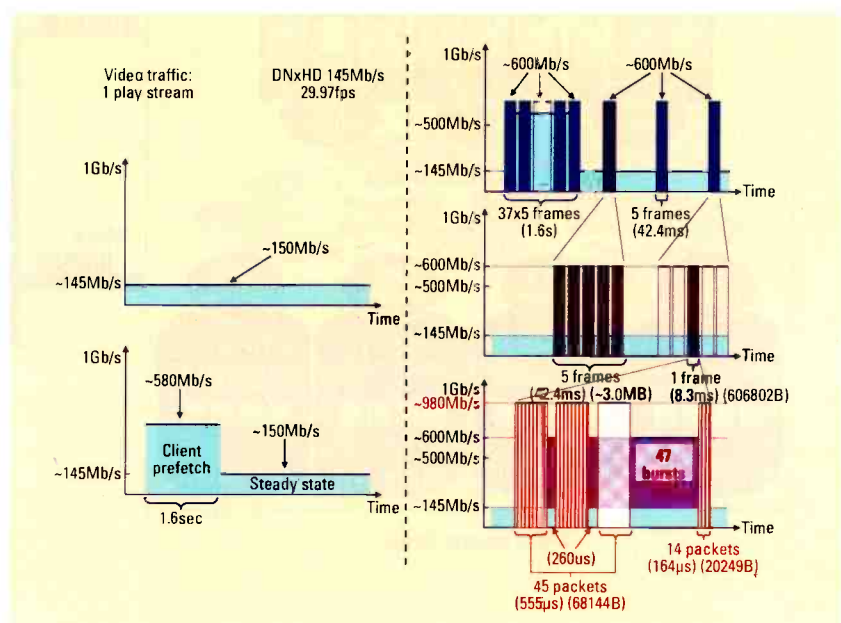

Figure 3. A look at how media traffic behaves on different time scales

period, but more than four times higher than the average throughput during the steady-state playout. For this codec and frame rate, each video frame corresponds with 606,208 bytes of video data, so the five-frame burst corresponds to around 3MB, with a duration of 42.4ms.

Looking at an even smaller time scale, on the level of individual packets, each video frame is actually split into 47 smaller bursts. Each of these smaller bursts consists of 45 (14 for the smaller last burst) 1518-byte packets, transmitted back to back within each burst. Hence, on this μ s time scale, a continuous burst of packets is measured at a throughput of 980Mb/s, reaching full line rate of the link for 555 μ s. This is 6.75 times higher than the average steady-state macroscopic bandwidth specified by the codec.

Implications for the IP infrastructure

Clearly, measuring data rates at a macroscopic average throughput is too limited to fully characterize

media traffic. It is only by analyzing the traffic at smaller time scales that we can determine how media traffic will be processed by the IP switch and understand the requirements of the network.

As we have seen, media flows that share a common link can interfere with each other on a small time scale, generating a local oversubscription of the switch buffers and ultimately introducing packet loss. Similarly, a bandwidth mismatch in the network

will put the internal switch buffers under pressure and can result in packet loss. The solution is to provide sufficient buffering.

The test analyzed the following links:
 1Gb (server) to 1Gb (client)
 10Gb (server) to 10Gb (client)
 10Gb (server) to 1Gb (client)

In the first two cases, traffic passes unhindered through the switch with no oversubscription or bandwidth mismatch in the network path.

Macroscopic quantities ... are no longer the only relevant parameters and must be interpreted in a different way.

will put the internal switch buffers under pressure and can result in packet loss. The solution is to provide sufficient buffering.

The next examination used a Cisco Nexus 7000 IP switch to assess its buffer performance and overall functionality in a media environ-

Hence, the detailed structural description of the bursty media traffic given above is valid for both cases. The traffic is bursty, and the microscopic SMB bursts are concatenated in case of multiple streams per video. This leads to high throughputs compared with the average macroscopic

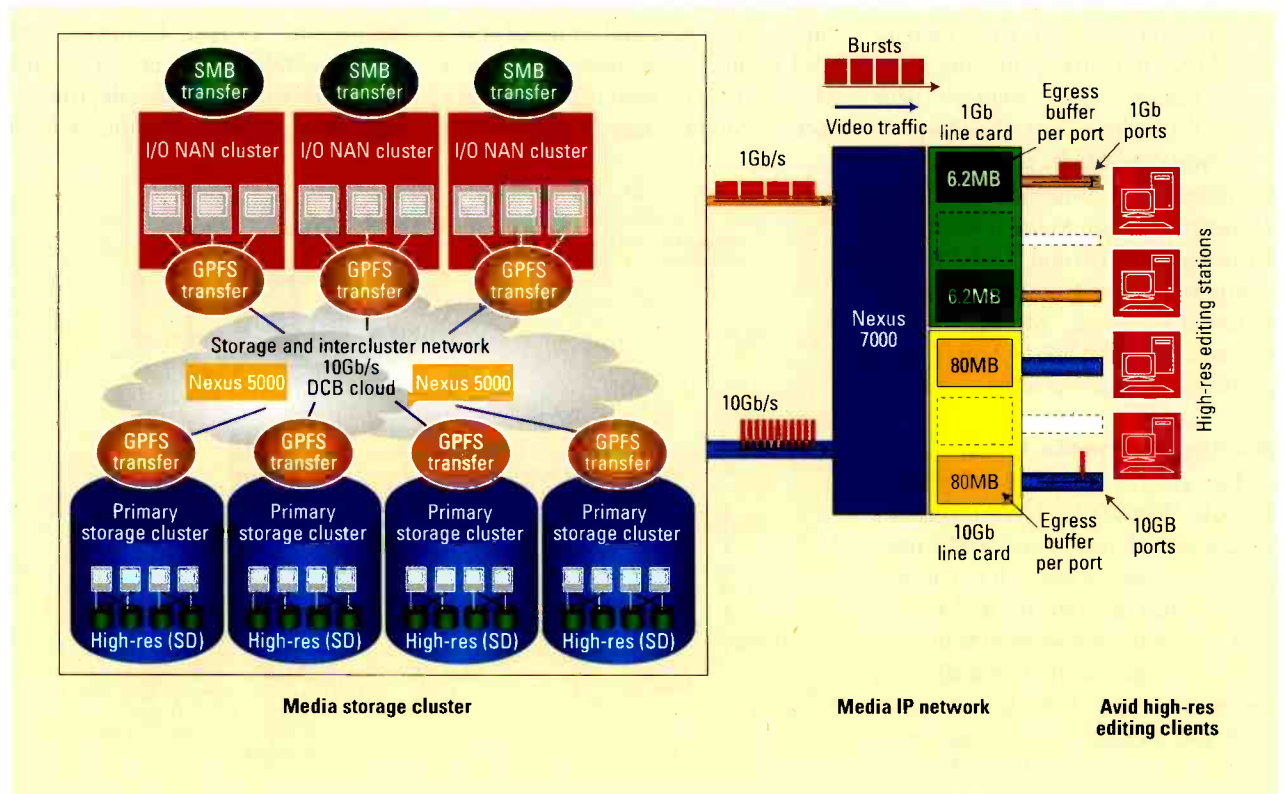

Figure 4. The test environment is assessed for its buffer performance and overall functionality in a media environment.

video specifications. Under these tests, the Cisco Nexus 7000 switch was perfectly capable of transporting these high loads.

In the third case, the 10Gb-to-1Gb bandwidth mismatch creates an internal oversubscription in the switch. Hence, at the 1Gb egress ports, packets arrive at a much higher rate than they can be forwarded to the client, stressing the egress buffer. The maximum burst that the SMB traffic will produce before it requires a response from the client is 68,144 bytes (TCP/IP overhead included). Because the egress port sends out packets at a rate 10X slower than the incoming rate, the egress buffer must be able to store 90 percent of this burst to avoid packet loss. This leads to a buffer requirement of around 60Kb per single video stream, or around 300Kb for a test using five streams. This is well within the specifications of the 48 x 1Gb port

blades of the Cisco Nexus 7000 switch (max 6.15MB/port).

Change must come

The way the IT world characterizes and defines IP traffic must change to accommodate the demands of today's

It is critical to understand that IP switches needed for media networks are not a commodity like in IT networking.

media. Macroscopic quantities such as average bandwidth, oversubscription and available capacity are no longer the only relevant parameters and

must be interpreted in a different way. Additional specifications on much smaller time scales are required, and a deeper understanding of the detailed traffic characteristics and network switch and buffer mechanisms should be modeled.

It is critical to understand that IP switches needed for media networks are not a commodity like in IT networking. Most classical IT switches are designed for environments where oversubscription is less likely. Such switches may lack the proper buffers or QoS capabilities to avoid transfer interference of large media files.

Be sure to carefully consider these factors when building a media network. **BE**

Luc Andries is ICT-architect for VRT-medialab.

VRT-medialab is the technological research department of the VRT, the public service broadcaster of Flanders, Belgium.

Dallas Cowboys Stadium Control Room features a Sony MVS HD Switcher



SONY

BURST is proud to be an authorized Sony Systems Integrator

"This is no run of the mill stadium control room. I wanted something different, something special, something tailored to our needs, and I knew BURST would give me exactly what I was asking for."

- Dwin Towell, Director Broadcast Engineering, Dallas Cowboys Stadium

Responsive, forward thinking, and flexible - BURST has the playbook to design, install, and integrate winning master control rooms. **BURST. We're on your team.**

NABSHOW
Where Content Comes to Life™

See Burst at NAB
Booth C11126.



BURST

Systems Integration
www.burstvideo.com
1.888.472.2820

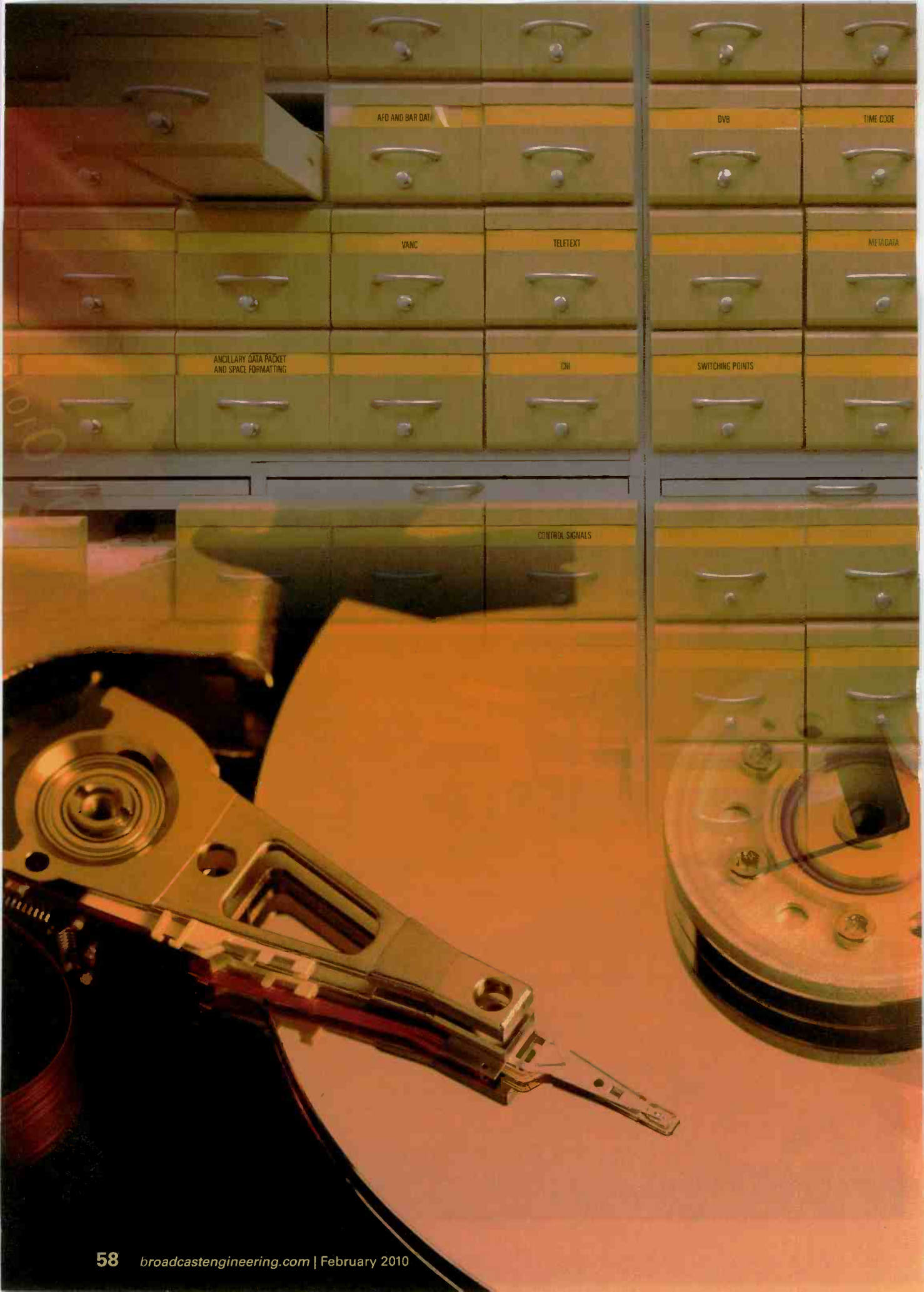

AFD AND BAR DATA

DVB

TIME CODE

VANC

TELETEXT

METADATA

ANCILLARY DATA PACKET
AND SPACE FORMATTING

CNI

SWITCHING POINTS

CONTROL SIGNALS

BY IAN HUDSON

Managing broadcast data

Broadcast is shifting rapidly from its traditional linear production model to file-based systems. This gives rise to tremendous flexibility, instant delivery and huge opportunities for cost reduction primarily through improved efficiency.

Those efficiencies can only be realized, however, if those files are both accessible and usable. Access relies on accurate information, much of which regards how the file is cataloged and archived. Usability relies on the format of all aspects of the content, the obvious picture resolution and audio format, but also the data carried both within the VBI, VANC and HANC.

	1970	1980	1990	2000	2010	2020
Viewing	Free TV		Subscription PPV		Transactional	
Revenue	Ratings-based advertising		Subscriber- based		Targeted value-based	
Medium	Terrestrial		PPV VoD Satellite Cable		Download Interactive e-commerce	
Other output	Cinema TV VHS		Digital cinema DVD Video games		HDTV Mobile Online gaming	

Analog		Digital	
Data	Teletext Time code Captions	WSS Teletext Time code Triggers EPG	AFDs V-chip Metadata Triggers Program descriptors Red button XDS OP47

Table 1. The use and amount of data is growing in line with changes in the broadcast industry and will continue to grow with developments like IPTV and with the changes from linear to file-based broadcasting.

Indeed, the flexibility and efficiency improvements can be fully realized only if the original content (picture + audio + data) can be read, managed, manipulated and converted to meet the final output criteria. Modern broadcast facilities rely on information: Equipment is triggered by cue tones, switched by active format descriptors (AFDs), aligned to time code and managed by automation. (See Table 1.)

Data, embedded within the content, is not only there for the benefit of the broadcaster, but also it is there for the viewer in the form of captions, teletext, program guides, red-button interactivity, parental control and much more. Regardless of whom the intended user may be, there are only three reasons for inserting data: to enhance, to control or simply to meet regional legal requirements. Whoever makes use of the data, for whatever reason that data was created and whatever the intended use, the importance of inserting, reading, managing and monitoring data efficiently and effectively throughout

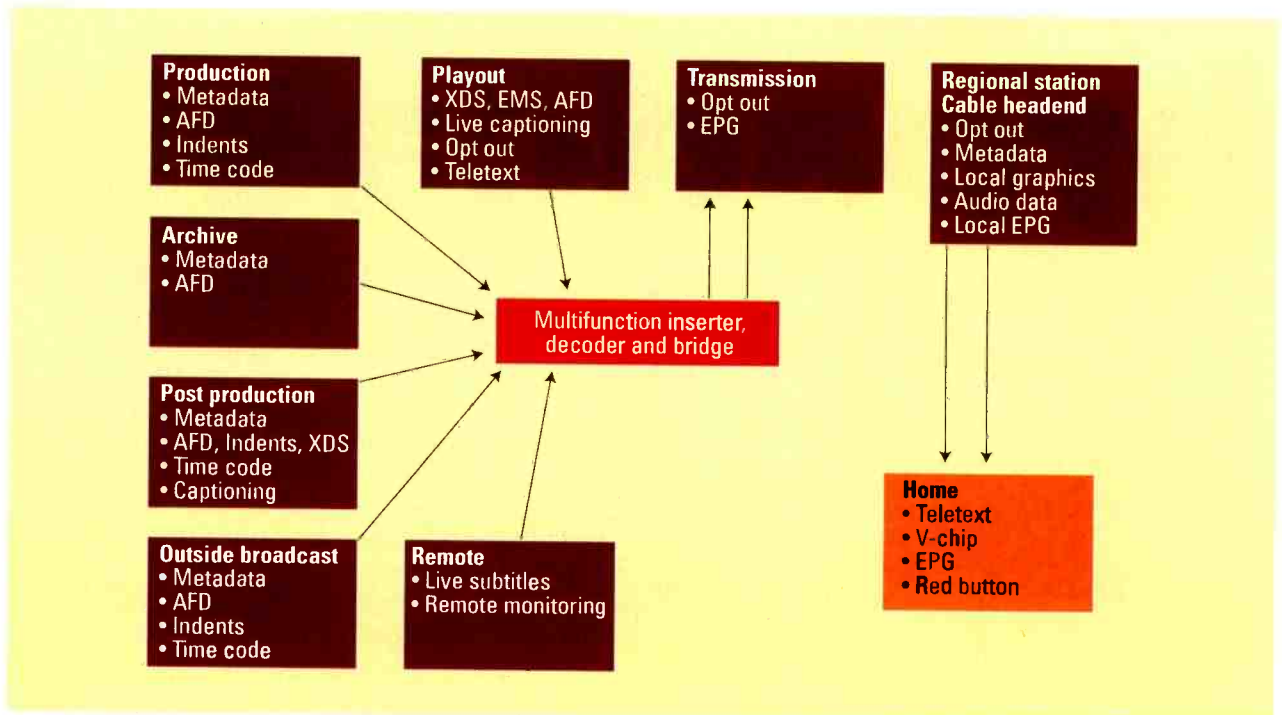

Figure 1. Data is used at every stage of the broadcast chain. Throughout that chain, data needs to be inserted, read, monitored and manipulated. The equipment to perform those tasks must be flexible, future proofed and capable of performing multiple functions in a multitude of formats.

BROADCAST ENGINEERING: B.E. IN THE KNOW!



Broadcast Engineering's not just in your mailbox. It's online. It's in your inbox. It's on your mp-3 player. It's delivering all of the industry's latest news, technology, and updates in the format you choose, and providing the solutions, training, and answers you need to help you get the job done right.

Visit us online at <http://broadcastengineering.com> to sign up for the FREE coverage you need to keep on top of the latest developments.

US/Canada Edition

World Edition

Podcasts

Essential Guides

broadcastengineering.com

Broadcast Engineering E-zine

E-newsletter Suite

Webcasts

NAB Special Report

IBC Product Scource

Digital Reference Guide

BroadcastEngineering®

It's Your 360-degree Connection to the World of Broadcasting.

the broadcast chain is essential. (See Figure 1 on page 60.)

Data insertion is commonplace throughout the broadcast industry and has been for the past 30 years. Initially, data was inserted into the VBI portion of the program stream as analog waveforms. With the advent of SDI, these waveforms were digitized. Indeed, much data today is still in analog format and simply converted to a digital waveform to be inserted into the SDI stream.

With the advent of HD, VBI has been superseded by VANC. In terms of the physical insertion of data, there is no real difference. The primary difference is HD carries only packetized data (i.e. not digitized waveforms).

transmission stream to put all this data in, but it proves the vast potential for data to be used in HD transmissions. A suitably equipped set-top box is able to read this data and processes it as required. The increase in volume of data will inevitably lead to increased interaction between the viewer and the broadcaster, making true interactive TV a certainty in the coming years.

Formats

Within the broadcast facility, there is no difference with regard to the transport or use of data in one format or another. Regardless of whether the data started life as an analog waveform and was subsequently digitized

is a robust signal. While in use, it is present on every frame. Because line 23 is considered part of the picture, it is effectively bandwidth-free. The primary disadvantage with line 23 is it can, when passing through the MPEG encoder, become corrupted by stray motion vectors unless care is taken in the encoding process.

Packet 31, however, is a teletext packet and is, therefore, passed without incidence by all encoders. Packet 31 is normally only transmitted with a single frame, so a dropped frame will result in a dropped cue tone and, therefore, a missed action somewhere downstream. If it were a trigger for an ad server, it could be a very expensive dropped frame indeed. Packet 31 could be pulsed with each frame, but this is not bandwidth-free. So Packet 31 is a simple solution and easy to work through encoders and decoders. A WSS waveform cue tone, on the other hand, is bandwidth-free and robust but not as simple to get through the entire signal chain.

Different hardware, in the same way as different data, also has pros and cons. A PC with a commercial SDI interface is a low-cost option and well-suited to offline subtitling. However, for live broadcast, low-cost commercial interface cards often cause both operational and quality issues. Professional-quality cards, on the other hand, can be prohibitively expensive. It is, therefore, more robust, reliable and less expensive to use an embedded system for data insertion, albeit, if required, interfacing with a standalone PC to provide the data carrying the captions.

Each format of data and the equipment to insert it has advantages and disadvantages. The important point for a modern broadcast facility is that it has the flexibility to choose what data type is inserted from a single hardware solution and that the solution is not a proprietary solution forced upon it. Similarly, as the world moves toward standardization of certain aspects of the broadcast chain, (for instance 16:9, driven by the TV set manufac-

There is no difference with regard to the transport or use of data in one format or another.

These are now formatted as digital ancillary data packets (with 000 3FF 3FF prefix), which carry parallel data rather than analog signals that have been digitized or serial digital data (e.g. video index).

This allows considerably more data per line than previously possible. For instance, one VBI line of teletext contains 40 displayed characters (+5 characters of run-in and framing codes). One line in 1080i video contains 1920 Y and C words in the active video portion (i.e. that used for VANC). One OP47 (see the teletext bullet point on page 65) multipacket can contain up to five analog teletext lines and is about 255 words long. It is theoretically possible to fit seven of these multipackets onto a single HD line (equivalent to 35 old teletext lines), or more than a full page on a single line. Again, it is theoretically possible to fit the same amount of data into both Y and C, which would give approximately 70 analog SD teletext lines on a single HD line.

Ultimately there are questions regarding bandwidth in the ASI

or is inserted as SD or HD-SDI, it is carried with the picture and audio as a single digital stream.

As discussed, the primary difference for the broadcaster is not the format of the data but the amount of data and the uses it is put to. For instance, widescreen signaling (WSS) on line 23 was primarily a European initiative. It was first introduced to account for the consumer take-up of 16:9 TVs, which was quicker and more widespread than in the rest of the world. WSS was introduced specifically to address the consumer requirements to switch formats between programs transmitted in 4:3 and those transmitted as 16:9. AFDs are in principle the same thing as WSS. However, AFDs are used extensively throughout the broadcast facility to switch, for instance, aspect ratio converters.

Similarly, cue tones or triggers can be in the form of a line 23 waveform (analog or digitized) or as a data string, e.g. a packet 31 teletext stream. There are always advantages and disadvantages to whichever is chosen. As an example, a line 23 waveform

turers) some equipment in much use today will become redundant. Therefore, it is important that the chosen solution has built-in flexibility in both the hardware and software, and that it is also future proofed, i.e. can be repurposed should requirements or standards change in the future.

Data

In principle, there are only two types of data that concern the broadcaster, that which is produced by or for them, such as subtitles, metadata and program guides, and that which is generated by a piece of hardware situated in the transmission stream — for instance, AFDs and cue triggers. The only question the broadcaster should need to answer is: Is the format of the raw data to be inserted analog, digital, RS422/485/232, TCP/IP or embedded within an existing SDI stream? None of this should matter to modern data encoders/inserters. Neither should it matter if the format of that data is not the format required for transmission.

For instance, data formatted to an SD standard when transmission is required in HD should be managed by the inserter hardware. Transcoding data between formats should be standard in any modern equipment. There is too much data and too much change for modern data management to be carried out by single-function boxes — one for insertion, one for decoding, one for monitoring, one for bridging/shuffling, etc. Today's modern data management systems must insert, read, bridge, shuffle, copy, move and transcode data in a single, cost-effective unit.

Flexibility

There are few guarantees in broadcast. The only guarantee that anyone can give with certainty is that broadcast has changed and will continue to change. Through that change, there is a need to replicate all or part of legacy systems, but in new formats.

One example is the growth of playout centers. Playout centers have long existed, but their scale and number

far exceeds that of only a few years ago. There is good reason for this — efficiency, cost saving and reduction of fixed overheads. Indeed, it is no different to the outsourcing and core business focus seen in almost every other industry over recent years. But this brings with it a series of challenges. Each broadcaster is used to doing things a certain way. Often the playout center has a service level agreement for one broadcaster that requires completely different data management requirements to any of the many channels it manages. Flexible systems are a must. The hardware and software within the system must accommodate and work with a multitude of different in-

presence of advanced set-top boxes, data for triggering revenue-gathering features — such as disabling fast forward functions during ad breaks or showing a small advertisement graphic during fast forward — can be implemented.

There is also the added complication, or should that be opportunity, of DVB or ASI insertion. Data can be inserted directly into the ASI stream with the relevant timing information added to the header to ensure accuracy of, for instance, switching of equipment or display of subtitles. This is especially useful where one particular point in the chain receives and retransmits programs in an MPEG form, negating the need to de-

Moving forward, with the increased presence of advanced set-top boxes, data for triggering revenue-gathering features can be implemented.

coming data — all while having the flexibility to meet their contractual obligations independently for each individual broadcaster.

The viewer

The data that reaches as far as the consumer is decoded by the set-top box or TV, and acted upon accordingly. For example, if data is received prompting an interactive icon to appear on screen, the set-top box recalls the icon and adds it to the picture. If DVB subtitles are present, the receiving device adds them to the picture when required. When AFDs associated with the program currently being viewed are present, the set-top box adds black bars to the sides of the picture so it doesn't get squashed when viewed on a 16:9 TV. Data is also inserted to enable interactive content and enhance the consumer experience, such as viewer participation in live voting and the ability to set viewing reminders for a program.

Moving forward, with the increased

code and re-encode in order to insert data. This saves capital, overhead and infrastructure costs while also maintaining picture quality.

Data types

The following is by no means an exhaustive list of data types, nor does it seek to give an in-depth explanation or analysis of the merits or limitations of each. There are specifications for data types that contradict and there are others that are evolving, but this just goes to prove the need for a flexible, future-proofed approach to managing data within the broadcast facility and beyond to the relay station and the viewer.

- *Ancillary data packet and space formatting.* There are two types of ancillary data packet in component (SDI) HD video: type 1 and type 2. This allows a wider range of data types (more than 29,000) to be used. The two types of data packet are the same size, and the only difference is the way the data is used inside the packet.

Type 1 data has a data block number (DBN), whereas type 2 has a secondary data ID (SDID). Type 1 data with a DBN is used when there is a requirement to distinguish several packets with the same data ID (DID). The most common type of data packet used with what was traditionally VBI data is type 2, with type 1 mainly

used for audio data.

- **VANC.** People often see the word VANC and think it is something mysterious, new and difficult to understand. In fact, it is in effect the same as VBI. The term VBI refers to the time taken for the cathode ray beam to return to the top of the frame after scanning a frame (or field), while the

term VANC means vertical ancillary data space, demonstrating that the space/bandwidth associated with the TV transmission is now firmly established as being used for transmitting ancillary data. (See Figure 2.)

- **AFD and bar data.** AFD and bar data is used to indicate how video shot in a particular aspect ratio should be displayed when shown on a display of a different aspect ratio. For example, a movie shot in 16:9 can be shown in two different ways when displayed on a 4:3 television. It can have bars added at the top and bottom to maintain the full image (the height of the bars being determined by the bar data element of the signal if the aspect ratio is greater than 16:9), or it can have the sides of the image cut off so that it fills the vertical space on the display. Correct AFD signaling ensures that the footage reaches consumers as the director intended.

- **Switching points.** Specific switching points exist for two reasons. The first reason is to ensure that a digital transmission can be switched to another source without picture disturbance that is visible to consumers. The second is to ensure that ancillary data is not corrupted when a switch takes place. (VBI data should not be transmitted on the switching line.) These switching points are within a specified zone on particular VBI lines. The switching line can differ depending on the video standard in use, and interlaced standards have a switching line specified in each field.

- **Control signals.** Control signals, also known as opt-outs, are used to trigger other pieces of equipment in the transmission chain. For example, a control signal can be inserted at the central playout point of a national television channel that has multiple regions. This signal can be used at the start of ad breaks to trigger advertisement servers located in the remote regions. These signals can also be used to switch other equipment in to play, such as remote servers — for instance, local advertising or news.

- **Time code.** Time code is used for

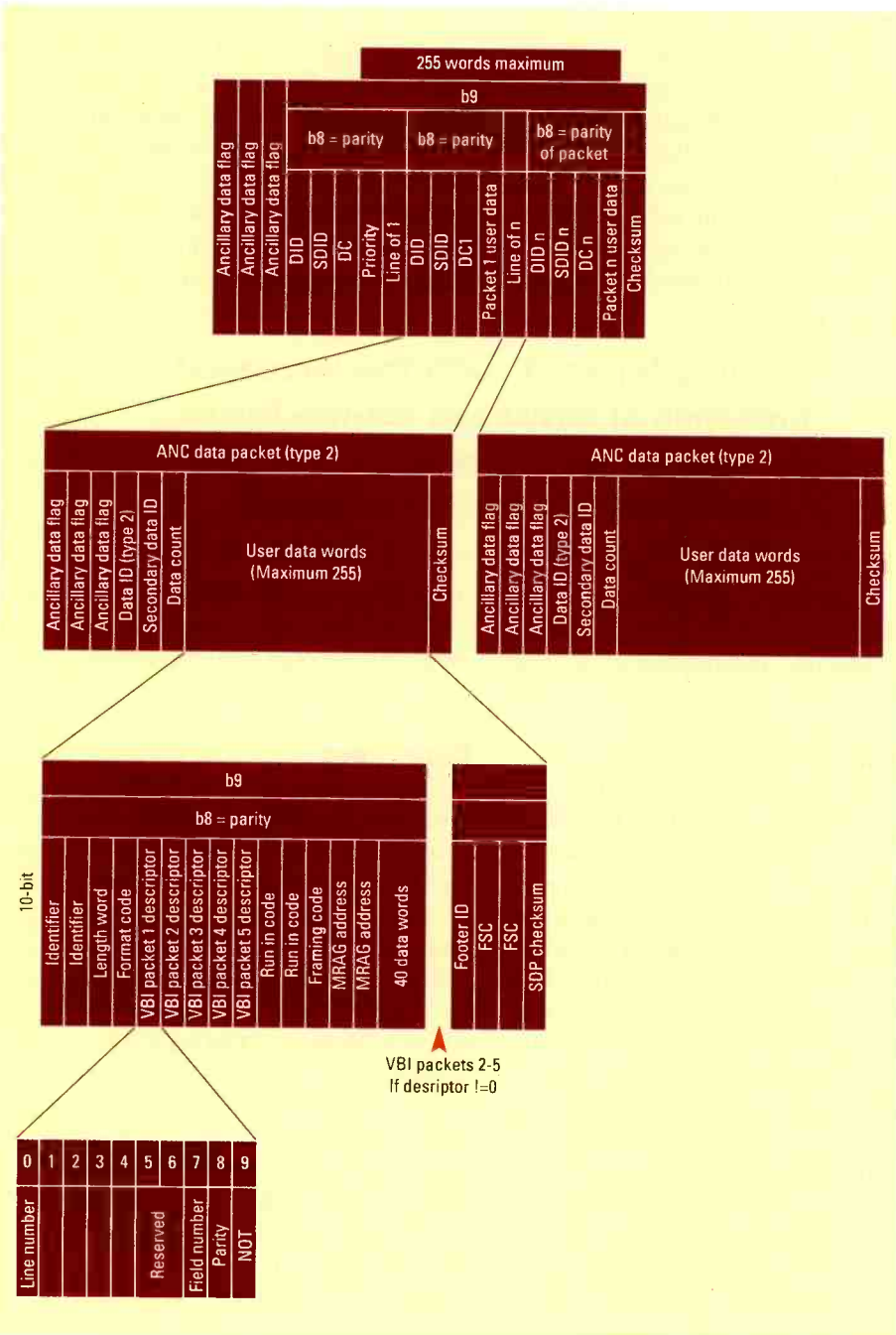

Figure 2. Shown here is the format of type 2 ancillary data in a VANC multipacket. Type 1 ancillary data has a similar format, with the secondary identifier (SDID) replaced by a data block number (DBN). Type 1 is more commonly used for audio data.

synchronization of equipment in the broadcast chain, such as subtitle/caption inserters, making sure the captions appear with the correct piece of video. It is also used for synchronizing automation, to ensure, among other things, that commercials start and end at the correct time, and for audio, to make sure it's in sync with the video.

- *Program descriptors.* Program description data is used in HD video to carry information that defines the characteristics of the audio and video material being broadcast, such as whether the service has captions, details of the audio signal, information for parental control and program genre.

- *eXtended Data Services (XDS)/V-chip.* XDS are used in NTSC video to carry data such as time information for setting clocks on VCRs and TVs. It also carries basic information such as program name and station identification.

Likewise, it is used to carry V-chip content rating data, which allows programs to be blocked based on the program content. The consumer's television is programmed to allow viewing of content up to a rating that is chosen as acceptable for that particular receiver, and viewing is blocked for any program outside this threshold.

- *DVB.* More data is being inserted directly into the ASI transport stream. Each multiplexed stream carries a number of programs (typically from two to 16) identified by the Program Allocation Table (PAT). Each program is mapped via the Program Map Table (PMT), which breaks the program into video, audio and data, each identified by Packet Identifiers (PIDs). Data can be common across many program streams or specific to a particular program stream. In deciding what data is common and what is shared, many factors are taken into account — for instance, whether the multiplexing is fixed data rate or statistical. Typically, the type of data inserted directly in the DVB stream includes idents, GPI triggers and subtitles.

In DVB subtitling, subtitles and basic graphics can be added to video after the compression stage. When the insertion occurs at this stage, the subtitles can either be converted to bitmap form (bitmap DVB subtitling), or the raw subtitle data is sent to the MPEG encoder (code-based DVB subtitling), before being sent to the mux and transmitted with the station output. The advantage of code-based subtitling is its backward-compatibility with teletext-based receivers, while bitmap subtitling has the

Metadata is probably the most misused and confused term in the broadcast industry.

ability to generate character-based subtitles, along with richer content using graphics, different fonts, sizes and colors.

- *Teletext (OP47).* Teletext is a means of transmitting basic pages of text information that can be decoded by the receiving television set. It is also a means of increasing revenue through advertising. One teletext page can be transmitted using the VBI data space in 25 lines of 625-line video. Pages are transmitted in a sequential manner, and data is normally inserted on several VBI lines to speed up page cycling and reduce the amount of time consumers have to wait for a page to load.

Teletext is also used as a means of transmitting subtitles/closed captions in SD 625-line video. However, teletext is represented by an analog waveform, so with HD services, the OP47 subtitling standard is the most commonly used to produce what appears to the consumer as the same end product.

- *Country and Network Identification (CNI).* CNI data was originally an analog waveform that gives country of origin information and is transmitted as a packet 30 teletext data packet. It is now available as OP47 packetized data and rarely used by broadcasters today. The interesting point for this document is its evolution from analog waveform to packetized data and its modern use, where it forms part of the audience viewing data. Its use is not widespread, but significant nonetheless. CNI shows that both data and its uses evolve and that unique uses for data, in whatever form, continue today.

- *Metadata.* Metadata is probably the most misused and confused term in the broadcast industry. Metadata is simply data that describes data. Think of it rather like a library system. The library is divided in sections, and each section is categorized and then subcategorized. If you use the system, you can find what you are looking for almost instantly. However, if you tried to find the specific volume by going through each shelf and each book, you may be at the library for longer than you would like.

Metadata is simply the categorization and subcategorization of information required by broadcast engineers, researchers, program makers and anyone else who needs to find a specific clip, or edit or produce content. It simply lets them know where they will find specific data they need to fulfill their objective.

Conclusion

Data, and its management, is an integral part of broadcasting. Its uses, formats, generation and transmission are all changing and will continue to change. Hardware and software must be able to accommodate not just today's requirements but legacy and future requirements, while being flexible enough to manage interim solutions. **BE**

Ian Hudson is CEO at Microvideo.

Dielectric's Symphony

In multistation broadcast tower facilities, controlling and managing the complex RF system is critical.

BY RUSSELL BROWN

Dielectric's Symphony RF control system allows multistation broadcast towers to control and monitor the transmitter outputs of every station, thus providing a comprehensive system for tower management. This system ensures the safety of tower workers and quickly switches to auxiliary antennas in case of damage to the main one.

Symphony replaces many custom, in-house built control or lock-out systems that used key locked switches and neon lamps to indicate the position of multiple broadcast transmitters' RF switches. These types of controls would prevent a transmitter from being switched back to an antenna that was being serviced, but they could not force stations to switch to the auxiliary antenna if the need arose in the middle of the night.

Why it is needed

The RF power meters and monitoring circuits of a transmitter are used to monitor and protect the transmitter and its immediate transmission system. In a single station site where the output of the transmitter directly connects to the transmission line on the tower and the antenna, this works fine. If a fault occurs somewhere within the line or antenna, the transmitter's virtual standing wave ratio (VSWR) circuits detect the increase in reflected power and cut the RF output of the transmitter. This works because of the direct connection between the transmitter's output and the final destination, which is the antenna.

When community antennas are used, this changes. In order to share a common antenna, the station's output must pass through multiple switches, channel filters and combiners to

reach the community antenna. Now the power carried by the transmission line to the community antenna has the combined power outputs of all the transmitters feeding it, which results in much higher power levels than any single station would produce. The power levels and VSWR at these points become critical to all the stations connected to it. It becomes impossible for any station to moni-

tor these parameters due to the isolation caused by the channel filters and combiners. Plus they would never see the combined signal of all the stations in the RF system.

A few years back, one tower with a community antenna system did not have any monitoring for the combiners and transmission line to the antenna. It wound up burning many hundreds of feet of transmission line due to an

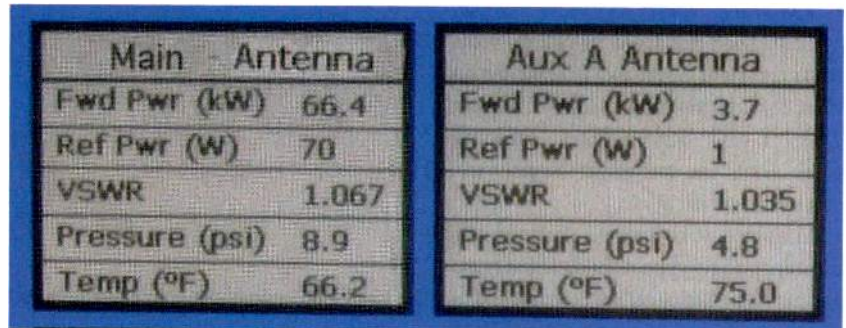

Figure 1. Close-up of information presented within the GUI

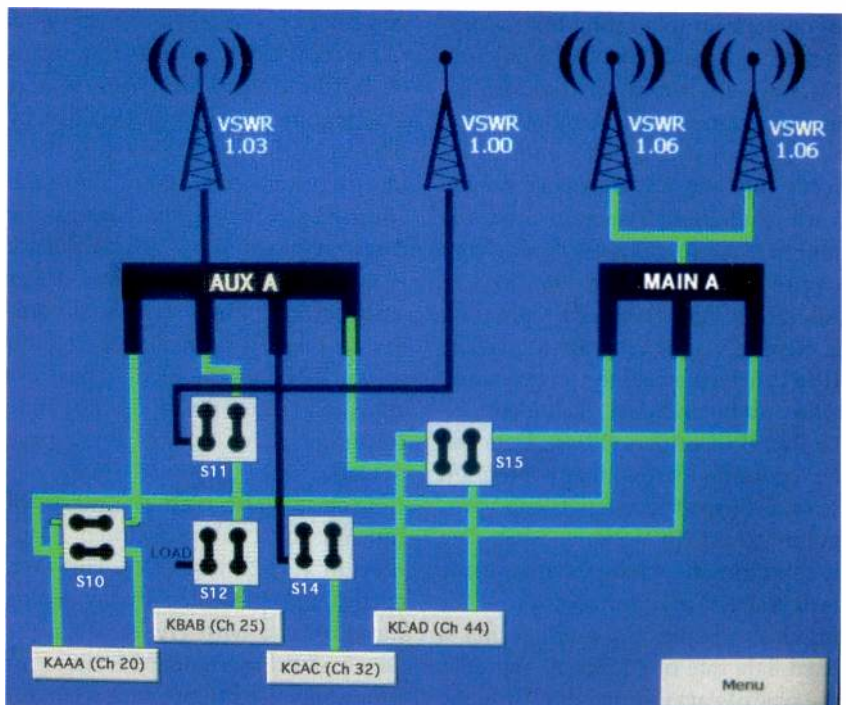

Figure 2. A GUI overview from the main screen of Dielectric's Symphony RF control system

undetected fault. A system like Symphony would have detected the problem and shut down that transmission line, and the transmitter's outputs, before the loss of all that line.

How Symphony works

In order for the Symphony system to control the RF parameters of all the stations, it utilizes programmable logic controllers (PLC) technology, which is widely used in industrial control systems and is recognized as being highly flexible, easy to use and most importantly, reliable. PLCs have inputs and outputs that connect to various equipment. These are controlled both by the human operator and a defined set of rules, which will take action if faults are detected within the RF system. (See Figure 1.)

The PLCs are connected to the RF switches to control and monitor their position. RF power sensors are attached to probes on the transmission lines that monitor both forward and reflected power levels. Temperature is also monitored.

Symphony provides a graphical user interface for monitoring and controlling every part of the system. Touch screens are used in both the individual transmitter rooms as well as central control points, such as the tower manager's office or a common lobby of the tower's building where everyone can see the system as a whole. (See Figure 2.)

In the transmitter room

Each station gets a PLC box and a rack-mounted touch-screen controller. The LCD screen shows all RF switches used by that station and provides control of them. Direct control is accomplished by touching the image of the switch and then choosing its position.

Or the system can be programmed to allow for simple on-screen push buttons that set all switches at once, i.e. TX to main antenna, to aux antenna or dummy load. In order to move the switches, there is an interface between the PLC in the room and the transmitter's interlock circuits to turn off the RF. The RF power monitors will not let any switch move unless that station's power has fallen below 500W. The PLC also has inputs for remote control of the switches and status outputs, as shown in Figure 3.

Some transmitters are now much more integrated with their RF switching and would basically fight any external system moving its switches. To solve this, Symphony can be programmed to send commands to the transmitter, letting it move the RF switches, and then the system monitors the switches to be sure they are in the correct position.

Due to its programmability, the system is flexible and can be adapted to almost any situation; the challenge is to plan ahead and know what you want it to do.

Heart of the system

The main controller is usually situated near the RF switches because this is where the bulk of the interface wiring is located. There are several PLCs, each monitoring and controlling RF switches, accepting input from power sensors that supply a 0V-5V output, as well as pressure sensors that monitor the transmission line pressure.

This main control station has a large touch-screen LCD monitor to allow for systemwide overview and control. This screen can be duplicated in several other locations around the tower building, providing complete control of the entire RF system for the tower.

The entire system is connected via Ethernet. If communications are lost for any reason, the system won't let the RF switches move for the affected section and will alert the operators to the problem. The interlocks to the transmitter will only open if there is a fault detected with the associated RF switch and not just on a loss of communications. This Ethernet/IP-based control allows the system to be remotely monitored via the Internet.

Symphony is a sophisticated single-to-multistation RF management system, providing centralized monitoring and control for the RF system from single TV or FM transmitters to towers that use community antennas.

BE

Russell Brown is chief engineer at KMTP-TV in San Francisco and writer of Broadcast Engineering's "Transition to Digital" e-newsletter.

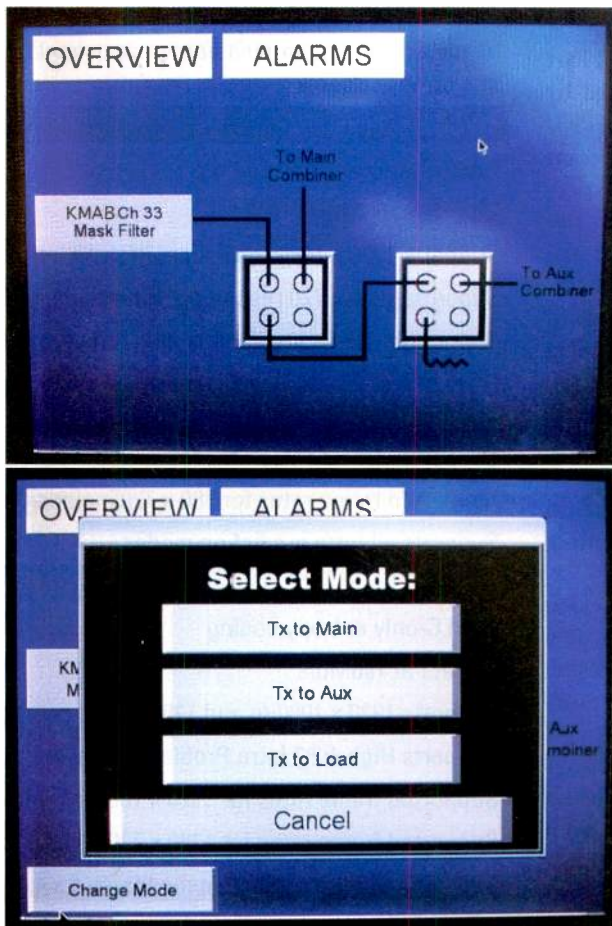

Figure 3. Transmitter room GUI control of RF switches

CoreEL's H.264 decoder

The decoder's single FPGA-based architecture does the same job that would require a farm of DSPs.

BY RAVI SRINIVASAN

HD video content is becoming rampant as more countries transition to DTV, and delivering HD content in a bandwidth-limited channel has become a challenge in itself. Catering to demanding broadcast and professional video applications requires a compression/decompression standard that allows no compromise in quality of content that has to be broadcast over a bandwidth-constrained network. To meet this demand, technology manufacturers are already rolling out products that include H.264 as the de facto standard.

Benefits of H.264

H.264/MPEG-4 AVC (MPEG-4 Part 10) video coding is standardized by the ITU-T in association with the ISO/IEC MPEG, together called the Joint Video Team. To cater to a wide variety of applications, ranging from low-data-rate, low-resolution consumer applications to high-quality content creation applications, the H.264 standard supports various profiles, including Constrained Baseline, Baseline, Main, Extended and High Profiles, as well as extension to existing profiles, called Fidelity Range Extension (FRExt). The latest extension to the standard includes Multiview Video Coding (MVC) for 3-D applications.

Broadcast and professional video applications require high-quality video at higher frame rates, such as 1080p60 performance. High Profile supports varied chroma subsampling formats (4:2:0, 4:2:2 and 4:4:4) with greater color bit depth ranging from 8 bits up to 12 bits and resolutions ranging from QCIF (176 x 144) to full HD (1920 x 1080), both progressive and interlaced scanning. It also supports adaptive block-transform switching between

4 x 4 and 8 x 8 macroblock and weighted prediction for scene changes.

The latest developments in the standard, in such areas as aspect-ratio and color-space conversion, are

specifically beneficial to professional video applications. Other standard features of H.264 include: multiple reference pictures, intra/interpicture prediction, motion compensation/

H.264 decoder

Supports High, Main and Constrained Baseline Profile decoders

Programmable color bit depth up to 12 bits

Supports 4:2:0, 4:2:2 and 4:4:4 chroma formats

Supports resolutions up to 1920 x 1080

Supports progressive and interlaced video inputs

Supports frame rates up to 60fps for progressive HD decoding

Supports high bit rates

Simultaneous multichannel decode

Validated on custom-built hardware using ITU-T, Fraunhofer and stress streams

AVC-Intra 50 decoder

CABAC-only entropy coding

Bit rate at 50Mb/s

Supports 1920 x 1080 resolution, High 10 Intra Profile at Level 4

Supports 1280 x 720 resolution, High 10 Intra Profile at Level 3.2

Support for 4:2:0 chroma sampling format and 10-bit color depth

Frames are horizontally scaled by 3/4 (1920 x 1080 is scaled to 1440 x 1080 and 1280 x 720 is scaled to 960 x 720)

Supported frame rates for 1440 x 1080 include 60i, 50i, 30p, 25p and 24p

Supported frame rates for 960 x 720 include 60p, 50p, 30p, 25p and 24p

Supports all Intra prediction modes — 4 x 4, 8 x 8 and 16 x 16

AVC-Intra 100 decoder

CAVLC-only entropy coding

Bit rate at 100Mb/s

Supports 1920 x 1080i/p and 1280 x 720p resolutions

Supports High 4:2:2 Intra Profile at Level 4.1 and 10-bit color depth

Supported frame rates for 1920 x 1080 include 60i, 50i, 30p, 25p and 24p

Supported frame rates for 1280 x 720 include 60p, 50p, 30p, 25p and 24p

Supports all Intra prediction modes — 4 x 4, 8 x 8 and 16 x 16

Table 1. CoreEL's H.264 HP and AVC-Intra decoders come in various configurations for broadcast and professional video applications.

estimation, temporal and spatial coding techniques, deblocking, entropy coding (CABAC/CAVLC), and a network abstraction layer (NAL) unit.

H.264 video provides better picture quality for a given data rate compared to its predecessors at the cost of higher computational power for compression

Manufacturers are rolling out products that include H.264 as the de facto standard.

and decompression, which leads to various implementations using standard PCs/servers, embedded processors, application-specific signal processors (ASSPs), digital signal processors (DSPs) and field-programmable gate arrays (FPGAs).

DSP vs. FPGA

DSP- or FPGA-based custom hardware is popular for broadcast and professional video applications. Today, with higher-performance FPGAs being available, FPGA seems to be a better alternative for such demanding applications. These implementations are now

possible using a single FPGA, which otherwise would require a farm of DSPs to do the same job. FPGAs also provide the same degree of flexibility as DSPs, making them more attractive.

CoreEL's H.264 High Profile decoder

CoreEL offers high-performance, high-quality and robust H.264 video decoding solutions on FPGAs for broadcast and professional video applications. Its H.264 hand-coded, real-time logic decoder is optimized for FPGA architectures, delivering higher performance at a lower clock speed and smaller memory footprint.

The decoder runs on a single FPGA and decodes H.264 HD and SD resolutions. It is also multichannel-capable with an optimal number of channels decoding simultaneously. The company's H.264 decoder solution is rich in features and comes in various configurations for different applications. (See Table 1.)

AVC-Intra decoder

Panasonic made a breakthrough in high-end broadcast and professional video cameras and recorder/players by introducing H.264 technology with Intra-frame-only processing branded as AVC-Intra, which is used

at very high bit rates, such as 50Mb/s and 100Mb/s. AVC-Intra has now become de facto technology in many of the upcoming cameras from various other manufacturers.

CoreEL has developed an AVC-Intra decoding solution (See Table 1.) and has tested it for such compliance using professional-level bit streams. Among other features, the solution includes robust error handling and error concealment features. The entire stream is divided into independent NAL units, and if any errors are detected, then the decoder stops decoding that particular NAL unit packet and continues to decode the next good NAL unit packet.

The design is also flexible and modular to meet the requirements of a wide array of applications. The decoder solution can be customized to achieve the desired bit rate, frame rate, resolution modes, chroma formats, bit depth, etc., and to decode multiple streams simultaneously. CoreEL's H.264 decoder supports a lower gate count and block RAM requirements, as well as a highly pipelined, scalable architecture for broadcasters transitioning to DTV.

BE

Ravi Srinivasan is assistant manager of technical marketing at CoreEL Technologies.

Curious? See you at NAB 2010, Booth C6747

RIEDEL
The Communications People

ARTIST DIGITAL MATRIX INTERCOM
The Solution for World Class Events.

Riedel Communications Inc. • 1721 Victory Blvd • Glendale, CA 91201 • USA • www.riedel.net

Deyan Automation's On Line MCR

Broadcasters can control automation via the Web.

BY DEJAN SEKE

Station managers, supervisors and engineers often find themselves in situations where they need to remotely access a station's automation software or equipment, especially if the station is running unattended. It can be for quality control, to occasionally make sure that "everything is OK," or it can be for a specific reason like making changes to an on-air playlist, recording a satellite feed or changing the power output of a transmitter. In practice, use of desktop-sharing applications or other types of control software is usually limited to a single computer; therefore a person would need to have his or her PC available at all times.

To avoid this restriction, Deyan

Automation recently introduced On Line MCR, a service that provides access to automation and equipment control applications through a Web browser. (See Figure 1.) Users can control and monitor on-air automation, ingest channels, timed scheduled ingest lists, transmission equipment, temperatures, relays, tower lights, etc., from any place with an Internet connection using any device capable of Internet browsing. This results in a few key advantages:

- A user is not limited to a single computer and is free to use any available computer regardless of its operating system (Windows, Mac OS, Linux, etc.).
- Service can be used through a smartphone.

When using a smartphone, a user is not limited to the available wireless networks, but can access the Internet through cell phone service.

How the site is set up

The default Web site consists of a log-in page, application control pages and user management pages. Which application control pages are shown depends solely on the user's system requirements. There is a default Web site design, but the system's flexibility allows the Web site to be modified or custom designed according to the user's specifications.

In the case of the on-air playout application (AirMaster), the default page displays an on-air playlist, real-time clock, remaining and elapsed

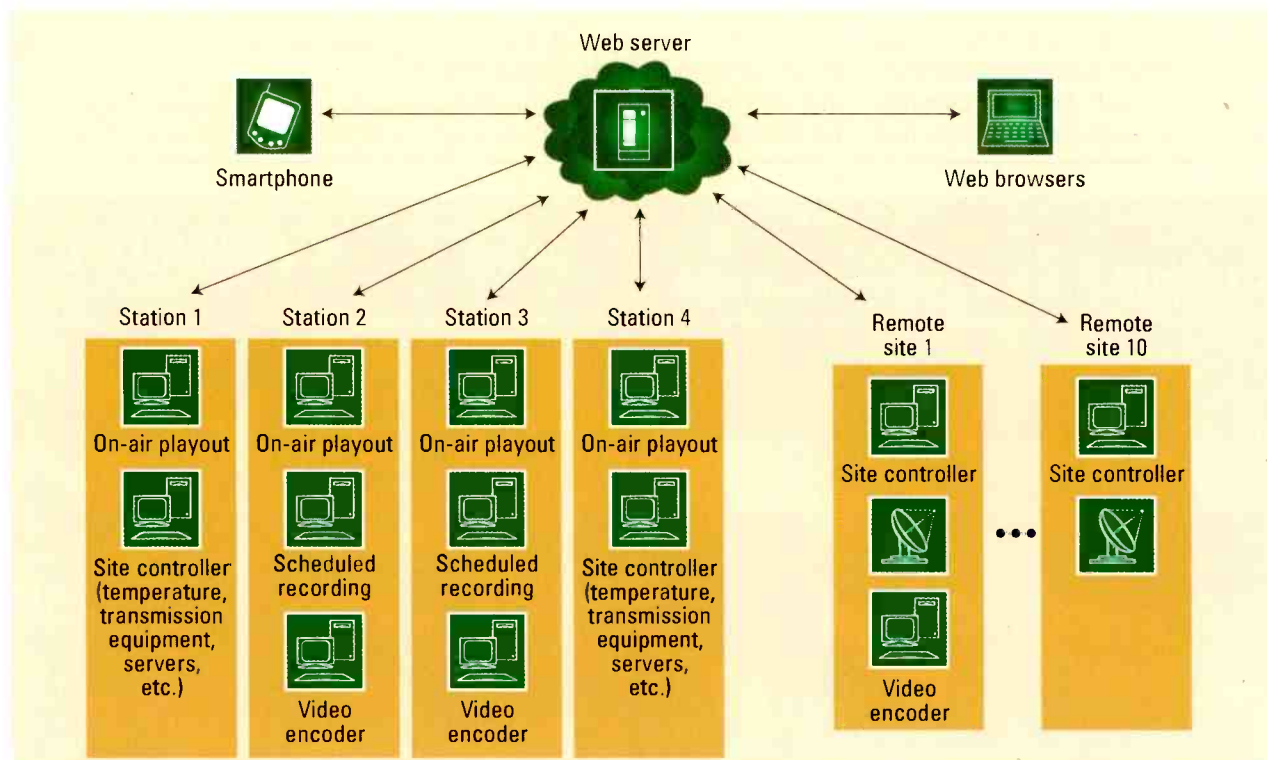

Figure 1. Deyan Automation's On Line MCR allows broadcasters to sign in to a default Web page and control station automation.

time of the on-air event, and playlist control buttons like take and hold; gives the option of an on-air database search and playlist editing; and can include live on-air video.

A page for an automated ingest application (ClipMaker) provides control of timed record lists of the remote application and allows users to place a video server into record manually. Just like with the on-air playout page, video and audio of a video server's output can be included in order to remotely monitor the recording process. It is also possible to keep multiple ingest applications in sync with the timed list located on the Web site, allowing users to set the ingest time for multiple video servers by editing a single record list. This can be handy in case the same satellite feed has to be recorded to video servers located in different facilities.

The default Web page for the hard-

ware monitoring and control application (HMC) displays a table with various parameters requested by the user, including relay states, temperature, UPS status, tower lights and satellite receiver information. The page will also display alarm conditions for each parameter that gets out of bounds.

Which pages a user is allowed to see and control is defined in the user management page. For example, permissions can be set so station engineers can monitor and control the status of equipment, and an MCR supervisor can monitor and control play and record lists, while the station manager monitors the entire system but may not be allowed to make changes.

In the case of a multichannel environment or if multiple remote sites are being monitored, an additional main page can be added to the site. This

single page displays alarm statuses of all the other pages. If an alarm condition occurs (such as missing a playlist clip, server failure or high temperature), it will also be reflected to this main page, thus allowing monitoring of the entire system through a single Web page. This effectively makes even a smartphone a centralcasting point. Streaming videos from each individual playlist can also be added. In addition, it is possible to send e-mails or SMS to required personnel in case an alarm has been triggered.

Conclusion

On Line MCR is a management tool that provides 24/7 access to almost the entire playout process of a station. It's available regardless of whether you're on the road, in a hotel or a restaurant.

BE

Dejan Seke is the owner of Deyan Automation.

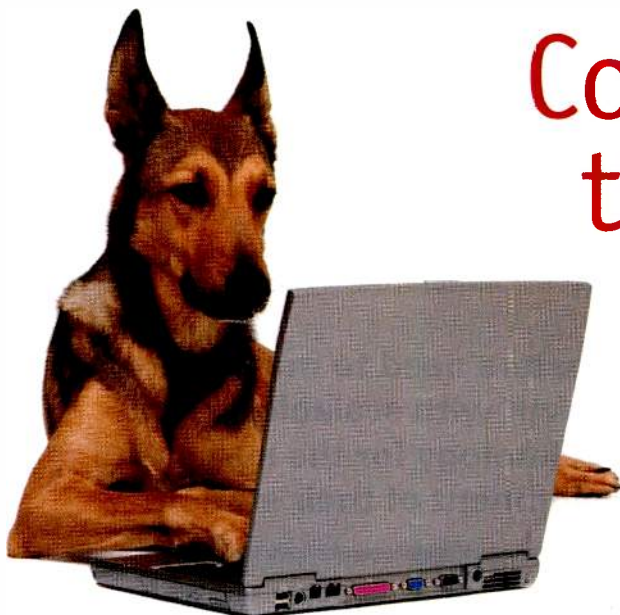

Come run with the big dogs!

Zeus Broadcast customers include some of the largest media and communications companies in the world. Why trust your equipment management needs to anyone else?



Zeus
BROADCAST

zeusbroadcast.com

Anytime, anywhere. That's the beauty of our 100% web-based equipment and service management system. Made by broadcasters for broadcasters, Zeus allows an infinite number of users to access the site from any Internet connection at anytime. Isn't that simple?

Abit's Show^{it} automation

The compact automation system easily adapts to changing workflows.

BY ROB LEISHMAN

Digital workflow is a common aim for broadcasters across the globe. On the one hand, they would like to realize the increased efficiency of the integration of different departments. On the other hand, given the ongoing economic challenges, they also need to make sure that the level of investment does not outweigh the benefits.

When it comes to broadcast transmission, the solution needs to ensure as much of the workflow as possible is automated. The automation system may, for example, be required to handle multiplatform content in addition to HD formats and conventional SD broadcast material, while at the same time managing both legacy-based hardware and software driven equipment. Yet, broadcasters also need to match plans for growth with scalable, future-proof technology for the successful development of their station.

What's the solution?

To manage these multiple technology challenges, it is necessary to select a system that can easily be adapted to a changing workflow. Abit's compact automation system Show^{it} achieves this by seamlessly linking playout, recording and archiving workflow, combining live feeds, pre-recorded material and special effects all registered in a heavily optimized database. The small platform is capable of providing workflow and playout automation for up to three transmission channels.

How does it work?

To realize overall frame-accurate broadcast, the communication to all of the devices needs to be synchronized, and Show^{it} achieves this through the

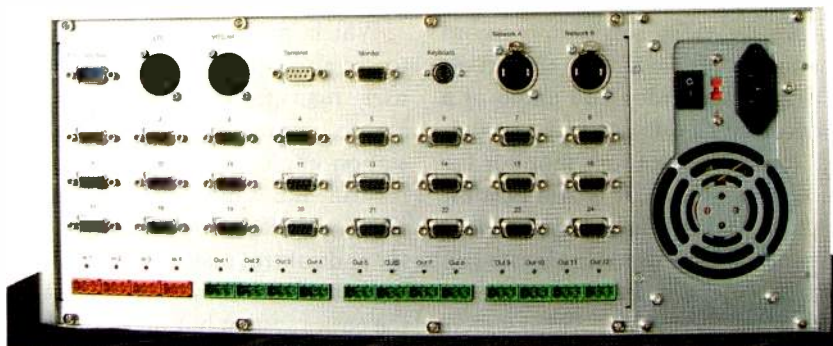

Abit's Showit is a compact automation system that seamlessly links playout, recording and archiving workflow.

utilization of a centralized architecture with a real-time operating system. This means it is possible to configure and easily change workflow. The system can logically link any type of device at a conceptual level through the incorporation of a range of templates, allowing the addition of any new device like a server, mixer or router at any time.

Tight real-time integration of a particular brand of device (regardless of whether that is a media management, storage or archive system)

plates assigned to each physical device are automatically reflected down to the applications it interfaces with, making changes to peripheral equipment a simple process.

The protocol driver for communicating with each specific device is maintained separately and operates at or close to the external physical connection. Integration is simplified as no control logic is included at this level, and as a result, the system can manage and control any current system or one that is yet to be created.

Broadcasters need to match plans for growth with scalable, future-proof technology for the successful development of their station.

is incorporated in software modules that operate in real time close to the external communication link. In this way, the nondevice-specific, top down arrangement means the system is essentially future-proof.

Each interface operates in accordance with high-level control algorithms so upgrades to logical tem-

Optimal workflow configuration is achieved by the creation of flexible routing tables, allowing high availability workflow through the physical router and mixer while applying rule-based control embedded in the application software or operator commands from the workstations.

This centralized architecture finds

the integrated broadcast automation software running on a master control processor while the communication servers communicate over a high-speed VME backplane, with Serial and GPI signals controlling the peripheral equipment over physical connections. The software running on the communication servers (protocol driver) runs on a real-time operating system that maintains low level synchronization of logical tasks and communication using the station time signal as a reference, resolving frame accuracy issues.

The centralized architecture allows a single channel to be broadcast on multiple channels, enabling last-minute changes to be reflected across the broadcast spectrum while taking into account varying factors for each stream, such as commercial regulations, time zone differences, transmission path timing characteristics, opt-

out scheduling and control signals for use in interactive services. Tightly coupled control algorithms allow seamless inclusion of branding and commercial placement in both HD and SD in

algorithms rather than device-driven transmission control provide a solution that meets broadcasters' specifications and evolving aspirations. The understanding that the specification

Tightly coupled control algorithms allow seamless inclusion of branding and commercial placement in both HD and SD.

accordance with the primary schedule or under the control of the production staff, up to the time of transmission.

Conclusion

In the past, large computer systems were required with extensive software development to provide a supplier delivered solution. Now with the combination of newer and faster processor cards, high-level flexible workflow

is the start and not the end is imperative in the broadcast industry. The combination of Show^{it} and the company's partnership-driven approach can now contribute to achieving digital workflow while still keeping budgets under control. **BE**

Rob Leishman is marketing manager for Abit.



**Tune into
Brad on
Broadcast**

for an inside take on the industry's hottest topics

Broadcast Engineering has launched an exciting new weekly dialog called *Brad on Broadcast*. Editorial Director, Brad Dick, hosts the blog and offers his viewpoints on key industry issues and those most affecting the magazine's readers. From technology to budgets, from competition to industry cutbacks, Brad tackles them all — and invites your feedback.

Armed with 18 years as a broadcast engineer and more than 20 years as a *Broadcast Engineering* editor, Brad Dick understands the challenges and needs that technical managers and engineers face. He's been on the front line, solved problems and learned from the experiences. Now he's sharing those thoughts in a weekly blog.

Tune in to become a part of this critical industry conversation.
<http://blog.broadcastengineering.com/brad>

The HM100 and HM700

JVC's camcorders offer the ability to switch between two file structures.

BY STEVE MULLEN

The ability of video camcorders to switch between different formats became common with the release of DVC-based units that could switch from DV to either DVCAM (Sony) or DVCPRO (Panasonic). More recently, camcorders have evolved to support multiple codecs, e.g., DVC-based formats (DVCPRO, DVCPRO50 and

two additions to its ProHD series — the GY-HM100 and GY-HM700. With these camcorders, JVC has taken advantage of the general industry move to file-based recording by adding a recording option — the ability to switch between two file structures.

The company has licensed from Sony the right to encode, using a

QuickTime (MOV) file structure. Therefore, both camcorders are able to record the multiple shooting options displayed in Table 1 to either MOV or MP4 files. (The 19Mb/s data rate is a JVC HD1 HDV-compatible format, while the 25Mb/s data rate is a Sony HD2-compatible format.)

Both camcorders write data to SDHC media. Data can be accessed from SDHC via a USB 2.0 connection when the cards are in the camcorder, or it can be read from cards inserted into a reader.

The GY-HM700 supports an additional media type when an optional JVC KA-MR100G memory recorder is installed. The KA-MR100G provides a slot for an SxS (Sony/SanDisk) card. Recordings, which can be made only at 35Mb/s and 25Mb/s, are treated in post as Sony XDCAM EX.

The camcorders' ability to write MOV files initially led to the impression that this file type was only for use with Final Cut Pro. And, conversely, MP4 files were to be written only when a Windows-based NLE was to be used. Working with the HM100, I learned this was incorrect.



The GY-HM100 weighs 3lbs, uses three 1/4in, 1280 x 720 progressive CCDs and features a Fujinon 10:1 zoom HD lens.



The GY-HM700 weighs 8lbs and uses three 1/3in progressive scan 1280 x 720 CCDs. Both the HM700 and HM100 record two channels of uncompressed 16-bit audio at 48kHz when recording at 25Mb/s and 35Mb/s.

DVCPROHD) and an H.264/AVC-based codec AVC-Intra.

Along the way, camcorders also acquired the ability to shoot at multiple frame sizes and frame rates. This flexibility, although obviously offering great value, has a downside. Producers, seemingly unaware of the many shooting options provided by today's camcorders, often fail to define the recording parameters required for the post-production workflow they plan to employ. Thus, post houses now routinely receive media shot with incorrect parameters. Moreover, different shooters, working on the same project, often set up their cameras differently. The greater the flexibility engineered into a camcorder, the greater the risk of these errors.

JVC-developed MPEG-2 encoder, a bit stream compatible with XDCAM EX. Additionally, it has licensed both an XDCAM EX-compatible MPEG-4 (MP4) file structure, as well as the

The next step in flexibility

At NAB2009, JVC introduced

Frame rate	Frame size		
	1280 x 720	1440 x 1080	1920 x 1080
23.98p	35Mb/s		35Mb/s
	19Mb/s		
25p/29.97p	35Mb/s		35Mb/s
	19Mb/s		
50p/59.94p	35Mb/s		
	19Mb/s		
50i/59.94i		35Mb/s only as MOV	35Mb/s
		25Mb/s	

Table 1. Data rates available as a function of frame size and frame rate

Editing MOV files

As expected, MOV files can be natively edited by Final Cut Pro (v6.0.4 or later) without any need to transcode to another format. Although MOV files can be edited directly from SDHC media, in most cases, media files will be dragged to a hard disk prior to editing. When FCP is installed, its MPEG-2 codec supports the reading of MOV files by other OS X applications, including Cinema Tools, Final Cut Express and iMovie 09 — plus the import, with transcoding to DNxHD, by Avid's Media Composer.

Macs, without FCP installed, require the addition of an XDCAM EX decoder, either the free Perian XDCAM component or XD Decode from Calibrated Software. Once installed, MOV files can be read by Adobe applications. The XP and Vista version

of XD Decode enable MOV files to be used by Windows applications, including the QuickTime player and Vegas Pro 8 and 9.

Editing MP4 files

Avid Media Composer V3.5 and V4.0, using Avid Media Access (AMA), can natively edit MP4 files. Native editing of MP4 files is also possible with Premiere Pro CS4, Grass Valley EDIUS 5.0 and Vegas Pro 9.

For OS X users who need to edit MP4 files, Calibrated Software markets its MP4-EX Import component, which enables MP4 files to be read by FCP. The component rewraps MP4 so it can be decoded by the FCP MPEG-2 codec. (Without this FCP codec installed, Calibrated Software's XD Decode component must be purchased.)

The free Sony XDCAM EX browser, available for OS X and Windows, can

transcode XDCAM EX to DV, as well as rewrap MP4 files to MXF clips that can be imported by versions of Media Composer without AMA. With the appropriate encoders purchased from Main Concept, the Sony browser can also transcode XDCAM EX clips to H.264/AVC (PSP and iPod), Windows Media, XDCAM HD and XDCAM HD422.

The vast number of shooting and recording options provided by the GY-HM100 and GY-HM700 make it absolutely necessary that producers develop and document a precise workflow for camera operators. This requirement will become more critical as camcorders increasingly offer multiple shooting and recording options. **BE**

Steve Mullen is owner of Digital Video Consulting.

subscriptions

Let *Broadcast Engineering* keep you up-to-date on the latest industry news, technology developments, new products and services...and more.

Apply for your free subscription today. Log on to broadcastengineering.com and click on "subscribe."

And...you can also sign up for any of the industry's leading e-newsletters from *Broadcast Engineering*.

broadcastengineering.com

BroadcastEngineering



A recording conundrum

The goal is achieving a standardized method of interchanging content between recording media.

BY JOHN LUFF

The history of video recording has a remarkably short timeline, at least in the commercial sense. The first generally available solution was the Ampex VR-1000, developed by a storied team in the mid-1950s. When the National Academy of Television Arts & Sciences belatedly awarded a Technical Emmy a few years ago, Charlie Anderson and Ray Dolby represented the rest of their colleagues (many deceased) and shared some wonderful stories. It is interesting to note that Ampex was an audio recording company that attacked the problem in a philosophical way as a scale up from the technologies used in analog audio recorders. However, in some fundamental ways, the company had to forget what it knew about audio and attack the wide bandwidth, tape-swallowing monster with innovation in order to get to a viable solution. One innovation was rotating heads; another was FM recording on magnetic tape.

A few other celebrated recorders were approached with similar innovation, perhaps none more fundamentally different than the first commercial digital recorder, the Sony DVR-1000 D-1 introduced about 20 years later. Digital video was not developed for the recorder; rather, the opposite is true. The ITU-R BT601 standard needed a recording system, and the natural extension was to assume tape was the medium that was appropriate. Indeed, primitive digital disks — both metal platters like those in current hard drives and oxide coated arrays of platters — were in common use, but with very limited storage capacity. Tape offered much higher storage density and commercially viable economics. Digital tape



Bosch's Quartercam recorder was created after former ABC executive Julius Barnathan told manufacturers he wouldn't buy a new tape format until a company made a 1/4in tape size.

offered uncompressed performance that didn't degrade from generation to generation — a pretty radical change in product concept.

In order to understand modern recording technologies, it's critical to know that commercially viable solutions can be made using many approaches, but the ones most successful no longer work financially unless the

adopts the fundamental technology and adapts it to the rigors of broadcast usage. Essentially every recorder, server and replay system available today leverages IT or consumer electronics research to achieve economics that can succeed.

This applies to every recording technology I looked at in researching this article. Hard drives are IT

Essentially every recorder, server and replay system available today leverages IT or consumer electronics research to achieve economics that can succeed.

technology was researched for other purposes. For example, the success of DVCPRO in the news marketplace was fueled by the research done by a consortium, including both Panasonic and Sony, into a DV-based consumer recorder standard. DVCPRO

hardware repurposed. Memory card recording is IT hardware, with applications in consumer camcorders. Optical disks are developed for both consumer delivery of packaged media and IT archival storage. It is important to know why this has become a

universal theme in our industry, applicable to everything from camera to displays. We are simply too small of a marketplace in the global economy to be of much interest to large-scale industrial development without multiple ways to use a product or component. In total, the broadcast hardware marketplace is smaller than the size of HP's printer business. (HP's 2009 Q4

like." This is not surprising. Each one has attributes that make it well suited to specific tasks, and certainly one of those attributes is cost. Each one has a dedicated marketing team trying to fight through a thicket of competing commercial solutions. I find it interesting that with the exception of the large networks around the world (the big three in the United States, BBC,

technology deployment. We used to have format wars, with some companies insisting they would only purchase a format if it was supported by more than one manufacturer. The result was industry cooperation, with SMPTE acting as the standards body that facilitated the exchange of design information necessary to achieve a unified standard.

If we could all agree on the coding standards for the essence, it would be easy to specify a standardized method of interchanging the content between various recording media.

Report showed that the company's printers and imaging revenue was ~\$24 billion in 2009 and ~\$29 billion in 2008). Broadcast worldwide is a fraction of one company's revenue in the IT sector.

If you want to make an efficient way to develop and market a technological product, don't spend a fortune on primary research applicable only to broadcast. Here's the best example: MPEG is decoder-centric. Encoders are expensive and a relatively small market. Decoders show up in orders of magnitude more places and are intended to be cheap to deploy. The broadcast industry adapted MPEG to video recording and developed the MXF standard based on something done to deliver video to the home cheaply. As my math professors used to say: Q.E.D. MPEG development was practical and chip deployment commercially viable because the market for consumer electronics swamped the potential for a broadcast product.

So it is not a surprise that using inexpensive components, we can build sophisticated and relatively expensive video recording systems — many of them. Charlie Jablonski, a former NBC engineering executive and SMPTE president, has often said NBC "... never met a tape format they didn't

NHK, ZDF and a few others), no one delivers specifications to manufacturers and says "develop this product, and we will buy it in quantity." Increasingly, even those important voices play a smaller role in defining recording products in advance. It has become more generally accepted that major users review rough designs and make suggestions about modifications to the packaging and performance that will make it more acceptable for their individual use.

I remember when Julius Barnathan, a longtime ABC executive, told every manufacturer that he was not buying a new tape format until someone got the tape size down to 1/4in. Bosch responded with what it cleverly called "Quartercam" (6.25mm in metric terms), which was probably a blatant play to ABC at the time. Today, that would be an unlikely story, but I know of one network that specifically told a manufacturer its news recording format would be acceptable if it also had an option for recording to removable memory cards, which was coincidentally already in development for consumer products at the same company.

Interchange wars

It is also important to point out one other parallel to early recording

technology deployment. We used to have format wars, with some companies insisting they would only purchase a format if it was supported by more than one manufacturer. The result was industry cooperation, with SMPTE acting as the standards body that facilitated the exchange of design information necessary to achieve a unified standard.

Today the battle is enjoined around file interchange as we move away from removable media for storage, and again SMPTE leads part of the charge to establish standards necessary to allow interchange of content. MXF is a central part of that interchange. But owing to the complexity of the problem, and the huge number of pages of technology the MXF standard contains, we still have not achieved a simple method for interchange. The Advanced Media Workflow Association picks up where SMPTE stopped with MXF and has created application specifications, which constrain MXF options with the goal of making content interchange more predictable.

It is worthy to note that MXF does not standardize the content, the essence itself, but rather standardizes the method of delivering a file that can be read if the receiver has codec appropriate to the essence. Therein lies part of the conundrum in modern recording systems. If we could all agree on the coding standards for the essence, it would be easy to specify a standardized method of interchanging the content between various recording media (hard disks, memory cards, optical media, etc.). I hope we get there in my lifetime. **BE**

John Luff is a broadcast technology consultant.

? Send questions and comments to: john.luff@penton.com

STORAGE & NETWORKING ONESTOP
at www.broadcastengineering.com

For more news and articles on storage & networking, visit our Web site and click on the **Storage & Networking** link at the top of the page

Blackmagic Design UltraScope v1.1

PCIe card and software package update features new composite waveform view digitally synthesized from the SD or HD video input; allows editors to align video levels in a more familiar, traditional way; can show luminance, composite or both displayed side by side; includes RGB parade, luma plus composite display and vectorscope waveform monitors; available as free download for existing UltraScope users.

408-954-0508
www.blackmagic-design.com

Element Labs SP2

Video processor works with STEALTH portable video display; supports creative mapping and 48Hz, 50Hz and 60Hz frame-rate modes; enables users to rotate STEALTH panels upside down or sideways to achieve more creative screens; DVI input mode allows STEALTH screens to be used in a wider film and TV market.

408-988-9400
www.elementlabs.com

ComNet ComWorx CNFE1CL1MC



Data transport solution accepts 10/100TX Ethernet data and transports it over common 75Ω coaxial cable or twisted-pair telephone wire; can extend distances between devices to as much as 500m on coaxial cable or up to 3000m on twisted-pair wire; features standard BNC connector or terminal block output port and RJ-45 connector input port; can operate in environments with extreme temperatures and vibration.

203-796-5300; www.comnet.net

Dalet

Advanced, portable Web-based media asset management and news production application uses latest Web 2.0 technologies; features professional video and audio production tools, an enterprise search engine and user-friendly interface; streams media in H.264 or MPEG-4, making remote access to the main archive simple and fast.

212-269-6700; www.dalet.com

Linear Acoustic



Compact 2RU multichannel audio and video monitor provides advanced audio metering functionality and performance; displays 16 bar graphs of embedded or AES audio simultaneously; features preset menus and shortcut keys that allow for rapid, intuitive access to critical elements of complex broadcast audio systems; can decode Dolby AC-3 or Dolby E, create downmixes from discreet or Dolby-encoded audio, analyze metadata, and store any input selection/listening mode to one of 24 user presets and recall them instantly.

717-735-3611
www.linearacoustic.com

Sony



Solid-state camcorder features Exmor CMOS sensor with ClearVid array to deliver HD resolution and low-light sensitivity with low noise; records AVCHD up to 24Mb/s; delivers 1920 x 1080 HD images with both interlace and progressive modes as well as native 1080/24p, 720/60p and MPEG-2 SD recording; includes both HD-SDI and HDMI outputs as well as two-channel linear PCM audio capabilities, 720/60p recording, built-in GPS function, SMPTE time code I/O and an upgrade option for switchable 60i/50i; users can record content to Memory Stick PRO Duo media and Class 4 or higher SDHC cards.

212-833-6800; www.sony.com

Enterprise Edition WebSpace module

NETIA

Asset management system simplifies cataloging, indexing, accessing and distribution of media; supports industry-standard formats, content ingest, browse proxy generation, media enrichment through speech-to-text functionality and easy access to media; incorporates Workflow Engine, which orders tasks to optimize efficiency and load balancing, automates content distribution processes, and includes a security and warning system; can perform automated transcoding and publishing of media and metadata to the Internet, VOD, mobile services and IPTV; includes Hypercast Warehouse set of archiving tools, which integrates with any environment and can be used to manage audio, video or images in all file formats (MXF, XDCAM, MPEG-4, MPEG-2, WMV, etc.).

888-207-2480; www.netia.com

Aviom

MT-X Expansion Box



Expansion box can be added to any A-16 or A-16II Personal Mixer; offers robust protection to the mixer's case and connectors while supplying additional audio connectivity; features 1/8in stereo headphone jack as well as separate XLR L/R audio outputs; all connectors are located on the underside of the unit, with an internal wire harness that connects to the A-16II audio output and A-Net input; includes a heavy-duty, locking EtherCon connector.

610-738-9005; www.aviom.com

PPC

MoCA Filter

Filter prevents interference between subscriber homes that use MoCA technology, minimizes MoCA energy on cable TV feeder and supports 1GHz passband; compliant with MoCA specifications and protects integrity of MoCA signal level within the subscriber's home.

315-431-7200; www.ppc-online.com

Boris FX Boris Continuum Materials

Graphics software generates realistic textures such as steel plates, bricks, clouds, granite, wooden planks and rock, among others, which are procedurally generated to ensure smooth render at any scale; provides a variety of animation parameters — including controls for the color, width, height and other aspects of the material; allows users to add 3D detail and lighting to the material surface as well as apply materials to realistic surfaces or use them as animated organic backgrounds; supports Apple Final Cut Pro, Final Cut Express, Motion, Adobe After Effects and Premiere Pro.

888-772-6747; www.borisfx.com

Valups

Tivit



Mobile DTV receiver can run for three hours of continuous TV reception and is smaller and lighter than a deck of cards; beams the TV signal via WiFi to a receiving WiFi device compatible with RTSP; works with 3G Apple iPhone, 3G iPod Touch, BlackBerry devices with WiFi, Motorola Android phones and Windows PCs; includes a microSD slot for a future conditional-access module that could accommodate subscription-based broadcast programming.

+82 2 2140 1910; www.valups.com

Axcera

ATSC M/H Mobile DTV equipment

Equipment includes TV broadcast solution and lab signal generation and distribution system; broadcast solution provides mobile DTV capability as part of a new system or retrofit upgrade; includes MHPM-A ATSC M/H preprocessor/multiplexer and Axciter Intelligent Modulator, along with encoding, service signaling and ESG equipment; DTxA2C distributed transmission adapter and “slave-mode” modulator options are also available to turn system into an ATSC A/110B-compliant single-frequency network; signal generation and distribution system provides a signal source for verifying and optimizing mobile DTV receiver performance; includes DM8BL-R ATSC M/H exciter and can be packaged with preprocessor or stream server that provides an ATSC M/H bit stream directly to the exciter; offers enough signal level to provide in-building UHF or VHF coverage through an antenna or cable distribution network.

800-215-2614; www.axcera.com

Technomad

Schedulon



Automatic MP3 player and recording system provides instant, manual playback of up to 99 knob-assigned, user-loaded audio files from a front-panel screen; allows instant playback on a user-defined schedule based on an internal clock or synchronized network time server; features an internal backup option that provides 20 minutes of battery-powered redundancy in the event of power loss, and keeps all scheduled playback events on target for about 75 minutes.

800-464-7757; www.technomad.com

RapcoHorizon

AC-Audio

Composite cable offers both AC power and two channels of digital audio within the same audio jacket; designed to be used with most new, professional-quality, self-powered speaker PA systems that provide both AC power and input signals simultaneously; consists of three 14GA conductors with rugged PVC outer jacket, separate from the audio channels; audio channels accommodate both digital and analog signals and are designed under AES/EBU standards; available in bulk and can be equipped with a variety of connector combinations.

800-467-2726

www.rapcohorizon.com

A PENTON MEDIA PUBLICATION

BroadcastEngineering®

www.broadcastengineering.com

Editorial Director: Brad Dick, brad.dick@penton.com
Editor: World Editor: David Austerberry, editor@broadcastengineeringworld.com
Managing Editor: Susan Anderson, susan.anderson@penton.com
Assoc. Editor: Collin LaJoie, collin.lajoie@penton.com
Assoc. Editor: Angela Snell, angela.snell@penton.com
Sr. Art Director: Michael J. Knust, mike.knust@penton.com
Art Director: Robin Metheny, robin.metheny@penton.com
Technical Consultants: Computers & Networking – Brad Gilmer
Digital Video – Aldo Cugini
Legal – Harry C. Martin
New Technology – John Luff
Industry Watcher – Anthony Gargano

Group Publisher: Wayne Madden, wayne.madden@penton.com
Marketing Dir.: Kirby Asplund, kirby.asplund@penton.com
Dir., Online Product Development: Dean Muscio, dean.muscio@penton.com
Vice President of Production: Lisa Parks, lisa.parks@penton.com
Production Manager: Kathy Daniels, kathy.daniels@penton.com
Classified Ad Coord.: Sarah Maxey, sarah.maxey@penton.com
Audience Development: Kris Cunningham-Kristi Cunningham, kris.cunningham@penton.com
Group Show Director/LDI: Sharon Morabito, sharon.morabito@penton.com

Penton Media

Penton Media, Inc.
249 West 17th Street
New York, NY 10011

Chief Executive Officer: Sharon Rowlands, sharon.rowlands@penton.com

MEMBER ORGANIZATIONS

Sustaining Member of:

• Society of Broadcast Engineers

Member, American Business Media; [missouri association of publications](http://missouriassociationofpublications.com)
The Missouri Association of Publications



BE US/Canada SUBSCRIPTION RATES: Free and controlled circulation to qualified subscribers. Non-qualified persons may subscribe at the following rates (Prices subject to change): USA and Canada, 1 year, \$99.00, 2 years, \$171.00, 3 years, \$242.00; Outside USA and Canada, 1 year, \$116, 2 years, \$204.00, 3 years, \$292.00 surface mail (1 year, \$193.00, 2 years, \$347.00, 3 years, \$506.00 airmail delivery).

BE World SUBSCRIPTION RATES: Free and controlled circulation to qualified subscribers. Non-qualified persons may subscribe at the following rates (Prices subject to change): USA, 1 year, \$94.00, 2 years, \$160.00, 3 years, \$226.00; Outside USA, 1 year, \$110, 2 years, \$193.00, 3 years, \$275.00 surface mail (1 year, \$182.00, 2 years, \$336.00, 3 years, \$490.00 airmail delivery).

ARCHIVES AND MICROFORM: This magazine is available for research and retrieval of selected archived articles from leading electronic databases and online search services, including Factiva, LexisNexis and Proquest. For microform availability, contact National Archive Publishing Company at 800-571-0600 or 734-761-4700, or search the Serials in Microform listings at napubco.com.

REPRINTS: Contact Penton Reprints to purchase quality custom reprints or e-reprints of articles appearing in this publication at 888-858-8851. Website: www.pentonreprints.com. Email: reprints@pentonreprints.com

PHOTOCOPIES: Authorization to photocopy articles for internal corporate, personal, or instructional use may be obtained from the Copyright Clearance Center (CCC) at 978-750-8400. Obtain further information at copyright.com.

PRIVACY POLICY: Your privacy is a priority to us. For a detailed policy statement about privacy and information dissemination practices related to Penton Media products, please visit our Web site at www.penton.com

EDITORIAL and BUSINESS OFFICE: Penton Media, 9800 Metcalf, Overland Park, Kansas 66212 • 913-341-1300 • penton.com

Copyright 2010, Penton Media, Inc. All rights reserved.

DVEO Broadcast Division *Extra Value for the Digital Age*

SD+HD-SDI Input or Output



VidPort SD-HD™

- Input card converts to output card
- Auto standards detection on input
- Linux® and Windows® support

858-613-1818
www.dveo.com



Get the best performance up to 6 GHz at the best price with Radiall's "True" BNC 75 ohm HDTV Connector Series!

Ideal for Broadcast Transmission System Applications



For a FREE White Paper and BNC 75 HDTV Connector, go to www.radiall.com

RADIALL

Broadcast Engineering

PRODUCTS & SERVICES SPOTLIGHT SECTION

Your **Product & Services Spotlight** ad provides you with a cost effective opportunity to:

- Position your company or brand
- Announce new products or services
- Promote and drive traffic to your website
- Keep your company top of mind every month

To advertise in the **Products & Services Spotlight** section, please contact:

JULIE DAHLSTROM
P 312.840.8436 F 913.514.3684
JULIE.DAHLSTROM@PENTON.COM

CLASSIFIEDS

For Sale



Acoustics First®
Toll-Free Number: **888-765-2900**
Materials to Control Sound and Eliminate Noise™
<http://www.acousticsfirst.com>

Lithium-Ion Batteries for Professional Video Cameras and Camcorders



OEM Direct Replacement
V-Block or U-Pin Mounts
Up to 100 watt/hour
LED or LCD Metering
External Power Port

videotechsupply.com

BROADCAST ENGINEERING

TO REACH INDUSTRY PROFESSIONALS PLACE YOUR AD TODAY!

JULIE DAHLSTROM
P 312.840.8436 JULIE.DAHLSTROM@PENTON.COM

Help Wanted

RADIO BROADCAST TECHNICIAN – Maintenance (BBG-10-005) LOCATION: Washington, DC

The Voice of America is seeking a full-time Radio Broadcast Maintenance Technician (RBT) to join our Radio Maintenance Service team in supporting radio broadcast facilities and other multi-media systems at VOA Headquarters in Washington, D. C.

MAJOR DUTIES:

- Troubleshoot, diagnose, repair, and perform preventative maintenance on all technical equipment in studio and production facilities, including portable audio and video multi-media devices.
- Install, construct, and provide design assistance, for new broadcast engineering projects or to upgrade existing broadcast systems and equipment.
- Prepare and process equipment and materials, and evaluate relevant equipment and tools for Radio Maintenance Service use.
- Preparation and timely delivery of required status information and reports including complete maintenance and operation logs, and documents.

QUALIFICATIONS REQUIRED:

Applicants must have technical experience in professional radio, television, and/or multi-media systems that clearly demonstrates the ability to troubleshoot and repair broadcast related equipment, including portable audio and video multi-media devices. The experience must have been progressively responsible and must clearly demonstrate the applicant's competence in troubleshooting and maintaining a diverse range of broadcast related equipment manufactured by a wide range of vendors in the broadcast industry.

Details about this position and how to apply can be found at:
<http://jobview.usajobs.gov/GetJob.aspx?JobID=85469772>

You can mail or hand deliver your application materials to the address below:

International Broadcasting Bureau
ATTN Office of Personnel
330 Independence Ave., SW, Rm. 1543
Washington, DC 20237

If you have questions regarding this position (Radio Broadcast Technician – Maintenance announcement (BBG-10-005) please contact: Leslie Brown (202) 382-7500.

	Page #	Advertiser Hotline	Website Address
AJA Video	29	800-251-4224	aja.com
Blackmagic Design	5	408-954-0500	blackmagic-design.com
Burst	57	888-472-2820	burstvideo.com
Canare Cable Inc.	46, 48, 50	973-837-0070	canare.com
Cobalt Digital	34	800-669-1691	cobaltdigital.com
Dolby Laboratories Inc.	15		dolby.com
Ensemble Designs	19	530-478-1830	ensembledesigns.com
ESE	31	310-322-2136	ese-web.com
Evertz Microsystems Ltd.	IBC	877-995-3700	evertz.com
For. A Corporation of America	17	714-894-3311	for-a.com
Harris	39	800-231-9673	broadcast.harris.com/x50
Harris	BC	800-231-9673	broadcast.harris.com/ multiviewers
Ikegami Electronics	11		ikegami.com
Lawo North America Corp.	30	416-292-0078	lawo.de
Linear Industries Inc.	3	847-428-5793	linear-tv.com
LYNX Technik AG	51	+49 6150 18170	yellobrik.com
Miranda Technologies Inc.	9	514-333-1772	miranda.com/loudness
NAB Show 2010	35		nabshow.com
Nevion	33	800-515-0811	nevision.com
Omneon	21	866-861-5690	omneon.com/ mediagridperforms
Panasonic Broadcast	IFC		panasonic.com/p2hd
Riedel Communications	23, 69	914-592-0220	riedel.net
Salzbrenner-Stagetec Media Group	47	888-782-4391	stagetec.com
Snell Group	13		snellgroup.com/ kahunaverse
Stanford Research Systems	45	408-744-9040	thinksrs.com
Streambox	49	206-956-0544	streambox.com
Triveni Digital	41		trivenidigital.com
Utah Scientific	25	800-453-8782	utahscientific.com
ViewCast	7	800-540-4119	viewcast.com\be
Zeus Broadcast	71	407-352-6501	zeusbroadcast.com
360 Systems	27	818-735-8221	360systems.com

SALES OFFICES

US/CANADA WEST

George Watts III
(360) 546-0379; Fax: (360) 546-0388
georgeww3@aol.com

EAST

Josh Gordon
(718) 802-0488; Fax: (718) 522-4751
jgordon5@verizon.net

MIDWEST

Emily Kalmus
(312) 840-8473; Fax: (913) 514-6301
emily.kalmus@penton.com

INTERNATIONAL EUROPE

Richard Woolley
+44-1295-278-407
Fax: +44-1295-278-408
richardwoolley@btclick.com

Israel

Asa Talbar
Talbar Media
+972-3-5629565; Fax: +972-3-5629567
talbar@talbar.co.il

JAPAN

Mashy Yoshikawa
Orient Echo, Inc.
+81-3-3235-5961; Fax: +81-3-3235-5852
mashy@fa2.so-net.ne.jp

CLASSIFIED ADVERTISING

Julie Dahlstrom
(312) 840-8436
Fax: (913) 514-3684
julie.dahlstrom@penton.com

REPRINTS

Penton Reprints
888-858-8851
www.pentonreprints.com

LIST RENTAL SERVICES

Marie Briganti, Walter Karl
(845) 620-0700
(845) 620-1885
marie.briganti@walterkarl.infousa.com

Customer Service:
913-967-1707 or 800-441-0294

Broadcast Engineering, February 2010, Vol. 52, No. 2 (ISSN 0007-1994) is published monthly and mailed free to qualified persons by Penton Media, Inc. 9800 Metcalf Ave., Overland Park, KS 66212-2216. Periodicals postage paid at Shawnee Mission, KS, and additional mailing offices. Canadian Post Publications Mail Agreement No. 40612608. Canada return address: Bleuchip International, P.O. Box 25542, London, ON N6C 6B2. POSTMASTER: Send address changes to Broadcast Engineering, P.O. Box 2100, Skokie, IL 60076-7800 USA. CORRESPONDENCE: Editorial and Advertising: 9800 Metcalf, Overland Park, KS 66212-2216 Phone: 913-341-1300; Edit. fax: 913-967-1905; Advert. fax: 913-967-1904. © 2010 by Penton Media, Inc. All rights reserved.

Alternative tools for broadcasters

Nonbroadcast products can sometimes fill the bill.

BY ANTHONY R. GARGANO

Requirements for equipment and other needs for broadcasters are traditionally filled by a range of broadcast manufacturers. We live in an age of the blending of the various forms media and the continuing evolution of the technology that is applied to create and deliver that media. Mindful that we are always on the lookout for tools and processes that can improve efficiencies or reduce costs, enhance production value or advance creative technique, we should occasionally take an outside-of-the-box look at the tools used in other industries. With that in mind, I recently attended the PhotoPlus Expo, a still photography and imaging trade show and conference held at the Jacob Javits Center in New York City. There were several products with broadcast applications — some obvious and others not so obvious.

DSLRs

One example of such a product is today's mid- to high-end DSLRs that include HD recording capabilities, some as high as 1920 x 1080 60p. Canon, Nikon, Sony and others all have DSLR models that now include the capability to record HD. These cameras have incredible low light sensitivity and an arsenal of interchangeable lenses with depth of field ranges that give the creative side of the house a terrific new production tool. The added bonus is that with lesser lighting requirements and a smaller field crew, the accountants are happy as well.

But as with any new tool, you need to know when it is appropriate for use. Sometimes there are drawbacks. For example, you can forget about using

HD DSLRs for a shoot that requires good live audio capture. And, things like time code ... well, let me explain it this way: I was speaking with a product manager about the company's still camera's video capabilities; when I mentioned "time code," his response was, "What's that?"

This lack of basic knowledge notwithstanding, for the appropriate ENG or production application, HD DSLRs can be incredibly useful and efficient tools. Channel 4 in the UK uses them for news. NBC's "Saturday Night Live" opening sequence this season was shot with several Canon HD video-capable DSLRs. The MTV production community has "discovered" HD DSLRs, and uses more and more of them to shoot music videos. Certainly, with growing adoption of HD DSLRs in the video production world, they will become time code-friendly and audio-capable.

Support equipment

Leaving the still camera milieu, thanks to solid-state and digital technologies, even traditional broadcast video cameras and camcorders have become significantly smaller and lighter over the years. Simultaneously, in the photographic industry, there has been an evolution of highly effective and relatively inexpensive still camera tripods and support equipment.

For example, Bogen Imaging's Manfrotto line of camera tripods and monopods offers fully capable professional support equipment. An inexpensive tripod, complete with a fluid head, can be purchased for less than \$500, and monopods cost much less than that. For heavier support needs, lightweight carbon fiber tripods com-

plete with fluid heads are available for \$1000 or less.

Camera Bits

Another little gem I found at the show was an inexpensive software program called Photo Mechanic by Camera Bits out of Portland, OR.

Most television stations, particularly those with large news activities, have a significant number of still images in their photo archives. If you have already invested in an expensive asset management system that handles all of your video footage and still photos, read no further. But if you are considering a way to manage those still archives or an expensive module to handle stills to add on to your video asset management system, you might want to take a look at Camera Bits.

It provides quick ingest and has a comprehensive set of metadata tagging tools. Batch processing capability is excellent, and it gives you a fast browser, allowing easy image resize and file size resolution adjustments. The next version, due out during the first half of this year, will incorporate additional features that will be of even more interest to the broadcaster.

Conclusion

So, this was just an example of broadcast-applicable tools from non-broadcast suppliers. Don't give up on your traditional providers! But don't overlook the opportunity to stretch that equipment budget or provide new creative tools from nontraditional sources.

BE

Anthony R. Gargano is a consultant and former industry executive.

? Send questions and comments to: anthony.gargano@penton.com



IP Based Multi-Image Display & Monitoring Solution

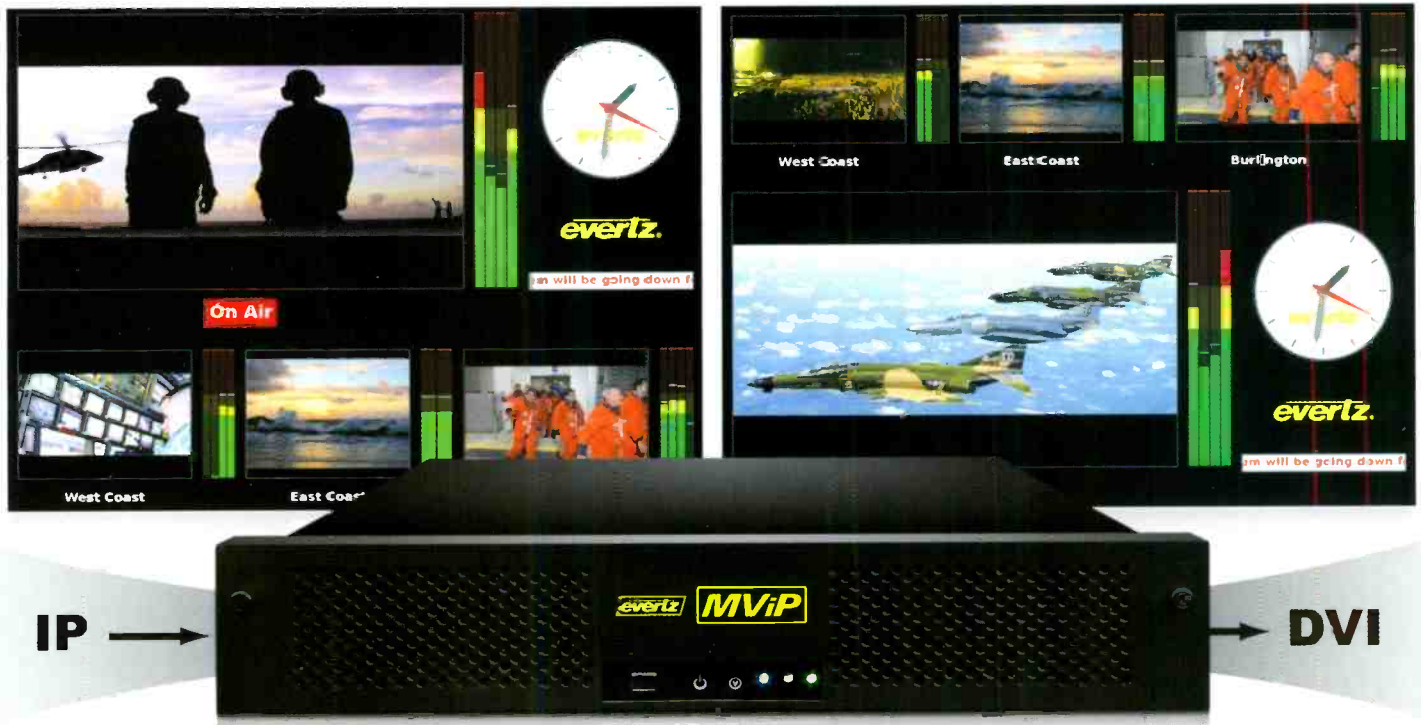

MViP is an IP Based Multi-Image Display & Monitoring solution targeted at applications where simple and efficient monitoring of audio and video from an IP transport stream is required.

MViP includes the ability to monitor at the transport stream level using Evertz® award winning TSM (Transport Stream Monitoring) technology. It also leverages industry leading AVM (Audio / Video Monitoring) technology from the MVP® to determine faults with the audio and video at the baseband level.

MViP has been developed to be used as a tool for digital headends, IPTV networks, and sites using IP for distribution with a requirement to monitor and display audio and video along with fault information and transport details on a simple-to-configure DVI based monitor. MViP supports all major video compression standards, and therefore can be used in almost any application where video and audio are being transported over IP. MViP is SNMP -enabled, which allows VistaLINK® PRO to configure and store all monitoring values and alarms.

1-877-995-3700 • www.evertz.com



US West Coast Sales
818.558.3910
LASales@evertz.com

New York Sales
newyorksales@evertz.com

Washington DC Sales
703.330.8600
dcsales@evertz.com

UK Sales
+44 118 935 0200
uksales@evertz.com

South-East Europe Sales
+385-1-2059-325
SEuropeSales@evertz.com

Dubai Sales Office
011-971-50693-0204
middleeastSales@evertz.com

Asia Pacific Sales
+852 2850-7989
asiapacificSales@evertz.com

CHANGE YOUR VIEW



See things differently with Harris multiviewers.

Award-winning multi-image processors from Harris deliver pristine pictures that will change the way you view your world. From a studio. In a master control suite. Or on a truck. Choose from the industry's widest range of solutions — all easily deployed into your workflow.

Harris multiviewers ... Look no further.

CHANGE YOUR VIEW

Learn more at www.broadcast.harris.com/multiviewers.

ONE Company. ONE Direction. The Future.

HARRIS® *assuredcommunications*®
Broadcast Communications • RF Communications • Government Communications Systems

www.harris.com