

JULY, 1961

BROADCAST ENGINEERING



THE TECHNICAL JOURNAL OF THE BROADCAST INDUSTRY



Reviewing One Kilowatt AM Transmitters



NOW

COLOR TV

From FOTO-VIDEO

NEWS FLASH!

United States Air Force, Pentagon, Orders \$450,000 Closed-Circuit Color TV System, Designed and Manufactured by FOTO-VIDEO To Meet Requirements of Speed and Security of Vital Information for National Defense.

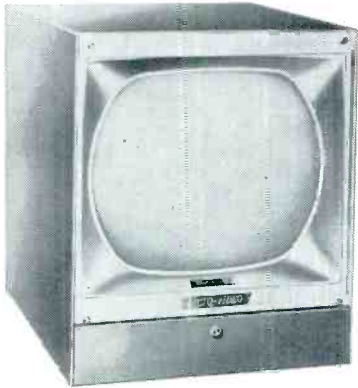

V-298
21" Color TV
Monitor
All Modular
Construction

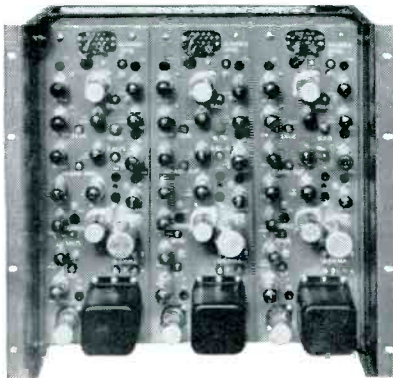
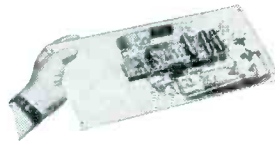
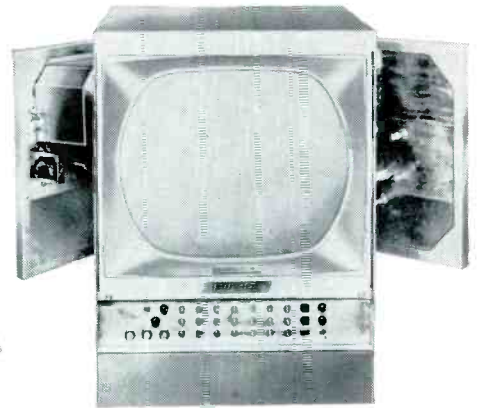

**V-225 Color Gamma
Correctors**



**V-229 Color Matrix
Delay**

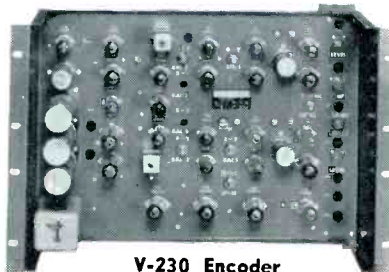

V-230 Encoder



**V-297 Color Masking
Unit**



**V-8 Color Sub-Carrier
Generator**



**V-516 Automatic Level
Control**



**V-139 Color Sync
Change Over**



**V-17 Color Burst Keying
Unit**



**V-29 Color Bar
Generator**

ALSO V-525 — 3-V Color Film Camera Chain • F-602 Color Film Slide Multiplexer • V-184 — 12 — 4 Color TV Diode Switcher • V-243 Color Stabilizing Amplifier • V-292 Color Special Effects Generator and Amplifier • F-107 — 1 Light Box and Test Chart Kit for Color • V-700 Transistorized Sync Generator • V-128 Transistorized Sync Slave

FOTO-VIDEO Electronics, Inc. Cedar Grove, N. J. Center 9-6100

West Coast Engineering-Sales: 1317 West 214 St., Torrance, Calif. — Spruce 5-1003
Washington, D. C.: 2409 Menokin Drive, Alexandria, Va. — King 9-5520

(Write or Phone for Information)

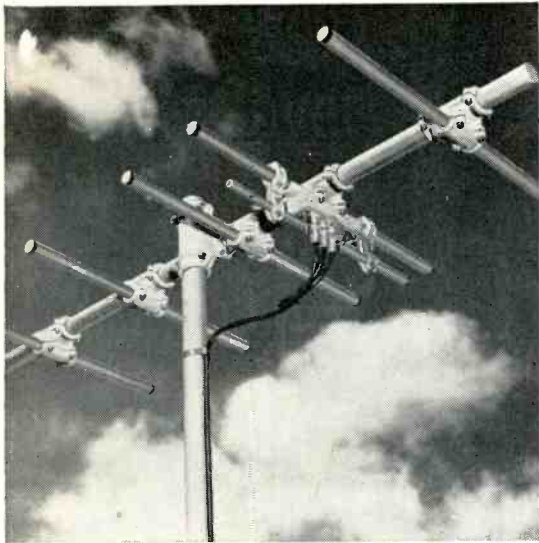

Cover
the
Hard-
to-Get
Spots

with the **RCA VHF**
Translator System (TRV-1A)

- Operates unattended
- One-watt output on all VHF channels
- Low intermodulation distortion
- Improves coverage of TV signals
- Handles both monochrome and color signals
- Equipment is self-contained, including power supply
- Mounts in standard 19" rack



The Most Trusted Name in Television
RADIO CORPORATION OF AMERICA

A dependable method for improving coverage in certain areas. Translates signals from one VHF channel to another. Consists of individual channel amplifiers, converters and filters necessary for complete system. Designed for unattended operation. Single- and double-conversion units are available. Special identification keyer is available to transmit call letters every half hour.

Wide-spaced Yagi antennas are used for both receiving and transmitting. Developed to provide high gain, maximum co-channel rejection. Offers exceptional mechanical strength. For additional gain, antenna may be stacked with custom phasing of the harness to provide increased co-channel interference rejection. Ideal for high tower and mountain top installations where wind velocities may exceed 100 mph.

Write for details. RCA Broadcast and Television Equipment, Dept. X-367, Bldg. 15-5, Camden, N.J.

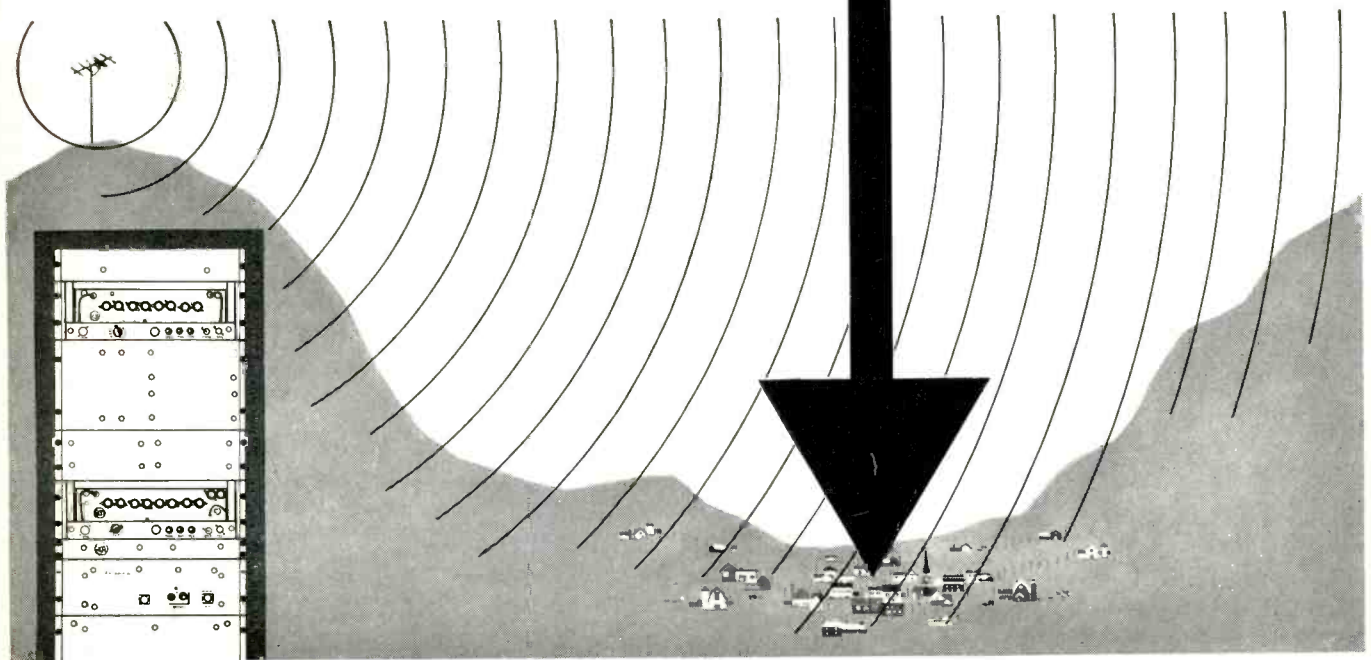



BROADCAST ENGINEERING

THE TECHNICAL JOURNAL OF THE BROADCAST INDUSTRY [®]

VOLUME 3

JULY, 1961

NUMBER 7

Contents

FM Stereophonic Broadcast Transmission Equipment Used at WEFM	4
A description of equipment and methods used in system of stereophonic broadcasting which has been adopted by the F.C.C.	
Television System Maintenance, Part IV	10
Frequency response and amplitude linearity.	
Reviewing One Kilowatt AM Transmitters	24
Transmitter builders are now offering a variety of specifications to prospects.	
Tips on Tape Storage	28
How to avoid deterioration of cellulose acetate magnetic tape during storage is discussed by the technical service manager of Minnesota Mining & Mfg. Co.	
TV Station Devises Do-It-Yourself Front Projection	32
Home-type viewer relieves production problems.	

Departments

Cues & Kinks	30
F.C.C. Regulations	34
Industry News	36
Product News	40
Index to Advertisers	42
Classified Ads	42
Professional Services	42

Cover Story

A composite illustration of the six types of one kilowatt AM transmitters presented in this issue. From upper left to right: Collins Radio, RCA, Continental Electronics, Bauer, ITA, and Gates Radio Co.

EDITORIAL

ROBERT E. HERTEL, Editorial Director
 JOHN L. HUMPHREYS, Associate Editor
 D. F. BOICOURT, Managing Editor
 DUDLEY ROSE, Presentation Editor
 E. P. LANGAN, Advertising Director
 S. F. WILSON, Production Manager

ADVERTISING SALES OFFICES

Flushing 54, New York

PAUL AND DON WEIL
 39-01 Main Street
 Telephone INdependence 3-9098

Chicago 1, Illinois

WILLIAM L. MILLER, JR.
 E. F. LUKENS
 C. E. PARKER
 307 N. Michigan Ave.
 Telephone FRanklin 2-5944

Cleveland 16, Ohio

DAVID H. HERTEL
 3100 Wooster Road
 Telephone EDison 1-2370

Southwest

C. H. STOCKWELL CO.
 4916 W. 64th Street
 Mission, Kansas
 Telephone RAndolph 2-4417

Los Angeles 57, California

MAURICE A. KIMBALL CO., INC.
 2550 Beverly Boulevard
 Telephone DUmkirk 8-6178

San Francisco 5, California

MAURICE A. KIMBALL CO., INC.
 681 Market Street
 Telephone EXbrook 2-3365

Paris 5, France

JOHN ASHCRAFT
 9 Rue Lagrange
 ODeon 20-87.

London W. C. 2, England

JOHN ASHCRAFT
 12 Bear Street
 Leicester Square
 WHitehall 0525

Tokyo, Japan

INTERNATIONAL MEDIA
 REPRESENTATIVES, LTD.
 Shadan Hojin, 14, 2-chome Marunouchi
 Telephone 571-4450

Editorial, Circulation and Advertising headquarters, 1014 Wyandotte St., Kansas City 5, Missouri; Telephone VIctor 2-5955.



Subscription Price: U. S. \$6, one year; Outside U. S. A., \$7. Single copies, 75 cents. Adjustments necessitated by subscription termination at single copy price.

Broadcast Engineering is published monthly by Technical Publications, Inc., 1014 Wyandotte St., Kansas City 5, Missouri, U. S. A.

Corporate Personnel: Robert E. Hertel, President; Frank D. Smalley, Executive Vice-President; E. P. Langan, Vice-President; Kenneth Long, Vice-President.

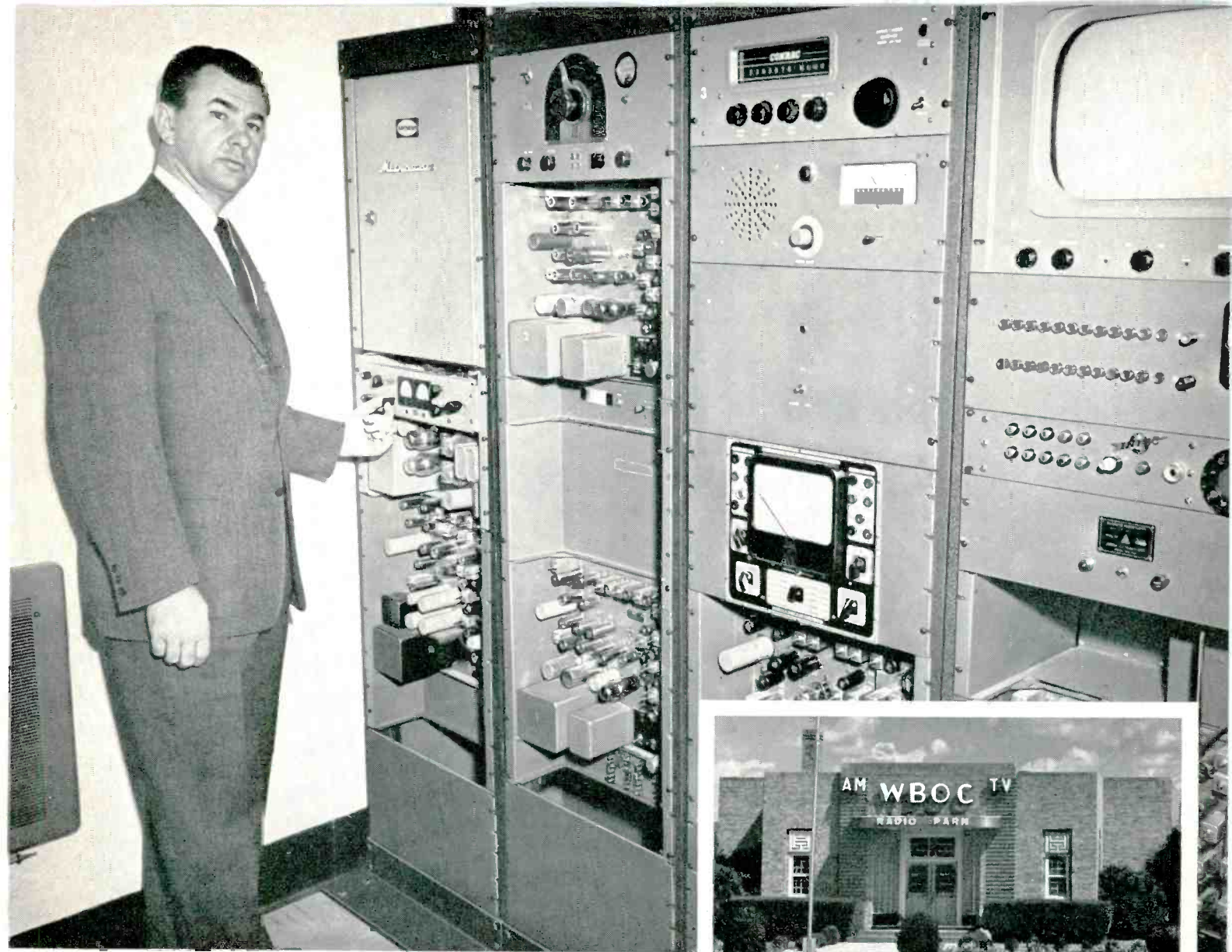

RAYTHEON MICROWAVE INTERCITY RELAY "EXCEEDED OUR GREATEST EXPECTATIONS"

Says Jack Ward, WBOC-TV's Chief Engineer

"Mark us down as a satisfied customer. After 7 months of operation, can truthfully say performance has exceeded our greatest expectations. My thanks to Raytheon . . . I have never worked with a more tireless, devoted group."

Such satisfaction with Raytheon Microwave service and equipment is typical. For Jack Ward and WBOC-TV in Salisbury, Maryland, Raytheon performed the following: 1st hop on the air in 34 days; entire 2-hop, 49-mile Raytheon KTR Intercity Relay system operating in 56 days from date of order!

If your summer plans include Intercity Relay, let Raytheon custom survey your requirements. This expert service provides a complete System Engineering budget estimate, without obligation.

To learn more about this service, about Raytheon 1/10 Watt and 1-Watt KTR's unsurpassed reliability in unattended operation, and about Raytheon's low interest, long term financing, write: Raytheon Communications and Data Processing Operation, 1415 Boston-Providence Turnpike, Norwood, Massachusetts.

RAYTHEON

RAYTHEON COMPANY

EQUIPMENT DIVISION

FM STEREOPHONIC BROADCAST TRANSMISSION EQUIPMENT USED AT WEFM

THE SYSTEM of stereophonic broadcasting on the FM broadcast band which has been adopted by the Federal Communications Commission will require additional equipment not now used for monophonic broadcasting. In addition, certain requirements are placed on the existing FM transmitter which are not specified for monophonic broadcasting.

In addition to the obvious pieces of equipment needed for FM stereophonic broadcasting, such as magnetic tape stereophonic playback equipment, stereophonic disk-repro-

ducing equipment and other stereophonic audio source, the following units are used:

1. *Audio console including matrix*—The audio console (matrix) contains two channels with their level controls ganged together, matrix circuitry for formation of (A+B) and (A-B) audio, matched 75 usec pre-emphasis networks, and time-delay equalizers variable to within 0.5 usecs.
2. *Audio amplifier and low frequency phase equalizer.*
3. *Double sideband-suppressed*

carrier AM subcarrier generator
 $\frac{1}{f}$
 (with — response)

4. *Carrier supply*
5. *Auxiliary phase modulator*

A block diagram of the FM Stereophonic Broadcast Transmission system at WEFM is shown in Diagram No. 1. At the extreme left of the block diagram, the left and right stereophonic audio sources are shown entering the audio console (matrix) where sum and difference audio components are made. The sum (A+B) audio component is passed through a 75 usec pre-emphasis network and then inserted at the normal audio input terminals of the Collins 734A transmitter exciter. The difference (A-B) audio component is passed through a matched 75 usec pre-emphasis network, a 28.5 usec time-delay network adjustable to a 0.5 usec accuracy, and then inserted at the input terminals of the audio amplifier and low frequency phase equalizer; the output then is applied to the double-sideband suppressed-carrier AM subcarrier generator which forms the 38 KC stereophonic subcarrier and the 19 KC pilot subcarrier for application to the 11.055 mc. *Auxiliary phase modulator.* At

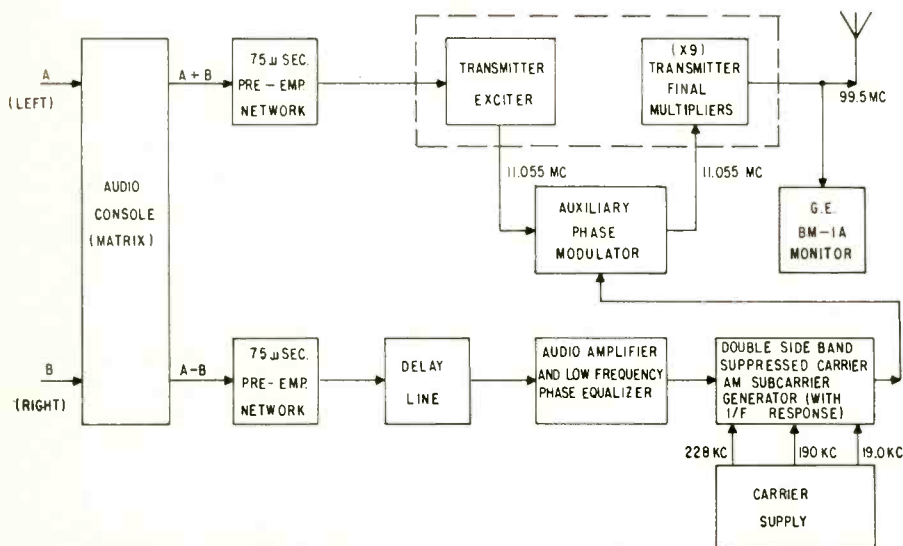

Diagram 1—Block diagram of stereo broadcast system at WEFM, Chicago.

By
 Radio Engineering Dept.
 Zenith Radio Corp.
 FM Station WEFM
 Chicago, Ill.

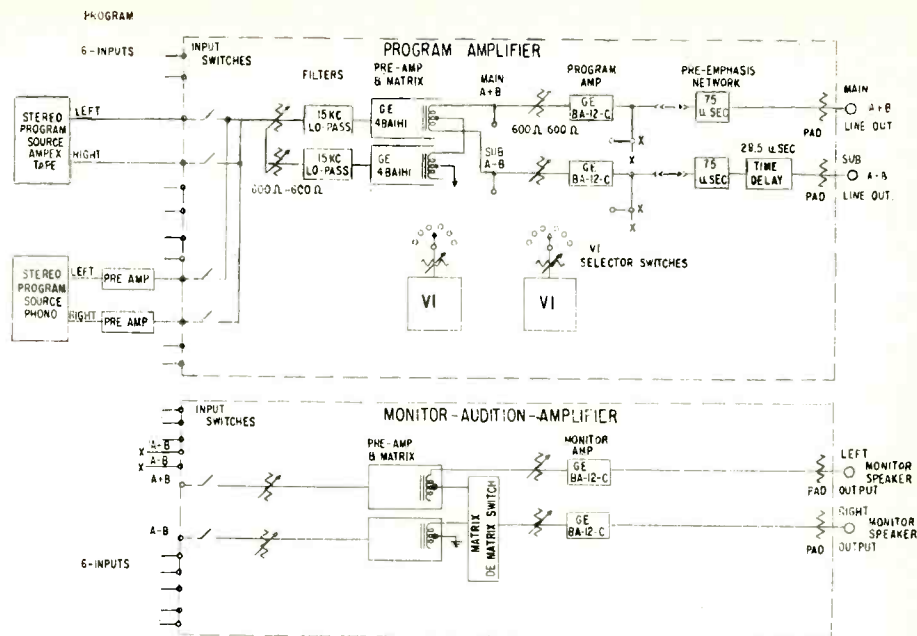

Diagram 2—WEFM stereo audio console block diagram.

this point in the system, the sum and difference components are combined in such a way that their phase and amplitude characteristics are matched, and then amplified and returned to the 734A Collins transmitter at 11.055 mc. to be multiplied nine times by the frequency multipliers and power amplifiers. Finally, the resulting 99.5 mc. output is applied to the antenna.

At the extreme right of the block diagram is shown the G.E. BM-1A modulation monitor for recovery of the stereophonic signal.

At the lower right of the block diagram is shown the carrier supply having as outputs: 190 KC, 228 KC, and 19 KC carriers for application to the double-sideband suppressed-carrier AM subcarrier generator.

Description of Units

1. *Audio console (matrix)*—A block diagram of the audio console is shown in Diagram No. 2. At the extreme left of the block diagram, the left and right stereophonic program sources are shown switchable to the input of a dual 600 ohm fader. The left and right outputs of the fader are applied to 15 KC low-pass filters for removal of spurious components that may exist above 15 KC. The two filter outputs are ap-

plied to identical G.E. 4BA 1H1 pre-amplifiers which are connected in a hybrid-circuit fashion at their outputs for formation of sum (A+B) and difference (A-B) audio signals. The two pre-amplifiers thus serve to matrix the left and right stereophonic program sources to form the main and subcarrier audio-modulation signals.

The sum (A+B) and difference (A-B) audio signals are each applied to identical G.E. BA-12-C program amplifiers which drive matched 75 usec pre-emphasis networks in the outgoing lines of the audio console. The sub-outgoing line has an additional 28.5 usec time-delay equalizer for matching the envelopes of the main and stereophonic subcarrier signals as observed at the discriminator of the G.E. BM-1A modulation monitor just preceding its de-emphasis network. The program amplifiers are capable of sufficient output to overcome the loss in the 75 usec pre-emphasis networks and still be capable of driving the Collins 734A transmitter exciter to 100 per cent modulation.

The lower portion of Block Diagram No. 2 shows the monitor-audition amplifier portion of the audio console.

This portion of the audio console is substantially identical to the program portion of the audio console with the only difference being in the matrix portion of the circuit. The matrix is capable of being disabled for the purpose of auditioning left and right stereophonic signals from either the original stereophonic program sources or the demodulated radiated signal. The monitor amplifier otherwise is usable as an emergency program amplifier.

2. *Audio amplifier and low frequency phase equalizer*—A schematic diagram of the audio amplifier and low frequency phase equalizer is shown in Diagram No. 3.

Compensation is required in the sub-channel for phase displacements of the sum (A+B) audio which arise mainly in the audio and modulator stages of the Collins 734A transmitter exciter. The required low frequency phase equalization is accomplished by means of three variable RC highpass-filter sections, each of which has a cutoff frequency which can be adjusted between 5 and 25 cycles per second. These adjustments allow the sub-channel compensation to match and equalize the phase characteristics of the main channel.

Compensation of pure time delay

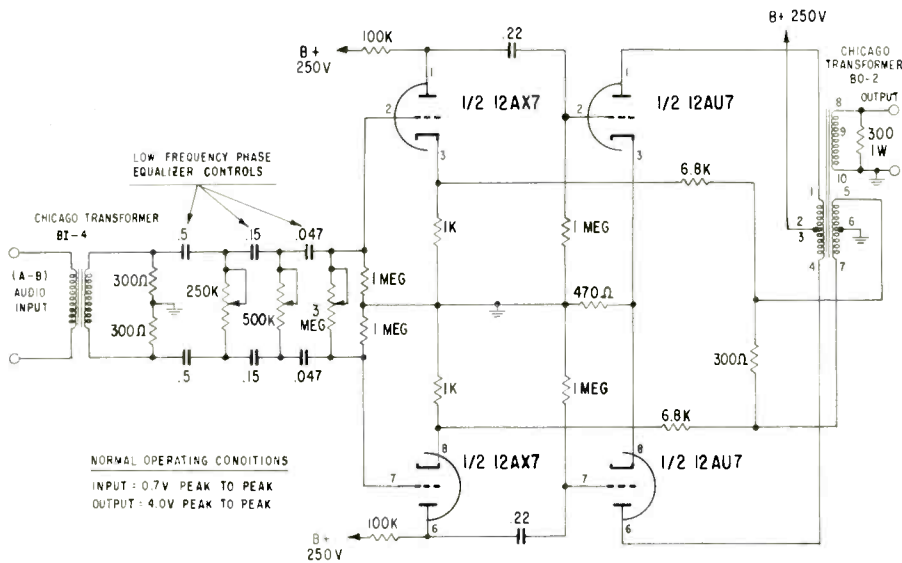

Diagram 3—Audio amplifier and low frequency phase equalizer.

is accomplished in the previously described audio console. Such compensation is required in addition to the low frequency phase equalization mentioned above.

The audio amplifier section provides sufficient gain to drive the double-sideband suppressed-carrier AM subcarrier generator with low distortion because of the use of a large amount of inverse feedback.

3. *Double-sideband suppressed carrier AM subcarrier generator*

(with $\frac{1}{f}$ response)—A schematic diagram of the double-sideband suppressed-carrier AM subcarrier generator is shown in Diagram No. 4.

In order to generate an extremely low distortion 38 KC AM subcarrier a two-step or double-modulation system has been used in the AM subcarrier generator.

The first step of this double-modulation process is accomplished in the 4-diode doubly-balanced ring modulator shown in the upper-left portion of Diagram No. 4. The first ring modulator is driven by a 190 KC carrier supplied by the carrier supply and, also, by phase equalized difference (A-B) audio supplied by the audio amplifier and low frequency phase equalizer. The resultant signal is a double-sideband suppressed-carrier AM subcarrier which is passed through a bandpass filter having a 190 KC center frequency and a 3 db bandwidth of 60 KC. The output of the

bandpass filter is amplified by a two-stage feedback amplifier which drives the second ring modulator.

The second step of this double-modulation process is accomplished in the second 4-diode doubly-balanced ring modulator shown in the left-center portion of Diagram No. 4. The second ring modulator is driven by a 228 KC carrier supplied by the carrier supply and, also, by the output of the 190 KC bandpass filter previously described. The resultant product of this modulation process is the required 38 KC double-sideband suppressed-carrier AM subcarrier. This signal is passed through a lowpass filter having an upper-cutoff frequency of 100 KC so that both the 190 KC and 228 KC component frequencies, as well as other spurious components, are removed from the 38 KC AM subcarrier.

In the lower-left portion of Diagram No. 4 is shown the circuitry which provides for phase and amplitude adjustments of the 19 KC pilot subcarrier supplied by the carrier supply.

The 19 KC pilot subcarrier is then applied to a two-stage feedback amplifier where it is mixed with the 38 KC AM subcarrier from the 100 KC lowpass filter. This combination is amplified by the feedback amplifier and sub-

jected to a $\frac{1}{f}$ frequency response characteristic developed in the output transformer of this amplifier.

The $\frac{1}{f}$ frequency response characteristic is needed to convert the phase modulation provided by the auxiliary phase modulator to frequency modulation.

A carrier suppression level of better than 40 db below maximum modulation is possible with the double-sideband suppressed-carrier AM subcarrier generator with a routine periodic check. A carrier-suppression level of better than 60 db below maximum modulation can be maintained for shorter intervals.

The non-harmonic distortion of the generator is approximately 60 db below maximum modulation.

4. *Carrier supply*—A schematic diagram of the carrier supply is shown in Diagram No. 5.

The carrier supply provides the three carrier frequencies used by the double-sideband suppressed-carrier AM subcarrier generator previously described. These three carrier frequencies are: 190 KC, 228 KC, and 19 KC. These carriers are derived from a common source to insure a constant phase and frequency relationship between them.

The common source for the carrier supply is a 19 KC crystal-controlled oscillator, shown in the lower-left portion of Diagram No. 5, which feeds a cathode follower (thus providing the 19 KC pilot subcarrier frequency output) and also feeds a frequency doubling full-wave rectifier circuit, thus providing a 38 KC signal to be shaped by a monostable multi-vibrator that, in turn, delivers squarewave pulses to a pulse-forming circuit in order to trigger a blocking oscillator which provides extremely sharp pulses for harmonic generation.

A bandpass filter tuned to the 6th harmonic of the 38 KC blocking oscillator signal delivers a 228 KC carrier frequency which then is amplified and fed to an output terminal.

A bandpass filter tuned to the 5th harmonic of the 38 KC blocking oscillator signal delivers a 190 KC carrier frequency which then is amplified and fed to an output terminal.

5. *Auxiliary phase modulator*—A schematic diagram of the auxiliary phase modulator is shown in Diagram No. 6.

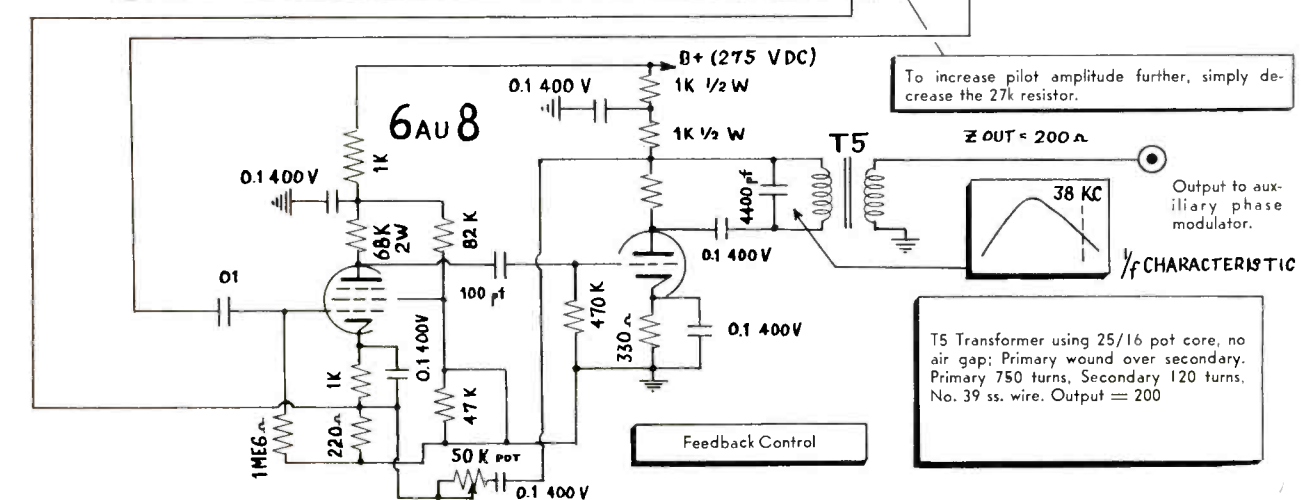
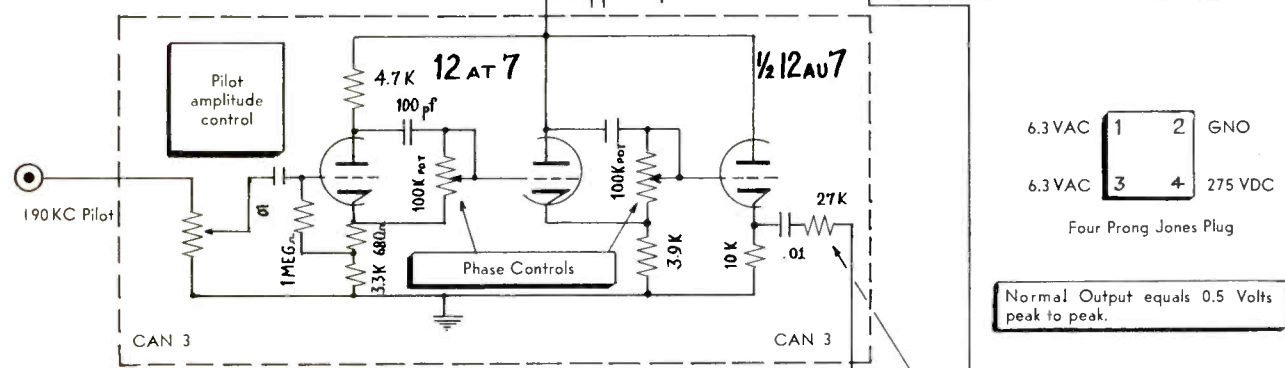
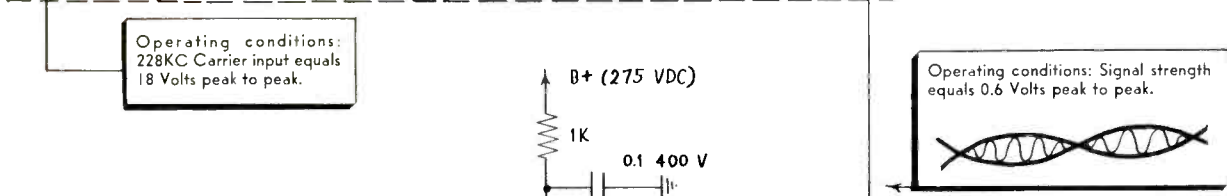
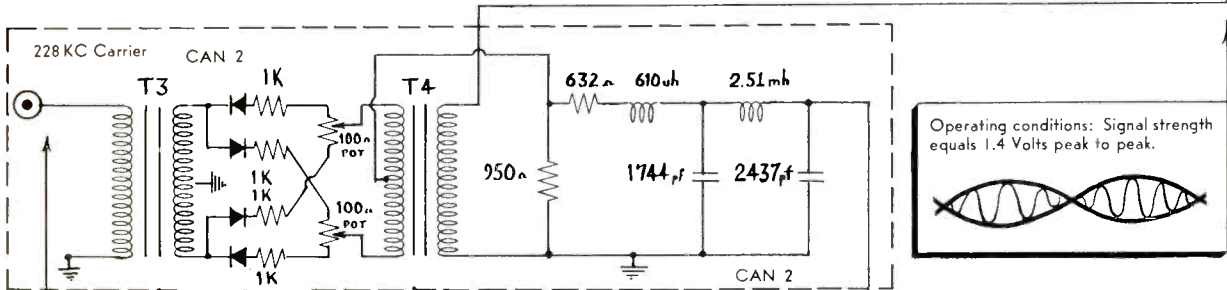
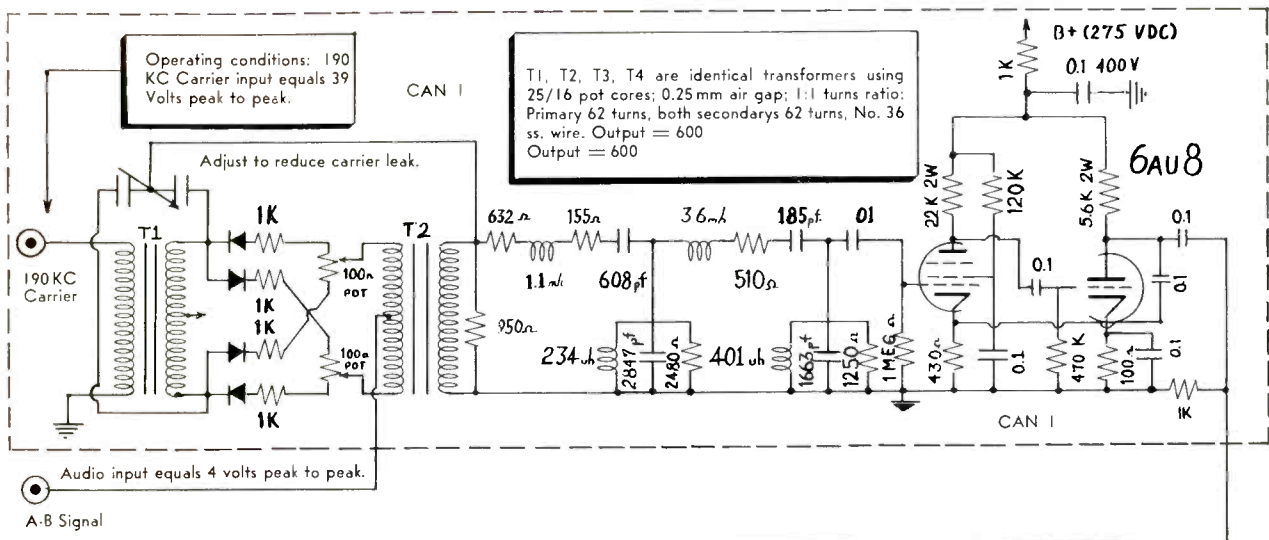

Diagram 4—Double sideband suppressed carrier AM subcarrier generator (with 1/f response)

TELEVISION SYSTEM MAINTENANCE

IV. Frequency Response and Amplitude Linearity (Part I)

EDITOR'S NOTE:

This is the fourth in a series of comprehensive reports on Telecast Systems Maintenance. This subject is presented in two parts. The concluding half will appear in an early issue.

By Harold E. Ennes,
Maintenance Supervisor,
Television City, Inc. (WTAE)
Pittsburgh, Pa.

All video line terminal equipment, from studio to transmitter, should exhibit flat response with satisfactory amplitude and phase linearity.

TO PROPERLY maintain a television broadcast system, the maintenance department is concerned with the following general characteristics:

1. Amplitude vs. frequency response. Includes frequency and phase response correction circuits to compensate deficiencies of pickup devices, reproduction devices and special processing amplifiers.
2. Amplitude linearity response. Includes so-called "Gamma" correction circuits to compensate for certain film characteristics and (in color) for picture tube characteristics.
3. Differential gain. Concerns any change in gain of a given single frequency with change in level from black reference to white reference. Although of most importance to color systems, is also a sensitive indicator of general system performance in a monochrome system.
4. Differential phase. Change of phase of a given frequency with change in level from black to white. Again, of prime importance to color

but also an extremely sensitive indicator of amplifier performance for monochrome systems.

What to Expect in Resolution

The degree of resolution to be expected differs between the studio and transmitter outputs. There is also a difference between ratios of horizontal to vertical resolution at the two locations.

Bear in mind the following fundamentals of vertical and horizontal resolution:

(A) Vertical resolution depends upon total number of scanning lines in a picture frame (fixed at 525), the size of the pickup tube and reproducing tube scanning beam, and the "Kell factor" which is defined later. System bandwidth is *not* a factor.

(B) Horizontal resolution depends upon the size of the pickup tube and reproducing tube scanning beam, and the system bandwidth.

Assuming optimum focus of pickup tube and reproducing tube, the vertical resolution will be the total

number of active lines (490 with 7 per cent vertical blanking) times the Kell factor of about 0.7 average. This results in approximately 340 lines of vertical resolution. The Kell factor considers the fact that horizontal lines of an image do not necessarily fall directly on the path of the pickup tube scanning beam, resulting in less than unity voltage output from the pickup device.

Horizontal resolution is influenced by system bandwidth where 1 mc bandwidth results in approximately 80 TV lines. This will be evident by the following analysis:

1. The scanning process aspect ratio requires that H resolution of a test chart be related to picture height.

2. For a number of lines (N), the width of each line is 1/N times the picture height.

3. Lines of H resolution/cycle=2. (One cycle equals two picture elements, since alternations are of opposite polarity.)

4. Ratio of H to V= $\frac{4}{3}$ =1.33







Most TV Camera and Microphone Cables Are Made by Belden



Belden offers a full range of application-designed wire and cable for TV and radio broadcasting, recording studios, remote control circuits, and related applications. Available from your Belden electronics distributor.



power supply cords • cord sets and portable cordage • electrical household cords • magnet wire • lead wire • automotive wire and cable • aircraft wires • welding cable

 <p>Plastic Microphone and Shielded Power Supply Cables</p>	 <p>Rubber Microphone and Shielded Power Supply Cables</p>	 <p>Broadcast Audio Cables</p>
<p>FREE: Write for copy of 7-page technical paper "Choosing a Microphone Cable."</p>		
 <p>75-Ohm Video Cable</p>	 <p>TV Camera Cables</p>	

8-6-1

Bauer Kit

1 Kw TRANSMITTER*

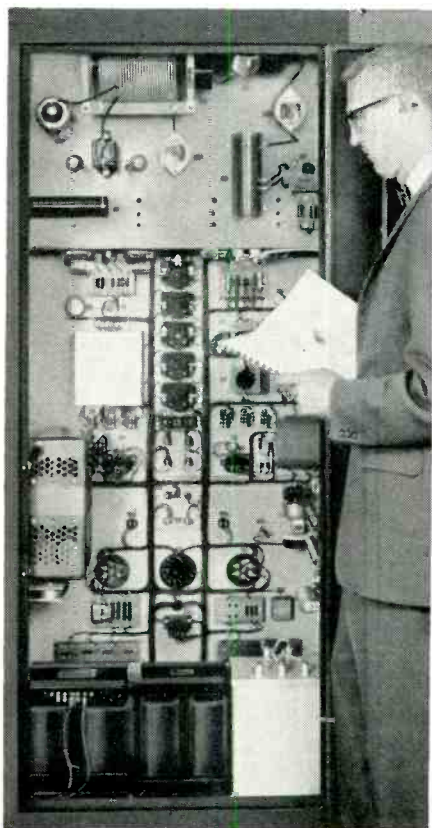

*From an Engineers' Viewpoint

The "Bauer Kit" Model 707 is the only 1000/250 watt AM transmitter with *Silicon Rectifiers* in all power supplies, a *Variable Vacuum Capacitor* and a *Constant Voltage Transformer*. Your assurance of maximum reliability and optimum performance. Note the simplicity of design with easy accessibility to all components, too. All components are standard items available at local sources.

Assembly of the "Bauer Kit" is actually easier than many consumer audio kits — the wiring harness is furnished completely pre-fabricated and coded. And when you complete the transmitter it will be fully inspected, tested and *guaranteed* by the Bauer Electronics Corporation.

Bauer 1 Kw Transmitter
(In Kit Form) \$3495.00*

Bauer 1 Kw Transmitter \$4495.00*
*FOB San Carlos, California

**WRITE FOR THE COMPLETE
ENGINEERING STORY TODAY!**

Bauer

ELECTRONICS CORPORATION

1663 Industrial Rd. • San Carlos, California

5. Therefore the H resolution multiplying factor is $2/1.33=1.5$

6. This factor times the *active* line interval (in u/s) specifies the horizontal resolution factor, or the number of lines resolving power per mc bandwidth.

7. Assuming minimum H blanking of 10.5 u/s, the active line interval is about 53 u/s, and 53 times 1.5 is approximately equal to 80 TV lines/mc.

The maximum video bandwidth of the transmitter is 4.18 mc. Therefore the maximum H resolution to be expected from the transmitter is 4.18 times 80 or 334 lines, about equal to V resolution. Thus the transmitter operator will observe essentially the same resolution on the vertical and horizontal wedges of the test chart for an optimized tuning condition. The test chart transmitted to the home viewer is normally arranged to have a minimum wedge equivalent to 320 lines horizontal resolution.

Although the transmitter is limited to essentially 4 mc video bandwidth, it is well known that due to accumulative factors of frequency-phase distortions, the better the picture going into the transmitter, the better the picture received in the home. For this reason, studio facilities are normally maintained to approximately twice the bandwidth employed by the transmitter, or 8 mc. Specifications of modern television studio equipment are well within 1 DB to 8 mc, and within 3 DB to 10 mc. Thus the studio operator will normally observe about 640 lines horizontal resolution ($8 \times 80 = 640$) which approaches the upper limit of the resolving power of most picture monitors, and which is almost a 2/1 ratio to the vertical resolution possible. This system bandwidth slightly exceeds the practical day-to-day resolution capabilities of the image orthicon and vidicon pickup tubes, with the exception of the newest $4\frac{1}{2}$ -inch image orthicon.

In addition, the best monochrome stations are maintained within color standards so that studio facilities are practically 100 per cent perfect in amplitude linearity, within 5 per cent differential gain (at 3.58 mc) and 3° differential phase. The overall (from studio inputs to transmitter output) differential gain should be within 20 per cent and

differential phase within 10 degrees, at 3.58 mc.

Amplitude vs. Frequency Requirements

The amplitude vs. frequency response of the television system must be such that the *overall* characteristic is reasonably flat over the required passband of 4 mc. It is realized, however, that the pickup device, whether it be an image orthicon, vidicon or flying-spot scanner, utilizes a scanning beam that has a definite minimum spot size. Since this spot is not infinitely small, the waveform resulting from scanning across sharp vertical lines in the image will not be the "ideal" square wave, but more nearly a sine wave. This "aperture distortion" may be compared to passing the signal through a low pass filter but without phase distortion. Circuits used to compensate this effect, in addition to pickup tube output capacitance does produce phase shift which must be corrected by "high-peaking" or "phase correction" circuitry which largely affect the gain at middle and low frequencies of the passband.

Since each pickup device varies over a limited range in characteristics, each camera chain incorporates the necessary correction

TABLE 1

Frequency in mc.	TV Line Equivalent
1	80
1.5	120
2.0	160
2.5	200
3.0	240
3.5	280
4.0	320
4.5	360
5.0	400
5.5	440
6.0	480
6.5	520
7.0	560
7.5	600
8.0	640
8.5	680
9.0	720
9.5	760
10.0	800



ANNOUNCES

EXTENDED WARRANTY ON BROADCAST VIDICONS

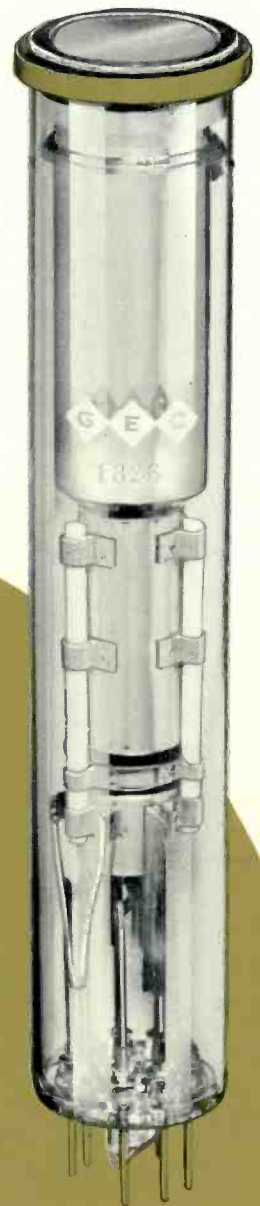

Gold
Electrical
Contact

**Vidicons will now be
warranted for 2,000 hours**

GEC Gold Electrical Contact Vidicons for studio applications are now carrying an extended warranty for 2,000 hours of operation. Tailor made exclusively for the broadcast industry, these new GEC Vidicons are now available for:

- Live pickup in b & w or color with or without dynamic focus.
- Film pickup in b & w or color with or without dynamic focus.
- Special purpose weather radar studio pickup.

Gold is used on the contact points eliminating formation of oxides and sulphides that create electrical contact problems. The Gold Ring immediately identifies the GEC Broadcast Vidicons covered by the new extended warranty.

GEC Gold Contact Vidicons are available exclusively for broadcast use. For further information contact your GEC Distributor, or write today to:

... where tube research begins



GENERAL ELECTRODYNAMICS CORPORATION

4430 FOREST LANE • GARLAND, TEXAS • BROADWAY 6-1161

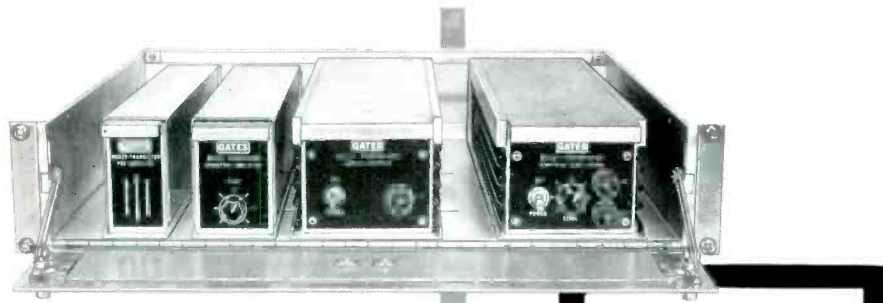

Entire amplifier system in 3½" high shelf assembly — Preamplifier, Program Amplifier, Power Supply and Monitor Amplifier.

another engineering first by Gates . . .

a complete transistor plug-in audio amplifier line that combines rigid specifications with compact design to solve the systems space problem.

A few of the features that make the Gates line of transistor amplifiers the outstanding value in broadcasting today: • Compact, all units mount in only 3½" vertical rack space • Low operating temperature eliminates any need for rack cooling • All amplifiers completely encased for strength and protection • Chassis for M-5701A and M-5702 is generous cast aluminum heat sink design (permits running at full continuous sine wave power at 55°C) • Industrial, American made, readily available transistors are used throughout • Priced competitively. Write today for the complete story . . . bulletin #52 . . . yours for the asking.

SPECIFICATIONS:

	M-6028 Preamplifier	M-5700A Program Amplifier	M-5701A Monitor Amplifier
Gain	40 db ± 1 db	80 db-reduced with internal control	90 db-reduced with internal control
Response	±.5 db 30 to 15,000 cps	± 1 db from 30 to 15,000 cps	± 1 db from 30 to 15,000 cps
Harmonic Distortion	.75% @ 30 cps 5% 50 to 15,000 cps @ + 18 dbm output	.75% @ 30 cps 5% 50 to 15,000 cps @ + 24 dbm output	1% @ 38 dbm @ 30 cps 1% @ 39 dbm 50 to 15,000 cps
Noise	-122 dbm relative input noise	-115 dbm, 68 db below -50 dbm input	-120 dbm relative input
Size	1¾" x 3⅛" x 10¾" 9 units/shelf	2-5/32" x 3⅛" x 10¾" 7 units/shelf	4⅛" x 3⅛" x 12¾" 4 units/shelf
Power	30V. DC @ 30 ma.	30V. DC @ 90 ma.	Self-contained power supply
Input Impedance	30/50-150/250-500/600 balanced or unbalanced	150/250-500/600 balanced or unbalanced	150/250-500/600 balanced or unbalanced
Output Impedance	150/250-500/600 balanced or unbalanced	150/250-500/600 balanced or unbalanced	8 ohms unbalanced
All Connectors	Amphenol Blue Ribbon type 26-4100-16P and 26-4200-16S		
M-5702 Power Supply	Supplies power for: 13-M-6028 or 4-M-5700 or 7-M-6028 + 2-M-5700 or any combination not exceeding 400 ma. Input: 110/117/125V., 50/60 cps Size: 4⅛" x 3⅛" x 12¾"-4 units/shelf		

circuitry for the pickup device. These special problems will be covered in future articles on the image orthicon and vidicon camera chains. We are concerned primarily at this time with distribution amplifiers, stabilizing amplifiers, microwave relays and all equipment which should exhibit "flat" frequency response with satisfactory amplitude and phase linearity.

A word of caution is in order at this point. Technicians have been known to "peak up" video amplifiers to obtain a sharp and "crisp" reproduction on a master monitor. This seems to be particularly tempting on certain types of video amplifiers employing a single "boost" or "peaking" circuit which is brought to the front panel for access. "Overpeaking" is most likely to occur in stations where personnel is divided permanently between studio and transmitter, and the overall system function is not continually borne in mind. As will be evident in following discussion, the practice of "overpeaking" to obtain a crisp picture on a studio monitor will sometimes result in a deteriorated picture in good home receivers.

Video monitors themselves may quite easily be checked for resolution capabilities with a sine-wave generator. The most convenient method is to feed the generator output through a "keyer" such as that shown by Fig. 10 of Article I (page 10, April '61, B/E), so that pedestal and sync may be inserted for stable monitor operation. (For a monitor driven by external sync or drive, blanking pedestal only is inserted). As the frequency is increased, the vertical lines on the picture tube become thinner (and fainter) until nothing but raster remains. By noting the maximum frequency at which the lines are just visible, the cutoff frequency of the monitor may be determined as shown by Table 1. The effect of brightness and contrast ratios on resolution may also be observed, as well as effect on comparative resolution capability between various areas of the raster.

Types and Applications of Test Signals

Fig. 1 illustrates the most popular and accepted types of test signals
Text continues on page 20. See Figure 1, page 16, and Figure 2, page 18.



GATES RADIO COMPANY

Subsidiary of Harris-Intertype Corporation

QUINCY, ILLINOIS

Offices in: HOUSTON, WASHINGTON, D.C. In Canada: CANADIAN MARCONI COMPANY

Export Sales: ROCKE INTERNATIONAL CORP., 13 EAST 40th STREET, NEW YORK 16, N.Y., U.S.A., Cables: ARLAB



COLLINS CLOSE-UP
no. 5 in a series

Rear view of the Collins 830E-1 5000-watt amplifier (left) and the 830B-1 250-watt driver.

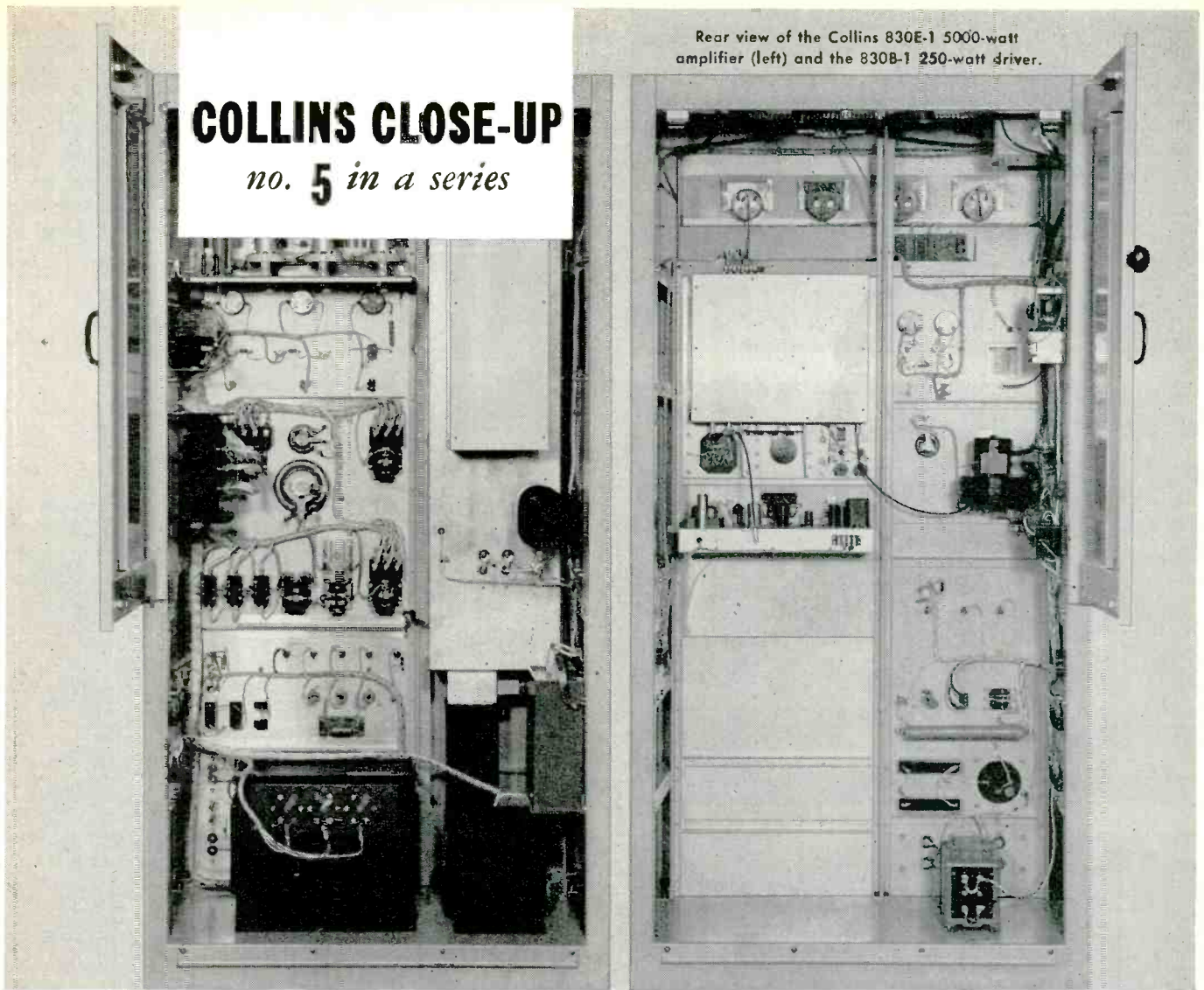

THE COLLINS 830E-1 5000-WATT FM TRANSMITTER GREET'S INSPECTION WITH WIDE-OPEN ARMS

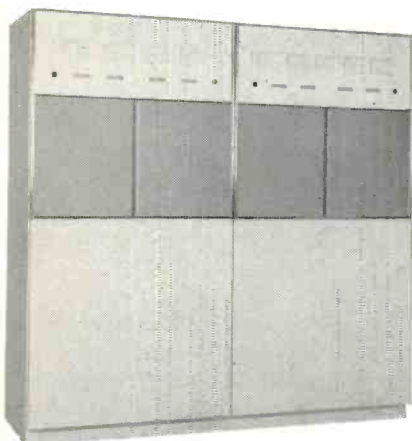

The wide, open back doors of a Collins 830E-1 FM Transmitter invite your inspection of this superior unit; they make all components and the straightforward circuitry easily accessible for inspection or maintenance.

Available with stereo multiplexing — A wide audio channel modulator in the Collins 830E-1 FM Transmitter eliminates channel crosstalk and assures stable stereo separation. The completely transistorized stereo multiplex system meets FCC specifications without continuous on-the-air adjustment. The SCA multiplex chassis features a built-in muting switch on the front panel, a monitor meter and a stabilized RC subcarrier oscillator which eliminates unwanted background noise ("birdies").

The unit is pushbutton operated and all RF circuits are tuned and metered from the front panel; all adjustments — including loading — may be made without taking the transmitter off the air.

Completely self-contained — The Collins 830E-1 FM Transmitter is completely self-contained. The high voltage transformer, directional couplers and filters are mounted inside the cabinet instead of being exposed or in a separate unit adjacent to the transmitter. The power supply of the driver uses silicon rectifiers to conserve space and guarantee reliable performance. The amplifier power supply may also utilize silicon rectifiers if specified.

The new 830E-1 was not only designed at Collins but is built at Collins to maintain the Collins reputation for quality.

For more information on the new 830E-1 FM Transmitter, contact your Collins Broadcast Sales Engineer, or write direct.



COLLINS RADIO COMPANY • CEDAR RAPIDS, IOWA • DALLAS, TEXAS • NEWPORT BEACH, CALIF.

July, 1961

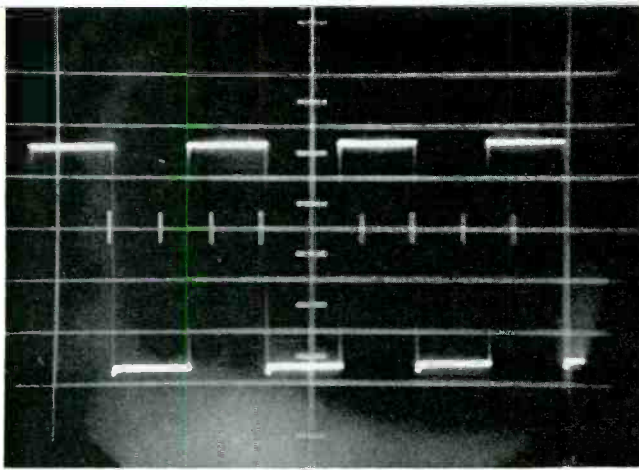

SQUARE WAVE

Very effective for amplitude and phase response checks if properly used and interpreted. Frequency and rise time of square wave determines spectrum which is valid to be checked. It will indicate performance of system from "D.C." to highest end of passband. Excellent for transient response checks, but more critical in requirements of proper use and interpretation than the sine² pulse for transient response test.

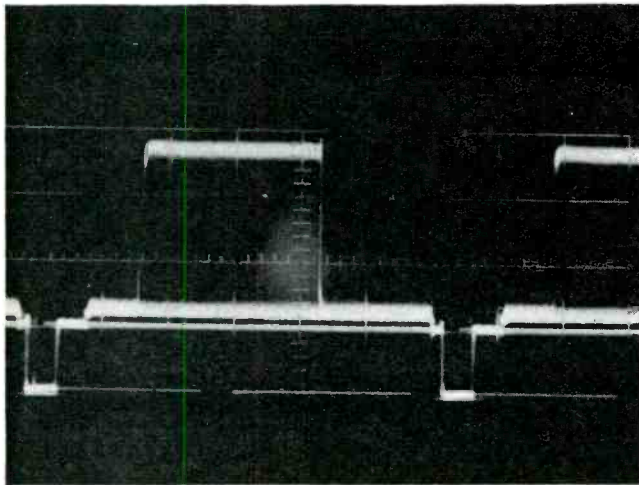

WINDOW

A most convenient check for low frequency response and for the all important "middle" frequencies at multiples of line scanning frequency. It is an excellent indicator of degree of "streaking" or "smearing" when observed on CRO rather than a picture monitor (see text).

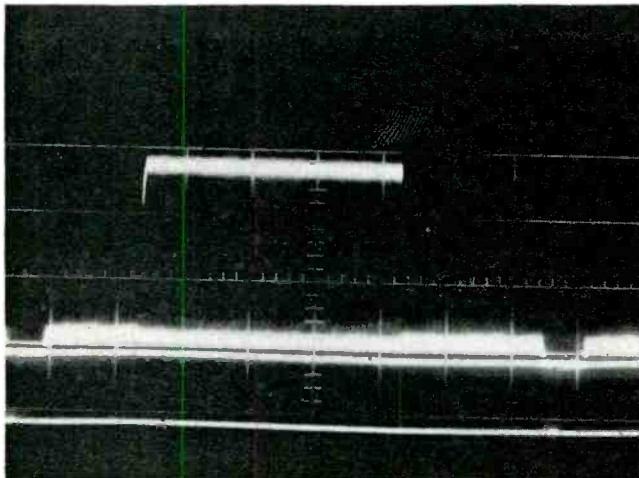

◀ **Horizontal**

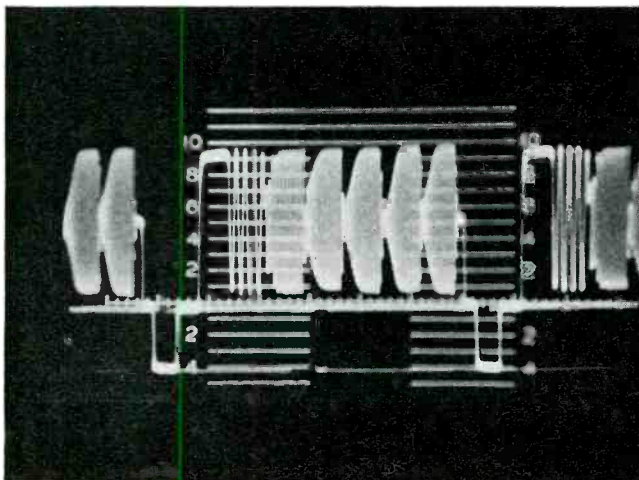

KEYED BURST

Normally used as overall transmission test for amplitude vs frequency check. Although variable, the frequencies of the sine wave bursts following the first white reference pulse are normally as follows:

0.5mc-1.5mc-2.0mc-3.0mc-3.6mc-4.2mc

Figure 1
TEST SIGNAL
GENERATOR OUTPUTS
(Equipment Inputs)

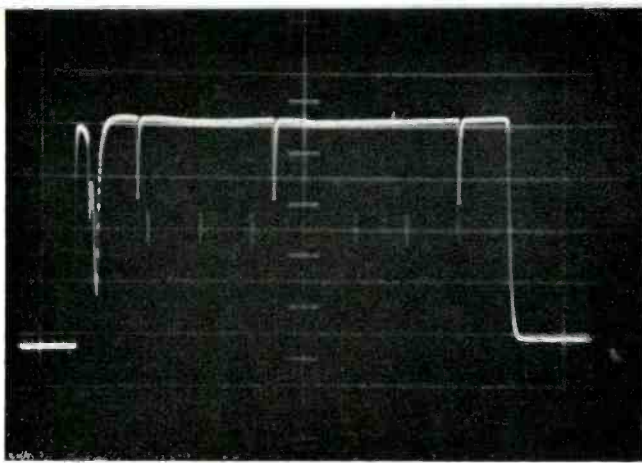

VIDEO SWEEP

◀ **Detected**

◀ **Undetected**

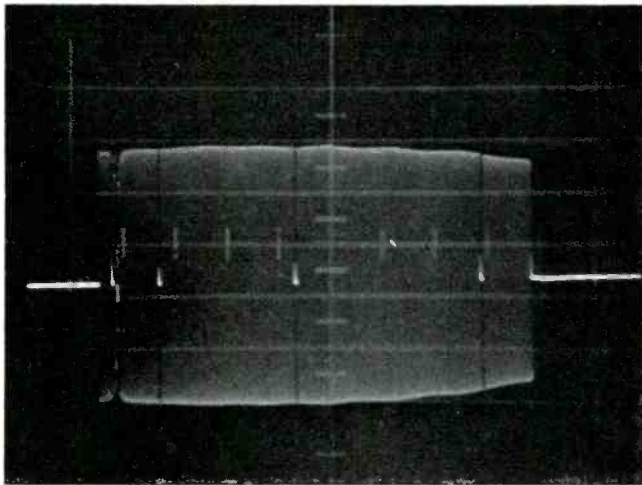

The most widely used and accepted method of obtaining amplitude vs frequency response from 100kc to 10mc. Like the square wave, this method must be properly used and set up to obtain valid checks. It will not indicate phase distortion as does the square wave, window, or sine² pulses.

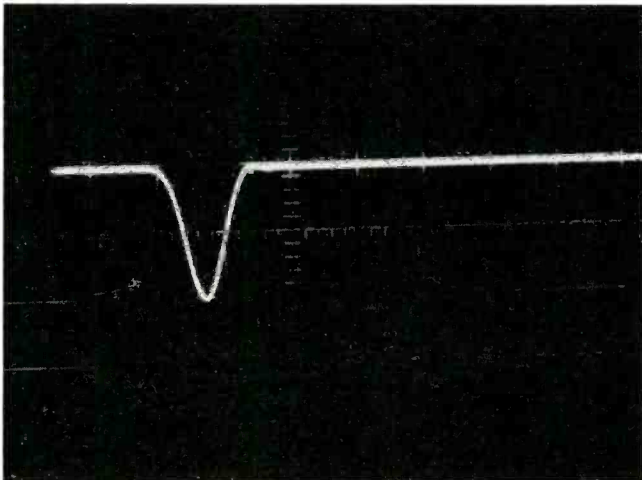

SINE²

◀ **Pulse, expanded**

Although not yet entirely accepted or understood in this country, this test is an extremely useful tool for phase distortion and transient response checks. This pulse, by definition, is a "standard" with reliable and fixed harmonic content; thus it is most suitable for network facilities since interpretation can be validly applied anywhere in the country without correction factors.

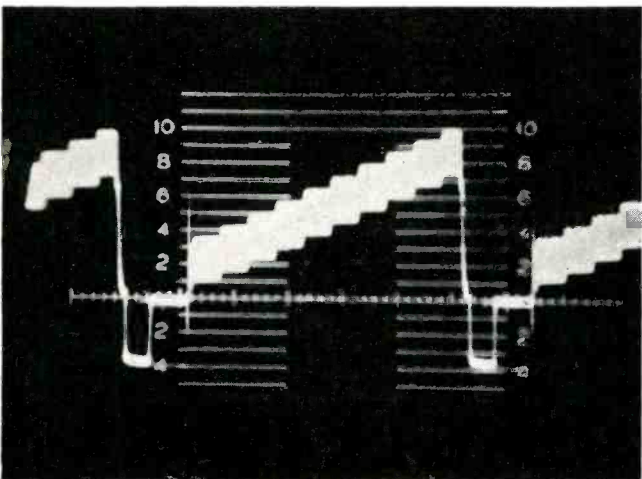



STAIRSTEP

◀ **With 3.58 mc on steps**

The most widely used and accepted method of checking amplitude linearity of video systems. Differential gain and phase may also be checked with a single frequency sine wave superimposed on the steps as shown in the photo.

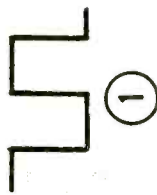
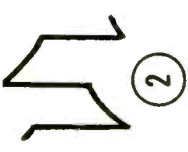
FIG. 2—USE OF SQUARE WAVE

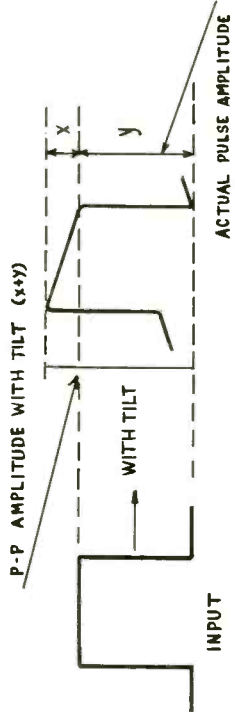
TEST SIGNAL	CRO INDICATION AT SYSTEM OUTPUT	EFFECT ON PICTURE	DEFECT	CAUSE
	 <p>①</p>	Normal picture.	No defects. Excellent low frequency response. Negligible phase shift.	
	 <p>②</p>	Shading top to bottom of picture. Loss of "setup". (see text).	Loss of low frequency gain with leading low frequency phase shift.	Coupling capacitors decreased in value; screen and cathode bypass capacitors; low frequency compensation circuits out of adjustment; grid resistors decreased in value; defective screen resistors; clamping circuit failure.
60 Cycle	 <p>③</p>	Shading top to bottom of picture. Increase of "setup". (see text).	Excessive low frequency gain with lagging low frequency phase shift.	Overcompensation of low frequency correction circuits; coupling capacitors; screen and cathode circuits; grid resistors (open or high).
	 <p>P-P AMPLITUDE WITH TILT (x+y) WITH TILT INPUT ACTUAL PULSE AMPLITUDE</p>			$\% \text{ tilt} = \frac{x}{y} \times 100$ <p>Example: $x = 1 \text{ cm}$ $y = 4 \text{ cm}$ then: $\frac{1}{4} = 0.25 \times 100 = 25\% \text{ tilt}$</p>

A

4

	Normal picture.	No defects. Excellent response at multiples of line scanning frequency.	Improper adjustment of peaking coils; plate load resistors increased in value; peaking coils; or decreased value of peaking coil shunt resistors.
①	Very poor resolution.	Poor middle and high frequency response.	Coupling circuit time constants; improper peaking adjustments; defective peaking coils; bypass capacitors or bypass time constants; irregular gain at middle frequencies.
	Black-following-white streaking. (Negative streaking horizontally).	Loss of low frequency gain with leading low frequency phase shift.	Misadjustment of phase correction circuitry or low frequency compensation circuit.
②	White-following-white streaking. (Positive streaking horizontally).	Mid & low frequency; too high with lagging low frequency phase shift.	
	Normal.	No defects. Good high frequency & transient response.	
B	Fair to poor resolution.	Poor high frequency response; excessive rise time.	Improper adjustment of peaking coils; defective peaking coils or low value of peaking coil shunt resistors; plate load resistors increased in value.
	Bad "edge effects"; "ringing" after five vertical lines image.	Excessive high frequency response; non-linear time delay; high frequency cut-off too rapid.	
①			
75 kc	C		
②			
③			

for television system analysis. The application of each type accompanies the photographs. There is no valid substitution of one for another; each individual type will describe the performance of the TV system over a limited gamut for which it is intended. Due to the nature of their composite signal, the Window (B), Keyed Burst (C) and the Stairstep (F) of Fig. 1 are the most convenient and readily applied sources for overall distribution and transmission tests. However, advantages and disadvantages exist for any one test signal as compared to another.

The square wave is a quite versatile test signal when the user follows the precautions mentioned with respect to the oscilloscope as outlined in Article I of this series. Frequency and rise time of the pulse determines the spectrum of the video passband which is valid to be checked for frequency-phase linearity and transient response. When the system includes a unit incorporating clampers (such as a stabilizing amplifier or the transmitter), the square wave should be keyed and sync inserted as discussed for Figs. 10 and 11 of Article I.

Fig. 2 outlines the basic analysis of a television system or single unit of such a system provided by the square wave signal.

Fig. 2 (A-1). The "ideal" transmission of the 60-cycle square wave. Indicates good low frequency response and negligible phase shift. A "flat" raster will be obtained (freedom from shading) and video "setup" level will be properly transmitted.

Fig. 2 (A-2). Indicates loss of low frequency gain with accompanying phase distortion. Raster will be gradually shaded from top to bottom. Video "setup" level will be reduced, resulting in excessive contrast and black compression on a monitor or receiver which was adjusted for a standard (distortion free) picture. Overall tilt (studio to transmitter output) should be held under 2 per cent for complete freedom from visual effects.

When this type of overall distortion is noted, individual units should be checked alone. This waveform at 60-cycles is very useful for setting coupling circuit time constants (where used) usually designated as

"tilt" controls. For example, the RCA TVM-1 series of microwave systems employ such controls in the modulator, monitor amplifier and receiver amplifier. The square wave is fed to the transmitter and observed at the klystron repeller with a low-capacity probe, and the modulator TILT control adjusted for flat response or the same tilt as indicated on the scope at the transmitter input. The monitor and receiver may then be adjusted for proper transmission of the square wave. Similarly, most "Lap-Dissolve" amplifiers used with switching systems incorporate this type of control so that the tilt can be removed before distribution to the transmitter terminal gear.

It should be realized here that point-to-point single-frequency sine wave runs might indicate a response down to 60 cycles well within 1 or 2 decibels of the reference frequency yet fail to pass a 60-cycle square wave with less than 20 to 30 per cent or more tilt. Loss of effective coupling circuit time-constants, or clamping failure, will cause this type of distortion. See Fig. 2 for things to check on each type of indicated distortion.

Fig. 2 (A-3). Indicates excessive low frequency gain as could be caused by overcompensation of a low frequency correction circuit. An increase of video "setup" level will occur, resulting in weak contrast on a monitor or receiver which was adjusted on a standard picture.

Fig. 2 (A-4). Shows method of measurement of a square wave with tilt. Note that the peak-to-peak amplitude is greater than the actual pulse amplitude in direct ratio to percentage of tilt. When the p-p amplitude exceeds the linear range of a video amplifier, clipping and further distortions result.

Fig. 2 (B-1). The "ideal" transmission of a 15,750 cycle square wave. An indication of excellent response at the very important line-frequency harmonics.

Fig. 2 (B-2). Rounded corners indicate poor middle-frequency and high frequency response. Picture resolution will be very poor.

Fig. 2 (B-3). Indicates loss of mid and low frequency gain. Horizontal lines will streak an amount dependent upon degree of tilt. The streaking will be white-following-

black or black-following-white, termed negative streaking because of the reverse polarity.

Fig. 2 (B-4). Mid and low frequency gain too high. Streaking will be white-following-white, or positive streaking. When accompanied by high frequency overpeaking, can cause severe edge effects as described more fully under description of the Window signal in the next installment.

Fig. 2 (C-1). The "ideal" reproduction of a 75 kc square wave indicates excellent high frequency and transient response providing the test signal has a rise time of 4 to 5 times that of the system to be checked. (See Article I of this series.)

Fig. 2 (C-2). Poor high frequency response with excessive rise time. Picture resolution will be fair to poor. Vacuum tubes should always be replaced one at a time before starting a video alignment to note results. This is particularly important in amplifiers employing negative feedback.

Fig. 2 (C-3). Excessive high frequency response, or cutoff too rapid. When aligning a video amplifier with video sweep, the response may be made "flat" to 10 mc only if a 75 kc square wave with a risetime of 0.02 microseconds has no greater than 10 per cent overshoot. The amplifier should be made flat only to the highest frequency at which this condition prevails. Attempting to exceed the gain-bandwidth product of the system leads to bad edge effects in the picture, and to "ringing" after fine vertical lines in the image. Overshoot through a sharp cutoff filter such as used at the transmitter should not exceed 18 per cent. Phase distortion is minimized here by the use of pre-distortion (phase-correction) units particularly in stations capable of meeting color standards. These units pre-suppose a "flat" response and minimum phase distortion of the video input to the correction circuitry.

The frequency of "ringing" is determined by expanding the first cycles of ringing to enable counting cycles per cm on the scope and using the following formula:

$$\text{Ringing freq} = \frac{\text{number cycles/cm (10}^6\text{)}}{\text{time interval (u/s) per cm}}$$

Editor's Note: Part 2 of Article IV will discuss the remaining test signals of Fig. 1 in the next installment.

INTRODUCING ANOTHER AMPEX FIRST IN TELEVISION TAPE RECORDING

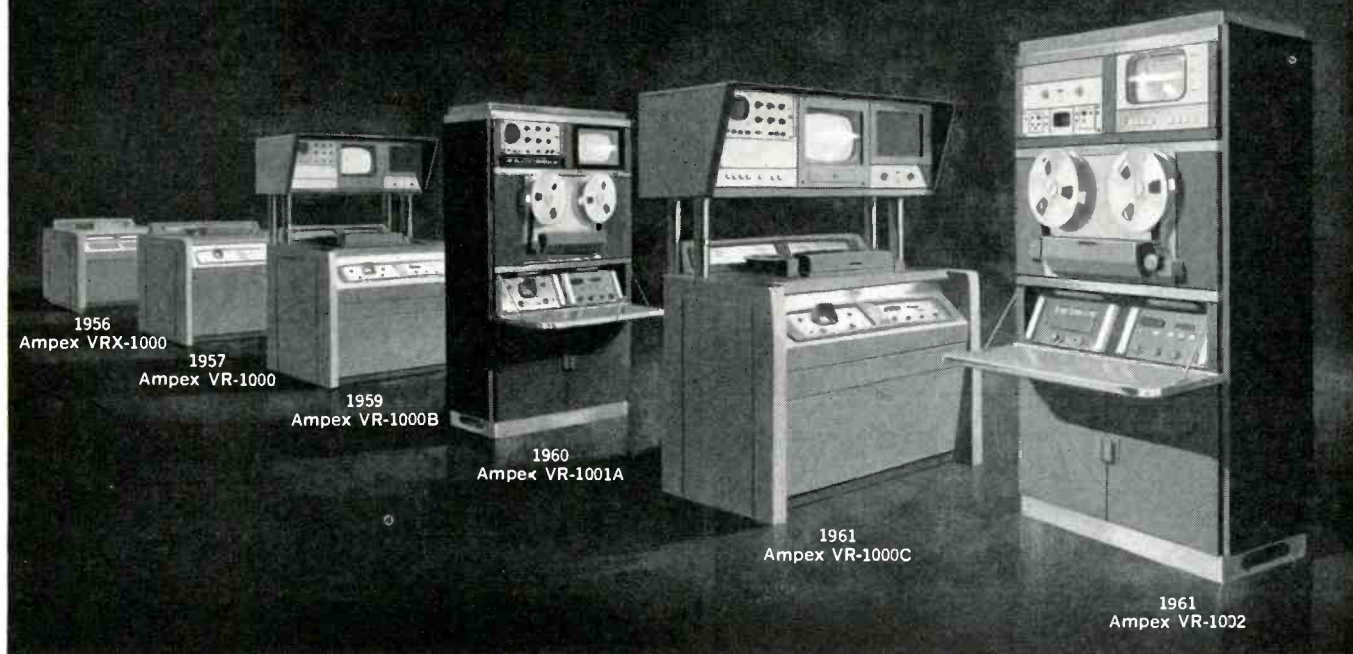

The new Ampex VR-1002 upright model represents the latest and most practical advance in Videotape* Recording, taking its place beside the VR-1000C console. It gives today's broadcasters the quality features they want most . . . in a new compact design that stresses simplified operation with major innovations and refinements in controls and circuitry. The objective of an exhaustive Ampex study of broadcast practices, the exclusive new VR-1002 offers owners unprecedented initial and operating cost savings, at the same time advances the standard of VTR performance.

Major new Ampex VR-1002 developments are (1) AFC Modulator which automatically locks carrier frequency to standard (2) control panel with all meters required for normal operation placed adjacent to their respective control knobs (3) Mark III recording head with individual transducers pre-selected and precisely matched for highest picture quality. Coupled with the new Ampex

Colortec* Direct Color System (optional equipment requiring no additional rack), the new VR-1002 upright provides the most life-like color on TV tape today.

For the station with space or budget limitations, for the console-equipped station requiring a companion recorder, for the station seeking an ideal mobile recording unit, the versatile new VR-1002 is the practical answer . . . the culmination of 15 years of specialization in magnetic tape recording by the company whose name means television tape recording — Ampex.

AMPEX VR-1002 OPTIONAL EQUIPMENT

Intersync* Television Signal Synchronizer • Amtec* (Ampex Time Element Compensator) • Colortec Direct Color System • Ferrite, "340" Long-life Video Head • Selective Editing • Monitor Rack • Tape Splicer Kit • Remote Control Facility • Audio Cue Channel Facilities • Interswitch* Multiple Line Standard Operation • Videotape Cruiser

For complete information, write Dept. E1 TM AMPEX CORP.

Pioneer and Leader in Magnetic Tape Technology **AMPEX VIDEO PRODUCTS COMPANY**
934 CHARTER ST., REDWOOD CITY, CALIF. . . . AMPEX OF CANADA LTD., REXDALE, ONTARIO



VIDEOTAPE TELEVISION RECORDERS: VR-1000C Deluxe Console, VR-1002 Upright Model. TELEVISION CAMERAS: Ampex/Marconi Mark IV

from General Electric
TWO NEW CAMERA TUBES
DEVELOPED TO MEET
YOUR TELECASTING
NEEDS



 **ELECTRONICS**

ZL-7802*

Supersensitive,
Large Dynamic Range,
Longer Life,
Very High Resolution,
Flatter Field,
Reduced
Beam-Bending,
No Orth Spot

*EIA designation GL-8092



ZL-7803†

High
Signal-to-Noise
Ratio,
Improved
Definition,
Flatter Field,
Reduced
Beam-Bending,
No Orth Spot

†EIA designation GL-8093



TV STATION-DESIGNED...

...for flexibility in your color
and special telecast work

ZL-7802 represents a significant advance in image orthicon design. It will pay dividends every day in your studio and remote telecasting. A high-gain, thin-film semiconductor target is the key to ZL-7802 sensitivity and ability to handle wide ranges of scene illumination. This supersensitive target improves depth-of-focus, effectively reduces "stickiness," and permits pickup of dramatically lighted scenes with a minimum of set-up time. The thin-film target also provides excellent high-amplitude response, greatly reduces susceptibility to permanent burn-in damage, affords stable operation during life and eliminates raster burns.

The addition of a field mesh in the scanning section provides excellent landing, shading and dynamic match in color cameras using three image orthicons. Because of this field mesh, only simple adjustments are required and you save on set-up time.

ZL-7802 is interchangeable with the 7629, 7513, 7293, 7293A, 5820 and 5820A.

...for quality you require in
critical video tape recording

ZL-7803 is specially designed for studio pickup service where you control lighting and demand high-quality performance. An improved target-mesh assembly assures you of a *high signal-to-noise ratio* (peak-to-peak signal vs. [RMS] noise — min.: 38, av.: 50). A special field-mesh in the scanning section enhances picture quality by providing sharp transition from black to white without spurious effect (white edges). This feature, by equalizing the decelerating field which the scanning beam encounters, causes the beam to strike the target in a more evenly perpendicular direction over the entire target area. This improves flatness of field and corner resolution . . . helps prevent distortion. The ZL-7803 will noticeably shorten your set-up time and reduce the need to compromise between sharpest focus and minimum background blemishes.

Now you don't have to use a costly color tube to achieve the quality you require in video taping. The ZL-7803 is competitively priced with standard camera tubes. Yet, the high signal-to-noise ratio provides premium video taping quality.

ZL-7803 is interchangeable with the 5820, 5820A, 7293, 7293A and 7513.

Try these new General Electric Image Orthicons in your own cameras. Put them on the tough jobs—for the ZL-7802, demanding special application, color, or low light-level work; for the ZL-7803, critical video taping or quality studio pickup service in black and white or color. You'll appreciate the way these tubes perform.

For additional information, call your General Electric industrial tube distributor or write for descriptive literature . . . ZL-7802 (ETR-2800) and ZL-7803 (ETR-2801) . . . to General Electric Company, Room 7249B, Owensboro, Kentucky.

Progress Is Our Most Important Product

GENERAL  ELECTRIC

Reviewing the One KW AM Transmitters

MORE firms are manufacturing AM transmitters with power output of 1,000/250 watts than it was reported two years ago in this journal (*Broadcast Engineering*, July, 1959). With the slow but positive growth of class IV stations increasing power to 1 KW, daytime and 250 watt cutback for nighttime operation, transmitter builders are now offering a variety of specifications to prospects.

Six manufacturing concerns are currently supplying domestic 1 KW

AM transmitters for immediate delivery. Two of the six suppliers have entered into the 1-KW power class just this year.

The increased competition will tend to standardize features, components and prices. As an example, five out of the six listed employ the same tube type in all power finals and modulator sections, type 4-400A, a tetrode requiring no neutralization.

There is one area where a divided opinion still exists. Three of the six

manufacturers feel the use of solid state silicon rectifiers offers distinct advantages. This new form of rectification provides dc power for bias, low voltage, and high voltage stages. The advantages claimed for this form of power source are:

1. Less outage and maintenance
2. Lower power requirements
3. Less tube replacement
4. Fewer number of tube types

Recent style changes of cabinetry are most evident by an outward glance. Color, shape, meters, control

ONE KW AM TRANSMITTER SPECIFICATIONS CHART

1 kw AM Transmitter Manufacturer & Model No.	A F Distortion, Max.—%	A F Frequency Response in cps	Dimensions HxWxD In Inches	Approx. Net Weight In Pounds	Number of Tubes	Number of Tube Types	Supplied with Dummy Load	SPECIAL COMMENTS
BAUER 707	2	30-12,000 within 1.5 db	75-30-25	800	9	4	Yes	Available in kit or factory wired.
COLLINS 20V-3	3 or less	30-12,000 within 1.5 db	76-38-27	1150	14	7	No	Forced air cooling directly on power tubes and modulators.
CONTINENTAL ELECTRONICS 314 D	3 or less	30-15,000 within 1.5 db	75-32-32	1100	17	9	Yes	Employs screen modulation, has no modulation transformer.
GATES BC-1T	3 or less	30-12,000 within 1.5 db	78-36-32	800	17	6	Yes	Low power AF and RF stages use printed wiring.
ITA AM-1000A	2	30-10,000 within 1.5 db	77-34-24	1000	9	3	Yes	Pretuned to freq., installation supervision provided with purchase.
RCA BTA-1R1	2	30-10,000 within 1.5 db	84-34-32 1/2	1700	9	5	No	Pretuned to freq., provision for 3 crystals, to include conelrad.

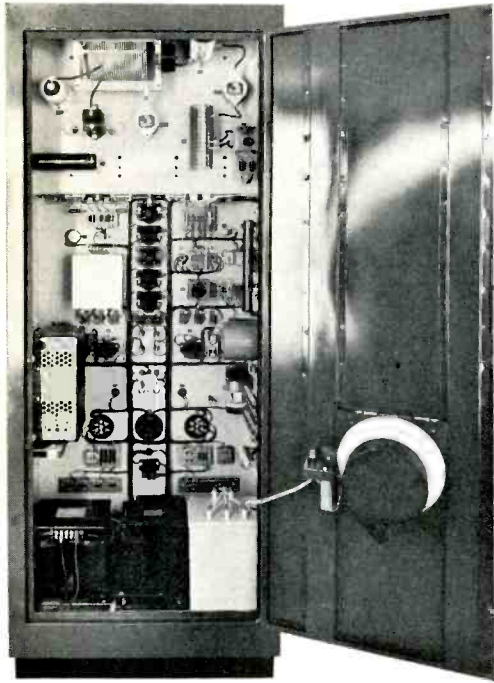

The Bauer 707, rear view.

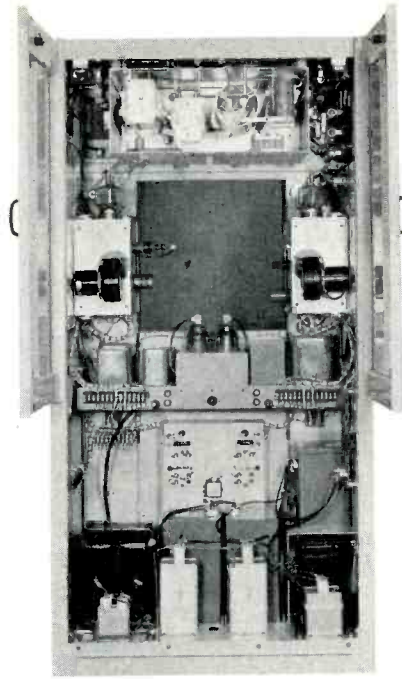

Collins Radio transmitter,
type 20V-3.

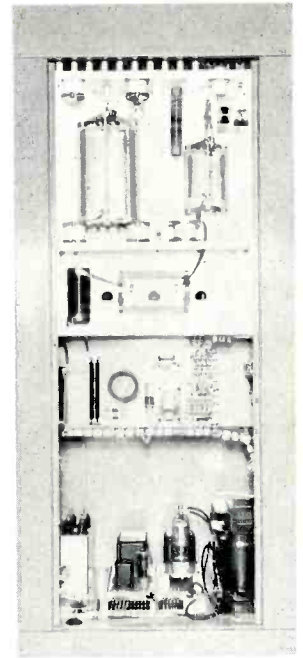

Model 314D,
Continental Electronics.

NOTE ON COMMON SPECIFICATIONS:

All transmitters listed are designed to operate on 60 cycle ac current, single phase, 208/240 volts.
All transmitters have a noise factor of 60 db below 100% modulation and require an audio input level of plus 10 db at 600 ohms.

Normal Rated Output In Watts	Frequency Range in kc	Frequency Stability plus-minus cycles	RF Output Unbal. in ohms	Carrier Shift in % (100% mod- ulation)	Power Demand at 1 kw output, in watts		Power Factor in %	Type of Crystal Oscillator	1 kw AM Transmitter Manufacturer & Model No.
					Average Modulation	100% Modulation			
1000/ 500/ 250	540- 1600	5	50	3 or less	3300	3950	Vacuum	BAUER 707
1000/ 500/ 250	540- 1600	5	50-70	3 or less	3250 (30%)	4150	83	Vacuum	COLLINS 20V-3
1000/ 500/ 250	535- 1620	5	50	2 or less	4000	90	Vacuum	CONTINENTAL ELECTRONICS 314 D
1000/ 250	540- 200 kc	10	50-70	3 or less	3940	Vacuum	GATES BC-IT
1000/ 250	535- 1620	5	40-250	3	3300	4000	90	Vacuum	ITA AM-1000A
1000/ 500/ 250	535- 1620	5	40-250	3	3200	3900	90	Temperature Controlled	RCA BTA-1R1

BOOST FM POWER ECONOMICALLY!



20 KW
S-E
AMPLIFIER

Don't obsolete your present FM transmitter simply to boost broadcast power. Standard Electronics' exclusive "Add-A-Unit" design permits you to retain your present equipment (regardless of make) and jump power up to 20 KW.

For example, the illustrated Standard Electronics 20 KW amplifier can simply be added to a 5 KW transmitter now in operation, and you can be broadcasting at a full 20 KW output!

Economy all the way. Save through non-obsolence and through the surprisingly low cost of a quality Standard Electronics amplifier.



Send for complete details.



standard electronics

DIVISION OF
REEVES INSTRUMENT CORP. - FARMINGDALE
SUBSIDIARY OF
DYNAMICS CORPORATION OF AMERICA
Farmingdale, New Jersey

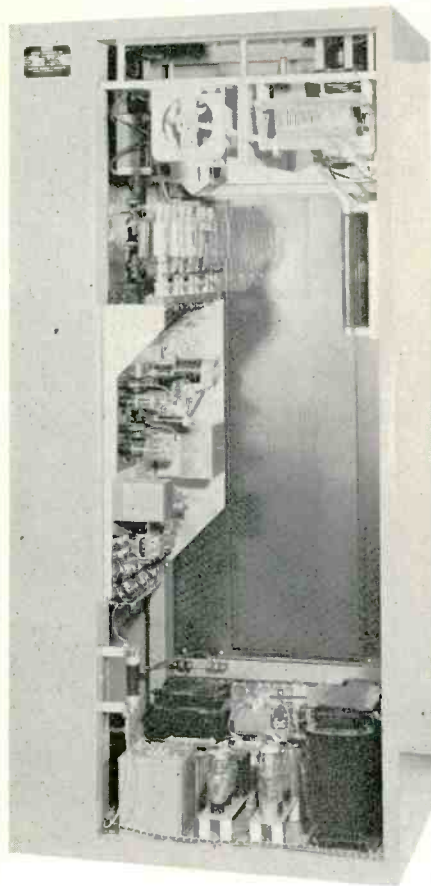

Gates Radio model
BC-IT transmitter.

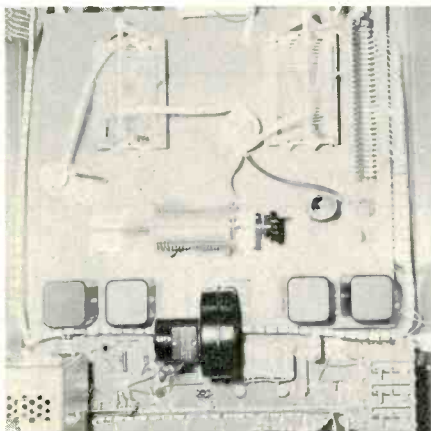

A view of the tank circuit
of ITA's AM-1000A

switches and dials are blended to catch the eye on some units.

A more simple operation for the less technical person is stressed today by all manufacturers of 1-KW transmitters. All units provide remote control facilities. A majority have built-in dummy load for preliminary tuning and testing. Most units have built-in power reduction from 1 KW to 250 watts as standard equipment while other units provide this as an optional feature.

A complete technical listing and specification of the six manufacturers of 1,000/250 watt AM transmitters is shown in Fig. 1. This provides a side by side observation of the features and facilities provided in this field.

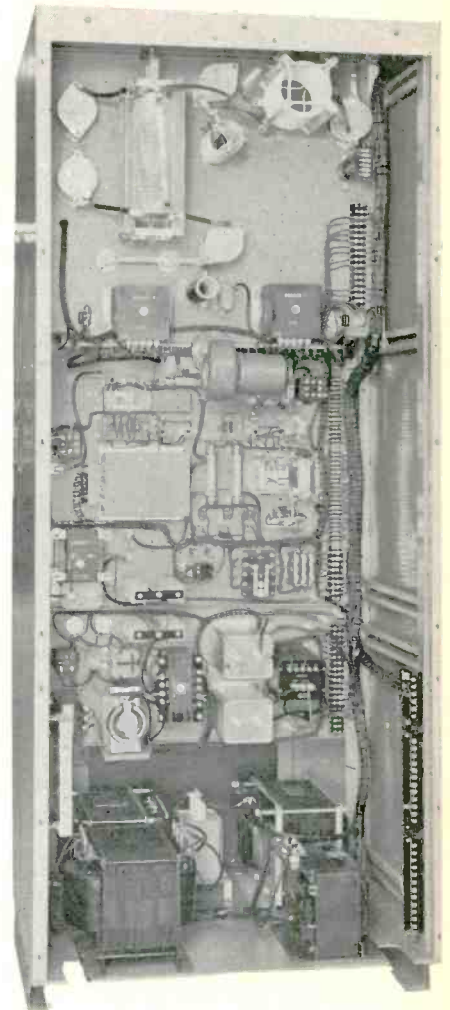

Looking inside the RCA
BTA-IRI transmitter.

PERFECT FOR MULTIPLEX STEREO BROADCASTING

**NOW!
FROM
GRAY**



**A STEREO
TONE
ARM
FOR THE
PROFESSIONAL**

The most versatile ever developed—

The ultimate in simplicity, ruggedness and reliability. Virtually maintenance free. Unexcelled audio performance. Sets a new low in tracking distortion. Response ± 1 DB from 5 cycles to cartridge limit.—This is the finest tone arm Gray has ever made and it is already setting new industry standards.— Here's why:

Plug in all cartridges including the G.E. Broadcast turn-around. Dual balanced line output.

New modular weight system allows mounting almost any cartridge with hardware supplied.

Individual slide "memory" of the physical and electrical arm adjustments for each cartridge.

Built-in calibration to allow instantaneous exchange of cartridges between arms.

Set up in seconds for monophonic or stereophonic operation as your Broadcast schedule dictates.

Eliminate forever special equipment or "lash ups". Available from stock now for immediate delivery.

Write today on your company letterhead for complete technical information, specifications, and application data.

GRAY SPECIAL PRODUCTS DIVISION 17 ARBOR ST., HARTFORD 1, CONN.

Tips on Tape Storage

By VICTOR A. MOHRLANT
Magnetic Products Laboratory
Minnesota Mining & Mfg. Co.

EDITOR'S NOTE:

The April issue of BROADCAST ENGINEERING carried a story on how cellulose acetate magnetic tape deteriorated after 10 years of storage. Here, 3M's Technical Service manager for magnetic products gives tips on how to avoid such deterioration by properly handling and storing tapes.

WITH each passing year since magnetic tape became radio's right arm in 1948* recording engineers have become increasingly aware of the importance of proper handling and storage of this relatively youthful medium. They have learned that tape can be played thousands of times without deterioration, yet special care is called for if the tape is to be stored for several years.

The following precautions should be taken to preserve the physical and magnetic properties of recordings which will not be played for prolonged periods:

Use Polyester-Backed Tape

Low humidity, such as exists in heated areas during cold winter

months, and high temperature over extended periods may cause the plasticizing agents in cellulose acetate tapes to evaporate, leaving the tape brittle. There are no plasticizers in polyester, so, if it is known in advance that a recording will be stored for several years, it is advisable to use a polyester-backed tape. Temperature and humidity changes cause reversible dimensional changes. Polyester has 50 per cent better resistance to temperature change and about 15 times better resistance to humidity change than acetate.

Control Temperature, Humidity

Ideally, magnetic tape should be stored at room temperature with relative humidity controlled between 40 and 60 per cent. If the relative humidity is subject to large variation, tape should be stored in metal cans sealed with pressure sensitive tape. The use of desiccants or humidifying agents is not recom-

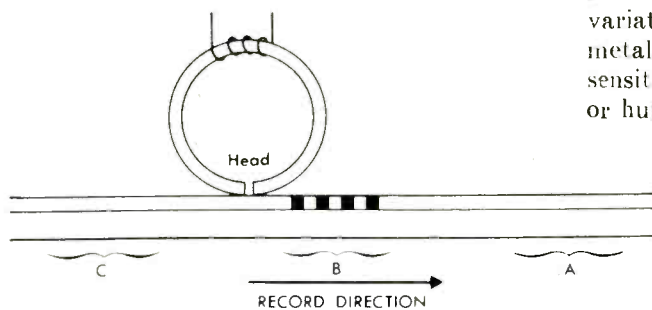

Figure 1

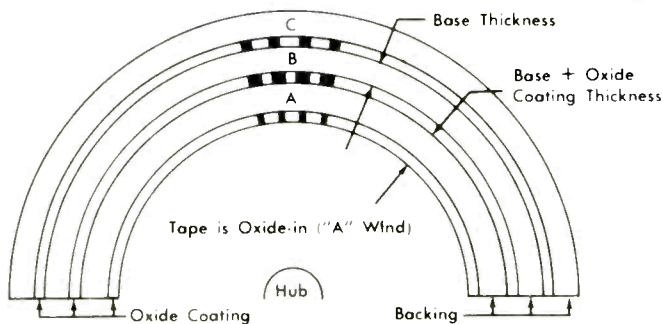

Figure 2

Tape stored on take-up reel. Section C receives most signal transfer, which appears as post-print on playback. This method of storage is recommended for master tapes.

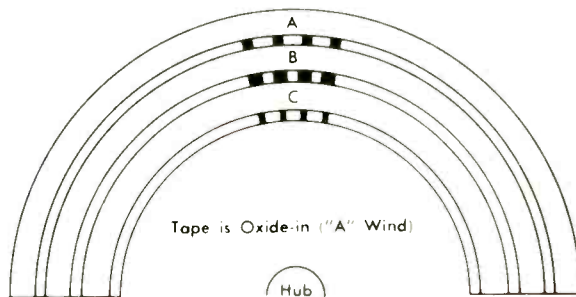

Figure 3

Tape rewound to and stored on stock reel. Section A receives most signal transfer, which appears as pre-print on playback.



mended because of the difficulty in controlling the results.

Brittle tape usually can be returned to a condition which will allow playing back the information recorded on it. A simple way to restore moisture, which has evaporated due to storage without temperature or humidity control, is to leave a wet sponge with the reel of tape in a closed vessel for 24 hours, being careful to keep the moisture from coming in direct contact with the tape.

Wind Tape Loosely on Reels

Most cases of tape distortion can be traced to excessive winding tension, uneven winding, or both. While the tension on the tape as it is being wound may seem small, a thousand odd layers, each contributing a minute stress, can add up to tremendous pressure on the tape nearest the hub. Physical distortion is minimized if the tape is prepared for storage

*In 1948 Minnesota Mining & Mfg. Co. marketed the first red oxide magnetic tape — "Scotch" brand No. 111 — which made it possible for ABC to pioneer magnetic recording in the broadcasting field.

by winding it evenly with relatively low tension so as to produce a rather soft, stable roll. These conditions can best be met if the roll is last wound at playing speed on the take-up reel of a professional machine properly adjusted for take-up tension. High speed winds are generally soft enough as a result of entrapped air, but an even wind usually is sacrificed in the process. Resultant "weaving" may lead to serious physical distortion if the reel is subjected to adverse storage and handling conditions, especially if the tape has an acetate base.

Store Tape Tail-End Out

Because of the great dynamic range involved with professional recording equipment, "printing"—the transfer of a recorded signal from a layer of tape in a roll to its adjacent layers—can occur during storage. Since the amount of print received by a given section of tape depends (among other things) upon the separation of this section from the section carrying the printing signal, the next *outer* layer of tape

from the printing signal in a normal oxide-in wind will receive more print than the next *inner* layer. This is true because the printing field, to produce relatively significant print, must reach the *top* surface of the oxide coating of the section undergoing print. Thus, to print the next outer layer of tape, the printing signal must pass through the thickness of the base material only. But to print the next inner layer of tape, the printing signal must pass through both the thickness of the base and the additional thickness of a layer of oxide.

This is illustrated in the diagrams, the elements of which have been dimensionally distorted for clarity. Figure 1 shows recording direction. Figure 2 shows tape stored on the take-up reel, with section C undergoing maximum print. On playback, section C goes past the playback head *after* the printing signal and is heard as *post-print*. Figure 3 shows tape rewound to and stored on the stock reel, with section A receiving maximum print. On playback, section A precedes the printing signal past the head and appears as *pre-print*.

Storing on the take-up reel, as in Figure 2, is recommended because it results, upon playback, in the stronger of the two prints appearing as post-print, and the weaker as pre-print. Post-print is less troublesome than pre-print because it is likely to be masked by the original signal. Pre-print, on the other hand, may be quite noticeable if it is strong, and if it is preceded by a quiet stretch of tape, as frequently is the case.

Rewind Tape Prior to Playing

The printed signal is transient; its level drops rapidly upon removal from the printing field. Measured a few minutes after removal from intimate contact with the printing signal, the printed signal will show a drop of 6 db or more from the level measured seconds after removal. This is one reason rewinding just before playing the tape is advisable—the printed signal thereby is reduced and there is usually not sufficient time before playback for a new signal of bothersome strength to be printed. In addition, rewinding ordinarily will release any

(Continued on page 39)

Cues and Kinks

A new name for an old column, formerly "Technical Hints," "Cues and Kinks" will be a regular monthly meeting place for the minds and experiences of our broadcast engineers. This area is yours, fellows. Contribute your pet project for the benefit of others. Mail your time-saving, problem-solving circuit or idea to: Cues and Kinks, Broadcast Engineering, 1014 Wyandotte St., Kansas City 5, Mo.

DING DONG COUNTER FOR CONELRAD

By VINCENT P. MARLIN
Chief Engineer, WFBL, Syracuse, N. Y.

THE NEW Conelrad alerting system proposed by the FCC and now under test would give sixty-second nation-wide Conelrad warning to AM, TV, and FM broadcast stations equipped with a news teletype machine from AP and UPI. This new system would still require present monitoring techniques but it would provide faster warning with a written notice.

A test or alert would originate from Colorado Springs, Conelrad control center for the United States. Upon a given command the two teletype wire services would be joined together and the alert or test sent out simultaneously. It would consist of a ten bell attention signal, a key word, then the text with a key word ending the message.

The purpose of this "Cue and Kink" is to have the unit count the ten bell attention signal and alert all station personnel as quickly as possible.

The material needed to complete the unit requires a 110-volt AC stepping relay with a reset coil, plus a 6-12 RPM timer motor (the type used in window displays).

The first action before installation is to receive permission to

mount a microswitch on the bell clapper function bar, inside the teletype machine. This switch will close the circuit each time the bell strikes.

Mount the microswitch in the teletype on a bracket for support, allowing the function bar that operates the bell clapper to close the microswitch during each bell ring. Provide slots instead of holes to permit adjustment. A cable with a removable plug is needed in case the teletype machine is moved for

cleaning. This cable plugs into the control box.

The purpose of the timer relay is to allow alarms to operate when there are ten consecutive bells, not five now and five more, thirty minutes later. The average bell rings about once per $\frac{1}{2}$ second, therefore, ten bells would be completed in approximately five seconds. The timer starts running at the same time the stepper relay begins to step. If the timer reaches its cycle before the stepper is at position number ten, the timer will reset the stepper relay to zero (that is if there were fewer than ten bells). The stepper must reach position ten before the timer resets the stepper in order for the alarm to sound. The speed of the timer should be approximately ten RPM (one cycle in six seconds). The timer motor shaft is fitted with a cam to operate the microswitch once, each cycle.

The relay is wired to stay on the tenth position, after counting ten bells, until reset manually. This action keeps the alarm on until someone comes to the teletype machine to read the alert copy.

The relay should have a reset coil, two sets of wiper contacts or off-home contacts; the latter operates the timer motor when the bell starts to ring in the teletype unit. The timer microswitch cam operates the stepper reset coil, restoring operations until the next set of bells ring.

The final step is to mount all the parts in an adequate chassis or box, keeping in mind that the unit will be near the teletype machine, on the shelf or table providing easy access to the reset switch.

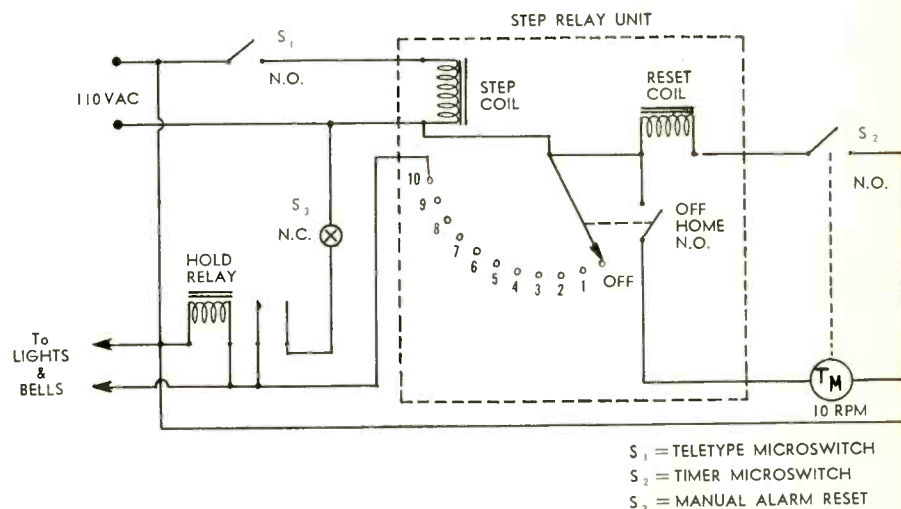

Introducing! The new E-V THIN MAN — the non-directional, voice-range, “invisible” microphone for vocalists, panel shows, group discussions, public address

Developed through close personal liaison with technical directors, audio engineers and performers, the E-V Thin Man features a 24-inch long, 1/8-inch thick semi-rigid tube with the microphone on the end . . . close to the sound source for full-range, pop-free response without distracting or obstructing the view of either the performer or the audience.

It's the latest Electro-Voice design achievement — and another reason why E-V microphones are used at major news events more often than the next four brands combined . . . 87.3% more often than any other single brand!

With the Model 652, you enjoy typically smooth E-V frequency response. Two transparent baffles allow accentuation of the presence range — the smaller for a 3 db boost and the larger for a 6 db boost at 5,000 cps. Used without a baffle, the Model 652 provides smooth response from 80 to 8,000 cps. It's the perfect answer for small stations, small studios with acoustic problems solved only by a close microphone!

For full information on the Model 652, write for our free, fact-filled specification sheet!

*Also available in 15" lengths as Model 652A.
Identical in all other respects.
List Price, \$120.00 (652 or 652A.)
Normal Trade discounts apply.*

ELECTRO-VOICE

BREAKS THE

SIGHT

BARRIER!



arcs down like this



extends out like this



can be hand-held like this



curves up like this



extends out like this



to the side like this

ELECTRO-VOICE, INC., Commercial Products Division
Dept. 711V, Buchanan, Michigan

Electro-Voice®

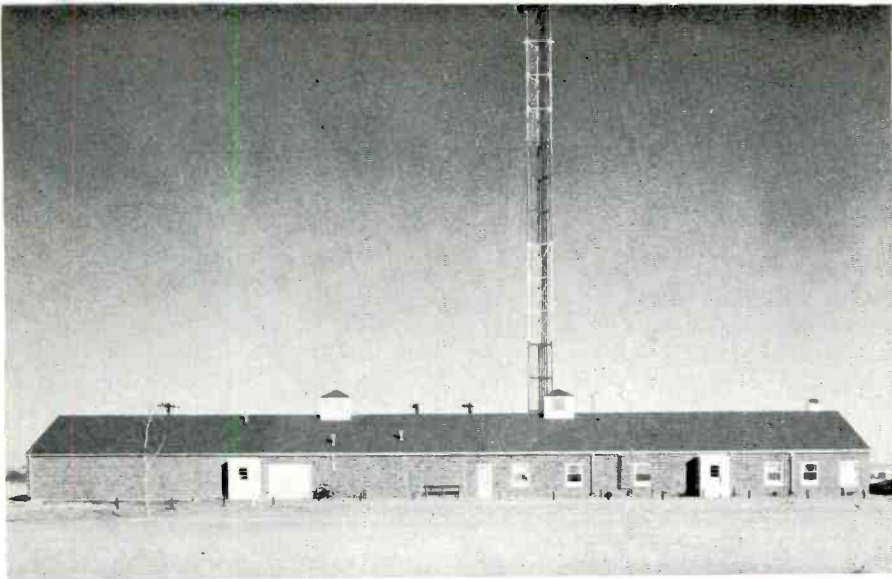

KHOL-TV studios at Holdrege, Neb.

Film Director Jim Bell takes slide-type Polaroid picture of a group of pictures to be used on next newscast. The negative (or positive transparency) of the four pictures is cut into negatives to form 2 x 2 inch slides.



Production Director Dick Larson inserts the projection screen in position in the news-set backdrop.

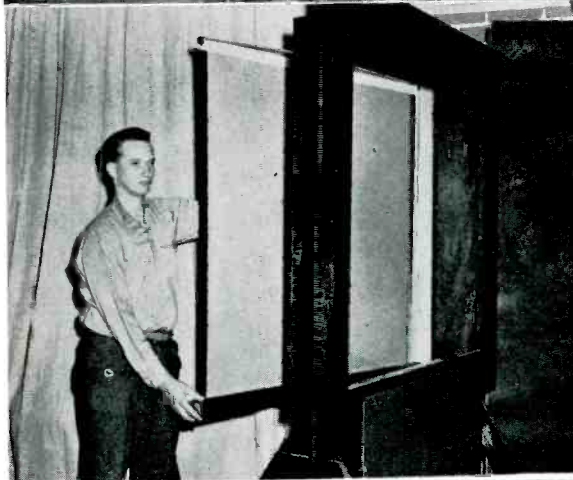

Newscaster Art Eckdahl is pictured with projection of a slide of Eisenhower. Viewers see both newscaster and newscast picture simultaneously rather than just picture of one or the other.



TV STATION

From
The Eastman Kodak Co.
Rochester, New York

A Holdrege, Neb., TV station (KHOL-TV) has come up with an ingenious "do-it-yourself" front projection technique which has added new sparkle and network-type polish to its nightly *Newscape* half-hour newscasts and saved twice its own cost recently by screening some sponsor "spots" after conventional projectors burned out on system.

Using a slide projector well known to amateur photographers but which is gaining increasing attention for commercial uses, KHOL-TV personnel have put together a front projection set-up which is described as "comparable to the ABC-TV projection image effect used on 'The Evening Report' news show."

The idea had its beginning with the purchase of Kodak Projector Model 520 and a 50 x 50 inch portable screen. According to KHOL-TV manager Jack Gilbert:

"Upon receipt of the projector, we rewired the motor switch so that whenever the projector was in operation, the motor would function constantly. Consequently, it added a safety feature that allowed the projection bulb to cool off sufficiently to reduce malfunction.

DEVICES DO-IT-YOURSELF FRONT PROJECTION

Home type viewer relieves production problems

"In operation, we use a three-inch lens which sufficiently covers the screen with a projection length of approximately 12 feet.

"The projector is mounted on a 24 by 24 inch piece of 3/4-inch plywood that functions as a platform. It is suspended by wire from the studio ceiling about six feet from the floor. The suspension gives studio personnel access to the projector by a portable ladder. It also keeps the projector off the floor area and offers freedom of cameras and props to move beneath.

"To change slides, we have installed a remote control switch onto the news desk. The newscaster thus changes slides at his command. An auxiliary switch is located in the control room near the production director. Therefore, the director can also change slides if needed.

"We also constructed a correlating black background for the announcer. Then we installed a small (50-watt) spotlight directly over the announcer's position for highlights. We aimed a Fresnel 500-watt spot in the announcer's face. It is rheostat controlled to pull the voltage down to 10 reflected candlepower radiat-

ing from the announcer. The projector screen reflected approximately 20 candlepower.

"Our engineering department recently replaced our Image Orthicon picture tube with a new type which presents increased sensitivity. With it, we experimented and discovered that a lens setting of f/5.6 produced the desired effect.

"The cameramen can move about in this set without difficulty. They can dolly into the image on the screen, announcer, or both, with ease. It creates a dimensional, mobile portrait of the news which has proved salable."

Shortly after the set-up went into operation, the whole project paid for itself twice over in the salvaging of some commercial slides.

Key to the money saving was the switch for the projector which was wisely located in the control room. When several standard 2 x 2 projectors burned out on system five minutes before they were scheduled to air a set of commercial slides, KHOL-TV Film Director Jim Bell transferred the slides from the burned out projectors to the new

projector, and no commercial time was lost.

The projection set-up pointed up its versatility during coverage of the Nebraska Primary Election, says Gilbert:

"We were using Camera No. 1 through the doorway of the station newsroom (not the news set), and superimposing the election totals over the images of the candidates.

"We then realized we had both of our 2 x 2 projectors in the film room loaded and still had 11 commercial dealer slides that also had to be projected on the screen in some way.

"We removed the News Projector from its studio perch, transplanted the Dalite screen in the studio hallway outside of the newsroom and came off of the supered slides to Camera No. 1 which was on the screen. Cameraman Dick Larson picked up the image on the screen. The result was that the dealers' slides got aired without a slip-up.

"On this occasion, we utilized the switch in the rear of the Model 520 to change slides. The cameraman merely locked the camera and changed the slides with the switch."

AMENDMENTS AND PROPOSED CHANGES OF F.C.C. REGULATIONS

Chapter 1—Federal Communications Commission

PART 1—PRACTICE AND PROCEDURE Local Notice Requirement in the Case of Broadcast Applications Filed Before De- cember 12, 1960, and Designated for Hearing on or After That Date.

It has come to the Commission's attention that there has been some confusion among applicants concerning the applicability of the local notice requirement of section 311 (a) (2) of the Communications Act of 1934, as amended, to applications filed prior to December 12, 1960 (the effective date of P.L. 86-752, requiring such notice), but designated for hearing subsequent to that date. Section 311 (a) (2) requires the applicant for an instrument of authorization in the broadcasting service to give notice of a hearing in the principal area which is served or is to be served by the station at least 10 days before commencement of the hearing. Section 1.362 (b) of the Commission's rules describes the notice requirement in greater detail and in particular requires publication twice a week for the two weeks immediately following release of the Commission's order specifying the time and place of the commencement of the hearing. Section 1.362 (c) of the rules requires that certain information concerning the notice be filed with the Commission within five days of the last date of publication or broadcast of the notice.

Under § 1.359 (h) of the rules, and pursuant to the effective date provisions

of section 4 (d) (2) (C) of P.L. 86-752, local notice of hearing must (except in assignment and transfer cases covered by § 1.359 (h) (1) be given in all cases designated for hearing on or after December 12, 1960, even if the application was filed prior to that date.

Because of the confusion which has existed, applicants who filed before December 12, 1960, and whose applications were designated for hearing on or after that date will not be penalized for failure to obtain timely compliance with the local notice requirement, and an extension of time for obtaining compliance, dating from the date of release of this notice, is hereby granted. Applicants in this category who are not in compliance should take immediate steps to comply with the requirements of § 1.362 (b) and (c) of the rules. Notice should be published twice a week for the two weeks following release of this notice, and the information required by § 1.362 (c) should be filed with the Commission within 5 days of the last day of publication or broadcast. Applicants in this category who have published the notice required by § 1.362 (b) and have filed the information required by § 1.362 (c), but who failed to do so within the time periods specified in those sections, need take no additional action. A waiver of the provisions of those sections requiring publication and filing within specific periods is hereby granted in such cases.

Any petitions for extension of time or

for waiver of the provision of § 1.362 (b) and (c) requiring publication within specific periods which may have been filed by applicants in such cases will be dismissed as moot. No hearing may commence until ten days after the notice requirement has been satisfied.

Adopted: May 11, 1961.

FEDERAL COMMUNICATIONS
COMMISSION,

[SEAL] BEN F. WAPLE,
Acting Secretary.

PART 3—RADIO BROADCAST SERVICES

Table of Assignments; Certain Television Broadcast Stations in Ogden, Utah.

1. The Commission has before it for consideration its notice of proposed rule making released February 17, 1961, proposing that Channel 24, now assigned to Ogden, Utah, be reserved for non-commercial educational use in that community.

2. Channels 9+, *18—, and 24 are now assigned to Ogden which has a population of 70,197 according to the 1960 U.S. Census. Commercial Station KVOG-TV has been authorized to use Channel 9 and educational Station KWCS-TV operated by The Weber County School District has been authorized to operate on Channel 18. Both of these stations now have license applications pending. No application has been filed for Channel 24.

3. Petitioner, the Ogden City Board of Education, in its petition for rule

JAMPRO TV & FM TRANSMITTING ANTENNAS

Special Designs

•

Foreign Sales by
ROCKE INTERNATIONAL CORP.

13 East 40th St., New York City 16, New York

from **MOSELEY ASSOCIATES**

Coming Soon

● **STEREO TRANSMISSION EQUIPMENT**

Available Now

- **FM MULTIPLEX SUBCARRIER GENERATORS**
- **RADIO REMOTE CONTROL SYSTEMS**
- **PROGRAM STL**

Modern Leasing Plans Available

MOSELEY ASSOCIATES

P. O. Box 3192, Santa Barbara, Calif.
4416 Hollister Ave. **WOODLAND 7-1469**

making, stated it has for some time been considering the use of television for educational purposes. Such use has also been considered by a committee consisting of 50 educators and laymen which has for the past two years been studying the curriculum of the Ogden Public Schools. Following this study, petitioner has authorized an application to be made for a television station on Channel 24 and desires that the channel be reserved for educational use.

4. For the past year and a half the Ogden Public Schools have been making use of the educational programming provided by educational Station KUED, Channel 7, Salt Lake City, Utah, operated by the University of Utah. Salt Lake City has a population of 182,121 according to the 1960 U.S. Census and is located some 30 miles south of Ogden. About 1,000 Ogden students have been receiving the foreign language programs provided by Station KUED and many other students have been using other programs from this station. The Ogden Public Schools have provided some of the programs broadcast by Station KUED.

5. The petitioner, the Ogden City Board of Education, also asserted that, while it is cooperating with the Weber County School District in its planned operation of educational Station KWCS-TV in Ogden, an additional television station is needed to provide a more inclusive offering of television instruction for students in the Ogden area.

6. The only comment filed pursuant to the notice of proposed rule making was that of the National Educational Television and Radio Center supporting the proposal. No other interest has been expressed in Channel 24 at Ogden and no party opposed the proposal. For the reasons stated the Commission finds that adoption of the proposal is in the public interest.

7. Authority for the amendment adopted herein is contained in sections 4 (i) and (j), 303 and 307 (b) of the Communications Act of 1934, as amended.

8. In view of the foregoing: *It is ordered*, That effective June 30, 1961, the table of assignments contained in § 3.606 of the Commission's rules and regulations is amended, with respect to the community named, to read as follows:

City:	Channel No.
Ogden, Utah.....	9+, *18—, *24

(Sec. 4, 48 Stat. 1066, as amended; 47 U.S.C. 154. Interpret or apply secs. 301, 307, 48 Stat. 1081, 1083; 47 U.S.C. 301, 307)

Adopted: May 17, 1961.

Released: May 22, 1961.

FEDERAL COMMUNICATIONS
COMMISSION,

[SEAL] BEN F. WAPLE,

Acting Secretary.

NO BETTER SOURCE FOR SPECIALIZED
TRANSFORMERS THAN THE EXPERTS AT



PEERLESS

Since 1935, Peerless has been the pioneer—designing and manufacturing transformers of the highest reliability to most-exacting specifications of the electrical and electronics industries. A policy of creative engineering, precision construction and rigid quality control has given Peerless acknowledged leadership—particularly in the design of specialized units. Pioneering in miniaturization, Peerless has also established the industry standards for reliability in sealing and ruggedness of packaging. Products range from units 1/10 cubic inch to more than 20 cubic feet, from fractional voltages to 30,000; from less than 1 cycle to almost a half megacycle; in 1, 2 and 3-phase or phase-changing configurations. Constructions cover the range from open-frame to potted, hermetically-sealed and vacuum-impregnated units. Whatever your transformer needs, Peerless can design to your specification and deliver in quantity. In addition to the units shown here, Peerless has solved these special problems:

- Miniature Inductance Unit, 4.85 henrys ($\pm 7\%$) at 150 ma, DC
- Miniature 400-cycle Filament Power Transformer for airborne operation
- Miniature Power Transformer, 3-phase, 400 cps to 1, 2 and 3-phase
- Miniature Audio Input Transformer, low-level input
- Miniature Hermetically-Sealed Output Transformer, 400 cps, high level

**LOW VOLTAGE, HIGH CURRENT AUDIO
OUTPUT TRANSFORMER 16595**

Single-phase, oil-immersed unit rated at power level of 26KVA. Frequency response of $\pm .5$ db from 20 cps to 5 KC. Above resonant frequency, at 28 KC, attenuation slope and phase shift are smooth and without irregularity. Suited to such applications as driving high-power shaker tables.

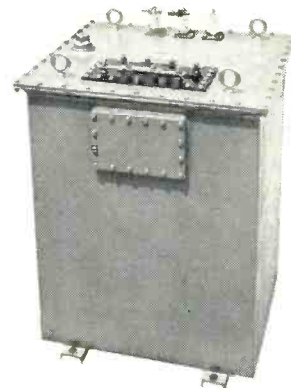

**20-20 PLUS SHIELDED INPUT
TRANSFORMER K-241-D**

Small size for such superb performance. Frequency response, 1 db: 10 to 25,000 cps. Primary balanced to attenuate longitudinal currents in excess of 50 db. Secondary may be used single-ended or in push-pull. Electrostatic shield between primary and secondary has 90 db electromagnetic shielding. Maximum operating level, +8 dbm.

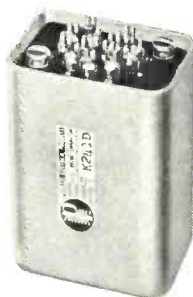

Whatever your transformer needs, Peerless engineers can design to any military or commercial specification and manufacture in any quantity. See REM for complete catalogue of standard units or write for information to Dept. B-7-PE



PEERLESS



ELECTRICAL PRODUCTS

A DIVISION OF ALTEC LANSING CORPORATION

6920 McKinley Avenue, Los Angeles 1, California



"Remember Maggie"

WORLD'S MOST WIDELY USED PROFESSIONAL TAPE RECORDER

More Maggies in professional use than all other makes combined.



THE S 36

The broadcaster's favorite for compactness, convenience, and professional audio quality.



THE PT 6

The rugged, reliable "Workhorse" of the broadcast industry.

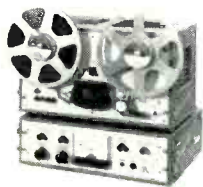

THE P 75

"The Editor" . . . includes all of the capabilities of the PT 6 plus extended performance and utility.

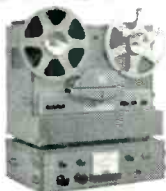

THE M 90

"Mighty" in all performance characteristics. Magnecord's prestige tape instrument.

FOR A COMPLETE LINE OF RECORDERS WITH PROFESSIONAL QUALITY AND DEPENDABILITY — "Remember Maggie."

SOLD ONLY THROUGH FRANCHISED MAGNECORD DEALERS

For the dealer nearest you . . . write

Magnecord
SALES DEPARTMENT
MIDWESTERN INSTRUMENTS, INC.
manufacturers of electronic data acquisition instruments

fill out coupon and mail today!

MAGNECORD SALES DEPT.
MIDWESTERN INSTRUMENTS
P. O. BOX 7509
TULSA 18, OKLAHOMA

PLEASE SEND ME COMPLETE INFORMATION ON _____

NAME _____

COMPANY _____

ADDRESS _____

CITY _____ STATE _____

Industry News

Prodelin Appoints Mumford Technical Service Engineer



Prodelin, Inc., Kearny, N. J., has appointed Sam Mumford as technical service engineer in the southern California area. The company has recently set up a newly integrated nation-wide sales and service organization to expand sales activities and increase service to its customers.

Mumford, in his new position, will be responsible for all technical service in connection with the company's products and installations in the West Coast area. Prior to his present appointment with Prodelin, he was associated with North American Aviation in the capacity of research analyst.

Digital Computer for Automatic Switching Control

A digital computer system designed especially for automatic and error-free program switching in television broadcasting stations has been developed by TRW Computers Co., a division of Thompson Ramo Wooldridge, Inc. The new system, called Tascon (for Television Automatic Sequence Control) has been announced by Dr. Joseph F. Mandli, general manager of the company.

With Tascon, switching orders for the entire program day can be stored in the computer memory. The operator can tell what is currently on the air, when the next switching sequence will begin and where the sound and picture will originate. During data entry, the Tascon displays can be used by the operator to verify each switching instruction before it is stored in memory.

Tascon systems are tailored to the individual requirements of small or large stations and can easily be adapted to station growth or modified

to fit new requirements or equipment changes. Tascon circuits that activate programming controls are said to be completely compatible with any of the voltage levels used in switching circuits of TV stations.

Sol Wiener Named Chief Value Engineer

Appointment of Sol Wiener as chief value engineer was recently announced by Paul H. Odessey, executive vice-president of Polarad Electronics. In this new capacity, Mr. Wiener will assume major responsibility for Polarad's component reliability and standardization programs under the control of Stanley Seifer, director of quality assurance.

Mr. Wiener joined Polarad in 1950 as a project engineer and was later appointed manager of the commercial production engineering department.

Polarad is a designer and manufacturer of microwave test equipment and electronic instrumentation.

Jerrold Names Beisswenger General Sales Manager



Beisswenger

Robert H. Beisswenger has been appointed General Sales Manager of Jerrold Electronics Corporation, according to an announcement made by Milton J. Shapp, president of the Philadelphia electronics company. In this capacity, Shapp stated, Beisswenger will co-ordinate the rapidly expanding activities of Jerrold's four sales divisions, which cover markets in the community antenna system industry, government, educational and industrial communications, consumer products for improving television reception in the home, master antenna systems for motels, hotels, hospitals, and test instrumentation equipment.

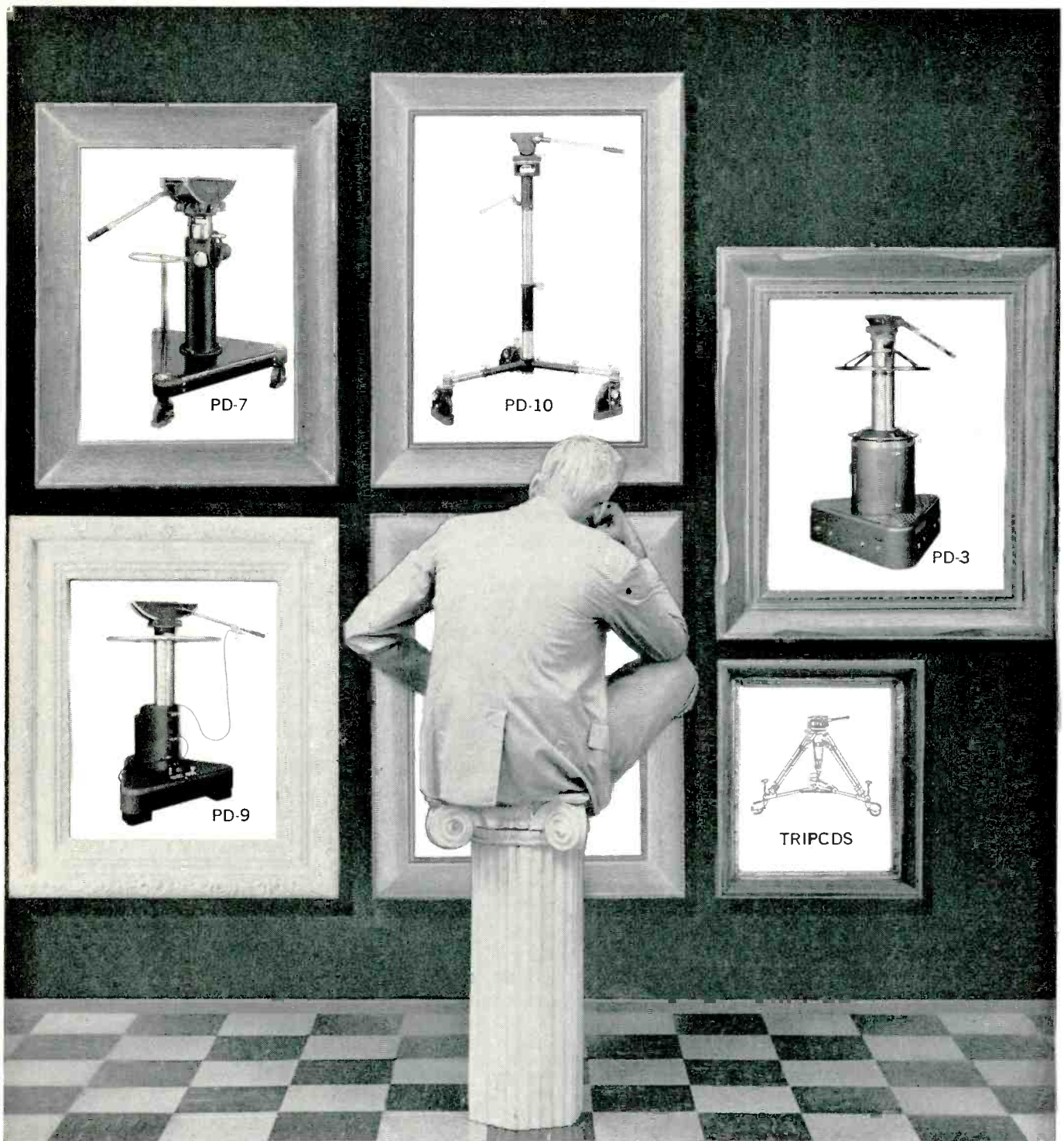

WHICH PEDESTAL IS BEST FOR YOU? You're on top with any camera pedestal from Houston Fearless. The smallest TV stations and the biggest networks have known this for years. In fact, most TV pedestals in use today were designed and built by HF. Small wonder. Houston Fearless grew up with the television industry, shared its problems, helped solve a few . . . and is still doing so. ■ What kind of camera mount does your station need? A rugged power-driven model that gives a feather touch to a big color camera? A tripod you can pick up with one hand? Houston Fearless has variations of both — and several in between. There's a size for every requirement, a model for every budget. ■ The light, maneuverable PD-7 has a hand wheel that raises or lowers the camera while dollying. Parallel or tricycle steering. The lightweight PD-10 rolls smoothly on 8" wheels. A hydraulic jack raises and lowers the column. Portable. Easily disassembled. The PD-3 gives a firm, steady mount and smooth dollying. The camera, counterbalanced, is easily raised by lifting on wheel. The rugged PD-9 has a motor-driven height adjustment. It gives smooth, steady mobility to biggest color or monochrome cameras. The versatile HF all-metal tripod and dolly offer maximum portability. Write for brochures on full HF pedestal line. Westwood Division **HF** Houston Fearless Corporation, 11851 Olympic Boulevard, Los Angeles 64, California

for your tower
requirements
check

ROHN SYSTEMS

A complete tower
erection service
that has these
special advantages:

- ✓ DEPENDABILITY
- ✓ RELIABILITY
- ✓ COMPLETE ENGINEERING
- ✓ COAST TO COAST SERVICE

Be sure to obtain price quotations and engineering assistance for your complete tower needs from America's foremost tower erection service.

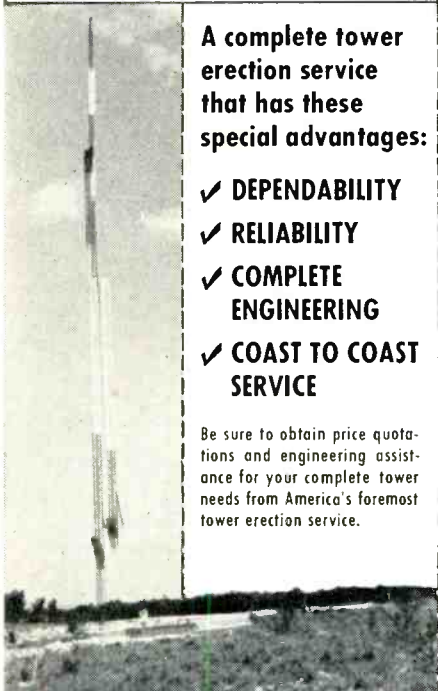

ROHN SYSTEMS, INC.

6718 W. Plank Road

Peoria, Illinois

Continental's

ANTENNA COUPLING EQUIPMENT

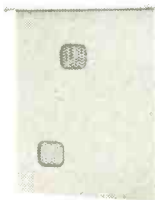

FRONT CLOSED

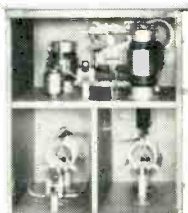

FRONT OPEN

Custom designed and manufactured
to meet customer requirements.

write for details today!

*Continental
Electronics*

MANUFACTURING COMPANY

4212 South Buckner Blvd. Dallas 27, Texas

☐ SUBSIDIARY OF LING-TEMCO ELECTRONICS, INC.

Industry News

William E. Roberts Named Ampex President

William E. Roberts, formerly executive vice-president of Bell & Howell Co., has been named president and chief executive officer of Ampex Corp., succeeding George I. Long, Jr., who will resign the top management post but will continue as director. The change becomes effective August 1, 1961.

Roberts joined Bell & Howell in 1936 and worked his way up through the company's management ranks, becoming operations vice-president and a member of the board of directors in 1950. He was named executive vice-president in 1953.

Frazer Joins Hoyles, Niblock & Associates

Hoyles, Niblock & Associates, consulting radio engineers and attorneys, North Vancouver, Canada, have announced that Edward J. Frazer, M.I.R.E., P.Eng., is now associated with their professional practice.

Frazer graduated from the University of British Columbia with a degree of B.A.Sc. in electrical engineering in 1958. During his undergraduate years he was employed by the Canadian Broadcasting Corp., and following his graduation he was engaged on radio and microwave systems engineering for the British Columbia Telephone Co.

Frazer is a member of the Assn. of Professional Engineers of B.C.,

the Institute of Radio Engineers, Sigma Tau Chi fraternity, and is active in several other organizations.

Harman-Kardon, Jerrold Combine to Form Diversified Company

Harmon-Kardon, Inc., manufacturer of high fidelity components and logic modules for data systems, has become part of Jerrold Electronics Corp., with the signing of closing papers by Milton J. Shapp, president of Jerrold, and Sidney Harman, president of Harman-Kardon. Harman-Kardon, located at Plainview, Long Island, will operate as a separate subsidiary.

Jerrold is a manufacturer of electronic amplification equipment for closed circuit television distribution systems, electronic test instruments and electronic consumer products.

Benham Named Engineering Manager at Crowell-Collier

Crowell-Collier Broadcasting Corp. has named Edward E. Benham as manager of engineering for the three-station broadcasting division. Robert M. Purcell, president of the corporation and general manager of KFVB, Hollywood, stated that Benham's great scope in the field of broadcast electronics will further the company's plans for expansion into radio and television.

Benham, a senior member of the Institute of Radio Engineers and the Society of Television Engineers, has been chief engineer for the past ten years for the Times-Mirror Broadcasting Co., owners of television station KTTV, Los Angeles.

Here is . . .

Spot-O-Matic

Cartridge Tape

SE-10
(Play and
record)



SE-11
(Playback
only)

Quality — Reliability — Economy

Write **SIERRA ELECTRONIC ENTERPRISES**

6430 Freeport Boulevard

Sacramento, California

Tape Storage

(Continued from page 29)

sticking from splices that may be present if the tape has been edited.

Use "Low Print" Tape

Best insurance of maintaining an absolute minimum layer to layer signal transfer is to use Low Print tape which assures a print level 6 db lower than conventional tapes. One such tape features the Low Print oxide coating on a 1½ mil polyester backing, for extra strength and resistance to storage conditions.

Do Not Store Unboxed Tape

The tape's original box provides protection against dust contamination and physical damage to the tape edges. Even better is to store the tape in metal cans, which can be sealed easily with pressure sensitive tape. Reels of tape should be stored "on edge" or lying flat on individual shelves. Stacking many reels one on top of the other should be avoided as the weight may distort the plastic reels or damage the edges of the tape. Normally, cleaning is not necessary. If dust contamination is excessive, reels may be vacuumed and the tape may be cleaned by wiping with a clean dry cloth while rewinding.

Avoid Magnetic Fields

While the magnetic properties of tape are very stable over long periods, care should be exercised to avoid accidental exposure to magnetic fields. Weak magnetic fields will increase print signal. Permanent magnets and strong electro-magnets very likely will cause erasure if placed within a few inches of the tape. (This is the principle utilized in the bulk erasing process in which a whole reel of tape is de-magnetized without unwinding.) For this same reason, tape should not be stored in cabinets with magnetic door latches.

Play Tape Periodically

Occasional use of recorded tapes improves their resistance to storage conditions. Running tape through a recorder is a simple way of relieving strains and adhesions before they seriously affect the tape. After each playing, the tape should be rewound loosely on the take-up reel, so it again is stored tail-end out.

**Classified Ads
GET RESULTS!**

McMartin FOR MULTIPLEXING!

If you are looking for the multiplex receiver that provides the greatest sensitivity... is the most dependable... look to McMartin, the standard of the industry.

Continental's advanced engineering... rigid quality control... special manufacturing techniques assure receiving equipment that will deliver the finest in sound over the greatest distances. What's more, McMartin guarantees your satisfaction. Send back any unit that does not function properly (at McMartin's expense) and it will be repaired or replaced free of charge.



Bob Flanders and McMARTIN Receiver

Says Bob Flanders, Director of Engineering for WFBM, Indianapolis, Ind., "We're quite satisfied with our McMartin receivers... they have allowed us to expand our coverage area."

CONTINENTAL MANUFACTURING, INC.

1612 California Street • Omaha, Nebr.



NOW! Rebroadcast TV into Problem Areas!

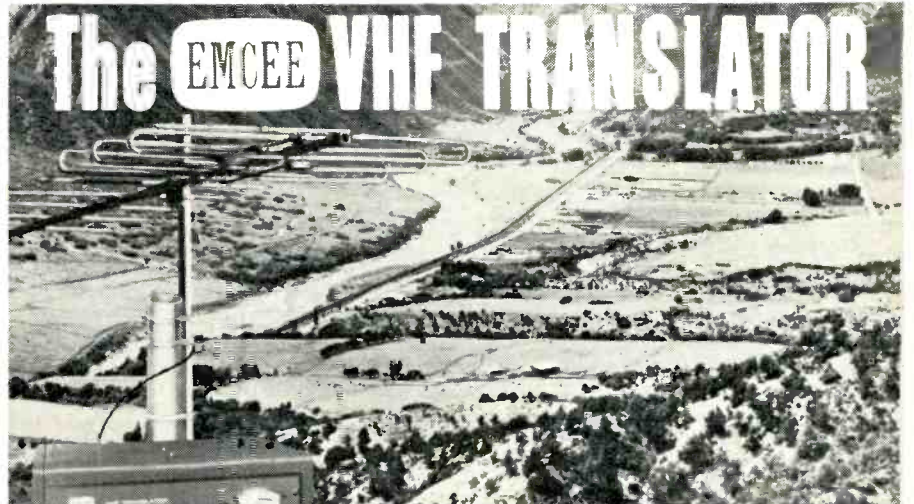

**BETTER TV coverage with the FIRST
FCC accepted FIRST integrated MOST
advanced VHF Translator to date.**

Here's the new VHF Translator with outstanding advantages for all installations. EMCEE Translators are the result of long experience in quality design and trouble-free construction by some of America's leading experts. Now fill in troublesome areas with the advanced EMCEE VHF Translator.

TRANSLATORS MAY BE RUN IN TANDEM TOO!



ELECTRONICS, MISSILES & COMMUNICATIONS, INC.
268 E. Third Street • Mount Vernon, New York

Gentlemen:

— Please rush free planning package including data sheet, complete installation check list, coverage calculation form.

— Please send free reprint of FCC rules covering translators.

NAME _____

ADDRESS _____

CITY _____

STATE _____

ELECTRONICS, **M**ISSILES AND **C**OMMUNICATIONS, INC.

266 E. Third Street • Mount Vernon, New York

**OVER
600
Symmetra-peak
USERS**

Over 600 AM, FM and TV stations throughout the world have —

- Increased normal effective voice power up to 2½ times.
- Improved overall limiter and AGC amplifier performance.
- Symmetrized non-symmetrical audio peak excursions.

Symmetra-Peak is a special passive network and its function is not duplicated by limiters or AGC amplifiers. Thus, Symmetra-Peak gives up to 4 db additional boost in station coverage. Order today or get a first-hand report by writing for a list of Symmetra-Peak customers in your own area.



ANOTHER FIRST BY THE DEVELOPER OF
CSSB AND FULL RANGE AM STEREO

Price: \$295.00 FOB Freeport, New York.

KAHN RESEARCH LABORATORIES, Inc.
81 South Bergen Place, Freeport, New York, Freeport 9-8800
World Wide Suppliers of Modern Communications Systems

**A NEW
SOLID STATE
VIDEO DISTRIBUTION UNIT**

Requires only 5¼" Rack Space

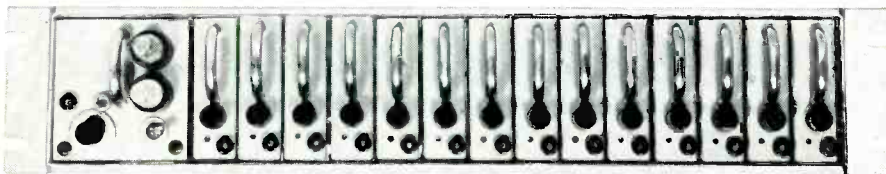

BRIDGING INPUTS (83-1R Connectors) . . . 14 CHANNELS
42 OUTPUTS . . . 75 OHM SENDING END TERMINATION
SOLID STATE POWER SUPPLY

S P E C I F I C A T I O N S

DIFFERENTIAL PHASE..... 2°
DIFFERENTIAL GAIN..... .02%
FREQUENCY RESPONSE..... Flat to 15 mc ± .2 db
TILT..... .1 db (60 squarewave)
ISOLATION..... 60 db at 3.58 mc (Ref 1 V PP)
POWER REQUIREMENTS..... 2.5 watts



SARKES TARZIAN INC

east hillside drive • bloomington, indiana
edison 2-7251

Write for complete
technical information
Broadcast Equipment
Division

Product News



TWO-HEAD VIDEO TAPE RECORDER

Telechrome Mfg. Corp., 28 Ranick Dr., Amityville, N. Y., has announced a newly-developed two-head video tape recorder for monochrome and color known as Telechrome JVC, model 770.

The tape recorder uses standard video tape and features simplified operation and maintenance; it is designed to eliminate banding, streaking and other common distortions, and provide for simultaneous recording and playback. The tape may be run forward, backward, or standing still for individual-frame reproduction. The VTR equipment may also be used for instrumentation, radar, telemetry and other applications, the manufacturer states.

Two sets of magnetic heads are used—a wide track one for recording, the other of narrower width for monitor and playback. This is said to ensure tapes being able to be easily interchanged between different machines. The two recording heads are mounted 180 deg. apart at the edge of a rotating drum, and produce one complete TV picture for each complete, 360-deg. rotation. Full picture and sync are recorded. The two reproducing heads function independently and are designed to enable the operator to playback and monitor the video simultaneously as it is recorded by the recording heads.

The manufacturer further states that since this system records a complete video signal with each half rotation of the head drum, horizontal striping, banding, color streaking—all the common ills of four-head systems, which must divide a picture into 16 horizontal sections—are eliminated.



STEREO MIXER

Ampex Professional Products Co. recently previewed its new MX-35, combination stereo/monophonic mixer. The MX-35 permits two-channel stereophonic recording with four inputs (which may be switched to, or divided between, either channel), or monophonic recording with four inputs.

The MX-35 employs a unique switching facility which permits feeding up to four

BROADCAST ENGINEERING

microphones and two high level line inputs to either the left or right output, or divided equally into both outputs. The ability to divide any given microphone into both outputs eliminates the "hole-in-the-middle" effect so common in music recording. Special coupling facilities permit the user to gang up to four MX-35 mixers for additional inputs, with overall gain controlled by the last unit in the system.

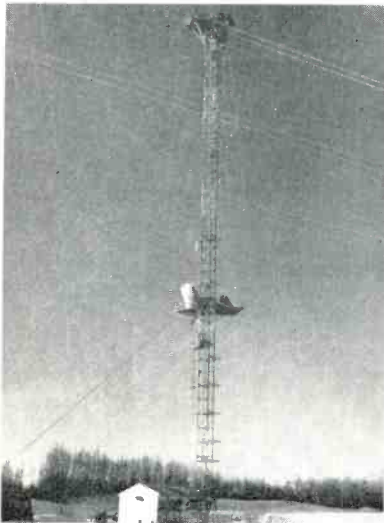

NEW MICROWAVE TOWER

A communication tower designed to support two platforms and up to six horn antennas at any height from 25 ft. to 500 ft., has been announced by Stainless, Inc., North Wales, Pa.

Designed and fabricated for Alberta Government Telephones by Stainless, Inc., and Walcan, Ltd., Stainless' Canadian subsidiary, the new tower is said to be the first of its kind to be used for horn antenna support. A guyed structure, it is more adaptable to exact transmission requirements than a self-supporting tower, and is expected to reduce the normal cost of tower material, installation and maintenance for this rigid service by approximately one-third. Sections of the new tower design are stock items at Stainless and at Walcan.

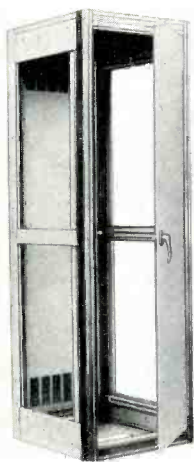

OPEN SIDE WALL CABINET RACKS

Par-Metal Products Corp., 32-62 49th St., Long Island City 3, N. Y., has announced series PR and FR open side wall cabinet racks especially designed for use in a row arrangement, and featuring easy access for intermediate rack-to-rack wiring.

The units have completely welded frame with top, bottom and uprights of 7/64-inch

steel. Horizontal moldings and vertical corner trims add a distinctive finishing touch. Corner trims can be furnished in a different color from the body of the rack. Units having only rear doors are designated as series PR; those with front and rear doors are series FR. Both types may be merged, using similar racks of differing widths, as long as equal height racks are used throughout.

The new cabinet racks can be furnished with detachable side panels, and may also be modified to contain other types of cabinet tops and doors. Standard fittings and accessories include vertical side supports, mounting brackets and shelves, sliding shelves and drawers, panel mounting angles, roller trucks, recessed rack sub-bases, panels of solid and louvered styles, etc.

Series PR and FR racks have four standard heights ranging from 48 1/8 inches to 83 1/8 inches; depths of 18 and 24 inches. Panel widths are 19, 24 and 30 inches. The units are offered in seven standard finishes.

MODEL 830 MULTIPLEX STEREO TEST GENERATOR

H. H. Scott, Inc., Instrument Div., 111 Powdermill Rd., Maynard, Mass., has announced the model 830 multiplex stereo generator, which operates in conjunction with an FM signal generator, an audio oscillator and an oscilloscope to provide a composite stereo signal in conformance with the recent FCC multiplex decision, Docket 13506.

Left and right channel information from a stereo record or tape may also be used as an input to provide a composite signal for listening tests of multiplex receiving equipment.

Initial production models are available for early July delivery. Regular production will not be available until September.

VHF TV TRANSLATOR

Adler Electronics, Inc., New Rochelle, N. Y., has announced a VHF-TV translator. The translator picks up a VHF-TV signal off the air and converts it to a different channel for rebroadcast. Power output is one watt. The translators operate unattended and can be remote controlled.



Mr. Parker H. Vincent, Chief Engineer
WMTW-FM, Mt. Washington TV Inc.
Poland Spring, Maine

"Even under demanding conditions, the performance of GEL equipment has been excellent and very trouble free."

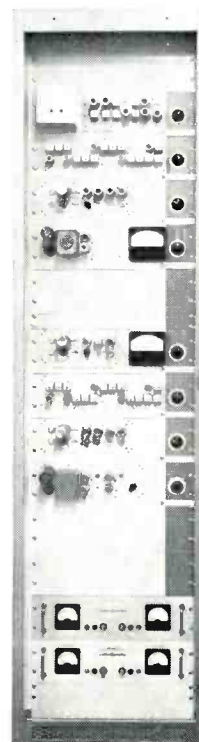

GEL FM MULTIPLEX SYSTEM

Can Be Used with Any FM Transmitter in the 88-108 mc Band

GEL makes available a complete FM line of high quality 15KW and 1KW Transmitters, and Exciters for converting conventional FM Transmitters to Multiplexing use.

Write to Broadcast Sales, Dept. 4
for GEL FM Technical Bulletins



**GENERAL
ELECTRONIC**

LABORATORIES, INC.

18 AMES STREET,
CAMBRIDGE 42, MASS.

TIGHT BUDGET? RENT CAMERA LENSES

Now! If you are working on a tight budget, but want to make a tremendous showing at a small outlay . . . your T.V. station can RENT the World's finest Lenses from B & J. Extensive selection! Off-the-Shelf Delivery! Pioneers in T.V. Optics—since 1936!

Write for new T.V. Lens Listing.

BURKE & JAMES, INC.

321 S. Wabash, Chicago 4, Ill.

Product News



NEW ULTRA-SENSITIVE FLUTTER METER

A new ultra-sensitive flutter meter with built-in, three-range filter, test oscillator, high gain preamplifier, and limiter for accurate measurement of flutter and wow, has been introduced by Amplifier Corp. of America, Instrument Div., 398 Broadway, New York 13, N. Y.

The unit is designed to fill the need for a sensitive, rapid and accurate method of visual indication of wow and flutter content of all types of tape recorders and playback equipment, including 33 1/3, 45 and 78-rpm discs, and 16 and 35 mm. sound film mechanisms. A built-in preamplifier and high impedance (1 megohm) input attenuator will accept voltages ranging from 1 millivolt to 300 volts. Connection may be made directly across magnetic tape playback heads, or across high level circuits delivering up to 300 volts.

A built-in 3,000-cycle oscillator is incorporated for recording purposes. This permits the flutter meter to be used as a complete instrument in itself and eliminates the necessity of calibrating and using external oscillators. A three-range filter is included to study and isolate flutter and wow components. These ranges are 0.5 to 6 cycles for wow, 5 to 250 cycles for flutter, and the combined flutter and wow of 0.5 to 250 cycles.

A frequency discriminator is used to demodulate the flutter signals, which are then read on a calibrated meter as RMS value of sine-wave flutter components. The built-in limiting preamplifier is said to prevent erroneous readings from amplitude modulation components.

The new flutter meter, model 590-A-1, is designed for use by schools, laboratories, broadcast stations, service technicians and recording equipment manufacturers. Assembled on a standard rack panel, dimensions are 8 3/4 inches high, 19 inches wide and 8 inches deep. Net weight is 18 lb.

SPECIAL-BODY TRUCK LEASE PLAN FOR TELEVISION INDUSTRY

A new, low-cost plan under which special-body trucks used in the television industry can be leased without maintenance for from four to eight years has been announced by Wheels, Inc., Chicago, Ill. The plan is said to be an innovation for special-body, over-the-road equipment used by television stations, and the equipment can now be leased without full maintenance, repair and garage service.

In order to qualify for a special-body truck lease, a firm must meet the following conditions: (1) The company must have a net worth of \$1 million, and (2) the company must have a record of profitable operations.

Further information may be obtained by writing to Truck Dept., Wheels, Inc., 6200 N. Western Ave., Chicago 45, Ill.

HEWLETT-PACKARD 1961 CATALOG
Hewlett-Packard Co., 1501 Page Mill Rd., Palo Alto, Calif., has made available the 1961 catalog of electronic test instruments.

The 220-page catalog contains complete listings, descriptions and specifications of the more than 400 test instruments offered by the company. Also included is a 16-page descriptive listing of the special systems and instrumentation produced by the company's Dymec Div.

Professional Services

VIR N. JAMES

**Specialty
Directional Antennas**

232 S. JASMINE DExter 3-5562
DENVER 22, COLORADO
Member AFCCE

CHARLES E. BRENNAN

(Member AFCCE)

DONALD A. WELLER

Consulting Radio Engineers

105 E. Lincoln Ave. • Milwaukee 7, Wis.
Humboldt 3-3370 Humboldt 3-3371

S. HIMMELSTEIN & COMPANY

Consulting Engineers

MAGNETIC RECORDING SYSTEMS

3300 West Peterson Ave. IRving 8-9850
CHICAGO 45, ILLINOIS

Precision Frequency Measurements
AM-FM-TV

COMMERCIAL RADIO MONITORING CO.

103 S. MARKET ST. LEE'S SUMMIT, MO.
Phone Kansas City, LA. 4-3777

- SYNCHRONOUS MAGNETIC FILM RECORDER/REPRODUCER
- MAGNETIC TAPE RECORDERS
- NEW—THE portable MINITAPE synchronous 13 lb., battery operated magnetic tape recorder for field recording.

THE STANCIL-HOFFMAN CORP.
845 N. Highland, Hollywood 38, Calif.
Dept. B HO 4-7461

Spotmaster

NO. 1 ®

In Cartridge Tape Equipment
SPOTMASTER 500
A complete Tape Cartridge Self-cuing,
Record Playback Combo Unit.
For Details or Demonstration, Write

VISUAL ELECTRONICS, CORP.

356 W. 40th St., New York 18, N. Y.

Advertisers' Index

Altec Lansing Corp.	35
Ampex Video Products Co.	21
Bauer Electronics Corp.	12
Belden Mfg. Co.	11
Brennan, Charles E.	42
Burke & James, Inc.	41
Collins Radio Co.	15
Commercial Radio Monitoring Co.	42
Continental Electronics Mfg. Co.	38
Continental Mfg., Inc.	39
Electro-Voice, Inc.	31
Electronics, Missiles & Communications, Inc.	39
Foto-Video Electronics, Inc.	IFC
Gates Radio Co.	14
General Electric Co. Receiving Tube Dept.	22-23
General Electrodynamics Corp.	13
General Electronic Laboratories, Inc.	41
Gray Mfg. Co.	27
Himmelstein and Co., S.	42
Houston Fearless Corp.	37
James, Vir N.	42
Jampro Antenna Co.	34
Kahn Research Laboratories	40
Magnecord Div., Midwestern Instruments	36
Moseley Assoc.	34
Peerless Electrical Products Div.	35
Radio Corp. of America	1, BC
Raytheon Co., Equipment Div.	3
Rohn Systems, Inc.	38
Sarkes Tarzian, Inc.	40
Sierra Electronic Enterprises	38
Stancil Hoffman Corp.	42
Standard Electronics	26
Telechrome Mfg. Corp.	IBC
Visual Electronics Corp.	42
Weller, Donald A.	42

Classified

Advertising rates in the Classified Section are ten cents per word. Minimum charge is \$2.00. Blind box number is 50 cents extra. Check or money order must be enclosed with ad.

EQUIPMENT FOR SALE

Transmission line, styroflex, heliax, rigid with hardware and fittings. New at surplus prices. Write for stock list. Sierra Western Electric Cable Co., 1401 Middle Harbor Road, Oakland 20, California. 6-61 tf

Collins 26C limiting amplifier also complete Rust Remote Control System with spare relays. Write for details WGAW, Box 87, Gardner, Mass. 7-61 It

BUY, SELL OR TRADE

Will buy or trade used tape and disc recording equipment — Ampex, Concertone, Magnecord, Presto, etc. Audio equipment for sale. Boynton Studio, 10 BE Pennsylvania, Tuckahoe, N. Y. 4-61 6t

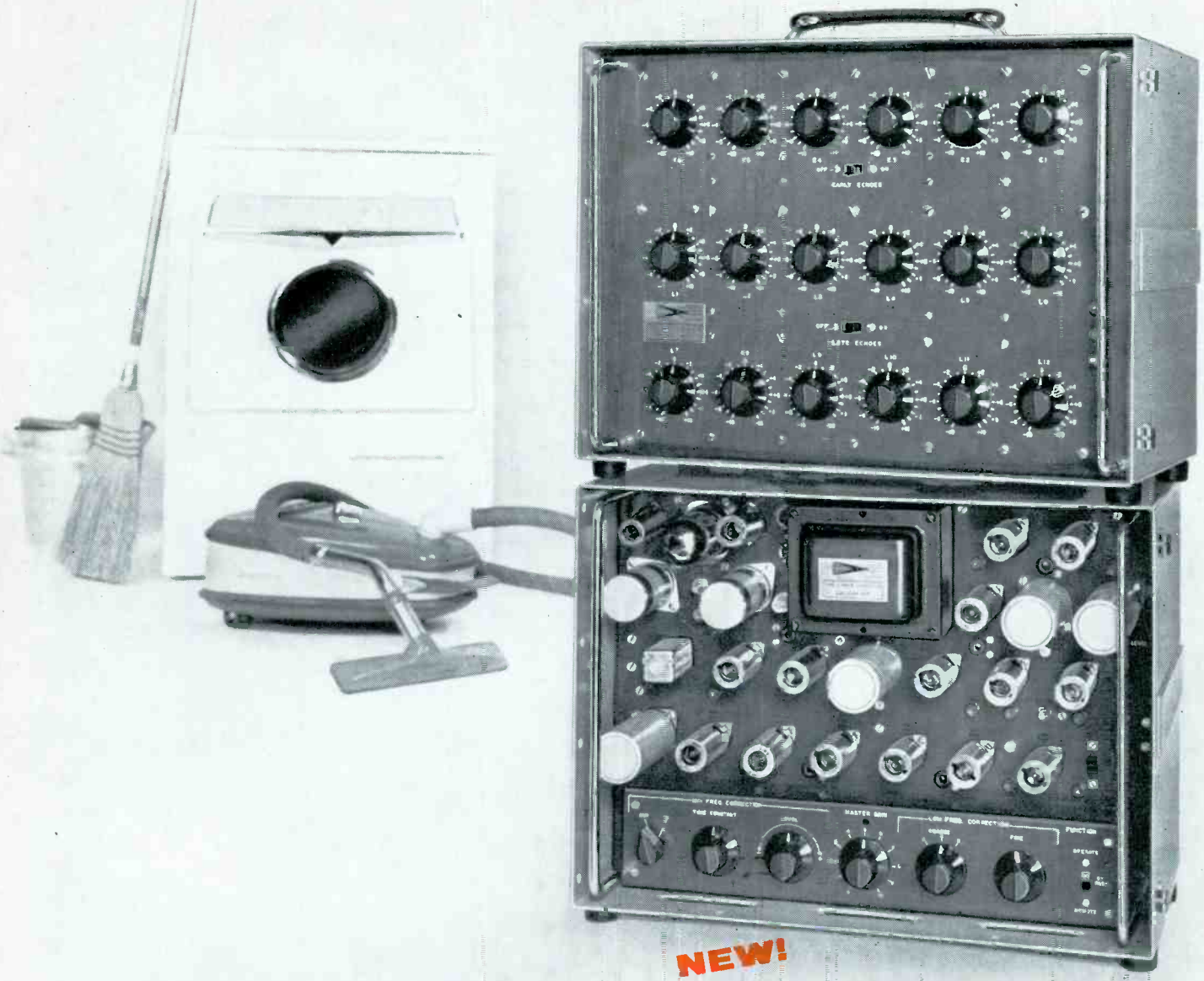

NEW!

...but only the "Twenty/Twenty" cleans up video transmission distortion



Photos, taken a few seconds apart, show how the Model 20/20 cleans up smears, overshoots, ringing and other waveform defects.

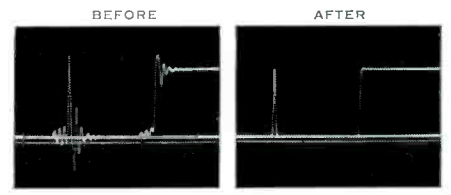

Waveform correction is illustrated by before-and-after photos of an expanded portion of Sine²-test signal. The Model 20/20 can be used with any desired test signal for pre-broadcast, or on-the-air correction.

The Model 20/20 Time Domain Equalizer is Telechrome's ingenious application of the proven "paired echo" principle to the problems of video transmission and video tape recording. Result: for the first time a practical, commercially-priced instrument that eliminates overshoots, ringing, smears and other waveform defects from monochrome, color, composite and non-composite signals.

Portable or rack-mounted, the Model 20/20 can be used anywhere in a television system. At the terminal end it eliminates difficulties regardless of where they originate. It is equally effective for pre-broadcast or on-the-air correction. And Telechrome's engineers have made it simple enough for easy use by anyone after only a brief demonstration. See for yourself how the Model 20/20 dramatically cleans up transmission quality, assures continuous broadcast fidelity for maximum viewer and advertiser appeal.

For a demonstration, contact H. C. Riker, Vice-President, Marketing.

TELECHROME

AT THE FRONTIERS OF ELECTRONICS

ELECTRONICS  DIVISION

TELECHROME MANUFACTURING CORP., AMITYVILLE, L.I., NEW YORK
 Division Offices: Lombard, Illinois • Van Nuys, California • Dallas, Texas • Washington, D.C.

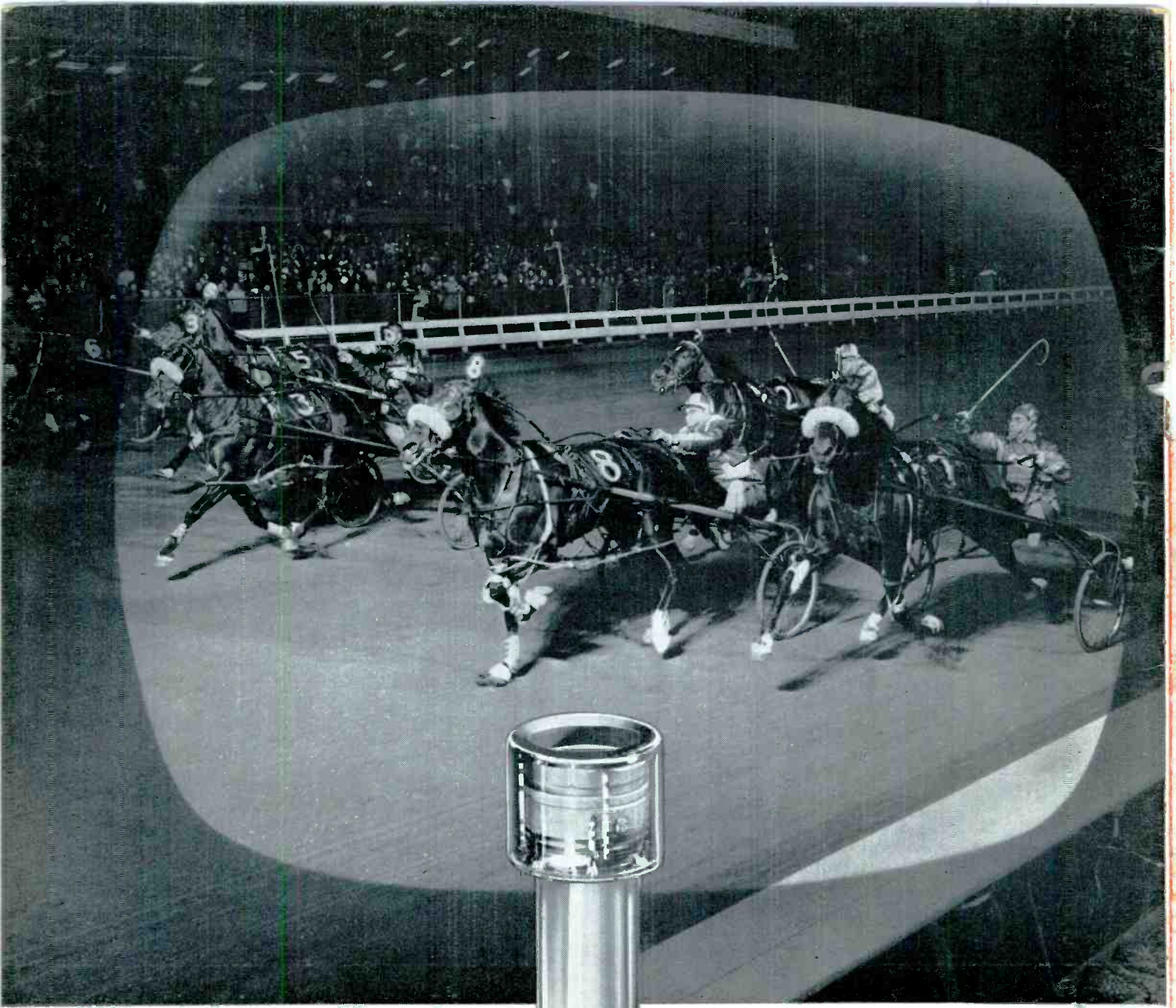

THE LIGHTS WENT OUT...

Thanks to the super-sensitivity of the RCA-4401-V1 Image Orthicon

One night last season at New York's Yonkers Raceway, halfway through a race, an entire bank of lights went out near the finish line. Yet with only a quick camera adjustment, TV pick-up of the rest of the race came in sharp and clear with the RCA-4401-V1 image orthicon.

So sensitive is the 4401-V1 that it produces an excellent picture of a difficult low-key subject (horses against a dark track) with an incident light level of no more than 20 footcandles on the track itself. And it could easily operate at half that amount of light!



BUT NOT THE PICTURE

The 4401-V1—expressly designed for remote B&W pickup at very low light levels—is but one of the broad RCA family of specialized image orthicons. Others include:

RCA-4401: For low-light level colorcasting—studio or outdoor. Available in matched sets of three for maximum performance in color cameras.

RCA-7513: Featuring special precision construction and new RCA field-mesh design for high quality color or B&W TV.

RCA-7293-A: A field mesh image orthicon having an image section designed to prevent highlight ghosts. Field mesh design to improve corner focus and prevent portacle effects. For E&W studio and outdoor pickup.

RCA-7295-A: A 4½ inch diameter field-mesh image orthicon with high resolution and very high signal-to-noise ratio, designed for tape and B&W studio broadcast use.

RCA-7389-A: A superior-quality field-mesh design 4½ inch image orthicon, with extremely high signal-to-noise ratio, for tape and exceptionally high-quality B&W studio pickup.

RCA-5820-A: For studio and outdoor pickup in B&W. The "standard" of broadcasting.

Whatever your station's requirements or special problems, there's an RCA image orthicon designed to meet them. For information on specific types, see your local RCA Industrial Tube Distributor.



The Most Trusted Name in Electronics
RADIO CORPORATION OF AMERICA