

SPECIAL AUDIO/VIDEO FEATURES

audio and acoustics: Acoustics for Recording Studios; Broadcast Engineers' Approach to Live Music Pickup

television and video: CATV Today, A Look at the Field; VTR-Cue; plus—Network Coverage of a Tragic Weekend; and, After the Freeze ?

Broadcast Engineering

the technical journal of the broadcast-communications industry



“DESIGN IT THE BEST YOU KNOW HOW, AFTER WHICH WE WILL PRICE IT”

This was the instruction from Gates management throughout the development of the BC-5P-2 5000 watt AM broadcast transmitter. That this directive became a reality is now history, as 218 of these transmitters now operate world-wide. Several of the design features, responsible for this universal acceptance, are listed below. In preparing this analysis, Gates recognizes that the items it omits could be construed as weak points. Actually, this effort is to cover the points that are of major importance to a buyer who is going to invest several thousand dollars for a 5000 watt transmitter.

TRANSMITTER SIZE: A prime objective was to fit the transmitter into the smallest possible room size, while staying within good engineering practice. There was no sensible reason, however, to build it so small that: (1) it is hard to service, (2) it runs hot, and (3) it cannot be 100% self-contained. After all, few things are worse than finding room and protection of life for an outboard high voltage power transformer. BC-5P-2 is 100% self-contained in 3 cubicles, each with its own cooling system. Floor size is 73½" across and 39½" front to back. With the 78" height, BC-5P-2 has a total cubage of 135.6, a minimum for both good cooling and serviceability with common sense ease.

TRI-UNIT COOLING: The BC-5P-2 features a special 3-cabinet cooling system consisting of blowers, each with 270 C. F. M. air capacity and ¼ H. P. motor, plus ceiling suction fan. Blowers are shock mounted to assure minimum low frequency noise.

FULL TEE NET TANK:

Gates does not stop at the dotted line . . . (below). The

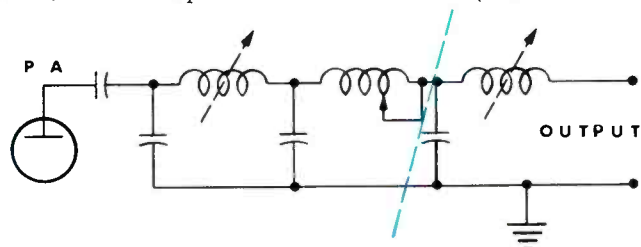

BC-5P-2 has a complete Tee network to guarantee meeting FCC harmonic reduction figures. FCC rules say this reduction is "as measured into a suitable load". Gates DOES NOT interpret a suitable load as an antenna coupler with its own network. The BC-5P-2 must meet FCC harmonic measurements at the transmitter output terminals into a pure resistance dummy antenna. Nothing else!

POWER AMPLIFIER COMPONENT VALUES: Lasting power is as important as output power. For this reason, Gates has installed what we firmly believe to be the largest power amplifier component list of any 5000 watt transmitter made. To prove this, we list these values for you to check.

Plate Tank Coil: Edgewound ribbon, Micalax insulated, rotating type for tuning, ⅛" x ½" ribbon, silver plated, 20 ampere rating.

Tank Vacuum Capacitor: Jennings Model M voltage 15,000 volts. Current: 21 amperes.

Shunt Capacitor No. 1 Tee Network: Ceramic insulated 5% Mica Type G3 rated at 15,000 volts and 21-27 amperes.

First Tee Net Coil: Edgewound, ribbon Micalax insulated, fixed tapped, ribbon 3/32" x ⅜" silver plated, 15 amperes.

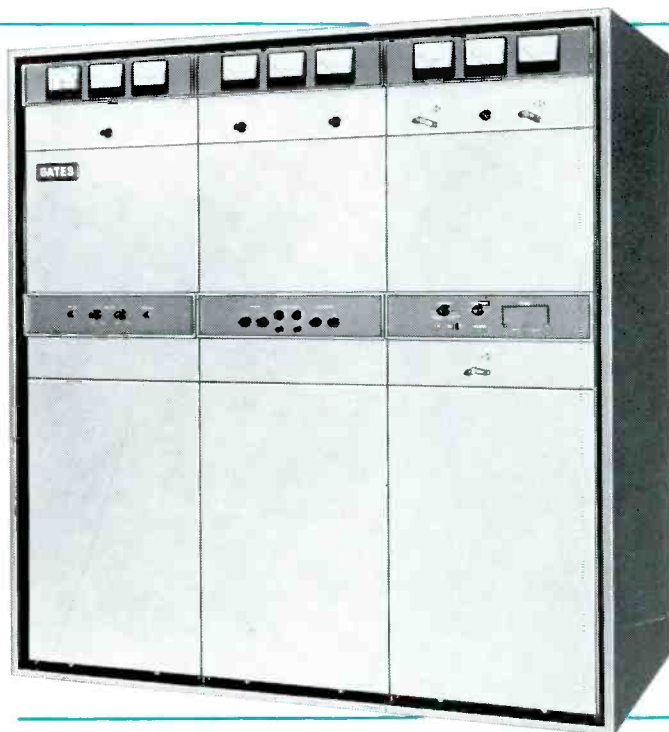

Second Tee Net Coil: Rotating type continuously variable edgewound ribbon, Micalax insulated. Ribbon ⅛" x ½". Silver plated, 20 amperes.

POWER OUTPUT: Capable of 5600 watts, the transmitter provides ample margin for losses incurred in directional arrays. The ability to modulate an easy 100% (note easy) is very important. The same modulator tube complement is used in the BC-5P-2 as in the Gates 10,000 watt model and at the same plate voltage.

TUBE OR SILICON RECTIFIERS: Gates has both. What should I buy? As silicon rectifiers cost more and must never fail (they are not replaced like a tube) Gates feels that the very best is necessary and demands 3 times voltage and 15 times current safety factors. If the equipment is operator-attended, such as with directionals, tubes might be preferred.

TRANSFORMERS: The heart of any equipment. Here, the number is important, as distribution of load has much to do with transformer and transmitter heat, and heat has very much to do with transmitter life. BC-5P-2 has a total of 22 sealed transformers and reactors, spaciouly distributed throughout the three cubicles. They are all made for 50 cycle service — a 20% bonus safety factor for 60 cycle users.

CABINET RADIATION: All broadcast transmitters must pass critical cabinet radiation tests to obtain FCC approval. To assure absolute cabinet radiation compliance, the entire RF driver/tank and output network are constructed within an 11 gauge aluminum housing.



GATES RADIO COMPANY

A Subsidiary of Harris-Intertype Corporation
QUINCY, ILLINOIS



Offices in: Houston, New York, Los Angeles, Washington, D.C.

In Canada: Canadian Marconi Company, Montreal • Export Sales: Rocke International Corporation, New York City

Circle Item 1 on Tech Data Card

SARKES



TARZIAN

SOLID STATE TELEVISION BROADCAST EQUIPMENT

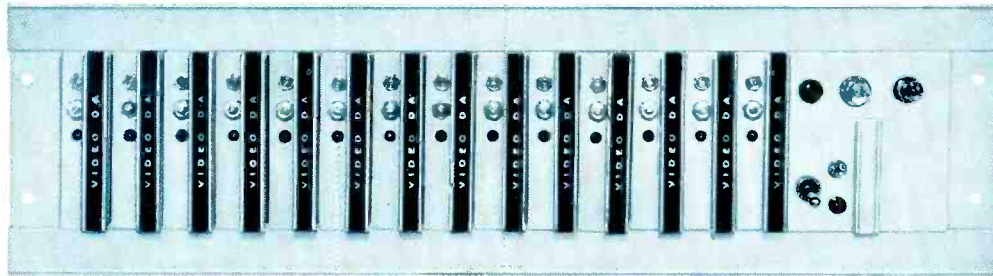

PULSE AND VIDEO DISTRIBUTION

Any combination of Tarzian solid state pulse and video DA's, plus power supply are housed in 14-channel frame. Each position includes dual loop through input connectors, three output connectors. Space provided for sync adder if required. Substantial saving in power and space.

First broadcast quality studio camera to be fully transistorized—all circuits. 1.5" image pick up tube and 1" vidicon tube . . . 35 mm optics . . . adjustable turret tension control . . . plug-in printed circuit cards . . . less than 20¢ per hour to operate . . . perfect for 80-90% of your live programming.

STUDIO CAMERA

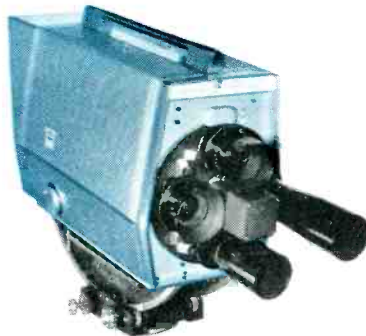

Also available: Compact VIS-75 Solid State Vertical Interval Switcher . . . VIS-88 Solid State Modular Switcher . . . Solid State Sync Generator . . . Transistorized STL Microwave Relay . . . Heterodyne Microwave Relay.

Tarzian's space-saving solid state broadcast

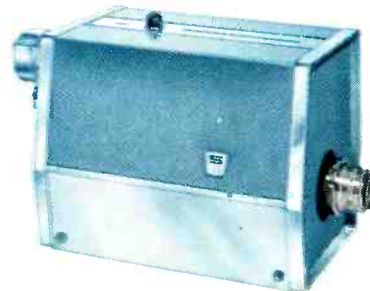

FILM CAMERA

Specifically designed for television film and slide pick up. Fully solid state including preamplifier . . . 1.5" image pickup tube and 1" vidicon tube . . . plug-in printed circuit cards . . . 1% sweep linearity . . . 1.5% geometric distortion . . . 35 mm optics.

equipment brings more dependability and convenience to your day-to-day studio operation. And, Tarzian's valuable system engineering assistance is yours for the asking—no cost, of course. Call or write for our brochure on Solid State Television Equipment.

SARKES



TARZIAN

BROADCAST EQUIPMENT DIVISION · BLOOMINGTON, INDIANA

Circle Item 2 on Tech Data Card

From
THE Translator Company

**NOW AVAILABLE:
"All about
extra
TV
Coverage
and
fill in
via
"Translators**

• Write today for your Planning Package from EMCEE, the Translator manufacturer with more experience and more models . . . UHF VHF . . . 1 watt to 100 watts.

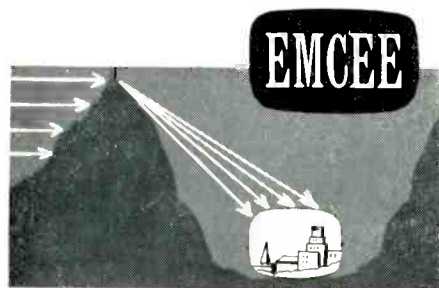

ELECTRONICS,
MISSILES AND
COMMUNICATIONS, INC.
160 E. Third St., Mount Vernon, N. Y.
10550 • 914-668-3012

Gentlemen:

Please send your "TV Coverage Planning Package."

Name _____

Address _____ City _____ State _____

Circle Item 3 on Tech Data Card

the technical journal of the broadcast-communications industry



Broadcast Engineering

Volume 6, No. 2

February, 1964

CONTENTS

FEATURES

CATV Today, A Look at the Field	10
by Sam Blakeman — Function, techniques, and equipment for community antenna television.	
Acoustics for Recording Studios	12
by Don Davis—The main considerations involved in planning a studio for recording or broadcasting.	
The Broadcast Engineers' Approach to Live Music Pickup	14
by Robert W. Carr—How to formulate a plan for on-location pickup of live music performances.	
The VTR-Cue	16
by Paul Yacich and Edward Tong — A device for automatically recording cue and control information on video tape leaders.	
Network Coverage of a Tragic Weekend	20
by John H. Battison — The fine efforts of the radio and television networks "in the public interest and necessity."	
When the Proof-of-Performance Fails	28
by Ed Murdoch — Conclusion of a troubleshooting series on correcting the conditions leading to a faulty proof.	
After the Freeze, . . . ?	36
Technical Talks — Review of the assignment and allocation situation as it is today.	

DEPARTMENTS

Letters to the Editor	6	Engineers' Tech Data	49
About the Cover	35	Advertisers' Index	50
Engineers' Exchange	38	Classified Ads	50
News of the Industry	40	Professional Services	50
New Products	47		

PUBLISHER: Howard W. Sams
GENERAL MANAGER: Mal Parks, Jr.
EDITORIAL: Exec. Editor, Verne M. Ray; Editor, Forest H. Belt; Managing Editor, Stuart N. Soll; Consulting Editor, John H. Battison.
CIRCULATION: Manager, J. A. Vitt; Fulfillment: Manager, Pat Tidd; Assistants, Katherine Krise and Cora LaVon Willard.
PRODUCTION: Manager, Robert N. Rippy.
ADVERTISING: Sales Manager, Dave L. Milling; EAST—Gregory C. Masefield, Howard W. Sams & Company, Incorporated, 3 West 57th Street, New York, N. Y., Phone MU 8-6350; MIDWEST—Hugh Wallace, Howard W. Sams & Co., Inc., 4300 West 62nd Street, Indianapolis 6, Ind., Phone AX 1-3100; SOUTHWEST—C. H. Stockwell Co., 4916 West 64th Street, Mission, Kansas, Phone RA 2-4417; LOS ANGELES 57, CALIF., Maurice A. Kimball Co., Inc., 2550 Beverly Blvd., Phone DU-8-6178; SAN FRANCISCO, Maurice A. Kimball Co., Inc., 580 Market Street, Phone EX 2-3345; PARIS 5, FRANCE, John Ashcraft, 9 Rue Lagrange, Phone ODeon 20-87; LONDON W.C. 2, ENGLAND, John Ashcraft, 12 Bear Street, Leicester Square, Phone WHITEhall 0525; TOKYO, JAPAN, International Media Representatives, Ltd., Kisha Kurabu 14, 2-chome Marunouchi, Phone (502) 0656.
SUBSCRIPTION PRICE: U.S. \$6.00, one year; \$10.00, two years; \$13.00, three years. Outside U.S.A. add \$1.00 per year for postage. Single copies, 75 cents, Back issues, \$1.00.
BROADCAST ENGINEERING is published monthly by Technical Publications, Inc., an affiliate of Howard W. Sams & Company, Inc. Editorial, Circulation, and Advertising headquarters: 4300 West 62nd Street, Indianapolis 6, Ind. Copyright © 1964 by Howard W. Sams & Co., Inc.

A HOWARD W. SAMS PUBLICATION





CBS Laboratories' Video Distribution Amplifier is all solid-state, maintenance free, and honestly meets the specifications written for it.

For further information write to:

CBS LABORATORIES
HIGH RIDGE ROAD STAMFORD, CONNECTICUT
A DIVISION OF COLUMBIA BROADCASTING SYSTEM, INC.

Circle Item 4 on Tech Data Card

the only switch with **CHANGEABLE** functions

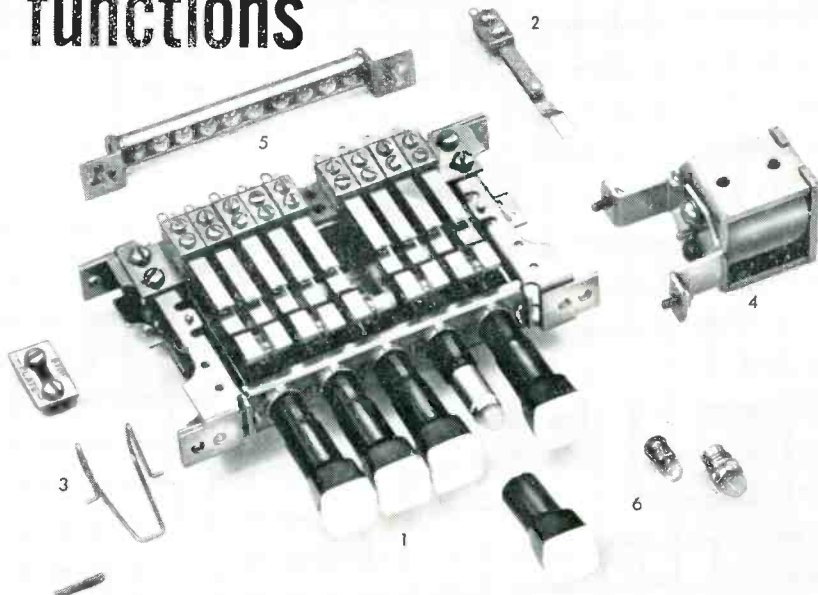

SWITCHCRAFT MULTI-SWITCHES Multiple Station Push-Button Switches

this is all you need!

The ultimate in dependability, simplicity—and versatility. Switchcraft's exclusive Componentized design gives you complete control over functions and operating characteristics . . . switches "grow" with the job, functions can be changed at any time—even in the field. Ideal for prototypes, R & D models . . . unsurpassed for production models whether switch functions are permanent, semi-permanent, expandable, add-on, or where unit should have re-claimable components. Since the multitude of possible functions are too numerous to mention here, such as electronic lock-up, push-lock/push-release, programming of switches, neon lighting, etc., only the basic switch functions are listed below to illustrate how Componentized design works:

1. **BASIC FRAME.** From 1 to 37 stations in one row! Or up to 100 stations or more in ganged assemblies. Rugged; heavy gauge welded steel. Illuminated (6V or 28V) or non-illuminated push-buttons.
2. **STACK SWITCHES.** Up to 16 switching circuits activated by any one station . . . up to 4 switching circuits per button. Long-life contacts (choice of palladium or silver) . . . famous Switchcraft quality throughout. Completely changeable, too.
3. **LATCH SPRING, STOP PLATE AND PIN.** Enable you to set up switches for 1. Interlock, 2. Non-Lock, 3. All-Lock, 4. Interlock and Non-Lock combinations.
5. **LOCK-OUT BAR.** Prevents 2 buttons from being depressed simultaneously.
6. **BUTTONS & LAMPS.** Replaceable from front of panel. Square, round; illuminated, white, colors; blank, numbered, lettered—you name it!

Whether you need a multiple push-button switch for launching missiles or "automating" drive-ins, investigate Switchcraft Componentized Multi-Switches—for reliability and versatility.

For complete details write for Engineering Specification Catalog No. S-306 or see your local Switchcraft Authorized Industrial Distributor for immediate delivery at factory prices.

SWITCHCRAFT
INC.

5535 N. Elston Avenue, Chicago 30, Illinois

Canada: Atlas Radio Corp., Ltd., 50 Wingold Ave., Toronto, Ontario, Canada

Circle Item 5 on Tech Data Card

LETTERS to the editor

DEAR EDITOR:

Mr. Aharrah of WAJP asked (in January "Letters to the Editor") if the console pictured in my cartridge rack article of the August issue is a Gates "Dualux." He also outlined a problem which arose when he switched both channels of his console into one output.

The console shown in Fig. 1 of the article is a "Gatesway." The switch referred to is the program circuit Normal-Emergency switch, in our console.

I would like to venture a guess that the difficulty Mr. Aharrah is experiencing is caused by improper phasing of the program amplifier outputs in his console. If this is the case, a considerable loss of output level and an increase in distortion would occur when both outputs are connected into one line. This can be checked by reversing the output connections of either amplifier.

TERENCE KING

Chief Engineer, Radio Station WILI
Willimantic, Conn.

Thanks for the prompt reply, Mr. King; let's hope your information will "console" Mr. Aharrah.—Ed.

DEAR EDITOR:

As chief engineer of station KLSN, first in the nation to broadcast stereo FM using production-made equipment, I read the December issue with interest.

First of all I would like to congratulate you and your staff on one of the most comprehensive coverages of the subject I have seen to date. There is one point, however, in the article, "Phase Checking of Stereo Channels," by Mr. Etkin, which calls for clarification.

The author asserts in a sweeping generalization that when the oscilloscope test is made, an in-phase condition is represented by a diagonal line sloping from lower left to upper right. This, he implies, is a rule-of-thumb to be used under any circumstances.

For reasons of technological and production convenience, a majority of the lower priced scopes are wired with the ++ quadrant at the upper left, not the upper right. Thus, a positive DC voltage applied to the horizontal input will produce a left, rather than a right, deflection of the beam. The result is, of course, that a line from upper left to lower right means the equipment is in phase—opposite to the would-be Etkin axiom.

Mr. Etkin may have deemed it unnecessary to point this out, assuming a technician would bother to take sufficient note of his instruments' operation. However, I fear the dominant impulse is to accept as gospel anything one reads in a nationally circulated magazine.

Perhaps the best advice is, to paraphrase Socrates, "Technician know thy test equipment!"

PAUL H. DAVIS

Chief Engineer, Station KLSN
Seattle, Wash.

**Belden camera cable
in WGN-TV's unique
"Patch Panel" minimizes
switch over problems**



In their new Mid-America Broadcast Center, WGN-TV, Channel 9, Chicago, employs a unique centralized "patch panel" containing Belden TV Camera Cable. The panel allows a total of 15 black and white cameras, or seven color cameras, to be controlled from a single master control area by one engineer. The "patch panel" also greatly reduces the number of control units required and permits units to be changed rapidly in event of control failure. Defective cameras can also be replaced quickly using the same control unit.

90% Of all TV-Camera, Microphone, and Audio Cables at WGN-TV are made by Belden. And, according to Woody Crane, Chief Engineer for Television at WGN, Belden Camera Cable was specifically selected for the "patch panel" because of its extremely reliable performance, high-conductor insulation resistance, and ability to withstand the rigors of rapid switch overs.

Belden manufactures a complete line of wire and cable for TV and radio broadcasting, recording studios, remote control circuits, and similar applications. Call your Belden electronic distributor.



Better Built—Better Buy—Belden



power supply cords • cord sets and portable cordage •
electrical household cords • magnet wire • lead wire •
automotive wire and cable • aircraft wires • welding cable

8-53

Circle Item 6 on Tech Data Card

Conrac picture monitor for 13" consoles

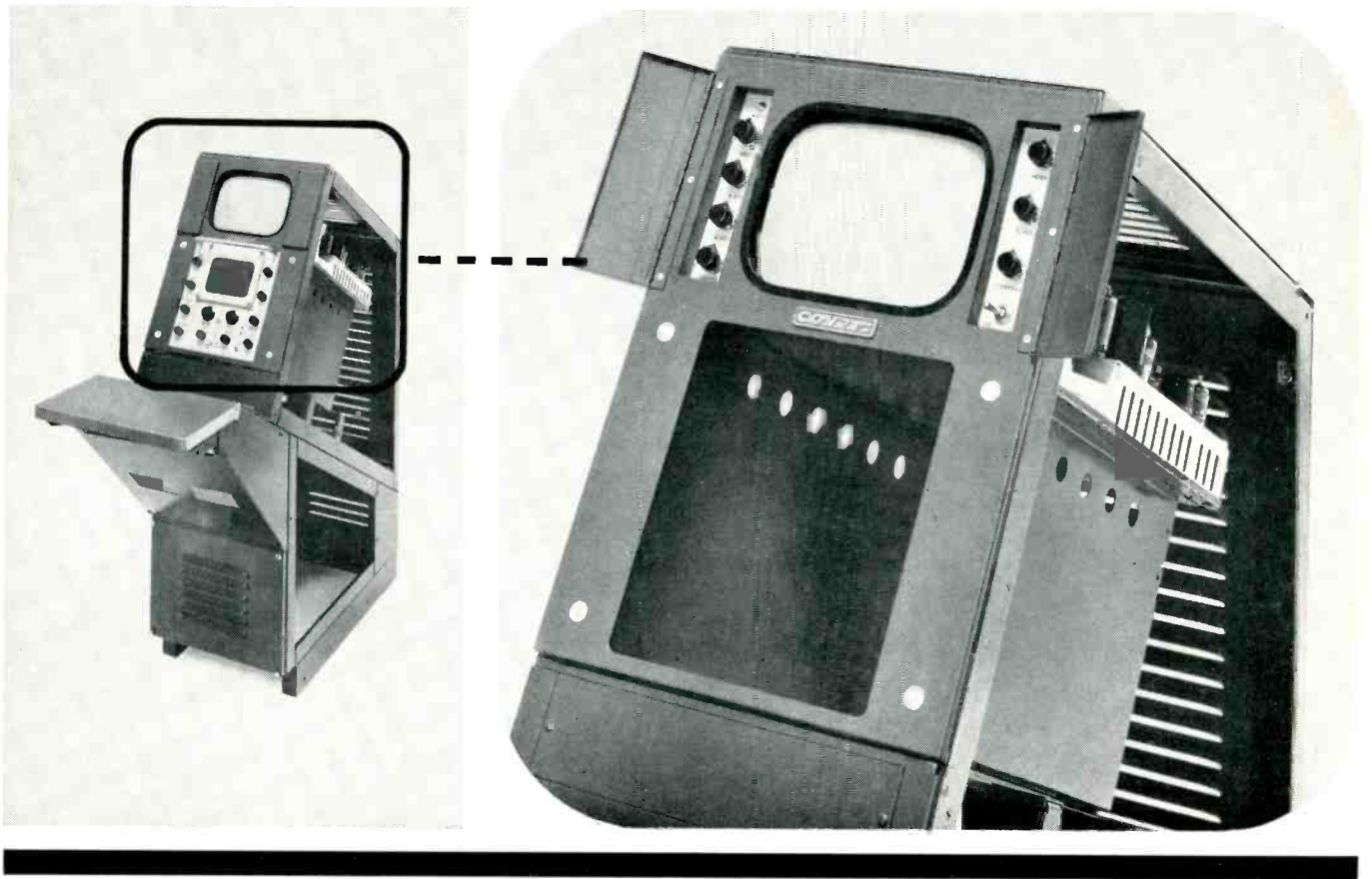

Specifically designed to fit thirteen-inch consoles, the CONRAC CTA8/TU is a direct replacement for the monitor portion of older master monitors. The housing has mounting facilities for the Tektronix 527 Scope to allow modernization of your equipment with a minimum of inconvenience.

This broadcast-quality monitor features low voltage regulation, video bandwidth flat to 10 megacycles, provisions for plug-in sync drop relay, and a kinescope with a laminated, bonded safety shield.

For complete specifications write CTA8/TU across your letterhead and send it to CONRAC, Glendora, California.

CONRAC **DIVISION** *Glendora, Calif.*
GIANNINI CONTROLS CORPORATION

Circle Item 7 on Tech Data Card

Tektronix waveform monitor for 13" consoles

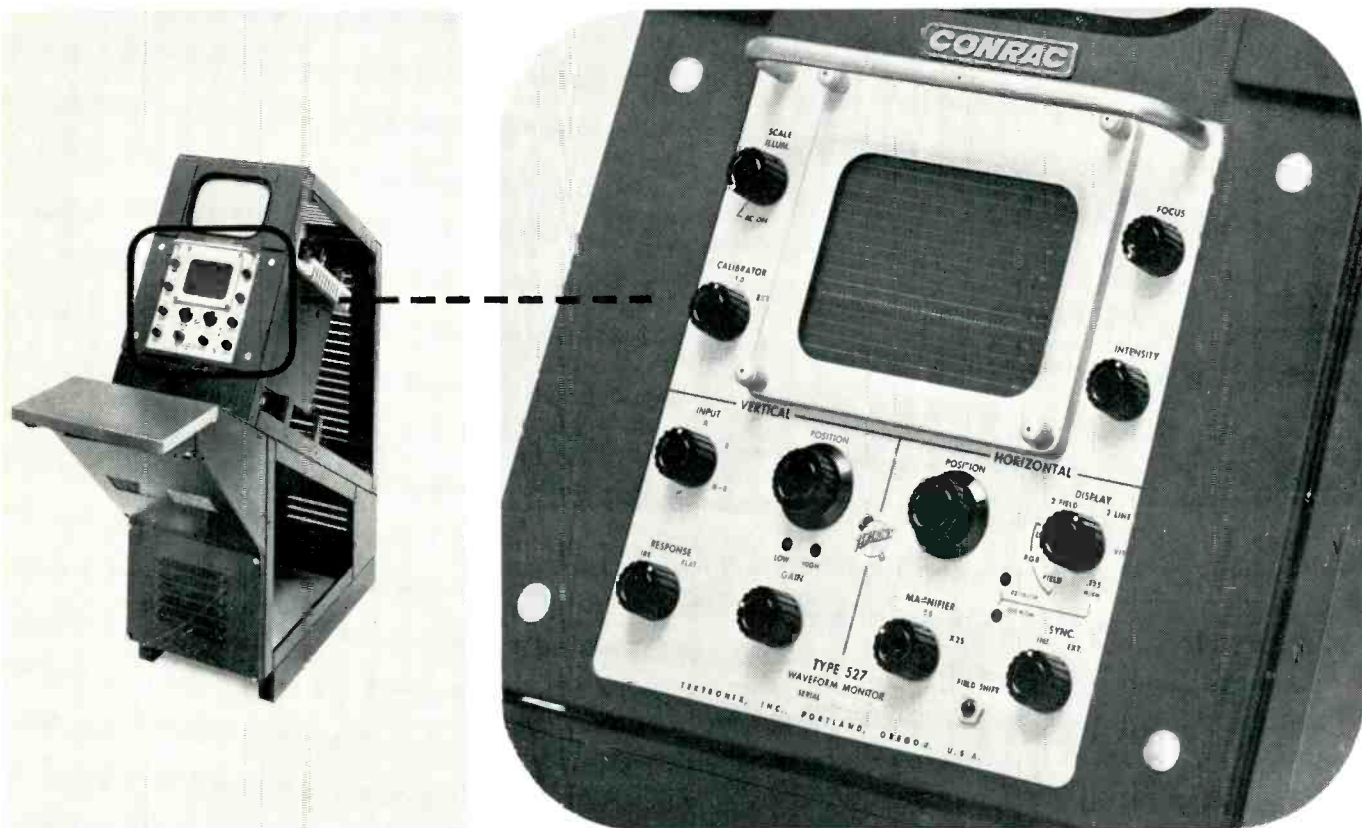

The Type 527 is a precision test instrument designed for displaying linearity, signal level, and bandwidth of television-signal waveforms.

It offers conventional 2 LINE and 2 FIELD displays . . . dual inputs which can be used differentially . . . 3 calibrated time-base rates at 0.125 H/CM, 0.025 H/CM, and 0.005 H/CM, which eliminate the need for time markers.

And it features sharp display readability over the full 7 cm by 10 cm viewing area.

Other features include:

Backporch DC Restoration with no colorburst distortion, Sensitivity from 0.25 v, minimum, to 1.6 v, maximum (for 140 IRE Units), Response flat within 1% from 60 cps to 5 Mc, Internal Calibrator for 1 v and 1.4 v pk-to-pk signals.

Type 527 Waveform Monitor \$925

Special Model—Type 527 MOD 132C, has all features of the standard model plus a line selector, which permits single-line analysis, and a video-distribution amplifier, which permits slaving a picture monitor to the waveform monitor display.

Type 527 MOD 132C Waveform Monitor \$1110
U. S. Sales Prices f.o.b. Beaverton, Oregon

Either model is fully compatible with the Conrac CTAB/TU Monitor.

Call your Tektronix Field Engineer for more information.

Tektronix, Inc.

P.O. BOX 500 • BEAVERTON, OREGON 97005 • Phone: (Area Code 503) Mitchell 4-0161 • Telex: 036-691
TWX: 503-291-6805 • Cable: TEKTRONIX • OVERSEAS DISTRIBUTORS IN 25 COUNTRIES
TEKTRONIX FIELD OFFICES in principal cities in United States. Consult Telephone Directory

Tektronix Australia Pty., Limited, Sydney, New South Wales • Tektronix Canada Ltd., Montreal, Quebec and Toronto, Ontario
Tektronix International A.G., Zug, Switzerland • Tektronix Limited, Guernsey, Channel Islands • Tektronix U.K. Ltd., London, England

Circle Item 8 on Tech Data Card

CATV TODAY, A LOOK AT THE FIELD

by Sam Blakeman* — The purpose, techniques, and equipment of CATV, with a review of the current state of development.

At the present time, there are over 600,000 individual subscribers to more than 1200 CATV systems in the United States; and the total is constantly growing. Thus, an audience of at least three million viewers and listeners is a fair estimate.

This audience demands, and gets from a modern system, not only more diversified programming than is normally available to the non-subscriber, but also "Class A" picture and sound on all channels. ("Class A" may be roughly defined as the picture and sound quality available to the big-city resident from his local stations.)

Importance to Broadcasting

Modern CATV systems provide two major benefits to the TV-FM broadcasting industry. They increase the coverage provided by an individual station and, at the same time, guarantee the best possible signals to their subscribers.

Coverage is extremely important to broadcasting stations since advertising revenues are based on the number of consumers reached. Quality of reception is equally important because both program and advertising presentation must be clear and understandable to hold the viewer's (or listener's) interest.

The Basic CATV System

The CATV systems presently in operation in the United States vary greatly in size and complexity. The very smallest may provide as few as three TV channels and serve only 150 subscribers. On the other hand, the largest systems provide up to 12 TV channels (including system originated TV programs of a public service nature and FM) to serve more than 10,000 subscribers.

Large or small, these systems are similar in at least the three respects outlined below.

Each consists of these major sections: 1. **Head-end**—At the control location, signals are either received from various sources or originated and then completely processed for transportation. 2. **Transportation system**—A coaxial cable main trunk and associated electronic equipment carry the processed signals to distribution points. 3. **Distribution system**—Coaxial cable feeder lines and associated electronic equipment deliver the signals to the set(s) of each system subscriber.

Each provides program quantity with picture and sound quality that is normally unavailable to its customers by other means.

Each is subject to the inexorable law of American free enterprise—the system must either improve service and grow, by taking advantage of pertinent advances in the state of the technical art, or merely maintain the status quo and watch the disappearance of the market for its product.

State of Technical Art

In general, the present technical status of CATV permits greater coverage with better picture and sound quality than was ever before possible. These improvements result from several closely related factors.

One factor is the continual flow of information concerning new and improved equipment, as well as up-to-date installation, maintenance, and measurement techniques provided by the manufacturers. This data, comprising technical literature, service notes, bulletins, and educational courses (conducted on the manufacturers' premises or in the field), enables all CATV personnel to be constantly aware of the latest technical advances.

Another factor is the improvement in CATV system overall performance specifications. Of course, these specifications have always stated that the picture and sound quality measured at the extremities of the system (and hence throughout the system) must not be visibly or audibly degraded from the quality provided at the head-end. Thus, criteria of system performance quality is established at the head-end. Specifications now call for the head-end output to approach more closely than ever the output of broadcasting equipment.

A third, and most important factor is the new equipment and improved versions of previously

*Jerrold Electronics Corp., Philadelphia, Pennsylvania.

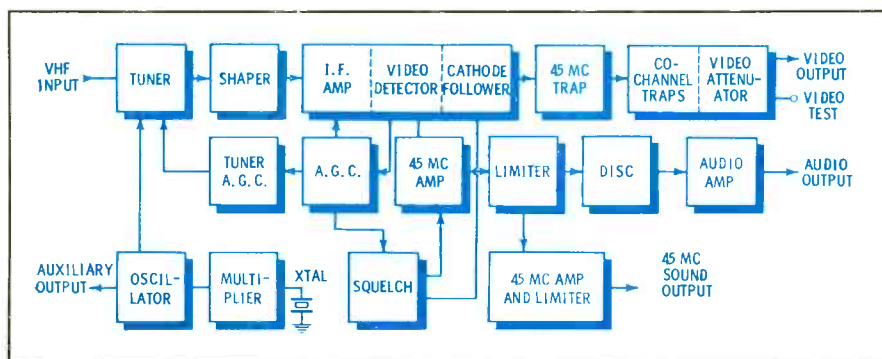

Fig. 1. Block diagram of typical crystal-controlled television channel demodulator.

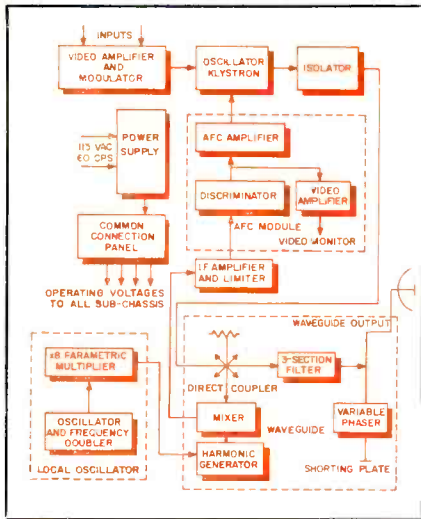

Fig. 2. A typical microwave transmitter.

available equipment being developed by the laboratories of the CATV manufacturers. New items are being currently marketed in each of the major categories: head-end, transportation, and distribution.

Head-End Equipment

Located at the main control center, or "head-end," are several types of equipment. These are all for signal reception and processing, and include: microwave transmitters and receivers, antennas, amplifiers, tuners, monitors, and recording devices.

Microwave

A major factor in the increase of modern CATV coverage is the availability of new wideband microwave equipment. These devices, when combined with VHF demodulating and modulating equipment, enable a CATV head-end location to receive signals from broadcasting stations located hundreds of miles away. TV channel input for the microwave transmitting equipment is provided by a TV demodulator (Fig. 1). The demodulator accepts the output from a conveniently-located VHF antenna and produces video and audio outputs. These are combined in a mixing pad and fed to the input of the microwave transmitter.

The latest video microwave equipment, available for either 6 to 8 kmc or 10 to 13, has exceptionally broad bandwidth (8 mc video) and stability of $\pm 0.005\%$. The devices are compact (due to modular construction), simple to operate, and easy to maintain. They are designed to be self-diplexing for multi-

channel operation without additional equipment. In addition, each transmitter and receiver has an individual power supply.

The output of the microwave transmitter (Fig. 2) is beamed by a microwave radiator (or "dish") over line-of-sight distances to a receiving antenna. The output of this antenna may be fed to another transmitter for further relaying, or to a TV modulator (Fig. 3) via a video/audio separator, or to both. The TV modulator (a companion piece to the TV demodulator) provides the necessary VHF output for the head-end units. A number of microwave links (sometimes called "hops") may be used to make up a microwave system. Any microwave receiver (Fig. 4) in such a system may be used to feed a CATV head-end.

New wideband microwave equipment enables signals from many previously "out-of-reach" stations to be delivered to a head-end. These additional signals, however, would be useless without equipment which can process up to 12 TV and FM channels for delivery to each system subscriber—without degradation of picture or sound quality.

VHF Channel Processor

Typical of the newer-type processing equipment is a device which completely controls any single VHF channel (2—13) so that adjacent channels on both the high and low bands can be fed to a transportation system (Fig. 5). The basic unit comprises a main chassis with built-in power supply and four modules. The modules are tuner, IF-AGC (intermediate frequency amplifier and automatic gain control), AFC-ASC (automatic frequency and sound control), and a standby carrier oscillator. An additional module, the crystal-controlled converter/amplifier, is selected to

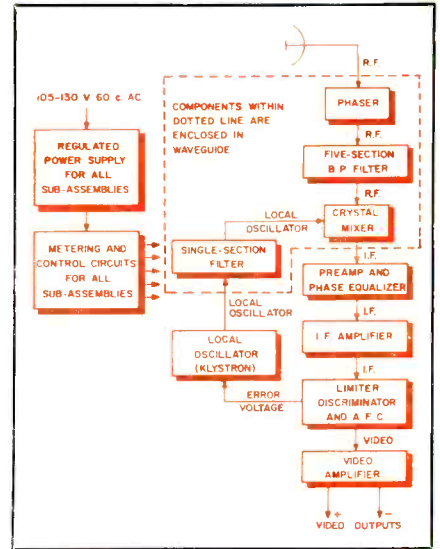

Fig. 4. One typical microwave receiver.

provide the particular output channel desired.

Power Supply—A central Solar-regulated power supply serves all modules. Additional voltage regulation is provided for the ASC and AGC circuits to ensure better stability.

Tuner—The tuner will receive any one of 12 VHF channels, according to the position of the selector switch. The tuning control circuitry incorporates a balance meter which gives visual indication that the tuner is set to the exact frequency. Automatic frequency control maintains the tuner locked precisely on frequency. A special AGC circuit maintains the best possible noise figure on weak antenna signals and prevents overloading on strong (up to 64,000 microvolts) signals. Finally, the tuner amplifies and changes the received signals to relatively low IF frequencies.

IF-AGC — The high-selective IF amplifier incorporates specially designed traps and filters to eliminate adjacent channel interference. This

• Please turn to page 45

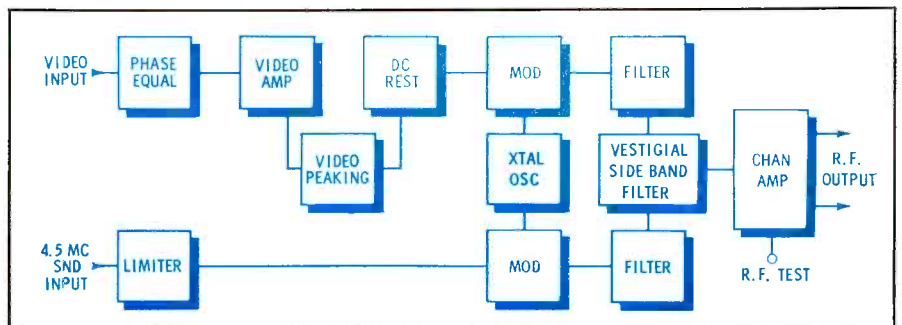

Fig. 3. Block diagram of a typical single-channel CATV television modulator unit.

ACOUSTICS FOR RECORDING STUDIOS

by Don Davis* — A discussion of procedures to follow and pitfalls to avoid in planning studio facilities for recording and broadcasting.

Webster's unabridged dictionary defines acoustics, in part, as an environment "made . . . to promote hearing." This is the goal sought in the design of a useful recording studio, which requires the environment "to promote hearing" during the act of recording and again for satisfactory playback.

There are four important considerations to any acoustical environment—be it home, church, auditorium, or recording studio. These considerations must be satisfactorily solved or the environment will be regarded as an "acoustical problem." They are:

1. **Quietness**—Noise levels must be sufficiently below the program material to be conveyed as to neither distract from nor interfere with the principal sound.
2. **Proper room shape and size**—The studio must be large enough to satisfactorily handle the desired programs, with surfaces arranged to insure adequate loudness and clarity of the program at the microphone.
3. **Proper reverberation**—The studio must have sufficient reverberation time at low frequencies to allow bass instruments to develop tone, but also have reverberation time at mid

*Regional Sales Mgr., Altec Lansing Corp., Elmhurst, Ill.

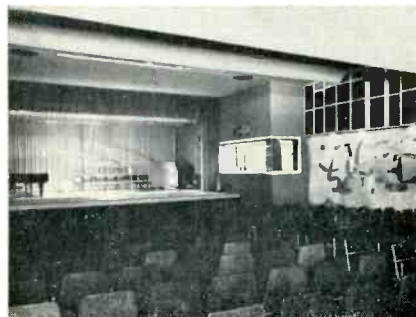

Fig. 1. View from the rear of studio A, showing acoustical treatment and layout.

Table 1. Cubic Volumes of Studios.

Number of performers	Studio Volume (in cubic feet)
4	1,500
8	4,000
16	12,000
32	30,000
64	82,000
128	220,000

and high frequencies short enough to assure clarity of speech.

4. **Proper distribution**—The studio must have proper shape to insure evenness of sound at all microphones.

Quietness

In planning a recording studio it must be realized that a noise level greater than 25 db (as measured on the A weighting scale of an ASA standard sound level meter) cannot be tolerated. In view of the extremely high noise levels prevalent today near airports, truck arteries, railroads, and areas of heavy industry, a very careful site survey is important in finding the quietest location possible for a studio, consistent with other requirements. Furthermore, after having located a site judged to be satisfactory, a noise survey should be made to determine how much sound isolation must be incorporated into the building to meet the requirements for quietness. This information allows the architect to specify in detail the transmission loss characteristics the walls enclosing the studio must have.

Awareness of the noise sources around the site also allows maximum effectiveness in planning the arrangement of studios within the building—such as locating the main

Editor's Note: The accompanying photographs of the studios at Radio DZXL, Manila, P.I., appear here through the courtesy of Bolt, Beranek, and Newman, Cambridge, Mass.

studio on the far side of the building from a heavily traveled street.

Careful control of the noise within the building must be considered—such as building vibrations from passing trucks, machinery, or railroads, and airborne noises such as ventilation, horns, office machinery, and maintenance crews.

Room Shape and Size

The studio must be large enough to handle the number of performers required. Typical specifications call for at least eight square feet of floor space for each performer.

Cubic volumes of studios with regard to the number of performers are shown in Table 1.

Within the requirements of size, room shape is quite important in a studio, particularly where music is to be recorded. Perhaps it would be more accurate to say room shape is important in a negative way—in that cube shapes and ratios of 1:2:3 are to be avoided. Parallel surfaces can give rise to flutter in a studio. Concave surfaces can cause focusing which destroys good distribution of sound within a room. A most desirable ratio of dimensions for a studio would be a ratio of the cube root of two. This separates dimensions by $\frac{1}{3}$ of an octave. Unfortunately, this is not a practical ratio for larger studios, as the ceiling height becomes too great.



Fig. 2. Treatment in studio B includes the resiliently suspended ceiling sections.

Naturally the presence of an audience will alter requirements, as may the instruments (e.g., pipe organs). Excellent ratios used in the past include 3.27:1.45:1.0, 2.4:1.5:1.0, and 3.2:1.3:1.0.

Dr. Leo L. Beranek points out in his book, "Music, Acoustics, and Architecture," that room shape is not important but acoustic narrowness is. If you have a studio with undesirable dimensions the installation of acoustic clouds or panels that alter the acoustical shape of the room may correct, to a great degree, the shape of the other walls.

The shape of the studio, as well as its dimensions, will be instrumental in determining the diffusion, dispersion, and distribution of the sound. To splay one wall even a mere one inch per foot from parallel will substantially reduce standing wave patterns in a studio.

Reverberation

Covering one hard, smooth surface with a suitable absorbing material can reduce flutter and excessive reverberation. The placing of absorbing materials in a studio is an art. While the exact amount of absorption required can be precisely calculated, the placement of the material cannot.

In general, it is not necessary or desirable to place absorbing material on both opposing surfaces. One frequent mistake is to put carpeting on the floor and acoustic tile on the ceiling. The result is a horrible fluttering echo between parallel side walls. The carpet acts as sufficient absorption between the floor and ceiling surfaces (while reducing overall noise in the room by muffling foot-falls). The tile on the ceiling could have been placed on one of the two side walls to eliminate the flutter echo.

Generally speaking, the ceiling is the least desirable surface on which



Fig. 3. View through double window of "living room studio," showing treatment.

to place acoustical treatment, while carpeting is one of the best forms of treatment. These normal absorbing materials—carpets and acoustical tile—do not provide low frequency absorption. Windows, doors, and large thin panels do, however, and the tailoring of the low frequency absorption in a studio is best left to a competent acoustical consultant. As a matter of simple fact, it is usually economical to engage the services of a professional acoustical consultant

Proper Sound Distribution

In the last two years several developments have changed the design philosophy of those involved with recording studios. First of all, very high quality directional microphones, notably the condenser cardioid types, allow most satisfactory recording work to be done in studios hitherto considered too reverberant. Such a microphone provides discrimination between the desired direct sound and the reflected reverberant sound.

The second development is stereophonic recording and broadcasting. Acoustical problems of a special nature arise in the design of studios used for dual microphone pickup. The special nature of the problems arise primarily as a consequence of the difference between monaural and binaural hearing. When we listen with both ears the sounds reaching one ear differ in loudness and phase from those reaching our other ear. These differences enable us to locate the source of the sound with some accuracy and concentrate on that source while ignoring, to a large extent, sounds coming from other directions. If we listen to an orchestra with only one ear we find our ability to discriminate between the direct and the reflected sound is diminished and the room sounds more reverberant and noisy. A monophonic microphone pickup suffers from the same handicap.

In the past, studios have been designed with one-eared listening characteristics in mind. Hence, they have tended to have short reverberation times on the order of 0.5 second at 512 cps and less than 1.0 second at the lowest frequencies. Speech was well served by these measures, but music suffered.

Another reason reverberation time was kept short is that one

had not only the studio to contend with, but the reverberation time of the listening room as well. If the studio and listening room both had a reverberation time of 0.5 second, the combined result is 0.6 second. Therefore, it has always been felt in the past that, for monophonic recording, the studio reverberation time should be kept quite short. Control rooms should be handled as if they were a typical living room or other listening area.

When recording stereophonically the engineer now has the opportunity to include the room characteristics (if desirable) in the recording and can tolerate much longer reverberation times.

For music, the only criteria that need be followed is that the auditorium have good musical acoustics. Reverberation times can be approximately 1.5 seconds at mid frequencies and often 3 to 4 seconds at low frequencies. Use of extremely wide range, low distortion, omnidirectional condenser microphones allow re-creating in the listening room the direct as well as reflected sound of the original hall. Speech problems can be solved by using directional microphones.

Testing

A word might be said here for those who wish to check the characteristics of new studios (to be sure specifications have been met) or studios already in use. It is possible today to test acoustical properties of rooms with great accuracy. The following tests are capable of such accuracy and assure the engineer of his new studio's integrity. They also allow an evaluation to be properly made of the older "problem" studio.

1. **Ambient noise levels by frequency**—These tests use a precision sound level meter con-

● Please turn to page 44



Fig. 4. AM announce studio has sound absorbing box units with slatted facing.

THE BROADCAST ENGINEERS' APPROACH TO LIVE MUSIC PICKUP

by Robert W. Carr* — Discussion of the important considerations in planning for live pickup of musical performances for broadcasting and recording.

C. E., the chief engineer, settled into a chair between the program manager and the sales manager and looked expectantly across the desk at the general manager.

"As you know, C. E., we have been looking for additional programming which can help us expand our market. One possibility that looks very good so far is to give your turntables an occasional rest by scheduling a live music series."

As the general manager paused, C. E.'s mind drifted briefly over his all too recent problems with the new stereo operation—and the fact that his only recent experience with live music was the rather incidental pickup of the football band during half-time.

"P. M. has done some serious exploring and is certain we can have a schedule of pickups with the Civic Orchestra and the University Symphonic Band, the two probably alternating on a weekly schedule. Before going any further though, I

think we'd better get an idea of what you will need."

C. E. thought for a moment and his eyes wandered over the display of record jackets decorating one wall of G. M.'s office. "I wish I could give you a pat answer, G. M., but there are just too many things that affect what I'll need. I'm sure we can get the pickup you want—and it seems to me that right there is our first step. I suggest that the four of us get together with a group of records this afternoon to get a feel of what you really want to hear. Then I can do some looking and listening at the pickup locations and give you a pretty good picture of what's involved. G. M. agreed, the group disbanded, and C. E. headed for the record library to select some examples for the meeting.

In this mythical setting, our chief engineer is facing a problem now confronting more and more broadcast engineers. His lack of a definite answer is not a display of indecision. It is evidence of the experienced engineer's ability to

recognize the complexity of a problem which may appear very innocent to the more casual. He is also indicating his understanding by recognizing that the problem of live music pickup is not entirely technical, but that the very first consideration might best be described as philosophical.

What, then, are the factors that make live music pickup a complex problem, and which must be considered by those who find themselves confronted with such an assignment? It would be ideal if a single article could provide a simple universal answer to all the problems which are inherent in live music broadcasting. Unfortunately, such a promise would be misleading. We can, however, analyze the contributing factors—not only to demonstrate the complexity of the problem, but also to hopefully suggest some specific avenues which may be followed to reach a workable solution.

The Philosophical Factor

The philosophical factor might be expressed most simply by asking, "What does the production staff expect to hear?" This question does not primarily relate to the nature of program material, or to a mere consideration of frequency response—although both are unquestionably significant—but rather to the overall character of the presentation.

To establish our perspective, let us follow C. E. to the record library. Here is the music the public is used to hearing. Whether reproduced on the home phono system or through the medium of radio, the products of the recording engineer have set the pace for what is expected in music reproduction. This is certainly no criticism of the record industry, but is simple recognition of the fact that many more



Fig. 1. Typical remote-pickup location for broadcast of symphonic band program.

records than concert tickets are sold each year. The character of reproduction carefully engineered into recordings is that which experience indicates the home music listener wants to hear.

Consider, for example, the disc he is playing now. If this character of presentation were expected, C. E. could well submit an estimate of approximately \$30,000 for additional equipment—and a requisition for a specially trained mixer to manipulate the new 16-channel console, and mix down the resultant eight-track recording into two appropriate “on the air” channels.

Are we saying that a broadcaster with only a reasonably normal equipment complement cannot hope to produce saleable stereophonic—or even monophonic—reproduction of live music? Certainly not! Consider the next disc, a product of a major record company, recorded at a concert location. This time, however, only a pair of carefully placed matched microphones were used to provide believable stereo reproduction of the entire orchestra, plus one or two additional microphones to properly balance the featured soloists. Despite the contrast with the first disc, the second is also a saleable and convincing presentation of music—and much more in keeping with facilities practical for the broadcaster.

The philosophical factor may be summarized by cautioning that the production requirements must be consistent with practical broadcast facilities and techniques. It is necessary that the production and engineering departments reach an understanding on the character of presentation desired before the technical factors can be properly considered.

Technical Factors

The technical factors are varied, frequently complex, and often stem from causes outside the engineer's control. Any of the factors, which will be briefly discussed here, could well be the subject of a separate article—or, in some cases, an entire volume.

The Physical Location

The physical surrounding is potentially a source of the most difficult and frustrating problems, largely because it is the least under-

stood and almost completely beyond the direct control of the engineer; yet it determines the very nature of the sound available.

The principal elements of room characteristic are implied in the terms “reverberation” and “frequency response.” Reverberation relates to the echo or liveness of the room, and is usually described in terms of “reverberation time” (the time during which an echo is audibly sustained). Since high frequency sound is more readily absorbed by draperies, seats, audience, and air, reverberation tends to be more of a low frequency effect (Fig. 1).

Frequency response refers to the coloration of sound as it travels through the room. Specific reflections from hard surfaces, reinforcement of tones by reverberation, and the amount of high frequency absorption in the room all contribute to this coloration. A particularly troublesome aspect is that frequency response usually varies throughout the room.

An outdoor location, with no structure surrounding the listening area, tends to minimize some of these effects. There is still sound coloration, however, because of the reflecting structure normally used to help direct sound into the audience area. Extraneous noise and the loss of overall sound energy due to the

lack of reflecting surfaces enclosing the listening area must also be considered.

While some of the location peculiarities are characteristic, and usually are desirable to lend authenticity and “presence” to the reproduced program, too much peculiarity can produce serious problems. The effect of over-colored frequency response requires little imagination. Echos and reverberation also play a major part, not only by running notes and phrases together unnaturally, but often by masking the stereo effect through indiscriminate acoustic mixing of what should be locatable sounds.

Except for such measures as carpeting a bare stage, selecting back drop materials, and arranging audience distribution, there is little the broadcaster can do to affect the physical properties of the room. However, he can control the final effect of the room characteristic (Fig. 2) by judicious selection of his pickup tools—a selection which he can make only after becoming familiar with the properties of the room.

To properly explore room properties, it is necessary to recognize a subtle factor in the hearing process. As we sit in a concert hall, the elements which we have outlined are present in varying degrees, but do not destroy our enjoyment of the music. Instead, our ears and brain combine in remarkable fashion to discriminate selectively against some of these elements and allow us to concentrate mainly on those characteristics we wish to hear. If we plug one ear most of this ability is lost, and the undesirable characteristics become very distracting.

The microphone, unfortunately, functions as a single ear. Even if we use two microphones feeding a stereo system, we regain only a small portion of our selective listening ability. In many cases we may expect our pickup tool, the microphone, to seemingly exaggerate the room characteristics; and it becomes important, in exploring the properties of a location, to do at least part of our listening as the microphone does—with only one ear.

The Microphone

Just as room characteristics are basic to the available sound, the

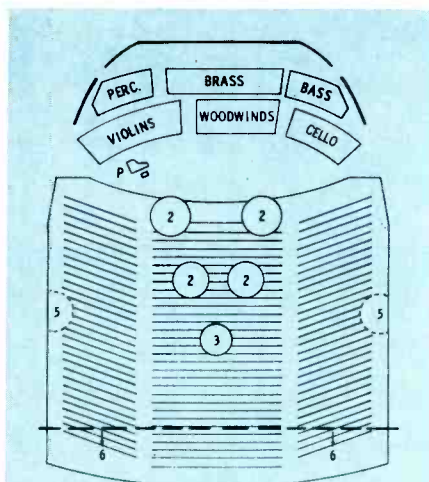

Notes: 1. Piano mike needed for balance and separation. 2. Good separation; tonal balance bad, loss of high reeds and 2nd violins; bad reflection on right side. 3. Very good tonal and directional balance just left of center; bad mixing and reflections above about 10' (check curved balcony). 4. Color not bad; right reflection better than (2), directional mic. should kill further; stay below 10'; reverb a little high, but check with audience in place. 6. Behind about row 25, coloration bad, spotty; heavy mixing.

Fig. 2. Six conditions at typical location.

● Please turn to page 41

THE VTR-CUE

by Paul Yacich and Edward Tong*
— Principles and design of a device
for automatically recording video
tape leaders.

Video tape recording might be described as a system of "electronic film." As in the case of photographic film, a leader is usually furnished for identification and to aid in proper timing. The convenience of precedence and excuse of tradition has led some stations to simply adopt the film industry's familiar "clapstick" and scribbled titleboard, for use in recording the leader. Others have come up with products of ingenuity and necessity to perform the task.

The SMPTE Proposal

The Society of Motion Picture and Television Engineers, in their May, 1961 Journal, published "Proposed American Standard Specifications for Monochrome Video Tape Leader, VTR16.3." The American Standards Association has brought this proposed standard before a board, known as the Sectional Committee on Combined Visual-Aural Magnetic Recording for Television. In the business of the committee the proposed standard is known as C98.2 "Specifications for Video

*WDSU-TV, New Orleans, La.



Fig. 2. Control panel of the signal device.

Tape Leader."

The standard proposes a leader which contains the following:

1. Ten seconds of blank tape to be used for threading the machine.
2. Thirty-five seconds of visual alignment signal such as a test pattern or stairstep containing reference black and white levels. Simultaneously a reference-level audio tone of 400 cps, $\pm 5\%$.
3. Fifteen seconds of visual identification information containing as a minimum the title, subject, production number, "take" number, recording studio name, and the date of recording. Simultaneously, an

aural signal with this same information shall be recorded at the reference level.

4. Ten or more seconds of aural cue signals consisting of 400-cps tone bursts, $\frac{1}{5}$ th of a second in duration, at one second intervals; these are to be recorded at reference level to within 2 seconds of program. In addition, a steady 400-cps signal is to be recorded 20 db below reference level beginning with the first tone burst and ending with the last. A visual signal should be recorded during the entire duration of the steady tone. Sync and setup only are to be recorded during the two-second period preceding program. If a visual cue signal (count-down) is used it should appear coincidentally with the tone bursts, which it should identify.

Design Considerations

Through analysis of the proposed specifications, we found the functions during the ten-second cue period to be the most difficult to accomplish manually, with uniformity. Therefore, the major function of our cueing device (Fig. 1) is to automate this time segment. The procedure involves three major steps. First, an accurate 400-cps tone burst at a certain preset level must be switched on for a fraction of a second; this is to occur eight or more times at one-second intervals. Also, another 400-cps tone, 20 db below the tone burst, level is recorded in the time interval between bursts. Thirdly, absence of both signals during the two-second period preceding the program must be assured. We considered the visual countdown of major importance and have incorporated it to identify the specified tone bursts.

In the VTR-Cue, the control of the entire complex sequence has been simplified to operation of one switch (Fig. 2). This switch has

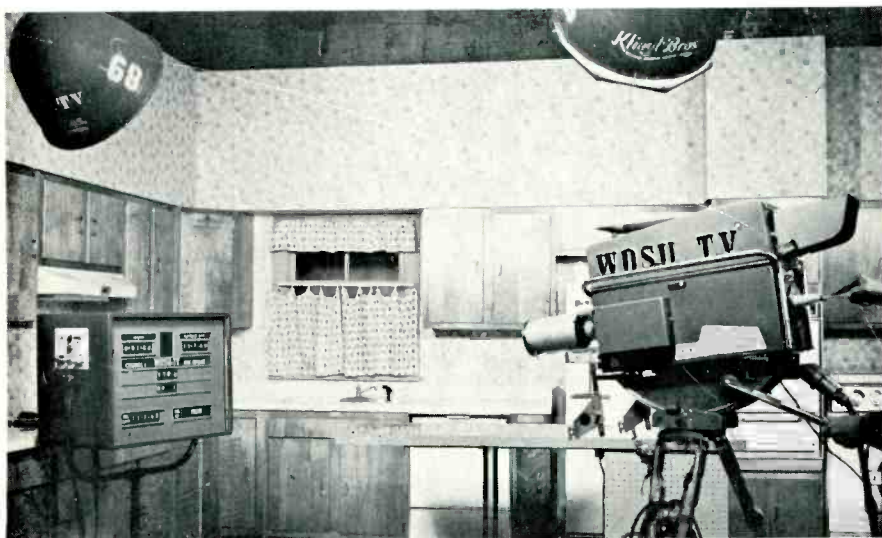

Fig. 1. The VTR-Cue operating in a studio.

three positions: center off, up for continuous tone, and down to initiate the countdown sequence.

The numerical indicator used for visual countdown was the only type available with large (3½") numerals, at the time we built the unit; it extends 12" behind the panel. However, there are other readout devices, available now, which take up less room. For example, the manufacturer of the unit we used now produces a newer model which employs an internal 90° mirror. This version is only 5" in depth, making possible a great reduction in the size of the cabinet.

Provision for the display and storage of four camera test charts (mounted on Masonite) is provided in the enclosure. This could be eliminated to further reduce the size. To assure legibility and uniformity in our title board, we use fixed slots into which printed title cards are fitted (Fig. 3).

Circuit Description

Switching

Fig. 4 shows the switching circuits of the VTR-Cue. When either S3 or S4 is momentarily pushed to the cue position, cue-start relay K3 is energized and latched by a set of its own contacts. K3 remains in this state during seconds (positions) 10 through 1 of stepping switch K1, since its DC is supplied through section K1C (shorting-type contacts). The second set of K3 contacts operates power relay K2 which applies 110 volts AC to the timing motor and 24 volts DC to the arm of S1. Keep in mind that at the end of the previous cycle of operation the motor was stopped with S1 in the position shown on the diagram. Thus, it is ready to operate K5 and turn on the tone burst for 1/5 of a second. K2 also

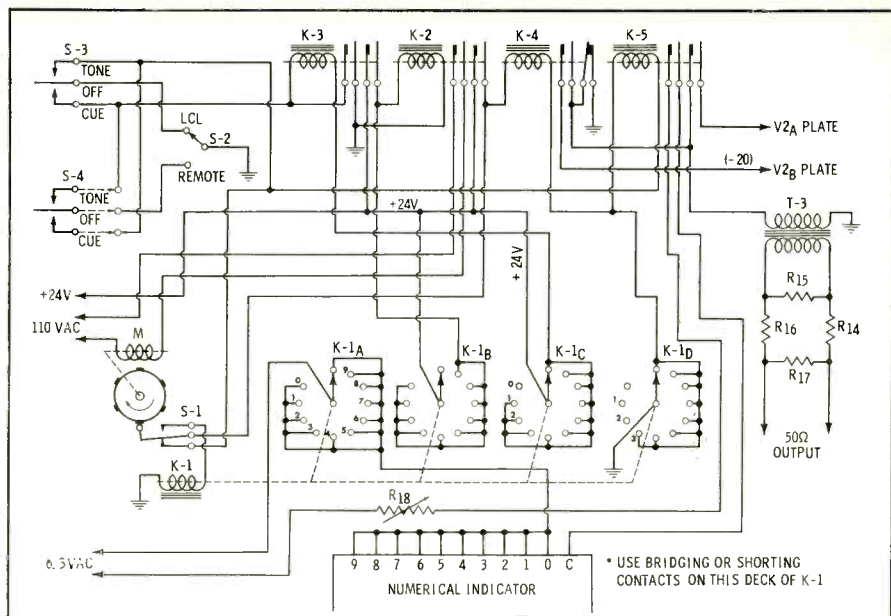

Fig. 4. Schematic diagram of the switching circuits used in the VTR-Cue.

applies 24 volts DC to K4, the -20 db continuous-tone relay.

After the cam (Fig. 5) has advanced for 1/5 of a second, S1 releases K5, terminating the tone burst and pulling up the armature of stepping relay K1. The relay does not step at this time since the spring loaded armature advances the switch only on termination of coil current. Four-fifths of a second later, at the end of the first second of countdown, this sequence takes place:

1. K1 is released by S1 and advances one step.
2. K5 is energized by S1, starts the second tone burst, and closes the indicator common circuit to the 6.3 volt AC source.
3. K1A lights lamp 9 in the visual indicator.

This cycle repeats eight times.

During seconds 2 and 1 preceding program material K1D breaks the common return of K4 and K5, disabling both tones. The output transformer primary is shorted to ground thus preventing leakage. The release of K5 also breaks the common lead of the numerical indicator. The lamps are thereby extinguished for the last two seconds; this reminds the switcher to fade, or cut to black.

Relay K3 is de-energized by K1C at the beginning of the first second. K2 is kept closed by K1B until it is advanced through position 10 (starting) at which time it removes motor power. K2 also removes voltage from K4 and K5 during standby. A synchronous gear-reduction

motor with positive clutch is used for quick starts and stops.

Oscillator and Power Supply

Almost any audio oscillator circuit can be used. The one we employ (Fig. 6) is simple and stable, employing only three controls. R-1 is adjusted for least distortion, while tone amplitude is set by R7 and R8. Low and high voltage power supplies are simple and straightforward. In the B+ supply, V4 provides adequate regulation.

Operation

In use, the VTR-Cue output is applied to one of the microphone inputs of the audio console. We installed the remote operate switch at the video tape machine location. For in-station tapes, we usually omit the 35-second period of visual and audio alignment signals called for in the SMPTE leader. A camera shot of the title board and a 400-cps reference tone are recorded for 15 seconds. Then, by switching S3 or

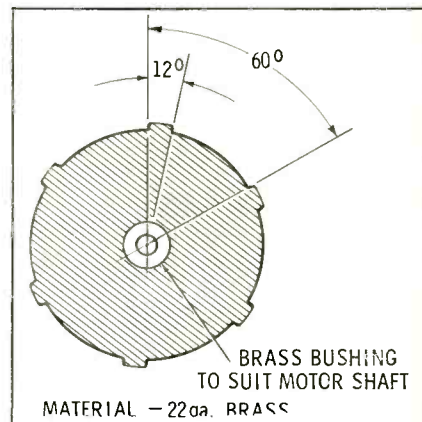

Fig. 5. Details of the 10-rpm timing cam.

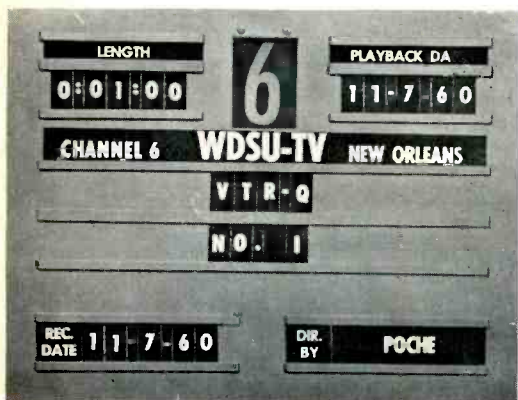

Fig. 3. Front panel with the slots for titles.

Parts List

Item	Description	Item	Description
C1	270-mmf ceramic capacitor	T3	audio matching transformer; primary, 50, 125-150, 200-250, 333, 500-600 ohms; secondary, 50K; 20 cps to 20kc (UTC A-20 or equivalent)
C2	.1-mfd tubular capacitor	CR1, 2, 3, 4	750-ma, 100 piv, silicon rectifier
C3, 4	470-mmf ceramic capacitor	V1, 2	12AU7
C5, 6	.003-mfd tubular capacitor	V3	6X4
C7, 9	10-mfd, 25-volt electrolytic capacitor	V4	OA2
C8, 10	.005-mfd capacitor	K2, 3, 5	relay, 24 volts DC, two sets form A contacts
C11, 12	20-mfd, 350-volt electrolytic capacitor	K4	relay, 24 volts DC, one set A and one set B contacts
C13	50-mfd, 150-volt electrolytic capacitor	K1	stepping switch, 24 volts DC, 11 positions, 4 sections, one section with bridging-type wiper
R1	1.5-meg potentiometer	S1	miniature switch with roller arm
R2	2.2K resistor	S2	wafer switch, single arm, two position
R3	33K resistor	S3, 4	lever switch, spdt, 3 position with center off, one position spring return, one position locking
R4	910K resistor	S5	toggle switch, dpst
R5	470K resistor	F1	fuse, 2 amp, 3AG
R6	1.5K resistor	M	motor, synchronous, positive clutch, 10 rpm (Hurst PCRS-10, or equivalent)
R7, 8	250K potentiometer	Indicator	Industrial Electronics Engineers, Inc. Series 80 or 100 one plane assembly, or equivalent
R9, 12	2.7K resistor		
R10, 11	10K resistor		
R13	4K, 10-watt wire-wound resistor		
R14, 16	82K resistor		
R15	560-ohm resistor		
R17	51-ohm resistor		
R18	50-ohm, 25-watt rheostat		
(Note: All resistors are 1/2-watt, 10%, unless otherwise noted.)			
T1	power transformer, 440 volts CT, 50 ma, 6.3 volts @ 2 amps		
T2	filament transformer, 24 volts, 1 amp		

S4 to the "Cue" position, VTR-Cue is put to work to provide the visual and audio cue sequence. At seconds 2 and 1, the video switcher fades to black and the audio operator advances his program mixer during the silence. It is of no consequence if he is too busy to switch or fade the

device out, since it is self muting. Our VTR-Cue has contributed to the production of a professional appearing product. During its three years of use at WDSU-TV, it has eliminated many errors in handling and identifying an ever growing library of videotapes. ▲

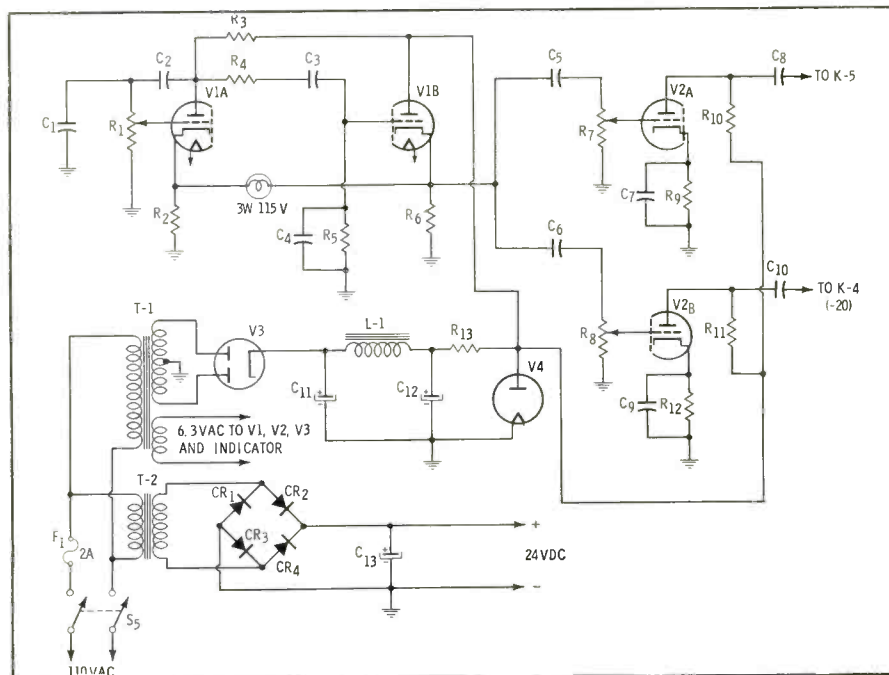

Fig. 6. Schematic diagram of the amplifier, oscillator, and power supply.

Why is the VR-1100 selling like sixty?



Ask the man who owns one.

We'll pick up the tab. Just call one of the stations listed below, keep track of the charges, drop us a line, and we'll reimburse you.

ALABAMA
WKRK Mobile

CALIFORNIA
KTVU Oakland
KXTV Sacramento

FLORIDA
WTVT Tampa

GEORGIA
WAll Atlanta
WTOC Savannah

ILLINOIS
WHBF Rock Island

INDIANA
WISH Indianapolis

KANSAS
KAKE Wichita

LOUISIANA
KPLC Lake Charles
KALB Alexandria

MASSACHUSETTS
WBZ TV Boston

MINNESOTA
WCCO Minneapolis

NEW MEXICO
KGGM TV Albuquerque

OREGON
KVAL Eugene
KEZI Eugene

PENNSYLVANIA
WHP TV Harrisburg
WFIL Philadelphia
WHYY Philadelphia — Educational
WDAU Scranton

TENNESSEE
WDCN Nashville

UTAH
KUED Salt Lake City — Educational

(Because of space limitations this is only a partial list of the many VR-1100 installations)

AMPEX CORPORATION
Redwood City, California



Circle Item 9 on Tech Data Card

BROADCAST ENGINEERING

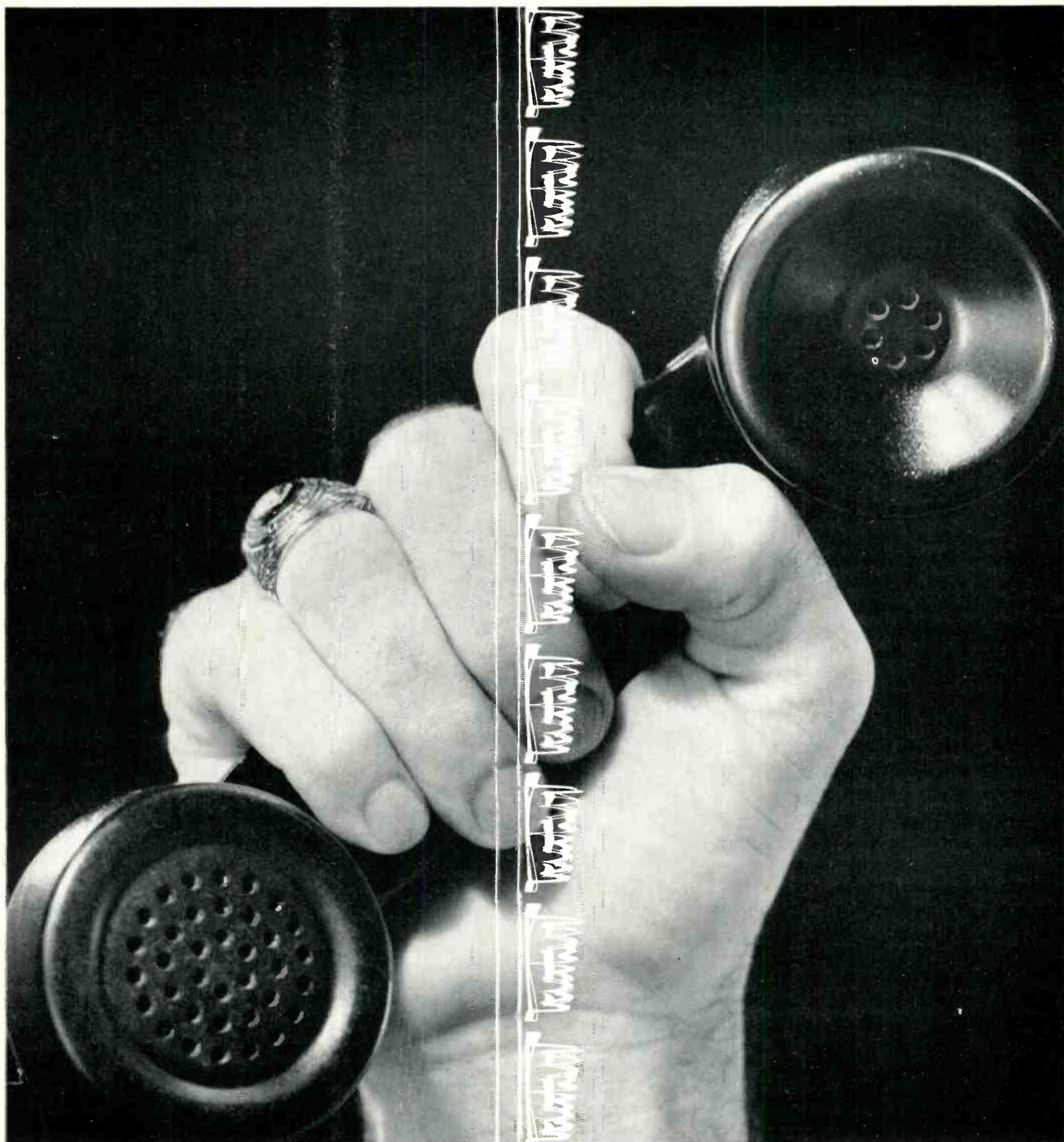

Find out why the VR-1100 is the world's fastest-selling VTR . . . with our dime.

Just call any of the broadcasters who have installed the new solid-state VR-1100. We'll pay the phone bill, and we'll stand or fall on what they tell you. Because we're not talking promises, we're talking about a new VTR that has gone into 60 installations in just 90 days. We're not talking promises, we're talking about a basic recorder so clearly a product of advanced engineering that it practically sells itself when we switch it on. We're not talking promises, we're talking about a \$35,000 recorder so reliable that

*TM Ampex Corp.

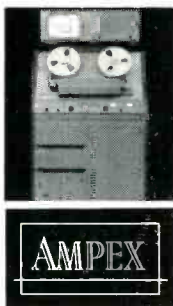

just about the only way to improve it is to add Ampex accessories. Accessories such as Electronic Editor, Amtec*, Intersync*, and color capability. Accessories we purposely made optional, so that you could add them when you needed them, and not have to pay for accessories you didn't need. We're not talking promises, we're asking you to talk to the people who can give you the straight-from-the-shoulder facts about the performance of the VR-1100. Why not take us up on it? Ampex Corporation, Redwood City, Calif.

Circle Item 10 on Tech Data Card

NETWORK COVERAGE OF A TRAGIC WEEKEND

by **John H. Battison*** — A brief look back at the fine efforts of the radio and TV networks "in the public interest, convenience, and necessity."

During the past several months, the country has read much about the low standards of television and opinions of Broadcasting's public service ideals. On the fateful twenty-second of November, 1963, an event occurred that shocked the world, and roused many people out of a lethargic "it can't happen here" attitude—John F. Kennedy, President of the United States, was assassinated. The events following this tragedy provided concrete proof of the extremely important role radio and TV play in the lives of every American today.

The efforts of the broadcasting industry have since been recounted in many ways, but our interest is in the technical and organizational phase. To provide BROADCAST ENGINEERING readers with a first-hand account of the vast ef-

forts we asked the networks for their stories.

At 1:32 PM on Black Friday, when the late President Kennedy was struck down, ABC went on alert and remained in that status for over 80 hours. Within minutes, more than 500 news and engineering personnel had been deployed from New York, Washington, D. C., and the network's affiliate WFAA in Dallas. Ten minutes after Elmer Lower, president of ABC News, had mobilized the network on a spot news basis, they were out of the "bulletin" business and well into a program of complete coverage that was to continue for 60 hours on TV and 80 hours on radio. The rapid pace with which events occurred displayed to advantage Broadcasting's true flexibility—only by radio and television could the sorrowing nation keep up with the mounting pace of tragedy

and the grim events as they unfolded.

The rapid movement of important persons and others from Washington to Texas, and back again, taxed networks' communications facilities to the utmost. If any lesson was to be learned by the purveyors of instant news, it could only have been the need for more and better means of communication with their men in the field. To the viewing public this difficulty was not apparent, but to the news directors it was a real (perhaps their worst) problem. The rapid arrivals of important people and the widening needs for coverage added to the task.

In keeping with the speed of modern communications, ABC-TV telecast early morning (3:19 to 3:29 AM) messages from British Prime Minister Home, and from Pope Paul. These were transmitted from Europe via satellite Relay and were exclusively aired by ABC-TV.

When the second murder occurred, ABC Radio's Bill Lord gave the eyewitness report, "He's been shot." Then ABC-TV followed with the first TV report of Oswald's death, showing film clips taken at the hospital. The usual role of network affiliate was reversed by WFAA and WFAA-TV in Dallas. Instead of being on the receiving end of the coaxial cable (as is usually the custom), these stations provided most of the technical facilities that helped ABC provide such complete coverage. It is in just such unexpected events as this foul deed that the true capacity of an affiliate is measured.

While the bulk of camera equipment came from the network, some was obtained from affiliates and even nonaffiliates in Washington, D. C. WTTG, the former DuMont station, loaned a field unit to ABC-



Fig. 1. A tense scene during the height of activity at ABC TV news control in New York.

Now . . . a new EASTMAN Sound Recording Tape!



LISTEN . . . New "R"-type Binder Assures Long-Term Sound Clarity . . .

AT LAST, a much superior binder—one that provides a super-smooth, tough, homogeneous oxide layer which dramatically suppresses tape noise and intermodulation distortion! You'll notice this in the new sound clarity.

At the same time, extremely abrasion-resistant, it prevents oxide build-up on the recording head, assures long-term excellence of performance.

Equally important are outstanding magnetic characteristics which make possible two superlative tapes of widely different performance characteristics: a superb low-noise, high-output tape and an extra low print-through tape.

STRONGER: DUROL support material, a specially prepared form of cellulose triacetate, is a good 40% stronger. *When it breaks . . . it breaks clean.*

For details, see your electronic supplier or write:
Magnetic Product Sales

EASTMAN KODAK COMPANY
Rochester, N.Y. 14650

MORE CONVENIENT: A continuously repeated permanent legend on the back of the tape offers a means of indexing.

Ask for EASTMAN Tapes at leading electronic supply houses: Type A303, a superior low-print tape with output comparable to a fine general-purpose tape . . . also Type A304, a high-output tape with low print-through.

©Eastman Kodak Company, MCMLXI.



For fast threading and extra convenience—the unique, handy, Thread-Easy Reel with indexing scale and built-in splicing jig.

Circle Item 11 on Tech Data Card

Enjoy Dynamic Programming with Spotmaster . . . the International
Standard of Excellence in Cartridge Tape Systems

Check SPOTMASTER

- ✓ Compact and rack-mount models
- ✓ Recorder-playback and playback-only models
- ✓ Monophonic and stereo units
- ✓ Delayed programming option
- ✓ Superior quality

500A
Compact
Recorder-
Playback



500A-R
Rack-Mount
Recorder-
Playback



SPOTMASTER tape cartridge equipment is the preferred choice on five continents. These quality-engineered machines permit snap-in cartridge loading and split-second, one-hand operation . . . plus all the other time-tested and field-proven SPOTMASTER features.

Write or phone today for full details about the wide range of rugged, dependable SPOTMASTER equipment . . . their outstanding features and options . . . modular construction . . . easy maintenance . . . complete line of accessories . . . competitive prices . . . lease/purchase plans. Remember, all SPOTMASTER models are backed up by an ironclad, full-year guarantee.

NEW DELAYED PROGRAMMING OPTION

The optional SPOTMASTER 500 A-DL (Delayed Programmer) provides a 5-second to 16-minute delay in the broadcast of program material. Permits instant censoring and deletion of objectionable material from interviews and other live originations while the program is on the air . . . also meets many other delayed programming requirements. With the DL function switched off, the unit operates as a standard 500A recorder-playback. Available in rack or compact models.

BROADCAST ELECTRONICS, INC.

8800 Brookville Road, Silver Spring, Maryland
Telephone: Area Code 301 • JUniper 8-4983



Sold nationally by:
VISUAL ELECTRONICS
356 W. 40th St., New York, N. Y.

Canada:
**Northern Electric
COMPANY LIMITED**
Branches from coast-to-coast in Canada



Fig. 2. Ron Cochran and Bob Young in the ABC news studio during broadcast.

TV, and from WJZ-TV, Baltimore, came another; three units came from the network's New York headquarters.

Videotape played a major part in keeping track of events; it is safe to say that without it none of the coverage could have been as complete. In this same way, audio tape was essential to the coverage by radio.

CBS Radio and TV covered the scenes from almost the beginning, with CBS "News Control" at the Graybar Building in New York masterminding the coverage of the sad weekend. This network used 300 producers, film personnel, and nontechnical people, plus almost 400 technicians and similar personnel; it took all these to cover the rapidly changing news centers.

During the 55 hours that CBS-TV covered the news from ten cities, a total of 35 live cameras were used. In Washington, it happened to be CBS-TV's turn to provide the Capitol-pool TV coverage, and here they used an additional 28 camera units. CBS had the sorrowful distinction of being the first to announce — unofficially — the death of the President. And at the trade mart in Dallas, CBS-TV affiliate KRLD-TV, had set up a live camera to record the President's originally intended arrival.

An event of such world-shattering significance always calls out the utmost effort from all involved, and it is here that good affiliates are so important. CBS was able to call on stations KNX in Los Angeles, WEEI in Boston, and WCAU-TV

Circle Item 12 on Tech Data Card

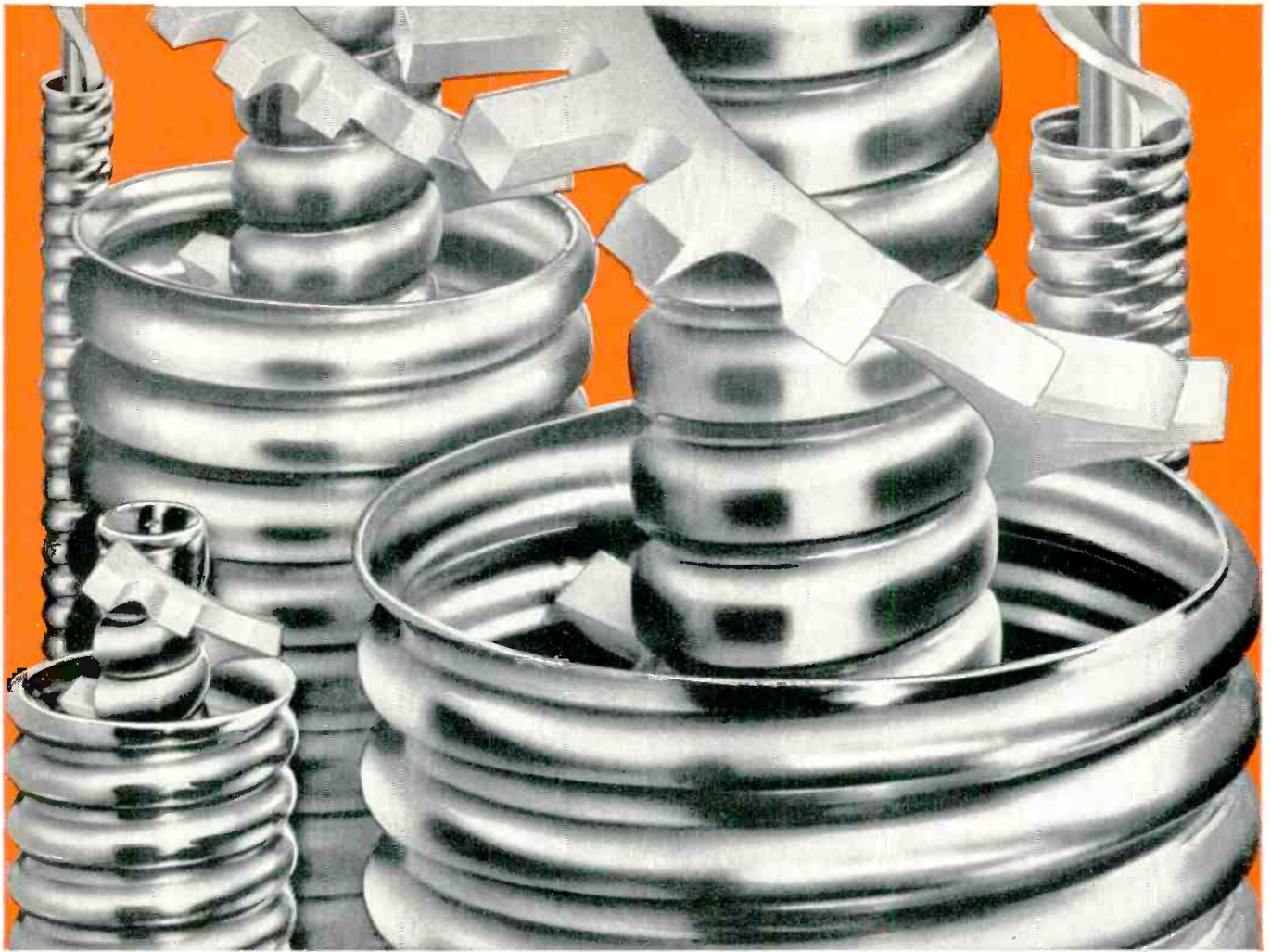

NOW
HELIAX
 IN 5 SIZES
 UP TO
5 INCHES



HELIAX is now available in a 5 inch size, adding to the range of applications of this low loss, flexible coaxial cable. Produced in continuous splice-free lengths. Type H9, 5" HELIAX is ideally suited for high power installations to 826 kw peak power, frequencies to 950 Mc.

Available in $\frac{3}{8}$ ", $\frac{7}{8}$ ", $1\frac{1}{2}$ ", 3" and 5" sizes, there is a HELIAX RF cable system, including fittings, from one source to meet your requirements. Write or call your Andrew sales engineer for complete information.

<p>5 easy steps for assembly of connector to Heliax Flexible Coaxial Cable</p>					
	<p>Step 1 Cut Heliax squarely. Assemble gasket and clamping body to outer conductor.</p>	<p>Step 2 Cut outer conductor with a tin snips to facilitate 90° flaring.</p>	<p>Step 3 Flare outer conductor back against the clamping body.</p>	<p>Step 4 Assemble inner connector to the center conductor.</p>	<p>Step 5 Assemble flare ring, O ring, anchor insulator. Thread outer body onto clamping body.</p>

Andrew

New York • Washington, D. C. • Boston • Dallas

P. O. Box 807 • Chicago, Illinois 60642

Los Angeles • San Francisco • Toronto • Montreal

Circle Item 13 on Tech Data Card

A MUST FOR EVERY RECORDING & BROADCAST ENGINEER

ALTEC'S COMPLETE LINE OF
STUDIO PLAYBACK AND SPEECH-
INPUT EQUIPMENT IN ONE HANDY
REFERENCE CATALOG.



Custom-built Altec control console in ABC-TV's Studio One, New York. Note jack panel containing 720 connections that permit virtually any patching configuration.



Banks of Altec 128B Amplifiers used for PLAYBACK monitoring by Universal Recording Corp., Chicago.



Control-room view of three A-7 Systems used for 3-channel PLAYBACK monitoring at United Recording Studios, Hollywood.



Monitoring with Altec "Duplex"® Speakers in Capitol's control room. More than 70 of these speakers are used throughout Capitol's recording studios in Hollywood.

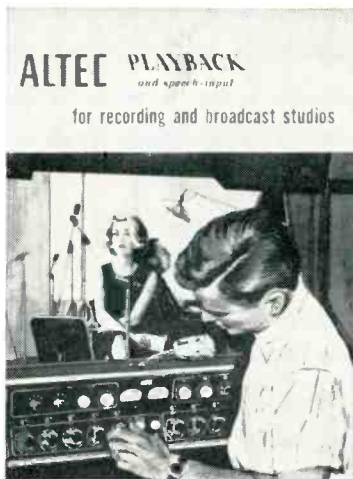

There's no longer any need to search through hundreds of Altec catalog sheets...everything is now together in one "book" especially prepared for the recording and broadcast engineer. In it, you will find complete information on...

- **SPEAKER SYSTEMS** to satisfy most stringent requirements of studio PLAYBACK. Indispensable for accurate A-B comparison of the taped recording with the live rendition for judging accuracy and realism.

- **MICROPHONES** including the only American-made condensers; 8 new models of studio dynamics featuring exclusive Altec Sintered Bronze Filters (some models come with individual, certified calibration curves); famous studio stand-bys, the W.E.-type 639 and 633; plus complete information on the revolutionary new 690A dynamic microphone / transistorized amplifier that directly replaces the carbon transmitter in ordinary handsets to provide broadcast quality in TV and radio programming.

- **AMPS AND PREAMPS** you've used or heard about, including a few that may be new to you. Covered are power, program, compressor, remote mixer amplifiers; preamplifiers; the all-purpose 250 SU Stereo Control Console.

- **TUNERS** guaranteed to meet the most critical FCC broadcast standards. The 314A FM MPX Tuner for the ultimate in multiplex network relay... and for off-the-air executive stereo monitoring, record and tape PLAYBACK, the 708A "Astro," the only AM/FM MPX Tuner-Amplifier with transistorized power output stages.

If you insist on the best in professional PLAYBACK and speech-input equipment, this new catalog is a MUST. Write to Dept. BE-2 for your FREE copy now, while a sufficient supply is still available.

©1963 ALTEC LANSING CORPORATION



ALTEC LANSING CORPORATION

LTV A Subsidiary of
Ling-Temco-Vought, Inc.
ANAHEIM, CALIFORNIA

in Philadelphia, for supporting material. CBS News then wove this material into the story of horror, with the skill of many voices and unseen producers.

NBC News drew heavily on its Dallas-Fort Worth affiliate WBAP-TV, which was covering the procession when the assassination occurred. Immediately thereafter, NBC began news coverage which continued for almost 72 hours on TV, and 68 hours on radio.

The nature of this infamous performance and the widely spaced locations of the principal characters made the operation more of a technician's project than a production team operation. The emphasis was on the eye, with the ear in support, alerting the viewer/listener to things the camera could not always show. This required 400 technicians and production personnel, with 44 cameras used in more than 65 locations. NBC had 21 cameras exclusively for its own programs, and 23 more in the network pool. One example of the problems involved was the necessity for rerouting to Washington the chartered 707 that was Dallas bound from New York, so the arrival of the late President's body at Andrews Air Force Base could be covered.

Bill Trevarthen, NBC's VP of Engineering, said that 33 mobile units were used—some of which were hurriedly converted from station wagons and sedans!

Mutual, the sole radio-only network, carried the story for 64 hours, feeding all its affiliates as well as more than 100 nonaffiliated stations who requested the live coverage. Charles Ray, vice president in charge of engineering, handled the technical aspects from the network's headquarters in Washington, D. C.

The loss of revenue by American stations who carried the coverage runs into more than \$30 million—difficult for some to offset against existing red ink. In contrast, the very fingers that point most vehemently at the alleged shortcomings of radio and television continued throughout to carry paid advertising. In all of these terrible events, radio and TV demonstrated both the maturity of experience and the good taste of sensitive executives who control these powerful voices of democracy.



YOU'LL NEVER FORGET
 the day you try RCA Red Seal Magnetic Tape

Try just one reel of RCA Red Seal Magnetic Tape! You'll be so pleased that chances are you'll never use any other brand of tape again. This is the tape RCA sound engineers developed for their own use, and they won't compromise on quality.

Every inch of Red Seal tape is minutely tested by experts for frequency response, distortion, drop-out, noise, and print-through. It's got to measure up to the stiffest specifications for coating

thickness, anchorage, layer-to-layer adhesion, aging, cupping, slitting and tolerances. Precise controls give every reel the same magnetic properties, the same bias characteristic — so you can use tapes interchangeably. Don't forget to try Red Seal Magnetic Tape soon. Why not take a few seconds right now to fill in the coupon and send for complete details on this new tape today!



The most trusted name in sound

Circle Item 15 on Tech Data Card

Magnetic Tape Products Marketing
 RCA Victor Record Division, Dept. BE103
 155 East 24th Street, New York 10, N. Y.
 Please rush me specifics on RCA Red Seal
 Magnetic Tape including all essential physical
 and magnetic characteristics.

NAME _____
 TITLE _____
 COMPANY _____
 ADDRESS _____
 CITY _____ ZONE _____ STATE _____



SPARTA-MATIC 300 Tape Cartridge System playback unit in a custom styled cabinet. Transistorized solid-state design, coupled with functional beauty.



300P and 300R for a record/playback combination. Units may be readily removed for remote use or maintenance. Brackets for 19" rack mounting are supplied.



300P units may be grouped in cabinet holding one to three playbacks. Custom cabinets finished in durable Dove Gray plastic laminate. Other colors available.

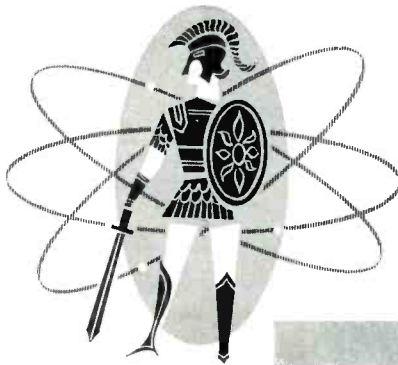

SPARTA

FIELD REPRESENTATIVES:

U. L. LYNCH, Grand Island, Nebraska, DU 2-4183

HERBERT L. ARMS, Coryden, Indiana, 738-5752

DENNIS L. SMITH, Puerta De Tierra, Puerto Rico, 722-0669

BO McMILLAN, Lake Oswego, Oregon, 636-6257

JOHN D. BROOKS, Albemarle, North Carolina, YU 2-5667

MILAN LEGGETT, Dallas 18, Texas, DA 1-2981

SPARTA-MATIC 200 Tape Cartridge System offers rugged simplicity with proven reliability. Attractive pricing that fits any Broadcasters budget.

200RP record/playback offers transistorized control circuitry for improved toneburst cueing. Compatible with all others, yet priced 20 to 40% less.

200RP STEREO record/playback for full fidelity FM broadcasting. Frequency response ± 2 db from 30 to 12,000 cps; wow and flutter under 0.2% RMS.





300RPP combination is another example of how 300 Series may be grouped to meet any requirement. The record amplifier may be used with either playback unit.

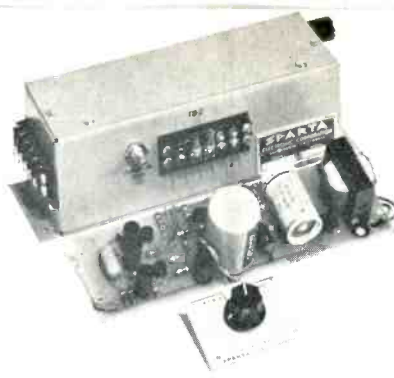

TEP-2 EQUALIZED TURNTABLE PREAMPLIFIER. All transistorized with self contained power supply and balanced output. Performance exceeds industry standards.



CP-5 PORTABLE TAPE CARTRIDGE playback. Light weight with convenient carrying handle to audition spots or programs anywhere in the station or clients office.

QUALITY + ACCEPTANCE = GROWTH

Success can be measured in a number of ways . . . but, this is the formula that has made a record sales year for Sparta. What better proof of excellence of product and service can anyone offer in a competitive industry?

CALL, WRITE OR WIRE SPARTA ELECTRONIC CORPORATION, 6450 FREEPORT BOULEVARD, SACRAMENTO 22, CALIFORNIA. AREA CODE: 916 421-2070

Circle Item 16 on Tech Data Card

JESS SWICEGOOD, Dothan, Alabama, SY 2-2161
EUGENE D. BRADLEY, Phoenix, Arizona, AM 6-2292
CHAS. A. SPRAGUE, Grand Rapids 8, Michigan, 534-4157

C. E. FELTNER, Kingsport, Tennessee, WA 6-8188
LEROY HAMILTON, Simpsonville, South Carolina, 963-4095
GLEN E. WEBSTER, Park Ridge, Illinois, 823-8206

A-10 AUDIO CONSOLE provides a total of eight inputs selected through four mixing channels with completely transistorized circuitry and plug-in modular construction.



A-50 PORTABLE STUDIO for production, remotes and Main studio. Four microphone, two turntable, and two tape machine inputs. Screw-in legs and bench/lid allow quick set-up.



CT-12 CUSTOM TURNTABLE CONSOLE complete with Sparta TEP-2 equalized preamplifier, turntable, tone arm and pick-up cartridge. Also available in 16" model.



WHEN THE PROOF-OF-PERFORMANCE FAILS

by Ed Murdoch* — Part Five.

Conclusion of series on troubleshooting a faulty proof; this month, frequency response.

In Part Four, several causes of and cures for distortion were discussed. These were the more common cases including component failure, tube unbalance, and DC problems. Before leaving the subject of distortion, let's look at a few other possible sources. Occasionally a trouble comes along which is quite puzzling at first, yet eventually yields to a simple solution. As an example of this kind of deviltry, consider the following experience.

Several years ago I replaced the 1621 output tubes in a console I was troubleshooting. Before inserting the new tubes I checked them thoroughly for conductance and element leakage, after warming each in the tube tester for about fifteen minutes. The mutual conductance readings of the two tubes matched perfectly—well into the green. However, with these tubes in the amplifier the distortion readings were even worse than with the old, almost worn-out tubes! A scope, connected to the analyzer output, showed the major part of the "distortion" was actually AC hum. I plugged the old tubes in again and found, although the distortion was relatively high, the hum was gone. Checking the new tubes again produced the same indications as before: no element leakage, perfect match, and high emission.

The facts finally penetrated my elephantine skull—the tubes became defective only under the operating conditions in the console. I engaged the services of an accomplice to switch the power supply off at my cue. As the switch clicked I pulled one of the tubes (wearing a heavy garden glove) and jammed it into the tube tester, which was already set for cathode-filament leakage. There it was—a bright

orange glow on the short indicator. After a minute or so the glow flickered and died; as far as the tube tester was concerned, the tube had become perfectly good.

I decided to continue the investigation. Out of six spares, four were apparently from the same factory-run, and developed shorts during the above test. The other spare 1621's were older, well matched, had high emission, and passed the "Quick Henry the Glove" test with flying colors. When placed in the amplifier, this pair reduced the distortion from 6% to less than 1%.

Now let's treat briefly a condition which will occur occasionally, and can be maddening for even the experts at times. This condition might be called "selective distortion"—i.e., the distortion at one frequency (or a narrow band of frequencies) is noticeably higher than the average readings for a broad band to either side. This is generally caused by parasitic oscillation which is more likely to occur in a class AB or B stage than in one operating class A. A transformer secondary and associated reactances can go into momentary oscillation, as high peak signal levels cause the grid circuit impedance of the following stage to suddenly decrease from a

very high to a very low value. This can result from overdrive; in this case the obvious remedy is to reduce the input signal to the stage (except when other deficiencies make the overdrive necessary). If the amplifier stage is not being overdriven, the usual remedy for parasitic audio oscillation is to connect a low value of resistance—50 to 100 ohms—in series with each grid, at the tube socket.

The preceding discussion refers to only the general case—other sources of parasitics might not be as easy to locate. Recently, while performing a proof, I ran across distortion which was apparent only in the vicinity of 5 kc; the scope indicated parasitic oscillations at this frequency. The oscillation was quickly isolated to the console, but at this point the job ceased being a picnic and assumed the aspects of a "whodunnit." Instead of being present only in the output amplifier, the parasitic condition was also found at the output of every preamp in the console. Lengthy troubleshooting indicated that everything was fine—except for the parasitic oscillation that "couldn't be there."

I was about to tie all the console wires together in various assortments of Boy Scout knots, and set the entire mess on fire with a blowtorch, when I noticed something else that shouldn't be there. A length of two-conductor cable, almost hidden by the main cabling, was draped across a corner at the rear side of a program-bus support. The two conductors were neatly soldered to the program bus.

By crawling all over and under the building, we traced the suspicious wire to another room (duplicate control room) where it connected to a couple of code-practice oscillators. The keying-jacks of these nefarious monsters were con-

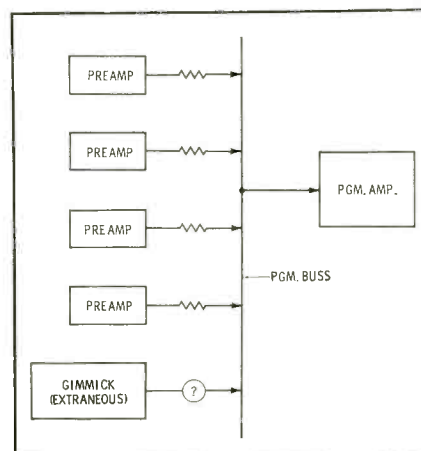

Fig. 1. All added circuits must be isolated.

*Chief Engineer, WMMB, Melbourne, Fla.

TWENTY TDA2 VIDEO/PULSE DISTRIBUTION AMPLIFIERS PRODUCE LESS HEAT THAN ONE 100-WATT BULB!



The Model TDA2 is a completely solid state instrument, transistorized all the way with a built-in regulated power supply. Built to meet the exacting standards of the industry, the TDA2 is being used by networks, telephone companies and TV stations all over the country.

The Model TDA2 Video/Pulse Distribution Amplifier is designed to accept composite or non-composite video at a bridging-type input of as little as 0.25 volt and delivers four individually isolated 75 ohm outputs of 1.0 volt, peak to peak. It will replace all tube type amplifiers without alteration of existing cables. Weighs under four pounds and is only 1¾ x 19 x 7 inches over-all.

PRICE: \$325.00 EACH, F.O.B. NASHVILLE, TENNESSEE



For complete information and specifications write:
Department T-2

INTERNATIONAL NUCLEAR CORP.

608 Norris Avenue

Nashville, Tennessee

Circle Item 17 on Tech Data Card

SPOTMASTER Tape Cartridge Winder



The new Model TP-1A is a rugged, dependable and field tested unit. It is easy to operate and fills a need in every station using cartridge equipment. Will handle all reel sizes. High speed winding at 22½" per second. Worn tape in old cartridges is easy to replace. New or old cartridges may be wound to any length. Tape Timer with minute and second calibration optional and extra. Installed on winder or available as accessory. TP-1A is \$94.50, with Tape Timer \$119.50.

Write or wire for complete details.

Spotmaster

BROADCAST ELECTRONICS, INC.
8800 Brookville Road
Silver Spring, Maryland

Circle Item 18 on Tech Data Card

The FAIRCHILD CONAX is EVERYWHERE!



You'll find a FAIRCHILD CONAX in round buildings, tall buildings, long buildings and square. Wherever recording is the art you'll find a FAIRCHILD CONAX discreetly at work.

The CONAX concept by FAIRCHILD allows the recording of higher level records through the inaudible control of high frequency information. The CONAX offers the only solution to amplifier distortion, cutter overload, tracing distortion and cutter burnout due to pre-emphasis (RIAA 75 micro-second curve).

The ability to make hot high level records that have "top-of-the-chart" sound is available only through the use of the patented FAIRCHILD CONAX.

FAIRCHILD CONAX is available for single (Model 600) or stereo operation (Model 602).

Write to FAIRCHILD — the pacemaker in professional audio products — for complete details.

FAIRCHILD RECORDING EQUIP. CORP.
10-40 45th Avenue, Long Island City 1, N. Y.

Circle Item 19 on Tech Data Card

nected to a concealed push-button at the main console; the oscillators were adjusted so their tones harmonized. When the announcer pushed the button, he was under the delusion that he was putting a "time signal" on the air. (He may have been—it depends on how you look at it.)

Disconnecting these contraptions killed the parasitic, and the 5 kc distortion reading returned to normal. Moral: Never bridge anything across anything else (Fig. 1), without proper isolation!

Audio Frequency Response

As indicated at the beginning of this series, audio response and distortion are relative. Yet, with respect to the FCC regulations, it is entirely possible for frequency response to be satisfactory, while distortion is excessive. For this reason considerable attention has been paid to methods for tracking down sources of distortion, with verification of response as an auxiliary consideration. If distortion is kept well within limits frequency response will generally hold its own, within the design capability of the equipment. If the troubleshooter were to approach the problem with an idea of improving response, the same technical attack would be required. However, after improved response was achieved, it might be found that improvement in distortion content was still insufficient.

The foregoing approach is based on the assumption that the gear in question is basically capable of meeting the operating requirements—most modern equipment is. However, there is a question of what is meant by "modern." Of course, all relatively new gear can be so de-

scribed. Even some equipment in use fifteen years ago could still be classified as modern by today's standards. However, the situation with many fifteen- to twenty-year-old systems is highly uncertain.

A great deal of older audio equipment is still in daily use around the country. At WMMB, for instance, we are using a console that has been in continual operation for more than fifteen years; yet its response today is still flat past 10 kc, and maximum distortion is under 1%. On the other hand, some of the aged devices operating today could barely meet FCC specs when they were brand new.

If your station is using old equipment which is marginal with regard to FCC requirements, audio frequency response **does** become of paramount importance in proof-of-performance measurements. If frequency response is sadly lacking at low and high frequencies (with accompanying high distortion at the extremes) and troubleshooting turns up no obvious defects, it is probable that you have "marginal-when-new" gear. There are several alternatives open in this case: (1) recommend purchase of new equipment; (2) overhaul present system to make it "squeeze through;" (3) overhaul and **modify** the equipment to actually surpass original, specs; or, (4) forget the whole business, and take up motorscooter racing.

The course of action depends on the individual circumstances. New equipment would probably be the best solution, budget permitting. Often, adequate overhaul is time consuming and costly. Modification should not be attempted unless the reader is fairly well versed in design theory, and experienced in con-

HERE'S AN EXCITER that WILL FACE THE MUSIC!

AND GIVE YOU

BRILLIANT STEREOGRAPHIC AND SCA REPRODUCTION.

Direct FM 10 WATT EXCITER • Model LPE-10

- approved for educational service.
- the ultimate in circuit design and unique construction.



MOSELEY ASSOCIATES INC.

TEL 967-1469 OR 967-8119
AREA CODE 805 PO BOX 3192
SANTA BARBARA, CALIFORNIA

Circle Item 20 on Tech Data Card

BROADCAST ENGINEERING

How sharp and clear can a color picture be?

Ask

WSM-TV, WGEM-TV, KMSP-TV,
WAST, WJXT, WRGB, WRAL-TV,
WESH-TV, WFIL-TV, WNBF-TV,
WAGA-TV, WFBG-TV, and WWJ-TV

about G.E.'s new 4-Vidicon Color Film Camera Channel.



General Electric's PE-24-A has already been ordered by 13 television stations across the country. What sold them? The fourth vidicon. A monochrome signal that gives the picture detail and luminance while the other three "paint in" the colors. Registration problem is eliminated. Result: you get a sharp, detailed picture for both color and monochrome reception. Program after program.

And you get it more economically. Because the

GE 4-V camera is transistorized, it operates cooler and has increased component life and reliability.

To see the PE-24-A in action, call or write Visual Communication Products, 212 W. Division St., Syracuse 8, N. Y.

B-6

Progress Is Our Most Important Product

GENERAL  ELECTRIC

VISIT GENERAL ELECTRIC PROGRESSLAND • A WALT DISNEY PRESENTATION • AT THE NEW YORK WORLD'S FAIR



Circle Item 21 on Tech Data Card

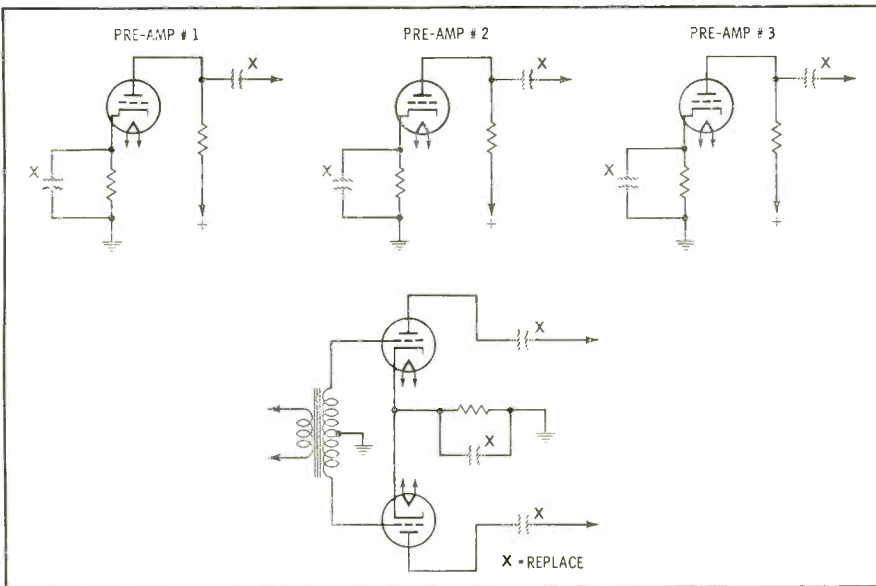

Fig. 2. All of the old coupling, filtering, and by-pass capacitors must be replaced.

struction.

Old equipment is just chock full of old parts! Unless adequate maintenance has been performed over the years, (and sometimes even if it has) normal debilitation will cause overall performance to sag—although no single part may be shorted or completely open. One maneuver which will often help im-

prove this type of equipment is to replace, without question, every single filter, bypass, decoupling, and coupling capacitor (Fig. 2) in the amplifier. Small-value oil-filled coupling capacitors should be replaced with mylar-dielectric tubulars. Filters and large bypass capacitors should be replaced with duplicates; replace an electrolytic with an elec-

trolytic, and an oil unit with a similar oil-filled capacitor. Voltage ratings should be observed, especially in the case of electrolytics; and always test the larger capacitors before wiring them into a circuit.

Circuit modification, as a remedy to poor performance in old equipment, should be preceded by capacitor replacement as described above. The extent of modification to be applied will depend on the improvement desired and the basic nature of the equipment. The limiting factor for audio response in old equipment is generally the transformers (Fig. 3). A substantial improvement in response of marginal equipment can be attained by replacing old output and interstage transformers with new, wide-range units. Attention should be directed also to the input transformers of all preamp channels in the console. While it would be rather costly to replace all these transformers, it may be possible to improve their performance with minimum expense. Most input transformers in broadcast equipment are loaded with a resistance across the secondary to

NEW COMMON POINT BRIDGE FOR PERMANENT INSTALLATION KNOW YOUR POWER AT ALL TIMES

- For permanent installation at common point
- Measure common point at any time, during normal operation
- Panel ammeter measures common point current
- Detect seasonal drifts in common point
- Greatly speeds readjustment of directional antennas
- Up to 5 kw power . . . 50 kw on special order
- Reads directly in resistance and reactance
- 30-100 Ω resistance, $\pm 50 \Omega$ reactance expanded scales
- Can be set up by your consultant to exactly agree with license value of common point
- Available without panel for mounting in your phasor



CPB-1

PRICE \$395 LESS AMMETER

Write for
Specification Sheet CPB-1

DELTA ELECTRONICS

DELTA ELECTRONICS, INC.
4206 WHEELER AVENUE
ALEXANDRIA, VIRGINIA

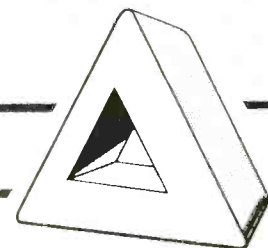

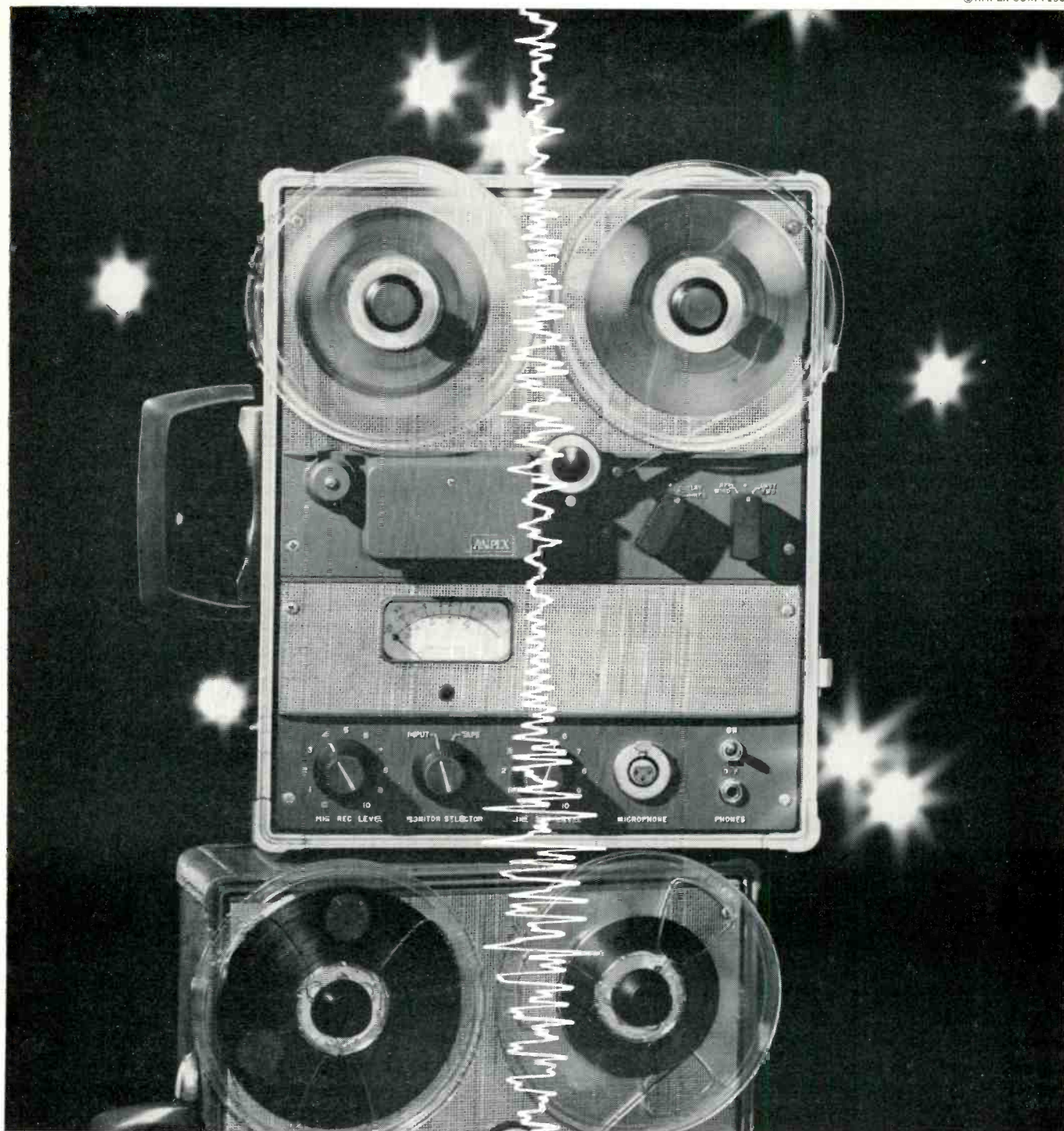

What can possibly follow the 601?

AMPEX 602

It's quite a number, the 602. A lightweight, low-cost, true professional field recorder made, of course, by Ampex. It's built on the foundation of the Ampex 601 (the recorder that was the workhorse of the entire broadcast industry), and the new Ampex 602 promises even to outdo the 601. Here's why. The 602 features completely new electronics circuitry. It has new solid-state rectifiers to keep the chassis cool, helping to prolong the life of the other components. It has XL type connectors for all line inputs. A built-in low



Circle Item 23 on Tech Data Card

impedance mike transformer. A higher power balanced or unbalanced 600 ohm output. And improved signal-to-noise ratio. These are just some of the advancements. The 602 is portable—ideal for field applications. Or it can be rack mounted. And it comes in a one-channel or two-channel model. Both backed by the Ampex "Four Star" One-Year Warranty. Both built to be extremely reliable—to follow and outdo the 601. For more information write Ampex Corp., Redwood City, Calif. Worldwide sales and service.



Here's A Preview of Next Month's Issue

SPECIAL NAB SHOW SECTION

Show preview, agenda for engineering conference, list of exhibitors, floor plan of exhibit floor, reports from consulting authors, news, prods, and other show information.

Other features will include:

PARALLEL OPERATION OF TV TRANSMITTERS

A DISCUSSION OF SCA SERVICE

DESIGN OF DIRECTIONAL ANTENNAS

MATCHING AND ISOLATING PADS

FCC THIRD CLASS BROADCAST ENDORSEMENT

THE OSCILLOSCOPE IN MAINTENANCE

Plus . . . SMPTE Preview, Engineers' Exchange, Book Reviews, Technical Talks, and many other important items you won't want to miss!

Reserve your issues now! Fill out and send in the handy subscription card bound in this issue, and receive the Broadcast Engineers' Maintenance Guide — absolutely FREE!

flatten the peak of high-frequency resonance, and to reflect the proper input resistance to the primary winding. In some cases, this peak might be just what is needed to help the following circuits over the hump. However, removal of the loading resistances might upset other circuit conditions. It is therefore necessary to make careful response and distortion measurements before permanently disconnecting the secondary-winding loading resistors.

If the secondary resistors are omitted, it may be necessary to load the primary of the transformer with a resistance equal to the nominal input impedance of the channel. This will preserve the characteristics of the device normally connected to the input for programming purposes. Certain microphones, for example, will not maintain proper frequency response unless loaded. Thus if the secondary no longer reflects the correct load to the primary, a correct match for the microphone must be furnished by a resistor connected across the input transformer primary terminals.

Amplifier frequency response can be further modified by addition of plate-to-plate or plate-to-cathode equalization networks; however, if transformers are severely limiting the frequency response, these circuits may not be very effective. Current feedback taken from the output transformer secondary might assist in making a marginal amplifier "legal," but would probably not flatten the response to "hi-fi" specs. It is a general engineering axiom that application of a worthwhile amount of negative feedback requires an additional stage of amplification. On the other hand, the amplifier may already be using as much feedback as its gain will allow.

This discussion of modification should not be construed as a set of instructions, but merely as a guide. Before any definite steps are taken, the matter must be investigated thoroughly. Familiarize yourself with the circuit in question, as well as practical design theory of amplifiers and associated networks. Even the previously mentioned replacement of an old output transformer is not always as simple as it sounds. Such a change must be approached with caution, since feed-

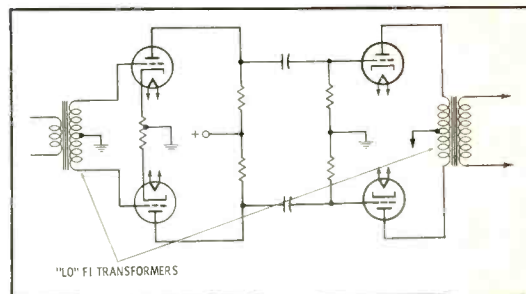
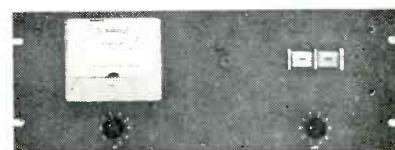

Fig. 3. An old transformer imposes limits. back networks associated with the original transformer may require modification to work properly with the new one—there's always something!

Conclusion

You are probably aware that the treatment in this series connotes a degree of "finickiness" not found in most radio or TV repair shops. Admittedly, some of the troubleshooting techniques will require a good deal of time, work, and patience. Perhaps you will never have to search for a noisy component, or measure the hum voltage of a power supply—but if the need does arise, I sincerely hope the material presented here will be of help to you. ▲



CONTINENTAL'S TYPE MR1C MONITOR RECEIVER

- Monitors transmitter operation at studio location
- Indicates relative field intensity at pickup point
- Has audio monitoring channel
- Gives warning lamp for carrier, buzzer alarm for loss of carrier

write for details today

Continental Electronics

PRODUCTS COMPANY
BOX 5024 • DALLAS 22, TEXAS • TELEX CEPCC
Subsidiary of Ling-Temco-Vought, Inc.

Circle Item 25 on Tech Data Card

BROADCAST ENGINEERING

**WHY
USE**

11

WHEN

5

WILL DO IT BETTER?

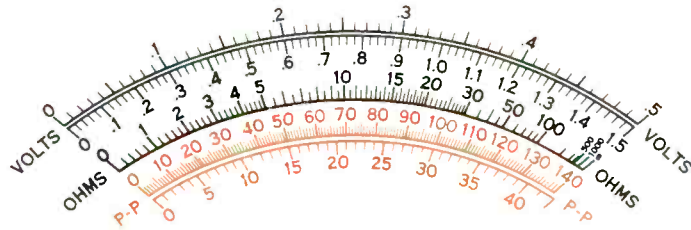

Eleven-scale VTVMs are "old hat." Hickok's new 5-scale VTVM (actually *one* basic scale covering *all* necessary ranges) simplifies your job and increases accuracy. The Model 470A features an AC-DC-Ohms single-unit probe to eliminate the need for multiple leads. You'll find 8 AC/DC ranges from 1/2 to 1500 volts, as well as peak-to-peak and resistance ranges, all on an easy-to-read 7-inch meter.

HICKOK

The HICKOK Electrical Instrument Company

10544 Dupont Avenue
Cleveland, Ohio 44108

Represented in Canada by Stark Electronics, Ajax, Ontario • Internationally by Hughes International, Husint, S. A., Culver City, California

Circle Item 26 on Tech Data Card

About the Cover



The cover photograph shows the Indianapolis Symphony Orchestra in rehearsal with musical director Izler Solomon conducting, while Ozzie Osborn and Tom Wendt of the WFBM Stations make a tape recording for later broadcast. The single microphone is supported high above and to the rear

of the conductor's position. The scene is the main auditorium at Clowes Memorial Hall, Butler University, Indianapolis, Ind. The Hall, completed in October, 1963, was built in the memory of the late Dr. George Henry Alexander Clowes, former research director for Eli Lilly and Co. Owned by

Butler University and operated on a nonprofit basis, the hall is used for drama, comedy, symphony, jazz, dance, opera, and individual performers or groups. The nine-story Bedford limestone and concrete structure was designed by Evans Wollen, Indianapolis, and John Johansen, New Canaan, Conn. associate architects. Bolt Baranek and Newman, Inc. were the acoustical consultants; a portion of their work can be seen in the acoustical "cloud" complex which is suspended from the ceiling to provide ideal sound conditions.

Credit for excellent cooperation during preparations for shooting the cover photo are extended to: Joseph Quinn, Symphony stage manager; Herman L. Lupe, Jr., lighting technician; Lester McGuire, Clowes Hall stage manager; Ron Languell and Charlie Metcalf, stage assistants. Charlene Hillman and Mary Bates, public relations directors for Clowes Hall and The Indianapolis Symphony respectively, provided essential aid. The color photograph is by Paul Cornelius and Joe Bretthauer, BROADCAST ENGINEERING photographers. — SNS

AFTER THE FREEZE, . . . ?

Technical Talks* — Summary of the allocation and license assignment situation as it is today.

At this time it is rather difficult to say whether the FCC's efforts to control, if not limit, the expansion of broadcasting have succeeded. Therefore, it might be of more value to think about what could happen **after** the last petition is filed by the broadcasters, and examined by the FCC.

AM Stations

Let's take a look at AM first. Early in 1962 the FCC declared a "freeze" on the acceptance of AM applications, unless certain requirements were met. This basic ruling was not unreasonable; however, in some cases the requirements were. Originally, if an application was in the FCC's hands on the cutoff date, it would not be accepted—regardless of when the work had begun. Many petitions were filed by aggrieved broadcasters whose costly (in many cases running to thousands of dollars) applications were thereby rendered worthless. The FCC, however, maintained refusal.

The main requirement under the decision states that 25% of either the population or area which is to receive the proposed service must not presently be covered by **any** station. In some cases this means that a new application could be made acceptable by distorting the proposed antenna coverage so that the serviceless 25% of an area could receive the new service—even though there is no one there to hear it!

Other cases concerned towns with populations of several thousand which had no radio station and did not receive the required 2 mv/m coverage to qualify for pri-

mary service from any other station. This ruling applied to towns of over 2,500 population. In the case of cities with fewer than 2,500 people, 0.5 mv/m will suffice, for they are considered nonmetropolitan areas.

Some applications were deemed not acceptable because the area just outside the city limits was served by a 0.5 mv/m signal—non-urban primary service! Since the population within the town (where 2 mv/m is required) did not comprise 25%, FCC requirements could not be met. Thus, towns with a real need for a **local** station were, and still are, denied service to which they are entitled. Petitions for acceptance on the basis of "needed" service were denied.

The proposed AM Rules are broadened somewhat to take into account financial aspects, which the FCC is not supposed to consider. In this way a relationship would be established between the population of a town and the number of radio stations allowed. One of the proposals was to allow one station for less than 10,000 people, ranging up to seven stations for towns of 1,000,000. The qualifying factor was still to be population, with the 25% requirement used only for nighttime operation. At this time no firm decision has been made. It is a reasonable assumption that whatever the outcome, protests will be filed by current and hopeful broadcasters. The question is: How many will welcome the artificial limitation by the FCC?

So perhaps we should say the freeze is still half on in the AM field. Certainly only those applications that comply with the May, 1962 requirements of 25% coverage of area or population will receive consideration, at present.

Other considerations exercising many broadcasters' minds are high-power operation, and duplication of service on 13 clear channels which were proposed by the FCC many years ago. No grants have been made on these disputed clear channels, some of which were downgraded to improve nighttime service. A number of applications are gathering dust in the FCC's files due to objections from occupants of the "degraded" channels. The only channel that has been so allocated is 770 kc. Through an error a decade or so ago, that channel has been occupied by WABC as Class I occupant, with KOB an official "sub"-occupant at night. If the duplication decision is ever put into final execution it will make WABC, the "flagship" of the ABC Network, the only New York national network station not truly clear-channel at night. The implications are obvious. As a preview of night duplication, the WABC situation points to a long and obstructed path the FCC may have to tread if such a decision is forced.

The other part of the clear channel question deals with use of high power, up to 750 kw, on these frequencies. Some applications have been presented to the FCC, but none have been granted; nor have any apparently received very serious consideration. From an engineering point of view there is no reason why such proposals should not be granted. The clear channels can accept the power with no production of troublesome interference. As a matter of fact, high-power operation is common south of the border—often to the dismay of our own broadcasters.

Because the only restriction of power on the clear channels is the **lower** limit (not less than 50 kw),

*By John H. Battison, Consulting Editor, Annapolis, Md.

there seems to be no reason for denying power increases for these stations—provided adequate precautions are taken to prevent effects of excessively high fields near the antenna.

FM Stations

In the field of FM, the situation is more easily defined. The freeze is over and engineering allocation is to be according to distance tables. It seems that many cities that deserve a station, and could have one by considerations of topography and engineering techniques—such as directional antennas—may be denied their only local outlet for civic expression.

Those fortunate applicants whose locations are in the table of allocated cities, have an FM station in their future. If, however, someone else files for the same facility, they are in for a hearing. For the loser, little opportunity exists to file for another facility; no matter how many new frequencies he finds usable by topographical and engineering considerations in the area, it is unlikely that such an application will be granted.

What Now?

We can sum up as follows: The AM freeze is still on with no thaw in sight; clear-channel duplication is still theoretically in effect with no action in sight; high-power (750 kw) operations are far from activation; FM is now the only aural service that has freedom of application—provided you choose to operate in a city which has unassigned but allocated channels. ▲

MOVING?

*Don't Lose
Touch . . .*

Receive B-E
as usual at
your new address



Write:

BROADCAST ENGINEERING
Circulation Dept.
4300 West 62nd St.
Indianapolis 6, Ind.

**SOMETHINGS
BREWING!**

It's a special blend of excitement and experience combined to form a rare 6 year old brew known as Telescript.

In recent months a totally new management team has been selected to direct and operate Telescript. A number of important developments have taken place... new products and services are being added and developed to complement and expand the Telescript product line.

Among the new products is the Shibaden 5820 Image Orthicon Tube. Telescript has been selected as exclusive distributor for this quality I. O. Tube.

The Shibaden tube matches and exceeds the performance and warranties of its competitors... yet it costs 25% less!

In coming months you can look forward to a number of important announcements from Telescript. Meanwhile, please write and ask for more detailed information about the Shibaden I. O. Tube.

TELESCRIPT INC.
155 WEST 72ND STREET, NEW YORK 23, NEW YORK
6505 WILSHIRE BOULEVARD., LOS ANGELES, CALIFORNIA 90048

ENGINEERS' EXCHANGE

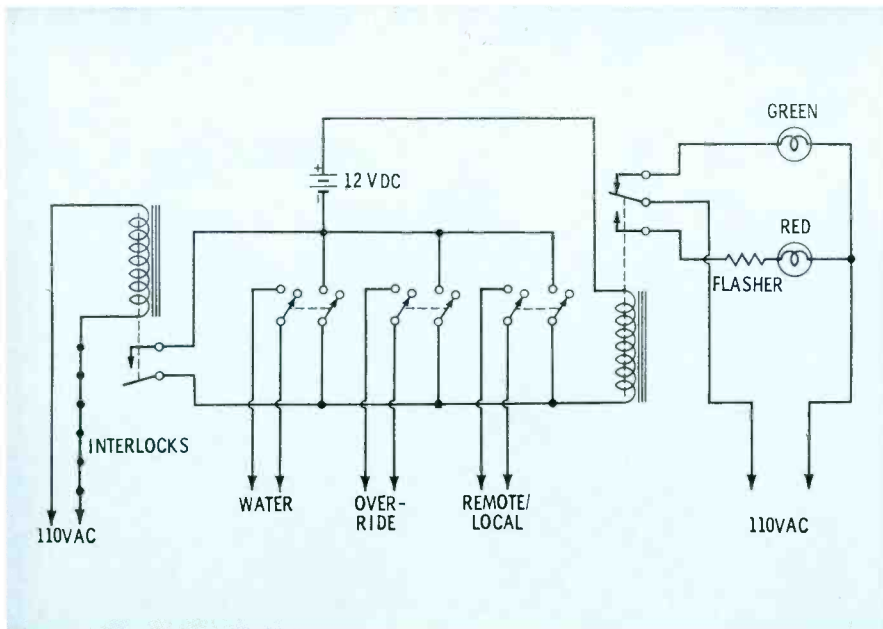

Traffic Light System

by Glenn D. Love, Technical Director, CFNB, Radio Atlantic, Fredericton, N. B.

We have been using a scheme that may "soothe the frayed nerves"

of other engineers, as it has our own. A "traffic-light" system we have installed allows us to leave the transmitter site, and be assured no functions were left in other than the normal mode.

We assembled two lamps and

some circuitry as shown in a small box and mounted the unit below the room light switch near the door. The green lamp lights when everything is normal. The red light indicates some function of the transmitters or associated equipment has been left in the improper mode. The unit can be adapted to a variety of uses; a few are shown here.

CFNB is remotely controlled 24 hours a day. When operation is handled at the transmitter, for maintenance or other purposes, the flashing red light is actuated, preventing us from departing while the studio is without control. The water-cooling system for the dummy load is similarly monitored—if it is inadvertently left on, the red light will flash. Also connected into the light system are the standby transmitter door interlocks, and the over-ride switch on the time delay relay.

This system has helped us avoid many headaches. Previously, there have been many times when many miles from the transmitter site I began wondering whether the situation was all normal. Now, when we switch off the room lights, and see

SMALLEST

This tiny handful is E-V's answer to studio requests for a truly miniaturized dynamic microphone. The Model 649B is just 2 1/4" long, weighs but 31 grams, yet has the remarkably high output of -61 db! Although just half the weight and bulk of competitive lavaliers, the 649B response is smooth, peak-free and full-bodied so that you can mix its output with that of any standard microphone!

No fragile "toy", the E-V 649B uses the famous Acoustalloy® diaphragm and a sturdy dynamic mechanism that is guaranteed unconditionally for two years except for finish, guaranteed for life against defects in materials or workmanship. It is omni-directional, with response tailored for the slightly "off-mike" location of a lavalier.

DYNAMIC LAVALIER!

A 649B in your studio will give your performers more freedom than they have ever had... while you get the fine sound and trouble-free operation that's traditional with all Electro-Voice microphones. Write for complete technical specifications today!

649B shown actual size. List

Price \$105.00.

ELECTRO-VOICE, INC., Commercial Products Division, Dept. 241V, Buchanan, Michigan
 Subscribe today to "Microphone Facts", fact-filled, free series on modern microphone techniques. Request on studio letterhead.

Circle Item 32 on Tech Data Card

the green "go" lamp shine, we know all is well.

Socket Adapters for Input Connections

by Philip Ross, WBNX Radio, Fort Lee, N. J.

With the advent of cartridge tape machines and other devices with high-level, unbalanced audio outputs, a matching problem has arisen. The difficulty is caused by the balanced, high-gain, low Z inputs of most consoles.

Skipping the console preamp stage and applying a signal directly into the grid of the following stage has these three advantages: (1) unbalanced, low-gain, high Z input; (2) full use of mixer control; (3) continued use of preamp stage for microphone or phono. However, printed circuits, disassembling problems, and downtime make this a formidable task.

This tedious undertaking can be avoided by the use of simple plug-in circuit entry devices known as test socket adapters. They are available from at least two manufacturers in 7 pin, 9 pin, and octal versions; all add less than 2" to the seated tube height. The RMA numbered solder lugs, arranged about the perimeter near the top of the adapters, can be used for permanent connection. For instance, the control grids of tube types 5879 and 7543 are available at pin number 1 on the 9 pin adapters. The photo illustrates the use of such an adapter in the tight preamp section of a Gates "Yard."

These adapters are also invaluable for checking operating potentials and other circuit parameters—without going underside! ▲



NOW! A RUGGEDIZED 4-400A!

Tired of interelectrode shorts and weak plate seals? Then investigate the new Penta PL-6775 power tetrode! Because of an exclusive Penta filament-supporting insulator, the PL-6775, unilaterally interchangeable with the 4-400A, can be mounted in any position and will withstand extremes in shock and vibration, without developing interelectrode shorts. The rugged and reliable PL-6775 has a one-piece plate cap and seal that won't easily break off, can't fall off. Even distribution of anode heat is assured by the exclusive Penta ribbed plate. Ratings of the ruggedized PL-

6775 are the same as those for the 4-400A, in all classes of service. A single tube will deliver up to 1100 watts of plate power output as a Class-C CW or FM amplifier. Two tubes in Class-AB₁ operation will provide up to 1550 watts of plate power output.

Write today for your free, factual Penta PL-6775 power tetrode data sheet.

PENTA LABORATORIES, INC.

312 North Nopal Street,
Santa Barbara, California

Trade Mark Reg. U. S. Pat. Off.

Export Agents:

Frazar & Hansen, Ltd., San Francisco 11, Calif.



PL-6775



Circle Item 30 on Tech Data Card

ANNOUNCING! NEW TOOL TO SOLVE TV LIGHTING PROBLEMS



Now used by major TV networks and stations in U.S. and abroad, the A-500 spot brightness meter permits fast analysis of any TV lighting problem. Features $\frac{1}{2}^\circ$ acceptance angle— $1/4000$ typical scene. Selectable color response—film, TV, eye. Applications include rapid, accurate measurement of scene luminance (brightness) ratios, lighting balance, screen brightness, costume and scenery reflectance, and kinescope brightness and contrast. Two versions: A-500 fL for measuring footlamberts and A-500 EC with integral exposure computer. Write for brochure.

 **GAMMA SCIENTIFIC, INC.**
5841 Mission Gorge Road, San Diego 20, Calif.

Circle Item 49 on Tech Data Card

MAKE YOUR
OWN TV SLIDES
in Seconds!

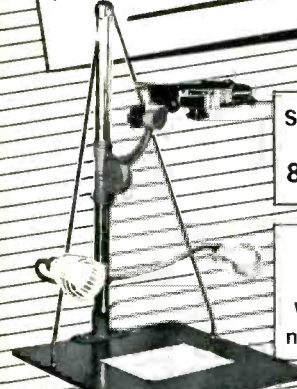

SHOOT ANY
COPY TO
 $8\frac{1}{2} \times 14$ "

2 x 2"
SLIDES
When you
need them!

Complete Modified Polaroid
Roll Film Camera Outfit

Charts, maps, titles
literally ANYTHING is just
60 seconds away from T.V.
slide form! Simple, self-
contained operation!
"Copy-Maker" includes
Lens and illumination!

FREE: 66th ANNUAL
Photo Equipment Guide—
BURKE & JAMES, INC.
321 South Wabash Ave
Chicago 4, Illinois



Circle Item 50 on Tech Data Card

NEWS OF THE INDUSTRY



KPAT Reports on Tape Units

Excellent performance has been cited in the use of the **KRS Stact-Broadcaster**, a new solid-state multideck broadcast audio tape cartridge unit, at **Station KPAT (AM/FM)**, Berkeley, California. A KRS unit has been operating there 24 hours a day for five months. The multiple cartridge system is actually six tape recorders in one package. It uses a continuous loop cartridge which can be reversed, and which can operate a full load of tape (up to 1200 feet) without slippage and associated flutter. Five decks are controlled remotely from the main board of KPAT's control room. The record deck can be controlled at the unit or remotely from the control room, providing flexibility of sources for the recording of spots, themes, and programs. The machine is installed between the KPAT AM transmitters. In the photo, Bob Sampson, KPAT technical supervisor, inserts a cartridge in the recording deck. The patch strip above the unit contains recorder and monitor inputs and monitor output.

Film Center Purchased

Atlas Telefilm, Ltd., of Toronto, Canada, announces that a wholly-owned subsidiary, **Festival Cinema, Ltd.**, has purchased for cash all the assets and business of **Film Laboratories**, also of Toronto. The plant will continue to rent facilities and supply services to commercial, television, theatrical, and educational film producers, both Canadian and international. The acquisition is in furtherance of announced plans for theater television. Operated successfully for 33 years, the firm was expanded with the growth of television and now has the largest and most complete range of motion pictures facilities in North America, east of Hollywood. Included are processing laboratories for color as well as black and white, three fully equipped sound stages, recording studios, dubbing theater, and supplementary facilities from machine shops to makeup.

Under its new ownership, the installation becomes the only full-scale, integrated film-making center, aside from government-owned facilities not available to private producers, which is Canadian-owned and operated.

Camera Tube Warranty Upped

The warranty on four types of television camera tubes has been increased as much as 60%, it was announced by the **General Electric Tube Department**. The warranty on tubes 5820A and 7293 glass-target broadcasting image orthicons has been increased from 500 to 750 hours. The warranty on types 7629A and 8092A low-light-level magnesium-oxide-target image orthicons has been increased from 750 to 1200 hours. Under the new warranties 100% credit is given up to 50 hours. Subsequent credit is pro-rated according to a new schedule.

Tower Firm Expands

Rohn Manufacturing Co. has acquired an interest in the **Vulcan-TV Mast & Tower Co., Inc.**, of Birmingham, Alabama. Vulcan is a prominent manufacturer of telescoping masts, tubing, TV guy wire, and accessories in the TV and electronics field. They also manufacture playground equipment and lawn furniture. Many items in the TV line now available from Vulcan will also be available from Rohn. The acquisition of Vulcan will give Rohn new manufacturing facilities in the southeast part of the United States and enable them to give better service to customers in that area.

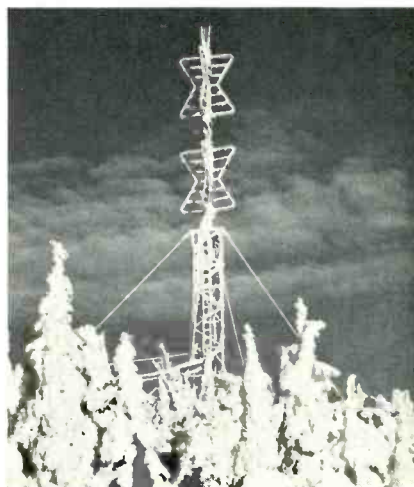

Snow and ice cover this VHF TV transmitting antenna at Copper Mountain, Terrace, B. C. Situated on the mountaintop, this **CFTK-TV** installation is accessible only by helicopter. Mr. E. J. Frazer, P. Eng., of the firm **Hoyles, Niblock and Associates**, consultants to the station, took the picture as he approached the remote site. **CFTK-TV-1**, Mount Hays, Prince Rupert, B. C., is also a mountaintop installation. ▲

Live Music Pick-Up

(Continued from page 15)

microphone is basic to achieving the desired reproduction. It is proper selection and use of the microphone which offers the only real control we have over the effects of room characteristics.

For such a vital control element, knowing that a microphone "sounds pretty good back in the studio" is just not enough. It is necessary to understand what elements of control different types of microphones can offer, and to become familiar enough with the characteristics of the location so that we may know what control is needed. Microphone frequency response is important; but the combined effect of microphone response and room characteristics, as altered by all the microphone properties, is the key to final on-the-air reproduction.

For example, a good unidirectional, or often a good bidirectional, microphone can do much toward controlling response coloration caused by sounds reflected from surfaces at various angles around the microphone. The directional microphone can also be of significant help in reclaiming the stereo effect in a very live or reverberant hall. When "tight-micing" is the only solution, it provides a means for separating between different sections of the band or orchestra so that balance may be maintained at the board.

On the other hand, the omnidirectional microphone can be a great help in either stereo or mono by preserving some room color in a very dead location.

While microphone placement is well recognized as important to producing a stereo effect, it has other significance. Proper placement with respect to the music source, or the reflecting surfaces behind it, can have much to do with the musical balance. Since the frequency response of the room varies with location, the microphone placement can contribute significantly to the overall reproduced frequency response. The distance between the microphone and the music can offer added control over the amount of room characteristic which is reproduced. With tight-micing, for example, room characteristics may be almost completely eliminated.

We can see that with even the



take me out to the ballpark...

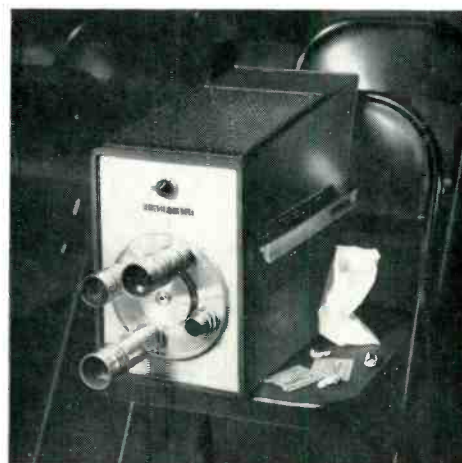

(and leave me there)

The Blonder-Tongue Observer 2 is a broadcast quality vidicon viewfinder camera. It's extremely light and portable, making it ideal for remotes. Also, picture quality is so close to that of an image orthicon, you can use it for up to 80% of your studio work.

You can buy the Observer 2 for a fraction of the cost of an image orthicon—\$4160. But, the biggest saving is in operating costs. For example, you can buy seven vidicon tubes for the price of a single image orthicon—and each vidicon lasts twice as long.

The B-T Observer 2 has an 8" viewfinder screen, a 4 lens turret, and reliable solid-state circuitry. To arrange for a demonstration by your local Blonder-Tongue representative, write:

BLONDER*TONGUE

9 Alling Street, Newark 2, N. J. • Canadian Division: Benco Television Assoc., Ltd., Toronto, Ontario

Circle Item 31 on Tech Data Card

most basic microphone arrangements—two matched microphones for stereo, or a single microphone for monaural—a judicious choice of the microphone type and placement makes possible a high degree of control over the reproduced effect. Except in very trying locations, incidentally, these basic approaches probably assure the most consistent program quality.

To help visualize what various microphone types can do for us, Table 1 lists key directional prop-

erties for the more common pickup patterns shown in Fig. 3. Two points should be considered in using this table: The directional properties are three dimensional (the patterns shown in Fig. 3 are one cross section through a sphere), and the numbers are based on an ideal microphone which exhibits the same directional properties at all frequencies and in all planes through its axis.

To best predict the performance of a microphone, therefore, it is necessary to make sure that its properties are reasonably uniform. To augment the manufacturer's data, a basic "feel" may be obtained as someone walks around a microphone in a dead studio, while talking at a constant level and maintaining a constant distance. Key factors are the amount of reduction at the null(s), the angle of the null(s), and the change in sound quality as the angle changes.

The Music Source

Physical arrangement of the source is another factor over which the engineer may have only limited control; but it is again important, particularly in producing a believable stereo effect. Physical arrangement of the orchestra or band may also have a significant bearing on the ability to achieve a reasonable

musical balance with simple microphone techniques.

The Console

There is no intention to connote an order of importance by considering the console, or board, last. In fact, the board is the very important point at which all of our considerations are put together in one package for presentation.

In the sequence of developing a live music pickup, the ideal approach would be to select the board last—to assure that the board properly complements the desired microphone approach. A board for the basic one- or two-microphone technique could be rather simple. If there were a number of isolated soloists or ensembles, the board could provide for proper microphone coverage of each. If a multiple microphone approach was necessary, the board would allow ample provision for mixing to achieve the proper balance.

Unfortunately, the ideal is often not consistent with economy. When cost limits the choice of the board, ingenuity becomes quite important. A possible approach might be to reconsider the other control elements—such as microphone placement or the number and type of the microphones. Another solution might involve taking soldering iron

RUSSCO SUPPLIERS of **QUALITY**

Q R K

PROFESSIONAL TURNTABLES



- Quality
- Continuous Performance
- Simplicity

Priced from \$115.00 to \$235.00

REK-O-CUT pick-up arms



12 inch \$34.95
16 inch \$36.95



Model 607

CONCERTONE tape recorders

Full track -or Stereo
Width 19" for rack mounting -also portable
Professional broadcast quality.

Send for prices and literature.



STANDFORD-OMEGA
Condenser Microphones

\$130.00 to \$150.00

Viking Tape Recorders Superex Headphones
Kwikheat Soldering Irons

Send for literature.

FAST FAST FAST Service

Shipment by Motor Freight, Air Freight or Parcel Post

RUSSCO Electronics Mfg.
6879 No. Sunnyside Clovis, California
Ph. 299-4692 Area code 209

Circle Item 36 on Tech Data Card

Table 1. Pickup Properties of Four Directional Microphone Types.

Property	Omn-Directional	Cardioid	Super-Cardioid	Cosine
Unidirectional effect ¹	0	17 db	23 db	0
Front to back reduction (on axis) ²	0	infinite (theoretical)	12 db	0
Null angle ³	180°	126°	90°
Random energy reduction ⁴	0	9.6 db	11.4 db	9.6 db
Effective pickup angle ⁵				
3 db down	360°	132°	114°	90°
6 db down	360°	180°	156°	120°

Notes:

1. Pickup reduction in back hemisphere compared to front.
2. Pickup reduction at 180° compared to 0°. (See No. 3).
3. Angle at which minimum pick up (null) occurs. As with cardioid (see No. 2) reduction at null is theoretically infinite.
4. Reduction in pickup of surrounding sound waves — compared to omnidirectional.
5. Included angle at microphone front for 3 or 6 db down at extremes.

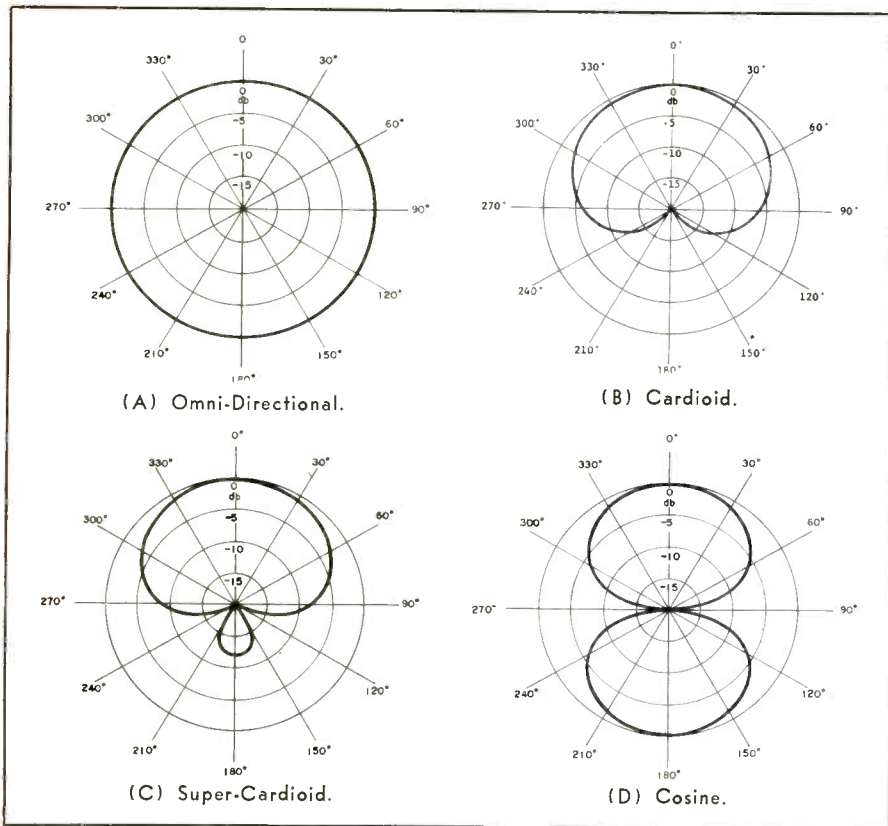

Fig. 3. Directional pickup patterns of four popular types of microphones.

in hand and modifying existing equipment, perhaps by adding one or two subchannels to the existing board.

Summary

Having looked at some of the important considerations in approaching a live music pickup, let's rejoin C. E. to see what progress he has made.

Our chief engineer has agreed with the production staff that the objective is a conservative, believable stereo presentation, with frequency response sufficient to lend authenticity to the music and with enough room coloration to suggest the location (but not so much as to conflict with the other objectives). They have selected a simply presented, but well accepted, live concert recording to define the goal.

C. E. has also determined that the pickups will be made with an audience present, and that the average audiences in one hall occupy about two-thirds of the seating, while approximately one-half occupancy is usual in the other.

He has attended a rehearsal of each group and, while he has no good provision for measuring the room characteristics objectively, he devoted himself to extensive listen-

ing (partly, we hope, with one ear) at various possible microphone locations. He has also made simple sketches of the hall and the normal physical arrangement of the musical groups. On the sketches he has jotted his notes regarding the characteristics of different microphone locations which he has studied.

Armed with these observations, his own experience with different microphone types (plus more detailed information which he has requested from microphone manufacturers), and comments of acquaintances who are also in the throes of this problem, C. E. is ready to develop tentative plans for approaching his assignment. These plans will be evaluated by listening again at the tentatively selected microphone locations during public concerts of each group.

When the program plans have crystallized and the schedule is at least tentatively established, there is one more step which C. E. should not overlook. We hope that he will go to the trouble of practicing—of recorded dry runs—not only to check out the equipment, but to perfect the setup and operating techniques which will assure the success of his, and your, live music pickup. ▲

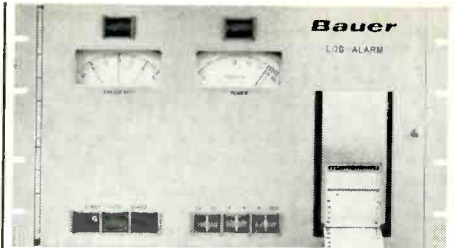

NEW.....

SIMPLE METHOD TO LOG TRANSMITTER READINGS

The Bauer "Log Alarm" is simple . . . accurate . . . easy to operate . . . permits better use of your manpower . . . meets all FCC requirements for automatic logging devices . . . all in 10½" of rack space.

Complete Details Available on Request!

Bauer

ELECTRONICS CORPORATION

1663 Industrial Road, San Carlos, California
Area Code 415 591-9466

Circle Item 28 on Tech Data Card

SPOTMASTER

RS-25



Tape Cartridge Racks

RM-100

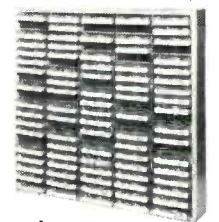

... from industry's most comprehensive line of cartridge tape equipment.

Enjoy finger-tip convenience with RM-100 wall-mount wood racks. Store 100 cartridges in minimum space (modular construction permits table-top mounting as well); \$40.00 per rack. SPOTMASTER Lazy Susan revolving cartridge wire rack holds 200 cartridges. Price \$145.50. Extra rack sections available at \$12.90.

Write or wire for complete details.

Spotmaster
BROADCAST ELECTRONICS, INC.
8800 Brookville Road
Silver Spring, Maryland

Circle Item 29 on Tech Data Card

Acoustics

(Continued from page 13)

- nected to a wave analyzer which interlocks with a graphic level recorder to plot the sound pressure level in db versus the audio frequency spectrum.
- Reverberation times by frequency**—Here a random noise generator driving a powerful audio amplifier and wide-range speaker system are turned on and off. The decay of the sound produced is measured at $\frac{1}{3}$ octave intervals through a sound level meter coupled to a wave analyzer which is interlinked with a high-speed recorder.
 - Transmission irregularity curves**—Using an interlinked oscillator and graphic level recorder to record the response of a loudspeaker system of known characteristics, you can observe the effect of the room on sounds put into it.
 - Pulse tests for reflection patterns**—Photographing (with an oscilloscope and camera) a switched pulse of 10 milliseconds duration, and its subse-

Table 2. Max. Studio Noise Levels.

Octave bands centered on freq. in cps	125	250	500	1000	2000	4000
SPL in db	38	30	23	18	15	12

- quent reflections in the studio, on a time base of 10 milliseconds per cm, reveals undesirable reflection patterns and localizes their source.
- Level searches to check distribution**—Using random noise in $\frac{1}{3}$ octave bandwidth, the room may be "searched" from wall to wall to determine the standing wave patterns and the distribution of sound in the studio.
 - Transmission loss checks**—By using the random noise generator amplifier and a loudspeaker system on one side of a wall, and the sound level meter, wave analyzer, and graphic level recorder on the other side, the attenuation of the wall at each frequency can be shown.

In Summary

Following is a checklist of basic points to consider in design:

- Noise criteria.** Noise in a studio

should not exceed the levels listed in Table 2.

- Distribution.** The design goal is to be able to place the microphones anywhere. Avoid parallel surfaces. Be careful of focusing caused by convergence of nonparallel surfaces.
- Reverberation.** Design for music. Meet other requirements (such as speech) by choice of microphone type and placement. Use isolation screens and absorbent wall panels.
- Ventilation** must handle the necessary capacity, but at low air velocity.
- Use **sound locks** for doors.
- Omit **windows**.
- Use quiet and absorbent **furnishings**: rubber feet on chairs, tables, and other pieces of furniture.

Special consideration must be given to the design and location of the following rooms and systems in the building housing the studios:

- Conference rooms
- Studios
- Control rooms
- Offices
- Switchboard
- Elevators
- Equipment rooms
- Heating and ventilating equipment
- Generator room
- Boiler room
- Rest rooms
- Telephones
- Maintenance areas
- Transformer vaults or other heavy electrical equipment. ▲

ABC-AM & TV • AMERICAN LUTHERAN CHURCH • BASIN STREET EAST • BELL TELEPHONE LABORATORIES • CADENCE RECORDS • CAPITOL RECORDS • CATHEDRAL OF ST. JOHN THE DIVINE • CBC-CANADA • CBS-AM & TV • CLEVELAND RECORDING CO. • COLUMBIA RECORDS • HITSVILLE, U.S.A. • LIBRARY OF CONGRESS • MGM PICTURES • THE MORMON CHURCH • NBC-AM & TV • NICOLET HIGH SCHOOL • PRATT & WHITNEY AIRCRAFT • RCA VICTOR RECORDING • RIVERSIDE CHURCH • THUNDERBIRD HOTEL • THE UNITED NATIONS • UNITED RECORDING SERVICE • UNIVERSITY OF GEORGIA • UNIVERSITY OF MICHIGAN • U.S. MARINE CORPS BAND • WARNER BROS. PICTURES • WBTV • THE WHITE HOUSE • WINS • WKIX • WTTG (NBC) ... and many hundreds more!



PROOF?

Meet some of the people who, over the years, have become Neumann condenser microphone owners...a cross section of our valued client list. Each day this list is enhanced by quality conscious seekers of the benefits these incomparable microphones offer. This recognition of leadership is due in part to Neumann's international reputation for the highest manufacturing and design standards in the industry; but the conclusive proof of the incredible quality, versatility, and stamina of Neumann microphones rests with those who depend on them every day, under every conceivable condition, and know the thrill of their trouble-free performance. We invite you to join these distinguished users and share their exclusive experience. It will be our pleasure to forward details on the complete line of Neumann microphones on request.

GOTHAM
AUDIO CORPORATION

2 WEST 46 STREET, NEW YORK, N.Y., 10036 • 212-CO-5-4111
In Canada: J-Mar Electronics Ltd., P.O. Box 158, Don Mills, Ontario

Circle Item 34 on Tech Data Card

BROADCAST ENGINEERING

CATV

(Continued from page 11)

circuitry assures minimum phase delay for the best reproduction of incoming color and black and white signals. The sync-pulse-reference AGC has a noise clipping circuit which provides constant-output levels not affected by power line or ignition noises. The fast action of this AGC helps to minimize flutter caused by airplanes.

AFC-ASC—The automatic frequency control circuitry provides correction voltage for the tuner. Automatic sound control circuitry provides limiting action at relatively low IF frequencies to control the on-channel sound carrier. Once set, the desired relationship between sound and video carriers for the channel is maintained.

Standby Carrier Oscillator—When a station goes off the air, a time-delay device is automatically energized. This unit triggers a crystal-controlled oscillator to provide a replacement carrier after 20 seconds. A warning light indicates that the original station is off the air.

Crystal Controlled Converter/Amplifier—The converter in this unit uses a crystal-controlled oscillator to change the IF frequencies to any desired TV channel. In the event that on-channel conversion (i.e., channel 2 to 2, 9 to 9, etc.) is desired, the converter oscillator is switched out of the circuit. Since the same oscillator is then used for both conversions, co-channel interference cannot be generated internally. An amplifier feeds the converted signal at a one-volt level to dual outputs. These outputs have an excellent match (VSWR 1.2:1) simplifying mixing with other equipment.

Twelve of these units can provide a completely-controlled head-end system from which 12 channels can be fed to individual subscribers



Fig. 5. A CATV single-channel processor.

without difficulty. In addition to technical advantages, the use of such equipment changes the old "antenna shack," with its maze of cabling between numerous devices, into an efficient, simple-to-service control center.

Other new CATV head-end equipment includes antennas with higher gain and better directivity, and new solid-state, mast-mounted preamplifiers. The latter are designed for maximum signal transfer from antenna to system, and compensation for down-lead losses without degrading the system noise figure.

Transportation Equipment

The basic material in CATV transportation systems is coaxial cable. Manufacturers are continually improving the cable so that signals may be transported over greater distances with less need for equalization and amplification. New solid-sheath aluminum cables provide lower signal losses than have been possible thus far.

Equalizers

Since several channels at different frequencies are carried on the same cable, and the loss of the cable changes with frequency, variances in level occur. Equalizers compensate for these differences, to maintain the proper relationship between signal levels at each amplifier location. Similar devices must be provided to compensate for temperature-dependent signal losses. Both types of equalizers are now available for all types of cable.

Amplifiers

Amplifiers for transportation systems are also much improved. New distributed amplifiers, which eliminate second and third order beat interference, are available for systems operating in the sub and low TV bands. Transistorized amplifiers (Fig. 6) now being introduced are more compact and easier to maintain. These new amplifiers can be mounted directly on the messenger strand so that they can be located exactly where required. The power consumption is so low that up to 16 units can be fed from a single power supply (the coaxial cable carries power as well as signals). New remote power supplies are now available for these ampli-

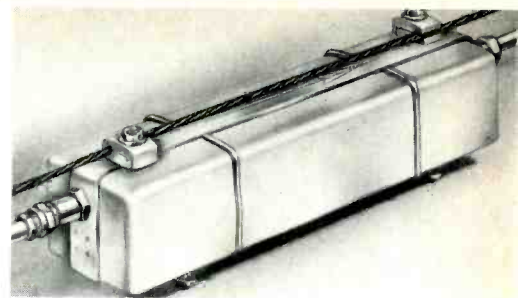

Fig. 6. A typical transistorized amplifier.

fiers. They are mounted within the weather enclosures at pole line locations (Fig. 7).

Distribution System Equipment

CATV distribution systems have been improved by the development of new amplifiers, feeder-line extenders, and tap-off units. The amplifiers permit expansion of existing systems and improve the coverage potentials of new installations.

The new pressure taps are easier to install than older types due to improved mechanical design. An isolation unit of the proper value is screwed into these pressure taps at installation. This insures proper isolation between line and set regardless of tap location on the feeder line. Properly installed, the taps are completely waterproof and provide excellent permanent connection to the feeder line.

The Future

Modern transportation facilities permit the modern American to live in places which until recently would have been considered isolated from civilization. Unlike the pioneer of yesteryear, he brings his conveniences with him. To many, a TV set is an essential part of a home. Therefore no place should be so remote as to separate the viewer from his favorite programs. Equipment and techniques in CATV keep pace with advances in all other communications fields. Thus, CATV serves as a vital link between the individual broadcasting station and consumers it could not otherwise reach.

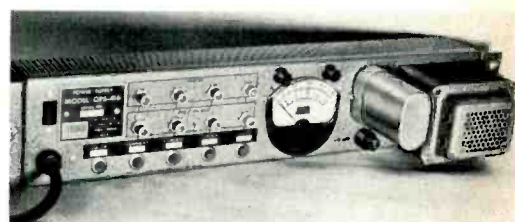
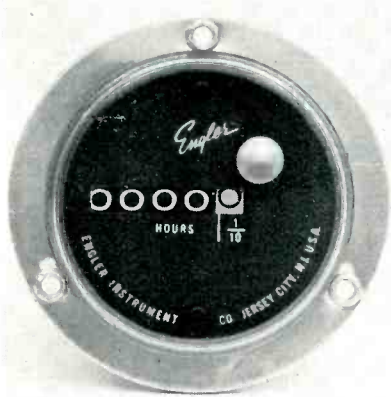

Fig. 7. An amplifier remote power supply.

NEW PRODUCTS



Elapsed Hour Meters

The Engler Instrument Co., manufacturer of registering and recording instruments, announces several additional models of their Hour Meter. Now available in both AC and DC are two types of reset models: face reset for quick and convenient resetting, and side reset for tamper proof resetting. Both features make it possible to reset the meter to zero from any point.

Circle Item 40 on Tech Data Card

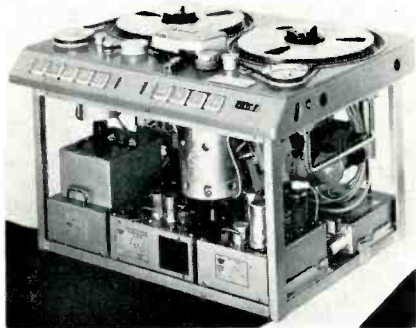

Studio Tape Recorder

Gotham Audio Corp. announces the availability of the new EMT Studer C-37 series master tape recorder. The machine, precision manufactured in Switzerland, has been well tried and proven, with over 300 units operating in broadcasting and recording installations throughout the world. Extreme attention has been paid to performance specifications, operating and maintenance ease, and editing functions. For example, wow and flutter content is 0.04% rms; signal to noise ratio is 66 db unweighted at 15 ips. A unique tensioning device allows smooth and uniform tape handling. All electronic and electro-magnetic elements are of the plug-in type. Editing features include built-in tape marker, motor driven cutting scissors, edit indexing, splicing block, and precision tape timer reading directly in minutes and seconds at any speed. The recorder is available in 1/4" full or two track, 1/2" three or four track, 1" four track, as well as film synchronous and preview head models. Four-track machines have complete sync monitoring amplifier and switching.

Circle Item 41 on Tech Data Card



Audio Source

Marconi Instruments announces a fully transistorized audio signal source, Model 2000. With distortion less than 0.05% from 63 cps to 6.3 kc and less than 0.1% from 20 cps to 20 kc, the instrument is designed for use on ultra-low-distortion telephone and audio circuits. Output is 4 volts into a matched 600-ohm load (unbalanced) and a choice of switch-selected output impedances is provided. New construction techniques enable the signal source to be supplied as two separate units comprising the oscillator, Model 2100, and monitored attenuator, Model 2160, in either bench or rack mount. Price of Model 2000 is \$745; Model 2100 is \$420; Model 2160 is \$325.

Circle Item 42 on Tech Data Card

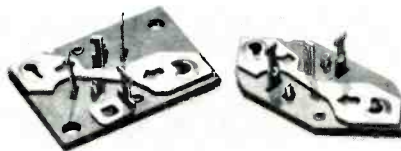

Power Transistor Sockets

Three new power transistor sockets have been announced by Industrial Electronic Hardware Corp. The new sockets are made of natural XP Bakelite, vacuum wax impregnated. The contacts are cadmium-plated brass and the thread is formed for a 6-20 screw. The CR steel plate has .104/.110 diameter hole.

Circle Item 43 on Tech Data Card

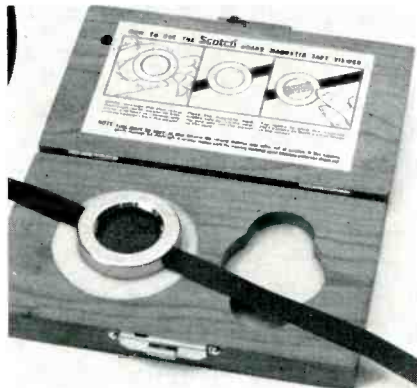

Magnetic Tape Viewer

A precision instrument which makes visible the data recorded on magnetic tape without damaging the tape has been developed by the 3M Company. The

"Scotch" brand Model 600 can be used to check tape recorder head alignment, track placement, pulse definition, inter-block spacing and dropout areas in computer and instrumentation work. It can also be used to examine and synchronize the audio track on video tape and the pattern of recorded sound on audible-range tapes. It will determine, easily and quickly, whether tools, heads, or guides are magnetized. The viewer requires no exterior chemicals or special preparation. Price is \$50.00.

Circle Item 44 on Tech Data Card

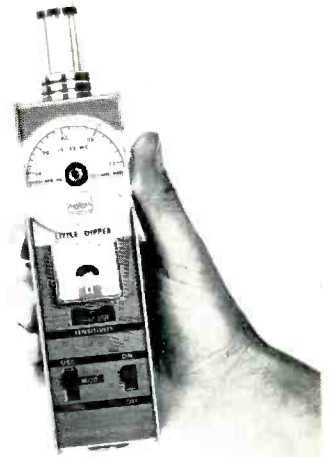

Transistorized RF Dip Oscillator

A portable RF dip oscillator is now available from Waters Mfg., Inc., Wayland, Mass. Trade-named the "Little Dipper," it performs all the functions of a grid dip oscillator, an absorption wavemeter, and—with its built-in audio modulation—a signal generator. Featuring a stabilized MADT transistor RF oscillator covering 2 to 230 mc, the unit has 7 coils (each carrying its own linear scale) and a frequency accuracy of $\pm 3\%$. The "Little Dipper" uses a 1-kc audio oscillator for modulation, and a DC amplifier and meter for detecting and indicating the dip. Price is \$129.75.

Circle Item 45 on Tech Data Card

Combo VOM/VTVM

Triplet Electrical Instrument Co. has announced the availability of a new version of the Model 631 combination volt-ohm-milliammeter and vacuum-tube voltmeter. The instrument offers 34 ranges including ten AC/DC volts, 6 DC resistance from 0.1 ohms to 150 megohms, and decibel and output readings in the VOM function. As a VTVM, the device has four ranges including one with 1.2 volts full-scale. The sensitivity 20,000 ohms per volt on DC ranges, and 5000 ohms per volt on AC. As a VTVM, the sensitivity is 11 megohms. The battery-operated meter employs a single switch for selecting all ranges. With a full line of accessories available, the meter alone is priced at \$69.50.

Circle Item 46 on Tech Data Card

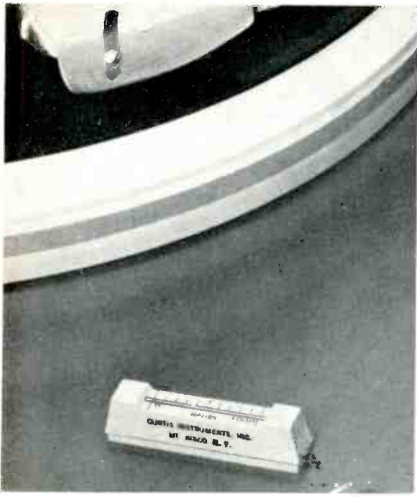

Stylus Wear Meter

A unique, inexpensive "plug-in" elapsed-time meter from Curtis Instruments permits measurement of actual operating hours and wear on styli, tape heads, and associated components such as pre-amplifiers and amplifiers. Only 1.81" long x .37" wide x .37" high, the "Indachron" utilizes an electrochemical meter element with traveling electrolyte gap. The elapsed-time meter consists of a plug-in indicator, separate molded zener-diode power supply, and socket plate. Mounting requires only two drilled holes in the panel of the turntable, tape recorder, or amplifier. Time is read directly from calibration marks on the Indachron, which is available in standard scales of 500, 600, and 1000 hours — all with $\pm 3\%$ accuracy. Once the indicator has run its cycle, it can be turned end-for-end and plugged in again, with readings indicating actual hours of use left. Price is \$16.45.

Circle Item 47 on Tech Data Card



Triple-Action Tape Head

Michigan Magnetics, Inc., has begun volume production of its triple-action, one component tape recorder head that records, plays, and erases. The all-metal faced head can erase one track at a time or both tracks simultaneously. Its tapered design prevents incorrect insertion of reels or tapes. Modifications can be made to meet any specifications, and both modified and standardized heads are competitively priced. The heads carry a 12-month warranty.

Circle Item 48 on Tech Data Card

SAMS TECHNICAL BOOKS
of special interest to Broadcast Personnel

JUST OUT!



New, updated 1964 Edition
NORTH AMERICAN RADIO-TV STATION GUIDE

by Vane A. Jones

The Handiest Station-Listing Ever Published!
Lists over 7500 AM, FM, and TV Stations
— 13 two-page TV Station Maps.

Mr. Chief Engineer:

How many copies do you need for your station?

ASK YOUR PROMOTION MANAGER—how many copies he wants for friends of the station.

THEN ASK YOUR SALES MANAGER—how many copies he wants for clients and prospects.

ALSO, ASK YOUR STATION MANAGER — how many copies he needs for News and Sports Directors and other department heads and station personnel. He may even want to offer them to listeners as a premium or good-will item.

AND, DON'T FORGET YOURSELF—total the number you'll need, and write the appropriate number in the coupon box below.

All stations listed by call letters and geographic location. AM, FM, and UHF also listed by frequency. Identifies network affiliation, lists day and night AM power, antenna height and ERP for all FM and stereo stations.

NO OTHER LIKE IT!

Have You Seen These?



BROADCAST ENGINEERING NOTEBOOKS

by Harold E. Ennes

Vol. 1: TELEVISION TAPE FUNDAMENTALS

Order BEN-1 Only \$5.95

Vol. 2: AM-FM BROADCAST OPERATIONS

Order BEN-2 Only \$5.95

Vol. 3: AM-FM BROADCAST MAINTENANCE

Order BEN-3 Only \$5.95

Vol. 4: TELEVISION SYSTEMS MAINTENANCE

Order BEN-4 Only \$5.95

Third-Class Broadcast Endorsement Problems?

You need the updated edition of . . .

Second-Class Radiotelephone License Handbook
. . . now containing all the questions and answers, as well as helpful text sections, needed to pass Elements I, II, and IX for the 3rd-class License with Broadcast Endorsement.

Order QAN-1 Only \$3.95

SEND NO MONEY • FULL RETURN PRIVILEGE

Howard W. Sams & Co., Inc., Dept. BE-264
4300 W. 62nd Street, Indianapolis 6, Ind.

ORDER TODAY

Please send _____ copies of the North-American Radio-TV Station Guide at \$1.95 each, plus other books checked below (quantity prices on request):

- BEN-1 BEN-3 QAN-1 \$.....enclosed. Send postpaid.
- BEN-2 BEN-4 FREE Booklist BILL ME (I pay postage).

Name

Address

City Zone State

Circle Item 35 on Tech Data Card

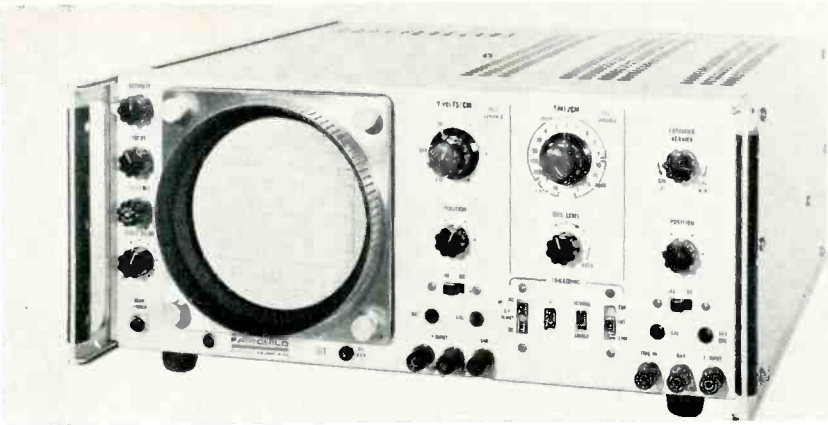

Laboratory Oscilloscope

A general purpose 500 kc laboratory oscilloscope is announced by the Scientific Instrument Department, **Du Mont Laboratories**, Divisions of Fairchild Camera and Instrument Corp. The type 701 oscilloscope features simplified panel controls, maximum drift stability through transistorization, reliability, and precision of measurement. The high-resolution CRT is available with an optional illuminated, no-parallax graticule. Sensitivity is 10 mv/cm and stable performance is assured by a silicon transistor output stage which directly drives the CRT deflection plates. Wide-range sweep circuits are calibrated within 3% from 5 μ sec/cm to 200 ms/cm. Continuous expansion control from X1 to X10 provides precise viewing of any section of the magnified sweep, with the fastest sweep at 10X extended to 1/2 μ sec/cm. Trigger circuits lock easily on the most complex waveforms. The price is \$450.00.

Circle Item 95 on Tech Data Card

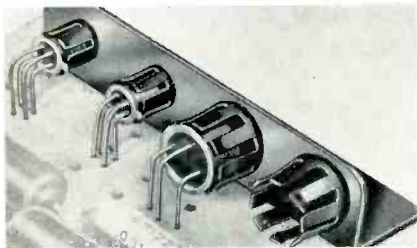

Dissipator-Retainer

IERC announces new low cost Thermo-Link retainers for TO-5 and TO-18 transistors. Spring fingers firmly grasp and retain the transistor case, yet allow a smooth press-fit installation. Parts stocking can be economized because one size fits all TO-5 size cases, while one other size fits TO-18 cases. The retainers may be riveted or soldered directly to printed boards, chassis, angle brackets, or overhead heat sinks. They are made of beryllium copper, providing excellent heat conduction from transistors when mounted to a metal chassis or thermal path. Price is 12¢ to 25¢.

Circle Item 96 on Tech Data Card

Silicon Rectifier Replaces 816

A rugged plug-in silicon rectifier manufactured by **International Rectifier Corp.** fulfills the need for a high reliability device to replace type 816 mercury vapor rectifier tubes. Rated at 7500 volts piv and 5300 volts maximum rms, the silicon ST-11 provides a maximum output current of 0.2 amps average at 75° C. This makes it highly suitable in transmitters for radio-TV broadcasting, teletype, telemetering, as well as airline and police communications. In a rugged package measuring only 4.06" x 1.2" (diameter), the unit provides virtually unlimited life. It can be operated in temperatures from -40° to 140° C, requires no warmup time, and generates a minimum of heat. Units are equipped



with a tube base to allow direct insertion into existing tube sockets. The price is \$24.75 each; in quantities of 1 to 99.

Circle Item 97 on Tech Data Card

Direct-Drive Cartridge Unit

A direct tape-drive cartridge unit, designed to eliminate speed differences between machines, also promises reproduction comparable to reel-to-reel units. **Automatic Tape Control**, developers of the unit, describe it as "one of the greatest advances in the cartridge tape field—the result of more than two years of engineering effort." The new system completely eliminates drive belts, which are said to be the principal cause of speed differences in cartridge recording and reproduction. Speed accuracy of the new drive system is better than 99.8% and high driving torque allows the use of any length or size of tape cartridge. Wow and flutter are reduced to no more than .2% rms. The direct tape-drive system can be provided as a modification to present equipment in the field, because considerable steps were taken to insure compatibility.

Circle Item 98 on Tech Data Card

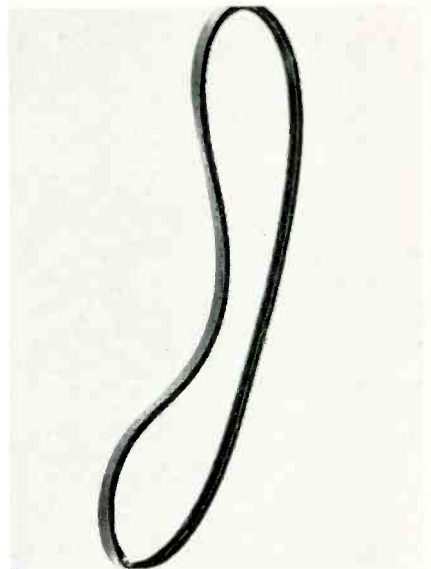

Conductive Gaskets

A complete line of gaskets made of electrically conductive silicone rubber is announced by **Multi-Flex Seals, Inc.** Designed for sealing electronic components from stray RF as well as fluid, the gaskets are available in any desired diameter, thickness, or shape. The units will operate over the temperature range of -150° F to +500° F. Basic electrical resistivity is 7 ohm/cm. Since the resistance can be varied from this point upwards, the electrically conductive gaskets can be employed in heating applications.

Circle Item 99 on Tech Data Card

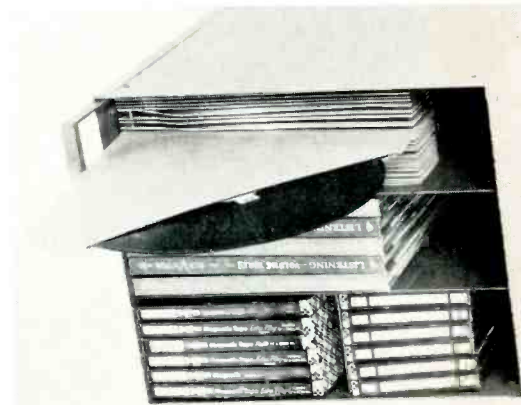

Disc and Tape Cabinet

A combination tape and disc operational storage cabinet is available from **Wallach & Associates, Inc.** Constructed entirely of steel, the cabinet is divided into three compartments. The first holds thirty individual records in pockets (built in); these can be 7", 10", or 12", or any combination of sizes. The second compartment holds five record albums (78 rpm) or twenty-five lp records in jackets. The third compartment holds twelve tape boxes, for 5" and 7" reels. The cabinet comes complete with 30 pockets, two sets of gummed consecutive numbers, 270 printed catalog cards, and a steel card file box. The price is \$26.25; with doors, \$33.75.

Circle Item 100 on Tech Data Card

ENGINEERS' TECH DATA SECTION

AUDIO & RECORDING EQUIPMENT

53. ATLAS SOUND—Data sheet describes controlled dispersion sound-column speakers for sound re-enforcement use in applications with feedback problems.
54. AUDIO DEVICES—Set of brochures shows line of magnetic tape, recording accessories, discs, and cutting styli.
55. BROADCAST ELECTRONICS—Line of cartridge equipment is listed in set of catalog sheets.
56. HARTLEY—Full-range magnetic suspension speaker for high-fidelity is described in spec sheet.
57. MILES REPRODUCER—Data sheet provides information on voice-actuated portable recorder.
58. NORTRONICS—Tape head replacement guide provides specs and information for professional applications.
59. QUAM-NICHOLS—Line of coaxial, extended range, and high frequency speakers is listed in brochure.
60. REK-O-KUT—Professional products data sheet covers several pieces of disc-cutting and playback equipment.
61. SAXITONE—Catalog of prerecorded stereo tape gives discount prices; catalogs list recorders and tape.
62. TURNER—Brochure describes broadcast dynamic microphone with adjustable frequency response.

COMPONENTS & MATERIALS

63. CANNON—Catalog describes square miniature rack/panel connectors with rear release system.
64. JOHNSON—Heavy-duty components for RF applications are detailed in catalog.
65. KURMAN—Specifications guide helps in selecting the proper relay from large stock.
66. MICON ELECTRONICS—50-page catalog is devoted to lines of 50- and 75-ohm coaxial connectors and devices.
67. ROBINS—Selection of XL connectors for audio and electronics applications is listed in catalog sheets.
68. SEAELECTRO—Data sheet describes subminiature recessed bulkhead RF jack.
69. SWITCHCRAFT—Product bulletin details line of jack panel accessories.
70. SYLVANIA—Brochures contain eight typical circuits for NPN germanium alloy transistors and capabilities of PNP epitaxial germanium transistors.
71. TENSOLITE—Technical bulletin describes round conductor flat cable that employs thin high temperature film to bond wires into ultra-compact assembly.
72. WESTINGHOUSE—Specification sheets provide characteristics of tubes in 6146 family of designs.

MICROWAVE DEVICES

73. MICRO-LINK—Set of booklets describe 10.5 to 10.7 kmc and 12.2 to 12.7 kmc business microwave, plus 2500 mc ETW microwave transmission system.
74. SINGER METRICS—8-page short form catalog covers more than 50 noise and intensity meters, associated instruments, and microwave components.

75. RAYTHEON—Closed-circuit television brochure contains data on microwave equipments and auxiliary components.

RADIO & CONTROL ROOM EQUIPMENT

76. McMARTIN—Catalog illustrates and details transistorized SCA multiplex tuner.
77. SPARTA—Data sheet describes professional turntables, cabinet units, and equalized turntable preamp.

STUDIO & CAMERA EQUIPMENT

78. AMPEX—Bulletin describes and illustrates compact mobile television recording installation in station wagon.
79. CONTINENTAL ELECTRONICS—Product sheets cover vidicon camera for industrial and educational applications.
80. TELESCRIPT—Illustrated bulletin presents Shibaden 5820 image orthicon tube.
81. TELEVISION ZOOMAR—Catalog cards describe zoom lenses with Zoom Rod control and servo control; information is provided on servo pan and tilt heads with preset and remote controls.
82. TERADO—Bulletin covers relays for TV camera operation, and transistorized power converter for camera and sound equipment.

TELEVISION EQUIPMENT

83. INTERNATIONAL NUCLEAR—Data sheet covers transistorized plug-in video/pulse distribution amplifier.
84. 3M—Periodical "Playback" contains information of interest to engineers and operators working with video tape recording.
85. TELEMET—Spec sheets detail color flying spot scanner and color signal generator.

TEST EQUIPMENT & INSTRUMENTS

86. EICO—32-page catalog shows test instruments, communications equipment, audio components, and tape decks.
87. POLARAD—Technical note describes phase-locked signal generators and spectrum analysers.
88. SECO—Folder includes specs and prices on latest tube and semiconductor testers.
89. TEXAS CRYSTALS—Catalog has transistorized oscillator circuits and information on how crystals are made with a listing of quartz crystals for frequency control.

TRANSMITTER & ANTENNA DEVICES

90. BAUER—Brochure describes "Log-Alarm" device which records all required parameters of a single transmitter operation, and provides visual and audible alarm system.
91. CO. EL.—Booklets cover broadband dipole TV antennas for VHF and UHF, multiguide slot antennas, directional antennas for 1 kw UHF, wideband FM antennas, VHF and UHF notch duplexers, and filterplexers.
92. FINNEY—FM and TV catalog is on specially cut-to-frequency single channel yagi antennas with either 300 ohm or gamma match for 50 or 72 ohms.
93. JAMPRO—Bulletins cover omnidirectional high-band VHF TV transmitting antennas for tower leg mounting.
94. MOSELEY ASSOCIATES—Bulletin is devoted to 10 watt direct FM exciter with stereo and SCA generators, for replacement or use as low powered educational transmitter.

Professional Services

VIR JAMES

CONSULTING RADIO ENGINEERS

Applications and Field Engineering
345 Colorado Blvd.
Phone: (Area Code 303) 333-5562

DENVER, COLORADO 80206
Member AFCCCE

- SYNCHRONOUS MAGNETIC FILM RECORDER/REPRODUCER
- MAGNETIC TAPE RECORDERS
- NEW—THE portable MINTAPE synchronous 13 lb., battery operated magnetic tape recorder for field recording.

THE STANCIL-HOFFMAN CORP.
845 N. Highland, Hollywood 38, Calif.
Dept. B HO 4-7461

JOHN H. BATTISON & ASSOCIATES

CONSULTING RADIO ENGINEERS TV-AM-FM & Microwave Applications and Installations

Specializing in all forms of communications engineering.
422 Washington Bldg. Washington 5, D. C.
Phone ST 3-3484
Established 1954

Classified

Advertising rates in the Classified Section are ten cents per word. Minimum charge is \$2.00. Blind box number is 50 cents extra. Check or money order must be enclosed with ad.

The classified columns are not open to the advertising of any broadcast equipment or supplies regularly produced by manufacturers unless the equipment is used and no longer owned by the manufacturer. Display advertising must be purchased in such cases.

PERSONNEL

Tape Cartridge equipment manufacturer located in Alabama is looking for good technicians who are capable of becoming engineers or engineering technicians. Man wanted must be capable of accepting project and completing it without continuous supervision. He should have mechanical ability as well as a good knowledge of electronic circuitry. A good working knowledge of transistors is essential. Salary commensurate with ability, excellent working conditions with many areas of advancement for men with ability and personal drive. Send complete resume including recent photograph to Broadcast Engineering, Box 2700. 2-64 1t

BROADCAST TECHNICAL SALES REPRESENTATIVE

Must have knowledge of antenna and transmitter equipment used in TV, radio and microwave broadcasting and understand its function, operating characteristics and maintenance problems. Successful applicant must be marketing ori-

ented and have proven administrative ability. Considerable travel necessary from midwest home office of highly reputable company. This salaried position offers unusual opportunity for rapid advancement. Write fully in confidence, stating salary desired, to Broadcast Engineering, Dept. 108. 2-64 1t

Sales Trainee

Opportunity for a young man with ambition who is willing to work hard for advancement with a major broadcast equipment manufacturer. You should have a degree and must have a technical background with experience in AM, FM or TV station operation and maintenance. If you have a sincere desire to sell broadcast equipment and the patience to learn how—send resume to Broadcast Engineering, Dept. 109 2-64 1t

SALES ENGINEER—Broadcast, AM, FM, TV, Microwave. 4 years experience, excellent sales record. Background, college, 20 years broadcast. Prefer South, will relocate. Broadcast Engineering, Dept. 107. 2-64 1t

EQUIPMENT FOR SALE

Commercial Crystals and new or replacement crystals for RCA, Gates, W. E., Bliley and J-K holders; regrinding, repair, etc. BC-604 crystals. Also A. M. monitor service. Nationwide unsolicited testimonials praise our products and fast service. Eidson Electronic Company, Box 96, Temple, Texas. 9-61 tf

TRANSMITTING TUBES FOR SALE—Immediate Delivery on 6076 Power Tetrodes, at \$235 each, 3X2500F3—\$170, 4507L—\$35, 4-125A—\$22.50, 872A—\$5.25, 575A—\$15.50. Also **SPECIAL HIGH QUALITY ENGLISH ELECTRIC** 6166—\$840. All tubes are factory new, 1000 hour warranty, from the largest wholesale supplier of broadcast tubes. Inquire about our special quotes for complete spare tube kits. **CALVERT ELECTRONICS, INC.**, Dept. BE-2, 220 E. 23rd St., New York 10, N. Y. (212) OR 9-1340.

Will buy or trade used tape and disc recording equipment—Ampex, Concertone, Magnecord, Presto, etc. Audio equipment for sale. Boynton Studio, 295 Main St., Tuckahoe, N. Y. 1-64 tf

RECORDING EQUIPMENT: 2 Ampex professional recorders C-354-2's; 2 used professional turntables 70-D, C-2752's; 1 Control Console including 1 Ampex Mixer and 2 Ampex Remote Control Units; 2 RCA M#44BX Broadcast Mikes. Most of equipment practically new. Used very little. Valued at least \$10,000.00. Will sacrifice for \$5,500.00. Terms if desired. Phone: 229-9577, 2901 No. Blackstone, Fresno, California. 2-64 1t

TRANSMITTING TUBE SALE: Completely Guaranteed. 5736—\$110, 6623—\$115, 891R—\$275 (869B—\$80), 1850A—\$275. Write for complete price list. Thor Electronics Corp., 287 Morris Ave., Elizabeth, N. J. 07207. 2-64 2t

Fairchild Conax—used three months—original price \$345—will sell for \$250. Also one factory rebuilt Presto 1-C Cutting Head—\$75. Quitting business. L. W. Longnecker, 10,389 McKinley, Osceola, Indiana. 2-64 1t

Advertisers' Index

Altec Lansing Corp.	24
Ampex Corp.	18, 19, 33
Andrew Corp.	23
Bauer Electronics Corp.	43
Belden Mfg. Co.	7
Blonder Tongue Labs.	41
Broadcast Electronics.	22, 30, 43
Burke and James, Inc.	40
CBS Labs, Inc.	5
Conrac Div., Giannini Controls Corp.	8
Continental Electronics.	34
Delta Electronics, Inc.	32
Eastman Kodak Co.	21
Electro-Voice, Inc.	38
Electronics, Missiles & Communications, Inc.	4
Fairchild Recording Co.	30
Gates Radio Co.	Cover 2
Gamma Scientific, Inc.	40
General Electric Co.	31
Gotham Audio Corp.	44
The Hickok Electrical Instrument Co.	35
International Nuclear Corp.	29
McMartin Industries.	Cover 3
Moseley Associates.	30
Penta Laboratories.	39
RCA Electronic Components and Devices.	Cover 4
RCA Victor Record Div.	25
Russco Electronics Mfg.	42
Sams, Howard W. & Co., Inc.	47
Sarkes Tarzian, Inc., Broadcast Equipment Div.	3
Saxitone Tape Sales.	50
Scala Radio Co.	50
Sparta Electronics Corp.	26, 27
Swichcraft, Inc.	6
Tektronix, Inc.	9
Telescript, Inc.	37

REMOTE THERMOMETER (Electronic)

Outside temperature from mike position. Installed in less than 1 hour. Ask about our other weather equipment. Send for Brochure P. O. Box 6111, 1246 Shafter St., San Diego 6, Calif. 2-64 1t

Scala Precision Antennas

- ★ OFF-THE-AIR PICKUP—FM or TV
- ★ LOW POWER UHF, VHF TV TRANSMITTING
- ★ STL AND TELEMETERING ANTENNAS

Engineered to meet rigid FM and TV station specifications, and to endure the tests of weather and time.

Built to your specifications by

SCALA RADIO CORP.

2814 19th STREET
SAN FRANCISCO 10
VA 6-2898

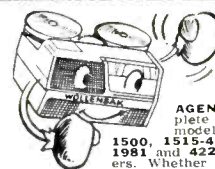

WOLLENSAK Tape Recorders

deliver a wallop bigger than many twice the size.

ATTN: SCHOOLS & GOVERNMENT PURCHASING AGENTS: We have the most complete selection anywhere. New models include: 524, 1400, 1440, 1981 and 422, & SA-421 speaker/amplifier or 1000 units.

1500, 1515, 1570, 1780, 1580, 1980, 1981 and 422, & SA-421 speaker/amplifier or 1000 units. Your order receives prompt attention.

REQUEST COMPLETE TAPE RECORDER DISCOUNT SHEET SAXITONE RECORDING TAPE

275' plastic, 3" (in mailable box) ..	.35
600' acetate (plastic) 5 inch.....	.75
600' MYLAR 5 inch reel85
900' MYLAR (polyester), 5 inch.....	.89
1200' MYLAR, 1/2 mil, 5 inch reel....	1.18
1200' acetate (plastic), 7 inch.....	1.59
1200' MYLAR, tensilized, 5 inch.....	1.15
1200' MYLAR, 1 1/2 mil. (strong).....	1.29
1800' acetate (plastic), 7 inch.....	1.39
1800' MYLAR 1 mil. thick, 7 inch.....	1.89
2400' MYLAR, untensilized, 7 inch....	2.59
2400' MYLAR, tensilized, 7 inch.....	2.89

(Greater discounts to quantity buyers)

Plus Postage
Save
30-60%
4-track Stereo music on tape. FREE 50-page catalog

SAXITONE

div. Commission Electronics, Inc.
1776 Columbia Rd., N.W., Washington 9, D.C.

See You at NAB — Booth 251

McMartin

No other FM MONITORS can do so much!



McMartin TBM-4000

**FM/SCA MULTIPLEX MONITOR
FCC TYPE APPROVED #3-116**

This is the most versatile instrument available for monitoring all main channel modulation and SCA Multiplex operating characteristics. Compatible with FM stereo.

Direct meter readings of:

- Total Modulation
- SCA Modulation
- Crosstalk
- SCA Injection
- SCA Frequencies



McMartin
TBM-3000



McMartin
TBM-3500

**FREQUENCY & MODULATION MONITORS
FCC TYPE APPROVED #3-113, #3-119**

- The TBM-3000 is a completely self-contained frequency monitor and the TBM-3500 is a self-contained modulation monitor.
- The 3000 used in conjunction with either the 3500 or 4000 fulfills the FCC requirement for a station monitor.
- The TBM-3500 is completely compatible with FM stereo.



McMartin TBM-2500

**RF AMPLIFIER FOR
REMOTE MONITOR OPERATION**

The TBM-2500 will drive any combination of two monitors including other brands.

- Isolated high and low level outputs.
- Excellent stability and long tube life.
- 2 watt output with 1000 μ v input.
- Complete with yagi antenna and coaxial cable.

McMartin

Originality by

McMartin Industries, Inc.

605 North 13th Street

Omaha, Nebraska

Code 402 — 342-2753

In Canada Sold By: Canadian Marconi Company, Montreal 16, P. Q.

New RCA-5820A Partial Adjustment Curve—Extension of the RCA-5820A warranty period from 500 to 750 hours' service provides more generous coverage.

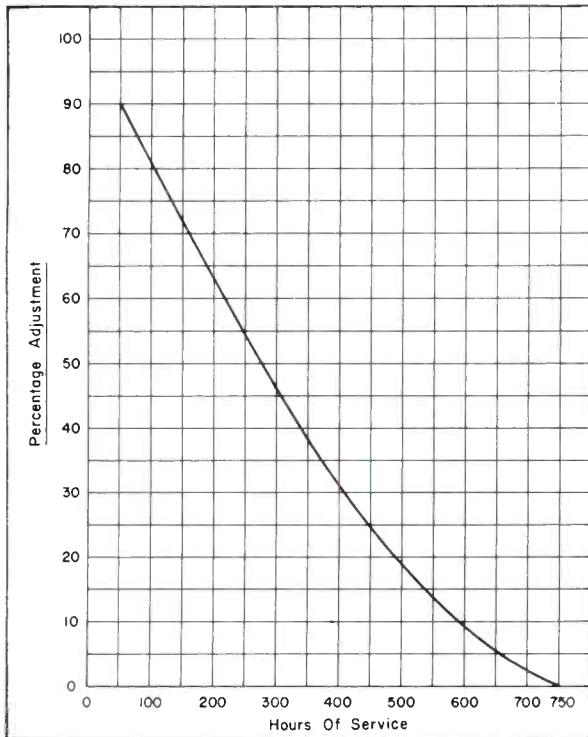

NEW! 50% LONGER WARRANTY COVERAGE

for the popular RCA-5820A image orthicon

RCA now gives further assurance of reliability and economy by extending the warranty period on the RCA-5820A from 500 to 750 hours of service. Hours of service are total hours of operation, including time that power is applied to filament or heater.

RCA electron tubes are manufactured to high quality standards and are warranted against defects in workmanship, materials and construction. If a defect is of a latent nature, it normally will reveal itself shortly after the tube is placed into service and RCA will allow adjustment for the RCA-5820A, subject to the terms set forth herein, in accordance with the following:

Full adjustment is allowed for tubes failing within 50 hours of service. Partial adjustment up to 750 hours of service is allowed in accordance with the Adjustment Policy Table which is shown graphically above. Adjustments are limited to claims presented within 1½ years after the tube was shipped by RCA Electronic Components and Devices.

RCA ELECTRONIC COMPONENTS AND DEVICES, HARRISON, N. J.



The Most Trusted Name in Electronics

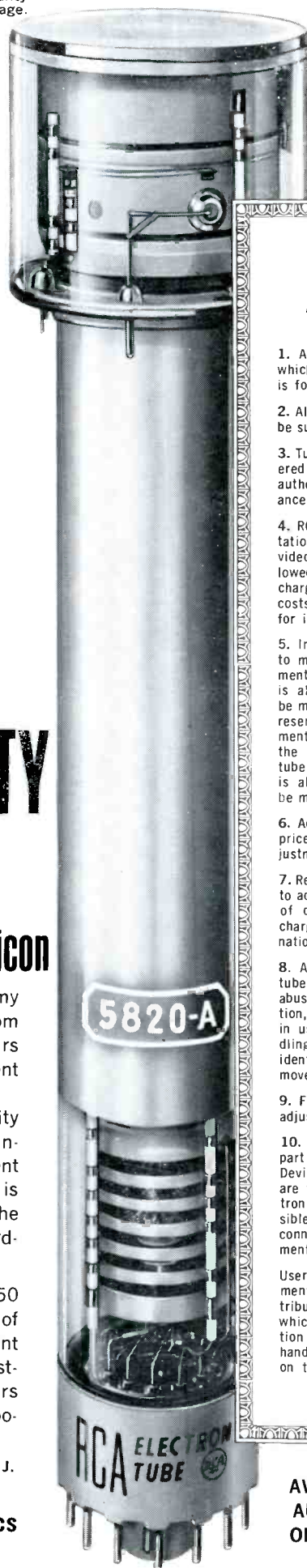

WARRANTY ADJUSTMENT TERMS

1. Adjustment will be limited to claims which are presented promptly after tube is found to be defective.
 2. All tubes claimed to be defective will be subject to inspection and test by RCA.
 3. Tubes returned to RCA will be considered for adjustment only if return was authorized by RCA and made in accordance with instructions issued by RCA.
 4. RCA will be responsible for transportation costs on returned shipments provided adjustment is subsequently allowed. RCA, however, cannot accept charges for packing, inspection, or labor costs in connection with tubes returned for inspection or adjustment.
 5. In all cases, RCA reserves the right to make adjustment by repair, replacement, or credit. Where full adjustment is allowable, adjustment normally will be made by replacement in kind but RCA reserves the right to limit the adjustment period on the replacement tube to the unexpired portion of the original tube warranty. Where partial adjustment is allowable, adjustment will normally be made by the issuance of credit.
 6. Adjustment credits will be based on prices in effect on date of claim for adjustment.
 7. Replacements for tubes found subject to adjustment will be shipped F.O.B. city of destination with transportation charges prepaid by RCA to city of destination.
 8. Adjustment will not be allowed for tubes which have been subjected to abuse, improper installation or application, alteration, accident or negligence in use, storage, transportation, or handling nor for tubes on which original identification markings have been removed, defaced, or falsified.
 9. Final determination as to where any adjustment is allowable rests with RCA.
 10. No warranties or obligations on the part of RCA Electronic Components and Devices, other than the aforementioned, are to be implied with respect to electron tubes, and RCA cannot be responsible for labor or any other charges in connection with the failure or replacement of electron tubes.
- Users should present claims for adjustment to their RCA special market distributor except that a claim for a tube which had an advance Return Authorization packaged with the tube is to be handled in accordance with instructions on the authorization.

AVAILABLE THROUGH YOUR
AUTHORIZED DISTRIBUTOR
OF RCA BROADCAST TUBES