

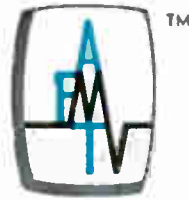

A HOWARD W. SAMS PUBLICATION



FEBRUARY 1965/75 cents

Broadcast Engineering

*the technical journal
of the broadcast-
communications industry*



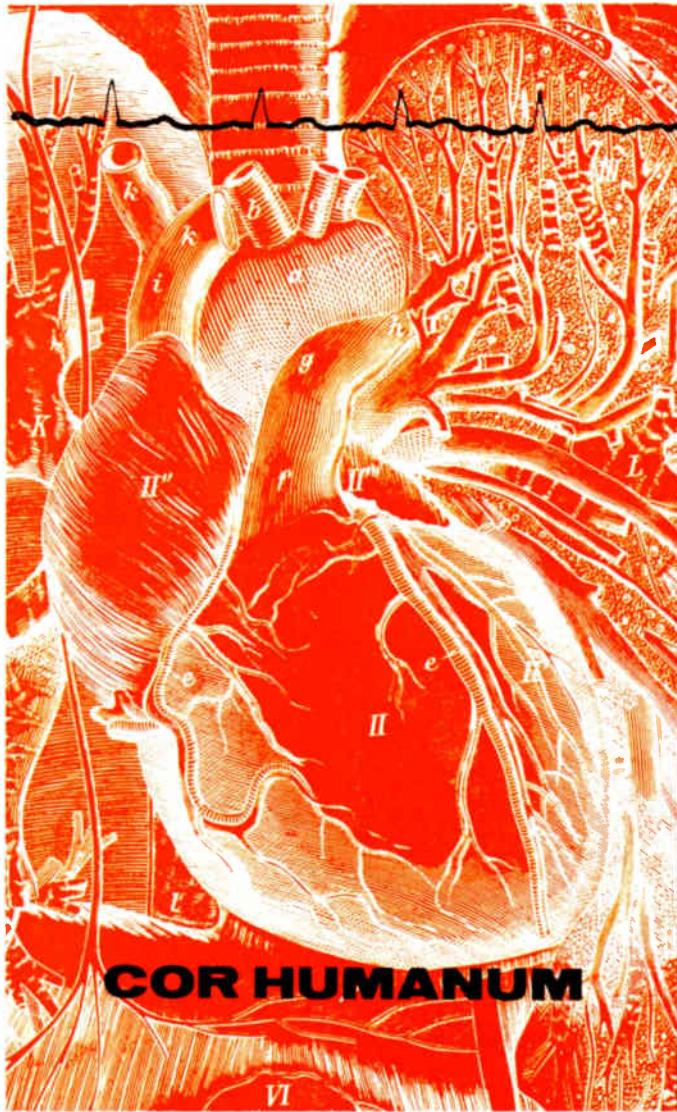

COR HUMANUM

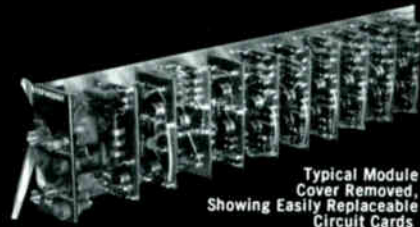
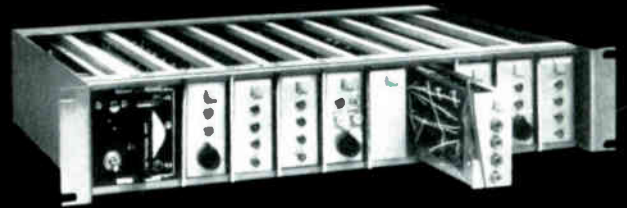

Typical Module
Cover Removed,
Showing Easily Replaceable
Circuit Cards

SYNC GENERATOR
***TV HEART**

2nd BEST WON'T DO

***SYNC GENERATOR—THE REAL HEART OF YOUR TV SYSTEM**

If it falters or stops, everything ceases! Like your heart, it sends pulses throughout your TV facilities. All other equipment depends on its **reliability, accuracy, stability**. Riker Industries Sync Generators are based on computer logic techniques — not merely transistorized versions of tube circuitry. Imagine an EIA Sync Generator so stable that no front panel adjustments are necessary. To be sure, parameters are adjustable but once set, they **DO NOT VARY**—pulse widths and amplitudes are controlled by fixed delay lines, binary counters and zener diodes. From a cold start, all levels are as pre-set. In long term use, there is no drift. Switchable-Free running, Crystal, AFC, Color.

All portions of the Riker Sync Generator are supplied as modules. Systems may be assembled to meet your exact present requirements. Features may be changed or added to meet future needs.

All units, 3½" high, may be rack mounted or in portable cases.

AVAILABLE MODULES: Timer • Pulse Gates • Counter • Pulse Amplifier • Sync Lock • Switchable 3 Speed Vertical Lock • Bar and Dot Generator • Remote and Automatic Sync Change-over • Color Frequency Standard • Subcarrier Regenerator • Diagonal Bar Generator • Vertical Phasing Module.

Proven by 4 years of continuous operation. In use in all major networks, prominent TV centers, the White House and many government agencies.

**IMMEDIATE
DELIVERY**

RIKER INDUSTRIES, INC.

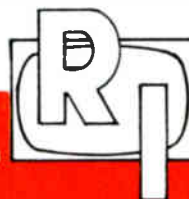

...thinking always of tomorrow

NORDEN LANE, HUNTINGTON STATION, NEW YORK: PHONE 516 HA 1-3444 • MIAMI • LOS ANGELES

Circle Item 1 on Tech Data Card

**How Fairchild puts
psycho-acoustics
to work
for your station!**

Now you can fully utilize the listening capabilities of your audience! Scientists for years have investigated and tabulated the various phenomena that make people want to listen. These findings come under the broad category of psycho-acoustics. Now Fairchild has harnessed many of these findings and incorporated them into a line of unique world-renown audio control devices which produce a sound easier to listen to and easier to perceive... in short a bright, crisp, lively sound which keeps your audience listening. This is the sound you need to help you sell your station to your audience and to your sponsors.



THE DYNALIZER

the Psycho-acoustic way to achieve a bright, full bodied easy-to-listen-to, easy-to-perceive station sound. The Dyalizer contours your station's frequency response to fully utilize the listening capabilities of your audience. Makes your station sound really big, big, big even on the smallest pocket receivers.



THE CONAX

the world-accepted way to control high frequency spillovers in FM due to preemphasis. Lets your station maintain real high levels even with brass and crashing cymbals and still avoid FCC citations.

THE REVERBERTRON



the new compact reverberation system which gives your station that real big voice. With the Reverbertron you can have that Carnegie Hall effect as close as

the gain control on the Reverbertron. And there's the added plus of an increase in apparent loudness of your station sound due to reverberation, as originally described by Dr. Maxfield.

For complete details on psycho-acoustic sound that sells write to Fairchild — the pacemaker in professional audio products.



Circle Item 3 on Tech Data Card

the technical journal of the broadcast-communications industry



Broadcast Engineering

Volume 7, No. 2

February, 1965

CONTENTS

FEATURES

Using Your Transmission Set 12
by Robert L. Miers — Some hints to help the AM-station engineer make use of this important test instrument.

Planning the Low-Budget UHF-TV Station 14
by George C. Sitts — Part I. The answers to some of the questions that arise during the planning of a small-market UHF station.

Semiconductor Applications in Broadcasting 16
by Samuel L. Marshall and S. E. Lipsky — An overall look at the uses of semiconductor devices in broadcast equipment.

Auto Tape Equipment 18
by Thomas R. Haskett — Part 3. This final part discusses the applications of tape recording to program automation.

Review of Vector Computation 22
by James M. Moore — A review of the fundamental information necessary to make practical use of vectors.

Maintaining Dependable CATV Service 28
by Chuck Shank — Some methods to help the CATV system provide its most important product, good pictures.

Coax Line for Transmitting 40
by Patrick S. Finnegan — A review of the characteristics of coaxial line and the most effective ways of installing it.

Concrete FM Tower in South Africa 50
by Steven A. Cisler — A unique structure designed to support FM transmitting antennas high above Johannesburg.

Radio Broadcasting in East Germany 56
by Steven A. Cisler — A glimpse of what broadcasting is like behind the Iron Curtain.

DEPARTMENTS

Letters to the Editor 6

Bulletin from Washington 33

The Chief Engineer 36

About the Cover 44

Engineers' Exchange 60

Book Review 65

News of the Industry 66

New Products 68

Engineers' Tech Data 72

Advertisers' Index 74

Classified Ads 74

PUBLISHER: Howard W. Sams

EDITORIAL: Editor, Forest H. Bell; Managing Editor, James M. Moore; Associate Editors, Allen B. Smith and George F. Corne, Jr.; Washington Correspondent, Howard T. Head.

CIRCULATION: Manager, Pat Tidd; Assistants, Katherine Krise and Cora LaVon Willard.

PRODUCTION: Manager, Robert N. Rippey; Art, Robert W. Pool; Photography, Paul A. Cornelius, Jr.

ADVERTISING: Sales Manager, Hugh Wallace; EAST—Gregory C. Masefield, Howard W. Sams & Company, Incorporated, 3 West 57th Street, New York, N. Y., Phone MU 8-6350; MIDWEST—Howard W. Sams & Co., Inc., 4300 West 62nd Street, Indianapolis 6, Ind., Phone AX 1-3100; SOUTHWEST—C. H. Stockwell Co., 4916 West 64th Street, Mission, Kansas, Phone RA 2-4417; LOS ANGELES 57, CALIF., Maurice A. Kimball Co., Inc., 2550 Beverly Blvd., Phone DU-8-6178; SAN FRANCISCO, Maurice A. Kimball Co., Inc., 580 Market Street, Phone EX 2-3365; PARIS 5, FRANCE, John Ashcraft, 9 Rue Lagrange, Phone ODeon 20-87; LONDON W.C. 2, ENGLAND, John Ashcraft, 12 Bear Street, Leicester Square, Phone WHitehall 0525; TOKYO, JAPAN, International Media Representatives, Ltd., Kisha Kurabu 14, 2-chome Marunouchi, Phone (502) 0656.

SUBSCRIPTION PRICE: U.S. \$6.00, one year; \$10.00, two years; \$13.00, three years. Outside U.S.A. add \$1.00 per year for postage. Single copies, 75 cents, Back issues, \$1.00.

BROADCAST ENGINEERING is published monthly by Technical Publications, Inc., an affiliate of Howard W. Sams & Company, Inc. Editorial, Circulation, and Advertising headquarters: 4300 West 62nd Street, Indianapolis 6, Ind. Copyright © 1965 by Howard W. Sams & Co., Inc.



A HOWARD W. SAMS PUBLICATION



BROADCAST ENGINEERING

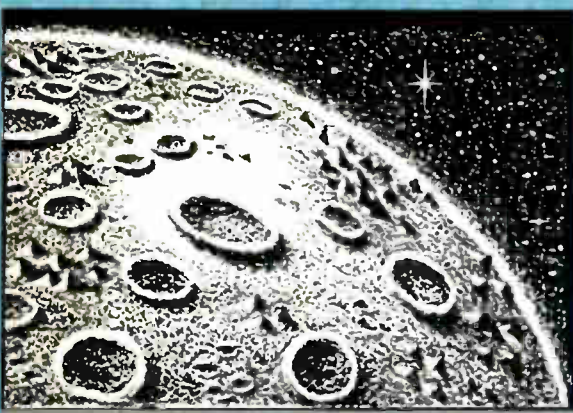

VME

Leads The Way!

IMAGE ORTHICONS • RESISTRONS
STANDARDS CONVERTERS • CENTRAL SYNC. SYSTEMS
ORTHICON CAMERAS • WIRELESS CAMERAS • VTRs

VME VTR'S The World's Only True Helical Recorder



VME 500

Only VME VTR's give you a true helix with resulting single video head simplicity. Exclusive alpha wrap on scanning drum gives 360° scan and absolute minimum image loss.

The VME 600 has the same superior construction and attention to detail inherent in the professional broadcast model VTR (VME 500). Only the VME 600 VTR, successfully demonstrated and professionally accepted by quality-minded TV stations, incorporates engineering advances of the more expensive VTR's selling for up to \$13,000.



VME 600

VME VTR PERFORMANCE DATA

FEATURES AND PERFORMANCE DATA	VME 500	VME 600
Price	\$13,900	\$2,950
Tape Size	2"	1"
Video Response	4.0 megacycles	3.5 mc
Number of Audio Tracks Available	1 to 16	1 to 8
Picture Quality	Full Broadcast	Exceeds 16 mm
Number of Scanning Heads to Replace	1	1
Head Replacement Cost	\$45.00	\$25.00
Scanning Drum Wrap	Helical Alpha (α) 360°	Helical Alpha (α) 360°
Tape Speed	6.75 i.p.s.	5.10 i.p.s.
Reel Size and Type	10 1/2" NARTB	8" NARTB
Video Head to Tape Speed	1180 i.p.s.	892 i.p.s.
Playing Time (With Scotch Standard #388 Tape)	2 hours, 20 min	1 hour, 23 min.

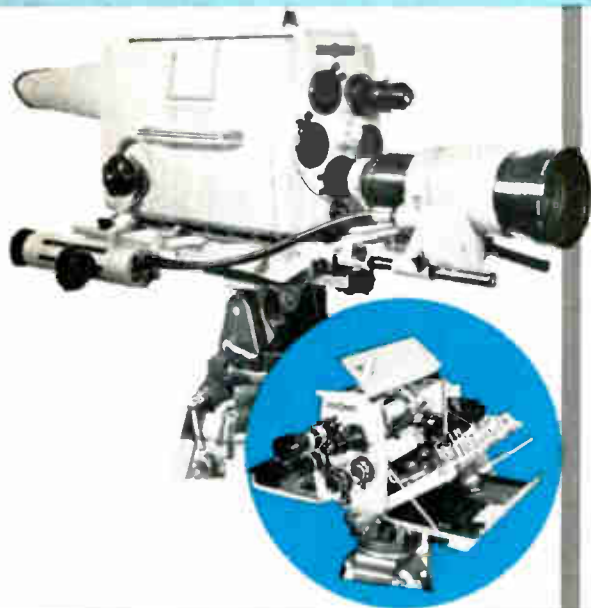

FOR STUDIO / FIELD BLACK AND WHITE PROGRAMS...

The New FERNSEH 3" ORTHICON CAMERA K075D

First temperature stabilized camera with total maintenance accessibility. Opens from sides, top, rear... inside decks slant out, too. Superior performance and maximum stability maintained regardless of temperature change. Features: Novel automatic temperature control for the camera tube • Noiseless fan virtually eliminates pickup by studio microphones • Heater equipment for rapid camera warmup • Iris control driven by noiseless servo motor — remote control and remote indicator at control position • Five-way lens turret with rapid change lens mounts and an illuminated test pattern projector • Lens indicator and camera signal lamp directly below viewfinder screen • Dynamic focus correction gives optimum focus and clean picture background • Automatically operating stabilizer keeps temperature of camera tube constant within a few degrees independent of the ambient temperature — corrects for ambients from 0° to 95° F. • The temperature of target of the image orthicon is read on the meter at the camera control position and is fully adjustable. Request quotation.

Circle Item 4 on Tech Data Card

Write today on your company letterhead for complete details



VIDEO-MEDICAL ELECTRONICS CORP. TIME & LIFE BUILDING
ROCKEFELLER CENTER

NEW YORK, N. Y. 10020. Telephone: 245-2411 Cable: VIDMEDCO. NEWYORK / Telex 224573

Exclusive distributors for:

Fernseh Wireless (26 lbs.) Monochrome Camera with Remote Sync. Used by networks at political conventions.

MORE ON-THE-AIR HOURS WITH THESE PENTA TUBES



PL-6775 unilaterally interchangeable with the 4-400A, reduces the problem of interelectrode shorts and weak plate seals. Because of an exclusive Penta filament-supporting insulator, the PL-6775 can be mounted in any position and will withstand extremes in shock and vibration. The rugged one-piece plate cap and seal won't easily break off, can't fall off. Ratings of this rugged tetrode, now widely used by broadcasters, are the same as for the 4-400A.

PL-4D21A is directly interchangeable with the 4D21 (4-125A) and offers a plate dissipation of 175 watts — 50 watts more than the 4D21 (4-125A). Broadcasters have reported up to three times the life of the conventional 4D21, thanks to the exclusive Penta ribbed anode and the one-piece plate cap and seal.



Write today for full details on both of these rugged, reliable Penta tubes.

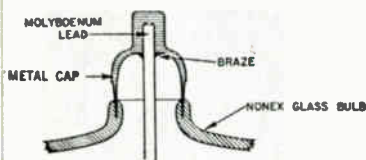

Rugged plate cap and seal used on PL-6775 and PL-4D21A. One-piece, low-loss seal has no screws or pieces to come loose. Won't break off.



THE PENTA LABORATORIES, INC.

A SUBSIDIARY OF RAYTHEON COMPANY

312 N. NOPAL ST. — SANTA BARBARA, CALIF. 93102

Circle Item 5 on Tech Data Card

LETTERS to the editor

DEAR EDITOR:

Some of your readers may need to know where to obtain service information or parts for ITA transmitters. The address is:

Mr. William Johnson
Chief Engineer
Wilkinson Electronics
1937 McDade Boulevard
Woodlyn, Pennsylvania

The telephone number is: area code 215, TR 4-5236. THOMAS R. HASKETT
Broadcast Consultant,
Cincinnati, Ohio

Tom is one of our Consulting Authors. This information is one of the little "extras" provided by this alert group.—Ed.

DEAR EDITOR:

Many times I've wished I had a small, transistorized audio oscillator for making quick frequency-response checks on a remote line, but I've never had time to work out a design for such a tool. An inexpensive unit capable of providing a few fixed frequencies and of being connected to the input of the remote amplifier would be fine. I wonder if anybody has ever built such a thing.

HOWARD WALDEN

Indianapolis, Ind.

Can any of our readers come to Howard's rescue with information on such a device they've built?—Ed.

DEAR EDITOR:

Recently I appealed to the local radio broadcasters for assistance in publicizing the change from CONELRAD to the Emergency Broadcast System, in an attempt to clarify confusion that still exists in the public mind.

They suggested a simultaneous broadcast over all local stations as having the greatest potential impact. Station personnel wrote the script for the taped program, which included the best-known local radio personalities and the Chairman of the Shasta County Board of Supervisors, the County Civil Defense Director, the Mayors of Redding and Anderson, representatives of the Sheriff's Department, and the Civil Defense Coordinator for Trinity County.

The broadcast originated in the studios of KQMS, was transmitted by wire to KAHR, and was then broadcast for off-the-air pickup and rebroadcast by the remaining four area stations. For a 15-minute period the entire area of Shasta and Trinity Counties was blanketed with this program explaining the Emergency Broadcast System.

I am very proud of this effort on the part of these people.

TOM H. GAINES

Shasta County Civil Defense Coordinator,
Redding, California

We appreciate your sending along this information about your EBS publicity campaign. Perhaps other broadcasters will want to try it.—Ed.

BROADCAST ENGINEERING

15 Years Old and Still Ahead of the Times!

E-V It may not look revolutionary today, but fifteen years ago the E-V 655 shown here was unique. Then it was the only truly omnidirectional dynamic microphone on the market. And it offered ruler-flat response from 40 to 20,000 cps, plus plenty of output for critical broadcast applications.

Even today, those specs are first rate. Many of the early 655's are still proving that in dependable daily service. But during the years, E-V has continued to refine and improve so that today's Model 655C can set even better records for performance and service.

Having proved the point, the 655 inspired a complete series of Electro-Voice omnidirectional microphones that serves every need over a wide price range. The full benefit of our fifteen years of design leadership is lavished on even the most modest model in the line.

For instance, every slim E-V dynamic microphone uses the famed Acoustalloy[®] diaphragm. This E-V exclusive insures more uniform response while withstanding the effects of high humidity, temperature, corrosion and shock. It makes E-V omnidirectional microphones almost indestructible.

You'll learn the real value of engineering leadership when you put any of these slim E-V dynamics to work in the field. You can do it with the extra assurance of a *lifetime* guarantee against defects in materials or workmanship. See them now at your franchised E-V microphone headquarters, or write for complete catalog today.



Normal trade discounts apply to list prices shown.

ELECTRO-VOICE, INC.
Dept. 252V, Buchanan, Michigan 49107

Electro-Voice[®]
SETTING NEW STANDARDS IN SOUND

Circle Item 6 on Tech Data Card



THIS IS THE TURNING POINT IN TELEVISION TAPE RECORDING:

The days of updating are over. The days of television tape recorder performance inadequate to the demands of teleproduction are over. The days of equipment performance inadequate to the demands of color recording are over. The days when you are asked to pay upwards of sixty thousand dollars for a recorder that will be technologically bypassed in less than two years are over. Now—for the first time—there is a recorder so advanced it can make superb, broadcast-quality fourth generation black-and-white tape copies. Now—for the first time—there is a recorder capable of producing superb, broad-

cast-quality third generation color copies. The VR-2000 is revolutionary in conception: Ampex engineers made an exhaustive mathematical re-examination of the signal handling theory which had been the basis for all the recorders developed in the last nine years. Result: a new standard utilizing a new high-band carrier/deviation frequency of 7.06 to 10.0 Mc. The VR-2000 is revolutionary in execution: the new criteria called for the development of a completely new head assembly, a completely new mechanical design, a completely new signal electronics system, with built-in Intersync television signal synchronization. Result: a recorder with a S/N ratio up to 46 db; a basic fre-

quency response to six megacycles depending on standard used; a transient response "K" Factor of less than 2%; moiré so minimal as to be virtually nonexistent. Result: a recorder which provides a total teleproduction capability that even includes frame-by-frame animation (when equipped with the exclusive Ampex Editec* System). Result: a recorder that delivers picture quality that has to be seen to be believed. Result: a recorder that marks the turning point of what can only be called a new era in television tape technology. Term financing and leasing available. For information call your Ampex representative or write: Ampex Corp., 401 Broadway, Redwood City, California.

THIS IS THE TURNING POINT IN TELEVISION TAPE PRODUCTION:



SUPERB, BROADCAST-QUALITY FOURTH GENERATION DUBS.

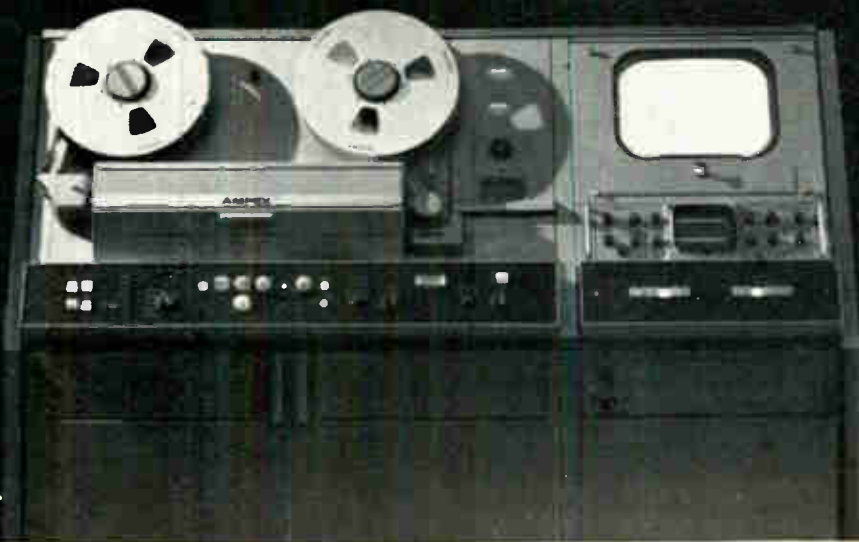

AMPEX VR-2000
TELEPRODUCTION
VIDEOTAPE* RECORDER.

Circle Item 7 on Tech Data Card

T.M. AMPEX CORP.

1 REG. U.S. PAT. OFFICE

©AMPEX CORP. 1965

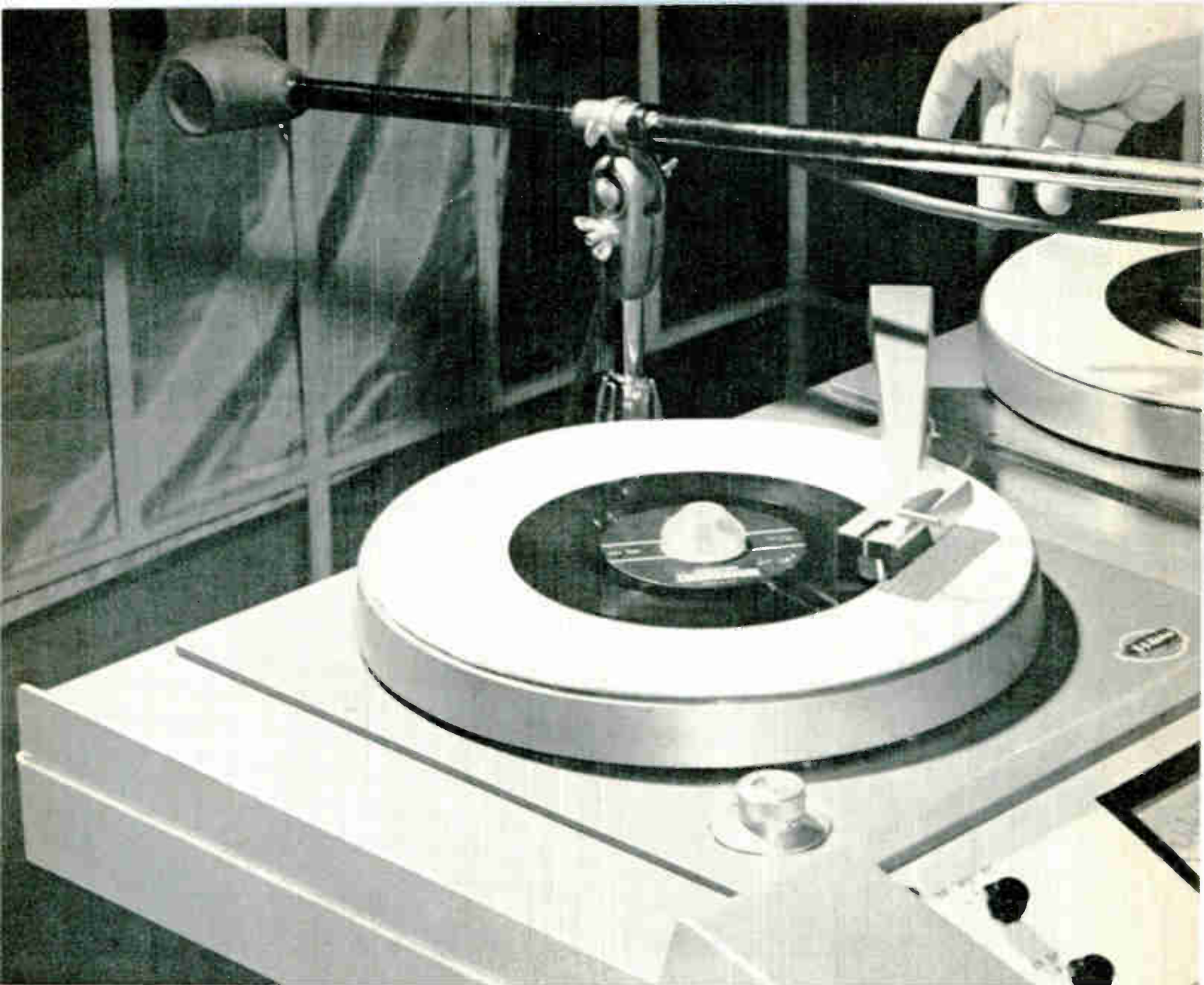

"NOBODY SWEATS"



Read what the pros really say about this

"It's an absolutely professional unit. Has all the built-in features of a station control room."

"We made a check-list, then went to all the manufacturers. Nobody had the completely right unit as a standard item—until Northern came up with this one. *It has every single item that we specified.*"

"Our unit has to take a real pound-

ing on rough roads. But when we get to a remote, we just connect up the lines, plug it in and we're in business."

"Our first unit (of two) is used in our Satellite Studio trailer. Because of its low heat output we saved the cost of extra blowers that other models would have needed."

"Northern are nuts to advertise this

only as a remote unit. It would be a natural as a regular studio control room."

"Maintenance is a snap. Just undo three screws and everything is accessible."

"The only thing that can stop this unit is lack of imagination by the station."



brand new transportable production centre

Capsule specs: start with an improved solid-state version of the rugged 22-type speech input console; add two 12" turntables, full cue, monitor and switching facilities; six additional inputs with plug-in pads for high-low input options. Engineer it for people, package it properly and make it transportable.

*DESIGNED AND MANUFACTURED IN CANADA
BY THE SAME TEAM THAT BUILT THE VIDEO
ROUTING SYSTEM FOR CBS, NEW YORK*

Northern Electric  *COMPANY LIMITED*

Specifications: write Dept. 9950, Belleville, Ontario, Canada.

USING YOUR TRANSMISSION SET

by Robert L. Miers, Consulting Engineer—Some hints for using a transmission set, with emphasis on AM frequency-response measurements.

The engineering staff of the average broadcast station is responsible for making the annual audio proof-of-performance measurements required by the FCC Rules and Regulations. These measurements consist of a noise and distortion check and a frequency-response check. The equipment used to make the measurements consists of an audio oscillator, a distortion meter, a detector, and a transmission set of some kind. Operation of the oscillator and the distortion meter should be explained fully in the instruction manuals supplied with the equipment. The detector can be of straightforward design. Recently, two different approaches to the construction of the transmission set were presented in *BROADCAST ENGINEERING*.^{*} This article presents some useful hints regarding the use of the transmission set in broadcast-station measurements.

Function of Transmission Set

Basically, the function of the transmission set is a very simple one: measuring the output level of the audio oscillator and then reducing this level a known amount so as to prevent overloading of the

^{*}"Two Low-Cost Transmission Sets," by Robert L. Miers and Frank B. Ridgeway, page 14, September, 1964, *BROADCAST ENGINEERING*.

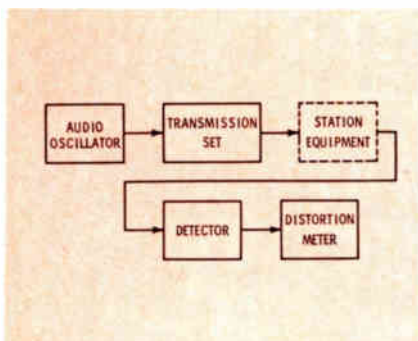

Fig. 1. Block diagram showing equipment interconnections for AM system tests.

input stages of the equipment under test. The reason for using a high oscillator output is obvious: The signal-to-noise ratio can be kept higher under this condition than when the output level of the oscillator is low enough for direct connection to a microphone preamplifier. This high signal-to-noise ratio is not lost by the insertion of attenuators in the system after the oscillator.

Frequency-Response Measurements

The transmission set is perhaps most useful in the area of frequency-response measurements. Several methods of measuring the response have been used. One such method makes use of a constant input level, another a constant output level. In the first method, the transmission set is used merely to set the level going into the equipment under test; thus the operator must rely on the accuracy of the output measuring equipment to determine the deviation from the reference signal level. In practice this is accomplished by holding the input level constant irrespective of the test frequency and reading the deviation on the modulation monitor or some other indicator.

The second method, using a constant output level, is usually more accurate and easier to perform than the first. This second method will be illustrated by the use of an example. The discussion will be based on a standard broadcast station having an audio chain composed of the following equipment: console with microphone preamplifiers and program amplifier, AGC amplifier, limiter, and transmitter.

The Equipment

The equipment is set up for the test as shown in Fig. 1. The audio

oscillator is connected to the transmission set, which in turn is connected to the microphone input terminals on the console. A sample of the RF signal is obtained from somewhere near the final tank circuit of the transmitter and fed into a detector. A distortion meter is connected to the detector output. If valid results are to be obtained from the measurements, good grounding procedures must be followed in setting up the equipment, and the measurements must be made with limiting or AGC amplifiers bypassed.

The detector in the station modulation monitor may be used for these measurements if none other is available. However, using a separate detector permits the engineer to check the modulation monitor as well. One such detector circuit is shown in Fig. 2.

The Technique

The FCC requires that the response of the system be measured in reference to 1000 cps; therefore, the first measurement must be a determination of the signal level necessary to modulate the transmitter to the required percentage of modulation at this frequency. To do this, adjust the 1000-cps system input to produce 100% modulation as observed on an oscilloscope.^{**}

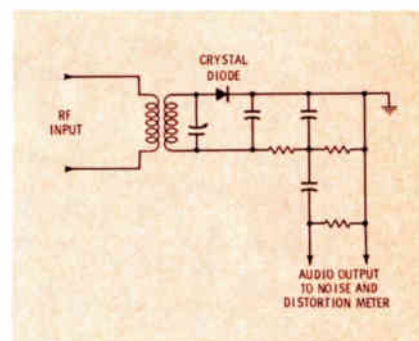

Fig. 2. Simple detector circuit suitable for use with the noise-distortion meter.

As an example, the oscillator output level might be +10 VU, and the attenuators might give a reduction of -64.2 db. The output level of the detector as measured on the VTVM circuit of the distortion meter should be recorded for use in plotting a calibration curve of detector-distortion-meter indication (at 100% modulation) vs. frequency. Such a curve will be useful later in determining lower levels of modulation to a high degree of accuracy.

After the 1000-cps reference level has been established, measurements can be made at the other required frequencies. Assume the oscillator is changed to have an output frequency of 5000 cps and its output level is adjusted to be exactly the same as at 1000 cps. The modulation level is again set at 100% by observation of the oscilloscope and adjustment of the transmission-set attenuators. The variation in response of the system is equal to the algebraic difference between the 1000-cps setting and the 5000-cps setting. Suppose the attenuators read -64.9 db; the difference is +0.7 db. One can reason this result by observing that there was more attenuation (less input to the tested system) in the circuit at 5000 cps than at 1000 cps; the system response must be greater at 5000 cps to produce the same output with less input. Repeating this procedure for the other test frequencies will result in the frequency response data (Table 1) necessary for plotting the curves required by the FCC for the 100% modulation condition. One such curve is shown in Fig. 3. For each frequency, the meter reading at 100% modulation should be recorded for use in plotting the calibration curve previously mentioned.

Modulation Percentages

Determination of the 85, 50, and 25% modulation levels by use of the oscilloscope could be done by the use of the following formula:

$$M = \frac{A - B}{A + B} \times 100\%$$

where,

M is the percentage of modulation, and

**See "Calibration of AM and FM Modulation Monitors," by Robert A. Jones, page 12, November, 1964, and "Letters to the Editor," page 6, January, 1965, BROADCAST ENGINEERING.

Table 1. A typical set of response measurements for 100% modulation.

	30 cps	50 cps	100 cps	400 cps	1000 cps	5000 cps	7500 cps
1	-60.9	-60.9	-60.9	-60.9	-60.9	-60.9	-60.9
2	-57.6	-58.2	-60.3	-60.8	-60.9	-60.0	-59.7
3	-3.3	-2.7	-0.6	-0.1	-0.0	-0.9	-1.7

Line 1 is the setting of the attenuators (in db) for the 1000-cps reference.

Line 2 is the attenuator setting that produced the same output (indicated on the distortion-meter-detector-circuit) at each frequency listed at the top of the table.

Line 3 is the algebraic difference between lines 1 and 2, or the relative response of the equipment under test.

A and B are dimensions measured from the trapezoidal pattern (A being the larger and B the smaller).

This method soon becomes a time-consuming task. Another way would be to observe closely the levels indicated by the modulation monitor. However, the monitor has not been calibrated to the accuracy that would be needed for this purpose. It will be noted that there are a 0-110% scale and a -20-to-0 db scale on the modulation-monitor meter (Fig. 4). This indicates that different percentages of modulation can be compared in terms of decibels. The basic decibel formula is: $db = 20 \log_{10} E_1/E_2$. Since the audio output voltage from the detector is proportional to the percentage of modulation, the ratio of the voltages for two given modulation percentages is the same as the ratio of the percentages. For instance, the audio voltage for 50% modulation is $\frac{1}{2}$ the voltage for 100% modulation (other things

being equal).

The modulation percentages of interest are 100% (easily read on the oscilloscope), 85%, 50%, and 25%. From the foregoing discussion, it can be seen that each percentage corresponds to "x number of db below 100%." If the input to the transmitter is reduced so that the detector voltage decreases by 1.4 db for 85%, 6 db for 50%, etc., the percentage of modulation has actually been reduced to 85%, 50%, etc.

The only problem remaining is to make sure that these level reductions are made accurately. If the distortion-meter-detector-circuit measures directly in db (as some distortion meters do) it is a simple matter to set the modulation level by this method. If the appropriate factor for the frequency in question is taken from the curve of calibration accuracy described earlier and is applied to the meter indications, no appreciable error is introduced

● Please turn to page 63

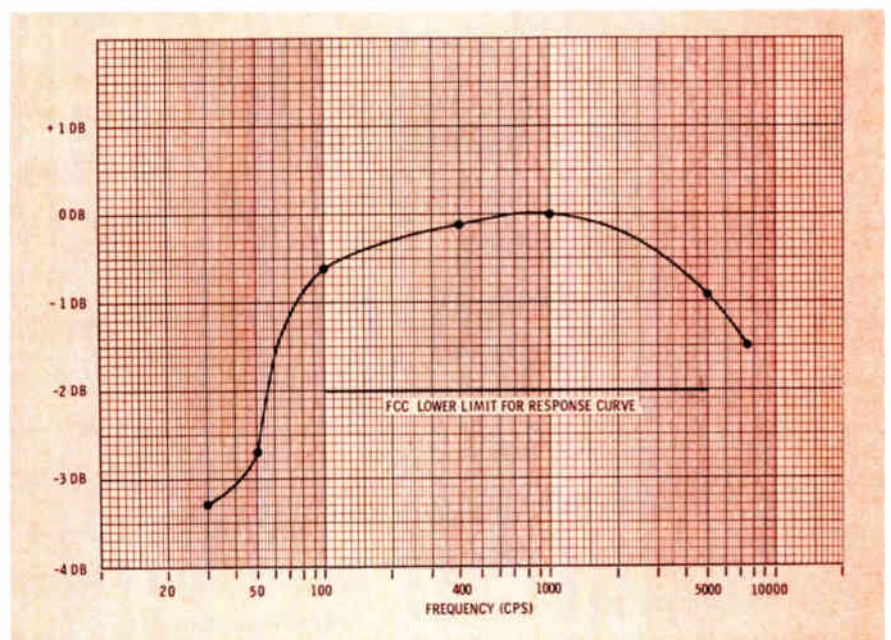

Fig. 3. A frequency-response curve for actual AM equipment (100% modulation).

PLANNING THE LOW-BUDGET UHF-TV STATION

by George Sitts, B-E Consulting Author,
Staff Engineer WHEN TV, Cortland, N.Y.
—Part. I. A compendium of ideas and
suggestions derived from interviews
with engineers who learned the
hard way, by experience.

The all-channel television receiver laws have stirred noticeable interest in the UHF band among medium-market radio broadcasters. To answer some of the questions of engineers and managers considering UHF in these markets, we visited several existing small- and medium-budgeted UHF television stations, talked to many engineers*, and examined their equipment.

Question: What is the first step in planning a low-budget UHF station?

Answer: The would-be owners and managers must decide what market area they want covered. When asked how best to determine potential audience, engineers volunteered that any area where net-

work service would compete with existing VHF service of the same network should be disregarded. To open an independent UHF station, in a market covered by VHF affiliates of the three major networks, will normally entail heavy operating losses for an indefinite period, even in a large urban area.

Q: Once the market area is decided, what comes next?

A: The second step is the selection of the best possible transmitter site. Because of the line-of-sight characteristics of UHF signals, a good site is worth thousands of dollars over a mediocre site because of savings in needed transmitter power, tower height, and translator coverage of shadow areas. While site hunting, look first for a site that will place the antenna within line-of-sight of as many viewers as possible in the market. You cannot count on dependable coverage of shadow areas, even if they are near the transmitter. For example, one station we visited, which had a visual ERP in excess of 200 kw, found it necessary to add a translator to cover homes less

than four miles from the tower, because they were shadowed. Selection of the site should depend on knowledge of the area, a careful review of topographical maps, and trips to several potential sites.

Q: How does one choose from several good sites?

A: Once the choice of sites has been narrowed to those most promising, estimate the transmitter power and tower height each site would need. Most engineers suggest a signal strength of at least 5000 uv/m over the cities and 2000 uv/m in the suburban areas. Besides, the FCC requires a grade-A signal covering the major city. The engineers we talked to found 10- or 12.5-kw transmitters worked fine. Those who had started with less power found it necessary to increase to get a satisfactory year-round signal into homes, while one engineer had reduced power because he found a change from 25 kw to 12 kw prompted no complaints, even after a full year's operation at the lower power.

Q: How do tower heights compare?

*Chief Engineers interviewed were: Mr. T. A. Greene, Chief Engineer of WSYE-TV, Elmira, New York, a UHF satellite of a Syracuse VHF station; Mr. Gino Ricciardelli, Chief Engineer of WINR-TV, Binghamton, New York, an AM-radio/UHF-TV combination with separate TV studios and transmitter; and Mr. Louis Stantz, Chief Engineer of WBJA-TV, Binghamton, New York, a low-budget UHF station with combined studio, offices, and transmitter. Photos by Peter L. Tarolli.

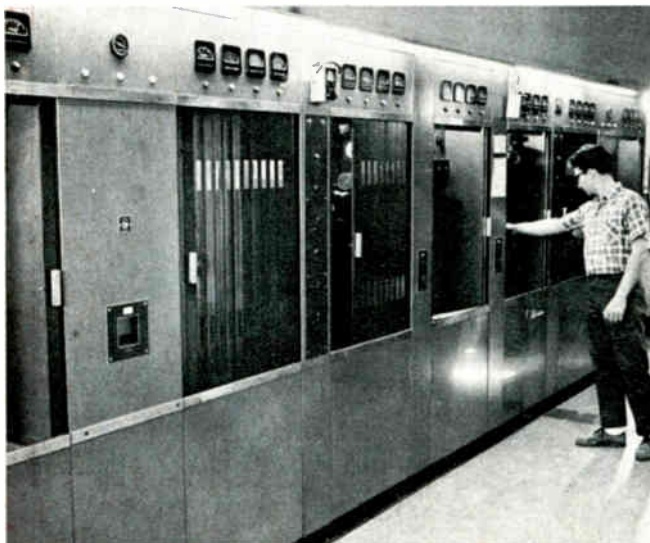

Fig. 1. Partial front view of a UHF-TV broadcast transmitter.

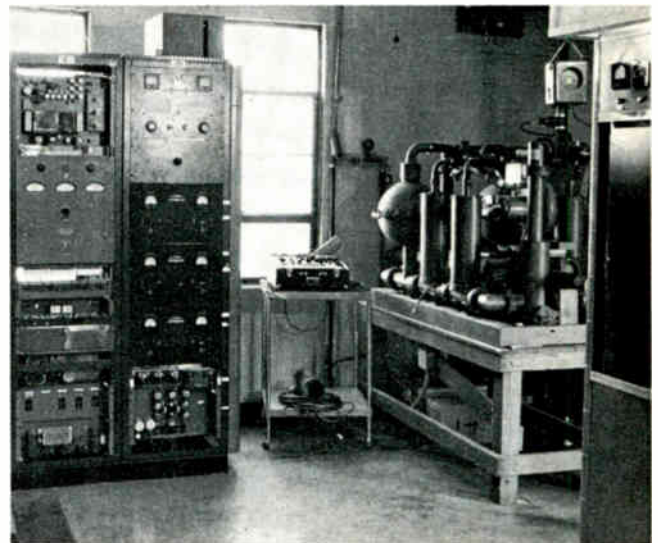

Fig. 2. Diplexer (right) and monitors for transmitter in Fig. 1.

A: Tower size was not as consistent as transmitter power. Towers ranged from 250' to 1000'—supporting the antenna high enough to eliminate most shadow areas. Tower height was used principally to overcome site disadvantages. In general, the better the site and terrain, the less tower height is needed.

Q: How are antenna gain and effective radiated power decided?

A: The stations we visited had antennas with gains from 20 to 55. Some electrical and mechanical tilt was also used to cover nearby receivers. All these antennas were of the omnidirectional type, although currently the FCC allows directional antennas in the UHF band. It was suggested by the engineers that, in planning a new operation, tower and antenna be custom designed to cover most effectively the specific market. Present developments in antenna design allow an engineer to put strong lobes of power into distant areas while supplying medium signals close in and nulling signals that would otherwise be dissipated into mountains or over water.

Q: What other factors can help in selecting a site?

A: There are several: First, if there is another UHF station already established in the area, consider locating the transmitter near it. Engineers who have transmitters located on opposite sides of a market area report they are sometimes faced with the problem of encouraging homeowners to install a separate antenna for each station.

Second, there are a number of factors which must be investigated to determine the total initial cost of the transmitting site—such as cost of land, building, tower erection, access road, availability of electrical power, phone lines, water, and sewage facilities.

Q: Are there any precautions to take when investigating these details?

A: There are several points. First, transmitters, except the very-low-power types, use three-phase AC power. A 12.5-kw transmitter uses about 400 amps of 230-volt three-phase power. Keep in mind that many rural high lines are not three-phase; be sure the power estimate specifies three-phase. Concerning building power, most of the locations visited used another 400 amps at 230 volts in addition to the transmitter demands.

Second, there are different ways to obtain a network signal. The major routes are covered by AT&T, which keeps signal quality high; if AT&T service is reasonably available, use it. Stations located away from AT&T video circuits must rely on other means of securing network service. The simplest is a direct air pickup of the network signal as it is broadcast from a station on a network circuit. Direct pickup has its disadvantages, though, because the fact that one has a network affiliation implies that strong network signals are not available in the area. It is true that the transmitter site, if it has been carefully selected, is likely to be an

excellent pickup point. It is also true that several thousand dollars could be spent on reception equipment which the average homeowner could not afford even if he had such a good location. In practice, however, most engineers find that the signal is not strong enough to be entirely satisfactory even though high-quality pickup equipment is used. In these cases, the stations microwave the signal from some pickup point closer to the sister network station. This is done either by a contract with a microwave network, such as those serving CATV's, or by setting up a special link.

Q: What recurring costs are associated with the site itself?

A: Water, power, telephone, road maintenance (repair and snow removal), taxes, and network-signal operation expense. After comparing the costs of each proposed site and its geographical location, pick the best and yet the most economical site.

Q: What steps come after selection of a good transmitter site?

A: Once the theoretical work is complete, obtain a land option on the site, remembering to allow enough space to include tower-guy anchors. Then file with the FCC for a television construction permit. Once this is approved, and it may take some time, the building can be planned.

The building should be located far enough from the edges of the property so the tower can be next

● Please turn to page 65



Fig. 3. Console serves as control center in typical UHF station.

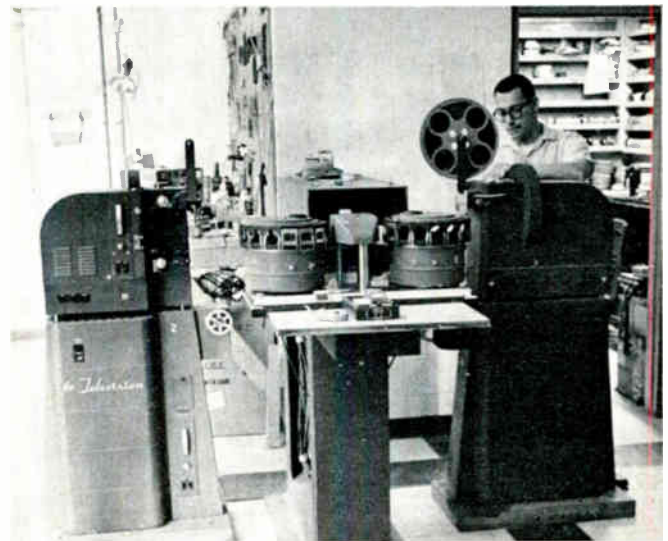

Fig. 4. Film island is located behind console in control room.

SEMICONDUCTOR APPLICATIONS IN BROADCASTING

by Samuel L. Marshall and
S. E. Lipsky — A look at some of the
ways in which semiconductor devices
are used in broadcast equipment.



Fig. 1. Solid-state remote-pickup units.

In recent years transistors have been used increasingly in broadcast transmitters. Although these applications have not always been concerned with the direct generation of RF power, recent improvements in transistor technology will permit the design of many oscillator and low-level stages utilizing high-performance transistors to replace vacuum-tubes.

At present, transistors are found mostly in audio and remote-pickup equipment. Here the advantages of extreme linearity, low hum and noise level, and low power consumption are important. In television remote-pickup equipment, use is made of the high circuit-density capability of the transistor to achieve portability. The high reliability of the transistor, as compared to the vacuum tube, is an advantage in relay equipment that must be capable of long periods of

dependable unattended operation.

Transmitter RF Design

Transistors used in RF-amplifier applications generally offer low gain and limited power-handling capability. This is due chiefly to the conflicting requirements of narrow base width and large junction area for heat dissipation.

The frequency of operation is a determining factor in the selection of a transistor for any transmitter RF application. In the common-emitter configuration, the alpha cutoff frequency is divided by the power gain. The capabilities of the transistor are thus limited as a function of frequency. Currently, transistors capable of direct operation at 160 mc with power outputs of two watts are generally available, and varactor multipliers can be used to provide power outputs of 10 watts at frequencies as high as 1000 mc with power inputs of 45 watts at fundamental frequencies around 80 mc.

Because of these considerations and the obvious advantages of portability and low power consumption, transmitter RF applications of transistors in broadcasting have been concentrated in the area of remote equipment.

Fig. 1 shows a solid-state TV relay transmitter and receiver. This equipment operates in the 2000-mc band to provide a relay link for

remote and special-event coverage. The transmitter (Fig. 2) produces 1 watt of power output and requires an input power of 32 watts. The frequency chain starts with a 500-mc transistorized oscillator followed by a four-times varactor multiplier. The receiver (Fig. 3) makes conventional use of transistors and features a 10-db noise figure.

Another application of transistors in television remote-pickup equipment may be found in the portable television pack set. One such system is comprised of three basic assemblies, the hand-held camera, the viewfinder, and the back pack (which includes the transmitter); Fig. 4 is a block diagram of the overall package, which is completely transistorized. In actual use, an additional 161-mc receiver is utilized to add a cue channel and to pick up a 60-cps reference signal to maintain synchronization of the equipment to the rest of the installation. The video signal is received by a tracking microwave receiving station, as shown in Fig. 5.

An indication of the type of solid-state RF design possible in transmitting equipment may be best illustrated by considering some present applications of RF transistors in communications equipment. Fig. 6 is a block diagram of a 150-mc, 15-watt FM transmitter. The circuit starts with an 18.75-mc oscillator, the output of which is mul-

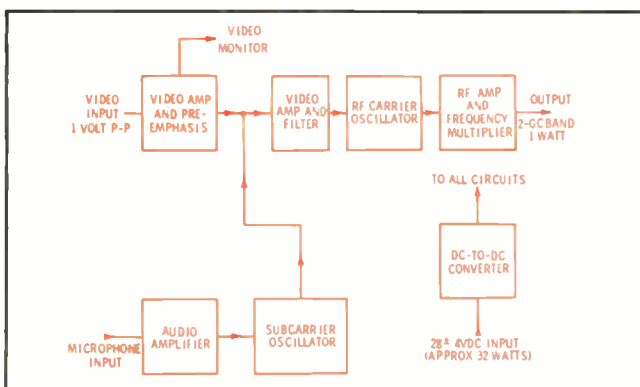

Fig. 2. Block diagram shows operation of TV relay transmitter.

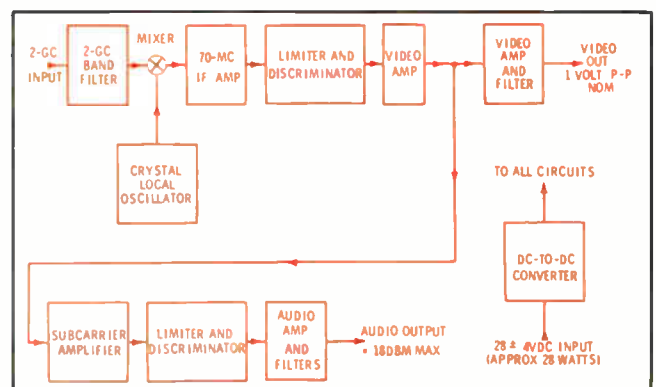

Fig. 3. Block diagram shows the stages of TV relay receiver.

tiplied and amplified to provide a 75-mc signal source to drive a varactor doubler.

In general, it is desirable to obtain the carrier-frequency output from a power amplifier. However, at high frequencies the dynamic output resistance is quite low, and the output coupling circuitry is heavily loaded. This limits the amount of useable power that can be transferred into the load. At a lower frequency, the dynamic output resistance of the transistor is higher, and the operation is more efficient. For this reason the varactor multiplier finds common use. Rejection of the fundamental signal (75 mc in this case) is always a requirement; this is usually accomplished by a parallel-resonant trap (L12-C23 in Fig. 7).

Frequency modulation is quite easily obtained by use of a reverse-biased varactor placed across the crystal. The OR gate shown in the power-supply circuit permits overriding the standby voltage when the high-voltage (40V) supply is activated for transmit. Circuits similar to the one described here can be found in equipment operating on frequencies as high as 235 mc.

Broadcast Studio Equipment

The transistor offers many advantages for broadcast studio equipment. Low noise and almost complete lack of hum and microphonics make the transistor desirable for use in input amplifier stages for both TV pickup equipment and low-level audio amplifiers. The fundamental low impedance of the device makes transistor circuitry highly compatible with audio transmission lines and low-impedance matching networks. High reliability and low heat dissipation offer further advantages in console and

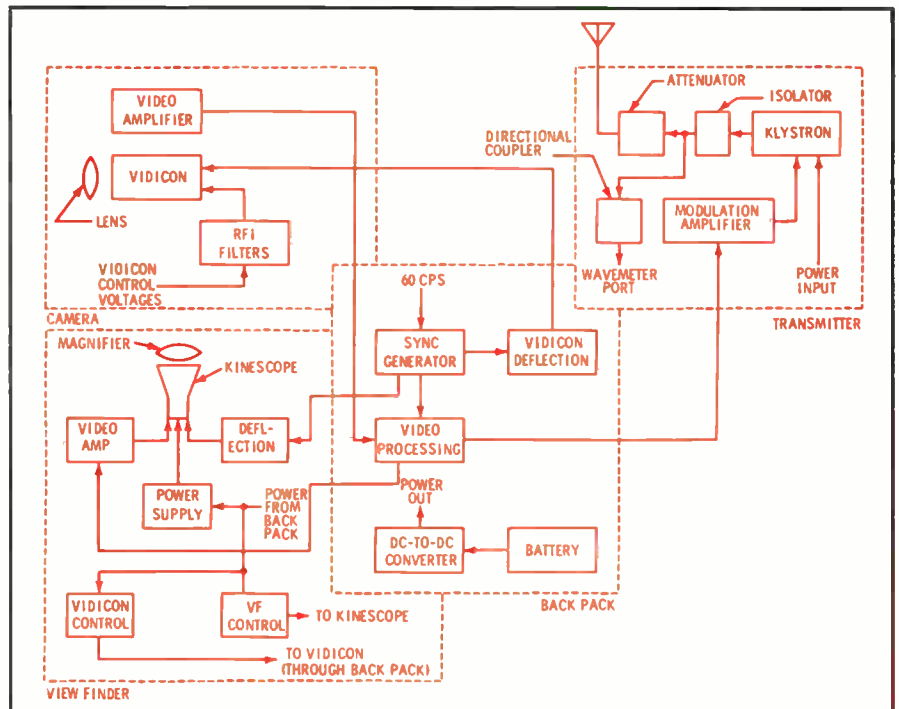

Fig. 4. Diagram shows transistorized, three-unit, portable remote camera system.

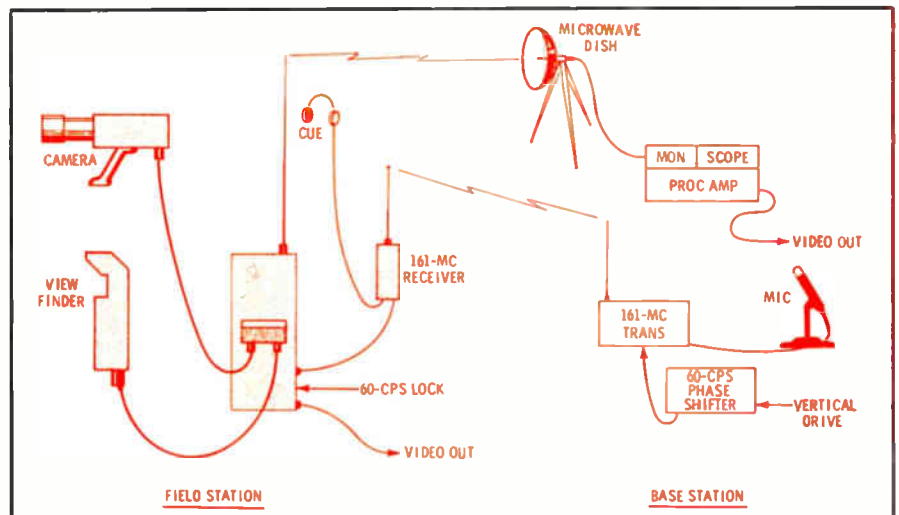

Fig. 5. Complete system used with the remote camera in the diagram of Fig. 4.

hard-to-service rack equipment.

Fig. 8 shows a fully transistorized color TV camera. The only vacuum tubes used are the four pickup tubes and the display tubes used in the

viewfinder and monitor. Transistorization makes this camera only slightly larger than tube-type black-and-white equipment. Some meas-

• Please turn to page 64

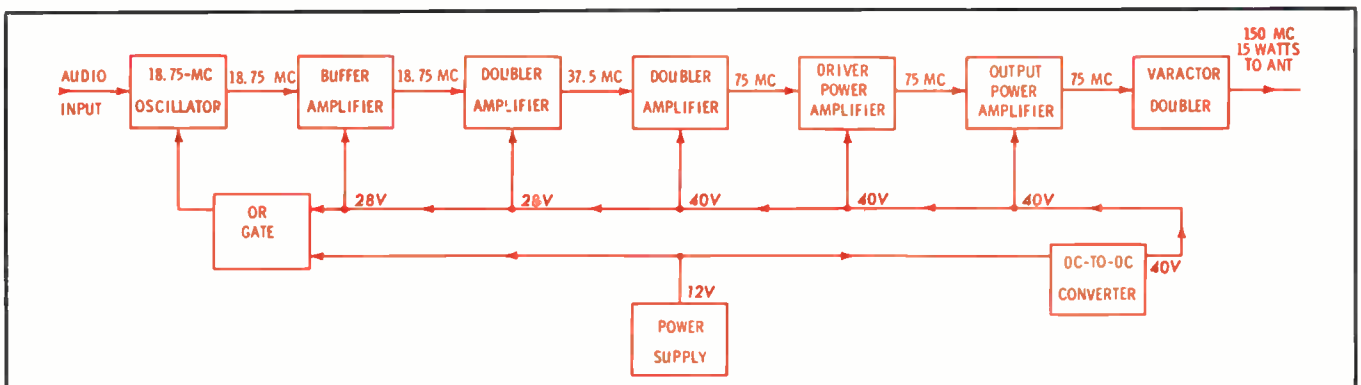

Fig. 6. This FM transmitter employs an entirely solid-state design and delivers an output power of 15 watts at 150 mc.

AUDIO TAPE EQUIPMENT

by **Thomas R. Haskett**, Consulting Author, Haskett & Volkman, Cincinnati, Ohio — Part 3. The conclusion of a thorough analysis of modern sound recorders for the broadcast industry.

The first installment covered studio-type and AC-operated portable recorders. In Part 2, we discussed on-the-scene battery-powered portables, examined film-sync systems, and peered closely at cartridge machines. This brings us logically to the subject of this final installment—automated audio systems.

Basic Principles of Automation

For many a radio station today, automation means the difference between profit and loss. All radio automation systems use audio tape gear in one form or another.

From the earliest days of FM simplex, it has been considered obvious that a human operator is wasting his time performing routine mechanical jobs, and management is wasting money paying him several dollars an hour for throwing switches and cueing records. Somewhere along the line, the idea of an automatic programming device was born. Since then the idea has been applied to SCA multiplex, main-channel FM, and, more recently, to AM. Wherever music constitutes the major program ingredient, automation can be used successfully.

Those elements in a station's programming which do not change from week to week are inserted in the system, placed on tape, and repeated *ad infinitum*. The elements that do change—such as spot announcements and/or promos—must be replaced in the system each time they change. Or they must be available in a "bank" which the system can draw upon any time they are scheduled. At any rate, because of duplication in music and some commercials, automating saves man-hours and dollars.

Small System

One of the earliest and simplest designs, still used today for limited applications and short intervals, is

the tape-controlled, nonclocked, two-source system. The first program source is an R-R (reel-to-reel) transport, diagrammed in Fig. 1, which contains voice announcements. Since there is no clock, control is effected on an elapsed-time basis. The second program source may be another R-R transport with a music tape, or a Seeburg changer containing a hundred 45-rpm records. The relay panel performs the actual switching functions.

Originally, the silence between announcements was used to trigger the relay panel into the following sequence of operations: start music-source motor; transfer amplifier input to music source; stop announce-source motor. After a musical selection, the sequence was reversed to produce another announcement. To prevent dead air or wowed records, an advance head was employed on the announce transport to sense upcoming silence, so that the record could be started ahead of the actual end of the announcement. However, record cueing was still a problem with the Seeburg changer, and was generally overcome by using a sound-operated relay. The record was then run into the music, backed up, and stopped—just as a human operator would do.

Two systems of control on the announce tape were then developed.



Automation programmer and logger.

A run-in transport with an advance head would cue itself to the next spot, in the same manner described above for discs. Another method was to use a subaudible tone (usually 25 cps) on the voice tape. A detector was installed on the control panel to respond to these 25-cps pulses and trigger the relays. This gave positive control of sequencing, and the 25-cps tone was filtered out of program audio. Meanwhile, the silence method ran into trouble on classical music, where low-level passages caused dropouts and falsing. One solution was to use a continuous 25-cps hold-in tone on the music tape. (Of course, this could not be done on the Seeburg changer.)

A belt-plus-suspenders system was then tried, which utilized both a 25-cps hold-in tone and a 35-cps sequencing tone. Tones were recorded on the music tape at -17 dbm, using filters. This has largely given way to the present standard—using 25-cps (sometimes 20-cps) sequencing cue on all R-R transports, whether music or voice. Referring again to Fig. 1, assume that a spot is being played on Source No. 1. At the spot's end, the beginning of the 25-cps pulse on the announce tape triggers the relay panel, which starts the motor of Source No. 2 and transfers transmitter audio feed from Source No. 1 to Source No. 2. Thus, following the spot, the listener hears music. Meanwhile, the 25-cps burst from Source No. 1 has armed another relay. The cessation of the burst fires this relay, which opens Source No. 1's motor circuit, stopping the transport.

Development of the cartridge tape recorder has increased the flexibility of automation systems. Thus, in the basic two-source system, the first source might be a single cartridge unit loaded with a

31-minute cartridge containing announcements. The second source could be a multiple-cartridge handler containing a number of musical selections on separate cartridges.

Medium System

More sophisticated and reliable operation over greater time intervals is possible with an intermediate system, which includes a programmer (or control), a clock, and two or three program sources (R-R, cartridge, or record changer). As Fig. 2 shows, the programmer frees the transports of the necessity of containing both control and program material, and allows more positive control, minimizing error.

Some programmers are self-contained, automatically sensing cues and triggering each sequence; others require detectors and slave relays to carry out these subsidiary functions. Ordinarily, the programmer is in charge of the system, running it on an elapsed-time basis according to a preset sequence of events. This may involve presetting a number of switches. However, at specified and regular intervals (say, every 15 minutes) the clock overrides the programmer, fading audio and transferring it, bringing the system back to real time. Motor-speed or control errors are thereby corrected.

Some systems use a time fader, which merely carries out orders of the clock regarding fading and transferring audio. Although available separately from some firms, this function is often included in the clock used by others. Medium systems usually have three program sources; while two sources can handle simple programming,

three allow variety in music and announcements.

Programmers cost from \$75 to \$3700, depending on the number of steps they can perform, the number of inputs they can handle, and whether or not they include such things as a clock, sensing and triggering relays, etc. Clocks cost from \$500 to \$1000.

Large System

All of the above elements, plus a few more, are used in a full system, which can program a station for long intervals (4, 8, or 12 hours) with an almost "live" sound. Two or three program sources, as outlined in Fig. 3, may be devoted to music exclusively—two for scheduled selections and one for fill. One source may contain a talk tape, wherein the DJ introduces records. Another source will, of course, handle spot announcements.

Since the use of a clock makes it possible to run entirely on real time, a time announcer may be used to inject a feeling of immediacy in the program. This usually consists of two transports (or a multiple-cartridge handler) arranged so that one channel contains even-numbered minutes, while the other has odd. A control chassis, acting upon trigger pulses from the clock, alternately cues up each deck. Hence one deck or the other is always cued and available for operation upon command of the programmer. Of course, only 30 announcements are needed on each transport. Meanwhile, the programmer has been preset to call on the time announcer at certain times during the broadcast day. No matter when these an-

nouncements are programmed to occur, the time announcer delivers the correct time. A time announcer costs \$1000 to \$1500 and includes both tape decks.

A seventh source—often a cartridge reproducer—may be used for news and other program segments wherein timeliness is important. These bits are recorded in another control room and inserted in the source, being already planned in the schedule. While this might seem a roundabout method of getting a newscast on the air, it's actually the simplest to use in a full automation system. The alternative is to revert to manual control, which disrupts the programmer's scheduling.

Accessory Devices

Restart is, in some cases, a device to provide an emergency sequencing pulse in a cartridge system, if such has been omitted through operator error when a particular cartridge was recorded. It prevents endless repeating of the same cartridge.

Another type of restart is combined with the silence alarm, to get the whole automation system going again after a predetermined period of dead air. This is merely a way to bypass a faulty source. Restart equipment costs approximately \$250 and is sometimes included with the programmer. Some silence alarms are also available separately at a cost of \$200 or so; they simply alert the human operator.

Sometimes, 25-cps generators (for recording control pulses on tape) and detectors are built into systems; in others, they are accessories. An all-cartridge system doesn't normally use 25 cps.

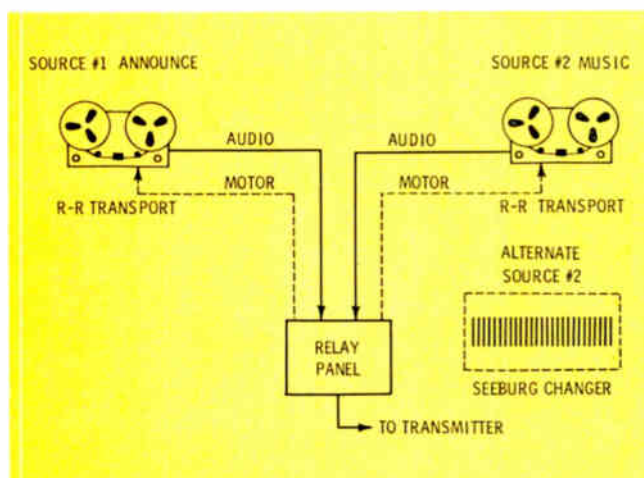

Fig. 1. A simple two-source audio system for radio automation.

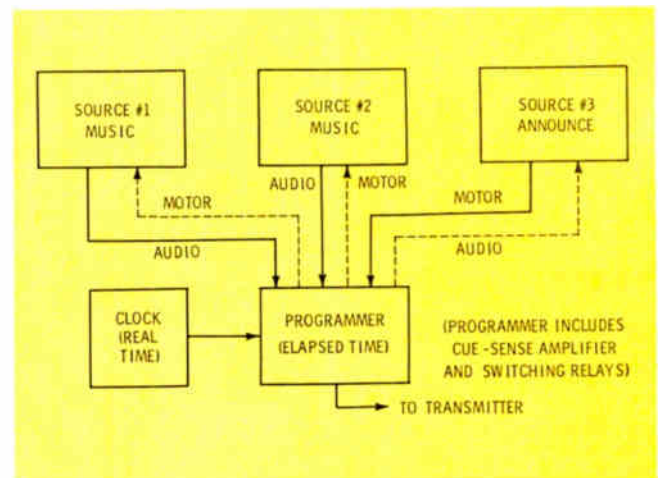
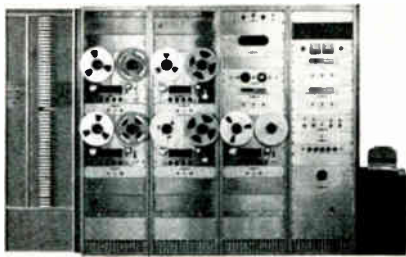

Fig. 2. This medium automation system includes a programmer.



Complex system uses R-R and cartridge.

The **cross-fader** is also optional on some systems, standard on others. It provides "voice over"—the mixing of voice and music from different sources, which creates a "live" sound. It costs about \$500.

The **source alternator** allows up to four program sources to be connected to a single input on the programmer. These four are then alternately selected—started, stopped, and switched. This feature can be used to multiply the maximum inputs in an existing system.

The **spot selector** permits the user to locate recorded spots, either on an R-R transport or on a multiple-cartridge handler. Cost is around \$1000, including tape decks.

The **network programmer** allows a network line to be integrated with local shows on a real-time basis, and costs \$4000 or so.

Although any automation system can be manually overridden, the need seldom occurs with a full system. For one thing, automatic restarts and loss-of-program alarms make it unnecessary. Also, many live segments can be smoothly integrated with the automated program by recording them on cartridges and feeding them in at preselected time slots. Of course, there are still a few programs that cannot be successfully automated—telephone interviews, sports, and some special events, for example. But these are exceptions.

Automation Systems and Services

Radio automation companies provide one, two, or three types of systems or services, or any combination. All modern systems can handle either mono or stereo.

The **equipment package** consists of specified devices which together will provide partial or full automation. Sometimes the package can be modified or expanded; sometimes it can't. Package cost varies from \$1850 to \$7500. At least one can be leased at a monthly cost of from \$350 to \$550.

The **custom installation** is extremely flexible and designed to the client's exact specifications. Hence the system can be simple or complex. A custom job is almost always used for full automation, especially by AM stations. Note that some firms manufacture both control and source components, while others manufacture only control, supplying source components from other companies. Custom jobs run \$5500 to \$18,000 and sometimes more.

The **program or music service** is often available separately for those stations which already possess equipment. Some program services and equipment are designed around each other, however, and must be obtained in combination. The difference between a program and a music service is that the first contains both music and talk (i.e., music intros) while the second contains only music. Generally, main-channel service is furnished at 7½ ips, while background music is at 3¾; mono is full or half-track, and stereo is half- or quarter-track. 20 or 25 cps cue is used. Cost varies from \$125 to \$850 monthly.

Reproducers

Wherever playback only of reel-to-reel tape is desired, reproducers are commonly employed; they contain mechanical and electronic components for playback, but not for erase or recording. **Transports** are just mechanical assemblies—no electronics, although heads are sometimes included. Broadcast automation systems are the major users of both these devices, but they can also be utilized for audition purposes. Transports are often purchased for special custom installations.

Some manufacturers offer reproducers, some offer transports, and some offer both. Almost all have the following minimum features: Standard 19" rack mounting; ¼" tape; 7½ ips; remote control. In addition, most have automatic shut-off and pushbutton control of tape motion, along with automatic reversing, 10½" or 14" reel capacity, and hysteresis-synchronous motor driving the capstan.

General features of reproducers and transports are: Mono or stereo—full, half, and quarter track on ¼" tape; some can take ½" and 1" tape; 3, 4, and 8 channels;

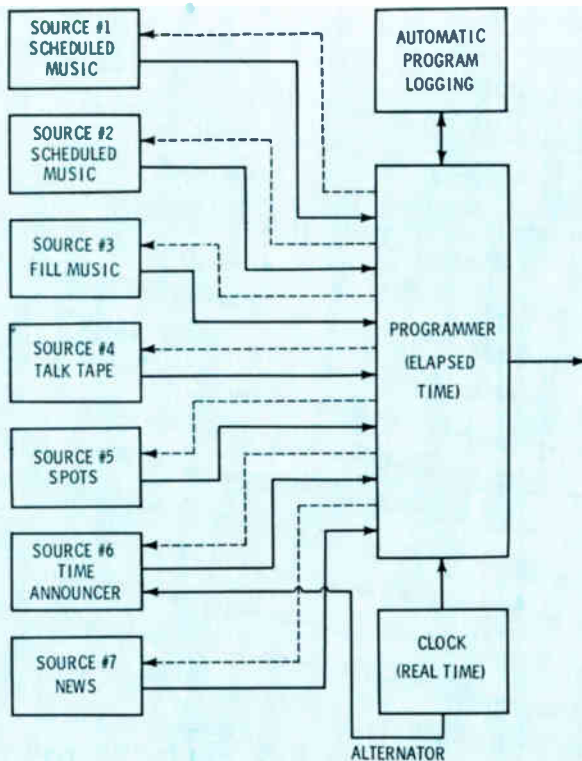

Fig. 3. Programmer-controlled, clocked, time-announced, logged—with multiple sources.

speeds from 60 to $1\frac{1}{8}$ ips, usually with a choice of two adjacent speeds: frequency response ± 2 db from 30 to 15,000 cps; stereo cross-talk 45-50 db; signal-to-noise 55 db; flutter and wow .1%; timing accuracy .2%; one to five heads, but usually two for reversible play; most have three motors. Output ranges from +4 to +18 vu, usually at 600 ohms balanced, but some have a cathode follower. Three brands use transistor electronics, and some have illuminated push-buttons and function lights. Prices range from \$300 to \$2380.

Logging Recorders

These machines are used to record information for legal or reference purposes, where intelligence is more important than fidelity. Long, continuous duty is necessary. They are usually set up for automatic operation, and tandem transports are used in three of those available.

Generally, there are two types of machines—simultaneous and sequential. Sequential machines record a single channel but reverse direction at end of reel, using four quarter-tracks on each reel. Simultaneous machines record from 1 to 32 channels of information at the same time, although some can be switched to a sequential mode. Tape widths are $\frac{1}{4}$ ", $\frac{1}{2}$ ", 1", and 2", and speeds are usually a combination of $3\frac{3}{4}$, $1\frac{1}{8}$, $15/16$, or $\frac{5}{8}$ ips. All machines come in rack mount, and have a frequency response of 300-3000 cps, harmonic distortion about 5%, signal-to-noise of 30-35 db, and flutter and wow of 1%.

Reel capacity is $10\frac{1}{2}$ " on most, and maximum time per reel varies from 8 to 34 hours. Continuous or intermittent function is available. voice-operated start, and switchable VU meters for setting levels. Some electronics sections are transistorized. Newer features include illuminated function lights, monitor amplifier and speaker, channel selector, twin power supplies with automatic changeover, time-cue injected on cue track (simultaneous models only), and AGC amplifiers. Pricing is \$658 through \$11,500.

Time-Delay Recorders

Machines in this class have this in common: Each records and plays

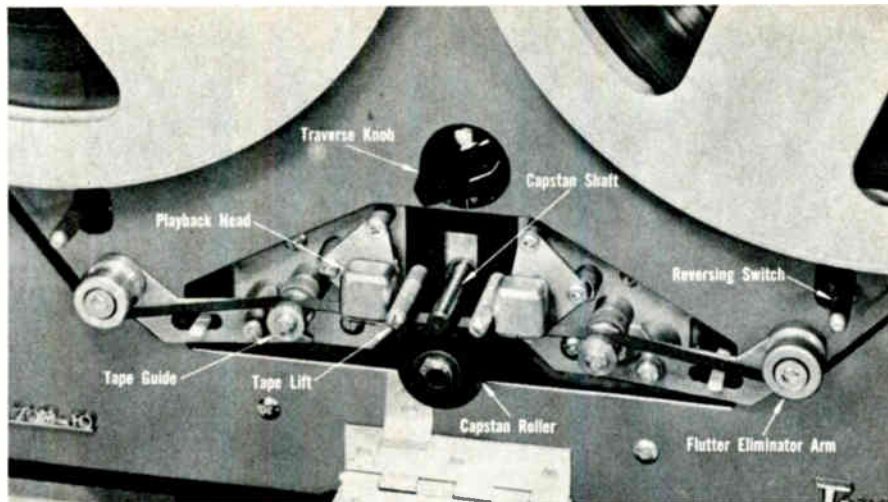

Some major mechanical system details of a reproducer-only reel-to-reel tape machine.

back continuously from a closed loop of tape, using separate record and reproduce amplifiers, making it possible to delay program material for a time which, in some cases, can be varied. Three brands are short-delay reverberation devices, and three brands are long-delay devices.

The reverberation devices permit a time delay of from 30 to 900 msec, sometimes variable. The usual arrangement is a single record head and several playback heads (often movable) arranged around a small closed loop of tape. There are also tone controls, and controls for the rate of decay. One manufacturer offers a stereo model. Pricing runs \$150 through \$3750, and the usual use is to enhance the sound of a recording or broadcast.

The long-delay devices are used for editing of live programs in which listeners telephone comments and the station must protect against objectionable language. These devices are simply cartridge recorders

that have been modified for continuous use as record-playback units. Time delay is variable from 3 seconds to 30 minutes, depending on length of tape in the cartridge. Cost varies from \$295 to \$750.

Conclusion

If any reader wishes to pursue further the subject of audio tape equipment, the following books will furnish basic theory and descriptions of techniques and practice.

Technician Level
Burstein, Herman, and Henry C. Pollak, **Elements of Tape Recorder Circuits**, Gernsback Library, Ind., No. 67, 1957, 223 pp., \$2.20.

Tuthill, C. A., **How to Service Tape Recorders**, John F. Rider, Publisher, Inc., No. 167, 1954, 160 pp., \$2.90.

Weiler, Harold D., **Tape Recorders and Tape Recordings**, Audio Library, Vol. II, Radio Magazines, Inc., 1956, 190 pp., \$2.95.

Westcott, Chas. G., and Richard F. Dubbe, **Tape Recorders—How They Work**, 2nd Ed., Howard W. Sams & Co., Inc., and the Bobbs-Merrill Co., Inc., TRW-2, 1964, 224 pp., \$3.95.

Engineering Level
Frayne, John G., and Halley Wolfe, **Elements of Sound Recording**, John Wiley & Sons, Inc., 1949, 686 pp., \$12.75.
Haynes, N. M., **Elements of Magnetic Tape Recording**, Prentice-Hall, Inc., 1957, 392 pp., \$7.95.

Haynes, N. M., **Transistor Circuits for Magnetic Recording**, Howard W. Sams & Co., and the Bobbs-Merrill Co., Inc., MTR-1, 1964, 384 pp., \$9.95.

Stewart, W. Earl, **Magnetic Recording Techniques**, McGraw-Hill Book Co., Inc., 1958, 272 pp., \$9.00.

Miscellaneous
Bibliography of Magnetic Recording 1900-1953, Sound Talk Bulletin No. 29, Magnetic Products Division, 3M Co., August 1964.

Hadady, R. E., **Bibliography of Magnetic Recording 1954-1961 Inclusive**, Kinelagic Corp., 1963, 19 pp., \$2.00. ▲

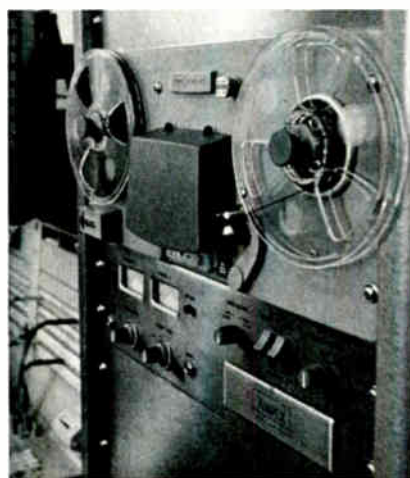

Logging recorder uses slow tape speed.

REVIEW OF VECTOR COMPUTATION

by James M. Moore—A review of what vectors are and how they are used in calculations.

Anyone who is seriously engaged in electronics has occasional encounters with vectors, either when reading technical literature or when solving technical problems. Those whose need to use vectors is infrequent often find that when the need arises their knowledge of the subject is somewhat "rusty." Here, then, is a review of the principles of vector computation that should prove helpful in clearing away the hazy spots.

What Are Vectors?

There are more rigorous mathematical definitions of a vector, but the following one is sufficient for most practical purposes: A vector is a quantity that possesses both magnitude *and* direction. Vector quantities include such things as force, velocity, and acceleration. (A scalar quantity has magnitude only.)

It is often necessary to have a graphical representation of a vector quantity. One cannot draw a picture of "velocity" or "force," so a symbolic representation is needed. An arrow is the logical choice; its direction represents the direction of the vector, and its length represents the magnitude. In common usage, the arrow itself is also called a vector.

It is convenient to specify vectors in terms of some coordinate system. When the tail of the arrow

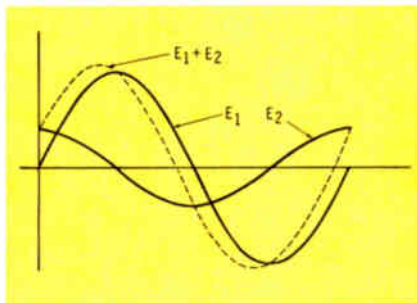

Fig. 2. Dashed curve is sum of others. is placed at the origin, the coordinates of the head end identify the length and direction of the vector (Fig. 1).

Vectors Representing Electrical Quantities

When a person deals with AC electrical circuits, many calculations involve quantities that can be represented mathematically by sine curves. However, sine curves are rather cumbersome with which to work. For instance, if the two solid sine waves in Fig. 2 are to be added, enough instantaneous sums must be found to plot accurately the resultant curve—and the addition of two sine-wave quantities is one of the simplest AC-circuit problems. Some more convenient representation of the quantities is needed.

Assume that a vector, *A* in Fig. 3, rotates (with its tail fixed at the origin) in a counterclockwise direction. Then suppose that the length of the vertical projection of *A* is

plotted as a function of angle θ . The result is a sine wave, as shown at the right in Fig. 3. Thus a sine wave can be represented by a rotating vector.

From the foregoing it follows that two sine curves on the same coordinate axes can be represented by two rotating vectors, as in Fig. 4. At the instant of time depicted in Fig. 4, the vertical projection of vector *A* is *y*, and the vertical projection of vector *B* is zero. After vector *B* rotates through the angle β , its projection will be *y*. Thus the angle β represents the phase difference between the two sine waves; vector *A* in this case leads *B*, or *B* lags *A*. The lengths of the vectors represent the peak amplitudes of the sine waves. The drawing at the left in Fig. 4, which shows the vectors stopped at some instant of time, is a *vector diagram* of the sine-wave quantities depicted in the right-hand portion of the figure. The value of this simple vector representation is that mathematical operations can be performed on the vectors much more easily than on the sine waves. The vectors resulting from these operations represent the sine waves that would result from performing the same operations on the original sine waves.

In order for the vector diagram to be useful, all the vectors must be stopped in rotation at the same instant. Furthermore, they must all be

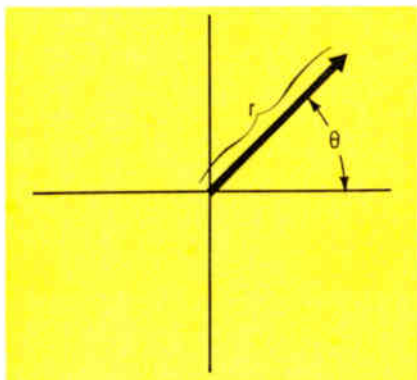

Fig. 1. Arrow represents vector quantity.

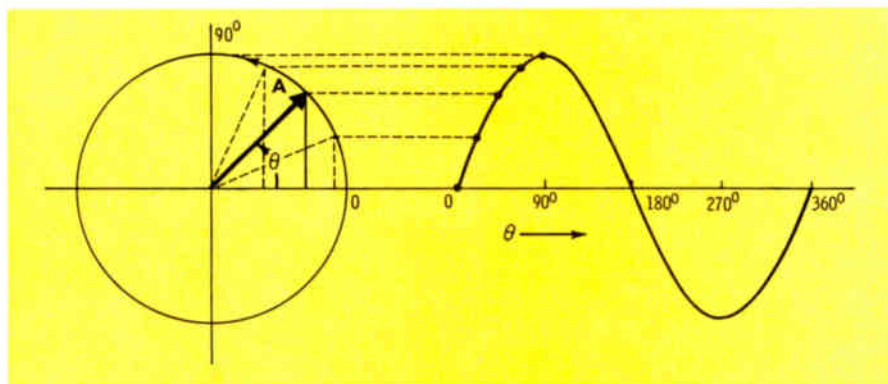

Fig. 3. Sine wave generated by plotting the vertical projection of a rotating vector.

rotating at the same angular velocity (and in the same direction—counterclockwise is standard); that is, the sine waves must be of the same frequency. And, of course, the electrical quantities involved must vary in a sine-wave manner. For convenience, one of the vectors in the diagram is usually taken as a reference, and the phase angles of the other vectors are measured relative to this vector.

The arrows used in this manner to represent sine-wave quantities are not vectors in the sense that arrows representing weight or wind velocity are vectors. For this reason, some authors prefer to call the former "phasors." The term "vector," however, has been used in this sense so long and so universally that this usage will be adhered to in the discussion that follows.

Vector Notation

For identification purposes, vectors are often represented by bold-face or italic letters. The absolute value of a vector, A , (that is, its magnitude) is often represented by the symbol, $|A|$. Other symbols are used in vector algebra of a more advanced nature than is discussed here.

It is frequently desirable to represent vector quantities in numerical terms so that computations can be performed. Where multiplication or division is involved, the vectors are usually written in the form, r/θ , where r and θ are defined as shown in Fig. 1 for each vector in the diagram. This *polar* form of notation, however, does not lend itself to vector addition and subtraction.

A vector can also be defined in terms of the vertical and horizontal coordinates of its head end (in other words, the horizontal and vertical components of its length). Thus in Fig. 5, the horizontal distance, a , and the vertical distance, b , define the vector, A .

When writing the numerical value of the vector, some way must be found to differentiate between the horizontal and vertical components. To explain how this is done, it is necessary to introduce the operator j . This operator, by definition, causes a vector to rotate 90° in a counterclockwise direction (Fig. 6). The vertical component of a vector can be treated as a horizontal component that has been rotated 90°

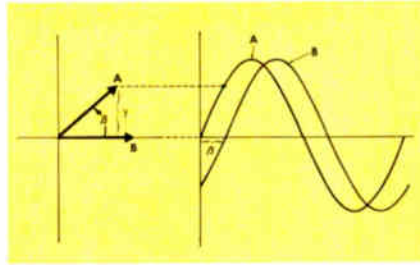

Fig. 4. Vector diagram at left serves to represent sine waves shown at the right.

by the application of the operator j . The vector in Fig. 5 would thus be written in *rectangular* form as: $a + jb$. This form of notation amounts to describing a vector as the sum of two vector components lying along the coordinate axes. (The relationship of a vector sum to its components will be developed later.)

Note in Fig. 6 that two successive applications of the operator j cause 180° rotation of the vector. Therefore, $j^2 = -1$, and $j = \sqrt{-1}$. Numbers that can be written in the form $a + jb$, where $j = \sqrt{-1}$, are *complex* numbers; therefore, in computations vectors are subject to the mathematical rules applicable to complex numbers.

It should be observed that impedance and admittance may also be represented as complex numbers. These quantities are simply the numbers that properly relate the voltage and current in a given circuit. That is, the impedance of the circuit is the number that must be divided into the voltage to yield the current that actually flows in the circuit (or multiplied by the current to give the voltage). Impedance is not a vector quantity like voltage and current, but all these quantities can be represented by complex numbers which follow the same mathematical rules. Thus voltages can be added to voltages, impedances can be added to impedances, currents can be multiplied by impedances, etc.

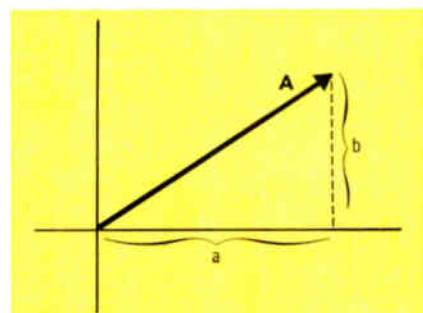

Fig. 5. Vector is defined by components.

Vector Algebra

The basic algebraic operations (addition, subtraction, multiplication, and division) can be performed on vector and complex quantities. It is only necessary to choose the proper form of notation and then to apply the appropriate rules.

Addition and Subtraction

The sum of two vectors representing electrical quantities is defined in a manner analogous to the resultant of two force or velocity vectors. As shown in Fig. 7A, the sum of vectors A and B is a third vector, C , determined by the indicated diagonal of a parallelogram having A and B as sides.

Vectors may be added graphically; the result is found by measurement from a scale drawing. The method of Fig. 7A or the simpler construction shown in Figs. 7B and 7C may be used. The latter two diagrams illustrate an important fact: The order in which vectors are added, regardless of the method used, does not affect the result.

To add three vectors by the graphical method, first find the sum of two of the vectors. The third vector is then added to this result. The method can be extended to the addition of any number of vectors.

Graphical solutions are frequently too cumbersome or inaccurate for use in practical problems, and the algebraic methods described in the following paragraphs are more widely used.

Vector quantities are written in rectangular form when addition is to be performed. If vector A in Fig. 7 is $6 + j3$ and vector B is $2 + j4$, their sum is found as follows:

$$\begin{array}{r} 6 + j3 \\ 2 + j4 \\ \hline 8 + j7 \end{array}$$

This result is, of course, vector C . The sum is equal to the algebraic sum of the real parts (in this case

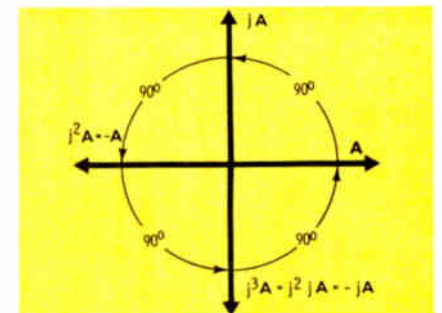

Fig. 6. Results of applying operator j .

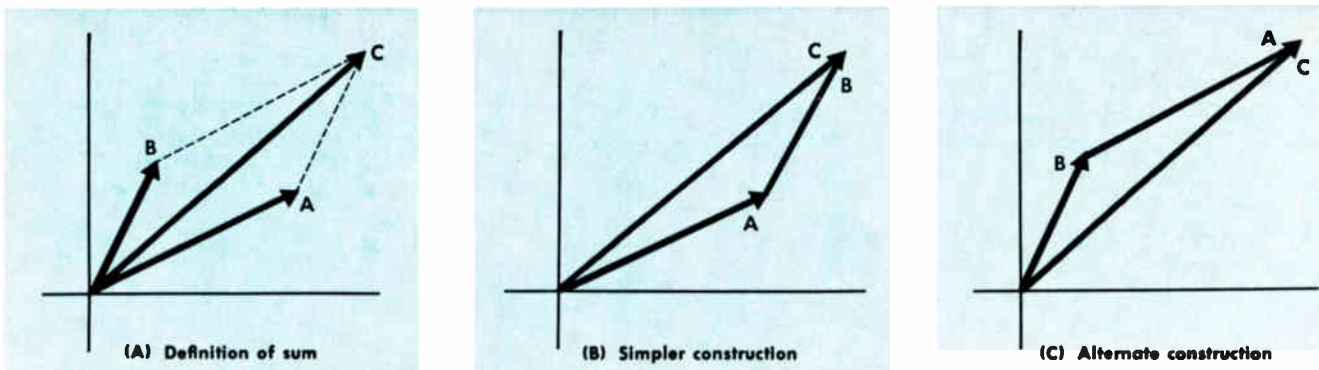

Fig. 7. The two vectors may be added in either order without affecting the magnitude or direction of their sum.

6 + 2 = 8) plus the algebraic sum of the j parts ($j3 + j4 = j7$). As a further example, three vectors are added as follows:

$$\begin{array}{r} 3 + j7 \\ -6 + j9 \\ 2 - j5 \\ \hline -1 + j11 \end{array}$$

Any number of vectors can be added in this way.

To subtract two vectors, simply rotate one of them through 180° and add. (Multiplication by j^2 , or -1 , has been shown previously to be equivalent to rotating the vector through 180° .) For example, the vector $5 + j3$ is subtracted from the vector $3 + j5$ as follows:

$$\begin{aligned} (3 + j5) - (5 + j3) \\ = (3 + j5) + (-5 - j3) \\ = -2 + j2 \end{aligned}$$

This computation is shown graphically in Fig. 8.

Multiplication and Division

Vector and complex quantities can be multiplied or divided in either the rectangular or polar form, although the latter is generally used because it is more convenient. The product of two complex quantities is a vector whose magnitude is equal to the product of the magnitudes of the quantities and whose phase angle is equal to the sum of the phase angles of the individual quantities.

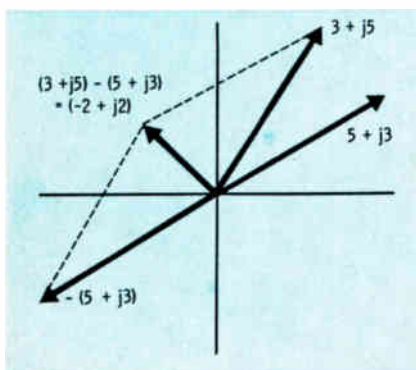

Fig. 8. Diagram shows vector subtraction.

Thus:

$$(A/\alpha) (B/\beta) = AB / \alpha + \beta$$

For example:

$$(5/30^\circ) (3/7^\circ) = 15/37^\circ,$$

and

$$(6/10^\circ) (2/-20^\circ) = 12/-10^\circ$$

As was mentioned, numbers in rectangular form may be multiplied. The general procedure is outlined symbolically below:

$$\begin{aligned} (a + jb) (c + jd) \\ = ac + j^2bd + jbc + jad \\ = (ac - bd) + j(bc + ad) \end{aligned}$$

The quotient obtained by vector division is a vector having a magnitude equal to the quotient of the magnitudes of the individual vectors and a phase angle equal to the difference between the phase angles of the individual vectors. In symbols:

$$\frac{A/\alpha}{B/\beta} = \frac{A}{B} / \alpha - \beta$$

Division in rectangular form is accomplished by rationalizing (removing the j term from) the denominator. A simple division can then be performed. Rationalization is achieved by multiplying both the numerator and denominator of the fraction by the *conjugate* of the denominator. The conjugate of a complex number is the same as the number except that the sign of the j term is reversed. As an example, $10 + j3$ will be divided by $2 + j2$:

$$\begin{aligned} \frac{(10 + j3) (2 - j2)}{(2 + j2) (2 - j2)} &= \\ \frac{20 + 6 + j6 - j20}{4 - j^24} &= \\ \frac{26 - j14}{8} &= \\ 3.25 - j1.75 \end{aligned}$$

Powers and Roots

The principle of multiplication can be extended to give the following rule for raising a complex number to a power:

$$(A/\alpha)^n = A^n / n\alpha$$

It can be readily seen, also, that a root of a complex quantity can

be found as follows:

$${}^n \sqrt{A/\alpha} = {}^n \sqrt{A} / \alpha/n$$

Changes of Notation

It is often necessary to change complex numbers from rectangular to polar form or vice versa. This is accomplished readily by making use of the relationships shown in Fig. 9. Vector A can be written either as r/α or as $a + jb$. Inspection of the diagram shows that $b/r = \sin \alpha$, $a/r = \cos \alpha$, and $b/a = \tan \alpha$. These equations give sufficient information for converting either form of notation to the other.

Suppose it is desired to change from polar form to rectangular form. The magnitude of r is known, and the values of the sine and cosine functions can be determined easily because the angle is known. By rearranging the equations in the preceding paragraph:

$$\begin{aligned} a &= r \cos \alpha, \text{ and} \\ b &= r \sin \alpha \end{aligned}$$

The vector can thus be written in the form:

$$A = r \cos \alpha + jr \sin \alpha$$

When the number is written in rectangular form, the conversion to polar form is as follows: Since $b/a = \tan \alpha$, the angle can be determined by first finding the tangent. The magnitude of r can be found in

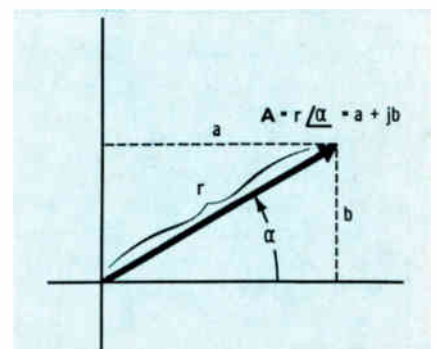
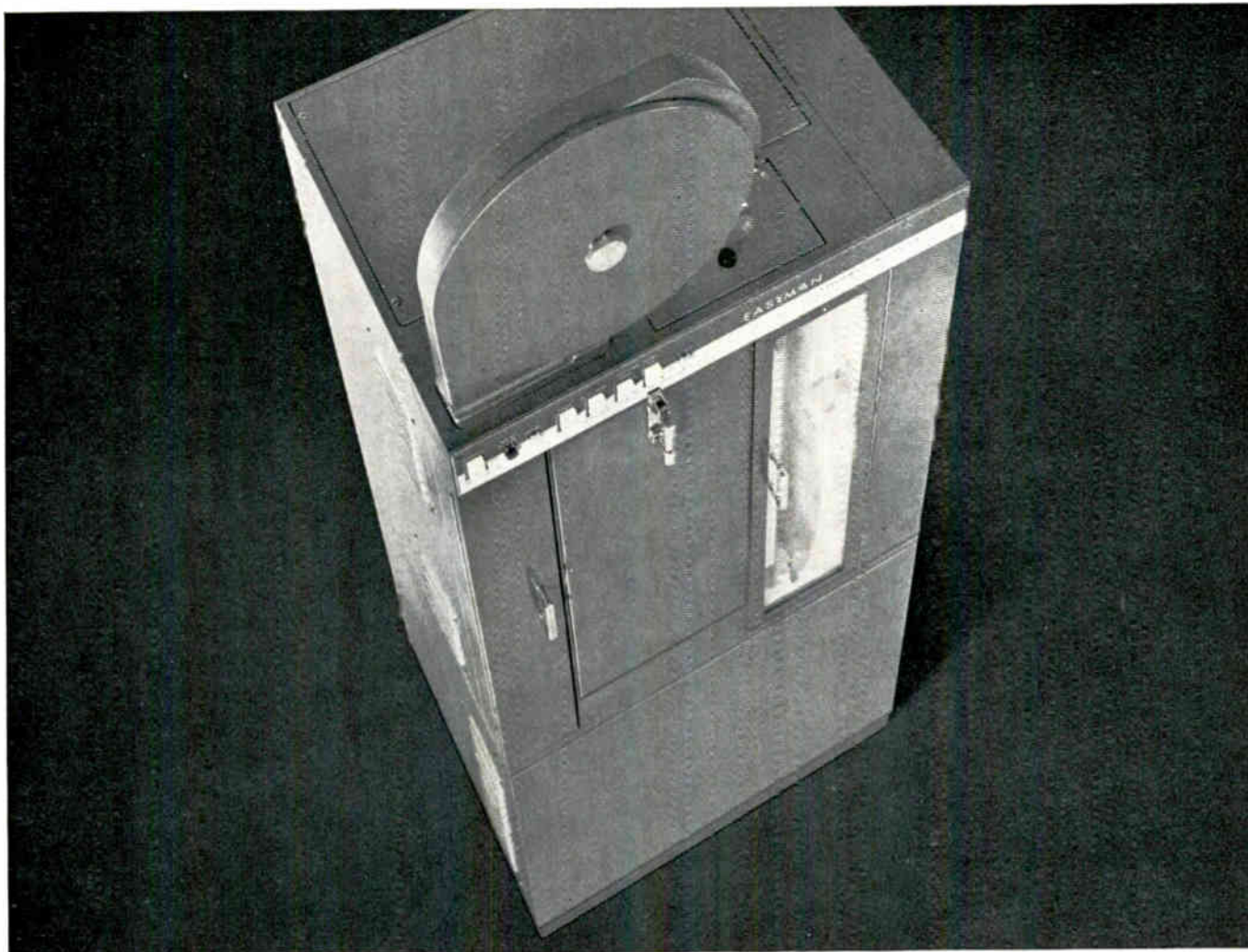

Fig. 9. Polar, rectangular forms related.



It processes films of superior image quality at projection speed. It provides finger-tip control . . . 1200-foot capacity . . . flexible development time.

But—What are the VISCOMAT Processor economics?

1 Because the operation of the EASTMAN VISCOMAT 16mm Film Processor is so automatic, skilled technicians are free to handle other functions. Processing is merely a matter of threading a leader, selecting the type of process, and pressing the "start" button. This is true push-button simplicity.

2 Chemicals aren't wasted, as they often are in conventional processing. Just the right amounts of viscous chemicals are applied to the film. And because the by-products of processing are washed away, film is always treated with fresh chemicals. What's more, the system prevents oxidation of the supply chemicals.

3 There's no time spent in mixing chemicals—they're packaged and pretested for immediate use. And since chemicals are used only once—then eliminated from the system—you never encounter the technical problems of replenishment. Now you can forget about running control strips, testing solutions and making complex adjustments and compensations.

4 Clean-up is a matter of a mere 20 seconds. The operator simply flips a switch and the interior sections are thoroughly washed. With conventional equipment, it might take a whole day to strip down and thoroughly clean a processing unit.

5 Only three square feet of floor space is required, thanks to the EASTMAN VISCOMAT Processor's compact design. This may represent a major economy—as well as a major convenience—for you. Service requirements are minimal—tempered water, a drain, and electricity.

The EASTMAN VISCOMAT Processor is part of a rapid-access 16mm film system that includes camera, films, processor and projector. For a booklet with complete details, write to:

MOTION PICTURE PRODUCTS SALES DEPARTMENT
EASTMAN KODAK COMPANY
 ROCHESTER, N. Y. NEW YORK, N. Y.
 CHICAGO, ILL. HOLLYWOOD, CALIF.

Circle Item 9 on Tech Data Card

any of the following ways:

$$r = \sqrt{a^2 + b^2}$$

$$r = \frac{b}{\sin \alpha}$$

$$r = \frac{a}{\cos \alpha}$$

In general, the last two calculations are more easily performed than the first, so the angle is usually determined first and the sine or cosine function then evaluated for the particular angle.

Peak and rms Values

As initially defined, the length of the rotating vector was proportional

to the peak value of the sine wave. If the results of the calculations are desired in terms of rms values, the conversion may be made after the computations are finished. It is just as easy, however, to specify all currents and voltages in terms of rms values before calculations are commenced. The lengths of all voltage and current vectors may then be made proportional to rms values. It is, of course, imperative that all currents and voltages in a given calculation be in the same kind of units—peak, average, rms, etc.

Power Computations

Perhaps not obvious at first, but true nonetheless, is the fact that one *cannot* multiply a complex current by a complex voltage and determine the real and reactive power from the real and j parts of the resulting number. To illustrate this, consider the voltage and current represented by the vector diagram in Fig. 10. The power is computed by:

$$\begin{aligned} P &= VI \cos \theta \\ &= 10 \times 4 \times .5 \\ &= 20 \text{ watts} \end{aligned}$$

The "reactive power" is:

$$\begin{aligned} P' &= VI \sin \theta \\ &= 10 \times 4 \times .866 \\ &= 34.6 \text{ vars} \end{aligned}$$

If the vector expressions for V and I are multiplied, the result is:

$$\begin{aligned} &(10 \angle 70^\circ) (4 \angle 10^\circ) \\ &= 40 \angle 80^\circ \\ &= 6.96 + j39.4 \end{aligned}$$

Obviously, 6.96 does not equal 20, and 39.4 does not equal 34.6; the two parts of the last answer thus do not have physical significance in the circuit.

The real and reactive power can be calculated, however, by multiplying the complex voltage by the conjugate of the complex current. Returning to the vector diagram of Fig. 10:

$$\begin{aligned} &(3.42 + j9.38) (3.94 - j.696) \\ &= 20 + j34.6 \end{aligned}$$

Here the real part of the result does represent the real power, and the j part does represent the reactive power. The plus sign indicates inductive vars.

Conclusion

The use of vectors provides an indispensable tool for the engineer or technician who must make calculations involving AC electrical quantities. But as with any tool, vectors, and their proper use, must be understood to be of value. This article has presented the basic principles involved in vector computation. ▲

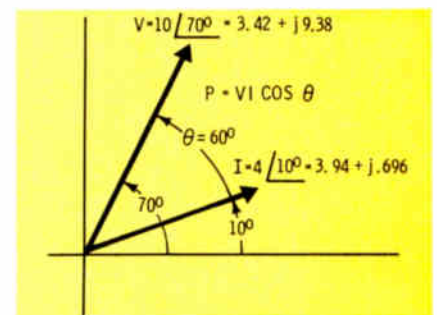

Fig. 10. Power calculation in AC circuit.

INNOVATION

... ANOTHER KEY TO

SPARTA SUCCESS

SPARTA-MATIC® 400 TAPE CARTRIDGE SYSTEM

400-RP RECORD/PLAYBACK



PRICE \$625.00

A compact Table-Top unit conforming 100% to new NAB Standards. All transistor modular construction. Whisper quiet action. 600 ohms balanced input and output. New "Micro-adjusting" head mount. Record circuits automatically de-energize to prevent accidental recording. Also available as playback unit only (400-P) — \$450.00.

For those who require rack mounted equipment, the SPARTA-MATIC 300-B Series is available. This model provides additional trip cueing for automation and other uses.

ANOTHER NEW
PRODUCT
INNOVATION
COMING
SOON!

Watch for another major product development to be released next month from SPARTA.

LOOK
TO
SPARTA
FOR THE
KEY
TO
BETTER
BROADCASTING

SPARTA ELECTRONIC CORPORATION

6450 FREEPORT BLVD. • SACRAMENTO, CALIF. 95822

Circle Item 10 on Tech Data Card

The Key to Quality in any CATV system

SUPERIOR COAXIAL CABLE with "Coppergard"

- Long-term transmission stability
- Sharp, clear pictures without interference
- Full spectrum capability
- 27 db minimum return loss

Quality-controlled from raw materials through every critical phase in the manufacturing process, SUPERIOR Coaxial Cable with Coppergard offers you performance unmatched by any other cable!

CHOOSE SUPERIOR CELL-O-AIR® COAX FOR AERIAL PLANT

Attenuation db/100' at 68° F					
	Ch. 2	Ch. 6	108 mc.	Ch. 7	Ch. 13
4920	0.72 db	0.89 db	1.03 db	1.35 db	1.50 db
4930	0.43	0.65	0.76	1.02	1.15

CHOOSE SUPERIOR "SOLID-D" COAX FOR BURIED PLANT

Attenuation db/100' at 68° F					
	Ch. 2	Ch. 6	108 mc.	Ch. 7	Ch. 13
6020	0.71	0.87	1.00	1.31	1.48
6030	0.52	0.64	0.75	1.00	1.13

For full information, write

SUPERIOR CABLE

SUPERIOR CABLE CORPORATION • HICKORY, NORTH CAROLINA

8574

"Cell-O-Air"
expanded
polyethylene
dielectric

EVERY REEL
SWEEP-TESTED
OVER ITS
FULL LENGTH

"Solid-D" solid
polyethylene
dielectric

MAINTAINING DEPENDABLE CATV SERVICE

by **Chuck Shank**, Manager and Chief Technician, Ottawa TV Cable Company, Ottawa, Ill.—A practical philosophy for maintaining consistent signal quality in a CATV system.

A CATV system is in business to sell good television reception. This reception must be consistently good, and when trouble does develop, the system technicians must be able to correct it quickly. Proper design, planning, and organization can go a long way toward achieving this goal.

Planning

Experience shows that establishing dependability really begins when the proposed CATV system is in the planning stage. The first step, of course, is to determine that there is a definite need for a system in the particular area of interest. A signal survey should be made over a period of at least three days; if the information is recorded over the full broadcast day, a more complete picture of signal strength and variations can be obtained. This information is extremely valuable in determining the tower height and location, noise level in the area, etc. Of course a

franchise and necessary working agreements with the local telephone and power companies are prerequisites.

Installation

After the planning has been completed, careful attention must be given to the installation phase.

The Head End

In most cases, the tower and head-end work should be completed first. This is usually done by a tower-construction company. All antennas must be mounted and phased correctly; a qualified technician should supervise this operation. It is a good idea for the technician to check all fittings and put his final approval on the antennas mounted on the boom before the assembly is raised into position. The equipment shack should be completed by the time the antennas have been placed on the tower.

The technician should not release the tower-construction crew

until he is satisfied that the job has been properly completed. Among other things, this means that all antennas are properly oriented and the best possible picture is obtained. (The results of the initial signal survey should give the technician a good idea of what to expect with respect to picture quality and signal strength.) The transmission lines running from the antennas to the head-end shack should be secured so that they do not become loose after a few months of service. Taping is not satisfactory; suitable fasteners designed for the purpose should be used instead. The technician should also make sure that the tower has been well grounded and that the tower lighting system is functional. It is a good idea to check the plumb of the tower and to make sure all the bolts are torqued properly. There is usually a one-year guarantee on the tower, but it is best to have the installation thoroughly checked before the tower-construction crew leaves the area.

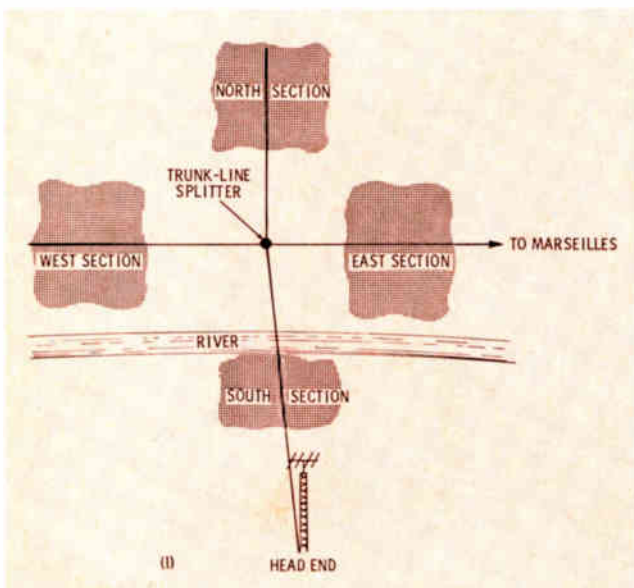

Fig. 1. Simplified diagram of the Ottawa TV distribution system.

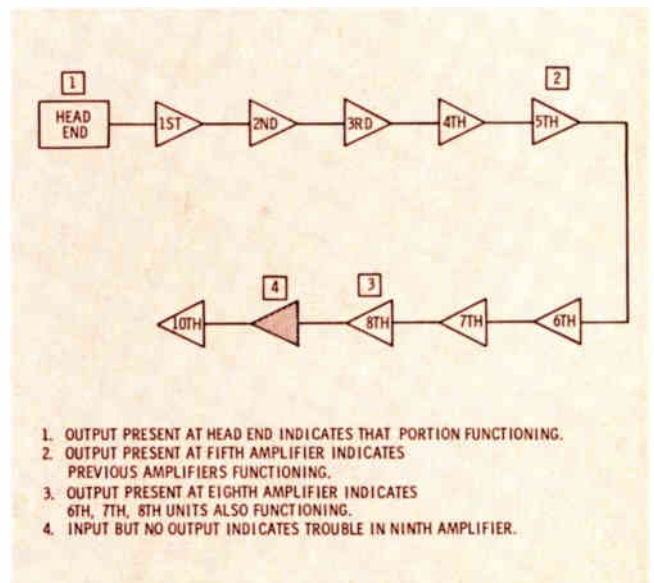
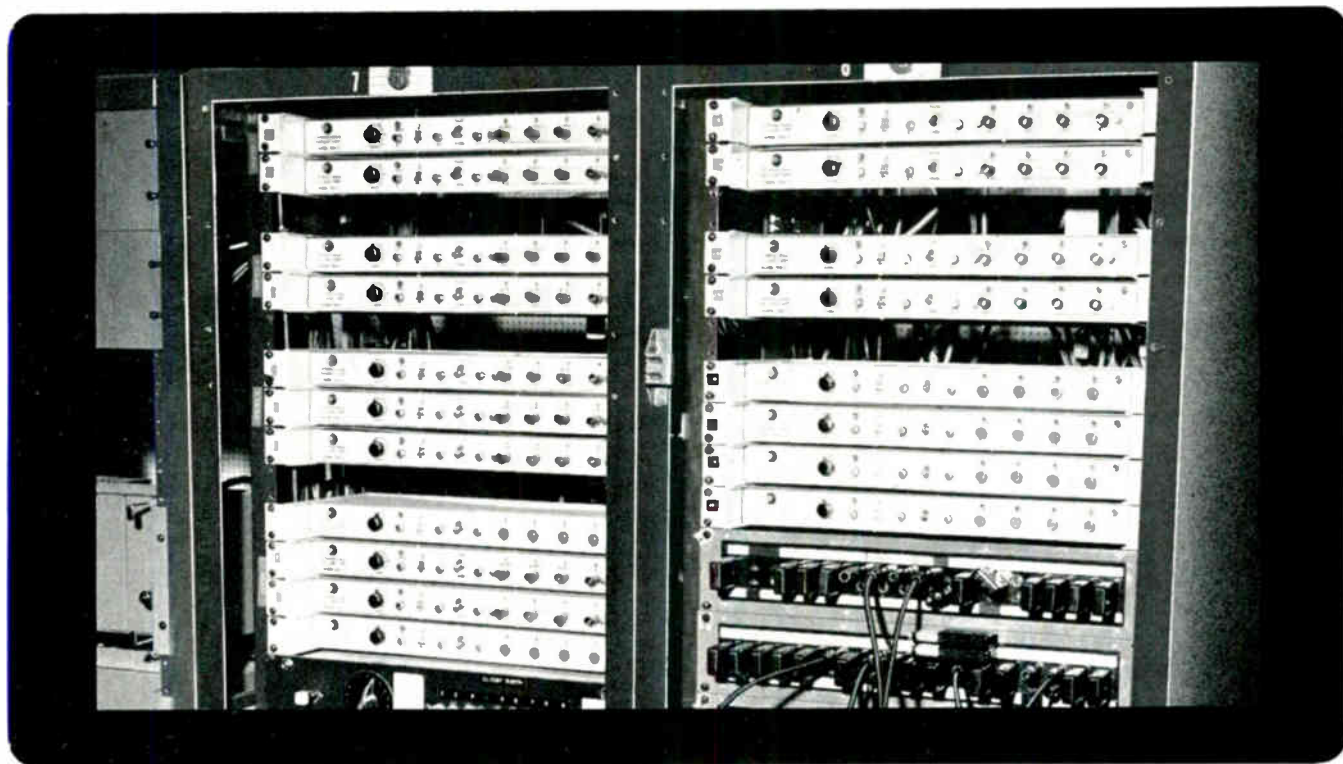

Fig. 2. Logical approach isolates defective amplifier in four steps.

WBAP - TELEVISION, FORT WORTH, PLEASED WITH INTERNATIONAL NUCLEAR TDA2 VIDEO/PULSE DISTRIBUTION AMPLIFIERS



TDA2's in use WBAP-TV, FORT WORTH, TEXAS
"We like International Nuclear DA's here at
WBAP-TV for three main reasons. First, they
take only 1¾" of rack space and fit a standard
19" rack. Second, each TDA2 has its own
built-in power supply. And third, each unit
operates either pulse or video with a flip of a
switch. A very reliable piece of equipment."
WBAP • AM • FM • TV, FORT WORTH, TEXAS



The Model TDA2 is a completely solid state instrument, transistorized all the way, with a built-in regulated power supply. Built to meet the exacting standards of the industry, the TDA2 is being used by networks, telephone companies and TV stations all over the country. The Model TDA2 Video/Pulse Distribution Amplifier is designed to accept composite or non-composite video at a bridging-type input of as little as 0.25 volt and delivers four individually isolated 75 ohm outputs of 1.0 volt, peak to peak. It will replace all tube type amplifiers without alteration of existing cables. Weighs under four pounds and is only 1¾ x 19 x 7 inches over-all.

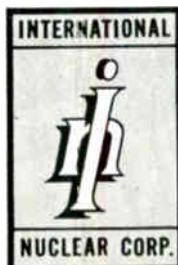

\$325.00 ea. F.O.B. NASHVILLE, TENN.

For complete information write:
Department TD-2

**INTERNATIONAL NUCLEAR
CORPORATION**

608 Norris Ave. — Nashville, Tenn. — Ph. 615 — 254-3366

Circle Item 12 on Tech Data Card

UP- DATE

YOUR OLD 3"

R.C.A. / G.E. / DUMONT / MARCONI & OTHERS / IMAGE ORTHICON T.V. CAMERA



with a

Cletron

3" IMAGE ORTHICON DEFLECTION YOKE

(Part No. OY-64)

- Flatter Field
- Sharper Corners
- Improved Resolution
- Quieter Image Section
- Better Cooling for Longer Tube Life

and 3" IMAGE ORTHICON ALIGNMENT COIL

(Part No. OA-3)

Cletron

Write today to:

CLEVELAND ELECTRONICS, INC.
1975 East 61st St. • Cleveland, Ohio 44103

Another quality product by
Cletron... Manufacturers of Deflection
Components, Custom Transformers
and Sound Reproducing Devices

Circle Item 13 on Tech Data Card

The Cable

After the head end is completed, attention may be turned to the distribution of the signals. Since the owner of the system is anxious to see what kind of pictures he will be selling, there is some value in extending the trunk line to his office as soon as possible. It should be borne in mind, however, that it often adds to the final construction cost to give this consideration.

The cable-construction crew must be completely capable of doing a good job that complies with all specifications of the power and telephone companies and applicable local construction codes. Coaxial cable must be handled with care to avoid cuts or other damage. Many systems are now using aluminum cable for trunk lines. Proper handling is even more essential with this type than with conventional cable; once a kink is made in aluminum cable it cannot be straightened again.

An experienced, conscientious crew will immediately repair any damage they cause to the cable. If these breaks are left unrepaired, water will eventually get into the cable, and degradation of picture quality will begin. Ultimately, severe ghosting will result, and the signal level at the end of the feeder lines will become too low.

Since cable is not available in large enough lengths to span from amplifier to amplifier, there are always splices in a system. The number of splices can be reduced, but not eliminated, by a good crew foreman. It is the duty of the foreman to mark each splice and indicate its location on a system map. Spraying the splices with white paint (or some other color that is easy to see from ground) helps the system technician identify them. Each splice must be made correctly, and there should be a loop left in the cable; usually an 8" or 10" loop is sufficient.

The technician should make readings on all lines to make sure they are terminated. The electrical print for the system should indicate the proper readings. The Chief Technician should be satisfied that all lines read correctly before accepting the completed job.

After all physical construction work is completed, the amplifier

levels are set, and the system is ready for connection to the individual receiving locations. Good workmanship and the use of proper tap-off units are essential if the desired end result—good received pictures—is to be obtained.

Troubleshooting

Even the most well constructed system is bound to develop trouble sooner or later. Adequate preparation and a systematic approach to locating trouble can reduce down time to a minimum. At the time of installation, all antenna leads should be properly tagged with a permanent material; adhesive tape is not satisfactory. Signal-level readings should be made at every input and output of the head-end equipment. The readings should then be posted in the head-end building and a master copy kept in the cable office. In addition, in each line- and distribution- amplifier housing should be posted a card giving the following information:

- (A) Normal input level on each channel.
- (B) Normal output level on each channel.
- (C) Identification of the source and resistance reading of every cable coming into the amplifier housing.

An example of systematic troubleshooting in the Ottawa, Ill., CATV system will be given. In this system the tower is located south of town. From there, signals are distributed to Ottawa, Marseilles (by a seven-mile trunk line), and the village of Naplate. From the antenna site a trunk line extends through the southern portion of Ottawa. After crossing the Illinois River, the cable enters a trunk-line splitter which divides the signal and feeds it to the north, east, and west sections of the system. The Marseilles trunk line connects to the eastern section. Naplate is served from the western section. A simplified diagram of the system appears in Fig. 1.

When a trouble call is received, we wait five minutes for additional calls to determine whether other sections are affected. By doing this, we can narrow down the trouble area without even sending men out.

As an example, assume all calls come from the south section. This

ANDREW



... Factory attached fittings



... Long lengths

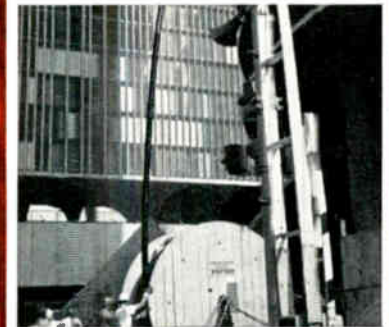

... No splices

HELIAX 5" air dielectric coaxial cable hoisted from street to Marina Tower rooftop in one continuous length for ABC-TV, Chicago

HELIAX® FLEXIBLE COAXIAL CABLE

guaranteed reliability for high power RF transmission



Actual measured VSWR for installed 742 foot length of 5" HELIAX

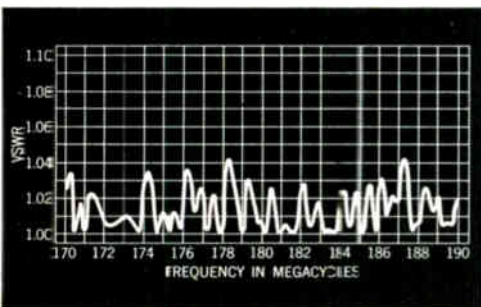

Long continuous lengths, and flexibility of Andrew HELIAX cable made this critical transmission line system possible. Installation required less than six hours. Cost was dramatically reduced.

Type H9-50 HELIAX cable insures long term reliability in high power RF transmission*. Corrugated copper inner and outer conductors absorb stress and cable retains superior electrical qualities after repeated flexing. Andrew end connectors firmly anchor inner to outer conductor and eliminate any RF noise from vibration or temperature changes.

Contact your Andrew sales engineer, or write for information on this superior transmission line.

*Handles average power of 250 kw @ 10 Mc or over 50 kw @ 200 Mc

20 YEARS OF ENGINEERING INTEGRITY
4-65

Andrew
CORPORATION
P. O. BOX 807 • CHICAGO, ILLINOIS U. S. A. • 60642

indicates the trouble is either at the antenna site or in one of ten amplifiers in the southern part of town. The antenna site is checked first; if satisfactory operation is found there, two courses of action are open. The technician can either check every amplifier in turn, beginning nearest the head end, or he can make spot checks. The second method is much to be preferred from the standpoint of minimizing the duration of the outage.

A good approach is to leave the head end and measure the output of the fifth amplifier (Fig. 2). If signal is present, the effort of checking the first four amplifiers has been saved. Assuming a good output is present at the fifth amplifier, the technician skips two units and goes to the eighth amplifier. If an output signal is present there, he goes to the ninth amplifier; if trouble is indicated there, the technician has isolated it with only four checks. If signal had not been present at the input to the fifth amplifier, the technician could have gone to the third amplifier. An output at that point would isolate the

trouble to the fourth amplifier; lack of input would indicate trouble in the first or second amplifier. The method consists essentially of breaking the system down into smaller and smaller sections until the trouble is isolated.

This method usually permits finding the trouble in three or four stops. The technician should carry with him spare amplifiers that have already been aligned with respect to cable length and tilt. And, of course, complete knowledge of the system is indispensable.

Customer Relations

Good customer relations are vitally important in the CATV business, and part of the responsibility in this area inevitably falls to the system technicians. There are a few basic rules that must not be forgotten:

- (A) All personnel should be polite when talking to customers.
- (B) Trouble calls should be answered as soon as possible after they are received.
- (C) The technician should satisfy the customer as to

whether the trouble is in the receiver or in the system. Occasionally it may be necessary to bring a TV test set into the home, since most subscribers do not understand the readings a technician takes on his field-strength meter. At no time should a technician tell a customer the trouble is in the set if he is not positive that the set is at fault.

There are certain receiver defects the cable office can identify, and this will save sending the serviceman out when no system trouble is involved. It is necessary for the Chief Technician to furnish the office girls with lists of definite set trouble, definite cable trouble, and troubles which can be due to either the cable or the set.

The most important factor in a profitable cable system is a good picture. A system is as good as the equipment in it and the personnel who maintain it. If you maintain high standards for both, your system has an excellent chance for success. ▲

Spotmaster

NEW 500 SERIES . . . World's Most Advanced Cartridge Tape Equipment

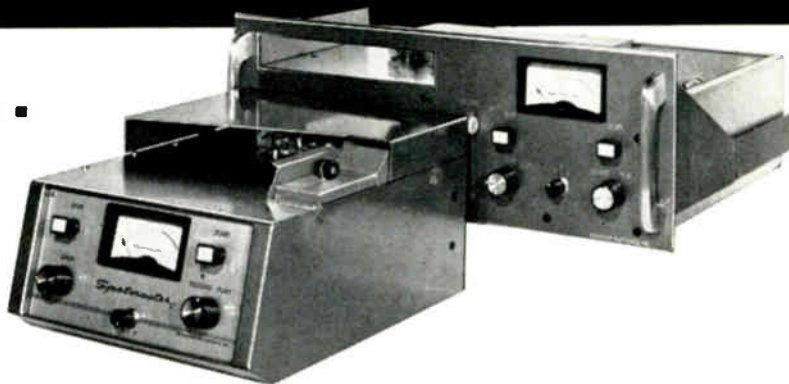

From the established leader in tape cartridge systems—SPOTMASTER—comes today's most advanced units, the 500B series. Featuring all-modular, all-solid-state design and your choice of 1, 2 or 3 automatic electronic cuing tones, the 500B continues the SPOTMASTER tradition of superior quality at sensible prices.

Check these other SPOTMASTER features:

- Meets or exceeds all existing and proposed NAB standards.
- Separate record and reproduce heads. A-B monitoring. Biased cue recording. Zener controlled power supply.
- Popular 500A series, today serving over 1,000 sta-

tions world-wide, now available at new low prices.

- 14 models match every programming need: recorder-playback and playback-only . . . compact and rack-mount . . . monophonic and stereo.
- Delayed Programming option permits instant deletion of objectionable material from live originations.
- Heavy duty construction throughout, with rugged hysteresis synchronous motors, top specs and performance.
- Lease/purchase option. Ironclad guarantee for one full year.

Write for complete information:

BROADCAST ELECTRONICS, INC.

8800 Brookville Rd., Silver Spring, Md. JU 8-4983 (301)



February 1965

We interrupt this magazine to bring you...

Late Bulletin from Washington

by Howard T. Head

Equal Treatment for Translators and CATV?

In a recent dissent to a Commission action granting two new UHF television translators in Iowa, Commissioner Kenneth Cox pointed out a seeming inconsistency in the handling of applications for translators and CATV microwave facilities. Unconditional authorizations have been awarded to UHF translators which bring in programs from distant stations, but the Commission continues to issue microwave CATV authorizations only to applicants who agree to refrain from duplicating programs available over local television stations. Under present Rules, both VHF and UHF translators may be authorized well beyond the Grade B contour of the station whose signal is being repeated. However, in the case of a broadcast licensee, VHF translator authorizations are granted only inside the Grade B contour of the licensee's station.

The FCC, the NAB, and the National Community Television Association (NCTA) are continuing attempts to reach agreement with respect to Federal control of all television distribution systems, both broadcast and cable. The present prospects for agreement appear slim, and the general topic is likely to come up for Congressional attention in the early months of 1965.

Change of TV Monitor Rule Postponed

In eliminating the requirement for television frequency monitors (January Bulletin), the Commission amended the Technical Rules to specify monthly measurements of the visual and aural carrier frequencies. This must be done by comparing them with one of the standard-frequency transmissions. The new Rules were originally scheduled to become effective December 22, 1964.

It has developed, however, that the time provided was too short to permit television stations to acquire the necessary equipment or to make the necessary arrangements for outside measuring services. Consequently, the Commission has extended to March 22, 1965, the date for compliance with the new Rules.

Action Expected on Commercial Loudness

After numerous attempts on the part of the Commission to establish specific technical regulations concerning the loudness of commercial announcements, it now appears likely that the Commission will issue some Rules covering this subject in the near future. The proposed new Rules generally abandon the original plan specifying detailed technical requirements, but approach

the problem in terms of warning the licensee to refrain from practices intended to enhance the apparent loudness of program material. If this approach is adopted, the Commission will point out the various factors which may result in apparently excessive loudness and issue a prohibition against improper use of such techniques.

Remote Control of TV Transmitters

NAB is shortly expected to file with the Commission a petition under preparation since last summer (see July Bulletin) asking the Commission to authorize the remote control of all television broadcast transmitters. At the present time, the Commission's Rules provide for remote control of all AM and FM transmitters on proper showing, but television remote-control authorizations are limited to UHF stations. The NAB petition will report on some successful experiments with remote control at several VHF stations.

Antenna-Farm Proposals Under Fire

The Commission's plans for proposing new Rules governing the establishment of "antenna-farm areas" for tall FM and television towers have met with concentrated opposition from a group representing virtually all segments of the broadcast industry. The basis for this opposition is the experience of commercial and educational applicants alike with the Federal Aviation Agency, to whom television applicants must go for aeronautical studies of tall-tower proposals prior to FCC action on broadcast applications. The broadcasters say that, in many instances, the FAA has been totally uncooperative and has exhibited complete lack of concern for the need for tall towers to provide adequate FM and television service to the public.

Although the proposals under consideration by the Commission assert the Commission's unquestioned authority to determine where tall towers should be located, the broadcast-industry groups are objecting to provisions in the proposal which would give still more weight to the FAA's views.

Stereo Via Relay Satellite

Tests are expected to be conducted early in February in which stereophonic FM signals will be sent across the United States by way of synchronous satellite Relay II. These tests -- which will be closed circuit -- will be an attempt to relay successfully the composite FM stereo signal, rather than to transmit the separate audio channels. If the tests are successful, they will strengthen considerably the United States position in advancing proposals for the adoption of the American stereo FM system for international use. Such a proposal is to be made at the Vienna CCIR meetings this spring.

Howard T. Head... in Washington

The soundest sound in FM is the new sound of GATES

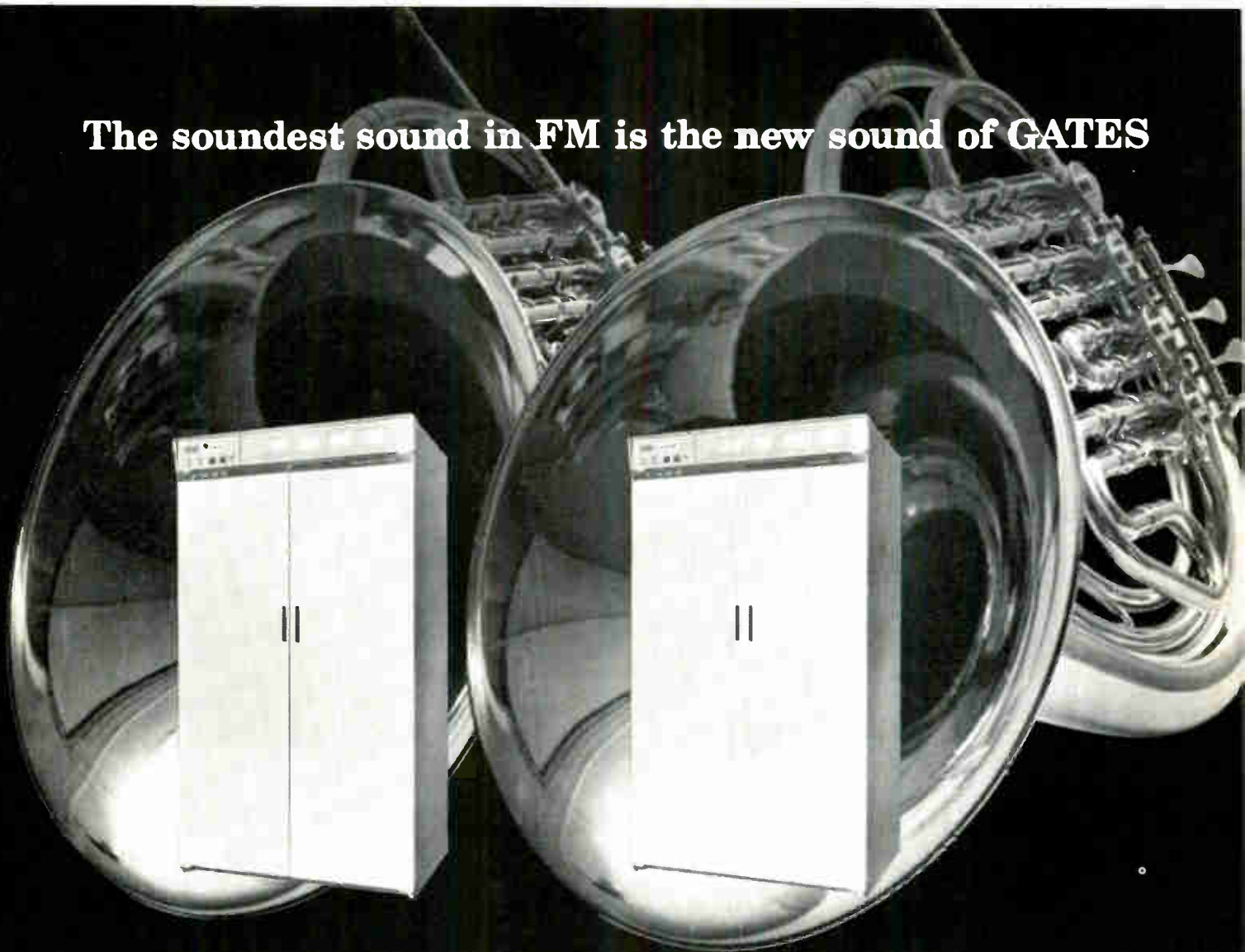

Now! Two new Gates Transmitters with "DCCCM"

Direct Crystal Controlled Cascade Modulation is quite a mouthful. But it's quite an earful, too. Featured in our handsome new FM-5G, 5000-watt, and FM-10G, 10,000-watt FM broadcast transmitters, it provides positive control of the mean carrier frequency with simplified, dependable circuitry. In addition, these two new transmitters feature solid state power supplies, new ceramic power tubes operating at a leisurely pace, plus a careful selection of quality components. Result: the ultimate in FM performance. And proof that the soundest sound in FM is the new sound of Gates.

Send for complete information on the new Gates FM-5G and FM-10G.

**HARRIS
INTERTYPE
CORPORATION**

GATES

GATES RADIO COMPANY
A Subsidiary of
Harris-Intertype Corporation
QUINCY, ILLINOIS 62302

Offices: New York, Houston, Los Angeles, Washington, D. C.
Export: Rocke International Corporation, New York City
In Canada: Canadian Marconi Company, Montreal

March
is NAB Show time,
and **BROADCAST
ENGINEERING** will be
ready with a big 24-page
supplement including . . .

- Convention agenda
- List of exhibitors
- Show news
- Previews of new products
- And other important features

As always, there'll be interesting and
informative feature articles, such as

- Aeronautical Field Intensity
Measurements
- Installing a 10-Watt FM
Station
- The 4-400A in AM Trans-
mitters

and

Engineers' Exchange
Letters to the Editors
News of the Industry
Engineers' Tech Data

Don't miss this special issue! To reserve
your copy, just fill out and send in the
convenient subscription card bound in
this issue—you'll receive the *Broadcast
Engineer's Maintenance Guide* free of
charge.

THE CHIEF ENGINEER

Helps Solve Your Technical Problems

Readers are invited to send their ques-
tions to the "Chief Engineer"; those of
most general interest will be published.

One of our authorized monitor points
has become quite unreliable due to recent
construction in the area. How can I get
permission to substitute a new monitor
point?

As a result of suburban growth, this
problem arises more and more fre-
quently. The procedure for obtaining
authorization to use another monitor
point is quite simple. You must state in
a letter to Mr. Ben F. Waple, Secretary
of the Federal Communications Com-
mission, Washington, D. C. 20554, the
reasons why the authorized monitor
point has become unusable. Attached to
this letter should be exhibits showing the
details of the new monitor point selected
on the same radial.

The exhibits should consist of a photo-
graph of the new monitor point clearly
showing the identifying features of the
location and the absence of overhead
wires. You must also give a complete
written description, including mileages
and directions on each road traveled, of
how to proceed to the location from the
transmitter building. A large-scale topo-
graphic map should be included on which
the transmitter building and the new
monitor point are clearly shown and the
roads from the transmitter building to
the monitor point are identified.

In order to determine the permissible
value of radiation at the new monitor
point, measurements must be made along
the radial route at nine or more of the
points used in the original proof of per-
formance and in subsequent skeleton
proofs of performance. These measure-
ments must be analyzed to show that the
inverse field strength in this direction
does not exceed the maximum value of
inverse field specified in the original
construction permit. The maximum per-
missible measured value of field strength
at the new monitor point is that value
which corresponds to radiation not ex-
ceeding the level for this direction stated
in the construction permit.

I am the Chief Engineer of an FM
station. In addition to our regular FM
operation, we also broadcast in stereo.
Are we required to conduct a stereo
proof of performance?

The Commission's Rules specify per-
formance standards for stereo operation,
and a literal interpretation of these Rules
would indicate that a complete proof of
performance on the stereo operation is
required. At the present time, however,
there is no type-accepted monitor suit-
able for use in making a complete stereo
proof of performance, and, therefore,
such measurements are not currently re-
quired. Commercially available equip-
ment should, however, be used to con-
duct a monaural proof of performance
through each stereo subchannel to com-
ply with the Commission's policy in this
regard. No doubt stereo measurements
will be required in the future.

NOW MEASURE FM STEREO AT 4% THE COST OF PRESENT UNAPPROVED STEREO MONITORS



\$89.50

Why spend \$2300 or more now when the FMD-1
Wide Band FM Detector will enable you to
measure your stereo composite signal?

MEASURES:

- Stereo Separation > 45 db
- Pilot Phase < 1/2°
- Stereo Levels (L+R), (L-R), Comp.
- Distortion < 0.1%
- AM Noise
- From Transmitter or Antenna

Ideal for stereo proof-of-performance and type-
acceptance measurements.

BELAR ELECTRONICS LAB.
1204 Childs Avenue • Drexel Hill, Pa.

Circle Item 18 on Tech Data Card

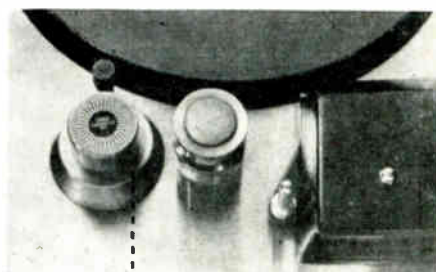

ARE YOU SURE OF YOUR TAPE SPEED?

Now you can replace
your worn stabilizer with
a new Lang Stabilizer Strobe and see at a glance
if your tape speed is accurate. New Lang Stabilizer
Strobe gives you constant 7½ and 15 i.p.s. speed
reading. Also the new Lang Stabilizer Strobe is
machined to within .0002 inches and contributes
to low flutter specifications. Guaranteed constant
and accurate reading of tapes on all Ampex
300/350 series tape recorders. Used by thousands
of Ampex owners throughout the world. 10-day
free trial.

Only \$21.00 with your used stabilizer

Order direct from

LANG ELECTRONICS INC.
507 FIFTH AVE., N. Y. 17

Circle Item 19 on Tech Data Card

BROADCAST ENGINEERING

How did they fill the holes in Manhattan?

WPIX-TV: G-E VHF Zig-Zag Installation (2nd from top)



The same way they're blanketing Houston...

G-E Candelabra: KPRC-TV (new G-E batwing), KHOU-TV (new G-E helical)

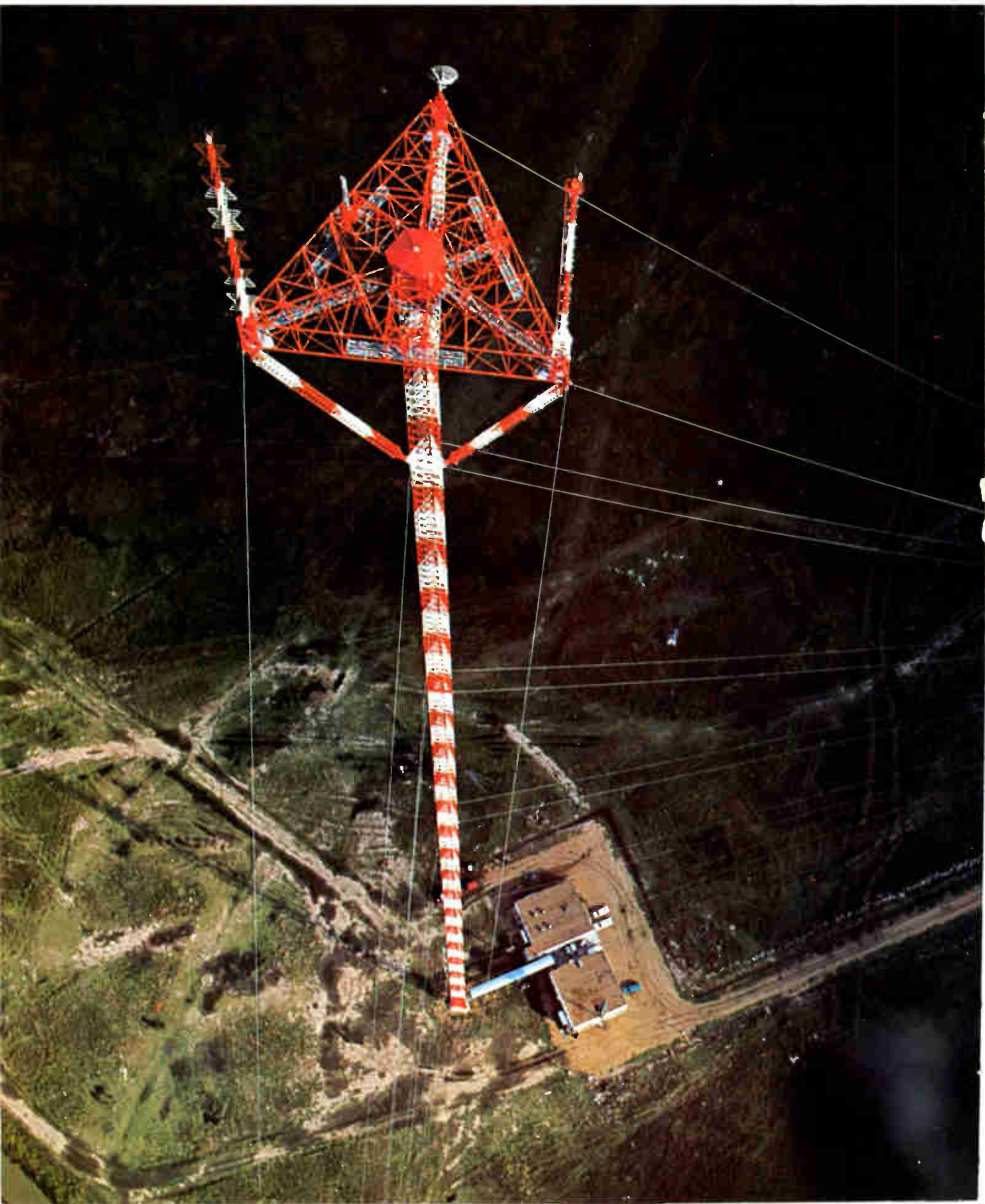

with image-building antenna performance by General Electric

“Outstanding Circularity”

WPIX-TV, Channel 11, New York City



Otis S. Freeman,

Vice President in Charge of Engineering:

“Both viewers and technical measurements tell the same story—our new G-E VHF Zig-Zag antenna fills the ‘holes in Manhattan’ we had with our former dipole-type unit. The Zig-Zag circularity is outstanding—better than plus or minus

1½ db. Signal strength is up 100 per cent and more in former null areas. Correlation is excellent between the Zig-Zag’s calculated pattern, test-site measurements, and field checks.”

“Met Tight Specifications—Plus!”

KPRC-TV, Channel 2, Houston, Texas



Paul Huhndorff,

Operations Manager:

“The decision to buy a G-E Antenna has proven more than satisfactory. The system met tight specifications with lower reflected energy, and this, coupled with less noise, has produced color pictures far exceeding our expectations. One thing that cannot be put into a contract is G.E.’s willingness to do more than the contract calls for.”

“Excellent System Capability”

KHOU-TV, Channel 11, Houston, Texas



M. A. Biggs,

Chief Engineer:

“G.E. demonstrated excellent system capability as prime contractor for the Houston candelabra installation. Our new G-E Helical Antenna was easily erected and installed. It was delivered virtually complete in assembly, and was lifted in one piece to its

pedestal mount atop the tower platform. G-E service personnel were diligent and completely satisfactory in their work on the installation.”

G. E. can help you improve your image.

General Electric patterns, performance, and system capability can best meet your specialized antenna requirements. Contact your G-E Broadcast Equipment Representative, or: General Electric Company, Visual Communications Products, 7-315, Electronics Park, Syracuse, N.Y. 13201.

Progress Is Our Most Important Product

GENERAL  ELECTRIC

COAX LINE FOR TRANSMITTING

by Patrick S. Finnegan, Consulting
Author, Chief Engineer, WLBC AM-TV,
WMUN FM, Muncie, Ind.—A look at
the characteristics of coaxial line
and some hints for installing it.

Coaxial transmission line has become so common in radio and television that one often tends to forget some basic factors which should be considered when installing or replacing this type of line. Coax line is available in a variety of sizes and types. Each type must be treated properly for best results.

Basic Features

Three general types of transmitting coax are currently used: rigid, semirigid, and flexible. These are available in diameters ranging from $\frac{7}{8}$ " to 9".

Rigid line comes in 20' sections, flanged at each end. Sections are bolted or clamped together at the flanges. The inner conductor is joined by a connector, called a **bullet**, that also serves as an anchor and an insulator. The outer conductor is usually made of hard-drawn copper, but it may be of aluminum for special applications.

Runs of semirigid lines are usually one continuous piece. An end seal or flange is used at each end of the run. The outer conductor may be either soft-drawn copper or aluminum.

Flexible line is also usually run in one continuous length. Small sizes may be obtained with aluminum outer conductors; the larger sizes are copper or copper-clad steel. Sizes up to 5" in diameter are available. Most flexible lines may be ordered with a polyethylene covering for protection of the line when it is to be buried.

Dry air or gas is commonly used as the dielectric, although some of the smaller cables contain a foamed polyethylene which serves as both the dielectric and the supporting spacer for the center conductor.

Spacers, or insulators, in air-dielectric lines may be made of Teflon, polyethylene, or steatite. Teflon is the best insulator at UHF

frequencies; the three are equally good for VHF and lower frequencies.

Lines are rated for both peak and average power-handling capability. The peak power rating depends almost entirely on the breakdown voltage between the inner and outer conductors; it does not depend on frequency. The determining factors are distance between the inner and outer conductors, dielectric strength of the air or gas, and the composition of the spacers, or insulators.

The peak power rating indicates the maximum power level that can be applied to the line at any moment. Since the power level in an AM system changes continuously during modulation, the following relationship of peak power to carrier power must be kept in mind:

$$P_c = \frac{P_p}{(1 + M)^2}$$

where,

P_c is the maximum carrier power,

P_p is the peak power rating, and
 M is the modulation percentage expressed as a decimal.

The average power rating depends on how much temperature rise due to heating of the inner conductor the insulators can withstand. Frequency is a main factor; the ratings drop off rapidly as frequency is increased. Polyethylene

in flexible cables has a maximum temperature rating of 175°F, and the teflon in rigid line has a maximum rating of 216°F.

The VSWR affects both the peak and average power ratings. Power ratings given in specification sheets are usually based on unity VSWR (the result of a perfectly matched termination on the line). In practice, a perfect match cannot be obtained when the termination is an antenna. Even though a system can be installed with a reasonably good match, later events, such as antenna icing, can cause a considerable mismatch. If the line is too small, irreparable damage can be caused by the resulting high VSWR.

Line losses are affected by diameter, length of run, and frequency. Smaller diameter, greater length, and higher frequency all result in greater losses for a given type of line. The total line loss determines the line efficiency, which is a major factor in determining the effective radiated power (ERP) of an FM or TV station. Specification sheets state the loss for 100' of line at a particular frequency. Most TV and FM stations have a line run of several hundred feet; the total loss can be computed by multiplying the loss per 100' by the number of 100' sections. When the total loss is known, the line efficiency can be determined and the actual amount of power reaching the antenna calculated.

Practical Applications

A few examples should help illustrate how the foregoing factors can affect selection of a line for a given application.

Suppose a new UHF TV station is to operate on channel 60 (746-752 mc). To cover its area properly, it will require an ERP of 220 kw. A 12.5-kw transmitter and an antenna with a power gain of 25

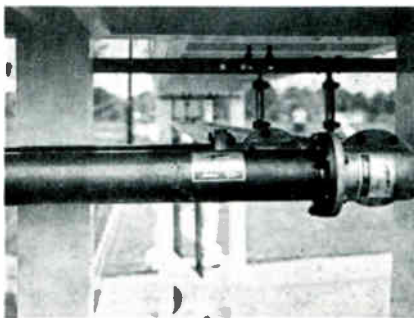

Closeup of hangers and line at WLBC-TV.



Sony targets the sound you want

Telemike Exclusive: Built-in Monitor Facility*

Now, with *three* readily interchangeable sound tele-probes, similar in principle to changeable telephoto lenses, you can 'zoom' in from varying distances for the precise sound you're after. The 18-inch probe may be used for 'close-ups,' as far back as 75 feet from the sound source; the 34-inch probe from 150 feet. A 7-foot probe is optional for distances beyond 150 feet.

*The most unique feature, a Sony exclusive, is the built-in, battery powered, solid state monitoring amplifier in the pistol grip handle, which assures the operator that he is transmitting the source with pin-point accuracy.

OTHER FEATURES. OTHER USES: The new Sony F-75 Dynamic Tele-Microphone is highly directional at the point of probe, with exceptional rejection of side and back noises (35 to 40 db sensitivity differential). Recessed switching allows quick selection of impedances (150, 250 and 10K). The uniform frequency response, controlled polar pattern, and unprecedented rejection of background noise eliminates feedback interference in P. A. systems.

The complete Sony F-75 Tele-Microphone includes two sound probes, 18 and 34 inch lengths, monitoring pistol grip handle and the Sony dynamic headset, all in a velvet-lined compartmentalized carrying case, for less than \$395. For specifications and a catalog of the complete line of Sony microphones, visit your nearest Sony/Superscope franchised dealer, or write: Superscope, Inc. Dept. 52, Sun Valley, Calif. *The best sound is Sony*

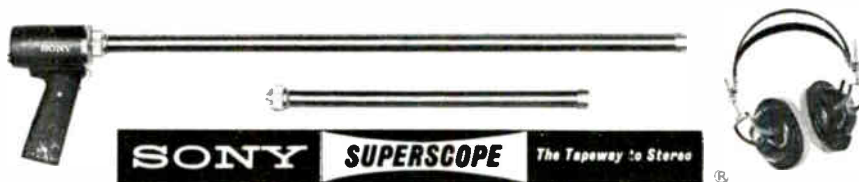

SONY SUPERSCOPE The Tapeway to Stereo

Superscope, Inc., Sun Valley, California

Circle Item 20 on Tech Data Card

will be used. Due to the height of the tower and the distance from the tower to the building, 700' of line will be required.

Antenna gain, power input to the antenna, and ERP are related as follows:

ERP = gain \times power input
 Since the ERP is to be 220 kw and the antenna gain is 25, the required power input to the antenna is:

$$\begin{aligned} \text{power input} &= \frac{\text{ERP}}{\text{gain}} \\ &= \frac{220 \text{ kw}}{25} \\ &= 8.8 \text{ kw} \end{aligned}$$

To state the result another way, a 3.7-kw power loss can be tolerated in the line, or the line efficiency can be no less than 71%.

By referring to line specifications, it is found that a rigid, 6 1/8"-diameter line has a loss of .18 db per 100' at the desired frequency and therefore a total loss of 1.26 db for the 700' line run. A loss of 1.26 db is equivalent to an efficiency of 75%. This can be determined directly from a table, or the ratio of output to input power can be determined and multiplied by 100%. Thus, 12.5 kw \times 75%, or 9.4 kw, is available to the antenna. The transmitter power may be adjusted downward or the ERP increased to approximately 240 kw. (Naturally, the figures on the application for CP must specify the actual powers used.)

In normal television service, the average power rating is the limiting factor; that is, if the line is large enough to withstand the average power transmitted, its peak power rating is more than adequate. The example 6 1/8" line has an average power rating of 51 kw.

The average power into the line is a combination of the outputs of both the aural and visual transmitters, since a common line is used. The aural transmitter is assumed to contribute about 6 kw and the visual transmitter to contribute 7.44 kw when transmitting a standard black picture. (Under this condition, average visual power equals the peak power divided by 1.68). A total average power into the line of 13.44 kw is thus indicated. During normal programming, the average visual power will be much lower.

Now VSWR enters the picture, and the rating must be reduced. For this purpose, it is wise to assume a VSWR value of 1.5; a value this high is unsatisfactory for normal television or FM stereo operation, but to allow for temporary icing conditions, a high figure should be anticipated. The peak power rating is simply divided by the VSWR value. Adjustment of the average power rating also includes a factor, taken from manufacturers' charts, which varies with frequency. For UHF frequencies, this factor is quite small numerically, and it is usually just as easy to divide by the VSWR value only and avoid the additional calculations. Application of these derating factors results in an average power rating of 34 kw.

From the standpoint of power-handling capabilities, the 6 1/8" line is well overrated for the example application, but the large-diameter line is required to reduce the losses at channel 60.

Now assume the same set of conditions as the previous case, except the station is assigned to channel 19 (500-506 mc). Line losses are now .13 db per 100', and the total line loss is .91 db for an efficiency of 81%. This would provide approximately 10 kw at the antenna input, and an ERP of about 250 kw would be available.

The next smaller line size is 3 1/8" in diameter. This line could handle the transmitter power safely, but the losses would be higher. On channel 60, the line efficiency would be 62%, and an ERP of only 190 kw could be obtained. But on channel 19, the efficiency would be 68%, permitting an ERP of 210 kw.

Installation

A reasonably accurate sketch of the run is helpful in planning. Such a sketch will insure that enough line sections, hangers, etc., are ordered. Everything necessary should be on hand before the installation

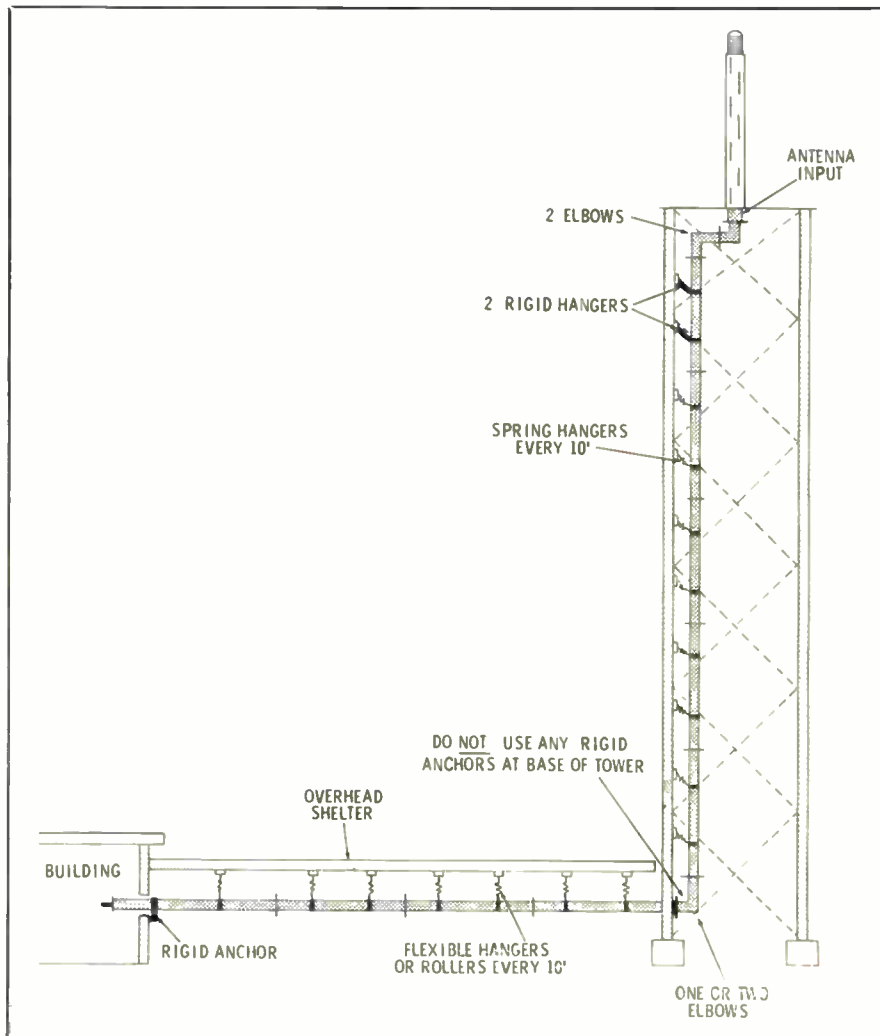

Fig. 1. Sketch shows installation details of a typical coaxial transmission-line run.

JAMPRO

HORIZONTAL AND VERTICAL FM ANTENNAS

The JAMPRO dual-polarized* FM antenna system offers the most practical method of achieving maximum RF radiation under the 1963 FCC FM regulations. These new rules permit as much vertically polarized ERP, as authorized horizontally. Vertically polarized radiation increases the signal many times, in FM car radios, as well as in home radios using built in antennas.

The JAMPRO dual polarized antenna is available in several combinations of vertical to horizontal gain ratios. For class A stations, the equal number of horizontal to vertical is most appropriate. For class B and C stations other combinations may be more desirable.

Power ratings are equal to standard horizontally polarized JAMPRO FM antennas, and vary from 10 to 25 kilowatts. Power gains are available up to 7.0 for the horizontal and vertical.

*U.S. PATENT PENDING

EXCLUSIVE ADVANTAGES OF THE JAMPRO DUAL POLARIZED FM ANTENNA SYSTEM

MORE SIGNAL INTO CAR RADIOS

The vertical polarization puts more signal into vertical car whip antennas.

MORE SIGNAL INTO HOME FM RECEIVERS

The vertical polarization, due to reflections, puts more signal into built-in antennas found in nearly all modern console type FM radios.

EXISTING JAMPRO ANTENNAS MAY BE CONVERTED

All existing JAMPRO FM antennas can be converted to dual polarized arrays with reduced horizontal gains.

DIRECT ENGINEERING SERVICES

JAMPRO antenna engineers are available to deal directly with any antenna problem.

MORE LISTENERS IN HILLY TERRAIN

Signal levels in reflection areas are increased with dual polarization.

LOW PRICE — QUICK DELIVERY

The dual polarization FM antenna provides the highest performance at the lowest price. Customized service makes for fast delivery.

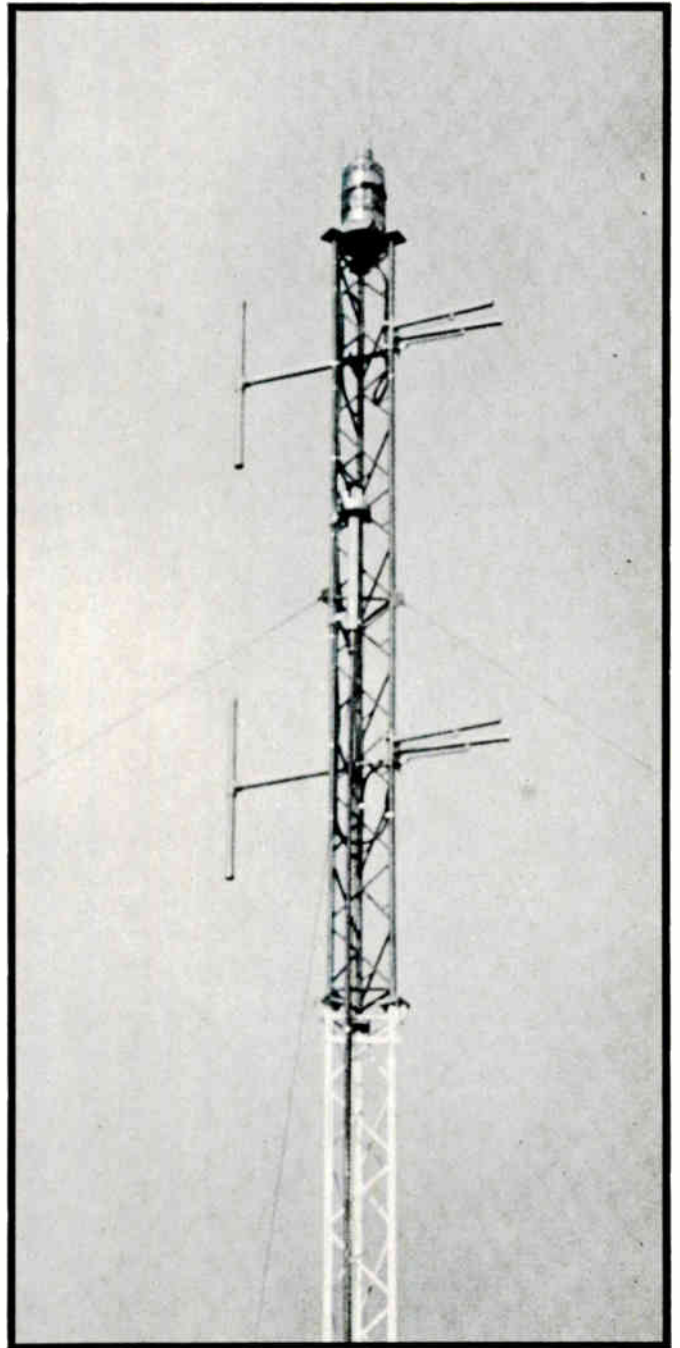

J A M P R O

ANTENNA COMPANY

6939 POWER INN ROAD
SACRAMENTO 28, CALIFORNIA

Circle Item 51 on Tech Data Card

About the Cover



Some idea of the enormity of the Empire State Building and its TV antenna tower can be gained by looking at the workmen silhouetted against the sky in our cover photo. These men are part of the crew installing a new channel 11 antenna for WPIX, New York.

Since the old WPIX antenna was installed on the tower in 1950, the number of high-rise business and residential buildings in the city has steadily increased. And reception problems increased as the number of tall buildings rose.

Based on data obtained by WPIX engineers from ground and air signal surveys, a "zig-zag" antenna was designed and custom-built for the station by the General Electric Company. The antenna consists of four aluminum panels, each measuring 21' x 30" and weighing 150 lbs. One panel is mounted on each side of the tower. Each panel has mounted on it a $\frac{3}{8}$ "-thick copper-clad zig-zag radiating element. The antenna is designed to give electrical beam-tilt, and a power gain of 4.5 makes possible an effective radiated power of 100,000 watts. De-icing is accomplished by passing a 300-amp current through the radiating elements.

Construction work was carried out between midnight and dawn so that no interference would be caused with the operation of the other stations sharing the tower.

is begun, and the work should progress as rapidly as possible so that the entire run can be sealed and gassed before extended exposure to the weather occurs.

Rigid Line

On tall towers, two or three rigid hangers should be placed at the top of the vertical run, below the antenna (Fig. 1). It is important that the antenna **does not** support the line. All the way down the tower, each 10' of line should be supported by a spring hanger, and every 10' of the horizontal run should be supported by some type of movable hanger. A rigid anchor should be installed where the line enters the building. The line will contract and expand due to temperature changes, and it must be allowed to move. This movement is maximum at the base of the tower, and the line **must not** be rigidly anchored at that point.

Two elbows should be used to join the antenna to the line. Such an arrangement permits the antenna to be opened when necessary without disturbing the rigid hangers. If no elbows are used, the rigid hangers must be loosened to allow separation of the line from the antenna, and it may require rigging equipment and more than one man to put the assembly together again.

While one elbow may be used at the base, two provide more flexibility, and it is not necessary to have the horizontal run meet the vertical run exactly at a right angle. All elbows should have swivel flanges on both ends; this permits a greater variety of angles to be accommodated.

The tower crew should "build" the line from the antenna downward. This method has several advantages: The rigid hangers hold the line in place from the start; spring hangers may be adjusted properly as they are installed; and, finally, the cut section will be at the base of the tower. Seldom does a line run require a whole number of 20' sections, and the last section must be shortened. If the field solder joint later leaks or breaks under pressure, the section can be replaced without calling in a tower crew.

Cutting Rigid Line

A hacksaw is usually best for

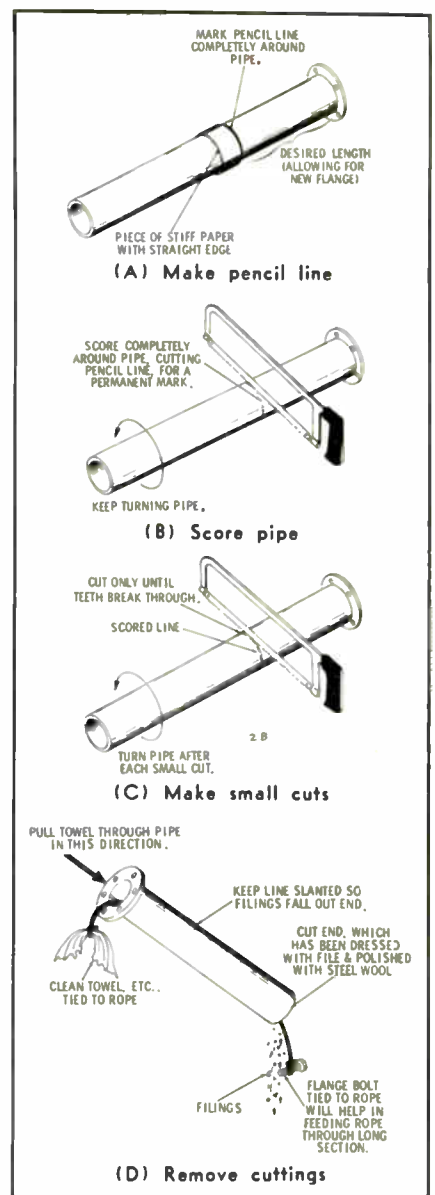

Fig. 2. A method for cutting rigid line.

cutting rigid line. A tubing cutter causes crimping of the line so that the impedance is changed, and there may be trouble mounting the flange or connector. If the cut is not perfectly straight, flanges will be angled, there will be difficulty in joining the line sections, and there will be added stress on the joint. The inner conductor should be completely removed from the pipe before the cut is made. A good cutting technique is illustrated in Fig. 2. First draw a pencil line all the way around the pipe. Next, use a hacksaw to score the pipe all the way around; then begin to make the cut. It is almost impossible to make an accurate cut by sawing across the pipe in one pass. Instead, cut until the blade just breaks through the pipe wall, turn



YOUR SYLVANIA DISTRIBUTOR HAS A

COMPLETE INVENTORY

From his full-line inventory of Sylvania industrial and commercial tube types, you get immediate off-the-shelf delivery. Electronic tubes for every application. Same-day service, wherever possible.

These are rugged, long-life electronic tubes,

proven by outstanding performance and characteristics over long periods of testing and in actual use.

Call your Authorized Sylvania Distributor.

Electronic Tube Division, Sylvania Electronic Components Group.

SYLVANIA
SUBSIDIARY OF
GENERAL TELEPHONE & ELECTRONICS GTE

NEW CAPABILITIES IN: ELECTRONIC TUBES • SEMICONDUCTORS • MICROWAVE DEVICES • SPECIAL COMPONENTS • DISPLAY DEVICES

Circle Item 22 on Tech Data Card

BETTER PICTURES

with the Visual Zoom Camera

The Mark 10 Visual Zoom Camera is the first truly new camera design since the beginning of commercial TV.

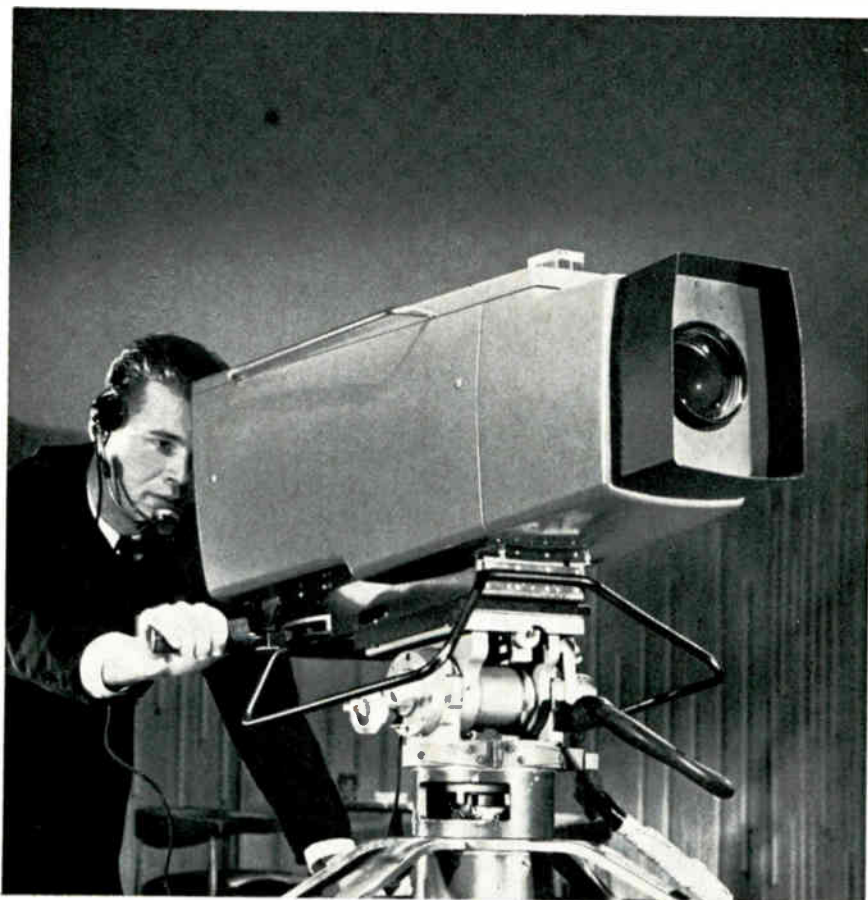

PICTURE SUPERIORITY



with the Visual Zoom Camera

- New 3" I.O. with best resolution
- Improved signal-to-noise ratio
- Better results without critical lighting
- Sharp edge transitions produce crisp, snappy pictures that "carry well". Preferred by audiences and sponsors alike.



Keeps You in View!

Write for descriptive bulletin No. 310.

Visual Electronics Corporation provides the broadcast industry with the first completely solid-state television studio product line.

VISUAL ELECTRONICS CORPORATION
356 west 40th street • new york, n. y. 10018 • (212) 736-5840

Circle Item 23 on Tech Data Card

the pipe and make another small cut, and repeat the procedure until the section is cut off. Deburr the cut edge with a file and polish with steel wool. All filings should be cleaned out of the pipe immediately by pulling a clean piece of cloth through the pipe a couple of times.

While swivel flanges cost a little more, they make the job easier. Fixed flanges require that the bolt holes and guide pins be aligned accurately before soldering; otherwise, it may be impossible to join the two sections. Instruction sheets supplied with the flanges show how much allowance to make in measurements to accommodate the flange and how much the inner conductor must be undercut to accommodate the bullet.

Both soft- and silver-solder flanges are available. Silver-solder flanges are best for outdoor use because such joints can withstand greater pressures than soft-solder joints. Silver soldering requires a hotter torch, however; a small oxyacetylene outfit with a No. 3 or No. 4 tip is satisfactory. An area sheltered from the wind will speed the work.

Different line manufacturers use various styles of insulators at different spacings along the inner conductor. For certain lengths of the cut section, the cut may occur at an insulator, and it may be impossible to get the bullet in place. There are a couple of tricks which help avoid this problem. In most cases, the length of line section to be cut can be increased or decreased an inch or two. A little foresight when making the measurement will place the cut for the inner conductor between insulators. Another approach may be used when the outside length must be

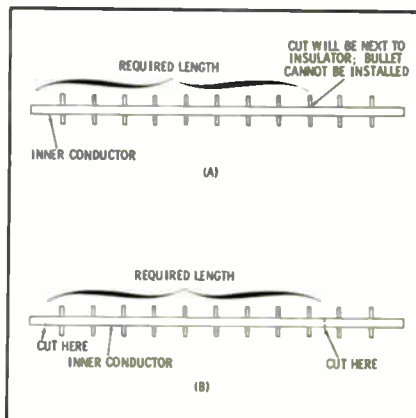

Fig. 3. Method of cutting inner conductor.

**If you are using
video tapes that
foul heads, shed (particularly at splices)
cause headwear
in less than 1,000 hours,
scratch easily,
show signs of wear at
700 passes or less,
STOP.**

More and more broadcasters are solving these problems with **Reeves Soundcraft Micro-Plate* Video Tape**. The 100% factory pre-tested HEAVY-DUTY video tape that meets or exceeds commercial broadcast standards for drop-outs and signal-to-noise ratio. Order today from your local Soundcraft office or call Danbury, Conn. Write today for free, fully documented technical bulletin RS64-26.



REEVES SOUNDCRAFT

Division of Reeves Industries, Inc.
Great Pasture Road, Danbury, Conn.

NAME _____

TITLE _____

STATION: _____

CITY _____ ZONE _____ STATE _____

*T.M.

Main Office: Great Pasture Road, Danbury, Conn. • NEW YORK: 302 E. 44th St. • CHICAGO: 28 East Jackson Blvd. • LOS ANGELES: 342 N. LaBrea Ave.

exact: Move the desired length along the inner conductor and make two cuts (Fig. 3).

Protecting Rigid Line

An overhead shelter should be provided for the horizontal run. This shelter protects the line from falling ice (or tools dropped from the tower) and can also provide the support for the line hangers.

When line for a new installation is ordered, it is always a good practice to order one or two sections more than will be needed. A spare

section of line will come in handy in the event a section is damaged during installation or if a section must be replaced in a hurry at some later time.

Storage of 20' line sections can be a problem, however, especially if the transmitter building is small. Stored sections should be sealed against dust and water; if spare end seals are available, the sections may be gassed. The best storage location is on a wall inside the building, up out of the way of damage. As an alternative, the spare

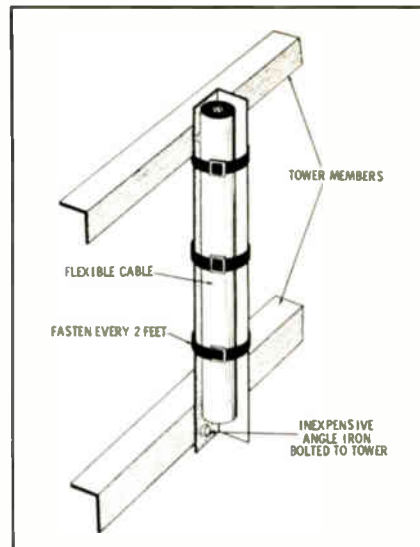

Fig. 4. Metal support for flexible line.

sections may be hung on a wall outside the building and covered by a box or false wall as a protection against weather and theft. If there is space on the tower, or under the horizontal shelter, the spare line may be supported there on regular hangers.

Flexible Line

Flexible line is mounted differently and more simply than rigid line. The cable is pulled up the tower by a hoist and is then fastened every 2' to a tower leg. Contraction and expansion are taken up by the line itself. If the installation requires the line to span open spaces, angle-iron supports should be used as in Fig. 4. Otherwise, vibration and flexing by the wind can destroy the line.

Maintenance

Daily inspection of the VSWR readings provides a warning of impending line problems. (Such readings can be logged during the daily transmitter inspection.) These readings reveal gradual deterioration. Regular checks of gas and tank pressures indicate when leaks are developing. Any sudden increase in gas consumption is a sure indication of a leak. During the annual tower inspection, bolts should be tightened and checks made for dents or other damage that may have occurred to the vertical run.

A properly designed and installed coaxial transmission line will require very little maintenance. Reasonable attention to these modest requirements should help to insure continuity of broadcast service. ▲

PROGRAM DIRECTORS
CHIEF ENGINEERS
EXECUTIVES

SAVE TIME

Identifying, Evaluating, Cataloging,
Inspecting 16mm Motion Picture Film
on the



moviola LIBRARY READER

- View at up to five times sound speed.
- View at governed sound speed.
- Twelve sided prism, high quality, projection system.
- Rapid rewind without switching reels.
- Performs all functions forward and reverse.
- Available with or without sound.

moviola
manufacturing co.
motion picture | tv equipment

5539 Riverton Ave., North Hollywood, Calif.
Telephone: 877-2173
Cable Address: Moviola, North Hollywood, Calif.

Circle Item 25 on Tech Data Card

Scala Precision Antennas

- ★ OFF-THE-AIR PICKUP — FM or TV
- ★ LOW POWER UHF, VHF TV TRANSMITTING
- ★ STL AND TELEMETERING ANTENNAS

Engineered to meet rigid FM and TV station specifications,
and to endure the tests of weather and time.

Built to your specifications by

SCALA RADIO CORP.

2814 19th STREET
SAN FRANCISCO 10
VA 6-2898

Circle Item 26 on Tech Data Card

SHURE

...broadcast audio
equipment that is
exciting the industry

MICROPHONES

Specially designed for exacting studio applications. Extensively field-tested, many in use by leading radio and TV stations.



**MODEL 576
OMNIDIRECTIONAL
DYNAMIC**

Only 3/4" diameter! 40% smaller diam., 60% smaller area than popular dynamic omnidirectionals. Virtually flat from 40 to 20 Kc. Rugged steel case.



**MODEL 570
LAVALIER DYNAMIC**

Outstanding on the job. Specially shaped response cuts "chest boom" . . . provides unequalled presence. Non-metallic "Flex-Grip" hanger . . . silent, secure. Only 3/4" diam.



**MODEL 546
UNIDIRECTIONAL
UNIDYNE III**

Uniquely uniform and symmetrical cardioid pattern solves many difficult studio and remote problems. Provides broad useful front coverage.



**MODEL 333
UNIDIRECTIONAL
RIBBON**

Extremely rugged. Exceptionally attractive and compact. Ideal for music (stereo or mono) and general applications on stand or boom. Super cardioid, flat wide-range response.

CIRCUITRY

Shure stereo equalizer and preamplifiers are praised as MAJOR contributions to upgrading station quality by broadcasters.

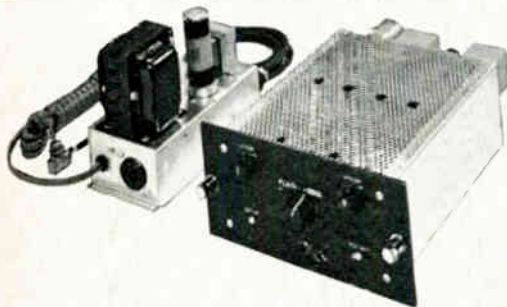

**SE-1 STEREO
TRANSCRIPTION PREAMPLIFIER**

Provides precise RIAA equalization from magnetic phono reproducers at line levels. Separate high and low frequency response trimmers. Lowest distortion, noise level, susceptibility to stray RF fields.

**M66 BROADCAST
STEREO EQUALIZER**

Passive equalizer compensates recorded frequency to three playback characteristics: RIAA, flat, roll-off. Provides precise equalization from magnetic pickup at microphone input level.



STONE ARMS & CARTRIDGES

World standard for quality sound.

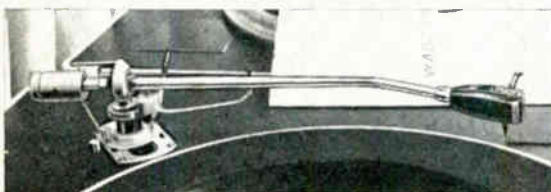

**SHURE SME
"THE BEST PICK-UP
ARM IN THE WORLD"**

Utterly beyond comparison. Supremely accurate, proved reliable in quality music stations.

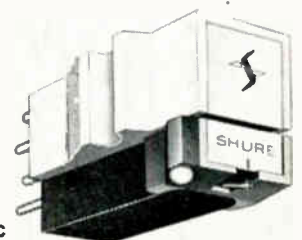

**STEREO DYNETIC
Phono Cartridges**

First choice on every count—standard in the quality music stations.

Write directly to Mr. Robert Carr, Manager of Professional Products Division, for personalized assistance, technical data, samples for testing: Shure Brothers, Inc., 222 Hartrey Ave., Evanston, Ill.

CONCRETE FM TOWER IN SOUTH AFRICA

by **Steven A. Cisler**, Consulting
Author, Louisville, Kentucky — An
unusual structure serves as the hub of
a nation-wide broadcast system.

Tallest man-made structure in all Africa, the soaring 772' Albert Hertzog tower dominates the skyline of Johannesburg, South Africa, and is visible from the air up to 100 miles away. This tower serves as the hub of the South African Broadcasting Corporation (SABC) national FM system which ultimately will include 127 transmitting stations. The story of this South African structure is a parallel to the increased interest of American radio and TV stations in combined tower facilities and pooled transmitter housing.

The Tower

The six 10-kw FM transmitters are housed at a level 15' above the ground. The transmitter outputs are fed through a single coaxial line to the antennas at the top of the tower. The installation is designed for automatic operation and reports regularly on its condition to a maintenance center responsible for a group of transmitting stations. Power is normally supplied by utility service, but a 200-kw diesel-powered emergency generating facility can be put in service within ten seconds after a power failure.

The Hertzog tower is one of the ten highest self-supporting concrete structures in the world—five of the others are in New York City. The South African FM structure is comparable in height to the Woolworth Building (790'), Rockefeller Center (830'), and the German radio tower at Nauen (880').

The period of time from first designs, in January, 1961, to completion of construction, in September, 1962, was only 20 months. Broadcasts began ten months after ground was broken for the foundations. (A similar but somewhat shorter tower at Stuttgart, Germany, required three years from design to comple-



Tower overlooks city of Johannesburg.

tion.) Nearly 7,000 tons of concrete were poured in building the Johannesburg tower. As each 7½' "story" was completed, the forms were raised above the completed section so that the next ring could be cast. An average of one ring, or story, was completed each day. The concrete was reinforced with 300 tons of mild- and high-tensile-strength steel bars. Additional strength is provided by the cross-section of the wall, which curves slightly inward in an exponential manner. Total weight of tower and mast is 7820 tons.

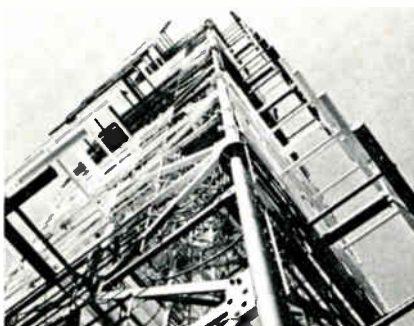

Antennas atop tower receive power from transmitters near base via a single line.

Brixton Ridge, the tower site, is overlain with a Jeppestown shale formation which has a high weight-bearing capacity. The ring-like foundation of the tower is triangular in cross section, 84' in diameter, 20' wide, and 7' deep. The foundation was cast in a continuous operation lasting 60 hours; 650 cubic yards, or 1320 tons, of concrete was required.

Because of the elastic nature of the tower itself, earth tremors are hardly felt in the observation turret. The tower is somewhat like a long stick with a weight at its top; when the stick is held vertically and shaken at its lower end, only a fraction of the shaking motion is transferred to the top. Engineers rate the tower capable of withstanding wind velocities of 116 mph with peak gusts at the tower top of 123 mph. At maximum wind load, the tower sways up to 8" at the observation platforms and 25" at the top of the steel mast.

Lightning has struck several times without damage. The antenna mast, the steel reinforcement in the tower, and the elevator shaft are all bonded to a radial network of buried copper grounding strips, each 150' long. The concrete shell and observation turret are electrically screened by the use of a metallic mesh covered by plaster sprayed on under pressure.

At the top of the concrete shaft and below the steel antenna mast, one open-air and three glassed-in observation platforms were built for public use. These are reached by an elevator having a capacity of 11 passengers and moving at 700' per minute. Around the elevator shaft is an emergency staircase, including a duct housing electrical and telephone cables, water pipes, and sewer lines. Each 45' diameter platform can accommodate 100 people.

Just What Does a TV Computer Programmer Do?

First thing it does is go to work saving money—if it's Tarzian's new Automatic Programmer for Television (APT). APT starts paying its own way immediately by eliminating make goods caused by operator error. It can't get flustered—can't panic. Prime time, or any time.

With a Tarzian computer programmer, productions run smoother . . . faster. At APT's command, intricate combinations of switches, fades, dissolves, supers, pre-rolls, previews, etc. are executed precisely as required by your programming. With NO mistakes. And all automatically, free-

ing station personnel for more productive effort. APT speaks your language, too. All this solid state workhorse needs to go into action is the information right off your program log. No confusing translation into computer lingo. And anyone who can read the log can load it into the computer. It's really that simple.

APT is a true computer—not just an automation switcher. It was designed solely for television—not modified from some other use. It's all solid state. It interfaces readily with existing equipment. And, it costs less than a VTR.

First computer programmer designed specifically for television by a major television manufacturer.

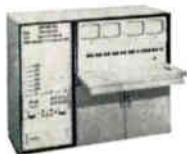

A call or letter brings our brochure with all the details.

S A R K E S
BROADCAST EQUIPMENT DIVISION



T A R Z I A N
BLOOMINGTON, INDIANA

Circle Item 28 on Tech Data Card

The inner tower core at this height (553 to 573') is 16' square. Double-glazed windows provide thermal insulation; the outer panes are designed to withstand wind pressure and vacuum up to 90 lbs. per square foot. These panes are tinted to reduce glare. The platform areas have air conditioning and concealed lighting. A small post office is available for visitors, and a restaurant with accommodations for 200 is built into the base of the tower and onto a cantilever balcony.

Aircraft-warning lights are installed around the concrete shell at

heights of 150, 300, 450, and 600' and at the midpoint and top of the antenna mast. Pairs of 500-watt flashing lamps are installed at the 300' and top levels. Twin 75-watt lamps are used at the other levels. The entire system conforms to the regulations of the International Air Transport Association. The tower itself is illuminated at night by four groups of floodlights mounted on the ground about 50' from the base and by lights on the top platform which shine up through the steelwork of the antenna mast.

Officials of the SABC involved



Scaffold and forms for one 7½' section.

in this project were H. O. Collett, Chief Engineer; B. J. Stevens, Assistant Chief Engineer; L. Durston, architect; and D. H. Mills, planning and development engineer of the FM service. Consulting engineers were Messrs. Ove Arup and Partners. Contractors were Messrs. Christiani and Nielson (S. A.) (Pty) Ltd.

The National FM System

Since 1959, the SABC has continuously planned the national development of FM through an active committee under the direction of Dr. P. U. Meyer, chairman of the board. The object is to provide good FM coverage of vast areas and a diversity of services in several languages to reach the Bantu, Afrikaans, and English-speaking population groups. The SABC committee evolved a plan to use six grids composed of a total of 127 separate transmitter locations and employing over 500 transmitters. The full plan is to be completed, in stages, by late 1967; the Hertzog tower is the heart of the first stage, the Transvaal complex.

Calculations for the grid patterns were made by computer at the Institute for Radiobroadcasting Engineering at Hamburg, Germany. Due to the complexity of the problem, the computer required four hours to arrive at an answer.

Transmitters are located on mountain tops to provide an average effective range of 60 miles. Five or six transmitters are located at each site. The Hertzog-tower antennas have a gain of 10 to produce 100 kw ERP. Most transmitters are unattended; engineering centers each monitoring ten stations are responsible for maintenance.

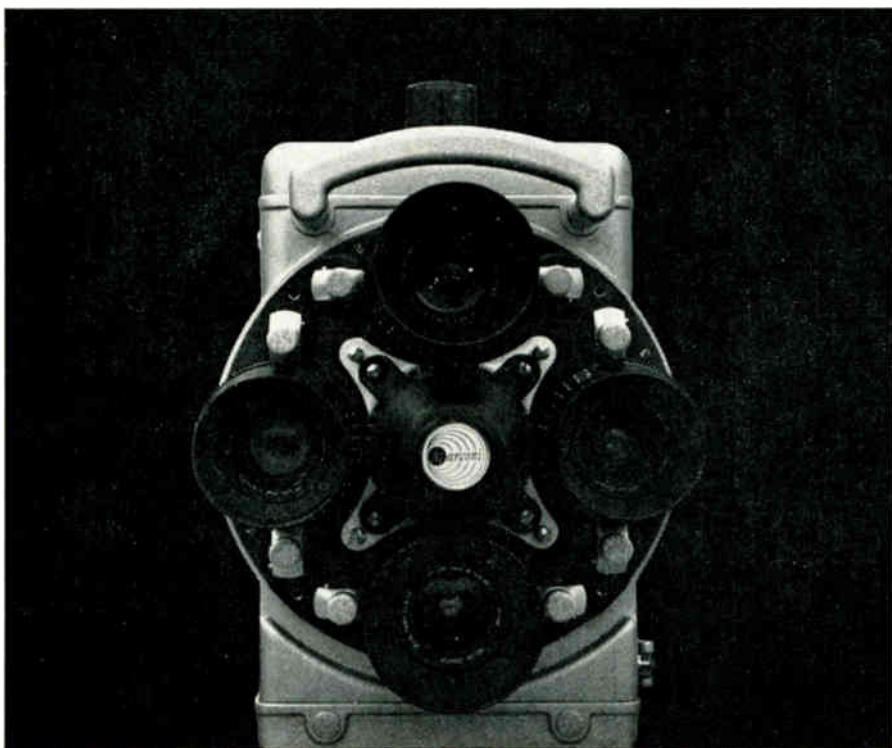

NO ONE HAS EQUALLED THIS CAMERA

It's certainly not for want of trying. Since Marconi introduced the first 4½ inch Image Orthicon camera, everybody and his brother have been trying to catch up. A thousand Marconi 4½" cameras have gone into service in 38 countries. The Mark IV has literally become the world's standard television camera. And for good reason. It's the camera that improved picture quality 50%. It was the first camera to make it possible for the cameraman to concentrate entirely on composition and focus—and leave all other functions to the control room. Another first: once you set it up it stays set up. Little wonder that a lot of people have been trying to duplicate it. But there's one hitch. While the others have been trying to build a camera

as good as the Mark IV, Marconi has been radically improving it. Long-lived silicon rectifiers have replaced selenium units in the power supply. A shielded yoke keeps the camera in focus even if there's magnetic interference. A solid-state head amplifier has been added. And the Mark IV is now instantly switchable from one world standard to another. In short: by the time somebody makes a camera as good as the 1959 model Mark IV, they'll have the 1964 model to contend with. And that goes for the whole line of Marconi specialties: vidicon telecine equipment, switchers, color cameras, closed circuit vidicon cameras and accessories. Distributed by Ampex Corp., Redwood City, California. Term leasing and financing is available.



© AMPEX CORP., 1964

Circle Item 29 on Tech Data Card

AMPEX



WHAT'S NEW

IN TV SOLID-STATE SWITCHING?

There's a big "Switch" in the operational philosophy, as well as the solid-state circuitry of these three new CDL switching systems. We're sure that before you install another switcher, you'll want to discuss with us our approach to Composite Switching, Automation, Integrated Audio/Video Controls, Double Re-Entry Switching, etc. — and what our precision craftsmanship does to safe-guard your investment and assure maintenance-free performance.



ONE OF THE THREE NEW CUSTOM-DESIGNED COMPOSITE STUDIO SWITCHERS AT WGBH (BOSTON)

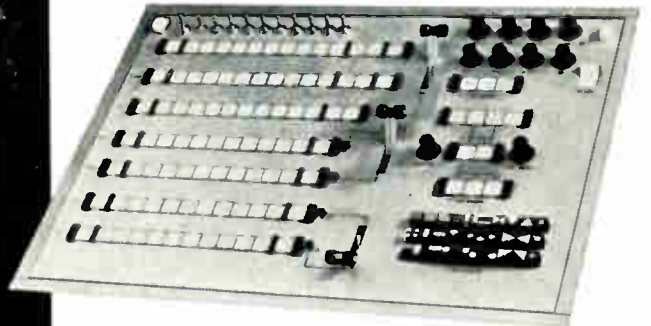

ONE OF EIGHT NEW CUSTOM-DESIGNED COMPOSITE SWITCHERS AT CBC

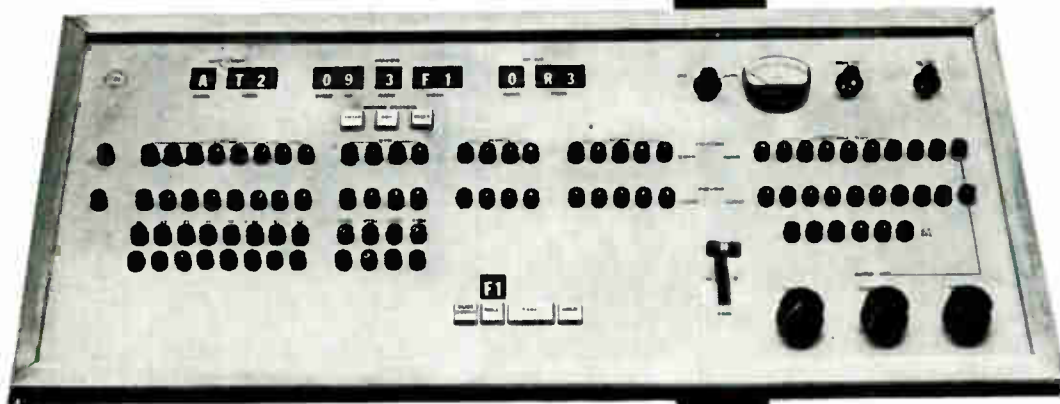

VSA-102 AUTOMATED STATION-BREAK VIDEO/AUDIO SWITCHING PACKAGE CHOSEN BY WMAL-TV (WASHINGTON)

FOR COMPLETE INFORMATION WRITE DIRECTLY TO:

WARD ELECTRONIC INDUSTRIES, Inc.

P. O. BOX 1045, MOUNTAIN SIDE, N. J. • (201)-232-1167

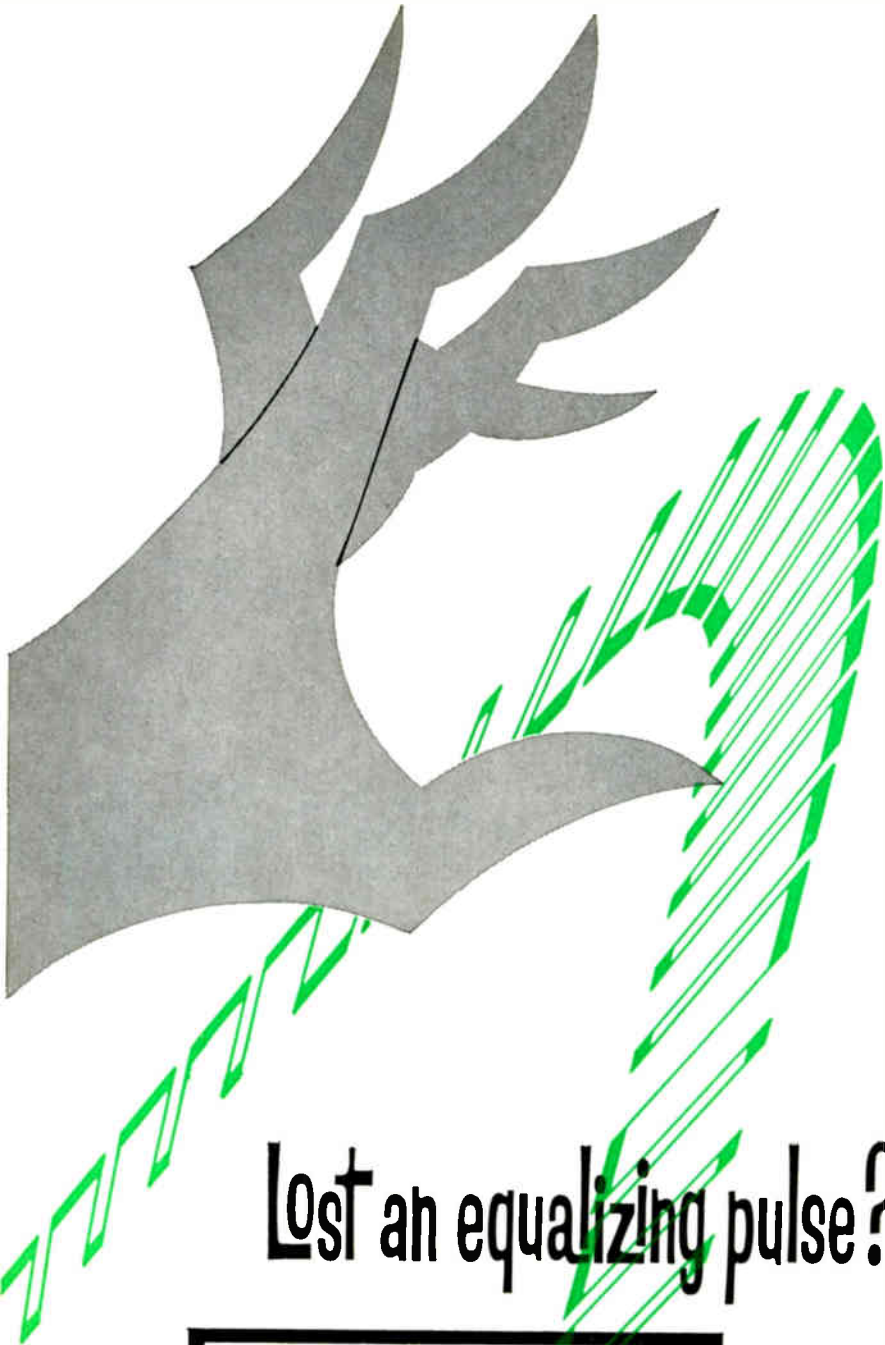

Lost an equalizing pulse?



IEEE BOOTH
NO. 2409

Why tie up your expensive line selecting monitors—looking to see if an equalizing pulse fell out between here and Washington? For \$425, the S32AR, the only wideband oscilloscope on a 5¼" panel, will monitor any incoming waveform. In the trigger circuits are a differentiator for the H pulses and an integrator for the frame group, ensuring a positive lock on composite video. Call or write today for full specifications.

data instruments

A DIVISION OF INDUSTRIAL ELECTRONIC HARDWARE CORP.



7300 CRESCENT BOULEVARD PENNSAUKEN, NEW JERSEY 609-662-3031

Circle Item 31 on Tech Data Card

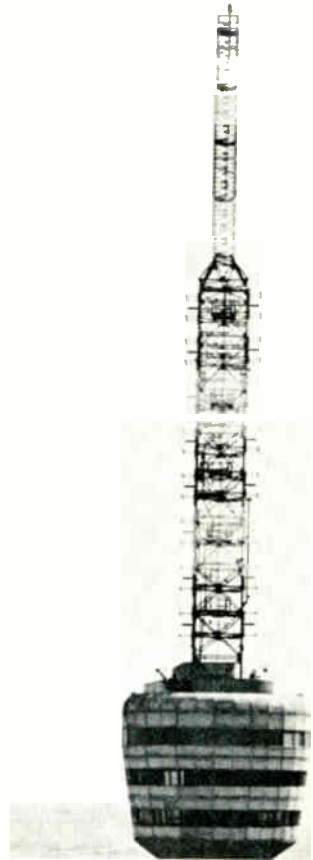

Observation platforms are near 540' level.

The system is designed so that the English and Afrikaans program services can be broadcast nationally or regionally at will. On the regional service there is a total of 11 programs, including the Springbok (commercial). Programs in seven native South African dialects are broadcast.

South Africa has many things to teach any nation interested in efficient use of FM for maximum service. ▲



Aerial view of the concrete FM tower.

BROADCAST ENGINEERING



ALUMIFOAM SEMIFLEXIBLE
(foam dielectric)



ALUMISPLINE SEMIFLEXIBLE
(air dielectric)

What ordinary flexible coaxial cable won't do... Times semiflexible will!

Here are 7 reasons why. More Isolation—at least 80 db more than ordinary coaxial cable. Uniformity average—VSWR 1.1 or less. Stability—10 times better. Lower Loss—30% less. Pulse Reflection—Less than 1%. Less Distortion.

Times is producing semiflexible coaxial cable with seamless aluminum outer conductor in two standard versions:

ALUMIFOAM—Foam polyethylene dielectric where pressurizing isn't practical.

ALUMISPLINE—Air dielectric where pressurizing is practical. Superior because the dielectric is uniformly extruded directly on the center conductor, guaranteeing lowest attenuation, VSWR, and good nanosecond pulse response.

Complete Package—Connectors, Too

Available for immediate delivery: Our line of TIMATCH[®] connectors with exclusive self-locking COILGRIP[®] clamp. Available for all cable sizes in all impedances.



TIMATCH[®] CONNECTOR

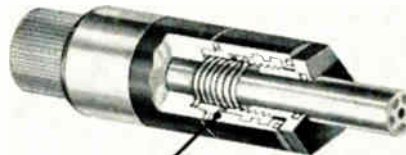

COILGRIP[®] CABLE CLAMP



DIVISION OF THE INTERNATIONAL SILVER COMPANY, WALLINGFORD, CONNECTICUT

TRANSMISSION SYSTEM DESIGN AND ENGINEERING • STANDARD & SPECIAL PURPOSE COAXIAL CABLE • MULTICONDUCTOR CABLE • COMPLETE CABLE ASSEMBLIES • TEFLON[®] HOOK-UP WIRE
Copyrighted 1964 *A DuPont Trademark

Circle Item 24 on Tech Data Card

RADIO BROADCASTING IN EAST GERMANY

by **Steven A. Cisler**, Consulting Author, Louisville, Kentucky—This is what radio is like on the other side of the Wall.

If there had been radio broadcasting in Civil War days, how would the operations of the two opposing sides have differed? A real-life parallel to this imaginary situation exists today in divided Germany. Because of the meager flow of factual information from East Germany to the free world, an outline of how the German Democratic Radio (GDR) operates should be of interest to American station managers and engineers.

The total destruction of the old broadcasting services in the closing days of World War II is well known. After the war, radio broadcasting facilities had to be built from the ground up, literally, in both the Eastern and Western zones. Modern German broadcasting equipment is well regarded by American engineers for its inherent quality and fine workmanship.

East German broadcasting is totally a state project. A broadcasting committee, headed by Dr. Gerhard Eisler and composed of the directors of the individual stations, controls the overall functioning of

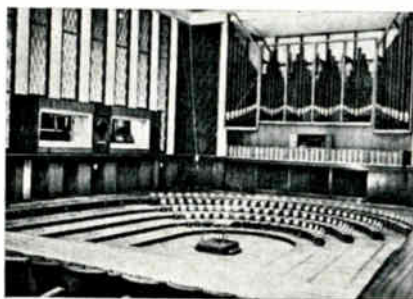

Large Berlin studio for musical shows.

the system. Five program schedules are broadcast over AM, FM, and SW. Program content is varied but always consistent with the aims of the state in cultural and political education.

The national system is known as DDR, or Deutscher Demokratische Rundfunk. This service provides two national programs, integrated in various locales with district programs originating from area studios. The DDR I program is broadcast from ten AM stations in major population centers; the stations operate on frequencies between 746 and 1570 kc. This service is backed up by eight major FM outlets. Some

of these operate in the same cities as the AM stations; others operate from locations selected for optimum regional coverage. The DDR II program is broadcast from a chain of 11 FM stations. Some are in the same locations as DDR I FM stations; others are not. All FM transmissions are on frequencies between 88 and 99.7 mc.

In East Berlin, two full-time services are originated by Radio Berlin and transmitted over four AM stations and nine FM outlets throughout the Eastern zone. Another service, known as Berlin Wave, employs two AM outlets and one FM station.

Still another GDR radio service is Radio Deutschlander, which operates a longwave (185-kc) station in Berlin and three medium-wave AM stations in outlying cities to give national coverage. This service also operates nine FM transmitters, for the most part in the same locations as those of DDR I and II. Radio Deutschlander presents much of the official state position on matters of national policy and develop-



A small Potsdam studio used for conference-type broadcasts.

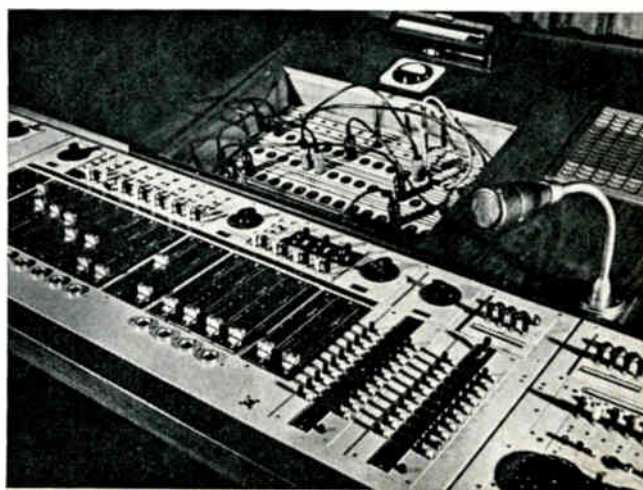

A typical mixing console located in one of the GDR studios.

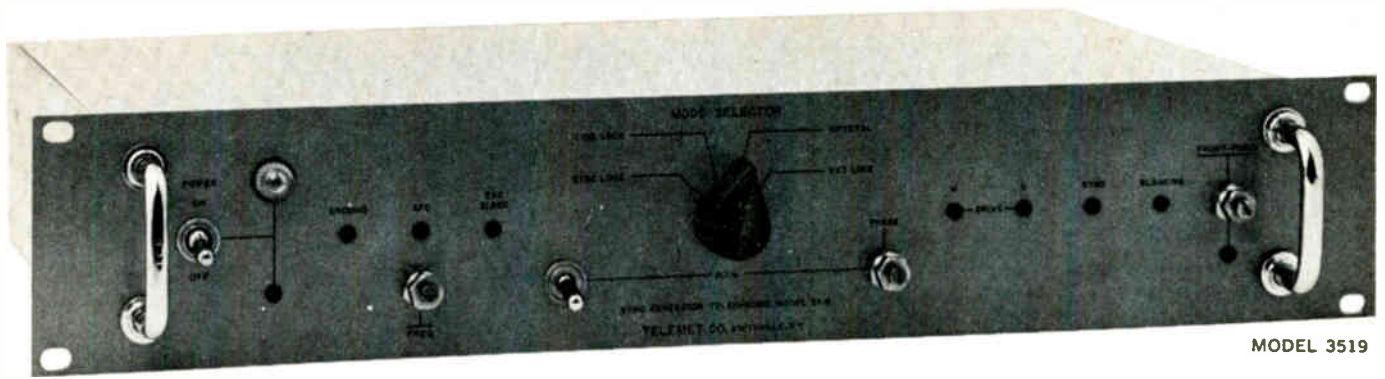

Where else can you get an
EIA Sync Generator that meets
ALL RS-170 requirements
PLUS the stringent specifications
of modern broadcasting at
Telemet's low price?

Nowhere else.

Model 3519 EIA Sync Generator is ideally suited to both broadcast and closed circuit operations; producing sync, blanking, H-drive and V-drive signals in accordance with RS-170 standards. Front panel switch selects four operational modes: Sync Lock—Line Lock—Internal Crystal Lock—Freerun or Lock to External 31.5 KC signal (Color Lock). Sync locks to remote video via Telemet Model 3513 Sync Lock unit. Use of integrated circuits enhances reliability and simplifies maintenance. All-silicon semiconductor components permit high ambient temperature operation. Write today for complete specifications.



TELEMET COMPANY
a division of
GIANNINI SCIENTIFIC CORPORATION
185 DIXON AVENUE, AMITYVILLE, N. Y. • PHONE (516) 541-3600

Circle Item 33 on Tech Data Card

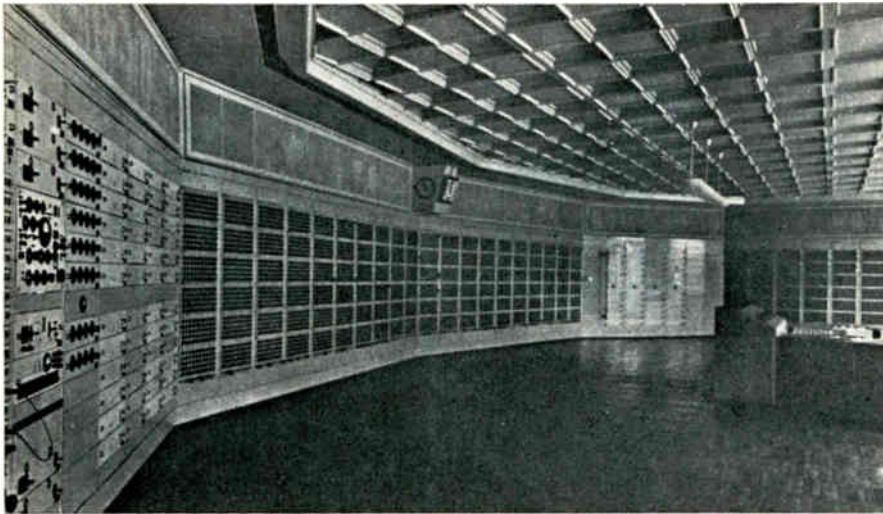

View of East German master control room shows patch bay, control operator's position.

ment of the state. Heavy emphasis is put on domestic and foreign news.

Thus, in the city of Berlin, a listener has access to five separate FM channels. In addition, three medium-wave and one long-wave AM station, mainly duplicating the FM coverage, are available.

Radio Berlin International broadcasts daily in nine languages. Both short and medium waves (the latter

for Europe only) are employed.

Emphasis is placed on rugged studio and transmitter installations designed to last and give minimum trouble. The heavy schedule of live-talent productions necessary to maintain the five separate program schedules requires not only a large staff but also spacious working studios and control rooms. Some of these are pictured with this article. General design follows the func-

tional styling seen in other European countries.

From the historic date of May 13, 1945, when broadcasting resumed in a war-racked East Berlin building—with Soviet soldiers keeping outside noises down for the sake of production—the DDR has progressed to its present status. Radio works with television in this German area to tell its story in competition with transmissions from the west across the Berlin Wall. ▲

MOVING?

*Don't Lose
Touch . . .*



Receive B-E
as usual at
your new address

Write:

BROADCAST ENGINEERING
Circulation Dept.
4300 West 62nd St.
Indianapolis 6, Ind.

CUT HOLES FAST

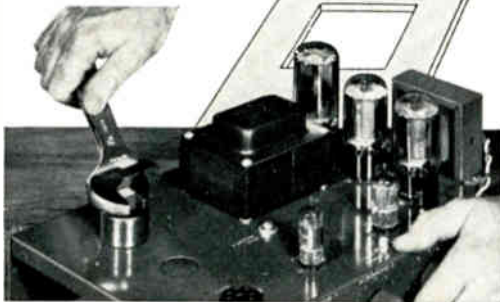

GREENLEE CHASSIS PUNCHES

Make accurate, finished holes in 1½ minutes or less in metal, hard rubber and plastics. No tedious sawing or filing — a few turns of the wrench does the job. All standard sizes . . . round, square, key, or "D" shapes for sockets, switches, meters, etc. At your electronic parts dealer. Literature on request.

GREENLEE TOOL CO. 
2028 Columbia Ave., Rockford, Illinois

Circle Item 30 on Tech Data Card

SPOTMASTER

RS-25



Tape Cartridge Racks

RM-100



. . . from
industry's
most comprehensive
line of cartridge tape equipment.

Enjoy finger-tip convenience with RM-100 wall-mount wood racks. Store 100 cartridges in minimum space (modular construction permits table-top mounting as well); \$40.00 per rack. SPOTMASTER Lazy Susan revolving cartridge wire rack holds 200 cartridges. Price \$145.50. Extra rack sections available at \$12.90.

Write or wire for complete details.

Spotmaster

BROADCAST ELECTRONICS, INC.
8800 Brookville Road
Silver Spring, Maryland

Circle Item 34 on Tech Data Card

BROADCAST ENGINEERING

new Tektronix transistorized video-waveform monitor

with capability for
analyzing VIT signals



You're looking at the back and top of a new video-waveform monitor, Type RM529. There are 45 transistors, 7 tubes, and 2 high-voltage rectifiers. All but 2 tubes and 2 transistors are socketed for easy servicing. There's no fan—it is not needed with the low power consumption of 80 watts to assure clean, quiet, long-life operation. Extremely compact, the Type RM529 uses an extremely bright crt with a full 6-centimeter by 10-centimeter viewing area—yet the instrument occupies only 5 1/4 inches of standard rack height.

you can do more with the  **RM529**
than you can with any other video-waveform monitor.

Here's why:

frequency responses—Four different frequency-response characteristics necessary to monitor all Video Test signals are provided:

1. CHROMA Response centered at 3.58 Mc bandwidth ± 400 kc to measure differential gain.
2. LOW PASS -6 db at 500 kc to see axis shift on Multi-Burst.
3. FLAT To 5 Mc $\pm 1\%$, to 8 Mc $\pm 3\%$.
4. IRE 1958 STD 23-S-1. Color subcarrier -20 db.

line selector—Provides stable displays of the Vertical Interval Test signals. Adequate brightness is provided even at the fastest sweep speed. Can display any line desired. Brightening pulse automatically intensifies the displayed line as viewed on the associated picture monitor. No modification to the picture monitor is required.

field selection—Positive acting circuit allows selection of the odd or even field for display. Noise will not cause random field changing.

dc restorer—A feedback-type restorer acts during the back porch time. Not affected by presence of color burst. Does not distort the burst. Front-panel switch can disable the restorer—when other than video waveforms are viewed.

Type RM529 Video-Waveform Monitor \$1100
For waveform photography, a Tektronix Type C-27 Camera is recommended. Bezels are available to adapt other cameras to the Type RM529.

U. S. Sales Price f.o.b. Beaverton, Oregon



Tektronix, Inc.

P. O. BOX 500 · BEAVERTON, OREGON 97005 · Phone (Area Code 503) 644-0161 · Telex 036-691
TWX 603-291-6805 · Cable TEKTRONIX · OVERSEAS DISTRIBUTORS IN OVER 30 COUNTRIES
TEKTRONIX FIELD OFFICES in principal cities in United States. Consult Telephone Directory.

ENGINEERS' EXCHANGE

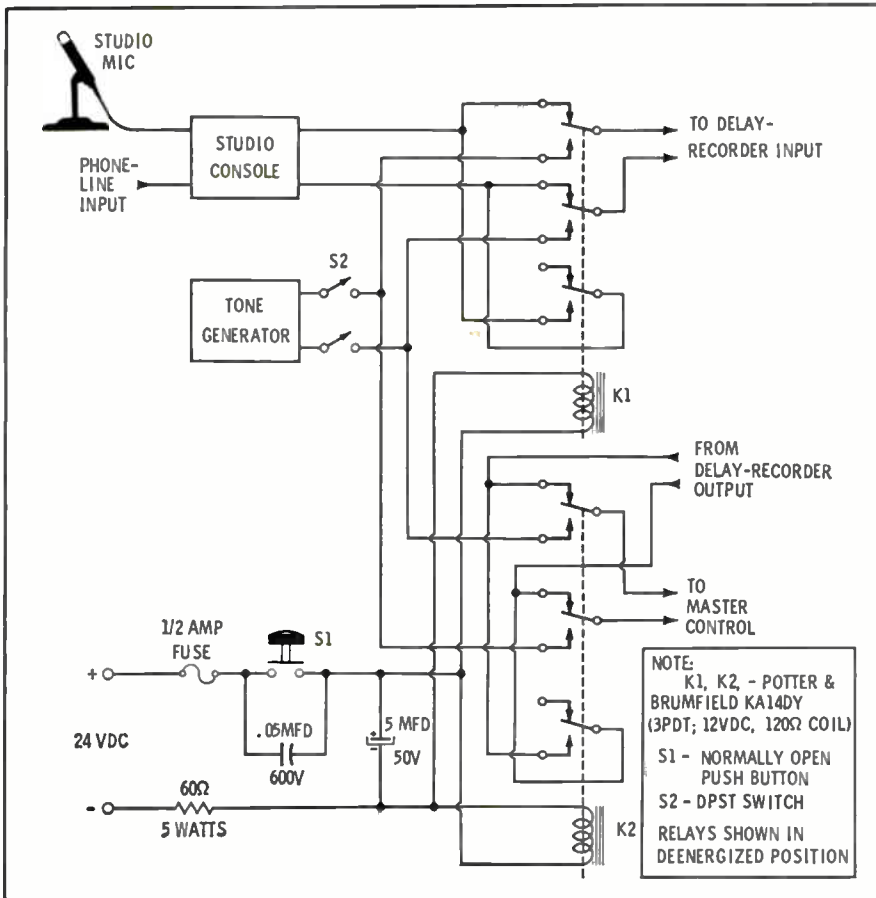

FOOLPROOF CUT BUTTON

by Steve P. Dow, Vancouver, B. C.

Programs in which members of the audience participate by tele-

phone are becoming more numerous. For such programs, a foolproof system that allows the operator to keep libelous, obscene, or other objectionable remarks off the air is

necessary. Shown in the diagram is a device that not only takes the material off the air but also lets the audience know that the show is still in progress. It also prevents undesired feed-through of the telephone-line signal.

In normal operation, the cut button (S1) is open, and both relays are deenergized. The output of the studio console is routed through a delay recorder to master control. The time delay provided by the recorder permits the operator to hear the program material a few seconds before it is broadcast and thus permits him to remove portions of it if necessary.

When the cut button is closed, both relays operate. The outputs of the studio console and the delay recorder are immediately shunted to prevent feed-through. Relay K2 now conducts a signal from the tone generator to master control so the listener knows that the program is still on the air. At the same time, relay K1 connects the generator to the input of the delay recorder. After the button is released, no program signals reach master control until the delay time elapses; the recorded tone fills this interval. The operator uses a telephone-company headset connected to the incoming line so that he can always hear the caller.

The console and recorder outputs are shunted to prevent low-level signals from feeding through the relays; if the tone generator should fail, these signals might be heard over the air. The use of two relays provides a degree of protection even if one of them should fail.

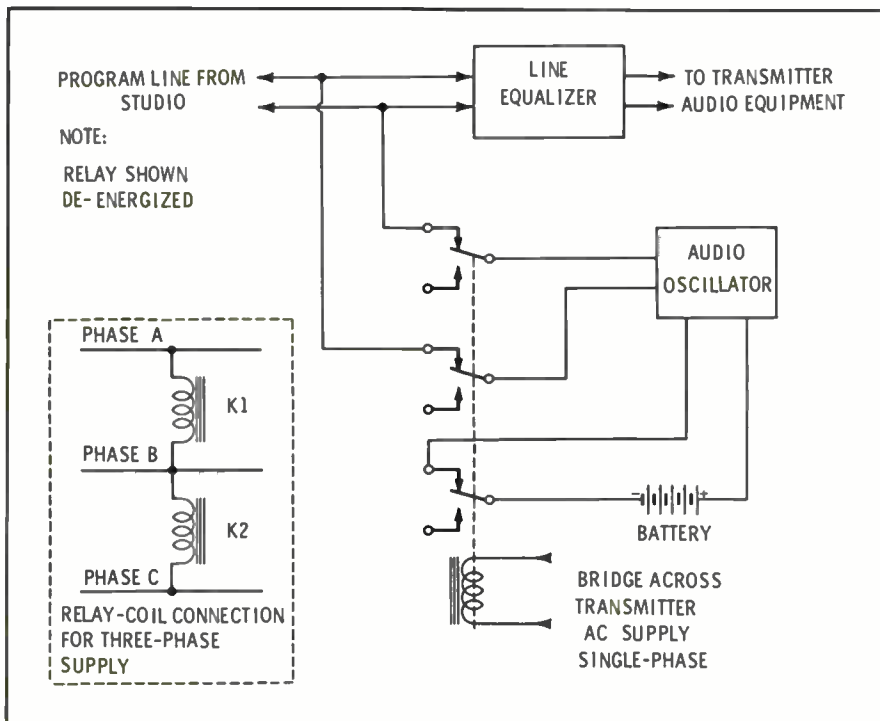

POWER FAILURE INDICATOR

by John P. Tucker, Clifton, Colorado

Power failures at the transmitter site of a remote-controlled station can often cause unnecessary worry and lost air time. It is usually necessary to call the engineer (probably out of bed) and have him drive to the site before it is determined that the power is off. Only then is the repair department of the power company alerted.

By using a transistorized audio oscillator (such as the one described

WOULD YOU INVEST \$665 TO DOUBLE YOUR EFFECTIVE PROGRAM POWER?

New VOLUMAX™ Automatic Peak Controller From CBS Laboratories Outmodes Limiters

Expanded effective range, more reliable reception in fringe areas — both can add to your station's audience and both can be achieved by simply replacing your present peak limiter with a solid-state VOLUMAX.



A new development from CBS Laboratories, VOLUMAX is the successor to peak limiters. Unlike conventional limiters, VOLUMAX does not force you to choose between reducing program level or suffering "pumping" and other audible distortions.

HOW IT WORKS

The secret of VOLUMAX's success is its ability to operate automatically at the most appropriate regulation speed for any program waveform.

After limiting a severe peak, conventional limiters use a long recovery time to minimize audible "pumping". Valuable modulation capability is wasted while the unit recovers from reduced gain.

VOLUMAX works in a completely different manner. Operating with dual

regulation speeds, VOLUMAX analyzes the waveform and provides either microsecond or millisecond action.

The net effect is that your effective radiated program level can be doubled.

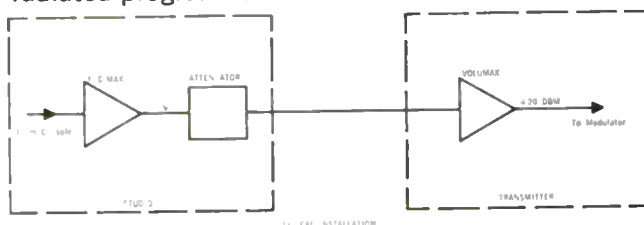

AUDIMAX + VOLUMAX = 8-to-1 INCREASE

When VOLUMAX is used in conjunction with CBS Laboratories AUDIMAX automatic level control, the combination permits an astounding 8-to-1 increase in effective program power. The AUDIMAX "rides gain" in the studio to provide a 4-to-1 increase. Then VOLUMAX controls modulation peaks at the transmitter to provide an additional 2-to-1 improvement.

TRY IT YOURSELF AT NO COST

Order a VOLUMAX and install it. Don't pay our invoice for 30 days; then send us your check or return the VOLUMAX. Or, if you're still a bit skeptical, we'll be happy to send you more complete details on which to base your decision to order a VOLUMAX.

... Quality Products for Professional Broadcasters

CBS LABORATORIES
Stamford, Connecticut
A Division of Columbia Broadcasting System, Inc.

Circle Item 36 on Tech Data Card

WHY SOME LOW-PRICED STOCKS BECOME HIGH-PRICED STOCKS

(For Example: XEROX, CONTROL DATA, SYNTEX)

It is not unlikely that the stock market may soon witness a renewed eruption of excitement among the "low-priced" stocks. Particularly now that many of the big-name, blue-chip stocks are selling at extremely rich price-earnings ratios.

Among the stocks now selling at \$1, \$5, \$10 or \$15 a share, there are indeed a number of real treasures—overlooked bargains that offer the possibility of spectacular rewards.

But a great many other stocks in the low price ranges lack the earnings credentials—current or projected—even to support their already "cut-rate" prices.

For stock market investors now seeking the genuine bargains, it is vital to bear in mind that low-priced stocks are governed by the same basic "rule" as all the rest: namely, a stock's price will be determined mainly by its earnings.

(Of the stock market's star performers of recent years—for example, such once-low-priced stocks as Xerox, Control Data and Syntex—all were powered on their upward ways by enormous earnings growth. In just the last 5 years, the market prices of those stocks have gone up by an average of more than 1000%.)

Performance Ratings: 159 Low-Priced Stocks

Value Line's comprehensive new Summary of stock market advices gives specific ratings of probable market performance for each of 159 low-priced stocks—stocks that recently sold between \$1 and \$20 a share. (The Summary also gives comparable performance ratings for more than 900 higher-priced stocks.)

These stock-by-stock performance ratings—reflecting the investigative work of Value Line's staff of 59 research professionals—are based on careful estimates of each stock's future earnings, both in the 12 months immediately ahead and in the next 3 to 5 years.

GUEST COPY

We will send you Value Line's new Summary of stock market advices—together with a special companion listing of the 159 stocks in the \$1 to \$20 range that are covered therein—as a special bonus under the Guest Subscription offered below.

With this Summary, you can check—immediately—Value Line's performance ratings for each of 159 low-priced stocks. Use the Summary to compare these low-priced stocks not only against each other, but also against any of the big-name, blue-chip stocks (all of which are also individually rated in this same Summary).

Under this offer, you will also receive—for only \$5, with full money-back guarantee—(a) List of 85 Best Stocks to Buy and Hold Now, (b) the next 4 Weekly Editions of the Value Line Survey with full page reports on each of 540 stocks in key industries, (c) a Special Situation Recommendation, (d) Four Reports on Especially Recommended Stocks, (e) Business and Stock Market Prospects (weekly), (f) The Value Line Business Forecaster (weekly), (g) "What the Mutual Funds Are Buying and Selling," (h) "What Company Insiders Are Doing in Their Own Stocks" (weekly), (i) Weekly Supplements and (j) Four Weekly Summary Indexes including all changes in rankings to date of publication.

To take advantage of this Special Offer, fill out and mail coupon below

Name

Address

City Zone State

Send \$5 to Dept. BN-10L



THE VALUE LINE
INVESTMENT SURVEY

Published by ARNOLD BERNHARD & CO., Inc.
(Founded 1931)

The Value Line Survey Building
5 East 44th Street, New York 17, N. Y.

on page 63 of the October, 1964, issue of BROADCAST ENGINEERING) plus a simple relay, power failure can be signalled to the studio over the program line. A simple phone jack on the line side of all equipment will allow the operator to monitor the line—presence of the tone means power is off at the transmitter. (The reason for going on the line side of all equipment is that most of the loss in an equalized line is in the equalizer—a line with 30 db loss may be losing 20 db or more in the equalizer. Going on the line side sends more easily heard tones to the studio.)

Since the oscillator does not present a balanced configuration, we decided to use two sets of contacts on the relay and isolate the oscillator completely from the line. We also deemed it wise to switch the battery off in order to stop the oscillator and prevent capacitive coupling to the line which would lower the signal-to-noise ratio and possibly even cause the tone signal to be heard on the air.

For extended relay life (particularly if inexpensive relays are used), a resistor may be placed in series with the relay coil. Choose a resistor of sufficient resistance and power rating to lower the voltage on the coil to about 200 volts (for a relay rated at 220 volts) so that the coil current, and consequently its temperature, is reduced.

The illustration shows a single relay for single-phase service (usually employed in transmitters of 1 kw and lower output) and two relays connected to monitor all three phases of a three phase supply (usually used in larger transmitters). When two relays are used in this way, the corresponding contacts are tied together so that action of either or both relays causes the oscillator to be connected to the line. If phase A opens, K1 is de-energized; if phase C opens, K2 is de-energized; if phase B opens, reduced voltage is applied to both relays, and both assume the de-energized position.

Our system at KWSL was in operation about 24 hours when it got its first use. It saved us a high-speed drive across town and into the country. Knowing what to expect certainly takes a load off the engineer's mind. ▲

Transmission Set

(Continued from page 13)

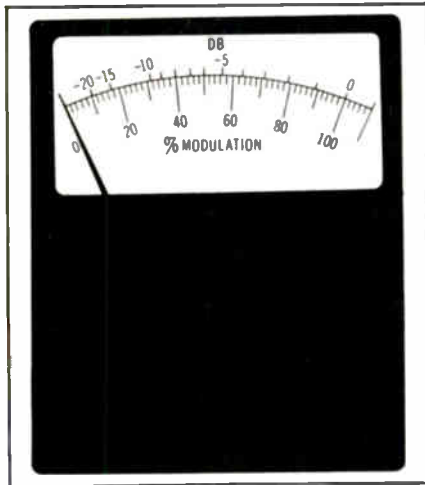

Fig. 4. Standard modulation monitor scales.

by this method of determining modulation percentage. The accuracy of the calibration curve depends on three things: the accuracy of the transmission-set attenuators, the accuracy of the VU meter in the set, and the accuracy with which the 100% modulation level was set.

Comparative Measurements

In measurement work of this kind it is important to have an understanding about measurements in general—such things as the distinction between absolute and comparative measurements. When a measurement must be absolute, it is imperative that the measuring instrument be calibrated against a standard. Since most stations do not have standards, the majority of their measurements must be made by comparative means. For example, one quick way to check the attenuators in a transmission set is to send a reference signal into the set and put a voltmeter across the output terminals. Then by inserting equal amounts of attenuation by two different attenuators, the linearity of the attenuators can be checked. This is a comparative measurement rather than an absolute measurement, since no standard was used.

Conclusion

One of the most common—and important—uses of the transmission set is in broadcast-station frequency-response measurements. Some ideas have been presented here to help the AM-station engineer make effective use of this valuable instrument. ▲

JUST OFF THE PRODUCTION LINES!

FIRST NEW STUDIO PRODUCTS FROM ALTEC'S AUDIO CONTROLS DIVISION

ALTEC 60A MICROPHONE EQUALIZER provides up to 12 db equalization, and 16 db attenuation at 100 cycles and 10 kc. Straight line controls are precisely calibrated in 2 db steps. Passive L/C/R bridged "T" network circuit. Compact plug-in design. 3½"H x 1½"W x 5½"D. \$225.00 net*.

ALTEC 61A & 63A PROGRAM EQUALIZERS provide continuously variable equalization at selectable frequencies: up to 12 db boost at 40 or 100 cycles, and 3, 5, 10, or 15 kc; 16 db attenuation at 100 cycles and 10 kc. Passive circuitry. 61A, for plug-in mounting, features straight line controls. 3½"H x 1½"W x 5½"D. Price \$250.00 net*. 63A, for standard rack mounting, has rear-mounted input and output terminals normaled through front-panel jacks and rotary control switches. \$342.00 net*.

ALTEC FIXED FILTERS AND ATTENUATORS employ passive constant "K" circuits. Toroidal coils assure minimum noise pick-up; units may be mounted anywhere.

64A NOTCH FILTER eliminates unwanted narrow-band frequencies with negligible effect on program material. The 64A is made to your specification with notch frequencies from 50 to 20,000 cps. Available as single or dual notch filter. Price on request. **65A LOW PASS** and **66A HIGH PASS FILTERS** provide attenuation of 18 db per octave from selected cut-off point. (30 db per octave units also available.) No insertion loss. The 65A may be ordered to any cut-off point from 50 to 20,000 cps; the 66A from 40 to 20,000 cps. 1-15/16"H x 1-15/16"W x 2-15/16"D. Price: 65A—\$30.00; 66A—\$45.00 net*. **71A RIAA Equalizer** obtains proper RIAA playback characteristics from disc masters. Same size as 65A and 66A. \$45.00 net*.



ALTEC VARIABLE LOW & HIGH PASS FILTERS provide 18 db per octave attenuation with 10 positions of LF and HF cut-off. With toroidally wound inductances, units

may be used in extremely low-level circuitry without noise or hum pick-up. Zero insertion loss. **68A LOW PASS FILTER** is 3"H x 2¼"W x 5½"D. Price \$115.00 net*. **69A HIGH PASS FILTER** is same size. \$120.00 net*.

67A VARIABLE LOW & HIGH PASS FILTER combines the 68A and 69A for rack mounting. Rear-mounted input and output terminals normaled through front panel jacks. \$310.00 net*.

ALTEC 470A AMPLIFIER can serve as preamp, line, booster, or program amplifier with no internal changes. All-silicon transistor circuitry delivers 0.5 watt and may operate continuously at 85°C without derating. *Frequency Response:* ±0.5 db, 20-20,000 cps. Less than 1% THD, 20-20,000 cps, with +27 dbm output. *Noise Level* (unweighted, 10-25,000 cycle band-pass): equivalent input noise, -127 dbm (input unterminated).

Overload Recovery Time: 5 microseconds for 100% overload. 3"H x 1¾"W x 11"D. Eight fit single 19" rack and feature large plug-in connectors. \$132.00 net*.

ALTEC 550A POWER SUPPLY can power up to fifteen 470A Amplifiers at full output. Entirely solid-state. External sensing circuit insures that output voltage will remain constant regardless of line voltage fluctuations. Under full 2 amp load, output ripple and noise is only 200 microvolts rms. 3"H x 3¼"W x 11¾"D. \$130.50 net*.

MOUNTING TRAYS & ASSEMBLIES are available for rack, console, or bench mounting of 470A and 550A units.

NEW... 844A MONITOR & PLAYBACK SPEAKER SYSTEM contains two LF speakers with HF sectoral horn and driver mounted below so that entire system may be mounted above the observation window. Only 24"H x 31"W x 16"D. \$327.00 net*.

*Send today on your letterhead for special professional discounts (available to bona fide recording and broadcast studios only). We'll send you name of nearest Professional Altec Distributor and the complete new Altec catalog covering studio equipment. Write Dept. BE-2



ALTEC LANSING CORPORATION
LTV A Subsidiary of
Ling-Temco-Vought, Inc.
ANAHEIM, CALIFORNIA

NEW ALL-TRANSISTOR MONITOR & LIMITER AMPLIFIERS, GRAPHIC EQUALIZERS, MIXER NETWORKS, MATCHING PADS, FIXED LOSS PADS, STRAIGHT LINE & ROTARY ATTENUATORS, PRECISION SWITCHES, AND OTHER NEW STUDIO PRODUCTS ARE ON THE WAY! WATCH FOR FUTURE ANNOUNCEMENTS IN THIS MAGAZINE.

Circle Item 38 on Tech Data Card

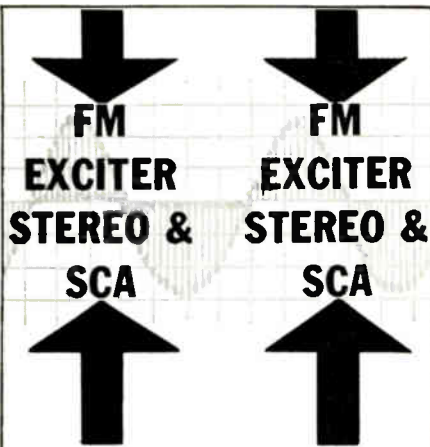

Brilliant stereophonic transmission is yours with the MOSELEY Model LPE-10 Direct FM Exciter . . . the ultimate in quality engineering, construction and, most important, performance! Designed-in reliability and stability . . . no need to constantly adjust for maximum separation and minimum cross talk. Update your pre-stereo equipment and signal quality with the LPE-10. FCC type accepted for stereo and SCA operation. For further information write:



P.O. Box 3192, Santa Barbara, Calif.
Telephone — Area Code 805
967-0424

Circle Item 39 on Tech Data Card

SPOTMASTER Tape Cartridge Winder



The new Model TP-1A is a rugged, dependable and field tested unit. It is easy to operate and fills a need in every station using cartridge equipment. Will handle all reel sizes. High speed winding at 22 1/2" per second. Worn tape in old cartridges is easy to replace. New or old cartridges may be wound to any length. Tape Timer with minute and second calibration optional and extra. Installed on winder or available as accessory. TP-1A is \$94.50, with Tape Timer \$119.50.

Write or wire for complete details.

Spotmaster
BROADCAST ELECTRONICS, INC.
8800 Brookville Road
Silver Spring, Maryland

Circle Item 40 on Tech Data Card

Semiconductor

(Continued from page 17)

ure of the improvement may be gained by considering the 500-watt input power requirements as opposed to the over 1300 watts required by a typical black-and-white field camera chain. The construction of the camera, as may be seen in the photo, makes use of plug-in transistor modules, which lend themselves to easy repair and replacement.

Transistors have been utilized in a wide variety of studio audio equipment. The solid-state monitor amplifier shown in Fig. 9 offers improved performance characteristics and a 30-watt input power requirement compared to 105 watts for its vacuum-tube predecessor. Ten transistors, including six in a class-B push-pull output stage, are used in a straightforward circuit design.

Transistor linearity and switching capabilities are well utilized in limiter amplifiers. A typical commercial unit is shown in Fig. 10. This device is a two-step audio-level limiter providing a slow AGC action and instantaneous diode limiting. The AGC amplifier is comprised of amplifiers X2-X5, rectifiers X10-X14, and the variable loss network. This chain maintains the output at a fixed level with an attack time of 3 msec and a recovery time of 100 msec. Short-duration peak signals pass through the chain unaffected until they are limited by the polarity sensor operating on amplifier stage X6-X9. Instantaneous limiting of the peaks is provided to assure that no overmodulation occurs.

Future Applications

Transistors will undoubtedly find increased application in the audio and video circuitry of broadcast equipment. Improved packaging density from the use of solid-state design is particularly significant for color equipment since, in many cases, three channels are required where only one existed previously.

RF applications of transistors in broadcast equipment will proceed more slowly since high power outputs are at present more economically obtained (in some cases solely obtained) with vacuum tubes. Semiconductor devices will be used more and more in remote-pickup equipment, especially for unattended re-

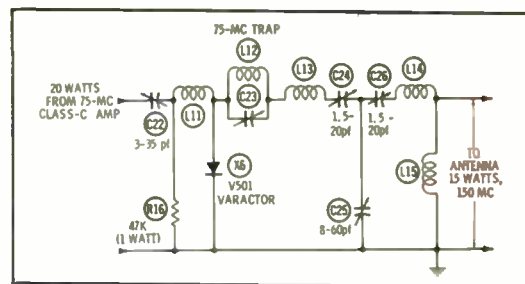

Fig. 7. Trap in output of the transmitter.

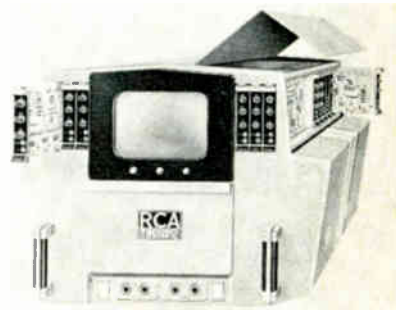

Fig. 8. Color camera uses circuit modules.

lay equipment in which reliability is the chief consideration. Low-level exciter stages and frequency-determination and control stages will also be subject to increasing use of transistors since lower power requirements and fewer heating problems simplify the achievement of stability. As solid-state technology advances, more higher-power applications will appear. Transistorization of power supplies and control circuits will become more prevalent. In short, transistor circuits will become even more common in broadcasting than they are today. ▲

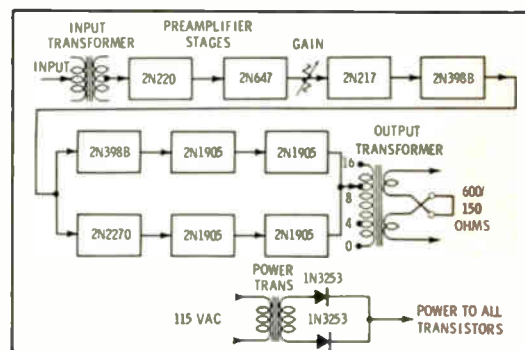

Fig. 9. Solid-state monitoring amplifier.

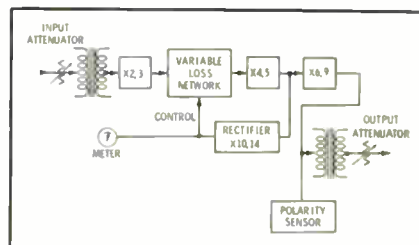

Fig. 10. A transistor limiter amplifier.

UHF-TV Station

(Continued from page 15)

to the building and the guy anchors inside the boundaries. The relatively high attenuation per foot in UHF transmission line makes it uneconomical to place the tower away from the building. The stations we visited situated their towers and buildings only a few feet apart and also spotted the final section of their transmitters as near as they could to the towers.

If you plan to put the offices as well as the programming and engineering areas in the same building, 1000 square feet of floor space will be needed for the technical department and another 1000 square feet for offices. When planning the building floor space, whether the building is to be newly built or already exists, begin by deciding where the transmitter will be. Engineers accustomed to AM transmitters are likely to underestimate the space a 10-kw UHF transmitter requires. Including both aural and visual transmitters, plus the power supply, diplexer, and heat-exchange equipment, such a transmitter would cover roughly ten times the floor space of a 5-kw AM transmitter. A 25-kw UHF transmitter and its auxiliary equipment are shown in Figs. 1 and 2.

Aside from the size consideration, transmitters require about 10' of ceiling height for cooling ducts. This one requirement may make impossible an otherwise ideal existing basement location.

Once the transmitter location is decided, the technical area can be planned. The exact layout of this

area depends on the shape of the space available; however, paramount consideration should be given to operating convenience. The most common arrangement in low-budget stations, which may rely on one-man operation, is to locate the master control area and the projection area in the same room with the transmitter and rack equipment. This allows the operator on duty to put up film, take transmitter readings, make adjustments, or do his switching while remaining within easy reach of all the other equipment.

The operator's chief position is at a control console (Fig. 3), much as in radio. This console has facilities to monitor, adjust, and switch video and audio. It also contains controls for the projectors.

Near the operator, either behind him or to one side, is the film island (Fig. 4). This contains a slide projector, at least one and probably two 16-mm television sound projectors, and a single television camera to pick up the images. Each projector lens points toward the center of the island where an optical multiplexer—a system of prisms or mirrors—feeds the three projector images into the camera.

The film storage and processing area is usually located somewhere near the film island. This is the equivalent to the record library of radio operation. Quite frequently it is a separate room where films can be timed, spliced, and stored. Storage is often on simple wall shelves.

Next month we will discuss operating equipment, equipment costs, a typical staff, and studio needs. ▲

BOOK REVIEW

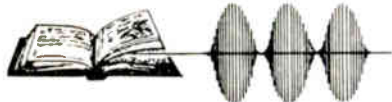

Audio and Acoustics; Author, G. A. Briggs; Sub-Editor, J. Moir; Wharfedale Wireless Works Ltd., Yorkshire, England; 167 pages, \$2.95. In the typical Briggs manner, this little (5½" x 8½", paperback) book begins by bringing the reader through a historical analysis to the modern state-of-the-art in audio and acoustic technology. An analysis of the human ear leads them to chapters on resonance, echo and reverberation, and transient response. The subject of room

acoustics is treated in detail by sub-editor Moir. There is even a chapter on stereo. The remainder of the book is devoted to the electronic and acoustic aspect of systems in concert halls, studios, and schools.

The book sets out to be a revision of Briggs's earlier book, **Sound Reproduction**, which was allowed to run out of print in 1962. Numerous reminders of this fact are sprinkled throughout the book, but ample new material is just as obviously included.

This book should offer a painless way for the reader to learn more about the theory and practice of audio and acoustics, at the same time being entertained by the engaging, free-swinging manner of Briggs's writing.

BIONIC INSTRUMENTS, INC. MODEL 6155

New Instantaneous Function Selection

REMOTE CONTROL FOR ANY AM or FM STATION

Minimum
Back Space
Requirement

Maximum Reliability
No Dials or Stopping Relays

\$895 Complete
With Four Meters

from Bionic Instruments, Inc. • 221 Rock Hill Road • Bala • Cynwyd, Pennsylvania

Circle Item 41 on Tech Data Card

Assure 100%
**COMPLETE
ERASURE**
of Recorded Tape
ON THE REEL



Use the

Magneraser®

— the Original and still the best!

Quickly erases a reel of magnetic tape or sound film of any size or type. Erasure is 100% complete even on a severely overloaded tape. Lowers background noise level of unused tape 3 to 6 db. Also demagnetizes record-playback and erase heads. Only \$24.00. Two-year Guarantee. Available at your dealer's or write us.

New ULTRA-SENSITIVE FLUTTER METER



With built-in Three-Range Filter, 3 kc Test Oscillator, High Gain Pre-amplifier and Limiter. Filter Ranges: 0.5 to 6 cps; 0.5 to 250 cps; 5 to 250 cps.

Designed for rapid visual indication of flutter and wow. Meets standards set by the IEEE . . . Condensed Specs.: Input Voltage, 0.001 to 300 Volts; Ranges, 0.01 to 3%; Limiter Range, 20 db.; Oscillator (built-in), 3000 cycles; Net Price, \$495.00 . . . Write for complete specifications and free 12-page booklet on Flutter



AMPLIFIER CORP. of AMERICA
398 Broadway, New York 13, N. Y. • WO 6-2929

Circle Item 42 on Tech Data Card

MAGN[⚡]PHASE

transmission line
protection system



protects antenna system from damage due to arcing
will instantly squelch transmitter output to prevent arc from being sustained by RF energy
immediately self-restoring
transmitter interruption goes unnoticed on the air

LTV

Continental Electronics
BOX 17040 / DALLAS, TEXAS 75217

Circle Item 43 on Tech Data Card

NEWS OF THE INDUSTRY

NATIONAL

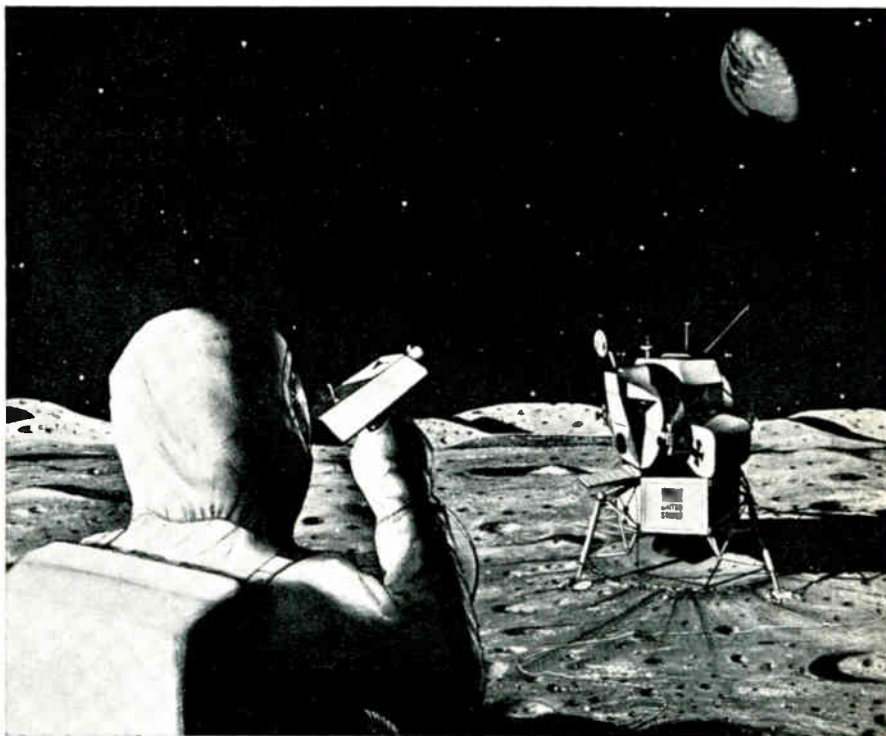

Lunar TV Camera

A television camera to be used by an astronaut to take the first pictures on the surface of the moon will be built by the Aerospace Division of the Westinghouse Defense and Space Center. A multimillion-dollar contract for producing 13 of the tiny cameras was awarded by NASA's Manned Spacecraft Center, Houston, Tex. Seven cameras will be flight-qualified models which will be used in early Apollo missions.

The scenes taken by the camera, in addition to views of the astronaut performing scientific tasks on the moon, will include views of the lunar landscape, the earth from the moon, and the lunar excursion module (LEM) at rest on the moon. Plans are for the historic scenes to be telecast "live" over commercial television networks. Transmission from the moon will be at 10 frames per second with resolution of 320 lines. This signal will be converted to commercial frame and scan rates at the earth receiving station for immediate rebroadcast over national TV.

Using a highly sensitive low-light-level SEC Vidicon imaging tube, the camera will be able to operate in almost total darkness. The camera will be required to operate over a temperature range of -300° F to $+250^{\circ}$ F in a complete vacuum and to withstand the effects of sand, radiation, and other harsh environmental conditions expected on the moon.

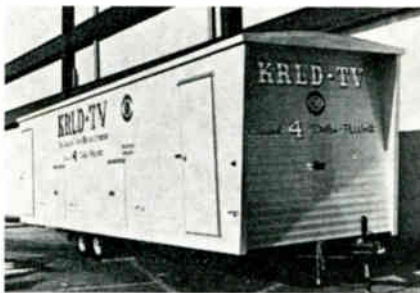

Mobile Production Unit

A fully air-conditioned and heated mobile television production control unit used in televising National Football League games and other programs requiring large production staffs recently was completed for KRLD, Dallas, by Heritage Mobile Homes, Inc., Grapevine.

Texas. The unit was built in nine days and went into action three days later. The use of the mobile production unit enables KRLD to separate the technical staff from programming people while giving more room for additional programming personnel when required. Accompanying the mobile unit, which is utilized for monitoring and signal equipment, are one or two vans containing technical equipment.

Business Outlook Good

In the company's annual business outlook, George S. Dively, Chairman, Harris-Intertype Corporation, observes that current business activity, well into the fourth consecutive year of strong growth, continues to be remarkably well balanced. Still further gains are likely if

industry maintains effective planning and avoids excessive inventories and un-sound credit extensions, if labor assumes its share of economic responsibility, and if the government pursues sound monetary policies with timely action when required. However, the ability of business, labor and government to continue to achieve these economic gains is likely to be further tested in 1965. Advertising expenditures accelerated in 1964 and will probably continue to do so in 1965. Since by far the largest part of broadcasting revenue is derived from advertising, this is a major factor in the growth of the industry. The consistent growth of advertising in America's mass-merchandising economy provides a good investment climate and economic justification for the purchase of new equipment by broadcast stations. Technological advances are resulting in better and more efficient equipment for broadcasting, and this is also contributing to industry growth.

INTERNATIONAL

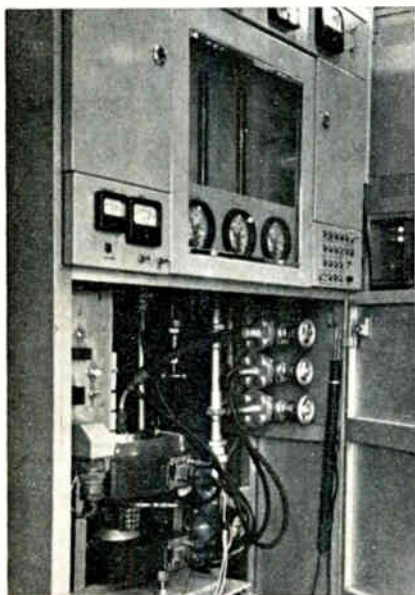

TV Via Syncom III

Equipment selected for transmission and reception of TV signals via Syncom III of the recent Tokyo Olympic Games included two Varian klystrons and a "Vac-Ion" eight-liter-per-second high-throughput pump. Near Tokyo, Japan, where the transmitter was built by Nippon Electric Co. and is being operated by NHK (Japan TV Network), is a VA-863 high-power klystron in a CW amplifier with 10-kw output at 7.125-8.500 gc. A VA-240 reflex klystron serves as a parametric amplifier at the Point Mugu (Calif.) receiving station.

STANCIL-HOFFMAN CORP.

- MINTAPE PROFESSIONAL BATTERY Operated Portable Recorder, Mono Stereo, Synchronous.
 - MAGNETIC FILM RECORDERS, Single and Multi-Channel, 16, 17½, 35 MM.
 - BROADCAST LOGGING Recorders, Slow Speed Single Channel to 32 Channels.
 - HIGH SPEED TAPE DUPLICATORS for Full, Half and Two Track Stereo Duplication.
- 921 N. Highland Ave., Hollywood 38, Calif.

New Cameras for Argentine Station

IGE Export Division of General Electric has received a major order to supply television studio equipment to one of Argentina's commercial TV stations. Seven 4½" image-orthicon television cameras will be furnished to Rio de la Plata TV Channel 13 and Producciones Argentinas de Televisione, S.A. (PROARTEL) in Buenos Aires. PROARTEL produces the programs which are broadcast by Rio de la Plata TV Channel 13 and other channels in Argentina. The seven cameras will be used to equip three new studios recently completed in Buenos Aires by Channel 13 TV. One of four channels currently operating in Buenos Aires, Channel 13 started broadcast operations in October 1960. Goar Mestre, a main stockholder and president of PROARTEL, is active, in partnership with CBS, Time, Inc., and local interests, in television operations in Venezuela and Peru, as well as Argentina.

PERSONALITIES

James E. Gray, chief engineer of WYDE, Birmingham, since 1957, has been named chief engineer of all stations owned by Basic Communications, Inc. Mr. Gray now heads engineering operations at WWVA AM-FM, Wheeling; WAKE, Atlanta; and WYDF. He joined the latter station in 1954 and gained recognition in Southern broadcasting circles for his production awards. Later, he delivered a major technical paper at the 1964 NAB convention, and he served on the NAB Engineering Conference Committee in 1962-63.



Thomas E. Davis, Marketing Manager of Ampex Corporation, has been elected Vice-President—Marketing for the corporation. Mr. Davis is responsible for marketing Ampex products throughout the United States. He joined Ampex in 1956 and held several divisional marketing and sales positions before becoming corporate marketing manager in 1962. Prior to joining Ampex, he was affiliated with Bing Crosby Enterprises, Los Angeles. ▲

New! LANG PROGRAM EQUALIZER



Surpasses All Others...

In design, performance and versatility! The new LANG PROGRAM EQUALIZER incorporates the finest features found in quality equalizers plus these

Exclusive Features —

Eight low boost shelf frequencies • Three low droop shelf frequencies • Eight high boost peak frequencies • Five high droop shelf frequencies • Frequency select switches and equalization controls for all boost and droop functions • All controls and switches may be used simultaneously • Low frequency peak boost by use of boost and droop controls • Equalization "on" lamp indicates when equalization is taking place and indicates plate power supply is functioning • Engraved stainless steel panel blends harmoniously with other equipment.

For complete details and new Lang Catalog write:

LANG ELECTRONICS INC.
507 FIFTH AVE., N.Y. 17
For all your audio needs — Look to Lang!

Circle Item 44 on Tech Data Card

AT LAST CARTRIDGE SERVICE YOU CAN COUNT ON



DID YOU KNOW

- You can have your old cartridges reconditioned by experts
- no charge for minor parts
- ALL** cartridges **PRETESTED** under actual broadcast conditions
- no minimum
- no service charge for small orders
- return shipment in 48 hours
- factory trained personnel
- new cartridge warranty
- You can have any size Fidelipac tape cartridge shipped immediately from stock
- You can have all cartridge parts for do it yourself cartridge maintenance.

JOA incorporates all of these as a part of their service to the broadcaster.

phone or write:



Cartridge Service
P. O. Box 3087,
Philadelphia, Pa. 19150
Area Code 215, TUrner 6-7993

Circle Item 45 on Tech Data Card

NEW PRODUCTS

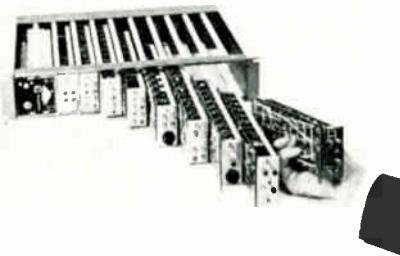

Modular Processing Amplifier

All-transistor modules are a feature of the Riker Industries Series 5300 video processing amplifier. Because of this design, flexibility is provided in meeting specific system requirements without the necessity of buying unneeded circuitry. In a monochrome application, four modules are required to provide the following functions: clamping, black clipping, remote gain control, video fading, white clipping, and sync processing and reconstruction. For color, one module is replaced, and a two-module blanking keyer is added. A new color burst from an optional burst-regenerator module may be inserted in the color signal. The new burst may be phased with a scope or color picture monitor by means of a circuit provision that alternates insertion of the new and existing bursts at the field frequency. The monochrome amplifier operates on any television standard. In color applications the blanking keyer requires changes in its timing circuits; this unit is available for either 525- or 625-line standards. The modules slide into a 3½" rack frame. Nine single modules and one pair (blanking signal and burst flag key for color signal sync deletion) are available.

Circle Item 110 on Tech Data Card

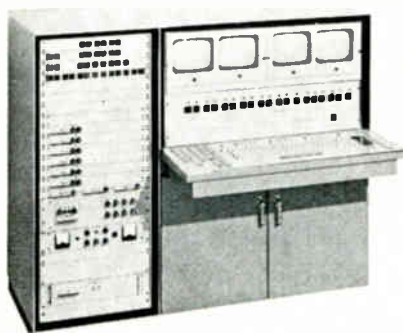

Computer TV Programmer

The APT-1000 solid-state computer programmer from Sarkes Tarzian is built around a magnetostrictive delay-line memory. Instructions are inserted into the memory by means of push buttons, and monitors and indicator lights give a continuous indication of system events. Provision is made for manual override of the programmed sequence at any time. Program instructions can include video source, audio source, type of transition from event to event, speed of transition, time the event must go on the

air, duration of the event, and special instructions (such as audio lock, projector roll-on, cue instructions, or manual-operate instructions). Memory information is destroyed only when new information is inserted or when the "Erase Memory" button is depressed. Both duration time and clock time can be programmed into the unit.

Circle Item 111 on Tech Data Card

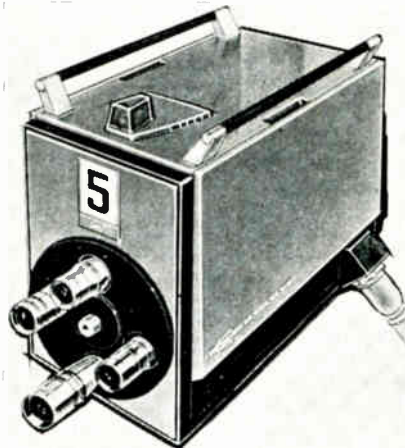

New TV Broadcast System

New matched-design commercial and broadcast television equipment has been introduced by the Dage Television Company. Designated the 520 broadcast chain, the system consists of a new solid-state vidicon camera (illustrated) having a minimum horizontal resolution of 800 lines, and a program control center providing the following functions: camera-control unit, waveform monitor, video switcher/fader, audio mixer system, film-chain projector control, and master console control with pulse-cross monitor. Also included is a film- and slide-projector multiplexer with an integral film-chain camera.

Circle Item 112 on Tech Data Card



Spectrum Analyzers

Owners of Tektronix oscilloscopes now need only buy a plug-in unit to obtain complete spectrum-analysis capabilities. Two types of spectrum-analyzer plug-in units are presently available. These are the L-20, with frequency range of 10 mc to 4 gc and minimum sensitivity of

-110 to -80 dbm, and the L-30, with a range of 1 gc to 10.4 gc and sensitivity of -105 to -70 dbm. Both units have a dial accuracy of ± 2 mc $\pm 1\%$ of RF frequency, dispersion of 2.5 kc to 60 mc, variable resolution from 1 kc to 100 kc, a marker continuously variable in frequency from 30 mc above to 30 mc below the RF frequency, and picket-fence markers at 100 kc and 1 mc separation. Log, linear, square-law, and video response characteristics are selectable at the front panel. Price of either model of the Spectropulse (TM) spectrum analyzer is \$1995.

Circle Item 113 on Tech Data Card

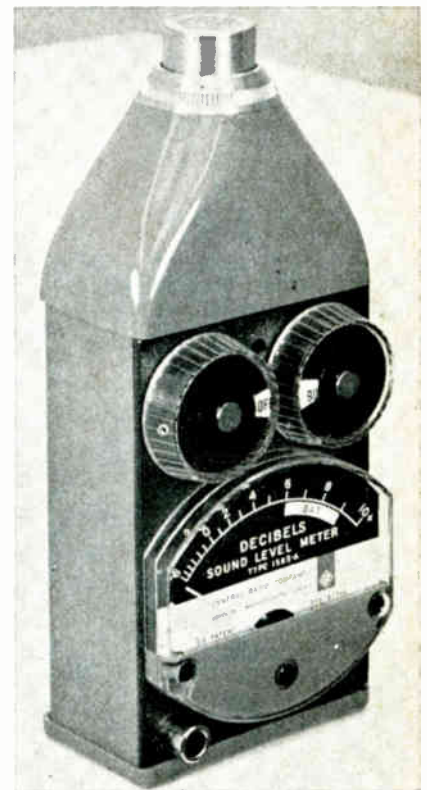

Solid-State Sound-Level Meter

General Radio Company has added to its line of sound- and vibration-measuring instruments a transistorized sound-level meter that fits in one hand and yet complies fully with the American and International Standards for sound-level meters. The Type 1565-A Sound-Level Meter measures sound levels from 44 to 140 db (referenced to .0002 microbar). Weighting networks and both slow and fast meter responses are in accordance with ASA and IEC specifications. The built-in microphone is a new measurement-grade ceramic unit. Microphone design and tapered cabinet configuration yield essentially nondirectional response. Vibration pickups and other transducers can be connected in place of the built-in microphone through an auxiliary adapter, and a front-panel output jack is provided for connection to an analyzer or recorder. One size-C flashlight cell supplies power for 35 hours of use. Overall dimensions are 3-1/16" \times 7-3/8" \times 2-1/8", and the instrument weighs 1-3/4 lbs. Its price is \$240.

Circle Item 114 on Tech Data Card

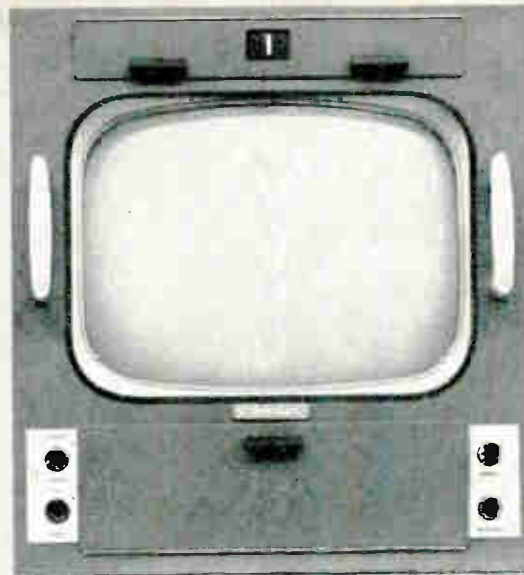

What's the difference between Conrac's 17" and 21" Color Monitors?

Both put color where black and white used to be.

Both have precision decoders cutting operating controls to just "contrast" and "brightness." A calibrated chroma control offers a "pre-set" position.

Both use solid-state switching instead of the mechanical relays normally found in color monitors.

Both give the operator complete control of individual guns to turn on the beams in any combination and in any desired sequence. Setting up of the monitors is both fast and easy.

Both feature a keyed back porch clamp allowing

set-up for true black level when operating on composite sync. A variable aperture corrector makes "crispness" of the picture possible.

Both offer a picture size switch which permits inspection of the picture edges, electrical centering controls, and bonded safety shields on the kinescope for the easiest possible tube cleaning.

So what's the difference? Oh, about four inches and thirty-six pounds.

CONRAC

GLENDORA, CALIF. / A DIVISION OF
GIANNINI CONTROLS CORPORATION

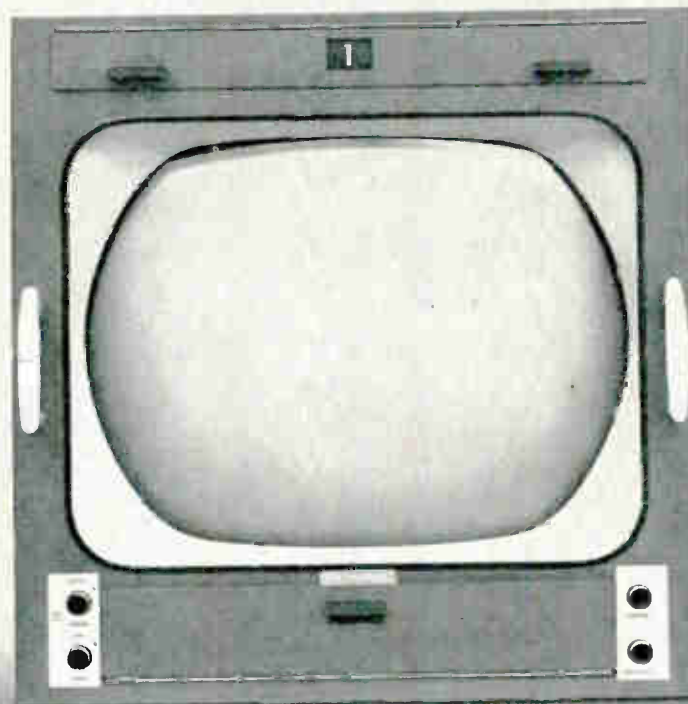

Circle Item 49 on Tech Data Card

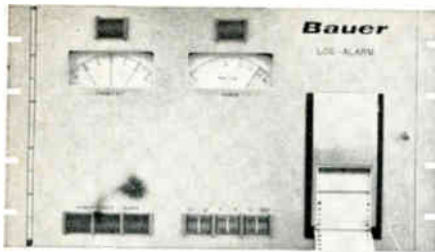

NEW..... SIMPLE METHOD TO LOG TRANSMITTER READINGS

The Bauer "Log Alarm" is simple . . . accurate . . . easy to operate . . . permits better use of your manpower . . . meets all FCC requirements for automatic logging devices . . . all in 10½" of rack space.

Complete Details Available on Request!

Bauer

ELECTRONICS CORPORATION

1663 Industrial Road, San Carlos, California
Area Code 415 591-9466

Circle Item 46 on Tech Data Card

VARIABLE Vacuum Capacitors

U150 25mmf-150mmf 23kv.....\$64.95
U250 50mmf-250mmf 15kv..... 64.95
Vacuum Switch, S.P.S.T.
(VS5) 24vdc coil.....6.95
(Quantity prices on request)

UNION TECHNICAL MATERIALS CO., INC.

24 Brandford Place .. Newark, N. J. 07102
Tel. 212-962-2370

Television/Field Broadcast Engineers

1st phone, transmitter and video operation, installation and maintenance experience. Considerable travel involved. Openings in East and South. Send resume to: Mr. D. K. Thorne, RCA Service Company, Cherry Hill, Camden 8, New Jersey.

An Equal Opportunity Employer

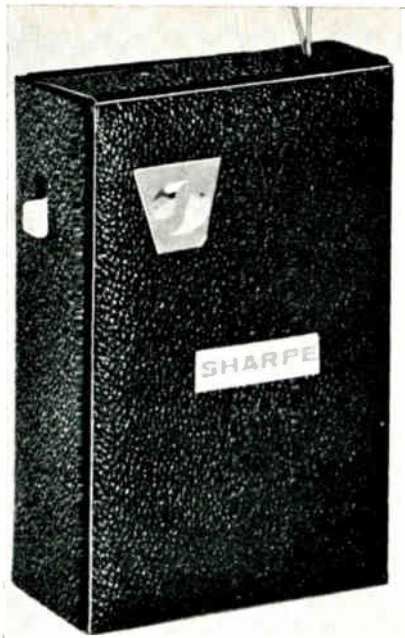

Miniature Wireless Microphone

A new wireless microphone, the same size as a package of "regular" cigarettes, features good pick-up sensitivity and freedom from static and background noise. The miniature FM transmitter is tuneable over the entire FM band, and no modifications or external connections to the receiver are required. The operating range is about 300'. The Sharpe Instruments, Inc. Model FMT-2 is fully transistorized and is enclosed in a metal case with washable vinyl cover.

Circle Item 115 on Tech Data Card



Boom Microphone

A new unidirectional boom microphone from Shure Brothers, Inc., Evanston, Ill., was developed to satisfy critical requirements of motion picture and television boom operation. The Model SM5A has an impedance of 50 ohms, and the SMB 150 ohms. Features include a polar pattern that is cardioid, symmetrical about its axis, and uniform with frequency; frequency response tailored to provide natural dialogue or vocal music pickup with good presence, yet suitable for scoring; an integral windscreens that is effective in outdoor locations and for fast boom swings; and a suspension system

with two-stage mechanical filter. Price of the SM5 is \$225.

Circle Item 116 on Tech Data Card

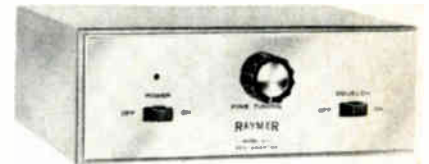

SCA Adapter

The Model 471 solid-state SCA adapter is intended for use with any broadband FM receiver or tuner. The adapter employs a noise-squelch circuit to eliminate background noise during intervals of silence between musical selections. The Trutone Electronics unit is designed to provide good audio frequency response coupled with low distortion and low crosstalk, even when the station is transmitting both stereo and SCA subchannels. A front-panel fine-tuning control is provided; SCA subcarriers between 20 and 75 kc may be selected by making an internal adjustment to the unit. In addition to the fine-tuning control, the adapter is provided with input and output jacks, a power on-off switch, and a squelch on-off switch. The circuit makes use of five transistors, four diodes, and one silicon power-supply rectifier. Price of the unit is \$64.50.

Circle Item 117 on Tech Data Card

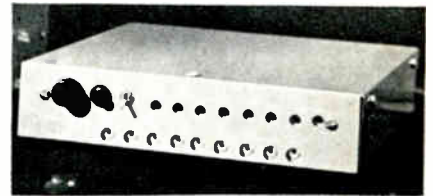

Micrologic Sync Generator

The Model FR-2 sync generator measures only 1¾" × 8½" × 9¼" and weighs 4 lbs. Featuring a self-contained solid-state regulated power supply, the new micrologic sync generator produces standard EIA synchronizing, blanking, and drive signals. The binary counter circuitry utilizes micrologic elements, and the unit has AFC circuitry with an optional provision for a crystal-controlled oscillator. The unit can be strapped to operate at 525, 625, 875, 945, or 1029 lines per frame. Front-panel test points are provided. The generator is produced by DuMont Laboratories, Divisions of Fairchild Camera and Instrument Corporation, Clifton, New Jersey.

Circle Item 118 on Tech Data Card

Contact Cleaner

"Relay Kleen" is a nonoily, nonflammable, no-residue degreaser and general solvent for cleaning gummy deposits. GC Electronics, a division of Textron Electronics, Inc., developed the substance for such applications as cleaning selectors, relays, and contacts in switchboards, automatic pinball or bowling machines, rocket and satellite circuitry, etc. The product does not contain carbon tetrachloride. Each 6-oz. pressurized can is furnished with an easily attached, pinpoint spray attachment for squirting into hard-to-reach areas.

Circle Item 119 on Tech Data Card

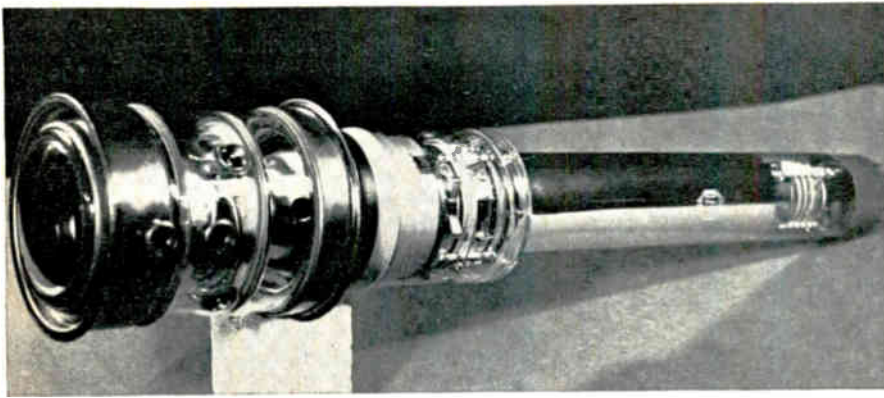

"See-In-Dark" Camera Tube

A "see-in-the-dark" television camera tube which can pick up an approaching aircraft's lights as far away as seven miles under weather blackout conditions was successfully demonstrated in a TV camera on the landing deck of the carrier U.S.S. Forrestal, during maneuvers off Norfolk, Va. The tube, called an intensifier image orthicon, was designed by RCA under U. S. Army Corps of Engineers sponsorship. The C74093A is a developmental tube for extremely low-light-level television viewing. It combines the elements of an image orthicon and an image converter tube, and is 22.4" long. The photocathode utilized permits gray-scale rendition of the image appearing on the monitor screen in nearly its true tonal gradation. The operator can choose parameters such that this tube will operate over a rather wide range of signal current or scene illumination; in general, the tube is not intended to be used with illumination greater than 10⁻⁶ foot-candles on the first photocathode. To use the C74093A in a standard image-orthicon camera, several modifications are necessary. A high-voltage power supply must be added for the image-converter section; the first photocathode, which is spherical, requires a spherical corrective lens system; and the video signal must be passed through a 2-mc low-pass filter to obtain a satisfactory signal-to-noise ratio.

Circle Item 120 on Tech Data Card

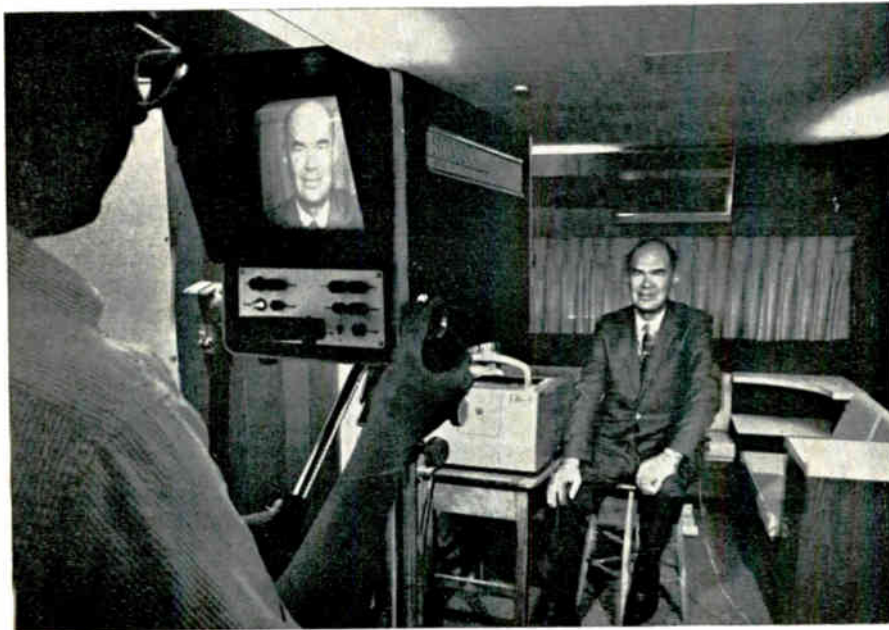

CC Camera With Viewfinder

A transistorized, high-resolution closed-circuit television camera with a built-in electronic viewfinder from Sylvania provides 800-line resolution in a rugged, lightweight package for studio, educational, business, research, and industrial use. Designated the Model 800V, the new camera features an 8" viewfinder with resolution of 600 lines. The viewfinder circuits are completely transistorized, except for the vidicon and high-voltage rectifier. The camera has a four-position lens turret and focusing knob. Manual lens selection may be made from the rear of the camera, and a manually controlled zoom lens may be used without modification to the unit. Inside, there are several plug-in modules: video amplifier, vertical and horizontal scan, EIA sync generator, high-voltage regulator, low-voltage regulator, preamp, and vidicon protector. Special check points have been provided so that any difficulties can be traced easily. The 800V weighs 38 lbs., measures 8¾" wide, 11¼" high, and 17¼" long, and carries a suggested price of \$4975.

Circle Item 121 on Tech Data Card



Portable Scope

The all-solid-state, militarized "tote scope" exhibits bandwidth extending from DC to 15 mc. This 18-lb. portable oscilloscope is a product of the Electronic Instrument Division of General Atronics Corporation. The K-115 is designed to operate reliably under extreme environmental conditions. Full transistorization reduces power consumption and heat dissipation and permits compact packaging. A rectangular CRT face plate allows a 2½" x 2" viewing area. A drip- and shock-proof carrying case permits the K-115 to be hand "toted" from bench to field. Accessories and instruction manual are conveniently stored in the front cover which protects the display area and front panel. An interchangeable dual-trace plug-in pre-amplifier and a power pack which permits up to four hours of self-powered operation are available.

Circle Item 122 on Tech Data Card

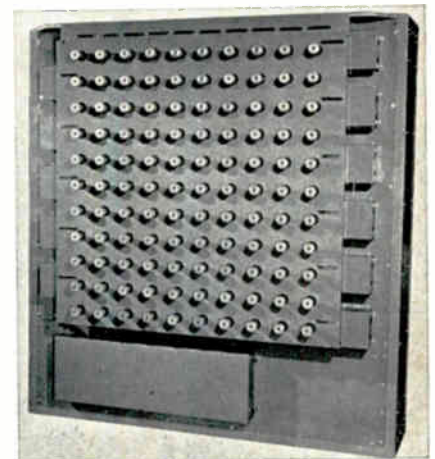

Antenna Switching Matrix

A high-power antenna switching matrix by Delta Electronics, Inc. is based on what is believed by Delta to be a new switching principle. The system uses a strip-line technique in a compact configuration. The Model SLS-1 is a 10 x 11 switching matrix based on this principle: 10 transmitters can be connected to any of 11 loads. The plunger-type switching mechanism completely removes all residual stubs from active circuits. The SLS-1 has a power rating of 50 kw average from DC to 30 mc. The characteristic impedance is 50 ohms with a VSWR of 1.15 or less, and cross-channel isolation exceeds 65 db. It has provision for connecting a remote-status panel. ▲

Circle Item 123 on Tech Data Card

ENGINEERS' TECH DATA

AUDIO & RECORDING EQUIPMENT

52. AMERICAN ELITE—Individual brochures on dynamic and condenser microphones and sound columns.
53. AMPEX—Information on tape duplicating system, communications logging recorder, and video tape recorders.
54. BROADCAST ELECTRONICS—Packet contains specifications and prices for "Spotmaster" cartridge-tape systems.
55. CONCORD—Booklet contains information and specifications on "R" series automatic stereo tape recorders.
56. CROWN INTERNATIONAL—Literature tells about solid-state SS700 series recorders.
57. GOTHAM—Flyer describes EMT Vid-E-Dit electronic video tape splicer.
58. GRINNAN—Catalog on fixtures for record libraries, complete with prices and order blanks.
59. 3M—Booklets on advertising, producing shows, and editing video tape.
60. MARANTZ—Four-page color brochure on Model 10B FM stereo tuner.
61. METROTECH—Bulletin on Model 1050 broadcast tape transport.
62. NORELCO—Technical specifications, applications notes, and other information on microphones and microphone accessories are provided in brochure.
63. SPARTA—Data sheet describes Model AS-100 stereo audio console with all-solid-state construction.
64. TELEPRO—Two-color brochure on "Fidelipac" automatic tape cartridges.
65. VIKING—Specification bulletins describe Model 96 tape transport system and Model 38 cartridge handler.
66. WALLACH ASSOCIATES—Brochure lists and discusses variety of record and tape-reel cabinets and tape-storage containers.

COMPONENTS & MATERIALS

67. AMPEREX—Condensed semiconductor catalog with listings and specifications on full line of germanium and silicon transistors.
68. BRADY—Self-bonding signature plates for studio property identification and control.
69. DIALIGHT—New catalog No. L-178 on subminiature incandescent and neon indicator lights.
70. EICO—1965 catalog includes listings of kits and wired test and Citizens band equipment.
71. E. F. JOHNSON—Catalog 560A gives information and prices on heavy-duty RF components.
72. MICON—Coaxial-connector catalog No. 103 depicts all necessary data to design, test, and assemble coaxial connectors into a system.
73. OHMITE—Bulletin 807 describes four diodes in a quad used as a ring modulator for single-sideband AM radio transmitter.
74. SWITCHCRAFT—Product bulletin No. 148 describes the latest insulated "Hi-D-Jax" ¼" phone jacks.
75. TEXAS CRYSTALS—8-page crystal catalog No. 964 includes transistor oscillator circuits.
76. TEXWIPE—Literature describes lint-free wiping cloth for tape heads, capstans, and other applications.

MICROWAVE DEVICES

77. MICRO-LINK—Brochures on Model 420A portable microwave relay link and Model 600 fixed-station relay link; also planning guide for 2500-mc instructional TV systems.
78. MICROWAVE ASSOCIATES—Brochures on solid-state TV STL, solid-state TV relay, and TWT high-power amplifiers.
79. SURFACE CONDUCTION—Bulletin on microwave-by-wire (G-line) for long-distance, broadband transmission.

MOBILE RADIO & COMMUNICATIONS

80. MARCONI—Technical paper entitled "White-Noise Loading of Multichannel Communications Systems."
81. MOSLEY—Literature describes Citizens band antennas.

THE PROFESSIONAL'S CHOICE IN MICROPHONES



D-119CS—newest addition to the renowned D-19 dynamic microphone line. Its professional qualities make it the logical choice for sound recording, broadcasting, sound reinforcement and home entertainment. It features an extended frequency range, bass roll-off switch, true cardioid characteristics, on-off switch and many more desirable features.

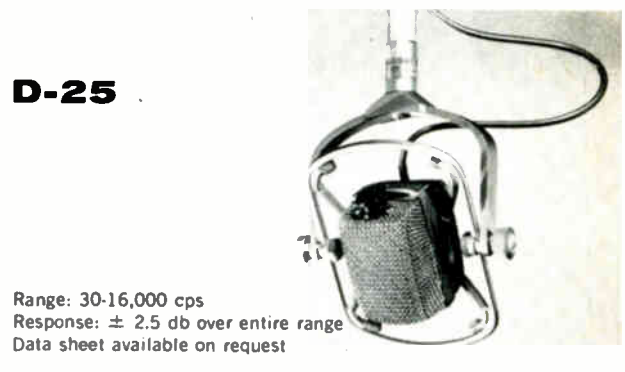

D-25—The popular studio dynamic directional microphone, has an exceptional pronounced cardioid polar pattern independent of frequency. This unusually flexible microphone is ideal for television and recording studio applications in any location. Typical of the preferred features is a two-step (-7 db and -12 db at 50 cps) bass attenuation switch...and there are more!

CONDENSER • DYNAMIC MICROPHONES

MADE IN AUSTRIA BY AKG GMBH.

Norelco®

**AUDIO VIDEO
PRODUCTS**

NORTH AMERICAN PHILIPS COMPANY, INC.
Professional Products Division, 100 East 42nd St., New York, N.Y. 10017

POWER DEVICES

82. HEVI-DUTY—Bulletin No. 7-12 describes line-voltage regulator that uses saturable-core reactor.
83. LECTROTECH—Separate bulletins detail solid-state modular power supplies and meter-protective devices.
84. ONAN—Catalog sheet describing diesel-driven electric generating plants.
85. TERADO—Booklet on *Trav-Electric*, a self-contained 60-cps AC power source.

RADIO & CONTROL ROOM EQUIPMENT

86. McMARTIN—Catalog sheet describing TBM-4000 main and SCA multiplex monitor.
87. RUST—Catalogue describes line of broadcast equipment; also data sheet on new 5-kw FM transmitter.

REFERENCE MATERIAL & SCHOOLS

88. CALVERT—Comprehensive manual on hydrogen-thyratron design and theory; includes diagrams of crowbar circuits for split-second power cutoff in case of overload.
89. CLEVELAND INSTITUTE—Booklet describes courses in electronics, including those for broadcast engineering and FCC license preparation.
90. RIKER—Brochure on how to assemble a custom video-processing amplifier with all-transistor video modules.

STUDIO & CAMERA EQUIPMENT

91. BLONDER-TONGUE—New catalog lists broad line of CCTV products and accessories.
92. CLEVELAND ELECTRONICS—Data concerns deflection yoke and alignment coil for 3" image orthicons.
93. DAGE—Information on 520 broadcast camera chain with DV 300 portable broadcast video tape recorder and FC-11 film chain.
94. INDUSTRIAL ELECTRIC REELS—Specification sheets on line of motor-driven and hand-operated microphone cable reels.
95. ZOOMAR—Bulletins contain descriptions of zoom lenses and remote-control systems for television cameras.

TELEVISION EQUIPMENT

96. CONRAC—Brochure on 17" and 21" color television monitors.
97. TELEMET—Literature describing equalizer-amplifier for phase and frequency correction of 75-ohm coaxial cable, twin-video distribution amplifier, and color standard with burst flag output.
98. VITAL INDUSTRIES—Data sheets describing video-distribution amplifier Model VI-10A, pulse-distribution amplifier VI-20, and video clamper/stabilizer VI-500.

TEST EQUIPMENT & INSTRUMENTS

99. DATA INSTRUMENTS—Short-form catalogue of oscilloscopes and accessories.

TOOLS

100. ENTERPRISE DEVELOPMENT—Bulletin features new desoldering-resoldering iron for use on printed circuit boards.

TRANSMITTER & ANTENNA DEVICES

101. ANDREW—Catalog 23 describes line of antennas, antenna equipment, and transmission lines.
102. ANDREWS—Brochures on general-line and VHF antenna towers.
103. CCA—Information available on complete line of AM and FM broadcast transmitters and accessories.
104. CORNELL-DUBILIER—Replacement component selector, TV-FM reception booklet, and 4-page rotor brochure.
105. CO-EL—8-page booklet on wide-bandwidth FM antenna.
106. E-Z WAY—Information on towers for AM, FM, and TV broadcast stations.
107. GATES—Latest information on dual-polarized FM antennas and new type 6300 transistor plug-in audio amplifiers.
108. JAMPRO—A new and enlarged catalog on dual-polarized FM antennas; describes horizontally and vertically interposed antennas and back-to-back-mounted antennas.

How to get... and hold a top job in AM-FM-TV...



*a message from Carl E. Smith, E. E.,
Consulting Broadcast Engineer*

In over 30 years in broadcasting, I've met hundreds of really top flight technical men and 98% of them were at or near the top because they "knew their stuff". There is no substitute for knowledge.

Even if a friend or relative can get you a good job, you'll fail mighty fast if you can't produce results. The first good emergency will separate the men from the boys. I've seen it happen again and again . . . when things start to go sour and the signal isn't what it should be, skill is the only acceptable solution.

To get and hold a top engineering job, you need advanced technical education. And you can get it through a program of college-level study used by broadcasting engineers for 30 years. Cleveland Institute's Advanced Communications Engineering Course has helped thousands of men prepare themselves for key positions in radio and television engineering. It can do the same for you.

So don't let that next promotion pass you by. Send the coupon below for full details. There is no obligation. I want you to know what you can accomplish . . . if you want to get ahead. If the coupon is gone, write: Cleveland Institute of Electronics, 1776 E. 17th St., Dept. BE-16, Cleveland, Ohio 44114.

SEND COUPON TODAY

Cleveland Institute of Electronics

1776 E. 17th Street, Dept. BE-16
Cleveland, Ohio 44114

Please send me *free* information on your Advanced Communications Engineering Course . . . without obligation.

Name _____

Address _____ (please print) County _____

City _____ State _____ Zip _____

A leader in communications training . . . since 1934

Professional Services

VIR JAMES

CONSULTING RADIO ENGINEERS
Applications and Field Engineering
345 Colorado Blvd.
Phone: (Area Code 303) 333-5582
DENVER, COLORADO 80206
Member AFCCE

JAMES C. McNARY

Consulting Engineer
National Press Bldg.
Washington 4, D. C.
Telephone District 7-1205
Member AFCCE

LAWRENCE BEHR ASSOCIATES, Inc.

RADIO ENGINEERING CONSULTANTS
FM Applications and Field Engineering
also
AM — Communications — CATV
LAWRENCE BEHR, PRESIDENT
2501 East Fourth Street
Greenville, North Carolina
919-PL 8-3966

OSCAR LEON CUELLAR

Consulting Radio Engineer
AM-FM-TV
411 Phoenix Title Building 623-1121
Directional Antennas Design
Applications and Field Engineering
Tucson, Arizona 85701
Member IEEE

CARL E. SMITH CONSULTING RADIO ENGINEERS

AM, FM, TV and CATV
8200 Snowville Road
Cleveland, Ohio 44141
Phone: 216-526-4386
Member AFCCE

CAMBRIDGE CRYSTALS PRECISION FREQUENCY MEASURING SERVICE

SPECIALISTS FOR AM-FM-TV
445 Concord Ave. Phone 876-2810
Cambridge, Mass. 02138

JOHN D. HASKETT THOMAS R. HASKETT

Broadcast Engineering Consultants
7265 Memory Lane
Cincinnati, Ohio 45239
513-931-0307

Classified

Advertising rates in the Classified Section are ten cents per word. Minimum charge is \$2.00. Blind box number is 50 cents extra. Check or money order must be enclosed with ad.

The classified columns are not open to the advertising of any broadcast equipment or supplies regularly produced by manufacturers unless the equipment is used and no longer owned by the manufacturer. Display advertising must be purchased in such cases.

EQUIPMENT FOR SALE

Will buy or trade used tape and disc recording equipment—Ampex, Concertone, Magnecord, Presto, etc. Audio equipment for sale. Boynton Studio, 295 Main St., Tuckahoe, N. Y. 1-64 tf

Ampex Head Assemblies for 300 and 400 series recorders reconditioned. Service includes lapping and polishing all three head stacks, cleaning entire assembly, readjusting and replacement of guides, and realignment of stacks as to azimuth and zenith. Full track assemblies—\$60.00. Taber Manufacturing & Engineering Co., 2619 Lincoln Ave., Alameda, California. 5-64 tf

Audio Equipment bought, sold, traded. Ampex, Fairchild, Crown, McIntosh, Viking, F. T. C. Brewer Company, 2400 West Hayes Street, Pensacola, Florida. 3-64 tf

Television/Radio/communications gear of any type available. From a tower to a tube. Microwave, transmitters, cameras, studio equipment, mikes, etc. Advise your needs—offers. Electrofind Co., 440 Columbus Ave., NYC. 212-EN-25680. 8-64 tf

COMMERCIAL CRYSTALS and new or replacement crystals for RCA, Gates, W. E. Biley, and J-K holders; regrinding, repair, etc. BC-604 crystals; also service on AM monitors and H-F 335B FM monitors. Nationwide unsolicited testimonials praise our products and fast service. Eidson Electronic Company, Box 96, Temple, Texas. 5-64 tf

Parabolic antennas, six foot dia., new, solid surface with hardware, dipole, etc. \$125.00 each. S-W Electric Cable Company, Willow & Twenty-Fourth Streets, Oakland, California. 832-3527. 10-64 tf

Everything in used broadcast equipment. Write for complete listings. Broadcast Equipment and Supply Co., Box 3141, Bristol, Tennessee. 11-64 6t

Laboratory Test Equipment, microwave components, all frequency and makes at real low prices. Write or call for information. Jericho Electronic Supplies, Sid Gordon Electronics, 80 West Jericho Turnpike, Syosset, Long Island, N. Y. (516) WA 1-7580. 12-64 6t

FOTO-VIDEO USERS—Denson Electronics Corp. has acquired extensive stock of equipment. Bargain prices. Free List, P.O. Box 85, Rockville, Conn. 12-64 3t

2 ITA FM10B exciters, 2 ITA FM10BG sub-carrier generators. WAMO, 1811 Blvd. of Allies, Pittsburgh, Pa. 12-64 1t

Four bay super-turnstile antenna, adjustable to channel 2 or 3. Fifty kilowatt rating. Used two years and in excellent condition. Write Broadcast Engineering, Dept. 121. 1-65 3t

AMPEX 350 SERIES reconditioned capstan idlers for \$7.50 exchange. Send us your old ones, or order them for \$10.00 and get \$2.50 back after sending the old ones in. Ours have new bearings, the rubber softened and surface precision ground. TABER MANUFACTURING & ENGINEERING CO., 2619 Lincoln Ave., Alameda, California. 1-65 12t

AMPEX 350 SERIES reconditioned capstan drive motors (BODINE NCH-33 only) \$85.00 exchange. Send us your old one, or order for \$100.00 and get \$15.00 back after sending old one in. Ours have new bearings and rewind stator. Package motor well. TABER MANUFACTURING & ENGINEERING CO., 2619 Lincoln Ave., Alameda California. 1-65 12t

WANTED TO BUY: Used Ampex 351 tape recorder. Full track, 7 1/2-15 ips. Must be in good condition. Call or write Earl Russell, KLEO, Wichita, Kansas, WH 3-0255. 2-65 1t

STUDIO EQUIPMENT: 2 Ampex PR-10 Remote Control Units, like new, \$50 each. 3 RCA 44-BX Junior Microphones, \$50 each. 1 Gates 65/66 Remote Amplifier, \$75. 1 Grundig 2147U AM/FM/SW Radio, good condition, \$35. Reasonable offers considered. WALL Radio, Adelphi University, Garden City, New York. 2-65 1t

EQUIPMENT WANTED

A 469-B condenser manufactured by Western Electric Company for their 504 B2, 3 kw FM transmitter. Contact Bill Bratton, Chief engineer, WLAP, Lexington, Ky. 606-255-6300. 11-64-6t

Personnel

Opportunity Overseas—Engineer needed by international consulting firm to work in southeastern Africa. No U. S. income tax. Housing furnished. Must have recognized training; studio, transmitter experience in commercial or educational radio and television. Teaching experience desired. Send qualifications to Broadcast Engineering, Dept. 126. 2-65 1t

First phone, excellent electronic background. Presently working in television. Will relocate anywhere. Age 22, married, seeking permanent position. Broadcast Engineering, Dept. 125. 2-5 1t

Advertisers' Index

Altec Lansing Corp.	63
Ampex Corp.	8, 9, 52
Amplifier Corp. of America	66
Andrew Corp.	31
Arnold Bernhard Co.	62
Bauer Electronics Corp.	70
Belar Electronics Lab.	36
Bionic Instruments, Inc.	65
Broadcast Electronics	32, 58, 64
CBS Labs, Inc.	61
Cleveland Electronics	30
Cleveland Institute of Electronics	73
Conrac Div., Giannini Controls Corp.	69
Continental Electronics	66
Data Instruments, Div. of Industrial Electronic Hardware Corp.	54
Eastman Kodak Co.	25
Electro-Voice, Inc.	7
Fairchild Recording Co.	4
Gates Radio Co.	35
General Electric Co.	37-39
Greenlee Tools	58
International Nuclear Corp.	29
JOA Cartridge Service	67
Jampro Antenna Co.	43
Lang Electronics, Inc.	36, 67
Moseley Associates	64
Moviola Mfg. Co.	48
Norelco Audio Video Products	72
Northern Electric Co., Ltd.	10-11
Penta Laboratories	6
RCA Employment	70
RCA Electronic Components & Devices	76
Reeves Industries	47
Riker Industries	2
Rust Corp. of America	3
Sarkes Tarzian, Inc.	51
Scala Radio Co.	48
Shure Brothers	49
Sony Super Scope	41
Sparta Electronics Corp.	26
Stancil-Hoffman Corp.	67
Superior Cable Corp.	27
Sylvania Electric Products	45
Tektronix, Inc.	59
Telemet Co.	57
Times Wire & Cable Co.	55
Union Technical Materials	70
Video Medical Electronics Corp.	5
Visual Electronics Corp.	46
Vital Industries	75
Ward Electronic Industries, Inc.	53

You asked for it — Now here it is!

An All New Solid State Video Clamper / Stabilizer Amplifier

The Vital Video Clamper Stabilizer Amplifier was designed to answer the need for a video processing unit which provides highest performance on color and monochrome television signals. It also has very high stability of all functions, achieved through the use of complete and accurate temperature compensation and excellent power supply regulation.



MODEL VI-500 VIDEO CLAMPER/STABILIZER AMPLIFIER

Here are a few of the functions performed by this unit:

- Maintains constant video and sync. levels at the output, measured in reference to blanking, despite large variations in video and/or sync. levels at the input. The peak to peak input level can vary from 0.5 volt to 4 volts while white peaks are held constant, within 2% of the present level at the output, measured in reference to blanking. May be used with non-composite signals.
- Provides a clean video signal at the output even if the input signal is mixed with as much as 10 volts of hum or other low frequency disturbances. More than 50 db. reduction of extraneous 60 cycle hum in the video signal is achieved by means of driven sync. tip clamps. There is less than 1% tilt on a 60 cycle square wave.
- Reformed, noise free sync. is combined with the composite output signal and maintained at a constant preset amplitude in reference to blanking regardless of input level variations. This sync. portion of the output signal is independently adjustable from less than 0.1 volt to more than 0.75 volt, peak to peak. An auxiliary sync. output is also provided which delivers a constant 4 volts, peak to peak of clean, reformed sync.
- Equalization for up to 1000 feet of Belden 8281 cable is provided which is accurate within 0.25 db. to 10 mcs. and is continuously adjustable for any length of Belden 8281 cable from zero up to 1000 feet. Negligible envelope delay is introduced at any setting. This equalization is also suitable for other cable types.
- A white stretch circuit (which may be completely switched out) has great flexibility of adjustment to more accurately match the compression characteristics of transmitters.
- Four identical video outputs are provided with 40 db. isolation at 3.58 mcs. between outputs.

Applications include:

- At the outputs of cameras, switchers, video tape recorders, microwave systems, long lines and off-air pickups.
- At the inputs of video tape recorders, microwave systems and transmitters.

Price for the VI-500 complete with remote controls \$1390.00

Write for complete information and specifications

VITAL INDUSTRIES

3614 SOUTHWEST ARCHER ROAD
GAINESVILLE, FLORIDA—PHONE 372-7254

Circle Item 48 on Tech Data Card

Created by the hand of experience



RCA-4415 AND 4416 IMAGE ORTHICONS

Living color with only black-and-white studio lighting

With this 3-tube set in the TV camera, the studio lighting you now use for B&W pickup is all you need to transmit superior color pictures. At the same time, you air high resolution pictures having normal tone rendition for B&W receivers. You avoid many of the lighting costs normally associated with high-quality studio color pickup...as well as the high scene-lighting temperatures and need for extra air-conditioning.

Precision construction, field mesh, and closely matched tube characteristics assure excellent registration and color uniformity over the entire scanned area.

RCA ELECTRONIC COMPONENTS AND DEVICES, HARRISON, N.J.



The Most Trusted Name in Electronics

High signal-to-noise ratio and signal output, and excellent life expectancy are additional features of the RCA-4415 and -4416.

This factory-matched set consists of two RCA-4415's and one RCA-4416 with a high blue sensitivity which increases over-all camera sensitivity by as much as a factor of two. For quick identification, each image orthicon is marked for its particular color channel.

Write or call your local distributor of RCA broadcast tubes for information on these orthicons that enable you to air living color with only B&W studio lighting.

AVAILABLE THROUGH YOUR LOCAL RCA BROADCAST TUBE DISTRIBUTOR
FOR NAME AND ADDRESS OF YOUR LOCAL DISTRIBUTOR WRITE OR CALL YOUR
NEAREST RCA DISTRIBUTOR PRODUCTS SALES OFFICE—NEW YORK, NEW YORK,
36 W. 49th St., (212) MU 9-7200; NEEDHAM HEIGHTS 94, MASSACHUSETTS 80 "A" St.,
(617) HI 4-8490; WASHINGTON 6, D. C., 1725 "K" St., N.W., (202) FE 7-8500;
ATLANTA, GA: 131 Peachtree St., N.W., (404) JA 4-7703; CLEVELAND, OHIO: 1621
Euclid Ave., (216) CH 1-3450; CHICAGO, ILL.: Merchandise Mart, (312) 467-5900;
DALLAS 7, TEXAS 7901 Carpenter Freeway, (214) ME 1-3050; KANSAS CITY 14, MO.,
7711 State Line, (816) EM 1-6462; HOLLYWOOD, CALIFORNIA: 6363 Sunset Boulevard,
(213) 461-9171, SAN FRANCISCO 2, CALIFORNIA: 420 Taylor St., (415) PR 5-5135-6-7.