

BROADCAST ENGINEERING[®]

October 1980/\$3



**How much does broadcasting pay?
A national salary survey**

Future of 1st Class License

A Broadcast Breakthrough of Minor Proportions.

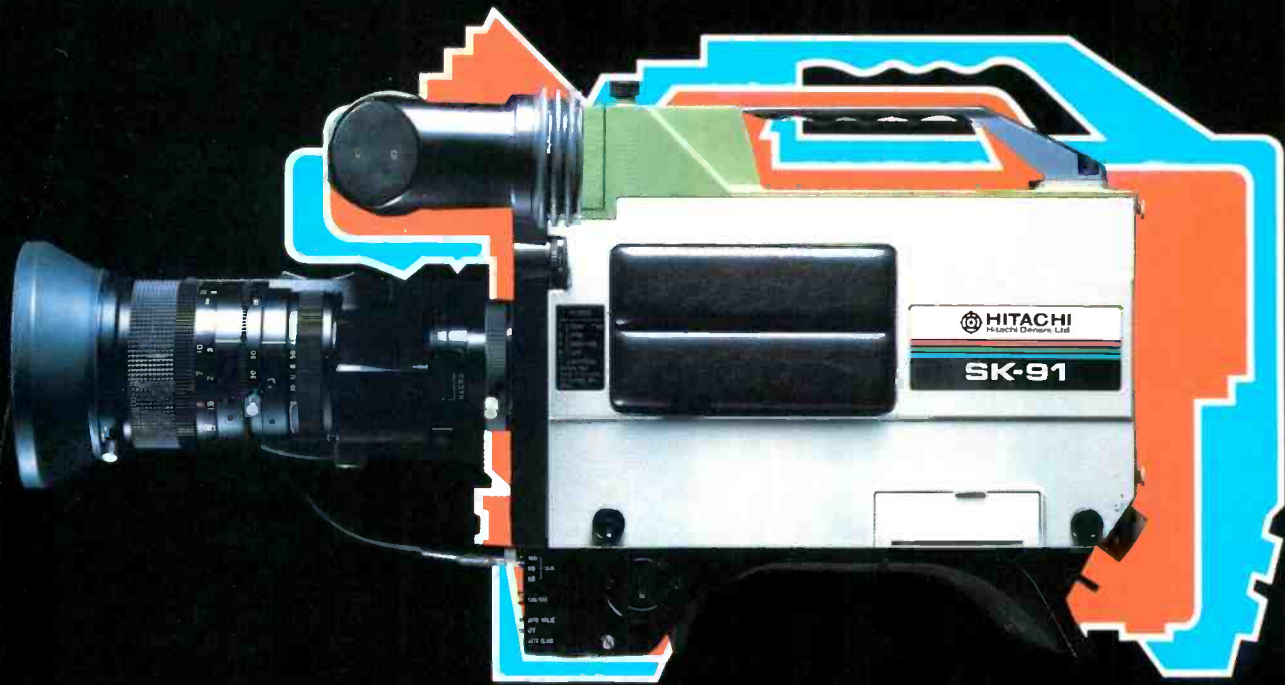

Hitachi SK-91... Critical inches shorter and precious pounds lighter.

Creating the world's smallest, lightest ENG/EPF broadcast camera was no small accomplishment. But making it so without sacrificing a single spec or capability qualified as a genuine breakthrough.

Of course, the beneficiary of our advanced engineering is you. You get all the performance that high technology has to offer in a more compact, efficient package. (Cameramen are amazed at the SK-91's responsive, featherlight handling.)

Image quality naturally adheres to the highest broadcast standards, with your choice of Saticons, Plumbicons®, or diode guns®, attaining up to 57dB and 600-line resolution. Why not call your local Hitachi

regional office and schedule a thorough in-person evaluation of the SK-91? We think you'll agree that a breakthrough of minor proportions can be of major advantage to you.

SK-91 SPECIFICATION HIGHLIGHTS

- Weight: 9-1/2 lbs.
- 57dB S/N ratio and 600-line resolution
- Auto digital white and black balance
- True ABO
- 2 ft. candle sensitivity
- Extremely quiet +9/+18dB gain
- Optional triax/digital unit
- Studio accessories for added versatility

©Registered trademarks of N.V. Philips

 **HITACHI**
Hitachi Denshi America, Ltd.

Tomorrow's Technology Today

175 Crossways Park West, Woodbury, N.Y. 11797 (516) 921-7200

• New York • Chicago • Los Angeles • Atlanta • Cincinnati • Dallas • Denver • Seattle • Washington, D.C.

Circle (1) on Reply Card

All those in favor of patch panels, raise your right hand.

Wrestling with those patch cords is cumbersome, awkward and not very good engineering.

But now there's a way to route audio signals with pushbutton ease. Without the patch cords. Without the separate amps, the noisy pots and the mad scramble to adjust levels every time you switch inputs.

Introducing the "electronic patch panel"

Meet the incredible new Ramko ARA-1612 Audio Router/Amplifier.

It lets you use front panel and/or remote control pushbuttons to route 16 inputs to any of 12 outputs, simultaneously or individually, with an instant LED display of what signal is going where.

Each balanced input has its own gain adjustment. The balanced outputs are buffered so you can feed a single input to all 12 outputs with *no* interaction. In addition, each output module contains stereo/mono switches enabling operation in either mode. And, incredibly, you need only a single shielded twisted pair to make all 16 inputs available at a remote location.

More good news.

The Ramko ARA 1612 system also features solid, broadcast-level

performance specs. Expandability up to 45 in and *thousands* out.

Remote control capability. A dual instant-switchover power supply for 100% on-air reliability. And it's backed by the only two-year warranty in the industry.

Our unique two-week free trial.

Try the Ramko ARA-1612 free for two full weeks (with prior credit approval) so you can pushbutton it through its paces.

Write Ramko Research, 11355 Folsom Boulevard, Rancho Cordova, CA 95670 for the details. Or just call (916) 635-3600 collect—we'll set you free.

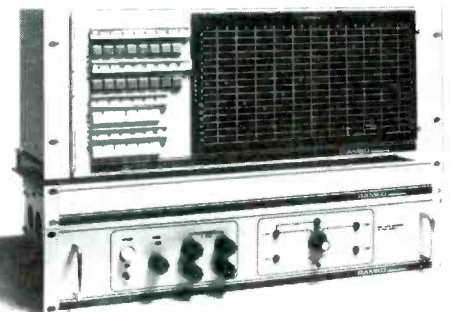

RAMKO
Brains, not brawn.

BROADCAST[®] engineering

The journal of broadcast technology

October 1980 Volume 22 No. 10

6 FCC Update
10 Station-to-station
12 Industry news

Association news
15 NAB
22 NRBA

-
- 24 **Automatic power level control (Part II)**
By R.M. Unetich and D.D. Harbert, RCA, Meadow Lands, PA
- 28 **Broadcasting salaries: A national survey**
By Joan Jackson, associate editor, and Kevin Kious,
managing editor
- 36 **SMPTE gets ready for major conference**
By Bill Rhodes, editorial director
- 42 **The future of AM and FM broadcasting**
By Wally Johnson, executive director, ABES
- 46 **67th AES convention**
- 58 **Eliminating the first class license: pros and cons**
- 62 **An automatic camera viewfinder switcher**
By Jack Hastings, chief engineer, WMAR-TV2, Baltimore, MD

66 Business news
71 People in the news
73 New products
77 Advertisers' Index
77 Classified ads

© Copyright, 1980, by Intertec Publishing Corporation. All rights reserved. Material may not be reproduced or photocopied in any form without written permission of publisher.

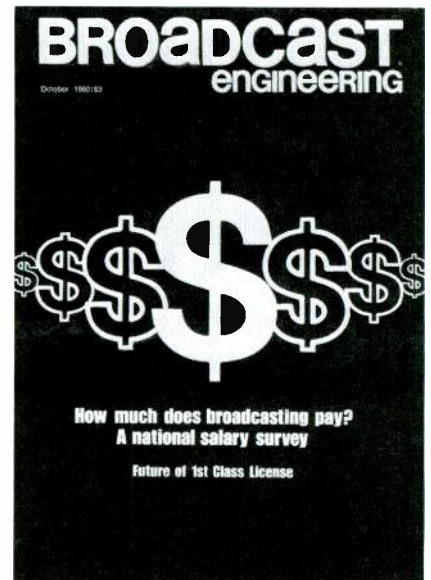

THE COVER

More than 1000 broadcast personnel responded to BE's survey on salaries. Details of the report are found in an article on page 28.

NEXT MONTH

- Digital Video Noise Reduction
- Noise Reduction in the Audio Signal
- Advances in Audio Processing
- The Democratic Convention
- Technical Highlights

BROADCAST ENGINEERING (USPS 338-130) is published monthly by Intertec Publishing Corporation, 9221 Quivira Road, P.O. Box 12901, Overland Park, KS 66212. Postmaster, return from 3579 to the above address.

Wireless Intercom System

Experience the freedom of intercommunications that is now available with the new Cetec Vega wireless intercom system. Since no cables are required between users, imagine how effectively the following situations could be handled:

- Cueing for sound, light and camera crew.
- Stunt coordination.
- Performer script cueing from script person off camera.
- Sound program monitoring.
- Communications over distances beyond speaking range, thereby eliminating the confusion of hand signals.

The compact transmitter and receiver offer duplex (simultaneous transmit and receive) or push-to-talk operation up to a range of 1000 feet. The systems are available with a complete line of accessories including single or double muff headsets or earpieces.

Cetec Vega's leadership in the wireless communications field assures you years of trouble free service and application flexibility not found in other similar systems.

GENERAL SPECIFICATIONS

Frequencies

150 to 216 MHz.
Crystal controlled frequency stability.

Battery Type and Life

9 volts/Mallory MN1604 alkaline or equivalent. 8 to 10 hours operation.

Transmitter Power

50 milliwatts (Approved for F.C.C. parts 90 and 74).

Receiver Audio Level

Operator Adjustable.

Audio Bandpass

300 to 3000 Hz.

Microphone Type

Electret.

Transmitter and Receiver

Dimensions

3.8" long x 2.8" wide x 1" thick.

Operation

Duplex operation capability, as well as simplex.



OR-1 Receiver



OT-1 Transmitter



Cetec Vega

Division of Cetec Corporation

P.O. Box 5348 • El Monte, CA 91731 (213) 442-0782 • TWX: 910-587-3539

Circle (5) on Reply Card



All Wireless Microphones Are Not Created Equal

This One is a
Telex

Wireless mics aren't new, and sometimes it seems as if all systems are basically the same. However, Telex and its Turner and Hy-Gain divisions have combined their 100 years of cumulative experience in microphone, antenna and rf development to produce a DUAL DIVERSITY WIRELESS SYSTEM THAT COSTS AS LITTLE AS SINGLE ANTENNA INSTALLATIONS. The FM receiver can be operated with one or two antennas. When two antennas are used, a unique automatic phase summation network (patent applied for) provides superb dual diversity reception.

The Telex wireless sounds as good as a hard wired mic, offers plenty of options and is economically priced. If you're interested in a wireless system that is *more* than equal—write us today for full specifications.

Quality products for the audio professional



TELEX

TELEX COMMUNICATIONS, INC.

9600 Aldrich Ave. So., Minneapolis, MN 55420 U.S.A.
Europe: 22, rue de la Légion-d'Honneur, 93200 St. Denis, France

Circle (6) on Reply Card

4 Broadcast Engineering October 1980

BROADCAST engineering®

Editorial, advertising and circulation correspondence should be addressed to P.O. Box 12901, Overland Park, KS 66212 (a suburb of Kansas City, MO); (913) 888-4664.

EDITORIAL

Bill Rhodes, *Editorial Director*
John Willisowski, *Video Editor*
Kevin Kiouss, *Managing Editor*
Joan Jackson, *Associate Editor*
Rhonda L. Wickham, *Editorial Assistant*
Mary Thornbrugh, *Editorial Assistant*
Pat Blanton, *Directory Editor*

ART

Dudley Rose, *Art Director*
Joy Viscek, *Graphic Designer*

TECHNICAL CONSULTANTS

Howard T. Head, *FCC Rules*
Harold L. Kassens, *FCC Rules*
Carl Babcoke, *Technical*
Donald L. Markley, *Facilities*
Art Schneider, A.C.E., *Post-production*

CORRESPONDING ASSOCIATIONS

American Society of TV Cameramen
Association for Broadcast
Engineering Standards
National Association of Broadcasters
National Radio Broadcasters Assn.

CIRCULATION

John C. Arnst, *Director*
Evelyn Rogers, *Manager*

ADMINISTRATION

R. J. Hancock, *President*
George Laughead, *Publisher*

ADVERTISING

Cameron Bishop, *Marketing Director*
Mary Birnbaum, *Production Manager*

Regional advertising sales offices listed near the Advertiser's Index.



Member,
American Business Press



Member,
Business Publications
Audit of Circulation

BROADCAST ENGINEERING (USPS 338-130) is published monthly by Intertec Publishing Corporation, 9221 Quivira Road, P.O. Box 12901, Overland Park, KS 66212. Postmaster, return form 3579 to the above address.

BROADCAST ENGINEERING is edited for corporate management, engineers/technicians and other station management personnel at commercial and educational radio and TV stations, teleproduction studios, recording studios, CATV and CCTV facilities, and government agencies. Qualified persons also include consulting engineers and dealer/distributors of broadcast equipment.

SUBSCRIPTIONS: BROADCAST ENGINEERING is mailed free to qualified persons in occupations described above. Non-qualified persons may subscribe at the following rates: U.S., one year, \$20; all other countries, one year, \$26. Back issue rates, \$5, except for the September Buyers' Guide issue, which is \$15. Rates include postage. Adjustments necessitated by subscription termination at single copy rate. Allow 6-8 weeks for new subscriptions or for change of address. Controlled circulation postage paid at Kansas City, MO.



© 1980. All rights reserved.

Intertec Publishing Corp.

TM 500 now gives you the quickest distortion measurements ever.

Introducing the AA 501 Distortion Analyzer and SG 505 Oscillator. Fast, automated and accurate.

This new pair of TM 500 Plug-ins makes distortion measurement truly automatic to save you both time and money. For production testing, the AA 501's automatic speed provides substantial labor reduction with no loss in accuracy. Together, the AA 501 and SG 505 have the lowest harmonic distortion plus noise (THD+N) rating in the entire industry: 0.0025%.

The SG 505 Oscillator outputs a sine wave with the lowest residual distortion on today's market (.0008%). The AA 501 Distortion Analyzer uses digital processing to lock in on test signals, set levels and adjust the notch filter for nulling. All measurements, including dB levels are precalculated and then displayed on an LED readout.



The AA 501 and SG 505 are both TM 500 Plug-ins that can be installed in any of five main-frames, including rackmount, bench and portable. They can also be separated and still used as a team, even though miles apart. Or configured with over 40 other TM 500 Plug-ins currently available.

To find out more about the AA 501 Distortion Analyzer and SG 505 Oscillator, contact your local Tektronix Field Office or write Tektronix, Inc.

TM 500 Designed for Configurability

For immediate action, dial toll free automatic answering service 1-800-547-1512

Tektronix®

COMMITTED TO EXCELLENCE

U.S.A.
Tektronix, Inc.
P.O. Box 1700
Beaverton, OR 97075
800/547-1512
Oregon 800/644-9051

Asia, Australia, Canada,
Central &
South America, Japan
Tektronix, Inc.
America's/Pacific
P.O. Box 1700
Beaverton, OR 97075

Africa, Europe
Middle East
Tektronix Int'l, Inc.
European Marketing
Center
Postbox 827
1180 AV Amstelveen
The Netherlands



FCC update



October 1980

By Howard T. Head and Harold L. Kassens

Low-power television stations proposed

The commission has proposed to establish a new class of low-power television broadcast station. The commission regards this innovation as the first new type of broadcast service to be inaugurated in more than 20 years. The proposed new class of station is essentially a television translator and, in fact, the only distinction will be that whereas translators simply pick up and rebroadcast the signals of a regular broadcast station, the low-power station will be permitted to originate its own programming. No restrictions are to be placed on the type of programming, which may even be pay-TV, although the requirements for copyright and retransmission consent will continue in force.

Operation will be permitted on both VHF and UHF channels 2 to 69, inclusive. Assignments will continue to be made in the same manner as translators, that is, on a strict noninterference basis. VHF translator output power will be a 10W restriction east of the Mississippi River. UHF output power will be raised from 100W to 1000W.

Although this is still a commission proposal, the commission will accept and grant applications that conform to the terms of the proposal. Preferences will be given to minority applicants and to those proposing an educational program service.

Here come the VHF television drop-ins

The commission established the present television channel allocations system in 1952 when it adopted its Sixth Report and Order. The system up until now has consisted of rigid mileage separations for co-channel and adjacent-channel interference, and in the case of UHF allocations, taboo mileage separations as well. If you met the mileages, you were in, and if you didn't, you were out.

Except for one case in the Virgin Islands, where any interference that

might have occurred would have been over water, the commission has until now held the line and has not made any new assignments where the mileage restrictions were not met.

Now that's all changed. The commission has made four short-spaced VHF drop-ins: Knoxville, Ch. 8; Salt Lake City, CH. 13; Charleston, WV, Ch. 11; and Johnstown, PA, Ch 8. Unless the commission changes its mind or the court changes its mind for it, those are here to stay.

At the same time it made those four short-spaced drop-ins, the commission proposed to open the gates to all VHF short-spaced drop-in proposals. Although the details have not been released as of this writing, it looks as though the commission will entertain co-channel shortages of as much as 75 miles and adjacent-channel shortages of up to 25 miles. In the case of co-channel shortages, there will be a requirement to provide equivalent protection to existing stations. This is to be accomplished by reducing height and power or by using a directional transmitting antenna. Actually the word protection is misleading because even with the equivalence the drop-ins will still cause considerable interference to existing service.

Another unsolved problem is that of carrier offset. The drop-ins must be offset from their neighbors, otherwise the interference will be intolerable; but there are only three positions in the offset schedule: 0kHz, +10kHz and -10kHz. And there is no logical way to add another. So when a channel is dropped in the middle of the triangle formed by its three neighbors, what's going to give?

First class licenses out the window?

The FCC has extended the review of its operator licensing program by issuing a Further Notice of Proposed Rule Making (Docket No. 20817) proposing to discontinue the issuance of new and renewed First Class Radio Telephone Operator

Licenses and to eliminate the requirement for license examination for persons who perform installation, maintenance and technical supervision at broadcast stations. Essentially, the commission is proposing that all persons performing technical duties at AM, FM, TV and Translator stations be required to hold only a Restricted Radiotelephone Operator Permit. The comment due date is November 14. All replies must be mailed by December 15. (See page 58 for more details.)

...But were afraid to ask

The commission is still wrestling with the technicalities that have to be cleared out of the way, but the day is coming when stations in the AM band will be separated by 9kHz instead of the present 10kHz.

Several plans are under consideration, but under the plan now most favored no one would have to change by more than 4kHz. To find out whether a station is one of the lucky ones, divide it by nine. If the division comes out even without a remainder, the frequency won't have to be changed. If there is a remainder, here's what it means.

| if the remainder is | go down in frequency |
|---------------------|----------------------|
| 1 | 1kHz |
| 2 | 2 |
| 3 | 3 |
| 4 | 4 |

| if the remainder is | go up in frequency |
|---------------------|--------------------|
| 5 | 4kHz |
| 6 | 3 |
| 7 | 2 |
| 8 | 1 |

If the remainder is 9, a mistake has been made in division.

Short circuits

The commission has issued a declaratory ruling that the pouring of concrete footings for a broadcast tower does not constitute premature construction. It wasn't always so... The commission has authorized an AM station in Iowa to operate during some nighttime hours with a power of 4W...The commission is proposing the conversion of all AM directional antenna radiation patterns to standard patterns...The Television Rules have been amended to permit the aural and visual transmitters to be operated separately with unrelated program material between midnight and 6AM...The commission's UHF Comparability Task Force has prepared consumer information on adequate home TV receiving antennas. □

CO-AX

DIGITAL REMOTE CONTROL

Our new and exciting co-ax digital remote control system provides dependable, studio-like remote control to ENG/EFP cameras in the field *at a fraction of the cost of other systems!*

It is the most affordable and reliable remote control system available on the market today. Easily interfacing with a full range of professional ENG/EFP video cameras currently in use, such as: Ikegami HL-77 and HL-79A, RCA TK-76B, NEC MNC-71 cameras, and many more.



Outstanding Features:

- System consists of mini-CCU, analog-to-digital encoder, and digital-to-analog decoder.
- Permits control of all functions normally required in OB van, including genlock.
- Digital encoder (19" rack-mounted) designed to accommodate two mini-CCU's to control two cameras (each equipped with its own decoder).
- Lightweight, camera-mounted decoder features intercom capability.
- Digitally encoded control data relayed to camera-mounted decoder through a simple, lightweight and reliable coaxial cable.
- Eliminates the need for expensive, bulkier, multi-core or triax camera cable, and reduces to a minimum the risks normally associated with the use of such camera cables.
- Low-cost coaxial cable allows complete remote control and camera set-up functions from greater distances with greater safety and utmost reliability.
- System is ideal for all extended shooting situations such as sports events, live concerts, political rallies, etc.

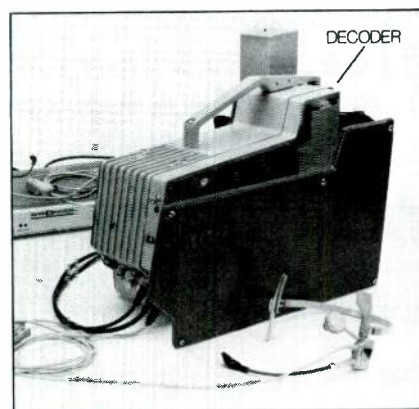

RCA TK-76B shown with decoder neatly "sandwiched" between camera body and door.

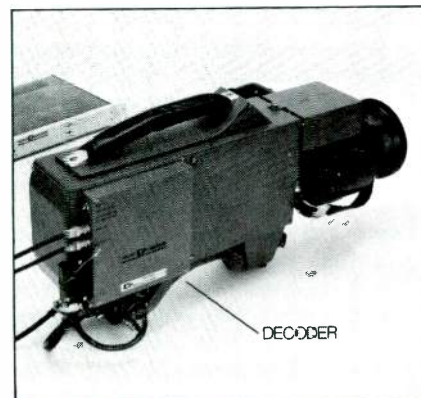

Ikegami HL-77 shown with side-mounted decoder.

For full details, call toll-free: 800-421-7486.

cinema E products
CORPORATION

Technology In The Service Of Creativity

2037 Granville Avenue, Los Angeles, California 90025
Telephone: (213) 478-0711 • (213) 477-1971 • Telex: 69-1339

...and what have we done for you lately?

*In 1964 we delivered the original
30mm Plumbicon® camera tube
that revolutionized TV broadcasting...*

*5 years later we introduced the 1-inch
Plumbicon tube that permitted
the design of more compact
broadcast cameras...*

*...and 5 years after that—
the 2/3-inch Plumbicon tube
brought broadcast quality to portable
cameras and gave us ENG...*

*Today, we bring you two of these
popular pickup tubes with further
improvements in performance.*

Ever since the original Plumbicon tube won the Emmy Award for having revolutionized color TV broadcasting, we've been keenly aware of the importance of the name Plumbicon to the TV industry which has come to depend on it as its assurance of consistent performance and quality. There's no disputing the fact that contemporary Plumbicon tubes outperform their original versions by a wide margin.

Two of the most recent improvements in the Plumbicon pickup tube line, (the 30mm XQ1410 and the 2/3-inch XQ1427) are described here. These tubes, like all Plumbicon TV camera tubes, offer unmatched resolution and sensitivity, superior color rendition...excellent highlight handling...low and steady dark current...high signal-to-noise ratio...minimal lag...stable operation over a wide temperature range...and long life.



Type XQ1427: Offers significantly higher resolution than earlier versions; modulation depth is 60% typical at 320 TV lines giving sharper, clearer pictures and allowing operation at lower light levels. New gun design and 1500-line mesh construction result in improved registration and geometry, reduction of flare by a factor of 3 and reduced beam landing error.



Type XQ1410: The XQ1410 gained immediate acceptance by the television industry as a significant advance over all previous 30mm tubes. This recognition is based on the XQ1410's dramatic reduction in lag (typically 37% below that of other 30mm Plumbicon tubes). The XQ1410 ends color-fringing, greatly reduces picture-smear and gives better dynamic resolution—even under poor lighting conditions. With its internal bias lighting, all three channels can now be balanced for identical lag characteristics. New gun construction gives improved resolution, (60% typical modulation depth at 400 TV lines). New mesh construction results in better geometry and registration and significantly reduces microphony.

Make no mistake — these are vitally important improvements on vitally important camera pickup tubes...but these developments are only part of the answer to — "What have we done for you lately?"

...and now the new generation of Plumbicon TV camera tubes: with them begins the age of Electronic Cinematography.



"Cinematography" once meant the creation of motion pictures on film, and film alone. But no more.

The new generation of Amperex Plumbicon TV pickup tubes, in combination with recent advances in new camera design and videotaping systems, is destined one day to reduce to near-zero the use of film in broadcast cinematography and in motion picture production. Now, indeed, begins a new era...and a new art form: Electronic Cinematography. All-electronic production will offer a technically superior product, and will permit shorter lead times between production and broadcast... and it allows motion picture directors to combine the creative aspects of single-camera film production with the immediacy of live-on-tape TV techniques.

All this has been no accident, of course. We, for instance, have been working toward this moment ever since the introduction of the original Plumbicon tube...right through the advent of ENG, first brought to reality by our 2/3-inch version of the Plumbicon tube.

This steady stream of advances in TV pickup tube technology now culminates in a new generation of Plumbicon tubes that offers major advances in resolution and lag performance...advances that were prerequisite to the dawn of the age of Electronic Cinematography.

Type S45XQ: Developed for use in new studio cameras that will accept 30mm tubes, has limiting resolution of 1600 TV lines, with modulation depth of 90% at 400 TV lines and 40% at 800 TV lines. Nothing like it has ever been offered in a broadcast quality tube. The S45XQ provides for external bias lighting; but decay lag, even without bias light, is typically only 5% after 50 milliseconds.

Type S73XQ: Physically interchangeable with conventional 1-inch broadcast Plumbicon tubes, can be used in existing studio and field production cameras with only minor circuit modifications. Typical limiting resolution of the S73XQ is 900 TV lines, with modulation depth of 65% at 400 TV lines. Overall signal-to-noise ratio can be maximized in the S73XQ by a low-capacitance target contact. A revolutionary gun design in the S73XQ reduces lag; decay lag is typically 2% at 50 milliseconds with bias lighting.

Both of these new-generation tubes inherit all the finer qualities of the original Plumbicon pickup tube: near-zero dark current...high sensitivity...resistance to burn-in, even in highlights...precise geometry and registration...and long life. You can expect from them what you have learned to expect from Amperex Plumbicon tubes; performance at the edge of tomorrow.

For more information, contact: Amperex Electronic Corporation, Slatersville Division, Slatersville, Rhode Island 02876. Telephone: 401-762-3800.

Amperex[®]
...dedicated to product excellence

A NORTH AMERICAN PHILIPS COMPANY

Circle (7) on Reply Card

Sensitivity of transmitter tubes to the audio signal

By John J. Webber
Chief operator
KHOW-AM, Denver

KHOW operates a Rockwell/Collins 828E-1 PowerRock AM transmitter, which uses the relatively new high- μ 3CX3000F7 triode in the modulator and PA. For several months, the transmitter would momentarily pop off the air and come right back up. Inspection would reveal no blown fuses, tripped breakers or overload tally lights. The transmitter would operate normally for a while before the problem recurred.

A pattern developed: the transmitter would pop off the air only on certain songs.

One night during maintenance, I drove the transmitter directly with an audio oscillator and slowly swept the low frequencies. At approximately 225Hz, the transmitter went into a fit of popping off, then on, then off. A few hertz up or down relieved the problem.

Consultation with Rick Tanner of

Rockwell/Collins revealed that other PowerRock users had experienced similar problems. Tanner had opened several defective tubes returned to the factory in an attempt to isolate the cause and found that the tube grid structure had warped and was no longer concentric around the cathode. In addition, the grid structure is mechanically resonant at 200-250Hz. The result was this: If a musical note at the grid's resonant frequency was presented to the transmitter, the grid structure would vibrate, bringing it in proximity to (or actually touching) the cathode. A cathode-grid short could develop and the change in the grid driving impedance was enough to set off the RF driver protection circuits if the PA tube was at fault. Or in the case of the modulator, the audio would momentarily disappear.

The reason for all this difficulty was the fact that the grid, as originally built by Eimac/Varian, was supported only at the bottom of the tube. The grid structure resembles fly screen in construction and dissipates up to 200W in operation. All that heat was warping the grid, although it would handle the load otherwise.

Rockwell/Collins informed Varian of the problem. Varian is now building 3CX3000F7s with a support ring at the top of the grid.

I informed Econco Broadcast Services of the problem and the

company is rebuilding 3CX3000F7s with pins to support the grid. I installed a set of rebuilt tubes in the transmitter and again slowly swept the low audio frequencies. There is no problem with carrier popping off or audio momentarily disappearing on certain songs any longer.

If you are not sure whether your tubes have pinned grids and your transmitter is exhibiting one or more of the above symptoms, try injecting audio directly into the transmitter, slowly sweeping the low frequencies. If the transmitter goes into convulsions at some discrete low frequency, there is a defective tube.

Incidentally, the same problem, only this time with 3CX3000F1s in the modulators of an RCA BTA-5R, was not diagnosed until the defective tube went into a dead cathode-grid short and was replaced. In that case also, certain songs would cause overloads and shutdown of the transmitter.

If you find that you have a defective 3CX3000F7 manufactured by Eimac/Varian that exhibits a grid-resonance problem, contact Ken Atkinson in Salt Lake City, (801-972-5000).

*Editor's note:

Effective October 1, Rockwell/Collins broadcast products are manufactured and marketed by Continental Electronics Manufacturing Co., Dallas, TX.

Using empty hour-long videotape reels

By Richard J. Dietz
producer-director
WFIE-ITV, Evansville, IN

Have you been throwing away your empty hour-long tape reels as we have been? We spool quite a bit of videotape to smaller reels, leaving dozens of empty hour-long reels that ended up in the trash. I had thought about the waste and wondered whether there couldn't be a practical use for these reels.

After we put an ENG van into use with inter-city microwave and an RCA TK-76 camera, we needed portable reels for microphone cable, video line and light-duty power line. We had purchased one portable reel for a previous mobile tape unit that had been in use during b&w days. After going out on remotes several times with what we call our Live Eye, ENG microwave system, having to roll up cables by hand and finding tangled cables a con-

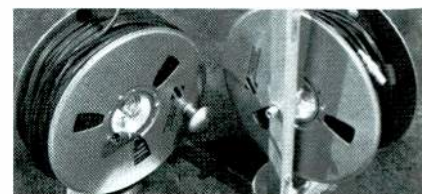
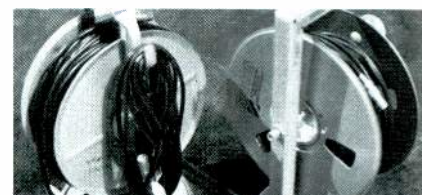
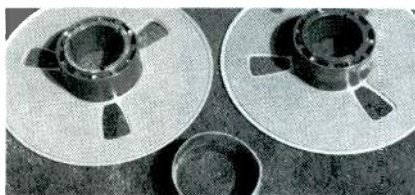
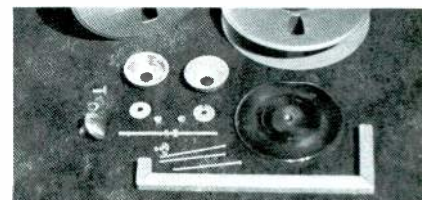
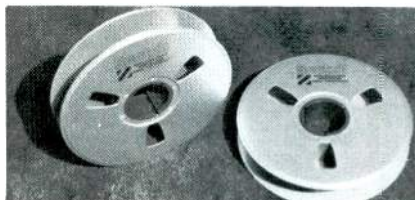

stant problem, I requested we purchase additional portable reels but found the budget slashed. The idea occurred to me to build something similar using videotape reels being thrown away. To hold more cable

we put two of them together, as shown in the photo sequence.

The total cost of building our homemade portable reel was about \$5 compared with \$180 for a commercially sold portable reel. □

NOW

A NEW STRENGTH IN RADIO BROADCASTING EQUIPMENT

BROAD PRODUCT LINES OF AM AND FM TRANSMITTERS

Starting October first, Continental Electronics offers broadcasters a complete line of high quality AM and FM radio transmitters, stereo studio consoles, antenna systems and related equipment.

The transmitter product line includes AM and FM transmitters 1 kW thru 50 kW.

This expansion is brought about in part by Continental's recent purchase of Collins Broadcast Products Group from Rockwell International Corporation.

NEW FACILITIES

New manufacturing facilities have been completed at Continental's plant in Dallas, to handle the additional product lines.

MARKETING AND FIELD ENGINEERING

Continental broadcast equipment, and existing Collins radio transmitters, can be serviced by a world-wide Continental field support and marketing group headquartered in Dallas.

This group has been expanded to meet customer requirements in a professional manner.

PIONEER AND LEADER IN HIGH-POWER RF SYSTEMS

Since its founding in 1946, Continental Electronics has pioneered many advances in high-power rf transmitter and systems technology at power levels from kilowatts to megawatts; for communications, radio broadcast, radar and scientific research applications.

Continental medium wave and short wave broadcast transmitters have achieved a world-wide reputation for quality components and construction; circuit innovations and unique, simple-to-operate designs which produce superior performance.

STRENGTH YOU CAN DEPEND ON

Whatever your radio broadcast needs may be, Continental offers quality equipment and competent marketing and engineering support.

For information on Continental broadcast equipment, call (214) 381-7161 or contact Broadcast Marketing Department, Continental Electronics Mfg. Co., P. O. Box 270879, Dallas, Texas 75227 Telex: 73-398

Continental Electronics



Circle (8) on Reply Card

Vital honored

On September 15, 1980, Vital Industries received the 1979-80 Engineering Achievement Award from the National Academy of Television Arts and Sciences.

The Emmy was awarded at a dinner held in the RCA Building, New York, NY.

Joint Emmy received

NBS, together with the Public Broadcasting Service and the American Broadcasting Company, has been awarded an Emmy by the Academy of Television Arts & Sciences for outstanding achievement in engineering development for the invention and development of closed TV captioning for the deaf. Closed captioning had its roots in a system called TVTime developed by NBS engineers in 1971 as a way to broadcast time and frequency information on television channels without disturbing regular shows. The system became a reality for American viewers last year with the decision of three major networks—ABC, NBC and PBS—to begin regular broadcasts of closed caption material and the establishment of the National Captioning Institute to do the captioning. Regular broadcasts of selected programming began last March.

Museum acquires home

On October 1, 1980, The Texas Broadcast Museum Inc., moved to the Higginbotham Pearstone Building, on the corner of Ross and Market Streets in downtown Dallas.

As funds permit, doors will be opened in January of 1981. More than \$200,000 worth of antique broadcast equipment, including a working 1938 vintage radio station are featured.

SMPTE's Conference sold out

All available booth space for SMPTE's 122nd Conference Equipment Exhibit has been taken, it was announced by SMPTE Conference vice president Harry Teitelbaum, Hollywood Film Co.

The 122nd Technical Conference is set for the New York Hilton Hotel in New York City, November 9-14, 1980. The exhibit will open Tuesday, November 11, at 10 am and run through Thursday at 6 pm.

The 300-booth exhibit will be occupied by 144 companies that represent most of the major manufacturers and suppliers of professional motion picture and television equipment. This will be one of the year's largest shows in which a combination of both film and video equipment is on display side by side under one roof. This is also the largest equipment show the SMPTE has ever had in New York, the previous record holder being the last New York exhibit in 1978 where there were 211 booths of equipment on display.

The SMPTE Conference will also feature five days of sessions on new developments in motion picture and television technology and applications.

NEC receives second Emmy

Nippon Electric Company received its second Emmy for Outstanding Engineering Achievement at this year's award ceremony in September. This year's Emmy was for NEC's DVE (Digital Video Effects) System. The first Emmy was awarded in 1975 for NEC's Frame Synchronizer.

The DVE System is a creative television production tool that allows a video frame or picture to be reduced or expanded in size, repositioned, frozen, and otherwise manipulated live or from videotape.

Studio and office complex

In early October the new \$2 million KBAK-TV (Channel 29) studios and office complex officially opened in Bakersfield, CA.

The 18,500-square-foot complex, located on a 25-acre site at Westwind Drive and 19th Street was designed by Millard Archuleta/Eddy, Paynter Associates, AIA, Bakersfield.

Broadcast facilities include two separate and independent production studios with separate control facilities. One studio will be dedicated for the exclusive production of local news and public affairs programming. The other will be used primarily for production of commercials for advertisers and for local public service announcements.

Grants awarded

The Department of Commerce has awarded four grants worth \$1.18 million under a new program to stimulate public service use of satellite communications.

Henry Geller, administrator of the National Telecommunications and Information Administration (NTIA), said the grant awards were "a major step in bringing the benefits of the national investment in satellite technology to the public sector."

The four recipients are:

The Appalachian Community Service Network. ACSN will expand its currently operating satellite/cable network, which offers instructional programming primarily in the Appalachian Region, to include national public service applications. This builds upon past federal commitment to transfer this activity from a NASA experiment to a commercial operation.

Bell and Howell Company. Bell and Howell, an international manufacturer of audio-visual hardware, will develop a Civic Affairs Network linking multiple locations through satellite earth stations. The network will be used by public service organizations and Federal Government agencies for training, education, teleconferencing and community outreach.

The Public Service Satellite Consortium. PSSC is a national telecommunications organization composed of about 100 non-profit entities and an experienced staff of communications experts. PSSC's satellite uplink, mobile facility, and other resources will be able to be better utilized both by PSSC alone and in collaborative efforts with other grantees.

American Educational Television Network. AETN is a new for-profit corporation which has reserved space on an RCA satellite to transmit specialized continuing education programming to members of professional associations and employee organizations, helping to meet state licensing and college credit requirements.

Cooperation among those awarded the grant is an essential element of the awards program, to help forge an integrated national system of public telecommunications services. The grants will also stimulate competition in various applications, resulting in the attraction of venture capital from private industry in the growing public service marketplace.

None Better.

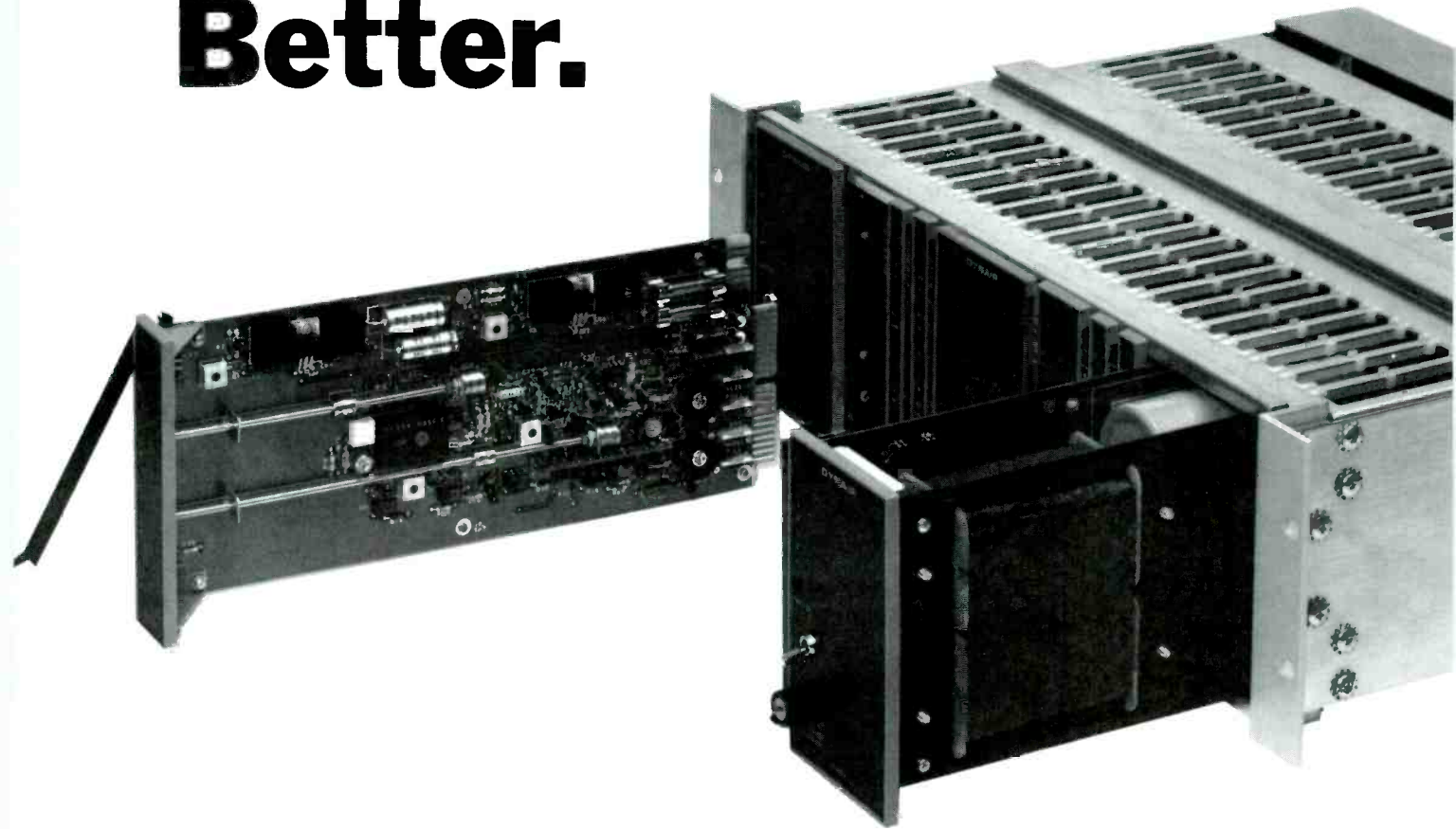

Today's modern television plant with multiple re-entry requirements and long cable runs needs the performance and inherent stability of Dynair's new Series 5300 television distribution equipment.

Advanced technology using precision hybrid video operational amplifiers and innovative circuitry, plus modern packaging make the Series 5300 the best choice for your system.

Let us tell you more about this superb line of equalizers and distribution amplifiers. Upgrade your present or next installation with Dynair.

DYNAIR ELECTRONICS, INC.

5275 Market Street, San Diego, California 92114; Telephone: 714/263-7711; TWX: 910/335-2040

Circle (9) on Reply Card

October 1980 *Broadcast Engineering* 13

Air Cooled Calorimeter-Load

FEATURES:

- Precise Power Measurement
- Exceeds FCC Specifications
- Mobile For Multi Use
- Interlock Protected
- Nonmeasurable VSWR
- Freq. Range D.C.-1.8 GHz

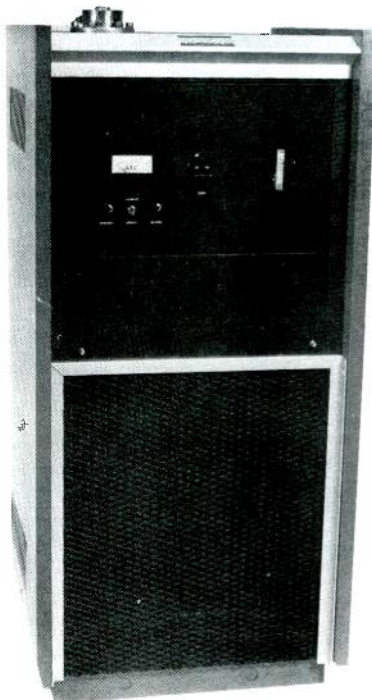

WILKINSON
ELECTRONICS, INC.

701 Chestnut St. • P.O. Box 738
Trainer, Pa. 19013 • Telephone (215) 497-5100
TWX 510-669-3188 • Cables: WILEC

Circle (10) on Reply Card

Industry news

CCI announces breakthrough

Comark Communications has announced that it has made a significant technical breakthrough concerning the operating efficiency of UHF broadcast television transmitter systems.

Currently, the average plant efficiency of a UHF television broadcast facility calculates to be 25% nominal. At best, an overall plant efficiency of 28% to 30% could be achieved using an anode pulser concept introduced by the Radio Corporation of America.

The significance of this development to the UHF broadcast television station owner will be to reduce his power bill by a minimum of \$35,000/year as compared to the average UHF television broadcast station operating today.

Executive praises US innovations

American innovation is keeping this nation technologically on top despite the aggressive advances of Asia, Germany and the rest of the Western World, according to RCA group vice president Dr. James Vollmer.

Vollmer, who is responsible for RCA's Government Systems and Commercial Communications Systems divisions, described a range of electronic inventiveness that may produce some interesting products in the future; for example:

Electronic interpreters. Advances in semiconductors and computers will see development of a box no larger than a camera that will allow people with different languages to communicate freely. An American, for example, will speak into the box, which will then repeat the sentence in another language, allowing person-to-person communication.

Electronic position locators. At sea, air and space, this is already a reality through radar and other means. Vollmer predicted that satellites will be able to pick up signals beamed through automobiles and provide a computer readout that will not only reveal where you are, but how you can get to where you want to go.

Home information centers. The television set will provide as many as 25 different services, ranging from entertainment to security, two-way communication, library services, financial management, shopping and more.

Vollmer says he sees the true challenge as deciding what we as a society want. "Engineers and scientists continue to invent and discover at a fantastic rate. We can do almost anything.

"The real issue is not the task of invention but that of investing and supporting the inventions," he said, adding, "our commitment to moving new ideas into the domain of daily use is what's in question."

BE completes national salary survey

The results are in for **Broadcast Engineering's** national salary survey of the broadcast industry. The study compiled the responses of 1065 personnel who receive BE.

Among the results were these: the median salary for the group technical management/engineering was found to be \$23,400 for television and \$17,200 for radio; the median raise reported for the past year for this group was 8.4% in television and 9.7% in radio.

More details are in a complete article beginning on page 28. □



Best Picture:

**SCOTCH ONE-INCH
VIDEO TAPE**

Scotch[®] is a registered trademark of 3M

For the second year in a row, Scotch[®] 479 won the award for the best picture of the year in a test of one-inch video tapes.

We scored well in all of the twelve categories tested, but especially well in the categories that commonly represent picture quality: color dropouts, high frequency dropouts, chroma noise, signal-to-noise ratio and stop motion.

These were scientific, quantitative tests, conducted as you would conduct them yourself, with no room for brand bias. The meters didn't play favorites. The standards were the same for every brand tested. And we tested every brand.

These kinds of test results don't surprise us. We pioneered the invention of video tape. And we've been setting the standard for quality ever since.

Our quality has always been consistent from the first replay to the

last. In fact, our sophisticated binder and oxide coating are more advanced than the binders and oxides on some quad tapes. They had to be advanced to meet the special durability demands of one-inch video production.

So choose Scotch 479 for your one-inch video production. You'll find it looks good from repeated mastering all the way through post production. And we've seen the test results to prove it.



3M



National Association of Broadcasters

1771 N Street, NW Washington, DC 20036

Network affiliation

The NAB has told the FCC that it is beyond its jurisdiction to require networks to affiliate with proposed UHF television stations in northern New Jersey.

The association stated that "the programming offered by the three national commercial networks pres-

ently reaches the New Jersey population with adequacy that will achieve close to 100% efficiency when present and proposed assignments to the southern portion of the state become operational."

Presunrise radio service

The NAB said that any action taken by the FCC authorizing presunrise service by Class II daytime-only AM stations should consider both aspects of NAB's overall daytime radio position: (1) the conversion of daytime facilities to fulltime operation and (2) not diminishing significantly the service provided by other classes of stations.

In its filing, NAB also said any FCC decision should be made within the framework of other pending and proposed proceedings concerning radio allocations and authorizations and under the review of a joint government-industry advisory committee—the formation of which NAB repeatedly has requested since February 1979.

Wasilewski comments on trial decision

Vincent Wasilewski issued the following statement on the US Supreme Court decision saying that without overwhelming reason to close them, trials must be open to the press and public.

"A badly frayed thread of our history has been restored by the Supreme Court. It has decided that there is a clear First Amendment right of public access to trials for as many of our citizens as 'choose to attend.'"

"In states where camera and microphone access to courts is already granted, America's broadcasters further the Supreme Court's newly restated goal that 'publicity of a judicial proceeding is a requirement...'

"In this decision, the court extends an opportunity and an olive branch to the news media. By contrast to old complaints that news coverage of a case may jeopardize

it Quality at \$990

THE PD II RECORDER plays mono tapes in "A" size cartridges. Stops automatically on 1kHz cue. Big and small buy it for the same reason: nothing else does this task so well, so long, so reliably, with so little maintenance. Also available in Reproducer Only for \$725.

CALL TOLL-FREE 800-447-0414

Ask about our no-risk, 30-day trial order. Call collect from Illinois, Alaska, Hawaii: (309) 828-1381. Standard 2-year warranty.

INTERNATIONAL TAPETRONICS CORPORATION 2425 South Main Street, Bloomington, Illinois 61701

Marketed exclusively in Canada by McCurdy Radio Industries, Ltd., Toronto



Circle (11) on Reply Card

Facts from Fluke on low-cost DMM's

Our new 4½-digit bench/portable: You've never seen anything like it.

Take a close look at the face of this instrument. Notice anything new? If you just realized you've never seen *words* on a low-cost DMM display before, you're on the right track.

This is the new 8050A from Fluke, the *lowest* priced 4½-digit multimeter available that uses microprocessor technology.

The legends on the LCD are clues to what makes the 8050A unique.

dB: You're right. The 8050A delivers direct readouts in dBm, referenced to any of 16 impedances. Use the "REF Z" button to scroll through the memory and locate the zero dBm reference you need,

then set it and forget it. No more tedious calculations or conversions.

REL: For relative measurements in the dB mode or offset measurements in all other functions. Lets you store any input as a zero value against which all others are automatically displayed as the difference. Another timesaving convenience.

HV: Just a reminder when your input is over 40V, so you won't forget about safety while in the dB or relative modes. Of course there's much more to the

8050A. True RMS measurements to 50 kHz. Conductance for measuring resistance to 100,000 Megohms and leakage in capacitors, pcb's, cables and insulators. Diode test, 0.03% basic dc accuracy and full input protection. Plus a large family of accessories. Just \$329 U.S.

For all the facts on the versatility and value of the new 8050A, call toll free 800-426-0361; use the coupon below; or contact your Fluke stocking distributor, sales office or representative.

FLUKE

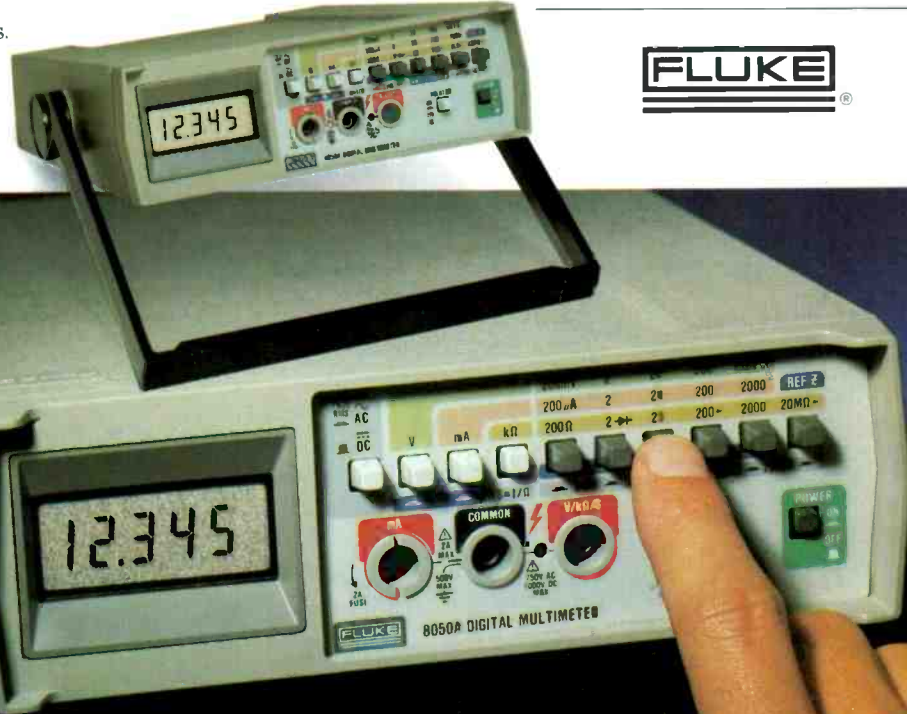

IN THE U.S. AND NON-EUROPEAN COUNTRIES: IN EUROPE: **BE 10/80**

John Fluke M'g. Co., Inc.
P.O. Box 4321C MS=2B
Mountlake Terrace, WA 98043
(206) 774-2481
Telex: 32-0013

Fluke (Holland) B. V.
P.O. Box 5053, 5004 EB
Tilburg, The Netherlands
(013) 673 973
Telex: 52237

- Please send 8050A specifications.
- Please send all the facts on Fluke low-cost DMM's.
- Please have a salesman call.

Name _____

Title _____

Mail Stop _____

Company _____

Address _____

City _____

State _____

Zip _____

Telephone () _____

Ext. _____

For technical data Circle (12) on Reply Card





The BCC-20 Digicam Edge. An EFP Camera that's 100% Ampex.

The best of Ampex technology has been designed into our computer controlled EFP camera. Built by Ampex in our new California facilities, the Digicam was designed to produce the highest quality picture both on location and in the studio.

A Computer In a Portable Head.

The BCC-20 Digicam's computer-in-the-head technology combines a microprocessor and digital memory with a powerful software program to give you full-time digital control of the camera.

Even with the power turned off, the Digicam's memory-in-the-head stores the operating parameters.

New to Camera Technology.

Unique with Digicam is Spatial Error Correction, which can achieve 0.05% registration in any of 182 zones of the picture. Using the Spatial Error Correction Cursor System, you can zero-in on any area of the picture and correct an error in seconds.

The Spatial Error Correction System allows the operator to easily overcome difficult distortions such as "bowing", "S" distortion and off-axis corner registration errors and quickly achieve perfect registration.

The MSP. Total Control Manually or Automatically.

The MSP (Master Set-Up Panel) is the control terminal for the Digicam System. It controls manual set-up of the Digicam, or automatic set-up when the ASU (Automatic Set-Up Unit) is used.

With the MSP and the ASU in use you can set-up as many as 8 cameras in far less time and with better results than a single, conventional camera.

In the self-contained mode, the Digicam head memory permits the MSP to be disconnected for true portable operation. And yet the operator can still use thumbwheel selector switches inside the camera head to make any operational last minute adjustments.

You'll find the Digicam by Ampex to be the most advanced portable camera available today. Call your Ampex representative and tell him you're ready for the Digicam edge!

Get the Ampex Edge.

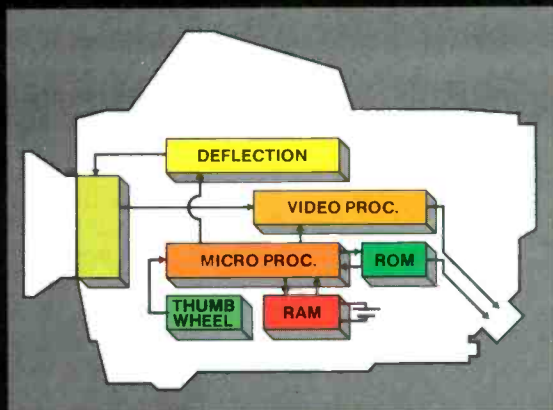

COMPUTER IN THE HEAD



MASTER SET-UP PANEL

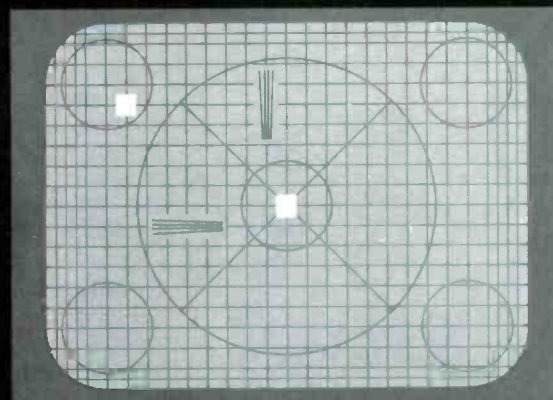

PERFECT REGISTRATION USING SPATIAL ERROR CORRECTION



Ampex Corporation, Audio-Video Systems Division
401 Broadway, Redwood City, CA 94063 415/367-2011

Circle (13) on Reply Card

THE NETWORKS' CHOICE. (AND EVERYONE ELSE'S.)

At Camera Mart, we've been a leading equipment supplier to broadcasters and producers for years. We're no strangers to the "instant" needs, unexpected calls, tough standards and difficult operating conditions that are often S.O.P. in this rough-and-tumble business. But you probably know that...at least, when it comes to film.

What you may *not* know is, for the past few years, we've been quietly doing the same in *video!* Testing and selecting the leading equipment for performance and reliability. And offering a wide selection of production and post-production components and packages—on rental, lease and purchase plans with our customary flexibility.

But don't take our word for it: talk to our customers. You'll see why so many people the industry depends on, depend on us.



Camera Mart

THE CAMERA MART, INC.

456 West 55th Street, New York 10019

(212) 757-6977/Telex: 1-2078

Sales • Service • Rental

See us at SMPTE Booth No. 97



NAB news

the right to a fair trial, the justices emphasize the availability of tested and perhaps new alternatives to the exclusion of reporters from courtrooms. Electronic journalists are ready to work with judges everywhere to assure that neither our First Amendment rights nor the Sixth Amendment rights of defendants are compromised as we together meet our responsibility to keep our audiences informed about the work of the courts.

"I have to admit some disappointment that the Supreme Court chose not to reverse its earlier decision that pretrial hearings may be closed to the public and news reporters. As many as 90% of all criminal cases are disposed of before trial. The court nonetheless has reaffirmed the value of public awareness about what their courts do. We hope that every trial judge, asked to lock the doors to a pretrial hearing, will thoroughly consider the Supreme Court's new emphasis on the public's need to know how justice is done."

Neuharth to keynote Executive Forum III

Allen H. Neuharth, chairman and president of Gannett, Rochester, NY, will be the keynote speaker at the NAB's Executive Forum III. The informal seminar for top broadcast executives is being held September 16-18 at the Sheraton-Fredericksburg Inn and Conference Center, Fredericksburg, VA. It is designed to examine the broadcasting challenges of the 1980s.

Discussions at the seminar will focus on programming, advertising, federal regulations, strategic planning, the value of broadcast properties and related business investment opportunities.

Satellite-to-home broadcasting

Saying that the principle of local broadcasts is central to the nation's television system, the NAB questioned the desirability of direct satellite-to-home broadcasting.

In a filing with the FCC on its report on the prospects for additional networks, NAB said David Rice's paper on the subject "devotes no time to discussion of the potential impact of DBS on our existing television broadcast system and the audiences it serves." Without this information, NAB stated, "the commission cannot properly and effectively exercise its regulatory authority on the issue of direct broadcast satellites." □

Circle (14) on Reply Card

It makes our competitors nervous to discuss these standard ADM benefits

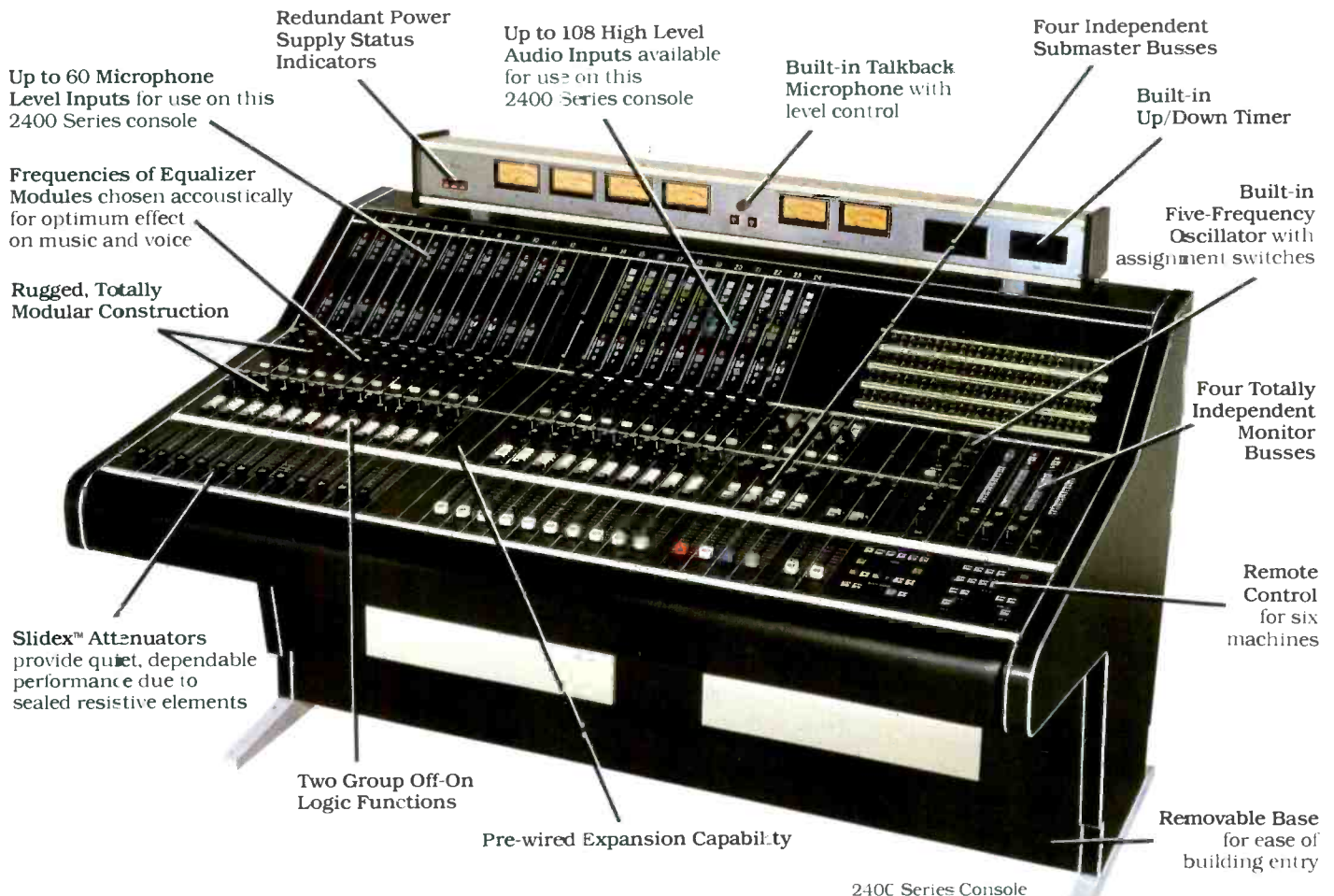

Talk to other console salesmen about any of these features and you'll get a lot of throat clearing and foot shuffling. Query our salesmen and you'll get a lot of facts about ADM features that help you do a better job and he'll tell you about our exclusive 5-year warranty. (Yes, we *have to* build them better, and we do!)

Learn more about our Series 3200, 2400, 1600 or 800 ADM Audio Consoles. Contact ADM Technology, Inc., 16005 Sturgeon, Roseville, Michigan 48066. Phone (313) 778-8400. TLX 23-1114

ADM[®]
The Audio Company

NRBA

National Radio
Broadcasters' Association

1705 De Sales Street, NW
Washington, DC 20036

Listening patterns

A recent survey conducted by Multiple Systems Analysis for Inside Radio offers suggestions on how a listener selects a favorite radio station.

Reportedly, 55% of men and 46% of women between the ages of 18-40 said they picked their favorite radio station by just simply scanning the dial. About 30% of the women said they heard about their favorite radio station through word-of-mouth, while 22% of men listed word-of-mouth.

Only 8% of men and 4% of women said they discovered their favorite radio station through exposure to advertising.

Government-industry committee

In a letter to Charles Ferris, FCC

chairman, NRBA executive vice president Abe Voron has repeated NRBA's request for the creation of a joint government-industry committee to (1) study the effects currently pending proposals and new technology will have upon radio, and (2) design a master plan for radio's orderly growth.

Cross-ownership bill

Cross-ownership bill HR-6228 went through the House Communications Subcommittee July 1. The bill, which was left practically unaltered, would codify the FCC's cross-ownership rules and would eliminate a licensee's other media holdings as an issue in renewal challenges, thereby grandfathering existing cross-ownerships. HR-6228 would also prohibit the FCC from considering ownership and management integration in renewals.

NRBA supported the portion of the bill prohibiting the FCC from considering a licensee's other broadcast holdings and management integration in license renewal proceedings, but strongly objected to the second portion of the bill, which would codify the FCC's newspaper-broadcast cross-ownership guidelines.

FM grows again

FM's overall share of the radio audience has jumped to a new high of 55% from 52.4%, according to a CBS Radio analysis of the RADAR-21 survey.

As expected, FM continues to lead the way during the weekend nighttime hours of 7-12. FM's report card shows a 63.7% audience share for Saturday night and 63.5% for Sunday night. The lowest FM share was the Monday-Friday morning drive slot, with a 46% share.

Radio-only legislation

Following a conference-call meeting of NRBA directors, Sis Kaplan, president, sent telegrams to members of the Senate Commerce Committee requesting that the radio provisions be withdrawn from the proposed compromise communications bill S-2827, in favor of radio-only legislation.

Though markup of the bill has been delayed, NRBA pointed out to committee members that "radio and television are so different as to require separate legislation." The new bill, intended to amend the Communications Act of 1934, "does not take into consideration the great differences that exist between radio and television" and virtually treats them as one entity. □

Case History #437

Electronic News Gathering is one of the toughest environments a microphone will ever encounter. Every mike we've seen has compromised the demand for low handling noise, fine audio quality and virtual indestructibility.

Credit the NBC Electronic Journalism Department/Operations and Engineering in New York for putting the Electro-Voice DO56 shock-mounted omni in the field. Although originally designed as an on-camera entertainment and MC's microphone, NBC found the DO56 to be the microphone that provides an audio signal commensurate with video in real-life crisis situations. In these situations audio often takes a back seat to video,

Electro-Voice DO56 Shock-Mounted Omnidirectional Microphone

resulting in a final product that doesn't accurately reflect the broadcaster's professional standards. NBC discovered that the DO56 takes the pushes, the shoves, the rubs and finger taps in stride. And when handling *really* gets rough, the DO56's unique internal shock mount virtually eliminates the bell-like clang transmitted by other shock-mounted mikes.

Congratulations to the NBC Electronic Journalism Department in New York. You found the solution — the DO56.

For an in-depth description of this and other case histories, get on the Electro-Voice "Mike Facts" mailing list. Write on your letterhead to Mike Facts, c/o Electro-Voice, 600 Cecil Street, Buchanan, MI 49107.

Ey Electro-Voice[®]
a gulton company



Circle (15) on Reply Card

Beyer. We make the best broadcast mics, too.

In recording studios, concert halls and theatres worldwide, Beyer is the premier name in microphones. Loved by performers and respected by engineers.

Now that same Beyer quality is available in a full line of innovative broadcast microphones, to meet every need and solve every problem.

The Beyer MCE 5 is the world's smallest electret condenser and provides true broadcast-quality audio from a 7 x 23 mm. cylinder weighing just 6.5 grams. It has wide frequency response, but is immune to most body noises. And you can hide it almost anywhere and connect it to a cable or a wireless transmitter.

If you can't get the mic near the sound source, try our Beyer MC 717 shotgun. It has a directional gain of at least 20 dB and a 40-20K frequency response.

The MC 717 is part of a modular condenser mic system consisting of six different transducer capsules plus amplifiers and phantom power supplies that can be perfectly tailored for a wide range of broadcast situations. They're all ruggedly built to handle ENG as well as studio work and can accept temperatures up to 160° and 99% humidity.

Other mics include: the M 55 — an omni-directional dynamic mic that is especially suited for reporters and field interviews; the M 69 — a uni-directional hypercardioid dynamic mic that is perfect for announcers on TV and a studio mic in radio stations; the M 88 — a uni-directional cardioid dynamic mic with warm and full bass response that is ideal for booth or radio announce. This is easily one of the best mics in the business — with a special suspension that eliminates transmitted noise if hand held. Our M 201 is another microphone with excellent vocal characteristics that is favored by singers and reporters alike.

There are many more mics in the Beyer line, plus stands, booms, headsets and accessories. Visit your local Beyer distributor for more information and specs.



MCE 5



MC 717



M 55

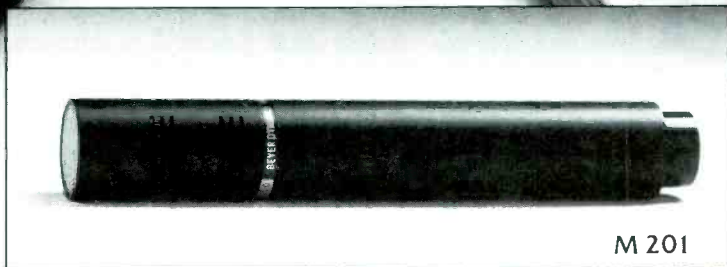

M 201

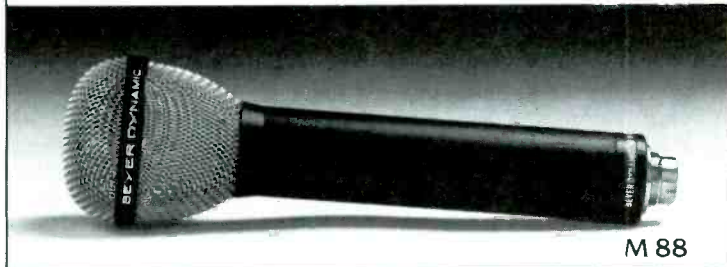

M 88

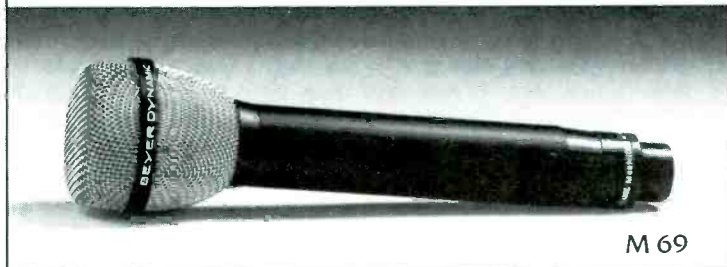

M 69

Beyer
Dynamic

BEYER DYNAMIC, INC.

5-05 Burns Avenue, Hicksville, NY 11801 • (516) 935-8000
In Canada, H. Roy Gray, Ltd.

Circle (16) on Reply Card

Automatic power level control and VSWR protection of modern television transmitters

Part II

By R.M. Unetich and D.D. Harbert, RCC, Meadow Lands, PA

Transistor protection systems

Protection against excessive drive due to an amplifier failure. The transistor normally operates in the closed loop mode. Therefore, the failure of one of the parallel 400W amplifiers results in an increase in drive to the remaining amplifiers in an effort to maintain full output power. This could cause the circuit breakers to trip, thus completely shutting down the driver. This problem is addressed by detecting the failure of one, two or more than two 400W amplifiers and then modifying the reference voltage in the power control circuitry to keep the remaining good modules operating at the original level.

A single fault causes a power output reduction to 50% of the original; two faults cause a reduction to 25%; and more than two faults will completely remove the drive. Each of the 400W modules has a fault sensing circuit that continuously compares the output RF level with the input RF level. The circuit is adjusted so that a 10% drop in output voltage is declared a fault. The determination of a fault is followed by the removal of bias to the module and a fault signal to the fault decoder portion of the control circuit. Once a fault has occurred, a latch is set and the module remains in the fault status until reset. In the fault decoder, standard logic techniques are used to decode the number of faults.

The only requirement on the speed of the fault decoder circuitry is that a fault be detected, decoded and the power reference voltage modified for the new power level before the ALC system applies excessive drive to the remaining good amplifiers. A response time of 10 to 20ms is sufficient.

Protection against excessive drive due to an ALC loop failure. Excessive drive could also be applied to the amplifiers by misadjusting the

power level while in the manual mode, by a component failure in the primary ALC loop or by someone accidentally removing the forward coupler cable from the output directional coupler. To prevent such an occurrence from possibly damaging the amplifiers or tripping the circuit breakers, a secondary ALC loop is used to set and hold the drive power at a safe level once a preset maximum limit has been exceeded.

The secondary ALC loop is needed to protect against failure of the primary loop in a minimum attenuation condition. An RF sample from the predriver is peak-detected then compared to a fixed, but adjustable dc level. When the peak detector output exceeds the fixed level, the overdrive latch is set, which causes the solid-state DPDT switch S1A and S1B to transfer from the normal to the overdrive position. In the overdrive position, a fixed dc voltage is applied to the primary ALC attenuator (atten. A), and the output from the overdrive operational amplifier is applied to the overdrive attenuator (atten. B). Thus, the transmitter is operating with a secondary closed loop system that maintains the output of the predriver at a fixed, safe, preset level. The overdrive mode is operative when the primary ALC loop is in either the closed loop or manual mode.

Protection against a power supply failure. The transistor amplifiers are protected against an overvoltage caused by a power supply failure by using an overvoltage protection circuit at the power supply output. Overvoltage protection circuits are commonplace; however, in a high-power solid-state amplifier, their design is a difficult problem. As an example, the overvoltage circuit in the solid-state driver has to apply a short to the output of a power supply with a 200A output capability and discharge a 0.6F bank of filter capacitors before the output voltage

can rise above a damaging level. A response time of 2ms is required.

Drive VSWR protection. The driver VSWR protection signal is derived from a peak-detected sample of the reflected power at the driver output. This signal, after passing through a selection gate, is compared with a fixed VSWR shutdown voltage in the control circuit. When the VSWR signal equals the shutdown reference, the comparator output goes high and immediately turns on transistor switches Q1 and Q2 through CR1; this action shorts out the control voltage to the pin diode attenuators, causing them to go to maximum attenuation, thus shutting off the RF drive within 5 to 10 μ s after the comparator output goes high.

The response time from the peak detector output to the comparator output is 10 to 15 μ s, which gives a total of 20 to 30 μ s VSWR shutdown time from the peak detector input to the attenuator output. When the VSWR shutdown comparator output goes high, the 10ms timer is triggered and its output holds the attenuator off through CR2 for 10ms. At the end of the 10ms period, RF drive is again applied.

If the fault has cleared, the output will attain its previous value and the system will resume its normal operation. If the fault has not cleared, the drive is removed once again for 10ms. If three faults occur within 15 seconds of the first fault, a counter generates a fault signal that keeps transistor switches Q1 and Q2 turned on and sends a VSWR fault signal to the power shutdown circuitry in the primary ALC loop. A fault signal is also sent to the PA control circuit that removes the plate and screen voltages. When the 10ms timer is triggered by the first VSWR fault, its output triggers a 15 second timer.

If one or two faults occur before

EXTEND YOURSELF.

If you've ever missed a great shot because of your equipment's limitations, it's time you discovered the incredible, versatile Canon J13X9BIE. A 13X zoom system that will expand your horizons and make you the envy of all your competition.

Here, in a single lens, plus modular accessory package, is the opportunity to realize almost any idea. Any job. Any technique. Any location. Inside or out. Day or night.

Lightweight and rugged and extremely fast at $f/1.6$, the J13X9BIE has a broad zoom range of 9mm to 118mm. But with our integral 2X range extender, its reach extends all the way to 236mm at a remarkably

sensitive $f/3.8$. For closeups, it's got a short 0.8M (31.5") M.O.D. plus built-in macro capability. And, of course, it's got adjustable back focus to work with any camera.

But Canon wants you to extend *all* your potential, so it provides the 13X with a complete accessory package. Like our no-light-loss 0.75X wide-angle attachment, giving you a 6.75mm focal length lens with full auto-iris capabilities. A 1.5X teleside converter for even greater focal length extension with no light loss. Remote focusing and zoom—manual or motorized—for tripod

work. And that's still only the beginning. To find out what the best EJ/EFP lens system can do for you, contact us for a demonstration, or specify the Canon J13X9BIE when ordering your new camera.

The next time you tackle an impossible assignment, take along the Canon 13X. If for no other reason than to watch the faces on the competition.



Canon®

Canon U.S.A., Inc. Head Office, 10 Nevada Drive, Lake Success, NY 11040 (516) 488-6700 • 140 Industrial Drive, Elmhurst, IL 60126 (312) 833-3070
123 Paularino Avenue East, Costa Mesa, CA 92626 (714) 979-6000 • Canon Optics & Business Machines, Canada, Ltd., 3245 American Drive, Mississauga, Ontario L4V 1B8, Can.
Canon Amsterdam N.V., Industrial Products Division De Boelelaan 8, Amsterdam, Netherlands

See us at SMPTE booth numbers 185 and 186

Circle (18) on Reply Card

October 1980 *Broadcast Engineering* 25

Spot Check.



The Dictaphone 4000 Logger, a complete broadcast recording-retrieval system, is the answer to a radio station's need to know. And show.

Now, from one dependable unit, you get an automatic, around-the-clock record of all essential broadcast information. It's all there, ready for quick retrieval and replay. So if advertisers want proof that their commercials are running on schedule or if the FCC wants to check your station breaks or public service announcements, you've got it all. On the record.

 **Dictaphone**

A Pitney Bowes Company

For more information on the 4000 Logger, fill in this coupon or call toll-free:

800-431-1708

Except in Hawaii and Alaska
(In New York call 914-967-7300)

Name _____ Title _____

Department _____ Phone _____

Address _____

City _____ State _____ Zip _____

Mail to: Dictaphone Corp., 105 Oak St., Norwood, N.J. 07648

Dictaphone is a trademark of Dictaphone Corp., Rye, N.Y.

JBE-100

Power level

the timer times out, a reset pulse is generated that sets the counter back to zero count. If three faults are counted before the end of the 15 second period, the internal reset pulse from the 15 second timer is disabled and the circuit has to be reset manually. The VSWR shutdown reference is normally set for a 10dB return loss at 100% power.

VSWR protection for the tube stage. The TTG Series transmitters use the VSWR protection circuitry developed for the solid-state driver to protect the tube stage against suddenly occurring VSWR faults. The protection signal is obtained from a directional coupler and peak detector located immediately after the tube amplifier/cavity to provide maximum protection from failure of any line section, filter or load for the tube. The peak detector output is then passed through a selection gate whose output is representative of the reflected power at either the driver output or the PA output, whichever is the highest. Thus, a VSWR fault shutdown will occur for a VSWR fault at either the driver output or the PA output.

There are some VSWR conditions such as antenna icing, which result in an increasing VSWR. It is best in this situation to maintain an output signal as long as possible without jeopardizing the PA or transmission line components. This is accomplished by applying the output of the VSWR turndown and metering peak detector, located immediately before the load element, to the reference modification portion of the ALC circuitry. When the VSWR increases to an adjustable threshold of 1.5:1, the output power is cut by reducing the power reference voltage. As the VSWR deteriorates, the forward power is further reduced until the magnitude of the reflected power at the PA output exceeds the VSWR shutdown threshold.

Summary

The reliability of modern closed loop television transmitter systems can be increased, maintenance costs reduced and downtime minimized by using solid-state RF devices up to the final high-power amplifier stage if: (1) RF drive is removed within 20 to 30 μ s after the occurrence of a VSWR fault; and (2) protection circuitry is provided to prevent the application of excessive drive and excessive power supply voltage and/or collector current in the transistor stages.

TIRED OF PATCHING FEEDS TO THE GM'S OFFICE?

(OR TO OTHER OFFICES, CLIENT VIEWING ROOMS, EDIT SUITES, ETC.?)

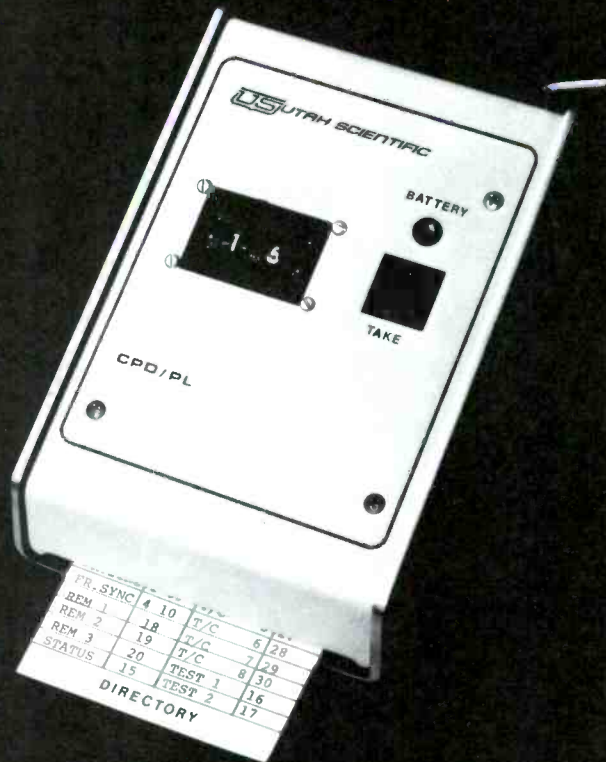

Give them one of these Utah Scientific Routing Switcher Controllers and let them do their own patching.

Utah Scientific's new CPD/PL control is a Party Line panel with a single coax control connection — no bulky cables to install. It is powered by a transistor radio battery providing many years life expectancy. It features a pull-out directory to aid the operator in source selection.

Since multiple CPD/PL's can all be connected to a single party line, many stations are installing coax drops throughout their plants giving them complete flexibility for present and future routing switcher control using these versatile panels.

SINGLE COAX CONNECTION — BATTERY POWERED — UNOBTUSIVE

TRY THAT ON YOUR GRASCOMFERNSAM DYNATEK SWITCHER!

US **UTAH SCIENTIFIC**
THE ROUTING SWITCHER PEOPLE.

2276 So. 2700 W. • Salt Lake City, UT 84119 • Phone 801-973-6840
TWX #910-925-4037

Circle (19) on Reply Card

Broadcast salaries

A national survey

By Joan Jackson, associate editor, and Kevin Kiouss, managing editor

One of the constants of any business is that employees are always aware of and concerned about their salaries.

To learn more about salary structures in the broadcast field and to inform its readers about those structures, **Broadcast Engineering** recently conducted an extensive study of salaries in broadcasting.

The study method

Information for this study is based on responses to 3000 questionnaires mailed August 8, 1980, to radio and TV station personnel who receive **BE**. The recipients were selected randomly (on an nth name basis) by a computer. Respondents were asked to report on their title, salary, salary increase for the past

year, type of facility and their facility's market.

The study was closed on August 26, 1980, at which time 1065 questionnaires had been received.

Response

The return rate for the questionnaires was 35%. Of those responses 54% were from radio stations and 46% were from TV stations. The two groups were further broken down into the categories of corporate management, operations management and technical management/engineering, which had the highest rate of response.

Job titles for the groups were: corporate management—president, owner, partner, chairman of the board, vice president and general manager; operations management—manager/director, station manager, production manager and program manager; technical management/

engineering—technical director/manager, chief engineer and engineer. The greatest number of responses for television came from those with the titles vice president, production manager and engineer. Radio's highest responses came from persons with the titles general manager, operations manager/director and chief engineer.

Results

The study showed that the median salary for corporate management in television is \$50,000 or more; 59.1% of the respondents fell into this category. The median for operations management is \$22,300; the largest number of responses fell into the category \$25,000-\$34,999. The median for technical management/engineering was \$23,400; the largest number of responses for this group also came from the \$25,000-\$34,999 category.

Note: Information for this survey was compiled by Kate Smith, market researcher, Intertec Publishing Corp.



Honeycomb
speakers
inspired by
today's
recording
technology.

To hear the full potential of today's digital tape and direct-to-disc recordings, our Professional Audio Division presents a speaker that's just as advanced, just as accurate. The Technics R&B Series Honeycomb Disc Speakers.

The special diaphragm is constructed like a flat, rigid honeycomb disc to eliminate the traditional acoustic problems of cone-shaped diaphragms. Best of all, phase linearity occurs automatically because the acoustic centers are distinctly aligned on the flat diaphragm surface.

The axial, symmetric "nodal driver" is designed to vibrate in a more accurate piston-like motion. This provides an extremely wide, flat frequency response, broad dynamic range and extremely low distortion.

And the flat leaf tweeter in the SB-7 and SB-10 is much lighter than many dome tweeters, for incredible high frequency response, up to 125 kHz.

The Technics R&B Series is available at select locations. Call our Professional Audio Division at 800-447-4700 (in Illinois, 800-322-4400) to hear the entire line of Honeycombs—the speakers that don't hold back today's recording technology.

Technics
R&B series

Circle (22) on Reply Card

National salary survey

Radio responses showed a median of \$25,500 for corporate management; the largest number of responses (26.1%) came from the \$25,000-\$34,999 group. The operations management median was \$16,250; 34.8% of the respondents, the largest grouping, reported salaries of \$10,000-\$14,999. The median for technical management/engineering was \$17,200; the greatest response (23.9%) came from those reporting salaries in the \$15,000-\$19,999 range.

From the study a further breakdown was made centering on the technical management/engineering group. Salaries were tabulated by station market: top 50, top 100 and below top 100. The highest salaries for television and radio fell into the top 50 category. For television the lowest median salary was in the top 100; for radio the lowest salary was in the below top 100 grouping.

Salary increases

A large percentage of television respondents reported a salary increase for the past year. More technical management/engineering

respondents (89.8%) reported receiving raises than the two other groups. The figure was 72.7% for corporate management and 84.9% for operations management. The largest raises were reported by operations management and the smallest by technical management/engineering. For all three groups in television, the largest percentage of respondents reported raises in the range of 7%-9%.

The technician management/engineering median was 8.4%. The figure was 9.4% for corporate management and 10.7% for operations management.

The salary increase percentages were lower for radio than for television. Operations management and technical management/engineering reported about 30 percentage points higher incidence of raises in the past year than corporate management.

The percentages of radio respondents were: corporate management, 41.3%; operations management, 73.3%; and technical management/engineering, 66.8%. Medians for radio were close for corporate

Respondents comment

Comments on compensation trends in the broadcast industry:

Where unions are the case for technical staff, compensation is higher for them than for the managerial staff. This to me is not due compensation for those who bear responsibility.

*Program producer
Top 50 TV station*

Being in a major market and a member of a labor union are the two main factors of at least continued cost of living pay raises. Also, the continued financial success of the station is important. When the salary level in broadcasting is considered against working any hours of day or night, plus holidays and weekends too, it's anyone's guess what compensation is correct when compared to other industries.

*Engineer
Top 50 radio station*

Compensation levels in middle and major markets are so inadequate (generally speaking) so as to be responsible for a shortage of **competent** engineers. You need an engineer to run radio stations, but low paying employers get **technicians** because they are unwilling to pay for an engineer.

*Chief engineer
Top 50 radio station*

The broadcast industry is not keeping pace with other industries, but if you enjoy your work and the freedom and responsibility that go with it, it can't be beat.

*Chief engineer
Top 50 radio station*

In lieu of salary, I have been offered significant bonuses for accomplishing certain objectives. I suspect other managers have experienced similar treatment.

*General manager
Below top 100 radio station*

Television

| Salary Level | Corp. Mgt. | Opr. Mgt. | Tech/Eng. |
|----------------------|------------|-----------|-----------|
| Less than \$10,000 |% | 1.9% | 2.0% |
| \$10,000 to \$14,999 | | 17.0 | 11.7 |
| \$15,000 to \$19,999 | 2.3 | 20.8 | 18.8 |
| \$20,000 to \$24,999 | | 22.6 | 25.7 |
| \$25,000 to \$34,999 | 13.6 | 24.5 | 28.1 |
| \$35,000 to \$49,999 | 25.0 | 13.2 | 11.7 |
| \$50,000 or more | 59.1 | | 2.0 |

Radio

| Salary Level | Corp Mgt. | Opr. Mgt. | Tech/Eng. |
|--------------------|-----------|-----------|-----------|
| Less than \$10,000 | 5.5% | 9.3% | 17.0% |
| \$10,000-\$14,999 | 6.9 | 34.8 | 22.4 |
| \$15,000-\$19,999 | 20.2 | 23.3 | 23.9 |
| \$20,000-\$24,999 | 16.1 | 16.3 | 18.5 |
| \$25,000-\$34,999 | 26.1 | 14.0 | 14.8 |
| \$35,000-\$49,999 | 11.9 | 2.3 | 3.0 |
| \$50,000 or more | 13.3 | | .4 |

Take a close look at what Tape Transports are going to be like in the '80s

The all new Telex 3000 is here NOW!

No industry has witnessed more technological improvements over the past few decades than our own. So, if you're looking for a tape transport for broadcast, studio or industry, it's important to choose a product with all the latest industry innovations in one unit, the NEW Telex 3000. Write for exciting details about these features.

- Interchangeable head blocks
 - A.Q.R. (Auto Cue Release)
- Differential electro-mechanical braking
 - Spill-proof logic
 - Motion sensing
 - Tape counter
- 4 head capability
 - Hyperbolic tape path
- Remote control capability
- Play only or record/play combinations
 - Auto cue/rewind/cycle
 - Dual speed
- Hysteresis drive motor
- Two torque spooling motors
 - Quiet operation
 - 120/240 volt operation
- Urethane pressure roller

Quality products for the audio professional



TELEX®

TELEX COMMUNICATIONS, INC.

9600 Aldrich Ave. So., Minneapolis, MN 55420 U.S.A.
Europe: 22, rue de la Légion-d'Honneur, 93200 St. Denis, France.

Circle (21) on Reply Card

National salary survey

(12%) and operations management (11.9%). The technical management/engineering median was 9.7%. The highest responses for corporate management and operations man-

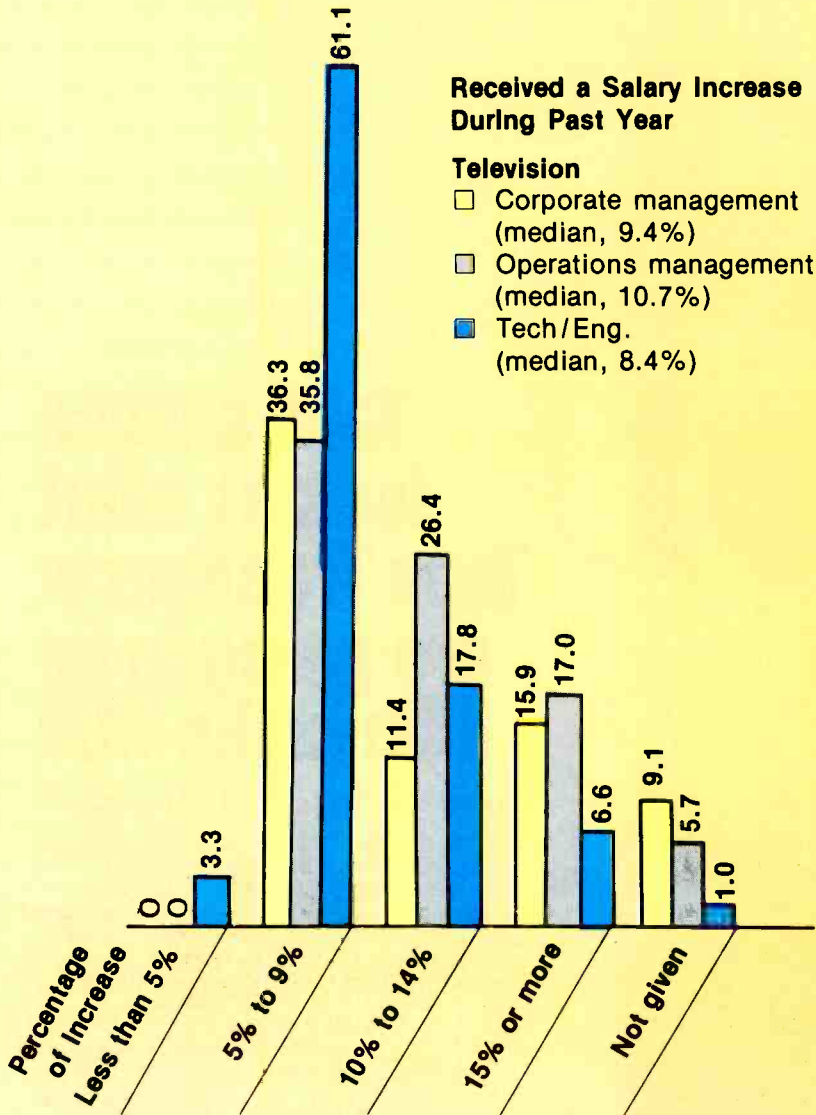

If you want to make a million, stay away from broadcasting. *Operations manager/director Below top 100 radio station*

Compensation trends in this market, which falls just below the top 100, is certainly not keeping pace with inflation. The way most engineers improve their salary is by moving from one station to another. There is also no incentive or additional compensation for improving one's skills. Most stations feel that the less paid for an engineer, the better. *Chief engineer Below top 100 radio station*

Compensation trends, specifically in non-sales areas, are inadequate to attract competent, career-minded professionals, especially in small and medium markets. We are continually complaining about the quality of young people entering the industry, but we refuse to offer the type of compensation packages necessary to attract the best minds to our industry. *President Below top 100 radio station*

Salaries seem to be rising faster than the Consumer Price Index (for technical people). *Engineering manager Top 50 TV station*

Broadcasting salaries are not keeping pace with cost of living. Compared to cost of living, salary here has fallen behind 30%-40% in the past 10 years. *Engineer Top 50 TV station*

Engineering outlook not so good. Automation takes the place of many and management fails to see the need for them. *Engineer Top 50 TV station*

Figures total respondents reporting raises by job category.

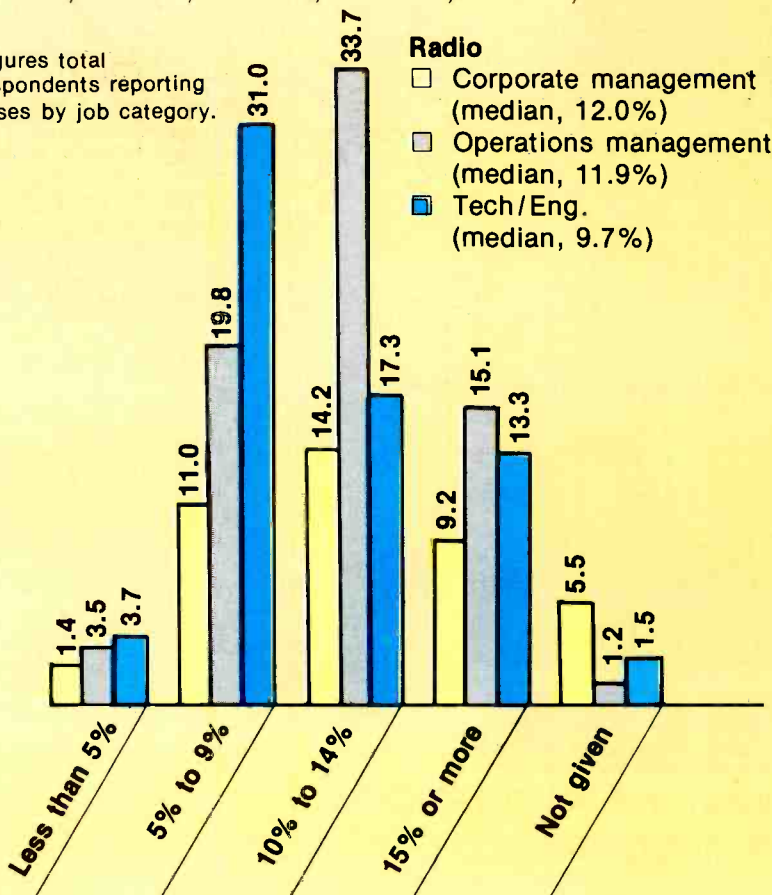



Ikegami Chooses
Anton/Bauer Batteries



Thomson Chooses
Anton/Bauer Batteries



Hitachi Chooses
Anton/Bauer Batteries



Panasonic Chooses
Anton/Bauer Batteries



Philips Chooses
Anton/Bauer Batteries



JVC Chooses
Anton/Bauer Batteries



Sharp Chooses
Anton/Bauer Batteries

**THE
INDUSTRY
STANDARD**

*anton
bauer*
BATTERIES

**CHOSEN BY MORE PROFESSIONAL
VIDEO MANUFACTURERS
THAN THE COMPETITION COMBINED**

Anton/Bauer batteries are chosen as standard equipment by more video camera manufacturers than the competition combined! That should come as no surprise. Considering the amount of time and money manufacturers invest in the design and performance of their camera, they will not tolerate any battery but the best.

Professional video equipment manufacturers and users can't help but be impressed by Anton/Bauer features such as rugged injection molded LEXAN cases; silver plated contacts; sleek, quick-change modular design (the original snap-on camera concept); the variety of fast and slow charges; plus the exclusive A/B Computerized Testing Center for maximum quality control, snap-on mounts for almost all cameras and VTR's, as well as belt holders and the Perpetual Power Belt.

Innovation, superior technology, craftsmanship and time-tested dependability make Anton/Bauer the choice of video manufacturers, television networks, over 1,000 video installations and countless independent users. Be in great company. Choose Anton/Bauer batteries.



Anton/Bauer Inc.

66 Center Street, Shelton, CT. 06484 (203) 735-3305

Circle (22) on Reply Card

Technical Management/Engineering

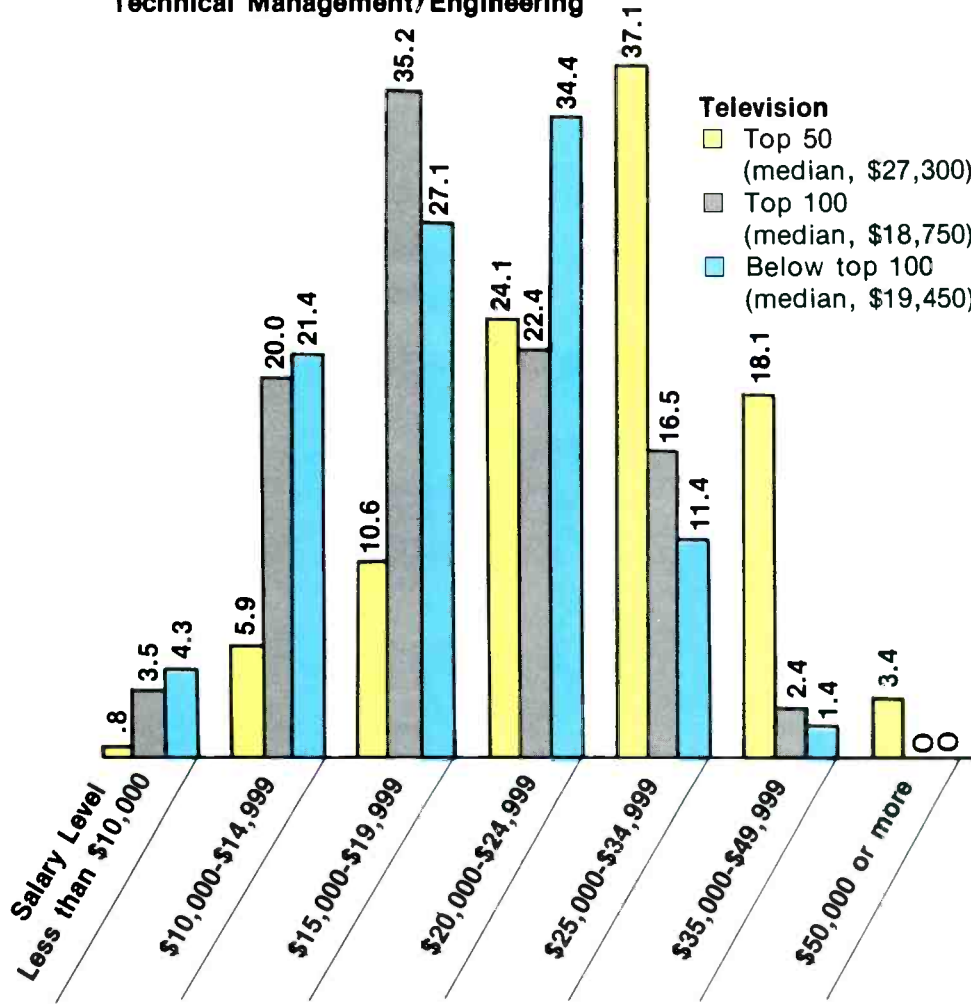

National salary survey

television respondents in the top 50 group was 8.2%; the top 100 had a median of 8.3% and below top 100 had 9.3%. The highest number of responses for all three markets fell in the 5%-9% category. For radio the median for the top 50 was 9.9%; both the top 100 and below top 100 had medians of 9.6%. The majority of responses for these markets also fell in the 5%-9% category.

Company auto instead of cash.
Chief engineer
 Below top 100 station

Not keeping up with inflation.
 We are losing employees to larger markets.
Chief engineer
 Below top 100 TV station

There is the same escalation of compensation in television as in other business though, because of a scarcity of qualified people, some positions are more so than justified, based on capabilities. In other cases, because of availability of qualified people, some are not earning what they should.
Vice president
 Below top 100 TV station

Salaries in broadcasting are highly inflated with no end in sight. Basic unskilled technicians at the network level can make, with overtime, in excess of \$50,000 per year. And on-air talent makes in excess of \$100,000 per year.
Technical director/manager
 Top 50 TV station

Due to the FCC dropping the requirement for a license for engineers, I see salary increases shrinking because stations are hiring people for \$3.50 an hour to try to do engineering work in TV stations.
Engineer
 Top 50 TV station

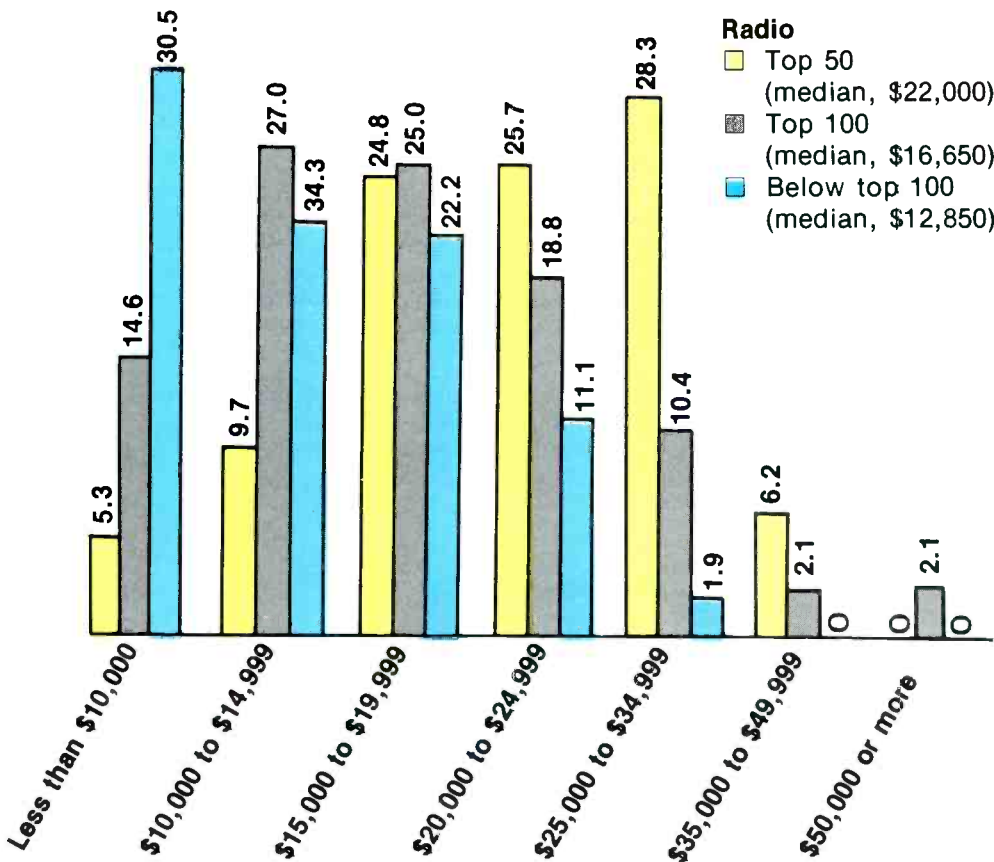

CMX SETS ITS MARK ON FAST, EASY EDITING

Watch Our SMART KEYS Give You The Edge.

Imagine a revolutionary new editor with a set of function keys that actually run along the edge of the CRT with the CRT itself labeling the keys. Press the right key for the function you want it to perform; then watch it take you through the editing process. Gone forever is the editor's search for a small key-cap legend on a complex keyboard. The editor/machine interface is reduced to the point of transparency. We call these keys SMART KEYS.™ We call our new editor THE EDGE.

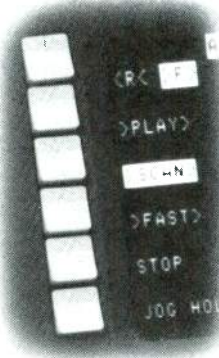

The Standard-Setter

CMX is the company that set the standard for computer-assisted editing over 11 years ago in broadcasting and teleproduction. We made video tape editing a practical art. Today we're still the standard.

Now we've taken the best and newest in microcomputer technology and developed an editor that is priced to bring truly sophisticated editing to everyone involved in post-production.

We didn't stop being smart at the function keys. We've reduced the operating mode buttons to three— MOTION, EDIT and MARKS.

The MOTION mode, you guessed it, controls the motion of the VTR's. Teamed up with our REEL MOTION CONTROLS you get a combination that's hard to beat. The motion controls are a joy to use and have the "feel" of "reels" along with a Hold function that permits viewing of tape at any speed.

The EDIT mode describes the type of edit—video, audio 1, audio 2, transition type, split, and two general purpose interfaces (GPI's) for control of external automatic switchers, character generators, digital video effects and still stores.

A super CMX exclusive lets you enter the location of splits and GPI events from audio-only or video content without the use of numbers. This mark function, the same as is used to select edit points, can be performed "on the fly" with user programmable reaction time still under CMX's Reel Motion Control.

™Orrox Corporation

The MARKS mode allows full access to time code numbers including set, trim, backtime, and transfer when you need them, yet another CMX exclusive.

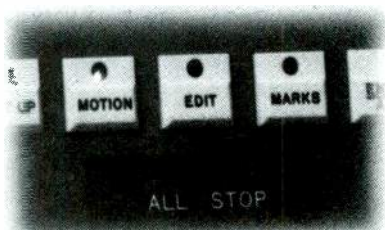

Fastest Edits

For maximum speed THE EDGE does open-ended edits automatically when you set "in" points and press RECORD. By pressing ALL-STOP you can end the edit with a clean "out" point. The Reel Motion Controls and MARK IN/OUT buttons are then active to select the next "in" points. The speed that these features provide is a must in today's ENG world and whenever maximum throughput is required of an editing system.

Along with Replay and Preview THE EDGE has Source-only and Record-only previews. To meet your critical speed requirements only THE EDGE provides these previews for Out-Point Only as well as Full-Edit.

Other features you'd expect from the leader include a CMX industry-standard Edit Decision List, mixing of SMPTE time code and control track (pulse count) as well as 1", 3/4" and 1/2" formats, built-in dissolve/fade, and preview switcher.

Here's an amazing CMX editing package. And even more unique is its price—starting at under \$17,000 in the U.S.

Remember we're the ones who started it all in editing. Every CMX video tape editing system ever installed is still in service. CMX customers are supported by the industry's largest force of editing system service specialists.

Set a new mark for yourself in editing speed and ease. Get THE EDGE.



THE EDGE™

CMX ORROX

The World Standard for Editing

Orrox Corporation, 3303 Scott Blvd., Santa Clara, CA 95050 (408) 988-2000 Telex 910-338-0554 Chicago (312) 325-8488/Los Angeles (213) 980-7927/New York (212) 371-1122

International Representatives: Magna Techtronics Pty. Limited, Artarmon, N.S.W., Australia/Totsu, Tokyo, Japan/TeknoMerica, S.A. Mexico City/F.W.O. Bauch Ltd., Herts, United Kingdom/Thomson-CSF, Gennevilliers, France/GTC GmbH, 2070 Grosshansdorf, W. Germany

Circle (23) on Reply Card

October 1980 *Broadcast Engineering* 35

SMPTE gets ready for major conference

By Bill Rhodes, editorial director

- November 9-14, 1980
- New York Hilton
- 25,000 square feet of exhibit space (sold out)
- 300 booths
- Record attendance expected

SMPTE registration hours:

Sunday Noon to 5 pm
 Monday 8 am to 5 pm
 Tuesday 8 am to 5 pm
 Wednesday 8 am to 5 pm
 Thursday 8 am to 5 pm
 Friday 8 am to Noon

SMPTE exhibit hours:

Tuesday 10 am to 8 pm
 Wednesday 10 am to 5 pm
 Thursday 10 am to 6 pm

According to Harry Teitelbaum, SMPTE conference vice president, the 122nd Technical Conference and Equipment Exhibit for the Society of Motion Picture & Television Engineers has sold all its available exhibit space and may set an attendance record.

The technical conference is slated for November 9-14 at the New York Hilton Hotel in New York City; exhibits are scheduled to open at 10 am Tuesday, November 11, and run through 6 pm Thursday, November 13. The split scheduling will permit attendance at technical sessions and the visiting of exhibitor booths with a minimum of conflict.

The 300-booth exhibit will be occupied by 144 companies representing most of the major manufacturers and suppliers of professional motion picture and television equipment. This will be one of the year's largest shows in which a combination of both film and video equipment is on display under one roof. This is also the largest equipment show SMPTE has ever had in New York, the previous record holder being the last New York exhibit in 1978 at which there were 211 booths.

In addition to the exhibit, the conference will feature five days of sessions on new developments in television and motion picture technology and applications. Many social activities are planned, including a Sunday evening social event, a Monday awards luncheon, Wednesday evening cocktail party and banquet, and a full week of activities for spouses.

The conference opening will stress new television technology, including the vitaphone story. The Monday afternoon session will feature an in-depth review of the history of British television from its earliest stages to the present day, primarily in terms of evolution of the technology, the art and craft of program making, and the culture. Comparisons may be drawn between the British and US patterns of development and an explanation offered for the differences in the style of output presented to viewers in the two countries.

During past SMPTE meetings, broadcasters, in particular, have expressed serious concern about the maintenance of the new technology equipment being developed—especially the complex digital systems. In response to this expressed concern, SMPTE is scheduling an afternoon session on Tuesday treating problems of maintenance. Although it is not directed to any specific area or industry, topics being considered include: equipment design, plant design, diagnostic techniques, care and training of good maintenance personnel, documentation and vendor support, and a panel discussion.

The Wednesday morning session will offer a look at production and post production for television. Topics being considered include: development of black and white and color television up to the NTSC standards: The work and the committees;

videotape post production 1980: equipment, operation and procedures; the advanced videotape editing/dubbing system in NHK; a lightweight portable broadcast camera with optional, digital setup control; the cost of camera mobility: Part 1—conventional cameras; Part 2—lightweight cameras; recent advances in the fast charging of sealed nickel cadmium batteries; a new approach to space ships and aerial scenes in television productions; a primer on vidicon-type pickup tubes; progress report on captioning for the deaf; and current developments in camera tubes.

On Thursday, the morning session devoted to lighting and sound should prove of equal interest to engineers in broadcasting and motion picture productions. Current topics being considered include: the development of stereo magnetic recording for film; a procedure for optimizing photographic sound recording system; the historical development of cinema architecture and its acoustical effect on filmsound recording; the emergence of cinematographic lighting techniques from those of still photography; high power single ended discharge lamps for film lighting; an innovative approach to HMI fixture design; digital audio technology: today and tomorrow; and fixtures for tungsten halogen lights.

The Thursday afternoon program, devoted to videotape editing, takes a historical look at television and presents some of the latest videotape equipment. Specific topics being considered are: the rise of mechanical television, 1901-1930, the development of the videotape recorder, the IVC 1-11: a different

Exhibitors at SMPTE Fall Exhibit

| | | |
|-------------------------------|---------------------------|------------------------|
| AATON Cameras | EEV | Neumade Products |
| Acmade Int'l/Eastern Editing | Eigen Video | NL Film Products |
| Adda | ELMO Mfg. | Norton Associates |
| Agfa-Gavaert | Ferrash | Nurad |
| Allen Products | Frezolini Electronics | Nytone Electronics |
| American Data | Fujinon Optical | OSRAM |
| Amperex Electronic | Fuji Photo Film USA | Oxberry |
| Ampex | General Electric | Pace Int'l |
| Anton/Bauer | Goldberg (J&R/Ciro) | Panasonic |
| Arriflex | Alan Gordon Enterprises | Perf-Fix |
| Arvin/Echo Science | Grass Valley Group | Peterson Enterprises |
| ASACA/Shibasaki | G. Spilker | Phillips Broadcast |
| Audio Kinetics (UK) Ltd. | Hazeltine | Plastic Reel |
| Balden Communications | Karl Heltz | Rank Cintel |
| Bell & Howell | Hitachi Denshi America | Rank Precision |
| Benley Colortran | Hollywood Film | RCA Broadcast |
| Bogen Photo | Houston Fearless 76 | Recortec |
| Bolex (U.S.A.) | Ikegami Electronics | Research Technology |
| Brunac Industries | Image Devices | RF Technology |
| Camera Mart | Image Transform | Rohde & Schwarz |
| Canon, U.S.A. | Industrial Sciences (ISI) | Rosco Labs |
| CECO Communications | U.S. JVC | SERA |
| Central Dynamics | # B Systems | Sigma Film Equip. |
| Century Precision Cine/Optics | Kilgali Brothers | Skiel |
| Cetec Vega | MLM Associates | Smith-Victor |
| Chyron Telesystems | LaVezi Machine Works | Snook (ROTEX) |
| Cinema Products | Lanco | Sony |
| Cinemilitis | L'paner-Smith | Sorenac-Eclair, U.S.A. |
| Cine 60 | Latic-TV Equipment | Steenbeck |
| Cinetron Computer Systems | Lowell-Light Mfg. | Strand Century |
| Clear-Corn Intercom Systems | LJM | Sylvania Lighting/GTE |
| CMX Systems/Orox | L-W International | Synco |
| Coherent Communications | NM Editing Systems | System Concepts |
| Compact Video Systems | Nagnasync/Moviola | TV Equipment Assoc. |
| C.E.I. | Nagna-Tech Electronic | Tektronix |
| Comprehensive Service A/V | Narconi Electronics | Tele-Cine |
| Comprehensive Video Supply | Natthews Studio Equipment | Telescript |
| Control Video | Nerlin Engineering Works | 3M - Minicom Div. |
| Convergence | Nicro Consull./Quantel | Tiffen Mfg. |
| Cranmet, S.A./PEP | Nicrotime | Toshiba Int'l |
| Datametrics | Nicrowave Assoc. Comm. | Union Connector |
| Datalton | Nole-Richardson | Uni-Set |
| Digital Video Systems | N.P. Enterprises | Utah Scientific |
| Dolby Laboratories | Notorola Comm. & Elec. | Videotek |
| Dynasciences | Novicam Corp. of Amer. | Weatherman |
| Eastman Kodak | Null-Track Magnetics | Winsted |
| Edutron | Nagra Magnetic Recorders | Zellian Enterprises |
| EEG Enterprises | NEC America | |



THE STUDER 069. A STUDIO IN A SUITCASE.

Wherever you're on the spot, the Studer 069 gives you everything you need. Fast. Mixer, limiter, telephone and broadcast line feeds, mikes, cables, monitor phones. All in a single suitcase or permanently parked in your mobile van. A two-minute set-up for sports coverage, interviews,

fast-breaking stories. Without jury-rigged lash-ups between multiple units to cause "technical difficulties."

The unique 069 Commentator Box gives you a single-run connection for two mikes, phones, or mike/phone combos, with full talkback and separate cue facilities. The mixer unit provides the engineer with complete telephone initiate/monitor facilities (local battery or central office powered) for dial system, balanced program line and radio link feeds. You can run the 069 from an AC power line, self-contained

NiCads, or a 12V car battery for complete operating freedom.

Two mike/line inputs and a separate recorder feed are individually assignable to either or both output channels, and all three have selectable low-cut and presence EQ. Four 6-way monitor switches and volume controls give both engineer and commentator the exact signal they need to hear in each ear.

The 069 is Studer's complete go-anywhere, be-prepared-for-anything answer for broadcast remotes. For a full descriptive brochure, contact Studer Revox directly.



STUDER REVOX

Studer Revox America, Inc.

1425 Elm Hill Pike

Nashville, TN 37210, (615) 254-5651

Offices: LA (213) 780-4234; NY (212) 255-4462

Circle (24) on Reply Card

Video:

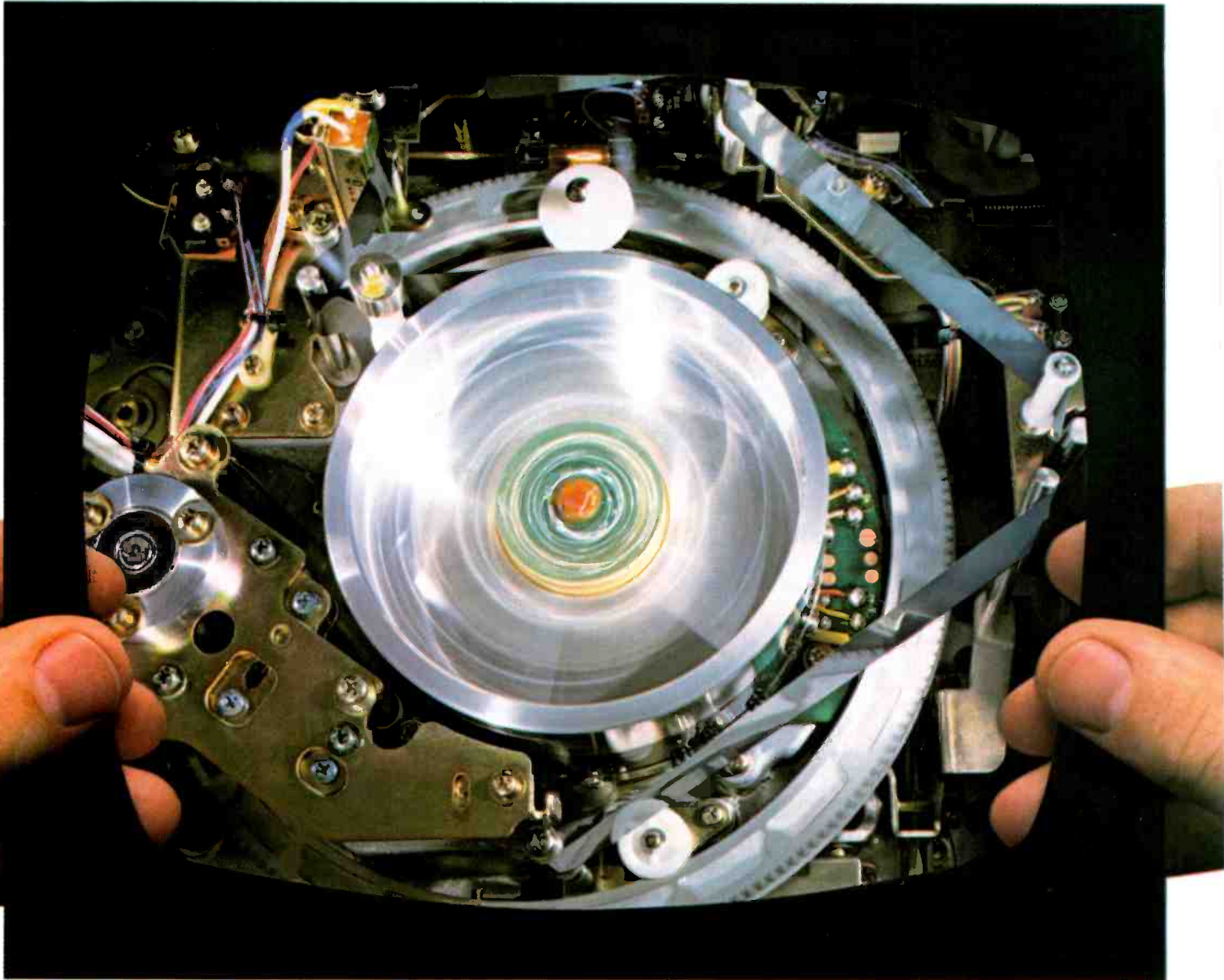

**It's time
for a new approach.
Introducing
JVC's TapeHandlers**

JVC has taken a new look at 3/4" Video Cassette Recording, with an eye for what you've been looking for.

Stability. Reliability.
Gentle tape handling.
Economy.

Take a look inside one of JVC's new TapeHandlers. You'll be amazed at what you don't see.

No pulleys.
No belts.
No idlers.

Instead, Direct Drive reel servos that keep tape tension constant for smooth and stable tape transport, reliable tape shuttling.

A simplified tape threading mechanism for gentle tape handling.

Four brushless motors that directly drive the capstan and drum servos to give stability and reliability, reduce luminance jitter to less than ± 5 microseconds.

A die-cast aluminum chassis to give strength, promote easy interchangeability, keep weight down.

NOT JUST NEW MECHANICAL DESIGN. NEW ELECTRONICS.

JVC's TapeHandlers not only have a new way to handle your tape, they have new electronics, too.

FM-FM direct dubbing capability for multi-generation duplication.

Microprocessor-based control logic for reliability and ease of operation.

Extremely stable horizontal phase lock.

Fully electronic tape counting and timing, with a brilliant fluorescent display.

UTMOST VERSATILITY. SIX UNITS. BROAD INTERFACING CAPABILITY.

JVC's heavy-duty TapeHandlers have been designed to have wider use than just professional video productions.

With their ruggedness, the six separate units can be used in varying combinations by anyone involved in video. And they interface without modification with most other microprocessor-based editing units on the market.

These units are just a start. Other fully compatible products, complementary in function, are soon to follow from JVC. The advances incorporated in the TapeHandlers are too important not to be extended to all who want and need to use video, at any level.

CR-8200U TapeHandler: THE NEW-GENERATION RECORDER/EDITOR.

The leader of JVC's TapeHandler Series is the all-purpose CR-8200U Recorder/Editor. A built-in rotary erase head and blanking switcher make it



RM-88U
RM-70U



CR-8200U



CR-6600U



CR-5500U

easy to perform automatic assemble (back space) editing and split insert editing—a must for professional quality video productions. The new FM-FM dubbing system transfers the chroma and luminance signals in FM form, to cut deterioration significantly. Capstan servo, of course, for top editing performance. Random access capability. Direct mode change without going through "Stop," to allow full remote control. Sub-carrier and external sync capability for use with Time Base Correctors. And, naturally, the new TapeHandler Direct Drive reel servo system to keep tape tension constant in all modes.

The CR-8200U TapeHandler is the ideal core unit around which to build a fully automatic electronic editing system

CR-6600U TapeHandler: THE FULL-FUNCTION RECORDER WITH ASSEMBLE-EDITING CAPABILITY.

The CR-6600U is the video-tape recorder designed for the busy studio. Its rugged construction and gentle tape handling give you the kind of reliability you need when workloads are heavy. The built-in automatic pre-roll mechanism and blanking switcher let you do assemble editing using only the record and pause buttons. FM-FM dubbing makes it perfect as a master VTR for multi-generation duping. Microprocessor-based logic allows full remote control. Two audio level control meters. External sync capability. TBC connections.

This is the recorder you'll value for its quality, reliability, versatility.

CP-5500U TapeHandler: THE COST-EFFICIENT PLAYER WITH ON-AIR QUALITY.

Want a low-cost player for stable and reliable on-air playback? That's the CP-5500U. Or use it with the CR-8200U and

an automatic editing control unit and you have a superb, fully automatic electronic editing system. Or take advantage of its FM-FM duping capability and use it as a companion to the CR-6600U.

It's a TapeHandler, with the stable tape transport that makes it perfect for these critical applications.

MICROPROCESSOR-BASED EDITING REMOTE CONTROL UNITS.

JVC offers you a choice of compact control units: the easy-to-operate RM-88U for precise timing of machine functions, the low-cost RM-82U, and the RM-70U full remote control unit with shuttle-search function. All are based on a full logic circuit using a microprocessor. And all have JVC's new SOFTOUCH shuttle-search control for fast and accurate location of editing points. Turning the rotary dial varies the tape playback speed continuously from still to 5 times normal, in both forward and reverse. When the desired speed is reached, just let go, and it remains locked at that speed. When you change modes, the dial automatically returns to the still position. No locking latches or pulling of knobs when you change from still to playback speed.

GET ALL THE DETAILS

Call your JVC Dealer. He'll be glad to demonstrate the TapeHandlers for you and let you try them for yourselves. Or, if you prefer to read about them first, send for our detailed catalog that spells out their specifications.

Write US JVC Corp.,
41 Slater Drive, Elmwood Park,
New Jersey 07407.

Phone toll free
800-821-7300
Ext. 7005

(In Missouri: 800-892-7655,
Ext. 7005).

Your choice.
Now. **JVC**[®]
US JVC CORP.



Circle (25) on Reply Card

The SMPTE Technical Program
Sunday, November 9
 Registration, afternoon
 Entertainment, evening
Monday, November 10
 Conference opening, morning
 Awards luncheon, noon
 The History of British Television, afternoon
Tuesday, November 11
 Motion Picture Film Production, morning
 Fellows luncheon, noon
 Problems of maintenance, afternoon
Wednesday, November 12
 Television production and post production, morning
 Motion picture laboratory technology, afternoon
 Banquet, evening
Thursday, November 13
 Lighting and sound for television and motion pictures, morning
 Videotape recording, afternoon
Friday, November 14
 Computer graphics, morning

The SMPTE technical program is still being formulated as **BE** goes to press.

The above listing shows its early structure, and a comprehensive program booklet will be distributed to those at the show.

SMPTE

approach; development of a high band U-Matic cassette recorder; design of a TV monitor: a new and accurate system for lining up system timing and sub-carrier phase; video-scope: an accurate method for certifying, timing and analysis of RS-170A systems; the new RCA one-inch Type C helical VTR; and automated enhancement for portable ENG recorders.

The Friday morning session on computer graphics and character generators will be of special interest to those from the television industry attending the show. Also, those attending this session can look forward to seeing some interesting segments displayed on monitors strategically placed around the session meeting room.

Awards luncheon

SMPTE's annual conference luncheon is being held on Monday, November 10, and will feature the presentation of SMPTE awards recognizing outstanding achievements in motion pictures and television, and service to the society.

SMPTE banquet

On Wednesday evening, Novem-

ber 12, SMPTE will hold its annual banquet, cocktail party and dance in the Grand Ballroom of the Hilton Hotel. Companies wishing to reserve tables at the banquet should get in touch with Kurt Wulliman, 3M Co., Photographic Prod. Div., 321 W 44th St., New York, NY 10036. Tables are being reserved on a first-come, first-served basis.

Committee meetings

Part of the SMPTE conference meetings are engineering committees that address topics related to television and motion picture engineering. Details will not be available until the convention starts. Attendance at these meetings is tightly controlled and space is limited. Persons concerned about specific sessions can check with SMPTE and arrange to have their views considered on key issues or to obtain an invitation to sit in on a session as an observer.

Further details about the 122nd SMPTE Technical Conference and Equipment Exhibit may be obtained directly from: Society of Motion Picture and Television Engineers, 862 Scarsdale Ave., Scarsdale, NY 10583. In case you can't make it to this year's show, **BE** will cover some of the television highlights in its January 1981 issue.

... *a legacy of innovation* ...

He's been our hero for a long time, that father of modern innovation, Benjamin Franklin. Through his example and Moseley's dedication to broadcasting we've built a reputation for being first in the industry. Moseley finds itself jumping into the forefront once again with a new line of audio processing equipment, engineered with the quality today's listeners demand.

The TAL-320 AM Audio Limiter brings AM broadcast sound to the quality level it deserves. With the advent of AM stereo, Moseley offers a product that maximizes the AM station's modulation while minimizing those undesirable by-products commonly associated with audio processing. The TAL-320 does just that.

Moseley's TFL-280B FM Audio Limiter, in service around the world, allows TV and FM stations loudness and clarity without distortion caused by old-fashioned clippers. Built-in 15 kHz audio lowpass filtering provides protection to the pilot and subchannels.

The TGR-340 Audio Gain Rider complements these limiters perfectly by subtly riding gain on the program line. A recovery-enabling gate freezes the gain-riding activity during pauses in program, preventing background noise from creeping up or fading down. Switchable, treble AGC cleanly solves the problem of STL, satellite-feed or tape-deck overload due to the pre-emphasis in those items.

The TAL-320, the TFL-280B and the TGR-340 join the Moseley family of products responding to today's needs in the broadcast industry. If listener fatigue is of concern, consider the Moseley audio line.

If Ben could see us now!



MOSELEY ASSOCIATES, INC.

A Flow General Company

Santa Barbara Research Park, 111 Castilian Drive • Goleta • CA • 93017
 (805) 968-9621 • Cable: MOSELEY • Telex 658-448



Circle (26) on Reply Card

Audio-Technica rewrites the book on professional phono cartridges.

Introducing The Professionals

The new Audio-Technica ATP Series Dual Magnet™ Stereo Phono Cartridges

What do you really need from a professional phono cartridge? Impeccable quality. Reliability. Uniformity. And reasonable cost. The goals we've met with the new ATP Series cartridges.

The new ATP Series are flat, smooth, low distortion performers that will do your station, studio, disco, library, or commercial installation proud. They are also very tough... the next best thing to "bullet proof". Because we know that "needle drop" isn't just a way to pay for music or SFX. It's a fact of life!

Both ATP cartridges and styli are *uniformly* excellent. When you at last need to replace a stylus, you always get "like new" performance again, and again, and again.

Don't confuse the ATP Series with other "professional" cartridges that are merely modified home units. ATP units don't have to be treated with kid gloves. And yet we haven't sacrificed tracking ability to make them rugged.

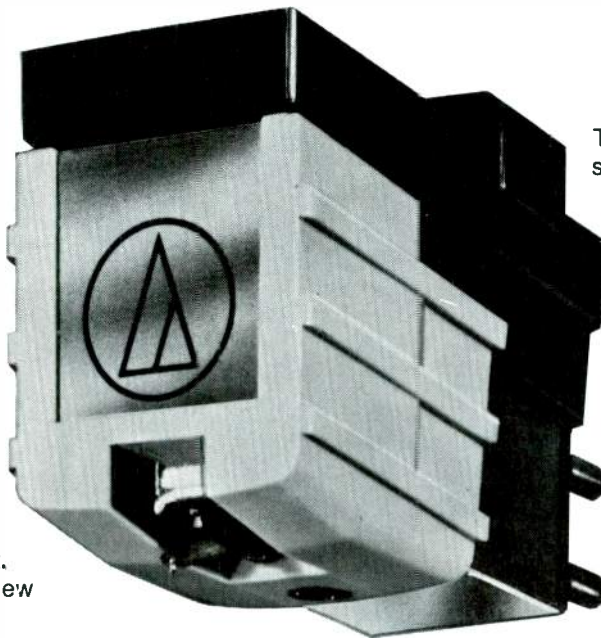

The all-new ATP cartridges were specially developed for the working environment. Three models provide a choice of either spherical or elliptical styli. Each cartridge is hand-tuned for optimum performance, with stereo channels matched within 1.5 dB to eliminate balance problems.

All ATP cartridges feature tapered cantilever tubes that combine high strength with minimum moving mass. There's no problem with back cueing, and the brightly colored cantilever tip is readily visible so that you can spot an LP cut quickly and accurately.

ATP cartridges are priced from \$45.00 suggested professional net. Write for complete specifications. Try the ATP Professionals on your own turntables. We know you'll be pleased with what you hear. From the thoughtful pros at Audio-Technica.



Upgrade your entire record-playing system with new ATP tone arms. Rugged and precise, like ATP cartridges. Professional in every respect. Model ATP-12T or ATP-16T just \$150.00 suggested professional net.

 **audio-technica**
* INNOVATION □ PRECISION □ INTEGRITY

AUDIO-TECHNICA U.S., INC. Dept. 100BE, 1221 Commerce Drive, Stow, Ohio 44224 • In Canada: Audio Specialists, Inc., Montreal, P.Q.

Circle (27) on Reply Card

October 1980 *Broadcast Engineering* 41

The future of AM/FM broadcasting: Effects of FCC standards

By Wally Johnson, executive director, ABES

The FCC has embarked on a program to make as many additional assignments as possible in the AM and FM broadcasting bands. The existing AM and FM technical standards have developed a broadcast system that is considered "mature"; limited numbers of additional stations are available in the larger markets. To create the poten-

tial for new stations, existing technical standards are being challenged in various procedures and rulemaking proposals and new technical rules are being proposed which, if adopted, would provide additional opportunities for new stations. Through greater diversity, which would come from additional competing stations, the theory is that

further deregulation would result.

AM/9kHz

In preparation for the March 1980 First Session of the Region 2 (Western Hemisphere) Administrative Conference on MF Broadcasting (Conference), the FCC adopted a Notice of Inquiry on June 21, 1979, inviting comments on 12 aspects of 9kHz spacing. In a notice dated December 12, 1979, the commission announced it had decided to recommend that the United States propose the adoption of 9kHz spacing for the purposes of the AM agreement to be negotiated by the Region 2 conference. This became the official position of the US delegation at the first conference in Buenos Aires. However, the 9kHz proposal was not adopted, further study was proposed and a decision is to be made at the second conference in November 1981, in Rio de Janeiro.

The initial US proposal regarding a change to 9kHz spacing involved a maximum 4kHz shift by existing stations. However, this plan results in few additional stations in the larger markets because of adjacent channel problems. As a result, four additional plans have been devised that either pair or group the new channels in ways that increase the potential for additional stations in the larger markets. One proposal calls for all 12 new channels to be placed at the top of the AM band. Each of the four new plans would result in stations moving their existing operations by more than 4kHz. It is obvious that the more the new channels are grouped, the more new assignments become possible in the larger markets. But, the more the channels are grouped, the greater the frequency shift required for existing broadcast stations and the greater the cost.

There are also interesting administrative matters for both the US (mainly the FCC) and the International Frequency Registration Board (IFRB) in Geneva. An additional, substantial, workload will be placed on the FCC to implement the agreement, especially if 9kHz spacing is adopted. Also, the IFRB will receive an added workload, because it will actually be required to make interference studies on each assignment and identify incompatibilities between countries. This could slow down the existing administrative machinery for reaching conclusions on applications for new stations or changes in existing stations.

On July 31 the commission adopted a 9kHz Interim Report and Further Notice of Inquiry in which it

Meet the console that takes on your personality

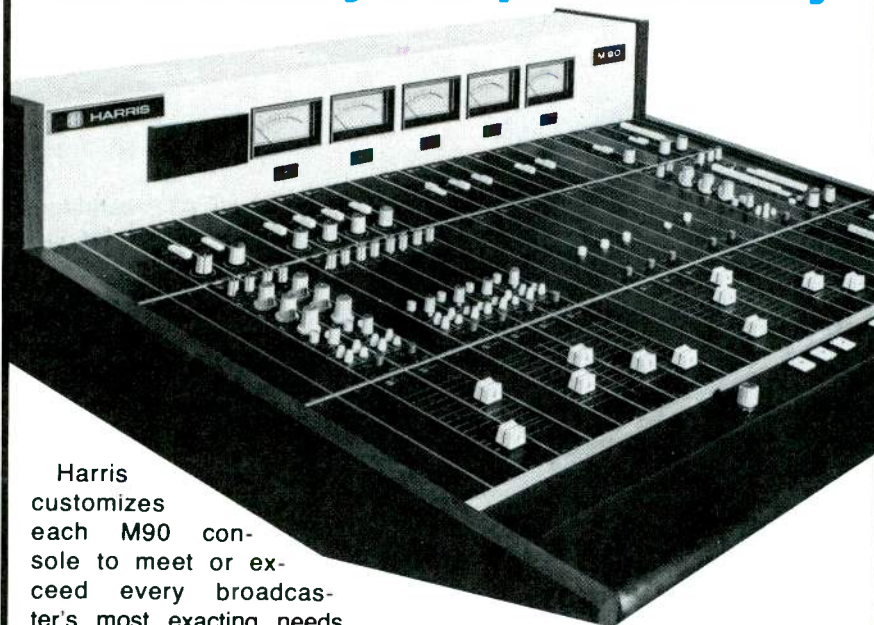

Harris customizes each M90 console to meet or exceed every broadcaster's most exacting needs.

The possibilities are unlimited with the M90! It's available in six different mainframe configurations with a wide choice of plug-in modules. A perfect professional *on-air* or *production* board.

You can start small with a basic number of modules and later expand as your requirements grow.

It allows flexibility for the quality-minded yet cost-conscious broadcaster.

Proven circuit reliability and RFI immunity make the M90 console a consistent performer.



Have Harris customize a console for you. Contact: Harris Corporation, Broadcast Products Division, P.O. Box 4290, Quincy, Illinois 62301. (217)222-8200.



HARRIS
COMMUNICATION AND
INFORMATION PROCESSING

Circle (28) on Reply Card

the
OPTEK 8000 Bulk Tape Degausser...
kiss the noise goodbye!

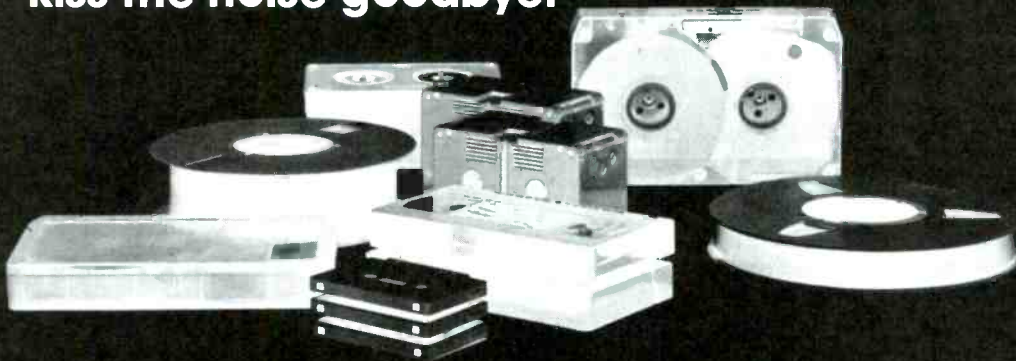

Signal and noise are gone. Wiped Clean. Even today's high density tape is no match for the new OPTEK 8000...the most powerful bulk tape recovery system available today. Fully automatic, hands-off operation provides fast—reliable signal erasure.

High performance "E" core coils virtually strip recorded material; with minimum heat, in less than 32 seconds. The 8000 does all the work...you load the tape, reels up to 16" diameter— $\frac{1}{4}$ " to 2" widths, set the coils and push the start button. That's it.

Design features include: high quality Bodine drive motor, total solid-state control logic (C-MOS), resonant coil technology, sturdy cast aluminum chassis and hi-tech style fiberglass cabinet.

If you're in the market for a quality conscious, cost efficient degaussing system that delivers recording tape that doesn't talk back...there's not another machine available today that can match the 8000's performance.

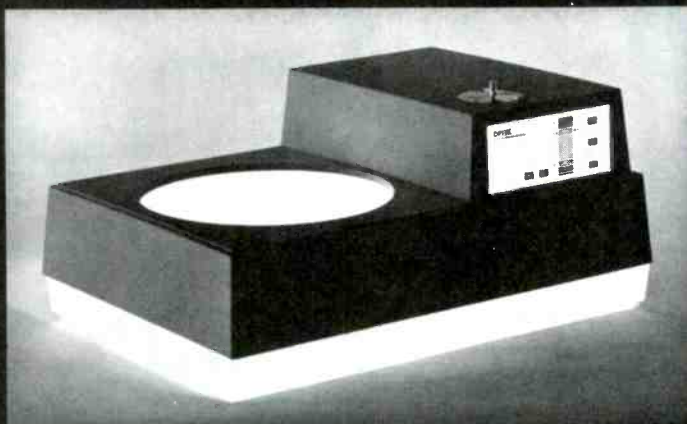

For complete technical information and the name of your nearest OPTEK distributor call or write: Mr. Eloy G. Chairez
OPTEK INCORPORATED, 1390 McCan Street, Anaheim, California 92806,
(714) 630-8280.

OPTEK

Circle (29) on Reply Card

Standards

asked persons interested in applying for new stations (that could go on the air by the end of 1987) to file statements of intent telling where the stations would be and what type of service they would offer.

The results of the Region II conference have the potential for making substantial changes in AM broadcasting service. Additional interference may result from some neighboring countries, and procedures will change because of the involvement of the IFRB in determining incompatibilities in assignments and the early notification of proposed assignments in an inventory, which in effect will protect them for five years.

Preparations for the second Region II conference are increasing in intensity. There is a commission advisory committee through which industry can join in the preparatory process. The time for preparation, however, is short. Meetings of government representatives are taking place in a Committee for the Inter-American Telecommunications (CITEL) working group and in a panel of experts, which are working

on procedures and positions that will be recommended for consideration at the second conference. Also, the FCC scheduled a Further Notice of Inquiry for adoption in late September; comments are due in December, and an FCC meeting is set for February 1, 1981, to determine positions on various issues. Conference proposals by the various governments are due in Geneva by March 1, 1981.

The commission's Clear Channel decision is not final yet. Requests for court review and petitions for reconsideration have been filed, and they will have to be acted upon before the decision can be implemented.

FM/Quadrasonics/AM Stereo

In FM broadcasting the commission has proposed a significant increase in available FM channel assignments in BC Docket No. 80-90. The proposal is to allow Class A stations to operate on Class B-C channels; add two new classes of stations—Class B1 and C1; permit Class B stations in Zone II; and require all existing Class B and C stations to meet operating minimums for power and antenna height, or be reclassified to a lower class. Comments on this proceeding are due

October 1.

The commission adopted a Notice of Proposed Rulemaking on July 17, which proposed to permit FM quadrasonic broadcasting. It proposed standards for both 4-4-4 and 4-3-4 modes, which will permit licensees to choose the quadrasonic mode best suited for their needs. The signal would be compatible with present stereo transmissions. Comments are due November 10.

A final decision to permit AM stereo has been postponed based on a Further Notice of Proposed Rulemaking issued by the commission. The proponents of competing systems have been asked to gather additional data to aid in selecting a system. They may present additional evidence in any category in which they feel their systems have been improperly rated. Comments were also asked on such items as the evaluation categories and methods used in choosing a system and whether the decision should be left to the marketplace.

The proposed changes described for AM and FM broadcasting show that even if they have developed into mature services they are still capable of exciting changes, preferably to give increased service to the public. □



Beaveronics, Inc.

STUDIO PRODUCTION VIDEO SWITCHING SYSTEMS

(Also available in PAL and PAL-M versions)

8 Haven Avenue
Port Washington, New York 11050
Tel: (516) 883-4414

Write or phone for details.

FOR REMOTE & SMALL PRODUCTION FACILITIES
MODEL J & D 712
\$7,400.00



12-input, 4-output mix-effects amp with downstream mixer, includes downstream preset & program busses with cut bar, RGB chroma key

Standard Features

- 12 inputs including Black-burst and Color Background
- Built-in Black Burst Generator
- Built-in Colorizer
- Built-in RGB Chroma keyer
- Four Switching busses
- Downstream Preset and Program Busses with cut bar
- Rack-mounted electronics
- Adjustable Soft Wipe
- Adjustable Border edges
- Color Matte
- Vertical Interval switching thru-out
- Illuminated Momentary Contact push buttons
- Internal, external, Chroma-key, and matte inputs to keyer

- Built-in pattern modulator with frequency and amplitude controls
- Full Tally
- Pattern symmetry control
- Illuminated Momentary contact push buttons for effects selection
- Normal/Reverse/Normal-reverse wipe transitions
- Pattern limit controls for presetting size of patterns or varying vertical and horizontal aspect ratio
- Loop-through inputs
- Input amplifiers with clamping
- Synchronous/Non-synchronous inhibit
- Modular construction with front access plug-in modules

Options:
Downstream Keyer

Prices and Specifications Subject to Change Without Notice.

FOR MODERATE SIZE FACILITIES
MODEL B1-154
\$12,990.00



15-input, 4-bus mix/eff/key amp with downstream mix/key amp. Many optional features including DSK & quad-split, etc.

FOR SOPHISTICATED FACILITIES
MODEL B1-156
\$21,795.00



15-input, 6-bus with two full mix/eff/key systems & dir. pgm & pre busses: many options available, DSK, quad, etc.

Circle (30) on Reply Card

All Beaveronics Switching Equipment Carries a Two Year Warranty

OTHER ITEMS AVAILABLE FROM BEAVERONICS

FAYAG MASTER CLOCK SYSTEMS

Available with accuracy better than 1 second/yr.



- Master control switchers AFV with audio breakaway
- Routing switchers with AFV

CHECK BEAVERONICS FOR:

- Specialized custom switchers
- Selected terminal equipment

ON THE OTHER HAND, OUR ROUTING SWITCHERS HANDLE GROWTH VERY NICELY.

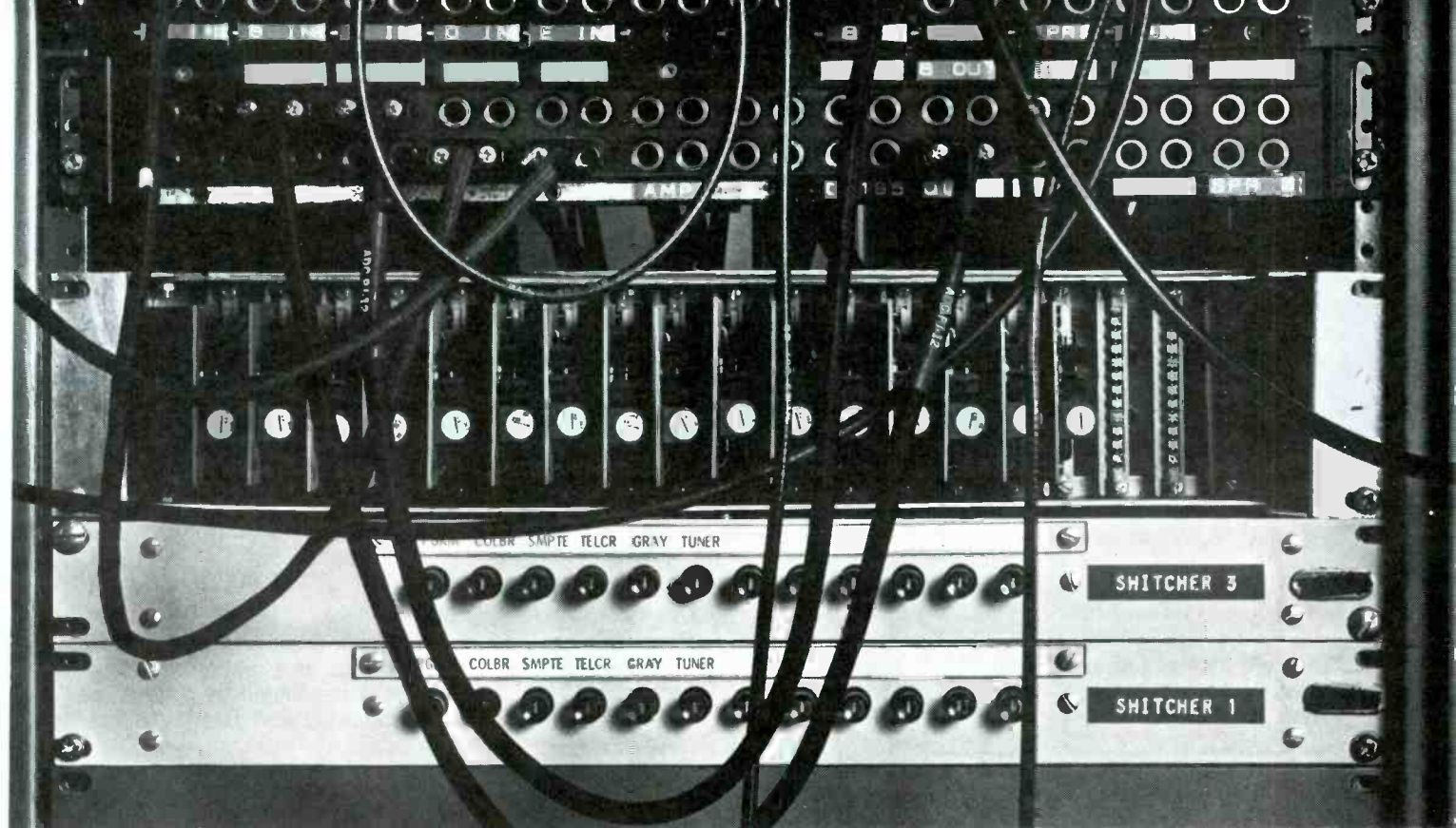

With a microprocessor-based 3M routing switcher, you can eliminate the problems of hard wiring once and for all. And specify just about any type of control you want.

It all depends on how you'd like to set it up. Our design engineers can then tailor the matrix for you. From your smallest requirement on up to any desired size. And they'll help you select the control that's best suited to your needs, too.

The choice is yours. Touchpad, thumbwheel, illuminated or L.E.D. pushbutton, machine, X-Y, or alphanumeric universal control. Even a terminal control that allows you "supervisory" control throughout the system, or computer control through our RS-232 port.

What's more, 3M routing switchers are easily expandable. Start with a matrix that matches your present requirements. Then as your studio grows, your routing switcher does, too. With the simple addition of extra frames and switch cards.

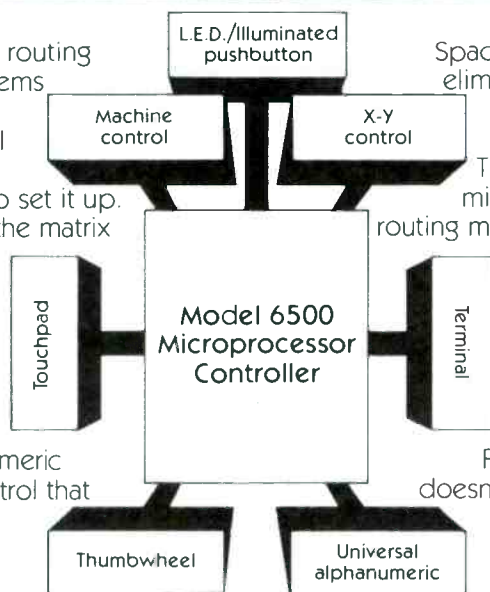

Space-guzzling, multi-conductor cables are eliminated. And so are unnecessary output panels. Because with our system, outputs can be reallocated as required.

The heart of the system, the Model 6500 microprocessor, as well as controlling the routing matrix, can be integrated with a machine control system to offer absolute production control of film chains, VTR's and other production machines.

Or it can be used as a stand-alone machine control system which offers the same coaxial wiring and expandability of the routing switcher panel.

Finally, a routing switcher whose growth doesn't depend on the size of your building.

For more information about 3M routing switchers, or a custom design consultation for your studio, call collect, (612) 736-1032. Or write on your letterhead to: Video Products/3M, Bldg. 223-5E/3M Center, St. Paul, MN 55144.

**THE ROUTING SWITCHERS THAT GROW
AS YOUR NEEDS GROW.**

67th AES convention

October 31-November 3, 1980
Waldorf-Astoria Hotel,
New York City

When the 67th Audio Engineering Society convention opens in New York in late October, the theme will be that of reaching out to audio engineers on important topics of the '80s. In keeping with this idea, scheduled topics include:

- Digital Techniques in Audio;
- New Measurement Applications;
- Studio Design Technology;
- The Development of New, High-Quality Disc Recording and Manufacturing; and
- The Growing Awareness of the Merging of Audio and Video Technologies.

To adequately cover these and other audio subjects, the convention will be expanded to include an unusually high number of technical papers. In addition, a series of workshops has been scheduled that deals with timely topics, such as digital editing, small studio update, high-speed tape duplication, and an educational open house for interested students. Two other workshops will be practical sound reinforcement techniques and practical video for the audio engineer. A special workshop on microphone

usage (originally presented at the Midwest Acoustic Conference in May 1980) will be presented.

The workshops are new this year.

They involve four days of intensive investigations in a workshop atmosphere, are conducted by professional practitioners and include a spe-

British companies to make strong showing at AES-New York

At least 21 British companies will exhibit new and established products at the AES Convention in New York. In addition to the new equipment, equipment introduced earlier at the AES Convention in Los Angeles in May will be displayed.

The following items highlight some of the latest equipment from British companies expected to be displayed at the New York convention. Some of these listings are late arrivals and do not appear on the roster of exhibitors.

Advanced Music Systems.

Latest audio units include a tape phase simulator, an analog system giving flanging, tunneling, vibrate and auto-pan effects with a choice of 20-80ms delay.

Audio and Design (Recording).

Offering new stereo/dual mono compressor/limiter with LED bar-graph reading for gain response and featuring infinitely variable compression slope.

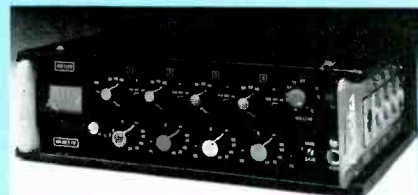

Audio Developments

Audio Developments. Unveiling two new mixers for professional use and for ENG applications. Featuring a prographic equalizer with memory for storing 32 curves.

Allen and Heath. Premieres working model of 16:4/2 mixing console, offering exceptional versatility at an attractive price.

PHILIPS®



Presents

World Class TELEVISION

The internationally recognized cameras and broadcast equipment preferred by broadcasters, production companies and industry around the world:



LDK-14
The years-ahead 2/3-inch field and studio camera family. Now with triax capability.



VIDEO 80
Modular camera and expandable production system in Broadcast and Institutional use around the world.



LDK-25B
Newest version of the World Class, state-of-the-art LDK 25/5/15 camera family. With innovations used by ABC in exciting coverage of the Winter Olympics.

Plus... a wide array of innovative World-Class products like:

Transmitters and Exciters

Fastest growing UHF/VHF transmitter line in North America.

Video Tape Recorders

1" type C, system and stand-alone.

New, Time Code Generator

SMPTE, PAL, SECAM rates, and film... 24 frames per second!

Tape Synchronizer

Television audio post production.

Digital Noise Reducer

Fully automatic.

New, Synch and Timing System

Built around ultra-stable Philips SPG sync generator.

Test and Measuring Equipment

Modulators, demodulators, VITS analyzer & generator, and new waveform monitor and vectorscope.

New, Teletex

Text display system component.

Contact your Philips representative today, indicating product interest, or call Philips Broadcast Equipment Corp., 91 McKee Dr., Mahwah, N.J. 07430. (201) 529-3800.

PHILIPS® *Innovative Leader in World Television*



BMI Broadcast Systems

AES convention

BMI Broadcast Systems. First public US showing of its new 24A Stereo Mixer. (System may be seen at the Allen and Heath booth.)

H. H. Electronics. Power loudspeakers boast superior structural accuracy of magnesium chassis to allow closer voice coil gap, higher magnetic field strengths and increased performance.

Unattended Transmitter Monitor, Alarm & Control

Model 5003

Installed at remote transmitter locations. Direct connection to public telephone network, leased lines, two-way radio or microwave network. Feeds data to Model 5004.

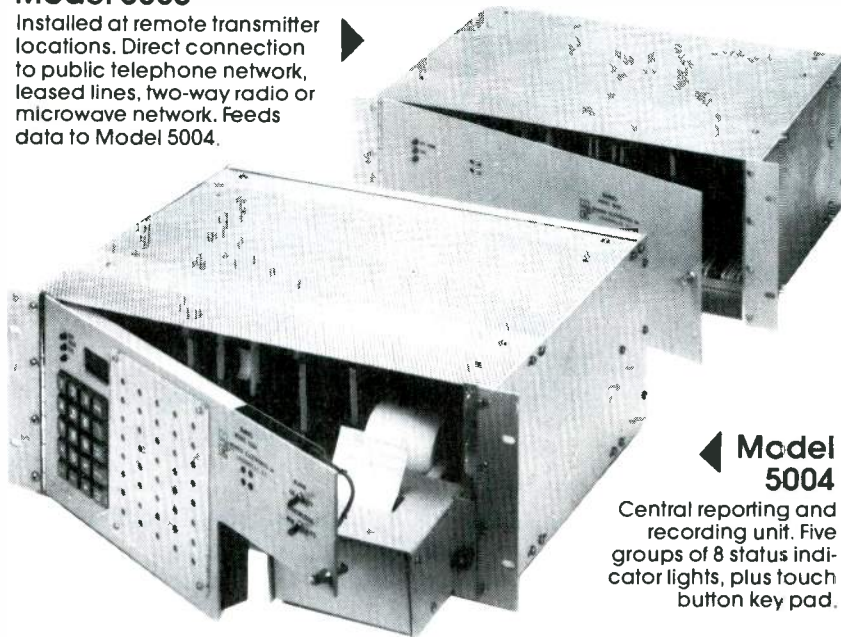

Model 5004

Central reporting and recording unit. Five groups of 8 status indicator lights, plus touch button key pad.

Remote Supervisory Model 5003

Capable of monitoring and controlling up to 5 transmitters at one remote site plus building status. It connects directly to dial-up public telephone, radio, or microwave. Stand by battery power supply is standard.

Central Model 5004

Displays the status of (8 to 48) remote contacts and has the hard copy data logger to provide the permanent record of time of day, date and status.

These two units can be equipped to provide building security with recordings to notify local security forces.

Send for full color, 4-page brochure.



MONROE ELECTRONICS, INC.

211 House Avenue, Lydonville, NY 14098
Phone: (716) 765-2254

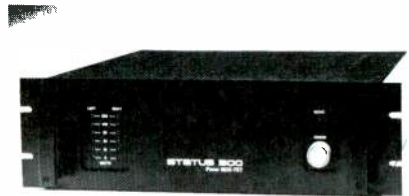

Raindirk

Raindirk. Showing new range of power amplifiers with MOS-FET output stages, stereo control unit with remote disc amplifier and 3-band equalizer, and a multi-track recording console.

Rank Audio Visual. New modular mixing system, graphic equalizer, and intercom system.

Soundcraft Electronics. US debut for the SCM 382-24 multi-track tape recorder and Series 800 console.

Trident Audio Developments. Premier of TSR professional 24-track tape recorder with new record-replay electronics offering superior S/N ratio.

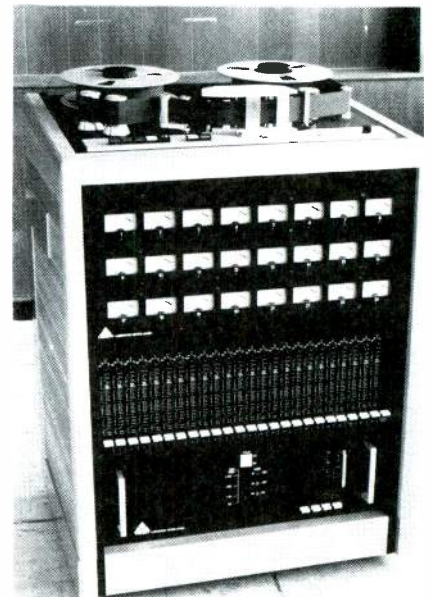

Trident Audio Developments

Circle (33) on Reply Card

OUR TAPE WILL IMPRESS YOU AS MUCH AS OUR SPECS

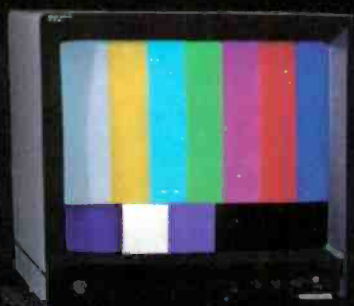

The two most important features of any videocassette are how *accurately* it reproduces original source material... and how *long* it will continue to do so. By these standards alone, Maxell's VHS, Beta and U-Matic videocassettes are clearly superior performers.

One of the prime reasons for this is our exclusive *Epitaxial*[™] video recording tape, which is formulated using a sophisticated technique of growing cobalt-ferrite particles onto a core of gamma-ferrite oxide. It is largely responsible for a tape with superior color, video and audio fidelity, with very low chroma noise and minimum head wear. Even repeated playback will not cause any critical loss of resolution.

Our cassette shells are made with the same quality and precision as the tape they house. So you can depend on Maxell for an outstanding performance every time. For every application.

But don't take *our* word for it. Our specs make things perfectly clear. Send for them today and get the whole picture for yourself.

Professional/Industrial Products, Maxell Corporation of America
60 Oxford Drive, Moonachie, NJ 07074



Circle (34) on Reply Card

maxell
PROFESSIONAL
INDUSTRIAL
PRODUCTS



Introducing the only $\frac{3}{4}$ " time code editing system that performs 20 automatic edits from multiple sources. The Panasonic 700 B-2 Series Time Code Editing System.

**700
B-2
SERIES**

Now Panasonic adds a new dimension to the speed and accuracy of time code editing with our new 700 B-2 Series Time Code Editing System. The AU-700 editing recorder, the AU-A70 programmable editing controller, and the AU-J10 multiple source adapter. Together they let you do what other time code editing systems don't: Perform up to 20 automatic, multiple-source insert and assembly edits. And the 700 B-2 Series is packed

with outstanding performance features.

The precision of direct drive.



Check out the excellent stability and precision of the AU-700's direct-drive video head cylinder and capstan servo motor. The superb performance and durability of our crystal-oriented HPF™ heads. All combine to produce an outstanding picture with horizontal resolution of 260 lines color, 330 lines

monochrome and S/N ratio of 46 dB color, 50 dB monochrome. You'll also get an edit with less video noise because video head switching has been moved to the vertical interval so it never shows up in the picture. At the same time, we incorporated DUB IN and DUB OUT connectors with separate Y/C signals and a flying erase head. And to keep that good-looking picture looking good, all circuitry is mounted in a durable annealed aluminum die-cast chassis.

The speed of microprocessors.

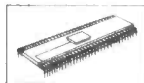

Another touch of ingenuity is the AU-700's microprocessor controls. Designed to work perfectly with the AU-A70 editing controller, they give you the speed, accuracy and versatility of full-logic, mode-to-mode switching. The AU-700 will accept SMPTE time code on a separate track or on audio track one as well as standard CTL pulses. And its electronic



Shown from left AU-700 editing recorder, AU-A70 programmable editing controller.

digital tape counter displays LED readouts of CTL pulses in minutes and seconds—even in fast forward and rewind.

Multiple source versatility.

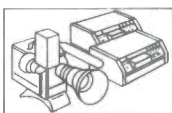

With our AU-A70 editing controller

not only can you generate and read time code pulses, microprocessors let it perform up to 20 time code edits automatically. Add an AU-J10 multiple source adapter and it will accept inputs

from two source decks and one live line plus perform A/B rolls. Microprocessors also let you automatically go to specific tape locations. You can also search both ways at speeds of 1/20X, 1/5X, 1X, 2X, 5X plus pause with picture. Other features include program check, program exchange, insert programming and overflow indication. For editing convenience, separate address time and lap time indicators are included. The AU-A70's error codes pinpoint any procedural

errors to avoid incorrectly programmed edits. The AU-A70 can also be used with any Panasonic sole-noid-operated 3/4" and 1/2" VHS™ decks. For worldwide versatility, there is a built-in voltage selector that is compatible with 100V / 120V / 220V / 240V AC, at either 60 Hz or 50 Hz.

Total service capability.

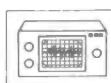

When it comes to servicing and maintaining the 700 B-2 Series, Panasonic backs you with a full net-

work of B-2 dealers, equipped with total service capability. Each has the parts, test equipment and technical expertise professional applications require. For further information, call your regional Panasonic office: Midwest—(312) 364-7936; Northeast—(201) 348-7620; Southeast—(404) 923-9700; Southwest—(214) 356-1388. The new 700 B-2 Series Time Code Editing System. Only from Panasonic.

Panasonic
VIDEO SYSTEMS DIVISION

Circle (35) on Reply Card



AKG C-567

**THE
"ALMOST"
INVISIBLE
CONDENSER
LAVALIER
MICROPHONE**



AKG ACOUSTICS, INC.

77 SELLECK STREET
STAMFORD, CT 06902

Circle (36) on Reply Card

AES convention

cial tape recorder maintenance clinic.

A tentative schedule of the technical sessions and special workshops is shown in the accompanying short article. Also listed separately are the convention exhibitors as available at press time. A final program and a complete exhibitor listing will

be available at the AES registration booths.

This year an expanded exhibit area will allow those who attend to view the latest in audio products, including new *digital product entries* on five levels of the convention hotel, including demonstration rooms. These demo rooms are

AES 67th CONVENTION CALENDAR *Times of workshops are subject to change*

Gray areas indicate Technical Sessions

Color boxes show Workshops

| | | | |
|-----------------|---------|---|---|
| FRIDAY | 8:30 AM | Business Meeting | |
| OCT. 31 | | | |
| | 9 AM | A TRANSDUCERS | DIGITAL EDITING |
| | 2 PM | B AUDIO RECORDING & REPRODUCTION | SOUND REINFORCEMENT |
| | 7 PM | C STUDIO TECHNOLOGY | AUDIO IN MEDICINE |
| SATURDAY | 9 AM | D SIGNAL PROCESSING & MICROPROCESSOR APPLICATIONS, PART I | POTENTIALS OF PERSONALIZED PRIVATE RECORDING STUDIOS |
| NOV. 1 | 2 PM | E SIGNAL PROCESSING & MICROPROCESSOR APPLICATIONS, PART II | EDUCATIONAL FAIR |
| | 7 PM | F SOUND REINFORCEMENT & ACOUSTICS | VIDEO FOR AUDIO |
| SUNDAY | 9 AM | G INSTRUMENTATION | HIGH-SPEED DUPLICATION |
| NOV. 2 | 2 PM | H DIGITAL TECHNIQUES | MICROPHONE TECHNIQUES |
| | 7 PM | SOCIAL HOUR & AWARDS BANQUET | |
| MONDAY | 9 AM | I BROADCAST AUDIO UPDATE | MULTITRACK TAPE RECORDER MAINTENANCE, PART I |
| NOV. 3 | 2 PM | J ELECTRONIC MUSIC | MULTITRACK TAPE RECORDER MAINTENANCE, PART II |
| | 5 PM | CONVENTION ENDS | |

Embarrassing questions to ask audio console salespeople

Sometimes it pays to ask questions. If the subject is audio consoles, asking difficult questions can be very revealing in comparing one console to another. Here are some of the questions that make most console salespeople squirm.

Is the console "human engineered"? Does the console have an esthetically "professional" appearance? Is the layout well defined and uncluttered? Are controls large? Do they fit the hand? Are they well labelled and lighted? Do they provide adequate visual feedback to affirm the position of the control? Is console nomenclature permanently engraved?

Easy to service? Are all components readily accessible and isolated for individual servicing? Are op-amps in plug-in sockets? Are there service loops in the wiring harness? Are extender boards provided? Are all wires uniquely numbered and referenced to your system documentation?

How responsive is the service department? Can they provide a history of fast, efficient customer service? Are they confident enough to furnish a complete list of customers for you to call?

ADM 1600
Audio Console
—Modest
but mighty.



How easy is installation? Is the console completely assembled and ready to install? Are installation points readily accessible? Are all program inputs and outputs uniquely transformer isolated?

How about specifications? Are the manufacturers' published specifications consistent and easily understandable or mired in the game called "specsmanship"?

How good is reliability? Do all modules receive three levels of testing? Does the total system receive 4 levels of performance verification? Do both the modules and system receive extensive burn-in?

Is the console backed by a 5-year, all-inclusive warranty? (Only ADM answers "yes" to that one.) ADM and only ADM answers all of these questions with a full, no weaseling, resounding "YES"! The only question remaining is, when would you like to talk to us about a new audio console?

For facts about our Series 3200, 2400, 1600, or 800 ADM Audio Consoles, contact ADM Technology, Inc., 16005 Sturgeon, Roseville, Michigan 48066. Phone (313) 778-8400. TLX 23-1114.

ADM® The
Audio
Company

AES convention

AES Convention Exhibitors

AB SYSTEMS
ACOUSTIC DESIGN BY JEFF COOPER
ACOUSTILOG, INC.
AGFA-GAVAERT
AKG ACOUSTICS
ALLEN AND HEATH BRENNELL LTD.
ALPHA AUDIO
AMBER ELECTRO DESIGN LTD.
AMPEX CORPORATION
AMPRO/SCULLY
ANALOGIC CORPORATION
ANVIL CASES, INC.

APHEX SYSTEMS LTD.
ASHFORD AUDIO PROD. CO. INC.
ASHLY AUDIO, INC.
ASSOCIATION OF SOUND &
COMMUNICATIONS ENGINEERS
AUDICO, INC.
AUDICON MARKETING GROUP
AUDIOARTS ENGINEERING
AUDIO & DESIGN (RECORDING) LTD.
AUDIO DEVELOPMENTS
AUDIO KINETICS (UK) LTD.
AUDIO PROCESSING SYSTEMS, INC.

AUDIO-TECHNICA U.S., INC.
AUDIO BY ZIMET, INC.
AUDIOTECHNIQUES, INC.
AUDITRONICS, INC.
BASF SYSTEMS
BEYER DYNAMIC
BGW SYSTEMS, INC.
B & K INSTRUMENTS
BOSE CORPORATION
THE BTX CORPORATION
CADAC/IRV JOEL
CALZONE CASE CO.
CERWIN-VEGA
CETEC GAUSS
CETEC VEGA
COMMUNITY LIGHT & SOUND, INC.
CON BRIO
CONSILIUM INDUSTRI AB
CONVERGENCE CORPORATION
COVER PUBLICATIONS
CREST AUDIO, INC.
CROSS COMPANY LTD.
CROWN INTERNATIONAL, INC.
DAVID LINT ASSOCIATES, INC.
dB-CASSETTE
dbx, INC.
D & D ENGINEERING
DELTALAB RESEARCH, INC.
DESIGN ELECTRONICS
DOLBY LABORATORIES, INC.
EASTERN ACOUSTIC WORKS, INC.
ELECTRO-HARMONIX
ELECTRO-VOICE/TAPCO
EMILAR CORPORATION
EMPIRICAL AUDIO
EUMIG (USA) INC.
EVENTIDE CLOCKWORKS, INC.
FAIRLIGHT INSTRUMENTS
FURMAN SOUND, INC.
GOTHAM AUDIO CORPORATION
GRANDY, INC.
HARRISON SYSTEMS, INC.
HEINO ILSEMANN GMBH
HEWLETT-PACKARD COMPANY
H.H. ELECTRONICS, INC.
HM ELECTRONICS, INC.
HUTCO
INFONICS
INOVONICS, INC.
INSTITUTE OF AUDIO RESEARCH
INTERFACE ELECTRONICS
INTERNATIONAL AUDIO, INC.
INTERNATIONAL CONSOLES
CORPORATION
ITAM
IVIE ELECTRONICS, INC.
JAMES B. LANSING SOUND, INC.
KEITH MONKS (USA) INC.
KIMBALL INTERNATIONAL, INC.
KING INSTRUMENT CORP.
KLARK-TEKNIK RESEARCH LIMITED
KLIPSCH & ASSOCIATES, INC.
LEXICON, INC.
LINK HOUSE PUBLICATIONS
LOCKWOOD & COMPANY
MARCONI INSTRUMENTS
MARSHALL ELECTRONIC
MARTIN AUDIO/VIDEO
CORPORATION
MCI, INC.
MEYER SOUND LABORATORIES, INC.
MCMIX AUDIO PRODUCTS, INC.
MIDAS AUDIO SYSTEMS, LTD.
MITSUBISHI ELECTRIC CORP.
MODULAR SOUND SYSTEMS
MTI CORPORATION
MUSICO
MUSIC TECHNOLOGY, INC.
MXR INNOVATIONS INC.
NADY SYSTEMS INC.
NAGRA MAGNETIC RECORDERS, INC.
NEAL FERROGRAPH
NEUTRIK PRODUCTS
NOISE LIMITED
ORANGE COUNTY ELECTRONICS
ORBAN ASSOCIATES, INC.
OTARI CORPORATION
PANASONIC P.A.D.
PEAVEY ELECTRONICS
PENTAGON INDUSTRIES

Grab a handful of VIZ value!

More Magic from the Wizard of VIZ

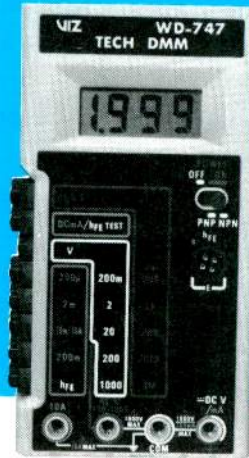

NEW Tech DMM WD-747 \$89.95

More premium quality features per dollar than any other hand-held 3½ DMM! The *only* one with built-in test socket for transistor h_{FE} . Side switches for easy one-hand use. Auto polarity/zero. Large 0.5" LCD digits. Resolution down to 100 μ V. Accuracy

better than 0.8% DCV. 10M Ω input impedance. Full overload protection. All functions color coded. Complete with battery, deluxe test probes and spare fuse. HV probe, multiplier resistor and "LED head" continuity probe available.



0.1% Accurate DMM WD-759 \$159.95

Want top quality? Here's the *only* hand held 3½ DMM with full info LCD readout: Function (V, A or Ω), Amount (numeric value) and whether AC or DC. Also the *only* one with full range high and low power ohms. Features auto polarity/zero, RF shielding, recessed input jacks, high impact case with front guard rail that protects against damage if dropped face down. Supplied with battery, tilt stand, spare fuse (stored inside case). Deluxe test probes have dual banana plug, alligator clip and "no-short" probe tip. Full one-year warranty. AC adapter, "LED-head" continuity probe and carry case available.

Lab accuracy WD-758 with LED readout \$149.95

See your VIZ distributor
Ask about the 7 VIZ bench
DMMs with prices to \$359



VIZ Mfg. Co., 335 E. Price St., Philadelphia, PA 19144

Over 70 test instruments in the line

Circle (38) on Reply Card

THE NEW 900 SERIES MODULAR SIGNAL PROCESSING SYSTEM. IT'S COMPACT. IT'S FLEXIBLE. IT'S dbx.

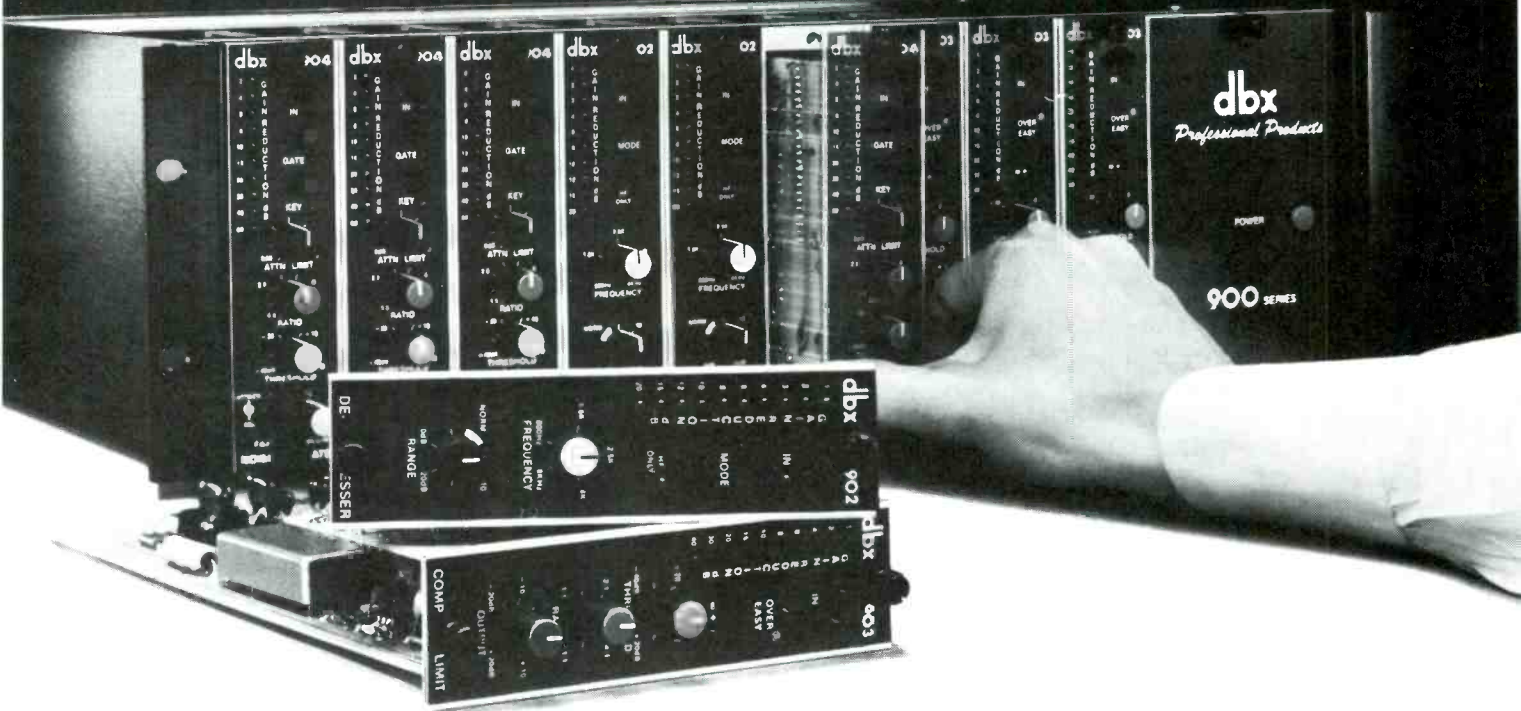

With rack space at a premium, you want to save space anywhere you can. That's why dbx is introducing the new 900 Series Modular Signal Processing System.

You start with a single, easy-to-install 5¼" x 19" rack with built-in power supply. Then just slip in the modules you need. Up to 8 dbx signal processors, with storage for a ninth.

But the modules themselves are the real stars.

Our Model 902 is the only de-esser that continuously analyzes the input signal spectrum, providing the exact amount of de-essing you want regardless of signal level. And the 902 can be used broadband or on high frequencies only.

The 903 Compressor offers a special negative compression feature. In use, it actually begins to attenuate at the threshold, which gives the signal a new sense of punch. Of course the 903 also features our Over Easy compression as well as true RMS level detection.

Our 904 Noise Gate features adjustable attack and release rates, Over Easy downward expansion, a special key input that allows you to gate one instrument by another, and a unique "gate" mode which eliminates the need to gain ride solos during multi-track mixdown.

The 900 frame accommodates dbx noise reduction modules as well.

And this is just the beginning of our signal-processing system. Soon we'll be offering an equalizer, a flanger, and more.

So now you've got a signal processing system that's everything you want.

It's compact. It's flexible. Best of all, it's dbx.

dbx, Incorporated, 71 Chapel St., Newton, MA 02195. 617/964-3210.

dbx[®]

SMPTE EDIT-CODE READER AND CHARACTER-GENERATOR



13:45:27.09

THE NEW STANDARD OF THE INDUSTRY

FEATURES: The McFadin Window™ wide range digital decoder, highly legible and unique FONT, 1-3/4" rack mounting, vertical interval display, all front panel controls, drop frame indicator, choice of Time-Code or User-Bits, regenerated Time-Code output (DUB), MODEL DR-107A.



504 W. Chapman Ave.
Orange, Ca. 92663 714-997-4151

Circle (40) on Reply Card

Buy MARATHON, jam-free, cartridges at direct factory prices!

Competitive prices — with these major benefits (there are 13 more!) . . .

- SUPERB FIDELITY: wow and flutter are virtually unmeasurable;
- Differential Hub and Ring assure life time jam-free running; (patented)
- ONLY TRUE NAB AA cartridge.

Send your Purchase Order or check. Shipments are made within 24 hours. And ALL Marathon carts are guaranteed!

(Ask for prices on our other carts, and accessories.)

The BEST — at competitive prices — since 1963!



NAB AA Type Cartridge shown

| Time At 7.5 IPS | | | #300 NAB Type AA | #300 NAB Type A | #300 Stereo Azml-Lok* |
|-----------------|-----------|------------|------------------|-----------------|-----------------------|
| 20 Sec. | 30 Sec. | 35 Sec. | \$2.35 ea. | \$2.50 ea. | \$3.75 ea. |
| 40 Sec. | 60 Sec. | 70 Sec. | \$2.50 ea. | \$2.75 ea. | \$4.00 ea. |
| 90 Sec. | 100 Sec. | 2:30 Min. | \$2.65 ea. | \$3.00 ea. | \$4.25 ea. |
| 3:30 Min. | 4:00 Min. | 4:30 Min. | \$2.75 ea. | \$3.25 ea. | \$4.50 ea. |
| 5:00 Min. | 5:30 Min. | 6:00 Min. | \$3.00 ea. | \$3.35 ea. | \$4.75 ea. |
| 6:30 Min. | 7:30 Min. | 8:30 Min. | \$3.25 ea. | \$3.50 ea. | \$5.00 ea. |
| 9:00 Min. | 9:30 Min. | 10:00 Min. | \$3.50 ea. | | |

MARATHON PRODUCTS CORPORATION

334 West Boylston Street, West Boylston, Massachusetts 01583
Phone 617-853-0988

Circle (41) on Reply Card

AES convention

PRO-TECH AUDIO
PUBLISON
QUAD EIGHT ELECTRONICS
QUANTUM AUDIO LABORATORIES
RAINDIRK LTD.
RANK AUDIO VISUAL
RECORDING FOR THE BLIND, INC.
RENKUS-HEINZ, INC.
ROGER BARTH K.G.
ROLANDCORP U.S.
RUPERT NEVE INCORPORATED
RWO/FOSTEX CORPORATION
SAE PRO PRODUCTS GROUP
SAGAMORE PUBLISHING COMPANY, INC.
SAKI MAGNETICS INC.
SANSUI ELECTRONICS
SESCOM, INC.
SHURE BROTHERS INCORPORATED
SIERRA AUDIO CORPORATION
SOLID STATE LOGIC LIMITED
SONTEC ELECTRONICS
SONY INDUSTRIES
SOUNDCRAFT ELECTRONICS, LTD.
SOUNDSTREAM, INC.
SOUND TECHNOLOGY, INC.
SOUND WORKSHOP PROFESSIONAL AUDIO PRODUCTS
SPECTRA SONICS
STANTON MAGNETICS INC.
STEPHENS ELECTRONICS, INC.
STUDER REVOX AMERICA INC.
STRAND CENTURY COMPANY LTD.
SWINTEK ENTERPRISES, INC.
SYNERGETIC AUDIO CONCEPTS
SYNTON ELECTRONICS B.V.
TABER MFG. & ENG. CO.
TANGENT SYSTEMS INC.
TANNOY PRODUCTS LIMITED
TAPCO/ELECTRO-VOICE, INC.
TAPEMAKER SALES CO., INC.
TEAC CORPORATION OF AMERICA
TECHNICAL AUDIO DEVICES (TAD)
TEKTRONIX
TELEX COMMUNICATIONS
3M COMPANY
TRIDENT AUDIO DEVELOPMENTS, LTD.
UNICORD
UNITED RECORDING ELECTRONICS INDUSTRIES (UREI)
URSA MAJOR, INC.
U.S. PIONEER ELECTRONICS CORP.
VALLEY AUDIO
VICTOR COMPANY OF JAPAN, LTD. (JVC)
WHITE INSTRUMENTS, INC.
WIREWORKS CORPORATION
WOELKE MAGNETBANDTECHNIK
XEDIT CORPORATION
YAMAHA INTERNATIONAL CORPORATION

usually good places to hear the latest in audio technology.

Studio tours

The convention will feature studio tours to give those who attend a chance to view the latest New York recording scene. This popular AES activity provides visitors with an opportunity to keep current on one of the most active recording centers in the world. Bus transportation will leave the Waldorf-Astoria on Saturday morning, November 1, starting at 8:30 am, and accommodations will be limited. Full convention program registration is required for participation. There will be a \$5 service charge for transportation. □



Blue chip ENG on a budget

If you thought that an Ikegami ENG camera's been beyond your budget till now, take heart. The HL-78A approaches the high performance standards of the HL-79A. But the price is encouragingly lower.

The HL-78A is the quintessential ENG camera—20 pounds complete with lens, battery and ready for action. It is beautifully balanced, human engineered, with BK-7 glass beamsplitter optics, and state-of-the-art electronics. +18 and +9 dB gain settings enable you to invade domains of darkness that daunt lesser cameras.

And with studio options like 4½-inch electronic viewfinder, remote paint box, program microphone and intercom, it does double duty. What's more, it meets EIA Std. RS-170A including SC-H phase criteria, with adjustable H&V blanking pulse widths to meet FCC limits. Put the HL-78A on your ENG team. See your Ikegami dealer/distributor or contact Ikegami Electronics (USA) Inc., 37 Brook Avenue, Maywood, N.J. 07607; (201) 368-9171. West Coast: 19164 Van Ness Ave., Torrance, CA 90501 (213) 328-2814; Southwest: 330 North Belt East, Suite 228, Houston, TX 77060 (713) 445-0100; Southeast: 552 South Lee St., Americus, GA 31709 (912) 924-0061.



Ikegami HL-78A

Circle (42) on Reply Card

October 1980 *Broadcast Engineering* 57

Eliminating the first class license: pros and cons

- Docket 20817
- Comments due by November 4, 1980
- Replies by December 15, 1980.

The FCC's proposal to eliminate the First Class Radiotelephone operator license for broadcast station technicians is causing the industry to take a fresh look at its technical requirements. Broadcasters are gathering in pro and con camps. One result may be the discontinuation of the First Class License. But the issue of how station managers

will select their technical personnel, and what criteria will be used to judge technical competence is still cloudy.

Major associations—NAB, NRBA, Society for Broadcast Engineers, Association for Broadcast Engineering Standards—are all gathering comments from their members to advise the FCC on this issue.

Some industry views

Some broadcast consultants think the First Class license gives station managers a minimum requirement for hiring engineers, but on the technical side, the exams are not particularly difficult for qualified engineers.

Major associations contacted have no official stands on the issue, but plan to file formal opinions on November 14. However, the following information was gathered from industry sources:

NAB is polling its constituents in efforts to formulate its stand.

NRBA's consultant Harold Kassens of A.D. Ring & Associates, said, "Just because someone holds a first class license doesn't mean an engineer is qualified." Kassens pointed out, as did the FCC, that many people take crash courses to pass the commission's multiple choice examination.

The **Society for Broadcast Engineers** plans to take this issue to its board of directors meeting in early October following the NRBA convention in Los Angeles. Bob Jones, SBE president, thinks the SBE will make its combined membership views known to the FCC as part of its association obligations. Separately, an SBE officer said he opposed abolishment of the First Class license requirement even though his station's management might approve it as a cost savings. Also, the SBE Certification Program might serve as a substitute for first class exams to help station managers find qualified technical personnel.

The **Association for Broadcast Engineering Standards**: Wally Johnson, executive director, expects to make a formal filing.

The FCC action

The commission has proposed discontinuing the issuance of new and renewed First Class Radiotelephone Operator Licenses and eliminating examinations for radio and television broadcast station technicians.

In a further rulemaking notice the commission proposed modifying the rules to allow individuals performing any technical duties at broadcast stations to hold any class of commercial radio operator license, including the Restricted Radiotelephone Operator Permit, and to make station licensees fully responsible

NEW FM AND TV FIELD STRENGTH METER FIM-71

- Accurate — Direct Reading — Volts or dB ■ 45 MHz to 225 MHz — Continuous Tuning ■ Peak or Averaging Detector (switch selectable) ■ Wide or Narrow IF Bandwidth (switch selectable) ■ 20 dB or 60 dB Meter Range (switch selectable) ■ AM or FM Demodulator (switch selectable) ■ Calibrated Dipole Antenna, Mounted on Case for Near-Ground Measurements or Removable for TASO Measurements ■ 140 dB Measurement Range (1 μ V to 10 V) ■ 4½-Inch, Mirrored Scale, Taut-Band Meter
- Front Panel Speaker
- Recorder Output
- Rugged, Portable Package ■ Calibrated Signal Generator, 45 MHz to 225 MHz
- Battery or External Power ■ Use as Signal Source/Selective Voltmeter for Insertion Loss Measurements of Filters, etc. ■ Measures FM Harmonics to -80 dB

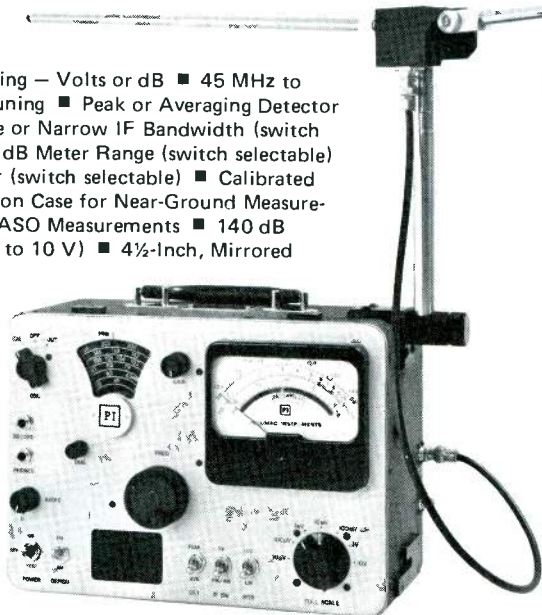

CONTACT US FOR DETAILS.

POTOMAC INSTRUMENTS

932 PHILADELPHIA AVE.
SILVER SPRING, MD. 20910
(301) 589-2662

Circle (44) on Reply Card

Fuji. When your job depends on it.

Video. You use it to make a point.
And a living.

That's why you need Fuji.

Because for networks, independent producers, audiovisual experts and other professionals who depend on us, near-perfect is never good enough.

Whatever the format—2" quad, 1", 3/4" U-matic® or 1/2" VHS or Beta cassettes—Fuji gives you the performance you need to look your best.

That's how we built our reputation for richer, more lifelike color. Clearer, sharper, crisper pictures. Superior consistency and durability. Plus freedom from dropouts, to protect your machines... as well as your reputation.

So, no matter what the job, get the tape that gets the applause. By making you look as good on the hundred-thirty-first playback as you do on the first.

Fuji. The professional tape professionals depend upon.



See us at SMPTE booth numbers 41 and 42

FUJI TAPE

One brand fits all. Better.

Magnetic Tape Division, Fuji Photo Film U.S.A., Inc.
350 Fifth Avenue, New York, New York 10001 (212) 736-3335

Circle (43) on Reply Card

1st class

for determining the competence of their technicians.

This action is part of a larger ongoing proceeding looking into FCC licensing of commercial radio operators in all services, broadcast and nonbroadcast, directed primarily to the radiotelephone operator class of license.

The commission noted there is evidence that the current First Class operator license examination may fail to accurately measure technical competence to install, maintain, repair and supervise operation of AM, FM and TV equipment. However, it is clearly impractical for the commission to test applicants directly on transmitting equipment—ie, to require applicants to make repairs, etc., in the presence of examiners.

The FCC said that even if an effective license examination procedure could be constructed, there appeared to be a number of other forces, especially other commission rules, requirements and potential sanctions, that could render technical operator licensing largely redundant. Also, the commission noted it recently had proposed making random, in-depth investigations of sta-

tions, including field audits that would cover station compliance with technical and nontechnical rules. Because these audits would pressure station licensees to abide by all FCC regulations and provide incentives to hire competent technical staffs, the need for operator licensing might be diminished further.

The FCC noted that because the First Class licensing requirement imposed costs on the commission and broadcast stations, and sometimes inappropriately excluded competent technicians who were not skilled in taking examinations, while providing primarily redundant benefits, it appeared to be in the public interest to eliminate the operator requirements to the maximum extent allowed by the Communications Act.

If the proposed rule modifications were adopted, the commission added, individuals holding First Class licenses would continue to hold them, but upon renewal they would be issued Radiotelephone Second Class license documents.

Further information concerning this Notice of Proposed Rulemaking can be obtained from Roy Kolly or Vernon Wilson, telephone (202) 632-7240, or Charles B. Goldfarb (202) 632-6460, FCC, Washington, DC. However, members of the public

should note that from the time a Notice of Proposed Rulemaking is issued until the matter is no longer subject to commission consideration or court review, the proceeding is governed by the interim policy of the commission on ex parte contacts.

A summary of procedures in the interim policy is available from the Commission's Consumer Assistance Office, FCC, Washington, DC 20554, (202) 632-7000.

Interested persons desiring to submit comments, proposals and recommendations pertaining to the above matter may do so on or before November 14, 1980. Replies to such comments, proposals or recommendations may be submitted on or before December 15, 1980. All relevant and timely filed comments will be considered. □

Write to the FCC, 1919 M Street, NW, Washington, DC 20554 to state your view on the elimination of the First Class license. Address your comments toward FCC Docket 80-481. Do it soon because the review is in early November. Let the FCC know what you think in this important issue.

PROTECT CARRY SHIP PACKAGE

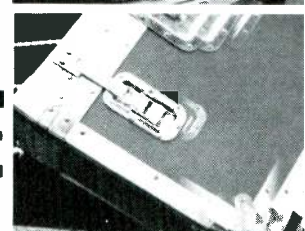
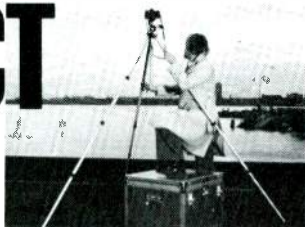

If you're constantly on the move, with no time for repairs, a Fiberbilt case or shipping trunk will protect your equipment and get it there safely...ready to set up and use. Cases and trunks in stock for most A/V equipment. Send for our "Going Places Cases" Catalog G.

Fiberbilt

Ikeheimer-Ernst Inc.
601 West 26th St. New York, N.Y. 10001
(212) 675-5820

Circle (47) on Reply Card

memo to advertisers...

November BROADCAST ENGINEERING will be analyzed for advertising readership and recognition by AD-Q, a division of Harvey Research Organization. We offer this sophisticated analysis as a free service to you. Measure your market impact. Advertising reservations for this analysis issue must be made by October 5. Call your BROADCAST ENGINEERING advertising sales representative TODAY.



BROADCAST

engineering



913/888-4664

FUJINON

ENG/EFP and BCTV lenses...to improve your image.



F/1.7 3.5x6.5 ultra-wide angle zoom



F/1.4
Ultra-wide 6mm



F/1.6 10x11
lightweight zoom



F/1.7
12x9 lightweight
zoom with 2.2X extender



F/1.7 14x9.5 lightweight zoom
with 2X extender



F/1.7 14x9.5 lightweight zoom
with diascope
and 2X extender



F/1.7 17x9 zoom
with built-in
2X extender



F/2 22x12.5 zoom
with built-in
2X extender



10x close-focusing
wide angle zoom



4-range 16X
wide angle zoom



30X twin range
field zoom



14X ultra high resolution zoom,
constant F/2.1 and built-in test
pattern projector and 2X extender

Here's the FUJINON line. With more ENG/EFP lenses than anyone else. All available with studio conversion kits for extra economy. All with adjustable back focus for faster lens changing.

If you want to get in close, consider the new 22X zoom with built-in 2X extender. It gives you F/2 speed with a total range of 12.5 to 550 mm. If you're already in close, use the unique F/1.4 6 mm ultra wide angle distortion-free lens. It

gives you a "0" MOD with a 70° horizontal field of view.

For studio and field productions, FUJINON BCTV lenses are now offered with built-in test pattern projectors for the fastest, most accurate computerized camera set up. (Not available on 10X wide angle zoom.)

For maximum definition, the new 14X ultra high resolution lens reads 1300 TV lines and maintains a fast F/2.1 in all zoom and focus ranges.

Quality, performance and service make FUJINON best. Camera manufacturers, networks, stations and production companies around the world have made FUJINON first. Before you buy any camera from any manufacturer or replace any lenses on your existing cameras, see the difference for yourself. Specify FUJINON. It will improve your image.

Circle (45) on Reply Card



Fujinon Optical Inc. 
672 White Plains Road
Scarsdale, New York 10583
(914) 472-9800

West Coast Distributor
FUJI OPTICAL SYSTEMS INC.
4855 Atherton Avenue
San Jose, California 95130
(408) 866-5466

See FUJINON at SMPTE Booth 253.

An Automatic Camera Viewfinder Switcher

By Jack Hastings, chief engineer, WMAR-TV2, Baltimore, MD

Many television stations use the auxiliary input to the studio camera viewfinder to display the effects generator picture to the cameraman. When there is only one effect, this is simple. It gets a bit difficult when there are two or three effects plus a quad split generator. Any manual system for switching the picture to the viewfinder results in an already overworked switcher having more work to do or the cameraman having to know which effects he is programmed on if he does the switching. He also must step through all the effects he is not on to arrive at the one he is on. In a fast moving show this is impractical. What is needed is a system that will

sense what effects the camera is programmed on and automatically send that effects picture to the viewfinder. This article describes a system that was developed for a Grass Valley 1600-7K switcher with three effects and a quad splitter.

The problem with an automatic system when there is more than one effects bus is that it has no way of knowing which bus to switch on if the camera was programmed on more than one bus. The solution was to have a logic system decide on the basis of an order of importance. The Grass Valley 1600-7K switcher has three effects buses, a quad split and preset and take bus. The order of importance is

shown in the chart of Figure 1. The sensing circuit is shown in Figure 2. The tally lamp bus idles at +4V. The Grass Valley instruction manual says that when the switcher button is pressed, the low side of the tally lamp goes to -5V. The lamp then has 9V across it and lights at low intensity. When the camera goes on the air, the high side goes to +9V and the lamp lights brightly. It was found that at the lamp, where the sensing circuit was connected, the low side voltage actually went to -2.75V or -3.75V depending on the bus, which would make an undependable logic level.

The circuit of Figure 2 takes care of the problem. When the lamp is

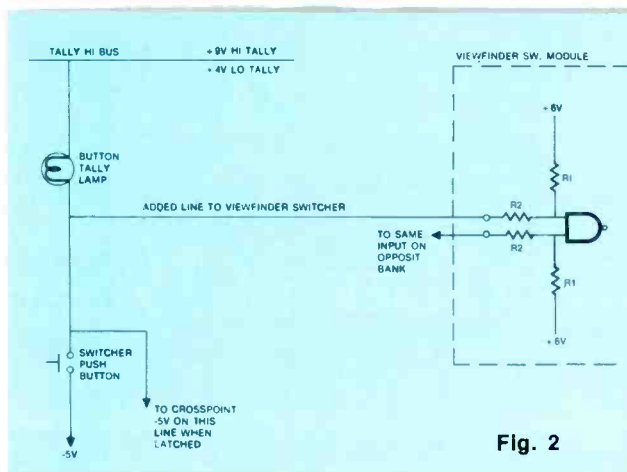

Fig. 2

The Galaxy... Variable Speed, DC Servo Turntable.

THE QRK Galaxy is the result of more than 36 years experience in turntable manufacturing, combined with the latest electronic technology. Compare these outstanding features:

- LED speed readout
- Slip cueing with no RPM loss
- Instant start-1/16 turn
- Adjustable speed control
- Back cueing with no motor drag
- Low rumble, wow & flutter



For more information, contact your local QRK/Broadcast Electronics distributor.

a FILMWAYS company

BE BROADCAST ELECTRONICS INC.

4100 N. 24th STREET, P.O. BOX 3606, QUINCY, IL. 62301, (217) 224-9600, TELEX: 25-0142

| Setup | Viewfinder will get |
|---|---------------------|
| Quad on Pgm/Pst and camera on Eff. 1 or 2 | Quad |
| Eff. 3 on Pgm/Pst and camera on Eff. 3 | Eff. 3 |
| Eff. 2 on Pgm/Pst and camera on Eff. 2 | Eff. 2 |
| Eff. 1 on Pgm/Pst and camera on Eff. 1 | Eff. 1 |
| Quad on Preset and camera on Eff. 1 or 2 | Quad |
| Quad on Eff. 3 and camera on Eff. 1 or 2 | Eff. 3 |
| Eff. 2 on Eff. 3 and camera on Eff. 2 | Eff. 3 |
| Eff. 1 on Eff. 2 and camera on Eff. 1 | Eff. 2 |
| camera on Eff. 3 | Eff. 3 |
| camera on Eff. 2 | Eff. 2 |
| camera on Eff. 1 | Eff. 1 |

Fig. 1

The order of importance increases from bottom to top, so if the camera is programmed on more than one effect the system will switch on the higher priority and block all others below it. The switcher should avoid having the camera programmed on two different effects. If it is desirable to have the camera programmed on two different effects because they are to be used in sequence, make sure that the higher order setup goes first.

U1,U2,U3,U4,U5,U6.-CD4011
 U7,U8,U9,U17,CD4001
 U10,U11.-CD4071B
 U12-CD4072B
 U13-CD4066
 U14-CD4050
 U15-VOID
 U16-CD4073B

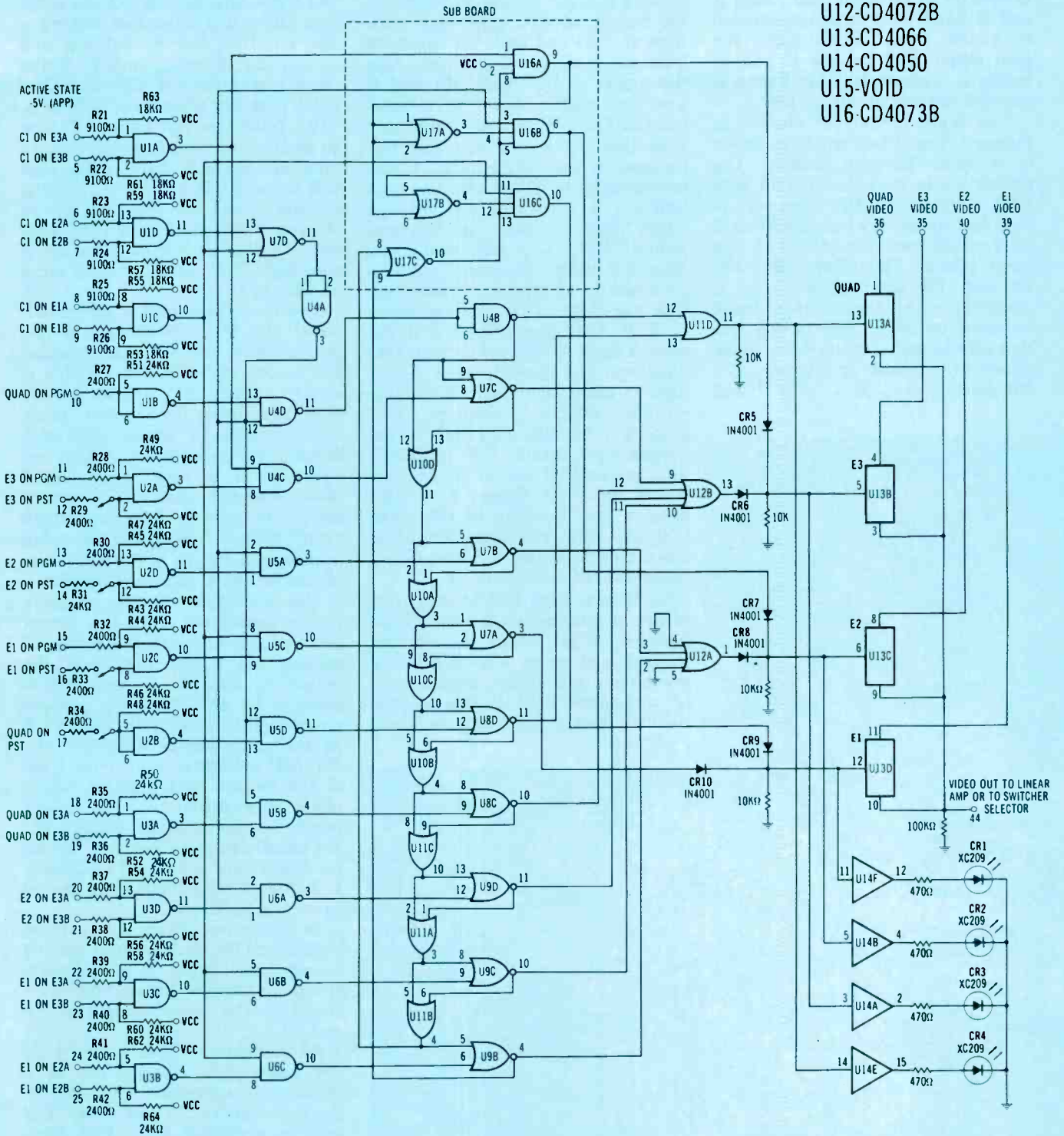

Fig. 3

Camera viewfinders

not lit, the gate sees a high due to the pullup resistor and the low side of the tally lamp, which is floating at +4V. When the lamp is lit, the low side of the tally lamp goes toward -5V. R1 and R2 are chosen to give 0V at the gate input. Both A and B bank buttons are connected to a dual input NAND gate. The gate output will be low if neither button is pressed. If either button is pressed the output will go high.

The logic circuit is shown in Figure 3. The video switching device is a quad bilateral switch. The circuit works as follows: NOR gate U7D detects if the camera is switched up on any bus of effects 1 or 2 which are the inputs to the quad effects. The other gates U4, U5 and U6 are activated by a combination of the camera being switched up on an effects bus and that effects switched up on another effects or on preset or program. The OR gates U10-A, B, C and D and

U11-A, B and C are used to shut off all lower ranking combinations.

Circuit operation

An example of circuit operation is as follows: Given the camera is switched up on A bank of Effects 1, and Effects 1 is switched up on Effects 2. At the same time quad is switched up on Effects 3. Since the camera is programmed on Effects 1, the output of U1C goes high and, through U7D and U4A, the inputs to U4D and U5B and D go high. Also the inputs to U5C and U6B and C are also high. Effects 1 is programmed on Effects 2 so U3B output goes high; U6C output now goes low because of two input highs. If the second input to U9B is also low then U9B out will go high and through U12A place a high on bilateral switch U13C. This will switch on Effects 2 video. However, quad is switched up on Effects 3. Therefore, U3A goes high. This puts two highs on U5B. U5B goes low, and if the second input to U8C is low then U8C goes high and through U12B puts a high on bilateral switch U13B. This switches Effects 3 video on. U8C going high has placed a high on the second input of U9D, U9C and U9B. This forces U9B output to go low, which turns off Effects 2. In like manner the IC chain of OR gates U10 and U11 will pass the highs down the chain and will shut off all lesser-ranked combinations.

So far we have had at least two pieces of information for each logic decision. What about the camera programmed on an effects bus and the effects bus is not programmed on any other bus? If this is true then the end of the OR gate chain

U10 and U11 will be low. This information can be used in a smaller logic circuit. A low at the end of the chain will place a high through U17C to the third input of U16A, B, C AND gates. If the camera is programmed on all three effects then number one input of U16A is high and U16A out goes high. This high is coupled to U13B and turns Effects 3 on. At the same time U17A and B go low forcing a low on 16B and C outputs and turning off Effects 2 and 1. If the camera is cleared off Effects 3 then U16A goes low shutting off Effects 3. U16A going low will cause U17A to go high. U16B will then go high to turn on Effects 2. U16B going high will cause U17B to go low, keeping Effects 1 off. If the camera is cleared off Effects 2 then U16B goes low, shutting off Effects 2 and U17B goes high. U16C goes high and turns on Effects 1.

The four video inputs are terminated and then distributed to like pins on each camera logic module. The output of the bilateral switch is sent to a linear IC wired as a unity gain line driver which then feeds the viewfinder or, in the case of a camera working with more than one switcher, it is sent to a second bilateral switch selector. This selector can be used to determine which switch output. A sketch of this setup is shown in Figure 5; the amplifier, shown in Fig. 4, uses a CA 3029A.

The switches on the sensing inputs associated with the preset bus are for the purpose of disconnecting the preset bus from the system in case the preset bus is going to be used for some purpose not related to on-air switching, such as switching studio monitors, etc. The LED indicators are on the front of the module and indicate which effect is switched on. All sensing points, except the six marked C1, are paralleled to all boards. The six marked C1 are connected to Camera 1, 2, 3 or 4 tallies depending on the camera logic board.

To summarize, there is a camera logic board for each camera feeding a switcher. There is a separate group of camera boards for each switcher. The power supply is +6 and -6V.

All switcher camera button tally low sides were brought out to a Winchester connector and sent to the logic unit via 23 pair cable. The unit is arranged in a Bud logic board nest with power supply, four camera boards for switcher A, four boards for switcher B and a switcher selector board. A third switcher with single effects is also fed into the selector board. □

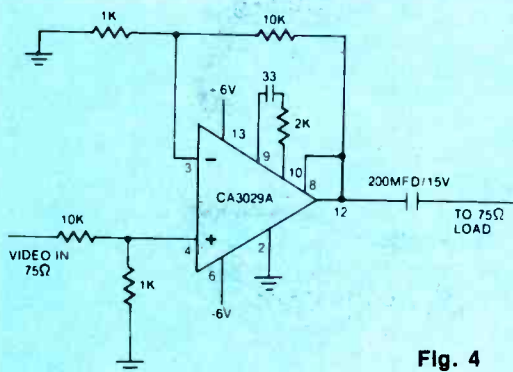

Fig. 4

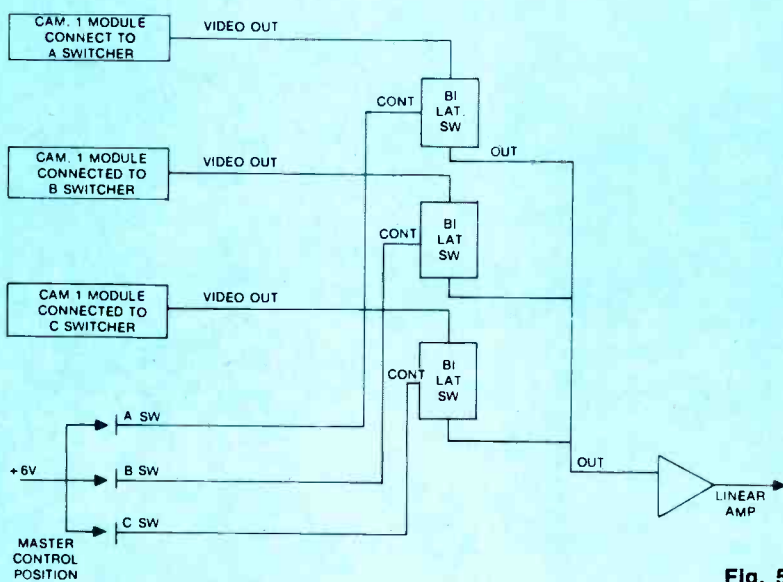

Fig. 5

QUANTAFONT™

Teleproduction Graphic Titlers

The unique microcomputer technology that enables self-contained, high performance titling at affordable costs.

SEE US AT SMPTE BOOTH NO. 179



Q-7A

- Proportional characters and spacing with NANOLOG 20 nsec resolution*
- 16 resident fonts from 8 to 64 raster lines high
- Colorized characters and backgrounds
- Full border and shadow edge selections
- Extensive composition and editing functions
- 10, 16-row page resident memory with memory protect battery
- Roll, crawl and flash with 2-speed control
- And more



Q-VII

- 3 resident fonts with 20 selectable display sizes of all fonts
- NANOLOG 20 nsec resolution*
- Colorized characters and backgrounds
- Full border and shadow edge selections
- 12, 16-row page resident memory with memory protect battery
- Extensive composition and editing functions
- Roll, crawl and flash with 2-speed control
- And more

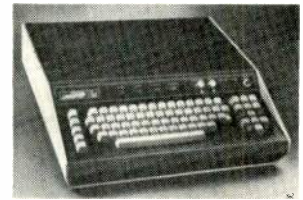

Q-VI

- 24 character sizes selectable by row
- Upper and lower case font of capital letters
- Character resolution up to 32 horizontal pixels
- Color backgrounds and graphic separators
- Extensive composition and editing functions
- 12, 16-row page resident memory with memory protect battery
- Roll, crawl and flash with 2-speed control
- And more
- Monochrome only (Q-VI/A)



Q-V

- 12 character sizes selectable by row
- Upper and lower case font of capital letters
- Character resolution up to 32 horizontal pixels
- 12, 16-row page resident memory
- Random access to 48 resident positionable titles
- Vertical title positioning at any raster location
- Roll, crawl and flash
- Mini-cassette extended memory — optional
- And more

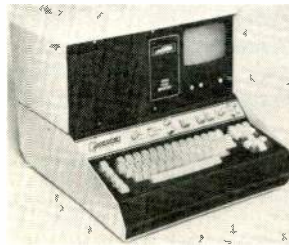

Flexible Disc Memory Accessories

- Single or dual mini-disc storage systems
- 100, 16-row pages per disc
- Random or sequential page access of less than .5 seconds
- Data block of titler resident memory per disc
- Memory console can accommodate 6-inch monitor



Digital Cassette Memory Accessories

- High speed computer grade cassette tape systems
- Block load storage of entire resident memory
- **Top mounting** console with or without 6-inch monitor
- **Self standing** style coordinated tape transport only

QST Sub Titling System

- Incorporates all of the Q-7A composing and display capabilities for self-contained, automatic sub-titling. Interfaces directly to audio or TTL level EBU/SMPTE time code.
- Full function titler for entry of translated text
 - Automatic disc indexing
 - Flexible title editing
 - Off-air edit and control display

Q-VI/M Automatic Mass Memory Display

- Programmable control over a digital cassette mass memory
- Over 3,000 rows — 400 pages, typical
- All display capabilities of Q-VI titler available for automatic recall

International Alphabets

- Accented international alphabets available for all titling systems



Mini-Cassette Digital Tape Transport

- **On board** mini-cassette digital tape extended memory — Q-V only
- Block load storage of resident memory on each side of mini-cassette

SYSTEM CONCEPTS
To Be Letter Perfect

System Concepts, Inc.
395 Ironwood Drive
Salt Lake City, Utah 84115
Phone: (801) 486-3833
TWX: 910-925-5684

Eastern Corporate Office and
System Concepts International
16006 Waterloo Road
Cleveland, Ohio 44110
Phone: (216) 692-3410
TWX: 810-421-8192

*Effective average start-point resolution with patent pending NANOLOG™ circuit.

Circle (49) on Reply Card

October 1980 *Broadcast Engineering* 65

Hancock named president of Intertec Publishing

The appointment of R.J. Hancock as president of Intertec Publishing Corporation, publishers of **Broadcast Engineering**, **Video Systems**, **Radio y Television** and **Electronic Servicing** magazines, among others, was announced in August by David S. Davidson, director—operations, consumer services, publishing and home products for ITT.

Hancock joined Intertec in 1960 and had been executive vice president since 1979. He succeeds George H. Seferovich, who retired after 32 years with the company.

Previously, Hancock was publisher of Intertec's Landscaping Group of magazines and advertising sales manager for various Intertec publications, including **Broadcast Engineering**.

He received a bachelor of science degree in advertising from Oklahoma State University.

Seferovich's positions with Intertec had included that of editorial



Jack Hancock (left) with former president George Seferovich.

director of **Broadcast Engineering** and **Electronic Servicing** magazines. He created several other publications, including **Video Systems** magazine.

BE staff expands

Kevin Kious has been named managing editor for Intertec Publishing Corporation's Electronic Group magazines, **Broadcast Engineering**, **Radio y Television**, **Video Systems** and **Electronic Servicing**, it was announced in July by George Laughead, group publisher.

A graduate of the University of Kansas School of Journalism, where he was editor of the 18,000-circulation daily student newspaper, Kious most recently was news editor of **Boxoffice**, a national weekly business publication for the motion picture industry.

Previously, he worked for the **Oakland Press**, a daily newspaper in Pontiac, MI.

Control Video expands

Control Video has moved its headquarters from Sunnyvale to Campbell, CA. The move was prompted by the needs of an expanding manufacturing operation. The company manufactures a line of software-based, micro-processor-controlled SMPTE readers, writers and VTR controllers.

AM and FM transmitter line

J. O. Weldon, president of Continental Electronics, Dallas, has announced the company's plan to expand its current line of radio broadcast equipment with the addition of both AM and FM transmitters, along with mono and stereo studio consoles and related equipment.

VIDEO SLATE BOARD WITH BUILT-IN CHARACTER GENERATOR

Now you can generate a count-down for ENG editing and film-to-tape transfers without tying up a camera.

- 3 pages for full screen information. (archive filing of tapes or to review tape content)
- plus 10 thru -1 second count-down.
- plus 2 pages of black.
- plus ready page.
- plus audio output on each second.
- plus three colors.

BEI P.O. Box 106A
Olathe, Kansas 66061
(913) 764-1900

Circle (50) on Reply Card

STL Offers The Most
Complete Selection
Of Test Tapes
Available Anywhere

STL can serve all your needs with precision test tapes for frequency alignment, level set, azimuth set, flutter & speed tests, sweep frequency tests and pink noise analysis. Also available is the Standard Tape Manual & the Magnetic Tape Reproducer Calibrator.

Phone for fast delivery or free catalog

STL
STANDARD TAPE LABORATORY, INC.
26120 EDEN LANDING ROAD #5, HAYWARD, CALIFORNIA 94545 • (415) 786-3546

Circle (51) on Reply Card

Portable Studio Quality. BCN-KCA

50 **BOSCH**
FERNSEH
1929-1979



The first portable studio quality recording system with reels and cassettes. 1 inch type B format according to SMPTE/EBU operating in all TV standards throughout the world. Full compatibility in the most extreme environmental conditions. Battery powered, self contained units: Cassette version BCN 5, reel to reel version BCN 20, compact light weight system camera KCA. The advanced and economical equipment for electronic news and field production. From Bosch.

BOSCH
Television Systems Division
Your Video System Partner

FERNSEH Inc.
The Video Corporation of
Bell & Howell and Robert Bosch

Robert Bosch GmbH, P.O.B. 429, D-6100 Darmstadt, Fed. Rep. of Germany * Fernseh Inc., P.O.B. 15068, Salt Lake City, Utah 84115, U.S.A. Phone (801) 972-8000, Telex TV 388352
Robert Bosch Ltd., P.O.B. 166, Watford, Great Britain - Robert Bosch Pty. Ltd., 69 Edward Street, Pyrmont, NSW 2009, Australia - Robert Bosch Pte. Ltd., P.O.B. 4, Thomson Rd., Singapore 20.

Business news

Continental's transmitter product line will be enlarged to include 1kW through 50kW AM transmitters and 1kW through 50kW FM transmitters.

The new line was available October 1. The change is a result of Continental's recent purchase of Collins Broadcast Products, and license to manufacture same, from Rockwell International.

New business

Canter-Redman Technologies is announcing the opening of its electronic engineering and consulting company at 321 West 44th St., in New York. Canter-Redman experience is in the audio and video fields, concentrating on prototype development and specialized audio and video equipment.

Designers see AVA in action

A public demonstration of the Ampex Video Art system for television graphic artists and operators was held at the Montreal convention of the Broadcast Designers' Association.

Ampex engineers and graphic artists from KTVU-TV, Oakland,

CA, and the Canadian Broadcasting Corporation provided the broadcast designers with extensive demonstrations and operational workshops on the AVA system during the four-day meeting.

Merger

The stockholders and officers of Allison Research, Valley Audio and Valley People announced the completion of negotiations to merge.

The operation will be known as Valley People Inc.

Norman Baker has been named president of the combined corporations. Baker has served in the capacity of vice president/general manager of Allison Research for the past four years, and will be responsible for executing the administrative affairs of Valley People. Bob Todrank, founder and past president of Valley Audio, was named executive vice president, and will primarily be in charge of marketing operations and studio consultation. Gary Carrelli will retain his title as a vice president of Valley People and will coordinate systems engineering, installations and repair/maintenance services. Paul C. Buff, founder and past president of Allison Research, will be named a vice president.

Concurrent with the merger, the formation of a satellite corporation dedicated specifically to new product development will be named Paul C. Buff, Inc.

Satellite television corporation formed

COMSAT General Corporation announced formation of a subsidiary, Satellite Television Corporation, as its vehicle to pursue the development and offering of a satellite-to-home subscription television service. The proposed service would offer multiple channels of entertainment and information to US consumers for a monthly subscription fee, and would supplement existing commercial television service available to American viewers.

Quantum Audio Labs acquires Audio Logic

Quantum Audio Labs has acquired Audio Logic. Audio Logic's operation will be consolidated into the Quantum Audio Labs' factory facility in Glendale, CA.

Sales and service for both product lines will be handled out of the Glendale facility; Audio Logic will operate as a wholly owned subsidi-

Ready to go...

CHYRONI[®] RGU-1

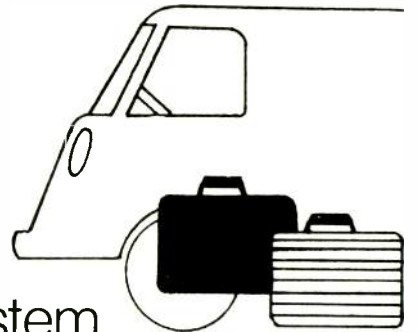

The portable graphics and titling system...

packaged to travel, to go where you go, as well as for in-house operation. Ingenious. Incorporating many features of the matchless **CHYRON IV**.

From CHYRON — the electronic graphics people.

CHYRONI TELESYSTEMS DIVISION OF CHYRON CORPORATION

265 Bethpage-Spagnoli Road, Melville, New York 11747

Telephone: (516) 249-3296 ■ Telex: 144522 CHYRON MELV

Ampex International is exclusive distributor for Chyron Graphics Systems outside the U.S.A. For information contact your nearest Ampex sales office.

SEE US AT SMPTE BOOTH NO. 11

Circle (53) on Reply Card

ary of Quantum Audio Labs, Inc. Audio Logic's product line includes the Discorama professional disco mixing console and specialized signal processing and monitoring equipment and will include expansion into advanced live music mixing systems.

ProTech Audio moves

ProTech Audio, formerly of Lake Ronkonkoma, NY, has moved to new headquarters, in the Flowerfield Industrial Park, on the North Shore of Long Island. The new address and phone number are: Flowerfield Bldg. #1, St. James, NY 11780 (516) 584-5855.

California Microwave acquires satellite transmission systems

California Microwave announced it has completed the acquisition of Satellite Transmission Systems, a New York supplier of turnkey digital satellite earth stations.

California Microwave acquired the remaining 80% interest in STS by purchasing 800,000 outstanding shares for an initial payment of \$2.3 million (\$1.7 million cash and 44,276 shares). Two additional payments will be made, based on STS pre-tax earnings in 1981 and 1982.

Each additional payment, which in no event will exceed the initial payment, may be made wholly or partially with common shares.

Audio Plus Video International acquires Worldwide Video Services

Audio Plus Video International has acquired Worldwide Video Services, which for the past two years has served as the marketing and sales representative for Audio Plus Video in the United States.

Under the new arrangement, WVSI will operate as a wholly owned subsidiary of Audio Plus Video.

Broadcast Electronics acquires QRK

Broadcast Electronics has relocated the manufacture of the entire line of QRK broadcast studio equipment from Fresno, CA, to its expanded Quincy plant. The QRK product line, recently acquired by Broadcast Electronics, includes 12-inch and 16-inch professional turntables, Rek-O-Kut tone arms, pre-amplifiers and audio consoles used by broadcasting stations and recording studios.

Construction has been completed of a 20,000 square foot addition to the Broadcast Electronics' Quincy plant, which was planned to accommodate the QRK product line as well as to provide additional space for manufacture of BE's new line of FM transmitters.

Ampex, Konishiroku form joint magnetic tape venture

Ampex Corporation and Konishiroku Photo Industry Co. Ltd. announced signing a joint agreement to begin marketing consumer video and audiotape in Japan.

Under the agreement, consumer video and audiotape will be marketed in Japan under the brand name "Magnax" by the end of 1980. Initially, products to be marketed in Japan will be manufactured at Ampex's Opelika, AL, facility. Manufacturing for this joint venture in a new facility near Tokyo will begin in September 1981 and is scheduled to be fully integrated a year later.

A. F. Associates represents Marconi Broadcast Products

A. F. Associates Inc. announced it has signed an agreement with Marconi Electronics Inc. appointing

REPLACEMENT TRANSFORMERS FOR GATES, COLLINS, RCA, ETC.



| | |
|--------------------------------------|--------|
| GATES PLATE TRANSFORMERS | |
| FM-250 | \$175 |
| FM-1B | \$400 |
| BC1E/F | \$350 |
| BC1G/H | \$350 |
| BC1T | \$350 |
| BC5P | \$1050 |
| GATES MODULATION TRANSFORMERS | |
| BC1 SERIES | \$400 |
| BC5 SERIES | \$1000 |
| GATES MODULATION REACTORS | |
| BC1 SERIES | |
| (40 HY @ 0.6 ADC) | \$400 |
| BC5 SERIES | |
| (35 HY @ 1.4 ADC) | \$600 |
| DC FILTER CHOKES | |
| 5.0 HY @ 1.0 ADC | |
| (REPLACES BE-0572) | \$175 |
| 5.0 HY @ 2.0 ADC | \$225 |
| 8.0 HY @ 1.5 ADC | \$200 |
| 10.0 HY @ 1.0 ADC | \$200 |
| MISCELLANEOUS | |
| RCA BTA 1R/S TRANSFORMER | \$400 |
| VANGUARD 1 PLATE TRANSFORMER | \$450 |
| COLLINS 20V2 PLATE TRANSFORMER | \$350 |

MANY OTHER TRANSFORMERS ALSO AVAILABLE. CALL US FOR FREE QUOTATIONS. LARGE STOCK AND FAST DELIVERY.

24 MONTH GUARANTEE ON ALL ITEMS

Peter W. Dahl Co.

4007 Fort Blvd. • El Paso, Texas 79930

Telephone (915) 566-5365

Circle (55) on Reply Card

The Professionals

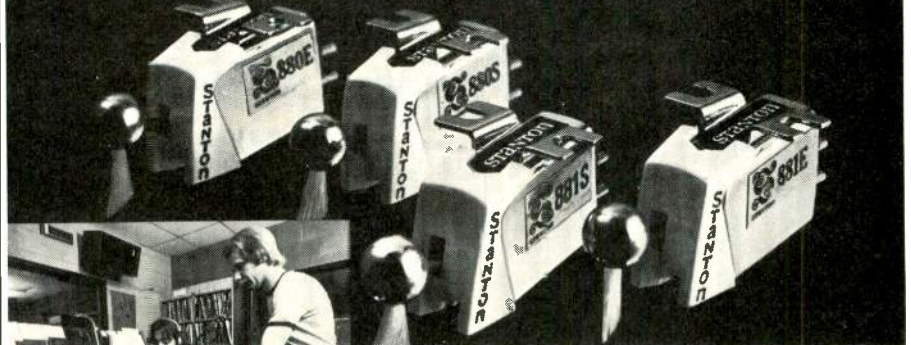

A complete new line of cartridges built to the exacting standards of professional requirements...

The famous Stanton 881S set a new standard of performance for world professionals and audiophiles alike. Now built to the same careful standards, Stanton introduces three new cartridges—881E, 880S and 880E. The 881E includes the calibrated perfection of the 881S but with an elliptical stylus. The 880S and 880E maintain the same high standards of performance, in applications where calibration is not of prime importance.

The "Professionals" a series of four cartridges featuring all the famous Stanton performance features at different price levels, designed for every budget requirement.

For further information write to Stanton Magnetics Inc., Terminal Drive, Plainview, N.Y. 11803

STANTON
THE CHOICE OF THE PROFESSIONALS™

Circle (54) on Reply Card

more than
360° phase
 more than
200 ft.coax
 inside this box



Infinitely adjustable Delay Unit makes trimming coax obsolete.

The UN360 is the modern MATTHEY way to time Studios/Remote Trucks/Video Equipments.

No Equalisers needed for Video use, they are already built inside.

Data from—



BILL PEGLER

Tel: 914-763-8893

Television Equipment Associates

Box 260, South Salem, N.Y. 10590

Circle (56) on Reply Card

A. F. Associates as the exclusive sales representative for all Marconi broadcast studio products. The agreement is limited to the continental United States. Under the terms of the agreement, A. F. Associates will be responsible for the sale, installation and servicing of the 1-inch C format VTR as well as accessories, cameras and standards conversion equipment.

Name change

Newsmaking International has changed its name to Dateline Communications. The address remains 1255 Lincoln Blvd., Suite 300, Santa Monica, CA 90401, (213) 393-9494.

Expanded multi-track capacity

Buzzy's Recording Services of Los Angeles is currently installing 45 channels of dbx Model 208 noise reduction equipment to supplement and update its multi-track capacity.

Dbx tape noise reduction is a linear-decibel system. It does not require critical level-matching for accurate compression/expansion tracking.

Rees Associates moves

Rees Associates Inc., architects, planners, consultants, moved to a new location June 20th. The new address is the Magnolia Building at Northwest 7th and Broadway in Oklahoma City.

RCA Americom relocates

RCA American Communications has relocated its executive, administrative and engineering offices to a new headquarters building in Princeton Forrestal Center, Princeton, NJ. The move was made less than a year after groundbreaking ceremonies were held on the company's 7.5-acre building site. The new address is 400 College Road East, Princeton, NJ 08540, telephone (609) 734-4000. □

Put your
 money where
 your Heart is.



SPECIFY

SILVERCEL BATTERIES

by **Yardney**

- Ideal For Electronic News Gathering ...Cameras And VTR Equipment
- 3 Times The Power...Much Less Weight

The accepted standard of excellence, Yardney Silvercels are LIGHTER but MORE POWERFUL. Many more running hours are built into Silvercels than any other system of comparable size and weight.

QUICK CHARGE when needed without battery damage. No discharge memory problems. Your camera will never be out-of-service because of charging problems.

Selected by original camera manufacturers and in demand as replacement batteries everywhere. Write for catalog.

Yardney
 ELECTRIC CORPORATION

82 Mechanic Street
 Pawcatuck, Connecticut 06379
 (203) 599-1100

Follow
 the
 Network Leaders

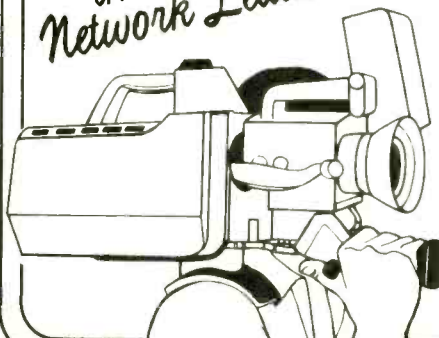

Circle (57) on Reply Card

people in the news

One of the electronics industry's highest forms of recognition was presented to **Charles W. (Charlie) Rhodes**, chief engineer, television products, Tektronix Inc., when he was named a Fellow of the Institute of Electrical and Electronics Engineer Inc. (IEEE).

Fernseh Inc., the new video corporation formed by Bell & Howell and Robert Bosch, has announced the appointment of **Dietmar Zieger** as vice president, marketing and product management. Zieger will be responsible for all activities related to the commercial marketing group.

Charles F. Rockhill has been appointed marketing manager of Moseley Associates Inc. Rockhill most recently was with Drake-Chenault, Canoga Park, CA, as western regional sales manager.

KSDK, Channel 5, St. Louis, MO, has announced the addition of three to its engineering staff: **Jon King**, from WTVG-TV, Toledo, OH; **Robin Nunnally**, from KRCG-TV, Jefferson City, MO; and **Jim Jackson**, from KWK Radio, St. Louis.

Bernard Lechner of RCA Laboratories has been named chairman of the broadcast television systems teletext subcommittee. Lechner succeeds **Robert A. O'Connor**, CBS Television Network, who resigned as subcommittee chairman.

James M. Brown, marketing manager of Cohu, Electronics Division, announced that **Albert L. Zoller** has been appointed Southeastern United States regional sales engineer for the San Diego television camera system manufacturer.

W. H. "Bill" Borman has been named national sales manager at the ADDA Corporation, Campbell, CA. He was formerly product manager at the Ampex Corporation and before that was OEM sales manager for the Computer Media Division at Memorex.

Jerry Fontenot has been named product manager at the Orrox Corporation. He will be responsible for The Edge, the company's new medium-priced computer-assisted editing system.

Herbert P. Michels of Livingston, NJ, has been named director of engineering at New Jersey Public Television. Before joining NJPTV, Michels was an engineering consultant to several clients, including Time Inc., on matters involving CATV, and broadcast and general communications while participating as part owner/manager of Standard Broadcast Station.

Kimiyasu Kobayashi has assumed the office of president of Toshiba America Inc., Wayne, NJ. He succeeds **Motoo Shinjo**.

Malrite Broadcasting Company has announced a major organizational restructuring in the Cleveland-based communications company. **Gil Rosenwald**, current vice president and general manager of WHK/WMMS, Cleveland, was named vice president-group operations, Malrite Broadcasting. **Bill Jenkins**, currently regional vice president responsible for North Carolina Operations (WCTI-TV and Outer Banks Cablevision), will also assume responsibility of

Perfect Timing

If You've Wanted To Put Time Code On Your Tape, But Can't Afford The High Cost Of SMPTE:

The ES 280 TIME CODE
GENERATOR/READER Is For You!

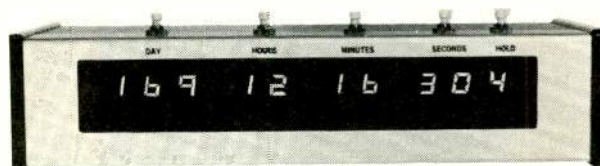

The new, low-cost way to provide time information on all your tapes, **ES 280** generates a time code which includes DAYS, HOURS, MINUTES, SECONDS AND TENTHS OF SECONDS.

With the flip of a switch, **ES 280** becomes a reader, to locate that certain place on the tape.

An Amplitude Control knob is located on the rear, so that you can use the 280 with *any* recorder, Video or Audio.

The 280 uses tones that are compatible with the cue tones used in cartridge recording.

ES 280 COSTS \$500.00

ES 281 (READER ONLY) \$375.00

Contact us or one of our dealers, and we'll tell you how you can get your own 280.



(213) 322-2136
142 SIERRA STREET • EL SEGUNDO, CA 90245

WILKINSON ELECTRONICS

AM-250SS SOLID STATE 250 WATT AM TRANSMITTER

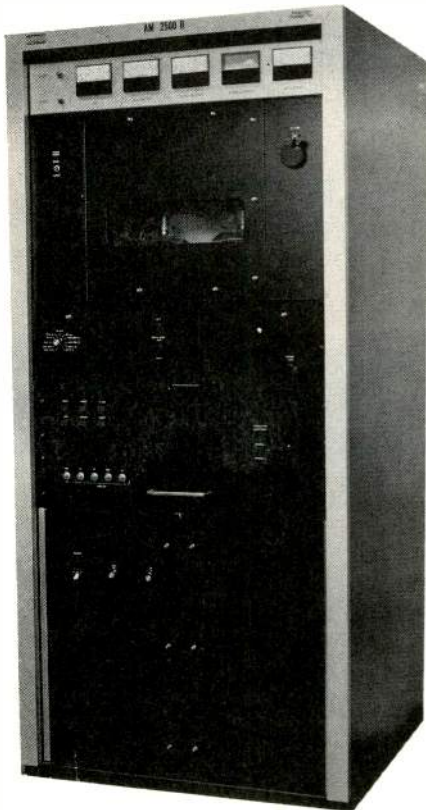

FEATURES

- Not Susceptible To Reacting Loads
- Low Operating Cost - Extreme Efficiency
- Drawer Construction - Extreme Accessibility
- Expandable - Combine two for 500 Watts
- Available at 125 Watts or Less
- Power Flexible - 115 or 220 volts AC
- 125% Modulation Capability
- Exceeds U.S. FCC Specifications

The Wilkinson Electronics AM-250SS is an all solid state 250 watt Am transmitter housed in an attractive 24 inch cabinet, 52 inches in height. All components are mounted in two drawers for maximum accessibility and ease of maintenance. Space is available in the cabinet for a second transmitter making it possible to combine two 250 watt units to obtain 500 watts. It is also available at any power below 250 watts at a reduced price.

WILKINSON
ELECTRONICS, INC.

701 CHESTNUT ST. • BOX 738
TRAINER, PA. 19013 • TELEPHONE (215) 497-5100
TWX 510-669-3188 CABLES: WILEC WILEC CHR

Circle (70) on Reply Card

72 Broadcast Engineering October 1980

People in the news

Malrite's new television property, WFLX-TV in West Palm Beach, FL. **Murray Green**, currently vice president and general manager of WNYR/WEZO and director of Rochester operations, was named regional vice president of WNYR/WEZO/WUHF-TV and Malrite Television Productions, Rochester, NY. **Doug Brown**, vice president and general manager of KEEY-AM/FM, Minneapolis/St. Paul, has been named regional vice president of KEEY-AM/FM and WZUU-AM/FM, Milwaukee.

Mike Goddard has accepted a position as national sales manager at the Control Video Corporation. His responsibilities include developing a sales strategy and setting up dealerships for the company's recently introduced line of SMPTE readers, writers and VTR controllers.

Hitachi Denshi America announced that **Jerry Brinnacombe**, currently Cincinnati regional manager, is to become Midwest regional manager. Replacing Brinnacombe is **Skip McWilliams**. McWilliams was previously with Klopf Audio Video in the position of field sales manager and before Klopf was with JVC as district manager for the Ohio territory.

Otari has appointed **Michael Pappas** to the newly created position of field sales engineer, broadcast industrial sales specialties. □

QUICK CONNECTIONS

Specify Lemo when ease of connection and disconnection is essential. To engage and lock, push straight in. To unlock and disengage, pull straight out. Simple!

Superb design and workmanship, ruggedness, miniature size and high density mounting,



LEMO USA INC

P.O. BOX 6626, SANTA ROSA, CA 95406 • 707/523-0600

Circle (60) on Reply Card

new products

Lighting control system

A compact microprocessor-based lighting control system, Colortrack, has been introduced by Berkey Colortran. The lighting control system is designed for use in television studio, theatrical and trouping applications. It features control of 96 dimmer channels and incorporates a color-coded CRT display that is color-coordinated with the operator's control keyboard for easy operation.

Circle (80) on Reply Card

Spectrum analyzer

A new spectrum analyzer, TF2371, has been introduced by Marconi In-

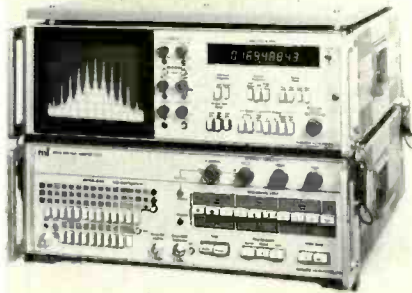

struments. The analyzer retains all the features of the TF2370 but extends the frequency range up to 200MHz.

Circle (82) on Reply Card

Frequency counter

The model 5612 frequency counter's sensitivity is typically 10mV-15mV over a range from 100Hz to 250MHz and 15mV to 50mV up into the 450MHz region.

Circle (81) on Reply Card



It is encased in a molded cabinet. Its combination carrying handle-stand can be positioned at various angles to facilitate readability and portability. Accuracy meets all FCC regulation requirements for broadcast, land-mobile, RF and telecommunications.

Circle (83) on Reply Card

Voltage suppressors

A new line of HDA Power Master transient voltage suppressors is available from W.N. Phillips. The Power Master dissipates destructive electrical transients produced by induced lightning, changing loads, switching SCR drive system, and cycling operation of most electrical equipment.

Circle (84) on Reply Card

AUDIO MIXER

Sale

*** 50 DOLLARS OFF!!**

Act Fast and Save half a hundred on that deluxe Russco Audio Mixer you always wanted! Order Now, offer expires Dec. 31st. Net 30 days to qualify.

| | |
|---|---------------------|
| STUDIO/MASTER 505 | SALE \$990 |
| 5 channel mono mixer, 4 channels w built-in preamps, 5th channel accepts 5 inputs on switches...Super! Table or rack mount. | |
| STUDIO/MASTER 505S | SALE \$1440. |
| 5 channel + Stereo mixer, built in monitor amp, cue switches on any channel...More! Table or rack mount. | |
| DISCO 421 REMOTE | SALE \$600. |
| Lightweight, super small 4 channel mixer (2 stereo) solid state, perfect for home recording/remotes. | |

RUSSCO

5690 E. SHIELDS AVE., FRESNO, CALIF. 93727
• CALL BARBARA GAUDIN at (209) 291-5591

Circle (71) on Reply Card

Winsted

THE MATCHMAKERS for the customized approach to videoproduction centers.

Portable PRODUCTION CONSOLE

For in-house or on location—a complete production facility in one compact portable unit. Ample 42" of rack space puts all your equipment within easy reach. Large selection of modular components offer many variations.

For full-line catalog of editing, production and dubbing consoles, tape and film trucks, film and videotape storage systems, call or write:

THE WINSTED CORPORATION
8127 Pleasant Ave. So. • Minneapolis, MN 55420 • 612/888-1957

MODEL 830

Phone Toll-Free
1-800-328-2962

Winsted

Circle (72) on Reply Card

System One™

- Reel to Reel
- Sequential Controller
- Random Selector
- Kartel
- Reel to Reel
- 19" Rack

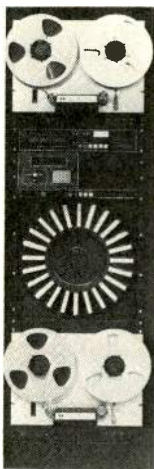

Mini One Bay . . .

an economical automation system that provides short walk away time. BC's programmable 1600S Sequential Controller gives access to 16 events — expandable to 32 — from up to 9 repeatable audio sources. Programmable clock repeats station format in 15 and 30 minute or 1 hour segments. Audio monitor alarm. Complete stereo system \$9225. F.O.B. plant.

BROADCAST CONTROLS

bc 9155 Brookville Road
Silver Spring, Maryland, 20910
(301) 587-3505
Circle (61) on Reply Card

Audio Tape for professionals

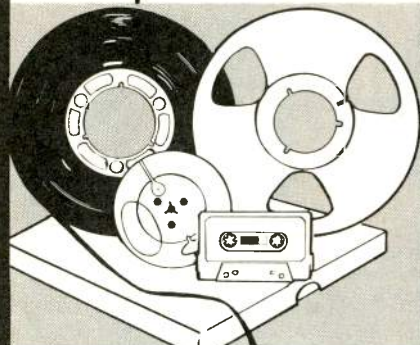

REEL TO REEL TAPE

Ampex, 3M. All grades.
On reels or hubs.

CASSETTES, C-10—C-90

With Agfa, TDK tape.

LEADER & SPLICING TAPE

EMPTY REELS & BOXES

All widths, sizes.

**Competitive!
Shipped from Stock!**

Ask for our recording supplies catalog.

Polyline Corp. 312/298-5300
1233 Rand Rd. • Des Plaines, IL 60016

15

Circle (62) on Reply Card

New products

Switcher

The 250 P/N (PAL/NTSC) from Vital is for use in television studios, production centers, remote control units, educational settings and numerous other television applications.

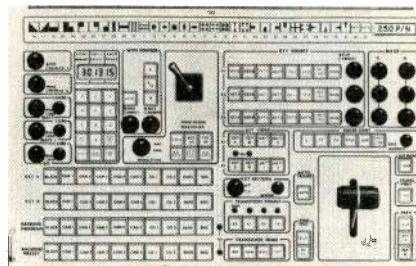

It provides switching, automation and preview capabilities totally unique to a switcher of its size. It is totally self-contained, easy to operate, economical to maintain and measures only 19"x12 1/4"x6".

Circle (85) on Reply Card

Digital audio delay

Wang time tunnel models 300 and 700 digital audio delay units with expand/compress feature variable delay, no moving parts, low noise and wide range audio.

Circle (86) on Reply Card

Charger

A charger designed for rechargeable nickel-cadmium battery packs has been introduced by Alexander Manufacturing. The charger is designed to recharge up to three BP-20

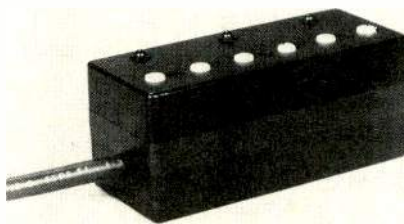

type battery packs, including the new Alexander BP20-11A replacement pack for ENG/EPF portable video cameras. With minor modifications, it can be adapted to recharge other packs.

Circle (87) on Reply Card

Bit error rate test set

Scientific-Atlanta has introduced its Series 4650 Bit Error Rate Test Set for serving test requirements of the growing DS-3 equipment market. The portable test set has new features to improve field commis-

50% OFF
G.E. & Sylvania

STAGE & STUDIO LAMPS
SAVE By Letting Us Bid
On Your Annual Needs!

We prepay trans. on \$200.00 net orders. We allow surface trans. overseas. Your satisfaction guaranteed. Order today, or write for Sittler's complete price sheet.

Sittler's SUPPLIES, INC.
702 E. Washington St., P.O. Box 10-A
Washington, Iowa 52353 Ph. 319-653-2123
In Iowa Call 800-272-6459

Circle (63) on Reply Card

FREE CATALOG & AUDIO APPLICATIONS

**OPAMP
LABS INC.**

CONSOLES
KITS & WIRED
AMPLIFIERS
MIC, EQ, ACN, LINE,
TAPE, DISC, POWER
OSCILLATORS
AUDIO, TAPE BIAS
POWER SUPPLIES

1033 N. SYCAMORE AVE.
LOS ANGELES, CA. 90038
(213) 934-3566

Circle (66) on Reply Card

DON'T LET INFLATION BLOW IT!

Use your "Dollars and Sense."

Send for this free booklet,
and information on how
to obtain bulk copies.



George W. Hayden
The Advertising Council
825 Third Avenue, New York, N.Y. 10022
Please send me a free copy of "Dollars and Sense," and information for ordering bulk copies.

NAME _____

TITLE _____

ORGANIZATION _____

STREET _____

CITY _____

STATE _____ ZIP _____

SIGNATURE



A public service message of The Advertising Council and The U.S. Departments of Agriculture, Commerce, Labor and Treasury. Presented by this magazine

sioning, maintenance and production testing of a T3, 44.736 Mbps digital communications transmission system. The Series 4650 is suitable for design, production and field testing of fiber optics transmission equipment.

Circle (88) on Reply Card

Battery packs and belts

Film Equipment Service Company's battery packs and belts feature rechargeable sealed lead-acid batteries. Sealed lead-acid battery units for film and video cameras and 30V lights overcome limitations and problems of other battery systems and offer reliability, ruggedness and long shelf and service life in performance.

Circle (89) on Reply Card

Microphone isolator

Tensimount universal microphone isolators from **PoleStar** eliminate floor vibration, shock and mechanical feedback that is transmitted through microphone stands. They accept any microphone up to 1-3/8



inch diameter (Tensimount I), or up to 2-5/8 inch diameter (Tensimount II), and provide more than 20dB of mechanical isolation. Tensimounts also adapt any microphone to fit a standard 3/4-inch stand.

Circle (90) on Reply Card

Spectrum analyzer

The 492P programmable spectrum analyzer, by **Tektronix**, provides a cost-efficient means of automating spectrum analysis. The instrument is fully programmable over the IEEE-488 bus for remote data collection and output, and offers internal processing ability to aid common spectral measurements. The 492P is a programmable version of the 492 spectrum analyzer. Both instruments cover the RF spectrum from 50kHz-220GHz (up to 21GHz in coax, above 21GHz using external waveguide mixers). The 492P features a 1000

point waveform memory, a 400-character input/output buffer, and uses a high-level programming language.

Circle (91) on Reply Card

Multi-channel auto biasing

An exclusive auto-bias accessory that further enhances the setup efficiency of the ATR-124 multi-channel audiotape recorder has been introduced by **Ampex**. Auto biasing quickly sets the right bias for any tape's characteristics. The ATR-124

equipped with this new accessory increases the bias level, stops and stores the correct amount of over-bias as selected. Once bias is set for a single channel it automatically becomes a gauged setting for other selected channels.

Circle (92) on Reply Card

Open reel tape series

TDK Electronics has introduced two lines of 1/4-inch open reel audiotapes. The GX series is designed for studio master use in live

Multiband Audio

Proven Better

More stations are using our device than ever before! Extreme flexibility and clean sounding! Definitely a proven performer.

Applied Technology Corporation—27106 46th S. Kent, WA 98031 (206) 854-4486

Circle (65) on Reply Card

INDESTRUCTIBLE AUDIO MIXER WITH UNLIMITED BATTERY LIFE . . . WELL, ALMOST . . .

Everything is recessed within a rugged U-channel. You can drive a truck over it. In intermittent use, 100 hrs. battery life! 4 mic. mixers, line input, 1kHz. tone, battery-test. True vu meter, 600 ohm transformer output @ 8vu, 90db gain, flat 20-20kHz., transformer inputs. Headset jack also feeds unbal. load. Weighs scant 3 1/4 lb.; less than 12" long; beltloop. Accepts external 12v.d.c. too. Includes standard XL mic. connectors.



AMA41



Ultra Audio Products
P.O. BOX 921 • BEVERLY HILLS
CA 90213 • 213/276-2726

Circle (66) on Reply Card

When accuracy Counts... Count on Belar for AM/FM/TV MONITORS



BELAR
AM MODULATION MONITOR



BELAR CALL ARNO MEYER (215) 687-5550
ELECTRONICS LABORATORY, INC.
LANCASTER AVENUE AT DORSET, DEVON, PA. 19333 • BOX 826 • (215) 687-5550

Circle (67) on Reply Card

**DON'T BUY
ANY BROADCAST CAMERA
BEFORE YOU
RENT
a Toshiba PK-39**

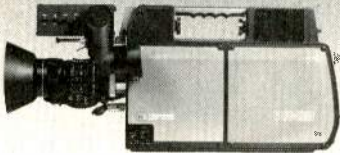

Look at all 3 before you buy any video camera. Compare the Toshiba PK-39 with the Ikegami HL79 or RCA TK76 for picture quality, ease of handling, flexibility — enjoy its unequalled light sensitivity and picture contrast. Rent a PK-39 for your next shooting from Miller — the video specialists. Call or write for moderate day and weekly rates.



**L. MATTHEW MILLER
Assoc. Ltd.**

Suite 1316, 205 East 42nd Street,
New York, NY 10017
Telephone: (212) 687-1168 • (800) 223-0620
Cable VIDEOUSA Telex 238917

VIDEO EQUIPMENT • RENTALS • SERVICE/
REPAIRS • VIDEOTAPE • EDITING

Circle (68) on Reply Card

AUDIO TRANSFORMERS

WOW!!

114 Different Types!
In Stock!
And Priced Right Too!

World Famous Sescom "MI-Series" Transformers
for Professional Audio Applications

Send for your FREE 1980 Catalog

SESCOM, INC. (702) 384-0993
Professional Sound Division (800) 634-3457
1111 Las Vegas Blvd. North, TWX 910-597-6506
Las Vegas, NV 89101 U.S.A.

Circle (69) on Reply Card

New products

music mastering. The LX series is designed for use in professional broadcast recordings.

Circle (93) on Reply Card

Microphone/line distribution amplifier

Modular Audio Products has introduced the self-powered rack mountable model 7823 microphone/line distribution amplifier. The 7823



includes the model 4003 transformer coupled microphone preamplifier with adjustable gain to 65dB, and the model 4820 balanced output distribution amplifier that drives eight 600 lines at +20dBm.

Circle (94) on Reply Card

Milliwattmeter

The Termaline RF Milliwattmeter from **Bird** terminates and measures the output of low power signal sources directly without the use of charts. A front-panel range-switch selects one of three ranges,



0-200mW, 800mW and 3W, without the need to transfer crystals. The unit is designed to measure output of broadband oscillators, signal generators, hand-held transceivers or any low-powered device.

Circle (95) on Reply Card

Voice logging recorder

The **Stancil-Hoffman Corporation** has introduced CRM 5600 voice logging recorder. The CRM 5600 can record up to 56 separate voice channels for 24 hours a day on a single reel of tape 1x3600. Logging recorders provide documentation



anytime vital voice communications are the focal point of a dispute. For the broadcasting industry in particular, the log resolves questions concerning the length and number of commercials, program content, music rights and royalties.

Circle (96) on Reply Card

**Put your
money where
your Heart is.**

**American
Heart
Association**
WE'RE FIGHTING FOR YOUR LIFE

professional services advertisers index

VIR JAMES

CONSULTING RADIO ENGINEERS
Applications and Field Engineering
Computerized Frequency Surveys
345 Colorado Blvd.
Phone: (Area Code 303) 333-5562
DENVER, COLORADO 80206
Member AFCCE

RALPH E. EVANS ASSOCIATES

CONSULTING COMMUNICATIONS ENGINEERS
216 N. Green Bay Road
Suite 208
Thiensville, WI 53002
Phone: (414) 242-6000 Member AFCCE

MIDWEST ENGINEERING ASSOCIATES

Consulting Engineers

6934 A N. UNIVERSITY
PEORIA, ILLINOIS 61614
(309) 692-4233
Member AFCCE

SMITH and POWSTENKO

Broadcasting and Telecommunications
Consultants

2000 N. Street, N.W.
Washington, D. C. 20036
(202) 293-7742

FRANK S. COLLIGAN

Telecommunications Consultant
Field technical services: A.M. directionals,
broadbanding, proofs, rehabilitations, feed
systems, custom components, instrumenta-
tion, reradiation, transmitters.
5111 WESTPATH COURT
WASHINGTON, DC. 20016
(301) 229-5577

dataworld inc

AM • FM • TV

Directories
Allocation Studies
Antenna Design
1302 18th St., N.W., Suite 502
Washington, D.C. 20036
(202) 296-4790

D. L. MARKLEY & Associates, Inc. CONSULTING ENGINEERS

206 North Bergan
Peoria, Illinois 61604
(309) 673-7511
Member AFCCE

McCLANATHAN & ASSOCIATES, INC.

Consulting Engineers
APPLICATIONS & FIELD ENGINEERING
TURNKEY INSTALLATIONS—RADIO & TV
DIRECTIONAL ANTENNA DESIGN
P.O. Box 750
PORTLAND, OREGON 97207
Phone: 503/246-8080 Member AFCCE
TWX 910-464-6112/Frontier

| | | | |
|---|--------|--|-----------|
| AKG Acoustics | 52 | International Tapetronics Corp. | 16 |
| ADM Technology | 21, 53 | Leitch Video Systems | IBC |
| Amperex | 8-9 | Lemo USA Inc. | 72 |
| Ampex Corp. | 18-19 | Marathon Products Corp. | 56 |
| Anton/Bauer Inc. | 33 | L. Matthew Miller Assoc. Ltd. | 76 |
| Applied Technology | 75 | 3M Magnetic Products Corp. | 15 |
| Audio-Technica | 41 | 3M Mincom Corp. | 45 |
| Automated Broadcast Controls | 74 | Maxell Corp. of America | 49 |
| Beaveronics Inc. | 44 | Monroe Electronics | 48 |
| Belar Electronics Lab Inc. | 75 | Moseley Associates | 40 |
| Beston Electronics Inc. | 66 | Opamp Labs Inc. | 74 |
| Beyer Dynamics Inc. | 23 | Optek Inc. | 43 |
| Robert Bosch Fernseh GmbH | 67 | Orrox Corp. | 35 |
| Broadcast Electronics Inc. | 62 | Panasonic Corp. | 50-51, 29 |
| Camera Mart Inc. | 20 | Philips Broadcast Equip. Corp. | 47 |
| Canon Video | 25 | Polyline Corp. | 74 |
| Chyron Corp. | 68 | Potomac Instruments | 60 |
| Continental Electronic Mfg. Co. | 11 | Ramko Research | 1 |
| Cetec Vega | 3 | Russco Electronics | 73 |
| Cinema Products Corp. | 7 | Sescom Inc. | 76 |
| Dictaphone Corp. | 24 | Sitler's Supplies | 74 |
| DBX Inc. | 55 | Standard Tape Lab Inc. | 66 |
| Peter W. Dahl Inc. | 69 | Stanton Magnetics | 69 |
| Dynair Electronics Inc. | 13 | Studer Revox America Inc. | 37 |
| ESE | 71 | System Concepts | 65 |
| ElectroVoice Inc. | 22 | Tektronix Inc. | 5 |
| Fiberbilt | 62 | Telex Comm. Inc. | 4, 31 |
| Fuji Photo Film USA | 59 | Television Equipment Assoc. Inc. | 70 |
| John Fluke Mfg. Co., Inc. | 17 | Ultra Audio Products | 75 |
| Fujinon Optical Inc. | 61 | Utah Scientific | 27 |
| Garner Industries | 62 | Viz Mfg. Co. | 54 |
| Gray Engineering Labs. | 56 | Ward-Beck Systems Ltd. | BC |
| Harris Corp. | 42 | Wilkinson Electronics Inc. | 14, 72 |
| Hitachi Denshi America Ltd. | IFC | Winsted Corp. | 73 |
| Ikegami Electronics Inc. | 57 | Yardney Electric Corp. | 70 |
| JVC. | 38-39 | | |

Professional Services (Cont.)

CHARLES F. KOCHER, P.E.

Consulting Radio and TV Engineer
Allocation Engineering
Antenna Systems
27235 Berkshire Drive
Southfield, Michigan 48076
(313) 357-2304
Member AFCCE

Radiotechniques

STATION DESIGN & CONSTRUCTION
TECHNICAL SERVICE • APPRAISALS
EQUIPMENT DESIGN & MANUFACTURING
402 Tenth Avenue, Haddon Heights, NJ 08035
(609) 546-1841

MOVING?

Please complete the
change of address
information on the
subscription form.

To ensure uninterrupted
delivery to new address,
answer all questions on
the form completely.

BROADCAST

engineering

BROADCAST engineering

Advertising Sales Offices

NEW YORK, NEW YORK

Joe Concert, 4 West 58th St.
New York, NY 10019,
Phone: (212) 888-1977

KANSAS CITY, MISSOURI

Jan Winters, P.O. Box 12901,
Overland Park, KS 66212,
Phone: (913) 888-4664

LOS ANGELES, CALIFORNIA

Herbert A. Schiff
3055 Wilshire Blvd., Suite 630
Los Angeles, CA 90010
Phone: (213) 387-0639

LONDON, ENGLAND

John Ashcraft & Co., 12 Bear St.,
Leicester Square, London, WC2H 7AS,
England;
Phone: 930-0525
Telex: 895-2387

AMSTERDAM, HOLLAND

John Ashcraft & Co., John J. Lucassen,
Akerdijk 150A, 1171 PV-Badhoevedorp
Holland,
Phone: 2968-6225

TOKYO, JAPAN

International Media Representatives, Ltd.
2-29 Toranomon 1-chome, Minato-ku,
Tokyo 105, Japan;
Phone: 502-0656

classified

Advertising rates in Classified Section are 50 cents per word, each insertion, and must be accompanied by cash to insure publication.

Each initial or abbreviation counts a full word. Minimum classified charge, \$4.00.

For ads on which replies are sent to us for forwarding (blind ads), there is an additional charge of \$5.00 per insertion, to cover department number, processing of replies, and mailing costs.

Classified columns are not open to advertising of any products regularly produced by manufacturers unless used and no longer owned by the manufacturer or a distributor.

TRAINING

ELECTRONICS DEGREE by correspondence. Earn A.S.E.T., then B.S.E.T. Free brochure. Grantham College, 2550 South La Cienega, Los Angeles, California 90034. 2-79-tfn

FIRST PHONE through cassette recorded lessons at home plus one week seminar in Boston, Philadelphia, Detroit, Atlanta or Seattle. Our twentieth year teaching FCC license courses. Bob Johnson Radio License Preparation, 1201 Ninth, Manhattan Beach, Calif. 90266. Telephone 213-379-4461. 8-78-tf

SERVICES

ONE STOP FOR ALL YOUR PROFESSIONAL AUDIO REQUIREMENTS. Bottom line oriented. F.T.C. Brewer Company, P.O. Box 8057, Pensacola, Florida 32505. 7-71-tf

SERVICES (CONT.)

HELIAX-STYROFLEX. Large stock—bargain prices—tested and certified. Write for price and stock lists. Sierra Western Electric, Box 23872, Oakland, Calif. 94623. Telephone (415) 832-3527. 1-73-tf

TRANSMITTER TUBES REPROCESSED—Save 40 to 50%. 3CX2500, 4CX5000, 4CX15000 and many others. Write for details. FREELAND PRODUCTS CO., 3233 Conti St., N.O., La. 70119, (504) 822-922. 6-79-tfn

ANDREW LINE & CONNECTORS READY FOR EMERGENCY SHIPMENT ANYWHERE BY AIR. Broadcast Consultants Corp., (703) 777-8660, Box 590, Leesburg, VA 22075. 10-79-tfn

COPPER STRAP, Ground Screens and #10 wire, BCA, (404) 487-9559. 1-80-tfn

BROADCAST CRYSTALS for AM, FM or TV transmitters, frequency change, repair or replacement of oven types. Also vacuum types for RCA, Gates, Collins etc. transmitters. Quality products, reasonable prices and better delivery! Don't be without a spare crystal. Frequency change and service for AM and FM monitors. Over 30 years in the business. Eldson Electronic Co., Box 96, Temple, Texas 76501. Phone (817) 773-3901. 7-80-tf

EQUIPMENT FOR SALE

RCA TT-50AH TV Transmitter, excellent condition, many spares, Channel 10, best offer. Robert Horton (615) 637-1010. 9-80-3t

1800 FEET PRODELIN LINE, 6-1/8 inch, (19 1/2 foot sections) hangers, elbows, flanges, best offer. Robert Horton, (615) 637-1010. 9-80-3t

IKEGAMI—HL-77 camera w/15-1 Ang. lens, AC pac, case, FPR: \$17,000. ALSO includes RGB Pre-Amp, ROV w/200' cable. Contact Carmi at Videography Company, 8928 Ellis Avenue, Los Angeles, California 90034, (213) 204-2000. 10-80-1t

REMOTE TRUCK with four cameras, one 2" recorder, two 3/4" recorders, Grass Valley support gear, two onboard generators, numerous lights, two audio boards, lots of extras. Check it out! Call Bob or Allen at (312) 972-0078. 10-80-2t

SPECTRUM DISPLAY—Full octave ATC 4550 demo unit. New with full warranty. Was \$1800. Sell for \$950. (206) 854-1004, 12428 23rd South, Seattle, WA 98168. 10-80-1t

EQUIPMENT FOR SALE: Harris FT-80 Solid-State FM Modulation Monitor and FS-80 Solid-State Stereo Modulation Monitor, Factory Calibrated, January 1980. Mint Condition. \$1417.00 For Both. KFMC 507-235-5595 For Information. 10-80-1t

AVAILABLE FOR SALE, one only RCA Transmitter, TTU - 1 BLA, complete system less antenna and transmission line on Channel #24. Will be available probably in September. Contact: Dr. Richard N. Sutton, KIDZ-TV, 500 Broad Street, Medical Arts Building, Wichita Falls, Texas 76301. 10-80-1t

4 MONTHS OLD—DEMO EQUIPMENT—Hitachi FP20S 3 tube Satlon w/10:1 Fuglinon lens, genlock and 9 other accessories...\$8450; Panasonic 9200A 3/4" VTR...\$2375; Panasonic WJ-5500A switcher...\$2965; Panasonic WV-5203 trip 5" BW monitor...\$620; Panasonic CT-1310M 13" CLR monitor...\$370. Panasonic NV-8170 VHS editor player, Panasonic NV-8200 VHS editor recorder, Panasonic NVA-950 editing controller, Panasonic NVA-620 interface unit, Panasonic NV-9240 3/4" editing player...\$3375. Panasonic NV-9800 3/4" editing recorder...\$5225. Panasonic NVA-960 editing controller...\$2249. A package price can be arranged on the entire lot. Corinthian Video, Indianapolis, Ind. (317) 773-6658 or (317) 984-3776. 10-80-2t

EQUIPMENT FOR SALE: TK-60's, TM-6, Pedestals, Cradle Heads, TK-80 Camera Cable, Gates and McMartin 5 Input Stereo Boards, Lenses—Varatol and other. ALL must go. Contact for offer for all or any: University of Maryland, Communications Arts & Theatre Department, Tawes Fine Arts Building, College Park, Maryland 20784, Attention: John Fleetwood. Or call 301-454-2541. 10-80-1t

HELP WANTED

CHIEF ENGINEER: I.T.F.S. 4-channel system serving Catholic education in N.Y. area. **DUTIES:** Maintain and supervise transmission, production and field service operation. **REQUIRES:** 1st F.C.C., experience with production and transmission and supervisory ability. **SALARY:** Negotiable (good growth experience). Send resumes to Dept 519, Broadcast Engineering, P.O. Box 12901, Overland Park, KS 66212. 10-80-1t

VIDEO ENGINEER: Must have proven ability in all aspects of studio operation including lighting, camera setup and general production operations. Three yrs. TV engineering experience required. Responsible for quality evaluation of video and videotape productions. Excellent benefits. Send resume to WHRO, Personnel Dept., 5200 Hampton Boulevard, Norfolk, VA 23508. Deadline October 30, 1980. EOE 10-80-1t

CHIEF ENGINEER for metropolitan Chicago cable television company. Will be building 3 television studios and master controls. Responsibilities include 3 Hitachi camera remote truck, Chyron, 1-inch C format videotape machines, ENG equipment, and staffing new department. Good Salary and benefits. Contact: Director of Programming, Cablevision of Chicago, 655 Lake Street, Oak Park, Illinois 80302. No phone calls. 10-80-1t

TELEVISION ENGINEERS: Television Engineers needed for expanding production facility. Must have 5 years experience in Video, Audio, or Videotape maintenance and/or operation. Send resume to Personnel Dept., Oral Roberts Evangelistic Association, P.O. Box 2187, Tulsa, OK 74171. 10-80-2t

MAINTENANCE ENGINEER needed for 5Kw AM, Class A automated FM in Midwest small market. Good salary, equipment, working conditions. Send resume, references, and salary requirements to Broadcast Engineering, Dept. 518, P.O. Box 12901, Overland Park, KS 66212. 10-80-2t

TELEVISION BROADCAST MAINTENANCE ENGINEER. Transmitter experience preferred. Salary negotiable. First Class License required. Call or write Chief Engineer, WMBB-TV, P.O. Box 1340, Panama City, FL 32401, (904) 769-2313. E.O.E. 10-80-3t

TELEVISION OPERATING ENGINEER for studio operations. Primary duties—quality control of signals and light duty maintenance. First Class License desired. Call or write Chief Engineer, WMBB-TV, P.O. Box 1340, Panama City, FL 32401, (904) 769-2313. E.O.E. 10-80-3t

TELEVISION MAINTENANCE ENGINEER: Near beautiful Monterey coast. First phone required. Minimum of 2 years television broadcast studio equipment maintenance experience. Maintain TCR-100, reel-to-reel quad, studio cameras and related equipment, plus some ENG/EFP maintenance. EOE. Send resume to Jim Bassett, C.E., P.O. Box 81651, Salinas, California 93912 (408) 422-6422. 10-80-1t

WANTED: CHIEF ENGINEER—For AM/FM facility in growing southwest market. First Phone and experience with transmitters and studio equipment necessary. Would be responsible for coordinating FM transmitter move. Excellent opportunity with growing broadcast group for engineer with ability and desire to advance. Send resume, references and salary requirements to Mike Fox, Box 7488, Amarillo, Texas 79109. 10-80-1t

TV ENGINEER: Houston independent UHF station needs a Transmitter Maintenance Engineer. Must have 1st class FCC license and minimum 5 years transmitter experience. Will assume responsibility of new facility construction. Send resume to Metromedia, Inc., P.O. Box 22810, Houston, Texas 77027. We are an equal opportunity employer. 10-80-1t

CHIEF ENGINEER: Vacation climate all year long. Management oriented chief needed to run well equipped engineering department with all the latest equipment. Some design work. We appreciate our engineers. Contact General Manager, Kill-TV, Corpus Christi, Texas, (512) 854-4733. 9-80-2t

LOOKING FOR GOOD ASSISTANT chief engineer, familiar with RCA transmitter—TR 600, TK 630 Sony, Phillips engineer. Contact: Jim Robinson/WECA-TV, 904-893-3127. 6-80-tfn

FIELD ENGINEER

Leading internationally known electronics firm seeks Field Engineer with heavy experience in servicing broadcast and CCTV color cameras.

Duties include periodic technical training of customers, engineering back-up for salesman on product demonstrations, resolving technical problems pertaining to camera installations in the customers facility and answering telephone inquiries from dealers and product users.

You will be based in the Metropolitan New York area, travel—40%, office—60% of the time. Position reports to Marketing Manager. Fringes include car.

Please send resume and salary requirements to

Broadcast Engineering
Dept 517
P.O. Box 12901
Overland Park, Kansas 66212

HELP WANTED (CONT.)

TELEVISION HELP WANTED—TECHNICAL: \$40,000+ FIRST YEAR GUARANTEED. Our company has grown so quickly in the past 5 years, we are in desperate need of a very special person who knows broadcast equipment intimately and has aggressive sales ability. We are diversifying into other areas and need someone to take over the equipment sales division. Responsibilities include sales of new and used broadcast equipment and further development of equipment sales division as business demands. We are a first rate company and believe in paying top dollar for the right person. Call Bill Kitchen, Quality Media Corp., (800) 241-7878. 9-80-TFN

ENGINEERS, TV Systems Engineers, Electronic Technicians, Technical Supervisors, Maintenance. Immediate openings. Experienced. Full time, Full benefits, plus Pension. Excellent Salary plus commissions. Send resume to Technical Operations, Inc., P.O. Box 840, New Hyde Park, N.Y. 11040, or call Personnel Mgr. (516) 352-2238. 9-80-tfn

TRANSMITTER ENGINEER: Minimum two years experience. First Class License required. Prefer high power FM or TV experience. Send resume to Personnel Director, Broadcasting, WSM, Inc., P.O. Box 100, Nashville, TN 37202. An Equal Opportunity Employer. 9-80-2t

POSITION AVAILABLE—POSITION TITLE: TELEVISION MAINTENANCE ENGINEER. REQUIREMENTS: First Class FCC license plus experience maintaining professional broadcast equipment, particularly RCA and Sony. The location is Prime Sunbelt, the staff progressive, the station public. Salary commensurate with experience. EQUAL OPPORTUNITY EMPLOYER. Send resume to: Director of Finance, WYES-TV, 916 Navarre Avenue, New Orleans, Louisiana 70124. 9-80-2t

IMMEDIATE OPENINGS FOR TECH SUPERVISOR: Mobile Production Company seeking supervisor for mobile truck. Maintenance required for quad tape, one inch tape, Grass Valley, Norelco PC-70 cameras. Contact: John Crowe, MCI Productions, #10 Greenway Plaza, Houston, Texas 77046, 713/627-9270. 9-80-2t

BROADCAST SYSTEMS PROFESSIONALS



WALSH

Broadcast Placement Service
The Commons West
Dept. B
638 Newtown Yardly Road
Newtown, PA 18940 USA

An Equal Opportunity Employer M/F

If you're involved in the growing field of broadcast technology, you know that only a handful of companies are responsible for decades of progress and innovation. Our client is at the top of that small group. Their name appears on broadcast equipment found almost everywhere in the world. Their tradition of excellence and imagination has been known and respected from the time the broadcasting industry began. With the help of talented people like you, they can continue to build on that reputation in the decades to come.

Our client has specific openings for **Design Engineers** who can design state-of-the-art camera and antenna systems. You will need either a BSEE or BSME, preferably with experience in broadcast equipment.

They are also looking for **Field Project Engineers** for world wide assignments. You should be interested in directing technical projects in a field that extends around the world. You should be willing to travel at least 50% of the time. To qualify you must have an understanding of the latest generation of T.V. broadcast equipment.

You will receive an excellent compensation package with top salaries and a complete benefits program. If you are interested in working with a leading manufacturer of broadcast equipment in one of the positions described above, or if you are qualified in other broadcast equipment areas, contact us by calling collect (215) 968-0707, or send us your resume.

HELP WANTED (CONT.)

Electronic Technician

OMS, Inc., a subsidiary of RCA, has an immediate opening for an Electronic Technician. Must be able to repair, maintain, and install TV Broadcast equipment; recommend design options; and prepare engineering change proposals for military customer. Must also be able to install cables and wiring and integrate electrical equipment. Must know wiring diagrams, wire lists, and work from engineering drawings. These position assignments are located at Patuxent River Naval Air Station, MD on the Chesapeake Bay.

Please send your resume and salary requirements to:

Mr. W. Strayer
RCA Service Company
5260 Port Royal Road
Springfield, VA 22151

Or call Mr. Strayer at (703) 321-8900, weekdays.

RCA/OMS, INC.

A Tradition On The Move!

Equal Opportunity Employer

SYSTEMS/PROJECT ENGINEER—We are a high technology electronics manufacturing systems and service company providing quality audio and video equipment for the broadcast industry. We are currently seeking candidates with 3-10 yrs. exp. in fixed and/or mobile electronic broadcast systems who will participate in equipment development from concept through installation and final testing. A desirable requisite is at least 2 yrs. electrical education or a BS degree. Qualified applicants, please send resume and salary requirements to: Corporate Recruiter, P.O. Box 7760, Burbank, CA 91505. 10-80-2t

CHIEF ENGINEER: Small/medium market station seeking aggressive, qualified Chief Engineer; must be familiar with AE600's, TK-76/BVU-100, TCR-100, RKP-45, TK-46, parallel GE transmitters, as well as microwave systems; 10 years + experience; salary DOE. Send all replies to Broadcast Engineering, Dept. 516, P.O. Box 12901, Overland Park, KS 66212. 10-80-1t

CHIEF ENGINEER: with automation experience and good maintenance habits who keeps orderly records. Call WCCF/WQLM, Punta Gorda, Florida. EEO Employer. 813-639-1188. 10-80-2t

ENGINEER/TECHNICIAN, ELECTRONIC: Campus instructional TV needs full time person to operate, maintain, modify network. Equipment involved: TV cameras, switchers, VCR, STL, transmitters, test equipment, etc. Requirements: FCC first class radio/telephone license, AA electronics or equivalent; ability to climb 60 ft. antenna tower; ability to lift/carry 100 pound boxes. Hold valid driver's license. Call: Pat Benefiel, (415) 497-4749, Personnel Department, STANFORD UNIVERSITY, Stanford, CA 94305. Equal Opportunity Employer Through Affirmative Action. 10-80-1t

THE REX HUMBARD MINISTRY has immediate openings for experienced video operator/engineer and videotape maintenance engineer with experience on late model RCA. Please send resume with salary history to T. Holleron, 2690 State Road, Cuyahoga Falls, Ohio 44223. 10-80-2t

HELP WANTED (CONT.)

SAN FRANCISCO BAY AREA. Competent maintenance and/or production engineer with good management skills. Experienced as C.E., state-of-the-art audio and RF, digitals, etc. Bill Motley, 231 Hartford, San Francisco, Ca. 94114. 10-80-1t

EVANGELICAL MINISTRY—studio maintenance engineer—immediate opening—must have first phone, experience with TR 600 quad TK-45 cameras, etc. Minimum two years broadcast studio equipment maintenance experience. Good salary, benefits, growth potential for qualified person. Send resume: David Hall, Chief Engineer, WHFT-TV 45, 3324 Pembroke Road, Pembroke Park, Florida 33021. Equal Opportunity Employer. 10-80-1t

CHIEF ENGINEER for independent video production facility. At least 5 years direct maintenance experience, systems design and installation. Extensive knowledge of state of the art equipment including 1" type "C" VTR's, TBC, color cameras, computer editing, switchers, etc. Position requires a self motivated individual with management skills. Contact Stu Lefkowitz, VPS, 1212 Tenth Street, Berkeley, California 94710. 415/526-6741. 10-80-1t

TELEVISION ENGINEER: Staff engineer for new PBS station operating on Channel 6. Installation, bench repair and some master control operation. First class FCC license required. Contact Personnel Office for application. Call John Bradley 816-429-4127 for information regarding qualifications. Centra Missouri State University is an Equal Opportunity, Affirmative Action Employer. 10-80-2t

ENGINEERING MANAGER: Newly created opening exists with major manufacturer of Radio Frequency supplies to administrate all facets of Engineering Division. Candidate should have at least five years experience in plant and/or project engineering administration. Experience in development of RF/Analog Circuitry strongly desirable. Excellent salary plus comprehensive benefits. Submit resume in strict confidence to: Director of Personnel, PLASMA-THERM, INC., Route 73, Kresson, NJ 08053. 10-80-1t

International Opportunities for Audiovisual Services

The King Faisal Specialist Hospital and Research Centre has current openings in its Audiovisual Department. The Hospital is a 250 bed specialty referral facility with a rapidly expanding Audiovisual Department.

The following positions are available:

Television Engineer—B.S. Degree in Electronic Engineering with 5 or more years practical experience in maintenance and repair of television and video systems. Thorough understanding of system set-ups and use of test equipment.

Television Technician—Associates Degree in Electronics or 2 years trade school and 5 years relevant experience including 2 years in maintaining and repairing television and video systems.

Both positions offer exceptional benefits including 30 day annual vacation, transportation, furnished housing, bonus pay and more.

Interested, qualified candidates should submit a resume with current salary to:

Linda Hugin
Hospital Corporation International
International Representative
One Park Plaza
Nashville, TN 37202

An Equal Opportunity Employer

HELP WANTED (CONT.)

ENGINEERING POSITIONS

We specialize in the placement of TV and Radio Engineers with Broadcast Stations, Manufacturers, Industrial TV, Production Facilities and Dealers; all levels, positions and locations nationwide. Professional, confidential - no fee. Best Industry reputation - over 1000 client contacts. To discuss your employment possibilities phone Alan Kornish at (717)287-9635 or send your resume' now. Employer inquiries invited.

KEY systems

NEW BRIDGE CENTER, KINGSTON, PA. 18704

TODAY VIDEO! TOMORROW THE WORLD! Exciting new post production facility looking for the right color corrector. Affiliated with a well-established animation house. Excellent working conditions. Fabulous benefits. Once in a lifetime opportunity! Please contact: Dave Seeger, Today Video, Inc., 45 W. 45th Street, New York, N.Y. 10036, (212) 391-1020. 10-80-1t

POSITION: Chief Engineer. **DUTIES**: Plan, install and supervise video-audio equipment needed for new production studio associated with state ETV network. **REQUIRES**: First Class ticket, high school graduate, Associate Degree in electronics desired, experience in installation, maintenance, operation of television studio technical production equipment. **SALARY**: Commensurate with experience. **CONTACT**: Hazel Fournier, Mobile County Public Schools, P.O. Box 1327, Mobile, AL 36633. Equal Opportunity Employer. **DEADLINE**: October 22, 1980. 10-80-1t

WANTED

WANTED: Pre-1926 radio equipment and tubes. August J. Link, Surcom Associates, 305 Wisconsin Ave., Oceanside, Ca. 92054, (714) 722-6162. 3-76-ft

HIGHEST PRICES PAID for 112 Phase Monitors and for clean, 12 year old or less, 1 KW and 10 KW AM Transmitters. All duty and transportation paid. Surplus Equipment Sales, 2 Thorncliffe Park Dr., Unit 28, Toronto, Ontario, Canada, M4H 1H2. 416-421-5631. 2-79-tfn

INSTANT CASH FOR TV EQUIPMENT: Urgently need transmitters, antennas, towers, cameras, vtrs, color studio equipment. Call toll free 800-241-7878. Bill Kitchen, Quality Media Corporation (In Georgia call 404-324-1271). 6-79-tfn

WANTED: Radio Transcriptions 16" E.T.'s, any Eddy Arnold, or other Country 16" or 12" Transcriptions. Will consider others. Interested in Radio Station Libraries to purchase, all speeds of records. Boyd Robeson, 2425 W. Maple, Wichita, Kansas 67213. (316) 942-3673, 722-7765 Eve. 9-80-tfn

******URGENTLY NEEDED****** 12AP4 (1803-P4) picture tubes and parts for R.C.A. TRK-12 antique television. Arnold Chase (203) 521-5280. 9-80-5t

WANTED! Transmitters. The Transmitter Company, Ellis Road, Rossville, Georgia 30741. Col. Jay Sadow, 404-866-3855. 10-80-1t

NEEDED: FM and AM transmitter, 4 bay antenna, tower, coaxial cable, and studio equipment. Missionary station—donation tax deductible. James Cunningham Assn., Box 711, Carlsbad, N.M. 88220, (505) 887-3809. 10-80-1t

WANTED: Two Sony DXC-1200 cameras in top operating condition. Write J. Vaughn, AUDIO-ACTIVE INC., R 1, Hwy. 304W, Delaplains, AR 72425. 10-80-3t

THE NEWEST
MEMBERS
OF THE
FAMILY:

SPG-140P
SPG-120N

MORE THAN
3700 OF OUR
NTSC OR PAL
SYNC GENERATORS
ARE NOW IN USE
IN OVER THIRTY
COUNTRIES AROUND
THE WORLD.

LEITCH

Progressive Concepts in Television Technology

SELTECH Equipment Ltd.
Rose Industrial Estate,
Cores End Road,
Bourne End,
Bucks SL8 5AT,
England

Advance Automation Pty. Ltd.,
6 Dansie Street,
Greenslopes,
Queensland,
Australia 4120

Leitch Video Inc.
1051 Clinton Street,
Buffalo, N.Y. 14206
U.S.A.
Tel.: (716) 852-1535

Leitch Video Ltd.
705 Progress Avenue,
Scarborough, Ontario,
Canada - M1H 2X1
Tel.: (416) 438-5060
Telex: 065-25420

Circle (2) on Reply Card

100 Huntley Street

100 Huntley Street, known to millions of television viewers across North America, Europe and the Far East, is both the title of a daily program series and the location of a dynamic production centre operated by Crossroads Christian Communications Inc. Network and syndicated programs in ten different languages are produced and mixed here in newly expanded facilities that include this comprehensive custom Ward-Beck model 790637 television audio control console.

WBS

First by Design.

Ward-Beck Systems Ltd., 841 Progress Avenue, Scarborough, Ontario, Canada M1H 2X4.
Tel: (416) 438-6550.

Ward-Beck Systems Inc., 6900 East Camelback Road, Suite 1010, Scottsdale, Arizona 85251