

OCTOBER 1963

50 Cents

(\$1.55 in Canada)

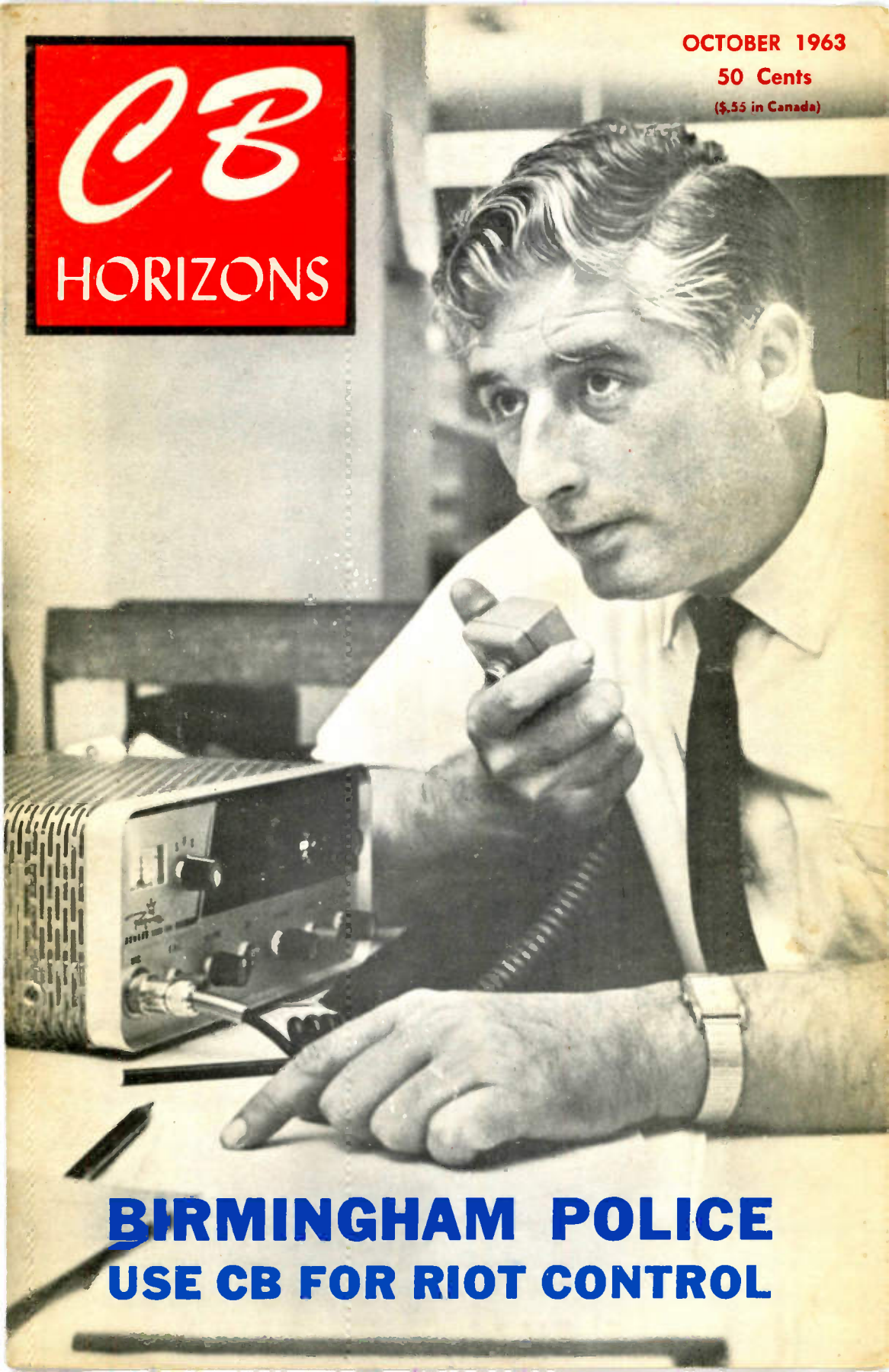

**BIRMINGHAM POLICE
USE CB FOR RIOT CONTROL**

GO SIDEBAND

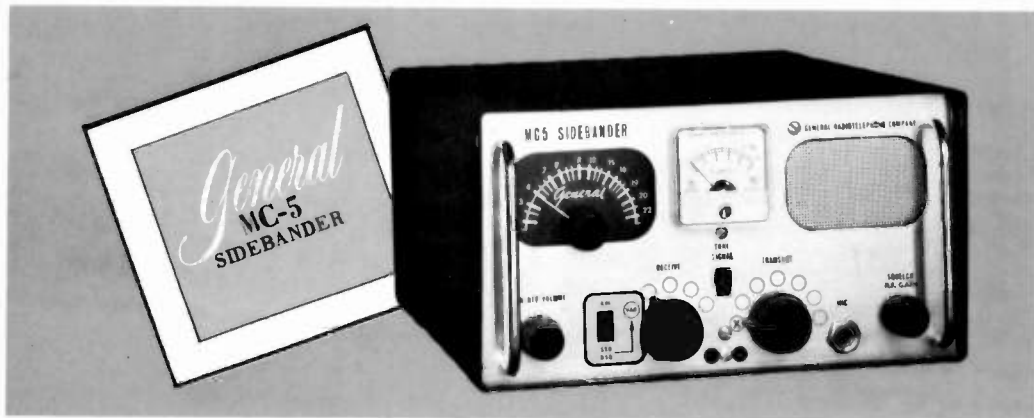

The World's Most Advanced 11 Meter 2-Way Radio!

Highlight Features: 15 WATT CONSTRUCTION.* 3.25 watts minimum output. Sideband receiver adapter for SIDEBAND reception. New Zener diode shunt noise-clamp and series gated limiter circuit for highest noise limiting ever achieved. New ultra-low drift oscillators for unsurpassed stability. New high level tone signal illuminated 'S' meter. 6V, 12V, 115V operation...\$229.95



Now! A 2-Way Communication System for Outdoor Use!

Featuring 15 WATT CONSTRUCTION* and Vibration Rated Service, the General VS-2 commercial and industrial 11 meter transceiver meets all outdoor requirements and may be used with utmost confidence on boats, trucks, tractors, combines, graders, or any heavy equipment demanding rugged, vibration-proof dependability...\$139.95

The General MH-6 'WEATHER-RAK' is designed for outdoor protection of the VS-2. Features snap latches for instant insertion or removal of the set. Mounted on four heavy duty vibration shock absorbers. Provision for mounting antenna directly atop unit. Weather resistant telephone black finish...\$29.95

**WIN!
FREE CB
EQUIPMENT
EVERY MONTH!**

See insert
card in back
of this issue.

*Under present rules part 19.32 the FCC does not provide for more than 5 (5) watt input in the Citizens Radio Service (26.965-27.225 MC Band)

GENERAL

WITH GENERAL!



The NEWEST CONCEPT in 2-Way Communications!

Simply plug the General SBT-3 Sideband Generator into the MC-5SB or any CB transmitter. The SBT-3 automatically generates double sideband suppressed carrier signal for greater range. True electronic switching - just plug the SBT-3 into your antenna. This unit may also be used on the 10 meter band. GO SIDE BAND WITH GENERAL TODAY....\$99.95.

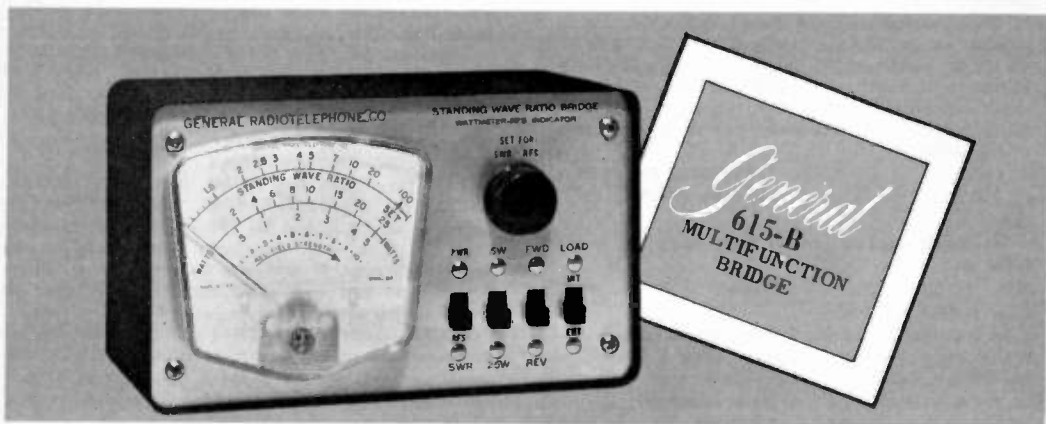

Complete Transmitter / Antenna System Analysis!

The General Model 615-B Multifunction Bridge is a single precision instrument that measures true power, standing wave ratio, and relative field strength. Calibrates and checks the performance of any 2-way radio from 27 MC to 54 MC. The 615-B is a new, improved version of the famous 615 which is the only all purpose unit built to perform all the functions necessary to obtain optimum performance from your transmitter, while allowing constant visual indications at the flick of a switch.....\$39.95

August Winner
of General's
Drawing
Mr. Charles M.
Baskins
182 Akone Pl.
Honolulu,
Hawaii

RADIOTELEPHONE COMPANY

3501 West Burbank Boulevard, Burbank, California
Phone: 849-6891 Area Code: 213

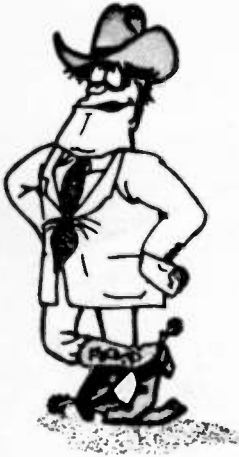

OZZIE'S MAIL BOX

(And each of our signs has a bottle of coke displayed on it.)

Rock Davis, KDB1044
Columbia, S.C.

Ozzie—

Concerning the mounting of signs telling traveling CB'ers the channel of operation in your town. We have signs entering on the main highways here in Louisville, Georgia. The signs are 2 feet by 3 feet with 2-4 inch letters. Reverend Emory Gilbert, 6Q4672, and I put up the first sign and on the way back to town (one mile) we heard the first CB mobile call in and ask for directions!

Sheldon Daitch, KDB5453
Louisville, Georgia

Ozzie:

The enclosed letter is a copy of one I mailed to Tom Kneitel, editor of S9. I thought you would be interested.

"As a very devoted CB'er, I feel I should write the following letter. I have been sitting back and watching what is going on in the CB world. Of most interest to every CB'er is the ridiculous feud going on between yourself and CB Horizons magazine. You have just about come to the point of name calling and fighting which is very childish. It appears you are not doing it for the betterment of CB, but because of personal reasons. I would like to point out to your most avid readers that you were once the Editor of CBH. Now just why would you be trying to knock your former employer?

When your magazine first hit the newsstands, I at first thought it was a new issue of CB Horizons. The complete format was identical. (It was evident that you at least got some good training while at CBH.) Now that CBH is informing CB'ers of a national organization, you have tried your best to destroy it. **Why?** There doesn't seem to be anything wrong with having a national organization to discuss with the FCC the future of CB. The Amateurs have an organization. The unions have representation. The farmers have it. Then why can't CB'ers have it?

Sure, the ACBA has voiced its opinions pro and con on the proposed Part 19. Why not? Are you going to sit back and let the FCC do as it pleases with CB? If so, then you might as well send in your ticket right now. If everyone belonged to a national organization and had equal representation, then we could all be better satisfied with CB.

Reading your August S9; I see that you put out the 'bait' and the ACBA bit. Now isn't that silly. You knew perfectly well that there is only one National CB organization at present, and you knew exactly who's toes you were stepping on.

If you feel we should let the FCC just write the rules and regulations as they please and no one try to do anything about it, then you may as well quit now. Because soon there will be so many rules against this and that, there will be no use for CB.

The future of your magazine and CB Horizons depends on the future of CB. Both magazines can contribute tremendously to the cause for better CB relations with the FCC. Let's combine these efforts and see if we can all come up with something to benefit the CB'ers."

Brown Thornton
KDB5075
Radioactive CB Sales
Oak Ridge, Tennessee

Brown—

For our answer to your letter to S9 Editor Tom Kneitel, see Channel 24, this month.

Dear Ozzie—

Do me a favor. Please make it clear to your readers that Mr. Ernie Walker, a fine individual and a man of conviction and determination, is NOT an official spokesman for the ACBA. Recently I picked up a copy of another CB publication and found printed in it the context of a wire from Mr. Walker to that magazine. It was signed with the title "Executive Secretary." It is true that Mr. Walker has apparently spent considerable time promoting the ACBA . . . but so have lots of others, myself included. The assumption of the title has led to the misunderstanding by many (including the magazine mentioned) of Ernie's status in the American Citizens Band Association. He is a member — just like me. He will have one vote when we hold elections. If he wants to write letters, address clubs, etc., on behalf of the ACBA that's great! But please remind your readers that the views expressed do not necessarily represent the position of the ACBA.

Rod Brown, KHC1636
Member, ACBA

Rod:

We won't need to remind them now. You've done it for us!

Ozzie

Dear Ozzie—

In your July issue we find an article concerning CB license fees. \$8.00 to be exact. Since I already have my license, will I have to pay \$8.00 too?

Marc Joondeph
KBG9040, Member ACBA
Ridgewood, N.J.

Marc:

As FCC Secretary Ben Waple explains in this issue of CBH, you pay the \$8.00 license application fee only with new or modified license applications. The fee is NOT retro-active.

Ozzie

Hi Ozzie—

After reading your July issue, I thought I should write. No one, as yet, has caught us asleep. The Central South Carolina Citizens Radio Club has 10 new road signs to be placed on the major roads leading into Columbus. Our signs are approximately 8 feet long and 2 feet high, lettered in red and black with a white background. I might suggest that the CB clubs contact their local soft drink distributors and ask them to make the signs for them. We did!

now MARK creates 46* out of 23 CB channels!

FIRST SPLIT-CHANNEL

TRUE SINGLE SIDEBAND



CB TRANSCEIVER
*with *Selectable
Upper and
Lower Sideband*

(*Patent Applied For)

**MARK
Model
SSB-27**

NEW MARK Sidewinder

First realistic answer to the crowded citizens band! Opens new channels of communication within the band!

MARK TRUE SINGLE SIDEBAND

Splits the channels. Doubles the effective number of channels available from the present 23 to upper and lower single sideband 46. It's like adding another citizens band!

MORE THAN JUST MORE CHANNELS

With Mark *True Single Sideband*, there is *NO carrier* to waste power or cause interference—and *NO duplicated sideband*. Provides 100% talk power. Concentrates all legal power in only *ONE* sideband, with *selectable use of the upper or lower.

Eliminates the whistles and heterodynes normally encountered in AM. Eliminates adjacent channel interference. Permits simultaneous communications by 2 systems (one on upper and one on lower sideband) on the same channel without mutual interference. Extremely simple to tune.

MORE GAIN—GREATER RANGE

The Mark Sidewinder offers approximately 10 times gain in system effectiveness—greatly improves signal-to-noise ratio—substantially increases the range and coverage—allows you to "get thru" under conditions where A.M. fails.

Available Through Local Distributors

(Also See the MARK Antenna Line)

MORE OUTSTANDING FEATURES

CRYSTAL OVEN (a Mark exclusive) maintains constant crystal temperature for absolute stability.

CRYSTAL LATTICE FILTER provides single sideband selectivity and maximum signal-to-noise ratio for greater sensitivity.

PRECISION CRYSTALS specially manufactured with 0.0015% accuracy.

VOICE LOCK, SQUELCH CIRCUIT and many other desired features.

NEW MARK SIDEWINDER TRANSCEIVER for Mobile and Base Station Use

Immediately makes available up to 10 of the 46 channels (5 on upper and 5 on lower sideband). Supplied with one crystal for operation on upper and lower sideband of one channel. Other channel crystals available. Available for either 12 VDC or 117 VAC operation.

Model SSB-27 Sidewinder for 12 VDC. CB Net. \$299.50

Model PS-1 AC Power Supply is available for use of Model SSB-27 on 117 VAC.

Accessory Mounting Bracket is available for easy installation in any car.

MARK PRODUCTS Division of Dynascan Corp.

1803 W. Belle Plaine, Chicago, Ill. 60613

- Send new Sidewinder Bulletin SSB-27
- Send new Antenna Catalog HW-21

Name _____

Address _____

City _____ Zone _____ State _____

CB HORIZONS

OCTOBER 1963

VOLUME 3 • NUMBER 10

PUBLISHED MONTHLY, ON BEHALF OF THE CITIZENS BAND RADIO USERS OF THE UNITED STATES AND THE WESTERN HEMISPHERE, BY HORIZONS PUBLICATIONS, INC., OKLAHOMA CITY 1, OKLAHOMA

STAFF

Bob Cooper, Jr., KEG2607
Editor-Publisher

Russ L. Miller
Resident Engineer

Bob Buckland, XM44168
Canadian Editor

Pedro Seidemann,
YV5-PS279
South American Editor

Gar Green, Jr., 1W4844
Editor-at-Large

Jamie Jones, KEG3290
CCM Project Coordinator

Stan Searle, KEG4537
Advertising Manager

Marvin Lawrence
Advertising Assistant

Charles Morton
Graphic Arts Director

Diane Mashore
Production Coordinator

Deborah Carter
Circulation Manager

Jean Schaefer, KEG4829
Art Director

Ronald Fortner
Univac Data Engineer

OFFICES

1025 N. Broadway
Oklahoma City 2, Oklahoma
Tel: CE 2-1108
Area Code 405

Subscription rate in the United States \$5.00 per year. Single copy price \$.50. Subscription rate outside the United States, \$6.00 per year. Single copy price outside the United States \$.55. Subscription remittances should be made on bank draft or with postal money order. CB HORIZONS (title registered United States Post Office) entered as third class postage material in Oklahoma City, Oklahoma. All copyright and editorial rights reserved by Horizons Publications, Inc., 1963.

- CONTENTS -

TECHNICAL—

SSB for CB, Part Two	18
More Audio From Mini-Mike	25
GW-11 External Crystal Socket	28
Mini-Mike Master Four	28

NEW CB'ER MATERIAL—

Reports From CB Listeners	34
Lafayette HE-90 Review	38
Electro-Winders Toroid Tenna Review	39
Sonar Business Radio BR-20 Review	40
New CB Products This Month	42

OPERATING NEWS—

Re-Newing Your CB License	14
Back-Seat Driving With CB	15
American CB Association News	46

Ozzie	4	Construction Box	28
CCM Directory	8	CB Datebook	32
Our Cover	8	CB Listener	34
Editorial	9	Lab Reports	38
Transceiver Give-Away	13	CB Showcase	42
Strays	17, 36, 44		

It's new...

Hy-Gain's

MODEL VP II

featuring

- Rugged 16 Telescoped Aluminum Radiator
- Massive Double Grip Mast Bracket
- Moisture Proof Solid State Loading Coil
- 6db Omni-directional Operating Gain

If performance and reliability are important to you...you'll like Hy-Gain's new Model VP II.

Here's a modestly priced antenna that is built to deliver excellent performance under the most severe weather conditions... gale force winds, ice, sleet or snow. Not only is the VP II almost indestructible mechanically... but its moisture proof solid state loading coil... and its protective shield surrounding the feedline connector also insure against electrical interruption caused by high winds and driving rain.

Fed with 52 ohm coax, the end-fed, $\frac{1}{2}$ wave length Model VP II develops low angle radiation that greatly intensifies the signal pattern. By reducing static build-up, the VP II also develops gains in signal-to-noise ratio of 6 to 20db. It's easy to install on masts up to 1 $\frac{1}{2}$ " O.D.

For performance you can depend on, you'll want Hy-Gain's new Model VP II, only **\$24.95 Net.**

*Get yours today from your favorite Hy-Gain Distributor
or write for the name of the Distributor nearest you*

HY-GAIN ANTENNA PRODUCTS CORPORATION
8456 N.E. Highway 6 Lincoln, Nebraska

EVERY PR CRYSTAL

is UNCONDITIONALLY GUARANTEED

Unconditional Guarantee is proof of the maker's absolute confidence in his product . . . and PR Crystals have been UNCONDITIONALLY GUARANTEED SINCE 1934. You're not taking the slightest chance when you put PRs in your transceiver, for you'll have the finest radio frequency control that money can buy! PR Crystals are made to PERFORM . . . under good conditions and bad. They have that extra measure of stability and dependability BUILT-IN, that guarantees years of outstanding performance. PRs are high-active crystals, they give you the strongest signal possible within power limits. That is VITAL in CB radio, for you get greater distance, clearer reception, maximum efficiency. Order several sets of PRs today . . . then you can switch channels at will.

TYPE Z-9R, TRANSMITTER CRYSTALS

Supplied in all 23 Citizens Band frequencies. Calibrated .005%. Hermetically sealed. .486" pin spacing; .050" pin diameter; .758" height above pins; width .720"; depth .309". Be sure to specify channel desired, make and model of equipment.



Type Z-9R — Transmitter Crystals \$2.95 Net

TYPE Z-9R, RECEIVER CRYSTALS

Same specifications as Z-9R Transmitter Crystals. Supplied for all 23 CB channels. Calibrated .005%. Be sure to specify channel number, make and model of equipment.

Type Z-9R — Receiver Crystals \$2.95 Net

MINIATURE TYPES Z-13 AND Z-13P, TRANSMITTER CRYSTALS

New small size, for transistorized and compact equipment. Supplied in all 23 Citizens Band frequencies. Calibrated .005%. Hermetically sealed; .192" pin spacing; .530" height above pins; width .402"; thickness .150". Type Z-13 has .040" diameter pins; Type Z-13P has .017 wire leads instead of pins. Be sure to specify channel number desired, make and model of equipment.



Z-13



Z-13P

Type Z-13 — Transmitter Crystals \$2.95 Net
Type Z-13P — Transmitter Crystals \$2.95 Net

MINIATURE TYPES Z-13 AND Z-13P, RECEIVER CRYSTALS — Same specifications as the transmitter crystals. Supplied for all 23 CB channels. Calibrated .005%. Be sure to specify channel number desired, make and model of equipment.

Type Z-13 — Receiver Crystals, \$2.95 Net
Type Z-13P — Receiver Crystals \$2.95 Net

ORDER
FROM
YOUR
CB DEALER



USE PR AND KNOW WHERE YOU ARE

PETERSEN RADIO COMPANY, INC.
COUNCIL BLUFFS, U.S.A.

EDITORIAL



CHANNEL

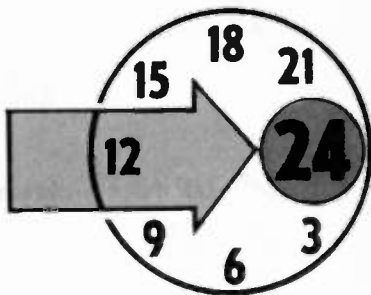

BOB COOPER, JR.—KEG2607

THE DEMOCRATIC WAYS OF A DEMOCRACY

In this issue of *CB Horizons*, CB'er (and CB store owner) Brown Thornton of Oak Ridge, Tennessee writes in the *Ozzie* column (to S9 editor Tom Kneitel)—

"The future of your magazine and *CB Horizons* depends on the future of *CB*. Both magazines can contribute tremendously to the cause for better *CB* relations with the FCC. Let's combine these efforts and see if we can all come up with something to benefit the *CB*'ers."

This has been our thinking for quite some time.

In his August issue, S9 editor Kneitel noted that "a representative of a national *CB* publication asked my support of the ACBA," while Kneitel was attending the May Parts Show in Chicago.

That representative was *Horizons*' sales manager Stan Searle, KEG4537.

If you read the August S9, you know that Kneitel spoke against S9's support of the ACBA.

If I may digress for a moment, I would like to quote from a letter that ACBA Office Manager Kenn Bostick wrote to *CB*'er KIC1000, Johnson City, New York, in August. It carries a message that I believe is well worth your consideration.

Kenn wrote "whether the ACBA is the organization that *CB* needs or not remains to be seen. There is no question that *CB* needs a strong force to clean up the band. And we want the ACBA to be that kind of force.

"But it will take the help of every conscientious *CB*'er in the land, you in particular since you feel so strongly about cleaning up the service, to work for a proper and fit representation before the FCC

and other radio service users.

"We need your help. If you disagree with the way things are being done, join up and then start a fight to get things done the way you think they should be. This will at least put the matter before the membership, who will vote on your proposals, and if they have merit, then your will will be done.

"The ACBA is a democratic organization. Its membership is open to anyone with a genuine interest in *CB* radio. Admittedly, some of its goals are a bit fuzzy at the moment, simply because too few members have taken the time to voice their suggestions and thoughts. But you and the other dissenters can change this in a minute by speaking up in this democratic organization."

Kenn's point was simply this. The ACBA is built upon the same foundation this country was built on. Representation through an elected body.

When you or I disagree with the way our federal government is running things, we turn the rascals out at the next election. The will of the majority rules.

We don't run out and turn in our U.S. citizenship simply because we disagree. We try to influence others who feel the way we do to speak out, form a voting organization, and then elect the kind of leader we believe best typifies our beliefs.

Not agreeing with the ACBA could be a very popular thing. It can also be a very foolish thing if you don't have something to offer in its place.

We would like to suggest and even urge that all of the Tom Kneitel's in this land exercise their democratic right as a *CB* devotee to join up in the ACBA and then

CONTINUED — page 56

30 DAY (ANNUAL) BONUS SUBSCRIPTION OPPORTUNITY

- ✓ UP to 15 issues for \$4.00 (a savings of \$2.50)
- ✓ FREE CBL (qsl) CARD PLASTIC HOLDER
- ✓ Special Combination Subscription – Summer Call-Book Package saves you up to \$3.45!

**SPECIAL BONUS OFFER EXPIRES OCTOBER 10TH
MAIL IN YOUR ORDER TODAY!**

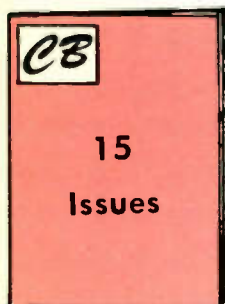

PLUS



=

\$4.00

Up to 15 months of CB Horizons and a free CBL card plastic packet (holds 20 cards!) for wall mounting, for \$1.00 less than the normal 12 month subscription alone!

OR

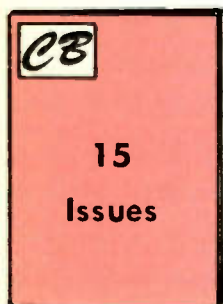

PLUS



PLUS

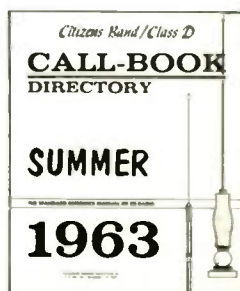

= **\$7.00**

Up to 15 issues of CB Horizons, a free CBL card plastic packet (holds 20 cards!), and a copy of the most popular CB Call-Book ever (Summer 1963 Edition — **just out!**) for \$1.95 less than the CB Horizons 12 month subscription and Call-Book cost alone!

THE CB GIVE-AWAY PRIZES CONTINUE TO PILE UP!

AND - we continue to
Give Them Away!



No Contests - No Jingles - Just Prizes!

Simply remove the Give-Away entry card (or a reasonable facsimile) from the insert to the left, fill it out, and mail it in. All cards are placed in a single Prize Hopper, and on October 10th, several cards will be drawn from the barrel, and prizes awarded to those who submitted the cards drawn. This month's First Prize is a brand-new Lafayette HE-90 transceiver, a fine performing 6-channel transceiver with tuneable receiver.

1. This is not a contest. No box-tops, no money, no jingles. Just prizes!

2. Event is sponsored by Data Servicing, Inc., operator of the Horizons data service bureau.

3. Simply fill in the Give-Away card to the left of this page, place a stamp on it, and drop it into the mail with a postmark prior to midnight October 10th.

4. All cards will be placed in a single container and one card will be drawn from the container by a bonded public accountant on October 17th. The individual submitting the card drawn from the container is the winner of the Lafayette HE-90 transceiver.

5. All cards become the property of Data Servicing, Inc., and no cards may be returned.

6. All employees or their immediate families of

Horizons Publications, Inc., Data Servicing, Inc., are not eligible for prizes.

7. Five additional prizes consisting of CB test equipment and/or antennas will be awarded to the individuals submitting the 2nd through sixth cards drawn from the container.

8. Winners will be notified by mail on October 18th and announced in the November issue of CB Horizons.

9. Valid entries will consist of the tear-out card provided to the left of this page, or reasonable facsimile.

10. Data Servicing, Inc. and/or Horizons Publications, Inc. assumes no liability for the execution of the principles or systems involved. Likewise, no responsibility is assumed for patent infringement, if any, resulting from application of this information.

AND NEXT MONTH

Lasso Yourself the
Biggest Prizes Ever!

NOVEMBER is CB BONANZA time from CB Horizons.

RE-NEWING YOUR LICENSE

(AND OTHER LITTLE-KNOWN FCC FACTS)

by
Ben F. Waple
Secretary
Federal Communications Commission

(Editor's Note: This material was prepared by FCC Secretary Ben F. Waple, in the form of a letter to CBH publisher Bob Cooper, answering a list of questions Cooper posed concerning the changes now taking place in the CB licensing structure. All data is exactly as set down by secretary Waple.)

RE-NEWING CLASS D LICENSES

The procedure for the renewal of Class B, Class C or Class D licenses in this service is essentially the same as that in applying for a new license.

In each case, FCC Form 505 is used to apply for a new license to replace an expiring license or a license which no longer properly describes the station (such as the number of units,) or the license (such as his permanent mailing address).

Whenever possible, the form should be filed at least 60 days prior to the date of expiration or the anticipated date of change. If an application for 'renewal' is filed with the Commission before the expiration of the old license, the licensee may continue to operate under that license, even after it expires, pending action on his new application.

MOVING SOON?

Please note that when a license moves so that his permanent mailing address is not the address shown on his license, the license is no longer valid and must be replaced. Also please note that any unexpired license

which is no longer valid for any reason or has been replaced by another license should be forwarded to the Commission for cancellation, either with the application for renewed or modified license, or upon receipt of the superceding document.

WHAT FORMS ARE VALID?

Only the 1962 versions of the FCC Form 505 are currently being accepted as applications for Class B, C or D licenses. These will be superceded in the fall by a 1963 revision, adapted to automatic data processing. When automatic data processing (ADP) of Class B, C and D license applications is instituted by the Commission, only applications on the 1963 version of the form will be accepted. In any case, when using any form, extreme care should be taken to see that all questions are properly answered and that all details of the station are shown exactly as they are to appear on the license.

Upon the activation of the ADP (equipment) in connection with Class B, C and D license applications, possibly late in 1963, the time delay between the date of submission of an application in good order and the date of issuance of the requested license should be reduced to a very few days. This, of course, may not materially affect the speed of handling problems cases which require personal review rather than machine processing.

ABOUT FILING FEES

With respect to the matter of filing fees, it should be noted that effective January 1, 1964, under provisions of the Commission's Order in Docket 14507, each Class B, C, or D license application in the Citizens Radio Service will be required to be accompanied

by a filing fee of \$8.00 in the form of a check, money order or draft.

This fee is not applicable to any application received by the Commission on or before December 31, 1963. It is also not applicable to the second submission of an application on which the fee has already been paid, but which has been returned to the applicant for correction or further information. Any application which is received on

or before January 1, 1964, on which the required fee has not been paid will be returned to the applicant without action. Payment of the fee is required with every application for a Class B, Class C or Class D license in the Citizens Radio Service regardless of the purpose of the application, except when filed by and in the name of a governmental entity.

Your Mother-in-Law Will Enjoy This —

Back-Seat Driving WITH CB

The age-old quip about your Mother-in-law directing your driving from the back seat of the family vehicle may be one step closer to actuality today, thanks to CB radio.

And teen-age driver's education students in White Plains High School, White Plains, New York are more skilled driving craftsmen for their liberal education in driving techniques . . . all thanks to CB.

A unique Drivers Ed program, conducted by the New York City area high school, just may be the forerunner to a nationwide trend in high school education-coordination of outdoor classes of many types, by CB Radio.

Dr. C. Darl Long, the school's principal, decided in 1959 that he would launch a trial period of tying his school's DE classes together through the installation of two-way CB radios in the student training vehicles, and coordinating the vehicles in the driving chores from an elevated control tower.

Dr. Long had a number of reasons to back up his wild scheme, which it turned out, wasn't so wild after all.

(A) COSTS — Now one teacher in the tower can do the work of seven teachers,

each individually situated in seven different vehicles. The radios are the tools of instruction. Previously each teacher set up his own road conditions and chose his driving circumstances for his pupils. This was usually done without regard to what the other six teachers were doing at the same time.



The seven driver training cars are lined up in front of control tower at start of period. Instructor in tower directs them to particular section of course each is to start period at, via Cadre CB radio.



(left to right) Henry J. McWhinnie, Chairman of the Health, Physical Education and Safety Program Department for White Plains High School; Dr. C. Carl Long, Principal; and White Plains Public Safety Commissioner Edward J. MacDonald. McWhinnie points to instructor in tower who, via Cadre CB radio equipment, controls the movements of the student-driven cars on the training track.

procedures.

(B) SAFETY — Now one man coordinates the entire field of seven cars. This compares with a busy airport and the control-tower

Now one teacher, using the radios, establishes the criteria for driving conditions and instructs each car individually on its next procedure, or all cars together on joint



Instructor Anthony Tramanda communicates with three student drivers, via Cadre CB radio from his control tower. He is telling drivers that they are following too closely behind one another as they approach three-way intersection with traffic light, one of the seven road conditions simulated on the driver training track.



Three driver training cars equipped with CB radio units (note whips on back of cars) in control tower created situation of two cars waiting for third to pass at yield sign location of driver training track. This is one of seven similar road situations created on the course to familiarize student drivers with actual road conditions they will encounter.



Instructor Fred Woodworth explains correct procedure for operation of push-to-talk microphone when communicating with tower and for identifying the mobile unit calling. Note school's call letters on sun visor of car.

Student answers call from tower instructing car to move to new location on driver training track. N.Y. State law forbids driver of vehicle to operate a communications device when car is in motion if it requires one hand leaving the wheel. This is one reason for having two students in each car. Second student acts as communications officer for driver student obeying instructions from tower or requiring explanation of a given situation, which may develop.

chief. Before, seven cars each went their own merry-independent ways.

(C) COORDINATION OF EFFORTS —

With CB radio directing the vehicles, students can be kept moving and less training time is wasted through lack of direction or motion. This is maximum utilization of the driver training period.

The CB gear installed by the school system for the program is the Cadre Industries Corporation's Model 500 transceiver. The transistor design is an important factor here since the students can't always be counted on to turn the equipment off after a class closes.

The school began the unique training program in 1959. To date there has yet to be an accident during the training program and the school reports they know of no accident that graduates of the training program have been involved in.

The school's enrollment, approximately 2,000, includes between 700 and 800 students each year that are required to take the Drivers Education course, prior to their graduation.

The one mile specially constructed Drivers Ed course was designed by the Commissioner of Vehicles for the city, and stimulates all normal driving problems. Each student puts in 18 hours of on the course training.

School officials report that students show an unusual amount of interest in the CB radios, and many youthful CB'ers in the White Plains area undoubtedly had their first taste of CB radio in the Drivers Education course at White Plains High School.

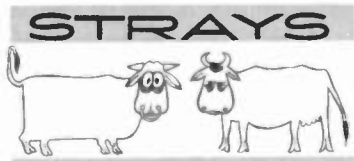

CITIZENS RADIO BEHIND BARS

Inquiry by the Denver FCC office of an illegal radio operation led to the Utah State Prison. It was disclosed that the wife of an inmate, a citizens licensee, had smuggled in radio equipment to amuse him during his incarceration. The licensee sold the unit to another prisoner (unlicensed) and assisted him setting up the "station" in a dormitory. The antenna was constructed from parts found in the prison junk yard. The licensee added use of his call sign as part of the sale. But, the warden confiscated the equipment and punished the operators with 30-days solitary confinement. The FCC, for its part, could

only write warning letters to the two parties of this inside job.

CITIZENS BAND DISBANDS

In another case, the FCC Allegan monitoring station intercepted weak signals on a police frequency. This led to the discovery of five adults using unlicensed both fixed and mobile transmitters in a "network" operation on the citizens band. It linked their homes in Tigerton, Big Falls and Split Rock, Wisconsin. Two of the operators had built the transmitters; the other operators includes a town marshal and his wife. None held FCC licenses. The "network" is now non-existent.

THEIR UNLUCKY DAY

Officials at a California race track, hearing voice transmission of numbers on their citizens station channel immediately following the start of each race, apprehended a man operating a walkie-talkie from the top deck of the grandstand. Investigation by FCC engineers showed further that the messages were received by an accomplice, stationed near the betting window, by means of an earplug attached to a receiver hidden in his hat. But the electronic aid was not profitable. Their last bet was \$100 on a horse that also ran!

SSB FOR CB

by
EDWARD F. HARRIS,
Executive Vice President
Dynascan Corporation
MARK PRODUCTS DIVISION

Consider for a moment what would be the result if the receiver in a double sideband communications system were capable of eliminating one of the two sidebands. This, of course, would require that the receiver be essentially a single sideband receiver in that it would necessarily have a highly selective filter capable of discrimination between the upper and the lower sideband. However, if the receiver is capable of receiving only one sideband and completely rejecting the other sideband, then the conditions for the reinjected carrier at the receiver are not so stringent as they are in the double sideband situation.

For example, referring once again to Figure 4, should the receiver be capable of receiving only the upper sideband and rejecting completely the lower sideband, then

Editor's Note:

In September's CB Horizons, Author-Engineer Ed Harris described the basic functions of sideband, as a topic, and promised to show the inner-workings of single side-band in his second installment. This is that second installment. Author Harris completes his treatment of sideband for Citizens Band with a recommendation for the orderly development of this mode of transmission, built around a division of existing 10 kc wide channels into a pair of sideband channels, one each for lower and upper sideband.

The Editors

of course the 1,000 cycle tone transmitted by the double sideband transmitter would be received at the receiver as a 900 cycle tone which while it would not be a perfect reproduction would be a reasonable reproduction and would not create the kind of distortion conditions that take place when the receiver is capable of receiving both sidebands. Conversely, if the receiver is capable of receiving only the lower sideband, then the resultant tone on the receiver would be 1,100 cycles, once again a reasonable condition without the distortion products.

It is however, not reasonable to develop equipment which is capable of transmitting double sideband but with a receiver good enough to receive one of the sidebands only. This concept does not lend itself to proper design considerations in the Citizens Band service. In addition, fortunately there is a history of double sideband operation in the Amateur radio frequencies over the past years.

During the middle and late 50's when sideband operation was becoming popular in the Amateur radio services, several manufacturers produced double sideband transmitters. There was no such thing as a double sideband receiver other than a simple AM communications receiver in which the beat frequency oscillator was used for reinjection of carrier. These receivers proved to be absolutely worthless and it was literally impossible to do a reasonable job with a double sideband transmitter and an AM receiver utilizing the beat frequency oscillator for carrier injection. All such attempts produced extreme distortions and very poor quality.

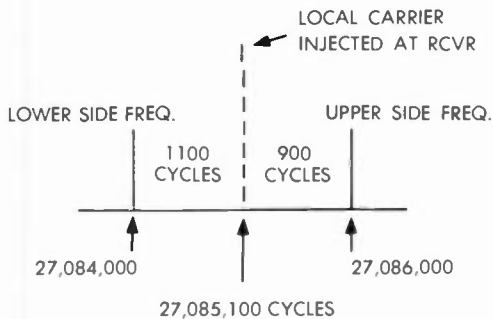

RECOVERY AT RECEIVER OF MORE THAN ONE TONE BY INJECTION OF OFF-FREQ. LOCAL CARRIER - DOUBLE SIDEBAND TRANSMISSION.

FIGURE FOUR

However, at the same time there were excellent single sideband receivers available with filters capable of rejecting either the upper or lower sideband on double sideband transmitters and with such equipment available there was a certain amount of successful double sideband operation. However, over the past few years, double sideband equipment has literally disappeared from the scene in Amateur radio services and all sideband communication is carried on with strictly single sideband performance in the transmitter and the receiver.

We therefore come to the consideration of the pure single sideband mode of communications. This implies that with reference to Figure 2 we must by some means completely eliminate the carrier and either the upper or the lower sideband frequencies. For our previous example, this would result in the condition as shown in Figure 5, in other words, transmission with the one sideband only and as shown, this would result in 27.086 being transmitted with the carrier at 27.085 being eliminated and the lower sideband at 27.084 being suppressed. The condition could just as easily be the reverse with the lower sideband transmitted and the upper sideband suppressed. In either case, the same amount of information would be transmitted and received since all the information is contained in one sideband.

To create this condition in the transmitter, it is necessary to utilize such items as

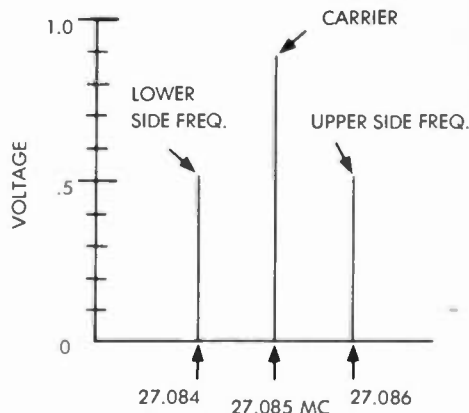

FREQUENCY SPECTRUM OF AM TRANSMITTER

FIGURE TWO

a balanced modulator which eliminates the carrier and a sideband filter which eliminates either the upper or the lower sideband. These techniques are now well established in the art and equipment and components are available to accomplish these functions.

Considering power levels, a similar situation exists for single sideband as is the case with double sideband. In other words, all the power is now generated in the one sideband instead of the two sidebands as described above. This then means that we obtain a peak power input of 10 watts in the single sideband and still remain within the requirements for 5 watts average input utilizing the .25 second response meter as previously described. The situation is not exactly equivalent to the double sideband

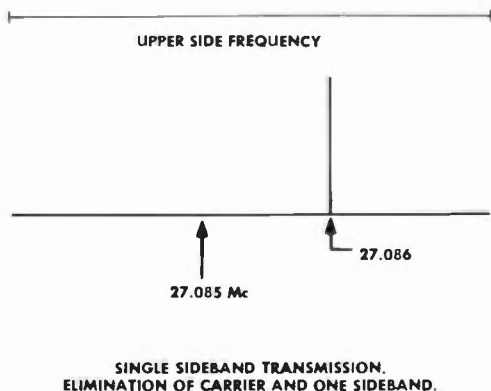

SINGLE SIDEBAND TRANSMISSION. ELIMINATION OF CARRIER AND ONE SIDEBAND.

FIGURE 5

case because in single sideband the carrier is usually removed at an early stage in the transmitter design and also, the sideband is suppressed with a filter in relatively low level stages. Therefore it is necessary to utilize amplifiers to increase the power from the low level stages and these amplifiers must all operate in a linear condition. Since Class C amplifiers cannot operate as linear amplifiers, it is necessary to resort to Class B amplifiers in order to produce the required linearity and these do not operate at efficiencies of the same order of magnitude as do Class C amplifiers. Therefore, we must consider an average efficiency for the single sideband case and the linear amplifier of approximately 50 per cent so that the 10 watt peak power input in single sideband would produce and output of 5 watts peak. When compared to the power in the AM sidebands, this would represent a power gain of 5 divided by 1.5 or approximately 3.3 times power gain in the transmitter and this represents somewhat more than 5 db gain over the AM system from a transmitter standpoint with single sideband.

In addition, with the single sideband technique, the receiver also must be capable of discrimination and it is general practice to utilize a receiver band pass of not more than 3 kc. Since the normal AM and double sideband receiver band pass will run in the region of 10 to 12 kc., we obtain a receiver gain in sensitivity due to reduced bandwidth of the order of 3 to 4 times. This represents a minimum of 5 db systems gain at the receiver and therefore, conservatively, in Citizens Band applications, the single sideband equipment will produce systems gain of the order of 10 db (10 times power equivalent ratio) over the AM consideration. This compares to 6 db systems improvement for the double sideband case. However, as has been established previously, the double sideband is not a practical system for the Citizens services due to distortion problems connected with stability, etc.

Ten times power gain is an extremely impressive advantage to be gained in any consideration and certainly should not be overlooked. The 10 db or ten times power gain condition, however, is not the only

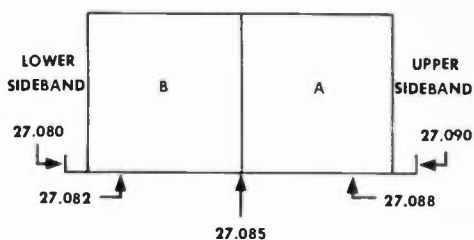

OPERATION OF TWO TWO-WAY COMMUNICATIONS SYSTEMS WITHIN THE 10 KC SPECTRUM OF CHANNEL 11. SYSTEM A OPERATES IN UPPER 5 KC BETWEEN 27.085 AND 27.090 AND SYSTEM B OPERATES IN THE LOWER 5 KC.

FIGURE 6

consideration by far which makes single sideband attractive to the Citizens Radio Service. Of equal importance and perhaps, by far the most important consideration in the Citizens Radio Service for the single sideband mode of communication is the fact that the single sideband equipment occupies no more than 3 kc of the spectrum. When compared to the AM or double sideband condition, which must occupy approximately 10 kc of the spectrum, this immediately looms as a tremendous opportunity to conserve spectrum space.

Working with the present FCC regulations and the tolerances imposed by the FCC on allowable deviation from center frequency of the channel, it immediately becomes feasible to place two communications systems on one existing channel utilizing single sideband. For example, with the Channel 11 description as shown, consider Figure 6 which depicts the Channel 11 center frequency as 27.085 mc. It is entirely reasonable with presently available single sideband techniques to set up a two-way communications system such as A, utilizing upper sideband and another two-way communications system such as B, utilizing the lower sideband. A would operate in the upper 5 kc between 27.085 and 27.090 mc and system B would operate in the lower 5 kc between 27.080 and 27.085 mc. Since the single sideband system requires only 3 kc for proper operation, both systems A and B would have 2 kc to spare within their 5 kc required band. However, since the FCC allows for

deviation from the center frequency of 27.085 of as much as 1.35 kc, this could use up as much as 1.35 kc of the additional 2 kc available so that there is always a guard band of at least .65 kc at either end of the two systems before the next channel is approached.

It is therefore immediately apparent that all of the 23 channels can be converted to two separate channels by splitting each channel into an upper 5 and a lower 5 kc and still remain within the requirements of the present FCC specifications.

At this point it is important to discuss more thoroughly the requirements for frequency stability in the single sideband system and the practical considerations at the present time necessary in obtaining these orders of frequency stability. In single sideband generally, it is necessary to maintain the frequency relationship between the carrier frequency and the injected frequency at the receiver within 100 to 200 cycles depending upon whether upper or lower sideband is being transmitted and received. The only problem connected with off frequency operation of the receiver injected carrier is that the entire frequency spectrum of the audio voice characteristic is shifted either up or down in frequency so that depending upon which side the carrier has moved to, we would get a reproduction of the voice which would sound either very low and bass or relatively high pitched and nasal. When the carrier is reinserted very close to the original frequency, the voice sounds normal and is indistinguishable from good AM in voice response characteristics.

At 27 mc as we have shown above, the .005 per cent frequency tolerance requirement set by the FCC therefore becomes out of the question since total variation of plus or minus 1,350 cycles goes way beyond the necessary requirements for single sideband carrier stability. If we improve this by a factor of 5 and go to .001 which is practical with present state-of-the-art crystals, we would get a total variation of plus or minus 270 cycles which is coming close but still not good enough.

It is therefore necessary to produce frequency stability of the order of .0005 per

cent so that frequency variations will not go beyond approximately 135 cycles and this can be attained only by operating present day crystals in a temperature controlled oven. If properly handled, such as oven may be constructed at a reasonable cost and therefore, not present a great burden to the designer of single sideband equipment and if the oven temperature is held within plus or minus about 5 degrees over the entire operating temperature range for the two-way communications equipment, this will be quite satisfactory. Such operating temperature ranges of course, can vary over wide limits depending upon where the equipment is operated and the season of the year. However, in normal automobile applications, it is felt that temperatures will get no lower than 10 degrees below zero and probably not much higher than 150 degrees fahrenheit on the hottest days. Actually, when temperature reaches that level it is practically impossible to drive an automobile and with the advent of more and more air conditioners under hot climate conditions, it is felt that this is an outside maximum on the high end.

Assuming therefore that the equipment, both transmitter and receiver, will operate under temperature controlled conditions with crystals in ovens, we therefore have established that netting of the two single sideband transceivers in a system will be accomplished within .001 per cent or within plus and minus 270 cycles of each other. This still presents a problem from the standpoint of perfect netting which is always desirable in that only with perfect netting can we obtain good listening conditions for voice communications where the voice sounds perfectly natural as in AM.

Fortunately, there is a relatively simple approach to adjust for this last 270 cycles and this is involved with the crystal oscillators themselves. It is quite practical with a small capacitor adjustment to pull the stable type crystal oscillator of the order of 300 to 400 cycles either way from center frequency. Thus, the provision of a small knob on the front panel of the equipment as a netting control which will enable the operator to adjust the exact frequency of his crystal os-

illator so as to obtain a natural sounding frequency response in his receiver, will result in the netting of both transmitter and receiver. This is due to the fact that the same crystal oscillator is used for transmit and receive functions in the single sideband transceiver design.

In addition, as it works out, with similar crystals and ovens, once the exact netting situation has been accomplished by the slight capacitor adjustment, all the units in a single sideband communications system tend to lock on and slight drifts tend to be in the same direction during warm-up so that further netting is very rarely required and short term stability for the period of a total contact over several transmissions is excellent. In fact, retouching of the netting control should not be necessary over periods as long as one hour or more once the equipment has gone thru the initial warm-up stages and is settled down. The initial warm-up stage usually is quite rapid with a thermostatically controlled oven since full oven heater power is applied during the cold period and therefore, crystal warm-up occurs very rapidly.

With the exact netting problem essentially solved from a practical standpoint utilizing an inexpensive oven and presently available crystals, the single sideband systems in Citizens Band applications become quite practical devices and not so much more expensive than standard AM equipment as to prohibit their use. It would seem that good, practical Citizens Band sideband equipment can be produced to sell in the range of \$300.00 list, per unit. Possibly, the most expensive component outside of the crystal and oven requirements is the necessary sideband filter and depending upon at which frequency the actual sideband filtering is done, prices of this filter will vary somewhat. However, in the overall picture the cost of developing one sideband remains surprisingly uniform in that cheaper filters at lower frequencies trade off for more complexity in circuitry required by additional mixers, etc. Whereas the higher frequency filters require crystal lattice construction which is always expensive; they do tend to eliminate some circuitry costs.

It is therefore established that \$300.00 list equipment is practical at the state-of-the-art for single sideband applications, that either upper or lower sideband is practical at the present state-of-the-art utilizing no more than 5 kc of the 10 kc assigned channel space and that therefore, two channels can be accommodated within each of the 23 available assigned channels at the present time. It must be understood that no change is necessary in FCC regulations — that all conditions exist both legally from a regulation standpoint and technically from an equipment standpoint today to take advantage of this situation to produce 46 channels out of the presently available 23 AM channels. This occurs within the FCC regulation of plus and minus .005 per cent frequency tolerance around the center frequency of each channel.

For the future, we may also consider a possible alteration of each of the 10 kc channels which now exist to accommodate three single sideband channels instead of the two now possible within FCC regulations. This is depicted in Figure 7 and would require a slight revision of FCC regulations to allow for the movement from center frequency of two of the three single sideband channels. For example, with the center frequency of Channel 11 at 27.085, we could postulate three subchannels, A, B, and C as shown in Figure 7, with the A subchannel operating in the 3 kc from 27.0805 to 27.0835; the B sub-channel operating from 27.0835 to 27.0865; and the C sub-channel operating from 27.0865 to 27.0895 mc. At the present time channels A and C would not meet FCC requirements since they would necessarily have to be established beyond the 1.3 kc limit which allows us to go only to 27.0863 as maximum excursion above the center frequency and to 27.0837 as a maximum excursion below the center frequency.

If, however, at some future date this slight revision could be made in the FCC regulations, then it would be perfectly realistic to provide for three single sideband channels in each of the 23 present Citizens Band channels or a total of 69 channels instead of the 23 presently available. Carry-

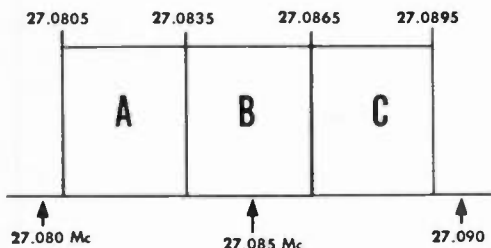

POSSIBLE ALTERATION OF 10 KC. CHANNEL (11) TO ACCOMMODATE THREE SINGLE SIDEBAND SUB-CHANNELS INSTEAD OF THE TWO NOW POSSIBLE UNDER PRESENT FCC REGULATIONS.

A—OPERATES AT 27.0805 UPPER SIDEBAND.

B—OPERATES AT 27.0835 UPPER SIDEBAND.

C—OPERATES AT 27.0865 LOWER SIDEBAND.

NOTE: GUARD BANDS OF 500 N REMAIN AT EACH END OF ASSIGNED CHANNEL (11).

FIGURE 7

ing this one step further and without a careful check of the various channel positions, we can recognize that the FCC has allotted 230 kc total spectrum to the Citizens Band service. Dividing this 230 kc by 3 gives us approximately 76 channels as an absolute maximum. However, it is very questionable as to whether this could ever be realized since the 230 kc assignment is not in a continuous spectrum and therefore it would have to be chopped up somewhat. Therefore the upper limit falls somewhere between 69 and 76 channels and we could reasonably expect a minimum of 300 per cent increase in spectrum utilization and a maximum of about 330 per cent increase in spectrum utilization, utilizing the above concepts.

Of course this does not provide for the accommodation of both AM and single sideband simultaneously since, of course the AM signals are radiating sidebands and at random frequency positioning so that interference problems would in general, be rather severe. The Citizens Band service has a tremendous advantage in these considerations over Amateur radio since the Citizens Band service is assigned in discreet 10 kc channels whereas Amateur radio services allow for the operation anywhere within the assigned frequency band limits.

On the other hand, even in Citizens Band

services restricted to 10 kc channels, there can develop rather difficult situations within present FCC regulations which allow for .005 per cent frequency tolerance. Essentially, with the above described single sideband equipment, the frequency tolerance setup is so much better than FCC requirements that such equipment could be considered a secondary standard for calibration of CB transceiver equipment. If the tolerance level is kept at the described point of .0005 per cent attainable with the crystal ovens and only single sideband stations operate on a particular channel, the interference problem would be essentially solved. The presence of an AM station on a common channel with single sideband will present a problem but should not be insurmountable. This is especially true when it is considered that the basic regulations written by the FCC for Citizens Band operation call for stations to remain off the air when the channel is being used and stand by until another station on the channel signs off. Of course this is not always practical since in some cases transmissions go beyond the normal listening range and interference with other communications networks considerably further away than the primary area and, in fact, some skip conditions produce signals coming in from other zones which cannot be expected to adhere to the regulation for channel standby if they are not hearing the stations they are interfering with.

In addition, with presently available sideband filters and especially those attainable within reasonable costs so as to maintain a reasonable price level for this single sideband equipment, unwanted sideband suppression of approximately 40 db can be obtained readily. This means that rather than the ideal condition of being able to put an upper sideband and a lower sideband station on the same channel with complete freedom of spillover, there would be a certain amount of unwanted sideband signal generated by each station. The level, however, is extremely low and tests have shown that two systems can operate on the same channel, side by side, one operating upper sideband and the other operating lower

sideband, and work within one mile of each other without mutual interference. At the very worst, the unwanted signal presents itself as a very low level garble approximately of the same magnitude as one might hear in cross talk over long distance telephone circuits and which do not interfere appreciably with the wanted communication. At distances closer than a mile, the interference level would increase and eventually reach the point where the strong unwanted local signal closer than a mile might interfere and override the wanted signal which might be several miles away. Statistically it is felt that this represents a very small fraction of the time involved on circuits and that such a problem will be meaningless as regards the utility of this service utilizing single sideband.

It is therefore highly recommended that in the beginning and as single sideband equipment becomes available to the Citizens Band user, that both the manufacturers of equipment and those operating in the Citizens Band field make every possible attempt to restrict the operation of their equipment to certain preferred channels. For example, it might be visualized that within areas in the beginning only a few of the available 23 channels be mutually agreed upon as single sideband exclusive operating channels. This will not only mean less interference between AM and single sideband stations but will create two channels for every one that are taken over by the single sideband users. In this manner, systems can be concentrated in these preferred channels to begin with and for example, Channel 3 might readily be a preferred channel with Channel 3 upper sideband utilized in the beginning. This is due to the fact that the spacing between Channel 3 and Channel 4 is 20 kc rather than 10 kc and allows for much better isolation of a possible AM sideband generated from Channel 4 which might interfere with Channel 3. This is only a suggestion but I am confident that with reasonable care and evaluation such systems may be worked out.

It is certainly not contemplated that AM equipment will stop being used at any time in the near future. However, even if at

some future date as many as 13 channels are retained for AM and only 10 channels assigned to single sideband, this could result in the simplest case in an effective 20 operating channels for single sideband and 13 for AM for a total of 33 and if the FCC would allow for the slight changes permitting 3 single sideband channels on each 10 kc spread, the 10 single sideband channels could then produce an equivalent of 30 plus the 13 AM or a total of 43 so that with reasonable accommodation between the two modes of operation, we could approach a 100 per cent increase in channels and still leave as many as 13 exclusively for AM.

It is hoped that the above discussion may help the average Citizens Band licensee and enthusiast to evaluate some of the forthcoming and more sophisticated methods of communications now available thru state-of-the-art advances. It is also quite clear that from the user standpoint, no matter how sophisticated systems become and what methods of transmission are utilized, operator convenience must be uppermost from a design criteria. For example, if single sideband equipment were capable of providing the added systems gain of the order of ten times power or 10 db along with the great advantages of allowing for the possible additional channels but in operation required a high order of operator technical competence in order to make the equipment perform satisfactorily, then of course, it would not be a useable or marketable product in the Citizens Band service.

Therefore, it is ultra-important that such considerations as extreme frequency stability for proper netting of the two single sideband units without undue operator adjustment be taken into account and it is especially important that good, natural voice audio characteristics be attainable so that the voice signals come thru clear, crisp, and completely intelligible without resort to special considerations. In other words, good single sideband audio circuits should be indistinguishable so far as the Citizens Band operator is concerned from the listening characteristics of good AM equipment.

Ed Harris

MINI-MIKE

The February issue of CB Horizons contained a report by a member of the Horizons Research and Development Lab on the subject of building a single transistor, powerless, audio pre-amp.

The idea and application was unique. Perhaps the complete applicability of the 'Mini-Mike' to more than a handful of transceivers was not.

More than a few readers have reported problems with (A) Locating the transistor type specified (B) Inadequate gain (C) Apparent audio oscillations (feedback type).

Let's tackle these problems one by one. We'll present two new circuits involving the 'Mini-Mike' approach here also. Both have been applied to a number of units available in the Horizons Lab and both have been found to be compatible with each unit tested.

THE TRANSISTOR TYPE

We never though Oklahoma City was the center of the rare transistor industry. Apparently it is. We specified, in the original February 1963 issue, a Delco DS-25 transistor. We specified this transistor because it was recommended to us by Delco for the application we had in mind. We simply went into our local Delco auto-radio supply house and he handed us a half-dozen.

Apparently few of our readers had such luck. The Delco DS-22 is an equivalent. The DS-22 is more like to be available in your area if reader mail is any accurate indication of Delco's distribution problems! (Note: RCA's 2N109 may also be used.)

INADEQUATE GAIN

Some transceivers use very-high impedance ceramic or crystal microphones. When

this type of microphone element is utilized with the original 'Mini-Mike' circuit, the "small-current flow" (transistor talk for the emitter to base current flow) is so limited or restricted as to eliminate the possibility of the circuit providing you with any gain.

Schematic number one shows you how to cure this problem. Our answer is to incorporate a base-biasing resistor and battery operate the unit. Result? Lots and lots of gain. The basic changes are simple and involve only the biasing resistor, a DC blocking capacitor, a switch, and of course the necessary battery.

All of these items can be installed into the original microphone case, especially in the case of the Turner 350C series (and Electro-Voice 714). The battery may give you a few headaches in making the components fit, but a number of very miniature hearing aid (or transistor activator) 9 volt batteries are available on the market. Rather than suggest a specific unit, which may not be available in your location, we'll leave the selection up to you.

Oh, before we leave the subject of changes to the original Min-Mike, note that the value of the load resistor (R2) is different. This was made necessary to insure the proper operation of the base-biased transistor circuit.

AUDIO OSCILLATION

Several readers indicated they felt they were getting audio oscillation from the unit due to reports from friends concerning audio squeals on their carriers.

They were partially correct. Feed-back it was, not audio oscillations as would emanate from an oscillator circuit.

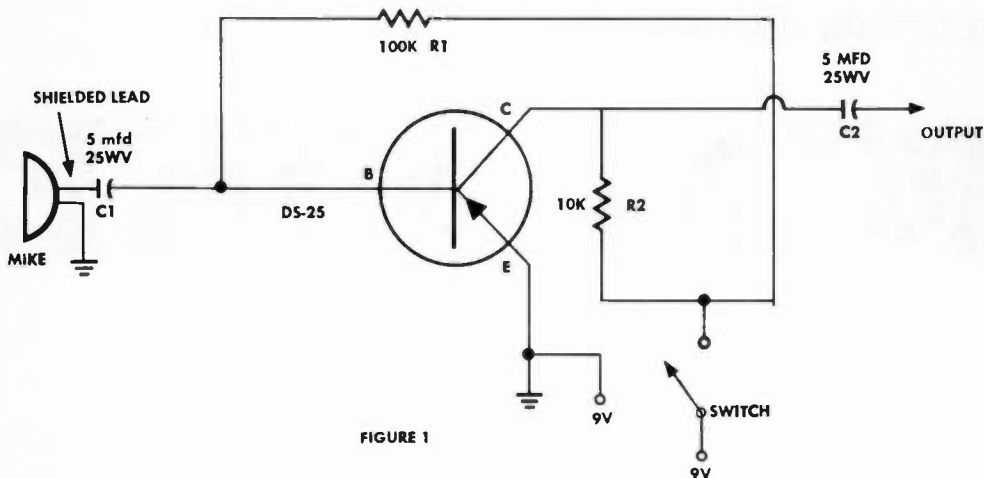

FIGURE 1

When a CB transceiver has a poor match to the antenna (high standing-wave-ratio), or when the final-power amplifier in the transmitter is very close to the audio amplifier (modulator) circuits of the unit, radio-frequency (27 megacycle) energy can float into the microphone amplifier circuit and induce RF feedback. This phenomenon can readily occur when additional gain is introduced and precautions not taken to prevent RF feedback, such as in the case of adding a Mini-Mike unit.

Figure Two shows you how to modify Mini-Mike to correct the problem. For extreme problems of RF feedback, it is suggested that you build the Mini-Mike into the mike case itself. (If the case has a plastic shell, line the inside with foil.)

CONCLUSION

The Mini-Mike is a simple and efficient method of improving the audio-punch of your CB transceiver. It is possible to obtain from 10 to 15 db additional audio gain by employing the existing audio amplifier circuits and the Mini-Mike circuit in combination. Many will find that Mini-Mike works best when built into the existing mike case, while others will wish to have Mini-Mike wired directly into the transceiver between the mike plug and the grid of the first audio amplifier.

If you would like to experiment with either of the above circuits, try adding a (transistor) base to ground resistor ($\frac{1}{2}$ watt — experiment with ohmage value). This will vary the gain of the unit.

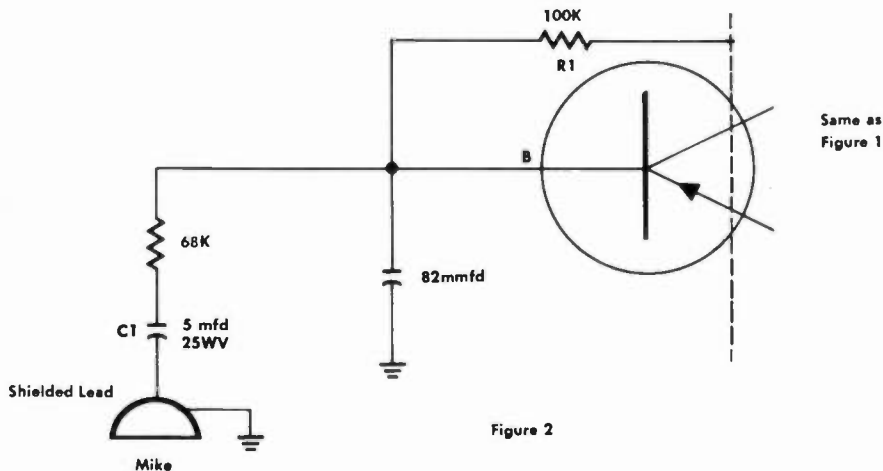

Figure 2

Same as Figure 1

from
ALLIED

NEW! *knight-kit*® Transistorized 10-Function Citizens Band Checker!

**NOW! GET TOP OPERATION
FROM YOUR CB TRANSCEIVER**

Performs 10 Functions:

1. Measures Relative SWR
2. Measures Output Power
3. Measures Percentage of Positive Modulation
4. Measures Percentage of Negative Modulation
5. Measures Field Strength
6. Measures Relative Crystal Activity
7. Serves as Signal Monitor
8. Serves as Crystal-Controlled RF Generator
9. Serves as Audio Generator
10. Serves as Code-Practice Oscillator

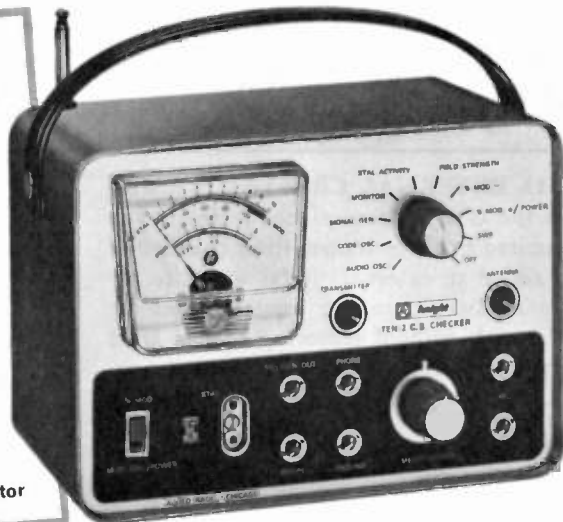

Knight-Kit Model Ten-2 Citizens Band Tester

In Kit Form

\$25⁹⁵

\$5 monthly
on Allied's
Credit Fund
Plan

- Assures You Top CB Performance
- Ideal for Fast, Accurate Troubleshooting
- Use for Alignment, Tuneup, and Calibration
- Transistorized, Compact, Completely Portable
- Easy-to-Read 2" Meter, Built-In Dummy Load
- Complete with Long-Lasting 9-Volt Battery

Now you can make sure you're getting top operation from your CB equipment! This new transistorized portable instrument easily and quickly evaluates and helps you improve performance in either fixed or mobile installations.

Actually 10 precision instruments in one, the "Ten-2" measures, with 10% accuracy, relative standing-wave-ratio of antenna arrays and transmission lines, percent of either positive or negative modulation, RF power output, relative field strength, and relative crystal activity. May also be used as a signal monitor, crystal-controlled rf generator, audio generator, and code-practice oscillator.

Large easy-to-read 2" meter has five scales and a sensitive movement. Front panel sockets ac-

cept any standard or miniature CB transmitting crystal. Front-panel jacks are provided for a key, headphone output, scope output, rf generator output, as well as Motorola-type sockets for CB antenna and transceiver inputs. Also includes durable built-in telescoping 40" antenna. Has two-transistor amplifier/oscillator circuit. Charcoal-gray cabinet, brushed aluminum panel, black and satin knobs; 5 3/8 x 7 3/8 x 4 1/4". Includes 9-volt battery and instructions. Shpg. wt., 4 lbs.

83 Y 823 FT. In easy-to-build kit form, only **\$25⁹⁵**

83 Y 561 FT. As above, but factory-assembled **\$39.95**

41 H 199 FT. PL-259-To-Motorola Plug Adapter **44¢**

**satisfaction guaranteed
or your money back**

NO MONEY DOWN: Take advantage of your Allied Credit Fund Plan!

ORDER TODAY FROM

ALLIED RADIO

ALLIED RADIO
100 N. Western Ave., Chicago 80, Ill.

Ship me the following:

- "Ten-2" CB Tester Kit 83 Y 823 FT.
 "Ten-2" Tester Assembled 83 Y 561 FT.
 PL-259-To-Motorola Plug Adapter 41 H 199 FT.
 \$ enclosed (check) (money order)
 Ship No Money Down on Allied's Credit Fund Plan

Name _____
PLEASE PRINT

Address _____

City _____ Zone _____ State _____

**ORDER
TODAY**

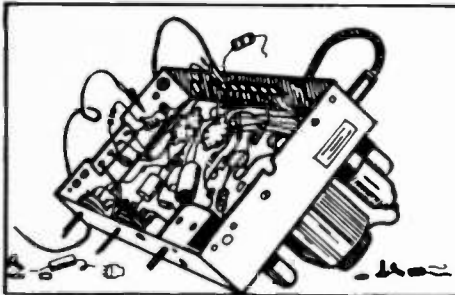

TECH TIPS

FOR CB'ers

GW-11 EXTERNAL CRYSTAL SOCKET

On the GW-11 transceiver by Heath, you are limited to three transmitting channels. I have added an external crystal socket to my set to facilitate changing crystals from the front panel, without removing the set from the cabinet. The diagram shows how the external socket is mounted. Choose a good

FRONT VIEW

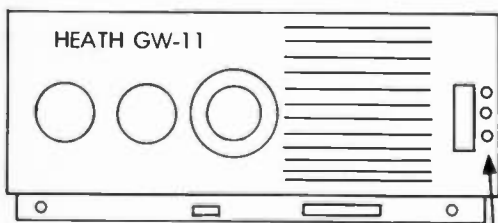

3 - 1/8" HOLES
FOR CRYSTAL
SOCKET

quality ceramic socket, with a small single hole mounting screw in the center of the socket. The three holes are positioned near the tuning meter. A piece of RG-58U, 1 1/2 inches to 2 inches long, is run from the two terminals on the rear of the socket to the front Heath provided socket directly behind and below. The shield of the coax goes to one socket pin, the center conductor to the other. On the existing socket, the braid is pushed into one of the socket holes, the center conductor into the other. Turn the chassis over and spot solder these two lead to the bottom of the chassis-mounted socket.

This short length of RG-58U should not introduce enough capacity into the crystal-oscillator circuit to affect the frequency of the transmitting crystal. It is advisable to

SIDE VIEW

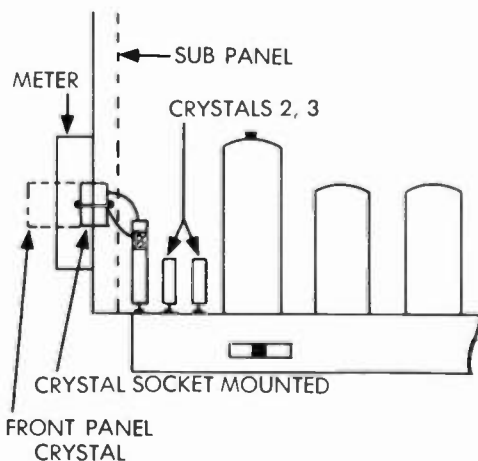

have the frequency checked, however, by first inserting the transmitting crystal into the second chassis-crystal socket, measuring the frequency at your local CB shop, and then inserting the crystal into the new front panel socket, and measuring the transmitting frequency again. If the variation is more than 400 cycles, re-do the coaxial lead and soldering job.

Gerald Pienschke, KHA7977
Berwyn, Illinois

MINI-MIKE MASTER FOUR

After receiving my February issue of CBH and reading about the Mini-Mike pre-amplifier, out came the money and junk box. When the pre-amp was finished, I, as any good CB'er would do, started to play with the original circuit. And out came the 'Master Four Mini-Mike.'

The circuit should be completely self ex-

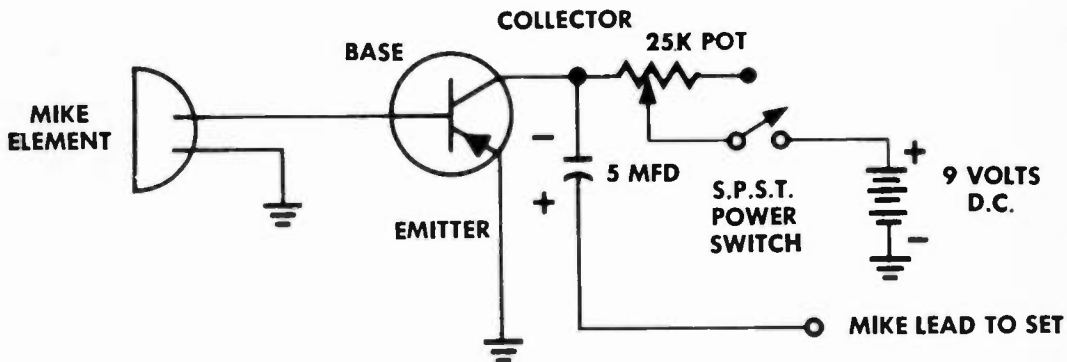

MINI-MIKE MASTER FOUR

planatory. The new pre-amp is being utilized as a mobile and a base (moneysaving) pre-amp. The 25K pot (gain control) was used only because it was in the spare-parts box. It probably would be better with a 50 K pot. It would be a real winner for you as

it has been for me.

Hat's off to CB Horizons again for a GOOD \$4.00 pre-amp.

Gary F. Anderson, KJB0050
Box 3706
Kingsley Field, Oregon

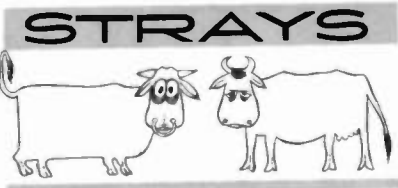

REMINDER-LICENSE FEES

Effective January 1, 1964, all Class D CB Applications filed with the Commission must be accompanied by a check or money order for \$8.00. The check is to be made out to the Treasurer of the United States.

CITIZEN BAND STANDARDS BY SONAR

When performance is critical and reliability a necessity SONAR CAN BE DEPENDED UPON. CB standards of Sonar must and will always be above and beyond what is expected. Write for full particulars.



MODEL G Featuring the NEW Sonar noise silencer. Dual conversion • RF output meter • Signal strength meter • Crystal spotting switch • illuminated panel • 8 channels crystal-controlled • Receiver tunes 23 channels • Class "B" modulation

Complete with 1 pair of crystals and microphone

\$229⁵⁰



MODEL E FCC type accepted • 8 channels, crystal-controlled transmitter/receiver • Tunable receiver for 23 channels • Powerful transmitter 100% Class B modulated • Automatic noise limiter • Lightweight, compact.

Complete with 1 pair of crystals and microphone

\$179⁵⁰

SONAR RADIO CORPORATION
73 Wortman Ave., Brooklyn 7, N. Y.

Please send me complete information on

Model E Model G 232

NAME.....

ADDRESS.....

CITY..... STATE.....

LAFAYETTE

World's Citizens Band Headquarters



LAFAYETTE 12-TRANSISTOR
C.B. "WALKIE-TALKIE" with SQUELCH

39.95 2-for-78.88

- Separate Microphone and Speaker
- Fully Transistorized
- Completely Wired — Ready to Operate
- With Carrying Case, Earphones, Antenna, Batteries and Crystal

HE-100L
Imported

NEW! LAFAYETTE 10-TRANSISTOR "WALKIE-TALKIE"
Similar to the great HE-100, but without noise squelch.
HA-60L Only 33.95; 2-for-62.90



LAFAYETTE
4-TRANSISTOR
C.B. "WALKIE-TALKIE"

HE-82L Imported

- Sensitive Superheterodyne Circuit
- Crystal Controlled Receive and Transmit
- Range up to 1 Mile
- Rugged Metal Case, Leather Carrying Case, Crystals and Battery

19.95
2-for-38.95



LAFAYETTE 9-TRANSISTOR
C.B. "WALKIE-TALKIE"

25.95 2-for-49.95

- Transmits and Receives up to 1.5 Miles
- Crystal Control on Transmit and Receive
- 9-Transistors plus Diode and Thermistor
- With Leather Carrying Case, Shoulder Strap, Earphone, Antenna, Batteries, Crystals

HE-29C Imported

LAFAYETTE 1-WATT
13-TRANSISTOR
C.B. "WALKIE-TALKIE"
with SQUELCH

- 10 Times More Powerful than 100 MW Units
- Powerful 2-Stage Transmitter with Silicon Output Transistors
- Crystal-Controlled Receive and Transmit
- Automatic Noise Limiter, Squelch, AVC
- Plug-In Battery Case, Telescopic Antenna, Earphone, Leather Carrying Case, Batteries, Crystals for Channel 13



66.50
2-for-129.00

Imported HE-75L

LAFAYETTE HB-115 PUSH-TO-TALK C.B.
TRANSCIVER



59.95

HB-115

Made in U.S.A.

- 8 Crystal-Controlled Transmit Positions
- Tunable Superheterodyne Receiver Over All 23 Channels
- Pi-Network for Maximum Power Output
- With Push-to-Talk Ceramic Microphone, Mounting Bracket, Channel 15 Transmit Crystal

LAFAYETTE "PRIVA-COM"™
SELECTIVE CALLER

- For Quiet Private Communications
- Tone and Light Signal
- With Mounting Bracket
- Ideal for use with all Lafayette Push-to-Talk C.B. Transceivers

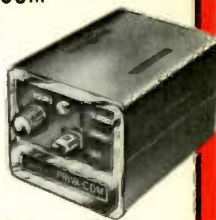

32.50
2-for-62.50

Made in U.S.A.

HA-100

LAFAYETTE
RADIO ELECTRONICS

SYOSSET, L. I., N. Y.
JAMAICA, N. Y.
NEW YORK, N. Y.
BRONX, N. Y.
SCARSDALE, N. Y.

NEWARK, N. J.
PLAINFIELD, N. J.
PARAMUS, N. J.
BOSTON, MASS.
NATICK, MASS.

FREE!

LAFAYETTE RADIO ELECTRONICS 1964 CATALOG NO. 640



LAFAYETTE GIVES YOU MORE IN '64

MORE CITIZENS BAND . . . Lafayette offers more transceivers, more Walkie-Talkies and more accessories than ever before.

MORE STEREO HI-FI . . . More HAM gear • More Test Equipment • More Tape Recorders • More Tools • More Tubes • More Books • More Cameras.

MORE BUYING POWER . . . Choose from Lafayette's three Easy Pay Credit Plans. **NO MONEY DOWN** — up to 24 months to pay—as little as \$5 monthly.

**422
Giant-size
Pages**

LAFAYETTE 23-CHANNEL CRYSTAL-CONTROLLED C.B. TRANSCEIVER

- 23-Channel Crystal-Controlled Receiver & Transmitter—All Crystals Supplied
- Dual Conversion Superhet Receiver Uses 1650 KC and 282 KC IF's for High Selectivity and Sensitivity
- 10 Tubes plus 3 Silicon Power Rectifiers for 17 Tube Performance



159.50

HB-222

Delivery Oct. 1963

Made in U.S.A.

LAFAYETTE DELUXE DUAL-CONVERSION C.B. TRANSCEIVER

- Super Selectivity, Sensitivity and Stability
- 9 Tubes plus 3 Silicon Diodes plus 2 Crystal Diodes for 17 Tube Performance
- Built-in 117V AC Power Supply and 12V DC Mobile Transistorized Power Supply
- With Bracket Handle, Push-to-Talk Ceramic Mike, Transmit and Receive Crystals for Channel 15 plus Crystal for Dual Conversion

129.50

HB-111

Made in U.S.A.



LAFAYETTE HE-20C DELUXE C.B. TRANSCEIVER

Made in U.S.A.



109.50

- 8 Crystal Receive Positions, 8 Crystal Transmit Positions
- Built-in Selective Call Circuitry and Socket
- 14 Tube Performance
- Built-in 12 or 6-Volt Power Supply
- With Push-to-Talk Ceramic Mike, Channel 9 Transmit and Receive Crystals

Mail the Coupon for your **FREE** Catalog

LAFAYETTE RADIO ELECTRONICS
Dept. CBI-3
P. O. Box 10
Syosset, L. I., N.Y. 11791

Please send me the free 1964 Lafayette catalog No. 640.

Name

Address

City Zone State

FEATURE FOR FEATURE — DOLLAR FOR DOLLAR YOUR BEST BUY IN CB RADIO

THE NEW RCA MARK VIII

27-Mc CITIZENS BAND 2-WAY RADIOPHONE

UP TO 9 FIXED, CRYSTAL-CONTROLLED
TRANSMIT-AND-RECEIVE CHANNELS.
PLUS ALL-CHANNEL TUNABLE RECEIVER.

CONVENIENT ACCESS TO CRYSTALS FOR QUICK CHANGING.

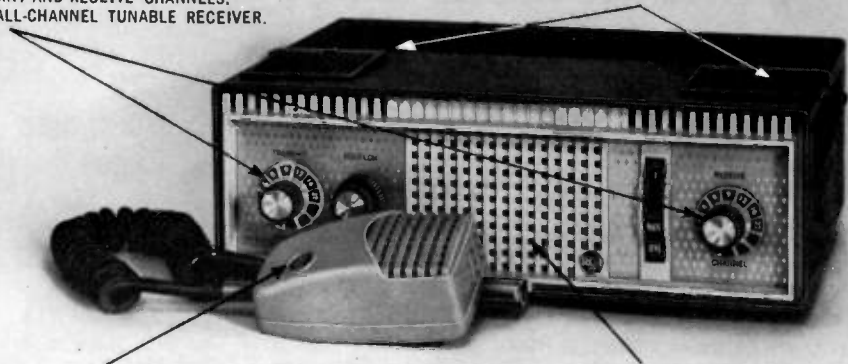

PUSH-TO-TALK CERAMIC MICROPHONE with coiled cord.

EXCELLENT VOICE REPRODUCTION—high intelligibility.

EXCELLENT TRANSMITTER
MODULATION CHARACTERISTICS

IMPROVED AUTOMATIC NOISE LIMITER
reduces effects of ignition and similar
interference.

COMPACT AND LIGHTWEIGHT
3½" high, 9 pounds. Fits easily under
any auto dashboard.

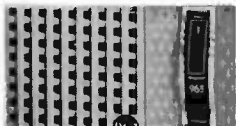

Continuously tunable receiver
picks up any of the 23 C-B
channels. Tunes either by
channel number or frequency.



Illuminated working channel.
Pilot lamps behind the fixed-
channel dials show the chan-
nels being worked.



Separate mobile power sup-
ply. (Optional) 6- or 12-volt,
for car or boat. All units
contain AC power supply.



Channel-marker kit. Select
channels best for your area,
then mark them with the self-
adhering labels included.

ONLY **\$149.50***

*OPTIONAL LIST PRICE

Get all the Facts Before You Buy.
Mail Coupon Today. Paste on 4¢ Post-Card.



The Most Trusted Name
in Electronics

RCA ELECTRONIC COMPONENTS AND DEVICES
Commercial Engineering Dept. #1-131-R
415 South Fifth Street, Harrison, N. J.

Please send more information on the RCA Mark VIII C-B Radiophone

Name _____

Address _____

City _____ Zone _____ State _____

TRAM TR-27E TRAM



ANOTHER STEP FORWARD IN CB COMMUNICATIONS TR-27E BASE STATION

Transmitter

70% or better Transmitter efficiency provides 3.5 watts guaranteed minimum RF Output with 100% High Level Modulation. (Keyed Compression - Base Station)

Receiver

Sensitivity - .1 uv. for 300 milliwatts of audio
Selectivity - 5 kc. @ 6 db. Adjacent channels 60 db. down
Signal to Noise Ratio - .3 uv. for 10 db.

TRAM Electronics will include in its ad each month a section on technical notes to provide interesting comments on specific TRAM circuitry. Offered particularly as a service to TRAM equipment owners, it will also point out to the general CB user the care with which quality equipment is designed.

Service techniques described in this section are for qualified service technicians. It may be desirable for owners of TRAM equipment to save these tips and attach them to their owners manuals.

TRAM SERVICE TIP No. 1

When tuning the 31.5 mc. 1st conversion receive oscillator coil (L2), tune for maximum D. C. voltage at pin #7 of the 6BK7 (V2). Then, looking at the coil from the bottom of the set, turn the slug counter-clockwise to drop the grid (pin #7) voltage two volts. This results in optimum oscillator stability.

The TRAM 23 base station, renowned for its superior performance and dependability under the most exacting conditions, is now offered in an improved model, the TR-27E. In addition to the many features that are standard on all TRAM units, you will find:

- The "s" meter is now a D'Arsonval moving coil type with an illuminated panoramic scale, accurately calibrated to 60 db over S9.
- The cabinet now has an extra durable wrinkle finish.
- The 23 channel selector switch carries the channel number illuminated in the panel.
- The receiver overload characteristic is improved by 20 db.
- Adjacent channel rejection is improved by approximately 5 db.
- And in many other respects the overall excellence of TRAM equipment has been given extraordinary consideration and effort.

TRAM ELECTRONICS, INC.
P.O. Box 187, Dept. 10A
Winnisquam, N.H., 03289

Please send by return mail at no obligation, detailed information and specifications on TRAM Citizens Band equipment.

Name _____ Call No. _____
 Street _____
 City _____ Zone _____
 State _____ Zip Code _____

TRAM ELECTRONICS INCORPORATED

P.O. BOX 187, DEPT. 10A

WINNISQUAM, N.H., 03289

TEL. 603-524-0622

THE CB LISTENER



Awards and Certificates for CB DX

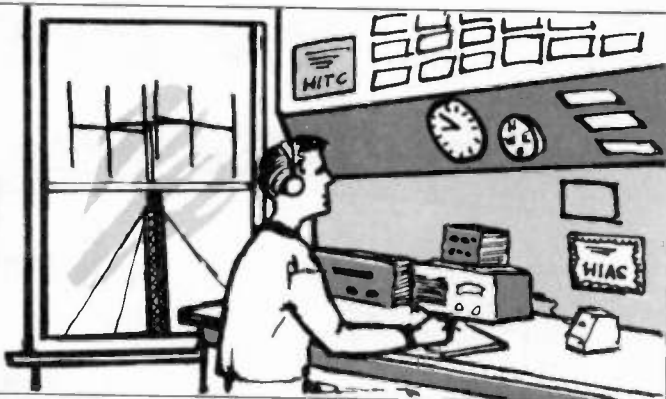

HEARD FIVE COUNTRIES AWARD

CB'er Arno Feltner, KED0775, New Braunfels, Texas has scored another first!

A CB listener extra-ordinaire, Arno has become the first to apply for and receive the HFC (Heard Five Countries — On CB) Award from CB Horizons.

You may recall in the July CB Horizons Arno applied for and received the HTC or Heard Three Continents Award.

The cards Arno submitted for the HFC award include verified confirmations from Mexico station (XB-3), Puerto Rico (22W-0274), Hawaii (KF10181), Canada (XM-13-306) and Venezuela (YY5 HST 1015).

In receiving the HFC award, Arno stands alone as not only the first CB'er to win this award, but the only CB'er to have won 2 of the six awards now available from CB Horizons.

The only 'heard' award he is missing is the real tough one . . . HAS, or Heard All States.

GUAM REPORTS IN

Herman C. S. Fong, 21W0170, located far to the west of all of us, at Agana, Guam (in the Pacific) writes that he, Ernest V. Sampson, 21Q0027 and Frank R. Scofield, 21Q0030, all located on Guam, are avid CB listeners, and are anxious to have heard reports from the 'mainland.'

Herman operates with a Webster 440 transceiver and his CBL card incorporates the exact and proper wording recommended by the CB Listener in the March issue of CB Horizons, when cards are to be used towards awards' applications.

Herman operates an insurance agency, and either of his two CBL cards would

21W0170

"YOUR GATEWAY TO THE ORIENT"



be a most handsome addition to your collection!

OTHER CARDS FROM AFAR

Last month we reported on a pair of stations that were being heard around the states, one XB-3 in Mexico and the other VGH3697 in Eleuthera, Bahamas.

Here are a pair of cards including the famous card of YV1WKC, Judibana (Coro) Venezuela which so many CB Listener reporters have noted in their reports. If your eyesight is good, this should be the Venezuela address many of you have been looking for.

VGH3697 stands by on channel 11 from the Bahamas, as reported in the September

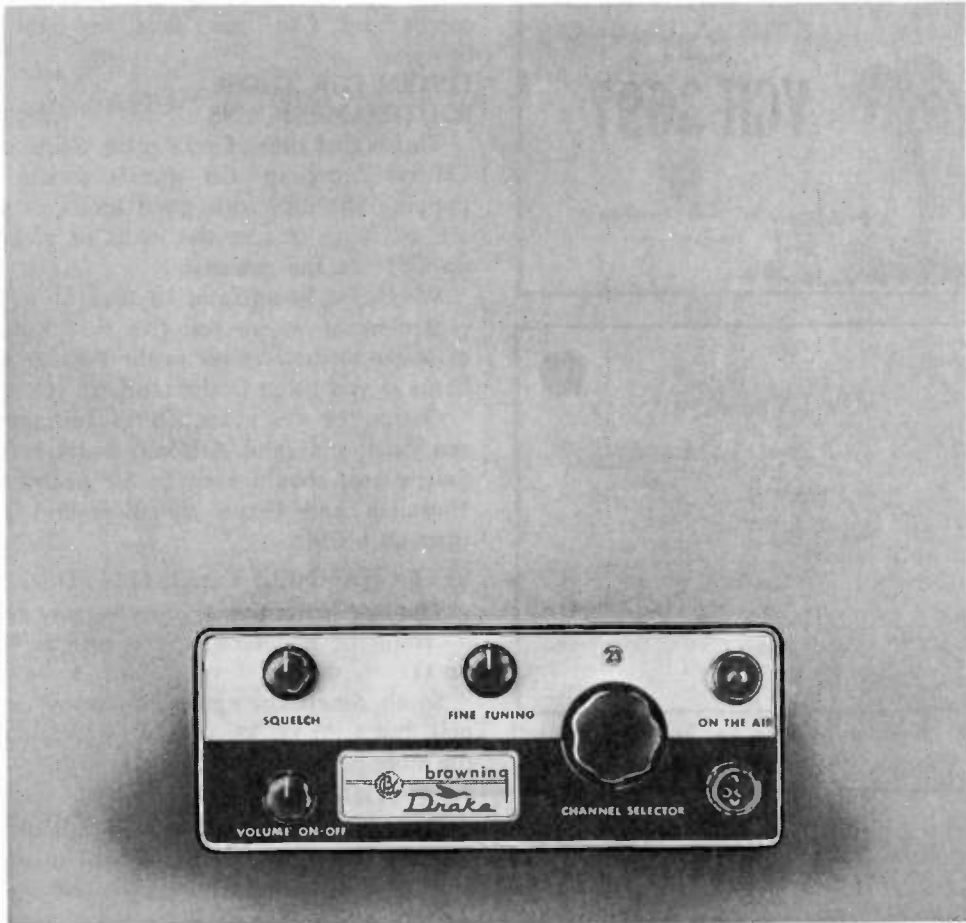

Think smallest.

Planning to buy a mobile CB rig? Think smallest. Buy the smallest 23-channel mobile CB transceiver on the market . . . the Browning Drake M-523. It's so compact it fits perfectly under the dash, and you can still ride three in front comfortably. Perfect for sports cars. The Browning Drake M-523 and M-506 (six-channel version) are 8" x 9" x 3" small. What's more, we use only tubes in the circuits for utmost reliability — and you don't have to be an electronics engineer to make repairs or change a tube. Right now we have over 100 franchised Browning Service Centers across the nation where you can see, try (if you have a license) and buy the Drake or any other Browning CB equipment. We will gladly tell you where the nearest one is in your area. Before you buy just any mobile CB equipment, THINK SMALLEST . . . BUY BROWNING. Then start enjoying CB as it should be.

Mail Coupon Today

Browning Laboratories, Inc., Dept. H
100 Union Ave., Laconia, N.H.

WITHOUT OBLIGATION, PLEASE SEND:

- Name of nearest Service Center.
- 16-page color CB catalog.

NAME _____

ADDRESS _____

CITY _____ ZONE _____ STATE _____

CALL LETTERS _____



LABORATORIES, INC.
LACONIA, NEW HAMPSHIRE

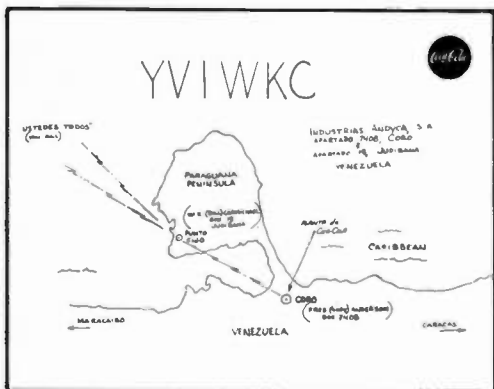
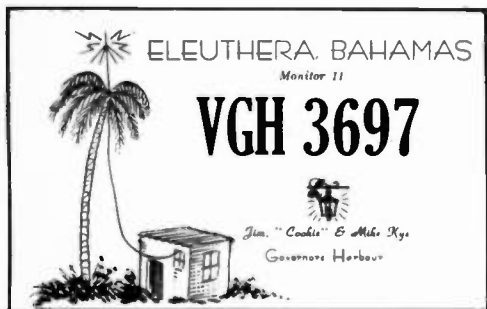

issue. No one to date has been able to tell this column who issues licenses in the Ba-

hamas, or where the strange VGH prefix comes from. Can you shed any light on this one?

LISTEN FOR THOSE SOUTH AMERICANS

This is that time of year again. South and Central American CB signals should be popping through with good levels as you are receiving this in the mails or picking up CBH on the newsstand.

Watch the hours from 12 noon to 6 PM, regardless of where you live, and keep a close ear to the receiver in the 7 to 10 AM hours if you listen in the southern states.

Out on the west coast, CB'ers from southern California (and Arizona) north to the Seattle area should keep an ear peeled for Hawaiian and Guam signals from 3 PM through 8 PM.

BEST CHANNELS TO LISTEN FOR DX?

The best bet is to stay away — way away — from the popular channels such as 7, 9 or 11.

South Americans operate on many channels, but 3, 5, 11, 15, 16 and 17 are among the more popular.

FILE YOUR REPORTS

There is no such thing as a Call-Book of CB'ers outside the USA. The Horizons' series of books for the 24 U.S. districts is unique in this respect.

However, by compiling information on the names and addresses of strange CB'ers located around the world, through this monthly column, we can all share in the wonderful world of CB DX Listening, and reap its rewards by collecting CBL cards from many rare and exotic spots on the globe.



SO YOU WANT TO TALK FARTHER!!

Here it is — A real voice amplifier that gives your signal modulation punch like nothing you have ever heard! Others will say you're running 20 watts or more. And your signal will sound like it! This precision voice amplifier is the finest on the market today, and you can wire it into your set!

Guaranteed for one year. If anything goes wrong, return the un-tampered with unit (keep your fingers out!) with \$5.00 and we'll send you a brand new CB Relayer! Epoxy sealed circuit, heavy duty steel case, quality front panel. This is not a toy. This unit gives your signal the modulation punch you have been looking for. Full price — \$32.50 postpaid.

Strayer Electronics (Two Way Division)
9353 Greenback Lane
Orangevale, California

Enclosed my check/money order for \$32.50
Send me my postpaid CB Relayer Voice Amplifier today!

Send me free data on the CB Relayer

Name _____

Address _____

City _____ Zone _____ State _____

(Calif. Res. add 4% sales tax)

CB SALESMAN WANTED

Must have extensive product knowledge and contacts in Citizens Band field. To handle established, high quality product line. Location: metropolitan New York. Little travel. Excellent opportunity offering high salary.

BOX 15 — CB HORIZONS

P.O. Box 1557, Oklahoma City 1, Okla.



COURIER 1-M

NOW!

QUIETEST

MOST POWERFUL

MOBILE

C.B. UNIT!

HEAR IT TO BELIEVE IT!

Write for Free Brochure \$229.50, list, slightly higher west of Rockies.



electronics communications, inc. 325 no. macquesten pkwy, mt. vernon, n. y.



REPORTS

OF PRODUCTS TESTED
BY OUR ENGINEERS

LAFAYETTE HE-90 TRANSCEIVER

Lafayette Radio Electronics 111 Jericho Turnpike, Syosset, L.I., New York, is responsible for considerable populating of 27 megacycle band.

One of the primary reasons for this success is the number of relatively in-expensive transceivers Lafayette has placed on the market.

Lafayette's model HE-90 is one of the latest in a line of popular transceivers made available by this firm.

Basically, the HE-90 series incorporates a 6 channel transmit-23 channel (tuneable) receive radio into a single compact ($6\frac{3}{8} \times 11\frac{3}{8} \times 5$ inches) package.

The receiver utilizes a Nuvistor stage (6DS4) for low noise-high gain amplification of signals received. 27 megacycle signals are converted to a 1650 kc intermediate frequency where i.f. amplification in a pair of tubes (6AU6A and 6U8/6EA8) brings the signal to the detector. A diode noise limiter in the 6T8A circuit brings the received signal to the detection stage where it is followed by a stage of audio amplification and then fed to a 3 watt (output) audio amplifier utilizing the popular 6AQ5A type tube.

The transmitter is a single tube affair featuring the also-popular 6AW8A. The triode half of the 6AW8A acts as an oscillator for the third overtone crystals, and the pentode section as the frequency multiplier.

The HE-90 unit has the following auxiliary functions: S and RF meter combination unit; final amplifier plate current meter/jack on the front panel (for tune-up by a licensed technician); crystal spotting of the transmitter channel on the tuneable receiver and a crystal receive-tuneable receive switch.

The HE-90 unit operates from 117 vac. Operation of the unit from either 6 or 12 volts dc requires the addition of Lafayette's HE91 (6 volt) or HE92 (12 volt) power unit.

The optional power unit, a small vibrator supply, is handy in that it can be mounted away from the transceiver inside the auto engine compartment or any other location

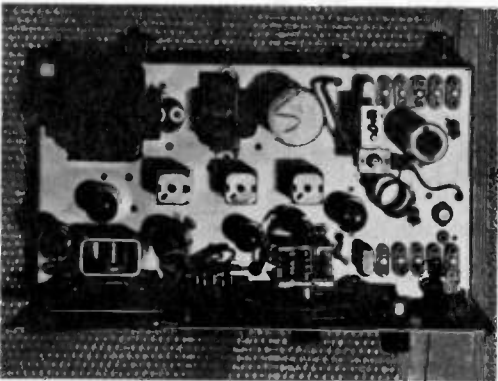
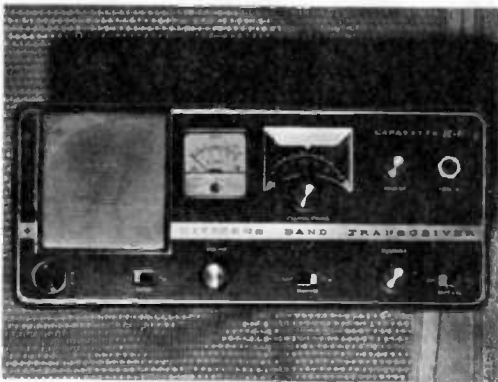

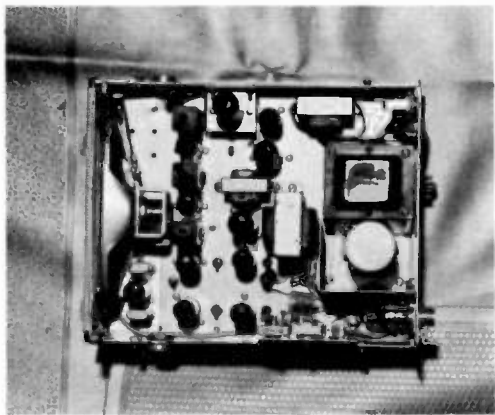

where it will not interfere with the installation (mobile) of the transceiver.

The transceiver contains a built-in TVI trap, designed to reduce harmonic radiation in areas where channel 2 television operation is local. The TVI trap is adjustable with a slug tuned coil and you can easily set the trap for maximum rejection of the transmitter's 2nd harmonic by observing the interference pattern (if any) on the television picture tube screen, and adjusting the trap for minimum interference.

An ear phone jack for headset listening is provided on the rear apron of the transceiver.

Lafayette provides a complete and informative manual on the transceiver's operation, including some basic data on aligning the receiver and adjusting the transmitter.

The transceiver, priced at \$94.50 is available through Lafayette Associate stores, Lafayette owned stores and the general catalogue.

ELECTRO-WINDERS 'Toroid-Tenna'

To most electronic types the term 'toroid' designates a component part in a radio-teletype converter mechanism. Ham-types are familiar with a toroid-coil in RTTY converters.

To find a 'toroid-coil' in a CB antenna immediately sets your mind to wandering.

It's probable Electro-Winders, Inc., 854 West Front Street, Covina, California did some mind-wandering on their own in the two years they worked with this unusual approach to making a short antenna do the work of a full-sized model.

The Electro-Winder folks have come up with a precision engineered and very nicely manufactured piece of CB mobile antenna, they call the 'Toroid-Tenna.'

Basically, they have discovered a method of making a toroid coil act as a loading (or shortening) device for a piece of stainless steel (the whip).

The end result is a 42 inch tall (long, high, etc.) mobile CB antenna that seems to function as if it were considerably longer (like 102 inches) with the efficiency and match of a full-sized antenna.

All of this, in itself, might not make the antenna too much out of the ordinary.

However, the antenna also features a screwdriver adjustment in the base which allows you to trim (or peak) the antenna to precisely the CB channel in use.

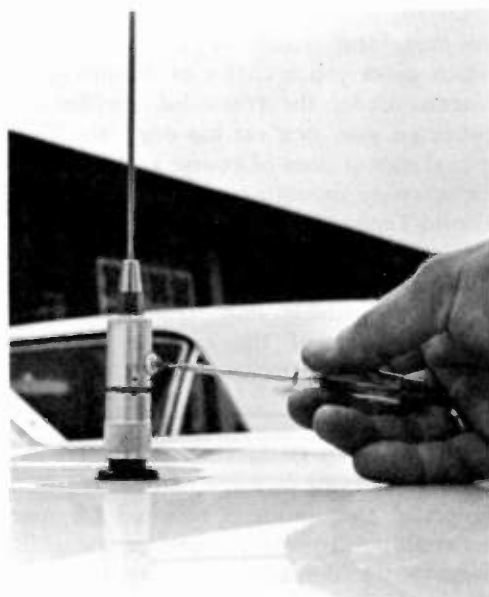

Because of the toroid-coil loading arrangement, and the companion screwdriver adjustment, we found that almost regardless of where on the vehicle (or on what type of vehicle) you mount the antenna, you can compensate for nearby proximity of metal support posts, other antennas, rooflines or whatever, by simply placing an SWR indicator (bridge) in the transmission line at the transceiver and adjusting your screwdriver

control until the SWR drops to 1 to 1, or no reflected power.

This does make the antenna truly versatile and more than a little handy to install and operate.

We also found that the approximately 40 inches of exposed 17-7 stainless steel radiator is very staunch. At 80 miles per hour we measured less than 4 inches of tilt at the top of the whip. It doesn't look that wind-resistant-less, but it is as tests have revealed. This indicates your signal will stay vertically polarized at high road speeds.

The Toroid-Tenna is a completely integrated package ending up at the base in a PL-259 type coaxial connector. This is unfortunate, we feel, because this restricts the type of mounts you can use the antenna with. It screws into a coaxial connector such as you are likely to find on the back of most CB sets.

Electro-Winder does have a very special, low-cost, and universal mount however which gives you a choice of mounting the antenna under the trunk lid, on the rain gutter (if your new car has one), etc. Their special mount does of course accept directly the screw-on mounting of the PL-259 based Toroid-Tenna.

We feel this is definitely a superior mobile antenna in many ways. The unit is currently available only from the manufacturer. Price of the antenna is \$19.95 and the universal mounts are \$5.95 each.

SONAR BR-20 BUSINESS RADIO

It was just one year ago that CB Horizons suggested that Business oriented CB users in metropolitan areas consider switching over to the dormant and very docile 27 megacycle Business Band frequencies.

Subsequently, a number of manufacturers have developed an interest in this "low band."

Sonar Radio Corporation, 73 Wortman Avenue, Brooklyn 7, New York has announced a new 14-watt 25 to 50 megacycle AM transceiver that meets the FCC's criteria for operation in and around the 27 megacycle Business Band.

Basically, the BR-20 is a CB transceiver that has been beefed up for more suds and



improved ruggedability. And it has a few items in the circuitry that the Commission requires for FCC Type Approval.

If you operate a business, virtually any kind of Business*, then you can operate the BR-20. All you do is file the fantastically simple Form 400, wait 30 days for your license, and you are on the air.

If you already have a CB installation, you can use your present antenna, feedline and mobile antennas, etc. Just substitute the BR-20 for your base and mobile rigs, re-peak the antennas slightly and you are in business with 14 watts.

Of course you are limited to a single operating channel (usually shared by only a couple of others), but if you are a true business user, this shouldn't bother you one bit.

The BR-20's we put into use on 27.265 megacycles (our BB channel here at Horizons ran between 13.5 and 14 watts input. The unit is plated modulated (AM), and power output averaged 8.7 watts in the mobile and 9.0 watts on base. In the four weeks we operated our units sans selective calling we heard one other station on the channel (in the middle of the summer and skip yet!) and this was a network of 18B stations up in Indiana who obviously bought the wrong crystals for their CB sets!

About four weeks after the tests began Sonar shipped us out a pair of their new SC-1 Selective Callers. The plugs on the

*See September 1962 issue of CB Horizons for a full report on Business Band in the 27 megacycle region.

CONTINUED — page 54

**FOR
ADULTS
ONLY!**



NEW CADRE C-75 CB TRANSCEIVER

The new Cadre C-75 1.5-watt, 2-channel transceiver is 15 times too powerful for youngsters (under 18 years of age) to operate, according to FCC regulations. Clearly, it's not a toy. It's designed for serious CBers who need 'big set' performance that can be used anywhere.

The new C-75, weighing less than 2 lbs; provides clear, reliable 2-way communications up to 5 miles and more. All solid state design creates an extremely rugged transceiver to absorb rough handling, stays on frequency. Two crystal-controlled channels spell perfect communications contact everytime. Sensitive superhet receiver ($1\mu\text{V}$ for 10 db S/N ratio) brings in signals in poor reception areas. Powerful transmitter has one watt output to the antenna. Adjustable squelch silences receiver during standby. AGC assures proper listening level. In a word, the C-75 has all the features you'd look for in a quality full size CB unit.

The C-75 has all the portable conveniences you'd want, too: operates on alkaline or mercury penlite cells (8-hour rechargeable nickel-cadmium battery available); ear-phone and antenna jacks; built-in retractable antenna; jack for base operation while recharging.

Use the Cadre C-75 anywhere in the field, for vehicle, office, boat or plane. Use it constantly too, because its all-transistor modular circuit (11 transistors and 2 diodes) is virtually maintenance free. \$109.95. Recharger and 2 nickel-cadmium batteries \$31.85.

Cadre also offers a complete line of 5-watt all transistor transceivers and accessories.

See your Cadre distributor or write
CADRE INDUSTRIES CORP.
 COMMERCIAL PRODUCT DIVISION □ ENDICOTT, NEW YORK
 □ AREA CODE 607, 748-3373. Canada: Tri-Tel Assoc., Ltd.,
 81 Sheppard Ave. W., Willowdale, Ont. Export: Morhan Ex-
 porting, 458 B'way, N. Y. 13, N. Y.

INCREASE

RANGE and QUALITY

with specifically engineered

Master Mobile

"CB" Antennas



Giant Q-11
 BASE STATION
 CUBICAL QUAD
 ONLY \$39.95 NET

Tailor made to increase range in limited CB band. Tough, lightweight components permit use with most TV-type rotors. Easily assembled on ground or tower.

SPECS: Forward Gain; 8 db; Front to Back, up to 40 db; Feed Type, 52 ohm coax; Polarization, horizontal or vertical; Longest Element, 9'8"; Boom Length, 66 1/2".

**GET ON
THE BEAM**

"AIR-SENTRY"
for Class D-27mc
Communication



\$13.20
NET



CG-275 Retractable Gutter Mount with positive lock



MMM-75 Adjustable for curved surface mounting

Guaranteed performance, mounting choice, less than 48", factory tuned, simple peaking adjustment... add up to preference. SPECS: 52 ohms, 60 watts max. power, RG-58 or equivalent, SWR-1.1 to 1 at resonant frequency. Complete with either mount.

**AIR SENTRY
"Shorty"
Model CB-1
\$10.95 NET**



Designed for car installation to cover all 23 channels. Top loaded fiberglass complete with shock spring, mount and 12' coax cable. Whip, 18" — overall, 23" — terminates in coax plug PL-259.

IF YOUR DEALER DOES NOT STOCK
 "MASTER MOBILE" ORDER
 DIRECT AND SEND
 HIS NAME

**SEND FOR "ANTENNA BUYER'S GUIDE"
with over 200 Antennas. It's FREE!**

Master Mobile Mounts

DIV. OF



4125 W. Jefferson Blvd.
 LOS ANGELES, CALIF.
 AREA 213, 731-2251

DATELINE - "CB INDUSTRY"

NEW PRODUCTS, SERVICES FOR 2-WAY RADIO

TRANSCIVERS

Allied Radio Corporation has announced a new low-cost portable hand-held communications system under their Knight-Kit manufacture.

The C-555 is a superhet transceiver kit featuring crystal controlled transmitting and receiving; 100 milliwatt input, an earphone jack, up to 50 hours of use with a single 9 volt cell, 5 transistor and 1 diode circuit, printed circuit board and a 40 inch telescoping antenna.

The coral-red-cased beauty will sell for just \$19.95 per with a optional carrying case and earphone.

Write for specs at Allied's CB Center, 100 N. Western, Chicago 80, Illinois.

Olson Electronics, Inc., 260 S. Forge Street, Akron 8, Ohio reports in on their Olson Side-Bander which is the third CB sideband unit to hit the market in recent weeks.



The new unit is equipped with all 23 crystals for 23 channel controlled receive and transmit. New double-sideband with reduced carrier plus push-pull modulation gives up to four times the range of other units, according to the people at Olson. Two dual function meters monitor strength of receiving and transmitting signals; plate voltage to the final amplifier and plate current in the final. A double conversion crystal controlled receiver responds to signals that are in the 1/2 microvolt class and provides up to 10 db signal to noise ratio. A special vernier tun-

ing control lets you slide around on receive to spot slightly off channel signals.

The unit has a dual power supply and operates from 117 vac and 12 vdc sources.

Price on the new sideband unit is \$219.95 from Olson stores.

Modern Sales Company, 2706 Acklen Avenue, Nashville 12 Tennessee has announced the availability of a new 8 channel crystal controlled transceiver.

The unit has 3 watts output, operates from 6, 12 vdc or 117 vac. It features a dual purpose meter for monitoring of power and modulation output.



The unit is an import, one of the first 5 watt base or mobile station imports from Japan.

Full details are available from the source in Nashville, including dealer application forms.

A new 1 watt fully transistorized portable CB transceiver has been announced by Inter-Mark Corporation, 29 West 36th Street, New York 18, New York.

The new unit is called the Cipher 1,000. It is powered by 12 'D' cells, with a lifetime of approximately 120 hours. It's circuitry contains a total of 15 transistors.

The unit weights in at 7 pounds, and is designed for portable carry-about use. It has a power input of 1 full watt and a power output of 1/2 watt or more. The receiver is a superhet with 8 kc bandpass in the i.f. stages.

The palm-sized microphone is a press-to-talk job and other controls include a power on-off switch, squelch and volume. The case



is a lightweight metal case built to take knock-about use in industrial or private applications.

Price on the new portable unit is \$129.95.

ECHO Communications, Box 223 Cedarsburg, Wisconsin has a new set of their own now.

Its the ECHO 880, a 23 channel tuneable, 12 channel transmit (with external crystal socket) transceiver that operates from 6 or 12 vdc and 117 vac.

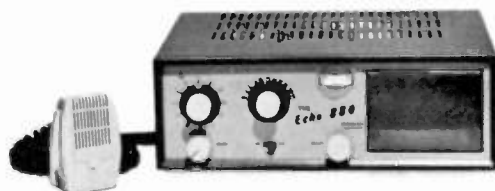

The set also features an illuminated S meter, crystal spotting provision (switch), auxiliary speaker terminals and easy access to crystals for quick changes.

The price is a secret which you have to write for, unless you are cagey and check page 26 of the August Directory issue of CB Horizons.

Write to ECHO at their Cedarsburg address anyhow and Sandy Wirth will send you a bit of information.

ANTENNAS

Antenna Specialists, 12435 Euclid Avenue, Cleveland, Ohio has announced a new CB beam antenna that should solve your CB Base to base and base to mobile problems with ease.

The new MR-77 gives the user a choice of either vertical polarized signals or horizontally polarized signals. Two separate feedlines to the antenna, plus a switch at the base, let you switch from vertical to horizontal whenever you find the need calls for a change in your wave pattern.

In the vertical position, AS/P says you get 7db gain and 15 db of front to back ratio. In the horizontal plane, you can boast of 6

Terry 18W3516 Owner of
Amateur Electronic Supply

KING OF TRADERS

says

**Trade in Your
Present CB
Equipment on**

**HALLICRAFTERS
CB TRANSCEIVERS**

\$5 DOWN

three years to pay



**NEW
HALLICRAFTERS
CB-3A \$159.95
ONLY \$5.77**

month (3 years

Look at these low payments on all
Hallicrafters CB Equipment

	1 Yr.	2 Yr.	3 Yr.
CB-3A 8 Channel	\$159.95	\$14.65	\$7.99
CB-5 Transistorized	199.95	18.32	9.99
CB-4 Hand Held (Ch. 11)	89.95	8.24	---

ACCESSORIES

HA-9 S meter Kit for CB-3A	\$ 8.95
HA-11 Noise limiter for CB-3A	\$15.95



**AMATEUR
ELECTRONIC
SUPPLY**

Complete Stock of Hallicrafters CB Equipment and accessories as well as S-wave Receivers and Ham Equipment.

To: Amateur Electronic Supply
3832 W. Lisbon Ave., Milwaukee 8, Wisconsin

Ship me a _____ on channel _____ (1 Free).
Please install Extra Channels for _____ (\$5.95 per channel).
I Enclose \$ _____ I will pay balance (if any)

in: C.O.D. 1 Year 2 Years 3 Years

For: 110 VAC & 12 VDC 110 VAC & 6 VDC

I want to buy a _____ and want to trade
a _____ which was originally purchased in:
 Kit Form Wired

In this form this unit originally sold new for
\$ _____ I purchased it New Used.

Name _____ Call _____

Address _____

City _____ Zone _____ State _____

Send FREE listing of used CB & Ham gear.

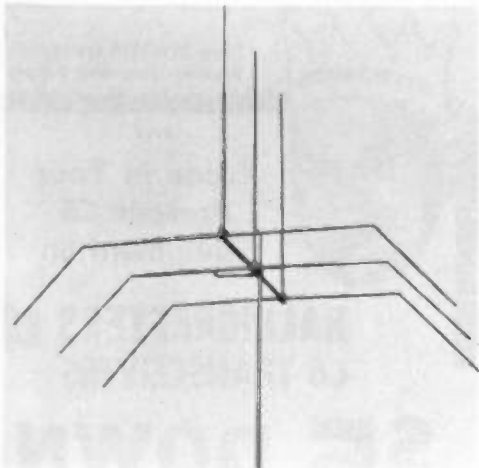

db gain and the same 15 db front to back.

All components are coded for fast, easy assembly, and the entire erected beam weighs 24 pounds dripping wet (or bone dry). See it at your nearest AS/P dealer. He probably has one up in the wind already.

Hy-Gain Antenna Products Corporation, Lincoln, Nebraska has a new and much improved version of their ever-popular CLR. Its the CLR Mark Two.

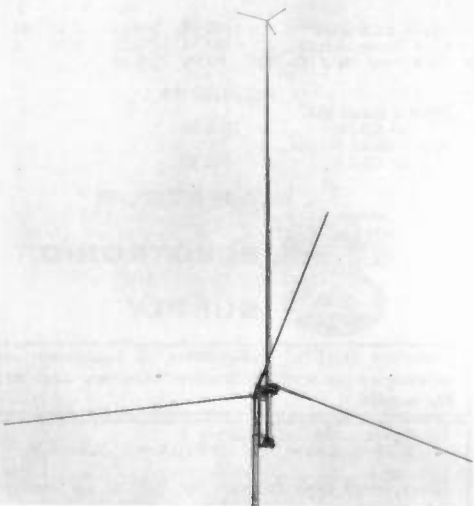

Hy-Gain reports every modern day electrical and mechanical innovation has been added to this new gain-vertical antenna. It develops 3.4 db of omni-directional gain, says Hy-Gain, is quick to assemble and very-very rugged.

It includes a built-in static arrestor for improved (6 db improved!) signal-to-noise ratio under noise conditions, which will help keep your receiver quiet.

The overall antenna height is 19 feet 10 inches which pushes you within competing distance of the 20 foot maximum allowable.

Everything about the CLR II is beefed up, from the heavy gauge seamless tubing to the iridite treated metal parts that defy corrosion and messy fitting in bad weather.

Hy-Gain boasts (and rightfully so) of 60,000 CLR's installed around the country, with the original version, and they feel that the new model will be a winner in every respect also.

See it at your Hy-Gain dealer, who also undoubtedly has one mounted well into the blue, already-yet.

New-Tronics Corporation, 3455 Vega Avenue, Cleveland 13, Ohio has just developed a new tuneable mobile CB antenna built along an entirely new principal. Basically, the new antenna is a copper sheathed fiberglass rod encapsulated in a waterproof plastic sheath. It is rugged and designed to take frequent bumps and grinds when the XYL forgets and drives into the garage or low hanging trees. The antenna is but 48 inches high and may be mounted in a convenient location. The antenna is tuneable over all 23 channels.

You can get the full story from your nearest Newtronics dealer, or directly from the folks at the factory.

Speaking of new antenna concepts, here is another first. Electro-Winders Company, 854 West 1st Street, Covina, California has a shortened mobile CB whip that is precision constructed, 42 inches short and screwdriver tuned over the entire CB range for real optimizing on your favorite channel or channels.

The new Toroid-Tenna features something else unique; a toroid-coil loading arrangement. This is their secret, they say, to (and here we quote) "Our guarantee is that the Toroid-Tenna has the lowest SWR and closest match ever achieved" on a mobile antenna.

Since you tune the antenna thru a screwdriver adjustment, there is no concern about 'tipping' the antenna with a hacksaw or file to trim it down to the frequency you want, and then finding out you have trimmed too far.

The antenna is mounted on a PL-259 coax connector and is available with a special universal base mount that allows you to mount it just about anywhere. Price on the new antenna for mobile use is \$19.95, available only from the factory for now. The universal mount is \$5.95 per.

ACCESSORY

Holstrom Associates, P.O. Box 8640, Sacramento 22, California has a new Audio-Aid-All clipper-filter that uses a zener diode clipper, two stages of selective audio amplification and an L/C filter to virtually "triple the average talk power" or modulation of any CB transceiver.

You get a very informative leaflet on the new product from the manufacturer. Kit form is \$10.99 each.

IMPORTANT CB DATES

The FCC advises that the new form 505's those which will be processed with automatic data processing equipment, have been delayed beyond the expected September 1 release date.

NO BUGS



IN MOSLEY ANTENNAS

SCOTCH-MASTER

UNI:LINEAR

Here is an Omni-Directional Vertical Ground Plane antenna which over shadows all other antennas of similar type available today . . . Why? . . . because of an extreme low angle radiation. A completely revolutionary matching system, featuring Grounded Element for lightning protection and drastic reduction of Rain Static Noise. These superior features combined with the world famous Mosley Construction assures the CB'er of an outstanding antenna for dependable communications.

SPECIFICATIONS AND PERFORMANCE DATA: Gain over standard ground plane - up to 4 db. VSWR: 1.5 to 1 or better over entire band. Feed Point Impedance: 52 ohm coax Unbalanced line. Assembled Weight: 8 pounds. Wind Load (EIA STD) 50 pounds. Antenna Height: Less than 20 ft. Number of Radials: 3. Antenna mounting fits masts up to 1½ inches ODO

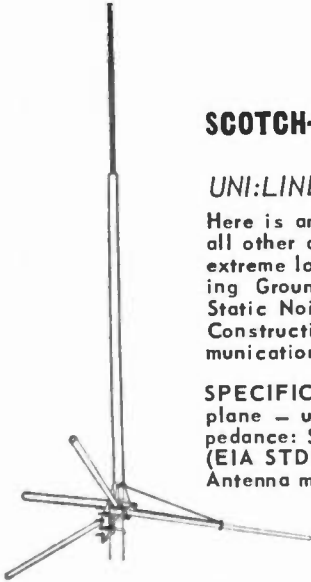

UL-27 List Price \$45.80

SCOTCH-MASTER

Here are two beams for the CB'er who wants the best point-to-point communications at lower costs. Mosley SCOTCH-MASTER A-311-S, three element and A-511-S, five element beams are designed for the economy minded CB'er who wants the world famous Mosley quality.

A-311-S

- No. of Elements - 3
- Antenna Weight - 12.5 lbs.
- Boom Length - 12'
- Maximum Element - 18' 8¼"
- Front-To-Back - 20 db.
- Vert. Wind Load - 65 lbs.
- Hor. Wind Load - 35 lbs.
- Forward Gain - 8 db.
- Type Matching - Gamma
- Impedance Point - 52 ohms.
- Radiation - Uni-Directional

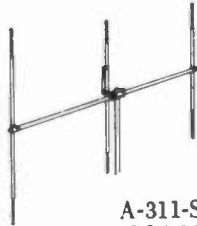

A-311-S
\$35.00

A-511-S

- No. of Elements - 5
- Antenna Weight - 16.5 lbs.
- Boom Length - 24 ft.
- Maximum Element - 18' 8¼"
- Front-To-Back - 20 db.
- Vert. Wind Load - 112 lbs.
- Hor. Wind Load - 62 lbs.
- Forward Gain - 9.5 db.
- Type Matching - Gamma
- Impedance Point - 52 ohms.
- Radiation - Uni-Directional

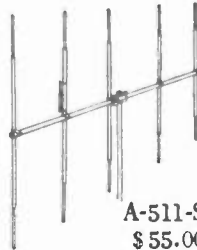

A-511-S
\$55.00

DELUXE LINE

A-311

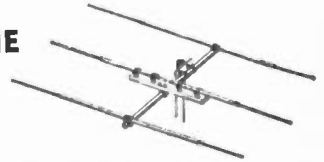

Dependable communications depend on the proper antenna system. Mosley's antennas are recognized for being tops in dependability. Mosley antennas, such as model A-311, are built of noncorrosive and rust-proof materials. All aluminum is heavy gauge 6061-T6, hardware is stainless steel and associated parts are expertly molded of durable plastic. Mosley antennas are designed for 52 ohm impedance.

A single A-311 beam, vertically mounted will give a gain in relative field strength of 8 DB over a reference dipole. This will increase the effective power of your CB transmitter to an equivalent of 32 watts.

A pair of A-311 beams, vertically, will give a gain in relative field strength of 11 DB over a reference dipole. This will increase the effective power of your CB transmitter to an equivalent of 63 watts Connecting transformer and stacking cable included with A-311 stacking kit.

A-311, 3 Element Beams . . . List \$46.88
A-311SK, Stacking Kit For Two A-311 Beams. . . List \$68.21

SO BUY Mosley

Electronics Inc
4610 N. LINDBERGH BLVD.,
BRIDGETON, MISSOURI



AMERICAN CITIZENS BAND ASSOCIATION



WS . . . NEWS . . . NEWS . . . NEWS . . . NEWS . . . NEWS . . .

It has been said that this monthly report to CB'ers (both present and future members of the ACBA) is for the open forum discussion of any topics which might lead to more and better understanding among CB'ers.

A CB'er from northern California traveling through the country in July, stopped in at the ACBA organizational office in Oklahoma City and talked with Kenn Bostick, our office manager there.

I, of course, as President Pro-Tem, do not reside in Oklahoma City (I'm in Kenova, West Virginia) so I didn't meet the gent from California. He left with Kenn a copy of a tentative agenda prepared for a CB club meeting that was held in Stockton (California) on June 2.

Since the agenda concerned the ACBA, and since the agenda brought up several questions which the Stockton CB'ers wished answered, Kenn Bostick passed the agenda along to me with the idea that I could possibly give these questions space in print so that all could share them.

Please keep in mind that in my position as President Pro-Tem, I am but a humble spokesman. Many of the questions involve basic policy already set forth by the Steering Committee of the ACBA.

As background, the Stockton, California group opened the meeting by reading aloud the ACBA Platform, which appeared in the July issue of CB Horizons, by your's truly. Then a discussion of 'need' for a national organization followed, with the noting that the ACBA has no constitution as of yet.

The Stockton club proposed to form a Watchdog Committee to study the growth

of the ACBA, and apparently report back to the club's members the progress the ACBA was making.

The Stockton club also discussed a number of items which it felt should be a part of the ACBA basic constitution, so as to (as they put it) "guarantee grass roots representation on the part of individual CB'ers, and not single out individual clubs as the regional spokesmen for the ACBA activities in their areas."

Here are the points which the Stockton club noted they felt should be in the Constitution of the ACBA, to adequately protect the membership in their area.

- (1) Prevention of the possibility of CB clubs or other groups from taking over the ACBA for their own interests.
- (2) Guarantee the paid-up member of his voting rights.
- (3) Amendments to the constitution should be voted upon by the full membership after publication of the full text of the proposed amendments.
- (4) Provide suitable procedures for recall of the elected Directors.
- (5) Provide suitable procedures for referendum ballots on petitions (to the FCC).
- (6) The results of the referendum ballots should determine the ACBA policy in any given area and it should thereafter be the job of the ACBA Directors to carry out that policy, with no power to reverse the policy as voted upon and decided upon by the majority of the voting members.
- (7) All meetings of the ACBA must be open to all paid up members.
- (8) A quarterly financial report should be published.

(9) The constitution must state that the ACBA is to be run on a non-profit basis.

(10) That no one may be denied membership in the ACBA because of race, color, religion or creed; or affiliation with any other CB organizations.

(11) That the ACBA must not engage in any games of chance in order to raise operational monies.

(12) That the ACBA will be guided by the principle that the Citizens Radio Service is a service for all citizens and not only certain types of citizens.

COMMENTS SOLICITED

Now, while the constitution of the ACBA is being formulated, is the time for interested members (and that should include all members) to voice their opinions of the items they would like to see in this most important document.

Let us hear from you.

45 DAY CHARTER MEMBERSHIP DRIVE ON

A special 'Over-The-Top' Charter Membership Drive is now on. ACBA Membership Committee Chairman Tommy Mellons, KDB0325, reports that all members have been mailed letters and enclosed Charter Membership Application blanks urging that they sign up a minimum of five (5) new Charter Members each. The goal of the drive is to accelerate the drive to 10,000 plus Charter members, thus speeding up the up-coming election of a permanent Board of Directors.

Membership Chairman Mellons reports "all Charter Members who sign up 5 or more new members during the Membership Drive will receive special ACBA Booster pins, for lapel wear, as a token of appreciation for their efforts."

The Booster pins will mark that member down through the years ahead as one of the original Charter Members who helped contribute to a supreme joint push over the 10,000 mark during this association's earliest organizing days.

It will be a proud CB'er indeed who, five, ten, even 15 years hence can wear and display his cherished ACBA Booster pin to national conventions and regional meetings.

**Paul W. Thacker, 19W4747
President Pro-Tem, A.C.B.A.**



Terry 18W3516 Owner of
Amateur Electronic Supply

says

Trade in Your Present CB Equipment on

HALLICRAFTERS CB TRANSCEIVERS

\$5 DOWN

three years to pay



**NEW
HALLICRAFTERS
CB-3A \$159.95
ONLY \$5.77**

a month (3 years)

Look at these low payments on all Hallicrafters CB Equipment

		1 Yr.	2 Yr.	3 Yr.
CB-3A 8 Channel	\$159.95	\$14.65	\$7.99	\$5.77
CB-5 Transistorized	199.95	18.32	9.99	6.38
CB-4 Hand Held (Ch. 11)	89.95	8.24	---	---

ACCESSORIES

- HA-9 5 meter Kit for CB-3A \$ 8.95
- HA-11 Noise limiter for CB-3A \$15.95



**AMATEUR
ELECTRONIC
SUPPLY**

Complete Stock of Hallicrafters CB Equipment and accessories as well as S-wave Receivers and Ham Equipment.

To: Amateur Electronic Supply
3832 W. Lisbon Ave., Milwaukee 8, Wisconsin

Ship me a _____ on channel _____ (1 Free).
Please install Extra Channels for (\$5.95 per channel).

I Enclose \$ _____ I will pay balance (if any) in:

C.O.D. 1 Year 2 Years 3 Years

For: 110 VAC & 12 VDC 110 VAC & 6 VDC

I want to buy a _____ and want to trade a _____ which was originally purchased in:

Kit Form Wired

In this form this unit originally sold new for \$ _____ I purchased it New Used.

Name _____ Call _____

Address _____

City _____ Zone _____ State _____

Send FREE listing of used CB & Ham gear.

hallicrafters gives you the basic superior performance you need for just \$159.95...

All the gadgets ever invented wouldn't improve the tremendous basic performance and reliability of the CB-3A. You get 8-channel, crystal controlled convenience... 100% modulation capability... 40 db. min. adjacent channel rejection... less than 1 μ v. sensitivity... 6 kc. selectivity... removable accessory panels and built-in accessory jack—plus a reliability record unequalled in the field.



CB-3A

eight-channel, dual conversion
basic transmitter/receiver

...and lets you decide which extras you want



HA-9 S-Meter Kit. Illuminated. Complete hardware; installs in minutes in removable CB-3A front panel. Universal, \$8.95.

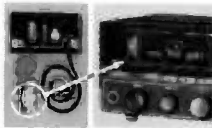

HA-11 Noise Eliminator. "Rocket Buster" deluxe. Mounts completely hidden on back of CB-3A; front panel thumb control. \$15.95.



HA-3 Noise Suppression Kit. Pass condensers, ground braid, etc. Minimize electrical system noise. \$13.48. SP-3 spark plug suppressor, \$2.95.



HA-12 Encoder/Decoder. Full duplex selective calling system. No tubes or transistors. Single switch operation. \$79.95. HA-12A Encoder only, \$44.95.

the new ideas in communications
are born at . . .



hallicrafters

5th and Kostner Avenues • Chicago 24, Illinois

Overseas Sales: International Division, Hallicrafters • Canada: Gould Sales Co., Montreal, P.Q.

WIN! FREE CB EQUIPMENT IN *General* RADIOTELEPHONE COMPANY'S MONTHLY DRAWING!

This month *General* is giving away a Model 615 SWR Bridge.



NO BOX TOPS! NO MONEY! NO CONTESTS!

DRAWING RULES: Enter by simply filling out the self-addressed post card below, and mail it to us before October 10th. The winner's name will be drawn, notified by mail, and announced on the inside front cover in *General's* December ad.

Drawing void in any locality or State where prohibited by law. Federal, State and Local Government regulations apply.

Prize winner will be selected in a random drawing conducted by Stanley R. Rader, Certified Public Accountant. Its decision, with respect to all phases of the drawing, will be final.

Entries limited to residents 18 years of age and older, of the United States and Puerto Rico. Employees and their families, of General Radiotelephone, General Dealers, Stanley R. Rader, Certified Public Accountant, and General Radiotelephone Company's Advertising Agency are not eligible.

★ ★ ★ ★ ★

Available now...



FREE!

General Radiotelephone's 1963 catalog: complete specifications, technical data and schematics on the Nation's most wanted CB and FM two-way Communications equipment. Fill in and mail the card below.

GOOD FOR OCTOBER DRAWING ONLY



GENERAL RADIOTELEPHONE COMPANY
3501 West Burbank Boulevard
Burbank, California

- Please rush FREE the General 1963 Catalog.
 Enter my card in the CB Drawing!

NAME _____

CB CALL _____

ADDRESS _____

CITY _____ STATE _____

NAME OF YOUR LOCAL CB DEALER _____

DEALER'S ADDRESS _____

CITY _____ STATE _____

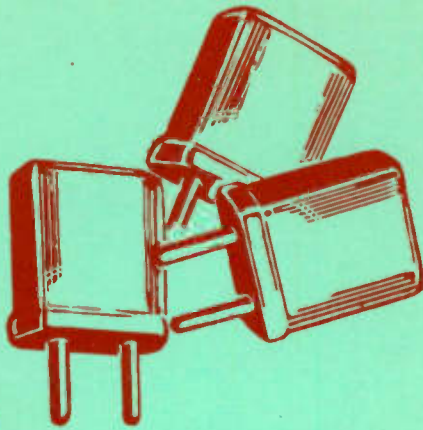

NOW!

.003% tolerance crystals at
no increase in price. One year warranty.
All channels in stock for most makes of
C.B. units. Net \$2.95 each.

See your General Dealer or write General
Radiotelephone. State make and model.

PLACE
4c STAMP
HERE

GENERAL RADIOTELEPHONE COMPANY

3501 W. BURBANK BLVD., BURBANK, CALIFORNIA

THIS SYMBOL REPRESENTS

**THE FIRST
 HONEST TO GOODNESS
 RANGE IMPROVEMENT IN
 CB MOBILE COVERAGE**

**It's the electrical symbol
 for the Toroid Transformer,
 featured exclusively in the
 NEW TOROID-TENNA**

Toroid-Tenna is the outgrowth of several years experience in exacting U.S. missile and satellite antenna projects, under the direction of Electro-Winders Co., Inc.

The Toroid-Tenna is a shortened whip (42") loaded at the base with the exclusive toroid transformer. Only the "toroid" short whip loading method produces a VSWR so nearly perfect (1 to 1)!

Toroid-Tenna has the lowest noise pick-up from surrounding noise sources (ignition, power line, neon signs) that we have ever measured! This is mobile range-gain for you because weak signals previously covered by noise are now readable—thanks to the unique toroid transformer!

Toroid-Tenna is tuned with a screw-driver adjustment in the completely shielded chrome plated base. You do not cut or trim this antenna for exact match. A perfect match between transmission line and antenna is guaranteed!

Toroid-Tenna's base is fitted with an element-proof PL-259 connector for quick screw-on attachment.

You owe yourself this extra measure of CB mobile coverage available only from Toroid-Tenna. Order one today and learn the truth for yourself!

\$21.95



**Ideal for Business and Casual
 Citizens Band communications... both!**



"412" Webster Band-spanner.

New Band-spanner C-B radio gives you the proper combination of new features needed for a double-barrelled positive performance!

Starts off with...

5 crystal controlled channels for Business use...

Adds a big plus...

Instant channel change from the front panel merely by plugging in proper quartz crystals...

Adds another plus...

Pre-wired for selective tone calling... just plug standard tone unit in rear receptacle provided.

Includes...

- A hot 0.2 uv dual conversion superhet.
- Wide level AVC control, ± 6 db, 5-100K uv.
- Adjustable squelch responds to 0.1 uv sigs.
- Audio output, 3.5 watts.
- Very high image rejection—90 db or more.
- Spurious response better than 60 db.
- 8 tubes, 2-dual purpose, plus rectifier.
- Full 5W max. input to PA—power output of 2.7W—modulation to 95%.
- Panel Instrument gives relative "S" readings—power output, modulation.

ELECTRO-WINDERS CO., INC.

PR Antenna Systems Division
 854 West Front St., Covina, California

Enclosed is my check (money order) for \$21.95 for a Toroid-Tenna. (In California, add 4% sales tax.)

Name _____

Address _____

City & State _____

SOME DISTRIBUTOR TERRITORIES OPEN.



317 Roebling Road,
 South San Francisco, Calif.

Please send information on "412" and full line catalog.

Name _____

Number Street _____

City Zone State _____

THROW AWAY YOUR TUBES!

Start getting the distance and clarity that only an ALL TRANSISTORIZED transceiver gives you. Here's a superior, all transistorized transceiver that will deliver the performance you have found lacking in all other 5 watt sets. The Tele-mate 500 contains more important features, dollar for dollar, than any comparably priced equipment on the market today. Because it's incredibly compact, 2¼"x 8"x 7½", it is no exaggeration when we say you'll find it practical for use anywhere... in all vehicles, in the home, business, farm or factory. If you're looking for dependable, powerful communications, find out about the Tele-Mate 500.



\$189.50

Shock-proof, satellite-type circuit board Light-weight, only 3½ lbs. 5 crystal controlled channels New transistorized noise limiter Sensitive receiver, 3 IF stages Adjustable squelch Microphone, mobile mounting bracket.

THE NEW TELE-MATE 500, GUARANTEED ONE FULL YEAR

Write for free color brochure to:
J. BRISKIN, INC., 14827 Ventura Boulevard
 Sherman Oaks, California
 Dealer inquiries invited



GOLDEN LINE CITIZENS' BAND CRYSTALS

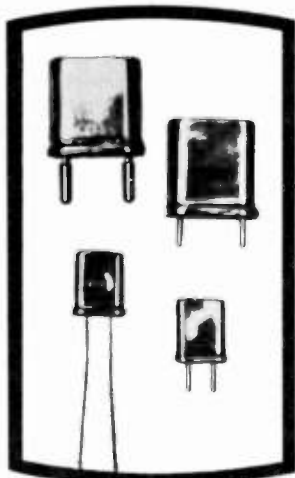

CRYSTALS are "HOTTER"

For the finest in CB transmission and reception, turn to the GOLDEN LINE of crystals — the "hotter" crystals that insure "close-on", "stay-on" performance regardless of outside temperature. The GOLDEN LINE is manufactured by crystal experts to rigid standards of activity, stability and calibration tolerance over wide temperature ranges. Each unit is hermetically sealed to preserve these important characteristics.

JK GOLDEN LINE Crystals are specifically made and mated to your set to give you the utmost in service and quality-performance.

THE JAMES KNIGHTS COMPANY, SANDWICH, ILLINOIS

"PRO.!"

NOT A BUZZER!
You Get the True Signal Tone!

\$6.50

KEY • **municator**
TRANSISTORIZED
TELEGRAPH KEY

Now at most radio distributors, a professional type cast metal telegraph key and ear phone at a low cost. Perfect for learning the code, and sending, qualifying for amateur license.

Plus Code characters and phonetics!
Easy method to learn code by tone!

DOW-KEY COMPANY
Thief River Falls, Minnesota

CLASSIFIED

Rates for classifieds are 10c per word for advertising which, in our opinion, is obviously of a non-commercial nature. A charge of 25c per word is made to all commercial advertisers or business organizations. We do not bill for advertising in CLASSIFIEDS, nor can we acknowledge receipt of copy sent in. Full remittance MUST accompany all orders. NOTE: The products and services advertised in this section are not guaranteed by the publisher of CB HORIZONS.

WANT A NEW CB UNIT? We will allow you up to \$100.00 on a trade for a new CB unit of your choice. Tell us what you have and what you want — we will rush you complete information. Dealerships available. **KNOX ELECTRONIC, INC.**, 67 North Cherry Street, Galesburg, Illinois.

CB'ers — The sincerest form of flattery. Often copied but never duplicated. Our easy-do Dual Conversion adapter kit improves selectivity, increases sensitivity, for HE-15 (A and B); Dewald 800, 910 (A and B) HE-20 (A, B, C); Eico 770, 771, 772; Mark VII RCA; Messenger; GW-10, etc. \$15.50-with tubes \$17.50. Also, Speech Clipper-kit, complete \$17.85 or \$5.00 plus COD. Results! Not promises. Free literature. Dept. 10-H, Bainbridge Radio Electronics, 2839 Briggs Avenue, New York 58, New York.

CONTINUED — page 57

TERRIFIC CB SALE!

- TRIUMPH 10-TRANSISTOR WALKIE-TALKIES** (2 or more) Sale ea. **\$29.95**
(noise limiter, bias stabilizer, adj. squelch, channel 7) (uses 8 penlight cells at 85c add) (extra xtls. are \$1.99 ea.)
- GC TENNA METER** (tunes any transceiver) (Reg. \$15.95) Sale **\$13.99**
(tune for max. power, check antenna performance, etc.)
- GC SIGNAL OPTIMIZER** (7 in 1 CB tester) (Reg. \$47.50) Sale **\$39.95**
(checks antenna power, modulation, field strength, SWR, etc)
- HY-GAIN NEW CLR 11 COLINEAR** (Bonus offer) Only **\$29.97**
(Bonus: 50 ft. of RCBu Foam cable and \$2.95 Mobile Handbook)
- AUTO BURGLAR ALARM** (protect your CB equipment) Sale **\$ 3.49**
- 15-PC MOBILE NOISE SUPPRESSOR KIT** (Reg. \$10) Sale **\$ 4.99**
- 12-POSITION CHANNEL SELECTOR** Sale **\$ 3.99**
- FAMOUS MAKE BODY MOUNT, SPRING, 102" WHIP ANTENNA** Sale **\$ 5.88**
- SINGLE BUMPER MOUNT, SPRING, 102" WHIP ANTENNA** Sale **\$ 8.99**
- DOUBLE BUMPER MOUNT, SPRING, 102" WHIP ANTENNA** Sale **\$ 9.99**
- MODEL CBC — CITIZENS BAND COUPLER** Sale **\$ 7.95**
(use your CB mobile antenna for both auto radio and transceiver)
(SEE SPECIAL COMBINATION OFFER BELOW! BIG SAVINGS!)

- HY-GAIN MOBILE CB ANTENNAS:** Topper series of toploaded whips
- MODEL TLWR** — Omni-topper — roof mount, (\$11.97 ea.) + CBC Only **\$14.47**
 - MODEL TLW-M** — single hole — top mount, (\$8.95 ea.) + CBC Only **\$11.45**
 - MODEL TLW-TM** — telescoping TLW-M antenna (\$8.95 ea.) + CBC Only **\$11.45**
 - MODEL TLW** — whip only — standard adaptor (\$6.96 ea.) + CBC Only **\$ 9.46**
 - MODEL TLWT** — same as TLW but telescoping (\$7.20 ea.) + CBC Only **\$ 9.70**

- ANTENNA SPECIALISTS MOBILE CB ANTENNAS**
- MODEL MR-52** — 48" Black Beauty Fiberglass (\$8.14 ea.) + CBC Only **\$10.64**
 - MODEL MR-53** — 48" Black Beauty Fiberglass (\$5.10 ea.) + CBC Only **\$ 8.10**
 - MODEL MR-58** — 48" Black Beauty Fiberglass (\$9.45 ea.) + CBC Only **\$11.95**
 - MODEL M-90** — 96" Whip only, Fiberglass (\$6.95 ea.) + CBC Only **\$ 9.45**

- MARK MOBILE HELIWHIPS:** (HW11-S series std. duty) — (HW11 series heavy duty)
- HW11-S SERIES** — (specify 18", 3 ft., 4 ft., or 6 ft.) (\$7.20) + CBC Only **\$ 9.70**
 - HW11 SERIES** — (4 ft. or 5 ft.) (\$9.95 ea.) + CBC Only **\$12.45**
 - HW11** — 6 ft. heavy duty (\$10.95 ea.) + CBC Only **\$13.45**
 - HWC SERIES** — top cow! mount heliwhips (\$9.95 ea.) + CBC Only **\$12.45**
(HWC series available in 18", 3 ft., or 4 ft.)

SALE ON ULTRA-40-LOSS FOAM COAXIAL CABLE!

- RGSBU** 50 Ft. for \$2.49 100 Ft. for **\$3.99**
- RGBU** 50 Ft. for \$4.95 100 Ft. for **\$8.99**

- GROUND PLANE ANTENNA SALE!** (discontinued model) Sale **\$ 3.99**
(solid radials, accepts PL-259, all sales final)
- SUPER 111** — 3 Element Heavy Duty Beam Sale **\$11.99**
(mounts vertically or horizontally)

- BIG \$\$\$ SAVINGS ON COAXIAL CONNECTORS!!!
- PL-259** — 39c ea. 10 for **...\$ 3.50** **PL-258** — 49c ea. 10 for **...\$ 4.50**
 - SO-239** — 39c ea. 10 for **...\$3.50** **UG-175** — 14c ea. 10 for **...\$ 1.19**
 - DM-1** (double male) ea. **...\$.95** **UG-176** — 14c ea. 10 for **...\$ 1.19**
 - M-359** (right angle) 39c ea. 10 for **...\$ 3.50**
 - TEE connectors** — \$1.95 ea. 10 for **\$17.50**
 - PP-677** — (SO-239 one end, auto plug on other) 89c ea. 10 for **\$ 7.90**
 - CB DEALERS:** Write for Quantity Prices

GROVE

ELECTRONIC SUPPLY COMPANY

4111 West Belmont Avenue
Chicago, Illinois 60641

- Rush Items Checked
- SEND NEW GIANT 1964 CATALOG

Name _____ (please print)

Address _____

City _____ Zone _____ State _____

KGH 5678

THREE INCH CALL LETTERS AND NUMBERS GUARANTEED TO STICK. WEATHERPROOF AND WATERPROOF. BRILLIANT SILVER REFLECTION.

FREE SAMPLE!

Write for more information concerning impressive desk plaques or any other CB call signs.

YOUR CALL SIGN \$1.00 postpaid
DEALER AND CB CLUB DISCOUNT

DYMOND SIGN DISPLAY CO.

4215 S. CEDAR STREET
LANSING, MICHIGAN

Name _____

Address _____

City _____ State _____

Dealer and/or Club _____

BR-20 — continued

SC-1 plug directly into a chassis mounted mating socket on the back of the BR-20's, so we had no trouble getting selective calling going. It worked fine, like selective calling should, and in areas where there is some activity on 27.265 (or any of the other BB 27 meg channels), they will undoubtedly keep everything quiet for you.

The SC-1 has one nice feature that should be noted here. When you have been called, via selective calling, and you are not present to return the call, a light on the front panel of the SC-1 comes on and the word "CALL" lights up. This tells you that a message has been received, and that you should return the call when you return. Nice.

We found BB range to be approximately 20-25% greater than CB, due to the extra few watts going to the antenna. However, these tests were run with the CB antennas mounted at legal CB heights. On BB you can run up to as much as 170 feet, or even

A COMPLETE LINE OF CITIZENS BAND CABLES FEATURING ALL NEW ALUMINUM CABLES

50 OHM — 1/2" ALUMINUM COMMUNICATIONS CABLE
SOLID SEAMLESS — ONE-PIECE ALUMINUM JACKET.

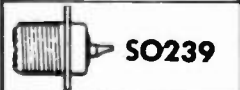
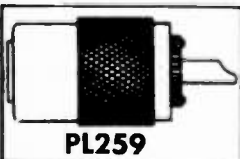

UHF SERIES CONNECTORS, MIL SPEC

6M & 11M
Generator
Filters

Cable
Assemblies



PL258



M358



M359



Write for Catalog and Price Information

DEPT. H.Z.

REGO INSULATED WIRE CO.

831 MONROE ST., HOBOKEN, N.J. — Phone OL 6-2020

higher with aircraft warning lights, so you can quickly visualize what would happen if you ran the antenna up in the breeze.

The BR-20 operates from 6 vdc, 12 vdc or 117 vac. It operates like a CB set (squench and volume) and is on a single channel so you don't have to worry about more than two knobs.

The only difficulty we experienced with the BR-20 was a bit of solder flux that had dropped onto the transmit-receive relay contacts on the receive side. The relay unit affected had to be cleaned with emery cloth, which required 30 seconds time.

Price of the units (without selective calling SC-1) is \$229.50 each.

*BB channels are 27.245, 27.255, 27.265 plus 27.410, 27.430, 27.450 and 27.470 megacycles. You specify which channel you wish to be licensed for on application Form 400.

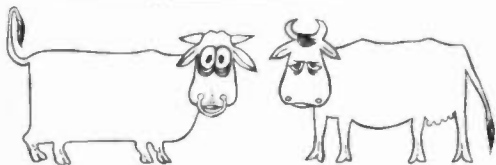

CB CLEARANCE SALE

Transceiver & Accessory Bargains!

Demonstrators — like new — never sold. In original cartons with warranty cards included!

SONAR "E" — 8 ch. + tuneable, with 4 sets xtals incl. Your choice of 6/115v or 12/115v. \$197.00 Value Special \$145.00

GENERAL MC-5 executive demonstrator model. 12/115v. A golden beauty! New set warranty card included. Complete with Snap-Rack and both power cords, plus 4 sets xtals. \$226.50 Value. Bargain at \$159.50

JOHNSON MESSENGERS — 5 ch. 12/115v. Just like new, complete with mobile mounting racks and ch. 1, 5 & 11 xtals. Original cost \$155.00. Now...\$109.50

TONE-ALERTS (Johnson) New. 6/115v and 12/115v. \$59.95 value. Special Buy \$44.50

KAAR TR 327 — New. 12/115v. with both power cords included. Ch. 18 & 23 xtals included. \$191.00 value. Super Special \$139.50

SONAR "E" — reprocessed. Used 90 days. Good condition. 6/115v. 2 sets xtals included. Special Clearance Sale Price \$99.50

PATCH-A-CALL phone patch units by Business Radio. Demonstrator models. No wiring into phone. \$64.95 regularly. Special \$24.50

TRIUMPH WALKIE-TALKIE — like new. Ch. 7 xtals and batteries included. Leather case and earphone. \$24.50

MAIL CHECK OR M.O. TODAY.

Prompt shipment guaranteed.

CB SUPPLY COMPANY

P.O. Box 10621 — Village, Okla.

Are tune ups torture?

Are you tired of weak, ineffective signals? Tune your rig by the most effective method available. Tune up with a Delphi Field Intensity Meter model 112.

Ultra Sensitive
Compact
Uses no Power



Monitors % Modulation
only
\$9.95

P.P.D. Anywhere
in U.S.

50 KC thru 500MC. .02 volts R.M.S. average sensitivity. Complete with antenna and choice of rubber feet or magnetic clamp for mobile use.

Dealer Inquiries Invited

DELPHI ELECTRONIC INSTRUMENT CORP.

57 South Grand Ave.

Baldwin, L.I., N.Y.

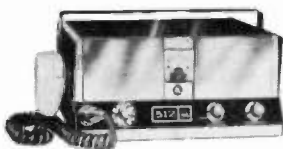

- 12 CHANNELS CRYSTAL CONTROLLED
- DUAL POWER
- 0.3µV SENSITIVITY
- 30db SELECTIVITY

SUGGESTED LIST \$149.50

Designed for top performance and rugged reliability

HALLMARK 512 CB TRANSCEIVER

See your dealer or write for name of your nearest dealer to:

HALLMARK INSTRUMENTS, INC.
6612 Denton Drive • Dallas 35, Texas

IF YOU SELL, SERVICE OR GIVE ORDERS, YOU NEED SONAR BUSINESS 2 WAY RADIO...

25 — 50
MCS
14 WATTS

FCC
TYPE
ACCEPTED

CONSTRUCTION



A complete power-packed dependable performer!

Amplitude Modulated

Quality designed and engineered for years of service and dependability
• Compact and lightweight • Easily installed in smallest vehicles • Smartly styled for office use • Greater range be-

cause of Voice-Power designed circuitry • Unexcelled reception
• Noise-free squench • Heavy-gauge aluminum construction • Easily serviced • Wired for instant use of the "Sonar-Call" selective calling system • Wired for Sonar High Power Linear Amplifier operation
• 1 year warranty • 12 VDC or 117 VAC and 6 VDC or 117 VAC operation
• Size: 11 1/4" L x 9 1/2" W x 4 3/4" H • Weight: 10 lbs.

BR-20 Business 2 Way Radio complete with mike, 2 crystals and 2 power cables **\$229.50**

100 and 1 uses in every type of industry and business

- Delivery services
- Garage
- Motor Carrier
- Construction
- Road building
- Farm
- Doctor
- Security guards

SONAR RADIO CORPORATION
73 Wortman Ave., Brooklyn 7, N.Y.

Please send me complete information on Business 2 Way Radio BR-20 Dept. 255

Name _____
Address _____
City _____ Zone _____ State _____

start the democratic processes of building a platform in the organization that they can believe in and fight for.

We would like to go one step further, in Mr. Kneitel's personal case, and enter a free-standing offer to meet with him at his convenience at a spot and time of his choosing to talk about a unified and united CB front for the industry. There is plenty of room for both publications, and we for one would very much like to see the rift smoothed over in favor of a unique working relationship between both publications, where both S9 and CBH join together in at least one area, the common support of a national organization that can stand up and speak out for all CB'ers, everywhere for all time.

What say Tom?

GLUTTON FOR PUNISHMENT?

The FCC, late in August, issued an announcement to wit a CB'er in Georgia was cited with a monetary fine for violation of 19.61 (a), or violation of permissible communications.

The fine levied was \$100.00.

Nothing too unusual about that, except that the CB'er in question had been slapped with a similar \$100.00 fine back in April, again for reported violation of 19.61 (a).

When the Commission first announced their monetary fines enforcement procedures, CB'ers as well as other two-way radio users let loose with a howl of protest. The protests fell on deaf ears and the monetary

fines went through.

At the present time a bill is pending before the House of Representatives which would remove from the FCC the power to levy fines. We doubt it will see the light of day for most Congressmen have little or no personal concern over the Commission's activities, especially in the field of two-way radio. The Commission could require all of us to paint our transmitters purple, apparently, and Congress wouldn't say boo.

But we are getting away from the point. Which is this. Monetary fines were supposed to clean up the band, make the bad boys be good and the badder boys get off CB.

Now violation of section 19.61 (a) is hardly treason. And it hardly makes one a bad boy. Mis-guided perhaps, bad no.

Especially when you consider that it is in the hands of the FCC official monitoring your transmissions to decide whether or not your message is substantive.

If this example of two fines, within a period of four months, to a single CB'er, is any example of how effective monetary fines are going to be in cleaning up CB, then we believe the Commission had better re-evaluate its policy. I for one couldn't stand the financial drain of \$100 every four months. Some fellows probably can.

The men will go on violating the rules and shelling out their \$100 fines everytime they are caught, and the boys will get caught once and have to sell their HE-20's to pay the fine.

OUR COVER

CB Radio in action during one of the year's biggest national news stories. Birmingham, Alabama was the setting and the prompt utilization of CB radio during a communications emergency saved the day for a pair of Birmingham groups.

On our cover, CB radio, ala the new Regency Range Gain transceiver, in the hands of Birmingham News reporter Tom Lankford, literally stopped the presses on a strife-torn Sunday as race riots swept through a section of town during late May. Lankford was on the scene as a bombing occurred and all land-line communications went dead. Using his mobile installation,

he dictated his front page story via CB and within an hour a special edition of the News was on the street reporting on "Birmingham's Darkest Hour".

The Birmingham Police Department's Intelligence Squad also put CB into use, again with the Regency unit. The Intelligence Squad had a special problem—they needed more than the usual one or two channels available in the regular police system. And they needed to move around fast enough to keep ahead of those who might want to intercept their messages.

The radios were air shipped to Birmingham courtesy of Regency especially for the usage reported here.

CLASSIFIEDS — continued

CB TRANSMITTERS — \$6.00. Other bargains, send 10 cents for list. Vanguard, 190-48 99th Avenue, Hollis 23, New York.

AAA-1 Clipper-Filter, triples talk power. Fits all transceivers — kit \$10.99; wired \$15.99. Heathkit owners, double reception, SK-4 RF preselector mounts inside GW-12; SK-3 inconspicuously attaches outside GW-10 or GW-11; either kit — \$8.99. Wired — \$11.97. DP-2 Coupler-Duplexer kit \$4.99, or \$4.00 with any other purchase. NEW! Solid state NJ-7 NOISEJECTOR yanks noise out by the roots, just wire it into any transceiver, \$4.49. All postpaid. Free kit, antenna list. HOLSTROM ASSOCIATES, Box 8640-B, Sacramento 22, California.

ALL QSL'S — \$2.50 per 100. Free catalogue. Longbrook, Box 393-B, Quakertown, N.J.

QSL's — Rainbows, etc. The finest. Immediate service, low prices. Samples 10 cents. Refundable. Harms, KD11143, 905 Fernald, Edgewater, Florida.

WANTED — your QSL card. Card for card swap guaranteed. Jim Cross, 755 S. Potomac Street, Hagerstown, Maryland 21740.

CB QSL CARDS — New, kute, klever, komical designs. Reasonable prices. Brilliant colors, including beautiful silver and gold. Samples free. Hellwig, Box 425, Lake Wales, Florida.

3 INCH NUMBERS & LETTERS. Guaranteed to stick. Weatherproof. Waterproof. Brilliant silver reflection. Your Call sign \$1.00 postpaid. Dealer and CB club discounts. Free sample. Write Dymond Sign Display, 4214 S. Cedar Street, Lansing, Michigan.

CB CLUBS — new illustrated literature on badges, decals and all the goodies. Errol Engraving, Attn. KBC0264, Westfield, Mass.

CALL CARDS — BADGES — DECALS — Goodies. Illustrated literature with samples, 25 cents. KBC0264, Errol Engraving, Westfield, Mass.

MODULATION BOOSTER — It's new! It's terrific. As much as doubles your transmit and receive range with no violation of FCC power regulations. Compact, easy to install, with instructions. New \$14.95. Dealers write, ROKO PRODUCTS, INC., Box 3766, Baltimore, Maryland.

ANTENNA SWITCH — Operates one CB from two antennas or two CB's on one antenna. Attractive stainless steel. Takes PL-259 plugs. Net \$7.95. ROKO PRODUCTS, INC., Box 3766, Baltimore 17, Maryland.

CB QSL CARDS — Quality work, fair prices, prompt service. Samples 10 cents (refundable). Hutchins Brothers, Thorndike, Maine.

CB QSL CARDS — Economically priced two and three color cards. Free samples. Paul's Little Print Shop, 7701 Tisdale, Austin, Texas.

CB QSL'S — Call-D-Cals 'The best for less.' Custom artwork or stock designs. Fast service. Special 100 — 3 color glossy cards \$3.20. Samples and free 10 code card — 25 cents. Refunded. Dick Stauffer, 19QA0625, 1996 N.M. - 18, Gladwin, Michigan.

CB QSL CARDS — highest quality — Brownie, W3CJ1/3W1974, 3110C Lehigh — Allentown, Pennsylvania. 24 page cut catalogue with samples, 25 cents.

QSL's — samples 25 cents (refundable). Quotes your designs on request. Send stamped, addressed envelope. Wildcat Press, 6707 Beck Avenue, North Hollywood, California.

CBL's — 200 printed in 3 colors lustre-coat stock drawn by our own artist. 20 designs (ten of each). \$6.90. Five day service, satisfaction guaranteed. Constantine Press, KCF0005, Bladensburg, Maryland.

Citizen Band QSL Cards — 100 2-color glossy, \$3.00. Postpaid, satisfaction guaranteed. Samples 10 cents. Rusprint, Box 7507, Kansas City 16, Missouri.

CB QSL CARDS — Samples 10 cents. Malgo Press, Box 375, Toledo 1, Ohio.

CBL's — We've printed millions! Outstandingly different for quarter centruy. WORLD FAMOUS RAINBO EFFECTS! Samples 25 cents (deductible). C. Fritz, Box 1684, Scottsdale, Arizona.

CB EQUIPMENT AND CALL-BOOKS — Outstanding deals on all CB needs. Special deal on package stations and accessories. Write, call or see Irving Grossman, 708 W. Columbia, Wildwood Crest, New Jersey.

QSL CARDS — Largest Selection — lowest prices. Samples and catalogue 25 cents. Refund or extra 25 cards with your first order. Debbeler Printing, 1309-H North 38th Street, Milwaukee, Wisconsin 53208.

FREE SAMPLES AND CATALOGUE — CB QSL Cards. \$2.50 per 100 in 3 colors. Garth Printing, Box 51, Jutland, New Jersey.

QSL's — special kromekote. Blue eagle background, gold embossed confirming data. 25 — \$2.00 postpaid. Samples 10 cents. ANDY's, 12 Bridge Street, Amsterdam, New York.

CB — QSL CARDS — 45 designs, FREE brochure. Woody, 2611 Shenandoah, St. Louis 4, Missouri.

QSL CARDS — many sharp, cartoon designs. Send for free brochure. F. B. Mathews Printing and Advertising, 1616 Rural Street, Rockford, Illinois.

NOW — A 23 channel position switch to fit your 50 or 100 model International Executives. Get complete enjoyment with this new 23 channel unit. Can be installed in 5 minutes. \$ 19.95 postpaid. See your dealer or order direct from B & S Electronics, P.O. Box 110, Redwood City, California. Dealer inquiries invited. Money back if not satisfied.

ATTENTION NEW JERSEY CB'ers — We are headquarters for all CB Call-Books, CB Horizons, CB reference manuals and the very finest in CB radio equipment. Don't buy until you check our deal. Martin A. Dibella Sales, 107 Reno Street, Newfield, New Jersey.

GOING AMATEUR RADIO? — Excellent condx Gonset six meter Communicator 3. First check for \$150.00. Guaranteed. D. Newcomer, 3241 N.W. 41st, Oklahoma City, Oklahoma.

NEW RCA TRANSCEIVERS — 5 watt crystal controlled. In original cartons. 6/110 and 12/110 powered. Both for \$60.00 plus freight. A. Saxer, 11701 Kensington, Los Alamitos, California.

PHASE 'EM for greater range

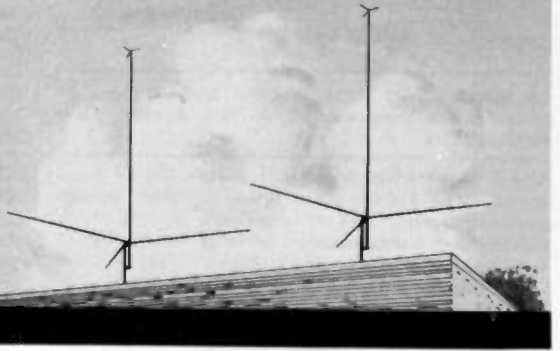

and get up to
4.5db
ADDITIONAL GAIN

with  **hy-gain's**

revolutionary **CO-PHASER**



Now...with Hy-Gain's revolutionary Co-Phaser, phased collinear antennas will virtually double your effective radiating power in a multi-directional pattern. This handsome little gray box of magic produces additional gain as additional gain should be produced...by combining the natural optimum performance characteristics of two phased collinear antennas and discriminately directing their power to where you want it. With a mere flip of the compass rose calibrated dial, the Co-Phaser transfers you from 3.86db additional broad-side gain to 4.5db additional "end-fire" gain off of either end of your phased array. The Co-Phaser also cuts out co-channel interference...gives you a stronger and clearer signal in areas you're accustomed to working and expands your range far beyond present "fringe" areas. It does not require external power...has no tubes or circuitry to introduce additional noise or interference.

For greater range...discriminate signals without the use of expensive rotators...you'll want Hy-Gain's revolutionary new Co-Phaser. Easily installed and modestly priced at only.....**\$14.95 Net.**

Get yours today from your favorite Hy-Gain Distributor or write for address of Distributor nearest you.

For complete Engineering Report on Phasing, write

HY-GAIN ANTENNA PRODUCTS CORPORATION
8455 N.E. Highway 6, Lincoln, Nebraska

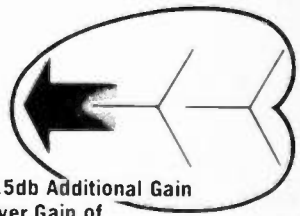

4.5db Additional Gain
over Gain of
Single Collinear



3.86db
Additional
Gain over
Gain of
Single
Collinear

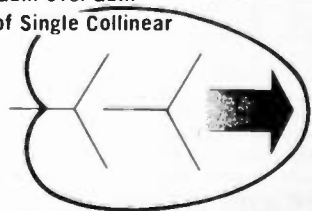

4.5db Additional
Gain over Gain
of Single Collinear

*Now! With Tunable Receiver
and 10-Channel Crystal Control!*

MESSENGER TWO

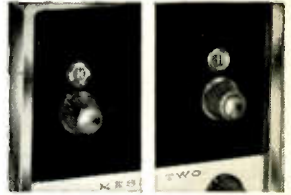

AT LEFT—Illuminated indicator and selector knob for crystal control.
AT RIGHT—Illuminated indicator and knob for tunable channel selection.



SLIDE SWITCH for selection of either crystal or tunable receiver control.



ACCESSORY SOCKET on rear panel (above power cord receptacle) for instant attachment of "Tone Alert"

High efficiency noise limiter—Excellent sensitivity! High adjacent channel rejection!

Everything you've ever wanted in a CB transceiver!

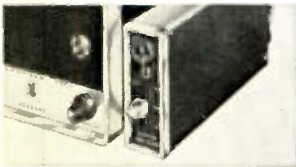

"TONE ALERT" SELECTIVE CALLING SYSTEM

Mutes speakers until one unit calls another—then automatically your stations receive audio note and indicator light flashes "on", remaining lighted until call is answered. Not a kit, ready to go! Plugs into "Messenger Two", fast hook-up to other transceivers!

Sharp selectivity guards against annoying random triggering. Wide range of tones permits 37 different systems to operate on same channel without overlap. Only 1½" x 4" x 7¼"—wired and tested.

Cat. No. 250-810
115 VAC and 6 VDC
Cat. No. 250-811
115 VAC and 12 VDC

\$59⁹⁵
NET

Available now—the new version of the popular "Messenger Two"! Pick any one of 10 channels for crystal controlled "transmit" or "receive"—instantly switch to all-channel tunable "receive" with handy slide switch. Channel indicators illuminate for either "crystal" or "tunable" settings—also serve as "off-on" indicators! Highly efficient circuit design makes full use of maximum legal power . . . delivers a penetrating signal that "outperforms 'em all!" Looking for maximum receiver sensitivity? This unit is hot—pulls in signals you wouldn't know were around with less sensitive equipment! New noise limiter circuit in the "Messenger Two" lets you know what QUIET really means in a CB rig! Positive acting "squelch" and automatic volume control circuits—push-to-talk microphone—crystals for 1 channel. 5½" x 7" x 11¾", installs anywhere.

Cat. No. 242-162 . . . 115 VAC and 6 VDC . . . **\$169⁹⁵**
Cat. No. 242-163 . . . 115 VAC and 12 VDC . . . **NET**

4-color BROCHURE.

Write for your free copy today!



E. F. JOHNSON COMPANY
2401 10th AVE. S. W. • WASECA, MINNESOTA

MANUFACTURERS OF THE WORLD'S MOST WIDELY USED PERSONAL COMMUNICATIONS TRANSMITTERS

THE NEW MULTI-ELMAC CD5A CITI-FONE

INCORPORATES ALL OUTSTANDING FEATURES OF PREVIOUS MODELS

PLUS-

★ A new "noise-immune," steep action squelch operates at .1 microvolt of carrier signal above noise level.

★ A new voltage doubler power supply with 40% higher voltage.

★ A new microphone pre-amplifier for greater talk power.

★ A new modulator/audio-output circuit designed around the type 6GW8 tube.

★ A tone alert connector for accessory.

★ New, functional and attractive front panel styling.

THESE **PLUS** FEATURES add up to increased operating pleasure with a Citizens Band transceiver engineered for greater RF output, increased modulation and superior receiving ability.



\$139⁵⁰

YOUR ASSURANCE
OF RELIABILITY



MULTI-ELMAC COMPANY

2147 WY.

OAK PARK 37, MICH.

JULIANA SARNO
 MEDFORD MASS
 K

BULK RATE
 U. S. POSTAGE
PAID
 Permit No. 26
 Tulsa, Okla.

CB HORIZONS
 P. O. BOX 1557
 OKLAHOMA CITY, OKLAHOMA