

# CATALOG F PART 2

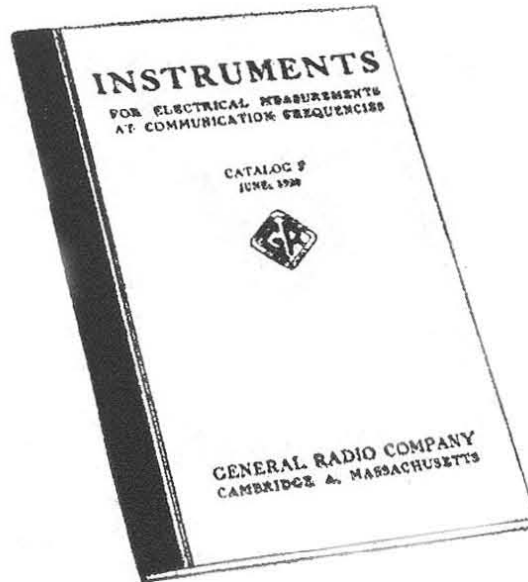

## FILE THIS WITH CATALOG F, PART 1

It's a comprehensive supplement to Part 1 of Catalog F. It describes all of the new instruments and announces many important specification changes in the others.

REVISED TO APRIL 1, 1931



GENERAL RADIO COMPANY  
CAMBRIDGE, A, MASSACHUSETTS

## WHEN YOU MOVE

don't forget to tell us about it.  
A postal card bearing your old  
and new addresses is effective  
insurance against missing the  
*Experimenter* and future supple-  
ments to this catalog

COPYRIGHT 1931  
BY THE  
GENERAL RADIO COMPANY

---

## *FOREWORD TO PART 2*

From time to time, as new instruments were developed and the specifications of other equipment were changed, a series of "Catalog Supplements" containing new data were published and mailed to everyone who had received a copy of Catalog F. Catalog F, with these supplements, constituted the complete catalog of the General Radio Company's laboratory apparatus until the publication of this booklet.

"Catalog F, Part 2," as this booklet is called, replaces all of the previous catalog supplements and supplies additional data which revises Catalog F to April 1, 1931. Besides, it contains cumulative indexes applying to both Part 1 and Part 2.

Users of Catalog F will find both indexes especially convenient when studying the specifications of instruments described in Part 1. A reference to the "Index by Type Number" on page 164 will, for instance, show at a glance whether Part 2 contains additional data.

A new series of catalog supplements will be issued as the occasion arises. These will bear the numbers F-300, F-301, F-302, etc. To avoid confusion, all of the old supplements (F-200, F-201, F-201A, and F-202) should be destroyed or marked "obsolete," inasmuch as all of the information they contain has been reprinted in Part 2.

---

---

# TABLE OF CONTENTS

FOR PART 1 AND PART 2

I. CONDENSERS . . . . .	5, 123
II. RESISTANCE DEVICES . . . . .	15, 126
III. INDUCTORS . . . . .	31, 129
IV. OSCILLATORS . . . . .	35, 130
V. AMPLIFIERS, COUPLING DEVICES, POWER-SUPPLY DEVICES, AND ACCESSORIES . . . . .	42, 133
VI. FREQUENCY- AND TIME-MEASURING DEVICES . .	51, 134
VII. BRIDGES AND THEIR ACCESSORIES . . . . .	74, 141
VIII. RADIO-FREQUENCY TESTING DEVICES . . . . .	88, 143
IX. MISCELLANEOUS LABORATORY EQUIPMENT . . . . .	93, 150
X. METERS . . . . .	99, 154
XI. RELAYS, SWITCHES, AND MISCELLANEOUS ACCESSORIES . . . . .	108, 157
INDEX BY TYPE NUMBER . . . . .	164
INDEX BY TITLE . . . . .	166

## CONDENSERS

**I**N the following chapter are described two additions to the line of General Radio condensers and several specification changes on those described in Part 1.

All General Radio condensers using soldered plates are manufactured under U. S. Patent No. 1,542,995. All those having plates other than a semicircular shape are manufactured under U. S. Patent No. 1,258,423.

### TYPE 539 VARIABLE AIR CONDENSERS

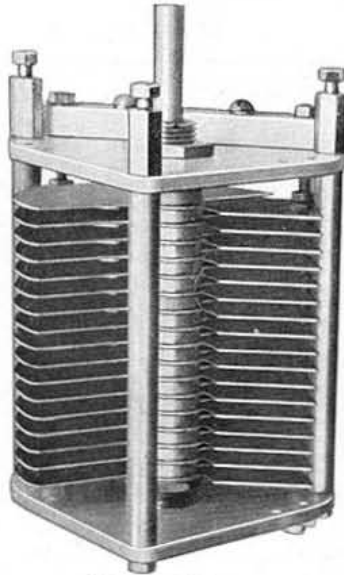

TYPE 539-J



TYPE 539-A

**T**HIS series of condensers, a new addition to the General Radio line, has been developed for general laboratory use. Particular pains have been taken to reduce the losses so that these condensers have lower losses than any of our other laboratory condensers. The figure of merit ( $R\omega C^2$ ) does not remain so nearly constant with setting nor is the stability of calibration quite so good as in the TYPE 222 Precision Condensers and in the TYPE 246 Variable Air Condensers.

*Range:* The capacitance values given in the price list are, respectively, the nominal maximum and minimum capacitance of each model. Each condenser has actual capacitance values greater than the maximum and less than the minimum, respectively.

*Rotor Plates:* Straight-line capacitance.

*Insulation:* Supports are made of isolantite. The high potential terminals of the mounted models are brought out through glazed isolantite bushings.

*Maximum Voltage:* The values given in the table of specifications are peak voltages corresponding to breakdown.

*Figure of Merit:*  $R\omega C^2$  is approximately  $0.03 \times 10^{-12}$  (based on measurements made at 1000 cps.).

*Drive:* Mounted models are supplied with dials carrying friction-type slow-motion drives. Unmounted models are supplied without knobs, dials, or friction drives.

*Calibration:* The maximum and minimum values of capacitance, accurate to within  $\frac{1}{2}\%$  of full scale are engraved on the metal name plate of each mounted model.

If desired, a calibration, accurate to within  $\frac{1}{2}\%$  of full scale, can be supplied for the 10-division points between 0 and 100

divisions. An extra charge (see price list) is made for this work. Calibrations can be made on mounted models only.

*Mounting:* These condensers can be supplied either unmounted or mounted on a black crackle-lacquer-finished aluminum panel in a polished walnut cabinet.

*Shielding:* The inside of each cabinet is lined with a copper shield which effectively minimizes the effect of stray fields.

*Dimensions:* The "height" of the mounted models given in the price list is the over-all distance from the bottom of the cabinet to the top of the knob. The panel size is  $6\frac{1}{2} \times 6\frac{1}{2}$  inches.

The unmounted models require a panel space of  $5\frac{1}{2} \times 5\frac{1}{2}$  inches. The "height" in the following table represents the distance the unit would extend *behind* the rear of the panel.

Type	Capacitance		Maximum Voltage	Mounting	Height	Weight	Code Word	Price
	Max.	Min.						
*539-A	500 $\mu\text{mf}$	50 $\mu\text{mf}$	1100	Mounted	.....	$8\frac{3}{8}$ in.	$6\frac{1}{2}$ lb.	ASSAY \$22.00
*539-B	1000 $\mu\text{mf}$	55 $\mu\text{mf}$	800	"	.....	$8\frac{3}{8}$ in.	$6\frac{1}{2}$ lb.	ASSET 23.00
*539-C	2000 $\mu\text{mf}$	60 $\mu\text{mf}$	550	"	.....	$8\frac{3}{8}$ in.	$6\frac{1}{2}$ lb.	ASTER 24.00
539-J	500 $\mu\text{mf}$	50 $\mu\text{mf}$	1100	Unmounted	.....	$7\frac{1}{8}$ in.	$2\frac{3}{4}$ lb.	ATLAS 10.00
539-K	1000 $\mu\text{mf}$	55 $\mu\text{mf}$	800	"	.....	$7\frac{1}{8}$ in.	$2\frac{3}{4}$ lb.	ATONE 11.00
539-L	2000 $\mu\text{mf}$	60 $\mu\text{mf}$	550	"	.....	$7\frac{1}{8}$ in.	$2\frac{3}{4}$ lb.	ATTIC 12.00
10-point Calibration Chart.....								CHART 1.50

\* Calibrations supplied only when ordered. Use compound words, ASSAYCHART, ASSETCHART, or ASTERCHART.

### TYPE 239 VARIABLE AIR CONDENSERS

THE full-scale value of capacitance, accurate to within 1%, is always entered on a chart permanently fastened to the bottom of each mounted model. We can supply, in addition to the calibration curve described on page 8, a calibration accurate to within 1% of full scale for every 10-division point between 10 and 100 scale divisions. These data are entered on the chart fastened to the bottom of the case. This work is not done unless specifically ordered, and a charge of \$1.50 is made. Customers ordering by telegraph or cable may use the code word CHART, e.g., BABELCHART, BANDYCHART, etc.

The "panel dimensions" specifications for the unmounted models refer to the panel space required to mount the condenser.

### TYPE 556 AMATEUR-BAND CONDENSER

THIS condenser has been designed for use in short-wave receivers and frequency meters where it is desired to spread a narrow band of frequencies over the whole  $180^\circ$  of the condenser scale. The spreading out is accomplished by giving the condenser a large value of zero capacitance. Three of the five rotor plates are complete circles, so that, in effect, the unit consists of a fixed condenser and a variable condenser in parallel. The circular plates also serve to shield the unit from "hand capacitance."

The capacitance values are such that, when the condenser is used in a dynatron-oscillator circuit, it will easily span the 3500 kc. to 4000 kc. amateur band with an approximately straight-line-frequency variation. By moving the outside circular rotor plate, which is held to the shaft by a collar and setscrew, it is possible to adjust the zero capacitance and, therefore, the frequency ratio over a considerable range.

This condenser supersedes the TYPE 557 Amateur-Band Condenser.

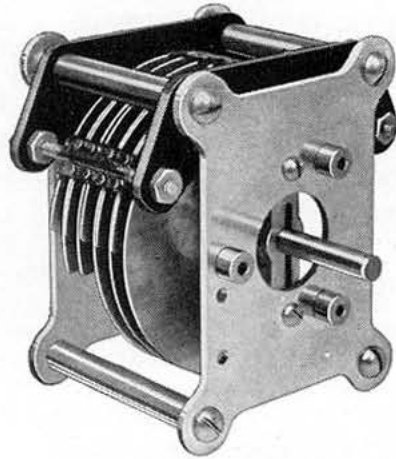

TYPE 556

*Range:* See price list.  
*Rotor Plates:* Three circular (360°) and two plates cut to give an approximately straight-line-frequency variation.

*Insulation:* Hard-rubber supports.

*Maximum Voltage:* 3500 volts, peak.

*Figure of Merit:*  $0.03 \times 10^{-12}$  (based on measurements at 1000 cps.).

*Mounting:* Unmounted model only. Supplied with mounting screws and drilling template. No counterweight is required for this condenser.

*Dimensions:* Panel space,  $3\frac{3}{4} \times 3\frac{3}{4}$  inches. "Depth" in the price list gives overall distance that the unit extends behind the panel.

Type	Capacitance		Depth	Weight	Code Word	Price
	Max.	Min.				
556	81 $\mu\text{f}$	53 $\mu\text{f}$	2 $\frac{7}{8}$ in.	1 lb.	AWARD	\$3.50

TYPE 380 DECADE SWITCH AND CONDENSERS

**T**HROUGH a typographical error in Part 1 of Catalog F, the data given in the price list on page 14 are incorrect. The correct characteristics are given below.

Type	Capacitance	Dielectric	Weight	Code Word	Price
380-A	1.0 $\mu\text{f}$ in steps of 0.1	Paper	1 $\frac{5}{8}$ lb.	ADAGE	\$10.00
380-B	0.10 $\mu\text{f}$ " " " 0.01	Mica	2 lb.	ADDER	20.00
380-C	0.010 $\mu\text{f}$ " " " 0.001	Mica	1 $\frac{1}{4}$ lb.	ADDLE	10.00

## RESISTANCE DEVICES

**A** NEW line of volume controls having many applications in voice-frequency recording and transmission systems is described in this chapter. A number of important modifications in the specifications of instruments described in Part 1 are also included.

### TYPE 102 DECADE-RESISTANCE BOXES

**T**HE maximum allowable current corresponding to a temperature rise of 20°C. for the 0.1-ohm units in the decade-resistance boxes should be 1.3 amperes and *not* 3 amperes as stated in Data Table 1, on page 17.

### TYPE 371 POTENTIOMETERS

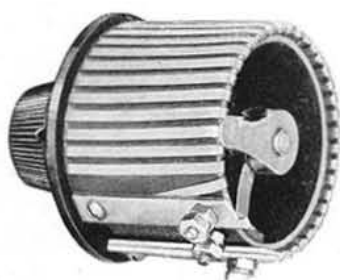

TYPE 371 (5 amp.)

**T**HE accompanying illustration shows a TYPE 371 Potentiometer rated at 5 amperes. It is designed for controlling the brilliancy of exciter lamps used in conjunction with photo-electric cells. Full specifications for this unit are given on page 28.

Note also that etched metal scales for these units are now available. See the description of the TYPE 318 Dial Plate on page 157.

### TYPE 214 RHEOSTATS AND POTENTIOMETERS

**A**LL of the rheostats and potentiometers, both panel-mounting and table-mounting models, which are priced at \$1.75 on pages 28 and 29, now carry a price of \$1.50. The price of the 2500-ohm rheostats remains at \$2.00.

Note that etched metal scales for these units are now available. See the description of the TYPE 318 Dial Plate on page 157.

### TYPE 552 VOLUME CONTROLS

**T**HESE units have been designed primarily to meet the voice-circuit requirements of high-grade broadcast transmission, sound recording and projection, and public-address equipment. Because of their accuracy, excellent frequency characteristics, and compactness, they will be found to be very useful for laboratory work in circuits where highly precise attenuation networks are not necessary.

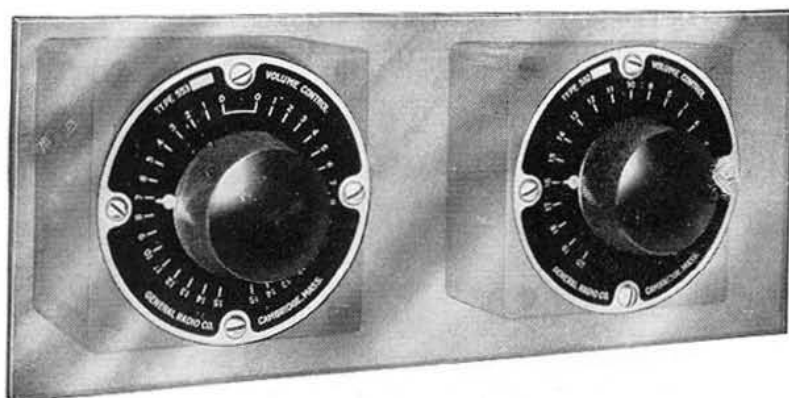

A TYPE 553 (left) and a TYPE 552 (right) Volume Control mounted on a glass panel



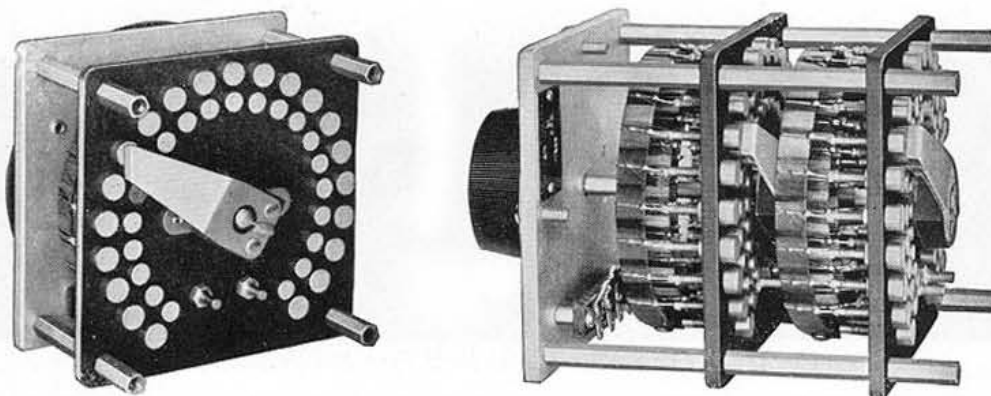

Internal construction of TYPE 552 and TYPE 553 Volume Controls. TYPE 552-LA (left) and TYPE 552-HB (right) with dust covers removed

Three types of section, the L, T, and Balanced-H, are available. The L-type should be used when it is desired to maintain the impedance constant in one direction only as the attenuation is varied, the T-type for constant impedance both ways from the attenuator, and the Balanced-H-type for constant impedance both ways and when the transmission circuit is to be balanced to ground.

The units are assembled so that clockwise rotation of the switch reduces the attenuation. The scale is engraved for each step from 20 to 0 with decreasing numbers in the clockwise direction. The loss in decibels actually introduced by the attenuator is found by multiplying the scale reading by the attenuation per step (1.5 db per step).

The design of the resistance elements permits of very rigid mechanical construction. The whole assembly is built to withstand the most severe service requirements. An adequate metal shield which covers the terminals is provided for minimizing electrical and mechanical disturbances.

No slide-wire contacts are used. This increases the reliability of the unit, at the same time making duplication of attenuator settings easily possible. Step-by-step contacts also have a considerably lower noise level than any type of sliding contact. These contacts have been run for 200,000 operations without appreciable wear. A thin film of clock oil is recommended for lubrication of the contacts. This will not interfere in any way with the electrical contact but will decrease wear considerably.

Panel mounting is accomplished by using the circular etched metal name plate, which carries the scale, as a drilling template. The same screws that mount the attenuator in the rear of the panel hold the scale to the panel.

*Range:* 0 to 30 db in 20 steps of 1.5 db each.

*Type of Winding:* Unifilar on thin bakelite strips.

*Accuracy of Adjustment:* All resistances are adjusted to within  $\pm 2$  per cent.

*Terminal Impedance:* See price list.

*Frequency Error:* The attenuation is in error by not more than  $\pm 1$  db at all settings up to 20 kilocycles.

*Dimensions:* All models require 4 x 4 in. panel space. The depth behind the panel varies with the model. See price list.

*Weight:* Varies with model. See price list.

Type	Attenuation	Section	Impedance	Depth	Weight	Code Word	Price
552-LA	30 db in steps of 1.5 db	L	50 ohms	2 $\frac{5}{8}$ in.	1 $\frac{3}{4}$ lb.	AFIRE	\$28.00
552-LB	30 db in steps of 1.5 db	L	200 "	2 $\frac{5}{8}$ in.	1 $\frac{3}{4}$ lb.	AFTER	28.00
552-LC	30 db in steps of 1.5 db	L	500 "	2 $\frac{5}{8}$ in.	1 $\frac{3}{4}$ lb.	AHEAD	28.00
552-TB	30 db in steps of 1.5 db	T	200 "	3 in.	2 lb.	ALIEN	34.00
552-TC	30 db in steps of 1.5 db	T	500 "	3 in.	2 lb.	ALARM	34.00
552-HB	30 db in steps of 1.5 db	Balanced-H	200 "	5 $\frac{1}{4}$ in.	3 lb.	ALBUM	48.00
552-HC	30 db in steps of 1.5 db	Balanced-H	500 "	5 $\frac{1}{4}$ in.	3 lb.	AGAIN	48.00

NOTE: These items are carried in stock. Units having detent contacts or different values of terminal impedance and attenuation per step can be built to order.

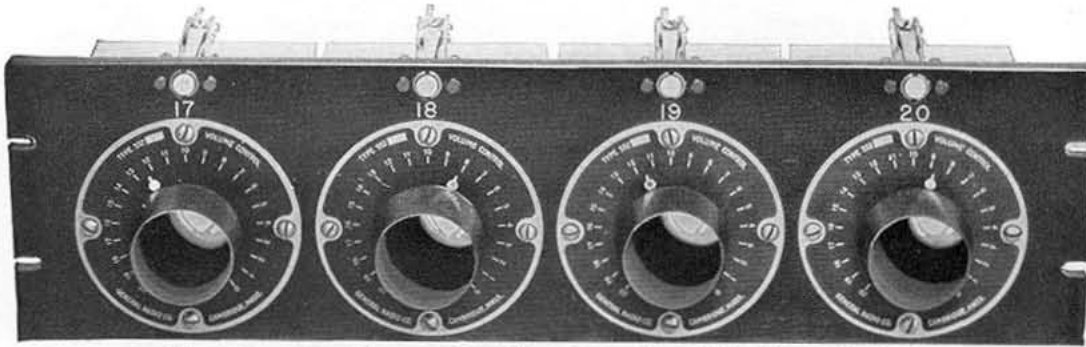

Four-channel mixing panel made up from TYPE 552 Volume Controls

### TYPE 553 VOLUME CONTROLS

THESE are similar in general construction to the TYPE 552 Volume Controls. They are designed for transferring the amplifying system, or fading, between two microphones or phonograph pickup units, at the same time making available a volume control for the unit in use. A range of 30 db in level is available in 2-db steps.

The network used is the usual Modified-T-type. With this network the output impedance varies from 30 per cent. low to 20 per cent. high from the specified impedance value when going from minimum to maximum setting of the switch. At the same time the input impedance from the pickup or microphone is varying from 0 error to 27 per cent. low from the specified impedance. These errors, unavoidable in this type of network, are not sufficient to interfere with the performance of the pickup system.

*Range:* 0 to 30 db in 15 steps of 2 db each on each side of zero.

*Type of Winding:* { Same as TYPE  
*Accuracy of Adjustment:* { 552 Volume  
*Terminal Impedance:* { Controls

*Frequency Error:* A maximum error of  $\pm 0.2$  db is maintained at all settings up to 20 kilocycles.

*Weight:* See price list.

*Dimensions:* Same as TYPE 552.

Type	Attenuation	Section	Impedance	Depth	Weight	Code Word	Price
553-FB	30 db in steps of 2 db	Modified-T	200 ohms	3½ in.	2 lb.	ALDER	\$28.00
553-FC	30 db in steps of 2 db	Modified-T	500 "	3½ in.	2 lb.	ALERT	28.00

NOTE: These items are carried in stock. Units having detent contacts or different values of terminal impedance and attenuation per step can be built to order.

## INDUCTORS

**A** FEW corrections and a few minor changes in the specifications of the General Radio inductors described in Part 1 are listed below. The attention of engineers is invited to the new inductance calculation charts mentioned in the notes on the TYPE 577 Inductors.

### TYPE 106 STANDARD INDUCTANCES

**I**T should be noted that the effect of these inductors on surrounding instruments and the effect of external fields on them are practically eliminated by the use of the astatic form of winding. In this the coil is wound in two sections, which are so assembled that their external fields neutralize.

### TYPE 107 VARIABLE INDUCTORS

**T**HE inductance values for the parallel connection are approximately  $\frac{1}{4}$  of the values for the series connection. Using the parallel connection permits a better overlap between the ranges of the three types.

The reader will, of course, have noticed that the maximum and minimum values of inductance for the series connection are interchanged in the tabular specifications on page 32.

### TYPE 577 INDUCTORS

**F**OR the convenience of those who wind their own inductors on the TYPE 577-U Form, a chart of inductance versus number of turns has been prepared. See the February, 1931, issue of the *General Radio Experimenter*.

The inductance values for TYPES 577-A, 577-B, and 577-C should be in microhenrys and not in millihenrys as stated on page 34.

## OSCILLATORS

A NEW beat-frequency oscillator, operated entirely by alternating current and covering a wide frequency range, is described in the following chapter. Additional information on the TYPE 423 Vacuum-Tube Oscillator is also included.

### TYPE 513-B BEAT-FREQUENCY OSCILLATOR (ALTERNATING-CURRENT OPERATED)

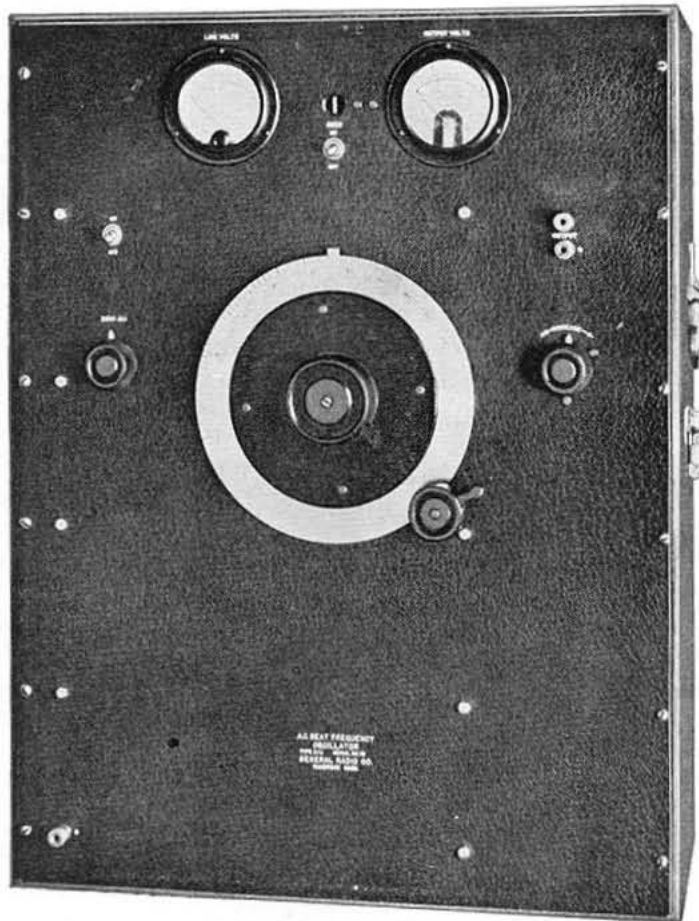

TYPE 513-B

THE distinguishing characteristic of this type of oscillator is its ability to maintain constant output and, at the same time, to cover continuously a wide frequency range with one control. This results from the use of two oscillators, one of fixed and the other of adjustable frequency. The filtered difference frequency resulting from the detection of the combined outputs of the two oscillators is amplified to a useful power level. By means of such a circuit, the entire audio-frequency range may be covered by the rotation of a single dial. This feature renders the beat-frequency type of oscillator useful for the rapid examination of all types of equipment.

Typical uses of the TYPE 513-B Beat-Frequency Oscillator include determination of resonance in transformers and loud-speakers, acoustical studies of rooms and walls, line equalization, and similar applications.

*General Description:* The design of the TYPE 513-B Beat-Frequency Oscillator is such that the waveform and power output are adequate for general use, and, when it is used in accordance with the operating instructions, the frequency calibration is excellent. The oscillators operate in the vicinity of 100 kc. and their circuits are adjusted so that the difference frequency

may be reduced to 1 cps. without their "pulling into step" with each other. Filtering and circuit design have eliminated the beat frequencies between harmonics of the oscillators and the fundamental frequencies of the oscillators themselves, sometimes encountered in instruments of this type.

*Frequency Range:* Calibrated between 10 cps. and 10,000 cps., it will actually deliver power at frequencies slightly lower and higher, respectively, than these.

*Frequency Stability:* A very high stability in each high-frequency oscillator is, of course, desirable in order to maintain a satisfactory frequency stability in the difference frequency. Since it is not feasible to maintain too high a degree of stability in this sort of instrument without making the cost prohibitive, a means of correcting for any drift of the component oscillators is provided. This is an auxiliary frequency control with which the user can bring the output frequency into agreement with that of a calibrated tuned reed. (See *Frequency Calibration.*)

Every effort has been made to reduce the frequency drift due to temperature changes. Coils and condensers of the tuned circuits have been placed in balsa-wood boxes to reduce temperature changes. The output frequency may drift 5 cps. to 15 cps. in the first two hours due to internal heating, but this effect is slight thereafter in the absence of a marked change in room temperature. A 15-volt change in the supply voltage causes 2 or 3 cps. shift in the output frequency. If the accuracy of the work justifies such a precaution, the oscillator frequency may, at any time, be checked against the tuned reed.

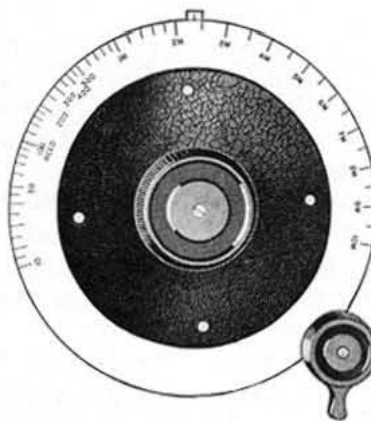

Main frequency control, TYPE 513-B

*Frequency Calibration:* A tuned reed adjusted to have its resonant frequency near 100 cps. is provided as a reference standard of frequency. The user sets the main tuning control on the instrument to a line marked REED and then adjusts a compensating condenser until the output frequency and the reed are in agreement as shown by maximum deflection of the reed. The REED mark is correctly placed to within

one cycle per second.

Each instrument is individually calibrated in terms of the General Radio Company's primary standard of frequency and the dial of the main tuning control is engraved at suitable intervals over the entire range. The dial is 8 inches in diameter and has a spread of 270° so that the scale is spread out over almost 18 inches. The user can, for one year from the date of purchase, rely upon the calibration being within 2% when the oscillator has been adjusted to the reed frequency at the REED point.

*Output:* Open circuit voltage: 15 volts to 20 volts over entire range; at least 20 volts with  $\pm 1$  volt variation above 80 cps. The output control is an 18,000-ohm voltage divider, the internal output impedance being 3500 ohms at maximum voltage. A 0-30 volt alternating-current voltmeter (similar to TYPE 488-A) is permanently connected across the OUTPUT terminals.

Maximum power output at 1000 cps.: load impedance of 3500 ohms, 30 milliwatts; load impedance of 10,000 ohms, 25 milliwatts.

Variations in output with line voltage are appreciable and for that reason a line voltmeter and rheostat are included in the instrument so that large fluctuations may be compensated for.

*Waveform:* Harmonics (chiefly second) amount to 5% to 10% of the fundamental amplitude above 100 cps. depending upon the load impedance. Above 100 cps. and with a 10,000-ohm load the harmonic content is about 5%. Below 100 cps. it increases rapidly, reaching 20% at 10 cps.

The amplitude of the "power-supply ripple" is approximately 0.25%. Carrier-frequency voltages from both oscillators have been eliminated by suitable filters.

*Tubes:* One 280-type tube is used as a rectifier, and five Radiotron or Cunningham or equivalent 227-type tubes are used as oscillators and amplifiers.

*Power-Supply:* 100-120 volt, 50-60 cps. line. About 50 watts are required.

*Terminals:* The power supply connects to a standard receptacle inside the cabinet. A ground terminal and the OUTPUT terminals are mounted on the panel.

*Mounting:* All apparatus is mounted on the engraved aluminum panel which is

finished in black crackle lacquer. The panel is mounted in a heavy oak case with brass carrying handles and lock. It may be bolted to the wall, hinges allowing the cabinet to swing out for replacing tubes, etc.

*Accessories:* The instrument is supplied without tubes but with a 7-foot cord for making connection to the power supply.

*Dimensions:* Panel size:  $24\frac{1}{4}$  x 19 x  $\frac{1}{4}$  inches; over-all cabinet size, including handles, 25 x  $20\frac{1}{2}$  x 11 inches. Screw holes in the panel are such that the instrument may be fitted into a TYPE 480 (standard 19-inch) Relay Rack.

*Weight:*  $71\frac{1}{2}$  pounds.

Type	Frequency Range	Operated	Code Word	Price
513-B	10-10,000 cps.	100-120 volts, 50-60 cps., a.c.	NATTY	\$450.00

### TYPE 423 VACUUM-TUBE OSCILLATOR

THIS is becoming an increasingly important accessory for the TYPE 224-A and TYPE 224-L Precision Wavemeters, for it enables them to be used as heterodyne wavemeters over the greater part of their range. With the TYPE 224-A Precision Wavemeter, it covers the range between 1200 kc. and 12.5 kc. (250 meters-24,000 meters), and with the TYPE 224-L Precision Wavemeter it covers the range between 6000 kc. and 500 kc. (50 meters-600 meters). (Note that since the description on page 40 was printed, it has been found impossible to guarantee that the dynatron oscillator will work over the entire range of the TYPE 224-A Precision Wavemeters with commercially available tubes.)

The calibration of the instrument depends upon the interelectrode capacitance of the tube used. Hence, when a calibration has been made, several tubes which do not change the calibration should be selected for use as spares.

The General Radio Company will calibrate any of these wavemeter-oscillator combinations on the following basis: The wavemeter calibration is used as a working basis so that this calibration should be accurate. If it has been in the hands of the user for more than one year, he should ask us to check it and, if necessary, to recalibrate it. A charge of \$5.00 per inductor is made for the new calibration, which, of course, has nothing to do with the charge for calibrating the dynatron oscillator.

With the calibrated wavemeter in hand, we determine the deviation between the setting of the wavemeter with the dynatron and the setting of the wavemeter shown on the calibration chart. We then plot a curve of this deviation against the normal wavemeter setting, the curves for all inductors being placed on one small chart. The percentage accuracy of this second calibration is the same as that for the wavemeter, i.e., 0.25%.

The charge for determining the deviation values over the entire working range of a wavemeter-oscillator combination is \$8.00. The charge for calibrating a single inductor is \$3.50.

## AMPLIFIERS, COUPLING DEVICES, POWER-SUPPLY DEVICES, AND ACCESSORIES

**I**N this chapter are listed three items which require minor changes in the specifications listed in Part 1, pages 42 to 50. Attention is also called to the fact that the General Radio TYPE 274 Transformer Mounting Bases are ideally suited for use with General Radio coupling transformers in experimental setups.

### TYPE 585-M2 MICROPHONE-TO-GRID TRANSFORMER

**T**HE voltage ratio of 1:11 given on page 45 is based on measurements between the whole of the primary and the whole of the secondary. The value for one section of the secondary would, therefore, be 1:5.5.

### TYPE 446 VOLTAGE DIVIDER

**T**HE resistance of the plate-supply section of this device was, through a typographical error, given as 1500 ohms instead of 15,000 ohms, the correct value.

The TYPE 446-P1 Extra Sliders listed on page 80 are marked, respectively, "C-PWR," "B+DET," "B+AMP," "B+PWR1." Users should specify which ones they want, if they have any choice.

### TYPE 437 AND TYPE 439 CENTER-TAP RESISTANCE UNITS

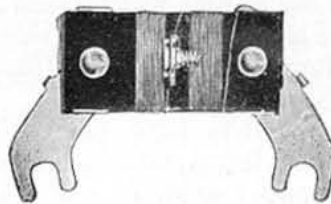

TYPE 439

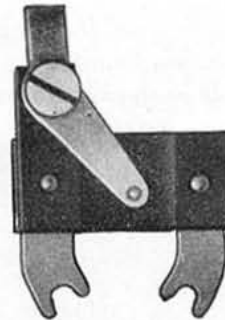

TYPE 437

**T**HE captions on the illustrations and the tabular specifications for these resistance units as given on page 50 are incorrect. The data presented here are correct.

Type	Resistance	Maximum Current	Center Tap	Code Word	Price
437	60 ohms	200 milliamperes	Adjustable	PERIL	\$0.50
439	60 ohms	200 "	Fixed	PASTY	0.35

## FREQUENCY- AND TIME-MEASURING DEVICES

**W**ITH the single exception of the new TYPE 575 Piezo-Electric Oscillator, a high-precision secondary standard of frequency, all of the data in this chapter clarify or modify the descriptions given in Part 1.

The attention of government and college standardizing laboratories is invited to the General Radio standard-frequency assembly which is a primary standard of frequency. Recent simultaneous checks upon a stable signal have shown that our own standard-frequency assembly operates in remarkably close agreement with the system maintained by the United States Bureau of Standards at Washington. In fact, several of the determinations agreed to within a few parts in ten million. This shows that the General Radio standard-frequency assembly is capable of highly precise work. Several are in use in American, Canadian, and foreign laboratories.

### TYPE 592 MULTIVIBRATORS

**R**EADERS who want to know more about the applications of the multivibrator in frequency measurements are referred for additional suggestions to the description of the TYPE 575 Piezo-Electric Oscillator which follows.

### TYPE 575 PIEZO-ELECTRIC OSCILLATOR (WITH TEMPERATURE CONTROL)

**T**HIS unit was designed for use as a secondary standard of frequency for general laboratory and station-monitoring purposes in conjunction with General Radio TYPE 376 Quartz Plates. It is, in principle, a combination of the TYPE 547-A Temperature-Control

Box and the TYPE 275 Piezo-Electric Oscillator described on page 57. Until now these two units have made the best simple secondary standard available, but the more compact assembly with its shortened and simplified radio-frequency wiring has resulted in a decided increase in the over-all frequency stability of the system.

As a result of lengthy tests on several General Radio TYPE 376-H Quartz Plates in a TYPE 575 Piezo-Electric Oscillator, we have been led to the conclusion that, "all things considered, it seems reasonable to expect the frequency variations under service conditions to be less than  $\pm 10$  parts per million." We cannot, however, *guarantee* stability of this order at the present time because of our inability to foresee all of the possible abuses to which the unit might be subjected. The user may, however,

expect to obtain comparable results if the unit be operated intelligently and with care. The results of the experiments referred to were published in the October and November,

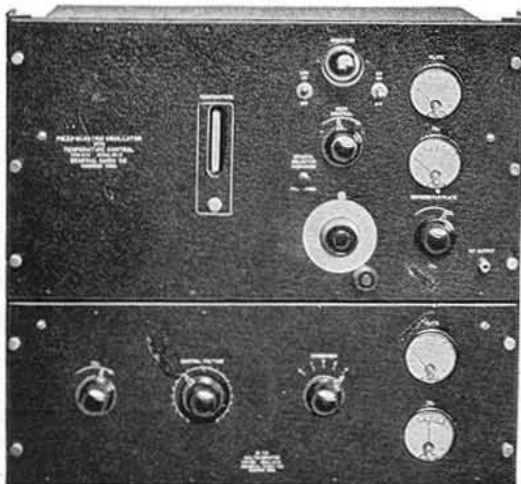

TYPE 592 and TYPE 575-AR assembled on a frame for convenience in making laboratory measurements





TYPE 575-AR

1930, issues of the *General Radio Experimenter*, copies of which are available to interested persons.

The use of this unit as a secondary standard for monitoring or making measurements at fundamental or harmonic frequencies of the quartz plate is fairly obvious, but it is worth noting that, when used in conjunction with a TYPE 592 Multivibrator as a harmonic generator, a series of harmonics covering a wide frequency band is obtainable. See page 51 for a general description of the multivibrator and its theory of operation.

If, for example, a 100-kc. TYPE 376-H Quartz Plate and a 10-kc. TYPE 592 Multivibrator are set up, several of the fundamental frequencies in the series 100/10 kc., 100/9 kc., 100/8 kc., . . . etc., are readily obtainable by adjustment of the multivibrator control voltage. By slight changes in the circuit constants of the multivibrator any one of the fundamental frequencies in the series 100/10 kc., 100/9 kc., . . . 100/2 kc., 100/1 kc., can be obtained. Harmonics up to at least the 300th are present in the output for each of these fundamental frequencies, and the frequency of each is known with the same percentage accuracy as the frequency of the quartz plate is known.

Harmonic series based on fundamental frequencies lower than 10 kc. are of little use without means for eliminating audio-frequency beats between harmonics.

The use of the two decimal fundamentals (10 kc. and 100 kc.) makes measurements so convenient that other control orders are seldom required. For the same reason, we recommend 100-kc. TYPE 376-H Quartz Plates for use in conjunction with the TYPE 592 Multivibrators.

*Oscillator System:* The circuit is similar to that described on page 57. Jacks are provided for connecting with a TYPE 275-P Inductor (see page 137) having a frequency range corresponding to the operating frequency. One inductor is supplied with each oscillator without extra charge when an order is placed at the same time for one or more TYPE 376 Quartz Plates.

The purchase of an *additional* TYPE 275-P3 Inductor is required if a 10-kc. multivibrator and a 100-kc. TYPE 376-H

Quartz Plate are to be used. The information concerning the correct inductor for other combinations may be obtained on application to the General Radio Company.

*Temperature-Control System:* Similar in construction to inner chamber of TYPE 591 Temperature-Control Unit shown on page 61. Jacks are provided for holding two TYPE 376 Quartz Plates, either of which may be made available by throwing a selector switch on the front panel. A thermometer (TYPE 547-P3) indicates the

temperature of the air surrounding the quartz plate. A mercury-type thermostat (TYPE 547-P2) controls the heater current through a relay mounted on the shelf base. A pilot lamp on the panel shows when heat is being applied. The power consumed by the heaters (when heating) is between 40 watts and 70 watts, approximately, depending on the setting of a rheostat in the supply circuit.

Temperature of the air in the inner chamber is held to within  $\pm 0.1^\circ\text{C}$ . for room temperature variations of  $\pm 11^\circ\text{C}$ . The operating temperature is intended to be  $50.0^\circ\text{C}$ ., but any value between  $40^\circ\text{C}$ . and  $60^\circ\text{C}$ . may be selected if desired.

Thermometer, thermostat, and pilot lamp are supplied. They are readily replaced in case of accidental breakage.

*Output:* Jack-top binding posts on the rear of the shelf make it possible to enter the plate circuit with telephone receivers or an audio amplifier for listening to beats between it and another oscillator (and their harmonics, of course).

Radio-frequency energy for monitoring and measurement purposes can be delivered to a binding post which is connected to the plate circuit of the oscillator through a very

small condenser. A wire leading to any circuit under measurement may be connected to this post.

*Power Supply:* Jack-top binding posts are provided on the rear of the shelf for connecting: (a) 6-volt battery for filament and thermostat relay; (b) 45-volt plate battery; and (c) 105-115 volt (a.-c. or d.-c.) supply for heaters.

*Tubes:* One UX-112A or its equivalent.

*Meters:* Plate-current meter, 0-5 mla.; filament and plate voltmeter, 0-7 and 0-140 volts with a push-button switch.

*Mounting:* The instrument is mounted on a  $\frac{1}{4}$  inch aluminum panel, 19 inches wide, which is finished in black crackle lacquer, ready for mounting on a TYPE 480 Relay Rack. It is supplied with a dust cover of nickel-plated brass and which also partially shields the unit from stray electric fields. This is ordinarily removed when the unit is mounted in a cabinet.

*Accessories:* Instrument supplied without quartz plate, tube, plate inductor (TYPE 275-P), or batteries.

*Dimensions:* Panel, 19 x  $10\frac{1}{2}$  inches; dimensions of apparatus behind panel,  $17\frac{1}{4}$  x  $10\frac{1}{2}$  x 10 inches with dust cover.

*Weight:* 30 pounds including dust cover.

<i>Type</i>	<i>Code Word</i>	<i>Price</i>
*575-AR   .....	LOYAL	\$200.00

\* Panel is engraved "TYPE 575."

### TYPE 575 PIEZO-ELECTRIC OSCILLATOR (WITH TEMPERATURE CONTROL)

#### ALTERNATIVE MOUNTING

**W**E are prepared to supply for cabinet mounting any TYPE 575 Piezo-Electric Oscillator in our stock. We replace the dust cover and supply in its place a polished oak cabinet.

*Dimensions:* Over-all dimensions (cabinet only, not including handles)  $19\frac{3}{4}$  x  $11\frac{1}{2}$  x 10 inches.  
*Weight:* 37 pounds.

<i>Type</i>	<i>Code Word</i>	<i>Price</i>
*575-AM   .....	LUNAR	\$220.00

\*Panel is engraved "TYPE 575."

ACCESSORIES AND REPLACEMENT FOR  
TYPE 575 PIEZO-ELECTRIC OSCILLATOR

Type		Code Word	Price
275-P	Inductors (see pages 58 and 137) .....	.....	.....
547-P2	Thermostat .....	LIBEL	\$20.00
547-P3	Thermometer .....	LILAC	4.00

TYPE 275-P INDUCTORS

**S**PECIFICATIONS on the TYPE 275-P Inductors have been revised since Part 1 of Catalog F was published. The table on page 58 is, therefore, replaced by the one below. These inductors are sufficiently uniform so that they are interchangeable in the TYPE 275, TYPE 375-A, and TYPE 575 Piezo-Electric Oscillators, even with high-precision quartz plates.

Type	Frequency Range		Code Word	Price
275-P1	50- 75 kc.	.....	PIEZOSGOAT	\$5.00
275-P5	75- 125 kc.	.....	PIEZOSRACK	5.00
275-P2	125- 200 kc.	.....	PIEZOSGIRL	5.00
275-P6	200- 350 kc.	.....	PIEZOSMILK	5.00
275-P3	350- 900 kc.	.....	PIEZOSSHOE	5.00
275-P4	900-2300 kc.	.....	PIEZOSSEAT	5.00



TYPE 275-P4

TYPE 375-A STATION PIEZO-ELECTRIC OSCILLATOR

**T**HIS instrument requires three tubes of the 112-A type. One is used in the piezo-electric oscillator and the other two in the amplifier. Recent tests indicate that much better results are obtained in eliminating the side-band tones from the monitor circuit if a 0.1 $\mu$ f to 0.2 $\mu$ f instead of a 1 $\mu$ f condenser be used.

TYPE 590 PIEZO-ELECTRIC OSCILLATOR

**T**HIS unit is ordinarily supplied for use in conjunction with a quartz crystal operating at 50 kc., but, if some other working frequency is required, we can install an inductor of suitable characteristics without extra charge.

No tubes are furnished.

### TYPE 547-P ACCESSORIES AND REPLACEMENTS

FOR the convenience of customers ordering by telegraph and cable, the code word **PIEZOSTOAD** has been assigned to the TYPE 547-P1 Connector Plate described on page 60.

### TYPE 591 TEMPERATURE-CONTROL UNIT

ALTHOUGH the TYPE 590 Piezo-Electric Oscillator and the TYPE 594 Heat-Control Unit are not included in the price of the TYPE 591 Temperature-Control Unit, we strongly recommend that the three be ordered together if the latter is to be used in a frequency-standards system. The TYPE 590 Piezo-Electric Oscillator is notable for its compactness, and it is unlikely that the user will be able to substitute a different oscillator without a considerable amount of inconvenience. The TYPE 594 Heat-Control Panel carries the meters, relays, and rheostats necessary for the proper operation of the thermostats.

The means for mounting a TYPE 376 Quartz Plate in this unit is described in the following section on the TYPE 591-P Accessories and Replacements.

### TYPE 591-P ACCESSORIES AND REPLACEMENTS



TYPE 591-P4 with TYPE 376 in position

SO that a TYPE 376 Quartz Plate may be housed in a TYPE 591 Temperature-Control Unit, the TYPE 591-P4 Adapter has been designed. It is mounted in the same manner as the TYPE 576-A Quartz Bar and is fitted with jacks so that the quartz plate may be plugged into it. With the adapter and the plate in place, another plate may be laid on the first one in the inner chamber of the temperature-control box and be kept at the correct operating temperature. Then, if it is desired to operate the second plate, only a short time is required for its temperature to become stable after the box has been reclosed. Specifications for the three TYPE 591-P Replacements described on page 61 are in no way altered.

*Dimensions:*  $3\frac{3}{4} \times 3\frac{1}{4} \times 1\frac{1}{2}$  inches.

*Weight:* 6 ounces.

Type		Code Word	Price
591-P4	Adapter for TYPE 376 Quartz Plate.....	AWING	\$3.00

### TYPE 376 QUARTZ PLATES

THE accompanying illustration shows the new chromium-plated mounting for TYPE 376 Quartz Plates. The name plate states the certified frequency and the amount, in kilocycles per second, by which the frequency may change and still remain within the guaranteed percentage accuracy.

The guarantee of accuracy for all TYPE 376 Quartz Plates is made on the assumption that the plate will be operated in a horizontal position, in an oscillator with a tube no larger than a 112-type, and with no more than 90 volts of plate battery. This seldom restricts the usefulness of the instrument, since the output of such an oscillator is adequate for all monitoring and laboratory measurement purposes.

In the past we have certified the two high-precision quartz plates (TYPE 376-F and TYPE 376-H) in oscillators which had not been built by General Radio provided only that the equipment had our approval. Difficulties involved in testing strange oscillators, in locating troubles, and in assuming responsibility for design features which appeared questionable to our engineers have made it necessary for us to discontinue this practice. In the future, therefore, all oscillators and temperature-control equipment with which TYPE 376 Quartz Plates are to be calibrated must have been manufactured by the General Radio Company.



TYPE 376

TYPE 576-A QUARTZ BAR AND HOLDER

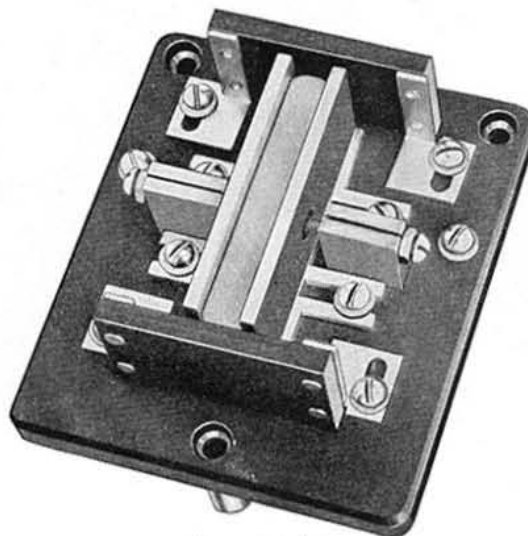

TYPE 576-A

THE accompanying photograph shows this unit as it is now being supplied. Changes are continually being made as further research shows us how its frequency stability can be improved.

This crystal is capable of a higher degree of frequency stability than any other commercially available unit. It is normally intended for use in a General Radio standard-frequency assembly where the crystal frequency is measured in terms of standard time. For this reason the adjustments are not sealed, and we have made no provision for certifying the accuracy to within which the bar has been adjusted to 50 kc. The frequency of the bar will, however, be so near to 50 kc. that only a slight adjustment of the adjusting control on the face of the TYPE 591 Temperature-Control Unit will be required to bring the frequency to the correct value.

For the convenience of customers ordering by telegraph and cable the code word PIEZOSMUSH has been assigned to the TYPE 576-A Quartz Bar.

TYPE 389-P INDUCTORS AND ROD MOUNTINGS

FOR the convenience of customers ordering by telegraph and cable the following code words have been assigned to the units described on pages 65 and 66:

Type	Code Word	Type	Code Word
389-P1	MAGNETOBOY	389-P3	MAGNETORUG
389-P2	MAGNETOTOP	389-P4	MAGNETOTOE

### TYPE 224 PRECISION WAVEMETERS

THE user of one of these wavemeters may rely upon its calibration being within 0.25% of the true frequency for one year from the date of purchase. At the end of that period the instrument should be returned to our laboratory for checking and possible recalibration.

The capacitance calibration is made at 26 points and may be relied upon to within  $1\mu\mu\text{f}$  for one year from the date of purchase.

### TYPE 624 PRECISION WAVEMETER

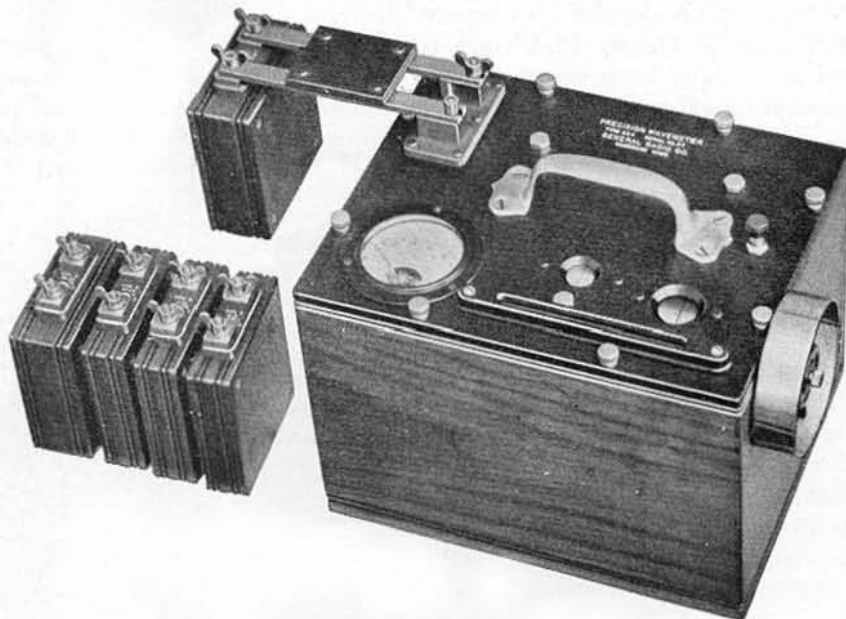

TYPE 624

THE description on page 68 fails to make it clear that this instrument is calibrated in frequency only. The accuracy of calibration is guaranteed to be within 0.1% for one year from the date of purchase, and we recommend that it be returned for checking at the end of a year. The capacitance calibration is good to  $1\mu\mu\text{f}$ .

Five (not six) inductors are normally supplied to cover the band between 25,000 kc. and 4270 kc. (12 meters and 53 meters).

Operation of the "push button" in the *resonance indicator* system throws in or out of circuit a small condenser in parallel with the main tuning condenser. The wavemeter setting is adjusted until operation of the push button causes no change in the deflection of the thermogalvanometer. This means that the incremental capacitance has spanned the resonance peak. For work at high frequencies, the accuracy of setting is considerably better than can be obtained by setting for maximum deflection.

### TYPE 511-P REPLACEMENT

FOR the convenience of customers ordering by telegraph and cable the code word SYNCROLITE has been assigned to the TYPE 511-P1 Neon Synchronizing Lamp.

## BRIDGES AND THEIR ACCESSORIES

**T**HE Wagner Ground is a useful adjunct to an impedance bridge, especially where the ratio arms are not equal. The TYPE 193-P1 Wagner Ground has just been developed as an attachment for the TYPE 193 Decade Bridge.

### TYPE 193-P1 WAGNER GROUND

**W**HEN comparing inductors or condensers by means of the TYPE 193 Decade Bridge, there is often a need for some means of eliminating the effects of stray capacitances to ground between the reactors under test, the power source, and the balance detector. This can be accomplished by means of a Wagner Ground which, in its simplest form, consists of an auxiliary pair of bridge arms placed in parallel with the power source and the ratio arms. Using the center junction point of the ratio arms and the grounded center junction point of the auxiliary arms for making connections with the balance detector, this new bridge may be balanced by changing the junction point on the auxiliary pair. When this occurs, the junction point of the ratio arms is balanced with respect to ground.

A complete discussion of the Wagner Ground may be found in a paper by J. A. Stratton, "A High-Frequency Bridge," published in the *Journal of the Optical Society of America* for October, 1926, and a briefer one, in the *General Radio Experimenter* for January, 1930.

*Description:* The Wagner Ground proper consists of a 400-ohm voltage divider, the position of the slider on which determines the position of the junction of the two auxiliary arms. This point is grounded through the GND terminal. Provision is made for inserting an additional 500 ohms

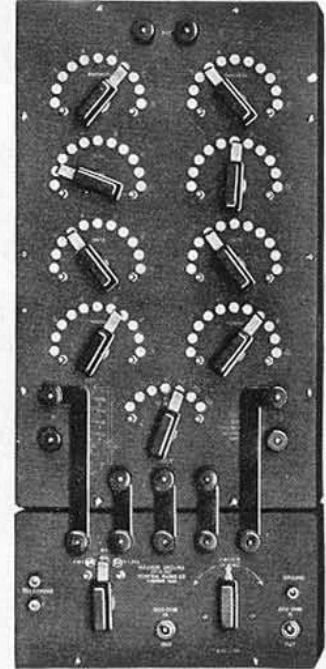

TYPE 193 and TYPE 193-P1

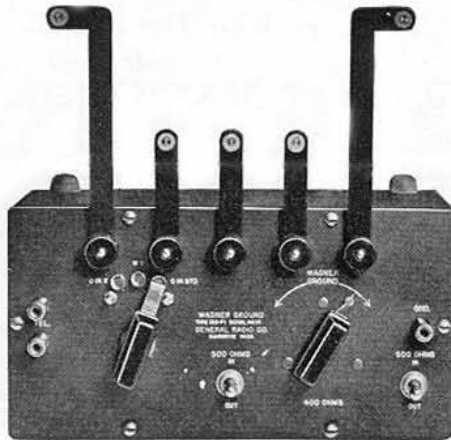

TYPE 193-P1

on either one or both sides of the voltage divider.

The 3-point switch accomplishes two things: It allows the balance detector to be connected to the Wagner Ground when in the wg position. When in the other positions the detector is connected to the decade bridge: in one position it throws  $R_C$  (see page 75) into the  $X$  arm, in the other, it throws  $R_C$  into the  $STD$  arm.

Complete operating instructions are packed with each unit.

*Mounting:* The Wagner Ground is designed to be connected to the decade bridge in the manner shown by the accompanying illustrations. Connector straps are furnished.

*Dimensions:* With the Wagner Ground attached, the over-all length of the bridge is increased to  $22\frac{1}{2}$  inches.

*Weight:*  $3\frac{3}{8}$  pounds.

Type	Code Word	Price
193-P1	GUNNY	\$20.00

TYPE 383 PORTABLE CAPACITY BRIDGE

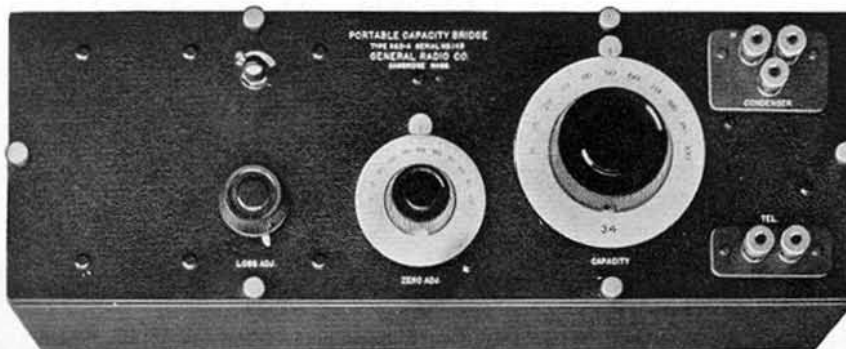

TYPE 383-A

A DESIGN of the low-capacitance model, more recent than the one on page 78 is shown in the accompanying illustration. The three terminals accommodate the corresponding plugs in the TYPE 383-P Bases, by means of which the bridge makes connections to the delta-connected capacitance network formed by the interelectrode capacitances of the vacuum tube.

The TYPE 383-P2 Base is supplied with the TYPE 383-A Portable Capacity Bridge without additional charge. None are supplied with the TYPE 383-B Portable Capacity Bridge (high-capacitance model).

TYPE 383-P ACCESSORIES



TYPE 383-P1



TYPE 383-P2

THE accompanying photograph shows the TYPE 383-P1 and the TYPE 383-P2 Bases for use in conjunction with the TYPE 383-A Portable Capacity Bridge when measuring the interelectrode capacitance of vacuum tubes.

For the convenience of customers ordering by telegraph and cable the following code words have been assigned.

Type	Code Word	Type	Code Word
383-P1	ADAPTORCAT	383-P2	ADAPTORDOG

TYPE 240 CAPACITY METER

SEVERAL readers of Catalog F have noticed that the schematic diagram and the actual wiring diagram in the cover of the instrument do not agree in the method of connecting the microphone hummer. The hummer is connected as shown in the accompanying diagram.

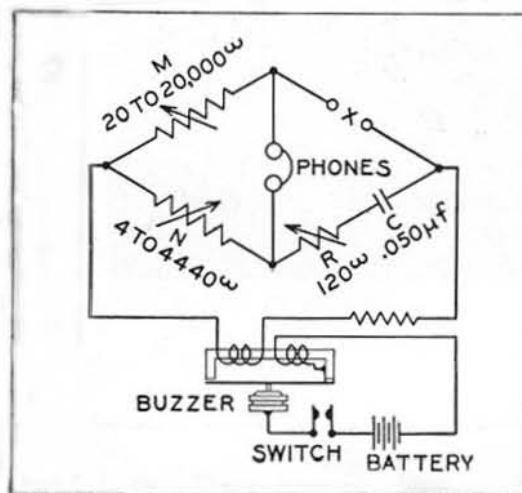

Corrected wiring diagram for TYPE 240



## RADIO-FREQUENCY TESTING DEVICES

**T**HE modified standard-signal generator for the radio serviceman referred to on page 88 was fully described in Catalog Supplement F-200. The description is repeated here so that Part 2, with Part 1, will give a complete account of all General Radio instruments.

Another important development in radio-frequency measurements is the modulation meter, a device for measuring the percentage modulation and for locating modulation faults in broadcast transmitters.

The TYPE 403-C Standard-Signal Generator has been made available for the measurement of radio-field intensity by the comparison method. The description on page 145 supplies additional information about this use.

### TYPE 457-A MODULATION METER



TYPE 457-AM

**P**ROPER operation of a broadcast transmitter requires more knowledge about the performance of the modulation system than the operating engineer has been able to obtain readily. Measurements of the percentage of modulation and the adjustment of the transmitter for the maximum amount of undistorted modulation have been difficult, involving as they have a well-developed experimental technique and relatively complex equipment. The advantages of a simple and accurate modulation meter will be apparent to every broadcast engineer.

The TYPE 457-A Modulation Meter is a direct-reading instrument for the accurate measurement of percentage modulation. It has a number of important uses. Determinations can be made while a program is in progress so that it may be used by the monitoring operator to indicate when the maximum allowable percentage modulation is being exceeded. This modulation meter is no more difficult to operate than a power-level indicator.

The maximum allowable percentage of modulation for any given adjustment of the transmitter can be determined by increasing the audio-frequency input voltage until further increases no longer produce proportional increases in percentage modulation. Greater values of percentage modulation indicate that the transmitter is being overloaded with resulting distortion. Since the percentage modulation can be measured on the

negative peaks of the audio-frequency wave as well as on the positive peaks, lack of symmetry in the modulation or shifts in the average value of the carrier voltage during modulation can be detected and steps taken to correct the maladjustment.

*General Description:* About 75 volts of modulated carrier voltage may conveniently be introduced into the modulation meter from a pickup inductor coupled to the output circuit of the transmitter. The power required to operate it (approximately 0.5 watt) is negligible even in low-power transmitters.

The instrument consists essentially of a linear rectifier for obtaining a wave identical in form with the envelope of the modulated radio-frequency wave and a means, including a vacuum-tube peak voltmeter, for examining the maximum and minimum values of the rectified wave. The circuit is arranged so that after a preliminary adjustment of the radio-frequency voltage applied to the rectifier, percentage modulation for either positive or negative peaks is given directly by a dial reading.

*Tubes:* Two UY-227 tubes or equivalent are required.

*Power Supply:* Two Burgess No. 5308 block batteries or equivalent 90-volt battery are required to deliver about 2 milliamperes. A battery compartment is provided inside the cabinet. Filament-heater power is supplied from the 105-115 volt, 50-60 cps. line.

*Terminals:* A receptacle for plugging in the 110-volt supply is provided on the right-hand side of the cabinet. Battery connections are made to flexible leads. On the front panel and on terminal plates at the back, duplicate pairs of binding posts are provided for the radio-frequency input and for the output of the linear rectifier so that it can be used with other analyzing equipment if desired.

*Accuracy:* In ordinary use the error is less than 5 per cent. in modulation at audio frequencies up to about 3000 cps. The inherent error of the instrument is considerably less than this, and, if sufficient care is used in setting it up and in taking observations, the error may be reduced to below 2 per cent. in modulation. For example, when the modulation meter reads 75 per cent. modulation, the true value will be between 73 and 77 per cent.

The accuracy is greater at high modulation percentages than at low and is greater at low modulation frequencies than at high.

The above values of accuracy may be expected for carrier frequencies in the range between 400 kc. and 4000 kc. (750 meters-75 meters, approximately). The instrument can be modified to permit its use on carrier frequencies as high as 15,000 kc. (20 meters), information about which will be supplied on request.

*Shielding:* A shield of nickel-plated brass protects the circuit from stray electric fields.

*Mounting:* The instrument is normally supplied mounted in a polished walnut cabinet, but we can supply it for mounting in a standard 19-inch relay rack. For details consult the description of the alternative mounting in the following section.

*Accessories:* The instrument is supplied with a 7-foot cord for making connections to the 110-volt line but without tubes, battery, or pickup inductor.

*Dimensions:* Panel size, 15 x 7 x  $\frac{1}{4}$  inches; over-all cabinet size, including handles,  $18\frac{1}{8}$  x  $10\frac{7}{8}$  x  $7\frac{3}{4}$  inches.

*Weight:* 25 pounds.

<i>Type</i>	<i>Code Word</i>	<i>Price</i>
*457-AM   (For cabinet mounting) . . . . .	MANGE	\$125.00
* Panel of instrument is engraved "TYPE 457-A"		

### TYPE 457-A MODULATION METER ALTERNATIVE MOUNTING

WE are prepared to supply any TYPE 457-A Modulation Meter in our stock for mounting on a General Radio Company TYPE 480 (standard 19-inch) Relay Rack. To do this we supply, instead of the cabinet, a pair of panel extensions for increasing the panel length to 19 inches. The brass shield regularly supplied is a sufficient protection against dust, and the shelf extending beyond it provides space for holding the battery.

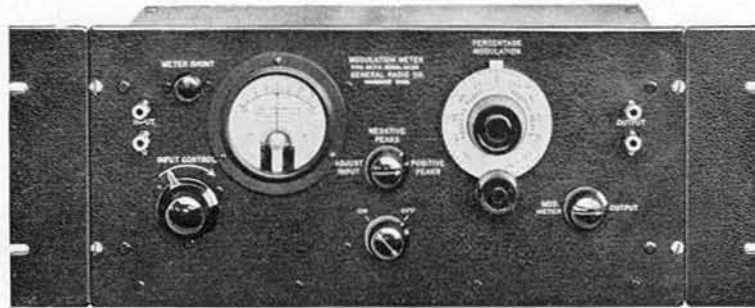

TYPE 457-AR

The instrument itself is identical with the TYPE 457-A Modulation Meter described in the preceding section.

*Dimensions:* Over-all depth behind panel, including battery shelf, 10 inches; panel size with panel extensions, 19 x 7 x 1/4 inches. *Weight:* 18 3/8 pounds.

<i>Type</i>	<i>Code Word</i>	<i>Price</i>
*457-AR   (For relay-rack mounting) . . . . .	MANGY	\$110.00

\*Panel of instrument is engraved "TYPE 457-A"

### TYPE 403-C STANDARD-SIGNAL GENERATORS

ALL TYPE 403-C Standard-Signal Generators have an improved shielding system which reduces the amount of radio-frequency magnetic leakage considerably. There is no change in the price (see pages 89-90). Owners of TYPE 403-C Standard-Signal Generators can have the new shielding added for a moderate charge.

The improvement consists in the following: (a) doubling the thickness of the copper shield above the tuning inductor; (b) soldering all parts of the box lining; (c) encasing the MODULATION VOLTAGE and MICROVOLTS meters in copper shields; and (d) placing an L-shaped shield along the upper front edge.

The new design makes the instrument of considerably more value in tests on sensitive receivers as well as in measurements of radio field intensity. The old models were adequately shielded for testing the general run of broadcast receivers, but our desire to apply the standard-signal generator to field-strength measurements imposed conditions more severe than were anticipated in the original design.

Tests indicate that the amount of leakage has been reduced considerably, especially from the front panel and the top of the signal generator. Although comprehensive data are difficult to express in a few words, the results of the following representative test may be helpful.

A loop having an effective height of about 5 cm. and an inductance suitable for tuning over the broadcast band with a 500- $\mu\text{mf}$  variable-air condenser was placed at three different points (Column 1 in the following table) near a new model standard-signal generator. At all three points the receiver connected to the loop gave the same power output as when 2 microvolts were introduced directly into the loop circuit. In Column 2 are shown the corresponding distances for the old model.

TABLE  
DISTANCES FROM SIGNAL GENERATORS TO PRODUCE EQUIVALENT OF 2 MICROVOLTS

<i>New-Shielding</i>	<i>Old Shielding</i>
----------------------	----------------------

*6 in. from front	17 in. from front
2 in. from side	3 in. from side
*5 in. from top	16 in. from top

\* When the loop was placed "6 in. from front" or "5 in. from the top" of one of the old models, the equivalent leakage was about 40 microvolts.

As a rough approximation it may be assumed that the field intensity of the "leakage" varies inversely as the square of the distance. This has been verified experimentally.

The new shielding is essential for the satisfactory measurement of radio field intensity by the comparison method described by Robert F. Field in the January, 1931, *General Radio Experimenter*. The charge for making the necessary changes in old models is \$22.00. Work must be done at the factory. Although the work usually does not affect either the frequency or the output-voltage calibrations appreciably, customers ought to have the calibrations checked at the same time.

A shielded 2-conductor test lead is now supplied as regular equipment with the standard-signal generator. One end is fitted with a TYPE 274-M Plug for plugging into the OUTPUT terminals; the other is fitted with spade terminals for connecting to the dummy antenna and the receiver under test.

### TYPE 403-P AND TYPE 403-Q INDUCTORS

THESE are intended for extending the frequency range of the TYPE 403-B and TYPE 403-C Standard-Signal Generators. The TYPE 403-P Inductors are uncalibrated; the TYPE 403-Q Inductors are calibrated.

A new inductor (TYPE 403-PS and TYPE 403-QS) has been recently developed for covering the range between 200 kc. and 150 kc. This is the frequency band in which many manufacturers of superheterodyne broadcast receivers are carrying on development work.

Except for this and the addition of code words, the following price list is identical with that on page 90.

*Weight:* Each inductor weighs approximately 5 ounces.

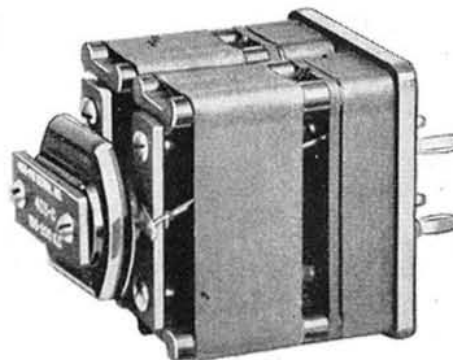

TYPE 403-PS

Type	Frequency Range	Code Word	Price
*403-P2	500-1500 kc.	STANSIGANT	\$12.00
*403-P3	175- 500 kc.	STANSIGBOY	12.00
*403-P4	70- 175 kc.	STANSIGCAT	22.00
*403-P5	33- 70 kc.	STANSIGDOG	22.00
*403-P6	15- 33 kc.	STANSIGEYE	22.00
*403-P8	150- 200 kc.	STANSIGFLY	16.00
	Frequency Calibration (per inductor)	CURVE	8.00

\* Frequency calibrations supplied only when ordered. The type numbers for calibrated inductors are: 403-Q2, 403-Q3, etc. For calibrated inductors use compound code words, e.g., STANSIGANT-CURVE, STANSIGBOYCURVE, etc. Standard-signal generator with which calibrated inductors are to be used must be submitted with order so that we can make calibrations and check the performance of the instrument.

### TYPE 403-P OUTPUT SHUNTS

THE internal output impedance of the attenuator in a TYPE 403-C Standard-Signal Generator is 10 ohms except at the 10M and 20M steps. By shunting the OUTPUT terminals with a TYPE 403-P9 Output Shunt this impedance becomes one ohm and the open-circuit voltage is reduced by a factor of 10. The shunt is useful where either the lower value of impedance or the lower range of output voltages is desired. Plugs for attaching the case of the unit to the OUTPUT terminals are provided. Connections to the circuit under test are made to the OUTPUT binding posts.

In making field-intensity measurements in connection with a balanced loop, it is desirable that the standard-signal generator introduce as little series resistance and as little



TYPE 403-P9

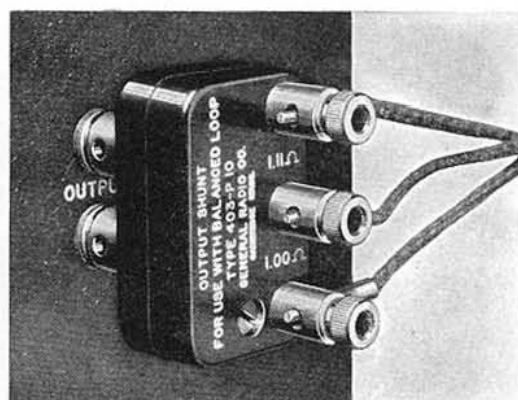

TYPE 403-P10

unbalance as possible into the loop circuit. These conditions are met by the use of a TYPE 403-P10 Output Shunt which consists of two series resistors. One resistor shunts the output terminals of the attenuator, reducing its apparent impedance to one ohm. The other is a 1-ohm resistor for balancing the effect of the shunted attenuator. Plugs for attaching the case of the unit to the output terminals are provided as well as three binding posts for making connections to the balanced loop. We will supply the TYPE 403-P10 Output Shunt instead of the TYPE 418 Dummy Antenna without extra charge if requested to do so when the order is placed for a TYPE 403-C Standard-Signal Generator.

*Dimensions:* The over-all size of each unit, exclusive of binding posts, is  $2\frac{1}{8}$  x  $1\frac{3}{8}$  x  $1\frac{5}{16}$  inches. The binding posts on the TYPE 403-P10 Output Shunt increase its third dimension to 2 inches. They include the TYPE 274-P Plugs.

Type	Weight	Code Word	Price
403-P9	1 oz.	STANSIGPIE	\$2.50
403-P10	3 oz.	STANSIGCUP	4.00

### TYPE 360-A TEST OSCILLATOR

**T**HIS instrument supersedes the TYPE 360 Test Oscillator described on page 91. The two are identical except that the VERNIER adjustment for the 175-kc. channel is calibrated at 1-kc. intervals between 170 kc. and 180 kc.

#### REMODELING OBSOLETE MODELS: TYPE 320 OR TYPE 360

We are prepared to remodel TYPE 320 and TYPE 360 Test Oscillators so that they can be used for testing present-day superheterodyne receivers. Full information will be supplied on request by the Service Department, General Radio Company. Be sure to give the following information about the test oscillator you propose to remodel: (a) type number, (b) serial number, (c) what if any remodeling has already been done?

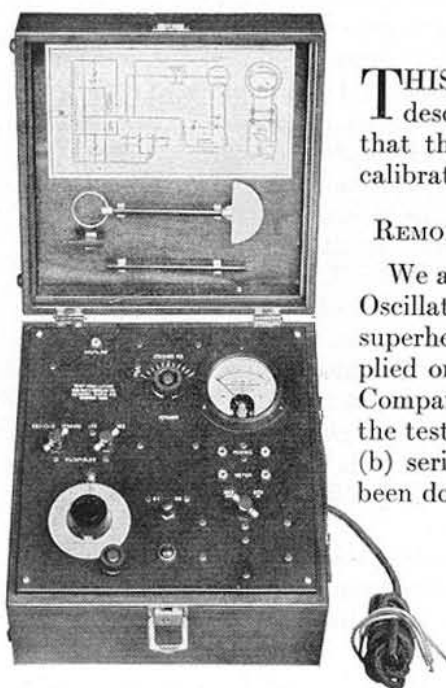

TYPE 360-A

## TYPE 404 TEST-SIGNAL GENERATOR

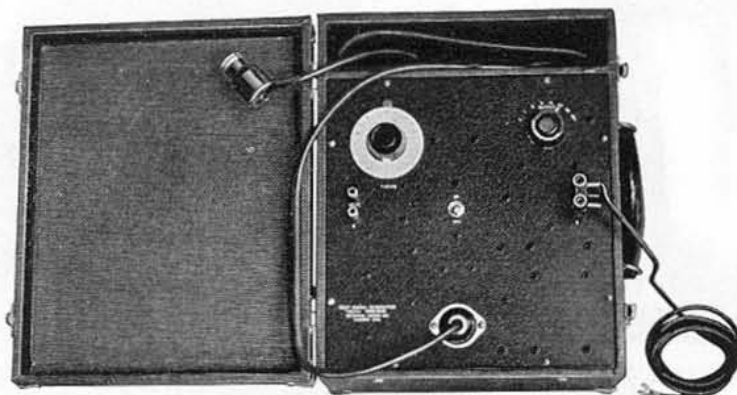

TYPE 404

WITH the increasing complication of commercial receivers a signal generator of simplified type is becoming a requirement in radio service work. A generator of this type need not set an exact standard of radio-frequency output, but should present a means of reliable comparisons between receivers, and of the same receiver under different conditions. Such a generator may be used for neutralizing and alignment of receivers, as a check of the receiver's initial condition, and to provide a means of knowing quantitatively the improvement made by means of any changes or adjustments in the receiver.

The comparative sensitivity of a receiver may be measured by means of an adjustable source of radio-frequency voltage. The method is to connect the test generator to the input of the receiver and to connect some sort of output indicator, e.g., the General Radio TYPE 486 Output Meter, to the output of the receiver. The test generator is then adjusted to give a standard reading on the output meter, and the output of the test generator taken as a measure of the comparative sensitivity of the receiver. The presence of defects will be indicated by the low sensitivity, and conversely, normal sensitivity is definite evidence that the set is not defective, or that defects have been successfully repaired.

The General Radio TYPE 404 Test-Signal Generator has been designed with the requirement of service testing in mind. It is portable, provides accurate comparisons, and operates from the alternating-current line. The generator consists of a modulated oscillator, tuning over the broadcast band, with a calibrated dial, and an attenuator. The circuits are carefully shielded, and filters prevent leakage into the alternating-current lines.

The attenuator has been carefully designed, and well shielded. The value of the instrument in making comparisons depends entirely on the accuracy of the attenuator, and this portion of the circuit has, therefore, received particular attention. The attenuator has voltage ratios of 1, 2, 5, 10, 20, 50, and 100; a range that will include all modern types of receivers. An additional set of terminals provides an output of about 0.1 volt. The error in attenuator ratios is less than 5 per cent. for adjacent ratios, and the cumulative error in the entire attenuator does not exceed 20 per cent. This means that the instrument will compare the sensitivity of two receivers with an accuracy of 5 to 20 per cent.

The absolute value of the output voltage may vary, due to changes in tubes, or in line voltage. The change in output due to line-voltage variations is approximately proportional to the change in line voltage, and may be corrected for, if the line voltage is measured.

The input to the attenuator is adjustable and is set at the factory. Where facilities are available for setting the input voltage to the attenuator from time to time, correction can be made for changes in tube conditions. The total voltage attenuation from the point of adjustment to the lowest output point is 1:100,000.

The oscillator is so designed that the output voltage is nearly constant over the entire frequency range. The voltage variation is less than plus or minus 5 per cent.

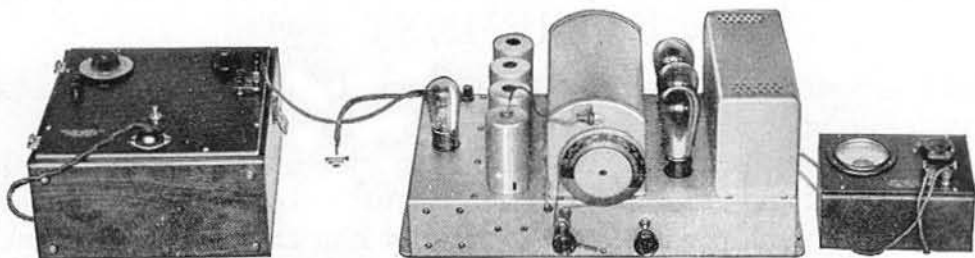

An early model of a TYPE 404 Test-Signal Generator and a TYPE 486 Output Meter set up for measuring the sensitivity of a receiver

Complete isolation from the line is essential in a device of this sort, since it will usually be connected to the same circuit as the receiver under test, and any radiation into the line will be picked up by the receiver. Careful filtering of the power line has eliminated leakage through these leads.

*Uses:* The TYPE 404 Test-Signal Generator will be found useful in the usual aligning and neutralizing adjustments. A further wide range of usefulness is in assaying the condition of a receiver in question. Since it is portable, it may be taken to the job, and will indicate at once whether or not there is any radical difficulty with the receiver, or whether the trouble is in location, antenna or ground installation, or is only imaginary.

It can further be used to check on the improvement resulting from changing tubes, or making adjustments in the receiver. The test-signal generator may also be used as a test on receivers in factory production.

*Modulation:* Modulation is obtained from the rectifier tube, i.e., the output from the rectifier tube is not completely filtered. This provides a complex modulation, containing both even and odd harmonics of 60 cycles.

*Accuracy:* Adjacent ratios 5 per cent.

Cumulative error in attenuator 20 per cent. Change in output with frequency  $\pm 5$  per cent. Calibration of tuning dial 3 per cent.

*Output Range:* Roughly 10-1000 microvolts. 0.1-volt output also provided.

*Shielding:* The filtering and shielding are such that the instrument may be used with receivers of the highest sensitivity. When the test-signal generator is properly grounded the leakage does not exceed an amount equivalent to 2 microvolts applied directly to the receiver input terminals.

*Tubes:* Two 226-type tubes are required for operation of the generator.

*Construction:* The instrument is contained in a shielded compartment of a leatherette carrying case fitted with a carrying handle. Another compartment is provided for storing tools and accessories. The panel is of aluminum with black crackle lacquer. A six-foot extension cord for the power supply and a shielded cable for connecting to the receiver under test are provided.

Type	Tuning Range	Dimensions	Weight	Code Word	Price
404	500-1500 kc.	11 $\frac{1}{4}$ x 11 $\frac{3}{4}$ x 7 $\frac{1}{2}$ in.	19 lb.	SULKY	\$95.00

## MISCELLANEOUS LABORATORY EQUIPMENT

**T**HE usefulness of the TYPE 338-L String Oscillograph described on page 93 has been further enhanced by the development of a continuous-film camera for recording any desired oscillographic phenomena. The oscillograph has enabled the user to view recurrent waveforms; the camera attachment now permits him to make a permanent record of transient, as well as recurrent, phenomena. The viewing box and the camera cannot be used simultaneously, but the trace can be transferred from one to the other in a fraction of a second.

The camera-oscillograph combination also makes an accurate high-speed chronograph. Timing may be done by a timing wave applied to the second string of a double string-holder or in terms of intervals marked on the film by a synchronous shutter driven from the 110-volt, 60-cps. power supply.

The camera equipment can easily be attached to any TYPE 338-L String Oscillograph, in no way interfering with the normal operation of the latter. There are three principal components, each of which must be ordered separately.

a) The TYPE 408 Oscillograph Camera contains the film-storage magazines and a means of driving the film or paper past an aperture for exposure, thus supplying the time axis in the resulting oscillogram.

b) The TYPE 409 Camera Shelf is the means for holding the oscillograph, the camera, and the rest of the optical system in the proper position. This unit is essential to the

proper operation of the camera with the TYPE 338-L String Oscillograph.

c) The TYPE 407 Synchronous Shutter is one means of timing the oscillogram. Its use is recommended but is not essential.

The prospective purchaser should order, in addition to the TYPE 338-L String Oscillograph and any extra string-holders he may require, the following:

1—TYPE 408 Oscillograph Camera .....	\$175.00
1—TYPE 409 Camera Shelf .....	30.00
At least 1 reel of TYPE 408-P1 Photographic Paper .....	3.25
At least 1 carton of TYPE 408-P2 Developing Powders .....	1.00
Total .....	\$209.25

We also recommend the purchase of

1—TYPE 407 Synchronous Shutter .....	60.00
Total .....	\$269.25

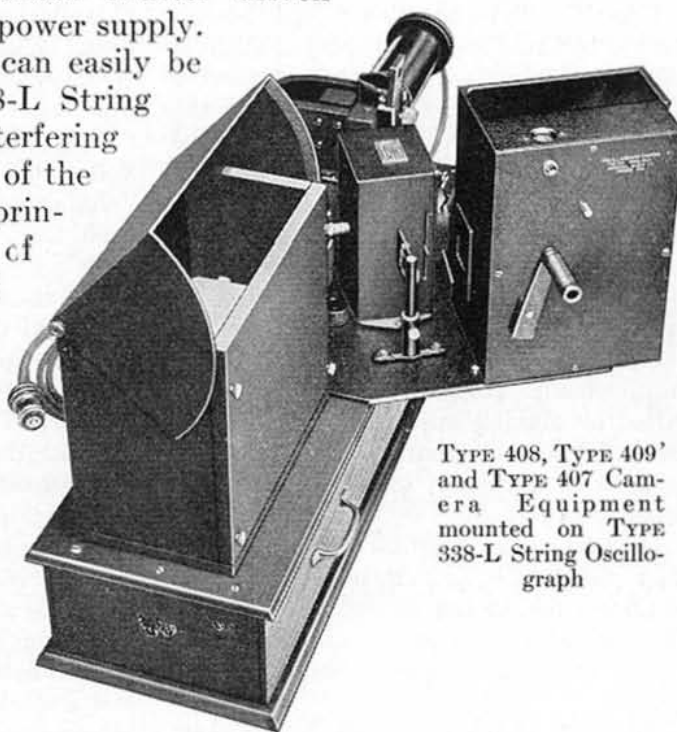

TYPE 408, TYPE 409'  
and TYPE 407 Cam-  
era Equipment  
mounted on TYPE  
338-L String Oscillo-  
graph



## TYPE 408 OSCILLOGRAPH CAMERA

**T**HIS is a hand-driven daylight-loading camera for use with standard-perforation, 35-millimeter motion-picture film or paper. The magazines hold 100-foot reels so that exposures of any length up to that amount may be obtained. A resettable counter measures the amount that has been exposed. A maximum film speed of 30 inches per second is obtainable so that, at maximum speed, a 1000-cps. trace will have a wavelength of approximately  $1/32$  inch. The camera may be used with the TYPE 338-L String Oscillograph, in ordinary daylight.

It may also be used to record traces from other types of oscillograph if suitable arrangements are made. We are prepared to modify any of these cameras for use with either vibrating mirror or cathode-ray oscillographs. Information will be supplied on request.

*General Description:* The camera consists of a rectangular aluminum casting with two separate compartments. One is the magazine for unexposed film, the other is the magazine for exposed film.

The film passes from the first magazine over a driving sprocket and thence through a light-tight slot into the second magazine. While on the sprocket it is momentarily exposed through a horizontal transverse slit mounted on the face of the camera. The vertical shadow image of the oscillograph string, condensed by a lens mounted on the camera shelf in order to intensify the illumination, vibrates along the slit perpendicular to the motion of the film. In this way, the trace of the vibrating string is recorded as a negative, in other words, as a white line upon a dark background.

*Optical System:* The film is exposed through a slit which is  $15/16$  inch in length (equal to the useful width of the 35-millimeter paper) and adjustable in width. No lenses are required in the camera itself.

*Film Data:* The use of 100-foot reels of Eastman No. 2, 35-millimeter recording paper is recommended, in fact all statements about the performance of the camera

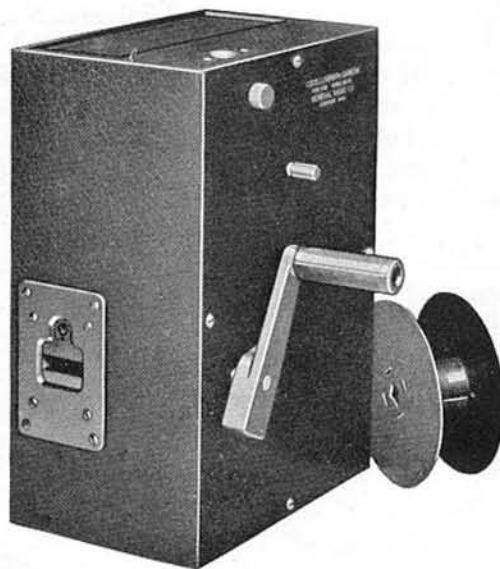

TYPE 408

in this description are based on the use of this paper. It is as fast as ordinary film but much easier to handle, and, when developed with the Eastman x-ray developer, it produces a contrasty and very satisfactory record. See the description of the TYPE 408-P1 Photographic Paper and TYPE 408-P2 Developing Powder.

If a record less than 100 feet long is required, the camera may be unloaded in the darkroom with no loss of film. If care be used, it can be unloaded in daylight with the loss of only a few inches of the unexposed film.

*Drive:* The driving sprocket and the "exposed reel" are driven by a hand crank. If desired, however, provision may be made for substituting a motor drive, and information about this modification may be obtained on application to the General Radio Company.

*Finish:* The aluminum camera case is finished in black crackle lacquer. All other parts exposed are finished in either black or white nickel plate.

*Accessories:* The camera is supplied with one blank reel but no paper.

*Dimensions:*  $6 \times 4\frac{1}{2} \times 9$  inches.

*Weight:* 10 pounds.

Type	Code Word	Price
408	ANGER	\$175.00

## TYPE 408-P ACCESSORIES

WE recommend the use of Eastman No. 2 recording paper in the TYPE 408 Oscillograph Camera and maintain a small stock made up with perforated leaders on 100-foot reels. It can also be obtained from the Eastman Kodak Company through any of the latter's own retail stores, but we understand that it is made up to order only. A user who has need of a sufficient quantity may be able to persuade his local dealer to carry a stock.

The use of Eastman x-ray developing powders is recommended. We carry these in stock in cartons of six pairs of packages, "12-ounce size."

Type		Weight	Code Word	Price
408-P1	100-ft. reel of Eastman No. 2 paper .....	12 oz.	OSCILOFILM	\$3.25
408-P2	Carton of x-ray developing powders.....	13 oz.	OSCILODOPE	1.00

## TYPE 409 CAMERA SHELF

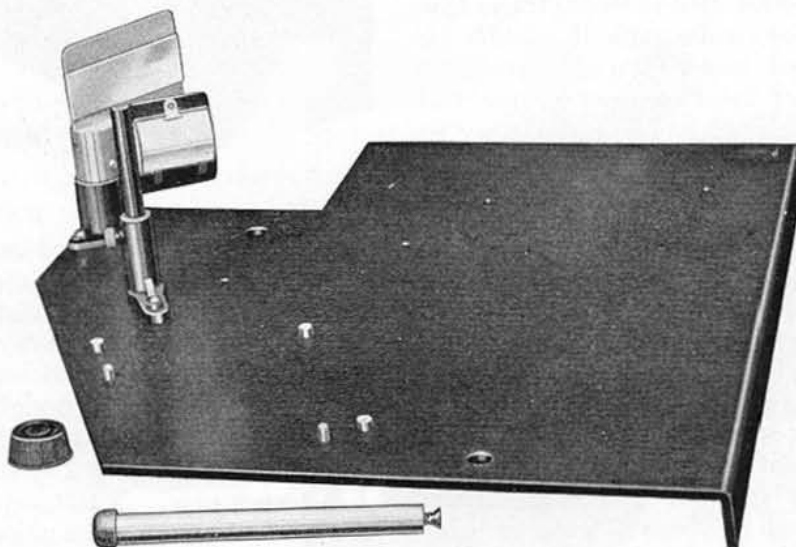

TYPE 409

THE camera shelf supports the camera on the oscillograph base and keeps the optical system in alignment.

*General Description:* The shelf is made of aluminum and is properly drilled for aligning the several parts. It is easily attached to the oscillograph equipment under the galvanometer. As part of the shelf is supplied a two-position mirror and mounting. This operates similar in principle to a graflex camera, a turn of the wrist serving to throw the string image from the rotating mirror box into the camera and vice versa. Simultaneous visual observations and photographic records are not possible, but one may closely follow the other.

Another part of the shelf equipment con-

sists of a mounting carrying a cylindrical lens having a horizontal axis. This lens is for the same purpose as that in the rotating mirror box; that is to say, it condenses a pencil of rays into a narrow horizontal beam focused along the slit, thereby increasing the intensity of illumination many fold.

The accompanying illustrations show the arrangement of the mirror and the condensing lens.

*Finish:* The shelf is finished in black crackle lacquer.

*Dimensions:* 15 x 15 inches, over-all.

*Weight:* 3 pounds.

Type		Code Word	Price
409	.....	ANNOY	\$30.00

TYPE 407 SYNCHRONOUS SHUTTER

**B**y means of this device narrow transverse time lines can be marked upon the oscillogram. These timing lines are spaced at intervals of 1/50th of a second, with additional identifying marks at every 0.1-second and at every 1-second interval.

*General Description:* The synchronous shutter is a manually-started synchronous motor, operating from the 60-cps. power supply. The shutter consists of a wheel of five spokes, mounted on the shaft. It is mercury-damped, and the accuracy of timing is therefore approximately equal to the accuracy with which the frequency of the power supply is maintained at 60 cps. The unit is mounted on the camera shelf, where the shutter wheel will intercept the light from the oscillograph, thereby making a white trace on the moving film or paper.

*Shutter:* The unit is supplied with a five-spoke wheel, but if timing lines, spaced at 0.01-second intervals are desired, the user may order a ten-spoke shutter, the TYPE 407-P1 Shutter Wheel, as additional equipment.

*Power Supply:* 105 to 115 volts, 60 cps. A short permanently attached cable is provided for making connections to the power-supply terminals on the TYPE 338-L String Oscillograph.

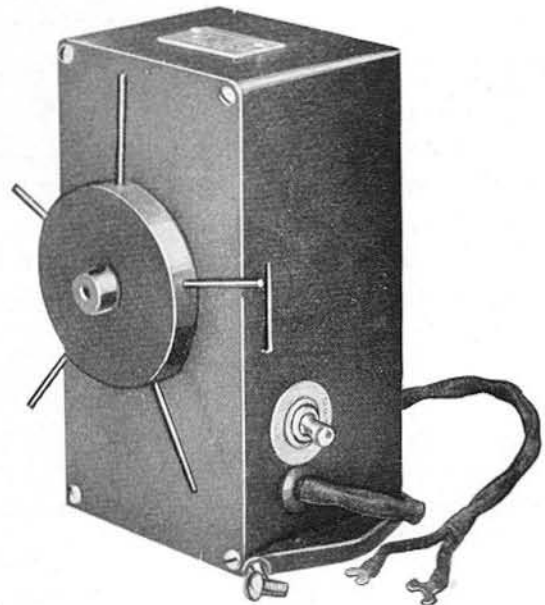

TYPE 407

*Finish:* The unit is finished in black crackle lacquer.

*Accessories:* Two machine screws for attaching the unit to holes in the TYPE 409 Camera Shelf are provided.

*Dimensions:* 4 x 3½ x 6 inches.

*Weight:* 4½ pounds.

Type	Code Word	Price
407	AMISS	\$60.00

TYPE 407-P ACCESSORIES

**A**TEN-SPOKE shutter wheel is available for users who wish timing lines at intervals of 0.01 second. It is easily attached to the drive shaft of the synchronous motor.

Type	Weight	Code Word	Price
407-P1   Shutter Wheel (10 spoke).....	7 oz.	ASPEN	\$10.00

## METERS

**T**HIS chapter describes for the first time two new elements for electric measuring circuits: the TYPE 492-A Oxide Rectifier and the TYPE 493 Thermocouples. They are intended for use with the user's own meters, a wide variety of suitable types being commercially available.

A modification in the TYPE 586-B Power-Level Indicator makes it possible to operate an auxiliary meter at a distance from the instrument itself.

### TYPE 586 POWER-LEVEL INDICATORS

**W**HEN the power-level indicator is used on recording circuits, it is sometimes desirable to have an auxiliary meter located at a distance from the point where the instrument is installed. This enables a second operator to keep in touch with what is going on in the recording circuit.

So that this can be done, all rack-mounting models (TYPE 586-B) are provided with an extra pair of terminals to which the external meter may be connected. These terminals are in series with the d'Arsonval movement of the meter in the power-level indicator and are bridged by a short-circuiting strap when not in use. The TYPE 586-P3 Meter described in the following section is intended for use as the external meter.

The insertion of the external meter will cause no appreciable error in the reading of the power-level indicator. Pickup is usually the factor that limits the distance at which the extra meter may be placed.

### TYPE 586-P ACCESSORIES

**T**HE TYPE 586-P1 Meter is a copper-oxide-rectifier voltmeter, identical with the indicating element in the TYPE 586-A Power-Level Indicator. It has a range of -10 db to +6 db with zero level at 0.06 watts on a 500-ohm line. It does not have the extra terminals for connecting in an external meter.

The TYPE 586-P3 Meter is similar to the TYPE 586-P1 Meter except that it is the d'Arsonval movement only, without an oxide rectifier. It is intended as the external meter for use with the TYPE 586-B Power-Level Indicator.

The following data apply to both meters:

*Dimensions:* Diameter,  $3\frac{1}{2}$  inches; depth, 2  $\frac{27}{32}$  inches.  
 $2\frac{1}{4}$  inches over-all. Mounting hole diam- *Weight:* 12 ounces.

<i>Type</i>	<i>Code Word</i>	<i>Price</i>
586-P1	POWLEVG0AT	\$20.00
586-P3	POWLEVMIK	18.00

### TYPE 492-A OXIDE RECTIFIER

**T**HE TYPE 492-A Oxide Rectifier is provided for use with relays and direct-current indicating instruments on alternating-current service. The unit is at present offered primarily for experimental use and the following specifications are indicative rather than positive.

It must be realized that the copper-oxide type of rectifier is subject to changes in both sensitivity and frequency characteristics with output load. The sensitivity also varies

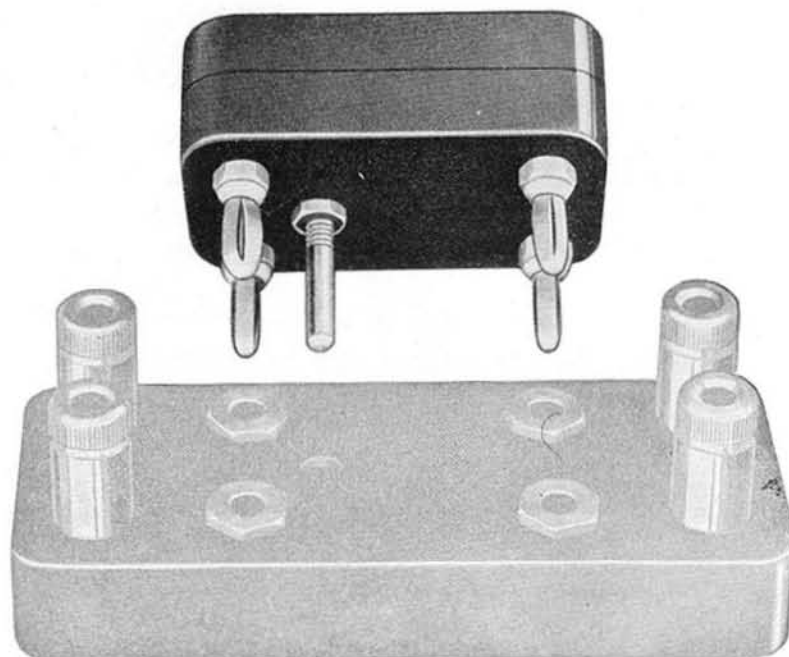

Mounting case for TYPE 492-A Oxide Rectifier and TYPE 493 Thermocouples with TYPE 274-RJ Mounting Base

with impressed voltage. The values given below approximate those obtained under usual conditions of voltage and load.

This rectifier unit is made for us by the General Electric Company.

*Frequency Error:* The rectifier may be used without appreciable frequency error at frequencies below 5000 cycles per second.

*Temperature Error:* Temperature errors of about 5% may be expected between normal extreme temperatures. Maximum sensitivity is obtained with a load of 5000 to 7000 ohms. This value should be used when the instrument is operating a relay. If a 200-milliamper micro-ammeter of about 500 ohms resistance is used, full-scale deflection will be obtained at about 2 volts

across the rectifier input.

The maximum current output from the rectifier should not exceed 15 milliamperes, nor should the impressed voltage exceed 3 volts.

Obviously, the apparent change of impedance with resistance can be greatly reduced by proper use of series and shunt resistance on the input side.

*Dimensions:* Size of case, exclusive of plugs,  $2\frac{1}{8} \times 1\frac{3}{8} \times \frac{3}{4}$  inches.

*Weight:* 4 ounces.

<i>Type</i>	<i>Code Word</i>	<i>Price</i>
492-A	FLORA	\$7.00

### TYPE 493 THERMOCOUPLES

WHILE indicating direct-current instruments can be made for currents as low as a few micro-amperes, dynamometer instruments for the measurement of alternating currents are not available in low ranges due to the inherent low efficiency of this type of instrument.

In the measurement of alternating currents of small magnitudes the heating effect of the current is generally utilized. In the thermocouple the heat caused by the flow of current through a wire is applied to a junction of dissimilar metals. Such a junction sets up a direct-current voltage which actuates a sensitive direct-current indicating meter. This

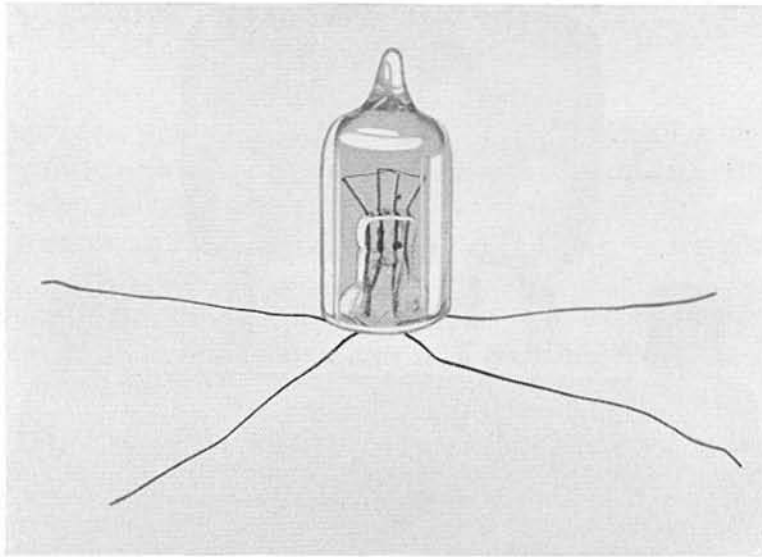

Vacuum thermocouple as mounted in TYPE 493 Thermocouples

type of instrument is a true integrating ammeter, since the direct-current meter reading is a function of average squared current in the heater. A thermocouple is, therefore, independent of waveform errors. Frequency errors occur only at frequencies so high that the shunting effect of stray capacitances in the couple mounting becomes significant.

*Construction:* The thermo-junctions used in the TYPE 493 Thermocouples are mounted in an evacuated glass bulb. The vacuum serves to provide radiation of heat from the couple and also reduces the effect of external temperature variations. The glass bulb is surrounded by felt and mounted in a bakelite container, fitted with plugs for plugging into a TYPE 274-RJ Mounting Base (see page 162). The thermo-junction is in direct contact with the heater wire.

The TYPE 493 Thermocouples are suitable for use on either alternating or direct current and may, of course, be calibrated on direct current. Reversed readings are desirable in making calibrations although reversal will not ordinarily change the indication by more than one-tenth millivolt.

*Couple Resistance:* 10 to 12 ohms, all types.

*Heater Resistance:* Plus or minus 10% of values given in following table.

*Electric Sensitivity:* Current for 10 millivolts plus or minus 10% of values given in following table.

*Thermal Sensitivity:* 26 microvolts per degree Fahrenheit.

*Coefficient of Resistance:* Couple elements, 0.00013 per degree Fahrenheit; heater, 0.00009 per degree Fahrenheit.

*Meter:* A millivoltmeter of 10 to 12 ohms resistance is recommended for use with these couples.

*Dimensions:* Size of case, exclusive of plugs,  $2\frac{1}{8} \times 1\frac{3}{8} \times \frac{3}{4}$  inches.

*Weight:* 4 ounces.

Type	Heater Resistance	Current to Give 10 milliwatts Open Circuit	Maximum Safe Current	Code Word	Price
493-A	0.5 ohms	100 mla.	415 mla.	.....	FUNNY \$12.00
493-C	2 "	100 mla.	150 mla.	.....	FOCUS 12.00
493-E	10 "	25 mla.	45 mla.	.....	FOLLY 12.00
493-H	100 "	8 mla.	12 mla.	.....	FORAY 12.00
493-K	450 "	4.5 mla.	7 mla.	.....	FORUM 12.00

## RELAYS, SWITCHES, AND MISCELLANEOUS ACCESSORIES

NEW dials, new vacuum-tube sockets, and a new mounting base have been added to the General Radio line of parts for experimental work in the laboratory. Several minor additions and corrections in specifications on the items described on pages 108 to 115 are also included in this chapter.

### TYPE 481 POLAR RELAY

THE "normal operating current" of 2 milliamperes mentioned on page 108 is the minimum current on which reliable operation can be expected. This rating is conservative, however, and operation can sometimes be secured on smaller currents.

Read "neutral position" instead of "mutual position" in the description on page 108.

### TYPE 318 DIAL PLATE

THE TYPE 318 Dial Plate is a photo-etched metal scale with raised nickel-silver markings on a flat black background. It carries twenty divisions equally spaced around an arc of 303°, one inch in radius, and it is intended for use with General Radio TYPE 214 and TYPE 371 Rheostats and Potentiometers. The same three machine screws which hold the rheostat or potentiometer to the panel will hold the TYPE 318 Dial Plate in position. The accompanying illustration shows the dial plate and a TYPE 214 Rheostat mounted on a panel.

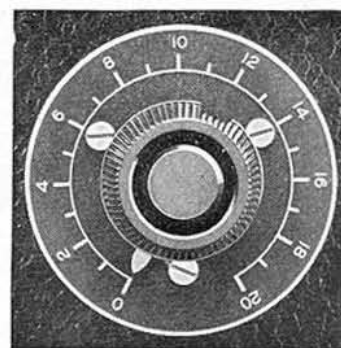

TYPE 214 Rheostat and TYPE 318 Dial Plate, showing method of mounting

*Dimensions:* Diameter, 3 inches.      *Weight:* 1 ounce.

Type	Code Word	Price
318	DEVIL	\$0.35

### TYPE 310 AND TYPE 317 DIALS

THESE dials meet the most rigid requirements for an inexpensive dial by means of which settings may be duplicated with precision. Fine markings facilitate accurate settings, and, since indicator and dial are both in the same plane, there is no parallax.

TYPE 310 Dials have a diameter of  $2\frac{3}{4}$  inches; the TYPE 317 Dials have a diameter of 4 inches.

Markings are etched in permanent black on the dull polished surface of the 1/32-inch nickel-silver dial plate. TYPE 310 Dials have 100, TYPE 317 Dials have 200 individual graduations equally spaced around an arc of 180° or 270° as specified in the following data table. The table also lists the diameter as well as the maximum and minimum distances that the shaft may extend beyond the front of the panel. The column "Knob Type" refers to the type number of the knob furnished with the dial. See pages 110 and 111.

The TYPE 310 and TYPE 317 Dials are equivalent, respectively, to the TYPE 502 and TYPE 503 Dials described in the following section except that the former have no friction drives. A good idea of their appearance, method of mounting the indicators, and fineness of the graduations can be gained from the illustration on page 159.

The indicator rides the edge of the dial even if the shaft be slightly out of true. An indicator, a machine screw and nut for fastening it, and a drilling template are packed with each dial.

Type	Dial		Knob Type	Shaft		Weight	Code Word	Price
	Diameter	Arc		Diameter	Length			
310-A	2 $\frac{3}{4}$ in.	180°	137-D	$\frac{1}{4}$ in.	$\frac{1}{2}$ - $\frac{3}{4}$ in.	2 oz.	DIZZY	\$0.80
310-F	2 $\frac{3}{4}$ in.	180°	137-D	$\frac{3}{8}$ in.	$\frac{1}{2}$ - $\frac{3}{4}$ in.	2 oz.	DEMUR	0.80
310-G	2 $\frac{3}{4}$ in.	270°	137-D	$\frac{3}{8}$ in.	$\frac{1}{2}$ - $\frac{3}{4}$ in.	2 oz.	DITTY	0.80
317-A	4 in.	180°	137-H	$\frac{1}{4}$ in.	$\frac{5}{8}$ - $\frac{7}{8}$ in.	4 oz.	DONOR	1.50
317-B	4 in.	270°	137-H	$\frac{1}{4}$ in.	$\frac{5}{8}$ - $\frac{7}{8}$ in.	4 oz.	DOWDY	1.50
317-F	4 in.	180°	137-H	$\frac{3}{8}$ in.	$\frac{5}{8}$ - $\frac{7}{8}$ in.	4 oz.	DOWEL	1.50
317-G	4 in.	270°	137-H	$\frac{3}{8}$ in.	$\frac{5}{8}$ - $\frac{7}{8}$ in.	4 oz.	DRAMA	1.50

### TYPE 502 AND TYPE 503 DIALS

THE TYPE 502 and TYPE 503 Dials are, respectively, the new TYPE 310 and TYPE 317 Dials equipped with a simple but effective slow-motion control. The dials and indicators are identical with the corresponding TYPE 310 and TYPE 317 Dials previously described.

The slow-motion device was originally designed for use on our line of laboratory measuring instruments, but we are offering it for general use in the belief that its ruggedness and simplicity will appeal to laboratory workers and amateurs. It is easy to mount, a center punch and a 7/16-inch drill being the only tools required. It is so designed that it in no way interferes with the mounting of the dial. Adjustments on the friction drive can be made without disturbing the calibration of the instrument to which the dial is attached.

Beneath the face of the dial is mounted a disc of slightly smaller diameter which is gripped by a friction wheel attached to the slow-motion drive knob. The friction-drive shaft is carried in a bushing inserted in the panel. The shaft hole in the bushing is slightly eccentric with respect to the center of the hole holding the bushing, thus affording a simple means of adjusting the amount of friction between the friction wheel and the disc behind the dial.

The TYPE 502 and TYPE 503 Dials are supplied complete with friction drive, indicator, indicator fastening screw and nut, and drilling template.

Type	Dial		Shaft Diameter	Dial Type	Approx. Reduction Ratio	Weight	Code Word	Price
	Diameter	Arc						
502-A	2 $\frac{3}{4}$ in.	180°	$\frac{1}{4}$ in.	310-A	1:3.3	3 oz.	DRUID	\$1.50
502-F	2 $\frac{3}{4}$ in.	180°	$\frac{3}{8}$ in.	310-F	1:3.3	3 oz.	DYING	1.50
502-G	2 $\frac{3}{4}$ in.	270°	$\frac{3}{8}$ in.	310-G	1:3.3	3 oz.	DAILY	1.50
503-A	4 in.	180°	$\frac{1}{4}$ in.	317-A	1:5	6 oz.	DRYAD	2.00
503-F	4 in.	180°	$\frac{3}{8}$ in.	317-F	1:5	6 oz.	DUCAT	2.00
503-G	4 in.	270°	$\frac{3}{8}$ in.	317-G	1:5	6 oz.	DUMMY	2.00

### TYPE 137 KNOBS

FOR the convenience of customers ordering by telegraph and cable the following code words have been assigned to the units described on pages 110 and 111.

Type	Code Word		Type	Code Word	
137-D	With Pointer	STANNOBANT	137-J	Without Pointer	STANNOBEYE
137-D	Without "	STANNOBUG	137-K	" "	STANNOBFAD
137-H	" "	STANNOBCAT	137-L	With "	STANNOBGAS
137-J	With "	STANNOBDOG			



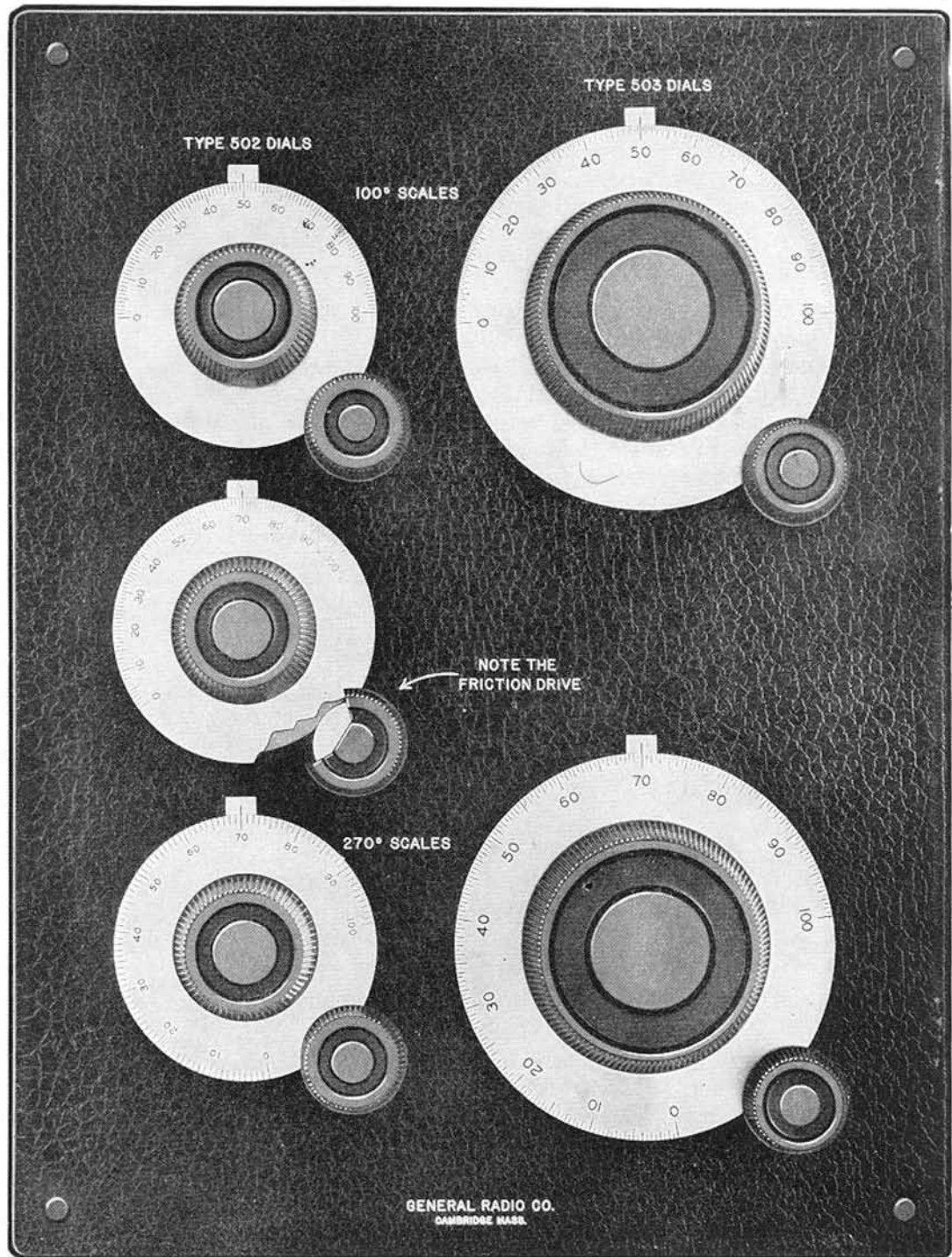

TYPE 502 and TYPE 503 Dials. TYPE 310 and TYPE 317 Dials have no friction drive, otherwise they are the same as TYPE 502 and TYPE 503 Dials

## TYPE 138 BINDING POSTS, SWITCH CONTACTS, AND STOPS

FOR the convenience of customers ordering by telegraph and cable the following code words have been assigned to the units described on pages 110 and 115.

Type	Code Word	Type	Code Word
138-A	STANPARCUP	138-B	CONTACTANT
138-W	STANPARCAP	138-C	CONTACTBUG
138-Y	STANPARMIK	138-D	CONTACTCAT
138-Z	STANPARHIT	138-Q	STANPARBUL

## TYPE 339 SWITCHES

THE specifications in the "dimensions" column at the top of page 113 are obviously incorrect. In the following corrected table the first dimensions refer to the maximum length of the mounted switch measured from the *front* (knob side) of the panel; the second, to the width of the unit; and the third, to its over-all height from the tip of the switch blades to the tip of the soldering lugs.

Type	Description	Dimensions	Code Word	Price
339-A	4 Pole Double Throw	$2\frac{9}{16}$ x $1\frac{5}{8}$ x $2\frac{3}{8}$ inches	PUPPY	\$2.50
339-B	2 Pole Double Throw	$1\frac{27}{32}$ x $1\frac{5}{8}$ x $2\frac{3}{8}$ "	PUTTY	2.00

## TYPE 638 AND TYPE 649 SOCKETS

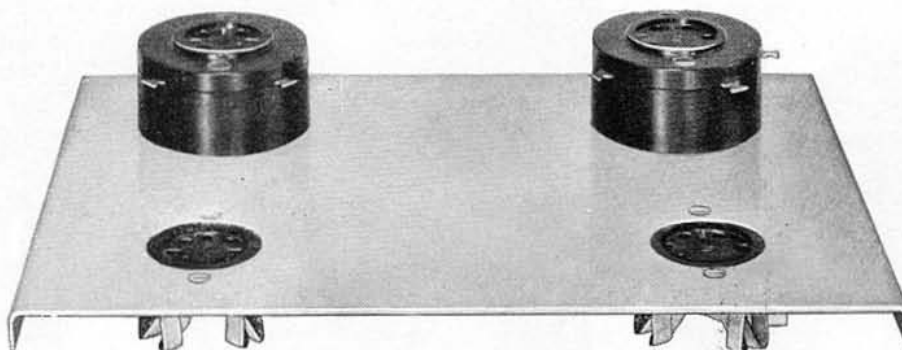

TYPE 649 (left) and TYPE 638 (right) Sockets mounted with and without the socket-mounting rings

THESE have been designed for general laboratory use where sockets even more sturdy than the TYPE 438 and TYPE 349 Sockets are required. The contact springs are made of phosphor bronze, specially tempered and shaped to resist fatigue. The mounting holes in the moulded bakelite bases are arranged so that the new sockets may be used as replacements for the TYPE 438 and TYPE 349 Sockets.

Ordinarily the new sockets are mounted behind holes in a thin bakelite or metal panel. They may, however, be mounted on the surface of a panel by using a TYPE 638-P1 Socket-Mounting Ring. The ring is required when the new sockets are used as replacements for the TYPE 438 and TYPE 349 Sockets.

*Dimensions:* "Diameter," given in price list is actual diameter of base exclusive of terminals. When socket is mounted behind panel: diameter of hole in panel is  $1\frac{3}{16}$  inches; contact springs extend  $\frac{13}{16}$  inch behind panel.

Type	Base	Diameter	Weight	Code Word	Price
638	UY—5-prong	2 in.	1 oz.	ALLOT	\$0.50
649	UX—4-prong	2 in.	1 oz.	ALOFT	0.45

TYPE 638-P1 SOCKET-MOUNTING RING

THIS is a bakelite ring for use with either the TYPE 638 or the TYPE 649 Socket as described on the preceding page. When the socket is so mounted, its upper surface is raised 1 1/32 inches above the panel surface.

Type	Weight	Code Word	Price
638-P1	1/2 oz.	ALONE	\$0.15

TYPE 656, TYPE 657, AND TYPE 658 SOCKETS

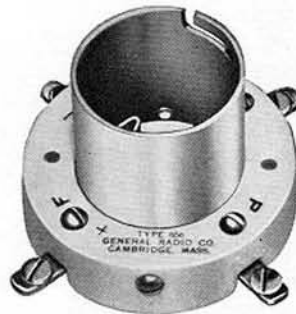

TYPE 656



TYPE 657



TYPE 658

BY special arrangement with the Isolantite Company of America we are listing the equivalent of our TYPE 156, TYPE 349, and TYPE 438 Sockets with glazed isolantite bases. The new sockets are designated, respectively, TYPE 656, TYPE 657, and TYPE 658.

Isolantite is an insulating material similar in appearance to white porcelain. The manufacturer claims that it is non-porous, that the dielectric losses are unusually low at very high frequencies, and that it has a low surface conductivity. The latter is a desirable feature in sockets that are to be used with photo-electric cells and their associated amplifiers.

The TYPE 656 Socket has a metal shell and is suitable for mounting 4-prong tubes either with or without the bayonet lock. If desired, the location of the bayonet lock may be shifted through 45° to accommodate the Western Electric Company's "E" tube.

The TYPE 657 and TYPE 658 Sockets are similar to the TYPE 349 and TYPE 438 Sockets. Positive contact with the sides of the tube prongs is insured by double-gripping springs. Both sockets have the raised ring around the top for guiding the prongs when inserting a tube.

*Dimensions:* "Diameter" given in price list is actual diameter of the base exclusive of terminals. "Height" in the following list of specifications refers to the over-all distance between the top of the socket and the mounting baseboard.

Type	Base	Diameter	Height	Weight	Code Word	Price
656	UX and W.E. "E"-tube	2 7/16 in.	1 27/32 in.	4 oz.	SOLID	\$1.50
657	UX — 4-prong	1 7/8 in.	1 5/16 in.	2 oz.	AMAZE	1.50
658	UY — 5-prong	1 7/8 in.	1 5/16 in.	2 oz.	AMONG	1.50

## TYPE 274 MOUNTING BASES

LOCATING pins are, of course, used with plug bases only. The *NOTE* at the foot of page 115 should read, "Locating pins now supplied with TYPE 274-CP and TYPE 274-EP."

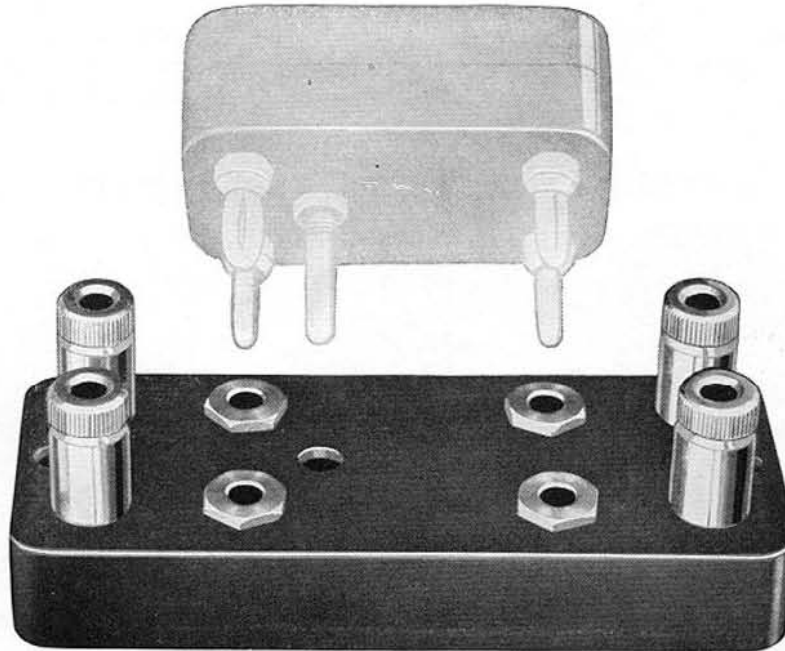

TYPE 274-RJ Mounting Base showing case in which the TYPE 492-A Oxide Rectifier and the TYPE 493 Thermocouples are mounted

The new TYPE 274-RJ Mounting Base has been designed particularly for use with the TYPE 492-A Oxide Rectifier and the TYPE 493 Thermocouples described on page 154. The jacks are placed so that the TYPE 274-CP Transformer Mounting Base may be used with it.

The new base is made of moulded bakelite, is fitted with four jacks and four jack-top binding posts, and is drilled to accommodate a locating pin. Two countersunk screw holes are provided.

*Dimensions:* Size of base, exclusive of binding posts,  $3\frac{3}{4} \times 1\frac{1}{2} \times \frac{5}{8}$  inches. *Weight:* 7 ounces.

<i>Type</i>	<i>Code Word</i>	<i>Price</i>
274-RJ	STANPARPUP	\$1.00

## CUMULATIVE INDEXES

INDEX BY TYPE NUMBER.....	164
INDEX BY TITLE.....	166

These indexes contain references to all the information published in Catalog F, Part 1 (the original Catalog F) and in Catalog F, Part 2 (this booklet).

## INDEX BY TYPE NUMBER

<i>Type</i>	<i>Instrument</i>	<i>Page</i>	<i>Type</i>	<i>Instrument</i>	<i>Page</i>
102	Decade-Resistance Box	16, 126	339	Switch	112, 160
106	Standard Inductance	31, 129	340	Rheostat	19
107	Variable Inductor	32, 129	349	Socket	113
125	Phantom-Antenna Resistor	30	356	Quartz-Plate Holder	63
127	Hot-Wire Meters	103	358	Wavemeter	69
133	Standard Resistances	18	359	Variable-Ratio Transformer	46
137	Knob	110, 158	360	Test Oscillator	91
138	Binding Posts	110, 160	360-A	Test Oscillator	147
139	Switch	112	361-B	Vacuum-Tube Bridge	81
156	Socket	113	361-P	Accessories	84
166	Telephone Transformer	47	366	Filter Choke	49
174	Direct-Reading Wavemeter	70	368	Variable Air Condenser	12
189	Galvanometer	102	371	Potentiometers	27, 126
193	Decade Bridge	75	374	Variable Air Condenser	11
193-P1	Wagner Ground	141	375-A	Station Piezo-Electric Oscillator	58, 137
202	Switch	112	376	Quartz Plate	62, 138
210	Ratio-Arm Box	87	377-B	Low-Frequency Oscillator	35
213	Audio Oscillator	41	379	Radio-Frequency Chokes	50
214	Rheostats and Potentiometers	28, 126	380	Decade Switch and Condensers	14, 125
216	Capacity Bridge	76	383	Portable Capacity Bridge	78, 142
219	Decade Condenser	14	383-P	Accessories	80, 142
222	Precision Condenser	6	384	Portable Radio-Frequency Oscillator	38
224	Precision Wavemeter	67, 140	384	Inductors	40
229	Galvanometer Shunt	86	387-A	Speaker Filter	47
239	Variable Air Condenser	8, 124	389-B	Magnetostriction Oscillator	64
240	Capacity Meter	80, 142	389-P	Inductors and Rod Mountings	65, 140
241	Microphone Hummer	41	403-C	Standard-Signal Generator	89, 145
246	Variable Air Condenser	7	403-P	Output Shunts	146
247	Variable Air Condenser	9	403-P	Inductors (for TYPE 403-C)	90, 146
249	Attenuation Box	22	403-Q		
260	Porcelain Insulator	114	404	Test-Signal Generator	148
268	Variocoupler	33	407	Synchronous Shutter	153
269	Variometer	33	407-P	Accessories	153
274	Plugs, Jacks and Bases	114, 162	408	Oscillograph Camera	151
275	Piezo-Electric Oscillator	57	408-P	Accessories	152
275-P	Inductors	58, 137	409	Camera Shelf	152
276-A	Quartz Plate	63	410	Rheostats and Potentiometers	30
280	Porcelain Insulator	114	413-B	Beat-Frequency Oscillator (Battery Operated)	37
285	Amplifier Transformer	43	416	Magnetostriction Rods	66
287	Direct-Reading Ohmmeter	104	418	Dummy Antenna	91
301	Rheostats and Potentiometers	29	423	Vacuum-Tube Oscillator	40, 132
302	Geared Dial	109	426-A	Thermionic Voltmeter	99
303	Geared Dial	109	427-F	A.C. Voltmeter	100
309	Socket Cushion	113	429	Attenuation Box	24
310	Dial	109, 157	437	Center-Tap Resistance	50, 133
317	Dial	109, 157	438	Socket	113
318	Dial Plate	157	439	Center-Tap Resistance	50, 133
321	Artificial-Cable Box	98	443	Mutual-Conductance Meter	83
329	Attenuation Box	23	446	Voltage Divider	49, 133
330	Filter Section	97	452-C	Voltage Divider	25
334	Variable Air Condenser	10	457-A	Modulation Meter	143
335-Z	Variable Air Condenser	11	480	Relay Rack	55
337	Switch	112	481	Polar Relay	108, 157
338	String Oscillograph and Vibration Galvanometer	93	486	Output Meter	106
338-P	Accessories	95			

INDEX BY TYPE NUMBER

165

<i>Type</i>	<i>Instrument</i>	<i>Page</i>	<i>Type</i>	<i>Instrument</i>	<i>Page</i>
488-A	A.C. Voltmeter . . . . .	101	573-A	Resistance-Impedance Coupler . . .	45
489-B	Twin Magnetostriction Oscillator. .	65	575	Piezo-Electric Oscillator . . . . .	134
492-A	Oxide Rectifier . . . . .	154	576-A	Quartz Bar (and Holder) . . . . .	63, 139
493	Thermocouples . . . . .	155	577	Inductors . . . . .	34, 129
502	Dials . . . . .	158	584	Alternating-Current Portable Radio-Frequency Oscillator . . . .	39
503	Dials . . . . .	158	585	Amplifier Transformer . . . . .	43, 133
507	Non-Polar Relay . . . . .	108	586	Power-Level Indicator . . . . .	106, 154
511	Syncro-Clock . . . . .	71	586-P	Accessories . . . . .	154
511-P	Replacement . . . . .	73, 140	587	Speaker Filter . . . . .	47
513-B	Beat-Frequency Oscillator (A.C. Operated) . . . . .	130	590	Piezo-Electric Oscillator . . . . .	59, 137
527-A	Rectifier Filter . . . . .	49	591	Temperature-Control Unit . . . . .	61, 138
529	Attenuation Box . . . . .	24	591-P	Accessories and Replacements . . .	61, 138
539	Variable Air Condensers . . . . .	123	592	Multivibrators . . . . .	56, 134
540	Filament Transformer . . . . .	48	593	Timing Unit . . . . .	73
541	Push-Pull Transformer . . . . .	46	594	Heat-Control Unit . . . . .	62
545	Transformer . . . . .	48	595	Power-Supply Unit . . . . .	56
547	Temperature-Control Box . . . . .	59	598-A	Fader . . . . .	26
547-P	Accessories and Replacements . . .	60, 138	624	Precision Wavemeter . . . . .	68, 140
547-B	Temperature-Control Unit . . . . .	60	624-P	Inductors . . . . .	68
552	Volume Controls . . . . .	126	638	Sockets . . . . .	160
553	Volume Controls . . . . .	128	638-P1	Socket-Mounting Ring . . . . .	161
554	Voltage Divider . . . . .	25	645	Laboratory Amplifier . . . . .	42
556	Amateur-Band Condenser . . . . .	124	649	Socket . . . . .	160
557	Amateur-Band Condenser . . . . .	12, 124	656	Socket . . . . .	161
558-P	Frequency Meter . . . . .	68	657	Socket . . . . .	161
565	Transformer . . . . .	48	658	Socket . . . . .	161

## INDEX BY TITLE

- Air condensers, see *Condensers*  
Ammeters, d'Arsonval, 102  
    hot-wire, 103-104  
Amplifier, coupling devices, 43-47, 133  
    laboratory, 42  
    transformers, 43-46, 133  
Antenna, dummy, 30, 91  
    phantom, resistor, 30, 91  
Anti-capacity switches, 112-113, 160  
Artificial cable box, 19, 98  
    lines, 19, 98  
Assemblies, binding-post, 114  
    standard-frequency, 51  
Attenuation boxes, 19-25  
    networks, 19-25  
Audibility meter, see TYPE 529, 24  
Audio oscillator, 41  
Ayrton-Perry resistors, 15-16  
Bar, quartz, 63, 139  
Bases, mounting, 114, 162  
Beat-frequency oscillator, 37-38, 130  
Binding-post assemblies, 114  
Binding posts, 110  
Bridge, accessories, 84-87, 141-142  
    capacity, 76-77, 78-79, 80-81  
    decade, 75-76, 141  
    impedance, 75-76  
    inductance, 74-76  
    mutual-conductance, 83-84  
    resonance, 74  
    vacuum-tube, 81-84,  
    Wheatstone, 74  
Cable, artificial, 19, 98  
Calibrated condensers, 5-9, 13-14, 123-125  
    inductors, 31-32, 129  
Camera, oscillograph, 150-153  
Capacitance, see *Capacity*  
Capacitors, see *Condensers*  
Capacity bridges, 76-77, 78-79, 80-81, 141-142  
    meter, 80-81, 142  
Center-tap resistors, 50, 133  
Charger, battery, 56  
Choke, filter, 49  
    radio-frequency, 50  
Clock, see *Synco-Clock*  
Condensers, amateur-band, 12, 124  
    calibrated, 5-9, 13-14, 123-125  
    decade, 14, 125  
    high-voltage, 10-11  
    loss-measurement, 76-77  
    mica-dielectric, 13-14, 125  
    micro, 12  
Condensers, paper-dielectric, 13-14, 125  
    precision, 6-7  
    variable air, 5-12, 123-125  
    vernier, 12  
Connector plate, 59-60  
Contacts, switch, 110  
Control, heat, 62  
    temperature, 59-62  
    volume, 25-26, 126-128  
Copper-oxide-rectifier, 154  
    voltmeter, 100-101, 105-107, 154  
Coupler, resistance-impedance, 45  
Coupling devices, 43-47, 133  
Cushion, socket, 113  
Decade bridge, 75-76, 141  
    condensers, 14, 125  
    resistance boxes, 16-18, 126  
    switch and condensers, 14, 125  
Dial, friction-drive, 158  
    geared, 109  
    plain, 109, 157  
    plate, 157  
    vernier, 109, 158  
Dielectric loss measurement, 76-77  
Direct-reading wavemeter, 70  
Divider, voltage, 25, 27-30, 49, 133  
Dummy antenna, 30, 91  
Dynatron oscillator, 40, 132  
Eliminator, plate-battery, 56  
Experimental inductors, 33-34, 129  
    wavemeters, 68-70  
Fader, 25-26, 128  
Field-strength measurement, 145-147  
Filament transformer, 48  
Filter choke, 49  
    electric wave, 97  
    rectifier, 49  
    sections, 97  
    speaker, 47  
Frequency measurement, 51-73, 134-140  
    meter, amateur-band, 68-69  
    see *Wavemeter*  
    standards, 51-73  
Friction-drive dials, 158  
Galvanometer, d'Arsonval, 102  
    hot-wire, 103-104  
    pointer, 102  
    vibration, 93-96  
Geared dials, 109  
Generator, standard-signal, 89, 145-149  
    test-signal, 148  
    see *Oscillators*  
Heat-control unit, 62  
Holder, quartz-plate, 62-63  
Hot-wire meters, 103  
Hum-balancing resistors, 50, 133  
Hummer, microphone, 41  
Impedance-resistance coupler, 45  
Inductance, standards of, 31-32, 129  
Inductors, 31-34, 129  
    fixed, 31, 34, 129  
    variable, 32-33, 129



- Insulators, porcelain, 113-114  
 Jacks, 114  
 Knobs, moulded, 110  
 Laboratory amplifier, 42  
 Line, artificial, 19, 98  
 Low-frequency oscillator, 35-36, 130  
 Magnetostriction oscillator, 64-66  
   rods, 66, 139  
 Meters, ammeters, 102-104  
   audibility, see *Audibility*  
   capacity, 80, 142  
   frequency, see *Wavemeters*  
   hot-wire, 103-104  
   modulation, 143-145  
   mutual-conductance, 83-84  
   ohmmeters, 104-105  
   output, 105-107  
   power-level indicators, 105-107, 154  
   voltmeters, 99-101, 105-107  
   wave, 66-70, 140  
 Microphone hummer, 41  
   mixing controls, 25-26, 27-30, 126-128  
   transformer, 44, 133  
 Microvolter, 88-91, 145-147  
 Mixing controls, 25-26, 27-30, 126-128  
 Modulation meter, 143  
 Monitor, frequency, 58-59, 134-138  
 Moulded knobs, 109, 110  
 Mounting bases, 114, 162  
 Multivibrators, 56, 134  
 Mutual-conductance meter, 83-84  
 Networks, attenuation, 19-25, 126-128  
 Non-polar relay, 108-109  
 Ohmmeters, 104-105  
 Oscillators, audio, 41  
   beat-frequency, 37-38, 130  
   dynatron, 40, 132  
   low-frequency, 35-36, 130  
   magnetostriction, 64-66  
   microphone-button, 41  
   microphone-hummer, 41  
   piezo-electric, 57-63, 134-139  
   portable radio-frequency, 38-40  
   reed-type, 41  
   standard-signal, 88-91, 145-147  
   station piezo-electric, 58-59, 134, 137  
   test, 91-92, 147-149  
   tuning-fork, 41  
 Oscillograph, string, 93-96  
   camera, 150-153  
 Output meter, 105-107  
 Oxide-rectifier, 154  
   voltmeters, 100-101, 105-107, 154  
 Phantom antenna, 91  
   resistor, 30  
 Pierce magnetostriction oscillator, 64-66  
 Piezo-electric oscillator, 57-63, 134-139  
 Plate, quartz, 62-63, 138  
 Plugs, 114  
 Polar relay, 108, 157  
 Porcelain insulators, 113-114  
 Portable capacity bridges, 78-81, 142  
   radio-frequency oscillators, 38-40  
 Potentiometers, 25, 27-30, 49, 126  
 Power, factor measurement, 76-77  
   level indicator, 105-107, 154  
   supply unit, 56  
 Precision condenser, 6-7  
   wavemeters, 66-68, 140  
 Push-pull transformers, 46  
 Quartz bar, 63, 139  
   plate, 62-63, 138  
   plate holder, 62-63  
 Rack, relay, 55  
 Radio-frequency chokes, 50  
   oscillators, 35-40, 132  
 Ratio-arm box, 87  
 Rectifier filter, 49  
   oxide, 154  
 Relaxation oscillator, see *Multivibrator*  
 Relay, low-current, 108, 157  
   non-polar, 108-109  
   polar, 108, 157  
   rack, 55  
 Resistance-impedance coupler, 45  
   standard, 18, 126  
   unit, center-tap, 50, 133  
 Resistors, Ayrton-Perry, 15-16  
   calibrated, 15-19, 126  
   phantom-antenna, 30  
 Rheostats, 27-30, 126  
 Rods, magnetostriction-oscillator, 66, 139  
 Sections, filter, 97  
 Service-testing equipment, 80-81, 83-84, 91-92,  
   104-105, 105-107, 147-149  
 Shunts, galvanometer, 86-87  
 Shutter, synchronous, 153  
 Socket cushion, 113  
   vacuum-tube, 113, 160-161  
 Speaker filters, 47  
 Standard-frequency assembly, 51-56  
   inductance, 31-32, 129  
   resistances, 18, 126  
   signal generator, 88-91, 146-147  
 Station piezo-electric oscillator, 58-59  
 Strain insulators, 113-114  
 String-holders, 95-96  
   oscillograph, 93-96  
 Supply, power, 56  
 Switch contacts, 110, 160  
   stops, 110, 160  
 Switches, 112, 160  
 Synchronous, motor, 71-73  
   shutter, 153  
 Syncro-Clocks, 71-73  
 Telephone transformer, 47  
 Temperature-control boxes, 59-62, 134-138  
 Test oscillator, 91-92, 147  
 Test-signal generator, 148  
 Thermionic voltmeter, 99-100

- Thermocouples, 155
- Thermometer, 60-61
- Thermo-regulator, see *Temperature-control boxes*
- Thermostat, 60-61
- Time measurement, 51-73
- Timing unit, 73
- Transformers, amplifier, 43-46
  - filament-heating, 48
  - mounting bases, 114, 162
  - plate-supply, 48
  - power-supply, 48
  - push-pull, 46
  - telephone, 47
  - variable ratio, 46-47
- Tube, vacuum, bridge, 81-84
- Vacuum-tube bridge, 81-84
  - oscillators, 35-40, 130-132
  - voltmeter, 99-100
- Variable air condensers, 5-12, 123-125
  - inductors, 32, 33, 129
  - ratio transformer, 46-47
- Variocoupler, 33
- Variometer, 32, 33
- Vernier condenser, 12
  - dial, 109, 158
- Vibration galvanometer, 93-96
- Voltage divider, 25, 27-30, 49, 133
- Voltmeter, oxide-rectifier, 100-101, 105-107
  - thermionic, 99-100
  - vacuum-tube, 99-100
- Volume controls, 25-26, 27-30, 126-128
- Wall insulators, 113-114
- Wave filters, 97
- Wavemeter, 66-70, 140
  - experimental, 68-70
  - precision, 66-68, 140

BLANK PAGE

# CATALOG F PART 2

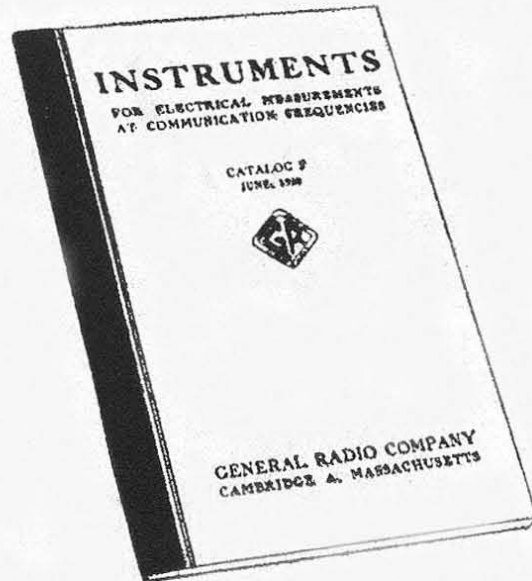

## FILE THIS WITH CATALOG F, PART 1

It's a comprehensive supplement to Part 1 of Catalog F. It describes all of the new instruments and announces many important specification changes in the others.

REVISED TO APRIL 1, 1931



GENERAL RADIO COMPANY  
CAMBRIDGE, A, MASSACHUSETTS