

Again we are proud to announce the mid-winter release of additional Heathkits. It is our firm belief that we can best serve you through constant engineering effort directed toward new kit development and improvements in existing kits. Make your next selection from this array of fine kits.

HEATH
1955



New 5" PRINTED CIRCUIT COLOR TV Oscilloscope KIT

PROVEN INSTRUMENT: Our advertising claims for this new-design oscilloscope have been proved by actual customer experience based on the more than 5000 units now in use. . . . The experience of our customers supports the results of our laboratory tests on every count. Not only has there been proof of the broad bandwidth, the extended sweep generator operation, and extreme stability of this Scope, but we find that the use of printed circuit boards has practically eliminated errors in wiring and incorrectly placed parts and is definitely a labor-saving feature. In all, the response to the Model 0-10 has been tremendous, fully supporting all our claims, and justifying the time and expense of this new oscilloscope design—as well as the use of printed circuit boards.

FEATURES: Aside from such outstanding characteristics as full 5 Mc bandwidth for color TV servicing, and extreme stability, the Model 0-10 offers wide range sweep generator operation. Covers 20 cps to 500,000 cps—5 times the usual range for scopes in this price classification!

Other features are: universal use of sealed, plastic molded condensers in all coupling and bypass applications—all ceramic condensers have numerical capacity values clearly imprinted—preformed and cabled wiring harness—Z axis input for intensity modulation of beam—peak-to-peak voltage calibrating source built in—retrace blanking amplifier—regulated power supply—electrically stable high insulation phenolic printed circuit boards—nylon insulating bushings for input terminal posts—step attenuated and frequency compensated vertical input circuit—push-pull horizontal and vertical amplifiers for balanced deflection—quick, positive trace positioning controls with no bounce or overshoot—excellent sync. characteristics—no trace foldover, usually encountered with overloaded input—entire area of cathode ray tube usable—sharp, hair-line focusing. The new Model 0-10 is an essential service instrument for both black and white and color TV.



MODEL
0-10

\$69.50
Shpg. Wt. 27 lbs.

SPECIFICATIONS:

- Vert. Sensitivity:**
0.025 V (RMS) per inch at 1 KC.
- Vert. Freq. Response:**
Flat within ± 1 db from 6 CPS to 2.5 MC., flat within ± 2 db —5 db from 2 CPS to 5 MC. Response at 3.58 MC is —1.5 db.
- Sweep Gen. Range:**
20 CPS to 500 KC in 5 steps; 20-100 CPS, 100 CPS—1 KC, 1 KC—10 KC, 10 KC—100 KC, 100 KC—500 KC.
- Synchronizing:**
External, positive or negative signal internally, or from line.
- Tube Complement**
(1) 5U1, (1) 6AB4, (1) 6BQ7A, (1) 12BH7, (1) 6CB6, (1) 12AT7, (2) 12AU7, (1) 6X4, (1) 1V2, (1) 6C4.
- Dimensions:**
8 $\frac{3}{8}$ " wide x 14 $\frac{1}{8}$ " high x 16" deep.

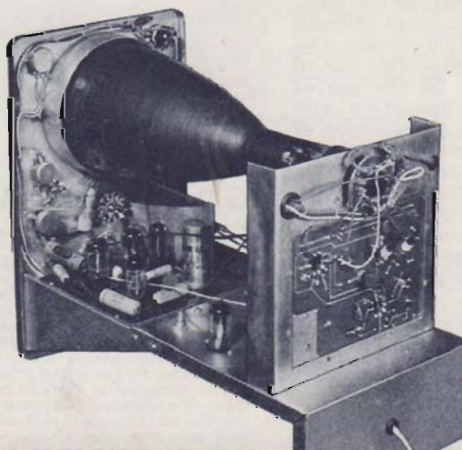

HEATH COMPANY

A SUBSIDIARY OF DAYSTROM, INC.

BENTON HARBOR, MICHIGAN

*Winter
Flyer*

New

100 WATT
PHONE-CW
TRANSMITTER
PAGE 3

New

DELUXE
HI-FI
AMPLIFIER
PAGE 11

New

TV ALIGNMENT
GENERATOR
PAGE 7

Heathkit COMMUNICATIONS receiver kit



Heathkit HAM



MODEL AR-2
\$25⁵⁰
 SHPG. WT.
 12 LBS.
 (LESS CABINET)

This desirable receiver is packed with features one would not normally expect at this price level. Just the kit for the beginning amateur, the short wave listener, or anyone whose listening interest extends beyond the standard broadcast band.

Covers from 550 Kc to 35 Mc in four bands and affords clean signal output, sharp tuning and good sensitivity over the entire range. Features transformer type power supply—miniature tubes and IF transformers—electrical bandspread—separate RF and AF gain controls—noise limiter—AGC—BFO—headphone jack—and 5½" PM speaker.

Construction Manual is complete with all data necessary for assembly, even for the beginner. The AR-2 contains the design features so essential in communications work—at a price you can afford.

CABINET: Fabric covered plywood cabinet available, complete with aluminum panel and speaker grill. Measures 12¼" wide, 6¾" high, 7¾" deep. Part No. 91-10, Shpg. Wt. 5 lbs.\$4.50

Heathkit vfo kit

MODEL VF-1

\$19⁵⁰

SHPG. WT.
 7 LBS.



A complete VFO kit for only \$19.50! Weigh this against the cost of crystals . . . and consider the convenience and flexibility of VFO operation. This is one of the most outstanding kits we have ever offered for the ham.

Covers 160-80-40-20-15-11 and 10 meters. Illuminated and precalibrated dial scale clearly indicates frequency on all bands and provides more than two feet of dial calibration. Reflects quality design in the use of ceramic coil forms and tuning condenser insulation, and copper plated chassis. Simply plugs into crystal socket of any modern transmitter to provide complete coverage of the bands from 160 meters through 10 meters. Uses 6AU6 Clapp oscillator, and OA2 voltage regulator for stability. May be powered from plug on Heathkit Model AT-1 Transmitter, or supplied with power from most transmitters. Construction Book even includes calibration instructions. A Heathkit "Best Buy" for you amateurs.



MODEL AC-1
 Shpg. Wt. 4 lbs. **\$14⁵⁰**

Heathkit

ANTENNA COUPLER KIT

Poor matching allows valuable communications energy to be lost. The Model AC-1 will properly match your transmitter to an end-fed long wire antenna. Also attenuates signals above 36 Mc, reducing TVI. 52 ohm coax. input—power up to 75 watts—10 through 80 meters—tapped inductor and variable condenser—neon RF indicator—copper plated chassis and high quality components.

HEATHKIT amateur transmitter kit

Treat yourself to the excitement of amateur QSO's with fellow hams all over the world. Literally thousands of these Heathkit transmitters are in use today, and you can "get on the air" as so many others have done. Enjoy the trouble-free operation of commercially designed equipment while still benefiting from the economies and personal satisfaction of "building it yourself."

The Model AT-1 is complete with its own power supply, and covers 80, 40, 20, 15, 11 and 10 meters. One knob bandswitching eliminates coil changing. Panel meter indicates grid or plate current for the final. Crystal operation or external VFO. Features you would not expect in this price range are included such as key click filter, line filter, copper plated chassis, prewound coils, 52 ohm coaxial output, and high quality components throughout. Instruction book simplifies assembly. 6AG7 osc., 6L6 final and 5U4G rect. Up to 35 watts plate power input.



MODEL AT-1
\$29⁵⁰

SHPG. WT.
 15 LBS.

Heathkit

GRID DIP METER KIT

This instrument was originally used primarily by radio amateurs for determining tuned circuit resonance, locating spurious oscillations and parasitics, neutralizing, and other important tests around the ham shack. Experience has indicated, however, that there is practically no end to its application in all phases of electronics. Thousands are now in use in service shops, laboratories, and home work shops, as well as the ham shack. It is an extremely valuable tool for locating TVI, aligning IF stages, traps, and filters, and accomplishing literally hundreds of jobs on all types of equipment. Covering from 2 Mc to 250 Mc, the GD-1B is compact and can be conveniently operated with one hand. Calibrated dial scale is easy to read and provision is made for further frequency notation on a logging scale. Uses a Simpson 500 µa. meter for indication, with a sensitivity control and headphone jack. Kit includes pre-wound coils and rack. Indispensable instrument for hams, engineers or servicemen. **MODEL GD-1B** Shpg. Wt. 4 lbs. **\$19.50**

Heathkit

IMPEDANCE METER KIT

Use the Heathkit Model AM-1 Antenna Impedance Meter for measuring antenna impedance, line matching purposes, adjustment of beam and mobile antennas, and to insure proper impedance match for optimum overall system operation. Used in conjunction with a signal source, it will determine antenna resistance and resonance, match transmission lines for minimum SWR (standing wave ratio), determine receiver input impedance and provide a close approximation of SWR. Will do also, as a phone monitor or relative strength indicator. 100 µa. Simpson meter employed. Covers the range from zero to 600 ohms. The cabinet is only 7" long, 2¼" wide, and 3¼" deep. A real bargain, and an instrument of many uses for the amateur. **MODEL AM-1** Shpg. Wt. 2 lbs. **\$14.50**

EQUIPMENT

Brand New...

Heathkit DX-100 PHONE AND CW transmitter kit



Available after March 15th



- ✓ Actual r. f. power output — 125 watts phone, 140 watts CW!
- ✓ Single-knob bandswitching for all bands from 160 meters through 10 meters.
- ✓ Built-in VFO, plus switch-selection of four crystals. (crystals not included in kit).
- ✓ Up to 100% modulation from built-in modulator with speech limiting.

- ✓ Unitized construction for easier handling and simplified assembly.
- ✓ Attractive appearance. All controls on front panel. High quality components throughout.
- ✓ Full TVI treatment — filtering, shielding, harmonic suppression, etc.
- ✓ Price includes: All tubes — power supplies — VFO — modulator — cabinet — and detailed construction book.

BANDSWITCHING!

MODEL DX-100

\$189⁵⁰

SHPG. WT.
120 LBS.
EXPRESS ONLY

DESCRIPTION: Here is the all-band higher power transmitter you radio amateurs have asked for. Combines all the latest design features and includes the VFO, modulator, and all power supplies. Provides CW or phone operation on all amateur bands from 160 meters through 10 meters. Actual r.f. output 125 watts phone, 140 watts CW.

This brand new Heathkit model has been fully treated for TVI reduction. All entering and leaving circuits filtered, pi network interstage coupling and output circuit for reduced harmonic output, and the cabinet itself is fully shielded. Single-knob bandswitching provided for all amateur bands. Operates on 160 meters without extra switching. Choice of VFO operation, or 4 different crystals. (Crystals not included.) High-grade, well-rated components used throughout, as manifested in ceramic switches, tube sockets, plate caps, and "potted" transformers.

FEATURES: Unitized sub-assembly type construction for ease of assembly, and convenient handling. Wiring harness used for further simplicity. Cabinet is furnished with the kit in knocked-down form.

Both sides of the power line are fused at the power plug for safety. Terminals are provided for remote control, or for taking out a

500 ohm audio line to an external modulator. Features a high-gain speech amplifier for dynamic or crystal microphone, and speech limiting for increased intelligence. Up to 100% modulation with plenty of audio power reserve, even at maximum r.f. output! Concentric control shafts employed for simplified tuning and adjustment. Panel meter reads driver plate current, final grid current, final plate current, final plate voltage, and modulator cathode current. Power input quickly determined!

Wide-spaced transmitting-type tuning condensers—copper plated chassis—extensive shielding—illuminated VFO dial and meter face—and many other "extras" not expected at this price.

SPECIFICATIONS: Covers 160, 80, 40, 20, 15, 11 and 10 meters with single-knob bandswitching. R.F. output power; 125 watts phone, 140 watts CW. Uses 6AU6 VFO, 12BY7 crystal osc.-buffer, 5763 driver, and push-pull 6146's for the final. Speech amplifier is a 12AX7, with a 12BY7 driver, and push-pull 1625's for the mod. Power supplies use 5V4 low voltage rect., 6AL5 bias rect., OA2 VFO voltage reg., and (2) 5R4GY's for high voltage rectification.

OVER-ALL DIMENSIONS: 20 3/4" W. x 13 3/4" H. x 16" D.

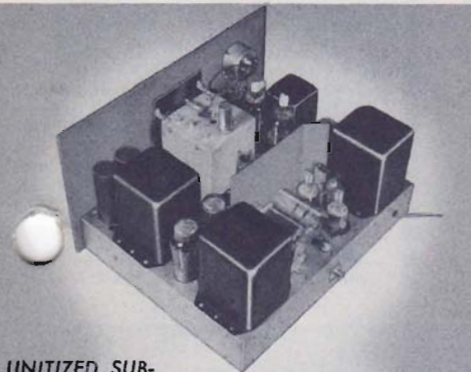

UNITIZED SUB-ASSEMBLY CONSTRUCTION

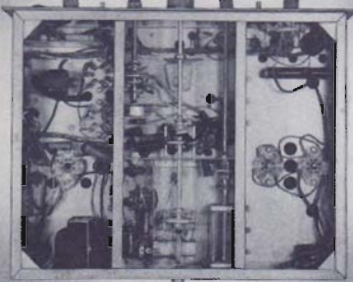

RUGGED STEEL CHASSIS FRAME

Suggested...

MODULATOR CIRCUIT FOR MODEL AT-1 TRANSMITTER

In response to many requests we are presenting herewith a schematic for the construction of a modulator for the Heathkit Model AT-1 Transmitter Kit. This is merely a suggested circuit—and is not a Heathkit. We do not sell a modulator kit for the AT-1, nor can we offer to sell parts for the construction of this circuit. Parts should be obtained locally, or purchased from one of the large mail-order radio parts suppliers.

Our tests have indicated that this modulator circuit will function satisfactorily with the AT-1 Transmitter. The information is presented here for those who wish to use it, but the project must be undertaken on each user's own initiative. The circuit is straightforward, and the parts are standard, readily available items—so that with normal care in construction, no trouble should be anticipated.

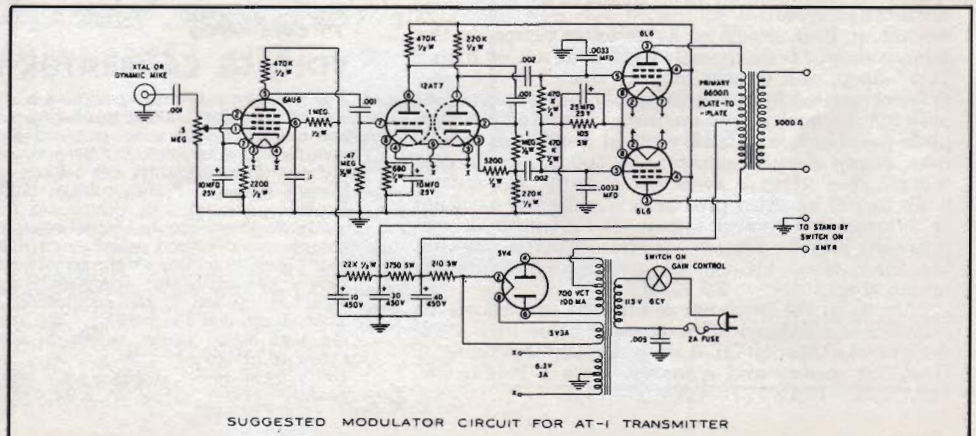

SUGGESTED MODULATOR CIRCUIT FOR AT-1 TRANSMITTER



5" FULL SIZE SCOPE

MODEL OM-1

\$49⁵⁰

Shpg. Wt. 26 lbs.

HEATHKIT

printed circuit
oscilloscope
kit

EXCEPTIONAL VALUE: Here is a full size 5" Oscilloscope, using printed circuits, with push-pull deflection amplifiers, vertical channel flat within 3 db from 2 cps to 200,000 cps, sweep circuit operation over 100,000 cps, and a host of other features—for only \$49.50. A versatile and valuable instrument design for general application wherever a reliable oscilloscope may be required. The only other Scopes using printed circuits sell for hundreds of dollars more.

DESIGN FEATURES: Adjustable spot shape control—r.f. connections to vertical deflection plates—external and internal sweep and sync. 1 v. peak-to-peak panel terminal reference

New 3" HEATHKIT printed circuit oscilloscope kit

MODEL OL-1

\$29⁵⁰

Shpg. Wt.
14 lbs.



The Heathkit Model OL-1 is an extremely low priced portable model for outside servicing, home workshop, ham shack, or as an extra Scope, in the service shop. Measures only 6 1/4" wide x 9 1/2" high x 1 1/4" deep, and weighs only 11 lbs.!

Incorporates features definitely not expected at only \$29.50, such as pre-engineered printed circuits, push-pull horizontal and vertical deflection amplifiers, sweep circuit operation to 100,000 cycles per second, and vertical amplifier channel flat within 3 db to 200 kc. Also provision is made for external or internal sync. and sweep. R.F. terminals are provided for the vertical deflection plates making the instrument ideal for transmitter modulation monitoring.

Now even the beginner or student can afford his own Scope. Topped-off with new color and knob design, the Model OL-1 is a typical example of Heathkit quality and economy. Uses 1-3GP1, 4-12AU7, 1-12AX7, 1-6X4, 1-1V2.

voltage—easy positive synchronization—and new, modern, professional appearing cabinet and panel styling. New sweep generator circuit provides frequency range of 20-100,000 cps, while printed circuit wiring insures duplication of laboratory pilot model performance, and reduced assembly time. Calibrated grid fits over CRT face.

SIMPLIFIED CONSTRUCTION: The assembly of the Model OM-1 is simplified for you in three ways. First the use of printed circuits cuts down on the actual time required for assembly, and reduces the possibility of error. Second, the open type layout employed in the circuit is ideal for kit construction, leaving plenty of working room. Third, the comprehensive construction book supplied with the Model OM-1 provides complete step-by-step instructions, pictorial diagrams, and schematic diagrams. Truly an outstanding instrument—and offered at a price you can afford.

SPECIFICATIONS: Vertical frequency response, ± 3 db 2 cps to 200 kc, ± 6 db 1 cps to 400 kc. Sensitivity, 0.09 volts RMS per inch peak-to-peak vertical at 1 kc. Sweep generator from 20 cps to 100,000 cps. Uses 5BP1 CRT, 3-12AU7, 1-12AT7, 1-12AX7, 1-6X4, 1-1V2. Dimensions 8 5/8" wide x 14 1/8" high, x 1 1/8" deep.



Heathkit VOLTAGE CALIBRATOR KIT

The voltage calibrator provides a convenient method for making peak-to-peak voltage measurements with an oscilloscope by establishing a relationship between the amplitude of an unknown wave shape and the known output of the voltage calibrator. Peak-to-peak voltage values are read directly on the calibrated panel scale without recourse to involved calculations. Convenient "signal" position on the panel switch bypasses the calibrator completely and the signal is applied to the oscilloscope input. This eliminates the necessity for transferring test leads. Operates within a voltage range of .01 to 100 v. peak-to-peak.

MODEL VC-2
Shpg. Wt. 4 lbs. **\$11.50**

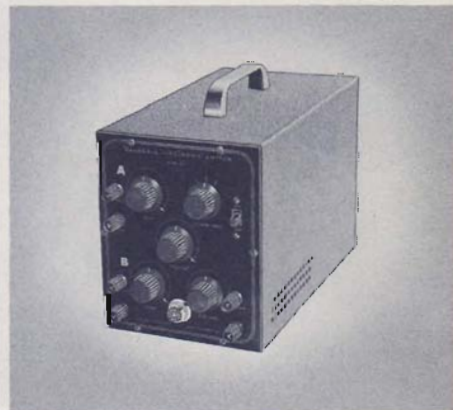

Heathkit ELECTRONIC SWITCH KIT

The Heathkit Electronic Switch Kit will electronically switch between two input signals to produce both signals alternately at the output. Used in conjunction with an oscilloscope, it will permit the observation of two signals simultaneously, either adjacent to each other or superimposed on each other. Features low, medium, and high frequency ranges which provide switching rates from 10 cps to 2000 cps. A valuable instrument for the research and development laboratory or for experimental work in the service shop. Also adaptable for use as a square wave generator in portions of the audio frequency range.

MODEL S-2
Shpg. Wt. 11 lbs. **\$23.50**

Heathkit LOW CAPACITY PROBE KIT

No. 342

\$3⁵⁰

Shpg. Wt.
1 lb.



Scope investigation of circuits encountered in TV requires the use of special probe to prevent loss of gain, circuit loading, or distortion. This probe features a variable capacitor to provide correct instrument impedance matching. Also the ratio of attenuation can be controlled.

Heathkit PRINTED CIRCUIT SCOPE DEMODULATOR PROBE KIT

No. 337-C

\$3⁵⁰

Shpg. Wt.
1 lb.



Extend the usefulness of your Oscilloscope by observing modulation envelope of r.f. or I.F. carriers found in TV and radio receivers. Functions like AM detector to pass only modulation of signal and not signal itself. Extremely helpful in alignment work. Applied voltage limits are 30 v. RMS and 500 v. DC.

HEATHKIT printed circuit vacuum tube voltmeter kit

MODEL V-7
\$24⁵⁰

Shpg. Wt.
7 lbs.



PRINTED CIRCUITS:

Heathkit printed circuit boards do not use "printed components." Only the circuit pattern appears on the board. Components are conventional, and leads are pushed through holes in the circuit board to be soldered on the other side. Thus a defective part can be removed and replaced when necessary. The identification of each part is screened onto the board, eliminating any chance for error.

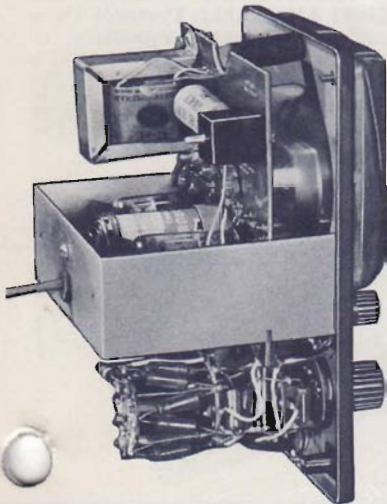

BRAND NEW DESIGN: The Heathkit Model V-7 VTVM has been completely revised and redesigned for 1955. It is new in so many respects, and yet no price increase has been made. It uses new printed circuits, offers a new peak-to-peak voltage scale, features functional control location on the front panel, and manifests outstanding new physical design. A modern instrument in every respect. The printed circuit feature, alone, simplifies the assembly procedure, cuts assembly time by one-half, and offers the assurance that the VTVM you build will function the same as our Lab. development model.

RANGES: Providing a polarity reversal switch, the Model V-7 affords 7 AC (RMS) and DC voltage ranges of 1.5, 5, 15, 50, 150, 500, and 1500; 7 peak-to-peak AC voltage ranges of 4, 14, 40, 140, 400, 1400, 4000; and 7 ohmmeter ranges of X1, X10, X100, X1000, X10K, X100K, and X1 megohm, plus a db scale. Zero-center operation is within the range of front panel controls. A high quality 4½" 200 microampere Simpson meter is employed. Featured, also, is a transformer-type power supply for circuit stability and isolation. Peak-to-peak operation is extremely valuable for FM and TV servicing. Input impedance is 11 megohms,

providing the high input impedance essential for critical voltage tests.

QUALITY COMPONENTS: 1% precision resistors are used to insure high accuracy on all test functions. "Open type" physical design behind the panel is ideal for kit construction. Instruction Manual complete in every respect so that the instrument can be assembled without difficulty. All material is bright, clean and new, specifically selected for this particular application.

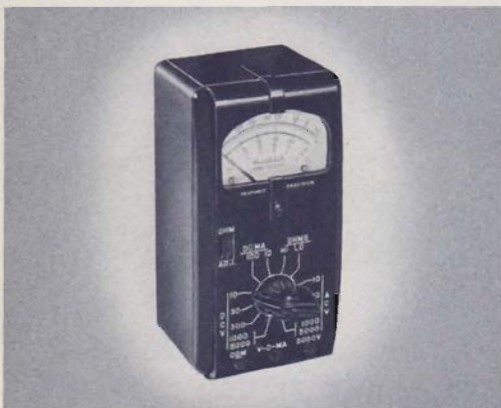

Heathkit HANDITESTER KIT

The M-1 is compact and portable in its sleek bakelite case, and is literally pocket size to fit in your coat pocket, tool box, glove compartment, or desk drawer. Measures AC or DC v. in 5 steps from a full scale minimum of 0-10 v. to a maximum of 0-5000 v. Measures direct current at 0-10 ma. and 0-100 ma., and provides ohmmeter ranges of 0-3000 and 0-300,000 ohms. Uses 400 microampere meter for sensitivity of 1000 ohms/volt. 1% precision divider resistors employed. Ideal tester for the hobbyist or beginner who wants to get started making basic measurements or tackling service jobs. Invaluable also as standby unit in the Service Shop when the main instruments are in use.

MODEL M-1
Shpg. Wt. 3 lbs. \$14.50



Heathkit 20,000 ohms/volt MULTIMETER KIT

The ideal personal instrument for you. Functional design is combined with comprehensive range coverage for maximum utility. 20,000 ohms/volt sensitivity on DC, and 5000 ohms/volt on AC. Voltage ranges for AC and DC are 0-1.5, 5, 50, 150, 500, 1500, and 5000 volts. Direct current ranges are 0-150 ua., 15 ma., 150 ma., 500 ma., and 15 amperes. Resistance ranges are X1, X100, X10,000, with db coverage from -10 db to +65 db.

Features 4½" 50 ua. meter, rich-looking molded bakelite portable case with carrying handle, polarity reversing switch, 2-color meter scale, 1% precision resistors in multiplier circuits. No external power required. Not affected by r.f. fields. Equally valuable for laboratory work, service work, or portable applications.

MODEL MM-1
Shpg. Wt. 6 lbs. \$29.50



Heathkit PRINTED CIRCUIT RF PROBE KIT

No. 309-C
\$3⁵⁰

Shpg. Wt.
1 lb.

The Heathkit RF Probe used in conjunction with any 11 megohm VTVM will permit RF measurements up to 250 Mc with ± 10% accuracy. Uses printed circuits for increased circuit stability and ease of assembly. Ideal for further extending service applications of your Heathkit VTVM. A useful accessory for those occasions when r.f. measurements are desired.

Heathkit PRINTED CIRCUIT PEAK TO-PEAK PROBE KIT

Now read peak-to-peak voltages on the DC scale of any 11 megohm VTVM with this new Probe, employing printed circuit for stability and low loss. Readings can be made directly from VTVM scales without calculation, from 5 Kc to 5 Mc. Note: Not required for the new Heathkit Model V-7 VTVM.

No. 338-C
\$5⁵⁰

Shpg. Wt.
2 lbs.

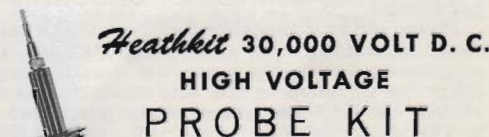

Heathkit 30,000 VOLT D. C. HIGH VOLTAGE PROBE KIT

No. 336
\$4⁵⁰

Shpg. Wt.
2 lbs.

For TV service work or any similar application where measurement of high DC voltage is required. Precision multiplier resistor mounted inside the 2 color sleek plastic probe body to provide multiplication factor of 100 on the DC ranges of the Heathkit 11 megohm VTVM.



MODEL TC-2

\$29.50

Shpg. Wt.
12 LBS.

HEATHKIT

tube
checker
kit

Heathkit
TV PICTURE TUBE
TEST ADAPTER

MODEL 355

\$4.50

Shpg. Wt.
1 lb.



The Heathkit TV Picture Tube Test Adapter is designed to be used with the Model TC-2 Tube Checker. Test TV picture tubes for emission, shorts, etc., and thereby determine tube quality. Tests picture tube without removal from TV set. A tremendous time-saver for the serviceman. Consists of 12-pin TV tube socket, 4 foot cable, octal connector, and necessary technical data. Extend the usefulness of your tube tester with this inexpensive device. Pays for itself in a very short time. At this price you cannot afford to be without one.

HEATHKIT

signal
generator
kit....

It is hard to believe that you can obtain so much for so little. At only \$19.50 the Heathkit Model SG-8 offers all the outstanding features required for a reliable basic service instrument. It is "serviceman engineered" to completely fulfill the signal source requirements of the serviceman and experimenter.

Covers the frequency range from 160 Kc to 110 Mc in 5 bands—all on fundamentals. Calibrated harmonic output extends usefulness of the instrument up to 220 Mc. Output is in excess of 100,000 microvolts, and the output signal is modulated at approximately 400 cycles. Audio output may be obtained for amplifier testing.

Prewound and precalibrated coils make calibration unnecessary for service applications. Construction is simple and straightforward, and the comprehensive construction book with step-by-step assembly procedure assures success. Build your own generator and save! All parts are included in the kit, ready for assembly. A reliable signal generator should be among the first test instruments purchased by the part-time serviceman or beginning service shop operator. Essential for IF and RF alignment jobs, and indispensable as a signal source for AF and RF signal tracing, and literally hundreds of jobs on all types of equipment. Pays for itself in a short period through service time it saves.

Provides a stable modulated or unmodulated r.f. output which can be controlled by both a continuously variable attenuator and a fixed step attenuator. Built-in internal modulation at 400 cycles, or can be externally modulated. Uses 12AU7 as a Colpitts oscillator and cathode follower, and a type 6C4 for 400 cycle oscillator. Don't be deceived by the low price. This is an outstanding, high quality instrument, being offered at an unbelievably low price.

MODEL SG-8

\$19.50 SHPG. WT.
8 LBS.



Heathkit
CONDENSER CHECKER KIT

Use the Model C-3 to quickly and accurately measure those unknown condenser and resistor values. All readings taken directly from the calibrated panel scales without any involved calculation. Measures capacity in four ranges from .00001 to 1000 mfd. Checks paper, mica, ceramic and electrolytic condensers. Power factor control is provided for accurate indication of electrolytic condenser efficiency. Selection of 5 polarizing voltages, 25 volts to 450 volts DC for indication of condenser operating quality under actual load conditions. Spring return test switch, automatically discharges condenser and eliminates shock hazard to the operator. Checks resistance in the range from 100 ohms to 5 megohms. Increased sensitivity coupled with an electron beam null indicator increases overall instrument usefulness.

MODEL C-3

Shpg. Wt. 7 lbs. **\$19.50**

EXCEPTIONAL BUY: A tremendous saving over the price of comparable commercial units—perhaps as much as \$50.00! At only \$29.50 the individual part-time serviceman or experimenter can afford to purchase his own tube checker. The Model TC-2 uses a 4½" Simpson meter with 3-color face for simple "good" and "bad" indications. Close tolerance resistors are used in critical test circuits. Will test all tubes commonly encountered in radio and TV service work.

FEATURES: Ten 3-position lever switches for "open" or "short" tests on each tube element. This is not only rapid and flexible, but insures the instrument against obsolescence. Top cap lead for testing tubes with grid caps or plate caps—neon bulb indicates filament continuity or shorts between tube elements—checks pilot lamps—line adjust control to compensate for line voltage variations—illuminated roll chart.

Tube test sockets are provided for 4, 5, 6 and 7-pin octal and loctal tubes. 7 and 9-pin miniature tubes, and the 5-pin hytron tubes. Blank space provided for future socket addition. Tests tubes for opens and shorts, and for quality on the basis of total emission. 14 different filament values are provided. The construction manual is complete in every respect.

PORTABLE CABINET AVAILABLE: Portable Tube Checker case may be purchased separately for the TC-2, and will also fit the earlier model TC-1 Tube Checkers. See description in Portable Tube Checker advertisement on this page. **Cabinet No. 91-8. Shpg. Wt. 7 lbs. Only \$7.50**



Heathkit PORTABLE TUBE CHECKER KIT . . .

The TC-2P is identical to the TC-2 except that it is housed in a rugged carrying case. This is a strikingly attractive and practical two-toned case finished in proxylin impregnated material. The cover is detachable and the hardware is brass plated. Topped off with a sturdy plastic handle, this case imparts a real professional appearance to the instrument. Ideal for home service calls or any portable application. Only \$34.50.

MODEL TC-2P

Shpg. Wt. 15 lbs. **\$34.50**

HEATHKIT TV ALIGNMENT generator kit....

MODEL TS-4

\$49⁵⁰

SHPG. WT.
16 LBS.



PHYSICAL DESIGN: Marker and sweep oscillators well isolated by shielding—single point chassis ground return at output terminals—heavy filtering used in power supply to avoid hum modulation. Incoming 110 V. line well isolated by r.f. filter to reduce leakage. "Unit" construction for compact assembly, short lead lengths, and ease of assembly.

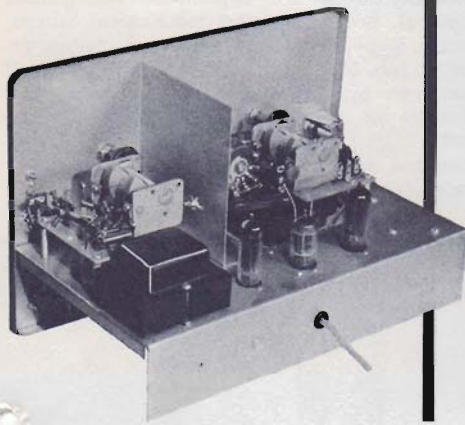

SPARKLING NEW DESIGN: The brand new, advanced-design Model TS-4 sets a new high standard for sweep generator operation, and offers tremendous improvements over the previous model. It features a brand new controllable inductor for all-electronic sweep, improved oscillator and automatic gain circuitry, higher R.F. output, center sweep operation, and much improved linearity. In addition, it offers smoother control knob drive action, universal type insulated shaft couplings, snug-fitting panel bushings and new "pod" type output cable termination. Calibrated in megacycles and for all VHF and UHF channels, this model covers all the frequencies encountered in both monochrome and color TV, as well as complete FM coverage—absolutely essential for the up-to-date service shop.

IMPORTANT FEATURES: Flat output over a wide frequency range is possible through voltage regulation and effective AGC action. Multiple markers available to identify band-width, etc. Electronic sweep accomplished without moving parts—complete absence of mechanical vibration—nothing to wear out. Sweep deviation controllable from 0 up to 40 Mc, depending upon base frequency. High r.f. output permits alignment of tuners, IF strips, boosters, etc., and even cold alignment of tuned circuits, filters and traps.

SPECIFICATIONS: Output frequency is on fundamentals from 3.6 Mc to 220 Mc in four bands. Output impedance is 50 ohms, terminated at both ends of output cable. Sweep deviation is continuously variable from 0 to 3 Mc lowest maximum deviation, to 0 to 42 Mc highest maximum deviation, depending on base frequency. Markers are available from 3 sources. The crystal marker oscillator provides markers at 4.5 Mc and multiples thereof. Crystal is included in kit. The variable marker oscillator covers from 19 Mc to 60 Mc on fundamentals, and up to 180 Mc on harmonics. Provision is made for external marker generator also. Effective two way blanking eliminates return trace, and phasing control is available also. Uses 6BQ7A, 12AT7, 12AX7, 6CL6 and 6X4. Construction Manual is complete in every respect for ease of assembly.



Heathkit LABORATORY GENERATOR KIT

Here is a signal generator suitable for laboratory or service shop applications where high accuracy and metered performance are essential. Covers from 150 Kc to 30 Mc on fundamentals in five easy-to-read bands. 400 cps modulation variable from 0 to 50%—r.f. output from 100,000 μ v to 1 μ v. 200 microampere meter reads r.f. output in microvolts, or modulation percentage. Both fixed step and variable output attenuation provided.

Uses voltage regulation, double copper-plated shielding, and Colpitts, r.f. oscillator for stability. Provision for internal or external modulation. Coaxial output cable (50 ohms) terminated in plastic "pod." Don't let the price deceive you! The Model LG-1 is a top-notch professional instrument for Laboratory or service work.

MODEL LG-1 **\$39.50**
Shpg. Wt. 16 lbs.



Heathkit BAR GENERATOR KIT

The operation of this device is so simple that it has become popular not only with TV servicemen, but also with beginners who wish to adjust their own TV set. Just connect the special output clip to the antenna terminals of a TV receiver and equally spaced horizontal or vertical bars are fed into the receiver. No internal connections required. Vertical and horizontal linearity controls may then be adjusted for accurate picture linearity without waiting for the transmitted test pattern to be available. Construction of this bar generator is extremely simple also, with the complete and comprehensive Construction Book supplied with the kit.

MODEL BG-1 **\$14.50**
Shpg. Wt. 4 lbs.



Heathkit VISUAL-AURAL SIGNAL TRACER KIT...

A Signal Tracer is extremely valuable in servicing AM, FM and TV receivers, especially when it comes to isolating trouble to a particular stage of the circuit under test. The Heathkit Model T-3 is literally packed with desirable features to save you valuable service time!

This visual-aural signal tracer features a high gain r.f. input channel which is used in conjunction with a wide range demodulator probe to permit signal tracing from the receiver antenna input clear through all RF, IF, detector and audio stages to the speaker. Separate low-gain channel provided for audio circuit exploration. Both visual and aural indication by means of speaker or headphone, and electron beam "eye" tube. Will determine relative stage gain through circuit under test.

Additional features are noise locator circuit for DC noise check on suspected circuit components, built-in calibrated wattmeter (30-500 watts), and panel terminals for "patching" output transformer or speaker into external circuit for test purposes. Incorporates combinations of test features not found in any other service instrument. Designed specifically for the radio and TV serviceman and "bench tested" for rapid, convenient operation.

MODEL T-3 **\$23.50**
Shpg. Wt. 9 lbs.

HEATHKIT *Audio* generator kit

SINE WAVE ONLY



MODEL AG-8

\$29⁵⁰

SHPG. WT. 11 LBS.

DESCRIPTION: This basic audio reference generator deserves a place in your Laboratory. An indispensable tool in almost any type of research or development. Complete frequency coverage is afforded from 20 cps to 1 Mc in 5 ranges and output is constant within ± 1 db from 20 cps to 400 Kc, down only 3 db at 600 Kc, and 8 db at 1 Mc. An extremely good sine wave is produced, with a distortion percentage below .4% from 100 cps through the audible range. Front panel frequency calibration is clear and sharp for accurate setting. Only the highest quality components are used in this professional type instrument to insure reliable operation.

Plenty of audio output for all applications, up to 10 volts under no load conditions. The output may be controlled with a continuously variable attenuator or a step-type attenuator

with settings of 1 μ v, 100 μ v, 1 v. and 10 v. Cathode follower output insures circuit stability.

APPLICATION: Use this fine instrument as a signal source for checking response characteristics of all types of audio equipment—including high fidelity amplifiers, speakers, or complete systems. Valuable, too, as an audio source for design problems in audio circuits, for matching audio lines, or checking transformer and filter characteristics. Equally valuable in the laboratory or the service shop. Literally hundreds of applications in physical, medical, industrial, and mechanical laboratories, aside from those in the electronic research lab. May be constructed in a few short hours to provide years of reliable service. Here is an instrument that can fulfill your audio signal source requirements in all professional applications. An unbeatable dollar value.

Heathkit AUDIO oscillator kit (SINE WAVE — SQUARE WAVE)



MODEL AO-1

\$24⁵⁰ SHPG. WT. 10 LBS.

The Heathkit Model AO-1 Audio Oscillator features sine or square wave coverage from 20 to 20,000 cps in 3 ranges. An instrument specifically designed to completely fulfill the needs of the serviceman and high fidelity enthusiast. Offers numerous advantages, such as high level output across the entire frequency range, low distortion and low impedance output. Special design features include the use of a thermistor in the second amplifier stage to maintain essentially flat output through the entire frequency range. The cathode coupled clipper produces good, clean square waves with a rise time of only 2 microseconds. The oscillator uses 1% precision resistors for greatest accuracy in the range multiplier circuits.



Heathkit "Q" METER KIT...

The use of the Heathkit Q Meter, has been extended to radio amateurs, service shops, and even hobbyists and experimenters, because of the low price.

Invaluable where special coils must be wound or component characteristics determined. Will measure the Q of condensers, r.f. resistance and distributed capacity of coils, etc. Uses a $4\frac{1}{2}$ " 50 μ a. meter for direct indication. Will Test at 150 Kc to 18 Mc in 4 ranges. Measures capacity from 40 mmf to 450 mmf within ± 3 mmf. Useful for checking wave traps, chokes, peaking coils, and indispensable for coil winding, determining unknown variable condenser values, etc. Research laboratory facilities are now available to all. An unbeatable dollar value.

MODEL QM-1 Shpg. Wt. 14 lbs. **\$44.50**



Heathkit VARIABLE VOLTAGE POWER SUPPLY KIT...

This brand new Heathkit provides hum-free DC output for B+, and 6.3 volts AC at 4 amps. for filaments. Output variable from 0 to 500 volts DC at no load, linear from 0 to 10 ma at 450 vdc and 0 to 130 ma at 200 vdc! Essential for circuit design and development as temporary power supply, and to determine design requirements for the ultimate power supply. It can be used to run tube curves for special conditions, and to determine component values.

Output voltage or current monitored on a large $4\frac{1}{2}$ " meter. The high voltage DC and low voltage AC are isolated from ground for use with AC-DC circuits, or to furnish a negative voltage value. An excellent addition to your work bench.

MODEL PS-3 Shpg. Wt. 17 lbs. **\$35.50**

Heathkit RESISTANCE SUBSTITUTION BOX KIT...

MODEL RS-1

\$5⁵⁰ Shpg. Wt. 2 lbs.



Provides switch selection of 36 RTMA 1 watt standard 10% resistors ranging from 15 ohms to 10 megohms. Numerous applications in radio and TV work.

Heathkit DECADE RESISTANCE KIT...

MODEL DR-1

\$19⁵⁰ Shpg. Wt. 4 lbs.



Twenty 1% precision resistors provide resistance from 1 to 99,999 ohms in 1 ohm steps. Indispensable around service shop laboratory, ham shack, or home work shop.

Heathkit CONDENSER SUBSTITUTION BOX KIT...

MODEL CS-1

\$5⁵⁰ Shpg. Wt. 2 lbs.



Very popular companion to Heathkit RS-1. Individual selection of 18 RTMA standard condenser values from .0001 mfd to .22 mfd. Aluminum panel, bakelite case, and includes 18" flexible leads with alligator clips.

Heathkit DECADE CONDENSER KIT...

MODEL DC-1

\$16⁵⁰

Shpg. Wt. 3 lbs.



Provides capacity values from 100 mmf to 0.111 mfd in steps of 100 mmf. $\pm 1\%$ precision silver-mica condensers used. High quality ceramic wafer switches for reduced leakage. Polished birch cabinet. Extremely valuable in all electronic activity.

New

Heathkit audio analyzer KIT



MODEL AA-1

\$59⁵⁰ SHPG. WT.
13 LBS.

PHYSICAL DESIGN: Notice the extremely attractive color and knob styling. Professional appearance is in keeping with the professional performance of which it is capable. Functional location of front panel controls for ease of instrument operation.

THREE INSTRUMENTS IN ONE: A Wattmeter, an AC-VTVM, and a complete IM Analyzer. The total price for these three Heathkit instruments separately was \$98.50. By carefully avoiding parts duplication and consolidating functions, it has been possible to establish a price of only \$59.50, a tremendous saving!

APPLICATION: A large number of audio tests can be made quickly and easily with the AA-1 Analyzer. The AC VTVM makes it possible to measure noise, frequency response, output gain, power supply ripple, etc. The wattmeter allows easy measurement of power output with either internal or external loads of 4, 8, 16 or 600 ohms. DB gain or loss can be noted quickly with the DBM calibration on the meter. High or low impedance IM measurements can be made quickly, and both high and low frequency generators are incorporated

within the instrument. Additional equipment and connections unnecessary. IM tests may be made at the amplifier output, or at the individual high impedance stages. Only 4 meter scales are employed and one of these is in color so that results are easily read on the scale.

SPECIFICATIONS: AC VTVM ranges are .01, .03, .1, .3, 1, 3, 10, 30, 100, 300 volts RMS. Wattmeter scales are .15 milliwatts, 1.5 milliwatts, 15 milliwatts, 150 milliwatts, 1.5 watts, 15 watts, 150 watts. IM analyzer scales are 1%, 3%, 10%, 30%, 100%. Built-in low frequency generator at 60 cycles, and high frequency at approximately 6 Kc for the IM analyzer.

Heathkit . . . IMPEDANCE BRIDGE KIT



MODEL IB-2
\$59⁵⁰ SHPG. WT.
12 LBS.

Here is an improved Impedance Bridge that is designed for accurate measurement of resistance, capacitance, inductance, dissipation factors of condensers, and the storage factor of inductance.

A 2-section CRL dial provides 10 separate "units" with an accuracy of .5%. Fractions of units are read on a continuously variable calibrated wire-wound control. D, Q, and DQ functions are all combined in one control with single knob operation. 1/2% deposited carbon type resistors are used in critical circuits, and 1/2% silver mica condensers were especially selected for this instrument. A Simpson 100-0-100 microammeter provides null indications.

Use it for determining values of unmarked components, checking production or design samples, etc. 1000 cycle oscillator built-in. Built-in power supply and 4 tube detector-amplifier. This professional instrument definitely must be classified in the "best buy" category.

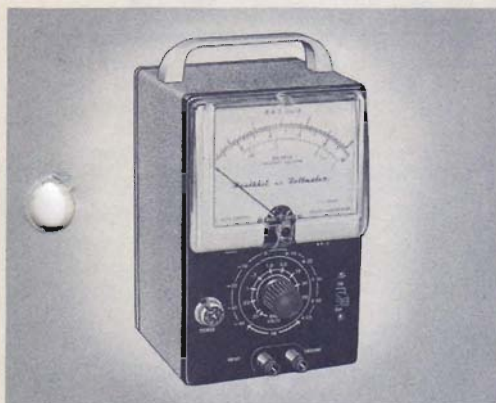

Heathkit A. C. VACUUM TUBE VOLTMETER KIT

The Model AV-2 makes possible the sensitive AC measurements required by laboratories, audio enthusiasts and experimenters. Few other devices can accurately measure a voltage as small as 1 millivolt at high impedance or cover the full range from 1 millivolt to 300 volts (a ratio of 300,000 to 1). Features high impedance, wide frequency range, very high sensitivity, and extremely wide voltage range. Frequency response is substantially flat from 10 cps to 50 kc.

Incorporates 10 full ranges of db scale from -52 db to +52 db. Especially useful for hum investigation, sensitive null detection, phono pick-up output measurements, frequency response checks, gain measurements, ripple voltage tests, etc.

MODEL AV-2 Shpg. Wt. 5 lbs. **\$29.50**



Heathkit DIRECT READING CAPACITY METER KIT

This brand new Heathkit design has already found extensive application in industrial situations where speed and convenience are of extreme importance. Ideal for testing in quality control work, for production line checking, or for rapidly comparing capacitor values to obtain special values or matched pairs. Features direct reading linear scales from 100 mmf. to .1 mfd. Necessary only to connect a capacitor of unknown value to the insulated binding posts and select the correct range. Capacity values then read directly on the calibrated scale. Not susceptible to hand capacity effects, and has a residual capacity of less than 1 mmf. Will even indicate the extremely low capacity of variable tuning condensers as they are rotated from one extreme to the other.

MODEL CM-1 Shpg. Wt. 7 lbs. **\$29.50**

MODEL SQ-1
\$29⁵⁰
SHPG. WT.
12 LBS.



Heathkit SQUARE WAVE GENERATOR KIT

Square wave testing is extremely valuable for undertakings in circuit analysis or development, and the Model SQ-1 is ideal for the study of amplifier distortion, high and low frequency response, to identify phase shift (especially important in video and oscilloscope amplifier design), show overshoot and damped oscillations and aid in the selection of proper circuit values.

Output frequency is variable from 10 cps to 100 kc in 4 ranges, and the output voltage is variable from 0-20 v. at low impedance. Output frequency ranges are 100 cps, 1 kc, 10 kc and 100 kc. This square wave generator has many applications in circuit development work and offers advantages not normally expected for an instrument in this price range.

Heathkit SINGLE-UNIT Williamson Type . . . High Fidelity amplifier kit

LOW COST: This unit is the lowest price Williamson Type Amplifier ever offered in kit form. By combining the main amplifier and power supply on a single chassis, and by using a newly designed Chicago output transformer, appreciable savings were made possible and are passed on to you. This new transformer is one of the latest designs in the hi-fi field, and offers considerable saving over transformers of equal quality. Performance characteristics of this fine high fidelity instrument are equal to those listed for the Heathkit Model W-3M on this page.

HIGH QUALITY: Here is your opportunity to build your own high fidelity system. This time-proven circuit has earned the

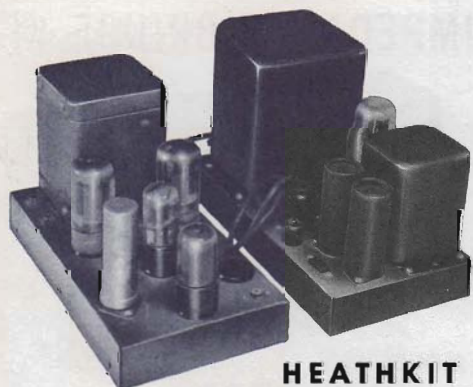

**HEATHKIT
DUAL-CHASSIS**

WILLIAMSON TYPE *High Fidelity* amplifier kit

This high fidelity Amplifier Kit is a dual chassis model, wherein the main amplifier and the power supply each have their separate chassis for flexibility of installation. It features the Acrosound "ultra-linear" output transformer, and has a frequency response within 1 db from 10 cps to 100,000 cps (comparable to the Model W-4M). Harmonic distortion and intermodulation distortion are less than .5% at 5 watts, and maximum power output is well over 20 watts. A truly outstanding performer.

Comprehensive construction book anticipates your every question to assure successful kit construction, even for the most nontechnical enthusiast. Experience the emotional impact of true timbre response, and brilliant "symphony hall" tone quality. The sheer magnificence of living music can be at your fingertips with this fine amplifier.

KIT COMBINATIONS

W-3M: Complete main amplifier and power supply for separate chassis construction. Shpg. Wt. 29 lbs., Exp. only

\$49⁷⁵

W-3: Consists of W-3M Kit listed above plus Heathkit Model WA-P2 Pre-amplifier shown on opposite page. Shpg. Wt. 37 lbs., Exp. only

\$69⁵⁰

acceptance of audio-wise enthusiasts at all levels of hi-fi music appreciation. Virtually distortionless output with plenty of reserve power for instantaneous power peaks of full orchestra, and clean, sharp voice for each individual instrument. Finest quality parts used throughout for long-life service. Output transformer taps of 4, 8, or 16 ohms for speaker of your selection.

CONSTRUCTION: The instruction manual for this kit is complete, so that it can be assembled successfully by anyone, even a beginner in electronics. Plenty of explanatory pictorial diagrams—and step-by-step instructions. It even explains how to read the resistor and condenser color code and defines commonly used schematic symbols. Helpful kit-building information is provided on such subjects as: "Recommended Tools," "Assembly," "Wiring," "Soldering," etc.



KIT COMBINATIONS

W-4M: Consists of main amplifier and power supply for single chassis construction. Includes all tubes and components necessary for assembly. Shpg. Wt. 28 lbs. Exp. only

\$39⁷⁵

W-4: Consists of W-4M Kit listed above plus Heathkit Model WA-P2 Pre-amplifier described on opposite page. Shpg. Wt. 35 lbs. Exp. only

\$59⁵⁰



HEATHKIT 6-WATT AMPLIFIER KIT

MODEL A-7B: Although not classified as a true high fidelity amplifier, this Heathkit amplifier actually exceeds specifications for many so-called "Hi-Fi" popular priced phono systems offered for sale, and is a top value in the low priced field.

Provides full 6 watts power output, more than adequate for normal home installations. Frequency characteristics are $\pm 1\frac{1}{2}$ db from 20 to 20,000 cycles. Transformer operated power supply—push-pull output—detailed Construction Manual—top quality parts—quality music reproduction without great expense. Output transformer tapped at 4, 8, and 15 ohms.

MODEL A-7C: Provides a preamplifier stage with two switch-selected inputs and proper compensation for variable reluctance or low level cartridges. Preamp. built on same chassis as main amplifier. Bass and treble tone controls provided. Model A-7C Shpg. Wt. 10 lbs., \$17.50.

MODEL A-7B
Shpg. Wt. 10 lbs. **\$15.50**

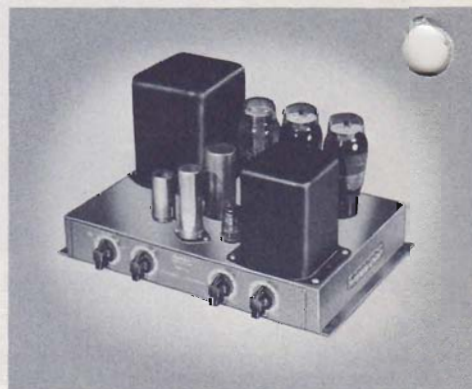

HEATHKIT 20 WATT *High Fidelity* AMPLIFIER KIT

The Heathkit Model A-9B offers you the least expensive route to real high fidelity performance. Full 20 watt output—push-pull 6L6's—separate bass and treble tone controls—frequency response ± 1 db 20 to 20,000 cycles per second—4 switch-selected compensated inputs—miniature tubes for low hum and noise level—output transformer tapped at 4, 8, 16 and 500 ohms. All necessary functions combined with minimum investment. Single chassis construction combines preamplifier, main amplifier and power supply in one unit and only \$35.50!

Uses 12AX7, (2) 12AU7's, (2) 6L6G's and 5V4G rectifier. All necessary construction material is furnished with the kit. An interesting "build it yourself" project, and an excellent Hi-Fi amplifier for home use. Well suited, also, for public address applications because of its high power output and quality audio reproduction. All controls conveniently located on front chassis apron, input jacks and output terminals on the sides.

MODEL A-9B
Shpg. Wt. 23 lbs. **\$35.50**

New High Fidelity amplifier kit

HEATHKIT
ADVANCED-DESIGN

BRAND NEW MODEL: This exciting new amplifier can provide you with the ultimate in listening pleasure. Incorporates new design features which result in true "presence" for the super-critical listener. Enjoy the startling realism of virtually distortionless reproduction from one of the most outstanding high fidelity amplifiers available today—at any price!

DELUXE FEATURES: A new design Peerless output transformer is employed to prevent loss in low frequency response—especially at moderate volume levels. Involves entirely new techniques in transformer design. KT-66 output tubes increase power handling capabilities to follow instantaneous power peaks of full orchestra. "Tweeter saver" suppresses high frequency oscillation, and new type balancing circuit is easier to adjust, and results in a closer "dynamic" balance between KT-66 output tubes. Features improved phase shift characteristics—reduced IM and harmonic distortion—and improved frequency response. Conservatively rated compon-

ents used throughout to insure years of trouble-free operation.

Cover guard fits over all above-chassis components for protection and enhances physical appearance, making the amplifier suitable for use in or out of a cabinet. Rich black and gold color styling harmonizes with Heathkit Model WA-P2 Preamplifier and blends with any room decoration. All connectors, including those for balancing, brought out to front chassis apron.

SPECIFICATIONS: Frequency response—within 1 db from 5 cps to 160 Kc at 1 watt reference. Harmonic distortion at 5 watt output—less than 0.1% at 20 cps, 0.062% at 10 Kc, and 0.94% at 20 Kc. I.M. distortion at 5 watt equivalent output—0.15% using 60 and 3000 cps. Power output—25 watts (1% distortion at 1 Kc). Output impedance—4, 8, or 16 ohms. Hum and noise—99 db below rated output, 80.2 db below ¼ watt. Uses (2) 12AU7 tubes, (2) KT-66's, and (1) 5R4GY. Overall dimensions are 8½" high x 8½" wide x 13" long.



KIT COMBINATIONS

W-5M Amplifier Kit: Consists of main amplifier and power supply, all on one chassis. Complete with all necessary parts, tubes, and comprehensive manual. Shpg. Wt. 31 lbs. Express only.....

\$59⁷⁵

W-5 Combination Amplifier Kit: Consists of W-5M Amplifier Kit listed above plus Heathkit Model WA-P2 Preamplifier Kit. Complete with all necessary parts, tubes, and Construction Manuals. Shpg. Wt. 38 lbs., Express only.....

\$79⁵⁰

Heathkit
High Fidelity

preamplifier kit



MODEL WA-P2

\$19⁷⁵

Shpg. Wt.
7 lbs.

- ★ Equalization for LP, RIAA, AES, and early 78's.
- ★ 5 Switch-selected inputs with individual pre-set level controls.
- ★ Separate bass and treble tone controls—special hum control.
- ★ Beautiful modern appearance blends with any interior color scheme.

MODERN STYLING: The clean modern lines of this preamplifier are accentuated by the satin-gold, baked enamel finish and gold-highlighted control knobs. Simplicity is the keynote, to blend harmoniously with any room interior—whether it be period or contemporary. The outstanding performance of the Heathkit Model WA-P2 is in keeping with its rich appearance. One of our most popular kits, and offered at an extremely low kit price. All components have been especially selected for their high quality. Features plastic-molded tubular condensers and disc ceramics with numerical value clearly stamped instead of color coded.

COMPREHENSIVE DESIGN: The Heathkit Model WA-P2 completely fulfills all the requirements for remote control, compensation, and preamplification for the Heathkit Williamson Type Amplifiers, and exceeds even the most rigorous specifications for high fidelity applications. Five separate input channels are switch-selected by this unit, (2-low level and 3-high level) and each input is provided with a separate audio level control, aside from the main volume control on the front panel. Full record equalization is accomplished with TURNOVER settings of "LP," "RIAA," "AES," and "Early 78," and ROLL-OFF settings of "0," "6," "12" (RIAA), and "16."

Other outstanding features are: Output jack for tape recorder—separate bass control with 18 db boost and 12 db cut at 50 cps—and treble control offering 15 db boost and 20 db cut at 15,000 cps. Overall frequency response (with controls set to "flat" position) is within 1 db from 25 cps to 30,000 cps. The hum and noise level is extremely low. Special hum control is provided to insure absolute minimum hum level. Cathode follower provides low impedance isolation for remote applications. Output lead length is not critical. This brilliant performer will do justice to the finest available program sources.

SPECIFICATIONS: Power requirements from Heathkit Williamson Type high fidelity Amplifier—6.3 VAC at 1 amp., and 300 VDC at 10 ma. Overall dimensions: 12¾" wide x 5¾" deep x 3¾" high. Uses two 12AX7's and one 12AU7. Simplified construction procedure is outlined in detail by the comprehensive instruction book.



BULK RATE
 U. S. POSTAGE
PAID
 BENTON HARBOR, MICH.
 Permit No. 273

"BUILD IT YOURSELF" is nothing new to Heathkit customers. They have been building their own kit form test equipment since 1946. They have also seen tremendous improvements materialize in Heathkit design and a steady parade of new Heathkit releases covering Amateur Radio and Hi-Fi as well as the instrument field.

The combination of good, modern design and high quality coupled with low kit cost, logically results in an unbeatable value for you! Hi-volume purchasing and hi-volume selling directly to you and not through a jobber or distributor, is responsible for the tremendous value offered. Truthfully, Heathkits offer the highest dollar value obtainable in the entire field of electronics.

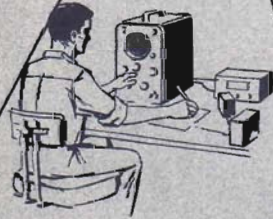

A-10 W.L. McADAMS
 3331ST TECH. TRN. SQD. BOX 84
 SCOTT AFB, ILL. 77

FORM 3547 REQUESTED

Heathkit 6-12 VOLT
**BATTERY ELIMINATOR
 KIT...**



MODEL BE-4
\$31.50
 Shpg. Wt. 17 lbs.

Here is the 12-volt Heathkit Battery Eliminator so necessary for modern up-to-date operation of your service shop. Furnishes either 6 or 12 volt output at the flick of a panel switch. Use it to service all the new 12-volt car radios in addition to conventional 6-volt models.

Provides two continuously variable output voltage ranges; 0-8 volts DC at 10 amperes continuously or 15 amperes intermittent, 0-16 volts DC at 5 amperes continuously or 7.5 amperes intermittent. The output voltage is clean and well filtered by two 10,000 mfd. condensers. Continuously variable output is of definite aid in determining the starting point of vibrators, the voltage operating range of oscillator circuits, etc. Panel meters read voltage and current output. Features fuse protection and an automatic circuit breaker. Will also double as a battery charger.

Heathkit
VIBRATOR TESTER KIT

Use the Heathkit Vibrator Tester to save many hours of service work. Test vibrators for proper starting. The easy-to-read meter indicates the quality of the output on a large BAD-GOOD scale. Checks both interrupter and self rectifier types of vibrators. Five different sockets for checking hundreds of vibrator types.

Operates from any battery eliminator capable of delivering continuously variable voltage from 4-6 volts DC at 4 amperes. Ideal companion piece for the Heathkit Model BE-4 Battery Eliminator Kit. The kit is supplied complete, and can be quickly assembled to provide many years of time-saving service in your shop. At this low Heathkit price you cannot afford to be without one.



MODEL VT-1
\$14.50
 Shpg. Wt. 6 lbs.

Heathkit
FM TUNER KIT

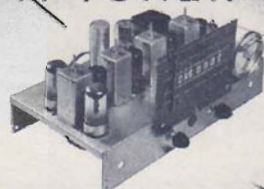

MODEL FM-2
\$22.50
 Shpg. Wt. 8 lbs.

Featuring wide frequency response and low noise, the Model FM-2 can be operated in conjunction with a high fidelity amplifier, or through the "phono" section of an ordinary radio.

Completely AC operated, eliminating hum problems of AC-DC circuits. Employs an 8 tube circuit with separate mixer and oscillator stages, 3 double-tuned I.F. stages, limiter and discriminator. Covers from 88 to 108 Mc.

Tuning unit is factory built. Slide rule dial—vernier tuning—and simple to operate. Ideally suited for your music room.



Heathkit
BROADCAST BAND RECEIVER KIT



MODEL BR-2
\$17.50
 Shpg. Wt. 10 lbs.
 (Less Cabinet)

Build your own receiver with confidence even if you are a beginner. Comprehensive instruction book anticipates your every question. Everything supplied to accomplish this "learn by doing" project. Trouble-free performance assured.

Features transformer type power supply, high-gain miniature tubes, built-in ferrite rod antenna, miniature I.F. transformers, planetary tuning from 550 Kc to 1600 Kc, 5 1/2" speaker. Also adaptable for use as an AM tuner, or phono amplifier.

CABINET: Proxylon impregnated fabric covered plywood cabinet available, complete with aluminum panel and reinforced speaker grille. Part No. 91-9, Shpg. Wt. 5 lbs., \$4.50.