

FALL & WINTER 1962-63

HEATHKIT CATALOG

STEREO HI-FI COMPONENTS • AMATEUR RADIO GEAR • TEST & LAB EQUIPMENT
MARINE EQUIPMENT • SCIENCE KITS • EDUCATIONAL KITS • WIRED EQUIPMENT



HEATH COMPANY
BENTON HARBOR, MICHIGAN
PLANT LOCATION: ST. JOSEPH, MICHIGAN

A Subsidiary of Daystrom, Incorporated

CATALOG 81/30



Deluxe AM/FM/Stereo Tuner
Experience a thrilling new dimension in listening with the new Heathkit AJ-41 deluxe AM/FM tuner with built-in Multiplex converter, \$119.95. See page 36.

Most Advanced Stereo Transistor Amplifier on the Market!
See the amazing new Heathkit AA-21 All-Transistor 70-watt Stereo Amplifier on pages 34 & 35. \$134.95



Deluxe Stereo/Hi-Fi Components
Designed to blend beautifully with home furnishings and to deliver unmatched stereo or monophonic reproduction of your favorite musical selections. Choose from many models to fit your budget . . . your every listening requirement! See pages 34 through 59.



Professional Stereo Tape Recorder
Heathkit AD-22 4-Track Recorder performs like \$800, sells for \$179.95! See page 49.



FM Table Radio & Multiplex Converter
Rich walnut cabinetry and thrilling FM Stereo performance in this matching stereo pair, \$109.90. See page 10.



Short Wave Listeners Receiver
Enjoy world-wide listening entertainment! See the Heathkit GR-91 at \$39.95 and many other home and hobby items on page 6 through 33.

Beautifully Designed Stereo/Hi-Fi Equipment Enclosures
Handcrafted cabinets to house all your Heathkit music equipment . . . convenient . . . elegant . . . priced from \$31.95. See pages 58 and 59.



Welcome to Heathkit . . . the world's finest electronic kits

If you are one who is investigating this fascinating hobby of kit building for the first time, you may be seeking reasons why you should choose Heathkit. I invite you to thoroughly read this 1963 Heathkit catalog, carefully compare your favorite Heathkit with any other brand, talk with a Heathkit builder (they're to be found the world over) . . . see what typical Heathkit buyers below have to say, and you'll discover for yourself why millions prefer Heathkit. I believe you will find the following are ten key reasons why Heathkit is the world leader in electronic kits: 1. Superior Quality Components . . . only standard parts of recognized quality are used in Heathkits . . . quality controlled for superiority. 2. Engineering Leadership . . . the largest, most experienced kit design-group in the world works for Heath . . . pioneers in the kit field. 3. Economy . . . you save two ways with Heathkits . . . by buying direct from the manufacturer (no middleman profit), and by "do-it-yourself." 4. Satisfaction . . . the fun of building your own electronic kits is quite beyond compare . . . a life-time hobby with useful end-products. 5. Guaranteed Performance . . . just follow the simple instructions with your Heathkit, it will perform to our published specifications. 6. Easy Assembly Instructions . . . the Heath-originated advances in the techniques of "check-by-step" instructions eliminate the need of a high degree of skill. 7. Convenient, Money-Saving Packaging . . . no frills, but all the parts (including factory recommended rosin core solder) protected and grouped for convenience and to save you even more money. 8. Exclusive Service Policy . . . only Heath offers both factory service and a nation-wide chain of factory authorized and trained service centers. 9. Over 250 Kits . . . the greatest lineup of electronic kits in the world . . . something for everyone's interest, everyone's budget. 10. Convenient Time-Pay Plan . . . no money down on any purchase from \$25 to \$600 . . . up to 18 months to pay . . . see the order blank for details.

If you are a long-time Heathkit fan, you'll find more new kits in this fall and winter edition of the 1963 Heathkit catalog than ever before . . . more than 100 new and restyled kits since the last edition . . . kits that reach new highs in professional performance and appearance. We suggest you keep this Heathkit catalog in a handy place for ordering and checking purposes just as millions of kit builders all over the world do, for this catalog has become the "arm-chair shopping center" for electronic kits . . . the standard reference of quality.

And, regardless of whether you are a beginner or an experienced Heathkit builder, we appreciate your comments, suggestions, and questions . . . just write us here at the Heath Company, Benton Harbor, Michigan.

Sincerely,
A. W. Greene
A. W. Greene, President



Money Back Guarantee

Heath Company unconditionally guarantees that each Heathkit® product assembled in accordance with our easy-to-understand instruction manual must meet our published specifications for performance or your purchase price will be cheerfully refunded.

OUR REPUTATION RESTS IN THE HANDS OF OUR CUSTOMERS

The following statements are typical of the many unsolicited praises we receive each day from Heathkit builders everywhere . . . proof that Heathkits are easy to build . . . that you can rely on Heathkit for greater quality, value and service.

"I have now completed the amplifier and to say the least, I had no trouble whatsoever building it. The moment I turned it on it worked perfectly."

John S. Dawe, Livonia, Michigan

"The Heath Company has managed to put on the market a product that in the finished state is better than many commercial units...the claims made for the performance of the units (walkie-talkies) are not in the least exaggerated."

Thomas W. Holm, Highgate Center, Vt.

"I have never heard another (speaker) system that sounds as pleasing as this one that is comparable in price."

Robert J. DeVitto, Bridgeport, Conn.

"I recently purchased a GR-91 General Coverage receiver from your company. I would say that every hour, penny and minute I spent on it was worth it. I found that half the fun of that receiver was putting it together. I'm glad I bought a Heathkit."

Dave Miner, Salt Lake City, Utah

"I would like to express my delight in the performance of the AA-161 14 watt monophonic amplifier purchased from you recently. It was apparent from the perfect packaging that here was no shoddy

material, from the construction outline that it would be simple to assemble, (five hours) and from the circuit drawing that it would be a dilly in performance. I wasn't disappointed."

L. K. Battson, Pensacola, Florida

"I would like to take this opportunity to say how I feel about your kits. I don't think there are any kits on the market at any price than can compare at dollar value with Heathkit."

W. A. Baxter, Santa Clara, Calif.

"I have heard nothing but good said about your products and I must agree. Your equipment compares favorably with those costing many times more, and are downright fun to build! Many thanks for all the hours of enjoyment my wife and I have had from your equipment."

G. L. Heckman, Kodiak, Alaska

"I am fourteen years old, and I enjoyed every minute of construction of your 25 watt High Fidelity Amplifier. Its tone, external appearance and overall quality convince me more and more of the sincerity of the Heath engineers in their quest for better equipment."

W. R. Yesbek, Jr., Silver Springs, Maryland

"I am twice as proud of my GR-21 FM Radio. 1. Because of your easy instructions, for one who never as much as touched a soldering iron before: it made the work a pleasure. 2. With my hands, I built a magnificent FM radio. A Heathkit! I needed no outside electronics man's help or advice.

Others shall hear of Heathkit from me. Thank you!"

W. L. Arnold, Jr., Townsville, Pa.

"This was my first attempt at such a project and inasmuch as I have no particular inclination toward electronics, I believe that such excellent results reflect credit upon the excellent engineering and careful consumer testing that evidently went into the product."

H. J. Stoefen, Springfield, Ohio

"I have never received finer kits, or service than I have received from your company. You can be sure I will be one of your best salesmen. May your company continue to prosper. My thanks also to your technical consultant."

John Palencak, Flint, Michigan

"Of all the concerns that I have done business with in this country, I have found none that give the service that the Heath Company does."

R. D. Springs, Cranston, Rhode Island

"About five years ago I purchased one of your amplifiers. It has given me one problem in the five years and that occurred just a couple of days ago. A 220K resistor blew out. I purchased another for 10 cents and installed it. Ten cents and a few minutes of my time, to me, is very reasonable for the only repair in that length of time. All the tubes are the original equipment. I praise you highly for the excellent quality of your kit!"

G. B. Mors, La Canada, California

... an earned
and valued
reputation



The Heath Company pioneered the concept of electronic kits and continues to lead the industry today. This world-wide leadership is the result of pace-setting standards for every Heathkit, satisfaction for every Heathkit customer, and complete devotion of our efforts to kits . . . kits are our business, not a sideline. The quality and value in each Heathkit is achieved by the following means, dedicated to serving you:

1. ADVANCED ENGINEERING

Heath engineers and technicians are specialists in the Heath-pioneered idea of transferring sophisticated electronic designs into do-it-yourself kits so economical that everyone recognizes their value, and so easy to build that anyone can assemble them and achieve factory-built per-



Heathkit engineering is led by the Director of Engineering and a group of Senior Engineers, each a specialist in his particular product line.

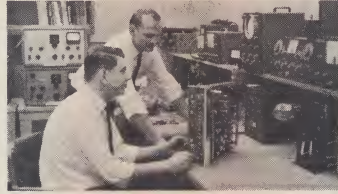

Ideas become electronic kits through the skill of Heathkit engineers and technicians, a skill in evidence in Heath's advanced engineering.

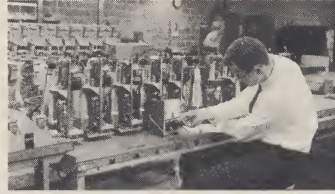

Engineers and technicians test every component specified for Heathkit designs to guard the quality you've come to expect from Heath.



Heath can guarantee kit specifications, regardless of the builder's experience, for each new design is "proof-built" by non-technical people.

2. WORLD'S EASIEST KITS TO BUILD

The world-famous Heathkit instruction manuals which accompany every Heathkit are the distillation of years of pioneering and searching for the one best way to enable you to build any kit regardless of your experience or skills.

Here are some of the Heath innovations in kit instructions: 1. Complete circuit descriptions supported by easy-to-follow pictures, no difficult technical language or "kiddie" talk. 2. Assembly tips show you how to do a professional job without specialized skills or background. 3. Parts are pictured with life-size drawings to enable you to associate names with physical objects. 4. Double check-point system of con-

struction notes . . . so complete that there is no need for elaborate packaging, thus saving you more money and enabling us to put more value into the kit itself. 5. Big pictorials that are right side up and bound in to match the text-steps . . . schematic tie-ins show each part you are installing in each step . . . detail action drawings with two column text show you *what* to do and *how* to do it. 6. Complete follow-up instructions . . . how to adjust your set with or without instruments . . . how to operate it properly for best results . . . tips on how to service it.

All of these and many more go into your Heathkit instructions to make your Heathkit-building so easy that anyone can do it!

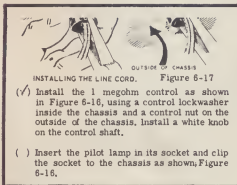

INSTALLING THE LINE CORD. Figure 6-17
(✓) Install the 1 megohm control as shown in Figure 6-16, using a control lockwasher inside the chassis and a control nut on the outside of the chassis. Install a white knob on the control shaft.
() Insert the pilot lamp in its socket and clip the socket to the chassis as shown, Figure 6-16.

DOUBLE-CHECK INSTRUCTIONS

Heath Check-by-Step Instructions have a double checking system . . . each step is checked off as it is performed . . . and each point that needs soldering has a number to denote the leads to be soldered.

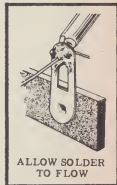

ASSEMBLY TIPS

The famous Heathkit instructions show and tell you how to start . . . proper methods . . . and how to quickly identify parts.

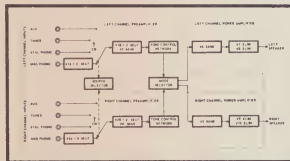

CIRCUIT DESCRIPTION

Simplified block diagrams accompany descriptions to thoroughly explain the operation of your Heathkit without complicated technical language.

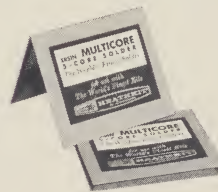

ERSIN MULTI-CORE SOLDER INCLUDED IN EACH KIT

A new addition to the famous Heathkit extra-value technique is this famous brand Ersin Multicore Solder. Each kit contains sufficient solder for you to complete the kit at no extra cost! We recommend this particular solder as being the high quality necessary for top performance and ease of construction, tailored especially for electronic soldering.

CONVENIENT, ECONOMICAL PACKAGING

The Heathkit packaging technique not only assures you of safe delivery of your kit, but also groups each type of parts into convenient packages in a simple manner that is effective and money-saving, thus permitting us to pass this extra economy to you in the form of better kits.

OPERATION TIPS

Heathkit instructions include tips on how to adjust your set for optimum performance . . . how to operate it properly . . . and how to service it should it become necessary.

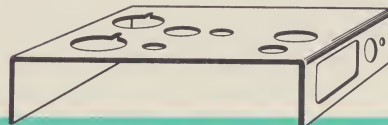

PRE-PUNCHED CHASSIS

All the hard work is done for you in Heathkits . . . chassis are punched, drilled and labeled to make your kit building easy, the results professional.

3. EXTRA CUSTOMER SERVICE



EXCLUSIVE SERVICE FACILITIES

A nation-wide chain of Heathkit service centers offers you fast, convenient service of factory-trained quality. And, if you prefer, you may use our in-plant, kit service center . . . it's staffed with experts in Heathkit construction. Only Heathkit provides this excellent service. (Sorry, we must refuse requests to service other brand kits, our service is devoted exclusively to Heathkits.)



FREE FACTORY CONSULTING SERVICE

Heath is alone in providing expert technician-correspondents at your beck and call . . . just drop them a line any time on any kit subject and they will be happy to help you . . . with a construction question or even recommendations on which kits are most suitable for your purposes. And it costs you nothing! It's another extra customer service exclusive with Heath.

FAST SHIPPING SERVICE

Heath Company has its own in-plant post office and fast contact with other shipping services to provide you with quick delivery of your favorite Heathkit right to your door. Orders are usually processed the same day received . . . on their way to your home within a few hours.

TIME PAY PLAN CONVENIENCE

Another service to Heathkit customers is the famous Heathkit Time-Pay plan . . . no money down, up to 18 months to pay. Orders from \$25 to \$600 are eligible. See the order blank for details and enjoy your Heathkit sooner with this easy time-pay plan.

4. COMPLETE SATISFACTION

QUALITY KITS

Quality you can see, quality you can compare . . . by weight, by appearance, by performance . . . by any standard. Quality designed into each unit, assured by rigid control during manufacture, use of only premium-quality components . . . quality you can rely upon to offer you the finest service for years to come . . . quality that is world-famous . . . ask a Heathkit owner and be convinced you get only the finest with Heathkit. We invite comparison of specifications of units costing up to twice as much.

FUN TO BUILD AND USE

Here's interesting work-with-your-hands type of fun. Exciting fun while you build an intricate piece of electronics . . . pleasurable times as you enjoy the famous Heathkit performance.



SATISFYING HOBBY

A life-time hobby that pays off! Building the electronic items you need can be one of life's most rewarding experiences. There is nothing quite so satisfying as seeing a Heathkit assembled with your own hands perform like an expensive, professionally-built model. Educational, too, for all ages 8 to 80!



BIG SAVINGS

You save two ways when you build a Heathkit! (1) Save by buying direct from the manufacturer. (2) Save up to 50% by building it yourself.

5. A KIT FOR EVERY INTEREST

... the World's Largest Selection, over 250 in all!



MUSIC LOVERS choose Heathkit Stereo/Hi-Fi . . . the world's largest selection of fine components from source to sound each with guaranteed performance specifications! See pages 35 to 60.

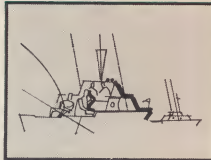

MARINERS choose Heathkit Marine Electronic kits for greater safety and more fun . . . performance you can depend on, savings you can count on. See pages 24 to 27.

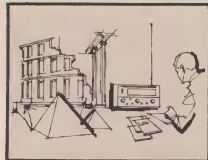

RADIO AMATEURS choose Heathkit for money-saving, record-breaking performance and value. Known the world over for quality. See pages 61 to 76.



HOBBYISTS, Citizen's Band enthusiasts choose Heathkit . . . the biggest CB line in the business! See these and other home and hobby items beginning on page 6 plus page 98.



ENGINEERS choose Heathkit test equipment for dependability with economy. Now with new professional styling, a greater value than ever. See pages 77 to 96.



EDUCATORS AND PARENTS choose Heathkit educational kits to foster greater interest in science, make learning more fun, more interesting. See pages 28 to 31, 33, and 97.

6. INDEX

STEREO & MONO HIGH FIDELITY

Acoustic Suspension speaker systems	55
Amplifiers,	
Hi-Fi	35, 37, 42, 43, 44, 46, 47
AM Tuners	36, 40, 41, 45
Cabinets, Hi-Fi	58, 59
FM Tuners	36, 40, 41, 45
Multiplex FM converter	45
Record Changers	52, 53
Speakers, Hi-Fi	60
Speaker Systems	54, 55, 56, 57
Stereo: Amplifiers	35, 37, 42, 43, 44
FM Multiplex converter	45
Headphones	56
Power Amplifiers	43, 44
Preamplifiers	38, 39
Record Player	52, 53
Tape Player	48, 49
Tape Recorder	48, 49
Tuners	36, 40, 41
Systems	12, 50, 51
Transistor Stereo Amplifier	35
Tuners:	
AM, FM, Stereo	36, 40, 41, 45
Turntables, Record	53

GENERAL PRODUCTS

AM Portable Radio	7, 8
AM Table Radio	8
Amplifier, Telephone	12
Antennas, CB	18
Broadcast Receivers	7, 8, 14, 15
Citizen's Band Selective Call	19
Citizen's Band Transceivers	16, 17, 18, 20, 21

Clock Radio	8
Special Value Items	32
Educational Computer	97
Educational Electronic Kits	28, 29, 30, 31
Electronic Toys	33
FM Auto Radio	11
FM Portable Radio	6
FM Table Radio	8, 10
Garage Door Opener	23
Ignition Analyzer	22
Ignition Timing Light	22
Intercom, Transistor	13
Multiplex FM Table Radio	10
Nut Driver Set	98
Portable Radios	6, 7, 8, 15
Public Address Equipment	32
Short Wave Listeners' Radios	14, 15
Soldering Iron	98
Tachometer	27
Telephone Amplifier	12
Tool Kits	98
Transistor Radios	6, 7, 8, 15
"Walkie Talkie" CB Transceivers	20, 21

MARINE EQUIPMENT

Depth Sounder	24
Direction Finder	25
Marine Radio Telephone	26
Marine Power Converter	27
Tachometer	27

AMATEUR RADIO EQUIPMENT

Adapter, Single Sideband	67
All-Band Receivers	14, 15
Amateur Band Receivers	62, 66, 68

Amateur Radio Accessories	62, 68, 72, 73, 74, 75, 76
Amateur Radio Beginner Course	75
Balun Coil	76
Communications Microphone	64
Crystal Calibrator	74
Dummy Load, Transmitter	74
Kilowatt Linear Amplifier	65
Log Books	73
Mobile Amateur Equipment	62, 63
Mobile Power Supply	76
Monitor Scope	73
Phone Patch	76
Power Supplies	72, 76
Receivers	62, 66, 68
Reflected Power Meter	74
SSB Adapter	67
Single Sideband Transmitter	63, 64
Transceivers, Amateur Band	71, 72
Transmitters	63, 67, 69, 70
Tunnel Dipper	75
Utility Power Supply	76
Variable Frequency Oscillator	68

TEST INSTRUMENTS

Audio Analyzer	88
Audio Generator	87
Audio Vacuum Tube Voltmeter	80
Analog Computers	97
Battery Eliminator	84
Capacitor Decade	90
Color Dot Generator	83
Condenser Checker	82
Electronic Switch	95
FM Test Oscillator	91
Handy Lab	89
Harmonic Distortion Meter	88
Ignition Analyzer	22

Ignition Timing Light	22
Impedance Bridge	91
Isolation Transformer	85
Multimeter (VOM)	80
Oscilloscopes	94, 95, 96
Probe Kits	78, 79, 96
"Q" Meter	91
Regulated Power Supply	84, 85
Resistance Decade	90
Signal Generators: Audio	87
RF	86
Signal Tracer	89
Substitution Boxes	90
Transistor Checker	81
Tube Checkers	92, 93
TV Sweep Generator	83
Vacuum Tube Voltmeters	78, 79, 80

EDUCATIONAL EQUIPMENT KITS

Analog Computers	97
Basic Electricity Course	28
Basic Radio Courses	28
Basic Transistors	29
Educational Computer	97
Instrumentation Course	29
Science Kits	33
Scope Applications	30
Signal Generator Applications	31
Test Instruments	77 to 96
VTVM Applications	30

SCIENCE KITS

Broadcaster, Transistor	33
Crystal Radio	33
Electronic Workshops	33
Intercom, Transistor	33
Radio, Transistor	33

Enjoy the clarity and fidelity only FM can provide . . . enjoy the new all-transistor Heathkit FM PORTABLE RADIO . . . another Heathkit First!

- 10 transistors, 2 diodes
- Vernier tuning for easy station selection
- Three IF limiters
- AFC and "defeat" switch
- Volume and tone control
- Push-pull output stage
- Big 4" x 6" speaker
- Telescoping antenna plus terminals for outside antenna
- Headphone jack
- Self-contained battery power supply

THROUGH HEATH
NEW
 RESEARCH
 GR-61
\$54⁹⁵



Here's the kit you asked for . . . the kit you've been waiting for . . . the new Heathkit FM Portable Radio, GR-61. With its self-contained battery power supply, it's ready to go wherever you go, to bring the clarity and fidelity of FM reception to your home, to the office, the beach, ball games, trips, hunting and fishing . . . anywhere within FM station range.

And this is no compromise circuit . . . just check the list of features above: a full ten-transistor, two-diode circuit with three IF limiter stages for full quieting, automatic frequency control (AFC) for drift-free reception, and a push-pull output stage for big-power, low-distortion sound . . . complete with a 4" x 6" oval speaker with heavy magnet for "big set" tone.

Easy to use, this beautiful FM portable features vernier tuning for easy station selection . . . a treble-cut tone control for tone just the way you like it. Tuning and volume control knobs are large, sure-grip plastic type, conveniently located on each end of the case accompanied by two smaller aluminum tone and AFC knobs. The antenna is a telescoping, whip-type, (heavily-chromed finish) which disappears into the case . . . extends to 34" when in use, for sensitive signal pick-up. Extra terminals allow for the additional signal capabilities of an outside antenna. The battery is the new leak-proof cathodic envelope type which is obtainable anywhere, and will last from 300 to 500 hours. For private listening or connection to a hi-fi system, a headphone jack is provided which automatically "cuts off" the speaker when a plug is inserted.

Easy to build, the GR-61 features prealigned IF transformers plus a factory assembled and aligned "front-end", and fast circuit board construction . . . assemble it in one or two evenings of your spare time.

Styled in handsome suntan simulated leather case with curved beige colored front grill, it matches the XR-2L Heathkit AM portable radio opposite. Less battery. 6 lbs.

Kit GR-61, no money down, \$6 mo. **\$54.95**
GRA-131-1, battery for above, 2 lbs. **\$1.10**

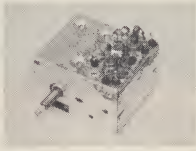

FACTORY ASSEMBLED AND ALIGNED TUNER
gets you off to a fast start in building this FM portable . . . just mount the tuner in place and proceed with following stages.

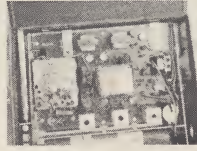

CIRCUIT BOARD CONSTRUCTION
cuts hours from kit construction and assures a stabilized, uniform result. . . just mount parts in place and solder the connections.

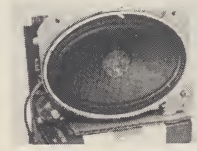

BIG-SET TONAL QUALITY
is assured by the 4" x 6" speaker . . . larger than most portables and many table radios have . . . heavy magnet means good bass response.

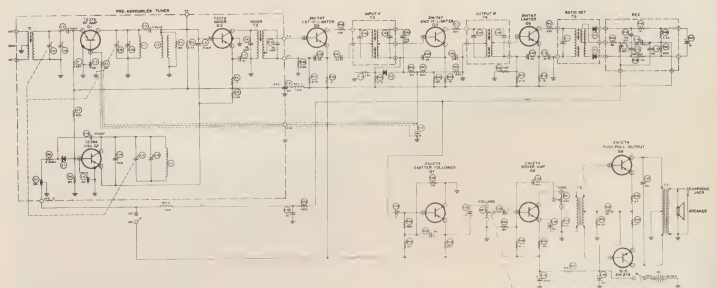

SPECIFICATIONS—Tuning range: 88 MC to 108 MC. IF frequency: 10.7 MC. Audio output: 250 milliwatts. **Loudspeaker:** 4" x 6" permanent magnet. **Battery:** 9 volt. Long-life, leakproof, Neda #1612, Eveready #2356. **Battery life:** 300 to 500 hours. **Dimensions:** 7¾" H x 10" L x 4" D. (overall)

Wherever You Go With Heathkit® Portable Radios

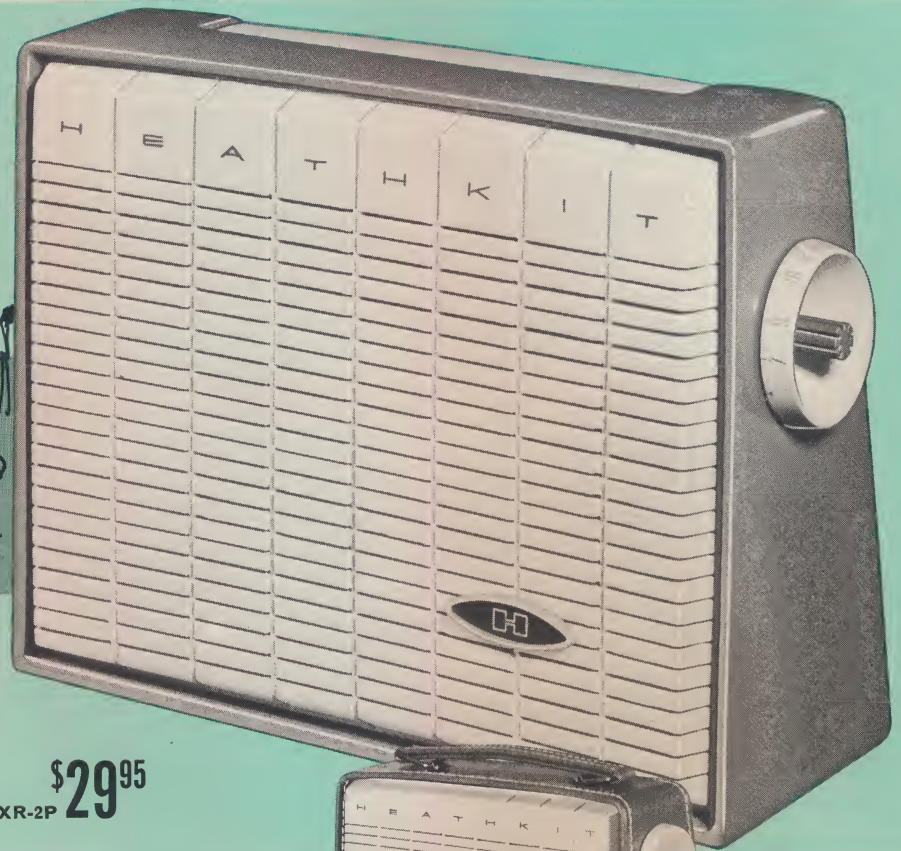

\$29⁹⁵
XR-2P



For quality radio reception everywhere,
take a full-size Heathkit AM PORTABLE with you

- Six-transistor, two-diode circuit
- Built-in rod antenna
- Big-set tonal quality with 4" x 6" speaker
- Vernier action tuning

You can count on the Heathkit XR-2 series portable radios to deliver the finest in performance wherever you are, for they are full-size portables with straight-forward circuitry and standard components. No crowded chassis, miniature parts or tiny speaker . . . the XR-2's feature a full-size chassis with plenty of room for easy kit building . . . standard components with built-in reserve performance for long life . . . and a 4" x 6" speaker for a big-set tonal quality that you can't get from miniature radios or even from most table radios. Six standard "D"-cell flashlight batteries will last most users from 500 to 1000 or more hours.

The six-transistor, two-diode superhet circuit provides high sensitivity and selectivity with a built-in rod antenna that helps pull in faraway stations across a full-band tuning range of 540 to 1620 kc.

Easy to use, these portables have big plastic control knobs on each end of the cases, pull-out carrying handles, fine dimensions (7³/₄" H x 10" L x 4" D), and light weight. The molded XR-2P model has a mocha colored cabinet with beige grill; the XR-2L features a sun-tan simulated leather case with beige grill . . . award-winning styling that is as handsome as the performance.

Build your own portable radio, build the Heathkit XR-2 in a matter of hours, easily. It's fun, it's satisfying, it's economical . . . order your XR-2 portable now. Batteries not included. Shipping weight 5 lbs.

Kit XR-2P (Plastic) . . . no money down, \$5 mo. **\$29.95**
Kit XR-2L (Sim. Leather) . . . no money down, \$5 mo. **\$34.95**

SPECIFICATIONS—Tuning range: 540-1620 kc. **Sensitivity:** 350 uv/m for 15 db signal-to-noise ratio at 50 mw output. **Transistors:** 6; 2N1108, 2N1110, 2N1111, R251, 2-R-250. **Diodes:** 2. **Loudspeaker:** 4" x 6" permanent magnet. **Battery life:** 500-1000 hours average use.

FULL-SIZE PORTABLES, the Heathkit XR-2 radios deliver large-set performance with big 4" x 6" speaker, roomy chassis that's easy to assemble, standard-size components, and use of long-lasting, inexpensive standard flashlight batteries.

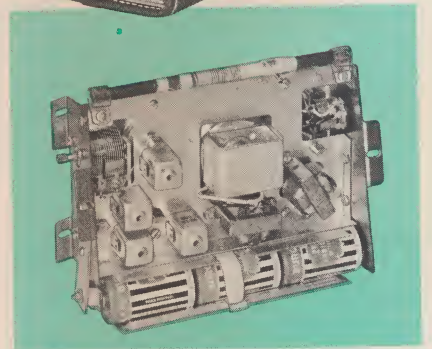

New Relaxed Credit Terms ORDER NOW! PAY LATER

With Heath's new credit terms you can order the kits you want now! No money down . . . up to 18 months to pay on any purchase of \$25.00 to \$600.00. Enjoy the pleasure of building and having your Heathkit while you pay for it in easy monthly installments.

Save Up To 50% With Heath Do-It-Yourself Electronic Kits



Choose a Versatile Heathkit

GR-10
~~\$19.95~~

NEW SPECIAL-VALUE PRICE
\$17.95

For that "extra" radio about the house, choose this low-cost Heathkit AM TABLE RADIO

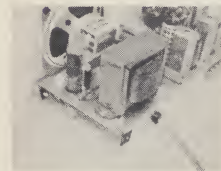

TRANSFORMER OPERATED power supply for safety.



VERNIER-ACTION TUNING for easy station selection.

GR-11
~~\$27.50~~

NEW SPECIAL-VALUE PRICE
\$24.95

Enjoy noise-free listening with this inexpensive Heathkit FM TABLE RADIO

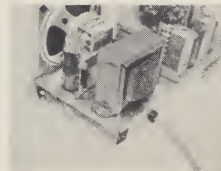

TRANSFORMER OPERATED power supply for safety.



PREASSEMBLED TUNING UNIT for fast kit building and factory-aligned performance.

GR-121
\$29.95

Your most "helping hand" ... the versatile Heathkit CLOCK RADIO

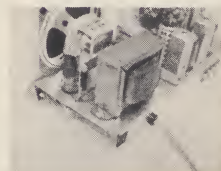

TRANSFORMER OPERATED power supply for safety.

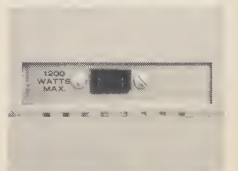

TIMER OUTLET automatically turns on appliances.

GR-131
~~\$19.95~~

NEW SPECIAL-VALUE PRICE
\$17.95

This Heathkit Transistor TABLE RADIO Doubles As a Portable

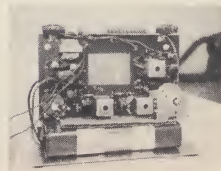

BATTERY fits conveniently in space provided under circuit board; lasts 500 to 1000 hours.

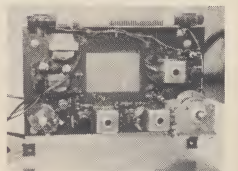

CIRCUIT BOARD construction means fast assembly and circuit stability.

Radio for Home, Work or Play

- Transformer operated power supply
- Superheterodyne design with AVC
- Vernier tuning for easy station selection

The Heathkit GR-10 AM table radio can take a proud place anywhere in your home, for it boasts highly styled cabinetry in muted ivory and beige plastic that complements any decor. This receiver has sensitivity and selectivity to spare due to its modern superheterodyne circuitry. What is more, it is safe to the touch, thanks to its transformer operated circuit which isolates it from the power line to eliminate shock hazards from "hot" chassis.

Deluxe features include a vernier action tuning mechanism that offers smooth, easy station selection . . . highly selective circuits that offer good station separation . . . high quality ferrite rod antenna that will

pull in even far-away stations with ease . . . extra antenna terminals for those who wish to use an outdoor antenna for very distant stations . . . and a built-in neon pilot light that will serve as a gentle reminder that the unit is on or off.

Easy to build with its roomy layout, you will find the GR-10 a fun-filled task that takes about four hours, provides a great deal of satisfaction in the doing, and even more in the using. Kit is complete to the last detail in instructions and high quality parts. 7 lbs.

Kit GR-10 **New Special-Value Price \$17.95**

SPECIFICATIONS—Frequency coverage: 550 kc to 1650 kc. **Control functions:** Volume, On-Off, Tuning. **Intermediate frequency (IF):** 455 kc. **Power supply:** Transformer-operated, half-wave rectifier. **Tubes:** (1) 12BE6 Pentagrid converter, (1) 12BA6 IF amplifier (1) 12AV6 Detector, first audio amplifier, (1) 50C5 Audio power amplifier (1) 35W4 Rectifier. **Speaker:** 3½" permanent magnet, 4 ohms. **Power requirements:** 105 to 125 volts AC, 50/60 cps. **Dimensions:** 5" H x 10" W x 5" D.

- Transformer operated power supply
- Vernier tuning for easy station selection
- Preassembled, prealigned FM tuning unit for ease of assembly

At this low price, you can afford to put an FM radio in every room of your home! This Heathkit GR-11 table radio brings you all the listening advantages of FM with its clarity and fidelity, yet it costs so little. The circuit uses five tubes which function like seven for full performance . . . a tuned RF stage, an oscillator-mixer, two IF stages second of which acts as a limiter on strong signals, a diode ratio detector, an audio driver stage, an audio power stage, and a tube rectifier . . . other fine features are the vernier action tuning to permit smooth, easy station selection . . . the built-in line-cord antenna for convenient local reception of stations . . . separate terminals for the attachment of an

outside FM or TV antenna to receive distant stations . . . the transformer-operated power supply, and the neon on-off indicator light.

The GR-11 FM table radio is easy to build for it is supplied with a factory assembled and aligned "front-end" tuner which not only assures you of proper performance when completed, but also gets you off to a fast start in the assembly. No special equipment is needed for alignment purposes, for the IF and ratio detector transformers are factory aligned, ready for installation. Complete assembly should take you about four hours.

Styling is in a "go anywhere" muted ivory and beige plastic. 7 lbs.

Kit GR-11, no money down, \$5 mo. **New Special-Value Price \$24.95**

SPECIFICATIONS—Tuning range: 88 to 108 megacycles. **Intermediate frequency:** (IF): 10.7 megacycles. **Demodulation stage:** Ratio detector. **Speaker:** 3½" diameter, 4 ohms. **Tubes:** (1) 17C9 dual tetrode, (2) 12BA6 pentode, (1) 35HB8 triode-pentode, (1) 35W4 diode. **Power requirements:** 105-125 volts, AC 50/60 cps. **Dimensions:** 5" H x 10" W x 5" D.

- Transformer operated power supply
- Timer operated outlet for household appliances
- Sleep switch—radio alarm—output jack for pillow speaker

A faithful servant in every sense of the word, this Heathkit GR-121 Clock Radio can be a help every day in many ways. No more rude awakenings, this gleaming ivory and beige beauty gently "brings you around" to the strains of your favorite type of music at the appointed hour. Then, if you are the laggard type, after about ten minutes the alarm sounds to put an end to sleep. Meanwhile, the clock/timer has started your morning coffee automatically. During the day, the latest in news and music is yours at the turn of a knob. At the end of the day, this constant companion is ready to lull you to sleep to music . . . for private listening, an output jack is provided for pillow speakers . . . and

it automatically turns itself off after a pre-set interval of up to one hour.

Easy to build, this low-cost Heathkit Clock Radio comes complete with all parts, cabinet, and complete instructions . . . assembly should take approximately five hours, an easy, fun-filled task that provides great personal satisfaction as well as tangible, lasting rewards.

Deluxe features include a built-in ferrite rod antenna for good reception, outside antenna terminals, high quality clock/timer unit with sweep-second hand, and a timer outlet for appliances. 8 lbs.

Kit GR-121, no money down, \$5 mo. **\$29.95**

SPECIFICATIONS—Tuning range: 535 kc to 1620 kc. **Intermediate frequency (IF):** 455 kc. **Controls:** Clock, Sleep timer, up to 60 minutes, Selector, Auto Radio, On, Off, Radio Alarm, Time Set and Alarm Set; Radio, Tuning, and Volume control with on-off switch. **Tube complement:** 18FX6 Oscillator-mixer; 18FW6 IF amplifier; 18FY6 Detector-1st audio amplifier; 34GD5 Audio Output; 36AM3 Rectifier. **Power supply:** Transformer-operated half-wave rectifier. **AC outlet:** Switched, 1200 watts maximum, located on rear. **Speaker jack:** For pillow or extension speaker, located on rear. **Dimensions:** 10" W x 5" H x 5" D.

- Six-transistor, two-diode circuit
- Battery powered for portability
- Big set tone from 4" x 6" speaker driven by push-pull output stage

Here's an all-around table radio that goes anywhere you wish . . . any room in the home, at work, or even as a portable at play, for it is battery powered . . . completely independent of household current! Through Heath research in transistor circuitry, it has been possible to design this six-transistor radio circuit with the long distance reception capability normally expected only of receivers costing as much as twice this low price. The radio uses a full size ferrite rod antenna to improve the reception of weak stations.

For tone that belies its small size, this Heathkit GR-131 boasts a

4" x 6" speaker (larger than most portables and many table radios), plus a push-pull type output stage like those used in good quality audio amplifiers for low distortion and greater output power.

Through utilization of a diagrammed printed circuit board, this radio can easily be constructed by the novice with complete confidence of successful results. Each part is shown clearly on the board, just insert the proper part, a touch of the soldering iron, and it's done! . . . construction time is approximately four hours. Power is supplied by a long-life (500-1000 hours) nine-volt battery (not included in kit).

Kit GR-131, 3 lbs. **New Special-Value Price \$17.95**

GRA-131-1: Battery for above . . . 2 lbs. **\$1.10**

SPECIFICATIONS—Tuning range: 540 to 1620 kc. **Loudspeaker:** 4" x 6" oval, permanent magnet type. **Battery:** 9-volt, Eveready #2356 (NEDA type 1612). **Battery life:** 500 to 1000 hours. **Transistors:** (1) T-6026 RF converter, (2) T-6025 IF amplifiers, (1) T-1577 Driver, (2) T-2286 Audio Output. **Sensitivity:** 200 uv/meter for 20 db signal-to-noise ratio at 50 milliwatts output. **Size:** 8" W x 6¼" H x 3" D.

A Matched Pair for FM Stereo Reception



GR-21
\$59⁹⁵

GRA-21-1
\$49⁹⁵



Hi-Fi FM Monophonic TABLE RADIO ... Engineered for FM stereo

- 88 to 108 mc FM coverage
- 7 tubes function like 11
- 6" x 9" dual-cone speaker
- Matches GRA-21-1 Stereo Converter perfectly
- Quality preassembled walnut cabinet

Here's a convenient one-unit FM table radio which combines all the qualities for which Heathkit is famous . . . preassembled, prealigned "front-end" tuner, quality audio amplifier, fine speaker, and a handsome walnut cabinet . . . all at one reasonable price.

The GR-21 has a 6" x 9" dual cone speaker with a 6.8 oz. magnet that gives true hi-fi sound reproduction. The preassembled, prealigned tuning unit makes assembly simple. Other features include flywheel tuning with vernier action, a tuning "eye", and lighted slide-rule dial for easy, accurate station selection. Automatic Frequency Control is easily switched on for drift-free reception. Powered by an AC transformer with silicon diode rectifiers, the GR-21 gives stable, efficient performance. The FM Multiplex Output jack and auxiliary audio input are designed to be used with the Heathkit GRA-21-1 Multiplex Stereo Converter (adjoining column) to provide an FM stereo system with matching components. Other extras in this instrument include: line cord antenna and external antenna terminals; switched AC socket for accessory power; and tone and volume controls. Comes with a 3/8" walnut veneer cabinet with furniture quality finish and a unique "relief" speaker grille that is offset from the front. Measures 15" L x 8" H x 6" D. 18 lbs.

Kit GR-21 . . . no money down, \$6 mo. \$59.95

Matching Multiplex FM STEREO CONVERTER

- Completely self-powered, self-contained
- Matches the GR-21 receiver perfectly
- Quality components assure long, faithful service
- Simple controls adjust stereo effect
- Can be operated 15' away from radio

The design of the GRA-21-1 emphasizes quality reproduction and channel separation for maximum stereo effect. A stable, synchronized local oscillator keyed to the stereo "pilot" provided in the new FM multiplex transmissions provides a strong restored subcarrier to assure low distortion. Carefully designed filter networks separate the stereo signal without introducing separation-degrading phase distortion.

With the Heathkit GRA-21-1 to accompany the GR-21 FM radio, you can have your choice of FM stereo reproduction or monophonic reproduction using the speakers in the radio and in the adapter, or you can use the radio alone. The simple controls on the GRA-21-1 include a master volume control for both channels. Balance is easily obtained by adjusting the receiver volume control to make both receiver and converter equal in volume. The tone control on the adapter functions independently of that on the radio. The function selector switch permits the desired mode of operation and turns off the AC power to the adapter when not in use or when not needed for the function being performed. The full-wave power supply uses modern silicon rectifiers and a power transformer for safety, low hum level and long tube life with a minimum of heat.

Quality 6" x 9" speaker, audio circuitry, and cabinetry match the GR-21 opposite for truly matched performance. Cabinet measures 15" L x 8" H x 6" D. 18 lbs.

Kit GRA-21-1, no money down, \$5 mo. \$49.95

HOW IT WORKS

Block diagram shows the simple connections which make these two units a complete FM Stereo Multiplex system.

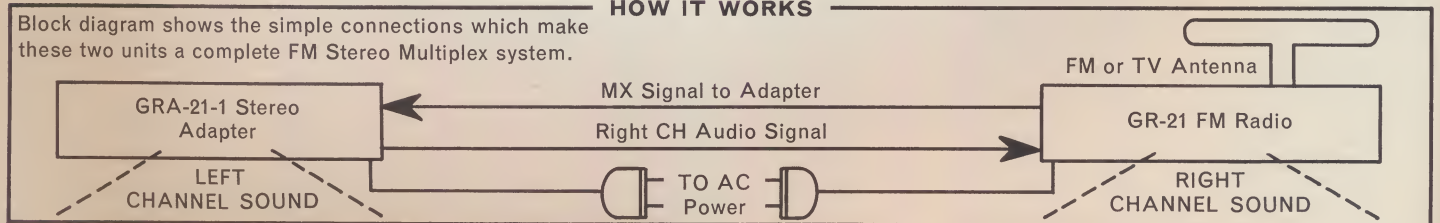

New Heathkit® FM Auto Radio



GR-41
\$64⁹⁵

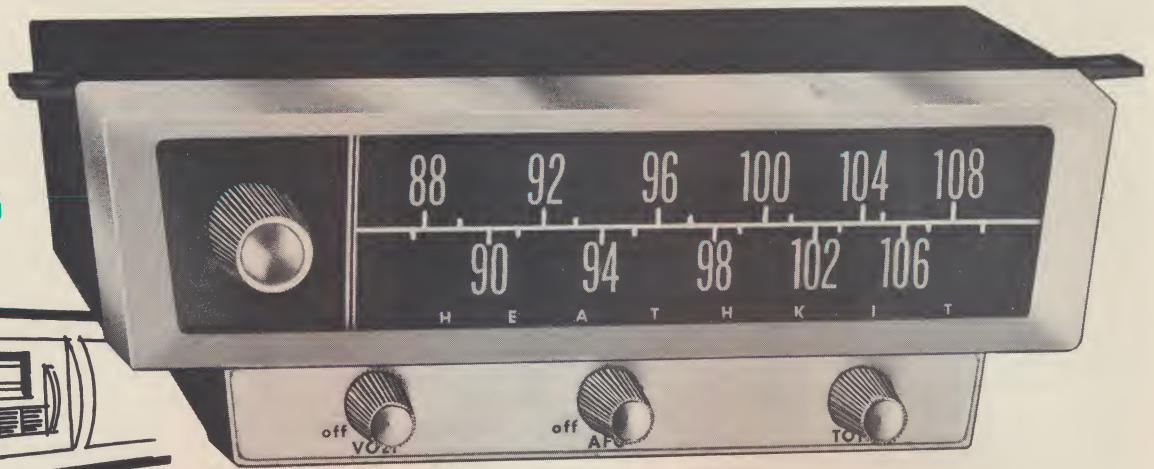

Enjoy matchless FM AUTO RADIO entertainment wherever you go with this easy to assemble and install kit!

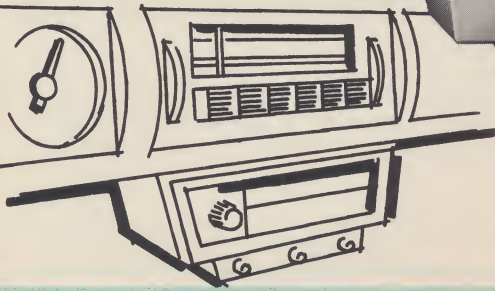

- 10 transistor circuit
- Preassembled, prealigned FM tuning unit
- Automatic frequency control stops drift
- Separate tuner and power amplifier for installation ease
- Easy circuit board assembly
- Beautifully styled

Now for less than half the price of competitive equipment, you can enjoy the matchless performance and superb entertainment offered by FM programming wherever you drive!

Design of the new Heathkit GR-41 FM Auto Radio features separate tuner and amplifier for installation ease, and broad band circuitry for true fidelity performance. The cool-running 10 transistor circuit covers the standard FM band from 88 to 108 mc with better than 1.25 microvolt sensitivity for a 20 db signal-to-noise ratio. Circuit features an RF amplifier, separate oscillator & mixer, 3 IF stages, 2 audio driver stages, and, push-pull output for full 10-watt power to speaker. Automatic frequency control provides drift-free FM reception. Simple controls consist of Tuning, On/Off-Volume, AFC defeat switch, and Tone Control. An antenna coupling cable and speaker control switch are included to utilize existing AM auto antenna and speaker. (Use accessories below if no AM radio is installed.) Clearly identified components, detailed pictorial diagrams and clearly marked circuit board make assembly easy. All critical components such as IF transformers, ratio detector transformer and factory-assembled FM tuning unit are aligned to exacting laboratory standards. Complete installation instructions are included for easy mounting in auto. Sturdy construction assures years of dependable, trouble-free performance. Built-in circuit breaker protection makes it unnecessary to replace fuses ever! Color styled in black with contrasting bright chrome bezel and knobs to complement all automobile interiors. Illuminated dial scale.

An outstanding FM radio value! . . . fun to build . . . fun to use . . . top quality throughout! Order yours today! 7 lbs.

Kit GR-41 . . . no money down, \$7 mo. \$64.95

ANTENNA ACCESSORY: Solid stainless steel whip, cut for 88-108 mc FM band complete with swivel mount, 15' coax cable, and connector for rear auto mount. 2 lbs. Model GRA-41-1 \$3.95

SPEAKER & GRILLE ACCESSORY: 6" x 9" high fidelity speaker with grille for easy rear deck mounting. 2 lbs. Model GRA-41-2 \$4.95



NOISE SUPPRESSOR KIT: Get better reception with this RF noise suppression kit. It reduces voltage regulator hash, generator whine and ignition coil interference; works on any engine. Includes 5 special design heavy duty thru-pass capacitors rated at 60 amps., 275° F. Easy to install on existing terminals and mounting bolts; no special brackets required. 3 lbs. Model GDP-192 \$16.95

ASSEMBLED TUNING UNIT: Supplied factory built and aligned. Assures top performance of completed unit, speeds assembly.

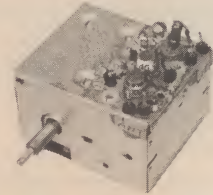

HIGH POWER PUSH-PULL OUTPUT: Delivers husky 10-watt output to speaker for "Living Room Quality" high fidelity enjoyment.

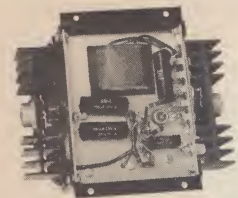

CIRCUIT BOARD CONSTRUCTION Simplifies and speeds assembly! Just insert components as marked on circuit board and solder on reverse side. Assures high circuit stability.

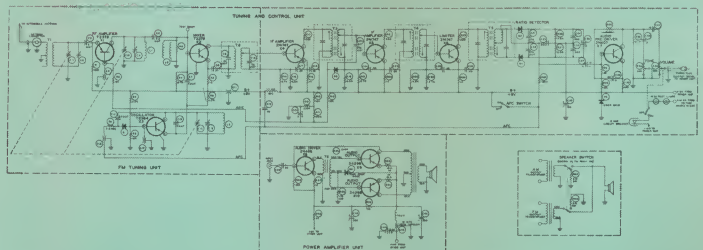
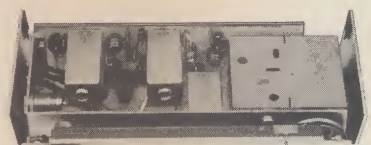

SPECIFICATIONS—Tuning range: 88 to 108 mc. **Quieting sensitivity:** 1.25 uv for 20 db signal to noise quieting. **I. F. frequency:** 10.7 mc. **I. F. rejection:** 70 db. **Image rejection:** 30 db. **Total bandwidth:** 340 kc (6 db down). **Audio power response:** ±1 db (60-12,000 cps). **Harmonic distortion:** Less than 1% @ 1 kc; Less than 3% 60-12 kc. **Power output:** 10 watts RMS, 20 watts peak. **Circuit:** 10 transistors. RF amplifier, oscillator, mixer 3 IF stages; 2 audio driver stages, push-pull output. **Controls:** Tuning; on/off, Volume; AFC defeat; Tone control. **Dimensions:** (RF unit) 2 1/2" H x 7 3/4" W x 4 3/4" D, (power amplifier) 2 1/4" H x 6 3/4" W x 4 3/4" D. **Power requirements:** 2 amperes @ 12 v. DC at full power output.

Heathkit Performance Specifications Are Guaranteed



\$19⁹⁵
GD-71

Telephone calls are easier with this handy TELEPHONE AMPLIFIER

- Ideal for office work, conference calls or busy housewives
- All transistor circuit—instant operation
- One 9-volt battery lasts up to 2,000 3-minute calls!

Invest a few hours in assembling this telephone amplifier . . . reap dividends of countless hours saved in your daily work. The Heathkit GD-71, a convenient accessory in home or office, frees your hands for other work while carrying on a normal two-way 'phone conversation.

When a call is received, you simply place the telephone handset on the amplifier cradle and you're ready to listen or talk, hands free. A switch automatically turns the unit on when the handset is placed on the amplifier. The GD-71 features an all-transistor circuit for instant operation . . . no warmup time is required. Power is furnished by a single 9-volt battery which will last up to 100 operating hours. Other features include a built-in speaker, inductive pickup coil, and adjustable volume control. The amplifier's volume and sensitivity allows talking and listening while you look for reference material, take dictation, make notes, etc. A circuit board and easy-to-follow instructions make assembly a simple one-evening project.

The many advantages of this telephone amplifier will be quickly realized when conference calls are in progress or where several people may wish to talk to the person on the other end of the line. Start enjoying the convenience of having your own telephone amplifier now. Less battery.

Kit GD-71 2 lbs. **\$19.95**
GWA-30 Battery Set: (2) one for operation, one spare, 1 lb. **\$2.95**

SPECIFICATIONS—Available power output: 150 milliwatts at 10% maximum distortion, from 300 cps to 3,000 cps. **Controls and switch:** Gain control, On-off switch actuated by telephone handset. **Circuit:** Transistorized; low-current, class B audio amplifier. **Input:** Inductive pickup coil. **Power supply:** 9-volt battery, type NEDA 1602. Provides up to 100 hours of operating time. **Current drain:** 10 to 30 ma, depending upon volume level. **Speaker:** 3" permanent magnet, 3.2 ohm voice coil. **Transistors:** (1) 2N1274 Driver, (2) 2N1274 Output (matched). **Cabinet:** Molded ivory plastic, 9½" L x 6" W x 5" H.

Budget-saving, space-saving Heathkit STEREO CONSOLE

- Ready to play or kit form
- Compact for true space economy
- Factory-assembled contemporary walnut cabinet
- 6 speakers—3 for each channel
- 60-15,000 cps response
- 4-speed stereo/mono record changer
- Anti-skate device included
- Sonotone stereo cartridge
- Turnover diamond and sapphire styli
- Separate dual bass and treble tone controls

\$129⁹⁵
in kit form

\$149⁹⁵
factory assembled



Kit Form
or
Factory
Assembled

Compare the size . . . compare the price! The Heathkit GD-31 Stereo-Phono Console is less than three feet long and just end-table high to fit easily in any room decor. The construction of the handsome factory assembled cabinet features a solid walnut frame, a walnut veneer front panel, and a matching wood-grained masonite sliding top. The light beige tapestry weave grille cloth covers the front and sides and accents its carefully-proportioned lines.

The GD-31 features six speakers—three for each channel—assuring wide range sound reproduction. Smooth "lows" are delivered by two 12" woofers, while "mid-range" and "high" are sparkingly reproduced by two 8" speakers and two 5" cone-type tweeters, mounted at wide dispersal angles in the cabinet. The 4-speed automatic record changer in the GD-31 plays 16, 33½, 45 and 78 rpm records in either monophonic or stereophonic form gently and faithfully. The changer is equipped with a Sonotone stereo cartridge with turnover diamond and sapphire styli. A record-saving "anti-skate" device insures proper performance and prevents damage to valuable recordings. Audio power in the GD-31 is supplied by the compact two-channel amplifier which produces a system response of 60-15,000 cps for thrilling wide range stereo. Easy-to-operate concentric volume controls and separate dual bass and treble tone controls are within easy reach on the cabinet front panel. Now is your chance to enjoy stereo in your home at a budget price. 70 lbs.

Kit GD-31 . . . no money down, \$12 mo. **\$129.95**
Assembled GDW-31 . . . no money down, \$14 mo. **\$149.95**
ADA-50-1 . . . 45 rpm adapter spindle . . . 2 lbs. **\$2.95**

SIX SPEAKERS . . . THREE PER CHANNEL

Here's how the six speakers in the GD-31 are placed to give you stereo sound in one compact cabinet. Featured are two 12" woofers, two 8" mid-range speakers and two 5" cone-type tweeters. Cabinet measures 31¼" L x 17¼" D x 26¼" H.

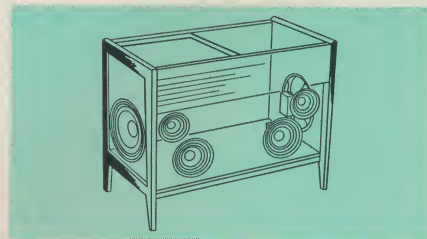

New Relaxed Credit Terms ORDER NOW! PAY LATER

With Heath's new credit terms you can order the kits you want now! No money down . . . up to 18 months to pay on any purchase of \$25.00 to \$600.00. Enjoy the pleasure of building and having your Heathkit while you pay for it in easy monthly installments.

Heathkit® Intercom Systems



SAVE TIME . . . SAVE STEPS . . . SAVE MONEY

The World's Most Convenient Type of Intercom . . . The Heathkit WIRELESS INTERCOM

- No connecting wires between units—just plug into nearest AC outlet—impossible to miss a call
- Add as many units as you like . . . at any time, to expand system
- All transistor circuit—built-in AC or DC power supply
- Economical to operate
- All-master system—any station may originate a call

Easiest of all! Simply plug the line cord into the nearest power outlet and it works . . . no other connecting wires between units. The power line is used as the transmission medium between intercoms. Each unit transmits a low frequency amplitude-modulated RF signal which travels along the power line to the next unit. Nothing could be easier.

Each unit features an all-transistor circuit and self-contained 117v. AC or DC power supply for high operating economy costs less than 3c per month to operate . . . instant operation without warmup time.

To make these units easy to live with, thoughtful additions have been made to the circuits such as a squelch circuit to maintain full quieting during standby periods, and an overload diode to prevent distortion on high-level signals.

Convenient to use, these units may be taken from room to room, wherever an intercom is needed. The large press-to-talk bar switch has a spring-return to listen position and a transmit "hold" position for dictation or babysitting. Two indicator lights are provided, amber for standby and red for transmit.

Cabinets are handsome two-tone beige plastic to "fit-in" anywhere.
Kit GD-51-2 (pair), 8 lbs. . . . no money down, \$5 mo. . . . \$45.90
Kit GD-51 (one station), 4 lbs. \$22.95

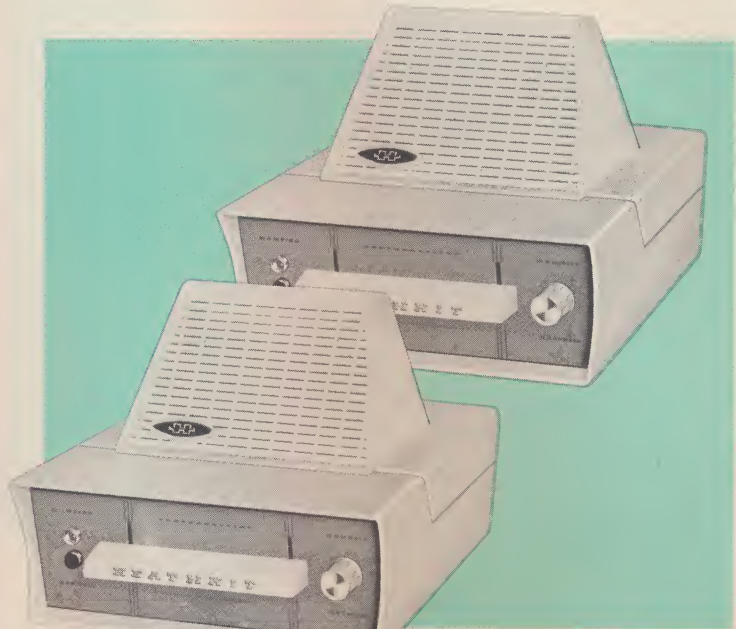

\$45.90 (pair)

GD-51-2

SPECIFICATIONS—Power requirements: 105-125 V 50/60 cycle AC or DC. Standby power: 2.5 watts. Transmit frequency: 220 kc & 180 kc (switch selected). Size: 6¼" H x 8" W x 7½" D.

This versatile Heathkit INTERCOM has provisions for indoor and outdoor remote stations . . . a complete system!

- Beautifully styled beige plastic cabinets
- Powerful 1 watt output—all-transistor circuit
- Master provides for up to 5 remote stations
- Weatherproofed outdoor remote station



GD-121 (Master)

\$29.95

Anyone can build and install this high performance intercom system. Covers both indoor and outdoor areas at tremendous savings over comparable ready-built systems. One watt output and specially designed frequency response assures crisp, clear communications. Master unit features an all-transistor circuit, built-in power supply, and separate level controls for listen and talk functions. Provision is made for up to 5 remote stations. Dependable lever switches permit selective call of any single remote or all-call for paging or announcements.

Indoor remotes are supplied with 50' of 3-conductor wire. 3-wire system permits two-way communication between any two remotes with only one initial setting of the master unit. Remotes have three-position listen-talk-monitor switch. In monitor position remote can be switched by the master to be heard anywhere in the house . . . perfect for babysitting! Outdoor remotes have doorbell button, weatherproof speaker, aluminum grill and weather seal. 50' of 2-wire cable included.

Kit GD-121 Master Station . . . 5 lbs., no money down, \$5 mo. . . . \$29.95
Kit GD-131 Indoor Remote . . . 3 lbs. \$8.95
Kit GD-141 Outdoor Remote . . . 2 lbs. \$5.95

SPECIFICATIONS—Power requirements: 117 v ac 50/60 cycles 2.5 watts (idling), 3.5 watts (full output). Transistors: four 2N1274. Dimensions: 6¼" H x 8" W x 7½" D (master), 5" H x 8" W x 6" D (indoor remote), 5¼" x 4¼" panel size (outdoor remote).

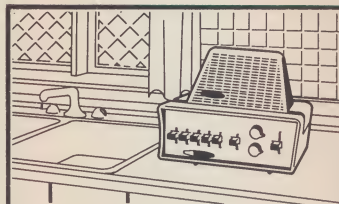

CONVENIENT!
Put the "master" in the kitchen; "remotes" in bedrooms, garage, shop, recreation room, etc.



FRONT DOOR REMOTE
Now you can answer the doorbell without appearing . . . just direct the caller to use the "remote".

Enjoy Your Heathkit Equipment While You Buy On Heath's Easier Time-Pay Plan—No Money Down

Heathkit® Receivers are World-Famous

Here's the fourth generation in the famous Heathkit General Coverage Receiver series . . . the GR-91 SHORT WAVE LISTENER'S RADIO

The Heathkit GR-91 General Coverage Receiver kit will bring hours of fascinating and dependable broadcast, amateur radio, and short-wave listening pleasure. In building this kit, just place the components directly into the circuit board and solder. This procedure minimizes the possibility of errors, greatly speeds assembly, assures proper construction and adds circuit stability. Even the youngsters will find this kit a joy to assemble since it is so easy to build.

This sensitive receiver covers 550 KC to 30 MC in four bands clearly marked on the illuminated 7" slide-rule dial and includes an extra "logging scale". The short wave listening bands are also clearly marked for ease of selection. The modern 4-tube superheterodyne circuit has high sensitivity and good stability, and the silicon rectifier power supply is transformer operated for safety.

The versatile features of this amazing unit include an illuminated tuning meter that shows relative signal strength from each station and front panel controls for audio gain, electrical band spread, AM-Standby-CW switch, bandswitch, BFO (beat-frequency oscillator), main tuning and antenna trimmer. On the rear of the chassis are a noise limiter switch, headphone jack, Q-multiplier input and antenna input. A built-in 3" x 5" speaker is included. The balanced (300 ohms) or unbalanced (75 ohms) antenna input allows coupling of popular antenna systems for better sensitivity. The "velvet-touch" tuning dial makes 16 revolutions to cover the dial completely—a great help in station selection with today's crowded bands.

Extremely handsome in its all-steel cabinet, the GR-91 has modern "low-boy" styling in a beige and aqua color scheme that will complement any room setting. 15 lbs.

Kit GR-91 . . . no money down, \$5 mo. \$39.95

SPECIFICATIONS—Frequency range: 550 kc to 30 mc in four bands. Short wave, broadcast bands clearly marked on dial. **Controls:** General coverage tuning, Bandsread tuning, Antenna trimmer, Bandswitch, Noise Limiter—ON/OFF, phone-Standby-CW switch, BFO control, Audio Gain, AC-ON/OFF, Headphone jack, Q-multiplier input jack. **Power requirements:** 105-125 V 50/60 cycles AC, 30 watts. **Dimensions:** 12¼" W x 5½" H x 8¼" D.



GR-91 \$39.95

- Covers 550 KC to 30 MC in four bands
- Seven inch illuminated slide-rule dial
- Illuminated relative signal strength meter
- Circuit board layout aids construction
- Built-in loudspeaker

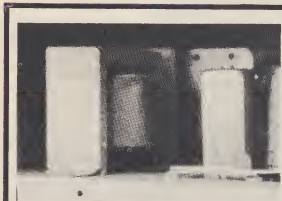

TRANSFORMER OPERATED POWER SUPPLY eliminates shock hazard of "hot" chassis found in ordinary sets.

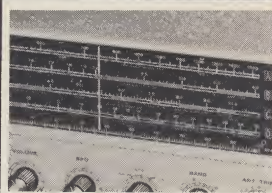

BIG 7-INCH TUNING DIAL has four bands covering 550 kc to 30 mc with Short Wave and Amateur Bands clearly marked plus an extra "logging" scale.

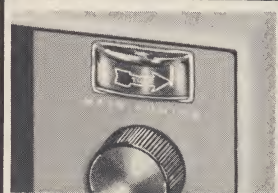

LIGHTED TUNING METER shows relative signal strength of stations . . . makes precise tuning easier.



GR-81 \$24.95

Low Cost SHORT-WAVE LISTENER'S RADIO . . . Heathkit GR-81 . . . with extended low-frequency coverage

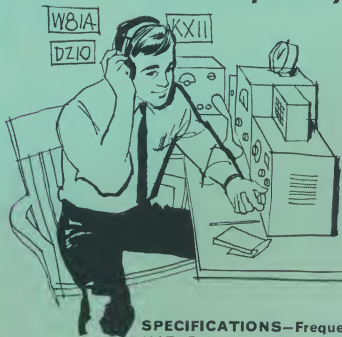

- Covers 140 kc to 18 mc in four bands
- Sensitive regenerative circuit
- Transformer isolated circuit
- Built-in speaker

SPECIFICATIONS—Frequency coverage: 140 kc to 18 mc on four bands. **Tube complement:** 12AT7 Detector/1st Audio 50C5 Audio Output, 35W4 Rectifier. **Power requirements:** 105-125 V 50/60 cycle AC only, 30 watts. Fused. **Controls:** Main tuning (calibrated), Bandsread, Band-switch, Regeneration, on/off volume, phone jack. **Dimensions:** 10" W x 7" H x 7" D.

for Short-Wave Listening



Kit Form
or
Factory
Assembled

GC-1A \$109⁹⁵



For top performance in a **SHORT-WAVE PORTABLE RECEIVER**, choose the **Heathkit GC-1A** and save over 50%!

Compare the price, compare the features, compare the specifications . . . you'll choose the GC-1A. Perfect for the avid short-wave listener, this all-band, all-transistor receiver is powered by 8 standard flashlight batteries for complete portability . . . and it is low-priced!

This powerful and superbly-designed instrument features high sensitivity, selectivity and stability which are the result of the many receiver "firsts" incorporated by the Heathkit engineers who designed it. The fixed-aligned ceramic IF "Transfilters" used in the "Mohican", which were developed primarily for military use, operate much the same as crystal lattice filters to shape the IF bandpass and offer excellent stability and selectivity. Other features of this unique receiver include: a 10 transistor, six diode circuit, Zener diode voltage regulation, built-in telescoping 50-inch whip antenna, flywheel tuning, panel tuning meter, built-in 4" x 6" speaker, head phone jack, and large slide-rule dial for tuning stations accurately and easily. The convenient panel controls include: on/off volume control, BFO pitch with on/off switch, RF gain, antenna tuning, electrical bandspread (oscillator tuning), ANL on/off, AVC on/off and Bandswitch. The GC-1A can be easily converted to 117 VAC household current instead of the battery supply, by simply plugging in Heathkit XP-2 Power Supply. The handsome styling of the Heathkit "Mohican" includes a one-piece metal cabinet with convenient carrying handle, die-cast metal knobs, a green and gray-green color combination. Experienced kit builders can assemble the GC-1A within 30 hours. Batteries not included. 18 lbs.

Kit GC-1A . . . no money down, \$11 mo. \$109.95

Assembled GCW-1A . . . no money down \$19 mo. \$193.50

SPECIFICATIONS—IF Frequency: 455 kc. Frequency coverage: 550 kc to 32 mc in 5 bands with calibrated bandspread scales (oscillator tuning) for 80, 40, 20, 15 and 10 meter amateur bands and 11 meter citizens band. **Selectivity:** 3 kc wide at 6 db down. **Sensitivity:** 10 uv broadcast band, 2 uv short wave bands for 10 db signal-to-noise ratio. **Output:** 400 milliwatts max. **Battery life:** up to 400 hours normal intermittent service using 8 standard size "C" cells. **Dimensions:** 6 $\frac{1}{2}$ " H. x 12" W. x 10" D.

- Completely self-contained
- Ten transistor, six diode circuit
- Flashlight battery power supply
- Fixed, aligned ceramic IF "Transfilters"
- Covers 550 kc to 32 mc in five bands
- Quality design-complete portability

10 TRANSISTORS, 6 DIODES . . . no hybrid circuits here, this world-circling receiver has an all semi-conductor circuit

CERAMIC IF "TRANSFILTERS," developed for military use, shape bandpass, offer superior selectivity, never need alignment.

BATTERY POWERED FOR PORTABILITY Uses 8 standard flashlight batteries to make it independent of power lines; use it anywhere . . . it works everywhere.

Kit XP-2, handy 117 v. AC power supply, plugs into back of set whenever you are near a power line to save batteries. 2 lbs. \$9.95

For the budget-minded short-wave listener, the new Heathkit GR-81 presents fine performance at low cost. Four bands cover 140 kc to 18 mc to bring you reception of international shortwave broadcasts, standard broadcasts, marine signals, low frequency aircraft beacons and weather, distress frequencies, government stations, radio amateurs, etc. As an example of its versatility, aviation enthusiasts or others interested in the latest weather reports will find it a low-cost way to receive the constant weather broadcasts on the low frequency aircraft band. Current affairs students will find the on-the-spot foreign broadcasts from London, Paris, Moscow, Tokyo, Berlin and other national capitals the ideal way to keep up-to-the-minute on world events. Amateur radio broadcasts make warm, friendly listening around the world. WWV (government stations) provide the world's most accurate time signals. For real life drama, monitor the marine and emergency frequencies.

The amazingly sensitive regenerative circuit features these front panel controls: On/off, Volume; Main and Fine tuning for easy station selection; 4-position Bandswitch; and Regeneration Control. Provisions for short or long antennas make possible good reception regardless of situation. Power supply is transformer isolated to eliminate shock hazard. Built-in 3" x 5" speaker and headphone jack are provided. Handsome beige steel cabinet "sets off" green front panel. Complete this easy to build kit in about six hours. 10 lbs.

Kit GR-81 . . . no money down, \$5 mo. \$24.95

FOUR SEPARATE BANDS cover 140 kc to 18 mc for low-frequency aircraft, marine, weather, distress, standard broadcast and most amateur band reception.

REGENERATION CONTROL adjusts the amount of re-amplification of the detector tube for the precise point where maximum sensitivity is secured.

BUILT-IN SPEAKER is a permanent magnet 3" x 5" oval-cone type, provided for good fidelity and complete listening convenience. Automatically "cuts off" when headphones are used.



Enjoy Highest Quality . . . Biggest Savings b



- Single channel, crystal-controlled accuracy—no tuning necessary
- Sensitive superheterodyne receiver—always on frequency
- Simple, straightforward circuit layout for easy assembly
- Built-in squelch and automatic noise limiter functions
- Complete with push-to-talk microphone and crystals
- Easy to operate and install with complete instructions furnished

New Heathkit low-cost CITIZEN'S BAND TRANSCEIVER . . . Ideal for personal or commercial use in fixed or mobile installations!

Here is an ideal transceiver for the Citizen's Bander who wants top performance . . . maximum ease of operation . . . and highest quality at the lowest possible cost! The new Heathkit GW-12 takes the most wanted features asked for by Citizen's Band users, eliminates the frills, to produce an exceptionally clean, easy to operate unit that will perform on a par with the best available!

The new GW-12 features crystal control of both transmitter and receiver on any single predetermined frequency . . . no drift or tuning dial inaccuracies that might prevent communications! Its high quality superheterodyne receiver is provided with adjustable squelch and automatic noise limiter functions to deliver crisp, clear communications.

A minimum of operating controls provide for simple, easy operation. Controls are on-off, Volume; adjustable squelch control to silence receiver during standby and push-to-talk switch in microphone. AC

power supply is built-in and provision is made for accessory power supply to allow operation on 6 or 12 volt DC in mobile installations. Kit is complete with microphone and crystals for one channel (specify channel preference, 1 to 23 upon ordering). Attractively styled in two-tone brown.

Kit GW-12A (AC only), 8 lbs., no money down, \$5 mo. **\$39.95**

Assembled GWW-12A (AC only), 8 lbs., no money down, \$8 mo. **\$79.95**

Kit GW-12D, (AC & DC), 11 lbs., no money down, \$5 mo. **\$44.95**

Assembled GWW-12D (AC & DC), 11 lbs., . . . no money down, \$9 mo. **\$84.95**

GWA-12-1: ACCESSORY DC POWER SUPPLY; Designed for GW-12A only. Operates on 6 or 12 V DC. Easily removed to restore AC operation. 3 lbs. **\$7.95**

GENERAL DESCRIPTION—Receiver section: 4-tube superheterodyne circuit with built-in squelch and noise limiter function. **Sensitivity:** 1 uv signal at antenna input produces 10 db signal to noise ratio. **Selectivity:** 7.5 kc at points 6 db down from peak response. **Transmitter section:** power input to final RF amplifier; does not exceed 5 watts. **Frequency control effectiveness:** within .005% of nominal crystal frequency over an ambient temperature range of -20 degrees F to +130 degrees F. **Power requirements:** 117 v. AC operation, 50 watts; 6 v. DC, 8 amps; 12 v. DC, 4 amps. **Dimensions:** 5 $\frac{1}{2}$ " H x 8 $\frac{1}{2}$ " W x 8" D. 9" D with GWA-12-1 power supply.

UNBEATABLE CB OFFER! MOBILE & FIXED STATION SYSTEM WITH ACCESSORIES, JUST \$99.95—

COMPARE IT WITH ANY OTHER—THIS IS THE BEST BUY IN THE INDUSTRY FOR PRICE & QUALITY

Fixed Station Kit GW-12A
Left, reg. \$39.95

Mobile Station Kit GW-12D
above, reg. \$44.95

Four Crystals
Included, two for each transceiver

DC Power Supply
for Mobile Operation
Included with GW-12D

New Fiberglass Mobile
Antenna Included
(Model GY-12 described
p. 18) Reg. \$8.95

15' Coax cable for
Mobile Antenna
50' Coax cable for
Fixed Antenna

Ground-Plane Fixed
Station Antenna
Included (Model
CBF-1 described
p. 18) Reg. \$17.95

Two Push-To-Talk
Microphones
Included

COMPLETE CB System package
\$99.95
SAVE from reg. price **\$1185**

Assembling Heathkit® Citizen's Band Radio Equipment



From
\$59.95

- 5 crystal-controlled transmit & receive channels
- Superheterodyne receiver with RF stage
- Built-in squelch and automatic noise limiter functions
- Available with or without built-in tone squelch selective call circuitry
- Convenient push-to-talk microphone—no relay
- Ideal for business or personal two-way radio communications

Kit Form
or
Factory
Assembled

New! SPECIAL DELUXE CB TRANSCEIVER . . . 5 Channels plus 4-Position Selective Calling—Exclusive with Heath!

An outstanding value for the serious CB user! Ideal for industrial and commercial use by fleet owners where many mobile units are required. The new GW-22 and GW-32 transceivers employ latest design features for long range communications with many extras for complete operating convenience and versatility. Performance and features exceed units costing several times this low Heathkit price!

Note these quality features: 5 crystal controlled transmit and receive channels; sensitive superheterodyne receiver with RF stage for increased sensitivity; high efficiency transmitter for greater output; built-in squelch and noise limiter functions for crisp, clear communications; improved push-to-talk circuitry eliminates need for relay. External connections for additional speaker also provided. In addition to these fine features the GW-32 models feature built-in selectable-call tone squelch (fully described on page 19) for added versatility and enjoyment in CB operations. This feature permits individual call of up to four different units operating on the same channel through use of a special four-tone resonant-reed relay . . . eliminates hearing unwanted CB conversations . . . stops annoying speaker hiss and noise during periods of standby.

Attractive styling features anodized trim strip and speaker grille set against dark brown panel.

Kit GW-22A (117 v. ac.) Less Selective-Call function 11 lbs.
no money down, \$6 mo. **\$59.95**

Kit GW-22D (6 or 12 v. dc.) Less Selective-Call function, 11 lbs.
no money down, \$7 mo. **\$64.95**

Kit GW-32A (117 v. ac.) With built-in Selective-Call, 12 lbs.
no money down, \$9 mo. **\$84.95**

Kit GW-32D (6 or 12 v. dc.) With built-in Selective-Call, 12 lbs.
no money down, \$9 mo. **\$89.95**

FACTORY WIRED AND TESTED (Available October):

Assembled GWW-22A (117 v. ac.) Less Selective-Call function, 11 lbs.
no money down, \$10 mo. **\$99.95**

Assembled GWW-22D (6 or 12 v. dc.) Less Selective-Call function, 11 lbs.
no money down, \$11 mo. **\$104.95**

Assembled GWW-32A (117 v. ac.) With built-in Selective-Call, 12 lbs.
no money down, \$13 mo. **\$136.95**

Assembled GWW-32D (6 or 12 v. dc.) With built-in Selective-Call, 12 lbs.
no money down, \$14 mo. **\$141.95**



EASY TO OPERATE: Simple controls consist of volume and squelch controls, channel selector, tone selector and tone call button.

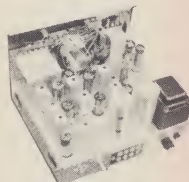

ADVANCED DESIGN CIRCUITRY: Latest design features assure top performance, long and faithful service. High quality components used throughout. Terminals for external speaker, external alarm, and time delay control shown on back panel.



SELECTIVE-CALL: Permits individual call of any similarly equipped unit. Just set tone selector and push tone call button to activate the other unit.



SPECIFICATIONS—RECEIVER SECTION: General description: 5-tube superheterodyne circuit with built-in squelch, noise limiter, RF amp., and switched 4-tone tone squelch functions. **Crystal controlled receiver tuning range:** Up to five of the 23 citizen's band channels as determined by the particular crystals installed in the unit. **Intermediate frequency:** 455 kilocycles. **Sensitivity:** 1/2 microvolt for a 10 db signal-to-noise ratio. **Selectivity:** 7.5 kc at points 6 db down from peak response. **TRANSMITTER SECTION:** **Nominal power input to final RF amplifier:** 5 watts. **Frequency control:** 3rd overtone quartz crystal as selected by the 5-position channel Selector Switch. **Frequency control effectiveness:** Operating frequency will be within .005% of nominal crystal frequency over an ambient temperature range of -20 to +130 degrees F. **Modulation:** AM plate modulation automatically limited to less than 100%. **Output impedance:** 50-70 ohms. **GENERAL: Tube complement:** 6CB6 receiver RF amplifier; 6U8 triode receiver crystal oscillator, pentode mixer; 6BJ6 IF amplifier; 6BJ7 detector diode, squelch diode, noise limiter diode; 6AN8 Pentode first audio amplifier, triode microphone preamplifier; 6AQ5 combination audio output modulator; 6AU8 triode transmitter oscillator, pentode driver; 5763 RF final amplifier; 6AN8 voltage amp cathode follower (tone section); 6C4 relay control tube (tone section). **Power requirements:** GW-32A—117 volts, 50/60 cps AC, 50 watts; GW-32D—6 volts DC, 8.0 amperes, 12 volts DC, 4.5 amperes. **Dimensions:** 9 1/4" D x 6 1/4" H x 9 1/2" W.

Save Up To 50% With Heath Do-It-Yourself Electronic Kits

Heathkit® Has The World's Biggest C-B Line!



- Extra transmitter stage for increased power
- Sensitive superheterodyne receiver
- Adjustable squelch—automatic noise limiter
- Crystal controlled or variable receiver tuning
- 3 crystal-controlled transmitting channels
- Push-to-talk microphone—tuning meter



Kit Form or Factory Assembled

A handsome economical unit for home or mobile installations

This popular Heathkit transceiver features handsome low-profile styling and many operational features for convenience and high performance in Citizen's Band communications. Reliably covers distances of up to 10 miles for hundreds of uses in business and personal communications.

Attractively styled in two-tone mocha and beige it is equally suited for either "home" GW-11A or "mobile" GW-11D installations. Neat, compact size permits easy under-dash mounting in automobiles.

Operational features include a convenient push-to-talk microphone, switch-selection of a crystal-controlled receiving channel or variable tuning of all channels. An illuminated dial, tuning meter and vernier tuning action permit smooth, easy station selection.

Other features include an extra transmitter stage for increased output power, built-in AC or DC power supply, sensitive superheterodyne receiver, "series-gate" noise limiter to minimize impulse-type noises (ignition interference, etc.) and adjustable squelch to silence the receiver during standby. Transmitter and receiver crystals for one channel are included (specify choice channels 1 to 23). 11 lbs.

CLEAN CONSTRUCTION: Neat placement of components makes assembly, maintenance, or adjustments simple. Note the high quality parts used throughout for years of trouble-free operation.

- Kit GW-11A (117 v. ac) . . . no money down, \$7 mo. **\$69.95**
- Kit GW-11D (6 or 12 v. dc) . . . no money down, \$7 mo. **\$69.95**
- Assembled GWW-11A (117 v. ac) . . . no money down, \$10 mo. . . . **\$99.95**
- Assembled GWW-11D (6 or 12 v. dc) . . . no money down, \$11 mo. . **\$104.95**

GENERAL DESCRIPTION—Receiver section: 4-tube superheterodyne circuit with built-in squelch and noise limiter function. **Sensitivity:** 1 uv signal at antenna input produces 10 db signal to noise ratio. **Selectivity:** 7.5 kc at points 6 db down from peak response. **Transmitter section:** power input to final RF amplifier does not exceed 5 watts. **Frequency control:** 3rd overtone quartz crystal. **Frequency control effectiveness:** within .005% of nominal crystal frequency over an ambient temperature range of -20 degrees F to +130 degrees F. **Modulation:** AM plate and screen modulation automatically limited to less than 100%. **Output impedance:** 50-70 ohms. **Tube complement:** (1) 6U8 Triode receiver crystal oscillator, pentode mixer, (1) 6C4 Receiver variable oscillator, (1) 6BJ6 1F amplifier, (1) 6BJ7 Detector diode, Squelch diode, Noise limiter diode, (1) 6AN8 Pentode first audio amplifier, triode microphone preamplifier, (1) 6AQ5 Combination audio output-modulator, (1) 6AU6 Triode transmitter oscillator, pentode driver, (1) 5763 RF final amplifier. **Power requirements:** 117V AC version, 45 watts; 6V DC version, 7.5 amps; 12V DC version, 4.5 amps. **Dimensions:** 4½" H x 15" W x 5¾" D.

Citizen's Band Antenna Accessories . . .

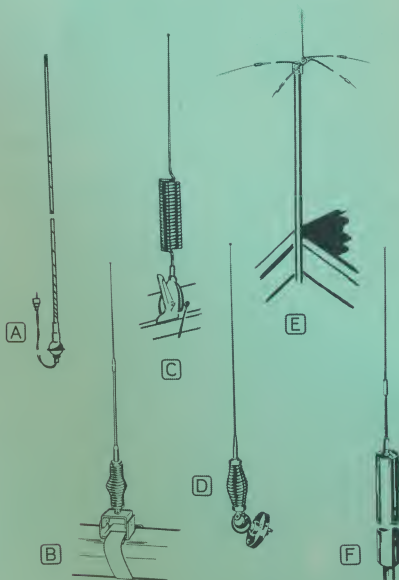

A Model GY-12 Cowl Mount Mobile ANTENNA

Continuously loaded 48" fiberglass whip. Excellent radiation pattern. Patented rocker support assures 8-point grounding. Furnished with 15' RG-58U cable and phono connector. 2 lbs. **\$8.95**

B Model GY-31 Bumper Mount Mobile ANTENNA

Excellent coverage in temporary or permanent mobile installations. Two-section 102" stainless steel whip antenna. Spring base. Stainless steel strap bumper mount. Includes hold down clip, 20' RG58AU cable, connector and hardware. 7 lbs. **\$14.50**

C Model GY-21 Mobile ANTENNA

For top coverage in permanent mobile installations. Two-section 102" stainless steel whip. Cadmium plated spring base. Swivel ball mount. Complete with mounting hardware, hold down clip, 20' RG58AU cable and connector. 5 lbs. **\$15.95**

D Model CBU-1 "Utility" ANTENNA

An excellent medium range antenna for temporary mobile or fixed station. Includes rugged clip mount and bracket. 45½" base loaded antenna with 12' cable and connector. 2 lbs. **\$9.95**

E Model CBF-1 "Fixed Location" ANTENNA

Excellent coverage non-directional ¼ wave "ground plane". Measures 9'4" from bottom of mounting bracket to top of vertical radiator. Complete with 50' RG58AU cable and mounting clamp. 6 lbs. **\$17.95**

F Model GY-11 "Fixed Location" ANTENNA

Omnidirectional operation, low radiation angle and low swr for outstanding CB communications. 18' ½ wave coaxial antenna consists of a 9' two-section aluminum rod top element and a 9' two-section 2" diameter aluminum skirt. Mounts on a 12' length of ¾" IPS pipe (not supplied). Includes 50' RG58AU cable and connectors. 6 lbs. **\$21.95**

Convert Your CB Station from "Party Line" Confusion to "Private Line" Convenience with the Exclusive New Heathkit 4-Position Selective-Call Kit



GD-162A
\$33⁹⁵

This new Heathkit also may be used with FCC type-accepted two-way radio equipment operating in any service where tone signaling is permitted. Examples are the Industrial, Business, Taxicab, Motor Carrier, Automobile Emergency, Railroad, Forest Products, Petroleum, and Power Radio Services.

- Eliminates hearing unwanted conversations on crowded CB channels
- Equips your station for selective calling
- Switch selection of four different tone signals
- All-tone monitor position—built-in power supply
- Relay contacts for connection of external alarm device
- Defeat switch allows normal operation at any time
- Easy to install on most popular CB units
- Another Heathkit First!

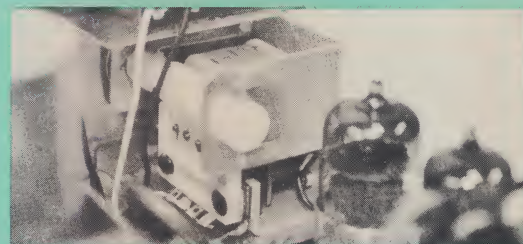

RESONANT REED RELAY: Tuned reeds produce calling tone or resonate at frequency of received signal to actuate switching relay.

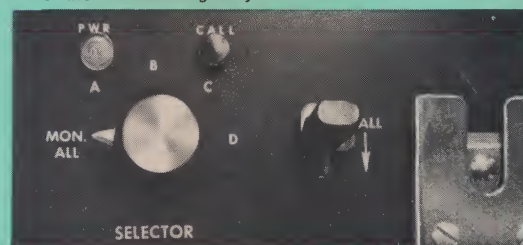

TONE SELECTOR: Front panel switch permits selective call on four different tone frequencies, plus single or all-tone monitoring.

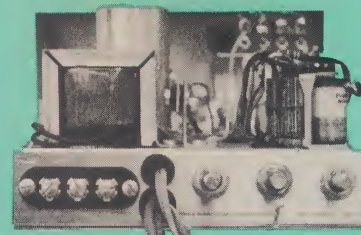

PROVISION FOR EXTERNAL ALARM: Terminal strip contacts permit connection of external alarm device such as buzzer, bell, etc., to alert listener when not in immediate vicinity of CB unit. Relay time "hold" adjustment, input and output controls are provided.

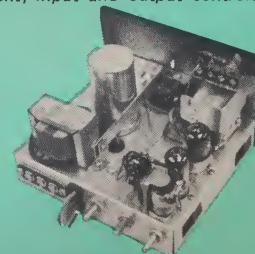

NEATLY DESIGNED: Quality components and well-engineered circuitry assure long-life and dependable performance. Easy to assemble and connect with complete instructions furnished.

First totally-new advance in CB equipment in two years! The new Heathkit Selective-Call Tone Squelch Kit offers many advantages on crowded Citizen's Band frequencies . . . permits selective-calling of up to four different units operating on the same channel . . . eliminates hearing unwanted conversations . . . stops annoying speaker hiss or noise during periods of standby!

Here's how it works . . . connected to your CB transceiver, the Tone Squelch operates as a speaker switch that is controlled by a resonant-reed relay which leaves the receiver speaker disconnected until actuated by a selected tone of sufficient intensity and duration to trip the relay. The relay then connects the speaker for a few seconds for you to hear the call letters and again returns to silent position. If the call is for you, just lift the microphone from its switched clip (to disable the tone-squelch) and carry on a normal conversation in the usual manner. Another advantage of using Heathkit tone squelch is that the absence of sound prior to receiving a signal immediately "alerts" the listener when a personal call is being received.

The resonant-reed relay provides four different tone frequencies to permit selective calling in multiple CB installations. To originate a call you need simply pick up the microphone, push the tone lever, call the station desired and wait for an answer! An all-tone monitor position is provided on the five-position tone selector if you desire to listen to all calls in your group. Other features include a manual defeat switch for normal operation, input and output level controls, a 0-to-10 second relay "hold" adjustment and terminal strip contacts for connection of an external alarm device, such as a buzzer, bell, etc., to alert the listener when not in the immediate vicinity of the CB unit. One GD-162 with each of your CB transceivers provides complete selective calling capability on both transmit and receive functions. Orders for multiple units will be shipped with the same tone-group relays. Installation instructions are included for most popular CB transceivers employing push-to-talk microphone. 6 lbs.

Kit GD-162A (AC) . . . no money down, \$5 mo. **\$33.95**
Kit GD-162D (DC) . . . no money down, \$5 mo. **\$37.95**

SPECIFICATIONS—Power requirements: AC version: 15 watts. DC version: 6 V—2 amps; 12 V—1.25 amps. **Controls:** Input and output level controls permit use with a wide variety of transceiver designs. A "Reset Time" control permits variations in "Speaker on" time after a tone is received. **Dimensions:** 6 $\frac{1}{2}$ " W x 4 $\frac{1}{4}$ " H x 6 $\frac{3}{4}$ " D.

You Get Twice As Much For Your Budget With Heathkit

Heathkit® Citizen's Band "Walkie Talkies".



Deluxe 9-transistor "WALKIE TALKIE" SUPERHET TRANSCEIVER . . . More features than units selling for twice the price!

- Crystal-controlled superheterodyne receiver with RF stage
- Built-in squelch & noise limiter circuit
- Better than 1 UV sensitivity for 10 DB S/N ratio
- Crystal-controlled transmitter
- 9-transistor circuit
- Economical battery power supply
- Handsomely styled two-tone aluminum case
- 1 to 3 mile operating range
- Conforms with FCC regulations, part 15 & 19
- No license, forms, tests or age limit requirements
- Easy circuit board assembly
- Hundreds of uses in business, industry & personal applications

This deluxe Heathkit "Walkie Talkie" is beautifully designed throughout for both ease of assembly and power-packed performance! Provides more features than units selling for twice the price, for an outstanding value in portable, two-way radio communications!

Features include crystal control of both transmit and receive functions, sensitive superheterodyne receiver with RF amplifier, squelch and automatic noise-limiter circuits for crisp, clear communications and a high efficiency transmitter with up to 100 milliwatts input. Effective communications can be maintained from 1 to 3 miles with similar units in unlicensed operation or can be extended in range considerably by using with licensed Class "D" Citizens Band units. Under extremely favorable conditions, communications may be established up to 10 miles.

Operation of the GW-21 is simple with only three controls—on/off—volume; squelch; and push-to-talk switch. An earphone and jack are provided for private reception. The 35" whip antenna collapses completely into the case for easy carrying. Operates up to 75 hours using a single 9-volt battery. Ideal for surveyors, construction workers, sportsmen, farmers, etc., for handy two-way radio communications. 2 lbs.

Kit GW-21 . . . no money down, \$5 mo. \$44.95

Kit GW-21-2 (pair) 4 lbs. no money down, \$9 mo. \$84.95

Assembled GWW-21 . . . no money down, \$8 mo. \$71.95

Assembled GWW-21-2 (pair) 4 lbs. . . . no money down, \$13 mo. \$136.50

GWA-30: BATTERY SET: (2) one for operation, one spare . . . 1 lb. \$2.95

GW-21
\$44⁹⁵

Kit Form
or
Factory
Assembled

SPECIFICATIONS—Receiver section: *Receiver Type—Crystal controlled, superheterodyne; Sensitivity—1 uv for 10 db SN; Selectivity—7.5 KC @ 6 db; Audio Power Output—150 mw; Speaker-Mike—2½" round PM; Controls—OFF-ON Volume and Squelch. **Transmitter section:** RF Input Power—100 mw; *Frequency Unlicensed—Crystal controlled 26.975 to 27.255 mc (any channel, 2 through 23, in the 11-meter band); *Frequency Licensed—Crystal controlled 26.965 mc to 27.255 mc (any channel, 1 through 23 in the 11-meter citizen's band); Crystal—Subminiature, plug-in type, tolerance .005%; Modulation—High level AM limited to less than 100%; Control—Single push-to-talk switch on side of cabinet. **Power supply:** **Battery—9 V type Neda #1602, Eveready #246, Burgess #2N6, Mallory #M1602, Ray-O-Vac #1602, RCA #VS305; Battery Life—Approximately 75 hours (normal intermittent use); Total Receiver Current Drain Standby—Approximately 12 ma; Total transmitter Current Drain—Approximately 30 ma. **General:** *Antenna—35" whip type, collapsible completely into cabinet; Transistors and Diodes—1-2N1726 RF amp, 1-2N1727 converter, 2-2N1108 IF amp, 3-2N185 audio, 1-R425 trans osc., 1-R424 RF amp, 1-Germanium Diode-detector, 1-Silicon Diode—squelch & noise limiter. **Cabinet dimensions:** 7½" H x 3¾" W x 1¾" D.

*Specify desired channel when ordering crystals. See crystal list.

**The antenna supplied and the specified battery must be used to insure compliance with FCC Rules & Regulations, Part 15.

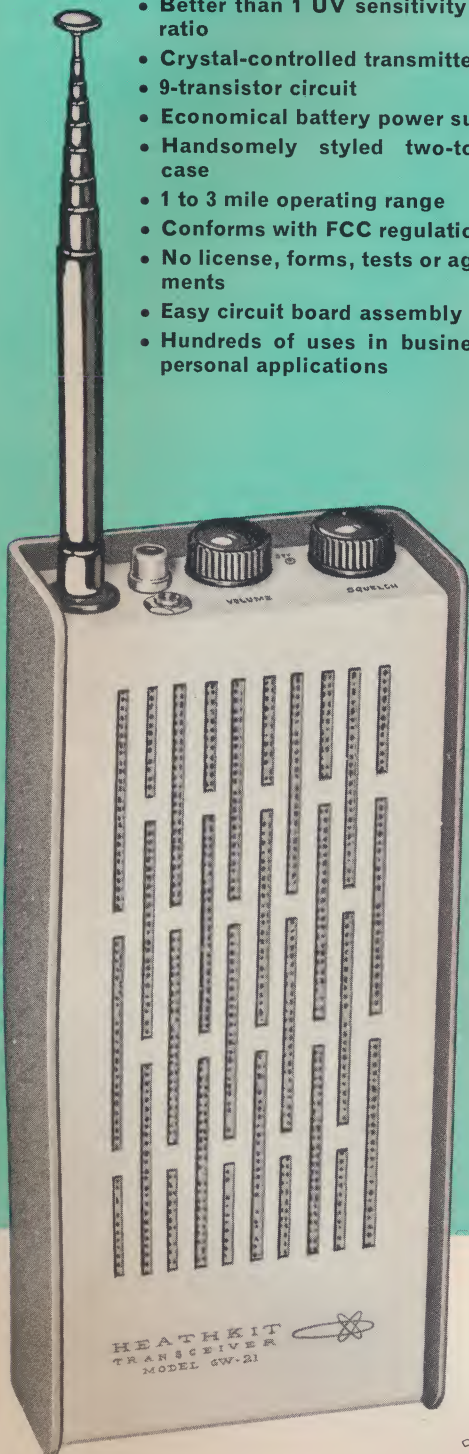

HEATHKIT
TRANSCIVER
MODEL GW-21

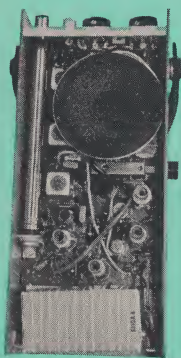

SIMPLE CONTROLS: Just set volume and squelch controls to desired level, push button on side to talk, release to listen! External antenna socket for extended range in licensed operation and earphone jack for private communications also shown.

EASY CIRCUIT BOARD ASSEMBLY: Prevents errors, assures fast, easy assembly and high stability.

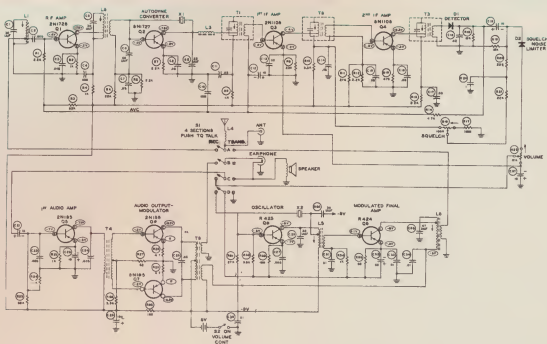

For Portable Two-Way Radio Communications

Low cost 4-transistor "WALKIE-TALKIE" . . .

Fun to build . . . Fun to use!

A sensational value at only \$46.00 a pair!

- No license, forms, tests or age limit requirements
- Hundreds of uses in business and personal communications
- Operates up to 1 mile between units . . . more with regular class "D" Citizen's Band Station
- Crystal-controlled transmitter—superregenerative receiver
- Small, compact, neatly styled in brown & beige steel case
- Simple circuit board construction
- Operates from a single 9-volt battery for up to 75 hours use
- Fully certified for unlicensed or licensed use (FCC regulations, parts 15 & 19)

GW-31
\$24⁹⁵



Kit Form
or
Factory
Assembled

You'll find this handsome hand-held walkie-talkie ideal for short-range, two-way radio communications. Conservatively rated, the Heathkit GW-31 is a low-cost, pocket-size transmitter and receiver combination which will cover an area ranging from 2 blocks to a mile or more, depending upon location and terrain. Ideal for use in business, industry, or personal use. Surveyors, construction workers, farmers, hunters, fishermen, etc., all have uses for this handy walkie talkie, to keep in touch with one another, coordinate functions, control operations, direct material handling, and many more useful applications! The GW-31 is attractively styled in a rugged steel case with brown and beige color. Its small compact size makes it easy to hold and operate.

Just two controls operate the unit . . . an on/off volume control and push-to-talk switch. The receiver is fixed-tuned to the frequency you wish to use and requires no further adjustment after initial setting. The specially-designed circuit features a frequency response tailored for maximum intelligibility in the voice range for crisp, clear communications. The 36" telescoping whip antenna collapses into the unit for easy carrying when not in use or slips easily into coat or trouser pocket. Assembly of the GW-31 is simple . . . all components mount on a circuit board that guards against wiring errors and assures consistent, reliable performance. Operates up to 75 hours on a single 9-volt battery. No license required for operation between similar units. Kit includes all parts, instructions and crystal for 1 channel (specify frequency, see list below). Less battery. 2 lbs.

Kit GW-31 . . . no money down, \$5 mo.	\$24.95
Kit GW-31-2 (pair) . . . 4 lbs., no money down, \$5 mo.	\$46.00
Assembled GWW-31 . . . no money down, \$5 mo.	\$37.75
Assembled GWW-31-2 (pair) . . . 4 lbs., no money down, \$8 mo.	\$71.95
GWA-30: BATTERY SET: (2) one for operation, one spare . . . 1 lb.	\$2.95

SPECIFICATIONS—Receiver: Superregenerative detector. **Sensitivity:** Usable with signals as low as 4 uv at antenna terminals. **Tuning range:** Fixed (by internal adjustment) to any channel, 1 through 23. **Audio power output:** 30 milliwatts. **Speaker:** 3.2 ohm, round. **Controls:** on/off volume, push-to-talk switch. **Transmitter RF input power:** approx. 90 milliwatts. **Transmitter frequency:** Crystal controlled unlicensed channels 2 through 23 (channel 1 through 23 for licensed operation). **Crystal:** Subminiature, plug-in type, .005% tolerance. **Microphone:** 3.2 ohm speaker. **Modulation:** high level AM limited to less than 100%. **Antenna:** 40" whip type, collapsible to 7 1/2". **Battery:** 9 V. **Battery life:** Approx. 75 hours (normal intermittent use). **Transistors:** 2N1108, R424, (2) 2N185. **Dimensions:** 6 1/2" H x 3 1/4" W x 2 3/4" D.

NOTE: Fully certified for unlicensed communications with similar transceivers operating in 26.97 to 27.27 mc band, under part 15 of FCC regulations. Since GW-31 is designed to comply with the requirements of part 19 of FCC regulations, it can also be used and licensed for communications with Class D Citizen's Band stations.

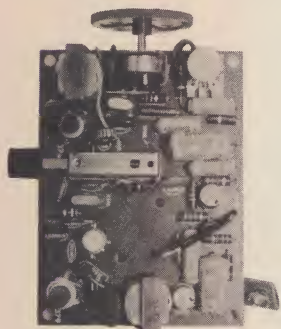

EASY CIRCUIT BOARD ASSEMBLY



CLASS D CITIZEN'S BAND CHANNEL NOS. AND FREQUENCIES

†1. 26.965 mc	7. 27.035 mc	13. 27.115 mc	19. 27.185 mc
2. 26.975 mc	8. 27.055 mc	14. 27.125 mc	20. 27.205 mc
3. 26.985 mc	9. 27.065 mc	15. 27.135 mc	21. 27.215 mc
4. 27.005 mc	10. 27.075 mc	16. 27.155 mc	22. 27.225 mc
5. 27.015 mc	11. 27.085 mc	17. 27.165 mc	*23. 27.255 mc
6. 27.025 mc	12. 27.105 mc	18. 27.175 mc	

†Cannot be used for unlicensed operation of GW-30, GW-31, and GW-21

*Shared with Class C Radio Control

NOTE: Specify first and second choice of frequencies. When ordering several units, specify frequency for each.

Heathkit Performance Specifications Are Guaranteed

Check Ignition Systems the Easy Heathkit® Way



Kit Form
or
Factory
Assembled

IO-20
\$89⁹⁵

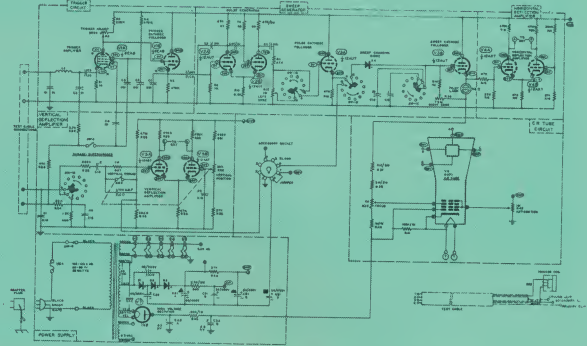

Tell-tale Patterns Show Ignition System Condition

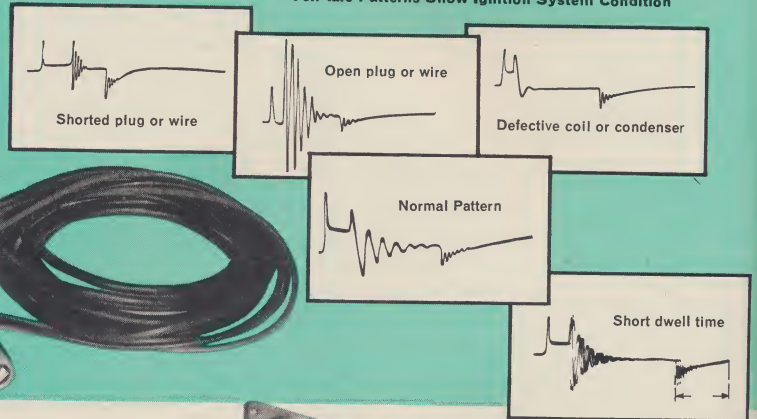

The Heathkit IGNITION ANALYZER is easier to use, easier to buy

- Shows trouble spots and results of corrective action taken
- Switch-selection of 4 different patterns without lead switching
- New improved trigger circuit for steady, locked-in patterns
- Vertical and horizontal "expand" for magnified views
- Easy to use, with complete instructions provided

Professional or hobbyist, with the Heathkit IO-20 Ignition Analyzer you can check the entire ignition system of any automobile easily and economically while the engine is operating and without removing any parts.

Designed by Heathkit engineers in close cooperation with major oil industries and automotive ignition specialists, the IO-20 lets you observe the common ignition system defects . . . shorted spark plugs, bad points, defective wiring, worn distributor parts, incorrect point dwell time, coil and condenser problems, etc. The special flexible switching system lets you select primary, secondary, parade or superimposed patterns without lead switching. With this versatile unit, you can easily see where the trouble spots are and observe the results of the corrective action taken. A new, improved trigger circuit provides a steady locked-in pattern display with vertical and horizontal expand for magnified views of any waveform, and features a current transformer housed in a rugged plastic clamp. Low power requirements make it ideal for use with a DC to AC inverter for "on-the-road" testing. Complete instructions included.

Corrosion-resistant aluminum case has brushed aluminum front panel, easily cleaned green enameled body, and convenient carrying handle; measures 8" H x 9½" W x 16" D. 15 lbs.

Kit IO-20 . . . no money down, \$9 mo. **\$89.95**
Assembled IO-20 . . . no money down, \$16 mo. **\$169.95**

SPECIFICATIONS—RPM range: 400-5000 rpm. **Displays:** Secondary, Primary, Parade, Superimposed. **Screen size:** 4¼" diameter. **Dwell measurement:** 4, 6 & 8 cylinder calibration on face plate. **Pattern height:** Secondary circuit, approx. 1"; Primary circuit, 6 volt system ¾", 12 volt system 1". **Vertical expand ratio:** 2 to 1. **Horizontal expand ratio:** 10 to 1. **Cable length:** 12' pickup clamp, 2' ground, primary and secondary clips. **Front panel controls:** Vertical position, right edge, left edge, **Front panel switches:** Parade-Superimposed, 6-position rotary; Off, secondary expand, secondary normal, primary normal, primary expand and accessory. **Internal controls:** Focus, astigmatism, trigger adjust. **Trigger method:** Current transformer clamp in rugged plastic housing. **Tube complement:** 5UP1, 1V2, 6EA8, 12AU7(2), 12AX7(2). **Rectifiers:** (3) silicon. **Power requirements:** 105-125 V, 50/60 cycles AC, 30 watts.

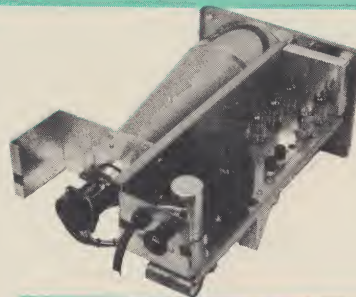

QUALITY CONSTRUCTION
includes extras like the CRT shield for minimum trace distortion, husky power transformer, neat, easy-to-build circuit layout.

ID-11
\$14⁹⁵



Kit Form
or
Factory
Assembled

Ignition TIMING LIGHT Accessory

- Intense white light
- Plugs into IO-20 Analyzer
- Hard rubber case with 10' cable

This convenient accessory plugs directly into the IO-20 Ignition Analyzer only, and is specially designed to assist you with your diagnosis. The unit produces an intense white light that shows timing marks on the engine even in brightly-lighted areas. It has a speed range of 0-1250 flashes per minute (0-2500 rpm for 4-cycle engine of current conventional automobiles). The hard rubber pistol-grip case with convenient 10' cable assures long life. Dimensions: 6" H x 7½" L x 2" W. 2 lbs.

Kit ID-11 **\$14.95**
Assembled IDW-11 **\$19.95**

Heathkit® Radio-controlled Garage Door Operator

- Opens and closes garage doors automatically
- Operates overhead track, and most jamb, or pivot type doors up to 8' high
- Fool-proof safety device disengages door upon meeting any obstruction
- Easy to install—complete instructions furnished
- Transmitter, receiver, and mechanism available separately or as a combination

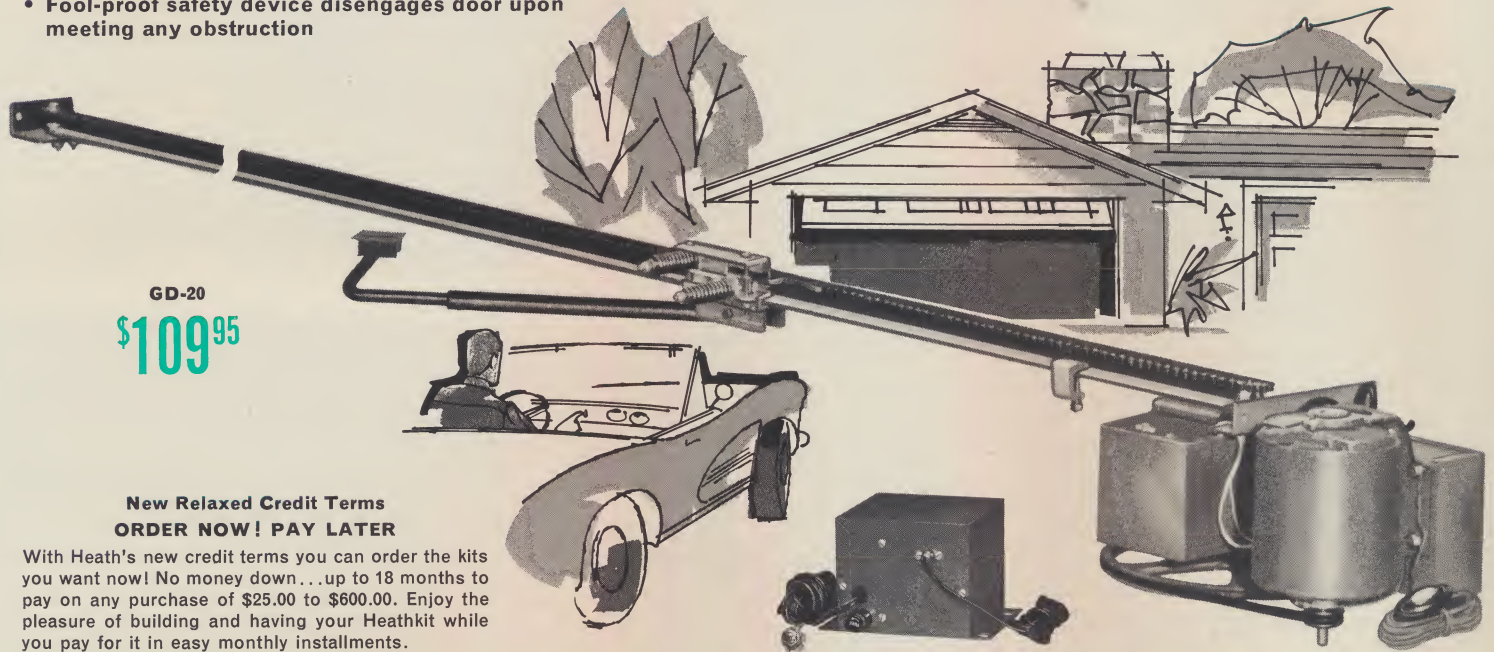

GD-20
\$109⁹⁵

**New Relaxed Credit Terms
ORDER NOW! PAY LATER**

With Heath's new credit terms you can order the kits you want now! No money down... up to 18 months to pay on any purchase of \$25.00 to \$600.00. Enjoy the pleasure of building and having your Heathkit while you pay for it in easy monthly installments.

Driving up to your garage is a pleasure when you own this time and effort saving Heathkit GARAGE DOOR OPERATOR

Enjoy the convenience of your own garage door opener! With the touch of a button, your garage can be opened, lighted, and closed without leaving the comfort of your car. No more getting out in the weather... no more lifting and straining... no more groping in the darkness. Kit includes all parts and instructions for easy assembly. Mechanism may be purchased separately for push-button operation from house or remote location, or complete with transmitter & receiver for radio-controlled operation.

"High Power" transmitter and special receiver design prevent operation from all but strongest of signals. Selectable tone-coding of signal permits operation of similar units in an area without interfering with each other. Mechanism is simple and easy to install, with a minimum of parts for long, reliable, trouble-free operation. Requires just 2 1/2" clearance above highest point of door travel. Any number of switches may be connected to the mechanism to operate door from house or garage, etc.; one is included with kit. Switch circuit uses safe 12 volt line for easy, inexpensive wiring.

Mechanism provides for a light that automatically turns on when door is opened and remains on for several minutes after door closes allowing time to enter house or to switch on main lights. This feature may be extended to control driveway, patio, breezeway lights, etc.

A unique safety device stops door by releasing it from mechanism should it meet an obstruction or fail to operate for any reason. Each direction of door travel has a separate, adjustable safety release. Operating force is adjustable to provide safe, gentle operation and a spring-loaded connecting arm assures a tight weather seal when door is closed. Multiple speed selection provides slower speed required by Jamb and Pivot type doors. Operation cycle is approximately 10 seconds. Order this handy household servant today and enjoy its time and labor saving conveniences!

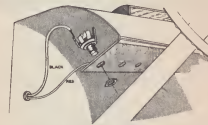

DASH-MOUNTED CONTROL BUTTON

No fumbling with unattached, separate mechanisms, this control button can be inconspicuously located on your automobile dashboard. Just touch it and your garage door opens!

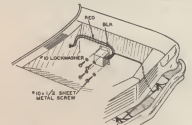

HIDDEN TRANSMITTER

This unit signals your garage door receiver to start the door mechanism operating. It can be located anywhere under the hood of your car, protected, out of the weather yet readily accessible.

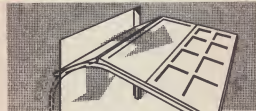

UNIVERSAL MECHANISM

Motor and mechanism will operate overhead and most jamb or pivot type residential garage doors... sizes up to 8' high!



MANUAL OPERATING SWITCH

Supplied with your kit, can be connected inside your house in any convenient place to permit opening the garage door without the use of the radio transmitter in your car.

- Kit GD-20; Mechanism, transmitter & receiver... 67 lbs... no money down, \$11 mo... **\$109.95**
- Kit GDA-20-1; Transmitter, 4 lbs... no money down, \$5 mo... **\$24.95**
- Kit GDA-20-2; Receiver, 3 lbs... **\$16.95**
- Kit GDA-20-3; Mechanism, 58 lbs... no money down, \$7 mo... **\$69.95**

TRANSMITTER SPECIFICATIONS—6 or 12 volt operation, 5 watts max. (FCC requirements) to final, 3 modulation frequencies approx. 2KC, 2.9KC & 3.7KC. Fused. 4 1/4" wide x 6" long x 4" high. 6AU8 & 12BH7. 27.255MC crystal controlled.

RECEIVER SPECIFICATIONS—117 V.A.C. 4 1/4" wide x 6" long x 4" high. 6BH6 & 6CB6. 10 W idle, 12 W with signal. 27.255 MC. 3 audio filter frequencies approx. 2KC, 2.9KC & 3.7KC adjustable to match Xmitter. Fused.

MECHANISM SPECIFICATIONS—126" length x 8 1/2" high x 13" wide. 100# max. operating force. Operate doors up to 8' high. 117 V.A.C. 1/2 H.P. motor. Fused.

Enjoy Your Heathkit Equipment While You Buy On Heath's Easier Time-Pay Plan—No Money Down

Heathkit®... the Value Standard in Marine Gear

MI-11
\$69.95

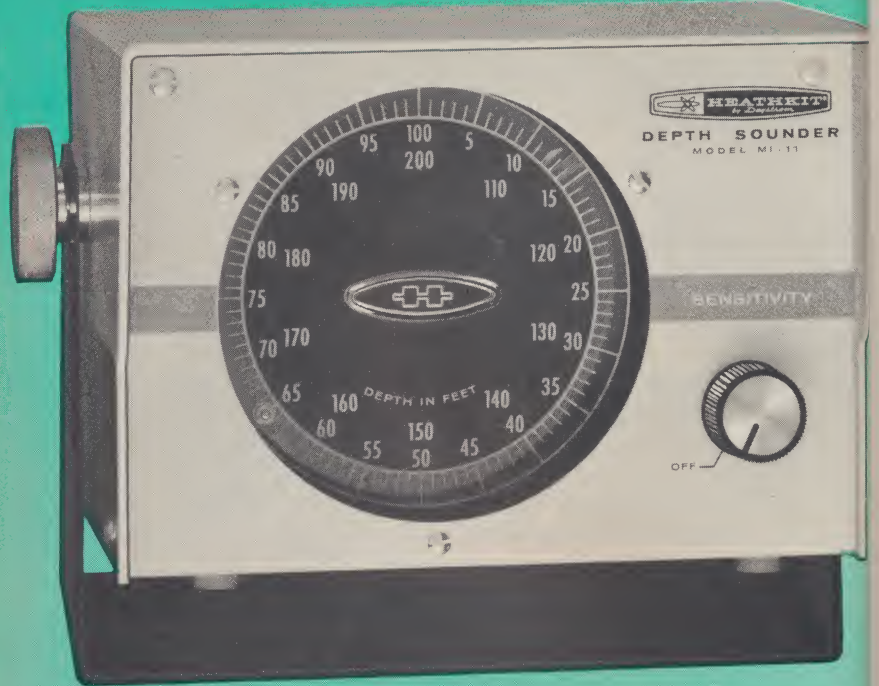

The new, improved Heathkit DEPTH SOUNDER has greater "depth reaching" ability and fresh, new styling, yet costs only \$69.95!

- Shows depth to at least 200 feet on hard bottom
- Five-transistor circuit with tuned amplifiers
- Circuit board construction—easy to build
- May be powered by internal or external batteries
- New compact cabinet in Heathkit advanced styling

Here's the successor to the famous Heathkit MI-10 depth sounder . . . the unit that set the value-pace for lower cost marine sounders. This new model, the MI-11, maintains that value-pace and adds extra performance features to make it an even more desirable addition to your boat's safety measures.

Styling of the new cabinetry is in the "sun-shield" form factor of Heathkit-Marine . . . a handsomely functional design in rust-resistant aluminum . . . finished in gray, white and black with accents of blue. Inside this beautiful cabinet is an improved circuit which uses five transistors, extra shielding and tuned amplifiers to achieve greater range . . . at least 200 feet on hard sandy bottoms, 100 feet on soft muddy bottoms. (100 feet for each dial revolution, calibrated to 200').

The two-conductor transducer cable and the cabinet act as extra shielding to reduce pickup of external electrical signals and ignition noise. Provision is made for powering from your boat's 12 volt battery if desired, maintaining the internal battery as emergency power. Construction is fast and easy with the new circuit board. Comes complete with "gimbal" type bracket for universal mountings. 9 lbs.

Kit MI-11 . . . no money down, \$7 mo. \$69.95

EASY TO BUILD
Printed circuit board construction—fast, easy with stability and uniformity assured.

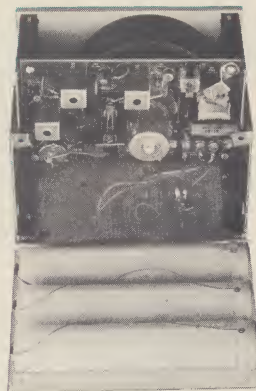

BATTERY POWERED FOR PORTABILITY Uses 9 standard flashlight batteries to make it independent of power lines; use it anywhere . . . it works everywhere.

SPECIFICATIONS—Dial: 0-200 feet in one foot divisions. **Range:** 0-200 feet on hard bottoms, 0-100 feet on soft bottoms. **Frequency:** 200 kc. **Sounding rate:** 1440 soundings per minute, or 24 per second. **Accuracy:** Within 5% of actual depth. **Depth indication:** Neon lamp flashing at 0 feet and again at indicated depth. **Transducer:** Barium titanate ceramic element encased in a waterproof housing with solid brass fittings; attached 15 foot length of 2 conductor shielded cable. May be mounted permanently to the hull or temporarily with a transom mount. **Controls:** Combined ON/OFF-Sensitivity. **Power supply:** 13.5 volts from nine self-contained size C flashlight cells, or external 12 volt battery. Flashlight cells are contained in three leakproof plastic housings. **Battery drain:** 50 milliamperes. **Average battery life:** 50 hours intermittent operation, 25 hours continuous operation. **Dimensions:** 7 1/4" W x 5 1/4" H x 7 1/2" D.

Accessory TRANSDUCER MOUNT for Depth Sounder

- Eliminates drilling through hull

This simple device, expressly designed for Heathkit Depth Sounder Transducers, eliminates the necessity of drilling through the hull of your boat, yet permits a permanent-type transducer mounting. Made of aluminum and plastic, it is completely adjustable to allow for the angle of the transom, and to maintain the proper depth.

Model MIA-11, 2 lbs. \$8.95



MIA-11
\$8.95



MR-21
\$109⁹⁵



**The Heathkit "Mariner"
3-BAND DIRECTION FINDER,
with improved performance and
handsome new styling, is a greater
marine radio value than ever!**

- Covers beacon/consolan, broadcast and marine telephone bands
- 10-transistor, 1-diode circuit
- Built-in BFO for receiving Consolan or CW signals
- Easy access to battery power supply
- Easy to build with prewired component package and pre-assembled tuner
- New styling, new colors
- Batteries last 500-1000 hours

Successor to the famous MR-11 and DF-3 Heathkit direction finders, this improved model offers new performance features, greater sensitivity, and a striking new cabinet . . . yet it costs no more than previous models. Ingenious engineering is the answer.

All bands function with greater sensitivity to provide you with greater range. New automatic gain control circuit gives a deeper null for easier bearing measurement. The beat frequency oscillator and extended tuning range put the convenience of Consolan navigation signals at your service for greater safety. Position bearings are shown on a large 6½" compass rose located under the rotatable ferrite loop antenna. A telescoping whip antenna and "sense" circuitry give true directions by resolving the confusion of the double null received on many RDF's. A big slide rule type tuning dial makes station selection easy, and the "tune-null" tuning meter aids accuracy when taking bearings. For added convenience during night use, a switch-selected dial and meter light is provided. The 4" x 6" PM speaker assures good tonal quality.

Handsomely styled in the new "sun-shield" form factor of Heathkit-Marine, the cabinetry is ruggedly attractive in rust resistant aluminum finished in gray, white and black with accents of blue. The new-design mounting bracket included protects your MR-21 by firmly holding it in position on board, yet permits easy removal when desired.

Put this Heathkit 3-band RDF aboard now for safety and for enter-

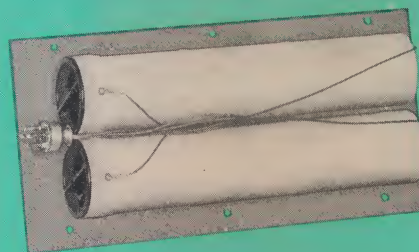

LEAKPROOF BATTERY HOLDERS
Protect your direction finder, keep interior ship-shape; easily accessible from rear of cabinet.

tainment . . . it's easier to build than ever with its prewired component package and preassembled and aligned tuner . . . it performs better than ever with its improved circuitry . . . it's better looking than ever . . . and it's a better value than ever at the same low price.

Kit MR-21, 12 lbs., no money down, \$11 mo. \$109.95

SPECIFICATIONS—Beacon band: 188 to 410 kc. Broadcast band: 535 to 1620 kc. Marine band: 1650 to 3450 kc. Sensitivity for 6 db signal-to-noise ratio: BC band, 40 uv/meter; Beacon band, 120 uv/meter; Marine band, 25 uv/meter. Normal bearing accuracy: ±3°. BFO: 455 kc, switch-selected. Speaker: 4" x 6" weather proofed. Power requirements: 9 volts from 6 standard size "D" flashlight batteries. Battery drain: 35 ma @50 mw output level. Battery life: 500-1000 hours. Dial light: Spring-return switch operated. Null and tuning indicator: 0-1 ma meter. Transistors: (1) T1363, (2) 2N1108, (1) 2N1109, (1) 2N1110, (1) 2N1111, (1) R251, (2) R250, (1) 2N238, (1) diode. Dimensions: 9" x 9¼" x 6½".

**New Relaxed Credit Terms
ORDER NOW! PAY LATER**

With Heath's new credit terms you can order the kits you want now! No money down . . . up to 18 months to pay on any purchase of \$25.00 to \$600.00. Enjoy the pleasure of building and having your Heathkit while you pay for it in easy monthly installments.

Kit Form or Factory Assembled, Your Dollar Buys More Value With Heath Equipment

Quality Design & Performance at Low Cost-

MWW-11A
\$259⁹⁵

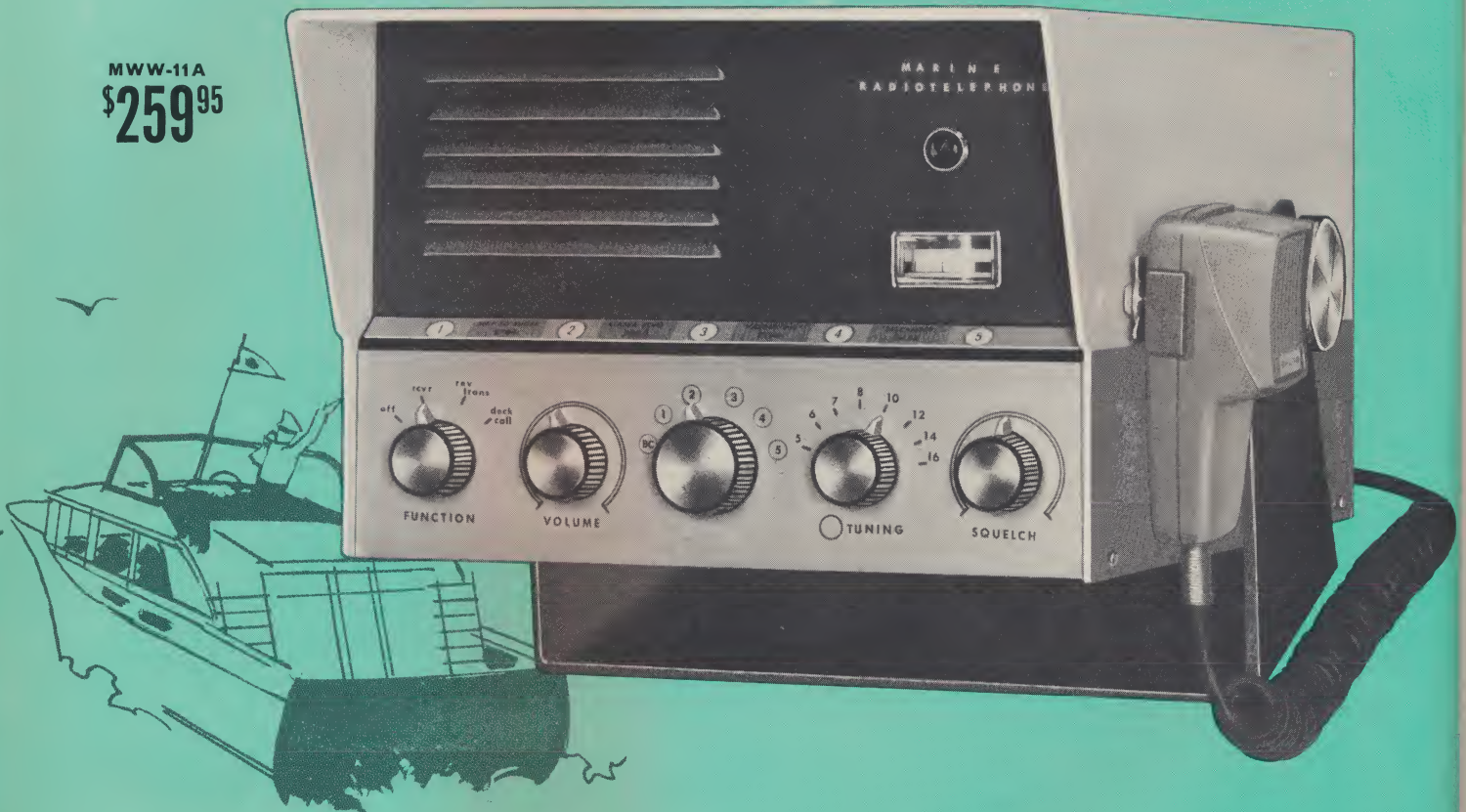

Heathkit transistorized TACHOMETER offers new high in versatility and accuracy

- Use with boat or car . . . works with all outboard and inboard marine engines and automobiles except diesels
- Two linear ranges . . . 0-4,000 and 0-8,000 rpm
- Unaffected by voltage or temperature variations
- Handsome brushed, anodized, die-cast aluminum case
- Lighted dial
- Simple installation and connections

The Heathkit MI-31 Tachometer can serve multiple duty for it works with many types of engines . . . 1-8 cylinder 2 cycle engines or 1-16 cylinder 4 cycle engines. Works with positive or negative ground ignition systems employing ignition coil and distributor; also operates with magneto systems when used with external battery. Range switch on back of housing selects either of the two ranges, making it usable for any application (idling, cruising or maximum speeds—inboard or outboard craft, standard or sports cars).

Multivibrator circuit uses two transistors and a zener diode for accuracy. Triggering pulse is taken across the distributor points, thus eliminating positive-negative ground problems. The zener diode maintains a constant operating point to eliminate errors caused by voltage variations. The brushed, anodized, die cast aluminum case makes a handsome appearance in any installation as well as effectively shielding the electronics (ball and socket permits universal mounting). Easy-to-build circuit board electronics. Lighted, translucent black dial with white numerals which glow red at night. 2 lbs.

Kit MI-31 \$22.95

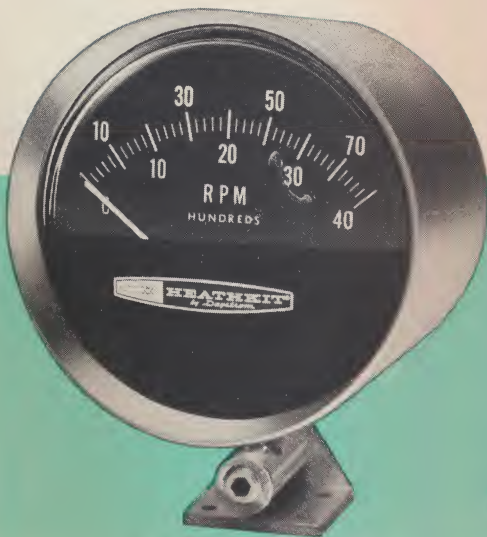

MI-31
\$22⁹⁵

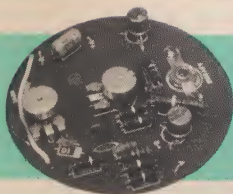

CIRCUIT BOARD CONSTRUCTION

All parts mount on this small printed circuit board enclosed in the handsome die-cast housing.

Heathkit 50-Watt Marine RADIOTELEPHONE . . . completely factory assembled and tested . . .

- Covers standard broadcast and 2-3 MC marine bands
- 5 crystal-controlled transmit & receive channels
- Dependable 8-transistor receiver
- Powerful 50 watt long-range transmitter
- Doubles as 8-watt deck-hailer or PA amplifier
- Built-in heavy-duty vibrator power supply
- F.C.C. type accepted

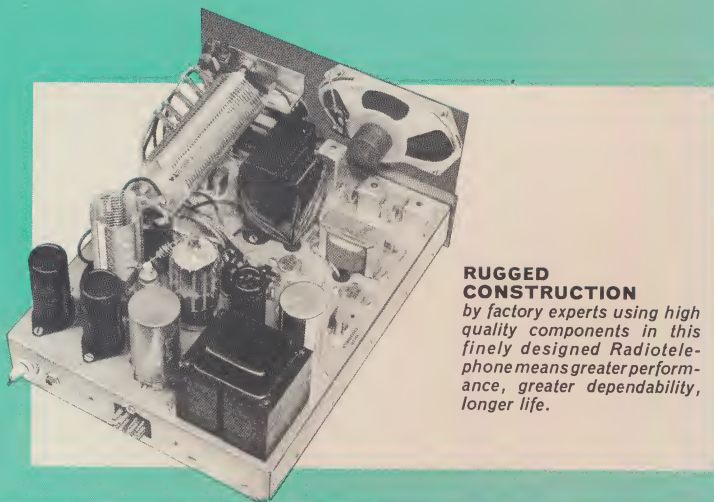

RUGGED CONSTRUCTION
by factory experts using high quality components in this finely designed Radiotelephone means greater performance, greater dependability, longer life.

An incomparable marine electronics value . . . extra performance features, highly styled beauty, and a market breaking low price . . . these characterize the Heath assembled and tested MWW-11A marine radiotelephone.

Circuit design features an 8-transistor receiver for dependable long-life performance with low current drain. Covers 2-3 mc marine band and standard broadcast band. Marine band is crystal-controlled in five switch-selected channels and broadcast band is variable tuned for complete coverage. Automatic noise limiter and front panel squelch control provide maximum clarity, minimum noise. 8-watt PA amplifier capability allows monitoring and entertainment or deck hailing. Powerful transmitter design with 12DQ6 final amplifier features 50 watt plate power input for strong signal output to reach that extra distance for added safety. 5 crystal-controlled transmitting channels and push-to-talk microphone permits convenient one-hand operation. A heavy-duty vibrator-type power supply is built in and features circuit breaker protection . . . no fuses. A panel meter indicates received signal strength or relative power output.

Styled in the new Heathkit Marine motif of gray, white and black with blue accents, the rustproof aluminum cabinet features a "sculptured" front panel (black upper section, blue offset ledge for easy reading of channel frequencies, and brushed aluminum lower section).

Included are, transmitter and receiver crystals for two channels (2182 and 2638 kc), mounting bracket, push-to-talk microphone with coil cord and mounting clip, installation and operating instructions. Final adjustments must be performed by an FCC licensed technician.

Assembled MWW-11A 25 lbs. no money down, as low as \$24 mo. **\$259.95**
Extra Transmitter & Receiver Crystals: any frequency in Continental U.S. 2-3 mc marine band. Specify transmitter and receiver frequency for each channel. Consult authorities in your area to determine frequencies most used. 1 lb. **\$2.95**

SPECIFICATIONS—Frequency range: 2-3 mc. **Broadcast:** 550-1600 kc. **Receiver sensitivity:** (providing 10 DB S/N ratio or better), Marine channels; 2 microvolts. Broadcast: 20 microvolts. **Audio output:** 3 watts to internal speaker, 8 watts to PA "deckcall". **Transistor complement:** (1) T1363 Mixer; (1) T1364 Oscillator; (2) T11364 I.F.'s (2) 2N1274 1st Audio and Squelch; (1) 2N301 Driver; (2) 2N1147 Audio Output and Modulator; (3) diodes, noise limiter and squelch. **Transmitter: RF input:** 50 watts. **RF output:** 25 W. min. **Transmitter tube complement:** (1) 6BA8 Oscillator and Buffer; (1) 12DQ6A Final Amplifier. **Power requirements:** 12 volts DC. Receiver only: 0.9 amp; Standby: 2.1 amp; Transmit: 13 amps. **Dimensions:** 7" H x 10" W x 13" D.

You can enjoy "shore-side" power aboard your boat
with this easy-to-build Heathkit

Marine POWER CONVERTER

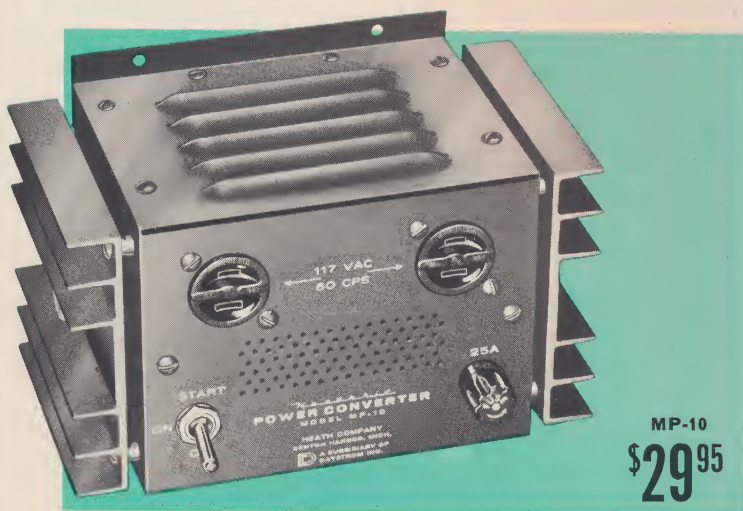

MP-10
\$29.95

SPECIFICATIONS—Power source: 6 or 12 volt storage battery. **Power output:** nominal 117 volt, 60 cycle AC; 12 volt operation, 175 watts continuous, 240 watts max.; 6 volt operation, 120 watts continuous and max. **Input Current for Continuous Ratings:** 6 volt operation, 25 amperes; 12 volt operation, 16.5 amperes.

- Converts 6 or 12 v. battery power to 117 v. AC
- Uses transistors for dependability and efficiency
- Two AC receptacles provided
- Ideal for lights and small appliances
- Compares with units costing several times more

Now you can enjoy the conveniences of regular household-type power aboard your boat. Just install this Heathkit Power Converter for plug-in power for lights or small appliances such as a soldering iron, small AC/DC radios, etc. (not recommended for TV sets, tape recorders, record players, portable refrigerators, or Citizen's Band transceivers which require alternating current with accurate wave form). The unit employs rugged power transistors to provide instant operation with no warmup period requirements. Finned "heat sinks" protect the transistors by dissipating heat quickly during maximum power loads. The unit is fused to protect it from overload damage. Two AC outlets and an on-off switch are provided for your convenience. Easy to build, you can assemble this unit in just a couple of hours. Measures 7½" x 5" x 5¼".

Kit MP-10, 7 lbs. . . . no money down, \$5 mo. . . . \$29.95

EK-1 **\$19.95**

Begin this Basic Education Series with the Heath BASIC ELECTRICITY Course EK-1

- Teaches basic electricity theory in everyday language
- Designed by science educators
- Results in handy DC meter of many uses

Designed for beginners in the field of electronics of junior high school level or above, this course teaches basic principles . . . the theory of voltage, current, and resistance, series and parallel DC circuits, meter circuits, and Ohm's law. The student performs basic experiments with dry-cell batteries, then begins assembly of an actual instrument which, when completed, is used to verify theorems in the text. The manual is profusely illustrated with pictorial diagrams that guide the reader through each phase of the various experiments. The textbook language is written so meanings are fully grasped without need for a technical vocabulary and knowledge.

Recommended for adults as well as youngsters, the EK-1 can open up a whole new world of knowledge, start youngsters on a scientific career, or provide the basis for an interesting spare-time hobby. Get started now in this new and exciting series of "learn-by-doing" educational kits . . . the EK-1 serves as a prerequisite to other courses.

Kit EK-1, 4 lbs. **\$19.95**



A KIT AND TEXT BOOK COMBINATION, the EK-1 includes all parts for experiments and you build a practical DC volt-ohm-milliammeter.

Expand Your Knowledge to Include The World of Communications with the Heath Two-Part BASIC RADIO Course

- Simplified basic theory
- Two-part textbook and kit project
- You construct a receiver as you learn
- Easy-to-understand, clearly illustrated



Learn basic radio theory and build a useful radio receiver at the same time!

When you begin this absorbing course, you will start with Basic Radio-Part I (EK-2A) and learn the basic components and elementary theory of a radio. As you delve into the mysteries of radio fundamentals, you simultaneously assemble a crystal receiver. Progressing from chapter to chapter in the textbook/instruction manual, you improve upon this elementary receiver by adding tuned circuits and tubes until you have built a regenerative receiver capable of pulling in stations hundreds of miles away.

With the additional parts supplied with Part II (EK-2B) you are able to improve upon the receiver built in Part I and upon completion, will have constructed a 2-band (550-1600 kc & 3-10 mc) superheterodyne receiver that picks up broadcast, amateur radio, marine and international stations.

And when you add the Heathkit Accessory Cabinet AK-8, your completed 2-band receiver is housed in an attractive cabinet suitable for use in any room in your home.

Both parts of the Basic Radio Course are written to educate youngsters and adults alike. These courses not only supply a wealth of information, but combine theory with actual construction and experimentation that greatly enhances the learning process. As educators well know, the "learn-by-doing" process is an approved method of teaching, and with these Heathkit Basic Radio Courses, you'll learn more thoroughly.

- Basic Radio Part I (EK-2A) . . . 6 lbs. **\$19.95**
- Basic Radio Part II (EK-2B) . . . 4 lbs. **\$19.95**
- Accessory Cabinet AK-8—A handsome housing for your completed EK-2B Receiver . . . 4 lbs. **\$3.95**

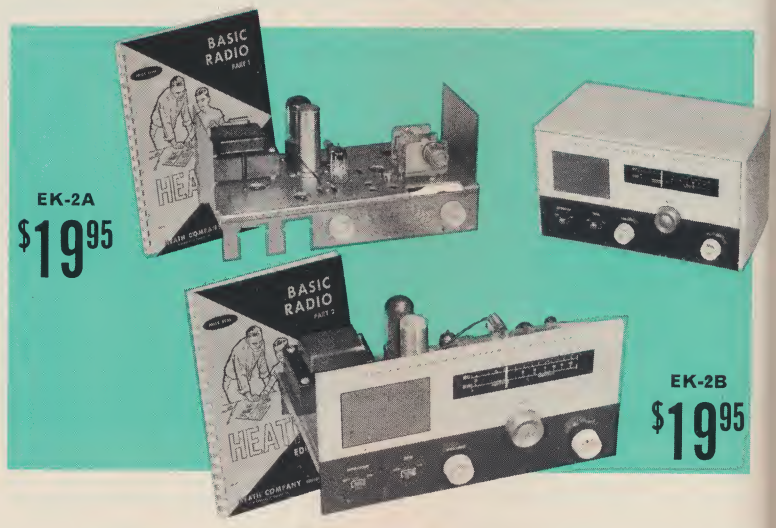

EK-2A **\$19.95**

EK-2B **\$19.95**

BASIC RADIO TEXTBOOK CHAPTER TITLES

PART I

- Lesson I How Do Voice And Music Get From A Broadcast Studio To Your Home?** How to Plot Your Broadcast Station Environment.
- Lesson II What Is A Broadcast Radio Signal?** How to Put Up A Broadcast Receiving Antenna.
- Lesson III What Three Things Must Radio Receivers Do?** How to Rectify Current and Voltage With A Crystal Diode.
- Lesson IV What Is A Detector Circuit?** How to Build A Radio Signal Detector.
- Lesson V What Is A Tuned Circuit?** How to Build A Tuned Circuit For Radio Signals.
- Lesson VI How Do Diode Vacuum Tubes Work?** How to Build A Vacuum Tube Signal Detector.
- Lesson VII What Does The Grid In A Vacuum Tube Do?** How to Build A Vacuum Tube Amplifier.
- Lesson VIII Can One Vacuum Tube Do Two Things At Once?** How to Build a Detector-Amplifier.
- Lesson IX How Is Feedback Used For Extra Amplification?** How to Build A Regenerative Detector Amplifier.

PART II

- Lesson I What Is A Transformer?** Putting The Transformer to Work.
- Lesson II How The Receiver Power Supply Operates** Testing the EK-2B Power Supply.
- Lesson III How Tubes Are Operating Voltages** Using the Triode And Pentode Amplifiers.
- Lesson IV What Does The Audio Section Of The Receiver Do?** Testing The Audio Amplifier.
- Lesson V How The Detector Circuit Operates** How to Build A Detector Circuit.
- Lesson VI What Does The RF Section Of A Receiver Do?** How to Build A RF Amplifier.
- Lesson VII What Is An Oscillator And How Does It Work?** How to Test An Oscillator Circuit.
- Lesson VIII What Is A Converter Circuit Used For?** How to Build A Superheterodyne Receiver.
- Lesson IX What Does Alignment Mean?** How to Align Your Superheterodyne Receiver.
- Lesson X What Are Short Wave Signals?** How to Add a Short Wave Band And BFO To Your Receiver.

Advance to the Age of Transistors with this BASIC TRANSISTORS Course



- Learn Transistor concepts and applications
- Easy to understand text
- Perform experiments as you learn

- All parts furnished with kit
- Results in a handy two-station intercom
- Textbook is a valuable reference source

The purpose of this educational kit is to explain in simple, easy-to-understand language the "how" and "why" of transistors and their associated circuitry, without the need of difficult mathematics. Through the concept of learn-by-doing the student learns not only from the textbook, but also from the interesting experiments performed. Some of the test circuits assembled by the student include a two-transistor radio, wireless broadcaster, audio amplifier, and an audio test oscillator. These are all wired on a special experimental chassis. Also included are all the necessary components and materials required to perform the final experiment . . . the complete assembly of a highly useful and functional two-transistor inter-communication system. Designed for youngsters and adults alike, the EK-3 provides the necessary background for the understanding of basic transistor theory which will simplify servicing and trouble-shooting of transistorized circuitry and equipment. 4 lbs.

Basic Transistors (EK-3) \$16.95

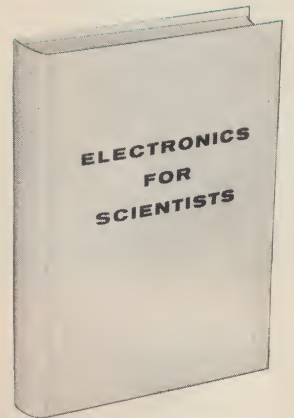
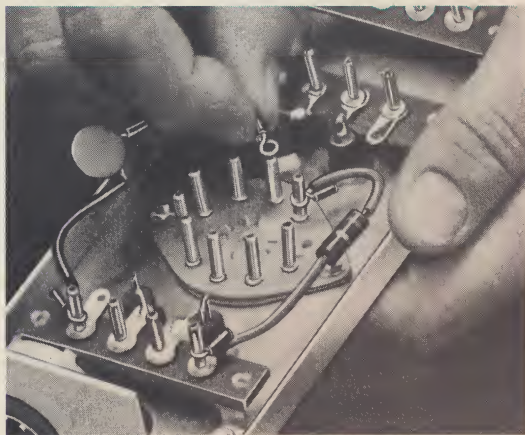

Here is a New Course for Scientists and Students Who Need a Working Knowledge of Electronic Instrumentation for Research

. . . a series of new "solderless" experimenting kits, plus wired instruments, and a new, authoritative textbook "Electronics For Scientists"



Heath is proud to introduce this new concept in electronics education. These special needs are fulfilled with this new system . . . solderless kits for experimenting and laboratory circuit development or for teaching basic electronics . . . wired instruments and test equipment for teaching scientific instrumentation for research, development and control . . . and a profusely illustrated book "Electronics for Scientists," (W. A. Benjamin, Inc., New York, 1962) that is written expressly for chemists, physicists, engineers, medical researchers, biologists, science students, and research workers who have little or no background in electronics, but need to gain a working knowledge of devices and circuits.

A low cost group consisting of power supply, components and chassis, and textbook, gets you started with this efficient, rapid-connect construction system that is ideal for trial circuits, all levels of teaching, and for circuit development. Many wired-and-tested instruments are also available, such as Servo Pen Recorder, Operational Amplifier System, Test Instruments, Transistor Power Supply and even a workbench. The system was originated by Dr. H. V. Malmstadt of the U. of Illinois and Dr. C. G. Enke of Princeton U. to teach principles, design, and use of instruments in scientific applications . . . to help scientists and students quickly overcome the "electronics barrier."

The textbook, "Electronics For Scientists," written by Malmstadt, Enke and Toren, begins with principles and leads systematically to specific circuits and devices used in current research and engineering

control problems. The experiments, which are presented at the end of each chapter, can be performed with the Heathkit instruments and rapid-connect parts. The book covers the following subjects: electrical measurements, power supplies, amplification by vacuum tubes and transistors, amplifier circuits, oscillators, comparison measurements, servo systems, operational amplifiers for measurement and control, electronic switching and timing and digital counting systems.

Kits, instruments and book are available separately or together from Heath. Send for FREE six-page descriptive folder, containing specifications and prices on the EU-series groups and components.

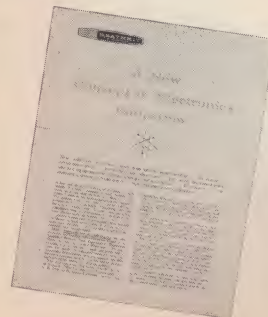

FREE FOLDER

- Full details about various systems and components available
- Descriptions, prices and specifications on all units
- Combination prices save extra dollars

Write for your FREE copy now!

Save Up To 50% With Heath Do-It-Yourself Electronic Kits

Heathkit® Technical Applications Series . . .



designed to teach professionals and beginners
the proper use of electronic instruments

- Designed for anyone who wants to learn more about test equipment
- Combination Kit/Textbook Project
- Simplified basic theory written in everyday language
- Interesting experiments performed as you learn
- Information applies to all VTVM's
- No previous electronic experience required



Kit EF-1, course . . . **\$8.95**

Buy in Combination With Your
Favorite Heathkit VTVM and Save

Combination Kit EF-1-3 . . . **\$32.50**



EF-1 . . . "How to Understand and Use Your Vacuum Tube Voltmeter"

The new Heathkit Technical Applications Series takes a new approach to technical information through the medium of writing in everyday language in a "learn-by-doing" concept with content material organized so that it proves of value to professionals and beginners. The professional will find the subjects ideal as "refresher" courses. The beginner will find the subjects presume no prior knowledge on his part and hence provide a perfect starting point.

This first in the new series, "How To Understand and Use Your Vacuum Tube Voltmeter," has as its objectives the teaching of the proper use of the VTVM, its many applications, and its advantages over other types of voltmeters. Those who have been using a VTVM for years will find this course of special interest. It covers a wide range of particular applications of the VTVM in many fields ranging from television repair to amateur radio. The methods of demonstration used and the discussion of the general principles of trouble shooting will prepare the reader for independent investigation of new problems as they arise in the future. Those who are just beginning their electronic education will find this course provides not only a firm foundation in the fundamentals of electronic theory, but also through the medium of using a VTVM while reading the text, gives the proper direction to secure maximum information from this basic instrument. This "learn-by-doing" method of working with a VTVM while covering fundamentals results in a greater degree of understanding with a clarity and reinforcement not achievable in any other way. Save by buying your VTVM and applications course together . . . see p. 78 & 79 for VTVM's.

The text covers the basics of electronics . . . electron flow, capacitance, inductance, transformers, diodes, triodes, and the theory of vacuum tube voltmeters and their maintenance. The arrangement of topics is in a logical learning sequence for the beginner and permits the professional to review quickly the basic concepts and move on to subjects of more specialized interest.

A power supply kit is included in this VTVM Applications Course which is assembled by the student and used in performing experiments detailed in the text. While intended primarily for use with the text experiments, the supply can be used for utility applications. It delivers AC or DC output of 120 volts at 20 ma, and 6.3 volts AC at 1.5 amps. It features an on-off switch, fused primary, and an 8 1/8" L x 2 3/8" H x 5" W chassis with the schematic screened on top.

To learn more about your vacuum tube voltmeter, to extend its usefulness into new fields, order your EF-1 VTVM Applications Course now.

Kit EF-1 . . . 3 lbs. **\$8.95**

The EF-1 VTVM Applications Text Covers the Following Subjects

PART 1. INTRODUCTION TO THE VTVM
Operation, What it does, Advantages, Safety

PART 2. POWER SUPPLY KIT CONSTRUCTION
Easy, check-by-step assembly. (Power supply is used in experiments contained in manual to support study of VTVM circuitry).

PART 3. BASIC THEORY OF ELECTRICITY
Electron flow; Charge; Ohm's Law; AC-DC; RMS power; Series & Parallel circuits; Capacitors, Inductors, Transformers, Power Supplies; Schematics; Crystal Diodes; Impedance.

PART 4. VTVM THEORY
VOM theory; VTVM advantages; Amplification; Triodes in detail; Basic VTVM circuitry; Refinements in VTVM design, including contact potential, bucking voltages, twin triodes, voltage doublers, AC response, special probes.

PART 5. VTVM MAINTENANCE
Care & Trouble-shooting of the VTVM.

PART 6. VTVM APPLICATIONS
1. Equipment check, Capacitor leakage, Battery check, Internal resistance, Maximum DC Power Transfer Theorem, DB scales, Continuity testing. 2. General Principles of Trouble-shooting, Cause-to-effect reasoning, Isolating the trouble, Use of block diagrams to simplify schematics, Special applications to TV, AM-FM, Audio amplifiers, Amateur Radio, Miscellany.

SPECIAL COMBINATION OFFERS SAVE MONEY

Kit EF-1-3, includes EF-1 above and IM-11 VTVM, p. 78. **\$32.50**

Kit EF-1-2, Includes EF-1 above and IM-32 VTVM, p. 79. **\$39.95**

"How to Understand And Use Your Oscilloscope"



- A combination experimental chassis & textbook project
- Simplified basic theory written in everyday language
- Interesting experiments performed as you learn
- Solderless spring-clip connectors permit fast, simple circuit changes in experiments
- Big, 100 page textbook remains a valuable reference source
- Ideal for beginners, schools and universities
- Buy with your favorite Heathkit 'scope and save

EF-2
\$9.95

\$57.95

Buy in Combination and Save
Combination Kit EF-2-3
Course & Scope

The Heathkit EF-2, Oscilloscope Applications Kit, is the second in the technical application series designed to help the beginner to better understand his service and test instruments. Persons already familiar with the oscilloscope will find a fresh, new approach to the basic theory and application of their instrument.

Theory and practical applications of oscilloscopes are presented in an easy to understand manner through a combination textbook and experimental chassis kit. The textbook is written in everyday language with all material organized to be of maximum help to the beginner and to provide complete and thorough coverage of the subject. The big, 100 page textbook includes a glossary and bibliography section and makes an excellent reference source for future use in oscilloscope applications.

The special experimental chassis and parts furnished are used to construct many different circuits for use in performing interesting experiments which illustrate and support the text. This concept of "Learn By Doing" has proven to be far more effective in teaching than basic theory alone, since it actually shows the reader what is happening in the circuit under test and how the instrument is used.

Special solderless spring-clip connectors make circuit changing simple after initial wiring of the experimental chassis and allow use of parts over and over again. Circuits constructed include a radio frequency oscillator, variable audio oscillator, two-transistor audio amplifier, square wave generator, and a multivibrator. Safe, dry cell batteries will furnish all power required. An excellent course for those who wish to learn more about the many applications of oscilloscopes. 2 lbs.

Kit EF-2 \$9.95
Kit EF-2-3, includes EF-2 above and IO-21 Oscilloscope, p. 95 \$57.95
Kit EF-2-4, includes EF-2 above and IO-12 Oscilloscope, p. 94 \$84.95

The EF-2 Oscilloscope Applications Text Covers The Following Subjects:

Part 1. Introduction to Oscilloscope Operation

Non-technical basic principles; Block diagram approach.

Part 2. Assembly of Experimental Chassis

Basic mounting and wiring procedures.

Part 3. General Principles of Electronics

Theory and experiments in Electricity; Parallel & Series Resistors; DC & AC; Capacitors; Inductance and Impedance; Vacuum Tube Diodes and Triodes; Transistors & Crystal Diodes.

Part 4. Basic Oscilloscope Theory

Introduction; Block diagram; Theory and Experiments on CRT; Power Supply; Horizontal & Vertical amplifiers; Synchronization.

Part 5. Maintenance and Service

Care and trouble-shooting of oscilloscope circuits.

Part 6. Special Applications

Wave Form Interpretation; DC Scopes; Dual Trace Scopes; Medical Applications; Industrial Applications; School Applications in Chemistry, Biology, Physics.

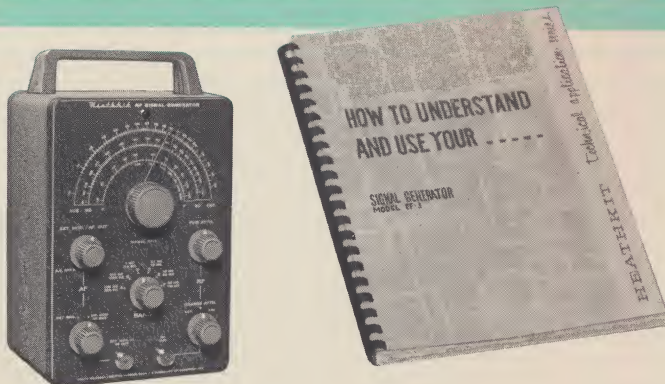

Coming Soon! . . . Another in the series of technical application courses . . . "How To Understand And Use Your Signal Generator"

This next Heathkit technical applications series on "How to understand and use your signal generator" will be of special interest to service technicians and beginners who wish to learn more about the use of radio and audio frequency generators in effective trouble-shooting of circuits. Theory, function and use of RF and audio signal generators will be covered in the same manner as the EF-1 and EF-2 kits, using a combination Textbook and Experimental Kit to illustrate and support the text. Another in the learn-by-doing series, designed to teach proper use of test instruments in servicing. Watch for future announcements.

Look To Heath For The Newest, The Finest in Electronic Kits

Heathkit® Close-Out Selection

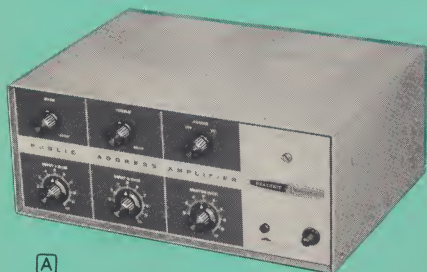

A



B



C

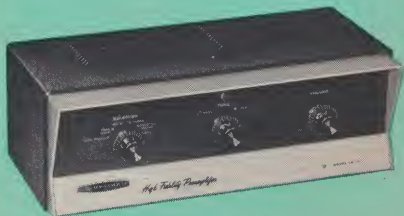

D



E

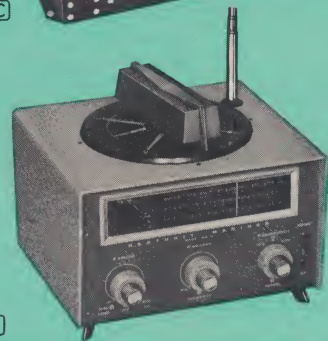

F

A Heathkit High-Fidelity PUBLIC ADDRESS AMPLIFIER . . . Was \$59.95 . . . Now \$44.95

Look at these features: 20 watt output, hi-fi rated; two inputs with switch-selected input matching; electrical mixing; tape recorder output; 4, 8, 16 ohm speaker and 70.7 volt line output; pilot light and "fuse-failure" indicator; rear hinge permits access to top or bottom of chassis without cabinet removal. When used with transformer below, "matching switches" select input impedance for 50, 150 or 300 ohm microphones or balanced or unbalanced 600 ohm lines. Measures 6¼" H x 14¼" W x 11¼" D.

Kit AA-31, 24 lbs. . . . no money down, \$5 mo. **\$44.95**

Model AN-11 Input Matching Transformer: matches any low impedance microphone or balanced or unbalanced lines. Primary tapped, 4 ranges from 30 to 600 ohms. Hum shielded with two mu metal shields and steel case.

Model AN-11 . . . (not shown) . . . 2 lbs. **Was \$11.95 Now \$7.95**

B Mobile PA AMPLIFIER . . . Was \$39.95 . . . Now \$29.95

A great value when it was introduced . . . an even greater value now. The Heathkit AA-80 mobile PA amplifier is an all-transistor circuit delivering a full 10 watts output! Operates from a 12 v. car battery; low current drain, instant operation, no warm-up, separate gain controls for microphone and music source. Two channel mixing with automatic "fade" of music source when used with 3-conductor microphone below. Plug in connections; outputs for 8 or 16 ohm speakers. Grey cabinet measures just 3½" H x 8¾" W x 7½" D. Kit includes mounting bracket. 6 lbs.

Kit AA-80 . . . no money down, \$5 mo. **\$29.95**

C Hi-Fi Rated 20-Watt Monophonic POWER AMPLIFIER

A restyled version of the famous Heathkit W-4B, this husky amplifier boasts 20 hi-fi-rated watts from its patented Heath ULTRA-LINEAR® output circuit with famous 5881 tubes and Chicago Standard transformer. Black and ivory; measures 15½" W x 7" H x 8¾" D.

Kit AA-71, 24 lbs. . . . no money down, \$5 mo. **Was \$41.44 Now \$34.88**

SPECIFICATIONS—Power output: 20 watts Heath Hi Fi Rating; 20 Watts IHFM Music Power Output (0.7% THD, 1 kc). **Power response:** ± 1 db, 30 cps to 15 kc, at 20 watts output. **Harmonic distortion:** Less than 2%, 30 cps to 15 kc, at 20 watts output. **Intermodulation distortion:** Less than 2% at 20 watts output using 60 and 6,000 signals, 4:1. **Hum and noise:** 95.2 db below 20 watts output. **Input sensitivity:** 2 v for 20 watts output. **Outputs:** 4, 8 and 16 ohms. **Damping factor:** 28.5:1. **Controls:** Output tube balance control, on-off switch. **Tube complement:** 2-5881, 2-6SN7, 1-5V4. **Power requirements:** 117 v 50-60 cycles, 115 watts. **Power outlets:** Octal socket for pre-amp power, supplies 275 v DC at 10 ma, 6.3 v AC at 1.1 amperes; 1 AC outlet switched.

Special Combination Price . . . AA-131 Preamp and AA-81 Amplifier below . . . Order Model AA-42 Was \$74.80 Now \$57.90 Save An Extra \$7.00 From Individual Prices

D High Fidelity Monophonic PREAMPLIFIER

- 6 switch-selected inputs including tape head
- Cathode follower output for low line loss
- Self-powered—use with any power amplifier

An outstanding Hi-Fi preamplifier value! Beautifully styled and versatile. Features 6 switch-selected inputs, built-in power supply, input level controls for phono and microphone inputs, cathode follower outputs and Baxandall type tone controls. Tape recorder output permits tape recording directly from the preamplifier. Handsomely styled in charcoal grey & ivory. 6 lbs.

Kit AA-131 **Was \$24.95 Now \$19.95**

SPECIFICATIONS—Input impedance: (At 1 KC) mag. phono 47 K ohm; tape head 82 K ohm; microphone 500 K ohm; tuner 1 megohm; xtal phono 1 megohm; aux. 1 megohm. **Input sensitivity:** (2.5v, rms output at 1 KC) Mag. phono .0035 v; tape head .004 v; microphone .01 v; tuner .1 v; xtal phono .12 v; auxiliary 1 v. **Outputs:** (2) Normal & Tape recorder. **Frequency response:** ± 1 db 20-20,000 cps. **Harmonic distortion:** 0.2% or less. **IM distortion:** 0.25% or less. **Dimensions:** 4¼" H x 13¼" W x 5¼" D.

E Hi-Fi Rated 35-Watt Monophonic POWER AMPLIFIER

- Patented Heath ULTRA-LINEAR® circuit
- Push-pull EL-34 output tubes
- Power response, ± 1 db 20 cps to 20 kc

An excellent companion for the Heathkit AA-131 Preamplifier! Delivers rich, full-range sound reproduction with a response of ± 1 db from 20 cps to 20 kc at full 35 watt output! Bias and balance controls assure extremely low distortion. Features a built-in level control and AC switch, Heath's patented ULTRA-LINEAR® circuit, and specially designed output transformer. Matches 4, 8, 16 and 32 ohm speakers. Black and metallic bronze with ivory accents. 24 lbs.

Kit AA-81 . . . no money down, \$5 mo. **Was \$49.95 Now \$44.95**

SPECIFICATIONS—Power output: 35 watts Heath Hi Fi Rating; 42 watts IHFM Music Power Output (0.7% THD, 1 kc). **Power response:** ± 1 db, 20 cps to 20 kc, at 35 watts. **Harmonic distortion:** Less than 2%, 20-20,000 cps at 35 watts output. **Intermodulation distortion:** 2% or less at 35 watts output 60 and 6,000 cps signals, 4:1. **Hum and noise:** 80 db below 35 watts. **Input sensitivity:** 0.9 v for 35 watts output. **Power requirements:** 117 v, 50-60 cycles, 100-130 watts. **Power outlets:** 2 AC receptacles, 1 switched 1 unswitched; Octal socket for pre-amp power, supplies 300 v at 10 ma DC and 6.3 VAC at 1.0 amperes. **Dimensions:** 12" W x 6¾" H x 8" D.

F 3-band transistor RADIO DIRECTION FINDER . . . Was \$109.95 . . . Now \$99.95

Your best buy in marine safety! This 3-band, 10-transistor, 1-diode marine radio direction finder covers beacon, Consolan, broadcast and marine-radiotelephone bands. Six flashlight batteries last up to 1000 hours. "Sense" antenna system eliminates double null. Has lighted dial and tuning meter, 4" x 6" speaker, carrying handle, and easy battery access. Tuning unit is assembled and aligned. Measures 9" L x 9¾" W x 6¾" H.

Kit MR-11, 12 lbs. . . . no money down, \$10 mo. **\$99.95**



Heathkit® Science Series Entertain and Teach

A TRANSISTOR INTERCOM KIT

Talk from room to room, or house to house, with this exciting Transistor Intercom—a 2-way beauty! “Master” unit and “slave-remote” station powered by inexpensive batteries. “Listen-talk” slide switch, volume control and “on-off” switch on “master”. All-transistor circuit. Easy assembly; all parts, tools, and manual of operating principles included. 3 lbs.

Kit SK-20.....\$13.95

B TRANSISTOR PORTABLE BROADCASTER

Your voice can be transmitted to any nearby AM radio without wires with this Broadcaster. Children can have hours of fun playing “announcer,” “pilot,” or “disc-jockey.” Complete “check-by-step” assembly instructions and basic radio theory included. Battery powered for safety and convenience. Kit includes all-metal case, all components and tools. 2 lbs.

Kit SK-10.....\$9.95

C CRYSTAL RADIO KIT

This “do-it-yourself” kit lets any boy or girl build their own private radio receiver. No soldering or batteries are required. Receiver circuit has a fixed diode detector and permeability tuned coil. Kit includes earphones, 50' of antenna wire, instructions and radio principles. Two-tone metal case. 1 lb.

Kit SK-70.....\$3.95

D TRANSISTOR RADIO KIT

You'll have lots of fun assembling your own transistor radio! The circuit board and solderless connections make it a “snap.” Included are transistor audio amplifier, germanium diode detector, earphone, all-metal cabinet, circuit board, screwdriver, and manual of instructions and operating principles. Safe for all ages with battery power. 2 lbs.

Kit SK-60.....\$7.50

E ELECTRONIC WORKSHOP “6”

Youngsters of all ages will find hours and hours of entertainment with this exciting new Heathkit. Six different and educational electronic experiments! You can build a code flasher, crystal radio, 2 transistor radios, wireless voice and code transmitters. Kit includes all necessary parts, hardware, screwdriver, solderless connectors, assembly instructions and operating principles. Battery operated. 2 lbs.

Kit SK-30.....\$8.95

F ELECTRONIC WORKSHOP “11”

Here are 11 different experiments designed by Heath to entertain while they teach! You can build 3 different transistor radios, a code practice flasher, wireless code and voice transmitters, electronic timer, burglar alarm, electronic flasher, audio signal injector and an intercom. All necessary tools and hardware for building are furnished. No soldering needed. Battery powered. 4 lbs.

Kit SK-40.....\$12.95

G ELECTRONIC WORKSHOP “19”—

the best ever

This largest Heathkit Workshop contains materials and instructions for building 19 different electronic items including: code flasher, public address system, 5 transistor radios, electronic timer, burglar alarm, electric eye, TV silencer, metronome, voice and capacity-operated relays, and more. Operates on safe, economical flashlight batteries. Fast solderless spring-type connectors make circuit changes simple. 4 lbs.

Kit SK-50.....\$19.95



Enjoy the World of Sound at its Finest... with Heathkit® Stereo/Hi-Fi



Music lovers and audiophiles everywhere have made Heathkit audio equipment the world leader . . . these are a few of the reasons:

AUDIOPHILE-ENGINEERED

Developed by engineers who truly love music, superior Heathkit audio equipment is also the result of devotion to a goal constantly held by everyone at Heath . . . finest performance, lowest possible cost. First to set standards of performance (the most rigid in the industry), Heathkit equipment is designed to meet the requirements of the most demanding listener . . . in specifications, appearance, and reliability. Note the new power and distortion curves which tell the all-important characteristics of Heath Amplifiers over the entire audible spectrum.

QUALITY THROUGHOUT

Quality begins with engineering, continues with the use of only premium quality components, and ends with functional, clean-lined design to produce professional-level equipment. Heath audio kits set the pace for quality-leadership . . . this is evidenced by the high regard with which they are held by users the world over. This intrinsic quality is carefully controlled during manufacture, assured in use by free factory consulting service and the most extensive service organization in the industry with centers throughout the country, as well as a factory service department, ready to serve you at any time.

EASY TO ASSEMBLE

Heathkits are the world's easiest to build with the famous "check-by-step" instruction manuals which pioneered big, fold-out detail diagrams and clear, concise language which assumes no previous experience or skills. All parts are included, plus special building-aid items and enough solder to make kit building even easier. All chassis are pre-punched, ready for parts mounting. Everything complete, ready for assembly. Millions the world over acclaim the superiority of Heathkit instructions for ease of building . . . instructions that tell you what to do and how to do it! Buy with confidence that you can build your favorite Heathkit . . . it's easy!

ECONOMICAL

Heathkit equipment represents that unique balance of quality with economy most kits fail to achieve . . . a balance that permits no compromise in performance so you get all you hoped for in results, yet through ingenious engineering, and mass buying of components, achieves a lower-than-expected price. And you save further dollars by buying direct from the factory, plus the big savings of assembling your own equipment. Enjoy the fun, satisfaction, and savings of building your own Heathkit.

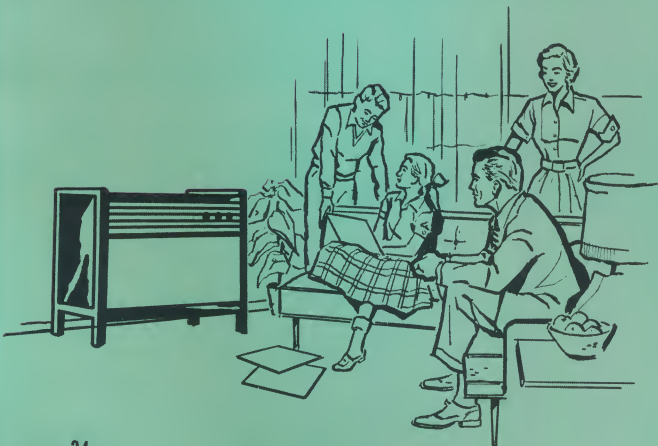

Heathkit Performance Specifications Are Guaranteed

New Heathkit

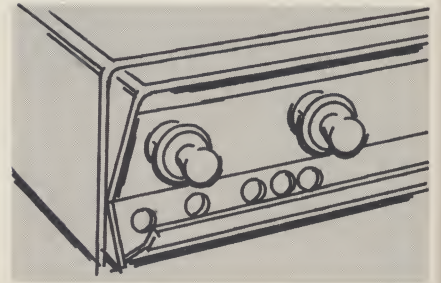

CONCEALED CONTROLS: Hinged lower front panel covers all secondary controls. Prevents accidental change in system settings . . . leaves only major controls out in open for clean appearance, easy operation.



UNIQUE ON / OFF SWITCH: Lower right panel is unique, push-to-turn-on . . . push-to-turn-off switch. No need to change or readjust volume or tone control settings from last listening level.

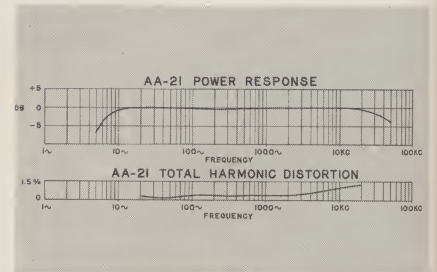

AMAZING PERFORMANCE: Power Response and Total Harmonic Distortion curves are made at 35 watts output per channel (70 watts total output). Compare these curves with those of any integrated amplifier, tube or transistor, and you'll see why the Heathkit AA-21 represents such an outstanding performance and dollar value!

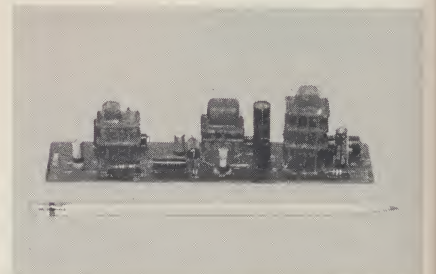

ENCAPSULATED CIRCUITS: Advanced design includes 6 epoxy-covered circuit modules (3 in each preamplifier circuit) to simplify assembly. Together they contain over 70 resistors and capacitors in sealed, factory-wired circuits, ready to install on the circuit board. This feature eliminates wiring errors, assures stable, reliable performance!

70 Watt Transistor Stereo Amplifier



AA-21
\$134⁹⁵

Kit Form
or
Factory
Assembled



100 WATTS IHFM
MUSIC POWER RATED

The most advanced AMPLIFIER in the high fidelity industry!
Engineered for full power wide range sound as you have never heard it

- Startling realism—superb dynamic range
- 13 to 25,000 cps ± 1 db at 35 watts per channel
- Smooth, full power delivery—fast, effortless transient response
- 28 transistor, 10 diode circuit
- Complete freedom from microphonics
- Encapsulated, epoxy covered circuit modules for easy assembly
- Professional, modern styling—cool operation

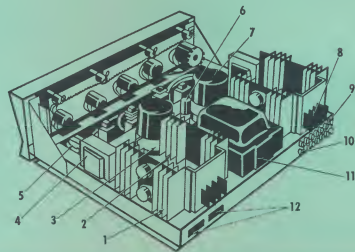

1. Eight Germanium Power Output Transistors mounted on four finned heat sinks
2. Output circuit breakers 3. Power amplifier circuit boards containing four transistors and six diodes 4. Two driver transformers 5. Two preamplifier circuit boards contain six epoxy-sealed component modules and ten transistors 6. Two Germanium driver transistors plus four electronic filter transistors 7. Filter condensers and four power supply diodes 8. Output terminal boards 9. Input jacks 10. Tape recorder output 11. Power transformer 12. AC outlets

Taking full advantage of the advanced state of transistor art . . . the new Heathkit AA-21 amplifier now obsoletes all others, tube or transistor! More than two years in development to assure the utmost in performance, the AA-21 has received nothing but praise by those who have seen and heard it! Rated at 35 watts per channel by Heath standards or 50 watts per channel at IHFM standards, this Heathkit combination stereo PREAMPLIFIER, POWER AMPLIFIER delivers full power over a range of 13 cycles to 25,000 cycles, ± 1 db! No compromise in dynamic range, no faltering power at the important high and low extremes of response . . . just the most satisfying solid sound you have ever heard. Its other specifications are equally impressive . . . completely factual and guaranteed!

Featuring 28 transistors and 10 diodes, the latest, most advanced in RCA semi-conductor technology, the Heathkit AA-21 not only offers industry-shattering performance, but also provides operational characteristics unique with transistors . . . cool operation . . . low power line requirements . . . steady performance under wide external temperature variations . . . and complete freedom from microphonics. The pace-setting design of this superbly engineered unit features a transformerless output circuit and multiple feed-back loops for finest fidelity. All controls are front-panel mounted for operating convenience. These include a 5-position dual concentric input selector which permits mixing inputs for tape recording purposes, etc., a 5-position mode selector, and dual concentric volume, bass and treble controls. A hinged lower front panel conceals the tape-monitor input switch, speaker phase reversal switch, loudness switch (to convert the volume control to a loudness control for compensated, low volume levels), and all input level controls. The lower right-hand section of the front panel is a unique on/off switch . . . touch to turn on . . . touch to turn off. All input and output connections are conveniently located on the rear chassis panel. Circuit safety is assured through the use of 5 new, fast-acting, bi-metal circuit breakers . . . no fuses to replace ever!

Kit assembly is fast and simple through the use of 5 circuit boards which eliminate most of the conventional point-to-point wiring. Preamplifier circuits are "capsulated" in 6 epoxy-covered modules containing 70 resistors and capacitors, all factory wired and sealed, ready for easy installation on the preamplifier circuit board.

Styling is beautifully accomplished in luggage-tan, vinyl-clad steel with polished, anodized aluminum trim, plastic upper front panel, extruded aluminum lower panel with matching vinyl inset, and soft, refracted panel-lighting. Designed to set a new standard of value, this finest of all stereo amplifiers carries a surprisingly low price tag . . . order yours now for early enjoyment! 28 lbs.

Kit AA-21 (Shipping Sept.), no money down, \$13 mo. **\$134.95**
Assembled AAW-21 (Shipping Oct.), no money down, \$21 mo. **\$219.95**

SPECIFICATIONS—Power output per channel: (Heath rating), 35 watts/8 ohm load—26 watts/16 ohm load—18 watts/4 ohm load; (IHFM music power output): 50 watts/8 ohm load—34 watts/16 ohm load—25 watts/4 ohm load (@ 0.7% THD, 1 KC). **Power response:** ± 1 db from 13 cps to 25 kc @ rated output; ± 3 db from 8 cps to 40 kc @ rated output. **Harmonic distortion (at rated output):** Less than 1% @ 20 cps, 0.5% @ 1 kc, 2.0% @ 20 kc. **Intermodulation distortion (at rated output):** Less than 1%, 60 & 6,000 cps signal mixed 4:1. **Hum and noise:** Tapehead, 40 db below rated output; Mag phono, 45 db below rated output; Aux. inputs, 60 db below rated output; Tape monitor, 70 db below rated output. **Channel separation:** 40 db min. @ 20 kc, 55 db min. @ 1 kc, 50 db min. @ 20 cps. **Input sensitivity:** (For 35 watts output per channel, 8-ohm load) Tapehead, 2 mv; Mag. phono, 3 mv; Tuner, .25 v; FM Stereo, .25 v; Aux., .25 v; Tape Monitor, .90v. **Input impedance:** Tapehead, 60 K ohm; Mag. phono, 30 K ohm; Tuner, 100 K ohm; FM Stereo, 100 K ohm; Aux., 100 K ohm; Tape Monitor, 47 K ohm. **Outputs:** 4, 8, & 16 ohms and low impedance tape recorder outputs. **Controls:** 5-pos. Selector (dual-concentric), 5-pos. Mode switch, dual-concentric Volume, Bass & Treble controls, Tape monitor sw., Loudness sw., Phase sw., Input level controls (all inputs except Tape Head & Tape Monitor inputs), Push-Push on/off switch. **Semiconductor complement:** 28 Transistors, 10 diodes. **Power requirements:** 105-125 volts, 50-60 cycles AC. 35 watts idling, no signal; 200 watts, full power out. @ 120 volts with no load on AC receptacles. **Power outlets:** 2 AC receptacles, 1 switched, 1 unswitched. **Dimensions:** 15 1/2" W x 5" H x 14" D.

Look To Heath For The Newest, The Finest in Electronic Kits

AJ-41
\$119⁹⁵

Coordinates . . . Deluxe Stereo Tuner

Kit Form
or
Factory
Assembled

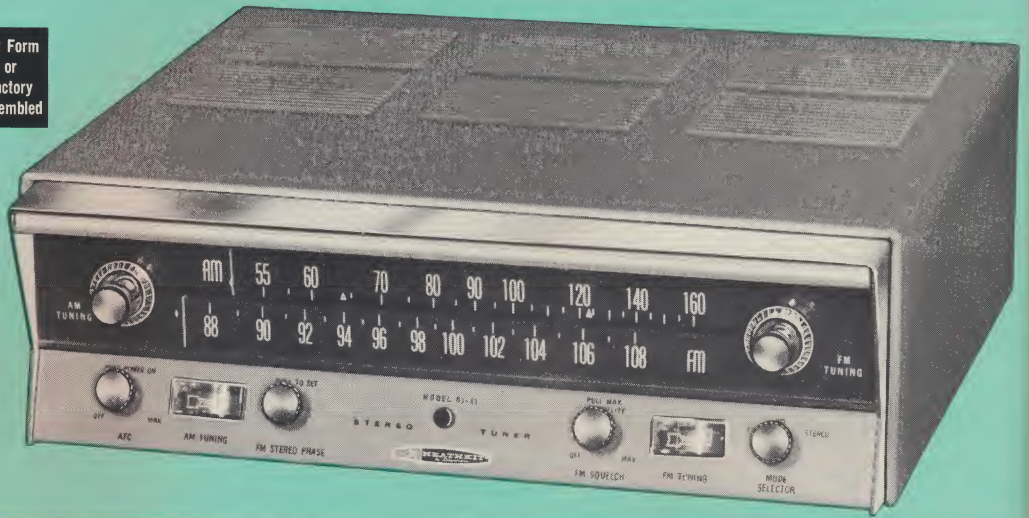

The most advanced tuner in Heathkit history . . . The AJ-41 receives AM, FM and Stereo FM Multiplex

- Built-in FM multiplex adapter
- Broad-band circuitry for full fidelity
- Automatic FM stereo indicator light—adjustable AFC for drift-free reception
- Adjustable FM squelch circuit for low noise between stations
- Stereo phase control for maximum separation & lowest distortion
- Improved action tuning meters for both AM and FM
- Filters for stereo tape recording
- Cathode follower outputs
- Preassembled tuning unit, prealigned coils
- Easy circuit board construction

Take a spin across the dial of this new Heathkit tuner . . . your listening choice is wide . . . maximum fidelity AM with its up-to-the-minute entertainment . . . the quiet, high fidelity sound of FM with its fine monophonic music . . . and now the wonder of Stereo FM with its realism, its spaciousness . . . it's all yours to command with the new AJ-41.

A neon light indicator shows when an FM stereo signal is received and individual tuning meters for AM and FM permit precise station settings. An FM squelch circuit eliminates noise between stations when tuning across the FM band. Cathode follower outputs provide low line impedance to minimize hum and high frequency losses in the inter-connecting audio cables. In monophonic AM or FM modes of operation the output stages are tied together to supply the same information to both the left and right channel amplifiers of a stereo system. In FM stereo position both channels function separately. A multiplex phase control permits fine tuning for maximum separation and minimum distortion.

Other fine features incorporated include; heavy die-cast flywheels for smooth tuning action, large slide-rule tuning dial with soft, glare-

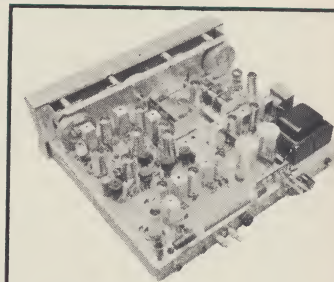

CIRCUIT BOARD ASSEMBLY

The Heathkit AJ-41 is easier to build and has greater stability thanks to its three circuit boards.

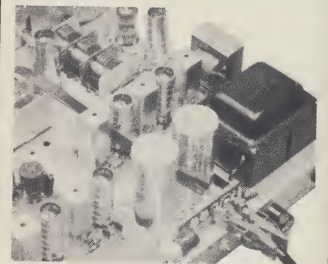

BUILT-IN MULTIPLEX CONVERTER

The Heathkit AJ-41 features the famous FM multiplex circuit built right in on a circuit board . . . an integral part of your tuner.

free refracted illumination, automatic frequency control on FM for drift-free reception, and a fidelity switch for normal or maximum AM fidelity. Deluxe styling features a luggage tan vinyl-clad steel cabinet and polished anodized trim. The superbly designed circuit features 3 circuit boards and a pre-assembled, prealigned FM tuning unit for easy assembly.

Kit AJ-41 . . . 24 lbs. . . no money down, \$11 mo. **\$119.95**
Assembled AJW-41 . . . no money down, \$18 mo. **\$189.95**

SPECIFICATIONS—Tuning range: 88 mc to 108 mc. **IF frequency:** 10.7 mc. **Frequency response:** ±2 db, 20 to 20,000 cps. **Antenna:** 300 ohm balanced (or internal for local reception). **Output voltage:** Nominal .5 volts (with 3 uv 30% modulation in). **Quieting sensitivity:** 2 uv for 20 db of quieting; 20 uv for full quieting (40 db). **Maximum deviation sensitivity:** 5 uv; (400 cycle 100% modulation). **Deviation sensitivity:** 20 KC (1100 uv in). **Harmonic distortion:** Less than 1% (1100 uv 400 cycle 100% modulation). **Image ratio:** 40 db. **AFC correction factor:** 12 db. **Amplitude modulation suppression:** 25 db. **Hum and noise:** 40 db below 30% modulation (20 uv in).

SPECIFICATIONS MULTIPLEX—Audio frequency response: ±2 db, 50 to 15,000 cps. **Sub-carrier bandpass:** ±3 db 23,000 to 53,000 cps. **Channel separation:** 30 db. **Hum and noise:** —55 db (relative to 1 volt rms output). **Output impedance:** Cathode follower, variable to 4,000 ohms (each channel).

SPECIFICATIONS AM—Sensitivity, narrow bandwidth position: 1400 kc, 5 uv; 1000 kc, 6 uv; 600 kc, 10 uv. (standard IRE dummy antenna, .1 volt RMS reference output). **Sensitivity change, narrow to broad position:** —5 db. **IF bandwidth, narrow:** 14 kc, 6 db down; **Broad:** 20 kc, 6 db down. **Image ratio:** 1400 kc 50 db; 600 kc 75 db. **Harmonic distortion:** Less than 1%. **Hum and noise:** 35 db below 30% modulation (1000 kc unmodulated with 100 uv in). **IF rejection ratio:** 1400 kc 42 db; 600 kc 38 db. **Power supply:** Transformer operated 50-60 cycle, 100 watts. **Dimensions:** 5 1/2" H x 15 1/2" W x 14" D.



Kit Form
or
Factory
Assembled

AJ-30 \$99⁹⁵

Deluxe Heathkit AM/FM TUNER . . . Finest quality throughout with performance to match

- Output for FM multiplex converter
- Superbly designed 16-tube circuit
- Soft, glare-free illuminated tuning dial

Similar to the Heathkit AJ-41 above but without the built-in FM multiplex stereo converter. Provision is made for external multiplex unit such as Heathkit AC-11. AM & FM sections of the tuner operate independently

permitting use of AM and FM simultaneously. 3 circuit boards and preassembled, prealigned FM tuning unit provide for fast, easy assembly. Features include: individual tuning meters, large slide-rule dial, flywheel tuning, automatic frequency control on FM, fidelity switch on AM, and deluxe styling.

Kit AJ-30 . . . 24 lbs. . . \$10 mo. **\$99.95**
Assembled AJW-30, \$15 mo. **\$159.95**

Heathkit—World Famous For Better Quality, Better Value Electronic Kits

and 50-Watt Amplifier... Our Finest!



\$84⁹⁵
AA-100

Kit Form
or
Factory
Assembled

The incomparable AA-100 by Heathkit... finest STEREO COMBINATION AMPLIFIER KIT anywhere

- 50 hi-fi rated watts (25 watts per channel)
- 5 stereo inputs
- Versatile controls
- Mixed-channel speaker output
- Separate monophonic phono input
- Circuit board assembly

The Heathkit AA-100 Deluxe Stereo Amplifier stands head and shoulders in value above any other stereo amplifier in the kit industry. Packed full of exciting features, this high-fidelity rated 50 watt amplifier outperforms units selling for twice its price. It's a mere \$84.95 in kit form, that's just \$1.70 a watt for two 25-watt channels of distortion-free power to handle every amplifying task in your stereo system.

The five stereo inputs can be utilized to the versatile advantage of your individual system components... there's a stereo magnetic phono input, a pair of tuner inputs for AM and FM, a pair of tape inputs and two pairs of auxiliary inputs. A separate monophonic magnetic phonograph input is also available. The input layout is further enhanced by the fact that tape playback heads can be accepted directly without external preamplification or equalization.

In addition to three different stereo speaker impedances, the AA-100 has a "mixed-channel" speaker output that can be used for stereo "center fill-in" or for monophonic sound in other rooms. The cathode follower outputs for tape recorders insure true sound reproduction without high frequency loss, regardless of the distance between the amplifier and the recorder.

The many controls of the Heathkit AA-100 speak clearly of its versatility and capability in any situation. Included are preamplifier input level controls, power amplifier input level controls, hum controls, "mode" selector, speaker phase reversal switch, balance and separation controls, ganged volume controls and separate concentric bass and treble tone controls to put you in complete command of every function with assurance of peak performance.

While the electronics of the AA-100 are enough to prove this stereo amplifier the best buy on the market today, the wonderful styling features of this beauty make it an even greater value. The luggage tan vinyl-clad steel cabinet looks and feels like real leather, but is practically indestructible because of its mar, scratch and stain-resistant qualities. The plastic control panel is framed by a bright metal trim and soft refracted lighting from above gives glare-free illumination of control settings. The fabulous AA-100 is the "stereo-twin" of the famous Heathkit AJ-41 Stereo AM/FM Tuner (opposite page)... they look alike, and will fit in any room decor in your home. Remember the Heathkit AA-100 Stereo Amplifier delivers more and costs less.

Kit AA-100... 31 lbs... no money down, \$9 mo... \$84.95
Assembled AAW-100... no money down, \$14 mo... \$144.95

SPECIFICATIONS—Channels: 2. **Power output:** 50 watts (25 w. per channel) Heath Hi-Fi Rating: 60 watts (30 w. per channel) IHFM Music Power Output (0.7% THD, 1 kc). **Power response:** ± 1 db from 30 cps to 15 kc at 25 watts output per channel. **Harmonic distortion:** Less than 0.5% at 25 watts, 1 kc. Less than 2% at 25 watts, 30-15,000 cps (each channel). **Intermodulation distortion:** Less than 1% at 25 watts, 60 and 6,000 cps signals mixed 4:1 (each channel). **Hum and noise:** Mag phono, 55 db below 25 watts output at 6 mv sensitivity. Tape head, 35 db below 25 watts output. Tuner and aux. inputs 70 db below 25 watts output. **Channel separation:** 42 db min. at 1 kc. **Input sensitivity:** For 25 watts output per channel; mono mag. phono, 1.5 mv; stereo mag. phono, 1.5 mv; tape head, 1 mv; tuner, 0.2v.; aux., 1 & 2, 0.2 v. **Input impedance:** Mag phono, 47 K ohms (may be changed); tape head, 470 K ohms; tuner & aux., 250 K ohms each. **Outputs:** 4, 8 and 16 ohms; cathode follower tape recorder outputs. **Damping factor:** 15. **Controls:** Function switch (4-position); selector switch (6-position); balance control (total range, 16 db); separation control; ganged level controls; dual-concentric bass & treble controls; phase and power switch. **Tube complement:** 2-EF86, 4-12AX7, 2-7199, 4-7591, 1-GZ34, 1-selenium bias rectifier. **Power requirements:** 117 volts, 50-60 cycles, 150 watts. **Power outlets:** 2 AC receptacles, 1 switched, 1 unswitched. **Dimensions:** 5½" H. x 15½" W. x 13½" D. (allow 1" for cables at rear).

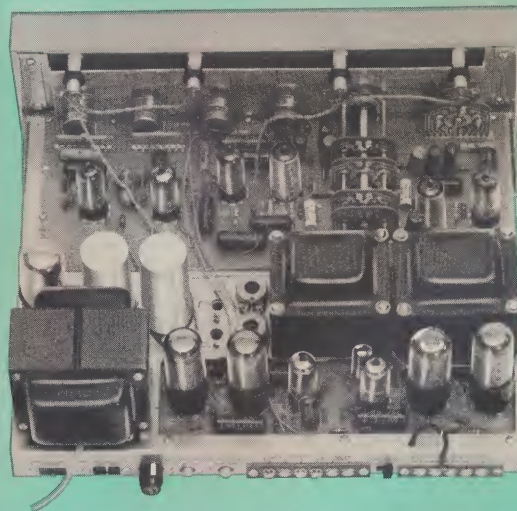

EASY TO BUILD, EASY TO USE

Assembly is easy with the circuit board construction of the AA-100; quality is obvious when you note the size of the husky transformers; connections are simple with all conveniently located and plainly labeled on the rear chassis panel.

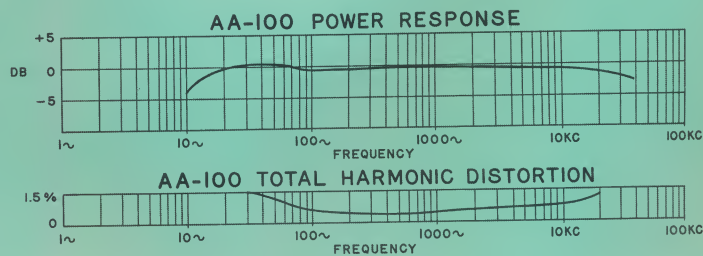

Kit Form or Factory Assembled, Your Dollar Buys More Value With Heath Equipment

Stereo Preamplifiers For



AA-11
\$84⁹⁵

PUSH-BUTTON CONVENIENCE

Push-button switches allow fast, easy selection of any desired input. Stereo and Monophonic modes of operation are clearly indicated on the attractively-screened plastic front panel to avoid confusion when operated by uninitiated members of the household.

HIDDEN SECONDARY CONTROLS

Clean, functional styling is achieved by placing all secondary controls behind this hinged front panel cover. Prevents confusion and accidental change in settings of controls which set initial conditions such as balance, phase, etc. Only volume, tone and input selectors are in open view on the front panel.

BAXANDALL TONE CONTROLS

Baxandall-type tone controls provide true, natural reproduction while giving you complete command of bass and treble tone quality in each channel to suit your individual listening preference.

EASY TO ADJUST INPUT LEVEL CONTROLS

Input level controls are provided for all inputs except Tape Head. They permit adjusting all inputs to the same level, making it unnecessary to change volume control setting when alternately using different program sources.

EASY ACCESS TO INPUT AND OUTPUT JACKS

All input and output jacks, one switched and one unswitched 117 VAC outlet, and fuse holder are conveniently located on the rear chassis apron. Jacks are clearly identified with information screened on the chassis. Cathode-follower outputs are provided for stereo and monophonic tape recording purposes.

The deluxe Heathkit STEREO PREAMPLIFIER ... worthy of the finest stereo systems

- Separate basic and secondary controls
- Push button selected inputs—greatly simplified operation
- Self powered—DC filaments—silicon diode rectifiers
- Switch-selected loudness or volume control
- Cathode follower outputs for stereo tape recording
- Controlled "Derived" center-channel monophonic output
- Rumble and scratch filters for optimum record reproduction
- Channel and phase reversal switches for convenience
- Low distortion triode stage circuit design
- More stages for more output, lower noise figures
- For use with any stereo or mono power amplifier



Whether you are like most of us who just like good music, or the more technically-inclined audiophile, you'll find the Heathkit AA-11 deluxe stereo preamplifier offers everything you've ever wanted in a master control center . . . deluxe styling to match the famous Heathkit AJ-41 tuner . . . versatile controls . . . and superb specifications.

To achieve both clean-lined design and simplicity of operation, all switches and controls are divided into two distinct groups; the first group is the basic, or primary, controls which are located on the plastic front panel. The other group is composed of secondary controls which are located behind the hinged cover on the lower front panel. The primary controls consist of NINE PUSH-BUTTON SWITCHES for selection of five stereo inputs, three monophonic inputs and on/off switch; a dual-tandem VOLUME/LOUDNESS control (one knob) which varies volume level of both left and right channels simultaneously; and separate dual-concentric (friction clutched) Baxandall-type BASS and TREBLE controls for individual channel adjustment. Center channel output also changes with these controls.

The push buttons allow fast, easy selection of (1) stereo phonograph (magnetic or ceramic); (2) stereo tape head; (3) stereo microphones; (4) stereo FM; (5) stereo auxiliary input; (6) monophonic AM tuner; (7) monophonic FM tuner; (8) monophonic auxiliary; and (9) OFF/ON switch. All equalization circuits are switched simultaneously by the program source selector buttons.

The secondary controls consist of (1) a BLEND control which varies from complete mixing of the left and right channel signals for monophonic output to complete separation for stereophonic listening, or any intermediate position to provide just the right amount of "center-fill" to eliminate the "hole-in-the-middle" effect; (2) a BALANCE control for adjusting channel outputs to equal amplitudes; (3) a SCRATCH FILTER switch to attenuate record surface noise; (4) a RUMBLE FILTER switch to attenuate turntable rumble; (5) a STEREO-MONO switch for monophonic record reproduction; (6) a CHANNEL REVERSAL switch to insure that each loudspeaker reproduces the correct stereo channel; (7) a PHASE REVERSAL switch to insure in-phase stereo speakers; and (8) a VOLUME-LOUDNESS switch which converts the volume control to a loudness control. The unique filter circuit employed for this purpose is so effective in maintaining proper tonal balance, even at exceptionally low background music levels, that correct and simultaneous adjustment of both volume and loudness may be achieved with a single control over its entire range . . . and it eliminates confusion when operated by a person unfamiliar with its function. Check the high performance specifications, convenience features and many extras you get at the amazingly low price of this quality preamplifier. 19 lbs.

Kit AA-11 . . . no money down, \$9 mo. \$84.95

SPECIFICATIONS—Channels: Two. **Inputs:** 5 stereo each channel and 3 monophonic. **Input impedance:** Tape head, 220 k ohms; Phono, 47 k ohms for magnetic, 75 k ohms when used with ceramic; Microphone, 500 k ohms; Multiplex, 600 k ohms and Aux, 600 k ohms. All monophonic inputs 600 k ohms input impedance. **Outputs:** One low impedance to power amplifier and one low impedance to tape recorder in each channel plus a "derived center channel" monophonic output at 1800 ohms impedance. **Frequency response:** ±0.5 db, 20 to 20,000 cps, ±2 db, 10 to 30,000 cps. **Harmonic distortion:** Max. .05% @ 2.5 volts output. **Intermodulation distortion:** Max. .09% @ 2.5 volts output. **Hum and noise:** All values relative to 2.5 V rms output; 2.5 mv input at Tape Head input, 50 db or better; 6 mv input at Mag. phono input, 60 db or better; 2.5 mv at Microphone input, 55 db or better; .1 v at High level input 65 db or better. **Channel separation:** 1 kc, 36 db or better. **Rumble filter:** 3 db down at 42 cycles, 12 db attenuation per octave. **Scratch filter:** 3 db down at 6 kc, 20 db attenuation per octave. **Baxandall tone controls:** 12 db boost, 16 db cut at 20 cps; 12 db boost, 20 db cut at 20,000 cps. **Controls:** Separate Bass & Treble, each channel; Volume-Loudness, Blend, Balance, Rumble Filter, Scratch Filter, Volume-Loudness switch, Stereo Mono switch, 9 push-button Source Selector switch, Phase Reversal switch, and Channel Reversal switch. **Tube complement:** (8) 12AX7, (2) 12AT7. **Power requirements:** 117 V AC, 50-60 cycles. **Dimensions:** 5 1/2" H. x 11 1/2" D. x 15 3/4" W.

Every Budget, Every Need

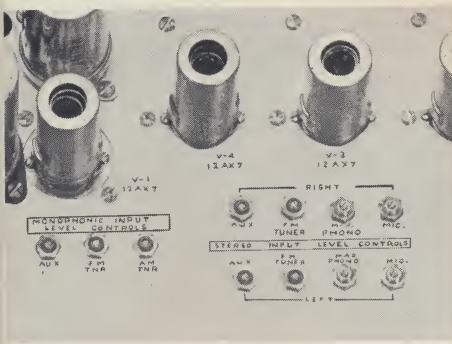
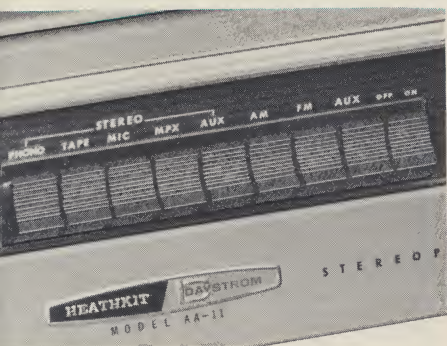

AA-141A
\$34.95

New, improved, low-cost
**STEREO PREAMPLIFIER . . . compare and
you'll agree it's an outstanding value**

- New extra stage for better specifications
- 4 inputs in each channel, 8 in all!
- 6-position function selector for stereo or monophonic modes of operation
- Cathode-follower outputs for low line loss and distortion
- Built-in power supply—use with any basic stereo amplifier
- Baxandall-type tone controls for better control at highs and lows



A better buy than ever, the new, improved Heathkit AA-141 Stereo Preamplifier now offers superior performance specifications and every modern convenience for stereo system control. Styled to match the new AJ-12, 22, 32, and 42 tuners in charcoal gray and luggage-tan, this preamplifier presents as striking an appearance as performance.

This quality stereo preamplifier can be used with any basic stereo power amplifier, since it has its own built-in power supply. Output cables are included for connection to the power amplifier, with cathode-follower output circuit design features to assure low line loss and installation flexibility in any system.

Four inputs are provided in each channel, eight in all, to accept practically any program source. An RIAA equalized input is provided for magnetic phonograph and a high level input is provided for crystal or ceramic phonograph cartridges. Two auxiliary high level inputs are provided for other program sources such as AM/FM tuners, tape recorder, TV, etc. Controls on the front panel consist of a six-position function selector which allows you to hear either channel individually through its own speaker, either channel through both speakers, normal stereo, or stereo channels reversed; separate concentric volume controls allow individual or simultaneous control of sound intensity of both channels; separate Baxandall-type tone controls give you complete command of bass and treble tone quality to suit your individual preference. The input switch selects any of the four input positions provided.

In addition to the cathode follower outputs to the power amplifiers, two high-level outputs are provided for tape recorder, allowing recording directly from the preamplifier. Two 117 volt AC outlets, one switched, one unswitched are provided for auxiliary equipment. Filament balance controls in each channel assure minimum hum and low distortion. An outstanding "buy" in a quality preamplifier at this low Heathkit price! 11 lbs.

Kit AA-141A . . . no money down, \$5 mo. \$34.95

SPECIFICATIONS—Channels: 2. Inputs (each channel): Mag Phono, Xtal Phono, Aux 1, Aux 2. **Input sensitivity:** (For 2.5 volts rms output at 1000 cps with the BASS and TREBLE controls set to the middle of their range): **Mag phono:** .006 volt. **Xtal phono:** .2 volt. **AUX 1 and 2:** .2 volt. **Input impedance:** Mag Phono 47 k ohm; xtal phono, 1 megohm; aux 1 and 2, 1 megohm; equalization RIAA for MAG PHONO; outputs (each channel) power amplifier, tape recorder. **Output impedance:** Power Amplifier, 1500 ohms; Tape Recorder, 1500 ohms. **Frequency response:** (with the Volume control at maximum and the Bass and Treble controls set approximately to the mid position): ± 1 db from 20 to 20,000 cps. **Harmonic distortion:** (at 2.5 volts rms output, using AUX 1 or 2 input): .1% or less. **Intermodulation distortion:** (at 2.5 volts equivalent rms output using AUX 1 or 2 inputs): .1% or less. **Channel separation:** 45 db or better 20 to 20,000 cps. **Hum and noise (below 2.5 volts rms):** Mag Phono, 55 db (or better); Xtal Phono, 65 db (or better); Aux 1 and 2, 65 db or better. **Tube complement:** 6—6EU7 tubes. **Controls and switches:** Source Selector Switch, Bass controls, Treble (or better); Aux 1 and 2, 65 db or better. **AC receptacles:** 1—switched, 117 V AC, 375 watts maximum. 1—unswitched, 117 V AC, 375 watts maximum. **Power supply:** Transformer-operated, using two selenium rectifiers in a voltage-doubler arrangement. **Power requirements:** 117 volts, 50-60 cps AC, 19.7 watts. **Dimensions:** 15 $\frac{1}{4}$ " W x 5 $\frac{1}{4}$ " H x 7-13/16" D, (overall).

Heathkit—Pioneer And World-Leader in Electronic Kits

A Complete Line of FM Stereo Tuners



Kit Form
or
Factory
Assembled



AJ-12
\$69⁹⁵

Choose Stereo or Regular FM Reception with the new Heathkit AJ-12 FM/FM STEREO TUNER

- Built-in FM Multiplex Converter
- FM Stereo Indicator light shows when stereo is being broadcast
- Stereo Phase Control for maximum separation and lowest distortion
- Adjustable AFC control for drift-free reception
- Filtered output for stereo tape recording off-the-air
- Circuit Board Assembly is fast and easy

Heath's latest contribution to your listening pleasure is this new AJ-12 FM/FM STEREO tuner. Here in one convenient, low-cost package are receiving capabilities for regular, monophonic FM and the beautiful multiplexed FM stereo programs being broadcast all over the country. Every feature for perfect reception has been included in the AJ-12: a built-in FM Multiplex Converter on a circuit board becomes an integral part of the tuner; a Stereo Indicator Light shows when the FM station you have tuned-in is broadcasting stereo so you may switch to that mode of operation; the Stereo Phase Control may be adjusted to assure maximum stereo separation and minimum distortion for the finest reception possible; adjustable Automatic Frequency Control (AFC) provides drift-free reception and assurance of proper tuning. Tuning is further facilitated by the new bar-type "eye" tuning indicator, the edge-lighted slide-rule tuning dial, and the smooth flywheel tuning mechanism. To permit off-the-air stereo tape recording, each output is especially filtered to eliminate interacting beat-notes, assuring clean, natural recordings with no extraneous noise.



EASY CIRCUIT BOARD ASSEMBLY: Prevents errors, assures fast, easy assembly and high stability.

Assembly is easy with the circuit-board construction which permits fast mounting of components and eliminates a large amount of the conventional wiring usually associated with a kit. The "front-end" of the tuner is factory assembled and aligned to assure factory-standard performance of your completed tuner.

Styling is in the luggage-tan vinyl-clad steel cabinet mode of Heathkit stereo/hi-fi with a charcoal gray front panel and polished anodized aluminum trim to match the AA-151 stereo amplifier styling shown on page 42.

Order your Heathkit AJ-12 Stereo FM Tuner now . . . it's your low-cost, high quality way to fine stereo broadcasts 16 lbs.

Kit AJ-12 (Shipping Oct.), no money down, \$7 mo. **\$69.95**
Assembled AJW-12 (Shipping Nov.), no money down, \$11 mo. **\$119.95**

SPECIFICATIONS—FM SECTION: Tuning range: 88 mc—108 mc. Intermediate frequency: 10.7 mc. Antenna: Balanced input for external 300 ohm antenna. Internal line antenna. Output voltage (30 microvolts—30% Mod.): 1 volt. Image ratio (30 microvolts —30% Mod. —98 mc): —45 db. Harmonic distortion (25 microvolts —100% Mod. —98 mc): Less than 1%. IF rejection (98 mc): —65 db. FM audio response (20-20,000 cps): ±1 db. AFC correction factor (Full AFC): 100 kc per volt. AM suppression: —27 db. Hum and noise (25 microvolts, 30% Mod.): —48 db. Quieting sensitivity: 20 db—2½ microvolts; 30 db—3½ microvolts; 48 db—30 microvolts (max. quieting). **FM STEREO CONVERTER SECTION:** Audio frequency response: ±2 db from 50 to 15,000 cps. Subcarrier bandpass: ±3 db from 23,000 to 53,000 cps. Channel separation: 30 db or more at 1 kc; 25 db or more at 10 kc. Hum and noise: —55 db relative to 1 volt rms output. Output impedance (Cathode Follower): Variable to 4000 ohms, each channel. Outputs: Left Channel—Right Channel.

The Heathkit AJ-11 AM/FM MONOPHONIC TUNER offers top-flight styling and performance

- Works with Multiplex Converter for stereo FM
- Two eye-tube tuning indicators
- Adjustable AFC on FM
- Fidelity switch for AM
- Built-in FM antenna

Kit Form
or
Factory
Assembled

AJ-11
\$69⁹⁵



For Your Complete Listening Pleasure

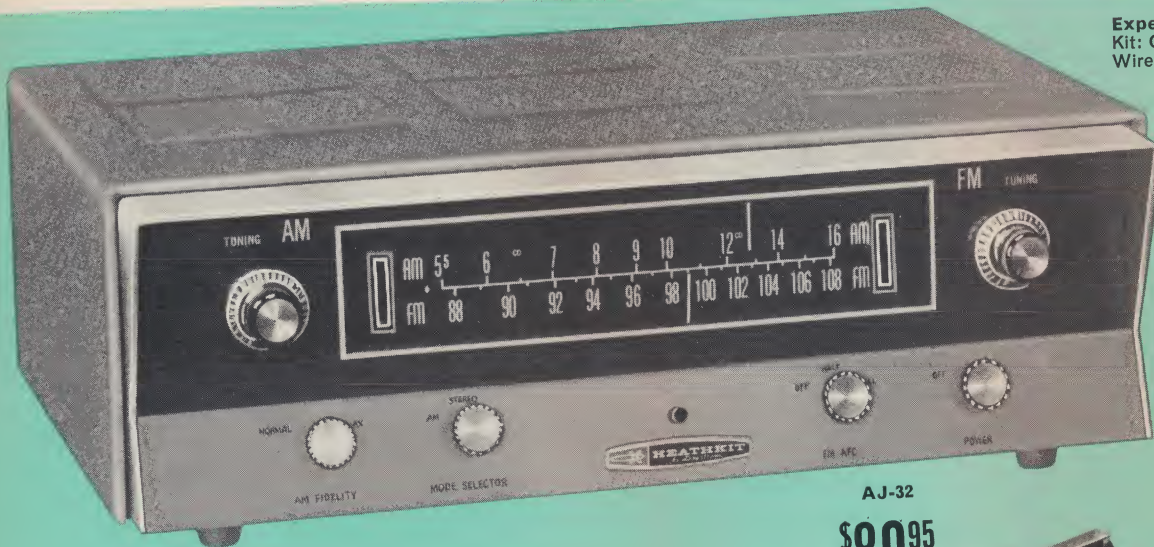

Expected Shipping Date
Kit: Oct. 5, 1962
Wired: Nov. 2, 1962

Kit Form
or
Factory
Assembled



New Low-Cost Heathkit TUNER AJ-32 has complete AM, FM and FM STEREO Reception Capabilities

- Built-in FM Multiplex Converter to Receive FM Stereo
- Stereo Phase Control for maximum separation, minimum distortion
- FM Stereo Indicator Light shows when received station is broadcasting in stereo
- Continuously variable AFC control for drift-free FM reception
- AM, FM, and Multiplex sections are mounted on circuit boards for unit stability and easy assembly

The latest in low-cost, all-mode tuners, the Heathkit AJ-32 boasts a group of extra-value features normally found only on much more expensive equipment. As examples: complete AM, FM, and Stereo FM reception is yours at the turn of a knob; a Stereo Indicator shows when FM stereo is being broadcast; the Stereo Phase Control assures maximum separation and minimum distortion; the continuously variable automatic frequency control (AFC) provides drift-free FM reception; to aid tuning, two bar-type "eye" tuning indicators are provided (one for AM, and one for FM), plus an edge-lighted slide-rule type dial, and flywheel tuning for both bands; an AM fidelity switch permits you to select the bandwidth you desire for maximum selectivity or maximum fidelity; outputs have special filtering to permit stereo tape recording of off-the-air material without broadcast beat-note interference, plus level controls to permit adjustment to the drive needs of your amplifier; built-in AM and FM antennas are provided for use in local signal areas, plus separate terminals for outside antennas.

Easy, accurate tuning is assured with the two eye-tube indicators. Engineered for full FM stereo reception when used with AC-11 converter (see p. 45). Drift-free FM operation provided with the preassembled, prealigned FM front end. A 3-position AFC switch holds FM stations to proper settings, regardless of signal strength. The AM Fidelity Switch gives you either increased selectivity or greater fidelity. Individual flywheel tuning provides selection ease and precision. There is a built-in AM rod antenna and FM line antenna, as well as terminals for external AM and FM antennas. Output level controls can be adjusted to suit your preamplifier. Multiplex adapter output jack is included. Large slide-rule dial is edge-lighted to accentuate numerals. Luggage tan vinyl-clad steel case with charcoal-grey front panel. 20 lbs.

Kit AJ-11 . . . no money down, \$7 mo. **\$69.95**
Assembled AJW-11 . . . no money down, \$12 mo. **\$129.95**

AJ-32
\$89.95

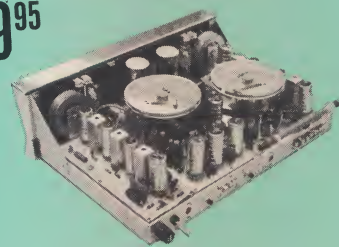

BUILT-IN MULTIPLEX ADAPTER
Separate, third, circuit board contains all stereo adapter components to add FM Stereo reception to your listening enjoyment. Two other circuit boards for AM and FM sections plus factory assembled "front end" make this tuner easiest to build.

Assembly is easy and fast with the preassembled and prealigned tuning unit plus circuit-board mounted parts for AM, FM and FM Multiplex sections. Styling is in the luggage-tan vinyl-clad steel mode of Heathkit stereo/hi-fi, with the charcoal gray front panel and anodized aluminum trim, which characterizes the mid-line motif, and perfectly match its AA-151 stereo amplifier partner shown on page 42.

Choose the new Heathkit AJ-32 Tuner for your radio listening . . . its versatility, superb quality, and smart styling make it a remarkable value.

Kit AJ-32 . . . 21 lbs., no money down, \$9 mo. **\$89.95**
Assembled AJW-32 . . . 21 lbs., no money down, \$14 mo. **\$149.95**

SPECIFICATIONS—AM SECTION: Tuning range: 550 kc—1600 kc. Intermediate frequency: 455 kc. Usable sensitivity (normal position): 1400 kc—10 microvolts (20 db of quieting); 1000 kc—15 microvolts (20 db of quieting); 600 kc—40 microvolts (20 db of quieting). IF bandwidth: Normal—6 db—7 kc; Maximum—6 db—12 kc. AM antenna: Built-in rod antenna with provisions for external antenna and ground. Output voltage (750 microvolts—30% Mod.): 1 volt. Image rejection: 1400 kc—40 db; 1000 kc—50 db; 600 kc—60 db. Harmonic distortion: (750 microvolts—95% Mod.): Less than 1%. Hum and noise: (5000 microvolts, 30% Mod.): 30 db. IF rejection: 1400 kc—30 db; 600 kc—50 db. **FM SECTION:** Tuning range: 88 mc—108 mc. Intermediate frequency: 10.7 mc. Antenna: Balanced input for external 300 ohm antenna. Internal line antenna. Output voltage (30 microvolts—30% Mod.): 1 volt. Image ratio (30 microvolts—30% Mod., —98 mc): —45 db. Harmonic distortion (25 microvolts—100% Mod., —98 mc): Less than 1%. IF rejection (98 mc): —65 db. FM audio response (20-20,000 cps): ±1 db. AFC correction factor (Full AFC): 100 kc per volt. AM suppression: —27 db. Hum and noise (25 microvolts, 30% Mod.): —48 db. **FM STEREO CONVERTER SECTION:** Audio frequency response: ±2 db from 50 to 15,000 cps. Subcarrier bandpass: ±3 db from 23,000 to 53,000 cps. Channel separation: 30 db or more at 1 kc; 25 db or more at 10 kc. Hum and noise: —55 db relative to 1 volt rms output. Output impedance (Cathode Follower): Variable to 4000 ohm, each channel. Outputs: Left Channel—Right Channel.

SPECIFICATIONS (FM)—Tuning range: 88-108 mc. **Quieting sensitivity:** 2.5 uv for 20 db quieting; 3.5 uv for 30 db; 25 uv for max. quieting (43 db). **Image ratio:** —45 db, 25 uv, 30% mod, 98 mc. **IF frequency:** 10.7 mc. **IF rejection:** (98 mc)—63 db. **Output:** Cathode follower type, variable to 800 ohms; level: 0.45 v, 25 uv, 30% mod. **Frequency response:** ±2 db, 20-20,000 cps. **Harmonic distortion:** Less than 1%, 25 uv, 100% mod., 98 mc. **Hum and noise:** —43 db, 25 uv, 30% mod. **RF stage:** 1 tuned RF amplifier. **AFC:** Switched, 3-positions, off-half-full. **Multiplex output:** Output supplied for external multiplex adapter.

SPECIFICATIONS (AM)—Tuning range: 550-1600 kc. **Sensitivity:** Narrow position: 1400 kc, 10 uv; 1,000 kc, 15 uv; 600 kc, 40 uv. **Frequency response:** ±2.5 db, 20-9,000 cps (40 db down at 10 kc). **Image rejection:** 1400 kc, 46 db; 1,000 kc, 45 db; 600 kc, 60 db. **IF frequency:** 455 kc. **IF rejection:** 1400 kc, 40 db; 600 kc, 33 db. **Output:** Cathode follower type, variable to 800 ohms; level, 1 v, 750 uv, 30% mod. **Harmonic distortion:** less than 1%, 750 uv, 95% mod. **Hum and noise:** 30 db down (5,000 cps, 30% mod). **RF stage:** 1 tuned RF amplifier. **AVC:** Derived from voltage doubler detector.

SPECIFICATIONS (general)—Tuning indicators: 2 magic eye tubes, one AM, one FM. **Controls:** AM bandwidth, broad/narrow; function selector, AM/Stereo/FM; FM AFC, full/half/off; AC power on-off; AM tuning; FM tuning; AM level; FM level. **Tube complement:** (AM) 2-6BA6, 1-6BE6, 1-6BN8, 1-6ME5. (FM) 1-6CY5, 1-6EZ8, 3-6AU6, 1-6BN8, 1-6ME5. Transformer operated, full wave voltage doubler with 2 silicon rectifiers. **Power requirements:** 117 v, 50-60 cycles, 40 watts. **Dimensions:** 15 1/2" W. x 5 1/2" H. x 11" D.

There's A Heathkit For Every Interest, Every Purpose, Every Budget

Enjoy the Satisfaction of Building



Kit Form
or
Factory
Assembled

Features patented Heath
ULTRA-LINEAR® circuit!



Just \$59.95 and a few fun-filled hours
can bring you this fine
28-watt STEREO AMPLIFIER

AA-151
\$59.95

- Two hi-fi-rated 14-watt channels
- Stereo or mono operation
- 4 Stereo inputs
- Versatile controls
- Perfect match for both AJ-12 and AJ-32 stereo tuners

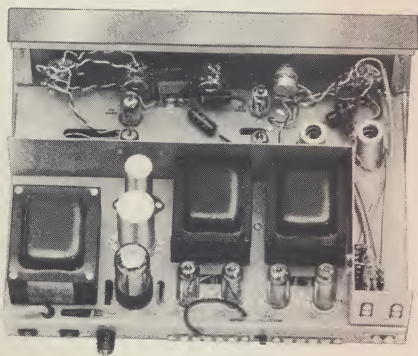
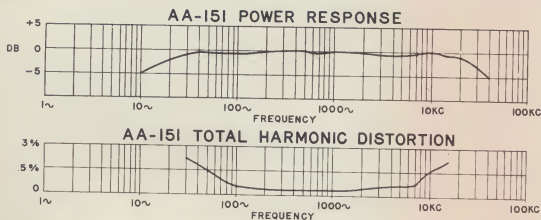

EXTRA-MARGIN COMPONENTS combine with skillful layout to produce an easy-to-assemble product which offers savings of up to 50% and years of faithful service. Note the big transformers used and the open, easy-to-get-at chassis.

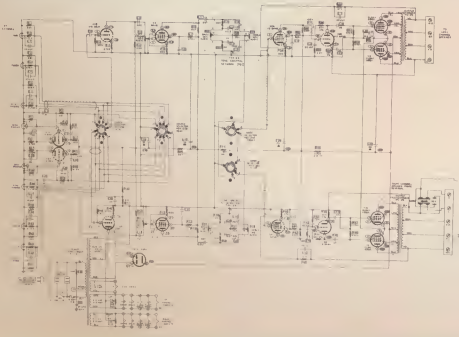

Value leader in the medium price class, this rugged combination pre-amplifier and power amplifier offers ample power, versatile controls and hi-fi-rated performance for your stereo listening pleasure.

With its handsome luggage tan vinyl-clad steel cabinet and charcoal grey front panel, it blends perfectly with both the AJ-12 FM Stereo Tuner and AJ-32 AM-FM Stereo Tuner (page 41). Outstanding in quality and flexibility, the AA-151 has fingertip controls that give instantaneous command over every function. A four input selector switch provides choice of magnetic phono, crystal phono, tuner or high level auxiliary input for tape recorder, TV, etc.

The six-position function selector switch gives you instant selection of either the left or right stereo signals independently or through both amplifier channels. It also selects "Stereo" or "Stereo Reverse" providing channel reversing function. A dual-concentric volume control incorporates a friction clutch which locks the volume controls together once the balancing of the output levels of the two amplifiers has been accomplished. Ganged dual tone controls adjust bass or treble response of both channels simultaneously. Proper speaker phasing is conveniently accomplished with the phase-reversal switch. Each channel is equipped with a filament balance control. Two AC outlets, one controlled by the power switch, the other unswitched, provide convenient accommodation for accessory equipment. The husky power supply which employs a GZ34 rectifier tube, provides the voltage regulation essential for high power output, while maintaining low distortion levels.

With this remarkable AA-151 Stereo Amplifier and either the AJ-12 or AJ-32 stereo tuner you will have a powerful stereo combination for your home system at a budget-conscious price. The AA-151 and the AJ-12 or AJ-32 are look-alike companions designed for each other with styling that will blend with any decor in your home. 27 lbs.

Kit AA-151 . . . no money down, \$6 mo. **\$59.95**
Assembled AAW-151 . . . no money down, \$11 mo. **\$119.95**

SPECIFICATIONS—Channels: 2. **Power output:** 28 watts (14 w. per channel) Heath Hi-Fi Rating: 32 watts (16 w. per channel) IHFM Music Power Output (0.7% THD, 1 kc). **Power response:** ±1 db from 20 cps to 20 kc at 14 watts output per channel. **Harmonic distortion:** Less than 2%, 30 cps to 15 kc at 14 watts output per channel. **Intermodulation distortion:** Less than 2% at 14 watts output per channel using 60 cps and 6 kc signal mixed 4:1. **Hum and noise:** Mag. phono input, 55 db below 14 watts; Tuner and crystal phono 65 db below 14 watts. **Channel separation:** Better than 45 db. **Input sensitivity:** For 14 watt output each channel (tone controls in "Flat" position): mag. phono, 0.004 volts at 1 kc; crystal phono, 0.2 volts; tuner and aux., 0.2 volts. **Outputs:** 4, 8 and 16 ohms. **Damping factor:** 10:1. **Controls:** Dual clutched volume, ganged bass; ganged treble; 4-position source selector; 6-position mode selector; speaker phasing switch. **Tube complement:** 2-6EU7, 2-6AU6, 2-6AN8, 4-EL84/6BQ5, 1-GZ34/5AR4. **Power requirements:** 117 volts, 50-60 cycles, 130 watts. **Power outlets:** 2 AC receptacles, 1 switched, 1 unswitched. **Dimensions:** 15½" W. x 5¼" H. x 11" D.

Your Own Stereo/Hi-Fi

Features patented Heath **ULTRA-LINEAR®** circuit!



**80-WATT
POWER AMP
AA-121
\$79⁹⁵**

- Full high fidelity power rating
- Mixed-channel center speaker output
- Fixed bias output stage
- Front panel controls
- Beautifully styled

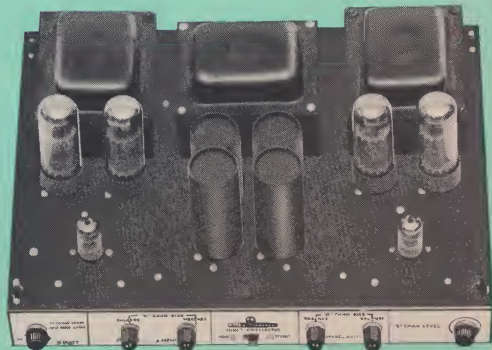

RUGGED
Thirty-nine pounds of conservatively rated components loaf along at a full eighty watts output with plenty of reserve.

The AA-121 . . . ready for any stereo or mono assignment with power to spare, superb fidelity, and extra value

With a modern design chassis of black enamel with ivory front panel and metallic bronze ventilated steel dust cover, this powerful "professional quality" stereo amplifier delivers a full 40 watts to each stereo channel, or if you desire, you can channel all 80 watts to a single monophonic outlet. A "stereo-mono" switch ties both amplifiers to one input-level control for monophonic operation. When used for stereo operation, individual level controls are provided for each channel.

Heath's patented **ULTRA-LINEAR®** circuit provides superb fidelity and the famous "bas-bal" output balancing circuit for reduced low frequency distortion. A phase reversal switch in one channel allows easy phasing of any speaker system. Other features include a mixed channel output for a center channel speaker installation when you want to get rid of the "hole-in-the-middle" effects of stereo applications. Fixed bias output stages assure minimum distortion. The fused, transformer operated silicon diode power supply provides extremely good regulation and cool operation. The surge protection device and conservative ratings insure long tube and power supply life. Two AC outlets, 117 volts, one switched and the other unswitched are provided for accessory equipment of your hi-fi/stereo system. The power on the AA-121 can be turned "on" or "off" either at the amplifier or the preamplifier, as desired.

This attractive and powerful stereo amplifier is designed for use with any self-powered preamplifier, but its color and lines will blend most tastefully with the Heathkit AA-11 (page 38) or AA-141 (page 39). 39 lbs.

Kit AA-121 . . . no money down, \$8 mo. \$79.95

SPECIFICATIONS—Channels: 2. **Power output:** 80 watts (40 w. per channel) Heath Hi Fi Rating: 98 watts (49 w. per channel) IHFM Music Power Output (0.7% THD, 1 kc). **Power response:** ±0.5 db, 20-20,000 cps, at 40 watts output per channel. **Harmonic distortion:** 1.5% or less, 20-20,000 cps, at 40 watts output per channel. **Intermodulation distortion:** 0.5% or less at 40 watts output per channel, 60 and 6,000 cps mixed 4:1. **Hum and noise:** 85 db below 40 watts output. **Channel separation:** 70 db or better at 1 kc. **Input sensitivity:** 0.95 volts rms for 40 watts output per channel. **Outputs:** 4, 8, 16, and 32 ohms per channel; center speaker terminals can be used with 4, 8 or 16 ohm speakers. **Damping factor:** 16:1, 8 and 16 ohm taps; 12.5:1, 4 ohm tap. **Controls:** A Channel: bias balance, bias voltage, level. B Channel: bias balance, bias voltage, level. Function selector; phase and power switches. **Tube complement:** 2-6AN8; 4-EL34, 4 silicon diode rectifiers, 1 selenium bias rectifier. **Power requirements:** 117 v, 50-60 cycles, 180-320 watts. **Power outlets:** 2 AC outlets; 1 switched, 1 unswitched. **Color and finish:** metallic bronze, expanded metal dust cover; black chassis with ivory lower front panel. **Dimensions:** 7 1/2" H x 15" W x 11" D.

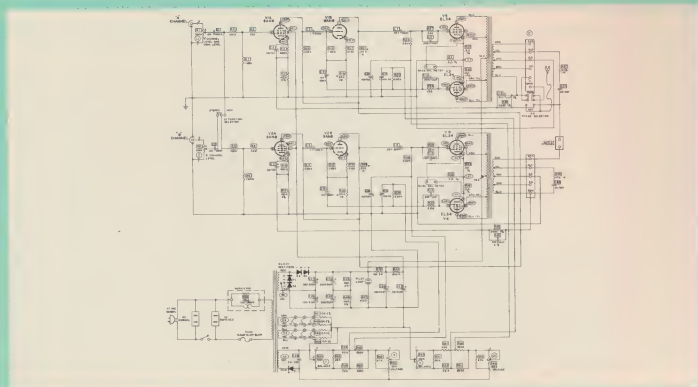
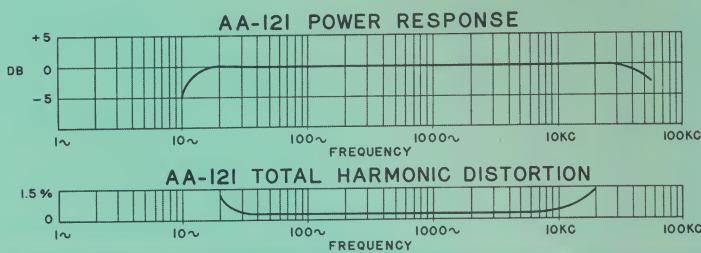

Save Up To 50% With Heath Do-It-Yourself Electronic Kits

Heathkit® Amplifiers

Fine Quality with Economy



AA-201 **\$31⁹⁵**

Here's a complete two channel
COMBINATION PREAMPLIFIER
and **AMPLIFIER unit**
for just **\$31.95**

- Smart new styling design
- Separate bass and treble tone controls
- Clutched volume controls
- 2 high level inputs

COMPACT

Proof that good things come in small packages . . . this well-designed, conservatively rated unit will surprise everyone with its performance.

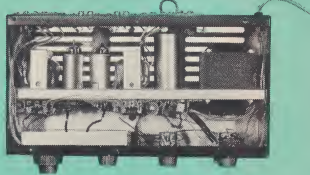

This combination amplifier-preamplifier delivers 3 watts per stereo channel . . . enough power for average listening tastes . . . and is just what you need for that second system you want to set up in the children's room, the recreation room or out on the patio. Other features include separate bass and treble dual channel tone controls to bring out the deep rich lows and the tingling highs in your favorite musical selections. Clutched volume controls give you freedom and ease of system control to make the listening suitable to your individual taste. A seven-position function switch selects either monophonic phonograph, Channel A tuner, Channel B tuner, stereo phonograph, stereo phonograph reverse, stereo tuner, or stereo tuner reverse. The two high level inputs will accommodate tuners and crystal or ceramic phonographs.

Compact, all-metal case is finished in jet-black enamel with an ivory front panel to highlight the control knobs.

Kit AA-201 . . . 12 lbs. . . no money down,
\$5 mo. **\$31.95**

SPECIFICATIONS—Channels: 2. Power output: 6 watts (3 w. per channel) Heath Utility Rating. **Power response:** ±1 db, 50-20,000 cps at 3 watts output per channel. **Harmonic distortion:** Less than 3%, 60-20,000 cps at 3 watts output per channel. **Intermodulation distortion:** Less than 3% at 3 watts output, 60 and 6,000 cps signals, 4:1. **Hum and noise:** 65 db below 3 watts output. **Input sensitivity:** 150 mv for 3 watts output each channel, crystal phono and tuner. **Outputs:** 4, 8 and 16 ohms. **Controls:** Dual clutched volume, ganged treble, ganged bass, 7-position selector switch, speaker phasing switch, on-off switch. **Tube complement:** 2-EL84; 2-7199; 1-EZ81. **Power requirements:** 117 v, 50-60 cycle, 75 watts. **Color and finish:** Black enamel with ivory front panel. **Dimensions:** 12½" W x 3¼" H x 6¼" D.

Ideally powered, ideally priced . . . the
AA-111 STEREO POWER AMPLIFIER
fills the majority of system needs

- Conservatively rated at 14 watts per channel
- Circuit boards for easy assembly
- Individual amplifier gain controls
- Phase reversal switch
- Supplies preamp power when needed



AA-111
\$44⁹⁵

ULTRA-LINEAR

Four EL-84 power tubes and the patented Heath **ULTRA-LINEAR®** output stage of this amplifier insure its amazing performance. Note easy circuit-board assembly.

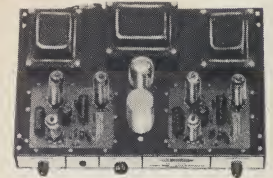

The two channels are hi-fi rated at a full 14 watts each and use Heath's patented **ULTRA-LINEAR®** circuit to bring you the finest in performance. And remember, you save valuable space in your high fidelity/stereo enclosure or shelves by assembling this compact AA-111, instead of two power amplifiers.

A printed circuit board for each channel simplifies assembly as does Heath's famous "check-by-step" instructions. The circuit boards also insure stability and uniformity of channel operation. Other features of this fabulous unit include individual amplifier gain controls and a one-channel speaker phase reversal switch. You can turn the AA-111 off at either the amplifier or the preamplifier. The output terminals accommodate 4, 8 and 16 ohm speakers and two 117 volt AC receptacles are provided for accessory equipment. The transformer operated power supply is fused for safety.

The AA-111 is designed as a complementary styled companion to the Heathkit AA-11 or AA-141 stereo preamplifiers (pp. 38, 39). And of course, it will function perfectly with any other preamplifiers. The rugged ventilated dust-cover of metallic bronze colored steel protects the components which are mounted on the black chassis. The chassis lower front panel is ivory. Overall dimensions: 13" W x 8½" D x 6" H.

Order your AA-111 stereo power amplifier now and see for yourself why this value-starred unit has quickly risen to the top of its field.

Kit AA-111 . . . 21 lbs. . . no money down, \$5 mo. **\$44.95**

SPECIFICATIONS—Channels: 2. Power output: 28 watts (14 w. per channel) Heath Hi-Fi Rating; 32 watts (16 w. per channel) IHFM Music Power Output (0.7% THD, 1 kc). **Power response:** ±1 db from 30 cps to 15 kc at 14 watts output per channel. **Harmonic distortion:** 2% or less at 14 watts, 30 cps to 15 kc. **Intermodulation distortion:** 2% or less 60 and 6,000 cps signals mixed 4:1 at 14 watts output per channel. **Hum and noise:** 76 db below 14 watts output. **Channel separation:** 65 db. **Input sensitivity:** 0.74 v for 14 watts output per channel. **Input impedance:** 500 K ohm pot. **Outputs:** 4, 8 and 16 ohm. **Damping factor:** 5.25:1, 4 ohm tap; 10.2:1, 8 ohm tap; 11.5:1, 16 ohm tap. **Controls:** Left and right channel gain; AC switch; phase switch. **Tube complement:** 2-7199; 4-EL84/6BQ5; 1-GZ34/5AR4. **Power requirements:** 117 v, 50-60 cycles, 115 watts. **Power outlets:** 2 octal sockets for pre-amp power; supply 300 v at 10 ma, 6.3 volts at 1.1 amps at each socket.

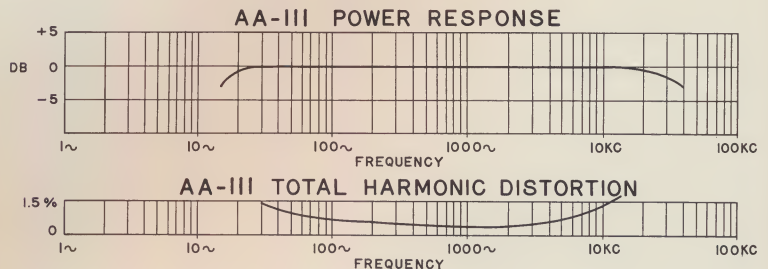

Heathkit® Monophonic Tuners and Stereo Converters

High Fidelity FM TUNER . . . low cost monophonic FM entertainment . . . convertible to stereo with external adapter

- Engineered for FM Stereo with the AC-11 Multiplex Converter
- Automatic Frequency Control (AFC)
- 5 tube circuit (9 tube functions)
- Preassembled, prealigned tuning unit



Add the listening beauty of high fidelity FM reception to your music system with the low-cost Heathkit AJ-31 . . . convert to FM Stereo at any time by adding the AC-11 Converter for its circuitry includes multiplex-engineered broad bandpass and a multiplex output jack. Other design features in this outstanding FM tuner kit value include a large slide-rule dial, fly-wheel tuning and switched AFC for drift-free reception. The preassembled, prealigned tuning unit assures factory-built performance and easy assembly. Cathode-follower output offers complete installation flexibility in your high fidelity system. Styling is in the Heathkit charcoal gray with ivory colored bezel and lower front panel accented by red. 8 lbs.

Kit AJ-31 . . . no money down, \$5 mo. **\$39.95**
 Assembled AJW-31 . . . no money down, \$7 mo. **\$69.75**

SPECIFICATIONS—Tuning range: 88 to 108 mc. **Quieting sensitivity:** 2.5 uv for 20 db of quieting 3.5 uv for 30 db of quieting; 25 uv for maximum quieting (45 db). **IF frequency:** 10.7 mc. **Image ratio:** 45 db. **AFC correction factor:** 75 kc per volt. **AM suppression:** 25 db. **Frequency response:** ±2 db 20-20,000 cps. **Harmonic distortion:** less than 1.5%, 1100 uv, 400 cycles 100% modulation. **Intermodulation distortion:** less than 1%, 60 cycles and 6 kc; mixed 4:1 1100 uv, 30% modulation. **Antenna:** 300 ohms unbalanced. **Output impedance:** 600 ohms (cathode follower). **Output voltage:** nominal .5 volt (with 30% modulation, 20 uv signal). **Power requirements:** 105-125 volts 50/60 cycle AC at 25 watts. **Overall dimensions:** 4-15/16" H x 13 1/2" W x 6" D.

Heathkit AJ-21 AM TUNER Extra-Value Features now are yours at a New Special-Value Price . . . Just \$27.95

- Superhet circuit with tuned RF stage
- Fidelity switch for normal or maximum IF bandwidth
- Transformer operated silicon rectifier power supply
- 10 kc whistle filter
- Voltage doubler detector circuit for low distortion

Big Volume Passes Extra Savings to You

Here's exciting listening at low cost! The Heathkit AJ-21 brings you truly unusual circuitry to provide high fidelity AM listening . . . fidelity that rivals FM in quality . . . and it all happens for just \$27.95.

This self-powered unit has a high gain rod antenna and a tuned RF stage for high sensitivity and a full wave voltage doubler detector for lower distortion. Add to these features a "fidelity" switch which gives you a choice of either maximum selectivity or maximum fidelity and you have a tuner that produces results from AM broadcasting that are truly unusual . . . distant station receiving ability that can best be described as "hot" plus fidelity that can only be described as high!

Tuning is easy with the edge-lighted slide-rule dial and heavy die-cast flywheel that spins the pointer across the dial. The circuit includes a built-in ferrite rod antenna plus terminals for connection of an outside antenna

NEW SPECIAL-VALUE PRICE \$27⁹⁵

Big Volume Permits New Special-Value Price On This Heathkit FM Stereo Converter . . . enjoy FM in Stereo now at Extra Savings!

- Use with any FM tuner having multiplex output
- Measures only 3 3/8" H x 3 1/2" W x 10 5/8" D overall
- Color styled to match Heathkit tuners
- Built-in power supply
- Easy to build



You can use the Heathkit AC-11 Multiplex Converter unit with any Heath or other high quality FM tuner which has a multiplex output. It is easy to build and easy to use with its point-to-point wiring and front panel control.

This compact, easy-to-assemble unit needs just a simple adjustment and it's ready to plug into the multiplex output jack of your FM tuner and the input jacks of your stereo amplifiers. The AC-11 has three tubes, a self-contained, built-in fused power supply with silicon rectifier, and prealigned coils. Low distortion is assured through the use of a simplified balanced diode detector. Controlled signal matrixing assures maximum separation of channels and gives you true stereo. The front panel separation control is provided for maximum separation. Included in the kit are three connecting audio cables (1 input, 2 output). 3 3/8" H. x 3 1/2" W. 10 5/8" D. 4 lbs.

Kit AC-11A (black case) . . . \$5 mo. **New Special-Value Price \$24.95**
 Kit AC-11B (luggage tan case) . \$5 mo. **New Special-Value Price \$24.95**
 Assembled ACW-11A . . . \$5 mo. **New Special-Value Price \$49.95**
 Assembled ACW-11B . . . \$5 mo. **New Special-Value Price \$49.95**

SPECIFICATIONS—Audio frequency response: ±2 db 50 to 15,000 cps. **Subcarrier bandpass:** ±4 db 23,000 to 53,000 cps. **Channel separation:** 30 db. **Hum and noise:** -55 db (relative to 1 volt rms output). **Input impedance:** 470 K ohms. **Output impedance:** 3000 ohms each channel (cathode follower output). **Input:** MULTIPLEX (from tuner). **Input signal voltage:** .4 volt minimum (from multiplex output of FM tuner). **Outputs:** LEFT CHANNEL; RIGHT CHANNEL. **Switch and controls:** OFF-ON switch; CHANNEL SEPARATION control; LEFT CHANNEL LEVEL control; RIGHT CHANNEL LEVEL control. **Tube-diode complement:** 1-12AU7 Amplifier-Cathode Follower; 1-12AU7 Amplifier-Oscillator; 1-12AU7 Cathode Follower Output; 2-Silicon Diode Rectifiers; 2-Crystal Diode Detectors. **Power requirements:** 117 volts AC, 50/60 cps, 12 watts.



for maximum signal pickup. Two outputs are provided, one is the "variable" cathode follower type for direct driving of power amplifiers with proper signal levels and minimum high frequency cable losses; the other output is "fixed" for use with preamplifiers. Choose high fidelity reception with the Heathkit AJ-21 high fidelity AM tuner. 9 lbs.

Kit AJ-21 . . . no money down, \$5 mo. **New Special-Value Price \$27.95**

SPECIFICATIONS—Tuning range: 550 kc to 1600 kc. **Intermediate frequency:** 455 kc. **Sensitivity (for 20 db quieting IHFM standards):** 1000 kc-8 uv. **IF bandwidth (6 db down):** NORMAL-7 kc.; MAXIMUM-18 kc. **Output impedance (cathode follower):** 5000 ohms. **Input signal for 1 volt output:** 2.5 uv-30% mod. 1000 kc. **Image ratio:** 1000 kc-50 db. **Harmonic distortion (750 uv 95% mod.):** Less than 1%. **Hum and noise (500 uv-30% mod.):** 40 db. **IF rejection:** 1000 kc-35 db. **Tube complement:** 2-6BA6, RF amplifier-IF amplifier. 1-6BE6, Oscillator-Mixer. 1-12AU7, AF Amplifier-Cathode follower. 2-Crystal Diodes, Audio Detector. 1-Silicon Diode, Rectifier (Power Supply). 1-No. 47 Pilot Lamp (Dial Illumination). **Power supply:** Transformer operated (fused). **Power requirements:** 117 V AC, 50/60 cycles at 19 watts. **Dimensions:** Overall—including cabinet and feet, 4-15/16" high x 13 1/2" wide x 6" deep.

Save Up To 50% With Heath Do-It-Yourself Electronic Kits



Heathkit® Monophonic Amplifier



Features patented Heath **ULTRA-LINEAR®** circuit!

Kit Form or Factory Assembled



NEW SPECIAL-VALUE PRICE \$29.95

AA-161 ~~\$33.54~~

Big Volume Passes Extra Savings to You

This superb monophonic **COMBINATION PREAMPLIFIER-POWER AMPLIFIER** has won thousands of friends throughout the music-listening world... returns to its original price because of volume purchases and big sales... **\$29.95**

- Hi-Fi-Rated at 14 watts
- Three inputs for any program source
- Complete controls on the front panel
- Separate bass and treble controls
- Smart charcoal and ivory styling with red accents

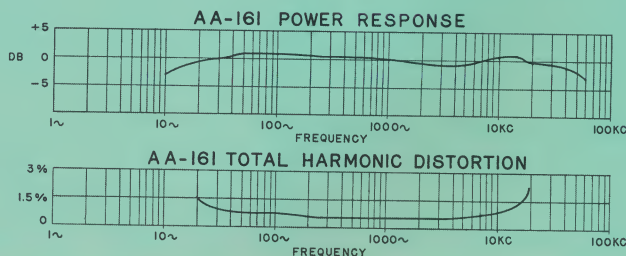

Continuing the heritage of the popular EA-series of Heathkit 14-watt monophonic combination amplifiers, this AA-161 is designed to power your high fidelity system economically, faithfully.

This striking unit incorporates a charcoal grey steel cabinet highlighted by an ivory colored bezel and bottom front panel. Combining a top-notch amplifier and preamplifier in a single low-cost package, the AA-161 provides rich, full range sound reproduction and low noise and distortion levels thanks to Heath's quality design and engineering "know-how". The use of miniature tubes throughout results in a compact chassis layout which is easy to construct. EL-84 power tubes in a push-pull output circuit perform outstandingly with the specially-designed output transformer. A filament-balance control virtually eliminates AC hum for superb listening at low volume levels. The three separate inputs of the AA-161 will accommodate magnetic and crystal phono cartridges, tape recorder or tuner program sources. Separate bass and treble tone controls enable you to precisely adjust the sound to your particular taste. 15 lbs.

Kit AA-161 . . . \$5 mo. **New Special-Value Price \$29.95**
 Assembled AAW-161 . . . \$6 mo. **New Special-Value Price \$54.95**

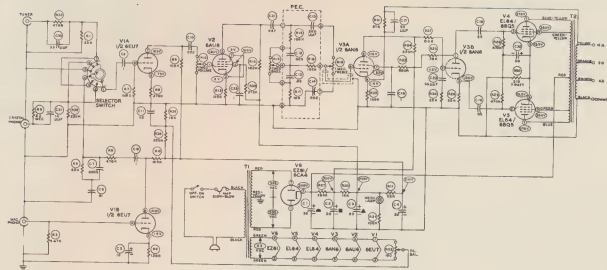

SPECIFICATIONS—Power output: 14 watts Heath Hi-Fi Rating; 16 watts IHFM Music Power Output (2% THD, 1 kc). **Power response:** ± 1 db 30-15,000 cps, 14 watts output. **Harmonic distortion:** Less than 2%, 30 cps to 15 kc, at 14 watts output. **Intermodulation distortion:** 2% or less at 14 watts output using 60 and 6,000 cps signals, 4:1. **Hum and noise:** mag. phono input, 55 db below 14 watts; tuner and crystal phono, 65 db below 14 watts. **Input sensitivity:** For 14 watts output; mag. phono, 0.004 v at 1 kc; crystal phono, 0.2 v; tuner 0.25 v, with tone controls flat. **Outputs:** 4, 8 and 16 ohms. **Damping factor:** 10:1. **Controls:** 3-position function selector switch, bass and treble tone controls, volume control. **Tube complement:** 6EU7, 1-6AU6, 1-6AN8, 2-EL84/6BQ5, 1-EZ81/6CA4. **Power requirements:** 117 v, 50-60 cycles, 55 watts. **Color and finish:** Charcoal grey steel cabinet and upper front panel with ivory colored bezel and lower front panel. **Dimensions:** 5" H x 13 3/8" W x 10 1/2" D.

... Pacemakers in Value



- Full 25 watt output—hi-fi rated
- Separate bass and treble tone controls
- Four switched inputs
- Modern styling—matches AJ-21 and AJ-31 tuners

AA-181 **\$42.95**

Compare this for value . . .

Heathkit 25-watt Monophonic COMBINATION AMPLIFIER for just \$42.95

Housed in a beautiful charcoal grey steel cabinet with ivory-colored bezel and lower front panel, this beautiful amplifier is a striking component in any music system setting.

In addition to these visual advances, the AA-181 gives you a pre-amplifier, power amplifier and power supply, all in one compact unit to provide more than enough hi-fi power to drive any acoustic suspension speaker system such as the Heathkit AS-2 or AS-10 (page 55). It has excellent gain characteristics and employs fixed bias push-pull 7591 tubes to provide 25 watts of dependable hi-fi rated power with minimum distortion. The preamplifier section features four separate inputs (microphone, magnetic phono cartridge, crystal or ceramic phono cartridge and auxiliary), each properly compensated and selected by the panel-mounted selector switch. The separate bass and treble tone controls each offer 15 db boost and cut. Twin-triode miniature tubes in the preamplifier, tone control and phase splitter stages assure low hum and noise levels. The output transformer is tapped at 4, 8 and 16 ohms to match practically any speaker system. A shielded, heavy-duty power transformer assures long, trouble-free life. The neon pilot light serves as a convenient operating reminder.

Kit AA-181 . . . 21 lbs. . . . no money down, \$5 mo. . . . **\$42.95**

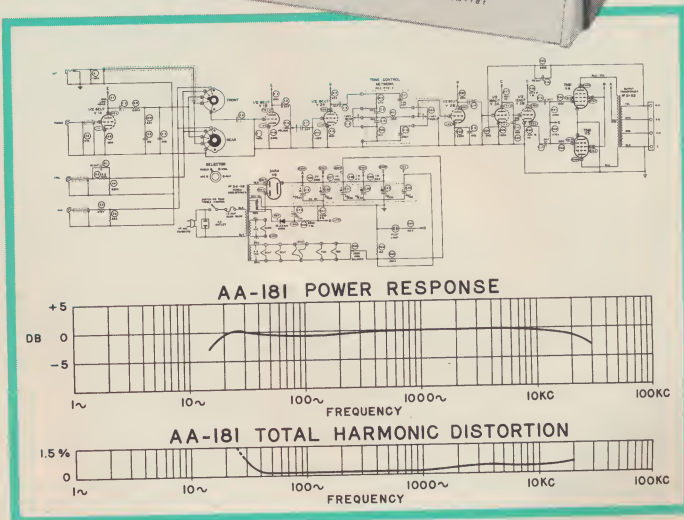

SPECIFICATIONS—Power output: 25 watts Heath hi-fi rating; 30 watts IHFM music power rating (0.7% THD @ 1 KC). Power response: ± 1 db, 30 cps to 15 kc, at 25 watts output. Harmonic distortion: Less than 2% at 30 cps—15 KC and less than 0.7% at 1 KC at 25 watts output. Intermodulation distortion: Less than 2% at 25 watts using 60 cps and 6000 cps signals 4:1. Hum and noise: Microphone —60 db or better; Mag. Phono —55 db or better; Xtal Phono —60 db or better; Auxiliary —60 db or better. Input sensitivity: For 25 watts output with tone controls flat—Microphone —9 mv; Mag phono —5 mv (at 1 KC); Xtal Phono —120 mv; Auxiliary —200 mv. Outputs: 4, 8 and 16 ohms. Damping factor: 9. Controls: 4-position selector switch, volume control, bass control and treble control with on/off switch. Tube complement: 2—6EU7; 1—12AU7; 2—7591; 1—5AR4; 1—Selenium bias rectifier. Power requirements: 117 volts 50-60 cps, 120-135 watts. Power outlets: 1 AC receptacle, unswitched. Indicator: Neon pilot light. Color & finish: Charcoal grey with ivory bezel and lower front panel. Dimensions: 13½" W. x 4-15/16" H. x 9½" D.



AA-191 **\$16.88**

SPECIFICATIONS—Power output: 3 watts, Heath Utility Rated. Power response: ± 1 db 60 cps to 15,000 cps at 3 watts output. Harmonic distortion: Less than 3% 60-15,000 cps at 3 watts output. Intermodulation distortion: Less than 3% at 3 watts output, 60 and 6,000 cps signal mixed 4:1. Hum and noise: 70 db below 3 watts. Input sensitivity: 0.15 v for 3 watts output, crystal phono and tuner. Outputs: 4, 8 and 16 ohms. Controls: bass, treble, volume, input selector switch, on-off switch. Tube complement: 1-EF86, 1-EL84/6BQ5, 1-6X4. Power requirements: 117 v. 60 cycles, 49 watts. Color and finish: Satin black, ivory face panel. Dimensions: 9½" W. x 3¾" H. x 6" D.

Here's a complete monophonic COMBINATION PREAMPLIFIER and POWER AMPLIFIER for just \$16.88!

- Three controls—bass, treble, volume
- Two separate inputs
- 3-watt power output
- New styling features
- Perfect for "starter" systems

Like its predecessor, the world-known Heathkit EA-1, this little giant is perfect for the high fidelity "beginner" or for powering a second system around your home—and it sells for just \$16.88.

With the addition of an economical Heathkit program source (tuner, crystal phono, tape recorder, etc.) the AA-191 becomes the "heart" of an "economy" music system. It has a built-in preamplifier which provides all the necessary tone and volume controls for excellent reproduction of your favorite musical selections. Two inputs accommodate tuner or tape recorder and crystal or ceramic cartridge record player. Outputs are provided for 4, 8 and 16 ohm speakers. 7 lbs.

Kit AA-191 **\$16.88**

There's A Heathkit For Every Interest, Every Purpose, Every Budget

New Heathkit® Stereo

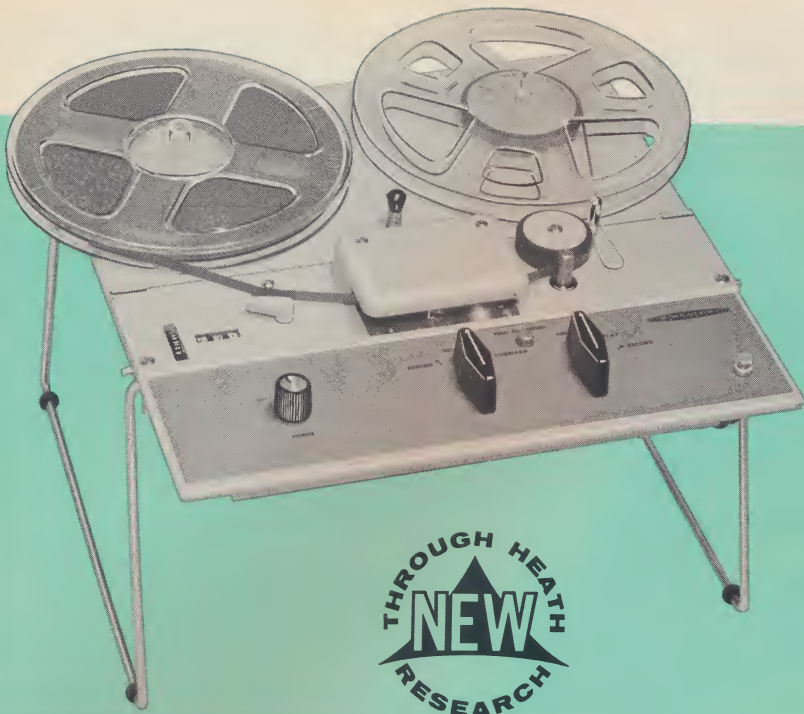

AD-12
\$124⁹⁵

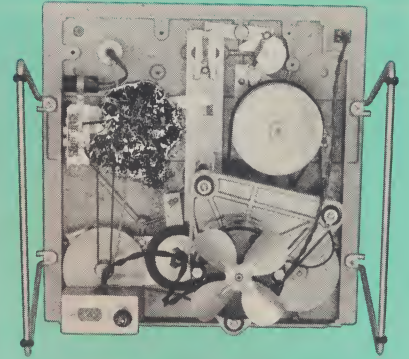

STURDY, SOLID
Sturdy characterizes the construction of this tape machine. Note the die-cast panel and motor mount—the simplicity of the mechanism—to assure long, trouble-free life.

4-Track STEREO TAPE PLAYBACK MECHANISM . . .

Converts at Any Time to A Complete Recorder

- Designed to play pre-recorded 4-track stereo and monophonic tapes through amplifier tape-head inputs
- Two speeds— $3\frac{3}{4}$ & $7\frac{1}{2}$ ips—selected by "push-pull" knob
- Three digit counter for fast selection of recordings and editing ease
- Fast forward and rewind—4-pole induction motor
- Professional-type die-cast frame
- Precision milled and mounted capstan
- Function control "neutral" position removes all pressure from rubber idler wheels to prevent flat spots
- Tape head alignment tape included
- Exclusive kit version of the VEGA of California tape deck so highly successful in the professional and educational fields

For you who have yearned to add stereo tape playing facilities to your music system . . . for you who have sought a reasonably priced tape machine that will deliver truly high quality, professional-type performance . . . the new Heathkit AD-12 stereo tape player is the answer. An exclusive Heathkit version of the highly successful VEGA of California tape mechanism so well known in professional and educational fields, the heritage of the AD-12 assures you of the long-lasting, pleasure-giving performance you've always wanted. Designed by world-famous tape recorder engineers in cooperation with our own Heathkit engineers, this new stereo tape player kit is a sturdy instrument of few mechanical parts which are extremely easy to assemble. The mechanism base plate or frame is a heavy unit of die-cast aluminum which provides the rigidity for accurate fitting of mechanical parts thus insuring long, trouble-free operation. No flexing or physical change here to cause later problems. Other professional-type features are: the precision milled and mounted capstan, large capstan flywheel to aid uniformity of tape speed, simple speed selection which quickly and reliably shifts the belt drive from one motor pulley to another to change speeds from $7\frac{1}{2}$ to $3\frac{3}{4}$ inches per second, self-energizing brakes which are actuated when switching the functions of the mechanism to any mode, a "holdback" arm that assures good tape-to-head contact, a "compliance" arm which provides constant take-up tension for low wow and flutter specifications (see below), and a three-digit counter to enable fast, easy re-selection of any pre-recorded tape portion. The motor mounting plate is of die-cast aluminum, resiliently mounted for quiet operation. Motor is fan-cooled. Sturdy wire rack included for construction ease and temporary operation.

Kit AD-12, mechanism only (no electronics) for playback of pre-recorded 4-track stereo or mono tapes through tape head input such as in the Heathkit AA-100 or AA-11; easily convertible to a recorder later by adding electronics. 15 lbs. . . . no money down, \$12 mo. . . . **\$124.95**

SPECIFICATIONS—Tape head: Type: 4-track. **Playback response:** ± 3 db, 40 to 15,000 cps at $7\frac{1}{2}$ ips; ± 3 db, 40 to 10,000 cps at $3\frac{3}{4}$ ips (with proper NAB equalization network). **Playback output:** 2.5 millivolts ± 3 db. **Gap width:** .00017". **Impedance:** High impedance, 3340 ohms. **Wow and flutter:** .2% or less at $7\frac{1}{2}$ ips, .3% or less at $3\frac{3}{4}$ ips. **Tape speeds:** $7\frac{1}{2}$ ips and $3\frac{3}{4}$ ips. **Motor:** Shaded 4-pole induction type. **Fast forward time:** Less than 100 sec for 1200 foot reel. **Rewind time:** Less than 100 sec for 1200 foot reel. **Reel size:** 7" or smaller. **Digital counter:** Zero reset with 3 digits. **Power requirements:** 55 watts, 117 volts 60 cps AC. **Color combination:** Beige deck and coppertone control panel. **Dimensions:** Overall: 12" W x 12" D x 8" H, 6 $\frac{1}{2}$ " required below mounting surface; 1 $\frac{1}{2}$ " required above mounting surface.

ADP-72
\$49⁹⁵

AK-1
\$9⁹⁵

CRYSTAL MICROPHONE
Features frequency response of 30 to 10,000 cps. Includes mike stand adapter, lavalier neckband and desk stand holder, plus 8' cable and phone plug. Order two for stereo recordings. 1 lb.
Model AK-1 **\$9.95**

ALTEC LANSING DYNAMIC MICROPHONE
This rugged omnidirectional high-impedance microphone is specially selected for fine quality recordings. Color styled in tan & brown to harmonize with Heathkit AD-22 & AD-12 Tape Recorders. Complete with base, slip-on stand adaptor, 15 ft. cable, phone plug, and instructions for connecting plug. 5 lbs.
Model ADP-72 . . . no money down, \$5 mo. **\$49.95**

SPECIFICATIONS: Type: Moving coil, Dynamic. **Frequency response:** 50-18,000 cycles. **Output impedance:** 20,000 ohms. **Output level:** -55 db/10 dynes/cm². **Pickup pattern:** Omnidirectional. **Hum:** -120 db (Ref.: 10⁻³Gauss). **Dimensions:** Microphone, 1 $\frac{1}{2}$ " diameter at top, 7 $\frac{3}{4}$ " L; Base 4 $\frac{1}{4}$ " W x 6 $\frac{1}{2}$ " D & approx. 3" H.

Tape Recorders ... Offer Professional Performance

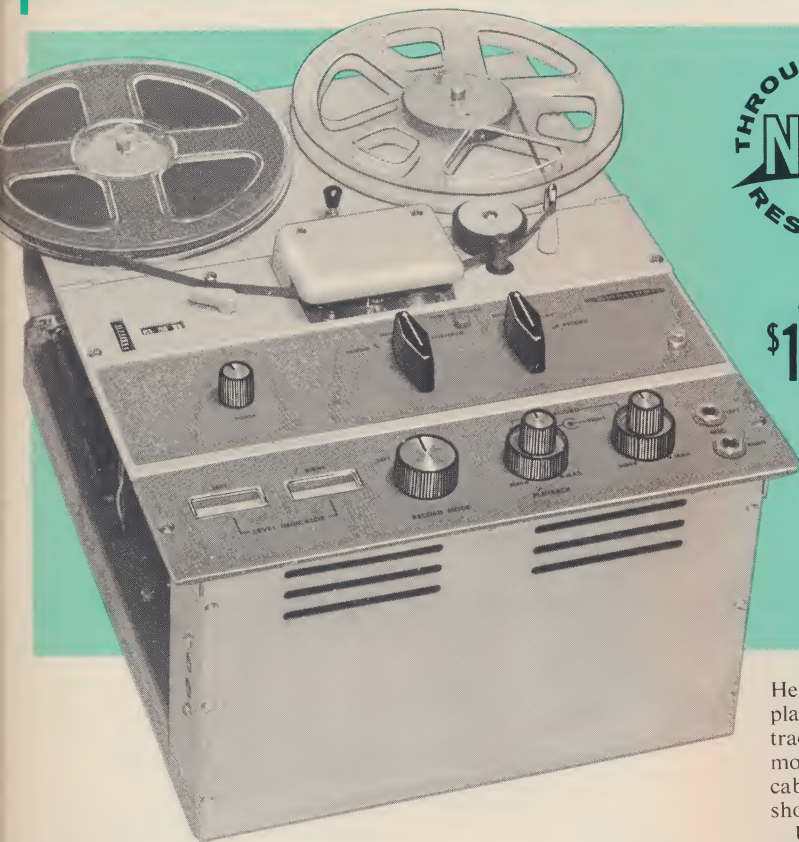

AD-22
\$179.95

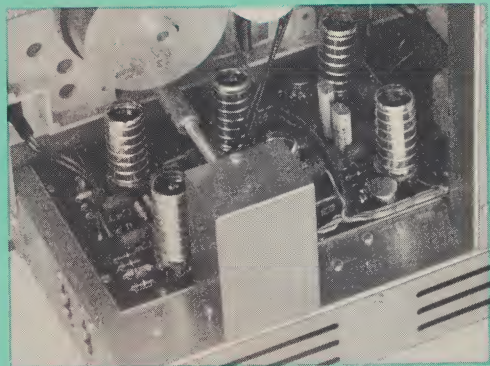

EASY CIRCUIT BOARD ASSEMBLY: Prevents errors, assures fast, easy assembly and high stability.

For a professional-performance 4-track STEREO TAPE RECORDER complete with recording electronics and playback preamplifiers, choose the Heathkit AD-22

- Record and reproduce 4-track stereo and monophonic tapes
- Two inputs per channel with mixing controls
- Circuit board construction
- Exclusive kit version of the VEGA of California tape deck
- Two VU type record-playback meters for precise levels
- Concentric, clutched level controls
- Bias-adjust and meter-calibrate controls
- Head alignment tape included
- Push-pull bias oscillator

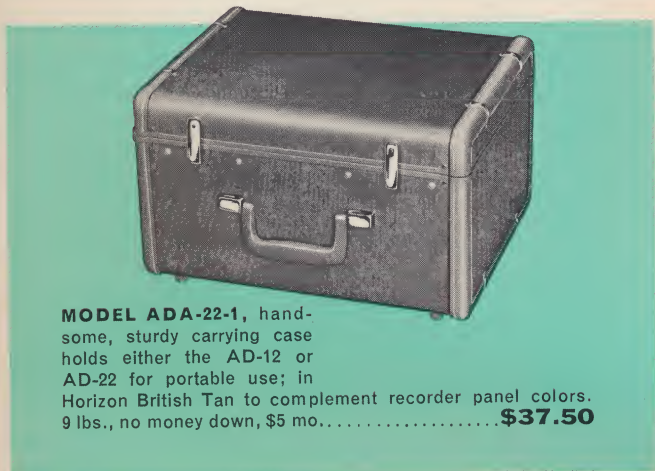

MODEL ADA-22-1, handsome, sturdy carrying case holds either the AD-12 or AD-22 for portable use; in Horizon British Tan to complement recorder panel colors. 9 lbs., no money down, \$5 mo. **\$37.50**

Here's the tape recorder that answers all your needs . . . record and playback of 4-track stereo . . . record and playback of four individual tracks of monophonic sound . . . playback of conventional half-track monophonic recordings . . . fits into your Heathkit stereo/hi-fi system cabinet . . . fits into its portable case for use away from home . . . in short, versatility that is remarkable.

Using the basic mechanism of the AD-12 on the opposite page, the AD-22 adds a quality electronics unit for complete recording facilities. Well-integrated physically, and easy to assemble, the electronic section uses circuit board construction for stability and simplicity. It incorporates two identical channels, each including a record-playback head, an erase head, and a preamplifier with NAB equalization. Both channels use the same power supply. Recordings can be made live from microphones, or from auxiliary sources such as AM and FM tuners, phonographs, TV, etc. Each channel has a high impedance microphone input, plus a line input. These inputs can be used simultaneously for mixing one input signal with the other for special effects, or they can be used individually . . . mixing controls are provided. The clutched, concentric level controls permit easy adjustment of both channels separately or simultaneously during playback . . . VU-type record-playback level meters allow accurate setting of controls for both functions . . . a record-interlock button prevents accidental erasure of pre-recorded tapes. For cueing and editing of tapes, the three-digit counter with thumb-wheel reset proves invaluable in permitting quick location of desired recordings. Optimum performance is facilitated by the provision of Hum-Null controls for each channel, Meter-Adjust controls and Bias-Adjust capacitors. Build this low cost, professional recorder and save.

Kit AD-22, mechanism and electronics for record and playback. 23 lbs. . . . no money down, \$17 mo. **\$179.95**

SPECIFICATIONS—Record-play head: Type, 4-track stereo; Gap width, .00017"; Impedance, High, 3340 ohms. **Erase head:** 4-track stereo. **Tape speeds:** 7½ ips and 3¾ ips as selected by speed selector. **Wow and flutter:** .2% at 7½ ips, .3% at 3¾ ips. **Signal-to-noise ratio:** 45 db or better at normal recording level. **Harmonic distortion (record-play):** 1% or less at normal recording level, with 400 cps signal, in accordance with NAB specifications. (National Association of Broadcasters). **Frequency response:** ±3 db, 40 to 15,000 cps at 7½ ips, ±3 db, 40 to 10,000 cps at 3¾ ips. **Playback equalization:** NAB. **Inputs (each channel):** Microphone, phone jack termination, 1 megohm; Line, phono socket termination 250 k ohm. **Input sensitivity (for normal recording level):** 5 millivolts for Microphone, 160 millivolts for Line. **Output (each channel):** 600 ohm cathode follower output for each channel, with phono socket termination. **Output level (each channel):** 1 volt or better (at normal record level). **Bias erase frequency:** 75 kc with push-pull oscillator for symmetrical waveform. Bias is adjustable for optimum performance. **Record level indicator (each channel):** VU type meter. **Motor:** Shaded 4-pole induction type. **Fast forward time:** Less than 100 seconds for 1200 foot reel. **Rewind time:** Less than 100 seconds for 1200 foot reel. **Reel size:** 7" or smaller. **Digital counter:** Zero reset with 3 digits. **Controls and switches:** Power switch (off-on); Rewind—forward control (rewind—neutral—forward); Function control (neutral-play-record); Push to record interlock button; record mode switch (left-right-stereo); playback level control, one for each channel, clutched type; record level control, left and right channel controls for microphone and line inputs, clutched type; meter calibrate control, one for each record level meter; Hum-Null, one for each channel; Bias-Adjust, one for each channel. **Tube and diode complement:** (6) 6EU7 tube, amplifier, (1) 12AU7 tube, bias oscillator, (2) Silicon diodes, power supply rectifiers, (4) Crystal diodes. **Power requirements:** 105-125 volts, 60 cps, 65 watts nominal. **Power supply:** Transformer-operated, half-wave voltage doubler. **Color combination:** Beige deck and coppertone control panel. **Dimensions:** Overall: 12" W x 15" D x 8" H. Mounting cutout required: 11½" W x 14¼" D. 7" required below deck and 1¼" required above mounting surface.

Enjoy Your Heathkit Equipment While You Buy On Heath's Easier Time-Pay Plan—No Money Down

Pick a Heathkit Stereo/Hi-Fi System

There's a Heathkit Stereo Hi-Fi System to fit y



AA-201
6-Watt Stereo Amplifier
\$31.95

AD-82 C
Stereo Record Player with Sonotone
Cartridge
\$32.95

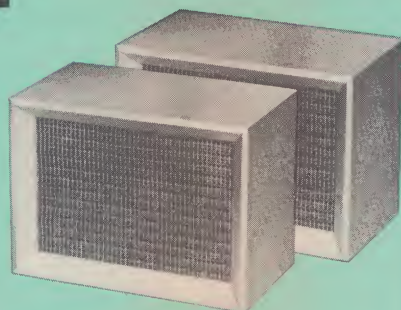

AS-41W
Speaker System (2)
\$12.95 each

Complete System Kit HFS-50
Reg. \$ 90.80
Save \$ 4.54
System Price \$86.26

5% DISCOUNT ON SYSTEMS!

Pick any selection of Heathkit high fidelity components which will make up a monophonic or stereo music system and take a 5% discount. Your system choice can qualify by including a music source such as tuner, record player, or tape deck; a complete amplifier or combination of amplifiers, and speakers to complete the system. Simply add up the prices of your individual components and deduct 5% on the order blank.

Save \$4.54

Quality Stereo Phono System for Just \$86.26 . . . Expands at Any Time

Included in this economical system is the Heathkit AD-82 Stereo Record Player with Sonotone 9TA-SD ceramic stereo cartridge and diamond and sapphire styli (page 53), the Heathkit 6-watt Stereo Combination Amplifier (page 45); and two AS-41W walnut speaker systems featuring 6 and 9 inch extended range dual-cone speakers and factory assembled and finished cabinets (page 56).

To receive monophonic FM broadcasts, you simply add the Heathkit AJ-31 FM Tuner (page 45). To receive FM broadcasts in stereo, add the Heathkit AJ-12 FM Multiplex Tuner (page 40). To enjoy monophonic AM radio programs, select the Heathkit AJ-21 AM Tuner (page 43).

System Kit HFS-50, 37 lbs. . . . no money down, \$9 mo. . . . \$86.26

AD-92 C
Stereo Record Changer
with G.E. Cartridge
\$44.95

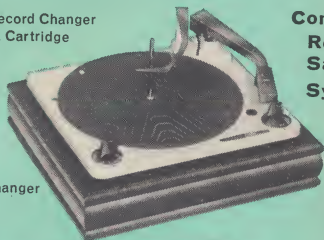

ADA-50W
Walnut Record Changer
Base \$5.95

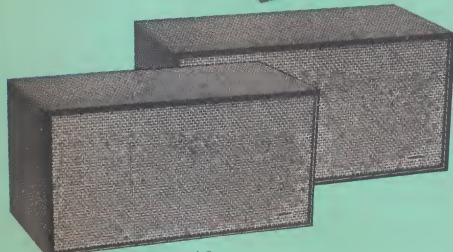

AS-51W
Walnut Two-Way Speaker System (2)
\$46.95 each

Complete System Kit HFS-51
Reg. \$274.70
Save \$ 13.73
System Price \$260.97

AJ-12
FM Stereo Tuner
\$69.95

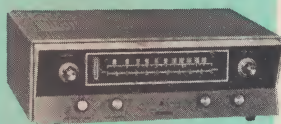

AA-151
28-Watt Stereo Amplifier
\$59.95

Save \$13.73

Mid-Power, Mid-Price Stereo System Includes FM Stereo Tuner and Record Changer

The HFS-51 will bring countless days of enjoyment to your family with FM stereo broadcasts or your favorite stereo recordings. Included in the system are the Heathkit AD-92 Automatic Stereo Record Changer with GE VR-1000-7 magnetic stereo cartridge and diamond stylus (page 52); the Heathkit ADA-50W walnut finished changer base (page 52); the Heathkit AJ-12 FM Stereo Tuner (page 40); the Heathkit AA-151 28-watt Stereo Combination Amplifier (page 42); and two easy-to-assemble, prefinished walnut AS-51W Two-way Speaker Systems featuring an 8" woofer and true compression-type tweeter (page 54).

All components of this remarkable system are simple to assemble thanks to Heath's famous "check-by-step" instructions and clear, uncomplicated diagrams and illustrations.

System Kit HFS-51, 104 lbs. . . . no money down, \$25 mo. . . . \$260.97



AA-111
28-watt Stereo
Power Amplifier
\$44.95

Complete System Kit HFS-52
Reg. \$350.65
Save \$ 17.53
System Price \$333.12



AA-141A
Stereo Preamplifier
\$34.95



AJ-32
AM/FM Stereo Tuner
\$89.95

AD-92 B
Changer with
Shure Cartridge
\$44.95



AS-10W
Walnut Acoustic
Suspension Speaker System (2)
\$64.95 each



ADA-50W
Walnut Changer Base
\$5.95

Save \$17.53

All-Component, Mid-Power Stereo System with Acoustic Suspension Speakers

This all-component, medium-power stereo system, the Heathkit HFS-52 is designed to bring you fine listening enjoyment and installation versatility at low cost. The system includes: a Heathkit AD-92 Automatic Record Changer with Shure M-77M-D stereo cartridge and diamond stylus (page 52); the Heathkit ADA-50W Walnut Record Changer Base (page 52); the Heathkit AJ-32 Medium Price AM/FM Tuner (page 41); the Heathkit AA-141A Stereo Preamplifier with its modern design (page 39); the Heathkit AA-111 28-watt Stereo Power Amplifier (page 45) and two Heathkit AS-10W Acoustic Suspension Speaker Systems with Walnut finish, each featuring a 10" acoustic suspension woofer and two 3 1/2" cone-type tweeters (page 55).

You can thrill to true stereo in a setting of your own choosing when you assemble and install the easy-to-build components of the HFS-52 System . . . and you'll save money because it's from Heath.

System HFS-52, 144 lbs. . . . no money down, as low as \$22 mo. . . . \$333.12

An Unbeatable Combination! Organ by Thomas KIT VERSION BY HEATHKIT®

After years of careful searching to find an organ that contains all the attributes you've come to expect from Heath—quality, economy, ease of assembly, and pride of ownership—we are extremely proud to announce this Heathkit version of the Thomas Organ. It's an electronic transistor organ everyone can afford—perfect for home, apartment, chapel or school use—the first *real* organ to break the price barrier! Hundreds of dollars less in price, beautiful in sound, handsome in appearance, and reliable in performance, this Heathkit version of the Thomas Organ features transistor circuitry for clear, undistorted tone, long life, and virtual elimination of service problems. And because of its transistor circuitry, the Heathkit version of the new Thomas Organ has a five year warranty period. Note the many features of this new kit organ—study them, compare them—then send for the demonstration record and hear this fine instrument for yourself.

the exclusive Heathkit version of

the all new **Thomas** TRANSISTOR ORGAN MODEL A

10 TRUE ORGAN VOICES

Fidelity of tone is one of the most impressive qualities of Thomas' beautiful voices. Try each one of them: listen to the true quality of the string voice, the clarity of the Flute, the richness of the Saxophone. Try them in various combinations and hear the wealth of special effects possible!

Upper manual voices: Trombone, Reed, Flute, Oboe, Cornet, Violin.

Lower manual voices: Saxophone, Horn, Viola, Diapason.

VARIABLE BASS PEDAL VOLUME

Continuously variable control allows you to regulate the volume of the rich pedal bass voice to suit the mood of the music.

MANUAL BALANCE CONTROL

A continuously variable Manual Balance Control makes it easy to adjust the relative volume of the two keyboards to accentuate either the upper or lower keyboard in any degree you desire for solo work.

VARIABLE VIBRATO

Add warmth and beauty to your music with the Thomas vibrato. For convenience, a single tab turns vibrato on-and-off instantly. Second tab permits the option of heavy or light vibrato. Choose the amount of vibrato to suit the music.

EXPRESSION PEDAL

Standard organ expression pedal allows you to adjust the volume from the softest whisper to the full majesty of the mighty organ.

HEEL & TOE BASS PEDALS, 13-NOTE,

You enjoy the ease and flexibility of playing the heel and toe pedals, usually found only on instruments costing hundreds of dollars more.

CORRECTLY POSITIONED OVERHANGING KEYBOARDS

Keyboards are arranged to conform with standard organ specifications. Each keyboard has 37 notes, range C through C. Upper keyboard overhangs so you may bridge the two keyboards easily.

BEAUTIFUL HARDWOOD CABINETS

Exquisitely designed cabinets are handcrafted from specially selected genuine walnut veneers, with solid hardwood used at all points which require extra strength and rigidity.

20 WATT PEAK POWER AMPLIFIER AND SPEAKER SYSTEM

You have a full frequency 12" speaker system and powerful 20 watt peak power amplifier built right into the console of your Thomas to assure wide dynamic range—clear, clean treble and full, rich organ bass.

COMPACT SIZE

34½" high, 39¾" wide, 21½" deep.

NO INSTALLATION NECESSARY

Plugs into any AC household outlet.

TRANSISTORIZED

For better tone—longer life . . . uses less power—virtually trouble free!

FIVE YEAR WARRANTY

The transistorized Tone Generator Boards . . . the Heart of the Organ . . . are warranted for FIVE Years. You buy with confidence when you buy a Heathkit version of the Thomas Organ. Replacement upon prepaid return of undamaged board to Heath Co.



Save An Extra 5%



Budget, your Home, and your Listening Needs

Save \$19.23

50-Watt Stereo System with Stereo Tuner and Stereo Record Changer plus New "Profile" Speakers

For sources of program . . . The Heathkit AD-102 automatic record changer with GE VR-1000-7 stereo magnetic cartridge complete with diamond stylus (page 52) . . . and the new Heathkit AJ-41 AM-FM-Stereo Tuner with built-in multiplex FM-converter (page 36). For source of power . . . the world-famous Heathkit AA-100 Fifty-Watt stereo combination preamplifier-power amplifier complete with versatile controls (page 37). For source of sound . . . the new Heathkit "Profile" speaker in beautiful walnut (page 54) . . . the flat speaker that goes anywhere, shelf, floor, or wall, for the ultimate in versatile speaker arrangements. And consider the low price for this superior system . . . compare it for value anywhere with components or consoles, kit or ready-built . . . you'll agree that it is a fine example of the extra value you always receive with Heathkit stereo/hi-fi equipment. 129 lbs.

System Kit HFS-53, no money down, \$24 mo. \$365.47

Complete System Kit HFS-53
 Reg. \$384.70
 Save \$ 19.23
 System Price **\$365.47**

AS-22W Profile Speaker (2)
 \$54.95 each

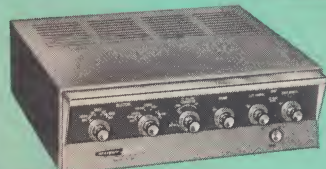
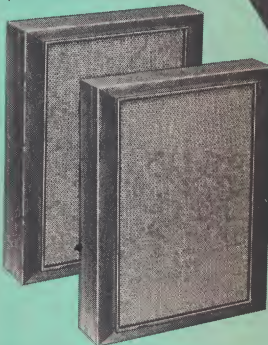

AJ-41 Deluxe AM-FM-Stereo Tuner
 \$119.95

AD-102 A Automatic Record Changer with G.E. Cartridge
 \$63.95

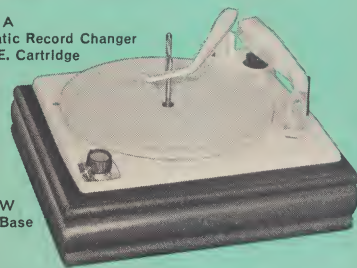

ADA-50W Walnut Base
 \$5.95

Save \$27.78

High Powered Stereo System—80 Watts—features Fairchild Record Player and Heathkit Stereo Tuner

The Heathkit HFS-54 Stereo System is a high-power, all-component system designed to bring you the finest in musical entertainment, whether it be on radio or recordings. This elaborate system includes: Fairchild turntable and arm (page 53); the Heathkit AJ-41 Deluxe AM/FM Stereo Tuner (page 36); the Heathkit AA-11 Deluxe Stereo Preamplifier (page 38); the Heathkit AA-121 80-watt Stereo Power Amplifier (page 44); and two Heathkit AS-2U unfinished Acoustic Suspension Speaker Systems (page 55).

System Kit HFS-54, 206 lbs., no money down, as low as \$34 mo. \$527.92

Complete System Kit HFS-54
 Reg. \$555.70
 Save \$ 27.78
 System Price **\$527.92**



AA-11 Deluxe Stereo Preamplifier
 \$84.95

ADP-21 Turntable Player
 \$124.95



AA-121 80-watt Stereo Power Amplifier
 \$79.95

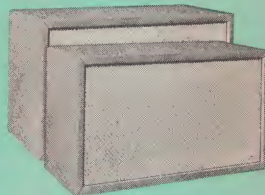

AS-2U Acoustic Suspension Speaker System (2) \$72.95 each



AJ-41 Deluxe AM/FM Stereo Tuner
 \$119.95

Save \$40.23

A Masterpiece—features 70-watt All-Transistor Stereo Amplifier plus the world-famous Heathkit "Legato Compact" Speakers

Masterpiece is defined as a thing of great art or craftsmanship . . . the definition is fitting for this Heathkit stereo system. Consider the program sources . . . the Heathkit AD-102 automatic record changer with the new Shure M-77M-D stereo magnetic cartridge with diamond stylus (page 52) . . . the versatile Heathkit AJ-41 AM-FM-Stereo tuner with built-in multiplex FM converter (page 36). Consider the power source . . . the new Heathkit AA-21 all-transistor seventy-watt stereo combination preamplifier—power amplifier (page 35), the latest word in stereo power sophistication and performance. Crowning touch . . . consider the sound source . . . the Heathkit "Legato" speakers (page 57) . . . matched by rating to the amplifier to accept every watt it can deliver . . . ready to reproduce all sounds anyone could ever hear (from 30-22,000 cps) . . . truly a masterpiece all the way. Consider the value and order your HFS-55 now. 328 lbs.

System Kit HFS-55, \$167.47 down, as low as \$40 mo. \$764.47

Complete System Kit HFS-55
 Reg. \$804.70
 Save \$ 40.23
 System Price **\$764.47**



AS-21W "Legato" Compact Speakers (2) \$239.95 ea.

AD-102 B Automatic Record Changer with Shure Cartridge
 \$63.95

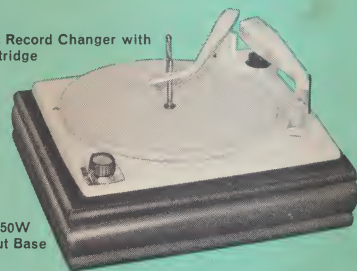

ADA-50W Walnut Base
 \$5.95



AJ-41 AM-FM-Stereo Tuner
 \$119.95

AA-21 All-Transistor 70-watt Stereo Preamp-Amplifier
 \$134.95

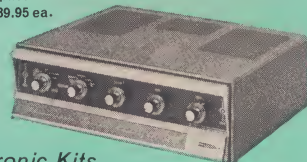

Save Up To 50% With Heath Do-It-Yourself Electronic Kits

Save with Heathkit® Record Changers and Turntables

New Heathkit AD-102 series STEREO/MONO AUTOMATIC RECORD CHANGERS with your choice of cartridges are exceptional values!

You choose the finest when you choose these record changers! Handsome in appearance, professional in features, faithful in performance, the Heathkit AD-102 series changers offer the latest in the art of automatic record handling. New 11" turntable offers better record support; "turntable pause" handles records gently; precision balanced arm suspension assures uniform, constant, low stylus pressure from the first to the last record (vernier adjustment); intermixes and plays all sizes of records regardless of sequence; double channel muting switch and RC network maintains silence for both stereo channels; "anti-skate" device prevents arm from skidding past lead-in grooves thus preventing record damage; pinpoint bearings assure maximum vertical and lateral compliance for minimum record wear and optimum tracking; quick change cartridge holder accepts all leading cartridges with provision for 2, 3, or 4 terminal stereo or mono cartridges (each channel has its own shielded 2-conductor cable). Four-pole, hum-shielded motor has shock mountings and balanced rotor for smooth, constant speed. Idler disengages in "off" position to prevent flat spots. Finished in white with brushed gold trim and oyster white turntable pad. Cartridge details will be found below. 12 lbs.

Kit AD-102 with C cartridge... no money down, \$6 mo. **\$57.95**
Kit AD-102 with A, B, or D cartridge, specify...
 no money down...\$7 mo..... **\$63.95**
ADA-60-1, 45 rpm adapter spindle for AD-102, 2 lbs..... **\$2.95**

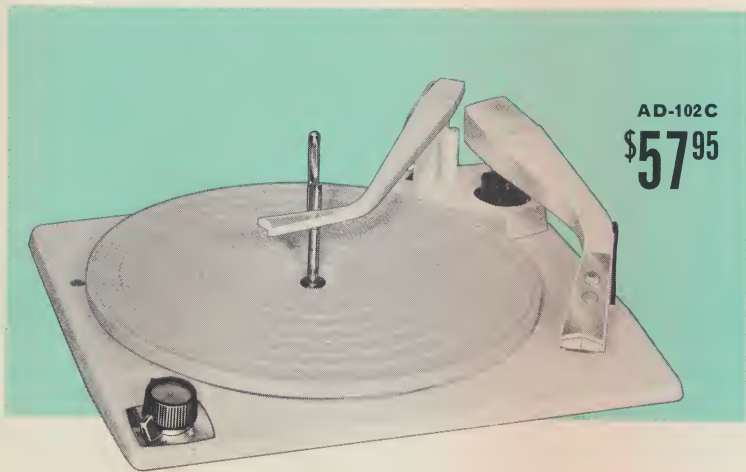

AD-102C
\$57.95

- New 11" turntable—4 speeds—16, 33½, 45 and 78 rpm
- Record protecting "turntable pause" and "anti-skate"
- Instant-change cartridge holder
- Automatic shut-off
- Noise muting switch and "pop" filter
- Beautiful white and gold finish
- Supplied with your choice of cartridge below

SPECIFICATIONS—Flutter & wow: 0.18% rms or less. **Turntable speed:** Accurate within ± 2%. **Change cycle:** Completed in 9 seconds. **Motor type:** 4-pole, hum shielded. **Type of drive:** Friction. **Tracking force:** 2 grams reliably initiates change cycle. **Record capacity:** Maximum of 10 records. **Control functions:** On-off switch; Manual Reject; Manual Speed Selector. **Dimensions:** 13½" W x 12" D x 5½" above and 3" below mounting board.

Budget-priced AUTOMATIC STEREO/MONO RECORD CHANGER

The Heathkit AD-92 Stereo Automatic Record Changer combines a variety of exceptional features usually found only on costlier units, but maintains an economy price tag designed to appeal to even the most budget-conscious hi-fi fan. It has an oversize 11" turntable which gives greater support to 12" records, an "anti-skate" device that protects records from the tone arm skating across lead-in grooves, and a sturdy mechanism for dependable performance. This remarkable changer plays 16, 33½, 45 and 78 rpm records automatically or manually, in stereo or mono with a simple wiring change. A plug-in mounting head gives you easy access to the cartridge for inspection or replacement. The mechanism shuts off automatically after the last record, a pop filter eliminates annoying switching noises. Cartridge details are given at bottom of this page. Attractive brown and beige colors. 10 lbs.

Kit AD-92 with C cartridge... no money down, \$5 mo. **\$38.95**
Kit AD-92 with A, B, or D cartridge, specify... no money down, \$5 mo.... **\$44.95**
ADA-80-1, 45 rpm adapter spindle for AD-92, 2 lbs..... **\$2.95**

SPECIFICATIONS—Flutter & wow: .2% rms or less. **Turntable speed:** Accurate within ± 2%. **Change cycle:** Varies with turntable speed, completed in 8 seconds at 33½ rpm. **Motor type:** 4-pole hum shielded. **Type of drive:** Friction. **Tracking force variation:** Less than 0.9 grams from first to last record. **Record capacity:** 10-12", 12-10". **Control functions:** on-off switch with "pop filter"; manual reject; manual speed selector. **Dimensions:** 13½" W x 11¼" D x 5 11/16" above and 2¼" below mounting board.

CHANGER BASES For AD-92, AD-102 Models, 3 lbs.

Assembled ADA-50W (walnut)..... **\$5.95**
Assembled ADA-50U (unfinished)..... **\$4.95**



AD-92C
\$38.95

- 4-speed—automatic or manual
- Choice of cartridges
- 11" oversize turntable
- Plug-in cartridge head
- Hum shielded motor

Your Choice of One of These Fine Stereo Cartridges is Furnished with Heathkit Automatic Record Changers & Turntables at No Extra Cost! Detailed Mounting Instructions are Included for Each Cartridge



A GE VR-1000-7
Manufacturer's Specifications: Frequency response: 20-20,000 cps, ±3 db. Output: 0.010v. Separation: 20 db. Load impedance: 47,000 ohms. Stylus: .7 mil diamond. Compliance: 4.5 x 10⁻⁶ cm/dyne, lateral; 4 x 10⁻⁶ cm/dyne, vertical. Tracking Force: 3-7 grams. Usual price when sold separately, **\$24.45**
 Specify Heath Model AD-112A



B Shure M-77M-D
Manufacturer's Specifications: Frequency response: 20-17,000 cps. Output: .009 v. Separation: 22.5 db @ 1 kc. Load impedance: 47,000 ohms. Stylus: .7 mil diamond. Compliance: 6 x 10⁻⁶ cm/dyne in all directions. Tracking force: 4-6 grams. Usual price when sold separately, **\$27.50**
 Specify Heath Model AD-122B



C Sonotone 9TA-SD
Manufacturer's Specifications: Frequency response: 20-17,000 cps. Output: .35 v. Separation: 29 db @ 1 kc. Load impedance: 1.5 megohms. Stylus: .7 mil diamond & 3 mil sapphire. Compliance: 5.3 x 10⁻⁶ cm/dyne in all directions. Tracking force: 2-4 grams. Usual price when sold separately, **\$11.70**
 Specify Heath Model AD-132C



D Pickering 380-C
Manufacturer's Specifications: Frequency response: 20-20,000 cps, ±2 db. Output: .015 v. Separation: 35 db. Load impedance: 47 k to 100 k ohms. Stylus: .7 mil diamond. Tracking force: 4-7 grams. Usual price when sold separately, **\$29.85**
 Specify Heath Model AD-142D



AD-30 **\$22⁹⁵**
(less base)

- Mechanism by Garrard of England—Kit by Heath
- Pre-assembled mechanism, arm and base
- Choice of cartridges

Low-Cost Heathkit 4-Speed STEREO/MONO RECORD PLAYERS

The low cost Heathkit AD-82 stereo/mono 4-speed record player combines the kit quality of Heath with the precision craftsmanship of Garrard of England. The turntable is resiliently mounted, accurately formed and features a protective rubber pad for record safety. When the tone arm is moved to the right with handy finger lift, the mechanism starts. Automatic shut-off occurs when the record is completed. Other features include: plug-in cartridge holder, stylus pressure adjustment. "Pop" filter reduces switching noise. 4-pole motor. Flutter and wow below .28% at 33 $\frac{1}{3}$ rpm. Cartridge details may be found at bottom of facing page. With 12" record requires mounting area 15" W x 13" D x 6" H. Cocoa brown and beige color. 9 lbs.

Kit AD-30 (mechanism & arm, less base, cartridge & cables), 7 lbs. **\$22.95**
Kit AD-82 with C cartridge ... no money down, \$5 mo. **\$32.95**
Kit AD-82 with A, B, or D cartridge ... specify; no money down, \$5 mo. **\$38.95**



ADP-61 **\$79⁵¹**

Combination Offer! Garrard Type A AUTOMATIC TURNTABLE Plus Your Choice of Cartridge For One Cent More Than Regular \$79.50 Cost of Turntable!

Automatic changer convenience with the advantages of a turntable too! The Garrard Type A automatic turntable combines the best of both. Perfectly balanced tone-arm is assured by the adjustable counter-weight; tracking pressure is set by moving a pointer to the desired point on a calibrated scale at the side of the arm. The six pound turntable is a "sandwich" of an inside drive table and a cast outside turntable separated by a foam barrier. The completely shielded four-pole motor has a micro-balanced armature and special design shock mounts. Automatic operation is your option at any time with Garrard's exclusive pusher platform, one-piece center spindle, and automatic shut-off. This is not a kit, but a complete, assembled unit, ready to use. Cartridge details may be found at bottom of facing page. 19 lbs.

Model ADP-61 with A, B, C, or D cartridge, specify ... no money down, \$8 mo. **\$79.51**
ADA-61-1, Garrard 45 rpm spindle, 1 lb. **\$3.80**
ADA-61-2, Garrard B8U unfinished base, 4 lbs. **\$4.45**
ADA-61-3, Garrard B8W walnut base, 4 lbs. **\$4.95**



ADP-21 **\$124⁹⁵**

- 33 $\frac{1}{3}$ & 45 rpm speeds
- Separate on-off switch
- Speed Sentinel controls and strobe disc
- Anti-skate arm-transport
- Linear separation, high compliance "moving magnet" stereo cartridge
- .0007" diamond stylus
- Rifle-drilled bearing well and heavy aluminum turntable panels

Exclusive Heath Price for Fairchild TURNTABLE, TONE ARM AND BASE

... **\$124.95**

The 440 turntable combines famous Fairchild "know-how" with clean functional design to provide extra features and superior performance. The two speeds—33 $\frac{1}{3}$ and 45 rpm—are selected by the "push-pull" selector knob, doing away with the necessity of reaching under the chassis or fumbling with belts. A unique Speed Sentinel control permits speed variation $\pm 1\frac{1}{2}\%$ to insure recording studio accuracy and to allow pitch changes when desired (a strobe disc is included in the kit). The turntable platter is solid cast aluminum, contoured for easy record handling . . . it is topped by a contoured center pin to protect the record's center-hole and covered with a compliant rubber pad to guard against abrasion. A rifle-drilled babbit bearing provides trouble-free, noiseless operation. The assembly of the table is simple.

The remarkable Fairchild 500 arm-transport has an "anti-skate" device to reduce tracking error, stylus wear and distortion as well as to protect your records. Its dynamic balancing eliminates undesirable springs. The moving-magnet type stereo cartridge with diamond stylus is the famous Fairchild SM-2. It is completely compatible for either stereo or mono records. The shock-mounted top plate is made of walnut. The matching walnut base complements the entire unit. 36 lbs.

Kit ADP-21 ... no money down, \$12 mo. **\$124.95**

SPECIFICATIONS—Impedance: 200 ohms per channel. **Inductance:** 500 mh per channel. **Dynamic mass:** 2 milligrams. **Track force:** 2.5 grams. **Compliance:** 5 x 10⁻⁶ cm/dyne. **Response:** 20-15,000 cps (± 2 db). **Separation:** 20 db (± 2 db) from 20-15,000 cps. **Recommended load:** 47K ohms per channel. **Output:** 5 mv at 3.8 cm/sec. **Wow:** .08% peak to peak. **Flutter:** Immeasurable. **Rumble (vertical and lateral):** —56 db below 7 cm/sec at 500 cps. **Dimensions:** 17 $\frac{3}{8}$ " W x 15" D, 3 $\frac{1}{2}$ " below mtg. board.

Enjoy Your Heathkit Equipment While You Buy On Heath's Easier Time-Pay Plan—No Money Down

For installation versatility, choose
**"Profile" . . . the new Heathkit
 3-WAY HI-FI SPEAKER SYSTEM
 that's only 5 inches deep!**

- Three speakers—10", 6" & 3½"—special designs
- Tube-tuned bass reflex cabinet
- Installs anywhere—floor, shelf, or wall

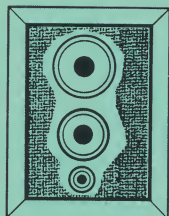
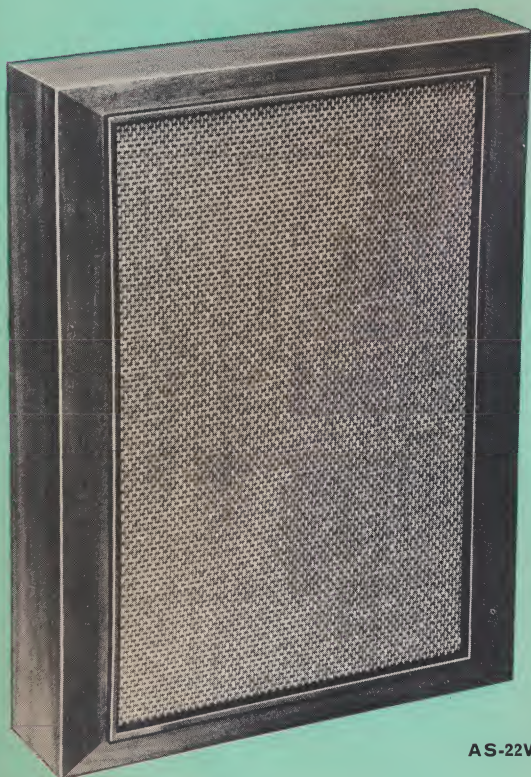

**THREE
 SPEAKERS!**

10" special inverted design bass woofer, 6" mid-range speaker with closed back, 3½" tweeter with closed back.

\$54⁹⁵

AS-22W

"Profile" is the slim, trim new Heathkit 3-way speaker system that's just five inches deep to fit anywhere you choose! Stand it on the floor, set it vertically or horizontally on a table or bookshelf, or even hang it like a picture on the wall!

Designed primarily to provide high fidelity performance in areas where speaker mounting space is limited, the AS-22 uses a tubeported bass reflex cabinet with a special inverted-type 10" woofer to achieve excellent low frequency reproduction up to the 2250 cycle crossover point. Mid-range and high frequencies are reproduced by the 6" and 3½" cone-type, closed-back speakers. The closed-back construction of these speakers prevents the back pressure of the woofer from causing distortion at mid-range and high frequencies. A crossover network is used to keep low frequencies out of the mid-range and high frequency speakers; also, these two speakers are acoustically designed to provide a flat frequency response at their crossover point. The factory assembled cabinet comes ready for speaker mounting, and includes hangers on the back for wall mounting, plus felt feet which can be placed on any side for free-standing use. Finished walnut or unfinished whitewood. 31 lbs.

Kit AS-22U, unfinished . . . no money down, \$5 mo. **\$49.95**
 Kit AS-22W, walnut . . . no money down, \$6 mo. **\$54.95**

SPECIFICATIONS—Frequency response: ± 5 db, 55 to 12,500 cps. Crossover frequency: 2250 cps. Recommended amplifier power: 10 to 25 watts. Nominal impedance: 8 ohms. Woofer: 10" special inverted design, 1.1 lb. Alnico V magnet. Mid-range: 6" closed back, 2.16 oz. Alnico V magnet. Tweeter: 3½" closed back, 2.15 oz. Alnico V magnet. Cabinet: bass reflex, tube-tuned, factory assembled of ¾" furniture grade plywood. Dimensions: 19½" W x 25" H x 5" D.

**The Heathkit TWO-WAY HI-FI SYSTEM
 a world-renowned performer at low cost**

- Factory assembled and finished cabinets
- Mahogany and walnut veneers or unfinished white hardwood
- High quality speakers of special design—8" woofer and compression-type tweeter with flared horn
- Built-in crossover network—tweeter level control
- May be used in upright or horizontal position



\$39⁹⁵

AS-51U

**TWO-WAY
 SYSTEM!**

8" bass woofer plus exponential horn with true compression driver for highs.

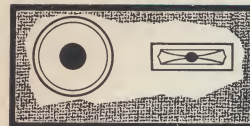

Thousands everywhere are enjoying the quality sound of this popular series of Heathkit speaker systems. Read the specifications and price and you'll know why these are such great values.

Two high quality speakers by Jensen, an 8" woofer and a true compression-type tweeter with flared horn provide exceptionally smooth response and clean audio reproduction over the entire basic frequency range of ± 5 db from 50 to 12,000 cps. A 1600 cps cross-over network is built-in, and a control is provided to adjust the power level of the tweeter to suit your listening requirements. Speaker impedance is 16 ohms and power rating is 25 watts of program material. The high efficiency design of the speakers allows use with high fidelity amplifiers having as little as 3 watts output.

Suitable for either vertical or horizontal mounting in book-shelves, etc., the AS-51 features a special tweeter mounting board that may be rotated so that the speaker maintains its proper plane in a horizontal position for wide-angle sound dispersion. Easily assembled in one evening, the AS-51 speaker requires only mounting of the speakers in the cabinet and wiring of the simple crossover network . . . everything else is already done for you!

The specially-designed bass-reflex cabinet is available in prefinished walnut and mahogany veneers, and also in unfinished white hardwood suitable for the finish of your choice. The high quality grill cloth in deep brown and tan non-sag plastic and fiber is accented in a thin, clean-lined frame formed by the extended cabinet edge. Its smart, modern appearance will complement any room decor. 24 lbs.

Kit AS-51U, unfinished . . . no money down, \$5 mo. **\$39.95**
 Kit AS-51W, walnut . . . no money down, \$5 mo. **\$46.95**
 Kit AS-51M, mahogany . . . no money down, 5 mo. **\$46.95**

SPECIFICATIONS—Frequency response: ± 5 db, 50 to 12,000 cps; Crossover frequency: 1600 cps; Power rating: Program Material —25 watts, Single Frequency —15 watts; Nominal impedance: 16 ohms; Speakers: Low Frequency—8" Jensen (special design), 6.8 oz. Alnico 5; High Frequency—Jensen compression driver with exponential horn (special design), 4.7 oz. Alnico 5; L-pad—level control for high frequency driver. Dimension: 11½" H x 23" W x 11½" D.

Feature Factory Assembled Cabinets

Here's an **ACOUSTIC SUSPENSION SPEAKER** that's easy to drive and easy to buy . . . the **Heathkit AS-10**

- 10" acoustic suspension woofer
- Two 3½" cone-type tweeters
- Preassembled cabinets in three finishes
- Takes only 10 watts to drive, yet handles up to 40 watts
- Covers 30—15,000 cps

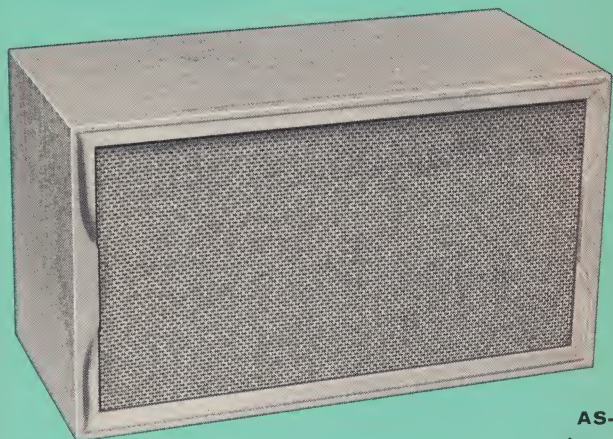

AS-10U
\$59⁹⁵

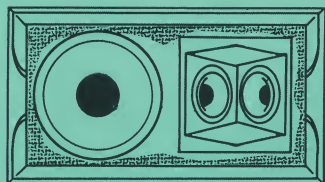

THREE SPEAKERS
10" Acoustic Suspension bass woofer and two 3½" cone-type tweeters in dispersed array.

Many have yearned for the advantages of the acoustic suspension speaker . . . its extended bass frequency response . . . the smooth high frequency response . . . the substantially lower distortion. But, many have been reluctant to budget for the higher initial expense of this type of speaker and the sometimes added expense of securing a new amplifier with sufficient power to drive it. Now, the Heathkit AS-10 does away with these disadvantages to bring you the exciting sound of acoustic suspension speakers that are easier to drive, and easier to buy.

Through an exclusive license granted to the Heath Company by Acoustic Research, Inc., the acoustic suspension system which provides the unique distortion-reducing properties of this type of speaker system is incorporated in the Heathkit AS-10. In essence, the speaker cone is mounted with a very free suspension, so compliant that it barely provides the elastic restoring force normally required. The full restoring force is then re-introduced via the pneumatic spring of the air enclosed by the cabinet. The cone literally rides on air instead of mechanical springs, and harmonic distortion is thereby substantially reduced.

The exciting AS-10 has in its bookshelf-size cabinet such features as a 10" acoustic suspension woofer and two 3½" cone-type tweeters. It requires as little as 10 watts to drive, covers 30 to 15,000 cps, and includes a high frequency control and crossover network. Rotatable tweeter mounting permits placing cabinet in horizontal or vertical position. Dimensions: 24" L x 11½" D x 13½" H. 39 lbs.

Kit **AS-10U**, unfinished . . . no money down, \$6 mo. **\$59.95**

Kit **AS-10W**, walnut . . . no money down, \$7 mo. **\$64.95**

Kit **AS-10M**, mahogany . . . no money down, \$7 mo. **\$64.95**

SPECIFICATIONS—Frequency response: ± 5 db 30 to 15,000 cps; **Crossover frequency:** 2250 cps; **Recommended amplifier power:** 10 to 40 watts rms; **Nominal impedance:** 16 ohms; **Tweeter:** two 3½" cone units, in dispersed array, 1.47 oz. Alnico 5 mag.; **Woofer:** 10" Acoustic Suspension, 1 lb. Alnico 5 mag. Resonant frequency (mounted) 58 cps.; **Crossover:** L-C network; **Horizontal dispersion:** 90 degrees.

Purchase the Heathkit version of the famous **AR-2 ACOUSTIC SUSPENSION SPEAKER SYSTEM** and save!

- 10" acoustic suspension woofer
- Two 5" cross-fired cone-type tweeters
- Preassembled, unfinished cabinet
- Exclusive with Heathkit

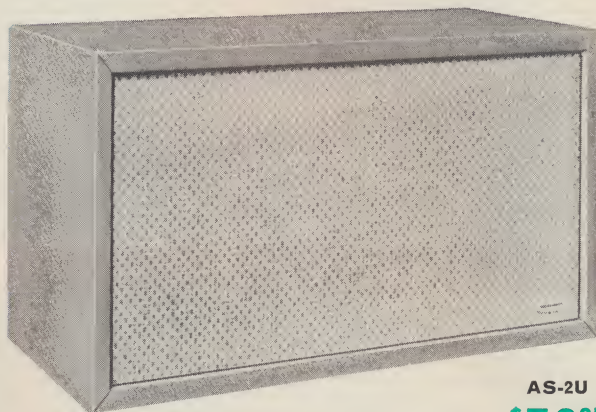

AS-2U
\$72⁹⁵

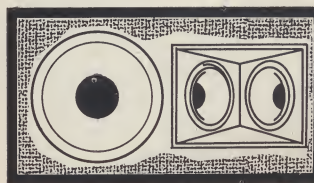

THREE SPEAKERS
10" Acoustic Suspension bass woofer and two 5" cone-type tweeters in dispersed array.

A revolutionary principle in speaker design, the Acoustic Research AR-2 speaker has been universally accepted as one of the most praiseworthy speaker systems in the world of high fidelity sound reproduction.

Because of an exclusive license granted to the Heath Company by Acoustic Research, Incorporated, you can now enjoy the quality and savings of the famous AR-2 acoustic suspension speaker system in kit form. The Heathkit AS-2U features a 10" woofer that delivers extended bass response with extremely low harmonic distortion. Also included in this excellent system are two cross-fired tweeters that give you outstanding high frequency distribution. This AS-2U kit is easy to build and includes parts for a 2000 cps L-C crossover network. The factory assembled cabinet comes unfinished to let you choose your own decorating preference in adding the unit to your home surroundings.

Read the impressive specifications below and be convinced of the superiority of this fine speaker system kit. Order your Heathkit AS-2 now and add the advantages of acoustic suspension sound to your stereo/hi-fi system. 44 lbs.

Kit **AS-2U**, unfinished . . . no money down, \$8 mo. **\$72.95**

SPECIFICATIONS—Frequency response: ± 5 db, 40 to 15,000 cps. **Crossover frequency:** 2,000 cps. **Recommended amplifier power:** 20 to 40 watts RMS. **Nominal impedance:** 8 ohms; **Tweeter:** two 5" cone units, specially treated and equalized, in dispersed array, 2.15 oz. Alnico 5 Magnet; **Woofer:** 10" Acoustic suspension, 1.1 lb. Alnico 5 Magnet. Resonant frequency (mounted) 58 cps.; **Crossover:** L-C network; **Horizontal dispersion:** 90°; **Size:** 24" W x 13½" H x 11½" D.

New Relaxed Credit Terms ORDER NOW! PAY LATER

With Heath's new credit terms you can order the kits you want now! No money down . . . up to 18 months to pay on any purchase of \$25.00 to \$600.00. Enjoy the pleasure of building and having your Heathkit while you pay for it in easy monthly installments.

Heath Has The World's Largest Selection of Electronic Kits

Heathkit® Offers a Selection of Speakers

An excellent "starter"

HI-FI SPEAKER SYSTEM KIT . . . just \$10.95

- 6" x 9" extended range dual-cone speaker
- Walnut or unfinished cabinets
- 60-16,000 cps response

The Heathkit AS-41 can be used in a variety of ways in your high-fidelity music system . . . as an extension speaker to other rooms, as a center fill-in speaker for a stereo system, for a budget-minded economy system for your recreation room or for a hi-fi/stereo beginner's system. The AS-41 speaker cabinet is completely factory assembled of furniture grade birch veneer plywood and measures 11" W x 8" H x 6½" D. It comes in walnut finish or unfinished. Equipped with a 6" x 9" extended range dual-cone speaker, it has a frequency response of 60 to 16,000 cps and 12 watts peak power rating. Just install the speaker in the cabinet, connect two leads and it's ready to use. 8 lbs.

Kit AS-41U (unfinished) **\$10.95**
Kit AS-41W (walnut finish) **\$12.95**

SPECIFICATIONS—Frequency response: 60 to 16,000 cps; **Speaker:** 6" x 9" oval extended range dual cone; **Magnet:** 6.8 oz. Alnico 5; **Power handling capacity:** 12 watts peak; **Impedance:** 8 ohms; **Resonant frequency:** 85 cps. **Leads:** 15' 2-conductor, rubber-covered.

Miniature HI-FI SPEAKER SYSTEM

features two separate speakers and unusual response

- Special 6" woofer—3" tweeter
- Factory assembled cabinet

Especially engineered to provide excellent wide-range audio reproduction from a very small enclosure, the Heathkit AS-81 hi-fi speaker system utilizes a bass woofer and cone-type high frequency tweeter in a special, integrated design. The 6" woofer is of the high-compliance type with a mass-loaded cone carefully matched to the enclosure to secure unusual bass response. The 3" tweeter is of the closed back type to prevent speaker interaction. Cabinet is assembled, ready for easy installation of the two speakers, crossover network and voice coil leads. 10 lbs.

Kit AS-81U (unfinished) **\$17.50**
Kit AS-81W (walnut) **\$19.95**
Kit AS-81M (mahogany) **\$19.95**

SPECIFICATIONS—Frequency response: ±5 db from 70 to 14,000 cps. **Crossover frequency:** 4000 cps. **Recommended amplifier power:** 6 watts. **Nominal impedance:** 8 ohms. **Cabinet:** Type, infinite; Dimensions, 10¾" W x 6½" H x 6-3/16" D; Material, ½" veneer plywood. **Speakers:** Tweeter, 3" cone type, 8 ohms, .53 oz. Alnico 5 magnet; Woofer, 5½" cone type, 8 ohms, 10 oz. syntox #6 magnet. **Crossover:** Capacitor type. **Finish:** AS-81U, Unfinished; AS-81M, Mahogany; AS-81W, Walnut.

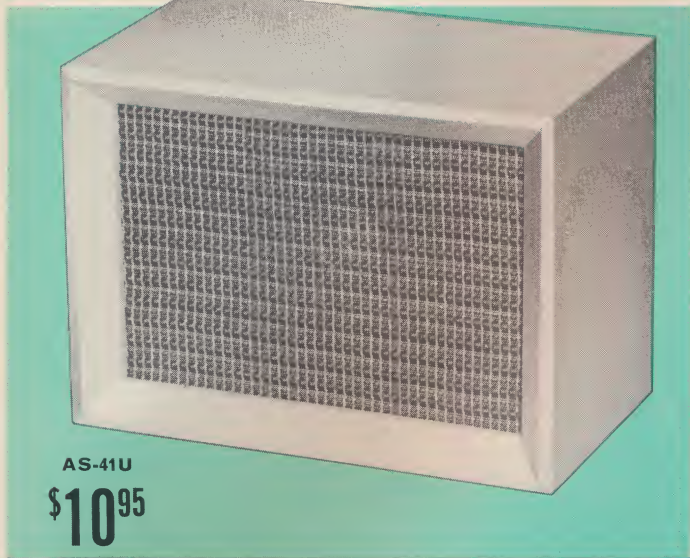

STEREOPHONIC HEADPHONES

Jensen HS-1L STEREO HEADPHONES

Designed to professional standards with advanced features for acoustic performance and comfort. Soft, contoured cushions provide acoustic seal without sensation of pressure and include complete adjustments for perfect fit. Special design, moving coil driver units are matched to close tolerances for accurate stereo balance and deliver clear, undistorted full range high fidelity response from 20 to 15,000 cps. Fluid damping of moving system yields superior response smoothness! Lightweight, sturdy and durable cases of marproof, breakproof nylon. Stainless steel yokes and vinyl enclosed headband springs. 2 lbs.

Model ADP-82 **\$22.50**

SPECIFICATIONS: **Drivers:** High-compliance, curvilinear, moisture resistant diaphragm. Aluminum voice coil, sintered magnetic circuit with efficient Alnico magnet. **Frequency range:** 20-15,000 cycles. **Power requirements:** Comfortable listening with 1/10 milliwatt. **Impedance:** 8-ohms each channel (may be connected to 4, 8, or 16 ohm amplifier outputs). **Sensitivity:** 95 db sound pressure level for 1 milliwatt input. **Connectors:** Spade terminals. **Cord:** 4-wire cable, 8 ft. long.





The incomparable LEGATO COMPACT . . . world-famous performance and value

- Speakers by Altec Lansing cover 30—22,000 cps
- Preamsembled cabinet in walnut finish, ready for speaker installation
- Modern styling matches AE-20 center cabinets
- 800 cps crossover network—completely assembled
- Can be driven by as little as 3 watts

“Legato” is defined in music terms as a smooth, even style, with no noticeable interruption between notes. It’s an apt word for the prize-winning performance of this fine speaker, the Heathkit AS-21 . . . a performance known by audiophiles everywhere for its acoustical excellence . . . a performance known by engineers as an achievement in sound technology.

When you unpack this AS-21, you will discover immediately why so many persons praise it. It features two 12” Altec Lansing “high compliance,” low-frequency speakers that cover the 30-800 cps range with rich, full-bodied tone. In addition, a newly-designed special Altec-Lansing exponential horn and high frequency driver combination covers frequencies from 800 to 22,000 cps with complete fidelity and brilliance. The special 800 cps crossover network is factory assembled and ready to install in the Legato Compact when you unpack it.

Another fabulous feature of this value-packed speaker system is the high efficiency of the speakers—amplifiers with just 3 watts output power can drive the system with ease, yet it is capable of handling program material of 30 watts.

The cabinets of the Legato Compact come in a handsome walnut finish and are completely factory assembled of ¾” furniture grade plywood. The styling matches the Heathkit AE-20 cabinets shown on page 58—they form a beautifully coordinated high fidelity sound center that will do credit to any home. Enjoy high fidelity sound unmatched in quality and value, order your “Legato Compact” now. 132 lbs.

Kit AS-21W . . . walnut . . . no money down, \$22 mo. **\$239.95**
AS-31: All components of AS-21 except cabinet for custom installations. Cabinet dimensions included . . . 53 lbs. . . . no money down, \$18 mo. . . . **\$184.95**

SPECIFICATIONS—Frequency response: 30-22,000 cps. **Power rating:** 30 watts program material
Nominal impedance: 16 ohms. **Cabinet type:** Modified infinite baffle. **Dimensions:** 32” L. x 19” D.
x32¾” H. **Magnet wts.:** Low-frequency drivers: 1½ lbs. each. High-frequency driver: .53 lbs. **Crossover network:** 800 cps constant K high frequency shelving type. **Driving power:** as low as 3 watts.



AS-21W
\$239⁹⁵

HIGH FREQUENCY DRIVER
and specially designed exponential horn by Altec Lansing with .53 lb. magnet . . . covers 800 to 22,000 cps . . . provides 90° horizontal distribution

LOW FREQUENCY SPEAKERS by Altec Lansing . . . famous, high compliance, 12” speakers with 1½ lb. magnets . . . cover 30 to 800 cps

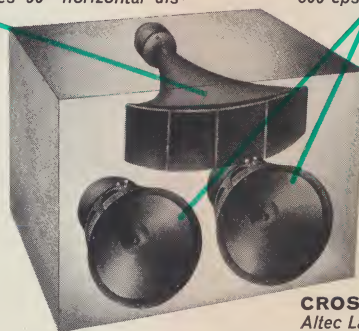

CROSSOVER NETWORK by Altec Lansing . . . 800 cps constant K shelving type

FOR PRIVATE LISTENING ENJOYMENT

Roanwell STEREO DYNAMIC HEADSET

First time ever offered for commercial use! Identical driver units are being used in manned space flight missions. Rigid military specifications and wide range frequency response make them ideal for use in stereo high fidelity applications. Finest quality throughout. Covers 30 to 18,000 cps with special moving coil dynamic drivers. Vinyl enclosed headband springs, full adjustments for perfect fit, and soft cushions for comfortable acoustic seal. 4-wire design eliminates amplifier phasing problems in stereo applications. 3 lbs.

Model ADP-102 . . . no money down,
\$5 mo. **\$37.50**

SPECIFICATIONS—Drivers: Moving coil, dynamic. **Sensitivity:** 105 db @ 1000 cps (ref. 0 db = .002 dynes per sq. centimeter with input of 1 milliwatt). **Frequency response:** 30-18,000 cycles. **Distortion:** Less than 3% with 100 milliwatt input. **Impedance:** 16 ohms.
Connectors: Spade terminals. **Cord:** 4-wire cable, 12 ft. long.



ADP-92
\$23⁹²

Telex ST-11 STEREO HEADSET

Enjoy your favorite music in complete comfort and perfect privacy . . . sit anywhere in the room without destroying stereo effect. The new Telex Stereo-Twin is comfortable, lightweight and easy to clean. Soft, pliable foam rubber muff shuts off outside noises, provides excellent seal without pressure through deep cavity design. Complete adjustments for perfect fit. Stainless steel headband and yoke assure long life, trouble-free operation. Special driver design gives faithful wide-range reproduction with exceptionally good low frequency response.

Model ADP-92 . . . 3 lbs. **\$23.92**

SPECIFICATIONS—Driver element: Dynamic. **Sensitivity:** better than 95 db. **Frequency response:** 16 to 15,000 cps. **Impedance:** 8 ohms for use with 3 to 16 ohm sources. **Power input:** 15 milliwatts, 1 watt maximum. **Cord:** 4-wire 12 ft. long with spade terminals. **Color:** Tan and brown.

Enhance the Visual Beauty of Your Stereo/Hi-

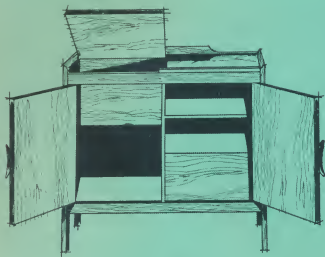
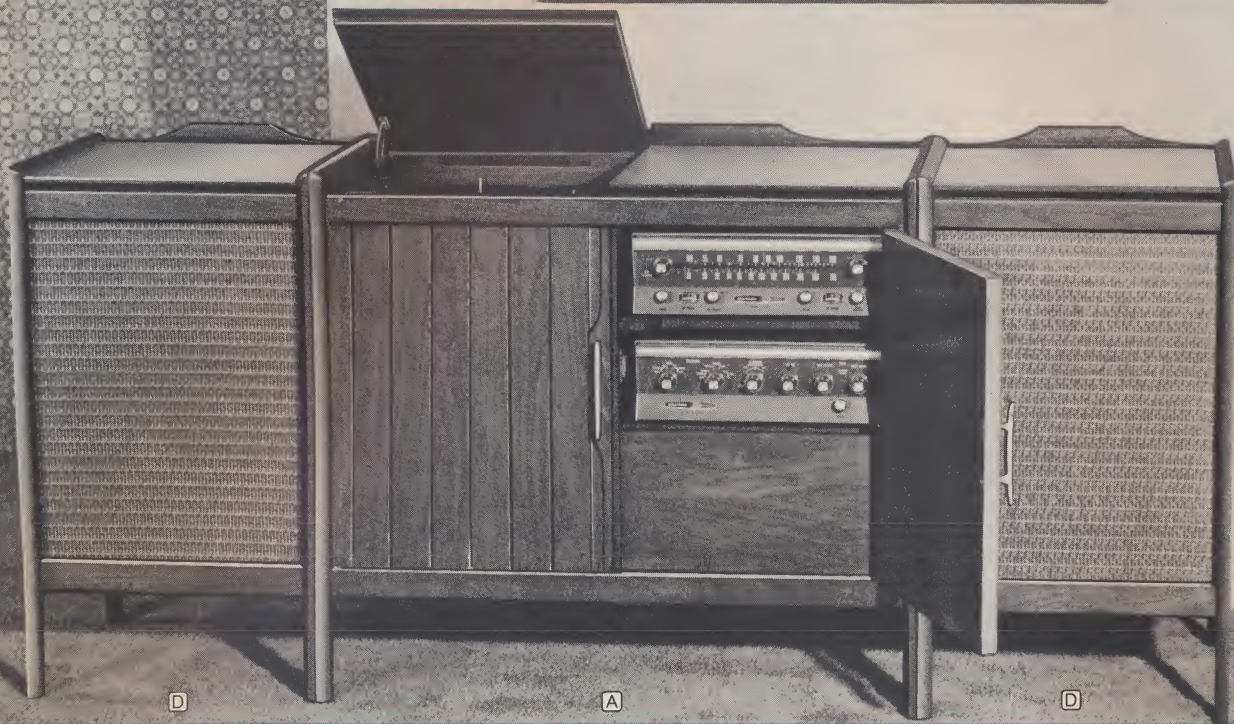

AE-20U
\$79⁹⁵

A DELUXE EQUIPMENT CENTER holds most Stereo/Hi-Fi Components

- Factory assembled, ready to use
- Walnut or unfinished
- Custom-designed for Heathkit components

The Heathkit AE-20 Equipment Cabinet is a craftsman-constructed, tastefully designed piece of furniture that will blend with any room decor in your home, whether your furniture styling is modern or traditional. The quality woods of the AE-20 are accented by design relief touches which are uncluttered and eye-arresting. Slim, curved brass handles on each door highlight the "sculptured" effect. The divided top panel is characterized by a "gallery" rail and indented-curve front edge.

This top quality AE-20 Equipment Cabinet by Heathkit is completely factory-assembled and ready to accommodate your hi-fi/stereo system components. It comes in either unfinished hardwood or hand-rubbed walnut finish. 90 lbs.

Model AE-20U (unfinished)...no money down, \$8 mo.....**\$79.95**
Model AE-20W (walnut)...no money down, \$10 mo.....**\$99.50**

EQUIPMENT ACCOMMODATIONS AND SIZES—Cabinet, overall: 36" W x 32½" H x 19" D. **Changer compartment:** 17" W x 15½" D, mounting board is uncut and can be adjusted in height to accept AD-82, AD-92, AD-102, or ADP-61 record equipment (but not ADP-21), and also AD-12 and AD-22 tape equipment; lid has adjustable friction-loaded support. **Record-tape recorder compartment:** 14½" H x 17" W x 17" D, for record storage; space is convertible with accessory sliding drawers below to accommodate Heath AD-12 and AD-22 tape recorders or AD-92 and AD-102 record changers. **Shelf compartments:** (2) each 17" W x 6" H x 17" D. (inside shelf 14" deep); either shelf accepts any Heath Stereo or Mono tuner, Stereo or Mono pre-amplifier or stereo or mono combination amplifier. **Power amplifier compartment:** 8½" H x 17" W x 15½" D. inside; accepts Heath AA-111 or AA-121 for stereo or any Heath monophonic amplifier.

DELUXE STEREO/HI-FI SYSTEM . . . contains the finest of the Heathkit line

For those who will be satisfied with nothing but the best, this system consists of the top models in all Heathkit stereo product lines. Outside, it looks like the photo above with its deluxe AE-20 walnut center cabinet and matching AE-40 walnut speaker cabinets. Inside, it's an audiophile's dream. Included is the AJ-41 AM-FM-Stereo tuner with built-in multiplex converter (p. 36); the new Heathkit AA-21 all-transistor 70-watt stereo combination amplifier-preamplifier (p. 35); the new Heathkit AD-102B automatic record changer with Shure M-77M-D cartridge with diamond stylus (p. 52); the AD-22 four-track stereo tape recorder (p. 49) complete with the AEA-12-4 tape recorder drawer below; two AK-1 ceramic microphones (p. 58) for live stereo recordings; and two Altec 605A 15" duplex hi-fi speakers (AS-70, p. 60) for exceptionally fine sound. Order as a system and save an extra \$54. 416 lbs.

System Kit HFS-57 . . . write for time payment details**\$1027.95**
 (including discount)

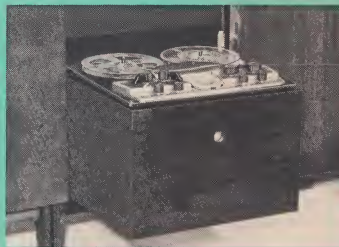

Record Changer & Tape Recorder Drawers from \$16.95

These newly-designed drawers will fit either the AE-20 center cabinet above or the new AE-12 "apartment-size" cabinet on the opposite page. Changer drawers are pre-cut for Heathkit changers AD-102 & AD-92; tape recorder drawers are uncut, but will accept Heathkit AD-12 & AD-22 decks.

Model AEA-12-1, unfin. changer drawer, precut, 11 lbs.....**\$16.95**
Model AEA-12-2, walnut changer drawer, precut, 11 lbs.....**\$17.95**
Model AEA-12-3, unfin., uncut recorder drawer, 15 lbs.....**\$18.95**
Model AEA-12-4, walnut, uncut recorder drawer, 15 lbs.....**\$19.95**

System with these Magnificent Cabinets



AE-12U **\$58⁵⁰**

B Space-saving, money-saving, "Apartment-size" EQUIPMENT CENTER

- Just half the width of regular cabinets
- Factory assembled, ready to use
- Houses everything but speakers

Styled and finished to match the beautifully compatible Heathkit cabinetry line, this compact component cabinet is just half the usual width, yet fits into any system scheme. Styling features the "sculptured" front panel and gallery rail which characterize Heathkit cabinetry. Dimensions are 32 $\frac{3}{8}$ " H x 18 $\frac{3}{4}$ " W x 19" D outside. Two shelf compartments (6 $\frac{1}{8}$ " H x 17 $\frac{1}{8}$ " W x 16 $\frac{3}{4}$ " D) hold any Heath stereo or monophonic tuner and any Heath stereo or monophonic combination amplifier. Compartment at bottom accepts either tape recorder or changer drawers (opposite page) to contain AD-102 or AD-92 changers or the AD-12 tape player or AD-22 tape recorder (measures 9 $\frac{1}{2}$ " H x 17 $\frac{1}{8}$ " W x 17 $\frac{1}{4}$ " D).

Model AE-12U, unfinished, 50 lbs...no money down, \$6 mo..... **\$58.50**
 Model AE-12W, walnut...no money down, \$7 mo..... **\$68.50**

C Low Cost SPEAKER CABINETS

Complements AE-20 and AE-12 center cabinets above. Accepts either 8 or 12 inch speakers plus optional-use 3 $\frac{3}{8}$ " x 10 $\frac{3}{16}$ " slot for horn tweeter. Tube-vented design permits optimum performance with any speaker (see page 60); instruction for tube modification included. Factory assembled cabinet measures 15" W x 19" D x 32 $\frac{3}{8}$ " H outside. 35 lbs.

Model AE-30U, unfinished...no money down, \$5 mo..... **\$31.95**
 Model AE-30W, walnut...no money down, \$5 mo..... **\$38.95**



Low Cost STEREO/HI-FI SYSTEM, Complete with Cabinets . . . Compare it with units costing twice as much!

For those who want the very most for their money, plus fine performance, this low-cost Heathkit stereo/hi-fi system is ideal. Outside, it looks like the photo above with its "apartment-size" AE-12 walnut center cabinet and complementing AE-30 walnut speaker cabinets. Inside are complete facilities: the new Heathkit AJ-32 AM-FM-Stereo tuner with built-in multiplex (p. 41) brings the joy of high fidelity AM and FM plus the wonder of new FM in stereo; for the listening pleasure that disc recordings offer, the Heathkit AD-92B automatic record changer (p. 52) is included, complete with its diamond stylus. For utmost fidelity, the Heathkit 28-watt AA-151 stereo combination pre-amplifier-power amplifier (p. 42) offers years of faithful performance. Each nuance of sound is faithfully reproduced by the two Electro-Voice LT-12 3-way hi-fi speakers (ASP-12, p. 60). Enjoy the superb performance of a component stereo system with the beauty of a console, and all at an unusually low price, with this Model HFS-56 System Kit. Order as a system and save an extra \$20.85. 177 lbs.

System Kit HFS-56...no money down, as low as \$26 mo..... **\$396.17**

D Deluxe SPEAKER CABINETS

Perfect match for AE-20 and AE-12 center cabinets above, down to the finest detail. Accepts either 12 or 15 inch speakers plus optional-use 3 $\frac{3}{8}$ " x 10 $\frac{3}{16}$ " slot for horn tweeter. Tube vented design permits best match for any speaker (see page 60); instruction for tube modification is included. Exceptionally handsome, this factory assembled speaker cabinet fits into any decor; measures 18 $\frac{1}{2}$ " W x 19" D x 32 $\frac{3}{8}$ " H outside. 44 lbs.

Model AE-40U, unfinished...no money down, \$5 mo..... **\$37.95**
 Model AE-40W, walnut...no money down, \$5 mo..... **\$44.95**

There's A Heathkit For Every Interest, Every Purpose, Every Budget

For Better Listening, Choose a Quality Speaker

Heath 12" Dual-Cone



For big value in a 12" speaker, choose the Heath US-2. Featuring a wide range frequency response, the US-2 has a concentrically mounted whizzer cone and a low frequency cone driven by one voice coil. Comes complete with instructions for building your own enclosure. Check the specifications below on this amazing value.

Model US-2 **\$11.95**

Heath 12" Co-axial



Compare this Heath 12" co-axial for performance, quality, and price . . . see its superior specifications below. A true co-axial speaker, it provides a smooth, broad frequency response from a separate tweeter and bass woofer. Built-in crossover network. Enclosure instructions provided; excellent for AE-30 cabinets, p. 59.

Model US-3 **\$19.95**

Electro-Voice LT-12 12" 3-Way

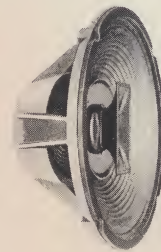

Actually three speakers in one; Sonophase® VHF driver, 12" woofer with Ceramic Indox magnet, and Radax® midrange cone. Extremely wide frequency response with three position brilliance switch to adapt characteristics to your home. Has built-in crossover network and rigid die-cast frame. Ideal for use with the Heathkit AE-30 cabinets, p. 59.

Model ASP-12
no money down, \$5 mo. **\$28.91**

Altec 755C 8" Speaker



Here's a compact speaker that provides wide frequency response and wide 90° angle of distribution. Its shallow 2¼" depth makes it ideal for mounting in walls, etc., for extension speakers for voice or music reproduction. It works well with small enclosed volumes; sealed enclosure of 1½ cubic ft. is optimum size.

Model AS-20
no money down, \$5 mo. **\$29.95**

Electro-Voice SP-12B 12" Co-ax

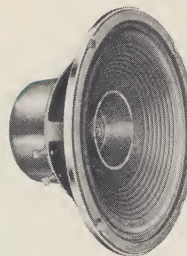

A very popular dual-cone speaker, this 12" unit uses the Radax® whizzer cone plus a bass woofer cone of high-compliance viscous-damped cloth suspension driven by a deep 2" diameter voice coil. Mechanical crossover occurs at 4500 cycles. Uses heavy Ceramic magnet for excellent bass response; see specifications below.

Model AS-30
no money down, \$5 mo. **\$34.30**

Electro-Voice SP-15B 15" Dual Cone



If you've been thinking of moving up to a big 15" speaker, consider this low cost, high value unit. It uses the Electro-Voice Radax® principle of two cones from one deep 2" voice coil with the woofer the high-compliance type with viscous-damped cloth suspension. Mechanical crossover occurs at 3500 cycles. Ceramic magnet. Specs. below.

Model ASP-71
no money down, \$5 mo. **\$42.14**

Jensen H-222 12" Co-ax

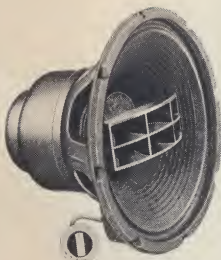

This highly popular co-axial speaker uses an electrically and acoustically independent woofer and tweeter. The tweeter is the compression type driver with a built-in 2000 cycle network and a 6-cell Hypex® exponential horn. Also included is the ST-946 high frequency level control. Noted for high efficiency, low distortion and wide dispersion of "highs".

Model ASP-61
no money down, \$7 mo. **\$62.50**

Jensen H-223F 12" Two-Way

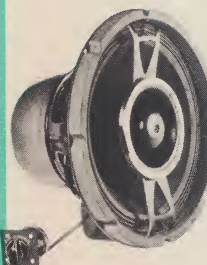

A high-quality, full two-way co-axial speaker, this fine unit uses a special "Flexair" woofer for excellent bass, and a concentric re-entrant type compression driver for high frequencies. The built-in L-C crossover network functions at 2000 cycles. A wired-in tweeter balance control is included.

Model AS-40
no money down, \$8 mo. **\$72.50**

Altec 605-A 15" Duplex



A standard of excellence! Two mechanically and electrically independent speakers in one frame. Low frequency unit has 3" edge-wound copper voice coil; the high frequency unit has a 1¾" aluminum voice coil and an exponential multi-cellular horn for 40° vertical and 90° horizontal distribution. Uses 1600 cps network with adjustable HF shelving control.

Model AS-70
no money down, \$17 mo. **\$177.00**

MANUFACTURERS SPECIFICATIONS

Model	Size	Impedance	Power Rating	Freq. Resp.	Cone Res.	Mag. Wts.	Shipping Wt.
US-2	12"	8 ohm	14 watts	50-12000 cps	55-65 cps	6.8 oz.	5 lbs.
US-3	12"	16 ohm	15 watts	50-15000 cps	65-75 cps	6.8 & 1.47 oz.	6 lbs.
ASP-12	12"	8 ohm	20 watts	40-18000 cps	55 cps	12 & 1.47 oz.	10 lbs.
AS-20	8"	8 ohm	15 watts	40-13000 cps	45 cps	(11000 gauss)	5 lbs.
AS-30	12"	16 ohm	20 watts	40-13000 cps	40-50 cps	1½ lb. cer.	11 lbs.
ASP-71	15"	16 ohm	15-20 watts	30-13000 cps	38 cps	1 lb. 6 oz. cer.	15 lbs.
ASP-61	12"	16 ohm	25 watts	30-15000 cps	60 cps	1¾ lb.	12 lbs.
AS-40	12"	16 ohm	30 watts	20-15000 cps	25 cps	1¾ lb.	12 lbs.
AS-70	15"	16 ohm	35 watts	20-22000 cps	25 cps	2¼ lb. & ½ lb.	37 lbs.



A World-Wide Voice... Heathkit® Amateur Radio Equipment

Hams of all nations use Heathkit gear for superior communications in all environments... these are the reasons:

VERSATILE

Ham ops everywhere know Heathkit ham gear to be the most versatile equipment... combination units ready for mobile or fixed station use... ready for any mode of operation including single sideband. Whatever your preference, whatever your budget, you'll find a Heathkit to suit your purposes... the most complete line of ham gear in the world!

DEPENDABLE

Heathkit ham equipment works!... the first time you try it, and every-time thereafter for years and years of faithful service. You can check this dependability for yourself on the ham bands... you'll find hams the world over still using the very first Heathkit ham equipment designed and manufactured well over a decade ago. Service you can count on!

QUALITY COMPONENTS

The reputation of Heathkit ham gear is based on many factors, but quality is paramount. Quality designs evolve into quality equipment only through the use of quality components... premium-quality, specified by Heath ham-engineers, purchased and constantly inspected to be sure only the best finds its way into Heathkit Amateur Radio equipment. Through such rigid insistence, your Heathkit delivers the performance you expect... longer.

HAM-ENGINEERED

You can count on Heathkit equipment to perform the operating job you want because all engineering is done by specialists in the field. Engineers with both academic and practical experience in the world of hamdom... each a licensed, operating ham... eager to improve the state of their favorite hobby with better designs, better Heathkits. There are more than 40 hams employed by the Heath Company, all anxious to serve you... listen for them on the air or write to them personally.

EASY TO ASSEMBLE

Heathkit ham gear is easy to assemble, for every unit is designed as a kit to build by amateurs, supplied with the world's easiest-to-follow instruction manuals, complete set of parts including exterior cabinetry, and factory consultants to help if you need it. Building your own Heathkit also adds that intimate knowledge of your equipment which enables you to get the most in performance.

BETTER VALUE

The combination of experience, knowing design using top quality components to produce a versatile, dependable unit that is easy to assemble, accounts for the greater value of Heathkit amateur radio equipment. And you save by buying direct and building it yourself. This combination accounts for the growth of Heath to a favored place in the hearts of hams everywhere as the greatest values in the ham world... over half a million ham Heathkits sold in the last decade!





Equip for Mobile "Fun"

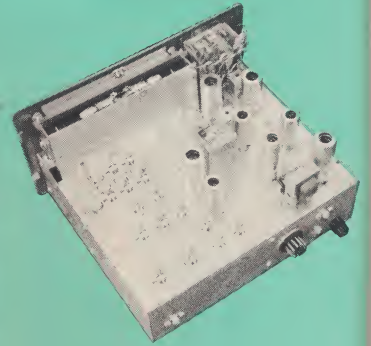

CONVENIENT All receiver adjustments are made from the top of the chassis. Each band is separately aligned to assure proper tracking on the dial.

HR-20
\$134⁵⁰

Heathkit HR-20 SSB MOBILE RECEIVER . . . New features, advanced design for fun-filled mobile operations

- Tunes SSB, AM & CW signals—80 through 10 meters
- Better than 1uv sensitivity on all bands
- Crystal bandpass filter for sharp selectivity
- Crystal controlled BFO for selectable sideband reception
- Built-in calibrated "S" meter—30-1 gear drive tuning
- Regulated local oscillator filament voltage

Outstanding performance and convenience are yours in this handsomely styled mobile receiver! Excellent sensitivity, selectivity and stability are provided by the modern 8-tube superhet circuit featuring a tuned RF stage, crystal bandpass filter, and extensive temperature compensation and voltage regulation of all oscillators. Operates SSB, AM and CW on 80 through 10 meters. Amateur frequencies are calibrated in five separate bands on a rotating slide-rule dial for precise frequency settings. Other features include a product detector for SSB, CW reception and a diode detector for AM. A series noise-limiter, controllable from the front panel, effectively reduces ignition, electrical and other forms of pulse type noises in AM signals. Front panel selection of either fast or slow AVC action tailors receiver response time to suit varying band conditions or types of transmissions. Panel meter is calibrated in "S" units from 1 to 9 and in db above +60 db. Outputs are provided for 8 ohm speaker plus a separate 500 ohm output for headset or anti-trip circuit in transmitter. A versatile performer, the HR-20 operates from a 12 volt car battery using the Heathkit HP-10 Mobile Power Supply or can be converted in minutes to fixed station operation using the Heathkit HP-20 AC Power Supply. Local oscillator filament is voltage regulated by a transistor and zener diode for mobile frequency stability. 17 lbs.

Kit HR-20...no money down, \$13 mo. **\$134.50**

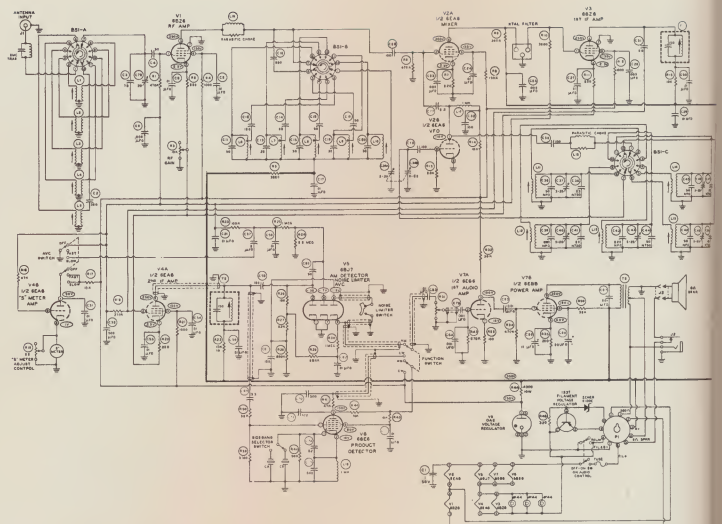

SPECIFICATIONS—Frequency range: 80 thru 10 meters in 5 bands, 3.5 to 4.0; 7.0 to 7.3; 14.0 to 14.35; 21.0 to 21.5; 28.0 to 29.7 MC. **Intermediate frequency filter:** Center frequency, 3.0 MC; Bandwidth at -6 db, 3.0 KC; Bandwidth at -60 db, 10.0 KC Max.; Hermetically sealed. **Panel controls:** Sideband Select; R.F. gain; A.F. gain—Off-On; Noise Limiter; AVC select; main tuning; band switch; antenna trimmer; SSB, CW-AM switch. **Signal-to-noise ratio:** 10 db at 1 microvolt or less. **Tube complement:** 6BZ6—R.F. amp.; 6EA8—Mixer Oscillator; 6BZ6—1st I.F. amp.; 6EA8—2nd I.F. amp (1/2); 6EA8—3rd I.F. amp (1/2); 6BE6—Product detector—BFO; 6BJ7—AM detector-noise limiter—AVC; 6BE8—1st Audio Output; 6A2—Voltage Regulator. **Output impedance:** 500 ohms and 8 ohms. **Power requirements:** 6.3 or 12.6 volts 4 amps AC or DC, 300 volts DC at 120MA. **Cabinet size:** 6 1/4" H x 12 1/2" W x 9 3/4" D.

Mobile BASE MOUNT KIT

Holds both transmitter and receiver conveniently at drivers side. Universal bracket has adjustable legs to fit most automobiles. 5 lbs.

Kit AK-6 **\$4.95**

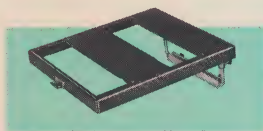

Mobile SPEAKER KIT

A matching companion for the HR-20 mobile receiver. Housed in rugged steel case with mounting bracket for easy installation. 5" PM speaker, 8 ohm imp. 3 lbs.

Kit AK-7 **\$5.95**

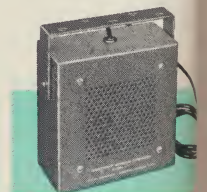

with Heathkit® SSB Mobile Gear

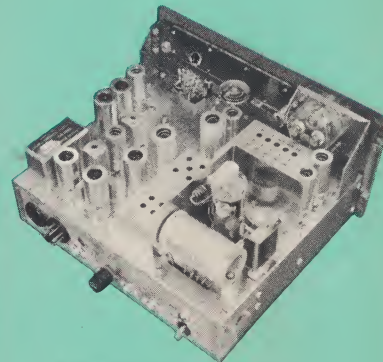

SUPERIOR! High quality and rugged design assure long life and dependable performance. Features popular 6146 final amplifier tube and ceramic form final tank coil.

HX-20
\$199⁹⁵

Heathkit HX-20 SSB MOBILE TRANSMITTER KIT . . . power packed performance

- Hermetically sealed crystal bandpass filter
- Crystal controlled dual conversion heterodyne circuitry
- Automatic level control for maximum talk power, low distortion
- Complete bandswitching of 80 through 10 meter bands
- All crystals furnished—ideal for mobile or fixed operation

Attractive, functional styling . . . 90-watt input and many more high performance features in the new HX-20, bring you all the fun and excitement of effective SSB mobile communications. Provides complete coverage and bandswitching of the 80, 40, 20 and 15 meter bands plus three 500 kc segments on 10 meters, using crystals furnished.

The HX-20 is a complete single-sideband suppressed carrier transmitter with automatic voice-operated transmit/receive switching (VOX) for SSB operation. A combination of crystal filtering and balanced modulator circuitry provide long term suppression stability making it unnecessary to constantly check carrier suppression. Other quality features include a temperature stable VFO operated from 5.0 to 5.5 mc, VOX or push-to-talk operation, anti-trip circuitry, fixed loading and "spotting switch" for either talk-on or zero-beat frequency spotting.

Special features include a multi-section hermetically sealed filter to shape audio response for excellent sideband suppression, dual conversion heterodyne circuitry with high frequency oscillators crystal controlled and automatic level control for greater talk power without distortion. A perfect mate to the Heathkit HR-20 receiver. Operates mobile using Heathkit HP-10 power supply or Fixed with HP-20 AC power supply. 19 lbs.

Kit HX-20 . . . no money down, \$19 mo. **\$199.95**
GH-12, push-to-talk microphone, 1 lb. **\$6.95**



SPECIALY-DESIGNED SSB MICROPHONE features ceramic element with shaped response for effective SSB communications, plus push-to-talk button and coiled cord; order model GH-12 below.

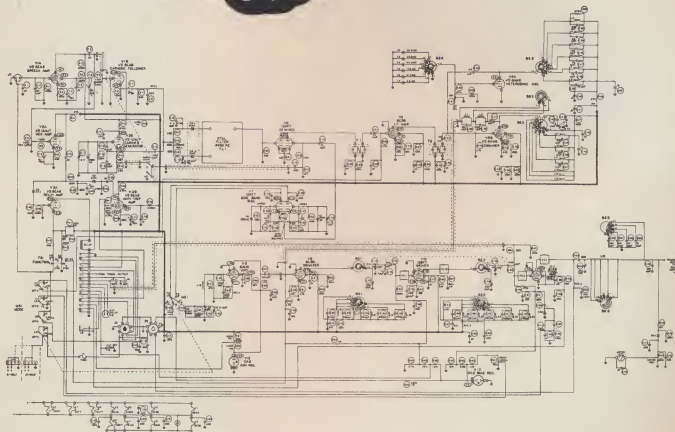

SPECIFICATIONS—Types of emission: SSB (Upper or lower) and CW. **Power input:** 90 watts PEP, SSB and CW. **Output impedance:** 50 to 75 ohms with not more than approx. 2:1 SWR. **Frequency range:** (MC): 3.5 to 4; 7.0 to 7.5; 14.0 to 14.5; 21.0 to 21.5; 28.0 to 29.5. **Frequency stability:** Overall frequency within 100 CPS after warmup. **Carrier suppression:** 50 DB below peak output. **Unwanted sideband suppression:** 55 DB below peak output. **Keying characteristics:** Grid block keying throughout. **Audio input:** High impedance microphone. **Power requirements:** 6.3 or 12.6 volts 4 amps.; —125 volts 20 milliamps; 300 volts 100 milliamps; 600 volts 130 milliamps (uses Heath HP-20 or HP-10 power supplies). **Cabinet size:** 12¼" W x 6¼" H x 9¾" D.

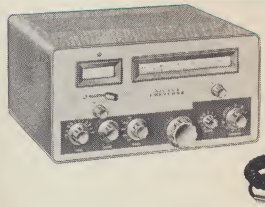

Heathkit "Cheyenne" 90-Watt INPUT PHONE & CW MOBILE TRANSMITTER

Operates AM phone or CW on 80 through 10 meters. Features built-in VFO, controlled carrier modulator, three exciter stages plus 6146 final amplifier and pi-network (coaxial) output. A "spotting switch" allows zero-beating incoming signals for off-the-air tuning and a specially designed microphone with push-to-talk switch assures effective modulation with plenty of "punch"! All power for mobile operation is furnished by the Heathkit HP-10 mobile power supply. Converts to fixed station operation in minutes using Heathkit HP-20 AC power supply. 23 lbs.

Kit MT-1 . . . no money down, \$11 mo. **\$105.95**

Save Up To 50% With Heath Do-It-Yourself Electronic Kits



Heath Brings You a Perfect Pair f

Heathkit "Marauder" SINGLE SIDEBAND TRANSMITTER . . . an unprecedented amateur value!

Over two years were spent in the development of the Heathkit "Marauder" to bring you performance, quality and dependability unheard of in this price range! Look at these features and then compare with similar units . . .

- Unmatched in features and performance at less than twice the price
- First complete filter-type SSB transmitter in kit form
- Operates SSB (upper or lower sideband), CW, AM, & FSK
- 180 watts PEP on SSB & CW . . . 80 through 10 meters
- Multi-section, hermetically sealed crystal band-pass filter
- Dual conversion, crystal controlled heterodyne oscillator
- Preheated, temperature compensated VFO
- Automatic level control for higher talk power
- Air-cooled, shielded final amplifier
- VOX controlled break-in CW operation
- 165 to 1 gear drive tuning assembly
- Beautiful exterior styling—chrome-plated knobs
- Perfect driver for "Warrior" KW Linear

Complete . . . nothing else to buy . . . all power supplies are built-in . . . all crystals are furnished for 80 through 10 meter coverage! An outstanding array of features combine with neat, functional styling in the HX-10, for convenience and quality at tremendous savings! Easy assembly is assured with clean, open circuit layout and a pre-cut, cabled wiring harness. High quality components, 16-gauge steel cabinet and heavy-duty, partitioned chassis assure a lifetime of rugged dependability.

All controls are located "out front" where you want them, for maximum ease of operation . . . no doors or hatches to open . . . no equipment to move! Attractive front panel has an edge-lighted slide-rule tuning dial and precision 165-to-1 worm-gear tuning assembly for smooth anti-backlash tuning with approx. 10 kc per turn for sharp, easy frequency selection. Other features include a full-function accessory socket for receiver muting, amplifier cutoff bias, 117 vac outlet for monitor scope or other accessories; "Spot" control; Voice control (VOX); Drive level control and many, many more! Here is a transmitter you will be proud to own and use for years to come! Assembly time approx. 60 to 80 hours. 92 lbs.

Kit HX-10 . . . no money down, as low as \$22 mo. \$334.95

SPECIFICATIONS—Emission: SSB (upper or lower sideband), CW, AM and FSK. **Power input:** 180 watts PEP—SSB and CW, 75 watts AM. **Output impedance:** 50 to 75 ohms with not more than approximately 2:1 SWR. **Frequency range (MC):** 3.5 to 4.1; 6.9 to 7.5; 13.9 to 14.5; 20.9 to 21.5; 27.9 to 28.5; 28.5 to 29.1; 29.1 to 29.7. **Frequency stability:** within 100 cps, after warmup. **Carrier suppression:** 50 db below peak output. **Unwanted sideband suppression:** 55 db below peak output. **Keying characteristics:** Break-in CW provided by operating VOX from a keyed tone using grid-block keying. **Audio input:** High impedance microphone or phone patch. **Audio frequency response:** 400 to 3000 cps at ± 3 db. **Power requirements:** OFF—4 watts; STANDBY—200 watts; KEY DOWN—400 watts at 117 volts, 50/60 cycles AC. **Cabinet size:** 19" W x 11 $\frac{3}{4}$ " H x 16" D.

COMMUNICATIONS MICROPHONE

An ideal companion for the HX-10 or any other transmitter, this Electro Voice dynamic microphone was specially modified to our specifications for SSB communications. Frequency response is limited from 300 to 3,000 cps voice frequencies with sharp cutoff above 3,000 cps. Rugged, die-cast zinc case and mike stand are chrome plated. Mike stand has grip-to-talk switch with lock position. Hi-Z output. Complete with 6' single and 6' multi-conductor shielded cable plus wiring diagrams for any fig. 2 lbs.

HDP-21 . . . no money down, \$5 mo. \$29.40

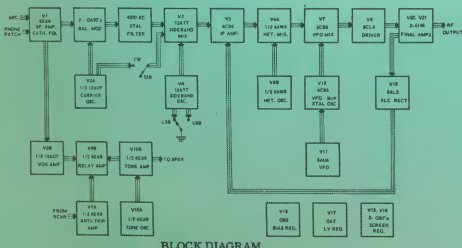

BLOCK DIAGRAM



High Power Single Sideband Communications



HA-10
\$229⁹⁵

Extend the effective range of your transmitter with the Heathkit "Warrior"

- Completely self-contained desk-top KW Linear
- Operates SSB, AM & CW on 80 through 10 meters
- Exclusive internal RF shielding for maximum TVI suppression
- Interlocked switching of HV for maximum circuit protection
- Low cost, high quality, 811A and 866A tubes
- Fan forced-air cooling—clean, functional styling
- Perfect KW Linear amplifier for "Marauder"

Radio Amateurs who want a big boost in transmitting power will find everything they need in the Heathkit "Warrior." This high quality, power-packed performer is a completely self-contained desk-top kilowatt linear, loaded with special features . . . and priced at only half that of comparable units. Note these many quality features . . . power supplies for HV, filament and bias are built-in . . . may be driven by a 50 to 100 watt output transmitter (no matching or swamping network required) . . . stable grounded-grid circuit puts part of drive in output for up to 70% efficiency . . . high quality, low-cost tubes, four paralleled 811A's and two 866A's forced-air cooled by a built-in fan . . . large oil-filled 8mfd, 2 KV capacitor and 5-50 henry swinging choke for high peak power output with low distortion . . . neutralized final provides a high degree of overall stability in conjunction with the grounded grid circuit design, interlocked switching prevents accidental applications of HV before switching on filament and bias . . . internal RF shielding provides maximum protection against TVI . . . monitor output gives constant output to scope regardless of frequency . . . rugged construction has 16 gauge steel chassis— $\frac{1}{8}$ " aluminum front panel—welded one-piece cabinet. All these features are combined into an extremely well laid-out circuit design that makes assembly an easy task which can be accomplished in a few evenings. Compare the Heathkit "Warrior" . . . feature for feature . . . quality component for quality component . . . you'll find no shortcuts . . . only the finest watts-per-dollar value in a kilowatt linear amplifier anywhere. 99 lbs.

Kit HA-10 . . . no money down, \$22 mo. **\$229.95**

SPECIFICATIONS—Maximum power input: SSB-1000 watts P.E.P., CW-1000 watts, AM-400 watts (500 watts using controlled carrier modulation), RTTY-650 watts. **Output circuit:** Variable pi-network (50 to 75 ohms). **Driving power required:** 50 to 75 watts—depending on frequency. **Input circuit:** Broad banded—requires no tuning. **Input impedance:** approx. 70 ohms; provides effective match for exciters having 50 ohm output impedance. **Band coverage:** 80, 40, 20, 15, 10 meters. **Panel metering:** Switch-selected, grid current, plate current, high voltage and relative power output for ease of loading. **Tube complement:** 4-811A, 2-866A. **Size:** 19 $\frac{1}{2}$ " W. x 11 $\frac{1}{2}$ " H. x 18" D.

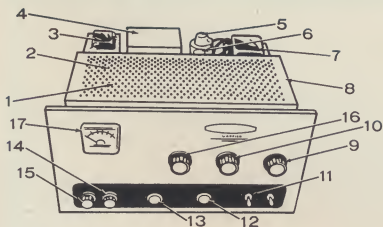

**HEATHKIT
"WARRIOR"
—FULL-FEATURED
FOR FINE
PERFORMANCE!**

1. Four 811A's 2. Fan cooling 3. 5-50 hy. swinging choke 4. 8 ufd, 2 KC, oil-filled filter capacitor 5. Two 866A's 6. Monitor scope output with level control 7. 1500 v. Power transformer 8. Internal RF shielding 9. Loading control 10. Band switch, 80 through 10 meters 11. Power and High Voltage interlocked switches 12. High Voltage pilot light 13. Power pilot light 14. Relative Power sensitivity control 15. Meter switch with Grid, Plate, Relative Power, and High Voltage positions 16. Tuning control with band markings 17. Meter

You Get Twice As Much For Your Budget With Heathkit



RX-1 \$299.95

Enjoy Deluxe Transmitting and Receiving Facilities

Deluxe Receiving Facilities . . .

"Mohawk" AMATEUR RECEIVER

- Amateur band coverage only for maximum stability and accuracy
- 1 uv input for 10 db signal to noise ratio, all bands
- Factory assembled and aligned coil/bandswitch assembly
- Rotating slide rule dial with vernier action tuning
- Built-in 100 kc crystal calibrator
- Rich, professional styling—chrome-plated knobs

Radio Amateurs who take pride in their equipment will quickly recognize the high standards to which this receiver was designed. Every deluxe feature required for clear, rock steady reception and full operating convenience has been incorporated for outstanding results in amateur communications!

The expertly engineered 15-tube circuit features double conversion with IF's at 1682 and 50 kc and covers amateur frequencies only for maximum stability and accuracy. Amateur bands 160 through 10 meters are separately calibrated on 7 bands with an extra band calibrated to cover 6 & 2 meters using converters with an IF of 22 to 26 mc. Excellent single sideband reception is obtained using a product detector and crystal controlled oscillators for upper and lower sideband selection.

Other features include 5 selectivity positions, bridged T-notch filter, built-in 100 kc crystal calibrator and vernier gear drive tuning. Rugged well-rated components are used throughout for years of dependable, trouble-free performance. 66 lbs.

Kit RX-1 . . . no money down, \$28 mo. **\$299.95**

SPECIFICATIONS—Fifteen tube double conversion superheterodyne receiver with selectable sideband. **First IF frequency:** 1682 KC. **Second IF frequency:** 50 KC. **Band coverage:** 160-10 meters. **Selectivity range:** 5 kc, 3 kc, 2 kc, 1 kc, .5 kc. **Bridged T notch filter:** 50 db rejection notch. **Panel controls:** RF Gain, Tuning, IF Gain, Antenna Trimmer, AF Gain w/on-off switch, Calibrate Set, T-Notch Tuning, Calibrate On, T-Notch Depth, CW-SSB-AM, ANL, Receiver-Standby, AVC, Upper-Lower Sideband, BFO, Selectivity, Band, Phones. **Tube complement:** 6BZ6 RF Amplifier, 6CS6 First Mixer, 12AT7 Oscillator-Cathode Follower, 6BA6 1682 kc IF amplifier, 6CS6 Second Mixer, 12AT7 1632-1732 kc crystal Oscillator, 6BA6 50 kc IF amplifier, 6BJ7 DET-AVC-ANL, 6CS6 Product Detector, 12AT7 First Audio S Meter Amp., 6AQ5 Audio Output, 6BA6 100 kc Oscillator, OA2 Voltage Regulator, 5V4 Rectifier. **Signal to noise ratio:** 10 db at less than 1 microvolt input. Converter IF 22 to 26 mc. **Power required:** 117 VAC, 50/60 cycle, 75 watts. **Cabinet size:** 19 1/2" W x 11 1/4" H x 16" D.

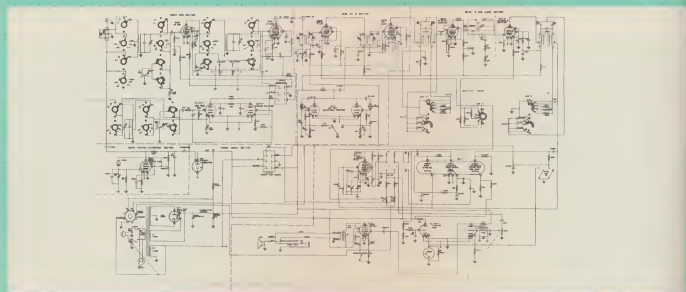

HIGH QUALITY components and materials. Coil/bandswitch on left half of chassis is supplied completely assembled and aligned.

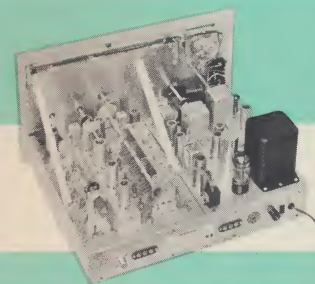

RUGGED coil/bandswitch assembly shows variable capacitors, ceramic coil forms and bandswitch wafers used for stability and high "Q"

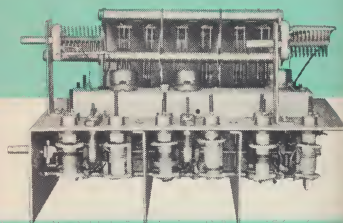

ACCESSORY SPEAKER KIT: Shown above; styled to match the "Mohawk". Heavy-duty 8" PM speaker. 8 ohms impedance, 4.7 oz magnet. 6 lbs.

Kit AK-5 **\$10.95**



with this Famous Heathkit® Pair

An amateur radio favorite . . .

Heathkit "Apache" TRANSMITTER

- 150 watts phone, 180 watts CW & SSB
- Covers 80 through 10 meter amateur bands
- Provision for SSB adapter built-in
- Rotating slide rule dial with vernier tuning
- Adjustable low-level speech clipping
- Time sequence keying—"spotting" push button

Seldom has an amateur transmitter achieved the popularity of the famed Heathkit "Apache"! Recognized everywhere for its high quality and dependability, the "Apache" and its matching counterpart the "Mohawk" receiver together form a fixed-station combination unmatched at this price anywhere! The "Apache" VFO provides minimum drift frequency control necessary for first-rate SSB transmission and provision is made for plug-in connection of the Heathkit SB-10 SSB adapter. Amateur coverage is from 80 through 10 meters with each band separately calibrated on a rotating slide-rule dial. Vernier tuning permits precise frequency settings with ample bandspread. Precision mechanical controls operate smoothly with positive-action characteristics found only in the most expensive equipment. Adjustable low-level speech clipping, time sequence keying, "spotting" push-button, a neutralized and extensively shielded final amplifier and pi network output coupling are some of the quality features designed into this unit. A fine rig for the amateur who wants the best . . . at the lowest possible cost. 110 lbs.

Kit TX-1 . . . no money down, \$24 mo. **\$252.50**

SPECIFICATIONS—Power input: 150 w PHONE, 180 w CW & SSB. Output impedance: 50-72Ω (non-reactive). Output coupling: Pi Network (coaxial). Operation: Crystal-VFO, CW-SSB-PHONE (time sequence keying, SSB requires external adapter). Band coverage: 80, 40, 20, 15, 10. Audio output: 100 watts at 300-3000 cycle (Adjustable low-level speech clipping; 500Ω output available). Tube complement—power section: 2 selenium rectifiers, 5V4 low voltage rectifier, 2-5R4GY HV rectifier, OA2 voltage regulator, 2-OB2 voltage regulators. Audio section: 12AX7 speech amplifier, 12AU7 clipper amplifier, 6AL5 clipper, 12BY7 audio driver, 2-6CA7/EL34 modulator. RF section: 6AU6, VFO, 6CL6 crystal oscillator-buffer, 5763 driver, 2-6146 parallel power amplifier, 6AQ5 clamp. Power requirements: 115 V AC, 50-60 cycles. Standby (AM, CW): 150 watts. Standby (SSB): 230 watts. CW: 420 watts (intermittent). Phone: 500 watts (peak). SSB: 500 watts (peak). Cabinet size: 19½" W x 11½" H x 16" D.

HEAVY-DUTY potted transformers, extensive shielding of final amplifier, fan forced-air cooling, specially-designed VFO and many more features combine to bring you effective and dependable communications in addition to easy assembly in the "Apache".

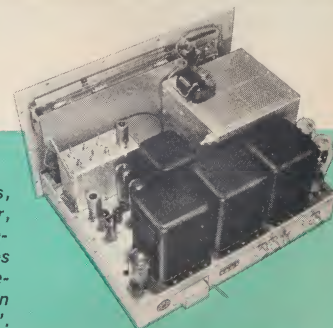

SSB ADAPTER KIT . . . more talk power . . . less fade and interference

- Produces USB, LSB or DSB signals
- Built-in VOX with anti-trip circuit
- Sealed audio phase shift network

\$93.50
SB-10



A convenient plug-in adapter for the "Apache" transmitter. May be used with similar transmitter with a few simple modifications. Produces USB, LSB and DSB signals with or without carrier insertion on 80 through 10 meters. The SB-10 allows operation entirely on fundamental frequencies by using the phasing method of generating a single sideband signal. The critical audio phase shift network is supplied completely pre-assembled and wired in a sealed plug-in unit. Also featured are single-knob bandswitching, an easy-to-read panel meter to aid in tuning and built-in VOX with anti-trip circuit. 12 lbs.

Kit SB-10 . . . no money down, \$10 mo. **\$93.50**

SPECIFICATIONS—Power output: 10 watts P.E.P. (peak envelope power). Power input: Less than 3 watts of RF at the fundamental operating frequency required. Carrier suppression: 40 DB. Sideband suppression: 30 DB. Output: Pi network, low impedance, coaxial. Input: Low impedance, coaxial. Band coverage: 80, 40, 20, 15, 10 meters. Circuitry: Phasing method of SSB signal generation with voice control and anti-trip action. Power requirements: 350 VDC at 85 ma and 6.3 VAC at 3.5 a. Meter: 2½" 200 ua movement, indicates carrier null and relative power output. Dimensions: 10" H x 6½" W x 13" D.

Heathkit Performance Specifications Are Guaranteed

For the Novice Amateur, a Matched Heathkit® Pa

A perfect mate to the DX-60 Transmitter . . .

Heathkit HR-10 AMATEUR RECEIVER

- Amateur band coverage only for high stability and accuracy
- Tunes SSB, AM & CW signals on 80 through 10 meters
- Large, slide-rule dial—approximately 6" of band spread
- RF stage for excellent sensitivity
- Prebuilt, aligned coil / bandswitch assembly
- Lattice-type crystal filter for high selectivity

**NEW
SPECIAL-VALUE
PRICE
\$79⁹⁵**

Big Volume Passes
Extra Savings to You

HR-10
\$82⁹⁵



3-GANG TUNING CAPACITOR for proper tracking of all circuits. Neat layout, quality components, and strong mechanical construction assure fine performance.



CRYSTAL CALIBRATOR, a handy plug-in accessory, it permits fast, accurate checks of dial calibration at any 100 kc point across the band.

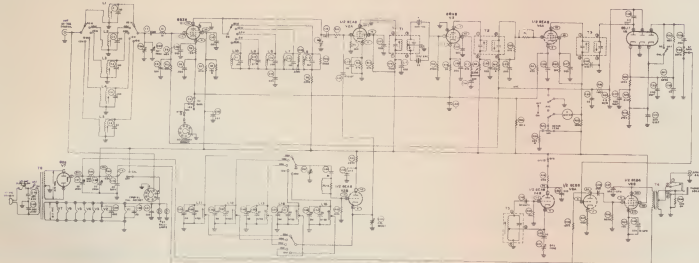

Handsomely styled, easy to build, and an exceptionally fine performer . . . a receiver any Radio Amateur would be proud to own! Features amateur band coverage only for maximum accuracy and stability. Each band is separately calibrated on a large easy-to-read slide-rule dial with 6" of bandspread for accurate frequency settings. The 7-tube super-heterodyne circuit features an RF stage for high sensitivity and a half-lattice crystal filter for excellent selectivity. A carefully-designed diode detector, plus BFO, provide excellent AM or CW and SSB reception. Other features include panel "S" meter, dial calibration control and provision for plug-in 100 kc crystal calibrator. Panel controls include: antenna trimmer, bandswitch, tuning, BFO tuning, RF gain, AF gain w/AC on-off switch, xtal. calibrator on/off, standby-receive switch, BFO on/off, AVC on/off and automatic noise limiter on/off switch. 8 ohm speaker jack and accessory socket on rear apron. 21 lbs.

Kit HR-10 . . . no money down, \$8 mo. **New Special-Value Price \$79.95**
Kit HRA-10-1, Plug-in 100 kc Crystal Calibrator 1 lb. **\$8.95**

SPECIFICATIONS—Frequency coverage: 80 through 10 meters. **IF frequency:** 1681 kc. **Sensitivity:** 1 uv for 10 db signal-to-noise ratio. **Image rejection:** 40 db or better. **Selectivity:** 3 kc at 6 db, 9 kc at 40 db. **Input impedance:** 50 to 75 ohm, coaxial. **Audio output impedance:** 8 or 500 ohm. **Tube complement:** 6BZ6, (2) 6EA8, 6BA6, 6BJ7, 6EB8, 6X4. **Power requirements:** 117 volts AC, 50/60 cycles, 50 watts. **Dimensions:** 13 3/4" W x 11 1/4" D x 6 1/2" H.

VARIABLE FREQUENCY OSCILLATOR . . . Extends operation to any frequency in the band!

- Provides complete amateur coverage at far below the cost of crystals
- Covers 80 through 2 meter amateur bands
- Each band separately calibrated on rotating drum-type slide-rule dial
- 28 to 1 gear reduction tuning
- Designed for & styled to match Heathkit DX-60 Transmitter

This handsomely styled transmitter accessory is rugged, reliable and loaded with special features! Provides stable frequency coverage of 80 through 2 meters at far below the cost of crystals for similar coverage.



HG-10
\$34⁹⁵

Heath Has The World's Largest Selection of Electronic Kits

...at a Price That Can't Be Matched

DX-60 PHONE AND CW TRANSMITTER . . . ideal for operation at 75 watt novice limit

- 90 watts phone or CW—80 through 10 meters
- Neutralized 6146 final amplifier
- Built-in low pass filter
- Grid block keying—easy access to crystal sockets
- Beautifully designed throughout—easy to assemble

DX-60
~~\$82⁹⁵~~

**NEW
SPECIAL-VALUE
PRICE
\$79⁹⁵**

Big Volume Passes
Extra Savings to You

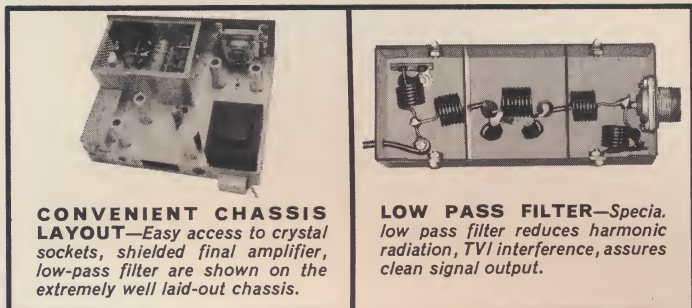

CONVENIENT CHASSIS LAYOUT—Easy access to crystal sockets, shielded final amplifier, low-pass filter are shown on the extremely well laid-out chassis.

LOW PASS FILTER—Special low pass filter reduces harmonic radiation, TVI interference, assures clean signal output.

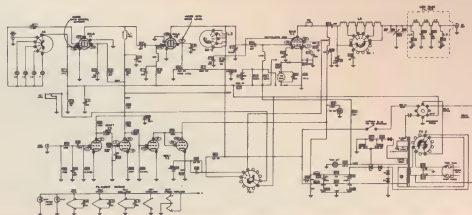

A sensational value for the beginning amateur . . . the DX-60 with its many design features offers more in quality, performance and dependability than any other unit in its price and power class! High quality components, clean, rugged construction and thoughtful circuit layout makes it an ideal "first" transmitter for the novice. Construction proceeds smoothly from start to finish with the complete informative instructions furnished. All parts are easily identified and a pre-cut, cabled wiring harness eliminates long, tedious wiring. Easy to operate too, with neat, functional panel layout. Features include a low-pass filter for harmonic suppression, neutralized final for high stability, and grid block keying for excellent keying characteristics. A front panel switch selects any of four crystal positions or an external VFO. Single knob bandswitching and pi network output coupling provide complete operating convenience. Panel meter shows final grid or plate current to aid in tuning. May be run at reduced power for novice operation. Less crystals. 25 lbs.

Kit DX-60, no money down, \$8 mo. . . . New Special-Value Price \$79.95

SPECIFICATIONS—Power input: 90 watts peak, carrier controlled phone or CW. Output impedance: 50-72 ohm (coaxial). Output coupling: Pi-network. Operation: CW or AM phone—crystal or VFO control. Band coverage: 80 through 10 meters. Power requirements: 105-125V, 50-60 cps, 225 watts. Dimensions: 13 1/4" W x 11 1/4" D x 6 1/2" H.

Designed as a plug-in accessory for the Heathkit DX-60 transmitter with all connecting cables supplied. May also be used with most other transmitters able to supply 140 v @ 25 ma and 6.3 v AC or DC @ .75 amps and whose signal input requirements do not exceed its specified output level. The circuit features the popular series-tuned Clapp oscillator with a cathode follower output for isolation and regulated plate voltage for maximum stability. Vernier tuning with a 28-to-1 gear drive provides smooth, easy frequency selection and a "spot" switch permits off-the-air tuning. Keys beautifully, with grid-block keying with the DX-60 or with cathode keying with other transmitters. Designed with rigid steel chassis for superior mechanical strength and freedom from chassis instability. An outstanding amateur value! **Kit HG-10 . . . 12 lbs., no money down, \$5 mo. . . . \$34.95**

SPECIFICATIONS—Band coverage: 80, 40, 20, 15, 10, 6, and 2 meters. VFO output frequencies: 80, 3.5 to 4 mc; 40, 7 to 7.3 mc; 20, 7 to 7.15 mc; 10, 7 to 7.425 mc; 6, 8.333 to 9 mc; 2, 8 to 8.222 mc. Load impedance: 50 K ohms or more. Output voltage: 5 volts R.M.S. or more, with no load. Output connections: phono plug. Front panel controls: Function Switch (Stby/Onr/Spot), VFO tuning & Band selector. Tube complement: 6CH8-oscillator-cathode follower; OB2-Voltage regulator. Power requirements: 1. From Accessory socket of DX-60, using cable furnished, 2. From Accessory socket of DX-40, with simple changes, 3. From other sources: 140 volts min. @ 25 ma; 6.3 volts ac or dc at 0.75 amp. Cabinet size: 9 3/4" wide, 9" deep, 6 1/2" high.

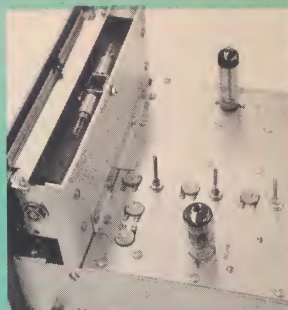

EASY-TO-READ DIAL
—Calibration points are clearly screened on the chassis. Rotating drum-type slide-rule dial is illuminated for easy reading.

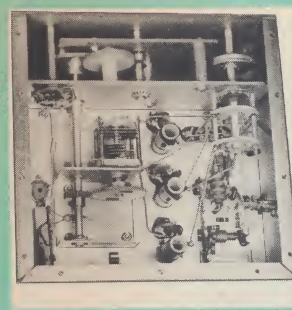

QUALITY CONSTRUCTION
—Rugged gear drive, high quality double-bearing tuning capacitor, temperature-compensated epoxy-coated coils and all high quality components assure high stability and reliable performance.

Outstanding Values for the VHF Amateur

\$179⁹⁵
VHF-1

Heathkit VHF TRANSMITTER . . . High power 6 & 2 meter facilities

- Up to 120 watts input on phone, 140 watts on CW
- Built-in VFO, modulator and power supplies
- "Spotting" push button for off-the-air tuning
- Extensive RF shielding for TVI protection
- Handsomely styled—ruggedly built—high quality throughout



Radio Amateurs with an eye toward high power VHF transmitting facilities will find the "Seneca" hard to beat! The rugged mechanical design, high quality, well-rated components used throughout assure long life and dependable performance for years to come. The highly efficient circuit design provides up to 120 watts input on AM and up to 140 watts input on CW, in 6 meter operation (slightly less on 2 meters) for an outstanding watts-per-dollar value.

Design features include controlled-carrier phone operation, built-in VFO for both 6 & 2 meters, four switch-selected crystal positions, extensive RF shielding and large slide-rule dial with vernier action tuning for precise frequency settings. Circuit has two built-in power supplies, five RF stages, two dual-triode audio stages and two popular 6146 tubes in the final amplifier.

A spotting switch is provided for "zero-beating" an incoming signal and allows tuning of the transmitter before switching on the final amplifier. Panel controls select VFO or crystal control and phone or CW operation on both six and two meter bands. Popular CAP and MARS VHF frequencies are also covered.

An auxiliary socket provides for receiver muting, remote operation of an antenna relay and remote voice control of the transmitter. Assembly of the "Seneca" proceeds smoothly with clean, well laid-out circuit arrangement and easy-to-follow Heathkit instructions. A fine rig for reliable DX communications. 59 lbs.

Kit VHF-1 . . . no money down, \$17 mo. **\$179.95**

SPECIFICATIONS—Power Input: 6 meters, 140 watts CW; 120 watts phone (peak). 2 meters, 110 watts CW; 95 watts phone (peak). **Output Impedance:** 50 to 72 ohm (non-reactive). **Output coupling:** adjustable link (coaxial connector). **Operation:** crystal, VFO, CW, phone. **Frequency coverage:** 48.9 to 54 mc, 143.7 to 149.3 mc. **Audio:** screen modulated, controlled carrier. **Power requirements:** 117 VAC 60 cycles; Standby (phone, CW) 120 watts, full load (phone, CW) 400 watts (Intermittent). **Dimensions:** 16 $\frac{1}{2}$ " W. x 10 $\frac{1}{4}$ " H. x 10" D.

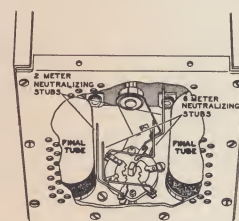
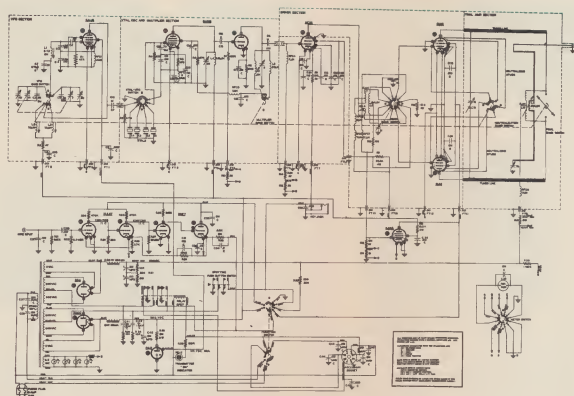

NEUTRALIZED: Switched neutralization circuit provides highest stability on both 6 & 2 meters.



HX-11
\$43⁵⁰

Specially designed for CW operations . . . Heathkit HX-11 CW TRANSMITTER

- Single-knob bandswitching
- Built-in low pass filter
- Built-in power supply
- 50-watt plate power input

NEAT, COMPACT LAYOUT: Compartmentalized construction and high quality components assure maximum performance and reliability.

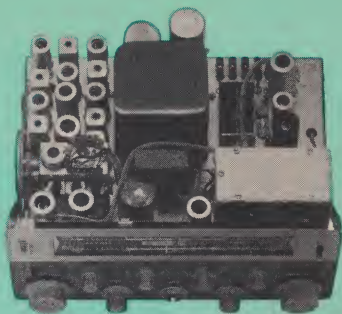

- Everything you need . . . transmitter, receiver, power supply . . . all in one compact unit
- 3-way power supply operates on 117 V AC, 6 or 12 V DC
- 10-watt RF output to antenna—6360 final amplifier
- Tracked VFO and exciter stages for single knob tuning
- Built-in low pass filter—push-to-talk microphone

HW-10
\$199⁹⁵



Operate "Mobile" or "Fixed" with these feature-packed 6 or 2 meter TRANSCEIVERS

The Heathkit 6 meter "Shawnee" and 2 meter "Pawnee" combine clean, functional styling and latest design features for outstanding performance on the VHF amateur bands. Operates "mobile" or "fixed" with built-in 3-way power supply. Transmitters feature a built-in temperature stabilized VFO and switch-selection of four crystal positions for net, novice, CAP and MARS operation; tracked VFO and exciter stages for convenient single-knob tuning over any 500 kc band segment; a "spotting" switch to zero-in signals; efficient 6360 final RF amplifier for 10 watt output to antenna; built-in low pass filter to suppress harmonics; dual-purpose modulator that doubles as 15 watt PA amplifier; push-to-talk ceramic element microphone. Receivers feature double conversion with first oscillator crystal controlled; voltage regulation on all oscillators for high stability; large, illuminated slide-rule dial for both receiver and VFO; an automatically switched panel meter to read signal strength or relative power output; squelch and noise limiter controls; 3" x 5" PM speaker; RF gain, BFO, and AVC on/off controls. The built-in 3-way power supply features transformer operation on 117 V AC and heavy-duty vibrator for 6 or 12 V DC operation. AC and DC cables are furnished with kit. A primary fused relay controls all power to the transceiver in mobile installations. Sturdy construction features wrap-around steel case and extensive shielding of transmitter, receiver and power supply sections. Mounting bracket included. Recommended for the more experienced kit builder. Average construction time is 60 hours. 34 lbs.

Kit HW-10 (6 meter transceiver) . . . no money dn., \$19 mo. . . . **\$199.95**
Kit HW-20 (2 meter transceiver) . . . no money dn., \$19 mo. . . . **\$199.95**

SPECIFICATIONS—RECEIVER SECTION—Frequency coverage: HW-20; 143.8 to 148.2 mc. HW-10; 49.8 to 54.0 mc. **IF frequencies:** Double conversion—First IF, 22 to 26 mc (tunable); Second IF, 2 mc. **Noise figure:** HW-20; 8.5 db or less, HW-10; 6 db or less. **Sensitivity:** .5 microvolts of input signal will provide an output signal better than 10 db over the noise level. **Squelch sensitivity:** Less than 1 microvolt. **Selectivity:** 15 kc at 6 db down. **Image rejection:** Better than 70 db. **IF rejection:** 50 db. **Input impedance:** 50 to 72 ohm, unbalanced. **Audio power output:** 3 watts (receiver operation); 15 watts (public address operation). **Headphone jack:** Low impedance, accepts PL-55 type plug (standard 2-conductor 1/8" sleeve). **External speaker socket:** 8 ohm impedance, accepts RCA type phono plug.

TRANSMITTER SECTION—Frequency coverage: HW-20; 143.8 to 148.2 mc (crystal or VFO control). HW-10; 49.8 to 54.0 mc (crystal or VFO control). **Modulation:** .01 volts minimum at 1000 cps = 100%. **RF power output:** 8 watts nominal AM, 10 watts nominal CW, 50 ohm nonreactive load. **Distortion:** 10% or less, with 100% modulation at 1000 cps. **Output impedance:** 50 to 72 ohm, unbalanced. **Low pass filter:** HW-20; 152 mc cutoff frequency. HW-10; 54 mc cutoff frequency. **Key jack:** Accepts PL-55 type plug (standard 2-conductor 1/8" sleeve). **Crystal sockets:** Accepts FT-243 type holders, pin diameter .093", pin spacing .466". **Microphone:** High impedance ceramic element push-to-talk type with coil cord. **Crystals:** (Not furnished) HW-20; 8 mc fundamental range (8,000 to 8,222 mc for 2 meter band). HW-10; 8 mc fundamental range (8,333 to 9,000 mc for 6 meter band).

GENERAL—Power requirements: Input voltage: 6.3V DC, 12.6V DC, 117V AC. Transmit—14.5 amps, 7.5 amps, 120 watts. Receive—8.5 amps, 4.5 amps, 60 watts. **Cabinet dimensions:** 6" H. x 10" D. x 12" W.

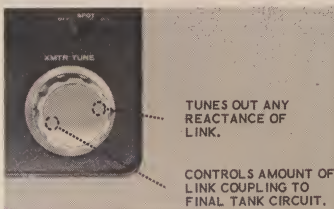

FINAL AMPLIFIER ADJUSTMENTS: Coupling and loading controls permit exact match to antenna.

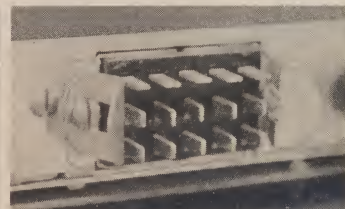

VERSATILE: Quick disconnect plugs allow fast, easy change from mobile to fixed operation. Cables included.

Here is an excellent CW transmitter for the novice or general class amateur who appreciates a clean, quality signal on the air! The efficient circuitry features a single 6DQ6A final amplifier stage with full 50-watt plate power input and a 6CL6 crystal oscillator. Covers 80 through 10 meter amateur bands, using either crystals or external high-output VFO. The husky power supply uses a heavy-duty 5U4GB rectifier and top-quality "potted" transformer for long service life. Design features include single-knob band-switching, switched antenna relay power, pi-network output coupling, built-in low pass filter and easy-to-read panel meter for final grid or plate current. Easy access to crystal socket is provided by a metal pull-out plug on the side of the cabinet. Very easy to assemble and operate with complete instructions supplied. 17 lbs.

Kit HX-11 . . . no money down, \$5 mo. . . . **\$43.50**

SPECIFICATIONS—RF power input: 50 watts CW. **Output impedance:** 50-600 ohm (non-reactive). **Output coupling:** Pi network. **Operation:** Crystal—external VFO. **Low pass filter cutoff frequency:** 34 MC. **Band coverage:** 80, 40, 20, 15, 10 meters. **Tube complement:** 5U4GB rectifier, 6CL6 oscillator, 6DQ6A final amplifier. **Power requirements:** 117 volts AC, 60 cycles, 150 watts. **Dimensions:** 13" W x 8 1/2" H x 7" D.

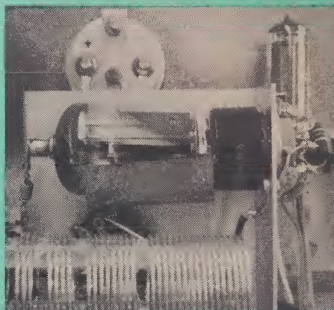

NEUTRALIZATION: Fixed neutralization circuit for high stability without adjustment.

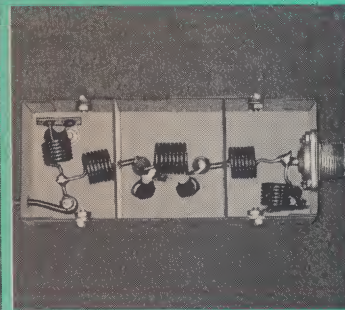

LOW-PASS FILTER: Suppresses harmonic radiation for maximum TVI protection.

Equip Your Amateur Station with



HW-29A
HW-30
\$44⁹⁵

Low-cost 6 & 2 meter TRANSCEIVERS ... Ideal for local net operations

- Crystal-controlled transmitters—5-watt input
- Tunable superregenerative receivers with RF stage
- Ideal for emergency communications, fixed or mobile

Thousands of these Heathkit transceivers now in use across the nation, in homes, offices, cars, trucks, boats, etc., attest to their popularity and proven performance on the VHF amateur bands. Neat, compact design, low cost and high versatility make them ideal for use in either mobile or fixed station installations.

Both 6 and 2 meter models feature crystal-controlled transmitters and tunable superregenerative receivers with RF stage. The highly sensitive receivers pull in signal levels as low as 1 microvolt and will produce complete quieting on reasonable signal levels. These transmitters, with a 5-watt input, are more than adequate for "local" net operations and the communications range is unlimited under "skip" conditions. Frequency multipliers on both models provide straight-through finals from an oscillator using a fundamental crystal in the 8 mc range. Other features include a built-in final amplifier metering jack and front panel press-to-talk transmit/receive switch. A "transmit-hold" position is provided for convenience in long transmissions.

Operates "fixed" with built-in 117 volt AC power supply or "mobile" using Heathkit GP-11 vibrator power supply shown below. Transfer from fixed station to mobile operation is easily accomplished in just seconds, using either AC or DC plug-in power cables furnished. Kit is complete with ceramic element microphone, power cables and easy-to-follow assembly instructions. Less crystal. Handsomely styled in two-tone mocha and beige. 8 lbs. each.

Kit HW-29A (6 meter) ... no money down, \$5 mo. **\$44.95**
Kit HW-30 (2 meter) ... no money down, \$5 mo. **\$44.95**

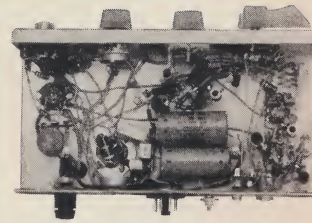
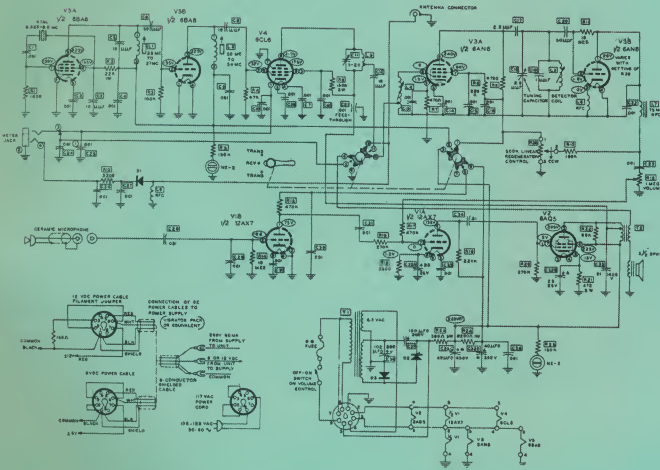

HIGH QUALITY: Slug-tuned coils, air-wound final tank coil and other quality components assure long life, dependable performance.

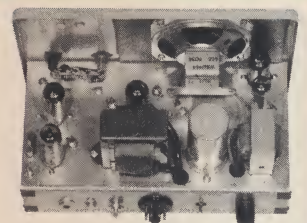

CLEAN DESIGN: Well laid-out circuitry and easy-to-follow instructions provide for easy, trouble-free assembly.

Mobile VIBRATOR POWER SUPPLY

- Operates from 6 or 12 volt source
- Silicon diode rectifiers
- Small, compact—easy to install

GP-11
\$16⁸⁸

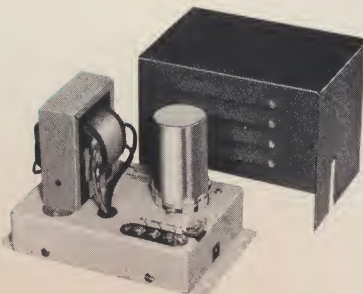

... Ideal for transceivers above

Ideal for converting 6 or 12 volt battery power to the plate power requirements of a wide variety of mobile equipment. Heavy-duty rated for use with Heathkit Amateur Band Transceiver models HW-29A and HW-30. Silicon diode rectifiers and alternate wiring instructions allow use on either 6 or 12 volt systems. Provision for remote on/off switching. Complete instructions for assembly and operation. Color styled in green and gray-green. 6 lbs.

Kit GP-11 **\$16.88**

SPECIFICATIONS—Power requirements: 6 volt version, 6.3 VDC @ 6.5 amperes; 12 volt version, 12.6 VDC @ 3 amperes for rated output. **Power output:** 250 VDC @ 100 ma, ICAS. **Power rectifier:** Two silicon diodes in voltage doubler circuit. **Vibrator:** Mallory type 1610 or equivalent. **Vibrator frequency:** Approximately 115 cps. **Overall dimensions:** 4 1/2" H x 6 1/2" W x 4 1/2" D.

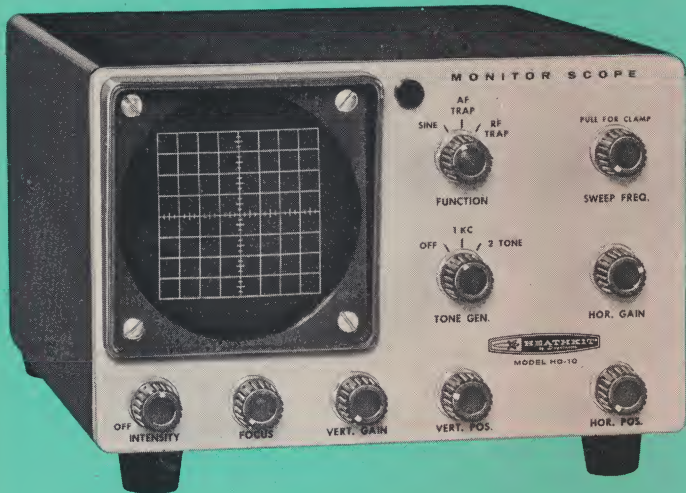

CLEAN CONSTRUCTION:
Beautifully designed throughout for ease of assembly, long life and dependable performance.

HO-10
\$59.95

Heathkit Amateur Radio MONITOR SCOPE

- Specially designed for amateur radio use
- Displays envelope, AF and RF trapezoid patterns
- Automatic switching between received and transmitted envelope patterns
- Built-in two-tone test oscillator
- 3" cathode ray tube—small, compact size
- Easy to install in antenna system feed line

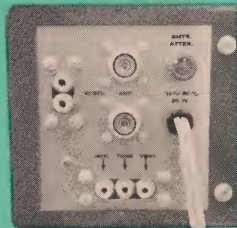
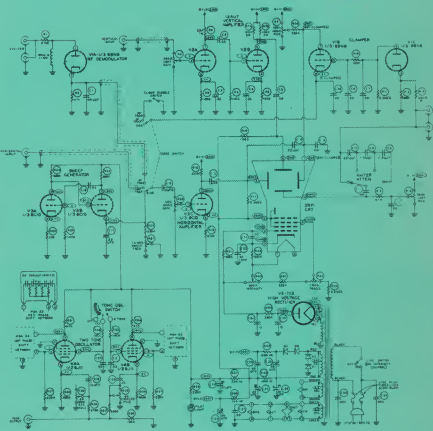

SIMPLE TO CONNECT: All input and output connections are clearly screened on the back panel. Also shown is the 4-position RF level attenuator.

The new Heathkit Monitor Scope provides the perfect answer for monitoring the modulation envelope of transmitted and received signals. Shows immediately whether signal is distorting or of proper quality for outstanding communications. Standard coaxial connectors are provided for simple connection to antenna system feed line. Phono jacks are provided for other connections.

The HO-10 is independent of frequency and requires no additional tuning when used with transmitters on all amateur bands from 160 through 6 meters. Handles power output ranging from 5 watts to 1 kilowatt. The HO-10 may be used for receive monitoring with tube type receivers having an IF frequency up to 500 kc. Automatic switching between transmit and receive is possible since transmit energy is fed to one vertical plate of the CRT and amplified received signal is fed to the other vertical plate. Transmitted displays include envelope, AF and RF trapezoid patterns. Horizontal sweep for envelope pattern is produced by a variable sawtooth generator. The RF trapezoid pattern is especially useful in checking for "flatopping" and non-linearity in SSB linear amplifiers. A clamping circuit pulls the spot off-screen during receive on trapezoid to prevent burning of phosphor on CRT. A two-tone test signal for transmitter adjustments and 4-position RF level attenuator also featured. 10 lbs.

Kit HO-10...no money down, \$6 mo. \$59.95

SPECIFICATIONS—Vertical channel (amplified): 500 mv/inch \pm 3 db, 10 cps to 500 kc, input impedance 50 K ohms. **Horizontal channel:** 800 mv/inch \pm 3 db, 3 cps to 30 kc, input impedance 1 megohm. **Tone output:** 15 mv @ approximately 1 kc and 1700 cps (switchable: OFF- 1 KC-Two-Tone). **Sweep frequency range:** 15 to 200 cps. **Transmitter power output limits:** 5 watts to 1 kilowatt. **Tube complement:** 3RP1, 1V2, 12AU7, 6BN8, 6C10, 6J11. **Rectifiers:** Silicon diodes for low level B+. **Power requirements:** 105-125 volts 50/60 cycle AC, 35 watts.

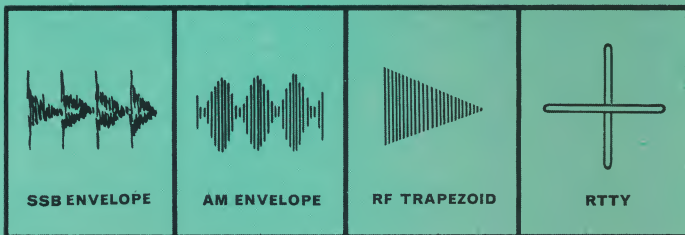

SSB ENVELOPE

AM ENVELOPE

RF TRAPEZOID

RTTY

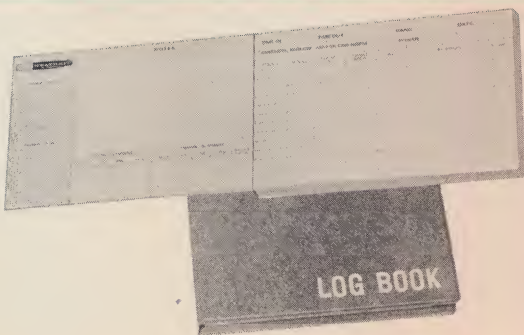

Heathkit Amateur Radio LOG BOOKS

The tremendous response received for the Heathkit Amateur Radio Log Book has prompted us to put it on a permanent basis available to all! A page is provided for each operating period with basic data logged only once. No more laborious transferring of notes for permanent filing. Space is provided for each station contacted and for additional info such as handle, QTH, reports, rig and comments. There's a calendar on each page and space for traffic and schedule summaries. Order the package of five special log pads and the attractive vinyl cover in which to insert the current log book. The cover measures just 8½" x 5½" closed, just right for your operating position. Replacement log books available separately.

No. 597-110... Five log books & cover...2 lbs. **\$2.95**
No. 597-111... Five replacement log book pads...1 lb. **\$1.95**

Handy, Versatile Station Accessories

Heathkit REFLECTED POWER METER . . .
shows antenna transmitter match



HM-11
\$15⁹⁵

- Indicates forward or reflected power and SWR
- Band coverage is 160 through 6 meters
- Handles peak power of well over 1 kilowatt
- Matches 50 or 75 ohm lines
- New styling matches other Heathkit equipment

An extremely useful amateur accessory! The Heathkit Reflected Power Meter checks the match of your antenna's transmission system by measuring the forward and reflected power or SWR (standing wave ratio). Percentage of forward and reflected power and voltage-standing-wave-ratio from 1:1 to over 3:1 are read on the built-in meter. A sensitivity control is provided to adjust for full-scale reading without reducing transmitter output. The HM-11 is designed to handle a peak power of well over 1 kilowatt and may be left in the antenna system feed line at all times. Components are provided for matching 50 or 75 ohm antenna lines. Ideal for use in matching impedances between exciters or RF sources and grounded grid amplifiers. Measures just 7 $\frac{3}{8}$ " x 4 $\frac{1}{8}$ " x 4 $\frac{5}{8}$ ". 2 lbs.

Kit HM-11 **\$15.95**

Heathkit RF POWER METER . . .
samples RF radiation to indicate relative transmitter output

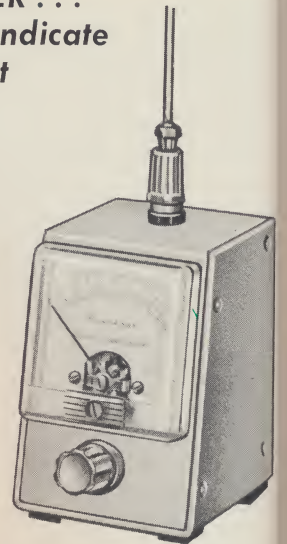

PM-2
\$12⁹⁵

- Operates with any transmitter
- Requires no external power source
- Sensitive 200 ua meter movement
- Small, compact size

This handy RF power meter gives a continuous indication of the relative power output of any transmitter by sampling the RF radiation near the antenna. A strong magnet in the base of the PM-2 holds it fast to any steel surface such as an automobile dashboard or transmitter cabinet allowing convenient installation wherever desired. No external power source is required for operation, RF energy is all that is required. The PM-2 operates with any transmitter, whether it be marine, mobile or fixed, that has output frequencies between 100 kc and 250 mc. Sensitivity is 0.3 volts RMS at antenna input terminals for full scale deflection. A high quality 200 ua meter movement is featured along with a panel control to set sensitivity level. 2 lbs.

Kit PM-2 **\$12.95**

Heathkit "Cantenna" TRANSMITTER DUMMY LOAD . . . Ideal for servicing and testing amateur gear

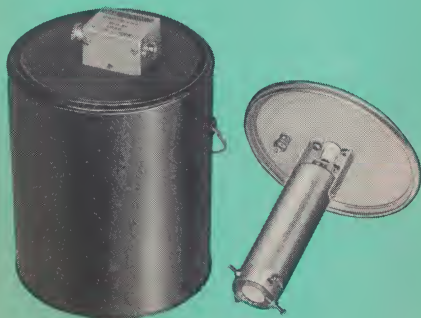

HN-31
\$9⁹⁵

With the new Heathkit transmitter dummy load you can forget about TVI, FCC violations, QRM, while servicing or testing transmitting equipment! Handles powers up to 1 kilowatt I.C.A.S. with less than 1.5 V.S.W.R. up to 300 megacycles. The wide frequency range makes it ideal for testing commercial, industrial, marine, aircraft, citizen's band equipment, etc. Impedance is 50 ohms. A coax input connector for the transmitter and a phono jack for dc output to VOM or VTVM, for relative power measurement, permit fast, easy connection to equipment. Features a special oil-cooled temperature-stable resistive element. Measures only 8 $\frac{7}{8}$ " H x 7" diameter. Oil capacity is 1 gallon (oil not included). 2 lbs.

Kit HN-31 **\$9.95**

Heathkit 100KC CRYSTAL CALIBRATOR . . .
high accuracy signals for calibrating communications equipment

HD-20
\$14⁹⁵



- Provides output at 100 kc intervals to over 54 megacycles
- Transistorized and battery powered for complete portability
- Small, compact size—measures only 2 $\frac{1}{2}$ " W x 4 $\frac{1}{2}$ " H x 2 $\frac{3}{8}$ " D

High accuracy signals from 100 kc to 54 megacycles are produced by the HD-20, at 100 kc intervals, to provide a precise means of setting communication receivers and transmitter VFO's. Operation of the crystal calibrator requires only connection to the antenna input of the receiver and switching the unit "on". The circuit is transistorized for long life and dependable performance. A single 9-volt battery will furnish all power required. Current drain is so slight that battery life almost equals shelf life. Calibration of the HD-20 is easily accomplished by tuning the receiver to WWV or any other station operating at a harmonic of 100 kc, and adjusting the HD-20 for "zero-beat". A .005% crystal is included with kit. 1 lb.

Kit HD-20 **\$14.95**

for the Radio Amateur



Heathkit "TUNNEL DIPPER" . . . first of its type . . . hundreds of uses in amateur radio work

- Tunnel diode oscillator—no tubes
- Covers frequency range of 3 to 260 mc
- Vernier gear drive tuning
- Enclosed drum-type dial with every scale nearly 7" long
- 6-color-matched coils and dial scales
- Sensitive 3-transistor meter amplifier
- Durable epoxy-coated plug-in coils
- Snap-on cover with built-in storage for coils
- Battery powered for complete portability
- Printed circuit for easy assembly
- Compact, measures only 5 3/4" L x 4 1/4" H x 2 3/4" W

The Heathkit Tunnel Dipper is a notable achievement in electronic design! It performs the functions of the famed "grid-dip" meter with latest electronic advancements. It features solid-state circuitry, using transistors, and a Tunnel Diode oscillator . . . it has no tubes, and no power cord. It is completely self-contained and portable.

The Tunnel Dipper may be used as an emergency signal generator or as a sensitive tuned RF detector. Its many functions may be used for finding resonant frequencies of tuned circuits, identifying parasitics, checking antennas for resonance, tuning traps and filters and many more! An exceptionally handy instrument for amateur radio and service work.

New styling features convenient control, meter and coil arrangement for simple, easy operation. Tuning dial and coils are color-matched for easy identification, preventing errors through reading wrong scale. Plug-in coils are epoxy-coated for stability and durability. Protective cover snaps off out of the way when unit is in use and has built-in storage space for coils. 3 lbs.

Kit HM-10 . . . no money down, \$5 mo. **\$34.95**

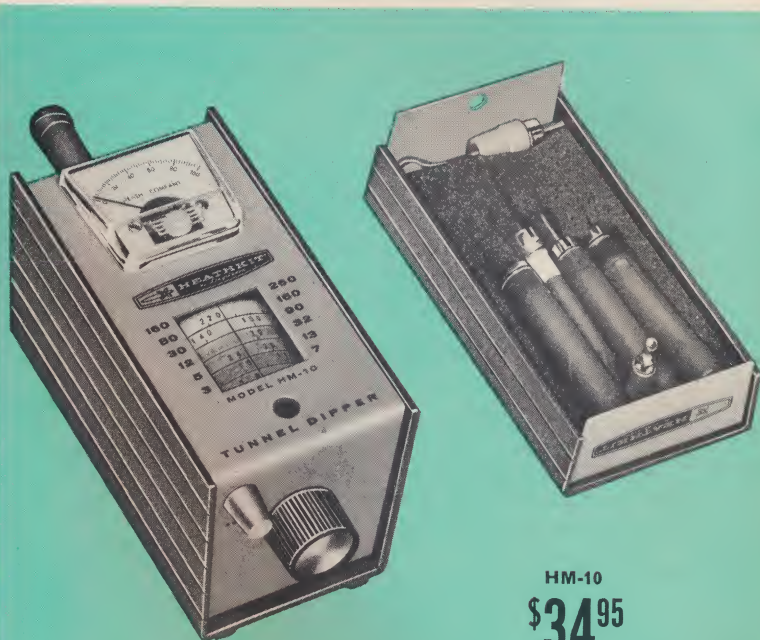

HM-10
\$34.95

SPECIFICATIONS—Size: 5 3/4" L x 4 1/4" H x 2 3/4" W. Controls: Switch—Off, Diode (wavemeter), OSC. Frequency tuning: Meter: 0-1 mc D'Arsonval; Transistors: 2N185 (3); Tunnel Diode: STD633. Frequency: 3-260 mc. Bands: 6. Temperature caution: Will not operate at freezing temperatures.



HD-11
\$14.95

Increase your receiver selectivity with the Heathkit "Q" MULTIPLIER

- Use with AC-DC or transformer operated receivers
- Built-in power supply—power light indicator
- Two peak I.F. positions (sharp or broad) plus rejection notch (null)

Use the Heathkit "Q" Multiplier with any communications type receiver having an I.F. frequency between 450 and 460 kc to increase selectivity greatly. This "electronic filter" provides an effective "Q" of approximately 4,000 for peaking or rejecting a signal on AM, CW or SSB. The HD-11 can be used to produce a sharply peaked I.F. curve for CW reception, broad peaked I.F. for phone operation or a deep rejection notch to eliminate a closely interfering heterodyne. Both peak or notch positions are tuneable to any point in the receiver's I.F. bandpass. Comes complete with connecting I.F. cable, plug and socket for attachment to the receiver. Ideal for CW reception and heterodyne rejection in SSB receivers such as the Collins 75S-1. Easy to build and operate with instructions provided. 2 lbs. net.

Kit HD-11 **\$14.95**

SPECIFICATIONS—Operating frequency: 450-460 kc. Operation: Off-Sharp Peak—Null—Broad Peak. Tube complement: 12AX7. Power requirements: 105-125 volts AC, 50-60 cycles, 4 watts. Dimensions: 7 3/4" W x 4 11/16" H x 4 3/4" D.

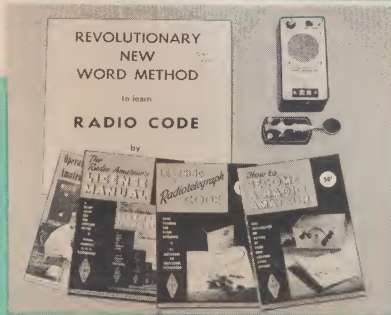

COMBINATION PRICE
SAVE \$3.00
\$15.95

A SPECIAL NEW COURSE FOR THE BEGINNING RADIO AMATEUR . . .

Everything you need to learn to obtain a license to operate an amateur radio station at a money-saving special price

- COURSE INCLUDES:**
- 4 ARRL handbooks, gateway to amateur radio
 - Set of three special code records
 - Code practice oscillator with key

Any aspiring young man or woman with a bent toward becoming an FCC licensed radio amateur will find the materials and components of this specially selected group an outstanding introduction to amateur radio. The course consists of four American Radio Relay League (ARRL) handbooks: How to Become a Radio Amateur; Learning the Radio-Telegraph Code; Radio Amateur's License Manual; and Operating an Amateur Radio Station. Also included is a set of three special records using the revolutionary new "word method" of teaching code. This method is unique in that it starts at 13 words per minute using simple material and continues at this same speed throughout the course. Instead of increasing the transmitting rate, the complexity of words is increased, thereby developing a high degree of proficiency in less time than would be required using conventional methods. A Heathkit CO-1 Code Practice Oscillator is furnished with an authentic telegraph key to enhance the learning process. The code practice oscillator features switch selection of either tone signal or blinker light for silent practice. Circuit is completely transistorized and battery powered for complete portability. Components also available separately.

- HDP-22 Amateur Radio Starter Group . . . 7 lbs. Save \$3. **\$15.95**
- HDP-32, Code Records . . . 3 lbs. **\$9.50**
- HDP-42, ARRL Books (4) . . . 1 lb **\$1.50**
- CO-1, oscillator plus key . . . 3 lbs. **\$7.95**

Save Up To 50% With Heath Do-It-Yourself Electronic Kits

Versatile Amateur Radio Accessories

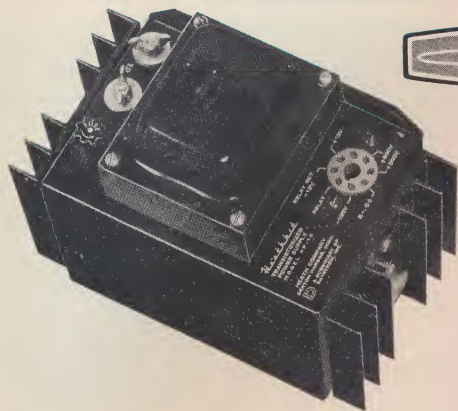

HP-10
\$44⁹⁵



HP-20
\$29⁹⁵

Transistor MOBILE POWER SUPPLY

- Powers both transmitter and receiver
- Instant starting—high efficiency
- Remote relay control of primary power

Ruggedly built for mobile installations! This husky power supply is designed to furnish all power required to operate both transmitter and receiver of Heathkit and many other makes of mobile communications equipment. The HP-10 operates from a nominal 12 volt DC source to provide both B+ and bias voltages with a combined continuous power rating of 120 watts. Circuit features two heavy-duty power transistors and long-life silicon rectifiers for high (75%) efficiency. Other circuit refinements include: relay control of primary power, heavy filtering of input and output leads, capacitor discharge resistors and effective suppression of voltage transients. Power take-off for equipment is through a standard octal socket with voltage points clearly screened on the power supply chassis. Easy to assemble and install. Fused. 10 lbs.

Kit HP-10...no money down, \$5 mo. \$44.95

SPECIFICATIONS—Input voltage: 11 to 15 V DC (12.6 nominal). Input current: 2 to 13 amps (as a function of output load). Total power output: 120 watts continuous, 150 watts normal intermittent operation. Power available: 600 VDC @ 200 ma or 600 VDC @ 150 ma & 300 VDC @ 100 ma, and bias of -125 VDC @ 30 ma. Efficiency: Approximately 75%. Maximum ambient operating temperature: 120 degrees F. at 120 watt continuous, 150 degrees F. at 120 watt intermittent operation (50% duty cycle). Dimensions: 8" W x 7 1/2" H x 6 1/4" D.

Utility AC POWER SUPPLY

- Powers mobile gear on standard household current
- Furnishes filament, B+ and bias voltages
- Extensive line filtering—dynamic regulation

Enjoy maximum versatility of Heathkit and most other mobile transmitters and receivers with this AC Power Supply. Operates on standard 117 volt AC household current to furnish filament, B+ and bias voltages to convert mobile gear to fixed-station operation. An on/off switch and pilot light are built-in to allow use as a master control center. Plug-in output connections are made to an octal socket with all voltage information clearly screened on the chassis for permanent reference. Sufficient current and voltage capability allow use of bias supply with voltage regulator tube. Other features include high value capacitors in the output of the RC filters for good dynamic regulation and silicon diode rectifiers for long-life and dependable performance. Fused for added protection. 14 lbs.

Kit HP-20...no money down, \$5 mo. \$29.95

SPECIFICATIONS—Power requirements: 117 volts AC, 50/60 cycles, 200 watts. Total DC continuous power output: 120 watts (600 volts @ 200 ma or 600 volts @ 150 ma & 300 volts @ 100 ma; bias of -130 volts @ 30 ma also provided). Filament power: 6.3 volts @ 11 amperes or 12.6 volts @ 5.5 amperes. Regulation: Approximately 10% (50% load to 100% load, from high voltage tap). Overall dimensions: 9" L x 4 3/4" W x 6" H.

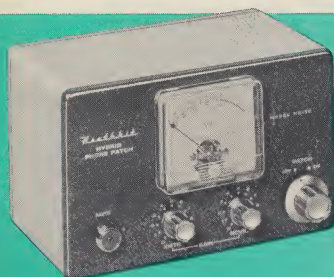

HD-19
\$29⁹⁵

Hybrid PHONE PATCH KIT . . . transfer calls from rig to phone in seconds!

- Convenient one-switch operation
- Allows VOX or manual operation

Amateur Radio operators can transfer audio signals between telephone lines and two-way radio communications equipment with maximum efficiency and performance with this easy-to-install hybrid phone patch. Operates with nearly all transmitters and receivers, including transmitters employing automatic voice control (VOX). Features include a standard VU meter for accurate monitoring of the output to any 600 ohm telephone line to prevent crosstalk, a single on/off function switch for ease of operation and separate transmit/receive gain controls. A special hybrid transformer provides a minimum of 30 db isolation between transmit and receive circuits and maintains a balanced phone line for minimum hum. Use with 3 to 16 ohm speakers and high impedance microphone input. 3 lbs.

Kit HD-19...no money down, \$5 mo. \$29.95

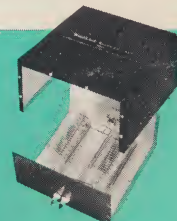

B-1
\$9⁹⁵

BALUN COIL SET

Matches unbalanced coaxial lines used on most modern transmitters to balanced lines of either 75 or 300 ohms impedance. Frequency range 80 through 10 meters; power inputs up to 200 watts. Bifilar wound coils. Cabinet dimensions are 9" square x 5" deep. Protective cover prevents damage by weather, etc., and allows installation wherever convenient. 3 lbs.

Kit B-1...no money down, \$5 mo. \$9.95

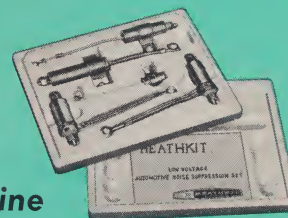

GDP-192
\$16⁹⁵

Heathkit universal auto & marine

RF NOISE SUPPRESSION COMPONENT SET

Get better mobile communications with this RF noise suppression kit. It reduces voltage regulator hash, generator whine, and ignition coil interference; works on any engine. Includes 5 special design heavy duty thru-pass capacitors rated at 60 amps., 275°F. Easy to install on existing terminals and mounting bolts; no special brackets required. 3 lbs.

Model GDP-192...no money down, \$5 mo. \$16.95

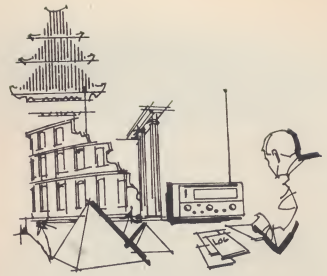

A World of Measurement is Made on Heath Test Equipment

research labs., industrial production lines, service organizations, and hobbyists of varying interests from all parts of the world rely upon Heathkit Test Equipment; here's why:

NEW PROFESSIONAL STYLING

Heathkit Industrial Designers take pride in announcing a New Look for Heathkit Test Equipment . . . a more professional look which is in keeping with the professional performance of Heath units. Three-color panels feature an aluminum base with dark gray forming the background for high-contrast white letters and red calibration scales, providing maximum readability. Black knobs with spun aluminum inserts and large, highly visible pointers accent this new, richly-handsome exterior . . . a look destined to be found wherever fine instruments are used.

LOW COST

You save two ways when you equip with Heathkit Test Equipment . . . you save by buying direct from the factory . . . and you save up to 50% by assembling your own equipment from Heathkits. The result is a cost so low for top quality instruments that you can afford the very best . . . Heathkit.

SKILLFUL ENGINEERING

Heath, kit pioneer and world-leader, employs the largest group of kit specialists in the industry. Those working exclusively in the Test Equipment Engineering Lab share decades of theoretical and practical experience . . . a combination which provides a balanced, knowledgeable approach to design problems. Dedicated to perfection, these men are constantly at work to better the already famous performance of Heathkit Test Equipment.

EASY TO ASSEMBLE

Heathkit Construction Manuals which accompany every kit are written to not only show you what to do, but how to do it! World-famous for their clarity, these Heathkit instructions lead you an easy step at a time to successful completion of your favorite Heathkit, using everyday language and assuming no special skill or background on your part. Diagrams clearly show where each part goes . . . perspective drawings for accurate placement . . . big fold-out sheets which can be detached if you wish . . . so complete they point the way like an instructor.

DEPENDABLE

Heathkits are dependable, accurate instruments, suitable for most testing requirements in many fields. This dependability is achieved through expert engineering, premium-quality components, and rigid inspection combined with unrelenting efforts to improve upon success.

QUALITY COMPONENTS

It is only fitting that the superior designs of Heathkit Test Equipment should be produced with only premium-quality parts. Heath Engineers specify only the finest, and inspect all parts under a constant Quality-Control Program to be sure that their insistence upon quality is maintained throughout, from the design boards to the finished product in your hands.





Kit Form
or
Factory
Assembled

Because this is the world's largest selling VTVM, we can pass on additional savings to you . . . a new low price for the IM-11 with probe, just \$24.95

- Single AC/Ohms/DC probe with switch
- 7 AC, 7 DC & 7 Ohms ranges
- Easy to read 4 1/2" 200 ua meter
- 1% precision resistors for high accuracy
- Extended low frequency response ± 1 db, 25 cps to 1 mc

Big Volume Passes
Extra Savings to You

**NEW
SPECIAL-VALUE
PRICE
\$24.95**

IM-11
~~\$29.95~~



The world-famous Heathkit VTVM has contributed more to the field of electronics than any other basic service instrument. Its quality and performance at low cost has made it a favorite for years and now with improved styling, better low frequency response and single test-probe convenience represents an even greater value!

Now designated the IM-11, this superb instrument features the same basic trouble-free circuit of the time-proven Heathkit V-7A. Functions include AC volts (RMS), AC volts (peak to peak), DC volts, resistance and db measurements. Improved response now reaches down to 25 cycles for those important low frequency tests. Precision 1% resistors and the high 11 megohm input resistance of the IM-11 assures high accuracy in every application by minimizing circuit loading of the unit under test. A large 4 1/2" 200 microampere meter is used for indication with clear, sharp calibrations for easy reading of all measurements. Front panel controls include a rotary function switch (with DC polarity reversing position to eliminate lead switching when alternately measuring positive and negative voltages), a rotary range selector, zero adjust and ohms adjust controls. Zero and ohms adjust controls feature small phenolic shaft knobs to minimize accidental change in setting.

The new, slim, all-purpose test probe is used for all measurements. A switch on the probe body provides simple selection of AC-ohms or DC functions and is equipped with a hook which enables clipping the probe to the circuit for "hands free" operation. A component circuit board assures stable, uniform circuitry and easy assembly. Test leads included. Less battery. 5 lbs.

Kit IM-11 . . . no money down, \$5 mo. . . . **New Special-Value Price \$24.95**
Assembled IMW-11 . . . no money down, \$5 mo. . . . **\$46.75**
EF-1-3 includes IM-11 and EF-1 applications course, p. 30. . . . **\$32.50**

SPECIFICATIONS—Meter scales: **DC & AC (RMS)**: 0-1.5, 5, 15, 50, 150, 500, 1500 volts full scale **AC peak-to-peak**: 0-4, 14, 40, 140, 400, 1400, 4000. **Resistance**: 10 ohm center scale x1, x10, x100, x1000, x10K, x100K, x1 meg. Measures .1 ohm to 1000 megohms with internal battery. **Meter**: 4 1/2" 200 ua movement. **Multipliers**: 1% precision type. **Input resistance DC**: 11 megohms (1 megohm in probe) on all ranges. **Circuit**: Balanced bridge (push-pull) using twin triode. **Accuracy**: DC $\pm 3\%$, AC $\pm 5\%$ of full scale. **Frequency response**: ± 1 db, 25 cps to 1 mc (600 ohm source). **Tubes**: 12AU7, 6AL5. **Battery**: 1.5 volt, size "C" flashlight cell. **Power requirements**: 105-125 volt 50/60 cycle AC 10 watts. **Dimensions**: 7 3/4" H x 4 11/16" W x 4 3/4" D.



SINGLE PROBE
Slim, all-purpose probe with switch for all functions and unique clip-action for hands-free connections.

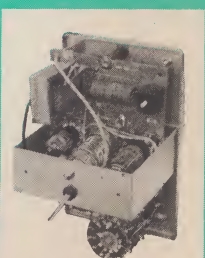

CIRCUIT BOARD ASSEMBLY
For uniformity and stability, as well as easy construction, the Heathkit IM-11 uses a printed circuit board for minimum component wiring.

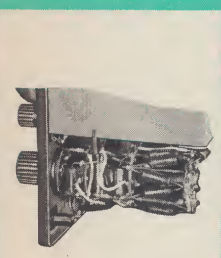

PRECISION RESISTORS
The IM-11 voltage divider networks use precision (1%) resistors to provide high instrument accuracy.

Extend the Operation of Your VTVM With

Heathkit etched circuit RF PROBE KIT

Kit Form
or
Factory
Assembled

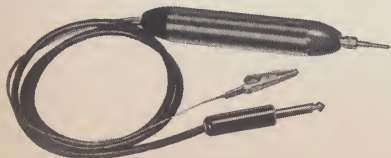

309-C
\$3.50

This handy Heathkit RF probe may be used with any 11 megohm VTVM for RF measurements up to 250 megacycles. A convenient and useful accessory for those occasions when measurements are necessary in RF work. A printed circuit is used for high stability and ease of assembly. Ideal for extending the service applications of your Heathkit VTVM. 1 lb.

Kit 309-C **\$3.50**
Assembled 309W-C **\$4.50**

These Famous Money-Saving Heathkits



Deluxe SERVICE BENCH VTVM . . . Big in size and performance!

- Oversize 6" 200 ua meter
- Expanded multi-colored meter scales
- 11 megohm DC input for high accuracy
- Separate low voltage AC scales
- Broad frequency response ± 1 db, 25 cps to 1 mc
- Recessed zero and ohms adjust controls

SPECIFICATIONS—Meter scales DC & AC (RMS): 0-1.5, 5, 15, 50, 150, 500, 1500 volts full scale (1.5 and 5 volt AC ranges read on separate scales). **Ohmmeter:** Scale with 10 ohm center x1, x10, x100, x1000, x10K, x100K, x1 meg. Measures 1 ohm to 1000 megohms with internal battery. **Multipliers:** 1% precision type. **Meter:** 6" 200 ua movement. **DC input resistance:** 11 megohms (1 megohm in probe) on all ranges. **AC input impedance:** 1 megohm shunted by 30 uuf (measured at input terminals). **Circuit:** Balanced bridge (push-pull) using twin triode. **Accuracy:** DC $\pm 3\%$, AC $\pm 5\%$ of full scale. **Frequency response:** ± 1 db 25 cps to 1 mc (600 ohm source). **Tubes:** 12AU7, 6AL5. **Battery:** 1.5 volt size "C" flashlight cell. **Power requirements:** 105-125 volts 50/60 cycle AC, 10 watts. **Dimensions:** 9 1/2" H x 6 1/2" W x 5" D.

High Quality Heathkit Probe Accessories

Heathkit 30,000 volt DC HIGH VOLTAGE PROBE Kit

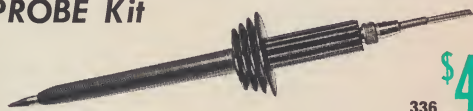

336

\$4.50

Kit Form
or
Factory
Assembled

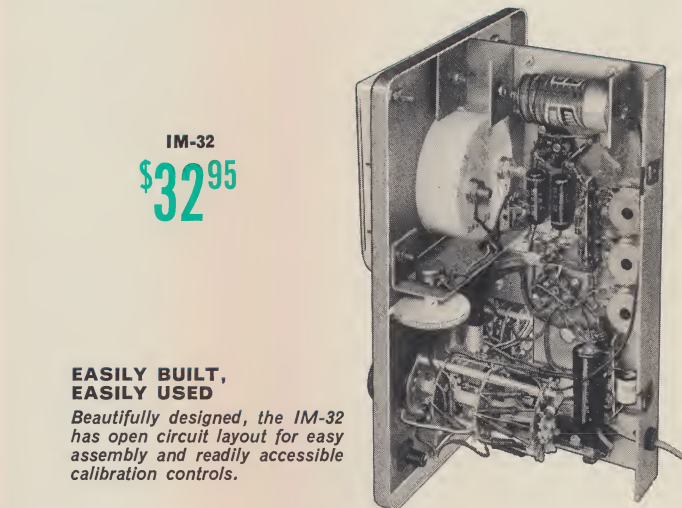

IM-32
\$32.95

EASILY BUILT, EASILY USED

Beautifully designed, the IM-32 has open circuit layout for easy assembly and readily accessible calibration controls.

Those who prefer a large VTVM with longer meter scales for easy reading will find this and many more features in the Heathkit IM-32. Specially designed for service bench use, the IM-32 adds new convenience and modern styling to the time-proven circuitry of the world-famous Heathkit V-7A VTVM.

In every field of electronics, voltage measurements are a necessary part of design work, maintenance, servicing, and trouble-shooting. The Vacuum Tube Voltmeter because of its inherent circuit design is by far the most accurate and dependable for use in any type of measurement. For example, the high input impedance minimizes the "loading" effect of the meter on the circuit under test, allowing far greater accuracy than can be obtained with other types of voltmeters.

Another advantage is that the voltages measured are not applied directly to the meter but rather to a vacuum tube which is limited to the amount of current it can draw, thereby protecting the sensitive meter movement against possible damage should a high voltage accidentally be applied while the range switch is in the wrong position. In the IM-32, the maximum voltage applied to the tube is 3 volts. Higher voltages are reduced through precision 1% voltage divider resistors with a total resistance of 10 megohms. An additional resistance of 1 megohm is located in the DC test probe to permit DC measurements in RF circuits with a minimum of disturbance to these circuits.

An extremely versatile instrument the IM-32 will measure AC (RMS) and DC volts to 1500 in seven ranges, resistance from .1 ohm to 1000 megohms in seven ranges and decibels from -10 to +65 db. DB calibrations are provided for relative voltage measurements with circuit components selected to give 10 db steps between ranges. Separate 1.5 and 5 volt AC scales are provided for high accuracy in low voltage AC measurements.

The generous proportions of the IM-32 permit wide spacing of controls for easy operation and room for mounting the large 6" 200 ua meter. Multicolored meter scales and high contrast panel screening show at a glance the correct scale and range in use for fast, easy reading of all measurements. Zero-adjust and ohms-adjust controls are recessed to prevent accidental change in settings. Clean, open circuit layout and a wiring harness assure easy assembly and maintenance. Test leads are included. Less battery. 6 lbs.

Kit IM-32...no money down, \$5 mo. **\$32.95**
EF-1-2 includes IM-32 and EF-1 applications course, p. 30. **\$39.95**

The Heathkit high-voltage probe will prove invaluable for TV service work or any similar application where measurement of high DC voltage is required. A precision multiplier resistor mounted inside the two-color sleek plastic probe body provides a multiplication factor of 100 on the DC ranges of any 11 megohm VTVM. Plenty of insulation for safety of operation. 1 lb.

Kit 336 **\$4.50**
Assembled 336W **\$5.50**

Quality Heathkit® Test Instruments

Heathkit AC VTVM... new styling... new features... for precision audio measurements

- 10 voltage ranges—0.01 to 300 volts rms full scale
- Extended frequency response ± 1 db 10 cps to 500 kc
- 10 megohm input impedance for high accuracy
- Calibrated db scale—measures -52 to $+52$ db

You'll find many plus features for precision AC measurements in the new Heathkit IM-21. Retaining all the fine features of the preceding model, the famous Heathkit AV-3, the IM-21 now adds extended frequency response, higher input impedance and new styling to the high sensitivity, excellent stability and ease of operation for highly accurate AC measurements in any application. New circuit design features include a cathode follower stage on all ranges for increased input impedance and a 2-stage amplifier with approximately 19 db of negative feedback for high output stability and linearity. With an added stage of frequency compensated voltage division using precision components and extended frequency compensation throughout the circuit, the frequency range of the preceding model is more than doubled. Also with ten times the input impedance, the circuit under measurement is virtually unaffected. The high quality meter employed features VU-type ballistic damping that is ideal for monitoring audio signals in such applications as tape recording and audio system measurements.

Kit IM-21, 4 lbs. . . . no money down, \$5 mo. **\$33.95**
 Assembled IMW-21 . . . no money down, \$7 mo. **\$60.25**

SPECIFICATIONS—Frequency response: ± 1 db 10 cps to 500 kc, ± 2 db 10 cps to 1 mc, all ranges. **Ranges:** VOLTS—Ten ranges from 0.01 to 300 volts RMS full scale. **Decibels:** Total range -52 to $+52$ db, meter scale -12 to $+2$ db (0 db = 1 mw in 600 ohms), ten switch selected ranges from -40 to $+50$ db in 10 db steps. **Input impedance:** 10 megohms shunted by 12 uuf on ranges 10 to 300 volts, 10 megohms shunted by 22 uuf on ranges .01 to 3 volts. **Tube complement:** (1) 6AW8, (1) 6EJ7/EF-184. **Accuracy:** Within 5% of full scale. **Power requirements:** 105-125 volts AC, 50-60 cycles, 10 watts. **Dimensions:** 7 $\frac{1}{2}$ " H x 4 11/16" W x 4 $\frac{1}{4}$ " D.

New Special-Value Price

on Heathkit 20,000 ohms/volt VOM

- Sensitive 50 microampere 4 $\frac{1}{2}$ " meter
- 1% precision resistors for high accuracy
- Total of 35 meter ranges on 2-color scale
- Battery powered for complete portability
- Sleek modern styling

The Heathkit model MM-1 is a highly accurate Volt/Ohm/Milliammeter designed for portable all-around use. It provides wide voltage, current, resistance and db ranges to cover hundreds of service applications. Sensitivity is 20,000 ohms-per-volt DC and 5,000 ohms-per-volt AC. Requiring no external source of power, the MM-1 is ideal for use in tests away from the test bench. Standard flashlight batteries furnish all power and are easily replaced when necessary.

Maximum accuracy is assured on all ranges by the use of 1% precision resistors and the large 4 $\frac{1}{2}$ " 50 microampere meter which has more than enough sensitivity for even the lowest voltages on the 1.5 volt scale. A single volt on the lowest range will provide a meter deflection of 2 $\frac{1}{4}$ " for accurate low-level indications.

A polarity switch is provided on the front panel to eliminate transferring of test leads when alternately measuring positive and negative voltages. All test jacks are recessed to eliminate shock hazard to the operator.

The components used in the construction of the Heathkit MM-1 were chosen for both quality and ease of assembly. Special resistor "rings" are used to provide firm mountings and easy access to the precision components and to eliminate excessive handling of the switch contacts during assembly. The sensitive meter movement is supplied already mounted to the front panel and the close-fitting case keeps out dust to protect all internal components. The sleek black bakelite case includes a convenient carrying handle of soft, pliable plastic. Complete with test leads. Less batteries. 4 lbs.

Kit MM-1 . . . \$5 mo. **New Special-Value Price \$29.95**

SPECIFICATIONS—Sensitivity: 20,000 ohms/volt DC, 5,000 ohms/volt AC. **Range AC & DC volts:** Full scale, 1.5, 5, 50, 150, 500, 1500, 5000. **Direct current:** 150 microamperes, 15, 150, 500 milliamperes, 15 amperes. **Ohmmeter:** 0.2 ohms to 20 megohms in three ranges. **Decibels:** -10 to $+65$ db. **Resistors:** 1% precision type. **Controls:** Range switch, Output —AC-DC Reverse DC switch, Ohms adjust control. **Batteries:** 1 type "C" cell, 4 penlight cells. **Dimensions:** 7 $\frac{1}{2}$ " x 5 $\frac{1}{2}$ " x 4".

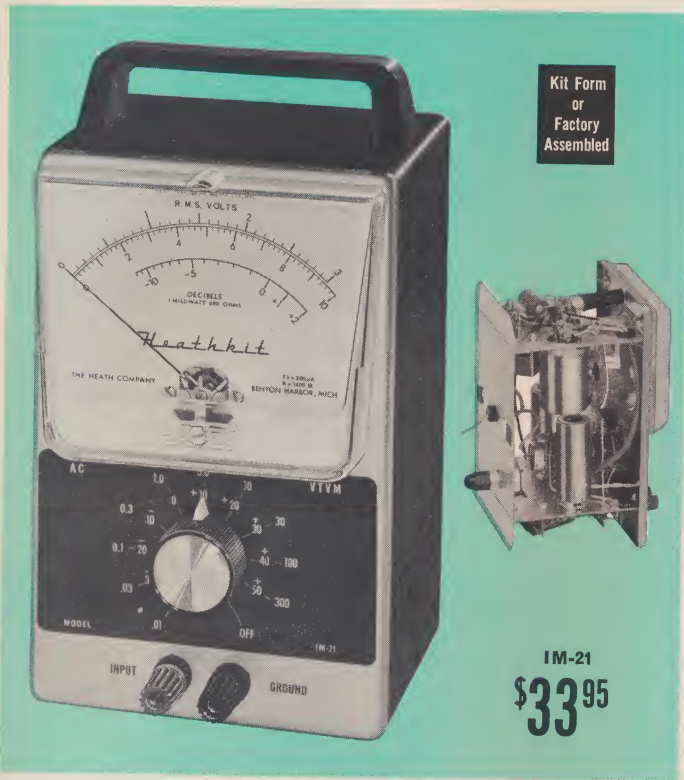

Kit Form
or
Factory
Assembled

IM-21
\$33⁹⁵



MM-1
~~\$33⁹⁵~~

Big Volume Passes
Extra Savings to You

PARTS EASILY ACCESSIBLE

Batteries snap in and out in seconds. Resistor "rings" eliminate excessive handling of switch contacts during assembly.

NEW SPECIAL-VALUE PRICE \$29⁹⁵

Deluxe Heathkit TRANSISTOR TESTER . . . lab-quality at low cost

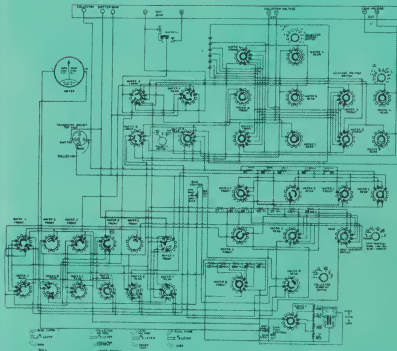

IM-30
\$54⁸⁸

- Complete DC analysis of all PNP, NPN transistors up to 15 amps
- DC gain (beta, alpha) read directly on calibrated scales
- 15 ua basic range for leakage (Icbo, Iceo) tests
- Four lever switches provide rapid test selection
- Built-in battery supply—provision for using external supply
- Ideal for servicing, design work, incoming inspection, production testing, etc.

A tremendous advance in transistor testing equipment! The Heathkit IM-30 with its superbly engineered circuitry and many unique design features provides lab-type facilities for complete and thorough DC analysis of all transistor types and highly accurate checks of diode characteristics. Ideal for use in servicing and industry where fast, easy testing, high accuracy, and versatility are prime factors to be considered.

Operation is simple! . . . four lever switches instantly select the desired test after initial setting of the voltage and current range switches. Tests selected by the lever switches include: base current, gain, collector current, collector voltage, leak voltage, short test, diode or collector-to-emitter leakage (iceo), and collector-to-base leakage (icbo). Four rotary switches, one for voltage and one for current on both gain and leakage set the desired conditions for testing. DC Beta and DC Alpha are read direct from the calibrated panel scale after meter is nulled. The gain control is a 3% wire-wound potentiometer which assures high accuracy. A variable bias control allows setting collector current to any desired value up to 15 amps. All basic tests may be performed using the internal battery supply. Internal batteries provide any test voltage up to 9 volts in 1.5 volt steps. External DC supply terminals are provided for higher voltages and current with appropriate meter ranges also provided. Detailed instructions. Less batteries. 7 lbs.

Kit IM-30 . . . no money down, \$6 mo. **\$54.88**

SPECIFICATIONS—Checks: Transistors up to 15 amps and diodes up to 1.5 amps. **Tests:** Shorts, DC Gain (Beta 0-300) (Alpha 0-.9967), Leakage (Icbo, Iceo), Diode Forward and Reverse Current. **Meter:** Current Ranges: 15 ua, 150 ua, 1.5 ma, 15 ma, 150 ma, 1.5 A, 15 A; Voltage Ranges: 1.5 V, 5 V, 15 V, 50 V, 150 V (100 K ohm/volt). **Power supply:** Internal, seven 1.5 volt size D batteries provide 1.5, 3, 4.5, 6, 7.5, 9 volts collector supply for gain or leakage and 1.5 volts for bias; External, 0-50 volts for gain, 0-150 volts for leakage and 1.5 volts for bias. **Bias control:** Permits any collector current from 10 ua to 15 amps for gain tests. **Gain control:** 3% wire-wound potentiometer has calibrated scales to give DC Beta and DC Alpha directly when meter is at null. **Lever switch:** Four spring return levers will individually select the following tests: Base Current, Gain, Collector Voltage, Collector Current, Leak Voltage, Short Test, Icbo and Iceo or diode currents. **Two voltage selector switches:** Gain and Leak Test Voltages can be individually preset at different voltage levels. **Two current range switches:** Collector and Leak currents can be individually preset on different ranges. **Transistor and diode connections:** Universal transistor socket and binding posts. **External power supply connections:** Binding Posts for Gain, Leak and Bias supplies.

SWITCH-SELECTED TESTS

Choose base current, gain, collector current, collector voltage, leak voltage, short test, diode or collector-to-emitter leakage (iceo) and collector-to-base leakage (icbo).



Heathkit® Transistor Testing Equipment

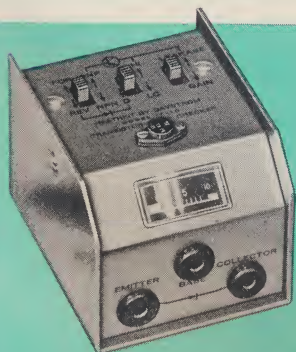

IT-10
\$6⁹⁵

Speed service operations with this handy TRANSISTOR/DIODE CHECKER

- Tests low and high power transistors
- Tests forward and reverse current of diodes

The tremendous rate at which transistors are being used in modern electronic circuitry calls for a simple, reliable transistor checker to help speed service operations . . . eliminate guesswork! This handy instrument tests transistors, diodes and also serves as a continuity tester . . . just the thing for carrying with you on service calls or for shop use. Tests low and high power transistors for short, leakage, open element and current gain. Versatile switching identifies transistors as to PNP or NPN type and eliminates transferring of test leads for diode testing. Removable test leads are provided for testing transistors which do not fit tester socket. Tester operates on two standard size "C" flashlight batteries for complete portability. Small, compact size allows easy carrying in tool box, glove compartment, etc., and the extended-edge case protects meter and switches against possible damage. Easy to assemble. Less batteries. 2 lbs.

Kit IT-10 **\$6.95**

SPECIFICATIONS—Transistor test: leakage, short, open and current gain. **Diode test:** forward and reverse current. Also serves as a continuity checker. **Switches:** Forward-Reverse/PNP-NPN, Diode/Hi-Lo, Leakage-Gain. **Power supply:** self-contained, two 1.5 volt size "C" flashlight cells. **Dimensions:** 3 1/2" H. x 3 1/8" W. x 3 3/4" D.

Budget Saving Capacitor Checkers

Safely tests all capacitor types . . . Deluxe Heathkit

CAPACITOR CHECKER



IT-11
\$29⁹⁵

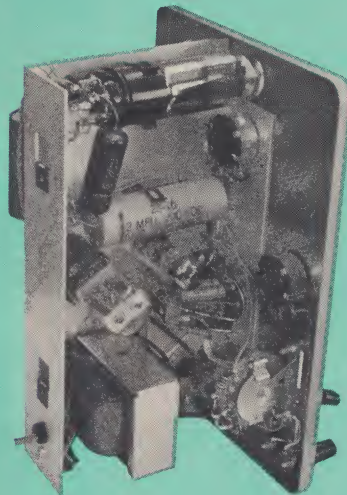

- NEW! . . . low bridge voltage for safe tests of miniature electrolytics
- NEW! . . . 16 switch-selected leakage testing voltages
- NEW! . . . comparator circuit—measure "L", "C", or "R" with external standard
- Measures capacity or resistance directly with internal standards
- Direct reading scales—no involved calculations
- Calibrated power factor control—"eye" tube indicator
- Easy to build and operate with complete instructions supplied

Many advanced design features are incorporated in this handsomely styled capacitor checker for quality and performance unheard of in this price range! The IT-11 tests capacitors of all types for value, leakage, shorts and power factor and also measures resistance from 5 ohms to 50 megohms. Capacity measurements are made in four ranges from 10 mmf to 1000 mfd. All readings are made on direct-reading scales . . . no involved calculations. The specially designed low-voltage bridge circuit used in the IT-11 now permits safe testing of easily-damaged miniature electrolytics such as used in transistorized equipment. A wide range of leakage test voltages and three leakage sensitivities (determined by type switch) allow testing capacitors at their rated values. As an additional safety measure, the leakage/discharge switch places a short across the internal standard and discharges the capacitor under test through a 10 K ohm resistor to prevent damage to capacitor or tester. Other features include "external-standard" terminals for rapidly comparing similar components up to a ratio of 25-1, measure unknown "R", "L", or "C" values, or determine transformer turns ratio directly; DC operation of the "eye" tube minimizes the fuzzy edge normally encountered when AC bridge voltage is applied directly; switch selection of either internal 60 cycle generator or external generator up to 10 kc. An extremely useful test instrument! Easy assembly and operation instructions included. 7 lbs.

Kit IT-11 . . . no money down, \$5 mo. . . . \$29.95

SPECIFICATIONS—Test circuit: AC bridge, powered through special bridge transformer by an internal 60 cycle supply or by an external audio generator with 10 volts output. Upper frequency limit: 10 kc. **Capacitance, 4 ranges:** 10 ufd to .005 ufd; .001 ufd to .5 ufd; .1 ufd to 50 ufd; 20 ufd to 1000 ufd. **Capacitor leakage:** DC test voltages from 3 to 600 volts in 16 steps. **Resistance, 3 ranges:** 5 ohms to 5000 ohms; 500 ohms to 500 K ohms; 50 K ohms to 50 megohms. **Comparator circuit:** External standard R, L or C; Max. Ratio 25-1. **Power supply:** Transformer-operated, half-wave rectifier. **Power requirements:** 105-125 volts AC, 50/60 cycles, 30 watts. **Dimensions:** 9½" high x 6½" wide x 5" deep.

"In-Circuit" CAPACITOR TESTER . . . saves time by testing capacitors right in the circuit

- Detects opens, shorts and intermittents
- "Eye" tube indicator

IT-22
\$10⁹⁵



With the Heathkit Capaci-tester you can check most capacitors for open or short conditions right in the circuit without disconnecting leads . . . saving both work and valuable time on the job. A five-position switch controls power to the instrument and selects the test to be made. Detects open capacitors from 50 mmf up, not shunted by an excessively low resistance value and shorted capacitors up to 20 mfd shunted by not less than 10 ohms. Intermittent capacitors are indicated by a flickering of the "eye" tube indicator. The IT-22 is designed to check all bypass, blocking and coupling capacitors of the paper, molded, mica, ceramic types only . . . uses a 60 cycle frequency for "short" test and 19 megacycle frequency for "open" test. 4 lbs.

Kit IT-22 . . . \$10.95

**New Relaxed Credit Terms
ORDER NOW! PAY LATER**

With Heath's new credit terms you can order the kits you want now! No money down . . . up to 18 months to pay on any purchase of \$25.00 to \$600.00. Enjoy the pleasure of building and having your Heathkit while you pay for it in easy monthly installments.

Save 50% On TV Test Gear



Stable all-electronic sweep circuit . . . TV ALIGNMENT GENERATOR KIT

- Complete FM and TV coverage—3.6 to 220 mc
- Built-in crystal and variable marker oscillators
- Excellent linearity for accurate waveform presentations



IG-52
\$54.95

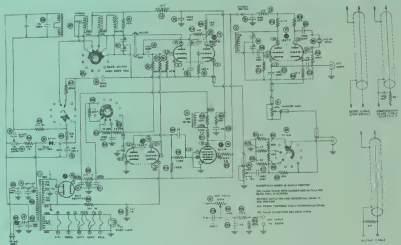

This popular Heathkit TV alignment generator has received wide acceptance in TV circles everywhere for its versatility, ease of operation and high reliability. Designed specifically for servicemen, the new IG-52 provides all the essential generator facilities required for fast, easy alignment of FM or TV sets.

Special design features include an all-electronic sweep circuit which uses a trouble-free controllable inductor to vary frequency by magnetic means . . . not mechanical . . . to produce wide range sweeps with excellent linearity and consistent results. The sweep circuit operates on fundamentals from 3.6 mc to 220 mc, in four bands. Sweep deviation is smoothly controlled from 0 to as high as 42 mc, depending upon center frequency. Fundamentals are used throughout the entire frequency range eliminating spurious beats and parasitics that are so often troublesome in beat frequency type sweep generators. Fundamental frequencies also provide greater RF output (well over .1 volt) at all frequencies, allowing cold alignment of tuned circuits, filters and traps, etc. Smooth control of signal output by both fixed-step and continuously-variable attenuators permits alignment of high gain stages without danger of overloading.

Crystal and variable marker oscillators are built-in. The 4.5 mc crystal (included with kit) provides output at 4.5 mc and multiples thereof for use in calibrating the built-in variable marker oscillator. Variable marker output is from 19 to 60 mc on fundamentals and from 57 to 180 mc on calibrated harmonics. Effective blanking eliminates return trace and a phasing control is also provided. An outstanding TV test instrument value. 13 lbs.

Kit IG-52 . . . no money down, \$6 mo. \$54.95

SPECIFICATIONS—Output impedance: 50 ohms terminated at both ends of cable. **Sweep deviation:** Continuously variable from 0-4 mc lowest max. deviation to 0-42 mc highest max. deviation (depending on base frequency). **Marker crystal:** 4.5 mc and multiples thereof. **Variable:** 19 mc to 60 mc on fundamentals, 57 mc to 180 mc on harmonics. **External marker terminals:** Provided on panel. **Attenuators:** Step-switch controls sweep and marker oscillators together, plus variable controls for each output. **Blanking:** Effective blanking eliminates return trace; phasing control also provided. **Cables:** 3 supplied, output, scope horizontal, scope vertical. **Power requirements:** 105-125 VAC, 60 cycles, 50 watts. **Dimensions:** 13" W x 8½" H x 7" D.

Your best buy in a color TV service instrument . . . Heathkit COLOR BAR & DOT GENERATOR

- Choice of six different patterns for color or B & W picture adjustment
- 10 vertical color bars—new shading bar pattern
- All frequencies crystal controlled for accuracy and stability



IG-62
\$64.95

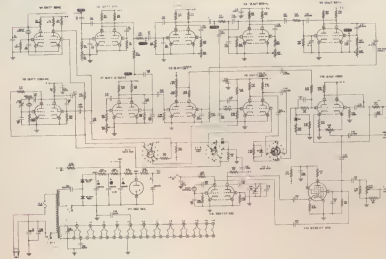

New professional styling and time-proven performance of the preceding model Heathkit CD-1 are combined in the new Heathkit IG-62 to bring you an outstanding color TV service instrument. Ideal for either color or black & white TV servicing, the IG-62 produces six different patterns for use in linearity and other picture adjustments on television receivers.

The switch-selected patterns include: white dots, cross hatch, vertical bars, horizontal bars, 10 color bars and a special shading bar pattern for screen and background adjustments. Crystal-controlled internal sync pulses at the same frame rate as the TV station lock the patterns firmly on the screen without jitter or crawl . . . no sine leads required. Any pattern may be selected without further adjustment to the receiver or generator after initial setting.

The 10 color bars are produced by the offset-carrier method and allow AFC, phase and matrix alignment. Color bars include a white leading edge and black trailing edge to check color fit.

The IG-62 is compact, light in weight and features smooth control action. RF output on any channel from 2 to 6 is provided with an RF level control to check sensitivity and prevent overloading of the automatic gain control. A crystal-controlled sound carrier with on/off switch is provided for adjusting the fine tuning control. The video output may be adjusted with the video level control to check color hue and sync with different signal levels. The power supply features voltage regulation and uses long-life silicon diode rectifiers. The 13-tube circuit has been carefully laid out for ease of assembly. Easy-to-follow calibration instructions are furnished with actual oscilloscope patterns to aid in alignment. Kit is complete with three crystals, test leads, and comprehensive instructions on the use of the instrument in adjusting color receivers. 12 lbs.

Kit IG-62 . . . no money down, \$7 mo. \$64.95

SPECIFICATIONS—RF output frequency range: TV channels 2 through 6. **Output voltage:** Variable from 100 to 100,000 microvolts. **Sound carrier:** Crystal controlled, unmodulated, 4.5 mc away from picture carrier; off-on switch provided. **Video output:** Positive or negative output variable from 0-10 volts peak-to-peak open circuit. **Modulation:** White dot pattern, cross hatch pattern, horizontal bars, vertical bars, 10 vertical color bars, shading bar pattern. **Tube complement:** 6-12AT7, 4-12AU7, 1-6BQ7, 1-6CS6, 1-0B2. **Power requirements:** 117 VAC, 50/60 cycles, 70 watts. **Dimensions:** 13" W x 8½" H x 7" D.

Heathkit Performance Specifications Are Guaranteed

Variable-Voltage REGULATED POWER SUPPLY . . . for experimenters, engineers

An extremely valuable instrument for laboratory use! Furnishes regulated B+, bias and filament voltages for countless experimental circuits. Regulated B+ output is continuously variable from 0 to 400 volts DC at up to 100 ma (125 ma maximum), Bias voltage is variable from 0 to -100 volts DC at 1 ma. 6.3 volts AC at 4 amps is also available for filaments. Output terminals are separate and insulated from chassis ground for safety in AC/DC work. Separate panel meters permit continuous monitoring of output voltage and current. A convenient standby switch and the use of separate filament and high voltage transformers permit all high voltages to be switched "off", leaving only filament voltage "on" while circuit changes are made . . . saves time by eliminating tube filament warmup time. Built-in circuit protection prevents damage to the power supply should the bias voltage be accidentally shorted. Rugged, well-rated components are used throughout for long reliable service and the instrument is fused for added protection. Professional styling with new three-color panel and black knobs with spun metal inserts reflect its outstanding quality. 15 lbs.

Kit IP-32 . . . no money down, \$6 mo. **\$56.95**



IP-32
\$56.95

- Furnishes B+, bias and filament voltages
- DC output variable from 0 to 400 volts
- Separate panel meters monitor output voltage and current
- Handsome restyled version of Heathkit PS-4 Power Supply

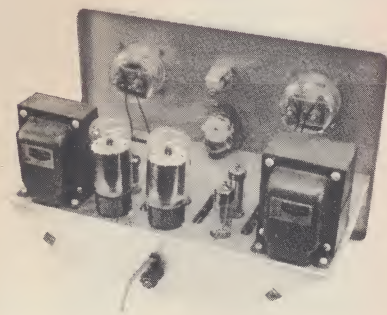

SPECIFICATIONS—Output: 0-400 volts regulated DC at 0-100 ma, cont., 125 ma intermittent, 0 to -100 volts DC at 1 ma variable bias voltage, 6.3 volts AC at 4 amps, filament voltage. **Regulation:** Output variation less than 1% from no load to full load; Output variation less than ±0.5 volt for a ±10 v. change at 117 v. AC input. **Ripple:** less than 10 millivolts RMS, ripple, jitter and noise. **Output impedance:** less than 10 ohms, DC to 1 mc. **Meters:** Voltmeter 0-400 V or 0-150 V.; Milli-ammeter 0-150 ma. **Dimensions:** 13" W x 8½" H x 7" D.

Low Ripple BATTERY ELIMINATOR KIT

- A handy source of 6 & 12 volt DC power
- Less than .3% AC ripple for smooth DC output
- Newly styled version of Heathkit BE-5

This modern battery eliminator provides a ready, reliable source of 6 or 12 volt DC power at the flip of a switch. Ideal for servicing all types of automobile radios, including transistor and "hybrid" radios which use both tubes and transistors. Transistor and "hybrid" radios can tolerate only a small amount of AC ripple and the special ripple filter circuit employed in this unit holds AC ripple to less than .3% for exceptionally smooth DC output. Output voltage is variable on both ranges from 0-8 volts or 0-16 volts. Two panel meters permit continuous monitoring of output voltage and current. Separate terminals are provided for "normal" and "highly filtered" output. This handy kit doubles as an excellent battery charger or marine converter. 21 lbs.

Kit IP-12 . . . no money down, \$5 mo. **\$47.50**

SPECIFICATIONS—Continuously variable output: 6 volt range: unfiltered, 10 amp continuous, 15 amp maximum, filtered, 5 amp continuous, less than .3% ripple. 12 volt range: unfiltered, 5 amp continuous, 7.5 amp maximum; filtered, 5 amp continuous, less than .3% ripple. **Power requirements:** 105-125 volts 50/60 cycles AC at 200 watts. **Dimensions:** 13" W x 8½" H x 7" D.



IP-12
\$47.50

Supplies for Every Testing Requirement



IP-20
\$72⁹⁵

New! SOLID-STATE, REGULATED POWER SUPPLY . . . offers more features than units selling for 5 times its price!

Here is another example of the advanced design test instruments available from Heath! Offering more features and circuit refinements than power supplies selling for as much as five times this low Heathkit price, the IP-20 represents an unbeatable value!

Providing high current capability, the IP-20 delivers up to 1.5 amperes from zero to 50 volts, with less than 150 microvolts AC ripple! Applications in Industry, Laboratory and Service are endless . . . ideal for use in design and development work of transistor circuits as well as in servicing!

The IP-20 uses a transistorized series-type voltage regulator and a Zener-diode to provide the voltage reference. Operation is stabilized by an OB2 VR tube for almost perfect line regulation. Advanced design circuitry uses a tapped power transformer rather than an adjustable auto transformer for voltage control and two heavy-duty power transistors, cooled by finned heat-sinks, to deliver reliable trouble-free performance at big savings! Other quality features include an adjustable current limiter control, which automatically limits the current output on any current range to protect both meter and circuit under test. Meter indicates current or voltage output, selected by a convenient panel switch. 14 lbs.

Kit IP-20 . . . no money down, \$8 mo. \$72.95

- Voltage regulated, transistorized circuitry
- Variable, 0 to 50 volt output at up to 1.5 amperes
- Four current ranges, 50 MA, 150 MA, 500 MA & 1.5 A
- Adjustable current limiter, 30 to 110% on each current range
- Relay protected against heavy overload & short circuit

SPECIFICATIONS—Input: 105-125 volts 60 cps; 125 watts at full load (50V, 1.5A). Output: 0.5-50 volts DC; 1.5 amps max DC. Load regulation: ± 15 millivolts, can be adjusted for no change. Line regulation: (105 to 125 VAC): Less than .005% change. Ripple & noise: Less than 150 microvolts. Transient response: Less than 25 microseconds. Output impedance: Less than .01 ohm DC to 10 kc; Less than .5 ohms 10 kc & up. Overload protection: current limiter & relay. Meter: $3\frac{1}{2}$ ", 1 ma, 50 ohm. Current ranges: 50 ma, 150 ma, 500 ma, 1.5 amp. Voltage ranges: 5V, 15V, 50V. Front panel controls: On/Off, coarse voltage switch, Fine voltage adjust, Current range switch, Current limit adjust, Meter slide switch, DC regulation, Reset Standby toggle switch. Output terminals: (3), plus (\pm 1), minus ($-$ 1), chassis ground. Dimensions: $9\frac{1}{2}$ " H x $6\frac{1}{2}$ " W x 11" D.

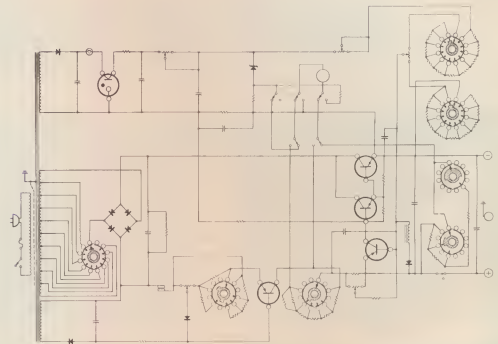

Variable-voltage ISOLATION TRANSFORMER KIT

- Controls AC line voltage to meet test requirements
- Power rated for color TV work—linear, expanded meter scale

An instrument of many uses in servicing and testing! It controls AC line voltage to equipment under test, isolates interference radiating devices from the power line since there is no direct connection between the primary and secondary of the transformer . . . protects against AC/DC set shock hazard, induces breakdown of weak or intermittent components by raising AC input voltage or permits testing under adverse conditions such as low line voltage. These and many more uses make it handy on any test bench. Two heavy-duty 8-position switches vary output in .75 volt steps from 90 to 130 volts AC. An expanded scale meter accurately monitors output voltage and a spring-return slide switch permits fast check of power line input voltage. Two AC receptacles accept 3-prong or standard-type plugs. Fused for protection. 21 lbs.

Kit IP-22 . . . no money down, \$6 mo. \$54.95

SPECIFICATIONS—Input: 105-125 volts 50/60 cycles. Output: Variable from 90-130 volts in steps of approximately .75 volt by means of transformer secondary tap switching. Meter: 90-140 volt scale, ± 1 volt accuracy. Switch selection of input or output voltage indication. Power rating: 300 watts continuous, 500 watts intermittent. Fuse: 8 ampere. Dimensions: $6\frac{1}{2}$ " W x $9\frac{1}{4}$ " H x 5" D.



IP-22
\$54⁹⁵



IG-102
\$27⁹⁵

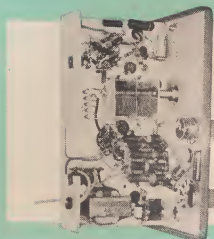

FACTORY ALIGNED COILS
Preassembled coil and band switch assembly, aligned to factory precision standards, assures accurate calibration of your completed instrument.

Equip your service bench with this accurate, reliable RF SIGNAL GENERATOR

- Wide frequency range—100 kc to 220 mc in six bands
- Large, easy-to-read frequency scales—2% accuracy
- Prewired /prealigned /coil /bandswitch assembly
- Newly styled version of popular Heathkit RF-1

Beautifully styled and thoughtfully engineered throughout, the IG-102 provides complete RF facilities with quality and performance unmatched at this low Heathkit price! The extremely wide range of frequencies covered by this instrument make it an invaluable addition to any service bench. Extended frequency coverage is provided in six bands . . . 100 kc to 110 mc on fundamentals . . . 110 mc to 220 mc on calibrated harmonics. Carefully designed circuitry achieves sine wave output with outstanding accuracy (2%) on all bands. Three large easy-to-read dial scales allow precise frequency settings throughout the entire frequency range. Modulated or unmodulated RF output is available at up to 100,000 microvolts, controlled by both fixed-step and continuously variable output attenuators. Internal modulation is at 400 cps and provision is made for external modulation at other frequencies. The 400 cps audio signal with 10 volt output may also be used separately for audio tests. 6 lbs.

Kit IG-102 . . . no money down, \$5 mo. **\$27.95**

SPECIFICATIONS—Frequency range: Band A, 100 kc to 320 kc; Band B, 310 kc to 1.1 mc; Band C, 1 mc to 3.2 mc; Band D, 3.1 mc to 11 mc; Band E, 10 mc to 32 mc; Band F, 32 mc to 110 mc. **Calibrated harmonics:** 110 mc to 220 mc. **Accuracy:** 2%. **Output:** Impedance, 50 ohms; Voltage, 100,000 uv. **Modulation:** Internal, 400 cps; 30% depth; External, approx. 3 V across 50 k ohms for 30%. **Audio output:** Approx. 10 V open circuit. **Tube complement:** (1) 12AT7, (1) 6AN8. **Power requirements:** 105-125 V 50/60 cycles AC, 15 watts. **Dimensions:** 6 1/2" W. x 9 1/4" H. x 5" D.

Save 50% or More by Building Your Own

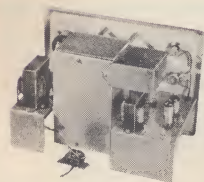

EXTENSIVE SHIELDING
Compartmentalized chassis construction effectively isolates critical stages and prevents spurious radiation.

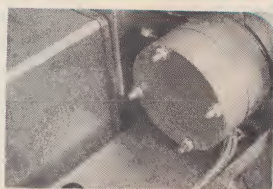

SHIELDED STEP-ATTENUATOR
Complete shielding between switch wafers as well as external shield cover assures non-interaction, true attenuation.



IG-42
\$56⁹⁵

LABORATORY RF GENERATOR KIT

- Metered output voltage and % modulation
- Double shielding of all oscillator circuits
- Operates on fundamentals—100 kc to 30 mc in five bands
- Ideal for use in design and development work

Designed for the professional service shop or laboratory, the new IG-42 features many extras for precision alignment. Frequency coverage is from 100 kc to 30 mc . . . all on fundamentals in five easy-to-read bands. The accurately calibrated 200 microampere panel meter indicates output in microvolts or percent modulation, as selected by a panel switch. Maximum metered output is 100,000 microvolts controlled by both fixed-step and continuously variable output attenuators. Modulation is variable from 0 to 50% at 400 cycles internally or externally between 60 cps and 10,000 cps. Extensive copper-plated shielding and line filtering minimizes RF radiation through the cabinet and line cord. The well-designed power supply is transformer operated for safety and high efficiency and features generous filter design and voltage regulation for smooth, stable plate voltage. Generator output impedance is 50 ohms. The terminating resistor, located in a plastic pod on the end of the coaxial cable furnished, is easily changed for specific impedances. Replacing the famous LG-1, this is a top-notch instrument throughout! 14 lbs.

Kit IG-42 . . . no money down, \$6 mo. **\$56.95**

SPECIFICATIONS—IG-42 frequency ranges: Band A, 100 to 290 kc; Band B, 280 to 1000 kc; Band C, 0.95 to 3.1 mc; Band D, 2.9 to 9.5 mc; Band E, 9 to 31 mc. **RF output:** Impedance, 50 ohms—voltage, 100,000 microvolts max. **Attenuator:** 10:1 per step, 5 steps—Fine, 10:1 continuous, indicated on meter. **Amplitude modulation:** CW, internal 400 cycles or external audio frequencies. **Modulation depth:** 0 to 50% variable, indicated on meter. **Tube complement:** 6AF4, 6AV5, 12AU7, 6B2. **Power requirements:** 105-125 V, 50/60 cycles. **Dimensions:** 13" W. x 8 1/2" H. x 7" D.

Produces near-perfect sine wave audio signals . . . Heathkit AUDIO GENERATOR KIT

- Switch-selected output frequencies, 10 cps to 100 kc
- Less than .1 of 1% distortion between 20 and 20,000 cps
- Output and frequency accurate to within $\pm 5\%$
- Neat, compact styling—easy to use—excellent resetability

The unique circuitry of the famous Heathkit AG-9A is the basis for this restyled instrument IG-72, to let you forget about input variations and distortion when working with audio circuits. Three rotary switches are used to select two significant figures and a multiplier to determine audio frequency. Frequency can be varied in steps of 1 cps from 10 cps to 100 cps and a four-position multiplier increases this range in multiples of 10 for an overall range of 10 cps to 100 kc. Accuracy is well within $\pm 5\%$ and distortion is less than .1 of 1% between 20 and 20,000 cps. Generator output is indicated on a large $4\frac{1}{2}$ " 200 ua meter calibrated in volts and decibels. The output attenuator operates in steps of 10 db and is calibrated in 8 full scale meter ranges. A slide switch allows selection of built-in or external load 600 ohm load. A wonderfully engineered kit you will enjoy using in all audio tests. 7 lbs.

Kit IG-72 . . . no money down, \$5 mo. **\$41.95**

SPECIFICATIONS—Frequency: 10 cps to 400 kc, switch selected, 2 significant figures and multiplier. **Output:** 6 ranges 0 to .003, .01, .03, .1, .3, 1 volts RMS into external 600 ohm load or with internal load into Hi-Z, 2 ranges 0 to 3, 10 volts RMS into a minimum of 10,000 ohms, -60 db to ± 22 db in 8 steps -60 dbm to ± 2 dbm (0 dbm = 1 mw in 600 ohms). **Distortion:** less than .1%, 20 to 20,000 cps. **Tubes:** (1) 6AU6, (1) 6CL6, (1) 6X4. **Power:** 105-125 volts AC, 50/60 cycles, 40 watts. **Dimensions:** $9\frac{1}{2}$ " W. x $6\frac{1}{2}$ " H. x 5" D.

PRECISION COMPONENTS
200 ua meter plus precision resistors in "cycle" switches contribute to the high accuracy of the completed instrument.



IG-72
\$41.95

Heathkit® Test Instruments



Wide range sine and square wave signals for audio tests . . . SINE-SQUARE WAVE GENERATOR KIT

- Covers 20 cps to 1 mc in 5 bands
- Less than .25% sine wave distortion
- Less than .15 microsecond square wave rise time
- Sine and square wave output available simultaneously

The high quality sine and square wave signals produced by this hand-somely restyled generator, along with its wide frequency range, make it useful in audio, TV, high fidelity, and general laboratory testing applications. Both sine and square wave outputs may be used separately or simultaneously as desired, without affecting either waveform. Separate output terminals and attenuators permit individual control. Output attenuators operate in steps of 10, 1, and .1 volt for both sine and square wave with an extra range of .01 volt provided for sine wave. Oscillator circuits are well shielded and a special control compensates for differences in tube characteristics during initial calibration to assure absolute minimum distortion. Also featured is an exact frequency calibrating system to insure proper tracking across the dial. Sine wave output impedance is 600 ohms and square wave output is 50 ohms at all settings of the output controls, except in the 10 volt ranges. Exceptionally well engineered throughout for maximum efficiency, ease of assembly and dependable performance. 12 lbs.

Kit IG-82 . . . no money down, \$6 mo. **\$51.95**

SPECIFICATIONS—Sine wave: Frequency range: 20 cycles to 1 mc. Output volts (RMS): 0 to 10 volts, 0 to 1 volt, 0 to .1 volt, or 0 to .01 volt when working into a high impedance load. Source impedance: ($\pm 10\%$): 10 volt range, 0 to 3.5 k ohm; 1V, .1V, and .01V range, 600 ohm. Distortion: Less than .25%, 20 to 20,000 cycles. Frequency response: ± 1.5 db 20 cycles to 1 megacycle. Square wave Frequency range: 20 cycles to 1 mc. Output volts: (P. to P.) $\pm 5\%$; 0 to 10 volt, 0 to 1 volt, 0 to .1 volt, into a high impedance load. Source impedance: ($\pm 10\%$): 10 volt range, 0 to 220 ohm; 1V and .1V ranges, 52 ohm. Rise time: less than .15 microsecond. General: Frequency accuracy: $\pm 5\%$. Power requirements: 105-125V AC, 50/60 cycles, 55 watts. Dimensions: 13" W. x $8\frac{1}{2}$ " H. x 7" D.

EXTRA-VALUE DESIGN
means better performance. Shielded tuning condenser and frequency multiplier switch—conservatively rated power transformer—silicon diode rectifiers—simplicity of circuitry—all contribute to high quality waveforms.



IG-82
\$51.95



Measure distortion at any audio frequency with the Heathkit HARMONIC DISTORTION METER



IM-12 **\$54⁹⁵**

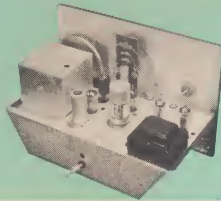

QUALITY DESIGN
Shielded tuning condenser in the Wein Bridge circuit. Two-stage amplifier voltmeter circuit. Transformer operated power supply, voltage regulated.

- Meter scales calibrated in volts rms, % distortion & db
- Measures distortion from 20 to 20,000 cps
- Measures noise levels down to -60 dbm
- Precision components for high accuracy
- New Heathkit styling—top quality throughout
- Complete instruction for easy assembly and operation

Resourceful engineering, traditional in Heathkit equipment, has reduced the highly-complex and costly equipment ordinarily required for harmonic distortion measurements to a simple, easy-to-use instrument, without sacrificing accuracy, stability or quality. Used with an audio generator such as the Heathkit IG-72 or IG-82, this instrument will accurately measure harmonic distortion at any frequency between 20 and 20,000 cps. Noise level measurements are read on a separate meterscale calibrated in db. High input impedance and 1% precision resistors in the VTVM voltage divider circuit assure excellent sensitivity and high accuracy. Distortion is read directly on the meter in ranges of 0-1, 3, 10, 30 and 100% full scale. Easy to assemble with complete instructions supplied. 11 lbs.

Kit IM-12 . . . no money down, \$6 mo. \$54.95

SPECIFICATIONS—Frequency: 20 cps to 20,000 cps in three ranges. **Distortion:** 1, 3, 10, 30, 100% full scale. **Voltmeter:** 1, 3, 10, 30 volts full scale. **Input resistance:** 300 k ohm. **Minimum input voltage for distortion measurements:** 0.3 volts. **Output voltage for monitoring:** 2.5 volts at full scale meter reading. **Accuracy:** Voltmeter, ± 5%; Distortion ± 5% of full scale, ± 0.1%. **Tube complement:** OA2, 6X4, 5879, 12AT7, 12AX7, 12BY7. **Power requirements:** 105-125 V, 50/60 cycles AC, 30 watts. **Dimensions:** 13" W x 8½" H x 7" D.

Three audio test instruments in one! . . . Heathkit AUDIO ANALYZER

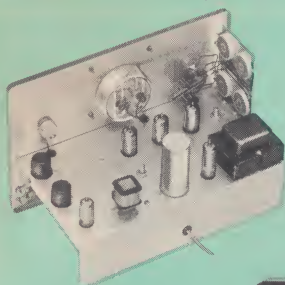

SUPERIOR COMPONENTS
Potted Hi-Q inductances for hi-pass and low-pass filter circuits. Special oscillator coil for low-distortion, high-frequency oscillator signal. Non-inductive load resistors.



IM-22 **\$56⁹⁵**

- Combines function of AC, VTVM, Wattmeter and IM Analyzer
- High and low frequency source for IM tests built-in
- Built-in load resistors for 4, 8, 16 and 600 ohms
- Large easy-to-read meter—simplified switching system
- Tremendous savings over purchase of 3 separate instruments
- A handsomely restyled version of the famous Heathkit AA-1

A sensational value for the audio enthusiast! Here in one compact, easy-to-use instrument are provided all the facilities you need for a thorough analysis of audio equipment. All basic functions of test leads furnished. The unique switching system used in this instrument allows use of any instrument separately or combines functions internally for greatly simplified operation . . . eliminates clutter and confusion of numerous instruments and test leads normally required. Non-inductive amplifier load impedances of 4, 8, 16 and 600 ohms are built-in and a high impedance position is also provided for stage-to-stage and other high impedance circuit analysis. High and low frequency generators are built-in so no additional equipment is required for IM distortion tests. Easy to build and operate with complete instructions furnished. 11 lbs.

Kit IM-22 . . . no money down, \$6 mo. \$56.95

SPECIFICATIONS—Frequency response—AC VTVM: 10 cycles to 100 kc ± 1 db. **Wattmeter:** 10 cycles to 50 kc ± 1 db. **I.M. Analyzer high pass filter:** 2000 cps to 12,000 cps. **I.M. Analyzer low pass filter:** 10 cps to 600 cps. **Range AC VTVM:** .01, .03, .1, .3, 1, 3, 10, 30, 100, 300 volts RMS full scale. **DBM:** -40, -30, -20, -10, 0, +10, +20, +30, +40, +50. Reads from -65 to +52 dbm. **Wattmeter:** 0.15 mw, 1.5 mw, 15 mw, 150 mw, 1.5 w, 15 w, 150 w, full scale. Maximum continuous power 25 watts, intermittent power to 50 watts. **I. M. Analyzer:** 1%, 3%, 10%, 30%, 100% full scale. **Input impedance—AC VTVM:** 1 megohm or 4, 8, 16 or 600 ohm switch selected. **I.M. Analyzer:** 1 megohm or 4, 8, 16 or 600 ohm switch selected. **Wattmeter:** 4, 8, 16 or 600 ohm internal load, 10,000 ohm across external load. **Output impedance—low and high frequency output:** 3000 ohm (600 ohm when shunted with 750 ohm resistor). **Internal generator frequencies—low frequency:** 60 cycles. **High frequency:** Approximately 6 kc. **Accuracy—AC VTVM and wattmeter:** Within 5% of full scale. **I.M. Analyzer:** Within 10% of full scale. **Power requirements:** 105-125 volts 50/60 cycles 20 watts. **Dimensions:** 13" W x 8½" H x 7" D.

Exact Purpose Equipment



Save time in servicing with this VISUAL-AURAL SIGNAL TRACER

- Traces RF, IF and audio signals
- Locates noisy and intermittent components
- Convenient RF-audio probe with switch
- Doubles as utility amplifier, test speaker
- Ideal for testing radios, tuners, amplifiers
- Ideal for transistor radio trouble-shooting

This Signal Tracer is one of the most effective trouble-shooting instruments you can own! Signal tracing has long been used as a means of quickly isolating a defective stage in servicing procedures throughout the world. RF, IF and Audio signals are traced visually through the "electron eye" tube indicator or audibly through the built-in speaker. Audio and RF inputs are handled by one convenient probe with switch-selection of either input. Signal tracing also provides a safe means of pinpointing faults in sensitive transistorized equipment which might be damaged using ordinary testing procedures. A unique noise locator circuit is provided in this instrument which is extremely helpful in locating noisy and intermittent components. Highly versatile, the IT-12 serves as a test speaker or utility amplifier in testing tuners, record changers, microphones, musical instrument pickups, and many more! A front panel switch disconnects the speaker from the output transformer when used as a test speaker for checking radio or TV sets where speakers have been left in the cabinet. The output transformer may also be used for substitution tests if desired. The many features and uses of this versatile unit combined with its low, economical price make it an extremely worthwhile investment in time-saving test equipment. The informative manual contains many useful tips on the applications of the kit. Easy to build with complete instructions furnished. 4 lbs.

Kit IT-12..... \$19.95

SPECIFICATIONS—Power supply: Transformer operated. **Power requirements:** 117 volts 50/60 cycles AC, 25 watts. **Tube complement:** 12AX7, 12CA5, 1629. **Speaker:** 3½" PM. **Probe and test leads:** 4' input lead for RF and audio with switch on probe body, 2-3' panel test leads with alligator clips. **Dimensions:** 4¼" W x 7½" H x 4" D.



IT-12
\$19.95

New Relaxed Credit Terms ORDER NOW! PAY LATER

With Heath's new credit terms you can order the kits you want now! No money down . . . up to 18 months to pay on any purchase of \$25.00 to \$600.00. Enjoy the pleasure of building and having your Heathkit while you pay for it in easy monthly installments.

Ideal for the hobbyist . . . Heathkit HANDY LAB

- Five functions in one instrument
- Simple one switch operation
- Battery operated for portability
- Easy to assemble—low in cost

This handy instrument features a DC voltmeter, transistorized signal generator, continuity checker, resistor and capacitor substitution boxes all-in-one! . . . and is battery operated for complete portability. A single 18-position switch selects any of its functions. A neon bulb indicates AC voltage over 85 volts and a #49 pilot lamp shows continuity up to 50 ohms. The many functions of the Handy Lab make it an excellent all-around instrument for the hobbyist. Test leads included. Less battery. 2 lbs.

Kit IM-20..... \$14.95

SPECIFICATIONS—DC voltmeter: Four ranges, 0-15, 50, 150, 500 volts full scale. **Meter:** 0 to 1 milliamperes, **Accuracy:** ±10% of full scale. **Input resistance:** 1000 ohms-per-volt. **Resistance substitution:** 100, 1000, 10k, 100k, and 1 M ohms, 1 watt 5% tolerance. **Condenser substitution:** .001, .005, .02, .1, and 8 ufd (electrolytic) at 400 volts. **AC indicator:** NE-51 neon lamp. **Continuity indicator:** #49 lamp. **Signal generator:** RF SECTION, preset adjustment from 450 kc to 700 kc, approximately 2 millivolts output. **AUDIO SECTION.** Approx. 1000 cps, 50 millivolts output. **Output impedance:** 220 ohm. **Transistors:** Two 2N1274. **Batteries:** Two 1.5 volt penlight cells. **Case:** Molded plastic. **Dimensions:** 6" H x 3½" W x 2½" D.



IM-20
\$14.95

There's A Heathkit For Every Interest, Every Purpose, Every Budget



IN-21
\$17⁹⁵

USEFUL in all types of design and development work
NEW STYLING features sloping front panel for new ease in reading and operating
PRECISION components for high accuracy



IN-11
\$24⁹⁵

Produce up to 1 Billion different R/C combinations with these New Heathkit Decades!

3-DECADE CONDENSER KIT

Precision accuracy in this laboratory-type capacitance decade provides convenient switch-selection of capacitor values from 100 mmfd to 0.111 mfd in 100 mmfd steps . . . all at 1% accuracy. Ideal for use in substitution tests, tuned circuits, bridge circuits, filter networks and many more applications where extremely high accuracy is important. Often it is faster and easier to determine capacitance values required in experimental circuits by using the IN-21 than to make involved calculations. Uses precision 1% silver mica capacitors rated at 350 volts DC continuous; 500 volts DC intermittent; and 1000 volts DC test. High quality ceramic wafer switches have positive detent action. Measures 7 $\frac{1}{8}$ " W x 4" H x 5" D. 3 lbs.

Kit IN-21 **\$17.95**

6-DECADE RESISTANCE KIT

Designed for laboratory use this extremely accurate resistance decade will provide any resistance value from 1 ohm to 999,999 ohms. You can add or subtract as little as 1 ohm in critical circuits with $\frac{1}{2}$ of 1% accuracy! Valuable for laboratory applications such as a multiplier, shunt, substitution resistor, or as an arm for AC and DC bridges. Ideal for use with the IN-21 capacitance decade where an extremely wide range of values are necessary for making resistance and capacitance networks. Range switches have make-before-break action for smooth switching without opening or shorting the circuit. Dimensions: 7 $\frac{1}{8}$ " W x 5" H x 6 $\frac{5}{8}$ " D. 4 lbs.

Kit IN-11 . . . no money down. \$5 mo. **\$24.95**

Ideal for Radio and TV Service Work . . . RESISTANCE SUBSTITUTION BOX KIT

Radio and TV service technicians will find useful applications for this handy kit. Ideal for experimentally determining desirable resistance values and for altering circuit characteristics where unknown or badly burned resistors are present due to circuit shorts in equipment under test. The IN-12 provides convenient switch-selection of any one of 36 E.I.A. standard 10% 1-watt resistors, ranging in value from 15 ohms to 10 megohms. A slide switch selects high or low resistance ranges. The IN-12 is housed in an attractive bakelite case for high insulation properties. Measures only 5 $\frac{3}{8}$ " L x 3 $\frac{1}{8}$ " W x 3" H. Entire kit is priced lower than the retail value of the resistors alone. 2 lbs.

Kit IN-12 **\$5.95**



IN-12
\$5⁹⁵

Quick Selection of Most Popular Condenser Values . . . CONDENSER SUBSTITUTION BOX KIT

Substitution tests in servicing are easily accomplished with this handy kit where an open or shorted condenser is suspected. An 18-position panel switch provides individual selection of any one of 18 popular E.I.A. standard condenser values ranging from 0.0001 mfd to 0.22 mfd. All capacitors are rated at 600 volts except the three smallest which are rated at 500 working volts and the two largest which are rated at 400 volts. Capacitors are silver-mica and molded tubular types of high quality. Flexible 18" test leads with alligator clips are furnished for easy connection to circuit under test. All capacitor values are clearly screened on the attractive three-color front panel for easy identification. Housed in sturdy bakelite case. 5 $\frac{3}{8}$ " L x 3 $\frac{1}{8}$ " W x 3" H. 2 lbs.

Kit IN-22 **\$5.50**



IN-22
\$5⁵⁰

Heathkit IMPEDANCE BRIDGE KIT

- Four popular bridges in one convenient instrument
- Battery type tubes—no warmup required
- Built-in phase shift generator and detector amplifier
- ½ % precision resistors and silver mica condensers
- Slanted control panel for easy reading of all measurements

Four popular laboratory-type bridge circuits are combined in this easy to use instrument.

The Wheatstone bridge for resistance measurements, the Capacity Comparison bridge for capacity measurements, Maxwell bridge for low Q, and Hay bridge for high Q measurements. The entire unit is self-contained and designed for rapid, accurate measurement of resistance, capacitance, inductance, dissipation factors of condensers and the storage factor of inductors. Panel controls are separate as to their function and clearly identified. A two-section CRL dial provides ten separate "units" switch-settings. Fractions of units are read on a continuously variable calibrated wire wound control. D, Q, and DQ functions are all combined on one shaft to provide single knob operation, eliminating confusion or incorrect dial settings. Battery-type tubes eliminate time-consuming warmup periods and minimize changes in operating characteristics due to thermal effects. The budget price of this feature-packed instrument puts it within easy reach of the service technician, radio amateur or home experimenter. 10 lbs.

Kit IB-2A . . . no money down, \$7 mo. **\$69.95**

SPECIFICATIONS—Circuit: 4-arm impedance bridge. **DC Measurements:** Built-in power supply. Binding posts provided for external supply. **Meter:** 100-0-100 microampere meter. **AC Measurements:** Built-in 1000 cycle generator. Terminals on panel for external generator at other frequencies. **Detector:** Vacuum tube detector and amplifier, using built-in meter. Terminals provided for external detector. **Resistance:** 0.1 ohm to 10 megohm. **Capacitance:** 100 mmf to 100 mfd. **Inductance:** 0.1 mh to 100 h. **Dissipation factor:** (D): 0.002 to 1. **Storage factor:** (Q) 0.1 to 1000. **Accuracy:** ½ % decade resistors used. **Tube complement:** (2) 1U4, (2) 1L4. **Power supply:** Transformer and selenium rectifier. **Power requirements:** 105-125 V, 50/60 cycles AC, 10 watts. **Dimensions:** 8" H x 17" W x 6" D.

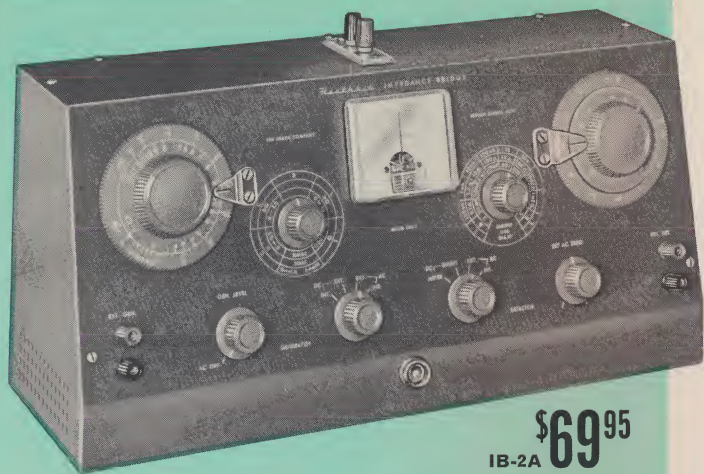

\$69.95
IB-2A

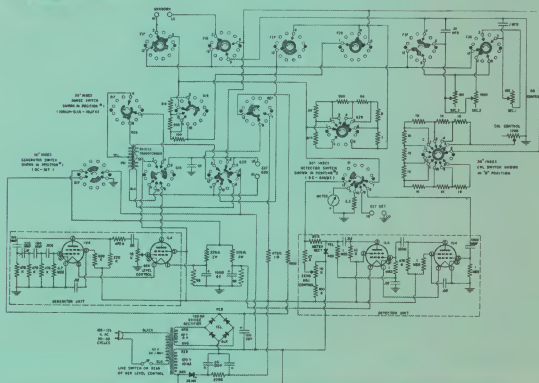

For fast easy Alignment of FM Tuners and Receivers . . . Heathkit FM ALIGNMENT GENERATOR

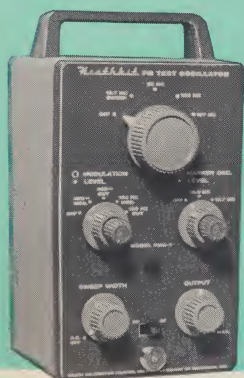

- Variable 10.7 mc sweep, 200 kc to over 1 mc
- Switch selection of 90, 100, & 107 mc signals
- 100 kc bandwidth markers for checking bandpass
- Neat, compact, easy to build and operate

\$34.95
FMO-1

This FM alignment generator, in a single, compact unit, provides all the essential generator facilities for fast, easy alignment of FM tuners and receivers. Unique circuit design provides 10.7 mc sweep (variable from 200 kc to over 1 mc) with crystal controlled center marker and 100 kc sub-markers for IF alignment. Convenient switch selection of 90, 100 and 107 mc signals permit fast, easy alignment and checks of dial calibration. Accuracy of alignment is assured by a built-in 10 mc crystal-controlled oscillator which is used with the 10.7 mc crystal in the initial calibration of the instrument. An internally generated 400 cycle tone may be used to modulate the RF signal or to check receiver audio circuitry. Test leads included. 4 lbs.

Kit FMO-1 . . . no money down, \$5 mo. **\$34.95**

SPECIFICATIONS—Output frequencies... for RF alignment: 90, 100 and 107 mc, switch-selected. **Modulation:** 400 cycle incidental FM. **For IF and detector alignment:** 10.7 mc sweep. **Sweep width:** 200 kc to over 1 mc. **Markers:** 10.7 mc (crystal); 100 kc sub-markers. **Modulation:** 400 cycle AM. **For other applications:** 10.0 mc (crystal) and harmonics; 100 kc and 400 cycle audio. **Tube complement:** (2) 6UB. **Power supply:** Transformer, selenium rectifier. **Power requirements:** 105-125 V, 50/60 cycle, 12 watts. **Cabinet size:** 7½" H x 4¾" W x 4¾" D.

Heathkit "Q" Meter . . . High Accuracy at low cost!

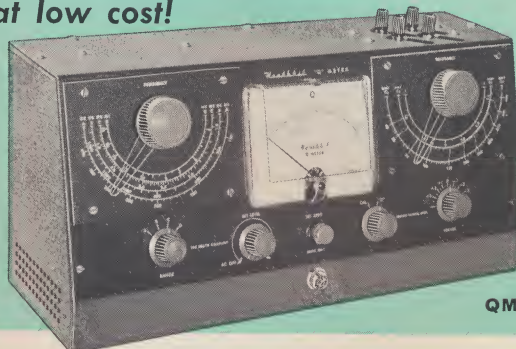

\$54.95
QM-1

- Tests components at operating frequency—150 kc to 18 mc
- Large 4½" 50 ua meter—easy to read dial scales
- Measures Q, L, and distributed capacity of coils
- No special alignment equipment required—test coil furnished
- Metered oscillator output for constant injection

A time and labor saving instrument for service shops and labs!

With this high quality "Q" meter on your workbench, you can test coils, condensers, chokes, etc., under actual operating conditions. You can determine values of unknown condensers, both fixed and variable . . . compile data for coil winding purposes . . . and determine distributed capacity and Q of coils. The wide range of inductance, capacitance and "Q" values measurable with the QM-1 will cover practically all values encountered. Q values are read directly on a large 4½", 50 microampere meter. Oscillator output is metered for proper injection level and provides wide frequency coverage on four bands. The power supply is transformer operated and voltage regulated for high stability. 14 lbs.

Kit QM-1 . . . no money down, \$6 mo. **\$54.95**

SPECIFICATIONS—Frequency: 150 kc to 18 mc in four bands. **Inductance:** 1 microhenry to 10 millihenrys. "Q": 250 full scale x1 or x2. **Capacitance:** Actual, 40 mmf to 450 mmf; Effective, 40 mmf to 400 mmf; Vernier ± 3 mmf. **Tubes:** (1) 12AT7, (1) 6AL5, (1) 12AU7, (1) 6X5, (1) OD3/VR150. **Power requirements:** 105-125 volts, 50/60 cycles AC, 30 watts. **Dimensions:** 8" H x 17" W x 6" D.

For Dependability, for Economy . .

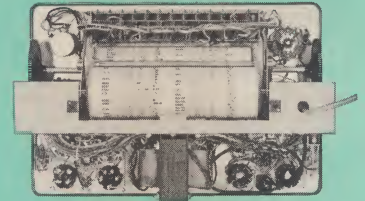

SPECIAL ROLL CHART MECHANISM: Spring-loaded chart rollers keep chart taut at all times for easy reading of tube data. Runs freely throughout entire length.

IT-21
\$44⁹⁵

- Latest design features and professional styling
- Tests all tube types including new Compactron, Nuovistor, Novar and 10-pin miniatures

- Multi-colored "bad-?-good" meter scale
- Constant tension, free-rolling roll chart mechanism
- Color-coded wiring harness for easy assembly

Eliminate guesswork . . . Check tubes fast with this New Heathkit TUBE CHECKER

No test bench is complete without a reliable tube checker! Tube failure accounts for almost 90% of all difficulties experienced in electronic circuits, and good service practices call for an immediate check of tube quality and performance before further circuit investigations are attempted.

This modern up-to-date tube checker will test all tube types encountered in everyday radio and TV servicing, including the new compactron, novar, nuovistor and 10-pin miniatures. Tubes are tested for quality on the basis of total emission, and for shorts, leakage, open elements and filament continuity. Tube quality is read on a multi-colored "Bad-?-Good" meter scale and a neon bulb indicator shows filament circuit continuity and leakage or shorts between elements.

Flexible overall operation is made possible by the use of multiple filament voltages, adjustable cathode current, variable meter sensitivity and individual tube element switching. Thirteen 3-position lever switches allow checking each tube element individually for open or short conditions and protect against obsolescence.

The specially designed roll chart mechanism features smooth free-rolling action and is spring loaded to keep the chart taut at all times for easy reading of all tube setup data. Roll chart and meter . . . are illuminated to facilitate reading in darkened areas. A thumbwheel drive knob on each side of the panel permits either hand operation of the roll chart. Test data for all currently used tube types are listed on the roll chart. Uncommon or seldom used tube types are listed on a separate supplement included with the kit. Information on all new tube types will be furnished automatically in supplement form for the remainder of the present calendar year to all Heathkit tube checker purchasers to further assure latest up-to-date information and testing facilities.

Proper test conditions are maintained through the use of a line-adjust control which compensates for differences in loading and AC line voltage. The compact size of the IT-21 with convenient carrying handle makes it ideal for portable use as well as on the test bench.

Neat, professional wiring and simplified construction of the tube checker is assured by a color-coded wiring harness and easy to follow instructions. Equip your service bench with reliable tube testing facilities with the Heathkit IT-21 . . . its handsome styling, fine performance and low cost make it an exceptionally fine value in dependable test facilities. 11 lbs.

Kit IT-21 . . . no money down, \$5 mo. \$44.95

SPECIFICATIONS—Tests: Emission, short, leakage, open element, filament continuity. **Sockets:** 4-pin, 5-pin, 6-pin, 7-pin large and pilot light, 7-pin miniature, octal, loctal, 10-pin miniature, 9-pin novar, 12-pin compactron, 5-pin nuovistor, 7-pin nuovistor. **Meter:** 1 ma, BAD-?-GOOD scale, illuminated. **Line voltage adjustment:** Step type. **Roll chart mechanism:** Constant tension, free-rolling, thumb-wheel operation, illuminated. **Filament voltage:** .63, 1.4, 2, 2.35, 2.5, 3.15, 4.2, 4.7, 5, 6.3, 7.5, 9.45, 12.6, 19.6, 25, 32, 50, 70, 110 V AC. **Element test voltages:** 30, 100, 250 V AC. **Power requirements:** 105-125 V AC, 50/60 cycles. **Dimensions:** 5½" x 8½" x 13".

TUBE DATA SUBSCRIPTION SERVICE

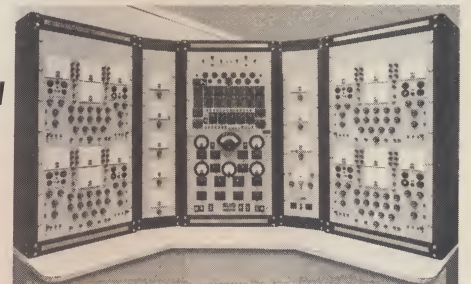

The unique tube data console above, developed by Heath engineers, is designed to provide accurate up-to-date information on all new tube types as they are developed. All new test data will be printed in supplement form every three months and sent to all subscribers. At the end of the year subscribers will receive a new roll-chart incorporating all new data previously published in supplement form. Free subscriptions are entered for each new Heathkit tube checker purchaser, terminating the following January 1, at which time a new roll chart and renewal notice will be sent.

Subscription rates are \$2.50 per year on the TT-1A type testers, \$1.50 per year for IT-21 and TC type checkers. If you own a Heathkit tube checker, send model number of your checker along with remittance . . . proper supplements and roll chart will be sent automatically. Enter your order for this valuable service today!

Equip with a Heathkit® Tube Tester



- Built-in adapter for testing new Compactron, Nuvistor, Novar and 10-pin miniature tube types
- Indicates Gm to 24,000 micromhos
- Ultra-sensitive grid current test
- Direct reading ohmmeter leakage test
- Built-in switch operated calibration circuit
- Constant current heater supplies



BUILT-IN CALIBRATION CIRCUIT: The switch-operated calibration circuit shown center foreground assures continued high accuracy. Note the rugged mechanical design and neat wiring achieved through cabled wiring harnesses.

TT-1A
\$149⁹⁵

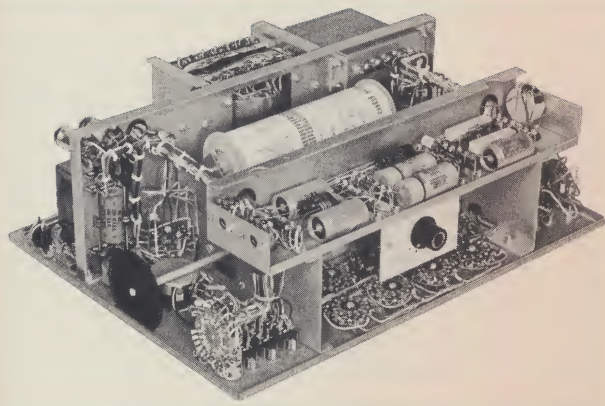

MUTUAL CONDUCTANCE TUBE TESTER . . . Deluxe features at low cost

COMPARE THIS PROFESSIONAL TUBE TESTER FOR VERSATILITY AND VALUE. This handsomely-styled instrument with its neat, functional panel layout provides for maximum operating convenience. Versatile switching facilities accommodate present tube types and allow adding future tube types as they become available to protect against obsolescence. The TT-1A will provide quick and accurate checks of transconductance and grid current in multi-element tubes and will also check diodes, rectifiers, voltage regulators, low-power thyratrons and electron eye-tubes. The adapter housed in the cabinet lid provides test facilities for new Compactron, Nuvistor, Novar, and 10-pin miniature tubes.

In transconductance test, mutual conductance values are read on the illuminated meter scale from 0 to 3,000 micro-mhos. Multipliers are used to accommodate Gm values above 3,000. The extremely sensitive circuit used in grid current testing will indicate as little as 1/4 micro-ampere and will often indicate a "reject" after the transconductance circuit has labeled it "O.K." This test is of particular value to servicemen as grid current is often the cause of malfunctioning TV circuits. The grid current circuit of the TT-1A tests for all three common causes of grid current: gas, leakage from grid to other elements, and grid contamination (grid emission).

Diode and rectifier tubes are tested on the basis of total cathode emission. In testing voltage regulator tubes, an independent, built-in variable DC power supply is used and direct reading voltage indications are given on the meter.

Other outstanding features to be found in the TT-1A include: a Constant Current Heater Supply which protects the tester from obsolescence by supplying the correct voltage for any tube types drawing 300 ma, 450 ma or 600 ma; a Life Test, which reduces the heater voltage of the tube under test by 10%, thus giving an estimate of its future life; a "Hybrid test," which not only provides a special low voltage plate supply for testing hybrid auto radio tubes, but also features an additional DC supply for the space charge grid permitting mutual conductance tests of space tubes in the usual manner; a direct

reading Leakage Testing Circuit; and a built-in switch-operated Calibration Circuit, eliminating the need for any standardized tubes, voltmeters or extraneous instruments of any kind. A Disconnect Switch removes all voltage potentials from the selector switches, protecting both tubes and tester from possible damage during switching. "Cathode buss," "Plate buss," and "Grid buss" switches allow the operator to test both sections of a twin triode individually with only one group of selector switch settings. Individual Selector Switches allow testing any tube, regardless of base pin arrangements. Other "service designed" features are: an illuminated roll chart with thumbwheel drive at each side, removable line cord, and 110 V AC outlet.

The beautifully written construction manual supported by detailed pictorial diagrams, seven color-coded wiring harnesses and transformer terminal board have reduced the highly complex circuitry of the TT-1A to an easy-to-build level. Average construction time by technicians is 40 hours. Unit is housed in an attractive black leatherette case with white trim, nylon feet and removable top. 32 lbs.

Kit TT-1A . . . no money down, \$14 mo. **\$149.95**

Adapter Kit TTA-1-1: Converts earlier model TT-1 to TT-1A.

Includes adapter and new cabinet. 13 lbs. **\$19.95**

SPECIFICATIONS—Power requirements—Voltage: 105-125, 60 cycle AC. **Watts:** 10-60 (dependent upon tube under test). **Plate supply:** (SILICON RECTIFIERS). **DC volts:** 26, 90, 135, 225 + variable 80 to 200 (Separate DC supply for space charge grids). **AC volts:** 20, 45, 177. **Bias supply:** (SILICON RECTIFIER). **Low range:** 0 to negative 5 volts DC. **High range:** 0 to negative 20 volts DC. **Signal voltages:** 2, 1, .5, .25 volts AC 5000 cycles. **Filament supply voltage:** .65, 1.1, 1.5, 2, 2.5, 3.3, 5, 6.3, 7.5, 10, 13, 20, 27.5, 35, 47, 70 and 115. Currents: 300, 450, 600 ma. (Note: Filament voltage is reduced 10% during life test). **Testing circuits GM:** (Mutual conductance-amplifiers) 0-24,000 micro-mhos. **Emission:** Rectifiers and diodes. **Leakage:** Direct reading ohmmeter. **Grid current:** 1/4 microampere sensitivity. **Voltage regulators:** Firing voltage and regulation tolerance. **Low power thyratrons:** Grid characteristics, conduction capabilities. **Eye tubes:** Control grid characteristics. **Meter AC:** 1000 ohms/volt (1 volt full scale). **DC:** 89 ma full scale. **Scales:** GM: 0-3000 micromhos. VR test volts: 0-200 volts. Leakage: 0-10 megohms. Diodes O.K. Rectifiers O.K. Line check arrow at midscale. **Tube complement:** (1) 3A4 oscillator, (1) 12AV6 meter control. **Calibration circuit:** Built-in switch operated. **Socket accommodations:** 4-pin, 5-pin, 6-pin, 7-pin combination and pilot light, 5 & 7-pin nuvistor, 7-pin miniature, 7-pin sub-miniature, 8-pin sub-miniature, octal, loctal, 9-pin miniature, 9-pin, Novar, ten-pin miniature, 12-pin Compactron. **Line voltage adjustment:** Continuously variable. **Roll chart mechanism:** Constant tension, free rolling, thumbwheel operated, illuminated. **Dimensions:** Cabinet (outside): 17 3/4" W x 13 1/2" H x 7 1/2" D. **Panel and chassis:** 17" W x 12 3/4" H x 5 1/2" D.

Enjoy Your Heathkit Equipment While You Buy On Heath's Easier Time-Pay Plan—No Money Down

EASY TO BUILD

Printed circuit board construction—fast, easy with stability and uniformity assured.

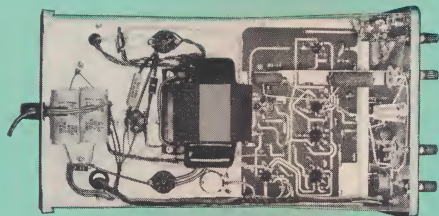

"Extra-Duty" Wide Band 5" Oscilloscope
... professional styling and features at low cost!

Here is an oscilloscope that will fulfill practically every lab or service requirement. Critical waveform observations are handled easily, with clear, sharp pattern displays in every application. Excellent linearity and lock-in characteristics allow viewing stable waveform presentations even at upper frequency limits. The unique Heath patented sweep circuit employed in this scope functions from 10 cps to over 500kc giving you five times the sweep range of most other scopes. This feature, coupled with the wide band amplifiers, essential in color TV work, make it ideal for general and specialized circuit investigations. Two extra, switch-selected, preset sweep frequency positions are provided for those who use certain frequencies repeatedly. Other features include push-pull output amplifiers, positive trace position controls, peak-to-peak calibration reference, 3-step frequency compensated vertical input, automatic sync circuit, Z-axis input, 5U1 CR tube, husky power supply, and a fresh, new styling concept. A superbly engineered instrument designed for years of fine performance. 23 lbs.

Kit IO-12 . . . no money down, \$8 mo. **\$76.95**
EF-2-4 includes IO-12 and EF-2 applications course, p. 31 . . . **\$84.95**

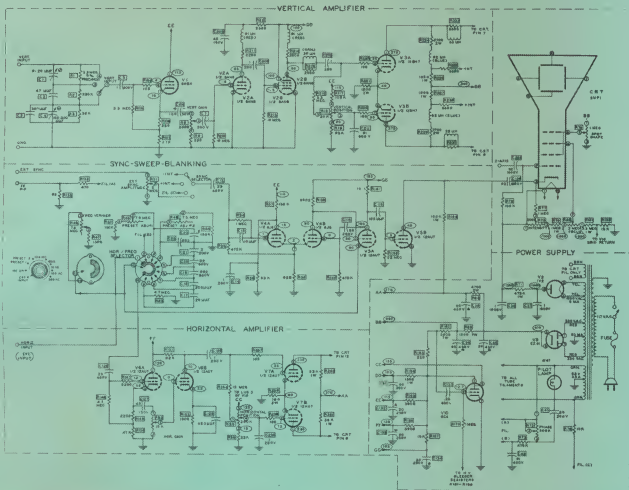

- Full 5 mc bandwidth for color TV servicing
- Push-pull horizontal and vertical amplifiers
- Heath patented sweep circuit—10 cps to 500 kc
- Switch-selection of 2 "preset" sweep frequencies
- 2 circuit boards and wiring harness for easy assembly
- Successor to famous IO-30 Scope

\$76⁹⁵
10-12

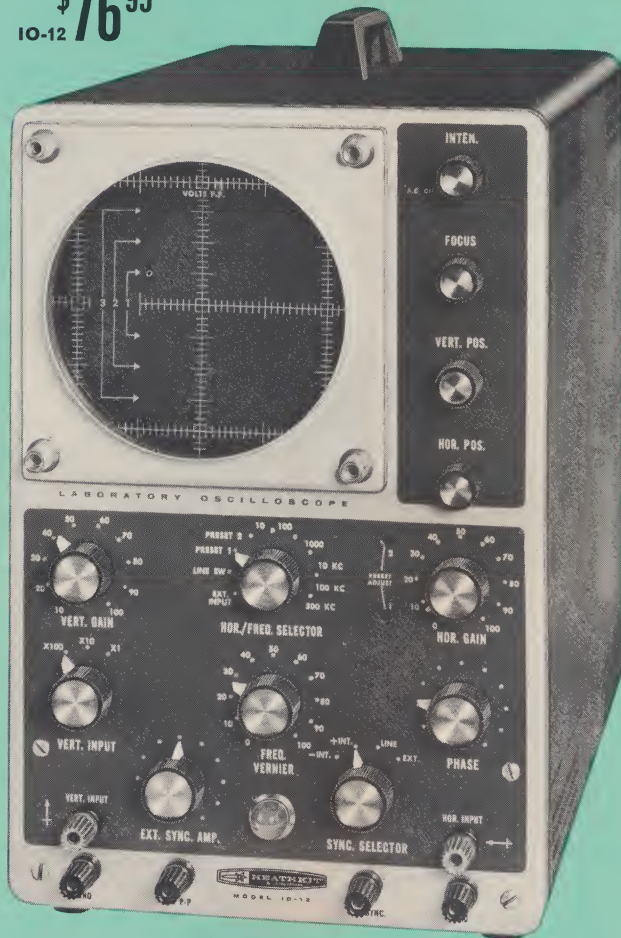

SPECIFICATIONS—(Vertical channel) sensitivity: 0.025 volt RMS per inch at 1 kc. **Frequency response (referred to 1 kc level):** ±1 db 8 cps to 2.5 mc; +1.5 to -5 db, 3 cps to 5 mc; response at 3.58 mc, -2.2 db. **Rise time:** 0.08 microseconds or less. **Input impedance:** (AT 1 KC) 2.7 megohms at X1; 3.3 megohms at X10 and X100. **(Horizontal channel) sensitivity:** 0.3 volts RMS per inch at 1 kc. **Frequency response:** ±1 db 1 cps to 200 kc; ±3 db 1 cps to 400 kc. **Input impedance:** 4.9 megohms at 1 kc. **Sweep generator:** Range 10 cps to 500 kc in five steps, variable, plus any 2 switch-selected preset sweep frequencies in this range. **Synchronizing:** automatic lock-in circuit using self-limiting synchronizing cathode follower. **Power requirements:** 105-125 volts 50/60 cycles AC at 80 watts; fused. **Dimensions:** 14 1/2" H. x 8 3/4" W. x 16" D.

**ORDER ANY HEATHKIT INSTRUMENT NOW . . .
PAY FOR IT IN EASY MONTHLY INSTALLMENTS**

Liberal credit terms now available at Heath let you order the kit or kits you need now! . . . no money down . . . up to 18 months to pay on any order amount of \$25.00 to \$600.00. Just fill out the form supplied on the handy order blank, list the kit or kits you want on the reverse side and mail to the Heath Co. Monthly payments are shown on the time payment chart. Once your credit is established you can Add-on purchases of \$25.00 or more with no down payment. Enjoy the savings of do-it-yourself kit construction now!

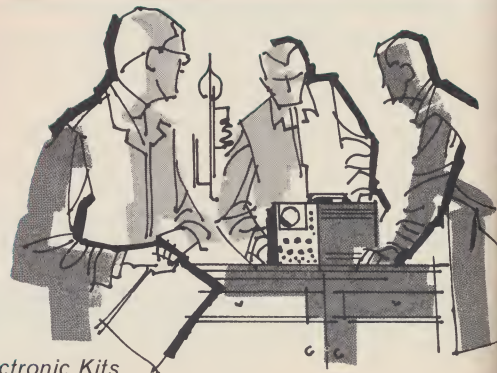

Heathkit—World Famous For Better Quality, Better Value Electronic Kits

for Every Testing Requirement, Every Budget



IO-21
\$49⁹⁵

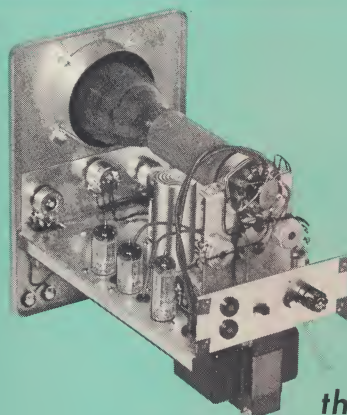

CONVENTIONAL CONSTRUCTION

Neat, open circuit layout is easy to assemble. Note big power transformers and CRT neck shield—examples of Heath's quality parts.

No finer scope at this price anywhere! . . .

GENERAL PURPOSE 3" OSCILLOSCOPE

- Push-pull vertical and horizontal amplifiers
- Wide-range sweep generator—20 to 100,000 cps
- Automatic sync—retrace blanking
- Clean, open circuit layout for easy, trouble-free assembly
- Compact design—light weight and portable for service work
- Access to vertical deflection plates—ideal for transmitter modulation monitoring

This amazing 3" oscilloscope is compact, lightweight, and surprisingly versatile in performance . . . fills hundreds of daily requirements in servicing. Ideal for home workshop, ham shack, or as an extra scope for all-around use. Its low cost makes it ideal for students or beginners just getting started in electronics.

The exceptionally clean, open circuit layout of this scope makes assembly easy, trouble-free. All parts are neatly arranged on the shallow chassis, eliminating cramped and hard-to-get-at-corners. Parts are easily identified and of highest quality throughout for long and dependable service life.

Circuit design features include identical vertical and horizontal amplifiers with a frequency response of ± 2 db from 2 cps to 200 kc, more than adequate for all general circuit investigations encountered in servicing. Sensitivity is .25 volts RMS/inch peak-to-peak deflection at 1 kc with an input impedance of 10 megohms shunted by 20 uuf. Provision is made for direct connection to the vertical deflection plates of the cathode ray tube . . . ideal for transmitter modulation monitoring. The Heath twin-triode sweep generator employed in this scope functions reliably from 20 to 100,000 cps in four switch-selected ranges with automatic sync and retrace blanking. Provision is made for line sweep and external or internal sweep. Other features include: a 3RP1 CR tube with special alloy neck shield to minimize the effects of extraneous fields; focus and astigmatism controls to assure a sharp, fine trace, and a husky power transformer. Power supply is fused for protection. All these desirable features make the IO-21 an unbeatable value! 14 lbs.

Kit IO-21 . . . no money down, \$5 mo. **\$49.95**
EF-2-3 includes IO-21 and EF-2 applications course, p. 31. . . . **\$57.95**

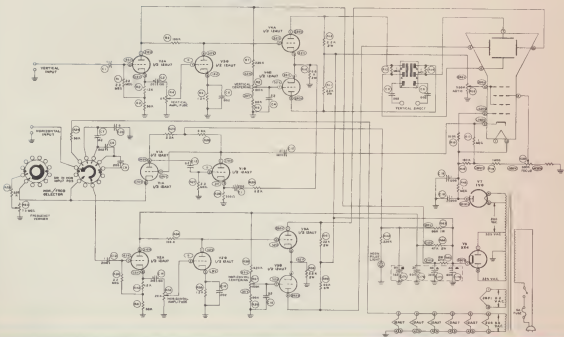

SPECIFICATIONS—(Vertical and horizontal amplifiers identical): Frequency response: ± 2 db, 2 cps to 200 kc. Sensitivity: .25 volts RMS/inch P-P deflection at 1 kc. Input impedance: 10 megohms shunted by 20 uuf. (Direct connection to vertical CRT plates on rear panel). Sweep generator: Range, 20-100,000 cps. Automatic sync, retrace blanking. Tube complement: (1) 3RP1 CR tube, (4) 12AU7 (deflection amplifiers), (1) 12AX7 (sweep generator), 6X4 (LV rectifier) (1) 1V2 (HV rectifier). Controls: Gain controls, Horizontal & Vertical; Centering controls, Horizontal & Vertical; Frequency Vernier; Horizontal Input, Sweep Range switch, (Focus and Astigmatism controls mounted on chassis). Power requirements: 105-125 volts AC, 50-60 cycle, 40 watts. Dimensions: 9½" H. x 6½" W. x 10" D.

Extend scope applications with this ELECTRONIC SWITCH KIT

Oscilloscope owners can extend the usefulness of their scope with this electronic switch. It permits simultaneous observation of two separate signals, such as input and output of amplifiers, for comparison purposes or stage gain measurements, etc. Both signals are reproduced alternately at the output at any one of four switching rates provided. Separate gain controls are provided for each channel with sync output to lock scope sweep or time base to the signal frequency. The two traces on the scope may be separated or superimposed on each other with the position control provided. The electronic switch functions at signal levels as low as 0.1 volt. Frequency response is ± 1 db, from 0 to 100 kc. Easy to use with complete instructions supplied. Measures 9½" W x 6½" H x 5" D. Operates on 105-125 volts, 50/60 cycle AC. 6 lbs.

Kit ID-22 **\$23.95**



ID-22
\$23⁹⁵

Look To Heath For The Newest, The Finest in Electronic Kits

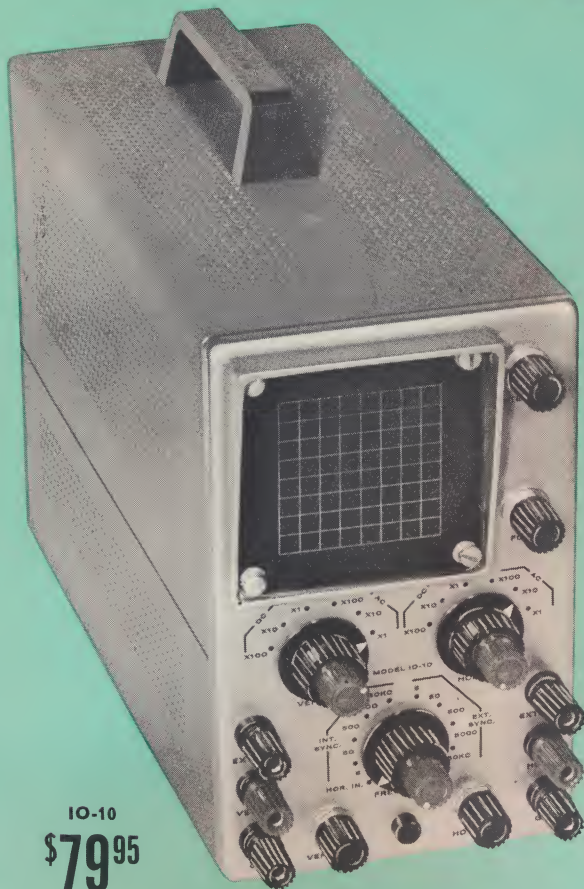

IO-10
\$79⁹⁵

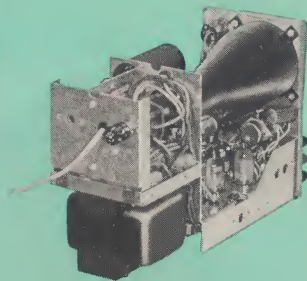

EXPECT FINE PERFORMANCE
This excellent 'scope has the capability and quality to deliver it. Note the special alloy CRT shield for minimum trace distortion—sectionalized chassis for better shielding—big power transformer for long life.

**"Space Saver" 3" DC OSCILLOSCOPE . . .
Small, Compact, Easy to Carry . . . Provides
Extremely Low Sweep Rates!**

- Identical vertical and horizontal DC or AC coupled amplifiers
- DC to 200 kc bandwidth—less than 5° phase shift
- Recurrent sweep generator, 5 cps to 50 kc in four ranges
- External capacitor binding posts for slower sweep rates
- Measures only 7 $\frac{1}{8}$ " H x 4 $\frac{5}{8}$ " W x 11" D.

If you need an oscilloscope that is versatile, capable of extremely low sweep rates, and easy to carry from job to job away from the test bench you'll find them all in the Heathkit IO-10! This beautifully designed, instrument requires only a fraction of the space occupied by scopes of comparable function, yet offers high versatility and fine performance characteristics for countless applications in industrial, medical and general service fields.

Equally useful in AC or DC applications, the IO-10 features identical vertical and horizontal amplifiers with a bandwidth of DC to 200 kc (2 db point) that may be either AC or DC coupled. The recurrent sweep generator covers 5 cps to 50 kc in four overlapping ranges. Lower sweep rates may be obtained by connecting a capacitor across the external binding posts provided. Selection of internal or external sync is available at the turn of a switch. A 3-position compensated input attenuator and continuously variable gain control in each channel allow smooth control of waveform display. Trace distortion due to magnetic fields is minimized through the use of a special alloy CR tube shield. An astigmatism control is provided to assure a sharp trace. The low relative phase shift of less than 5° between channels makes the IO-10 ideally suited to such applications as a readout indicator for computers, or for phase shift measurements. All critical voltages are regulated and the power supply is transformer operated for safety and high efficiency.

Kit is complete with 3RP1 CR tube. An outstanding array of features, coupled with low cost and versatility, make the IO-10 a scope you will be proud to own and use. 14 lbs.

Kit IO-10 . . . no money down, \$8 mo. **\$79.95**

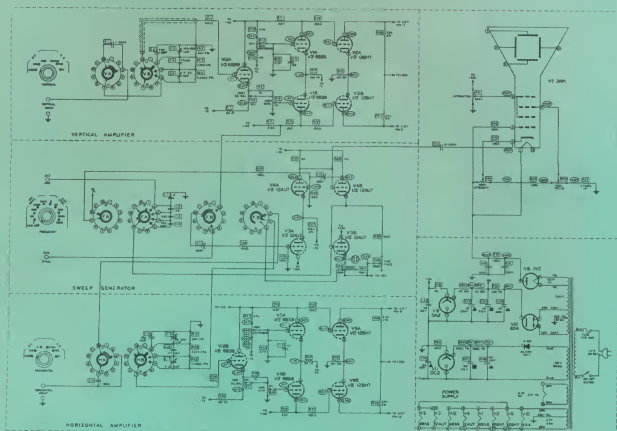

SPECIFICATIONS—(Vertical and horizontal channels identical): Bandwidth: DC to 200 kc (2 db point). **Sensitivity:** 0.1 V (peak-to-peak) per $\frac{1}{4}$ " (uncalibrated). **Attenuator:** 3-position, compensated type. **Gain control:** Continuously variable. **Input impedance:** 3.6 megohms shunted by 35 mmf. **Coupling:** Either AC or DC, switch-selected. **Relative phase shift between channels:** Less than 5°. **Sweep generator (recurrent type):** Linear saw-toothed produced by multivibrator type generator covering 5 cps to 50 kc in four overlapping ranges. "External capacity" binding post for lower sweep rates. **Sync provision:** Either internal or external, switch-selected. **Power requirements:** 105-125 V 50-60 cycle AC at 100 watts max. **Dimensions:** 7 $\frac{1}{8}$ " H x 4 $\frac{5}{8}$ " W x 11" D.

**Scope Demodulator
PROBE KIT . . . extends
scope use**

337-C **\$3⁵⁰**



This demodulator probe permits scope observation of modulation waveform of RF and IF signals. Functions as an AM detector to pass only modulation of signal and not the signal itself. Voltage limits are 30 V RMS and 500 V DC. Useful in all types of radio and TV servicing. 1 lb.

Kit 337-C **\$3.50**

**Low Capacity PROBE
KIT . . . reduces
circuit loading**

PK-1 **\$4⁹⁵**

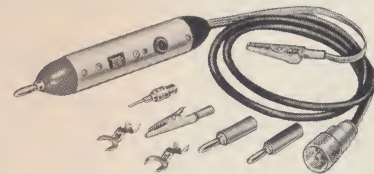

An essential scope accessory for high frequency work. Minimizes loss of gain, circuit loading or distortion caused by overloading of scope. Switch on probe allows direct or X10 attenuated operation. A variable capacitor permits adjustment to match scope input. 1 lb.

Kit PK-1 **\$4.95**

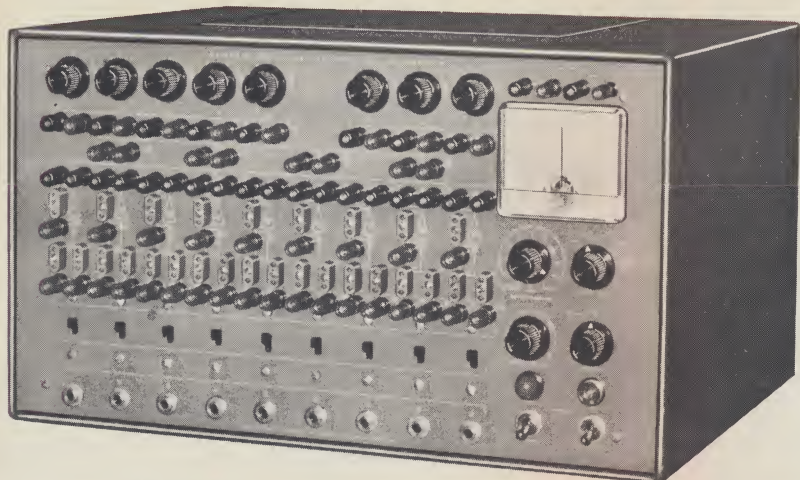

\$199⁹⁵
EC-1

CLEAN CHASSIS LAYOUT

Note the nine operational amplifiers, front panel component wiring, and power supplies—open, neat layout for easy wiring.

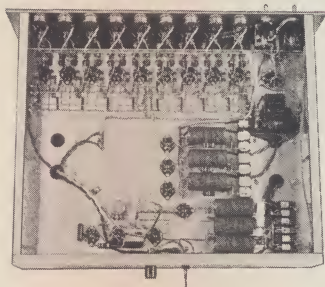

Low Cost Heathkit EDUCATIONAL ANALOG COMPUTER KIT . . . Ideal for Teaching, Demonstrating! . . . Unmatched in Value!

The Heathkit model EC-1 is the lowest cost analog computer of its quality on the market! Used widely in industry and in educational institutions, the EC-1 is capable of solving a multitude of complex mechanical and mathematical problems with swift electronic accuracy. Many industries are now using this versatile computer to train computer operators and engineers. Schools and colleges find it ideal for teaching engineering, physics and mathematics. Knowledge of basic principles of analog computer application are easily obtained in using the instrument and computer design knowledge is enhanced through familiarity with the EC-1 circuitry.

Completely self-contained, the EC-1 features nine DC operational amplifiers with provision for balancing without removing problem setup. It also features three initial condition power supplies, five coefficient potentiometers, four sets of relay contacts, an electronically regulated power supply and a built-in repetitive oscillator for automatic operation. Included with the kit is an assortment of precision resistors, capacitors, special silicon diodes, and patch cords for setting up scores of complex computer problems. All components are mounted on plugs for convenient and rapid insertion in the problem-board sockets. All panel markings and symbols are standard computer type.

Problem results are read directly from the panel meter and provision is made for measuring results with an external read-out device such as a DC oscilloscope, pen recorder, etc.

The Heathkit Educational Analog Computer is ideally suited for assembly by students and newcomers to the world of computers. The chassis layout is clean and wide open allowing the beginner to construct the instrument quickly and easily following the famous Heathkit "check-by-step" instructions and clearly illustrated pictorial diagrams. The informative manual supplied with the kit illustrates operating procedures and basic computer information as well as showing how to set up and solve typical problems.

A handsome rugged steel case with convenient access hatch houses the computer and measures only 19 3/4" W x 11 1/2" H x 15" D. The specially designed, heavy-duty chassis and ruggedly-braced front panel permits firm mounting of the computer in a standard relay rack if so desired.

The economical low cost of the Heathkit EC-1, coupled with its obvious quality and versatility, make it one of the greatest buys ever offered by the Heath Company. In this day of increasing use of analog computers, the EC-1 can be your first step in obtaining a practical working knowledge of this fascinating field. 43 lbs.

Kit EC-1 . . . no money down, \$19 mo. \$199.95

SPECIFICATIONS—Amplifiers: Open loop gain approximately 1000. Output —60 +60 volts at .7 ma. **Power supplies:** ±300 volts at 25 ma electronically regulated; variable from +250 to +350 by control with meter reference for setting +300 volts. Negative 150 volts at 40 ma regulated by VR tube. **Repetitive operation:** Multivibrator cycles a relay at adjustable rates (.1 to 15 cps), to repeat the solution any number of times; permits observation of effect on solution of changing parameters. **Meter:** 50-0-50 ua movement. **Power requirements:** 105-125 volts, 50/60 cycles, 100 watts.

**Advanced Computer Facilities at Budget Cost!
ELECTRONIC ANALOG COMPUTER KIT (ES-Series)**



Model ES-2
Amplifier Power Supply

GROUP C

\$945⁰⁰

Model ES-401
Voltage Regulator Transformer

Model ES-201
DC Operational Amplifier

Model ES-600
Function Generator

SEND FOR FREE FOLDER . . . for complete computer story. Explains groups and function of each unit in the group, and prices.



Keeping pace with "space-age" requirements in business and industry, the Heathkit ES-Series computer provides an advanced electronic slide-rule for simulating and solving design problems in automotive, missile, aircraft, nuclear, and dozens of other fields. Typical problems solved by the computer relate to mechanical vibration and oscillation, dynamic heat transfer, automotive suspension systems, aircraft and missile stability and control, fluid flow, simulation of nuclear reactors, rigid body dynamics, and many other complex mathematical problems. The ES-series is available in a wide choice of component groups to meet any individual requirement.

Full Component Group C \$945.00

INDIVIDUAL COMPONENTS AVAILABLE:

Model No.	Description	Price
ES 2	Amplifier power supply kit	\$146.50
ES 50	Reference power supply kit	20.95
ES 100	Initial condition power supply kit	20.50
ES 151	Relay power supply kit	10.95
ES 201	Operational amplifier kit	15.50
ES 400	Cabinet kit	317.50
ES 401	Voltage regulator transformer kit	85.95
ES 405	Patch cord kit (contains 12 patch cords)	15.95
ES 447	Coefficient potentiometer kit	26.95
ES 450	Auxiliary coefficient potentiometer kit	74.50
ES 505	Repetitive oscillator kit	17.50
ES 600	Function generator	72.95

Let us prove that you can build a Heathkit®

This easy-to-assemble **TRANSISTOR PORTABLE RADIO KIT** includes a free tool kit...everything you need to build it!

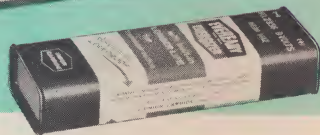

GR-151
\$21⁹⁵

- Powerful 6-transistor, 2-diode circuit
- Big 4" x 6" PM speaker for fine tone
- Easy circuit board assembly
- Attractive long-wearing simulated leather case
- Battery included
- Compares with portables costing \$40 and more

Let us prove that you can build a Heathkit... begin with this outstanding portable radio value. Assembly is simple!... easy to follow instructions and clear pictorial diagrams guarantee your success. All parts mount on a clearly marked circuit board which minimizes the possibility of wiring errors and assures high circuit stability. Coil and I.F. transformers are pre-aligned to exacting factory standards so it is ready to play the moment assembly is completed.

Everything is provided to make this kit as much fun to build as it is to use! Kit includes all parts for radio, a 9-volt battery and all the tools required for assembly. The deluxe 6-transistor superheterodyne receiver features a full-size built-in ferrite rod antenna to pick up distant stations with ease, a large 4" x 6" permanent magnet speaker for amazing tone quality and a special over-load diode for clear, distortion free reception. A single 9-volt cathodic envelope battery pack (included) powers the set 500 to 1000 hours! You'll use this handsome portable everywhere you go!

Kit GR-151, Radio & Tool Set... 5 lbs. **\$21.95**

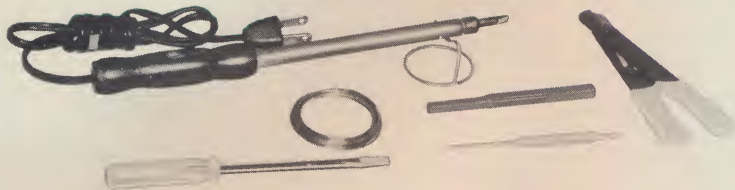

Proper tools make kit building simple



GH-52
\$14⁹⁵

New Heathkit SOLDERING IRON KIT

Designed for maximum performance and versatility, this new soldering iron kit will be your favorite once you've used it. It includes a 6 volt, 25 watt, General Electric midjet-type industrial soldering iron with an ironclad tip which has a long lasting working surface. The power supply is transformer operated and has four switch selected heat ranges (standby-low-medium-high) plus "off" position. The iron can also be connected for high or low line voltage thus effectively giving you a selection of eight heat ranges. The iron is lightweight and small in size making it ideal for working in tight quarters such as circuit boards, yet it has the heating capabilities required for big jobs too! A special clip is provided which holds the iron securely yet allows fast removal or insertion. While in the clip, the iron is shielded by a "cage" to prevent accidental burns. 5 lbs.

Kit GH-52..... **\$14.95**

Weller 8200K Dual-Heat SOLDERING GUN



490-26
\$5⁸³

Save time and get professional soldering results in your kit building with this Weller Soldering Gun. Switches instantly from "high" (140 watts) or "low" (100 watts) with Tigermatic control. Prefocused spotlight illuminates work. Entire kit includes soldering gun, soldering aid, wire cleaning brush, and packet of Kester radio solder. 3 lbs.

Model 490-26..... **\$5.83**

Heathkit BASIC TOOL SET



TK-1
\$9⁹⁵

Provides all the basic tools required to build practically any Heathkit. Kit contains longnose pliers, diagonal sidecutters, two screwdrivers and a 30-watt soldering iron. Pliers and sidecutters are equipped with vinyl insulated handles. All tools are top quality case-hardened steel for rugged duty and long life. Also handy for many repair jobs around the home. 2 lbs.

Model TK-1..... **\$9.95**

490-27
\$6⁴²



Xcelite #137 NUTDRIVER SET

For Heathkit building or "fix-it-yourself" jobs around the house. Seven color-coded nutdrivers in a handy self-supporting rack. Tough plastic handles. Polished alloy steel shanks. Contains the following sizes: 3/16", 1/4", 5/16", 11/32", 3/8", 1/2" and 9/16". Shanks are drilled 1 1/4" deep to allow tightening over long screws. The two largest have hollow shafts for nut installation on controls switches, etc. 3 lbs.

Model 490-27..... **\$6.42**

GH-10
\$19⁹⁵



Heathkit DELUXE TOOL SET

Here is a fine assortment of quality tools that will make your Heathkit building or any fix-it task easy—and fun! Includes: a combination wire stripper & diagonal sidecutter, midjet long nose pliers, three screwdrivers, Weller 8200K dual-heat soldering gun, soldering instruction booklet, solder joint brush, radio solder, 5 nut drivers, nut starter and soldering aid. 6 lbs.

Model GH-10..... **\$19.95**



Superb New Instrument Styling
 The rich, professional styling of Heathkit Test Instruments present a quality, modern attractive appearance on any test bench. Deep charcoal grey panels, high contrast white panel screening with calibration marks in red, large meters and easy-to-read dial scales are all designed for ease of operation. See pages 77 through 97 to fill your every test requirement.



World's Largest CB Line
 Select from many beautifully styled Citizen's Band Transceivers, Walkie-Talkies, Selective-Call Tone Squelch, and accessories. GW-11 opposite, \$69.95. See pages 16 through 21.



High Performance Amateur Radio Equipment
 Enjoy complete Amateur Radio facilities with handsomely styled Heath Amateur Equipment. Operate "Mobile", "Fixed", AM, CW or SSB . . . above HR-20, \$134.50; HX-20, \$199.95. See pages 61 through 76.



Outstanding Values in Marine Gear
 Engineered to excel, yet inexpensive to own through direct-buying and do-it-yourself savings. Depth Sounder, left, \$69.95; 50-watt Radiotelephone, right, \$259.95. See pages 24-27.



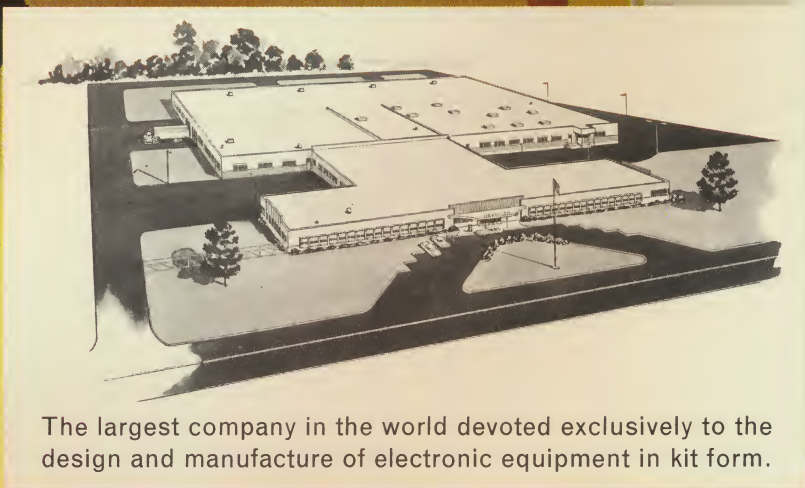

The largest company in the world devoted exclusively to the design and manufacture of electronic equipment in kit form.

All prices quoted are Net F.O.B. Benton Harbor, Michigan, and apply to Continental U.S. and Possessions only! Prices herein effective August 15, 1962. All prices and specifications subject to change without notice.

HEATH COMPANY

A Subsidiary of Daystrom, Inc.

BENTON HARBOR, MICHIGAN

TWX—ST. JOSEPH, MICH. 58

WUX—BENTON HARBOR, MICHIGAN

PHONE • YUKON 3-3961

81/30

CASH
Please use registered mail for currency.

C. O. D.
20% deposit required

TIME PAY.

ADD ON

ORDER BLANK

1 PLEASE PRINT OR WRITE NAME AND ADDRESS PLAINLY

PLEASE DO NOT WRITE IN THIS SPACE

2 SHIP TO ANOTHER ADDRESS? Give directions here.

5 IF YOU HAVE MOVED SINCE YOUR LAST ORDER—
write your old address here:

STREET ADDRESS _____

CITY _____

STATE _____

3 CHECK HOW YOU WANT ORDER SHIPPED

Parcel Post Motor Freight Express

6 TO HELP US SERVE YOU BETTER, will you please answer the following questions?

What type of Heathkit interests you most? Hi FI Instruments

Amateur Radio Marine

Other _____

What new Heathkits would you like us to make? _____

ON EXPRESS ORDERS if station is in different town than your post office address, show name of town where shipment should be sent:

TOWN _____ STATE _____

4 IS THIS YOUR FIRST ORDER? _____ IF PREVIOUS TIME PAY CUSTOMER, GIVE CURRENT ACCOUNT NUMBER _____

SHIPPED	B. ORD'D.	QUANT.	MODEL	KIT DESCRIPTION	WT.	PRICE EACH	TOTAL	
PLEASE DO NOT WRITE IN THIS SPACE ONLY ITEMS IN THIS COLUMN ARE CHARGED FOR	ITEMS LISTED IN THIS COLUMN ARE TEMPORARILY OUT OF STOCK. THEY WILL FOLLOW SHORTLY, UNLESS CANCELLED.							

7 MERCHANDISE ORDERED FROM CAT. NO. _____

DATE SHIPPED		8 Total amount of order.
AMOUNT		
SHPG. CHG.		Amount for parcel post. Do not remit for express charges.
TOTAL		Amount due Heath from previous order.
YOU REMITTED		TOTAL AMOUNT
BAL. DUE		<input type="checkbox"/> DOWN PAYMENT (optional)
REFUND		<input type="checkbox"/> Ship Bal. C.O.D. 20% deposit required
		UNPAID BAL. (total order less down payment)

IMPORTANT. Please use a separate sheet for all correspondence, to speed your order and assure a prompt reply to your letter.

All prices quoted are net F.O.B. Benton Harbor, Michigan, and apply to the United States, F.P.O. and A.P.O. areas.

All prices and specifications subject to change without notice.

Orders from F.P.O.'s and A.P.O.'s must include sufficient postage.

All C.O.D. orders must be accompanied by 20% deposit.

PARCEL POST ORDERS should include postage for weight shown.

TIME PAYMENT ORDERS except A.P.O.'s and F.P.O.'s will be shipped express or motor freight. Transportation costs for all express or motor freight shipments will be collected at the time of delivery.

SEE REVERSE SIDE for time payment details on orders of \$25 or more.

CASH ORDERS. This is the only invoice you will receive, please save for your records.

INVOICE

Open your Heath account with no money down!

LIBERAL TERMS! Time payments are available to anyone in the U.S. or FPO and APO areas. No money down on orders of \$25 to \$600; over \$600 write for details. Up to 18 months to pay on orders over \$300; write for details. Here's all you do . . .

- 1 Fill out the order blank.
- 2 Sign your name in the TP agreement below, fill in the credit statement and the monthly payment. (See Chart) If you wish to send down payment, show this amount also.
- 3 Send the above to Heath Company, Benton Harbor, Michigan . . . we'll take care of the details.

"ADD ON" Purchases—Once your credit is established and you have made at least three payments, you can "add-on" purchases of \$25.00 or more with no down payment. List the items you want on the reverse side, check the "add on" box at the top and give your account number in (4). Be sure to sign the Time Payment Agreement, and send to us with your original Payment Book.

EASY PAYMENT CHART					
Unpaid Balance	Carrying Charge	Up To 12 Monthly Payments*	Unpaid Balance	Carrying Charge	Up To 12 Monthly Payments*
Up to \$20.00	\$ 2	\$ 5	160.01-170	\$ 17	\$ 16
\$ 20.01-30	3	5	170.01-180	18	17
30.01-40	4	5	180.01-190	19	18
40.01-50	5	5	190.01-200	20	19
50.01-60	6	6	200.01-210	21	20
60.01-70	7	7	210.01-220	22	21
70.01-80	8	8	220.01-230	23	22
80.01-90	9	9	230.01-240	24	22
90.01-100	10	10	240.01-250	25	23
100.01-110	11	11	250.01-260	26	24
110.01-120	12	11	260.01-270	27	25
120.01-130	13	12	270.01-280	28	26
130.01-140	14	13	280.01-290	29	27
140.01-150	15	14	290.01-300	30	28
150.01-160	16	15	†Over \$300.00 write for details		

*All monthly payments are for amount shown except for last payment which is for the odd amount remaining due.

TIME PAYMENT AGREEMENT

NOTE: Time payment agreement cannot be accepted from persons under 21 years of age. If you are under 21, have this form filled out by a person of legal age, regularly employed or engaged in business. He can make the purchase for you, and will be responsible for payment.

TO: HEATH COMPANY BENTON HARBOR, MICHIGAN

Enclosed is a deposit of \$_____ (Deposit optional) on the Easy Payment cost of the equipment on the reverse side. I will pay \$_____ each month to you at the above address starting 30 days after shipment, until the total time payment price is paid.

Title to and right of possession of said equipment shall remain with you until all payments have been made. Upon default on any payment due on this contract, the full amount unpaid hereon, at your option, shall become immediately due and payable and you may either hold me liable for said amount or repossess the equipment. If you shall repossess, all payments made may be retained as rent for the use and depreciation of said equipment. The loss, injury or destruction of the equipment after I have received it shall not operate as payment or in any manner release me from any obligation hereunder.

If this order is not accepted, you shall refund the down payment with notice of non-acceptance. Acceptance shall be effected when the equipment designated on the reverse side hereof is shipped to me. I certify that all statements in the Credit Statement set forth below are true and complete and are made for the purpose of obtaining credit. This contract is to be governed by the laws of the State of Michigan.

Enter Date _____ Sign Here _____

CREDIT STATEMENT

(IMPORTANT: Please fill in completely. Omissions and errors cause delays.)

PRINT FULL NAME _____ Age _____ Military Serial No. _____
First Middle Last (if serviceman)

WIFE'S NAME _____ Names of Children and ages _____

Residence _____ City _____ State _____ How Long _____

Own or Buying Landlords If Owned Rent Live with Parents No. of Rooms _____ Paid Monthly \$ _____ Phone No. _____
 Name Mtg. Held By _____ Street _____ City _____ State _____

Previous Address _____ City _____ State _____ How Long _____

Previous Landlord _____ Address _____

Employed by _____ Street _____ City _____ State _____

Position _____ How Long _____ Dept. or Badge No. _____ Salary \$ _____

Previous Employer _____ Street _____ City _____ State _____ How Long _____

Wife's Employer _____ Street _____ City & State _____

Position _____ How Long _____ Dept. or Badge No. _____ Salary \$ _____

Other Income—Give Details _____ Total Family Income \$ _____

Your Bank _____ Address _____ Type of Account _____

CREDIT REFERENCE (Give 2 Merchants, Firms or Finance Companies with whom you do or have done business.)

First Credit Reference _____ Address _____ Present Balance \$ _____ Monthly Payment \$ _____

Second Credit Reference _____ Address _____ Present Balance \$ _____ Monthly Payment \$ _____

Nearest Relative _____ Address _____ Relationship _____
(Do not list those with whom you are living)

8 WAYS EASIER • 8 WAYS BETTER!

1. It's easy to order
 2. No down payment required
 3. Up to 18 months to pay
 4. Make "add on" purchases anytime with no down payment.
 5. Send no money for 30 days—first payment not due until one month after shipment.
 6. You always know your exact balance—no monthly statements
 7. Low, low credit service charges
 8. A personalized account
- IT'S AS EASY AS 1-2-3 TO OPEN YOUR HEATH ACCOUNT!

Use the attached Order Blanks and Handy Envelope to speed your Heathkit order today

Open your Heath account by filling in the time payment statement

It's as easy as 1-2-3 to open your Heath account!

LIBERAL TERMS! Time payments are available to anyone in the U.S. or FPO and APO areas. No money down on orders of \$25 to \$600; over \$600 write for details. Up to 18 months to pay on orders over \$300; write for details. Here's all you do . . .

- 1 Fill out the order blank.
- 2 Sign your name in the TP agreement below, fill in the credit statement and the monthly payment. (See Chart) If you wish to send down payment, show this amount also.
- 3 Send the above to Heath Company, Benton Harbor, Michigan . . . we'll take care of the details.

"ADD ON" Purchases—Once your credit is established and you have made at least three payments, you can "add-on" purchases of \$25.00 or more with no down payment. List the items you want on the reverse side, check the "add on" box at the top and give your account number in (4). Be sure to sign the Time Payment Agreement, and send to us with your original Payment Book.

EASY PAYMENT CHART					
Unpaid Balance	Carrying Charge	Up To 12 Monthly Payments*	Unpaid Balance	Carrying Charge	Up To 12 Monthly Payments*
Up to \$20.00	\$ 2	\$ 5	160.01-170	\$ 17	\$ 16
\$ 20.01-30	3	5	170.01-180	18	17
30.01-40	4	5	180.01-190	19	18
40.01-50	5	5	190.01-200	20	19
50.01-60	6	6	200.01-210	21	20
60.01-70	7	7	210.01-220	22	21
70.01-80	8	8	220.01-230	23	22
80.01-90	9	9	230.01-240	24	22
90.01-100	10	10	240.01-250	25	23
100.01-110	11	11	250.01-260	26	24
110.01-120	12	11	260.01-270	27	25
120.01-130	13	12	270.01-280	28	26
130.01-140	14	13	280.01-290	29	27
140.01-150	15	14	290.01-300	30	28
150.01-160	16	15	†Over \$300.00 write for details		

*All monthly payments are for amount shown except for last payment which is for the odd amount remaining due.

ENJOY YOUR FAVORITE HEATHKIT NOW

ATTENTION RATED FIRMS

Firms and institutions that are rated are invited to open 30 day charge accounts. Firms without rating can open a charge account by submission of 4 references.

Heathkit Catalogs for your friends...

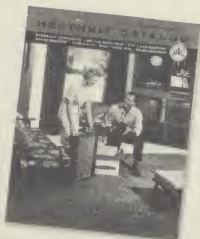

We'll be happy to send your friends their own personal catalogs . . . just fill in and mail the cards below or give the cards to your friends. Everyone interested in electronics will want the new Heathkit 1963 Catalog . . . it's the world's biggest kit catalog!

for a friend!

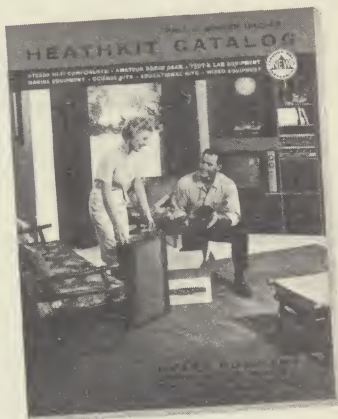

PLEASE SEND A FREE 1963 HEATHKIT CATALOG TO MY FRIEND WHOSE NAME AND ADDRESS IS LISTED BELOW

Name _____

Street _____

City _____ Zone _____ State _____

for a friend!



PLEASE SEND A FREE 1963 HEATHKIT CATALOG TO MY FRIEND WHOSE NAME AND ADDRESS IS LISTED BELOW

Name _____

Street _____

City _____ Zone _____ State _____