

HEATH/ SCHLUMBERGER ELECTRONIC INSTRUMENTS

JUNE 1974

Heath/Schlumberger Instruments
Benton Harbor, Michigan 49022
Catalog 811/13 © 1974 by Heath Company

- Frequency counters
- Oscilloscopes ● Meters
- Generators ● Power supplies
- Strip chart recorders
- Malmstadt-Enke laboratory stations
- Analog-digital designer systems

NEW in this catalog:

Portable dual trace
oscilloscope...pg. 12

Function generator...pg. 16

Low-cost strip chart
recorder...pg. 22

HEATH

Schlumberger

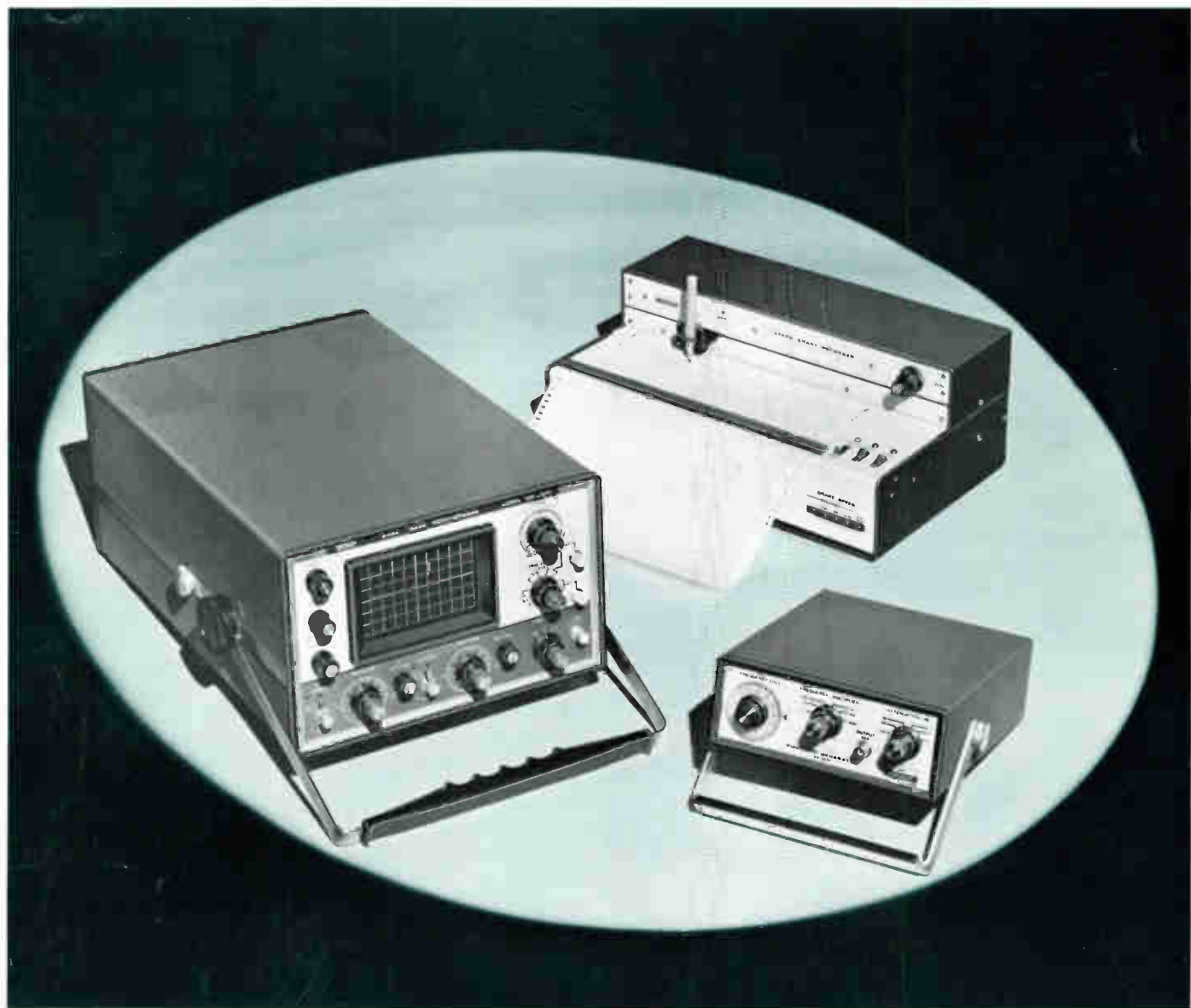

HEATH/SCHLUMBERGER

... puts more value into your instrument dollar by offering direct factory-to-you sales

Whether your application is in science, industry or education, Heath/Schlumberger can fill your instrumentation requirements. And by ordering your instruments directly from our factory in Benton Harbor, you enjoy lower prices, top quality and fast delivery. You also have the benefit of direct access by phone or letter to factory sales, applications and service personnel. Our personnel are ready to give you any necessary assistance in technical advice, parts replacement or service.

Our approach is one of high performance, low cost and basically simple design. Our experience and technology have been utilized fully to present the complete line of instruments described in this catalog.

The Heath/Schlumberger 30-day "try before you buy" plan.

We're so sure that our instruments can deliver on our claims that we'll let you try any instrument in your own lab for 30 days. Just send us your purchase order stipulating that you would like the 30-day trial. If you find that the instrument is not suitable, for **any** reason, just return it within the 30 day period and pay shipping costs.

Factory assembled and fully tested. All Heath/Schlumberger instruments are assembled in a separate facility at the Heath plant in Benton Harbor. And we inspect, test, and calibrate **every** instrument to make sure we did the job right.

Guaranteed specifications. Because you buy a product based on its specs, we think it's only fair to guarantee that those specs will stay the same for a reasonable period of time. If one of our products fails to meet even one spec within a year from purchase, send it back. We'll make it right.

Fully warranted for one year. All Heath/Schlumberger products carry a one-year parts and labor warranty...not just on the specs, but on the complete instrument.

Heath's "Plain Language" warranty stands firmly behind your purchase.

During your first year of ownership, any product which we find defective, either in materials or workmanship, will be replaced or repaired free of charge at the factory, at any retail Heath Electronic Center, or through any of our authorized overseas distributors. And we'll pay shipping charges to get the replacement or repaired unit to you — anywhere in the world.

This protection is exclusively yours as the original purchaser. Naturally, it doesn't cover damage by misuse, fire, flood or acts of God. But, it does insure the performance of your Heath electronic product anywhere in the world — for most any other reason.

After-Warranty Service. What happens after warranty? We won't let you down. If your Heath/Schlumberger product needs repairs or you need a part, just write or call the factory, your nearest retail Heath Electronic Center, or any Heath authorized overseas distributor. We maintain an inventory of replacement parts for each model at most locations — even for models that no longer appear in our current product line-up. Repair service and technical consultation are available through all locations.

Dependable factory service. Our complete service department offers prompt repair and servicing of any Heath/Schlumberger instrument. And every instrument is returned completely factory tested and calibrated. Repair service is also available through all Heathkit Electronic Centers.

Quantity discounts. Quantity discounts are available for every instrument in our line. For complete information on specific requirements, contact Heath/Schlumberger Instruments, Benton Harbor, Michigan 49022; phone 616-983-3961.

Technical applications assistance. We design our equipment to provide many years of service, and we want to make sure it does. If you need help of any kind...technical advice, parts replacement, service or assistance in choosing more equipment...just call or write us.

Sales outlets in major cities and overseas. The same services and equipment that are offered through the mail are also available at all Heathkit Electronic Centers and most overseas locations...sales, service, 30-day trial, technical assistance, etc. Check the list on page 35 for the location nearest you.

Ordering information

Heath/Schlumberger Instruments offers four convenient methods of purchase...by mail, by telephone, our factory sales showroom or any of the Heathkit Electronic Centers located in the major metropolitan areas.

By Mail

Companies, educational institutions and governmental agencies may order by sending their purchase order. We will bill on 30-day terms. Individuals should order by letter. Always use the same name whenever you order. We will bill purchase order buyers for parcel post charges. Individuals should include check or money order plus shipping charges if parcel post is used. Charges for other shipping methods will be collected by the carrier.

By Telephone

Anytime day or night. For product or parts orders only, call 616-983-7381 day, night, weekends or holidays for prompt order service and information on product availability. For all other business...product assistance, order checking, and if you'd like to order a product at the same time, call 616-983-3961 weekdays from 8 AM to 4:30 PM Eastern Daylight Time for proper routing.

Visit Our Factory Sales/Showroom

Heath/Schlumberger Instruments is located on Hilltop Road in St. Joseph, Michigan. Our sales/showroom is open Monday through Friday from 8:30 AM to 5 PM, and on Saturday from 9 AM to 3 PM.

Heathkit Electronic Centers

See page 35 for locations and telephone numbers of all Heathkit Electronic Centers.

A low-cost introduction to our instruments . . . when you order the manual

If you've been wondering about a particular instrument, but would like to take a close look before you buy...send for the complete operation/service manual. Manuals for the EU-801A and EU-801C cost \$10.00 each. Manuals for all other instruments are \$2.00 each except for the EU-50-, EU-800- and EU-900- series circuit cards which cost 50¢ each. Of course, you get your money back on the manual when you purchase the instrument.



HEATH/SCHLUMBERGER FREQUENCY COUNTERS...

offer more performance for less money. We offer a range of counters to cover most of today's measurement problems. The chart below shows some of the applications in which each of our counters can be used, including the "best buy" for each application. All of our counters have been precision designed, thoroughly tested and are backed by a one-year parts and labor warranty. You can't go wrong with a counter from Heath/Schlumberger.

| | Citizens Band Class C & D | Low Band VHF-FM | High Band VHF-FM | UHF-FM (420-525) | AM Broadcast | FM Broadcast | VHF-TV | Video Tape & TV — General | General Lab Research | Crystal Mfgs. | Marine Two-Way | Aircraft | Amateur Radio | Amateur Radio-FM | Garage Door Openers | Musical Instruments | General Industrial Applications | Radio Control* | Military Communications | Civil Air Patrol | MARS-HF | MARS-VHF |
|-----------------|---------------------------|-----------------|------------------|------------------|--------------|--------------|--------|---------------------------|----------------------|---------------|----------------|----------|---------------|------------------|---------------------|---------------------|---------------------------------|----------------|-------------------------|------------------|---------|----------|
| SM-118A p. 5 | • | | | | • | | | • | • | • | | | • | | | • | • | | | | • | |
| SM-128A p. 4 | • | • | | | • | • | | • | • | • | | | • | | | • | • | • | | | • | |
| SM-128B p. 4 | • | • | | | • | • | | • | • | • | | | • | | | • | • | • | | | • | |
| SM-110A p. 6 | • | • | • | | • | • | | • | • | • | • | • | • | • | | • | • | • | | • | • | • |
| SM-110B p. 6 | • | • | • | | • | • | | • | • | • | • | • | • | • | | • | • | • | | • | • | • |
| SM-110C p. 6 | • | • | • | • | • | • | • | • | • | • | • | • | • | • | • | • | • | • | • | • | • | • |

• Indicates Heath "best buy."

* Not usable on pulse-only systems.



SM-102A Programmable Timer

The SM-102A Programmable Timer is a compact, lightweight instrument for measuring time interval, period and frequency ratio with 100 ns resolution.

Factory assembled & calibrated SM-102A, 7 lbs. . . \$395.00

SM-102A SPECIFICATIONS: START/STOP INPUT — Input Impedance: 1 megohm shunted by less than 50 pF. **Maximum Input Voltage:** ±50 V DC referenced to ground for either, or both sides of Input. **Sensitivity:** Zero crossing mode: 100 mV rms. TTL/relay mode: TTL compatible. **Minimum Pulse Width:** Zero crossing mode: 100 ns at 300 mV pk-pk. TTL/relay

mode: 50 ns at TTL levels. **GENERAL — Range:** Time A-B: 0.1 μs to 10⁴ sec. Period Average: 5 x 10⁻⁴ sec to .99999 sec. Events: 1 to 99999. **Resolution:** Time A-B: 100 ns to 100 ns. Period Average: 100 ns/number of periods averaged. **Accuracy:** ±1 count, ± time base accuracy, ± trigger error (start/stop). **External Oscillator Input Range:** DC to 12.5 MHz. Aging Rate: less than 5 ppm/year. **Line Voltage Stability:** Less than ±1 part in 10⁷ for 10% line variation. **Temperature Stability:** ±5 ppm 10°C to 40°C ambient. Referenced at 25°C. **BCD Output:** 5 digits of BCD, Overrange flag, Completion flag, 5 V reference (1 KΩ impedance), Ground, and Range programming inputs (binary). **Power Requirements:** 105-125 volts, 50/60 Hz, 23 watts. **Dimensions:** 9 3/4" deep, 6 3/4" wide, 2 1/4" high. **Net Weight:** 4 1/2 lbs.

Measuring from a single source

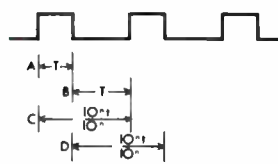

- A. Positive pulse width
- B. Negative pulse width
- C. Leading edge period or period average
- D. Trailing edge period or period average

Measuring from independent start/stop sources

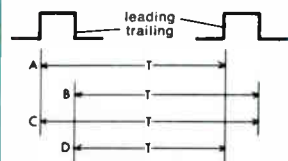

- A. Leading edge to leading edge
- B. Trailing edge to trailing edge
- C. Leading edge to trailing edge
- D. Trailing edge to leading edge

AUTORANGING 110 MHz COUNTERS

VHF capability
at an HF price!



- 5 Hz to 110 MHz guaranteed range, 2 Hz to 140 MHz typical
- 15 mV sensitivity guaranteed, 2-10 mV typical
- Choice of standard or high stability timebase

The Heath/Schlumberger SM-128A and SM-128B... a pair of high performance counters at very reasonable prices. The SM-128s deliver guaranteed performance to 110 MHz with 15 mV sensitivity. Typical performance is considerably better: 140 MHz and 2-10 mV sensitivity. A front panel sensitivity control allows adjustment of the input amplifier trigger level above and below the zero-crossing point... ideal for counting frequency in the presence of noise. Two preset gate intervals of 1 second and 10 ms are switch-selectable, or use the auto-ranging function, which automatically determines the correct range for maximum resolution without overranging. The SM-128A uses a standard clock stable to ± 10 ppm over the operating temperature range. For applications requiring very high precision, choose the SM-128B with temperature stability of ± 1 ppm. Additional features of both versions include 7-digit LED readout with leading zero blanking... high impedance

input for minimum loading... external time base oscillator input for very high accuracy measurements of frequency ratio work... dual primary power supply... rugged, compact design.

Factory assembled & calibrated SM-128A,
standard timebase, 10 lbs. \$325.00

Factory assembled & calibrated SM-128B,
high stability time base, 10 lbs. \$395.00

Cables, probes & terminations are on page 15.

SM-128A & B SPECIFICATIONS: Input: 5 Hz to 110 MHz guaranteed; 2 Hz to 140 MHz typical. Sensitivity: 15 mV rms guaranteed; 2 to 10 mV typical. Input Impedance: 1 megohm/15 pF. Maximum Voltage: 200 V rms. Time Base Oscillator, SM-128A: Frequency: 1 MHz. Settability: ± 0.1 Hz. Maximum Aging Rate: Less than 1 ppm/mo. (less than 7.5 ppm/yr). Temperature Stability: ± 10 ppm max., 0-40° C. Time Base Oscillator, SM-128B: Frequency: 1 MHz. Settability: ± 0.1 Hz. Maximum Aging Rate: 1 part in 107/mo. (1 part in 10⁶/yr). Temperature Stability: ± 1 part in 10⁶, 0-40° C. External Oscillator: Frequency: DC to 2 MHz. Sensitivity: TTL or 2.5 V rms from 50 ohm source. Protection: -5 V peak to +10 V peak. Ranges-Gate Interval: Manual: kHz, 1 s; MHz, 10 ms. Auto: kHz, 10 s; kHz, 1 s; MHz, 100 ms; MHz, 10 ms. Range and gate interval are dependent on incoming signal. General: Display Time: 200 ms plus gate interval. Power Requirements: 120/240 VAC, 50/60 Hz, 25 watts maximum. Operating Temperature Range: 10-40° C. Dimensions: 2 $\frac{3}{4}$ " H x 7 $\frac{1}{4}$ " W x 10 $\frac{1}{2}$ " D (less handle). Net Weight: 5 lbs.

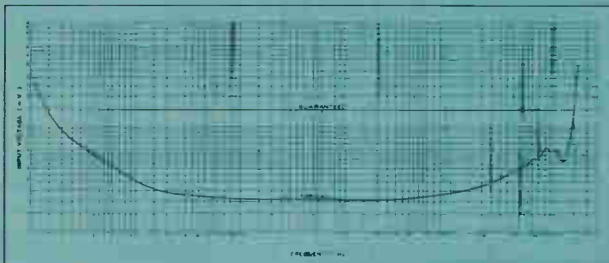
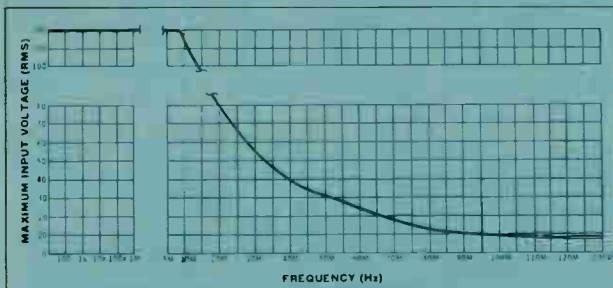

AUTORANGING 30 MHz COUNTER

The lowest cost
30 MHz autoranging
counter on the market



- 5 Hz to 30 MHz range guaranteed, 2 Hz to 40 MHz typical
- 10 mV sensitivity guaranteed, 5.5 to 7.5 mV typical
- Adjustable input sensitivity for greater versatility

A price/performance ratio that speaks for itself... see the graphs below. 30 MHz guaranteed, 40 MHz typical. The picture above shows a 118A actually being driven by a typical laboratory generator at 58 MHz! Input sensitivity is guaranteed to be 10 mV across the range, but typically it runs from 5.5 to 7.5 mV. Two preset switch-selectable gate intervals allow resolution down to 3 decimal places. Autorange automatically determines correct range for maximum resolution without overranging. Adjustable input sensitivity allows adjustment of the input trigger level... excellent for eliminating the effects of

noise on the signal. The SM-118A is loaded with other features too: 6-digit LED display with leading zero blanking... high impedance input... external clock input... 120/240 VAC power supply... convenient carrying handle/tilt stand. Try a 118A on your own bench for 30 days and be convinced. See page 2 for details.

Factory assembled & calibrated SM-118A, 7 lbs. . . \$225.00
See page 15 for cables, terminations and other accessories.

SM-118A SPECIFICATIONS: Frequency Range: 5 Hz to 30 MHz guaranteed; 2 Hz to 40 MHz typical. Input Sensitivity: 10 mV guaranteed; 5.5 to 7.5 mV typical. Input Impedance: 1 megohm shunted by less than 15 pF. Maximum Input Voltage: 200 V rms. Time Base: Frequency: 1 MHz ± 0.1 Hz. Temperature Stability: ± 10 ppm maximum, 0° to 40° C, referenced to 25° C. Long Term Stability: 1 part in 10⁶ per mo. EXTERNAL OSCILLATOR - Frequency: DC to 2 MHz. Sensitivity: TTL or 2.5 V rms from 50-ohm source. Protection: -5 V peak to +10 V peak. RANGES-GATE INTERVAL - Manual: kHz - 1 s, MHz - 10 ms. Auto: kHz - 10 s, kHz - 1 s, MHz - 100 ms or 10 ms (dependent on incoming signal). Readout: Six 7-segment LED displays plus 3 incandescent lamps for Range and Overrange. Display Time: 200 ms plus gate interval. Power Requirements: 120/240 VAC, 50/60 Hz, 20 watts maximum. Operating Temperature Range: 10-40° C. Dimensions: 10½" D x 7¼" W x 2¼" H. Net Weight: 4¾ lbs.

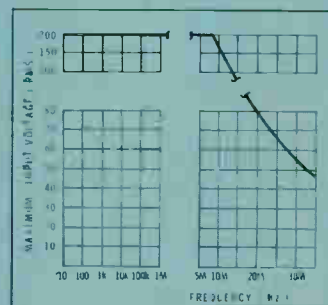
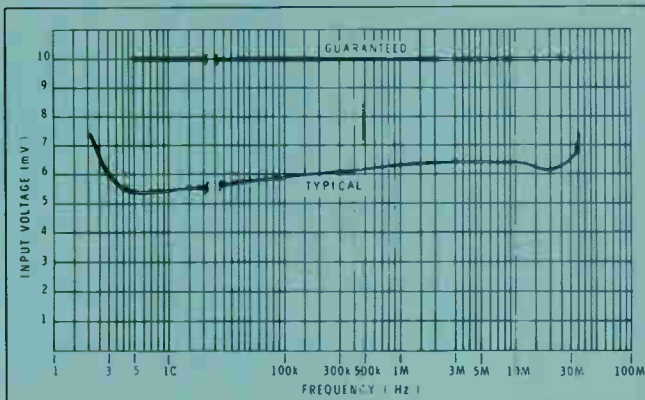

HEATH
Schlumberger

HEATH SM-110 SERIES

price/performance
benchmark for the
industry



The world's best counter values come from Heath!

All three models share the following features: separate 1 megohm/15 pf and 50 ohm inputs...7 digit LED readout plus overrange...leading zero blanking...0.1 Hz resolution...1 MHz time base...external clock input for frequency ratio measurements...front panel pushbutton reset...convenient carrying handle/tilt stand.

- SM-110A features 1 Hz to 180 MHz range . . . 1 MHz crystal controlled time base . . . low cost.
- SM-110B provides high stability TCXO time base . . . complete remote programming capability . . . BCD output . . . 1 Hz to 180 MHz range.
- SM-110C features prescaled 600 MHz range . . . 1 Hz to 180 MHz direct counting range . . . high stability TCXO time base . . . complete remote programming capability . . . BCD output.
- SM-110C acceptable for AM & FM Broadcast.

The SM-110A . . . unquestionably the world's best buy in a VHF counter.

The SM-110A provides a frequency range of 1 Hz to 65 MHz on the 1 megohm input and a 10 MHz to 180 MHz range on the 50 ohm input. Sensitivity is very high: 10 mV rms at 35 MHz...15 mV rms at 180 MHz. The standard 1 MHz crystal time base provides accuracy and stability enough for most general design and testing applications: stability is 1 part in 10^6 per month; and the crystal circuit is factory set to ± 0.1 Hz. Field recalibration to ± 0.1 Hz to compensate for temperature and aging changes is easily accomplished. A front panel rotary switch allows fast selection of time bases: 10 seconds (Hz), 1 second (kHz), and 0.1 and 0.01 seconds (MHz).

Factory assembled and calibrated SM-110A, 10 lbs. \$495.00

The SM-110B . . . 180 MHz range and total computer or manual remote programming capability.

The SM-110B features the same high input sensitivity and wide frequency range as the SM-110A, together with a very high stability TCXO timebase allowing more precise measurements. Long term stability is 1 part in 10^7 per month...1 part in 10^6 per year. The TCXO is factory set to ± 0.1 Hz, and can easily be field recalibrated to this value. The SM-110B also incorporates complete remote programming capability, making it ideally suited to remote monitoring or controlled situations, mini-computer based applications or experiments requiring printed output or BCD information. Inputs allow total external manual or computer control of Range, Input Select (either high or low impedance input), Reset and Count Inhibit, using standard TTL-level logic. Outputs are seven digits of BCD frequency information, Overrange Flag, Decimal Points, Print Command and 5 volt reference and ground to drive all remote programming inputs. The internal 5 V supply eliminates the need for an external TTL-level supply when in the remote programming mode.

Factory assembled and calibrated SM-110B, 10 lbs. \$625.00

The SM-110C . . . 600 MHz range . . . complete remote programming capability . . . acceptable for AM and FM broadcast.

The SM-110C is a very high performance counter with the features and capability to handle the most exacting measurements. It includes all the features mentioned for the "A" and "B" models: separate high and low impedance inputs, extremely stable TCXO time base and complete remote programming capability. The SM-110C provides a frequency range to 600 MHz (prescaled by 10) for measurement capability well into the UHF region with correctly positioned decimal points. The frequency ranges on the 50 ohm input can be selected by a front panel switch: 10 MHz to 180 MHz direct counting and 40 MHz to 600 MHz prescaled. The frequency range on the 1 megohm input is the same as the SM-110A and SM-110B...1 Hz to 65 MHz.

Factory assembled and calibrated SM-110C, 11 lbs. \$795.00

The Heath/Schlumberger "guaranteed-typical" approach to specs... compare it against the competition

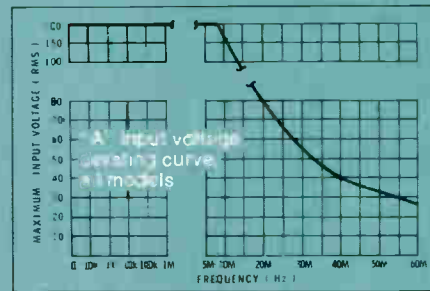
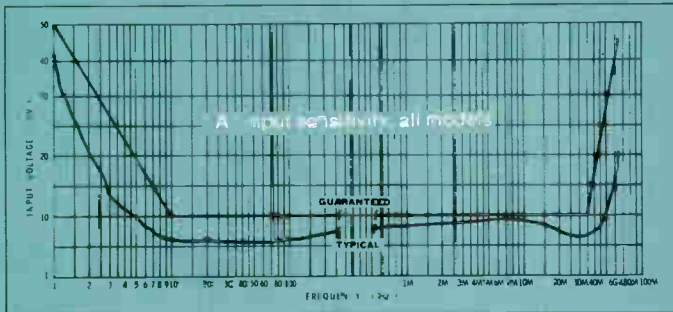
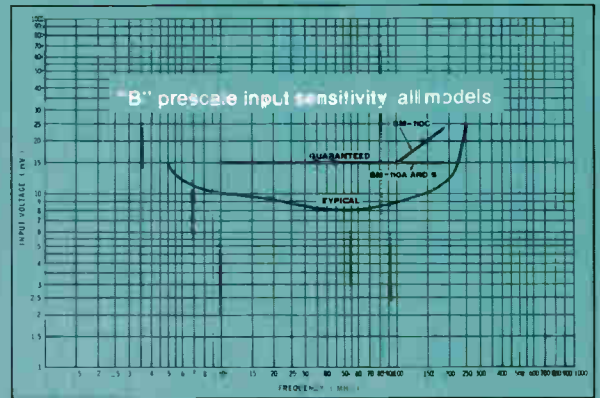
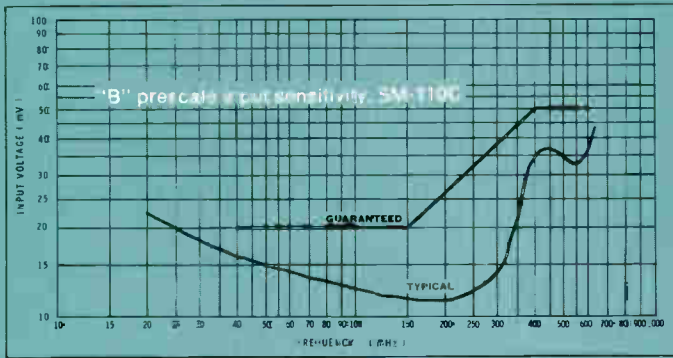

SM-110-Series Specifications

| | SM-110A | SM-110B | SM-110C |
|-------------------------------|--|---|--|
| Frequency Range — guaranteed* | "A" Input 1 Hz to 65 MHz | "B" Input 10 MHz to 180 MHz | "A" Input 1 Hz to 65 MHz |
| | | "A" Input 1 Hz to 65 MHz | "B" Input 10 MHz to 180 MHz |
| | | | "A" Input 1 Hz to 65 MHz |
| | | | "B" Input 10 MHz to 180 MHz direct: 40 MHz to 600 MHz prescaled by 10. |
| typical* | 1 Hz to 230 MHz | | 1 Hz to 600 MHz |
| Input Impedance | All models "A" input 1 megohm/15 pF, "B" Input 50 ohms. | | |
| Input Sensitivity* | All models: 10 mV @ 35 MHz; 15 mV @ 180 MHz. | | 50 mV @ 600 MHz. |
| Maximum Input* | All models: "A" input, 200 V rms @ 10 MHz, derated to 45 V rms @ 35 MHz. "B" input, within specs to 2 V rms; protected to 5 V rms. | | |
| Time Base, type | 1 MHz crystal | 1 MHz TCXO | 1 MHz TCXO |
| stability | ±0.1 Hz | ±0.1 Hz | ±0.1 Hz |
| long term stability | 1 part in 10 ⁵ /mo. 7.5 parts in 10 ⁴ /yr. | 1 part in 10 ⁷ /mo. 1 part in 10 ⁶ /yr. | 1 part in 10 ⁷ /mo. 1 part in 10 ⁶ /yr. |
| temperature stability | ±10 parts in 10 ⁵ , 0-40° C. | ±1 part in 10 ⁶ , 0-40° C. | ±1 part in 10 ⁶ , 0-40° C. |
| ranges | All models: Hz — 10 sec., kHz — 1 sec., MHz — 100 msec., and MHz — 10 msec. | | |
| External Oscillator | All models: Input frequency, DC to 2 MHz. Sensitivity, TTL level or 2.5 V rms with 50 ohm source resistance. Protection, -5V peak to +10V peak. External Oscillator Input = 10 ¹ , ±10 ² , ±10 ³ & ±10 ⁴ . | | |
| Remote Programming: | None | Standard | Standard |
| inputs | None | TTL-level data required to control Range, Reset, Input Select and Count Inhibit. Logic 0, less than 0.8 V; Logic 1, greater than 2.0 V but less than 5.5 V. | |
| outputs | None | 7 digits of 8-4-2-1 BCD, Overrange Flag, Decimal Points, Print Command, 5 V reference (will drive all remote programming) and Circuit Ground. | |
| time base ranges | None | 10 Sec., 1 Sec., 0.1 Sec., 0.01 Sec., 0.001 Sec., 100 μs., 10 μs., 1 μs. | |
| Readout | All models: seven 7-segment LEDs plus overrange indication. | | |
| Display Time | All models: 0.2 sec. plus gate interval. | | |
| Reset | Manual on front panel. | Manual on front panel; remote reset with external programming. | |
| Operating Temperature Range | All models: 10 to 40° C ambient. | | |
| Power Requirements | All models: 120/240 VAC, 50/60 Hz. 45 watts. | | |
| Dimensions | All models: 2 3/4" H x 8 1/2" W x 12 1/8" D. | | |
| Net Weight | 7 1/2 pounds | 7 1/2 pounds | 8 pounds |

All specifications given at 25°C unless otherwise noted.
*Refer to charts above for additional information on these specifications.



SOLID-STATE 2½-DIGIT MULTIMETER

Our lowest cost
digital multimeter is
loaded with features



- Measures DC volts, AC volts, DC current, AC current and ohms • 1 megohm input impedance
- 2½ -digit cold cathode tube readout
- Convenient front panel DC polarity switch
- Excellent resolution • Comes complete with test leads

A versatile performer at a price you can afford... the obvious choice for design, service and hobby applications. The SM-600 measures DC voltage to 1000 V full scale. The front panel polarity switch adds extra convenience to all measurements by eliminating lead switching...makes diode front-to-back measurements as easy as pushing a switch. Measures AC voltage up to 700 V rms, and the wide 25 Hz to 10 kHz response increases versatility even more. Both AC and DC current can be measured up to 2000 mA... and resistance up to 2 megohms. Four overlapping AC, +DC, -DC and current ranges, and five resistance ranges make operation fast and simple.

The bright 2½ -digit cold cathode tube readout ends the parallax and interpolation errors common with analog meters, and the decimal point is correctly positioned on all ranges for all functions. Lighted front panel indicators show overrange, positive and negative DC voltages and current at a glance. Resolution is 10 mV, 10 μ A and 1 ohm. Accuracy is very good for a digital multimeter in this price range: 1% on DC volts, 1½ % on AC volts and AC/DC current, and 2% on ohms. The all-solid-state design uses integrated circuits for clear, non-blinking display; dependable analog to digital ramp converter updates the display every 16 milliseconds.

Features of the SM-600 include overload protection on all ranges...three-wire line cord...dual primary power transformer for 120 or 240 VAC operation...isolated floating ground...completely enclosed heavy-gauge aluminum case for safe, rugged use. For convenience, the SM-600 has a handy, built-in carrying handle, tinted viewing window and universal banana jack input.

Looking for a high performance, low cost way to put a digital multimeter on your bench? We've got it...order your SM-600 today.

Factory assembled & calibrated SM-600, 6 lbs. . . . \$120.00
Probes and other meter accessories are on page 15.

SM-600 SPECIFICATIONS — RANGES (Full Scale): DC Volts: 0-2, 20, 200, 1000 V. DC Current: 0-2, 20, 200, 2000 mA. AC Volts: 0-2, 20, 200, 700 V rms (25 Hz to 10 KHz). AC Current: 0-2, 20, 200, 2000 mA rms (25 Hz to 10 kHz). Ohms: 0-200, 2 K, 200 K, 2 M ohms. **MAXIMUM INPUT LEVELS:** DC Volts: 1000 VDC (2 V range: 200 VAC). AC Volts: 700 VAC rms (2 V range: 140 VAC rms). AC & DC Current: 3 A (fuse protected). **Input Impedance:** 1 megohm for voltage ranges, 2 V drop maximum for current ranges; **Overrange:** 25% within maximum input limits. **RESOLUTION (Lowest Range):** Volts: 10 mV. Current: 10 μ A. Ohms: 1 ohm. **ACCURACY (Full Scale \pm 1 digit):** DC Volts \pm 1%. AC Volts: \pm 1.5%. AC & DC Current: \pm 1.5%. Ohms: \pm 2%. **Sample Rate:** Line frequency. **Power Requirements:** 110-130 V, 50-60 Hz, 8 watts max. (220-260 V, 50-60 Hz by changing internal jumper wires). **Fuse Requirements:** 120-volt operation—¼ ampere, 125 V quick-blow. 240-volt operation—½ ampere, 250 V quick-blow. **Current-Ohms protection:** 3 ampere. **Dimensions:** 7¼" H x 5¾" W x 3½" D. **Net Weight:** 2½ lbs. **Operating Temperature:** 0-40°C. **NOTE:** Specifications are referenced to 25°C unless otherwise noted.

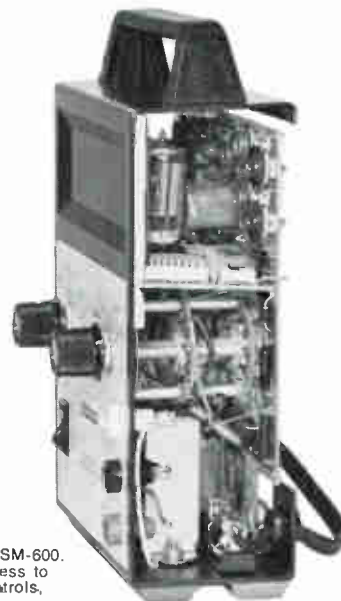

Interior of the SM-600. Note easy access to calibration controls, upper right.

3½ AND 4½ DIGIT MULTIMETERS

Put one of these on your bench and take the guesswork out of measurements

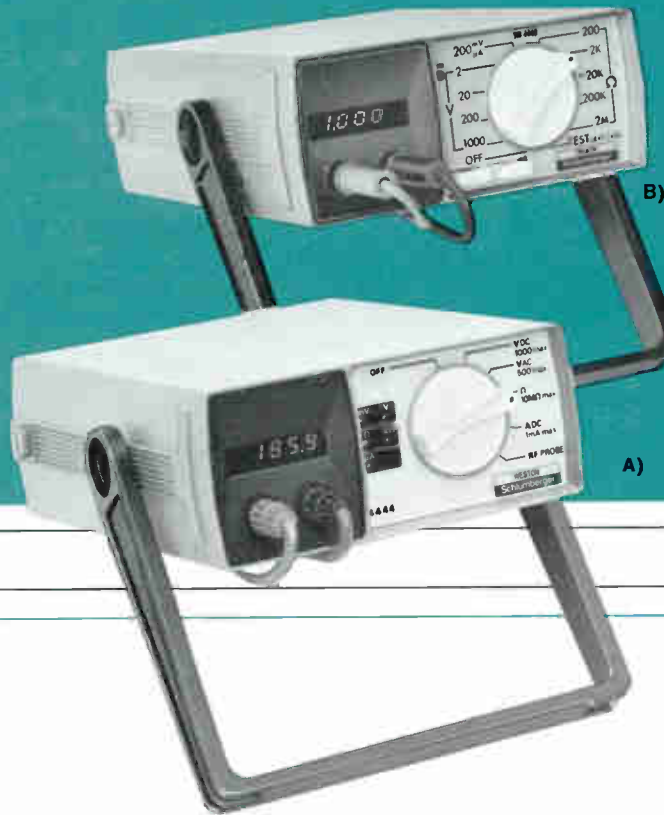

A) Autoranging 4½-digit multimeter was \$575 . . . Now only \$435

- Instant autoranging using new triple slope integration • 10 μ V resolution • 0.02% accuracy • 1000 megohm input impedance

The SM-4444 DMM is designed for maximum operating convenience. Just select the type of measurement to be made, connect the test leads and read the 4½ digit LED display. . . instant autoranging provides polarity, units, decimal and optimum reading . . . all automatically. Any input from 10 μ V to 1 kV can be applied at any time to the instrument without fear of damage . . . the SM-4444 will instantly range out of trouble. Leading zero blanking is built in. A line-frequency-locked integrating A-D converter stabilizes readings in spite of excessive noise and line interference. The floating input and good isolation provide excellent series and common mode rejection. The DC accuracy of $\pm 0.02\%$ and 1000 megohm input Z, plus 10 μ V sensitivity and bias current less than 0.2 nA make the SM-4444 ideal for measurements in very high impedance circuits.

Factory assembled & calibrated SM-4444, 4 lbs. . . \$435.00
See page 15 for meter accessories.

SM-4444 SPECIFICATIONS: DC VOLTS: Ranges & Input Sensitivity: 0-100 mV, 10 μ V; 0-1 V, 100 μ V; 0-10 V, 1 mV; 0-100 V, 10 mV; 0-1000 V, 100 mV. **Input Resistance:** 1000 megohms on 100 mV, 1 V and 10 V ranges; 10 megohms on 100 V and 1000 V ranges. **Accuracy:** $\pm 0.02\%$ of reading ± 1 digit. **Overload Protection:** 1000 V. **DC CURRENT: Range & Input Sensitivity:** 0-10 μ A, 1 nA; 0-100 μ A, 10 nA; 0-1 mA, 100 nA. **Current Shunt:** Less than 100 ohms. **Accuracy:** $\pm 0.05\%$. **Overload Protection:** 50 mA. **AC VOLTS: Range & Input Sensitivity:** 0-100 mV, 10 μ V; 0-1 V, 100 μ V; 0-10 V, 1 mV; 0-100 V, 10 mV; 0-700 V, 100 mV. **Input Impedance:** 1 megohm shunted by less than 100 pF. **Accuracy (40 Hz to 10 kHz):** $\pm 0.2\%$ of reading. **Overload Protection:** 1000 V. **RESISTANCE: Range & Input Sensitivity:** 0-1 k, 100 m Ω ; 0-10 Ω , 1 Ω ; 0-100 k Ω , 10 Ω ; 0-1 M Ω , 1 k Ω . **Range Measuring Current:** 0-1 k Ω , 100 μ A; 0-10 k Ω , 100 μ A; 0-100 k Ω , 100 μ A; 0-1 M Ω , 1 μ A; 0-10 M Ω , 1 μ A. **Accuracy:** $\pm 0.05\%$ of reading. **Overload Protection:** 200 V. **GENERAL: CMRR:** DC measurement \rightarrow 120 dB at DC, >130 dB at 60 Hz. Max. common mode voltage 500 V DC or peak. **NMRR:** DC measurement \rightarrow 60 dB at 60 Hz. **Temperature Range:** 0 to 45°C. **Out-Of-Range Indication:** Overrange "1" in "ten thousands" position blinks and balance of readout blanks out. **Power Requirements:** 117/234 V, 50/60 Hz, 8 watts. **Dimensions:** 2¼" H x 5½" W x 7" D. **Net Weight:** 2.2 lbs.

Note: Accuracy on all functions is guaranteed for a 90-day period.

B) Choose battery or line models of this portable 3½-digit multimeter

- Measures AC/DC volts, ohms, current • 3½ digit LED readout • Completely portable . . . batteries & charger supplied • High-accuracy line-operated version now available

The SM-4440 is a low cost portable digital multimeter designed specifically for field use. A single front panel switch allows measurement of AC or DC volts from 200 mV to 1 kV . . . resistance from 200 ohms to 2 megohms . . . plus AC and DC current. Special features include high visibility LED readout with automatic blanking of unused digits to conserve battery life . . . patented dual slope high impedance bipolar A-D converter for excellent accuracy and long term stability . . . overload protection with spare fuses included . . . built-in test capability for both battery condition and LED and logic failure.

Factory assembled & calibrated SM-4440, 5 lbs. . . \$250.00

Factory assembled & calibrated SM-4449, line-operated version of the SM-4440 with 0.1% accuracy and additional 2 mA current range, 5 lbs. . . \$250.00
Meter accessories are on page 15.

SM-4440 & SM-4449 SPECIFICATIONS: DC Volts: Ranges and Input Impedance: 199.9 mV, 50 megohms; 1.999 V, 500 megohms; 19.99 V, 10 megohms; 199.9 V, 10 megohms; 999 V, 10 megohms. **Rated Accuracy:** **SM-4440:** $\pm 0.3\%$ of reading ± 1 digit on all ranges; **SM-4449:** $\pm 0.05\%$ of reading ± 1 digit on 200 mV and 2 V range. All others $\pm 0.1\%$. **AC Volts: Ranges:** 199.9 mV; 1.999 V; 19.99 V; 199.9 V; 999 V. **Input Impedance:** 10 megohms on all ranges. **Rated Accuracy:** $\pm 0.5\%$ of reading ± 1 digit on all ranges. **Frequency Range:** 40 Hz to 10 kHz; 40 Hz to 2 kHz on 1 kV range. **DC Current: Range:** 199.9 μ A. **Rated Accuracy:** $\pm 0.4\%$ of reading ± 1 digit. **AC Current: Range:** 199.9 μ A. **Rated Accuracy:** $\pm 0.7\%$ of reading ± 3 digits. **Ohms: Ranges and Nominal Voltage Drop:** 199.9 ohms, 0.2 V; 1.999 k ohms, 2 V; 19.99 k ohms, 2 V; 199.9 k ohms 0.2 V; 1.999 M ohms, 2 V. **Rated Accuracy:** $\pm 0.5\%$ of reading ± 3 digits on all ranges. **General: Display:** 1999, -1999 (non-blinking) 0.19" LEDs. Leading zero blanking—least significant digit never blanked. Overrange indication—blinking 1 in thousands place with a polarity and decimal indication. Balance of digits blanked. Moving decimal point. **Conversion Rate:** approx. 4/second. **Polarity:** automatic **CMRR:** 80 dB (approaches infinity on battery). **NMRR:** 35 dB. **Power Requirements:** **SM-4440:** Portable battery operation standard. Up to 12 hrs. use on a full charge. Supplied with four nickel cadmium "C" cells and 117 V, 60 Hz charger; **SM-4449:** 120 VAC 50/60 Hz, 8 watts. **Temperature Range:** 15-35 degrees C with guaranteed accuracy. Operable from 0-50 degrees C. **Dimensions:** 2¼" H x 5½" W x 7" D. **Net Weight:** 2½ pounds.



PORTABLE VOLT-OHM METERS

The advantages of a
conventional multimeter
plus portability

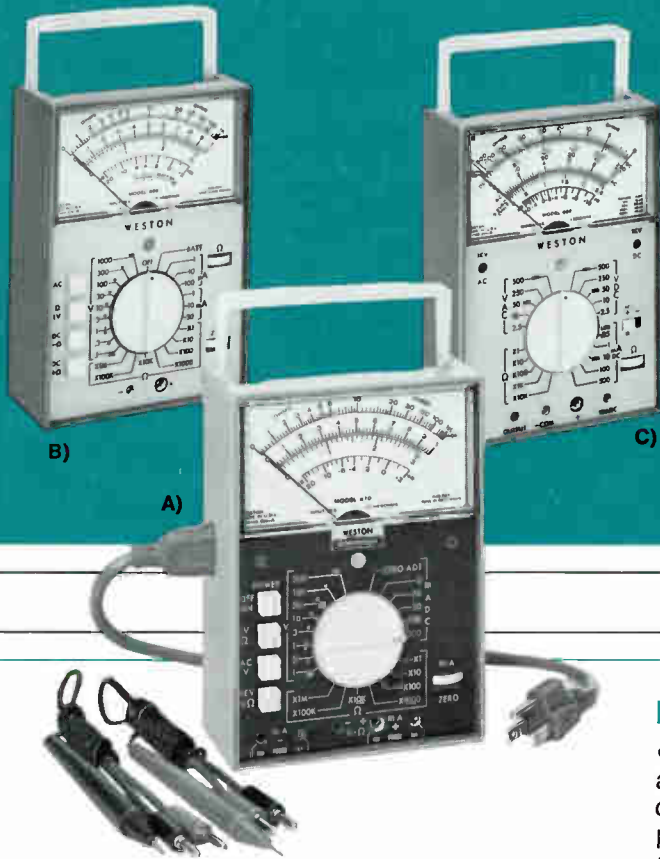

A) FET VOM permits "in-circuit" DC current measurement

- Four-terminal DC current measurement capability on PC boards without breaking connections.
- Conventional two-terminal current measurement capability
- Automatic positive & negative polarity indicators
- Normal power & low power ohms measurement

The SM-670 is the only FET VOM currently available that permits DC current measurements to be made on printed circuit boards in operating instruments without disturbing circuit components. It is a portable, self-contained unit usable wherever there is 115V power.

The SM-670 also offers all the advantages of a conventional FET VOM. Voltage ranges start at 100 mV full scale and go to 300 volts in eight steps with 10 megohm input impedance. Conventional current measurements can be made using standard probes supplied with the meter. Fourteen resistance measurement ranges are provided—seven using a normal power (1.5 volt max.) circuit and seven using a low power (85 mV max.) circuit. dB measurements use eight ranges from -40 to +52 dB.

Factory assembled & calibrated SM-670, 2 lbs. . . . \$249.50
Check page 15 for meter accessories.

SM-670 SPECIFICATIONS: DC VOLTAGE RANGES: 100 mV, 300 mV, 1V, 3V, 10V, 30V, 100V, 300V. Accuracy: $\pm 2\%$ of full scale. Input Resistance: 11.1 megohms. AC VOLTAGE RANGES: 100 mV, 300 mV, 1V, 3V, 10V, 30V, 100V, 300V. Accuracy: $\pm 3\%$ of full scale. Input Resistance: 10 megohms/100 pF. Frequency Response: $\pm 5\%$, 40 Hz to 10 kHz. RESISTANCE RANGE: (7 normal & 7 low power ranges) R x 1 (10 Ω center scale), R x 10, R x 100, R x 1K, R x 10K, R x 100K, R x 1 Meg. Accuracy: $\pm 3\%$. DC CURRENT RANGES: 3 mA, 10 mA, 30 mA, 300 mA. Accuracy: $\pm 3\%$ of full scale (two-terminal), $\pm 5\%$ of full scale (four-terminal). DECIBEL RANGES: -40 to -18, -30 to -8, -20 to +2, 0 to 22, 10 to 32, 20 to 42, 30 to 52. GENERAL: Temperature Influence: $\pm 1\%$ of full scale for a $\pm 10^\circ$ C change from 25 $^\circ$ C ambient on all ranges except the 4-terminal current circuit. Warm-up period: 15 minutes. Overload Protection: 220 VAC or VDC on all voltage, ohms and two-terminal current ranges; 125 VAC or VDC on 4-terminal ranges. 1000 volts AC or DC on 10V through 300V range. Power Requirements: 115 volts, 60 Hz, 3.5 watts. Dimensions: 7" H x 5" W x 2 1/4" D. Net Weight: 2 lbs.

B) Portable FET input multimeter

- Measures AC/DC volts, AC/DC current, ohms and dB
- Special low-voltage circuit for "in-circuit" resistance measurements
- Input protected to 220V
- High impact thermoplastic case and ruggedized taut band meter movement
- Batteries and test leads included

Factory assembled & calibrated SM-666, 4 lbs. . . . \$132.50
For meter accessories see page 15.

SM-666 SPECIFICATIONS: DC VOLTAGE RANGES: 0.1, 0.3, 1, 3, 10, 30, 100, 300, 1000. Accuracy: $\pm 2\%$ of full scale. Input Resistance: 10 megohms. AC VOLTAGE RANGES: 0.1, 0.3, 1, 3, 10, 30, 100, 300, 1000. Accuracy: $\pm 3\%$ of full scale. Frequency response: 0.1-30 volt ranges: $\pm 3\%$, 50 Hz to 20 kHz; $\pm 5\%$, 20 kHz to 50 kHz. 100, 300 volt ranges: $\pm 3\%$, 50 Hz to 10 kHz; $\pm 5\%$, 10 kHz to 20 kHz. 1000 volt range: $\pm 3\%$, 50 Hz to 1 kHz; $\pm 5\%$, 1 kHz to 5 kHz. RESISTANCE RANGES: x1, x10, x100, x1000, x10K, x100K, x1 Meg. DC CURRENT RANGES: 1 μ A, 10 μ A, 100 μ A, 1 mA, 30 mA. Accuracy: $\pm 3\%$ of full scale. Loss: 100 millivolts. AC CURRENT RANGES: 1 μ A, 10 μ A, 100 μ A, 1 mA, 10 mA, 30 mA. Accuracy: 0.1 μ A to 30 mA $\pm 4\%$ of full scale value. Loss: 100 millivolts. Frequency response: 1 μ A, 10 μ A ranges: $\pm 3\%$, 50 Hz to 5 kHz. 100 μ A range: $\pm 3\%$, 50 Hz to 20 kHz. 1 mA to 30 mA ranges: $\pm 3\%$, 50 Hz to 50 kHz. DECIBEL RANGES: -40 to +62. GENERAL: Voltage Dividers: $\pm 1\%$ metal film resistors on most ranges. Batteries: Four 1.5V "AA" cells, one 1.5V "D" cell (supplied). Dimensions: 7" H x 5" W x 2 1/4" D. Test Leads: Supplied.

C) Portable general purpose VOM

- Measures AC/DC volts, DC current, ohms and dB
- 20,000 ohms/volt DC sensitivity, 5,000 ohms/volt AC sensitivity
- Diode-protected, taut band 4 1/2" meter
- DC polarity reversal switch

Factory assembled & calibrated SM-660, 4 lbs. . . . \$65.00
For meter accessories see page 15.

SM-660 SPECIFICATIONS — Sensitivity: 20,000 ohms/volt DC; 5000 ohms/volt AC. Range: DC Volts: 0.25, 2.5, 10, 50, 250, 500, 1000 volts. AC Volts: 2.5, 10, 50, 250, 500, 1000 volts. DC Current: 0.05, 1, 10, 100, 500 mA, 10 amps. Ohms: 2000, 20,000, 200,000, 2 meg, 20 meg, full scale. Decibels: -10 to +10, +2 to +22, +16 to +36, +30 to +50, +36 to +56. AC CURACY: DC Volts: $\pm 2\%$, 0.25 to 1000 V, $\pm 3\%$, 5000 V. AC Volts: (60 Hz), $\pm 3\%$, 2.5 to 1000 V, $\pm 4\%$, 5000 V. DC Current: $\pm 1.5\%$, 0.05 mA, $\pm 2\%$, 1 to 500 mA, $\pm 2\%$, 10 amps. Ohms: Approximately $\pm 2\%$ of scale length. Frequency Influence, AC ranges: 2.5 V, 25 Hz-1 MHz $\pm 2\%$; 1 MHz-5 MHz, $\pm 5\%$. 10 V, 25 Hz-100 kHz, $\pm 2\%$; 100 kHz-500 kHz, $\pm 5\%$. 50 V, 25 Hz-50 kHz, $\pm 2\%$; 50 kHz-100 kHz, $\pm 5\%$. 250 V, 25 Hz-25 kHz, $\pm 2\%$; 25 kHz-50 kHz, $\pm 5\%$. 500 V, 25 Hz-10 kHz, $\pm 2\%$, 10 kHz-50 kHz, $\pm 5\%$. 1000 V, 25 Hz-10 kHz, $\pm 2\%$; 10 kHz-50 kHz, $\pm 10\%$. Front Panel Controls: Function-range switch, ohms adjust control, polarity selection switch. Meter Movement: 50 microamperes, 1600 ohms, diode protected, taut band. Batteries: 1 type D cell, 1.5 volts. 1 NEDA #208 battery, 15 volts (supplied). Dimensions: 7" H x 5" W x 2 1/4" D. Net Weight: 2 lbs.

FAMOUS HEATH VTVMS

Rugged reliability and low cost
make these VTVMs the most
popular on the market



C)

B)



A)

A) The SM-20A... our most popular VTVM

- Measures \pm DC volts and AC rms and p-p volts ... plus ohms
- Large, easy to read $4\frac{1}{2}$ " meter
- 11 megohm DC input impedance
- Single test probe for all measurements

We've sold tens of thousands of these VTVMs over the years ... and popularity like that doesn't happen by accident. The SM-20A is designed to be a rugged, versatile little meter for service, design and educational applications... and the low cost makes it a favorite for home hobbyists too. Check the specs and the price; you'll see why the SM-20A has been so popular for so long.

Factory assembled & calibrated SM-20A, 6 lbs. . . . \$60.00
Meter accessories are on page 15.

SM-20A SPECIFICATIONS — Meter scales: DC & AC (rms): 0-1.5, 5, 15, 50, 150, 500, 1500 V full scale. **AC peak-to-peak:** 0-4, 14, 40, 140, 400, 1400, 4000 V full scale. **Resistance:** 10 ohm center scale x1, x10, x100, x1000, x10k, x100k, x1 meg. Measures .1 ohm to 100 megohms. **Meter:** $4\frac{1}{2}$ " 200 μ A movement. **Input resistance DC:** 11 megohms (1 megohm in probe) on all DC ranges: 1 megohm/35 pF on all AC ranges. **Circuit:** Balanced bridge (push-pull) using twin triode. **Accuracy:** DC $\pm 3\%$, AC $\pm 5\%$ of full scale. **Frequency response:** ± 1 dB, 25 Hz to 1 MHz (600 ohm source). **Tubes:** 12AU7, 6AL5. **Battery requirements:** 1.5 V, size "C" cell (not supplied). **Power requirements:** 120/240 VAC, 50/60 Hz, 10 W. **Dimensions:** $7\frac{3}{8}$ " H x $4\frac{1}{8}$ " W x $4\frac{1}{4}$ " D. **Net Weight:** $3\frac{1}{2}$ lbs.

B) Service bench VTVM

The SM-21A is a service bench version of the SM-20A described above. It features a rugged all metal case with gimbal bracket for bench or shelf mounting.

Factory assembled & calibrated SM-21A, 7 lbs. . . . \$75.00
See page 15 for meter accessories.

SM-21A SPECIFICATIONS — DC VOLTMETER — Ranges: 0-1.5, 5, 50, 150, 500, 1500 V full scale; up to 30,000 V with accessory probe. **Input Resistance:** 11 megohm (1 megohm in probe) on all ranges: 1100 megohms with accessory probe. **Circuit:** Balanced bridge (push-pull) using twin triode. **Accuracy:** $\pm 3\%$ of full scale. **AC VOLTMETER — Ranges:** 0-1.5, 5, 15, 50, 150, 500, 1500 rms scales (.353 of peak-to-peak). **Frequency Response (5 V range):** ± 1 dB 25 Hz to 1 MHz (600 ohm source, referred to 60 Hz). **Circuit:** Halfwave voltage doubler, using twin diode. **Accuracy:** 5% of full scale. **Input Resistance & Capacitance:** 1 megohm/40 pF measured at input terminals (200 pF at probe tip). **OHMMETER — Ranges:** Scale with 10 ohm center X1, X10, X100, X1000, X10k, X100k, 1 meg. Measures 0.1 ohm to 1000 megohms with internal battery. **Meter:** 6" 200 μ A movement, polystyrene case. **Probe:** Combined AC-OHMS-DC switching probe, single jack input for probe and ground connections. **Dividers:** 1% precision type. **Battery:** $1\frac{1}{2}$ V, "C" cell. **Power Requirements:** 120/240 VAC, 50-60 Hz, 10 W. **Dimensions:** 5" H x $12\frac{1}{8}$ " W x $4\frac{3}{4}$ " D. **Net Weight:** 5 lbs.

C) Laboratory AC VTVM

- Measures AC voltage from 10 Hz to 1 MHz
- 10 ranges from 10 mV to 300 V full scale

The SM-22A AC Vacuum Tube Voltmeter measures AC voltages from 10 Hz to 1 MHz. Almost any type of AC voltage, filament voltage, power line voltage, noise voltage or even output or gain measurements can be made quickly. Ten switch-selected voltage ranges from 10 mV to 300 V full scale are provided. Each range is also calibrated in dB for convenience.

Factory assembled & calibrated SM-22A, 6 lbs. . . . \$75.00
See page 15 for meter accessories.

SM-22A SPECIFICATIONS — Frequency response: ± 1 dB 10 Hz to 500 kHz, ± 2 dB 10 Hz to 1 MHz, all ranges. **Ranges:** Ten ranges from 0.01 to 300 V rms full scale. **Decibels:** Total-range -52 to +58 dB, meter scale -12 to +2 dB (0 dB = 1 mW in 600 ohms), ten switch selected ranges from -40 dB to +50 dB in 10 dB steps. **Input Impedance:** 10 megohms shunted by 12 pF on ranges 10 to 300 V, 10 megohms shunted by 22 pF on ranges .01 to 3 V. **Accuracy:** Within 5% of full scale. **Power requirements:** 120/250 VAC, 50/60 Hz, 10 W. **Dimensions:** $7\frac{3}{8}$ " H x $4\frac{1}{8}$ " W x $4\frac{1}{4}$ " D. **Net Weight:** 3 lbs.

HEATH

Schlumberger

Available August 1, 1974



NEW PORTABLE DUAL-TRACE OSCILLOSCOPE

A lab-grade oscilloscope
with easy-to-operate
controls and 1 mV/cm
sensitivity

Compare these performance features with the competition...

- DC-15 MHz bandwidth with post-accelerated CRT for high brightness
- 1 mV/cm input sensitivity
- Clearly labelled, conveniently positioned controls for simplified operation
- Rugged, dependable construction
- All major circuitry on 5 removable circuit boards for modular field servicing
- 45 MHz typical triggering bandwidth
- Time base sweep to 100 nsec/cm
- Vertical delay lines provide at least 20 nsec of pretriggered waveform for complete signal display
- Y_1 or Y_2 trigger selection
- X-Y capability
- Fully regulated power supplies—operate on any line voltage from 100 to 280 VAC
- Designed & built by Heath—specialists in high performance, low-cost instrumentation

The new Heath/Schlumberger SO-4510 Oscilloscope is a triggered, dual-trace, DC to 15 MHz lab-grade instrument. Its portability, ease of operation and 1 mV input sensitivity make this scope ideal for the wide range of measurements typically encountered in development laboratories, scientific research and the servicing of contemporary electronic circuitry.

Each of the vertical input channels provides an unusual maximum signal sensitivity of 1 millivolt over the full bandwidth. The attenuator networks can be switched through 12 calibrated ranges to set deflection factors from 1 mV/cm to 5 V/cm. An internal delay line starts the horizontal sweep prior to the beginning of the vertical signal. It allows display of at least 20 nsec of the pretriggered waveform, insuring that the complete vertical waveform will be displayed.

Digitally-controlled logic in the time base circuitry provides automatic triggering for easy operation—no stability control is necessary. A reference baseline is generated when the trigger signal is absent. The Trigger Select switch and Level control allow the time base to be precisely triggered at any point along the positive or negative slope of the trigger signal. The

automatic position of the level control triggers at the zero crossing point. In the normal mode, the level can be set to trigger at any amplitude of the trigger signal. Level is adjustable over the complete 6 cm vertical span. Various trigger signals can be selected, including a sample of Channel Y_1 or Channel Y_2 input signals, an externally applied trigger signal or a sample of the power line voltage. The Trigger Mode switch controls the trigger input bandpass for filtering out any unwanted trigger noise.

Modes of signal display are selected by the position control for each channel and the Time Base switch. Either channel can be displayed as a function of time, or both channels can be displayed together. At slower sweep speeds, the vertical channels are alternately displayed at a 200 kHz rate (chopped mode) so both signals appear as a function of the same time base. For faster sweep speeds both signals are displayed alternately (alternate mode) on successive sweeps. X-Y operation uses Channel 1 for horizontal deflection and Channel 2 for vertical deflection.

The Time Base control provides 22 calibrated time bases from 0.2 sec/cm to 0.1 μ sec/cm in a 1-2-5 sequence. A concentric control provides continuously variable speeds between switch positions. Any sweep speed can be expanded five times when the variable control is pulled out. An externally generated time base can also be selected by the time base control.

A calibrated 1 volt peak-to-peak square wave signal is provided through a front panel connector, allowing easy calibration checks and probe compensation adjustments. The fully regulated power supply provides stable voltages to all critical circuits regardless of varying line voltage and load conditions. An adjustable AC line switch is easily accessible and is used to match the regulated power supply to any line voltage from 100 volts to 280 volts AC.

The SO-4510 is remarkably easy to service. Loosening two thumbscrews permits removal of top and bottom cabinet sections for complete access to the interior—great for classroom demonstrations, too. All major circuitry is contained on five circuit boards for easy trouble-shooting. And push-on connectors permit fast removal of any board. Even the CRT can be removed and replaced in a matter of minutes.

Every component of the SO-4510 has been engineered to provide maximum performance and reliability. The 6 x 10 cm CRT has post-deflection acceleration for a brighter trace and faster writing speeds. Printed circuit board switches are used for dependable operation and long life. Front panel controls are clearly labeled and positioned for ease of operation.

The multi-position carrying handle permits positioning of the SO-4510 for the best viewing angle. The line cord storage retainers on the rear panel also allow vertical positioning and storage.

Factory assembled & calibrated SO-4510, 34 lbs. . . . \$750.00
See page 15 for scope probes and accessories.

SO-4510 Specifications

VERTICAL:

- Input Impedance:** 1 M Ω shunted by 38 pF.
- Maximum Input Voltage:** 400 volts peak combined AC and DC.
- Sensitivity:** 1 mV/cm to 5 mV/cm in a 1-2-5 sequence, accurate to within 3%. Uncalibrated, continuously variable between steps with a minimum sensitivity of approx. 15 V/cm.
- Frequency Response:** DC to 15 MHz (-3 dB).
- Rise Time:** 24 ns.
- Overshoot:** Less than 3%.
- Vertical Windows:** 2 minimum.
- Vertical Modes:** Channel Y1, channel Y2, Y1 and Y2 chopped, channels Y1 and Y2 alternately. Modes selected by the channel Y1 position, channel Y2 position, & time base switch.

HORIZONTAL:

- Modes:** Sweep, X-Y, and external.
- Time Base:** 200 mS to 100 nS/cm in 22 calibrated steps, with a 1-2-5 sequence; accurate to within 3%. Uncalibrated, continuously variable between ranges with a maximum of approx. 500 mS/cm.
- X5 Sweep Magnifier:** Accurate to within 5%.
- Input Impedance:** Approx. 200 k Ω .
- Input Sensitivity:** 0.2 V/cm (approx.). No attenuator; negative signal causes trace to move to right.
- X-Y Sensitivity:** 1 mV/cm to 5 V/cm in 1-2-5 sequence.
- X-Y Phase Shift:** Less than 3° at 100 kHz.

TRIGGER:

- Delay Line:** Allows display of at least 20 nS of pretriggered waveform.
- Bandwidth (normal mode at 1 cm deflection):**
AC: 20 Hz-30 MHz, typically 20 Hz-40 MHz.
ACF: 15 kHz-30 MHz, typically 15 kHz-45 MHz.
DC: DC-30 MHz, typically DC-45 MHz.
- Bandwidth (automatic mode at 1 cm deflection):**
DC-10 MHz typically DC-25 MHz.
- Sensitivity:** Less than 0.5 cm.
- External Input Sensitivity:** Less than 0.5 V, typically 0.1 V.
- External Input Impedance:** 1M shunted by approx. 30 pF.

GENERAL:

- Operating Temperature:** 10°C to 40°C.
- CRT Acceleration Potential:** 4000 V regulated.
- CRT Type:** 6 x 10 cm Spiral PDA.
- CRT Phosphor:** P31.
- Power Supplies:** Fully regulated.
- AC Line Switch:** Allows operation from a 100-140 VAC or 200-280 VAC power source.
- Input Connectors:** Coaxial BNC.
- Graticule Illumination:** Adjustable.
- Dimensions:** 6 $\frac{1}{8}$ " H x 12 $\frac{3}{8}$ " W x 21 $\frac{1}{2}$ " D. (handle extended).
- Net Weight:** 24 lbs.

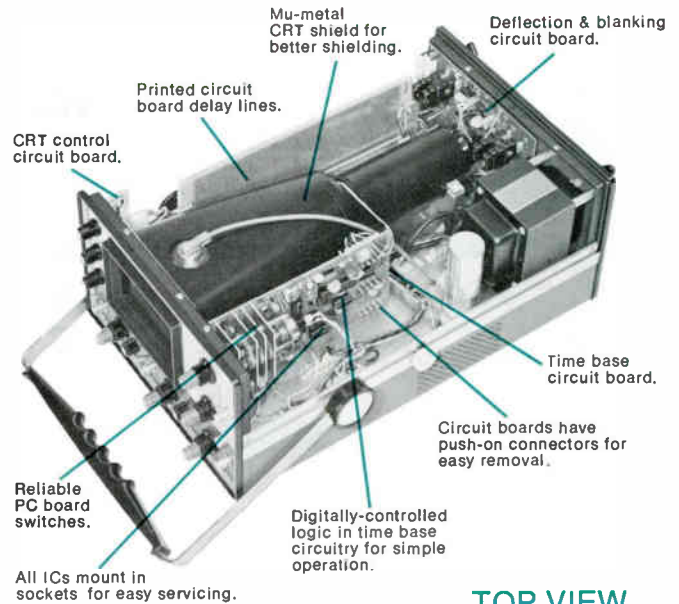

TOP VIEW

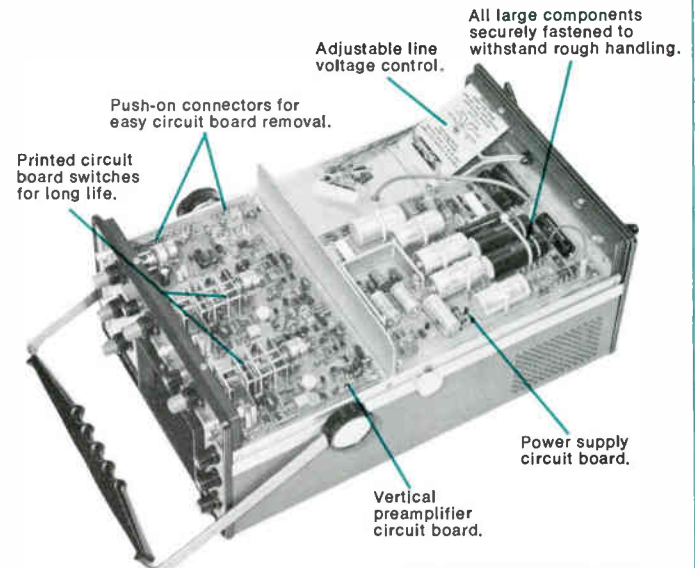

BOTTOM VIEW



VERSATILE, SOLID-STATE OSCILLOSCOPES

Choose either
15 MHz or 5 MHz
bandwidth models



A) DC to 15 MHz triggered scope

- DC to 15 MHz vertical bandwidth with 24 ns rise time
- 10 mV input sensitivity
- 22 sweep rates from 2 s/cm to 0.2 μ s/cm
- X5 calibrated sweep magnifier

A precise, solid-state laboratory or service bench oscilloscope designed to meet the needs of contemporary electronics. The vertical bandwidth of DC to 15 MHz satisfies the requirements of most laboratory, design or trouble-shooting applications.

Vertical sensitivity of 10 mV/cm and 12 calibrated vertical attenuator positions up to 50 V/cm accommodate a broad range of input signals. A variable gain control gives precise control between settings. The input impedance is 1 megohm shunted by 40 picofarads and will accept up to 600 VDC.

Any one of 22 calibrated time bases from 2 s/cm to 0.2 μ s/cm (X5 magnifier for max. sweep of 40 ns/cm) can be selected by the Time/cm switch to provide accurate frequency measurements of the applied signal. The horizontal amplifier accepts external inputs from DC to 1 MHz with an input impedance of 1 megohm. A two-position X1 and X10 horizontal attenuator with vernier is built into the Time/cm switch.

Trigger controls include selection of either normal or automatic modes, AC-DC coupling; external triggering and plus or minus slope triggering. All functions are selected by clearly labeled front panel switches.

A big 6 x 10 cm screen with lighted graticule makes for easy, accurate measurements. Features include a CRT bezel with standard camera mount dimensions, flush-mounted handle for easy stacking and easily-removable side panels for quick accessibility.

Factory assembled & calibrated SO-106A, 40 lbs. . . \$475.00

SO-106A SPECIFICATIONS — Vertical — Input impedance: 1 M Ω shunted by 40 pF. Maximum input voltage: 600 volts DC. Sensitivity: 10 millivolts/cm. Frequency response: DC to 15 MHz, ± 3 dB with 4 cm deflection. Rise time: 24 ns. Attenuator: 12 positions in a 1, 2, 5 sequence 0.01 volt/cm to 50 volt/cm $\pm 3\%$. Horizontal — Input impedance: ≈ 1 M Ω . Sensitivity: Less than 0.5 volt/cm. Frequency response: DC to 1 MHz, ± 3 dB. Attenuator: 2 position, X1 and X10. Time Base — Sweep: 22 steps in a 1, 2, 5 sequence, 2 s/cm to 0.2 μ s/cm, $\pm 5\%$. Horizontal expansion: X5 $\pm 5\%$. Trigger modes (switch selected): AUTO/NORMAL; + or -; AC/DC; INT/EXT. Trigger sensitivity — Internal: 1 cm display. External: 0.5 volt peak-to-peak. Calibrator — Signal Source: 4 MHz oscillator, crystal controlled $\pm 0.01\%$. Outputs (TTL square wave, peak-to-peak): Front panel: 1 kHz; 0.4 volt $\pm 5\%$. Internal: 1 kHz, 2.5 volts (approx.). 1 kHz, 5 volts (approx.). 10 kHz, 3 volts (approx.). 100 kHz, 3 volts (approx.). 1 MHz, 3 volts (approx.). 2 MHz, 3 volts (approx.). General — Input connections: Vertical: Coaxial, BNC. Horizontal: Banana jack. Trigger: Banana jack. CRT accelerating potential: 2800 volts DC, regulated. CRT type: 5ABP31, 6X10 cm viewing area; green medium persistence phosphor. Retrace suppression: DC-coupled unblanking of the CRT. Graticule: Engraved, 6X10 cm, edge lighted. Power requirements: 110 to 130 VAC or 220 to 260 VAC, 50/60 Hz, 45 watts. Overall dimensions: 12 $\frac{3}{4}$ " H x 10 $\frac{3}{4}$ " W x 20" L. Dimensions include all protruding surfaces; knobs, handle, feet, etc. Net weight: 32 lbs. NOTE: Specifications measured at 25°C with 120 VAC line voltage.

B) Solid-state DC to 5 MHz scope

- DC to 5 MHz bandwidth with 80 nsec rise time
- 30 mV input sensitivity
- Five sweep ranges, 10 Hz to 500 kHz
- External sweep and sync inputs
- Built-in 1 volt p-p reference

An excellent general purpose scope... ideally suited for lab and classroom use or demonstration... the perfect choice for general service and design work in audio, TV and receiver circuitry. Its solid-state design provides extended life, outstanding reliability and superior performance.

The wide band response, fast rise time and excellent sensitivity make the SO-107A a truly high performance, low cost scope. Vertical bandwidth of DC to 5 MHz and switch-selected AC or DC coupling add extra convenience and versatility. Frequency-compensated 3-position attenuator accommodates varying input levels. A separate switch position permits grounding the amplifier input to provide a zero reference line. An FET input circuit provides the high input impedance necessary to minimize circuit loading. Input sensitivity is 30 mV/cm; rise time is 80 nanoseconds.

The recurrent, automatic sync sweep generator provides five sweep ranges from 10 Hz to 500 kHz. A separate frequency vernier control permits selection of the desired sweep rate to give a stationary trace. An external horizontal input allows the sweep signal to be applied by an external generator. The front panel internal-external switch and external sync connector provide a means for applying an external sync signal. A one volt peak-to-peak output provides a signal that can be used as a comparison to determine the value of an unknown voltage.

The CRT used in the SO-107A provides a brilliant, easily-read trace — even in areas such as classrooms with high ambient light levels. The highly visible trace coupled with the large 5" CRT make the SO-107A ideal for classroom demonstration purposes. A 6x10 cm ruled graticule makes trace amplitude easy to determine. For additional convenience and versatility, the CRT bezel may be replaced by a standard scope camera mount.

Factory assembled & calibrated SO-107A, 31 lbs. . . \$200.00

SO-107A SPECIFICATIONS — VERTICAL CHANNEL — Sensitivity: 30 mV/cm p-p, uncalibrated. Frequency Response: DC — 5 MHz, ± 3 dB. Rise Time: 80 ns. Input Impedance: 1 megohm shunted by 35 pF. Attenuator: 3-position, frequency compensated; x1, x10, x100. HORIZONTAL CHANNEL — Sensitivity: 0.1 V/cm. Frequency Response: 1 MHz ± 3 dB. Input Impedance: 1 megohm shunted by 50 pF. SWEEP GENERATOR Type: Recurrent, automatic sync. Range: 10 Hz - 500 kHz in five switch-selected steps, continuously variable between steps. GENERAL — Cathode Ray Tube: Type 5DEP1, green medium persistence phosphor. Viewing area 6x10 cm. Power Supplies: All solid-state rectifiers, all amplifier supplies regulated. Power requirements: 110/130 or 220/260 VAC, 50/60 Hz, 70 W. Overall Dimensions: 12 $\frac{3}{4}$ " H x 9 $\frac{3}{4}$ " W x 16 $\frac{1}{4}$ " D, including knobs, handle, feet, etc. Net Weight: 27 lbs.

SUBSTITUTION BOXES AND ACCESSORIES

Check your bench inventory...there's probably something here that you need.

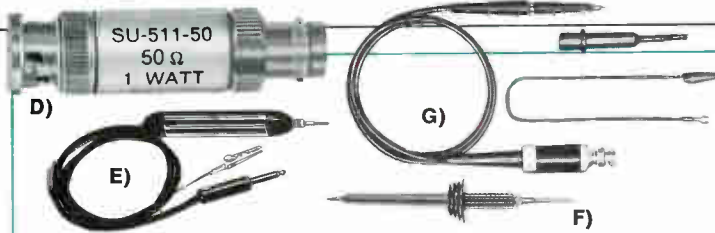
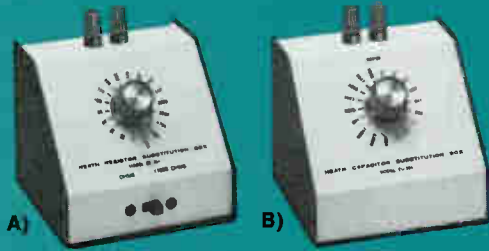

A) Resistance substitution box

- Switch-selection of 36 resistance values
- 15 ohms to 10 megohms • 18 position rotary switch with slide switch for x1 and x1000 • All resistors are 1 watt, 10% • 5-way binding posts accept 3/4" dual banana plugs • 4 1/4" H x 4 3/4" W x 4 1/4" D

Assembled EU-28A, 2 lbs. \$31.00

B) Capacitance substitution box

- 0.001 mfd to 0.22 mfd range • Switch-selection of 18 values • High quality silver-mica and molded tubular capacitors • All voltage ratings 400 V or better • 5-way binding posts • 4 1/4" H x 4 3/4" W x 4 1/4" D

Assembled EU-29A, 2 lbs. \$29.00

C) Decade resistance box

- Provides any resistance value from 1 to 9,999,999 ohms in 1 ohm steps • Precision $\pm 0.1\%$ and 1% resistors used throughout

Assembled EU-30A, 3 lbs. \$75.00

EU-30A SPECIFICATIONS — Range: 1 ohm to 9,999,999 ohms in 1 ohm steps. Resistors: 1 watt precision, with $\pm 0.1\%$ accuracy, except those in the X1 decade which are $\pm 1\%$ accuracy. Maximum Voltage and Current For Each Decade: Decade: X1, X10, X100, X1k, X10k, X100k, X1M Voltage (V): 1, 3, 2, 10, 32, 100, 320, 500 Current (mA): 570, 185, 57, 18, 5.7, 1.8, 0.17. Decade Taps: 6 taps terminated in banana jacks and wired between adjacent decades. Switch Contacts: Solid silver alloy. Minimum DC Resistance: Approximately 0.1 ohm at binding posts with all decades set at 0. Temperature Coefficient: ± 100 ppm/degree C. Readout: Numbered discs on switch shafts; visible through windows above each decade. Dimensions: 2 5/8" H x 13 3/8" W x 2 1/8" D. Weight: 2 1/4 lbs.

D) 50-ohm termination

UHF termination used to eliminate improperly terminated cables which can cause incorrect count or no count in frequency counters and distorted waveforms in scopes. DC to 1 GHz range; power rating is 1 watt. VSWR: 250 MHz, 1.2:1; 600 MHz, 2:1.

Factory assembled SU-511-50, 1 lb. \$15.00

E) Etched circuit RF probe

The PKW-3 Probe provides RF voltage measurement capability for any 11 megohm DC input voltmeter. Frequency response is linear from 1000 Hz to over 100 MHz. RF voltages of 90 volts rms or less can be easily measured, as well as RF voltages superimposed on DC potentials of 1000 V or less.

Factory assembled PKW-3, 1 lb. \$7.00

F) 30 KV DC probe

The 336W Probe increases all voltage ranges by a factor of X100 when connected to a VTVM with an input resistance of 11 megohms. It increases the input resistance to 1100 megohms, permitting measurements to be made in high resistance circuits with negligible loading.

Factory assembled 336W, 1 lb. \$7.95

The above probes are not for use with SM-4440, SM-1242, SM-666, SM-660, SM-670 multimeters.

G) High frequency compensated probe

The PKW-101 can be used with any measuring instrument having a 1 megohm input impedance. It is ideal for use with the EU-70A and SO-106A scopes. Features include 10 megohm input impedance shunted by 11.5 pF; DC-60 MHz bandwidth; x10 attenuation; 500 VAC and VDC voltage rating; compensation for matching to any 1 megohm scope input shunted by 15-47 pF; BNC connector; combination spring-loaded outer hook connector and fine pointed inner tip probe.

Factory assembled & calibrated PKW-101, 1 lb. \$23.95

PKW-101 SPECIFICATIONS — Input impedance: 10 megohm shunted by 11.5 pF. Compensation: Allows matching to any 1 megohm scope input shunted by 15-47 pF. Bandwidth: DC to 60 MHz. Attenuation: x10. Voltage rating: 500 volts, AC & DC. Scope connector: BNC. Probe: Spring-loaded outer hook connector and fine-pointed inner tip combination. Cable length: 3 1/2 feet. Net weight: 15 oz.

Accessory cables

Accessory cables...ideal for inter-connecting various types of bench equipment such as scopes, counters, generators, etc. All cable is RG-58A/U, 53 ohm characteristic impedance.

Factory assembled SU-501-1, 1 ft., BNC/BNC, 1 lb. . . \$5.00

Factory assembled SU-501-3, 3 ft., BNC/BNC, 1 lb. . . \$5.00

Factory assembled SU-501-6, 6 ft., BNC/BNC, 1 lb. . . . \$5.00

Factory assembled SU-502-3, 3 ft., BNC/UHF, 1 lb. . . . \$5.00

Factory assembled SU-503-3, 3 ft., BNC/Banana, 1 lb. . . \$5.00



NEW FUNCTION GENERATOR... ONLY \$140



Simple operation and functional design combined in an accurate, 0.1 Hz-1 MHz instrument

- 0.1 Hz to 1 MHz range
- Sine, square or triangle waveforms
- Calibrated attenuation from 0 to 50 dB
- Easy to operate
- Compact size
- Adjustable tilting handle

The new Heath/Schlumberger SG-1271 Function Generator combines wide frequency range, compact size and reliable Heath engineering in a low-cost generator that will satisfy the most sophisticated requirements. All controls are located on the front panel for convenient operation. Clearly legible controls assure correct first-time operation, making it ideal for student use.

The SG-1271 will provide sine, square or triangle waveforms over a frequency range of 0.1 Hz to 1 MHz. The large tuning control allows fast and precise control of frequency over a 100:1 range. The six-position Frequency Multiplier is the only other control needed to set any frequency. The output supplies a 10-volt peak-to-peak signal into a 50-ohm load. A calibrated step attenuator adjusts from 0 to 50 dB in 10 dB steps—considerably more attenuation than offered by other function generators in this price range. The variable attenuator control provides up to 20 dB attenuation for each step. Attenuator accuracy is ± 1 dB.

Frequency accuracy of the SG-1271 is $\pm 3\%$. Nonlinearity of the triangle waveform is 5% maximum, with waveform symmetry within 10%. Square wave rise and fall times are 100 μ sec. maximum. Choice of 105-130 or 210-260 VAC operation is made by positioning a chassis-mounted switch and using the appropriate fuse.

Most of the components are mounted on a single circuit board, making the SG-1271 easy to service. And the 1271 remains fully operational with all components exposed—handy for classroom demonstrations. Its light weight and small size allow it to be placed almost anywhere. The adjustable tilting handle provides easy carrying and positioning for best access to the front panel controls.

The SG-1271 is a compact, easy-to-operate function generator that will prove invaluable on any lab or test bench. It packs a lot of performance into a small package—at a price low enough to fit every budget.

Factory assembled & calibrated SG-1271, 7 lbs. . . . \$140.00

Cables and accessories for use with the SG-1271 are described on page 15.

Three basic waveforms are generated by the SG-1271

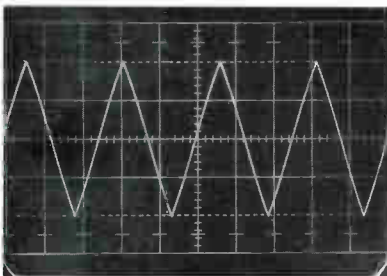

Triangle...maximum nonlinearity is 5%. Waveform symmetry is maintained within 10% of 50% duty cycle.

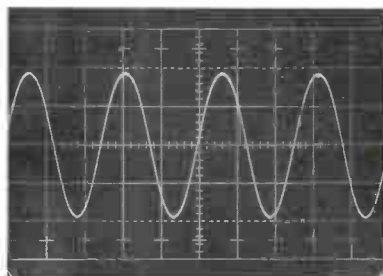

Sine wave...harmonic distortion is 3% maximum from 5 Hz to 100 kHz.

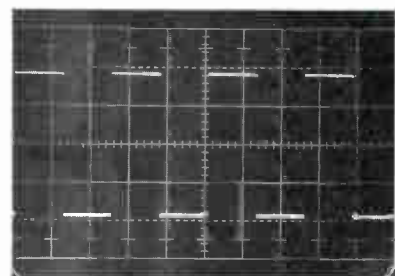

Square wave...maximum rise or fall time is 100 nanoseconds with symmetry within 10% of 50% duty cycle.

The new SG-1271 offers more performance for less money... just compare these specifications

SG-1271 Specifications

Frequency Range: 0.1 Hz to 1 MHz.

Frequency Accuracy: $\pm 3\%$ of full scale on dial.

FUNCTIONS:

Triangle Waveform: Nonlinearity, 5% maximum. Symmetry within 10% of 50% duty cycle.

Square Waveform: 100 nanosecond maximum rise or fall time. Symmetry within 10% of 50% duty cycle.

Sine Waveform: Harmonic distortion; 3% max., 5 Hz to 100 kHz.

Attenuator: 0 to 50 dB in 10 dB steps. 0 to 20 dB minimum variable. ± 1 dB accuracy.

Output: 10 volts peak-to-peak into 50 ohms. ± 1.5 dB flatness from 0.1 Hz to 1 MHz. 50 ohms impedance $\pm 5\%$.

Power Requirements: 105-130 volts or 210-260 volts RMS, 50-60 Hz, 15 watts max.

Operating Temperature: 0 to 40°C.

Dimensions: 3" H x 7 1/4" W x 8 7/8" D (with handle removed).

Net Weight: 4.2 lbs.

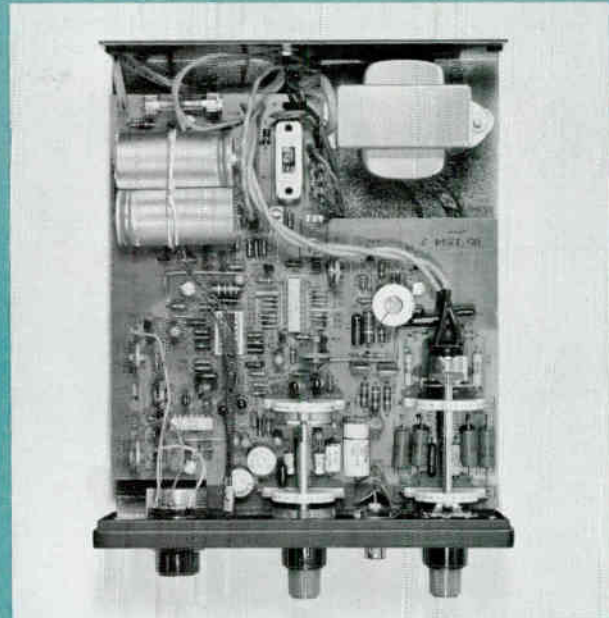

Most components are mounted on a single circuit board, making the SG-1271 easy to service — and handy for classroom demonstrations.



EU-81A solid-state function generator... a precise, versatile signal source

- Sine, square and triangle output
- 0.1 Hz to 1 MHz in seven ranges
- Linear dial
- Front panel adjustable DC offset
- Voltage controlled oscillator.

The EU-81A provides low-distortion sine, square and triangle waveforms. Output is variable over seven decades from 0.1 Hz to 1 MHz. The 50-ohm output provides compatibility with most common test and lab instruments. Clearly labeled controls, pushbutton selection of range and function and a large, calibrated linear dial make frequency selection fast and accurate. Panel attenuation of 40 dB is available...20 dB (nominal) by pushbutton plus 20 dB variable.

A front panel TTL-compatible square-wave sync output gives additional versatility; use to sync scopes and eliminate re-triggering when changing output level or frequency. It can also be used to drive a frequency counter or as a TTL source in

place of the main output. Front panel DC offset is variable up to the maximum signal amplitude. The built-in voltage controlled oscillator provides a 10:1 variable sweep range.

Inside the EU-81A you'll see evidence of careful, thorough engineering. The main timing capacitors are all metallized polycarbonate to assure excellent frequency stability and linearity under conditions of changing temperature, humidity and age. All circuit boards are rugged G-10 glass epoxy. Calibration controls are readily accessible. And each EU-81A is thoroughly inspected and "burned-in" for 20 hours to assure performance and reliability.

Uses of the EU-81A include providing the VCO in phase lock loops for FM detection or precise frequency multiplication; testing amplifier frequency response, distortion and stability; repetition rate generator; tone generator; variable beat frequency oscillator.

Factory assembled & calibrated EU-81A, 8 lbs. . . . \$245.00

EU-81A SPECIFICATIONS — Output: All modes, 50 ohm output impedance. 10 V P-P into 50 ohm load. 20 V P-P open circuit. Adjustable DC offset continuously variable to maximum signal amplitude. **Attenuator:** Variable 20 dB control (nominal); fixed 20 dB pushbutton. **Frequency range:** 0.1 Hz to 1 MHz in 7 decades; continuously adjustable with linear dial. **Triangular waveform:** 95% linearity to 100 kHz. **Sine waveform:** Harmonic distortion — 1%, 5 Hz to 100 kHz ($\frac{1}{2}\%$ typical); less than 2% to 1 MHz. **Square wave:** 125 ns rise or fall time. **Waveform symmetry:** $\pm 2\%$ to 100 kHz. **Frequency dial accuracy:** $\pm 3\%$ of full scale. **Frequency stability after 1 hour with external voltage control:** 1 Hz to 1 MHz, $\pm 0.05\%$ for 10 minutes; $\pm 0.3\%$ for 24 hours. 0.1 Hz to 1 MHz, $\pm 0.25\%$ for 10 minutes. **Vertical precision:** Triangular amplifier—0.2 dB to 1 MHz. Square amplifier—0.2 dB to 1 MHz. Sine amplifier—0.2 dB to 100 kHz, down 2 dB at 1 MHz. **External frequency control:** Sweep mode, ± 10 V maximum into 10 k ohms. Voltage control mode, 0-10 V into 100 k ohms. **Control linearity:** 1%. **Operating temperature:** 10 to 40 degrees C. **Power requirements:** 120/240 VAC at 18 watts, 50-60 Hz. **Dimensions:** 5 7/8" H x 8 7/8" W x 11 1/2" D. **Net weight:** 6 lbs.

HEATH
Schlumberger

TV ALIGNMENT GENERATORS

Service any B&W or color TV with these low-cost Heath generators



A)

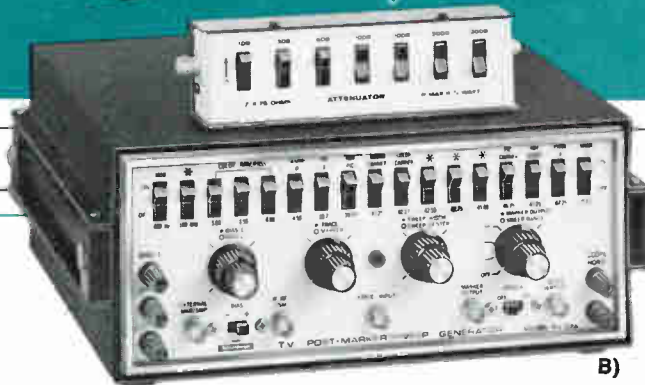

B)

A) Solid-state color bar/dot generator

- Produces 12 patterns: dots, crosshatch, horizontal and vertical lines, color bars and gray scale patterns in either 3x3 or 9x9 display • Clear raster for purity adjustments • RF output for channels 2 through 6

Accurately adjust color circuitry and tri-gun convergence systems quickly, easily, and at low cost. The SG-28A delivers everything you need in a color service instrument at a fraction of the price of competitive models. Compare the features: The SG-28A provides 12 patterns plus a clear raster for purity adjustments. Patterns are available in the standard 9 x 9 display or the exclusive Heath 3 x 3 display. Crystal-controlled sync signals provide necessary blanking and lock the pattern firmly for minimum jitter. And the sync signals are also available on the front panel. Features include adjustable video and RF output, with RF available for channels 2 through 6... crystal-controlled 4.5 MHz oscillator for sound carrier adjustments... adjustable chroma control... red, blue and green gun switches and grid jacks... two front-panel 500 W AC line outlets for connection or other equipment... rock-solid stability and excellent accuracy.

Factory assembled & calibrated SG-28A, 10 lbs. ... \$135.00
See page 15 for accessories.

SG-28A SPECIFICATIONS — PATTERNS — Purity: Produces a snow-free raster for purity adjustments. **Dots*:** 9 x 9 produces a display of 110 small dots. 3 x 3 produces a display of nine dots for convergence adjustments. **Cross-hatch*:** 9 x 9 produces a display of 11 vertical and 10 horizontal lines. 3 x 3 produces a display of three vertical and three horizontal lines for convergence and linearity adjustments. **Horizontal Lines*:** 9 x 9 produces a display of 10 horizontal lines. 3 x 3 produces a display of three horizontal lines for vertical linearity and pin-cushion adjustments. **Vertical Lines*:** 9 x 9 produces 11 vertical lines. 3 x 3 produces a display of 3 vertical lines for horizontal linearity and convergence adjustments. **Color Bars*:** 9 x 9 produces a display of ten standard color bars. 3 x 3 produces a display of three standard color bars. **Gray Scale:** Provides a wide bar cross-hatch pattern with six shades of brightness for color gun level adjustments. **OUTPUT SIGNALS — Video:** Greater than ±1 volt peak-to-peak composite signal for composite signal injection beyond the video detector. **RF:** Variable to approximately 50 mV output, channel 2 through 6, for composite signal injection into the TV receiver antenna input terminals. **Sync:** Greater than 3.5 volts peak-to-peak signal for servicing sync circuits without video, or sets having separate video and sync demodulator phase adjustments. **POWER SUPPLY: Input:** 120/240 VAC, 50/60 Hz. **Output:** 3.6 VDC, 500 mA, zener regulated. **Dimensions:** 13½" W x 5¼" H x 8" D. **Net Weight:** 6½ lbs.
* If receiver under test has no overscan.

B) SG-57A post marker/sweep generator decreases alignment time... increases profit

- Produces all the most-used alignment frequencies for TV IF, color bandpass, FM IF and VHF channels 4 & 10 • 15 crystal-controlled markers • 3 sweep oscillators • Post-injection marker circuitry • Two bias supplies • External attenuator supplied • Complete with 4 coax cables, 4 test leads and demodulation probe

Complete any alignment job quickly, easily and at low cost. With just the Heath/Schlumberger SG-57A, a scope and a VTVM, you're ready to align virtually any B&W or color receiver on the market. Check overall receiver frequency response from the antenna terminals through the tuner, IF strip, video detector, to the color bandpass amplifier outputs. Sweep-modulated picture carriers are provided... not only at 45.75 MHz for the tuner mixer input, but also at 67.25 MHz for the antenna terminal input. And the external attenuator lets you set bandwidth accurately in seconds.

15 crystal-controlled markers... 4 for color bandpass, 1 for FM IF, 8 for TV IF frequencies from 39.75 to 47.25 MHz... plus markers for channels 4 & 10 picture and sound carriers. Accurately locate picture and sound carriers, 6 dB points, trap locations. Three sweep oscillators in stable Colpitts circuits produce the 5 most-used ranges using harmonics... for color bandpass, FM IF, Video IF bandpass, VHF channels 4 & 10.

Features include switchable retrace blanking... phase control for matching to scope... trace reverse... 400 Hz modulation... hi-Z trace amplifier.

Factory assembled & calibrated SG-57A, 16 lbs. ... \$235.00
Need extra cables or probes for the bench? See page 15.

SG-57A SPECIFICATIONS — Marker frequencies: 100 kHz. **Marker frequencies, crystal-controlled:** 3.08, 3.58, 4.08, and 4.50 MHz ±0.1%. 10.7, 39.75, 41.25, 42.17, 42.50, 42.75, 45.00, 45.75, 47.25, 67.25 and 193.25 MHz ±.005%. **Modulation frequency:** 400 Hz. **Input Impedance:** External Marker/Sweep, and Attenuator — 75 ohms. Trace in — 220 k ohms. **Output Impedance:** Marker Output, Sweep Output IF/RF VSM and Attenuator — 75 ohms. Scope Vert. — 1 k ohms. **Bias voltage:** Two individually adjustable 15 VDC, 10 mA supplies; Positive or negative polarity. **Type of marker:** Birdie. **Controls:** Bias controls; Marker/Trace — dual concentric; Sweep Width/Sweep Center — dual concentric; Marker Out — concentric with Sweep Range switch; and Phase. **Switches:** Rocker type — separate switch for each of the above listed frequencies; Blanking, On/Off; Trace Reverse; Modulation On/Off. Power On/Off; Bias + or -. **Sweep frequency ranges and output voltage:** LO Band — 2.5 to 5.5 MHz ±1 dB at 0.5 volts rms (min.) fundamentals, and 10.7 MHz on harmonics. IF Band — 38 to 49 MHz ±1 dB, at 0.5 volts rms (min.) fundamentals. RF band — 64 to 72 MHz ±1 dB at 0.5 volts rms (min.) fundamentals and 192 to 198 MHz on harmonics. **Attenuator:** Total of 70 dB of attenuation in seven steps — 1 dB, 3 dB, 6 dB, 10 dB, 10 dB, 20 dB and 20 dB. **Power requirements:** 120 V, 60 Hz AC at 4.5 watts. **Dimensions:** 5½" H x 13½" W x 12" D. **Net Weight:** 14 lbs.

AUDIO AND SINE -SQUARE WAVE GENERATORS

These low cost, high performance generators have a place on your bench



B)



A)

A) Low distortion audio generator

- Sine wave output from 10 Hz to 100 kHz
- Output metered in both volts and dB
- Less than 0.1% distortion across the entire audio range . . . ideal for amplifier work

Provides near-perfect sine wave signals. Excellent as a source for bridge and harmonic distortion measurements, as an external modulator for RF signal generators, and in testing audio amplifiers for gain and response. The SG-28A will provide output from 0.003 to 10 V into a high impedance (10k ohm or greater) load or from 0.003 to 1 V into a 600 ohm load.

Factory assembled & calibrated SG-72A, 9 lbs. \$85.00
Cables, probes & terminations are on page 15.

SG-72A SPECIFICATIONS: Frequency Range: 10 Hz to 100 kHz. Frequency Selection: Switch-selected, two significant figures and a multiplier. Output Voltage Ranges: eight ranges, 0.003 to 10 V full scale with 10 k ohm minimum external load. Six ranges, 0.003 to 1 V full scale with 600 ohm external load. Output Impedance: 10 V range, 0-1000 ohms; 3 V range, 800-1000 ohms; 1 V range and lower, 600 ohm external and 290 ohm internal load. dB Ranges: -62 to +22 dB; -12 to +2 dB on the meter and -50 to +20 dB on the output switch in 10 dB steps. dBm Ranges (600 ohm external load): -62 dBm to +2 dBm. 0 dBm = 1 mw in 600 ohms. Output meter accuracy: ±5% of full scale when properly terminated. Frequency Accuracy: 5%. Distortion: less than 0.1% 20-20,000 Hz. Power Requirements: 120/240 VAC, 50-60 Hz, 40 watts. Dimensions: 6½" H x 9½" W x 5" D. Net Weight: 6 lbs.

B) SG-18A solid-state sine-square wave generator

- Sine wave output available from 1 Hz to 100 kHz with low distortion
- 5 Hz to 100 kHz square wave output with fast risetime
- Outputs available simultaneously or independently

A highly versatile, low cost addition to any bench. The SG-18A is ideal for gain and frequency response measurements in audio amplifiers, as a signal source for harmonic distortion measurements or as an external modulator for RF signal generators.

Sine wave signals are available from 1 Hz to 100 kHz with distortion less than 0.1%. Eight switch-selected output ranges from 0.003 to 10 V are provided when operating into a high impedance (10 k ohm min.) external load. Six ranges from 0.003 to 1 V are available when operating into the internal 600 ohm load or external load. A meter monitors the sine wave output, and is conveniently calibrated in both volts and dB. Square wave output is available from 5 Hz to 100 kHz with peak-to-peak output levels of 0.1, 1 and 10 V into a load of 2000 ohms or greater. Risetime is 50 nanoseconds, making the SG-18A ideal for checking audio amplifier response or use as a trigger for digital circuitry testing. Frequency is quickly and accurately selected using front panel switches for 0-100, 0-10, and x1, 10, 100 and 1000 multipliers. A separate vernier control is provided for the 0-1 range. Other features include output available simultaneously or independently at 5-way banana jacks . . . switchable internal or external load . . . dual primary transformer for 120 or 240 VAC operation . . . built-in carrying handles for easy portability.

Factory assembled & calibrated SG-18A, 10 lbs. . . . \$110.00
See page 15 for cables and other accessories.

SG-18A SPECIFICATIONS — GENERAL: Frequency selection: 0-100 switch (steps of 10), 0-10 switch (steps of 1), 0-1 control (vernier) & multiplier switch (x1, 10, 100, 1000). **SINE WAVE OUTPUT:** Output voltage: 8 ranges, 0.003 to 10 V rms (full scale) with 10 K ohm or higher external load. 6 ranges, 0.003 to 1 V (full scale) with 600 ohm internal or external load. dB ranges: -62 dB to +22 dB, -12 dB to +2 dB on meter and -50 to +20 dB on amplitude switch in 10 dB steps. +2 dB max into 600 ohm load. (0 dB = 1 mW in 600 ohms). Output variation: ±1 dB 10 Hz to 100 kHz. Output indications: Two voltage and one dB scale on meter. Output impedance: 10 V range; 0-1000 ohm; 3 V range; 800-1000 ohm, 1 V range and lower; 600 ohm. Meter accuracy: ±5% of full scale with proper load termination. **SQUARE WAVE OUTPUT:** Output voltage (peak-to-peak): 0.1, 1, 10 V into 2000 ohm load or higher. Output impedance: 0.1 V and 1 V ranges: 52 ohm; 10 V range; up to 220 ohm. Power requirements: 120/240 VAC, 50/60 Hz, 6 watts. Dimensions: 5½" H x 13¼" W x 7" D. Net Weight: 7 lbs.



HIGH & LOW VOLTAGE SUPPLIES

Ideal for design & service applications



B)



A)

A) 0.5-50 VDC regulated supply

- Adjustable current limiting up to 1.5 A
- Very low ripple and noise
- Floating output
- Overload protected

Our finest low voltage supply. The SP-27A is packed with the features you need for design and service work, and it's priced to fit your budget. Output voltage is selected in 5-volt increments by the Coarse Voltage switch, with infinite adjustment provided by the Fine Voltage control. Output current limiting is also selected in fixed ranges with a Fine Current control for vernier adjustments. The SP-27A is protected against overloads by an automatic current limiter and overload relay circuits.

The large 3½-inch meter can be switched to measure either output voltage or output current. Indicator lights show which function is being monitored. Meter scales are color matched to the coarse voltage and current range switch markings.

Floating output is provided by completely isolated positive and negative front panel binding posts. A separate binding post is provided for making connections to the chassis. The Reset/Standby switch allows shutting off power to the circuit under test without disconnecting the supply.

Factory assembled & calibrated SP-27A, 15 lbs. . . \$150.00

SP-27A SPECIFICATIONS — Input: 120/240 VAC, 50/60 Hz; 135 W at full load (50 V, 1.5A). Output: 0.5-50 VDC; 1.5 amps max. DC. Load regulation: ±15 mV, can be adjusted for no change. Line regulation: for a 5% change in line voltage, less than 0.05% change. Ripple & noise: Less than 250 μV. Transient response: Less than 25 μsec. Output impedance: Less than .075 ohms from DC to 10 kHz, less than .3 ohms 10 kHz & up. Overload protection: Current limiter & relay. Meter: 3½", 1 mA, 50 ohm. Current ranges: 50 mA, 150 mA, 500 mA, 1.5 A. Voltage ranges: 5V, 15V, 50V. Front panel controls: On/Off Coarse voltage switch, Fine voltage adjust, Current range switch, Current limit adjust. Meter rocker switch, Reset/Standby toggle switch. Output terminals: (3), plus (+), minus (-), chassis ground. Dimensions: 5½" H x 13¼" W x 9" D. Net Weight: 12 lbs.

B) High voltage supply delivers B+, filament and bias voltages

- 0-400 volts DC output at 0-100 mA
- 0-100 volts DC bias voltage at 1 mA
- 6.3 or 12.6 volts AC filament voltage output

The SP-17A is a high voltage bench supply with all the features and performance you're likely to need, yet the price is realistically low. This power supply is a compact, convenient source of variable regulated high voltage, variable bias voltage and filament voltage for laboratories and service shops.

The SP-17A provides the three most-used voltage ranges for work with tube circuits: B+, C- and filament voltages, all available in a single bench-top supply. The B+ output is regulated to better than 1%, no load to full load. Ripple and noise are less than 10 mV. Bias voltage is available from 0 to 100 V at 1 mA, with a special control for fine adjustment of the lower voltages in the range. Filament voltages of 6.3 and 12.6 are available either independently or simultaneously, up to a maximum power output of 25 volt-amperes. The filament circuit may be left on while switching off the high voltage circuit. This eliminates repeated tube warmup time.

Separate panel meters allow accurate monitoring of output current and voltage. The voltmeter is switch-selectable from the front panel for either the 0-400 or 0-150 VDC range. The front panel DC On/Standby switch instantly shuts off power to the load without having to disconnect the load physically. All output binding posts are insulated from the chassis to allow the high (B+) and bias (C-) voltages to be used as either negative or positive voltage sources.

Built-in circuit protection prevents damage if the bias voltage output circuit should accidentally be overloaded, and the input circuit is fused for additional protection.

Factory assembled & calibrated SP-17A, 21 lbs. . . \$125.00

SP-17A SPECIFICATIONS — Output: 0-400 V regulated DC at 0-100 mA continuous, 125 mA intermittent, 0 to -100 VDC at 1 mA variable bias voltage, 6.3 VAC at 4 amps., 12.6 V at 2 amps. (25 VA max. AC load), filament voltage. Regulation: Output variation less than 1% from no load to full load. Output variation less than 1% for a ±10 V change at 117 VAC input. Ripple: Less than 10 millivolts rms, ripple, jitter and noise. Output impedance: Less than 10 ohms, DC to 1 MHz. Meters: Voltmeter 0-400 V or 0-150 V; Milliammeter 0-150 mA. Power requirements: 120/240 VAC, 50/60 Hz, 150 W max. Dimensions: 5½" H x 13¼" W x 11" D. Net Weight: 16 lbs.

REFERENCE & LOW VOLTAGE SUPPLIES

Indispensable aids for any bench

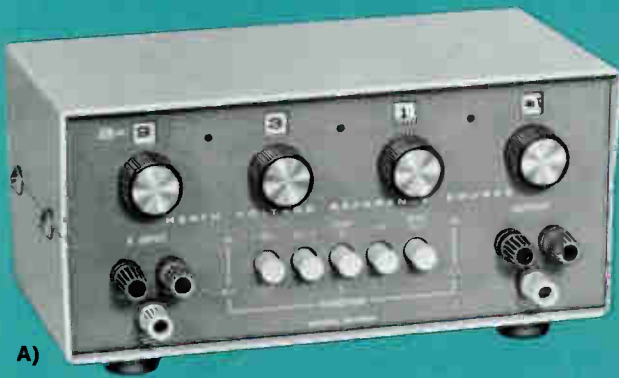

A)



B)

A) Voltage reference source

- 0-10 volts DC output • Zener stabilized to 15 ppm/hr • Voltage-to-current accessory included

The EU-80A is a very accurate, regulated variable DC voltage standard designed for convenience and versatility. Pushbutton function switches select the mode of operation for use as a DC voltage standard; a 60 Hz signal source for oscilloscope calibration; or a precision sum or difference source for voltage comparisons, potentiometric measurements and bucking voltage applications.

Three direct-reading voltage controls and a range switch on the front panel vary the output from 10 μ V to 10 volts. Decimal point position is indicated by one of three neon lamps. Pushbutton controls permit output polarity reversal and selection of a 60 Hz chopped DC square wave output.

A voltage-to-current accessory is provided to allow the EU-80A to be used as microampere or nanoampere current source. This type of high-resistance current source is very useful as a precision calibrator for low-resistance circuits which are found in applications such as operational amplifiers and servo systems.

Factory assembled & calibrated EU-80A, 6 lbs. . . . \$150.00

EU-80A SPECIFICATIONS—Output: Output Voltage: 0-10 VDC, regulated. Accuracy: As allowed per 0.1% resistors. Stability: 15 ppm/hr; 1000 ppm/mo. Regulation: Less than 0.05% change with a 90 to 130 VAC line voltage change. Noise: Less than 1 mV. Output Current Using Voltage-To-Current Accessory: 0-10 μ A in 1 M ohm positions; 0-10 nA in 1 G ohm position. Output Current Accuracy: 1% in 1 M ohm position; 2% in 1 G ohm position. Controls: Range Selector: Four position — 10V, 1000 mV, 100 mV, & 10 mV. Voltage Selectors: 10 position switches for first two digits & continuous adjustment for third digit. Function Switches: On/Off; S/A \pm S; DC-S/chop-S; +S/—S. Power Requirements: 105-125 or 210-250 VAC, 50/60 Hz, 10 watts. Dimensions: 4 $\frac{3}{4}$ " H x 9 $\frac{1}{2}$ " W x 6 $\frac{3}{4}$ " D. Net Weight: 4 $\frac{3}{4}$ lbs. including E-to-I accessory.

B) 0-15 VDC regulated power supply

- Adjustable current limiting 37-750 mA
- Regulated to 0.02% • External programming capability

An excellent bench supply. The EU-41A provides highly stable, ripple-free output from 0-15 VDC with current limiting from 35-750 mA. Output voltage is regulated within 0.02% and is continuously adjustable over the entire range.

The output can be shorted out for extended periods without damage. When an excessive load is connected to the output, a current-limiting indicator on the front panel signals the overcurrent condition. Other features include output available at 5-way binding posts and octal socket, solid-state design and compact dimensions.

Factory assembled & calibrated EU-41A, 7 lbs. . . . \$85.00

EU-41A SPECIFICATIONS—Output voltage: 0-15 volts DC, continuously variable. Output current: 0-750 mA. Current limiting: 35-750 mA continuously variable. Regulation: \pm 0.02% with line voltages between 105 and 125 volts or load current from 0-750 mA. Ripple: 0.2 mV rms. Stability: \pm 0.02% for 8 hours. External programming: Output to input voltage ratio is adjustable from 0 to 1.2:1. Input impedance is 8,000 ohms. Power requirements: 105-125 volts, or 210-250 volts. 50/60 Hz, 55 watts maximum at full load. Dimensions: 5" H x 8 $\frac{1}{4}$ " W x 7 $\frac{3}{4}$ " D. Net Weight: 4 $\frac{1}{2}$ lbs.



NEW LOW-COST CHART RECORDER

Functional design and easy operation combine for maximum versatility on a low budget

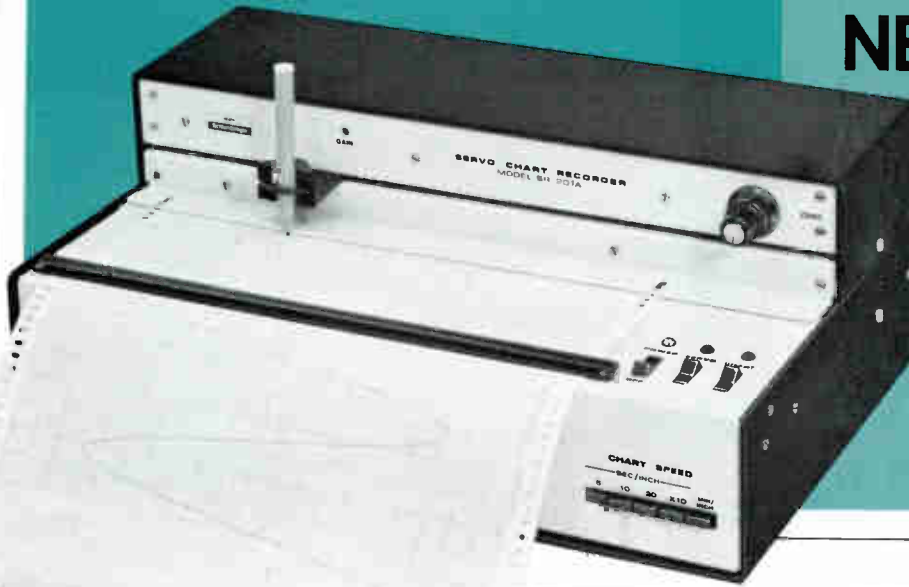

The **SR-201A Strip Chart Recorder** is a versatile, low-cost instrument. The 10 mV input span, 1 second balance time, functional design and ease of operation make it a natural for student use. And its accuracy, stability and low maintenance are ideal for applications in industrial or university research labs. The SR-201A is completely factory calibrated and will perform for long periods with a minimum of care.

The digital logic circuits which drive the chart motor are synchronized with the line frequency to insure accurate chart speeds. A total of 12 chart speeds from 5 sec/in to 200 min/in can be selected in a 1, 2, 5 sequence. Front panel push-buttons give instant response with no complicated mechanisms or gear changes.

Separate Power, Servo and Chart switches allow independent or simultaneous operation of the servo mechanism and chart drive for ease of prerecording adjustments. The coarse and fine Zero Position controls allow rapid and precise pen positioning adjustments anywhere within the range span.

The SR-201A is a true potentiometric recorder. The high input impedance prevents circuit loading. The input will float to ± 100 VDC and is useful when the signal source and the SR-201A have different ground potentials. The 130 dB common mode rejection protects against line noise without affecting performance. A temperature-stabilized reference voltage eliminates the need for an internal reference battery.

The disposable, nylon-tipped pen supplied eliminates complicated pen cleaning or messy ink refills. This pen was designed especially for writing at slow speeds. Multi-colored plots can be obtained by simply changing pens. The pen holder will accept many different types and styles of pens.

Paper loading is easy. Just lift the tip-back top and insert the paper. There is no complex alignment or threading system when you load a new roll of paper. And charts can be easily

rerolled for comparative recordings. One roll of SU-445-17 chart paper is supplied (see below).

Other features include a light-operated modulator and a low-maintenance gearless servo drive system for quiet operation. The flat recording surface is easily accessible, allowing pertinent notes to be added as events occur. Solid-state circuitry and plug-in integrated circuits greatly increase the accuracy, stability and reliability of the SR-201A.

The SR-201A is an outstanding value at a very low price. Try one for 30 days and be convinced...see page 2 for more information.

Factory assembled & calibrated SR-201A, 15 lbs. . . \$255.00
SU-445-17 inch calibrated chart paper. 0.5" major divisions.

120-ft. roll.

1-9 Rolls **\$4.75 ea.** 24-96 Rolls **\$4.00 ea.**
10-23 Rolls **\$4.50 ea.** 97-199 Rolls **\$3.50 ea.**

Write for prices on orders exceeding 200 rolls.

Pens. The SR-201A uses the same pens as the SR-255B recorder on page 27. Please refer to that page for descriptions and ordering information.

SR-201A SPECIFICATIONS: Chart Span: 10 mV full scale. Chart Width: 10-inch grid, markings 0-100, right to left. 120-ft. roll. Recorder Pen: Disposable nylon-tip, blue. Balance Time: Approx. 0.1 sec/in, 1 second full scale. Input Circuit: Self-balancing potentiometer. Maximum Recommended Source Impedance: 100 kilohms. Overall Error: Less than 1% of full scale. Dead Zone: Less than 0.5% of full scale. Nonlinearity: Less than 0.5% of full scale. Chart Speeds: 12 speeds, pushbutton selected. 5, 10, 20, 50, 100, 200 sec/inch & 5, 10, 20, 50, 100, 200 min/inch. Floating Input: ± 100 VDC max. with respect to ground. Input Resistance: Essentially infinite at null. Line Frequency Rejection (input shorted): 130 dB in common mode. Reference Source: Zener-regulated supply. Modulation Frequency: Approximately 240 Hz. Power Requirements: 120/240 volts, 60 Hz, 14 watts. Dimensions: 6" H x 15" W x 9 1/2" D. Net Weight: 10 lbs. 4 oz.

PROGRAMMABLE STRIP CHART RECORDER

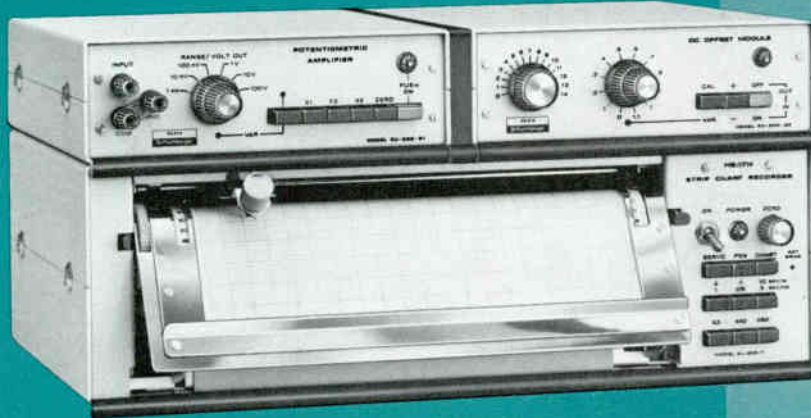

**EU-205B offers performance
& features comparable to
systems costing much more**

- 18 calibrated & continuously adjustable spans from 1 mV to 500 V full scale
- 23 chart speeds from 30 in/min to 0.2 in/hr
- 15 full scales of offset on all spans
- 10-inch chart width
- 0.2% $\pm 5 \mu\text{V}$ accuracy
- Completely programmable

The Heath/Schlumberger EU-205B Recorder System offers more performance and value than competitive recorders costing considerably more.

The EU-200-01 Potentiometric Amplifier Module (page 24), part of the 205B system, provides true potentiometric input on 18 calibrated, switch-selected spans from 1 mV to 500 V full scale...10-megohm input impedance on 1 to 500 V ranges. A variable control furnishes uncalibrated adjustment between steps over the range from less than 1 mV to greater than 500 V. An internal jumper can be shifted to provide 18 calibrated ranges from 1.25 mV to 625 V for centimeter chart paper compatibility. Refer to page 25 for types of chart paper available. The EU-200-02 DC Offset Module (page 24) in the 205B system provides 15.1 calibrated scales of suppress, positive or negative, with 0.1% accuracy.

Twenty-three front-panel pushbutton-selected speeds from 30 inches/minute to 0.2 inches/hour are instantly available. The digital-drive stepper motor system provides extremely accurate chart drive with none of the disadvantages of conventional mechanical systems. Each motor step moves the chart paper less than the pen width so that the resultant curve is smooth. The chart drive is easily synchronized with external devices such as wavelength drives, etc.

The 205B can be completely controlled by external devices. A readily accessible connector block on the rear panel provides inputs and outputs for virtually all functions. Any device that generates TTL logic signals or contact closures may be used for control, making it a logical addition to any automated system.

Additional features include a removable three-position writing table, optional retransmitting potentiometer for transmitting pen position information to an external device, easy conver-

sion to metric chart paper, disposable pens and rack mounting accessories.

The complete EU-205B system consists of the EU-205-11 Recorder Mainframe (see page 24), the EU-200-01 Potentiometric Amplifier Module and the EU-200-02 DC Offset Module, one disposable blue pen and one roll of SU-445-17 inch calibrated chart paper.

Factory assembled & calibrated EU-205B System,
40 lbs. \$710.00

EU-205B SYSTEM SPECIFICATIONS — Input Ranges (full span): 1, 2, 5, 10, 20, 50, 100, 200, 500 mV; 1, 2, 5, 10, 20, 50, 100, 200, 500 volts. Continuously variable between ranges with overlap. **Offset:** 0 to 15.1 full scales of suppress on all ranges, + or - polarity, calibrated steps and continuously adjustable between calibrated ranges. **Chart Width:** 10 inches or optional 25 cm. **Balance Time:** Approx. 0.5 second full scale. **Chart Speeds:** 23 speeds from 30 in/min to 0.2 in/hr., selected by 6 pushbuttons. **Type of Input:** Floating potentiometric on 500 mV & 625 mV ranges and below. Input divider on 1 V and 1.25 V ranges and above. **Writing Panel:** 3 positions — vertical, 30 or 45 degrees from vertical. **Pen Lift:** Electric pushbutton; provision for automatic remote control. **Recorder Pen:** Disposable, fiber tipped. **Mounting:** Bench type with provision for rack mounting with optional hardware. **SYSTEM ACCURACY: Overall Accuracy:** $\pm 0.2\%$. **Linearity:** 0.1%. **Offset Accuracy:** $\pm 0.1\%$. **Dead Zone:** Less than 0.1% of full scale. **Mechanical Error:** 0.1%. **Range Divider Error:** $\pm 0.1\%$. **Preamplifier Gain Error:** (EU-200-01 Potentiometric Amplifier Module): Less than $\pm 0.1\%$ plus $\pm 5 \mu\text{V}$ input offset. **GENERAL: Maximum Input Voltage:** 70 V on 500 mV & 625 mV ranges and below, 700 V on 1 & 1.25 V ranges and above. **Recommended maximum source impedance:** 50 k ohm max. on mV ranges for optimum pen response; 10 k ohm max. on volt ranges for 0.1% loading error. **Input impedance:** Potentiometric input (infinite at balance). 500 k ohms off null on 500 mV & 625 mV ranges and below. 10 megohms on 1 V and 1.25 V ranges and above. **Noise rejection** (1 mV scale): CMRR at line frequency 120 dB; 1 k ohm unbalance with common mode signal connected to common terminal. DC CMRR 160 dB. NMR 40 dB. **Reference:** Temperature-compensated zener diode with 0.0025%/°C temperature stability rating. **Power Requirements:** 105-125 or 210-250 VAC, 50/60 Hz, 60 watts. **Ambient Operating Temperature Range:** 10 to 40 degrees C. **Overall Dimensions:** 8 3/4" H x 17 3/8" W x 13 1/2" D with writing panel in 45° position.

Pens, paper and accessories for the EU-205B are described on page 25.



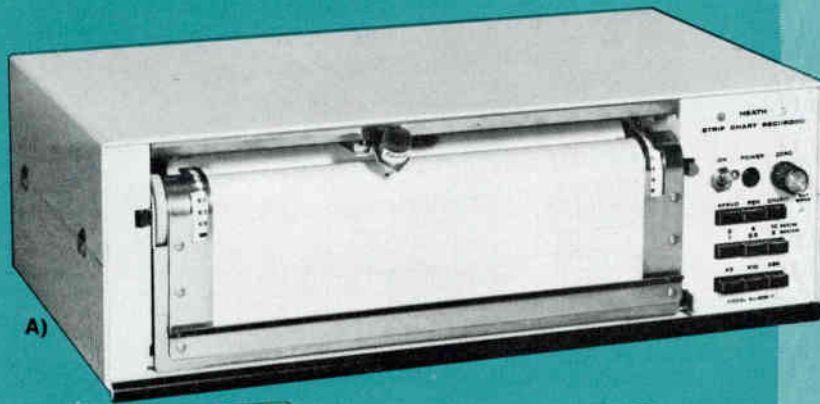

A)



B)



C)

"200-SERIES" RECORDER & MODULES

The lowest cost high performance lab recorder available

A) EU-205-11 Multi-speed recorder mainframe

- 1-volt span full scale • 23 chart speeds • True potentiometric input • Remote programming

The EU-205-11 is a 1-volt span, research-quality, true potentiometric servo recorder. The basic Y-span of 1 volt provides maximum compatibility with a wide variety of preamplifiers and signal conditioning circuits that provide 1 volt outputs. 23 chart rates from 30 inches/minute to 0.2 inches/hour can be selected using the six front panel pushbuttons.

Factory assembled & calibrated EU-205-11 1-volt Recorder Mainframe, including one blue pen and one roll of inch calibrated chart paper, 24 lbs. \$445.00

EU-205-11 SPECIFICATIONS — MECHANICAL: Chart Width: 10 inches or optional 25 centimeters. Chart Speeds: 23 speeds, selected by 6 pushbuttons: 2, 5 or 10 seconds per inch. Optional 1, 2.5 or 5 seconds per centimeter. Chart Speed Multiplier Pushbuttons: x3, x10 and x60 may be used singly or in any combination. Writing Panel: three positions. Slewing Speed: 20 inches per second. Pen Lift: controlled by pushbutton on front panel or remote control operation by means of connections to rear panel connector. Recorder Pen: fiber tipped, disposable. Mounting: bench mounting standard; optional rack mounting with accessory hardware. **ELECTRICAL:** Sildewire Linearity: 0.1%. Span: 10 inches; calibrated 0-1 volt full scale. 25 cm; calibrated 0-1.25 volts full scale. Reference Stability: 0.0025%/°C. Dead Zone: less than 0.1% of full scale. Mechanical Accuracy: 0.1%. Damping: factory preset for optimum damping. Internally adjustable. Input Impedance: true potentiometric "infinite" at balance. Approximately 500 k ohms off null. Recommended Source Impedance: maximum of 10 k ohms for maximum speed response. Limited response speed with maximum of 50 k ohms. Type of Input: floating potentiometric. **AUXILIARY INPUTS (made on rear panel):** External Chart Drive: enables chart drive to be synchronized with an external signal source. Remote Servo Mute, Remote Pen Lift, Remote Chart Control, Pen Motor External Drive. **AUXILIARY OUTPUTS:** Sildewire, Chart Drive, Calibrated Reference Supply, Zero Control, Servo "On" Signal, Chart "On" Signal, Null Signal. **GENERAL:** Power Requirements: 105-125 or 210-250 VAC, 50/60 Hz, 40 watts. Auxiliary AC Outlet: 3-conductor grounded outlet, 3 amps maximum. Switched on and off by front panel Power switch. Overall Dimensions: 17 1/2" W x 5 3/4" H x 13 1/2" D with writing panel in 45 degree position. Net Weight: 18 lbs. Ambient Temperature Range: 10 to 40 degrees C.

B) Potentiometric Amplifier Module

The EU-200-01 Potentiometric Amplifier Module provides 1-volt output for any input between 1 mV and 500 V.

Factory assembled & calibrated EU-200-01 Module, 8 lbs. \$185.00

EU-200-01 SPECIFICATIONS: Sensitivity range for 1 volt out: 1, 2, 5, 10, 20, 50, 100, 200, 500 mV; 1, 2, 5, 10, 20, 50, 100, 200, 500 volts. Accuracy: ±0.1% divider error plus ±5 μV offset. ±0.1% gain error. Type input: Floating potentiometric on 1-500 mV. Maximum voltage input: On 1 to 500 mV ranges, 70 volts; on 1 to 500 volt ranges, 700 volts. Input Impedance: True potentiometric. Approximately 500 k ohms off null on 1 to 500 mV ranges; 10 megohms on 1 to 500 volt ranges. Recommended maximum source impedance: 50 k ohm maximum on mV ranges for optimum pen response; 10 k ohm maximum on volt ranges for 0.1% loading error. Switched variable ranges: Allows for full scale calibration of span at values between calibrated ranges. Ambient operating temperature range: 10 to 40 degrees C. Offset: Input jacks for external DC offset from the EU-200-02 module or 0.500 volts per full scale suppression. Outputs: Signal: maximum voltage swing ±10 volts. AC Power — unswitched AC line. DVM output: Edge connector for external monitoring of: decimal, decade range and voltage output. Power requirements: 105-125 or 210-250 volts AC, 50/60 Hz, 6 watts. Overall size: 8 1/2" W x 2 1/2" H x 9 1/2" D. Rack mounting: Optional with accessory hardware.

C) DC Offset Module

The EU-200-02 DC Offset Module provides up to 15.1 full scales of calibrated suppress with 0.1% accuracy.

Factory assembled & calibrated EU-200-02 Module, 7 lbs. \$110.00

EU-200-02 SPECIFICATIONS: Range: Offset from 0 to 15.1 units, positive or negative polarity, in 1-unit or 0.1-unit steps. Each unit equals 1 volt of offset when used with the EU-200-01 Potentiometric Amplifier Module. Accuracy: ±0.1%. Ambient operating temperature: 10 to 40 degrees C. Switched variable gain: Allows for uncalibrated gain adjustment between 0.1 unit steps. Polarity switch: Selects positive or negative output. Output: Offset — 0.5V per unit of offset. DVM Monitor — 100 mV per unit of offset. Power requirements: 105-125 or 210-250 volts, AC, 50/60 Hz, 4 watts. Dimensions: 8 1/2" W x 2 1/2" H x 9 1/2" D. Rack mounting: Optional.

Recorder Accessories

SU-205-01 Centimeter Chart Transport, for use with SU-445-18 and SU-445-21 chart paper. 5 lbs. \$53.00

SU-121-22 Retransmit Potentiometer, for transmitting pen position information to an external device. Factory installed. Add \$60.00 to EU-205-11 price.

SU-200-RM Rack Mounting Hardware. Contains brackets and hardware to mount one EU-205-11 or four "200 series" modules in a standard 19" rack. 6 lbs. \$25.00

"200-SERIES" MODULES & ACCESSORIES

A full line of modules and accessories to make your system even more versatile



A) Limit detector module

The EU-200-91 Limit Detector Module provides visual and audible alarms, relay controls and TTL-compatible signals when an input voltage exceeds a preset limit. Any signal source providing an output from -2 volts to +2 volts can be continuously monitored by comparison to the internal reference supply. This range can be extended to ±10 volts with an external reference. The input level is set using front panel controls, and can be maintained to ±2 mV.

Factory assembled & calibrated EU-200-91 Module, 8 lbs. \$95.00

EU-200-91 SPECIFICATIONS: Limit Range: With internal reference: ±2.000 volts. With external reference: ±10 volts maximum. Limit Accuracy With internal reference: ±7 mV at 23°C. With external reference: Limited by reference accuracy and Comparator Drift (see below). Resolution: 1 mV. Comparator Hysteresis: <0.1 mV. Comparator Drift: <0.1 mV/°C (after 30 minute warmup). Reference Voltage Drift: 0.025% of setting or 0.1 mV/°C, whichever is greater (after 30 minute warmup). Long Term Reference Calibration Drift: 0.2% maximum. Maximum Input Voltage: ±12 volts. Maximum Recommended Source Impedance: 1000Ω. Maximum Relay Load (Form C Contacts): 2 amperes, resistive. Relay Response Time (Form C Contacts): <10 ms when input signal is 10 mV over limit. Logic Output: TTL levels capable of sinking 14 mA at a 0 level. Logic 0 <0.4 volts. Logic 1 >2.4 volts but <5.5 volts. Logic Response Time: <1 ms when input signal is 10 mV, over limit. Line Voltage Effect: 25 μV/volt change. Power Requirements: 105-125 volt, 50/60 Hz, 10 watts. (Can be rewired for 210-250 volt operation). Dimensions: 8¾" wide x 11½" deep x 3¼" high.

B) Multiplexer module

The EU-200-92 is an analog multiplexer that can sequentially sample up to four differential signals using internal electronically-programmed reed relays. Four scanning models are available. Any channel may be selected manually with the front panel pushbuttons.

Factory assembled & calibrated EU-200-92, 9 lbs. . . \$175.00

EU-200-92 SPECIFICATIONS—SIGNAL INPUTS/UNIT: 4. INPUT SIGNAL LEVEL: 100 mV to 28 VDC full scale. INPUT SIGNAL CURRENT: 0 to 125 mA. CONTACT RESISTANCE: 2 Ω maximum. CROSSTALK: -80 dB @ 10 kHz with 1Ω source impedance. -110 dB @ dc with 1 kΩ source impedance. NOISE: <0.5 mV rms with 1 kΩ source impedance. COMMON MODE INPUT IMPEDANCE: >5 x 10⁸ Ω shunted by <30 pF. NORMAL MODE INPUT IMPEDANCE: >5 x 10⁸ Ω shunted by <30 pF. INTERNAL PROGRAMMER RATE: Variable 1 to 0.05 samples per second. INTERNAL PROGRAMMER TIME JITTER: <5%, typical. EXTERNAL PROGRAMMER INPUT: Signal: TTL compatible, 5 samples per second maximum. (Logic 0 <0.4 volts. Logic 1 >2.4 volts but <5.5 volts). Maximum rise time: 1 volt/sec. Minimum pulse width: 100 ns. APERTURE TIME ERROR: <1 ms referenced to the channel identification signal at the rear panel connector. PEN LIFT OUTPUT: TTL level 0 to lift recorder pen when Input channels switch. Holds pen up until pen servo null is obtained. Supplies 2.5 volts @ 2 mA for a 1 level. Capable of sinking 35 mA for a 0 level. EVENTS OUTPUT: TTL level 1 indicates channel 1 operation. Supplies 2 mA @ 2.5 volts for 1 level. Capable of sinking 10 mA for a 0 level (open collector gates). OPERATING TEMPERATURE: 10°C to 40°C ambient. POWER REQUIREMENTS: 105-125 volts, 50/60 Hz, 10 watts. (May be rewired for 210-250 volts). DIMENSIONS: 8¾" wide, 11½" deep, 3¼" high.

C) Low-Pass Filter

The SU-200-LP Filter is designed for use with the EU-205B Recorder System. It was designed primarily for low-level measurement applications such as gas chromatography where electrical noise obscures useful data collection.

Two switch-selected filter ranges are provided: 60 dB with a response time of approximately 1 second, and 40 dB with a response time of approximately 0.6 second.

Factory assembled & calibrated SU-200-LP, 2 lbs. . . \$35.00

"200-Series" Accessories

Chart Paper

SU-445-17 Inch calibrated chart paper. 0.5" major divisions.

SU-445-18 Centimeter calibrated chart paper. 10 mm major divisions. Requires SU-205-01 Centimeter Chart Transport, p. 24, or SU-255-MC Metric Conversion, p. 27.

SU-445-21 Centimeter ruled chart paper. Similar to SU-445-18 except ruled 0 to 250 mm on Y axis. Requires SU-205-01 Centimeter Chart Transport, p. 24, or SU-255-MC Metric Conversion, p. 27.

SU-445-20 Inch/Centimeter calibrated chart paper. Ruled exactly like SU-445-17 in X-axis & SU-445-18 in Y-axis.

All Paper (120 ft. rolls):

| | | | |
|-----------------------|------------|------------------------|------------|
| 1-9 Rolls | \$4.75 ea. | 24-96 Rolls | \$4.00 ea. |
| 10-23 Rolls | \$4.50 ea. | 97-199 Rolls | \$3.50 ea. |

Write for prices on orders exceeding 200 rolls.

Pens

The standard pen is recommended for chart speeds over 1 min/in (30 sec/cm); the slow speed (under 1 min/in chart speed) type will write properly at full slewing speed but not bleed at dwell.

- SU-406-83 Standard blue pen
- SU-406-86 Standard red pen
- SU-4066-31 Slow speed blue pen
- SU-4066-30 Slow speed red pen

All Pens:

- 1-9 Pens (all colors) \$2.00 ea.
- Lots of 10 (one color) \$15.00 lot
- Lots of 100 (one color) \$140.00 lot



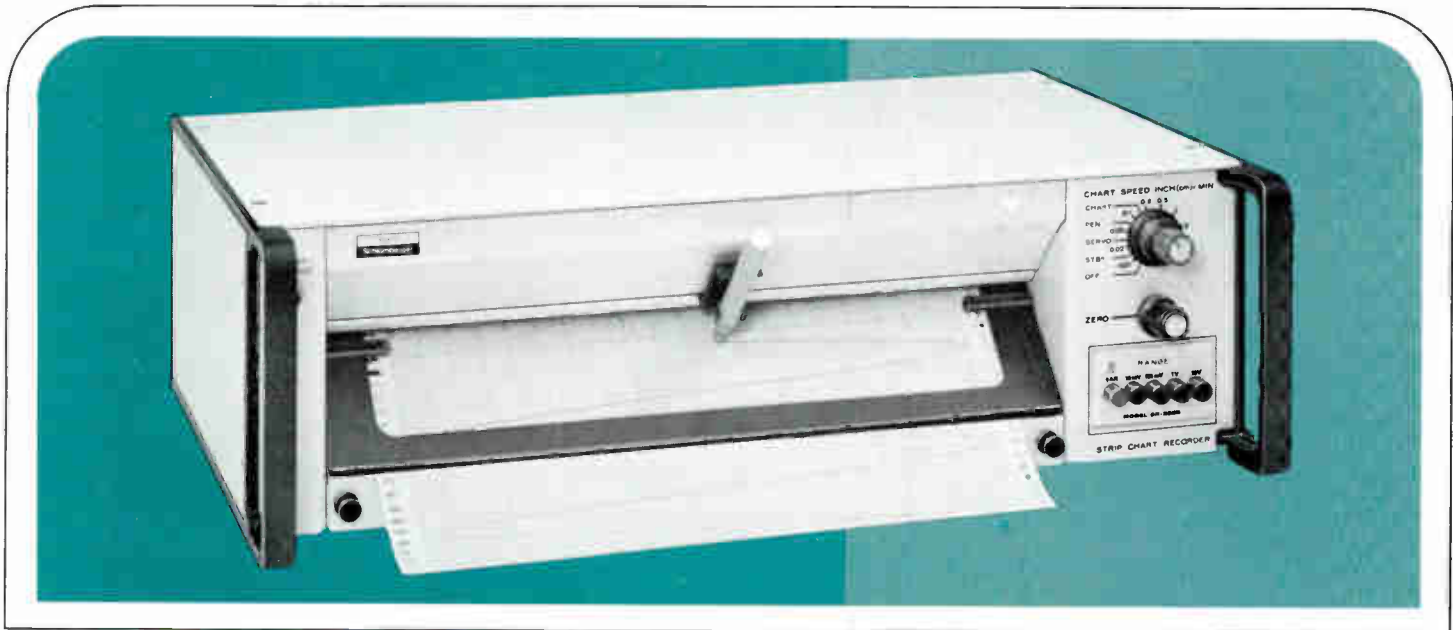

SR-255B STRIP CHART RECORDER

Loaded with standard features that are optional on most other recorders

- Four calibrated input ranges • 10" chart width
- Ten accurate, digitally-derived chart speeds • One second full scale writing speed • Fast, easy paper loading • Complete remote control capability for all functions • Front panel pushbutton chart advance • Disposable nylon-tipped pens • Easy conversion to metric work

The Heath/Schlumberger SR-255B is the industry's most extraordinary value in a strip chart recorder. Compare the lengthy list of features that are standard in the 255B against the competition. Compare the performance specifications. And then compare the price. The SR-255B clearly offers much more recorder for your dollar.

The SR-255B gives you pushbutton-selection of four calibrated spans: 10 mV, 100 mV, 1 V and 10 V full scale. A Variable span capability is also built-in, and enables you to extend the range to 100 V full scale for even greater flexibility.

Heath/Schlumberger pioneered the use of the digitally-driven stepper motor in strip chart recorders many years ago. This system uses a precision stepper motor that is synchronized to the frequency of a highly stable internal oscillator or external TTL level signal. Digital logic circuitry increments the stepper motor in exact amounts. There is no backlash as is common in gear-train designs and no complicated mechanical devices to become worn or out of adjustment. The SR-255B uses this stepper motor design to provide chart speeds of 10, 5, 2, 1, 0.5, 0.2, 0.1, 0.05, 0.02 and 0.01 inches or cm per minute. All speeds are instantly selectable with the front panel rotary switch. Speeds are accurate to better than 0.5%.

The floating input provides more than 10^7 ohms input impedance with less than 10 nA bias current on the 10 mV, 100 mV and 1 V ranges. This input impedance is higher than many other recorders and minimizes source loading. Input impedance on the 10 V range is 1 megohm. The SR-255B eliminates many noise problems by having a built-in switchable input filter. When switched into the circuit, both normal and com-

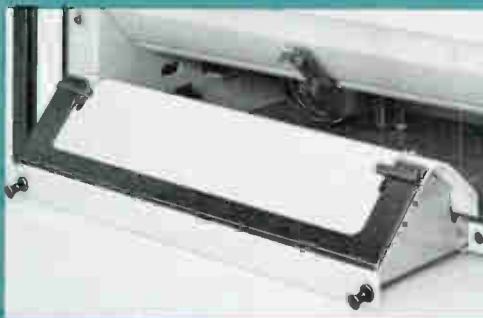

Pull-out chart transport makes paper loading fast and easy.

Front panel controls: Concentric chart speed and function switches, pen zero adjust and pushbutton switches for input span selection.



Front panel pushbutton provides automatic chart advance at 10 inches per minute regardless of setting of chart speed switch.

mon mode rejection are increased 20 dB, and the higher the frequency, the greater the rejection.

A rear-panel connector allows total recorder control from a remote location. Chart control, pen lift, servo, signal input and chart signal in and out are all available. All control lines are TTL-compatible.

The SR-255B is one recorder you won't have to dismantle to load. The entire chart transport can be removed from the recorder in seconds, and paper changed in just a few more. More and more measurements are being conducted using the metric system, and the 255B is ready. The change from inch to centimeter calibration is quick and easy...the user merely substitutes the metric chart drive gear and paper sprockets and makes a very minor electrical adjustment.

Other features include disposable nylon-tipped pens...front panel pushbutton chart advance...low profile design...standard rack-mount dimensions with rack handles built-in...electrical pen lift...external chart drive input...all solid-state design.

Need to be convinced? Try the SR-255B in your lab for 30 days. See page 2 for details.

Factory assembled & calibrated SR-255B, 20 lbs. . . \$365.00

NOTE: A 1 V span version is also available for OEM use and special applications...model SR-255A. Write for prices and delivery information.

SR-255B Accessories

Paper. The SR-255B uses the same chart paper as the EU-205B recorder on page 25. Please refer to that page for a description of the types of paper available.

Pens. Blue and red disposable pens with nylon tips are available either singly or in lots of 10 or 100 of either color. These pens will perform properly at any speed.

SU-406-92, red pen

SU-406-93, blue pen

All pens:

1-9 pens (all colors) **\$2.00 ea.**
Lots of 10 (one color) **\$15.00 lot**
Lots of 100 (one color) **\$140.00 lot**

Metric Conversion. This accessory package consists of a centimeter chart drive gear and centimeter paper sprockets, plus necessary tools and set screws. Installation procedures are fully described in the manual that accompanies the conversion kit, and the conversion can be accomplished in just a few minutes. No recalibration of the recorder is necessary.

SU-255-MC Metric Drive Conversion, 1 lb. \$14.00

Rack Mount Accessory. This accessory allows the SR-255B to be installed in a standard 19" rack, and consists of two metal brackets painted to match the recorder and necessary hardware.

SU-255-RM Rack Mount Accessory, 3 lbs. \$10.00

SR-255B Specifications

MECHANICAL:

Chart Width: 10 inches or 25 cm with optional metric chart drive.

Chart Speeds: 10, 5, 2, 1, 0.5, 0.2, 0.1, 0.05, 0.02, 0.01

inches/minute. (cm/min with metric chart conversion installed.)

Chart Speed Stability: less than 0.5% error over operating temperature range.

Pen Lift: electric; activated by front panel control. Provision for automatic remote control, TTL compatible.

Recorder Pen: Disposable, nylon tipped.

Mounting: Bench type; provision for rack mounting with optional hardware.

ELECTRICAL:

Writing Speed: Greater than 10 in/sec. 25 cm/sec.

DC Input Ranges: Calibrated: 10 mV, 100 mV, 1 V, 10 V full scale. 12.5 mV, 125 mV, 1.25 V, 12.5 V full scale metric. Variable: 10 mV to 100 mV full scale. 12.5 mV to 125 V full scale metric.

Maximum Normal Mode Input Voltage: 100 VDC, 130 V @ greater than 50 Hz on 10 mV, 100 mV and 1 V ranges. 500 VAC or VDC on 10 V range.

Maximum Common Mode Input Voltage: 400 V.

Type of Input: Floating with greater than 10⁷ ohms input impedance and less than 10 nA bias current on 10 mV, 100 mV and 1 V ranges. 1 megohm on 10 V range.

Zero Suppression: Zero may be set to any position on chart.

Overshoot: Less than 1% of full scale.

Overall Error: Less than 1% of full scale guaranteed; 0.5% typical.

Dead Zone: Less than 0.5% of full scale.

Non-linearity: Less than 0.5% of full scale.

Zero Setting Drift: Less than 10 μV/°C referenced to input, 10 mV range.

Standardization Drift: Less than 0.005%/°C.

Range Selector Error: Less than 0.5%.

Line Frequency Rejection: 20 dB normal mode with filter out. 40 dB normal mode with filter in. 80 dB common mode with filter out, 1 k unbalance. 100 dB common mode with filter in, 1 k unbalance.

REAR PANEL CONTROLS & CONNECTIONS:

Input: High input, Common input and chassis ground. Standard dual banana plug spacing.

Chart Drive Switch: Selects either internal chart drive clock or external chart drive clock.

Filter Switch: When switched in, line frequency rejection is increased 20 dB. See Line Frequency Rejection specification above.

Remote Connector: Allows remote control of all recorder functions and connection of input signal. Functions available are as follows: Chart Control; Pen lift; Servo Mute; Chart Signal Out; Chart Signal In, (all TTL compatible); Control Common; Signal Input; Null Signal; and Signal Input/Pen Null Common.

GENERAL:

Operating Temperature Range: 10-40°C.

Power Requirements: 120/240 VAC, 50/60 Hz, 30 watts maximum.

Fuse Requirements: ½ amp 125 V slow-blow or ¼ amp 250 V slow-blow.

Dimensions: 5¹/₃₂" H x 17¹/₃₂" W x 12⁵/₁₆" D. Standard rack compatible with accessory hardware.

Net Weight: 20 lbs.



Teflon®-coated pen carriage eliminates periodic lubrication and insures proper pen travel.

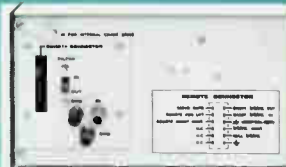

Rear panel: Input with standard banana plug spacing, input filter switch, external/internal chart drive switch, remote programming connector block are all readily accessible.



Servo and range circuit boards. Note calibration controls on top for easy access. All circuits in the SR-255B are interconnected with a plug-in wiring harness.

HEATH
Schlumberger

HEATH/MALMSTADT -ENKE LAB STATIONS



EU-101C Lab Station... a complete facility for teaching and research

- Fully assembled and calibrated instrumentation enabling study of basic and advanced areas of electronics, instrumentation, computers and digital techniques
- Compact electronics center for everyday use in the physics, chemistry or bio-medical research lab.

The Heath/Malmstadt-Enke lab stations provide all of the instruments, power supplies and components necessary for a college-level course in instrumentation electronics... for physics, engineering, chemistry and the bio-medical sciences.

Heath/Malmstadt-Enke lab stations are complete laboratory testing and circuit development stations for teaching and research. All instruments are of research laboratory quality. The ability to use the same instruments for learning and research makes the transition from understanding to application immediate, simple and effective. Everything needed for a highly flexible university-level course is here in a single, integrated system: all instrumentation, power supplies, special parts and chassis, standard components, cabinets, tools, texts and workbook.

The EU-101C Lab Station was specially engineered by the Heath Company in conjunction with Dr. H. V. Malmstadt of the University of Illinois and Dr. C. G. Enke of Michigan State University. The entire system is designed to teach electronics with emphasis on the principles, design and use of instruments in scientific applications. Included in the EU-101C Lab Station is the EU-200-81 Servo Amplifier/Electrometer Patch Module. This instrument permits detailed study and experimentation in the area of servo systems, instrumentation amplifiers and electrometers. It is used for the study of electronic

and electromechanical feedback principles. The price of the EU-200-81 has been reduced and will be maintained until our present inventory is exhausted.

EU-101C Lab Station Components

(page numbers refer to pages in this catalog)

| | | |
|------------------|---|------------------|
| EU-30A | Decade Resistance Box (p. 15) | \$ 75.00 |
| SP-17A | High Voltage Power Supply (p. 20) . . . | \$125.00 |
| EU-41A | Low Voltage Power Supply (p. 21) . . . | \$ 85.00 |
| EU-51A | Experimental Parts Group | \$145.00 |
| SO-4510 | Dual Trace Oscilloscope (p. 12) | \$750.00 |
| EU-80A | Voltage Reference Source (p. 21) | \$150.00 |
| EU-81A | Function Generator (p. 17) | \$245.00 |
| EU-200-81 | Servo Amplifier/Electrometer Patch Module | \$175.00 |
| EU-205-11 | Recorder Mainframe (p. 24) | \$445.00 |
| EU-801A | Analog Digital Designer (p. 30) | \$530.00 |
| EU-801D | Digital Instrument Designer (p. 30) . . . | \$734.00 |
| EU-800-CC | Quad J-K Flip-Flop Card (p. 32) | \$ 24.00 |
| EU-800-JE | And-Or-Invert Gates Card (p. 32) | \$ 18.00 |
| EU-900-CA | Booster OA Card (p. 32) | \$ 40.00 |
| EU-900-JA | 8-Bit Analog Switch Card (p. 33) | \$ 40.00 |
| EU-900-NC | Dual FET OA Card (p. 33) | \$ 65.00 |
| SM-660 | Weston 660 VOM (p. 10) | \$ 65.00 |
| EU-28A | Resistance Substitution Box (p. 15) . . . | \$ 31.00 |
| EU-29A | Capacitance Substitution Box (p. 15) . . . | \$ 29.00 |
| PKW-101 | Oscilloscope Probes @ 23.95 ea. (p. 15) | \$ 47.90 |
| GH-25 | Tool Kit | \$ 22.95 |
| EUP-51 | Electrical Analog Measurements & Transducers Text (p. 29) | \$ 3.95 |
| EUP-52 | Control of Electrical Quantities Text (p. 29) | \$ 3.95 |
| EU-101C | System Price | \$3849.75 |

Complete teaching/learning centers for study of basic and advanced electronic concepts



Low-cost EU-99C Lab Station

- Low-cost lab station — ideal for individual or group instruction
- Additional instrumentation or components may be added for expansion to the larger EU-101C Lab Station

With the EU-99C Lab Station, Heath/Schlumberger provides a low cost, fully instrumented lab facility — a "starter set" version of the more complete EU-101C Lab Station. The instrumentation included in the EU-99C is the same basic instrumentation included in the EU-101C but does not include instruments used for more specific studies such as the EU-801D Digital Instrument Designer.

EU-99C Lab Station Components

(page numbers refer to pages in this catalog)

| | | |
|-----------|--|-----------|
| EU-30A | Decade Resistance Box (p. 15) | \$ 75.00 |
| EU-41A | Low Voltage Power Supply (p. 21) | \$ 85.00 |
| EU-51A | Experimental Parts Group | \$145.00 |
| SO-4510 | Dual Trace Oscilloscope (p. 12) | \$750.00 |
| EU-80A | Voltage Reference Source (p. 21) | \$150.00 |
| SG-1271 | Function Generator (p. 16) | \$140.00 |
| EU-801A | Analog Digital Designer (p. 30) | \$530.00 |
| EU-800-CC | Quad J-K Flip-Flop Card (p. 32) | \$ 24.00 |
| EU-800-JE | And-Or-Invert Gates Card (p. 32) | \$ 18.00 |
| EU-900-JA | 8-Bit Analog Switch Card (p. 33) | \$ 40.00 |
| EU-900-NC | Dual FET OA Card (p. 33) | \$ 65.00 |
| SM-660 | Weston 660 VOM (p. 10) | \$ 65.00 |
| EU-28A | Resistance Substitution Box (p. 15) | \$ 31.00 |
| EU-29A | Capacitance Substitution Box (p. 15) | \$ 29.00 |
| PKW-101 | Oscilloscope Probes @ 23.95 ea. (p. 15) | \$ 47.90 |
| GH-25 | Tool Kit | \$ 22.95 |
| EUP-51 | Electrical Analog Measurements & Transducers Text (p. 29) | \$ 3.95 |
| EUP-52 | Control of Electrical Quantities Text (p. 29) | \$ 3.95 |
| EU-99C | System Price | \$2225.75 |

New modular text/workbooks illustrate today's instrumentation and control concepts through lab experiments

The Malmstadt-Enke Instrumentation Series is an exciting development which combines the principles of analog and digital electronics with important measurement and control concepts and interesting applications. The first three modules have been written by Dr. H. V. Malmstadt, C. G. Enke and S. R. Crouch. They are published by W. A. Benjamin, Inc.*

MODULE 1 — "Electronic Analog Measurements and Transducers." In this module, the principles of the electrical quantities of charge, current and voltage are thoroughly discussed and related to important transducers and measurement systems.

EUP-51 "Electronic Analog Measurements and Transducers" text with experiments, 2 lbs. \$3.95

MODULE 2 — "Control of Electrical Quantities in Instrumentation" Module 2 presents the control of basic electrical quantities with resistors, capacitors and inductors and then moves systematically to the many semiconductor control elements that have revolutionized modern scientific instrumentation. All devices and concepts are illustrated with potential applications.

EUP-52 "Control of Electrical Quantities in Instrumentation" text with experiments, 3 lbs. \$3.95

MODULE 3 — "Digital and Analog Data Conversions." Measurement systems are described and analyzed as a sequence of interdomain data converters. It is shown how data can be encoded in three classes of electrical data domains: analog, digital, and time, and the many methods of converting between electrical domains are developed and illustrated with practical examples.

EUP-53 "Digital and Analog Data Conversions" text with experiments, 1 lb. \$3.95

*For a brochure describing the texts and text/workbooks in this series contact W. A. Benjamin, Inc., 2725 Sand Hill Road, Menlo Park, CA 94025

HEATH
Schlumberger

ANALOG-DIGITAL DESIGNERS

Versatile breadboarding systems for design, research & education



A) Basic and computer logic analog-digital designers

- Custom-design your own instrumentation and digital circuits with the EU-801A Analog-Digital Designer
- EU-801C logic training system allows valuable insight into the fundamental nature and purpose of the general purpose mini-computer

The **EU-801A Basic ADD** is a unique breadboard system that allows you to investigate, experiment or custom-design virtually any analog or digital circuit...including complete, functional subsystems, systems and instruments. The exclusive system is built around plug-in logic circuit cards that can be patched together with ordinary hookup wire or component leads...there is no soldering involved.

Factory assembled & calibrated EU-801A, 28 lbs. . . \$530.00

The complete 801A System includes:

- 1 EUP-53 "Digital and Analog Data Conversions" text
- 1 EU-801A Operation Manual
- 1 EU-801A Basic ADD, composed of the following modules, cards, and accessories:

- | | |
|---------------------------------------|--|
| 1 EU-801-11 Digital Power Module | 1 EU-800-LA Dual Monostable Card |
| 1 EU-801-12 Binary Information Module | 1 EU-800-JD Relay Card |
| 1 EU-801-13 Digital Timing Module | 1 EU-800-HB Comparator/V-F Card |
| 1 SU-800-RC Three-Module Cabinet | 1 EU-900-NA Operational Amplifier Card |
| 1 SU-50-HA Patch Wire Assortment | 1 EU-50-MC Dual Inline IC Card |
| 4 EU-800-JC NAND Gate Cards | 2 EU-50-MD Multiple Connector/Blank PC Cards |
| 2 EU-800-CB Dual J-K Flip-Flop Cards | |

Individual modules, cards, accessories, etc. are available separately... see pp. 31-34.

The **EU-801C Computer Logic ADD** includes everything you need to start learning or teaching the logic operation of small computers by using that logic. Included is the "Digital and Analog Data Conversions" text that provides up-to-date course material for the study of modern digital logic. Hardware in the system includes power, binary information and timing modules and plug-in logic circuit cards.

Factory assembled & calibrated EU-801C, 30 lbs. . . \$410.00

The complete 801C System includes:

- 1 EUP-53 "Digital and Analog Data Conversions" text
- 1 EU-801C Operation Manual
- 1 EU-801C Computer Logic ADD, composed of the following modules, cards and accessories:

- | | |
|---------------------------------------|--|
| 1 EU-801-11 Digital Power Module | 3 EU-800-JC NAND Gate Cards |
| 1 EU-801-12 Binary Information Module | 2 EU-800-CB Dual J-K Flip-Flop Cards |
| 1 EU-801-13 Digital Timing Module | 1 EU-800-CC Quad I-K Flip-Flop Card |
| 1 SU-800-RC Three-Module Cabinet | 1 EU-800-JE And-Or-Invert Gates Card |
| 1 SU-50-HA Patch Wire Assortment | 2 EU-50-MD Multiple Connector/Blank PC Cards |

Individual modules, cards, accessories, etc. are available separately... see pp. 31-34.

B) EU-802D Digital Instrumentation ADD

- A universal counter-timer-DVM that can be expanded for teaching and design
- Counter DC-40 MHz; 100 mV sensitivity
- Period/Time: 1 μ sec \pm 1 count resolution
- Events: 40 MHz max. repetition rate; 19,999 maximum number of events
- DVM: 1, 10 & 100 V ranges with 100% overrange; \pm 0.1% or better accuracy on all ranges; 10 megohm input Z; 100 μ V resolution

The **EU-802D Digital Instrumentation ADD** is capable of use in design work as a counter-timer-DVM or in teaching or research labs for the study and manipulation of digital instrumentation circuitry. All circuits and functions are usable as a pre-wired unit for digital measurement of voltage, events, frequency and time, or separately to provide counting, indication and timing functions for other applications.

Factory assembled & calibrated EU-802D, 29 lbs. . . \$795.00

Factory assembled & calibrated EU-801D, (EU-802D less power supply module, for owners of EU-801A or EU-801C ADD systems), 28 lbs. . . \$734.00

EU-802D/801D SPECIFICATIONS — COUNTER/TIMER: Input Impedance: 1 M Ω shunted by <15 pF. Maximum AC Input Voltage: 50 V rms to 40 MHz. Maximum DC when AC coupled: 500 V. Maximum DC when DC coupled: 50 V. Frequency Mode: Sensitivity (after 5 minute warm-up): 100 mV rms. Frequency Range: DC-DC to 40 MHz. AC-20 Hz to 40 MHz. Period and Time Modes. Resolution: Up to 1 μ sec \pm 1 count. Minimum Pulse Width (DC coupled): 15 n sec at 300 mV (requires zero crossing). Maximum Recommended Rise and Fall Time (DC coupled): 100 n sec. Events Mode: Maximum Repetition Rate: 40 MHz. Maximum Number of Events: 19,999. **DVM:** Range: 1V, 10V, 100V; Impedance: 10 M Ω on all ranges. Accuracy: \pm 0.05% of full scale \pm 1 count or 1 V range; \pm 0.1% of full scale \pm 1 count on 10 & 100 V ranges. Over Load Protection: 800 V on all ranges. Above specifications at 25 $^{\circ}$ C, after one hour warm-up. **GENERAL:** Time Base: 1 MHz \pm 2 Hz. Stability: \pm 10 ppm, 10 $^{\circ}$ C to 40 $^{\circ}$ C ambient, referenced at 25 $^{\circ}$ C. Power Requirements: EU-801D +5 V at 850 mA, +15 V at 110 mA. -15 V at 30 mA. +170 V at 40 mA. EU-802D 120/240 VAC, 50/60 Hz, 70 watts maximum. Net Weight: EU-801D 10 lbs. EU-802D 17 lbs. **Dimensions:** EU-801D (bail folded) 12" wide, 6 $\frac{1}{2}$ " high, 9 $\frac{1}{2}$ " deep. EU-802D (bail folded) 17 $\frac{1}{2}$ " wide, 6 $\frac{1}{2}$ " high, 9 $\frac{1}{2}$ " deep.

"800-SERIES" MODULES

Expand the capability of any Analog-Digital Designer with extra modules

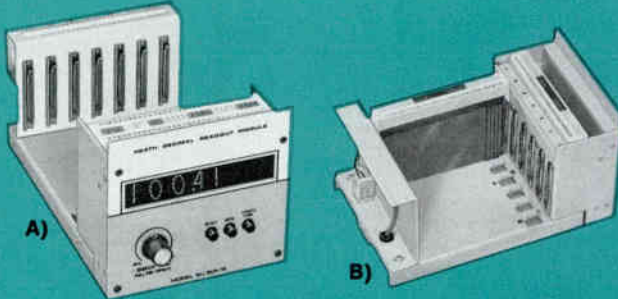

A) Decimal readout module

This module provides 4½ digits of readout for a 1-2-4-8 BCD TTL input and the basic display-cycle controls to permit patching a wide variety of digital circuits. With other cards and modules it is convenient for decimal and octal counting, computing and memory circuits, or as a counter, timer, frequency meter, DVM, etc.

Factory assembled & calibrated EU-801-15, 5 lbs. . . \$199.00

EU-801-15 SPECIFICATIONS — Input Load Unit/Fan-Out Definition: ILU of 1 — Logic 1, 2.0 V min. @ 0.04 mA; Logic 0, 0.8 V max. @ -1.6 mA. Fan-out of 10 — Logic 1, 2.4 V min. @ 0.4 mA; Logic 0, 0.4 V max. @ 16 mA. **READOUT — Display:** 4 cold-cathode display tubes; BCD input provides 0000 to 9999 readout. Input Load Unit of 2 for each input. "1-shaped" neon lamp for left-most digit extends display to 19999. **Decimal Points:** Left decimal point in each tube can be lit independently. Input Load Unit of 5 for each decimal point. **Status Lights:** 4 lights illuminate separate areas of translucent window in panel. Input Load Unit of 5 for each light. **PUSHBUTTONS — Memory:** Complementary logic outputs, 0 & 5 V. Fan-out of 10 per output. **Start/Stop:** Complementary logic outputs from cross-coupled NAND gates for bounce-free switching. Fan-out of 9 per output. **Reset:** Complementary logic outputs with fan-out of 10 per output. Can be coupled thru monostable for 1 us pulse. **MONOSTABLES — Display Time Multi-vibrator:** 1 to 0 transition at input triggers 0.3 to 8 sec logic pulse at complementary outputs, adjustable by front panel control. Input Load Unit of 1; fan-out of 10. **Reset Monostable:** 1 to 0 transition at input provides 1 us output pulse. Input Load Unit of 1; fan-out of 9. **GENERAL — Card Capacity:** 7 cards. **Power Requirements:** +5 V; +170 VDC. Supplied by EU-801-11 power module. **Dimensions:** 5¼" H x 5¾" W x 9¾" D. **Net Weight:** 2½ lbs.

B) Auxiliary module

The Auxiliary Module holds and provides power connections for up to seven plug-in cards. The multiple connector card permanently mounted in the module is a convenient connection area when several patch wires are connected to a single point. A plug-in multiple connector/blank PC card is also supplied for additional multiple connections, or it can be etched by the user for a particular circuit.

Factory assembled EU-801-14, 4 lbs. \$41.00

EU-801-14 SPECIFICATIONS — Size: 5¼" H x 5¾" W x 9¾" D. **Weight:** (without plug-in cards) 2½ lbs. **Card Supplied:** One EU-50-MD Multiple Connector/Blank PC Card.

C) Digital power module

The Digital Power Module provides all voltages and currents necessary to operate the modules and cards of ADDs. Five

different voltages are available: +5 VDC, +15 VDC, -15 VDC, 5V half-wave AC at line frequency to provide a signal for timing purposes, and +170 VDC.

Factory assembled & calibrated EU-801-11, 8 lbs. . . \$90.00

EU-801-11 SPECIFICATIONS — 5 VOLT SUPPLY: Output voltage: 5 VDC. Output current: 2 A max. with 0.2% voltage regulation. **Ripple and Noise:** Less than 40 mV at rated output. **170 VOLT SUPPLY:** Output voltage: 170 VDC unregulated. Output current: 50 mA max. **Ripple:** Less than 10 V at rated output. **±15 VOLT SUPPLY:** Output Voltage: ±15 VDC. Output current: 150 mA for +15 V, 150 mA for -15 V. Output voltage regulation: ±0.5% (with line voltage between 105 and 135 V). **Ripple and Noise:** Less than 60 mV at rated output. **Power requirements:** 120/240 VAC, 50/60 Hz. **Dimensions:** 5¼" H x 5¾" W x 9¾" D.

D) Binary information module

The Binary information Module can be used to provide selected logic levels to other circuit cards in the system and to display logic information. It can also hold and provide power connections for up to seven plug-in circuit cards.

Factory assembled & calibrated EU-801-12, 5 lbs. . . \$59.00

EU-801-12 SPECIFICATIONS — Lamp Driver Input: Logic 1 +2.4 V to +5 V at 4 mA per input. **Fan in Load Units per Lamp Circuit:** 5. **Switch outputs:** Logic 0 0 V, 0 ohm; Logic 1 +4.5 V, 470 ohm. **Fan Out Load Units per switch circuit:** 10. **Power requirements:** +170 V at 40 mA max. for lamp circuits; +5 V at 100 mA max. for switch circuits; +5 V, +15 V, -15 V and common ground for card pin connectors. **Dimensions:** 5¼" H x 5¾" W x 9¾" D.

E) Digital timing module

The Digital Timing Module provides timing pulses and other repetitive waveforms for the digital and analog circuits of an ADD. Logic 1 and logic 0 pulses, square wave and complementary square wave and ramp are all available simultaneously.

Factory assembled & calibrated EU-801-13, 5 lbs. . . \$69.00

EU-801-13 SPECIFICATIONS — Power Requirements: +5, +15, -15 V DC and ground. **Output Waveforms:** Complementary square wave, complementary pulse and sawtooth. **Frequency Range (with internal ±5% timing components):** Calibrated 1 kHz, 100 Hz, 10 Hz, 1 Hz and 0.1 Hz; variable from 0.1 Hz to 10 kHz. **Frequency range (with external capacitor):** Complementary square wave and sawtooth waveform to 100 kHz, complementary pulse waveform to 30 kHz. **Output Voltage:** 4 V peak (typical). **Frequency Stability:** 0.2% per hour. **Fan Out:** 10. **Rise Time of Square Wave and Pulses:** 20 ns (13 ns typical). **Dimensions:** 5¼" H x 5¾" W x 9¾" D.



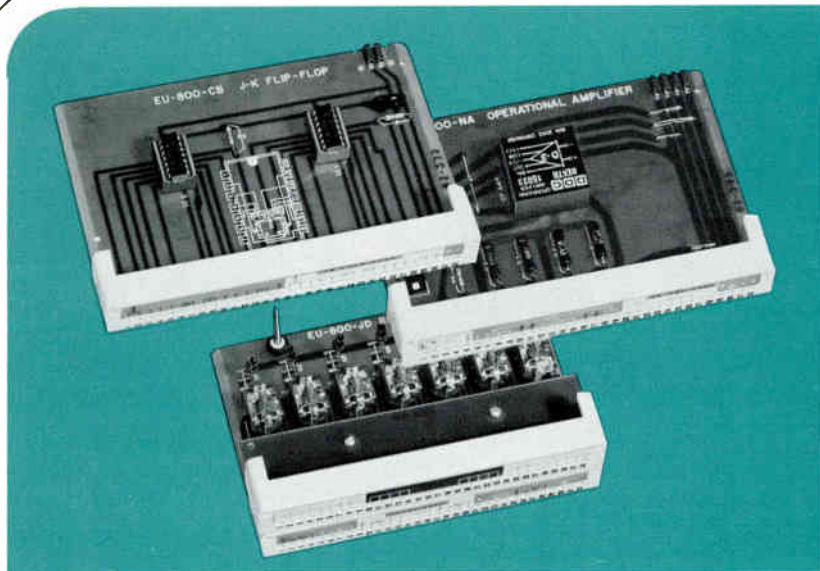

PLUG-IN CIRCUIT CARDS

Logic function
circuit cards compatible
with all ADD units

EU-800-CB Dual J-K Flip-Flop Card

APPLICATIONS: Synchronous and asynchronous binary counters, BCD counters, up and down counters, ring registers.

Factory assembled and calibrated EU-800-CB, 1 lb. . . \$19.00

EU-800-CC Quad J-K Flip-Flop Card

APPLICATIONS: Binary and BCD counters, up and down counters, shift registers, synchronous and asynchronous counters.

Factory assembled and calibrated EU-800-CC, 1 lb. . . \$24.00

EU-800-DC Decimal Readout Adapter

The EU-800-DC is a neon-tube visual display device designed to plug into the Heath EU-800-DE DCU Card.

Factory assembled and calibrated EU-800-DC, 1 lb. . . \$15.00

EU-800-DD Quad DCU Card

APPLICATIONS: Instrumentation and counting circuits.

Factory assembled and calibrated
EU-800-DD, 2 lbs. \$90.00

EU-800-DD SPECIFICATIONS: **Input Requirements:** Counting: Inputs 1 & 2. Load Units, 3; Pulse width, 10 ns; Rep rate, 50 MHz. **Reset:** Inputs 26 & 27. **Load Units:** 1; Pulse width, 600 ns; Rep rate, 12.5 MHz; Logic Level 1. **Memory:** Inputs 23 & 24. Load Units, 4; Pulse width, 600 ns; Rep rate, 12.5 MHz. **Memory Control:** Input 25. Load Units, 1; Pulse width, 600 ns; Rep rate, 12.5 MHz. **Output Capabilities:** **Reset Out:** Output 10. Fan Out, 10. **BCD:** Output 4. Fan Out, 10. $\div 10$. Fan Out, 2. $\div 10^2$, $\div 10^3$, $\div 10^4$. Fan Out, 6.

EU-800-DE IC DCU Card

APPLICATIONS: Any decimal counting operation using digital readout.

Factory assembled and calibrated EU-800-DE, 1 lb. . . \$40.00

EU-800-JC Nand Gate Card

APPLICATIONS: Basic Nand, And, Or and Nor gates. Adders, flip-flops, pulse & square wave generators, decoding matrices.

Factory assembled and calibrated
EU-800-JC, 2 lbs. \$16.00

EU-800-JD Relay Card

APPLICATIONS: Study of switches and switching logic, basic gate configurations, logic trees; relay characteristics: contact bounce, transfer time, pull-in and release currents.

Factory assembled and calibrated
EU-800-JD, 2 lbs. \$31.00

EU-800-JD SPECIFICATIONS—Relays: 7, single-pole, double throw. **Coil Rating:** 200 ohm DC resistance; 20 mA pull-in current. **Contact Rating:** 24 V DC, 2 A max. non-inductive load. **GENERAL—Input Signal to Card:** Logic 1 (+2.4 V min. to +5 V max.) **Input Current:** 0.4 mA per relay circuit. **Transistors:** 7 NPN. **Power Requirements:** +5 V DC, 20 mA per relay.

EU-800-JE And-Or-Invert Gates Card

APPLICATIONS: Gating, memory, signal selecting and decoding circuits.

Factory assembled and calibrated
EU-800-JE, 2 lbs. \$18.00

EU-800-JJ Gate and Overrange Card

APPLICATIONS: Counting, timing and time-frequency measurement circuits.

Factory assembled and calibrated EU-800-JJ, 1 lb. . . \$26.00

EU-800-KC 1-MHz Crystal Time Base Card

APPLICATIONS: Instrument calibration. Any circuit requiring accurate logic level pulses from 1 μ sec to 10 seconds.

Factory assembled and calibrated EU-800-KC, 1 lb. . . \$65.00

EU-800-KC SPECIFICATIONS—Time Base Accuracy: ± 2 Hz. **Time Base Stability:** ± 10 ppm. from 10-40°C. **Aging Rate:** Less than 10 ppm/yr. **Inputs:** External oscillator; internal oscillator; data select A, B and C; strobe; reset; preset. **Outputs:** 2 Complementary outputs; scaler outputs from 1 μ sec to 10 seconds in 7 decade steps. **Fan in:** 1. **Fan out:** 10.

EU-900-CA Dual Booster Op Amp Card

APPLICATIONS: Any op amp circuit requiring an output up to 300 mA.

Factory assembled and calibrated EU-900-CA, 1 lb. . . \$40.00

EU-900-CA SPECIFICATIONS: **Voltage Gain:** 0.85 minimum. **Current Gain:** 3000. **Output Z:** 10 ohms. **Input Z:** 400 k ohms. **Output Voltage Swing:** ± 11 VDC. **Input Bias Current:** 60 μ A. **Adjustable Current Limit:** ± 0.5 mA to ± 300 mA. **Preset Current Limit:** ± 25 mA. **Power Requirements:** ± 15 VDC @ 30 mA max., $V_{in}=0$, $R_f=0$. **Full Load Peak Current:** 700 mA maximum.

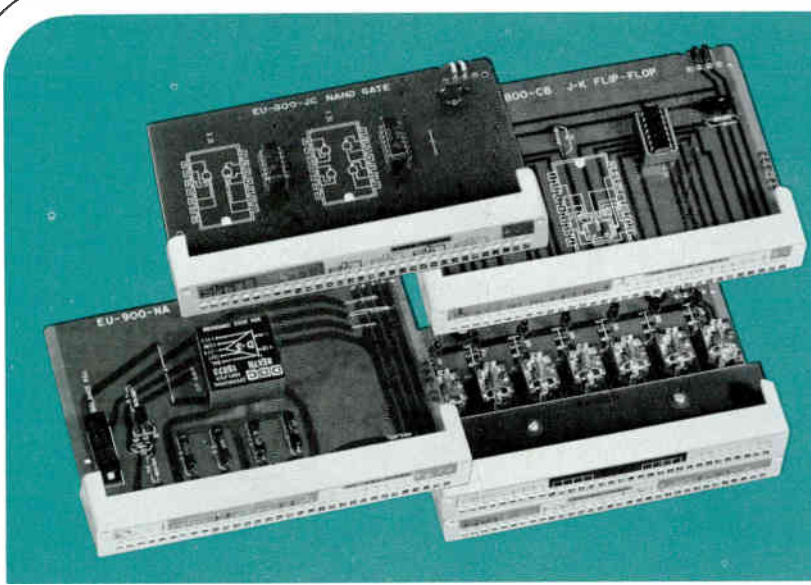

PLUG-IN CIRCUIT CARDS

A wide variety of
analog function cards
for every application

EU-900-DA Instrumentation Amplifier Card

APPLICATIONS: Circuits where differential input and high common mode rejection are required.

Factory assembled and calibrated

EU-900-DA, 1 lb. \$140.00

EU-900-DA SPECIFICATIONS: Gain: 1 to 1000 in decade steps $\pm 1\%$. Gain Non-linearity: $\pm 0.05\%$. Maximum Input Voltage: ± 15 V. Differential Input Impedance: 20 megohm $\pm 10\%$. Common Mode Input Impedance: 105 megohm $\pm 20\%$. Input Range: ± 10 V, ± 1 V, ± 100 mV, ± 10 mV. Voltage Offset: ± 1 mV/ $^{\circ}$ C at gain of 1000. Current Offset: 2 pA typical. Bias Current: ± 5 pA typical, doubles for each 10° C change. Frequency Response: 1 kHz minimum @ 0.1% gain accuracy; 15 kHz @ 3 dB gain accuracy. Settling Time to 0.1% (10 V step): 500 μ sec maximum. CMR (DC to 100 Hz, gain 10, balanced source): 80 dB minimum. Output Noise (gain of 1, 10 or 100, 0.01 Hz to 1 MHz): 2.5 mV rms maximum.

EU-900-GB Track and Hold Card

APPLICATIONS: Preprocessing a signal before it is sent to a high-speed AD/ converter.

Factory assembled and calibrated

EU-900-GB, 1 lb. \$200.00

EU-900-GB SPECIFICATIONS: Voltage Range: ± 10 V maximum. Tracking Mode Error: ± 2 mV maximum. Sampling Mode Error: ± 3 mV (nonadditive) maximum. Voltage Decay (25° C): 50 mV/sec maximum. Temperature Stability: 100 μ V/ $^{\circ}$ C maximum. Acquisition Time, 10 V step to 0.01%: 30 μ sec maximum. Aperture: 50 nsec maximum. Feedthrough @ 20 kHz: -80 dB maximum. Feedthrough @ 1 kHz: -100 dB maximum. Supply Voltages: $+5$ V @ 92 mA; $+15$ V @ 15 mA. -15 V @ 15 mA.

EU-900-NA Op Amp Card

APPLICATIONS: As an Amplifier: Inverting amp, Noninverting amp, Follower Amp, Current amp, Nonlinear amp, Sample and Hold Follower, Sample and Hold Amp. As a Generator: Controlled Current and Voltage Sources, Sweep Generator. As a Computer: Sum and Difference, Integration, Differential Equations: As a Sensor: Sensing and Comparator circuits.

Factory assembled and calibrated EU-900-NA, 1 lb. . . \$40.00

EU-900-NA SPECIFICATIONS: DC Gain, Open Loop: at 10 k ohm load, 100 dB typical; at rated 5 k ohm load, 90 dB typical. Frequency for Full Output: 13 kHz typical. Frequency for Unity Gain: 1-2 MHz. Slewing Rate: 0.8 V/ μ sec. Peak Output Voltage (at rated 5 k ohm load): ± 11 V to ± 13 V. Peak Output Current: ± 3.5 mA. Differential Input Impedance: 60 M ohm. Common Mode Input Impedance: 1600 M ohm. Broadband Input Noise to 10 kHz: 5 μ V rms. Common Mode Voltage Peak: ± 11 V max. Common Mode Rejection Ratio: 110 dB. Power Requirements: voltage ± 15 V, quiescent current 6.6 mA max., full load peak current 8.8 mA max., short circuit current 12 mA max. Transistor Circuit: input signal ± 13 V DC (output of op. amp.), output signal 0 to 5 V approx., inverted.

EU-900-EB High Speed A/D Converter Card

APPLICATIONS: Any application requiring high speed A/D conversion.

Factory assembled and calibrated

EU-900-EB, 1 lb. \$245.00

EU-900-EB SPECIFICATIONS: Input: 0-10 V, $+5$ V or ± 10 V full scale range. Input Impedance: 10 k ohm/10 pF. Resolution: 10 bits. Quantizing Error: $\pm 1/2$ LSB max. Conversion Rate: 50 μ sec max. Zero Error: adjustable to zero. Gain Error: adjustable to zero. Temperature Coefficient: Offset (zero error) -20 ppm/ $^{\circ}$ C max.; Gain ± 50 ppm/ $^{\circ}$ C max. Fan In: 1 on Transfer input; 2 on Convert Start. Fan Out: 30 on Transfer output.

EU-900-EA Dual Slope A/D Card

APPLICATIONS: Any circuit requiring A/D conversion.

Factory assembled & calibrated EU-900-EA, 2 lbs. . . \$105.00

EU-900-JA 8-Bit Analog Switch Card

APPLICATIONS: Any analog switching circuit, such as series, shunt, series-shunt or multiplexers.

Factory assembled & calibrated

EU-900-JA, 1 lb. \$40.00

EU-900-JA SPECIFICATIONS: Analog Input Voltage Range: -5 V into approx. 30 V. Control Input: TTL logic (input load unit = 1). "On" Resistance, D to S, @ 15 V, 25° C: 10 ohms typical, 25 ohms max. "Off" Resistance, D to S @ 15 V, 25° C: 10^{10} ohms typical, 10^7 ohms min. Max. Switch Current: 10 mA. Max. Switching Rate: 100 KHz. Power Requirements: -15 VDC @ 2 mA; $+5$ VDC @ 15 mA. Full Load Peak Current: 110 mA @ 5 VDC; 40 mA @ -15 VDC.

EU-900-NC Dual Op Amp Card

APPLICATIONS: Analog computation, analog control, a-d conversion, d-a conversion.

Factory assembled & calibrated EU-900-NC, 1 lb. . . \$65.00

EU-900-NC SPECIFICATIONS: Op Amp: DC Voltage Gain, Open Loop: 100dB min. Frequency for Full Output: 100 kHz min. Frequency for Unity Gain: 4 MHz min. Slewing Rate: 6 V/ μ sec. min. Peak Output Voltage: ± 10 V min. @ rated 2 k ohm load. Peak Output Current: ± 5 mA min. Differential Input Impedance: 10^{11} ohms typical. Common Mode Input Impedance: 10^{11} ohms typical. Input Voltage Characteristics: Initial Offset adjustable to zero; Drift vs. Temperature ± 50 μ V/ $^{\circ}$ C maximum; Drift vs. Time, 100 μ V/24 hr. Input Bias Current: 0.10 nA max, Drift vs. Temperature, doubles for every 10° C change. Broadband Input Noise: 10 μ V rms max. to 10 kHz. Common Mode Voltage Peaks: ± 10 V max. Common Mode Rejection Ratio: 66 dB typical. Power Requirements: Operational Amplifier: ± 15 VDC @ 20 mA quiescent, 30 mA full load peak.



"800-SERIES" ACCESSORIES

Low cost accessories
mean added versatility
for your ADD unit

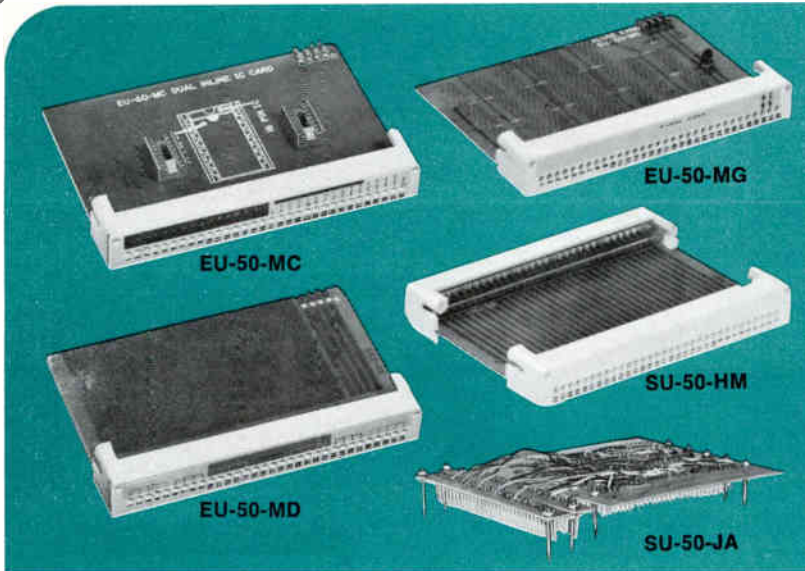

EU-50-MC Dual In-Line Card

The Dual In-Line Card contains two 16-pin dual in-line IC sockets connected to a row of 32 patch connectors on the top of the card. Special foil pads are provided for soldering jumper wires and/or other components on the board.

Factory assembled EU-50-MC, 1 lb. \$20.00

EU-50-MD Multiple Connector/Blank PC Card

This card provides tie points for patch connections to other modules and cards. Patch connectors along the top of the card are connected in 4 groups of five and 3 groups of four each, allowing additional connections to be made to seven different points. Connectors may be separated to permit patch connections to circuits which you may etch and build on the card.

Factory assembled EU-50-MD, 1 lb. \$14.50

EU-50-MG Kluge Card

This card provides pre-drilled and etched foil pads for up to eleven 14 or 16-pin dual in-line ICs. Buses for ground, 5 V & ± 15 V are also included.

Factory assembled EU-50-MG, 2 lbs. \$24.00

SU-50-HM Extender Card

This card permits patch-wire connections to be made to pins in Heath instruments and modules using 32-pin male connectors.

Factory assembled SU-50-HM, 2 lbs. \$14.00

SU-50-JA Permanent Patch Accessory

The SU-50-JA is the fast, simple, convenient way to make a complete "permanent" circuit out of "800-series" modules

and cards. Once the patch accessory is "hard-wired" to match a successful wire-patch, it can be plugged or unplugged in seconds. The SU-50-JA consists of two large printed circuit boards containing seven 32-pin plug-in connectors, and two small patch boards. Each large board will accommodate up to seven plug-in cards...a complete module.

SU-50-JA, 2 lbs. \$46.00

SU-50-HA Patch Wire Assortment

The wire assortment consists of 156 pieces of prepared wire in 6 colors and 4 lengths. The lengths and quantity are as follows: 3½", 60; 6½", 48; 10", 24; 15", 24.

SU-50-HA, 2 lbs. \$6.00

SU-800-RC 3-Module Cabinet

The SU-800-RC three-module cabinet measures 17½" W x 9½" D x 6¼" H and provides a convenient mounting for 3 modules. A removable cover provides easy access to the modules and circuit cards. The modules can be held in place permanently with the thumbscrews provided. The three-position support bail on the bottom of the cabinet can be folded flat so the cabinet will sit flat on a shelf or bench or tilted for easy access to the cards and patch connectors or front panel controls and indicators. The cabinet can be readily rackmounted with the SU-800-RD accessory below.

Factory assembled SU-800-RC, 3 module cabinet, 8 lbs. \$21.00

SU-800-RD Rack-Mount Accessory

The rack mounting accessory enables installation of three modules in a standard 19" rack quickly and easily. Includes two end plates painted to match the ADD and all necessary hardware.

SU-800-RD, 2 lbs. \$8.00

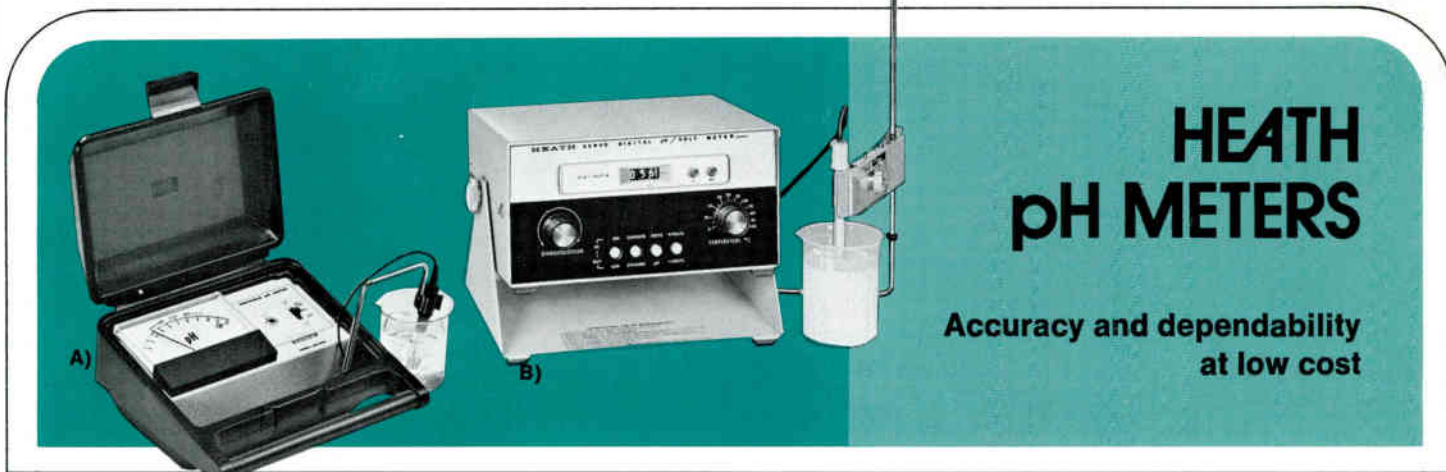

A) Portable pH meter offers 0-12 pH range

Factory assembled & calibrated SM-101A, 4 lbs. \$79.00

SM-101A SPECIFICATIONS — Range: 2-12 pH (Meter reading can be shifted to 0-10 pH by adjusting the Set control.) Accuracy: ± 0.1 pH, when measured within 3 pH of the buffer point. (Unit calibrated at 25 degrees C, for measurements between 2 and 12 pH.) Readability: 0.05 pH. Power Requirements: Standard 9-volt transistor battery (supplied). Net Weight: 2½ lbs.

B) Digital pH/mV meter features 0.02 pH resolution

Factory assembled & calibrated EU-302A, 10 lbs. \$195.00

EU-302A SPECIFICATIONS — Ranges: 0-14 pH; 0-1.4 volts. Resolution: 0.02 pH; 0.002 volts. Accuracy: $\pm 0.5\%$ of full scale. Temperature Compensation: 0 to 100 de-

grees C, manual control. Input Connectors: Standard glass electrodes (Beckman Type). BNC, and pin or banana jacks for reference electrodes, 5-way binding posts for polarization current. Outputs: chart recorder; 10 mV/pH. Polarization, 10 μ A. Power Requirements: 10 watts, 120/240 VAC, 50/60 Hz. Dimensions: 11" W x 7½" H x 9" D. Net Weight: 8 lbs.

pH accessories

EUA-20-12 pH/mV Test Unit provides quick checkout for pH meters, recorders and electrometers.

Factory assembled & calibrated EUA-20-12, 4 lbs. \$55.00

Combination pH Electrode for EU-302A pH meter. Both pH and reference electrodes in a single envelope.

Factory assembled & calibrated SU-20-23, 2 lbs. \$34.00

Heathkit Electronic Centers:

Units of Schlumberger Products Corporation

Heathkit Electronic Centers offer complete display, demonstration, personal assistance and immediate delivery. The local selling price includes freight from factory (not included in factory mail order prices) plus a small amount to cover local store overhead.

ARIZONA: Phoenix, 85017, 2727 W. Indian School Rd., Phone: 602-279-6247; **CALIFORNIA:** Anaheim, 92805, 330 E. Ball Rd., Phone: 714-776-9420; El Cerrito, 94530, 6000 Potrero Ave., Phone: 415-236-8870; Los Angeles, 90007, 2309 S. Flower St., Phone: 213-749-0261; Pomona, 91767, 1555 N. Orange Grove Ave., Phone: 714-623-3543; Redwood City, 94063, 2001 Middlefield Rd., Phone: 415-365-8155; San Diego (La Mesa, 92041), 8363 Center Dr., Phone: 714-461-0110; Woodland Hills, 91364, 22504 Ventura Blvd., Phone: 213-883-0531; **COLORADO:** Denver, 80212, 5940 W. 38th Ave., Phone: 303-422-3408; **CONNECTICUT:** Hartford (Avon, 06001), 395 W. Main St. (Rte. 44), Phone: 203-678-0323; **FLORIDA:** Miami (Hialeah, 33012), 4705 W. 16th Ave., Phone: 305-823-2280; Tampa, 33614, 4019 W. Hillsborough Ave., Phone: 813-886-2541; **GEORGIA:** Atlanta 30305, 5285 Roswell Rd., Phone: 404-252-4341; **ILLINOIS:** Chicago, 60645, 3462-66 W. Devon Ave., Phone: 312-583-3920; Chicago (Downers Grove, 60515), 224 Ogdan Ave., Phone: 312-852-1304; **INDIANA:** Indianapolis, 46220, 2112 E. 62nd St., Phone: 317-257-4321; **KANSAS:** Kansas City (Mission, 66202), 5960 Lamar Ave., Phone: 913-362-4486; **KENTUCKY:** Louisville, 40243, 12401 Shelbyville Rd., Phone: 502-245-7811; **LOUISIANA:** New Orleans (Kenner, 70062), 1900 Veterans Memorial Hwy., Phone: 504-722-6321; **MARYLAND:** Baltimore, 21234, 1713 E. Joppa Rd., Phone: 301-661-4446; Rockville, 20852, 5542 Nicholson Lane, Phone: 301-881-5420; **MASSACHUSETTS:** Boston (Wellesley, 02181), 165 Worcester Ave., Phone: 617-237-1510; **MICHIGAN:** Detroit, 48219, 18645 W. Eight Mile Rd., Phone: 313-535-6480; E. Detroit, 48021, 18149 E. Eight Mile Rd., Phone: 313-772-0416; **MINNESOTA:** Minneapolis (Hopkins, 55343), 101 Shady Oak Rd., Phone: 612-938-6371; **MISSOURI:** St. Louis, 63123, 9296 Gravois Ave., Phone: 314-638-5100; **NEBRASKA:** Omaha, 68134, 9207 Maple St., Phone: 402-391-2071; **NEW JERSEY:** Fair Lawn, 07410, 35-07 Broadway (Rte. 4), Phone: 201-791-6935; **NEW YORK:** Buffalo (Amherst, 14226), 3476 Sheridan Dr., Phone: 716-835-3090; Jericho, Long Island, 11753, 15 Jericho Turnpike, Phone: 516-334-8181; New York, 10036, 35 W. 45th St., Phone: 212-765-4590; Rochester, 14626, 1384 Long Pond Rd., (Long Ridge Plaza), Phone: 716-227-4750; White Plains, 10603, 7 Reservoir Rd., Phone: 914-761-7690; **OHIO:** Cincinnati (Woodlawn, 45215), 10133 Springfield Pike, Phone: 513-771-8850; Cleveland, 44129, 5444 Pearl Rd., Phone: 216-886-2590; Columbus, 43229, 2500 Morse Rd., Phone: 614-475-7200; **PENNSYLVANIA:** Philadelphia, 19149, 6318 Roosevelt Blvd., Phone: 215-288-0180; Philadelphia (Frazer, 19355), 630 Lancaster Pike, Phone: 215-647-5555; Pittsburgh, 15235, 3482 Wm. Penn Hwy., Phone: 412-824-3564; **RHODE ISLAND:** Providence (Warwick, 02886), 558 Greenwich Ave., Phone: 401-738-5150; **TEXAS:** Dallas, 75201, 2715 Ross Ave., Phone: 214-826-4053; Houston, 77027, 3705 Westheimer, Phone: 713-623-2090; **WASHINGTON:** Seattle, 98121, 2221 Third Ave., Phone: 206-682-2172; **WISCONSIN:** Milwaukee, 53216, 5215 Fond du Lac, Phone: 414-873-8250.

Overseas:

AUSTRALIA: Schlumberger Instrumentation Australia (Pty.) Ltd. Victoria — Box 138, 112 High St., Kew, 3101; N.S.W.: Schlumberger Instrumentation Australia (Pty.) Ltd., Suite 7, P. & M. Bldg., 134 Willoughby Rd., Crows Nest, 2065; **AUSTRIA:** Schlumberger Overseas GmbH, A-1120 Wien XII, Meidlinger, Hauptstrasse 46, Austria; **BELGIUM:** Heath Electronic Center, Avenue du Globe, 16-18, (Palais des Sports et du Spectacle "Forest National"), B-1190, Brussels, Belgium; **CANADA:** Heath Company, 1480 Dundas Hwy. East, Mississauga, Ontario, Canada; **ENGLAND:** Heath (Gloucester) Ltd., Bristol Road, Gloucester, England; **FRANCE:** Heathkit Schlumberger, 84, Boulevard Saint Michel, 75006-Paris, France; Heathkit Electronic Center, 47 Rue de la Colonie, F-75013 Paris, France; **WEST GERMANY:** Heathkit-Gerate GmbH, Robert-Bosch-Strasse 32-38, 6079 Sprengling, West Germany; **ITALY:** Schlumberger Italiana SPA, Divisione Strumetazione, 13, Via Pompeo Neri, I-20146, Milano, Italy; **NETHERLANDS:** Heath Electronic Center, Pieter Caland Laan 106-110, Amsterdam-Osdorp, Netherlands; **SWEDEN:** Heathkit Electronic Center, Pontongargatan 38, Box 12081, S-102 23 Stockholm Sweden; **SWITZERLAND:** Schlumberger Messgerate A.G., 8040 Zurich, Badenerstrasse 333, (Postfach 139), Switzerland; Schlumberger Instrumentation S.A., 15 Rue de Jeu De L'Arc, 1211 Geneva, Switzerland.

International Distributors and Agents

ARGENTINA: Fotovolt S.A., Buenos Aires; **BOLIVIA:** Telco Ltd., LaPaz; **BRAZIL:** Blucil Comercial e Importadora Ltda., Sao Paulo; **CHILE:** W. Reichmann y Cia Ltda, Santiago; **COLOMBIA:** Instrumentacion, H. A. Langebaek & Kier Ltd., Bogota; **CYPRUS:** P. Phasaras, Nicosia; **ECUADOR:** Suministros Tecnicos Ltda., Guayaquil; **GREECE:** Kostas Karayannis, Athens; **GUATEMALA:** Electronica Cientifica, S.A., Guatemala, C.A.; **HONG KONG:** Excel Hi Fi Co.; **JAPAN:** Sony Trading Corp., 3-5 Akasaka 1-Chome, Minato-Ku, Tokyo 107; **KOREA:** Asia Science & Co., Seoul; **LEBANON:** Projects, Beirut; **MALAYSIA:** Mechanical & Combustion Engineering Co. Ltd., Singapore; **MEXICO:** Mexitek, SA, Mexico; **NEW ZEALAND:** Elekon Overseas Ltd., Auckland; P. H. Rothchild & Co., Ltd., Lower Hutt; **PERU:** Electronic Supply S.A., Lima; **PHILIPPINES:** Guevara & Sons, Inc., Manila; **PUERTO RICO:** Electronics of Puerto Rico, Inc., Hato Rey; **SINGAPORE:** Mechanical & Combustion Engineering Co. Ltd., Singapore; **SOUTH AFRICA:** Metlionic Pty. Ltd., P.O. Box 39690 (Cor. Louis Botha & Forest Rd.), Bramley, Transvaal, So. Africa; **TAIWAN:** MacKarl & Co., Taipei; **THAILAND:** Charturong Arphon Ltd., Bangkok; **TURKEY:** Mevag Corp., Istanbul; **URUGUAY:** BGH, S.A., Montevideo; Marrone Radio Ltd., Montevideo; **VENEZUELA:** Corporacion de Maquinarias, Arte y Tecnica Instrumental, de Venezuela, Caracas; **SOUTH VIETNAM:** Cong Ty Xuyen Son, Saigon.

For information regarding authorized distributors elsewhere, contact: Heath Company, International Division, P.O. Box 440, St. Joseph, Michigan 49085, U.S.A. Cable: HEATHCO; telex: 72-9421; telephone: 616-983-3961.





Heath/Schlumberger Instruments
Dept. 583-132
Benton Harbor, Michigan 49022

Please send
Heath/Schlumberger Catalogs
to the following names:

Name _____
Title _____
Company _____
Address _____
City _____
State _____
Zip _____

Name _____
Title _____
Company _____
Address _____
City _____
State _____
Zip _____

NEED ADDITIONAL HEATH/SCHLUMBERGER CATALOGS?

Use the coupon at left to request
Heath/Schlumberger Catalogs for
your friends and associates. If more
than two catalogs are needed, just
send a request on your letterhead. We'll
send the catalogs promptly and add
the names to our mailing list to insure their
receipt of future Heath/Schlumberger catalogs.



send catalog requests to
**HEATH/SCHLUMBERGER INSTRUMENTS
DEPARTMENT 583-132
BENTON HARBOR, MICHIGAN 49022**

INDEX

Ordering & shipping information 2
Electronic Instrumentation
Frequency counters 3-7
Digital multimeters, VTVMs 8-11

Oscilloscopes12-15
Generators16-19
Power Supplies20-21
Strip Chart Recorders
SR-201A Low-cost Recorder 22
Modular recorder systems23-25
SR-255B Recorder26-27

Malmstadt-Enke Lab Stations28-29
Analog-Digital Designer Systems
Computer logic & basic ADD systems .. 30
800-Series modules 31
Circuit cards and accessories32-34
pH Meters 35
Heathkit Electronic Centers 35



Heath/Schlumberger Instruments
Benton Harbor, Michigan 49022

ADDRESS CORRECTION REQUESTED

RECEIVING DUPLICATE COPIES OR INCORRECT ADDRESS?

If you receive extra copies of this catalog, please send us
the address labels from any undesired copies and we will
delete these from our mailing lists. Also, if your address
is incorrect, send us the address label along with your
correct name and address (including ZIP code) and we will
make the necessary changes.

All prices quoted are Mail Order, Net F.O.B. Benton Harbor,
Michigan and apply to United States and Possessions only.
Prices herein effective May 15, 1974. Printed in U.S.A.

**BULK RATE
U.S. POSTAGE
PAID
Heath Company**

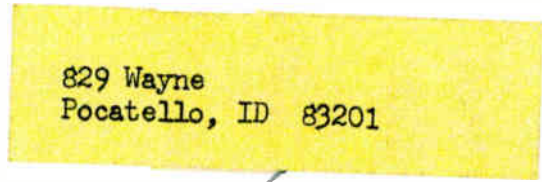

83201PIC05J1033FRE POC
~~J PRICE
1033 W FREMONT 1
POCATELLO ID 83201~~