

Heathkit



Enjoy your vacation,
we'll watch the house.
See page 3.

Summer audio sale.
Half price on all
remaining units!
See pages 12-14.

Learn electronics by
video. See page 35.

Volume 221

Summer 1990

Contents

Security and Lighting 2-11

Home security systems, indoor and outdoor motion sensor lighting, a full line of X-10 controllers and modules, plus a convenient auto security system.

Home Entertainment 12-21

Half-price sale on all audio equipment! Plus TVs, camcorders, VCRs and more.

Computers 22-31

Powerful portable and desktop computers, the new flat tension monitor on page 28, peripherals and accessories for your workstation.

Weather 32-34

The Advanced Weather Computer and accessories on pages 32 and 33, plus more useful weather instruments.

Education 35-61

Exciting home video tutorials on page 35, award-winning home study courses and trainers. Earn Continuing Education Units (CEUs) with each course you complete.

Amateur Radio 62-77

The Heath exclusive IntelliRotor on page 67, new ham shack software, plus the Pocket Packet TNC, ready for its second space mission.

Instruments 78-89

Oscilloscopes, frequency counters, DMMs and more. New flexible test leads are on page 89.

Favorite Kits, Tools 90-99

Three exciting new starter kits on page 91, a full line of kit building tools, clocks and much more.

Ordering Information 50-53

Order by phone toll-free, 24 hours a day, seven days a week; by mail or by fax. Use Heath Revolving Charge, VISA, MasterCard or American Express.

Design complete home security and comfort from your computer

While you're at home or away, let the Home Control Interface manage your home's lighting, temperature, appliances and more. You can tailor your own personal security and convenience system to fit your family's needs – right from your computer.

The interface works with any computer that has an RS-232 port. Simply load the software, plug the included cable into the serial port and connect the interface. After programming the interface, disconnect it. It doesn't tie up your computer.

The interface works by sending digitally encoded signals through your home wiring to X-10 modules (shown on page 10) allowing automatic or manual control of up to 256 modules and 128 timed events. Each module can be programmed to turn off and on at scheduled times during the week.

As a security system, the interface deters intruders by making your house look and sound lived in when you're not there. You can schedule your inside and outside lights, radio, stereo system and television to turn on and off at different times of the day and night for as long as you're away. This gives you complete peace of mind when you're on vacation or have to leave for extended periods of time.

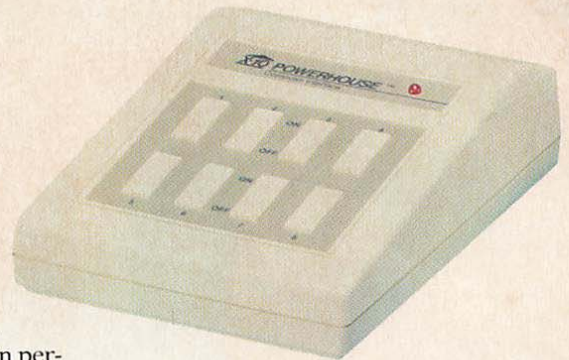

For convenience when you're at home, you can program the interface around your daily schedule. Wake up to stereo music, start the coffee, turn up the heat or air conditioning and turn on the lights – all before you get out of bed. Plus, you can program the interface to turn on your TV when your favorite show comes on in the evening, to turn on and later dim the lights as it gets dark.

Expand your system with controllers, light and appliance modules, wall switch modules, the burglar alarm interface, and X-10 compatible indoor/outdoor lighting controls in this section. The applications are endless.

BC-290-A Interface for Apple IIe/IIc. (3 lbs.) **\$59.99**

BC-290-M Interface for 128K Mac, 512 Mac, Mac Plus, Mac II, Mac SE, Mac XL (cable adapter required for Mac Plus, II, SE, XL). (2 lbs.) **\$59.99**

BC-290-P Interface for IBM PCs and compatibles. (2 lbs.) **\$59.99**

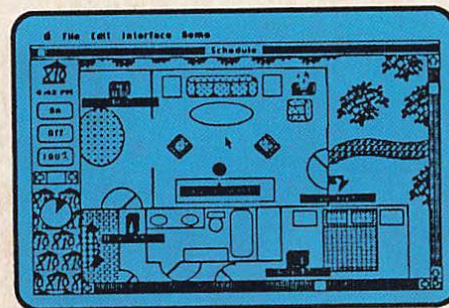

Mac graphics look just like your home. You can place icons wherever you want them on a Module Map or design your own.

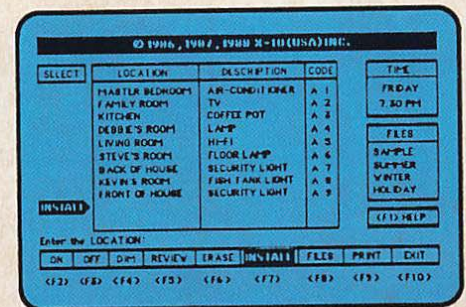

IBM graphics show programs on a charted screen. Selections are made with cursor and function keys.

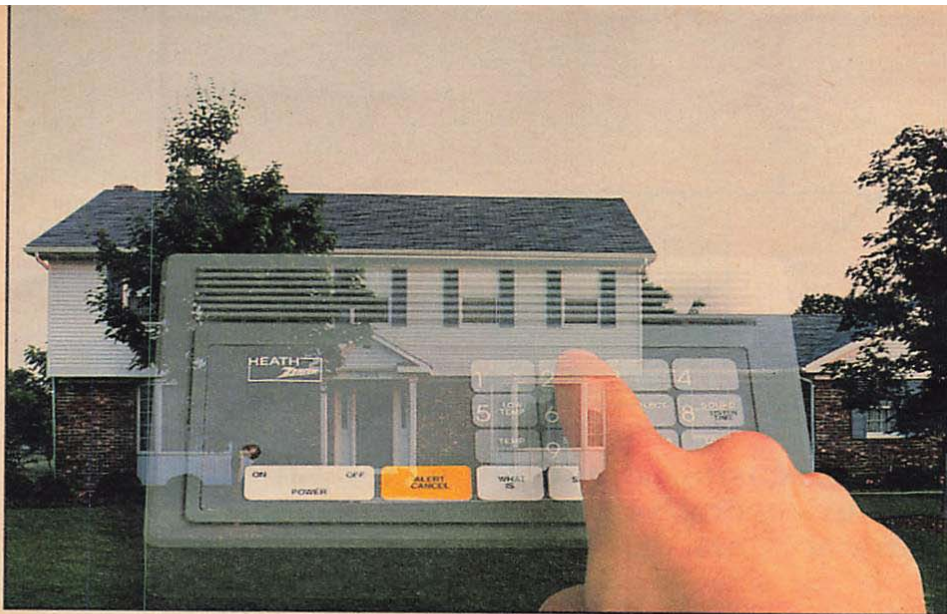

The House Sitter monitors your home

"This is 555-3210. Alert condition is OK. Temperature is 65°. Electricity is on. Sound level is OK." After hearing this comforting message, you can return to your beach chair, take another sip of your tropical punch and completely and totally relax, knowing your house is safe in your absence.

Monitor your home from a vacation spot, monitor a vacation cabin from your primary residence or simply call in from the office to be sure everything is in order. Our House Sitter Security Monitor/Dialer gives you complete peace of mind when you're away from home.

When you call, the House Sitter will report on the AC electric power, the room temperature — comparing it with high and low limits you've previously

set, loud noises such as burglar alarms and fire alarms, the unit's own battery backup condition, and an additional alert condition such as an alarm from a compatible security system. You can even listen to the sounds in the room using the built-in microphone.

Or, set the unit to call out to announce any alert condition that's outside your preset limits. You can program up to four numbers such as your office phone, neighbors' and relatives' phones. The House Sitter will call for temperatures that are too high or low, for loud noises and other alert conditions.

Connects to any standard phone jack. Six AA batteries (not included) are required for battery backup. Pulse dialing and answering machine compatible. **Assembled SD-6230 (1 lb.) . \$129.95**

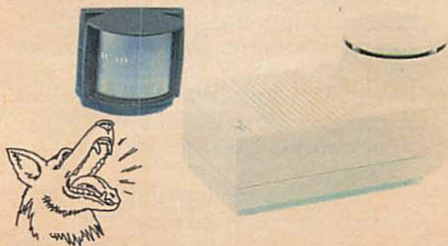

The Barking Dog, rated one of 1989's most popular home products

Building Supply Home Centers magazine* lists our Barking Dog Security Alarm among its top 12 *most asked about* products in the past year. This novel solution to home security will guard your house for an evening or a week, never needing to be fed or taken for a walk.

The Barking Dog uses passive infrared (PIR) technology to detect the presence of heat in motion. When someone crosses the pie-shaped detection zone, the person's body heat triggers the realistic bark of a good sized dog, giving an intruder the impression that an angry animal is just behind the door.

The detection zone extends up to 70 feet from the PIR unit. You can reduce that distance if your house is less than 70 feet from the street, and can also adjust the left-right sensing area. Exclusive pulse count technology reduces false triggering since the unit must verify more than one pulse before it goes off.

Fast and easy to install, the Barking Dog adjusts for high or low volume, switches to an ordinary door chime or can be turned off altogether.

Assembled SD-6000 (3 lbs.) . \$59.95

*Source: Building Supply Home Centers, December, 1989.

Enjoy your trip, we'll watch the house

The best time to think about protecting your home is now. Before you leave on vacation and before something goes wrong. We all know there are plenty of expensive security systems on the market. But for most people's needs, these high-priced systems aren't really necessary. Without talking to an expert, however, it's hard to know what else is available and how a particular lighting fixture or alarm would meet your specific needs. Let's take a look.

Motion sensor lighting (shown on pages 4 and 6) can be installed outdoors in any number of locations: over the garage, at the front door, over detached buildings such as barns and sheds. When one of these sensors detects heat in motion, it triggers the attached light, exposing anyone in the vicinity.

The SL-6120 on page 7 is a sophisticated indoor motion sensor that can be installed in any room of the house. It includes random and security settings that cause lights to turn on and off at irregular times when you're not at home and flash if an intruder enters the room.

The House Sitter, described on this page, lets you actually "talk with your house" from your vacation location. You can call in at any time of day to find out if the power is working, if the temperature setting is where you want it and if any alarms have triggered since you last called.

A different type of house sitter is the Barking Dog Security Alarm shown at left. Also triggered by heat in motion, this electronic canine sounds truly vicious from behind closed doors.

The X-10 computer interface on the facing page allows you to program home security from a computer. This means that while you're away, lights, radios and TVs can turn on and off at random times so the house looks and sounds awake and alive. The X-10 Timer Command Console on page 9 also includes a security mode for random on and off of lights and appliances.

A wireless, plug-in system, the Supervised Home Protection System on page 5 sets off alarms and flashes lights when a protected door or window is opened. You can customize it to your home's size and needs by simply adding more accessories.

Choose one or several Heath Zenith security and lighting products shown on these pages to help keep your home safe for this vacation and many more to come. An exciting vacation is one you'll always remember. But an uneventful homecoming is the very best kind.



Screw-in Adapter



Wired Adapter

Motion sensing adapters fit your decorative outdoor lights

Now you can have the security and convenience of motion sensing lighting with your decorative lights. You'll have complete peace of mind each time you leave home. If prowlers approach, instant lighting will send them running. When you, your family and friends arrive, the warmth and convenience of automatic lighting welcome you home.

These motion sensing adapters feature pulse count technology which requires a series of pulses in a pre-set period of time before turning your lights on. This reduces false triggering by 75% and saves electricity, too.

You can choose between the SL-5211 Screw-in Adapter and the SL-5210 Wired Adapter. The SL-5211 requires no installation; simply screw it into the socket of your decorative light. The SL-5210 wires easily into the junction box behind your light fixture.

Coverage with either adapter is pie-shaped, approximately 2000 sq. ft. extending 60 ft. from the sensing source. Includes automatic shut-off, manual override and adjustable mount. The control is UL approved.

- Assembled SL-5210 Wired Adapter (5 lbs.) \$34.97
- Assembled SL-5211 Screw-in Adapter (1 lb.) \$39.97



Sensor mounts to tree or fence

Receiver replaces existing wall switch

Wireless light control automatically turns on outdoor lights

Don't worry about leaving the lights on even though you won't be home until after dark. The minute you pull into the driveway the Wireless Motion Sensor Light Control turns on your outdoor lights, welcoming you home. Or, mount the sensor inside in a hall, stairway or garage. You don't have to worry about entering in the dark, fumbling for switches or even putting down your packages.

Place the wireless sensor up to 150 ft. from the receiver. As it detects heat from a moving object, the sensor transmits radio signals to the receiver which activates the lights. Plus, pulse count technology enables the sensor to reduce false triggering by up to 75%.

Installation is easy, too. The receiver simply replaces an existing wall switch, and the sensor mounts securely on a wall, fence or any vertical surface.

The light control features manual override and a 30 second to 20 minute adjustable shut-off. A unique code selection eliminates interface with other wireless units, and an energy-efficient photocell deactivates the unit during daylight hours. FCC and UL approved. Sensor requires a 9V transistor battery (not included). Requires neutral wire in the switch box.

- Assembled SL-5420 (2 lbs.) \$69.97

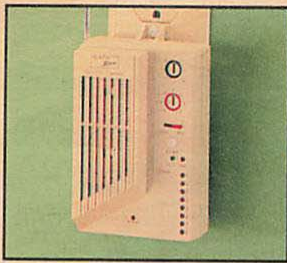

Control Center plugs into any wall switch, no wiring is necessary. Controls up to 16 security zones.

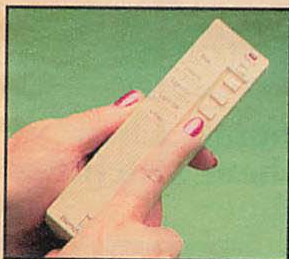

Remote Control arms and disarms the system and controls lights and other X-10 modules.

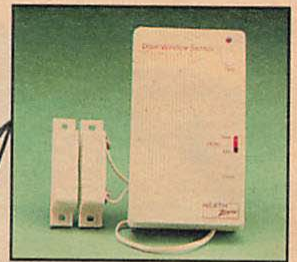
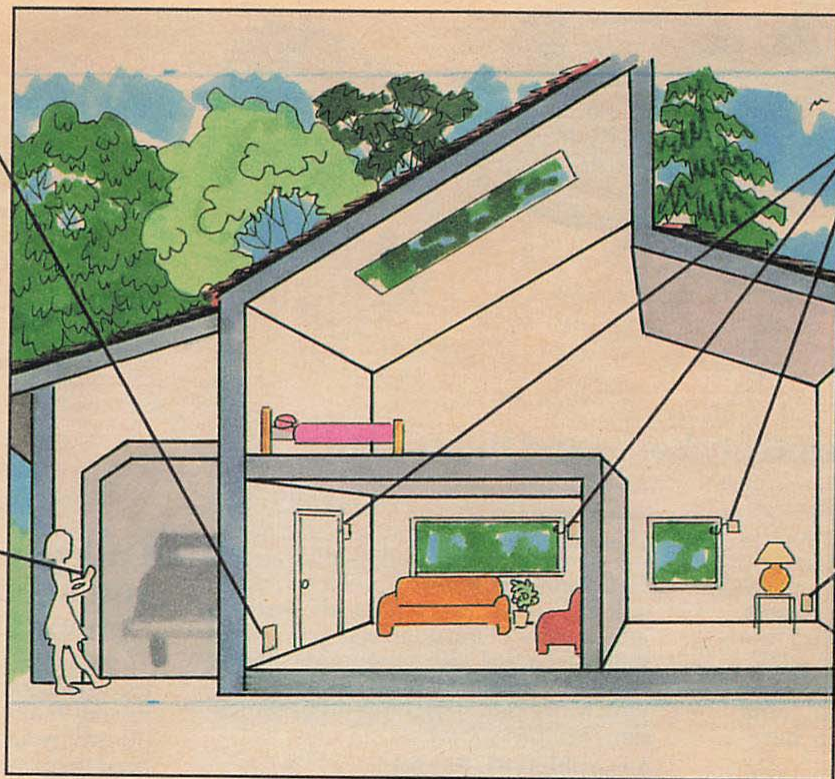

Door/Window Sensor attaches to doors and windows and sets off an alarm if they're opened.

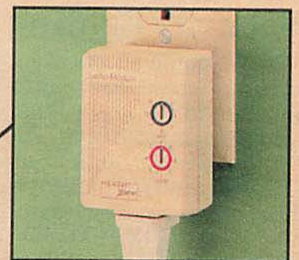

Lamp Module lets you control lights from the remote control and flashes them on and off during an alarm.

Easy-to-install, expandable security system protects your home

Today crime is a reality in large and small communities alike. Just pick up the newspaper any day of the week and read about homes that have been burglarized. Once, expensive, complex, professionally installed security systems were the only answer. But today, the protection you and your family deserve is available in a professional quality, easy-to-install, expandable system that costs under \$100!

Our Wireless Supervised Home Protection System offers features never before available in a do-it-yourself security system. It's supervised which means it checks itself to make sure all sensors are working properly. It's easy to install, too. By simply plugging in the control center and pushing four buttons, you have a system that's ready to go. And, you can design your own system by choosing accessories that provide the protection your family needs.

The system works by setting off a loud alarm when a protected door or window opens. At the same time, both indoor and outdoor lights flash on and off when indoor lights are connected to BC-465 Lamp Modules and outdoor lights are controlled by BC-467 Wall Switches. When the system is disarmed, a chime sounds from the control center each time a door or window is opened. This chime can be turned on and off.

Additional features include 16-zone protection, battery backup, dual alarm, entry and exit delays and an intrusion point indicator. The SS-6100 system includes a plug-in control center, a remote control for arming and disarming the system and controlling lights, a door/window sensor with magnetic reed switch and magnet, and a lamp module. Expand with up to 16 door/window sensors and up to 8 remote controls.

The system is compatible with any of the X-10 modules shown on page 10. It comes with three door/window warning labels that give additional protection to your home and its contents.

Assembled SS-6100 (2 lbs.) \$99.97

Save with the SS-6100 Expansion Pack. Includes three Door/Window Sensors, five sets of magnetic contacts, 12 feet of extension wire and 2 additional warning labels.

Assembled SSA-6100-9 (1 lb.) \$79.97

Accessories:

Additional Lamp Module

Assembled BC-465 (1 lb.) \$12.99

Additional Door/Window Sensor

Assembled SSA-6100-2 (1 lb.) \$29.97

Additional Remote Control

Assembled SSA-6100-3 (1 lb.) \$24.97

Wall Switch Module

Assembled BC-467 (1 lb.) \$12.99

Power Siren. Plug-in 105 dB indoor alarm.

Assembled SSA-6100-4 (1 lb.) \$39.97



ORDER TOLL-FREE ANYTIME

800-253-0570

FAX: 616-982-5577

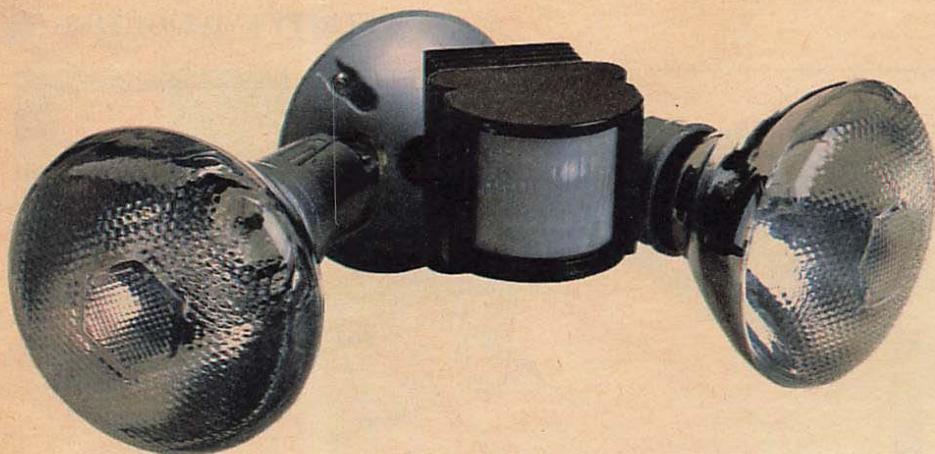

Security lighting protects home and lights yard

Welcome guests to your home with an illuminated walkway or driveway, or frighten intruders by flooding your yard with inescapable light. The Pulse Count Motion Sensor Light Control uses a PIR (passive infrared) sensor that detects heat in motion from up to 70 feet away in an adjustable 110° arc – over 4,000 sq. ft. of coverage. Plus, this professionally reliable light control uses pulse count circuitry which helps to reduce false triggering by up to 75%.

Features include an adjustable light

shut-off delay, a built-in photocell that deactivates the control during daylight hours and manual override which lets you switch on controlled lighting after dark. Raintight housing protects the unit from wind, rain and harsh weather. This compact light control is easy to install and comes with a mounting plate and light fixtures. Uses household 120 VAC, 60 Hz power. UL approved. Dimensions are 2 3/4" x 3" x 7".

Assembled SL-5315-A
(3 lbs.) \$49.97

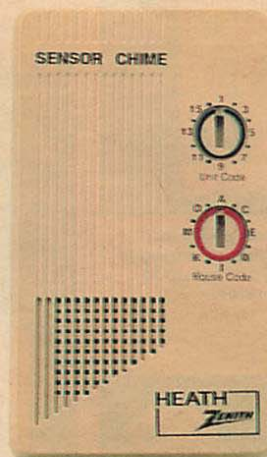

Call your family when you need them with the Sensor Chime

Now you can call someone in from the workshop, garage or attic without raising your voice. The Sensor Chime pleasantly alerts your family that you need them even when they're in distant parts of the house.

This plug-in chime works with any of the X-10 controllers shown in this section (controllers sold on pages 8 and 9) for many imaginative and convenient applications.

Keep an X-10 controller in a central location and put the chime modules wherever you need them around the house. You'll no longer need to drop what you're doing to call someone to the phone or to notify the family that dinner is ready. Simply press a controller button and pleasant sounding chimes call them for you. An excellent aid for the elderly, handicapped or bedridden, too.

Add an additional Sensor Chime to the SLS-5320-A package below left. You'll have an audible alert of approaching visitors even when you're in distant parts of the house. UL approved.

SL-5321 (1 lb.) \$19.97

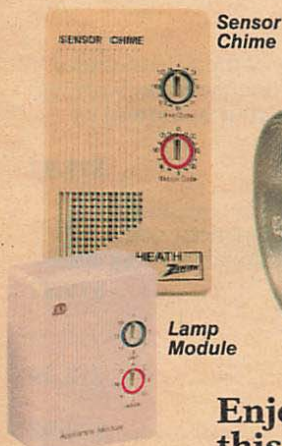

Enjoy security and convenience with this money-saving package

We've combined several of our finest security and lighting products into a single money-saving package to give you security and convenience both when you're at home and when you're away. This package includes the Advanced Light Control, SL-5321 Sensor Chime (described at right) and BC-465 Lamp Module (page 10).

Heat in motion triggers the system. When the outdoor light control senses activity, it sends a signal through the electrical wiring in your

home to turn on an inside light that is plugged into the lamp module. Plus, the light control activates the Sensor Chime which gives you an audible alert that someone is near.

Detection field covers over 4000 sq. ft. Includes sensitivity adjustment, manual override, adjustable shut-off delay, mounting plate (other than shown) and light fixtures. Rated UL raintight.

Assembled SLS-5320-A
(3 lbs.) \$69.97



TECHNICAL CONSULTATION

When you have a question about the kit you're building or about an assembled product, our expert technical consultants are only a phone call away. Their numbers are listed on page 51.

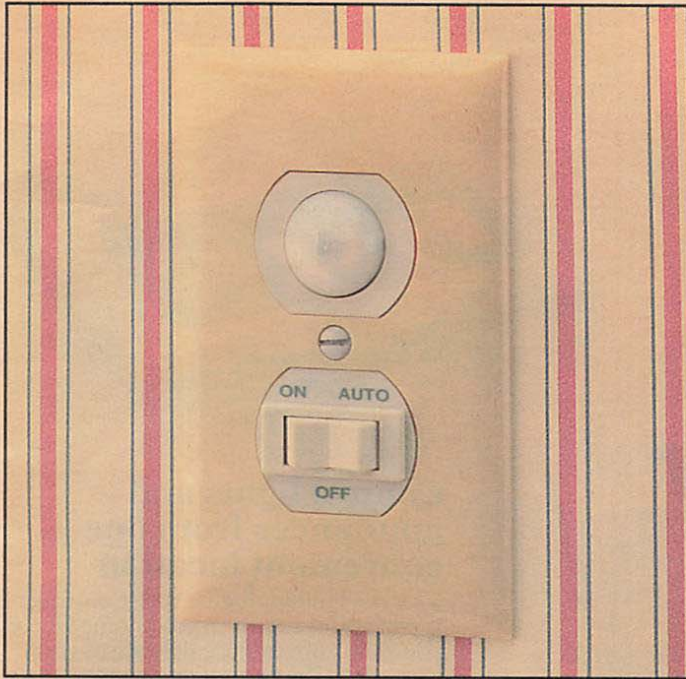

new Motion sensing wall switch works with both 3-way and single switch circuits

No more fumbling for light switches in the dark or dropping everything in your arms just to turn on the lights. The new Motion Sensing Wall Switch turns lights on automatically when you enter a room, then shuts them off after you leave.

A convenient addition to any room of your house, the SL-6107 is particularly useful in hallways, basements and garages. You'll never have to worry if someone forgets to shut off the lights.

The motion sensor uses passive infrared technology to detect heat in motion. As soon as the sensor detects movement in its 20 ft. detection field, it turns on the lights. An adjustable time delay keeps the lights on for a period of time and then automatically shuts them off again. And an adjustable, energy-saving photocell allows you to adjust the daylight sensitivity.

This indoor light control simply replaces your existing light switch, and works with both single and 3-way switch circuits. Includes a three position switch for manual control as well as automatic.

Use with incandescent indoor or outdoor lights, minimum 25 watts, maximum 300 watts. UL approved. Cover plate not included.

Assembled SL-6107 (1 lb.) \$24.97



TECHNICAL CONSULTATION

When you have a question about the kit you're building or about an assembled product, our expert technical consultants are only a phone call away. Their numbers are listed on page 51.

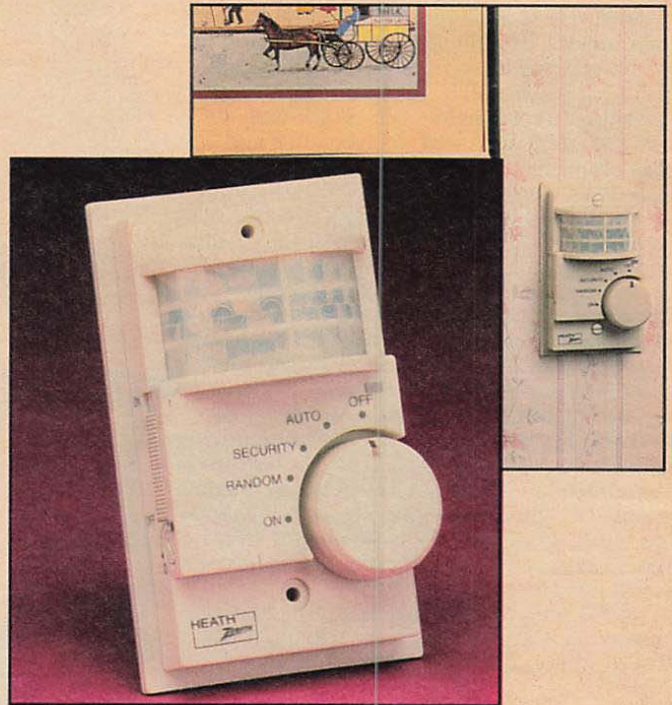

Enjoy motion sensor lighting and added security features with the Motion Sensing Security Switch

All the convenience and energy savings you've experienced with outdoor motion sensor lighting are now available for the inside of your home, too. Enter a dark hallway or room and a light comes on instantly. Leave the area and the light shuts off automatically. No more need to fumble for hard-to-find switches and no more reason to leave lights blazing when no one's in the room.

Our Motion Sensing Security Switch replaces an ordinary wall switch in your home. It turns lights on when it senses body heat and motion, and even dims several times before shutting off...giving you plenty of time to turn on another light or to leave the room.

In addition to convenience, unique security features make the Security Switch a valuable addition to your home. Select the random mode and over a 4½ hour period lights come on and stay on after dark for random lengths of time, making your house look lived in.

You can also set the switch to the security mode. With this setting, lights flash if someone enters the room. They remain on after the flashing stops, alerting you to the fact that someone has been in the house.

The Motion Sensing Security Switch is easy to install, too. Just connect the wires and screw it in. And, it comes in a neutral, cream colored casing so it's inconspicuous on most any wall. Designed for single switch systems, incandescent lights only. Includes manual override. UL approved.

Assembled SL-6120 (1 lb.) \$34.97

Home convenience made easy with X-10 controllers and modules

Wake up to fresh brewed coffee, keep your house looking lived in after you've gone and turn on your house lights as soon as you pull into the driveway. All by presetting lights and appliances to turn on and off - automatically. An X-10 system adds both convenience and peace of mind to your lifestyle. The applications are endless.

You'll need two basic elements: a controller and any number of modules. When you push a controller button, command signals travel over your existing house wiring to the modules. Lights and appliances connected to the modules are then activated. You can even control groups of lights at the same time, simply by setting an entire group to the same code.

X-10 means convenience...and peace of mind, too. If you hear a suspicious noise during the night, just touch the *All Lights On* button on your controller for instant illumination inside and out. Or, when you're away from home, set your lights, stereo and TV to go on and off at random intervals so your house looks and sounds lived in.

X-10 home convenience is simple to use and fun to expand. Once you've tried it, you'll want to create your own unique X-10 home.



Control lights and appliances from one convenient location

The handy, plug-in Mini Controller is perfect for rooms in your home where you want convenience lighting at your fingertips. The controller activates up to eight modules (shown on page 10) at a time, allowing you to control lights and appliances all over the house from one location.

The controller is easy to install too, simply plug it into any wall outlet. It sends signals over your existing house wiring to control light or appliance modules in other parts of your home. A single rocker key activates all the modules at once, and lights can be brightened and dimmed individually or in groups.

Assembled MC-460 (1 lb.) ... \$12.99

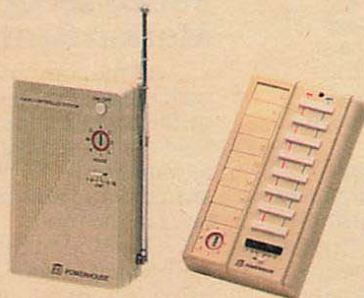

Remote control system

This convenient system includes a handheld remote control transmitter and a combination plug-in transceiver/appliance module, giving you remote control of up to eight modules or groups of modules. Turns lights and appliances on and off from up to 150 feet away, inside or outside the house. Also dims lights.

- Assembled BC-5000 (1 lb.) \$39.99
- Assembled BC-501 Additional Receiver (1 lb.) \$27.99
- Assembled BC-504 Additional Transmitter (1 lb.) \$19.99

Mini controller starter set only \$19.99!

Begin your X-10 system with the MC-460 Mini Controller and your choice of one of the following modules: BC-465 Lamp Module, BC-467 Wall Switch Module, BC-466 or AM-486 Small Appliance Module, or HD-243 15-Amp Heavy Duty Appliance Module. To order, list both model numbers and prices, then take a \$6.00 allowance on your order. (2 lbs.)

Remote light controller turns lights on automatically when it gets dark

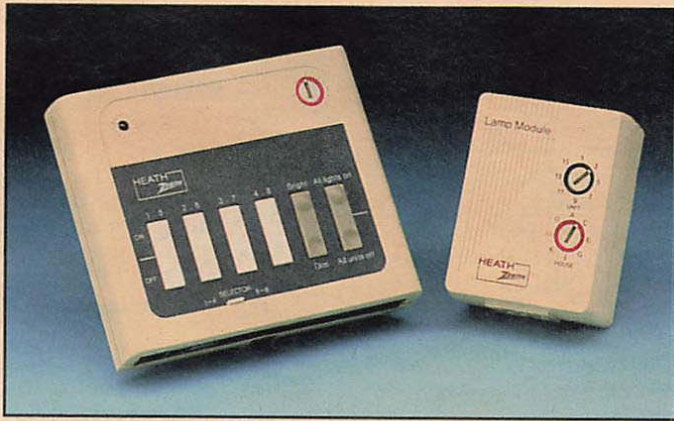

Enjoy the convenience of automatic light control along with centralized remote control of your lights and appliances. With the AutoRemote Light Controller you can set any four groups of lights to come on at dusk. Turn them off with a touch of a button, or leave lights on until dawn when they turn off automatically.

Control up to eight lights and appliances anywhere in the house from one convenient location. You can turn off the TV, dim lights, even turn all lights off by touching one button. Includes a plug-in lamp module. Works with all X-10 modules described on page 10.

Assembled SL-6320-A
(2 lbs.) \$29.97

Timer command console provides versatility

The Timer Command Console combines the features of a mini controller, timer and alarm clock into one unit. Plug it in anywhere and program up to four groups of lamps or appliances to go on and off at times you choose. Or, control up to eight groups manually.

Special function keys include *Daily* for automatic on/off at fixed times, *Once* for one time on/off, *Security* for random on/off so your house doesn't look like it's being controlled by a timer, *All Lights On*, for turning all lights on during an emergency, and *Sleep* which turns off a selected module – such as your stereo –



60 minutes after you've turned it on. Includes battery backup. Requires four AA batteries (not included).
Assembled MT-522 (3 lbs.) .. \$29.99

Expanded convenience with the maxi controller

Control all the lights and appliances in your house from one convenient location with the Maxi Controller. Use it on a table or night stand to instantly control up to 16 modules or groups of modules throughout your house.

The controller turns lights and appliances on and off. Brightens and dims lights too. Installation is easy. Simply plug in the controller; it works with your existing home wiring to control selected modules.



Assembled BC-503 (1 lb.) ... \$24.99



new Universal module controls low voltages

Operate your sprinkler system and garage door opener from inside your house with the Universal Module. Use the module with any X-10 controller described on these pages to provide an isolated contact closure for devices that operate on 120V or less, as a beeper, or both.

As a beeper, the modules can be set to make a momentary or continuous tone. You can use it as an alarm to wake you in the morning, when it's hooked to the Timer Command Console (at left). Or, set the module to make a momentary beep, and use it to call family members from remote parts of the house, workshop or garage. Used with an X-10 compatible motion detector, the beeper can even announce when someone is approaching your front door.

As an isolated contact relay module, the Universal Module can be set to provide momentary or sustained contact closure. It will operate drapery controls, window openers, gate operators and more.

Installation is easy. Just wire the item you wish to operate to the terminals on the lower part of the module, then plug the module into an existing wall switch. The module receives signals over your existing house wiring from your controller.

Contact rated for 15A resistive at 120V AC, 500W for incandescent lamp load, 1/3 h.p. inductive (for motors), 5A at 24V DC and 10A at 30V AC UL approved.
Assembled UM-506 (2 lbs.) .. \$24.99



Turn lamps on or off from a distance

The X-10 Lamp Module lets you turn lights on and off anywhere in the house without leaving your chair or bed. Also brightens and dims any incandescent lamp up to 300 watts. Plugs into ordinary outlets.

Assembled BC-465 (1 lb.) \$12.99

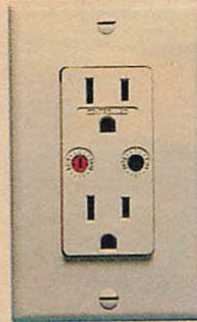

Wall module for small appliances

Replace any existing wall receptacle with an X-10 Wall Receptacle Module. You'll have remote X-10 control of the top outlet while the bottom outlet continues to function normally. Controls any appliance up to 15 amps from anywhere in the house. Rated at 1800 watts unrestricted.

Assembled BC-227 (1 lb.) \$19.99

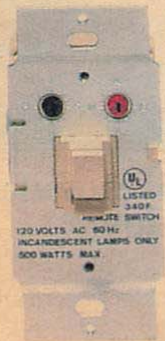

Wall switch module brightens and dims

This module replaces an existing wall switch to control important indoor and outdoor lights from anywhere in the house. The module installs like an ordinary dimmer, and conveniently dims and brightens selected lights. Rated for 500 watt maximum, 60 watt minimum, incandescent only. Includes push button for on/off control at the wall switch.

Assembled BC-467 (1 lb.) \$12.99

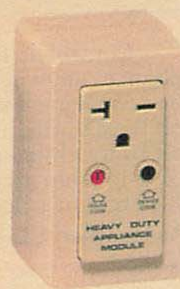

Module for use with heavy duty appliances

This handy appliance module operates with 220V, 20-amp air conditioners, water heaters and other heavy duty appliances from anywhere in your house.

Simply plug your appliance into the module and plug the module into an outlet. No wiring is necessary. For single phase or split phase (220/240V, 50Hz) wiring only.

Assembled BC-245 (1 lb.) \$29.99

Assembled HD-243 15-Amp Module (1 lb.) \$12.99

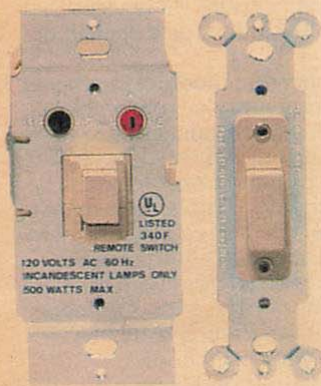

Light stairways and halls without fumbling for switches

This set includes a master and a companion switch for controlling any light that currently operates from two locations, such as the bottom and top of a stairway. The set also dims and brightens lights from anywhere in your house. For 500 watt maximum, 60 watt minimum incandescent lights only.

Assembled BC-4777 (1 lb.) \$19.99

Assembled CS-277 Additional Companion Switch (1 lb.) \$7.99

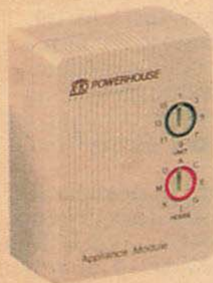

Conveniently control small appliances

The three-pin grounded Small Appliance Module lets you turn on and off appliances anywhere in the house. Rated 15 amp for resistive loads such as coffee pots and heaters, 1/3 h.p. for motor loads, 400 watts for TVs and 500 watts for lamps. New latching mechanism

retains setting when power is restored after an outage.

Assembled BC-466 (1 lb.) \$12.99

Burglar alarm interface adds more protection

Protect your home and belongings with the X-10 Burglar Alarm Interface. When your alarm trips, all lights connected to plug-in modules and wall switch modules turn on instantly. You can even set the interface to flash all lights on and off as an additional deterrent.

Connect this alarm to the output of any alarm panel or central controller of your existing alarm system via two screw terminals, then plug the interface into any AC outlet. Alarm output can be either dry contact closure or low voltage (AC, DC or audio 6-18 volts).

Add X-10 modules and controllers for an expanded security system. Plus, you'll enjoy the daily benefits of an X-10 operated home.

Assembled BC-284 (1 lb.) \$39.99



ORDER TOLL-FREE ANYTIME

800-253-0570

FAX: 616-982-5577



Protect your vehicle with a remote control security system

Protect your vehicle and its contents with this complete remote control alarm system from Techguard. You'll have maximum protection from break-in at every vital entry point. Easy, two-wire installation makes the system a snap to install.

You can arm and disarm your vehicle from up to 100 feet away, with a handy remote transmitter you take with you when you leave the car. And a current-sensing feature with fail-safe circuitry prevents false alarms whenever your car's electric cooling fan activates. After triggering an alarm, the system automatically resets itself.

In addition, a warning light that fits on your dash alerts potential vandals to the existence of an alarm system, and a high power 125 dB siren sounds in case of forced entry. Includes two remote control key chain units with panic buttons for added personal protection.

1 Assembled RA-6000 (3 lbs.) \$99.95

Accessories:

Door Lock Interface locks and unlocks existing factory power door locks from the remote control.

2 Assembled DL-1 (1 lb.) \$44.95

Starter Interrupt Kit disables ignition when alarm is activated.

3 Assembled RK-1 (1 lb.) \$15.95

Parking Light Flasher Accessory helps locate your car in a crowded parking lot.

4 Assembled PL-1 (1 lb.) \$29.95

Hood/Trunk Light activates light and alarm when hood or trunk is opened.

5 Assembled HT-1 (1 lb.) \$9.95



Protect yourself from angry dogs with the ultrasonic Dazer

No more snarling dogs racing to the attack. Now you can be in control when you walk, jog, run or ride your bike. Just grab the ultrasonic Dazer and watch angry dogs stop in their tracks.

The Dazer produces a discomfiting – but not harmful – high frequency sound that's audible to dogs but not to people. And it's effective from a distance of up to 15 ft.

Made of lightweight, high impact plastic, the Dazer includes a low battery indicator, belt clip and 9-volt battery. Also helpful in training dogs. A great gift idea.

Assembled GD-3650 (2 lbs.) .. \$29.95



Programmable thermostat

EnerGenius does for you what it's hard to remember to do for yourself. It sets back your thermostat while you're gone during the day and adjusts the temperature to your specified comfort level in time for your return. A saving of up to 30 percent a year.

And, it's easy to use. Program up to four temperature changes a day, with separate programs for weekdays and weekends and separate memories for summer and winter. Quick touch temperature override and long term manual operation give you additional flexibility.

Designed for compatibility with gas, oil and electric heating and air conditioning systems with 24-volt controls, and with electronic spark ignition systems.

Assembled E-930 (1 lb.) \$69.99

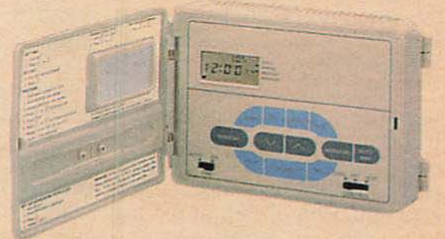

ALL AUDIO NOW AT HALF-PRICE SAVINGS!



Outstanding reception made easy with this digital stereo tuner

Easy enough for the beginner yet challenging enough for the experienced kit builder, the AJ-2520 gives you a unique opportunity to understand your stereo tuner inside and out.

The 2520 guarantees optimum sound quality with a digitally synthesized, quartz-locked tuning system that uses a combination of a digital frequency control system and a highly accurate quartz reference crystal. The control system automatically locks onto the assigned frequency of any broadcast and compares it to the reference frequency 25,000 times per second. The result is not just automatic centering, but drift-free reception, as well. An all-metal chassis helps maintain audio signal purity by providing shielding and noise rejection.

With 16 station FM or AM memory, you'll have plenty of room to program all of your favorite frequencies. And, in case of power failure, station memory is retained for up to one week.

When Harman Kardon* specially designed the 2520 Tuner for Heath, they used meticulous care in circuit layout and component selection to help minimize harmonic distortion and cross-coupling. A Low Group Delay I.F. (Intermediate Frequency) section makes for even lower distortion and wider stereo separation.

Other features include a 3-segment LED signal strength meter, muting, manual up/down tuning, bi-directional tuning and tuned indicator. Dimensions are 2¾"H x 17½"W x 14¼"D.

Kit AJ-2520 (10 lbs.) Was \$229.00 Now **\$114.50**
Assembled AJW-2520 (10 lbs.) Was \$249.00 Now **\$124.50**

Specifications: **Usable FM Sensitivity:** 10.8 dBf/0.95 µV. **50 dB Quieting Sensitivity:** 37 dBf mono, 19.4 µV stereo. **THD:** 0.2% mono, 0.3% stereo. **S/N:** 82 dB mono, 74 dB stereo. **Capture Ratio:** 1.3 dB. **Alternate Channel Selectivity:** 50 dB. **Power Supply:** 120 VAC, 60 Hz. **Power Consumption:** 14 W.

Get control over your audio signal with this preamplifier

With the AP-2510 Preamplifier you not only get a quality component designed for Heath by Harman Kardon, but you get the satisfaction of saying, "I built it myself."

Virtually eliminating dynamic distortion, the 2510 features an ultrawideband frequency response and low negative feedback. These qualities help deliver an extremely fast transient response – a necessity in the accurate reproduction of digital recordings.

Transient response is also improved in the phono section, thanks to the use of dual RIAA equalization circuitry. This type of circuitry requires only low levels of negative feedback throughout the audio range. If you prefer a Moving Coil (MC) cartridge on your turntable, there's no need to worry. Our unit's MC head amplifier allows the use of nearly all MC cartridges. In addition, the 2510 features capacitance trim for the widest, flattest frequency response from Moving Magnet (MM) phono cartridges.

Other features include low noise discrete circuitry, subsonic and high cut filters, and a tape copy selector for dubbing between two tape decks or recording from another input. You'll also enjoy tone defeat which maximizes the purity of the signal



when tone controls aren't necessary, and switchable bass and treble turnover frequencies which allow you to custom-tailor the tone control to your listening environment. Includes inputs for two tape decks, two turntables, a CD player and a video sound source. 4"H x 17½"W x 13¾"D.

Kit AP-2510 (19 lbs.) Was \$349.00 Now **\$174.50**
Assembled APW-2510 (16 lbs.) Was \$399.00 Now **\$199.50**

Specifications: **Frequency Response:** 0.1 Hz-180kHz. **THD:** 0.006%. **S/N:** 83 dB phono (MM), 80 dB phono (MC), 92 dB aux, 92 dB tape. **Input Sensitivity/Impedance:** 2.2 mV/47k ohms 130pF phono (MM), 130 µV/56 ohms phono (MC), 130mV/22k ohms aux, 130mV/22k ohms tape. **Output Level:** IV Rated, 10V Max. **Filters:** 15 Hz Subsonic (6dB/Octave), 6kHz High Cut (6dB/Octave). **Power Supply:** 120 VAC, 60 Hz. **Power Consumption:** 45W.

*Harman Kardon is a registered trademark of Harman Kardon, Inc.

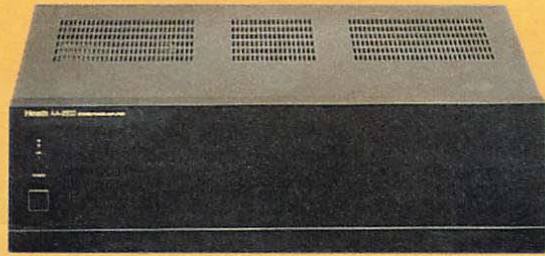

100W power amplifier unleashes the potential of your music

Featuring a High Instantaneous Current Capability (HCC) of 60 amps, the 2500 Power Amplifier develops far more power under peak loads than its already impressive 100W per channel. The result is more headroom to handle today's demanding digital recordings.

Specially designed for Heath by Harman Kardon, the 2500 also demonstrates exceptionally wide bandwidth. Its low 12dB of negative feedback provides improved transient accuracy and phase linearity. In addition, a massive toroidal power trans-

former eliminates the stray magnetic fields that cause hum.

A superior example of high technology electronics, the 2500 features four dual polarity power supplies that eliminate channel-to-channel interference and assure proper balance of current between high and low level stages.

Another advanced feature of the 2500 is a protection circuit that shields speakers from turn-on transients. It also prevents short circuits by muting audio if a load of less than 2 ohms is placed across the speaker terminals.

When you assemble the AA-2500 yourself, you not only save, you get the satisfaction of knowing the care and effort you put into the construction of your new amplifier. Dimensions are 5 $\frac{3}{4}$ "H x 17 $\frac{1}{2}$ "W x 14 $\frac{1}{2}$ "D.

Kit AA-2500 (33 lbs.) Was \$449.00 Now **\$224.50**
Assembled AAW-2500 (30 lbs.) Was \$499.00 Now **\$249.50**

Specifications: **Power Output:** 100W RMS per channel into 8 ohms, 20Hz-20kHz. **THD:** <0.06%. **HCC:** 60A. **Power Bandwidth:** 10Hz-70kHz (half rated output into 8 ohms). **Frequency Response:** 0.1Hz-170kHz (at 1W output, +0/-3dB). **S/N:** 98dB (IHF-A Wtd). **Input Sensitivity:** 1V/22k ohms. **Power Supply:** 120 VAC, 60Hz. **Power Consumption:** 550W.



Get remote control convenience with the Heath compact disc player

The ADW-2530 is a remote control compact disc player that uses a three-beam laser optical head for precise tracking and exact laser positioning. Also used are a Sample-and-Hold Processor to reduce switching noise and a Discrete Analog Output Section for decreasing intermodulation distortion.

With the 10-function wireless remote control, you can skip forward and reverse, repeat, program, display, skip, search, play/pause and stop/clear – all from the comfort of your favorite armchair.

In addition, you can quickly scan through a disc to find your favorite passage with 2-speed audible cue and review. And, 36-track programmable memory lets you custom select which songs will play and in what order. Also included are track and index search, and separate analog, digital and transport power supplies. Dimensions are 3 $\frac{3}{4}$ "H x 17 $\frac{1}{2}$ "W x 10"D.

Assembled ADW-2530 (11 lbs.) . Was \$349.00 Now **\$174.50**

Specifications: **Frequency Response:** 4Hz-20kHz \pm 0.5dB. **THD:** 0.03%. **S/N:** 103dB. **Dynamic Range:** 96dB. **Channel Separation:** 83dB. **Wow-and-Flutter:** Immeasurable. **Signal Detection:** 3-Beam Semiconductor Laser. **Error Correction:** CIRC System. **Quantization:** 16-bit. **Sampling Frequency:** 88.2kHz. **Line Output Level/Load Impedance:** 2.0V/10k ohms. **Power Consumption:** 15W.



The Heath ACW-2540 Cassette Deck for exacting sound reproduction

Developed specially for Heath by Harman Kardon, the ACW-2540 employs Dolby® HX Professional, a headroom extension system that retains dynamic audio signals during recording – an especially important feature when recording

from CDs. In addition, recording levels are easily set with the 7-segment LED peak metering system.

With Ultrawideband technology, the ACW-2540 produces a frequency response of 20Hz-20kHz (\pm 3dB), using any tape formulation. Matching each tape formulation is effective and convenient too, with the bias fine trim control. And, Dolby B noise reduction circuitry reduces tape hiss considerably, while Dolby C knocks it out – dropping noise well below the level of audibility.

Also includes an Amorphous Tape Head, record mute, memory search, MPX filter, metal tape capability and a solenoid transport for smooth operation. 4 $\frac{3}{4}$ "H x 17 $\frac{1}{2}$ "W x 10 $\frac{1}{4}$ "D.

Assembled ACW-2540 (12 lbs.) . Was \$349.00 Now **\$174.50**

Specifications: **Heads:** 2. **Frequency Response:** 20Hz-20kHz \pm 3dB (all formulations). **THD:** 1.0%. **S/N:** 57dB no NR, 65dB Dolby B, 73dB Dolby C. **Channel Separation:** 45dB. **Wow-and-Flutter:** 0.05% WRMS. **Line Input Sensitivity:** 50mV (0dB). **Output Level:** 580mV (0dB, 10k ohm load).

Dolby is a registered trademark of Dolby Laboratories, Inc.



Save on 3-way floor-standing speaker system

The Heath/JBL* 3-way floor-standing speaker system combines quality electronics and fine cabinetry for a pleasurable kit building experience.

You'll enjoy accurate stereo imaging from the three vertically aligned drivers — a 12" Aquaplas laminate low-frequency transducer, a 5" high-polymer laminate mid-frequency transducer and a 1" pure titanium diaphragm high-frequency transducer. Together these drivers ensure a clean, flat frequency response. In addition, the speaker system is ported to extend the low-frequency response and allow it to operate with negligible distortion, for startling realism. Constructed of real walnut veneer, the 1230 loudspeakers look good with or without their grilles because of a finished facing board. 40" H x 14" W x 10½" D.

Kit AS-1230

(58 lbs.) Was \$349.00 each Now **\$174.50**

Assembled ASW-1230

(58 lbs.) Was \$399.00 each Now **\$199.50**

Specifications: **Configuration:** 3-way ported enclosure. **Recommended Amplifier Power Range:** 10-200 watts. **Sensitivity:** 91 dB. **Frequency Response:** 60 Hz-20 kHz (-3 dB). **Frequency Range:** 45 Hz-23 kHz (-10 dB). **Woofer:** 12" Aquaplas laminate low-frequency transducer. **Midrange:** 5" high-polymer laminate mid-frequency transducer. **Tweeter:** 1" pure titanium diaphragm high-frequency transducer. **Impedance:** 8 ohms. **Crossover:** 800 Hz, 4,000 Hz.

*JBL is a registered trademark of JBL, Inc.



High-performance 2-way bookshelf speaker system for less than \$130!

Enclosed in an attractive walnut vinyl veneer cabinet, the Heath/JBL* 2-way bookshelf speaker system offers you compact performance. The 1082 speaker system delivers exacting sound reproduction from a 1" pure titanium diaphragm high-frequency transducer and an 8" high-polymer low-frequency transducer. In addition, precise circuitry, as well as low loss capacitors, provides maximum performance. Dimensions are 23" H x 13¼" W x 9" D.

Kit AS-1082

(29 lbs.) Was \$129.95 each Now **\$64.98**

Assembled ASW-1082

(28 lbs.) Was \$159.95 each Now **\$79.98**

Specifications: **Configuration:** 2-way ported enclosure. **Recommended Amplifier Power Range:** 10-100 watts. **Sensitivity:** 90 dB. **Frequency Response:** 80 Hz-20 kHz (-3 dB). **Frequency Range:** 50 Hz-23 kHz (-10 dB). **Woofer:** 8" high-polymer low-frequency transducer. **Tweeter:** 1" pure titanium diaphragm high-frequency transducer. **Impedance:** 8 ohms. **Crossover:** 3 kHz.

High-tech stereophones

Using technologically advanced titanium elements, these two stereophones reproduce every detail of digital recordings. In addition, tuning each channel to perfection is made easy with the unique in-line volume/balance control. Other common features include a full length coiled cord and a ¼" plug.

Open-Air Stereophone. The TE-200 features comfortable hear-through ear cushions that let you absorb yourself in music, without shutting out your surroundings. Frequency response is 20-20,000 Hz.

1 Assembled TE-200

(2 lbs.) Was \$49.95 Now **\$24.98**



Display your audio components in this attractive cabinet

Made of select oak solids and veneers, the AE-2501 stereo equipment cabinet uses hidden construction and a metal-to-metal fastener assembly for greater strength and durability.

Features include four shelves (one a glide-out), ⅜" tempered glass with oak wood trim and hidden casters. Dimensions are 46½" H x 22¾" W x 16½" D.

AE-2501

(102 lbs.) Mtr. Frt. \$189.95

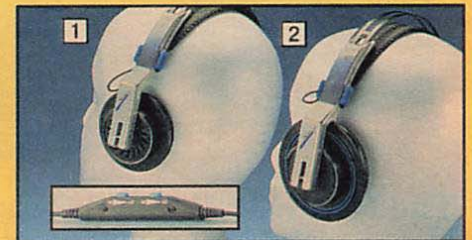

Closed-Back Stereophone. The TE-400's closed-back design eliminates background noise for private listening. Frequency response is 20-30,000 Hz.

2 Assembled TE-400

(1 lb.) Was \$59.95 Now **\$29.98**



Simulated TV picture

Easy-to-build 9" color television

The GR-9009 9" diagonal color television is designed to go anywhere you go. It operates anywhere there's normal house current (AC) or from a 12-volt DC (negative ground) lighter socket in automobile electrical systems.

This easy-to-carry, ultra-compact portable with all its advanced features provides you with excellent performance wherever you take it. The chroma-color contrast picture tube features reflection-absorbing glass for exceptional contrast and color fidelity. You get bright, true-to-life colors with its black matrix and tinted phosphors. Plus, the in-line electron gun produces remarkable picture detail and dramatically improved edge and corner sharpness. Quartz-controlled electronic tuning has 178 channel capability and makes channel selection convenient and exact — with no moving parts to wear out or cause picture problems. Once adjusted, the TV maintains accurate color, tint and contrast with the auto-control color system. The system also blends color levels and tint for lifelike flesh tones and assures color stability.

The GR-9009 portable is also easy to operate. Programmable up/down channel scanning lets you scan your favorite channels or all available channels. Or make instant channel changes simply by pressing *Enter* after you've selected the channel number.

Most circuit boards are pre-assembled to make building easier. And the GR-9009's built-in cross-hatch generator lets you adjust the set for optimum color alignment. Includes sun screen, earphone, built-in whip antenna, DC power cord and flush-mounted carrying handle. 10¼" H x 10½" W x 11⅞" D.
Kit GR-9009 (25 lbs.) \$269.95



HOME ENTERTAINMENT

Eliminate coffee table clutter with a Memorex universal remote control

The Memorex CP⁸ Universal Remote Control (URC) provides convenient operation of up to eight different remote controls all from a single unit.

Unlike other remotes, the CP⁸ is capable of remembering sequences of steps usually needed for equipment switching and mode selection. It can remember 24 different sequences of up to 48 commands each.

Other features include a built-in clock, five timers for unattended operation, infrared power booster, large 8-digit LCD display, five minute memory backup when changing batteries, write-on keypad labels and display light for operation in low-light situations. The CP⁸ requires four AA alkaline batteries for operation.

Assembled CP-8 (2 lbs.) \$79.95

Control your TV, VCR and CATV all from one remote with Zenith's PCC

Operate your TV, VCR and cable converter from a single remote control. Zenith's Personal Control Center (PCC), programmable for multiple brands, is as easy to use as any ordinary remote. Set the switches one time only to operate specific products. The on/off, volume, mute and other control functions will remain independent and you can operate them from any mode. Designed to control units operated via IR (infrared) signals. Three AAA batteries included.

Assembled PCC-200 (2 lbs.) . . \$29.95

Operates recent models of these TV brands**:
Akai • AOC • Centurion • Coronado • Curtis Mathis • Daytron • Emerson • Fisher • GE • Goldstar • Hitachi • JCP • JVC • KMC • KTV • Magnavox • Marantz • MGA • Mitsubishi • NEC • Panasonic • Philco • Philips • Portland • Quasar • Radio Shack • RCA • Sampo • Samsung • Sanyo • Scott • Sears • Sharp • Sony • Sylvania • Teknika • Toshiba • Wards • Yorx • Zenith.

Operates recent models of these VCR brands**:
Akai • Broksonic • Cannon • Citizen • Curtis Mathis • Daytron • Emerson • Fisher • Funai • GE • Goldstar • Hitachi • JVC • Kenwood • Magnavox • Marantz • Marta • Mitsubishi • NEC • Panasonic • Pentax • Philips • Pioneer • Quasar • RCA • Realistic • Samsung • Sanyo • Scott • Sears • Sharp • Shintom • Sony • Sony Video 8 • Sylvania • Symphonic • Tashiko • Teac • Toshiba • Vector Research • Wards • Yamaha • Zenith Beta • Zenith VHS.

Operates these cable converters**:
Gemini MAC10 • General Instrument Starcom CS, XT • Hamlin CRP6, CRP6S, CRP7, CRP8, RCPX •



Jerrold 400, 440, 450, 700, 770, SRCII, VI • Macom Satellite • Macom • Oak 500, 550, RCU-400, Sigma, TC56 • Panasonic TZ120, TZ170 • Philips CP67, CP100, CP200, CTC8R, CTC9, CV1000, CV2000, CV2500, CVS2700, PG67, TS67 • Pioneer BR50, BR80, BR81 • Regency • Scientific Atlanta 8550 • Texscan • Tocom RC100, VIP • Toshiba • Viewstar MXC2001A, MXC2501, VSC2000, VSC2020, VSC2040, VSC2500, VSC2511 • Zenith Drake Satellite • Zenith.

**Zenith cannot guarantee the PCC will operate every model of the brands listed because of possible changes by the manufacturer.



Simulated TV pictures



Feature-packed TV/
VCR remote control

Monitor all the action with our 27" digital picture-in-picture TV

Enter a world of almost unlimited viewing options with Heath's 27" picture-in-picture TV. Store your favorite channels with on-screen programming. Watch one video source on the main screen and another in a framed screen inset. Swap the inset with the main screen at any time to keep up with the most important action. And you can even sample and freeze video from three different TV channels in separate insets.* All by remote control!

Component Quality Sound

It's obvious that audio is an after-

thought in the design of most televisions. The GR-2701 was engineered with a premium stereo sound system that brings greater realism than ever to television viewing! Two built-in 2-way stereo speaker systems deliver deep bass response and greater dynamic range for true component system sound. An MTS stereo decoder unlocks exciting stereo telecasts, in addition to simultaneously telecast audio programs (SAP).

Unlimited tuning options

A quartz-controlled 178-channel tuner receives all VHF and UHF broad-

cast channels and up to 122 cable channels, automatically locking onto the exact frequency for a striking picture. The GR-2701 even receives World System Teletext programming, providing news, sports, weather or business reports right on your TV (where service available).

A comprehensive jack panel provides connections to components such as VCRs, camcorders, home video games, satellite receivers and audio speakers. The remote control even operates Zenith VHS video recorders.

On-screen menus let you easily adjust almost any setting by remote control or from the convenient front panel controls. A built-in automatic demonstration guides you through the use of menu-driven controls, such as selecting channels, adjusting volume, and viewing inset pictures.

Build it yourself

Discover the fun and educational value of kit building with this easy-to-assemble kit. We guarantee your success with clearly written, step-by-step assembly manuals and pictorials. And, if you need help, our experienced technical consultants are available at 616-982-3307.

Cabinet comes in handsome honey oak finish on genuine wood veneers and hardwood solids. Swivel base. Dimensions are 29 $\frac{3}{8}$ "H x 41"W x 20 $\frac{3}{4}$ "D.

Kit GR-2701-H

(239 lbs.) Mtr. Frt. . Last Call! \$849.00



Experience double the TV excitement with picture-in-picture

*Inset picture functions require external TV tuner such as a VCR.

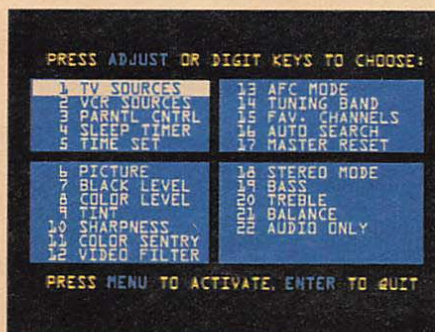

Adjust TV settings with the convenient on-screen menus



Keep track of news and life-style topics with built-in World System Teletext

High-technology Heath 20" stereo television with remote control

SKILL LEVEL 2 The remarkable picture quality and sound characteristics of our kit 20"-diagonal stereo TV will bring new life to your television viewing. And, the contemporary styling of the Stardust Black finish cabinet gives the unit the good looks to blend in with any entertainment system.

The Chromacolor Contrast Picture Tube combines tinted phosphors and black matrix with reflection-absorbing glass. This gives you a more detailed picture with exceptional contrast and color fidelity. The picture is electronically sharpened by a comb filter that provides maximum resolution of the TV signal. A removable tinted glass panel further enhances picture contrast, and a computer brain maintains picture quality.

MTS stereo reception

You'll enjoy rich stereo sound with the Multi-Channel Television Sound (MTS) system. Incoming stereo signals are decoded and sent to separate stereo amplifiers that drive two 3½" oval front-firing speakers for powerful sound. The set even reproduces second audio (non-stereo) sound when broadcast.

No need to worry about drifting signals, because a quartz-controlled electronic tuner automatically locks onto the exact broadcast frequency. The 178 channel tuner permits reception of all VHF/UHF broadcast channels and up to 122 cable channels.



Multi-Brand remote control

Take command of a variety of television features from the infrared remote control. Turn the TV on/off, activate the on-screen menu display, adjust TV functions and select channels. You'll scan favorite channels, adjust volume, mute sound, set time, even recall channel number and time, flash back and set the sleep timer. The remote is also programmable to operate most popular brands of TVs, VCRs and cable converters.

Get the most out of your video camera, video disc player or VCR, including S-VHS (providing over 400 lines of reso-

lution), with the auxiliary jack panel. Audio/video input/output jacks, including a Y/C connector, allow direct hook-up between video/audio sources and the TV for superior picture and sound.

Assembly is a snap, because all boards except one are preassembled and tested. In addition, a portable cross-hatch generator is included for making color alignment adjustments that can exceed factory specifications! Dimensions are 19¼" H x 20½" W x 19" D.

Kit GR-2033 (80 lbs.)

Mfr. Frt. \$449.00

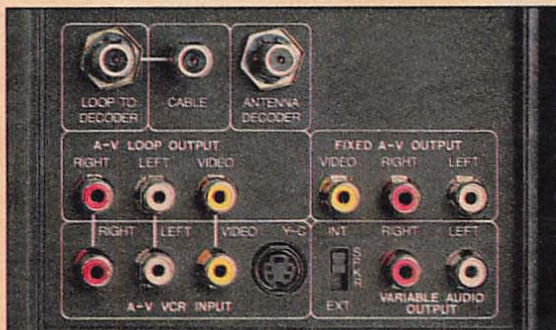

The auxiliary jack panel features a variety of audio/video input/output jacks that provide monitor capabilities. A Y/C connector allows direct connection of S-VHS VCRs for high quality video with over 400 lines of resolution.



TECHNICAL CONSULTATION

When you have a question about the kit you're building or about an assembled product, our expert technical consultants are only a phone call away. Their numbers are listed on page 51.



Three rear-panel inputs make it easy to keep patch cords for your most frequently used components out of the way. And, to allow quick hookup of video cameras and portable VCRs, the fourth input is conveniently located on the front panel. There's no need to pull everything apart just to connect an additional audio/video component!

"S-Video" jacks (for compatible high-resolution video components) are provided for two inputs, dubbing output and monitor output. And to add even greater realism to your viewing, audio output jacks are included for easy connection to stereo systems.

Say goodbye to crawling around behind your audio/video components to make temporary connections. Select, monitor, dub and record with ease by adding the new AVS-10 to your system. Dimensions are 2" H x 17" W x 9 1/4" D.

Assembled AVS-10 (4 lbs.) .. \$99.95

new Take control of video component monitoring, dubbing, and recording, with the new AVS-10

Every time you add a component to your video system, managing all the cords and connections becomes more of a headache! Hook up a cable to record, swap cables to see what's coming over the receiver, pull everything apart just to use your video camera. It's enough to make you feel like an old-fashioned telephone operator! With so many things to untangle, just watching TV can become a challenge.

You can turn your separate video components into an easy-to-control, integrated video system with Heath's new AVS-10 Audio-Visual Selector. The AVS-10 offers flexible video monitoring, dubbing and recording capabilities in a compact unit. It's master control for up to five video components!

Used in conjunction with your VCR,

the selector lets you record any one of four attached sources, including VCRs, TV tuners, videodisc players, video cameras, or video games. And at the same time, you can monitor any of the sources, even those not being recorded, with push-button ease! The AVS-10 isn't just for people with lots of video components. It makes monitoring and dubbing easier even for owners of two VCRs.



Monitor Out/Audio Out
Connect to the input terminals of the monitor TV, the audio input terminals of the monitor TV, stereo system or both.

Dubbing Out
Connect to the input terminals of the audio and video components you want to record to.

Inputs 1, 2, and 3
Choose up to three components for rear-panel input. Front panel input four is especially easy to get to any time!



Surround Sound speakers (sold separately below).

Kit ADS-2550 (12 lbs.) \$199.95

Accessory:

Surround Sound Speakers. Included FREE with purchase of AD-2550! Each speaker includes a 4" driver housed in a black, vinyl-finished ported enclosure. 8-ohm impedance. Dimensions are 9" H x 6 3/4" W x 4 1/8" D.

Assembled ASW-24 (10 lbs.) pair \$49.95

Specifications: **SEPARATION:** Front Center to Surround: 70 dB at 400 Hz referenced to 1 kHz Consumer Test Tape. **Output Power:** 20 watts total RMS power into 8 ohms. 25 watts into 4 ohms. **FREQUENCY RESPONSE:** Front Channels: ± .5 dB, 18Hz-40kHz. **Surround Channels:** ± .5 dB of Dolby Surround Specification. **TOTAL HARMONIC DISTORTION:** Front Channels: .05% 20Hz-20kHz. **Surround Channel:** .38% max. across full range. **OUTPUT NOISE, A-WEIGHTED:** Front Channels: -85 dB at 1V RMS, -95 dB from peak level. **Surround Channel:** -65 dB at 1 watt/8 ohms, -80 dB from peak level. **Input Level:** .1 to 2.8 VRMS. **Output Level:** 4 VRMS. **Input Balance Range:** 6.7 dB of correction. **Input Impedance:** 47k ohms. **Output Impedance:** 2.5k ohms max.

Theater audio comes home with Heath's surround sound decoder, now with FREE speakers

Dramatic theater-quality Dolby Stereo sound is locked into many pre-recorded video tapes and television programs, just waiting to be heard. Heath's Dolby Surround Sound Processor brings Dolby Stereo-encoded video to life and adds startling depth and realism to your viewing.

With a push of a button you can select from three different surround sound modes: Dolby Surround, Music Surround and Mono Enhance for synthesized stereo and surround effects.

AS LOW AS \$15 PER MONTH ON YOUR HEATH REVOLVING CHARGE

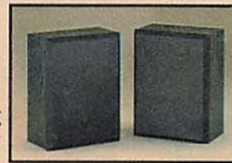

With its own 20-watt built-in amplifier, the AD-2550 actually drives the included set of Surround Sound Speakers, eliminating the need for an extra amp. In addition to stereo inputs, outputs are included for left front, center, right front, sub-woofer and surround sound.

Start enjoying sensational, three-dimensional sound immediately with the AD-2550 and a set of free Heath

* Your actual monthly payments may vary depending on your account balance.



Sleek 6-head Hi-Fi stereo VCR with wireless remote

AS LOW AS \$30 PER MONTH ON YOUR HEATH REVOLVING CHARGE

With all the advanced features in the VRF-510-HF, you may never go to a movie theater again! By using two rotary, slant azimuth audio heads, this VHS Hi-Fi VCR achieves a dynamic range of over 80 dB – for stereo sound approaching compact disc quality. A built-in MTS (Multi-Channel Television Sound) decoder processes broadcast TV-stereo and SAP (Second Audio Program) signals, when available.

The VRF-510-HF features HQ circuitry and two pairs of video heads, one for the most economical use of tape (EP mode), and the other exclusively for picture quality (SP mode). Your picture will appear clear and undistorted when you pause to view a particular moment in your tape.

For convenience, remote on-screen programming lets you set your VCR's controls all from the comfort of your favorite chair. Just watch your screen as you program days, start and stop times, channels, recording speed and other secondary

controls. You can even program your VCR for unattended recording of up to eight events over a two week period.

With the 178 channel quartz electronic tuner you can access 122 cable channels either by direct access or scanning. In addition, with 5-speed ($\frac{1}{30}$, $\frac{1}{24}$, $\frac{1}{18}$, $\frac{1}{12}$ and $\frac{1}{6}$ normal speed) slow motion, you can reduce favorite programs to a crawl.

Other special features include Auto Power-On with Auto Play, Rewind, Eject, and Next Function Memory; automatic digital tracking; Instant Timer Record; VHS Index Search System; Go-To Counter; and a multi-brand wireless remote, compatible with most remote controlled TVs, VCRs and cable TV decoders. And on non-broadcast channels, Zenith's Silent Blue Screen replaces noisy static. Dimensions are $3\frac{1}{8}$ " H x $17\frac{1}{8}$ " W x 13" D.

Assembled VRF-510-HF (19 lbs.) \$569.00

*Your actual monthly payments may vary depending on your account balance.



Zenith VHS recorder with on-screen remote programming

The VRF-160 is a 2-head, HQ (high quality) VCR with convenient on-screen programming. Easy-to-read instructions appear on your TV screen and guide you through timer programming, tape search operations, and tuner and VCR set-up procedures.

You'll enjoy extremely accurate and stable reception with the 178-channel, electronic quartz tuning system. The cable-ready tuner receives VHF, UHF and up to 122 cable channels. And you can scan through channels quickly, because the VRF-160 automatically retains in memory all the locally broadcast or cable TV channels and eliminates those that are non-active.

Other features include Go-To Counter; dual function wireless remote; 2-week, 4-event timer; VHS Index Search System; Instant Timer Record; Real-Time Tape Counter and Auto Power-On with Auto Play, Rewind and Eject. Dimensions are $3\frac{3}{8}$ " H x $17\frac{1}{8}$ " W x 13" D.

Assembled VRF-160 (16 lbs.) Last Call! \$299.00



Compact 4-head VCR with remote control

Three inches narrower than a conventional VHS deck, the 4-head VRF-250 features 178 channel quartz electronic tuning, including 122 cable channels. High quality (HQ) circuitry enhances picture quality, and double azimuth heads provide clear slow motion, speed search and still frame.

No need to turn on the power of your Zenith VCR because with Auto Power-On the VRF-250 does it for you. With Auto Eject, you can take a tape out of your VCR without turning on the power, and with Auto Rewind your tape will rewind itself when completed.

Further features include 5-speed clear slow motion; VHS Index Search System; Go-To Counter; dual function wireless remote; 2-week, 4-event timer; remote on-screen programming; Instant Timer Record and Silent Blue Screen on non-broadcast channels. Dimensions of the Compact VCR are $3\frac{3}{8}$ " H x $14\frac{1}{8}$ " W x 13" D.

Assembled VRF-250 (17 lbs.) \$349.00



new

Hidden-Link makes any remote audio/video system "out of sight!"

Operate remote audio/video components even though they're not in plain sight with the Hidden-Link remote control relay system. Now you can install equipment in solid door cabinets, in closets or even in other rooms and still enjoy their remote control convenience. It's easy with Hidden-Link.

The tiny Hidden-Link unit receives signals from your existing remote control and then relays them to your equipment via a small cable. Attached to the end of the cable are two infrared senders that install in front of your concealed components. Each sender relays received signals to the infrared windows on your equipment. And because Hidden-Link is a relay system, you'll enjoy all the features of your existing remote controls.

No electrical connection means installation is quick and easy. No wiring also means Hidden-Link won't void the manufacturer's warranty on your existing audio/video components. As an added bonus, we're including a 50 foot extension cable for extended control. Hidden Link's dimensions are a compact 7/8" H x 3 3/8" W x 2" D.

Assembled GD-3700 (2 lbs.) \$49.95



Second generation without CopyCam



Second generation with CopyCam



new

Make video copies that rival first generation with CopyCam

You've invested top dollars in a first-rate camcorder, so you don't want to settle for second-rate copies. Enjoy the same sharp video you taped, transfer-to-transfer, with the CopyCam camcorder enhancer.

Most units adjust only video gain, leaving image accuracy and sharpness untouched. Only CopyCam makes true changes to the edge definition and detail of your second-generation video copies. The result is a picture clarity you'll swear is first generation.

CopyCam also has a unique AudioZoom feature that lets you selectively boost the audio signal by as much as 20 dB. You get improved sound clarity even from muddy originals. CopyCam also lets you split your camcorder's single audio channel into two channels for use with stereo VCRs.

CopyCam takes only minutes to install between your camcorder and VCR, but its benefits you'll enjoy for years to come. Also great for improving tape-to-tape video transfers. Audio/video patch cable included. CopyCam measures only 1 1/2" H x 6 1/2" W x 4 1/4" D.

Assembled GD-3710 (2 lbs.) \$59.95

Zenith VHS-C camcorder with carrying case



With this Zenith VHS-C camcorder, you get all the features of a full size unit in a camera that takes up only half the space. At less than 3 lbs., this compact camcorder lets you film longer – without the bulk and weight of larger cameras.

Picture quality will be excellent, regardless of your recording speed, thanks to the four video heads used in the compact camcorder. Automatic exposure ensures accuracy indoors and out, even in extremely low lighting, down to 8 lux. High quality (HQ) circuitry with White Clip and Detail Enhancement gives you excellent picture detail and clean, crisp images. Plus, the 1/2" CCD pickup device has 360,000 picture elements for superior color and over 400 lines of horizontal resolution, while still offering reduced power drain.

Other features include high speed 1/1000 shutter for recording fast action shots, f/1.4 auto focus lens with 6:1 power zoom and macro capability, fully automatic white balance and iris with backlight compensation, electronic viewfinder, flying erase head, omni-directional condenser microphone, and 3-way power capability.

Included accessories are AC adapter/charger, rechargeable battery, mini-cassette tape, cassette adapter, 75-ohm RF cable, RF converter unit, and lens hood and cap. A bonus is the included hard-shell carrying case.

Assembled VMS-6180 (11 lbs.) \$699.00

Economical slide and movie converter

Enjoy watching your slides and 8mm or 16mm home movies on TV without the bother of setting up a projector and screen. This converter makes it easy to transfer slides and movies to video. You can even add your own soundtrack using your VCR. Either narrate the occasion or add music. Making copies for family and friends is inexpensive, too. The converted tapes make wonderful gifts that remind special people of special occasions. An adjustable tablepod mount allows for easy set up with your projector and video camera. Unit may be shipped with black or white casing. Color choice is not available.



Assembled BV-612 (3 lbs.) \$79.95

SAVE \$30 on this video converter package. Includes BV-612 Slide and Movie Converter and V-617 Photo Converter.

Assembled BVS-612 (9 lbs.) \$129.95

Zenith full-size camcorder with 8:1 zoom

The VMS-7150 is a full size HQ camcorder that uses the same standard VHS



format tapes you use in your VCR. With these full size cassettes, you get more time filming and less time changing tapes.

Let this camcorder work for you with its quick and precise auto focus system. This image sensing system includes a two speed f/1.4-2.2 auto focus lens and 8:1 power zoom with macro capability. The variable high-speed shutter operates at 1/60, 1/250, 1/500 speed or at 1/1000 speed – for fast action shots.

Superior picture quality is a standard feature of the two head VMS-7150. A 1/2" CCD pickup device delivers outstanding color and picture resolution with less power drain. You can even record great pictures in poor lighting situations – to as low as 7 lux.

Further features include an animation mode with variable shutter speeds for shooting individual frames of illustrated animation, flying erase head for precise edits, date/time insert capability, title memory insert, self timer, electronic viewfinder, unidirectional microphone, background music input, audio/video input, 3-way power, and fully automatic white balance and iris with backlight compensation.

Standard accessories include a rechargeable battery pack, AC power adapter/battery charger, RF converter unit, 75-ohm RF cable, A/V output cable, shoulder strap, and lens hood and cap. Made-to-fit hard-shell carrying case included.

Assembled VMS-7150 (14 lbs.) \$1195.00

Store photos on videotape with this handy converter

Boxes of photos from several years back. Albums you never really had time to organize. Sound familiar? With the Photo Converter you can transfer all your photo prints up to 4 by 6 inches onto videotape. A special macro lens and built-in balanced fluorescent illumination eliminate glare from the photographs, giving you excellent picture quality. You can view your family album on TV and even add music or other audio through your VCR. The Photo Converter mounts on its own tablepod for easy alignment with a video camera. Unit may be shipped with black or white casing. Color choice is not available.

Assembled V-617 (6 lbs.) \$79.95

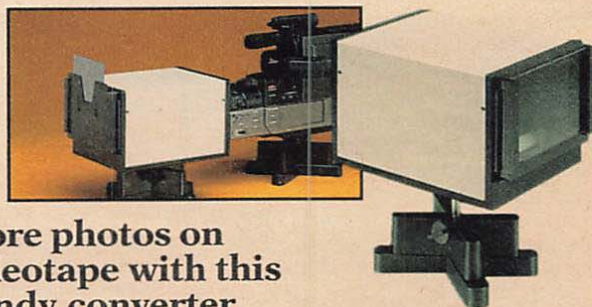

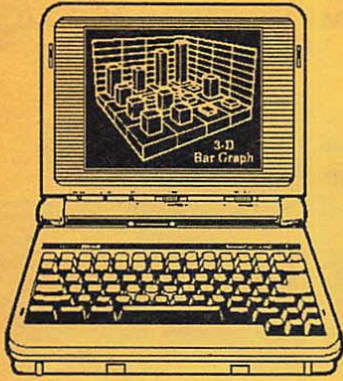

We work hard to deliver the most reliable, compatible and defect-free computer in the industry

Today, it seems like everyone's selling personal computers. To most people, personal computers are just machines with a keyboard and a screen. You can pick one from a line-up of lookalikes, take it home in a cardboard box, unwrap the cord and turn on the power.

Heath provides an alternative for computer buyers who want to do more than just plug in a ready-made computer. Heath computer kits offer superior performance – and the satisfaction and pride of building a high-power laptop or desktop computer yourself.

Heath's kit computers deliver the same exceptional value and uncompromising computing muscle found in the top selling and highly acclaimed Zenith Data Systems computers, their fully assembled cousins.

When you build a Heath computer, you help build in the quality yourself – using conveniently pre-assembled components such as precision hard drives, torture-tested circuit boards and rugged keyboard modules.

Heath computer kits. What a great idea. Because it's not just a computer you buy. It's a computer you build.



Betty Cannady operates the GenRad workstation where every circuit board is individually tested.

Heath quality control: our toughest customer

Heath applies some of the most stringent quality standards in the computer industry. Every circuit board in a Heath computer is individually tested during manufacturing, followed by a random sampling by Quality Assurance inspectors. Many companies just use statistical quality control, Heath goes one step farther, inspecting all circuit boards and power supplies that go into every kit. Your Heath computer kit's freedom from defects equals freedom from repair

headaches for you.

We've compared our own warranty service records against independently gathered* failure data on computers built by other leading manufacturers in the industry. Our conclusion is that Heath's reputation for trouble-free service is well deserved. With a Heath computer you can expect a quality product that will deliver years of reliable operation.

*Source: Opportunities in Personal Computer Servicing: A National Survey in Malfunction Repair by Business Products Consulting Group & MSM – The Magazine for Computer Service Managers.



Tim Tibbott tests with the most popular hardware and software products to ensure your Heath computer's compatibility.

Compatibility that's unsurpassed

Not every PC is completely "IBM compatible," a discovery you could make when you're trying to run a favorite program. Heath computers are tested to ensure full compatibility with more than 150 widely used hardware

and software products. Plus, with enough optional memory added, our computers can run under Xenix, Unix, or OS/2 in addition to MS-DOS. No one surpasses Heath's compatibility.

Expert computer sales consultants can help you save on your next computer purchase

At Heath Company we're dedicated to making your computer purchase the easiest ever. That's why we've established a team of expert computer sales consultants to help you choose equipment to meet your particular needs - from education and business to computer-aided design and desktop publishing. And, if you decide you want a complete workstation, we'll give you a special price that's sure to fit your budget.

Quality products

We're dedicated to bringing you the finest products, from the workhorse HS-3629 for the advanced student, to the portable, yet powerful Heathkit HS-3286 for the executive on the go. We also carry quality peripherals and software that complement your system. When you talk to our computer consultants, make sure you ask for more information on products not included in this catalog.

Buying a computer has never been easier

In keeping with our easy purchase pledge, we've made buying equipment a simple procedure. Just look through the following pages and note any computer products you might need to enhance your system. Then give our expert computer sales consultants a call at **1-800-753-5454**. They'll guide you through the process of choosing equipment that meets your exact needs. Or if you have questions regarding products not featured in the catalog, give them a call. Our consultants are available to assist you Monday through Friday from 8:00 a.m. to 4:30 p.m. Eastern Time.

Support, even after the purchase

We've been in business for over 40 years and we'll be here tomorrow to stand by our products. This means the help doesn't stop after your purchase your equipment. We continue to support you with our famous technical assistance and service. And, we include a 1-year limited warranty will all Heathkit products.

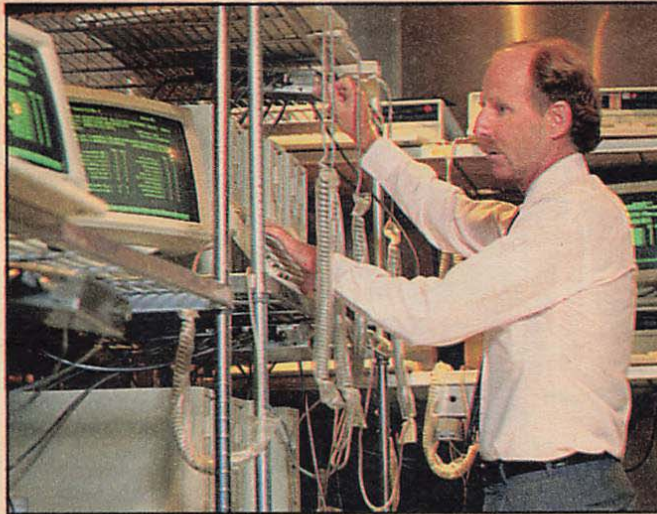

Tom Colligan inspects disk drives that we've terrorized in our environment chamber.

Torture-tested drives and controllers

When you purchase a drive with the Heath label, you know it has passed rigorous read/write and environmental tests that guarantee its reliability and data integrity. In fact, we tested and abused almost \$2 million

worth of drives and controllers last year. Why? Because our goal is to ensure that you, our customer, get only the best drives the market has to offer.



Ray Dalrymple operates the Electrostatic Discharge Gun that tests your Heath computer's resistance to dangerous shocks.

You're covered under Heath interference protection

All Heath computer models are tested and periodically retested to ensure that your finished computer will comply with stringent FCC Class B standards for electromagnetic interference (EMI). This means that you probably won't have problems with computer generated interference to your favorite TV or radio programs, or to nearby two-way radio equipment. Note that Class A standards are much less stringent and are intended for industrial, business or commercial envi-

ronments. Equipment built to the Class A standard may cause significant problems in a home setting.

We also design our computers with maximum protection against electrostatic discharge, the accidental transfer of dangerous shocks to a computer's sensitive internal parts. Heath's rigorous testing of all its models dramatically reduces the chance that walking across a carpet and touching your computer will interrupt your work or cause damage.



HS-2862 12 MHz laptop computer. Less than 11 lbs. without battery.

After just one short evening of kit building fun, you'll have a powerful laptop computer that outperforms most desktop PCs.

If you know how to use a Phillips screwdriver, you have what it takes to assemble our 286 laptop computer.

CALL FOR NEW LOW PRICING!

new

Powerful kit 286 laptop computer with crisp VGA display

SKILL LEVEL 1 With all the power of a desktop PC, the HS-2862 makes the perfect travelling companion. In fact, the HS-2862 has enough power to double as both your laptop on the road and your desktop in the office.

Combining full PC compatibility and AT computing power, the HS-2862 comes packed with 1MB of standard RAM, enough for those long spreadsheets and databases. And the 640 x 480 Page White VGA display is a pleasure to look at. Brilliant engineering in a surprisingly small package.

Heathkit HS-2862: Includes a 4.0 A/hr NiCd battery. Software: MS-DOS, Integrated 7+, Diagnostix and Lap-Link. Kit HS-2862 (31 lbs.) *Call for price!*

Accessories:

1MB RAM Expansion Card. Configurable for EMS or extended memory. Assembled ZA-180-66 (1 lb.)

2MB RAM Expansion Card. Configurable for EMS or extended memory. Assembled ZA-180-64 (1 lb.)

80C287 Numeric Co-processor
Assembled Z-416-SS (1 lb.)

20MB Hard Drive Assembled HA-2862-2 (2 lbs.)

40MB Hard Drive Assembled HA-2862-4 (2 lbs.)

5.25" External Disk Drive. Includes cable and 110 VAC adapter. Assembled ZAS-180-54 (8 lbs.)

Numeric Keypad Assembled ZA-3034-NP (2 lbs.)

Expansion Chassis. Requires ZA-180-91 (above right). Assembled ZA-3040-EB (5 lbs.)

Adapter Cable Assembled ZA-180-91 (3 lbs.)

Rapid Charge Battery Assembled ZA-180-85 (3 lbs.)

4.0 A/hr Battery Assembled ZA-180-65 (3 lbs.)

2400 Baud Internal Modem
Assembled ZA-181-23 (2 lbs.)

Carrying Case Assembled ZA-180-83 (3 lbs.)

SPECIFICATIONS **HS-2862**

Microprocessor 80286

Clock Speed 12 MHz

Memory Standard: 1 MB Optional: 3 MB

EMS Memory Yes

Floppy Disk Drive 1.4 MB 3.5"

Display Page White, 640x480

Standard Ports 1 parallel, 1 serial,
640 x 480 VGA video, external drive

Keyboard Full size, 79 keys

Co-processor Slot Yes

Clock/Calendar Yes

Operating System MS-DOS 3.3 +

Power Supply/Charger 120/240 VAC, 50/60 Hz

Dimensions 3" H x 12¼" W x 12¼" D

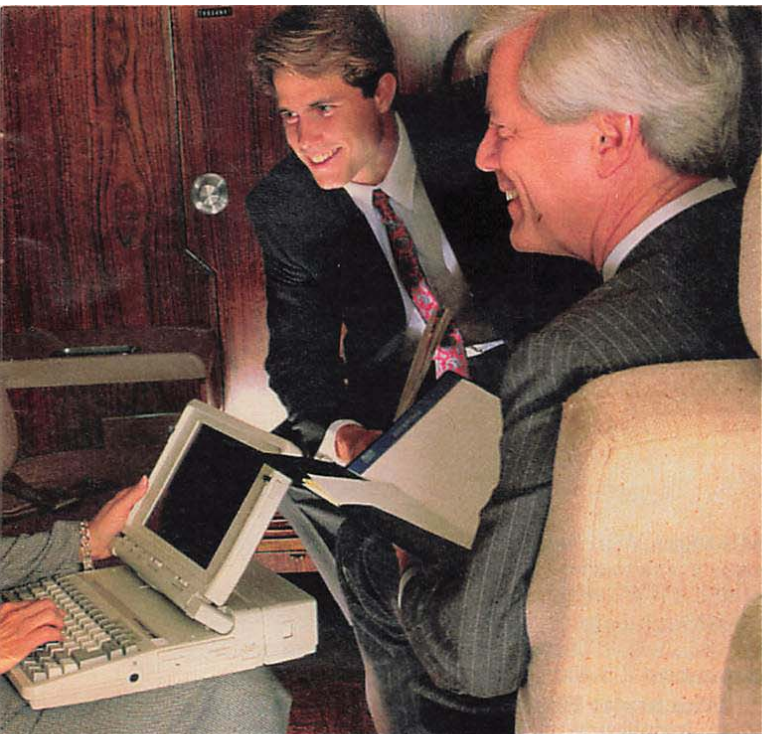

Build your own 80386SX-based laptop computer in only one evening.

High contrast Page White display rivals desktop CRT screen quality.

The powerful HS-3286 weighs less than 15 lbs.

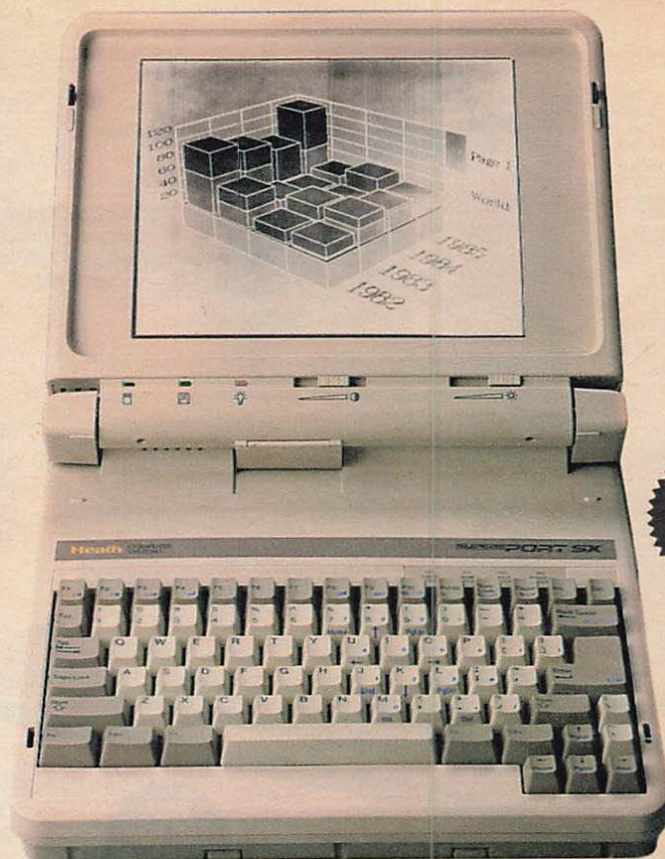

CALL FOR NEW LOW PRICING!

new **The laptop that outperforms many desktop computers**

If your work requires all the power a 386 machine can deliver but often takes you out of the office, then take along the Heath SupersPort 386 SX laptop computer – the road/office solution. With its standard 2 MB system RAM and 16 MHz zero wait state clock speed, the HS-3286 handles even the most power-hungry programs. Our kit laptop also features the highly acclaimed Page White display and a unique Power Management System that lets you allocate power when and where you need it.

In just a few hours of assembly, you'll have your laptop ready to work for you at home, office or on the road. The HS-3286 is the workstation that's always at your side!

Heathkit HS-3286: Includes a 4.0 A/hr NiCd battery. Software: MS-DOS, Integrated 7+, Diagnostix and Lap-Link. Kit HS-3286 (31 lbs.) *Call for price!*

Accessories:

2MB RAM Expansion Card. First memory expansion card configured for EMS or extended memory. Assembled ZA-180-86 (1 lb.)

2MB RAM Expansion Card. Second or third memory expansion card configured for EMS or extended memory. Assembled ZA-180-87 (1 lb.)

80387SX Numeric Co-processor Assembled ZA-3700-CI (1 lb.)

20MB Hard Drive Assembled HA-3286-2 (2 lbs.)

40MB Hard Drive Assembled HA-3286-4 (2 lbs.)

5.25" External Disk Drive. Includes cable and 110 VAC adapter. Assembled ZSS-180-54 (8 lbs.)

- 3.5" External Disk Drive.** Includes cable. Assembled ZA-1-4 (2 lbs.)
- Numeric Keypad** Assembled ZA-180-89 (2 lbs.)
- Expansion Chassis.** Requires ZA-180-91 (below). Assembled ZA-3040-EB (5 lbs.)
- Adapter Cable** Assembled ZA-180-91 (3 lbs.)
- Rapid Charge Battery** Assembled ZA-180-85 (3 lbs.)
- 4.0 A/hr Battery** Assembled ZA-180-65 (3 lbs.)
- 2400 Baud Internal Modem** Assembled ZA-181-23 . (2 lbs.)
- Carrying Case** Assembled ZA-180-83 (3 lbs.)

SPECIFICATIONS		HS-3286
Microprocessor		80386SX
Clock Speed		16 MHz
Memory	Standard: 2 MB Optional: 8 MB	
EMS Memory		Yes
Floppy Disk Drive		1.4 MB 3.5"
Display		Page White, 640x480
Standard Ports	1 parallel, 1 serial, 640 x 480 VGA video	
Keyboard		Full size, 79 keys
Co-processor Slot		Yes
Clock/Calendar		Yes
Operating System		MS-DOS 3.3 +
Power Supply/Charger		120/240 VAC, 50/60 Hz
Dimensions		3" H x 12¼" W x 12¼" D



25 MHz HS-3629 desktop computer with 3.5" floppy drive and 2 MB standard system RAM

CALL FOR NEW LOW PRICING!

HS-3629: the most powerful computer kit ever

SKILL LEVEL 1 This powerhouse pulls away from any pack of PCs, bringing exceptional computing power to your desktop. Its 32-bit, 25 MHz 80386 processor has the muscle to blaze through the most demanding programs.

The HS-3629 is perfect for windowing operations, desktop publishing, software development, CAD/CAM, large spreadsheets and networking. With zero wait state technology and the ability to run most PC and AT compatible software at a swift 25 MHz, the HS-3629 specializes in high-intensity computing.

Discover the ease of computing with 386 power and the simplicity of assembling this extraordinary computer yourself!

Heathkit HS-3629-A: Includes 16K cache memory and an HVB-550 video card. Software: MS-DOS, Integrated 7+, Diagnostix and Windows 386.

Kit HS-3629-A (46 lbs.) *Call for new low pricing!*

Accessories:

3.5" 1.4MB Disk Drive. Black. Requires ZCA-14 (below).
Assembled ZD-14 (3 lbs.)

ZCA-14 Cable
Assembled ZCA-14 (1 lb.)

5.25" 1.2MB Disk Drive
Assembled ZD-12 (5 lbs.)

5.25" 360K Disk Drive
Assembled Z-207-7 (5 lbs.)

40MB 28ms Winchester Hard Drive. Includes all installation cables and formats at 44MB.

Assembled HWD-4028 (4 lbs.)

80MB Winchester Hard Drive. Requires Z-417-2 cable when installing in floppy-only models. Formats at 72MB.

Assembled ZD-800 (1 lb.)

Winchester Hard Drive Cable. Required for the installation of the first ZD-800 Winchester hard disk drive.

Assembled Z-417-2 (1 lb.)

Memory Expansion Card.

Holds up to 4 simms.

Assembled ZA-3600-MQ (1 lb.)

1MB Memory Expansion Simm

Assembled ZA-3600-ME (1 lb.)

2MB Memory Expansion Simm

Assembled ZA-3600-MG (1 lb.)

80387 25 MHz Numeric Co-Processor

Assembled ZA-3600-CI (1 lb.)

Weitek's 25 MHz Numeric Co-Processor

Assembled ZA-3600-CW (1 lb.)

Color Video Card. Dual ports allow you to use either a VGA monitor such as our FTM, or an EGA, CGA, MDA or Hercules monitor. Automatic sensing and switching allows you to run software written for one display mode in other modes.

Assembled HVB-550 (1 lb.)

SPECIFICATIONS		HS-3629
Microprocessor		80386
Clock Speed		25 MHz
Memory	Standard: 2 MB	Optional: 64 MB
EMS Memory		Yes
Floppy Disk Drive		1.4 MB 3.5"
Expansion Slots		4
Video Card		HVB-550
Standard Ports		1 parallel, 2 serial
Keyboard		101 keys
Co-processor Slot		Yes
Clock/Calendar		Yes
Operating System		MS-DOS 3.3+
Power Supply		115/230 VAC, 50/60 Hz
Dimensions		6" H x 21" W x 17" D

Computer Sales: Call 1-800-753-5454, Monday-Friday, 8:00 a.m.-4:30 p.m. E.T.

Heath/Zenith Computer Centers* from coast to coast

ARIZONA - Phoenix, 85017
2727 W. Indian School Rd.
602-279-6247

ARIZONA - Tucson, 85710
5616 E. Broadway
602-745-0744

CALIFORNIA - Anaheim, 92805
330 E. Ball Rd.
714-776-9420

CALIFORNIA -
San Jose (Campbell), 95008
2350 S. Bascom Ave.
408-377-8920

CALIFORNIA - San Diego
(La Mesa), 92041
8363 Center Dr.
619-461-0110

CALIFORNIA - Los Angeles, 90007
2309 S. Flower St.
213-749-0261

CALIFORNIA - Rancho Cucamonga,
91730
10532 Acacia St., Suite B3
714-987-5195

CALIFORNIA -
Redwood City, 94063
2001 Middlefield Rd.
415-365-8155

CALIFORNIA - Sacramento, 95825
1860 Fulton Ave.
916-486-1575

CALIFORNIA - Woodland Hills, 91364
22504 Ventura Blvd.
818-883-0531

COLORADO - Denver
(Westminster), 80003
8685 Sheridan Blvd.
303-429-2292

FLORIDA - Hialeah, 33012
4705 W. 16th Ave.
305-823-2280

FLORIDA - Jacksonville, 32225
9426 Arlington Expressway
904-725-4554

FLORIDA - Orlando
(Altamonte Springs), 32714
445 W. State Hwy. 436
Suite 1037
407-682-9111

FLORIDA - Tampa, 33614
4019 W. Hillsborough Ave.
813-886-2541

GEORGIA - Atlanta, 30342
5285 Roswell Rd.
404-252-4341

HAWAII - Honolulu
(Pearl City), 96782
98-1254 Kaahumanu St.
808-487-0029

ILLINOIS - Downers Grove, 60515
224 Ogden Ave.
708-852-1304

ILLINOIS - Schaumburg, 60173
1213 E. Golf Rd.
708-330-1717

ILLINOIS - Skokie, 60076
3606 W. Dempster
708-583-3920

INDIANA - Indianapolis, 46220
2112 E. 62nd St.
317-257-4321

KANSAS - Kansas City
(Mission), 66202
5960 Lamar Ave.
913-362-4486

KENTUCKY - Louisville, 40243
12401 Shelbyville Rd.
502-245-7811

LOUISIANA - New Orleans
(Kenner), 70062
1900 Veterans Memorial Hwy.
504-467-6321

MARYLAND - Baltimore, 21234
1713 E. Joppa Rd.
301-661-4446

MARYLAND - Rockville, 20852
5542 Nicholson Lane
301-881-4458

MASSACHUSETTS -
Peabody, 01960
242 Andover St. (Rt. 114)
508-531-9330

MASSACHUSETTS -
Wellesley, 02181
165 Worcester Ave. (Rt. 9)
617-237-1510

MICHIGAN -
Farmington Hills, 48018
29433 Orchard Lake Rd.
313-553-4171

MICHIGAN - East Detroit, 48021
18149 E. Eight Mile Rd.
313-772-0416

MICHIGAN - St. Joseph, 49085
2987 Lakeshore Drive
616-982-3215

MINNESOTA - Minneapolis
(Hopkins), 55343
101 Shady Oak Rd.
612-938-6371

MINNESOTA - St. Paul, 55105
1645 White Bear Ave.
612-778-1211

MISSOURI - St. Louis
(Bridgeton), 63044
3794 McKelvey Rd.
314-291-1850

NEBRASKA - Omaha, 68134
2311 N. 90th St.
402-391-2071

NEW JERSEY - Ocean, 07712
1013 Slate Hwy. 35
201-775-1231

NEW JERSEY -
Fair Lawn, 07410
35-07 Broadway (Rt. 4)
201-791-6935

NEW YORK - Amherst, 14226
3476 Sheridan Dr.
716-835-3090

NEW YORK - Jericho, L.I. 11753
15 Jericho Turnpike
516-334-8181

NEW YORK - Rochester, 14623
937 Jefferson Rd.
716-424-2560

NEW YORK -
N. White Plains, 10603
7 Reservoir Rd.
914-761-7690

NORTH CAROLINA -
Greensboro, 27407
4620-C W. Market St.
919-299-5390

OHIO - Cincinnati
(Springdale), 45246
131 West Kemper Rd.
513-671-1115

OHIO - Cleveland, 44122
28100 Chagrin Blvd.
216-292-7553

OHIO - Columbus, 43229
2500 Morse Rd.
614-475-7200

OHIO - Toledo, 43615
48 S. Byrne Rd.
419-537-1889

OKLAHOMA - Tulsa, 74146
3158 S. 108th E. Ave.
918-627-9712

OREGON - Portland
(Tigard), 97223
10115 S.W. Nimbus Ave.
Nimbus Center
503-684-1074

PENNSYLVANIA - Frazer, 19355
630 Lancaster Pike (Rt. 30)
215-647-5555

PENNSYLVANIA -
Pittsburgh, 15235
3482 Wm. Penn Hwy.
412-824-3564

TENNESSEE - Memphis, 38117
700 Mount Moriah
901-684-1161

TEXAS - Dallas, 75218
12022C Garland Rd.
214-327-4835

TEXAS - Fort Worth, 76116
6825-A Green Oaks Rd.
817-737-8822

TEXAS - Houston, 77008
1704 W. Loop N.
713-869-5263

TEXAS - San Antonio, 78216
7111 Blanco Rd.
512-341-8876

UTAH - Salt Lake City
(Midvale), 84047
58 East 7200 South
801-566-4626

VIRGINIA - Alexandria, 22303
6201 Richmond Hwy.
703-765-5515

VIRGINIA - Virginia Beach, 23455
1055 Independence Blvd.
804-460-0997

WASHINGTON - Seattle, 98109
505 8th Ave. N.
206-682-2172

WISCONSIN - Milwaukee
(Wauwatosa), 53226
845 N. Mayfair
414-453-1161

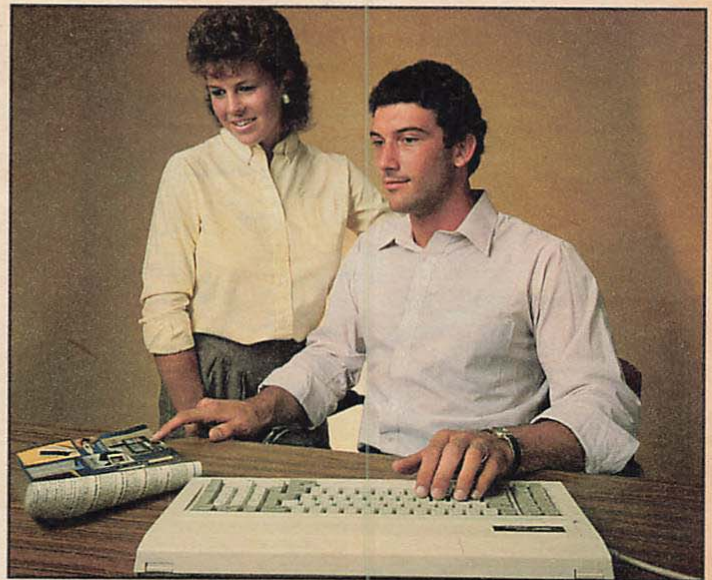

Tomorrow's shopping is here today with the Heathkit Online Catalog

Enjoy the ease and convenience of shopping by computer with the Heathkit Online Catalog through CompuServe. Just type **GO HTH** at any ! or **OK** prompt and get instant access to innovative electronic products.

The recently revised Heathkit Online Catalog now features a variety of new and exciting sections for you to shop from. Stop by our What's New area featuring the latest in Heath's kit and assembled products, or browse through our Blockbuster Specials, highlighting exceptional values and price reductions on selected items. You can even place your order online using your VISA, MasterCard, American Express or Heath Revolving Charge.

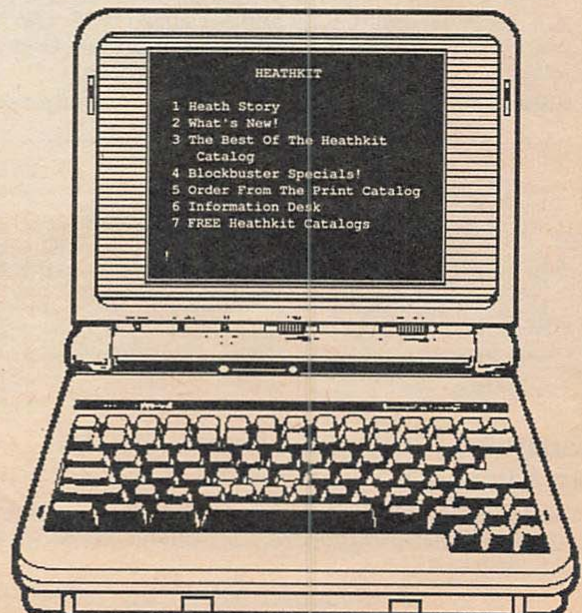

*Heath/Zenith Computer Centers are units of Veritechnology Electronics Corporation in the U.S.

- Advertisement -



ORDER TOLL-FREE ANYTIME

800-253-0570

FAX: 616-982-5577

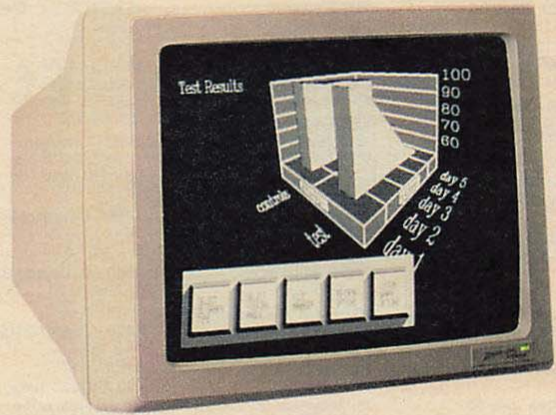
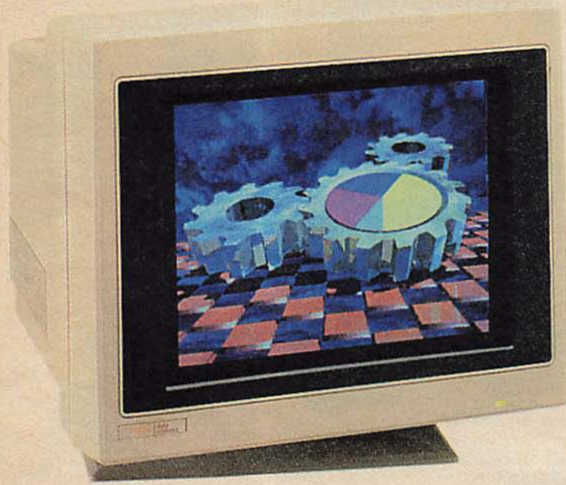

new Flat technology monitor makes conventional CRTs obsolete

An outstanding achievement in video display technology, the 14" Zenith Data Systems ZCM-1492 is a benchmark by which all other monitors should be judged. Its flat tension mask screen produces a brilliant image not found in a conventional CRT, and colors remain true even at high intensities. You'll enjoy dramatically improved contrast for jet blacks, more pronounced highlights and softer colors. In addition, the perfectly flat tube virtually eliminates glare, reducing eye strain. And because the screen is flat, you can take accurate measurements as well as high quality photographs directly off the screen. The ZCM-1492 is capable of resolutions up to 640 x 480 at a 31 kHz scan rate.

The monitor works with video from the Z-449 and HVB-550 video cards, or the output from the IBM PS 2 computer and other VGA compatible video cards. It can also display CGA, MDA/Hercules, EGA and Advanced EGA. 12½" H x 14¾" W x 15" D. FCC Class B, UL and CSA approved. Uses 115/230 VAC, 50/60 Hz. Includes a tilt/swivel base.

Assembled ZCM-1492 (45 lbs.) *Call for price!*

14"-diagonal monochrome monitor

Also from Zenith Data Systems comes this VGA compatible monochrome monitor. The page white phosphor CRT reduces eye strain commonly experienced with prolonged hours in front of a video monitor. Designed for use with the Z-449 and HVB-550 video cards, and other VGA compatible cards. Attached 15-pin D connector cable included. 115 VAC, 60 Hz. Dimensions are 10"H x 12¾"W x 13"D.

Assembled ZMM-149-P (21 lbs.) *Call for price!*

Smart Watch adds time and date

Add battery-backed time to your computer with the Smart Watch 10-year clock/calendar – without using an expansion slot. Includes software for displaying time and date, and setting DOS time. Use with floppy or Winchester drive computers. For use on Heath/Zenith 150 series PCs.

CB-5063-50 (3 lbs.) **\$34.00**



Enhanced keyboard from Zenith Data Systems

You'll simplify keying and reduce typing errors when you replace your old 84-key keyboard with this 101-key board from Zenith Data Systems.

As a starter, special function keys have increased from 10 to 12 and they're now located above the alpha numeric keys. Cursor and screen control keys are separated from the keypad, and *Print Screen*, *Pause* and *Scroll Lock* are grouped together in the upper right hand corner.

Accessory ROMs are needed for different computer requirements. ROMs for other Heath/Zenith PCs are listed in the keyboard installation instructions.

Assembled ZKB-2 (6 lbs.) **\$149.00**

Accessories:

ROM Upgrade for H/Z-200 Computers
ZCA-10 (1 lb.) **\$24.80**

ROM Upgrade for H/Z-159 Computers
ZCA-11 (1 lb.) **\$12.80**

Computer Sales: Call 1-800-753-5454, Monday-Friday, 8:00 a.m.-4:30 p.m. E.T.

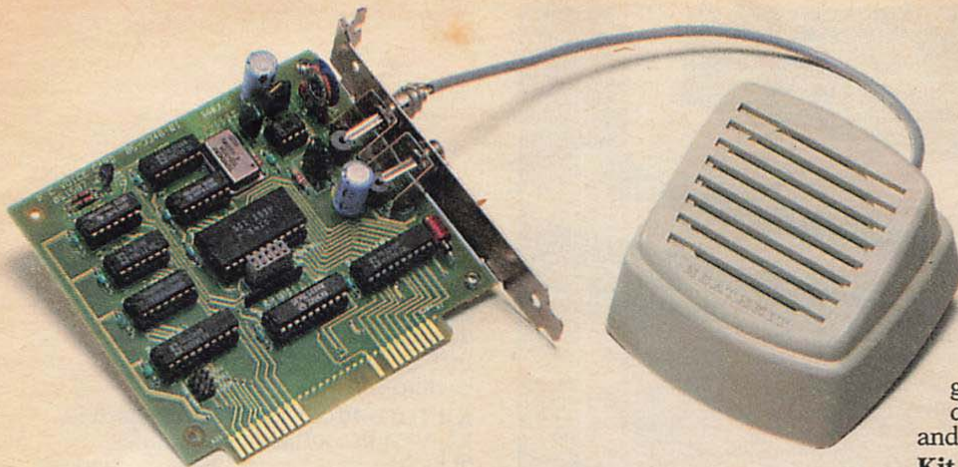

amateur radio application, add a voice to sent and received RTTY messages using a TNC like our HK-232-A on page 65. The voice card will enable your computer to vocalize any ASCII text received through a serial port at baud rates from 150 to 38.4K. There's even an exception file for those special pronunciations.

The Computer Voice Card works on IBM PC/AT, PC/XT and compatibles. Included voice software lets you easily interface to DOS and high level languages. Speaker options can be enabled or disabled automatically at computer boot-up and/or as text is being spoken.

Kit HV-2000 (2 lbs.) \$89.95

Specifications: **SPEECH ATTRIBUTES:** Modes: 2, Immediate and Transitioned Inflection. **Number of Phonemes:** 64. **Phoneme Durations:** 4. **Speech Rates:** 16. **Inflection (Pitch) Levels:** 4096. **Transitioned Inflection Levels:** 32. **Transitioned Inflection Rates:** 8. **Musical Pitch Frequencies:** 49 (4 octaves). **Amplitude Settings:** 16. **Vocal Tract Filter Frequencies:** Over 250. **Articulation Rates:** 8. **UNIQUE WORD EXCEPTION FILE:** **Number of Words:** 100 maximum. **Size of File:** 2048 bytes maximum. **ELECTRICAL:** **Computer Interface:** Standard 62-finger PC bus card. **Line Output:** 10k ohms. **Speaker Output:** Approximately 500 mW into 8 ohms. **Power:** 5 volts DC at 275 mA max., 12 volts DC at 10 mA (obtained from PC bus). **PHYSICAL:** **Size:** Half card.

Add a voice to your computer

 Give your computer a distinctive voice or voices with the Computer Voice Card. You can add vocal prompts to batch files or have your computer speak the contents of any text file, including WordStar. The applications of this card are extensive, including, for example, making a computer more accessible or easier to use by the visually impaired.

The Computer Voice Card plugs into an expansion slot and receives data off of the bus. That information is converted by a synthesizer into an audio signal and amplified. The signal is then reproduced by an included external speaker into words, sentences, sound effects or music.

Extensive software, which is included, makes this the easiest-to-use, most versatile speech synthesizer you can buy. Special terminal emulator software that enables you to add a voice to modem communications is also included. Or, for an



MANUAL PREVIEW
Preview the Heathkit manual of your choice before you order the kit. You'll see for yourself how easy kit building really is. Turn to page 53 for our Manual Preview Offer.

This easy-to-build EPROM eraser saves you time and money

 This simple-to-build kit cuts memory device costs by letting you use EPROMs again and again. You can even salvage some from certain types of discarded equipment. The ID-4803-H EPROM Eraser will erase all 24, 28 and 40 pin ultraviolet erasable integrated devices.

Just place them on the unit's locking, non removable tray – it can hold up to seven ICs – and insert the tray into the eraser. A lamp-on indicator tells you when the unit is in operation. A safety interlock system prevents accidental exposure to ultraviolet rays if the unit is opened during the erasing process.

The EPROM Eraser is compact, easy to operate and easy to build using ordinary kit building tools.

Kit ID-4803-H (4 lbs.) \$49.95

Specifications: **Erase Time:** 3 minutes per watt-second of erase energy specified by manufacturer. **Capacity:** Seven 24-pin, six 28-pin or four 40-pin IC's. **Typical Tube Life:** 3000 hours. **Power:** 120 VAC, 60 Hz. **Dimensions:** 2 1/2" H x 3 1/4" W x 13 1/4" L.



Erase up to seven integrated circuits at a time with the ID-4803-H



Mount the HBT-40 internally or in the optional external mounting kit (inset)

Backup tape drive lets you work with confidence

SKILL LEVEL 1 If your work depends on what's on your disk drive, you shouldn't start another file before adding a Winchester backup tape drive to your computer. Our kit 40MB streaming tape drive provides

you with reliable backup of Winchester hard disks and floppy drives. Set the unit to operate automatically at regular intervals or you can stop and back up your work whenever you choose.

Both models use standard DC2000 1/4" tape cartridges that are interchangeable between units. The tape drive fits internally in a 3.5" floppy slot and comes with adapters for a 5.25" slot. If, however, you can't sacrifice a floppy slot, external mounting kits are available. Includes easy-to-use menu-driven backup software.

Kit HBT-40-XT For Heath/Zenith PC, XT, IBM PC, XT and compatibles. (4 lbs.) *Call for price!*

Kit HBT-40-AT For AT or AT compatible computers. (4 lbs.) .. *Call for price!*

Accessories:

External Mounting Kit. For the HS-40 and HS-42 line of computers. Includes all necessary hardware.

Kit HBT-40-H4 (2 lbs.) .. *Call for price!*

External Mounting Kit. For all other Heath desktop computers. Includes all necessary hardware.

Kit HBT-40-HZ (3 lbs.) .. *Call for price!*

External Mounting Kit. For IBM or compatible systems with a 4-port floppy controller. Includes all necessary hardware.

Kit HBT-40-SD (3 lbs.) .. *Call for price!*

40MB Tape Cartridge
HBT-40-1 (1 lb.) **\$19.95**

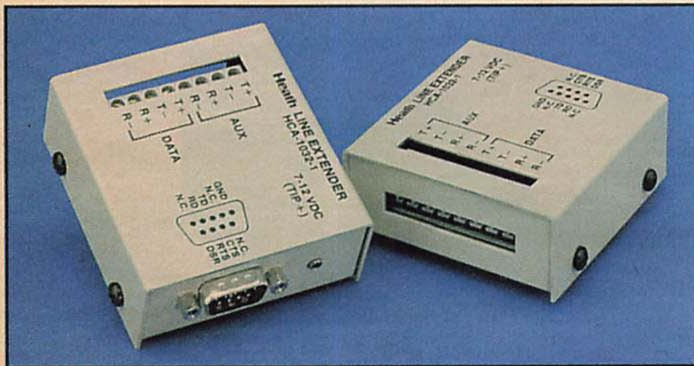

Extend serial connections over 4000 feet with line extenders

Connect computers and peripherals over 4000 feet apart using 4-conductor wiring with Heath Line Extenders. Now you can send that last minute invoice to the printer in shipping even though it's at the other end of the plant. Or, put a

computer in the kids' room and let them access your computer's modem in the den. Line Extenders are perfect anytime you need serial transmissions over large distances.

Normally, RS-232 serial cables are limited in length to 50 feet or less to avoid data loss. Heath Line Extenders break the 50 foot barrier by converting data from RS-232 to RS-422 for transmission, then back to RS-232 at reception. By using differential signals, RS-422 provides much better immunity to noise than traditional RS-232 installation - extending data transmission capabilities.

Two Line Extenders are required for operation, one at each end of the connecting cable. Power is supplied by an included power cube. Four-conductor wiring not included.

Assembled HCA-1032-1 (2 lbs.) **each \$29.95**

Specifications: **Interfaces:** RS-232 and RS-422. **Baud Rates:** Up to 19,200. **Number of Circuits:** Four: 2 transmit, 2 receive. **Handshaking:** RTS/CTS or DTR/DSR; jumper selectable. **RS-232 Connector:** 9-pin D type. **RS-422 Connector:** 8-wire connector block. **Cable Length:** Up to a maximum of 4000 feet (4-conductor). **Power:** 7 to 12 VDC with supplied wall cube.

Computer Sales: Call 1-800-753-5454, Monday-Friday, 8:00 a.m.-4:30 p.m. E.T.

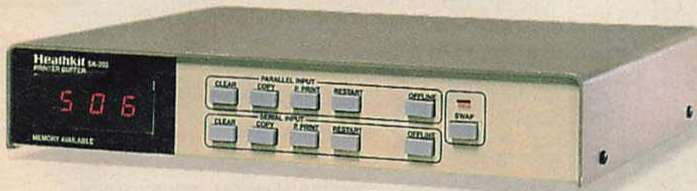

Printer buffer saves computer time

SKILL LEVEL The Heathkit Printer Buffer lets you use your computer while a document is printing. It accepts data as fast as your computer can send it with serial baud rates up to 38.4K and parallel rates to 100,000 CPS. Data is then stored in 64K of memory, equal to 21 typewritten pages and expandable to 512K. That's the equivalent of 168 typewritten pages.

Both serial and parallel ports allow you to connect more than one computer and printer. This means files can be accepted from both computers, then sent to separate printers at the same time. Or send files to your choice of printer. Priority print means you can interrupt printing, print a priority document, then reprint the interrupted document. Even print up to 99 copies of a particular file.

Through self diagnostics, the Printer Buffer checks its own memory each time you turn it on. And, to prevent memory overload, a front panel display shows remaining free memory. Operates on 108-132 VAC, 60 Hz. 1½"H x 9¼"W x 8"D.

Kit SK-203-H (5 lbs.) \$169.95

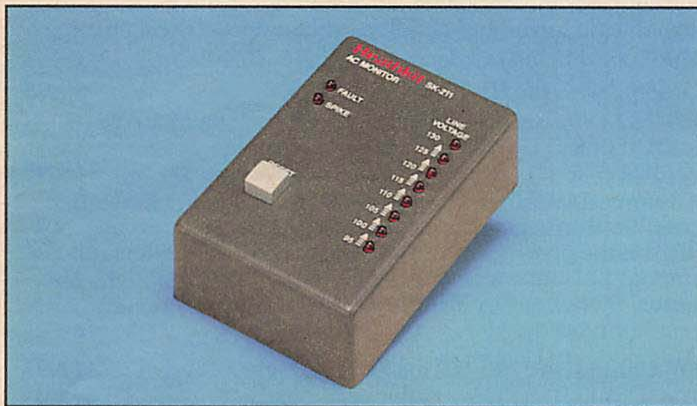

Heathkit AC Line Monitor shows what your line is doing

SKILL LEVEL Keep track inexpensively of an important part of your system, the AC power line. With the Heathkit AC Line Monitor, you can monitor voltage sensitive equipment such as computers, communications gear and medical apparatus. Eight LED indicators show voltage from 95 to 130 VAC in five volt steps. Plus, a separate fault LED lights if the voltage falls below 90 VAC, and a separate spike LED lights if a voltage transient occurs. Dimensions are 3⅝"H x 2⅜"W x 1¼"D.

Kit SK-211 (1 lb.) \$29.95



Control a computer and peripherals from one power director

SKILL LEVEL Add convenience and protection to your computer system with the Heathkit AC Conductor. Simply plug the AC line cords of your equipment into the conductor, then control the power to each from the conductor's front panel. Power switches are there in front of you, easy to control.

The AC Conductor filters line voltage and helps shield your equipment against power line spikes, thanks to a protective MOV device. A 15 amp fused line adds protection against excessive loads.

Plug up to five pieces of equipment into the conductor — computer, monitor, printer, modem, plus one more of your choice. A flip of the master switch and all five turn on. Or turn on each individually. Separate LEDs show you what's on and what's not.

An additional convenience is the turntable base. You can rotate your monitor to the most comfortable viewing angle, giving you convenience and protection without losing valuable desk space. Dimensions are 1¾"H x 13½"W x 14"D.

Kit SK-209 (11 lbs.) \$49.95

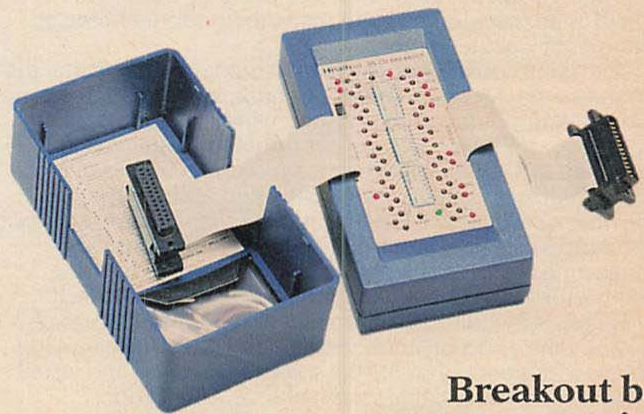

Breakout box saves setup time

SKILL LEVEL The Heathkit Breakout Box is a valuable time saver. It provides you with access to all 25 lines of RS-232C cable linking computer system devices. Twelve LEDs monitor key signal lines while 23 lines can be switch disabled, then cross connected. Built-in dual DTE and DCE gender connectors eliminate the need for adapter cables and connectors, and two AA batteries power the line monitoring LEDs, though they're not needed for the unit to operate. Five jumper wires are included. Dimensions are 2⅜"H x 3½"W x 6¼"L.

Kit PMK-130-H (2 lbs.) \$69.95

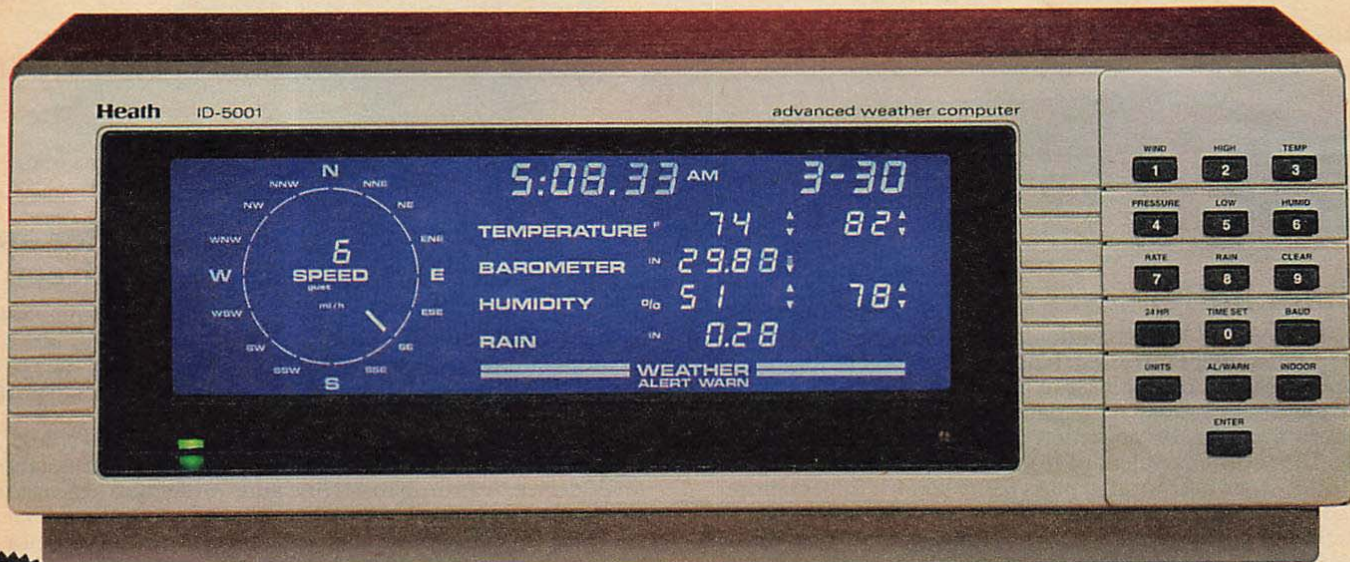

Overall dimensions: 5 3/4" H x 15 1/2" W x 8 3/4" D

AS LOW AS \$30 PER MONTH ON YOUR HEATH REVOLVING CHARGE

Our Advanced Weather Computer comes ready-to-use or ready-to-build

You no longer have to depend on weather reports from stations many miles away. Accurate, up-to-date information is always at your fingertips with the ID-5001 Advanced Weather Computer. Available ready-to-use or ready-to-build, the ID-5001 is an essential weather instrument for the home or professional weather center.

A striking cobalt blue, the backlit digital liquid crystal display shows wind speed in miles per hour, knots or kilometers per hour. A 16-point compass shows wind direction. Indoor and outdoor temperatures are continuously displayed in Fahrenheit or Celsius, barometric pressure in inches of mercury or millibars. Arrows show rising and falling values and their rates. A 6-digit 12- or 24-hour clock displays day and date, and features selectable automatic leap year and daylight savings time correction. No need to worry about resetting the clock for time changes, it automatically corrects itself.

Displays include minimum and maximum readings plus time and date of occurrence, wind chill temperature and fog display (with optional humidity sensors). Audible and visual *Alert* and *Alert-Warn* signals warn of severe conditions.

Note: Boom requires one of the cables listed at right. Order with your ID-5001 or IDW-5001.

Kit ID-5001-C (18 lbs.) \$499.95

Assembled IDW-5001 Includes RS-232 Interface and Humidity Sensor. 120 VAC only. (20 lbs.) \$999.95

Receive a FREE RS-232 Interface Accessory (a \$49.95 value) when you purchase the ID-5001-C Weather Computer, the IDA-5001-1 Humidity Sensor, below, and the IDA-5001-2 Rain Gauge Sensor, above right.
Kit IDS-5001-2 (25 lbs.) \$599.85

Accessories:

Indoor/Outdoor Relative Humidity Sensor
 Kit IDA-5001-1 (3 lbs.) \$59.95

32

Rain Gauge Sensor Kit IDA-5001-2 (3 lbs.) \$39.95

Technical Manual. Comprehensive manual especially for the engineer includes detailed circuit descriptions, numerous signal wave forms and detailed explanation of the technology. IDA-5001-4 (2 lbs.) Ordered separately \$24.95

Ordered with the ID-5001-C or IDW-5001 \$29.95

RS-232 Computer Interface. Includes installation parts for ID-5001-C. Hayes command compatible. Kit IDA-5001-3 (1 lb.) \$49.95

Advanced Weather Computer Software. Check weather conditions instantly on screen, as often as you like; you won't disrupt the program you're working on. Stores data in industry-standard file format. For IBM or compatible computers. Use Lotus, Symphony or Windows to graph and manipulate data. IDA-5001-5 (2 lbs.) \$49.95

50' Cable IDA-1290-1 (2 lbs.) \$12.95

100' Cable IDA-1290-2 (4 lbs.) \$22.95

150' Cable IDA-1290-3 (6 lbs.) \$32.95

Specifications: **WIND SPEED:** **Gust Mode Instantaneous peak speed. **Average Mode:** 60 second averaging. **Accuracy:** ±5% or better. **WIND DIRECTION:** **Gust Mode:** 1 second averaging. **Average Mode:** 60 second averaging. **Wind Mode:** 60 second averaging of displays to nearest 10°

THERMOMETER: Temperature: -40°C to +70°C. -40°F to +158°F. **Accuracy:** ±1 from -40°C to +70°C. ±2° from -40°F to +158°F. **BAROMETER: Pressure Range:** 28.00 to 32.00 in. Hg. 948 to 1083 millibars. **Accuracy:** 29.00 to 31.00 in. Hg. ±.25% plus ±.033%/°C (±.075 in. Hg. plus ±.01 in. Hg./°C).

RAIN GAUGE: Units: inches to 99.9, centimeters to 250, automatic decimal point adjust. **Repeatability:** ±1 count in 10 for 1-inch-per-hour rainfall. **RELATIVE HUMIDITY: Measurement Range:** 10%-90%. **Operating Range:** 0°C to 50°C (32°F to 122°F). **GENERAL:** 120/240 VAC, 50/60 Hz.

**Your actual monthly payments may vary depending on your account balance.

**In conformance with the National Weather Service and FAA guidelines for Wx instrumentation at supplementary aviation Wx reporting stations.

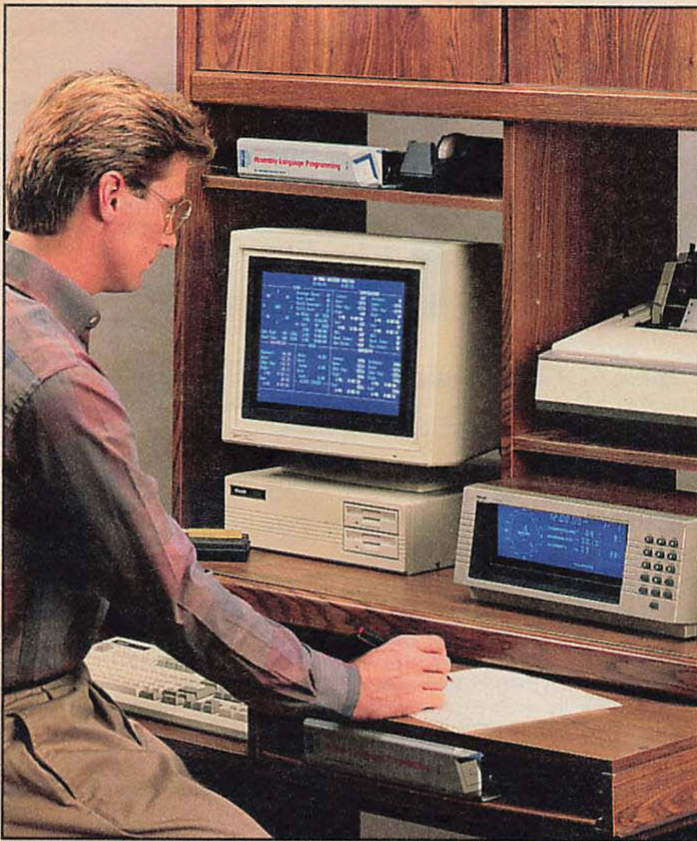

Interface the ID-5001 with an IBM or compatible computer for a sophisticated weather data storage and analysis system.

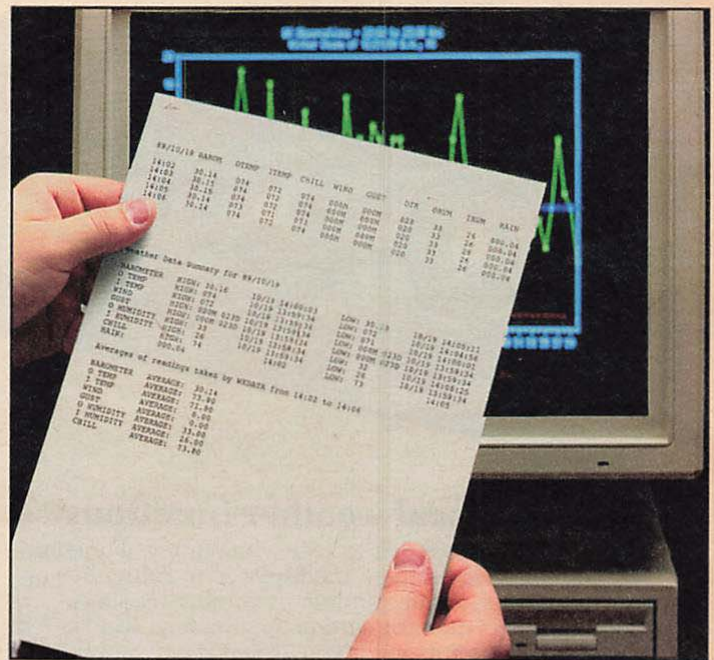

Combine your ID-5001 with the IDA-5001-3 RS-232 Computer Interface and IDA-5001-5 Advanced Weather Computer Software for an elaborate weather data recording system. This setup lets you collect data from the ID-5001 at user-selected intervals and save it on disk for later retrieval. The measurements are stored in plain ASCII (text) format so you can print them out on your printer, read them to your screen, or process them into other programs, such as spreadsheets, for detailed analysis.

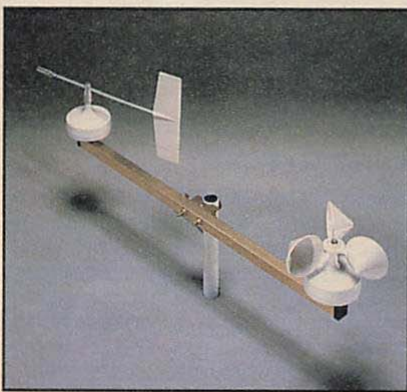

Precision boom assembly includes wind vane and cups for respectively measuring wind direction and speed.

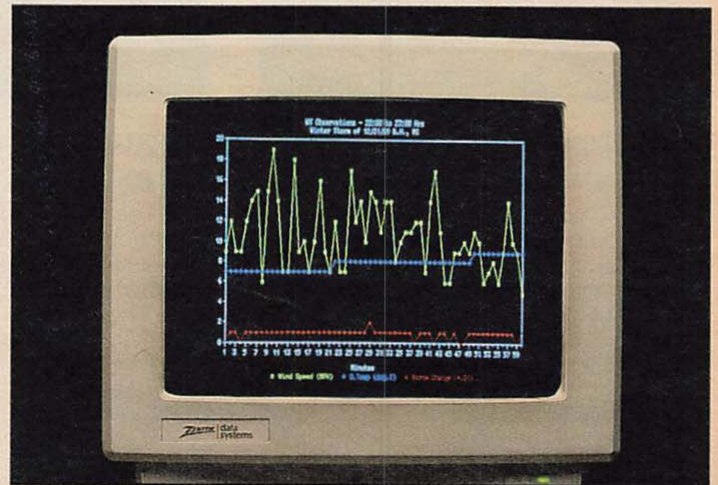

Creating graphs and charts from collected data is easy, because the IDA-5001-5 Advanced Weather Computer Software saves information in standard ASCII format – allowing easy transfer to other software packages. Using a spreadsheet program such as Lotus, you can examine gathered data and generate graphic representations of changing climate conditions.



MANUAL PREVIEW
 Preview the Heathkit manual of your choice before you order the kit. You'll see for yourself how easy kit building really is. Turn to page 53 for our Manual Preview Offer.

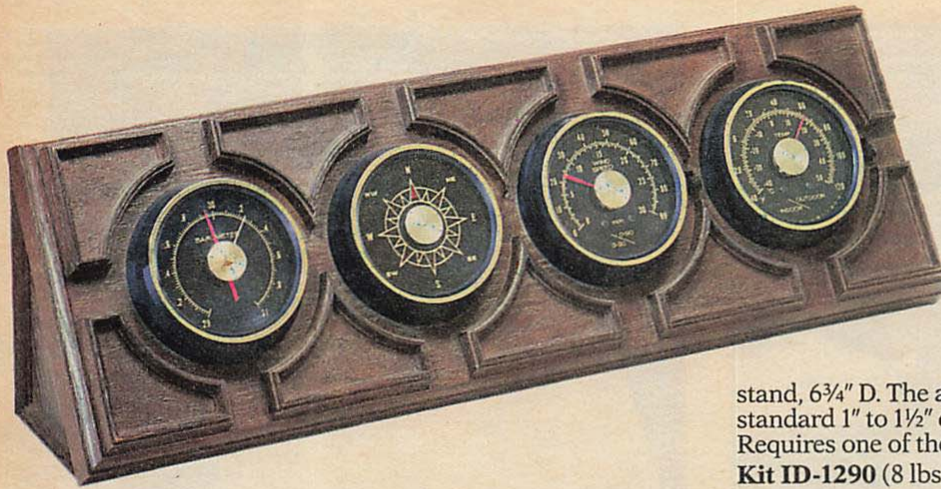

TECHNICAL CONSULTATION

When you have a question about the kit you're building or about an assembled product, our expert technical consultants are only a phone call away. Their numbers are listed on page 51.

stand, 6 $\frac{3}{4}$ " D. The anemometer/weather vane mounts to any standard 1" to 1 $\frac{1}{2}$ " diameter mast. Uses 120 VAC, 60 Hz. Requires one of the cables listed below.

Kit ID-1290 (8 lbs.) **\$189.95**

Accessories:

50' Cable, IDA-1290-1 (2 lbs.) **\$12.95**

100' Cable, IDA-1290-2 (4 lbs.) **\$22.95**

150' Cable, IDA-1290-3 (6 lbs.) **\$32.95**

Specifications: **Wind Speed:** 0-30 mph, ± 2 mph; 0-90 mph, ± 5 mph. **Direction:** 8-point readout over 360 $^\circ$; 16-point resolution by lighting two adjacent lights. **Temperature:** 0 $^\circ$ to +120 $^\circ$ F, $\pm 2^\circ$ F (typ. INDOOR); -40 $^\circ$ to +120 $^\circ$ F (typ. OUTDOOR). **Barometric Pressure:** 28-31 inches of mercury within 0.5 inches, accurate up to altitudes of 10,000 ft. **Operating Temperature:** Receiver: 32 $^\circ$ to 100 $^\circ$ F. Transmitter: -40 $^\circ$ to +120 $^\circ$ F.

Monitor five local weather functions

Keep track of the weather in style with our Five-Function Weather Station. Temperatures are displayed in Fahrenheit or Celsius with a switch to select indoor or outdoor readings. High quality sensors monitor barometric pressure, wind speed and direction. The station operates with minimum power consumption, and its corrosion-resisting remote boom assembly ensures years of troublefree service. Wall-mounted, set dimensions are 20 $\frac{1}{2}$ " L x 7" W x 2" D; desk-mounted, with included



Monitor air moisture for comfort and savings

Now you can reduce heating and cooling costs with our Relative Humidity Instrument. It helps you determine when to turn on the humidifier indoors or to paint outdoors. You get accurate readings even in remote locations with the electronic sensors and 100' transmission cable. Bright $\frac{1}{2}$ " digits display the humidity in percent for easy readability. Choose alternate indoor/outdoor readings or display one reading constantly. Dimensions are 2 $\frac{1}{2}$ " H x 7" W x 5" D.

Kit ID-2295 (6 lbs.) *Last Call!* **\$119.95**

Specifications: **Measurement Range:** 10%-90% relative humidity. **Accuracy:** 25 $^\circ$ C, ± 10 counts; 0 $^\circ$ -55 $^\circ$ C, ± 20 counts. **Operating Temperature Range:** 0 $^\circ$ -55 $^\circ$ C (32 $^\circ$ -131 $^\circ$ F). **Power Requirements:** 120/240 VAC, 50/60 Hz.

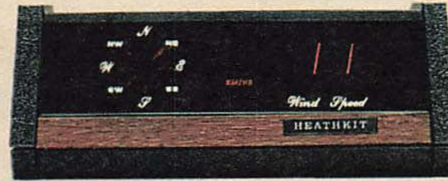

Digital indicator measures winds

The Heathkit Digital Wind Speed/Direction Indicator combines a corrosion-resisting anemometer and a weather vane for truly accurate readings. The attractive indoor console display features 16-point resolution for easy viewing. You can wire the indicator to read in two of three scales: mph, km/h or knots. Plus you can calibrate for either true north or magnetic north. Requires one of the 8-wire cables sold above. 2 $\frac{1}{2}$ " H x 7" W x 5" D.

Kit ID-1590 (7 lbs.) *Last Call!* **\$119.95**

Specifications: **Wind Speed:** 0-99 mph, ± 1 digit or $\pm 10\%$. **Wind Direction:** 8-point readout over 360 $^\circ$ with 16 points of resolution. **Wind Speed Sensitivity:** 3 mph, 4 km/h, or 2 knots. **Operating Temperature:** Receiver: 0 $^\circ$ to 150 $^\circ$ F. Transmitter: -40 $^\circ$ to 150 $^\circ$ F. **Power Requirements:** 108-132 VAC, 50/60 Hz.



Digital thermometer is easy to read

Accurate temperature readings are also convenient with our Digital Indoor/Outdoor Thermometer. Large, orange display digits can be clearly seen at any time of day or night, plus two sensors allow for continuous or alternating indoor/outdoor readings. The 2 $\frac{1}{2}$ " digit display even shows above- and below-zero temperatures in Fahrenheit or Celsius. Operates on 120 VAC, 60 Hz (Order ID-1390-BE for 240 VAC, 50/60 Hz operation.) Dimensions are 2 $\frac{1}{2}$ " H x 7" W x 5" D.

Kit ID-1390-B (4 lbs.) *Last Call!* **\$99.95**

Specifications: **Temperature Range:** -40 $^\circ$ to +120 $^\circ$ F, -40 $^\circ$ to +50 $^\circ$ C. **Accuracy:** $\pm 1^\circ$ C from -15 $^\circ$ C to +50 $^\circ$ C, $\pm 2^\circ$ C from -40 $^\circ$ C to -15 $^\circ$ C; $\pm 1^\circ$ F from +20 $^\circ$ F to +120 $^\circ$ F, $\pm 2^\circ$ F from -40 $^\circ$ F to 20 $^\circ$ F.

Home video education

Learn electronics the easy way. These exciting, new full-color videos supplement our Basic Electronics Series courses on pages 36 and 37. We've used animation to explain key concepts and included self review questions throughout the tapes. Each VHS video lasts approximately one hour and comes with an activity-filled student workbook plus an explanation of the answer for every problem.

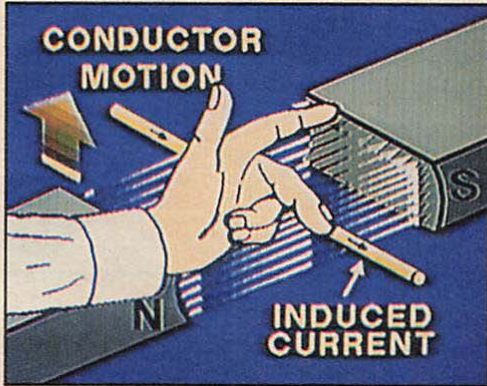

DC electronics

This first video in the series begins with an explanation of electron movement and carries you through the actual troubleshooting and repair of a simple electronic circuit. You're introduced to DC current and voltage, resistance, inductance, capacitance, Ohm's law, magnetism and DC electrical measurement. You'll compute current, voltage and resistive values and learn how inductors and capacitors are made and used. You'll even learn the correct use of ammeters, voltmeters and ohmmeters.

EV-3101-A (2 lbs.) \$39.95

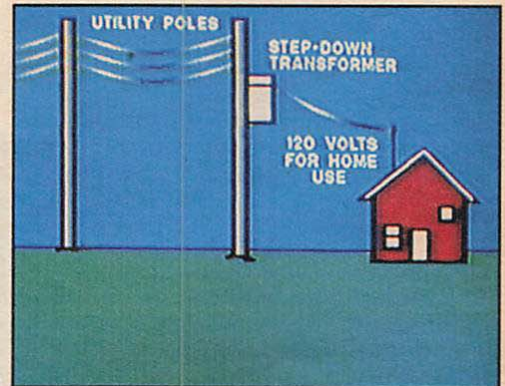

AC electronics

The AC Electronics video explains the principles of AC current and voltage, and AC electrical measurement. You're introduced to the AC applications of capacitance, inductance and transformers. Other topics shown include sinusoidal and non-sinusoidal waveform generation, waveform analysis, motors, generators and various test instrument meter movements. To fully benefit from this video presentation, you should first complete the EV-3101-A video or be familiar with the principles of DC electronics.

EV-3102-A (2 lbs.) \$39.95

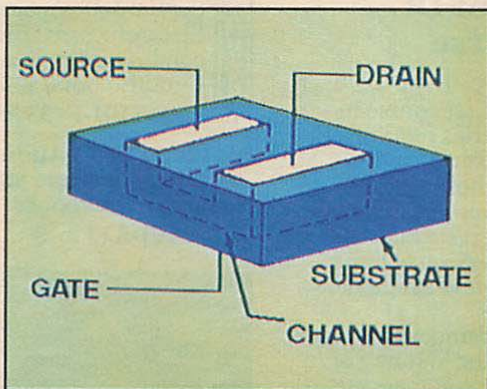

Semi-conductors

The Semiconductors video explains semiconductor fundamentals, plus the principles of discrete devices, integrated circuits and optoelectronic devices. You'll learn how semiconductor devices are made, what a PN junction is and its role in electronic theory. Principles of diode, bi-polar, unijunction and various optical devices are also explained.

To fully benefit from this video presentation, you should first complete the EV-3101-A and EV-3102-A videos or have equivalent experience.

EV-3103-A (2 lbs.) \$39.95

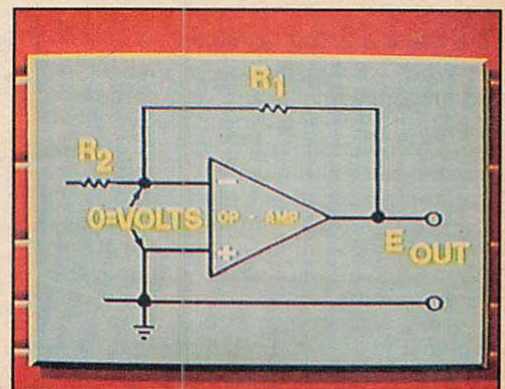

Electronic circuits

In this fourth video in the series, you'll learn about amplifier configurations, biasing, coupling, audio amplifiers, video and operational amplifiers, and closed-loop vs. open-loop operation. You'll also learn about differential amplifiers, rectifier circuits, voltage regulation, oscillator fundamentals, and more.

To fully benefit from this video presentation, you should first complete the EV-3101-A, EV-3102-A and EV-3103-A videos or have equivalent experience.

EV-3104-A (2 lbs.) \$39.95

Begin your success story today

Prepare for job advancement or simply learn about electronics for your own enjoyment with Heathkit Educational Systems individual learning programs. Our award-winning courses are designed so you can gain the skills you want and need at a pace that works for you, without the pressure of scheduled exams and projects.

Deadlines are yours alone

The only deadlines you'll have to worry about are those you set for yourself. Whether you want to learn electronics for fun and personal enrichment or for job training or retraining, you'll find the self-paced system one you can tailor to your own needs. Do your learning in the evening when you're comfortably settled in at home, or pick up your text and take it with you when you travel. When you learn is up to you.

Time and cost effective

There's no need to pay for courses that don't interest you. We offer a topic-specific approach to learning that means *you* decide what you want to know – without the need to follow a lengthy curriculum. And learn as quickly or as slowly as you want. Our self-paced instructional programs are time-effective and cost-effective because *you're* in charge of your learning. You'll achieve the goals you set for yourself at your convenience...and at a cost that's hard to beat.

Complete testing service

When you finish a course, mail us the completed final exam. We'll grade it for you, and we'll send you a free certificate of completion for any score of 70% or better. You'll also receive valuable Continuing Education Units (CEUs), recognized by many employers and professional organizations as evidence of personal achievement and continued job related training.

And, we keep your records on permanent file so you can request a transcript of your CEUs at any time.

Money-back guarantee

If you're not 100% satisfied with any course you order, we'll be happy to send you another in its place. Or, if you prefer, we'll refund the complete purchase price when you return the course to us along with your original receipt.

Heathkit Educational Systems is licensed by the state of Michigan and accredited by the National Home Study Council.

Basic electronics

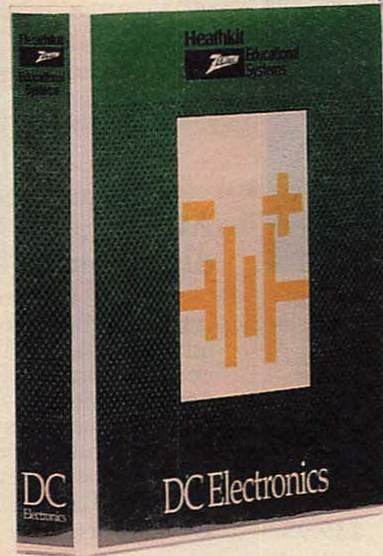
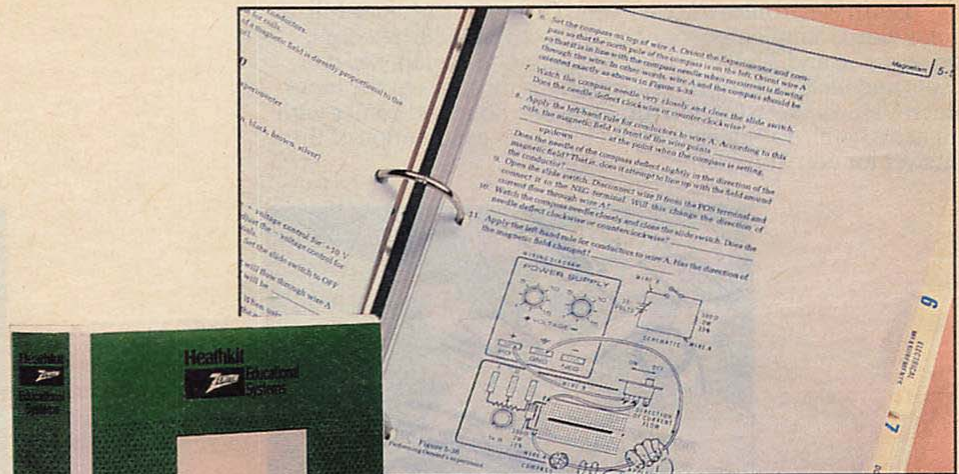

Fundamentals of DC electronics course

• Earn 2.0 CEUs

Newly revised, this first course in our Basic Electronics Series requires no previous electronics background. DC Electronics teaches you how to define and solve basic electronics problems related to current, voltage, resistance and power. An entire chapter covers Ohm's law, the most important and fundamental concept in electronics.

After gaining a solid understanding of the basic material in the first half of the course, you'll learn about magnetism, electrical measurement, DC circuits and fundamental network theorems, inductance and capacitance. You'll also learn about the construction, operation and purpose of electronic devices such as resistors, relays, motors and generators.

This course teaches you basic safety procedures designed to protect you and your test equipment, and how to build and experiment with basic DC circuits that you design yourself.

Twenty-one hands-on experiments give you practical experience constructing DC circuits, drawing schematic diagrams and measuring current, voltage and resistance.

You'll need the ET-3600 Analog Trainer on page 38, and a multimeter to perform the experiments.

EE-3101-B (7 lbs.) \$39.95

SAVE Save \$30.00! Package includes the DC Electronics course and the ET-3600 Analog Trainer on page 38.
EES-3101-E (13 lbs.) . . . \$129.90

SAVE Save \$50.00! Package includes the ET-3600 Analog Trainer, DC Electronics, AC Electronics, Semiconductor Devices and Electronic Circuits courses.
EES-3101-F (33 lbs.) . . . \$279.75

DC Electronics Audiovisual Package contains two lecture audio tapes and illustrated workbook.

EEA-3101-A (2 lbs.) \$19.95

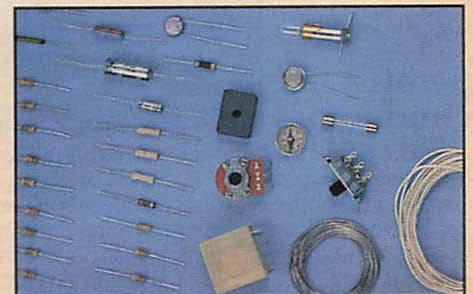

Complete parts pack includes everything for performing course experiments.

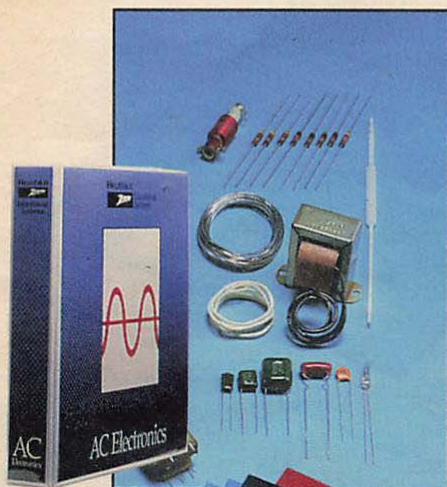

Fundamentals of AC electronics course

• Earn 1.5 CEUs

After completing DC Electronics, you're ready for the theory and application of alternating current. In this newly revised second course in the series, you'll learn the differences between AC and DC and between reference ground and earth ground. You'll understand capacitance, inductance, impedance and how their related devices are formed.

Ten course experiments range from measuring AC voltages to designing a resistive load. You'll analyze both AC sine waves and a variety of AC circuits, determine transformer turns ratios and perform important calculations involving impedance, current, voltage and power ratios. When you've completed the course, you'll know how to convert to power from quantities such as horsepower, watts and current. For the course experiments you'll need the ET-3600 Analog Trainer (sold on page 38), a multimeter and an oscilloscope.

This informative course comes with complete parts package.

EE-3102-B (7 lbs.) \$39.95

AC Electronics Audiovisual Package contains two lecture audio tapes and illustrated workbook.

EAA-3102-A (2 lbs.) \$19.95

ORDER TOLL-FREE ANYTIME

800-253-0570

FAX: 616-982-5577

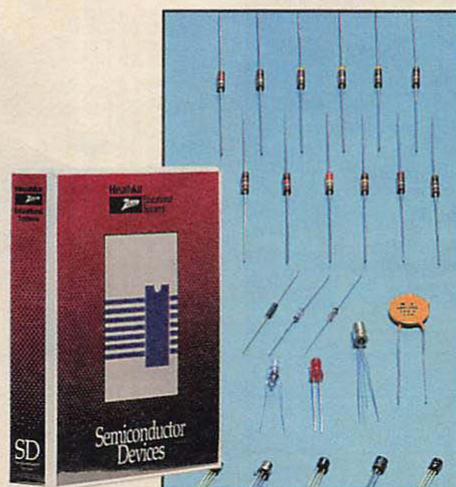

Semiconductor devices course

• Earn 3.0 CEUs

Build your knowledge of semiconductor technology with this important course in our Basic Electronics Series. Both theory and practice are integral parts of this recently revised course.

As part of the hands-on learning, Semiconductor Devices teaches how to handle semiconductor components properly and how to test semiconductor devices. You'll analyze DC circuits and use semiconductors in practical circuits. In addition, you'll familiarize yourself with semiconductor schematic symbols and packages, devices and transistors. Plus, in twelve course experiments you'll work with linear and digital components, semiconductor construction and semiconductor device operation, and observe firsthand the characteristics of a variety of amplifiers.

The course comes in a heavy three ring binder and includes final examination and experiment parts package. Resistors, capacitors, diodes, transistors, an LED, a lamp and an IC are included in the parts package.

Before taking Semiconductor Devices you should complete DC Electronics and AC Electronics, or have equivalent knowledge. A multimeter and the ET-3600 Analog Trainer (shown on page 38) are necessary for performing the course experiments.

EE-3103-B (6 lbs.) \$59.95

Semiconductor Devices Audiovisual Package contains two lecture audio tapes and illustrated workbook.

EAA-3103-A (2 lbs.) \$19.95



Electronic circuits course

• Earn 4.0 CEUs

Also recently revised, the fourth course in the series will give you new insights into the electronic products you use every day. In seven units, Electronic Circuits covers concepts such as bias, oscillation, amplitude and frequency modulation and their relation to amplifiers, comparators, active filters and pulse shapers.

Fascinating hands-on experiments give you the chance to analyze simple electronic circuits. From there, you'll move into circuit construction as you build transistor and integrated circuit amplifiers, oscillators, active filters and more. Nineteen exciting experiments in all. To analyze circuit operation, you'll need a multimeter and an oscilloscope. Course experiments use the ET-3600 Analog Trainer (sold on page 38).

Included with the self-instruction text is a complete parts package with over 100 parts. It contains resistors, controls, capacitors, inductors, diodes, transistors, ICs, an audio transformer, a stabistor, a speaker, a lamp, a crystal and an alignment tool. Everything you need to complete the experiments.

Optional audio tapes along with a carefully illustrated workbook add to your learning.

EE-3104-B (7 lbs.) \$69.95

Electronic Circuits Audiovisual Package contains two lecture audio tapes and an illustrated workbook.

EAA-3104-A (2 lbs.) \$19.95

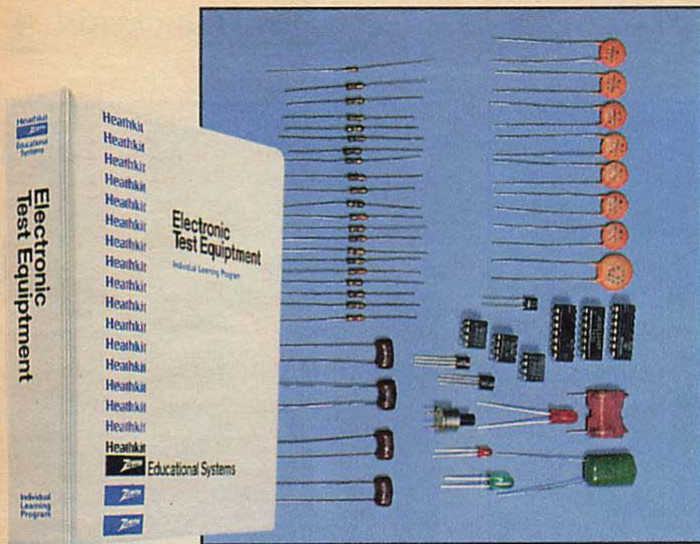

Electronic test equipment course

• Earn 6.0 CEUs

Electronic Test Equipment is designed for the person who wants to become proficient with bench and field equipment. It teaches you to take measurements using digital and analog meters, voltmeters, ammeters, ohmmeters and oscilloscopes.

Beyond the basics, you'll study in depth the oscilloscope, oscilloscope circuits, the cathode ray tube and concepts such as sensitivity, delayed sweep and dual trace. You'll also gain a solid understanding of the curve tracer, basic spectrum analyzer, logic tester, digital logic probe, transistor tester, audio generator, RF generator and function generator.

We teach you to recognize sources of error in electronic counter readings, increase the frequency range of electronic counters and design and construct RF impedance matching pads. You'll also check the output frequency and amplitude calibration of a signal generator and the bandwidth, vertical gain and time base calibration of your oscilloscope.

To perform the 15 exciting experiments, you'll need a digital multimeter, an analog meter, oscilloscope, frequency generator and frequency counter. This course also uses the ET-3600 Analog Trainer (shown at right).

We recommend completion of our Basic Electronics Series courses (on pages 36 and 37), plus EE-3201-A Digital Techniques (page 44) – or equivalent knowledge – before taking Electronic Test Equipment.

This comprehensive study in test instruments comes with a complete parts package containing resistors, capacitors, diodes and other components required for the experiments.

EE-3105-A (9 lbs.) \$69.95

Electronic Test Equipment Audiovisual Package contains two lecture audio tapes and an illustrated workbook.

EEA-3105-A (2 lbs.) \$19.95

Our customers write...

The course materials are excellent – among the best I have ever seen as a veteran of many correspondence courses."

Frank S. Stanich
Iron River, Michigan



ET-3600
Analog Trainer

Shown with
optional Backpack
and Breadboard
Experiment Module



Analog trainer

The powerful and versatile ET-3600 enables you to learn by working with real electronic circuits. Use it with the experiments in our Basic Electronics Series courses (on pages 36 and 37). This trainer features a removable solderless breadboard that accepts up to #20 solid wire and the leads of almost any standard electronic component for easy circuit building. The ET-3600 includes variable, regulated positive and negative 15 VDC power supplies with short-circuit and overload protection, 15 and 30 VAC sources, and a 200 Hz to 20 kHz frequency generator with sine wave and square wave outputs. Operates on 120/220 VAC, 50/60 Hz. Dimensions are 4¼" H x 12" W x 11⅞" D.

Kit ET-3600 (6 lbs.) \$119.95

Assembled ETW-3600 (6 lbs.) \$199.95

Accessory:

Extra Breadboard Block (not shown)

Assembled ETA-3600-1 (1 lb.) \$19.95

Save \$50.00 on this trainer package. Includes the ET-3600 Analog Trainer (above), the ET-3567 Accessory Backpack, and the ETB-3300 Breadboard Experiment Module (both on page 56).

ETS-3600 (14 lbs.) \$289.95

new Display your diploma with this attractive frame

Now you can proudly display your hard-earned diploma in this new, high-quality frame. The frame is made of heavy simulated walnut board with a clear plastic covering to keep your diploma dust-free. An attractive addition to any room in your home. Holds an 8½" x 11" certificate and hangs vertically or horizontally.

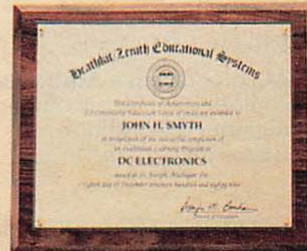

EPP-1 (3 lbs.) \$13.95

Advanced electronics

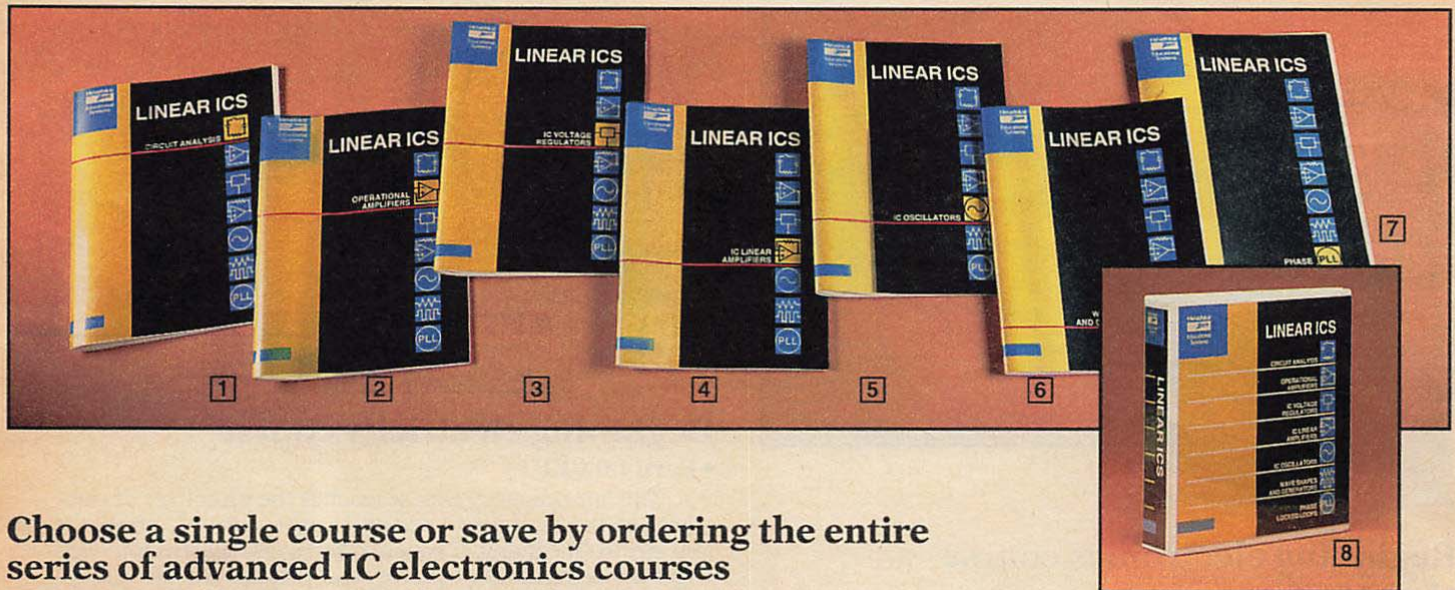

Choose a single course or save by ordering the entire series of advanced IC electronics courses

This series of electronics courses lets you study in depth the areas that interest you. Whether you're a hobbyist or a professional, you can choose a single course or take the whole series for a thorough grounding in advanced electronics.

Each course includes an activity guide and frequent self-test questions that reinforce the text material. Answers are provided. You'll also find exercises and experiments that give you practice with the circuits you're studying, and a final examination that tests your overall learning. A complete parts package comes with each course.

To get the most from these courses, you should complete the Basic Electronics Series (see pages 36 and 37) or have equivalent knowledge. You'll need a VOM, an oscilloscope and the ET-3600 Analog Trainer (page 38) to perform the course experiments.

Fundamentals of Circuit Analysis

Learn the concepts of input and output impedance, voltage sources, current sources, and gain. Review analysis techniques of Thevenin and Norton equivalent circuits. The Z parameter analysis technique for amplifier circuit analysis is also included.

1 EE-115-1 (1 lb.) \$14.95

Operational Amplifiers

The operational amplifier is one of the most versatile integrated circuits ever created. You'll learn the fundamental properties and features of an operational amplifier, the circuit diagram, the physical packaging and connections.

2 EE-115-2 (1 lb.) \$14.95

IC Voltage Regulators

Observe closely the IC chip that can take the place of several discrete components. You'll learn about the operation of components in an unregulated power supply, the causes of load voltage variations in an unregulated supply and the methods of power supply regulation.

3 EE-115-3 (1 lb.) \$14.95

IC Linear Amplifiers

Learn how linear amplifiers work and how to use them. Take an in-depth look at various amplifier configurations. Areas covered include basic amplifiers, low frequency, high frequency, wideband and special amplifier circuits.

4 EE-115-4 (1 lb.) \$14.95

IC Oscillators

This course takes you inside IC oscillators and shows you how to work with them. You'll learn basic oscillator theory plus various methods of oscillation. And you'll study LC, RC, voltage controlled and crystal oscillators in detail.

5 EE-115-5 (1 lb.) \$14.95

Wave Shapes and Generators

Get a thorough understanding of these circuits that can enhance or change the shape of existing waves. You'll learn about signal generators, basic filter circuits, differentiators, integrators, logarithmic and exponential amplifiers.

6 EE-115-6 (1 lb.) \$14.95

Phase Locked Loops

This specialized chip is now widely used to sense differences or changes in some parameters and provide a means of correcting the change. You'll learn about the components and basic operation of a phase-locked loop. You'll also learn about the operation of digital and analog phase detectors and the VCO in a phase locked loop.

7 EE-115-7 (1 lb.) \$14.95

Series Binder

Keeps your courses neat and accessible.

8 EE-115-8 (3 lbs.) \$9.95

SAVE Save almost \$25.00 on the complete IC Electronics Series. Includes each of the seven courses described above plus the series binder.

EES-115 (10 lbs.) \$89.95

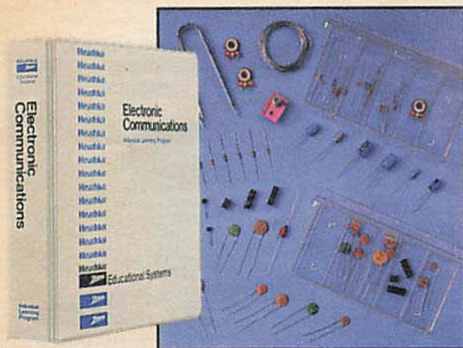

Electronic communications course

• Earn 2.0 CEUs

This course gives you a detailed look into the principles of electronic communications. It explores with you the technologies of transmitters and antennas, frequency and time division multiplexing, transmission lines, electromagnetic radiation and propagation.

In study material and hands-on experiments, the comprehensive text covers topics including amplitude, angle and pulse modulation. You'll actually build an AM transmitter, a balanced modulator, an AM detector, an FM transmitter and an FM receiver.

To perform the seven course experiments you'll need the ET-3600 Analog Trainer described on page 38, a multimeter and an oscilloscope. We recommend that you complete our Basic Electronics Series courses (pages 36, 37) or have equivalent knowledge before taking Electronic Communications.

To reinforce your learning, our Electronic Communications Audiovisual Package contains lecture tapes and an illustrated workbook you can refer to as you listen to the tapes.

EE-3106-A (7 lbs.) \$64.95

Electronic Communications Audiovisual Package

EEA-3106-A (2 lbs.) \$19.95

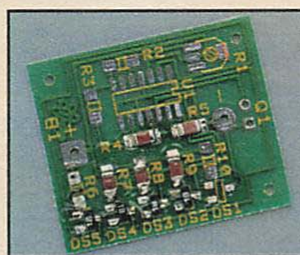
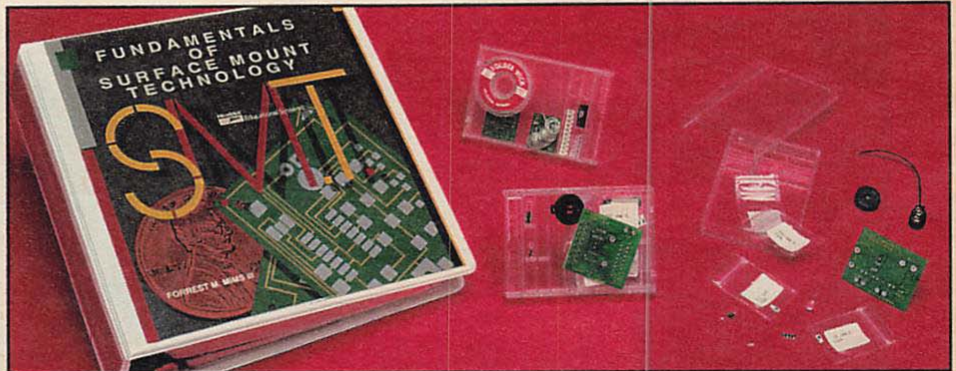

Practice board

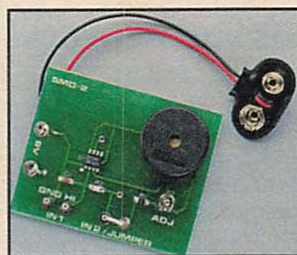

Audio oscillator circuit

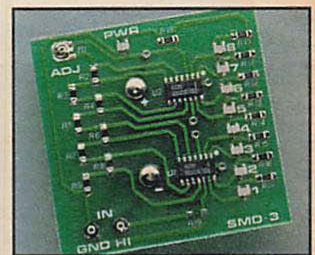

LED bar graph

Surface mount technology course teaches the fundamentals of miniaturized electronics

• Earn 3.0 CEUs

This heavily hands-on course familiarizes you with every aspect of surface mount technology (SMT). When you complete the course, you'll understand the basics of planning, designing, assembling and soldering surface mount boards. You'll be able to desolder and replace surface mount components. And you'll have practical hands-on experience in assembling working surface mount circuits.

The projects, pictured above, give you the chance to work with surface mount resistors, capacitors, light-emitting diodes and integrated circuits. These projects require only a low wattage soldering iron.

In the first, you'll practice several

methods of soldering and desoldering surface mount components (SMCs) to a practice printed circuit board. Next, you'll assemble an audio frequency oscillator from SMCs and experiment with it. And finally, you'll build a somewhat more complex circuit, an 8-element LED bar graph.

Study units include a discussion of the advantages and disadvantages of SMT, the different kinds of surface mount components, the planning and design of circuit boards, and soldering techniques – both hand and automated.

This excellent introduction to the world of surface mount technology requires only a basic knowledge of electronics principles.

EI-3135 (5 lbs.) \$99.95

Our customers write...

I have built Heathkits since I was 8, when my father introduced kit building to me by giving me my first kit – a photoelectric switch. Building Heathkits led me to my career path in electronics. ...I still enjoy building Heathkits. Nothing is so absorbing, so satisfying.”

Kevin Rose
Maryland Heights, Missouri

ORDER TOLL-FREE ANYTIME

800-253-0570

FAX: 616-982-5577

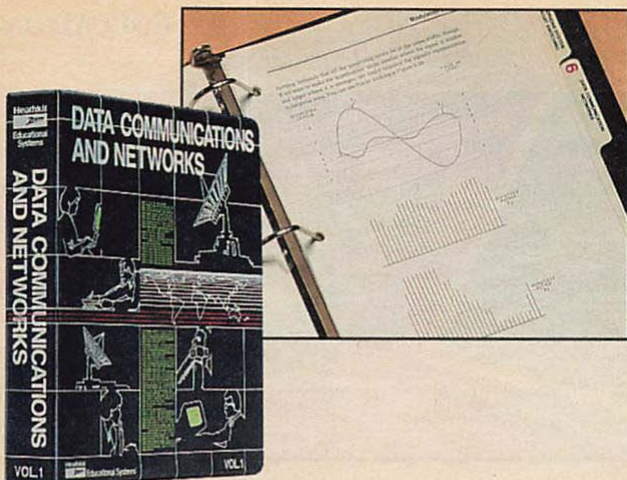

Data communications and networks course • Earn 7.0 CEUs

This course gives you an understanding of the concepts, terminology, equipment and techniques that make up today's data communications systems. Centered on computer communications, Data Communications and Networks highlights digital and analog signaling techniques, terminals and codes, modulation and multiplexing, and transmission media telephone networks. It also provides you with an overview of current digital data networks, communication protocols and phone circuits, as well as communication channels for both analog and digital transmissions.

You'll see how data networks are used by the consumer. You'll also study transmission errors and how they're corrected. Because security is an important concern, we give you the chance to analyze the major security issues involved, and we describe how these systems can be protected from unauthorized access.

To get the most from the course you should first complete EE-3101-B DC Electronics, EE-3102-B AC Electronics (pages 36 and 37) and EE-3201-A Digital Techniques (page 44) or have equivalent knowledge. You'll use the ET-1000 Circuit Design Trainer (right), a multimeter and a dual trace oscilloscope to perform the 11 experiments.

EE-8090 (11 lbs.) \$99.95

SAVE \$50.00 Save \$50.00 on this digital technology package. Includes the course EE-8090 Data Communications and Networks and the ET-1000 Circuit Design Trainer, shown at right.

EES-8090 (25 lbs.) \$269.90

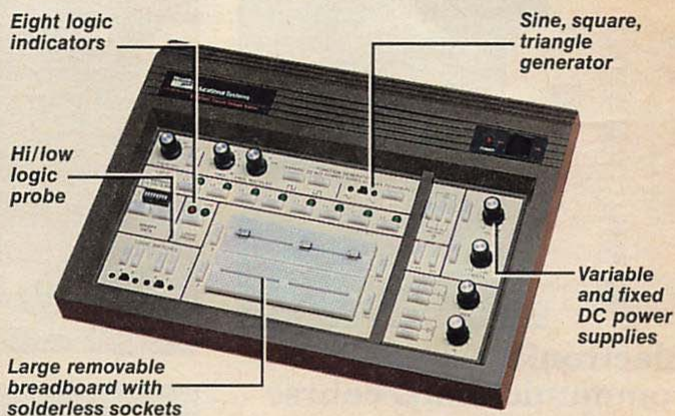

Analog/digital circuit design trainer

Our solderless double breadboard trainer is a regular minilab for learning the basic techniques of circuit design. With it you'll get practical hands-on experience designing, building and testing prototype circuits. You can use the ET-1000 to perform experiments in passive, transistor, analog and digital circuit design. And after designing and building your own circuits, you can use it to troubleshoot your designs.

The ET-1000 features double breadboards with solderless sockets for quick, easy circuit assembly and testing, and connector blocks that allow solderless connections between parts and wires. It also has variable and regulated positive and negative DC power supplies. And it includes a built-in function generator for producing sine, square, triangle and pulse waveforms from 1 Hz to 100 kHz in five switch-selectable ranges. A logic probe detects and indicates low and high logic levels.

Other features include two "no-bounce" logic switches, variable 1K and 100K ohm resistors, eight switches for selecting logic lows or highs, and eight LED logic-state indicators.

Listed by Underwriters' Laboratory (UL) and Canadian Standards Association (CSA). Uses 105-130 volts or 210-260 volts RMS at 50/60 Hz. 4 3/4" H x 5 3/4" W x 10 3/4" D.

Kit ET-1000 (14 lbs.) \$219.95

Assembled ETW-1000 (13 lbs.) \$299.95

Accessory:

Extra Removable Breadboard ET-1000-1 (1 lb.) ... \$29.95

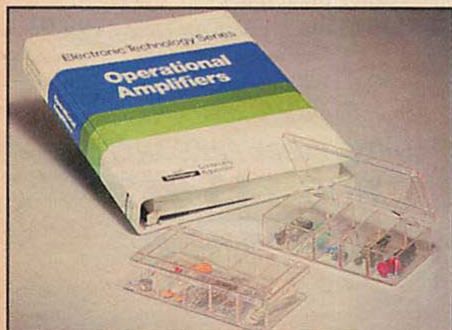

Operational amplifiers course • Earn 3.0 CEUs

This detailed course investigates op-amp parameters, basic op-amp linear circuits, integrator and differentiator circuits and more. You'll learn about current/voltage and voltage/current converters, generators, active filters and bipolar FET op-amps, plus single supply operation and nonlinear signal processing circuits.

The course is laid out in a text-workbook format and includes 36

experiments to help you apply what you learn.

Use with the ET-3600 Analog Trainer (page 38), the ET-3567 Accessory Backpack and ETB-3300 Experiment Module (both on page 56), an oscilloscope, multimeter and frequency generator. A background in basic electronics is recommended before taking this course.

EE-101 (5 lbs.) \$49.95



Fiber optics course

• Earn 3.0 CEUs

Our five-unit course in fiber optics gives a thorough understanding of this important technology. Study begins with the nature of light and principles of light as a transmission medium. You'll go on to study the active devices used to generate, detect and process optically transmitted data.

You'll learn about laser emissions and principles associated with the injection laser diode used in fiber optic circuits. When you've completed the course, you'll be thoroughly familiar with the electromagnetic spectrum. You'll understand fiber optic interconnection devices and be able to compare

them in cost and performance.

Hands-on experiments include constructing a modulated source driver circuit, a fiber optics receiver circuit and an actual operational fiber optic link. Use the ET-3700 Digital Trainer (page 44), an oscilloscope, a multimeter and common hand tools with the experiments.

We recommend you complete EE-3101-B DC Electronics (page 36) and EE-3102-B AC Electronics (page 37) or have equivalent knowledge before taking Fiber Optics. A complete parts package is included with the course.

EE-4201 (6 lbs.) \$99.95

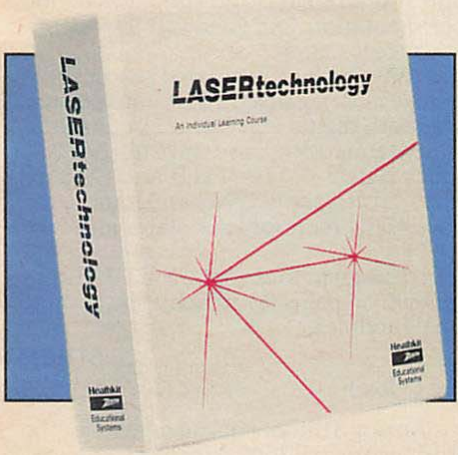

Laser technology course

• Earn 3.0 CEUs

We've designed this course to give students a thorough understanding of laser basics, plus an opportunity to practice the technology. Laser Technology covers such topics as how laser light is generated and how it can be modulated, which characteristics it has in common with ordinary light and how each component contributes to the overall operation of the laser. You'll learn the effects and potential hazards of laser light and study the effects of infrared radiation.

Fifteen course experiments cover such topics as transmitting and

reproducing sound over a laser beam and measuring radiometric light. You'll experiment with irradiance, diffraction and interference, beam diameter, critical angle and focal length, and with Fresnel Reflection, polarization, and light and data transmission. Course experiments are performed with the ETS-4200 Laser Training System, described below.

Basic electronics and algebra are recommended prerequisites for Laser Technology.

EE-110 (7 lbs.) \$99.95

Laser training system

Discover the fun of owning a professional grade laser you can build yourself. Learn about the technology with the Laser Technology course (above), then create your own hi-tech experiments and explore exciting practical applications.

The trainer features a helium neon (HeNe) gas laser that generates an intense, easy-to-see red light with a 632.8 nm wavelength and output power of 0.4-0.9 mW. Beam diameter is 1/e² 0.49mm with divergence of 1.64 mrad and random polarization. You can modulate the beam up to 10% for voice experiments.

The system includes a receiver/monitor for receiving the beam and measuring the relative signal power, and a built-in detector, audio amplifier and speaker. A tripod mount and signal input jacks to use with an external source are also included. UL and CSA listed, requires 120 VAC, 60 Hz 15 watts power.

Kit ETS-4200 (12 lbs.) \$279.95
 Assembled EWS-4200-A (5 lbs.) \$395.00

SAVER Save \$30.00 on this laser training package. Includes the ETS-4200 Laser Training System and the course EE-110 Laser Technology, described above.
 EES-110 (19 lbs.) \$349.90

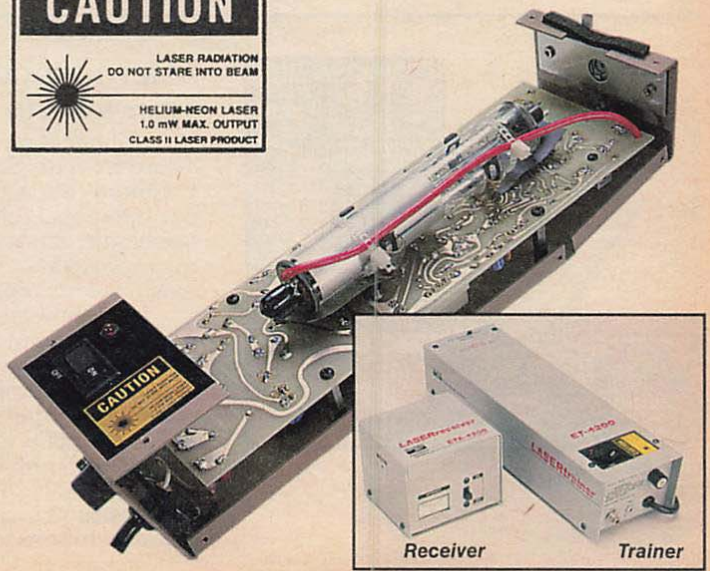

Digital processing

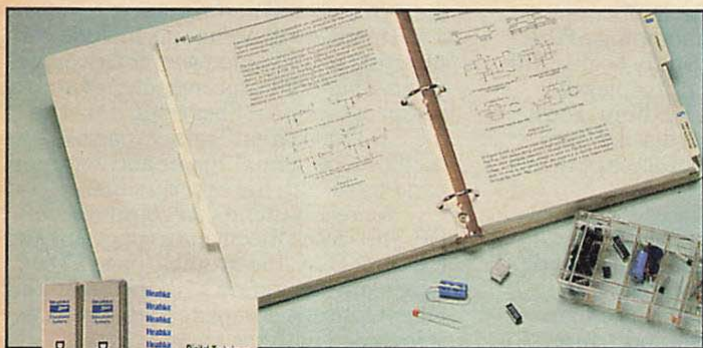

Digital techniques course

• Earn 4.0 CEUs

Learn the fundamentals and theory of digital logic, including number systems, the design and application of modern digital circuitry and the skills necessary for designing combinational and sequential logic circuits. To perform the course experiments you'll need the ET-3700 Digital Trainer (right), a multimeter and an oscilloscope. Included are components for performing all experiments.

Our Basic Electronics Series on pages 36 and 37 will give you the necessary background to successfully complete the Digital Techniques course.

EE-3201-A (7 lbs.) \$99.95

SAVER Save \$50.00 on this digital package. Includes the course EE-3201-A Digital Techniques and the ET-3700 Digital Trainer, shown at right.

EES-3201-C (17 lbs.) \$169.90

Audiovisual Package includes two audio cassette tapes and illustrated workbook. **EEA-3201-A** (2 lbs.) \$19.95



A trainer for digital techniques

SKILL LEVEL 2 The versatile Digital Trainer speeds and simplifies digital circuit design and experimentation, and gives you the opportunity to practice what you're learning.

The trainer features three built-in, regulated power supplies which furnish positive and negative 12 VDC and positive 5 VDC voltages to power both digital and linear circuits. In addition, it supplies a line-frequency square wave (60 or 50 Hz); complementary clock signals of 1 Hz, 1 kHz and 100 kHz; logic and data switches to control input levels and four LED logic-state indicators to visually monitor logic states and transitions.

The Digital Trainer is designed to accept the ET-3567 Accessory Backpack (shown on page 56), which allows you to experiment with optional modules.

Kit ET-3700 (6 lbs.) \$119.95

Assembled ETW-3700 (6 lbs.) \$199.95

SAVER Save \$50.00 on this Analog Trainer package. Includes the ET-3700 Analog Trainer, the ET-3567 Accessory Backpack and the ETB-3300 Breadboard Experiment Module (both on page 56).

ETS-3700 (16 lbs.) \$289.95

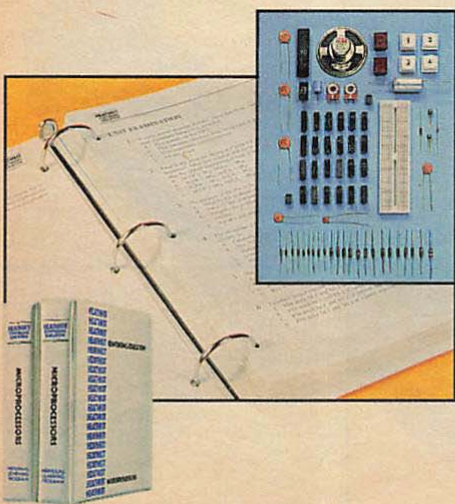

Microprocessors course

• Earn 8.0 CEUs

Winner of an international award from the Society for Technical Communication, this first course in our traditional microprocessing series teaches the fundamentals of 8-bit microprocessors, microcomputers and machine level programming.

Microprocessors begins with a review of computer number systems and codes, and continues with terms and conventions, programming instructions, writing and executing programs, and computer arithmetic. Your study will include valuable details about the 6800/6808 microprocessors, architecture, instruction sets, addressing modes, stack operations and much more.

The course includes an extensive number of programming and hardware interfacing experiments. You'll use the ET-3400 or the ET-3400-A Microprocessor Trainer shown on page 45, a multimeter and an oscilloscope to perform them.

We recommend EE-3201-A Digital Techniques (above) as a prerequisite to this beginning microprocessing course.

EE-3401-A (10 lbs.) \$99.95

SAVER Save \$60.00 on this microprocessing package. Includes the course EE-3401-A Microprocessors and the ET-3400-A Microprocessor Trainer. **EES-3401-A** (17 lbs.) ... \$299.90

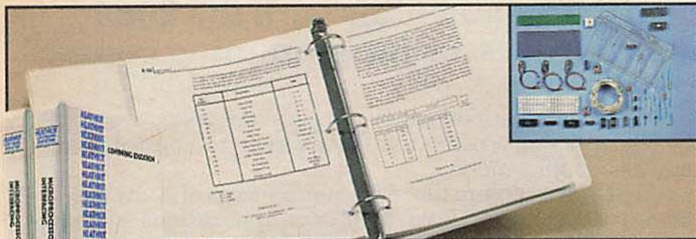

Microprocessor interfacing course

• Earn 7.0 CEUs

Once you've learned microprocessor fundamentals, you're ready to move on to interfacing techniques and advanced microprocessors.

Our Microprocessor Interfacing covers the 6800 family, including the powerful 6809, and continues to the 68000 processor. Eleven units explore such topics as advanced peripheral interfacing (PIA), analog conversion, serial data communications, memory devices and programmable timers.

Ten course experiments give you hands-on experience with display multiplexing, I/O control and handshaking using the PIA, analog-to-digital conversion and interfacing. Other experiments give you the chance to perform parallel-to-parallel conversion using the 6850 asynchronous communications interface adaptor (ACIA), serial standard conversion, 2716 EPROM programming and ROM/EPROM interfacing. And you'll have actual experience with 6840 programmable timer module (PTM) input and output, as well as 6809 software operation. To complete the experiments, you'll need the ET-3400 or ET-3400-A Microprocessor Trainer, shown below, a multi-meter and an oscilloscope.

We recommend that you complete EE-3401-A Microprocessors, page 44, before beginning Microprocessor Interfacing, or have equivalent knowledge.

EE-3402 (11 lbs.) \$99.95

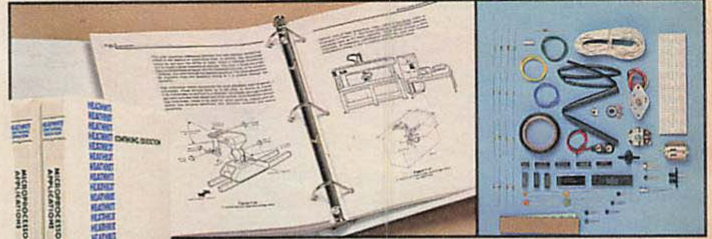

Microprocessor applications course

• Earn 8.0 CEUs

Microprocessor Applications is designed to give advanced students an understanding of how a digital microprocessor can control events in an analog world. The course covers microprocessor applications in the consumer market and in business and industry, plus it looks into changes the future may bring in microprocessor applications.

Study includes microprocessor sensors and transducers, temperature, light, position, motion, force, pressure and flow. The course also covers microprocessor control of devices and circuits, digital-to-analog conversion techniques and analog signal conditioning.

The 13 hands-on experiments let you construct a microprocessor-controlled digital multimeter and a thermometer, plus a microprocessor/stepper motor interface with a control circuit, and a programmable digital frequency synthesizer. You'll need the ET-3400 or ET-3400-A Microprocessor Trainer, below, a VOM and an oscilloscope to perform the experiments.

Before you begin Microprocessor Applications, we recommend that you complete the courses Microprocessors (page 44) and Microprocessor Interfacing (at left) or have equivalent knowledge.

EE-3405 (10 lbs.) \$99.95

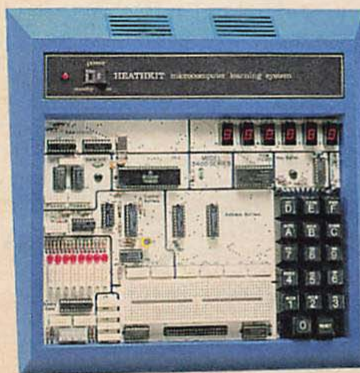

8-bit microprocessor trainer

SKILL LEVEL 3 Our versatile, low cost Microprocessor Trainer is designed to give you hands-on experience with microprocessor operation, programming and applications. This flexible, general-purpose training unit and microprocessor breadboard can also be used as a miniature digital computer for experiments in our microprocessor course series.

Built around the popular 6808 microprocessor unit, the Microprocessor Trainer includes 512K user-accessible RAM and a 1K monitor ROM. The large, solderless breadboard gives you the opportunity to build prototype logic circuitry, and the 17-key hexadecimal-based keypad and six 7-segment LED display digits make entering and troubleshooting experimental programs easy.

Built-in +5 VDC at 1.5 amps and ±12 VDC at 50 mA power supplies furnish power to the internal circuitry and breadboard area with sufficient reserve to power related course experiments. Requires 120 VAC, 50/60 Hz at 30 watts maximum power. 3½" H x 12½" W x 11¾" D.

Kit ET-3400-A (7 lbs.) \$259.95

Assembled ETW-3400-A (6 lbs.) \$399.95



TECHNICAL CONSULTATION
When you have a question about the kit you're building or about an assembled product, our expert technical consultants are only a phone call away. Their numbers are listed on page 51.

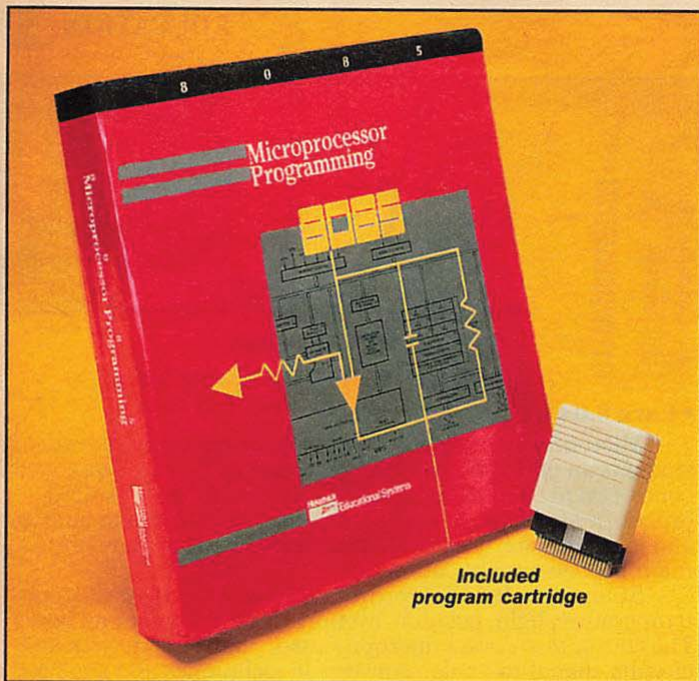

Learn fundamentals with the 8085 microprocessor programming course

• Earn 4.0 CEUs

This new Heathkit course gives you the chance to master the 8085 microprocessor, used today in many consumer and industrial applications.

In it you'll explore the main components of a microprocessor system and learn their uses, applications and functions. You'll learn to write, edit and debug programs in assembly language and to analyze programming problems and develop flowcharts to help solve them. Plus, you'll find out how to program a microprocessor-based system in both machine and assembly language. When you complete the course, you'll be ready to move on to 16-bit microprocessors.

The ETW-3800 Microprocessor Trainer with the ETC-8085 CPU Module (found in the EWS-8085 package on page 47) is necessary for performing the 19 exciting course experiments. All other materials are supplied in the experiments parts package.

We recommend you complete the Digital Techniques course (page 44) or have equivalent knowledge before taking 8085 Microprocessor Programming.

EE-8085 (7 lbs.) \$99.95

new Further your knowledge of the 8085 microprocessor

• Earn 8.0 CEUs

Learn more about microprocessor programming and interfacing with this challenging course. It furthers your knowledge by teaching state-of-the-art interfacing and applications concepts. You'll learn how to interface with memory for program storage and I/O devices for system communication. You'll also discover how to apply the microprocessor to real-world tasks by understanding analog/digital conversion, signal conditioning, sensors, motor speed measurement, control devices and more. With this knowledge, you'll discover endless ways to apply microprocessor technology.

In addition, the final chapter includes 18 exciting course experiments which will help you understand and learn the principles taught in the text. Plus, you're given the tools and encouraged to try some of your own original interfacing ideas. Experiments are designed to be performed on the ETW-3800 Microprocessor Trainer with the ETC-8085 CPU Module (found in the EWS-8085 package on page 47).

We recommend that you complete the EE-8085 Microprocessor Programming course (shown above) before taking 8085 Microprocessor Interfacing and Applications.

EI-8085 (7 lbs.) \$129.95

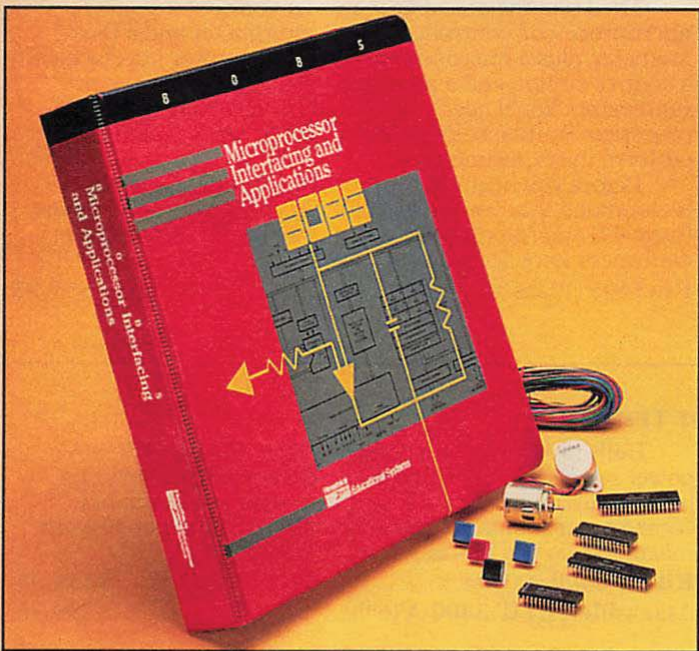

Our customers write...

I'd like to compliment you on your electronics educational courses which I've been buying lately. For years I've avoided them...and instead went about teaching myself via books from various places, etc. The result has been very spotty knowledge...mistakes on projects...and a lot of

frustration. So I finally broke down and spent the money on your microprocessor course. It was such an improvement, I'm now kicking myself for not having started out with your courses long ago; it would have saved a lot of time, trouble, and ironically money!"

Dennis Buswell
Jefferson City, Montana

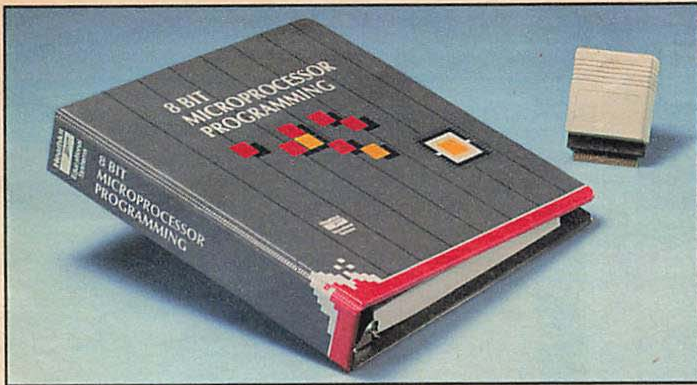

8-bit microprocessor programming course teaches fundamentals

• Earn 6.0 CEUs

Written expressly for the beginner in 8-bit microprocessor programming, this comprehensive course focuses on programming the MC6811 as representative of the Motorola 6800 family. Microcomputer basics and essential terminology begin the course. Hands-on experiments, including use of the Microprocessor Trainer shown below, give you valuable practice. Plus, with the included program cartridge you can load over a dozen lengthy experiment programs in only seconds. To get the most out of this course, you should first complete Digital Techniques (page 44) or have equivalent knowledge.

EE-3810 (3 lbs.) \$99.95

REVIEW Save over \$45.00 on this microprocessing package. Includes the EE-3810 8-Bit Microprocessor Programming course, the ETW-3800 Microprocessor Trainer and ETC-6811 CPU Module described below.

EES-3810 (11 lbs.) \$749.00

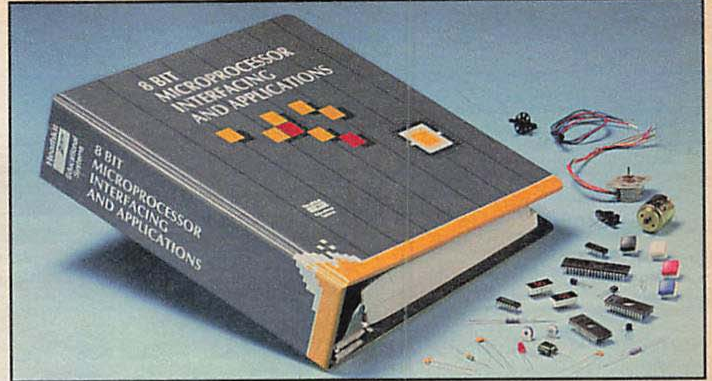

8-bit microprocessor interfacing and applications course

• Earn 8.0 CEUs

8-Bit Microprocessor Interfacing and Applications picks up where 8-Bit Microprocessor Programming leaves off. Like its companion course, this material reflects the latest in microprocessor technology.

The course includes chapters on serial and data communications, memory, temperature and optical sensing, control devices and circuits, and microprocessor applications.

Also included are 19 activity-packed experiments, plus the components necessary to perform them. You'll work step by step to the point where you can actually interface a microprocessor to the outside world.

We recommend you complete the Digital Techniques course (page 44) and 8-Bit Microprocessor Programming (at left) or have equivalent experience before taking this course. Use it with our Microprocessor Trainer and the ETC-6811 CPU Module described below.

EE-3820 (7 lbs.) \$99.95



Versatile 8-bit microprocessor trainer

You can use this rugged trainer with many of the latest 8-bit microprocessors, simply by switching plug-in modules. Plug in the ETC-6811 CPU Module and use it with the courses shown above. Or plug in the ETC-8085 CPU Module for use with the 8085 Microprocessor Programming course on page 46. Either way, this flexible trainer is the perfect tool for learning programming, interfacing and applications.

With recessed connector blocks, built-in short circuit protection and data-saving circuitry, the ETW-3800 is built to

withstand rigorous use. And, its fully integrated firmware leads you through the complexities of 8-bit technology in clear, understandable steps.

An RS-232 interface allows you to use the trainer with a terminal and even download HEX files from a computer. And a built-in sonic logic probe lets you check high, low or pulse signals, both visually and audibly.

The ETC-6811 CPU Module comes with 26K user available RAM, 16K ROM and operates at a clock frequency of 921 kHz. The ETC-8085 CPU Module comes with 24K RAM, 24K ROM and operates at a clock frequency of 1.8 MHz. Requires 120 VAC, 60 Hz.

Assembled EWS-6811 includes the ETW-3800 Microprocessor Trainer and ETC-6811 CPU Module. (8 lbs.) \$695.00

Assembled EWS-8085 includes the ETW-3800 Microprocessor Trainer and ETC-8085 CPU Module. (7 lbs.) \$695.00

Accessories:

CPU Module ETC-6811 (2 lbs.) \$199.95

CPU Module ETC-8085 (1 lb.) \$199.95

Memory Module stores lengthy MPU programs for future use. ETC-128 (2 lbs.) \$59.00

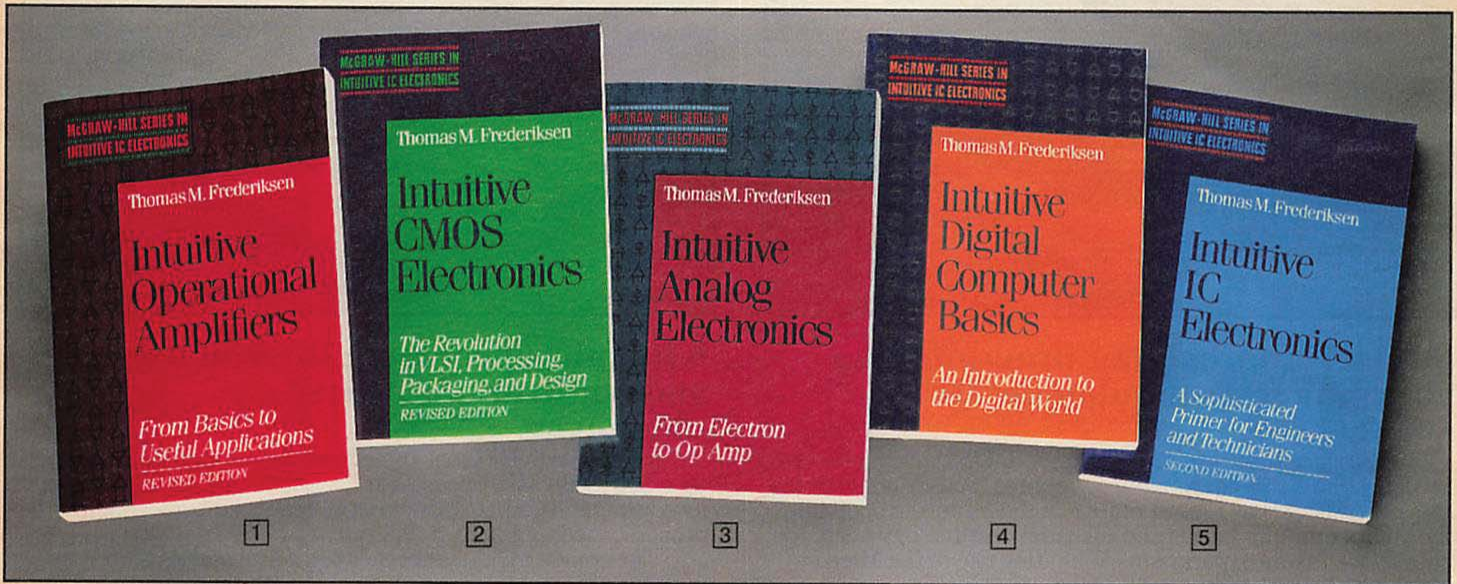

McGraw Hill course series in intuitive IC electronics

This exciting series will help you gain an intuitive understanding of electronics and computers. The series is written at a level most people understand and is filled with frequent diagrams and illustrations. Plus, each book will help you build a solid base upon which you can increase your knowledge of electronics. You'll get an inside look at devices and circuits from the electron level and up, with mathematics kept to a minimum. You'll also learn the workings of integrated circuits, digital computers, operational amplifiers and more.

The series is written by Thomas M. Frederiksen, a renowned and practicing expert in the field. Frederiksen currently holds more than 40 patents on linear ICs and devices and frequently contributes to professional literature. This informative series is ideal for engineers, managers, students, hobbyists and anyone with an interest in electronics.

Intuitive Operational Amplifiers

This course gives designers, technicians, managers and general readers a straightforward, plain English explanation of op amp circuits and applications. Includes numerous illustrations of op amp circuits, models and successful applications. Math is kept to a minimum, with emphasis on the "how to."

1 EBM-1 (2 lbs.) \$19.95

Intuitive CMOS Electronics

This look at intuitive CMOS (complementary metal oxide semiconductor) electronics tracks the evolution of the technology, explores the many new developments and discusses practical applications and much more. An excellent resource for anyone who designs, produces, purchases and works with CMOS technology.

2 EBM-2 (2 lbs.) \$19.95

3 EBM-3 (2 lbs.) \$21.95

Intuitive Analog Electronics

Here's a straightforward explanation of basic electronics and analog systems at a level most readers can understand. Intuitive Analog Electronics takes a hands-on, non-mathematical approach to how and why analog circuits work. Experiments require only an inexpensive digital multimeter.

3 EBM-3 (2 lbs.) \$21.95

Intuitive Digital Computer Basics

Written for the non-electronics professional as well as electronics engineers and managers, Intuitive Digital Computer Basics gives you an understanding of the technical principles behind digital electronics. A detailed description of the basics plus a look at what the future holds, written in easy-to-understand language.

4 EBM-4 (2 lbs.) \$24.95

Intuitive IC Electronics

Learn all about integrated circuits in this clear, highly readable text. You'll get an inside look at modern semiconductor devices, from the simplest to the most sophisticated. You don't need any prior electronics knowledge to understand the course, and math is kept to a minimum. Covers most important recent advances in IC electronics.

5 EBM-5 (2 lbs.) \$19.95



ORDER TOLL-FREE ANYTIME

800-253-0570

FAX: 616-982-5577

Communications

Telephone systems course

Open your telecommunications study with the Telephone Systems Fundamentals course. It takes you through the basics of telephony to the applications used by today's communications industry. Use with the ETB-5010 companion Experiment Modules (page 57), the ETW-5000 Multipurpose Experimenter (below) and the ET-3567 Accessory Backpack (page 56). To get the most out of this course you should first complete Concepts of Electronics, Electronic Fundamentals (both on page 39) or Electronic Circuits (page 37).

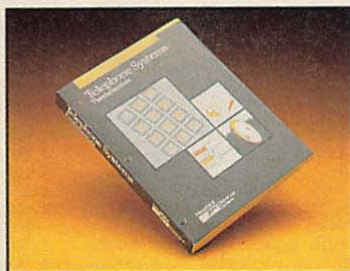

EB-5010 (2 lbs.) \$24.95

Communications systems course

Continue your telecommunications training with the Communications Systems course. It looks at electronic communications systems, AM signal characteristics, sampling, angle modulation and antenna theory. Theories are translated into real applications with the ETB-5020 companion Communications Module (page 57), the ET-3567 Accessory Backpack (page 56) and the ETW-5000 Multipurpose Experimenter (below). To get the most out of this course, you should first complete the Telephone Systems course, at left.



EB-5020 (2 lbs.) \$24.95



Multipurpose experimenter simplifies circuit design tasks

This universal experimenter includes all the necessary functions to help you design and troubleshoot electronic circuits.

The ETW-5000 comes complete with a built-in analog power meter, wide band amplifier, attenuator, audio amplifier, frequency counter, and function and carrier generators. You get all these instruments in one convenient package, and at a significant cost savings over buying them separately. The function generator features variable waveform symmetry and the carrier generator offers AM, FM and sweep capabilities.

Add the ETW-3567 Accessory Backpack and the ETB-3300 Breadboard Experiment Module (both on page 56) for a time-saving solution to circuit design and testing problems. Whether you're a design engineer, technician or experimenter, you'll appreciate having the instrument you need at your fingertips. Includes a speaker monitor. Operates on 120/220 VAC, 50/60 Hz. Dimensions are 4 1/4" H x 12" W x 11 1/4" D.

Assembled ETW-5000 (8 lbs.) \$549.95

SAVER Save \$70.00 on this multipurpose experimenter package. Includes the ETW-5000, the ETW-3567 Accessory Backpack and the ETB-3300 Breadboard Experiment Module.
EWS-5000 (14 lbs.) \$699.90

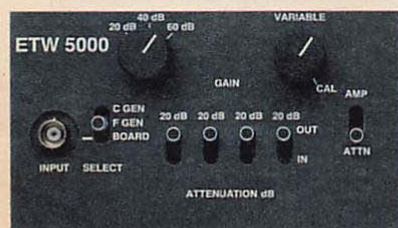

Attenuator and wide band amplifier



AF/RF power meter reads 0-1 VDC



Audio amplifier with 1.3 watts max. output



Multifunction carrier generator

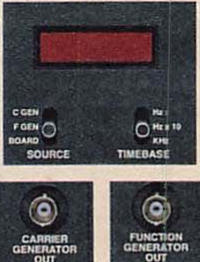

Frequency counter with external board input



Function generator with three waveforms

ORDER BY PHONE: 1-800-253-0570

Use your VISA, MasterCard, American Express or Heath Revolving Charge. Our operators are ready to serve you 24 hours a day. For the most efficient handling of your order, please fill out your order form before you call.

ORDER BY FAX: 1-616-982-5577

Use our new 24-hour fax hotline to transmit your order in only seconds. For fastest service, complete the order form in the center insert and fax us a copy.

ORDER BY COMPUTER:

Enjoy the ease and convenience of shopping by computer with the Heathkit Online Catalog through COMPUSERVE. Just type **GO HTH** at any ! or **OK** prompt and get instant access to exciting electronic products.

ORDER BY MAIL:

Please follow these steps so we can process your order quickly:

1. Use the order form in the center insert.
2. Use the same name each time you order.
3. Give your full address, including apartment number if any. Include zip code and daytime phone number.
4. Include quantity, model number, description, price and ship weight (listed in parentheses following each product) for each item you order. Figure shipping and handling charges from the rate chart at right.
5. Please attach a separate sheet to order replacement parts and manuals, or for any correspondence.

SHIPPING INFORMATION

1. Find your zone number using the zone chart above right.
2. Locate the shipping weight of each item ordered in the first column of the rate chart.
3. Determine the shipping charge for each item.

Please note: Heath shipping charges are for mailable items only. Charges are based on carton weight. For multiple orders, total the shipping costs of products requested. Shipping weights for single products shipped in more than one carton, or of excess length, have been adjusted to provide correct postage.

Surface shipments: For products weighing less than 70 lbs., see zone and rate charts for freight costs.

Motor freight shipments: Items indicated as motor freight exceed size or weight limitations of small package carriers. Motor freight charges must be prepaid by the customer. Call 1-800-253-0570 for freight costs.

Air freight shipments: See rate chart for 2nd day air charges. Next day air may also be available to your area. Call 1-800-253-0570 for information. Service is based on number of business days after shipment's departure.

APO/FPO shipments: Military overseas shipments must weigh less than 70 lbs. and not exceed 107" length and girth combined. Use Zone A charges for West Coast, Zone B for East Coast and Miami shipments.

Rural route and P.O. box addresses: Use Zone A.

Hawaii, Alaska, Puerto Rico addresses: Use air freight service and cost. Add \$10 surcharge.

ZONE CHART

Your zone is indicated by the first three digits of your ZIP Code.

Zip Code Prefixes	UPS Zone	Zip Code Prefixes	UPS Zone	Zip Code Prefixes	UPS Zone	Zip Code Prefixes	UPS Zone	Zip Code Prefixes	UPS Zone	Zip Code Prefixes	UPS Zone
004-005	5	200-232	4	342-346	5	470-472	3	600-609	2	820	5
010-069	5	233-237	5	349	6	473	2	610-619	3	821	6
070-083	4	238-259	4	350-353	4	474-475	3	620-623	4	822	5
084	5	260-261	3	354	5	476-477	4	624-628	3	823-826	6
085-089	4	262-278	4	355-359	4	478	3	629-668	4	827	5
		279	5	360-361	5	479-496	2	669-679	5	828-832	6
100-104	4	280-283	4	362	4	497-499	3	680-687	4	833	7
105-108	5	284-285	5	363-369	5			688-699	5	834	6
109-113	4	286-289	4	370-386	4	500-516	4			835-838	7
114-115	5	290-292	5	387	5	520-524	3	700-722	5	840-847	6
116	4	293	4	388	4	525	4	723-727	4	850-864	7
117-119	5	294-295	5	389-397	5	526-528	3	728-732	5	865-885	6
120-123	4	296-297	4	399	4	530-534	2	733	6	889-898	7
124-126	5	298-299	5			535-539	3	734-768	5		
127-128	4			400-406	3	540	4	769	6	900-921	8
129	5	300-303	4	407-409	4	541-546	3	770-778	5	922-925	7
130-149	4	304	5	410-412	3	547-548	4	779-789	6	926-934	8
150-153	3	305-307	4	413-426	4	549	3	790-792	5	935	7
154-160	4	308-310	5	427-432	3	550-566	4	793-799	6	936-960	8
161	3	311	4	433-436	2	567	5			961	7
162-163	4	312-329	5	437-457	3	570-572	4	800-802	5	970-976	8
164-165	3	330-334	6	458	2	573-588	5	803-805	6	977-984	7
166-199	4	335-338	5	459-462	3	590-597	6	806-807	5	985-986	8
				463-469	2	598-599	7	808-816	6	988-994	7

RATE CHART

Shpg. wt.	Zone 2	Zone 3	Zone 4	Zone 5	Zone 6	Zone 7	Zone 8	Zone A	Zone B	2nd Day Air
1	\$1.63	\$1.77	\$1.93	\$2.01	\$2.09	\$2.19	\$2.28	\$2.40	\$2.40	\$6.00
2	1.64	1.78	1.16	2.28	2.46	2.62	2.81	2.40	2.40	6.00
3	1.72	1.93	2.34	2.53	2.77	3.03	3.28	3.45	4.32	6.00
4	1.81	2.08	2.53	2.72	3.04	3.35	3.59	4.13	5.33	6.00
5	1.90	2.17	2.62	2.85	3.23	3.61	4.01	4.86	6.37	6.50
6	1.99	2.21	2.68	2.93	3.33	3.77	4.23	5.71	7.66	7.50
7	2.07	2.23	2.73	3.01	3.47	3.97	4.47	6.39	8.67	8.50
8	2.16	2.27	2.81	3.21	3.74	4.29	4.87	7.07	9.68	9.50
9	2.27	2.38	2.96	3.39	4.00	4.61	5.27	7.76	10.69	10.50
10	2.35	2.49	3.09	3.56	4.23	4.93	5.64	8.44	11.70	11.50
11	2.45	2.60	3.23	3.78	4.48	5.27	6.08	9.12	12.71	12.50
12	2.56	2.74	3.40	3.99	4.79	5.62	6.50	9.81	13.72	13.50
13	2.63	2.86	3.58	4.21	5.08	5.99	6.93	10.49	14.73	14.50
14	2.67	2.99	3.77	4.42	5.36	6.33	7.36	11.17	15.74	15.50
15	2.74	3.11	3.93	4.65	5.64	6.70	7.79	11.86	16.75	16.50
16	2.81	3.24	4.10	4.88	5.94	7.05	8.22	12.54	17.75	17.50
17	2.86	3.37	4.27	5.09	6.22	7.40	8.65	13.22	18.76	18.50
18	2.95	3.49	4.44	5.31	6.50	7.76	9.07	13.90	19.77	19.50
19	3.05	3.64	4.62	5.52	6.80	8.12	9.50	14.59	20.78	20.50
20	3.18	3.77	4.79	5.75	7.08	8.46	9.93	15.27	21.79	21.50
21	3.30	3.90	4.97	5.98	7.36	8.83	10.36	15.95	22.80	22.50
22	3.40	4.03	5.14	6.19	7.65	9.18	10.79	16.64	23.81	23.50
23	3.50	4.15	5.31	6.41	7.94	9.53	11.21	17.32	24.82	24.50
24	3.60	4.28	5.48	6.63	8.23	9.89	11.65	18.00	25.83	25.50
25	3.70	4.40	5.65	6.85	8.50	10.25	12.07	18.69	26.84	26.50
26	3.80	4.53	5.83	7.08	8.80	10.59	12.50	19.37	27.84	27.50
27	3.89	4.68	6.01	7.29	9.08	10.96	12.94	20.05	28.85	28.50
28	3.99	4.80	6.18	7.51	9.37	11.31	13.35	20.73	29.86	29.50
29	4.08	4.94	6.35	7.74	9.66	11.67	13.80	21.42	30.87	30.50
30	4.18	5.07	6.54	7.98	9.98	12.06	14.27	22.10	31.88	31.50
31	4.27	5.23	6.75	8.24	10.30	12.44	14.74	22.78	32.89	32.50
32	4.35	5.39	6.94	8.50	10.63	12.84	15.21	23.47	33.90	33.50
33	4.44	5.52	7.15	8.75	10.95	13.23	15.68	24.15	34.91	34.50
34	4.52	5.67	7.33	8.96	11.25	13.61	16.15	24.83	35.92	35.50
35	4.62	5.79	7.49	9.19	11.54	14.01	16.59	25.52	36.93	36.50
36	4.70	5.93	7.67	9.42	11.83	14.35	17.04	26.20	37.93	37.50
37	4.79	6.07	7.85	9.64	12.12	14.73	17.47	26.88	38.94	38.50
38	4.88	6.19	8.02	9.87	12.42	15.08	17.91	27.56	39.95	39.50
39	4.96	6.32	8.21	10.08	12.71	15.44	18.34	28.25	40.96	40.50
40	5.05	6.44	8.37	10.31	12.99	15.81	18.77	28.93	41.97	41.50
41	5.13	6.59	8.54	10.53	13.38	16.17	19.21	29.61	42.98	42.50
42	5.22	6.72	8.73	10.76	13.57	16.52	19.64	30.30	43.99	43.50
43	5.30	6.84	8.90	10.98	13.87	16.89	20.08	30.98	45.00	44.50
44	5.39	6.99	9.08	11.20	14.16	17.24	20.51	31.66	46.01	45.50
45	5.47	7.11	9.25	11.42	14.44	17.60	20.95	32.35	47.02	46.00
46	5.57	7.24	9.43	11.66	14.74	17.97	21.38	33.03	48.02	46.50
47	5.66	7.38	9.61	11.87	15.03	18.33	21.82	33.71	49.03	47.00
48	5.74	7.50	9.78	12.10	15.32	18.69	22.25	34.39	50.04	47.50
49	5.83	7.64	9.96	12.31	15.61	19.06	22.68	35.08	51.05	48.00
50	5.91	7.77	10.12	12.54	15.90	19.40	23.12	35.76	52.06	48.50
Each Add'l lb.	.03 lb.	.04 lb.	.05 lb.	.06 lb.	.07 lb.	.10 lb.	.12 lb.	.69 lb.	1.01 lb.	.85 lb.

For weights over 50 lbs. and up to 70 lbs.



ORDERING INFORMATION

TERMS:

Major Credit Card Purchases. Use VISA, MasterCard or American Express to charge Heathkit products. Just include your card number, expiration date and your signature in the spaces provided on the order form. Charge replacement parts to your major credit card, too.

Heath Revolving Charge. You can open a new Heath account with a purchase as small as \$100 with 10% down. Use the credit application in the center insert of this catalog. Once your account is open, you may add to your existing balance in any amount within your credit limit.

Commercial Accounts. Heath offers net 30-day terms to companies with rated credit. Call 1-800-253-0570.

Educational Accounts. Heath offers net 30-day terms to Patterson-listed educational institutions. An authorized purchase order is required. Call 1-800-253-0570.

Note: All credit orders subject to Heath Credit Department approval.

FAIR CREDIT BILLING ACT:

The following notice is required by the Fair Credit Billing Act

IN CASE OF ERRORS OR INQUIRIES ABOUT YOUR BILL

The Federal Truth in Lending Act requires prompt correction of billing mistakes.

- If you want to preserve your rights under the Act, here's what to do if you think your bill is wrong or if you need more information about an item on your bill:
 - Do not write on the bill. On a separate sheet of paper write (you may telephone your inquiry but *doing so will not preserve your rights under this law*) the following:
 - Your name and account number (if any).
 - A description of the error and an explanation (to the extent you can explain) why you believe it is in error.
If you only need more information, explain the item you are not sure about and, if you wish, ask for evidence of the charge such as a copy of the charge slip. Do not send in your copy of a sales slip or other document unless you have a duplicate copy for your records.
 - The dollar amount of the suspected error.
 - Any other information (such as your address) which you think will help the creditor to identify you or the reason for your complaint or inquiry.
 - Send your billing error notice to the address on your bill which is listed after the words: "Send inquiries to:"
Mail it as soon as you can, but in any case, early enough to reach the creditor within 60 days after the bill was mailed to you. If you have authorized your bank to automatically pay from your checking or savings account any credit card bills from that bank, you can stop or reverse payment on any amount you think is wrong by mailing your notice so the creditor receives it within 16 days after the bill was sent to you. However, you do not have to meet this 16-day deadline to get the creditor to investigate your billing error claim.
- The creditor must acknowledge all letters pointing out possible errors within 30 days of receipt, unless the creditor is able to correct your billing during that 30 days. Within 90 days after receiving your letter, the creditor must either correct the error or explain why the creditor believes the bill was correct. Once the creditor has explained the bill, the creditor has no further obligation to you even though you still believe there is an error, except as provided in paragraph 5 below.
- After the creditor has been notified, neither the creditor nor an attorney nor a collection agency may send you collection letters or take other collection action with respect to the amount in dispute; but periodic statements may be sent to you, and the disputed amount can be applied against your credit limit. You cannot be threatened with damage to your credit rating or sued for the amount in question, nor can the disputed amount be reported to a credit bureau or to other creditors as delinquent until the creditor has answered your inquiry. However, you remain obligated to pay the parts of your bill not in dispute.
- If it is determined that the creditor has made a mistake on your bill, you will not have to pay any **FINANCE CHARGES** on any disputed amount. If it turns out that the creditor has not made an error, you may have to pay **FINANCE CHARGES** on the amount in dispute, and you will have to make up any missed minimum or required payments on the disputed amount. Unless you have agreed that your bill was correct, the creditor must send you a written notification of what you owe; and if it is determined that the creditor did make a mistake in billing the disputed amount, you must be given the time to pay which you normally are given to pay undisputed amounts before any more **FINANCE CHARGES** or late payment charges on the disputed amount can be charged to you.
- If the creditor's explanation does not satisfy you and you notify the creditor in writing within 90 days after you receive this explanation that you still refuse to pay the disputed amount, the creditor may report you to credit bureaus and other creditors and may pursue regular collection procedures, but the creditor must also report that you think you do not owe the money, and the creditor must let you know to whom such reports were made. Once the matter has been settled between you and the creditor, the creditor must notify those to whom the creditor reported you as delinquent of the subsequent resolution.
- If the creditor does not follow these rules, the creditor is not allowed to collect the first 50% of the disputed amount and **FINANCE CHARGES**, even if the bill turns out to be correct.

7. If you have a problem with property or services purchased with a credit card, you may have the right not to pay the remaining amount due on them, if you first try in good faith to return them or give the merchant a chance to correct the problem. There are two limitations on this right:

- You must have bought them in your home state or if not within your home state within 100 miles of your current mailing address; and
- The purchase price must have been more than \$50.

However, these limitations do not apply if the merchant is owned or operated by the creditor, or if the creditor mailed you the advertisement for the property or services.

COMMERCIAL, INDUSTRIAL AND EDUCATIONAL SALES:

Custom Orders. Heath Company fills custom orders for any of its kit or assembled products. Plus, we'll customize your purchases of 250 units or more to reflect your company's image and market. We can also tailor our highly acclaimed educational materials to suit your target market, and even add your company logo.

Orders Above 250 Units. To find out how to put Heath quality products in your package or to get information about quantity sales and specific modifications, write Heath Co., P.O. Box 1288, Benton Harbor, MI, or call Contract Sales: 616-982-3519.

Orders Under 250 Units. For orders of less than 250 units, write (see above) or call Marketing Services: 616-982-3454. Give us a call to find out what we can do for you.

ASSISTANCE AND INFORMATION:

Weekdays 8:00 A.M. to 4:30 P.M. Eastern Time

Customer Service (questions about your order, returns)	1-800-253-0570
Replacement Parts Orders (please have Heath part number available when you call)	616-982-3571
Dealer Sales	616-982-3313
Overseas Orders	616-982-3512
General Office (non-order calls)	616-982-3200

Technical Assistance:

• Amateur Radio	616-982-3296
• Computer Hardware	616-982-3309
• Education	616-982-3980
• Favorite Kits, Security	616-982-3496
• Home Entertainment	616-982-3307
• Test Equipment, Weather, Clocks	616-982-3315

CAREER OPPORTUNITIES:

The following exciting and challenging job opportunities currently exist at Heath Company.

• Educational Media Designers	• Production Supervisors
• Technical Writers	• Computer Technicians
• Hardware/Software Design Engineers	• QA Engineers
	• Test Engineers

To find out more, call or send your resume and salary requirements to Ms. Pat Kauffman or Mr. Steve Slonkosky, Heath Company, Dept. HS90, Hilltop Rd., St. Joseph, MI 49085, (616) 982-3203.

An Affirmative Action Employer

No Risk Purchase Policy

We want you to be 100% satisfied with every item you purchase from Heath Company. We back all our products with a friendly customer support team who will make every effort to ensure your satisfaction.

If you're not completely satisfied with any item purchased from Heath Company, simply return it to us within six months from the date of purchase for a full refund or credit. At Heath Company your satisfaction is always guaranteed. It's that simple.



Summer, 1990

Dear Friends,

While reading through my monthly stack of magazines the other day, I came across another major article on the inadequacy of math and science preparation in our schools. Our students are not receiving the knowledge they'll need to compete for even the most routine jobs in the future. That's why it's more important than ever that we parents step in and take an active role in providing our children with the necessary skills to survive.

At Heath we're trying to do our part by introducing a whole new series of fundamental kits that are not only fun to build and operate, but teach underlying electronic principles. With each project we include a detailed assembly manual that explains the principle in simple terms and short quizzes that challenge your child's new found knowledge.

You'll find these starter kits on pages 90 and 91. Unmask PIR technology and its ability to detect heat in motion with the Infrared Motion Sensor kit. Discover the amazing things piezoelectric film can do with the Dragonfly or Magical Film Speaker projects. No matter which kit you choose, each is a wonderful learning opportunity for children and parents alike.

Best Regards,

William E. Johnson, President
Heath Company

Manual Preview Offer

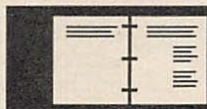

If you'd like to see how easy kit building really is, order one of our world famous assembly manuals first. Each manual is written by our own technical writers and includes step-by-step instructions and pictorials of key assembly steps that give even the novice electronic kit builder the tools necessary to succeed.

If after previewing the manual you buy the kit, we'll deduct the price of the manual from your purchase. Most of our manuals sell for \$8.00. If the one you're interested in costs less than \$8.00, we'll refund the overpayment. If it costs more than \$8.00, we'll bill you for the balance. Please add 10% for shipping and handling for each manual ordered. Send your request to Heath Company, Parts Department, Benton Harbor, Michigan, 49022.

Technical Consultation



Our specially trained technical consultants are available 8:00 A.M. to 4:30 P.M. Eastern Time, Monday through Friday. Experts in their product lines, they'll help you troubleshoot a kit building problem or answer your questions about a product.

Their phone numbers are listed on page 51, according to product category. Call or write them in care of Heath Company, Technical Consultation, Benton Harbor, Michigan, 49022.

Heath Revolving Charge

Heath Revolving Charge (HRC) is a powerful buying tool when it comes to purchasing the latest in kit and assembled electronic products. It gives you a preferred customer status that lets you buy products now and extend payments over time. To open an HRC account, complete the credit application on the order form and start enjoying the purchasing power of a Heath Revolving Charge.

All prices quoted are mail order. Net FOB Benton Harbor, MI and apply only in the United States and Possessions. Prices, special offers herein are effective June 11, 1990 through September 23, 1990. Prices, product availability and specifications are subject to change without notice. Any special offers in this catalog may not be used in combination with other discounts. Heath Company cannot be responsible for typographical and pictorial errors. Printed in the U.S.A.

Computer courses and software

Advance into the computer world with exciting and informative Heathkit Educational Systems computer-based courses. They're designed and written by our expert writers to help you understand computer basics and more advanced



Micro-computer professor tutorial • Earn 2.0 CEUs

Become your own computer consultant with this thorough tutorial on personal computer systems. You'll learn to make informed purchasing decisions to address your particular needs.

You'll also learn to do a computer needs assessment and to relate these decisions to selecting software and hardware, choosing the proper location for your computer system, identifying and troubleshooting hardware and software

problems, and performing routine preventative maintenance.

Included are an MS-DOS Version 3.0 Quick Reference Guide, a 3.5" and a 5.25" experiment disk, two needs-assessment worksheets and two sets of 10 disk labels. You'll need a Heath/Zenith, IBM or compatible PC using the MS-DOS operating system.

EC-1123 (5 lbs.) **\$29.95**

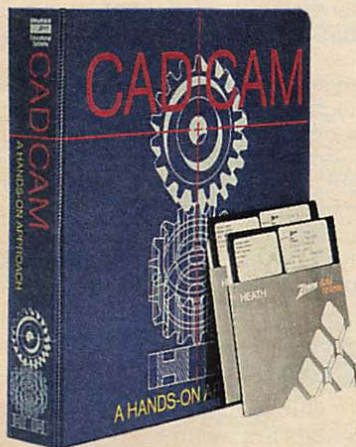

CAD/CAM course

• Earn 6.0 CEUs

With this exciting computer-aided design (CAD) and computer-aided manufacturing (CAM) course you'll gain valuable information about the advancement in tools and techniques in the manufacturing environment.

You'll study the workshop concept, hardware and software, cost parameters associated with CAD/CAM, numerically controlled machinery, data communications and intelligent machines. You'll also learn about robotics, factory management and manufacturers' automated protocol. Plus advanced CAM systems, local area networks, process planning and material requirements planning.

We've included AutoCAD software for the seven on-disk experiments. With it you'll be able to make and modify CAD drawings, create symbols, zoom in to show microscopic detail and zoom out for a macroscopic overview. The perfect way to develop skills in computer-aided design.

The experiments require a Heath/Zenith or IBM compatible PC equipped with 256K RAM, two 5.25" disk drives and CGA or Hercules video capability. Please note that the software will not operate with EGA or VGA video.

EES-109 (12 lbs.) **\$49.95**



Artificial intelligence and expert systems course

• Earn 6.0 CEUs

This comprehensive course gives you all the information you need to stay on top of the artificial intelligence (AI) explosion. How AI differs from conventional computing, advantages and disadvantages of AI, and how it applies to problem solving are a few of the topics covered.

You'll learn the benefits of expert systems; how they're applied in control, diagnosis and planning; plus the 10 steps to creating an expert system. You'll also gain a practical understanding of how AI is applied to robotics and an overview of AI programming.

In addition, Artificial Intelligence gives you an understanding of natural language processing and voice recognition, how natural language processing systems work and how they apply to real world situations – from natural language interfaces and language translation to grammar analysis and abstracting. You'll also learn how speech recognition is applied, classifications of speech recognizers and how speech recognition systems work.

You'll need a Heath/Zenith or IBM compatible PC with one disk drive and 512K RAM to perform the 13 course experiments contained on two 5.25" floppies. We've also included a two-disk demonstration of Texas Instrument's Easy expert systems program. We recommend a general knowledge of a programming language such as Basic or C before taking this course.

EC-1126 (6 lbs.) **\$69.95**

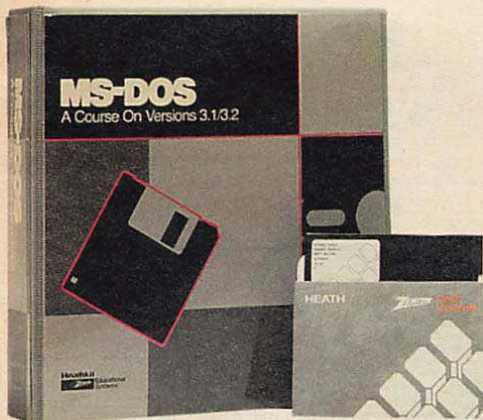

MS-DOS* course • Earn 4.0 CEUs

Learn your computer's operating system so you can take full advantage of its capabilities. This comprehensive course starts at the beginner's level and works up to the advanced use of the MS-DOS Debug command.

You'll discover how to copy programs from existing diskettes, configure your system for virtually any peripheral, troubleshoot and more.

You'll learn to recover from common disk errors, create and use sub-directories to organize data, and use batch files. Plus, you'll learn to use the Edlin editor, develop an understanding

of input/output redirection, plan and use a hard disk system, and examine and change files and disk data with Debug.

The course includes a 5.25" and a 3.5" experiment disk with 33 hands-on experiments that give you the opportunity to apply and master each topic you study. To perform the experiments you'll need an MS-DOS-based PC with a minimum 256K memory and two floppy disk drives.

EC-1121-A (6 lbs.) \$59.95

*MS-DOS is a registered trademark of Microsoft Corp.



C programming course

• Earn 3.0 CEUs

In this carefully paced course written for the novice programmer, you'll become familiar with the powerful language of C, its structure and statements. The course concentrates primarily on C's structure and syntax, leaving system programming theory to more advanced courses. More intricate in syntax and capabilities than languages such as BASIC, FORTRAN, Pascal and COBOL, C is quickly becoming the preferred language of computer scientists, electrical engineers and others who work closely with computer operating systems.

Included is Ecosoft's C Compiler and CED Editor software, a \$59.95 value – FREE. You'll need a Heath/Zenith or IBM compatible PC with at least 384K RAM (a hard disk drive is recommended), PC or MS-DOS version 2.0 or later and at least one 5.25" floppy disk drive. Please note that our C programming course does not operate with MS-DOS and PC-DOS 4.0 or higher.

To get the most out of this course you should be familiar with one or more high-level programming languages and have a feel for structured, or modular programming principles.

EC-1124 (3 lbs.) \$99.95

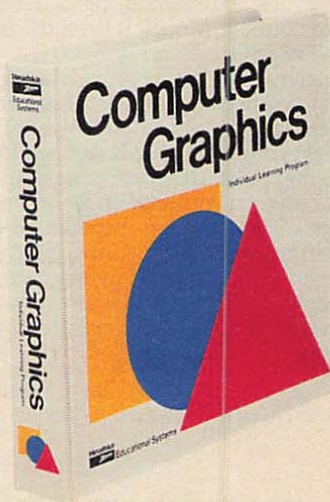

High resolution graphics course

• Earn 6.0 CEUs

Give your imagination free rein as you create your own high resolution graphics. This exciting course presents a broad overview of the exciting world of computer graphics and gives you the skills you need to create your own unique programs.

You'll learn to draw lines and figures using pixels, use advanced color graphics commands and merge text with graphics. You'll even discover how to animate graphics and how to photograph graphics on-screen using ordinary camera equipment!

Programming experiments are included on a 5.25" floppy and are written in Microsoft BASIC. You'll need an MS-DOS-based PC equipped with a color graphics card to perform the experiments. You'll also need Microsoft BASIC or BASICA for an IBM PC. Sketching worksheets with acetate overlays are provided.

If you're familiar with your computer's operating system, have a working knowledge of BASIC programming language and an understanding of simple algebra, you have all the background you need to enjoy this exciting course.

EC-3000 (6 lbs.) \$39.95

Experimentation accessories

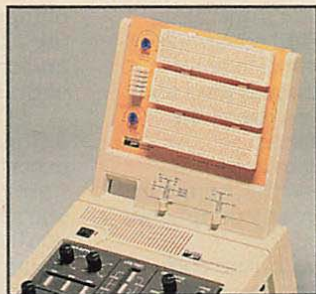
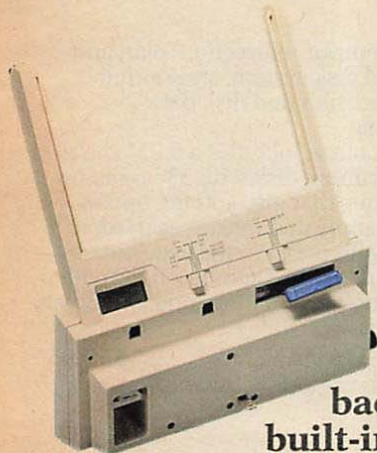

Accessory backpack with built-in digital multimeter

The Accessory Backpack will give you years of reliable performance for bench testing, experimenting and learning with Heathkit trainers and courses. Mount it directly onto the ET-3600, ET-3700, ETW-3800 and ETW-5000 trainers. The backpack includes programmable, positive and negative 1.2-15 VDC power supplies for powering analog, linear and CMOS circuits, in addition to a 5 VDC power supply for TTL logic circuits. A 3½ digit digital voltmeter allows AC and DC voltage measurements up to 500 volts, DC current measurements up to 200 mA and resistance measurements up to 2 meg. Another feature of the backpack is fused, high-impedance voltmeter input that gives maximum circuit protection and minimum circuit loading. Construction is easy with most components mounted on two circuit boards. Included are a quality loudspeaker and connectors for accepting experiment modules from Heathkit courses.

Kit ET-3567 (6 lbs.) \$119.95
Assembled ETW-3567 (6 lbs.) \$199.95

Wire terminal wrap module

With this module you'll get the experience you need to build real-world prototype circuits. This double-sided circuit board is designed for use with the ET-3567

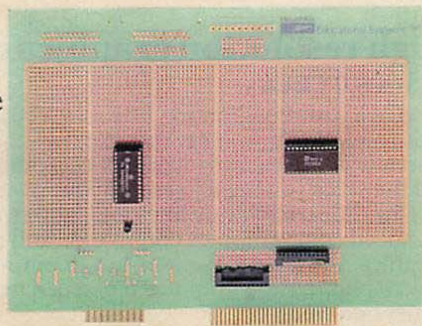

Accessory Backpack and our ET-3600, ET-3700, ET-3800 and ETW-5000 electronic trainers.

The techniques you'll learn in wire wrapping are particularly useful with today's complex electronic circuits. You'll learn to make strong, durable connections even when there's little space between terminals. In fact, you'll learn to make connections that will last for years, yet can be easily removed if necessary.

Assembled ETB-6000 (2 lbs.) \$39.95

Breadboard experiment module

This module is ideal for designing and experimenting with prototype circuits that extend beyond the physical capacities of the ET-3600, ET-3700, ETW-3800 and ETW-5000 trainers. The module slides into the Accessory Backpack to add more breadboarding capabilities to your trainer. The solderless sockets in the three large 640-hole breadboards accept solid wire up to #20, along with the leads of most common electronic components. The ETB-3300 also gives you access to +5 VDC power supplies, variable positive and negative 1.2-12VDC power supplies and the internal trainer speaker.

Assembled ETB-3300 (2 lbs.) \$99.95

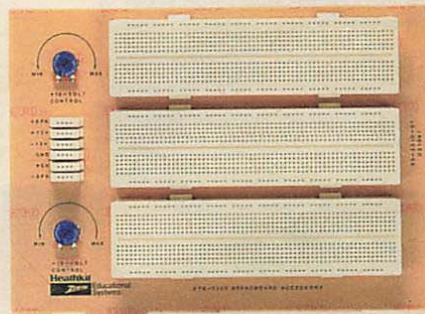

Electronic circuits experiment module

This experiment module gives you hands-on experience with electronic circuitry. Fifty on-board experiments in the student workbook explore such topics as biasing schemes; common emitter, base and collector amplifiers; and differential, tuned and complementary power amplifiers.

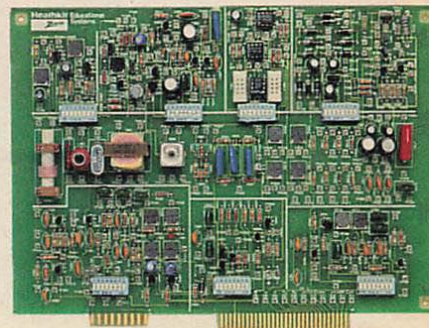

Each experiment comes with detailed step-by-step instructions. The Instructor's Guide helps to further explain and demonstrate electronic circuitry. This circuit board can also be used to teach troubleshooting with 56 possible fault insertions.

To see how the various circuits operate, you'll need the ET-3600 Analog Trainer (page 38), the ET-3567 Accessory Backpack (above, left), an LCD digital multimeter (included with the Backpack) and a dual trace oscilloscope.

This module is designed to reinforce the text materials of our EE-3104-B Electronic Circuits course on page 37.

Assembled ETB-6104 (1 lb.) \$199.95
 Accessories:

Student Workbook EB-6104-71 (3 lbs.) \$12.95
Instructor's Guide EB-6104-52 (1 lb.) \$9.95

Telephone systems experiment set

Two plug-in experiment modules teach you the concepts of telephone systems. Plug them into the ET-3567 Accessory Backpack (page 56) used with the ETW-5000 Telecommunications Trainer (page 49). Included are two telephone sets with plugs for interconnections, a synthetic telephone circuit with loading elements and an audio filter set. You'll also get an artificial transmission line, an audio noise source with adjustable weighting and an audio linear/non-linear processor mixer/modulator. Use the ETB-5010 with the Telephone Systems Fundamentals course shown on page 49.



Assembled ETB-5010 (7 lbs.) \$449.95

Accessories:

Student Workbook EB-5010-40 (2 lbs.) \$12.95

Instructor's Guide EB-5010-50 (1 lb.) \$11.95

Communications systems experiment module

Like the modules at left, the ETB-5020 Communications Module gives you the advantages of experiments already built into a printed circuit board. Use it with the ET-3567 Accessory Backpack (page 56) and the ETW-5000 Telecommunications Trainer (page 49). Included are an amplitude modulator, a balanced modulator, a superheterodyne receiver, a diode detector, and a frequency modulator and demodulator. You also get a pulse modulator, a division multiplexer and a transmission line analyzer. Use the ETB-5020 with the Communications Systems course on page 49.

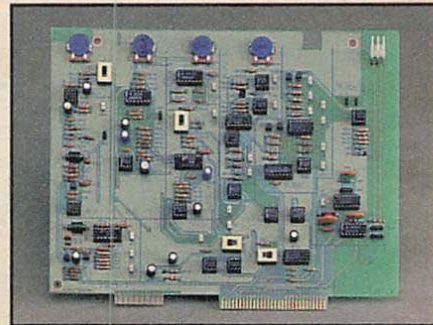

Assembled ETB-5020 (7 lbs.) \$249.95

Accessories:

Student Workbook EB-5020-40 (2 lbs.) \$12.95

Instructor's Guide EB-5020-50 (1 lb.) \$11.95

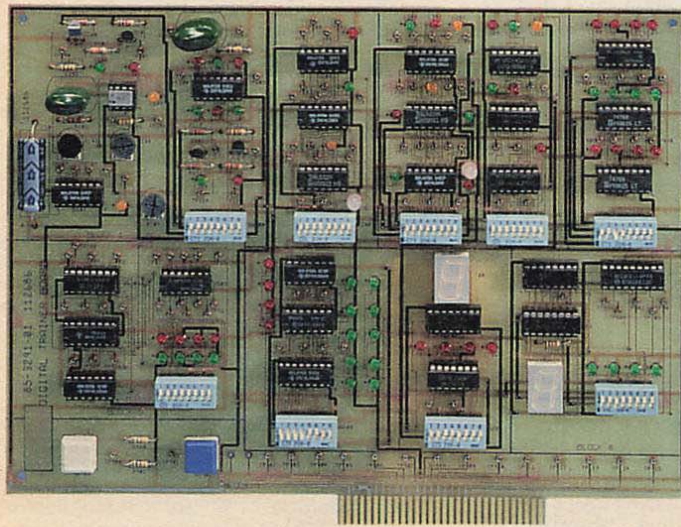

Digital circuits experiment module

This module is designed to reinforce the text materials of the Digital Techniques course (page 44). It provides visual demonstrations of digital electronics concepts and theories applied to real circuits.

You'll develop hands-on knowledge of digital circuitry as you perform the troubleshooting exercises and experiments that are prewired for substantial savings. The Instructor's Guide provides additional circuit descriptions, experiment information and demonstrations.

You'll need the ET-3700 Digital Trainer (page 44) and the ET-3567 Accessory Backpack (page 56). A dual trace oscilloscope is also helpful. This experiment module includes open inputs and outputs you can use to design and build circuits other than those illustrated in the manual.

Assembled ETB-6201 (2 lbs.) \$149.95

Accessories:

Student Workbook EB-6201-71 (1 lb.) \$12.95

Instructor's Guide EB-6201-52 (1 lb.) \$9.95



ORDER TOLL-FREE ANYTIME

800-253-0570

FAX: 616-982-5577



TECHNICAL CONSULTATION
 When you have a question about the kit you're building or about an assembled product, our expert technical consultants are only a phone call away. Their numbers are listed on page 51.

Test instruments

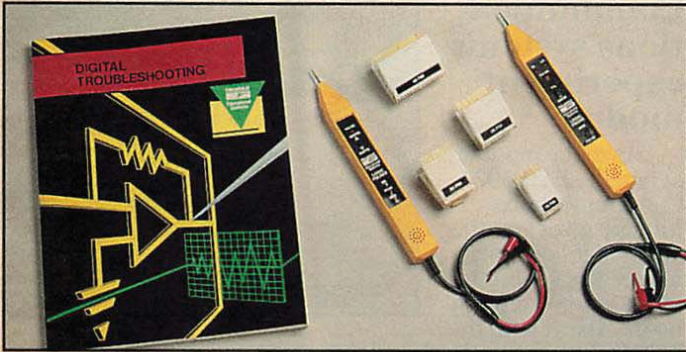

Digital test set course teaches you to troubleshoot your own circuits

Learn to diagnose, isolate and repair defective digital equipment with this important course, written for engineers, technicians and scientists.

You'll learn how to use a logic pulser and probe to test and troubleshoot digital circuits quickly, easily and safely. You'll also learn how to troubleshoot using other common test instruments such as the VOM, DMM and oscilloscope. The course comes with a pulser/probe set and four spring-loaded IC clips with gold-plated pins. The clips fit virtually any common integrated circuit and give you easy access to IC pins.

ETI-7510 (2 lbs.) \$69.95



AS LOW AS \$30 PER MONTH ON YOUR HEATH REVOLVING CHARGE

Enjoy easy operation with this digital multimeter

Every electronics lab needs solid, dependable test instruments. The kind that give accurate readings, time after time. Our new ETI-7000 series instruments are specifically designed to be physically and electrically rugged.

The ETI-7000 series instruments are simple to use, too. They feature large, easy-to-read displays and clearly labeled, easily accessible buttons and knobs.

The rugged, ETI-7010 Digital Multimeter is just one member of the complete ETI-7000 line of instruments. Slide it into the ETI-7050 Instrument Cabinet (shown on page 60) or use it as a stand-alone multimeter. Either way you'll enjoy reliable service for years to come, plus a host of important features that will help make your work a pleasure.

Built to withstand even the toughest conditions, this full-function instrument offers overload protection for common

voltages found in the lab, an audible continuity test and a diode test.

You can select voltage, current or resistance ranges. Easy push-button operation makes it a cinch to use, and the large, bright 3½ digit LED display is easy on your eyes. The ETI-7010 is housed in an attractive, yet durable steel cabinet and comes with one pair of test leads, spare 2 A fuse and operator's manual. Listed by Underwriters Laboratories (UL) and certified by the Canadian Standards Association (CSA) as meeting their product safety standards.

Assembled ETI-7010
(5 lbs.) \$310.00

Specifications: **Display:** 3½ digit LED, reads 1.999 maximum. **Polarity:** Automatic, "-" negative polarity indication. **Overrange:** Highest digit of "1" or "-1" is displayed, all other digits blanked. **Measurement Range:** 2.5 measurements per second. **Operating Temperature:** 0-50 degrees C (32-122 degrees F) at 0-75% Relative Humidity

(R.H.). **Storage Temperature:** -20-+60 degrees C (-4-+140 degrees F) at 0-80% R.H. **Accuracy Specifications:** 23 ± 5 degrees C (73 ± 9 degrees F) at 0-70% R.H. **Power:** 100/120/220/240 VAC ± 10% 50-60 Hz. **DC VOLTAGE: Range:** 200 mV, 2 V, 20 V, 200 V, 500 V. **Resolution:** 100 μV, 1 mV, 10 mV, 100 mV, 1 V. **Accuracy:** 0.5% of reading + 1 digit. **Input Impedance:** 10 MΩ. **AC VOLTAGE: Range:** 200 mV, 2 V, 20 V, 200 V, 1000 V. **Resolution:** 100 μV, 1 mV, 10 mV, 100 mV, 1 V. **Accuracy:** @ 45-500 Hz ± (1.0% of reading + 4 digits). **Input Impedance:** 10 MΩ in parallel with less than 100 pF. **DC CURRENT: Range:** 200 μA, 2 mA, 20 mA, 200 mA, 2 A, 20 A. **Resolution:** 100 nA, 1 μA, 100 μA, 1 mA, 10 mA. **Accuracy:** 200 μA, 200 mA ± (1.0% of reading + 1 digit); 2-10 A ± (1.0% of reading + 3 digits). **AC CURRENT: Range:** 200 μA, 2 mA, 20 mA, 2 A, 10 A. **Resolution:** 100 nA, 1 μA, 100 μA, 1 mA, 10 mA. **Accuracy:** 200 μA-20 A @ 45-500 Hz ± (1.5% of reading + 4 digits). **RESISTANCE: Range:** 200 Ω, 2 KΩ, 20 KΩ, 200 KΩ, 20 MΩ, 2 MΩ. **Resolution:** 0.1 Ω, 1 Ω, 10 Ω, 100 Ω, 1 KΩ, 10 KΩ. **Accuracy:** 200 Ω ± (0.75% of reading + 4 digits); 2 kΩ, 2 MΩ ± (0.75% of reading + 1 digit), 20 MΩ (1.5% of reading + 5 digits). **Maximum Open Circuit Voltage:** approx. 0.6 V. **DIODE TEST:** Measures approximate forward voltage of silicon or germanium diode or semiconductor junction. **INSTANT CONTINUITY:** Built-in buzzer sounds when resistance is less than 100 Ω. **Maximum Test Current:** 1.5 mA. **Maximum Open Circuit Voltage:** 3.2 V. **Dimensions:** 2½" H x 9¾" W x 8¾" D.

ORDER TOLL-FREE ANYTIME

800-253-0570

FAX: 616-982-5577

*Your actual monthly payments may vary depending on your account balance.



Function generator with counter

Equip your test bench with the function generator that's as durable as it is useful. The ETI-7020 is a general purpose signal source with a frequency range of 0.02 Hz to 2 MHz. Outputs include square, triangle, sine, sweep and pulse.

There's even an independent, built-in frequency counter for setting the generator frequency output or for mea-

suring external sources. Additional features include special circuitry on both inputs and outputs that guards against accidental overload by voltage commonly found in the lab, and a bright, easy-to-read LED display. UL approved.

Assembled ETI-7020
(6 lbs.) \$375.00

Specifications: **Output:** sine, triangle, square wave, TTL, GMOS square wave, pulse, ramp, sweep. **Input:** voltage, controlled frequency (VCF), external frequency counter. **Frequency Range:** 0.02 Hz-2MHz in seven ranges. **Voltage-Controlled Frequency:** approximately +10V input for 1000:1. **Sweep Characteristics:** Internal: linear, log. **Sweep Rate:** 0.2 Hz-100 Hz (5 seconds-10 ms), adjustable. **Sweep Width:** variable from 10:1-1000:1. **Sine Wave Distortion:** 10 Hz-100 kHz < 1%. **Triangle Wave:** linearity 99% at 100 kHz. **Square Wave:** rise/fall time < 100 ns. **TTL:** Rise/fall time < 25 ns will sink 20 TTL loads. **Level:** amplitude fixed > +3V (open circuit). **CMOS:** rise/fall time < 60ns. **Level:** +5-15V, adjustable. **Main Output Amplitude:** > 20V P/P (open circuit) > 10V P/P (into 50Ω load). **Output Impedance:** 50Ω ± 10%. **Attenuator:** -20 dB, -40 dB. **DC Offset Control:** variable +10 to -10V (open circuit) +5 to -5V (into 50Ω load). **Duty Cycle Control:** 40 to 1 minimum duty cycle change. **FREQUENCY COUNTER:** Accuracy: time base accuracy ± 1 count. **Time Base:** oscillation frequency: 10 MHz. **Temperature Stability:** 0.50 degrees C ± 20 ppm. **Counting Capacity:** six-digit. **Resolution:** 10 seconds, 1 second, 0.1 second, 0.01 second. **Frequency Range:** 0.1 Hz-10 MHz. **Sensitivity:** < 20 mV RMS. **Maximum Input Voltage:** 150V RMS. **Input Impedance:** 1MΩ. **Dimensions:** 2 1/2" H x 9 3/4" W x 7 1/2" D.

Universal frequency counter gives quick, accurate measurements

Here's a true universal counter that's easy to use and a pleasure to own. You'll enjoy quick, accurate frequency measurements with this member of the ETI-7000 series. The ETI-7040 offers two input channels and a frequency range of 5 Hz to 175 MHz. Plus, it has all the functions you need: period, period average, ratio, time interval, totalize and self test.

Its crystal-controlled oscillator ensures superior time base accuracy, and an adjustable trigger level stabilizes readings on complex waveforms. Includes a bright eight-digit LED display, reset button and special protection circuitry that safeguards both you and your lab.

Assembled ETI-7040 (5 lbs.) \$360.00

Specifications: **FREQUENCY A, Range:** 5 Hz-175MHz. **Resolution:** 0.1 Hz-1 kHz, in decade steps. **Accuracy:** ± 1 count ± time base error. **display:** kHz or MHz with decimal point. **PERIOD A, Range:** 0.5 μ seconds - 200,000 μ seconds. **Frequency Range:** 5 Hz-2MHz sine wave. **Resolution:** 100 ps-100 ns in decade steps. **Minimum Pulse Width:** 250 ns. **Average:** 1, 10, 100 or 1,000 cycles averaged, depending on RESOLUTION setting. **RATIO A/B, Frequency Range A:** 5 Hz to 10 MHz. **Frequency Range B:** 5 Hz-2 MHz. **Display:** numerical ratio with decimal point. **TIME INTERVAL A TO B, Range:** 0.5 μ seconds. **Frequency Range:** 5 Hz-2 MHz, sine wave. **Resolution:** 100 ps-100 ns in decade steps. **Pulse Interval (A to B):** 250 ns minimum. **Display:** ms or μ seconds with decimal point. **Average:** 1, 10, 100 or 1,000 intervals averaged. **Single Event Capability:** pressing RESET primes unit for measurement of "once only" event. **TOTALIZE A, Range:** 5 Hz-10 MHz sine wave. **Count Capability:** 0-99,999,999 before OVERFLOW. **CHANNEL A INPUT CHARACTERISTICS, Bandwidth:** 5 Hz-175 MHz, AC coupled. **Sensitivity @:** 175 MHz; 150 mV RMS, 150 MHz; 100 mV RMS, 125 MHz, 50 mV RMS, 5 MHz(k); 20mV RMS, 10 Hz; 20 mV RMS. **Impedance:** 1MΩ, < 40 pF. **Attenuator:** x1,



x10, switchable. **Slope:** +, -, switchable. **Trigger Level:** preset or variable. **LP Filter:** 10 kHz, nominal -3 dB cutoff frequency; **Maximum Input:** 250V RMS. **CHANNEL B INPUT CHARACTERISTICS, Bandwidth:** 5 Hz-2 MHz, AC coupled. **Sensitivity:** 30 mV RMS. **Impedance:** 1MΩ, < 40 pF. **Attenuator:** x1, x10, switchable. **Slope:** +, -, switchable. **Maximum Input:** 125 V RMS. **TOTALIZE START/STOP INPUT, Logic Levels:** standard TTL levels. **Loading:** one standard TTL gate. **TIME BASE CHARACTERISTICS, Type:** crystal controlled oscillator. **Internal Frequency:** 10 MHz. **Stability:** ± 0.1 ppm (± 1 Hz). **Line Voltage Stability:** less than ± 1 ppm with +10% line voltage variation. **Temperature Stability:** less than ± (.± 10 ppm) from 0-50 degrees C ambient temperature. **Maximum Aging Rate:** ± 10 ppm/year. **DISPLAY CHARACTERISTICS, Display:** eight 0.43" seven segment digits with kHz μ second, MHz/ms, GATE and OVERFLOW indicators. **GENERAL, Reset:** resets the counter and display to zero. **Hold:** Hold: except in TOTALIZE mode, any measurement in progress is stopped, the counter is reset and the last complete measurement is displayed. **Power Requirements:** 120/240 VAC ± 10%; 50-60 Hz, 20 VAC; domestic units factory wired for 120 VAC. **Dimensions:** 2 1/2" H x 9 3/4" W x 7 1/2" D.

Triple output power supply is designed for safety

The ETI-7000 series Power Supply puts safety first. Equipped with special protective circuitry, it guards against accidental short circuits or over-voltage from circuits you're testing. Front panel circuit breakers are simple to reset, and each output has its own overload indicator.

This Power Supply has one fixed and two variable outputs. Easy-to-read dual analog meters let you measure voltages and monitor current without using a multimeter. There's even an independent tracking mode.

Like the other ETI-7000 series test instruments, the Power Supply comes in a sturdy steel case.

Assembled ETI-7030 (11 lbs.) \$395.00

SPECIFICATIONS: Line Voltage Range: 120/240 VAC, $\pm 10\%$. Line Frequency: 50/60 Hz. Maximum Power Consumption: 165 voltampere, 131 watts. Operation Temperature: 0-40 degrees C (32-104 degrees F) at 75% Relative Humidity (R.H.). Storage Temperature: $-10 + 60$ degrees C at 80% R.H. Outputs: two 0-20 VDC, one 5 VDC. Voltage 5V: $\pm .1$ VDC @ 2A maximum. Voltage 0-20 VDC: 0-20 VDC @ 0.5A maximum. Load Regulations (5V): 0.1% + 5 mV. Line Regulation (5V): 0.1% + 5 mV. Load Regulation (0-20V): 0.01% + 3 mV. Line Regulation (0-20V): 0.01% + 3 mV. Ripple/Noise: 2 mV RMS (5 MHz-1 MHz). Tracking Error: $\pm 0.2\% \pm 20$ mV. Indicator: analog type front panel meter. Voltage Range: 0.25 VDC $\pm 2.5\%$ of full scale. Current Range: 0-600 mA DC $\pm 2.5\%$ of full scale. Dimensions: 5 $\frac{1}{16}$ "H x 9 $\frac{5}{16}$ "W x 9 $\frac{1}{2}$ "D.



Organize and protect your equipment in this instrument cabinet

The ETI-7000 series Instrument Cabinet is designed to hold and protect your instruments. You'll enjoy the convenience of a compact, all-inclusive workstation that's economical, too. This rugged steel cabinet features a drop-down, lockable door that makes your system virtually tamper-proof.

Three internal and two external outlets allow you to plug your instruments directly into the cabinet. One switch turns everything on and off, and a central circuit breaker guards against overloads. In addition, a ground fault interrupt on the external outlets protects both you and your equipment by constantly monitoring the output. If a dangerous current-to-ground leak should occur, the power shuts down automatically.

Knockouts are provided for permanent wiring installation, and an optional blank panel accessory maintains a systems look when the cabinet is partially full. UL approved. 10 $\frac{3}{8}$ "H x 14 $\frac{1}{8}$ "W x 13"D.

Assembled ETI-7050 (14 lbs.) \$225.00

Accessory:

Blank Panel ETI-7060 (1 lb.) \$9.95

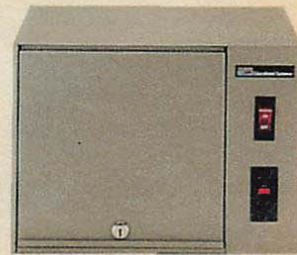

Classroom courses

Our individual learning programs are available in classroom versions for the college, technical school or corporate training class. Courses are listed by category along with instructor's guide, workbook, trainer, parts package and video cassettes, when available.

More than 70 Heathkit Educational Systems representatives in the U.S.A. and Canada are available to help you plan your curriculum, customize your labs and more. They also offer an entire line of educational products in addition to those offered in the Heathkit Catalog. For the representative in your area, call 616-982-3281.



Course	Text ship wt. 2 lbs.*	Price	Workbook ship wt. 2 lbs.*	Price	Instructor's Guide ship wt. 1 lb.*	Price	Assembled Trainer ship wt. 6 lbs.*	Price	Parts ship wt. 1 lb.*	Price	Video Cassettes ship wt. 2 lbs.*	Price
Introductory												
Concepts of Electronics	EB-6140 (3 lbs.)	24.95	EB-6140-40 (1 lb.)	11.95	EB-6140-50	9.95	ETW-3600	199.95	EB-6140-30	29.95	NOT USED	
Concepts of Electricity	EB-3100 (1 lb.)	21.95	EB-3100-40	11.95	EB-3100-50	9.95	ETW-3600	199.95	EB-3100-30	34.95	NOT USED	
Basic Electronics												
DC Electronics	EB-6101-A	21.95	EB-6101-41 (1 lb.)	11.95	EB-6101-51	9.95	ETW-3600	199.95	EB-6101-31 (2 lbs.)	24.95	EV-3101-A	39.95
AC Electronics	EB-6102-A (3 lbs.)	21.95	EB-6102-41	11.95	EB-6102-51 (2 lbs.)	9.95	ETW-3600	199.95	EB-6102-31	19.95	EV-3102-A	39.95
Semiconductor Devices	EB-6103-A (3 lbs.)	21.95	EB-6103-41	11.95	EB-6103-51	9.95	ETW-3600	199.95	EB-6103-31	19.95	EV-3103-A	39.95
Electronic Circuits	EB-6104-A	21.95	EB-6104-41	11.95	EB-6104-51	9.95	ETW-3600	199.95	EB-6104-31	34.95	EV-3104-A	39.95
Electronic Fundamentals	EB-200 (6 lbs.)	39.95	EB-200-40 (1 lb.)	21.95	EB-200-50	11.95	ETW-3600	199.95	EB-200-30	59.95	NOT USED	

Course	Text ship wt. 2 lbs.*	Price	Workbook ship wt. 2 lbs.*	Price	Instructor's Guide ship wt. 1 lb.*	Price	Assembled Trainer ship 6 lbs.*	Price	Parts ship wt. 1 lb.*	Price	Video Cassettes ship wt. 2 lbs.*	Price
Basic Electronics (Cont.)												
Test Instruments	EB-6105 (4 lbs.)	21.95	EB-6105-40	11.95	EB-6105-50	9.95	ETW-3600	199.95	EB-6105-30	29.95	NOT USED	
Electronic Communications	EB-6106	21.95	EB-6106-40 (1 lb.)	11.95	EB-6106-50	9.95	ETW-3600	199.95	EB-6106-30	34.95	NOT USED	
Digital Techniques	EB-6201-A (3 lbs.)	24.95	EB-6201-41	11.95	EB-6201-51	9.95	ETW-3700	199.95	EB-6201-31	34.95	NOT USED	
Digital Techniques Additional Experiments	NOT USED		EB-6201-71 (1 lb.)	12.95	EB-6201-52	9.95	ETW-3700	199.95	NOT USED		NOT USED	
Data Communications and Networks	EB-8090 (5 lbs.)	24.95	EB-8090-40 (1 lb.)	11.95	EB-8090-50	9.95	ETW-1000 (13 lbs.)	299.95	EB-8090-30	19.95	NOT USED	
Advanced Electronics												
Operational Amplifiers	EB-601	21.95	EXPERIMENTS IN TEXT		EB-601-50	9.95	NOT USED		EB-601-30	24.95	NOT USED	
Optoelectronics	EB-605	21.95	EB-605-40 (1 lb.)	11.95	EB-605-50	9.95	NOT USED		EB-605-30	29.95	NOT USED	
Laser Technology	EB-610	21.95	EB-610-40 (1 lb.)	11.95	EB-610-50	9.95	EWS-4200-A (5 lbs.)	395.00	EB-610-30 (3 lbs.)	39.95	NOT USED	
Electro-optics	EB-611	21.95	EB-611-40 (1 lb.)	11.95	EB-611-50	9.95	NOT USED		EB-611-30 (2 lbs.)	79.95	NOT USED	
Linear IC Electronics	EB-615 (3 lbs.)	21.95	EB-615-40 (3 lbs.)	11.95	EB-615-50	9.95	ETW-3600	199.95	EB-615-30 (2 lbs.)	39.95	NOT USED	
SMT												
Surface Mount Technology	EB-3135	24.95	EB-3135-40	12.95	EB-3135-50	10.95	NOT USED		EB-3135-30	69.95	NOT USED	
Microprocessor Technology												
Microprocessors	EB-6401-A (4 lbs.)	24.95	EB-6401-41 (1 lb.)	11.95	EB-6401-51	9.95	ETW-3400-A	399.95	EB-6401-31	64.95	NOT USED	
Microprocessor Interfacing	EB-6402 (5 lbs.)	24.95	EB-6402-40 (1 lb.)	11.95	EB-6402-50	9.95	ETW-3400-A	399.95	EB-6402-30	64.95	NOT USED	
Microprocessor Applications	EB-6405 (3 lbs.)	24.95	EB-6405-40	11.95	EB-6405-50	9.95	ETW-3400-A	399.95	EB-6405-30 (2 lbs.)	54.95	NOT USED	
8-Bit Microprocessor Programming	EB-6810	24.95	EB-6810-40 (1 lb.)	12.95	EB-6810-50	10.95	EWS-6811 (8 lbs.)	695.00	EB-6810-30 (3 lbs.)	29.95	NOT USED	
8-Bit Interfacing Applications	EB-6820 (3 lbs.)	24.95	EB-6820-40	12.95	EB-6820-50	10.95	EWS-6811 (8 lbs.)	695.00	EB-6820-30 (2 lbs.)	74.95	NOT USED	
8085 Microprocessor Programming	EB-8085	24.95	EB-8085-40	12.95	EB-8085-50	10.95	EWS-8085 (7 lbs.)	695.00	EB-8085-30	49.95	NOT USED	
8085 Microprocessor Interfacing and Applications	EBI-8085 (3 lbs.)	24.95	EBI-8085-40	12.95	EBI-8085-50	10.95	EWS-8085 (7 lbs.)	695.00	EBI-8085-30	99.95	NOT USED	
Advanced 16-bit Microprocessors	EB-8088 (4 lbs.)	24.95	EB-8088-40	11.95	EB-8088-50	9.95	ETW-100 (33 lbs.)	799.00	EB-8088-30	59.95	NOT USED	
Robotics and Automation												
Intelligent Machines	EB-1900	21.95	EB-1900-40 (1 lb.)	11.95	EB-1900-50	9.95	NOT USED		EB-1900-30 (2 lbs.)	39.95	NOT USED	
Electronics for Automation	EB-1901	21.95	EB-1901-40 (1 lb.)	11.95	EB-1901-50	9.95	NOT USED		EB-1901-30	69.95	NOT USED	
Industrial Robotics and Automation	EB-1903 (3 lbs.)	21.95	EB-1903-40 (1 lb.)	11.95	EB-1903-50	9.95	EWS-19-32 (100 lbs.)	1295.00	EB-1903-30 (2 lbs.)	64.95	NOT USED	
HERO 2000: Programming and Interfacing	EB-1950 (5 lbs.)	59.95	NOT USED			NOT USED			NOT USED			
Robotics & Ind. Electronics	EB-1801 (4 lbs.)	29.95	EB-1801-40	14.95	EB-1801-50	9.95	ETZ-18-Z (95 lbs.)	1995.00	EB-1801-30 (2 lbs.)	44.95	NOT USED	
HERO 1 Advanced Experiments	EB-1802 (1 lb.)	24.95	NOT USED			NOT USED			NOT USED			
Computer Servicing												
Computer Fundamentals	EB-2001 (3 lbs.)	21.95	EB-2001-40	11.95	EB-2001-50	9.95	ETW-100 (33 lbs.)	799.00	EB-2001-30	39.95	NOT USED	
Computer Peripherals	EB-2002	21.95	EB-2002-40 (1 lb.)	11.95	EB-2002-50	9.95	ETW-100 (33 lbs.)	799.00	EB-2002-30	39.95	NOT USED	
Computer Maintenance	EB-2003	21.95	EB-2003-40 (1 lb.)	11.95	EB-2003-50	9.95	ETW-100 (33 lbs.)	799.00	EB-2003-30	29.95	NOT USED	
CAD												
AutoCAD	EB-609 (6 lbs.)	39.95	NOT USED		NOT USED		NOT USED		NOT USED		NOT USED	
Applied Physics												
Mechanisms: Fundamentals of Mechanical Devices	EW-4300	24.95	EW-4300-40	17.95	EW-4300-50	10.95	ET-4400	649.00	NOT USED		NOT USED	
Telecommunications												
Telephone Systems	EB-5010	24.95	EB-5010-40	12.95	EB-5010-50	11.95	EWS-5000 (14 lbs.)	699.90	ETB-5010 Exper. Modules	449.95	NOT USED	
Communications Systems	EB-5020	24.95	EB-5020-40	12.95	EB-5020-50	11.95	EWS-5000 (14 lbs.)	699.90	ETB-5020 Exper. Module	249.95	NOT USED	

*Standard ship weight unless otherwise stated.

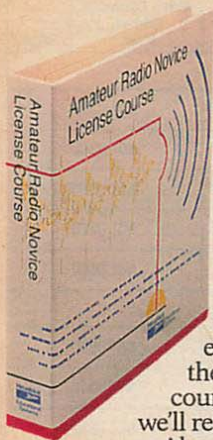

Our novice ham course contains the latest FCC regulations • Earn 1.0 CEU

Join the world of amateur radio and communicate one-on-one with interesting people all over the world. We can get you started today with our Novice License Course. In the comprehensive study package you'll find information on how you apply to take the latest novice class license test. In addition, practice exams and a final examination give you the confidence to pass the exam the first time. We guarantee our course will help you earn your novice ticket or we'll refund your money.

Also in the course package you'll receive a cassette tape to help you learn international Morse code and the FCC rule book to explain the latest changes. Pass the optional final exam and receive 1.0 Continuing Education Unit (CEU).

ER-3701-B (6 lbs.) **\$44.95**

SAVE Save over \$15 on this amateur radio package. Includes ER-3701-B Novice License Course, HD-1416-H CW Code Oscillator (page 77), plus a 10% certificate good for up to \$10 off any Heathkit amateur radio product.

ERS-3701-B (7 lbs.) **\$54.90**



Move up to general class and enjoy more operating privileges

• Earn 5.0 CEUs

Enjoy added general class privileges: more frequencies to operate on, radio teletype, slow scan TV, facsimile and satellite activity. An impressive list of incentives adds up to more QSOs, more QSLs and thousands of new friends.

Our general class course takes you through the material covered on the written test. Its in-depth coverage will give you more than enough information to pass either the technician or general class exam. Extra code practice teaches from 0-15 wpm.

When you pass your general exam, send us a copy of your license or notice to receive 5.0 Continuing Education Units. We're so sure our courses will prepare you for the exam that we guarantee a full refund in the event you don't pass.

ERS-3702-C (26 lbs.) **\$64.95**

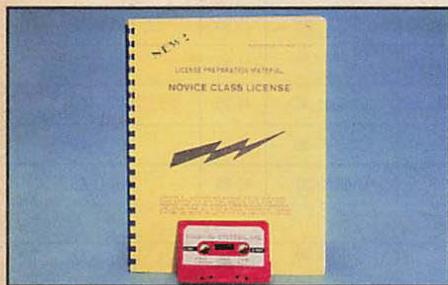

Amateur radio exams

Study for your amateur radio license with the exam study booklets pictured above. The booklets contain every question in the FCC pool for all elements of the exam, correct answers and distractors or "wrong" answer choices. In exams requiring a code element, study material includes a cassette tape for code practice. Bookware contains well over \$100 in discount coupons from major manufacturers, redeemable when you pass your exam.

Novice Bookware	
HDP-1611 (1 lb.)	\$19.95
Technician Bookware	
HDP-1612-T (1 lb.)	\$19.95
General Bookware	
HDP-1612-G (1 lb.)	\$24.95
Advanced Bookware	
HDP-1613 (1 lb.)	\$19.95
Extra Bookware	
HDP-1614 (1 lb.)	\$24.95



Use a computer to study for your radio exams

This computer software offers the most up-to-date, FCC approved questions for all five exams, including the latest enhanced novice class. Continually updated, the software contains both a CW practice program and complete multiple choice questions from the FCC approved pool of questions used for actual exams. For use with Heath/Zenith and IBM PCs.

Novice Software	
HDP-1601 (1 lb.)	\$39.95
Technician Software	
HDP-1602-T (1 lb.)	\$34.95
General Software	
HDP-1602-G (1 lb.)	\$34.95
Advanced Software	
HDP-1603 (1 lb.)	\$49.95
Extra Software	
HDP-1604 (1 lb.)	\$49.95

Take the work out of learning code with the Morse Tutor

Combine the power of your PC and Morse Tutor to learn or improve your international Morse code capabilities. The included diskette contains easy, self-paced lessons that take you from beginner all the way through extra class.

The program begins at the standard five word-per-minute (wpm) requirement needed to gain your novice ticket, but you'll find yourself increasing the tutor's speed as your code proficiency improves. In fact, you can adjust code speed to well over 100 wpm.

Learning new characters is a snap, because Morse Tutor displays the character you're learning on-screen at the same time you hear the sound of the dots and dashes. The program then shows the letter or number five times before moving on to the next character. In addition to letters and numbers, Morse Tutor teaches punctuation marks and other special characters required by the Federal Communications Commission.

Added features include an adjustable tone frequency, a possible one billion random QSOs and parameter memory from one lesson to the next. Operates on IBM PC, XT, AT or compatibles.

HRD-102 (1 lb.) **\$19.95**

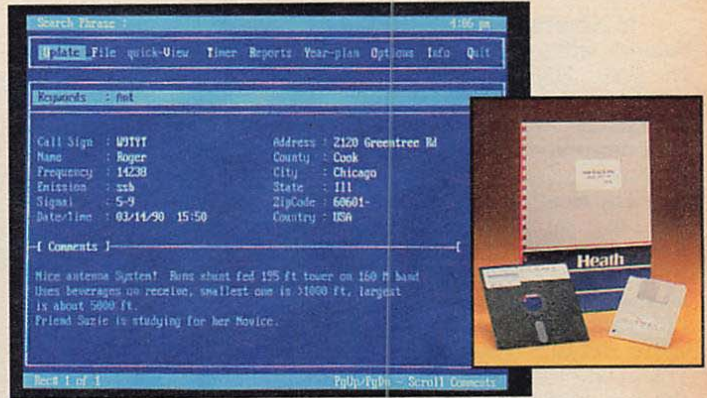
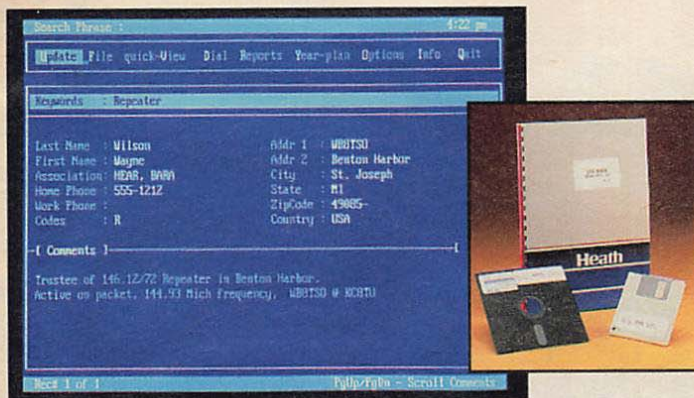

new The computerized assistant that locates former calls in moments

Designed to run on your IBM PC or compatible, Logbook is your personal amateur radio database manager, organizing call sign, name, frequency, emission type, signal quality, date/time, address, and up to 100 lines of comments per record. Keep your contact information up to date and reestablish rapport with former calls quickly. Logbook stores main records in RAM for lightning-fast searching and sorting, prints address sheets or reports in a variety of formats. Requires 256K memory, disk drive, monochrome or color monitor.

HRD-104 (1 lb.) \$29.95

new View, print, auto-dial amateur radio contacts fast with Ham Shack Pro

Organize all the details about your amateur radio contacts and retrieve important information in a moment with Ham Shack Pro, offered exclusively by Heath. Ham Shack Pro turns your IBM PC or compatible into a virtual information "gofer," complete with pop-up calendar for current month. It not only prints address sheets or reports in a variety of formats, but electronically dials any telephone number stored in the data base you create. Requires 256K memory, disk drive, monochrome or color monitor.

HRD-105 (1 lb.) \$29.95

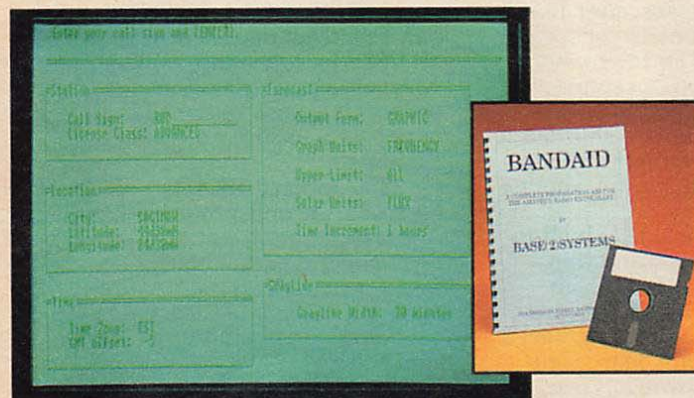

Take the guesswork out of DXing with this propagation program

Written for IBM PC and compatible computers, BandAid is a menu-driven propagation program that determines the best time and band to work a particular country. In addition to calculating wave propagation, you can use BandAid to maintain a QSL logbook, make grayline predictions and to generate MUF and LUF graphs and tables. The program is also great for finding world HF beacons, locating any station on a world map and determining operator-authorized frequencies. BandAid requires 256K RAM and a color graphics card.

HRD-103 (1 lb.) \$39.95

Worldwide propagation is only a keystroke away with MufMap

MufMap is an IBM compatible program that displays graphically, on a world map, the best possible frequency to use to work a particular country. Simultaneously displaying all 10-, 15- and 20-meter band openings, MufMap can project past, present and future RF wave propagation to any part of the world for any given time of day or time period. MufMap can also generate MufMovies, which show changing band conditions over a selected period of time. Great when preparing for DX contests! Requires 256K RAM and a color graphics card.

HRD-101 (1 lb.) \$39.95

Heath Pocket Packet returns to space

In November the Space Shuttle Atlantis will travel into space carrying the Heath HK-21 Pocket Packet TNC. This voyage marks the second time the HK-21 has traveled into space in recent months – the first aboard Columbia in May.

The Heath Pocket Packet is part of a program called the Shuttle Amateur Radio Experiment (SAREX), whose primary purpose is to interest the public, students in particular, in amateur radio and the United States space program. Because of its compact size, the HK-21 was the perfect choice for mounting into the Shuttle's special SAREX casing unit.

Twelve hours of packet daily

During the five day mission, known as STS-37, Marine Corps Lt. Col. Ken Cameron, KB5AWP, will operate the SAREX hardware using voice, packet, and slow-scan and fast-scan TV on the 2 meter amateur radio band. Packet transmissions will last for approximately 12 hours daily. During this time amateur radio operators around the world can send and receive messages to and from Lt. Col. Cameron.

Pocket Packet – a vital link

Transmissions will originate from a Heath Pocket Packet mounted aboard Atlantis, to an identical unit at the Johnson Space Center's Amateur Radio Club station, W5RRR, in Houston, Texas. From there, the astronaut's signals will be rebroadcast to WA3NAN at the Goddard Spaceflight Center in Washington, DC, and to W6VIO at the Jet Propulsion Laboratory in Pasadena, California. These retransmission centers, plus W1AW at the ARRL Headquarters in Newington, Connecticut, and other repeater groups, will relay the signals to amateur radio operators across the nation.

A network of information

On the network, you'll hear information regarding planned transmission times, NASA mission commentary and all two-way voice communications with Atlantis. To ensure the accuracy of network information, the Johnson Space Center will also feed mission news by computer to the coordinating stations.

So tune up your station and get into all the excitement, as the Heath Pocket Packet once again travels into space.



Link up with the Heath pocket packet TNC

Packet radio is the fastest-growing segment of amateur radio today. With our Pocket Packet TNC you get the latest and smallest TNC available, and it's TNC-2 compatible.

If your handheld transceiver, like most, uses a mini phone jack for speaker output and a sub-mini for microphone, in about 20 seconds you can connect your transceiver to the pocket packet unit at any time with the two shielded cables supplied. To connect the unit to your base or mobile transceiver, another cable is also supplied.

The HK-21 even includes a built-in mini bulletin board so you and your friends can leave messages for each other. They access your station with a *Connect* request and automatically get a sign-on message. Bulletin board commands include the following: *W(rite)* writes a message to a specific call; *R(ead)* reads a message sent to your call; *F(iles)* lists the last 10 – or all – messages

in the system, plus the date each message was left; *M(ine)* lists only messages left for you. Additional commands are *H(elp)* or *?*, *K(ill)* and *B(ye)*.

The HK-21 requires a 9 to 13.8V supply @ 40 mA nominal current. Front panel switches disable RS-232 and turn off LEDs for maximum power savings when used as a remote site digi. You can connect it to your station's 12 volt supply or order PS-2350 120 VAC Battery Eliminator.

The optional HKA-21-1 battery pack fits inside the unit, powering it for hours. And it recharges from the 12 volt DC jack on the pocket packet unit.

Assembled HK-21
(2 lbs.) \$199.95

Accessories:

Optional Battery Pack Assembled
HKA-21-1 (1 lb.) \$17.95

Battery Eliminator Assembled
PS-2350 (1 lb.) \$7.95

Our customers write...

"I cannot say enough good things about this tiny TNC. The instructions are very plain and understandable. I am using the unit with a Micro 2 AT Icom handheld transceiver and an IBM compatible running (the program) PROCOMM. This setup seems perfect for the packet station."

Dan Lampman (AB4DA)
West Palm Beach, Florida

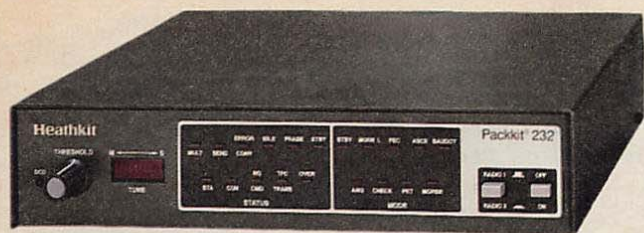

PackKit multi-mode TNC includes new mailbox board

The Heathkit PackKit multi-mode TNC now includes our new mailbox board, a \$49.95 value, absolutely free. This versatile board lets you operate your PackKit as a personal packet mailbox or local BBS. Feature packed, our TNC also lets you work CW at speeds you never dreamed of and gets you on AMTOR, ASCII, RTTY and NAVTEX. With the addition of a graphics printer, you can even print weather facsimile pictures.

A unique *Signal* command causes PackKit to determine correct RTTY, ASCII or AMTOR mode for the signal you're listening to and presets baud rate and mode. It even inverts the signal if necessary. Use the *Opmode* command to display full details of your current operating mode without having to change mode.

The unit supports all common baud rates for Baudot RTTY and ASCII, and CW from 5 to 99 WPM. Radio link rates are supported to 1200 baud (9600 with external modem) and computer data rates to 9600 baud. What's more, no special software is needed. Use with any modem communication package made to run on your computer or order Ham-Pak software (below). You can use the HK-232-B with computers or terminals using an RS-232 industry standard serial port.

For flexibility, PackKit has two independent, selectable rear-panel connection ports that provide interchangeable HF or VHF operation. All you need to do is connect your radio's PTT line, speaker output and microphone input. The same connections work for all other modes, too – even CW. And, for easy HF tune-up, the PackKit TNC features a built-in front panel bar graph indicator.

Includes operational manual with hookup connections for most popular HF and VHF radios. Operates on 12 VDC at 750 mA with 10% ripple or less. 2½" H x 8¼" W x 11" D.

Kit HK-232-B (5 lbs.) \$279.95



Save \$15 on this complete packet communications package. Includes HK-232-B Heathkit PackKit multi-mode TNC and HKA-232-3 Technical Manual (sold below).

HKS-232 (7 lbs.) \$289.90

Accessories:

Ham-Pak Communications Software Program

Use with Heath/Zenith, IBM PCs and compatibles.
HKA-232-2 (1 lb.) \$19.95

Technical Manual. Comprehensive manual includes alignment, troubleshooting – with over 80 waveforms, circuit board layout and detailed circuit description.
HKA-232-3 (2 lbs.) \$24.95

Power Supply 12V DC 1 Amp. Requires 120 VAC.
 Assembled **HKA-232-4** (4 lbs.) \$19.95

Mailbox Board. Turn your HK-232 or HK-232-A into a personal packet mailbox. Also makes a great local BBS.
 Assembled **HKA-232-5** (1 lb.) \$49.95

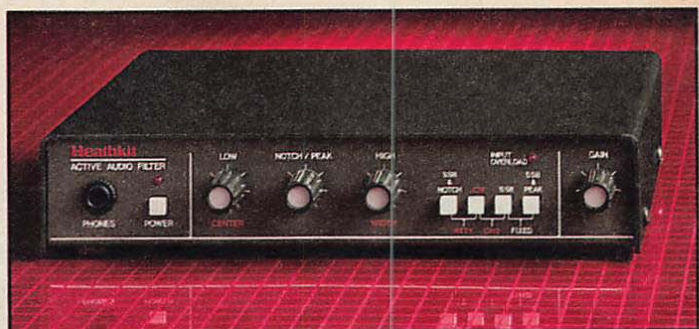

Multi-mode SSB/CW/RTTY active audio filter makes the tough ones easy to copy

Solve overmodulation splatter, partially overlapped sideband signals and more with the Heathkit Active Audio Filter. The HD-1418 consists of five-pole (section) high-pass and low-pass filters, plus a two-pole notch/peak filter. You can move these filters through a 300 to 2500 Hz audio frequency band to help you select or reject certain frequency components of signals you tune in with your shortwave equipment. Versatile power requirements make the Active Audio Filter usable almost anywhere. Just supply 7-13.5 volts AC or 9-18 volts DC. For AC power operation, purchase our 120 VAC Power Adapter Cube, PS-5012, sold below. Dimensions of the Active Audio Filter are 1⅞" H x 8⅞" W x 6⅝" D.

Kit HD-1418 (3 lbs.) \$89.95

Revolutionize your CW with the programmable μmatic memory keyer

Add programmable excellence to all your CW. Patented command strings let you store text in buffers; select speed, weight, spacing or message repeat count for each; and link them together in any sequence. A special editing feature lets you correct programming errors. Enter text and send with any setting you wish. Text can be added into a buffer message being sent. CMOS memory with battery backup retains the buffer contents and last selected setting when the keyer is without power. 1⅝" H x 4⅞" W x 6" D.

Kit SA-5010-A (3 lbs.) \$129.95

Accessory:
120 VAC Power Adapter Cube
 Assembled **PS-5012** (1 lb.) \$15.95

Specifications: **Speed Range:** 1 to 99 wpm. **Character/Word Spacing:** Less than or equal to speed setting. **Number of Buffers:** 1 to 10. **Buffer Size:** 240 characters plus commands. **Weighting:** Normal plus 5 light and 5 heavy settings. **Auto Message Repeat:** 0 to 9 (sent 1 to 10 times). **Keyer Output:** Solid state: +250 volts @ 100 mA; –200 volts @ 40 mA. **Sidetone:** Approximately 300 to 1500 Hz, adjustable. **Power:** External transformer (optional) or 11 to 16 VDC @ 200 mA.

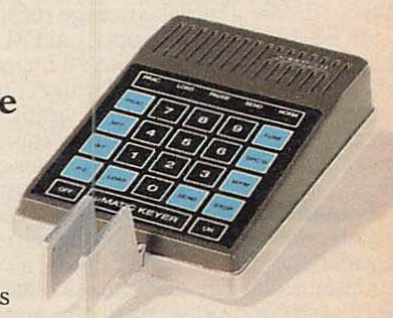



Save \$230 on the SB-1400 and its companion power supply

HF Transceiver. This feature-packed transceiver delivers 100W of PEP output on all nine HF amateur bands, with 100kHz-30MHz general coverage reception.

An SSB/CW/AM and optional FM transceiver, the SB-1400 features dual VFOs along with 20 memory channels. These channels can store mode and skip-scan status allowing for auto resume scanning of selectable memories, controlled from the microphone up/down keys. In addition, you can store independent transmit and receive frequencies on 18 of the memories for easy recall of split-frequency operations.

Behind the SB-1400's convenient front panel layout are many standard features including narrowband (500Hz) CW and wideband (6kHz) AM IF filters, a switchable 20dB receiver attenuator, a clarifier, and a noise blanker for better reception under harsh conditions. You'll also appreciate that the transmitter power amplifier is cooled by an internal fan and is enclosed in its own diecast aluminum heat-sink chamber, which allows for full power operation of FM and Packet, RTTY, AMTOR and SSTV.

Tuning is a snap with the user-selectable coarse and fine tuning steps provided in each mode: 25Hz and 2.5kHz for SSB and CW, 1kHz and 100Hz for AM, and 5 and 12.5kHz for FM with an optional FM Module.

Assembled SB-1400 (9 lbs.) Limited Quantities ... \$799.95

Specifications: **RECEIVER: Sensitivity:** SSB & CW: 0.25 μ V above 1.5 MHz, 0.5 μ V (500kHz-1.5 MHz); AM: 1 μ V above 1.5 MHz; FM: (option) 0.7 μ V for 12 dB SINAD above 28 MHz. **IF Frequency:** 47.055, 8.215 MHz (and 455 kHz FM triple conversion). **Image Rejection:** > 70 dB above 1.5 MHz. **IF Rejection:** > 60 dB above 1.5 MHz. **Selectivity:** SSB; CW(W); AM(N), 2.2 kHz at -6 dB, 5 kHz at -60 dB; CW(N), 500 Hz at -6 dB, 1.8 kHz at -60 dB. **TRANSMITTER: Amateur Bands:** 160m, 80m, 40m, 30m, 20m, 17m, 15m, 12m and 10m. **Output:** 100W PEP (SSB, CW and optional FM), 25 watt carrier (AM). **Harmonic and Spurious Output:** Exceeds FCC requirements: **RF Connector:** SO-239 type. **Supply Voltage:** 13.5 VDC 19 amps max. @ \pm 10%.

AS LOW AS
\$45 PER MONTH
ON YOUR HEATH
REVOLVING
CHARGE

Operate your SB-1400 from a computer with our interfacing software listed below.

Speaker/Power Supply. Delivers full 20 amp output for 30 minutes on and 30 minutes off. Other features include thermally switched quiet cooling fan; high quality 3-watt, 4-ohm speaker; 13.5 VDC at 20 amps; and 117 VAC, 50/60 Hz operation. UL listed.

Assembled SBA-1400-4 (17 lbs.) ... \$329.95

Save \$230 on this amateur radio package. Includes SB-1400 100W HF All-Mode Transceiver and SBA-1400-4 Speaker/Power Supply.

SBS-1400-1 (26 lbs.) ... \$899.90

Accessories:

Mobile Bracket. Take your SB-1400 on the road with you. Bracket mounts above or below the dash and features quick release.

Assembled SBA-1400-3 (1 lb.) ... \$25.95

Switching Relay. Protect your rig from transient high voltage. Use if switching voltages are greater than 150 volts or current is in excess of 1.5A. Features an outboard relay for non-QSK linear amplifiers. Maximum switching voltage is 250V.

Assembled SBA-1400-5 (1 lb.) ... \$17.95

Interfacing Software. Operate your SB-1400 from an IBM or compatible computer with this easy-to-use software package. Screen layout is similar to transceiver display, and all memory contents are shown for easy review and selection. Features flexible QSY function, large frequency display, HV-2000 Voice Card (page 29) support, and transient or memory-resident operation. Requires TTL to RS-232 interface cable sold below. **SBA-1400-7 (1 lb.) ... \$39.95**

TTL to RS-232 Interface Cable. Allows connection of your SB-1400 to a computer with a standard RS-232 serial port. **SBA-1400-8 (1 lb.) ... \$49.95**

*Your actual monthly payments may vary depending on your account balance.

Thu 3-15-1990 238°
9:28:56 PM (Remote)

In standby mode, IntelliRotor's 40-character LCD display shows local day, date, time and current bearing.

60°S/ 63°W FD80 168°
4:29:02 AM 7174 mi

Push one button and read selected country's latitude, longitude, grid square, bearing, time and distance.

South Shetland Is.
CE9, HF0, LU, UP8, 4K1

View names and possible prefixes for any of over 400 countries in the permanent database.



Compact controller fits almost anywhere – even mounts on a wall. Power supply (inset) can be placed out of sight, up to six feet away.

new All-new IntelliRotor makes beam antenna rotation automatic!

You know the old routine. Find the location you want to work on a map or chart, calculate the bearing, rotate the beam, double-check the bearing. Want to work another location? Repeat the procedure all over again.

IntelliRotor puts an end to the hassle of rotating your beam antenna manually. With just a few keystrokes, IntelliRotor lets you choose from a permanent database of over 400 countries, including their coordinates and time zones, or lets you enter and store your own.

In its default mode, IntelliRotor's 40-character LCD display shows the current time, date, day of the week and bearing to 1°. Bearing is also displayed on a compass rose of 16 LEDs, with a resolution of 32 points, or 11.25 degrees. In addition, the display shows country names, a prefix list, target bearing, short/long path distance, latitude and longitude, grid square and the time in target country.

Use the IntelliRotor's built-in QWERTY-style keyboard to enter any of these: the name of the country (or just the first few letters), a prefix (or partial prefix), latitude and longitude, grid square or the bearing in degrees. With a few keystrokes,

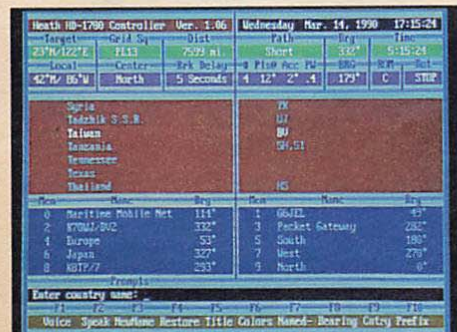

Included software lets you operate the controller from a PC-compatible computer, complete with screen displays.

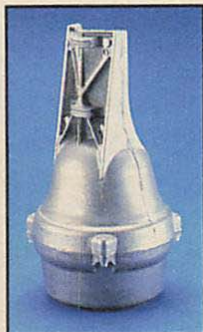

Rugged HD-3 Rotor is the perfect partner for your IntelliRotor.

IntelliRotor immediately starts rotating your antenna to the country you want.

Scan through the built-in database to obtain information before you rotate the antenna, or customize the list to make your beam selections even more convenient and precise. IntelliRotor lets you edit any entry or enter up to ten of your own named and detailed bearings for later use. Of course, you can always rotate the beam manually, with a constant visual update on the current angle. And sight-impaired users can choose to have IntelliRotor announce current bearings in Morse code at 20 WPM.

The IntelliRotor features superior rotor control with motor pulsing, automatic braking, and initial back-rotating to protect the brake from locking due to wind-loading. IntelliRotor even monitors the rotator's duty cycle to make sure it can't overheat.*

Since the IntelliRotor's compact controller module is linked to a separate power unit that can be placed out of sight, you save valuable table or shelf space. Or, use the unit's serial port and included software (supplied on both 5.25" and 3.5" disks) to control the IntelliRotor from a PC-compatible computer, either as a transient program or pop-up. The program shows all the information from the controller's display, and more, on your computer's screen. If a Heath HV-2000 voice card (sold on page 29) is installed in the PC, sight-impaired amateurs can gain full access to the IntelliRotor's functions.

Compatible with all Ham-M (series 3, 4, 5 and 6), Ham-II, Ham-III, Ham IV, T²X, CDE TR-44, CD-45 (series 2) and M2 rotators. Or order with cable and new rotator mechanism below.

Kit HD-1780 (6 lbs.) Available August **\$279.95**
Assembled HDW-1780 (11 lbs.) .. Available August **\$349.95**

Accessories:

125' Standard Rotor Cable
Assembled HDA-1780-1 (6 lbs.) **\$69.95**

200' Heavy Duty Rotor Cable
Assembled HDA-1780-2 (17 lbs.) **\$129.95**

Telex Ham IV Rotor, manual and hardware
(control box not included)
Assembled HDA-1780-3 (15 lbs.) **\$319.95**

Note: Telex/hy-gain* honors their rotator warranties when used with this product.

Mini-deluxe 2 meter and 450 MHz transceivers

Our 2 meter and 450 MHz Mini-Deluxe transceivers provide impressive capabilities in a compact size.

The HW-2-M and HW-4-M boast a highly sensitive receiver section at 0.158 μV for 12 dB SINAD. True broadband transceivers, the Mini-Deluxe HTs retain their excellent receiver sensitivity and power output even outside the amateur band.* You can actually achieve a full 5 watt output with the optional high-power battery pack.

Both models feature 21 memory frequencies (20 + 1 call) – more than you'll ever need! You can scan only favorite memory channels, all channels or even full band, excluding any frequency or range. Or, enter frequencies directly from the keyboard or via a rotary channel selector.

Other features include hi/med/low power, Auto-Power Off, dual frequency watch, 43 mA RX squelched, 13 mA RX battery save, DTMF, LCD display, duplex operation, battery saver standby mode and PTT lockout. Both models include a 7.2 V, 700 mA/h battery and charger.

Assembled HW-2-M 2 Meter Handheld Transceiver. (2 lbs.) **\$379.95**

Assembled HW-4-M 450 MHz Handheld Transceiver. (2 lbs.) **\$399.95**

Accessories:

Handheld Microphone Speaker

Assembled HWA-180 (1 lb.) ... **\$34.95**

Headset. With push-to-talk switch.

Assembled HWA-190 (1 lb.) ... **\$32.95**

CTCSS Unit

Assembled HWA-302 (1 lb.) ... **\$64.95**

Small Soft Carrying Case. For transceivers using the HWA-305 Battery Pack.

Assembled HWA-345 (1 lb.) ... **\$14.95**

Regular Carrying Case. For transceivers using the HWA-310 Battery Pack.

Assembled HWA-350 (1 lb.) ... **\$16.95**

Large Carrying Case. For transceivers using the HWA-320 or HWA-325 Battery Pack.

Assembled HWA-355 (1 lb.) **\$18.95**

Specifications: GENERAL: Frequency*:

2M: 144-147.995 MHz. 4M: 438-449.995 MHz.

Modulation Type: F3. Microphone Input Impedance: 600 ohms. Speaker Impedance: 8 ohms. Operating Voltage: 5-16 VDC. Antenna Impedance: 50 ohms. Power Supply: 7.2 VDC (nom.) Dimensions: 5 1/4" H x 2 3/16" W x 1 1/4" D. Weight: 10.6 oz. TRANSMITTER: Output Power: 5 W (hi), 2.5 W (med), 0.35 W (low). Spurious Signal Ratio: -60 dB. Max Deviation: ± 5 kHz. Modulation: Reactance. RECEIVER: Sensitivity: 0.158 μV . Squelch Sensitivity: 0.1 μV . Circuitry: Double-conversion superheterodyne. Audio Output: 250 mW at 8 ohms. Note: Specifications are within amateur band.

*May be modified for out-of-amateur-band operation for MARS, CAP and embassy operators. Contact Heath Customer Service for full information. Proof of participation required.



5 1/4" H x 2 3/16" W x 1 1/4" D

Batteries and chargers for Mini-Deluxe HTs

Compact Rechargeable NiCd Battery Pack. 7.2 V, 400 mA/h.

1 Assembled HWA-305 (1 lb.) **\$64.95**

Standard Rechargeable NiCd Battery Pack. 7.2 V, 700 mA/h.

2 Assembled HWA-310 (1 lb.) **\$59.95**

High-Power Rechargeable NiCd Battery Pack. 12 V, 600 mA/h.

3 Assembled HWA-320 (1 lb.) **\$89.95**

Long-Life Rechargeable NiCd Battery Pack. 7.2 V, 1000 mA/h.

4 Assembled HWA-325 (1 lb.) **\$79.95**

Wall Charger. For use with HWA-305, HWA-310 or HWA-325 battery packs. Plugs directly into a wall outlet.

9 Assembled HWA-330 (1 lb.) **\$16.95**

Automatic Quick Charger

Desktop unit charges battery in 1 hour then switches to trickle charge. Auto shut-off.

10 Assembled HWA-340 (4 lbs.) **\$119.95**

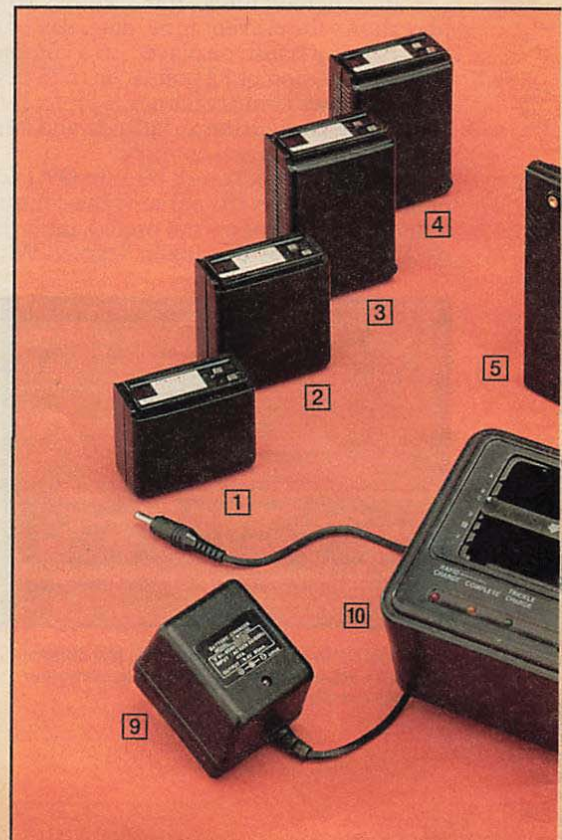

Micro-deluxe 2 meter and 450 MHz transceivers

Designed with the user in mind, our 2 meter and 450 MHz Micro-Deluxe transceivers use batteries that hinge onto the back of the units instead of adding to their length. This arrangement lets the HTs retain their same basic form even with the largest capacity batteries. Slip one into your pocket or hook it on your belt – no more hassles with bent clips or tangles with car seatbelts.

You'll appreciate the sensitive receiver section at 0.158 μ V for 12 dB SINAD. The HW-2-P also features true broadband reception for sensitive out-of-band operation.* And with the optional high-power battery pack, a full 5 watt output is possible on both HTs.

With 21 memory channels (20 + 1 call) you can group scan or perform an all-memory scan. Scanning of the dial frequency provides a 1 MHz scan, all scan or program scan. Or enter frequencies directly from the keyboard or via a rotary channel selector.

Standard features include DTMF, LCD display, duplex operation, Auto-Power Off, Auto-On Timer, one button open squelch, PTT lockout, hi/med/lo power, 9-step programmable battery saver, and a 7.2 V, 700 mA/h battery and charger.

Assembled HW-2-P 2 Meter Handheld Transceiver. (2 lbs.) \$399.95

Assembled HW-4-P 450 MHz Handheld Transceiver. (2 lbs.) \$419.95

Accessories:

Handheld Microphone Speaker
Assembled HWA-180 (1 lb.) . . . \$34.95

Headset with push-to-talk switch.
Assembled HWA-190 (1 lb.) . . . \$32.95

CTCSS Unit
Assembled HWA-402 (1 lb.) . . . \$64.95

Carrying Case
Assembled HWA-450 (1 lb.) . . . \$17.95

Specifications: **GENERAL:** Frequency*: 2P: 144-147.995 MHz. 4P: 438-449.995 MHz. **Modulation Type:** F3. **Microphone Input Impedance:** 600 ohms. **Speaker Impedance:** 8 ohms. **Operating Voltage:** 5.5-16 VDC. **Antenna Impedance:** 50 ohms. **Power Supply:** 7.2 VDC (nom.). **Dimensions:** 4 $\frac{3}{8}$ " H x 2 $\frac{1}{4}$ " W x 1 $\frac{3}{16}$ " D. **Weight:** 12.3 oz. **TRANSMITTER: Output Power:** 5 W (hi), 2.5 W (med), 0.3 W (low). **Spurious Signal Ratio:** -60 dB. **Max. Deviation:** \pm 5 kHz. **Modulation:** Reactance. **RECEIVER: Sensitivity:** 0.158 μ V. **Squelch Sensitivity:** 0.125 μ V. **Circuitry:** Double-conversion superheterodyne. **Audio Output:** 400 mW at 8 ohms. Note: Specifications are within amateur band.

*May be modified for out-of-amateur-band operation for MARS, CAP and embassy operators. Contact Heath Customer Service for full information. Proof of participation required.



4 $\frac{3}{8}$ " H x 2 $\frac{1}{4}$ " W x 1 $\frac{3}{16}$ " D

Batteries and chargers for Micro-Deluxe HTs

Compact Rechargeable NiCd Battery Pack. 7.2 V, 400 mA/h.

5 Assembled HWA-405 (1 lb.) \$64.95

Standard Rechargeable NiCd Battery Pack. 7.2 V, 700 mA/h.

6 Assembled HWA-410 (1 lb.) \$59.95

High-Power Rechargeable NiCd Battery Pack. 12 V, 600 mA/h.

7 Assembled HWA-420 (1 lb.) \$89.95

Long-Life Rechargeable NiCd Battery Pack. 7.2 V, 1200 mA/h.

8 Assembled HWA-425 (1 lb.) \$79.95

Wall Charger. For use with HWA-405, HWA-410 or HWA-425 battery packs. Plugs directly into a wall outlet.

9 Assembled HWA-330 (1 lb.) \$16.95

Automatic Quick Charger

Desktop unit charges battery in 1 hour then switches to trickle charge. Auto shut-off.

10 Assembled HWA-340 (4 lbs.) \$119.95





Portable yet powerful 2 meter and 450 MHz handheld transceivers

Put more fun and enjoyment into portable communications with these compact 2 meter and 450 MHz transceivers. Besides power and easy one-handed operation, they offer many impressive features with options.

One of these features is the double-conversion superheterodyne receiver section that's extremely sensitive at $.158 \mu\text{V}$ for 12 dB SINAD within amateur bands. They also have thumb-wheel tuning, hi/low power operation, squelch, repeater \pm offsets, and optional CTCSS and DTMF capabilities. Each model includes one HWA-110 rechargeable battery pack and one HWA-130 wall charger.

- Assembled HWS-2 2 Meter Handheld Transceiver** shown with optional Touch Tone Encoder.
(2 lbs.) **\$199.95**
- Assembled HWS-4 450 MHz Handheld Transceiver.**
(2 lbs.) **\$219.95**

RTD Get a free mobile battery charger when you purchase one of the handheld transceivers listed above. Just enter HWA-150 on the order form and "No Charge" in the price column.

Accessories:

- 120 VAC Wall Charger**
Assembled HWA-130 (1 lb.) **\$13.95**
- Soft Carrying Case.** For HWS-2 and HWS-4.
Assembled HWA-240
(1 lb.) **\$7.95**
- CTCSS Unit.** Includes programmable dip switches for any tone frequency on the HWS-2 and HWS-4.
Assembled HWA-220
(1 lb.) **\$52.95**

- Touch Tone Encoder.** Use with the remote control function on the HWS-2 or HWS-4.
Assembled HWA-230 (1 lb.) **\$29.95**

Specifications: **GENERAL:** Frequency: 2: 144 - 147.995 MHz. 4: 440 - 449.995 MHz. **Emission Type:** FM. **Microphone Input Impedance:** 600 ohm. **Speaker Impedance:** 8 ohm. **Operating Voltage:** 5.5 - 11 VDC. **Antenna Impedance:** 50 ohm. **Power Supply:** 9 VDC (nom.) **Dimensions:** 5.2" H x 2.4" W x 1.3" D. **Weight:** 14.3 ozs. **TRANSMITTER:** **Output Power:** 3 W (hi), 400 mW (lo). **Spurious Signal:** -60 dB. **Max. Deviation:** ± 5 kHz. **Modulation:** Reactance. **Built-in Microphone:** Electret condenser type. **RECEIVER:** **Sensitivity:** $0.158 \mu\text{V}$. **Squelch Sensitivity:** $0.1 \mu\text{V}$. **Circuitry:** Double conversion superheterodyne. **Selectivity:** -60 dB. **Audio Output:** 400 mW at 8 ohms.

- More accessories for handheld transceivers on pages 70 and 72:
- 120 VAC Desktop Quick-Charge Charger**
Assembled HWA-140 (2 lbs.) **\$39.95**
- Mobile Car Battery Adapter.** For charging battery during operation.
Assembled HWA-160 (1 lb.) **\$42.95**
- Microphone Speaker**
Assembled HWA-180 (1 lb.) **\$34.95**
- Headphone.** With push-to-talk switch.
Assembled HWA-190 (1 lb.) **\$32.95**
- Extended Life Rechargeable NiCd Battery Pack**
Assembled HWA-125 (1 lb.) **\$72.95**
- Small Rechargeable NiCd Battery Pack.** For normal wattage output operation.
Assembled HWA-110 (1 lb.) **\$49.95**
- Large Rechargeable NiCd Battery Pack.** For higher wattage output operation on the HWS-24-HT only.
Assembled HWA-120 (1 lb.) **\$59.95**



HW-24



HW-24-H

Keep in touch with Heath mobile twin band transceiver/repeaters

10W & 50W Twin Band Transceiver/Repeaters. Tune up to 20 memory channels – 10 on each band – with the 10W and 50W VHF/UHF twin band transceiver/repeaters. Also set split or simplex receiver-transmitter operation for each memory channel. For repeater operation, you can memorize an offset frequency and a tone control frequency on all band channels. And, two internal VFOs allow simultaneous monitoring of one channel on each band.

Duplex operation gives you a semi-duplex QSO using the two VFOs and a memory frequency. You get full duplex operation when you use a combination of the VHF and UHF bands. A frequency mode switch gives you either 1 MHz or 100 kHz steps or one of five (5, 10, 12.5, 20 or 25 kHz) channel step options. You can even use different channel steps for the two bands.

Receiver frequency response* is an impressive 130-169.995 MHz on VHF and 360-489.995 MHz on UHF. Both the VHF and UHF sections feature pin diode transmit/receive switching with no mechanical relays. The result is high reliability and fast transmit/receive times for packet operation. In addition, high VSWR shutdown protects your unit in case of an antenna failure or a mismatched antenna system.

Both the HW-24 and HW-24-H include an automatic repeater function. Just set your cross band frequencies (including repeater offset) for each band and enter the repeater mode – with or without hang tail. Use as an emergency repeater or remote link, or use two units placed apart as a permanent repeater (no cavities) linked on UHF. Even use in your car as a relay between your UHF HT and a VHF repeater that you would not normally be able to access with just an HT – great for Field Day!

Made of rugged cast aluminum, both units feature large controls for easy operation. Individual volume and squelch controls and individual status display include the operating frequency plus the "S"-meter/RF output indicator for each band. Change frequencies directly from the microphone's up/down buttons or a rotary channel selector. A keylock switch locks the microphone's up/down buttons to prevent you from accidentally changing the frequency while making keyboard entries. And, a 16 button DTMF pad lets you use your microphone to control some repeaters and make telephone calls through equipped repeaters.

Like all Heath amateur radio products, the HW-24 and HW-24-H are backed by our knowledgeable technical consultants. Licensed ham operators, they're ready to assist you Monday-Friday, 8:00 a.m. to 4:30 p.m. E.T. at 616-982-3269.

Assembled HW-24 10W Twin Band Transceiver/ Repeater. (7 lbs.) \$599.95

Assembled HW-24-H 50W Twin Band Transceiver/ Repeater. (7 lbs.) \$699.95

Specifications for HW-24 and HW-24-H: **Frequency Range***: VHF: 144.000 to 147.995 MHz. UHF: 438.000 to 449.995 MHz. **Modulation Type**: F3. **Microphone Input Impedance**: 600-. **Speaker Impedance**: 8-. **Antenna Impedance**: 50-. **Input Voltage**: 12 to 16 volts DC. **Operational Temperature Range**: -4°F to +140°F. **Antenna Connector**: SO-239 type. **Memory Channels**: 10 per band, VHF and UHF. **Scanning**: 1 MHz segment, all band, all memory channels, or selected memory channels. **Tone Squelch**: Simplex/Duplex; user selected. **Automatic Repeater**: VHF to UHF, or UHF to VHF.

*May be modified for out-of-amateur-band transmit operation for MARS, CAP and embassy operators. Contact Heath Customer Service for full information. Proof of participation required.



Heath's advanced broad-band receiver with battery-powered portability

The HW-24-HT VHF/UHF Dual Band HT packs world winning capabilities into an amazingly compact size.

First, the receiver sensitivity spec is an unbeatable $0.158 \mu\text{V}$ for 12 dB SINAD. That's important since handheld units are usually operated from rubber duck antennas.

72

Second, the Heath Dual Band HT offers extremely broad frequency coverage. From 130 MHz to 169.995 MHz and from 360 MHz to 469.995 MHz (except 400-418 MHz) on receive.

Finally, Heath HTs in general require less power on receive and far less power on transmit. As a result, battery life is substantially better than that available with other units. At full 5 watts Tx output, the HW-24-HT requires only 1000 ma VHF or 1300 ma UHF. Compare this with the major competitor at 2000 ma VHF and 2200 ma UHF for the same power to the antenna.

Other deluxe features: 22 Memories (20 memories + 2 call memories, and the call memories can be your favorite repeaters if you wish). Plus a full-function keyboard you can use to enter new frequencies either directly or with a rotary frequency selector that doubles as a quick channel selector in the memory mode.

Heath HTs have more scanning modes too: Scan the first 10 memories or last 10, scan all 20 memories, or scan only selected memory channels. Use selected memory scan to temporarily block out a channel you still want to keep in memory. Scan a 1 MHz segment of the band, all except 1 MHz, or scan the entire band. Double the number of scanning modes, because in any mode you can select Pause Scan or Busy Scan. Pause Scan stops on an active channel, but resumes after a few seconds so you hear everything that's going on. Busy Scan stops on an active channel and holds until the frequency goes clear. Dual Watch lets you monitor two frequencies at the same time. It causes the HT to hold on the alternate channel as soon as it goes busy. Great for listening to two repeaters at the same time, especially when you don't want to miss anything on one of them.

The HW-24-HT includes a full 16 key DTMF pad plus VHF/UHF full-duplex operation that allows full duplex telephone calls through equipped repeaters.

And if all this weren't enough, we've even lowered the price on the HWS-24-HT system.

Assembled HWS-24-HT. Includes rechargeable battery, power cube and extra empty battery shell. (4 lbs.) . . . **\$469.95**

Get a free mobile battery charger when you purchase the HWS-24-HT. Just enter HWA-150 on the order form and "No Charge" in the price column.

Accessories:

Soft Carrying Case. For the HWS-24-HT using the HWA-110 battery (sold on page 70).

Assembled HWA-250-A (1 lb.) **\$16.95**

Large Soft Carrying Case. For the HWS-24-HT using the HWA-120 or HWA-125 battery (both sold on page 70).

Assembled HWA-260-A (1 lb.) **\$19.95**

SEE "MORE ACCESSORIES" ON PAGE 70.

Specifications: **Frequency Range***: VHF: 144.000 to 147.995 MHz. UHF: 438.000 to 449.995 MHz. **Modulation Type**: F3. **Microphone Input Impedance**: 600~. **Speaker Impedance**: 8~. **Antenna Impedance**: 50~. **Input Voltage**: 12 to 16 volts DC (5.5 to 16 volts DC on the HT). **Operational Temperature Range**: -4°F to +140°F. **Antenna Connector**: BNC type. **Memory Channels**: 10 per band, VHF and UHF. **Scanning**: 1MHz segment, all band, all memory channels, or selected memory channels. **Tone Squelch**: Simplex/Duplex; user selected.

*May be modified for out-of-amateur-band operation for MARS, CAP and embassy operators. Contact Heath Customer Service for full information. Proof of participation required.

AS LOW AS \$45 PER MONTH ON YOUR HEATH REVOLVING CHARGE

Get high performance from the Heathkit 1000W linear amplifier

You get unparalleled performance at an affordable price with the Heathkit Linear Amplifier. It's a completely self-contained, grounded grid linear amplifier designed to operate at 1000 watts PEP output on SSB or 850 watts output on CW and 500 watts RTTY. The SB-1000 covers 160, 80, 40, 20 and 15 meter amateur bands with tuned input filters your solid state rig will like. Also included are WARC and most MARS bands at 80% of rated output.

Instant heat tube gets you on the air faster

The amplifier uses a single 3-500Z tube in a high efficiency circuit for top performance. And its high silicon steel E-I core transformer takes up less room, runs cooler and gives you more high performance power than other models. Other selected features include door knob caps in critical RF circuits, adjustable ALC so your amplifier works with any rig, a stiff full-wave power supply with computer grade capacitors, a quiet computer-style fan, and plate and load controls with smooth vernier tuning. And, since the tube is an instant heating type, transmission can begin as soon as you turn on the amplifier after tune up.

Special RF section delivers maximum efficiency

The High-Q tank circuit and superb layout and design of the RF section result in maximum efficiency and put the RF power out on your antenna where it belongs - instead of burning it up as heat in the tube. Even the path of air flow was considered important in the design of the SB-1000. Intake is from the left side where the cool air flows over the power supply diodes, electrolytic caps and power transformer, then through the fan and into a completely separate RF compartment, where it is directed around the amplifier tube. Here temperature and smoke movement studies enabled the layout of an RF section which is both electrically and thermally efficient, where air turbulence could be maximized in order to efficiently remove heat from tank circuit components. The result? A reliable, top-performing amplifier. In fact, seasoned amateurs who have used the SB-1000 talk about the first class "feel" of the amplifier, how nicely it tunes and how well it performs in the pileups.

Continuously monitored grid current

Front panel meters are illuminated and grid current is continuously monitored for protection and long tube life. The amplifier may be operated from 120 VAC or 240 VAC (operation from a 240 volt AC line is recommended), 50/60 Hz power sources. Each side of the line cord is separately fused. Dimensions are 8 1/4" H x 14 1/2" W x 13 7/8" D.

Kit SB-1000 (57 lbs.) \$799.95

OSK Board. Includes parts for installation in SB-1000.
Assembled SBA-2001-1 (1 lb.) \$249.95



Specifications: **INPUT:** Circuit type: Pi-network. **Maximum VSWR at resonance:** 1.3:1 or less. **Minimum 2:1 VSWR bandwidth:** 20% or greater. **Maximum drive power permissible:** 100 W. **Typical drive for full power output:** 85 W. **OUTPUT:** Circuit type: Pi-L network. **1/2 hour continuous carrier:** 500 watts. **30 second continuous carrier:** 850 watts. **1/2 hour PEP two-tone test:** 850 watts. **30 second PEP two-tone test:** 1000 watts. **POWER SUPPLY:** Circuit type: Voltage doubler. **No load voltage:** 3000. **Full load voltage:** 2700. **Full load current:** 0.45 amp. **Regulation:** 10%. **Transformer:** 22 lbs. Hypersil steel. **Maximum draw at rated output:** 12 amps at 120 V, 60 Hz. **TUBE:** Type: 3-500Z. **Continuous dissipation:** 500 W. **Warm-up time:** 10 seconds. **Estimated life:** 20,000 hours. **GENERAL:** **Metering:** Dual meters; plate volts, plate current, grid current, power output PEP. **ALC:** Adjustable, 0-20 V, negative going, phono jack. **MARS/WARC:** Yes, set to nearest amateur band. **Keying:** Requires contact closure or sink of +12 VDC at 100 mA, phono jack. **RF Connectors:** SO239. **Line Connector:** NEMA 5-15P, standard 120 V three wire. **Frequency Coverage:** All amateur bands from 1.8 to 21 MHz, including WARC and most MARS. **Third Order IMD at Rated Output:** -35 dB.



MANUAL PREVIEW
Preview the Heathkit manual of your choice before you order the kit. You'll see for yourself how easy kit building really is. Turn to page 53 for our Manual Preview Offer.



Personalized name plate

You've finished your kit and everything looks and works perfectly because you built it yourself. Indicate the special care and skill you've invested in your finished kit with an engraved name plate. Made of solid brass and brushed to a jeweler's finish, the name plate has a self-adhesive backing for easy, no-mess application.

FILL IN THIS COUPON TO ORDER

Please send _____ solid brass name plate(s) with name engraved. Enclosed is \$_____ (\$2.00 for one, \$1.60 each for two or more) which covers first class postage & handling.

Please print your name in capital letters using no more than 14 characters (including spaces).

--	--	--	--	--	--	--	--	--	--	--	--	--	--	--	--	--	--	--	--

Print name here

Name: _____

Address: _____

City: _____ State: _____

GDP-1225 Zip: _____

*Your actual monthly payments may vary depending on your account balance.



Heathkit deluxe QRP CW transceiver

SKILL LEVEL 3 The Heathkit HW-9 is a compact 80 through 10 meter HF transceiver created with the avid low-power CW operator in mind. Designed to cover the lower 250 kHz of the 80, 40, 20 and 15 meter amateur bands, the HW-9 can also cover the 30, 17 and 12 meter WARC bands and the lower 250 kHz of the 10 meter band with the optional HWA-9 Band Pack.

Broadband design means you no longer need to tune circuits within a band. Just turn the band switch and select the desired frequency. The wide-band front-end uses a double-balanced mixer and 4-pole crystal filter to handle wide dynamic range signals with ease and to eliminate the customary RF amplifier in the receiver section.

The HW-9 uses a single conversion in the main signal path to reduce spurious responses and to maintain superior image rejection. In addition, a balanced product detector followed by an active audio filter provides outstanding performance. And, Receiver Incremental Tuning (RIT) lets you tune the receiver 1 kHz above or below the transmit frequency.

Microelectronic circuits reduce transceiver weight, while providing a level of performance and features you wouldn't expect at this price. Features

include continuously variable RF power output up to four watts, relative signal/power strength meter and AGC circuits.

Rugged and lightweight, the HW-9 is ideal for portable operation. You can supply power to your HW-9 with batteries, lighter socket, solar photovoltaic array or by 120 VAC with the optional PSA-9 Power Supply. Dimensions are 4 1/4" H x 9 1/4" W x 8 1/2" D.

Kit HW-9 (8 lbs.) \$249.95

Accessories:

SKILL LEVEL 3 **Band Pack.** Expands the transmission and reception capabilities of your HW-9 Transceiver from four to eight amateur bands. Provides full coverage on all the amateur bands from 80 through 10 meters.

Kit HWA-9 (1 lb.) \$44.95

SKILL LEVEL 3 **Power Supply.** 12.6-volt, 1-ampere, voltage regulated power source.

Kit PSA-9 (4 lbs.) \$39.95

Specifications: **TRANSMITTER: RF Output Power:** 4 watts, except 3 watts on 10 meters. **Transmitter Frequency Offset:** App. 700 Hz. **Antenna Load Impedance:** At least 90% of rated power with less than 2:1 SWR. Protected against high SWR. **Harmonic & Spurious Radiation:** -35 dB & -40 dB maximum, at rated output. **T/R Operation:** CW, full break-in. **RECEIVER: Sensitivity:** 0.2 μ V for readable signal; 0.5 μ V or less for 10 dB S+N/N. **Selectivity:** Wide, 1 kHz max. @ 6 dB; Narrow, 250 Hz @ 6 dB. **Dynamic Range:** 85 dB. **Image & IF Rejection:** 60 dB, min. **Audio Hum Noise:** -60 dB. **Audio Output:** 1 watt into 8 Ω .



Accurate QRP wattmeter

SKILL LEVEL 1 Your low-watt HF or VHF station will operate at peak power efficiency when you're using the responsive HM-9 Wattmeter. A reliable instrument for measuring RF power output and the SWR of an amateur radio station, the HM-9 with 3:1 SWR bridge simplifies continuous metering of exciter or amplified output level. Plus it gives you quick, exact SWR readout for fine-tuning your antenna system. Wire the HM-9 for monitoring in three different ranges: 1.8-30, 50-54 or 144-148 MHz. Full scale ranges from 0-5 watts and 0-50 watts with exceptional $\pm 10\%$ accuracy! Reads SWR from 1.1:1 to 3:1. Dimensions are 2 5/8" H x 5 3/8" W x 7" D.

1 **Kit HM-9** (3 lbs.) \$59.95

100-watt antenna tuner with 4:1 balun

SKILL LEVEL 1 You can have almost unlimited matching capabilities with the HFT-9-A. It provides matching to a wide range of output impedances with a built-in 4:1 ferrite balun. The HFT-9-A includes connectors for coaxial feed, balanced line and long-wire antennas. A large 12-tap, air-wound inductor, with silver-plated wire and tap switch, allows precise matching capability between 1.8 and 30 MHz. Adjustments are easy with continuously variable transmitter/antenna controls. The HFT-9-A's small size and easy assembly make it perfect for mobile HF operation and an outstanding addition to any amateur radio station. Dimensions are 2 5/8" H x 5 3/8" W x 7" D.

2 **Kit HFT-9-A** (3 lbs.) \$59.95

SAVE Save on this amateur radio package. Includes the HM-9 QRP Wattmeter and the HFT-9-A Antenna Tuner. **QRS-9** (14 lbs.) \$109.95



Companion station speaker to HW-9

SKILL LEVEL 1 The Heathkit Station Speaker is a 3" communications receiver speaker housed in a custom designed cabinet to match the HW-9 QRP transceiver, shown above. The 8-ohm speaker has a frequency response of 200 to 5000 Hz and can handle 1.5 watts RMS. Dimensions are 8" H x 4 1/2" W x 6 3/4" D.

Kit SP-99 (3 lbs.) \$29.95



Antenna noise bridge

SKILL LEVEL 1 Reveal the cause of any mismatch between station transmitter and antenna with the Heathkit Antenna Noise Bridge. A tone-modulated broad-band noise signal is generated in the bridge and coupled to an impedance bridge. Then, using your station receiver as an indicator, the impedance bridge measures the resistive and reactive components of your antennas. Use the noise bridge also to preset an antenna tuner for faster tune-ups, tune a quarter-wave transmission line and measure the value of unknown capacitors and inductors.

A front panel LED indicates power on, front panel controls give direct readout of resistive and reactive characteristics of the antenna being tested. The rear panel includes external power jack and coaxial connectors for receiver and unknown antenna connections. Requires 9V battery or PS-2350 Battery Eliminator, listed below. 2 1/4" H x 5 1/8" W x 5" D.

Kit HD-1422-A (2 lbs.) \$49.95

Specifications: **Resistance:** approx. 0-200 Ω. **Capacitance:** ± 60 pF **Operating Range:** 1-30 MHz.

Deluxe antenna tuner

SKILL LEVEL 2 Use the Deluxe Antenna Tuner to match an antenna to your transmitter at any frequency in the 160-10 meter HF spectrum. You get all the features of a first-rate antenna tuner combined with most of the features of a dual wattmeter. In addition, it covers the 160-meter and WARC amateur bands.

The tuner will effectively tune and match balanced or unbalanced feedlines and single-wire and ladder lines at the full legal power limit of your station. With its continuously variable inductor, you're guaranteed precise antenna matching from 1.8 to 30 MHz, including the MARS frequencies and all the newly allocated bands. A convenient front panel counter lets you quickly set the inductor to previously calibrated frequencies.

With a single switch you can select a dummy load or any of three permanently connected antennas, including a long-wire antenna. You'll enjoy the convenience of never having to connect and disconnect feed lines to load your transmitter into the dummy load.

Dual wattmeters read both forward and reflected average power, in two ranges, for more efficient low band operation. The wattmeter section of the antenna tuner installs directly into your transmission line to measure the power on all frequencies between 1.8 and 30 MHz. It measures output up to 200/2000 watts in the forward direction and up to 50/500 watts reflected. Dual meters indicate the forward and reflected power separately with a high degree of accuracy. A factory aligned and calibrated sensor head ensures that you



get the highest accuracy measurement. SWR indications on the reflected meter provide direct readings from 1:1 to 3:1.

The silver-plated straps and roller contact assembly minimize RF loss at high frequencies. And the large feed-through insulators withstand high-voltage RF. The antenna tuner handles power inputs up to 2000 watts PEP on SSB and 1000 watts CW. With its factory-calibrated components, easy-to-read dual wattmeters and front panel controls, the Deluxe Antenna Tuner is an indispensable addition to your system. Dimensions of this versatile tuner are 5 3/4" H x 14 1/2" W x 13 7/8" D.

Kit SA-2060-A (20 lbs.) \$399.95

Specifications: **Frequency Range** (continuous tuning): 1.8 to 30 MHz. **INPUT POWER CAPABILITY:** SSB: 2000 watts (peak). CW: 1000 watts. **Input Impedance:** 50 ohms. **Output Impedance:** Wide range. **Balanced to Unbalanced Transformation:** 4:1 balun. **Meter Functions:** Forward and Reflected average power, and SWR. **METER RANGES: Forward** (2 ranges): Low - 0-200 watts. High - 0-2000 watts. **Reflected** (3 scales): Low 0-50 watts. High - 0-500 watts. SWR - 1:1 to 3:1. **WATT-METER ACCURACY** (full scale): 200 W and 2000 W (FWD), 500 W (REF): ± 5% (AVG). 50 W (REF): ± 7.5% (AVG). **Insertion SWR:** Less than 1.1:1.

Hear all the action with the active SWL antenna

SKILL LEVEL 1 Perfect for portable use or locations where an outside antenna is not available, the Heathkit Active SWL Antenna allows you to receive radio signals from 300 kHz to 30 MHz. And it acts as a high frequency preamplifier when used with an external 50 ohm antenna. You can also use the HD-1424-A as a preselector for both indoor and outdoor antennas. It has a built-in collapsible antenna and provisions for a 50 ohm antenna. Requires 9V battery or PS-2350 Battery Eliminator. 2 1/4" H x 5 1/8" W x 5" D.

Kit HD-1424-A (2 lbs.) \$59.95

Accessory:

Battery Eliminator

PS-2350 (1 lb.) \$7.95



VLF converter lets you tune in the world

SKILL LEVEL 1 Listen to the U.S. Submarine Fleet, European broadcasts and other distant transmissions below the standard AM band. The VLF Converter installs in your receiver antenna line to let you listen to the 10 to 500 kHz band from 3.510 to 4.010 MHz on your CW receiver. The converter contains a local oscillator generating a 3.5 MHz signal that, when mixed with the incoming VLF frequencies on your antenna, produces an RF signal that can be heard on any CW receiver capable of tuning 3.510 to 4.010 MHz. Requires 9V battery, PS-2350 Battery Eliminator, listed at left, or any source of DC power, 8.5 to 14 volts. The VLF Converter measures only 5 1/8" H x 5 1/8" W x 2 1/4" D.

Kit HD-1420 (2 lbs.) \$49.95



1.6-250 MHz dip meter

SKILL LEVEL 1 Use the multipurpose Dip Meter to find approximate resonant and operating frequencies of either energized or de-energized circuits. The HD-1250 helps adjust traps, detect parasitic oscillations and harmonics, measure unknown Q/L/C values, locate sources and frequencies of RF energy. Use too as a signal generator, relative field strength meter or receiver alignment tool. Requires 9V battery. 2" H x 2 1/4" W x 5 7/8" D.

Kit HD-1250 (4 lbs.) \$129.95

Specifications: **Controls:** Tuning capacitor, oscillator level, ON/OFF. **Meter Movement:** 150 μ A. **Solid-State Circuits:** 1 NPN transistor oscillator, 1 dual-gate MOSFET amplifier, 2 diffused silicon hot carrier diode detectors.



Dual HF wattmeter

SKILL LEVEL 1 Achieve peak efficiency on low bands. The HM-2140-A monitors both forward and reflected power in your transmission line. A second scale on the reflected meter reads SWR directly from 1:1 to 3:1. Output is measured up to 200/2000 watts PEP ($\pm 5\%$) forward direction and up to 50/500 watts reflected. Pushbutton switch to high or low power ranges for precise readings. Dual-position switch lets you read PEP or average power. Requires 9V battery or use 120 VAC with the PS-2350 Battery Eliminator. 4 1/8" H x 7 1/2" W x 6 3/8" D.

Kit HM-2140-A (5 lbs.) \$129.95

Accessory:

Battery Eliminator

Assembled PS-2350 (1 lb.) \$7.95



This outlet box is smart

SKILL LEVEL 1 Flip on your transceiver and your whole system powers up. The Smart Outlet Box turns on six other units when the unit plugged into its control socket goes on. Our highest quality. Offers surge protection, noise filtering. 2 1/4" H x 14 1/4" W x 2 3/4" D. 10A capacity.

Kit GD-1495 (5 lbs.) \$59.95

Closed-back headphones

Comfortable 8-ohm headphones feature 40 to 15,000 Hz frequency range, 2 1/4" speakers, individual volume controls and 10' coiled cord. Easily adjustable for precise fit.

Assembled HDP-1396
(2 lbs.) \$16.95



Control the airwaves with the touch tone decoder

SKILL LEVEL 1 Hear only messages meant for you – not extraneous monitor racket. Connect the Touch Tone Decoder in series with your receiver or scanner speaker. Turn it on and it mutes the speaker until it detects the unique DTMF code you've programmed. Use also for operation of single functions in the control of a repeater, or as a secondary control link for autopatch on/off. You can preset the open line time for up to eight minutes or enter a two-digit code to open and close the line at will. Requires 7.5-11 VAC, 11-16 VDC or PS-5012, below.

Kit HD-1530 (2 lbs.) \$79.95

Accessory:

120 VAC Power Adapter

Assembled PS-5012 (1 lb.) \$15.95

Take to the road with this 2-meter mobile antenna

The Heath HDP-1474 is a high performance 2-meter mobile antenna that installs in only minutes, but delivers years of trouble-free service.

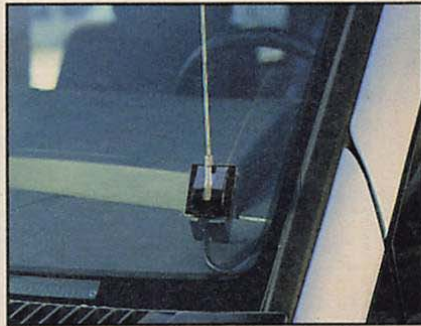

This unique antenna mounts directly onto your windshield and transmits and receives data through the glass. You don't have to worry about measurable signal energy loss, because impedance at the glass interface is high. And, a special tuning slug lets you achieve extremely low VSWR.

Installation takes only minutes and best of all there are no holes to drill! A special adhesive system gives you all-weather protection and long lasting hold.

The stainless steel whip is 33 inches long and is easily adjusted to a vertical position. You can remove the whip for car wash clearance.

Assembled HDP-1474 (2 lbs.) \$29.95

Coaxial switch

SKILL LEVEL 1 Manually route one RF source to any one of several antennas or loads, while grounding all outputs not in use. Switch from up to four antennas or interconnecting equipment. Handles 2 kW PEP with maximum 1.1:1 SWR to 250 MHz. Built-in mounting brackets. Mount width: 4 1/4"

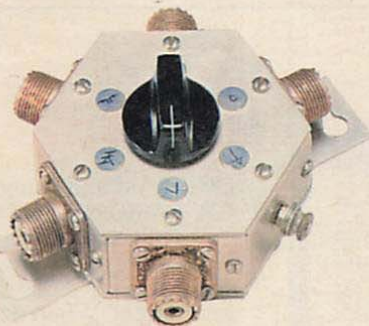

Kit HD-1234 (1 lb.) \$29.95

High performance broadband antenna

SKILL LEVEL 1 The HA-2513 covers amateur radio, public service, CB, police, fire and government frequency bands. Transmit with up to 200 watts of power with SWR below 2:1 on all ham bands between 50 and 1300 MHz. Ultra-wideband design offers excellent reception from 25 to 1300 MHz. This versatile antenna effectively covers the 6, 2,220, 450, 902 and 1296 meter amateur bands.



Compact and lightweight, the Heath HA-2513 installs anywhere space is at a premium - even on apartment balcony railings. Vertically polarized, omnidirectional pattern, unity gain. Rust-free stainless steel parts and hardware. The HA-2513 stands 5 1/2 feet tall and requires a 1-2" mast for proper installation. A 50-foot coaxial cable is required.

Kit HA-2513 (6 lbs.) \$69.95



Heath antenna dummy load

SKILL LEVEL 1 Eliminate unnecessary QRM during tune-up and minimize mistakes while performing hot gear maintenance or alignment. Handles 1 kW of RF with VSWRs less than 1.5:1 up to 450 MHz. Requires 1 gallon mineral or transformer oil.

Kit HN-31-A (3 lbs.) . . . \$24.95

Remote coax switch

SKILL LEVEL 1 Switch antennas from inside your station with the Remote Coax Switch. Remote and indoor control units connect through your coax cable to eliminate multiconductor control cable. Tower- or mast-mounted remote operates up to four antennas. Handles 2000 watts PEP and has a VSWR of 1.15: or less. Frequency range is from 1.8 to 54 MHz with impedance of 50 to 70 ohms and loss at 54 MHz of less than 0.2 dB. Uses 120 VAC. Control: 2 5/8" H x 5 1/2" W x 7 1/2" D. Remote: 7 1/8" H x 8 3/8" W x 4 1/2" D.

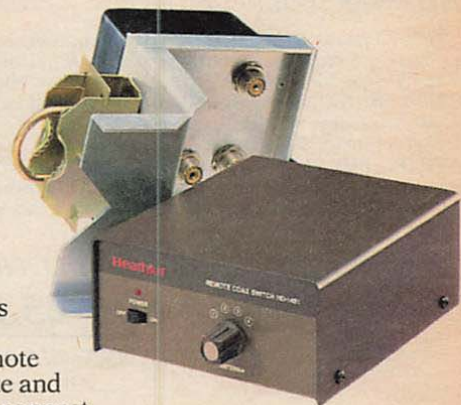

Kit HD-1481 (5 lbs.) \$79.95



Build up your code speed with the CW code oscillator

SKILL LEVEL 1 The CW Code Oscillator features a telegraph key with adjustable rebound, built-in speaker, headphone jack, volume and tone controls. And once you get your amateur radio license, your unit can serve as a side tone oscillator for any transmitter using negative-grid block keying. The HD-1416-H operates on a 9V transistor battery (not included).

Kit HD-1416-H (1 lb.) \$24.95



Precision scope calibrator

Keep your scope up to specs at all times. The IG-4244 provides all the accuracy you'll need for making critical scope adjustments and calibrations.

Kit IG-4244 (6 lbs.) \$199.95

Specifications: **TIME OUTPUT SIGNAL:** Range: 0.5 s to 10 ns square wave in a 1-2-5 sequence. **Accuracy:** 0.015%. **Amplitude:** 0.5 s to 20 ns - 100 mV to 1 V peak. 10 ns - 100 mV to 0.5 V peak. **Rise Time:** <1 ns. **VOLTAGE OUTPUT SIGNAL:** Ranges: 1 mV to 100 V peak square wave in a 1-2-5 sequence. **Accuracy:** Within 1% into a ≥ 1 M Ω load when calibrated with an external voltmeter. **Rise Time:** <5 μ s. **Frequency:** Approximately 1 kHz. **SINE WAVE OUTPUT SIGNAL:** Frequency: Approximately 1 kHz. **Amplitude:** Approximately 1 volt peak-to-peak. **GENERAL: Power Requirements:** 120/240 VAC, 50/60 Hz. **Dimensions:** 3" H x 7 1/4" W x 9 1/2" D.



ORDER TOLL-FREE ANYTIME

800-253-0570

FAX: 616-982-5577

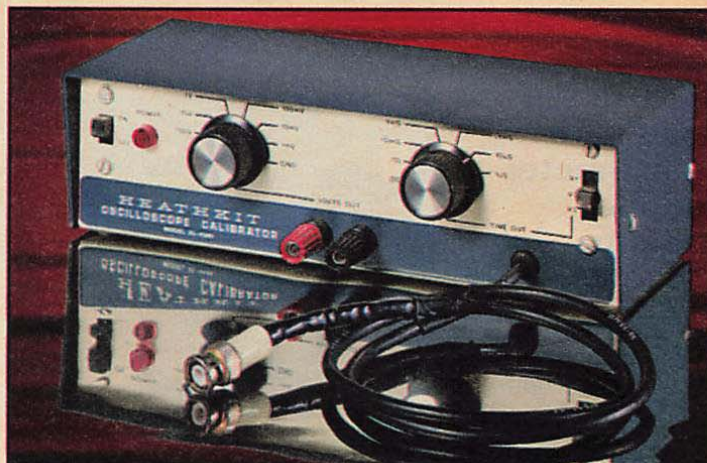

Economical scope calibrator

This crystal controlled, fast-rise square wave generator provides you with the accurate time and amplitude signals you'll need to calibrate most Heathkit and other oscilloscopes.

Kit IG-4505 (4 lbs.) Last Call! \$59.95

Specifications: **TIME SIGNAL:** Range: 0.5 s to 1 μ s square wave in a 1-2-5 sequence. **Accuracy:** 0.01%. **Amplitude:** Approx. 200 mV peak. **Rise Time:** ≤ 4 ns. **Overshoot:** $\leq 3\%$. **Output:** 50 Ω terminated cable. **VOLTAGE SIGNAL:** Ranges: 1 mV to 100 V peak square wave. **Accuracy:** Within 2%. **Rise Time:** ≤ 2 μ s. **Frequency:** DC, 2 Hz to 10 kHz in a 1-2-5 sequence. **GENERAL: Power:** 120/240 VAC, 50/60 Hz. **Dimensions:** 2 3/4" H x 9 1/8" W x 4 1/4" D.



Digital memory oscilloscope

The ID-4850 turns your personal computer or scope into a dual trace 50 MHz digital storage scope capable of displaying fast digital pulses.

When attached to a PC, the ID-4850's functions are controlled from the computer keyboard. Display one or two channels on a graphic 8 x 10 division graticule. On-screen menus show all scope functions. Automatically obtain readouts of voltage, time and frequency at any point on a waveform. Even store waveforms on a floppy disk for later comparison. You'll need a null-modem cable to connect the ID-4850 to your Heath/Zenith, IBM PC or compatible computer equipped with an RS-232 port, CGA graphics card, 5.25" disk drive,

128K RAM and using MS-DOS Version 2.0 or later. GW-BASIC required only for customizing.

This versatile digital scope also enables you to upgrade a low-bandwidth, single-channel bench scope to a powerful dual trace 50 MHz storage instrument. When used with a scope, the ID-4850's operations are controlled from the clearly marked front panel, and all settings are plainly identified by bright LED indicators. Your scope must have a 5 MHz or greater bandwidth, one vertical channel with 0.5 V/division sensitivity, ability to trigger from a second source and triggered sweep (on the plus slope of a TTL level signal). The ID-4850 requires two BNC to BNC coaxial cables when upgrading a bench scope.

Kit ID-4850 (11 lbs.) \$299.95

Assembled SD-4850 Fully assembled and calibrated. (11 lbs.) \$495.00

Specifications: **VERTICAL: Deflection Factor:** Sensitivity: 5 mV/div to 5 V/div; 10 steps in a 1-2-5 sequence. **Vertical Response:** 5 mV to 5 volts/div. **Rise Time:** 7 ns or less. **Overshoot:** Less than 5%. **Maximum Input:** 125 volts peak combined AC and DC. **HORIZONTAL: Time Bases Ranges:** 20 s/div to 10 ns/div in a 1-2-5 sequence. **Maximum Sampling Rate:** Real Time: 100 KS/S. Equivalent Time: 5 GHz. **GENERAL: Vertical Resolution:** 8 bits (1 part in 256). **Record Length:** 512 samples. **Interface:** RS-232C. **Baud Rate:** 110 to 9600 baud (selected by internal jumper). **Power:** 120 VAC, 60 Hz. **Dimensions:** 4 1/2" H x 10" W x 12 1/2" D.

Deluxe oscilloscopes, 25 or 40 MHz

AS LOW AS \$40 PER MONTH ON YOUR HEATH REVOLVING CHARGE

These deluxe instruments not only give you accurate measurements, they include extra features that save you time and make them a pleasure to own. Identical in most respects, our new scopes provide more performance per dollar than you'll find elsewhere.

Important measurement features

You'll value the 1-millivolt-per-division sensitivity that lets you measure signals too small for 5 millivolt instruments, and the 10X horizontal magnifier that lets you expand signals twice as much as ordinary 5X magnifiers.

TV horizontal and vertical triggers let you look at TV waveforms that confuse less sophisticated trigger circuits, and the trigger holdoff function lets you achieve stable triggering on repetitive pulse trains. Use the A + B mode with B inverted to make differential measurements without ground reference, and the XY mode for Lissajou patterns.

Extras you may not find elsewhere

These scopes operate on 90-264 VAC, 50/60 Hz so they're at home anywhere in the world. Each includes a built-in component tester for in-and-out-of-circuit current vs. voltage testing of many different types of components. And a beam finder saves you time by forcing off-screen traces back on screen.

The deluxe handle makes carrying easy and doubles as a tilt bail for adjusting the viewing angle. Graticule illumination simplifies taking measurements under low light conditions - almost a necessity if you expect to record measurements with an oscilloscope camera. And a built-in calibrator lets you check instrument accuracy and adjust the compensation of your probes. The SO-4554 even features 9kV accelerating potential for bright traces at higher sweep speeds.

These professional-looking instruments offer features you'll use and enjoy and a styling you'll be proud to display at the center of your workbench. For optional probes see page 88.

25 MHz Oscilloscope
Assembled SO-4552 (22 lbs.) \$399.95

40 MHz Oscilloscope
Assembled SO-4554
(22 lbs.) ... Was \$599.95 Now \$579.95



Specifications for SO-4552 and SO-4554: **VERTICAL DEFLECTION:** Deflection Factor: 5 mV to 5 V/DIV; 10 steps in 1-2-5 sequence with variable control. **Magnification:** X5 times (1 mV to 1 V/DIV). **Accuracy (1 kHz):** ±3% at CAL'D; ±5% at CAL'D for X5 gain. **SO-4552 Bandwidth (referenced to 5 divisions at 50 kHz):** DC to 25 MHz (at -3 dB). DC to 10 MHz (at -3 dB) on 1 mV/DIV range. **SO-4552: Rise Time (referenced to 5 divisions):** Approx. 18 ns. **SO-4554: Bandwidth (referenced to 6 divisions at 50 kHz):** DC to 40 MHz (at -3 dB), DC to 15 MHz (at -3 dB) Approx. 9 ns. **Overshoot:** Less than 5%. **Maximum Input:** 400 V (DC + AC peak). **Operating Modes:** CHA, CHB, DUAL (ALT or CHOP), and ADD. **HORIZONTAL DEFLECTION:** Triggered Operation: Sweep Time: .2s to .1 μs/DIV; 20 steps in 1-2-5 sequence with variable control. **Magnification:** X10. **Accuracy:** ±3% for X1 and ±6% on X10. **X-Y Operation:** Sensitivity: Same as CHA and CHB deflection factor on corresponding axis. **Frequency Response:** DC to 1 MHz (at -3 dB). **TRIGGER:** Source: CHA, CHB, LINE and EXT. **Coupling:** AUTO, NORM, TV-V, TV-H. **Slope:** "+"; pull TRIG LEVEL control knob for "-". **External Input:** Input Impedance: 1 MΩ, 30 pF. Maximum Input Voltage: 300 V (DC + AC peak). **GENERAL:** Power: 90-132 VAC or 198-264 VAC, 50/60 Hz, 40W. **Dimensions:** 5¼"H x 12¾"W x 17¼"D. **Weight:** 17.2 lbs.



*Your actual monthly payments may vary depending on your account balance.



Our own PC logic analyzer

2 This versatile test instrument is another Heath exclusive. Use it to troubleshoot or verify the proper operation of a wide variety of circuits containing sequential and/or combinational logic. And with the included specific software, this analyzer is fully keyboard configurable and menu driven. The Logic Analyzer can check a 16-bit wide data bus or 16 separate logic test points in circuits with clock speeds up to 10 MHz. You can display acquired data on screen in state or timing displays including hex/octal and ASCII equivalents, an address relative to triggering and other information.

Save this data to disk for later examination or comparison.

Software is included for use with PC compatible computers equipped with an RS-232 card, color graphics card, single 5.25" disk drive and 128K RAM minimum, a serial cable and MS-DOS Version 2.0 or later. The IC-1001 is also compatible with terminals or computers running terminal emulation software. Powered by an included 120 VAC wall cube. Dimensions of the Logic Analyzer are 1 3/4" H x 9 1/4" W x 8 1/2" D.

Kit IC-1001 (4 lbs.) \$259.95

512 MHz frequency counter

2 An ideal compact and portable frequency counter for checking mobile car, boat and airplane transmitter frequencies. A seven-digit LED display gives 10 Hz resolution in the low 50 Hz to 50 MHz range and a 100 Hz resolution in the high 40 MHz to 512 MHz range.

Kit IM-2400 (3 lbs.) \$149.95

Accessories:

Telescopic Antenna

Assembled SMA-2400-1 (1 lb.) . . \$9.95

120 VAC Battery Eliminator/Charger

Assembled PS-2404 (1 lb.) \$7.95

Specifications: **INPUTS:** Sensitivity: 25 mV RMS guaranteed (10 mV RMS typical). **Input Protection:** 150 V RMS to 100 kHz derated to 10 V RMS at 50 MHz on low range, 5 V RMS on high range. **GENERAL:** Gate Time: 1 second or 0.1 second (switch selected). **Power:** Five 1.2 volt nickel-cadmium batteries (included) or external battery-charger/eliminator. **Dimensions:** 1 5/8" H x 3 3/8" W x 8 3/8" D.



High precision 512 MHz universal counter

3 A .2 ppm time base makes this counter the tool of choice when high precision is required. Even suitable for adjusting frequency in most FCC licensed commercial transmitters. Includes ratio and period functions. Use with Telescopic Antenna, sold above right.

Kit IM-2420 (9 lbs.) Last Call! \$299.95

Assembled SM-2420 (9 lbs.) \$389.95

Specifications: **FREQUENCY MEASUREMENT:** Range: Input A, 5 Hz to 50 MHz. Input B, 40 MHz to 512 MHz. **Sensitivity:** 25 mV RMS (4 to 15 mV RMS typical). **Display Resolution:** Input A, 0.1 Hz to 10 Hz. Input B, 1 Hz to 1000 Hz. **PERIOD MEASUREMENT:** Input: Input A only. Range: 5 Hz to 10 MHz. **Display Resolution:** 100 ns to 0.1 ms in decade steps. **RATIO B/A MEASUREMENT:** Input Frequency Limits: Input A, 5 Hz to 25 MHz. Input B, 50 MHz to 512 MHz. **Effective Range:** From 1.6 to 1.024 x 10⁸. **OSCILLATOR:** Frequency: 10 MHz. **Crystal Aging Rate:** <1 ppm/yr. **Stability:** ±0.2 ppm, 0° to 40°C. **GENERAL:** Power: 120/240 VAC, 50/60 Hz. **Dimensions:** 4 1/2" H x 10" W x 12 1/2" D.

Low cost 225 MHz frequency counter

2 An accurate and dependable benchtop counter, with the features most needed and a price that's sure to please. A 10 ppm time base provides ample accuracy for most common measurements, and an 8-digit display lets you resolve down to 1 Hz below 100 MHz, 10 Hz above 100 MHz. Use with Telescopic Antenna, sold above.

Kit IM-2410 (6 lbs.) \$149.95

Specifications: **Frequency Ranges:** 10 Hz to 50 MHz. 20 MHz to 225 MHz. **Sensitivity:** 10 Hz to 50 MHz range: 25 mV RMS maximum (10 mV typical) from 10 Hz to 30 MHz and 50 mV RMS maximum from 30 MHz to 50 MHz. 20 MHz to 225 MHz range: 25 mV RMS maximum (10 mV typical). **Input Impedance:** 1 MΩ shunted by ≤24 pF. **Input Protection:** 150 VAC up to 100 kHz, derated to 5 VAC from 160 MHz to 225 MHz. **Internal Time Base Frequency:** 3.58 MHz. **Setability:** ±1 ppm. **Temperature Stability:** ±10 ppm from 0°C to 40°C. **Gate Time:** 1 second or .1 second, switch selectable. **Power Requirements:** 108 VAC to 132 VAC or 216 VAC to 264 VAC. 50 to 60 Hz. 25 watts maximum. **Dimensions:** 3 3/8" H x 7 1/4" W x 9 1/2" D.



Easy-to-operate clamp-on ammeter

This pocket size clamp-on meter provides high accuracy in measuring AC amps and volts plus a resistance scale. And for instant continuity checks, a built-in buzzer sounds when resistance is less than 2 kohms. This handy meter features data hold display readings for all functions and ranges, a large 3½-digit LCD display, 1.0% basic accuracy and a black and red probe set. Includes 9 volt battery.

Assembled SM-2208 (1 lb.) . . \$59.95

Specifications: **AC VOLTAGE: Ranges:** 750 V, 200 V. **Accuracy:** ±(1.0% of reading + 3 digits) from 45 Hz to 400 Hz. **AC CURRENT: Ranges:** 200 A, 300 A. **Accuracy (50/60 Hz):** ±(2.0% of reading + 1 digit). **RESISTANCE: Range:** 2000 ohms. **Accuracy:** ±(1.0% of reading + 1 digit). **Other Features:** Automatic polarity, over range indication, automatic zero, low battery indication. **Dimensions:** 1" H x 2½" W x 7¾" L.



500-volt insulation tester reveals faults others miss

This insulation tester lets your SM-2374 (at right) detect moisture in air conditioning coolant, check insulation resistance on motors and transformers, test for moisture or deterioration in wiring and cables, and test for carbon tracks in switches, breakers and relays. A 2000-megohm range, 500-volt power source reveals problems that ordinary ohmmeters miss. Safety-designed test leads and carrying case included.

Assembled SM-2376 (2 lbs.) . \$49.95

Specifications: **ACCURACY: Range:** 20MΩ, 2000MΩ. **Measurement Range:** 100 kΩ to 19.99 MΩ, 10 MΩ to 1999 MΩ. **Accuracy:** ±(2% rdg + 2 counts), ±(4% rdg + 2 counts) for 500 MΩ and under; ±(5% rdg + 5 counts) for higher resistances. **GENERAL: Test Voltage:** 500 VDC. **Power Source:** 4 AA batteries. **Battery Life:** 30 hours. **Dimensions:** 2" H x 2¾" W x 3½" L.



Digital clamp-on meter for heavy-duty applications

This compact, handheld AC current meter, with 1000-amp capability, is the ideal measurement tool for the electrician or service technician. AC/DC voltage, resistance and continuity measurements are standard features. Digital accuracy, rugged construction, and a protective hard carrying case with shoulder strap and belt loop make this the right tool for heavy-duty applications. Includes leads.

Assembled SM-2374 (2 lbs.) . \$79.95

Specifications: **DC VOLTAGE: Range:** 1000V. **Resolution:** 1V. **Accuracy:** ±(0.5% rdg + 1 count). **AC VOLTAGE: Range:** 750V. **Resolution:** 1V. **Accuracy:** ±0.5% rdg + 1 count). **AC CURRENT: Range:** 200A, 1000A. **Resolution:** 100 mA, 1A. **RESISTANCE: Range:** 2000Ω, 20Ω. **Resolution:** 0.1Ω, 10Ω. **CONTINUITY: Range:** 2000Ω. **GENERAL: Power Source:** 9V battery. **Battery Life:** 150-200 hours. **Dimensions:** 1½" H x 2½" W x 9" L.

Portable video alignment generator goes where you need it

Whether you're a hobbyist wanting to fine-tune your own color TV picture or a service technician needing an alignment tool for the shop, our new 5260 will certainly do the job.

You have a choice of six patterns – three crosshatch and three dot – for color convergence alignment and picture width, vertical linearity and height adjustments. And, battery operation gives you full portability. Includes modulated RF output for color convergence alignment of TV receivers and composite video output for color convergence alignment of monitors.

Kit IG-5260 (2 lbs.) \$59.95

Assembled SG-5260 (2 lbs.) \$79.95

Specifications: **Display:** Crosshatch and dots: 1 x 1, 7 x 11, 15 x 21 matrices. **RF Carrier:** Channel 3, 61.250 MHz ± .005%, crystal controlled. **RF Output:** 3000 μV minimum into 75 ohms. (Phono plug to type F adapter supplied.) **Video Output:** 0.8 V peak-to-peak minimum into 75 ohms (available at phono plug.) **Power Requirements:** 9-volt battery, not included. **Dimensions:** 1½" H x 6¼" W x 3¼" D.

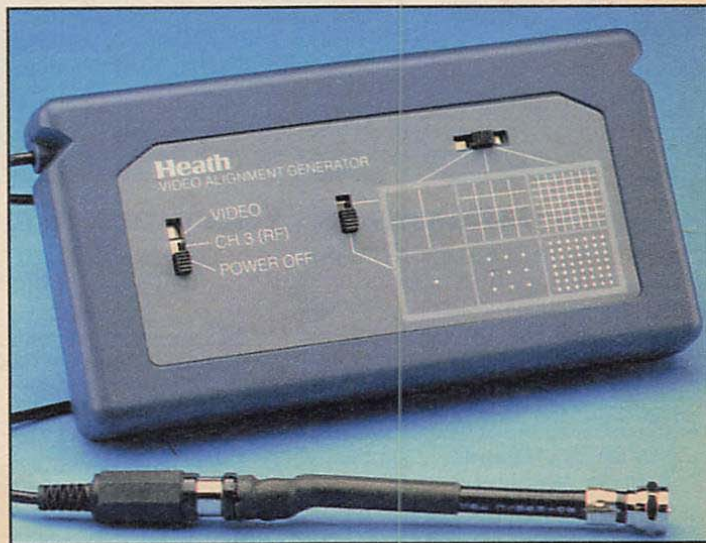



Benchtop 3½-digit LED full-function DMM

This push-button ranging meter features diode and internal battery test, blanking, polarity and overrange indicators, built-in battery charger and auto decimal point location. Input protected, test leads included.

Kit IM-2260 (5 lbs.) \$129.95

Specifications: **VOLTAGE RANGES:** DC: 2V, 20V, 200V, 1000V. **Basic Accuracy:** ±(0.5% of reading + 1 count). AC: 2V, 20V, 200V, 750V. **Basic Accuracy:** ±(1.0% of reading + 3 counts). **Frequency Response:** 40 Hz to 1 kHz, ±0.5%. **Input Impedance:** 10 megohms. **CURRENT RANGES:** 2 mA, 20 mA, 200 mA, 2000 mA, 10 A. **Basic Accuracy DC:** ±(1.5% of reading + 1 count). AC: ±(2.0% of reading + 1 count). **OHMS RANGES:** 2 kΩ, 20 kΩ, 200 kΩ, 2000 kΩ, 20 MΩ. **BASIC ACCURACY:** ±(0.25% of reading + 1 count). **Power:** Heath PS-2404 120 VAC Adaptor (p. 80) or six 1.5 volt batteries. **Dimensions:** 3" H x 8½" W x 11" D.



new Ruggedized autoranging DMM

Housed in an industrial grade, safety-yellow case, our new Ruggedized Autoranging DMM is both shock- and water-resistant – perfect for those tough jobs. The LCD display features large 3½ digit numerals and a 40-segment analog bar graph for easy nulling and peaking. The display also includes auto polarity, overrange indicator, measurement hold and visual unit display annunciators.

Measurement functions include AC and DC voltages and currents, resistance, normal and low power test voltages, memory, continuity and diode test. Current ranges are fuse protected. Deluxe test probes included.

Assembled SM-2380 (2 lbs.) . \$89.95

Specifications: **VOLTS DC:** Ranges: (5) 200 mV-1000 V. **Accuracy:** ±(0.5% of reading + 1 digit). **Input Impedance:** 10 MΩ and <100 pF. **Resolution:** 100 μV to 1 V. **VOLTS AC:** Ranges: (4) 2 V-750 V. **Accuracy:** ±(1.25% of reading + 5 digits). **Input Impedance:** 10 MΩ and <100 pF. **Resolution:** 1 mV to 1 V. **AMPS DC:** Ranges: (5) 200 μA, 2 mA, 200 mA, 2000 mA, 20 A. **Accuracy:** 2000 mA and 20 A Ranges: ±(1.5% of reading + 3 digits). Other Ranges: ±(0.75% of reading + 1 digit). **AMPS AC:** Ranges: (5) 200 μA, 2 mA, 200 mA, 2000 mA, 20 A. **Accuracy:** (40 Hz to 500 Hz) 2000 mA and 20 A Range: ±(2.0% of reading + 5 digits). Other Ranges: ±(1.25% of reading + 5 digits). **RESISTANCE/CONTINUITY:** Ranges: (6) 200 Ω, 2 kΩ, 20 kΩ, 200 kΩ, 2 MΩ 20 MΩ. **Accuracy:** 20 MΩ Range: ±(1.5% of reading + 5 digits). Other Ranges: ±(0.75% of reading + 1 digit). **DIODE CHECK:** Ranges: (3) 0-200 mVDC, 0-2.0 VDC, 0-3.0 VDC nominal. **Accuracy:** ±(1.5% of reading + 5 digits). **GENERAL:** Power: 9 volt battery included. **Battery Life:** 500 hours. **Dimensions:** 1½" H x 3½" W x 6¼" L.



4½ digit DMM with .03% accuracy, true RMS

This no-frills benchtop DMM is the instrument you'll turn to for accurate and reliable measurements. At .03% accuracy is unusually good, even for a 4½ digit unit.

True RMS capability means the SM-2360 won't be fooled by odd signals. You'll use it to make frequency measurements on 20 kHz and 200 kHz with resolution comparable to a frequency counter. Includes dB scale, a big plus for anyone doing serious audio work; audible continuity test; data hold and automatic polarity indication. Comes with test leads, spare 2A fuse.

Assembled SM-2360 (6 lbs.) . . Limited Quantities! \$269.95

Specifications: **VOLTAGE RANGES:** DC: 200mV, 2V, 20V, 200V, 1000V. **Accuracy:** ±(0.03% rdg + 3 digits). AC: 200 mV, 2V, 20V, 200V, 1000V. **Accuracy:** 45 Hz to 300 Hz: 0.05%, 10 counts; 20kHz to 50kHz: 3%, 30 counts. **CURRENT RANGES:** DC: 200 μA, 2mA, 20mA, 200mA, 2000mA, 20A. **Accuracy:** 200μA to 200mA ranges: ±(0.3% rdg + 10 digits); 2000mA, 20A ranges: ±(0.75% rdg + 10 digits). AC: 200μA, 2mA, 20mA, 200mA, 2A, 20A. **Accuracy:** 200 μA to 200mA: 0.75%, 10 counts to 2.0%, 10 counts; 2000mA to 20A: 1.0%, 10 counts. **GENERAL:** Power: 6 D cell batteries or PS-2404 Battery Eliminator page 80. **Battery Life:** 1000-2000 hours. **Dimensions:** 2½"H x 9½"W x 7½"D.



Super DMM even measures frequency to 20 MHz

Slip this versatile DMM into your pocket and take it with you wherever the job happens to be. You'll enjoy the features of a full test bench packed into a single handheld unit.

This portable DMM gives you 0.5% basic accuracy and an amazing list of features: AC frequency measurements as high as 20 MHz – and, to levels as low as 200 mV; resistance up to 2000 Megohms; capacitance, transistor hFE and LED tests. The SM-2372 even works as a logic probe up to 20 MHz. This

valuable tool packs more measurement capability than any we've ever offered. Test leads included.

Assembled SM-2372 (2 lbs.) \$89.95

Specifications: **VOLTS DC: Ranges:** (5) 200 mV-1000V. **Accuracy:** ±(0.5% rdg + 1 digit). **Input Impedance:** 10 MΩ. **Resolution:** 100μV to 1V. **VOLTS AC: Ranges:** (5) 200 mV -750V. **Accuracy:** ±(1.0% rdg + 4 digits) except 1.5% rdg for 750V range. **AMPS DC: Ranges:** 200μA, 2mA, 20mA, 200mA, 10A. **Accuracy:** 10A range: ±(2.0% rdg + 3 digits), others: ±(1.0% rdg + 1 digit). **AMPS AC: Ranges:** 200μA, 2mA, 20mA, 200mA, 10A. **Accuracy:** 10A range: ±(2.0% rdg + 4 digits), others: ±(1.2% rdg + 4 digits). **RESISTANCE: Ranges:** (7) 200 Ω-2000 MΩ. **Accuracy:** 200 Ω range ±(1% + 3 dgt), 20 MΩ range ±(3% + 1 dgt), 2000 MΩ range ±(5% + 10 dgt) + 10 dgt, other ±(.8% + 2 dgt). **FREQUENCY:** 2 kHz-20 MHz. **GENERAL: Power:** 9 volt alkaline battery included. **Battery Life:** 20-100 hours according to mode (alkaline battery). **Dimensions:** 1 1/4" H x 3" W x 6 1/2" L.



Full function DMM with extra capabilities

This handy DMM gives you the capabilities you'll need for lab, workbench or portable jobs. The 3 1/2 digit display gives you readings to 1999 and automatic polarity indication.

Functions include resistance, capacitance, transistor DC gain and diode test. Current ranges – except for the 10A range – are fuse protected. Separate

voltage and current inputs protect both the DMM and the circuitry you're testing, and a handy continuity function alerts you to low resistance between the probes. Test leads included.

Kit IM-2311 (2 lbs.) \$49.95

Assembled SM-2311 (1 lb.) \$59.95

Specifications: **VOLTS DC: Ranges:** 200 mV, 2V, 20V, 200V, 1000V. **Accuracy:** ±(0.5% rdg + 1 count). **Input Impedance:** 10 MΩ. **Resolution:** 100μV to 1V. **VOLTS AC: Ranges:** 200 mV, 2V, 20V, 200V, 750V. **Accuracy:** 200 mV to 200V: ±(1.0% rdg + 4 counts), 750V: ±(1.5% rdg + 4 counts). **AMPS DC: Ranges:** 200μA, 2mA, 20mA, 200mA, 10A. **Accuracy:** 200μA to 200mA: ±(1.0% rdg + 1 count), 10A: ±(2.0% rdg + 3 counts). **AMPS AC: Ranges:** 200μA, 2mA, 20mA, 200mA, 10A. **Accuracy:** 200μA to 200mA: ±(1.0% rdg + 1 count), 10A: ±(2.0% rdg + 3 counts). **CAPACITANCE: Ranges:** (5) 200 pf-20 μF. **Accuracy:** ±(3% + 10 counts). **RESISTANCE: Ranges:** (6) 200 Ω-20 MΩ. **Accuracy:** 200 Ω range ±(1% rdg + 3 counts), 20 MΩ range ±(3% rdg + 1 count), other ±(.8 rdg + 1 count). **GENERAL: Power:** 9 volt battery included. **Battery Life:** 400 hours. **Dimensions:** 1 1/4" H x 2 3/4" W x 5" L.

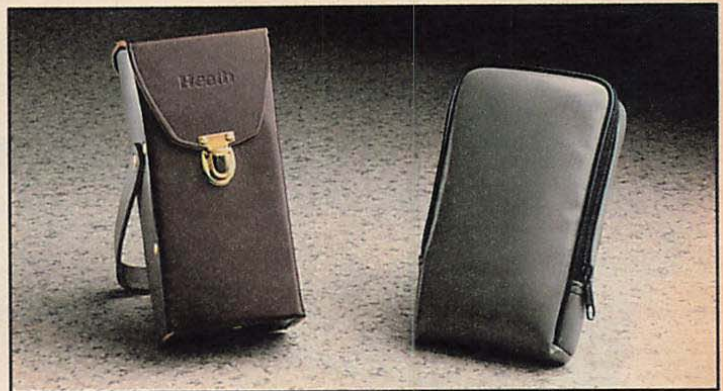

new Protect your meter with a deluxe carrying case

Give your meter the protection it deserves with a durable hard or soft carrying case. Easy to open and close, both cases have enough room to store your test leads, and an extra battery and fuse. A convenient belt loop lets you keep your meter right at your side. Hard shell case dimensions are 1 5/8" H x 3 1/2" W x 7 1/2" L inside and 3 1/4" H x 3 3/4" W x 8" L outside. Soft shell case dimensions are 1 1/2" H x 3 3/4" W x 7 1/4" L inside and 2 1/4" H x 4 1/4" W x 7 3/4" L outside.

Assembled SMA-2399-1 Hard Case (2 lbs.) \$19.95

Assembled SMA-2399-2 Soft Case (1 lb.) \$9.95



Smallest auto-ranging DMM made

You won't find a DMM smaller than this one. It fits in your shirt pocket with room to spare, and it's practically goof proof. The 3 1/2 digit display shows readings up to 1999. A handy extra meter that's affordable and accurate. Test leads included.

Assembled SM-2300-A (1 lb.) \$19.95

Specifications: **DC VOLTS: Ranges (5):** 200 mV to 500V (max.). **Input Resistance:** 11 MΩ (approx.). **Accuracy: (+ 4 digits):** 200 mV: ±2.0%; 2V: ±0.7%; 20V-500V: ±1.3%. **AC VOLTS: Ranges (4):** 2V to 500V (max.). **Input Resistance:** 11 MΩ (approx.). **Accuracy: (± 8 digits):** 2V to 500V: ±2.3% (40-500 Hz). **RESISTANCE: Ranges (6):** 200Ω to 20MΩ. **GENERAL: Power:** 9V battery included. **Dimensions:** 3/8" H x 2 1/4" W x 4 1/4" L.

New premier test lead set. See page 89.

2 MHz swept function and pulse generator

This general purpose signal source offers a broad range of service, design, hobby and research applications. Outputs include sine, square, triangle, pulse and ramp signals. Frequency range extends from 0.02 Hz to 2 MHz in seven pushbutton ranges. Other features include variable and fixed attenuators, duty cycle control, variable DC offset control, signal inversion, internal and external sweep and TTL pulse outputs. Compact cabinet is stackable.

Assembled SG-1274 (6 lbs.) \$199.95

Specifications: **Waveform:** Sine, Square, Triangle, Pulse. **Frequency:** 0.02 Hz-2 MHz in 7 ranges. **Scale Error:** $\pm 5\%$ of full scale. **Output Impedance:** 50 ohms $\pm 10\%$. **Output:** 5 mV P-P (min.) to 20 V P-P (max.) continuously variable into an open circuit. **Attenuator:** 0 dB-20 dB. **DC Level:** +10 V to -10 V (open), continuously variable with zero offset SW. **Duty Cycle:** 20%-80% continuously variable with 50 - 50 calibrated SW. **Total Harmonic Distortion:** $<1\%$ from 10 Hz to 200 kHz (of sine wave). **Input Impedance:** 10 $\Omega \pm 10\%$. **Square Wave Rise/Fall Time:** <100 ns. **Pulse:** >3 V P-P (open). Rise/Fall Time <25 ns. Sink: 20 TTL. **VCF:** 0 to ± 10 V. Control frequency to 100: 1 min.

Sweep. **SWEEP CHARACTERISTICS:** **Internal:** Linear. **Sweep Rate:** 0.5 Hz (2 sec. period) to 50 Hz (20 ms period, continuously variable). **Sweep Width:** Variable from 1:1 to 100:1. **Power:** 100/120/220/240 VAC ($\pm 10\%$), 50/60 Hz. **Dimensions:** 2 1/2" H x 9 1/2" W x 7 1/2" D.



Audio frequency signal generator

Use this generator's sine and square wave outputs as a signal source for harmonic distortion measurements, as an external modulator for RF generators or in tests of audio amplifiers for gain or frequency response. You can also use the square wave output to trigger digital instruments. Sine and square wave levels are independently adjustable from 0-3 volts, although frequencies .10 Hz-100 Hz, are identical. Use both signals simultaneously or independently.

Housed in a 5280 series instrument cabinet, the Audio Generator is stackable with other instruments in the 5280 line. Cabinet includes convenient storage compartment.

Kit IG-5282 (5 lbs.) \$79.95

Specifications: **Frequency Output:** 10 Hz to 100 kHz in four ranges. **Sine Wave Voltage:** 0 to 3 volts RMS. **Square Wave Voltage:** 0 to 3 volts peak. **Power:** Two 9-volt transistor batteries (not included) and/or IPA-5280-1 Power Supply (page 87). **Dimensions:** 11" H x 5 3/4" W x 7 3/4" D.

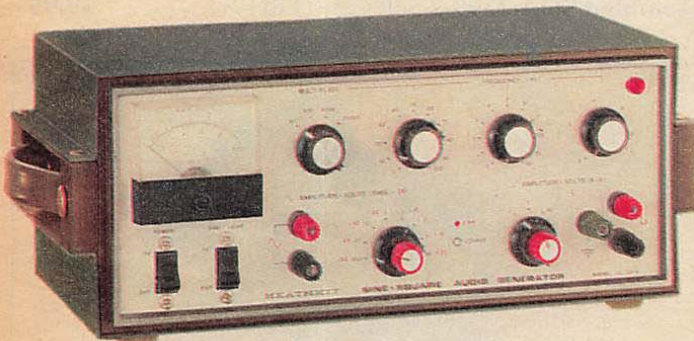

Sine and square wave generator

This 1-100 kHz signal generator supplies high quality sine waves for accurate testing of audio amplifiers, and clean square waves for checking digital instruments and frequency responses.

Kit IG-5218 (10 lbs.) \$199.95

Specifications: **SINE WAVE OUTPUT:** Internal Load: Internal 600 Ω load available on 0.003, 0.01, 0.03, 0.1, 0.3 and 1.0 volt ranges. **dB Ranges:** -62 to +22 dB (-12 to +2 dB on meter; -50 to +20 dB in eight 10 dB switch positions.) +2 dB maximum into 600 Ω load. **Output Variation:** ± 1 dB from 10 Hz to 100 kHz. **Output Indication:** 2 voltage scales and 1 dB scale on front panel meter. **Output Impedance:** 10 volt range; 0-1000 Ω . 3 volt range; 800-1000 Ω . 1 volt range and lower; 600 Ω . **Meter Accuracy:** $\pm 10\%$ of full scale with proper load termination. **Distortion:** Less than 0.1% from 10 Hz to 20 kHz. **SQUARE WAVE OUTPUT:** Frequency Range: 5 Hz to 100 kHz. **Output Impedance:** 52 Ω on 0.1 V and 1.0 V ranges. Up to 220 Ω on 10 V range. **Rise Time:** Less than 50 nanoseconds. **GENERAL:** **Frequency Selection:** First 2 significant figures on 0-100 and 0-10 switches each in 10 steps. Third figure on continuously variable 0-1 control. Multiplier switch; X1, X10, X100, X1000. **Frequency Error:** $\pm 5\%$ of first and second digit. **Power:** 120/240 VAC, 50/60 Hz. **Dimensions:** 5 1/8" H x 13 1/4" W x 7" D.

Digital LC bridge

SKILL LEVEL 1 This versatile instrument verifies capacitors and inductors, plus checks the associated dissipation or loss factor. A four-point Kelvin input connection eliminates the variable effects of components with large lead lengths or large lead diameters. A null control also eliminates stray capacitance on the lower ranges. Separate rear panel connectors allow the application of a DC voltage for batch testing or the hookup of a plotter for charting capacitance and voltage curves.

Kit IT-2240 (11 lbs.) \$199.95

Specifications: **INDUCTANCE: Ranges:** 200 μ H to 2000 H in 8 decade steps. **Accuracy: (± 4 counts):** $\pm [0.5\% (L) + 1.5\% (L) \times D + 0.5 \mu\text{H}]$ for readings from 10 to 2000 counts when the Bridge is calibrated using laboratory standards. **CAPACITANCE: Ranges:** 200 pF to 2000 μ F, 8 decades. **Accuracy (± 2 counts):** $\pm [0.5\% (C) + 1.5\% (C) \times D + 0.5 \text{ pF}]$ for readings from 10 to 2000 counts when the Bridge is calibrated using laboratory standards.



DISSIPATION: Range: 000 to 1999, limited to $D \times \mu\text{F} = 1000$ on 2000 μF range. **Accuracy (± 20 counts):** $\pm 3\%$ for value displays greater than 200 counts. **GENERAL: Overvoltage Protection:** Input protected against ± 20 VDC/VAC (5 seconds maximum), or capacitor up to 2000 μF charged to 50 VDC and by an internal 1-ampere fuse. **Power:** 120 VAC, 60 Hz. **Dimensions:** 3 $\frac{3}{4}$ " H x 10" W x 12 $\frac{1}{2}$ " D.

3 $\frac{1}{2}$ digit handheld LCR meter

You get more ranges to cover more capacitors, inductors and resistors with this compact, digital LCR meter. And you get the accuracy you would expect from a full-size bench model. The SM-2255 even takes the dissipation factor into account, like our LC Bridge shown above.

The SM-2255 features an easy-to-read, 3 $\frac{1}{2}$ digit LCD display, fast rotary switch range selection plus a compact design. The LCR meter comes with test leads, 9-volt battery, spare fuse and operator's manual.

Assembled SM-2255 (2 lbs.) \$159.95



Specifications: **RESISTANCE: Ranges:** 20 Ω , 200 Ω , 2 k Ω , 20 k Ω , 200 k Ω , 2 M Ω , 20 M Ω . **Resolution:** 0.01 Ω , 0.1 Ω , 1.0 Ω , 10 Ω , 100 Ω , 1 k Ω , 10 k Ω . **Accuracy:** 20 Ω : $\pm (2\% \text{ rdg} + 2 \text{ dgt})$; 200 Ω to 2 M Ω : $\pm (0.5\% \text{ rdg} + 1 \text{ dgt})$; 20 M Ω : $\pm (3\% \text{ rdg} + 1 \text{ dgt})$. **INDUCTANCE: Ranges:** 200 μ H, 2 mH, 20 mH, 200 mH, 2 H, 20 H, 200 H. **Resolution:** 0.1 μ H, 1.0 μ H, 10 μ H, 100 μ H, 1.0 mH, 10 mH, 100 mH. **Accuracy:** for $D < .5$: 200 μ H: $\pm (3\% \text{ rdg} + 1 \text{ dgt})$; 2 mH to 200 mH: $\pm (2\% \text{ rdg} + 1 \text{ dgt})$; 2 H, 20 H: $\pm (3\% \text{ rdg} + 1 \text{ dgt})$; 200 H: $\pm (5\% \text{ rdg} + 1 \text{ dgt})$. **CAPACITANCE: Ranges:** 200 pF, 2 nF, 20 nF, 200 nF, 2 μ F, 20 μ F, 200 μ F, 2000 μ F. **Resolution:** 0.1 pF, 1 pF, 10 pF, 100 pF, 1 nF, 10 nF, 100 nF, 1000 nF. **Accuracy:** 200 pF: $\pm (3\% \text{ rdg} + 1 \text{ dgt})$ for $D < .1$; 2 nF to 2 μ F: $\pm (2\% \text{ rdg} + 1 \text{ dgt})$ for $D < .5$; 20 μ F, 200 μ F: $\pm (3\% \text{ rdg} + 1 \text{ dgt})$ for $D < .5$; 2000 μ F: $\pm (5\% \text{ rdg} + 1 \text{ dgt})$ for $D < .1$. **DISSIPATION: Range:** 0 to 19.99. **Accuracy (typical for $D < .5$):** $\pm (2\% \text{ rdg} + [3 + (200/\text{value})] \text{ dgt})$ for L value; $\pm (2\% \text{ rdg} + [2 + (200/\text{value})] \text{ dgt})$ for C value. **GENERAL: Display:** 3 $\frac{1}{2}$ -digit with battery low indicator. **L, C Test Method:** 1000 Hz sine wave on 200 pF/ μ H to 2 μ F/H ranges; 120 Hz on others. **Power:** Single 9-volt battery (included). **Dimensions:** 1 $\frac{5}{8}$ " H x 3 $\frac{1}{2}$ " W x 6 $\frac{7}{8}$ " L.

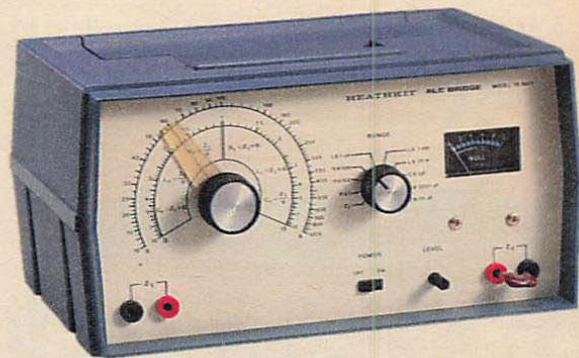

Versatile RLC bridge

SKILL LEVEL 1 This general-purpose instrument lets you check the values of unknown or obliterated resistors, capacitors and inductors. Front panel terminals are provided for components under test and for an external standard. The stackable cabinet includes a storage compartment.

Kit IB-5281 (5 lbs.) Last Call! \$89.95

Specifications: **Resistance Ranges:** 10 Ω to 10 M Ω in three ranges. **Inductance Ranges:** 10 μ H to 10 H in three ranges. **Capacitance Ranges:** 10 pF to 10 μ F in three ranges. **Oscillator Frequencies:** 1 kHz, 10 kHz. **External Standard Range:** 1:1 to 10:1. **Power:** Two 9-volt transistor batteries (not included) and/or IPA-5280-1 Power Supply (page 87). **Dimensions:** 5 $\frac{3}{4}$ " H x 11" W x 7 $\frac{3}{4}$ " D.



TECHNICAL CONSULTATION

When you have a question about the kit you're building or about an assembled product, our expert technical consultants are only a phone call away. Their numbers are listed on page 51.



0-30 volt power supply gives more performance for less money

Good, clean output, overload protection, constant voltage mode, constant current mode, plus meters for both current and voltage. Our SP-2762 power supply gives you all this at 0-30 volts and a full 3-amp output. Just what you need for your design bench, service shop or ham shack.

Also remarkable is a very affordable price tag. You'll find the SP-2762 one of the best performance-per-dollar power supplies on the market today.

Assembled SP-2762

(14 lbs.) \$169.95

Specifications: **OUTPUT: Volts:** 0-30V. **Amps:** 0-3A. **Ripple:** <5 mV peak-to-peak. **Line Regulation:** 0.01% + 2 mV. **Load Regulation:** 0.01% + 3 mV. **Power:** 120/240 VAC, 50/60 Hz. **Dimensions:** 6 1/4" H x 8 1/2" W x 10 1/2" D.



Regulated power supply

Use this power supply to test new ideas and circuits in stereo vacuum tube amplifiers and amateur radio gear. Or, power any circuit up to 400 volts DC with this well regulated, variable-output high voltage power supply. Built in is a 0 to -100 volt DC tube bias supply. And, separate 6.3 and 12.6 VAC heater filament voltages are accessible from front panel binder posts.

Kit IP-2717-A (19 lbs.) \$199.95

Assembled SP-2717-A

(20 lbs.) \$299.95

Specifications: **B+** **VOLTS: Voltage:** 0 to 400 volts DC, regulated. **Current:** 0 to 100 mA continuous, 125 mA intermittent. **Regulation:** Output variation less than 1% from no load to full load. **Ripple:** Less than 10 mV RMS. **C-** **VOLTS: Voltage:** 0 to -100 volts DC at 1 mA. **FILAMENT VOLTS: Voltage:** 6.3 VAC at 4 amperes or 12.6 VAC at 2 amperes. **GENERAL: Power:** 120/240 VAC, 50/60 Hz. **Dimensions:** 5 1/2" H x 13 3/4" W x 11 1/4" D.



Triple output DC supply

This supply furnishes the vast majority of power requirements for almost any test and measurement application. It lets you monitor voltage or current without tying up a multimeter. A special built-in tracking circuit maintains the voltage difference between supplies when you're working with operational amplifier circuits.

Kit IP-2718 (12 lbs.) \$139.95

Assembled SP-2718

(12 lbs.) \$200.00

Specifications: **Outputs:** 5 VDC +5% at 1.5 amps. Two outputs at 0-20 volts DC at 0.5 amps, continuously adjustable. **Regulation:** <0.1% on 20 V supplies, <3% on 5 V supplies. **Power:** 120/240 VAC, 50/60 Hz. **Dimensions:** 4 1/2" H x 10 3/4" W x 9" D.

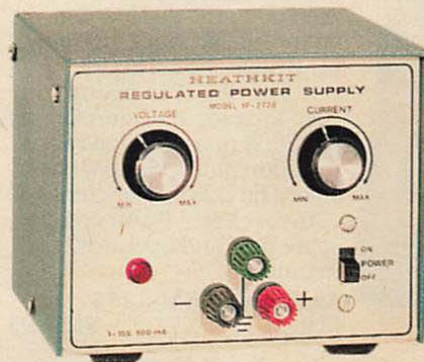

An economical power supply

In a few hours you can put together a truly handy power supply. With variable 1- to 15-volt DC output, this power supply is useful in many digital and analog circuit applications. Even use it as a substitute for batteries when checking out portable equipment. Programming terminals on the rear of the cabinet let you use an AC or DC voltage from another source to control output voltage of this power supply.

Kit IP-2728 (5 lbs.) Sorry, no longer available.

Specifications: **Load Regulation:** Less than 50 mV, no load to full load. **Ripple and Noise:** Less than 5 mV. **Current Output:** 500 mA max. **Current Limiting:** Adjustable 10 mA to over 500 mA. **Power:** 120/240 VAC, 50/60 Hz. **Dimensions:** 4 3/8" H x 5 1/2" W x 5 3/4" D.



Noise generator kit

SKILL LEVEL To properly check out any stereo or sound system with a spectrum analyzer, you need a noise source with a nearly constant energy output. This easy-to-build Pink/White Generator will do just that...and at a fraction of the cost of comparable noise generators.

Kit AD-1309 (2 lbs.) \$39.95

Specifications: **Frequency Response:** Pink Noise, ± 1 dB from 20 Hz to 20 kHz. White Noise, ± 3 dB from 20 Hz to 20 kHz. **Output Levels:** >350 mV RMS, >1.5 V peak. **Power:** 9-volt battery (not included). **Dimensions:** 2 $\frac{5}{8}$ " H x 4 $\frac{1}{8}$ " W x 4 $\frac{1}{8}$ " D.

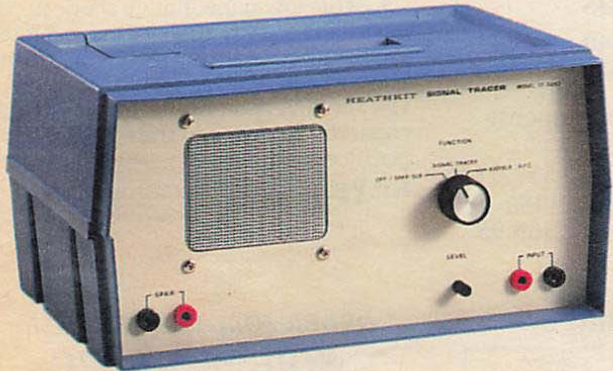

Handy signal tracer

SKILL LEVEL An effective tool for quickly tracing signals in radio and TV receivers. Lets you check voltages and resistance by simply listening to an audible tone. Also lets you detect faulty RF or IF stages, even isolate faulty components.

Kit IT-5283 (5 lbs.) \$59.95

Specifications: **Speaker:** 3" permanent magnet, 16 Ω . **Power:** Two 9-volt transistor batteries and/or IPA-5280-1 Power Supply. **Dimensions:** 5 $\frac{3}{4}$ " H x 11" W x 7 $\frac{3}{4}$ " D.

Decade resistance kit

SKILL LEVEL This accurate laboratory-type instrument supplies a wide range of resistance values for use in electrical measurements. Use it whenever you need an accurate variable multiplier or shunt, substitute resistor, or as an arm for DC and AC bridges. An easy-to-build kit that will supply any resistance value from 1 to 999,999 Ω in 1 Ω steps.

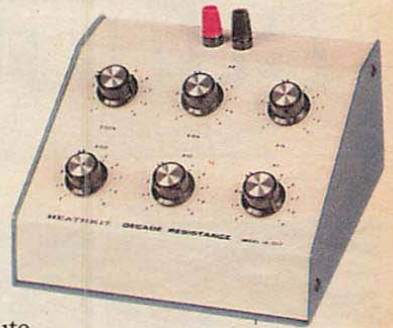

Kit IN-3117 (3 lbs.) \$99.95

Specifications: **Resistors:** Precision, 1/2% accuracy, 1 watt. **Max Current:** X1 = 1000 mA, X10K = 300 mA, X100 = 100 mA, X1K = 30 mA, X10K = 10 mA, X100K = 3 mA. **Dimensions:** 5" H x 7 $\frac{1}{2}$ " W x 6 $\frac{5}{8}$ " D.

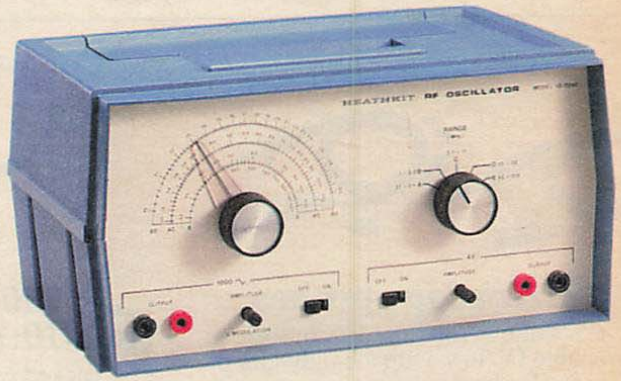

Low-cost RF oscillator

SKILL LEVEL The IG-5280 provides AM modulated or unmodulated RF signals in five overlapping bands. Use its wide frequency range to align receivers covering the AM, FM, television, longwave and shortwave broadcast bands. Includes an easy-to-read dial scale. The one kHz RF modulator also serves as a convenient audio signal source. The cabinet of the IG-5280 is stackable and features a handy storage compartment.

Kit IG-5280 (5 lbs.) *Last Call!* \$119.95

Specifications: **RF OUTPUT: Frequency:** 310 kHz to 110 MHz in five bands. 100 MHz to 220 MHz using calibrated harmonics. **Voltage:** Approx. 100 mV RMS. **Internal Modulation:** 1 kHz. **AF OUTPUT: Frequency:** 1 kHz. **Voltage:** Approx. 2 volts RMS. **GENERAL: Power:** Two 9-volt batteries (not included) and/or IPA-5280-1 Power Supply (below). **Dimensions:** 5 $\frac{3}{4}$ " H x 11" W x 7 $\frac{3}{4}$ " D.

5280-series DC supply

SKILL LEVEL This power supply simultaneously furnishes DC power to all our 5280-series instruments. You can wire the unit to operate on 120 or 240 VAC. Dimensions are 6" H x 3 $\frac{3}{4}$ " W x 3" D.

Kit IPA-5280-1 (3 lbs.) \$39.95

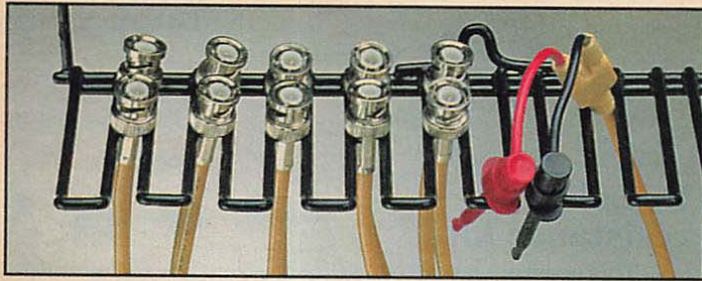

BNC cable set simplifies connections

Our BNC connector set provides you with 10 handy coax cables for instrument and other connections. Mount the included rack on your workshop wall for easily accessible cable storage. Included are two 3 ft. BNC male/dual E-Z hook connectors, three 1½ ft. BNC male/BNC male connectors, three 3 ft. BNC male/BNC male connectors, and two 6 ft. BNC male/BNC male connectors.

Assembled HCA-5002 (3 lbs.) \$29.95

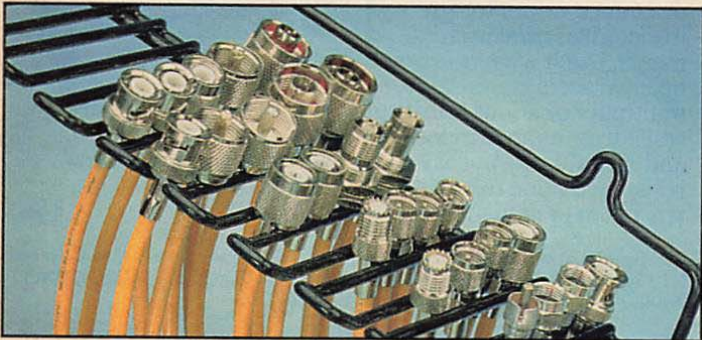

Our coax adapter cables now include F and RCA connectors

Solve frustrating coax connection problems with this convenient adapter cable assortment. Connect BNC to BNC, BNC female, UHF, mini UHF, N, TNC, F or hook clips. Connect RCA to RCA, F, BNC or UHF. Connect N to UHF, N or TNC. Connect UHF to UHF, mini UHF to mini UHF, F to F, BNC female to BNC female or TNC to TNC. Twenty cables in all help you make almost any connection. And, the cables come in high visibility yellow for easy identification. Two handy storage racks keep your cables neatly organized.

Assembled HCA-5001 (3 lbs.) \$69.95

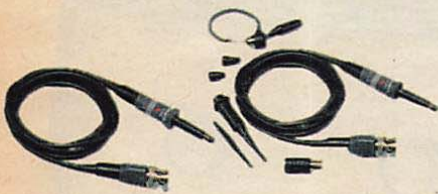

250 MHz scope probes

A set of two modular 10X probes, switchable 1X/10X, with a bandwidth of 250 MHz. Packaged with accessory tips.

Assembled P-250-2 (1 lb.) . . . \$99.95



new 150 MHz probe with 10:1/1:1 ratios

Packed with features, our new P-150 probe delivers premium performance at an affordable price. Advanced circuitry delivers quick pulse response and faster risetime – less than 1.5 ns.

Assembled P-150 (1 lb.) \$37.95

Assembled PS-150 Set of two P-150 probes. (2 lbs.) \$69.95



Oscilloscope probe

SKILL LEVEL 1 This low-capacitance scope probe is useful for tracing waveforms in TV circuits without causing signal distortion. Has switchable 1X and 10X positions. Use the 10X position for minimum capacitive loading of the circuit, the 1X position for maximum sensitivity.

Kit PK-1 (1 lb.) \$17.95

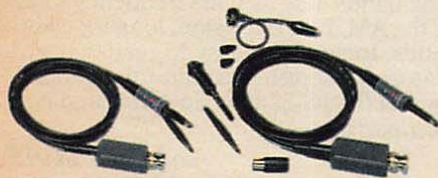

350 MHz scope probes

A set of two modular 10X probes with a bandwidth of 350 MHz. Packaged with a full complement of accessory tips.

Assembled P-350-2 (1 lb.) . . . \$79.95

Match a probe to your scope's capability

Scope Bandwidth (MHz)	P-150 150 MHz	P-250-2 250 MHz	P-350-2 350 MHz	
25	120.1	24.9	24.9	Approx. Bandwidth of Scope and Probe
50	83.2	49.0	49.5	
100	47.4	92.8	96.2	
200	24.6	156.2	173.6	

ORDER TOLL-FREE ANYTIME

800-253-0570

FAX: 616-982-5577



Deluxe connector kit includes F and RCA adapters

Make different types of coaxial connector adapters with gold plated pins and Teflon insulation. Just screw the required connector to one of the interfaces. No crimping or soldering is needed. In just seconds you'll have that special coaxial connection you require. Kit contains male and female N, F, RCA, BNC, UHF, SMA, TNC and mini UHF connectors. A handsome, padded, zippered case is included with this deluxe kit to protect your connectors and to keep them looking new after years of service.

Assembled HCA-3001 (2 lbs.) \$79.95



Easy-to-build logic probe

SKILL LEVEL 1 This quick-checking logic probe detects and indicates high and low logic levels in 5 VDC TTL circuits up to 100 MHz and 15 VDC CMOS circuits up to 80 MHz. Indicator lights located at the tip of the probe show high or low logic levels. Power is provided to the logic probe from the circuit under test through 34" leads. An additional detachable ground clip is included for high frequency operation.

Kit IT-7410 (1 lb.) Last Call! \$39.95

Specifications: **AC THRESHOLD LEVELS:** TTL Logic ZERO (V): 0.8 ± 0.15 @ 5 VDC. TTL Logic ONE (V): 2.1 ± 0.25 @ 5 VDC. CMOS Logic ZERO (%): $30 \pm 10\%$ of supply voltage. CMOS Logic ONE (%): $70 \pm 10\%$ of supply voltage. **INPUT IMPEDANCE:** 400 k Ω in parallel with 10 pF. **RESPONSE LIMIT:** 10 ns for single pulse of train for TTL and CMOS. **Probe Input Protection:** ± 50 VDC, continuous, ± 175 VDC (124 VAC), 5 seconds. **Power:** 4.75 to 5.5 VDC @ 75 mA max. (TTL). 4.75 to 15 VDC @ 115 mA max. (CMOS). **Dimensions:** 9 1/4" L x 1" Diameter. **Weight:** 2 1/2 ounces.

All-in-one 40 kV probe



SKILL LEVEL 7 With this one probe you can measure voltages up to 40,000 with an accuracy of $\pm 3\%$ in any negative ground circuit. Measurements are read directly from a built-in meter.

CAUTION: We value you as a friend. Please follow all safety practices when measuring high voltages.

Kit IM-5215 (2 lbs.) \$49.95

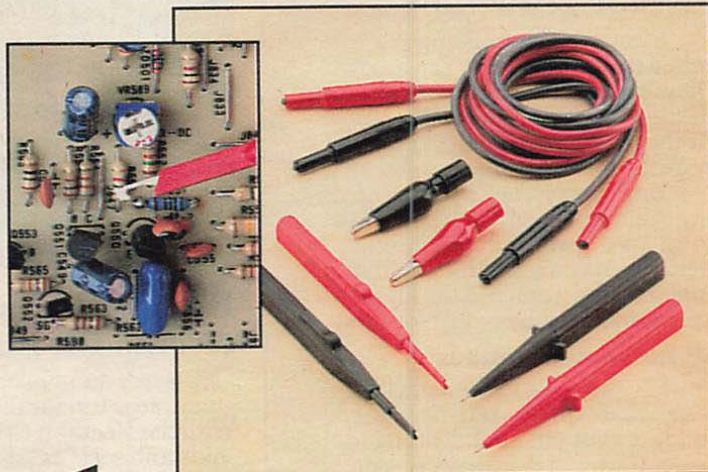

new Premier test lead set

Your meter works fine, but your leads have seen better days. Sound familiar? Now you can replace those old leads with the industry's finest. Cables are silicone-rubber insulated making them extremely flexible and burn-resistant. And, spring-loaded safety shields cover the banana plugs on both ends of the cables. This set includes 2 cables (1 red, 1 black), 2 standard probes, 2 alligator clips, 2 spade lugs and 2 retractable hook tips – just like expensive scope probes. A great addition to any test bench!

Assembled P-5 (1 lb.) \$29.95

SAVER Save \$5 on this instrument package. Order the P-5 Test Lead Set with any DMM costing \$50 or more and take \$5 off your order.

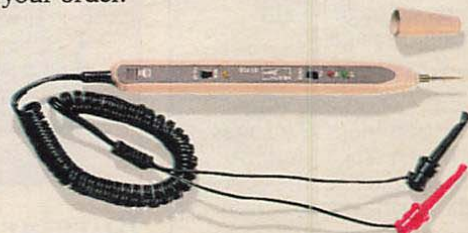

TTL/CMOS logic probe

This probe evaluates circuits and isolates faulty components, checks out TTL and CMOS circuits up to 20 MHz.

Assembled ST-7420 (1 lb.) \$12.95

Specifications: **Input Impedance:** 1 Megohm. **LOGIC THRESHOLDS:** TTL: Low, $0.8V \pm 0.2V$ DC; High, $2.3V \pm 0.2V$. CMOS: Low, 30% of circuit Vcc; High, 70% of circuit Vcc. **GENERAL: Controls:** Threshold select (TTL or CMOS), Pulse/Memory. **Pulse LED (Yellow) Flashing Time:** 500ms. **Power Supply Protection:** $\pm 20V$. **Supply Voltage Range:** 5V-15V.

Digital pulser probe

Similar in appearance to the ST-7420 above, the ST-7430 lets you inject substitute logic pulses into circuits for quick testing.

Assembled ST-7430 (1 lb.) \$12.95

Specifications: **Sync Input Impedance:** 1 meg. **Pulse Width in Pulser Output:** 10 μs at 100 mA load. **Pulse Width in Pulser Output:** 0.5 and 400 PPS. **Output Current:** Pulse Mode: 100 mA sink or source max. 90% Pulse Mode: 20 mA sink or source max. **Supply Voltage:** 5 to 15 volts.

Kit building is not just for grownups

Electronic kit building is a hobby the whole family can enjoy. There's a kit for everyone: a burglar alarm or a wireless microphone for the kids, a computer, clock and more for the rest of the family.

You'll experience a feeling of pride and achievement when you finish an electronic kit, and excitement when you test it for the first time. Then you can use the kit for your work, a hobby or just for fun.

All-inclusive manuals

The manuals for our starter kits include everything you'll need for building your kit. Each manual includes a parts list, instructions on how to make soldering connections and step-by-step assembly instructions. Also included is a section that tells you all about your kit and how to use it, plus a trouble-shooting guide that tells you what to do if anything ever goes wrong.

Kits are educational

Building electronic kits is educational, too. You'll learn electronics at your own pace and have fun while you're learning. Plus, building starter kits prepares you for more advanced projects and can even spark an interest in future electronics training. (See our easy-to-understand basic electronics videos on page 35 and courses beginning on page 36.)

Get in on the fun

Join thousands of other enthusiastic electronic kit builders of all ages in this exciting hobby. You'll understand the fun, the challenge, the cost savings...and the special satisfaction of saying, "I built it myself." Plus, you'll understand how electronic equipment *really* works.

Our customers write...

"I build your products and enjoy them. I have only built three so far. I've built the Sound Activated Switch, Wireless Microphone, and Electronic Door Lock. I am 10, almost 11. Please write back."

Douglas Phelps III
(now 12, almost 13)
Cary, Illinois

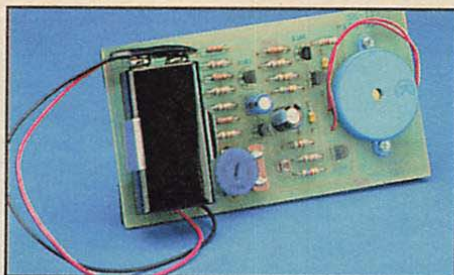

Build the electronic cricket for family fun

SKILL LEVEL 1 Here's an unusual house pet that guarantees fun for the whole family. With the Heathkit Cricket, the game of "hide and seek" takes on a new meaning. Hide the Cricket anywhere in the house, then turn off the lights. Your pet chirps when the room is dark and becomes silent when you turn lights on.

Why does the Cricket chirp only when it's dark? Find out for yourself by learning how a light-dependent-resistor works. Also learn that the Cricket's buzzer is a piezoelectric device that vibrates to make sound. Requires a 9-volt battery (not included).

Kit SK-113 (1 lb.) \$12.95

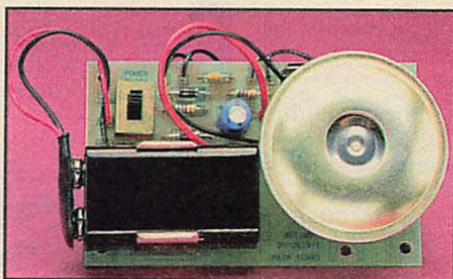

Burglar alarm keeps your belongings safe

SKILL LEVEL 1 Be the first in your neighborhood to have your own mini alert system. Use it to protect your bedroom, tree house or even the family car. The loud squeal will send intruders running. The Heathkit manual shows you how to set up both home and car security systems, plus how to hook up a bell or the alarm buzzer externally.

Then use detective-like skills to learn exactly how your burglar alarm operates. The manual explains about the silicon-controlled rectifier and why it is so important. Uses a 9-volt battery (not included).

Kit SK-115 (1 lb.) \$14.95

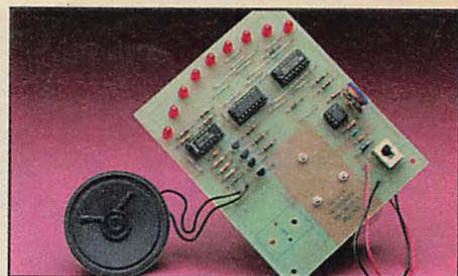

The metronome that never needs winding

SKILL LEVEL 1 Beethoven had one, so did Schubert. Now you too can have your own metronome, and build it yourself. The Heathkit electronic Metronome uses a curved string of nine LEDs that flash back and forth from one end to the other. A clicking sound you can set from 40 to 240 beats per minute helps you keep your tempo perfect.

Then learn how your new metronome keeps perfect time. Find out how five major circuits all work together to count, make a clicking sound and make the LEDs light in sequence. Works with a 9-volt battery (not included).

Kit SK-114 (1 lb.) \$19.95

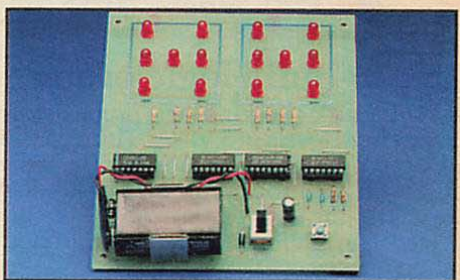

Electronic dice do the job for you

SKILL LEVEL 1 Your favorite card and board games take on a new twist when you play with the Heathkit Electronic Dice. No more rolling dice the old fashioned way. Simply push a button and watch the LEDs light. In an instant, they'll produce a random combination of two of the possible eleven patterns for a game that's exciting and fun.

Plus, you'll learn about integrated circuits, LEDs, counters, clock circuits and more. Find out how they all work together to roll your dice. Uses a 9-volt battery (not included).

Kit SK-117 (1 lb.) \$19.95

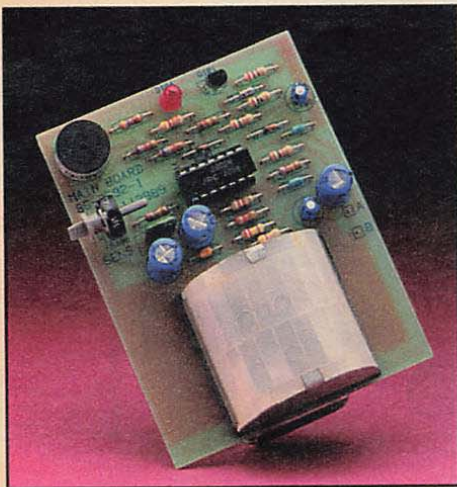

new Infrared motion sensor detects visitors

SKILL LEVEL 1 Need an automatic doorbell/security alarm for your treehouse, fort or room? Then the Infrared Motion Sensor is for you. The sensor detects movement and body heat, triggering a beeper and an LED to let you know someone is nearby.

Find out how infrared detection works, what a Fresnel lens is and how it catches and directs light. And learn how pyroelectric sensors are optical devices, much like your eyes, that detect changes in infrared energy.

You'll enjoy using the Infrared Motion Sensor long after it's built. Requires a 9-volt battery (not included).

Kit SK-116 (1 lb.) \$24.95

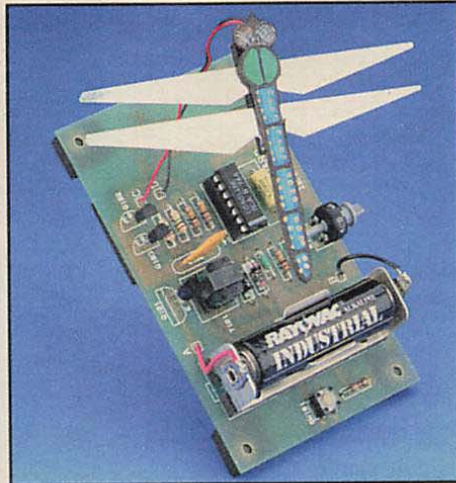

new A dragonfly you can keep inside the house

SKILL LEVEL 1 Even your mom will like this interesting little bug. The Heathkit Dragonfly looks like it's really flying with paper-thin wings that move without any visible mechanism. How does this happen? The wings are made of an amazing high-tech material called piezoelectric film that actually changes shape and size when voltage is applied.

Learn how piezoelectric materials, bimorphs and voltage work together to make your Dragonfly operate. And after it's finished, take your insect to school to show your friends.

Requires a standard 1.5-volt AA battery (not included).

Kit SK-118 (1 lb.) \$21.95

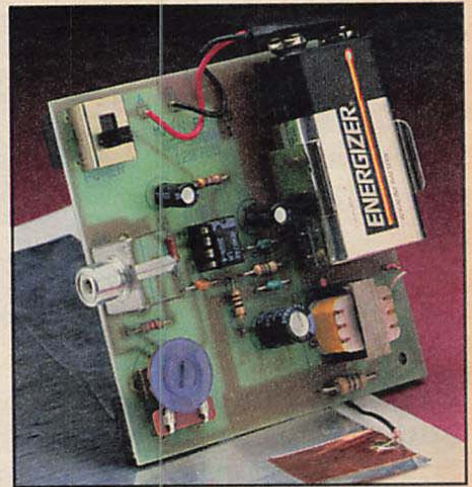

new Make balloons talk with the Magical Film Speaker

SKILL LEVEL 1 Amaze your family and friends with a Mylar balloon, a mirror or a picture on the wall that talks and plays music. You can use the Magical Film Speaker to liven up parties, entertain guests, perform ventriloquist acts and other exciting experiments.

Piezoelectric film is the key. Simply tape the Magical Film Speaker to an object; the tape transmits sound. You'll learn how to increase and decrease sound by bending the film, watch the film change shape and size, see how it reacts to a light bulb and more!

Requires a standard 9-volt battery (not included).

Kit SK-120 (1 lb.) \$21.95



Learn how to solder correctly with our soldering course

This Heathkit Educational Systems course teaches you everything you need to know about soldering. You'll learn the techniques, the proper tools to use and how to clean your soldering iron.

The text is well illustrated and easy to read. Plus, you'll receive a parts pack including solder and all the parts you need to practice what you've learned.

EI-3133 (3 lbs.) \$19.95

ORDER TOLL-FREE ANYTIME

800-253-0570

FAX: 616-982-5577





Regulate small appliance motor speed and save wear and tear on appliances

SKILL LEVEL 1 This handy control lets you save energy and wear on motorized appliances and tools. It's ideal, for example, for varying the motor speed of electric hand tools and small household appliances. In the included assembly manual you'll also learn about the operation of a diac and triac for AC control. 120 volts AC, 60 Hz. 2" H x 5³/₈" W x 3⁵/₈" D.

Kit SK-103 (1 lb.) Last Call! \$39.95



The educational DC power supply kit is a handy beginner project

SKILL LEVEL 1 Power up your hobby kits, tape player or CB with the DC Power Supply. It has a variable output from 4 to 18 volts and supplies 3 amps 50% duty cycle or 2 amps continuous. In the included assembly manual, you'll also learn the purpose of a power transformer and rectifier, filter and regulator circuits. Dimensions are 3" H x 4¹/₂" W x 6¹/₂" D.

Kit SK-101 (5 lbs.) \$47.95



An intercom system for your home

SKILL LEVEL 1 Use the Heathkit Intercom to talk to a family member in another room without leaving what you're doing, or call someone to the phone without running to another room or shouting for them. Your whole family will appreciate the convenience and the excellent audio quality of this system.

At least two intercoms must be used, and you can

link up to four units using two-conductor wire. The intercom runs for months on one 9-volt battery (not included) because current is drawn only when the unit is in operation. Or power your unit with the PS-2350 Battery Eliminator (sold on page 93). Along with assembly instructions, the SK-108 includes a manual section on audio amplifier theory and impedance matching. Dimensions of the unit are 4¹/₂" H x 3¹/₄" W x 1³/₄" D.

Kit SK-108 (2 lbs.) \$21.95

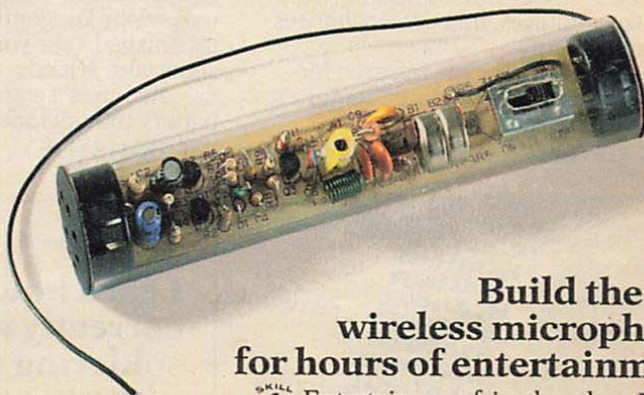

Build the FM wireless microphone for hours of entertainment

SKILL LEVEL 1 Entertain your friends or be a DJ for your own radio show with this FM Wireless Microphone kit. Transmit your voice to any FM radio up to 50 feet away. It's a fun and easy kit you can build in a few hours. You'll learn FM radio theory, too. Operates on two watch batteries (included).

Kit SK-106-H (1 lb.) \$12.95



Dual-mode stereo synthesizer for more exciting sound

SKILL LEVEL 1 Your favorite TV programs will come to life with the dual-mode Stereo Synthesizer. This kit converts your TV's mono input into two different channels for more exciting sound and more fun TV viewing. Along with assembly instructions, the SK-107 manual explains low pass, high pass and band pass filters. Requires a 9-volt battery or the Battery Eliminator.

- Kit SK-107** (1 lb.) \$19.95
- Accessory:
- Battery Eliminator**
- Assembled PS-2350 (1 lb.) \$7.95



One-watt audio amplifier increases audio output

SKILL LEVEL 1 Here's a fun kit to use with your radio, portable tape player, intercom or TV sound system. You'll get more sound and extra listening enjoyment. A phono input and output socket on the amplifier makes hookup between your audio equipment and speaker easy.

The SK-104-H assembly manual also teaches you how to change gain and frequency response. Requires a 9-volt battery or the Battery Eliminator (left).

- Kit SK-104-H** (1 lb.) \$19.95

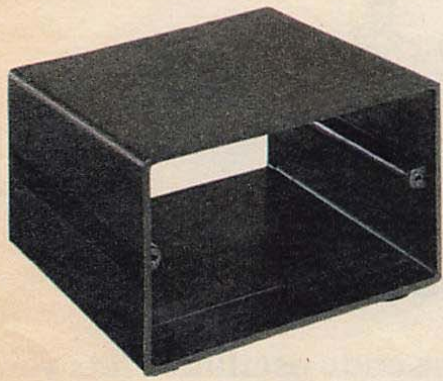

Cabinet gives your audio amplifier and synthesizer the final touch

Finish up your SK-104-H Audio Amplifier or SK-107 Stereo Synthesizer (described above) with this attractive black cabinet.

- SK-99** (1 lb.) \$6.95



Enjoy lively parties with the sound flasher

SKILL LEVEL 1 Add sparkle to your next get-together with the Sound Flasher. Watch

the fun as music and voices in the room cause lamps or party lights to brighten and dim. The SK-109 assembly manual explains rectifier theory and shows how pulses control lamp brightness. Operates on 120 VAC, 60 Hz. Dimensions are 2 1/4" H x 3 1/8" W x 5 7/8" D.

- Kit SK-109** (1 lb.) \$19.95

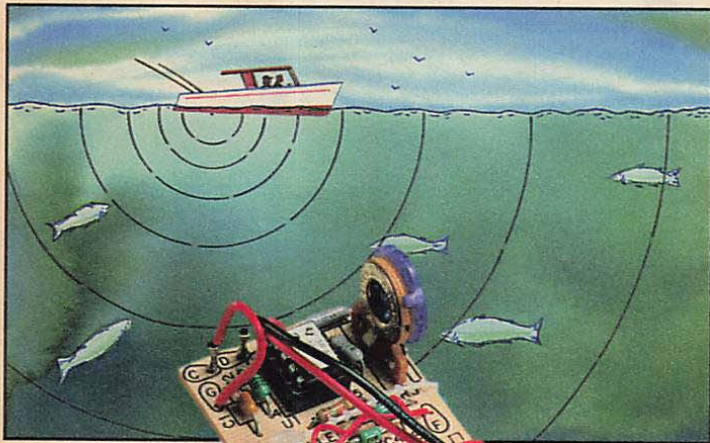

Next time you go fishing take along the fish caller

SKILL LEVEL 1 You'll find that it's easy to attract and catch fish with our simple-to-build Fish Caller. The Fish Caller produces a sound that travels through water to attract hungry fish to your boat or dock. You'll also learn about the 555 IC timer in the included assembly manual. Requires a 9V battery (not included).

Kit SK-105-H (1 lb.) \$7.95



Control lamps from a distance with the sound activated switch

SKILL LEVEL 1 Turn on a TV or a lamp from across the room – just by clapping your hands. The first time the switch picks up a loud sound it turns on the device. The following loud sound turns it off again. Learn about flip-flop circuits in the included assembly manual. The switch uses 120 VAC. Dimensions are 2 1/4" H x 3 1/8" W x 5 7/8" D.

Kit SK-111 (1 lb.) \$19.95



Keep your hands free for other tasks with the speaker phone

SKILL LEVEL 1 Now you can continue with other activities during a telephone call. The Heathkit Speaker Phone starter kit frees both your hands while you carry on a phone conversation. You can even answer your phone without lifting the handset from its cradle. Connect the speaker phone to your phone line by plugging it into your standard modular telephone connector. In the included assembly manual, you'll learn about rectifiers and filters, too. Includes volume, privacy and answer controls. Dimensions are 2" H x 5 3/4" L x 4 3/4" D.

Kit SK-110 (2 lbs.) \$44.95



The Morse code oscillator lets you practice your skills

SKILL LEVEL 1 Learn international Morse code with this low-cost code practice oscillator. Enter code on the built-in pushbutton or hook up your own keyer to the kit. Adjust the tone and volume to your liking, too. A great practice aid for beginners in amateur radio, this kit also demonstrates the use of the 555 IC timer, explained in the included assembly manual. Requires 9V battery (not included) or PS-2350 Battery Eliminator on page 95.

Kit SK-102 (1 lb.) \$14.95

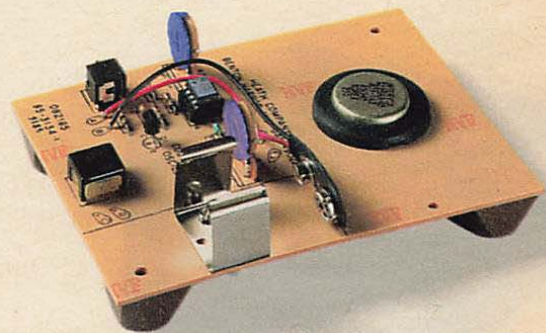



Pocket-size radiation monitor

SKILL LEVEL 1 Check suspected radioactive elements with this compact, hand-held Geiger counter. The affordable RM-4 Monitor uses the sensitive, industry-standard Geiger-Mueller tube to detect and warn of low levels of radiation – even “harmless” levels.

For the ultimate in accuracy, the monitor can be calibrated to a standard traceable to the National Bureau of Standards Cesium 137 Gamma source as an option. A flashing red LED indicates detected radiation. And as an additional warning, you can be alerted with an audible beeper which is easily turned on and off from a front panel control switch. Plus, the easy-to-read meter shows measured radiation levels on three selectable ranges.

Comes with a convenient zippered carrying case with belt clip and carrying strap. Requires a 9-volt battery (not included). Dimensions are 5 3/4" H x 2 7/8" W x 1 1/2" D.

Kit RM-4 (2 lbs.) \$129.95



MANUAL PREVIEW
Preview the Heathkit manual of your choice before you order the kit. You'll see for yourself how easy kit building really is. Turn to page 53 for our Manual Preview Offer.



Portable AM radio is ideal first kit

SKILL LEVEL 1 Enjoy quality reception with this compact AM radio. It features a high-gain antenna and a 2-inch dynamic speaker for clear, crisp sound. Use a 9-volt transistor battery (not included) or the PS-2350 Battery Eliminator with 120 VAC. Separate earphone is supplied.

Kit GR-1009 (2 lbs.) \$29.95

Accessory:
Battery Eliminator Assembled PS-2350 (1 lb.) \$7.95



Non-abrasive jewelry cleaner

SKILL LEVEL 1 Now you can use the same ultrasonic method popular with professional artisans, jewelers and coin collectors to clean and sanitize precious, delicate items. The Heathkit Ultrasonic Cleaner makes items sparkle like new. It literally vibrates dirt, stains and undissolved solids from hard-to-clean jewelry, watch parts, glass, coins, dentures and more. All delicate items, except pearls and turquoise, are safely cleaned without abrasion.

The Ultrasonic Cleaner uses ordinary laundry soap or softener for most cleaning jobs. Just fill the 6" L x 4" W x 2 3/8" D tank with one inch of solution and this gem of a cleaner is ready to go to work. Plugs into household AC outlet.

Kit GD-1151-H (4 lbs.) \$99.95

How time is measured

The National Bureau of Standards (NBS) provides the standard reference time for the United States. To understand how the NBS transmits time and how the Heath Most Accurate Clock brings precision time into your home, first take a look at how it's measured.

International solar time is measured astronomically at the prime meridian, also known as the Greenwich Mean. However, this time is too imprecise for scientific, time-interval measurements. Much more accurate time is achieved with cesium beam frequency oscillators (atomic clocks), which provide consistent interval measurements. Since solar and atomic clocks differ over extended periods, Universal Coordinated Time (UTC) was developed.

Universal time (UTC)

Used by the NBS, UTC provides the consistent timing of atomic clocks while still maintaining accurate solar time. The Master Standard Atomic Clock in Paris determines the basic time intervals (fractions of a second) for the UTC. This time is called International Atomic Time or TAI.

The Master Standard Atomic Clock is maintained by the Bureau International de l'Heure. The Bureau has the responsibility of correcting TAI time so it remains in agreement with solar time. The Bureau does this by adding positive or negative "leap" seconds during the final minute of June 30 or December 31. For a positive leap second, the final minute has 61 seconds; a negative leap second has 59 seconds in the final minute.

Transmitting BCD signals

How then, does the NBS transmit time signals to the Most Accurate Clock? Radio Stations WWV (Colorado) and WWVH (Hawaii) transmit time information referenced to cesium standards. A tone burst signals the beginning of each minute and a sub-audible tone is used to send a Binary Coded Decimal (BCD) signaling time-of-the-year, hour and minute information, UT-1 correction data for navigators, and standard or daylight savings time. BCD signals are updated every minute.

The Most Accurate Clock automatically scans WWV or WWVH signals on 5, 10 and 15 MHz for the clearest radio signal transmission, decodes the data and displays the correct UTC time. This brings precision time directly to you.

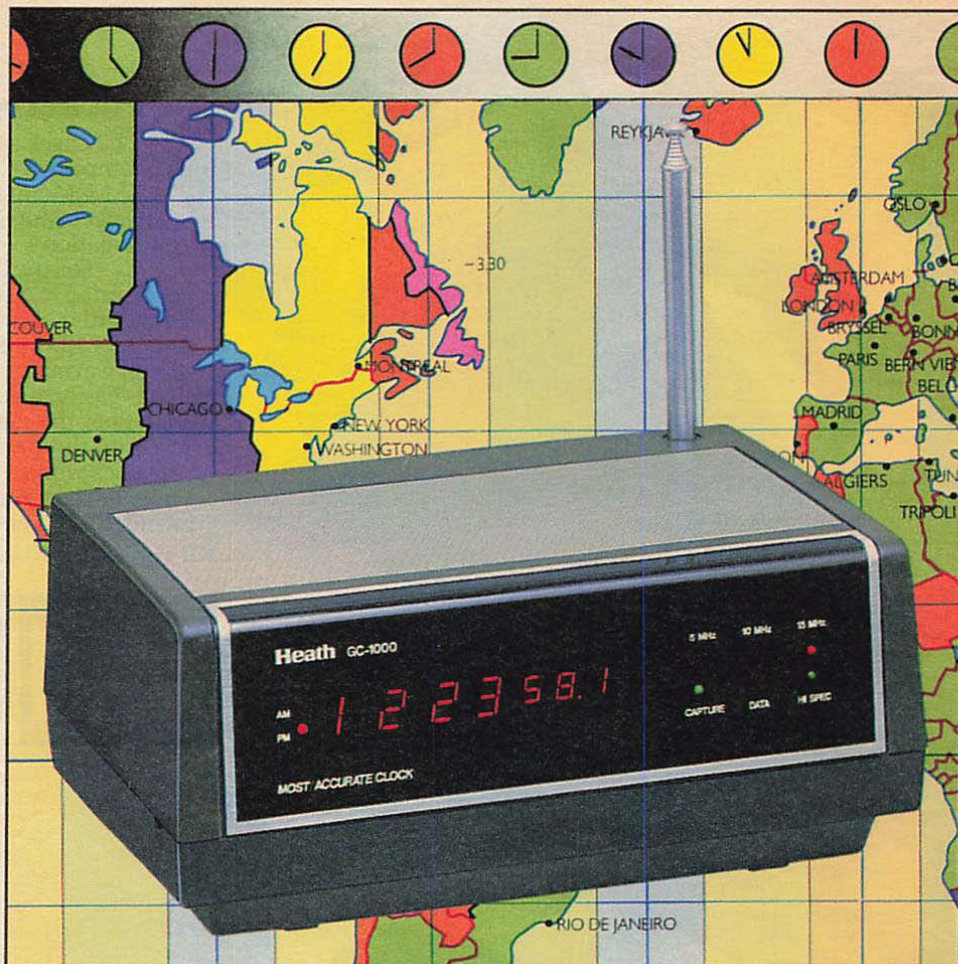

© Esselte Map Service. Reproduced from the World in Maps "Earth 1990" wall calendar published by EARTHBOOKS, Incorporated, Denver, Colorado.

Know the exact time anywhere in the world with Heath's Most Accurate Clock

Experience the precision of a microprocessor-based time piece synchronized with the National Bureau of Standards' (NBS) cesium atomic clock. The patented Heath Most Accurate Clock automatically scans for three NBS radio station frequencies (WWV/WWVH at 5, 10 and 15 MHz) and receives Binary Coded Decimal (BCD) signals to give you the hour, minute, second and tenth-of-a-second in Universal Coordinated Time.

Build this unique clock yourself or buy it completely assembled and ready-to-use. This precision instrument features a highly visible 7-digit display for easy readability. The GC/GCW-1000-H can display UTC or any of the world's standard 24 time zones. A propagation delay switch even corrects the time lost for the WWV/WWVH signal to reach your clock. Front panel LEDs include capture, data, and hi spec plus three frequency indicators. The capture LED lights when the WWV/WWVH 1000-Hz tone burst is detected. The data LED flashes when BCD signals are received. And the hi spec LED lights when complete time information is received and displayed.

Audio announcements of the time can be monitored with built-in speakers adjusted from a rear panel volume control. Uses 120 VAC or 12 VDC. An outdoor antenna is recommended, but may not be required in your area. Assembled GCW-1000-H includes RS-232 interface for connection to your computer clock.

Kit GC-1000-H (6 lbs.) \$249.95
Assembled GCW-1000-H (6 lbs.) \$380.00

External antenna connector RS-232C connector for output to a computer 3.6 MHz connector delivers a reference frequency

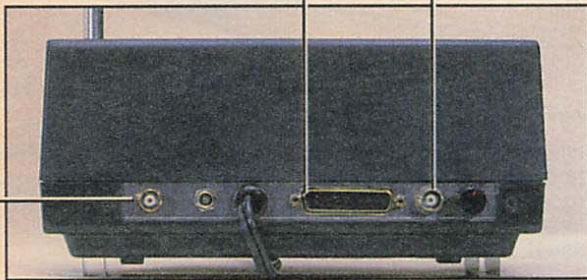

Back panel input/output connections include volume control for monitoring the NBS broadcast

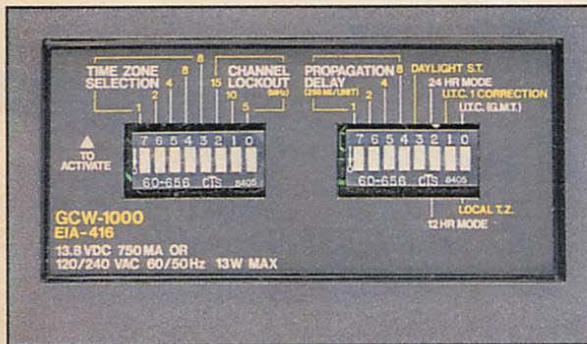

Case bottom dip switches for time correction adjustments

Accessories:

- Computer RS-232 Interface** for connecting the GC-1000-H to your computer's internal clock.
Kit GCA-1000-1 (1 lb.) \$49.95
- Heath/Zenith Interfacing Software**
GCA-1000-3 (1 lb.) \$49.95
- Technical Manual** Comprehensive manual includes expanded circuit description, large schematics, disassembly procedure, alignment procedure and IC data charts.
GCA-1000-4 (1 lb.) \$24.95

Outdoor Antenna Tuned dipole antenna effective on 5, 10 and 15 MHz. Mounts on vertical mast or tower leg and includes 50 ft. of transmission cable and CNC connector.

GCA-1000-5 (4 lbs.) \$99.95

SAVER Save \$15 on this high-tech time package. Includes GC-1000-H Most Accurate Clock and GCA-1000-4 Technical Manual.
GCS-1000-1 (7 lbs.) \$259.90

GC/GCW-1000 Specifications: **Receiver:** AM heterodyne, single conversion with tuned RF amplifier. **Sensitivity:** 1µV or less for 10 dB s + n/n. **Audio Output:** 250 mV into 8 ohms. **Clock Accuracy:** Within ± 10 mS when Hi Spec LED is on. **Reference Frequency Output:** 3.6 MHz (trimmed by inboard intelligence). **Power Requirements:** 120/240 ± 15 VAC, 50/60 Hz @ 100 mA or 11 to 16 VDC @ 750 mA (150 mA with display turned off). **Dimensions:** 3 7/8" H x 9" W x 6 1/4" D less antenna. **Operating Temperature:** 32 to 100°F (0 to 38°C).

Digital clock with battery backup

SKILL LEVEL 1 Dependable and easy to use, this reliable digital clock is perfect for anyone just getting started in kit building. Time and date are displayed in large 4-digit, 7-segment LEDs. For comfortable reading day or night, brightness automatically varies according to surrounding light. A built-in battery backup feature keeps internal circuitry running in case of power failure, and a snooze button causes the alarm to sound at 9-minute intervals each time you press it. Attractively styled dark grey cabinet measures 2 7/8" H x 7 1/8" W x 4 3/8" D. Operates on 120/240 VAC, 50/60 Hz. Battery not included.

Kit GC-1108 (4 lbs.) \$27.95



Our customers write...

I have built four of these clocks (GC-1108); one for myself and three as gifts. The GC-1108 is a very nice item, and many of my friends have made nice comments about it. All of the kits that I have ordered from you were very easy to build. I am quite happy with all of them!"

Jeffrey L. Mercer
Moundsville, West Virginia



ORDER TOLL-FREE ANYTIME

800-253-0570

FAX: 616-982-5577

Storage tray

4" long nose pliers

Diagonal cutters

Wire strippers

Interchangeable tips



4 oz. rosin core solder

1/4" nut driver

Slotted screwdriver

Phillips screwdriver

Soldering aid tool

20-watt soldering iron

Electronic tool kit with carrying case

This is a perfect selection of tools for the kit builder. Included are a Weller 20-watt soldering iron with two interchangeable tips, a soldering aid, a 4 oz. spool of solder, wire strippers, diagonal cutters, 4" needle nose pliers, 1/4" nut driver, and a slotted and Phillips screwdriver. These tools are contained in a durable 3" H x 10 3/4" W x 10" D carrying case with a built-in carrying handle. All tools are stored in a molded storage tray.

Assembled GHP-1270 (2 lbs.) \$42.95

Weller temperature-controlled soldering station



This lightweight soldering pencil features low voltage, 700°F closed loop temperature control for steady and fast soldering and a component-protecting grounded tip. Detachable stand contains a water reservoir.

Assembled GDP-1108 (5 lbs.) ... \$89.95

Accessory:

5 Assorted Tips GDP-1109 (1 lb.) \$17.95

Precision LUXO magnifier lamp

See the most minute details with the famous LUXO magnifier lamp – even those hard-to-see soldering connections. This precision-ground 2 to 1 magnifier provides a wide, distortion-free view of a circuit board through its polished 5" lens. And, an energy-conserving, 22-watt circular fluorescent bulb provides uniform and shadowless lighting. Lamp moves at a touch and stays where you put it. Arms have 45" total reach. Includes clamp-type mounting bracket. 120 VAC, UL approved.

Assembled GDP-200 (7 lbs.) \$89.95

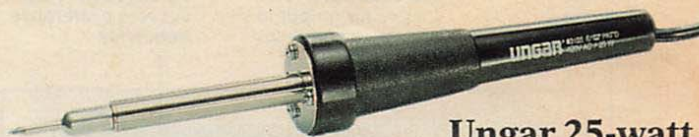

Ungar 25-watt 700°F soldering iron

Ungar irons combine economy with performance for all types of home and work jobs. This 4-ounce unit is ideal for hobbies and delicate repairs. Its replaceable tip design accommodates the variety of accessory tips shown below. And the heat-resistant handle is molded for comfortable handling. UL listed. Iron holder included.

Assembled GDP-3125 (1 lb.) \$9.95

	(2) pencil
	(2) small chisel
	(2) long taper chisel

Replacement tips

2 pencil tips, 2 small chisel tips, 2 long taper chisel tips.

GDP-3100 (1 lb.) \$7.95

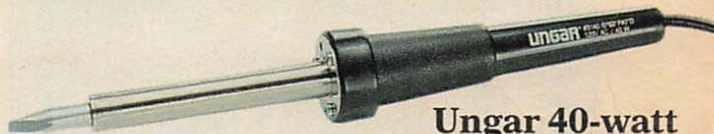

Ungar 40-watt 900°F soldering iron

This tool is essential for every work bench and tool kit. Balanced and cool-to-the-grip, this 40-watt soldering iron is the one you'll use for bigger electrical repair, electronics, hobby and kit assembly jobs. It features a replaceable tip design to accommodate the variety of tips described above. UL listed, comes with its own holder.

Assembled GDP-3140 (1 lb.) \$12.95

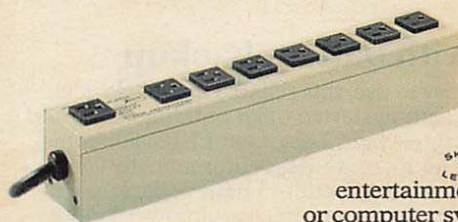

Smart outlet box

It's perfect for your entertainment center, work bench or computer system. Simply plug the main unit into the control outlet, the other components into the remaining outlets. Power the current-sensing socket and all your equipment comes on at the same time. Surge protection, 10-amp capacity.

Kit GD-1495 (5 lbs.) \$59.95

Headband magnifier

This comfortably fitting magnifier with adjustable headband frees both your hands for work. Shatter and scratch resistant lenses magnify 2 1/2 times. Fits over eyeglasses.



Assembled GDP-201 (1 lb.) \$24.95

Building a Heath electronic kit is fun and easy. By following simple step-by-step instructions, you can build any kit we sell. World-famous Heathkit manuals are your key to successful kit building.

"We won't let you fail."

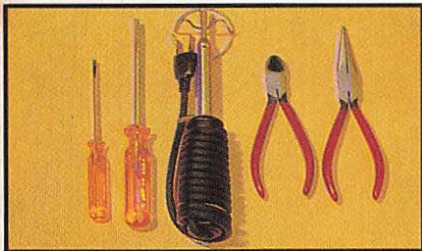

Tools: A few simple tools are all you need. You'll learn about electronics as you experience the fun of kit building.

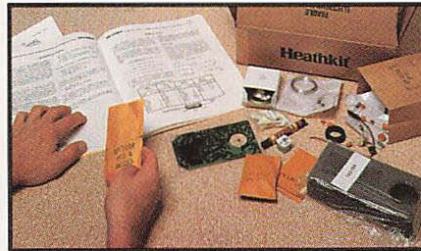

Parts inventory: Before you begin, check all parts against the parts list included in each manual.

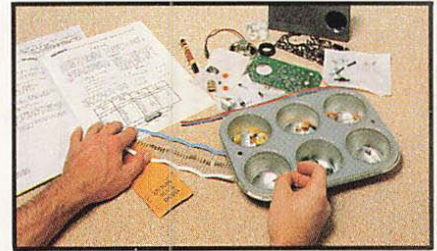

Organization: Now organize the parts so your kit building progresses smoothly. The rest is easy.



Soldering: Read through the soldering guide included with each kit for tips on good soldering techniques.

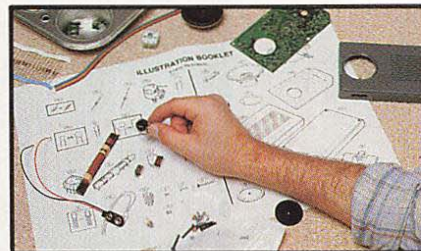

Illustrations: As you build, refer to the clearly labeled illustrations of key assembly steps.

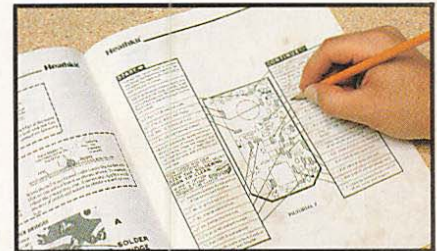

Step-by-step instructions: Follow the carefully written instructions for guaranteed success.



Operation: And now, turn on your finished kit. Be ready to experience the pride and satisfaction of success!



Maintenance: Refer to the troubleshooting section of your manual for information on keeping your kit in good working order.



Technical assistance: And, if you need advice, our technical consultation experts are only a phone call away.



ORDER TOLL-FREE ANYTIME

800-253-0570

FAX: 616-982-5577

Heathkit
HEATH COMPANY
BENTON HARBOR, MI 49022

BULK RATE
U.S. Postage
PAID
Heath Company



ORDER TOLL-FREE ANYTIME

800-253-0570

FAX: 616-982-5577

CURRENT RESIDENT OR

*****5-DIGIT 45133
221-412

PAUL W TERRELL MD
PO BOX 340
HILLSBORO OH 45133

CATALOG CODE 221-412

WE WANT YOU TO BE 100% SATISFIED WITH EVERY ITEM
YOU PURCHASE FROM HEATH COMPANY. THAT'S WHY WE
BACK ALL OUR PRODUCTS WITH OUR NO RISK PURCHASE
POLICY. SEE PAGE 53 FOR DETAILS. 0002

Our customers write...

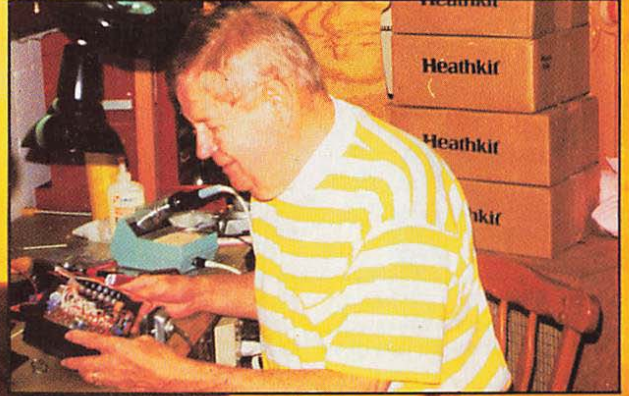

Since 1955, building Heathkits has been and still is a major part of my life. During this 34 year time period I have completed 192 Heathkits. All of these kits are operational and most are used on a daily, weekly or monthly basis. You might say that building Heathkits has become somewhat of a profession with me.

Tom Cleland
Marietta, GA

I wanted to write personally and thank you and the Heath Co. This only goes to confirm something die known for a long time - the quality of your products is only exceeded by your concern for your customers. Again, Thanks.

James B. Whitehead
Mentone, AL