

THE WORLDS GREATEST RADIO, TV and HI-FI CENTER



LAFAYETTE

1955

Gift Guide

TRANSISTOR RADIO KITS

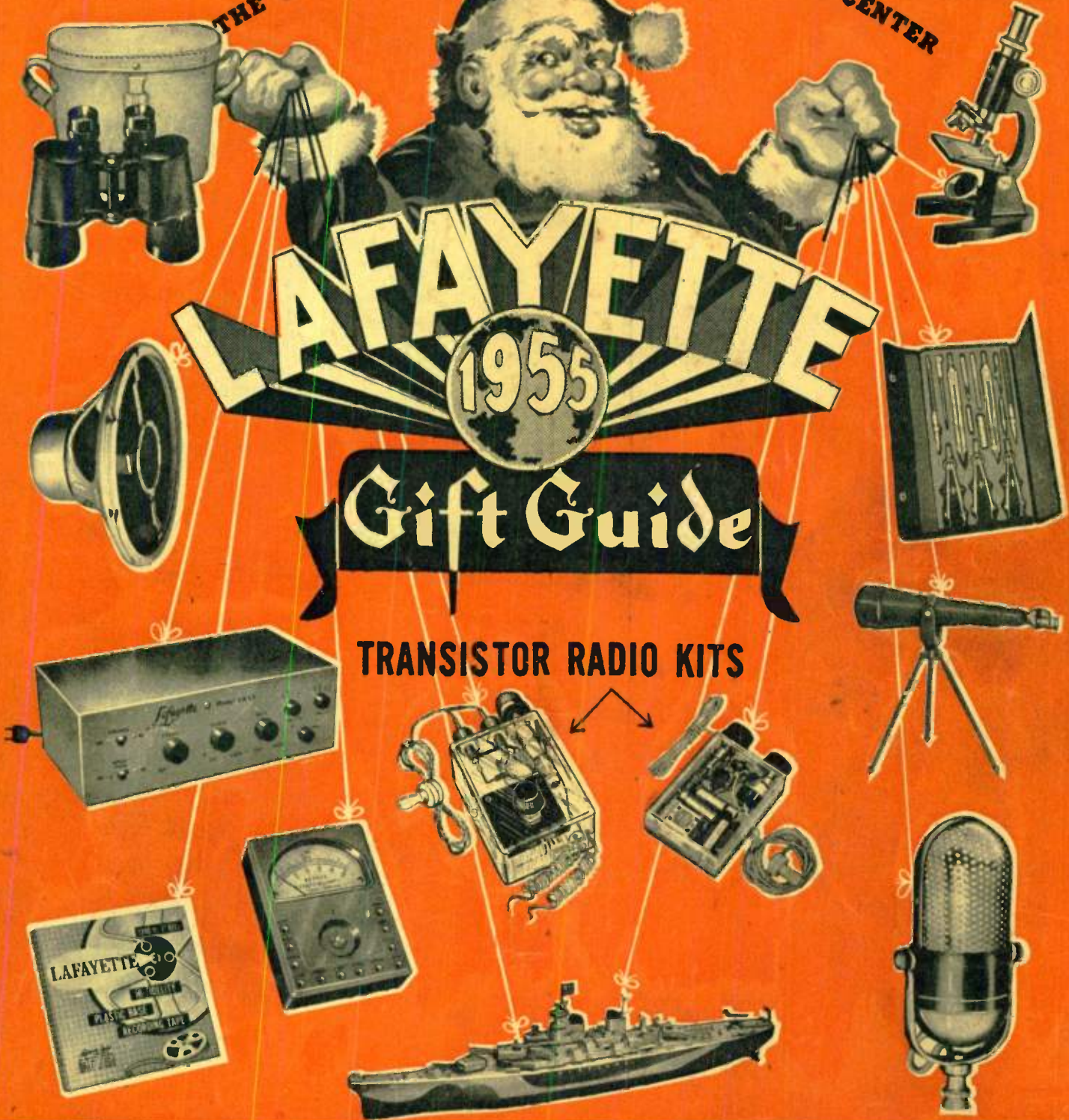

Lafayette Radio

To Speed Shipment on Your Order Please Mention
Catalog 12-5
 Remit by Check or Money Order. Include sufficient money for Postage. We Refund unused amounts.

NEW YORK, N. Y.	100 Sixth Ave.
BRONX, N. Y.	542 E. Fordham Rd
NEWARK, N. J.	24 Central Ave.
PLAINFIELD, N. J.	139 West 2nd St.
BOSTON, MASS.	110 Federal St.

The Hi-Fi Phono System Buy of the Year!

Lafayette
LA-21



FOR
22.50 AMPLIFIER
ALONE



5 Tweeter

Cross over
Network



G. E. RPX-050A



Collaro R-C-54



G. E. 12"

8 WATT PUSH-PULL AMPLIFIER WITH PREAMP FOR G.E. RELUCTANCE CARTRIDGE

This High-Fidelity 8 watt amplifier offers superb reproduction at a lower than ever price. Frequency response ± 1 db at 30 — to 20,000 cycles. Push-pull output for minimum distortion at normal level — only 1% at full 8 watts output. Noise level 50 db below rated output. Separate bass and treble controls — 15 db bass boost and treble attenuation. Self contained pre-amplifier designed for use with variable reluctance and magnetic type cartridges (crystal cartridges cannot be used). Tubes: 1-6SC7, 1-6SL7GT, 2-6V6GT, 1-6X5GT. Output impedance 4-8 and 16 ohm. Size 9"x7"x5 1/2". For 110-125 Volt 60 cycle AC operation.

LA-21 Shpg. wt. 10 lbs. NET **22.50**

AUTOMATIC HI-FI COMBINATION SYSTEM WITH G.E. 12" 25 WATT SPEAKER

The complete HI-FI Phono system including the Lafayette LA-21 HI-FI 8 watt push-pull amplifier. The latest model Collaro R-C-54 Intermix 3 speed changer, with the G. E. RPX-050A Turnover cartridge and G. E. 12" HI-FI 25 watt PM speaker complete system.

NET **69.50**

AUTOMATIC HI-FI COMBINATION SYSTEM WITH 2 WAY SPEAKER SYSTEM

The complete system same as system above but with addition of 5 Tweeter and Cross-over Network.

SY 21 NET **74.50**

An Exquisite Phono For Music Lovers

LAFAYETTE

• HI-FI-PHONOGRAPH •

- 2 WAY SPEAKER SYSTEM WITH CROSSOVER NETWORK
- FAMOUS COLLARO 3 SPEED AUTOMATIC RECORD CHANGER
- WITH G.E. VARIABLE RELUCTANCE PICKUP RPX-050A
- LAFAYETTE PUSH PULL HI-FI AMPLIFIER

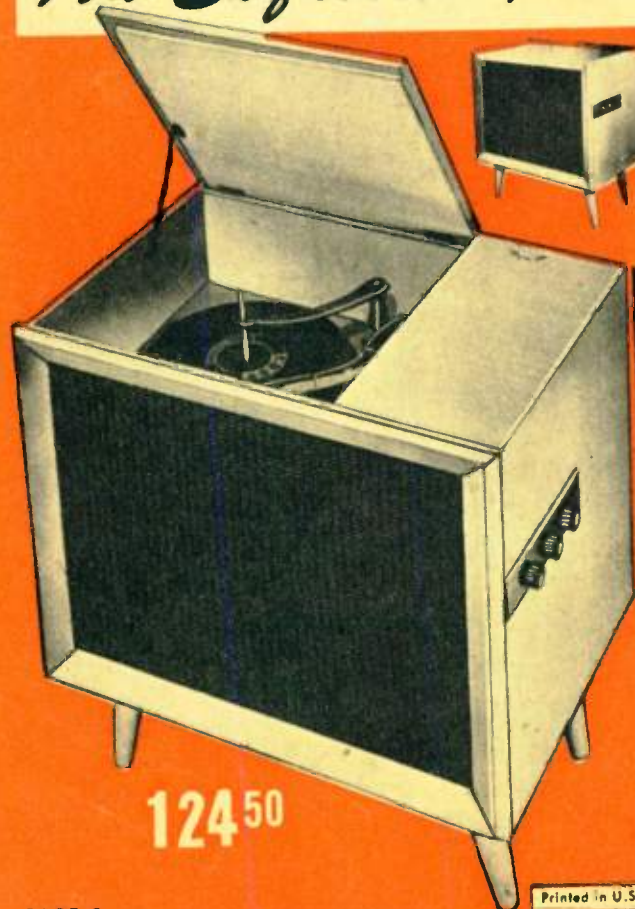

124.50

A complete high fidelity console phonograph which cannot be appreciated until you see it and hear it. A rare opportunity for the Music Lover who has always wanted an exquisitely, compactly designed cabinet (measures 25 1/2" H, 16" D, 25 1/2" W) and get tone reproduction that surpasses instruments considerably larger and bulkier and costing many times more. In the Lafayette Model PH-40 you get all these features plus. Uses the Lafayette Model LA-20 push-pull HI-FI amplifier which was especially designed for the Audio Hobbyist and Music Lover; the famous Collaro automatic 3-speed record changer—noted for its High Fidelity performance; the G.E. variable reluctance magnetic pickup (RPX-050A) Has a 2-way Speaker System and Crossover Network, consisting of an 8" PM heavy duty G.E. 12 watt speaker with 6.8 oz. Alnico V magnet acting as a "woofer", plus an especially designed 5" PM tweeter and crossover network to increase the high fidelity range up to 15,000 cycles, housed in an acoustically designed enclosure for maximum high quality performance. Clean, smooth reproduction, with an unmistakable presence of the 2-way speaker reproducer—will recreate a tone balance which is unbelievable. Cabinet is finely constructed of choicest hardwoods, is hand rubbed in the tradition of fine furniture. Available in mahogany, blonde finishes.

An Ideal Phono for a small room in a hotel or apartment. The finest phonograph available in design, quality of components, performance and Value. Shpg. Wt. 75 lbs.

PH-55 (specify finish) NET **124.50**

Printed in U.S.A. ENTIRE CONTENTS COPYRIGHTED 1953 BY RADIO WIRE TELEVISION, INC.

Lafayette's

KNOCK OUT PRICES

Lafayette

fm-am receiver chassis including POWERFUL 12" PM Speaker



49.50
LESS SPEAKER

- Built-in preamplifier for reluctance pickup. • Beam power audio output.
- 3-Position equalizer switch to compensate for recording characteristics in LP, AES or European recordings. • Automatic volume control.
- 12" PM heavy duty speaker.

The Model 100 incorporates an improved frequency modulation circuit that is drift compensated to eliminate the need for troublesome automatic frequency control circuits; an extra stage of RF gain on FM; high fidelity AM-FM reception; a preamplifier tube for use with reluctance type phono pickup cartridges; a Ferrite Loop Stick antenna for AM and a folded dipole for FM reception; full use of dual purpose tubes to obtain maximum performance; tone control; automatic volume control; beam power audio output; a special heater winding with a control to balance out residual line frequency hum; easy tuning combined with an easily readable, attractive "slide rule" dial that is further enhanced by the recent addition of a 3-position equalizer switch to compensate for recording characteristics in LP, AES or European recordings. The Model 100 tunes from 535 to 1720 Kc on AM and from 88 to 108 Mc on FM. Sensitivity is such that outside antennas usually are not necessary. Tube Complement: (2) 6BA6, 6BE7, 6AU6, 6AL5, 12AT7, 6AV6, 12AX7, 6V6GT, and 5Y3GT rect. The Model 100 is a superheterodyne AM-FM radio receiver chassis designed to operate on 105/126 volts AC, 50/60 cycles. Power consumption is 95 watts. It is of rugged construction using high quality components and is dressed off with a professionally designed attractive panel in grey that will neutrally blend into any home surroundings, whether installed in a cabinet or console or in a bookcase. Supplied ready to operate, complete with tubes, antenna and all necessary hardware, plus 12" heavy duty PM speaker. Dimensions: 13 1/2" W x 7 1/2" H x 9" D. Shpg. wt. 18 lbs.

MODEL 100—Receiver Chassis Less Speaker.....Net **49.50**
MODEL 100—with 12" Heavy Duty PM Speaker.....Net **54.50**

Lafayette's DELUXE FM-AM RECEIVER CHASSIS

- 13 TUBES PLUS RECTIFIER
- PRE-AMP FOR RELUCTANCE CARTRIDGES
- DRIFT COMPENSATED
- HI-FIDELITY QUALITY

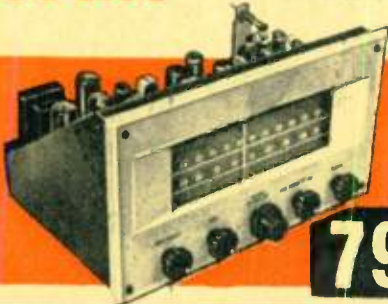

79.50

LAFAYETTE MODEL 200 DELUXE FM-AM RECEIVER CHASSIS

A DeLuxe Superheterodyne AM-FM Radio Receiver chassis designed to operate on 105/126 volts AC, 50/60 cycles. Incorporates an improved frequency modulation circuit that is drift compensated to eliminate the need for troublesome automatic frequency control circuits; 6 gang tuning condenser; high fidelity AM-FM reception; tuned RF amplifiers to make use of low field strength signals; a pre-amplifier for use with reluctance type of phonograph pickup cartridge; a Ferrite Loop Stick antenna for AM and a folded dipole for FM reception; AF input; line power outlets; auxiliary position on switch for use when TV Audio is channeled through set; push-pull beam power audio amplifier; full range bass and treble controls; automatic volume control; provision for external antennas; matching networks for use with

either high or low impedance pickup; a special heater winding with a control for balancing out residual line frequency hum; multitap output transformer to match 4, 8 and 500 ohms. Has a dual control which operates a record roll-off equalizer network to compensate for recording characteristics in long playing, AES or European recordings. Tunes from 535 to 1720 Kc on AM, and from 88 to 108 Mc on FM. Has 13 tubes plus a rectifier. Tube complement is (3) 6BA6, (2) 6BE6, 6AU6, 6AL5, 6CA, 6AV6, 12AT7, 12AX7, (2) 6V6/GT and 5Y3GT Rectifier. Supplied ready to operate complete with tubes, antenna, and all necessary hardware. Chassis is 13 1/2" wide x 7 1/2" high x 10" deep. Weight 17 1/2 lbs. each.

LAFAYETTE MODEL 200NET **79.50**

A COMPLETE HI-FI AM-FM PHONO-RADIO COMBINATION

A new DeLuxe 13 Tube (plus rectifier) FM-AM receiver chassis Model LA-200 combines many important features and quality construction to assure excellent FM-AM performance. Combined with push-pull beam power audio, provides remarkable pure music throughout the entire audio spectrum. With the latest model Collaro RC-84 Intermix 3-speed Record Changer equipped with the G.E. RPX-050A Turnover Reluctance Cartridge and the Electro-Voice Model SP-12B 12" Coaxial Speaker you are provided with a 2-way speaker system that assures clean, sparkling wide-range reproduction. All units supplied complete with plugs, jacks, cable and hardware—ready for quick and easy installation. Shpg. wt. 60 lbs.

HF-101.....Complete System.....Net **134.50**

If desired with Diamond Sapphire styli, \$11.95 additional.
If desired with G.E. RPX-052A Diamond and Sapphire Turnover Cartridge, \$12.50 additional.



AND DON'T FORGET LAFAYETTE'S MONEY BACK GUARANTEE

NEW! LAFAYETTE LA-57 10 watt HI-FI AMPLIFIER

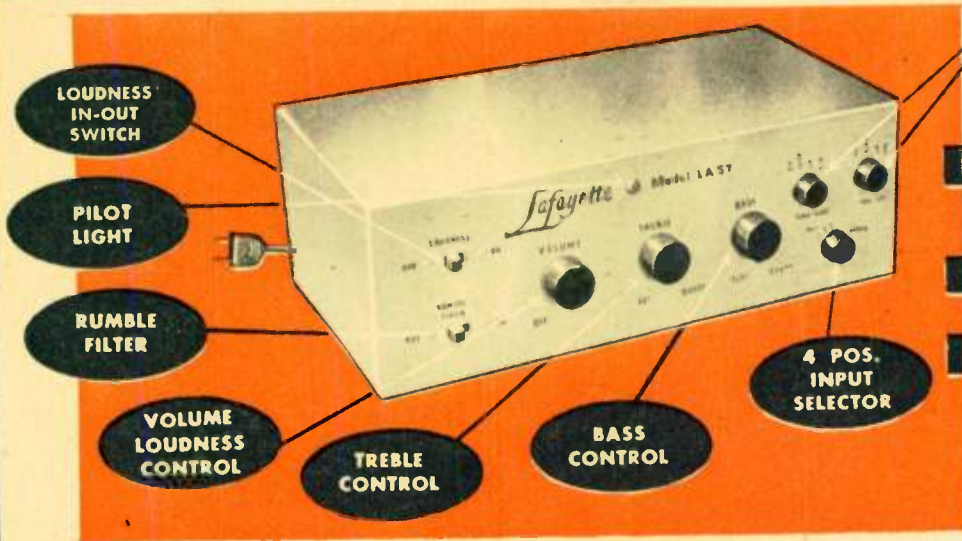

WITH 16 POSITIONS OF EQUALIZATION

PLUS —

INPUTS FOR CRYSTAL PHONO, GE OR MAGNETIC PHONO TUNER, TV AND TAPE

PLUS —

TAPE OUTPUT JACK

PLUS

MORE READ BELOW

...and only Lafayette could bring you all this at the unbeatable price..

44.95

Lafayette engineers took advantage of the latest techniques in printed circuitry and production methods to produce this modern, streamlined high fidelity amplifier packed with features that characterize the best amplifiers on the market at a price never before approached for such a unit. Read these specifications: **EQUALIZATION:** 2 controls give you 16 combinations to match the varying recording characteristics of different record manufacturers. You can hear every type of phono recording, LP, POP, RIAA, EUR, etc. the way it was actually recorded. **FREQUENCY RESPONSE:** covers from 20 to 20,000 cycles with such absolute fidelity that there is only ± 1 db variation in this entire range. **POWER OUTPUT:** Handles peaks up to 13 watts. Low distortion level measures only 3% at 8 watts. **HUM LEVEL:** 45 DB on phono (RIAA) 65 db on aux and 70 db on min. volume. **TREBLE CONTROL:** Gives 11 db boost or 15 db cut at 10,000 cycles. **BASS CONTROL:** Provides 11 db boost at 50 cycles. **RUMBLE FILTER:** May be cut in or out as necessary where motor or other very low frequency noise is present. **VOLUME CONTROL:** Smooth control to set

proper listening level. **LOUDNESS SWITCH:** On & off switch, converts volume control to a loudness control while at low level prevents the loss of frequencies to which the ear is less sensitive. **INPUTS:** The LA-57 has inputs to accommodate every type of phono whether of the magnetic, variable reluctance or crystal type, for radio tuner, TV or recording tape. **SPEAKER OUTPUTS:** Connections for either 8 or 16 OHM. **DAMPING FACTOR:** of 6. controls excessive diaphragm vibration at resonant frequencies. **SENSITIVITY:** Of .7 volts at AUX inputs and 8 MV at magnetic phono input. **PILOT LIGHT:** On front panel. **INTERLOCK CORD:** Safety type AC line cord. **SIZE AND STYLING:** Sleek modern styling. Case 4" H x 11" L x 5" D. Attractively finished in gold with contrasting masking. **INSTALLATION:** If desired to panel mount upper shield is removable. Rough cut hole in panel is all that is needed. Shpg. wt. 14 lbs.

LAFAYETTE LA-57

NET 44.95

LAFAYETTE HIGH FIDELITY PHONO SYSTEM

The introduction of the Lafayette LA-57 amplifier makes possible this unusually low priced high fidelity phono system. It consists of the LA-57 10 watt amplifier, the world famous Collaro RC-34 3 speed record changer equipped with the RPX-050A G.E. variable reluctance hi-fi cartridge with dual sapphire styli and a 12" Electrovoice SP12-B speaker. This system will give you real enjoyment of your fine phonograph records. Complete with all plugs and cables. Shpg. wt. 40 lbs.

SYSTEM HF-104 NET 99.50

SYSTEM WITH GRANCO FM TUNER

Same system as above plus Granco FM tuner. Add the fine FM music broadcasts to your enjoyment.

SYSTEM HF-105 NET 129.50

\$99.50 LESS TUNER



req. price \$130.00

12" Electrovoice SP12-B

RPX-050A G.E.

Collaro RC-34

Granco FM tuner

Lafayette AN OUTSTANDING ENGINEERING ACHIEVEMENT

High Fidelity Outperform Any Amplifier In Its Price Range Or Your Money Back

Model LA-54



employs features found only in most expensive amplifiers!

59.50

- Record equalizer has separately adjustable turn-over and roll-off providing a choice of 16 different playback characteristics to match all recordings accurately.
- Includes phono preamplifier with inputs for magnetic, ceramic or crystal pickups.
- Special take-off jack for recording on tape.
- The amplifier has excellent power output at both very low and very high frequencies.
- FM (capacitance) input.

**A BRILLIANT
NEW CONCEPTION**

**PERFECT
AMPLIFICATION**

**DESIGNED
FOR TOMORROW**

Nothing before has been offered to equal it in the annals of the high fidelity market. The first complete audio amplifier incorporating compensated preamplifier, tone controls, power amplifier, and power supply all built upon a "printed circuit" wiring plate. This is the circuit technique developed and proved successful BY THE ARMED FORCES DURING WORLD WAR II. A major achievement in fine audio amplifiers. Combines technical perfection, startling realism and advanced features. The advantages of extended power range are provided without sacrifice of important low level characteristics. Here are both low distortion and plenty of reserve power. Only years of research and specialization could produce so advanced an instrument. The power output at both low and high frequencies exceeds any requirement but is indicative of the superb response achieved throughout the useful band from 20 to 20,000 cycles. Of major importance is the way this amplifier adapts itself to associated equipment and to particular room acoustics.

LOOK AT THESE SPECIFICATIONS! POWER OUTPUT: 12 watts, 24 watts peak at 1% harmonic distortion; 5 watts at 1% inter-modulation distortion; 3 db power rating, 30 cycles to 20,000 cycles. FREQUENCY RESPONSE 20-20,000 cycles \pm 1 db. INPUTS: Radio, TV-Sound and Tape inputs: 1 megohm impedance. Phonograph inputs: 27,000 ohms for magnetic and dynamic cartridges. Built-in equalizer for use of ceramic, FM (capacitance) and crystal pick-ups; adjustable equalization effective on all types of pick-ups. SENSITIVITY (Gain Factors): 6 millivolts at magnetic-phono input required for 12 watts output. 0.3 volts required at Tuner, Tape, TV inputs for 12 watts output. 42 db gain between magnetic-phono input and tape take-off jack. 10 db gain between Radio, Tape, TV inputs and tape take-off jack. OUTPUT IMPEDANCES: 4, 8 and 16 ohms. DAMPING FACTOR: 15. Source impedance much lower than internal resistance of loudspeaker. FEEDBACK: Four negative feedback loops result in virtual elimination of distortion; 20 db feedback around voltage and power amplifier stages. QUIETNESS: Noise plus hum 75 db below maximum output on Radio, TV, Tape input. 70 db below maximum output on phonograph input. (54 db below effective program level with 10 millivolts input.) TAPE TAKE-OFF JACK: Provides output of sufficient level to drive any tape recorder. Independent of volume control setting. POWER OUTLET: 110 volts for tuner, record player, etc., controlled by on-off switch. CONTROLS: SELECTOR (and TURN-OVER control), 7 positions. Radio, TV, Tape and 4 phonograph positions for the following Turnover characteristics: AES, NARTB*, 800, LP, ROLL-OFF: 4 positions of high-frequency record compensation: LP (16), NARTB* (13.7), AES (12), RIAA. *78 (0). Figures in parentheses indicate db roll-off at 10,000 cycles. *New NARTB is identical with RIAA, RCA-Victor New Orthophonic, and new AES. BASS: Continuous control: 16 db boost to 16 db cut at 50 cycles; marked "flat" position. TREBLE: Continuous control: 12 db boost to 15 db cut at 10,000 cycles; marked "flat" position. LOUDNESS (VOLUME): With ON-OFF switch, compensated for loudness (Fletcher-Munson) curves. TUBES: Six in all doing the work of nine. No difficult-to-locate or special types used. 3-12AX7, 2-6AQ5, 1-6X4. DIMENSIONS: Only 4 1/4" high, 10 1/2" long and 8" deep from front panel to clearance over jacks on back panel. Shpg. Wt. 12 lbs.

MODEL LA-54..... **59.50**

A HI-FI SYSTEM WITH SUPERLATIVE HI-FI PERFORMANCE

A completely matched and wired FM-AM phono system, consisting of the skillfully engineered Bogen Model R-660 FM-AM Tuner, the Lafayette Model LA-54 Hi-Fi 12 watt Amplifier, employing features found only in the most expensive amplifiers; the world-famous Collaro RC-54 (the latest model) Intermix 3-speed Record Changer with the G.E.RPX-050A Triple-Play Turnover Reluctance Cartridge; and the Electro-Voice Model 12TRXB 12" Triaxial Speaker. With this system all the magic of high fidelity reproduction is now easily yours. Phenomenal bass response, full bodied mid-range and silky-smooth upper octaves to the highest audible frequencies provide an unusual musical balance without making effects or imposed distortions. All units are supplied complete with plugs, jacks, cable and hardware—ready for quick and easy installation. Prepared cables simply plug into each other. The handsome design of all components blends beautifully with any decorating scheme. Shpg. wt. 65 lbs.

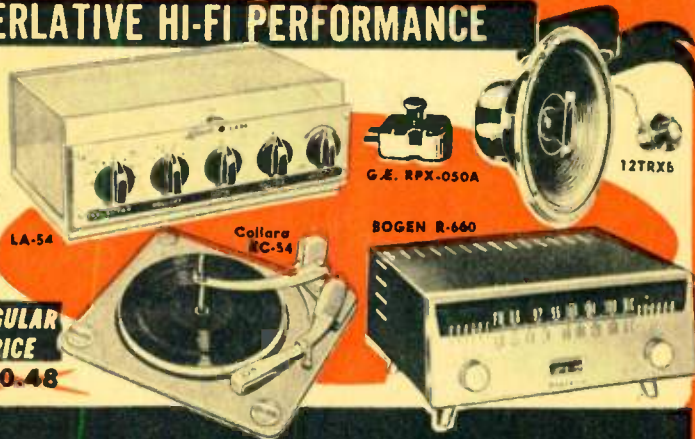

HF-100 Complete System Net **270.50**

**REGULAR
PRICE
300.48**

LA-54

G.E. RPX-050A

144.50

A PHONO SYSTEM THAT WILL DELIGHT THE MUSIC LOVER

Never in the annals of Hi-Fidelity has a phono system of this quality — at this price — been offered. This system consists of the famous Lafayette LA-54 12-Watt Amplifier, with a frequency response from 20-20,000 cycles; the Electro-Voice Triaxial Model 12TRXB 12" Hi-Fi Speaker; and the latest Collaro RC-54 3-Speed Intermix Record Changer with G.E. RPX-050A Turnover Reluctance Cartridge. Here is a system with low distortion and plenty of reserve power. The power output at both low and high frequencies exceeds any requirement; 16 positions of record compensation, designed without compromise to deliver magnificent audio fidelity. Complete with all plugs, cables and hardware. Shpg. wt. 48 lbs.

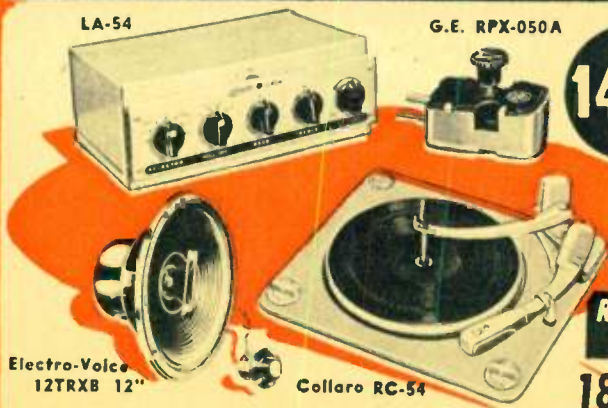

Electro-Voice
12TRXB 12"

Collaro RC-54

**REGULAR
PRICE
180.17**

HF-102 Complete System Net **144.50**

Lafayette

LEADERS

TREMENDOUS VALUES!
SMASHED HI-FI PRICES!

COMBINATION DEAL
99.95



Especially LAFAYETTE DE LUXE MODEL LA-401 FM-AM TUNER and MODEL LA-500 20 WATT HI-FI AMPLIFIER COMBINATION MODEL LA-401 AM TUNER

The Lafayette Deluxe Model LA-401 FM-AM Tuner and the Lafayette Model LA-500 20 WATT HI-FI Amplifier combination. This combination offers deluxe FM-AM reception and unusually fine phono reproduction. Two separate chassis assure exceptional performance without hum—no chassis includes FM-AM tuner; the other includes power supply and 30 Watt HI-FI Audio Amplifier. It is rugged, sturdy construction using high quality components, professionally designed to blend into any home surroundings, whether installed in a cabinet, console or a bookcase. **SALIENT FEATURES:** The Model LA-401 incorporates an improved frequency modulation circuit that is drift compensated plus automatic frequency control; 6-gang tuning condenser; tuned RF amplifiers to make use of low field strength signals; pre-amplifier for use with reluctance type phonograph pickup cartridges; output from detector to jack on rear; a ferrite loopstick antenna for AM and a line cord antenna for FM reception; full range bass and treble tone controls with 18 db range; auxiliary position on switch for audio input; two line power outlets; automatic volume control; provision for external antenna; special control for balancing out residual line frequency hum; easy flywheel tuning combined with an attractive, easily readable "slide-rule" edge-lighted dial; dual control which operates a record roll-off equalizer network to compensate for recording characteristics in long-playing. AM or European recordings. The LA-401 tunes from 535 to 1720 kc on AM and from 88 to 108 Mc on FM. Outside antennas are usually not needed. The set is manufactured under licenses from RCA and Hazeltine and is RMA listed code #174. **Technical Performance Data—Sensitivity:** AM: 75 microvolts per meter (ferrite loopstick antenna) for 4 db S/N ratio, FM: 8 microvolts required for 30 db quieting. **Selectivity:** AM: 10 Kc; 6 db. FM: 210 Kc; 6 db. **Ratio detector peak to peak bandwidth:** 300 Kc. **Audio output impedance:** High impedance amplifier grid input circuits (to be used with LA-500 Amplifier and Power Supply). **Audio Frequency response:** —3 db: 20-15,000 cps. **TUBE COMPLEMENT:** 12 tubes: 6BA6 AMRF Amplifier; 6BA6 FMRF Amplifier; 6BE6 AM Oscillator and Mixer; 6BA6 IF Amplifier; 6AU6 FM Detector Driver; 6AL5 FM Detector; 6C4 FM Oscillator; 6BE6 FM Mixer; 6C4 AM Detector; 6AV6 1st Audio Driver; 12AU7 Tone Control Amplifier; 12AX7 Phono Pre-amp. **DIMENSIONS AND WEIGHT:** Chassis is 13 1/2" W, 7 1/2" H and 10" D. Shpg. Wt. 13 lbs. Operates at 105-125 Volts AC 50-60 cycles, power consumption 135 watts.

LAFAYETTE MODEL LA-500 HI-FI 20 WATT AMPLIFIER

AUDIO AMPLIFIER: A deluxe power supply and audio amplifier designed specifically for use with the Model LA-400 Tuner pictured above. However, this unit may be used wherever a high quality audio amplifier is required. Operates at 105/125 Volts AC, 50/60 cycles, with a power consumption of 135 watts when used in conjunction with the Model LA-400. **SALIENT FEATURES:** The Model LA-500 incorporates a parallel push-pull beam power output circuit; self-balancing phase inverter system; extended range high-fidelity response is obtained through use of specially designed output transformer combined with an inverse feedback circuit; the selected output impedances for speaker requirements are 4, 8, 16, 250 and 500 ohms. The unit is manufactured under licenses from RCA and is RMA listed code #174. It is supplied ready to operate. **TUBE COMPLEMENT:** 6 tubes; 6J5 Audio Driver; 6J5 Phase Inverter; four 6V6/GT Beam Power; Audio Output; two 6Y3/GT Rectifier. **DIMENSIONS AND WEIGHT:** Chassis is 13 1/2" wide, 7 1/2" high and 9" deep. Shpg. wt. 18 lbs.

LAFAYETTE Model LA-401 FM-AM Tuner and LAFAYETTE Model LA-500 20 Watt Amplifier complete with tubes and all necessary hardware.

COMPLETE HI FI SYSTEM COMBINATION DEAL

This system consists of the Espey FM-AM Tuner Model 401 and the Espey 20 Watt Hi Fi Amp. Her Model 500s the Electro Voice Model SP-12B 12" Hi Fi Speaker the world famous Collaro RC-34 3 speed Record Changer equipped with the RPX-050A GE, variable reluctance hi-fi cartridge.



159.95

PRICES IN THIS CATALOG ARE SUBJECT TO CHANGE WITHOUT NOTICE

Pilot High Fidelity PILOTONE Amplifiers

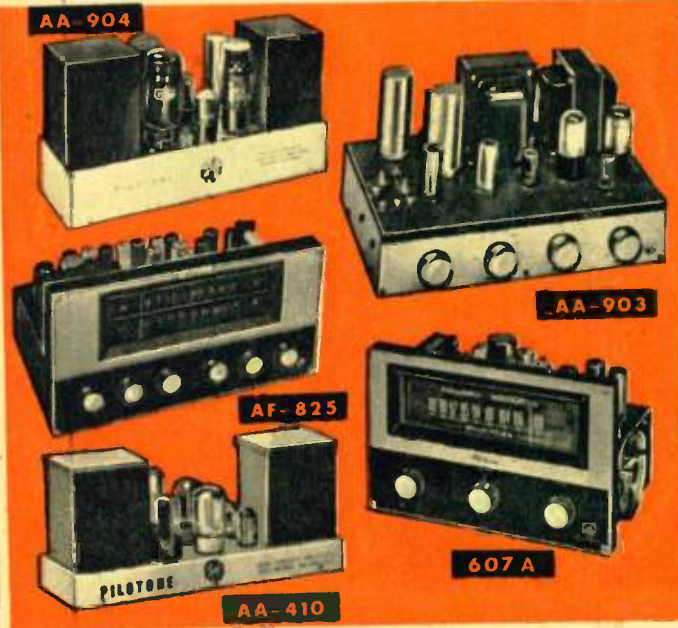

AMPLIFIER — MODEL AA-903

Williamson type 10 watt Amplifier, with built-in Pre-amplifier. Contains 7 tubes including Rectifier and push-pull output tubes. Controls are mounted behind decorative front panel which may be easily removed for cabinet installation, and includes, On-Off Volume, separate Bass and Treble Controls and Equalizer selector switch for LP, NAB, AES and Foreign Recording. Frequency Response ± 1 db 15 to 40,000 cycles. Distortion less than 1%. Hum level 70 db below 1 volt. Three inputs are provided for Radio and Auxiliary equipment and one input is provided with adjustable impedance for matching the various magnetic cartridges.

Amplifier Model AA-903 NET **69.50**

MODEL AA-410 — 15 WATT

HIGH FIDELITY PILOTONE AMPLIFIER

A basic Williamson-type High Fidelity Amplifier. Ideal for remote control from Pilotone pre-amplifiers or Pilotone. **SPECIFICATIONS:** POWER OUTPUT—15 Watts maximum. **FREQUENCY RESPONSE**—Plus/minus 1 db 15 cps to 40,000 cps at rated output. (15 Watts) **TOTAL HARMONIC DISTORTION**—Less than 1% at 15 Watts from 30 cps to 15,000 cps. Less than 0.1% at 5 Watts from 30 cps to 15,000 cps. **INTERMODULATION DISTORTION**—Less than 2% at rated output. **HUM AND NOISE LEVEL**—90 db below rated output. **OUTPUT IMPEDANCES**—4, 8, and 16 Ohms. **TUBE COMPLEMENT**—one each 6C4, 12AU7, two 6X4 and 6Y3/GT rectifier. U/L Approved. Chassis finished in brushed gold. Size: 12" x 4 1/2" x 6 1/2" High. Shpg. Wt. 16 lbs.

MODEL AA-410..... NET **49.50**

PILOT FM TUNER MODEL 607A

The new Pilot FM Tuner Model 607A is designed to give a very high standard of FM performance despite its low-cost. Incorporates automatic frequency control for simple "lock-in" tuning and drift-free reception. Tuned R.F. amplifier. AFC can be switched off. Has cathode-follower with 500 ohm output impedance. Response ± 0.5 db from 20-20,000 cycles. Sensitivity: 5 microvolts for 20 db quieting input for crystal Phono. Has built-in antenna. Tubes: 26BA6, 6U8, 6AU6, 6AU5, 12AU7, 6AB4, 6X4. Size 9 1/2" x 10 1/2" x 7 1/4". For 110-120 volts, 60 cycle AC. Shpg. Wt. 10 lbs.

MODEL 607A-List 99.25..... Net **69.50**

MODEL AA-904 AMPLIFIER

The dependable world famous Williamson circuit now in a new, convenient, compact size. A worthy companion to the famous, dependable Pilotone. **SPECIFICATIONS:** FREQUENCY RESPONSE: ± 1 db, 15 cps to 50,000 cps at 15 Watts. ± 1 db, 20 to 20,000 cps at 1 Watt. **TOTAL HARMONIC DISTORTION:** Less than 0.1% at 10 Watts output from 30 cps to 15,000 cps. Less than 0.3% at 25 Watts output from 30 cps to 15,000 cps. **INTERMODULATION DISTORTION:** Less than 0.5% at 10 watts. **HUM AND NOISE LEVEL:** 90 db below 10 watts. **OUTPUT IMPEDANCES:** Two 8 and 16 Ohm. **TUBE COMPLEMENT:** Two each 6AV6 and 6Y3/GT. One 5Y3/GT rectifier. **SIZE:** 14" Wide x 4 1/2" Deep x 7 1/4" High. U/L Approved. Shpg. Wt. 25 lbs.

MODEL AA-904..... NET **89.50**

AF-825 PILOTUNER

The precision engineering—the sensitivity, selectivity and stability—of this superb Pilotuner are up to the high level that has won world-wide fame for Pilot as The Standard of Excellence. **SPECIFICATIONS:** Frequency Range: FM-88 to 108 MC, AM-540 to 1700 Kc. Sensitivity: FM—3 Microvolts for 20 db quieting, AM—5 Microvolts for .2 volt output. **Selectivity:** FM—6 db down at 200 Kc, AM—6 db down at 9 Kc. **Peak to peak separation:** 320 Kc—Linear for 190 Kc. **Antenna Input:** FM—300 ohms to match external dipole, or built-in line cord antenna, AM—Internal ceramic powdered iron loopstick with provision for matching to standard RMA external antenna. **Tone Control Range:** (20 cps, 100 cps, 800 cps, 10,000 cps, 20,000 cps.). Boost (19 db, 12 db, 0 db, 14 db, 19 db.). Cut (19 db, 12 db, 0 db, 14 db, 19 db.). Audio Output Im-

pedance: 500 ohms cathode follower. Input Impedance: Tape, AUX: 470,000 ohms. Phono with Preamp in: 6800 ohms to 100,000 ohms variable with calibrated pot. **Audio Sensitivity:** For 1 volt output, Full Armstrong Dual Cascade Limiter—Discriminator circuit on FM. **FM Features:** Built-in power line antenna. Tuned RF Amplifier stage for improved sensitivity and selectivity. 3 gang tuning condenser. Automatic frequency control (AFC) for ease in tuning. On position on selector switch provides for disabling the AFC to allow tuning to a weak station adjacent to a strong station. Temperature compensated oscillator for minimum drift. Fully shielded against oscillator radiation to conform with FCC radiation specifications. Shpg. Wt. 16 lbs.

AF-825—Pilotuner..... Net **129.50**

IN HIGH FIDELITY



PILOT AF-860 FM-AM TUNER
The New Pilot FM-AM AF-860 Tuner with complete preamp and built-in equalizer. Armstrong dual Cascade limiter discriminator circuit on FM provides excellent sensitivity. Continuously variable AFC with 2-stage IF amplifier gives broad or sharp AM bandwidth. Dual equalization—5 position of Roll-off (0.8-16, 20 and 13.5 db) and Turnover. Cathode follower output. Sensitivity FM: 1.5 uv for 20 db quieting. AM: 2 uv for 20 db quieting. Distortion less than 0.2% at 1v output. Input: magnetic phono; tape; auxiliary. Has tuning meter. Brushed gold-chassis, gold and Maroon front panel. Size 7 1/4" x 14 1/4" x 9" deep for 110-120V 60 cycle AC. Shpg. Wt. 21 lbs.

PILOT 860—List 299.25...Net 179.50

PILOT AF-724 FM-AM TUNER
This new model incorporates many superb features hitherto unheard of at its moderate price. Incorporates automatic frequency control (AFC) for ease in tuning. One position on selector switch provides for disabling the AFC to allow tuning for weak station adjacent to a strong station. Sensitivity: FM-3.5 microvolt for 20 db of quieting. AM-5 microvolts for 20 db of quieting. Audio Frequency Response: ± 0.5 db 20 cycles to 20,000 cycles. Audio output impedance 500 ohms, cathode follower. Tuned R.F. amplifier stage. Temperature compensated oscillator for minimum drift. Built-in high efficient ceramic powdered iron loop antenna. Tubes 6BA6, 6U8, 6BA6, 6AU6, 6AV5, 12AU7, 6AB6, 6X4. Size 11 1/4" x 6 3/4" x 8 1/4" deep for 110v. 50-60 cycle AC. Shpg. Wt. 13 1/2 lbs.

PILOT AF-724...Net 89.50



GOLDEN BELL FM-AM TUNER MODEL 2255
A compact, high-fidelity FM-AM Tuner expressly designed and finished for open-shelf or table-top use—too beautiful to hide. Excellent companion unit for the 2256, or other quality amplifiers. Has grounded-grid input stage, double tuned limiter, Armstrong circuit AFC and cathode follower output. Built-in AM antenna. Controls: Selector, Off-On, AM, FM with AFC, FM without AFC. Momentary AFC—defeat switch. Tuning sensitivity FM, 4uv for 20 db quieting. Tubes: 2-12AT7, 1-6BE6, 1-6BA6, 2-6AU6, 1-12AU7, 1-6AU5; plus selenium rectifier. 4" x 9" x 8 3/4"; Brown and Gold. For 110v, 50-60 cycle AC. Shpg. wt. 9 lbs.

MODEL 2255—List 166.50...Net 97.97

BELL MODEL 2256 HI-FI 12 WATT AMPLIFIER
Beautiful to look at and functionally complete, 12 watts with .5% distortion. Frequency Response: 20-20,000 cycles, plus or minus 1/2 db; 6 Inputs; Radio, crystal Pickup; 2 Magnetic pickup, special for frequency Modulated and Ceramic pickups, Tape Recorder or TV Controls; (5) Equalization and Selector switch (7 positions) 78, RPM, COU, UP, RIAA, NARTB, FFRK, European; Radio, Tape; Gain Control: 4, 8, 16 ohm, high impedance Jack for Tape or Disc. Tubes: 1-12AX7, 2-12AT7, 2-6V6GT, 1-5Y3GT; 8 3/4" x 9 3/4" x 4". Shpg. wt. 14 lbs.

MODEL 2256—List 149.90...Net 88.18

harman kardon



HARMAN KARDON MODEL A-200 FM-AM TUNER
A compact beauty with astonishing performance at modest cost. Featuring excellent sensitivity, selectivity and stability. Built-in power supply. Simple cabinet installation. Note these features. SENSITIVITY: FM—5 microvolts for 30 db quieting. SELECTIVITY: FM—200 KC bandwidth 8 db down. AM—8 KC bandwidth 6 db down. FM DRIFT: ±15 KC (maximum). IMAGE REJECTION: 30 db minimum. ANTENNA INPUT: FM—300 ohms; AM—Built-in low noise loopstick plus high impedance input terminal. AUDIO OUTPUT: 1 volt at high impedance. DISTORTION: Less than 1% at rated output. FREQUENCY RESPONSE: FM—±1/2 db 20-20,000 cycles. AM—±3 db 20-3,000 cycles. HUM LEVEL: 85 db below 100% modulation. TUBE COMPLEMENT: 2-12AT7, 1-6BE6, 1-6BA6, 2-6AU6, 1-6AL5 plus selenium rectifier. CONTROLS: (2) 1-Tuning and AFC Defeat; 1-Function and power (1—phono and power off, 2—AM, 3—FM, 4—phono and power on). Finished in burnished copper and black. SIZE: 5 3/4" high x 9 1/4" wide x 8" deep (excluding knobs). Shpg. Wt. 9 lbs.

H-K Model A-200...NET 69.50



HARMAN KARDON MODEL A-310 AM-FM TUNER
CIRCUITS: FM: Armstrong Circuit with Dual Limiters (Double Tuned) and Foster-Seeley Discriminator. Automatic Frequency Control. Low noise, all triode front end with tuned cascade RF amplifier and triode mixer. AM: Superheterodyne with tuned RF stage, and ferrite loop antenna. Two IF stages. 10 KC whistle filter. AVC operative over four stages. SENSITIVITY: FM: 1.5 microvolts for 30 db quieting; 1.3 microvolts for 20 db quieting. AM: Terminal Sensitivity: 3 microvolts. Loop Sensitivity: 1.5 microvolts/meter. SELECTIVITY: FM: 200 KC bandwidth; 6 db down. AM: 10 KC bandwidth; 6 db down. FM Discriminator peak to peak separation: 375 KC. FREQUENCY RANGE: FM: 88-108 MC. AM: 530-1650 KC. FM DRIFT: ±2% KC with AFC on; ±20 KC with AFC off. IMAGE REJECTION: FM: 30 db. AM: 50 db. IF REJECTION: FM: 70 db. AM: 30 db. ANTENNA INPUT: FM: 300 ohms. AM: Built-in low noise ferrite loopstick plus high impedance terminal for external antenna. DISTORTION: Less than 1% harmonic on FM. Less than 1% harmonic for up to 80% mod. on AM. FREQUENCY RESPONSE: FM: ± 1/2 db 20 to 30,000 c.p.s. AM: 3 db 20 to 3,000 c.p.s. HUM LEVEL: 65 db below 100% modulation.

AUDIO SECTION
CIRCUITS: Cathode Follower Output. OUTPUT LEVEL: FM: 8 1/2 volts for 100% modulation; 1 volt for 30% modulation. AM: 1 volt (average). OUTPUT IMPEDANCE: Low Impedance Cathode Follower.

OVERALL SPECIFICATIONS
CONTROLS: (Total 2) Function (OFF-AM-FM with AFC-FM without AFC) and Tuning/momentary AFC Defeat. TUBE COMPLEMENT: (Total 12) 1- 6BK7A, 1-12AT7, 1-6BA6, 1-6BE6, 3-6AU6, 1-6AL5, 2-6AU6, 1-12AU7, 1-6X4. DIMENSIONS: 12 1/4" wide x 6" high x 8 1/4" deep (including ferrite loopstick, not including knobs). SHIPPING WEIGHT: 14 pounds.

HK MODEL A-310...NET 125.00



HARMAN KARDON MODEL A-400
Cathode follower driven precision tuning meter • Armstrong system with ten tuned circuits including two IF stages and two double tuned limiters • Tuned pentode RF stage—low noise matched • 3 microvolt sensitivity for 30 db quieting • Two controls: Variable AFC/Power, and Counterweighted Tuning • Output level control • Two bridged cathode follower outputs • Harmon-Kardon flat silhouette (only 4" H. x 11 1/4" W. x 7 1/2" D. (with knobs))

Model A400...net \$89.95

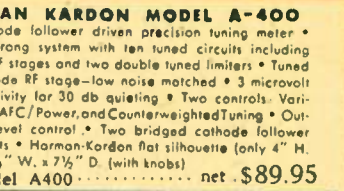

HARMON KARDON 30 WATT POWER AMPLIFIER MODEL C-300 SPECIFICATIONS
POWER OUTPUT: 30 watts @ 0.5% 1M (40 & 7,000 cps); 4:1 ratio) peak power: 50 watts. FREQUENCY RESPONSE: ± 1 db 20-40,000 cps at rated power. ± 0.1 db 20-40,000 cps at 15 watts. DAMPING FACTOR: variable from 0.1 to 20. HUM: minimum volume hum: -83 db below 30 watts auxiliary position hum: -78 db below 30 watts phono position hum: -73 db below 30 watts. INPUT: auxiliary: adjustable between 0.25 and 5 volts, phono: selectable to match rated output of Fairchild, G.E. and Pickering cartridges. OUTPUT IMPEDANCES: 4, 8 and 16 ohms. TONE CONTROL RANGE: ± 18 db at 50 cps and 10,000 cps. FRONT PANEL CONTROLS: (A) Contour PUT IMPEDANCE: Monitor output: 500 ohms cathode follower. Recording output: 500 ohms cathode follower. PHONO EQUALIZER: Bass turnover: RIAA, LP, AES, 400 cycles Plus/Minus 1 db referred to standard playback curve. Treble Roll-off: db down at 10 KC. RIAA (-13.5) —30, -16, -8, 0. TONE CONTROL RANGE: 20 cps 100 cps 800 cps 10,000 cps 20,000 cps db boost 10 13 0 14 19 db Cut 19 12 0 14 19. LOUDNESS CONTROL: Compensator Type. VOLUME CONTROL: Dual Unit, compensated for flat frequency response at any setting. INDICATING METER: Range: + 60 db above 150 microvolts (0 db). Meter range switch varies sensitivity in 10 db steps. Front panel switch connects meter to monitor or record output. MICROPHONE CHANNEL: Separate Volume Control allows mixing with inputs into any other channel. TUBE COMPLEMENTS: 1-5879 Phono preamplifier, 1-12AX7 5ig and phono preamp, 1-12AX7 Voltage and tone amplifier, 1-12AU7 Dual cathode follower, 1-12AT7 Decibel meter amplifier — Rectifier, 1-6X4 Power rectifier. POWER SUPPLY: 105-120V 60 cycles 30 watts with 2 convenience outlets. FRONT PANEL: Detachable, etched Richlow brass; can be mounted vertically for Custom Installation. CABINET: Attractive Mahogany cabinet 6" high x 13 1/4" wide x 9 1/4" deep. Shpg. wt. approximately 10 pounds.

Model PA-913...Net 119.50



FAMOUS BELL HIGH-FIDELITY AMPLIFIER MODEL 2200C 20-WATT AMPLIFIER
This amplifier is the latest to come out of Bell's renown engineering laboratories. It has been under development for over a year and has incorporated in its design all of the features most desired by lovers of high fidelity reproduction. The Model 2200 has a removable etched dial plate and is supplied complete with six 1/2" extension shafts for console or custom installation. It also has a socket for plugging in a pilot light, if one is desired (see accessory below). Three 117 volt A.C. outlets are provided on back of chassis to permit you to control your entire custom installation with the master power switch on the amplifier.

Technical Specs: POWER OUTPUT: 20 watts with less than 0.5% harmonic distortion. Hum: 80 db below rated output. Bass Control: -17 db to +15 db at 40 cycles. Treble Control: -28 db to +18 db at 13 kc. Other Controls: 8-pos. Record Equalizer, Selector Switch, Volume. Power Switch. Inputs: Radio, crystal phono, 2 magnetic phono (one for microphone and tape. Output Impedances: 4, 8, 16 ohms. Damping Factor: 12:1. Tubes: 28C7, 68N7G, 68L7Q, 2-68A1, 814G rectifier. Size: 4 1/2" x 7 1/2" x 10 1/2". With tubes and shaft extension kit. For 110-120v. 50-60 cycle AC. Wt. 28 lbs.

Model 2200C List 164.00 Net 87.95

Model 2200E 20-Watt Amplifier. For Models 2122C and 2200C with etched dial plate, 847 lamp, 5 ft. RJ cord and plug. Wt. 6 lbs. List. \$25 NET

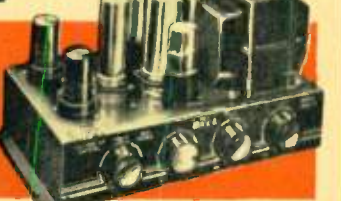

FAMOUS BELL HIGH-FIDELITY AMPLIFIER MODEL 2122C 10-WATT AMPLIFIER
This new and improved version of our popular 2122 amplifier has incorporated all the desirable features that are most wanted by high fidelity enthusiasts. In addition to having inputs for a radio tuner and any crystal pickup, this amplifier contains two special inputs for the new type Magnetic pickup. Built-in pre-amplifiers and individual equalization of each of the Magnetic inputs assures proper match and response from the various types of new Magnetic pickups.

TECHNICAL SPECS: POWER OUTPUT: 10 watts at 2% distortion. Peak power 15 watts. FREQUENCY RESPONSE: 20 to 20,000 cycles plus or minus 1/2 db with controls adjusted for flat response. HUM LEVEL: 65 db below rated output. FOUR INPUTS: Rear Panel: Radio Tuner. Auxiliary Tape; TV or Crystal #1 Magnetic Pickup, #2 Magnetic Pickup. CONTROLS (Four): 5 Position Selector Switch with 2 position equalization. POPULAR, LOUDNESS, COL-LEP, AES-RGA, FFRK-EARLY 78; one tuner and one auxiliary. Overall Volume Control. Bass Tone Control: Minus 14 db to plus 13 db variation at 100 cycles. Treble Tone Control w/AC Switch: Minus 13 db to plus 12 db variation at 10 KC cycles. OUTPUTS: Rear Panel: 4, 8, 16 ohms. Chassis Deck: High impedance jack for disc or tape recorders. Socket for Bell Model 2201 Pilot Light Assembly. POWER CON: 75 watts. Chassis Deck: 50-60 cycles. TUBES (Six): 2-68C7, 1-68L7, 1-68L7Q, 1-5Y3GT. SIZE AND WEIGHT: 8" Deep, 11 1/4" Wide, 6" High. Net Wt. 10 1/2 lbs.

Model 2122C—List \$99.90...NET 82.87



PA 913 PREAMPLIFIER
The Pilotrol PA-913 Professional preamplifier Equalizer has been designed to meet the requirements of the most discriminating user. Features:

SPECIFICATIONS
VOLTAGE OUTPUT: 5 Volts Max. FREQUENCY RESPONSE: Plus/Minus 1 db 20 to 40,000 cycles. DISTORTION: Less than 0.2% at 1 Volt Output. INTERMODULATION DISTORTION: Less than 0.2% at 1 Volt Output. SENSITIVITY: Six 3 Millivolts Phono 3 Millivolts Radio.

INPUT IMPEDANCE: Mic: 500,000 Ohms Radio Tape, Aux: 500,000 ohms Phono variable: 6800 to 100,000 ohms. HUM LEVEL: 80 db below 1 Volt. OUTPUT IMPEDANCE: Monitor output: 500 ohms cathode follower. Recording output: 500 ohms cathode follower. PHONO EQUALIZER: Bass turnover: RIAA, LP, AES, 400 cycles Plus/Minus 1 db referred to standard playback curve. Treble Roll-off: db down at 10 KC. RIAA (-13.5) —30, -16, -8, 0. TONE CONTROL RANGE: 20 cps 100 cps 800 cps 10,000 cps 20,000 cps db boost 10 13 0 14 19 db Cut 19 12 0 14 19. LOUDNESS CONTROL: Compensator Type. VOLUME CONTROL: Dual Unit, compensated for flat frequency response at any setting. INDICATING METER: Range: + 60 db above 150 microvolts (0 db). Meter range switch varies sensitivity in 10 db steps. Front panel switch connects meter to monitor or record output. MICROPHONE CHANNEL: Separate Volume Control allows mixing with inputs into any other channel. TUBE COMPLEMENTS: 1-5879 Phono preamplifier, 1-12AX7 5ig and phono preamp, 1-12AX7 Voltage and tone amplifier, 1-12AU7 Dual cathode follower, 1-12AT7 Decibel meter amplifier — Rectifier, 1-6X4 Power rectifier. POWER SUPPLY: 105-120V 60 cycles 30 watts with 2 convenience outlets. FRONT PANEL: Detachable, etched Richlow brass; can be mounted vertically for Custom Installation. CABINET: Attractive Mahogany cabinet 6" high x 13 1/4" wide x 9 1/4" deep. Shpg. wt. approximately 10 pounds.

Model PA-913...Net 119.50

PILOT PROFESSIONAL PA 913 PREAMPLIFIER
The Pilotrol PA-913 Professional preamplifier Equalizer has been designed to meet the requirements of the most discriminating user. Features:

SPECIFICATIONS
VOLTAGE OUTPUT: 5 Volts Max. FREQUENCY RESPONSE: Plus/Minus 1 db 20 to 40,000 cycles. DISTORTION: Less than 0.2% at 1 Volt Output. INTERMODULATION DISTORTION: Less than 0.2% at 1 Volt Output. SENSITIVITY: Six 3 Millivolts Phono 3 Millivolts Radio.

INPUT IMPEDANCE: Mic: 500,000 Ohms Radio Tape, Aux: 500,000 ohms Phono variable: 6800 to 100,000 ohms. HUM LEVEL: 80 db below 1 Volt. OUTPUT IMPEDANCE: Monitor output: 500 ohms cathode follower. Recording output: 500 ohms cathode follower. PHONO EQUALIZER: Bass turnover: RIAA, LP, AES, 400 cycles Plus/Minus 1 db referred to standard playback curve. Treble Roll-off: db down at 10 KC. RIAA (-13.5) —30, -16, -8, 0. TONE CONTROL RANGE: 20 cps 100 cps 800 cps 10,000 cps 20,000 cps db boost 10 13 0 14 19 db Cut 19 12 0 14 19. LOUDNESS CONTROL: Compensator Type. VOLUME CONTROL: Dual Unit, compensated for flat frequency response at any setting. INDICATING METER: Range: + 60 db above 150 microvolts (0 db). Meter range switch varies sensitivity in 10 db steps. Front panel switch connects meter to monitor or record output. MICROPHONE CHANNEL: Separate Volume Control allows mixing with inputs into any other channel. TUBE COMPLEMENTS: 1-5879 Phono preamplifier, 1-12AX7 5ig and phono preamp, 1-12AX7 Voltage and tone amplifier, 1-12AU7 Dual cathode follower, 1-12AT7 Decibel meter amplifier — Rectifier, 1-6X4 Power rectifier. POWER SUPPLY: 105-120V 60 cycles 30 watts with 2 convenience outlets. FRONT PANEL: Detachable, etched Richlow brass; can be mounted vertically for Custom Installation. CABINET: Attractive Mahogany cabinet 6" high x 13 1/4" wide x 9 1/4" deep. Shpg. wt. approximately 10 pounds.

Model PA-913...Net 119.50

New! Bogen HIGH FIDELITY REPRODUCTION EQUIPMENT

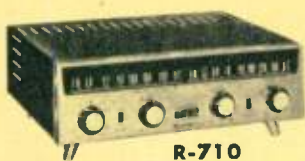

R-710



FM-50



R-660

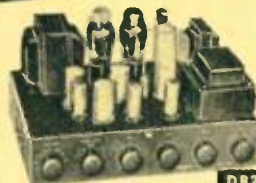

DB20

NEW BOGEN MODEL R 710 FM-AM TUNER

Offers the utmost in tuning ease and delivers exceptional fine FM-AM music reproduction. Features 2 position sharp cut off high & low frequency filter controls. Feedback type tone controls, cathode follower output. Precise record equalization from 20C to 20,000 cycles. Loudness Contour Selector control. Provision for balanced 300 ohm input as well as shielded 70 ohm input. This insures improved sensitivity and greater freedom from ignition and other interference. Tuning meter on both AM and FM makes possible simple and easy tuning in for minimum noise and distortion. New AFC circuitry provides tighter oscillator frequency control and assures continuous distortionless output. Controls: Bass, Treble, Loudness Contour: 3 Pos. Input 5 Pos; Equalization 5 Pos; EU78; POP; NAB; Col LP; RIAA; Available in chassis form or in handsome metal enclosure. Size 15" x 11" x 5 1/2". Shpg. wt. 19 lbs. For 110-120 volt AC, 60 cycle operation.

MODEL R-710 Less Metal enclosure NET 139.50
SERIES B ENCLOSURE with legs NET 7.30

NEW BOGEN R660 FM-AM TUNER

Extremely sensitive and highly stable on FM and AM, new AFC circuitry provides tighter oscillator frequency control and insures continuous distortionless output. Provision for balanced 300 ohm input, as well as shielded 70 ohm input. This insures improved sensitivity and greater freedom from ignition and other interference. Also built-in line antenna for strong signal areas. AVC on FM insures proper selectivity, and avoidance of strong station interference in very strong signal areas. Double limited and Armstrong discriminator provides full limiting on very weak signals. Tuning meter on both AM and FM makes possible simple and easy tuning in for minimum noise and distortion. Available in chassis form or in handsome metal enclosure. Tubes used: 2 each 6BA6 and 6AU6; 1 each 12AT7, 6U8, 6BJ7, 6BF6, 12AU7 and 6X4 rectifier. Size 12" x 11" x 5 1/4". For 110-125 Volt AC operation. Shpg. wt. 27 lbs.

R-660 less enclosure NET 119.50
IN SERIES A Metal enclosure with legs NET 7.00

NEW BOGEN FM TUNER MODEL FM-50

Expertly engineered tuner for those who require FM reception. Balanced 300 ohm input, as well as shielded 70 ohm input. This insures improved sensitivity and greater freedom from ignition and other interference. AVC on FM insures proper selectivity, and avoidance of strong station interference in very strong signal areas. Limiter & Foster Seeley discriminator provides full limiting on very weak signals. New AFC circuitry provides tighter oscillator control and assures continuous distortionless output. Frequency response 15-15,000 cps. - 1/2 db. available in chassis or in metal cabinet. Size 12" x 11" x 5 1/2". Shpg. wt. 00 lbs. for 110-120 Volt AC operation.

MODEL FM-50 Less enclosure NET 79.50
SERIES A METAL ENCLOSURE & LEGS NET 7.00

NEW BOGEN

DB20 HIGH FIDELITY AMPLIFIER

The DB20 is a truly remarkable new amplifier featuring the most complete and versatile control of sound reproduction available today in a single chassis high fidelity model. A ten position Input Selector provides a choice of radio, television, tape and seven different equalization curves for disc recordings. Has a built-in preamplifier for Q.F., Pickering, Audax and similar magnetic pickups. Power output: 20 watts at 0.5% peak 30 watts. Frequency response: 20-20,000 c.p.s. 0.7 db. Gain: Magnetic, 106 db; crystal and radio, 93 db. Tone corrector range: Bass control, -17 to +18 db at 40 c.p.s.; Treble control, +15

to -21 db at 15 KC. Output impedance: 8 or 16 ohms. Damping factor: 13. Record equalization positions (7): LP, AEA, NAB, AM78, EU78, FRRR, POPULAR. Input Selector positions: Mag. phono, radio, TV, tape. 5 loudness contour selector positions: Loud (flat), Loud (-10 db), Medium (-20 db), Soft (-30 db), Soft (-40 db). Power consumption: 117 volts, 60 c.p.s., 150 watts. Tubes: (3) 12AT7, (1) 12AU7, (2) 6L6G, (1) 6U8G rect. Dimensions: 15" W x 9 1/2" D x 8" H. Wt. 25 lbs.

MODEL DB20. Amplifier and Tubes. 99.00
NET

CUSTOM FM-AM PHONO SYSTEM OF FINE PERFORMANCE

A high quality FM-AM system for installation in modern furniture, custom cabinets, wall, etc. Each unit has been carefully selected to give top quality performance. The phono system consists of the Bogen DB-20, 20 watt HI-FI amplifier, Bogen R660 FM-AM tuner, the Jim Lansing 12" speaker, and the Famous Collaro RC-54 3 speed record changer with the New G.E. RPX-052A Diamond & Sapphire Turnover Cartridge. Amplifier is highly rated by famous national research organization—amazing rich, perfect reproduction throughout the audio spectrum. Tuner has excellent sensitivity, drift compensated clear bass and crisp clear high frequency reproduction. For 110-120 volt 60 cycle AC. Shpg. wt. 85 lbs.

HF-111 — Complete System, ready for installation. NET 339.50

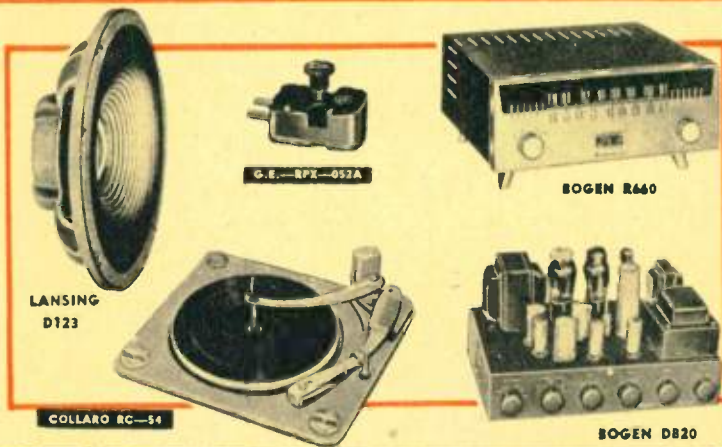

net \$339.50

IN AMERICA'S FINEST HOMES

Every component in this laboratory high fidelity system is in itself a gem of design, engineering and performance — combined into a system, the performance far surpasses the most critical requirements of music lovers and audio perfectionists, they achieve a standard of sound that is truly breathtaking. System consists of the Fisher Model 80R FM-AM tuner, McIntosh 30 Watt Model MC30 Amplifier, the McIntosh Model CB Audio Control Preamplifier, the latest Collaro RC-54 3 speed Record Changer with the G.E. RPX-052A Diamond & Sapphire turnover cartridge, and the famous Jim Lansing D34001 speaker system, which delivers magnificent audio, with its Koustical Lens, famous for its ability to reproduce throughout its entire treble range; amazingly rich perfectly defined reproduction throughout the balance of the audio spectrum is provided by the Model 30A 15" speaker; speaker system also includes 3 position switch for adjustment of treble output. For 110-125 volt 60 cycle operation. Shipping wt. 290 lbs.

HF-110 Complete FM-AM Phono system with Jim Lansing D34001 Speaker System. NET \$830.50

net \$830.50



Lafayette ...The House of High Fidelity presents

FISHER AUDIO EQUIPMENT

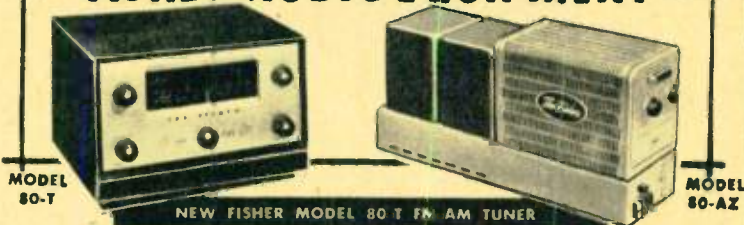

The toast of professionals, the New Fisher FM-AM Tuner, Model 80-T provides a level of performance that far exceeds the most critical specifications. FM-AM: 2 professional, micro-accurate tuning meters; dual antenna inputs; separate front ends. AM: Two adjustable band-width IF stages; 10 kc whistle filter. FM: Cascade tuned RF stage for maximum signal to noise ratio. Two IF stages followed by 2 cascaded limiters and a Foster Seeley Discriminator. Adjustable AFC; 20 to 20,000 cycles \pm 5 db frequency response. Has complete professional control facilities on separate interlocked chassis with exclusive, separate tape head playback preamplifier, equalized to NARTB; Preamplifier-Equalizer that has adequate gain for lowest magnetic pickup; six record equalization settings; variable crossover-type Bass and Treble Tone controls; 20 to 20,000 cycle \pm 5 db frequency response; two cathode follower outputs; self-powered; Eight controls—Bass, Treble, Equalization Selector, Volume, Loudness Balance, AFC/Power, Channel Selector and Station Selector. Tube complement: 2-6BQ7A, 1-6CB6, 1-6BE6, 1-6AU6, 1-6AL5, 2-12AX7, 2-6BJ6, 3-6CA, 2-6U8, 1-6X4. Dimensions: 12 $\frac{3}{4}$ " W, 8 $\frac{3}{4}$ " D, 6" H. Shpg. Wt. 21 lbs. Fisher 80-T Net 199.50

THE FISHER MODEL 80 AZ AMPLIFIER

New 30-watt amplifier with PowerScope. Instantly shows the peak load, in watts, on your speaker system. The first amplifier with a positive indicator to prevent voice coil damage. Handles 60-watt peaks. Less than 0.5% distortion at 30 watts; less than 0.5% at 10-watts. Uniform response 10 to 50,000 cycles; within 0.1 db from 20 to 20,000 cycles. Hum and noise level better than 96 db below full output. Three separate feedback loops for lowest distortion and superior transient response. Intermodulation distortion less than 0.5% at 25 watts and 0.2% at 10 watts. Three controls: PowerScope, Z-Matic and Input Level. 8 or 16 ohm output. Tubes 1-12AT7, 1-12AU7A, 2-EL37, 1-5V4G, 1-PowerScope Indicator, 1-Regulator. Size: 16 $\frac{1}{2}$ " x 4 $\frac{3}{4}$ " x 6 $\frac{1}{2}$ " high. Shpg. Wt. 22 lbs. Fisher 80-AZ Net 99.50

THE FISHER MODEL FM 80

The Fisher FM-80 combines starting sensitivity, compact design and micro-accurate tuning. Two tuning meters—one indicates signal strength, and the other shows when station is tuned properly. Armstrong system, dual limiters and cascade R.F. stage provides extreme sensitivity. Frequency response \pm 1 db 20—20,000 cycles. Variable automatic Frequency control and two cathode-follower outputs. Convenience 0-to-100 logging scale; 10 tubes and 614 rectifier; 4 $\frac{1}{2}$ " x 12 $\frac{3}{4}$ " x 7 $\frac{3}{4}$ " deep. For 105-125 V., 50-60 cycle AC. Shpg. Wt. 15 lbs. FISHER FM-80 Net 139.50

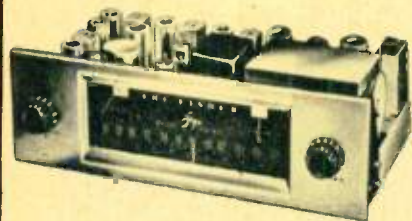

FISHER MASTER AUDIO CONTROL



\$99.50

REMARKABLE FEATURES OF THE FISHER 80-C

- Professional, lever-type equalization for all current recording characteristics.
- Seven inputs, including two Phono, Mic and Tape.
- Two cathode-follower outputs.
- Complete mixing and fading on two, three, four or five channels.
- Bass and Treble-Tone Controls of the variable-crossover feedback type.
- Accurately calibrated Loudness Balance Control.
- Self-powered.
- Inherent hum: non-measurable. (On Phono, 72 db below output on 10 mv input signal; better than 85 db below 2v output on high-level channels.)
- IM and harmonic distortion: non-measurable.
- Frequency response: uniform 10 to 100,000 cycles.
- Separate equalization and amplification directly from tape playback head.
- Four dual-purpose tubes, all shielded and shock-mounted.
- Separate, high-gain microphone preamplifier.
- Push-Button Channel-Selectors with Individual Indicator lights and simultaneous AC On-Off switching on two channels (for tuner, TV, etc.)
- Master Volume Control plus 3 Independent Level Controls on front panel.
- 11 Controls plus 5 push-buttons.
- Three auxiliary AC receptacles

SIZE: Chassis, 12 $\frac{1}{2}$ " x 7 $\frac{3}{4}$ " x 4 $\frac{1}{4}$ " high. In cabinet, 13 $\frac{1}{2}$ " x 8" x 5 $\frac{1}{4}$ " high. Shipping weight, 10 lbs. Chassis only **\$99.50** Mahogany or Blonde Cabinet, **\$9.95**

SCOTT

310A FM MONITOR TUNER



Most important new development in tuner design. The 2 mc. wide-band detector, 8 limiters and full 150 KC wide flat pass-band IF characteristics make tuning completely non-critical and drift-free. Dynaural Interstation noise suppressor. Automatic gain control. Tuning and signal strength meter. Three IF's, 3 limiters. A true 2 micro-volts on 800 ohm input for 20 db quieting. Cathode follower output. Capture ratio better than 2.5 db; 85 db rejection of spurious response from cross modulation of strong local signals. 10 tubes. Size: 13 $\frac{1}{2}$ " x 4 $\frac{1}{2}$ " x 9 $\frac{1}{2}$ ". Attractively styled case for operation from 105-125V., 50-60 cycles AC. Shpg. Wt. 14 lbs.

SCOTT 310A—List \$249.10 NET 146.51

McIntosh

C-8 AUDIO COMPENSATOR

88.50



The new latest McIntosh C-8 Audio Compensator is a complete control center for home entertainment systems. Designed for use with the Basic Amplifier Model MC-30. Features 5 turnover and 2 roll-off slide switches; 5 position rumble filter; 5 position aural compensator; 5 position input selector, Bass, Treble, Off-on-Volume, Switch for FM or magnetic cartridges. Inputs: 2 tuner, tape crystal mike, 1 low impedance mike, 1 high level magnetic phono, rumble filter to minimize very low frequency noise. Size: 5 $\frac{3}{4}$ " x 10" x 7 $\frac{1}{4}$ ". Tubes 3-12AX7. Takes power from MC-30 or 50W-2 Amplifier. Shpg. Wt. 7 $\frac{1}{2}$ lbs.

MODEL C-8...leas cabinet NET 88.50

MAHOGANY CABINET for C-8 Compensator listed above. Size: 4 $\frac{1}{2}$ " x 11-9/16" x 7 $\frac{1}{4}$ ". Shpg. Wt. 1 $\frac{1}{2}$ lbs. NET 8.00

McIntosh

MC-30 30 WATT AMPLIFIER

143.50



Designed for those who expect the finest, the McIntosh MC-30 sets a new standard among amplifiers today. It brings almost an unbelievable clarity of tone—clean, pure living sound, flawless audio reproduction at peak power handling capacity. Designed for use with C-8 pre-amplifier. Also for use with quality FM-AM tuners. Only 0.5 volt input is required for full 30 watt output. Response: \pm 1 db, 20 to 30,000 cycles at 80 watts. Harmonic Distortion: less than $\frac{1}{4}$ % at 30 watts, 20 to 20,000 cycles. Intermodulation: Less than 0.5% for instantaneous peak power below 80 watts. Hum and Noise: 90 db below rated output. Output: 4, 8, 16 and 800 ohm. Uses 8 tubes and rectifier—2-1614's in output. Attractive black and chrome finish. Size: 8" x 13" x 8". For 110-125V., 60 cycles AC. Shpg. Wt. 38 lbs.

MODEL MC-30 NET 143.50

50W-2—50 Watt Basic Amplifier. Ideal for use with C-8... NET 249.50

McINTOSH MODEL MC-60 NET 198.50

SCOTT 710A STROBOSCOPE TURNTABLE



The radically new mechanical design of this professional turntable reduces annoying disturbances such as motor rumble, "wow" and flutter to limits so low as to be inaudible and virtually unmeasurable. This is possible through the use of unique dual-stage mechanical vibration filtering and high compliance torsional filtering. A significant design contribution is the rigid connection of the integral pickup-arm

125.00

mounting board to the turntable bearings through a heavy aluminum casting. This prevents acoustic feedback and other undesirable results of vibration differences between pickup-arm and turntable.

Individual vernier speed controls to permit matching the pitch of accompanying musical instruments. Built in expanded scale optical stroboscope for exact speed control, while record is actually being played. Has aluminum base plate with mahogany strip for mounting pickup-arm. Size 16 $\frac{1}{2}$ " x 14". Requires 5" below motor board. Less mounting base (see below) for 110-120 Volt 60 cycle A.C. Shpg. wt. 26 lbs.

LIST \$170.00 NET 125.00

Mounting Base For above Mahogany finish. Shpg. wt. 3 lbs.

LIST \$24.95 NET \$14.65

SCOTT 210-C POWER AMPLIFIER

The Scott 210-C Hi-Fi Amplifier has Dynaural Noise Suppressor, 8 position record compensator, Loudness control, Bass and treble control. Maximum treble boost is 26 db at 20,000 cycles; maximum bass boost of 35 db at 30 cps; 5 position input selector, inputs for tuner, tape, TV, magnetic Phono and constant amplitude phono. D.C. operated preamp circuit. Frequency response 19—35,000 cycles. Harmonic Distortion: 0.5%. Intermodulation Distortion (list order) 0.1%. Speaker output impedance: 2, 4, 8 and 16 ohm tubes. 6AU6, 4-12AU7, 12AX7, 2-6U6G, 5V4G rectifier. Housed in maroon crackle finish case. Size 14 $\frac{1}{2}$ " x 4" x 13". For 105-125V A.C. operation 50-60 cycle. Shpg. wt. 22 lbs.



LIST \$287.50

NET \$169.05

LAFAYETTE

HI-FI FM-AM PHONO COMBINATION

WITH 2 WAY SPEAKER SYSTEM INSTALLED IN HANDSOME CABINET

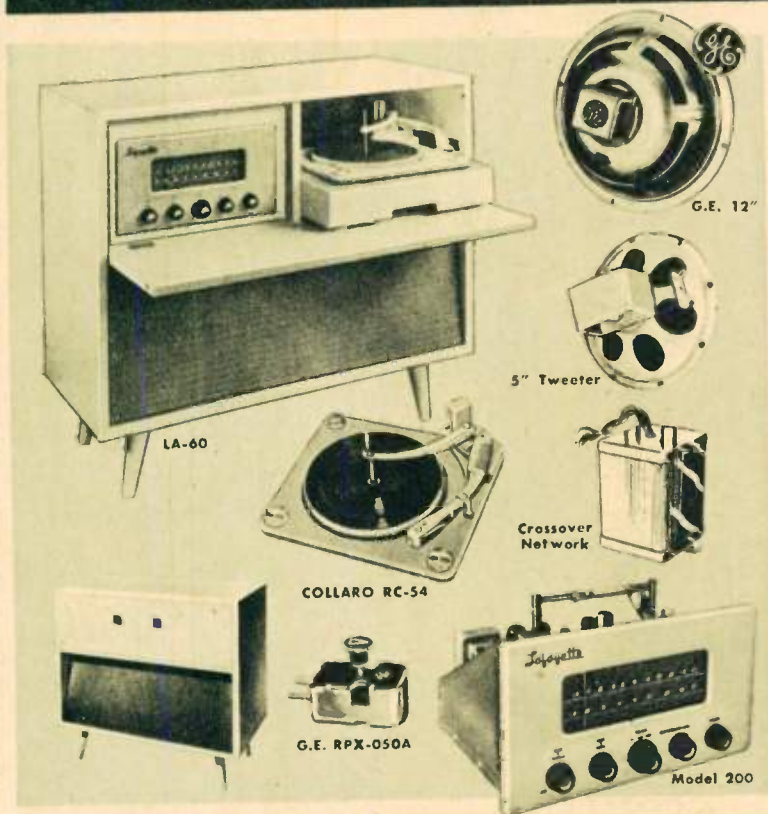

For those who want a completely matched and wired FM-AM Phono System, Completely Installed in Handsome Console Cabinet, Lafayette presents the new Model LA-60 Radio Phono Combination. Contains everything you need for brilliant music reproduction. The attractive Console combines graceful styling with true functional design. Equipped with the Model 200 DeLuxe FM-AM receiver chassis (13 tube plus rectifier), with 10 watts of push-pull amplification and preamplifier. Has a dual control to compensate for Long Playing, AES, or European recordings. The record changer is the famous COLLARO RC-54 3-speed changer with G.E. RPX-050A Turnover Cartridge. Also includes a 2-Way Speaker System consisting of a G.E. 12" — 25 watt PM Speaker acting as "Woofer" and a 5" Tweeter with Crossover Network. The Tweeter, or treble speaker reproduces treble notes, overtones and harmonics with remarkable richness and "presence". This is super-value in custom Hi-Fi Radio Phono combinations which outperforms commercially assembled radio phonos costing several times its price. The console is 32 1/4" H, 35 1/2" W, 15 7/8" Deep. For 110-120 V, 60 cycle AC operation. Shpg. wt., 155 lbs.

Model LA-60—Complete — in Unfinished Console Net **219.50**
Complete — in Mahogany or Blonde Net **234.50**

Console only: For those who have their own equipment and wish to purchase the console only — Dimensions of equipment compartments: Speaker Compartment 34" W, 13" H, 14" Deep. Equipment Compartment: 16 1/2" W, 14 7/8" D, 10 1/4" H, same dimensions for record changer compartment. Shpg. wt., 90 lbs.

Unfinished Net **69.50**
In Mahogany or Blonde Net **86.50**

\$219.50 Complete

LAFAYETTE

HI-FI FM-AM PHONO COMBINATION INSTALLED IN CABINET

All components in Lafayette Model LA-61 Complete FM-AM Phono Radio Combination have been critically selected to give you positive assurance of top value for your Hi-Fidelity dollar. The complete console and its units form a beautifully balanced combination for reproducing both FM and AM broadcast recorded music with full thrilling realism and excellent tonal balance with all makes of records. Completely matched and wired; consisting of the Harmon-Kardon Model A-200 FM-AM Tuner, the Lafayette LA-57 Hi-Fi Amplifier, the Collaro RC-54 Three Speed Record Changer with G.E. RPX-050A Turnover cartridge, and a 2-Way Speaker System consisting of a G.E. 12" — 25 watt PM Speaker acting as "woofer" and a 5" Tweeter with Crossover Network. Provides excellent audio fidelity and smooth dependable performance. All cabinet materials are carefully selected. Pull-out changer drawer has ball bearing slides. This unit represents a rare harmony of beautiful styling and High Fidelity performance. Compare features and you will find it is a real value in complete Hi-Fi Radio-Phono Combinations. If you desire, you can get the console unfinished — perfect to match the style and finish of the rest of your furnishings. Size: 32 1/4" H, 35 1/2" W, 15 7/8" D. For 110-120 Volts 60 cycle AC operation. Shpg. wt., 160 lbs.

Lafayette Model LA-61
Complete — in Unfinished Console Net **257.50**
Complete — in Mahogany or Blonde Net **272.50**

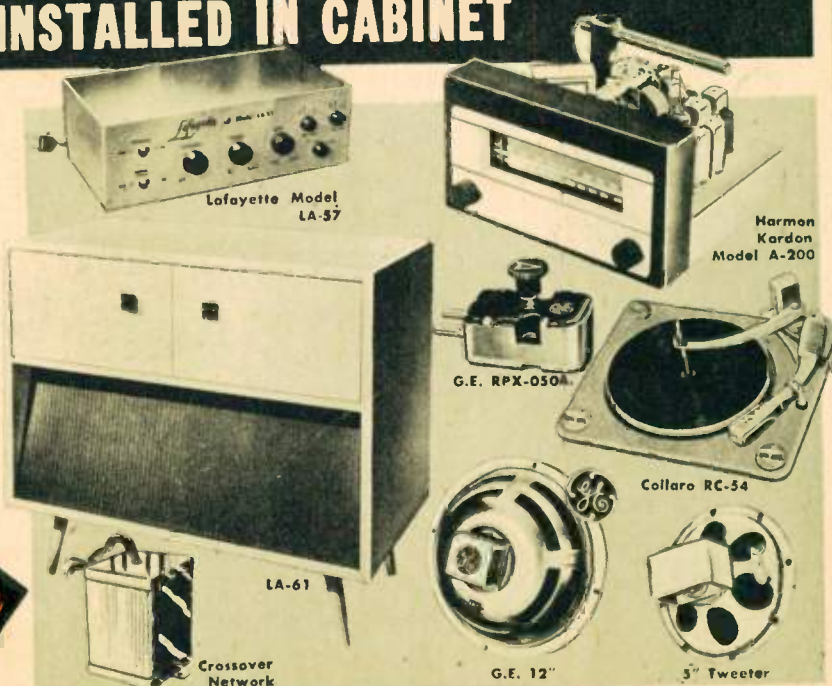

\$257.50 Complete

LOOK AT THESE PRICES

At first no one could believe it!

HI-FI MULTI SPEAKER SYSTEMS

8" PM-6.8 oz. Woofer
5" PM Tweeter
Crossover Network
20-15,000 cycles

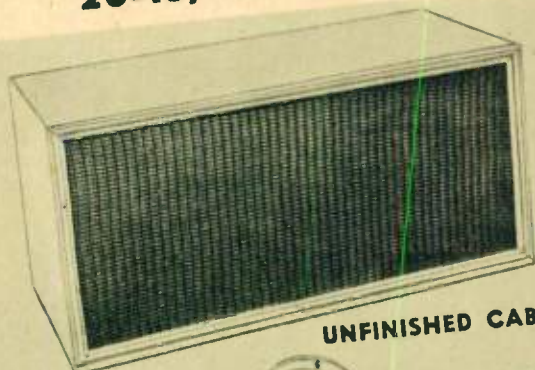

UNFINISHED CABINET



5" Tweeter



Network

'Woofer'

Now, for the first time, an enclosure that will give you real High Fidelity performance in a small package—with the advantage of the 2-way speaker principle. Positively will outperform any speaker arrangement costing twice as much. Comprises a special G.E. 8" PM 12-watt speaker with 6.8 oz. magnet acting as a "woofer" plus a 5" specially designed PM Tweeter and Crossover Network to increase the high frequency range up to 15,000 cycles. Clean, smooth reproduction, with the unmistakable "presence" of the 2-way hi-fi reproducer—will recreate a tone balance which is unbelievable.

UNFINISHED CABINET

Cabinet is unfinished—handsomely styled—made of finest birch, perfect for the Blond or Mahogany finish you want, or you can paint it to match the style and finish that blends in with the rest of your furniture. Reproducer is completely enclosed. Size: 23 1/2" L x 11 1/4" W x 10 1/2" D. Shpg. Wt. 22 lbs.

- No. SY-10—Complete 2-way Speaker System And Crossover Network Net 29.45
- Installed in unfinished cabinet Net 13.75
- No. SY-11—Complete System (Less cabinet) Net 19.50
- No. SB-34—Cabinet only

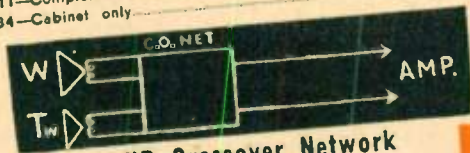

5" Tweeter AND Crossover Network



5" Tweeter



Network

A specially designed 5" Tweeter and Crossover Network that will assure high frequency response when used with any speaker you now possess. You can now make your present speaker into a 2-way speaker system increasing the high frequency range up to 15,000 cycles. Diagram included. Shpg. Wt. 5 lbs.

- STOCK NO. SY-14 Net 7.95
- Stock No. MS-71 Crossover Network only Net 5.95
- Stock No. SK-35 5" Tweeter only.....Net 2.45

12" PM-9 oz. Woofer
5" PM Tweeter
Crossover Network
20-15,000 cycles



Corner Horn Enclosure.



G.E. 12"



5" PM Tweeter



Network

CORNER HORN ENCLOSURE 2-Way Speaker System (Unfinished)

Now you can enjoy the finest and yet pay no more. A full 2-way speaker system for the audio enthusiasts. Especially designed corner horn enclosure makes possible extended bass response and eliminates cabinet resonance. Excellent performance is achieved in direct radiation of high frequencies. The 2-way speaker system consists of the Famous G.E. 12" PM heavy duty 25 watt speaker with 9 oz. magnet acting as a "woofer", a specially designed 5" PM Tweeter with Crossover Network to increase the high frequency range to 15,000 cycles; in an unfinished Corner Horn Enclosure, which you can finish to match the style and finish that blends in with the rest of your furniture. Reproducer is completely enclosed. All units are mounted, ready for use. Size: 21" W x 31 1/4" H x 13 1/4" D. Shpg. Wt. 48 lbs., Enclosure only 35 lbs.

- Model SY-13 Net 57.95
- Model SB-35 Unfinished Corner Horn Enclosure Net 44.95

12" UNFINISHED SPEAKER BAFFLES

Unfinished reflex baffles for Hi-Fi speakers. Careful acoustic design assures excellent performance. Constructed of selected veneer. Front panel behind grille cut for 12 speaker and 5" Tweeter with acoustic port. Supplied with block of wood to cover 5" tweeter hole if tweeter is not used. Front is covered with attractive plastic grille. All sanded and ready for finishing. Dimensions 23 1/2" x 33 1/4" x 12 1/4". Shpg. Wt. 30 lbs.

Model SB-36 Net 29.95

UNFINISHED 12" SPEAKER BAFFLE WITH TWO-WAY SPEAKER SYSTEM

The 2-way speaker system described below (SY-12) completely installed in this unfinished baffle. Model SY-15 Net 43.90

2-WAY SPEAKER SYSTEM

- G.E. 12" PM—25 Watt—9 oz. magnet 'Woofer'
- 5" Tweeter and Crossover Network



G.E. 12"



5" Tweeter



Network

Ideal for custom installations, where a 2-way speaker system is desired to obtain a high degree of audio fidelity at a price that will fit your pocketbook. You can now replace your old speaker in your present phonograph with a 2-way speaker system that will give you clean, distinct bass response provided by the Famous G.E. heavy duty 12" PM 'woofer' with exceptionally large Alnico V magnet (9 oz.), and increase the high frequency range with the 5" Tweeter and Crossover Network, making this assembly a complete 2-way music system which will recreate a tone balance that will astonish you. Will outperform any speaker arrangement costing 2 or 3 times Lafayette's Price. Wiring Diagram included. Shpg. Wt. 13 lbs.

STOCK NO. SY-12 Net 15.75

LAFAYETTE

LEADERS

High Fidelity

SPEAKERS & SYSTEMS

UNIVERSITY Hi-Fidelity SPEAKERS



UNIVERSITY

MODEL 6201 HI-FI COAXIAL

Enjoy balanced response and full range reproduction with this 12", 25-watt, high fidelity coaxial speaker. Low frequencies handled by large, one-piece molded cone; high frequencies by a tweeter driver unit and horn coaxially mounted. Tweeter provides high frequency arc that blends with low frequency output to form a uniform area of sound 80° wide. A built-in, 2000-cycle crossover network assures maximum efficiency of the woofer and tweeter. **44 10**
University Model 6201.



308

312

315

MODEL 308 8" TRIAXIAL SPEAKER

Nothing else like it! An 8" 3-way triaxial speaker for high fidelity installations where space is at a premium and quality is not to be compromised. Special diaphragm and voice coil assembly operating with exclusive University all-Alnico V "W" magnet provides response down to 50 cycles. Full bodied mid-range is reproduced from patented "diffusion" device through a 1,000 cycle mechanical crossover, and clean brilliant highs from the compression driver unit wide angle tweeter to 15,000 cycles through 5,000 cycle electrical crossover. Impedance 8 ohms, power capacity 25 watts. 8-7/16" diameter, 8 3/4" deep. Shpg. Wt. 5 lbs.

UNIVERSITY 308.....NET 35.28

MODEL 312 12" TRIAXIAL SPEAKER SYSTEM

A new challenge by University in the 12" field. Embodies the "Diffusicon" principle for full-bodied mid-range and the new HP-308 Super tweeter for clean, brilliant highs. Alnico V exclusive "W" magnet and duraluminum voice coil suspension used in woofer section results in deep rich and highly efficient bass response. Mechanical crossover at

1,000 cycles and built-in L/C electrical dividing network at 5,000. Complete with high frequency balance control wired to 36" extension. Impedance 40-17,000 cycles, 25 watts power capacity. Impedance 8 ohms 12 1/2" diameter, 8" deep. Shpg. Wt. 12 lbs.

UNIVERSITY 312.....NET 56.45

MODEL 315 15" TRIAXIAL SPEAKER

A triaxially mounted 3-way speaker system designed with emphasis on balance and presence. Balanced so carefully that no "balance" control is needed. Reproduces with such full-bodied clarity that its superior quality of presence is readily apparent. Built around the sensational CI-W woofer assembly, mid-range is provided by the patented "diffusion" device with 1,000 cycle mechanical crossover, and the highs from a compression heavy duty driver

unit wide angle tweeter through an L/C electrical network crossing over at 5,000 cycles. Very high frequencies further diffracted by apertures in horn mouth acoustic screen. Heavy all-die cast aluminum speaker super-structure ensures rigid trouble-free assembly. Overall response 30-16,000 cycles. Impedance 8 ohms. Power capacity 50 watts. Dimensions 15 1/2" diameter, 12" deep. Shpg. Wt. 24 lbs.

UNIVERSITY 315.....NET 129.36

ALTEC

ALTEC LANSING HIGH FIDELITY SPEAKERS



The new Altec-Lansing duplex speakers, models 601A and 602A, are guaranteed by Altec-Lansing to have a frequency range from 30 to 20,000 cycles. Both of these speakers are full 2-way speaker systems and include the Altec N3000A network which provides a crossover at 3,000 cycles. The frequencies between 30 and 3,000 cycles are reproduced by the high efficiency cone speaker with 3" aluminum edge wound ribbon voice coil. All frequencies from 3,000 to 20,000 cycles are produced smoothly and efficiently by the model 3000A high frequency unit mounted on the pole piece. Three steps are provided on the network for adjustment of the high frequency level. Smooth distribution is effected throughout by the use of a sectioned horn similar to that in the already famous 604B Altec-Lansing speaker. These speakers were designed primarily for high fidelity custom home music systems and have a power handling capacity of 20 watts continuous, 30 watts peak. Both speakers are identical with the exception that the model 601A is on a 12" frame and the 602A is on a 16" frame. Shpg. Wt. 12" size, 15 lbs. Shpg. Wt. 16" size, 25 lbs.

Altec-Lansing model 601A, 12" coaxial speaker, including network.....NET 99.00
Altec-Lansing model 602A 16" coaxial speaker, including network.....NET 114.00

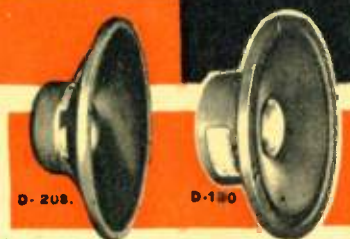

JIM LANSING SIGNATURE SPEAKERS

MODEL D-130 15"
The famous Jim Lansing precision engineered and constructed speakers are made to supply the finest loudspeaker performance possible without compromise, dependent only on your audio system. The 15-inch D-130, with a power handling capacity of 25 watts, has a virtually flat frequency response from 80 to 12,000 cps. Has a one-piece molded cone with aluminum high frequency center diaphragm. Uses an edge wound ribbon voice coil with a diameter of 4" 3/8 lb. Alnico V permanent magnet. Nominal impedance 10 ohms. Completely enclosed metal net mounted in heavy, rigid aluminum frame. O.D. 15 1/2"; depth 6 1/2"; shpg. wt. 23 lbs.

Jim Lansing D-130 Signature Speaker..... **76.00**

JIM LANSING

MODEL D-208 8"

MODEL D-208. A moderate priced 8" model with a power input of 12 watts. Has 15 oz. Alnico V PM, edge wound ribbon voice coil and aluminum high frequency center diaphragm vetted to eliminate non-linear compression effects. Impedance 8 ohms. O.D. 8 1/2"; depth 2 1/2". Voice coil diameter 2". Shpg. wt. 5 lbs.

Jim Lansing Model D-208..... **25.92**

Electro-Voice

RADAX COAXIAL SPEAKERS

Discovery of the E-V RADAX Principle provides an economical and super-efficient method of utilizing two disparate coaxially mounted cones to divide the audio spectrum... while both operate from only a single voice coil.



Built-in mechanical crossover from the low-frequency cone to the high-frequency propagator permits design of each cone for optimum response. This provides a true coaxial two-way speaker system that assures clean, sparkling wide-range reproduction. Frames are extra sturdy. Both speaker cones are moisture inhibited.

Model SP8B Radax Super-Eight. 8-inch coaxial speaker. Resonance 65 cps. 15-20 watts. Response 35-13,000 cps ± 6 db. 16 ohms impedance. Sens. rtg. 44 db. Crossover, 6000 cps. 1 lb. Alnico V magnet. 8 1/2" diam., 7" baffle opening. 4 1/2" depth behind mtg. panel. Shpg. wt. 8 1/2 lbs.

List Price.....\$47.50 Net 27.93

Model SP12B Radax Twelve. 12-inch coaxial speaker. Resonance 50 cps. 15-20 watts. Response 30-13,000 cps ± 6 db. 16 ohms impedance. Sens. rtg. 45 db. Crossover, 4500 cps. 1 lb. Alnico V magnet. 12 1/2" diam., 11" baffle opening. 5 1/2" depth behind mtg. panel. Shpg. wt. 9 1/2 lbs.

List Price.....\$49.50 Net 29.13

Model SP12 Radax Super-Twelve. 12-inch coaxial speaker. Resonance 43 cps. 25 watts. Response 30-13,000 cps ± 5 db. 16 ohms impedance. Sens. rtg. 48 db. Crossover, 4000 cps. 3 lb. Alnico V magnet. 12 3/4" diam., 11" baffle opening. 7 1/2" depth behind mtg. panel. Shpg. wt. 26 lbs.

List Price.....\$95.00 Net 55.76

Model SP15 Radax Super-Fifteen. 15-inch coaxial speaker. Resonance 40 cps. 30 watts. Response 30-13,000 cps ± 5 db. 16 ohms impedance. Sens. rtg. 50 db. Crossover, 3000 cps. 5 1/2 lb. Alnico V magnet. 15 1/2" diam., 13 1/2" baffle opening. 9" depth behind mtg. panel. Shpg. wt. 44 lbs.

List Price.....\$130.00 Net 76.44

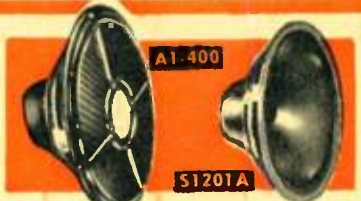

A1-400

S1201A

The G.E. A1-400 Coaxial Speaker

An exceptional, wide angle dispersion loudspeaker for discriminating high fidelity enthusiasts. New concept of smooth realistic reproduction made possible by exclusive new G.E. developments in coaxial design. Uses high efficiency Alnico "V" ring magnets and aluminum base voice coils in both bass and treble speakers. Response, 40 to 15,000 cps. flat ± 5 db. Power rating 25 watts integrated program material. Impedance 8 ohms. No external crossover network required. 12 1/2" dia. x 8 1/2" deep. Wt. app. 7 1/2 lb. Shipping wt. app. 9 lb.

GE A1-400 Speaker.....NET 41.11

GE S1201A 12-Inch

This deluxe 12" Alnico V PM speaker is very popular for home hi-fi units, public address, etc. where 25 watts handling power with 50-13,000 cps frequency range at moderate cost make it a universal favorite. Incorporates late speaker design developments for brilliant highs, mellow bass response. Heavy Alnico V magnet, aluminum base voice coil. Impedance 8 ohms. 8 1/2" deep. List \$33.05. Shpg. wt. 9 lb.

GE S1201A 12" Speaker.....NET 19.95

15" COAXIAL SPEAKER 12" COAXIAL SPEAKER

- 21.5 OZ. ALNICO V MAGNET
- 25 WATT - 1 1/2" VOICE COIL
- 30-30,000 CYCLES 4.5" PM TWEETER



Not just a big frame with a tiny magnet, but a real 15" speaker with a heavy 21.5 oz. Alnico V Magnet and a full 1 1/2" voice coil that gives real efficiency and power handling capacity. This woofer with the 4.5" PM tweeter and built in cross-over network affords remarkable coverage of the audio range - 30 to 20,000 cycles. You get greater efficiency at all volume levels. This deluxe extended range dual speaker system is ideal for hi-fi radio-phonograph installations. 8 ohm voice coil. Simple installation - only 2 wires to connect. Shpg. wt. 13 lbs.

SK-23.....NET \$19.95

8" COAXIAL SPEAKER

The perfect answer to High Fidelity audio reproduction in limited space. Alnico V magnets in both woofer and tweeter. Built-in hi-pass filter. 8 ohm coil. Wt. 6 lbs.

SK-24.....NET \$8.25

Extended range dual Speaker System for FM or AM Radio, Television, Sound and Wide Range Record Phonographs.



Quick, easy, modernizing replacement of old style single range Speakers.

\$9.75

Stock No. SK-22

12-inch Alnico V PM with 1 inch voice coil and heavy one piece cone. Specially designed 3-inch Alnico V PM tweeter completes this combination speaker, range 40 to 17,000 cps. Built-in high pass filter. Installs same as regular PM speaker only two wires to connect. Impedance 8 ohm Wt. 5 lbs.

HIGH-FIDELITY CARTRIDGES and ACCESSORIES

GENERAL ELECTRIC PHONO ACCESSORIES

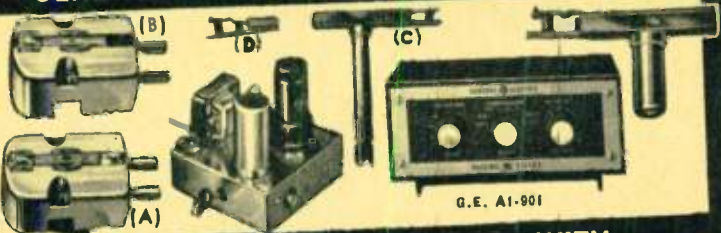

NEW SERIES "A" CARTRIDGES WITH INDIVIDUALLY REPLACEABLE SLIDE-IN STYLI

"TRIPLE PLAY" CARTRIDGES (A)

These convenient dual-stylus Triple-Play variable reluctance cartridges do the work of two cartridges. A simple twist of the knob brings either long-play or standard stylus into position, and eliminates plug-in heads. With .001" and .003" replaceable styli.NET 8.20

SINGLE STYLUS CARTRIDGES (B)

Variable reluctance cartridges with replaceable sapphire styli for long play (33 1/3, 45 RPM) records. Provides smooth, wide range reproduction. Station type stylus used in all models. Includes preamplifier. For pickup arms with 1/2" quiet center. Shpg. wt. 6 oz.NET 5.85

RPJ-01A List \$9.95NET 5.85
Same as above, but for standard, 78 RPM records. With replaceable needles.NET 5.85
RPX-01A List \$9.95NET 5.85

DUAL-TIPPED STYLI (C)

Complete assembly with individually replaceable slide-in styli for both old type and new "A" type cartridges.

Type	Stylus	Radius	NET EACH
RPJ-007A	Sapphire .001"	.0025"	3.50
RPJ-010A	Sapphire .001"	.003"	
RPJ-013A	Diamond .001"	.003"	18.23
	Sapphire .003"		
RPJ-011A	Diamond .001"	.0025"	29.37
RPJ-012A	Diamond .001"	.003"	

SLIDE-IN STYLI (D)

Replacement for all G.E. cartridges or styli with suffix letter "A" after type no. and new broadcast series RFX145-146-147.

Type	Stylus	Radius	NET EACH
RPJ-015	Sapphire .001"	.0025"	1.96
RPJ-015	Sapphire .0025"	.0025"	
RPJ-015	Sapphire .003"	.003"	

RPJ-01D	Diamond .001"	15.68
RPJ-02D	Diamond .0025"	
RPJ-03D	Diamond .003"	

Single styli for replacement in old type single cartridges. Cannot be used in "A" type. Single-tipped styli

Type	Stylus	Radius	NET EACH
RPJ-088	Sapphire .001"	.0025"	2.08
RPJ-088	Sapphire .0025"	.0025"	
RPJ-088	Sapphire .003"	.003"	
RPJ-084	Diamond .001"	.0025"	16.17
RPJ-082	Diamond .0025"	.0025"	
RPJ-083	Diamond .003"	.003"	

GOLDEN TREASURE CARTRIDGES Diamond Tipped

Music lovers are confronted by two major problems—how to obtain the best possible record reproduction and, at the same time, save their favorite records from wear and distortion. The four "Golden Treasure" cartridges supply the best possible answer to these problems.

RPX-02A With stylus having .001" diamond tip and .003" sapphire tip.NET 22.90
List \$38.95
RPX-03A With stylus having two diamond tips: .001" and .003".NET 34.05
List \$37.90
Gold-plated cartridges with diamond-tipped styli for minimum record wear and long stylus life. Wt. 6 oz.
RPX-04A With .001" diamond-tip stylus for MG records.NET 19.90
List \$33.95
RPX-05A With .003" diamond-tip stylus for standard 78 r.p.m. records.NET 19.90
List \$33.95

BROADCAST CARTRIDGES

For low impedance input

Complete with styli

Type	Stylus	Radius	NET
RPX-145	Diamond .001"	.0025"	19.96
RPX-146	Diamond .0025"	.0025"	19.96
RPX-147	Dual	.001"/.0025"	34.05

Replacement Parts Kit, for Triple Play cartridge. Includes, spring, washers, plastic knob. Wt. 2 oz.NET 29.90
RRP008—List. 30c

GE PRE-AMPLIFIERS

Self powered preamp for use with GE or similar magnetic cartridges and pickups. Has 6007 tube in equalizing circuit, plus rectifier. Input in equalizing circuit, plus rectifier. Includes input jack and 1 1/4" output lead with 1/4" phono plug. For 117 volts, 60 cycles AC. 8 1/2 x 8 1/2 x 3 1/2". Complete with tube. Shpg. wt. 2 lbs.NET 17.95
RPX-003A—List \$17.95

G. E. A1-901 RECORD FILTER AND COMPENSATOR

Improve your hi-fidelity performance. Three independent filter controls combine to filter all undesirable noise, and to correct tonal balance for every record. 14 separate frequency adjustments are provided covering the entire audio-frequency range. Adds new brilliance to the oldest records and supplements the richness of good sound reproduction. Lo-cut-off control with 4 adjustments for suppression of turntable rumble, vibration, etc.; Hi-cut-off control with 4 adjustments for depression of record scratch and high frequency distortion; compensator control with six adjustments for most widely used recording curves. Automatic bass and treble equalization. Connects between cartridge and preamp. For use with systems using G.E. or similar types of magnetic cartridges. Handsome cabinet, size 7-9/16" L x 3-9/16" D x 8-9/16" H. Shpg. Wt. 5 lbs.NET 19.55

G.E. A1-901NET 19.55

PICKERING

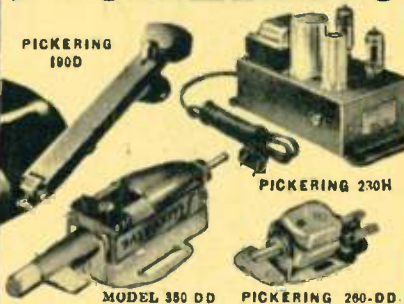

PICKERING MAGNETIC CARTRIDGES

Have received universal acclaim for their high quality and true fidelity reproduction of lateral phonograph records and transcriptions. For standard or MG records. Response essentially flat from 20 to 20,000 c.p.s. Have new lower mass, higher compliance element. .001" stylus for MG; .0025" and .0027" styli for standard records. Supplied with mounting clips for Gardnar or Webster changers free. Shpg. wt. 4 oz.

Type	Stylus Supplied	List	Net
8120M	Sapphire .0025"	16.50	9.90
D140B	Diamond .0025"	41.50	24.80
D140B	Diamond .001"	60.00	38.00
8100B	Sapphire .001"	25.00	15.00
R150	Less stylus	18.50	9.90

*Response to 20,000 c.p.s. For 78 r.p.m. Model 8-30 .003" Sapphire Stylus. For R-150 cartridge above.NET 2.40
List \$4.00

NEW MODEL 260-DD TURNOVER CARTRIDGE WITH DIAMOND TIPPED STYLUS

The new Pickering 260-DD turnover cartridge is the latest contribution to the technique of recording recorded music. Uses 2 separate "back-to-back" cartridges with diamond tipped styli. Eliminates cartridge head removal when changing from MG to standard records. Response essentially flat 20-20,000 c.p.s. Output 30 mv at 10 cm per second. With .001" and .0025" diamond tipped styli. Shpg. wt. 4 oz. List \$100.00NET 60.00

MODEL 260 DB CARTRIDGE

Identical to the 260DD above except with one diamond MG and one sapphire standard styli. PICKERING 260 DB.Net 48.00

PICKERING SERIES 240 CARTRIDGES

Same cartridges as used in 260 series but single instead of double. Supplied with holder and frame. MODEL D240 with MG diamond stylusNet 37.50
MODEL D220 with standard diamond stylusNet 27.60
MODEL 8-220 with standard sapphire stylusNet 12.60

PICKERING 230H PREAMPLIFIER

Engineered to equalize properly the bass response of records and provide necessary gain for Pickering, Amdax, GE magnetic cartridges. Frequency response 40-20,000 cps ± 2 db. Compensates for 6 db/octave loss below 500 cps. High impedance output, average 2 volts. 11um level 50 db below maximum signal. Less than 0.2% intermodulation distortion at normal level. Self-powered. Requires 6A1G, 6C4, 6X4 (not supplied). Size: 7 1/2 x 3 3/4" deep. For 117 volts, 60 cycles AC. Shpg. wt. 4 lbs. List \$40.00. PICKERING 230HNET 24.00

PICKERING "FLUXVALVE" PICKUPS

For the first time Pickering offers a very wide response (VWR), high output, replaceable stylus type turnover pickup: The Model 350 "Fluxvalve". Based upon the newly patented Fluxvalve principle, this cartridge offers features of both design and performance that were heretofore unattainable. MODEL 350 DD—DUAL DIAMOND STYLUSNET \$63.00
MODEL 350 DB—DIAMOND SAPPHIRE STYLUSNET 49.50

REPLACEMENT STYLUS

D 3510—.001 DIAMOND STYLUS21.00
D 3527—.0027 DIAMOND STYLUS21.00
S 3527—.0027 SAPPHIRE STYLUS7.50

PICKERING 132E RECORD COMPENSATOR

TYPE 132E—List \$20.00NET 12.00

PICKERING 190D 18" TRANSCRIPTION ARM

Radically new design for hi-f quality. Vertical mass minimized to track any record—even warped ones. No spurious arm resonance, rugged bearings, minimum pivot friction, statically balanced. Easily mounts with turntable on board prox 17" x 17". Height adjust for turntables 1/2" to 2" high. Sensitive tracking force adjustment. Plug in cartridge holder. PICKERING 190DNET 31.50

FAIRCHILD MOVING COIL CARTRIDGES



This remarkable high — compliance cartridge brings amazing lifelike quality to the most delicate nuances of recorded sound. Virtually hum free. Impedance 70 ohm. Output 50 mv. 1/2" mtz. ctr. With diamond stylus. Requires preamplifier. Shpg. wt. 4 ozs.

Type	Stylus	NET EACH
220A	.001"	37.50
220B	.0025"	
220C	.003"	

Type 280-12" TRANSCRIPTION ARM: New professional type arm for music systems. Minimum tracking error. Takes single or Dual Stylus cartridges. Shpg. wt. 6 lbs. NET29.50

Type 281-18" TRANSCRIPTION ARM: Same as above arm but for up to 18" records. Shpg. wt. 8 lbs. NET29.50

RECOTON — GOLDRING Model 300 Turnover Cartridge



Entirely unique, and exclusive, among the "500's" features is the push-pull coil arrangement which automatically cancels out inductive hum picked up from the radiation of changer motors and other nearby electrical devices. This feature permits users of the "500's" to realize the full potential of the variable-reluctance principle, and at the same time removes any annoyance which is inherent in many cartridges of the magnetic type.

The "500" will fit any tone arms having standard half-inch mounting holes; thus it may be used to replace any cartridge without alteration of playing equipment.

No. 500SS — Cartridge with two sapphire styli9.71
No. 500SD — Cartridge equipped with diamond and sapphire styli.Net 22.93
No. 500DD — Cartridge with two diamond styli.Net 35.16

GENERAL ELECTRIC

Lafayette GREAT BARGAIN SALE!



SALE! Webcor
24.95
3 SPEED AUTOMATIC RECORD CHANGER
 Buy at Lafayette's LOW SALE PRICE

- Brand new fully automatic 3 speed record changer
- Dual turn-over cartridge with dual styli
- Automatic shut-off after last record

You'll find this famous Webcor Diskchanger not only in Webcor Phonographs but in radio phonograph combinations of other famous manufacturers. This is truly supreme excellence in record changing. Not only does it play all 3 speeds and all sizes of records, but it plays up to four hours automatically then shuts itself off after the last record has played. The Webcor Diskchanger was designed for swift, silent record changing; smooth, accurate turntable speeds; and gentle treatment of your precious records. To obtain these qualities, Webcor has included such outstanding features as the: Balanced Tone Arm, Electrostatically Flocked (super-soft) turntable, Shpg. Wt. 16 lbs

PK-49 Singly, ea. 24.95
WEBCOR WITH G. E. CARTRIDGE
 STOCK NO. PK-46 Name as above but with G. E. RPX-050A Triple-play cartridge
 List Price, \$31.75.....NET 27.95

BOGEN 3-SPEED Model B50-16LC TRANSCRIPTION TURNTABLE



The new Bogen Model B50-44C manual player of transcription quality. Features variable speeds from 29 to 86 rpm with notches for 33 1/3, 47 rpm and 78 rpm, takes all records up to 16" in diameter. Turntable (3 1/2 lbs.) is balanced and weighted, covered with molded rubber padding for greater record protection. Heavy duty 4 Pole Motor. High starting torque. Special bearings with large oil reservoir. Velocity trip, automatic start and stop. Less than 1% fluctuations over line voltage variations from 95 to 125 volts. Pick-up arm is die-cast metal. Wow is less than 1/2 of 1%. Adjustable tracking pressure of 4 to 6 grams, for LP and 12 to 39 grams for standard records. Mounting space 15" wide, 11 1/4" deep, 2 1/4" above and 2 1/4" below mounting board. Supplied with one plug-in head for magnetic or crystal cartridge. For 110-120 Volt, 60-60 cycle AC. Shpg. wt.

NET 40.40

EXTRA PLUG-IN-HEAD: 1.35
 for above, NET

MOUNTING BASE: for above Hand-some Brown finish, shp. wt. 5 lbs.
 NET 3.30

Made of 16 gauge steel. Ball bearing, double-extension type, for mounting changers. Length 15", travel length 11", extended 22". Shpg. Wt. 5 lbs.
 ML-34.....per pair NET 1.95
SHORT TYPE
 Same construction as above but length 13", travel length 9", extended 19". Shpg. Wt. 1 lb.
 ML-74.....per pair NET 1.50

GARRARD



GARRARD "CROWN" MODEL RC90

The finest record changer in Garrard's history, with innumerable unique and entirely exclusive features. Plays all record sizes, all speeds. Features an entirely new type of strong, silent 4-pole motor with all three speeds adjustable. Speed adjustment is not achieved by mechanical braking but by an eddy current brake control. All speeds are, therefore, magnetically controllable, with sufficient variation at each speed for any purpose. Supplied with a regular spindle. A large center spindle for 45 RPM 7" records is available. Automatically stops after last record and tone arm returns to rest. Equipped both with muting switch which operates during changing cycle, and suppressor network across AC switch to eliminate loud "pops." Operates at 100 to 130 or 200 to 250 volts, 60 cycles. 13 1/4" left to right by 13 1/4" front to rear by 5 1/2" above motor board by 3 1/4" below motor board. Supplied complete with spring mountings, regular and large center spindles, transit fixing screws, two plug-in cartridge shells, template and instruction manual. Shpg. Wt. 23 lbs. Supplied less cartridges.

MODEL RC90.....NET 68.11

GARRARD 45 RPM SPINDLE.....Net 3.50

GARRARD PLUG-IN SHELL for RC90, complete with Dual Stylus, Turn-Over Crystal Cartridge. 6X/T90.....5.88

MODEL RC90 with G.E. RPX-050A Triple Play cartridge with dual sapphire stylus installed. Net 71.50

MODEL RC90 with G.E. RPX-052A GOLDEN TREASURE Triple Play cartridge with diamond and sapphire stylus installed. 82.13

3 SPEED RECORD CHANGERS



GARRARD "TRIUMPH" 3-SPEED CHANGER
 The newest addition to the Garrard line, the Cadillac of record players. Designed for music lovers who demand the finest in record performance. The new Garrard "Triumph" plays all 33 1/3, 45 and 78 RPM records. Features automatic switch-off after playing last record of any stack of 10 or 12 inch records. A separate spindle is available for use on 45 RPM records to change them automatically. Heavy duty, silent motor, and heavily weighted turn-table for constant speed. Muting switch silences pick-up arm when changer is changing records. Jewel mounted, tangential pick-up arm. The new Garrard "Triumph" is supplied with two plug-in heads and mounting hardware for most crystal and magnetic cartridges. Accommodates the GE reluctance cartridges. Overall size 13 1/4" wide, 13 1/4" deep, 8" high. Extends 2 1/4" below motor board, 5 1/4" above. For operation on 100-130 volts, 60 cycles AC. Cartridges not included.

MODEL RC80. Shpg. Wt. 20 lbs..... 48.51

PLUG-IN CRYSTAL CARTRIDGE

Garrard plug-in shell for "Triumph" changer, complete with dual stylus, turn-over crystal cartridge. GX/80. Shpg. Wt. 1 lb..... 5.88

MODEL RC80 with G.E. RPX-050A Triple Play cartridge with dual sapphire stylus installed. Net 51.95

MODEL RC80 with G.E. RPX-052A GOLDEN TREASURE Triple Play cartridge with diamond and sapphire stylus installed. Net 62.53

SLIDE-OUT DRAWER RECORD CHANGERS



Designed for custom installations of record changers in bookcases, cabinets, tables, etc. Made of durable plywood and equipped with heavy duty steel slides which operate smoothly and quietly on ball-bearings. Slides extend drawer up to 10 1/4" beyond edge of cabinet. Supplied either blank or cut to your specifications. Unfinished wood permits your painting to suit your own decor. Size 16 x 16 x 3 1/2". Shpg. Wt. 8 lbs.
 PK-47—blank Net 6.95
 Same as above, cut to your specifications. Specify make and model of changer or sand template.
 PK-48—cut Net 7.95

BALL BEARING HEAVY DUTY DRAWER SLIDES

Stock No. ML-34.....1.95

FAMOUS V-M-TRI-O-MATIC RECORD CHANGERS



Play all records, 33 1/3, 45 and 78 Rpm in all sizes. Combination "feeler" arm and button automatically adjust the pickup for proper set-down, regardless of record size. Completely Jamproof — pickup can be held at any time without damaging mechanism. 10" and 12" records of some speed can be intermixed. Model 931 is less cable and plug; mounting space 13 1/4" W x 12" D; 5" above and 3" below plate for operation from 110-125 Volt, 60 cycle AC.
MODEL 931A: With turnover crystal cartridge and Dual needle. Shpg. wt. 11 lbs. NET 30.22

MODEL 938B — HF CHANGER: Size 13 1/4 x 13 1/4" requires 5" clearance above mounting board and 3 1/2" clearance below. Less cartridge, AC cord and output cable. Shpg. wt. 12 1/2 lbs. LIST PRICE — 59.95 NET 38.97

MODEL 938B, GE — HF CHANGER with G.E. RPX-050A TURNOVER CARTRIDGE. NET 43.90

MODEL 936B HF CHANGER ON METAL BASE: As above but with gold finish metal base, 6" AC cord and 4 ft output cable. Size 13 1/4" x 13 1/4" x 8 1/2". Shpg. wt. 18 1/4 lbs. LIST 69.95. NET 48.47

45 SPINDLE

V-M "45" SPINDLE. Permits playing 45 rpm records without using spindle spider. For above changers: also Models 950, 950GE, 955 and 955GE. Shpg. wt. 8 oz. List, 2.95, NET 1.88

MODEL 936B GE (same as above) but with G.E. RPX-050A Turnover cartridge. NET 49.90

THE NEW VM MODEL 1200 4 SPEED CHANGERS!

Automatically plays 33 1/3, 45, and 78 rpm records plus the new popular talking book 18" rpm speed. Other features are: Easy-Lift record support arm, New, low-torque mechanism aluminum die cast tone arm, new patented drive motor etc. Size 12 1/4" dup, 13 1/4" wide, 8-5/16" high overall. Shpg. wt. 15 lbs. for 110-120 volt 60 cycle AC operation.

MODEL 1200 WITH CRYSTAL TURNOVER CARTRIDGE: LIST PRICE — 46.50 NET 30.22

MODEL 1200, G.E. WITH G.E. RPX-050A TURNOVER CARTRIDGE: LIST PRICE — 51.50 NET 33.47

MODEL 1225 CHANGER ON METAL BASE, in matching colors, with Crystal Turnover cartridge, size 12" x 13 1/4" x 8 1/2", shpg. wt. 20 lbs. LIST PRICE — 49.95 NET 32.66

MODEL 1225 G.E. CHANGER ON METAL BASE, in matching colors, with G.E. RPX-050A turnover cartridge. LIST PRICE — 54.95 NET 38.91

Lafayette

RECOMENDS NEW

Collaro RC-54



THE
WORLDS FINEST
Fully Automatic
3 Speed
Intermix
Record Changer

Made In England



GSA



GPA



LAFAYETTE
UNHESITATINGLY
RECOMMENDS THE
Collaro
AS THE FINEST
HIGH FIDELITY
CHANGER AVAILABLE

Contains Features Found In no Other Changer

The Collaro is designed and engineered to meet the most exacting requirements of the finest audio systems. Superbly constructed and simple to operate, it performs with unerring accuracy and silent smoothness. Designed for service and safety. Children won't damage the Collaro by moving the arm—it's jam-proof. The powerful 4-pole motor and weighted balanced turntable assure freedom from "wow". Painsstaking attention has been devoted to the minutest details. Check these features.

FEATURES

POWERFUL 4-POLE MOTOR—with dynamically balanced rotor, and integrally built 3-speed drive mechanism. **SIMPLE 2-KNOB CONTROL**—consisting of single-knob speed selector and single-knob control for 'on', 'off' and 'reject'. **WEIGHTED STEEL TURNTABLE**—runs on hardened spindle with cushioned ball-thrust race for smooth, silent operation. **LARGE IDLER WHEEL**—with molded-on, precisely ground rubber drive for quiet, constant speed performance. **AUTOMATIC IDLER DISENGAGEMENT**—when changer switches to 'off'—prevents development of flat spots. **AUTOMATIC SWITCH-OFF** after last record side is played insures that changer can never be accidentally left running. **INSTANT REJECT**—eliminates time lag between control and response mechanism. Reject impulse immediately raises tone arm from record. **AUTOMATIC MUTING SWITCH** shorts out pickup during all but playing cycle. Eliminates 'clicks' and run-in groove noise. **UNIVERSAL SPINDLE**—gently lowers record stack into feed position—accommodates all record types, including 45 rpm records with hole adapters (special 45 rpm slip-on spindle available as accessory—\$3.23 net). **RUBBER TURNTABLE MAT**—eliminates record slippage. Does not shed or

retain dust and abrasive grit. **STYLUS PRESSURE ADJUSTMENT**—permits setting of pressure to as little as 3 grams with perfect tracking. **PLUG-IN HEADS**—2 furnished—accommodate standard crystal, ceramic and magnetic cartridges—quickly interchangeable. **SIMPLE INSTALLATION**—for easy replacement of existing changers. Finished in cream or two-tone gold and maroon. Cushion springmounts built-in. **DIMENSIONS**—12 x 13½ inches. Clearance required above mounting board—5½"; below—2¾".

COLLARO MODEL RC-54 INTERMIX CHANGER LESS CART- RIDGE. List, \$65.00 Net 47.77

COLLARO RC-54 Intermix changer with G.E. RPX-050A Triple Play cartridge with Dual Sapphire installed. Net 49.95

COLLARO RC-54 Intermix changer with G.E. RPX-052A Triple Play GOLDEN TREASURE cartridge with Diamond and Sapphire styli installed. Net 59.95

ACCESSORIES

45 RPM SPINDLE. Slips on in place of regular spindle, eliminating use of spiders on 45 RPM records.

GSA Spindle Net 3.23

TURNOVER CARTRIDGE with sapphire needles

MODEL O Cartridge Net 6.47

AUDAK ADAPTER, plug-in adapter for use with Audak L6 cartridge.

GPA Audak Adapter Net .82

NOTE: Plug-in shells supplied with changer accommodate all other standard cartridges such as G.E., Electro-Voice, etc.

COLLARO *transcription* TURNTABLE



THE NEW COLLARO MODEL 2010 consists of a heavy non-magnetic, specially balanced turntable designed with greater weight in rim for added flywheel effect. A 4 pole dynamically balanced, induction motor. The spindle-shaft is fitted with a 3-step pulley, which provides ratio differential for 3 speed operation. The Collaro Transcription cartridge is a crystal pickup of unusual qualities. Response is 40 to 16,000 cycles. LOW mass and high lateral compliance contribute to a very low order of IM distortion. Deck size 15½" x 12½", above deck 2¾" below deck 3¾". Cartridge output 10 volt at 100 cycles (3.16 cm/sec at 18" C), equivalent capacity 1500 mmd. IM distortion: Less than 1% at normal stylus pressure. Complete with Transcription cartridge.

NET

49.34

REK-O-KUT TRANSCRIPTION TURNTABLE

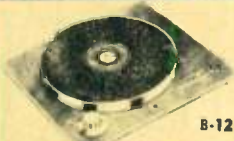

B-12H

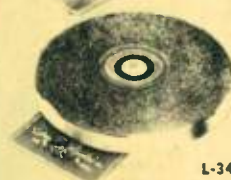

L-34

MODEL B-12H: A professional quality 3 speed transcription turntable for 78, 45 and 33½ rpm. Noise level is 50 db below average recording level. Self lubricating hysteresis motor. Internal rim drive—disappearing 45 rpm adapter built into turntable. Lathe turned and balanced cast aluminum turntable. Table mat of Corprene affords maximum record traction. Equals all standards set by NARTB. Mounts in cut out 13½" x 14¾". Requires 1" clearance above and ½" below board. 110V, 60 cy. AC only. Shpg. Wt. 17 lbs.

MODEL B-12H 119.95

MODEL B-12: Same as above—except with 4 pole induction motor Noise level 40 db down.

MODEL B-12 74.95

MODEL L-34: 2 speed 33½ and 45 rpm. 4 pole induction motor. 1½" Turntable. Shpg. Wt. 15 lbs.

MODEL L-34 Net 49.95

MODEL LP-743: 3 speed—78, 45, 33½ rpm. 12" turntable—4 pole induction motor. Shpg. Wt. 15 lbs.

MODEL LP-743 Net 59.50

LAFAYETTE FINEST QUALITY

PLASTIC BASE HIGH FIDELITY RECORDING TAPE



Quality guaranteed tape as good or better than any other Tape on market or your money refunded

Try a starting Buy! Lafayette made a terrific deal with one of the leading and largest manufacturers of recording tape in the country to supply us with their regular tape, of the same quality and standards of manufacture as their own tape which sells for almost twice our price. We have placed orders for millions of feet in order to obtain a low price and we are passing the Savings On To You. WE GUARANTEE ABSOLUTE SATISFACTION OR YOUR MONEY BACK. IF YOU DON'T AGREE THAT OUR TAPE MEETS EVERY CLAIM WE MAKE FOR IT SEND IT BACK AND WE WILL CHEERFULLY REFUND YOUR MONEY. The finest, professional-quality recording tape obtainable. Highest performance for thousands of playings. Red Oxide Base in a smooth, uniform coating; greater signal strength; with maximum fidelity; uniform frequency response from 40-15,000 cps at 7 1/2" per second; and freedom from background noise and distortion. The plasticized cellulose acetate base will not stretch or break at many times the maximum tension encountered in service. Each reel is individually boxed.

1200 ft.-7" REEL
Per 1200 ft. Roll.....
SHPG. WT. 14 OZ.

\$1.59 each
LOTS OF 10

single.
1.69
EA.



SCOTCH RECORDER TAPE

Fig. A. SCOTCH RECORDING TAPES. Made by the world's largest manufacturer of pressure-sensitive tapes, Scotch Brand offers the advantages of better frequency response at slow recording speeds; low noise level; greater signal strength; even and constant tracking; less cross-talk; greater freedom from breakage; ease of editing and cleaner erasures with low power. Frequency response 40-15,000 c.p.s. at 7 1/2" per second. All on plastic reels except: * - on NARTB 10 1/2" reel; † - on NARTB Hub; ‡ - on 7" Metal Reel; § - on NARTB 14" Reel. Type 111A-Magnetic Coating Facing-In Plastic Base

Type No.	Size	List Price	1-11 Each	12 or more Each
111A-1.5	1/4"x150'	.85	.57	.51
111A-3	1/4"x300'	1.50	1.00	.90
111A-6	1/4"x600'	3.00	2.00	1.80
111A-12	1/4"x1200'	4.70	3.13	2.82
111A-12M†	1/4"x1200'	4.70	3.13	2.82
111AP-12‡	1/4"x1200'	5.20	3.47	3.12
111A-24H§	1/4"x2400'	8.50	5.67	5.10
111A-24R*	1/4"x2400'	10.90	7.27	6.54
111A-48H†	1/4"x4800'	17.00	11.33	10.20
111A-48R‡	1/4"x4800'	22.10	14.73	13.26

△ professional reel. Has large hub to reduce timing error and output variation.

MAGNETIC TAPE SPLICER



\$1.47

An excellent accessory that splices tapes accurately and eliminates joint noise. Both ends of tape are cut simultaneously. Nickel-plated brass finish. Wt. 1 lb. P1632B



METAL TAPE STORAGE CHESTS

DELUXE AUTOMATIC CASE

A heavy gauge all steel tape carrying and storage chest. Holds 12 7" or 5" tape reels and cans. Ideal for convenient filing and storing of tape reels. Protects against accidental exposure in the presence of magnetic fields. Finger tip pressure on piano-type key selects and rolls out the reel of your choice. Platinum grey hammeroid finish. Folding handle - dimpled for stacking. Complete with index cards for quick identification. Shpg. Wt. 8 lbs.

ML-59

Net ea. 6.75



STANDARD CASE

Standard Case: Sturdy all steel carrying case. Holds 12 7" or 5" reels and cans. Twin snap locks for positive closure. Perfect portability—ideal for filing and storage. Guards against exposure to moisture and accidental erasure. Finished in platinum grey hammeroid. Handle folds for compactness. Includes index cards for quick identification. Metal separators hold each reel erect. Shpg. Wt. 5 lbs.

ML-60

Net ea. 2.99



METAL STORAGE CANS

Can holds 7" 1200 ft. tape reel. Gives ultimate in protection to precious recordings. Handsome finish of grey hammerstone enamel. Cans are ribbed for stacking—give maximum storage in minimum space. Precision fit makes opening and closing easy. Fit perfectly in chests shown above. Shpg. Wt. 8 oz.

ML-61

Net ea. 46c
Lots of 6, ea. 42c



ADHESIVE REEL LABELS

Per Pack of 30
Net 16c

Convenient press-on adhesive labels for positive identification of tape reels. Easy to apply or remove.

AUDIO SELF-TIMING LEADER TAPE

Durable plastic material with spaced markings for accurate timing at all standard speeds. Individually boxed in 100 ft. rolls. Net 35c

AUDIOPoint RECORDING NEEDLES

Dural shank recommended for professional use; brass for semi-professional and home recording. Type 145, 205 and 20L has 87° included angle; 14L has 70°. Steel needles average 15 to 30 minute recording time; sapphire average 6 hours and can be resharpened at nominal cost.

Type	Description	EACH
145	Sapphire Short Dural	4.41
14L	Sapphire Long Dural	4.41
205*	Sapphire Short Dural	4.41
20L*	Sapphire Long Dural	4.41
2025	Sapphire Short Brass	3.53
202L	Sapphire Long Brass	3.53
345	Stellite Short Brass	1.18
24L	Stellite Long Brass	1.18
80	Steel Steel Pkg. of 3	1.03

*For Cutting Microgroove. All Others Standard



RECORDISC RECORDING BLANKS

For Semi-Professional and Home Use. Orange Label: Processed paper base with a cellulose Nitrate coating. Double faced.

Stock	Dia.	Each	6 for
ORANGE LABEL	6 1/2"	.17	.90

Red Label: Professional grade with cellulose nitrate coating. .021" aluminum base.

Stock	Dia.	Each	5 for
RED LABEL	6 1/2"	.27	1.20
	8"	.33	1.50
	10"	.53	2.40
	12"	.67	3.00

Purple Label: Aluminum based, low cost disc.

Stock	Dia.	Each	5 for
PURPLE LABEL	6 1/2"	.20	.90
	8"	.27	1.20
	10"	.40	1.80

"GM" label is wide range: Semi-professional .021" Aluminum base.

Stock	Dia.	Each	5 for
GM LABEL	8"	.53	2.40
	10"	.67	3.00
	12"	.82	3.75

NEW 7" AUDIODISC FOR 45 RPM

Red Label aluminum base recording disc made to exact dimensions of commercial 45 RPM records. Complete with center hole adapter that permits these discs to be cut on any standard disc recorder having the conventional center pin and drive arrangement. Playback on any 45 RPM player or changer.

RED LABEL 7" AUDIODISC.....ea. 75c
Lots of 25.....16.90

NEW! Time & 1/2 Recording Tape

1800 FT. - 7 INCH REEL

Lafayette leads again with this latest development in Plastic Base High Fidelity Recording Tape at a price you can afford

Now you can put that entire symphony on one reel of tape. New developments in thin base plastics now give you 50% more playing time on a 7" reel — Think of it — on dual track recording at 7 1/2" per second you get 96 minutes — over 1 1/2 hrs. — of playing time on a single reel. At 3 3/4" per second you get 3 hours and 12 minutes! Lafayette's new TIME + 1/2 tape is of the same high quality that has made the Lafayette Standard Tape the nation's outstanding value. Full depth red oxide coating firmly and uniformly bonded to base assures you of the finest professional quality high fidelity recordings. Frequency response at 7 1/2" per second is 40-15,000 cycles. This is top quality tape — free of splices, background noise or distortion. No cupping, curling or chipping. We're proud of this new tape and back it up with our MONEY BACK GUARANTEE. Try it — you be the judge. If you're not satisfied return it for a full refund. Shpg. wt., 1 lb.

\$2.59
EACH Singly

245
EACH
In Lots
of 10



TELEPHONE PICKUP

FOR RECORDING TELEPHONE CONVERSATIONS

Induction telephone pickup Telephone conversations can now be picked up with no tapping of wires or special telephone circuits. Simply place the phone base, either cradle or upright type, on the pickup platform and connect the leads to the high impedance input of any medium gain audio amplifier, or directly to any tape disc or wire recorder.

STOCK NO. MS-14

\$2.95



EDITALL TAPE SPLICER



EDITALL TAPE SPLICER

Designed by the tape editor of a major network, the Editall splicer speeds cutting without producing fatigue. Used by broadcast stations, networks, and recording studios. An absolute necessity in building a library of tape recordings. Solidly made of precision-machined Duraluminum. Holes provided for convenient mounting. NET \$0.50

FLAHAN TAPE THREADER



- IT'S NEW!
- THE TAPE THREADER YOU'VE BEEN ASKING FOR!

At last! No more awkward fumbling, threading a reel. Just place the tape against the reel, slip your Flahan threader over the capstan shaft and over the empty reel. Tip of threader holds the tape firmly against the reel. A few turns on the crank, and you're ready to play or record. Can be used as a manual crank to rotate reel by placing tip in slot nearest spindle. Saves time — saves tape. Shpg. wt., 2 oz.

MS-222

79¢

REEVES SOUNDRAFT "PLUS 50" RECORDING TAPE

- 50 EXTRA PLAYING TIME
- DUPONT MYLAR BASE

Recognized as "the world's finest" for every phase of high fidelity magnetic recording. Uniform low, middle, and high frequency response. No friction, chatter, or squeal. The long-playing time of "Plus 50" is due to its backing of Dupont "Mylar", only 1/1,000 inches thick, yet so strong that it will preserve your finest recordings virtually forever without cupping, curling, or chipping.

Type	Reel*	Length	List Price	Each
PL-2	3"	225'	1.50	.88
PL-9	5"	900'	4.40	2.59
PL-18	7"	1800'	7.95	4.67

* plastic



PERMOFLUX TELEPHONE PICKUP



MODEL MS3-A. Newly designed telephone pickup for attaching to earpiece of telephone instrument for picking up both sides of a telephone conversation. Can be used with either cradle type or old style telephones. Output of pickup can be fed directly to microphone input of any tape, wire or disc recorder — or amplifier. No electrical connection to telephone is necessary; pick-up slips easily and quickly on to telephone earpiece. This method of pickup makes possible a high degree of fidelity — assuring reliable recordings of important telephone conversations. Size, 3 1/2" dia., 1 1/4" d. Complete with 6 ft. of shielded cable. Shpg. wt., 8 oz.

MODEL MS3-A. List, 17.50.
NET EACH 10.28

ATTA-GLANCE DISCS

- CATALOGING INDEXING DISCS.

The Atta-Glance tape selector disc fits on the spindle and revolves with the reel. It combines I.P.S. timing, editing, indexing, and cataloging right on top of the reel for fast easy reference. Simple to select starting and finishing positions for each subject recorded. Permits accurate editing, indexing and cataloging.

MS-223, 5" dia.	Each 15¢
8 for	1.00
MS-224, 7" dia.	Each 15¢
8 for	1.00

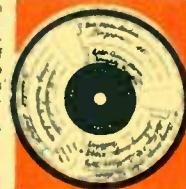

ELECTRO SCRIBER TELEPHONE PICKUP

- NEW WAY TO AMPLIFY, RECORD AND MAKE A PERMANENT RECORD OF

YOUR TELEPHONE CONVERSATIONS.

Avoid the anxiety and expense resulting from "re-hash" of long distance conversations. Simply place phone base on Electro Scriber. Plug Electro Scriber into amplifier if improved reception is desired, or into recorder if a permanent record is desired. Turn on amplifier or recorder and relax. The conversation will be clearly audible to you or anyone else in the room, or you will have a clear permanent record, if recorded.

MS-220 — Model ES701 — for standard cradle phone 7.35

MS-221 — Model ES702 — for push button phone 8.53



SCOTCH SPLICING TAPE

Pressure-sensitive tape made especially for splicing and editing magnetic tape. Wound on handy metal dispenser.

Scotch 41-1/25, 1/2" x 150 in. Net 35¢
Scotch 41-7/32L, 7/32" x 66' Net 52¢

SCOTCH EMPTY PLASTIC REELS



Supplied with their own Index box. All plastic except as indicated.

Type No.	Size	List Price	1-11 or more Each
RB-3	3" (150')	.25	.17
RB-4	4" (300')	.55	.37
RB-5	5" (600')	.65	.44
RB-7	7" (1200')	.75	.50
RB-7M*	7" (1200')	.75	.50
RB-7P*	7" (1200')	1.25	.84
RB-10 1/2 M#	10 1/2" (2400')	4.50	3.00
RB-14 M#	14" (4800')	8.70	5.80

* Metal † Plastic Professional for IIIAP Tape # NARTB Metal

SHURE RECORDING HEADS



Fig. A

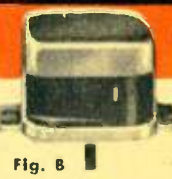

Fig. B

Fig. A — SHURE 815 TAPE RECORDING HEAD
Record — playback — erase. Upper track recording. Low impedance record — playback coil. Use of head doubles recording time of any size roll of tape. Records 1/2 side of standard 8mm 1/4" tape. Permits full hour of recording on 1200' of 8mm tape at 7 1/2" per second. Mounted in hum-shielded case. Uniform output; excellent frequency response. Shpg. wt., 4 oz.
SHURE 815 HEAD List 13.50 Net 7.94

SHURE TR5B TAPE RECORDING HEAD
Same as Model 815 except with 14-inch completely insulated leads and Cinch plug attached. Shpg. wt., 10 oz.
SHURE TR5B HEAD List, 15.00 Net 8.82

SHURE TR5K TAPE RECORDING HEAD
Record-playback-erase. High impedance coil. Upper track recording. Cinch plug attached. Shpg. wt., 8 oz.
SHURE TR5K HEAD List, 14.50 Net 8.53

Fig. B — SHURE 816 TAPE RECORDING HEAD
Record-playback. Upper track recording. High impedance record-playback coil. Excellent frequency response. Shpg. wt., 4 oz.
SHURE 816 HEAD List, 15.50 Net 8.17

WILCOX-GAY

PRESTOMATIC

PUSH-BUTTON KEYBOARD

TAPE RECORDERS

W-G TAPE RECORDIO

Wilcox-Gay, pioneer name in home recorders, has achieved in the Recordio a significant advance in tape recording progress. Never before has a unit so rich in fidelity, range and tone qualities been available for professional and home recording.

THE SPECIAL MODEL 5A W-G TAPE RECORDIO

Frequency Response—85 to 8,000 cycles. Wow & Flutter—0.5% and 1% I.P.S. Speed or R. and Reels—Uses "5", "7" reels. 35db minimum. Speed Selector, 3 1/2 and 7 1/2 I.P.S. Speech or Music. Radio-Phono-TV Input Jack. This low level input permits recording from Radio, Phono, or TV. Also used as low level constant output, Microphone, Hi-Fi Seal crystal, Record Lock Button. Prevents accidental erasure. External Speaker Jack. Full range variable control from maximum brilliance to a operation of external speaker. Tone Control—Full range variable control from maximum brilliance to a deep rich bass tone. Bass—Automatic, positive, exclusive. Volume Control—Bass and treble compensated for best reproduction. Power Requirement—115V AC—60 cycle. Public Address System—Speech or entertainment can be recorded at the same time the unit is being used as a public address system, with external speaker. Amplifiers—3 watts output. Fast Forward and Fast Reverse—Rewinds 7" tape in less than 2 1/2 minutes. Duplicating Tapes—Using two units—exact copies can be made. Tube Complement—6AV6, 12AX7, 6X4. Standard Accessories—Microphone, 3" reel tape, 5" empty reel, line cord. Size—14" x 12" x 6". Wt. Approx. 26 1/2 lbs. U.L. Approved. Net 86.63

Model 5A, Tape Recorder—Dual Speed—3 1/2 and 7 1/2 I.P.S. List, 129.95 Net 97.47
Model 5M, Tape-Recordio—Dual Speed—3 1/2 and 7 1/2 I.P.S. List, 149.95 Net 105.37
Model 5B, Tape-Recordio—Dual Speed—3 1/2 and 7 1/2 I.P.S. Dual Speakers—Tape Timer. List, 169.05

W-G MODEL 5F THE DELUXE TAPE RECORDIO

Never before has a unit so rich in fidelity, range and tone qualities been available for professional and home recording. Powerful enough to meet any volume requirement... sensitive enough to pick up the faintest whisper... with High Fidelity, Stereophonic 3D Sound. FREQUENCY RESPONSE: 70 to 10,500 cycles. WOW & FLUTTER: .5 @ 7 1/2 I.P.S., .5 @ 3 1/2 I.P.S. SIGNAL TO NOISE: 35 db minimum. SPEED SELECTOR: 3 1/2 and 7 1/2 I.P.S. PUSH-PULL AMPLIFIER: Delivers 7 watts of undistorted output. DUAL SPEAKERS: 10" and 7" speakers. REEL LOCK: 3" 5" 7" reels. VISUAL TAPE INDEX: Any selection on tape located quickly by number. PUSH-BUTTON TYPE RECORD LOCK: Prevents accidental erasure. RADIO-PHONO-TV EXTENSION SPEAKER JACKS: To utilize any arrangement of external speakers. RADIO-PHONO-TV INPUT JACK: This low level input permits recording from Radio, Phono or TV. Also used as low level constant output in "play" position. BASEL MICROPHONE: Hi-Fi Seal Hi-Fi Crystal. TWO RECORD LEVEL INDICATORS: "Normal" and "Overload." TONE CONTROL: Full range variable control from maximum brilliance to a deep rich bass tone. VOLUME CONTROL: Bass and treble compensated for best reproduction. PUSH-PULL: Recording and playback. POWER REQUIREMENT: 115V AC-60 cycle. PUBLIC ADDRESS SYSTEM: Speech or entertainment can be recorded at the same time the unit is being used as a public address system, with external speaker. REMOTE CONTROL: Built-in accessory outlet permits "ON and OFF" operation from a distance. FAST REWIND and FAST FORWARD: Rewinds 7" tape in less than 2 1/2 minutes. DUPLICATING TAPES: Using two units—exact copies can be made. TUBE COMPLEMENT: 6Y3, 12AX7, 12AV7, 6AQ6 (2). STANDARD EQUIPMENT: 3" reel tape, empty 7" reel, microphone, built-in line cord, Radio, TV, Phono recording cord. SIZE: 10" x 15 1/2" x 14 1/2". Wt. 35 lbs. U.L. Approved. Model 5F, Tape-Recordio—Dual Speed—3 1/2 and 7 1/2 I.P.S. Push-pull Output, Dual Speakers, Tape Timer. List, 199.95 Net 119.97

MODEL 5A



MODEL 5F

119.97

W-G RECORDIO ACCESSORIES

HC-12 Remote Hand Control with 18 ft. Connecting Cable and Plug for 4A, 4B, 4F, 5F Series only. List, 9.95
9-2221-1 Microphone extension cord complete with connectors 12 1/2 ft. List, 3.00
9-2221-2 Microphone extension cord complete with connectors 25 ft. List, 5.50.
20-233 Radio-Phono Recording Cable for 3, 4 and 5 aeries (except 4C10). List, 1.85
9-2240 Patch Cord for Duplicating Use with 3, 4 and 5 aeries (except 4C10). List, 1.45

PENTRON Monomatic Tape Recorder



PENTRON
PACEMAKER

PENTRON
CLIPPER

PENTRON CLIPPER TAPE RECORDER MODEL RWN DUAL TRACK DUAL SPEED

MONOMATIC CONTROL: MONOMATIC is a single knob control providing instant selection of Record or Play, in either 7 1/2" or 3 1/2" tape speeds, as well as Fast Forward and Fast Rewind. Any position may be selected by a flick of the finger in either tape speed. TWO TAPE SPEEDS: 7 1/2" and 3 1/2" per second. STRAIGHT-LINE SLOT LOADING OF TAPE. OPERATES IN ANY POSITION. 2 INPUT JACKS: Microphone input jack for recording from microphone. Radio input jack for recording direct from radio, TV sound or phonograph. 2 OUTPUT JACKS: Auxiliary Speaker Jack for direct connection to any external speaker. AUXILIARY AMPLIFIER Jack for direct connection to any external amplifier. FAST FORWARD AND FAST REWIND: UP TO THREE HOURS RECORDING AND PLAYBACK on 7" reel (using new long play tape). RECORD-PLAYBACK and ERASE HEADS FEATURE REMOVABLE POLE PIECES. MATCHING MICROPHONE INCLUDED. COMPLETELY PORTABLE AND SELF-CONTAINED. GENEROUS STORAGE AREA FOR ACCESSORIES. SIGNAL TO NOISE RATIO: 42 db. SEPARATE RECORD-PLAYBACK and ERASE HEADS. Exclusive Pentron design features removable pole pieces; professional quality. SPEAKER: 4x6 Oval Alnico V. POWER OUTPUT: 4 watts. RECORD LEVEL INDICATOR: Neon Bulb. MOTOR: Powerful, heavy duty, constant speed, perfectly balanced. TUBE COMPLEMENT: 1-5879, 1-12AX7, 1-6AQ6, 1-6X4 rectifier. OVERALL DIMENSIONS: 15 3/4 x 13 3/4 x 8 1/2" H. Line Voltage: 105-120 volts AC 60 cycles. Wt. 23 lbs. Net 99.50
PENTRON CLIPPER, List 120.50

PENTRON PACEMAKER TAPE RECORDER MODEL T-90

FREQUENCY RANGE: 7 1/2" per sec. -50 to 10,500 cycles. 3 1/2" per sec. -50 to 8,000 cycles. RECORDING TIME: 3 hours on 7" reel using new long play tape. CAPACITY: 90 minutes at 7 1/2" per second. 3 hours at 3 1/2" per second. CONTROLS: UNIMAGIC CONTROL—single level control for Play or Record, Fast Forward and Rewind—separate magnetic control into Play position. ONE KNOB SPEED CHANGE for 7 1/2" or 3 1/2" tape speeds. VOLUME CONTROL with off-on switch. TONE CONTROL for continuously variable response with motor off-on switch. SIGNAL TO NOISE RATIO: 35 db. SEPARATE RECORD-PLAYBACK and ERASE HEADS. Exclusive Pentron design features removable pole pieces; professional quality. SPEAKERS: 2 Alnico V; 1 woofer 1 tweeter. POWER OUTPUT: 4 watts. RECORD LEVEL INDICATOR: Neon Bulb. MOTOR: Powerful, heavy duty, constant speed, perfectly balanced. TUBE COMPLEMENT: 1-5879, 1-6SL7, 1-6AV6, 1-6X4. Overall Dimensions: 13 x 15 x 10". Wt. 27 lbs. For 105-120 volts AC 60 cycles. Net 139.50
PENTRON PACEMAKER, List 189.50

PENTRON RECORDER ACCESSORIES

X-166 Accessory cord with standard plug for recording from external radio or phono. List, 2.50
X-167 Extension mike cord with standard plug. List, 7.50
X-310 Accessory cord with miniature pin plug for recording from external radio or phono. List, 2.00
X-311 Extension microphone cord with miniature pin plug. List, 7.00 Net 5.25

MASCO 500 TAPE RECORDER

The new Masco 500 is packed with features. Instant selection of either 3 1/2" or 7 1/2" inches per second speeds. Dual track recordings up to 2 hours on standard 7"—1250 ft. reel, or up to 3 hours on new "thin" tapes. Has inputs for microphone and radio-phonograph. Outputs for external amplifier and external speaker. Frequency response from 30-12,000 cycles ± 3 db at 7 1/2" per sec. Wow is less than 0.3%. Signal to noise ratio better than 45 db. Has 2 recording level indicators. Simple to operate; one knob does all the work. No tape spillage or breakage. Safety "record lock" button prevents accidental erasures. Monitor switch to cut internal speaker in or out. High speed forward and rewind—instantly reversible—winds 1250' reel in 1 1/2 minutes. Patch cord enables direct recording from phono pickup or from radio or TV set; also used to play recorder through your hi-fi speaker or amplifier. Standby position keeps machine ready to record. Power output 5 watts. Truly portable—weighs only 23 lbs. Complete with ceramic microphone with 10 ft. cable, 7" reel with 625 ft. tape, 7" empty takeup reel and 6 ft. patch cord. Shng. Wt. 28 lbs.

- Two-speed, Dual Track
- Single Shift Knob Control
- High Speed Forward and Rewind
- Two Inputs—Two Outputs
- Instantaneous Stop

121.47



MASCO 500.....NET 121.47

AUDIO HEAD DEMAGNETIZER



When a recording machine leaves its factory, the heads are unmagnetized. However, music and speech consist of a series of transients, often not symmetrical in peak value. Other asymmetrical transients may occur in line noise, in starting and stopping the machine, and particularly during tests. The effect is cumulative, and after a week of steady use the recording head may have picked up enough magnetism to raise the noise level by several db and to increase second harmonic distortion slightly. The Audio Head Demagnetizer, Type No. 400, is an AC magnet assembly provided with extended pole pieces shaped to fit the contour of the recording head. Properly used, this head demagnetizer will remove any permanent magnetism which may have accumulated in the recording head—thereby reducing noise level which is attributable to this cause.

THE AUDIO HEAD DEMAGNETIZER— No. 400—List \$12.00.....Net 7.05

7.05

You Can't Beat LAFAYETTE'S



BEST BUY
3-SPEED
PORTABLE PHONO

15.95

With this portable phonograph you can play any record up to 12" size at 33 1/3, 45 or 78 r.p.m. A simple slide switch selects the proper speed. The light weight pickup arm is equipped with an all-groove needle—one needle for all records. The phonograph amplifier has a selenium rectifier and

drives a fine Alnico V speaker. The volume control is equipped with an on/off switch—the entire unit designed to provide shock proof operation. Attractive 2-tone case. For 110 Volts 60 cycles only. Size: 12 1/2" x 10 1/4" x 5 1/4". Shpg. Wt. 10 lbs. PH-26—3-speed portable phono. NET 15.95

THE LAFAYETTE STAR

- With G.E. Variable Reluctance High Fidelity Cartridge!
- Dual Sapphire Styl!l
- 6" x 9" Alnico V Wide Range Heavy Duty PM Speaker

UNBELIEVABLE QUALITY AT AN UNHEARD OF PRICE

This new deluxe 3-speed phono incorporates the famous G.E. RPX-050A triple-play cartridge with frequency response to 10,000 cycles in a special lightweight arm. The G.E. magnetic cartridge has two sapphire needles to play standard and LP records; with remarkable fidelity. Built-in preamplifier for G.E. magnetic cartridge. Large size 6x9" oval PM speaker, amply baffled in a large size chamber to give clean undistorted output. Size: 14" x 9" x 16". Finished in Mahogany or Oak wood grain leatherette with gold grilles. Shpg. wt., 16 lbs. PH-25. Net 35.45



PLAYS ALL SPEEDS ALL SIZES

\$35.45



THE LAFAYETTE "STANDARD"

23.95

• Dual Turnover Cartridge With Dual Styl!l
A standby for years, the Lafayette Standard has been restyled. In an especially attractive case. Plays any size record up to 12" with this new extremely compact portable 3-speed phono player. A simple slide switch instantly regulates the motor for 33 1/3, 45 and 78 r.p.m. Precision built motor for "wowless" reproduction at all speeds. Has amplifier with long-life selenium rectifier and Alnico V speaker. Volume and tone controls. Turnover cartridge with two needles. Shockproof, heavy-duty, constant 3-speed motor. Covered in your choice — of Tan, Brown, or Maroon saddle or Grey Shantung, white beaded. Size: 15" x 11" x 6". Shpg. Wt. 12 lbs. PH-29

NET 23.95

PORTABLE AUTOMATIC 45 RPM RECORD CHANGER - PLAYER

- Plays a Stack of 14 45 RPM Records Automatically.
- Completely Self Contained -No Need to Connect to Radio

An attractively styled portable phonograph for all types of 45 RPM records. Self contained powerful amplifier and Alnico V speaker. Automatically changes records; plays a full stack of 14 for up to 2 hours of continuous music. Has full range volume control. Wood case, with lock corner construction, is covered in wood grain leatherette. Truly portable, only 8 1/4" x 7 1/4" x 11 1/4". Shpg. Wt. 9 lbs.

PH-42

NET 24.95



PORTABLE CLOCK RADIO and 3 Speed Phono Combination

A Deluxe Portable clock-radio and 3 speed phonograph combination of fine quality, good looks, versatility and low price. A five tube superhet circuit covers the entire broadcast band. Efficient built in loop antenna brings in signals sharp and clear. A Genuine Sessions Electric clock will start phonograph or radio. Has heavy duty Alnico V PM speaker. Phonograph plays all 3 size records in all 3 speeds with lifelike reproduction and minimum distortion. Has dependable rim-drive, constant speed motor. Lightweight pick-up arm with dual purpose needle to play all 3 speeds. Sturdy all wood portable case covered with Mahogany or Oak wood grain, size 10 1/4" x 12 1/2" x 8. Shpg. Wt. 15 lbs. For operation from 105-125 Volt AC.

PH-41

Net 32.50

3-SPEED PHONOGRAPH WITH DUAL SPEAKERS

21.35

Plays all speeds and all sizes through 12". Two Alnico V speakers one on each side of case, gives greater dispersion of sound. Lightweight tone arm is equipped with universal all purpose needle. Has both volume and tone controls. Heavy duty constant speed motor. Attractive 2-tone covering. Size: 12 1/2" x 11 1/4" x 8". Shpg. wt., 10 lbs. PH-27

NET 21.35



DELUXE 3-SPEED AUTOMATIC PLAYER

- V-M Intermix Record Changer Shuts Off After Last Record
- Turnover Cartridge—Dual Styl!l
- 6" Alnico V P.M. Speaker

49.50

This deluxe 3-speed portable phono with automatic 3-speed V-M changer will reproduce a stack of 33 1/3, 45 or 78 rpm records automatically. Powerful amplifier uses 2 tubes and has a separate rectifier. Fine Alnico V 6" PM speaker for excellent tone and volume. Featherweight pickup features a dual reversible cartridge—each with its own long-life needle. Separate volume and tone controls. Provides instant changeover to play 78 rpm and both speeds of LP records. Plays all records with lid closed. Quiet, smooth operating changer for years of trouble-free performance. Covered in two-tone green and beige. Size 20 1/2" x 13 1/2" x 8 3/4"; 25 lbs. For operation on 110-120 volts, 60 cycle AC. PH-34

Net 49.50



HI-FIDELITY PORTABLE AUTOMATIC 3 SPEED PHONOGRAPH

- COLLARO—the world's finest HI-FI Intermix Record Changer
- G.E. Variable Reluctance Triple Play Cartridge
- Dual Sapphire Styl!l

It took a whole page elsewhere in this catalog to describe the fine features of the world famous Collaro changer made in England. Powerful 4-pole motor, weighted turntable and featherweight tone arm both mounted on ball bearings, jam-proof mechanism, automatic muting switch—are a few of its features. It's equipped with the equally famous G.E. high fidelity triple-play RPX-050A cartridge that covers a frequency range of 25-20,000 cycles! Add to this a heavy 8" wide range speaker, full range tone control and volume control, a triple negative feedback circuit, tone compensating network, and an excellent amplifier—and you have a real high fidelity phonograph. Covered in green or maroon monique with linen trim and gold grilles. Size 18 1/2" x 15 1/2" x 9". Shpg. Wt. 26 lbs. PH-35

Net 69.50



SALE!

EXCLUSIVE!

VHF-UHF TUNER



QUANTITY LIMITED ORDER YOURS NOW!



5.45 EA
In Lots Of 3
Singly
5.95

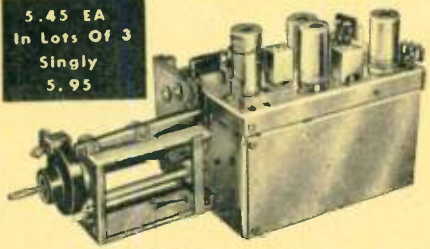

VHF-UHF FIG A

4.45 EA
In Lots Of 3
Singly
4.95

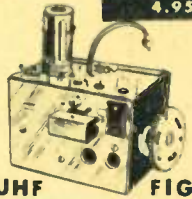

UHF FIG B

5.45 EA
In Lots Of 3
Singly
5.95

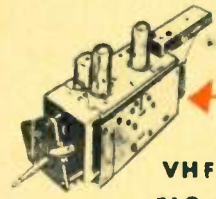

VHF FIG C

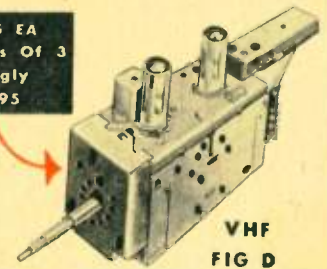

VHF FIG D

Brand new genuine RCA TV tuners complete with tubes and diodes. These tuners are exact replacements for over 160 popular RCA 17 to 27" sets. Quantities are limited and they won't last long at these prices.

RCA TUNER MODEL	RCA STOCK NUMBER	TYPE	TUBES AND DIODES	FIG.	SHPG. WT.		In Lots		RCA TUNER MODEL	RCA STOCK NUMBER	TYPE	TUBES AND DIODES	FIG.	SHPG. WT.		In Lots	
					LBS.	Each	Of 3	Each						LBS.	Each	Of 3	Each
KRK-11A	77150	VHF	1 EA. 6BQ7A, 6x8	D	7	5.95	5.45	KRK-29B	78489	VHF	1 EA. 6BQ7A, 6x8	C	7	5.95	5.45		
KRK-11B	77662	VHF	1 EA. 6BQ7A, 6x8	D	7	5.95	5.45	KRK-12	77597	VHF/UHF	2-6BQ7A, 1 EA. 654, 6AF4 and 1N82	A	11	5.95	5.45		
KRK-22A	77845	VHF	1 EA. 6BQ7A, 6x8	D	7	5.95	5.45	KRK-12A	78335	VHF/UHF	2-6BQ7A, 1 EA. 654, 6AF4 and 1N82	A	11	5.95	5.45		
KRK-22C	77812	VHF	1 EA. 6BQ7A, 6x8	D	7	5.95	5.45	KRK-12C	78884	VHF/UHF	2-6BQ7A, 1 EA. 654, 6AF4 and 1N82	A	11	5.95	5.45		
KRK-29	78230	VHF	1 EA. 6BQ7A, 6x8	C	7	5.95	5.45	KRK-27	78251	UHF	1 EA. 6AF4, 1N82	B	4	4.95	4.45		
KRK-29A	78416	VHF	1 EA. 6BQ7A, 6x8	C	7	5.95	5.45										

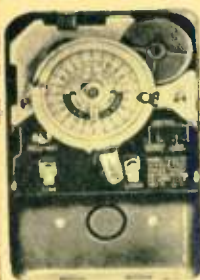

INDUSTRIAL TIMER SWITCH

4000 WATT CAPACITY
Turns equipment "on" and "off" once in 24 hours, or from one to twelve "on" and "off" operations a day can be obtained by use of extra trippers. Extra trippers can be added without removing dial. Min. on or off time 1 hr.—max. on or off time 23 hours. Can be turned on or off manually with reset SPST switch rated at 35 amps. Has convenient mounting holes and knockouts. Large numbers—easy to read—easy to set. Gray steel case with knockouts—hinged door—can be locked or sealed. UL approved. Operates on 110 volt 60 cycle AC only. Size 7 1/2" L x 5" W x 3" D. Shpg. Wt. 4 lbs.
MS-82 Net 7.12

INTERMATIC TIME-ALL 7.97

THE AUTOMATIC TIMER WITH THE MIRACLE MEMORY
Makes practically everything electrical completely automatic. Will handle load up to 1050 watts. Turns radio on and off—does not have to be reset each night. Defrosts refrigerator—turns lights on and off—controls roaster, electric blanket, air conditioner, washing machine, coffee maker, vaporizers, etc. 30 min. minimum on time—23 hours maximum. As easy to set as an electric clock. Stands on any surface—can be hung on wall. Easy-to-read 24 hour "day and night" dial. Operates day after day without attention. Can be controlled manually without automatic reset. Plug in receptacle for equipment to be controlled. For 110 volt 60 cycle AC only. Complete with 6 ft. cord and plug. Instructions included. 5"x4"x2 1/2". Shpg. Wt. 2 lbs.
MS-81 Net 7.97



PORTABLE TWO SPEED PRECISION TIMER



TWO TIMERS FOR THE PRICE OF ONE!
IDEAL FOR HOME, OFFICE, SCHOOL OR LABORATORY WORK REQUIRING CRITICAL 1 SECOND TO 1 HOUR TIMING!
Indispensable for timing precise, short operations such as boiling eggs, pressure cooking, heat and sun lamp treatment, photo printing, long distance calls, etc. It times up to 1 hour in minutes, and up to 6 minutes in seconds. Timing speed instantly changed by the flick of a fingertip lever. A clear, resonant bell sounds at end of timing period. Attractive portable white plastic case, white and chrome dial, white knob. 3 3/8" x 3 3/8" x 2-11/16". Shpg. wt. 2 lbs.
MS-147 NET \$3.70

TIME SWITCHES FOR WALL BOX INSTALLATION



A dependable and versatile time switch to automatically turn off attic fans, porch and garage lights, window lights, heating units, etc. at any preset time. Has special HOLD feature: turn of a knob cuts out timing mechanism and allows unit to be used as a regular toggle switch. Capacity 20 amps, 125 volts AC. Satin-chrome dial 4 1/2" H x 3" W; switch 2 1/2" H x 1 3/4" W x 1 1/4" D. Fits any standard rectangular wall box, Shpg. wt. 3 lbs.
MS-135—time range up to 1 hour Net 4.46
MS-136—Time range up to 12 hours Net 5.21

4 BUTTON ALARM TIMER SWITCH



SLEEP SWITCH
BUZZ ALARM
AUTOMATICALLY TURNS ON RADIOS, ETC.
We've done it again. We bought up the overstock of an equipment manufacturer to bring you this automatic 4-button timer at a giveaway price. Turns on radios, TV sets, toasters, etc. at any preset time within 12 hour period. Built-in SPST switch handles up to 15 amp 115 volts. Has sleep switch so you can go to sleep to music—it will automatically shut off radio at preset time up to 90 minutes. And it also tells time. For 110-120V 60 cycle. Shpg. Wt. 1 1/2 lbs.
MS-105 Net 5.70

FAMOUS MAKE TIMER SWITCH

BELOW JOBBER COST!
Another Lafayette Scoop! A radio manufacturer, making clock radios, overpurchased on electric clocks—needed the cash—liked our gran-backs, and Lafayette got the deal. Automatically turns on radios, television sets, toasters, coffeemakers, etc.—at any pre-set time within 12 hour period; also tells time. Built-in single-pole switch handles up to 15 amp, 115 volt. Requires 3 1/2" diameter round hole. Depth behind dial face 2 1/4".
UL approved. For 105-125V, 60 cycle AC. Shpg. Wt. 1 1/2 lbs.

\$395



Stock No. MS-62

PHONO PRICES SLASHED!



BUILD YOUR OWN RECORD PLAYER

Mr. Serviceman—Now you can build your own record player with these economical build-your-own kits. Each kit contains a rim drive motor with velvet finish turntable, a 5" PM speaker with matching output transformer, a two-tube AC-DC amplifier with tone and volume control complete with tubes, 3 SPEED KIT has turnover cartridge with two needles; single speed has single cartridge with all purpose needle.

SINGLE SPEED KIT
78 RPM

Complete kit as described above.
Shpg. wt. 9 lbs.
Stock No. KT-10

\$9.95
e.o.

3 SPEED KIT
33 1/2-45-78 RPM

Complete kit as described above.
Shpg. wt. 9 lbs.
Stock No. KT-11

\$12.95
e.o.

3-SPEED PHONO MOTOR WITH TURNTABLE

Plays 33 1/2, 45, and 78 RPM records. Quiet dependable operation assured by rubber shock-mounted friction motor. Speed change control permits instantaneous shifting of proper idler for desired speed. Mounting centers 4 1/4" 3/4". Depth below base mounting plate 2 1/4". For 110V, 60 cycles AC. Shpg. wt. 3 1/2 lbs. List Price \$10.95.



SINGLE SPEED PHONO MOTOR WITH TURNTABLE

Same as above but for single speed only.

Stock No. ML-13.....Net **4.95**
NO. PK-50—MOUNTING BOARD for Motor.....Net 1.46

Stock No. ML-12.....Net **3.49**
NO. PK-43—MOUNTING BOARD for Motor.....Net 1.46

WOOD BASES FOR 3 SPEED RECORD CHANGERS



4.95

Wood bases of finest veneer cut to fit Garrard changer, Garrard player, Webster, V-M, Collaro, G.I. Smoothly joined, attractively finished in dark mahogany or blond. Specify finish and model changer.

MAHOGANY.....NET **4.95**
BLOND.....NET **4.95**
GARRARD MODEL T BASE.....NET **4.95**

MOUNTING BOARDS FOR RECORD CHANGERS



1.46

Strong, durable 1/4" gumwood, smoothly sanded and cut out for Garrard, Collaro, Webster, V-M, Collaro, G.I. Unfinished for easy staining. Specify for particular model changer desired.

MOUNTING BOARD.....NET **1.46**

5 WATT MIKE PHONO AMPLIFIER

15.75

STOCK NO. ML-35



A compact, 5 watt amplifier with many applications, such as, low powered P.A. System, Paging System and Phonograph amplifier. It is designed to be used with either a microphone and/or phonograph. Separate inputs and gain controls are provided for microphone and phonograph. The latest compensated tone control circuit is used and is effective on both inputs. AC "on/off" switch incorporated on tone control. Inputs: 1 microphone, 1 phonograph. Controls: 1 tone, 1 microphone, 1 phonograph. Output impedance 32 ohms. Supplied complete with tubes: 1-6SL7GT, 1-6V6GT and 1-6X5 rectifier. Size 8 1/2 x 5 x 5 H. For 110 Volts AC operation only. Shpg. Wt. approx. 10 lbs. **15.75**

WIRELESS BROADCASTER

- Play your phonograph through any radio anywhere in the house without connecting wires.
- Talk through your radio by microphone.

9.75



Lafayette's new wireless broadcaster will extend your enjoyment of your phonograph to every room of the house that has a radio. After connecting the phono, you simply tune in on the radio just like any radio station. Frequency adjustable for reception between 700 KC and 1700 KC on broadcast band — pick your spot so it will not interfere with regular broadcasts.

Has provision for crystal, G.E. and magnetic cartridges. Also has input for crystal microphones as well as low impedance magnetic microphone, so you can broadcast your voice through the radio. Extremely quiet and distortionless.

Plenty of power. Circuit has 12SC7, 12SK7GT tubes plus selenium rectifier. Volume control with on-off switch. Handsome gray hammerstone finish chassis 4 7/8" W x 5 3/4" D x 1 1/2" H. Shpg. wt., 4 lbs. Completely wired and assembled with all tubes and operating instructions. For 110V AC/DC operation.

LA-14
PA-24 Crystal microphone

NET **9.75**
NET **4.25**

SHIELDED PHONO LEADS



40" long shielded phono cable. Over-all Polyethylene insulation. Ideal for phono connections or for testers.

MS-80.....Net 27c ea.
In lots of 10.....**24c ea.**

PHONO PICKUP ARM

Shell only. With threaded stud for mounting. Takes any standard cartridge.

PK27.....**.79ea**



PHONO OSCILLATOR

4.95



For use with all types of phonos. Compact, well-built unit, tuned within broadcast band. Completely wired ready for use. Supplied with RCA type phono tubes, 1-12BE6 and 1-35W jack, hant antenna, 6 ft. AC cord. For 118V AC/DC operation. Shpg. wt. approx. 2 lbs.

PK-25.....**4.95**

2-TUBE PHONO AMPLIFIER

3.50 with Tubes



A two tube phono amplifier using a 50L6 and 35Z5 tube as rectifier. Well-built, good tone and volume. Contains volume control with switch. AT A BIG SAVING!
PK-24—Two tube amplifier **3.50**
COMPLETE WITH TUBES

AC-DC Phono Amplifier

3.25



Equipped with a variable tone control and a separate volume control. Delivers two watts output. Phonograph motor connects to the amplifier. Uses 50L6, 12SQ7, and 35Z5 rectifier. For 110-120V, 60 cycles AC or 110-120 V. DC. Supplied with line cord and plug, but less tubes. Shpg. wt. 2 lbs.

PK-23.....**3.25**

AND DON'T FORGET LAFAYETTE'S MONEY BACK GUARANTEE

Sensational! REMOTE CONTROL FOR SILENT T.V. VIEWING



- SIMPLE TO ATTACH TO ANY TV SET OR RADIO
 - SEE AND HEAR—NOISELESSLY—CONVENIENTLY
 - LOOK AT THESE FEATURES!
1. **FOR LATE LISTENERS.** One or two people can both see and hear the program with the loudspeaker cut off. Tops for enjoying the late-late show without disturbing the rest of the household or the neighbors.
 2. **FOR HARD OF HEARING.** They can see and hear without turning the set volume so high that others can't stand the noise. They can listen either with the loudspeaker cut off or, if the rest of the family want to hear, with the speaker on.
 3. **FOR NOISY PROGRAMS.** Don't let the kids' "Wild Westerns" bother you. Let them view and listen with the speaker cut off.
 4. **FOR NORMAL OPERATION.** Does not affect your regular use of the T.V. set. Does not have to be disconnected from set.
 5. **REMOTE CONTROL.** Comes complete with 20 ft. of cable so it can be operated comfortably from a distance. Has its own volume control, speaker on-off switch, and two sets of jacks so either 1 or 2 ear phones can be connected.
 6. **DYNAMIC EAR PHONE.** Set is supplied with one of ARGONNI exclusive HI-FI dynamic miniature earphone. Highly sensitive and efficient. Phone is complete with 3 ft. cord and tips, ready to insert in control box.
 7. **CONVENIENT.** Size only 3 1/4" x 2" x 1 1/4". Complete with 1 earphone and 20 ft. cable. Completely wired with instructions. Shpg. wt. 3 lbs.

MODEL MS-128 NET 6.50

EXTRA EARPHONE

To plug in to extra jacks on control box so two can listen. MS-124 NET 1.95



A QUALITY HEARING AID at an UNBELIEVABLE PRICE

QUALITY BUILT FOR YEARS OF OUTSTANDING PERFORMANCE



29.95

- Completely self contained Batteries slip into your Breast Pockets.
- 3 Position TONE CONTROL. You select the tone best suited to your ear.
- Powerful Amplifying System.
- Extra Sensitive Microphone. Its pickup will amaze you.
- Continuously variable Volume Control.
- Tiny Sensitive Dynamic Ear Receiver.

10 DAY FREE TRIAL—MONEY BACK GUARANTEE

Lafayette brings to the hard of hearing for the first time a new modern streamlined hearing aid at 1/3 the usual price for instruments of this quality. It has everything! First, it's modern. Small, about the size of a pack of cigarettes, it slips neatly into a breast pocket with only a fountain pen type clip showing. Actual size is 3 1/4" H x 2 3/4" W x 1/2" D. Weighs only 5 ozs. with batteries. No extra pouch or bag to carry batteries—it's completely self contained, operating on 3 small batteries inside the case. Special hinged back makes replacement simple. The tiny dynamic ear receiver fits snugly and inconspicuously. Second, it's functional. Has tremendous sensitivity and power for severe cases of hearing impairment yet with the smooth volume control you can set it for your particular condition or for the various requirements of daily living—the home, theatre, radio, etc. Clarity of tone and intelligibility are further insured by a 3 position tone control giving you a choice of emphasis on any particular range of tones to satisfy the needs of different acoustical conditions. Thirdly, it's economical. Only Lafayette's tremendous purchasing power could import an instrument to sell at such a price, backed by this 1 year warranty. We'll replace any defective parts (except batteries and cords) due to normal usage for 1 year after date of purchase without charge. Supplied complete with batteries installed and slipper carrying case. Shpg. Wt. 3 lbs.

Model MA-100—Complete. Net 29.95

REPLACEMENT BATTERIES

Both models use 1 each of following:

BURGESS type Z — 1 1/2 Volt 7c
BURGESS type Y18—22 1/2 Volt 87c

EXTRAORDINARILY
POWERFUL YET
SMALL IN SIZE



QUANTITY LIMITED SPECIAL ...ORDER NOW

TIMEX MAGNETIC DISC RECORDER

- A RECORDER AND PLAYBACK MACHINE PLUS A 45 RPM RECORD PLAYER

There's a limited quantity of these units that originally sold at \$9.95. Records either from microphone or directly from radio or T.V. on thin coated magnetic discs. You can erase and use the discs over again thousands of times. The discs can be folded and mailed to any other Timex owner. You can record at either 45 RPM or 16-2/3 RPM. Has built in 4 tube amplifier with 12AX7, 6C4, 50C5 and 35W4, and plays back through its own PM speaker. With addition of record player kit below it will play all standard 7" 45 RPM records. Recorder comes complete with Shure microphones, magnetic eraser, patch cord for recording directly from radio or TV without using microphone, and 1 recording disc. Beautiful case, finished in mahogany and gold, measures 9 1/2" x 11 1/2" x 3" high. Shpg. wt., 11 lbs.

TIMEX RECORDER Net 29.95

TIMEX RECORD KIT

Contains a plug in head with phono cartridge, and center hole adapter. Use to plug regular 45 RPM records.

TIMEX RECORD KIT 3.96

MAGNETIC RECORDING DISCS

Package of 6 discs
1.19

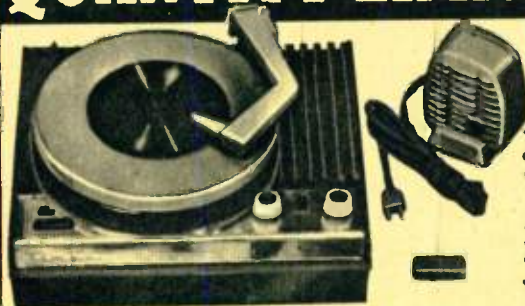

URANIUM HUNTERS

PROSPECTORS - ENGINEERS - HOBBYISTS

PRECISION RADIATION

108
GEIGER
COUNTER

29.95



New, low priced Geiger counter featuring high sensitivity to radio-active substances and extremely compact design. Fits in pocket or palm of hand. Detects uranium ore, cosmic rays, radium and x-rays by instantly producing a loud series of clicks in earphone. The number of clicks increases as counter approaches source of radio-active material. Uses a miniature amplifier tube, one 22½V, hearing aid battery and one flashlight battery. Replacement cost of batteries is nominal. They are easily changed by anyone without use of tools. Geiger tube operates at 300V, and is protected by an automatic safety device which prevents excessive voltage. Strong plastic case 1½x3x5". Supplied complete with headset, batteries, radio-active sample and instruction.

Precision Radiation Model 108—
Shpg. wt. 3 lbs. 29.95

New!

EICO

GEIGER
COUNTER

KIT
19.95



Simple to use. Rugged, dependable, super-sensitive—at the industry's lowest cost! Excellent for prospecting, industrial, scientific and civil defense work. Finds even poor uranium deposits almost as well as little as .01% uranium; .03 milliroentgens/hour. Dual simultaneous indications: flashing neon panel lamp; and clicks from headphone plugged into panel jacks—you can detect even while you ride your car! All-electronic battery-operated circuit with no moving parts. Super-sensitive 300-volt geiger tube with very-thin brass envelope. Tube is more rugged and sensitive, and sensitive along a greater part of its length than corresponding glass type geiger tubes. Tube life is 500 million to 1 billion counts. Sensitivity is 3000 counts/min/hr. Radioactive test sample supplied. SPECIFICATIONS: Tubes—2-11½". Power Supply—900-volt, induction coil, low-drain type. Potentiometer adjustment of voltage permits operation over entire battery life. Size: 7 x 4½ x 2¼". Sturdy drawn-aluminum case; hammerhead finish.

No. 803K—Less 2-67½V & 2-1½V batteries 19.95

PRECISION
RADIATION
GEIGER
COUNTERS

99.50



Professional type, extremely sensitive unit detects beta particles as low as 160 K.E.V., as well as gamma rays, x-rays and cosmic rays. Has all three ways of indicating radio-activity: neon flasher, earphone and 3-range meter—.2, 2 and 20 milliroentgens/hr. full scale. Detects even the faintest traces of uranium/hr. full scale. Detects regulator circuit eliminates need for any adjustments. Rugged, weatherproofed case, 3½x4½". Uses 2 flashlight cells and 2 small 45V. batteries. Earphone, batteries, carrying belt and tube included.

Model 106—Shpg. wt. 7 lbs. 99.50

Model 107—Same as above plus a directional, stainless steel probe enclosing Geiger tube. Sliding shield around probe used for discriminating between betas and gammas. 3-ft. polystyrene coaxial cable connects probe with case. Side clamps on case support the probe when not in use. Shpg. wt. 8 lbs.

Precision Radiation Model 107..... 139.50

CALIBRATED RADIUM STANDARD

Kit contains five certified radium standards covering the range from 100 to 1,000,000 disintegrations per minute. Standards are mounted on engraved discs. Each gold-plated standard is individually packed in a clear plastic box—all contained in a hinged case. Permanent standards are used to test and calibrate any counter, scintillator, ionization chamber, Geigerscope or any other detector. Supplied complete with handling forceps, plastic instrument cap and data sheet giving the certified alpha, beta and gamma activities of the five standards. Shpg. wt. 2 lbs.

MS-118..... Net 4.16

ULTRA VIOLET BULBS

Long Wave Ultra Violet Bulb: Powerful 250 watt ultra violet source. Fits ordinary 110 volt socket. The filter is built in—nothing else to buy. Produces fluorescence in many uranium minerals—other minerals—chemicals—oils—plastics—fabrics—etc. Perfect for fluoride bead test. Complete with data sheet on fluorescent materials. Shpg. wt. 8 ozs. MS-121..... Net 1.67

Short Wave Ultra Violet Bulb: Simple source of short wave ultra violet radiation. Produces fluorescence in tungsten ores—carbonates—and other materials which do not react to long wave UV. Produces ozone—deodorizes—sterilizes air. Gives full range of UV. Use with either 110V. or portable battery. Complete with special socket—simple diagram—direction and data sheet. Shpg. wt. 1 lb

MS-122..... Net 2.45

BEAD TEST KIT

One of the most sensitive means of detecting and confirming uranium minerals. Distinguish between uranium and thorium. The sodium fluoride bead test is used in conjunction with ultra-violet light. Only the best of materials are used in this kit. The chemically pure sodium fluoride meets American Chemical Soc. specifications. Kit contains enough for hundreds of tests. Purified platinum wire bead holder. Complete kit contains sodium fluoride, bead holder with glass handle, forceps and direction sheet. All in clear plastic case that fits your pocket. Shpg. wt. 1 lb.

MS-120..... Net 1.67

RADIOACTIVE ORE SPECIMEN KIT

Four rich mine samples from different parts of the country. Packed in a pocket size clear plastic box. Representative samples of all five commercially important radioactive ores. These are real "museum pieces". Help you to become familiar with physical properties of ores. Supplied complete with data sheet giving all the identifying characteristics and important mineralogical properties. Shpg. wt. 2 lbs.

MS-119..... Net 1.67

PROFESSIONAL GEIGERSCOPE

Detects Uranium and radio-activity. Designed for the prospector—chemist—civil defense worker—physicist—industrialist. Requires no power source—converts energy of alpha rays into visible signals. Will detect a smaller single crystal of radio-active mineral than a Geiger counter. Detects and measures any alpha-active isotope down to the range of a millionth of a microcurie. Sturdy—durable—portable as a pocket watch. Detects contamination of air—surfaces—hands—apparatus—measures fallout. Complete with radium standard—ore sample—air tight holster and instructions. Shpg. wt. 8 ozs.

MS-113..... Net 4.16

STANDARD MODEL

Similar to above, but less radium standard—eye piece—and holster. Includes ore sample and directions.

MS-114..... Net 98c

ATOMIC PROSPECTORS KIT



4.16

A complete set of basic tools for the prospector. Equally useful to the amateur and the professional. Includes a standard model Geigerscope for detecting radioactivity—steel goldpan—made to professional standards—panning instructions—Atomic Prospectors Handbook—magnifying glass—forceps—streak plate—magnet—uranium ore sample. Plus a bag of placer ore containing uranium, thorium, titanium, zircon, garnet and gold—for familiarizing yourself with the operations. Shpg. wt. 3 lbs. MS-115..... Net 4.16

ATOMIC PROSPECTORS HANDBOOK

Describes methods and apparatus used in field and lab. Detailed—concise—"all meat." Contains charts—maps—and illustrations. Clearly understandable. MS-116..... Net 59c

ULTRA VIOLET FLASHLIGHT



2.50

Brand new, inexpensive, completely portable ultra-violet light. Developed specifically for the uranium prospector. Special bulb, reflector and filter lens concentrates the long wave ultra-violet into a powerful beam. Will cause fluorescent uranium minerals to glow at a distance of ten feet or more. Compact, rugged and operates on ordinary flashlight batteries. Will also cause fluorescence in many other minerals and materials. Supplied complete with data sheet listing fluorescent minerals. Less Batteries. Shpg. wt. 2 lbs.

MS-117..... Net 2.50

BURGESS #2 Cells..... each 10c

TRANSISTOR Circuits & Kits



TWO TRANSISTOR RADIO RECEIVER KIT

Regenerative Detector with Transformer
Coupled Audio Stage

This compact regenerative transistor receiver kit has given more than ample earphone volume on broadcast stations located several hundred miles away. When used with a 60 ft. outside antenna, stations well beyond 1000 miles have been repeatedly heard right through the numerous superpowered N.Y.C. locals. This indicates its sensitivity and selectivity. This receiver makes a reliable receptor for emergency use during power failure, should a sudden air-attack occur. Though built for earphones, many of the local broadcasting stations can be received at moderate room volume on a PM speaker with a suitable matching transformer. For all around speaker operation LAFAYETTE'S KT-69 TRANSISTOR AUDIO AMPLIFIER KIT with Class "B" Push Pull Transformer (Argonne) coupled, may be added whenever the builder desires. Kit comes complete with TWO Transistors, Argonne Transistor Audio Transformer, Perforated Masonite 7x11 Board, allowing room to add additional audio stages for speaker operation, when desired, Schematic Diagrams Plus 115 page Book, showing more than 50 practical transistor circuits and How-To-Do-It Instructions. Shpg. Wt. 3 lbs.



Net 10.95

10.95

TRANSISTOR AUDIO AMPLIFIER

for SPEAKER OPERATION CLASS "B" PUSH PULL TRANSFORMER
COUPLED 1/4 WATT POWER OUTPUT

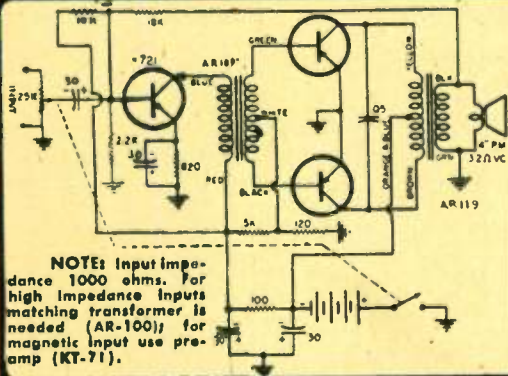

NOTE: Input impedance 1000 ohms. For high impedance inputs matching transformer is needed (AR-100) for magnetic input use preamp (KT-71).

Transformer coupling between transistor amplifier stages provides impedance matching and allows the use of less stages for the same overall gain than p-c interstage coupling. With the new Lafayette KT-69 Kit you can now build a self-powered (4-1 1/2 volt penlite cells) push-pull Class "B" transistor audio amplifier having a frequency response from 100-8,000 cps, and the overall power gain is in excess of 50 db. The Argonne Transistor Transformers used in the kit were specially designed for transistor circuits. An important feature of these transformers is their high inductance and low DC resistance. The total harmonic distortion at 400 cycles and 100 mw is 5%. Kit comes complete with 8 Transistors, 2 Argonne Push-Pull Input and Output Transformers, Battery Holders, Resistors, Aluminum Chassis, 8"x4"x1", and Schematic Diagrams.

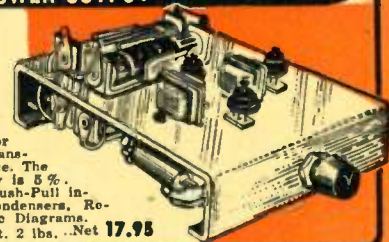

KT-69 Complete Kit including batteries Shpg. Wt. 2 lbs. Net 17.95

TWO TRANSISTOR PREAMPLIFIER KIT

Humless — Distortionless — Noiseless

To you, the experimenter, with the Lafayette KT-71 you can now build a simple transistor preamp, in a matter of hours, for a cost considerably less than that of the commercially available single-tube magnetic pickup preamplifiers. The overall result will be a noiseless, humless, and virtually distortionless amplifier. A straightforward circuit is used with grounded emitters and no tricky feedback (see diagram). The output impedance is very low and therefore long leads from the preamp cause no losses. The complete unit is mounted on aluminum chassis size 5"x4"x1" power supply and all. There are features to this little job not to be overlooked. The hum is practically zero. The hum pickup and microphonic susceptibility of the preamp are so low that the unit may be mounted directly below the arm on a changer. The kit comes complete with Two Transistors, Battery Holders, Resistors, Condensers, Aluminum Chassis, etc., and Schematic Diagram, and batteries.

KT-71 Shpg. Wt. 2 lbs. Net 8.85

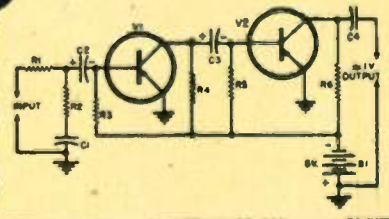

TWO TRANSISTOR POCKET RADIO RECEIVER KIT

With Regenerative Circuit and Transistor
Transformer Audio Stage

Packed into a 2 1/2" x 3 1/2" x 1 1/4" Plastic Case, this Two Transistor Radio Receiver Kit offers many surprises. Regeneration "Soups Up" the performance of transistor Receivers. Simple transistor radios without regeneration are just crystal detectors followed by audio amplification and there is no R.F. amplification, and sensitivity and selectivity are always poor. In contrast With this, this Lafayette Kit, KT-68, utilizing a regenerative detector circuit and one stage of transformer coupled audio, gives you high gain and sharp selectivity. In the wee hours, you may pull in stations halfway around the country. At the beach, on picnics or camping trips, the set will deliver almost any station on the dial, with more than ample volume. It has more battery life than you would dream of getting from a flay 15 volt battery. The kit comes complete, with TWO TRANSISTORS, Argonne specially designed Transistor Audio Transformer, Dynamic Earphones, Bakelite Board for mounting parts, Transparent Plastic Case, Condensers, Resistors, etc., including Schematic and Instructions. Shpg. Wt. 1 1/2 lbs.

KT-68A—Complete kit with batteries but less earphones. Net 11.80
KT-68—as above but with MS111 crystal earphones. Net 13.30
MS-260—Super power, high output dynamic earphone for optimum results. Net 3.95



11.80

LESS EARPHONE

TRANSISTOR CODE PRACTICE OSCILLATOR KIT

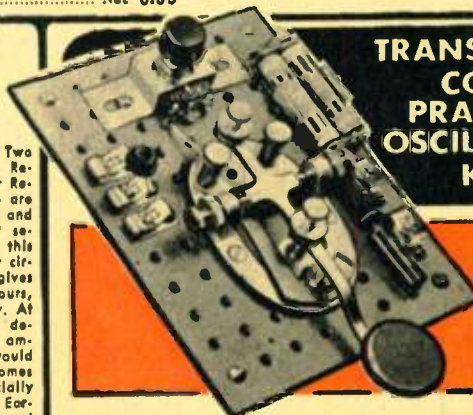

2.99

For those interested in mastering the international code, an audio tone oscillator is essential. The circuit of this transistorized feedback oscillator has the simplicity of the neon glow, the signal strength of the vacuum tube, and requires only two penlite cells for weeks of service. It may be used for solo practice, or two may send and receive with the same unit. Kit comes complete with Transistor, Telegraph Key, Resistors, Condensers, Masonite Board, etc., and Schematic Diagram.

KT-72 Including batteries Shpg. Wt. 1 1/2 lbs. Net 2.99
Cannon ECI — Single Headset Net 1.13

LAFAYETTE

Leads the Field in

TRANSISTORS Circuits Kits & Components



5 TRANSISTOR AUDIO AMPLIFIER KIT

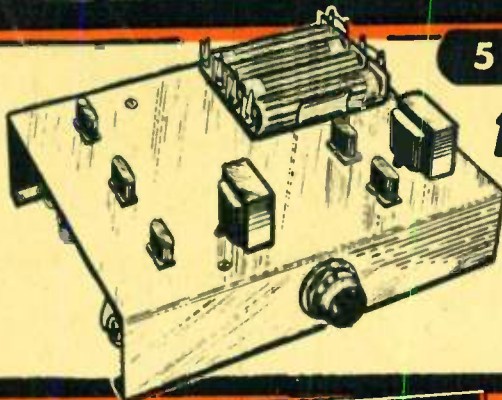

19.50

- Class B Push-Pull Output for speaker operation
- Preamp stage for magnetic cartridges
- Input for magnetic cartridge or crystal mike
- Input for crystal cartridge or tuner

Here is the first practical completely transistorized audio amplifier kit using 5 transistors and 2 special Argonne push-pull input and output transformers. Two inputs are provided, one for magnetic cartridges and crystal mikes, one for crystal cartridge and radio tuners. Operates on only 4-1 1/2 V penlite cells. The preamp stage is designed for such phono cartridges as the GE variable reluctance and equalization required. The preamp stage features magnetic cartridges, and provides extra amplification and equalization required. The preamp stage features extremely low distortion, noise and hum. The Argonne transformers are the highest quality. Specially tuned for transistor circuits. A volume control is provided. Kit is complete with 5 transistors, two Argonne transformers, condensers, resistors, batteries, battery holders, chassis and all new necessary parts with schematic and pictorial diagrams and instructions for assembly and operation. Chassis size 5 1/2" L x 4" W x 1". Shpg. wt., 2 lb.

KT-82 Including batteries Net 19.50

CADMIUM SULPHIDE PHOTOCELL RELAY KIT

11.50

Cadmium sulphide is another semi-conductor used as the active material in modern photocells. This kit utilizing the active material in modern photocells has a high sensitivity, serves as the heart of burglar alarm systems, lighting control systems, door openers, meter or similar devices. The relay circuit is operated directly from the 110 volt A.C. line, incorporates a 5823 cold-cathode tube resulting in quick relay operation at very low illumination levels. Relay contacts rated at 5 amps. Kit comes complete with cadmium photocell, tube, resistors, condensers, metal case and chassis, size 3" x 4" x 3". Schematic diagram and instructions. Shpg. wt., 4 lbs.

KT-81 - Complete Kit Net 11.50

PORTABLE TRANSISTOR RADIO

- Completely self contained with built in 4" speaker
- 6 Transistor + diode circuit with push-pull output

47.50

Here is the first transistor radio of this quality to be offered at this price. You must listen to it to appreciate the quality, the sensitivity and the power. Everything you would expect from a vacuum tube set, plus the lightweight and economy of long-life, low drain transistors. Covers the entire broadcast band. The circuit consists of 6 transistors plus diode detector, full AGC, volume control, 3 ferrite tuned I.F. transformers, new novel stable converter, and ferrite loop antenna. The audio system is free of microphonics, and terminates in push-pull output to a 4" permanent magnet speaker. Easy to handle, light weight attractively styled cabinet is sturdily constructed of hi-impact plastic. This set is cheaper to operate than vacuum tube sets. Batteries have extra long life due to small drain of transistors. Size 2 1/2" x 8 1/4" x 7". Completely wired and ready to operate. Less batteries. Shpg. wt., 4 lbs.

Model 1N681 Net 47.50
Eveready No. 276 Battery Net 1.18



TRANSISTOR TELEPHONE PICK-UP AMPLIFIER KIT

TWO CAN LISTEN ON SAME PHONE CONVERSATION

With this ingenious Kit you can build a tiny transistorized telephone pick-up amplifier, with which two people can listen in on telephone conversations without the need of an extension phone. Also serves as a high gain amplifier to feed into a tape recorder, for recording telephone conversations. Can also be used as a portable amplifier with crystal microphone and matching transformer when desired. The circuit utilizes a transformer coupled audio for high gain and two R-C, coupled stages. Kit comes complete with 3 Transistors, Transistor Audio Transformer, Condensers, Resistors, etc., and Plastic Case. Size: 2 1/2" x 1 1/2" x 3 1/2". Including batteries Shpg. Wt. 2 lbs.

KT-76 Complete Kit ... Less Telephone Pick-Up and Ear Phone Net 9.98
MS-16 Telephone Pick-Up Net 2.98
MS-111-Crystal earphone for above 1.49
MS-260-Super power high output dynamic earphone for optimum results Net 3.98



ELECTRONIC STERILIZER KIT

8.20

An ultra-violet germicidal lamp kit—easy to build—high efficiency at low cost! Lamp provides 2537 Å ultra-violet. Destroys mold and bacteria. Has wide application in nurseries, hospitals, schools—or wherever air sanitation is needed. Can be used in clothes hampers—closets—rest rooms—refrigerators. Installed in air conditioning or heating ducts. Serves both to destroy bacteria and freshen stale air. Consists of 8 watt germicidal lamp—lamp sockets—starter—starter socket—pre punched white enameled fixture box—SPST switch—line cord and plugs—necessary nuts, bolts and screws. Includes simple wiring diagram. Net 8.20

KT-79 ... Shpg. Wt. 2 1/2 lbs. Net 8.20
Same as above but fully wired. Strip type fixture for wall installation. Line cord and switch not supplied. Net 8.95

PL-17 ... Shpg. Wt. 2 1/2 lbs. Net 8.95

TRANSISTOR POCKET RADIO RECEIVER KIT

Utilizing One Transistor and Crystal Diode Detector with New Miniature 365 mmf Variable Condenser

4.95

Here is an ideal low cost transistor pocket radio kit for students, hobbyists and the experimenter, who desire to obtain a practical knowledge of transistorized circuits. The circuit utilizes a Ferris-Loopstick and a specially designed miniaturized 365 Variable Condenser permitting the entire receiver to be built in a plastic case size 3" x 2" x 1". The 1N64 Crystal Diode is used as a detector, the transistor is connected as a grounded emitter amplifier. This receiver with a 50 foot antenna and good ground will bring in good reception over a 50 mile radius. The kit comes complete with transistor, crystal diode, battery holders, batteries, condensers, resistors, plastic case, etc., plus a 115 page book, showing more than 80 practical transistor circuits and How-To-Do-It-Instructions.

KT-80 Complete Kit (less earphones) Shpg. Wt. 1 1/2 lbs. 4.95
1 Miniature Crystal Ear Receiver MS-111 1.49





KITS Build 'em Yourself!

SAVE UP-TO 50%

MODEL BUILDERS

HIGH FIDELITY AMPLIFIER KIT

10 WATT — BUILT-IN
PREAMPLIFIER

for
G.E. Reluctance Cartridge



FREQUENCY RESPONSE: 30 — 15,000 CYCLES

This high fidelity amplifier has been designed for home installations or other applications where high quality reproduction is required. Separate tone controls are utilized for bass and treble attenuation. This is accomplished by means of an inverse feedback circuit. Specifications: power output 10 watts or 32 db. less than 3% distortion, frequency response: 30 to 15,000 cps \pm 1.5 db. tone control: produces maximum bass boost of +8 db at 100 cps, treble control produces maximum treble boost +10 db at 10,000 cycles, hum: —70 db below rated output, tube complement: 1—6XCT 1—6SL7 1—6V4GT 1—6X4GT power consumption: 70 watts 110-120 volts 60 cycles. Shpg. wt. 15 lbs. Complete with 3D diagrams and instructions. With matching output transformer. NET 21.95

KT-23—Complete with tubes.

PHILMORE TRANSISTOR RADIO KIT

Build this broadcast receiver that operates on only one small penlite battery. Includes a germanium diode crystal detector together with a transistor operated audio amplifier stage. The high "Q" litz wound coil is tuned by a variable condenser. Smart poly-styrene case 3 1/2" x 2 1/4" x 1 1/4". Supplied with all ohm headphones. Wire and solder not included. Shpg. wt. 1 lb.



- PHILMORE TR-101 KIT..... 5.85
- EC-1 HEADPHONE..... 1.13
- RCA VS-034 BATTERY..... .07
- KT-77 AERIAL KIT FOR IMPROVED RECEPTION..... .81

PHILMORE RADIO KITS

DUAL BAND BROADCAST-SW KIT



Covers the entire broadcast band from 550 to 1700 Kc. Plus the 6-18 Mc. band for Shortwave listening. Picks up Ham messages, foreign stations, air-to-ground, etc. Extreme sensitivity provided by regenerative circuit design. Powerful enough to drive a 4" PM speaker! Simple to construct. Picture type diagrams and schematics are clear and simple to follow. You will need only the simplest tools. Comes complete with all necessary parts, hardware and 4" PM speaker. Less solder, wire and tubes. Tubes needed: 50L6, 12S7, 35Z5. Size: 12 1/2" x 5 1/4" x 4 1/4". Operates on 105-125 volts, 60 cycles AC or DC. Shpg. wt. 4 lbs.

MODEL 7001C.....NET 11.76

TWO-TUBE BROADCAST KIT

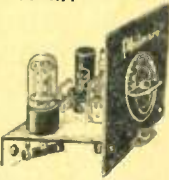

The perfect kit for the beginner. A really good receiver that is easy to build. Excellent sensitivity and selectivity provided by regenerative circuit. Construction aids in basic knowledge of circuitry. Covers standard broadcast, 535-1650 Kc. Screwdriver, pliers and soldering iron are the only tools needed. Picture diagrams and schematics require no previous experience to follow. Complete with all necessary parts and hardware, less wire, solder and tubes. Tubes needed are (1) 12S7J and (1) 35Z5 rect. Operates on 105-125 volts, 60 cycles AC or DC. Size 6 1/4" x 5 1/4" x 4". Shpg. wt. 2 lbs.

MODEL 7001B.....NET 7.35

EXPERIMENTERS MULTI-PURPOSE KIT

10-IN-ONE

RADIO-KIT



1. Broadcaster Receiver
2. Phonograph or Microphone Amplifier
3. Phono Oscillator
4. Home Broadcast Station
5. Code Practice Oscillator
6. Capacity Operated Relay
7. Signal Tracer
8. Electronic Timer
9. Electronic Switch
10. Photo Cell Relay

13.95

Here is an ideal kit designed for both beginners and advanced radio students. You can build 10 different circuits shown above—they all work—and learn important fundamentals and functioning of different circuits. You can do many novel and interesting things; such as, play your phonograph through your radio, broadcast your voice through your radio, etc. Kit is complete with breadboard, microphone, 3 tubes and all necessary parts for construction with 12 page manual of instructions and schematic and pictorial diagrams. Less headphones, photo cell and socket, wire and solder. Shpg. Wt. 10 lbs.

- KT-36.....NET 13.95
- Photo Electric Cell type 868.....NET 2.85
- Amphenol 77M1P4 Socket for above.....NET 7c

Meissner "Build Your Own" KITS

MODEL 3BK KIT



Model 3BK. Regenerative grid leak detector with resistance coupled pentode audio stage. 3 tubes—6B7G and (2) 50B5. Uses any magnetic phones with impedance of 2,000 ohms or more. With coil covering broadcast band. B20 below. For 105-125 V. AC-DC. 7 1/2" W. x 4 3/4" H. x 4 3/4" D. Less headphones. Easily assembled from pictorial diagram and schematic.

3BK—Shpg. wt. 2 1/2 lbs. NET 12.35

PLUG-IN COILS FOR ABOVE

- Type 18-3500—175 to 540 KC..... 1.76
- Type 18-3502—1.35 to 4.5 MC..... 87c
- Type 18-3503—3.2 to 8.2 MC..... 87c
- Type 18-3504—7.9 to 18 MC..... 87c
- Type 18-3505—15 to 34 MC..... 87c

MEISSNER "HOW TO BUILD" MANUAL

Contains a wealth of information on basic theory, design and construction of AM, FM and TV circuits, phono pickups, audio amplifiers, speakers, disc recorders, etc. Fully illustrated with charts, radio formulae, schematic and pictorial wiring diagrams. NET 1.47

PHILMORE CRYSTAL DETECTORS AND ACCESSORIES

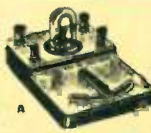

FIG. A. This crystal receiving set will bring in broadcasting stations loud and clear up to 25 miles away. Equipped with super sensitive crystal. STOCK NO. 7001.....NET 1.46

FIG. B. A high grade glass enclosed detector complete with super sensitive crystal. STOCK NO. 7008.....NET .44

FIG. C. Fixed crystal detector, excellent sensitivity and permanently adjusted. STOCK NO. 7002.....NET .71

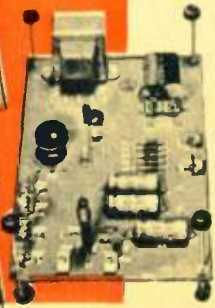

FIG. D. Crystal detector, provides quick and accurate adjustments on any point of crystal. STOCK NO. 7003.....NET 26c

FIG. F. Highly sensitive galena crystal. STOCK NO. 7004 Each 12c.....10 for 1.08

FIG. G. Cuts in on broadcasts and permits program to talk or sing through the radio or speaker. Button switch cuts mike in and out of broadcast. Equipped with 9 ft. cord. STOCK NO. 500H.....NET 1.85

NEW! TRANSISTOR CIR-KIT



- 12 FUNDAMENTAL TRANSISTOR CIRCUITS
- 2 COMPLETE MANUALS

Here is an easy way by practical methods to acquire a real basic knowledge of transistors and their application. Contains parts to build 12 circuits covering such items as using junction transistor as detector amplifier, single stage grounded emitter, base and collector transistor audio amplifier, coupling networks, transistor volume control circuits, bias and stabilizing methods etc. 14 additional circuits can be built by adding components. Also includes 106 page Howard Sams manual on Transistors plus a second manual covering construction of the 12 circuits. Shpg. Wt. 10 lbs. NET 14.65

KT-37 with transistor.....NET 14.65

PHILMORE CRYSTAL RADIO KIT

Excellent for beginners. Provides basic radio theory. Not a toy. Kit includes a fully wound easy-to-use slide-coil, crystal detector, and case whiskers. No soldering necessary—the only tool needed is a screwdriver. Shpg. wt. 1 lb. PHILMORE 7000K.....1.29



1.29

DO IT YOURSELF- Build Your Own Kits!



7-IN-1 MULTI-CIRCUIT RADIO LAB KIT WITH HEADPHONE

- ONE TUBE BROADCAST RECEIVER
- CODE BLINKER — LIGHT
- WIRELESS HOME BROADCASTER
- SIGNAL TRACER
- CODE PRACTICE KEY
- SINE WAVE GENERATOR
- WIRELESS CODE PRACTICE OSCILLATOR

With this smaller version of the 10-IN-1 kit, you can build any one of the 7 circuits. 16 Page Instruction book shows pictorially how to wire quickly and easily and explains the basic operation of these circuits including many fundamentals of radio servicing. Perfect for electronically minded youngsters. Kit is complete with earphone, 6SN7 tube, board, power transformer, selenium rectifier, resistors, condensers and all necessary parts. Less wire. Shpg. wt. 4 lbs. Net 8.60

KT-42

GERMANIUM DIODE RADIO SET KIT



Real basic kit using the new germanium diode. Builds a highly sensitive radio set. Requires no batteries or power supply. Kit includes pre-wound coil, single gang condenser, germanium diode, board, template, headphone, knob, hardware and instruction book. Less wire. Shpg. wt. 2 lbs. Net 3.29

KT-43



2-IN-1 KIT

5.35

• PERSONAL 1 TUBE RADIO
• WIRELESS HOME BROADCASTER

Requires no soldering. All wires and parts fit into clips. You can build a vacuum tube operated radio with volume control and on-off switch. Covers the broadcast band; or you can build a wireless home broadcaster with which you can broadcast your own voice thru any radio in the house within 50 ft.; or you can connect it to a phonograph and play records through your radio—without any connecting wires. Kit is complete with tube, variable condenser, pre-wound tuning coil, volume control, switch, board, template, instruction and earphone (which doubles as a microphone). Less batteries. Shpg. wt. 3 lbs. Net 5.35

KT-44.....Net 5.35

BATTERIES

Kit uses one each.....Net .10
RCA #V8038—1½ volts.....Net 1.42
RCA #V8038—4½ volts.....Net 1.42



HI-FI PUSH-PULL PHONO AMPLIFIER KIT

Here in kit form is a quality phono amplifier that is packed with features. It uses 4 tubes—a 12AX7, a 6W4 rectifier and two 6X4's in a push-pull output circuit that carries plenty of power with low distortion. It utilizes inverse feedback and is designed to take advantage of modern hi-fi recordings and phono cartridges. Similar circuits have been used with the thousands of high priced cartridges (see our phono pages) in tone and volume controls. Kit is complete with all essential parts including tubes and output transformer, with complete pictorial and schematic diagrams. Shpg. Wt. 4 lbs. Net 9.95

KT-38.....Net 9.95



AC-DC BROADCAST RADIO SET KIT

- COMPLETE WITH TUBES AND CABINET
- 16 Page INSTRUCTION BOOK plus 3D COLOR EYE-O-GRAMS

Not just ordinary schematic and pictorial diagrams, but a new simple method that makes building a circuit 3 differently colored sheets show the wiring for each circuit; each of these transparent sheets show the wiring for each circuit; each of these sheets show the wiring for each circuit; each of these sheets show the wiring for each circuit. A master copy shows all 3 steps in individual colors—and when you're through you'll have a fine super set covering 550 to 1800 KC. in modern brown plastic cabinet with built-in antenna. Size 8x5x5. Complete kit with 3 tubes, cabinet, speaker, and all parts. Shpg. Wt. 7 lbs. Net 14.95

KT-19.....Net 14.95



ECONOMY ANTENNA KIT

81c

Ideal for use with small crystal and diode sets, for both broadcast and shortwave. Kit contains 50 ft. of standard copper aerial wire, 25 ft. lead-in wire, lead-in strip, ground clamp, 2 antenna insulators, 2 nail-knob insulators and instructions. Shpg. wt. 2 lbs. Net 81c

KT-77.....81c

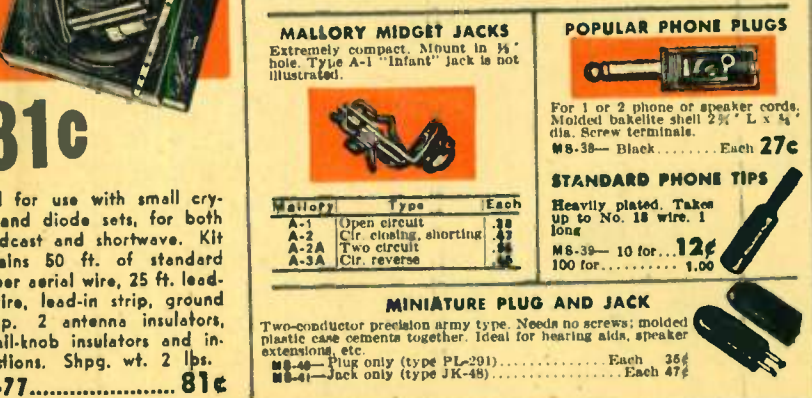

HEADPHONE CUSHIONS FOR ALL PHONES

These headphone cushions fit all types of headphones. They are made of soft rubber and supply the utmost in comfort for the listener. They are especially important for listening for long periods of time. In addition, they perform the function of acting as a shock absorber in case of accidental banging or dropping.

M5-34 —Pair.....82c 10 Pairs for.....7.38

PHONE AND SPEAKER CORDS

4½ Feet Long

Sturdily made, with cotton braid insulation. 4½ feet long. 39c

M8-35—Double type. 1 end spade tip, other straight.....39c
M8-36—Double type. Pin tips both ends.....27c
M8-37—Single type. Pin tips both ends.....27c

MALLORY MIDGET JACKS

Extremely compact. Mount in ¼" hole. Type A-1 "Infant" Jack is not illustrated.

Mallory	Type	Each
A-1	Open circuit	38
A-2	Clr. closing, shorting	42
A-2A	Two circuit	44
A-3A	Clr. reverse	46

POPULAR PHONE PLUGS

For 1 or 2 phone or speaker cords. Molded bakelite shell 2 1/8" L x 3/4" dia. Screw terminals.

M8-38—Black.....Each 27c

STANDARD PHONE TIPS

Heavily plated. Takes up to No. 18 wire. 1 long

M8-39—10 for.....12c
100 for.....1.00

MINIATURE PLUG AND JACK

Two-conductor precision army type. Needs no screws; molded plastic case cements together. Ideal for hearing aids, speaker extensions, etc.

M8-40—Plug only (type PL-201).....Each 36c
M8-41—Jack only (type JK-48).....Each 47c

4.70

HEARING AID FOR RADIO

New headphone type hearing device increases radio enjoyment for persons who find it difficult to hear radio programs properly. Also for private listening without disturbing others. Quickly and easily attaches to any radio in a matter of minutes. Supplied with switch permitting speaker only; phones only or both. Low-resistance phones match loudspeaker coil.

DC-2.....4.70
DC-1—Same bus with single phone.....3.37
K-4 —3-way switch adapter only.....1.88



"EMPIRE" DOUBLE HEADSET

Low priced, light weight set with large magnet and double coils. Adjustable steel headband. 4½ ft. cord.

EC-2. 2000 ohms EA. 1.91
EC-3. 3000 ohms EA. 2.06

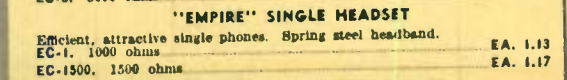

"EMPIRE" SINGLE HEADSET

Efficient, attractive single phones. Spring steel headband.

EC-1. 1000 ohms EA. 1.13
EC-1500. 1500 ohms EA. 1.17

BRANDES "ADMIRAL" HEADPHONES

A rugged, "matched-tone" headset. Extra large diaphragms. Double coils, chrome steel magnets. Adjustable steel headband. 4½ ft. cord.

BA-2. 2000 ohms EA. 2.39
BA-3. 3000 ohms EA. 2.69
BA-5. 5000 ohms EA. 3.43

BRANDES "SUPERIOR" HEADPHONES

A "matched-tone" headset of same general construction as the "Admiral" but has terminals on the outside.

BS-2. 3000 ohms EA. 2.20

MINIATURE AND SUB MINIATURE SPECIALTIES

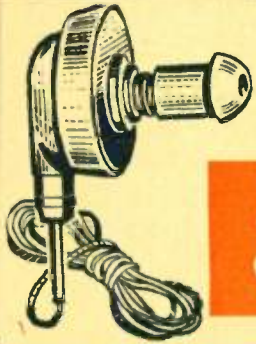

NEW! SUPER POWER DYNAMIC EARPHONE FOR TRANSISTOR CIRCUITS

SPECIAL HIGH OUTPUT-FOR LOW POWER CIRCUITS

395

Lafayette brings you the answer to the problem of the low output inherent in transistor circuits, where the power is so low you cannot afford to lose any of it. You'll be amazed at the difference in volume when you use this new dynamic earphone. Extra efficient construction with a powerful magnet gives up to 3 times the volume of other dynamic earphones, and at the same time gives you the quality of reproduction that is possible only with a dynamic unit. We've tried it on all kinds of transistorized circuits, and this remarkably efficient earphone preserved the precious power so well that in many cases the program was plainly heard with the earphone 2 feet away from the ear. It is not, of course, limited in use to low power devices — it will give superior performance wherever a high impedance dynamic earphone is required. AC impedance 8000 ohms, DC resistance 2000 ohms. Comes complete with 3 ft. detachable plug-in cord.

MS-260

Net 3.95



CRYSTAL EAR PHONE

Small, almost weightless, plastic ear phone with crystal element, that features high power and sensitivity. Ideal for all applications where a very high impedance unit is preferred. Fits comfortably in the ear. Complete with 3 ft. plastic covered cord.

CAN BE USED AS MICROPHONE

This unit is so powerful and sensitive that it can be used as a close-talking highly directional crystal microphone. Just screw off the ear-insert and your earphone becomes a mike to use for all sorts of experiments and gadgets.

MS-111.....Net 1.49

1.49

DYNAMIC EAR PHONE

A new lightweight plastic ear phone especially imported by Lafayette to bring you the high quality of a dynamic ear phone with the ease and comfort of an almost weightless unit—at a price less than half that of any comparable unit. Fits right into ear. Excellent sensitivity of 65 db. Ideal for use with miniature sets, hearing aids, transcribing, etc. DC resistance 2000 ohms, impedance 5000 ohms at 1000 cycles. Complete with 3 ft. plastic covered cord.

MS-72

Net 1.95

LOW IMPEDANCE MODEL FOR SILENT LISTENING OR VIEWING
Will replace speaker on any radio set or T.V. for silent listening, by direct connection to secondary of output transformer. Impedance 8 ohms.

MS-100

Net 1.95

"GENIAC"

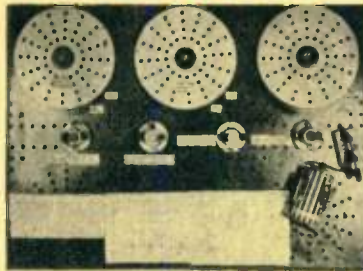

The Fascinating Electric Brain Kit

- SCIENTIFIC • ENTERTAINING • INSTRUCTIVE
- SOLVES SCORES OF INTERESTING PROBLEMS

An unusual kit for the construction of simple electric brain machines. It is an introduction to the design of reasoning, computing, arithmetical, puzzle-solving and game playing circuits. You can make a machine to play TIT-TAC-TOE, an adding machine, solve puzzles like the Fox, Hen and Corn, secret decoder, burglar alarm. 43 page instruction manual shows how to build any one of 33 circuits. Simple enough for any intelligent boy to assemble. No soldering required. All connections made with nuts and bolts. Each kit runs on one flashlight battery. Included in set. All parts mount on pre-punched masonite board 16½" x 11¾". Shpg. wt. 5 lbs.

KT-78

Net 17.95

TECHMASTER HIGH FIDELITY AUDIO AMPLIFIER KITS

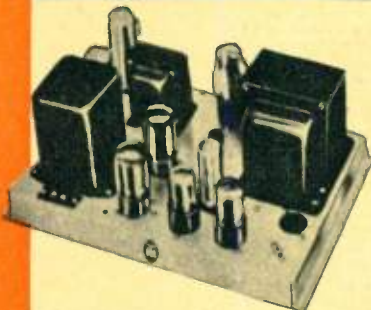

20 WATT WILLIAMSON TYPE AUDIO AMPLIFIER KIT

An outstanding amplifier for the most discriminating hi-fi enthusiast. Employs Williamson type circuit for extremely wide response with negligible distortion. High-quality parts include a new aerial output transformer designed especially for use in Williamson-type circuits. The TM-15A is ideal for use with the finest hi-fi equipment available. Maximum Power Output: 20 watts. Frequency Response: ± 1 db, 8-100,000 cps at 5 watts; ± 1 db, 10-70,000 cps at 10 watts. Intermodulation or Harmonic Distortion: Both less than 0.25% at 10 watts and 0.5% at 15 watts. Hum and Noise: 10 db below 15 watts. Inverse Feedback: 20 db. Gain: 1.1 volt for 20 watts output. Has no controls; high impedance input for tuner or pre-amp. Tubes: 2-6BN7's, 2-5881, 5Y4G Rectifier. Complete with tubes, parts, punched chassis, instructions. 9x12x3½". 105-125 cps, 50-60 cycles AC. Shpg. Wt. 27 lbs.

TM15A

Net 49.95

DELUXE SELF-POWERED PREAMP-EQUALIZER KIT



Anyone can build this fine self-powered preamp-equalizer, and have a really professional instrument that will provide new beauty and versatility to your music reproducing system. Has 4 input channels, one low level high gain and 3 high impedance. Separate bass and treble controls give 15 db boost or attenuation at 20 cycles and 20 KC respectively. Perfect matching of recording curves assured by 5 position equalization control for 78 RPM, Old 78's RIAA, FPBB and AES. Has 12AX7, 12AU6, and 681 tubes plus selenium rectifier. AC power supply for 115V 60 cycle — isolated transformer. Cathode follower output. Loudness compensating control. It's simple to build. Sockets, terminals and connectors riveted on chassis. Simple diagrams. Kit is complete with all tubes, cabinet and matching gold euc'cheon. Size 9½" x 3¾" x 4¾". Shpg. wt. 5 lbs.

TECHMASTER TM-16SP

Net 24.50

REAR SEAT AUTO SPEAKER KIT



DeLUXE 6" x 9" KIT WITH 2.15 OZ. ALNICO V MAGNET

A complete kit for adding another speaker in the rear of your car. You get a 6" x 9" PM speaker with a 2.15 oz. Alnico V magnet (the same heavy duty type you find in kits selling for twice this price); a CRI PK300 three position switch so you can select either speaker alone or both together, dial plate with mounting bracket, knob and hardware; a chrome grille, wire and wiring instructions. Simple to install. Shpg. Wt., 5 lbs.

SK37

Net 4.75

DeLUXE 5" x 7" KIT

Contains same accessories as above kit — except uses 5" x 7" speaker and chrome grille. Shpg. wt., 3 lbs.

SK-42

Net 4.32

"TINY ATOM" ELECTRIC MOTORS

FOR HOBBY · RESEARCH · INDUSTRY



"TINY ATOM" ELECTRIC MOTORS

- Operates Models
- Moving signs—turntables!
- Hobby—Industry—Experiment!

The "Tiny Atom" is a 6000 RPM D.C. motor. Runs on flash light or door bell batteries. The field is an Alnico permanent magnet. Wire wound laminated steel core armature—brass sleeve bearings—phosphor bronze brushes. Same construction encased in transparent Polystyrene. Completely enclosed in a fine motor of small size. The ultimate in a fine motor of small size! Only 1" x 1 1/4" x 1 1/2" Shaft length is 2"—diameter 3/32". Weighs approximately 2 oz. Instantly reversible at any speed or load. Shpg. Wt. 6 oz.

In lots of 3, **1.33 ea.**
No. 3-100—1 1/2-3 V.D.C. Singly ea. **1.50**

6 VOLT MOTOR—Same as above but with Silver Graphite brush tips and special 6 volt winding.
In lots of 3, **1.67 ea.**
No. 6-100—3-6 V.D.C. Singly ea. **1.87**



HI-DRIVE MOTOR

- Highest quality, low cost motor on the market
- Exceptionally low drain assures longest battery life and economy of operation.
- Tests prove you get up to 2,000 hours' motor life (no load)

Here is a reliable miniature power source with a multitude of applications for the operation of toys, and many other pieces of small equipment. Interesting educational, practical size—1-9/16" high, 1-13/32" wide, 1-1/8" long, 1-21/32" overall length. Speed—2,000 RPM to 10,000 RPM at no load. Variations depend upon types of brushes, commutators and voltages. Weight—Without pulley, 1.94 ounces. 3/32" hardened and polished steel shaft balanced to .0005 tolerance. Self-lubricating, life-time oilless bronze bearings. Alnico permanent magnet. Motor runs in any position and is reversible. Brushes replaceable with one screw.

No. 7-100 1/2-3V, Bronze Brush In lots of 3 Each **1.33**
Singly, each **1.50**
No. 8-100 3-6V, Carbon Brush In lots of 3 Each **1.67**
Singly, Each **1.87**



BALL BEARING MOTOR WITH 5 DRIVE ACCESSORIES

A highly adaptable—extra sturdy—miniature reversible motor. Rugged—DC motor. —ball bearing—will stand fast cooling and will stand rough handling. Operation 3 to 6 V.D.C. Permanent Alnico V magnet—wound rotor—heavy long wearing brushes. Complete with pulley—2 pinions—worm gear and spur gear. Designed to overcome the problems encountered in driving models, toys and experimental equipment. Dimensions: 1 1/4" H x 1" W x 1 1/2" L. Shaft 3/16" x 3/32". Weights approximately 2 oz. Shpg. Wt. 8 oz.

In lots of 3, **2.67 ea.**
Singly ea. **3.00**

No. 96—3-6 V.D.C.



PULLEY KIT

An assortment of 8 pulleys and 2 tension belts. Provides the right pulley power for the job. Handy for applying screw belts—mock ups—twin etc. Size 1/2" to 3/4" diameter. Single Shpg. Wt. 1/2 lb.

No. 88—Pulley Kit
In lots of 3 **1.33 ea.**
Singly ea. **1.50**

SUPER POWER KIT

- Practical—Educational
- Motivates Models—Mock ups, etc.

The most complete miniature motor kit ever offered. Everything the hobbyist—model maker—Industrial designer needs. Solves the problem of motivating hobby items—model railroad equipment—research project devices—moving signs—displays, etc. Contains the 3-100 motor plus over 30 gears—pulleys—pinions—3 step cones—gear housing—small parts—friction drive—battery leads—drive belt—etc. All the necessary heavy, clear plastic case. Case measures: 3 1/2" x 9 1/2" x 2 3/4". The widest possible range of use. No. 700—Deluxe Kit

In lots of 3 **6.67 ea.**
Singly ea. **7.50**

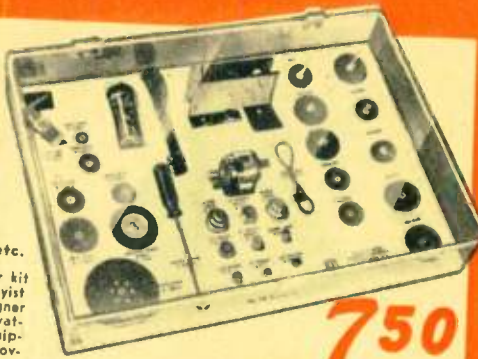

MOTOR ASSEMBLY KIT

- Build-it-yourself!
- Electrical—Mechanical Training Aid!
- Interesting School Project!



2.25

The "Tiny Atom" motor in dis-assembled form! Perfect educational aid! The basic principles of this miniature motor are the same as those of all DC motors. Ideal for schools—day camps—youth organizations—or anyone who enjoys creating with his own hands. The kit contains all necessary parts to make a 1/2 to 3 V.D.C., double shaft, reversible motor with clear plastic housing. Also includes pulley, shafts, brackets, worm gear and pinions for applying motor to work. Complete in a hinged plastic case with comprehensive instruction book. Shpg. Wt. 1 lb.

No. 3113—Assembly Kit In lots of 3 **2.00 ea.**
Singly ea. **2.25**



VARIABLE SPEED POWER APPLICATOR

- World's Smallest Useful Source of Power!

3.00

A "Tiny Atom" motor and a complete set of parts for a variable speed applicator or gear train. Includes 10 gears—7 pinions—2 drive shafts, a pulley and a supporting frame. Motor and gears may be mounted on the frame. Gear train is accurately and sturdily built of steel and brass. Drive shaft speeds from 30 RPM to 400 RPM can be obtained by changing gear and pinion combinations. Ample power is delivered to motivate a host of models—model R.R., accessories—signs and gadgets. Can be used in conjunction with other power drive accessories to obtain additional speed ranges and many types of drives. Shpg. Wt. 2 lbs.

No. K-3000 In lots of 3 **2.67 ea.**
Singly ea. **3.00**

POWER DRIVE KIT



Designed to supply all the components needed to provide drives of different types for mechanical setups—toys—models—boats—model R.R. accessories—and other movable gadgets. Contains a "Tiny Atom" motor, parts for belt, direct connected, spur gear and worm drive. Pinions are brass, long wearing, accurately made of solid gears, crown gear for right angle drive, friction drive wheel, power transmission belt, battery leads, pulleys, spacers, washers, set screws, extra shafts, small parts and screw driver. With this combination of units, practically every type of drive can be constructed. A wide range of speeds is available at the point of power take off. All parts are made of durable metal to close tolerances. Steel and brass drives are long lasting—quiet—positive. Shpg. Wt. 2 lbs.

No. K-4000 In lots of 3 **3.33 ea.**
Singly ea. **3.77**

POWER ACCESSORY KIT

Similar to above but less motor—battery leads—and screw driver. Brings the means of power transfer to your "Tiny Atom" motor. Shpg. Wt. 1 1/2 lbs.

No. K-3700 In lots of 3 **2.00 ea.**
Singly ea. **2.25**

ACCESSORY KIT

Small kit of power accessories offers many possible drive combinations. Contains necessary parts for belt—direct—worm gear and spur drive. 4 shafts—2 pulleys—worm gear—2 pinions—washers—set screws—etc. Shpg. Wt. 8 oz.

No. K-1300 In lots of 3 **67c ea.**
Singly ea. **75c**

AND DON'T FORGET LAFAYETTE'S MONEY BACK GUARANTEE

PAGE 29

MODERN AND MAGNIFICENT

Motorola

TERRIFIC SAVINGS on AUTOMOBILE RADIOS

UNIVERSAL TYPES

These compact models combine the power supply, tuning unit and speaker all in one complete radio. Install easily in-dash or under dash of most cars. Plates available for in-dash installation per chart below.

MOTOROLA MODEL 404 TOP CAR RADIO VALUE

Five tube plus rectifier, Big PM speaker, Slide rule dial, manual tuning.

FOR UNDERDASH MOUNTING. Shpg. Wt. 12 lbs.

MODEL 404.....Net 35.95
MODEL 412—For 12 Volt Cars.....Net 35.95

MOTOROLA MODEL 554

PUSH BUTTON AUTOMATIC TUNING AT BUDGET PRICE
Complete, all in one automatic push button model for easy installation in-dash or under dash of most cars, has Variable Tone Control and giant 5 1/2" extended tone speaker. Shpg. Wt. 13 lbs.

MODEL 554 —.....Net 47.95
MODEL 554-12 for 12 Volt cars.....47.95

TRIM PLATES FOR IN-DASH MOUNTING

WITH MODELS 404, 412, 554, and 554-12. Specify year and make of car as plates are specially designed for each car.

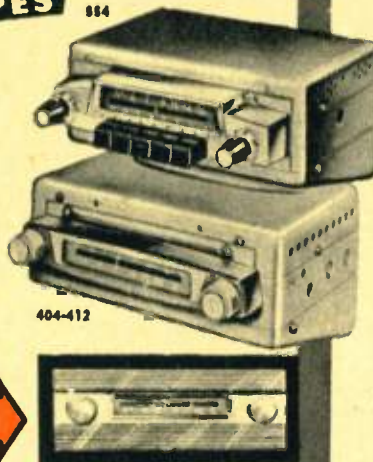

MAKE - YEAR OF AUTO	MODEL 404, 412	MODEL 554, 554-12	MAKE - YEAR OF AUTO	MODEL 404, 412	MODEL 554, 554-12
Cadillac 1949-52	1.27	1.27	Ford Truck 1948-50	1.27	
Chevrolet 1952-54	4.30		Mudson 1951-53-54	1.27	1.27
Chevrolet 1941-48	1.27		Int'l Truck 1950-53		1.27
Chev/GMC Truck 1948-53	1.27		Mercury 1949	1.27	1.27
Crosley 1948-52	1.27	1.27	Mercury 1942-48	4.30	4.30
DeSoto 1949-50		1.27	Plymouth 1953-54	4.30	4.30
Dodge 1949-50		1.27	Plymouth 1951-52	8.48	
Dodge Truck 1951-52	1.27	1.27	Plymouth 1949-50	1.27	1.27
Ford '54	5.54	5.54	Pontiac 1949-52	1.27	1.27
Ford 1952-53	4.30	4.30			
Ford 1951	4.30	1.27	Willys 1952-55	1.27	1.27
Ford 1949-50	4.30	1.27	Willys 1948-51	1.27	1.27
Ford 1942-48	4.30				
Ford Truck 1951-52	1.27	1.27			

MOTOROLA SPECIAL CUSTOM SERIES FORD - CHEVROLET - MERCURY



Auto Radios

Push button tuning — Manual tuning
Powerful circuit using 5 tubes plus rectifier.
Heavy 5 1/2" PM speaker, automatic volume control, acoustifactor tone control, low battery drain, 6 volt operation—everything you can ask for in a set specifically designed to fit your car. Available in either push button or manual tuning.

MANUAL MODEL CTM3-4
Model CTM3—For Chevrolet 52-54—.....NET 43.24
MODEL CTM3—For Chevrolet 55—12 volt.....Net 44.50
Model CTM3—For Ford 49-50—.....NET 43.24
Model CTM3—For Mercury 52-53-54—.....NET 43.84
PUSH BUTTON MODEL CTA3-4
Model CTA3—For Chevrolet 52-54—.....NET 59.95
MODEL CTA3—For Chevrolet 55—12 volt.....Net 58.95
Model CTA3—For Ford 49-50—.....NET 58.95
Model CTA3—For Mercury 52-53-54—.....NET 63.74

THE UNIVERSAL CUSTOM - MANUAL



Here is a revolutionary design—a car radio so compact and readily installed that it fits virtually any car new or old. Can be slipped into practically any dash dial opening. Has "Volumatic" control which completely eliminates the annoying "signal-drop" when you pass under a viaduct, over a bridge or between tall buildings. Has 5 tubes plus rectifier with iron core coils, and separate powerful 5 1/2" PM speaker. Trim plates are available as listed below to make a custom installation for many cars.
Motorola BM—6 Volt less trim plate 38.98
Motorola BM—12 Volt less trim plate 38.98

TRIM-PLATES FOR BM—Specify make and year of car

YEAR	MAKE	NET	YEAR	MAKE	NET
54-55	Buick 12 volt	4.28	52-54-55	Marcury	4.86
1955	Chevrolet 12 volt	4.28	54-55	Oldsmobile 12 volt	4.28
1955	DeSoto	4.86	1955	Packard	4.28
1955	Dodge	7.80	53-54-55	Plymouth	4.86
53-54	Dodge	4.86	51-52	Plymouth (w/o Grille)	9.35
1955	Ford	9.35	1955	Pontiac	4.28
52-53-54	Ford	4.86	53-54-55	Studebaker	4.28
			53-54-55	Volkswagen	4.28

AUTO ANTENNAS

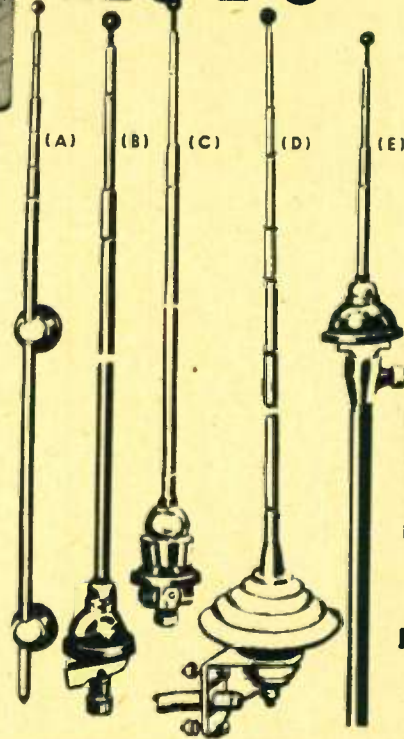

STANDARD SIDE GOWL (A)

3 sections, extends to 61 inches from 25" collapsed. Tenite static ball, 2 black stand-off insulators—36" lead. Shpg. wt. 1 1/4 lbs.
AA-12.....Net 1.59

UNIVERSAL MOUNT ABRIAL (C)

3 sections; extends to 60" but for top cowl, rear deck mounting, or almost anywhere on car. Adjusts to any angle. 48" lead. Shpg. wt. 1 1/4 lbs.
AA-22.....Net 2.59

DELUXE SIDE GOWL (A)

For long distance and greater sensitivity, 4 sections, extends to 97" from 31" collapsed. Chrome static ball and 2 chrome capped bakelite insulators. 36" lead. Shpg. wt. 1 1/2 lbs.
AA-15.....Net 3.11

HOT-ROD AERIAL (D)

4 section, extends to 108" from 38" collapsed. Has shock absorbing solid rubber mount, red tenite static ball, red ceramic insulators. For rear mount on fender or under trunk door. With 15 foot polyethylene cable. Shpg. wt. 3 lbs.
AA-23.....Net 4.98

TOP COWL MOUNT (B)

3 sections, extends to 85 1/2" from 23" collapsed. Chrome static ball, chrome trimmed bakelite insulator. Single hole mount. Self-tighten on car exterior. 48" lead. Shpg. wt. 1 1/4 lbs.
AA-21.....Net 2.19

DISAPPEARING AUTO ANTENNA (E)

For concealed installation on fender or top cowl. 3 sections, collapses to 7" and extends to 52". Chrome static ball. Self-aligning adjustment. 39" lead. Shpg. wt. 2 lbs.
AA-24.....Net 3.18



MOTOROLA
SET FOR
1954 — 1955
BUICK

39.72

Mounts perfectly with matching plate supplied in all 54-55 Buick 12 volt cars. Completely self con-

tained, has 5 tubes plus rectifier and big PM speaker. Shpg. wt. 13 lb.

LAFAYETTE'S SPECTACULAR MULTITESTER VALUES



HIGH SENSITIVITY AC-DC MULTITESTER
20,000 ohms per Volt

The new Lafayette High Sensitivity Multitester is a complete instrument (not a kit) Here is an instrument packed with every desirable feature found only in instruments costing twice as much. One of the most sensitive multitesters ever offered. 20,000 ohms per volt DC; 8,000 ohms AC, having a high sensitivity 45 microamps meter. Full scale AC-DC voltage ranges are 0-10V, 0-50V, 0-250V, 0-500V, 0-1000V; DC current ranges 50 microamps, 2.5 ma, 25 ma, 250 ma. Resistance: 0-5K ohms, 0-50K ohms, 0-500K and 0-5 megohms. Decibel range: -20 +5 db; +5 +22 db (0 db = 0.775V - 600 ohms). Extreme versatility and accuracy. 1% precision resistors; 3" meter; beautiful plastic front, with metal bottom for ruggedness. Size: 3 1/2" x 5 1/2" x 2 1/2". Complete with batteries and leads. Shpg. Wt. 4 lbs. **NET 19.95**
RW-300 In lots of 3 **19.25**

19.95

NEW POCKET AC-DC VOM MULTITESTER
1,000 ohms per Volt



This instrument is one of the best buys that Lafayette has ever offered in a Wide Range AC-DC MULTITESTER. An ideal portable unit that meets the need for a compact, yet rugged test instrument. Has ease of operation usually FOUND ONLY IN MORE EXPENSIVE INSTRUMENTS. Has 1000 ohms/volt sensitivity on both AC or DC. Uses full 3" rectangular meter with large easy to read scale. Uses 1% precision resistors, jeweled D'Arsonval microamp meter movement. Ranges: AC-DC and output volts 0-5, 0-25, 0-250, 0-1000V; DC current 0-1, 0-10, 0-100, 0-250, 0-1000 MA; Resistance 0-10K and 0-100K ohms. In handsome sturdy bakelite case. Size: 4 1/2" x 3 1/2" x 1 1/2". Supplied Complete with test leads and batteries. A Must for every serviceman, shop, Laboratory or experimenter—and at Lafayette's Price you can afford to own one. Shpg. Wt. 2 1/2 lbs. **MODEL RW-27C-Complete Single, ea. 7.95**

7.95

SENSITIVE AND ACCURATE AC-DC MULTITESTER
2000 OHMS PER VOLT ON BOTH DC AND AC



An unusual buy in a very accurate and sensitive VOM. Features single selector switch for all ranges. Has 3 " sensitive 140 microamp meter, 2000 ohms per volt on both AC and DC. 21 full scale ranges, consisting of AC-DC Voltage Ranges: 0-6; 0-12; 0-60; 0-300; 0-1200 Volts; DC Current Ranges: 0-300 ua; 0-3 MA; 0-300 MA; Resistance Ranges: 0-20 K ohms; 0-2 Meg ohms; Decibels: 0 db +5 db; +20 db; +54 db; +48 db (0 db = 0.774V); Extreme versatility and accuracy. 1% precision resistors; beautiful plastic front with metal bottom for ruggedness and shielding. Size 3 1/2" x 5 1/2" x 1 1/2". Shpg. Wt. 3 lbs. **MODEL RW-360 Complete**

12.95

In lots of 3 **12.45**
Singly, ea. **12.95**

NEW! SLOPING PANEL MULTITESTER

2,000 Ohm per Volt Sensitivity on both DC and AC



• High Sensitivity 3/4", 160 Microamp Meter Insures Accuracy • 25 Full Scale Ranges • Sloping Panel for Easy Reading • 4 Resistance Ranges on Two Separate Scales • 5 Output Ranges to Measure AC with DC present • Convenient Pocket SIZE 3 1/2" x 5 1/2" x 2-2/8". This unusual Multitester is a complete instrument (not a kit) with high quality and sensitive 160 microamp meter. Features extreme versatility, accuracy and ruggedness. In an attractive bakelite front panel with metal bottom for ruggedness and shielding. Single switch selects all ranges; 1% precision resistors used throughout. An outstanding instrument, for the professional, serviceman or Laboratory. **FULL SCALE RANGES-DC Volts:** 0-10; 0-60; 0-350; 0-500; 0-1000. **AC Volts:** 0-10; 0-60; 0-250; 0-500; 0-1000. **Output Volts:** 0-10; 0-25; 0-50; 0-250; 0-500. **DC Current:** 0-500 microamps; 0-5 MA; 0-25 MA; 0-250 MA; Resistance: 0-1K; 0-10K; 0-100K; 0-1 Meg; Decibels: +22 and +50 db (0 db = 0.775V - 600 ohm). **COMPLETE** with test leads and **BATTERIES**. Shpg. wt. 4 lbs. **MODEL RW-28Y...NET 14.95** In lots of 3, ea. **14.25**

14.95

ANOTHER OUTSTANDING LAFAYETTE VALUE TUBE TESTER!

• Priced to fit the Serviceman's Pocket-book.

• Most advanced engineering to fit the Serviceman's needs.

26.95



A new streamlined tube tester with a realistic approach to the problem of quickly testing the ever increasing number of tube types. It incorporates new and advanced engineering features and all at a price of about half of even the most ordinary tube tester. Read these Specifications. **"FREE POINT" ELEMENT SELECTOR SWITCHING:** Newly designed. It reduces possibility of obsolescence to a minimum because any pin may be used as a filament pin and voltage applied between it and any other pin, or even the "top cap". Tubes with tapped filaments or with filaments terminating in more than 1 pin are truly tested. **MULTIPURPOSE TUBES:** Special isolating circuit allow each section of multi-purpose tubes to be tested individually as if it were in a separate envelope. **SHORTS AND LEAKAGES:** Supersensitive method checks shorts and leakages up to 5 megohm between any and ALL elements; continuity between various sections individually indicated. **SIMPLICITY:** Fast simple operation. The 4 position fast action snap switches are all numbered in exact accord with RMA standards. Thus when testing element terminating in Pin No. 7 of a tube—you use button No. 7. You can't insert a tube in the wrong socket—there's one for each type of tube base. **TUBE TYPES:** Tests all octal, loctal, 7 pin miniatures, 9 pin miniatures as well as the new noval and Sub-Minor types. Old type sockets used for testing obsolete types—that you rarely see anymore—have been eliminated. **SIZE:** A practical size to carry with you as well as for use in the shop—only 8 1/2 x 6 3/4 x 2 1/4" deep. Shpg. Wt. 5 lbs. **MODEL TC-55—complete with carrying case and instructions. 26.95**

CRT TUBE TESTER
15.85



A complete picture tube tester. Has self-contained built in power supply. Tests all magnetically deflected picture tubes from 7 to 30 inches either in the set or out of the set. Tests for quality by emission method. All readings on "Good-Bad" scale. Tests for inter-element shorts and leakages up to 5 megohms—tests for open elements. Operates on 110VAC. Bakelite case. Size 6 1/2 x 3 1/2. Shpg. Wt. 3 lbs. **Net 15.85**
Superior TV-40

CD FLYBACK AND YOKE CHECKER

45.52



Rapid and convenient means of detecting defects in yokes and flybacks. Extremely sensitive—will detect in a single shorted turn. Will also detect "opens" in transformers—yokes—coils and switches—shorted tube elements. Detects any major change in inductance. Meter is a 4 1/2" 50ma full scale sensitivity Microammeter. Divided into 4 sections—reading "Good", "Bad", and "Replace". Employs a 6V 60 cycle, frequency is 1000 cycles modulated at osc. circuit. Contained in a portable metal carrying case with a hammered gray finish. Recessed carrying handle. Size 5 1/2" x 7" x 10". Shpg. Wt. 10 lbs. **BP-80** **Net 45.52**

PRICES IN THIS CATALOG ARE SUBJECT TO CHANGE WITHOUT NOTICE

PAGE 31

Hallicrafters

Prized
By Experts

THIS NEW
EQUIPMENT
ADDS NEW THRILLS

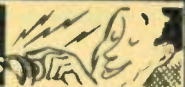

RADIO APPARATUS

POLIC-ALARM



S-38D

New and latest version of the world famous S-38 SWL receiver. The low cost radio that amazes the experts in smart new styling and performance. Offers world-wide reception for the shortwave listener and the new radio amateur. Also tunes the regular standard broadcast band. Has regular communication-type controls for greater flexibility of operation. **4 BAND COVERAGE.** Three shortwave bands 1650 KC-32 MC; Broadcast Band 540-1650 KC. Separate bandspread dial simplifies tuning the crowded shortwave bands. Up-to-the minute **AC-DC SUPERHET CIRCUIT** provides maximum sensitivity and selectivity, employing 4 tubes plus rectifier. 5" PM Speaker gives excellent tone quality; 2 watts audio output. Tip jacks for use when headphone reception is desired. Oscillator for reception of code signals or AM phone transmission. Standby-receive switch. The cabinet is tops in styling; Gray steel, silver frame trim. Size 12 1/4" wide, 7" high, 7 1/4" deep. For 105-125 volts, 50-60 cycles AC or DC. Shpg. Wt. 13 lbs.

HALLICRAFTERS S-38D

Net 49.95

220 Volt Adapter Cord for above

Net 2.00

S-53A LOW COST RECEIVER

The world's finest communication receiver with truly professional performance at a low cost. Contains the latest sensitive powerful circuit that provides thrilling world-wide reception. Full coverage of all frequencies; 6 Amateur Bands, Police, Aircraft, Marine, Foreign and domestic shortwave broadcasts and other services, as well as the standard broadcast band. Excellent signal to noise ratio. Tunes To 54.5 MC; Range 540-1630 KC; 2.5 to 6.3 MC; 6.3 to 16 MC; 14 to 31 MC; 48 to 54.5 MC; Excellent amateur 6 meter reception. Edge illuminated slide-rule dial. All controls clearly identified: Main Tuning; Bandspread; Bandswitch; Volume-On-Off; Sensitivity-Phono; Stand-by; Tone; Automatic Noise Limiter; Phono-Code Switch; Speaker-Headphone Switch. 5" PM Speaker. Tubes Used: 1-6CA osc. (temperature compensated for minimum drift); 1-6BA6 mixer; 2-6BA6 IF's; 1-6H6 detector-AVC noise limiter; 1-6SC7 BFO-1st AF; 1-6K6GT output (2.5 watts); 1-5Y3GT rectifier. Safin Black Steel Cabinet with brushed chrome trim. Size 12 1/4" x 7" x 7 1/4" deep. Piano hinge top. For 105-125 volts, 50-60 Cycles AC. Shpg. Wt. 20 lbs.

HALLICRAFTERS S-53A

Net 89.95

NEW S-85 AND S-86 COMMUNICATIONS RECEIVERS

The newly styled S-85 communications receiver is the latest version of the S-40 series. Contains the same sensitive powerful circuit of former years, yet combines the newest in circuit and style refinements. Bandspread dial is now calibrated for 10, 11, 15, 20, 40 and 80 meter amateur band to give greater tuning accuracy. 4 tuning ranges—standard broadcast 61600 KC-34 MC. **FEATURES:** RF amplifier; 2-IF amplifiers; BFO with variable pitch control; automatic noise limiter; 3-position tone control; built-in 5" PM speaker. **TUBES USED:** 6SG7 RF amplifier, 6SA7 converter, 2-6SK7 IF amplifiers, 6SC7 BFO and audio amplifier, 6K6GT audio output, 6H6 ANL-AVC detector, rectifier is 5Y3GT. **FRONT PANEL CONTROLS:** Sensitivity, band selector switch, volume, AVC on/off, main tuning, noise limiter on/off, AM/CW, tone (high-medium-low) and AC on/off, pitch control, standby, receive. Panel jack for headphones. Gray and black steel cabinet with brushed chrome trim and red pointers. Piano hinge top. Size 18 1/2" wide, 8 1/4" high, 10" deep. For 105-125 volts, 50-60 cycles AC. Shpg. Wt. 36 lbs.

HALLICRAFTERS S-85

Net 119.95

MODEL S-86—Same as S-85 in design and appearance, but for operation from 105-125 volts DC or 50-60 cycle AC. Shpg. Wt. 32 lbs.

HALLICRAFTERS S-86

Net 119.95

MODELS S-94 AND S-95 CIVIL PATROL RECEIVERS

These two new high performance receivers replace the popular models S-81 and S-82. **COVERAGE:** S-94 from 30 to 50 Mc. S-95 from 150 to 173 Mc. These new sets are over 10 times as sensitive, have greatly increased audio power output, and include an extremely reliable adjustable Built-In Relay Squelch System. This type of squelch system is a must for monitor receivers, as it completely disables the entire audio system and not a murmur can be heard from the speaker until a signal is received. **ADDITIONAL FEATURES:** Low noise grounded grid RF amplifier. Separate high gain DC amplifier for squelch system. Wide impedance range antenna input system for maximum performance with any antenna. Low oscillator radiation. Greater frequency stability. Sensitivity under 1/2 microvolts. Provisions for headphones. Built-in Speaker. **CONTROLS:** Tuning, Volume/off, Squelch/off. **TUBES:** 6AB4 grounded grid low noise RF amplifier, 12AT7 high frequency oscillator and mixer, 2-12BA6 IF amplifiers, 12AL5 ratio detectors, 6BH6 1st audio amplifier, 50L6 power output, 12AU7 squelch DC amplifier, 1 selenium power rectifier. **CABINET:** Attractive Gray steel cabinet with silver trim panel and red pointer. Size: 12 1/4" W x 7" H x 7 1/4" D. For 105-125 Volts, 50-60 cycles AC. Shpg. Wt. 12 1/2 lbs.

HALLICRAFTERS S-94 OR S-95

Net ea. 59.95

LATEST MODEL SX-99 RECEIVER

The all new SX-99 is one of the best values in the medium priced communications receivers field. Represents an outstanding achievement in communication receiver engineering with superb reception never before found in this type of equipment. Crystal filter—Calibrated electrical bandspread—"S" meter. Also features RF and AF gain controls, large, illuminated, easy-to-read dials, and new cabinet styling. Frequency from 540 KC to 34 MC in 4 ranges; the standard AM broadcast band, plus 3 shortwave ranges. World-wide reception. Receives police, aircraft, marine, Amateur stations, as well as foreign and domestic shortwave transmissions. **FEATURES:** Calibrated electrical bandspread for 10, 11, 15, 20, 40 and 80 meters; "S" meter is calibrated in units of 6 db to 59 and in db above 59 for accurate signal reports; Crystal filter for razor-sharp selectivity; RF stage and 2 IF stages for very high sensitivity; Terminals for 3.2 ohm and 500 ohm speaker; 3-position tone control; separate BFO with pitch control; automatic noise limiter. **TUBES USED:** 6SA7 converter, 6SC7 RF amplifier, 2-6SK7 IF amplifiers, 6SC7 BFO and audio amplifier, 6K6GT audio output, 6H6 ANL-AVC-detector; rectifier is 5Y3GT. Size: 8 1/2" x 18 1/4" x 11" deep. For operation from 105-125 volts, 50-60 cycles AC (less speaker—see R-46A). Shpg. Wt. 36 lbs.

HALLICRAFTERS SX-99

Net 149.95

NEW R-46A MATCHING SPEAKER

Net 19.95

MODEL SX-96 SELECTABLE SIDE-BAND RECEIVER

This new receiver incorporates major improvements in stability by additional temperature compensation of the high frequency oscillator circuits and the employment of Crystal Control second conversion oscillators. **FEATURES:** Full precision gear drive dial system on both main tuning and bandspread dials. 50 Kc highly selective IF system plus a mixer type second detector. Second conversion oscillator is crystal controlled. Upper or lower side-band is selectable by means of a panel switch. Low drift. **FREQUENCY RANGE:** 530 Kc to 1580 Kc; 1720 Kc to 4.9 Mc; 4.6 Mc to 13 Mc; 12 Mc to 34 Mc. **CONTROLS:** Sensitivity, Band Selector, Volume, Tuning, AVC on/off, Noise limiter on/off, Bandspread, Selectivity, Pitch Control, Reception, Standby, Phones jack. **TUBES:** 6CB6 RF amplifier, 6AU6 1st converter, 6CA4 HF oscillator, 6BA6 2nd converter, 12AT7 dual crystal second converter, 2-6BE6 50 Kc IF amplifiers, 6BE6 50 Kc mixer type second detector, 6AL5 AVC-noise limiter, 6SC7 1st audio and BFT, 6K6 power output, 5Y3 rectifier, VR-150 voltage regulator. **CABINET:** Gray and black steel with brushed chrome trim and red pointers. Piano hinge top. Size: 18 1/2" W x 8 1/2" H x 10 1/4" D. For 105-125 Volts, 50-60 cycles AC. Less Speaker (use R-46A speaker). Shpg. Wt. 43 lbs.

HALLICRAFTERS SX-96

Net 249.95

MONITORADIO



FM
RECEIVER
30-50
MC BAND

Powerful AC FM receiver for municipal departments and industry. Frequency range 30-50 MC. Sensitivity at 10 db signal to noise — 3 MV. Squelch operates at 2 MV. Selectivity ± 60 KC at 3 db. 0.8 watts output at 10% distortion. Built in 5" speaker. Reliable built in electronic squelch — adjustable from front panel. Two tone metal cabinet — 11 1/4" x 17 1/2" x 8 1/2". Illuminated slide rule dial. Fully tuned RF stage for better image rejection. Tubes 6-BJ6, 1-6U8, 1-6AL5, 1-12AX7, 1-6AK6, 1-6X4 rectifier. Shpg. wt., 16 lbs.

Monitoradio MR-33

Net 62.50

MR 10 Similar to above but for 152

174 MC band

Monitoradio MR 10

Net 62.50

POLIC-ALARM FM RECEIVERS



Dependable, versatile, inexpensive FM receivers for State-Municipal-County Police, buses, taxicabs, hospitals, etc. Sensitive superheterodyne circuit — 100 kc selectivity — drift compensated — 10 MV sensitivity. Built in 5" speaker. Tubes, 1-12AT7, 2-6BJ6, 1-19T8, 1-35B5, 1-35W4 rectifier. Ant. Imp. 72 ohms. Size 10 1/2" x 7" x 6 1/2". 115 Volts AC or DC. Shpg. wt., 8 lbs.

Polic-Alarm PR-31 30-50 MC

Net 49.95

PR-74: Same as above for 72-76 MC.

Polic-Alarm PR-74

Net 49.95

PR-9: Same as above for 152-174 MC.

Polic-Alarm PR-9

Net 49.95

MICROPHONES

*Fine Quality
At History Making Prices!*

A BUY OF A LIFETIME HIGH QUALITY TOP NOTCH CRYSTAL MICROPHONE



COMPARE IT WITH
ANY MIKE AT
2 to 3 TIMES
THE PRICE

3.95 each
in lots of 3
Singly, ea. 4.25

Lafayette makes history with a high quality **CRYSTAL MICROPHONE** at a price that is 60% less than any comparable Crystal Microphone on the market today. Excellent for PA systems, home recorders and general applications. Frequency response 30 to 10,000 cycles. Output level—52 db. provides ample output for use with low gain amplifiers. Uses quality moisture sealed crystal. Die cast case in rich green baked enamel finish, with chrome grill. Completely equipped with 5 feet of shielded cable. Mike may be used on any stand with $\frac{3}{8}$ "-27 thread. Grill diameter $2\frac{1}{4}$ ", depth $4\frac{1}{4}$ ", height $4\frac{1}{2}$ ". Shpg. Wt. $3\frac{1}{2}$ lbs.

STOCK NO.
PA-24

PA-24—In lots of 3, each 3.95
Singly, each 4.25

STUDIO CRYSTAL MICROPHONE

- DUAL CRYSTAL CARTRIDGES
- ALL DIRECTIONAL
- FINE QUALITY
- HIGH OUTPUT

6.95

ea. in lots of 3,

single, each
7.25



Here is a microphone with a 360° pickup, and the added power and sensitivity of two individually shock mounted and phased crystal cartridges. This arrangement assures you of maximum pickup from all sides. Swivel mounted to give fuller flexibility. Case is chrome plated. Standard $\frac{3}{8}$ "-27 thread. Overall size 7" H x 3" W complete with 4 ft. cable. Shpg. wt. 4 lbs. PA-17—

In lots of 3, each **6.95**
Singly, each **7.25**

CRYSTAL MICROPHONE CARTRIDGE

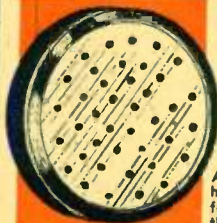

- REPLACEMENT FOR
ASTATIC SHURE, AND
MANY OTHER POPULAR
MICROPHONES

1.95

A universal crystal microphone cartridge with heavy flexible rubber cushioned rim designed for speedy, economical repair. Fits tens of thousands of the most popular microphones such as the astatic JT 30 etc. Overall diameter $2\frac{1}{4}$ ", depth $\frac{1}{2}$ ". Output—52 db. Excellent frequency response. Shpg. wt. 8 oz.

PA-27—In lots of 3, each 1.75
Singly, each 1.95

A Fantastically Low Price! HIGH OUTPUT DYNAMIC MICROPHONE WORTH MANY TIMES ITS PRICE

List Price
~~\$47.00~~



12.45

In Lots of 3

STOCK NO.
PA-19

Single ea.
12.95

AT LAST! A Hi-Fi Dynamic Mike for Public Address etc. at a price you'd expect to pay for a good crystal mike!

Lafayette went abroad to obtain a high quality **DYNAMIC MICROPHONE** at a price that is 70% less than any comparable dynamic microphones on the market today. Exceptionally fine for public address, recording and other general purpose use. Substantially flat response, 60-10,000 cps, assures faithful reproduction of speech and music. Impedance 40,000 ohms $\pm 15\%$ at 1000 cps. Output level—55 db. Die cast metal case finished in light grey and fine chromium. Compact and light weight. Net Wt. 1 lb. Head at fixed tilt of 15°. Equipped with 6 ft. well shielded low-loss special vinyl-jacketed cord. Standard $\frac{3}{8}$ "-27 thread. Dimensions 1-23/32" high, 2" wide, 3/4" deep. Shpg. Wt. 3 lbs.

LAFAYETTE'S OWN LAPEL MICROPHONE



- FULL -55 db OUTPUT LEVEL!
- IDEAL GENERAL PURPOSE MIKE!

Reg Price
\$16.00

Most compact—specially engineered crystal microphone. Attaches to the lapel. Only $1\frac{1}{2}$ " in diameter. Fantastically light weight—weighs only $1\frac{1}{2}$ ozs. Including 5 feet cord! Exceptional frequency responses provides high level speech intelligibility. Output level—55db. "Sealed-in" moisture proof crystal—pressure actuated. Handsome, heavily chrome plated case and clip for attaching to lapel. Ideal for inexpensive P.A. systems—home recording—general purpose. High impedance. Includes 5 ft. of extra light weight shielded single conductor cable. Shpg. Wt. 1 lb. PA-18—

Net 2.95

Never Before
At This
History Making
Price!

A LAFAYETTE SCOOP!

Top Quality

CRYSTAL
MIKE

2.95



New, attractively styled crystal microphone for all general applications—public address, home recordings etc. Frequency response 30 to 10,000 cycles. Output level—52 db; tilting head, die cast case with rich gray baked enamel finish. Chrome grill. Completely equipped with 5 feet of shielded cable. Grill dia. $2\frac{1}{4}$ ", depth $3\frac{3}{4}$ ", height 4". Shpg. wt. 3 lbs. One of the best buys in the country.

PA-28 Each **2.95**

MINIATURE CRYSTAL MICROPHONE



1.95

Here's a typical Lafayette special for the experimenter, student or dealer. An extremely sensitive and small crystal microphone used in hearing aids and other small apparatus. Can be used as lapel mike—miniature transmitter mike—for concealed locations, etc. Its size and performance gives it joint versatility. Brand new. Size only $1\frac{1}{4}$ " Diam. x $5/16$ " deep. Imported to save you money.

MS-108.....Net 1.95

ELECTRIC DRILL ATTACHMENTS

MAKE YOUR DRILL DO A 1000 & 1 JOBS

FAMOUS 1/4" DRILL WITH JACOBS GEARED CHUCK

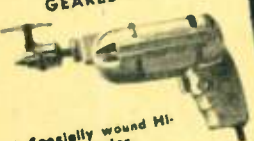

- Specially wound Hi-Torque motor.
- Ball-thrust bearing.
- Jacobs keyed chuck.

Powerful, lightweight drill, for home or shop. Capacity: 1/4" in steel, 1/2" in hard wood. Speed at full load: 1,800 r.p.m. Heavy duty trigger switch with "lock" and instant release. With Jacobs geared key chuck. For 115 volts AC-DC. Shpg. Wt. 4 lbs. MD-108—

Net \$13.39

New! PET HI-POWER DRILL, GRINDER & POLISHER KIT

Handiest helper you can have! A complete set for home or shop use. 34 pieces handle drilling, grinding, polishing, buffing and sanding. Kit contains 1/4"-1600 rpm drill with hand tile chuck, 7 carbon steel drills 1/16" to 3/8", molded rubber disc, burna disc, polishing bonnet, 12 sanding discs, grinding wheel, 8 piece adapter set to hold handle, drill stand and rugged use any wheel—any line. Approved 110-130 Volts AC or DC. Shpg. wt. 1 1/2 lbs. MD-33.....NET 16.98



16.98



HI SPEED COPE SAW DRILL BIT DRILL-SAW-CUT-REAM

Four jobs with one bit. Use with any electric drill or drill press. Cuts circles, ovals, squares, etc. Withstands severe continuous use. Cuts wood, plastic, bakelite, steel, brass, copper, etc. Amazing Swivel Action of Arbor cuts large groove with little power, no heavy duty drill is necessary; assures accurate and parallel cuts with no torn or ragged edges. No sanding necessary! "Dado-Arbor" is easily and quickly removed to use the saw for straight or angle cuts. Precision Graduated Depth & Bevel Gages adjust for cuts to 1 3/4" in depth, bevels from 0 to 45°. Adjustable Rip Gage for accurate strips; Adjustable Visual Guide to follow line, 5" (ARCO SAFE CUT) Blade, Strong Safety-Yoke & Worm Drive Clamp; Right Angle Gear Drive with Steel Gears; Self-Lubricating Lifetime Bearings. Fits any 1/4" drill. Complete with "Dado-Arbor", Depth-Bevel-Rip Gages & 5" "Arco Safe-Cut" Blade. With instructions and 90-Day Factory Guarantee. Shipping weight 4 lbs. MD-197.....Net 9.75

- MD-74 All Purpose Bit Net 1.59
- MD-75 Wood Bit Net 1.59

"6 in 1" ADJUSTABLE DRILL

- COUNTER SINK - COUNTER BORES - DRILLS
- FOR EVERY STANDARD LENGTH WOOD SCREW
- FOR POWER OR HAND TOOLS!

1.47

Adjustable drill for hand and power tools. Pre-drills a precision hole—countersinks and counters bores in one simple step. Fully adjustable depth, shank depth, counter sink and counter bore. Speeds assembly and prevents splitting. Use in any electric drill or hand drill. Cuts in wood—plastic—film—Shpg. wt. 8 ozs.....Net 1.47

- MD-173—#8 up to 2 3/4".....Net 1.47
- MD-174—#10 up to 2 3/4".....Net 1.47
- MD-175—#12 up to 2 3/4".....Net 1.47
- MD-176—Set of three above.....Net 3.99

ROTO AUTOMATIC HACKSAW



• Small, Compact, Powerful!
• Nothing To Wear Out!
Fits any 1/4" Electric Drill. Cuts any wood, metal or plastic up to 3/8". There are no gears or bearings to wear out. Saw blade is only exposed moving part. Folds to 1 1/2" x 2 1/2"—fits any tool box. Less than dead hacksaw blades. Handle covers and protects saw blade when not in use. Shpg. wt. 1 lb. MD-60.....NET 3.72

ROTO SANDER ATTACHMENT
Attaches to Roto Hack Saw above. 3" x 5" surface sands with grain. Does every job from rough to fine. Shpg. Wt. 1 lb. MD-111.....Net 2.93

ROTO HOLESAW



Adjustable drill for hand and power tools. Pre-drills a precision hole—countersinks and counters bores in one simple step. Fully adjustable depth, shank depth, counter sink and counter bore. Speeds assembly and prevents splitting. Use in any electric drill or hand drill. Cuts in wood—plastic—film—Shpg. wt. 8 ozs.....Net 1.47

- MD-173—#8 up to 2 3/4".....Net 1.47
- MD-174—#10 up to 2 3/4".....Net 1.47
- MD-175—#12 up to 2 3/4".....Net 1.47
- MD-176—Set of three above.....Net 3.99

• 4 Different Size Holes With One Hole Saw!
• Cuts Through Any 3/4" Stock... Wood, Plastic or Metal.
Cuts 1", 1 1/2", 2" and 3 1/2" holes in any 3/4" stock. Works with any 1/4" drill or drill press. Light, rugged aluminum arbor and pilot drill—inside 4 saw blades of high quality, high-carbon steel. Complete with arbor and 4 saws. Shpg. wt. 1 lb. MD-59.....NET 3.72

ARCO SAW WITH DADO-ARBOR

EVERY 1/4" ELECTRIC DRILL BECOMES A PORTABLE SAW



\$9.75

Cuts 2 x 4's in one cut
New No. 456 "ARCO-SAW" with revolutionary Adjustable "Dado-Arbor" cuts any size groove up to 1 1/2" wide by 1" deep at any angle from 0 to 45°—in ONE CUT! Amazing Swivel Action of Arbor cuts large groove with little power, no heavy duty drill is necessary; assures accurate and parallel cuts with no torn or ragged edges. No sanding necessary! "Dado-Arbor" is easily and quickly removed to use the saw for straight or angle cuts. Precision Graduated Depth & Bevel Gages adjust for cuts to 1 3/4" in depth, bevels from 0 to 45°. Adjustable Rip Gage for accurate strips; Adjustable Visual Guide to follow line, 5" (ARCO SAFE CUT) Blade, Strong Safety-Yoke & Worm Drive Clamp; Right Angle Gear Drive with Steel Gears; Self-Lubricating Lifetime Bearings. Fits any 1/4" drill. Complete with "Dado-Arbor", Depth-Bevel-Rip Gages & 5" "Arco Safe-Cut" Blade. With instructions and 90-Day Factory Guarantee. Shipping weight 4 lbs. MD-197.....Net 9.75

- MD-118 Safecut Blade.....1.30
- MD-118 Hycarbon Crosscut Blade.....1.30
- MD-117 Hycarbon Rip Blade.....1.30
- MD-116 Hycarbon Combination Blade.....1.30

ARCO JIG SAW

• With Circle Cutter and Rip Gage



7.50

Cuts perfect circles any size up to 20" diameter; rips accurate widths any size up to 10" wide. An especially desirable home workshop tool because of its versatility. Does work of Jig, Keyhole, Coping, Rip, Crosscut, Band and Hacksaw! For intricate patterns, the Jig Saw is simply guided over the cutting line while the Automatic Air-Blower blows sawdust away from blade. Cuts plywood, plastics, wallboard, metals—even lumber up to 2 x 4's! Starts inside holes without boring. Has Right Angle Drive, strong Safety-Yoke and Worm Drive Clamp. Self-Lubricating Lifetime Bearings. Blades are easily changed in seconds with ordinary screwdriver. Complete with Circle-Cutter & Rip Gage, Jig Saw Blade, instructions and 90-day Factory Guarantee. Shipping weight 4 lbs. MD-198.....Net 7.50

- Jigsaw—Less Circle Cutter and Rip Gage. Shipping weight 3 lbs. Net 6.69
- MD-56 Replacement Blades—Package of 6 Ass'd. Net 1.46
- MD-57

POWER BORING BITS



1.69

• 8 PIECE SET
Designed for longer life — faster cutting — smoother boring in wood — plastics — hardened pressed steel. Blades — size for smooth hole. Faster boring — no clogging — no burning. Interchangeable cutters with a single minimum friction. Fit any 1/4" drill. Sizes include 3/8", 1/2", 5/8", 3/4" and 1". Shpg. wt. 1 lb. MD-181.....NET 1.69

NEW! IMPROVED MODEL! Screw-Drill Countersink Kit

2.32



Twist reduces chip clogging
Does 4 operations in one! Countersinks for screws in wood or metal—Drills shank clearance hole—Drills accurate pilot hole—Drills to correct depth, prevents splitting. Do four complete operations in the time it takes to do one. Hole and countersink are always the proper size and depth. Fits all 1/4" drills. Use in any electric drill—drill press—or hand drill. Kit of 5 contains one each 3/8" x #7, 1" x #8, 1 1/4" x #8, 1 1/2" x #10 and 1 3/4" x #12 Screw-Drills. Shpg. Wt. 1/2 lb. MD-93.....Net 2.32

NEW VERSAMATIC POWER TOOL

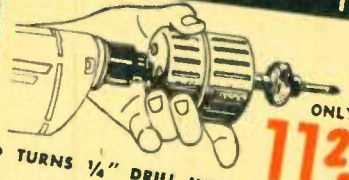

ONLY 11.25

• TURNS 1/4" DRILL INTO HIGH POWER TOOL
• REVERSES — INCREASES POWER — REDUCES SPEED!
Seven to one speed reduction develops tremendous torque! Hand clutch control for easy, instant stop-start action! Look at these fabulous features! Power screw driver—drill tapping handle—reverses! Power screw driver—Perfect for concrete or any kind of masonry drilling! Professional tool that anyone can use! Comes complete with Phillips bit—1/4" socket set adaptor—wrench and instruction book. Shpg. wt. 5 lbs. MD-193.....Net 11.25

STOCK UP on these OUTSTANDING Values

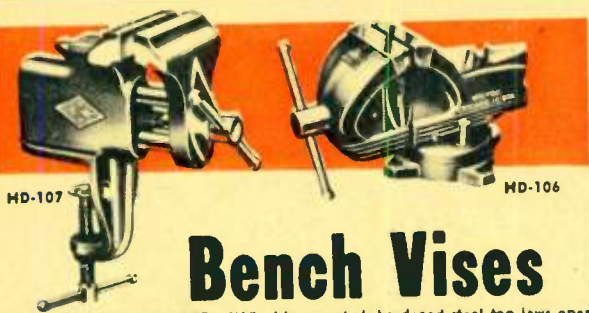

Bench Vises

SHOP KING SWIVEL BASE: 3 1/2" wide, serrated, hardened steel top jaws open to 4" maximum. Swivel base has 200° rotation—locks by slide for nut. Equipped with easily removed pipe-vise jaws. Beautifully designed—precision machined—sturdily constructed. Complete with polished, removable top jaws—pipe jaws and cut-off tool. Flange mount bolts to bench. Shpg. Wt. 18 lbs.

HD-104 Net 7.35

CLAMP-ON BENCH VISE: Sturdy, practical and efficiently constructed. 2 1/2" wide jaws—open to a maximum 2 1/2". Twin guide rods and precision drive screw assure smooth action—rigid grip. Jaws accurately machined, polished and lacquered. Unexcelled for ordinary jobs in shop, home or garage. Shpg. Wt. 3 1/2 lbs.

HD-107 Net 2.25

SAW-MATIC 8" TILT ARBOR SAW

DOES EVERYTHING SAWS COSTING 5 TIMES AS MUCH CAN DO

A mechanical marvel, this 8" TILT-ARBOR SAW gives fast, accurate, versatile performance. Blade tilts to 45° cutting angle. You can mitre, bevel or saw any length at any angle, yet table and work stay level. Cuts joists, siding, rafters, joists, slots, dados and moldings. Takes any bench saw attachment. Does all types work—crosscut, rip, bevel, mitre. Other features include steel safety guard, self-aligning rip fence, large polished non-rotation blade, accurate tilt scale, mitre to any angle, removable dado plate, arbor mounted in double self-lubricating bearings. Cuts up to 2 1/4" thick iron extensions (not supplied) 6" x 14". Shpg. Wt. 35 lbs. List 28.00

21.00

HD-127 Net 21.00

ACCESSORIES

HD-128—EXTENSION—Wt. 5 lbs. Net ea. 2.95

HD-129—V Belt and Pulley Net ea. 1.59

HD-130—Extra 8" Raw Blades Net ea. 1.49

ML-47—1/2 H.P. 1735 RPM Split Base Motor. Net 17.50



WOODWORKERS VISE

- 6 1/2" x 3 1/2" JAWS!
- OPENS TO 4 1/2"!

▲ Fine, practical tool for the small shop—home—farm or garage. Ruggedly built—will not loosen or slip. Guides face ground and finished. 5/8" diameter screw—8 thread per inch. Saves time and labor—indispensable to the woodworker. Perfectly balanced—designed for hard use. Shpg. wt. 6 lbs.

HD-182 NET 2.79

ELECTRIC HANDI-SPRAYER 5.97

In lots of 3

Save time and money! 80 lb. nozzle pressure gives professional results. Sprays all types of paints, enamels and lacquers. Any sprayable liquid! Exclusive swivel nozzle permits spraying up, down, or sideways without tilting jar. Instant spray control—fingertip adjustment from mist to cone or straight stream! High Impact plastic housing—all parts of stainless steel and brass. Complete with 24 oz. Mason Jar and 8 ft. cord. Shpg. Wt. 4 lbs.

HD-T3—Net ea., 6.25—Lots of 3, 5.97 ea.



TAP, DRILL AND DIE SET



Useful set for handy men and model shop workers. Three 1" dia. dies (4-34, 6-32, 8-32) with die stock; three taps (4-34, 6-32, 8-32) and 3 matching tap drills for these taps. Tap holder and mahogany case. Shpg. Wt. 3 lbs.

HD-28 Net 4.26

JACOBS TYPE DRILL CHUCK

- GEARED TOOTH CHUCK
- FITS STANDARD 1/4" DRILLS

Comparable to Jacobs 1B. Key type geared tooth chuck. Capacity 0-3/4", thread 3/8" x 24". Ruggedly constructed. Polished finish. Used as standard equipment on most electric drills. Made to rigid specifications. Compare our really low price. You'll find this same chuck selling for twice as much! Shpg. wt. 1 lb.

HD-184 NET 3.38



SPIN-X WRENCH SET

- SAVES TIME — SAVES SPACE!

Designed especially for — and Radio repair work. Eight sizes — 3/16" — 1/4" — 9/32" — 5/16" — 11/32" — 3/8" — 7/16" — 1/2". Saves time — saves space — easy to handle. Two tools replace eight socket wrenches. Tempered tool steel. Fits hand for quick, easy gripping. Complete with plastic case. Shpg. wt. 1 lb.

HD-187 NET 1.65



ROTO-TRIM

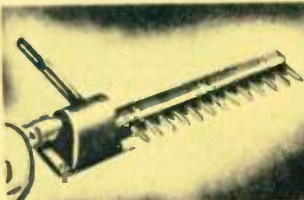

Here's the drill attachment you've been looking for. Keep your whole yard neatly trimmed. Converts any 1/2" electric drill into an easy handling-bean cutting Hedge Trimmer. Trims shrubs, hedges and grass easily and smoothly. Ridged steel and aluminum construction. Hardened steel gears and cam. 10" cutting blades designed for maximum efficiency. Light weight—precision balanced for easier handling. Handle turns blade to any angle. Shpg. Wt. 3 lbs.

HD-97 Net 8.59

50 ft. TROUBLE LAMP

- 2 SIDE OUTLET TOOL

All rubber sheath — all copper wire! Flip-Lock case eliminates removing from handle to re-lamp. Uses any standard lamp. Heavy rubber plug-push switch—rugged rubber handle. Fifty feet of rugged, flexible cord. Light and handy — rugged convenience. Light and power where you want it. A necessity in the shop—home—garage—car. Shpg. wt. 4 lbs.

EL-41 NET 1.80



ROTO-SABRE SAW

8.97

- Designed for concrete work.
- All moving parts of hardened and ground alloy steel.
- Oil impregnated bearings throughout.
- Housing of die-cast aluminum.

Built for the heaviest work—priced for the lightest budget! Easy to operate—attaches to any 1/2" electric drill or drill press. Comparable to highest priced attachments. Fully enclosed for maximum safety. Complete with 3 blades—1 each wood, metal and scroll. Shpg. Wt. 1 1/2 lbs.

HD-88 Net 8.87



TWIST DRILL SET

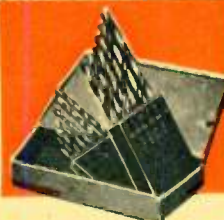

Set of 13 high quality chrome vanadium twist drills. Sizes 1/16" to 1/2" by 64ths. Less Index. Shpg. Wt. 6 oz.

HD-114 98c

As above but complete with metal Index. Shpg. Wt. 8 oz.

HD-113 1.59



NEW! DEVIL-LEVEL

- MEASURES IN DEGREES — MEASURES INCH-RISE-PER FOOT!
- FLOATING POINTS FOR HAIRLINE ACCURACY!
- NEW PRECISION PRINCIPLE!
- LOOKS LIKE A JEWEL — WORKS LIKE A TOOL!

The first new leveling device in over a hundred years! Uses a floating pointer to give hairline readings in degrees and inch-rise-per foot. Gives true level or inclination at a glance. Pocket size — 2" square by 1" thick. Molded case of specially selected plastic. Pointer bob with machined tip floats in oil — always exact readout on precision scale. Reads any angle instantly. Square case permits leveling from top — bottom-slides. Easily mounted in span bar for leveling rough leveling from top — rafters — doors — appliances — benches — decks. Gives inclination on any large job — beams pipes — eaves — etc. Beautifully simple — nothing to break or get out of order! You could not get greater accuracy at five times this price. Shpg. wt. 4 ozs.

HD-185 NET 1.65

BEAM COMPASS RULE

- CIRCLES UP TO 12 FT. IN DIAMETER!



Draws — cuts — scribes accurate circles up to 12 feet. Imported Swedish beam compass rule accurately draws large radius arcs — or cuts leather, fabrics, thin metal and scribes on any material. Steel tape is calibrated in inches down to 32nds. Tape locks to desired radius. Uses same pen or pencil used in rest of drawing. Sturdy casing. Easily changed center point. No extra parts to buy. Shpg. wt. 1 lb.

HD-180 NET 1.49

QUALITY TOOLS at new LOW PRICES

21 PIECE SOCKET SET



A TRAY FULL OF SOCKETS!!

A real jewel of a tool set! Fourteen sockets from 1/4" to 1-5/16"—handle 98% of all nuts and bolts in use! Seven inch reversible ratchet handle, 1 1/4" Amber handled extension fits sockets from 1/4" to 7/16", for radio—TV—and automotive, 3/4" offset wrench for sockets from 1/4" to 7/16", 7/16" extension for ratchet fits sockets from 7/16" to 15/16". Reversible screw-driver bit for ratchet handle. All in a steel carrying tray with plenty of room for your other most needed tools! Each piece has a high lustrous finish for long life. Guaranteed against defects in material and workmanship. Shpg. Wt. 5 lbs.

HD-161.....Net **4.49**

SAN-DAL

- POWERFUL—POSITIVE BALL BEARING MOVEMENT.
- QUICKLY AND EASILY ATTACHED TO ANY STANDARD DUTY 1/4" ELECTRIC DRILL
- SANDS—BUFFS—POLISHES.



Ideal for home or shop. One hand operation. Aluminum die castings throughout. Unique clutch type drive prevents drill burnout. Will not stall under pressure. No oiling or maintenance necessary. Sturdy—positive drill seating and centering device. Needed wherever a 1/4" drill is used. Shpg. Wt. 5 lbs.

HD-188.....Net **7.50**

UNIVERSAL DRILL PRESS

- Converts Elec. Hand Drill To Drill Press



Here is a handy accessory item which acts as a drill stand and converts any 1/4" electric hand-drill into a drill press. Maximum length of travel is 2 1/2". Overall height is 16 1/2". Sturdily constructed. Powerful spring holds drill in place when not in use. Shpg. Wt. 9 lbs.

MD-120.....Net **8.19**

Hand Vise

79c



The only practical way to grip and hold small parts and pieces. 1 1/4" die cast jaws open to 1/2". Mounted on a 4" comfortable, ferruled wooden handle. Holds work for drilling, marking, filing, sawing, etc. Endless uses in shop and handwork. Shpg. Wt. 1 lb.

MD-96.....Net **79c**

FAMOUS WELLER SOLDERING IRONS

WELLER 8100-K SOLDERING KIT



LATEST WELLER-SOLDER GUNS

New High Wattage Guns—These latest model guns have everything! Increased wattage—dual spoolites—rugged plastic case—featherweight balance. Come equipped with cord, plug and one tip. 110-120 volt AC 60 cycles.

PROFESSIONAL SOLDER GUNS STANDARD DUTY GUNS

Model S-400. Single-heat type. 125 watts. Shpg. wt. 3 lbs. List \$12.15. NET **8.77**
Lots of 3, EACH **7.89**
Model D-440. Dual-heat type. 100-150 watts. Shpg. wt. 3 lbs. List \$14.95. NET **10.73**
Lots of 3, EACH **9.65**

HEAVY-DUTY GUNS

MODEL S-500. Single-heat type. 250 watts. Shpg. wt. 3 1/2 lbs. List \$13.50. NET **9.75**
Lots of 3, EACH **8.77**
MODEL D-550. Dual-heat type. 200-275 watts. Shpg. wt. 3 1/2 lbs. List \$16.25. NET **11.71**
Lots of 3, EACH **10.53**

REPLACEMENT TIPS

No. 7128. For light-duty models S-400 and D-440. PKG. OF 2 **28c**
No. 7250. For models WS-200, WD-250, S-500 and D-550. PKG. OF 2 **35c**
No. 7300. Chisel tip. For use only in older models S-107 and D-207. Not interchangeable with tips used in guns listed above. PKG. OF 2 **28c**



5.83

A complete soldering set. Weller soldering gun delivers over 100 watts and heats in 5 seconds. Gun has trigger switch control and dual spotlights to illuminate work. Uses long life inexpensive replaceable tips. Kit also includes soldering aid to make tight wire twist and help open old soldered joints, and brush to insure clean connections. Shpg. wt. 4 lbs.

WELLER 8100-K.....List 7.95.....Net **5.83**

WELLER SOLDERING KIT



Here's everything you need for hundreds of homecraft and hobby jobs. Does all the many electrical soldering jobs around the home and shop—plus plenty of heat for sheet metal—pots—pans—cans—etc. Cut plastic tiles—repair plastic toys. Kit includes 250 watt instant heat—dual spoolite Weller gun—ample supply of Kester solder—coloring tip—smoothing tip—cutting tip—tip interchange wrench—two instruction booklets—sturdy metal case for convenient storage. Shpg. Wt. 5 lbs.

WELLER 8250-AK.....Net **10.99**

UNGAR ELECTRIC PENCIL AND SOLDERING SET



One complete set for home craftsmen and hobbyists. Set contains six interchangeable tips; four for burning and embossing of wood, plastic, leather, cork, etc., and two for soldering. Five sheets of embossing foil, abrasive cloth, complete set of instructions for working wood, plastic, leather and cork. Illustrated catalog of plaques and projects. Heating unit is UL approved and guaranteed for 10,000 hours.

MODEL 217.....EACH **1.96**
Lots of 6, ea. **1.59** Lots of 12, ea. **1.47**

WALL INSTANT

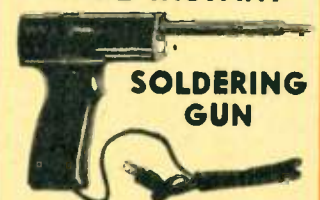

Trigger type transformers soldering gun. Heats in seconds. No replacing of tips—pre tinned 1/2" tip lasts as long as element. Weighs only 6 ozs. Starting wattage 150, idling wattage 75 9" long, UL approved cord and plug. Shpg. wt. 1 1/2 lbs.

WALL 2387.....Net **4.48**

WALL 2387L - with light Net **5.24**

REPLACEMENT ELEMENT —

TIP ASSEMBLY.....Net **2.98**

POWER CRAFT JIG & SABER SAW

The perfect standard duty jig saw for hobbyist, shop and handyman. Ruggedly constructed—easy to use—recommended motor 1/4 H.P. Depth of throat 12". Table of heavy gauge steel measures 8 1/2" x 8 1/2". Uses standard 6" or 6 1/2" blade any width up to 3/16". Stroke is 1/16". Enclosed mechanism—run in light grease. Self-Lube bronze bushings and hardened working parts for long wear and durability. Two piece cast frame—16" high, 17 1/2" long overall. Uses 3" pulley. Motor not included. Shpg. Wt. 14 lbs.

HD-67.....Net **9.35**



9.35

UNGAR SOLDERING PENCILS



Latest model. Check these improvements. Cooler handle of molded plastic. Perfect balance. Firm fit cork grip. Spring action rivet for positive contact. Ceramic insulation for double safety. Extra-flexible cord. 7" overall length.

MODEL 776, Cord, Handle Only.....ea. **1.10**
Lots of 10.....each **89c**

REPLACEMENT TIPS

New "Eltaloy Tips". Super versatility—greater economy! You no longer have to discard the heating unit—it can be used with tip after tip. Threaded "tips" screw into heating unit. Standard element and tip are 20 watts. *Extra hot—37.5 watts. Heat to 600° in 40 seconds.

Fig.	Type	Standard Tips	EA.	10. EA.
F	534	Pyramid	98c	79c
G	539	Chisel		
E	540	Marking		
F	1236*	Pyramid	1.18	96c
E	1239*	Chisel		
B	231	Pencil	16c	13c
C	332	Offset		
A	333	Chisel		
D	535	Ht. Unit	98c	79c
D	1235*	Ht Unit	1.10	96c
New 776 Handle and 536 Tip.....ea. 2.08				
Lots of 10.....ea. 1.68				
New 776 Handle and Ht Unit				
1236 Tip.....ea. 2.28				
Lots of 10.....ea. 1.85				

UNGAR SUPER HI-HEAT TIPS

850° and 1,000° tip temperature—only 4 1/2 wattal. Especially engineered for Production and Heavy Duty. Machined from Tellurium Copper with special pure silver and iron plating.

Fig.	Type	Descript.	EA.	10. EA.
E	4038	Chisel	1.35	1.01
D	4036	Heat Unit	2.35	1.91
E	4039	Pyramid	1.35	1.01
E	4039	Heavy Chisel	1.35	1.01

14.91 PBT PORTABLE SPRAY OUTFIT

- Powered by any 1/4" Electric Drill.
- Compact—Sturdy—Light weight.
- Twin-cylinder

This is the newest tool attachment for your 1/4" electric drill! Anyone can do a professional job on furniture—autos—cabinets—equipment. Twin cylinder compressor delivers .5 cu. ft.—25 PSI at 1800 RPM. Adjustable bracket permits any 1/4" drill to serve as power source. Includes adjustable nozzle to handle various liquids—one quart capacity siphon type spray gun threaded for standard mason jars—10 ft. rubber hose—50 lb. capacity air gauge—three adapters to fit practically any air inlet valve—twin cylinder compressor with 0-40PSI pressure regulator. Only 14" x 7 1/2" x 7 1/2". Shpg. Wt. 8 lbs.

MD-134.....Net **14.91**



10.99 WELLER POWER SANDER



- Positive Straight Line Action Sands with The Grain
 - Large Sanding Area Full 28 sq. inch
 - Powerful High Speed Cool Motor
 - 14,400 Strokes Per Minute
- Power-packed reciprocating type motor in easy-grip case only 2 1/2" high with push-button control. No torque, bucking or on-off fingertip control. No torque, bucking or twisting. Positive straightline action. Tension-lock paper holder. Rubber insulators between motor and housing minimizes noise. 28 sq. in. sanding area. Complete with 8 ft. cord, 6 sheets asst. sandpaper and polishing cloth. Shpg. Wt. 3 1/2 lbs.

WELLER 700.....Net **10.99**

Unique **HOLIDAY** Specials

At **Lafayette's**
BUDGET PRICES

Lafayette

**BRINGS THE STARS
TO YOUR HOME**

- The famous-fabulous Spitz, Jr. Planetarium!
- It operates right in your home—scientifically plotted accurate as a professional model.
- Projects nearly 400 stars—more than 70 constellations!
- Easy to operate—works on ordinary household current.

Designed by Armand Spitz—world's leading producer of planetariums—the Spitz, Jr. Planetarium is as accurate as a \$2,000.00 professional model. Two simple adjustments show the sky as it appears from any point in the Northern Hemisphere—for any month of the year! Latitude and daily motion are controlled by hand. A rheostat controls the brightness of every star. More than a toy—children, and parents, too, find the Junior Planetarium fascinating—educational—and fun. The projector will cover a "sky" of about 40 square feet. Horizon stars are projected on the walls and all have a very realistic appearance. The stars can be made to sweep across your own private "heavens"—rising in the East and setting in the West. A touch of the brightness control and the stars begin to glow and brighten before your eyes. From the Equator to the North Pole—for any time of year or any part of our hemisphere—the Planetarium will flood your walls and ceilings with the mystery and beauty of the heavens. A natural for today's space-minded youngsters. Perfect for schools—written 32 page book by Armand Spitz, containing charts and illustrations for easy identification. Planetarium 14 1/2" high and weighs 3 lbs.

Spitz, Jr. Planetarium—List \$15.00.....**NET 10.75**

SKY ZOO PROJECTOR SPHERE

This unit converts the Spitz Jr. Planetarium to project the actual figures of the major constellations on the walls and ceiling of any darkened room. Floods your own private "sky" with the mythical figures of the constellations, Leo the Lion, The Big and Little Bears, Scorpius, Cygnus, Orion and many others. Complete with instruction book. Shpg. wt., 1 lb.

Sky Zoo Sphere.....**List 4.00.....Net 2.70**

SOUTHERN HEMISPHERE PROJECTOR

Enables the user to convert Planetarium to project the heavens as seen from below the Equator. Locates your position anywhere in the southern hemisphere—shows stars invisible to people living north of the Equator. Shpg. wt., 1 lb.

Southern Hemisphere Projector.....**List 4.00.....Net 2.70**



10.75



**TV TUBE
CADDY**

\$6.75

Here's a real value in a portable caddy. Holds up to 130 tubes. Unique break-away section makes everything quickly available. Has compartment designed for carrying instruments and large tools and a 3 section compartment for smaller tools wire solder, etc. Wood case with plastic coated fabric covering measures 16" W x 12 1/2" H x 8" D. Shpg. wt. 13 lbs.

ML-75.....Net 6.75



**SUPER STEEL
TOOL
CHEST**

\$4.25

A steel chest built to last. Removable tote-away. Double lock seamed construction, reinforced corners, continuous hinge, steel handle, regular key lock plus hardware. Baked enamel interior. Steel gray outside finish. Size 16 x 7 x 7".

MC-22.....**Net 4.25**

WELDALL—the wonder Welder!

- Ends makeshift-temporary repairs!
- It spot welds—sweat welds—tins—solders copper, aluminum, gold, silver and bronze!
- Works off automobile battery—4 to 12 volts—or house current with transformer!

A new all purpose welder for a thousand and one workshop or home repairs. Mends and repairs countless items. Works safely—without flame! The Weldall works quickly—easily—safely—economically! This is not a gadget—but an industrial type spot welder and soldering pliers designed for light industrial and home-shop use. Does the work of soldering irons—braising torches—and spot welders. Repairs tools—machinery—household articles—toy—etc. Build wrought iron furniture—metal cabinets—heat metal for bending and shaping—releases rusted and frozen nuts and bolts through heat expansion. A necessity for repairmen—hobbyists—home owners—farmers—jewelers—plumbers—air conditioning and all other mechanics. The uses for Weldall are limited only by your own ingenuity! Simple and direct action due to unique piler design. Specially formulated hard-carbon electrodes will spot weld almost any type of metal. Weldall offers clean, quiet operation—with no fire or shock hazard. Ideal for field work where electricity is not available. Weldall includes tool with switch, heavy duty plastic covered cables, battery clamps, and operating instructions. Transformer available for use on house current.

WD-133.....**Net 10.95**

WD-134 12V. 60A. Transformer.....**Net 17.95**



**ELECTRONIC
FLASH KIT**

- BUILD YOUR OWN PHOTOGRAPHIC "STROBE"
- ELECTRONIC FLASH TUBE GIVES THOUSANDS OF FLASHES
- Watt-second output is 60
- Flash duration 1/1000 second



33.75

You can now own a portable electronic flash unit at low cost. No more fusing with replacement of photoflash bulbs—the electronic flashtube can be flashed thousands of times under normal use. The kit is complete with the flash-gun, the electronic Photo-flash tube, case, special Photo-flash capacitor and all necessary parts and hardware. 12 page instruction manual with easy to follow large drawings. Anyone can build it. Case size 7 5/8" x 2 1/2" carry the batteries. Shpg. wt. 6 lbs. (less batteries which are not supplied).

ML-65.....**Net 33.75**

Deluxe Model

Same as above but 120 watt—second output ML-83

**Net 48.50
11.12**

SPECIAL BLENDER SALE

• HOLDS 54 OZSI

15.95

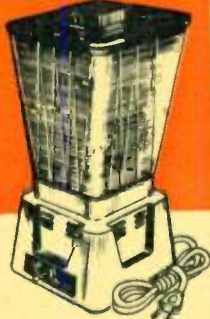

Holds nearly twice as much as the average blender! Real "party size". Liquidize fruits and vegetables. Square shape give increased circulation—better blending. One ounce "Remove-Cap" for non-stop blending. Chops, grinds, blends, mixes, pulverizes, shaves, mashes, shreds, powders, creams, minces, whips, churns. Light weight—easier to handle—easier to pour. Highly stable—solid cast metal base. Deep fitting—non spill top. White enamel base. 110 V.A.C.—D.C. 13 1/2" high overall. Shpg. wt., 8 lbs.

AP-10.....**Net 15.95**

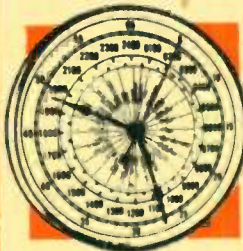

**24 - HOUR
STATION
CLOCK**

- Tell world-wide time at a glance!
- Ideal clock for the amateur, short-wave listener and for commercial stations.

TD-2400, self-starting, accurate clock for telling world-wide as well as local time. Calibrated in hours, 0100 to 2400, in minutes and seconds, 1 to 60. Has black hands with red sweep second hand. 6" dia. rotating inner dial, frictionally attached to hour hand, in red and blue. Shows time directly in all time zones. Simply set hour hand and inner dial for your time-zone, then read the time in any zone easily, quickly, accurately. 10" dia. For 110-120 volt, 60 cycles, A.C. Shpg. wt., 4 lbs.

ML-82—Net including excise tax.....**13.25**

FOTOLECTRIC PHOTOCELL KIT

• BUILD YOUR OWN ELECTRIC EYE
KIT
12.64



Complete kit provides all parts and instructions for fascinating, instructive building of electric eye. Designed by engineers for use by hobbyists—teachers—students. Opens and closes circuits—automatically operates various electrical devices. Will respond to light from ordinary light bulb. Black wrinkle case—5 1/4" x 5 1/4" x 2". Shpg. wt., 8 lbs.

Werner No. 69.....**Net 12.64**
Light Source—For use with Werner 69 Kit. Covers distance up to 15 feet. 4 1/2" x 4 1/4" x 2 1/2". Shpg. wt., 8 lbs.

Werner No. 39.....**Net 7.94**

MORE LAFAYETTE SCOOPS!

ENGLISH ALNICO-ALCOMAX MAGNETS LABORATORY QUALITY AT REDUCED PRICES

LABORATORY SET

This set has been specially designed for schools, laboratories, and technicians, for testing and demonstrating the magnetic properties of permanent magnets of different shapes and sizes. It is invaluable for plotting magnetic fields. Fine hardwood case contains a pair of bar magnets 2"x1/2" diam., a horseshoe magnet 1 3/4" high x 1 1/2" x 3/4" deep with 1/4" spacing between poles, and a bridge magnet 1 1/2" high x 28/32" x 1/2" deep with 1/4" space between poles. All magnets are Alnico Horseshoe and bridge magnets supplied with plated keepers. Case is 2 1/2" x 1 1/4" x 5" wide with clasp and hinges. Shpg. Wt. 1 1/2 lbs.

345



F-58

Net 3.45

MASCO E-Z TALK 2 Station Intercom System



- First Time at a Price to Fit Everybody's Purse!
- For Home Intercom or Baby-Sitter

14 65

A complete 2 station intercom system that is easy to install and simple to operate. Master station has volume control with on-off switch. Remote can answer calls from a distance as there is no switch to operate on remote. Remote is always "open", making its use as a "baby-sitter" ideal. Low hum and noise. Alnico V PM speakers. Metal cabinets—size 6 1/2" x 3 3/4" x 4 1/2" H. System is complete with 2 stations, 50 ft. of cable and instructions. Shpg. Wt. 6 1/2 lbs.

MASCO E-Z TALK SYSTEM

NET 14.65

BIG BEAM

Sealed Beam Beacon Lamp

Powerful and versatile portable hand lamp. Operates as a lamp, a flashing red beacon, or both. The flashing beacon may be positioned up or down. Sealed beam bulb keeps mirrored reflector dust free. 4" chrome-plated steel lamphood. Chrome-plated steel arm fits snugly over handle. Beacon flashes 60 times per minute. Steel weather-proof case with hinged cover and snap catch. Operates on one battery. Shpg. Wt. 3 lbs. List 10.50.

ML-66—Less Battery Net 6.98
Burgess No. F4H battery Net 61c
Wt. 1 1/2 lbs.



6.98

"DIAL-A-MATIC" ADDING MACHINE

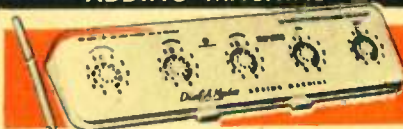

ADDS UP TO 99,999—SUBTRACTS—MULTIPLIES

Fast—accurate—precision engineered. Moving parts made of DuPont Nylon. Just dial your numbers—read your answer! Great for general daily calculations—small business—and homework. Fits pocket or purse—mechanically guaranteed. With dialing stylus. Shpg. wt., 1/2 lb. F-189

Lots of 3, each 1.35
Singly, each 1.50

TAP-A-LINE HANDY 8 in 1 OUTLET



- In radio and television shops
- In the home workshop
- In the kitchen
- On the farm

Tap-A-Line multi-plug is a handy time and nuisance saver. Avoids shifting of plugs—stringing extension cords. Makes continuously available up to 8 different appliances at one time. Easy to install or use unmounted. Grips plugs securely at all times. A must for use in areas having a limited number of outlets. Rated at 1000 watts. Ivory colored tough plastic—12" long by 1" square. Four ft. heavy cord and plug. Tap-A-Line is safe—convenient—handy. Shpg. Wt. 1 1/2 lbs.

EL10.....Net 1.47
EL11, same as above—but 2 ft. long
Net 2.40

WIRELESS MICROPHONE

No wires necessary. Talk through your radio speaker with this battery powered mike, up to 75 ft. from set. Broadcasts from 1000-1700 kc. Merely tune radio to a non-interfering point on the dial within this range. Lightweight, plastic unit, 6 3/4" H, 5 1/2" D, 5" base.

BATTERY MODEL—Operates on self-contained battery. Complete with tube, guide book and batteries.

ML-27—Shpg. Wt. 3 lbs. 8.50

AC-DC MODEL—Plugs into regular 110 V AC or DC outlet—complete with tube and guide book.

ML-46—Shpg. Wt. 3 lbs. 8.50



6.50

POCKET GENERATOR FLASHLIGHT

- NO BATTERIES—EVER!
- ALWAYS READY TO OPERATE!

The perfect pocket flashlight for home—car—or to carry with you. Plenty of bright light just by successive activation of generator level. No batteries to corrode or go dead. Balanced flywheel generator for ease of operation. Only 2 3/4" x 1" x 1 1/4", slips easily into pocket or purse. Never wears out. Ideal for campers—tourists—motorists. Weighs only 6 ozs. Made in Germany. Shpg. wt. 1 lb. F-169.....NET 3.79



PORTABLE
6 VOLT SPOTLIGHT
1.89

SIMPLY PLUG
INTO AUTO
CIGARETTE LIGHTER

* FAMOUS MAKE

Ideal emergency light that plugs into auto cigarette lighter and gives a powerful beam that can be sent in any direction. Has 12 ft. cord and suspension hook so you can use both hands. Aluminized reflector concentrates light from GE 6 V protected bulb. Built in cord reel. Fits in glove compartment. 6" high. Shpg. Wt. 2 lbs. MS-65 Net 1.89



CRADLE TYPE TELEPHONE INTERCOM

- BUILT-IN BUZZER SYSTEM
- OPERATES UP TO 1 MILE
- USE FOR DESK OR WALL

This two station telephone set is completely self powered. Operates on easily replaced economical self-contained #1 flashlight battery. Built-in buzzers for signalling other party. Feather touch talk buttons. Electro-magnetic earphones give clear and loud reproduction. Simply connected by 2 conductor wire. Cradles are designed to set on desk or hang on wall. Made of durable heavy high impact plastic. Complete set consists of 2 phones, 2 cradles, 50 ft. wire and batteries. Shpg. Wt. 3 lbs.

ML-68—Complete set..... 3.95
WR-12—100 ft. coil wire..... 1.19
WR-18—250 ft. coil wire..... 2.80

3.95

OUTSTANDING IMPORTED VALUES

GERMAN ARMY KNIFE



A 12.50 VALUE

FOR
3.75 only

- Made of Finest Solingen Steel.
- Latest Model with Scissors.

The famous knife of the German Army! Made in Solingen, West Germany, of super fine steel. Holds edge sharp enough to shave with! Finest hunting, fishing, and all 'round sporting AID made! Includes a 2 3/4" saber type blade, 1 3/4" utility blade, standard screw driver, Phillips screw driver, 3" compound toothed saw blade, reamer-punch-awl blade, can opener, bottle opener, and pair of fine quality scissors. Withstands the roughest treatment. Fine Solingen Steel assures years of dependable service. Shpg. wt. 1 lb.

F-121.....Net 3.75

SPORTSMAN'S COMBINATION KNIFE

3.25

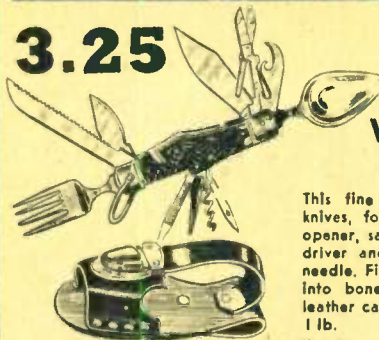

In genuine leather case

A COMPLETE
12 PIECE
CAMPING KIT
WORTH 3 TIMES
THE PRICE

This fine imported camping kit contains 2 knives, fork, spoon, scissors, can and bottle opener, saw and fish scaler, awl punch, screw driver and file, corkscrew, and a sailmaker's needle. Fine steel blades. All tools fold neatly into bone handle 4 1/2" long complete with leather carrying case with belt loop. Shpg. wt. 1 lb.

F-148.....Net 3.25

NAUTICAL BRASS BAROMETER

REGULAR

\$10.00

VALUE



- BOATS
- CLUBS
- DENS

Fine, imported brass barometer—specially designed for boats—equally at home in your living room or den. Silvery dial with fine black markings. Reads "Stormy—Change—Very Dry"—measures from 27" to 32" with subdivision of 0.1. Has third scale divided from 900 to 1065 millibars. Beveled crystal face 3/4" in dia., 4" dia. back flange with three mounting holes, 1 1/2" deep overall. Highly polished nautical brass case. Adjustable for local height above sea level by means of screw at rear. Shpg. Wt. 1 lb.

F-165.....Net 4.75

4X40 FIELD GLASSES

3.98



- SENSATIONAL VALUE!
- Imported from West Germany.
- Built in magnetic compass.

A fine 4 power field glass with 40 mm objective lenses. Smoothly operating central focus for quick adjustment. Variable inter pupillary adjustment permits setting to your eye width. Rugged frames for all round use. Finely ground and polished lenses. Magnifies objects 4 times! 40 mm objective lenses suitable for night viewing. Do not confuse these glasses with "toys" selling for even moral Light weight—maximum light gathering power—large field of view. Complete with neck strap. Shpg. Wt. 2 lbs.

F-39—Tax Included.....Net 3.98

3.95

5" BAROMETER

- Reads 26 to 32 Inches • Precision Movement
- Handsome Styling



Produced in Germany by expert craftsmen—unquestionable quality—unbelievable price! Calibrated in 1/100", 1/10" and inches from 26" to 32". Ivory porcelainized metal scale with black and red lettering reading: Stormy—Rain—Change—Fair—Very Dry. Richly polished mahogany stained hardwood case. Black indicator arrow shows atmospheric pressure. Brass arrow sets for reference reading to show degree of change. Polished brass bezel, plano crystal face, open dial reveals intricate mechanism. 5/4" in diameter by 1 1/2" deep. Tells weather 12 to 24 hours in advance.

F-11.....NET 3.95

SHIP'S WHEEL BAROMETER

- Precision Movement
- Handsome Styling
- Solid Brass Spokes

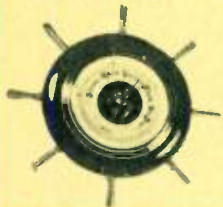

Beautifully styled to look like a ship's wheel, this German-made barometer with its solid brass spokes, hardwood polished case, brass bezel and porcelainized scale is both attractive and dependable. Handsomely lettered reading "STORMY - RAIN - CHANGE - FAIR - VERY DRY". Open face reveals intricate inner mechanism. Pointer shows atmospheric pressure on scale reading 26 to 32 inches. Tells weather 12 to 24 hours in advance. Diameter 5 1/4" by 1 1/2" deep. Shpg. wt. 3 lbs.

F-51.....Net 5.25

Micro-Telescope



3.98

Two precision optical instruments in one handy pocket unit. When collapsed it is a 50X microscope with a self contained concave illuminator mirror. Extended it becomes a 10X Telescope! 5" collapsed—extends to 8 1/2". Carried as easily as a fountain pen. All metal construction with a grey enamel and chrome finish. Remarkable versatility in one instrument. Ideal for field work—nature study—sports—etc. Shpg. Wt. 1/2 lb.

F-38.....Net 3.98

2.75

HAND TALLY REGISTER

- 4 DIGIT CAPACITY • COUNTS 0-9999
- SINGLE TURN RESET KNOB



Registers 0 to 9999. Highly polished chromium plated brass case. Attached finger-ring and compact shape for comfort in holding. Plunger operated for smooth, easy action. Large, clearly read numerals. Knurled reset knob sets register to zero in one turn. Precision accuracy for lab, school and industrial users. Invaluable for inventory control—gate checking—traffic, etc. Small Size, approx. 1 1/2" x 1 1/4", permits concealed operation. Shpg. Wt. 1/2 lb.

F-48.....Net 2.75

RECTANGULAR READER



2.50

Imported rectangular reader at an amazingly low price. Exceptionally clear optically ground and polished lens. Lens is 2" x 3 3/4". Set in molded frame of ebony plastic. Focus: 8 inches. Shpg. Wt. 1 lb.

F-40.....Net 2.50

FLEXIBLE DESK MAGNIFIER



2.25

Small, compact stand magnifier for bench or desk use. 3X lens is 2 1/2" in diameter—has 3 1/2" focus. Enclosed in black enameled brass rim—horse-shoe base in black finish—has two chrome plated universal joints for adjustment in any direction. Shpg. Wt. 1 lb.

F-41.....Net 2.25

INDOOR-OUTDOOR THERMOMETER

- EASY TO READ.
- MAGNIFYING CASE.



- ACCURACY GUARANTEED.

Instant comparison of room and outdoor temperature. "Inside" location ideal for quick, easy reading. Tells at once if air-conditioner or furnace is operating properly. Magnifying case and single centered scale permits easy reading from any position or distance in the room. Guaranteed accuracy as

specified by the U. S. Bureau of Standards. No moving parts to become worn. Easily, quickly installed. Attractive charcoal gray background—white scale—red fluid tubes. Complete with instructions and mounting hardware. Shpg. Wt. 1 lb.

F-166.....Net 3.60

LAFAYETTE'S DIRECT IMPORTATION FROM ABROAD...AND YOU GET THE BENEFITS AT GIVE AWAY PRICES!!!

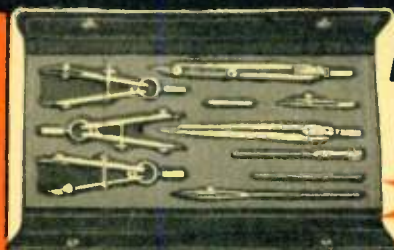

DRAFTING SET

2.59

Made in Germany of hard rolled, nickel plated brass. All instruments are nested in a fitted, velvet lined case. Contains three side wheel 3 3/4" bow instruments—one a divider, one a pencil and one a pen. All have reversible needle point. 5/4" compass with pen and pencil parts—and lengthening bar. 5/4" divider with straightening device. 5" ruling pen. Extra handle for use with pen and pencil parts. Cap-sule with extra leads. This is one of the finest values Lafayette has ever offered. Perfect for schools, labs, industrials or wherever precision drawing sets are used. Your money back if you do not agree that this set is worth twice our low, low price!

F-13.....NET 2.59

SPECIAL COMBINATION OFFER DRAFTING AND DRAWING SET

Consists of F13 drafting set and F49 drawing set. Shpg. Wt. 2 lbs. Stock No. F50.....Net 4.25



PROFESSIONAL GIANT BOW DRAFTING SET

- 6" Size with Center Wheel Adjustment
- Finely Balanced—Professional Type

Professional quality utility set in a fitted, velvet lined case. Made in Western Germany of nickel plated, hard-rolled brass. 6" giant bow has preferred center wheel adjustment. Makes circles from 1/4" to over 10" in diameter. Set includes 6" giant bow, interchangeable pen and pencil parts, extra needle for using bow as divider, handle for use with pen and pencil parts, lead, lead box and repair parts. Quality features make this set worth many times our low price—You must agree—or your money back! Shpg. Wt. 1 lb.

F-44.....Net 2.95

IMPORTED MARCHING COMPASS



Made in Germany by the leading European compass manufacturers. Indispensable for campers, hikers, hunters, tourists, etc. Same type as those extensively used by the armed forces to determine one's position in unknown country. Jeweled needle—luminous cardinal points—rotating twin scale, 0-64 and 0-360—sighting line and mirror for accurate bearings—locking device—setting edge calibrated in millimetres—rugged, ebony finish case. Can also be used to measure the width of an objective. Complete with instructions.

F-118.....Net 2.45

JWELED NEEDLE COMPASS

Here's a precision compass by a famous compass manufacturer—each compass is made by precision craftsmen and assures dependable accuracy. Heavy brass case is nickel plated and highly polished. Hinged cover, 1 3/4" beveled crystal face, swivel carrying ring. Metal scale fully calibrated, has luminous marking at cardinal points. Needle is suspended on a jeweled bearing—has luminous tip. Locking device holds needle in position—highly polished inner band permits reading from any angle.

F-12.....NET 99c



COMPLETE DRAWING SET

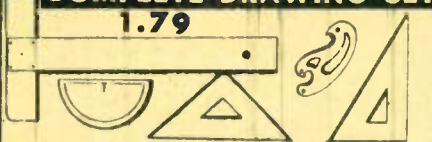

These drawing kits were especially designed for students of mechanical drawing and engineering. Perfect for professional people needing inexpensive, accurate instruments for home or office use. Consists of: 18" wooden T square, 6" transparent 45-90° triangle, 8" transparent 30-60° triangle, 6" 180° transparent protractor with etched rule and french curve cutouts, 5/4" transparent french curve. Guaranteed to be worth many times our low price. Shpg. Wt. 1 lb. F-49.....Net 1.79

ELECTRONIC DRAFTING TEMPLATE

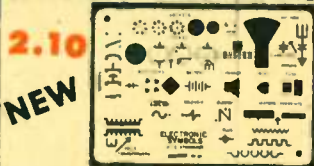

Exceptionally accurate! Made to J.I.C. standards for electronic symbols. All elements of electronic and CR tubes are provided for—plus tube bases for 7, 8 and 9 prong tubes. Includes latest symbols—transistors diodes—rectifiers—plugs, etc. Covers all electronic symbols. Size 7" x 5". Thickness .030. Shpg. wt. 4 ozs. F-151.....Net 2.10

GIANT BOW BEAM COMPASS



3.45

- Telescoping extension bar.
- Draws circles up to 28" in diameter.
- Center wheel adjustment.

Made in Germany of nickel plated, cold rolled brass. Divider is 6" long—has knuckle joint—interchangeable pen and pencil parts—telescoping beam—reversible needle point—center wheel acts as micrometer. Makes circles from 1/4" to 28" with extension bar. A professional instrument with a wide range of utility.

F-116.....Net 3.45

SWISS STOP WATCHES

- 7 JEWEL MOVEMENT
- DUAL SCALE—DECIMAL AND 1/5th
- FOR SPORTS OR INDUSTRIAL

Seven jewel—Swiss made stop watch has both decimal and 1/5th second scales. Outer scale is 60 seconds divided into 1/5th, inner scale is divided into 100 parts. Large hand completes turn in 60 seconds—small hand registers up to 30 minutes. "Time out" feature gives start-stop-start action. Both hands "fly back" to zero when desired. Rugged—accurate—easy to use. Shpg. wt. 12 oz.

F-52.....Net 8.49



WORLD FAMOUS *Sanhart* PRECISION ADDITION-DOUBLEHAND TIMER!

- Compare complicated time data. 13 Jewels - 1/5 Sec. and 1/100 Min.

Exclusive with Lafayette! One of the world's finest 13 jewel lever movement stop watches. Equipped with self-compensating hair springs screwed on metal dials for high accuracy of dial divisions and centricity, independent hammer springs for guaranteed "flyback" even after thousands of uses. Controlled energy from main spring—results in highest possible degree of accuracy. Equally useful in sports, laboratory, time studies and complicated comparison timing. Twin dials divided into 1/5 sec. and 1/100 min. Includes 30 min. register. Starts and stops with pressure on crown. Pressure on right side button stops trail hand and returns it to moving hand. Left side button slips all hands to zero. Serves to record any number of intermediate time data operations.

F-150.....Net 39.95 ea.



ILLUMINATED MAGNIFIER

- 5X MAGNIFICATION—2" FIELD!
- REGULAR 10.95 VALUE!

A fine, fixed-focus illuminated magnifier—magnifies work 5 times. Field of vision is 2" at 1 1/4" working distance. Unlimited usage in industry—shop—hobbies. For checking tools and die—castings—forgings—welds—etc. Inspection of meter movements—fine soldering electronic repairs. Magnified area easily accessible through cut out invaluable in hobbies such as stamp or coin collecting, photography, entomology—mineralogy—etc. Excellent map reader. Completely portable—uses two No. 2 cells for power. Weight 3 1/2 lbs., length 8 3/2" overall. Shpg. wt. 1 1/2 lbs.

F-193.....Net 4.49

MAP MEASURER & COMPASS



- Not a gadget—but a real instrument
- Measures distances on any size map.
- Measures curved or irregular shapes.

Exclusive at Lafayette! A map measurer with built-in compass! For the motorist—camper—hunter—boating enthusiast. An indispensable unit of equipment. Just trace along route on map and multiply miles—per inch factor by reading on dial. Also reads directly in inches up to 39". Built-in magnetic compass has cardinal and secondary points—full 360° markings in tenths. Accurate and dependable. Complete with leather sheath. Shpg. Wt. 8 oz.

F-47.....Net 1.59

VEST POCKET MAGNIFIER



Pocket size magnifier has 45 mm lens—magnifies three times. Brings subject matter into sharp clear focus. Heavy plastic rim protects against chipping. Swings into genuine leather case. Shpg. Wt. 5 oz.

F-46.....Net 49c

LAFAYETTE can save you up to **50%** on



DRAFTING

and

DRAWING

Essentials

TECHNICAL DRAFTING SET

- Center Wheel Adjustment
- Professional Quality
- German Craftmanship
- A \$15.00 Value

5.95

A fine set of imported nickel plated brass instruments priced for below the usual price for this quality. Contains $6\frac{1}{2}$ " self-centering compass, one leg knuckle joint with divider, pencil, pen spring bow divider $4\frac{1}{8}$ ", center wheel centering divider, spring bow needle point, spring bow pencil and interchangeable needle point, both $4\frac{1}{8}$ " adjustment with interchangeable needle point; two wheel adjustment and interchangeable needle point; $5\frac{1}{2}$ " ruling pens; extra handle for pen and pencil parts kit; adjustment tool; lead case and leads; and spare parts kit; all in velvet lined snap closing case. Shpg. Wt. $1\frac{1}{2}$ lbs. Net 5.95



Sale!

8" ADJUSTABLE TRIANGLE

Handiest device ever! Transparent plastic. Trace any angle of graduations on arc give angle, outer row give elementary angle. Has four openings for drawing circles $\frac{1}{2}$ ", $\frac{3}{4}$ ", $1\frac{1}{4}$ " and $1\frac{1}{2}$ " diam. Tapered to divide any line into equal parts by swinging angle. Useful for stairway drawing, architectural letter spacing. No protrusions to tear tracing paper. Shpg. Wt. 6 oz.

1.98

Net 1.98

RADIO ELECTRONIC SCALE

$1\frac{1}{2}$ " x 8" **.35**

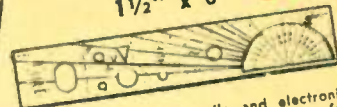

A protractor ruler with radio and electronic symbols. Ideal circuit diagram builder for hams, students and technicians. Transparent. Shpg. Wt. 4 oz. Net 35c

FRENCH CURVE SET



2.40

Made of crystal clear plastic, .090 thick. Set consists of eight French curves. Excellent for general applications. Shpg. Wt. $\frac{1}{2}$ lb. Net 2.40

LETTERING GUIDE SET

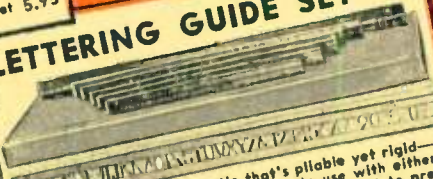

Made of transparent plastic that's pliable yet rigid— a must for good lettering. Simple to use with either sharp pencil or ink. Each guide has undercut to prevent ink smears when moved. Each has complete alphabet, all numbers plus commonly used signs. Most letters formed with one operation. Set consists of six guides. Sizes $\frac{1}{8}$ ", $3/16$ ", $1/4$ ", $5/16$ ", $3/8$ " and $1/2$ ". Shpg. Wt. $\frac{1}{2}$ lb. Net 5.98

No.	Size	Each	No.	Size	Each
F-79	$\frac{1}{8}$ "	69c	F-82	$\frac{3}{8}$ "	1.19
F-80	$3/16$ "	85c	F-83	$5/16$ "	1.35
F-81	$1/4$ "	98c	F-84	$1/2$ "	1.65

SLIDE RULE



Precision made instrument of fine laminated construction. This rule has decimal equivalents, equivalent settings and a rule with both inch and metric scales. There are A, B, C, C1 and D scales on the back. Side and log, sine and tangent on the back. Complete with instructions. Shpg. Wt. 4 oz. Net 49c

ARCHITECTS AND ENGINEERS SCALEMASTERS

Here is the triangular scale achieved in a flat scale. Eliminates searching, squinting, twisting, turning to find needed scale. Scales exposed to full view, slotted openings for convenience. Heavy laminated transparent plastic. Architects scale has 14 half scales and 16ths — 32nd — 1 ft. — including 3". Saves time, prevents errors. Engineered for dependable performance. Shpg. wt. 4 oz. Net .65

Engineers Scale: Similar to above. Has 9 full divided scales and meters. Shpg. wt. 4 oz. Net .67

F-152 — Architects Scale..... Net .67
F-153 — Engineers Scale..... Net .67

SPEEDY PRECISION DOTTER

Revolutionary Drawing Device. Interchangeable refills enable production of even dotted lines, dash and dot, or dash and two dots. Transparent plastic fully graduated in centimeters and inch. Ideal for draftsmen, architects, layout men, students, artists, etc. Supplied with dotter insert only. See below for other inserts. Shpg. Wt. 6 oz. Net 98c

F-67 — Any Type 25c
F-68A — Dotter Refill
F-68B — Dot and Dash Refill
F-68C — 2 Dots and Dash Refill

LETTERING PEN

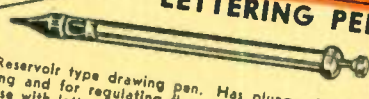

Reservoir type drawing pen. Has plunger for filling and for regulating flow of ink. Designed for general applications. Shpg. Wt. 3 oz. Net 1.15

DRAWING AID



Sturdy transparent template $3\frac{1}{4}$ " x 11". Contains most useful hexagons from $3/32$ " to $9/16$ ". One edge beveled with 6° scale in 16ths. All openings beveled and allowance for pencil point. Series of lugs raises template from paper to permit ink drawings. Shpg. Wt. 4 oz. Net 98c

IMPORTED RULING PENS

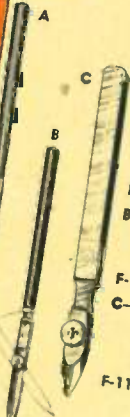

Finely made ruling pens at Lafayette's unbeatable prices! Imported from Germany. Made of hardened steel — specially tempered and pointed.

A — 5" ruling pen with spring blade and round black handle. Net, ea. 69c

B — $5\frac{1}{2}$ " ruling pen with cross joint blade — easy to clean without resetting — round black handle. Net 89c

C — $5\frac{1}{2}$ " Swedish detail pen — for drawing heavy, long lines — large ink capacity — aluminum handle — spring blade. Net 89c

STYRENE TRIANGLES

Crystal clear transparent triangles with finger lifts. Double bevel in cutout allows easy pickup. Sturdy. 100 thick. Average Shpg. Wt. $\frac{1}{4}$ lb.

SIZE	30/60°		45/90°	
Inches	No.	Each	No.	Each
6	F-71	23c	F-74	30c
8	F-72	30c	F-75	60c
12	F-73	60c	F-76	82c

CALIBRATED TRIANGLES

Many tasks can be completed without changing instruments. Clearly marked with degrees, metric scale, inches, 10th to inch and architectural scales. Shpg. Wt. $\frac{1}{4}$ lb. Two sizes available. Net 35c

F-69 — 6" — 45/90 Degree Net 35c
F-70 — 8" — 30/60 Degree Net 35c

PLASTIC FOLDING PARALLEL RULES

These rules meet government specifications. Made of black vinyl with corrosion resistant metal parts. Equipped with friction pads to prevent slipping. Shpg. Wt. $\frac{1}{2}$ lb. Net 1.98

F-92 — 12" long Net 1.98
F-93 — 18" long Net 2.65

PLASTIC T SQUARE

WITH ADJUSTABLE PROTRACTOR HEAD

Adjustable protractor head clearly marked to 180° easily set and fastened. Transparent arm gives clear full view of subject matter. All plastic — light weight. Adapted for ink ruling. Head fits snugly against board. Shpg. Wt. $\frac{1}{2}$ lb. Net 1.98

F-99 — 18" long..... Net 1.98
F-100 — 24" long..... Net 2.35

UNUSUAL OPTICAL VALUES

IMPORTED TO SAVE YOU MONEY

ASTRONOMICAL TELESCOPE WITH TRIPOD AND CARRYING CASE

40X, 64X, and 89X

Professional instrument for students of astronomy and long distance viewing. Has 3 collapsible sections and extendable wooden tripod. Precision made, high optical performance, with magnifications of 40X, 64X and 89X. Has 4X cross-hair finder; 3 eye pieces—20 mm, 12.5 mm and 9 mm; erecting prism for terrestrial viewing; diagonal prism for right angle viewing. Objective lens is 60 mm diameter, fully corrected, achromatic coated. Comes complete in wooden carrying case. Height with tripod extended 5 1/2 ft. White enamel finish. Weight of telescope, tripod and case, each approx. 6 lbs. Total shpg. wt. 25 lbs. Made in Japan.

F-102—Complete Set

Net 69.50

69.50



NEW REDUCED PRICE \$69.50

40 POWER PRISMATIC TELESCOPE

- Prismatic system — similar to fine binoculars!
- 40X for astronomical or terrestrial viewing!
- All metal construction!
- RACK and PINION FOCUSING.

Combines astronomical and terrestrial features in one instrument of professional quality. Objective lens is 60mm — almost 2 1/2" — fully corrected, achromatic and coated. Image erecting system—smooth sliding focus—deep anti-glare ringed shade—gleaming white enamel finish. Perfect for amateur astronomy—nature study—spotting targets—or just "looking around". Includes hard wood and metal tripod with fully adjustable mounting head. Tripod extends approximately 5 1/2 ft. Overall length of telescope is approximately 29". Lafayette's famous "money-back guarantee" applies as always. Shpg. Wt. with tripod 10 lbs.

F-120

Net 32.50

32.50



PORTABLE 70X MICROSCOPE

"A real gem—very well made—very valuable for mineralogists, etc." V. R. Rawson, Chairman Science Dept., White Plains High School.

- Pocket Size for Field or Lab.
- Ideal for Mineralogy—Entomology—Metallurgy.
- Achromatic Lenses.

One of finest precision optical imports Lafayette has ever offered. Unparalleled for "rock-hound", prospectors, industrial, coin and stamp collectors, students and hobbyists! Indispensable for examination of gross and opaque subjects. Highly polished—finely machined chromium plated brass tubes, mount and tripod legs. Sliding draw tube permits focusing on objects from flat surface to 1 3/4" high. Ideal for inspecting large specimens—small parts—surfaces of large pieces—that no standard microscope can accommodate. Size collapsed is only 4 3/4" — fully extended 4 1/2" less tripod. Includes soft leather zipper case and tripod legs. Weight only 8 oz. and measures 4 3/4" x 1 1/4" overall in case. Perfect portability. You must be 100% satisfied—or your money back! Shpg. Wt. 1 lb.

F-37

Net 8.49

8.49



30 POWER TELESCOPE

- Weighs only 8 ounces!
- All metal—chrome trimmed!
- With plush-lined leather case!

Precision machined body. Hand ground, hard coated, achromatic lenses. Sharp, clear, brilliant images in the same manner as fine binoculars. Used in hunting—sports—vacationing. For long distance or close up views. Brings objects 30 times closer! Highly polished plated tubes for smooth, easy sliding focusing. Collapses to 7"—extends to 14 1/2". Not a cheaply made toy telescope. But one of Lafayette's finest optical bargains. As always you must be satisfied—or return for immediate refund. Shpg. Wt. 2 lbs.

F-59

Net 5.95

5.95



30X ALL PURPOSE TELESCOPE

- WITH TRIPOD AND WOODEN CASE
- 40mm COATED ACHROMATIC OBJECTIVE!
- 59' FIELD AT 1000 YDS.!
- BODY OF DURALUMINUM AND BRASS!

See the craters on the moon! Watch planes—ships—birds and animals. Spot .22 calibre bullet holes at 200 yds.!

Just in time for vacationists—hikers—campers—boating—bird watching—any of the many outdoor activities. A typical Lafayette buy! Full two feet long closed—27 1/2" extended. Achromatic coated objective is 40mm in diameter—clear aperture is 38mm—or 1 1/2". Body diameter is 1 1/4". Lens erecting system gives upright image. Focuses from 40 feet to infinity. Adjustable horizontal swing tension and adjustable azimuth tension knob. Can be used with camera tripod. Smooth sliding draw tube focusing—with coated ocular lens. Complete with 1 1/4" tripod—bracket—Shpg. Wt. 5 lbs.

F-139

Net 11.95

11.95



New

STUDENTS • PRELIMINARY SURVEYING INSTRUMENTS • ENGINEERS

HAND SIGHTING LEVEL



1.98

- Rack And Pinion Focusing
- New Brass Bound Army Type!
- Requires No Complicated Calculations!

Indispensable to home owner—students—engineers—gardeners—plumbers—masons. Fits in the palm of your hand and sighted like a telescope. Enables user to quickly and accurately project a level line of sight. Replaces expensive surveying equipment for laying out garden—fences—patios—drains—ditches—piers—roads—etc. So simple and accurate, anyone can use it. Nicely finished and baked on enamel—brass bound. Directions included with each instrument. Shpg. Wt. 1/2 lb.

F-60

Net ea. 1.98

LOCKE HAND LEVEL



4.45

- Precision Survey Instrument!
- More Than 50% Below Regular Price!

A precision manufactured sighting level — made entirely of brass. Adjustable focus by means of draw tube. Securely mounted prismatic system. Bubble is magnified 4 times for sighting ease. Virtually dust proof. For laying foundations—grading—fences—roads—drains—etc. All preliminary surveys. 5 1/4" long closed. Includes heavy leather case and strap. Shpg. Wt. 2 lbs.

F-137

Net 4.45

ABNEY CLINOMETER LEVEL



8.95

A finely made surveying instrument of professional quality. Made entirely of brass. The Abney topographic level enables the user to determine ground elevation—measures degrees of slope or inclination—run a level line—etc. Permits preliminary surveying with little or no experience. Fine prismatic system. Arc scale is divided into 60 degrees both sides of zero. Vernier scale reads 1 to 10 minutes. Arc swings from 0 to 90 degrees. Used by farmers—builders—gardeners—caretakers—maintenance men—etc. Particularly useful in laying out drains—retaining walls and fences—driveways—fields—etc. Includes leather case and strap. Imported to save you 50% of regular cost. Shpg. Wt. 3 lbs.

F-138

Net 8.95

EXCLUSIVE! IMPORTED 500X MICROSCOPE

NEW 30 POWER 60mm SPOTTING SCOPE

- Binocular type focusing! • Prismatic Lens system!
- Weighs only 11 ozs.
- 12 1/2" long!



Complete with tripod and Case!

17.95

• Coated Optics!
• All Metal Construction

Not just another spotting scope — but a prismatic telescope using the same fine features as expensive binoculars! Fine prismatic lens systems eliminates distortion, gives sharper detailed definition and a greater field of view. Field of view is 85 feet at 1000 yds! Both front and rear optics are coated. High relative brilliance due to great 60mm (almost 3 in.) objective lens. Threaded metal dust cover screws into position over front lens when not in use. Exceptionally small and light — weighs only 1 1/2 lbs. Including metal tripod! Tripod — has adjustable tension mount which permits sighting up, down, across or at any angle. The perfect companion for shooting — hunting — viewing — naturalists — and hobbyists. Comes equipped with 1 1/2" tripod and mount and slippered leather carrying case for both scope and tripod. Shpg. wt. 2 1/2 lbs.

F-149.....NET 17.95

MANSFIELD MOVIE ACTION EDITOR

For 8 and 16 mm

- Picture screen 2 1/2" x 3 1/2"
- Glass Prism Shutter!
- 1600 ft. geared rewinds!
- Automatic Slicing!

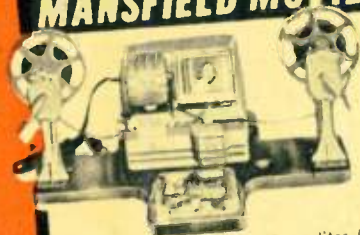

\$29.75

Latest model Mansfield action editor for home or professional use. Newest type film gate makes threading of film easy and scratch-proof. Front access door allows adjustable needs-sharp focusing. Constant and brilliant illumination from single contact 30 watt bulb and condenser makes image easily seen in light room. All die cast constructed viewer. Automatic splicer assures fast, clean splicing. Consists of: two 1600 ft. geared rewinds with metal base and prism shutter, automatic steel splicer, brilliant viewer. Mounted on metal base with grey enamel finish. A precision instrument designed to allow viewing and editing of movies with simplicity and accuracy. Shpg. Wt. 8 lbs.

F-30 8 mm Editor
F-31 16 mm Editor

Net 29.75
Net 33.75

SUPER DRAWING OUTFIT



- COMPARE OUR PRICE!

Lafayette has designed this set with the professional draftsman and advanced student in mind. Contains all the necessary equipment for drafting mechanical drawing, designing, engineering. Sturdy accurate components. Includes 20" x 24 1/2" drawing board 2 1/2" square, 10" 30°/90° triangle, 8" 45° triangle, french curve, 12" triangles and art gum eraser. 4 pencils pencil pointer, erasing shield, thumb tacks. Times our low price. An unbeatable value! Shpg. wt. 10lb.

F-180.....NET 9.00

SPECIAL COMBINATION OFFER

Consists of F-65 Technical Drafting Set and F-180 Super drawing outfit.
F-181.....NET 13.75

8" PROPORTIONAL DIVIDERS

- IMPORTED FROM GERMANY
- COMPARE OUR PRICE & QUALITY

Extremely accurate finely made proportional dividers. Basic equipment for draftsmen—architects—engineers—students. Replacable steel points — in hard, leather covered, felt lined case. Used for proportional reductions and enlargements, copying drawings into equal parts, quick solving dividing lines or circles into equal parts, quick solving of difficult measuring problems, finding distances on maps without scales, etc.

(b) 8" Aluminum proportional divider. Similar to above. Flat form—replacable steel points. Pressure setting. Graduated for lines from 1/2" to 10" — Circles from 8" to 20". Excellent accurate utility model. Shpg. wt. 8 ozs.
F-167 — (b).....NET 3.50

(a) 8" long — of heavy Nickel Silver. Precision machined. 1000 and pinion movement to facilitate setting. Profile form. Graduated for lines from 1/2" to 10". Circles from 8" to 20". An exceptionally fine instrument of professional quality. Micrometer Adjustment—Nickel Silver.
F-159 — (a).....NET 12.95



QUADRUPLE REVOLVING TURRET MICROSCOPE

500 Power
8 1/4" HIGH



NEVER BEFORE OFFERED TO THIS MARKET!

- EXCLUSIVELY LAFAYETTES AT THIS HISTORY MAKING PRICE!
- RANGE OF 500X-300X-150X-75X!

7.45

CHECK THESE FEATURES
CHECK THIS PRICE!

One of the greatest optical values Lafayette has ever offered! New four lens turret offers greater range and facilitates micro-observation. Turret-holds four achromatic objective lenses giving range of 75 x 150 x 300 x and 500 x! All metal construction—heavy horseshoe base. Black satin professional finish — high lighted with brushed chrome. Finely machined rack and pinion gear, dual knob focusing. Ocular lens is the widely accepted Huygenian type. Professional type inclination joint — inclines to 90°. Substage plano biologists and botanists, hobbyists, or as inexpensive second instrument for the professional. Backed by Lafayettes famous "Moneyback" guarantee! Includes detailed wooden carrying case and sample slides. Shpg. wt. 5 lbs.

F-168

NET 7.45

ELECTRIC CONTROLS TEMPLATE



- CONFORMS TO J.I.C. STANDARDS

J.I.C. standard symbols to assist in drawing and drafting circuits for electrically controlled machinery. Indispensable for electric automation of production processes. Includes pressure, temperature, liquid level and flow actuated switches. Controls fuses, circuit breakers, plugs, ground transformer, coils, etc. Precise, rapid circuitry is achieved with use. Size 9" x 3 3/4". Thickness .030. Shpg. wt. 4 ozs.

F-155.....NET 1.75

ELECTRICAL DRAFTING TEMPLATE



- CONFORMS TO JAN SPECS

Designed for electrical and electronic engineers and draftsmen. For drawing symbols conforming to JAN sds. 13 specifications. Capable of reproducing hundreds of electrical and electronic symbols with great neatness and accuracy. Includes symbols for vacuum tubes, transformers, coils, relays, terminal strips, circuit breakers, fuses, resistors, rheostats, capacitors, jacks, switches, etc. Has protractor for laying out tap switches. Guide for wires and cables. A time saving instrument of professional quality. Size 6-3/16" x 5". Shpg. wt. 4 ozs.

F-156.....NET 1.80

ISOMETRIC ELLIPSE TEMPLATE



25 LARGE ISOMETRIC ELLIPSES

Twenty five ellipses. 1 1/4" to 2" in 1/8" increments. 2" to 7" in 1/4" increments. Ellipses are 35° 18". All are drawn in halves and lined up on their large axes. Sizes are measured along isometric axis. Constructed of very heavy, clear plastic. All edges are bevelled. Indispensable to drafting and drawing. Actual size is 10" x 8". Thickness .080. Shpg. wt. 8 ozs.

F-157.....NET 3.50

WIRING TEMPLATE

- ELECTRIC AND ELECTRONIC SYMBOLS TO JAN SPECS.

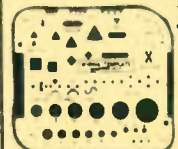

Electrical and electronic symbols conforming to JAN sds 13 specifications. Grouped and arranged for greatest ease in drawing. Includes eighteen circuit breakers — fuses — switches — resistors — rectifiers — coils — etc. Highly accurate. Terrific time saver. Size 6 1/4" x 7" Thickness .030. Shpg. wt. 4 ozs.

F-154.....NET 1.75

HARD MAPLE PANTOGRAPH

3.75

- ENLARGES — REDUCES — REPRODUCES!
- PRECISION SUSPENDED!
- NEVER BEFORE UNDER \$5.00!

21" adjustable pantograph — 21 different ratios from 1 1/2" to 8. Enlarges, reduces or reproduces drawings, sketches — diagrams — pictures — maps — etc. Most rapid, accurate means of reducing or enlarging to scale. Lacquered highly finished bars are 21" long and 3/8" wide. Heavy metal standard, with bearing eliminates all friction. Chrome plated hardware — ratio thumb screws and nuts. Complete with lead, accessories and detailed instructions. Shpg. wt. 2 lbs.

F-158.....NET 3.75

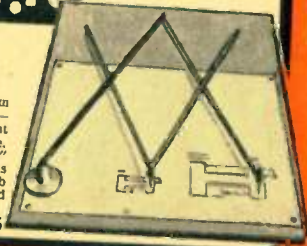

ELECTRIC MOTOR DRIVEN MODEL BOATS

Speedy — *Sleek* — *Sturdy*

Imported by Lafayette—to save you money! These are accurate scale models—complete in every detail. No assembly—not a kit. Just add a battery—flip a switch—and watch these seaworthy little craft zip! Each is beautifully finished with non-peeling marine paint. Equipped with bright, nickel plated deck hardware. Many have operating lights. Readily adaptable to "radio control". All include battery operated motor—switch control—drive assembly—wiring—clips—etc. Amazing precision construction—beauty—completeness. And you can't beat these prices!

15 1/2" OUTBOARD SPEEDBOAT

7.95



15 1/2" double cockpit speedboat. Driven by battery-powered outboard motor—plenty of reliable power! Motor mounts and steers exactly like full size outboard. 3 positions control—forward—reverse—off. Features headlight—steering wheel—built-in compass—grooved, mahogany-stained decks. 15 1/2" long, 5" beam. Uses 3 "D" cells. Shpg. wt. 3 lbs.

F-170 NET 7.95
ea. .10
Batteries for above: Burgess No. 2

15 1/2" OUTBOARD HYDRO-PLANE

7.95



15 1/2" stem to stern—8" beam! True scale hydrofoil construction for flashy performance. Done in 3 colors with mahogany-stained bow. Outboard is exact reproduction of full size motor. Switch controlled forward and reverse. Uses 3 "D" cells. Fleet—flashy—fully wired! Shpg. wt. 3 1/2 lbs.

F-171 NET 7.95
ea. .10
Batteries for above: Burgess No. 2

12" "CHRIS CRAFT" SPORTS CRUISER

7.95



Perfect scale model—12" long with a 3 3/4" beam. Double cabin style. Beautifully finished. Red and green running lights. Exceptionally well detailed. Deck housing, removable. Uses 2-Z cells. Shpg. wt. 2 1/2 lbs.

F-172 NET 7.95
ea. .08
Batteries for above: Burgess No. 2

12" INBOARD RUNABOUT

2.75



Flashy, perfect miniature runabout! 12" long with a 3 1/4" beam. Double cockpit design with removable hatch cover. Grooved mahogany stained decks. Battery operated headlight. Has steering-wheel deck fittings—flag—etc. Uses 2-O cells. Shpg. wt. 2 1/2 lbs.

F-173 NET 2.75
ea. .10
Batteries for above: Burgess No. 2

27" TWO PROPELLER SUBMARINE

18.50



Twenty-seven inches of slick—smooth—seagoing—submarine symmetry! Two feet, three inches long with a three inch beam. Twin propellers are driven feet, three inches long with a three inch beam. Battery operated, by one powerful motor through an ingenious gear train. Battery operated, switch controlled search and running lights. Finely detailed miniature accessories. Removable superstructure. Faithful replica of full sized subs. Uses 3 "D" cells. Shpg. wt. 5 1/2 lbs.

F-174 NET 18.50
ea. .10
Batteries for above: Burgess No. 2

21.50

32" TWIN MOTOR BATTLEWAGON



Husky—hefty—heavy weight of the fleet! Fashioned after the mighty battleship "Missouri". Two feet, eight inches long and four and one half inches in the beam. Expertly finished—satin smooth lacquer. Scaled accessories of almost every above deck feature to be found on the real thing. Most are moveable! Two electric motors to drive the twin propellers. Most are searchlights and running lights. Fit to grace the mantel of the most particular model enthusiast. Exceptionally fine detailing and construction. Uses 6 "D" cells. Shpg. wt. 8 lbs.

F-175 NET 21.50
ea. .10
Batteries for above: Burgess No. 2

13" NAVAL PATROL BOAT

4.45



Swift little copy of the famous Patrol Torpedo boats. Thirteen inches long and four inches in the beam. Typical superstructure and armaments—AA guns—torpedos—depth charges—etc. Uses 2 "D" cells. Shpg. wt. 2 1/2 lbs.

F-176 NET 4.45
ea. .10
Batteries for above: Burgess No. 2

SUPER MINI-MOTORS

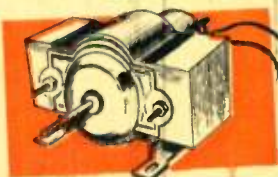

High speed—powerful, battery operated motors. For hobbyists—labs—industry. Instantly reversible. Operate from flashlight batteries. Two pole permanent magnet field. Brass sleeve bearings—phosphor bronze brushes. Industrial design casing and mount. Shaft diameter 3/32". Entirely enclosed—chrome plated.

1/30 h.p.—1.5 to 8 V.D.C. operating voltage, 6 V.D.C. Power consumption 200-250 MA. 2,800 to 4,000 RPM oh 6 V.D.C. Weight 5 oz. Overall dimensions: 2 1/8" x 1 3/8" x 1 1/2". Shaft length 2 1/2". Shpg. wt. 8 oz.
F-177 NET 1.49

1/60 h.p.—1.5 to 4.5 V.D.C. operating voltage, 3 V.D.C. Power consumption 250-350 MA. 5,000 to 6,000 RPM at 3 V.D.C. Weight 2 oz. Overall dimension: 1 3/4" x 1 1/4" x 1 1/4". Shaft length, 2". Shpg. wt. 4 oz.
F-178 NET 85c

IMPORTED BINOCULARS

With Coated Achromatic Lenses and Prisms



NEVER BEFORE AT THESE HISTORY MAKING PRICES

Lafayette has gone "all-out" to present these fine, imported Zeiss type binoculars at heretofore unheard of prices! Each of these extremely precise optical instruments have coated lenses—clamped in (not just glued!) prisms—light weight alloy all metal bodies—weather proof, tear proof outer coverings—maximum light transmission—minimum distortion. Made by leading optical manufacturers to our own rigid specifications. Whether you are a yachtman—hunter—hiker—sports fan—or a bird watcher—you'll find the binoculars you need in Lafayette's great selection. And Lafayette's famous money-back guarantee applies as always.

INSIDE INFORMATION ON BINOCULARS

FOCUS—mechanism is either central focus (C.F.) by means of a single wheel and one adjustable eye piece, or individual focus (I.F.) wherein both eye pieces are separately adjustable.

POWER—is the number of times an image is magnified through your binoculars. For example 7X (7 power) means the object will appear 7 times larger (or closer)

than with the naked eye. The second number used (i.e. the "50" in 12X, 50) is the diameter in millimeters of the objective lens.

COATED LENSES—tend to reduce reflection and pass up to 50% more light than uncoated lenses.

FULLY GUARANTEED FOR 6 MOS. AGAINST MECHANICAL AND OPTICAL DEFECTS.

		Shpg. Wt. 2 lbs.	NET 10.75
F-182	6x, 15 I.F.		NET 17.95
F-105	8x, 30 I.F.	Shpg. Wt. 3 lbs.	NET 17.95
F-15	7x, 35 I.F.	Shpg. Wt. 3 lbs.	NET 20.95
F-183	7x, 35 C.F.	Shpg. Wt. 3 lbs.	NET 20.95
F-184	7x, 35 C.F.	Wide Angle - Shpg. Wt. 3 1/2 lbs.	NET 29.50
F-103	7x, 50 I.F.	Shpg. Wt. 3 1/2 lbs.	NET 21.50
F-184	7x, 50 C.F.	Shpg. Wt. 3 1/2 lbs.	NET 23.95
F-117	10x, 35 C.F.	Shpg. Wt. 3 lbs.	NET 27.95
F-104	12x, 50 I.F.	Shpg. Wt. 4 1/2 lbs.	NET 27.95
F-118	16x, 50 C.F.	Extra Light Weight - Shpg. Wt. 3 1/2 lbs.	NET 31.50

Add 10% Fed. Tax to Above Prices

STEREO CAMERA

Complete Outfit

3 DIMENSION HI-FI PHOTOS

Reg. List **29.95**

- Takes single pictures - or Stereo
- Ruggedly constructed - Simple to use
- Color or Black and White
- Complete with Flash Unit - 3D Viewer - Frames - Leather Case - Straps

Leave it to Lafayette! Never before - a complete 3-D Camera Kit at a price as low as ours! Now anyone can capture the fullness - depth - detail - and vivid colors of lifelike stereo pictures. 3-Dimensional pictures add Hi-Fidelity to Photography! Uses standard size 127 film - takes 8 stereo pairs or 16 single pictures. Matched, coated, fluoron lenses - fixed focus, F9 and F16 stops. Built-in flash synchronization. Speeds 1/20th and bulb. Shutter cocking lever prevents double exposure. Lightweight body covered with black leatherette - trimmed with brushed aluminum. Genuine leather carrying case and straps. Collapsible optical viewer folds flat to fit pocket - purse - or gadget bag. As simple to use as a box camera. You get the 3-D Camera - leather case - straps - flash gun - 3-D Viewer - and frames. Shpg. wt., 3 lbs.

F-179

Net 9.95

STEREO HIT

9.95

IMPORTED SURVEYING TRANSIT

- Survey Easily and Accurately!
- Superb Professional Quality!



34.50

This professional surveying compass is designed to meet the needs of builders - carpenters - landscapers - farmers - maintenance men - caretakers of schools and estates - etc. Particularly useful in laying out driveways - fields - drainage slopes and ditches - connection to sewers - aligning fences and walls - erecting small buildings - grading - etc. Ideal as a simple preliminary surveying instrument, for use in taking courses - horizontal angles - vertical angles - tangents - vein tracing. Can also be used as a contact level - clinometer - and plumb. Telescope is 8x, 5 1/2" long, dustproof, achromatic lens system. Wide field - inverted image. Internal focusing for sharp focus control. Cross hairs in fixed focus. Compass 3 1/2" dia. - 2 1/2" jeweled center needle with stop-graduated on raised ring 1° divisions - two spirit levels. Vertical angles are measured on a vertical arc in single degrees numbered 0-90-0. Micrometer drive through 5" for fine adjust of clinometer. Plumb pointer on vertical arc. Clinometer - compass - and ball and socket head can be locked in position. Complete with ball and socket head - leather case and straps - plumb bob - and telescoping tripod. Shpg. Wt. 11 lbs.

F-186

Net 34.50

BINOCULAR MOUNTING CLAMP

Indispensable accessory for high powered binoculars. Fits all sizes - individual or central focus. Used with standard camera tripod. Cannot scratch or damage finest binoculars. Holds binoculars steady for long range - extended period use. Light alloy construction - satin black finish. Shpg. wt. 1 1/2 lb. F-187

NET 2.45



POCKET WARMER

- Warmth for up to 24 hours

- With new-improved burner

Indispensable for outdoor activities on cold days. For hunters - fishermen - sports fan - skaters - skiers - golfers. Use lighter fluid - benzine - white gas as fuel. Safe - practical - cold weather sports accessory. Can not burn - or spill on clothing. Ideal for TV installation work in cold weather. Slim - attractive - pocket size. 4" x 2 1/2" x 1 1/2". Heavily chrome plated. Complete with velvet draw string cover and instructions. Shpg. wt., 1 1/2 lb.

F-188

Net 1.39

new! MONARCH 3-SPEED AUTOMATIC "INTERMIX" RECORD CHANGER

MADE IN ENGLAND



\$23.00
in lots of 3

The new British Made Monarch automatically plays 7" 10" or 12" records - at 33 1/3, 45 or 78 R.P.M. Intermixed in any order! Features a 4-Pole induction type motor eliminating "rumble" and "wow". Pickup automatically returns to rest and motor switches off after last record. Rotocom combined 3-Speed control and "on" - "off" - Reject switch. Fitted suspension springs - eliminates feed back. Ten record capacity. Simple design guarantees long life and trouble free operation. Tone arm unflinchingly comes down directly into the lead groove of the record. Operates on 100-125 VAC 60 cy. Shpg. wt., 15 lbs.
Model UA6 - 3 speed changer

Less cartridge	NET Ea. in lots of 3	23.00
	Single Ea.	24.50
- With crystal Turnover Cartridge	NET Ea. in lots of 3	28.00
	Single Ea.	27.50
- With Goldring #500 Cartridge	NET Ea. in lots of 3	30.00
	Single Ea.	32.50

45 RMP Spindle: Fits in place of regular spindle. Eliminates use of spiders.

Monarch 45 Spindle NET 1.00

LAFAYETTE GEIGER COUNTER KIT

- BUILD YOUR OWN LOW COST URANIUM DETECTOR
- USES SAME HIGHLY SENSITIVE COUNTER TUBE FOUND IN \$100 DETECTORS

Lafayette has engineered this high quality radiation detector with your pocketbook in mind. Some measure of the value you receive at this low price is the Victoreen 1B85 - same tube used in detectors selling for \$100. As simple to operate as it is to construct. Radiation is detected as clicks in the headphone, the heavier and closer the radiation, the more rapidly the clicks increase. Uses long life, low cost batteries. Kit is complete with all parts, bakelite cabinet, Victoreen 1B85 tube, radio-active sample, batteries, headphone and simple instructions and diagrams for construction and operation. Size 6 3/4 x 5 1/4 x 2-5/16". Shpg. wt., 2 1/2 lbs.

KT-75 KIT NET 14.95
Extra set of batteries for above NET 1.07

\$14.95

WITH HIGH SENSITIVITY
VICTOREEN TUBE 1B85



Lafayette Radio
FAMOUS IN RADIO FOR 33 YEARS

NEW YORK 13, N. Y., 100 Sixth Ave.
REctor 2-8600
BRONX 58, N. Y., 542 E. Fordham Rd.
FOrdham 7-8811
NEWARK 2, N. J., 24 Central Ave.
MArket 2-1661

PLAINFIELD, N. J., 139 West 2nd St.
PLAINfield 6-4778
BOSTON 10, MASS., 110 Federal St.
MUBbard 2-7850

Our 5 Big Showrooms Open Evenings:
NEW YORK } open Thursdays
BRONX } till 9:00 P.M.
PLAINFIELD, N. J. }
NEWARK, N. J. } open Wednesdays till 9:00 P.M.
BOSTON } open Mondays till 9:00 P.M.

To Speed Shipment on Your Order Please Mention CATALOG 12-5

Include sufficient money for postage. We refund unused amounts.

TRANSISTOR Specials

NEW! RAYTHEON CK-722

HERMETICALLY SEALED
P-N-P

Only 99c



CK-760 (2N112) 4.65

GENERAL ELECTRIC



NEW TRANSISTOR
TYPE 2N107
P-N-P
\$1.25

LAFAYETTE RADIO

100 SIXTH AVE. NEW YORK 13, N.Y.
Return Post Guaranteed

BULK RATE
U. S. POSTAGE
PAID
New York, N. Y.
Permit No. 8486

MR & MRS I C ... LEAD
2772 KENSINGTON PL E-SR
COLUMBUS 2 OHIO