

LAFAYETTE

Gift Guide

Cat. 306



BOSTON, Mass.
 110 Federal St.
 Hubbard 2-7850
 open MONDAY
 'till 8:45 P.M.

BRONX, N.Y.
 542 E. Fordham Rd.
 Fordham 7-8813
 open THURSDAY
 'till 8:45 P.M.

Lafayette Radio

NEW MAIL ORDER & SALES CENTER
 IN NEW YORK CITY
165-08 LIBERTY AVE.
JAMAICA 33, N. Y.
 JAmaica 3-4600 open FRIDAY 'till 8:45 P.M.

100 SIXTH AVE.
NEW YORK 13, N. Y.
 REctor 2-8600
 open THURSDAY 'till 8:45 P.M.

NEWARK, N.J.
 24 Central Ave.
 Market 2-1661
 open WEDNESDAY
 'till 8:45 P.M.

PLAINFIELD, N.J.
 139 W. 2nd St.
 PLainfield 6-4718
 open THURSDAY
 'till 8:45 P.M.

New!

Lafayette CUSTOM HI-FI "MUSIC MATES" STYLE MATCHED TUNER AND AMPLIFIER



43.50
Less Cage

- MODEL LA-40 15 WATT MUSIC MATE AMPLIFIER**
- 20-20,000 CPS 0.5 DB
 - DISTORTION LESS THAN 1%
 - PUSH-PULL EL84 OUTPUT TUBES
 - TAPE HEAD AND RECORD EQUALIZATION
 - RUMBLE FILTER • LOUDNESS CONTROL
 - BASS, TREBLE AND VOLUME CONTROLS
 - 5 INPUT CHANNELS



64.50
Less Cage

- MODEL LT-40 MUSIC-MATE DELUXE FM-AM TUNER**
- ARMSTRONG CIRCUIT • AFC DEFEAT
 - AUTOMATIC FREQUENCY CONTROL
 - TEMPERATURE COMPENSATED OSCILLATOR
 - 6 TUBES PLUS MATCHED PAIR CRYSTAL DIODES PLUS RECTIFIER
 - MEETS FCC RADIATION REQUIREMENTS
 - FOSTER-SEELEY DISCRIMINATOR

MODEL LA-40 15 WATT MUSIC MATE AMPLIFIER

Beautifully styled and moderately priced, the Lafayette Music Mate amplifier has all the basic features needed for a fine high fidelity system. It utilizes the new premium quality EL84 tubes to give plenty of distortion-free power. Inputs and proper equalization are provided for tuner, pre-recorded tape and every type of phono cartridge and record. Also has an auxiliary input for such devices as TV Audio, extra crystal phono or preamplified playback from tape recorder.

The Music Mate has a tape output jack for use with tape recorders. Through this jack you can feed any of the input signal to a tape recorder. Because this jack is unaffected by the amplifier volume and tone controls, you can record programs using the equalization of your tape recorder while listening to the program through your hi-fi system.

In addition to the separate bass, treble and volume control, there is a 3 position loudness switch to retain the correct tonal balance between high and lows at different volume levels. Objectionable motor vibration, sometimes introduced by some record changers and turntables, can be eliminated by the rumble filter switch. A hum adjustment control minimizes subsidiary hum.

An additional unit such as a phonograph or tuner may be plugged into the auxiliary AC outlet and turned on or off simultaneously with the amplifier.

The Lafayette Music Mate amplifier is finished in attractive dark maroon and gold and matches in styling the Lafayette Music Mate Tuner.

It is designed for simple mounting in cabinet or in panel. For this purpose order the model LA41 (less cage). For use on shelf, the model LA40 is supplied with an attractive cage.

SPECIFICATIONS

POWER OUTPUT: 15 Watts continuous, 30 Watts peak. **FREQUENCY RESPONSE:** ± 0.5 DB from 20-20,000 cycles. **DISTORTION:** Less than 1%. **GAIN:** Magnetic Phono, Tape = 112DB; Crystal Phono = 80 DB; Tuner, Aux = 75 DB. **SENSITIVITY:** Mag. Phono, Tape = 4MV; Tuner, Aux = 0.25V; Crystal Phono = 0.16 V. **NOISE AND HUM:** Tuner, Aux = 75 DB below rated output. Phono and Tape = 55 DB below rated output. **5 INPUTS:** Crystal or Ceramic Phono, Magnetic Phono, Tape, Tuner, Aux. **7 CONTROLS:** Function and Equalization Selector, Volume, Bass, Treble-AC Power, Loudness, Rumble Filter Hum Adjustment. **EQUALIZATION:** 3 positions: 78, R1AA (LP), Tape, (NARTB). **TONE CONTROL ACTION:** Cut or boost 10 DB on both bass or treble. **OUTPUT CONNECTIONS:** Speaker term and tape output jack. **OUTPUT 5PKR. IMP.:** 4, 8, 16 ohms. **POWER OUTLET:** Conventional AC Power Outlet on Rear Controlled by front panel AC switch. **TUBES:** Two EL84, ECC83/12AX7, 6U8, and E281 rectifier. **SIZE:** 12 1/2" W x 8 3/4" D. x 4 1/4" H. **SHIPPING WT.:** 12 lbs.

Lafayette LA-41 Amplifier (less Cage)	Net	43.50
Lafayette LA-40 Amplifier (with Cage)	Net	46.50

MODEL LT-40 MUSIC-MATE DELUXE FM-AM TUNER

The Lafayette Music Mate Tuner is a sensitive, selective, stable FM-AM tuner with all the basic features for a deluxe high fidelity system. It has the same beautiful styling as the Lafayette Music Mate amplifier, and matches it in decor. Freedom from drift is assured by the temperature compensated oscillator and programs once tuned in are "locked in" by automatic frequency control action. The circuit uses 6 tubes, a rectifier plus 2 long-life matched germanium crystal diodes to reduce hum. Frequency response extends to 20,000 cycles. Covers the entire FM and AM ranges. The AM section is a superheterodyne with automatic volume control action. Has built-in antennas for both AM and FM as well as provision for outside antenna. The technical specifications shown on hum and distortion clearly indicate the excellent reception you will get with the Music Mate. Finished in attractive dark maroon and gold.

Easily mounted in cabinet or on panel. For mounting, order model LT-41 (less cage). For use on shelf or furniture, order LT-40 (with cage).

SPECIFICATIONS

CIRCUIT: FM: Armstrong circuit with limiter and Foster-Seeley Discriminator, AFC, AFC defeat, temperature compensated oscillator. AM: Superheterodyne with AVC. **SENSITIVITY:** FM: 5 Microvolts for 30db quieting AM: Loop 100 μv/m for 20 db S/N. Terminal sensitivity 5 μv for 20 db S/N. **RANGE:** 88-108 MC and 530-1650 KC. **FM DRIFT:** ± 5 KC MAX. **SELECTIVITY:** FM: 200 KC bandwidth 6 db down. AM: 8 KC bandwidth 6 db down. **DISTORTION:** Less than 1%. **FREQ. RESPONSE:** FM: 20-20,000 cycles ± 1 db; AM-20-5000 ± 3 DB. **HUM LEVEL:** 60 DB below 100% modulation. **RADIATION:** Meets FCC requirements. **TUBES:** 2 - 6AU6, 1 each 6AB4, 12A17, 6BA6, 6BE6 plus 6X4 rectifier and matched pair 1N542 crystal diodes. **STAGES:** FM: 2 IF; limiter and untuned RF; AM: 2 IF stages. **CONTROLS:** Tuning, band selector, AFC defeat, power. **ANTENNA:** Built-in 300 ohm FM line antenna and ferrite AM loopstick. Provision for outside antenna. **SIZE:** 13 1/2" W x 5 7/8" D x 4-3/16" H. **SHIPPING WT.:** 10 lbs.

Model LT-41 Tuner (less cage)	Net	64.50
Model LT-40 Tuner (with cage)	Net	67.50





Lafayette HI-FI "Music-Mates" SYSTEMS

STYLED MATCHED
COMPONENTS

(NO
CABINETS
REQUIRED)

AS LOW AS
109.50

ECONOMY "MUSIC MATES" PHONO SYSTEM

Here's thrilling high-fidelity at down-to-earth prices! Provides exceptionally fine audio fidelity plus dependable performance. If the components were purchased individually, the total cost would be 134.83 — which gives you a big savings of 25.33! This system is built around the exclusive Lafayette value-packed money-saving LA-41 15 watt "Music-Mate" Amplifier (without cage). Also included are the Garrard RC-121-4 "Renova" 4-speed Automatic Manual and Intermix Record Changer (less base) equipped with the new GE VRII Triple Play Variable Reluctance Cartridge Model 4G-052 with Diamond LP and Sapphire Standard Styl; the Lafayette SK-58 Coastal HI-FI Speaker with Brilliance Level Control and noted for its thrilling wide range performance. This phono system is supplied with color-coded plugs and interconnecting cables for quick easy installation. For 110-120 volts 60 cycle AC. Shpg. wt., 39 lbs.

MF 190 Economy Phono System Net 109.50
MF 191 As above but with cover for amplifier Net 113.00

DELUXE "MUSIC MATES" PHONO SYSTEM

The Deluxe "Music Mates" Phono System consists of all of the quality components in the ECONOMY system above, plus an attractive cage for the amplifier, a Mahogany or Blonde (specify which) Wood Base for the Record Changer and a Lafayette Resonator Speaker Enclosure in which to mount the speaker. Cabinet is lined with acoustic material. Front has attractive picture frame molding and fine quality plastic grille cloth. Cutout for 12" speaker. Dimensions: 20"W x 16"D x 23"H. Complete system with coded plugs and cables. Shpg. wt., 76 lbs.

MF-192 Deluxe Phono System With CAB-16 Mahogany Resonator Speaker Enclosure and Mahogany Changer Base Net 142.50
MF-193 Deluxe Phono System with CAB-17 Blonde Resonator Speaker Enclosure and Blonde Changer Base Net 144.50

FM-AM PHONO SYSTEM DELUXE "MUSIC MATES"

This superb FM-AM Phono System includes all of the items in the Deluxe Phono System above plus Lafayette's exclusive LT-40 "Music-Mate" Deluxe FM-AM Tuner (in cage). This system consists of all the items illustrated. Complete system with color-coded plugs and interconnecting cables for quick, simple installation. Shpg. wt., 86 lbs. Specify finish of wood base desired.

MF-194 Deluxe Phono System With CAB-16 Mahogany Resonator Speaker Enclosure and Mahogany Changer Base Net 206.50
MF-195 Deluxe Phono System with CAB-17 Blonde Resonator Speaker Enclosure and Blonde Changer Base Net 208.50

LAFAYETTE DELUXE PHONO SYSTEM

A SUPER-VALUE PHONO SYSTEM TO
DELIGHT THE MUSIC LOVER

This extraordinary value in a phono system enables you to enjoy outstanding high-fidelity performance despite either limited quarters or a limited budget! This exclusive Lafayette phono system is composed of top-performing components throughout which bring realism to the reproduction of living music. The system is built around the new incomparable Model LA-40 15 Watt "Music-Mate" Amplifier — an amplifier whose features, specifications, smart styling and price are causing the entire industry to sit up and take notice. In addition to the amplifier in an attractive metal cage, the system includes the Garrard RC-121-4 "Renova" 4-speed Automatic Manual and Intermix Record Changer with either Mahogany or Blonde Wood Base (Specify Choice) and equipped with the new GE VRII Series Triple Play Variable Reluctance Cartridge Model 4G-052 with Diamond LP and Sapphire Standard Styl. Sound reproduction is sparklingly accomplished by the University Model UXC-123 12" 3-Way DiAxial Speaker an integrated 3-way speaker assembly completely wired with built-in L/C network and Brilliance Control and the Lafayette CAB-19 Highboy Style Bass Reflex Cabinet designed to give proper baffling to the entire speaker system and improve the bass response. This cabinet is available in either lustrous hand-rubbed Mahogany or Blonde (Specify finish) and is 28 1/4"W x 16 1/4"D x 23 1/4"H. If the components were purchased individually, the total cost would be 225.78. However, this complete, compact, space-saving system is priced to save you 45.83 on the total cost of these individual components. When ordering specify finish of wood base and bass reflex enclosure. System is supplied with color-coded plugs and interconnecting cables for quick simple installation. For 110-120 volts 60 cycle AC. Shpg. wt., 81 lbs.

MF-196 Complete system 179.95

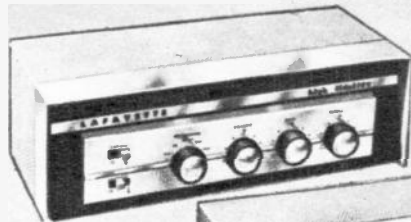

LA-40 "MUSIC-MATE"
AMPLIFIER



LT-40 "MUSIC-MATE"
TUNER



NEW GE 4G-052
DIAMOND-SAPPHIRE
CARTRIDGE



GARRARD
RC-121
4-Speed
RECORD
CHANGER

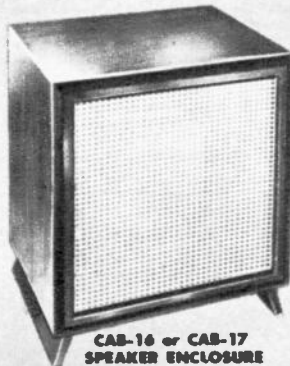

CAB-16 or CAB-17
SPEAKER ENCLOSURE

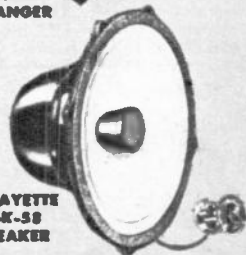

LAFAYETTE
SK-58
SPEAKER

ONLY 179.95
YOU SAVE
45.83

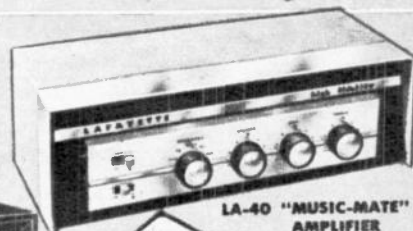

LA-40 "MUSIC-MATE"
AMPLIFIER



GARRARD
RC-121-4
Speed
RECORD
CHANGER

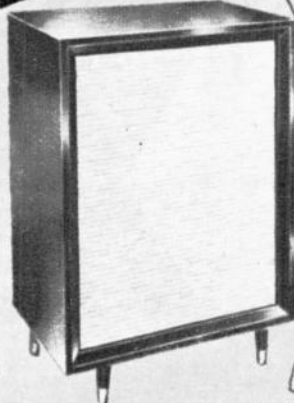

CAB-19 HIGHBOY
SPEAKER ENCLOSURE



UNIVERSITY
UXC-123 SPEAKER



GE 4G-052 CARTRIDGE
WITH
DIAMOND-SAPPHIRE
STYL

Shipping Weights Given Are Approximate

New!

Lafayette

Another Amazing
Hi-Fi Amplifier Value
Available Only At
Lafayette!



64.50

LA-69 20 WATT HI-FI AMPLIFIER

THE MOST EXTRAORDINARY
HI-FI VALUE EVER OFFERED

20-40,000 CPS — 6 INPUTS
24 POSITIONS OF EQUALIZATION

Guaranteed To Outperform Any Amplifier
In Its Price Range Or Your Money Back

Lafayette confidently presents the new LA69, successor to the enthusiastically acclaimed LA59. Superb high-fidelity performance meeting the most critical standards is available at less than half of what you might expect to pay for a comparable unit. Engineered to include every practical feature making a worth-while contribution to hi-fi reproduction, the LA-69 is rated at 20 watts. The output stage utilizes two newly developed EL84/6BQ5 tubes, outstanding for superior performance, ruggedness and longer life. Extreme versatility in tape recording and playback results from the tape input and output jacks in conjunction with the new tape monitor-playback switch and the tape position on the input selector switch. Incorporates advanced printed circuit techniques in the two boards used. The frequency response is phenomenal—even at over 83% of full output, it is within ± 1 db from 20 to 40,000 cycles, with the range extended further at lower wattages. Three negative feedback loops virtually eliminate distortion. The unit is extremely sensitive and has effective individual rumble filter and loudness controls which can be cut out of the circuit at will. Separate adjustable roll-off and turnover control provide 24 equalization positions to compensate for recording curve characteristics. Continuously variable bass and treble controls make possible an infinite selection of tone compensating adjustments. There are 5 input jacks for Radio, TV, Tape, Magnetic Phono and Crystal Phono. A tape output jack and outputs for 8 and 16 ohms are also provided. Rear of chassis has hum balancing, radio and phono input level controls, 2 AC convenience outlets and fuse mounted in extractor post. Tubes are 2-EL84/6BQ5, 2-12AX7, 1-6AN8, and 1-EZ81 rectifier. Modern streamlined "pancake" styling having beautiful satin-gold panel, gold perforated cage, and attractive contrasting dark maroon trim and lettering. Front is removable for easy panel mounting. **IMPORTED TO SAVE YOU MONEY.** Size: 13 $\frac{1}{2}$ " W x 8 $\frac{1}{2}$ " D (exclusive of knobs) x 4 $\frac{1}{2}$ " H (including rubber feet). Shpg. Wt., 19 lbs.

LAFAYETTE LA69—AmplifierNet **64.50**

- ① New Tape Monitor-Play Switch
- ② Loudness Control
- ③ Volume Control
- ④ Treble Control
- ⑤ Bass Control
- ⑥ Rumble Filter Switch
- ⑦ Six Position Roll-Off Control
- ⑧ Input Selector and Turnover Control

TECHNICAL SPECIFICATIONS

POWER: 20 watts normal, 40 watt peak, at 1% harmonic distortion. **RESPONSE:** 20 to 40,000 cycles ± 1 db at 15 watts. **EQUALIZATION:** 24 positions to match all types of recordings. **RUMBLE FILTER:** On-Off, eliminates Motor noises. **LOUDNESS CONTROL:** On-Off, maintains high and low frequencies at low volume levels. **TAPE CONTROL:** Monitor-Play, controls tape playback and recording. **BASS CONTROL:** Continuously variable; 16 db boost to 16 db cut, "flat" position marked. **TREBLE CONTROL:** Continuously variable; 12 db boost to 15 db cut at 10,000 cycles, "flat" position marked. **HUM CONTROL:** Balancing control on rear of chassis. **PHONO LEVEL & RADIO LEVEL:** Individual input level controls on rear of chassis. **INPUTS:** 5 jacks for radio, tape, TV, magnetic phono and crystal or ceramic phono. **OUTPUTS:** Tape jack and choice of 8 or 16 ohm speaker. **SENSITIVITY:** Full rated output with input of only 8 mv in magnetic input or 0.3V in radio, tape or TV. **QUIETNESS:** Noise plus hum is 75 db below maximum output on radio, TV, tape inputs; 70 db on phono input; 54 db below effective program level with 10mv input. **FEEDBACK:** 3 negative feedback loops; 20 db feedback around voltage and power amplifier stages. **POWER OUTLETS:** 2 accessory 110V AC outlets for phono tuner, etc. **FUSE:** 2 Amp fuse mounted in extractor post for easy replacement. **MOUNTING:** Front removable for simple, fast mounting. **STYLE:** Modern low-lined "pancake" satin-gold panel, gold cage, maroon trim. **POWER SOURCE:** 110-120 Volts, 50-60 cycles AC only.

NEW! Lafayette DELUXE HI-FI FM TUNER COMPLETELY WIRED AND TESTED.

- Armstrong Circuit with Dual Limiters
- Temperature Compensated and AFC
- 9 Tubes Plus Selenium Rectifier
- Custom Styled

Lafayette engineers bring to the discriminating music lovers who confine their broadcast listening to FM (the true hi-fi spectrum), a tuner giving the utmost possible value in performance and quality. Features Armstrong circuit with Foster-Seely discriminator, 3-gee condenser with tuned RF stage, 4 IF stages (including dual limiters), AFC and AFC defeat, temperature compensated circuitry, and has 9 tubes plus selenium rectifier. Sensitivity 3.5 μ v for 20-30db. Distortion less than 1%. Frequency response 20-20,000 cycles ± 0.5 db. Cathode follower and high impedance outputs. Meets FCC requirements for radiation. Low modern lines, attractively finished in brushed gold-brass and maroon, for shelf or table top use. Completely self powered and wired, ready for operation. Size: 14" W x 7" D x 4 $\frac{1}{2}$ " H. Complete with cover. Shpg. wt., 13 lbs.

LT-60—FM tunerNet **49.95**

LAFAYETTE 12 WATT AMPLIFIER WITH CASE

Complete 12 Watt Power Amplifier with Built-in Pre-amplifier-Equalizer
Brings Real Hi-Fi at Low Cost

The Lafayette LA-22 amplifier features wide range frequency response and low hum and distortion. Utilizes premium quality EL84 tubes in a pentode connected balanced output circuit. Five inputs provided for every type of phono cartridge, tuner, tape head, TV, crystal phono, etc. Function selector and equalization switch give instant choice of proper equalization for all types of records and tape head. Loudness control approximates Fletcher-Munson characteristics for tonal balance at low listening levels. Bass and treble controls afford wide variation of cut or boost of highs and lows. Frequency response 30-20,000 cps ± 1 db. Sensitivity, for full output $\frac{1}{2}$ V on tuner, crystal or aux., 8 mv for magnetic phono or tape head. I.M. Distortion less than 1 $\frac{1}{2}$ %. Attractively finished to harmonize with both modern and traditional decor, its appearance matches the Lafayette LT-25 tuner. Size 13 $\frac{3}{8}$ " x 6 $\frac{1}{8}$ " x 4 $\frac{1}{2}$ ". Shpg. wt., 15 lbs.

LA-22 Amplifier, Complete With Removable Case.....Net **33.50**

LAFAYETTE HI-FI FM-AM TUNER WITH CASE

- Armstrong Circuit With Limiter
- Temperature Compensation and AFC
- Foster-Seely Discriminator
- Custom Styled

Like its matching amplifier, the Lafayette LT-25 FM-AM tuner is a most unusual value with outstanding specifications and superlative performance. Circuit features temperature compensation for stability and low drift, AFC to "lock-in" the station and AFC defeat for precision tuning of weak stations. Inertia flywheel makes tuning smooth. High selectivity and sensitivity. Meets FCC requirements for radiation. Distortion less than 1% on FM and AM. Frequency Response 20-20,000 cps ± 1 db on FM; 20-5000 cps ± 3 db on AM. Hum level 60 db below 100% modulation. Attractively finished to match the LA-22 amplifier. Comes complete with removable cover, with provisions for mounting either in cabinet or on panel. Size 13 $\frac{1}{8}$ " x 8-3/16" x 4 $\frac{1}{2}$ ". Shpg. wt., 15 lbs.

LT-25 FM-AM Tuner, Complete With Case.....Net **49.50**

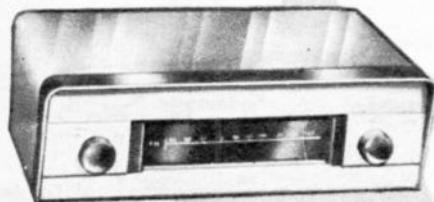

LT-60
WIRED
FM TUNER
49.95



LA-22
WIRED
12 WATT
AMPLIFIER
33.50
WITH
CASE

NEW! MATCHED
TUNER AND AMPLIFIER

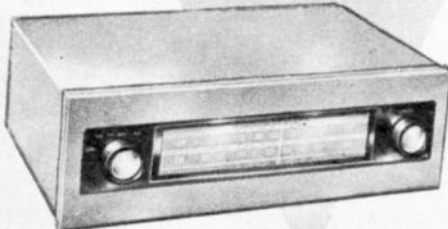

LT-25
WIRED
FM-AM
TUNER
49.50
WITH
CASE

Lafayette RECOMMENDED HI-FI SYSTEMS

FM-PHONO HI-FI SYSTEM

Enjoy outstanding hi-fi performance from this exceptional combination of space saving components enthusiastically recommended by Lafayette's hi-fi experts. This modestly priced up-to-the-minute FM-Phono System brings you thrillingly realistic sound at truly remarkable savings. This system revolves around the new Lafayette LA-69 20-Watt Hi-Fi Amplifier and its superb performance which surpasses the most critical requirements of music lovers. Twenty-four combinations of record equalization provide an almost endless variety of tone compensation to match varying recording characteristics.

In addition to the LA-69 amplifier the complete system includes new Lafayette LT-60 Deluxe FM Tuner with its excellent sensitivity and outstanding performance; the famous Garrard RC121 4-Speed Record Changer featuring full automatic and optional manual and "Simpli-mix" operation; the new improved GE VR11 Variable Reluctance Triple Play Turnover Cartridge with genuine GE diamond and sapphire styli; the Lafayette Model PK-111 Record Changer Base smoothly joined and attractively finished in dark mahogany or blonde (please specify which); the celebrated Lafayette SK-58 12" Coaxial Hi-Fi Speaker with built-in crossover network and brilliance control and Lafayette Resonator Enclosure provide excellent wide range frequency response without reverberation or vibration. Supplied with coded plugs and interconnecting cables for quick easy installation. For 110-120V 60 cycle AC. Shpg. wt. 91 lbs.

HF-212—Complete FM-Phono System With Mahogany Changer Base and Speaker Enclosure.....Net **199.95**

HF-213—Complete FM-Phono System With Blonde Changer Base and Speaker Enclosure.....Net **201.95**

PHONO SYSTEM—LESS FM TUNER

Complete Phono System with all components as above except LT-60 FM Tuner. With coded plugs and cables. Shpg. wt. 78 lbs.

HF-210—Phono System With Mahogany Speaker Enclosure and Changer Base.....Net **152.50**

HF-211—Phono System With Blonde Speaker Enclosure and Changer Base.....Net **154.50**



Lafayette MATCHED HIGH FIDELITY

EVERYONE WANTS HIGH FIDELITY NOW EVERYONE CAN AFFORD IT!

**LAFAYETTE BUDGET
PRICED HIGH FIDELITY SYSTEM
AS LOW AS \$99.95**

An excellent high fidelity phono system using the Lafayette LA-22 12 Watt Amplifier with Case having built-in preamplifier-equalizer. The Collaro Model TC-340 4-speed Record Changer is supplied complete with the latest GE VR11 Series Magnetic Variable Reluctance Cartridge with dual sapphire styli and Record Changer Base in either Mahogany or Blonde finish. The attractively styled Lafayette Resonator Speaker Enclosure in which to mount the speaker also comes in either Mahogany or Blonde finish. Available with either the Lafayette SK-22 12" Hi-Fi Coaxial Speaker or the Lafayette SK-58 Wide Range Coaxial Speaker with built-in crossover network and brilliance control. System coded for simple, quick assembly. Shpg. wt. 75 lbs. Phono system less tuner.

HF-188—Phono System with Mahogany finish base and cabinet and SK-22 Speaker.....Net **99.95**

HF-189—Phono System with Blonde finish base and cabinet and SK-22 Speaker.....Net **101.95**

HF-214—Phono System with Mahogany finish base and cabinet and SK-58 Speaker.....Net **118.45**

HF-215—Phono System with Blonde finish base and cabinet and SK-58 Speaker.....Net **120.45**

MATCHED FM-AM PHONO SYSTEMS

Above systems are available with the Lafayette LT-25 FM-AM Tuner having outstanding specifications and which matches the amplifier in both attractive appearance and superlative performance. Systems complete with all components and coded plugs and interconnecting cables. Shpg. wt. 90 lbs.

HF-216—FM-AM-Phono System with Mahogany finish base and cabinet and SK-22 Speaker.....Net **147.45**

HF-217—FM-AM-Phono System with Blonde finish base and cabinet and SK-22 Speaker.....Net **149.45**

HF-218—FM-AM-Phono System with Mahogany finish base and cabinet and SK-58 Speaker.....Net **165.95**

HF-219—FM-AM-Phono System with Blonde finish base and cabinet and SK-58 Speaker.....Net **167.95**

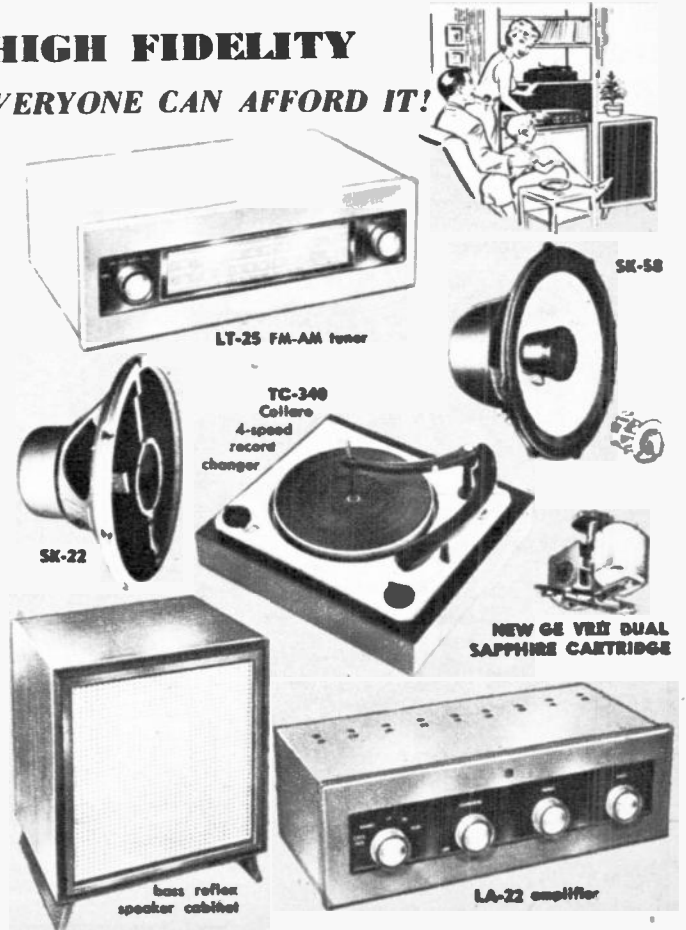

SUPER-VALUE HI-FI PHONO SYSTEM WITH BELL "PACEMAKER" AMPLIFIER A LAFAYETTE "BEST BUY"

COMPONENTS	
BELL 2285 "PACEMAKER" AMPLIFIER	48.95
GARRARD RC-121-4 RECORD CHANGER	42.50
MAHOGANY WOOD BASE	3.95
NEW GE 4G-052 DIAMOND-SAPPHIRE CARTRIDGE	19.33
UNIVERSITY ENCLOSURE WITH SPEAKER	76.50

REGULAR PRICE
191.23

ONLY

129.50

YOU SAVE 61.73

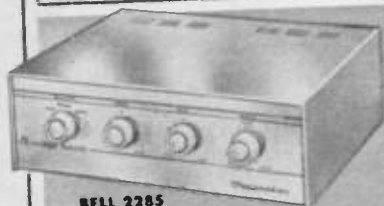

BELL 2285
PACEMAKER AMPLIFIER



GARRARD
RC-121-4
RECORD
CHANGER (on base)

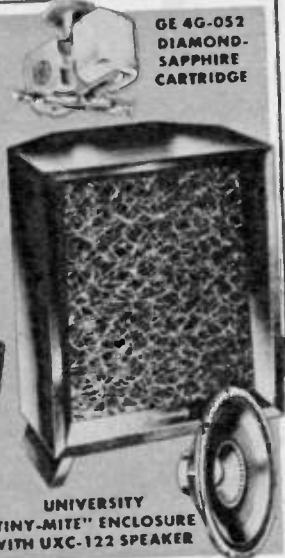

UNIVERSITY
"TINY-MITE" ENCLOSURE
WITH UXC-122 SPEAKER

GE 4G-052
DIAMOND-
SAPPHIRE
CARTRIDGE

This top-performing phono system is the biggest value in hi-fi ever offered. Built around the Bell "Pacemaker" amplifier, this system is designed to provide the utmost in truly pleasurable record listening. Requires the smallest possible amount of space, with no additional cabinets being needed. In addition to the Bell 2285 "Pacemaker" 10 Watt Amplifier, the system includes the famous Garrard RC-121-4 "Renown" 4-Speed Automatic Manual and Intermix Variable Reluctance Triple Play Cartridge with Diamond LP and Sapphire Standard Stylus; the widely acclaimed University "Tiny-Mite" Enclosure with UXC-122 12" DiAxial Speaker. The system is ready to play — you need just connect the color-coded plugs and cables for quick easy installation. For 110V 60 cycle AC. Shpg. Wt., 65 lbs.

HF-199—Complete System with Mahogany Base and enclosure 129.50
HF-200—Complete System with Blonde Base and enclosure 129.50

SHERWOOD DELUXE 36 WATT FM-AM PHONO MUSIC SYSTEM AN OUTSTANDING HIGH FIDELITY PACKAGE!

REGULAR PRICE
456.28

ONLY

365.02

YOU SAVE 91.24

COMPONENTS	
SHERWOOD S-2000 FM-AM TUNER	144.50
SHERWOOD S-1000 II AMPLIFIER	114.50
COLLARO RC-440 RECORD CHANGER	41.50
MAHOGANY WOOD BASE FOR CHANGER	3.95
NEW GE DIAMOND-SAPPHIRE CARTRIDGE	19.33
UNIVERSITY 6303 SPEAKER	83.00
CAB-19 ENCLOSURE	49.50



SHERWOOD S-2000

SHERWOOD S-1000 II

UNIVERSITY 6303
SPEAKER

COLLARO RC-440
(ON BASE)

GE 4G-052 DIAMOND-
SAPPHIRE CARTRIDGE

CAB-19

An exceptional value in a custom matched combination of the very finest in high-fidelity instruments. The heart of this system is the Sherwood Model S-1000 II 36 Watt Amplifier. The heart of this system is the Sherwood Model center in a beautiful cabinet, a new versatile amplifier-preamplifier-control S-2000 FM-AM Tuner in a beautiful cabinet; the new Collaro RC-440 Intermix Record Changer and Mahogany Base; the new GE VRII Series Variable Reluctance 4G-052 Triple Play Cartridge with Diamond-Sapphire speaker and Lafayette 6303 famous high quality 15" 3-way extended range or Blonde finish (Specify which). The Sherwood Amplifier and Tuner both come system is ready to play requiring only the connection of color-coded plugs and cables. For 110V 60 cycle AC. Shpg. Wt., 120 lbs.

HF-197—Complete Music System Net 365.02
HF-198—Same system less speaker enclosure and base for changer Net 322.26

BOGEN FM-AM PHONO SYSTEM

SUPERB HIGH-FIDELITY PERFORMANCE
DELUXE MUSIC SYSTEM AT BUDGET COST.

COMPONENTS	
BOGEN RR501C TUNER-AMPLIFIER	134.50
COLLARO RC-440 RECORD CHANGER	41.50
WOOD BASE FOR CHANGER	3.95
UNIVERSITY UXC-123	64.00
GE 4G-052 DIAMOND-SAPPHIRE CARTRIDGE D/S	19.33
RESONATOR TYPE ENCLOSURE	29.50

REGULAR PRICE
292.78

ONLY

230.22

YOU SAVE 62.56



UNIVERSITY UXC-123 SPEAKER

COLLARO
RC-440 4-SPEED
RECORD CHANGER

GE 4G-052
DIAMOND-SAPPHIRE
CARTRIDGE

LAFAYETTE RESONATOR
ENCLOSURE CAB-16

BOGEN RR501C TUNER-AMPLIFIER

Enjoy the thrilling realism and presence of a live orchestra right in the home with this system which provides the most complete hi-fi performance at very modest cost. Each component has been selected to give maximum value in its price class. A few minutes of pleasurable listening will convince you of the unusually smooth, full-range reproduction of which this system is capable. Included in this system is the Bogen RR501C Tuner-Amplifier which combines in a single chassis a sensitive FM-AM tuner, preamplifier and 10 watt hi-fi amplifier. This unit is smartly styled for open shelf, table top or custom installation. The new Collaro RC-440, 4-speed, fully automatic and manual, Intermix Record Changer performs excellently in handling the record playing function of this system. It is equipped with the new Series VRII Variable Reluctance Model 4G-052, Triple Play Cartridge with Diamond LP and Sapphire Standard Stylus. The University UXC-123 fine triaxial 12" speaker and Lafayette Resonator Enclosure provide excellent wide range frequency response without reverberation or vibration. All units are supplied with color coded plugs and interconnecting cables for quick easy installation. For 110-120 volts 60 cycles AC. Shpg. wt., 76 lbs. Complete system less tuner-amplifier enclosure and record changer base.

HF-201—Deluxe Phono System with Cab-16 Resonator Speaker Enclosure and Mahogany Changer Base. 230.22
HF-202—Same with blonde base and enclosure 230.22
HF-203—Same system less speaker enclosure and base for changer 203.46

Metal cabinet for tuner-amplifier

BCB Blonde or BCM Mahogany

Net 7.50

CUSTOM PACKAGED HIGH FIDELITY

EASILY ASSEMBLED

COMPONENTS

AMPLIFIER	99.50
RECORD CHANGER	42.50
CARTRIDGE	19.33
CHANGER BASE	3.95
SPEAKER	66.00
SPEAKER CABINET	29.50
REGULAR PRICE.....	260.78

COMPLETE DELUXE CUSTOM PHONO SYSTEM

NO ADDITIONAL CABINETS NEEDED!
ONLY.....208.50
YOU SAVE.....52.28

COMPONENTS

AMPLIFIER	59.95
RECORD CHANGER	42.50
CARTRIDGE	8.95
SPEAKER	33.00
REGULAR PRICE	144.40

LOWEST-PRICED CUSTOM PHONO SYSTEM
FEATURING FAMOUS NAME COMPONENTS
ONLY 109.50
YOU SAVE 34.90



HARMON-KARDON T-12 TUNER



GARRARD RC-121 4-SPEED RECORD CHANGER

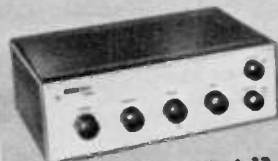

HARMON-KARDON A-12 AMPLIFIER



NEW GE VRII DUAL SAPPHIRE CARTRIDGE

UNIVERSITY UXC-122 SPEAKER

Lafayette now makes it possible for every modest budget music lover to enjoy exciting wide range music reproduction with this low-cost phono system featuring famous name components. Here is what you get: Harmon-Kardon A-12 12-watt amplifier having an excellent frequency response; Garrard RC-121 4-speed automatic and manual record changer with new 121-4 "Renown" 4-speed variable reluctance cartridge and dual GE VRII Series Triple-Play Variable Reluctance Cartridge and dual sapphire styli; the famous University UXC-122 12" 2-way diffoaxial speaker. System is complete with color-coded plugs and cables, ready for quick, easy installation. For 110-120 volts, 60 cycles AC. Shpg. wt., 35 lbs.

MF-206—Complete Phono System Less Tuner and Record Changer
 Base..... **109.50**

FM-AM RADIO PHONO SYSTEM—Same as above plus Harmon-Kardon T-12 FM-AM Tuner in handsome copper with black case. Shpg. wt., 45 lbs. Net **179.50**

MF-207—Radio Phono System Less Record Changer Base..... Net **3.95**

PK-111—Record Changer Base in Mahogany or Blonde. Specify Finish. Shpg. wt., 5 lbs. Net **3.95**



Pilot AA-920 Amplifier



Lafayette CAB-16 Speaker Cabinet



Electro-Voice 12TRXB Speaker



Garrard RC-121 4-SPEED RECORD CHANGER



NEW GE VRII TRIPLE PLAY CARTRIDGE WITH DIAMOND-SAPPHIRE STYLI

Know the pleasure of real high-fidelity sound with this deluxe yet economical grouping of exceptionally fine components. Complete in itself; requires no special cabinets. Heart of the system is the outstanding Pilot AA-920 20-watt amplifier and audio control center with frequency response of 20 to 20,000 cps \pm 1db at 20 watts with less than 1% distortion, finished in burgundy and brushed brass. Included also are the superb Electro-Voice Model 12TRXB 3-way triaxial speaker with high frequency level control; the famous Garrard RC-121 4-speed automatic and manual full intermix record changer, equipped with the NEW GE VRII Series Model 4G-052 Variable Reluctance Triple Play Cartridge with genuine GE diamond-LP and sapphire-78rpm styli; the Lafayette PK-111 changer base of finest veneers, finished in dark mahogany or blonde (please specify which); and the Lafayette CAB-16 bass reflex speaker cabinet, solidly made of 3/4" stock (finished in mahogany or walnut—please specify which). System comes with color-coded plugs and interconnecting cables for simple installation. For 110-120 volts, 60 cps AC. Shpg. wt., 82 lbs.

MF-180—Deluxe Phono System with Cab-16 Resonator Speaker Enclosure and Mahogany Changer Base. SPECIAL LAFAYETTE PRICE—Net **208.50**

MF-181—Deluxe Phono System with Cab-17 Resonator Speaker Enclosure and Blonde Changer Base. Net **210.50**

UNSURPASSED HIGH FIDELITY SOUND FISHER FM-AM CUSTOM MUSIC SYSTEM

COMPONENTS

AMPLIFIER	99.50
PREAMPLIFIER	99.50
TUNER	169.50
RECORD CHANGER	54.50
CARTRIDGE	37.50
SPEAKER	162.50
REGULAR PRICE.....	623.00

ONLY.....498.40
YOU SAVE..... 124.60



Fisher Model 80-R FM-AM TUNER

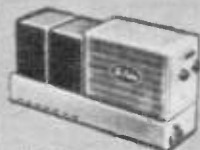

Fisher Model 80-AZ Amplifier



Fairchild 125A LP Cartridge



Garrard RC-88 4-SPEED RECORD CHANGER



Stephens 206AXA 15" Coaxial Speaker

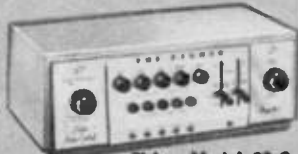

Fisher Model 80-C Preamplifier

A feature-packed Lafayette music system for the most critical audiophile who wants the very best high fidelity performance. Perfectly matched components have been selected, each representing the ultimate in verbatim sound-reproducing capability. This is a system anyone would be proud to own, to install in the most richly-furnished living room, to demonstrate to his friends and neighbors—or just to listen to fine music for the sheer joy in listening it is possible to obtain with this equipment. Here is what you get: The world-renowned Fisher Model 80-R FM-AM tuner, with separate AM and FM tuning meters, extremely high sensitivity for distant and hard-to-get local stations, FM frequency response 20 to 20,000 cps \pm 1/2db (supplied less cabinet); the Fisher Model 80-AZ Laboratory Standard 30-watt amplifier with response of 10-50,000 cps \pm 1db and less than 1/2% distortion at 30 watts and with "Power Scope" visual peak power indicator; the Fisher Model 80-C Master Audio Control preamplifier with full facilities for adding either a tape recorder or tape mechanism to the system later (supplied less cabinet); the Garrard Model RC-88 imported British 4-speed deluxe automatic and manual record changer with watch-like construction and equipped with the outstanding Fairchild Model 125A LP cartridge with diamond styli; and the Stephens Model 206AXA "Trusonic" 15" coaxial speaker with 7 1/2 lb. magnet and multi-cellular high frequency horn. System comes complete with color-coded plugs and interconnecting cables, ready for installation. For 110-120 volts, 60 cps AC. Shpg. wt., 95 lbs. less covers for Tuner and Preamplifier

MF-169—Complete FM-AM Music System..... SPECIAL LAFAYETTE PRICE—Net **498.40**

FISHER-CRAFTED CABINET FOR 80-R—Mahogany or Blonde. Specify which and ADD to above system. Net **17.95**

FISHER-CRAFTED CABINET FOR 80-C—Mahogany or Blonde. Specify which and ADD to above system. Net **9.95**

Lafayette

DELUXE HI-FI CUSTOM SYSTEMS

THE MOST FOR YOUR MONEY IN CAREFULLY SELECTED FAMOUS BRANDS

Each hi-fi system listed below has been painstakingly selected and is recommended by Lafayette as a "best-buy". You enjoy big savings when you buy a complete system, since they are priced at far less than the total cost of the individual components. The amount you save is clearly shown in each listing. All systems are ready to use and are supplied with color-coded plugs and interconnecting cables for quick simple installation.

PILOT PHONO SYSTEM

Pilot AA-903B Amplifier.....	79.95
Electro-Voice 12TRXB 12" Coaxial	66.00
Garrard RC-121 4-Speed Changer	42.50
PK-111 WOOD BASE.....	3.95
NEW GE Diamond-Sapphire Cart. 19.33	
Regularly	207.78
HF-168. Sale Price.....	166.15
You Save	41.55
Shpg. wt., 47 lbs.	

Electro-Voice 12TRXB 12" Coaxial



Garrard RC-121 4-Speed Changer



NEW GE DIAM.-SAPH. CARTRIDGE

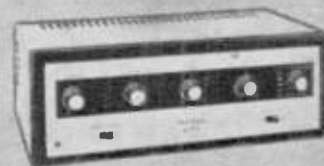

Pilot AA-903B Amplifier

FISHER PHONO SYSTEM

Fisher CA 40 Amplifier.....	139.50
University 6303 15" Speaker	83.00
Garrard RC-121 4-Speed Changer	42.50
PK-111 WOOD BASE.....	3.95
NEW GE Diamond-Sapphire Cart. 19.33	
Regularly	288.28
HF-174. Sale Price.....	230.68
You Save	57.60
Shpg. wt., 57 lbs.	



Fisher CA 40 Amplifier



Garrard RC-121 4-Speed Changer



University 6303 15" Speaker

NEW GE DIAM.-SAPH. CARTRIDGE

SCOTT PHONO SYSTEM

Scott 99C Amplifier less case	99.95
Electro-Voice 12TRXB Triaxial	66.00
Garrard RC-121 4-Speed Changer	42.50
PK-111 WOOD BASE.....	3.95
NEW GE Diamond-Sapphire Cart. 19.33	
Regularly	231.73
HF-175. Sale Price.....	185.39
You Save	46.34
Case Extra..... 9.95	Shpg. wt., 47 lbs.

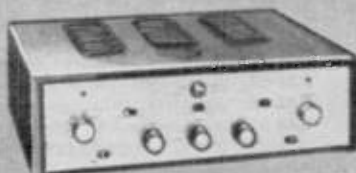

Scott 99C Amplifier



Garrard RC-121 4-Speed Changer

Electro-Voice 12TRXB Triaxial



NEW GE DIAMOND-SAPPHIRE CARTRIDGE

BELL FM-AM RADIO-PHONO SYSTEM

BELL 2520 FM-AM TUNER.....	95.00
BELL 2325P AMPLIFIER (less case)	99.95
UNIVERSITY UXC-123 SPEAKER	64.00
CAB-19 BASS REFLEX CABINET.....	49.50
COLLARO RC-440 4-SPEED CHANGER	41.50
NEW GE DIAMOND-SAPPHIRE CARTRIDGE	19.33
PK-111 WOOD BASE.....	3.95
Regularly	373.23
HF-204.....Special Price	299.50
You Save	73.73
Specify Mahogany or Blonde Finish for Wood Base and Cabinet.	
Amplifier Case Extra.....	9.80
Shpg. wt., 115 lbs.	

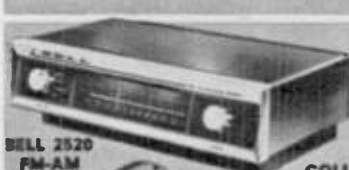

BELL 2520 FM-AM TUNER



COLLARO RC-440 4-SPEED CHANGER ON BASE



UNIVERSITY UXC-123 SPEAKER



BELL 2325 AMPLIFIER

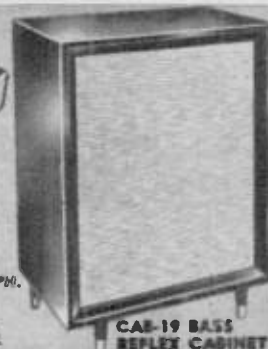

CAB-19 BASS REFLEX CABINET

NEW GE DIAM.-SAPH. CARTRIDGE

HARMON-KARDON FM-AM RADIO-PHONO SYSTEM

HARMON-KARDON TA-1040 TUNER AMPLIFIER.....	250.00
UNIVERSITY 6303 15" SPEAKER	83.00
CAB-19 BASS REFLEX CABINET.....	49.50
COLLARO TC-340 4-SPEED CHANGER	37.50
NEW GE DIAMOND-SAPPHIRE CARTRIDGE	19.33
PK-111 WOOD BASE.....	3.95
Regularly	443.28
HF-205.....Special Price	354.60
You Save	88.68
Specify Mahogany or Blonde Finish for Wood Base and Cabinet.	



COLLARO TC-340 4-SPEED CHANGER ON BASE

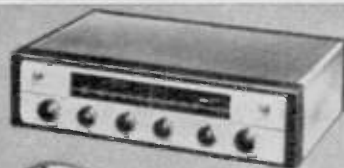

HARMON-KARDON TA 1040 TUNER-AMPLIFIER



UNIVERSITY 6303 SPEAKER

NEW GE DIAMOND-SAPPHIRE CARTRIDGE

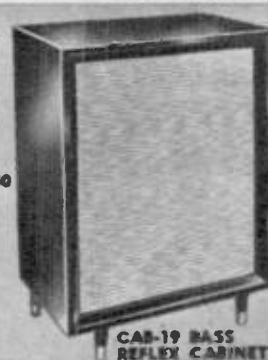

CAB-19 BASS REFLEX CABINET

LAFAYETTE SPECIAL HI-FI SPEAKER ENCLOSURE & SPEAKER COMBINATIONS AT TREMENDOUS SAVINGS!

**NEW
RESONATOR
SPEAKER
ENCLOSURE**



FOR 12" SPEAKERS
(NOTE: SPEAKERS ARE NOT MOUNTED)

**A
Real
Space
& Money
Saver!**

THE CABINET—New, lowboy console bass reflex cabinet for 12" high fidelity speakers shown on this page. Completely assembled and finished unit constructed of 3/4" stock of the finest genuine mahogany and walnut veneers. Solidly built and acoustically designed to provide wide range frequency response without reverberation or vibration. Cabinet is lined with acoustic material to prevent cabinet resonance. Front panel has attractive picture frame molding and fine quality plastic grille cloth that matches the finish. Baffle area approximately 4.3 cubic feet. Cutout for 12" speaker. Dimensions: 20" wide, 23" high, 16" deep. Shpg. wt., 38 lbs.

- CAB-16—Finished Cabinet only
(Specify Walnut or Mahogany) Net **29.50**
- CAB-17—Same as above in Blonde
finishNet **31.50**

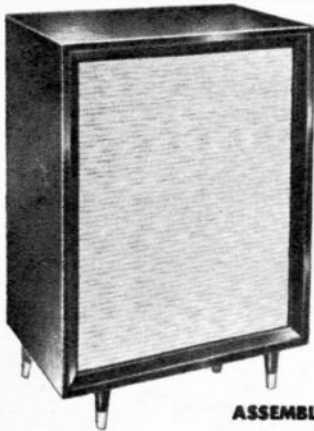

ASSEMBLED OR KIT FORM

Available in Unfinished or Finished Models
These highboy and lowboy style bass reflex cabinets are completely assembled and solidly constructed of 3/4" white birch. Finished models are available in lustrous, hand-rubbed mahogany or blonde, and measure up to the high quality finish standards of fine furniture. They are designed to give proper baffling to your entire speaker system and actually improve the overall response of any system. Front panels are handsomely detailed with picture frame molding and covered with pleasing plastic grille that blends with any finish. Attractively tapered offset legs are edge-tipped with brass ferrules. All models are lined with acoustic material to eliminate reverberation and cabinet resonance. Four cutouts plus a port duct are provided: One for a 15" speaker and adapter board for 12" speakers, another for an 8" speaker and adapter board for 5" speakers, and two cutouts to accommodate Lafayette HK-3 or MW-7 high frequency tweeters, if desired. Wood blocks are supplied to cover those cutouts which are not used. The unfinished models are smoothly sanded for painting or fine quality staining and polishing. Dimensions of lowboy (less legs): 28 1/2" wide, 23 1/2" high, 16 1/4" deep. Highboy has same dimensions with height and width interchanged. Legs are 7" high. Shpg. wt., either model, 54 lbs.

- CAB-13. Assembled, Unfinished HighboyNet **39.50**
- CAB-19. Mahogany or Blonde Finish Highboy (Specify finish)Net **49.50**
- CAB-14. Assembled, Unfinished LowboyNet **39.50**
- CAB-20. Mahogany or Blonde Finish Lowboy (Specify finish)Net **49.50**

LAFAYETTE SPEAKER CABINET KITS

The same unfinished bass reflex enclosure as described above except in kit form. Do-it-yourself and save money with Lafayette's extra low prices. Instructions, all parts, hardware and grille cloth are included. Shpg. wt., 54 lbs.

- CK-10—Unfinished Highboy Kit.....Net **27.75**
- CK-11—Unfinished Lowboy Kit.....Net **27.75**

ELECTRO-VOICE 12TRXB & LAFAYETTE RESONATOR ENCLOSURE

- E-V Model 12TRXB Speaker Only
Shpg. wt., 14 lbs.....Net **64.68**
- SY-105 Special Combination Price
(Mahogany or Walnut) Specify
whichNet **75.70**
- SY-106 In Blonde, Combination
Price Speaker & Cabinet.....Net **77.70**
Total Shpg. wt., 52 lbs.



**YOU SAVE
18.48**

UNIVERSITY UXC-123 & LAFAYETTE RESONATOR ENCLOSURE

- UNIVERSITY MODEL UXC-123
Speaker Only
Shpg. wt., 7 lbs.....Net **62.72**
- SY-111 Special Combination Price
(Mahogany or Walnut) Specify
whichNet **76.62**
- SY-112 In Blonde, Combination
Price Speaker & Cabinet.....Net **78.62**
Total Shpg. wt., 45 lbs.



**YOU SAVE
15.60**

UNIVERSITY 6303 — LAFAYETTE BASS REFLEX ENCLOSURE

SPECIAL COMBINATION

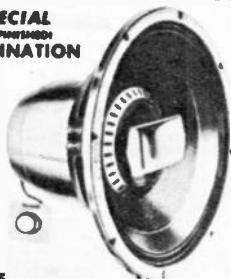

- Total Shpg. Wt., 66 lbs.
- SY-115—Includes CAB-13 Unfinished Highboy and University 6303 Speaker.....Net **92.50**
 - SY-116—Includes CAB-14 Unfinished Lowboy and University 6303 Speaker.....Net **92.50**
 - SY-117—Includes CAB-19 Finished Mahogany or Blonde Highboy and University 6303 (specify finish).....Net **104.50**
 - SY-118—Includes CAB-20 Finished Mahogany or Blonde Lowboy and University 6303 (specify finish).....Net **104.50**
 - University 6303—Speaker Only. Shpg. wt., 15 lbs.....Net **78.50**

PRICE **92.50** YOU SAVE **25.50**

ELECTRO-VOICE 15TRXB A LAFAYETTE BASS REFLEX ENCLOSURE

SPECIAL COMBINATION



- Total Shpg. Wt., 71 lbs.
- SY-123—Includes CAB-13 Unfinished Highboy and E-V 15TRXB Speaker.....Net **92.80**
 - SY-124—Includes CAB-14 Unfinished Lowboy and E-V 15TRXB Speaker.....Net **92.80**
 - SY-125—Includes CAB-19 Finished Mahogany or Blonde Highboy and E-V 15TRXB (specify finish).....Net **102.80**
 - SY-126—Includes CAB-20 Finished Mahogany or Blonde Lowboy and E-V 15TRXB (specify finish).....Net **102.80**
 - E-V 15TRXB—Speaker Only. Shpg. wt., 17 lbs.....Net **77.42**

PRICE **92.80**
**YOU SAVE
24.12!**

Lafayette HIGH-FIDELITY COMPONENTS



**LAFAYETTE
EXCLUSIVE**

Reg. Value
44.50
Net
29.50

12" HIGH FIDELITY COAXIAL SPEAKER

- FREQUENCY RANGE 30-15000 CPS
- HANDLES 20 WATTS OF POWER
- COMPLETE WITH LEVEL CONTROL
- POWERFUL TSK-5 MAGNETS
- SPECIAL SHEEP-SKIN-EDGED CONE

This Lafayette exclusive import is a highly efficient 12" coaxial speaker and represents an exceptional high fidelity value. The low frequency woofer has a 12" special chemically processed fibre composition cone with logarithmically placed pleats. The low resonant cone achieves a floating edge by means of a free edge of sheepskin which suppresses unwanted circular and radial nodal vibrations and insures clear beautiful tone quality. A 2 1/2" tweeter is coaxially mounted within its own metal case and protective grille with front mounted diffuser. The construction is such that there is no back radiation whatsoever. A crossover network to provide proper separation of high and low frequencies, and having a crossover point of 3000 cps, is also built-in. Highly efficient TSK-5 magnets permit a compact system, delivering full-bodied brilliant tone. A high frequency level control provides variation of up to 6 db cut. Power handling capacity is 20 watts continuous and 35 watts peak. Voice coil impedance 8 ohms, resonant frequency 40 cps. Connections are made to screw cap terminals. Rugged all-metal frame. If made in this country this speaker would sell for at least \$49.50. Shpg. wt. 11 lbs.

SK-58

Net **29.50**

HIGH FREQUENCY TWEETER WITH ACOUSTIC LENS

NEW



14.95

Enjoy the brilliant performance of a two or three-way system by adding this tweeter to your present system. Special diaphragm gives distortion-free wide range reproduction from 2000 cps to beyond audibility. Handles up to 25 watts of power. The highly directional characteristics of high frequencies is overcome by the wide dispersion angle of the short horn and the acoustic lens. This combination disperses and radiates the high frequency notes throughout the entire listening area. The lens is detachable and can be mounted on the outside of a panel or cabinet. Separate base is provided for external mounting. Tweeter size, 4 1/2" L., 3" diameter. Base, 1 1/2" H. Acoustic lens extends 2 1/2" in front of and 1 1/2" above top of tweeter. Aluminum voice coil, 16 ohms impedance. Crossover network required, preferably one with level control, such as Lafayette LN-2. Instructions included. Shpg. wt., 5 lbs.

Imported to Save You Money!

HW-7-Tweeter with Acoustic Lens Net **14.95**



CONE TYPE METAL-CASED HI-FI TWEETER

- FREQUENCY RESPONSE 2000-16,000 CPS.
- HANDLES 20 WATTS
- IMPORTED TO SAVE YOU MONEY

Without doubt one of the finest cone type high frequency tweeters we have ever tested, and is exceeded in performance only by diaphragm type tweeters. It is particularly efficient in the higher end of the audio spectrum where ordinary cone tweeters tend to lose clarity and volume. With this tweeter added to your present system, you will be able to hear all the fine transients and high notes of the upper register as they were actually recorded. Entirely enclosed in metal case with base for standing by itself, or mounting on a flat surface. Bracket is supplied for mounting on panel or in cabinet. Requires crossover network such as Lafayette LN-2. Diameter, 3". Depth, 2 1/4". Voice coil impedance 8-16 ohms.

HK-3—Hi-Fi Tweeter... Shpg. wt., 4 lbs. Net **5.95**

LAFAYETTE 2 AND 3-WAY CROSSOVER NETWORKS



8.75

NEW

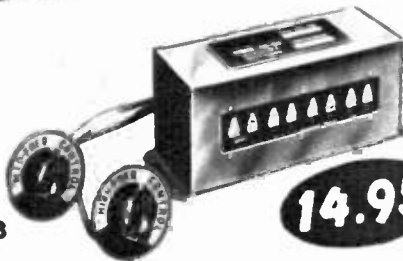

14.95

TWO-WAY CROSSOVER—Capacitive-Inductive network with 2000 cps crossover, and built-in continuously variable level-brilliance control that permits adjustments to match room acoustics perfectly. Channels all frequencies above 2000 cycles into the high frequency tweeter of a multi-speaker high fidelity system. The control is on a 2 1/2 ft. long cable to permit mounting on a panel removed from the network. Matches speakers with 8-16 ohm voice coil. Careful design has reduced insertion loss to a minimum. Enclosed metal case 6" L., 2 3/4" H., 2 3/4" D. Easily accessible screw terminals for input and speakers. With instructions. Shpg. wt., 5 lbs.

LN-2—2-Way Crossover Network with Control... Net **8.75**

THREE-WAY CROSSOVER—A carefully designed and engineered 3-way crossover network with continuously variable "brilliance" and "presence" controls. Separates audio frequencies and feeds them to low frequency woofer, mid-range speaker and high frequency tweeter. Crossover is at 350 and 5000 cps. The network is a true inductance-capacitance unit. Two built-in controls are wired on 2 ft. extension cables for remote mounting. Insertion loss has been reduced to a minimum. Crossover is enclosed in heavy metal case 8" L., 3 1/4" H., 2 3/4" W. Easily accessible screw terminals for input and speakers. With instructions. Shpg. wt., 7 lbs.

LN-3—3-Way Crossover Network with Controls... Net **14.95**

NEW LAFAYETTE SUPER TWEETER



5.95

Moving coil tweeter with crossover at 4000 cycles. Reproduces an unusually wide range of frequencies from 4,000 to 16,000 cycles with smooth response, excellent balance and low distortion. Exclusive acoustic lens for efficient wide angle high frequency dispersion. Entirely enclosed in a metal case with a base bracket for either standing by itself, for mounting on a flat surface, or can be mounted vertically in a baffle cut out. Capacity 20 watts of program material when used in a multiple speaker system. Impedance 16 ohms. Baffle hole diameter 2 3/4". Handsome case and brass finished metal lens. Supplied with long leads. Shpg. wt., 3 lbs. SK-87 Super Tweeter... Net **5.95**

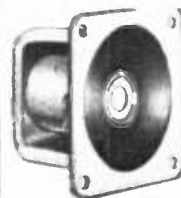

NEW LAFAYETTE "POINT SOURCE" TWEETER

Lafayette's latest Danish import features extremely low distortion and flat response of 3000 to 16,000 cps \pm 2.5 db. Acts as point source of high frequency sound for maximum wide-angle dispersion without use of horns—excellent as tweeter or super-tweeter in multiple-speaker installations of the highest quality. For use in 10 watt systems with 12 db/octave crossover network at 3000 cps or higher. Use 2 or more of these units for higher powered systems. Size 2" x 2" x 1 1/2" deep. 8 ohm voice coil. Shpg. wt., 1 lb.

SK-91... Net **3.75**

NEW 2-WAY CROSSOVER NETWORK

A constant impedance L-C network with 4000 cps crossover. Designed to be particularly effective when used in conjunction with the super tweeter SK-87 or wherever a crossover at 4000 cycles is desired.

Impedance 16 ohms, attenuation 6db/octave. Easily accessible screw terminals for input and speakers. Enclosed metal case, 2 1/2" diameter and 2 3/4" high. Bracket provided for mounting. Shpg. wt., 2 lbs.

LN-4 Crossover Network... Net **4.50**

AND DON'T FORGET LAFAYETTE'S MONEY BACK GUARANTEE

Lafayette CUSTOM DESIGNED

3 WAY SYSTEM WITH 15" WOOFER . . . 8" MID-RANGE SPEAKER . . . HORN TWEETER . . . CROSSOVER NETWORK

PHANTOM VIEW SHOWS HOW SYSTEMS MOUNT IN CABINET

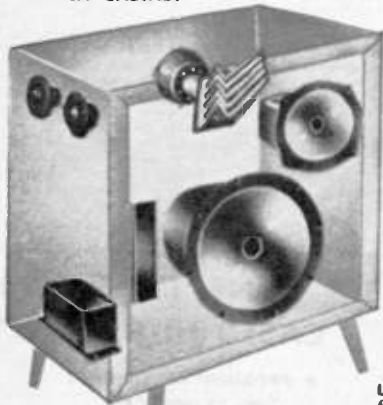

CABINET NOT INCLUDED



- 15-INCH WOOFER WITH 31.5 OZ. MAGNET (SK-67)
- 8-INCH MID-RANGE SPEAKER (SK-74)
- NEW HIGH-FREQUENCY ACOUSTICAL LENS TWEETER (HW-7)
- 3-WAY CROSSOVER NETWORK (LN-3)

Lafayette presents this outstanding 3-way speaker system designed for the high fidelity enthusiast who desires performance formerly possible in multi-speaker systems costing many times this price. You won't believe your ears when you hear the superb reproduction throughout the entire audio spectrum. The SK-67 15" woofer provides phenomenal bass response, the SK-74 8" speaker delivers full bodied, mid-range frequencies, and the HW-7 high frequency acoustical lens tweeter faithfully reproduces the highest audible frequencies. Crossover points at 350 and 5000 cycles are provided by the LN-3 3-way inductance-capacitance network with continuously variable presence and brilliance controls that adjust tone balance to personal taste. Shpg. wt., 25 lbs.

SY-93. Complete System as listed above.....Net **55.50**

True HI-FI Reproduction at a Budget Price!

3-WAY SYSTEM INCLUDES

- 12-INCH WOOFER WITH 21.5 OZ. MAGNET (SK-68)
- 8-INCH MID-RANGE SPEAKER (SK-74)
- METAL-CASED CONE TYPE HI-FI TWEETER (HK-3)
- 3-WAY CROSSOVER NETWORK WITH CONTINUOUSLY VARIABLE PRESENCE & BRILLIANCE CONTROLS (LN-3)

Here is another 3-way speaker system designed to save you money and make your next hi-fi project quick and easy. Truly a triumph in the field of acoustics. This combination created intense interest with budget-minded music lovers at various trade and consumer shows because of its unusual performance capabilities. Each component is specifically designed to reproduce its own range with optimum fidelity. The system consists of the SK-68 12" Woofer which gives exceptionally clean mellow bass frequencies from 35 to 350 cycles, the 8" Driver which reproduces the mid-range frequencies from 350 to 5000 cycles clearly and true-to-life, and the new metal-cased HK-3 High Frequency Tweeter which provides brilliant treble response in the 5000 to 16,000 cycle region. The LN-3 Crossover Network, crossing over at 350 and 5000 CPS, completes this ultra modern system. Has "Brilliance" and "Presence" controls. Shpg. wt., 22 lbs.

SY-92—Complete system as listed above.....Net **38.50**



2-WAY SPEAKER SYSTEM 25 WATTS 50-16,000 CYCLES



Here's real economy in a complete 2-way high fidelity speaker system designed for the buyer with a small budget. The system consists of a GE 12" woofer with a frequency response of 50 to 13,000 cycles, and 1 1/2" aluminum voice coil capable of handling 25 watts of program material. Metal-cased, HK-3 cone type high frequency tweeter extends range of system to 16,000 cycles. LN-2 capacitance-inductance crossover network has continuously variable level-brilliance control to compensate for varying room acoustics. Woofer has 9 oz. Alnico V magnet. Shpg. wt., 15 lbs.

SY-85. Complete 2-way Speaker System....Net **23.50**

DELUXE 2-WAY SYSTEM 35 CPS TO BEYOND AUDIBILITY

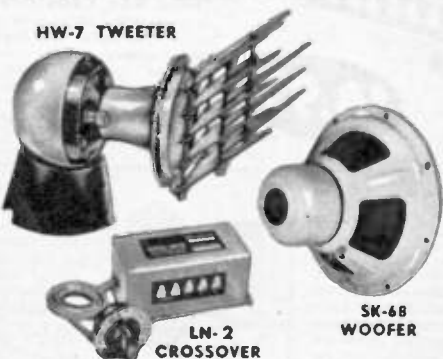

A modest budget no longer has to limit the quality and calibre of your high fidelity aspirations. This is a truly deluxe speaker system which gives you a frequency range that extends from 35 cps to beyond audibility. It includes the SK-68 12" woofer with a heavy, 21.5 oz. Alnico V magnet and 1 1/2" voice coil rated at 25 watts, HW-7 diaphragm type high frequency tweeter complete with sound dispersing, louvered acoustic lens, and LN-2 capacitance-inductance crossover network with level-brilliance control. The entire assembly gives you a wide range 2-way speaker system at a remarkably low price. Shpg. wt., 22 lbs.

SY-86. Complete 2-way Speaker System....Net **36.50**

2-WAY SPEAKER SYSTEM 40-16,000 CYCLES



This 2-way speaker system is another excellent buy for the moderate purse. It is basically the same as the SY-85 system described at the top of the page, but incorporates the deluxe SK-68 speaker with 21.5 oz. Alnico V magnet. This results in more efficient reproduction and extension of the lower register. Complete system includes the SK-68 12" 25 watt woofer, HK-3 cone type tweeter and LN-2 crossover network with level-brilliance control. Range of system 35-16,000 cycles. Shpg. wt., 18 lbs.

SY-87. Complete System.....Net **27.50**

2 WAY & 3 WAY SPEAKER SYSTEMS

LAFAYETTE 3-WAY SYSTEM

with 15" WOOFER . . . 8" MID-RANGE SPEAKER
. . . HORN TWEETER . . . CROSSOVER NETWORK

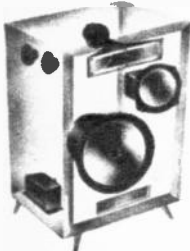

PHANTOM VIEW SHOWS
HOW SYSTEMS MOUNT
IN CABINET

SPEAKER
SYSTEM
only 42.50

CABINET
NOT INCLUDED



JENSEN
8-INCH
MID-RANGE



JENSEN
15-INCH
WOOFER



LAFAYETTE
LN-3
CROSSOVER



JENSEN
TWEETER

This new multi-speaker system provides true high fidelity reproduction at the lowest price ever. Included in the 3 way system are a Jensen 15" woofer, Jensen 8" mid-range speaker, Jensen compression driver horn tweeter and Lafayette LN-3 capacitance-inductance crossover network. Crossover is at 350 and 5000 cycles, and unit is supplied with two, built-in, continuously variable "presence" and "brilliance" controls wired on 2-ft. extension cables. Outstanding bass and mid-range response, plus brilliant reproduction of the highest audible frequencies result in superb performance from this 3-way system throughout the entire audio spectrum. Power handling capacity in bass reflex enclosure, 25 watts. Impedance 16 ohms. Shpg. wt., 19 lbs.

SY-98—Speaker System.....Net 42.50

Completely assembled bass reflex cabinets constructed of 3/4" hardwood, ready for finishing. Dimensions of highboy, less legs: 29" H, 23 1/2" W, 16" D. Lowboy same size with H and W dimensions interchanged. Legs are 5" H. Shpg. wt., 42 lbs.

CAB-23—Highboy Cabinet
Only.....Net 39.50

CAB-24—Lowboy Cabinet
Only.....Net 39.50

LAFAYETTE 2-WAY SYSTEM with 15" WOOFER . . . HORN TWEETER . . . CROSSOVER NETWORK

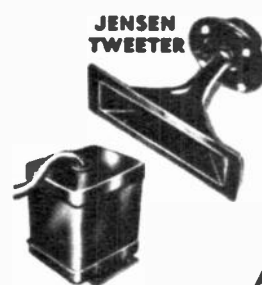

LAFAYETTE
L-C CROSSOVER



JENSEN
15" WOOFER

A Superb HI-FI Buy!
Only 27.50

Another new Lafayette 2-way speaker system that provides full frequency response at a low budget price. The system includes a Jensen 15" woofer, Jensen compression driver horn tweeter, and Lafayette inductance-capacitance (L-C) 2000-cycle crossover network. In a bass reflex enclosure, power handling capacity is 20 watts. Enjoy rich extended bass response and brilliant, high-frequency reproduction of the finest high fidelity recordings. Impedance 16 ohms. Shpg. wt., 12 lbs.

SY-96—Speaker System.....Net 27.50

Completely assembled bass reflex cabinet (23 1/2" W, 33 1/2" H, 12 1/2" D), constructed of 3/4" hardwood, ready for finishing. Shpg. wt., 30 lbs.

CAB-23 or CAB-24—Cabinet only.....Net 39.50

LAFAYETTE 2-WAY SYSTEM WITH 12" WOOFER . . . HORN TWEETER . . . CROSSOVER NETWORK



CABINET
NOT
INCLUDED

PHANTOM VIEW SHOWS
HOW SYSTEMS MOUNT
IN CABINET



JENSEN
TWEETER



JENSEN
12-INCH WOOFER

LAFAYETTE
L-C CROSSOVER

Mount this 2-way speaker system in a bass reflex enclosure described on the opposite page and enjoy full range reproduction of your favorite recordings and radio program material. Power handling capacity 20 watts. System includes Jensen compression driver horn tweeter, Jensen 12" woofer and Lafayette inductance-capacitance (L-C) 2000-cycle crossover network. Impedance 16 ohms. Shpg. wt., 11 lbs.

SY-95—Speaker System.....Net 23.95

Completely assembled bass reflex Cabinet (23 1/2" W, 33 1/2" H, 12 1/2" D). Constructed of 3/4" hardwood, ready for finishing. Shpg. wt., 30 lbs.

CAB-23—Cabinet only.....Net 39.50

2 WAY SYSTEM WITH 8" WOOFER HORN TWEETER CROSSOVER NETWORK



JENSEN
TWEETER
JENSEN
8-INCH
WOOFER



LAFAYETTE
L-C CROSSOVER

only
19.95

Here is a speaker system that solves space and cost problems for the audiophile who wants a compact unit at a low price without sacrificing wide range frequency response. System includes a special Jensen 8" woofer speaker, compression driver horn tweeter, and Lafayette inductance-capacitance (L-C) 2000-cycle crossover network. Power handling capacity 20 watts in bass reflex enclosure. Impedance 16 ohms. Shpg. wt., 8 lbs.

SY-94—Speaker System.....Net 19.95

SPEAKER SYSTEM WITH CABINET

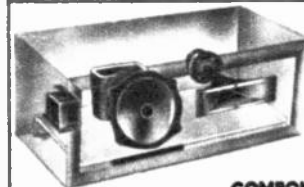

PHANTOM VIEW
SHOWS HOW
SYSTEM
MOUNTS
IN CABINET

AS LOW AS
37.50

COMPONENTS UNMOUNTED

Completely assembled bass reflex cabinet (23 1/2" W., 11" H., 10 1/4" D.) and SY-94 speaker system described above, at a special low price. Cabinet is constructed of 3/4" hardwood, available finished or unfinished, and smoothly sanded for custom finishing. Total shpg. wt., 30 lbs.

SY-133. SY-94 and SB-51. Unfinished.....Net 37.50

SY-134. SY-94 and SB-52. Mahogany.....Net 40.50

SY-135. SY-94 and SB-53. Blonde.....Net 40.50

CABINET ONLY

SB-51. Unfinished. Shpg. wt., 22 lbs.....Net 19.50

SB-52. Same except Mahogany finish.....Net 22.50

SB-53. Same except Blonde finish.....Net 22.50

5" TWEETER AND CROSSOVER NETWORK

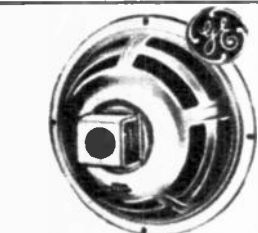

GE 12" Woofer



5" Tweeter



Crossover
Network

2-WAY SPEAKER SYSTEM

- G.E. 12" PM—25 Watt—9 oz. magnet 'Woofer'
- 5" Tweeter and Crossover Network

Ideal for custom installations, where a 2-way speaker system is desired to obtain a high degree of audio fidelity at a price that will fit your pocketbook. You can now replace your old speaker in your present phonograph with a 2-way speaker system that will give you clean, distinct bass response provided by the Famous G.E., heavy duty 12" PM 'woofer' with exceptionally large Alnico V magnet (9 oz.), and increase the high frequency range with the 5" Tweeter and Crossover Network, making this assembly a complete 2-way music system which will recreate a tone balance that will astound you. Will outperform any speaker arrangement costing 2 or 3 times Lafayette's Price. Wiring Diagram included. Shpg. wt., 13 lbs.

STOCK NO. SY-12.....Net 17.50



5" Tweeter



Crossover
Network

A specially designed 5" Tweeter and Crossover Network that will assure high frequency response when used with any speaker you now possess. You can now make your present speaker into a 2-way speaker system increasing the high frequency range up to 15,000 cycles. Diagram included. Shpg. Wt. 5 lbs.

STOCK NO. SY-14.....Net 7.25

STOCK NO. MS-71 Crossover Network

only.....Net 4.95

STOCK NO. SK-35 5" Tweeter only.....Net 2.45

Lafayette HI-FI Speakers At Pocket Book Prices

15" COAXIAL HIGH-FIDELITY SPEAKER

30-20,000 CPS—25 WATTS—
21.5 OZ. ALNICO V MAGNET

Superb standard of performance throughout the audio spectrum. Consists of specially designed 15" woofer with a full 5" high-frequency tweeter, coaxially mounted, and 1½" voice coil. Extra heavy magnets are used in both units for highest efficiency and smoothest response. The 15" woofer gives the deep, rich bass notes for complete satisfaction. Frequency response: 30-20,000 CPS. Crossover frequency: 3500 CPS. Handling capacity: 25 watts, 35 watts peak; Impedance: 8 ohms. Rugged seamless cone, finished in attractive non-marking brown hamerloid enamel. Shpg. wt., 13 lbs. Cone Resonance 45 cycles

SK-70.....Net 25.50

12" COAXIAL HI-FI SPEAKER

Same magnet weight and characteristics as above except for diameter. Cone Resonance 50 cycles

SK-71—12" Coax.....Net 22.50

5-INCH HIGH-FREQUENCY TWEETER

25 WATTS—WITH BUILT-IN CROSSOVER NETWORK
CROSSOVER FREQUENCY 2000 CYCLES

A fully enclosed high-frequency tweeter with a sensitivity and smoothness which in many cases outperforms the much more costly compression horn types of tweeter. Clean, with extended high frequency response of 600 to 15,000 CPS and crossover frequency of 2500-3500 CPS, this tweeter will handle output of amplifiers up to 25 watts. Will increase the frequency response range and add much to the realistic reproduction of the original performance. Voice coil dia. ¾"; Impedance 8 ohms; rugged seamless cone—inherently moisture resistant; 3.16 oz. Alnico V magnet, with built in crossover network. Shpg. wt., 2¼ lbs.

SK-72.....Net 5.25

SK-73—Less crossover network.....Net 4.50

HI-FI COAX SPEAKER WITH DUAL TWEETER

An unusual value in a hi-fi speaker. Rated at 20 audio watts, this speaker has two 3½" high frequency units coaxially mounted in a 12" low frequency woofer giving smoothness and wide dispersion at all frequencies. Has large 14.7 oz. Alnico V magnet. Rugged housing—no resonance from thin metal stampings. Frequency coverage substantially flat from 30 to 19,500 cycles. 8 ohm voice coil. Worth twice the price. Shpg. wt., 10 lbs.

SK-44.....Net 22.95

8" HI-FI WIDE RANGE SPEAKER

50—13,000 CPS

Answers the need for a good quality but moderately priced speaker with a range of 50-13,000 cycles. An extremely smooth single cone reproducer—ideally suited for Hi-Fi systems. Excellent for limited space—good overall balance—power handling capacity: 8 watts—6.8 oz. Alnico V magnet—frequency response: 50-13,000 CPS when properly baffled. Rim treatment on cone minimizes possibility of diaphragm distortion. Voice coil impedance: 8 ohms. Shpg. wt., 4 lbs. Cone Resonance 85 cycles

SK-69.....Net 6.25

8" MID-RANGE & WOOFER

A low frequency bass reproducer, free from distortion and capable of clean reproduction down to 40 cycles. Ideal for use with tweeters and crossover networks to make up a 2-way or 3-way system. Can also be used with additional speakers as a multi-speaker woofer. Perfect, too, as mid-range unit in low cost 3-way systems. Crossover at 350 CPS; frequency response 350-13,500 cycles; suitable for crossover to 5000 cycles. Impedance 8 ohms. Cone Resonance 150 cycles

Shpg. wt., 4 lbs.
SK-74.....Net 6.50

12" COAXIAL SPEAKER

EXTENDED RANGE DUAL SPEAKER SYSTEM! FOR FM OR AM RADIO, TELEVISION, SOUND AND WIDE RANGE RECORD PHONOGRAPHS. QUICK, EASY, MODERNIZING REPLACEMENT OF OLD STYLE SINGLE RANGE SPEAKERS.

12-inch Alnico V PM with 1 inch voice coil and heavy one piece cone. Specially designed 3-inch Alnico V PM tweeter completes this combination speaker, range 40 to 15,000 CPS. Built-in high pass filter. Installs same as regular PM speaker only two wires to connect. Impedance 8 ohm. Wt. 8 lbs.

SK-22.....Net 9.95

8" COAXIAL SPEAKER

The perfect answer to High Fidelity audio reproduction in limited space. Alnico V magnets in both woofer and tweeter. Built-in hi-pass filter. 8 ohm coil. Wt. 6 lbs.

SK-24.....Net 8.45

15" ECONOMY COAXIAL

A tone coaxial speaker with a 5" tweeter coaxially mounted within the 15" speaker. Frequency response 45-12,000 cycles. Handles 20 watts of power. Has built-in 1800 cycle crossover. High efficiency Alnico 5 magnets. Cadmium plated corrosion resistant frame. Shpg wt., 11 lbs.

SK-89.....Net 14.75

15" HI-FI LOW FREQUENCY WOOFER

• 31.5 OZ. ALNICO MAGNET
• 20 TO 5000 CYCLES—35 WATTS

This efficient 15" low frequency woofer incorporates many exclusive features. For original equipment or replacement, it provides highly efficient extended low-frequency response. Ideal for assembling 2- and 3-way speaker systems. Handles 35 watts of audio power. Frequency response ± 2 db 20 CPS to 1000 CPS, and ± 5 db from 20 CPS to 500 CPS with proper baffling. Voice coil dia. 2", Impedance 8 ohms. 31.5 oz. Alnico V magnet. Finished in beautiful brown enamel. Cone is seamless type, permanently bound to voice coil. Shpg. wt., 13¼ lbs. Cone Resonance 45 cycles

SK-67.....Net 23.95

12" HI-FI LOW FREQUENCY WOOFER

21.5 OZ. ALNICO V MAGNET—25 WATT

Provides efficient, extended low-frequency response of ± 5 db from 35 to 8000 CPS, and features 25 watts of power handling capacity. Perfect for high-fidelity installations or for modernization of older equipment. Ideal for assembling 2- and 3-way speaker systems at a budget price. Enclosed magnet structure—completely dust-proof. Compliance of outer cone and inner spider carefully calculated for best bass response. 21.5 oz. Alnico V magnet, 1½" dia. voice coil, 8 ohm impedance. All exposed surfaces are finished in beautiful brown enamel. Shpg. wt., 8 lbs. Cone Resonance 50 cycles

SK-68.....Net 16.50

TV EXTENSION SPEAKER

Full range 4" x 6" auxiliary speaker in an acoustically constructed, finished wood cabinet. Two built-in volume controls allow use of extension speaker alone, TV speaker alone, or both together for stereophonic sound quality. No need to get out of your easy chair to change the volume level. Wonderful for the hard of hearing when used as a close-up personal speaker. Mahogany finish, with gold grille. Shpg. wt. 4 lbs.

SK-76.....Net 6.97

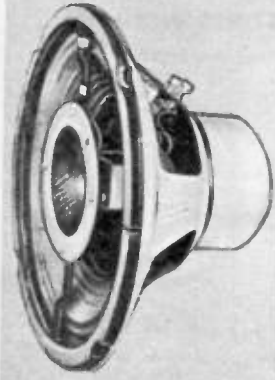

SK-24

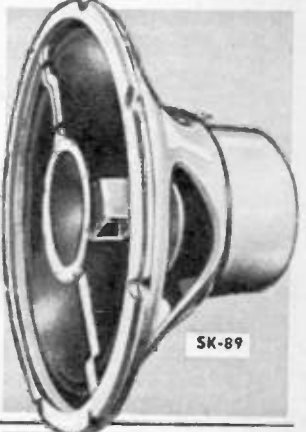
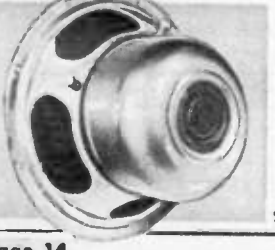
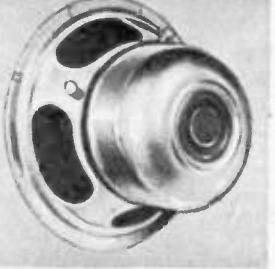

SK-89

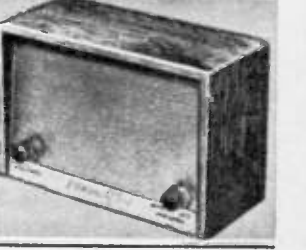
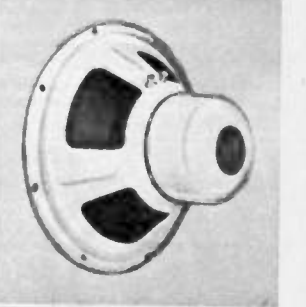

Garrard 4-SPEED RECORD CHANGERS- with 37.50 FAIRCHILD DIAMOND CARTRIDGE



COMPLETE WITH FAIRCHILD DIAMOND LP CARTRIDGE
83.41 NET

RC88 TRIUMPH II



COMPLETE WITH FAIRCHILD DIAMOND LP CARTRIDGE
71.65 NET

RC121 RENOWN



COMPLETE WITH FAIRCHILD DIAMOND LP CARTRIDGE
96.15 NET

RC 98 CROWN II

4-Speed deluxe Auto-Manual changer, successor to the RC80 Triumph. Full manual position with finger-tip control gives this automatic changer the versatility of a single-play turntable. Smooth, quiet shaded 4-pole "Induction-Surge" motor, silent free-wheeling ballbearing turntable mount and oversized live rubber idler traction wheel. Features a true-turret drive with all 4 speeds operating off the motor on a single turret which eliminates drive belts. Shielded condenser-resistor network and reinforced automatic muting switch. Heavy steel precision turntable covered with rubber tractor mat. Simplified stylus pressure and pickup height adjustments. Watch-like construction with sensitive trip mechanism, automatic stop and shutoff brake. Foolproof, gentle record pusher platform. Floating motor completely isolated and damped. Size 15 1/2" x 13 1/4" with 5 1/4" clearance above and 3 3/8" clearance below mounting board. Complete with line cord, pickup lead, plug-in shells, mounting hardware, standard and manual spindles, 45 rpm adaptor. Less cartridge and less automatic 45 rpm spindle. Shpg. wt. 16 lbs.

- Model RC88 - Less cartridge Net 53.41
- Model RC88/GE - With New GE VRII Series Triple Play Dual Sapphire cartridge Net 62.18
- Model RC88/GE-B - With New GE VRII Series Triple Play Diamond-Sapphire Cartridge Net 72.32
- Model 4558 - 45 RPM automatic spindle for use with RC88 Net 3.43
- MAHOAGANY OR BLONDE WOODBASE CUT TO FIT ABOVE PK-111 - Specify finish. Shpg. wt., 5 lbs. Net 3.95
- MOUNTING BOARD TO FIT ABOVE
- PK-110 - Unfinished. Shpg. wt., 3 lbs. Net .95

A deluxe straight spindle type record changer compact enough for replacement use, yet superior to other fixed spindle types. Features "Simpli-Mix" operation whereby 12", 10", or 7" records may be stacked together, bottom to top in this order, loaded on the fixed spindle at one time and the overarm placed in position. Automatic operation results with the tone arm dropping into correct position regardless of record size. 45 RPM records are placed using clip-in adapters or with optional automatic spindles available below. Fully automatic and manual operation. "Induction-Surge" motor true-turret drive, ballbearing turntable mount, tone arm, stylus-pressure adjustments, trip mechanism, automatic stop and practically all of the features found in the new Garrard changers are likewise incorporated in this model. Size 14 1/2" x 13" requiring 4 3/4" clearance above and 3 3/8" below motorboard. 100-130/200-250 volts, 60 cycle AC operation. Complete with line cord, pickup cable, plug-in shell, mounting hardware, Less cartridge and less 45 RPM automatic spindle. Shpg. wt. 14 lbs.

- MODEL RC121 - Less Cartridge Net 41.65
- MODEL RC121/GE - With New GE VRII Series Triple Play Dual Sapphire Cartridge Net 50.42
- MODEL RC121/GE-B - With New GE VRII Series Triple Play Diamond-Sapphire Cartridge Net 60.56
- MODEL 45521 - 45 RPM automatic spindle for use with RC121 Net 3.43
- MAHOAGANY OR BLONDE WOODBASE CUT TO FIT ABOVE PK-111 - Specify finish. Shpg. wt., 5 lbs. Net 3.95
- MOUNTING BOARD TO FIT ABOVE
- PK-110 - Unfinished. Shpg. wt., 3 lbs. Net .95

The RC 98 CROWN II 4-speed Super Auto-Manual record changer combines all of the advancements of the RC90 which it succeeds, and of the new RC88, including Garrard's new automatic and full manual performance. In addition, it contains several new high-fidelity innovations which are characteristic of the model. A feature is its exclusive all-speed variable control which makes possible a continuously variable + or - wide range adjustment of each speed. This is important to those with "perfect pitch" since it permits the RC98 to be "tuned" to the pitch or key of a musical instrument. This variable speed control is obtained by means of an all electrical rheostat operation varying the voltage in the motor coils with no friction or efficiency losses. A special 45 RPM automatic spindle is included in the RC98 standard spindle equipment. Cabinet dimensions are the same as the RC88. Complete with line cord, pickup lead, plug-in shells, mounting hardware, spindles including automatic 45 RPM spindle, less cartridge. Shpg. wt. 17 lbs.

- MODEL RC98 - Less Cartridge Net 66.15
- MODEL RC98/GE - With New GE VRII Series Triple Play Dual Sapphire Cartridge Net 74.92
- MODEL RC98/GE-B - With New GE VRII Series Triple Play Diamond-Sapphire Cartridge Net 85.06
- MAHOAGANY OR BLONDE WOODBASE CUT TO FIT ABOVE PK-111 - Specify finish. Shpg. wt., 5 lbs. Net 3.95
- MOUNTING BOARD TO FIT ABOVE
- PK-110 - Unfinished. Shpg. wt., 3 lbs. Net .95

TC-340 4-SPEED TRANSCRIPTION CHANGER



COMPLETE WITH FAIRCHILD 225A DIAMOND LP CARTRIDGE
66.75 Net

COMPLETE WITH PICKERING 350 DS DIAMOND-SAPPHIRE CARTRIDGE
68.25 Net

New! Collaro 4-SPEED RECORD CHANGERS & TRANSCRIPTION CHANGERS

TC-340 "CITATION"

Latest English import, among the finest available! A radically new, economical, precision changer. "Semi-magic" tone arm AUTOMATICALLY "feels" the record size. Will handle 7", 10" and 12" records stacked in order of decreasing size. Tone arm is a one piece, dynamically balanced transcription type, free of audio resonances. Extremely low tracking error and lowest possible vertical and horizontal friction; will accept all standard high fidelity cartridges. WOW AND FLUTTER: less than 0.25% RMS at 33 1/3 RPM. 2-WAY: switch for operation as manual high-fidelity turntable. Heavy duty 4-pole shaded pole motor. Heavy rim-weighted turntable. 4 speeds: 78, 45, 33 1/3, 16 2/3 RPM. Automatic shut-off after last record. FOOL-PROOF, JAM-PROOF.

Muting switch and "pop-click" filter. Removable rubber turntable mat. Attractively two-toned to go with any decor. Tropicalized. Size 12" x 13 1/2"; clearance 5" above and 2 1/2" below motor board. PRE-WIRED FOR SIMPLE INSTALLATION. Shpg. wt., 20 lbs.

- COLLARO TC-340-E - Less cartridge Net 36.75
- COLLARO TC-340-O - With Collaro Studio "O" Crystal Cartridge Net 39.74
- COLLARO TC-340-GE - With NEW GE-4G-050 Dual Sapphire Cartridge Net 45.52
- COLLARO TC-340-GE-B - With NEW GE-4G-052 Diamond-Sapphire Cartridge Net 55.69

RC-440 4-SPEED RECORD CHANGER



COMPLETE WITH FAIRCHILD 225A DIAMOND LP CARTRIDGE
70.67 Net

COMPLETE WITH PICKERING 350 DS DIAMOND-SAPPHIRE CARTRIDGE
72.17 Net

RC-440 "CORONATION"

Worthy successor to a long series of Collaro English record changers. FULLY AUTOMATIC INTERMIXING—handles 7", 10", 12" records stacked in any order. Features popular universal plug-in head shell suitable for any standard hi-fi cartridge, precision mechanism with heavy, rim-weighted turntable, automatic shut-off after last record. Wow and flutter less than 0.25% at 33 1/3 RPM. 4 speeds: 78, 45, 33 1/3, 16 2/3 RPM. Heavy duty 4-pole shaded pole motor. FOOL-PROOF, JAM-PROOF! 2-WAY: switch converts at will to operation as manual high-fidelity turntable. Muting switch and "pop-click" filter. Removable rubber turntable mat. 8-second change cycle, independent of speed setting. Two-toned finish. Tropicalized to withstand adverse weather and humidity conditions. Size 12" x 13 1/2"; clearance 5 1/2" above and 2 1/2" below motorboard. PRE-WIRED FOR SIMPLE INSTALLATION. Shpg. wt., 20 lbs.

- COLLARO RC-440-E - Less cartridge Net 40.67
- RC-440-O - With Collaro Studio "O" Crystal Cartridge Net 43.66
- RC-440-GE - With NEW GE-4G-050 Dual Sapphire Cartridge Net 49.44
- RC-440-GE-B - With NEW GE-4G-052 Diamond-Sapphire Cartridge Net 59.61
- COLLARO ACCESSORIES
- COLLARO GPE - Empty plug-in head shell for RC-440 "Coronation" series Net .83
- COLLARO GPEO - Head shell with Collaro Studio "O" cartridge for RC-440 "Coronation" Net 4.16
- COLLARO GSA - Automatic 45RPM adaptor spindle for all Collaro changers Net 3.23

TC-540 4-SPEED TRANSCRIPTION CHANGER



COMPLETE WITH FAIRCHILD 225A DIAMOND LP CARTRIDGE
75.57 Net

COMPLETE WITH PICKERING 350 DS DIAMOND-SAPPHIRE CARTRIDGE
77.07 Net

TC-540 "CONTINENTAL"

NEW and unmistakably the finest British precision changer with exceptional custom features, from Collaro, Ltd., the world's largest mfr. of high fidelity record changers. FIRST to embody a transcription-type tone arm—one piece, dynamically balanced, free of audio resonances, with minimum tracking error, lowest possible vertical or horizontal friction, same low stylus pressure for last record as for first; accepts all standard high fidelity cartridges. FULLY AUTOMATIC INTERMIX—handles 7", 10" and 12" records in any order. Automatic shut-off after last record. Automatic idler disengagement to prevent "bumps" and "wow". Heavy, rim-weighted balanced turntable; extra-heavy duty 4-pole motor; exclusive micro-finished motor shaft polished to .000006 inches for lowest possible noise. 4

- speeds: 78, 45, 33 1/3, 16 2/3 RPM. 2-WAY: switch for operation as manual turntable. Wow and Flutter less than 0.25% RMS at 33 1/3 RPM. JAM-PROOF. Muting switch and "pop-click" filter. Rubber turntable mat. Tropicalized. Size 12" x 13 1/2"; clearance 5 1/2" above and 2 1/2" below motorboard. PRE-WIRED. Shpg. wt., 20 lbs.
- COLLARO TC-540-E - Less cartridge Net 45.57
- COLLARO TC-540-O - With Collaro Studio "O" cartridge Net 48.56
- COLLARO TC-540-GE - With NEW GE-4G-050 Dual Sapphire Cartridge Net 54.34
- COLLARO TC-540-GE-B - With NEW GE-4G-052 Diamond Sapphire Cartridge Net 64.51

Lafayette

VISCOUS DAMPED PICKUP ARMS

ONLY Lafayette CAN BRING YOU A VISCOUS DAMPED TRANSCRIPTION TONE ARM AT SUCH A PRICE!

THE PROFESSIONAL 12" PK-90



LICENSED UNDER CBS
U. S. PATENT NO. 2676806

\$11.95

- JEWEL BEARING SUPPORT
- PERFECT RECORD TRACKING
- AUTOMATIC FLUID CONTROL
- INSTANT PLUG-IN CARTRIDGE CHANGE
- ACCOMMODATES ALL POPULAR AMERICAN CARTRIDGES

This transcription arm, with its "floating action" principle of viscous-damping, gives dependable and stable operation. It is supported at a single point by a pivot and jewel bearing having negligible friction. Damping is accomplished by a silicone fluid occupying the gap between ball and socket. The result is high compliance and practically no tracking error. Damage to record or stylus is impossible if the arm is accidentally dropped. Low frequency resonance, skidding and groove-jumping are also minimized. The tone arm plays all size records including 12", and accommodates virtually all hi-fi cartridges by means of precisely engineered adapters which simplify installation and provide proper stylus pressure. Gray hammertone finish. Shpg. wt., 2 1/2 lbs.

PK-90—Transcription Tone Arm.....Net **11.95**

LAFAYETTE PROFESSIONAL 16" VISCOUS-DAMPED TRANSCRIPTION TONE ARM



PK-170

PLUG IN HOLDERS FOR
POPULAR MODEL CARTRIDGES

\$17.95

Here is one of the finest professional, transcription tone arms available today, imported by Lafayette Radio, and sold at the lowest price ever. Every important tone arm design and construction feature has been incorporated into this new addition to Lafayette's high fidelity family of fine products. Viscous damping means "floating action" fluid control which regulates the horizontal and vertical movement of the arm. This suspension principle virtually eliminates groove jumping and skipping. Tone arm resonance is eliminated and perfect compliance is achieved at all speeds with correct stylus pressure. The silicone oil chamber is completely enclosed and sealed against leakage. All tone arm adjustments are easily accessible and include means for correcting height of arm, stylus pressure and leveling of the arm. The amount of damping and pressure is controlled by manual viscosity adjustments mounted on top of the arm. Records and stylus cannot be damaged when the tone arm is accidentally dropped. The slide-in cartridge holders and separate weights permit instantaneous mounting of all standard types including GE turn-over cartridge. An adjustable height pickup rest, three cartridge holders, and leads for connection to amplifier are supplied with the pickup arm. Rich, hammertone gray finish. Overall length of arm 14 1/2". Shpg. wt., 3 1/2 lbs.

PK-170—Transcription Tone Arm.....Net **17.95**

ARGONNE PROFESSIONAL DELUXE 12" VISCOUS DAMPED TONE ARM

LICENSED UNDER CBS U.S. PATENT NO. 2676806

PK-150



NET ONLY

FOUR PLUG-IN ADAPTERS
FOR STANDARD CARTRIDGES

\$19.95

LICENSED UNDER CBS
U. S. PATENT NO. 2676806

WITH NEW REVOLUTIONARY PATENTED PRINCIPLES

- EXCLUSIVE SEALED OIL CHAMBER ELIMINATES POSSIBILITY OF LEAKAGE
- FACTORY ADJUSTED FOR OPTIMUM DAMPING POSITION
- CORRECT STYLUS PRESSURE AUTOMATICALLY APPLIED

A new Argonne (Model AR-600) import for the discriminating audiophile who wants tone arm perfection. Here is an arm utilizing distinctive design and construction to provide features not found in other viscous damped tone arms. An entirely new principle is used to provide a sealed chamber to eliminate fluid leakage, a common defect of other viscous damped types. The tone arm is adjusted for optimum damping at the factory prior to shipment and in practically all instances requires no further adjustment. Four adapters are supplied to accommodate all popular standard make cartridges (GE, Fairchild, Pickering). When mounted in its proper adapter, the correct stylus pressure is automatically applied for each specific cartridge. Perfect damping with a high grade silicone oil having a negligible temperature coefficient, single point pivot support for smoother action, and convenient variable height and leveling adjustments are a few of the other features of this excellently designed unit. Viscosity of oil keeps stylus in the groove and absorbs shocks and undesirable arm vibrations. Tone arm resonances are non-existent within the audio range. Equipped with pickup rest and tone arm lift. Finished in attractive gray hammertone. With installation instructions. Shpg. wt., 3 lbs.

PK-150—Transcription Tone Arm.....Net **19.95**

DELUXE WOODBASES AND MOUNTING BOARDS FOR TRANSCRIPTION TURNTABLES



- INDIVIDUAL ADJUSTABLE FEET FOR ACCURATE LEVELING
- FREE-FLOATING FOAM RUBBER MOUNTED MOTOR BOARD
- ATTRACTIVE CUSTOM CABINETMAKERS FINISHES
- FINEST SELECTED HARDWOOD VENEERS

These substantial woodbases are deluxe units which are made of the finest selected hardwood veneers by skilled craftsmen. All have firmly secured mitered corners. The four bumper feet are individually adjustable for accurate leveling. The free-floating mounting board is foam rubber mounted, and the top has a finish matching the wood base. Available in five attractive cabinetmaker finishes. The mounting board is pre-cut to accommodate PK-300 or PK-225, and is also supplied uncut for any popular make of turntable. The elegant styling and finish add beauty to any high-fidelity installation.



FOR 12" TONE ARMS

For installations using a turntable and 12" tone arm mounted on woodbase. Overall size 20" w x 16" d x 5 3/4" h. Shpg. wt., 13 lbs.

CUT OUT FOR PK-300

- PK-195—Mahogany
- PK-196—Blonde
- PK-197—Ebony
- PK-198—Walnut
- PK-199—Fruitwood

CUT OUT FOR PK-225

- PK-201—Mahogany
- PK-202—Blonde
- PK-203—Ebony
- PK-204—Walnut
- PK-205—Fruitwood

PK-124—Same as above except supplied uncut for mounting other makes of turntables. Specify finish.....Net **14.95**

PK-206—Pre-cut unfinished mounting board for PK-300 turntable. 19" w x 15" d x 3/8". Smoothly sanded for easy finishing. Shpg. wt., 3 lbs.....Net **1.95**

PK-207—Pre-cut unfinished mounting board as above for PK-225 turntable. Shpg. wt., 3 lbs.....Net **1.95**

FOR 16" TONE ARMS

For installations using a turntable and 16" tone arm mounted on woodbase. Overall size 22" w x 16 1/4" d x 5 3/4" h. Shpg. wt., 15 lbs.

CUT OUT FOR PK-300

- PK-175—Mahogany
- PK-176—Blonde
- PK-177—Ebony
- PK-178—Walnut
- PK-179—Fruitwood

CUT OUT FOR PK-225

- PK-181—Mahogany
- PK-182—Blonde
- PK-183—Ebony
- PK-184—Walnut
- PK-185—Fruitwood

PK-186—Same as above except supplied uncut for mounting other makes of turntables. Specify finish.....Net **15.95**

PK-187—Pre-cut unfinished mounting board for PK-300 turntable. 21" w x 15 3/4" d x 3/8". Smoothly sanded for easy finishing. Shpg. wt., 3 lbs.....Net **1.95**

PK-188—Pre-cut unfinished mounting board as above for PK-225 turntable. Shpg. wt., 3 lbs.....Net **1.95**

NEW!
PROFESSIONAL!

LAFAYETTE TRANSCRIPTION TURNTABLES

LAFAYETTE MODEL PK-300

The Finest Transcription Turntable For Professional Or Audiophile!

- BUILT-IN STROBOSCOPE AND VIEWER FOR EXACT SPEED DETERMINATION • MAGNETIC BRAKE FOR INSTANTANEOUS SPEED VARIATION • RC FILTER NETWORK • 12" CAST-ALUMINUM RIM-DRIVEN TURNTABLE • HEAVY DUTY 4-POLE CONSTANT SPEED MOTOR • VARIABLE SPEED CONTROL PERMITS ADJUSTMENT OF EACH SPEED WITHIN $\pm 7\%$ • SPEED SELECTOR SAFETY SWITCH • FREELY-FLOATING MOTOR MOUNT

New 3-speed instrument to delight the connoisseur. The balanced turntable has an extra-heavy rim for smooth, effective flywheel action. Rim driven by perfectly true pulleys and an oversized idler wheel; ball-bearing mounted to assure noiseless, rumble-free rotation. Heavy-duty, high torque, constant speed 4-pole induction motor with virtually no magnetic leakage or hum pickup even with the sensitive variable reluctance cartridges. Variable speed control, utilizing an efficient magnetic and frictionless eddy-current brake action. A built-in stroboscope and optical viewer permit exact speed adjustment even while records are being played. With power off, the idler wheel is automatically disengaged, keeping it perfectly round and true and preventing rumble. Speed selector safety switch protects the operating mechanism by making it obligatory to pass through an OFF position when switching speeds.

The motor is isolated by shock mounting. An RC filter network does away with unwanted shut-off noise.

For 110-130 Volts, 60 cycle AC. Draws 12 watts. Size: 13 1/2" d, 14" w; clearance 2 3/4" above motorboard (excluding pick-up arm) and 3 3/4" below. Supplied with a heavy rubber record cushion, 45 RPM adapter and mounting plate for tone arm. Shpg. wt., 20 lbs.

PK-300

Net 49.50

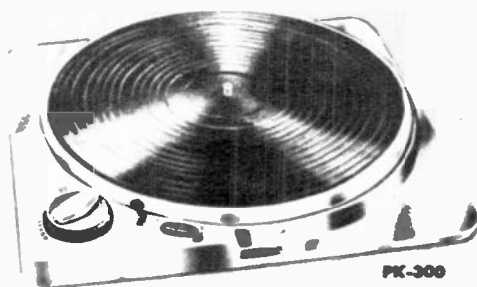

PK-300

LAFAYETTE COMBINATIONS FOR EXTRA SAVINGS!

- PK-300 Turntable, PK-90 Tone Arm, New GE VRII Series "Triple-Play" Cartridge Model 4G-052 with Genuine GE Diamond and Sapphire StylusSPECIAL! Net 72.50
- Same as above, with Fairchild 225A Cartridge with Diamond LP StylusSPECIAL! Net 90.50
- Same as above, with Pickering 350DS "Fluxvalve" Cartridge with Diamond and Sapphire Stylus.SPECIAL! Net 92.00
- PK-300 Turntable, PK-170 Tone Arm, GE VRII Series Model 4G-052 Cartridge with GE Diamond and Sapphire Stylus.SPECIAL! Net 78.50
- Same as above, with Fairchild 225A Cartridge with Diamond LP StylusSPECIAL! Net 96.50
- Same as above, with Pickering 350DS "Fluxvalve" Cartridge with Diamond and Sapphire Stylus.SPECIAL! Net 98.00

LAFAYETTE MODEL PK-225

Professional Turntable with HYSTERESIS-SYNCHRONOUS MOTOR!

The LAFAYETTE TRUE HYSTERESIS-SYNCHRONOUS MOTOR. Since many so-called "hysteresis" motors have appeared and will continue to appear on the market, it is important that you know the difference between the real thing, as provided by Lafayette, and the imitators with partial hysteresis motors!

ONLY HYSTERESIS-SYNCHRONOUS MOTORS—SUCH AS LAFAYETTE'S—are free from speed variations due to fluctuations in line voltage, load and temperature!

ONLY HYSTERESIS-SYNCHRONOUS MOTORS—SUCH AS LAFAYETTE'S—are the smoothest type known, completely free from "cogging" (the minute variations of speed which show up as waw and flutter)!

ONLY LAFAYETTE'S HYSTERESIS-SYNCHRONOUS MOTOR, in its price class, is made to extremely fine tolerances (on the order of .0001 inches)! Only Lafayette's motor has 16 cores, a high permeability rotor magnet, ball thrust bearings, oilite sleeve bearings plus felt oil reservoir, cooling fins as an integral part of the rotor and a hollow rotor core for maximum efficiency and minimum heat. Only Lafayette's motor can be oiled from above, without disassembly, through a unique oil feed system. Only Lafayette's motor has a self-aligning armature.

ONLY LAFAYETTE CAN GIVE YOU A REALLY PROFESSIONAL TURNTABLE WITH TRUE HYSTERESIS-SYNCHRONOUS MOTOR AT SUCH AMAZINGLY LOW PRICES!

Here's THE turntable—the last word in professional high-fidelity performance! A fine precision instrument in every sense. Just look at some of these OUTSTANDING FEATURES:—WOW AND FLUTTER: Less than 0.2%. • TURNTABLE: Heavy, diecast aluminum. Lathe-turned for perfect balance and concentricity. 12" diameter—weighs approx. 4 lbs. and provides amazingly constant speed; the extra-heavy rim acts just like a flywheel to prevent speed variations. • TRUE HYSTERESIS-SYNCHRONOUS MOTOR: For smooth, low-noise, wow- and flutter-free operation. • RUMBLE AND NOISE: 50db below average recorded level. • INTEGRATED SPEED CONTROL: For all 3 speeds—78, 45 and 33 1/2 rpm. • 2 OVERSIZE, HEAVY DUTY IDLERS: Precision-ground; provide positive constant-speed rim drive. • SINGLE BALL THRUST BEARING: Turntable rides smoothly over ball bearing floating on thin film of oil. • FREE-FLOATING, SHOCK-MOUNTED MOTOR • RUBBER CUSHION SHOCKMOUNTS • AUTOMATIC IDLER DISENGAGEMENT • CORK AND RUBBER MAT • STAINLESS STEEL PRECISION SPINDLE • POWER REQUIREMENTS: For 105-130 volts, 60 cps AC; draws 16 V.A. • ACCESSORIES SUPPLIED: 45 RPM adapter, Strobe disc • SIZE: 2 1/4" above and 4" below motor board; 14 3/4" deep x 12 1/4" wide • SHIPPING WEIGHT: 16 lbs.

LAFAYETTE MODEL PK-225

Net 64.50



PK-225

TOP INTERIOR VIEW OF LAFAYETTE'S HYSTERESIS-SYNCHRONOUS MOTOR



LAFAYETTE MONEY-SAVER COMBINATIONS

- PK-225 Turntable, PK-150 12" Tone Arm, New GE VRII Series "Triple-Play" Cartridge Model 4G-052 with Genuine GE Diamond and Sapphire Stylus.SPECIAL! Net 89.50
- Same as above, with Fairchild 225A Cartridge with Diamond LP Stylus.SPECIAL! Net 107.50
- Same, with Pickering 350DS "Fluxvalve" Turnover Cartridge with Diamond and Sapphire Stylus.SPECIAL! Net 109.00
- PK-225 Turntable, PK-170 16" Tone Arm, GE VRII Series Model 4G-052 Cartridge with Diamond and Sapphire Stylus.SPECIAL! Net 87.50
- Same as above, with Fairchild 225A Cartridge with Diamond LP Stylus.SPECIAL! Net 105.50
- Same, with Pickering 350DS "Fluxvalve" Turnover Cartridge with Diamond and Sapphire Stylus.SPECIAL! Net 107.00

LAFAYETTE MANUAL TRANSCRIPTION PLAYER

- MAGNETIC BRAKE FOR FINE ADJUSTMENT OF EACH SPEED • 4-POLE, HEAVY DUTY TRANSCRIPTION-TYPE MOTOR • STYLUS WEIGHT ADJUSTMENT SCREW ON TONE ARM

All the important features of professional transcription players have been incorporated in this precision turntable. Extremely smooth and quiet heavy duty 4-pole motor plays 78, 45 and 33 1/2 RPM records. Exclusive magnetic brake, controlled by knob on base plate, permits instantaneous fine adjustment of each speed. Stroboscope disc included checks speeds. Speed selector safety switch protects mechanism by making it necessary to pass through OFF position when switching from one speed to another. 10" weighted turntable has rubber traction mat. Mounting plate has pickup rest and ON-OFF switch. Size: 12-15/16" left to right. 10 1/4" front to rear. Requires 2 3/4" clearance below motor board and 3" above. With AC line cord, 2 plug-in heads, output cable, 45 RPM adapter. For 105-120V., 60 cycles AC. Shpg. wt., 12 lbs. (NOTE: For protection in shipping, tone arm is separate. Just fasten to mounting plate.)

PK-160—Less cartridge and base.....Net 25.95

PK-164—Same as above except equipped with genuine GE triple-play magnetic cartridge VRII and dual diamond-sapphire stylus.....Net 37.50

Wood base, cut out for PK-160 Manual Player. Top quality veneer attractively finished in mahogany or blonde (Specify).

PK-162—Shpg. wt., 5 lbs.....Net 3.95

Unfinished mounting board only, cut out for PK-160 player. Strong, durable 3/8" gumwood, ready for stain or paint.

PK-163—Shpg. wt., 1 lb.....Net .95



with
TONE ARM
and TWO
PLUG-IN HEADS



**MODELS
702-
712**

MODELS 702 and 712 SINGLE SPEED RECORDERS
Economical single-speed recorders that have all the major features of many more expensive models. Dual track — use both edges of standard 1/4" recording tape for maximum recording and playing time. With exclusive original Wilcox-Gay "Prestomatic" pushbutton keyboard for the ultimate in operating simplicity. Other features include: For 3", 5" and 7" reels; transistor preamplifier; radio-phono-TV input jack [may also be used as an "external amplifier" output]; microphone input; external speaker output jack; 2 recording level indicators — "Normal" and "Distort"; full range tone control; automatic positive erase; volume control; 3-watt amplifier output; fast rewind (2 1/2 minutes for 1200' reel); record monitor switch for switching speaker on or off while re-

cording; record-lock button to prevent accidental erasure; wow and flutter (Model 702) 0.5%, (Model 712) 0.3%; frequency response (Model 702) 85 to 7000 cps, (Model 712) 85 to 8500 cps; signal-to-noise ratio 35 db. A socket is provided for remote start-stop operation. Tubes: 2N133 transistor, 6AQ5, 12AX7, 6X4 (rectifier). Power requirements 70 watts at 117 volts, 60 cps AC. Size 14" x 12" x 8". Shpg. Wt., 28 lbs. Supplied complete with crystal microphone, 3" reel of tape, 5" empty takeup reel, detachable AC line cord.
WILCOX-GAY MODEL 702 "THE STUDENT" Net 74.96
For 3 1/2 I.P.S.
WILCOX-GAY MODEL 712 "THE PREP" Net 74.96
For 7 1/2 I.P.S.



**MODEL
732**

MODEL 732 "THE COUNSELLOR" DUAL-SPEED RECORDER
Dual speed, dual track recorder with bass- and treble-compensated volume control for boosting output at the low and high ends of the audio spectrum to compensate for human hearing characteristics. Features include: 4" x 6" Alnico 5 speaker; record-lock button to prevent accidental erasure; "Prestomatic" pushbutton keyboard; transistor preamplifier; tape speeds of 3 3/4 and 7 1/2 I.P.S.; radio-phono-TV input (may also be used as low level "external amplifier" output); neon "Normal" and "Distort" recording level indicators; external speaker jack; full range tone control; automatic, positive erase; 3-watt amplifier; fast forward and fast re-

wind speeds; record monitor switch; frequency response 85 to 8000 cps; wow and flutter .35% at 7 1/2 I.P.S., .5% at 3 3/4 I.P.S.; signal-to-noise ratio 35 db; for up to 7" reels. Remote start-stop accessory socket is provided. Tubes: XN132 transistor, 6AQ5, 12AX7, 6X4 (rectifier). Power requirements 70 watts at 117 volts, 60 cps AC. Size 14" x 12" x 8". Shpg. wt., 28 lbs. Supplied complete with crystal microphone, 3" reel of tape, 5" empty takeup reel, detachable AC line cord.

**WILCOX-GAY MODEL 732
"THE COUNSELLOR"** Net 90.96



**MODELS
752-
772**

MODEL 752 "THE SENATOR" EXTENDED RANGE RECORDER
This high-fidelity dual speed — dual track recorder features an extended range 5" x 7" dual cone speaker and a visual tape index with radio-type pointer scale for quickly locating any selection on a reel of tape. Other features include: 3 3/4 and 7 1/2 I.P.S. speeds; for up to 7" reels; transistor preamplifier; Prestomatic keyboard; record-lock to prevent accidental erasure; radio-phono-TV input which may also be used as a low level "external amplifier" output; "Normal" and "Distort" neon recording level indicators; external speaker output; full range tone control; bass- and treble-compensated volume control; fast forward and fast rewind speeds (2 1/2 min-

utes for 1200' tape); record monitor switch; automatic stop; frequency response 65 to 10,000 cps; wow and flutter .35% at 7 1/2 I.P.S., .5% at 3 3/4 I.P.S.; signal-to-noise ratio 35 db; socket for remote start-stop; storage compartment for line cord and microphone. Tubes: XN132 transistor, 6AQ5, 12AX7, 6X4 (rectifier). Power requirements 70 watts at 117 volts, 60 cps AC. Size 13 3/8" x 14-11/32" x 8 3/8". Shpg. Wt., 32 lbs. Supplied complete with crystal microphone, 3" reel of tape, empty 7" takeup reel, built-in AC line cord.

**WILCOX-GAY MODEL 752
"THE SENATOR"** Net 110.46



**MODEL
762**

MODEL 762 "THE EXECUTIVE" 2-SPEAKER RECORDER
This superb new model features a roll-top carrying case in which two 7" reels may be played completely enclosed. 8-watt push-pull amplifier with wide-range tonal response of 65 to 12,500 cps, a 5" x 7" extended range speaker plus a high frequency tweeter, and an automatic shut-off switch. Other advanced features include: dual speed — 3 3/4 and 7 1/2 I.P.S.; dual track; transistor preamplifier; visual tape index (counter); record-lock to prevent accidental erasure; radio-phono-TV input jack which doubles as an output for external amplifier; full range tone control; bass- and treble-compensated volume control; fast forward and fast rewind speeds; Prestomatic pushbutton keyboard; record monitor (speaker) switch; socket for accessory start-stop remote control; "Normal" and "Distort" recording level indicators; wow and flutter 0.3% at 7 1/2 I.P.S.; 0.5% at 3 3/4 I.P.S.; signal-to-noise ratio 35 db; storage compartment for spare reels of tape, microphone, line cord and patch cord. Tubes: 2N132 transistor, 6AV6, 12AX7, 2-6AQ5, 5Y3GT (rectifier). Power requirements 110 watts at 117 volts, 60 cps AC. Size 15 7/8" x 14-11/32" x 9 1/2". Shpg. wt., 39 lbs. Supplied complete with crystal microphone, 5" reel of tape, empty 7" takeup reel, built-in line cord and patch cord for recording from radio-phono-TV.

**WILCOX-GAY MODEL 762
"THE EXECUTIVE"** Net 124.97

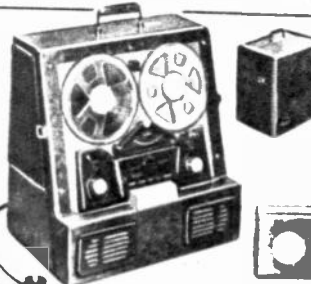

**MODEL
772**

MODEL 772 "THE PRESIDENT" WITH ROVING SPEAKER
Identical in features and characteristics with Model 762 but with two-tone gray fabric-covered luggage-type case, microphone with push-to-talk switch, extension speaker jack, and with 15 1/2" x 5 1/2" x 2 1/8" roving extension speaker in gray case with 18' cord and plug.

**WILCOX-GAY MODEL 772
"THE PRESIDENT"** Net 143.72



**MODEL
782**

MODEL 782 "THE ROYAL" DELUXE 4-SPEAKER RECORDER
This deluxe high-fidelity recorder features an 8-watt push-pull amplifier with response of 65-15,000 cps, 2 — 6" x 9" dual cone extended range speakers plus a high frequency tweeter built in, a roving extension speaker, extremely low wow and flutter (0.2% at 7 1/2 I.P.S., 0.38% at 3 3/4 I.P.S.) and remote control for instant start-stop record or playback. Other outstanding features include: 3 3/4 and 7 1/2 I.P.S. speeds; cover may be closed with reels up to 7" in diameter in position; transistor preamplifier; Prestomatic pushbutton keyboard; visual tape index; record-lock; radio-phono-TV input-output; professional type Humi-Seal hi-fi crystal microphone with switch and 12' cord; switch to permit use of microphone while playing back, recording, or using recorder as a phonograph amplifier; "Normal" and "Distort" recording level indicators; full range tone control; bass- and treble-compensated volume control; fast rewind and fast forward speeds; signal-to-noise ratio 35 db; automatic shut-off; record monitor (speaker) switch; storage compartment for spare tape, microphone, line cord, patch cards, remote control and roving speaker. Tubes: 2N132 transistor, 6AV6, 12AX7, 2-6AQ5, 5Y3GT (rectifier). Power requirements 110 watts, 117 volts, 60 cps AC. Size 16 3/4" x 16 1/2" x 11 1/4". Shpg. Wt., 49 lbs. Complete with 7" reel of tape, empty 7" take-up reel, patch cord for recording from radio-phono-TV, microphone, AC line cord, remote control and roving speaker.

**WILCOX-GAY MODEL 782
"THE ROYAL"** Net 168.72

MODEL 4C10 "THE VERSATILE" TAPE & DISC RECORDER
You can make tape recordings from records, disc recordings from tape, or original tape or disc recordings with microphone or from radio or television with this highly versatile instrument. The features include: high speed tape wind — forward and reverse; "Normal" and "Overload" recording level indicators; bass- and treble-compensated volume control; radio-phono-TV input jack; external speaker output jack; full range tone control; 6" x 9" Alnico 5 speaker; can be used as a public ad-

dress amplifier. Hum level — 45 db. Frequency response is 80-6000 cps ± 3db. Uses up to 5" reels of tape. Tape speed is 3 3/4 I.P.S. dual track; record speed is 78 rpm. With controlled-reluctance dynamic microphone, two-toned streamlined carrying case, tape reels. Size 19" x 16 1/2" x 11". For 117 volts, 60 cps AC. Shpg. Wt., 32 lbs.

**WILCOX-GAY MODEL 4C10
"THE VERSATILE"** Net 124.97

Wilcox-Gay Accessories

Model SK-1 Stereo Kit—Includes in-line (stacked) head, 5" reel of stereo tape, all connectors. For conversion of all 7-series recorders listed. Net 18.33

Model RCK-1 Remote Control Kit—For remote start and stop operation of all 7-series units except 782. Includes solenoid and power supply assembly, hand control and cable, all mounting parts. Net 17.70

Model 9-221-2 Microphone Extension Card—25' long, with connectors. Net 4.33

Model 20-233 Radio-Phono Recording Cable—Patch cord for use with Wilcox-Gay 3, 4, 5, 6 and 7 series (except 4C10). Net .81

Model 9-2249 Patch Card for Duplicating Use—When connecting recorder to recorder for tape duplication. For Wilcox-Gay 3, 4, 5, 6 and 7 series (except 4C10). Net .87

PENTRON STEREO & MONAURAL TAPE RECORDERS AND MECHANISMS WITH NEW 3rd DIMENSION TONE QUALITY

WHEN YOU HEAR STEREOPHONIC SOUND YOU WILL NOT BE SATISFIED WITH LESS THAN THE BEST

FREE

5 1200 FT. ROLLS OF LAFAYETTE HIGH FIDELITY TAPE WITH PURCHASE OF PENTRON TAPE RECORDER

"MERCURY"

**109.95
MONAURAL**

**139.95
STEREOPHONIC**



"CHAMPION"

**149.95
MONAURAL**

**179.95
STEREOPHONIC**



"ARISTOCRAT"

**189.95
MONAURAL**

**219.95
STEREOPHONIC**

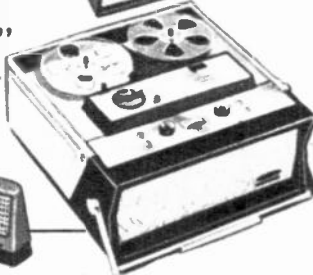

"MERCURY" MODEL NL-1S

All the most recent developments in tape recorders are included in the MERCURY and brought to you by LAFAYETTE at a price everyone can afford! Has stacked stereo head for stereophonic (binaural) playback and can also be used for standard, monaural record/playback; equipped with extra preamplifier which can be plugged into your radio, TV set or hi-fi amplifier to provide stereophonic playback. Has a high quality long-lasting mechanism, extremely simple to operate and with new, professional quality recording head with a quarter-mil gap for superior tone. Dual Speed (3 1/2 and 7 1/2 IPS), Dual Track. Freq. Response 40-11,000 cps for 7 1/2 IPS; 40-7,000 cps at 3 1/2 IPS. SIMPLE ENOUGH FOR YOUR YOUNGSTER IN GRADE SCHOOL—only one rotary control for Play, Record, Fast Forward, Fast Rewind. Interlock Button prevents accidental erasure. TWO INPUTS for Mike or Magnetic Phono and for Radio, TV,

Crystal or Ceramic Phono Cartridge. Outputs (two) for External Amplifier and External Speaker. Signal-Noise Ratio 45 db. Six-inch extended range speaker. Balanced 4-pole motor. Takes 3", 5" or 7" reels for up to three hours of playing time. Has Speed Change Lever, Volume Control, Tone Control; Neon Bulb Recording Level Indicator. Flutter and Wow under 0.4% at 7 1/2 IPS. Four Watt Amplifier. Power Consumption 70 watts at 105-120 volts. 60 cps AC. Underwriters' Laboratories Approved. Beautifully styled with gold trim, gray mechanism, blue case. Comes with 5" reel of tape, empty 7" takeup reel, crystal microphone, instructions. Dim: 14" wide x 17" deep x 11" high. Shpg. wt. 29 lbs.

PENTRON NL-1S Stereo...List 189.95...Net 139.95
PENTRON NL-1 Monaural—Similar to above but for standard half-track monaural use only...List 149.95...Net 109.95

"CHAMPION" MODEL NL-2S

The CHAMPION is an ultra-modern, deluxe recorder at a modest price, with stereo (stacked) playback, monaural record or play, "magic eye" recording level indicator, quarter-mil gap heads for superb tone, easy-reading digital type tape footage counter, 6" woofer-speaker and 4" tweeter with cross-over network for true high-fidelity, and the ultimate in simplicity of control. Single rotary control for Play, Record, Fast Forward, Fast Rewind. Extra pre-amp on stereo model for second channel connects to your radio, TV set or hi-fi amplifier for two-channel stereophonic playback—a thrilling experience. Has interlock button to prevent accidental erasure of tape, speed change lever, volume control, tone control. Dual track, Dual Speed (3 1/2 and 7 1/2 IPS). For 3", 5", 7" reels. Five watt amplifier. Frequency Response 40-13,000 cps at 7 1/2 IPS; 40-7,000 cps at 3 1/2 IPS. Signal-to-noise ratio 48 db. Flutter and Wow less

than 0.4% at 7 1/2 IPS. 4-pole, shaded pole heavy duty balanced motor, quality mechanism. Separate power switches for motor and amplifier—permits easy use as public address system. Inputs for microphone or magnetic phono and radio, TV or crystal or ceramic phono cartridges; outputs for External Speaker and External Amplifier. Power requirements 80 watts at 105-120 volts, 60 cps AC. Underwriters' Laboratories Approved. Styled with gold trim, gray mechanism, gray case. Supplied complete with 5" reel of tape, empty 7" takeup reel, crystal mike and simple instructions. Dimensions 14" wide x 16 1/2" deep x 10 1/2" high. Shpg. wt. 33 lbs.

PENTRON NL-2S Stereo...List 249.95...Net 179.95

PENTRON NL-2 Monaural—Similar to above but for standard half-track monaural use only...List 209.95...Net 149.95

"ARISTOCRAT" MODEL NL-3S

Truly an ARISTOCRAT among tape recorders, with numerous professional features for the best in tape recording at reasonable prices. Stacked stereo or monaural playback; monaural recording, half-track. Built-in illuminated VU meter recording level indicator, frequency response 40-15,000 cps at 7 1/2 IPS (40-7,500 cps at 3 1/2 IPS) due to use of quarter-mil gap heads; four speakers—two six-inch woofers with heavy magnets, one six-inch mid-range speaker, one extended-range exponential tweeter; double L-C cross-over network. Has foolproof AUTOMATIC SHUT-OFF SWITCH that stops motor the instant tape breaks or runs out; with automatic idler disengagement, there is no danger of flat spots. Amplifier remains on after motor shuts off to eliminate need for re-warmup. Digital-type counter with manual reset. Balanced heavy-duty motor, quality mechanism. One, simple rotary control for Play, Record, Rewind, Fast Forward. Has Speed Change Lever (for 3 1/2 and 7 1/2 IPS speeds), Interlock Button to prevent accidental erasure.

Volume Control, Tone Control, Flutter and wow less than 0.4% at 7 1/2 IPS. Signal-to-noise ratio 50 db. Inputs (two) for mike or magnetic phono and for radio, TV, crystal or ceramic phono; outputs (two) for External Amplifier and External Speaker. U/L Approved. Stereo model has extra preamp for second channel which may be connected to radio, TV set, hi-fi system to provide the ultimate in realism which stereophonic sound can provide. Power requirements 110 watts at 105-120 volts, 60 cps AC. Attractive in appearance, with gold trim, brown mechanism, brown and tan case. Comes complete with 5" reel of tape, empty 7" takeup reel, crystal microphone, simple instructions. Dim: 17 1/2" wide x 17 1/2" deep x 11" high. Shpg. wt. 38 lbs.

PENTRON NL-3S Stereo...List 309.95...Net 219.95

PENTRON NL-3 Monaural—Similar to above but for standard half-track monaural use only...List 269.95...Net 189.95

PENTRON STEREO/MONAURAL TAPE DECKS WITH RECORDING PLUS PLAYBACK

Designed for use with Pentron Tape Preamplifiers listed below, or others, to provide stereophonic (binaural) recording and playback, monaural record/playback, or may simply be used with high fidelity systems for either monaural or stereo playback. Two complete tape preamplifier/amplifier/speaker systems are needed for stereophonic playback. Enjoy the full dynamic and tonal range and the sense of "presence" you can achieve with the tape recordings these units can provide!

General Specifications: Mechanisms listed below are all dual speed (3 1/2 and 7 1/2 IPS), dual track. Speed-change lever on top plate. Frequency Response 40-14,000 cps with proper equalization, due to use of quarter-mil gap heads. Simple, Single Rotary Control for Fast Forward, Fast Rewind, Play, Record. Standard pin jacks for easy connection to preamps. Two auxiliary AC outlets, controlled by the mechanism's power switch. Idlers are disengaged in the Neutral position to prevent flat spots. Flutter and Wow less than 0.4% at 7 1/2 IPS. Heavy duty balanced 4-pole rugged, long-life mechanism. 21 oz. flywheel. Takes up to 7" reels. Speed variation ± 2% max.

Mounting: Vertical, horizontal, or angle — cutout required 10-3 3/4" x 13" x 7". The Pentron digital footage counter can easily be added if desired. Highly styled-finished in gray and gold. Power Requirements 55 watts, 117 volts, 60 cps AC. Supplied complete with cutout template drawing and removable shock-absorber mounting brackets, two grommets to hold reels in position when mounting mechanism vertically, and instructions.

PENTRON MODEL TM-1 TAPE MECHANISM — Monaural half-track recording and playback only. Has one combination record/play/erase head. **Net 84.50**

PENTRON MODEL TM-3 TAPE MECHANISM — Stereophonic (staggered) recording and playback and monaural record/playback. Has two combination record/play/erase heads. **Net 95.00**

PENTRON MODEL TM-4 TAPE MECHANISM — Stereo recording and playback, stacked (in-line) or staggered; also monaural record/playback. Has one stacked (in-line) head, one combination record/play/erase head. **Net 109.95**

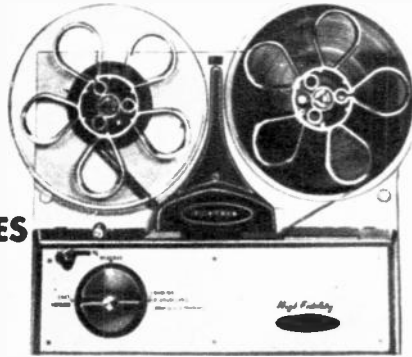

TM SERIES

PENTRON CONVERSION KITS FOR STEREO TAPE PLAYBACK

Add the realistic beauty and "living presence" of stereophonic sound to any Pentron tape recorder (except Models RWN and CT-1) with one of these kits.

MODEL SA-2 — Converts the following Pentron models to stacked stereo operation: T-90, MF-400, TR-4, HT-225, 9T3, 9T3-C, HFV-500, TM-56, and the NL-Series. Will also convert previously converted staggered models to stacked operation as well. Consists of: preamplifier, 2-heads (1-stacked, 1-combination play/record/erase), bracket with Azmur-X head adjustment, wires, hardware, and simple step-by-step instructions. **Net 37.50**

MODEL SA-4 — Similar to above; for conversion of Models TM-1 and TM-3 mechanisms to stacked and staggered stereo. Includes stacked head and instructions. **Net 18.95**



CA-13 PLAY-RECORD PREAMPLIFIER

General Specifications: Hum 50 to 60 db 1 volt rms output dim. 11-5/16" x 5" x 8" deep. All units self-powered, for 117 volts, 60 cps AC.

PENTRON CA-11 PREAMPLIFIER — For tape playback. Use one CA-11 for monaural playback only with TM-1 mechanism. Response 40-14,000cps; 1% distortion. Gain Control. Shpg. wt., 5 lbs. **Net 39.95**

PENTRON CA-13 PREAMPLIFIER — For recording or playback. Use one CA-13 for monaural and binaural (stereo) recording or playback with TM-3 or TM-4 mechanisms. Response 40-14,000 cps; 2% distortion. Record/Play Switch, Gain Control, Safety Interlock Button. Inputs for microphone plus radio or phono. Illuminated VU meter recording level indicator. **Net 79.95**

PENTRON CA-15 PREAMPLIFIER — Dual channel playback preamp for monaural or binaural (stereo) use. Connect to two sound systems. Use one CA-15 with Pentron TM-3 or TM-4 for playback only. Response 20-20,000 cps; 1% distortion. **NETS equalization:** volume and equalization control for each channel plus master gain control. Shpg. wt., 6 lbs. **Net 79.95**

PENTRON TAPE PREAMPLIFIERS

FOR USE WITH TM OR OTHER TAPE MECHANISMS/STEREO OR MONAURAL RECORD/PLAYBACK OR PLAY ONLY.

TAPE RECORDER ACCESSORIES

X-166 Cord with clips at one end, standard plug at other end for recording from radio or phono. **Net 1.88**
X-167 Mike extension cord, 20', with standard plug. **Net 5.63**

X-155 Telephone pickup. **Net 8.95**
FP88 Foot Pedal Attachment for Pentron NL-1(S), NL-2(S), NL-3(S) recorders. Sterns and stops tape. Attaches in two minutes with out tools. **Net 12.95**

X-188 DIGITAL COUNTER KIT Easy reading, manual reset. May be readily added to any of the Pentron TM mechanisms shown on this page. **Net 12.95**

CA-14 MICROPHONE MIXER-PREAMPLIFIER For use with any tape recorders or public address systems. Four channel, six inputs (four mike, two high impedance phono). Dim. 11-5/16" x 5" x 8" deep. Shpg. wt. 4 lbs. **Net 39.95**

AND DON'T FORGET LAFAYETTE'S MONEY BACK GUARANTEE

LAFAYETTE DIAMOND STYLI

ALL DIAMOND STYLI ARE NOT ALIKE
FULL 1 YEAR GUARANTEE

- MADE FROM WHOLE DIAMONDS • PRECISION GROUND AND POLISHED
- VERTICALLY AND EDGEWISE GRAIN ORIENTED • SHADOWGRAPHED

Lafayette diamond stylus are not made from "chips". Each is made from an individual tiny diamond, carefully sieved and selected for proper size. Especial care is taken so that the grain structure is properly oriented vertically and edgewise to use the most wear-resistant surface of the diamond. They are ground and polished to almost unbelievable tolerances and smoothness and shadowgraph tested. With a Lafayette diamond stylus you both preserve your records and pay less per play!



Replacement Styli for G.E. Cartridges

FOR GE "CLIP-IN" CARTRIDGES

MODERNIZE YOUR OLD TRIPLE-PLAY CARTRIDGE. THESE ASSEMBLIES REPLACE BOTH THE OLD AND NEW SERIES "A". ONCE INSTALLED, YOU CAN REPLACE ONE POINT AT A TIME.

Here's new economy in a replacement for the old GE RPJ-013 and the new RPJ-013A dual stylus. No need to throw away the entire unit when one point is worn. With this type, you can replace either the diamond or sapphire separately. The replacement simply slides into place. Complete assembly with diamond and sapphire stylus.

7.50

diamond sapphire



PK-65 list 31.00.....	Net 7.50
DUAL DIAMOND. Replaces old GE RPJ-012 and new RPJ-012A.	
PK-66 list 49.95.....	Net 13.75
DUAL SAPPHIRE. Replaces old GE RPJ-010 and new RPJ-010A.	
PK-67 list 8.95.....	Net 2.25

DIAMOND AND SAPPHIRE CLIP-IN STYLI

Individual stylus replacements that clip in to all GE "A" series.
 PK-70 Diamond 1 mil (LP) replaces GE RPJ-01D.....Net 6.75
 PK-69 Sapphire 1 mil (LP) replaces GE RPJ-01S.....Net 1.25
 PK-68 Sapphire 3 mil (78) replaces GE RPJ-03S.....Net 1.25

STYLI FOR OLD TYPE GE CARTRIDGES

Exact replacement for all old type single needle GE cartridges.
 PK-31 Diamond 1 mil (LP) replaces GE RPJ-004.....Net 6.75
 PK-16 Sapphire 1 mil (LP) replaces GE RPJ-005.....Net 1.19
 PK-15 Sapphire 3 mil (78) replaces GE RPJ-001.....Net 1.19

DUAL DIAMOND

For old type GE cartridges not using clip-in tips. Has diamond LP and diamond 78 points.

PK-32.....Net 15.95



LAFAYETTE DIAMOND STYLI FOR POPULAR CARTRIDGES



Fig. A. For Astatic cartridges LQD, LQD-1, QT-33-J, QT-33M, CQ-J, CQ-M CAC. with diamond tip for 33 1/2 and 45 rpm.

PK-128.....Net Each 5.95

Fig. B. For Astatic cartridges AC-J, AC-M, AC-CJ, AC-CM, ACD, 10L3, 11L3. with diamond tip for 33 1/2 and 45 rpm.

PK-129.....Net Each 5.95

Fig. C. For Astatic cartridges GC-D, 55-T, 55-TJ, RCA cartridge 100329. Twin tip-diamond 33 1/2 and 45, sapphire 78 rpm.

PK-134.....Net Each 6.95

Fig. D. For Magnavox cartridges 5601334-4, 560153. Twin-tip-diamond 33 1/2 and 45, sapphire 78 rpm.

PK-135.....Net Each 6.95

Fig. E. For RCA cartridges 9890, 38453, 38598, 74067, 74625, 75575, 75967, 75976, 76318. With diamond tip for 33 1/2 and 45 rpm.

PK-132.....Net Each 5.95

Fig. F. For Ronette cartridges TO-284-OV, RA-284-OV Webster Electric cartridges A-103, A-201. With diamond tip for 33 1/2 and 45 rpm.

PK-127.....Net Each 5.95

Fig. G. For Shure cartridges W22A, W22AB, W21A, W21AR, WC22AB, P72V, P73, P76V, P77, PCA1V, Admiral 409A11, Webster Electric F-11, F-11-1.

PK-133.....Net Each 5.95

Fig. H. For Sonotone cartridges 2T5, 9980, Magnavox 560161, RCA78748, 79807, 100653, Twin tip-diamond 33 1/2 and 45, Sapphire 78 RPM.

PK-126.....Net Each 6.95

Masco E-Z TALK 2-STATION SYSTEM

Specially priced at **11.71**

- First Time at a Price to Fit Everybody's Purse!
- For Home Intercom or Baby-Sitter

A complete 2 station intercom system that is easy to install and simple to operate. Master station has volume control with on-off switch. Remote can answer calls from a distance as there is no switch to operate on remote. Remote is always "open", making its use as a "baby-sitter" ideal. Low hum and noise. Alnico V PM speakers. Metal cabinets—size 4 1/2" x 3 1/4" x 4 1/2" H. System is complete with 2 stations, 50 ft. of cable and instructions. Shpg. Wt 6 1/2 lbs.

MASCO E-Z TALK SYSTEM NET 11.71

FANON Fanfare INTERCOMS

FANON 2-STATION WIRELESS INTERCOM

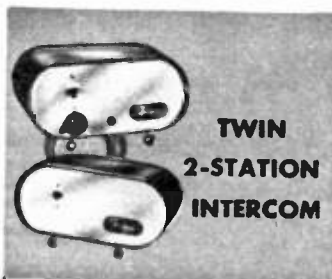

- SMART NEW STYLING
- ECONOMICALLY PRICED
- OUTSTANDING PERFORMANCE

A low cost intercom combining maximum convenience, smart styling and quality performance. Simple and safe to use. Extremely sensitive... ideal as a "baby-sitter". Provides modern communications between offices, departments, living quarters, etc. Remote has "talk-listen" switch for privacy where required. Master unit has volume control, on/off switch, separate press-to-talk switch and pilot light. Complete with 50 ft. of cable. More can be added. Cabinets of grey steel with perforated white front panel. Size of each station, 8" x 4" x 4". Shpg. wt. 6 lbs.

Fanone FX-2.....Net 18.37
 Fanone FS (extra Remote).....Net 7.35

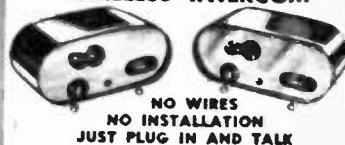

NO WIRES NO INSTALLATION JUST PLUG IN AND TALK
 Makes use of existing power lines for transmission of voice. Each unit is a miniature radio transmitter and receiver. Simply plug into electrical outlets, AC or DC, in the same or adjacent buildings on the same power circuits, and talk! Economical to use, powerful and sensitive. Underwriters' Laboratories approval means safety to use. Each unit has volume control with on-off switch, 2- or 3-wire line selector switch for different types of building wiring, and adjustment for Noise Silencer which keeps out power line noises until desired voice signal comes through. More stations may be added to any system. Operating frequency 200 kc. Output power 2 1/2 watts. Power Consumption 30 watts. Tubes: 12AX7, 2-90C5; 35W4 rectifier, 1N51 diode, NE-2 neon pilot light. For 105-125 volts AC or DC. Size 8" x 4" x 4". Ebony Black metal cabinets, antique gold panels. Shpg. wt. 10 lbs.

FANON FW-20—2-Station Wireless Net 46.75
 FANON FW—Extra Station For FW-20 Net 23.37
 FANON FW-20D—Same as FW-20 but deluxe brass finish Net 49.69
 FANON FWD—Extra Station for FW-20D Net 24.85

COMBINATION PHONO TABLE RECORD CABINET

Here's an attractively finished unit that is not only a beautiful piece of furniture, but that has the functional design to make it really useful. A phonograph or tape recorder may be placed on the amply sized top. The storage space has a vertical divider for 10" or 12" records or albums. The horizontal divider for 45 RPM records and albums is removable so space can be utilized for flat or upright stacking. Made of high grade beautiful furniture veneer, sturdily and solidly built, finely finished and styled. Size 28" high x 22 1/2" wide x 18 1/2" deep. Shipped knockdown. Simple to assemble. Shpg. wt. 18 lbs. Available in mahogany or blonde finish. Specify color.

Less sliding doors
 Universal 13M Cabinet MAHOGANY..... 14.90
 Universal 13B Cabinet BLONDE..... 16.40
 Similar to above except with sliding doors
 14M Mahogany.....Net 17.90
 14B Blonde Oak.....Net 19.40



14.90

• With self leveler brass ferrules

ACCESSORIES FOR TAPE RECORDING

DELUXE CARRYING CASE



All-metal tape or record carrying case. Holds 35 reels of tape in either boxes or cans, or from 250 to 300 45 rpm records in convenient indexed storage file. Supplied with 2 index cards and 2 sets of reference tabs numbered from 1 to 150 for use with 45 rpm records. Folding handle on removable cover. Twin snap locks keep cover tightly closed. Large storage space subdivided by metal separators. Handsome hammerloid finish. Size: 15" x 7 1/2" x 12 1/2". Shpg. wt., 10 lbs.

ML-33.....Net 5.40

METAL TAPE STORAGE CHEST

2.99



STANDARD CASE

Standard Case: Sturdy all steel carrying case. Holds 12 7" or 5" reels and cans. Twin snap locks for positive closure. Perfect portability—ideal for filing and storage. Guards against exposure to moisture and accidental erasure. Finished in platinum grey hammerloid. Handle folds for compactness. Includes index cards for quick identification. Metal separators hold each reel erect. Shpg. Wt. 5 lbs.

ML-60

Net ea. 2.99



7 INCH EMPTY PLASTIC REELS

INDIVIDUALLY BOXED

Fine plastic reels for recording tape. MS-267.....in lots of 6, Each .38
Singly, Each .45

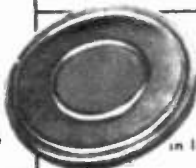

NEW LOW PRICE!

39c in lots of 6

MAGNETIC TAPE SPLICER



1.47

An excellent accessory that splices tapes accurately and eliminates joint noise. Both ends of tape are cut simultaneously. Nickled brass finish. Wt. 1 lb.

MS-289.....1.47

METAL STORAGE CANS

Can holds 7" 1200 ft. tape reel. Gives ultimate in protection to precious recordings. Handsome finish of grey hammerstone enamel. Cans are ribbed for stacking—give maximum storage in minimum space. Precision fit makes opening and closing easy. Fit perfectly in chests shown above. Shpg. Wt. 8 oz.

ML-41

Net ea. 41c
Lots of 6, ea. 39c

Argonne TELEPHONE PICKUP FOR RECORDING TELEPHONE CONVERSATIONS



Induction telephone pickup. Telephone conversations can now be picked up with no tapping of wires or special telephone circuits. Simply place the phone base, either cradle or upright type, on the pickup platform and connect the leads to the high impedance input of any medium gain audio amplifier, or directly to any tape, disc or wire recorder. Shpg. wt. 8 ozs.

MS-16.....Net 2.95



STERADAPTER Convert Your Recorder to Binaural Playback

Permits full-fidelity playback of "in-line or stacked" stereophonic tape recordings. Quick, easy installation using ordinary tools. Designed to fit almost all popular make tape recorders. Fits only recorder having mounting room on side of case and a clear passageway for tape to travel across the face of the deck. (See Illustration). After installation, one channel plays through your present recorder and second channel plays through any other amplifier system having a preamp. If your system does not have a preamp, you will require preamp listed below.

MODEL 4902—Dactron 2 Channel Steradapter Net 22.46

MODEL 4501A—Dactrol 1 Channel Transistor Booster Preamp with volume control.....Net 18.37

INDUCTION TELEPHONE PICKUP



7.35

Newly designed telephone pickup that attaches to earpiece of telephone by a suction cup. Picks up both sides of conversation and may be used on any type telephone. No electrical connection to telephone needed. Just connect directly to any recorder. This method of pickup gives high output and exceptional fidelity. Complete with 6 ft. cord and instructions. Shpg. wt. 1 lb.

MS-328.....Net 7.35

CONVERSION UNITS FOR VIKING

To convert Viking to in-line stereo. Contains head, hardware and new capstan cover.

MODEL 4800.....31.85

2 Channel transistor preamplifier.....29.35

VIKING MODEL 4502.....

TAPE RECORDISTS KIT

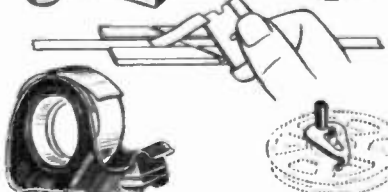

A handy assortment of most essential items for the tape recording enthusiast. Contains PK-102 Long Life Cleaner and lubricant kit, Cousino tape splicer, Flahan tape threader, 150' roll 1/2" splicing tape, 150' roll leader-timer tape, and package of 12 7" at-a-glance cataloging indexing discs. Shpg. wt. 3 lbs.

MS-372.....4.69

MICROTRAN BULK TAPE ERASER AND DEMAGNETIZER



An absolute must for stereo recording! Most stereo recorders do not provide facilities for pre-erasing both tracks, and tapes must be pre-erased in bulk. Develops a high intensity AC magnetic field and erases recorded material and noise from any magnetic tapes without rewinding and without wear on recording heads. More effective erasure than most built-in tape recorder erase heads—restores tape to "like-new" condition or better. Takes 5", 7" or 10 1/2" reels. Spindle removable for other reel sizes. May also be used as demagnetizer for tape heads, watches, metal, etc. Power requirements 5 amps at 117 volts AC. Size 3" x 5" x 8". Shpg. wt. 8 1/2 lbs.

ML-106.....Net 20.22

ROBINS "GIBSON GIRL" SPLICER



Cuts 2 rounded indentations in the tape splice, leaving the edges of the tape which contact parts of the recorder entirely free of adhesive. Adhesive deposited on initial parts of recorder is a frequent cause of wow and flutter. As little as 1/4" tape need be removed. Shpg. wt. 1/2 lb.

MS-288.....Net 6.25



"LONG LIFE" TAPE RECORDER MAINTENANCE KIT • CLEANER & LUBRICANT

The "Long Life" kit contains both a cleaner and lubricant for tape recorder heads and guides. The cleaner dissolves grease and grit, removing foreign matter from heads and tape, while lubricant reduces friction to a minimum. Recordings have greater clarity and better frequency response. Brushes contained in bottle caps. 2 oz. of each fluid. Shpg. wt. 1/2 lb.

PK-103—Recorder Cleaner & Lubricant Kit.....Net 1.50

AUDIO "400" HEAD DEMAGNETIZER 5.88

In normal use, the recording head which left the factory unmagnetized tends to accumulate magnetism. This may substantially increase the noise level. The audio demagnetizer will remove any permanent magnetism from the head. Operates on 110V and 60 cycle AC. Shpg. wt. 1 lb.

Audio 400 Demagnetizer Net 5.88



NEW! Deluxe RECORD CARE KIT



A complete set of accessories essential to the care of your records and equipment. Includes authoritative book on the care of recordings. Includes 1-75 power microscope with needle groove; 1-Clarkston Pressure Gauge; 1-Anti-static spray and applicator; 1-Polyfoam turntable mat; 1-Level for turntable; 1-Record cloth; 1-Clip-on needle brush; 12-12" Polyethylene record sleeves; 15-10" Polyethylene record sleeves; 1-Strabosee card; 1-Book on the care of records. Shpg. wt. 6 lbs.

PK-138.....Net 7.45

**New!
YEARS AHEAD!**

Lafayette

STEREO TUNER KIT

KT-500
74.50
IN KIT FORM

**A BINAURAL FM-AM TUNER
THAT MAKES EVERY OTHER
TUNER OBSOLETE!**

- **THE MOST FLEXIBLE TUNER EVER DESIGNED.**
Use It as a Binaural-Stereophonic FM-AM tuner
Use It as a Dual-Monaural FM-AM tuner
Use It as a straight Monaural FM or AM tuner

- **SEPARATE FM AND AM SECTIONS.**
Each with separate 3 gang tuning condenser
Each with flywheel tuning
Each with its own volume control
- **11 TUBES + TUNING EYE + SELENIUM RECTIFIER.**
FM: 4 I.F. stages + Foster Seeley Discriminator
AM: 2 I.F. stages + tuned RF stage
- **DUAL DOUBLE-TUNED TRANSFORMER COUPLED LIMITERS.**
Extreme sensitivity. Full limiting on signals as low as 1 mv.
- **ARMSTRONG CIRCUIT WITH FM/AFC AND AFC DEFEAT**
- **DUAL CATHODE FOLLOWER OUTPUT**
- **PRINTED CIRCUIT CONSTRUCTION. TWO PRINTED CIRCUITS**
- **FREQUENCY RESPONSE 20-20,000 CPS ± 1/2 DB**

HOW STEREOPHONIC LISTENING IS ACHIEVED



TUNER

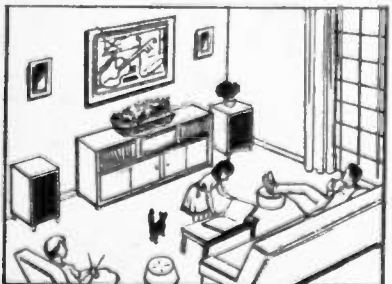
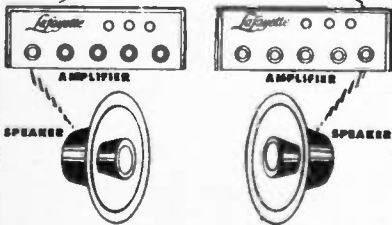

THE LAFAYETTE STEREO-TUNER IS UNIQUE AND INCOMPARABLE

THE STEREO-TUNER IS YEARS AHEAD

More than a year of research, planning and engineering went into the making of the Lafayette Stereo-Tuner. It was designed not only to be a fine quality high-fidelity tuner, not only to include every practical and worthwhile feature, but also to protect your investment for the coming years. Binaural broadcasting (simultaneous transmission on both FM and AM) has already started, and will naturally become more and more the method of high-fidelity broadcasting. The unique design of the Lafayette Stereo-Tuner protects you against obsolescence.

The FM and AM sections may be operated either independently of each other or together. For binaural (stereophonic) broadcasts, separate output jacks are provided so that the 2 channels may each be simultaneously fed to individual amplifier-speaker systems to enjoy the ultimate in high-fidelity stereophonic sound.

You can also, through the same type of dual amplifier-speaker system, use it as a dual-monaural tuner. In this way, the music lovers can listen to FM in one room, while the younger-set can listen to a different program on AM in another room. Of course, it can also be used like the ordinary type of FM-AM tuner to listen to only one program on either FM or AM.

The FM and AM sections have separate volume controls so that, when used for binaural programs, a proper balance can be set for each channel. Without this all important feature, the wonderful realism of stereophonic sound would be destroyed. Convenient front panel switch changes from binaural to monaural use. Simplified accurate knife-edge tuning is provided by magic eye which operates independently on FM and AM. Automatic frequency control locks in FM signal permanently.

Apart from its unique flexibility, this is, before all else, a quality high-fidelity tuner incorporating features found exclusively in the highest priced tuners. As shown by the number and types of tubes, no "short-cuts" have been used. With the Lafayette Stereo-Tuner you are assured of noise-free, drift-free, distortion-free reception. You will not only hear this quality, you will sense it even in the mechanical details; in the "feel" of the velvet-smooth easy flywheel tuning, in the professional appearance of the tastefully selected colors. The just-right shade of gold-brass escutcheon contrasts just enough with the dark maroon background, and is set off by matching maroon knobs with gold inserts. Carefully designed for ease of installation in cabinets if desired. Size is 13 3/4" H x 10 3/4" D x 4 1/2" H. Shipping weight 18 lbs. Supplied complete with cover. Made in U. S. A.

SPECIFICATIONS

RANGE: FM 88-108MC, AM 530-1650KC. **FM CIRCUIT:** Armstrong, low noise front end with triode grounded grid amplifier and triode mixer. Double tuned dual limiters, Foster-Seeley discriminator, AFC and AFC defeat. **AM CIRCUIT:** Superhet with 3 stages AVC, 10kc whistle filter, ferrite antenna. **DISTORTION:** Under 1% harmonic on FM; under 1% on AM for up to 80% modulation. **HUM LEVEL:** 60db below 100% modulation. **SENSITIVITY:** FM—full limiting on signals as low as 1µv, 2µv for 30db quieting; AM Terminal Sensitivity 5µv. **SELECTIVITY:** FM 200kc bandwidth; 6db down, AM 8kc BW; 6db down. **FREQUENCY RESPONSE:** FM 20-20,000 cps ± 1/2db, AM 20-5,000 ± 3db. **FM DRIFT:** ± 5kc Maximum. **IMAGE REJECTION:** FM 40db; AM 30db. **I.F. REJECTION:** FM 70db; AM 50db. **RADIATION:** MEETS FCC REQUIREMENTS. **OUTPUT LEVEL:** FM 2 1/2 V for 100% modulation, 1V for 30%; AM average 1V. **CONTROLS:** 5 controls; FM VOL, AM VOL, FM Tuning, AM Tuning, and five position function selector switch. **TUBES:** 4-6BA6, 2-6AU6, 1 each 6BK7A, ECC85, 6AL5, 6BE6, 12AU7 and 6U5 tuning eye. Selenium rectifier. **OUTPUT IMPEDANCE:** Low impedances cathode follower. Output jacks for FM, AM or Binaural. **ANTENNA INPUT:** 300 ohms.

IN KIT FORM

The Lafayette Stereo-Tuner was designed with the builder in mind. Two separate printed circuit boards make construction and wiring simple even for such a complex unit. Complete kit includes all parts and metal cover in the step-by-step instruction manual, schematic and pictorial diagrams.

KT-500.....Net 74.50

IMPORTANT DELIVERY INFORMATION

The response to our recent announcement of the Lafayette Stereo tuner has been so phenomenal that we already have a substantial backlog of orders. Delivery will start approximately Jan. 15, 1958 and all orders will be filled in order of receipt. Order now and be one of the first to own this outstanding tuner.

Lafayette

DELUXE HIGH FIDELITY KITS AMPLIFIER & PREAMPLIFIER KITS

MASTER AUDIO CONTROL CENTER with EXTRA CATHODE FOLLOWER CHANNEL FOR CONTROL OF BINAURAL (STEREO) TUNER OR SECOND PREAMP HIGHLY FLEXIBLE—CANNOT BECOME OBSOLETE!



NET
39.50

designed by
VICTOR BROCIER
One of America's Outstanding
Audio Engineers

MODEL KT-300
MASTER AUDIO CONTROL CENTER KIT
(AVAILABLE COMPLETELY WIRED AS MODEL LT-30)
MADE IN U.S.A.

An outstanding achievement in the audio field. Practically distortionless, hum-free amplification, with sensitivity enough for any magnetic phono pickup or tape head and inputs for control of up to 7 different program sources. The second channel provided allows you to control a stereo (binaural) tuner or the output of a second preamplifier, using the Lafayette preamp as the control center—ideal when converting existing hi-fi systems to stereo. Finest quality parts throughout, with special low-noise resistors where required.

SPECIFICATIONS — CONTROLS: PHONO TURNOVER-INPUT SELECTOR: Radio, Aux, Tape, plus 4 phono turnover frequencies—AES, RIAA (NARTB and NEW AES), 800, LP, ROLL-OFF: LP, RIAA, AES, 10.5 (Old London LP), 5 (FFRR 78), Flat, plus NARTB tape head position. BASS: 16 db boost, 18 db cut, at 30 cps. TREBLE: 11 db boost, 18 db cut, at 10,000 cps. LOUDNESS-VOLUME: Concentric dual control, one with power on-off switch. Separate Loudness on-off switch. TAPE MONITOR SWITCH: For recorders with monitoring head and preamp. RUMBLE FILTER SWITCH. GAIN CONTROL. RADIO INPUT LEVEL CONTROL. INPUTS: Radio, Tape, Tape Head, Aux, Magnetic Phono, High Level Phono (Crystal, Ceramic, FM or Capacity Pickups), High Level for control of 2nd channel of binaural (stereo) system. HARMONIC DISTORTION: Less than 0.07% at 1 volt output; less than 1/4 of 1% at 5 volts out. INTERMODULATION DISTORTION: Less than 0.09% at 1 volt out. FREQUENCY RESPONSE: Uniformly flat over entire audible spectrum. OUTPUTS (3): Amp. No. 1 cathode follower—permits cable up to 100' (6' cable furnished); Amp. No. 2 cathode follower—output of 2nd channel (unamplified); Tape Recorder—permits recording while listening or monitoring with monitoring switch—unaffected by volume or tone controls. 3 AUXILIARY AC channel (unamplified); Tape Recorder—permits recording while listening or monitoring with monitoring switch. GAIN AND SENSITIVITY: Mag.—54 db (2mv. input produces 1 volt output; Radio, Tape, Aux—14 db (0.2 volts in produce 1 volt out. DYNAMIC RANGE: No increase in output distortion with up to 1 volt to magnetic phono input HUM AND NOISE: 80 db below 3 volts at full gain (radio, tape, aux inputs); better than 60 db below effective program level at full gain with 10mv. phono or tape input. TUBES: 3-6CC33 plus 2-selenium rectifiers. POWER REQUIREMENTS: 105-125 volts, 50/60 cps AC. FINISH: Anodized gold-finish aluminum panel, case gold finish with dark maroon trim and with matching maroon knobs with gold inserts. Die-formed metal case designed for shelf, tabletop or cabinet mounting (on panels up to 3/4" thick). SIZE: 12 3/4" w x 9 3/8" d x 3 3/4" h. SHIPPING WEIGHT: 10 1/2 lbs. MODEL KT-300 KIT—Complete with all parts, tubes, case and detailed construction manual with step-by-step instructions, detailed assembly and mechanical drawings

Net 39.50
MODEL LT-30—Lafayette Master Audio Control Center completely wired and tested, with case, ready for operation. With complete operating instruction manual
Net 59.50

70-WATT DELUXE BASIC AMPLIFIER

MADE IN
U.S.A.



NET
69.50

MODEL KT-400
70-WATT AMPLIFIER KIT
(AVAILABLE COMPLETELY
WIRED AS MODEL LA-70)

- FREQUENCY RESPONSE 10-100,000 CPS \pm 1 DB AT 1 WATT
- POWER RESPONSE 20-20,000 CPS \pm 1 DB AT 70 WATTS WITH LESS THAN 2% HARMONIC DISTORTION
- VARIABLE DAMPING
- MATCHED-PAIR KT-88 OUTPUT TUBES
- METERED BALANCE & BIAS ADJUSTMENTS
- ULTRA-STABLE CIRCUITRY
- PRINTED-CIRCUIT WIRING
- FAMED CHICAGO WIDE-RANGE LINEAR OUTPUT & POWER TRANSFORMERS

DESIGNED BY
VICTOR BROCIER
One of America's
Outstanding Audio Engineers

FEATURES: A very conservatively rated amplifier designed for continuous heavy duty and specifically intended as a perfect companion-piece for any of the newest high-fidelity speakers and components. The matched-pair push-pull KT-88's, normally top-rated at 100 watts, are used for only 70 watts maximum output. Similarly, only highest quality, conservatively-rated components are used throughout.

To achieve maximum stability without regard to the kind of speaker load used, phase-correction networks have been kept to a minimum and the power supply uses pure resistance-capacitance filtering to avoid the potentially resonant and unstable performance of choke-filtered circuits.

The calibrated variable-damping factor control provides optimum performance from any of the amplifier output taps with any speaker system, without affecting volume level or frequency response. The control can be switched out of the circuit, if desired.

The Balance-Adjust Control and Meter enable you to match output tubes when they are replaced. The Bias adjustment, also read on the built-in meter, is a further provision for correct operation of the output tubes when replaced and is your assurance of continuous top quality performance.

SPECIFICATIONS: POWER OUTPUT: 70 watts continuous sine wave, 80 watts program material, 160 watts instantaneous peak. HUM AND NOISE: 90 db below rated output. HARMONIC DISTORTION: Less than 1%, 20-20,000 cps at 60 watts, \pm 1 db; less than 2% at 70 watts. IM DISTORTION: Below 1 1/2% at 70 watts (60 and 7000 cps); less than 1% at 60 watts and below 0.3% at 30 watts. FREQUENCY RESPONSE: 10-100,000 cps \pm 1 db at 1 watt, with gradual controlled roll-off above 100,000 cps; 20-20,000 cps \pm 1 db at 70 watts. STABILITY: No peaking or marginal instability with reactive loads. DAMPING FACTOR: Variable 0.5 to 12. INPUT SENSITIVITY: 2.0 volts for 70 watts output. CONTROLS: Calibrated variable damping factor control, bias adjust, balance adjust, and meter switch. METER: Clear plastic-front rectangular meter. TUBES: 2-KT88, 6AN8, GZ34 (Rectifier) plus selenium rectifier. REAR PANEL: Incorporates octal socket (unwired) for use in supplying power for preamplifier, 2 auxiliary 117 volts AC outlets, 2 speaker terminal strips; input jack, and fuse. OUTPUT TAPS: 4, 8, and 16 ohms. SIZE: 14 1/2" w x 10" d x 7 3/4" h. SHIPPING WEIGHT: 40 lbs.

Net 69.50
MODEL KT-400 KIT—Complete with all parts, printed circuit, tubes, case, and detailed, easy-to-follow step-by-step instructions, schematics and pictorial diagrams
Net 94.50
MODEL LA-70—The Lafayette deluxe 70 watt basic amplifier, completely wired and tested, ready for operation with complete operating instructions.....

BUILD YOUR OWN HI-FI KITS

LAFAYETTE'S FM-AM TUNER KIT

- SIMPLIFIED DETAILED INSTRUCTION MANUAL
- MEETS FCC REQUIREMENTS FOR RADIATION
- GROUNDING GRID TRIODE AMPLIFIER
- ARMSTRONG FM CIRCUIT WITH FOSTER-SEELEY DISCRIMINATOR
- AFC DEFEAT CIRCUIT WITH FRONT PANEL CONTROL

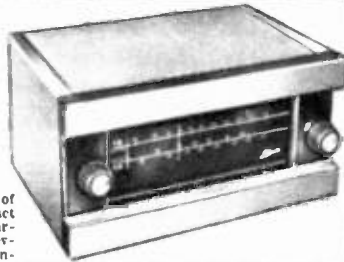

The excellence of its design and the quality of its components combine to provide this compact high-fidelity FM-AM tuner with superb characteristics normally found in units costing several times as much, and with performance unbelievable at this low price. Features Armstrong FM circuit with limiter and Foster-Seeley discriminator. Simplified tuning with slide-rule dial and flywheel counterweighted mechanism. AFC defeat circuit combined with tuning control. Attractive etched copper-plated and lacquered finish.

SPECIFICATIONS

FREQUENCY RANGE: FM, 88-108 MC; AM, 530-1650 KC. **ANTENNA INPUT:** FM, 300 ohms; AM, Ferrite loopstick and high impedance external antenna. **CONTROLS:** 2—a function control for AM, FM, PHONO, TV and a tuning/AFC defeat control. **DISTORTION:** Less than 1% rated output. **FREQUENCY RESPONSE:** FM, ± 5 db 20 to 20,000 cps; AM, ± 3 db 20 to 5000 cps. **SENSITIVITY:** FM, 5 μ V for 30 db quieting; AM, Loop sensitivity 80 μ V/meter. **SELECTIVITY:** FM, 200 KC bandwidth, 6 db down — 75 KC FM discriminator peak to peak separation; AM, 8 KC bandwidth, 6 db down. **IMAGE REJECTION:** 30 db minimum. **HUM LEVEL:** 60 db below 100% modulation. **TUBE COMPONENT:** 2-12AT7, 1-6BA6, 1-6BE6, 2-6AU6, 1-6AL5 plus 1-8X4 rectifier. **SIZE:** 5 1/2" high x 9 1/2" wide x 9 1/2" deep (excluding knobs). **CONSUMPTION:** 30 watts. For 110-120V 60 cycles AC. Less metal case. Shpg. wt., 9 lbs. **KT-100** kit, less case.....Net **34.95**
ML-100—Metal cage for above, shpg. wt., 3 lbs.....Net **5.00**

3 TRANSISTOR HI-FI PREAMPLIFIER KIT KT-117

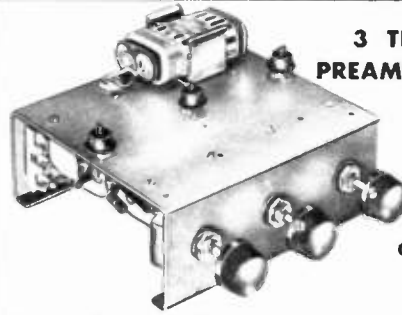

With Volume, Bass and Treble Controls

WITH NEW GE 2N190 TRANSISTORS

Lafayette 3 Transistor Hi-Fi Preamplifier Kit KT-117 provides the voltage gain necessary for the operation of even the lowest level magnetic cartridges and microphones. It may be used with Hi-Fi equipment to provide stable, low noise preamplification with extremely low power consumption, zero hum and without any microphonics inherent in vacuum tube preamplifiers. It is ideal as a remote preamplifier since it is battery operated and can be connected by cable up to 175 ft. from associated equipment. It has its own Bass and Treble controls for improved quality of reproduction, and uses 3 quality audio transistors. Frequency Response is 20 to 20,000 cycles. 40 db maximum gain. Zero hum level; Noise level—approx. 48 db below 10 millivolts input for high impedance cartridges, better than 52 db below 2 millivolts for low impedance cartridges; Four inputs: Three phono inputs—high output cartridges, high impedance variable reluctance cartridges and low impedance low output cartridges; Microphone input. From 0.5 to 1 volt output; Controls—Phono—Microphone, Hi-Lo Level, Power-Volume, Bass and Treble. Complete with all parts, transistors, pre-punched chassis, battery and detailed step-by-step instructions. 4 1/2" x 3 1/2" x 1 1/2". Shpg. wt., 2 lbs.

KT-117—Complete Kit

Net **18.45**

Build-it-Yourself and Save with NEW EICO HIGH FIDELITY AMPLIFIER KITS

12-WATT WILLIAMSON-TYPE HI-FI AMPLIFIER . . . PREAMP . . . CONTROL SECTION



COMPLETE KIT..... **34.95**
WIRED..... **57.95**

Compact, attractively styled amplifier with complete front end facilities and true high fidelity performance. Direct tape head and magnetic phono inputs with NARTB (tape) and RIAA (phono) feedback equalizations. Dual triode circuit for variable turnover bass and treble feedback-type controls. Power output: 12 watts continuous, 25 watts peak. Intermodulation distortion 1.5% at 12 watts, 0.55% at 6 watts, 60 to 6000 cps. Frequency response: 12-50,000 cps ± 0.5 db at 1 watt; 25-20,000 cps ± 0.5 db at 12 watts. 4 Controls: Selector switch, level control, bass and treble controls. Speaker connections for 16, 8, and 4 ohms. Tubes: (2) ECC83/12AX7, ECC82/12AU7, (2) EL84, EZ81. Size: 3 1/2" H, 12" W, 8 1/4" D. Shpg. wt. 13 lbs. With instructions.
HF12K—Complete Kit.....Net **34.95**
HF12—As above, factory wired.....Net **57.95**

50-WATT ULTRA-LINEAR AMPLIFIER PREAMPLIFIER CONTROL SECTION

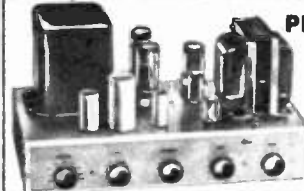

69.95
Complete Kit

Here is a new high powered, high fidelity amplifier with virtually absolute stability and flawless transient response under load. Extremely high quality output transformer, fully potted in seamless steel case. Preamplifier-equalized control section has five equalizations for LP's and 78's including RIAA, variable turnover feedback tone controls, loudness and level set controls. Six inputs include four high level switched inputs for tuner, TV, tape, crystal/ceramic phono, and two low level inputs for magnetic and high quality crystal cartridges. Has hum balance control. Power output 50 watts continuous, 100 watts peak. Harmonic and intermodulation distortion less than 1%. Frequency response 15-30,000 cps ± 0.1 db. Hum and noise 60 db below rated output. Speaker connections for 4, 8, 16 ohms. Size 7" H, 14" W, 8" D. Shpg. wt. 29 lbs. With instructions.

HF52K—Complete Kit.....Net **69.95**
HF52—As above, factory wired.....Net **109.95**
Model E-1—Matching Cover.....Net **4.50**
HF50K—Power Amplifier Kit only.....Net **57.95**
HF50—Factory wired Amplifier only.....Net **87.95**
Model E-2—Matching Cover.....Net **4.50**

HIGH FIDELITY PREAMPLIFIER

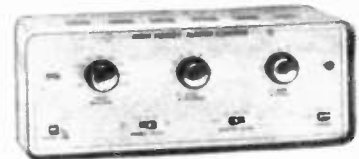

COMPLETE KIT ONLY **24.95** **Factory Wired** **37.95**

Provides complete control and switching facilities for the finest power amplifiers. Has feedback-type, sharp cutoff scratch and rumble filters (12db/octave). Low distortion feedback tone controls include five most common recording curves for LP's and 78's plus RIAA. Tone controls provide large boost or cut in bass or treble with mid-frequencies and volume unaffected. Equipped with loudness control, four high level switched inputs (TV, tuner, tape, aux.) and three low level inputs for all cartridges. Has hum balance control and four convenient outlets. Negligible hum, noise, harmonic and intermodulation distortion. Frequency response 8-100,000 cps ± 1 db. Size: 4 1/2" H, 12-5/16" W, 4 1/8" D. Shpg. wt. 8 lbs. With instructions.

HF61AK—Complete Kit.....Net **24.95**
HF61A—Same as above, factory wired.....Net **37.95**
HF61K—Same as HF61A Kit except with power supply.....Net **29.95**
HF61—Same as above, factory wired.....Net **44.95**

New! 60 WATT ULTRA-LINEAR HI-FI POWER AMPLIFIER KIT with ACRO TO-330 Output Transformer

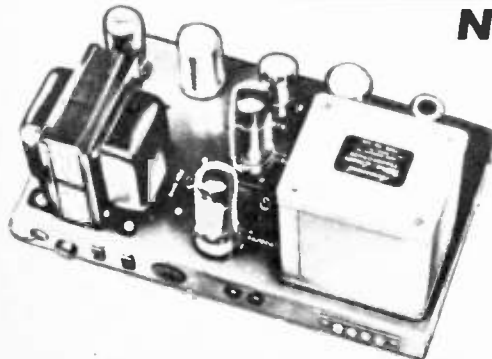

COMPLETE KIT
72.95
WIRED
99.95

Enjoy superb performance and save money too by building this top quality amplifier using the finest components and proven design features. The kit includes Acrosound's famous TO-330 output transformer which provides high undistorted power, push-pull parallel ultra-linear operation. Circuit includes EF86 low-noise voltage amplifier direct-coupled to 6SN7GT8 cathode-coupled phase inverter driving two EL34 output tubes operated with fixed bias. Rated power output 60 watts, with 130 watt peak. Intermodulation distortion less than 1% at 60W. Harmonic distortion less than 0.5%, 20-20,000 cps. ± 1 db at 60W. Frequency response: 16-90,000 cps. ± 0.1 db at 60W. Damping factor 17. GZ34 rectifier with indirectly heated cathode eliminates high starting voltage on electrolytics and delays B+ until tubes warm up. Has input level control, bias and bias-balance adjustments, standard socket for preamp power take-off and remote on-off switching. 7x14x8". Shpg. wt. 30 lbs. With instructions, tubes and all parts.

Elco HF60—Amplifier Kit.....Net **72.95**
Same as above completely wired.....Net **99.95**
Model E-2—Matching Cover.....Net **4.50**

EASY TO BUILD HIGH FIDELITY KITS

Enjoy the Best and you Save More!

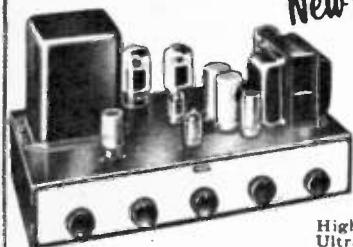

New! EICO 20 WATT HIGH FIDELITY AMPLIFIER KIT MODEL HF20K

- ± 0.5 db 13 to 35,000 cps; ± 1.5 db, 7 to 50,000 cps
- COMPARES WITH MOST EXPENSIVE AMPLIFIER MADE!
- BEST BUY IN SUPERLATIVE HIGH FIDELITY AMPLIFIERS!

High quality equalizer and control section plus 20 watt Ultra-Linear Williamson-type power amplifier. Low distortion feed-back equalization; 5 equalizations provided for "Flat" positions at center settings of control knobs. Loudness control and separate level set control both on front panel. Provides adjustable Fletcher-Munson compensation or no compensation when desired. Loudness control can be adjusted to give desired listening level without affecting tape output. Permits use of up to 30 ft. of cable. Six inputs: 4 high level switched inputs — Tuner, TV, Tape, Auxiliary (crystal/ceramic phono or second tuner); 2 low level inputs (not switched) — provides proper pick-up loading and attenuation for all leading magnetic, FM and high quality crystal cartridges without changing resistors. Hum balance control for balancing out 60 cycle residual hum.

Power Consumption: 110-120 volts, 60 cps, 100 watts. Tubes: 2-12AX7, 2-12AU7A, 2-6L6GB, 1-5U4GB. Handsomely styled to eliminate the necessity for cabinetry. Size: $8\frac{1}{2}$ " H, 15" W, 10" D. Shpg. wt., 24 lbs.
EICO MODEL HF20K — KIT, Complete Net **49.95**
MODEL HF20 Factory Wired Net **79.95**
ENCLOSURE FOR HF20 Net **4.50**

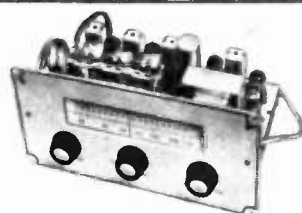

DeLuxe 9 TUBE FM TUNER KIT

- DUAL LIMITERS—FOSTER-SEELEY DISCRIMINATOR
- CATHODE FOLLOWER OUTPUT
- TUNED RF FRONT END
- SELF-CONTAINED AC POWER SUPPLY
- RESPONSE 20-20,000 CPS $\pm .5$ DB
- TEMPERATURE COMPENSATED ARMSTRONG CIRCUIT
- 9 TUBES PLUS SELENIUM RECTIFIER

Quality parts plus an excellent circuit make this a top-notch unit. Uses a 3 gang variable, iron core tuned I.F.'s and discriminator transformers, heavy 16 gauge copper plated and lacquered chassis. Features include Armstrong circuit, hum level -70 db below average output, output volts average .5 volts RMS, sensitivity of 10 u/v -20 db, 200kc bandwidth and tuned RF stage. Controls are tuning, volume with On-Off switch, and FM-Phono switch. Covers 88-108mc. Self-contained 115 volt 60 cycle AC power supply. Tubes are 4-6AU6, 2-6AB4, 1 each 6CB6, 6AL5 and 6CA cathode follower output plus selenium rectifier. Every part is of finest quality—even the sockets are mica filled. Illuminated dial, rich gold finished escutcheon panel and matching brass-inlay knobs. Chassis dimensions $9\frac{1}{2}$ " L x 5" H, x $5\frac{1}{2}$ " W. Included is 24 page $8\frac{1}{2}$ " x 11" book complete with pictorial, mechanical and schematic diagrams, plus step by step assembly instructions. Kit is complete with tubes and all parts. Shpg. weight 11 lbs.

KT-107 Kit **37.95**

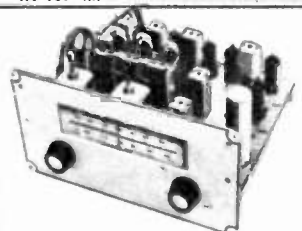

12 TUBE AM-FM TUNER KIT

- 12 TUBES PLUS CRYSTAL DIODE DETECTOR
- DUAL LIMITERS—FOSTER-SEELEY DISCRIMINATOR
- ARMSTRONG CIRCUIT—TEMPERATURE COMPENSATION
- FM RESPONSE 20-20,000 CPS $\pm .5$ DB
- 6 SECTION VARIABLE-TUNED RF STAGES

Build this fine 12 tube AM-FM tuner that covers both 88-108MC and 530-1650KC AM and FM bands with superb quality. Frequency response is 20-20,000 CPS $\pm .5$ db on FM, and 20-7500 CPS ± 3 db on AM. Twelve tube circuit includes 4-6AU6, 2-6AB4, 2-6BA6, 1 each 6CB6, 6AL5. EC on "A" cathode follower output plus 1N34-60 crystal diode detector, action variable condenser, iron core tuned I.F., discriminator, antenna, RF and oscillator coils. Band width is 200KC. Mus tunz⁴ RF stage in both AM & FM. Hum level is -70 db below average output. Drift is held to minimum by temperature compensation. Extremely sensitive, 5-10 u/v, 20-30 db on FM, 5 microvolts on AM. Controls are tuning and 3 position switch for AM, FM, On-Off. Copper plated lacquered 16 gauge chassis measures $9\frac{1}{2}$ " L x 5" H x 8" W. Rich gold finished escutcheon panel and brass inlay knobs. 24 page instruction manual is replete with easy to follow pictorial, mechanical and schematic diagrams with step by step instructions for assembly and operation. External power supply required is 190 volts DC-55 ma and 6.3 volts AC 4 amp. **KT-109** power supply is ideal for this purpose. Kit is complete with all parts and tubes. Shpg. weight 12 lbs.

KT-106 AM-FM KIT NET **43.95**

UNIVERSAL POWER SUPPLY

12.80

Completely wired. Choke filter system, electrostatically shielded, hum free. Completely isolated. Delivers 190 volts DC at 55 ma and 6.3 V at 4 amp. Size: $3\frac{1}{2}$ " W x $4\frac{1}{2}$ " H x 8" D. Shpg. Wt. $8\frac{1}{2}$ lbs.

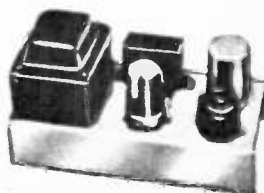

KT-109 Power Supply **12.80**



NEW DYNAKIT MARK III 60 WATT POWER AMPLIFIER KIT

- PRE-WIRED PRINTED CIRCUIT ASSEMBLY
- MATCHED PAIR PREMIUM TUBES
- CHOKE FILTERING TO MINIMIZE NOISE

Compact 60 watt basic amplifier designed for finest listening quality in modern hi-fi installations. Pre-wired printed circuit assembly with parts mounted assures correct trouble-free construction in as little as three hours. Accurate and simple bias setting independent of meter accuracy. Balancing or critical adjustments are not required to meet performance specifications. Frequency response better than $\pm .5$ db from below 6 cps to above 60 kc. Response at any level up to 60 watts is $\pm .1$ db over a range in excess of 20 cps to 20 kc. 1M distortion less than 1% at 60 watts, .5% below 50 watts and .04% at average listening levels. Less than 1% harmonic distortion within 1 db of 60 watts from 20 cps to 20 kc. Excellent transient response on pulses, square waves, etc., and noise 90 db below maximum. 4, 8, and 16 ohm outputs. Utilizes 1 6AN8, 2 KT88 (or 6550), 1 GZ34 and selenium rectifier. Washable, chip-proof vinyl coated finish on cover. All parts, tubes and protective cover included in kit. Shpg. wt., 28 lbs.

MARK III 60 Watt Amplifier Kit Net **79.95**
 Above, Completely Wired and Tested. Net **99.95**

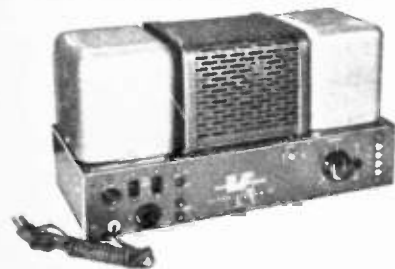

NEW ACRO SOUND ULTRALINEAR II 60 WATT POWER AMPLIFIER KIT

79.50

The Acrosound Ultra-Linear II is a 60 watt power amplifier utilizing ultra-linear circuitry and new feedback design to provide a new standard of stability in feedback amplifier performance. A variable damping control is adjustable between .5 and 10 for optimum speaker match, without volume change, increased distortion or frequency discrimination. Critical wiring is preassembled on a printed circuit board. A full choke condenser power supply and fully potted transformers are supplied, and tubes are operated well within ratings. New TO-600 output transformer with low leakage reactances between windings and novel feedback windings is used. 1M distortion less than 1% at 60 watts for any standard combination of test frequencies. Harmonic distortion less than 1% at any frequency between 20 cps and 20 kc at power output within 1 db of 60 watts. Sensitivity is 2 volts RMS for 60 watts output. Hum is 85 db below rated output. Output impedances of 4, 8, and 16 ohms. The tube lineup consists of 2 EL34/6CA7, 12AU7, 12AX7 and GZ34. The amplifier is attractively styled and presents a professionally finished appearance that is both functional and pleasing, with dark brown chassis and cover, and light brown transformer cans. Size $7\frac{1}{2}$ " x $1\frac{1}{2}$ " x 8". Shpg. wt., 30 lbs.

ACRO SOUND 60 Watt Amplifier Kit Net **79.50**
 Above, Completely Wired and Tested. Net **109.50**

RADIO Control Equipment

RADIO CONTROL RECEIVER

Reg. Value
~~\$13.00~~

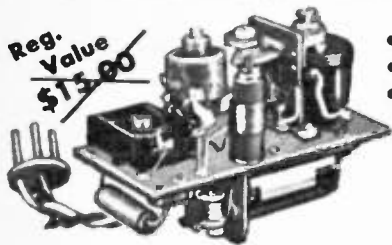

- ASSEMBLED
- TESTED
- READY TO GO

SPECIAL!
8.95

A truly sensational value in a superbly designed and constructed hard-tube R/C receiver. Operates on popular exam-free 27.255 MC remote control band. Extremely efficient and dependable, this amazing receiver has more than adequate sensitivity for a range of approximately 1 mile. Outstanding for economy of operation, its minimum life with initial 354 tube is several thousand hours! Ingeniously constructed for unmatched stability of performance, and to withstand unusual vibration and shock. Requires one 1.5 volt A battery, one 45 volt B battery and 24" antenna lead. Size: 1 3/4" x 1-15/16" x 3". Weight 3.3 oz.

F-208 Net 8.95

RADIO CONTROL TRANSMITTER

ASSEMBLED — TESTED — GUARANTEED

- Not a Kit — Fully Wired —
- Includes Tube and 27.255 Mc Crystal • No License Examination Required!
- Range 1 Mile and More!

Foolproof, factory assembled and tested transmitter. Weighs only a scant 4 1/2 lbs. with batteries. Uses powerful 3A5 tube for all the range you need. Antenna is 4 ft. 6 in. long — six sections telescope down to 10 inches. Novel "plug-in" feature permits simple removal and replacement of antenna. Overall dimensions are 4" x 4" x 12", exclusive of antenna. Will operate any R/C receiver at 27.255 MC. Power output affords unusual range of control. Less batteries. Shpg. wt., 3 lbs. F-249

Batteries for F-249 Transmitter
1—Burgess 2D or RCA V5069 Net, Each .53
2—Burgess XX45 or RCA V5016 Net, Each 2.28

SPECIAL COMBINATION OFFER

Consists of R/C Transmitter (F-249), and R/C Receiver (F-208)

F-259—Combination.....Net 22.90

R/C MANUALS

BK-900 Model Control by Radio 1.00
BK-910 Radio Control Handbook 2.25



27.255 R/C CRYSTAL



Used in remote control of model planes, boats, cars, etc. Low drift, high output. Tolerance .04%. Size 0.720" wide, 0.309" deep, 0.758" high. 1/2" between pins.

MS-296 Net 2.95

Crystal Socket: Low loss, ceramic socket for 27.255 crystals. Small light-rugged.

MS-297 Net .15

LORENZ REMOTE CONTROL TRANSMITTER KIT

FOR MODEL PLANES, BOATS AND CARS

As Described in POPULAR ELECTRONICS

The Lorenz Remote Control Transmitter is a highly efficient instrument designed to operate on the license free "Citizen Band" frequency of 27.255 megacycles. The only F.C.C. regulation is that on F.C.C. form 505 (supplied with kit) be filled out and sent to the nearest F.C.C. office.

Designed for use with any "Citizen Band" remote control receiver such as Lafayette KT-84. Transmits signals which are picked up by the receiver for the purpose of remotely controlling model planes, boats, cars and other mechanical units. Its power output provides a wide range of control. Truly tops for value and dependable performance shpg. wt. 4 lbs.

KT-87 — Less Batteries Net 14.95
1—RCA V5069 Battery Net 53¢
2—RCA V5016 Batteries 2.45 Each Net 4.90

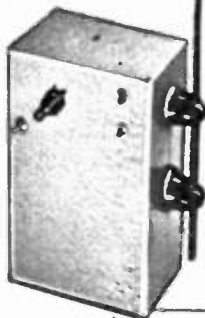

NEW! MULTI-PURPOSE ELECTRIC SERVO MECHANISM

- DESIGNED FOR HOBBYISTS — PRICED FOR HOBBYISTS
- POWERFUL, MOTOR DRIVEN R/C ACTUATOR
- POSITIVE, INSTANTANEOUS ACTION
- FOR MODEL BOATS AND CARS

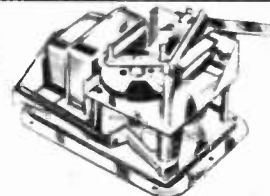

Lafayette's new, motor driven, remote control servo-mechanism. Imported by Lafayette to sell for half the price of any comparable unit! Carefully constructed for power, durability and rugged use. Operates with any single channel, remote control receiver and transmitter. When operated at the prescribed 3 volts, the action is accurate and rapid. Provides for selective steering and automatic return to neutral. Extremely efficient when used with model boats or land vehicles. Hobbyists will find uses for the servo-mechanism restricted only by their imagination. Single pulse operation — electronic neutralization. Measures only 2 1/2" x 2" x 1 3/4" overall. Includes instructions and linkage to extend actuator arm. Shpg. wt., 8 oz.

F-327

Net 5.95

TRANSISTORIZED RECEIVER KIT

- PLANES • BOATS • CARS
- THE MIGHTY MITE OF THE R/C FIELD!
- WEIGHS 1 OZ. • 100% SUB-MINIATURIZED!

Lafayette takes the lead in the popular R/C held with this super sensitive and efficient subminiature transistorized "Citizen Band" receiver kit. Operates on 27.255 MC and can be used with any "Citizen Band" remote control transmitter. A perfect mate for Lafayette Remote Control Transmitter Kit KT-87. Planned for compactness and sturdiness to withstand severe vibration and shock, yet weighs no more than 1 oz. 2-1/16" L x 1 1/2" W x 1-11/16" D, overall. Uses one 1-1/2 V and one 45V batteries. Battery size depends on size of model

KT-84

11.75

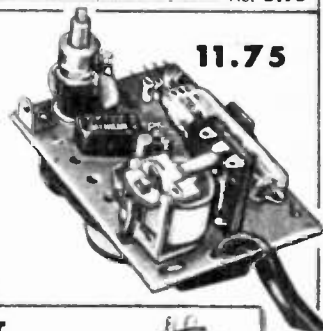

REMOTE CONTROL ESCAPEMENT

- AT THE LOWEST PRICE ANYWHERE!

A sturdy 2 arm self-neutralizing escapement. Completely wired (not a kit). Converts electrical impulses from remote control receiver to mechanical motion for varying movement of plane, boat, or car. Four 90° rotations—two by armature activation, two by neutralization. Has ratchet governor for maintaining foolproof rotating speed. Weighs only 7/8 oz. Size: 1-3/8" L x 2" W overall. Shpg. wt., 5 oz.

F-255.....Net 2.45

COMPOUND REMOTE CONTROL ESCAPEMENT

- LAFAYETTE'S AMAZING VALUE IN A 4-ARM SELF-NEUTRALIZING COMPOUND ESCAPEMENT!
- NO NEED TO WORRY ABOUT LOSING YOUR MODEL!

You have no sequence of operation to worry about! Simple as A B C! One pulse always gives right turn; two pulses always gives left turn. Three pulses closes the circuit for the supplementary control such as motor (F-257) or elevator, if used. The rudder always returns to neutral position after any turn as soon as transmitter keying button is released. With ratchet governor for foolproof operation. Sturdy construction—low current drain. Uses 1-1/2 volt battery. Weighs 1-1/8 oz. Size: 2-7/8" L x 1-9/16" overall. Shpg. wt., 6 oz.

F-256.....Net 3.95

REMOTE ENGINE CONTROL ESCAPEMENT

Lafayette's exciting new air-bleed self-neutralizing remote engine control. Varies engine speed of your model. Neutral position of one arm is low speed, neutral position of 2nd arm is high speed, and maintained activated position of either arm (armature activated) stops motor. Perfect mate for Lafayette F-256. Compact and weighs only 3/4 oz. Requires 1-1/2 volt battery. Low current drain. Size: 1-3/8" x 1" x 3/4". Shpg. wt., 5 oz.

F-257.....Net 3.45

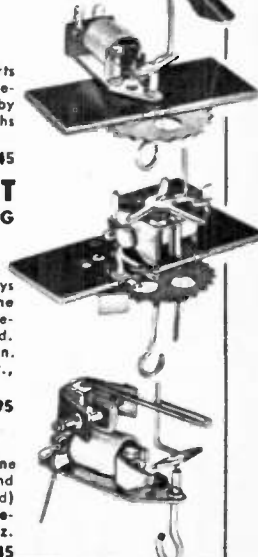

"JEWEL" REMOTE CONTROL RELAY

2.75

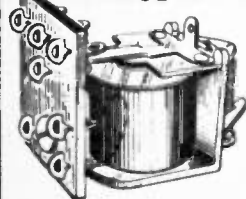

- The Mighty Mite of the R/C Field
- Weighs less than 1/2 oz.!
- Size: 3/4" H, 17/32" W, 1-1/16" L

A natural for remote control receivers, it is highly sensitive, and built to withstand severe crashes. The smallest commercial job available, it weighs less than 1/2 oz. Factory adjusted to pull in at 1.4 MA. drop out at 1.2 MA D.C. Single pole, double throw. Used in outstanding R/C receivers. 5,000 ohm coil. IMPORTED TO SAVE YOU MONEY.

F-260—Relay Net 2.75

Lafayette TRANSISTOR SUPERHET KITS

POCKET AND HOME RADIOS • FOR SPEAKER AND EARPHONE OPERATION



BUILD A 6 TRANSISTOR SUPERHET RECEIVER

- 100% SUBMINIATURE PARTS—NO COMPROMISES!
- LABORATORY DESIGNED—SENSITIVE, SELECTIVE, STABLE!
- CLASS B PUSH-PULL AMPLIFICATION—PLENTY OF POWER!

Superb Performance! Incomparable Value!

FOR GROUP AND PRIVATE LISTENING

Transistor-wise Lafayette is proud to present its 6 Transistor Superhet Receiver Kit KT-119. An outstanding achievement of constant research and design, this kit represents the optimum in sensitivity, selectivity and stability. You'll be amazed at its superior commercial quality! You'll be elated with its surprising performance! The circuit, using 3 high frequency RF Transistors, 3 dependable audio Transistors and Crystal Diode, features a specially matched set of 3 I.F.'s, Oscillator, High-Q Loop, Class B Push-Pull Audio Amplification, and Transformer Coupling in audio and output stages. Special care has been taken in the design for exact impedance matching throughout to effect maximum transfer of power. Has efficient 2 3/4" speaker for exemplary reproduction, and earphone jack for private listening. Complete with all parts, transistors, pre-punched chassis, and easy-to-follow step-by-step instructions. 6" x 3 1/2" x 1 1/2". Shpg. wt., 3 lbs.

KT-119—Complete Kit—Less Case and battery.....	Net	29.95
BATTERY—9 VOLTS RCA VS300.....	Net	1.23
OR BURGESS P6.....	Net	.77
MS-339—Sturdy, attractive brown leather case with carrying strap for KT-119. 6" x 3 1/2" x 1 1/2". Shpg. wt., 1 lb.....	Net	2.95
MS-366—Sensitive matching earphone.....	Net	1.29

4 AND 6 TRANSISTOR SUPERHET KITS—POCKET AND HOME RADIOS FOR SPEAKER AND EARPHONE OPERATION

POCKET SIZE: 4" L x 3-5/16" W x 1" D BUILT-IN ANTENNA! REQUIRES NO EXTERNAL ANTENNA OR GROUND!



Lafayette engineers have designed this fascinating 4-transistor superhet receiver kit in a unique and interesting form. It is, by itself, a completely self-contained pocket sized personal portable set which operates a miniature earpiece so only you can hear; by plugging into the KT-96 kit listed below. It is instantly converted to a full 6-transistor home radio, complete with speaker for the entire family to enjoy. Circuit features use of 4 transistors (2 high frequency and 2 audio type) plus a germanium diode, 2 I.F. stages and built-in high gain ferrite core and antenna. The result is a sensitive, stable and selective set covering the entire broadcast band. Requires no outside antenna or ground connection. The kit is furnished complete with transistors and all parts, including battery and chassis already drilled and punched. The earpiece and carrying case are accessory items, not supplied. All necessary pictorial and circuit diagrams are furnished with simple, easy-to-follow instructions.

KT-94 —Kit, shpg. wt., 2 lbs.....	Net	19.95
MS-311—Leather Carrying Case.....	Net	1.95
MS-260—Super power dynamic earpiece.....	Net	3.95
or MS-368—SENSITIVE ECONOMY DYNAMIC EARPHONE.....	Net	1.44

2-TRANSISTOR PUSH-PULL OUTPUT KIT WITH SPEAKER SELF-CONTAINED IN BEAUTIFUL PLASTIC CASE

• CONVERTS 4-TRANSISTOR KIT INTO A 6-TRANSISTOR HOME RADIO WITH SPEAKER
Add a completely transistorized push-pull audio stage to your 4-transistor receiver. Complete stage including speaker and case measures only 3" H x 2 3/4" W x 1 3/8" D. Plugs right into 4-transistor kit above. Converts your 4-transistor set to a 6-transistor plus diodes superhet receiver. Performance equal or superior to commercially wired sets selling at more than twice the price. Kit includes 2 transistors, 2 transformers, 2 1/2" PM speaker, pre-punched chassis, speaker case to hold entire stage, battery, hardware, instructions and diagrams.

KT-96—Shpg. wt., 1 lb.....	Net	11.50
----------------------------	-----	-------

3 TRANSISTOR SUPER-HET POCKET RADIO KIT KT-116

• CONVERTER, 2 IF STAGES, DIODE AND AUDIO OUTPUT
DESIGNER'S DREAM IN A TRUE POCKET SUPERHET RECEIVER!
NO EXTERNAL ANTENNA! NO EXTERNAL GROUND!

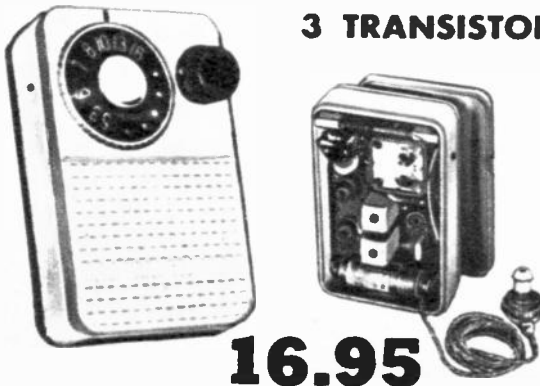

A highly sensitive, super-selective true pocket superhet receiver that will surprise you with its performance over the complete broadcast band. Just place it in your shirt pocket, place the earphone to your ear, and you're in for a treat! Best of all! No pesky external antenna and ground leads to worry about! The circuit uses 2 high frequency converter and IF Transistors, 2 specially matched IF transformers for maximum power transfer, an efficient crystal diode for detection and a dependable Audio Transistor in a single-ended audio output stage. The components are housed in an attractive professional-looking plastic case. Comes complete with ON-OFF knob and stylish station dial that adds considerable class to the receiver's appearance. Complete with all parts, transistors, battery, case, dial and easy-to-follow step-by-step instructions. 4 1/2" x 2 1/2" x 1-1/16". Shpg. wt., 1 lb.

KT-116—Complete Kit.....	Net	16.95
MS-260—Super power dynamic Earphone.....	Net	3.95
or MS-368—SENSITIVE ECONOMY DYNAMIC EARPHONE.....	Net	1.44

Lafayette TRANSISTOR KITS



TWO TRANSISTOR POCKET RADIO RECEIVER KIT With Regenerative Circuit and Transistor Transformer Audio Stage

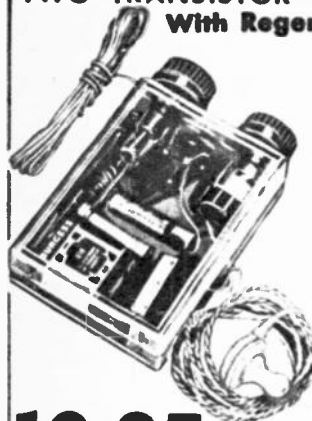

Packed into a 2 1/2" x 3 1/2" x 1 1/4" Plastic Case, this Two Transistor Radio Receiver Kit offers many surprises. Regeneration "Soups Up" the performance of transistor Receivers. Simple transistor radios without regeneration are just crystal detectors followed by audio amplification and there is no R.F. amplification, and sensitivity and selectivity are always poor. In contrast With this, this Lafayette Kit, KT-68, utilizing a regenerative detector circuit and one stage of transformer coupled audio, gives you high gain and sharp selectivity. In the wee hours, you may pull in stations halfway around the country. At the beach, on picnics or camping trips, the set will deliver almost any station on the dial, with more than ample volume. It has more battery life than you would dream of getting from a tiny 15 volt battery. The kit comes complete, with TWO TRANSISTORS, Argonne specially designed Transistor Audio Transformer, Antenna lead, Bakelite Board for mounting parts, Transparent Plastic Case, Condensers, Resistors, etc., including Schematic and instructions. Shpg. Wt. 1 1/2 lbs.

10.95
LESS EARPHONE

KT-68A—Complete kit with batteries but less earphone. Net 10.95
KT-68—as above but with MS111 crystal earphone. Net 11.40
MS-260—Super power, high output dynamic earphone for optimum results. Net 3.95

TRANSISTOR CODE PRACTICE OSCILLATOR KIT

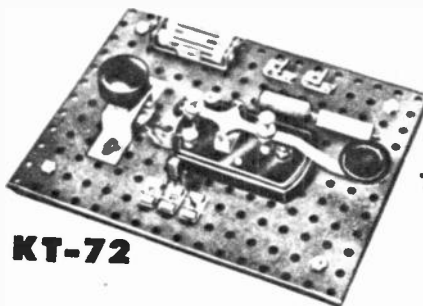

COMPLETE
WITH
TELEGRAPH
KEY &
TRANSISTOR

2.99

For those interested in mastering the international code, an audio tone oscillator is essential. The circuit of this transistorized feedback oscillator has the simplicity of the neon glow, the signal strength of the vacuum tube, and requires only two penlite cells for weeks of service. It may be used for solo practice, or two may send and receive with the same unit. Kit comes complete with Transistor, Telegraph Key, Resistors, Condensers, Masonite Board, etc., and Schematic Diagram. KT-72 including batteries Shpg. Wt. 1 1/2 lbs. Net 2.99
Cannon AM-15-1—Single headset Net 1.18

KT-97



1 AND 2 TRANSISTOR POCKET RADIO KITS ONE TRANSISTOR POCKET KIT — KT-97 • WITH NEW SUPER-SELECTIVE TAPPED FERRI-LOOP

• PREPUNCHED CHASSIS FOR EASY ADVANCEMENT TO 2 TRANSISTOR KIT

An ideal, neat and low-cost transistor pocket radio kit for students, hobbyists and experimenters interested in a practical and basic knowledge of transistor circuits. Employs the new tapped variable Ferri-Loop and a specially designed miniaturized 365 uuf variable capacitor for super selective tuning. Includes a Crystal Diode detector and a reliable transistor in a grounded emitter amplifier stage for maximum output. Will give good reception up to 50 mile radius with approx. 50 ft. antenna and a good ground. Complete with transistor, crystal diode, penlight battery, plastic case, variable capacitor, tapped Ferri-Loop, resistor, capacitors, a neat prepunched metal chassis that makes advancement to the 2 Transistor Kit easy-as-pie. With simple, detailed How-To-Do-It Instructions. Size: 3 3/4" x 2 3/4" x 1". Shpg. wt., 1 lb.

KT-97 — Complete Kit (less earphone) Net 4.50

TWO TRANSISTOR POCKET RADIO KIT — KT-98

The 1 Transistor Pocket Radio Kit plus an additional resistance coupled transistor stage for increased sensitivity and greater output. Can receive even the weaker stations with an approx. 50 ft. antenna and ground. Includes all the KT-97 parts plus one transistor, 2 resistors, one capacitor and transistor socket. Complete with simple, detailed instructions. Size: 3 3/4" x 2 3/4" x 1.3-1/16". Shpg. wt., 1 lb.

KT-98 — Complete 2 Transistor Kit (less earphone) Net 5.95
MS-111 — Crystal Earphone for KT-97 and KT-98 Net 1.19
MS-260 — Super power high output dynamic earphone for optimum results Net 3.95

LAFAYETTE EXCLUSIVE ADD-A-UNIT TRANSISTOR EXPERIMENTERS KITS

KT-88

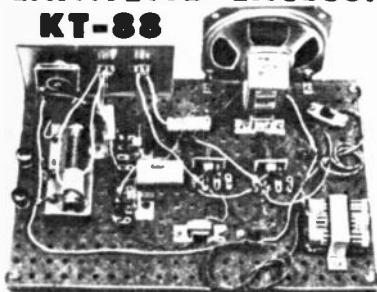

NEW! PRACTICAL! PROGRESSIVE! Lafayette's transistor lab kits will introduce you to the new miracle of the electronic age — the transistor. You build practical operating units with both NPN and PNP transistors that teach you the fundamentals of transistor circuitry. Additional kits expand the usefulness of the basic kit without duplicating parts so you can economically carry on further experiments.

THE 5-IN-1 BASIC KIT

- BUILD A SIMPLE RECEIVER
- BUILD A REGENERATIVE RECEIVER
- BUILD A CODE TRANSMITTER
- BUILD A LIGHT-POWERED RECEIVER
- BUILD A CODE PRACTICE OSCILLATOR

With the basic 5-in-1 Kit you can build any of these 5 projects. They are simple to assemble from the instructions and each in turn utilizes basic principles and some of the circuitry of the previous project. You build not only such basic units as receivers and code oscillator and transmitters but even a receiver operated by a sun battery! You learn to work with sub-miniature parts such as the exclusive Lafayette variable condenser that is only 3/16" thick by 1 1/2" square. Kit is complete with all parts, schematic, pictorials and instructions. Less headphone, tape and solder. Shpg. wt., 4 lbs.

KT-88 . . . 5-in-1 BASIC KIT Net 11.95
CANNON EC-1 . . . HEADPHONE 1.13
MS-368 . . . SENSITIVE MINIATURE EARPHONE 1.44

13-IN-1 EXPANSION KIT

- SENSITIVE PHOTO CELL RELAY
- RAIN ALARM
- LIGHT-POWERED OSCILLATOR
- ELECTRONIC RELAY
- SIMPLE PHOTO CELL RELAY
- HIGH GAIN RECEIVER
- ELECTRONIC METRONOME
- WIRELESS MICROPHONE

An exciting addition to the KT-88 kit to enable you to continue this fascinating and educational program of instruction, including the making of printed (etched) circuitry. The additional parts, diagrams and instructions (along with the parts in the basic 5-in-1 kit) cover the 8 added projects listed above. You'll be able to do such interesting things as broadcasting through your radio without connecting wires, detect moisture or rain, make light actuated relays and much more. And when you've done all these, you can look forward to more Lafayette expansion kits to increase the utility of the kits you already have. Kit is complete with all parts and instructions. Shpg. wt., 3 lbs.

KT-89 . . . EXPANSION KIT Net 7.50

24-IN-1 ADVANCED KIT

- HIGH GAIN REGENERATIVE RECEIVER
- ELECTRONIC TIMER
- LIGHT BEAM RECEIVER
- "ALL-FREQUENCY" SIGNAL GENERATOR
- CODE PRACTICE OSCILLATOR WITH LOUDSPEAKER
- LOUDSPEAKER OPERATED METRONOME
- DELUXE RAIN ALARM WITH SPEAKER
- MUSICAL LIGHT TOY
- SOUND SWITCH
- AUDIO AMPLIFIER
- "DELUXE" LOUDSPEAKER RECEIVER

Lafayette's latest challenging additions to the exciting new transistor ADD-A-UNIT KITS KT-88 and KT-89. Expand your knowledge of the thrilling transistor by building these enjoyable advanced practical operating units. You build an efficient Electronic Timer, specially useful for short intervals; a Speaker operated Metronome for comfortable musical practice; a "Musical Light" Toy that is fun for the children and will mystify guests at the house; a Sound Switch that will delight you as a TV commercial killer; a reliable Audio Amplifier for phono and public address operation; a "DELUXE" Loudspeaker Receiver that will surprise you with its performance, and many more! The parts supplied with this kit together with those in the KT-88 and KT-89 cover the 11 added advanced projects listed above. Complete with all parts and instructions. Shpg. wt., 5 lbs.

KT-90 . . . Net 12.50

**SPECIAL
Combination
Price**

**KT-88
KT-89
KT-90
ALL 3 KITS FOR
29.95**



Net **18.75**

KT-88 and KT-89 Kit bought together

EDUCATIONAL! PRACTICAL! FUN TO BUILD!

SHORT WAVE CONVERTER KIT LAFAYETTE 10-IN-1 LAB KIT • EDUCATIONAL • PRACTICAL



- LISTEN TO SHORT WAVE STATIONS
- POLICE CALLS—SHIPS—PLANES—HAMS
- FOREIGN COUNTRIES

Easily constructed—fascinating addition to any existing receiver. Converts any superheterodyne radio into a double superheterodyne short wave receiver. No electrical connection between radio and converter are used. A magnetic pick-up device is included for coupling the radio and converts electronically. Can be used with any loop or ferrite rod antenna. Receives all short wave broadcasts from 2 megacycles through 18 megacycles. Self contained power supply. Uses two flashlight cells and one 45 volt battery. Kit includes plastic case, 3A5 tube, variable condenser, chassis, hardware, front panel, set of plug-in coils and complete instructions. Shpg. wt., 2 lbs.

KT-123Net 9.80
 KT-77—Economy Antenna Kit.....Net 1.05
 Batteries for above 2-#2 cells.....ea., Net .10
 1-XX30 45 volts.....ea., Net 1.58

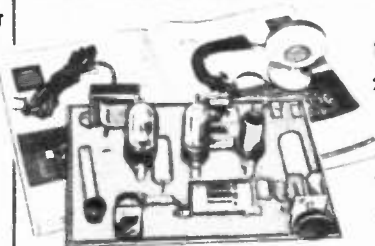

Here is a new laboratory tested experimenters kit designed to provide maximum instruction and entertainment and which is ideal for both the beginner and advanced experimenter. Features practical and interesting circuits which enable you to do many novel and interesting things while learning how these circuits function. You can broadcast your voice or play a phonograph through your radio from anywhere in the house, send code through a headphone or radio, or use light or body capacitance to activate electrical circuits. Safe, low voltage is utilized. Kit is complete with perforated mounting board, 3 vacuum tubes, microphone and all parts necessary for construction. A detailed 12 page instruction manual contains simple-to-follow pictorial and schematic diagrams for each project. Less headphone, photoelectric cell and socket, wire and solder. Shpg. wt., 5 lbs.

KT-36ANet 12.95
 PHOTOELECTRIC CELL TYPE 868..... 2.85
 AMPHENOL 77MIP4 SOCKET FOR ABOVE..... .08
 CANNON AM-15-1 1000 OHM SINGLE HEADPHONE..... 1.18

You Build:

1. RADIO RECEIVER
2. PHONO-MICROPHONE AMPLIFIER
3. PHONO OSCILLATOR
4. BROADCAST STATION
5. CODE PRACTICE OSCILLATOR
6. SIGNAL TRACER
7. CAPACITY OPERATED RELAY
8. ELECTRONIC TIMER
9. ELECTRONIC SWITCH
10. PHOTOCCELL RELAY

NEW! "SUNFLEX" 45 TRANSISTOR REFLEX RADIO RECEIVER KIT



- FOR SOLAR OR FLASHLIGHT BATTERY OPERATION
- NPN-PNP COMPLIMENTARY SYMMETRY CIRCUIT SUPER-REFLEXED FOR 3 TRANSISTOR PERFORMANCE
- BUILT-IN "HI-Q" FERRITE ANTENNA

An efficient and economical miniature receiver kit for earphone operation. Uses one NPN transistor, one PNP transistor and a crystal diode in an ingenious reflexed complimentary symmetry circuit for 3 transistor performance. Gives surprisingly good reception of local stations in most locations without external antenna or ground connections. Antenna plug-in lead supplied for reception of distant stations. Current drain is less than 1 millamp. Operates on 2 inexpensive penlight flashlight batteries (3 volts) or will give lifetime performance in sunlight or under artificial light with use of amazing new silicon solar battery (not supplied). Ideal for the beach, ball games and other outdoor uses as well as for indoors. Complete with all parts, transistors, diode, perforated chassis, two-tone plastic case, batteries, wire, solder and easy to follow instructions. Size 4 1/2" x 3-5/8" x 1-5/8". Shpg. wt., 1 lb. KT-132—KIT (less earphone).....Net 11.95
 MS-260 — Super power dynamic earphone..... Net 3.95

GERMANIUM DIODE RADIO KIT

Real basic kit using the new germanium diode to build a highly sensitive radio set. Requires no batteries or power supply. Kit includes pre-wound coil, single gang condenser, germanium diode, board, template, headphone, knob, hardware and instruction book. Less wire. Shpg. wt. 2 lbs.



KT-43.....Net 3.26

ECONOMY ALL-PURPOSE DYNAMIC EARPHONES.

- FOR TRANSISTOR AND SUBMINIATURE RECEIVERS
- FOR SILENT RADIO AND TV LISTENING.

A sensitive all-purpose earphone designed with both your listening pleasure and pocketbook in mind. Extensive range and excellent tone combine to provide excellent reproduction. Lightweight, equipped with a practically invisible ear support, that slips comfortably over either ear, from which the earphone can't slip out or fall. Ideal for use with TV and radio sets, amplifiers, miniature and transistor receivers, etc. Attractive unit with shiny chrome finish. Complete with a 3 ft. cord. A super value at this price. Shpg. wt., 5 oz.



MS-365 6 ohm impedance, with phone tip plugs. For silent radio or TV listening..... Net 1.10
 MS-367 2000 ohm impedance, with phone tip plugs..... Net 1.25
 MS-366 6 ohm impedance with subminiature phone plug and matching phone jack..... Net 1.29
 MS-368 2000 ohm impedance with subminiature phone plug and matching phone jack..... Net 1.44

As Low
As \$1.10

MIGHTY SUBMINIATURE "HELIODYNE" SOLAR SILICON BATTERY

- LATEST, MOST EFFICIENT TYPE OF SUN BATTERY
- USED BY ARMED SERVICES TO POWER ELECTRONIC EQUIPMENT

The most efficient type of solar battery yet developed to generate electrical energy from sunlight or from light rays from other sources. Rated 3.2 volts at 2 milliamperes. Ideal for operating Lafayette "Sunflex" Radio Receiver Kit or any other receiver drawing up to 2 ma at 3 volts. 1-1/16" L x 3/32" W.

MS-420—"HELIODYNE" SILICON SOLAR BATTERY.....Net 6.65



NEW! 4 TRANSISTOR TELEPHONE PICK-UP AMPLIFIER KIT

- FOR FAMILY AND BUSINESS GROUP LISTENING
- HI-GAIN AMPLIFIER FOR PHONO AND MIKE



Lafayette's new Super-Sensitive 4 Transistor Telephone Pick-up Amplifier with class "B" push-pull output for efficient speaker operation. Permits the whole family to enjoy phone conversations. Invaluable on long distance calls, as well as for group listening on business calls and conferences. No need for extension phones! Just place the pickup coil under the telephone cradle base, or in case of metallic base, near phone receiver and you'll marvel at how loudly and clearly the two-way conversation comes through the speaker. Uses transformer coupling for optimum performance. The kit comes complete with all parts including 4 transistors, 3 transistor audio transformers, speaker, volume control, an attractive ripple-finish metallic cabinet, a pre-cut metallic chassis that makes mounting and wiring of parts a "snap", wire and solder, less battery and pick-up coil. Includes easy-to-follow illustrated instructions. Size 4 1/2" H x 4 1/4" W x 4 1/4" D. Shpg. wt., 3 lbs.

KT-131 Complete Kit Less Battery & Pickup Coil.....Net 17.95
 BATTERY 9 Volts RCA VS305 or Equivalent.....Net 1.30
 MS-16 Telephone Pickup Coil.....Net 2.95

TRANSISTORIZED CODE PRACTICE OSCILLATOR KIT

- SPEAKER OPERATED



7.95

An ideal Code Practice Oscillator for group and classroom code practice, as well as for those who prefer loudspeaker to earphone listening. This attractive unit incorporates a well designed transistor audio circuit with a variable control for varying the signal tone. You choose the pitch which is most pleasing to you. Ingeniously designed on a neat pre-punched metal chassis to fit around the magnet of an extra efficient speaker. All the components (except the key) are housed in a 3-1/16" x 2 3/4" x 1 3/8" attractive maroon colored sound box acoustically designed for superior speaker performance. You'll be delighted with the tone and volume of the signal. Complete with all parts, transistor, speaker, case, battery, and simple step-by-step instructions. 3-1/16" x 2 3/4" x 1 3/8". Shpg. wt., 1 lb.

KT-118—Complete Kit—Less Key.....Net 7.95
 MS-319—Key for KT-118. Shpg. wt., 1/2 lb.....Net 1.25

Auto Radios-Rear Seat Speakers-Silent Viewer

MOTOROLA AUTO SETS

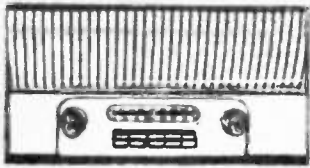

SPECIAL CUSTOM SERIES

- TRANSISTOR POWERED
- PUSH BUTTON TUNING
- CUSTOM FITTED TO EACH CAR

**BUICK - CHEVROLET - DODGE
OLDSMOBILE - PONTIAC -
VOLKSWAGON**

Specifically designed to custom fit your car with simplest installation. Sensitive transistor powered circuit uses 5 tubes plus rectifier. Heavy duty 6"x9" PM speaker, automatic volume control, and tone control. Low battery drain. Available for 6 or 12-volt operation (specify).

Model

CTA6X —For Chevrolet 55-56.....	} NET EACH	59.95
CTA7X —For Chevrolet 57.....		
BKA6X —For Buick 56.....		
BKA7X —For Buick 57.....		
DG7A —For Dodge 57.....		
OE7X —For Oldsmobile 57.....		
PCA7X —For Pontiac 57.....		
VWA7 —For Volkswagon 53 thru 57.....		

STATION WAGON REAR SEAT AUTO SPEAKER KITS

- CUSTOM DESIGNED HOUSING TO FIT YOUR CAR
- EASY TO INSTALL—NO HOLES TO CUT

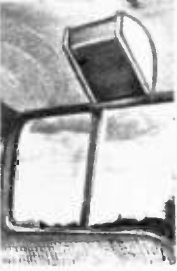

Solves problem of installing additional speaker in station wagons. NO SPEAKER HOLES TO CUT! All wires, brackets and screws are hidden from view after installation. Good quality 6 x 9" speaker mounted in handsome ivory and gold housing designed to fit your particular car. The 3-way switch

controls choice of either speaker alone, or both together. Supplied complete with all parts, hardware and instructions. Shpg. wt. 6 lbs.

NO.	CAR	YEAR	} ANY TYPE 8.08
SB-41	Ford & Merc.	52 thru 56	
SB-43	Ford & Merc.	57	
SB-42	Chev. & Pont.	55 thru 57	
SB-42	Buick	55 thru 56	
SB-42	Packard	57	
SB-44	Plym. & Dodge	56	
SB-46	Plym. & Dodge	} 57	
SB-46	De Soto & Chrysler		
SB-47	Rambler	56 thru 57	
SB-48	Buick & Oldsmobile		

CONVERTIBLE AND SPORT CARS REAR SEAT SPEAKER

- ONE MODEL FITS ALL
- NEW 2 1/2" x 10" SPEAKER

Engineered so that one model fits practically all convertible and sports cars. 2 1/2" x 10" speaker, silicone treated to resist water damage, mounted in a high impact, high gloss, styrene moulded cabinet. Directs sound to rear seat occupants. Back of front seat section serves as bass resonator.

Mounts above knee-level—does not interfere with entering or leaving car. No wires show. Neutral ivory color. Can also be used in boats, aircraft, and as an extension speaker. Complete with harness. Shpg. wt. 6 lbs.

SB-58.....Net 8.08

UNIVERSAL CUSTOM SERIES WITH EXTERNAL OVAL PM SPEAKER

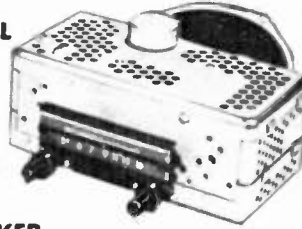

A truly flexible car radio that can be installed in a wide variety of makes and years, including some foreign sports cars. Equipped with tone control, noise eliminator circuit and automatic volume control. Powerful 6x9" speaker* gives exceptional music and voice reproduction. Iron core IF and diode coils for maximum efficiency.

7M - 6—For 6-volt Battery.....	Net	41.25
7M - 12—For 12-volt Battery.....	Net	43.75
7MX —For 12-volt Transistor Powered.....	Net	43.75

TRIM PLATES FOR ABOVE—SPECIFY MAKE AND YEAR

YEAR	MAKE	NET
54-55-56-57	Buick, 12V.	4.35
53-54-55-56-57	Chevrolet	4.35
57 *	Chrysler	6.75
55-56	De Soto	4.35
57 *	De Soto	6.50
55-56-57 *	Dodge	4.75
53-54	Dodge	4.35
52-53-54	Ford	4.35
55	Ford	6.95
56-57	Ford	4.35
52-53-54-55-56-57 *	Mercury	4.35
54-55-56	Oldsmobile	4.35
55-56	Packard	4.35
53-54-55-56-57	Plymouth	4.35
55-56-57	Pontiac	4.35
56-57-58	Renault	6.75
53-54-55-56-57	Studebaker	4.35
53-54-55-56-57-58	Volkswagon	4.35

*1957 Chrysler, Dodge and Plymouth have 5x7" speaker

Deluxe REAR SEAT AUTO SPEAKER KIT

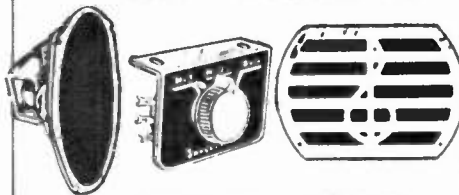

DeLUXE 6" x 9" KIT WITH 2.15 OZ. ALNICO V MAGNET

A complete kit for adding another speaker in the rear of your car. You get a 6" x 9" PM speaker with a 2.15 oz. Alnico V magnet (the same heavy duty type you find in kits selling for twice this price); a three position selector switch so you can select either speaker alone or both together, dial plate with mounting bracket, knob and hardware; a chrome grille, wire and wiring instructions. Simple to install. Shpg. wt. 5 lbs.

SK-37.....Net 4.65

DELUXE 5" x 7" KIT

Contains same accessories as above kit—except uses lighter 5" x 7" speaker and chrome grille. Shpg. wt. 3 lbs.

SK-42.....Net 3.92

FADER TYPE AUTO KITS

Rear seat auto speaker kits, identical to the above but with fader type control, which gradually increases volume on one speaker while diminishing other. Speakers can be set at equal volume or any variation desired. Shpg. wt. 5 lbs.

SK-55—5 x 7 kit.....Net 4.16

SK-56—6 x 9 kit.....Net 4.89

HI-FI REAR SEAT AUTO SPEAKER KITS FEATURING 6 x 9 COAXIAL SPEAKER WITH TWIN TWEETERS



Add Hi-Fi Listening to Your Car

Identical to SK-37 auto speaker kit shown at left except for high fidelity 6 x 9" coaxial speaker instead of single cone unit. Excellent for the music listener who wants fine quality reproduction in his car.

SK-77—Shpg. wt. 6 lbs.....Net 8.80

FADER TYPE AUTO KIT

Coaxial kit identical to SK-77 but with fader control which gradually increases volume on one speaker while diminishing volume on other. Speakers can be set at equal volumes or any variation desired.

SK-78—Shpg. wt. 6 lbs.....Net 9.00

REMOTE CONTROL FOR SILENT TV VIEWING

- SIMPLE TO ATTACH TO ANY TV SET OR RADIO
- SEE AND HEAR — NOISELESSLY — CONVENIENTLY
- LOOK AT THESE FEATURES!

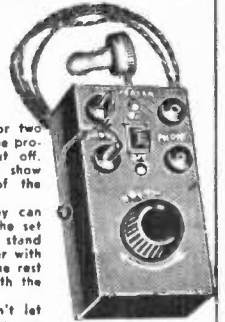

- FOR LATE LISTENERS:** One or two people can both see and hear the program with the loudspeaker cut off. Taps for enjoying the late-life show without disturbing the rest of the household or the neighbors.
- FOR HARD-OF-HEARING:** They can see and hear without turning the set volume so high that others can't stand the noise. They can listen either with the loudspeaker cut off or, if the rest of the family want to hear, with the speaker on.
- FOR NOISY PROGRAMS:** Don't let the kids' "Wild Western's" bother you. Let them watch and listen with the speaker cut off.
- FOR NORMAL OPERATION:** Does not affect your regular use of the T.V. set. Does not have to be disconnected from set.
- REMOTE CONTROL:** Comes complete with 20 ft. of cable so it can be operated comfortably from a distance. Has its own volume control, speaker on-off switch, and two sets of jacks to either 1 or 2 ear phones can be connected.
- DYNAMIC EAR PHONE:** Set is supplied with one of AR-GONNE exclusive, Hi-Fi dynamic miniature earphone. Highly sensitive and efficient. Phone is complete with 3 ft. cord and tips, ready to insert in control box.
- CONVENIENT:** Size only 3 1/4" x 2 1/4". Complete with 1 earphone and 20 ft. cable. Completely wired with instructions. Shpg. wt. 3 lbs. MODEL MS-125 NET 6.50

EXTRA EARPHONE

To plug in to extra jacks on control box so two can listen. AR-51 NET 1.95

NOISE SUPPRESSOR KITS

For all 6 cylinder cars. Includes spark plug suppressors—distributor suppressor—generator and light or ammeter condensers. With instructions. Shpg. wt., 6 oz.

MS-418.....Net 2.16

MS-419 for 8 cylinder cars.....Net 2.59

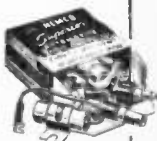

YOUR EICO KIT...LIFETIME SERVICE..LAB PRECISION..LOWEST COST

NEW DC WIDE BAND EICO MODEL 460K 5" OSCILLOSCOPE

COLOR AND MONOCHROME LABORATORY AND TV SERVICE SCOPE LIFETIME GUARANTEE! • 5 MC BANDWIDTH AND DC AMPLIFIERS!
Flat from DC to 4.5 mc for reproduction of 3.58 mc sync burst and oscillator signals in color TV sets. Vertical amplifier direct-coupled and push-pull throughout. Cathode follower between stages. High vertical sensitivity - 25 millivolts per inch. Balanced or unbalanced inputs. Four step frequency-compensated attenuator in both AC and DC positions. Accurate direct peak-to-peak voltage measurement. Automatic sweep limiter and amplifier wave forms automatically synchronized. Pre-set TV V and H sweep positions (30 cps and 7875 cps). Edge-lit lucite graph 5 in. screen with dimmer control. Controls on clearly visible deep etched satin-finish front panel. Can be built as home special equipment or special knowledge. Truly an unmatched engineering achievement for your test bench!
Size: 13" W x 8 1/2" H x 16" D; Shpg. wt., 30 lbs.
MODEL 460K - Oscilloscope Kit Net 79.95
MODEL 460 - As above, but factory wired. Net 129.30



MODEL 232K PEAK-TO-PEAK VACUUM TUBE VOLTMETER

• **THE NEW LEADER IN PROFESSIONAL PEAK-TO-PEAK VTVMs**
• **WITH THE SENSATIONAL AC/DC UNI-PROBE!**
Measures directly peak-to-peak voltage of complex and sine wave; 0-4, 14, 42, 140, 420, 1400, 4200 DC/RMS sine volts; 0-1.5, 5, 15, 50, 150, 500, 1500 (up to 30,000 volts with HVP probe, & 250 mc with PRP probe). Ohms: 0.2 ohms to 1000 megohms. Individual leads on every 7-section. Calibration without removing from cabinet. 4 1/2" meter, can't-burn-out circuit. Zero center. 1% multipliers. With sensational new AC/DC Uni-Probe that performs all functions. Exceptional stability and accuracy. Size: 8 1/2" x 8" x 5 1/2". Shpg. wt., 7 lbs.
Model 232K - Kit, complete Net 29.95
Model 232 - As above, but factory wired Net 49.95



NEW! DYNAMIC CONDUCTANCE TUBE AND TRANSISTOR TESTER MODEL 666

An ideal tube tester for color and monochrome TV servicing. Tests all receiving tubes under simulated operating conditions, including 4, 5, 6, 7-pin, octal, loctal, miniature 7 and 9-pin, subminiature 5, 6, 7-pin (in-line base) and 8-pin (circular base) receiving tubes, transmitting and special-purpose tubes, VR, cold-cathode rectifiers, magic eye and hallast tubes. Tests color and black-and-white TV picture tubes with accessory adaptor. Tests p-n-p and n-p-n transistors with recognized dependable 1000 megohm individual leads on every 7-section. Calibration without removing from cabinet. 4 1/2" meter, can't-burn-out circuit. Zero center. 1% multipliers. With sensational new AC/DC Uni-Probe that performs all functions. Exceptional stability and accuracy. Size: 8 1/2" x 8" x 5 1/2". Shpg. wt., 7 lbs.
Model 666K - Kit, complete Net 69.95
Model 666 - Factory wired Net 109.95

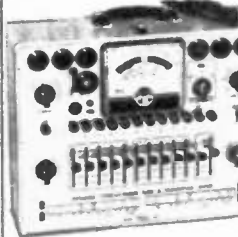

EICO MODEL 324K RF SIGNAL GENERATOR

• **New one generator covers whole range of 150 kilocycles to 435 megacycles!**
For IF-RF alignment, signal tracing and trouble-shooting of TV, FM, AM sets all on fundamentals; marker generator for alignment of new h-f and older i-f TV IF's. 400 cps sine wave audio testing. Range: 150kc-145mc on fundamental; 11-435 mc on calibrated harmonics. ± 1.5% frequency accuracy. Variable depth of internal modulation 0-50% by 400 cps. Colpitts oscillator. Variable gain external modulation amplifier; approx. 3 volts or 30% modulation. Target-mounted, slug-tuned coils. RF output 100,000 microvolts. AF output up to 10 volts. Size: 8" x 10" x 4 1/2". Shpg. wt. 10 lbs. For 105-125 V AC 50/60 cps.
Model 324K - Kit, complete NET 26.95
Model 324 - Factory wired and tested NET 39.95



MODEL 147K DeLUXE MUTLI-SIGNAL TRACER

Unsurpassed facilities for RF/IF/audio signal tracing and trouble shooting AM/FM/TV sets. Simultaneously observe 2 patterns on 1 scope; compare voltage and current amplitudes, waveforms, frequencies and phase relationships; set up voltage reference level, etc. Separate audio and RF and low gain audio input channels. Magic eye monitors both channels in addition to speaker for signal strength and gain per stage. Continuously variable switching ranges from 10 to 2000 cps. With shielded RF demodulator and audio probes. For 105-125V AC, 50/60 cps, 25 watt. Size: 6" x 8" x 6". Shpg. wt., 7 lbs.
Eico Model 147K Deluxe Multi-Signal Tracer Kit NET 24.95
Model 147 Deluxe - Above, but factory wired. NET 39.95

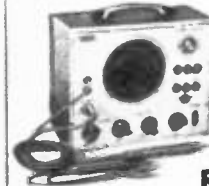

RETMA CAPACITANCE SUBSTITUTION BOX MODEL 1120

Enables rapid substitution of a wide range of RETMA capacitance values from 0.0001 to 0.22 MFD in an operating circuit to determine value needed for best performance and to find value of badly damaged or illegible capacitors. Minimum accuracy ± 10%. Uses silver-mica and molded plastic capacitors rated approx. 600 volts. Satin-finish aluminum panel. Size: 3 1/2" H, 6 3/4" W, 3 1/4" D. Shpg. wt., 2 lbs.
Model 1120K - Kit Net 5.95
Model 1120 - Factory Wired Net 9.95



RETMA RESISTANCE SUBSTITUTION BOX MODEL 1100

Enables rapid substitution of a wide range of RETMA resistance values from 15 ohms to 10 megohms in decade multiples of 15, 22, 33, 47, 68, 100 ohms. Uses standard 1 watt, ± 10% RETMA resistors. Convenient 5-way jack-top binding posts. Handsome satin aluminum front panel. Size: 3" H, 8 1/2" W, 3 1/2" D. Shpg. wt., 2 lbs.
Model 1100K - Kit Net 5.95
Model 1100 - Factory Wired Net 9.95

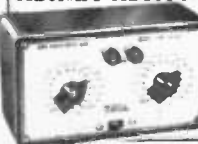

MODEL 221 VACUUM TUBE VOLTMETER

Versatile top-quality laboratory-precision VTVM for trigger-fast operation and lifetime dependable service. 15 different ranges. Large rugged 4 1/2" meter, can't burn-out circuit. New zero center for TV & FM discriminator alignment. Electronic AC & DC ranges: 0-5, 10, 100, 500, 1000 v. (30,000 volts and 200 MC with HVP-1 and P-75 probes). Ohmmeter ranges, 2 ohms to 1000 megohms. 2B circuit. New stable double triode balanced bridge circuit - extreme accuracy. 26 megs DC input impedance. Attractive 3-color etched rubberproof panel; rugged steel case. 116 v., 60 cycle AC. 9-1/16" x 6" x 5". Shipping Weight, 10 lbs. Includes all parts and tubes.
Eico Model 221-K - Kit complete. Net Each 25.95
Eico Model 221 - Factory wired. Net Each 39.95
Carrying Case for Model 221 VTVM - Black leatherette case for portability and protection. Zipper top and inside pocket for leads. Shpg. wt., 3 lbs. Net 3.95



EICO MODEL 377K SINE & SQUARE WAVE AUDIO GENERATOR

• **AN EXCELLENTLY DESIGNED GENERATOR THAT REPLACES TWO SEPARATE INSTRUMENTS FOR LESS THAN THE PRICE OF ONE!**
When Bridge (using circuit: 1 1/2 resistors and 4-gang condenser. Frequency range: Sine wave, 20-200,000 cps; square wave, 60-50,000 cps. Response ± 1.5 db, 60-150,000 cps. Distortion less than 1%. Hum less than 0.4%. Accuracy ± 3%. Output: 1000 mva across 1000 ohm rated load (100 mw). Size: 7 1/2" x 11 1/2" x 7 1/2". Shpg. wt., 14 lbs.
Model 377K - Kit, complete Net 31.95
Model 377 - As above, but factory wired and tested Net 49.95



NEW! UTILITY TESTER MODEL 540

An all-in-one Multi-Range ac/dc voltmeter, ammeter, ohmmeter, wattmeter and leakage checker. Indispensable in home repairs of electrical appliances and in automotive trouble-shooting of batteries, generators, distributors, etc. 4 ranges from 0-3000 volts ac/dc; current range 0-15 amps ac/dc, 3 1/2" meter in clear lucite case. Size: 3 3/4" x 6 1/2" x 3 1/2". Rugged black bakelite case. Shpg. wt., 3 lbs.
Model 540-K - Kit Net 12.95
Model 540 - Factory Wired Net 15.95



MODEL 625K TUBE TESTER

Features lever-action switches for testing each tube element. Tests all standard AM, FM and TV tubes including 9-pin miniature, VR, magic eye and pilot bulbs. Large 4 1/2" meter has colored markings to indicate condition of tube. Illuminated roll chart gives tube test settings at a glance. Has two leads with grid-clip connectors. Also tests for shorts and open elements. Protective overload pilot bulb. Built-in power supply. For parts, etc. Size: 12 1/2" x 9 1/2" x 4 1/2". Shpg. wt. 13 lbs.
Eico Model 625K Tube Tester Kit 34.95
Model 625 - As above, but factory wired 49.95



MODEL 950 BK R.C. BRIDGE & R-C-L COMPARATOR

• **EXCELLENT VALUE, HIGHLY DEPENDABLE!**
Latest bridge-type instrument directly reads 0.5 ohms - 500 megs resistance (4 ranges), 100 mfd - 5000 mfd capacitance (4 ranges), and power factor. Kit includes precision calibrating resistor. Unique comparator range for R.C. & L comparison measurement against external standard. Leakage testing of all capacitors at rated working voltage with internal 0-500 vdc source. Electron-ray tube as bridge balance and capacitor indicator. Attractive, durable case, neat easy-to-read characters. Size: 8" x 10" x 4 1/2". Shpg. wt., 8 lbs.
Model 950BK - Kit complete NET 19.95
Model 950K - As above, but factory wired NET 29.95

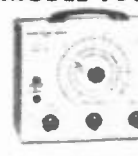

EICO MODEL 1050 BATTERY ELIMINATOR AND CHARGER

Battery eliminator for bench testing and servicing 6V or 12V car radios. Charges for 6V or 12V batteries. DC output: 0-8V or 0-16V; 6V-12V toggle switch. Current rating at 0-8V: 10A continuous; 0-16V: 5A continuous. Current rating at 0-16V: 6A continuous; 0-8V intermittent. Continuous voltage adjustment with Variac-type transformer. Separate voltmeter and ammeter. Fused primary, automatic reset overload relay for secondary. Input: 105-125 VAC, 50-60 cps. Power: 150 watts. Rugged blue-gray laminated steel cabinet; may be wall mounted. Overall dimensions: 10 1/2" x 7 1/2" x 8 1/2". Wt. 15 lbs.
EICO KIT 1050 KIT NET 29.95
MODEL 1050 - As above, but factory wired and tested. NET 39.95

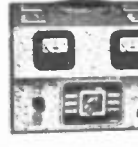

MODEL 1055K BATTERY ELIMINATOR ACCESSORY FILTER

Supplies additional filtering for output of Eico 1050 6V and 12V Battery Eliminator, or similar unit, required for powering 6 or 12 Volt transistor, tube and "hybrid" (tube plus transistor) automobile radios. 4" W x 5" H x 5 1/4" D. Shpg. wt., 8 lbs.
Model 1055 Kit Net 11.95
Model 1055 Factory Wired Net 15.95



MODEL 1060K BATTERY ELIMINATOR & CHARGER

Extra filtered 6V and 12V battery eliminator and charger for transistor, tube or "hybrid" automobile radios. Also charges 6 or 12 volt extra battery, etc. 8 1/2" H x 10 1/2" W x 7 3/4" D. Shpg. wt., 2.1 lbs.
Model 1060 Kit NOT ILLUSTRATED Net 38.95
Model 1060 Factory Wired Net 47.95



EICO PROBES	DESCRIPTION	KIT		Net
		Net	Wired	
Scope Demodulator Probe	PDK	3.75	PD	3.75
Scope Div Probe	PDR	2.75	PD	3.95
Scope Low Capacity Probe	PLCK	3.75	PL	5.75
Set of 3 Scope Probes		9.95		14.95
Peak-to-peak probe for 11 megohm VTVM	PTPIK	4.95	PTP-11	6.95
Peak-to-peak probe for 25 megohm VTVM	PTP25K	4.95	PTP-25	6.95
R.F. Probe for 11 megohm VTVM	PRFIK	3.75	PRF-11	4.95
R.F. Probe for 25 megohm VTVM	PRF25K	3.75	PRF-25	4.95
*30 KV H.V. Probe (Wired only)	HVP-1	6.95		6.95
*30 KV H.V. Probe (Wired only)	HVP-2	4.95		4.95
*Specify male end model of instrument.				
†For all VTVM or 20,000 ohm/volt V.O.M.				

UNI-PROBE

New Uni-Probe, a half-turn of probe-tip selects VTVM DC or AC-OHMS.
Uni-Probe Kit NET 4.95
Uni-Probe - Factory wired NET 6.95

5 MC CRYSTAL 4.5 MC CRYSTAL

Designed for all generators and oscillators, these highest quality crystals accommodate all standard sockets and circuits and give excellent performance with EICO Model 360 TV-FM Sweep Generator. No. G-5 Net 3.95
No. G-4.5 Net 3.95



LAFAYETTE SENSATIONAL VALUES! IN COMPLETELY WIRED TEST EQUIPMENT at LESS than the PRICE of KITS!

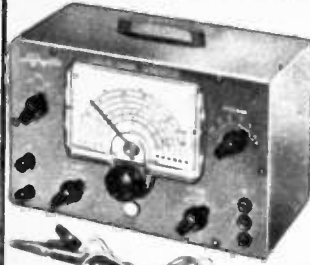

LAFAYETTE SIGNAL GENERATOR

NEVER BEFORE HAS A COMPLETELY WIRED AND TESTED INSTRUMENT OF SUCH ACCURACY AND QUALITY BEEN OFFERED AT SUCH A PRICE!

- FREQUENCY 120 KC TO 260 MC
- 120 KC TO 130 MC ON FUNDAMENTALS
- LABORATORY ACCURACY AND QUALITY

A completely wired and tested instrument not to be confused with units sold in kit form at almost the same price, but with a quality and accuracy of instruments 3 to 4 times its price. Six overlapping ranges generate signals of 120KC—320KC, 320KC—1000KC, 1MC—3.2MC—11MC, 11MC—38MC and 37MC—130MC all on fundamentals with calibrated harmonics from 120MC to 260MC. Selector switch gives instant choice of ranges. Switch gives choice of internal modulation of 400 CPS or use of any external source at other frequencies. For audio testing the 400 cycle signal can be used separately. Outputs are unmodulated RF, modulated RF and 400 CPS audio. RF output is in excess of 100,000 microvolts and jacks are provided for choice of either high or low RF output. Stability is insured by special circuit design. Has a fine adjustment RF control. AF output is 2-3 volts, AF input is 4 volts across 1 megohm. Large clear 5 inch etched dial plate and pointer are protected by transparent plastic bezel. Common AF terminals for EXT-MOD input and INT-AF for audio tests eliminate need for special AF output connectors. Machine engraved panel lettering. Handsome gray metal case with carrying handle. Measures 8 1/2" x 10" x 4 1/2". Comes complete with pair of leads. AC line cord and plug. Operates on 105-125V 50-60 cycle AC. Shpg. wt., 8 lbs.

22.50

LAFAYETTE LSG-10 SIGNAL GENERATOR

22.50

TV-FM SWEEP & MARKER ALIGNMENT GENERATOR

Compare it with instruments at twice the price!

- SWEEP RANGE 3MC-260MC
- MARKER RANGE 3MC-225MC
- COMBINATION CRYSTAL AND VARIABLE MARKER—1% ACCURATE
- SUPPLIED WITH 4.5MC CRYSTAL 0.002% ACCURATE
- SWEEP WIDTH 0-12MC CONTINUOUSLY VARIABLE
- 2-5" DIALS

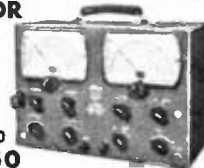

FACTORY WIRED AND TESTED

The Lafayette LSG-50 is a factory-wired and calibrated precision instrument for fast alignment of IF and RF stages of TV and FM receivers. Accurate, linear electromagnetic sweep system covers 3MC-120MC and 140MC-260MC. Sweep width continuously variable 0-12MC. 3 volts RMS, 60 cps sine wave (for oscilloscope) available from front panel. Marker covers 3MC-225MC in 4 ranges. Combination of crystal and variable marking. Marker calibration accuracy better than 1%. 4.5MC crystal mounts on front panel and accurate to 0.002%. Extra input for external marker. The built-in marker may be used independently of the sweep. RF output 100,000 microvolts, controlled by 3-step (X1, X10, X100) and continuously-variable fine adjustment attenuators. Output impedance 75 ohms, unbalanced. CONTROLS: Sweep Width, Horizontal Phase, Retrace Blanking with Off position, Marker Amplifier, RF Attenuators, Sweep Range Selector, Marker Range Selector. Crystal socket, pilot light, external marker input also on front panel. 2-5" easy-to-read dials with vernier-driven dial pointers. Sturdy gray wrinkle metal cabinet with handle. Complete with tubes, 75 ohm output and external marker input cables, 4.5MC crystal. Size 9" x 13 1/2" x 6". Shpg. wt., 20 lbs.

MODEL LSG-50 Net **79.50**

FM-TV MARKER GENERATOR WITH VERTICAL-HORIZONTAL BAR GENERATOR

- GENERATES VARIABLE VERTICAL & HORIZONTAL BARS
- FREQUENCY RANGE 3.5MC-250MC IN 6 BANDS
- COMBINATION CRYSTAL & VARIABLE MARKER—1% ACCURATE



LSG-30 FACTORY WIRED

The LSG-30 is a precision TV and FM marker and bar generator. Range 3.5MC-250MC in 6 bands. Combination crystal and variable marking. Marker calibration accuracy better than 1%. 4.5MC crystal supplied mounts on front panel—accuracy to 0.002%. The LSG-30 also supplies adjustable-frequency vertical and horizontal bars for fast visual adjustment of TV linearity without a test pattern. The audio horizontal bar modulation frequency (approx. 720 cps, variable) also serves as modulator for marker signal, permitting use in stage-by-stage alignment and eliminating need for an additional instrument. 100,000 microvolts RF output, controlled by continuously variable attenuator. Output impedance 75 ohms, unbalanced. Front panel controls: Frequency Range Selector, Signal Selector (CV, Vert. Bar, Horiz. Bar, Xtal) RF Attenuator, Horiz. Bar Control, Vertical Bar Control, Power On-Off. Also on front panel are crystal socket, output connector, pilot light, ground post, and easily readable 5 1/2" dial with clear plastic cover and vernier-driven dial pointer. Sturdy gray wrinkle metal cabinet with handle. Complete with tubes, 75 ohm coaxial cable and crystal. Size 8" x 12" x 5". Shpg. wt. 9 lbs.

MODEL LSG-30 Net **49.95**

NEW POCKET AC-DC VOM MULTITESTER

2,000 ohm per Volt Sensitivity on both DC and AC

- 160 ua 3" METER
- 1% PRECISION RESISTORS
- SILVER CONTACT SELECTOR SWITCH



FULL SCALE RANGES

DC Volts: 0-10; 0-50; 0-500; 0-1000 Volts—AC Volts: 0-10; 0-50; 0-500; 0-1000 Volts—DC Current: 500 ua and 500 ma—Resistance: 0-10K; 0-1 Meg—Decibels: -20 to +22; +20 to 36 db (0 db = 0.775 V)—Capacity: 250 mmfd to 2 mfd—.005 mfd to 1 mfd—Output Ranges: 0-10; 0-50; 0-500; 0-1000 volts

8.95

Best Buy in America! A very accurate and sensitive VOM. This Multitester is a complete instrument (not a kit) with high quality and sensitive 160 microamp meter; 2000 ohm per volt on both AC and DC. Single selector switch, 1% precision resistors, 3" meter. Features extreme versatility, with metal bottom for ruggedness and shielding. First capacity range requires 50 volt AC source. Second capacity Complete with test leads and batteries. Shipping weight 4 lbs. RW-27A Complete **8.95**

HIGH SENSITIVITY 20,000 OHM PER VOLT DC 10,000 OHM PER VOLT AC MULTITESTER



LOOK AT THESE FULL SCALE RANGES!

D.C. Volts: 0-6; 0-30; 0-120; 0-600; 0-1200; 0-6000 Volts—A.C. VOLTS: 0-6; 0-30; 0-120; 0-600; 0-1200 Volts—RESISTANCE: 0-10K; 0-100K; 0-1 Meg; 0-10 Megohms—D.C. CURRENT: 0-60 Microamp; 0-6; 0-60; 0-600 Milliamps—DECIBEL: 20 to +17 db (0 db = 0.775V)—CAPACITY: .0001-.01; .005-.15 mfd—INDUCTANCE: 20-2000 henries—OUTPUT RANGES: 0-6; 0-30; 0-120; 0-600; 0-1200 Volts

19.95

The new Lafayette high sensitivity Multitester is a complete instrument (not a kit). In addition to its unusual sensitivity of 20,000 OHMS PER VOLT ON D.C. AND 10,000 OHMS PER VOLT ON A.C., and the extraordinary number and scope of its ranges, it is packed with features that would make it cost at least twice as much if made in this country. Uses 1% precision resistors, silver contacts on selector switch, 35 ua 3" meter. Dependable, rugged and accurate. Even the test leads are heavy duty with high voltage insulation. Voltage source required for low capacity range is 120V A.C. for high range capacity and inductance scale is 6V A.C. Attractive plastic front with metal bottom. Size 6 1/4" x 4 1/4" x 2 1/2". Complete with batteries and leads. Shipping weight 4 1/2 lbs. RW-30A Singly, Each **19.95** In lots of 3, Each **19.25**



New!
An Exceptional Value

14.50

HIGH SENSITIVITY POCKET MULTITESTER 20,000 OHM PER VOLT DC—10,000 OHM PER VOLT AC

- 36 UA 3" METER
- 1% PRECISION RESISTORS
- EFFICIENT SINGLE SELECTOR SWITCH RANGES

DC VOLTS: 0-10V; 50V; 250V; 500V; 1KV
AC VOLTS: 0-10V; 50V; 250V; 500V; 1KV
DC CURRENT: 0-50UA; 1MA, 25MA, 500MA
RESISTANCE: 0-50,000; 500,000; 5 Megohm
DECIBELS: -20 to +22; +20 to +36

A terrific buy in a convenient, accurate completely wired instrument at a price lower than that of kits not having comparable features. This instrument has a 3" 36 UA meter, 1% precision resistors, a single selector switch in addition to its high sensitivity of 20,000 ohms per volt on DC and 10,000 ohms per volt on AC. It is extremely accurate, versatile and rugged. Attractive plastic front in rugged shielding metal case. IMPORTED TO SAVE YOU MONEY. Size: 3 3/4" x 5 1/4" x 1 3/4". Complete with batteries and test leads. Shpg. wt., 3 1/2 lbs. RW-50 Net **14.50**

LAFAYETTE VALUE PACKED BUYS

RCA "MAGIC BRAIN" TV REMOTE CONTROL

Reg. \$59.95
Special
\$9.95



For all KCS96, KCS97, and KCS66 thru KCS92 Series Chassis—

Over 200 Different RCA Models! Control your RCA TV set from any remote spot in the room (up to 30 ft.) without getting up or touching the receiver! Also perfect for bed ridden or physically handicapped persons who cannot get around easily.

Here is what the remote control can do: (1) TURN SET ON; (2) SELECT DESIRED CHANNEL; (3) ADJUST THE VOLUME; (4) ADJUST PICTURE; (5) ADJUST FINE TUNING; (6) TURN SET OFF. A single compact unit that fits the palm of your hand, gives you all this control from your easy chair. The flat interconnecting cable is easily concealed under the carpet or along the floor baseboard. Installation of all other components is made at the receiver. Components include Relay Chassis, Motor Bracket Assembly, Remote Control Head and Cable, Switches, Mounting Straps, Terminal Board, Resistors, Capacitors and Neon Lamp. Detailed installation instructions included. Shpg. wt., 10 lbs.
TL-46. RCA No. 274 Remote Control.....Net **9.95**

QUANTITY LIMITED!

A LAFAYETTE SPECIAL TUBE TESTER!

COMPLETELY WIRED NOT-A-KIT

A new streamlined tube tester with a realistic approach to the problem of quickly testing the ever increasing number of tube types. It incorporates new and advanced engineering features and all at a price of about half of even the most ordinary tube tester. Read these Specifications.

"FREE POINT" ELEMENT SELECTOR SWITCHING: Newly designed, it reduces possibility of obsolescence to a minimum because any pin may be used as a filament pin and voltage applied between it and any other pin or even the "top cap". Tubes with tapped filaments or with filaments terminating in more than 1 pin are truly tested.

MULTIPURPOSE TUBES: Special isolating circuit allow each section of multi-purpose tubes to be tested individually as if it were in a separate envelope.

SHORTS AND LEAKAGES: Supersensitive method checks shorts and leakages up to 5 megohm between any and ALL elements; continuity between various sections individually indicated.

SIMPLICITY: Fast simple operation. The 4 position fast action snap switches are all numbered in exact accord with RMA standards. Thus when testing element terminating in pin No. 7 of a tube—you use button No. 7. You can't insert a tube in the wrong socket—there's one for each type of tube base.

TUBE TYPES: Tests all octal, loctal, 7 pin miniatures, 9 pin miniatures as well as the new novel and Sub-Minar types. Old type sockets used for testing obsolete types—that you rarely see anymore—have been eliminated.

SIZE: A practical size to carry with you as well as for use in the shop—only 8 1/2 x 6 3/4 x 2 1/4" deep. Shpg. Wt. 5 lbs.

MODEL TD-55—complete with carrying case and instructions..... **26.95**



26.95

20,000 OHM PER VOLT MULTITESTER SEMI KIT

A New Kind of Kit



THE DIFFICULT WORK IS ALREADY DONE



YOU WIRE IN ONLY A FEW PARTS

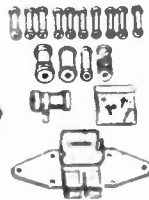

- 20,000 OHMS PER VOLT DC—5,000 OHMS PER VOLT AC
- 40 MICROAMPERE 3" D'ARSONVAL METER MOVEMENT
- HIGH INPUT RESISTANCE ON ALL DC AND AC RANGES

The semi-kit is a new concept in test equipment kits. The meter, rotary selector switch, ohms adjust control, terminal strips and studs all are already mounted on the front panel, with most of the wire leads from the switch in place with one end free. All that remains to be done is to mount the battery holder and wire in the multipliers and resistors, a job so simple you'll finish before you realize it, and best of all, you'll have one of the finest high sensitivity multitesters on the market. Ranges: DC VOLTS 0-10, 50, 250 and 1000; AC VOLTS 0-2.5, 10, 250 and 1000; DC CURRENT: 0-100 UA and 250 MA; DC RES: 0-5000—500,000—5 Megohm with center scales of 50, 5000 and 50,000 ohms; DECIBEL: —20 to +10 db and —8 to +22.

When used in a circuit, the high input resistance on all DC and AC ranges does away with the highly inaccurate readings common to low resistance testers which load the circuit. Black bakelite molded case size 3 3/4" x 4 3/4" x 1 3/4". Complete with test leads, all parts and complete instructions. Shpg. wt. 3 lbs.

TK-20—KIT..... **11.95**
TK-20—WIRED. Same as above, completely factory wired..... **17.50**

INTERMATIC TIMERS

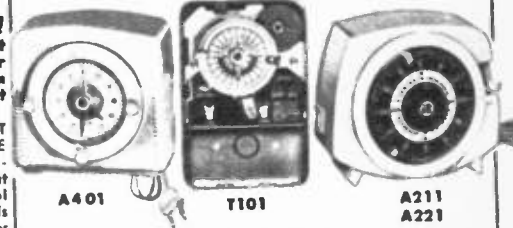

A401

T101

A211
A221

MODEL A211 TIME-ALL • THE AUTOMATIC TIMER WITH THE MIRACLE MEMORY.

Makes practically everything electrical completely automatic. Will handle load up to 1650 watts. Turns radio on and off — does not have to be reset each night. Defrosts refrigerator — turns lights on and off — controls roaster, electric blanket, air conditioner, washing machine, coffee makers, vaporizers, etc. 30 min. minimum on time — 23 hours maximum. As easy to set as an electric clock. Stands on any surface — can be hung on wall. Easy-to-read 24 hour "day and night" dial. Operates day after day without attention. Can be controlled manually without automatic reset. Plug in receptacle for equipment to be controlled. For 110 volt 60 cycle AC only. Complete with 6 ft. cord and plug. Instructions included. 5" x 4" x 2 1/2". Shpg. wt., 2 lbs.

MS-81 A211 TIME-ALL..... Net **7.97**

MODEL A221 TIME-ALL Similar to A211 except has capacity of 875 watts..... **6.64**

MS-359 A221..... **6.64**

MODEL A401 CLOCK TIMER

Not only tells time, but turns appliances both on and off automatically for periods of 15 minutes to 5 1/2 hours. Cooks dinner while you're away, wakes you to music, controls electric fans, heaters, radios, TV sets, etc. No installation problem — just plug it in and set. Capacity 1650 watts. Plaston case 4 1/4" W x 4 1/2" H x 2 1/4" D. 6 ft. cord. For 110V 60 cycle AC. Guaranteed for 1 year. Shpg. Wt., 3 lbs. Price includes excise tax.

MS-104..... Net **9.67**

TYPE T101 TIME SWITCH

Turns equipment "on" and "off" once in 24 hours, or from one to twelve "on" and "off" operations a day can be obtained by use of extra trippers. Extra trippers can be added without removing dial. Min. on or off time 1 hr. max. on or off time 23 hours. Can be turned on or off manually with reset SPST switch rated at 35 amps. 4000 watt capacity. Has convenient mounting holes and knockouts. Large numbers — easy to read — easy to set. Gray steel case with knockouts — hinged door — can be locked or sealed. UL approved. Operates on 110 volt 60 cycle AC only. Size 7 1/4" L x 5" W x 3" D. Shpg. wt., 4 lbs.

MS-82 T101..... Net **7.12**

MS-360 P101. Similar to T101 except case is equipped with receptacle and 6 ft. cord set for plug-in. Capacity 1250 watts..... **8.42**

PORTABLE 2-SPEED PRECISION TIMER

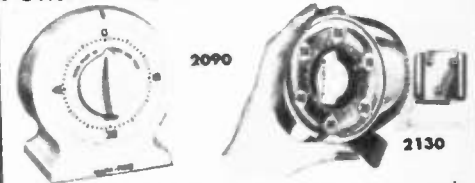

2090

2130

Indispensable for timing precise, short operations such as boiling eggs, pressure cooking, heat and sun lamp treatment, home permanents, photo developing and printing, long distance calls, etc. Times up to 6 minutes in seconds and up to 1 hour in minutes. Exclusive 2-speed feature permits instant timing speed change by flick of a lever. A clear, resonant bell sounds at end of timing period. Can be attached to any surface with handy wall bracket supplied or can stand upright. Smartly styled in white with dial face a rich copper tone. 4" x 2 1/2". Shpg. wt., 2 lbs.

MS-294 MODEL 2130..... Net **4.68**

UTILITY HOUSEHOLD TIMER

This reliable, low-priced timer in a neat durable white plastic case has innumerable household timing uses, i.e., cooking, baking, home permanents, games, remembering appointments, TV and radio programs, etc. Attractive modern design. Times any interval up to one hour accurately and gives resonant bell signal at end of period. Large easy to set and easy to read dial. 3 1/2" x 3" x 1 1/2". Shpg. wt., 1 1/4 lbs.

MS-295 MODEL 2090..... Net **2.95**

Lafayette's EXCLUSIVE VALUES

NEW! MODERN 4-SPEED TURNOVER PICKUP



- 2½ VOLT OUTPUT
- TURNOVER CRYSTAL CARTRIDGE
- DUAL SAPPHIRE
- 40-12,000 CYCLES

A terrific value! Modern plastic straight-line design with offset head and turnover 2½V crystal cartridge with dual sapphire styli. Stylus pressure adjustable by variable spring tension. Finger lift for ease in handling. Overall length 8½". Height from base to bottom of arm 15/16". Simple base mount with 1¼" spaced mtg. holes. Shielded leads. Smooth gray finish plastic arm. Shpg. wt. 2 lbs.

PK-157Net 2.45
 PK-158 sapphire LP replacement needleNet .69
 PK-159 sapphire std. replacement needleNet .69

4-SPEED TURNOVER HIGH OUTPUT PICKUP

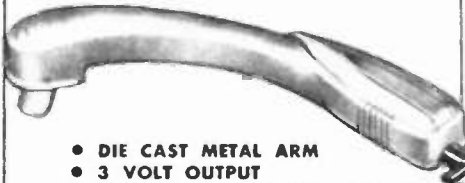

- DIE CAST METAL ARM
- 3 VOLT OUTPUT
- TURNOVER CRYSTAL CARTRIDGE
- DUAL SAPPHIRE STYLI
- 40-12,000 CYCLES

A die cast metal arm with a wide range cartridge that has an unusually high output of 3 Volts. Turnover type with dual sapphire styli. Simple single hole mount. Attractively decorated design. Arm is finished in baked maroon enamel. Overall length 8½". Shpg. wt., 2½ lbs.

PK-89 singly, eachNet 3.75
 in lots of 3, eachNet 3.45

NEW! 4-SPEED HI-FI TURNOVER PICKUP

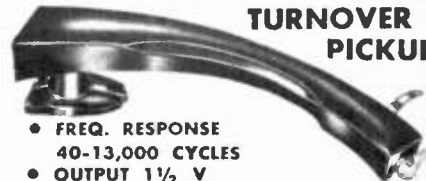

- FREQ. RESPONSE 40-13,000 CYCLES
- OUTPUT 1½ V
- ADJUSTABLE HEIGHT
- TURNOVER CRYSTAL CARTRIDGE
- DUAL SAPPHIRE STYLI

This is a feature packed pickup. In addition to the turnover 1½V wide range crystal cartridge with dual sapphire styli, it has an adjustable base so that height from base to bottom of arm can be varied from 1¼" to 1-9/16". Stylus pressure adjustable by variable spring tension. Finger lift provides easy handling of arm. Curved and straight lines are combined in an unusually attractive design. Plastic arm 9½" long overall. Base 1¼" W with mtg. holes on 1½" centers. Shielded leads. Satin smooth bright maroon finish.

PK-146 Shpg. wt., 2 lbs.Net 2.75
 PK-158 Sapphire LP replacement needleNet .69
 PK-159 Sapphire STD replacement needleNet .69

NEW "DYNA-SLIM" MICROPHONE

- HIGH IMPEDANCE — 50,000 OHMS
- ON-OFF SWITCH
- "QUICK-SLIP" ADAPTER

6.95



New dynamic, high output microphone with all the features of "mikes" costing 3 times Lafayette's price! Output level —55 db. Smooth response from 60 to 10,000 cycles. Omnidirectional head. External on-off switch. Slips on or off stand adapter in a wink. Standard ¾" —27 adapter permits tilting mike for multi-angle use. Satin black and chrome finish. Complete with detachable cable and connector. 8" long, 1¼" max. dia. tapered barrel 7" . Shpg. wt., 2 lbs.

PA-43Net 6.95

TOP QUALITY CRYSTAL MIKE

A LAFAYETTE SCOOP!

A new, attractively styled crystal microphone for all general applications such as public address and home recording—at a history making low price! Frequency response 30-10,000 cycles. Output level—52 db. Tilting head, attractive plastic case. Can be used on any stand with ¾"-27 thread. Completely equipped with 5 ft. plastic covered shielded cable. Grill diam. 2¼", depth 3½", height 4". Shpg. wt., 2 lbs. One of the best buys in the country! PA-42Net 2.95



MIKE STAND

Economical desk stand. Chrome plated; heavy cast base finished in gray wrinkle. 4¾" diam., 7" h. Felt pad; ¾" —27 thread; adjustable collar. Shpg. wt., 2 lbs.

PA-34Net 1.29

GUITAR MICROPHONE

MAGNETIC TYPE ALNICO V MAGNET

Complete with Individual Tone and Volume Controls



9.95

FOR GUITAR WITH F HOLES

High impedance contact type microphone specially designed for use with guitar. Easily mounted under strings without special attachments. Separate variable tone and volume controls permit wide adjustment to suit personal requirements. While in mounted position, microphone unit can be raised or lowered easily on rod to create varying tonal effects. Supplied with 8 ft. cable and attached standard size phone plug for connection to amplifier. Shpg. wt., 2½ lbs.

PA-38 GUITAR MICROPHONENet 9.95

HARMONICA CONTACT MICROPHONE

This is a fine quality, sensitive, crystal contact microphone with a high output that is especially designed to fit harmonicas. When the relatively weak sound of a harmonica is amplified, the results are astonishing. The microphone may be connected to any P. A. system, the audio section of a phonograph, or radio. Installation is simple. The microphone bracket slips under the screw on the bass end of the harmonica and the leads connect to the amplifier system. It is sturdy built and measures only 1½" L x ¾" W x ¾" D. Complete with 7 ft. shielded cable.

PA-35Net 2.95

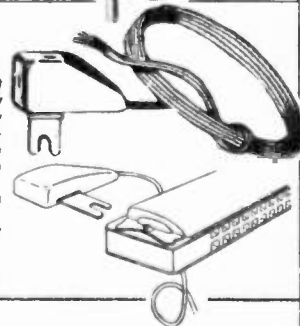

METAL RECORD CARRYING CASES AND RACKS

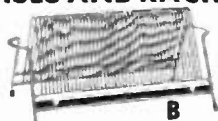
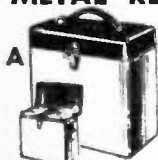

A For travel and home storage of records. Feature all metal, rolled-edge construction, string hinges and lock, and wide comfortable plastic handles. All except model 57 have embossed index for separation and protection of records. Model 57 holds records in envelopes. Attractive 2-tone wrinkle finish.

Stock No.	Model	Capacity	Shpg. Wt.	Net
PK-113	57	48-7" Records	2 lbs.	1.27
PK-114	58	60-7" Records	4 lbs.	2.29
PK-55	43	50-10" Records	6 lbs.	4.55
PK-57	46	36-12" Records	7 lbs.	4.90

B Holds 50 records all sizes. Handsomely styled with convenient handles, plasticized wire separators and plastic feet. With index. Shpg. wt., 4 lbs.

PK-147Net 1.95

WIRELESS BROADCASTER

Play your phonograph through any radio anywhere in the house without connecting wires. Talk through your radio by microphone.



Lafayette's new wireless broadcaster will extend your enjoyment of your phonograph to every room of the house that has a radio. Simply tune in on the radio just like any radio station. Frequency adjustable between 700 KC and 1700 KC on broadcast band.

Has provision for crystal, G.E. and magnetic cartridges. Also has input for crystal microphones as well as low impedance magnetic microphone, so you can broadcast your voice through the radio. Extremely quiet and distortionless. Volume control with on-off switch. Handsome gray hammettone finish chassis 4¾" W x 5¼" D x 1½" H. Shpg. wt., 4 lbs. Completely wired and assembled with all tubes and operating instructions. For 110V AC/DC operation.

LA-14Net 9.75
 PA-42 Crystal microphoneNet 2.95

LIVING LANGUAGE COURSE



FRENCH
 ITALIAN
 GERMAN
 SPANISH

ONLY 9.95

- 40 Expert Lessons

Look what you get! 40 expert lessons recorded on 4 LP records. A conversational manual that repeats each recorded lesson in print. You can both hear and see all the words! You benefit from the double impact of sight and sound. . . learn faster, retain the lessons better. Also included is a Common Usage Dictionary that lists over 16,000 frequently used words and phrases, translated from the foreign language you choose into English and vice-versa. You can grasp them at a glance! Entire Living Language Course consisting of 4 records and 2 books. Shpg. wt., 4 lbs.

PR-11 (Specify Language Desired) 9.95

SPECIAL! THOR #20 - 2.5 Amp 1/4" Drill

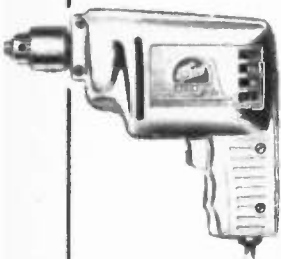

- UL APPROVED • HELICAL CUT GEARS
- BALL THRUST BEARINGS
- GEARED CHUCK AND KEY

A real heavy duty 1/4 in. drill-manufactured rated at a full 2.5 amps. Preferred and used by professional mechanics for many years. Built for continuous production on wood or metal. Powerful, UL approved, universal motor. 1/4" capacity in steel. 3/4" in hardwood. Ball and self lubricating bronze bearings throughout. No load speed 2400 RPM. Strong, lightweight, cast aluminum alloy housing. Specially designed gear chain for greatest torque. Locking Trigger switch. Backed by Lafayette's famous Money Back Guarantee. Shpg. wt., 5 1/2 lbs.

HD-266 Net 12.95

THOR HI-POWER 3/8" SPEED DRILL



- HEAVY DUTY — CONTINUOUS OPERATION!
- RATED FULL 2.5 AMPS!
- 3/8" JACOBS GEARED CHUCK!
- DESIGNED FOR MAINTENANCE AND INSTALLATION!

More power for service work — production lines — mechanics — or anyone requiring a continuous duty drill. 3/8" capacity in steel — 1" in hardwood. Highly polished cast aluminum housing — ball thrust bearings — other bearings oilless anti-friction bronze. 1000 RPM no load speed — 650 RPM full load speed. Trigger switch with locking pin. 6 ft. 3 conductor SJ cord grounds motor housing. Geared chuck takes shanks up to 3/8". Universal series wound motor. For use on 110-120V AC/DC. Shpg. wt., 6 lbs.

26.25

THOR 325 List 35.00 Net 26.25

THOR BENCH SPEED GRINDER

3450 RPM NO LOAD SPEED • HUSKY 1/12 HORSE POWER MOTOR



The perfect grinder for the small shop — garage — maintenance man. Twin 4 1/2" x 3/4" wheels. 1 — 60 grit and 1 — 120 grit. 3/8" arbor hole. Light weight die cast aluminum case. Rubber feet for operation anywhere. Can be bolted to bench or service truck. Self aligning oilless bearings. 6 ft. heavy duty cord. 7 1/2" overall length. Blue wrinkle finish. Use on 110-120V. 60 cycle AC only. Shpg. wt., 9 lbs.

THOR 117 List 16.50 Net 12.07

THOR HEAVY DUTY 1/2" SPEED DRILL

- THE STANDARD FOR SERVICE • 1/2" GEARED CHUCK WITH KEY!
- CAST-IN FRAME AIR COOLING AND LUBRICATING!



The perfect combination of power — rugged construction — lightweight — and ease of handling. Die cast polished aluminum housing. Removable side handle. Capacity 1/2" in steel — 1" in hardwood. Heavy duty radial and end thrust ball bearing on spindle — self aligning bronze bearings elsewhere. 6 ft. 3 conductor SJ cord. UL approved. Trigger switch with locking pin. 650 RPM no load — 425 RPM full load. Heavy duty, universal, series wound motor. 13" overall length. Use on 110-120V AC/DC. Shpg. wt. 12 lbs.

22.10

THOR 400—List 39.50 NET 22.10

WEN ELECTRIC POWER SAW



A truly universal power saw for the home workshop. Cuts 2x4's easily in seconds! Safe to use, easy to handle. Does the work of a rip saw, a jig saw or a band saw. Operates as coping, crosscut, scroll, hack or keyhole saw. Makes its own starting hole on inside cuts. Saws wood, plastics, metals, composition, hard rubber, etc. Cuts straight lines, curves, circles and intricate designs. Air stream blows sawdust off guide line. Well balanced, light weight, 115V AC-DC 1.8 amp motor. 2650 strokes per minute. Length of stroke 3/8". 6 3/4" L x 5" H. 6" UL approved cord. Supplied with 3 assorted blades. Shpg. wt. 4 lbs.

WEN MODEL 505—In lots of 3.....Each 19.57
SinglyEach 22.01

BLADES FOR WEN SAW

WEN 50-A-35—Pkg. of 3 Coarse cutting blades70
WEN 50-A-36—Pkg. of 3 Med. cutting blades..... .70
WEN 50-A-37—Pkg. of 3 Fine cutting blades..... 1.26
WEN 50-A-34—Pkg. of 3 Assorted blades..... .84

WEN SAW TABLE

- MAKES THE WEN 505 SAW YOUR MOST VERSATILE TOOL!
- CUT CIRCLES! MITRE! SCROLL SAW! DOVETAIL!

Precision features not found on any saw table near this price. Saws any angle — rip — cut perfect circles — use as scroll saw — square with perfect accuracy. Make dovetail joints and other deluxe cuts made only on expensive machinery. Table is 5" x 13" x 7 1/2", heavy gauge steel. Wen 505 Saw snaps and locks into place at once. Includes protractor, protractor fence, circle cutting device, jointer and 8 blades. 14 pitch blade for wood — 8 pitch blade for joints — knife blade for leather, rubber, paper, etc. — 32 pitch high temper blade for bakelite, formica and sheet steel. Shpg. wt., 12 lbs.

WEN 571 Net 9.52

THOR

15T SPEED SANDER

Here's Our Hot Sander Special



- PROFESSIONAL PERFORMANCE! • MOTOR DRIVEN — 3450 RPM
- SANDS — SMOOTHS — BUFFS — POLISHES — RUBS!
- USE SWET OR FREE (WET) ABRASIVES!

Get this new top quality sander for all sanding uses. Here's an orbital motion, motor driven finishing sander (no load speed — 3450 RPM) that sands, smooths, buffs, polishes, or rubs with both sheet abrasives or wet (free) abrasives. Sanding area — 4 1/2" x 5 1/8". Features all sealed ball bearings; direct-connected air-cooled motor. Rugged blue hammerloid cast aluminum body. Handy switch prevents accidental starting. UL approved. Use on 110-120V 60 cycle AC only. Shpg. wt., 7 lbs.

THOR 15T—List 24.95 NET 17.12

THOR 3509—Lambwool polishing pad NET .85

THOR S-106—18 sheets assorted sandpaper NET .85

THOR 3/8" CAR AND HOME POLISHER KIT

- POWER PACKED 3/8" DRILL & POLISHER KIT
- PROFESSIONAL DESIGN AND QUALITY
- GEARED CHUCK WITH KEY

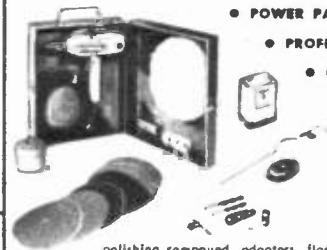

Exceptionally powerful — lightweight — 3/8" Speedrill-Polisher. Extra long grip and auxiliary side handle for additional thrust and ease of handling. Sealed radial and end thrust ball bearings on spindle. 1400 RPM no load—900 RPM full load speed. UL approved. 10 ft. 3 conductor SJ cord. Kit contains: #36 Speed Drill-Polisher, 3/8" geared chuck and key, 7 drill bits, wire brush, 6 sanding discs, 6" rubber backing pad, 6 1/4" lamb's wool bonnet, paint stirrer, hand felt buffer, carlum oxide polishing compound, adaptors, flanges, etc., instruction manual. Steel carrying case can also be used as wall rack. Shpg. wt., 10 lbs.

THOR 34K—List 49.95 Net 39.16

Model 36—3/8" Speedrill-Polisher with discs, bonnet and backing pad only. Shpg. wt., 7 lbs.

THOR 36—List 39.95 Net 31.29

DELUXE 45 Pc. WORKSHOP KIT

- POWERED BY 1/4" DRILL WITH JACOBS GEARED CHUCK



Everything the home workshop—hobbyist—craftsman could require in a power tool kit. You get a UL approved 1/4" drill with Jacobs geared chuck, 4" saw attachment, 4" saw blade, horizontal bench stand, 3 piece drill press, steel saw table with protractor, lamb's wool polishing bonnet, cloth buffer, rubber backing pad, seven drill bits, paint mixer, 3 grinding wheels, 12 sanding discs, eight piece adapter set. Shpg. wt., 20 lbs.

HD-258 Net 29.95

FAIRCHILD 7" PORTABLE POWER SAW

- 1 1/4 HP—8 AMP MOTOR—5500 RPM!



The famous Fairchild "Big 7" power saw—with power to spare for the toughest jobs. Maximum depth of cut — 3/4" at 90°—at 45°, 2-1/16". Depth adjustment calibrated to 0. Positive action depth and angle adjustments. Rip guide gauge graduated from 1/4" to 6". Retractable blade guard. Helical drive gears. Standard 1/2" round arbor. Bright finish die cast aluminum housing. Three position handle and rear mounted controls. 9 ft. heavy duty cord. 110-120V. AC/DC. Shpg. wt., 12 lbs.

HD-259—List 39.95 Net 29.96

HD-260—7" Crosscut Blade

HD-261—7" Rip Blade

HD-262—7" Combination Blade

HD-263—7" Fine Tooth Blade

Choice each 2.25

New! WEN 2 SPEED 3/8" POWER DRILL

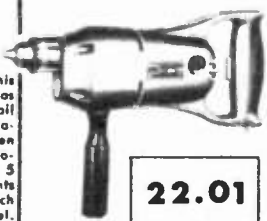

22.01

- HI SPEED—3000 RPM; LOW SPEED—1000 RPM
- CAPACITY IN WOOD 1/16" to 2 1/2"—IN STEEL 1/16" to 1/2"
- BALL THRUST BEARINGS

One drill with the proper speed and torque for every job. Husky—powerful—but not bulky. Hi speed for sanding—sawing—grinding—brushing—buffing. Low speed for polishing—waxing—screwdriving—paint mixing—masonry drilling. Ingeniously wound motor delivers maximum torque under load. Auxiliary handle can be inserted at top or bottom. Change speed by shifting from power take off A to B. 3/8" geared chuck. Trigger switch with locking pin. 6 ft. rubber covered cord. UL approved. Overall length 12 1/4" 110-120V. AC/DC. Shpg. wt., 5 lbs.

WEN 808—List 29.95 Net 22.01

Most Wanted Tools for Service-Shop-Home

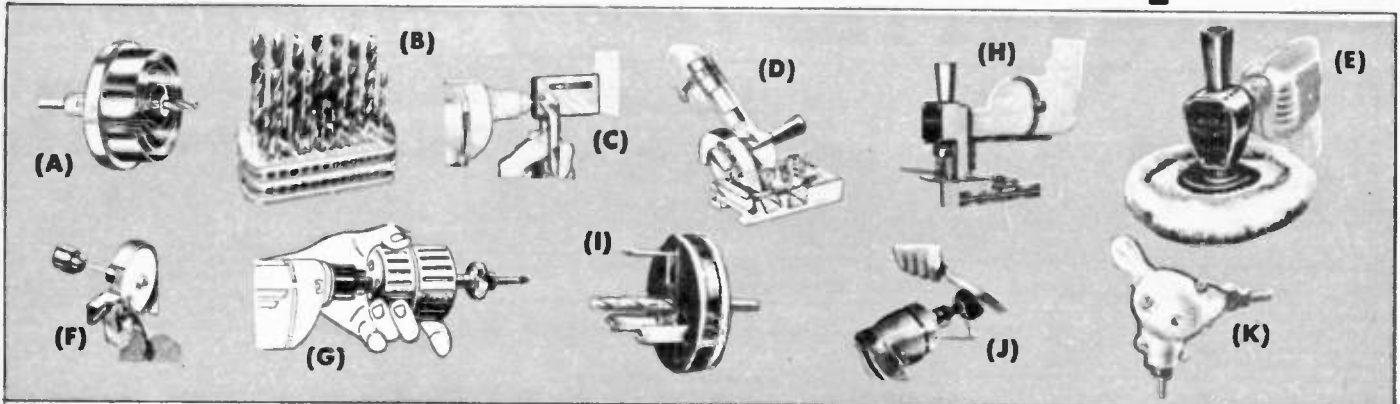

(A) HOLE SAW—4 SIZES

Cuts 1", 1 1/2", 2" and 2 1/2" holes in any 3/4" stock. Works with any 1/4" drill or drill press. Consists of strong alloy tool head, 4 shatterproof blades. "Slug-Ejector" and 1/4" drill bit. Shpg. wt., 1 1/2" lbs.

HD-224.....Net 4.50

DELUXE HOLE-SAW—Same as above but has 7 blades. Cuts 1", 1 1/4", 1 1/2", 1 3/4", 2", 2 1/4", and 2 1/2" holes.

HD-225.....Net 5.95

(B) 29 PIECE DRILL SET

A superior grade of chrome vanadium twist drills. Precision ground, hardened, sharpened. Give long lasting use under the most rugged conditions. Full range of sizes. 1/16th to 1/2" by 64ths. Convenient metal stand, each receptacle clearly marked. Shpg. wt., 4 lbs.

HD-214.....Net 6.89

(C) HACKSAW ATTACHMENT

Fits any 1/4" Electric Drill. Cuts any wood, metal or plastic up to 3/8". There are no gears or bearings to wear out. Saw blade is only exposed moving part. Folds to 1"x1 1/2"x4"—fits any tool box. Uses standard hacksaw blades. Handle covers and protects saw blade when not in use. Shpg. wt., 1 lb.

HD-60.....Net 3.72

(D) ARCO SAW WITH DADO-ARBOR

• CUTS 2 x 4's IN ONE CUT

Revolutionary new "Arco-Saw" with Adjustable "Dado-Arbor" cuts any groove up to 1/2" wide x 1" deep on ONE CUT! Arbor swivels sawblade to cut large grooves with little power—no heavy duty drill needed. "Dado-Arbor" easily removed for straight and angle cuts with precision Depth-Bevel-Rip Gages. Has 5" Safecut blade. Fits any 1/4" drill in 1 minute. With instructions and factory guarantee. Shpg. wt., 4 lbs.

HD-197.....Net 8.63

HD-115—Safecut Blade.....1.33

HD-116—Hycarbon Crosscut Blade.....1.33

HD-117—Hycarbon Rip Blade.....1.33

HD-118—Hycarbon Combination Blade.....1.33

NOTCHING AND NIBBLING TOOL

- TAKES STOCK UP TO 16 GAUGE

An ideal bench tool for large or small shops. Perfect for the advanced hobbyist and handyman. Cuts perfect—burr free—1" x 1" notches in stock up to 16 gauge. 1" x 3/4" nibbling die makes nibbling intricate shapes simple. Dies are easily interchanged.

HD-274 with 90° 1" x 1" Notch Die.....12.75

HD-275 with 1" x 3/4" Nibbling Die.....12.75

HD-276 Notch Die only.....5.95

HD-277 Nibble Die only.....5.95

(E) ARCO ANGLE-BUFFER

Converts any 1/4" electric drill into powerful, smooth running right angle buffer and sander. Swivel action permits use at any angle on all types of surfaces. Flat—curved—or irregular shapes are easy to work. Large handle for added safety and ease of handling. Includes 5" molded head—5 1/2" lambs wool polisher—and sanding disc. Shpg wt., 2 lbs.

HD-133.....Net 4.88

(F) DRILL MATE SHARPENER

Mandy low cost drill sharpener—sharpens drills from 1/16" to 1/4" size. Use it also to sharpen chisels, knives, plane bits, scissors, wood bits, carving tools, etc. 1/4" shaft fits any electric drill. Nylon bearing—permanently lubricated. Drill holder is factory preset—no angle adjustments to make. Adjustable tool rest fits to any angle. Grinding wheel is high grade, fine grit, aluminous oxide stone. Shpg. wt., 3/4" lb.

HD-243.....Net 2.21

(G) NEW MODEL 4100 VERSAMATIC

- WITH YANKEE STYLE BIT HOLDER
- TURNS 1/4" DRILL INTO HIGH POWER TOOL
- REVERSES—INCREASES POWER—REDUCES SPEED

Seven to one speed reduction develops tremendous torque! Hand clutch control for easy, instant stop-start action! Look at these fabulous features! Power screw driver—handles largest screws—reverses to extract them! Power drill tapping head! Plenty of power for oversize drilling! Perfect for concrete or any kind of masonry drilling! Low speed and high power for hole saw attachments! A professional tool that anyone can use! Comes complete with screwdriver bit—Phillips bit—1/4" socket set adapter—wrench pin and instruction book. Shpg. wt., 5 lbs.

HD-195.....Net 11.25

1/2" CHUCK FOR VERSAMATIC

Geared chuck—5/64" to 1/2" capacity—#33 taper to fit Supreme Versamatic. Shpg. wt., 1/2 lb.

HD-268.....Net 6.95

4 TOOLS IN 1 FOR INDUSTRIALS EXPERIMENTERS REPAIR SHOPS MODEL WORKERS SCHOOL SHOPS HOME WORK SHOPS.



- PUNCHES
- SHEARS
- RIVETS
- FORMS

An ideal tool for plant, shop or home use. Used extensively in industrial plants on small jobs. Handles stock up to 1" wide—to 16 gauge. Punches clean, sharp, smooth, burr-free holes—up to 1" from edge—1/8", 5/32", 3/16", 7/32" and 1/4" round. Forms bends up to 90° in rod or bar stock. Cleanly shears metals up to 1" wide, 16 gauge, without distortion. Rivets easily with any type solid or hollow rivet. Rivets up to a maximum combines thickness of 3/8". Shpg. wt. 15 lbs.

HD-233.....Net 10.39

EXTRA PUNCH SETS

HD-234 Hex—3/16", 1/4" and 3/8".....Net 1.45

HD-235 Square—1/4" and 3/16".....Net .95

HD-236 Rectangular—1/4"x3/16" and 3/8"x5/16".....Net .95

HD-237 Oval—1/4"x3/16" and 3/8"x5/16".....Net .95

(H) ARCO JIG SAW

Cuts perfect circles any size up to 20" diameter; rips accurate widths any size up to 10" wide. An especially desirable home workshop tool because of its versatility. Does work of Jig, Keyhole, Coping, Rip, Crosscut, Band and Hacksaw! For intricate patterns, the Jig Saw is simply guided over the cutting line while the Automatic Air-Blower blows sawdust away from blade. Cuts plywood, plastics, wallboard, metals—even lumber up to 2 x 4's! Starts inside holes without boring. Has Right Angle Drive, strong Safety-Yoke and Worm Drive Clamp, Self-lubricating Lifetime Bearings. Blades are easily changed in seconds with ordinary screwdriver. Complete with Circle-Cutter & Rip Gage, Jig Saw Blade, Instructions and 90-day Factory Guarantee. Shpg. wt., 4 lbs.

HD-196.....Net 8.25

Jigsaw—Less Circle Cutter and Rip Gage. Shpg. wt., 3 lbs.

HD-56.....Net 7.50

Replacement Blades—Package of 6 Asstd.

HD-57.....Net 1.46

(I) ADJUSTABLE HOLE SAW

Fits any 1/4" electric drill or drill press. Drills any diameter hole from 1/8" to 2 1/2". Maximum depths of cut 1 1/2". Dial indicator sets hole size without removal from chuck. Blades of finest cutting steel. Shpg. wt., 1 1/2 lbs.

HD-257.....Net 5.11

(J) KNIFE SHARPENER DRILL ATTACHMENT

Practical-efficient-precision built knife sharpener. Attaches to any 1/4" or 3/8" drill. Puts a perfect edge on any knife. Sharpens both sides of blade at once. Uses top quality Norton Alundum abrasive wheels. Oilite brass bearings never require lubricating. Nickel plated steel shaft. High impact polystyrene casing. Shpg. wt., 1 lb.

HD-272.....Net 2.69

(K) BABCO RIGHT ANGLE DRIVE • HALVES OR DOUBLES DRILL SPEED

Close coupled-right angle attachment for working in confined spaces. 2 to 1 gear ratio permits halving or doubling drill speed. High speed for drilling and sanding—slow speed for polishing—large hole drilling—masonry drilling, etc. Fits 1/4" chuck or may be screwed directly to drill spindle. Includes 3/8"-24 male and female adapters—and 1/4" plain shaft adapter. Shpg. wt., 1 lb.

HD-269.....Net 3.30

18" BENDING AND FORMING BRAKE

- FOR EXPERIMENTERS—SERVICEMEN—SHOPS •
- CLEAN SMOOTH BENDS
- FORMS UP TO 90°
- HANDLES UP TO 18" WIDTH IN UP TO 16 GAUGE THICKNESS.

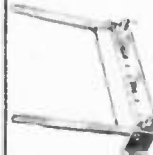

Unique design permits forming chasis, boxes, covers, trays, etc. by means of 1" deep slots in brake-bar which allow corners to fold in. Provides flange edges up to 1" high. Easy to adjust for thickness, accuracy, angle of bend. Rugged construction offers a life time of service. Shpg. wt. 20 lbs.

HD-232.....Net 15.95

...LAFAYETTES *Leading Tool Values!!!*

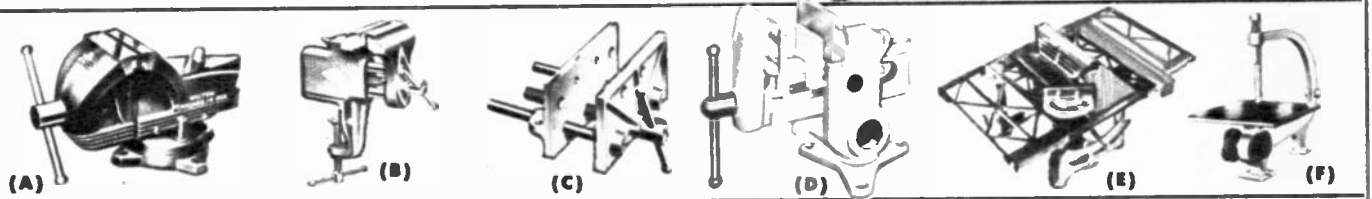

SHOP KING SWIVEL BASE (A): 3½" wide, serrated, hardened steel top jaws open to 4" maximum. Swivel base has 200° rotation—locks by slide for nut. Equipped with easily removed pipe-vise jaws. Beautifully designed—precision machined—sturdily constructed. Complete with polished, removable top jaws—pipe jaws and cut-off tool. Flange mount bolts to bench. Shpg. Wt. 18 lbs.
MD-106 Net **8.93**

CLAMP-ON BENCH VISE (B): Sturdy, practical and efficiently constructed. 2½" wide jaws—open to a maximum 2½". Twin guide rods and precision drive screw assure smooth action—rigid grip. Jaws accurately machined, polished and lacquered. Unexcelled for ordinary jobs in shop, home or garage. Shpg. Wt. 3½ lbs..
MD-107 Net **2.25**

• **6½" x 3½" JAWS!**
WOODWORKERS' VISE (C): A fine, practical tool for the small shop—home—farm or garage. Ruggedly built—will not loosen or slip. Guides are of finely machined, cold rolled steel. Gray iron jaws—face ground and finished. ¾" diameter screw—6 thread per inch. Saves time and labor—indispensable to the woodworker. Perfectly balanced—designed for hard use. Shpg. Wt. 6 lbs.
MD-182 Net **2.79**

• **OPENS TO 4½"!**
VERSA-VISE (D): All the features of a regular vise—plus locks in any position, just tighten jaws. Turns to any work position. Use standing or laid flat—turns 360° either way. Larger jaw surfaces—3½" x 2½"—plus removable pipe jaws. Jaws open 5". Almost as useful as an extra arm for the craftsman—carpenter—hobbyist—welder—etc.
MD-282 Shpg. Wt., 17 lbs. Net **10.49**
Right Angle Adapter: Adds belt adjustment for holding work at any angle. Shpg. Wt., 2½ lbs.
MD-283 Net **2.18**

8" TILT ARBOR SAW (E): Fast, accurate, versatile performance. Blade tilts to 45°. Table and work remain level. Takes any bench saw attachment. Crosscuts, rips, bevels, mitres. Steel safety guard. Self aligning rip fence. Accurate tilt scale. Removable dado-plate. Self-lubricating bearings. Cuts up to 2½". Precision built of cast iron. Table size 11" x 14". Extensions 6" x 14" (not included). Shpg. Wt., 35 lbs.
MD-127 Net **21.00**
MD-128 6" x 14" Extension Net. each **2.95**
MD-129 V Belt & Pulley Net **1.49**

JIG AND SABER SAW (F): Standard duty jig saw for shop and handyman. Throat depth 12". Table 8½" x 8½". Stroke is 9/16". Uses 6" or 6½" blade up to 3/16" wide. Self lubricating bronze bushings. 16" height x 17½" long overall. 3" pulley. Shpg. Wt., 14 lbs.
MD-67 Net **9.35**
 Self lubricating bronze bushings. 16" height x 17½".

WELLER 8100-K SOLDERING KIT

5.83

A complete soldering set. Weller soldering gun delivers over 100 watts and heats in 5 seconds. Gun has trigger switch control and dual spotlights to illuminate work. Uses long life inexpensive replaceable tips. Kit also includes soldering aid to make tight wire twist and help open old soldered joints, and brush to insure clean connections. Shpg. wt. 4 lbs.
WELLER 8100-K.....List 7.95.....Net **5.83**

"250 WATT" WELLER SOLDERING KIT

10.99

Here's everything you need for hundreds of homecraft and hobby jobs. Does all the many electrical soldering jobs around the home and shop—plus plenty of heat for sheet metal—pots—pans—cans—etc. Cut plastic files—repair plastic toys. Kit includes 250 watt in-stand heat—dual spotlights Weller gun—ample supply of Kester solder—soldering tip—smoothing tip—cutting tip—tip interchange wrench—two instruction booklets—sturdy metal case for convenient storage. Shpg. Wt. 5 lbs.
WELLER 8250-AK Net **10.99**

SOLDERING KIT UNGAR

**HEAVY DUTY
PRECISION
ELECTRICAL**

2.06

Latest, handiest, multi-purpose soldering kit in the famous Ungar line. A complete set for servicemen, workshop, hobbyist, home handyman—anyone who needs a soldering iron. Kit contains an extra heavy duty soldering unit for radio, TV or electrical appliance work. A precision unit for printed circuits, instruments and miniature parts. A circuit tester for electrical trouble shooting, trouble and test light, heavy duty handle for soldering units and amper paper and insulating tape. Soldering units are UL approved. Shpg. wt. 2 lbs.
MODEL 507—In lots of 6, each..... **3.99**
 Singly, each..... **4.49**

UNGAR ELECTRIC PENCIL AND SOLDERING SET

2.06

One complete set for home craftsmen and hobbyists. Set contains six interchangeable tips; four for burning and embossing of wood, plastic, leather, cork, etc., and two for soldering. Five sheets of embossing foil, abrasive cloth, complete set of instructions for working wood, plastic, leather and cork. Illustrated catalog of plaques and projects. Heating unit is UL approved and guaranteed for 10,000 hours. Shpg. Wt. 1 lb.
MODEL 217 **EACH 2.06**

ARROW GUN TACKER KIT

• **ONE SQUEEZE—AND YOU'VE NAILED IT!**

Kit contains everything you need for 100's of nailing jobs. One hand operation—double leverage for ease in handling. Shoots a staple ever you'd drive a nail. T-50 gun handles four different staple sizes, ¼", ⅜", ½" and 9/16". Includes T-50 gun, 5000 ass't. staples and staple remover. Shpg. wt., 5 lbs.
MD-296 Net **11.63**

NEW VIS-A-PART BOARDS

• **STORE SMALL PARTS—EASILY—SAFELY—NEATLY—INEXPENSIVELY!**

Eliminates screw on caps! Makes use of convenient wall space. Saves floor and drawer space. Ends time wasting searching through drawers and bins. One glance locates the part you need. Jars slide securely into metal holders. Inserted or removed with one simple motion. Wood grain Marlite board holds up to 24 jars. Holders are firmly riveted to back-board. Pre-punched for hanging on any wall. Keeps small parts within plain sight and easy reach. Indispensable for screws, nuts, nails, parts, seeds, spices, etc. Hundreds of uses in shop, home or garage! Complete with jars.
MD-166 24 jars 18"x18" Board. Shpg. Wt. 9 lbs. **3.63**
MD-167 12 jars 18"x18¼" Board. Shpg. Wt. 5 lbs. **1.97**
MD-168 6 jars 18"x5" Board. Shpg. Wt. 2½ lbs. **1.05**

TV TUBE CADDY

Designed with the serviceman in mind. Center section has 6 sections. Three hinged swing-out sections each with its own button-down cover. One top section undivided for larger items, other top section divided lengthwise. Made of heavy wood, with 4 metal braces at hinge corners. Lever-action snap locks. Plastic carrying handle. All hardware nickel plated. Size 16¼" L x 13½" H x 8¼" W. Covered with tough wear resistant material. Shpg. wt., 10 lbs.
ML-58 Net **10.75**

PIN-UP WORKSHOP UNIT

• **THE MOST CONVENIENT TOOL STORAGE!**
 • **12 SQ. FEET OF STORAGE SPACE!**
 • **SET UP IN SHOP—GARAGE—HOME!**

5.87

One handy package provides approximately 12 square feet of storage space. Four squares of tempered perforated hard-board for complete flexibility of design in hanging 62 special fixtures plus small parts—jars—shelf brackets—screwdriver holder—exclusively designed for holding the largest variety of tools. Mounts easily on any flat surface. Pre-coated hardboard is ½" thick—may be painted to suit. Unique self-locking fixtures can't "give" or twist out. Supplied complete with fixtures—mounting screws—spacers—and instructions. Shpg. wt., 15 lbs.
MD-120 Net **5.87**

SUPER TOOL CHEST

—A steel chest built to last. Removable tote-away. Double lock seamed construction, reinforced corners, continuous hinge, steel handle, regular key lock plus hardware. Baked enamel interior. Steel gray outside finish. Size 16 x 7 x 7". Shpg. wt., 8 lbs.
MC-22 Net **4.70**

TV TUBE CADDY

Here's a real value in a portable caddy. Holds up to 130 tubes. Unique break-away section makes everything quickly available. Has compartment designed for carrying instruments and large tools and a 3 section compartment for smaller tools, wire solder, etc. Wood case with plastic coated fabric covering measures 16" W x 12½" H x 8" D. Shpg. wt., 13 lbs.
ML-75 Net **6.75**

VALUES for SERVICEMEN & DEALERS

3 IN. BELT SANDER

• FOR WOOD—METAL—PLASTICS
• SANDS—DEBURRS—SHARPENS
Belt driven, bench model, medium duty sander. Self lubricating "Oilite" bearings. Entire sanding surface adjustable through a 90° arc. Compound angles up to 45° x 45° can be worked. Table can be removed to accommodate any length work. Adaptable for right or left hand drive. Standard 3" x 24" belt size. Readily replaceable. Complete with tractor, 1/2" x 3" x 7 1/4" steel platen, 2" machine pulley, 3" x 24" belt. Shpg. wt., 10 lbs.
MD-278Net 17.95

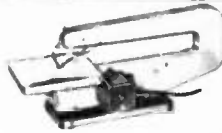

DREMEL JIG-SAW

• POWERFUL ROTARY MOTOR

Cuts and outperforms heavier units selling for much more. Extra rugged, built for heavy-duty use. Cuts wood up to 1 1/4" thick—plastics—light metals. 15" throat—cuts to center of 30" circle. Powerful, self contained, rotary motor. Exclusive rocking action. Table tilts to 45°. Safe enough for youngsters. 8" x 23" x 9 1/2" overall. For 110-120V 60 cy. AC only. UL approved. Shpg. wt., 14 lbs.
HD-295Net 23.48

ELECTRIC HANDI-SPRAYER

Save time and money! 80 lb. nozzle pressure gives professional results. Sprays all types of paints, enamels and lacquers. Any sprayable liquid! Exclusive swivel nozzle permits spraying up, down, or sideways without tilting jar. Instant spray control—fingertip adjustment from mist to cone or straight stream! High Impact plastic housing—all parts of stainless steel and brass. Complete with 16 oz. Mason Jar and 8 ft. cord. Shpg. wt., 4 lbs.
HD-73Net, ea. 6.25
Lots of 3, ea. 5.97



WELLER POWER SANDER

10.99

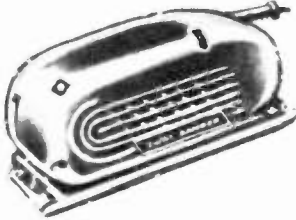

- Positive Straight Line Action Sands with The Grain
- Large Sanding Area Full 25 sq. Inch
- Powerful High Speed Cool Motor
- 14,400 Strokes Per Minute

Power-packed reciprocating type motor in easy-grip case only 2-5/16" high with push-button on-off fingertip control. No torque, bucking or twisting. Positive straightline action. Tension-lock paper holders. Rubber insulators between motor and housing minimizes noise. 25 sq. in. sanding area. Complete with 8 ft. cord, 6 sheets ast. sandpaper and polishing cloth. Shpg. wt. 3 1/2 lbs.
WELLER 700Net 10.99



DREMEL MOTO-SAW

Lightning fast—makes 7200 strokes per minute and cuts 1 foot a minute through wood up to 3/4" thick! The only electrically driven hand jig saw that saws the most intricate patterns, cuts at any angle and works on assembled projects. Automatic switch in the handle. For 110 volts, 50/60cycles. AC Supplied complete with cord and plug and 3 blades. Shpg. wt., 2 lbs.
HD-293Net 5.37
HD-294—12 extra BladesNet .47



DIAL TYPE TELEPHONE INTERCOM

• DIAL-TO-RING
• OPERATES UP TO 1 MILE

Full size—standard telephone shape—battery operated—two station set. The loudest—clearest battery operated telephone available. Operates on easily replaced flashlight cells. No buttons to push for signaling or talking. Perfect for communications room to room—office to office—house and garage—hundreds of installations. Extremely rugged construction. Includes instructions and 50 ft. of wire. Less batteries.
ML-104Net 5.70



DREMEL MOTO-TOOL KIT

Designed for light grinding, polishing, drilling, carving, sanding, sawing, engraving, routing, etc. Handles as easily as a pencil. Does fine detail work with pinpoint accuracy. Ideal in shop, industry, lab, hobby, model making, home work shop, etc. Automatic chuck lock—oil-less bearings—bakelite housing. Works in wood—metal—plastics—glass—leathers—etc. Includes steel cutters, emery wheels, drum sander, mandrels, brushes, cut-off wheels, polishing wheels, dressingstone, polishing and sanding accessories, etc. All in steel case, 110-120V. AC/DC. Shpg. wt., 5 lbs.
MD-292Net 16.86

GRIPSO TRIGGERMATIC VISE PLIERS

- SMOOTH TRIGGER RELEASE



Vise pliers lock on with one ton grip. Turnbuckle adjustment with concealed threads. Releases instantly with the touch of a finger. 5 tools in one: hand vise—nut wrench—pipe wrench—clamp—pliers. Shpg. wt. 1 1/2 lbs.
MD-238Net 2.07

24-HOUR STATION CLOCK

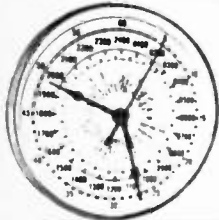

- Tell world-wide time at a glance!
- Ideal clock for the amateur, short-wave listener and for commercial stations.

TD-2400, self-starting, accurate clock for telling world-wide as well as local time. Calibrated in hours, 0100 to 2400; in minutes and seconds, 1 to 60. Has black hands with red sweep second hand. 6" dia. rotating inner dial, frictionally attached to hour hand, in red and blue. Shows time directly in all time zones. Simply set hour hand and inner dial for your time-zone, then read the time in any zone easily, quickly, accurately. 10" dia. For 110-120 volt, 60 cycles, A.C. Shpg. wt., 4 lbs.
ML-82—Net including excise tax..... 14.85

TERADO DC to AC CONVERTERS

SENIOR CONVERTER (FIG. A)

Model 6-1160. Changes 6 volts DC to 110V AC. Capacity 40-45 watts. Will operate small radios, phonographs, small machines in car, boat, cabin or trailer. Plugs into car cigarette lighter. Fully filtered. Ready to operate. Size 2 1/2 x 2 1/2 x 4". Shpg. wt., 3 1/4 lbs.
TERADO 6-1160—List 21.95.....Net 12.91

TERADO 12-1160—As above but for 12 volts—
List 21.95.....Net 12.91

AUTO SHAVER CONVERTER (FIG. B)

Make an auto/home shaver out of any electric razor. Just plug into your cigarette lighter and you're ready to shave in your car. Converts your 6V. or 12V. auto current to 110V. Works in boats, too! Complete with case for razor and plug. Shpg. wt., 2 lbs.
A-615 — 6 Volt.....Net 7.61
A-1215—12 Volt.....Net 7.61

JFD "MAGIC GENIE" INDOOR ANTENNA



Here is the beautiful new look in indoor antennas. Enjoy the finest indoor TV reception without sacrificing room decor. A 12-position golden electronic selector tunes in sharp, crisp pictures on all channels, tunes out ghosts and interference. Tune your favorite station with the selector and see how the exclusive printed circuit "clarifier" intensifies picture contrast and sharpens picture detail. Designed for both color and black and white TV broadcasts. It has two, four-section ball-socket telescoping dipoles that give unlimited dipole angle and spacing combinations—higher gain in less space. Attaches easily and permanently to back of any TV set—portable, table model or console. Hank of transmission line from element box is equipped with spade lugs for convenient connection to receiver antenna terminals. Shpg. wt., 3 1/2 lbs. List \$17.95. Unconditionally guaranteed.

MG350—JFD "Magic Genie" Antenna (Mahogany)Net 9.95
MG150—JFD "Magic Genie" Antenna (Money Blonde)Net 9.95

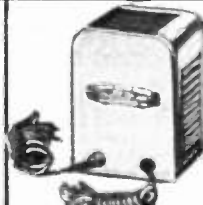
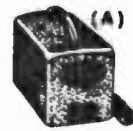

4 AMP CHARGERS

Here is a small, highly efficient unit that will recharge most batteries overnight. The 4 ampere charging rate tapers to approximately 2 amps as the battery becomes fully charged. Equipped with special "Charger-Guard" which provides instantaneous and full automatic protection against short circuits and overloads. No manual resetting of a circuit breaker or replacing of blown-out fuses. Selenium rectifier and quality construction. Quickly connected without disconnecting or removing the battery from your car. Operates on regular 110-115 volt 60 cycle AC house current. Steel case is 4 1/4" x 4 1/4" x 6 1/4". Complete with cables. Shpg. wt. 6V model 4 1/2 lbs., 12V model 6 lbs.
AX-2—for 6 volt batteriesNet 9.11
AX-12—for 12 volt batteriesNet 11.73

SCHAUER BATTERY CHARGERS

- 6 VOLT • 12 VOLT
6 AMP CHARGERS

Heavier 6 ampere charger that will completely charge the average run-down battery in 7 to 9 hours without disconnecting or removing it from the car. Has the same protective "Charger-Guard" feature as the AX-2. Equipped with an accurate numerical dial ammeter that shows the exact charging rate going into the battery. Steel case size 6 1/4" x 6" x 7 1/4". Complete with cords and battery clips. Operates on 110-115 volt 60 cycle AC. Shpg. wt. 6V model 8 lbs., 12V model 10 lbs.

BX-2—for 6 volt batteriesNet 13.03
BX-12—for 12 volt batteriesNet 16.28

CHARGER PLUG

For use with all Schauer chargers. Eliminates need of attaching charger leads to battery. Charger connected simply by plugging into car's cigar lighter receptacle. Fits all cars. Shpg. wt. 1/2 lb.
A-8410 6 volt charger plugNet 1.15
A-8412 12 volt charger plugNet 1.15

GIFTS FOR THE HOBBYIST - STUDENT - EXPERIMENTER

ATOMOTRON

- MINIATURE ATOM SMASHER
- PRODUCES 75,000 VOLTS
- ABSOLUTELY SAFE



In no sense of the word a toy or gadget. The ATOMOTRON is a scientific instrument capable of producing 75,000 volts—makes sparks up to 2" long—yet it is absolutely safe because the current is infinitesimal. The science teacher—science lover—or hobbyist can perform experiments to astound students—friends—family. Makes smoke disappear—defy gravity—turns propellers at a distance—transforms atomic energy into light—makes artificial lightning—smashes atoms—demonstrates ionic space ship drive—and many other experiments. Constructed of the finest materials. Will do exactly—for instruction purposes—what generators that cost 3 to 10 times more will do. The perfect device to teach the secrets of atomic physics and electricity. Will hold an audience spellbound as it performs trick after amazing trick. Includes an experiment kit and illustrated experiment manual. Manual explains the "how" and "why". You will invent many new experiments of your own. A fine research tool that will give years of beneficial service to the institution or individual who owns one. Available in kit form or assembled.

F-324 Kit form—Shpg. Wt. 3 lbs. Net 14.95
F-325 Assembled—Shpg. Wt. 4 lbs. Net 19.95

ALCOMAX MAGNETS

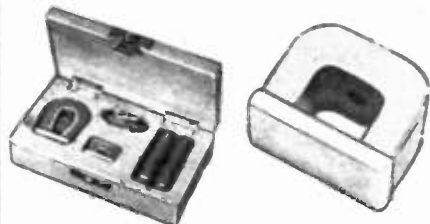

- LIFTS 50 TIMES ITS OWN WEIGHT

Made of Alcomax—a material with 12 times the magnetic energy of tungsten steel. Designed for most efficient performance/weight ratio—will lift up to 50 times its own weight. Horseshoe shape with plated keeper. Ideal for such applications as magnetic clutch, lifting, work holding, elec. relays, etc. Size 1 1/2" H x 1 1/2" D x 1 1/4" W. Distance between poles is 7/8". Shpg. wt., 1/2 lb.

F-55 Net 2.40

LABORATORY SET

This set has been specially designed for schools, laboratories, and technicians, for testing and demonstrating the magnetic properties of permanent magnets. Fine hardwood case contains a pair of bar magnets 2" x 1 1/2" diam., a horseshoe magnet 1 1/2" high x 1-5/16" x 3/8" deep with 5/16" spacing between poles, and a bridge magnet 7/16" high x 28/32" x 5/16" deep with 1/8" space between poles. Shpg. wt., 1 1/2 lbs.

F-58 Net 3.45

POCKET WARMER

- Warmth for up to 24 hrs.
- With new-improved burner



Indispensable for outdoor activities on cold days. For hunters - fishermen - sports fans - skaters - skiers - golfers. Use lighter fluid - benzine - white gas as fuel. Safe - practical - cold weather sports accessory. Can not burn - or spill on clothing. Ideal for TV installation work in cold weather. Slim - attractive - pocket size. 4" x 2 1/2" x 1/2". Heavily chrome plated. Complete with velvet drawing cover and instructions. Shpg. wt. 1/2 lb.

F-188 Net 1.39

\$2.59 UTILITY DRAFTING SET

- EXCEPTIONAL VALUE

Made in Germany of hard rolled, nickel plated brass. All instruments are nested in a fitted, velvet lined case. Contains three side wheel 3 3/4" bow instruments—one a divider, one a pencil and one a pen. All have reversible needle point. 5 1/4" compass with pen and pencil parts—and lengthening bar. 5 1/4" divider with straightening device. 5" ruling pen. Extra handle for use with pen and pencil parts. Capsule with extra leads. Perfect for schools, labs, industrials or wherever precision drawing sets are used.

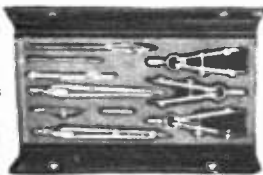

F-13 Net 2.59

NEW! DRAFTETTE

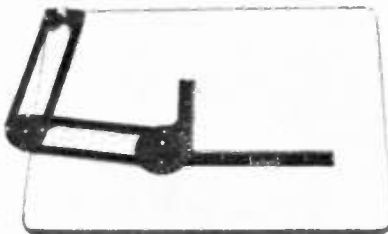

ENGINEERS DRAFTSMEN ARTISTS

THIS IS IT!!

- COMPACT • VERSATILE • QUALITY
- ECONOMY • PRECISION • RUGGED

Bigger and better than ever! One inch longer than previous model! Full 180° protractor scale. Finest aircraft aluminum, black satin finish. Engraved, white filled numbers and scale markings. Machine calibrated to ± .0005 of an inch. Requires no special training to use. Folds like a jackknife . . . slips into drawer or briefcase. Eliminates clutter of T-square, ruler, protractor, triangles. Clamps to drawing board or sketch pad. 101 practical uses in work, studies and hobbies. Lay out chassis, diagrams, sketches, design detail, surveys, etc. Costs far less than other drafting machines. Shpgt. wt. 1 lb.

F-287—List 4.95 Net 3.95

DRAFTETTE with 10"x13" DRAWING BOARD

Same fine drafting machine as above including a lightweight sturdy drawing board. Shpg. wt. 2 lbs.

F-288—List 5.95 Net 4.75

DRAFTETTE with 11"x17" DRAWING BOARD

F-287 drafting machine with lightweight board for larger layouts. Shpg. wt. 3 lbs.

F-289—List 6.50 Net 5.20

SPORTSMANS COMBO-KNIFE

2.25

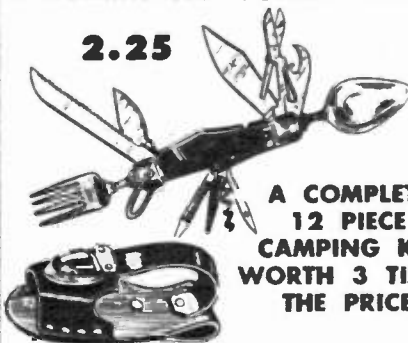

A COMPLETE 12 PIECE CAMPING KIT WORTH 3 TIMES THE PRICE

This fine imported camping kit contains 2 knives, fork, spoon, scissors, can and bottle opener, saw and fish scaler, awl punch, screw driver and file, cork-screw, and a sailmaker's needle. Fine steel blades. All tools fold neatly into bone handle 4 3/4" long complete with leather carrying case with belt loop. Shpg. wt. 1 lb.

F-148 Net 2.25

30X, 60MM SPOTTING SCOPE



17.95

- BINOCULAR TYPE FOCUS
- PRISMATIC LENS SYSTEM

A prismatic telescope using the same fine features as expensive binoculars! Field of view is 85 feet at 1000 yds! Both front and rear optics are coated. High relative brilliance due to great 60mm objective lens. Exceptionally small and light—weighs only 1 1/2 lbs. including metal tripod! The perfect companion for shooting—hunting—viewing—naturalists—and hobbyists. Comes equipped with 11 1/2" tripod and mount and zippered leather carrying case for both scope and tripod. Shpg. wt., 2 1/2 lbs.

F-149 Net 17.95

AUTO-BOAT COMPASS

- Cars-Boats-Trucks-Tractors
- Illuminated and Non-Illuminated



Mounts anywhere on cars-boats-trucks-tractors-motorcycles. Non-glare, universal mounting bracket. Most easily compensated compass available. Just a twist of the bottom or top knob. Extremely accurate. Constructed to withstand all driving shocks. Important to the daily driver. Invaluable for boats and tractors. Large viewing window and figures for ease of reading. Includes mounting accessories and instructions. Illuminated model includes both 6 and 12 volt bulbs. Shpg. Wt. 1 lb.

F-322 Non-Illuminated Net 3.75

F-323 Illuminated Model Net 4.49

MARCHING COMPASS

Made in Germany by the leading European compass manufacturers. Indispensable for compass, hikers, hunters, tourists, etc. Same type as those extensively used by the armed forces to determine one's position in unknown country. Jeweled needle—luminescent cardinal points—rotating twin scale, 0-64 and 0-360—sighting line and mirror for accurate bearings—locking device—setting edge calibrated in millimetres—rugged, ebony finish case. Can also be used to measure the width of an objective. Complete with instructions.



F-118 Net 2.45

ILLUMINATED MAGNIFIER

- 5X MAGNIFICATION—2" FIELD!
- ONLY 2.95



A fine, fixed-focus illuminated magnifier—magnifies work 5 times. Field of vision is 2" at 1 1/2" working distance. Unlimited usage in industry—shop—hobbies. For checking tools and dies—castings—forgings—welds—etc. Inspection of motor movements—fine soldering electronic repairs. Magnified area easily accessible through cut out invaluable in hobbies such as stamp or coin collecting, photography, entomology—mineralogy—etc. Excellent map reader. Completely portable—uses two No. 2 cells for power. Weight 3/4 lbs., length 8 1/2" overall. Shpg. wt., 1 1/2 lbs.

F-193 Net 2.95

GIANT BOW BEAM COMPASS

- Draws circles up to 28" in diameter.

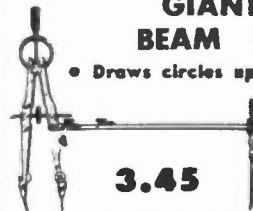

3.45

- Telescoping extension bar.
- Center wheel adjustment.

Made in Germany of nickel plated, cold rolled brass. Divider is 6" long—has knuckle joint—interchangeable pen and pencil parts—telescoping beam—reversible needle point—center wheel acts as micrometer. Makes circles from 1/4" to 28" with extension bar. A professional instrument with a wide range of utility.

F-116 Net 3.45



LAFAYETTE

MICRO-ENGINEERED

TESTED & SELECTED for... CONSISTENT QUALITY

IMPORTED

MICRO-OPTICS

New!

29.95



800X "MICRO-SEARCH"

Laboratory Standard Microscope

- RECENTLY DEVELOPED DESIGN
- INFINITE MICRO-METRIC SLOW MOTION ADJUST
- HUYGENIAN EYEPIECES — ACHROMATIC OBJECTIVES
- 100X-160X-200X-320X-500X-800X

A truly fine dry system microscope, suitable for a wide range of laboratory-professional-and college use. Monocular tube of most recent, one-piece, design. Spiral rack and pinion focusing mechanism. Coaxial, dual knob, coarse adjustment. Infinite micro-metric, fine adjustment. "T" shaped, dove tailed, slide, of improved design-automatic stop prevents over-rise. Square stage, 70mm X 75mm, with click stop, substage, diaphragm. 30mm plano-concave reflex mirror. Paired, Huygens eyepieces of 10X and 16X. Three achromatic objectives of 10X, 20X and 50X. Refined, horseshoe design, base. Overall height 10". Gray satin finish, chrome trimmed. Dove tailed, fitted cabinet of selected oak with rubber bumper feet and carrying handle. Shpg. wt., 7 lbs.

F-291 Net 29.95

New!

10.95

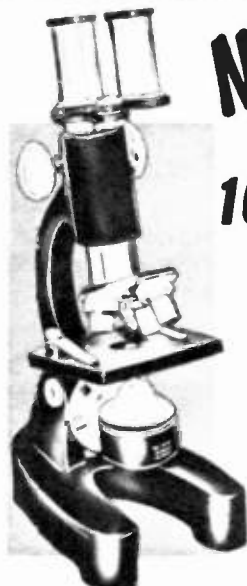

600X "BI-OCULAR" MICROSCOPE

- NEW—TWIN LENS "BI-OCULAR" TURRETI
- BUILT-IN SUB-STAGE MICRO-LITE!
- 600X—400X—300X—200X—120X—80X!
- ONLY AT LAFAYETTE!

The latest advance in Micro-Optic design. Free swinging, twin-lens, Bi-Ocular turret permits instant variation of magnification without disturbing subject set-up. Triple objective click-stop turret in concert with 10X and 15X "Bi-Oculars" give six ranges of magnifications. You can swing instantly from 80X to 120X—or 200X to 300X—or 400X to 600X without resetting subject or microscope. "Micro-Lite", with automatic on-off switch, gives brilliant, color corrected, field of view. Dual knob, rack and pinion focusing, 8 1/2" high, overall. All optics are achromatic. Ocular lenses are Huygenian type. Includes sub-stage mirror for viewing by reflected light. 90° inclination joint. Includes dovetailed wooden carrying case and sample slides. Shpg. wt., 5 lbs. Less batteries.

F-270 Net 10.95

LAFAYETTE MICRO-LITE

- USE WITH ANY MICROSCOPE
- FURNISHES BRIGHT, EVEN LIGHT

Specially designed for microscope illumination. Provides a bright, evenly lighted field of view. Controlled intensity, by means of focusable condenser lens. Lamp may be raised or lowered to any desired height on its 4 1/2" stanchion. Inclination and elevation joint permit swinging through 360° in both horizontal and vertical plane. Fully adjustable for transparent or opaque specimens, direct or indirect illumination. Invaluable where oblique light is necessary. Operate on 110-120 volts AC/DC. Lamp is easily replaced. Self contained switch, cord and plug. Lamp body is 5 1/2" long, stand is 3 1/2" high including base. Shpg. wt., 1 lb.

F-268 Net 2.95



2.95

500X "MICRO-LITE" MICROSCOPE

7.95

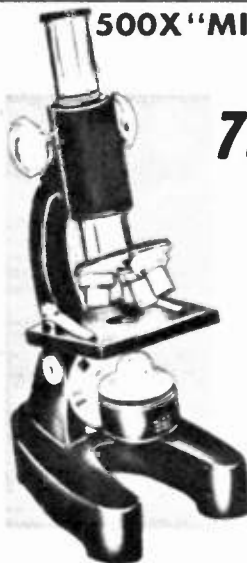

- 4 OBJECTIVE CLICK-STOP TURRETI
- EXCLUSIVELY LAFAYETTE'S AT THIS MICRO-SCOPIC PRICE!
- RANGES: 500X — 300X — 150X — 75X
- BUILT-IN SUB-STAGE ELECTRIC "MICRO-LITE"

Another fine optical value from Lafayette. Built-in battery operated, Micro-Lite makes micro-observation more convenient — less troublesome — than ever. Special, tinted bulb helps prevent color aberration and insures a brilliant field of view under any conditions. Click-stop turret holds 4 achromatic objective lenses giving magnification of 75X, 150X, 300X and 500X. Huygenian type ocular lens. Dual knob, rack and pinion focusing, 8 1/2" high overall. Professional type 90° inclination joint. Black satin and chrome finish. "Micro-Lite" has automatic switch — goes on when swung into position. Includes mirror for viewing by reflected light. Backed by Lafayette's famous "Money Back" Guarantee. Includes dovetailed, wooden carrying case and sample slides. Shpg. wt., 5 lbs. Less batteries.

F-269 Net 7.95
TYPE "Z" batteries (2 required) ... Each .08

PREPARED MICROSCOPE SLIDES



- SPECIALLY SELECTED MICRO-SUBJECTS.
- ADD TO THE ENJOYMENT OF YOUR MICROSCOPE.
- PROFESSIONALLY PREPARED.

Specially selected slides of universal interest. Carefully prepared—cleaned, dissected, embalmed, stained, mounted and covered. Slides are professional size. Set includes 12 prepared slides and slotted, covered box for filling and storing.

F-123—Parts of Insects.....	Net 1.39
F-124—Spiders and Disease Carriers.....	Net 1.39
F-125—Tiny Creatures found around House.....	Net 1.39
F-126—Sea Life.....	Net 1.39
*F-128—Structure of Blood.....	Net 1.15
F-130—Life cycle of Insects.....	Net 1.39
F-131—Bacteria.....	Net 1.79
F-132—Pond, Marsh and Sea Life, Plankton.....	Net 1.59
F-134—Micro-Animals.....	Net 1.29
F-135—Micro-Organisms.....	Net 1.29
*F-136—Substance of Cells.....	Net .89
F-261 Tactile Fibres.....	Net 1.29
F-262 Starch Grains—silver stained.....	Net 1.29
F-263 Structure of Leaves.....	Net 1.39
F-264 Plant Reproduction.....	Net 1.89
F-265 Anatomical Tissue.....	Net 2.09
F-266 Honey Bee Organs.....	Net 1.39
F-267 Disease Germs—silver stained.....	Net 1.79

*—Set of 6 slides.

MECHANICAL SLIDE HOLDER

- CENTERS SUBJECT MECHANICALLY.

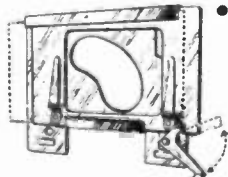

An ingenious, inexpensive device to aid in centering—positioning—and shifting slide mounted subjects. Designed to work with our F-269 and F-270 microscopes—or others having no larger stages. Made entirely of plated brass. Will accommodate slides up to 1" x 3". An indispensable accessory for the careful study of mounted micro-subjects.

F-122 Net 1.50

HUNTING WITH THE MICROSCOPE

- NEW EDITION



Guide for beginners and advanced users of microscopes. How the microscope works. How to prepare and study cultures — set up a microscopic zoo and garden — grow micro organism — perform micro surgery. Profusely illustrated with photographs and drawings. 14 chapters of easy-to-read, highly informative text.

BK-1440 1136 pages 5 1/2" x 8" Net .89



Lafayette CAMERA DIVISION

**WE INVITE COMPARISON!
WE DEFY COMPETITION!!**

ALL MERCHANDISE SOLD ON A MONEY
BACK GUARANTEE—YOU BE THE JUDGE

Completely NEW! Exclusive Import SAVE \$33.00 SPECIAL PURCHASE

- DOUBLE EXPOSURE PREVENTION • F3.5 HARD COATED LENS • SHUTTER SPEEDS TO 1/200th • BUILT IN FLASH SYNCHRONIZATION • AUTOMATIC FILM STOP AND EXPOSURE COUNTER • OPTICAL EYE LEVEL VIEWFINDER
- RAPID FILM ADVANCE

\$19.50

Has everything you need for fast, accurate shooting. Designed to fit your needs — priced to fit your budget. Many features found in the most expensive cameras. Quality design coupled with ease of operation. Fast F3.5 hard coated anastigmat lens for full color or black and white. Speeds of 8, 1/25, 1/50, 1/100 and 1/200 sec. Synchronized for flash unit. Automatic exposure counter. No double exposure — film advance pre sets shutter. Cable release socket. Depth of field scale permits easy snapping of objects at different distance within the "in focus range". Detachable back, accessory shoe. Tripod socket. All metal body finished in brushed chrome and black "Morroco". PC flash terminal. Lens mount diameter 31.8 mm. Less case. Shpg. wt. 2 1/2 lbs.

F-217 with Leather Eveready Case..... Net 19.50

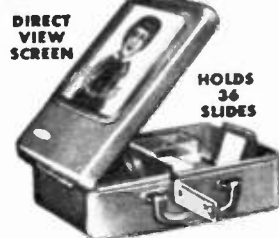
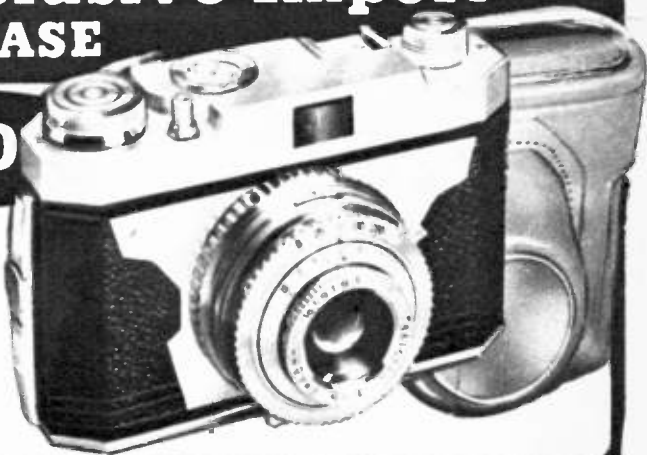

DIRECT
VIEW
SCREEN

HOLDS
36
SLIDES

FAST SLIDE
CHANGE LEVER

CLOSED

FOR
PROJECTION

PORTABLE 35 MM TABLE VIEWER & PROJECTOR 49.50 VALUE!

SPECIAL
ONLY

23.50

F3.5 Lens Projects Color Slides — Sharp Brilliance
Here is a lightweight and compact 35 MM viewer that compares with models selling for more than twice the price! Precision made... simple, fool-proof construction. Use it as a table viewer with the self-contained 5 1/2" square ground glass screen, or project your slides on a light-colored wall or projection screen and enjoy a 10 sq. ft. picture with the same sharp focus. Magazine holds 36 slides that change with the flick of a lever. Compact steel case with carrying handle measures only 10" x 7" x 3 1/2" deep. Supplied complete with standard 100-watt projection bulb, F3.5 lens, projection mirror, view screen, on-off switch, line cord and instructions. For 105-115 V. AC operation.

F-276 — Shpg. wt., 5 lbs. Net 23.50

Lafayette's PROFESSIONAL FLASH GUN

Exceptionally fine flash gun. Designed for use with twin-reflex cameras — equally useful with any synchronized camera. Extra sturdy battery case of chrome plated brass. 3 1/2" heavily chromed reflector takes either bayonet base or screw base without adapters. Bulbs lock in firmly — eject surely. Has extension socket — test switch — on/off switch for conserving batteries. Extra heavy bracket and 3" x 3 1/2" platform holds all cameras firmly. Uses 2 "C" (2#1) batteries or 8-C pack such as Mallory PX-10. Gun may be removed from bracket and hand held for "bounce-flash". Includes detachable cord — mounting bracket — test bulb. Shpg. wt., 2 1/2 lbs.

F-275..... Net 5.95



NEW PANHEAD SELFTIMER

• The latest in camera "gadgets":

Brand new design — universal panhead and selftimer combination unit. Use with any camera having tripod socket and cable release socket. Panhead tilts and pans with one motion. Pans 360° — tilts 180°. Heavily chromed — large platform. Timer operates cable for motionless shots. Removable handle to save space. Makes any tripod a truly universal accessory. Includes 16" cable release and spare Lieca type fitting. Shpg. wt., 2 lbs.

F-306..... Net 3.95

900X LABORATORY MICROSCOPE

- The most practical instrument for Botany—Zoology—Pharmacology — Bacteriology — and general Laboratory use.
- Highly efficient—exceptional construction.
- Huygenian Oculars — Achromatic Objectives.

Only Lafayette's policy of importing direct makes it possible to offer an instrument of this quality at this price. Mechanically and optically one of the finest instruments Lafayette has ever offered. A truly fine dry system microscope suitable for a wide range of laboratory — professional — and college use. Dual-knob monocular tube — spiral rack and pinion focusing mechanism. Revolving disc substage diaphragm. Triple revolving nosepiece with achromatic objectives of 5X—10X—and 40X. Two Huygenian eyepieces of 10X and 15X give a range of 50X—100X—150X—400X and 900X. Plano-concave reflex mirror 1 1/2" in diameter. Banding device permits 90° inclination. Approx. 11" high retracted. Complete with fitted hardwood case and slides. Shpg. Wt. 8 lbs.

F-107..... NET 49.50



49⁵⁰



3 LENS TURRET MICROSCOPE

100X-200X-300X
At a Microscopic
Price

We made a deal with a big importer. He needed cash—Fast! So he came straight to big-buying Lafayette—made us a hard-to-believe offer—and we closed the deal then and there! You get the lowest prices ever on a truly fine instrument—precision built for accuracy and long lasting service. Triple position turret holds 3 achromatic color-corrected objectives for magnification of 100X, 200X and 300X power! Heavy base and stand—inclines through 90°. Dual knob focusing by rack and pinion. Adjustable plano sub-stage mirror. High grade microoptics used throughout! Complete with fitted wood-on carrying case and slides. Shpg. Wt. 4 1/2 lbs.

F-10..... NET 3.95

3.95

LAFAYETTE CAMERA DIVISION presents the **TARON** PHOTOGRAPHIC SYSTEM *Versatility at Low Cost!*

TARON 'RANGEFINDER 35'

- 5 ELEMENT F2.8 COATED LENS!
- COUPLED RANGEFINDER

only **37.50** less case

- ✓ BRILLIANT COMBINED VIEW-RANGE FINDER! ✓ SINGLE STROKE RAPID FILM TRANSPORT!
- ✓ NINE SHUTTER SPEEDS TO 1/300! ✓ MXF SYNC-ALL SPEEDS — ALL BULBS — PLUS STROBE!
- ✓ F2.8 45mm COATED LENS! ✓ HI-SPEED REWIND!
- ✓ STANDARD PC FLASH TERMINAL! ✓ DOUBLE EXPOSURE PREVENTION!
- ✓ BUILT-IN SELF TIMER!

Lafayette's outstanding camera value! Precision-made to order for the camera fan who is a wise buyer. Check the features — then compare Lafayette's price with any other brand. Fast F2.8 coated anastigmat lens and extra-wide lens aperture for brilliant, sharper full color or black and white even in poor light. Sight and focus through combined range-view finder. Fully synchronized at all speeds for class F, M and electronic flash. Speeds from 1 sec to 1/300th. Rapid advance sets shutter, counts exposure and transports film. Built-in delayed action timer — automatic exposure counter and film stop. Hi-speed rewind with folding lever. Standard accessory shoe on top-film type indicator. All metal body with brushed chrome trim-black leatherette covering. 20 or 36 exposures on black and white or color 35mm film. PC flash terminal. Shpg. wt. 3 lbs. Use series 6 accessories.

F-196	Net 37.50
F-197 Leather Eveready Case. Shpg. wt. 1/2 lb.	Net 3.95
Three piece outfit — camera above — Eveready case — and folding BC flash gun. Shpg. wt. 4 1/2 lbs.	Net 44.95
F-198	Net 44.95



Auxiliary lens pictured not included

NEW! TARON AUXILIARY LENSES

- TELEPHOTO — TWICE AS CLOSE!
- WIDE ANGLE — 75% MORE AREA!
- CLOSE UP — DOWN TO 6 1/2"!



PACKAGE DEAL
29.95

Telephoto shots — wide angle shots or extreme close ups. Easy as 1-2-3 with the new Taron auxiliary lenses. Each lens is hard coated for maximum light transmission. Prefocused and color corrected. No increase in exposure setting is necessary. Wide angle and telephoto lenses screw into lens mount. Bring your subject twice as close with the Taron Telephoto — add 75% more area with the Taron Wide-angle. Indispensable for panoramic shots. Close up lens kit consists of +1, +2, and +3 Proxar lenses — allows focussing down to 6 1/2" for amazing close-up results. All Taron auxiliary lenses are supplied in cowhide cases. Use with any color or black and white film. The close up lenses require an adapter ring for mounting on your camera. Shpg. wt. of each auxiliary lens approx. 6 ozs.

F-292 — AUX. TELEPHOTO LENS (A)	Net 9.90
F-293 — AUX. WIDE ANGLE LENS (A)	Net 9.90
F-294 — CLOSE UP SET (B)	Net 8.91
F-297 — VIEW FINDER FOR TELEPHOTO AND W-A LENS (C)	Net 1.69
F-314 — ADAPTER RING FOR CLOSE UP (D)	Net 1.95
PACKAGE DEAL: One each of the auxiliary lenses, close up set, adapter, and view finder. Shpg. wt., 1 1/2 lbs.	Net 29.95
F-298	Net 29.95

TARON FOLDING BC FLASH GUN



- FOLDS LIKE A FAN TO 4" x 2 1/4"
- EFFICIENT B-C OPERATION!

Brand new — unique — pocket size — completely folding flash unit of Lafayette's famous low-cost! Efficient 4 1/2" diameter metal reflector has pebbled finish to eliminate hot spots. B-C combination for surefire and hi voltage. Heavy molded battery case with built in test lamp — bulb ejector — extension socket. Standard shoe with pressure adjust fits accessory clips. Uses standard bayonet base flash bulbs. Novel, useful exposure guide built in on rear of case. Complete with cord for PC fitting and condenser. Shpg. wt. 1 lb.

F-209 Complete with case. Net **3.99**

Net **3.99**

NEW BOOSTER EXPOSURE METER



- COMPLETE WITH "64x" BOOSTER CELL-MATCHED LEATHER CASES — NECK CHAIN.
- REFLECTED AND INCIDENT LIGHT. QUICK ACCURATE ONE HAND OPERATION. VERSATILE — SIMPLE — DIRECT READING.
- ASA FILM INDEX RATINGS FROM 3 TO 3200.

Shutter speeds 60 seconds to 1/1000th sec. Lens apertures from F:1 to F:32. Polaroid exposure numbers, 1-9. Direct light value scale (LVS) reading 1-18. Movie camera, frames/second: 8-64. Reflected and Incident light measuring methods. Booster cell increases low light sensitivity for extremely low light readings. Complete with incident light attachments — booster cell — matched leather cases — meter chain. Shpg. wt., 1 lb.

F-296 Net **9.95**



TARON PAN-HEAD TRIPOD

- LIGHTWEIGHT — STURDY — LOW COST

Five section, chrome plated, brass tripod. Extends to 45" telescopes down to 12 1/2". Weighs only 20 ozs. Tension adjust screws for each leg. Camera retaining screw on panhead rotates — makes turning camera unnecessary. Pans and tilts with a single motion. Handle is detachable. Pans 360° — tilts 145°. A "must" to take the "jiggle" out of those special shots. Shpg. wt., 2 1/2 lbs.

F-295 Net **4.99**

Net **4.99**



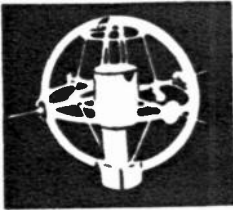

LAFAYETTE'S ASTRONOMICAL VALUES for the International Geophysical Year

NEW!



35.50

3 IN. REFLECTING TELESCOPE

- ADJUSTABLE EQUATORIAL MOUNTING
- MIRRORS ACCURATE TO 1/4 WAVE LENGTH
- ALUMINIZED AND QUARTZ OVER COATED

The finest 3" reflecting telescope available for the astronomer with a limited budget. Proven to the specifications of outstanding experts. Fully 3" Telescope available with an adjustable equatorial mount—permanently collimated mirrors—aluminized and quartz over coated mirrors guaranteed accurate to 1/4 wave or better. Adjustable for proper tracking in Right Ascension and Declination. Seamless aluminum tube. All castings carefully machined and assembled. Trip-proof tripod. Ideal for the beginner and amateur astronomer. 60X permits observation of Moon craters and mountains—Saturn's rings—Jupiter's satellites—double stars—clusters—and refulee. Complete with instructions. Shpg. wt., 12 lbs.

F-315Net **35.50**
F-316—As Above, 4 1/2", 50X-100X.....Net **59.85**
F-317—As Above, 6", 50X-100X-200X,
Pedestal cantilever Base.....Net **259.50**

MT. PALOMAR TELESCOPE

8.39

- WORKING SCALE MODEL
- MORE THAN A "TOY"
- BAUSCH & LOMB REFLECTOR LENS
- SEE THE MOON'S CRATERS — JUPITER — SATURN

Working scale model of the 200 inch Mt. Palomar telescope. Bausch and Lomb prime focus reflector lens—optically ground and polished. Rigid design—

sturdy operating controls to better enable the young astronomer to study the Moon — Saturn — Jupiter — and all the wonders of the night sky. More than a toy — an accurate, powerful optical instrument. Educational — Interesting — and fun to use! A natural for today's space minded youngsters — suitable for the amateur astronomer. Complete kit including easy to follow instructions and illustrated "Star Guide". Shpg. wt. 5 lbs.

F-223List 11.95Net **8.39**
Fully assembled — Ready to use. Exactly as described above but completely assembled. Shpg. wt. 5 lbs. F-224List 14.95Net 16.49

IMPORTED BINOCULARS WITH COATED ACHROMATIC LENSES AND PRISMS

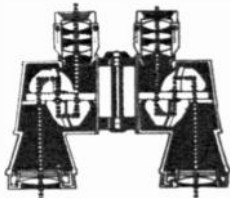

Lafayette has gone "all-out" to present these fine, imported Zeiss type binoculars at heretofore unheard of prices! Each of these extremely precise optical instruments have coated lenses—clamped in (not just glued!) prisms—light weight alloy all metal bodies—weather proof, tear proof outer coverings—maximum light transmission—minimum distortion. Made by leading optical manufacturers to our own rigid specifications. Whether you are a yachtman—hunter—hiker—sports fan—or a bird watcher—you'll find the binoculars you need in Lafayette's great selection. And Lafayette's famous money-back guarantee applies as always.

FOCUS—mechanism is either central focus (C.F.) by means of a single wheel and one adjustable eye piece, or individual focus (I.F.) wherein both eye pieces are separately adjustable.

POWER—is the number of times an image is magnified through your binoculars. For example 7X (7 power) means the object will appear 7 times larger (or closer) than with the naked eye. The second number used (i.e. the "50" in 12X, 50) is the diameter in millimeters of the objective lens.

COATED LENSES—tend to reduce reflection and pass up to 88% more light than uncoated lenses.

		Includes Hard Plastic case	
F-182	6x.15 I.F.	Shpg. Wt. 2 lbs.	NET 16.78
F-15	7x.35 I.F.	Shpg. Wt. 3 lbs.	NET 17.98
F-183	7x.35 C.F.	Shpg. Wt. 3 lbs.	NET 20.98
F-184	7x.35 C.F.	Wide Angle—Shpg. Wt. 3 1/2 lbs.	NET 29.98
F-185	7x.50 I.F.	Shpg. Wt. 3 1/2 lbs.	NET 21.80
F-186	7x.50 C.F.	Shpg. Wt. 3 1/2 lbs.	NET 24.98
F-104	12x.50 C.F.	Shpg. Wt. 4 1/2 lbs.	NET 27.98
F-118	16x.50 C.F.	Extra Light Weight—Shpg. Wt. 3 1/2 lbs.	NET 31.80
F-185	20x.50 C.F.	Shpg. Wt., 4 1/2 lbs.	NET 37.80

Add 10% Fed. Tax to Above Prices

BINOCULAR MOUNTING CLAMP

Indispensable accessory for high powered binoculars. Fits all sizes—individual or central focus. Used with standard camera tripod. Holds binoculars steady for long range—extended period use. Satin black finish. Shpg. wt., 1/2 lb.

F-187Net **2.45**



NEW! 132X 88X 64X 40X ASTRONOMICAL TELESCOPE



Regularly 125.00

**Special
69.50**

- 800 MM FOCAL LENGTH
- 2.4" OBJECTIVE LENS
- SLOW MOTION CONTROLS

All new, 1958 version of Lafayette's famous 2.4" refracting telescope. A professional instrument for the amateur astronomer. Fully coated and corrected for coma and spherical and chromatic aberration. Fork type altazimuth mount has slow motion controls for both altitude and azimuth. Focusing by means of draw tube, rack and pinion drive with coaxial knobs. Body tube of white enameled duraluminum. Moving parts of heavily chrome plated brass. Includes 5X20mm focusing view finder with etched cross-hairs. 4 coated eyepieces, 6mm, 9mm, 12.5mm, 20mm. Sunglass, erecting prism, star diagonal, wooden cabinet, tripod with chain brace. Optical specifications: Objective lens 62mm, focal length 800 mm. Shpg. wt., 25 lbs.

F-329Net **69.50**

NEW! 90X ASTRONOMICAL TELESCOPE SPECIAL PRICE

39.50

- 90X - 50X - 25X
- 2.06" OBJECTIVE LENS
- REGULARLY \$75.00



A fine, low cost, instrument for the beginner in astronomy. Lenses are coated and corrected. Altazimuth mount—may be used on table or other flat surface by removing tripod legs. Three eyepieces, 90X7mm, 50X12.7mm, 25X25mm. Sunglass and star diagonal for viewing convenience. Correcting system affords erect image for terrestrial and astronomical viewing. 3X finder scope, easily collimated. Focusing by means of rack and pinion gear system. Body tube of white enameled duraluminum. Extra large dew cap protects lens from condensation—excludes stray light. Moving parts of chrome plated brass. Collapsible wooden tripod with chain brace. 52mm objective lens, focal length 630mm. Light weight for ease of handling. Shpg. wt., 20 lbs.

F-319Net **39.50**

SPITZ JR. PLANETARIUM



- BRINGS THE SATELLITE INTO YOUR HOME!
- PROJECTS - LOCATES - TRACES THE SATELLITE!
- PROJECTS 400 STARS! - 70 CONSTELLATIONS!
- SCIENTIFIC - EDUCATIONAL - ACCURATE

A REAL PLANETARIUM AS ACCURATE AS A professional model. See an exact reproduction of all the stars and constellations as they appear every month of the year. A special adaptor permits the projection of the satellite in its proper place in your "private sky". Instructions written by Armand Spitz—leading astronomer—detail methods for locating the "Satellite" in the heavens at any specific time—in any specific place. Just darken your room and the heavens are on your walls and ceilings. More than a toy... you can spend hours with this educational scientific marvel. Designed by Armand Spitz, world's leading astronomer. Complete with beautifully written 32-page book containing charts and illustrations for identification of thousands of stars, planets, and constellations. A natural for today's space minded youngsters. Shpg. wt., 3 lbs.

SPITZ JUNIOR PLANETARIUMNet **10.75**

SKY ZOO PROJECTOR SPHERE

Converts the Spitz Jr. Planetarium to project the actual figures of the major constellations on the walls and ceiling of any darkened room. Floods your own private "sky" with the mythical figures of the constellations. Complete with instruction book. Shpg. wt., 1 lb.

Sky Zoo Sphere—List 4.00Net **2.70**

SOUTHERN HEMISPHERE PROJECTOR

Convert Planetarium to project the heavens as seen from below the Equator. Shows stars invisible to people living north of the Equator. Shpg. wt., 1 lb.

Southern Hemisphere Projector—List 4.00Net **2.70**

Lafayette LEAD Values IN RADIO SETS

THE LAFAYETTE NOVELETTE *The First Really New Idea In Pocket Radios In Twenty Years.*

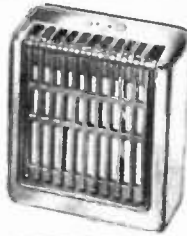

17.95

- **POCKET SIZE:** The set measures only 5½" L x 3½" H x 1½" D.
- **SEPARATE SPEAKER:** Superb tone quality. Case measures 2¾" W x 3" H x 1¾" D.
- **BEAUTIFULLY STYLED:** Handsome maroon plastic case with clear lucite dial with silver lettering

The Lafayette Novelette is the finest handiest little portable set you can buy. Because the speaker is in its own properly baffled case free from the space limitations of self-contained speakers, the tone quality is superb. A 3½ ft. extension cord enables the speaker to be placed conveniently wherever desired so all can hear. When you want to listen "silently" without disturbing anyone else, you simply plug in the personal earpiece in place of the speaker. It is therefore ideal for both home use or to take with you on picnics, camping, or wherever you go. It slips right into your pocket. The circuit is very selective, sensitive, and powerful using 4 tubes with built-in antenna. The Novelette comes complete with tubes, speaker and earpiece. Less batteries. Shpg. wt. 3 lbs.

PS-100 — LAFAYETTE NOVELETTE (less batteries)	Net	17.95
Requires 1 — Burgess U30	Net	1.75
Requires 1 — Burgess #1	Net	.10

NEW "5 in 1" ALL TRANSISTOR PORTABLE RADIO



SIZE
5¾"W
x 3½"H
x 1¾"D
36.50

IT'S A POWERFUL POCKET RADIO, HEARING AID, PRIVATE LISTENING RECEIVER, BABY-SITTER-INTERCOM AND AMPLIFIER FOR REMOTE RECEPTION.

A new transistorized miniature high power pocket portable with good sensitivity and tone quality. A single, extra long life, low cost battery powers the unit for approximately 6 months. Converted to a sensitive hearing aid by a flip of a switch and plug-in of earphone. The earphone also converts the receiver to a sensitive personal radio for individual listening. By plugging in a remote speaker, the unit becomes an intercom baby sitter or sickroom calling device. The plug-in speaker can also be utilized for additional volume for radio reception at any remote point. Has built-in loop antenna and ferrite tuned IF transformer. Genuine leather case and carrying handle. Shpg. wt., 1 lb.

IN-458—Less Battery and Earphone	Net	36.50
MS-366—Sensitive Matching Earphone	Net	1.29
Burgess 2N6 or RCA VS305 Battery for Receiver	Net	1.30

NEW CROSELY TRANSISTOR BOOK RADIO

Reg. 50.00
only **17.95**

- SELF POWERED
- DESIGNED FOR GIFT GIVING
- THE PERFECT ENTERTAINMENT COMPANION



Lafayette's Luxury Transistorized Book Radio makes a fabulous gift! Twin transistors in Class B output give five times the usual audio level of similar sets using a sub-miniature output tube. A new printed circuit unaffected by moisture and vibration for long, trouble free operation. So compact you can slip the Book Radio in your pocket—carry it wherever you go. Latest ferrite core antenna—pulls in even distant stations—over the entire AM range. Automatic power switch turns radio on and off when cover is opened and closed. Low battery drain accomplished by balanced circuitry using three sub-miniature tubes and two transistors. Clear acetate dust jacket, gold inscribed gift card, gold transfer kit for inscribing signature and special mailing carton included for gift-giving. Quantities are limited. Dimensions: 2-1/32" H x 7" W x 4-21/32" D. Shpg. wt. (less batteries) 2½ lbs.

TRANSISTOR BOOK RADIO (less batteries)	Net	17.95
Batteries for Above 1-V5086	Net	1.75
1-V5400	Net	1.80

6 TRANSISTOR SUPERHET RADIO



- POWERFUL 4" ALNICO 5 SPEAKER
 - LOW BATTERY DRAIN
 - 3 TUNED IF STAGES
 - PUSH-PULL 300 MW OUTPUT
- 32.50**

An all-transistor portable radio having hi-gain super-sensitive reception. A class B push-pull output stage supplies abundant power to the 4" Alnico speaker. The superhet circuit features 6 transistors and a diode, fully automatic volume control, trouble-free printed circuit, and ferrite loop antenna. Exceptional sensitivity, selectivity and interference rejection is achieved by the 3 stages of IF amplification. Weight with batteries less than 3½ lbs. Scuff-proof Texon case in British Tan. Size 9¼"W x 6¾"H x 3¼"D. Shpg. wt., 5 lbs.

IN-684—Less Battery	Net	32.50
Burgess D6 or RCA VS306 Battery	Net	1.16

REGENCY FM TELEVERTER

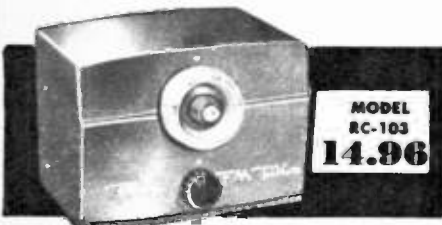

MODEL
RC-103
14.96

- MAKES ANY TV SET AN FM RECEIVER
- COMPLETELY TRANSISTORIZED
- SIMPLY INSTALLED BY ANYONE

The Regency Model RC-103 Televerter makes any TV set an FM receiver at the flip of a switch, yet does not interfere with normal TV reception. Utilizes the TV audio system and large speaker baffle to produce tone quality for superior to small table model FM receivers. Completely transistorized, its power source is 3 tiny penlight batteries with current drain so low (300 µA) that battery life expectancy approaches shelf life. Simply installed by anyone in 5 minutes—the only connections necessary are to TV set antenna terminals and antenna. Meets FCC radiation requirements. Large easy-to-read dial and planetary drive make fine tuning easy and razor sharp. Housed in attractive 4½" x 6" x 4½" plastic cabinet. Shpg. wt., 5 lbs.

Regency RC-103—FM TELEVERTER	Net	14.96
BURGESS CELLS (3 needed)	Net	1.30

TABLE MODEL SUPERHET



- AC-DC SUPERHET CIRCUIT
 - POWERFUL ALNICO 5 SPEAKER
 - BUILT-IN LOOP ANTENNA
 - HANDSOME BAKELITE CABINET
- 13.95**

Handsome compact table model distinguished for its unusual styling and performance. Latest AC-DC 5-tube superhet circuit provides surprising sensitivity and selectivity, with built-in antenna for strong reception anywhere. Complete broadcast band coverage from 550 to 1700 KC with excellent clear tone qualities on all stations. Civilian Defense Conelrad frequencies clearly indicated. Refreshingly styled in attractively colored bakelite cabinet with ivory trim. For 110 volts AC or DC. Size 8½" x 5¼" x 4½". Shpg. wt., 5 lbs.

IN-591	Net	13.95
--------------	-----	-------

DELUXE CLOCK RADIO

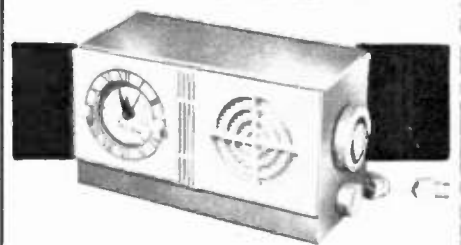

- SELF-STARTING CLOCK
 - SWEEP SECOND HAND
 - 5 TUBE SUPERHET CIRCUIT
- 19.95**

An incomparable clock-radio value. Self-starting clock has sweep-second hand. Turns radio on automatically, also has buzzer which sounds if you doze off again. All clock knobs are conveniently located on the front of the timer with Alarm set, Time set, and Radio "on-off" switches clearly indicated. Superior quality 5 tube superheterodyne receiver, brings in signals sharp and clear. Beautifully styled in attractive colors. Sizes 8½" x 5¼" x 4½". For 110-120 Volt 50-60 cycle AC only. Shpg. wt., 5 lbs.

IN-592	Net	19.95
--------------	-----	-------

Modern Styling LAFAYETTE PHONOGRAPHS Budget Priced

4-SPEED PORTABLE PHONOGRAPH



With this portable phonograph you can play any record up to 12" size at 33 1/3, 45 or 78 rpm, or at the new "Talking Book" speed of 16-2/3 rpm. A single lever selects any speed. The lightweight pickup arm is equipped with a single all-purpose needle, for all records. A special hub, for 45 rpm records, is provided; the hub retracts below the turntable level when other records are played. Volume control, with on-off switch. Fine quality Alnico 5 pm speaker. Attractive 2-tone leatherette-covered case. For 117 volts, 60 cps AC. Dimensions 12 1/2" x 10 1/4" x 5 1/4". Shpg. wt., 9 lbs.

PH-60 Net 15.95

4-SPEED PORTABLE WITH TURNOVER CARTRIDGE



Extremely compact, light in weight. Turnover cartridge provides separate needles for microgroove (33-1/3, 45 or 16-2/3 rpm) and for standard 78 rpm records. A single lever control selects any speed. Precision, heavy-duty motor for constant speeds. Has quality 6" Alnico 5 pm speaker, separate volume and tone controls. Retractable 45 rpm spindle built in; player takes all record sizes up to 12". An excellent phonograph at an unusually low price. Covered in attractive Green Cobra and Ivory Tutone leatherette. For 117 volts, 60 cps AC. Dimensions 16" x 6 1/4" x 12". Shpg. wt., 12 lbs.

PH-61 Net 22.50

NEWEST LAFAYETTE HIGH-FIDELITY "STAR"

- GE Reluctance Triple Play Cartridge With 2 Sapphire Styli



- Dual Speakers: 6" x 9" Wide Range And 4" Tweeter

The famous Lafayette "Star" now incorporates an extended-range speaker system with 50 to 15,000 cps response. The 4-speed phonograph plays all record sizes up to 12" and has the famous GE variable reluctance "triple-play" cartridge with two sapphire-tipped needles. With retractable spindle for 45 rpm records. Separate bass and treble tone controls and volume control. The 2 speakers produce a real feeling of "presence." Non-slip rubber turntable mat. Size: 8 3/4" x 13" x 16". Covered in your choice of Ginger Congo or Gray Congo leatherette. For 117 volts, 60 cps AC. Shpg. wt., 14 lbs.

PH-62 Net 37.50

PORTABLE 45 RPM AUTOMATIC RECORD CHANGER



- PLAYS A STACK OF 14-45 RPM RECORDS AUTOMATICALLY

An attractively styled portable phonograph for all types of 45 RPM records. Self-contained powerful amplifier and Alnico V speaker. Automatically changes records: plays a full stack of 14 for up to 2 hours of continuous music. Has full range volume control. Wood case, with lock corner construction, is covered in charcoal stripe leatherette with Ivory trim. Truly portable, only 8 1/4" x 10 3/4" x 7". Shpg. wt., 9 lbs.

PH-42 Net 26.95

QUALITY 4-SPEED AUTOMATIC CHANGER



SPECIAL!
33.50

- FULLY AUTOMATIC INTERMIX RECORD CHANGER
- TURNOVER CARTRIDGE

This excellent record changer provides quality reproduction for better than its extremely low price would indicate. The BSR automatic changer will play at 16 2/3, 33 1/3, 45 and 78 rpm and will intermix a stack of up to 10-7", 10" and 12" records in any order. Automatic shutoff after last record. Lightweight, cushioned pickup arm with turnover cartridge and 2 permanent-type needles. Amplifier provides plenty of power for parties or dancing. Alnico 5 pm speaker for fine sound reproduction. Heavy-duty 4-pole motor drives rubber mat turntable. Cabinet is wood, covered with simulated-leatherette styled in two-tone brown and beige with gold-finish beading. Sturdy plastic handle and bronze finish hardware. For 105-125 volts, 60 cycles AC only. Size 13 1/4" w x 11 1/2" d x 8 1/2" h. Shpg. wt., 20 lbs.

PH-53 Net 33.50

HI-FIDELITY PORTABLE RECORD CHANGER



- GE TRIPLE-PLAY CARTRIDGE
- DUAL SPEAKERS

This portable phonograph contains the world-famous Callara 4-speed automatic record changer, made in England. Powerful 4-pole motor; weighted turntable and featherweight tone arm; jam-proof, child-proof mechanism; automatic muting switch; and automatic intermixing of 10" and 12" records — are but a few of the outstanding features. Equipped with the GE "triple-play" high fidelity cartridge with dual sapphire styli. Incorporates a 6" x 9" Alnico 5 pm wide-range speaker and a 4" Alnico 5 pm high frequency speaker (tweeter) to provide a startling "presence" effect and a response of 50 to 15,000 cps. Separate bass and treble tone controls, volume control, negative feedback — all combine to provide an excellent high fidelity phonograph. Covered in your choice of Charcoal Cobra Grain with Ivory Congo or Ginger Congo and Ivory leatherette. For 117 volts, 60 cps AC. Sizes 20" x 13" x 9"; Shpg. wt., 25 lbs.

PH-63 Net 69.50

DELUXE HI-FI PORTABLE CHANGER



- GARRARD CHANGER • GE CARTRIDGE • 2 SPEAKERS
- PUSH-PULL AMPLIFIER

Lafayette's finest high-fidelity automatic portable. Incorporates the world-famous Garrard automatic record changer, imported from England. Equipped with GE "triple-play" magnetic cartridge with dual sapphire styli. The powerful push-pull amplifier has 4 tubes plus selenium rectifier; separate bass and treble tone controls; loudness control, and contour control. The combination of the last 2 controls provides extra boost to compensate for the characteristics of the audio spectrum to compensate high and low ends of the audio spectrum to compensate for the characteristics of the human ear. 2 speakers, 8" and 4" Alnico 5 pm for 50 to 15,000 cps response with minimum distortion. Covered in your choice of Charcoal Congo with Ivory trim or Brown and Ivory leatherette. Size 20 1/2" x 13 1/2" x 8 1/4". For 117 volts, 60 cps AC. Shpg. wt., 25 lbs.

PH-65 Net 77.25

AND DON'T FORGET LAFAYETTE'S MONEY BACK GUARANTEE

LAFAYETTE

MATCHED HI-FI PHONO SYSTEM

Special!
COMBINATION OFFER



Reg. Price ~~153.55~~
119.50

NOTHING FINER AT THIS PRICE!

NOBODY BUT LAFAYETTE can bring you a phono system of this quality and at this price. Indeed a Lafayette "best buy" system designed around the new Lafayette LA-69 20 watt amplifier. The performance of this phono system surpasses the most critical requirements of music lovers at a price below that of commercial phonographs. Twenty-four combinations of record equalization provide an almost endless variety of tone compensation to match varying recording characteristics. In addition to the LA-69 this system includes the famous Garrard RC121 4 Speed Record Changer featuring full automatic and manual positions and Simple-mix operation; the new Improved VR7II Variable Reluctance GE Triple Play Turnover Cartridge Model 4G-052 with genuine GE diamond and sapphire stylus; the celebrated Lafayette SK-58 12" Coaxial HI-FI Speaker. All units are supplied with plugs, jacks and prepared color coded interconnecting cables for quick easy installation. For 110-125 volt, 60 cycle AC. Shpg. Wt.. 50 lbs.
MF-179—Complete Phono System Net \$119.50

LAFAYETTE HIGH FIDELITY RECORDING TAPE



1.49 ea.
in LOTS OF 10.
Single, each
1.59
CAT NO RT-10

GUARANTEED SPLICE FREE ALL LAFAYETTE TAPES SOLD ON MONEY-BACK GUARANTEE

Lafayette's huge purchasing power enables our providing you with standard first-quality tape at almost half the price you would pay for the same tape with the manufacturers' own labels. WE GUARANTEE SATISFACTION OR YOUR MONEY BACK! The finest professional-quality recording tape available. Highest performance for thousands of playings. Uniformly-coated red oxide on plastic base with high output and uniform frequency response of 40-15,000 cps. 1200 ft. reel gives 1 hr. of recording time at 7 1/2 inches/sec and dual track, and 2 hrs. at 3 3/4 inches/second. 1800 ft. reel gives 1 1/2 hrs. recording time at 7 1/2 ips dual track, and 3 hrs at 3 3/4 ips. A true Lafayette value backed up by our Money Back Guarantee. You be the judge—try it!

RT-10—1200 FT. 7" REEL { 1.49 EA. IN LOTS OF 10
1.59 SINGLY
RT-11—TIME & HALF 1800 FT. 7" REEL { 1.88 EA. IN LOTS OF 10
1.98 SINGLY

FREE

If You Do Not Have Our Big 1957-1958 General Catalog #305, Paste Coupon On Post Card And Mail To Box 511, Jamaica 31, N. Y.

Name _____
Address _____
City _____ State _____
Lafayette Radio P.O. Box 511
JAMAICA 31, N. Y.



NATIONALLY ADVERTISED

4-SPEED AUTOMATIC RECORD CHANGER

39.50 ~~Reg. 59.50~~

COMPLETE WITH NEW GE VR7II SERIES DIAMOND-SAPPHIRE CARTRIDGE



new GE VR7II Series Triple Play Cartridge

NOT A CLOSEOUT—NOT A DISCONTINUED Model. This is a nationally advertised, latest model record changer, with new GE VR7II Series Triple Play Cartridge with G.E. Genuine diamond and sapphire stylus and is priced so low that we DARE NOT mention the manufacturer's name. This fully automatic record changer has exclusive and deluxe features for the finest hi-fi systems, such as automatic intermix, muting switch, click filter and automatic shut-off after last record. Heavy duty 4-pole shaded pole motor with heavy rim-weighted turntable. 4 speeds, 78, 45, 33 1/2, 16-2/3 RPM. Negligible wow and flutter. We are so confident that you will be happy with this purchase, that if for any reason you do not feel you have received an exceptional value, we shall cheerfully refund your purchase price. Size 12 1/4" x 13 3/4", requiring 11/16" clearance above and 2-11/16" below motorboard. Shpg. wt., 21 lbs.

PK-250 RECORD CHANGER (less woodbase) with NEW GE 4G-052 Diamond-Sapphire Cartridge Net **39.50**
MAHOGANY OR BLONDE WOODBASE CUT TO FIT ABOVE
PK-111—Specify Finish. Shpg. wt., 5 lbs. Net **3.95**

Form 3547 Requested

JOHN R. YOUNG 6-59
P O BOX 265
GROTTONES VA

LAFAYETTE RADIO
165-08 LIBERTY AVE.
JAMAICA 33, N. Y.

BULK RATE U.S. POSTAGE PAID
New York, N. Y.
Permit No. 8486