



**AM-FM-TELEVISION  
BROADCAST  
EQUIPMENT**

# BROADCAST EQUIPMENT CATALOG

**AM, FM AND TELEVISION  
1950**

Price . . . Two Dollars



BROADCAST EQUIPMENT SECTION

**RADIO CORPORATION OF AMERICA**

Engineering Products Department

Camden, N. J.

AUDIO EQUIPMENT AM-FM-TV	5
VIDEO EQUIPMENT	109
TRANSMITTERS AM-FM-TV	215
ANTENNAS AM-FM-TV	285
TEST AND MEASURING EQUIPMENT	337
OTHER RCA PRODUCTS	369
INDEX	404



## FOREWORD

This Broadcast Equipment Catalog is intended to serve as a buying guide to the user of this type of equipment. An attempt has been made to present a clear and concise picture covering: features, uses, description and specifications for each item of broadcast equipment.

RCA manufactures a complete line of broadcast equipment from microphone to antenna inclusive—for FM, AM and Television. This line includes not only the operating units but also such necessary accessories as monitoring and test equipment. RCA is equipped to furnish custom built studio equipment and antenna phasing equipments. RCA designs and manufactures the components for its broadcast equipment whenever necessary or desirable to insure maximum performance and reliability. Major items of such components are tubes, inductance coils, mica capacitors, crystals and transformers.

RCA is the leader in the field of broadcast equipment. This is evidenced by the fact that for seventeen years RCA equipment has outsold all other manufacturers. This record includes large and small stations—among them a large proportion of the most notable installations made during this period. RCA has been and will continue to be an active leader in FM development. RCA pioneered the development of electronic television. Twenty-five years of progress in the radio field plus vast wartime experience has given RCA an engineering background for the production of the most advanced and highest quality broadcasting apparatus.

Readers of this catalog are invited to communicate with the nearest RCA Regional Office for additional information or individual bulletins on the equipment shown herein. Separate catalogs or descriptive bulletins are available on other lines of RCA equipment such as Sound, Theatre, Aviation, Mobile Communications, Scientific Instruments.

# BROADCAST EQUIPMENT SALES POLICY

## Foreword

The present statement sets forth basic conditions under which RCA sells broadcast equipment as described in this catalog, and notes certain supplemental information. This statement does not apply to the sale of tubes or sound film recording equipment, for which separate, standard sales and lease policies are in effect.

RCA broadcast equipment is sold directly through RCA Regional representatives, who are familiar with broadcast equipment and related problems.

## Contract Procedure

All sales based on orders for transmitters, antennas and custom built or special apparatus and on orders over \$5,000 are made in accordance with the conditions of the RCA Standard Proposal Form for the sale of broadcast equipment and with any agreement stipulated thereon for individual customers.

## Prices

RCA broadcast equipment prices are net f.o.b. factory or warehouse, which is Camden, New Jersey, for most items. These prices do not include any federal, state or local taxes based upon use or measured by sale or use and unless otherwise noted do not include federal excise tax. Any such taxes in effect at the time of shipment will be billed separately or will be included in the prices when required and will be due and payable upon delivery.

RCA's prices do not include installation or installation supervision unless specifically mentioned in a written condition or proposal. Purchaser assumes responsibility for installation and operation of the equipment as well as for obtaining all necessary licenses, permits, etc.

NOTE: The service of factory trained personnel who are specialists in the supervision of the installation of broadcast equipment and in its maintenance and repair may be obtained through an order placed with the RCA Service Company, Inc. It is recommended that the advantages of this service be considered at the time of purchase of any major broadcast equipment.

In the case of orders under the Standard Proposal Form the billing prices are based on those prices effective at the date of the order to the extent indicated in the final contract. In the case of orders not under the Standard Proposal Form the billing prices are those prices in effect on the date of shipment.

RCA endeavors to keep its published prices current; however, all published prices are subject to change without notice.

## Payment

Terms of payment are subject to approval of RCA's Credit Department at Camden, New Jersey.

## Delivery

RCA's delivery of broadcast equipment will be f.o.b. factory or warehouse, which is Camden, New Jersey for most items. The Purchaser shall be responsible for all transportation charges, and shipments will normally be forwarded with shipping charges "collect". As an accommodation, when specifically requested to do so by the Purchaser's order, RCA will prepay transportation charges and invoice them to the Purchaser as a separate item.

Delivery will be made to a carrier specified by the Purchaser, unless none is specified, in which event it will be to a common carrier selected by RCA. In the absence of specific routing instructions from the purchaser, RCA's judgment with respect to the selection of a route will be final.

As a special service with respect to shipments overland, by inland waterways or by air we carry All Risk Transportation Insurance for the benefit of our Broadcast Equipment customers, and your interests will be amply protected in all shipments of equipment while in transit by the methods indicated

above, at no additional expense to you, provided that you inspect all shipments upon receipt and report any shortages or damages at once to the carrier and to RCA.

RCA will endeavor to meet delivery schedules but it assumes no liability for damages of whatever kind for delays in delivery. No delays in delivery shall relieve the purchaser of his obligation of performance.

## Patent Licenses

RCA broadcast equipment is licensed for radio telephone or television broadcast transmission under United States patents owned by RCA or under United States patents under which RCA is licensed.

## Patent Protection

RCA, at its own expense, will defend any suit which may be brought against a purchaser of broadcast equipment from RCA for infringement of United States patents by the equipment furnished when sold or used for radio telephone or television broadcast transmission, and in any such suit will satisfy any final award for such infringement. This is upon the condition that the purchaser gives RCA prompt notice of such suit and full opportunity to conduct the defense thereof. No costs or expenses shall be incurred for the account of RCA without its written consent. If the purchaser's sale or use of such equipment for radio telephone or television broadcast transmission shall be prevented by permanent injunction, RCA shall substitute for the infringing equipment other equally suitable equipment or, at RCA's option, obtain for the purchaser the right to sell or continue the use of such equipment or, at RCA's option, take back such equipment and refund any sums which the purchaser has paid RCA therefore, less a reasonable amount for use, damage and obsolescence.

## Warranty

Except for electronic tubes, which bear their own warranty which accompanies them at the time of their sale, RCA warrants its broadcast equipment to be free from defects in material and workmanship under normal use and service for a period of one year from the date of delivery. RCA's obligations under this warranty are limited to the repair or replacement of defective parts and the shipment of such repaired or replacement parts to the purchaser f.o.b. factory. Equipment furnished by RCA but listed as manufactured by another bears only the warranty given by such other manufacturer. No warranties other than those set forth herein are given or are to be implied with respect to broadcast equipment. In no event is RCA liable for consequential damages.

## Repaired and Returned Apparatus

Before an apparatus is returned to RCA for repairs or adjustments shipping instructions and an identifying number should be obtained from the nearest RCA Regional Office. RCA assumes no responsibility for unauthorized returns.

## Equipment Modifications and Withdrawals

RCA reserves the right to make, without notice, modifications of the equipment described in this catalog without affecting its right to sell such equipment under orders based on the catalog description, provided, however, that the modifications shall not materially affect performance. These modifications of equipment may be made by RCA or its suppliers from time to time for reasons such as improvement in performance, simplification in design, or availability of material. RCA also reserves the right to withdraw from sale, without notice, any equipment described in this catalog.

## Acceptance of Order

No order shall be binding upon RCA until accepted by it in writing at Camden, New Jersey, and the banking, negotiation or other use of the down payment shall not constitute an acceptance by RCA. Orders received by Regional Offices will be forwarded promptly to RCA's Camden office.



# ORDERING INFORMATION

Apparatus prices have been arranged in the order of listing in the Broadcast Equipment Catalog and are indexed to catalog pages. Please refer to the type and MI number on the page listing the apparatus and then consult this price list in accordance with the page number. Prices on custom-built equipment and other items not listed may be obtained from your nearest field representative.

It is requested that your purchase orders specify the method of transportation desired. Otherwise, RCA will use its best judgment as to the cheapest method of transportation, although this may not always result in the most rapid delivery. Certain items, such as vacuum tubes, are usually shipped by express because of design of carrying container, insurance, etc.

---

NOTE: Master Item (MI) numbers used to identify apparatus on invoices and packing slips are given for each unit.

---

YOU CAN LOCATE YOUR NEAREST RCA REPRESENTATIVE FROM THIS LIST OF

## FIELD OFFICES

36 West 49th Street  
NEW YORK 20, NEW YORK  
Circle 6-4030

522-533 Forsyth Building  
Forsyth and Luckie Streets, N.W.  
ATLANTA 3, GEORGIA  
Walnut 5946

1355 Market Street  
SAN FRANCISCO 3, CALIFORNIA  
Hemlock 1-8300

1907-11 McKinney Avenue  
DALLAS 1, TEXAS  
R-1371, 1372, 1373

221 West 18th Street  
KANSAS CITY 8, MISSOURI  
Victor 6410

666 North Lake Shore Drive  
CHICAGO 11, ILLINOIS  
Delaware 7-0700

718 Keith Building  
CLEVELAND 15, OHIO  
Cherry 3450

1560 North Vine Street  
HOLLYWOOD 28, CALIFORNIA  
Hollywood 9-2154

1625 K Street, N.W.  
WASHINGTON 6, D. C.  
District 1260

# **AUDIO EQUIPMENT AM - FM - TV**

	<b>Page</b>
<b>MICROPHONES</b>	<b>10</b>
<b>CUSTOM-BUILT EQUIPMENT</b>	<b>29</b>
<b>CONSOLETES &amp; SWITCHING</b>	<b>34</b>
<b>AUDIO AMPLIFIERS</b>	<b>48</b>
<b>REMOTE EQUIPMENT</b>	<b>63</b>
<b>RACKS &amp; RACK EQUIPMENT</b>	<b>70</b>
<b>POWER SUPPLIES</b>	<b>84</b>
<b>TURNTABLES</b>	<b>86</b>
<b>RECORDERS</b>	<b>90</b>
<b>LOUDSPEAKERS</b>	<b>103</b>

# Recommended Equipment Lists

The following equipment lists have been prepared as an aid to the selection of broadcast audio equipment required for an average studio installation and for audio and monitoring equipment required for use with a transmitter at the transmitter location. These lists should be used only as a guide in the selection of equipment since the individual requirements of each station must be considered carefully before the proper equipment selection can be made.

Equipment listed for the studio will successfully handle an average installation where not more than two studios are required. For more than two studios consideration should be given to the more extensive equipment requirements such as master control switching with individual studio control. RCA broadcast audio engineers will gladly assist in planning master control installations when these are required.

Transmitter monitoring equipment lists suggest typical equipment for use when the transmitter is located at a point remote from the studio and for use when the transmitter and studio are at the same location. An equipment list is given also for use where MI-11623 transmitter control rack is to be used with control desks which are supplied as standard equipment with RCA BTA-5F, BTA-10F, BTA-50F and BTF-50A Transmitters.

The equipment lists include:

1. AM or FM Studio Equipment
2. AM and FM Studio Equipment
3. AM and FM Remote Equipment
4. Professional Type Recording Equipment
5. Standard Type Recording Equipment
6. AM or FM Transmitter Audio and Monitoring Equipment
  - A Transmitter and Studio at Same Location
  - B Transmitter at Location Remote from Studio
  - C Transmitter at Location Remote from Studio, where MI-11623 Rack is desired to be used with transmitter control desk.

## 1. AM or FM Studio Equipment

Suggested apparatus list for handling two studios, an announce booth, control room microphone, two turntables and equalization for remote lines.

Item No.	Qty.	Description	MI No.
1	1	76-B5 consolette and power supply	11613-D/ 11301-B
2	1	Set of tubes for consolette and power supply	11252

Item No.	Qty.	Description	MI No.
3	4	Relays for studio lights	11702
4	2	"On Air" lights	11706-1
5	2	"Audition" lights	11706-3
6	1	Speaker relay for announce booth	11703-A
7	2	Type 70-D turntables U/G	11801
8	2	Type BA-2C booster amplifiers	11226-B
9	2	Tube kits for BA-2C	11287
10	2	Type 44-BX velocity microphones (one for each studio)	4027-G
11	2	Type 77-D polydirectional microphones (one for each studio)	4045-C
12	1	Type 88-A pressure microphone (one for announce booth)	4048-E
13	1	Type KB-2C "Bantam" velocity microphone (for control room)	11001
14	2	Type 90-A deluxe program stands	4090-A
15	1	Type KS-1A floor stand	12065
16	1	Type KS-3B boom stand	11056
17	1	Type 91-B desk stand	4092-C
18	1	Desk stand for KB-2C	12066
19	6	Microphone connectors	4630-B
20	6	Wall receptacles	4624-A
21	1	Type BR-84B cabinet rack	30951-B84
22	2	Single trim strip	30566-G84
23	1	Terminal board mounting bracket	4570-A
24	1	Power terminal strip	4568
25	1	Audio terminal block	4569
26	2	Type 33-A jack strip	4645-A
27	1	Double jack mat	11502-A
28	4	2' patch cord	4652-2B
29	1	Type BE-1B variable line equalizer	4196-B
30	1	Type BA-14A monitor amplifier (for house speakers)	11234
31	2	Tube kits for BA-14A	11267
32	2	Type LC-1A loudspeaker	11411/11401
33	1	Type BR-2A panel and shelf	11598/11599
34	3	Studio accordion edge speaker (for talk-back in studios)	12435/13225
35	1000'	Interconnecting cable (Rack wiring)	63-A
36	500'	Interconnecting cable (speaker circuits)	64
37	500'	Interconnecting cable (filament circuits)	65



## 2. AM and FM Studio Equipment

Suggested apparatus for separate programming of AM and FM channels. The suggested equipment list assumes four studios, two announce booths, four turntables and equalization for remote lines.

Item No.	Qty.	Description	MI No.
1	2	Type 76-D studio consolette and power supply	11631 11301-B
2	2	Sets of tubes for 76-D consolette and power supply	11628-B
3	*1	BCS-2A switching system	11622
4	2	Console supervisory kits (one for each consolette)	11714
5	6	"On Air" light	11706-1
6	4	"Audition" light	11706-3
7	10	Relay for studio light	11702
8	2	Speaker relays (for announce booth)	11703-A
9	4	Turntables 70-D	11801
10	4	Type 44-BX velocity microphone (one for each studio)	4027-G
11	4	Type 77-D polydirectional microphones (one for each studio)	4045-C
12	2	Type 88-A pressure microphone (for announce booth)	4048-E
13	2	Type KB-2C "Bantam" velocity microphone (for control rooms)	11001
14	4	Type 90-A deluxe program floor stand	4090-A
15	2	Type KS-1A floor stands	12065
16	1	Type KS-3B boom stand	11056
17	1	Type KS-4A Magic Lock Boom Stand	11052
18	2	91-B desk stand	4092-C
19	2	Stands for KB-2C "Bantam" velocity microphone	12066
20	12	Microphone connector	4630-B
21	12	Microphone wall receptacles	4624-A
22	1	Type BR-84-B cabinet rack	30951-B84
23	2	Single trim strip	30566-G84
24	1	Terminal board mounting bracket	4570-A
25	1	Power terminal strip	4568
26	1	Audio terminal block	4569
27	2	Type 33-A jack strip	4645-A
28	1	Double jack mat (for 33-A)	11502-A
29	8	2' patch cord	4652-2B
30	2	Type BE-1B variable line equalizer	4196-B
31	2	Type BA-14A monitoring amplifiers (for house speakers)	11234
32	2	Tube kits for BA-14A	11267
33	2	Type BR-2A panel and shelf	11598/11599

\* If more than two consolettes are needed, substitute the BCS-1A switching system.

Item No.	Qty.	Description	MI No.
34	2	Type LC-1A loudspeaker (for control rooms)	11411/11401
35	6	Accordion edge speakers for talk-back in studios, etc.	12435/13225
36	2000'	Interconnecting cable (rack wiring)	63-A
37	1000'	Interconnecting cable (speaker circuits)	64
38	500'	Interconnecting cable (filament circuits)	65

## 3. AM and FM Remote Equipment

Suggested equipment for handling average remote requirements.

Item No.	Qty.	Description	MI No.
1	2	Type OP-6 remote amplifiers	11202-A
2	2	Tube kits for OP-6 (one each)	11253
3	2	VU meter kits for OP-6 (one each)	11251
4	2	Cover for OP-6	11256
5	1	OP-7 portable mixer-preamplifier	11213
6	1	Tube kit for OP-7	11254
7	1	Cover for OP-7	11257
8	1	Battery box for OP-6 and/or OP-7	11214
9	1	Cover for battery box	11258
10	3	Type 88-A microphones	4048-E
11	5	Microphone cable plug	4630-B
12	2	59-B portable microphone stand	4093-B
13	1	Collapsible banquet stand	4095-A
14	2	Microphone carrying case	4085
15	100'	Microphone extension cable	42
16	2	Extension cable plugs	4620-B

## 4. Professional Type Recording Equipment

Suggested apparatus for producing high quality recordings using Type 73-B professional recording equipment.

Item No.	Qty.	Description	MI No.
1	2	Type 73-B professional recorders	11825/11850-C
2	3	Sapphire styli	4842
3	1	Orthacoustic recording filter	4916-A
4	1	Type BA-14A Monitoring amplifier	11234
5	1	Set of tubes for BA-14A	11267
6	1	Type BR-2A panel and shelf (for amplifier if used)	11598/11599
7	1	Limiting amplifier Type 86-B (complete with tubes)	11216-E

<i>Item No.</i>	<i>Qty.</i>	<i>Description</i>	<i>MI No.</i>	<i>Item No.</i>	<i>Qty.</i>	<i>Description</i>	<i>MI No.</i>
8	1	Type 33-A jack strip	4645-A	8	1	Type 33-A jack strip	4645-A
9	1	Double jack mat (for 33-A)	11502-A	9	1	Double jack mat (for 33-A)	11502-A
10	4	2' patch cord	4652-2B	10	4	2' patch cord	4652-2B
11	1	VU meter panel	11265	11	1	VU meter panel	11265
12	1	Filament transformer, 6.3 V for VU meter panel lamp	11606	12	1	Filament transformer, 6.3 V for VU meter panel lamp	11606
13	1	Type BR-84-B cabinet rack	30951-B84	13	1	Type BR-84-B cabinet rack	30951-B84
14	2	Single trim strip	30566-G84	14	2	Single trim strip	30566-G84
15	1	Terminal board mounting bracket	4570-A	15	1	Terminal board mounting bracket	4570-A
16	1	Terminal power strip	4568	16	1	Terminal power strip	4568
17	1	Terminal audio block	4569	17	1	Terminal audio block	4569
18	1	Type 57-E switch and fuse panel	4395-E	18	1	Type 57-E switch and fuse panel	4395-E
19	3	Blank panels 8 $\frac{3}{4}$ "	4594-B	19	1	Type RS-1A suction equipment	11857
20	1	Blank panel 7"	4593-A	20	1	Chip collector and hose assembly	11858
21	1	Blank panel 3 $\frac{1}{2}$ "	4591-B	21	2	Automatic equalizers for 72-D recorder	11101-A
22	1	Type RS-1A suction equipment	11857	22	3	Blank panel 8 $\frac{3}{4}$ "	4594-B
23	1	Chip collector and hose assembly	11858	23	1	Blank panel 7"	4593-A
24	*2	Automatic equalizer for 73-B recorder	11100-A	24	1	Blank panel 3 $\frac{1}{2}$ "	4591-B

## 5. Standard Type Recording Equipment

Suggested apparatus for making high quality recordings by using recording attachments for the 70-D transcription turntables.

<i>Item No.</i>	<i>Qty.</i>	<i>Description</i>	<i>MI No.</i>
1	2	Type 72-D recording attachments with standard recording head	11901
2	3	Sapphire cutting styli	4842
3	1	*Orthacoustic recording filter	4916-A
4	1	Type BA-14A Monitoring amplifier	11223-B
5	1	Set of tubes for BA-14A	11267
6	1	Type BR-2A panel and shelf for amplifier (if used)	11598/11599
7	1	Type 86-B limiting amplifier (complete with tubes, panel and shelf)	11216-D

## 6. AM or FM Transmitter Audio and Monitoring Equipment

TRANSMITTER AND STUDIO AT SAME LOCATION

<i>Item No.</i>	<i>Qty.</i>	<i>Description</i>	<i>MI No.</i>
1	1	BR-84 cabinet rack	30951-B84
2	2	Single trim strips (cabinet rack)	30566-G84
**3	1	Type WF-48A frequency monitor (AM)	
**4	1	Type WM-43A modulation monitor (AM)	
5	1	Type 86-B limiting amplifier (complete with tubes, panel and shelf)	11216-D
6	2	Type 33-A jack strip	4645-A
7	1	Double jack mat (for 33-A)	11502-A
8	2	Blank panel 8 $\frac{3}{4}$ "	4594-B
9	2	Blank panel 5 $\frac{1}{4}$ "	4592-B

Item No.	Qty.	Description	MI No.
10	1	Blank panel 3½"	4591-B
11	1	Blank panel 1¾"	4590-B
12	1	Type 57-E switch and fuse panel	4395-E
13	1	Terminal block mounting bracket	4570-A
14	1	Terminal power strip	4568
15	1	Terminal audio block	4569
16	1000'	Interconnecting cable (rack wiring)	63-A
17	1000'	Interconnecting cable (filament circuits)	65

**TRANSMITTER AT LOCATION REMOTE FROM STUDIO**

1	1	BR-84 cabinet rack	30951-B84
2	2	Single trim strip (cabinet rack)	30566-G84
**3	1	Type WF-48A frequency monitor (AM)	
**4	1	Type WM-43A modulation monitor (AM)	
5	1	Type 86-B limiting amplifier (complete with tubes, panel and shelf)	11216-D
6	1	Type BA-14A monitoring amplifier	11234
7	1	Set of tubes for BA-14A	11267
8	2	BA-2C booster amplifiers (for microphone and turntable)	11226-B
9	2	Sets of tubes for BA-2C	11287
10	2	BR-2A panel and shelf (for monitor and booster amplifiers)	11598/11599
11	1	Type 33-A jack strip	4645-A
12	1	Double jack mat (for 33-A)	11502-A
13	1	Type BE-1B variable line equalizer	4196-B
14	1	VU meter panel	11265
15	1	Filament transformer, 6.3 V for VU meter panel lamp	11606
16	1	Blank panel 7"	4593-A
17	1	Terminal board mounting bracket	4570-A
18	1	Terminal power strip	4658
19	1	Terminal audio block	4569
20	1	Type 57-E switch and fuse panel	4395-E
21	3	2' patch cord	4652-2B
22	1	Type 88-A pressure microphone	4048-E
23	1	Type 91-B desk stand for microphone	4092-B
24	1	Microphone cable plug	4630-B
25	1	Microphone wall receptacle	4624-A
26	1	Type 70-D turntable	11801-A
27	1	Type LC-1A monitoring speaker	11411/11401
28	1000'	Interconnecting cable (rack wiring)	63-A
29	1000'	Interconnecting cable (filament circuits)	65

\*\* When used for FM, space occupied will be utilized for FM frequency and modulation monitor Type WF-5A.

**Transmitter Location Remote From Studio Where MI-11623 Transmitter Control rack Is Desired to Be Used With Control Desk Supplied With RCA Transmitters BTA-5F, 10-F, 50-F, and BTF-50A**

The MI-11623 Transmitter Monitor and Amplifier Cabinet Rack has been designed to operate with the Control Desks supplied with the BTA-5F, 10-F, 50-F and BTF-50A Transmitters to provide a complete and flexible system of controls and monitors.

Item No.	Qty.	Description	MI No.
1	1	Transmitter monitor and amplifier cabinet rack	11623

This cabinet rack is supplied with the following equipment:

2	Type 33-A jack strip complete with mat
1	Type BA-14A monitoring amplifier and tubes
1	Type 86-A1 limiting amplifier and tubes
1	Type 36-B panel and shelf for limiting amplifier
1	Type 57-C switch and fuse panel
2	*Type BR-2A panel and shelf

**MOUNTINGS AND WIRING ARE ALSO PROVIDED FOR THE FOLLOWING ACCESSORY EQUIPMENT:**

2	Type 56-C fixed line equalizers	
2	Type 15-KC high frequency compensators (to be used in the 56-C)	
1	FM pre-emphasis equalizer	4926-A
1	Power reduction panel	4309-B
1	Hum equalizer	7264-E
3	Type BA-11A amplifiers	11218-A
1	Type BX-1E pre-amplifier power supply	11305-B
1	Blank panel drilled and tapped for mounting 3 MI-11713 line transformers	
1	VU meter panel	11265
1	Filament transformer (for VU meter)	11606
1	Sola voltage regulator	11280

**Notes:**

1. Space and wiring are available at the top of all MI-11623 racks for mounting the Frequency Monitor WF-48A and Modulation Monitor WM-43A, or combination FM Frequency and Modulation Monitor Type WF-5A.

2. Side panels and trim strips for cabinets are available at the customer's specific requirements.

\* One shelf contains the BA-11A amplifier and the other is wired to accommodate 3 BA-11A pre-amplifiers and 1 BX-1E power supply for the pre-amplifiers.



# RCA Microphones

## Microphones General Information

The excellence of RCA microphones is the result of continued effort on the part of Research, Development and Production personnel to produce a superior product. Out of this work have come the several types of broadcast microphones listed in the catalog. There is considerable overlap in the applications of the various types, but each does possess certain attributes which make it particularly well suited to some specific applications. These have been noted for each microphone in the catalog in order to assist in the selection of the microphone best suited for the intended application.

## High Quality Broadcast and Television Microphones

Broadcast-type microphones such as the Types 44-BX, 77-D and 88-A all have certain common performance criteria which make them especially suited to this application. They have smooth response-frequency characteristics over the audio range, low distortion, high input levels, well-shielded output transformers to prevent hum pickup, and where necessary, are shock mounted to reduce the pickup of low frequency building rumble. Performance features which are unique to each particular type are listed and the applications discussed in the catalog.

## Public Address Microphones for Broadcast Use

Public Address Microphones such as the MI-6206 and the KN-1A have been designed as economy microphones. In general, frequency range and sensitivity have been sacrificed to some extent in order to gain ruggedness and lower cost. The response limitations should be borne in mind when these microphones are used in Broadcast applications.

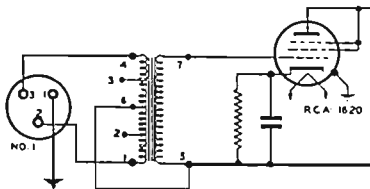

No. 1 Input Channel of OP-7 Portable Preamplifier showing unloaded transformer input

## Unloaded Transformer Input

RCA Broadcast Microphones are designed to work into a microphone preamplifier whose input transformer is unloaded. Under this condition of operation the full generated voltage of the microphone appears at the grid of the first tube resulting in a gain in signal-to-noise ratio of between 3 and 6 db as compared with a matched resistance load. The exact value will depend on whether the major source of noise is in the microphone amplifier or in the output resistance of the microphone.

## Microphone Resistance Loading

Microphones which are relatively inefficient or in which there is a great deal of damping associated with the moving system will in general have their frequency response characteristics little changed by electrical loading. The 88-A and 77-D (in the pressure position) are examples of this.

Highly efficient microphones, particularly those in which the moving system is mass controlled usually show impedance variations for a constant generated voltage. Such microphones will have their response characteristics adversely affected by resistance loading because the mechanical constants of the moving system will be disturbed by the reflected resistance load. The Type 44-BX, and 77-D (in the bi-directional and uni-directional positions) are examples of this. Resistance loading on these will generally result in a loss in low frequency response.

## 150 Ohms vs. 250 Ohms

Where microphones are connected to unloaded input transformers, impedance matching is not a consideration and the effects of connecting microphones with an output impedance of 150 ohms to a microphone amplifier designed to operate from a 250 ohm source and vice versa will usually be of small consequence. The effect on the level is shown in the tabulation below.

Mic. Output Impedance	Level Change db	
	250	150
250	0	+2.2
150	-2.2	0
Amp. Input Designation	250	150

In addition there will be some change in the overall response-frequency characteristic of the system below 100 cycles and above 5000 cycles, the magnitude depending on the connection and the design of both the microphone and the amplifier input transformer. Variations in response with the usual broadcast quality microphone amplifiers will in most cases not exceed  $\pm 2$  db.

When microphones are connected to a resistance load the following changes in level will result when the output is referred to a matched condition.

Mic. Output Impedance	Level Change db	
	250	150
250	0	-2.5
150	+2.0	0
Load Impedance	250	150

## Microphones Shipped Less Plug

RCA microphones are supplied less the plug for connection to the wall outlet or amplifier system. This is done to allow the user to select any desired plug. As a convenience two types of Cannon plugs are cataloged and either may be ordered as an accessory if wanted.

## Microphone Mounting

RCA has standardized on the rugged  $\frac{1}{2}$ " pipe thread for microphone mounting. This size thread makes it easy to add microphone stand extensions, booms, etc., for they may be easily made up locally from standard  $\frac{1}{2}$ " pipe and fittings. Most of the stands listed may also be used with microphones having a  $\frac{5}{8}$ "-27 thread by removing an adapter which is supplied as a part of the stand. Various adapters are also supplied for microphones should the use of the  $\frac{1}{2}$ " pipe thread prove inconvenient.

## Effective Output Level

When a microphone is connected to an unloaded input transformer its power output cannot be expressed in dbm because no appreciable power is delivered by the microphone. The logical approach to the problem is to arrive at some figure which when combined with the conventionally measured ampli-

# RCA Microphones

fier gain will give the correct value of output level. This figure is listed in the catalog for each microphone and is called the Effective Output Level and differs from a proposed RMA standard rating only in the value of sound pressure. The Effective Output Level is based on a sound pressure of 10 dynes per square centimeter and the RMA rating on .0002 dynes per square centimeter.

The RMA standard defines the system rating ( $G_M$ ) of a microphone as the ratio in decibels relative to 0.001 watt per 0.0002 dynes per square centimeter of the maximum electric power available from the microphone to the square of the undisturbed sound field pressure in a plane progressive wave at the microphone position. Expressed mathematically,

$$G_M = (20 \log_{10} \frac{E}{P} - 10 \log_{10} R_{MR}) - 50 \text{ db.}$$

where E = the open circuit voltage of the microphone

P = the undisturbed sound field pressure

$R_{MR}$  = the microphone rating impedance

Electrical reference level = .001 watt

Sound pressure = .0002 dynes/sq. cm.

While this may look complex, the application is simple. In order to find the equivalent of the figure given as Effective Output Level, it is only necessary to add to the value of  $G_M$  the sound pressure level in db relative to 0.0002 dynes per square centimeter. As an example the value of  $G_M$  for the Type 44-BX Velocity Microphone is -149 db, and the usual sound pressure of 10 dynes per square centimeter corresponds to a level of +94 db. The value of  $G_M$  for a sound pressure level of 94 db is therefore -55 dbm, which is identical with the Effective Output Level. When the RMA rating is used, the output level of the microphone can be obtained by simply adding to the value of  $G_M$  the sound pressure level of the program material as measured in any of the readily available sound level meters.

## Hum Pickup Level

An arbitrary standard 60 cycle a-c field of  $10^{-3}$  gauss has been established as a reference. It is fairly representative of fields measured at typical microphone locations in broadcast studios. The hum level is referred to .001 watt and is calculated in the same fashion as the Effective Output Level, using as the output voltage the voltage produced by the standard field.

Type No.	Use***	Directional Characteristic	Effective Output Level dbm*	Output Impedance Ohms	Frequency Response cps	Hum Pick-up Level db**	Finish	Fitting
44-BX	Broadcast & TV Program & Announce	Bi-directional	-55	30/150 250	50-15,000	-112	Satin Chrome and Umber Gray	1/2" Pipe Thread
77-D	Broadcast & Tv Studio & Remote Program Announce Booms	Poly-directional	-57	30/150 250	50-15,000	-125	Satin Chrome and Umber Gray	1/2" Pipe Thread
88-A	Broadcast & TV Studio & Remote Program Announce	Non-directional	-55	30/150 250	60-10,000	-109	Satin Chrome and Umber Gray	1/2" Pipe Thread
KB-2C	Broadcast & TV Studio & Remote Program Announce	Bi-directional	-55	30/150 250	60-10,000	-108	Satin Chrome and Umber Gray	5/8"-27 Thread
MI-6206-G	Broadcast & Television (a) Talkback	Non-directional	-56	250	80-8,000	-109	Umber Gray	5/8"-27 Thread
KN-1A	Broadcast & Television (a) Talkback	Non-directional	-57	250	100-8,000	-109	Satin Chrome and Umber Gray	5/8"-27 Thread

\* Reference level 0.001 watt, sound pressure 10 dynes per square centimeter. This corresponds to a rating by the proposed RMA system at a sound pressure level of 94 db.

\*\* Level referred to a hum field of  $10^{-3}$  gauss.

\*\*\* For details refer to description of each particular type.

# Polydirectional Microphone, Type 77-D



**Features**

- High quality reproduction over the entire audio frequency range.
- Selection of directional pattern to control ratio of direct-to-reverberant sound pickup.
- Wide pickup angle on front as a uni-directional microphone.
- Three position voice-music switch allows selection of best operating characteristic for voice or music.
- Selection of directional pattern to eliminate unwanted sound.
- Satisfactory operation in high hum fields because of exceptionally good shielding.
- Efficient shock mounting.
- Small size—lightweight for TV boom operation.
- Attractive appearance.

**Uses**

The RCA 77-D high-fidelity microphone provides a choice of directional pattern in its use in AM, FM and TV broadcast studios. As a bi-directional microphone, the 77-D can be used in place of the 44-BX with some loss in high frequency response. As a *uni-directional microphone*, the 77-D may be used to advantage in the following applications:

- (1) General Programs and Announce in Studios.
- (2) Television Booms—The required amount of microphone movement is reduced. The pickup of unwanted sound back of the microphone is reduced. The working distance to the microphone is increased.
- (3) Programs where it is desirable to cover a large area with a single microphone.
- (4) Programs where studio acoustics are more live than optimum.
- (5) Programs where it is desirable to eliminate audience noise originating behind the microphone.

(6) Programs where the directional pattern permits orientation to eliminate undesirable reflections.

(7) Programs where the announcer must work close to the microphone.

(8) General Programs and Announce in Remote Locations.

(9) Plays, stage presentations, banquets, news events where it is desirable to reduce the pickup of sound behind the microphone.

(10) Programs where the directional properties will help to reduce the effects of an overly reverberant location.

As a **NON-DIRECTIONAL MICROPHONE** the following applications are suggested:

(1) Announce in studios and remotes where the announcer must work very close to the microphone.

(2) Out-of-door programs and announce where the microphone need only be protected against rain.

The 77-D is extremely versatile and experience has shown that its characteristics may be adjusted to cover almost any pickup condition.

**Description**

The moving element of the 77-D is a thin corrugated metallic ribbon clamped at the ends and suspended in the air gap of a magnetic circuit consisting of a permanent magnet and pole pieces. One side of the ribbon is open and the other is connected by means of a tube to a folded acoustically damped pipe contained in the center section of the microphone. Directly behind the ribbon there is an aperture in the connecting tube, the size of which may be varied by means of a rotating shutter. The position of the shutter determines the directional properties of the microphone. When the aperture is completely open, the microphone has a bi-directional pattern; when the aperture is completely closed, the microphone is non-directional; and with a critical size of opening the microphone becomes uni-directional. Other positions of the shutter results in patterns intermediate between the above three.

The position of the shutter may be selected by turning a slotted shaft which is brought out flush with the rear of the windscreen. The directional pattern corresponding to the shutter position is indicated on a plate mounted on the screen and marked "U", "N" and "B". If desired, the microphone may be locked in the uni-directional position by means of a cover plate marked "U" which fastens over the indexed plate. The bottom portion of the microphone contains an impedance matching transformer and switch for selecting response characteristics for Voice or Music. The switch shaft is slotted and accessible through a hole in the bottom of the lower shell. The transformer is exceptionally well shielded against stray magnetic fields.

A protective cloth bag, MI-4087, is shipped with each microphone.

**Specifications**

Directional Characteristics (adjustable, see curves)	(Bi-directional, Uni-directional, Non-directional)
Output Impedance	30/150/250 ohms
Effective Output Level (Uni-directional)	-57 dbm*
Hum Pickup Level	-125 dbm**
Frequency Response	50-15,000 cycles
Finish	Satin chrome and umber gray
Mounting	1/2" pipe thread
<b>Dimensions, Overall:</b>	
Height	11 1/2"
Width	3 3/4"
Depth	2 1/2"
Weight (unpacked, including mountings)	3 lbs.
Cable (MI-43-A, 3 conductor shielded)	30' (no plug)
Stock Identification	MI-4045-B

**Accessories**

Protective Cloth Bag \_\_\_\_\_ MI-4087

\* Referred to 0.001 watt and a sound pressure of 10 dynes/cm<sup>2</sup>. This is equivalent to the proposed RMA rating at a sound pressure level of 94 db.

\*\* Level referred to a hum field of 0.001 gauss.



**Directional Response Patterns**

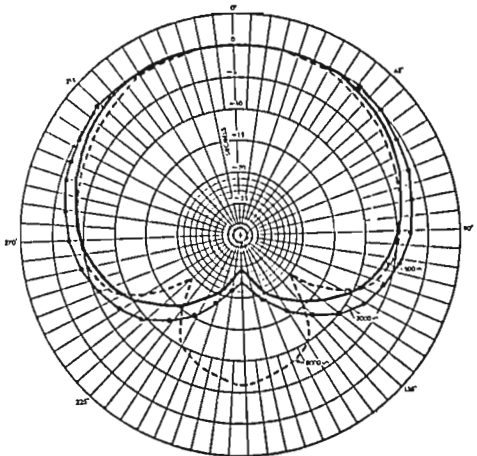

*Uni-Directional Position*

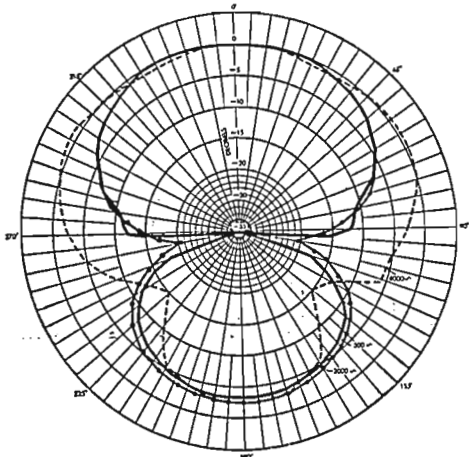

*Bi-Directional Position*

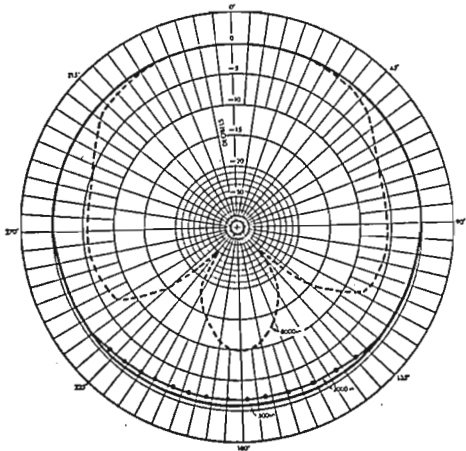

*Non-Directional Position*

**Frequency Response Curves**

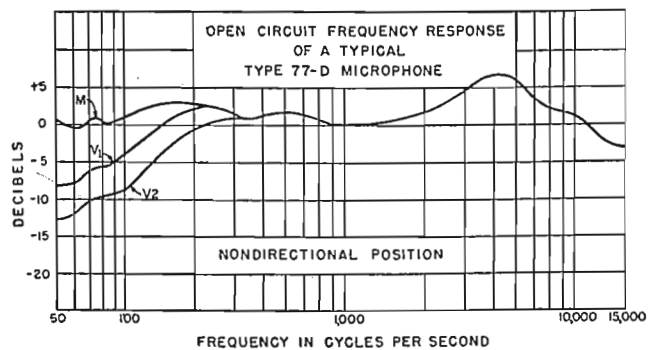
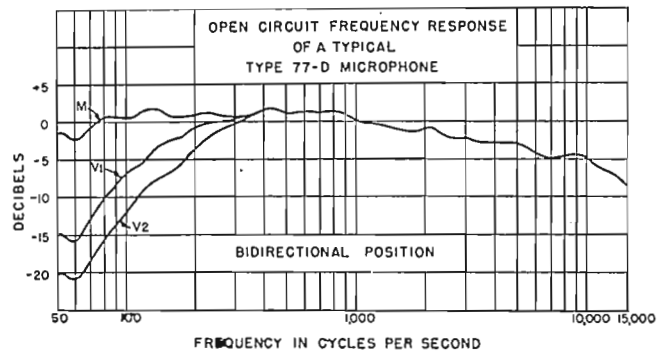
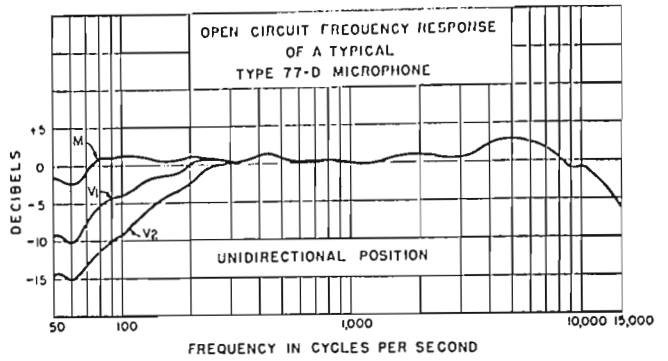



**RCA Velocity  
Microphone  
Type 44-BX**  
Effective Output Level, -55 dbm  
Hum Pick-up Level, -112 dbm



**RCA Polydirectional  
Microphone  
Type 77-D**  
Effective Output Level, -57 dbm  
Hum Pick-up Level, -126 dbm

# Broadcasting's Best...

These are the network favorites.

Year after year they serve more broadcast and television audiences than any other microphone. Yet, despite their overwhelming popularity, RCA's engineering continues to make both even better than before.

The 44-BX is the bi-directional type—designed for AM, FM, and TV studios where highest quality reproduction is desired. It provides high-fidelity output over the entire audio range—and is free from cavity or diaphragm resonance and pressure doubling.

The 77-D is the polydirectional type . . . quickly adjustable to *any* pick-up pattern you want. A 3-position voice-music switch enables you to select the best operating characteristic for voice and music. *Hum pick-up level, -126 dbm!*

RCA 44-BX and 77-D microphones are yours for immediate delivery. Simply call your RCA Broadcast Sales Engineer. Or write Dept. 19 JB, RCA Engineering Products, Camden, New Jersey.

# Velocity Microphone, Type 44-BX

## Features

- Excellent reproduction of the entire audio frequency range.
- No loss in quality with off axis pickup.
- Artists may be placed on both sides of the microphone.
- Pickup of reflected sound reduced.
- Quality smooth as a result of the absence of pressure doubling, cavity and diaphragm resonance.
- Response may be adjusted to provide best possible frequency characteristics for either vocal or musical pickup.
- Unaffected by temperature humidity or air pressure.
- Shock mounted.
- Attractive appearance.

## Uses

The 44-BX is intended primarily for AM, FM and TV studio use where a microphone of the highest quality of reproduction is desired. It has the following general uses.

### A. BROADCAST STUDIO—

- (1) *General Program and Announce.*
- (2) *Plays* where the players may be grouped around the microphone.
- (3) *Conference Pickup* where the participants are seated on opposite sides of a table.
- (4) *Programs* where studio acoustics are more live than optimum.
- (5) *Programs* where the microphones may be suspended overhead and angled to reduce audience noise.
- (6) *Programs* where the direction pattern permits orientation to eliminate undesirable reflections from walls.

### B. BROADCAST REMOTE—

- (1) *General Program and Announce.*
- (2) *Plays* and other stage presentations where the microphone may be suspended overhead and angled to reduce audience noise.
- (3) *Programs* where the directional properties reduce the effect of an overly reverberant location.

The 44-BX microphone is not recommended for outdoor use because of the relative sensitivity of the microphone to wind.

## Description

The Type 44-BX Velocity Microphone is a Bi-directional microphone in which the moving element is a thin, rather narrow, corrugated metallic ribbon supported at the ends and placed between the pole pieces of a magnetic circuit. Because of its lightweight, the motion of the ribbon corresponds very closely to the velocity of the air particles and the voltage generated in it is, therefore, a reproduction of the sound waves which traverse it. An impedance matching transformer and compensating reactor are located in the base of the microphone and the upper perforated portion provides a windscreen of distinctive shape.

The 44-BX is attractively finished in satin chrome and a neutral umber gray to harmonize with modern studio interiors. The yoke mounting permits a wide range of tilting angles and the shock mounting reduces undesirable pickup from floor vibrations.

## Specifications

Directional Characteristics	Bi-directional
Output Impedances	30/150/250 ohms
Effective Output Level	-55 dbm*
Hum Pickup Level	112 dbm**
Frequency Response	50-15,000 cycles
Finish	Umber gray and satin chrome
Mounting	1/2" pipe thread
Dimensions, overall	
Height (including cushion mounting)	12"
Width	4 3/4"
Depth	3 3/8"
Weight (unpacked, including mountings)	8 1/2 lbs.
Cable (MI-43A) 3 conductor shielded	(30 feet (no plug))
Stock Identification	MI-4027-G

\* Referred to 0.001 watt and a sound pressure of 10 dynes/cm<sup>2</sup> (94 db level).

\*\* Referred to 0.001 watt and a 60 cycle hum field of 0.001 gauss.

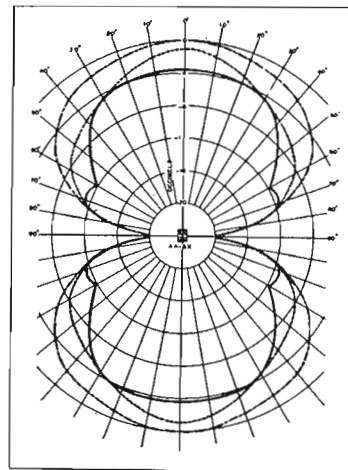

Directional characteristic of a typical 44-BX Velocity Microphone

———— 10,000 cps  
 - - - - - 6,000 cps  
 - · - · - 1,000 cps

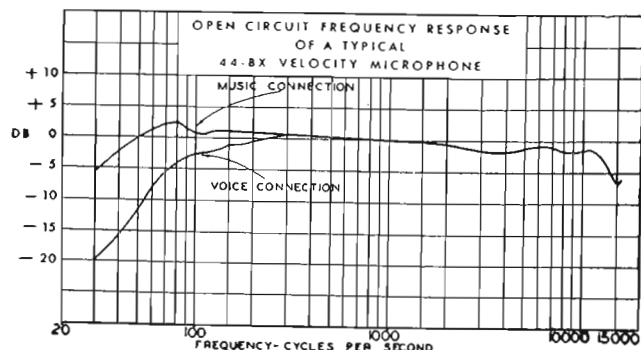



# "Bantam" Velocity Microphone, Type KB-2C

## Features

- Miniature size—ideal for concealment.
- Cable disconnect at microphone makes handling easy.
- Excellent response over the essential audio range.
- Directional pattern allows orientation to reduce pickup of unwanted reflections.
- Shock mounted.
- Insensitive to stray magnetic fields.
- Low cost.
- Adjustable low frequency response.
- Voice or music pickup.

## Uses

The "Bantam" Velocity Microphone, Type KB-2C, is used in AM and FM broadcast studios, in remotes and in television programs where it is essential that the artist's face must be in full view. The microphone is small enough to permit complete concealment if desired.

In addition, the KB-2C will give excellent service in any of the applications suggested for the 44-BX Velocity Microphone with no sacrifice in output level and an imperceptible change in quality. Cognizance must, however, be taken of the fact that the windscreening in the KB-2C is not as effective as on the 44-BX. It is, therefore, best not to attempt to work as close to the KB-2C if excitation due to breath puffs are to be avoided.

## Description

The KB-2C is a miniature Velocity Microphone whose principle of operation is no different than that of the 44-BX. The small size (without sacrifice in output level) is obtained through the use of highly efficient magnetic materials which are placed in the most advantageous places. The ribbon and pole piece assembly is contained in the upper screened portion and the transformer and compensating reactor in the housing immediately below. Output impedances of 30/150/250 ohms are provided. The screened portion is pivoted and may be tilted forward or backward through an angle of approximately 30 degrees. On one side below the pivot is a screwdriver-type switch for selecting the bass response for voice or music. The cable can be disconnected by opening the back portion of the shank and disengaging the concealed plug. An "XL" type male insert is supplied as a part of the microphone.

For desk positions, the KS-5A low-height stand is recommended for use with the KB-2C. Any standard floor stand or collapsible stand may be used for other applications.

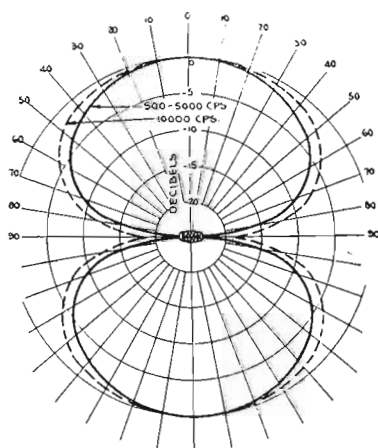

*Directional Characteristics of a Typical KB-2C  
Velocity Microphone*



## Specifications

Directional Characteristics	Bi-directional
Output Impedances	30/150/250 ohms
Effective Output Level	-56 dbm*
Hum Pick-up Level	-108 dbm**
Frequency Response (see curve)	60-10,000 cycles
Finish	Satin chrome and umber gray
Dimensions (overall including stand fitting):	
Length	8 7/8"
Width	1 7/8"
Depth	1"
Weight Less Cable (unpacked)	12 oz.
Mounting	5/8"—27 fixture thread
Stock Identification	MI-11001
(Includes 30 feet MI-43 3 conductor shielded cable)	

## Accessories

Adaptor (5/8"—27 microphone thread to 1/2" pipe thread on stand)	MI-12053
Cable Only (three conductor shielded)	MI-43-A
Desk Stand (umber gray metalustre)	MI-12066
Desk Stand (black)	MI-12066-A
Cannon Microphone Plug—Type P (male)	MI-4630-B
Cannon Microphone Plug—Type XL (male)	MI-12059

\* Referred to one milliwatt and a sound pressure of 10 dynes/cm<sup>2</sup>.  
 \*\* Level referred to a hum field of 1 x 10<sup>-3</sup> gauss.





RCA TYPE KB-2C

The KB-2C shown here is actual size.

# New VELOCITY MICROPHONE

*Bantam Size!*

**B**ECAUSE this man is talking into the new miniature KB-2C, his audiences hear him . . . and see him! Hear him—because the KB-2C has "big mike" quality. See him—because the KB-2C is one of the *smallest* high-quality microphones yet designed. It's ideal for conventions and night clubs. And it's ideal for general station and other indoor uses.

output level, —56 dbm. Three output impedances provided; 30, 150, and 250 ohms, in accordance with RMA standards.

Plenty of operating conveniences, too. You can tilt the KB-2C backward and forward on its swivel through an angle of about 30 degrees. You can select your bass response by means of a screwdriver-type switch located under the swivel pivot. You can disconnect the cable right at the microphone. For desk positions, use RCA's type KS-2A low-height stand. For other services, use any standard floor stand or collapsible stand.

More about the 12-ounce KB-2C from your RCA Broadcast Sales Engineer. Or write Dept.

Using highly efficient magnetic material . . . and a magnet structure that's a part of the microphone case itself, here's a microphone that's as "light as a feather"—and so small it fits into your pocket. Its directional characteristics provide a symmetrical figure eight . . . with surprisingly uniform frequency response between 60 and 10,000 cps. Hum level, —108 dbm. Effective

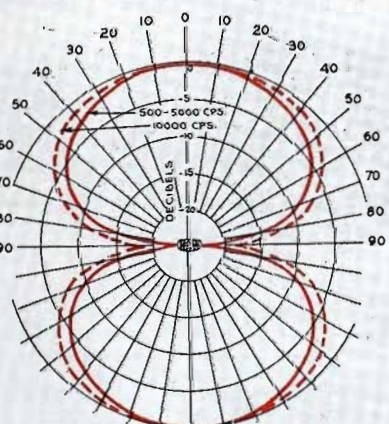

Directional characteristics of a typical KB-2C microphone.

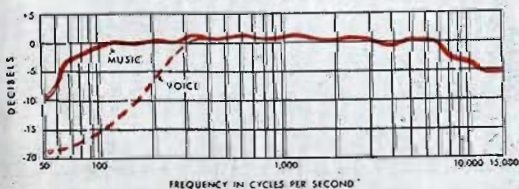

Open Circuit Frequency Response of a typical KB-2C microphone.



# Pressure Microphone, Type 88-A

## Features

- Uniform response over the essential audio frequency range.
- Not sensitive to wind and mechanical vibration.
- Lightweight.
- Small size.
- Rugged construction.
- Low cost.
- Attractive appearance.
- Frequency characteristic independent of source distance.

## Uses

The 88-A microphone is suitable for use in broadcast AM, FM and Television studios for the following applications: (1) Programs where concealment of the microphone is desirable; (2) Programs where the artist must work extremely close to the microphone; (3) Programs where audience participation requires the use of a microphone which is rugged and may be readily handled; (4) Announce where the announcer must work very close to the microphone; (5) Newscasting and conference programs where each participant has a microphone; (6) Broadcast and Television Remotes; (7) Programs and Announce on remotes where a rugged microphone is required which will not be excessively boomy when worked close; (8) Sportscasting where a light rugged microphone is required; (9) Out-of-door remotes of all kinds where the microphone will be subjected to weather; (10) News events where small size microphone will not hide speaker; (11) Interview programs where the light weight of the microphone facilitates quick and easy handling.

## Description

In the 88-A Microphone the sound pressure actuates a thin but rugged molded diaphragm to which an annular coil is attached. The coil is in the air gap of a magnetic structure and connected to an impedance matching transformer which provides output impedances of 30/150 and 250 ohms. The voltage response of the microphone is made approximately independent of frequency over the audio range by coupling acoustic circuits to the diaphragm. For frequencies below 2000 cycles the microphone is non-directional.

The microphone angle may be adjusted by means of a ball and socket joint and locked in position with a thumbscrew.

## Specifications

Directional Characteristics \_\_\_\_\_ Semi-directional  
 Output Impedances \_\_\_\_\_ 30/150/250 ohms  
 Effective Output Level \_\_\_\_\_ -55 dbm\*  
 Hum Pickup Level \_\_\_\_\_ -109 dbm\*\*  
 Frequency Response \_\_\_\_\_ 60-10,000 cycles  
 Finish \_\_\_\_\_ Satin chrome and umber gray  
 Mounting \_\_\_\_\_ 1/2" pipe thread  
 Dimensions, Overall:  
 Height (including Mounting) \_\_\_\_\_ 4 1/2"  
 Diameter \_\_\_\_\_ 2 1/8"  
 Weight (unpacked) \_\_\_\_\_ 1 lb.  
 Cable (MI-43, three conductor shielded) \_\_\_\_\_ 30' (no plug)  
 Stock Identification \_\_\_\_\_ MI-4048-E

\* Referred to 0.001 watt and a sound pressure of 10 dynes/2. This corresponds to the proposed RMA rating at a sound pressure level of 94 db.

\*\* Level referred to a hum field of 0.001 gauss.

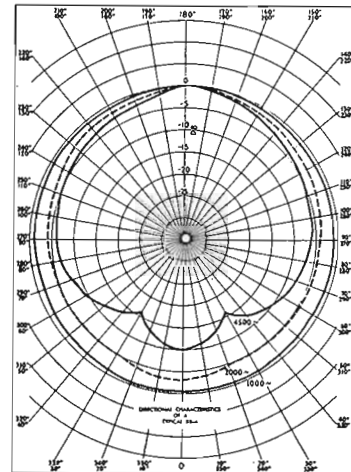

*Directional characteristic of a typical 88-A Pressure Microphone*

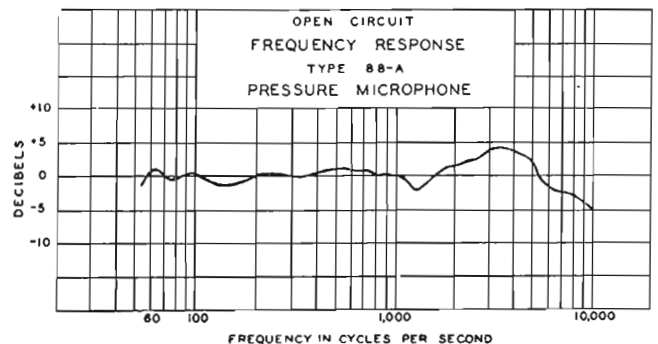

# Microphones, MI-6206-E and KN-1A

## Aeropressure MI-6206-E

### Features

- Low cost.
- Good frequency response.
- High output level.
- Baffle for adjusting directivity.

### Uses

The MI-6206-G is suitable for use in: (1) public address systems where a quality pressure microphone is required; (2) broadcast studio talk-back circuits; (3) broadcast announce emergency applications.

### Description

The MI-6206-G is a moving coil microphone similar in operating principle to the 88-A Pressure Microphone but having a more limited frequency range. The MI-6206-G is relatively non-directional below 1000 cycles and increasingly directional above that frequency. The directional pattern may be either sharpened or broadened depending upon the position of the paracoustic baffle supplied. With the concave side toward the front of the microphone the directional pattern is narrowed and with the convex side forward the pattern is broadened.

The microphone is supplied with either a short length of cable and a Type "XL" Plug (MI-6206-G) or a 30-foot length of cable without plug (MI-6206-E). The angular position of the microphone may be adjusted to suit the user.



### Specifications

Directional Characteristics	Semi-directional
Output Impedance	250 ohms
Effective Output Level	-56 dbm*
Hum Pick-up Level	109 dbm**
Frequency Response	80-8,000 cycles
Finish	Two tone umber gray
Mounting	$\frac{3}{8}$ "-27 fixture thread (MI-12051 Adaptor required for $\frac{1}{2}$ " pipe thread.)
Dimensions, overall	
Length	5"
Diameter	$2\frac{1}{8}$ "
Weight (unpacked)	$2\frac{1}{4}$ lbs.
Stock Identification:	
With 30 ft. Cable (MI-42, No Plug)	MI-6206-E

## Announce Microphone, Type KN-1A

### Features

- Low cost.
- Lightweight and small size.
- Concealed plug connection.
- Good frequency response.
- Shank may serve as handle.
- High output level.

### Uses

The Announce Microphone, Type KN-1A has the following applications: (1) public address systems where a quality pressure microphone is required; (2) broadcast studio talk-back systems; (3) broadcast announce emergency applications; (4) interview-type programs where frequency range may be adequate.

### Description

The KN-1A Microphone is a moving conductor type of an entirely new design with modernistic lines. The microphone unit and shank are mechanically connected through a swivel which allows the microphone to be moved through an angle of 80 degrees. In addition to serving as a stand or handle, the shank conceals the usual unsightly plug connection. Access to the type "XL" plug used is obtained by lifting the cover which forms the back portion of the shank. The microphone mounting is a  $\frac{5}{8}$ "-27 fixture thread, and



an MI-12053 adaptor is necessary where the microphone is to be used with stands having a  $\frac{1}{2}$ " pipe thread.

### Specifications

Directional Characteristic	Semi-directional
Effective Output Level	-57 dbm*
Hum Pick-up Level	109 dbm**
Frequency Response	100-8,000 cycles
Output Impedance	250 ohms
Finish	Two tone umber gray
Dimensions:	
Length	$9\frac{3}{4}$ "
Width	$1\frac{1}{2}$ "
Depth	2"
Weight Less Cable (unpacked)	$1\frac{1}{4}$ lbs.
Mounting	$\frac{5}{8}$ "-27 fixture thread
Stock Identification:	
With 30' Cable	MI-12081-C

### Accessories

Desk Stand (gray metalustre) MI-12066

\* Referred to one milliwatt and a sound pressure 10 dynes/cm<sup>2</sup>.  
 \*\* Level referred to a hum field of  $1 \times 10^{-3}$  gauss.

# Microphone Stands

## Banquet Stand, MI-4095-A

### Features

- Compact and convenient for portable use.
- Rugged construction.
- Easy to assemble or take apart.
- Adjustable height.
- Attractive appearance.

### Uses

This microphone stand is the ideal for banquets or other occasions where a sturdy, attractive and truly portable design is required.



### Description

The MI-4095-A is of novel construction in that its base forms a compact carrying case for the entire stand. The hollow under side of the base casting accommodates the stand's three telescoping tubular sections and two fin type legs fold into the base sides. When unfolded the legs extend 5 1/4" from center of the vertical rod. The bottom of the base is covered with felt.

### Specifications

Height—Adjustable 10 3/4" to 24 3/4"  
 Base Dimensions 3 5/8" x 10 1/2" x 1 5/8"  
 Microphone Mounting 1/2" pipe thread or 5/8"—27 fixture thread with adaptor removed  
 Weight \_\_\_\_\_ 5 lbs.  
 Finish—Umber gray and satin chrome  
 Stock Identification MI-4095-A

## Desk Stand, Type KS-5A

The desk stand, Type KS-5A, is a neatly designed stand primarily for use with the KB-2C and KN-1A microphones. It is of cast metal and attractively finished in gray metalustre. The microphone is held rigidly in position by 5/8"—27 thread bolt. The bottom is cushioned by a strip of rubber, giving adequate protection to any finely finished surface.

### Specifications

Dimensions:  
 Length \_\_\_\_\_ 4 1/8"  
 Width \_\_\_\_\_ 5 3/8"  
 Height \_\_\_\_\_ 3 3/4"  
 Weight \_\_\_\_\_ 1 1/4 lbs.  
 Fitting Size (of mike extension) \_\_\_\_\_ 5/8"—27 thread  
 Stock Identification:  
 Gray Metalustre \_\_\_\_\_ MI-12066



## Desk Stand, Type 91-B

### Features

- Small size.
- Heavy base with felt covered bottom.
- Adjustable height.
- Attractive appearance.

### Uses

The 91-B is a heavy-based desk stand designed especially for studio or announce use. It is attractive in appearance and easily mounts the heaviest of studio microphones.

### Description

The 91-B is finished in umber gray with satin chrome trim. The base is felt covered to prevent marring the surface on which it is placed. The stand is provided with alternate mounting extensions—one 3/4" and one 1 3/4", the choice depending on the type microphone to be mounted.



### Specifications

Microphone Mounting \_\_\_\_\_ 1/2" pipe thread  
 Base Dimensions \_\_\_\_\_ 4 1/2" x 6 5/8" x 3/4"  
 Finish—Umber gray with polished chromium trim  
 Weight \_\_\_\_\_ 4 lbs.  
 Stock Identification \_\_\_\_\_ MI-4092-C

## Announce Stand, Type 91-A (Specially designed for the Type 44-BX Microphone)

The 91-A is a simple but attractive desk stand for 44-BX Microphones. It is finished in dark umber gray metalustre and its base rests on three felt buttons. Height of the 44-BX Center above desk is 8 3/8". Base diameter, 7". Use only with Type 44-BX Microphone.

### Specifications

Weight (unpacked) \_\_\_\_\_ 3 1/2 lbs.  
 Stock Identification \_\_\_\_\_ MI-4058-C





# Microphone Stands

## Desk Stand, MI-13240

This sturdily constructed desk stand is ideal for use with the lighter microphones where a low cost stand is needed. The stand is 6 $\frac{3}{4}$ " high and the 4 $\frac{3}{4}$ "-diameter base is equipped with four rubber feet. The stand is attractively finished in umber gray with polished chrome trim. As supplied the stand mounting is  $\frac{1}{8}$ " pipe thread; with the adaptor removed the mounting is a  $\frac{5}{8}$ "-27 fixture thread.

Weight (unpacked) \_\_\_\_\_ 14 ozs.  
Weight (packed) \_\_\_\_\_ 1 $\frac{1}{2}$  lbs.



## Announce Stand, MI-4096

This attractively-designed announce stand is adjustable from 8 to 10 $\frac{1}{2}$ ", making it ideal for use on a desk or table. It is finished in chromium and black and features a 7 $\frac{1}{2}$ " base. The microphone mounting is a  $\frac{1}{2}$ " pipe thread, and with the adaptor removed, may be used with microphone having a  $\frac{5}{8}$ "-27 fixture thread.

Weight (unpacked) \_\_\_\_\_ 4 lbs.



## Pushmike Stand, MI-6427



This smartly designed table stand features a built-in microphone switch and is suitable for use with all RCA pressure type microphones. The switch is of the D.P.D.T. long leaf anti-capacity type and permits turning the microphone on and off right at the microphone stand. It may also be used for "push-to-talk" operation or lock-in "Talk" position.

The stand is 4 $\frac{3}{4}$ " high with 5 $\frac{3}{4}$ " base and is attractively finished in chromium. The microphone mounting is for a  $\frac{5}{8}$ "-27 male or female thread. Stock #33543 Adaptor is available on separate order for microphone with  $\frac{1}{2}$ " pipe thread.

Weight (unpacked) \_\_\_\_\_ 1 $\frac{1}{8}$ " lbs.  
Stock Identification \_\_\_\_\_ MI-6427  
(Includes MI-6425 Stand and MI-6426 Base)

## Pushmike Adaptor, MI-6425

An adaptor with a built-in microphone switch of the D.P.D.T. long leaf anti-capacity type. The switch permits "push-to-talk" operation or locked-in "talk" position and may be used with any floor or table stand having  $\frac{5}{8}$ "-27 fixture threads. The adaptor is an extremely light compact unit finished in chromium. It is 4 $\frac{3}{4}$ " long, 1 $\frac{3}{8}$ " in diameter and weight is  $\frac{3}{4}$  lbs. unpacked.



Fitting \_\_\_\_\_ Bottom  $\frac{5}{8}$ "-27 fixture thread (female)  
Top \_\_\_\_\_  $\frac{5}{8}$ "-27 fixture thread (female) with added  
 $\frac{5}{8}$ "-27 thread, male nipple  
Weight (unpacked) \_\_\_\_\_  $\frac{3}{4}$  lb.  
Stock Identification \_\_\_\_\_ MI-6425

## Microphone Adaptors

RCA offers a comprehensive stock of microphone adaptors suitable for microphones and stands, etc., used in the broadcast field. A recent questionnaire confirmed that for its simplicity in procurement and availability, the  $\frac{1}{2}$ " standard pipe

Stand Thread	Microphone Thread	Stock Identification
$\frac{1}{2}$ " pipe thread	$\frac{1}{8}$ " pipe thread	MI-12051
$\frac{1}{2}$ " pipe thread	$\frac{5}{8}$ "-27	MI-12053
$\frac{1}{2}$ " pipe thread	$\frac{5}{8}$ "-24 (W.E.)	MI-12057
$\frac{3}{8}$ "-24 (W.E.)	$\frac{1}{2}$ " pipe thread	MI-12057-A
$\frac{5}{8}$ "-27	$\frac{1}{8}$ " pipe thread	MI-6229
$\frac{3}{4}$ "-27	$\frac{1}{2}$ " pipe thread	MI-12055

thread was infinitely more popular than any other pipe size. For this reason, RCA has standardized on the  $\frac{1}{2}$ " standard pipe thread, and avails broadcasters of adaptors to suit any application.



MI-12055



MI-12051



MI-6229

# Microphone Stands

## Program Stand, Type 90-A

### Uses

The Type 90-A Program Stand is used in broadcast studios where a stand is required which will be attractive in appearance and give stable support even to the heavier types of microphones.

### Description

The 90-A floor stand is a sturdily constructed stand which will give stability to the heaviest microphones. The base is weighted and has equalizing projections which assure a firm position on an uneven floor. The column is equipped with a simple clamping device which permits height adjustments to be made easily and quietly without operating any release mechanism. The up and down operation is smooth and the locking operation positive. The patented clamp is mechanically simple and is ruggedly constructed to give years of service.

The stand as supplied may be used with any microphone having a 1/2" pipe thread and by simply removing an adapter fitting with any microphone having a 5/8"-27 fixture thread. The 90-A is finished in satin chrome to harmonize with RCA Microphones. Cable guides are included to hold the microphone cord close to the stand at the base.

### Features

- Hundreds giving excellent performance in leading broadcast studios.
- Suitable for use with all RCA Microphones.
- Large heavy base with equalizing projections assure sturdy support of microphone.
- Simple non-slide, trouble free clamping device.
- Attractively finished in satin chrome.



### Specifications

Height of Stand \_\_\_\_\_ Adjustable from 3'8" to 6'2"  
 Microphone Mounting \_\_\_\_\_ Standard 1/2" pipe thread or  
 \_\_\_\_\_ 5/8"-27 fixture thread  
 Diameter of Base \_\_\_\_\_ 12 1/4"  
 Weight (unpacked) \_\_\_\_\_ 33 lbs.  
 Finish \_\_\_\_\_ Satin Chrome  
 Stock Identification \_\_\_\_\_ MI-11050  
 Accessory Item—Cable Hook \_\_\_\_\_ MI-11099

## Floor Stand, Type KS-1A

### Uses

The Type KS-1A Floor Stand is used in Broadcast studios where some stability of support may be sacrificed for ease of placement changes. Especially recommended for use with the lighter microphones.

### Description

The KS-1A microphone stand features the same patented smooth height adjustment of the 90-A in a stand of much lighter weight. The column and telescoping tube are finished in satin chrome and the base in dark umber gray wrinkle to harmonize with RCA microphones. Cable guides are included to hold the microphone cord close to the stand at the base.

The stand as supplied may be used with any microphones having a 1/2" pipe thread and by removing an adapter fitting with any microphone having a 5/8"-27 fixture thread.

### Features

- Suitable for use with all RCA Microphones.
- Low price.
- Smooth operation with automatic clamping and release device.
- Light weight.
- Heavy ten inch base.
- Sturdy construction.
- Attractively finished.



### Specifications

Height of Stand \_\_\_\_\_ Adjustable from 3' 2" to 5' 5 1/2"  
 Microphone Mounting \_\_\_\_\_ 1/2" pipe thread or  
 \_\_\_\_\_ 5/8"-27 fixture thread  
 Diameter of Lower Tube \_\_\_\_\_ 1"  
 Diameter of Base \_\_\_\_\_ 10"  
 Weight (unpacked) \_\_\_\_\_ 14 lbs.  
 Finish \_\_\_\_\_  
 Base \_\_\_\_\_ Dark umber gray  
 Stand \_\_\_\_\_ Satin chrome  
 Stock Identification \_\_\_\_\_ MI-12065

## Cable Hook, MI-11099

### Uses

Attached to the 90-A or any other 1 1/4" round tube stand the MI-11099 provides a convenient method of holding the cable when it is not in use.

### Description

The Cable Hook is simple to install, and may be easily adjusted to the proper height. Merely tightening a smooth locking nut holds it in position.



### Features

- Can be attached or removed in a few seconds.
- Saves wear on the cable.
- Keeps cable out of the way when not in use.

### Specifications

Weight \_\_\_\_\_ 15 oz.  
 Finish \_\_\_\_\_ Satin chromium  
 Hole Diameter \_\_\_\_\_ 1 1/4"

# Microphone Stands

## Boom Stand, Type KS-3B



### Features

- Sturdy construction, strong tubing and castings.
- Large base with rubber tired casters.
- Easily adjusted over wide range of heights and boom length.
- Positive locking adjustments.
- Air cushion lowering brake, releases for easy lift.
- Lightweight.

### Uses

For broadcast AM and FM studios and Television applications: (1) Programs where the best microphone position cannot be reached with a conventional floor stand; (2) Piano pickup; (3) Orchestral pickup where the stand may be substituted for microphones suspended overhead; (4) Television Programs where movement of the microphone is not required.

### Description

The KS-3B boom length and the counter balance overhang are easily adjustable, and the position selected is securely locked by wing-type handwheels. The microphone fitting is swivel mounted, thus eliminating the need of rotating the microphone when attaching it to the stand. Movement of the stand is quiet and easy because of the smooth-rolling rubber-tired casters with which it is equipped. Once the stand is properly placed the casters can be locked by means of foot-operated locks. Cable supports are provided along the boom for the microphone cable.

For storage or for convenient transport the legs and the boom may be folded against the center column to make a relatively small package.

The KS-3B boom stand is finished in satin chrome and gray to harmonize with RCA microphones.

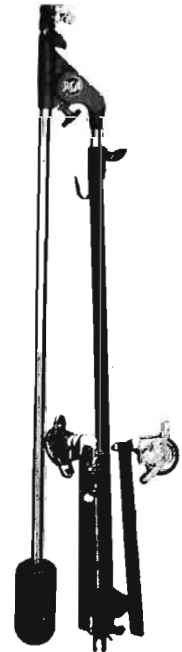

KS-3B shown collapsed

## Three-Section Microphone Stand, MI-6208

### Features

- Utility stand for floor or banquet use.
- Three sections for easy packaging or carrying.
- Heavy ten-inch base.
- Attractive appearance.

### Description

The MI-6208 is a convenient and attractive stand for floor or banquet use. It is especially suitable for portable use since it may be taken apart into three sections for easy packing or carrying. The stand has a heavy ten-inch gray crackle base which is trimmed with satin-silver stripes. The stand finish is chrome.

### Specifications

Height (for floor use—3 sections)  
Adjustable from 3' 11" to 5'  
Height (for banquet use—2 sections)  
Adjustable from 1' 6" to 2' 7"  
Microphone Mounting— $\frac{1}{2}$ " pipe thread  
Finish  
Stand \_\_\_\_\_ Polished chromium  
Base \_\_\_\_\_ Gun metal crackle with  
satin-silver stripes  
Weight (unpacked) \_\_\_\_\_ 11 lbs.  
Stock Identification \_\_\_\_\_ MI-6208



### Specifications

Height of Stand—Adjustable from  
5' 2" to 8' 8"  
Horizontal Arm Adjustment (With  
overhang to rear) \_\_\_\_\_ 3' to 6'  
Microphone Mounting—Standard  $\frac{1}{2}$ "  
pipe thread  
Weight (unpacked) \_\_\_\_\_ 64 lbs.  
Finish—Satin stainless steel and gray  
Stock Identification \_\_\_\_\_ MI-11056

## Portable Stand, Type 59-B

### Description

The 59-B is a folding, lightweight and rugged stand which is unexcelled for field use. It features a tripod base and a patented clutch arrangement which permits height adjustments to be quickly made without the operation of a mechanical release.

### Specifications

Height—Adjustable from 3' to 5'  
Weight (unpacked) \_\_\_\_\_ 3 $\frac{1}{2}$  lbs.  
Finish \_\_\_\_\_ Satin chrome  
Microphone Mounting— $\frac{1}{2}$ " pipe  
thread or  $\frac{5}{8}$ "—27 fixture thread  
with adaptor removed.  
Stock Identification \_\_\_\_\_ MI-4093-B

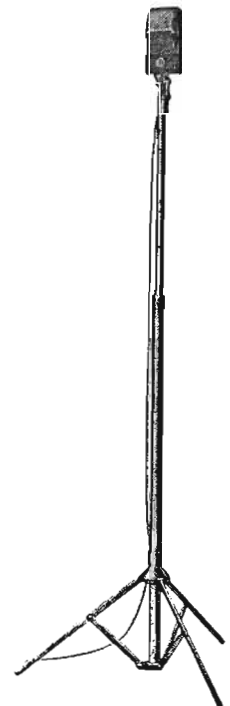





## RCA *Audio Accessories*

**FOR EVERY STATION NEED—AM·FM·TV**

REPRESENTED HERE are items from broadcasting's most complete line of fine audio accessories. Microphone stands . . . studio warning lights . . . cabinet racks . . . panel-mounted auxiliary units . . . transformers of many kinds. In all, more than 100 different items—with every type of unit you need from large size cabinet racks down to patch cords.

Designed by audio men *for audio men*, these accessories are built with the professional thoroughness needed to meet the most exacting requirements of broadcast use. Mechanically and electrically, every unit is built to "take it."

For information on RCA's complete line of audio accessories . . . immediately available from stock . . . call your RCA Broadcast Sales Engineer, or Dept. 7-G, Engineering Products, RCA, Camden, New Jersey.

# "Magic Lock" Boom Stand, Type KS-4A

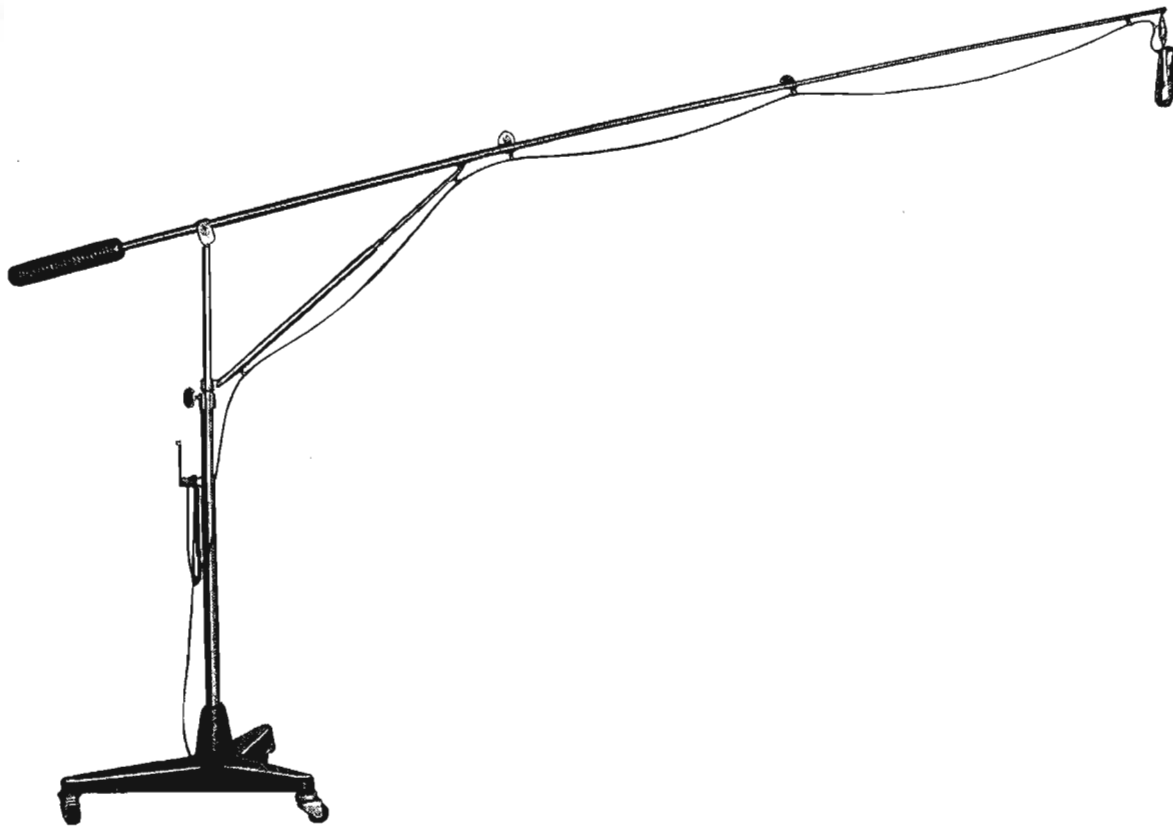

## Features

- Remarkable dimensional flexibility—a 13' arc extending to 21' high.
- One arm universal action.
- "Magic Lock", insuring positive and instantaneous action.
- Microphonic noises reduced to a minimum.
- Mobility—base will pass through any door.
- All steel construction—satin chrome finish.
- Low operating expense—no maintenance required.
- Suitable for catwalks, etc., with mounting bracket.

## Uses

The "Magic Lock" Boom Stand, Type KS-4A is used in Broadcast and Television studios where it is necessary to elevate a microphone to a considerable height or distance from the point of support.

## Description

The "Magic Lock" Boom Stand is another addition to the series of microphone stands employing the "magic lock" principle. The ingenuity of this patented device is unexcelled by any other type of mechanism produced. It allows a one hand movement of the boom without operation of screws or release mechanisms and will retain a positive position without any possibility of slipping.

The KS-4A is of all steel construction with a satin chrome finish throughout except for the low gravity cast iron base, which is dark umber gray. The main shaft of the stand utilizes

one main "magic lock" which constitutes an instantaneous and positive action in the vertical plane. The securing screw brake controls and locks the boom movement in azimuth.

The boom, with two telescoping 4' sections, has a controllable arc of approximately 180° by virtue of another "magic lock". The microphone may be elevated and rotated in azimuth to any point by a one arm operation of counter balance. The base has a radius of 26", giving it great mobility, and allowing it to pass through any standard door. The stand and base are supported by three large, heavy-duty ball bearing casters, rubber covered to insure a smooth and silent operation. The microphone cable is guided at six locations and thus eliminates any possibility of fouling apparatus or instruments. If desired, the boom's vertical shaft may be removed from the housing and used on a catwalk or a wall fitting bracket.

## Specifications

### Dimensions:

Weight of Microphone	Radius of Arc	Height
1 lb.	13'	21'
4 lbs.	9'	17'
8 lbs.	6'	14'

Counter Balance \_\_\_\_\_ 2' from center yoke  
 Boom When Closed \_\_\_\_\_ 5' radius  
 Adjustable Height Above Floor \_\_\_\_\_ 6' to 9'  
 Finish \_\_\_\_\_ Satin chrome  
 Weight \_\_\_\_\_ Approx 200 lbs.  
 Microphone Thread \_\_\_\_\_ Standard 5/8"—27 with adaptor to 1/2"  
 Stock Identification \_\_\_\_\_ MI-11052

# Microphone Boom & Perambulator, MI-26574

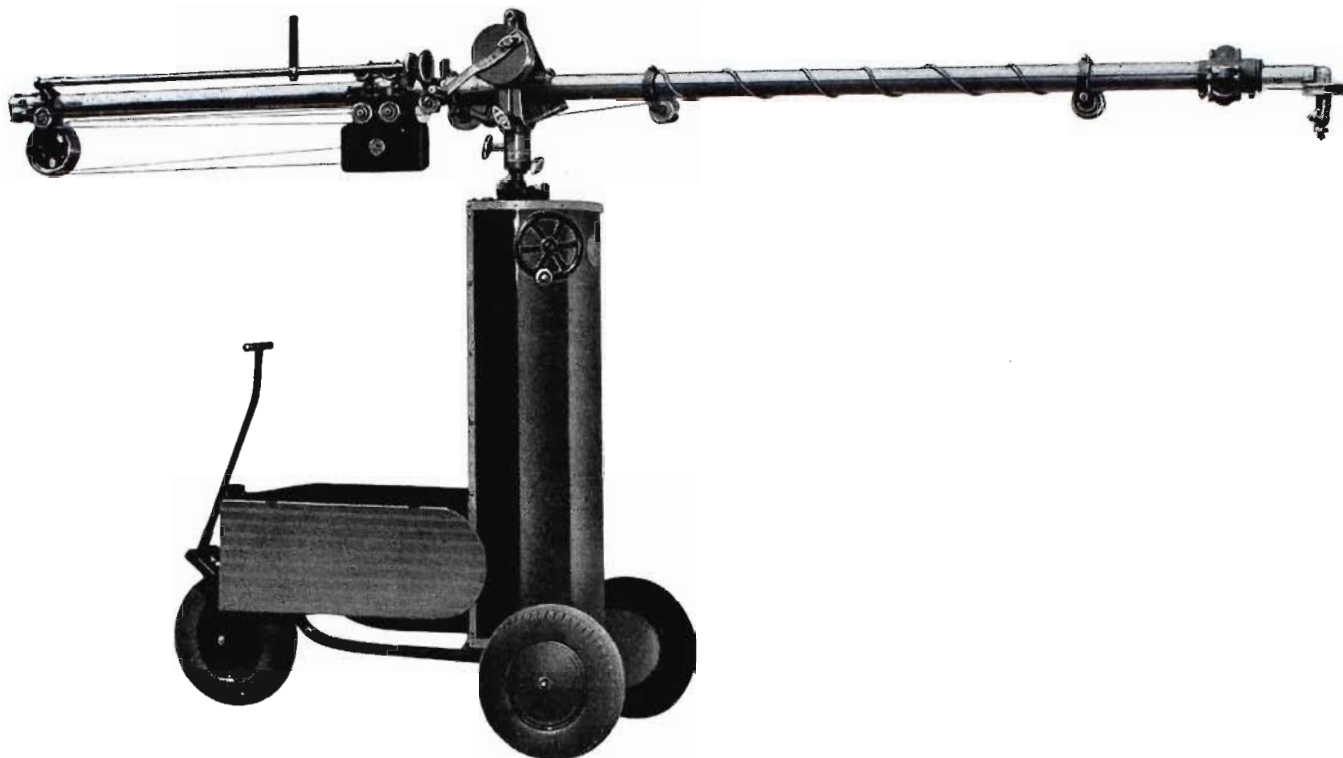

## Features

- Boom and perambulator can be passed through narrow doorways.
- Duraluminum tubing for boom assures rigidity and light weight.
- "Gunning" device revolves directional microphones through 280°.
- Radius of boom can be extended to 17 feet—retracted to 7 feet, 4 inches.
- Boom fitted with adjustable counterbalance for different microphones.
- Quiet in operation.

## Use

The MI-26574 Microphone Boom and Perambulator is designed for use in broadcast or television studios. It enables the operator to quickly place the microphone with respect to the sound source. He can closely follow the sound, or move from one source of sound to another easily and quietly.

## Description

The perambulator is constructed of steel tubing with drop-rim type wheels and pneumatic tires. The steering wheel swivels 180° and can be clamped to hold a given radius. The tiller when pushed back operates a toggle brake on the steering wheel. It is also provided with steps which aid the operator in mounting the platform when it is elevated. Operated by a

hand wheel, the elevating column raises the boom from a height of 6 feet, 5 inches to 9 feet, 5 inches. The operating platform raises with the boom. The wheel tread of the perambulator can be narrowed to 27 inches and the leaf portions of the table can be lowered to permit passing the perambulator through a 30-inch door.

A hand crank governs extension and retraction of the boom, and a hand rail controls elevation and horizontal traversal. As the boom is retracted, the microphone cable is received on take-up sheaves. The movement of the telescoping member is counterbalanced by weights which can be adjusted to properly balance different microphones. Since many microphones are directional, the boom is fitted with a "microphone gunning" device which revolves the microphone through 280°.

## Specifications

### Dimensions:

Maximum Height (with boom pedestal elevated)	9' 5"
Maximum Height (with pedestal lowered)	6' 5"
Length of Boom:	
Extended	17'
Retracted	7' 4½"

### Weight:

Boom (with gunning device)	66¾ lbs.
Counterweights for Boom	35¼ lbs.
Perambulator	421 lbs.
Stock Identification	MI-26574



# Microphone Plugs and Receptacles

RCA Microphones are sold without plugs in order that the purchaser may use any type desired. The Cannon Type "P" Plugs are recommended for their reliability and ruggedness. This series of Cannon Plugs is used in all RCA remote amplifiers. The Cannon Type "P" Plugs and Receptacles stocked by RCA have steel jackets, which are preferred to the die cast type, for their increased ruggedness. All fittings are finished in satin chrome.

A miniature size plug was developed to obtain a cable connection that could be housed in the stem of the KB-2C Microphone. These microphone plugs are identified as the Cannon XL-3 Series. A split gland type of cable clamp will accommodate cable diameters up to .290 inch. All of the "XL" Cable Connectors have zinc alloy die cast shells and are supplied with a bright nickel finish. Positive latch locks prevent accidental disconnecting. Connectors are disengaged by pressing release buttons and pulling connectors apart. Rubber bushings prevent wear on the cable covering and provide a grip on the cable.

## CANNON "P" SERIES OF PLUGS

Description	Cannon Stock No.	RCA Stock Identification
Male Plug for Microphone Cords	P3-CG-12S	MI-4630-B
Wall Receptacle for Above Plug	P3-35	MI-4624-A

Note: The MI-4624-A Receptacle will fit in a standard a-c outlet box.

Extension Cord—Female Connector	P3-CG-11S	MI-4620-B
---------------------------------	-----------	-----------

## CANNON "XL" SERIES OF PLUGS

Description	Cannon Stock No.	RCA Stock Identification
Male Plug for Microphone Cords	XL-3-12	MI-12059
Female Connectors—Extension Cord	XL-3-11	MI-12058

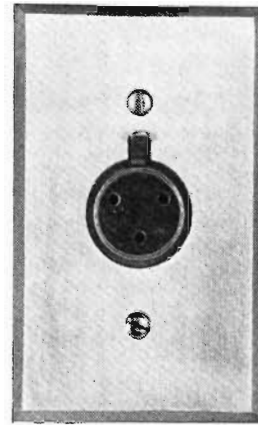

MI-4624-A Wall Receptacle



MI-12059



MI-12058



MI-4620-B Cord Connector



MI-4630-B Microphone Plug

# Microphone Cables

RCA microphone cables are of rugged construction and are jacketed with a neoprene compound to insure long life. They are especially designed for broadcast service either studio or remote.

## Cable MI-43-A

Use \_\_\_\_\_ Cable for low impedance microphone circuits  
 Type \_\_\_\_\_ Three conductor, twisted  
 Conductors \_\_\_\_\_ Stranded, equivalent to #20 AWG  
 Insulation \_\_\_\_\_ Special rubber compound  
 Shield \_\_\_\_\_ Tinned copper. Complete coverage without loss in flexibility  
 Outer Covering \_\_\_\_\_ Black neoprene compound

Overall Diameter \_\_\_\_\_ .0312 maximum  
 Stock Identification (specify length in feet) \_\_\_\_\_ MI-43-A

## Cable MI-62

Type \_\_\_\_\_ Two conductor twisted  
 Conductors \_\_\_\_\_ Stranded, equivalent to #18 AWG  
 Insulation \_\_\_\_\_ Special rubber compound  
 Shield \_\_\_\_\_ Tinned copper. Complete coverage without loss in flexibility  
 Outer Covering \_\_\_\_\_ Black neoprene compound  
 Overall Diameter \_\_\_\_\_ .0312 maximum  
 Stock Identification (specify length in feet) \_\_\_\_\_ MI-62

# Interconnecting Cables

The majority of cables required to interconnect the various components of a broadcast audio assembly are of a special type and cannot be readily purchased from the local electrical dealer. In order to avoid unnecessary installation delays, RCA carries in stock four of the generally used special type cables.

## Stranded Conductor Cable, MI-34

Use \_\_\_\_\_ Recommended for audio circuits where extra flexibility is required  
 Type \_\_\_\_\_ Shielded, twisted pair, stranded, composed of 7— $.010$  tinned copper conductors equivalent to #22 AWG  
 Insulation \_\_\_\_\_ Vinyl resin insulated with lacquered rayon braid  
 Shield \_\_\_\_\_ Tinned copper braid  
 Overall Diameter \_\_\_\_\_ Approximately  $.166$ "  
 Color Code \_\_\_\_\_ Red and black  
 Rating \_\_\_\_\_ 300 volts  
 Stock Identification (stocked in 1000 ft. rolls) \_\_\_\_\_ MI-34

## Stranded Conductor Cable, MI-35

Use \_\_\_\_\_ Especially recommended for 110 volt supply and filament circuits  
 Type \_\_\_\_\_ Shielded, twisted pair, stranded, composed of 16— $.010$  tinned copper conductors equivalent to #18 AWG  
 Insulation \_\_\_\_\_ Vinyl resin insulated with lacquered rayon braid  
 Shield \_\_\_\_\_ Tinned copper braid  
 Overall Diameter \_\_\_\_\_ Approximately  $.236$ "  
 Color Code \_\_\_\_\_ Red and black

Rating \_\_\_\_\_ 300 volts  
 Stock Identification (stocked in 1000 ft. rolls) \_\_\_\_\_ MI-35

## Stranded Conductor Cable, MI-49

Use \_\_\_\_\_ Especially recommended for audio circuits and general rack wiring  
 Type \_\_\_\_\_ Shielded, twisted pair, stranded, composed of 10  $.010$  tinned copper conductors equivalent to #16 AWG  
 Outside covering of cotton braid.  
 Insulation \_\_\_\_\_ Varnished cambric covered with a serving of cotton  
 Shield \_\_\_\_\_ Tinned copper braid  
 Overall Diameter \_\_\_\_\_ Approx.  $.025$ "  
 Color Code \_\_\_\_\_ Red and black  
 Rating \_\_\_\_\_ 600 volts  
 Stock Identification (stocked in 1000' rolls) \_\_\_\_\_ MI-49

## Solid Conductor Cable, MI-63-A

Use \_\_\_\_\_ General purpose audio transmission line  
 Type \_\_\_\_\_ Twisted two-conductor, solid copper, shielded, tinned #19 AWG  
 Insulation \_\_\_\_\_ Varnished cambric covered with a serving of cotton  
 Shield \_\_\_\_\_ Tinned copper braid  
 Overall Diameter \_\_\_\_\_ Approx.  $.025$ "  
 Color Code \_\_\_\_\_ Red and black  
 Rating \_\_\_\_\_ 600 volts  
 Stock Identification (stocked in 1000' rolls) \_\_\_\_\_ MI-63-A

# Cable Accessories

## Grounding Sheath Connectors, MI-11270

Consisting of companion inner and outer sleeves and available in two sizes, the MI-11270-A small connectors are for use with MI-34 shielded twisted pair, and MI-11270-B (larger size) for MI-35, MI-49 or MI-63-A. Connectors serve as convenient terminations for the shields of twisted-pair cables, avoid shifting of shields, and provide a suitable connection or ground point. (Ground wire may be crimped between inner and outer connector.)



MI-11270-A Connectors

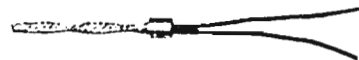

MI-11270B Connectors

Connectors for MI-34 Cable (boxes of 1000) \_\_\_\_\_ MI-11270-A

Connector for MI-35, MI-49, or MI-63-A Cable (boxes of 1000) \_\_\_\_\_ MI-11270-B

## Wedge-on Tool, MI-11271

This tool is necessary for quick and easy "pressing-on" of ground sheath connectors, MI-11270. The Wedge-On tool firmly grips both connector pieces and presses (in one operation) the cable shield between inner and outer connector sleeves.

Wedge-on Tool, MI-11271

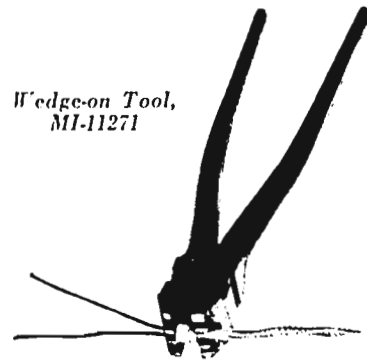

All frayed edges are cleanly cut away and a perfect electrical and mechanical connection results.

Approximate Length \_\_\_\_\_ 10"  
 Approximate Weight \_\_\_\_\_  $1\frac{1}{2}$  lbs.  
 Stock Identification \_\_\_\_\_ MI-11271

## Cable Lacing Cord

Two sizes of cords are available for general cable lacing and dressing uses. Cords are of strong materials such as linen and hemp and thoroughly impregnated with a beeswax and paraffin mixture. Cords are supplied in one pound spools as shown below.



Stock Identification	Type	Plys	Yds/lb	Average Break Strength
MI-11719-A	No. 6 med.	4	580 $\pm$ 35	30 lbs.
MI-11719-B	No. 12 lvy.	8	290 $\pm$ 18	60 lbs.

## CUSTOM-BUILT EQUIPMENT

In addition to the comprehensive line of standard studio-control equipment so familiar to the industry, RCA specializes in custom designing and building complete speech-input systems to meet the individual needs of stations and networks. For more than 15 years, RCA engineers have worked closely with the nation's leading broadcast engineers in the design, production and installation of many such equipments, a few of which are pictured on these pages. Studio-control systems of this type are tailor-made . . . with just the right facilities for controlling program operations and reproducing high-fidelity sound.

Since no two broadcast stations have the same operating requirements, the corresponding equipment needs naturally differ for each installation, ranging from special equipment for small

and medium-size stations to more complex systems for the largest network installation. In planning new installations, RCA "Custom-built" equipment service is available to every AM, FM and Television station whether small or large—and on almost any working arrangement desired. RCA "Custom-built" service means more than just so many racks or pieces of equipment,—it includes, in fact, the services of the entire RCA engineering staff. In some cases, broadcast station engineers may wish to lay out and design the system themselves, complete with specifications. In such instances, RCA will provide specially-built units or modify standard equipment to meet these specifications in every detail. On the other hand, where stations so desire, RCA engineers will study the requirements of the station, make overall and detailed layouts, and draw up specifications for the needed equipment.

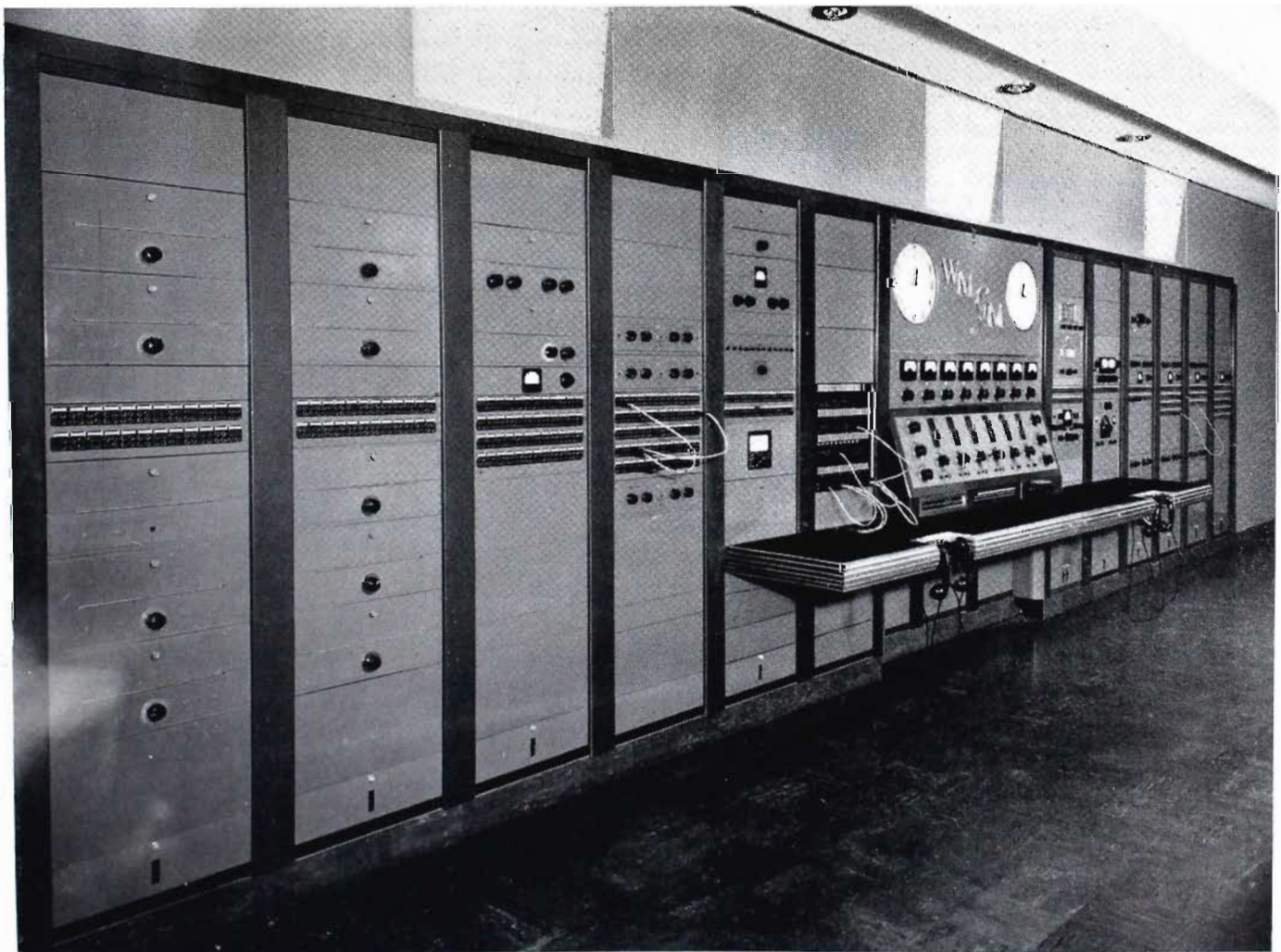

*WJMG, New York. This master control installation, including 12 deluxe audio equipment racks, is just one part of WJMG's modern 6-studio layout. Designed for AM, FM and TV operation, this console handles 10 studio inputs and feeds 6 channels simultaneously, or individually by a preset relay system.*



**CUSTOM BUILT**

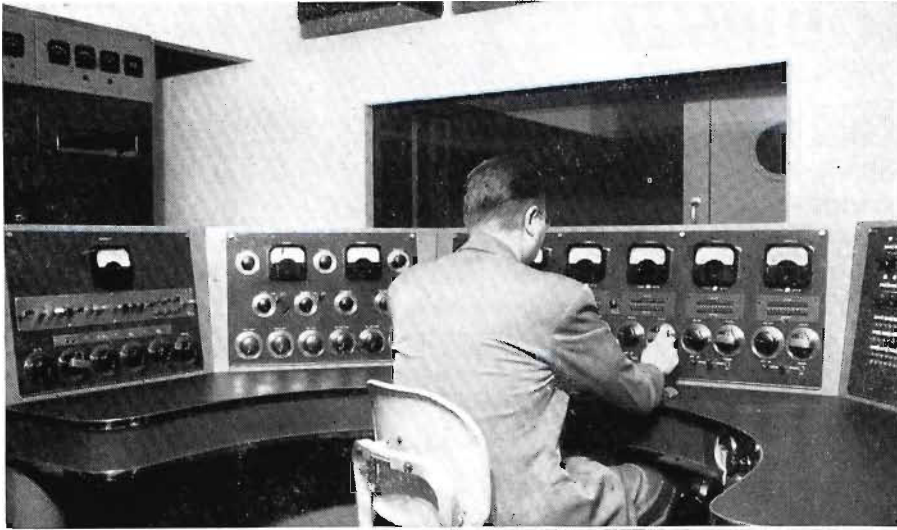

*KOMO, Seattle. This master control console—with 9 deluxe audio equipment racks (at rear, not visible)—is one unit of KOMO's completely new and modern 7-studio system. It incorporates complete center panel switching for 10 studios and 6 outgoing channels (KOMO-AM, KOMO-FM, network plus 3 emergency).*

*WNEW, New York. This master control installation—in WNEW's 7-studio lineup is flanked on each side by 5 deluxe audio equipment racks. It has complete facilities for control and preset switching of 7 studios to 10 outgoing lines . . . and for feeding cue from any channel to any studio.*

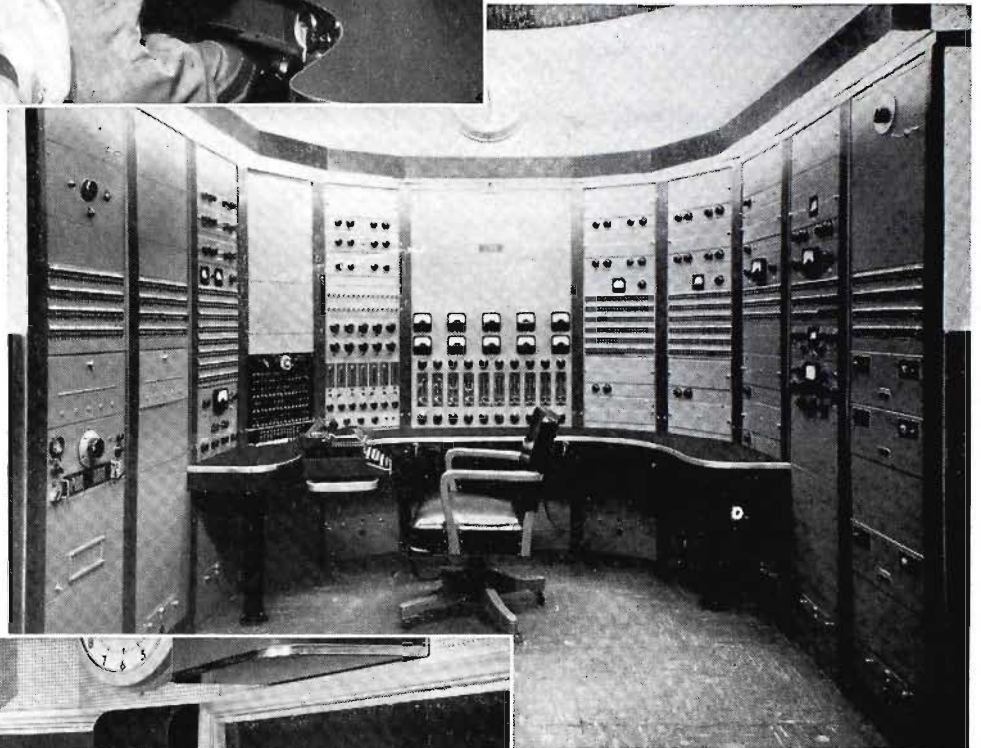

*WJPG-FM, Green Bay. One of the specially-built studio-control consoles in WJPG-FM's 4-studio arrangement. Complete two-channel operation (AM and FM), simultaneous audition and broadcast from any combination of studios, remote lines, cueing and talkback are provided.*

*WJBP, Baton Rouge. Here is a specially-built console which combines master and studio control operations at one location. Master control incorporates mechanically interlocked push-button switches to avoid the possibility of program overlap.*

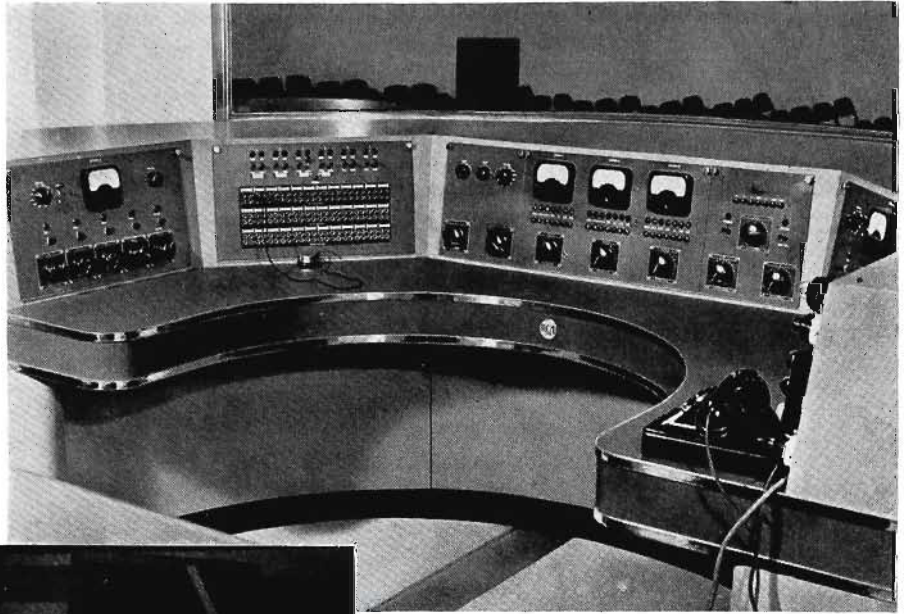

*WMGM, New York. This deluxe custom-built studio console provides complete facilities for the control of auditorium-type studio "A", largest of WMGM's 6 studios.*

*WJAC, Johnstown, Pa. In this speech input layout, custom-built matching-end consoles contain auxiliary switches and controls. They are used in conjunction with a standard 76-series console to provide increased flexibility and convenience.*





## CUSTOM BUILT

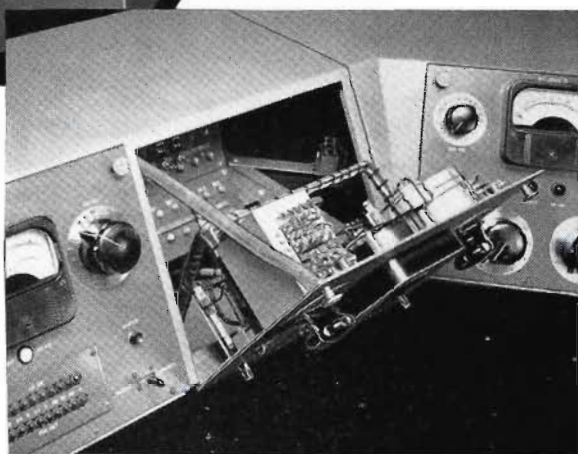

Combining master and studio control facilities, this all-metal console includes eight individual panel sections which are: l. to r. (Studio "B", Remote Line, MCR (4 panels), Studio "C", Announce and Studio "D".) Front cover panels in lower desk sections are removable to provide access to relays, terminal boards and coils. Desk design and panel spacing permits four video monitors to be mounted directly on top of the center section.

Here, one of hinged console panels is tilted forward to show how easily components and wiring may be reached.



The arrangement above shows how special matching consoles are designed for desk-top use with any standard 76-series console. Such consoles may contain special talkback facilities, order wire ringdown circuits, monitor controls and signal lights. Jack panels may be included, if desired, for use with the 76 console. In addition to the special end cabinets shown here, "straight" type cabinets to match 76-series console are also available.

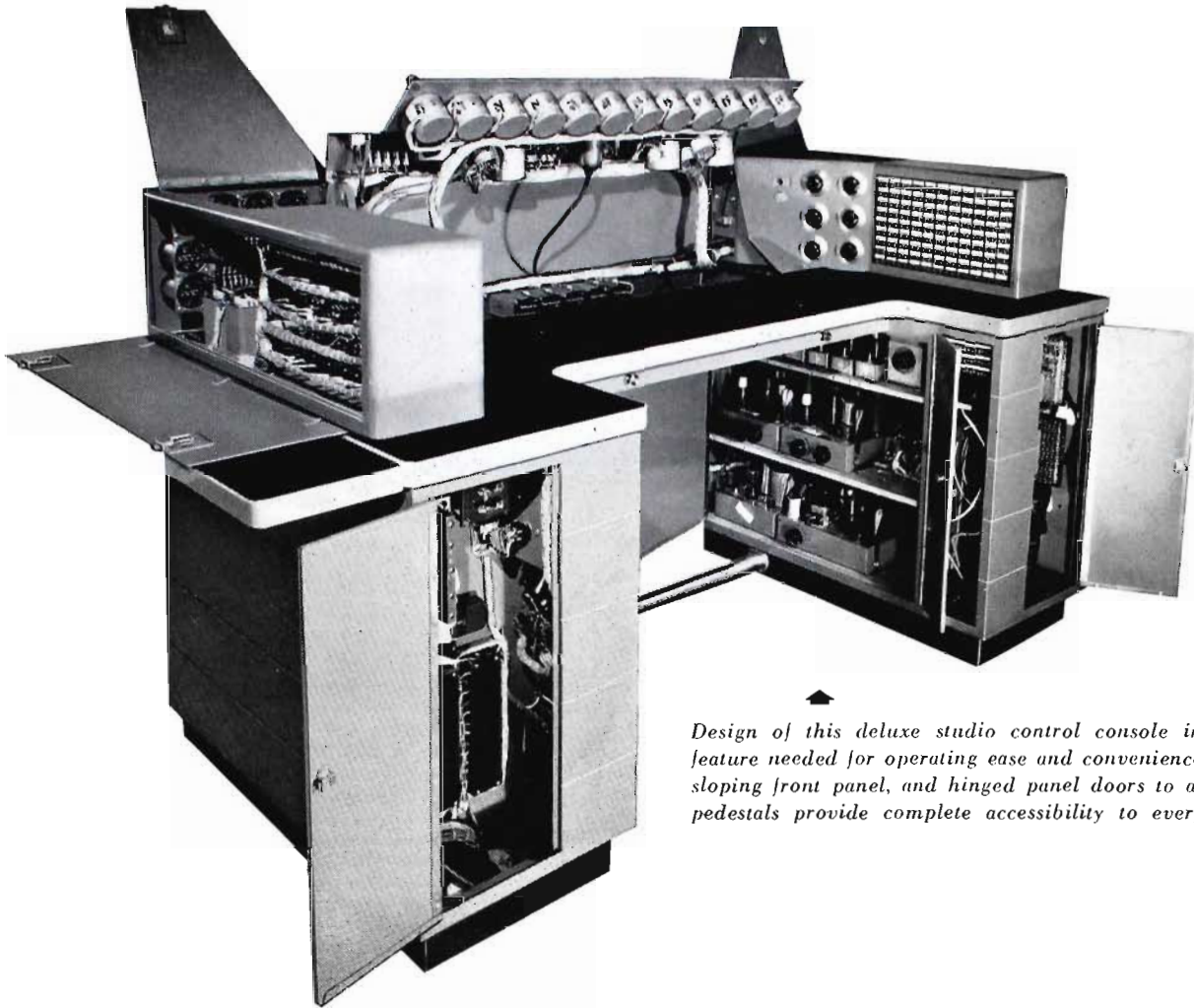

Design of this deluxe studio control console includes every feature needed for operating ease and convenience. The hinged sloping front panel, and hinged panel doors to all turrets and pedestals provide complete accessibility to every component.

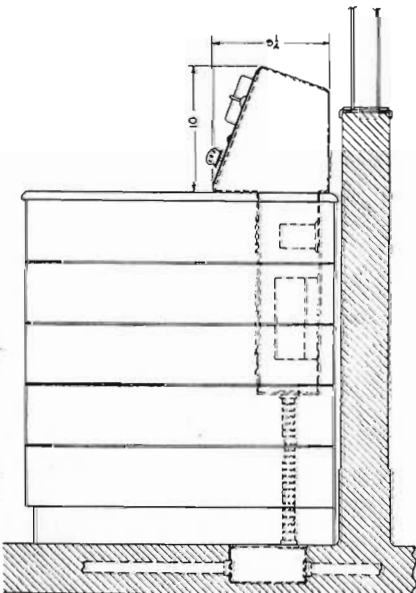

This cross-section view shows how the console at right was designed to permit some components to be mounted below the desk top. This results in small turret size and provides maximum visibility into the studio.

The studio console design shown below employs varied colored knobs and switch handles for easy and quick identification of certain controls. All escutcheons and dial plates are of nickel silver for attractiveness and long wear.





# Studio Consolette, Type 76-B5



## Features

- Complete high fidelity speech input system for two studios, announce booth, turntables and remotes.
- Excellent frequency response—low distortion for FM or AM.
- No broadcast time lost from amplifier or power supply failures. Duplicate equipment may be quickly connected by means of switches.
- 8-watt monitoring and audition amplifier with interlocked relay circuits for three loudspeakers.
- Full facilities for simultaneous audition and broadcast.
- Push button selector switches—six channel mixer.
- Large vu meter connected to rotary selector switch permits accurate program monitoring and checks plate currents of all tubes in program channel.
- Talk-back system independent of program channel—interlocked switching prevents feed-back.
- Easy access for maintenance.
- Heavy duty power supply for external mounting allows space for full-sized components in small sized console.

## Uses

The 76-B5 provides a completely flexible and high quality speech input system for FM as well as standard broadcasting. The new design supersedes the type 76-B2 and is advantageous by its increased flexibility in the switching of the 4th mixer position from Studio B to the Announce Booth or control room. This model also uses push button switches of an improved design.

The 76-B5 provides all the amplifying control and monitoring equipment required to handle successfully two studios, an announce booth microphone, a control-room announce microphone, two transcription turntables and six remote lines. Full facilities are provided for simultaneously auditioning and broadcasting from any combination of the studios, turntables or remote lines.

## Description

All the amplifying and control equipment is mounted in a single metal console and the power supplies are located in a metal box designed for wall mounting.

The standardized, illuminated volume indicator meter is furnished calibrated in "vu's." This meter is also used to measure the plate current of all the tubes in the program channel. The meter is switched to the various tubes by means of the rotary switch which is mounted to the left of the meter. An adjustable attenuator at the right of the meter allows the 100% mark on the scale to be calibrated for +4, +8, +12, and +16 vu.

The console contains four pre-amplifiers, one high-gain program amplifier and one high-gain 8-watt monitoring amplifier. A six position mixer is utilized with the pre-amplifiers connected to four of the mixers and banks of mechanically inter-

locked push-keys connected to the remaining two. The output of each mixer connects to lever keys so it may be switched to the input of the program amplifier for broadcasting or to the monitor amplifier for auditioning. These key switches are interlocked to disconnect the studio loudspeakers and operate "On Air" light relays. A three position key switch in the input of the fourth pre-amplifier permits it to operate from a microphone in the studio, announce booth, or local control room. The push-keys on the fifth and sixth mixer positions allow any one of six remote lines and two turntables to be instantly connected to the input of either of the two mixers. Additional push-key sets provide circuits for feeding cue to remote lines and for bringing in monitoring circuits such as transmitter or master control outputs. A monitoring headset jack is supplied and the headphones may be connected to the output of the program channel, the remote line push-keys, or the incoming network by means of a three-position lever switch. Lever-keys permit using monitoring amplifier for program amplifier in emergencies. Talkback facilities are included and separate push-keys permit talking back to either of the two studios or to the remote lines. The talk-back circuits are interlocked to prevent feed-back or program interruption.

An "Over-ride-Record" switch is provided which permits the remote operator to call in on any of the six remote lines and over-ride the program on the control room speaker. The "Record" position of the switch furnishes a signal source for

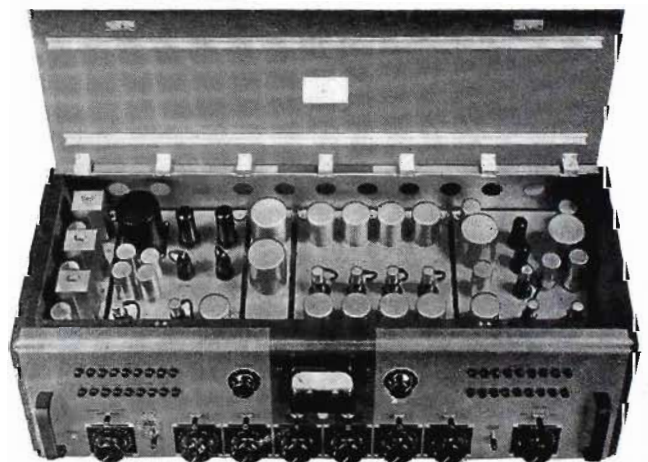

76-B5 with top raised

an external recording amplifier. Two remote line repeating coils and attenuator pads are provided.

The console is constructed of metal with wooden style plates on each end. A lid is provided for access to tubes, etc. from the top and is equipped with sturdy concealed hinges. The entire console chassis is hinged across the back to permit quick and easy access to every component and all the wiring. Handles on the front panel facilitate opening the chassis for inspection. When the chassis is opened, all the mixers are made accessible for servicing.

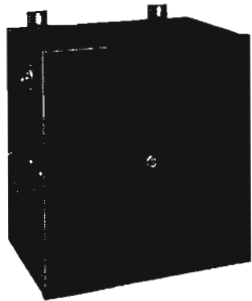

Wall Mounting  
Power Supply

The metal power supply box is equipped with a hinged front door and a hinged chassis. Two separate rectifier and filter units provide power for the program amplifier—preamplifiers, monitoring amplifier, three speaker interlocking relays and up to 4 external 12 volt relays for studio signal lights. A switch permits feeding the preamplifiers from the monitor supply in emergencies.

### Specifications

Source Impedance	
Microphones	30/50 or 250 ohms
Remote Lines	150, 300 or 600 ohms
Turntables	250 ohms
Monitor Cue	20,000 ohms
Load Impedance	
Line	500/600 ohms
Speaker (total of four speakers)	each 15 ohms

### OUTPUT LEVEL

Line (distortion less than 0.5% 50-7500 cycles)	+18 dbm
Maximum Line Output Level	+26 dbm
(With 1.0% rms distortion at frequencies 50-7,000 cycles)	
Speaker (distortion less than 3% 50-7500 cycles)	8 watts
Gain (maximum microphone to line)	112 db

Transcription Input to Line	81 db
Frequency Response (to line or speaker)	$\pm 2$ db 30-15,000 cycles
Noise Level (below +18 db output, 68 db gain)	-68 db
Power Input: 105/125 volts, 50/60 cycles	225 watts
Dimensions	Console      Power Supply
Length	39"      15"
Height	10 1/2"      15"
Depth	17"      8"
Finish	Two-tone umber gray      Dark umber gray
Weight, unpacked (less tubes)	135 lbs.      60 lbs.
Stock Identification	MI-11613-D      MI-11301-B

### Accessories

- BA-2C Booster Amplifier (one required for each 70-D turntable) MI-11226-B
- Tube Kit (complete tube complement for 76-B5) MI-11252
  - 11 RCA-1620      1 RCA-5U4G
  - 2 RCA-1621      2 RCA-1622      1 RCA-5Y3GT/G
- Alternate Tube Kit (complete tube complement) MI-11252-D
  - 11 RCA-6J7      1 RCA-5R4GY
  - 2 RCA-6F6      2 RCA-6L6      1 RCA-5Y3GT
- On-Air Light Relay (one required for each studio on air or audition light) MI-11702
- Speaker Relay (not required unless an interlocked speaker is desired in Announce Booth) MI-11703-A

Components Easily  
Accessible with this  
Hinged Feature

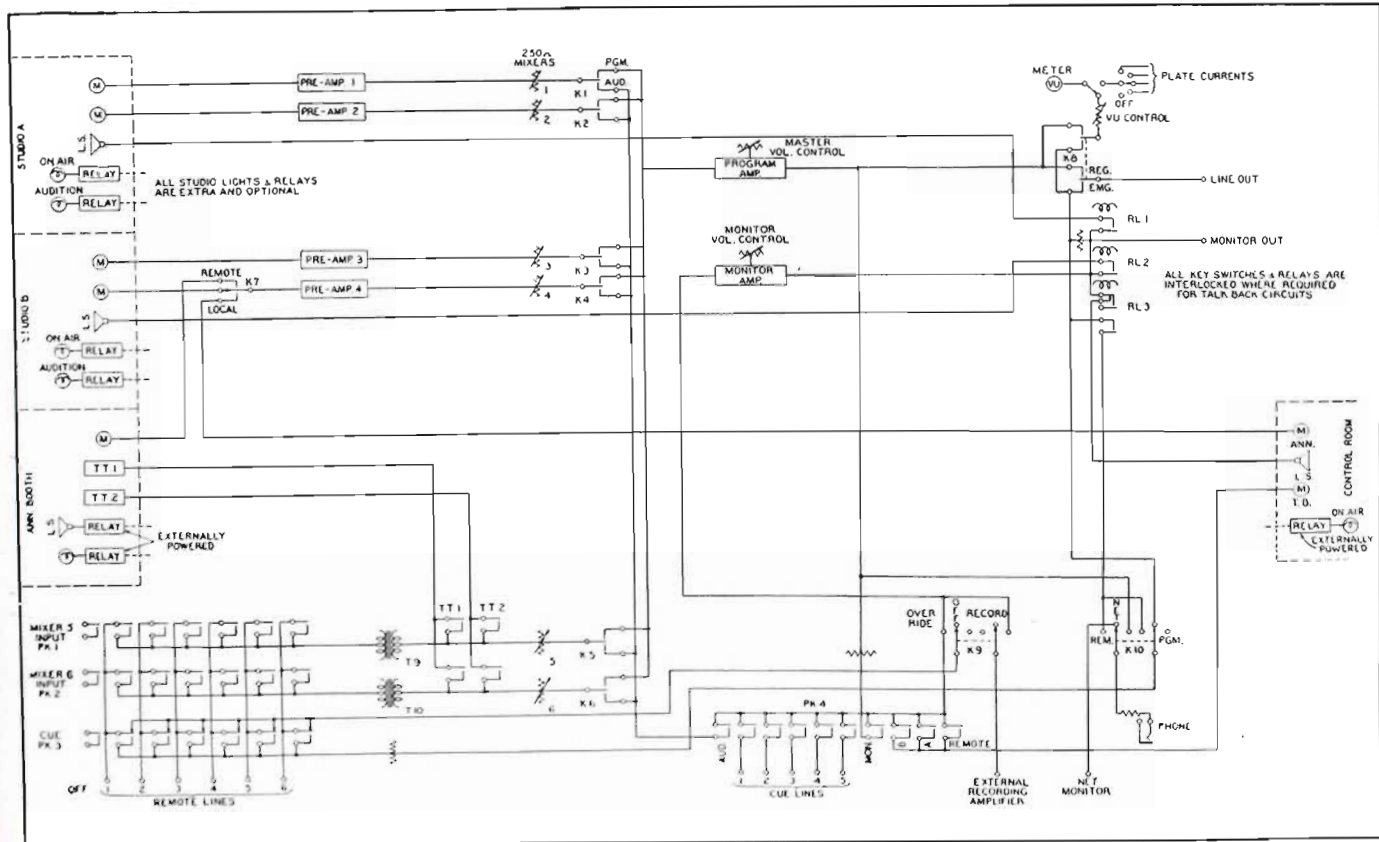
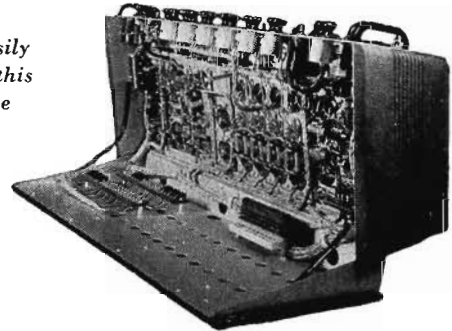

Simplified block diagram of 76-B5 Console



# Broadcasting's favorite

**DELIVERY  
NOW**

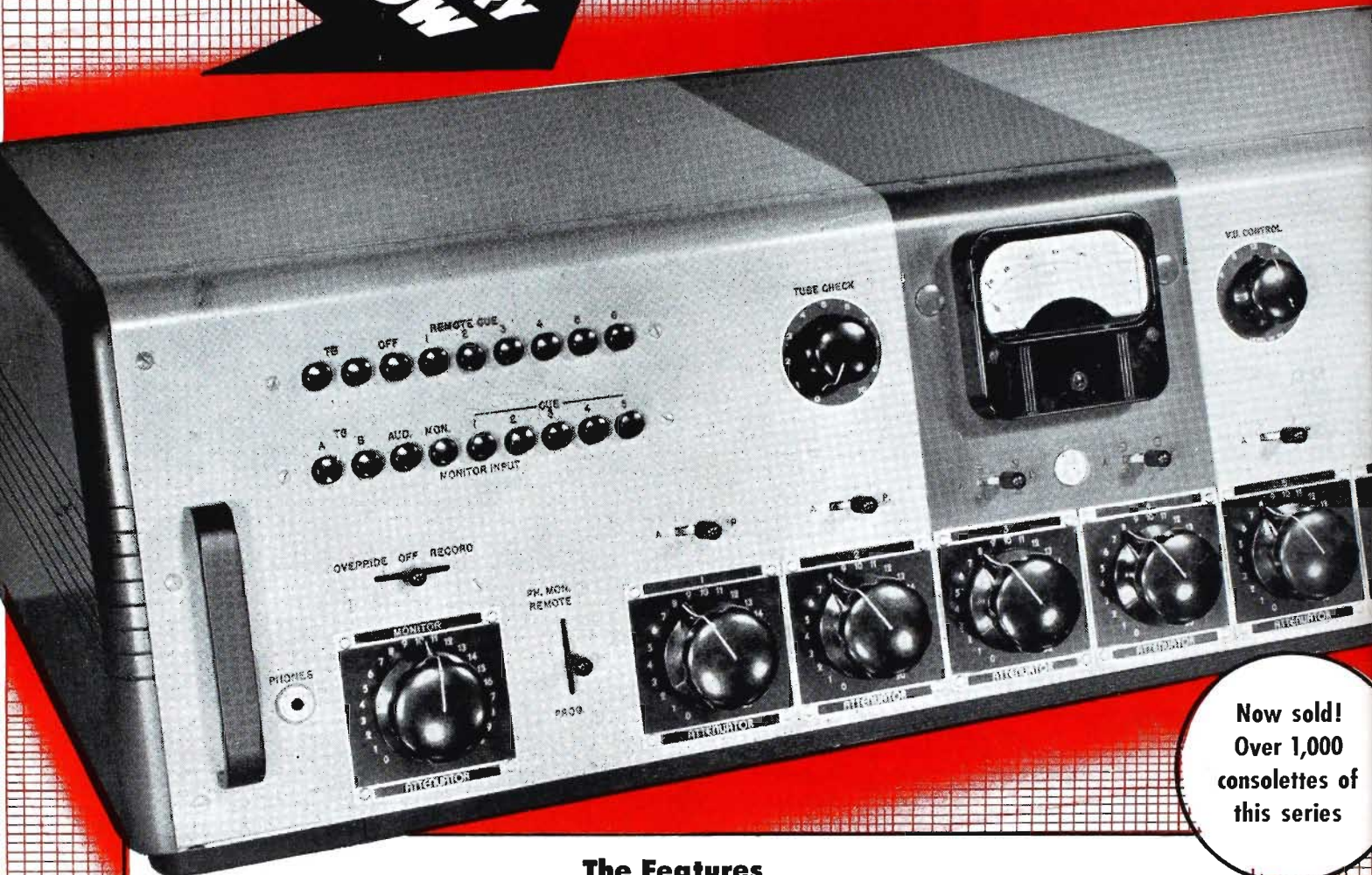

**Now sold!  
Over 1,000  
consolettes of  
this series**

## The Features

- Four pre-amplifiers.
- Over-ride facilities for all remote lines. Permits engineer or announcer on remote broadcast to "call-in" by over-ride on control room speaker.
- Six-channel mixer.
- Direct talk-back system to any studio and any remote line. Studio speakers and remote lines are interlocked to prevent feedback.
- Cue feed to remote lines.
- Five spare monitor inputs for monitoring externally produced programs, such as networks, other studios, outgoing channels, etc.
- Large VU meter connected to rotary selector

switch permits accurate program monitoring. Plate current checking system for all tubes and program channel.

- No lost time due to possible failures of amplifiers or power supplies. Emergency operation may be obtained quickly by means of switches.
- Headphone monitoring across output line, monitor and external source, such as network.
- Recorder feed.
- Low-noise, low-microphonic type-1620 tubes.
- Built-in isolation coils for remote lines and turntable booster amplifiers.



# Consolette . . .

## for AM, FM and TV

NOTHING like the 76-B5 Consolette to keep studio programs and rehearsals in motion. Because there's nothing like it for flexibility and easy operation. It provides program quality that meets FM requirements. It has full facilities for simultaneous auditioning and broadcasting . . . for practically any combination of studios, turntables, or remote lines. It performs all the amplifying, monitoring, and control functions of most large and small stations—AM, FM, and TV sound.

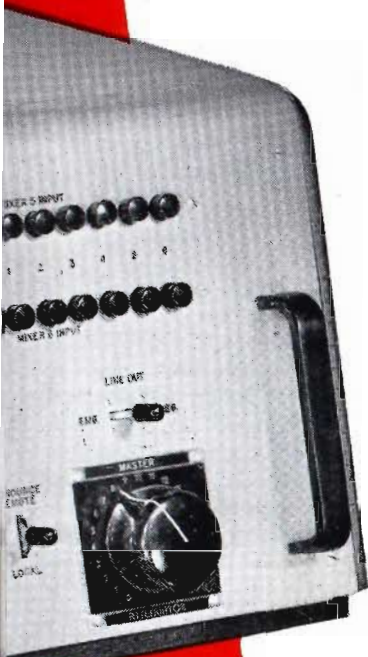

### Here's where you use it

- For two-studio operation, using two microphones in each—one announce booth microphone, and one control-room microphone.
- For single-studio operation . . . using four microphones, one announce booth microphone, and one control-room microphone.
- For two transcription turntables using external booster amplifiers.
- For remote lines—up to six! With independent control of each.

### NOW . . . Switching Systems for RCA Consolettes

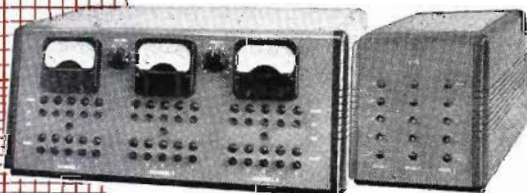

Master Control

Sub-Control

**Type BCS-1A**—Handles the output of as many as five control consolettes. Feeds three outgoing lines. Enables you to monitor studio, network, recording room, remote inputs. Switches these inputs into transmitter or network lines.

**Type BCS-2A**—For the smaller station requiring only two RCA consolettes. Handles up to four studios and two announce booths. Routes your program to two outgoing lines (AM, FM, or either transmitter and a network lines).

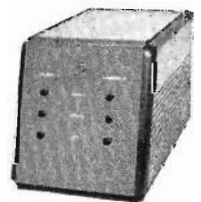

Sub-Control

For complete technical information on the 76-B5, the consolette that's backed by more than 20 years of broadcast engineering experience *in the field*—call your RCA Broadcast Sales Engineer. Or write Dept. 19GB.

# Studio Consolette, Type 76-D



## Features

- Two large VU meters connected to rotary selector switches permit accurate program monitoring and plate current checks of all tubes in program channels.
- Complete AM or FM studio system for large and small stations.
- Six microphone inputs, six mixers, six pre-amplifiers, eight watt monitoring and auditioning facilities.
- Complete high fidelity speech input system for two studios, announce booth, turntables and remotes.
- Excellent frequency response—low distortion for FM or AM.
- Minimum time lost from amplifier or power supply failures. Emergency switching facilities available.
- Talk-back system independent of program channel—interlocked switching prevents feed-back.
- Easy access for maintenance.
- Heavy duty power supply for external mounting allows space for full-sized components in small sized console.

## Uses

The new 76-D Studio Consolette incorporates two VU meters to permit additional flexibility in auditioning and presetting program signal levels in advance, without any interruption of the program "on-the-air." Moreover, the 76-D design consolette possesses six pre-amplifiers and additional flexibility on the fifth and sixth mixer positions. Offering complete versatility and flexibility of operation, the 76-D is admirably suited for AM, FM or TV sound studio control. It provides complete, high-fidelity control for two studios, or for single studio use in large stations.

## Description

The 76-D provides all the amplifying control and monitoring equipment required to operate efficiently a control room, two studios and announce booth, two transcription turntables, four remote lines and five cue circuits. The consolette contains six pre-amplifiers, six mixer positions, a high-gain program ampli-

fier and an eight watt monitoring amplifier which may be utilized to feed an external recording amplifier. All amplifier inputs and outputs are terminated in terminal strips, thereby allowing intermediate jack facilities for patching, etc. The fifth and sixth mixer positions are flexible and may be used as microphone inputs (giving each channel a 112 db gain) or switched to serve four remote lines and two turntables. Turntables 1 and 2 have their respective cueing keys which allow cueing signals to be fed to an external amplifier. The 76-D is attractively finished and in all respects similar to the 76-C series consolettes.

The two standardized, illuminated volume indicator meters (Program and Monitor) are furnished calibrated in "vu's." The "PGM" meter is used to measure the plate current of all the tubes in the program channel. The meter is switched to the various tubes by means of a rotary switch. Each meter has a companion attenuator which allows the 100% mark on each meter scale to be calibrated for +4, +8, +12 and +16 VU.

A monitoring headset jack is supplied and the headphones may be connected to the output of the program channel, the remote line push-keys, or the incoming network by means of a three-position lever switch. Lever-keys permit using monitoring amplifier for program amplifier in emergencies. Talkback facilities are included and separate push-keys permit talking back to either of the two studios or to the remote lines. The talk-back circuits are interlocked to prevent feed-back or program interruption.

An "Over-ride-Record" switch is provided which permits the remote operator to call in on any of the four remote lines and over-ride the program on the control room speaker. The "Record" position of the switch furnishes a signal source for an external recording amplifier.

The console is constructed of metal with wooden style plates on each end. A lid is provided for access to tubes, etc., from the top and is equipped with sturdy concealed hinges. The entire console chassis is hinged across the back to permit quick and easy access to every component and all the wiring. Handles on the front panel facilitate opening the chassis for inspection. When the chassis is opened, all the mixers are made accessible for servicing.



The metal wall cabinet power supply (MI-11301-B) is equipped with a hinged front door and a hinged chassis. Two separate rectifier and filter units provide power for the program amplifier — pre-amplifiers, monitoring amplifier, three speaker interlocking relays and up to 4 external 12 volt relays for studio signal lights. A switch permits feeding the pre-amplifiers from the monitor supply in emergencies.

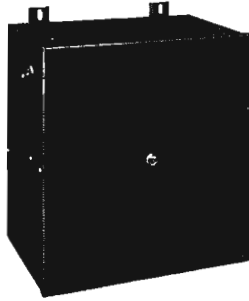

Wall Mounting Power Supply

### Specifications

- Source Impedance:**  
 Microphones \_\_\_\_\_ 30/50 or 250 ohms  
 Remote Lines \_\_\_\_\_ 150, 300 or 600 ohms  
 Turntables \_\_\_\_\_ 250 ohms  
 Monitor Cue \_\_\_\_\_ 20,000 ohms
- Load Impedance:**  
 Line \_\_\_\_\_ 500/600 ohms  
 Speaker (total of three speakers) \_\_\_\_\_ Each 15 ohms  
 Headphone Output \_\_\_\_\_ 5000 ohms
- Output Level:**  
 Line (distortion less than 0.5% 50 to 7500 cycles) \_\_\_\_\_ +18 db  
 Maximum Line Output Level  
 (distortion less than 1% at 50 to 7500 cycles) \_\_\_\_\_ +26 dbm  
 Speaker (distortion less than 3%, 50 to 7500 cycles) \_\_\_\_\_ 8 watts  
 Gain (maximum microphone to line output) \_\_\_\_\_ 112 db  
 Frequency Response  
 (to line or speaker) \_\_\_\_\_ ±2 db 30 to 15,000 kc  
 Noise Level (68 db gain, +18 dbm output) \_\_\_\_\_ -68 db  
 Power Input (105/125 volts, 50/60 cycles) \_\_\_\_\_ 225 watts

### Dimensions:

	Console	Power Supply
Length _____	39"	15"
Height _____	10½"	15"
Depth _____	17"	8"
Weight _____	140 lbs.	60 lbs.
Finish _____	Two-tone U/G	Dark U/G
Stock Identification _____	MI-11631	MI-11301-B

### Accessories

Tube Kit (complete tube complement for 76-D) \_\_\_\_\_ MI-11268  
 13 RCA-1620 \_\_\_\_\_ 1 RCA-5R4GY  
 2 RCA-1621 \_\_\_\_\_ 1 RCA-5Y3-GT/G  
 2 RCA-1622 \_\_\_\_\_

Alternate Tube Kit (complete tube complement) \_\_\_\_\_ MI-11268-A  
 13 RCA-6J7 \_\_\_\_\_ 2 RCA-6L6  
 2 RCA-6F6 \_\_\_\_\_ 1 RCA-5R4GY  
 1 RCA-5Y3GT \_\_\_\_\_

On-Air Light Relay (one required for each studio on air or audition light) \_\_\_\_\_ MI-11702

Speaker Relay (not required unless an interlocked speaker is desired in Announce Booth) \_\_\_\_\_ MI-11703-A

Components Easily Accessible with this Hinged Feature

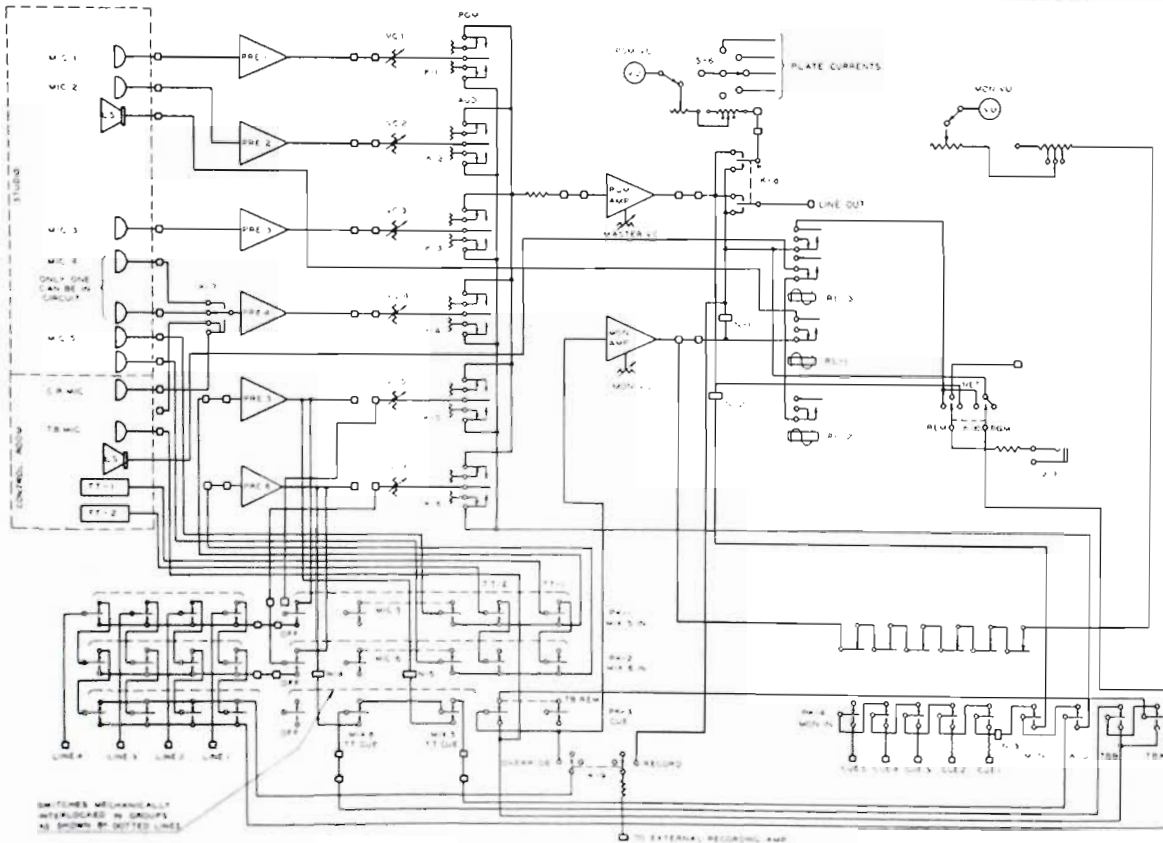
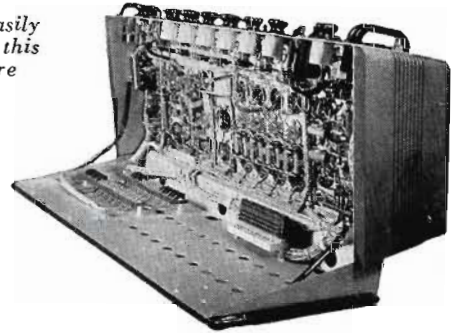

Simplified block diagram of 76-D Console

# Television Audio Equipment



## Features

- Provides facilities for handling sound channel of TV film projectors.
- Provides means for feeding transcription sound to TV studio for sound effects.
- Accommodates talkback and cue requirements of studio, projection room and order wire circuit.
- Custom-built console arrangements can be supplied to meet more elaborate TV requirements.

## Uses

RCA TV audio equipment items are employed by television stations to provide complete audio control facilities for control rooms and studios. The block diagram (page opposite) and photo above illustrate how RCA audio equipment may be combined to accommodate a TV station employing a single studio, announce booth, a projection room and control room. Other arrangements of equipment may be employed depending upon the size, number of studios and other requirements of the TV station. Custom-built TV consoles and associated equipment can be furnished to satisfy large or elaborate station requirements.

## Description

In addition to standard TV audio equipment such as RCA microphones, turntables, mike booms, stands, amplifiers, jacks, power supplies and other rack equipment—the BCS-3A TV switching console and RCA consolettes are available to the TV broadcaster. For example, the BCS-3A television auxiliary switching console (at left in photo above) is designed for use with the 76 series consolette in expanding TV audio control facilities. A spare volume control is provided which may be patched into a circuit as required. With the BCS-3A, it is possible to feed turntables to a loudspeaker for background purposes—or for accompanying a vocalist. A roving Vu meter provides for presetting audio levels of remote programs. Private line telephone ringdown circuits provide means for contacting offices and remote points.

Basic audio and talkback requirements fulfilled by the particular layout illustrated are as follows:

### STUDIO:

- (1) Four studio microphones with four additional microphone lines that can be patched to consolette input circuits.
- (2) Studio loudspeaker for turntable feed and talkback.
- (3) On-Air Signals.
- (4) Talkback from audio engineer to microphone boom operator.
- (5) Talkback from director to camera operators (order wire circuit).

### FILM PROJECTION ROOM:

- (1) Control for sound outputs of two film projectors.
- (2) Talkback from director to film projection room.

### CONTROL ROOM:

#### A. Mixer Facilities

- (1) Mix and switch four microphone lines.
- (2) Patching facilities for four additional microphones.
- (3) Mix audio outputs of two film projectors.
- (4) Mix and switch remote and network lines.
- (5) Mix and switch outputs of two turntables.

#### B. Talkback enabling audio operator to talk to microphone boom operator.

#### C. Talkback enabling program director to talk to camera operator and to film projection room, announce booth and studio.

#### D. Feed turntables to studio loudspeaker for background purposes, or for accompaniment of vocalist and other similar purposes. (Possibility for the output of the turntable at the same time to be mixed as a part of the consolette program.)

**CONTROL ROOM: (Continued)**

- E. Feed loudspeakers in studio control room, studio, announce booth, and projection room. Studio control room equipment able to feed one regular and one spare program line.
- F. Program line feed to house monitor circuit through an isolation amplifier.
- G. Program cue to camera and boom operators.
- H. Termination and equalization facilities provided for 24 remote broadcast and private lines. Ringdown equipment provided for magneto telephones. Equalization of telephone lines to 15 kc.
- I. Consolette switching facilities for feeding cue programs or "on-air" monitor circuit into studio when not in use.

**ANNOUNCE BOOTH:**

Announce booth containing these audio items:

- (1) a microphone
- (2) a monitor loudspeaker,
- (3) "On-Air" light.

**Equipment Required**

(For Typical Audio Layout Corresponding to Layout Diagram)

For additional description and technical data on equipment items below as well as other audio items—refer to Audio Section of catalog.

- 1 Special Audio Rack of Equipment
- 1 BCS-3A Auxiliary Switching System
- 1 Type 76 Series Consolette and Power Supply MI-11613-D and MI-11301-B
- 1 Tube Kit for Consolette MI-11252
- 2 Studio Light Relay MI-11702
- 1 "On Air" Sign MI-11706-1
- 1 "Audition" Sign MI-11706-3
- 2 Type 70-D Turntables MI-11801

- 2 Type BA-2C Booster Amplifier MI-11226-B
- 2 Tube Kit for Booster Amplifier MI-11287
- 1 Type KB-2C Talkback Microphone MI-11001
- 1 Desk Stand for KB-2C MI-12066
- 2 Type LC-1A Speaker MI-11401/11411
- 2 Talkback Speakers MI-12435
- 2 Masonite Wall Speaker Cabinet MI-13225
- 2 Type 88-A Microphone MI-4048-D
- 2 Type 91-B Desk Stand MI-4092-C
- 2 Type 44-BX Velocity Microphones MI-4027-E
- 4 Type 77-D Microphone MI-4045-B
- 4 Type 90-A Program Stand MI-11050
- 1 Type KS-3B Boom Stand MI-11056
- 1 Type KS-4A Boom Stand MI-11052
- 4 Cable Hook MI-11099
- 10 Wall Receptacle (for Microphones and 70-D) MI-4624-A
- 11 Cable Plug (for Microphones and 70-D) MI-4630-B
- 3 Cord Connector MI-4620-B
- 50' Cable MI-43
- 1 Fixed Pad 6 db MI-4171-29
- 4 Patch Cord—2 feet MI-4652-2A
- 1 Relay Power Supply, 12 v., 1A MI-11303
- 2 16mm Equalizer MI-26313

**Announce Booth**

- 1 Type KB-2C Microphone MI-11001
- 1 Desk Stand for KB-2C MI-12066
- 1 Cable Plug MI-4630-B
- 1 Wall Receptacle MI-4624-A
- 1 "On Air" Sign MI-11706-1
- 1 Talk-back Speaker MI-12435
- 1 Wall Speaker Cabinet MI-13225
- 1 Studio Light Relay MI-11702
- 1 Speaker Relay Kit MI-11703-A

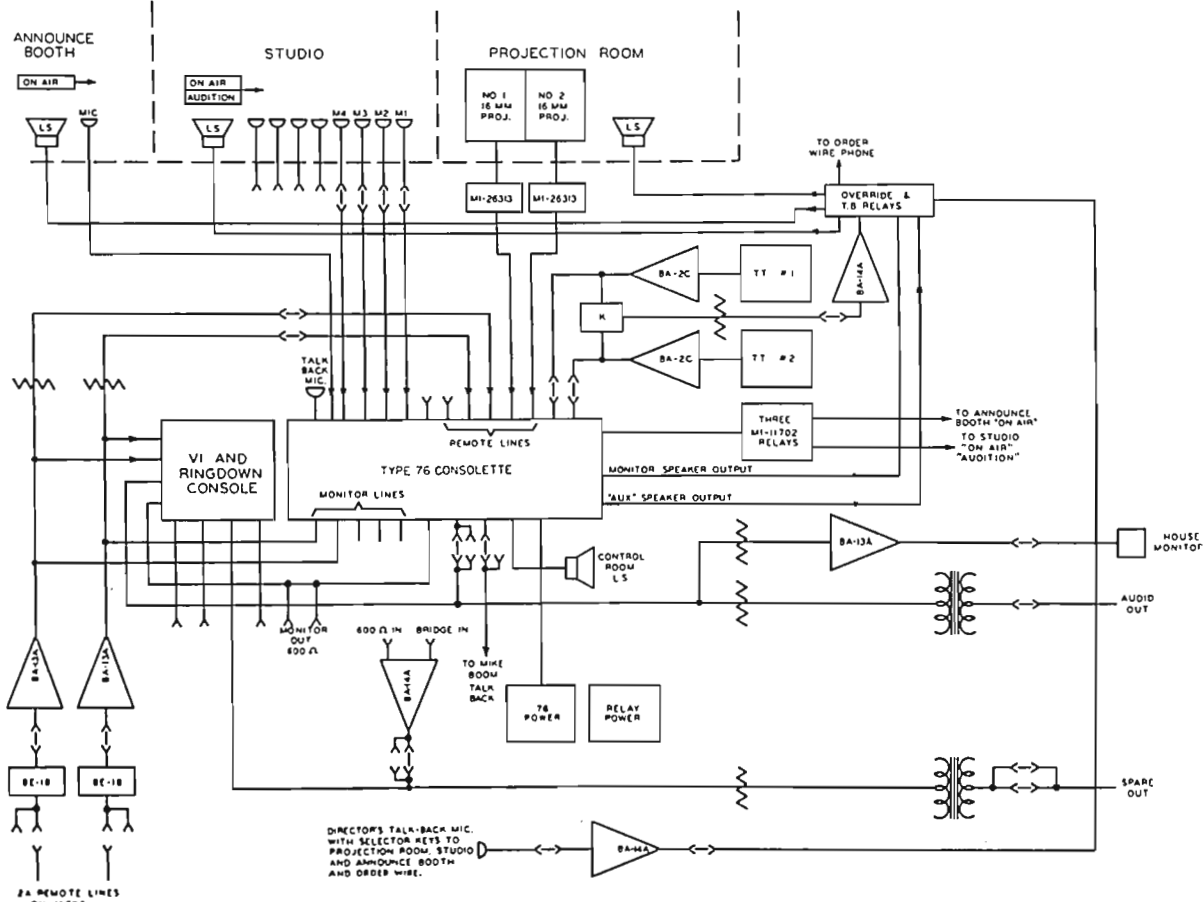



# Switching System, Type BCS-1A

## Features

- Facilities comparable with custom-built equipment.
- Control of 5 consolettes to 3 outgoing lines.
- Attractive styling blends with all RCA consolettes and equipment.
- Eliminates any possibility of 2 programs feeding one outgoing line.
- AM, FM and utility, or any desired combination.
- Monitoring facilities for all channels, networks, etc.

## Uses

The BCS-1A switching system has evolved after numerous requests from broadcasters to develop a "fool-proof" system of flexible switching for stations operating several studios to more than one outgoing channel. With the addition of FM to many stations, it has become apparent that a separate system for AM and FM transmitter channels is desirable. This feature decreases the possibility of inadvertent switching and also enables the operator to satisfactorily adhere to switching functions as assigned.

## Description

The BCS-1A is a relay operated system consisting of a master switching console, usually installed in the main control room, and a studio console for each control room. The complete system provides the master switching console with handling capacity for one to five studio consoles, with each studio console handling two studios and one announce booth. This system will switch the output of five consoles to three outgoing lines. The unique design of the relay interlocking feature prevents the feeding of more than one program to an outgoing line, or lines, although supporting program material may be handled as remotes by the originating studio.

The Master Switching Console (see photograph) has three groups of lights and switches and an associated VU meter for each of the three outgoing channels. In each group the top row of lights indicates which of the five studio switching consoles is feeding the outgoing channel. The associated switches for each studio are immediately below the lights. A studio release switch for each outgoing channel is on the next row. "Studio Controls" are on the lower two rows. A moni-



Master Switching Console

toring amplifier input selector switch is placed on the left of the center VU meter to provide a cue check on monitoring of programs on any of the three outgoing lines, anyone of the five originating consolettes and two spare positions for user's choice, such as networks, remotes and recording, etc. A step-by-step bridging type volume control on the right hand side controls the level of the monitoring amplifiers.

The Studio Switching Console (see photograph) has three vertical rows of lights and switches, each vertical being associated with an outgoing channel. Reading from top to bottom, the horizontal rows are the "On-Air" lights which light only in the program originating control room and indicate which outgoing channel or channels the originating control room is feeding. The next row is "In Use". These are operated when the originating studio, or any other studio, is feeding program to the channel. The "On" switch which controls each channel is on the next row. The "Off" switch and the "Studio Control" lights are the bottom two rows.

Some operating features are as follows:

- The master control switching unit can put any studio on or off the air at any time. It is the only unit which has unqualified control.
- The master switching control can extend control to any studio control and any outgoing bus or buses that are desired. This is accomplished by the operation of the studio control switch on the master switching console, the status of this control is indicated by the lower signal light row on each control box.
- The studio control feature prevents unauthorized switching from occurring in control rooms not in use.
- A studio control set up for the next program as indicated by the studio control light cannot interrupt the originating studio using the channel. Only the studio feeding or the master control can release the channel. This is a very important feature. The new originating studio is advised of the channel availability by the extinguishing of the "In Use" signal light for that channel. When the "On" button is depressed the studio is placed on the air and the "In Use" and "On Air" lights are lighted to indicate that the studio is feeding the channel.
- The system can be operated as a "roving" control if an operator is not stationed at the master control. The studio control switches for all studios and channels that will be used can be turned on and control can be handled at the studio controls without benefit of the master control operator.

All relays and main terminal blocks are located in the base of the master switching unit and readily accessible by raising the top and front portion of the case which are hinged at the rear. With the minimum of channel switching, the minimum power required for the operation of the complete system (master and studio consoles) exceeds 1 amp. The MI-11304



Studio Switching Console

Relay Power Supply (maximum output 5 amps.) is therefore recommended.

The master switching console is the common point for all control wire connections. 19 conductors are required from this console to each studio console if all three outgoing channels are used. No jumpers are required at any terminal blocks in case the maximum number of control boxes are not used. MI-61 shielded, 15-pair (twisted) cable is available for wiring between the Master Switching Console and the Studio Switching Consoles.

**Specifications**

**Dimensions:**

**Master Switching Console**

- Length \_\_\_\_\_ 24"
- Height \_\_\_\_\_ 10½"
- Depth \_\_\_\_\_ 17"
- Weight \_\_\_\_\_ (approx.) 80 lbs.

**Studio Switching Console**

- Length \_\_\_\_\_ 10½"
- Height \_\_\_\_\_ 10½"
- Depth \_\_\_\_\_ 17"
- Weight \_\_\_\_\_ (approx.) 30 lbs.

**Stock Identification:**

- BCS-1A Master Switching Console \_\_\_\_\_ MI-11625
- BCS-1A Studio Switching Console (each unit) \_\_\_\_\_ MI-11625-A

**Accessories**

- Relay Power Supply \_\_\_\_\_ MI-11304
- BA-13A Program Amplifier (Carbon Control) \_\_\_\_\_ MI-11233-A
- BA-13A Program Amplifier (Step-by-step Control, Daven) \_\_\_\_\_ MI-11233-F
- BA-14A Monitoring Amplifier \_\_\_\_\_ MI-11223-B
- BR-2A Panel and Shelf \_\_\_\_\_ MI-11598/11599
- LC-1A Loudspeaker (Umber Gray) \_\_\_\_\_ MI-11401/11411
- LC-1A Loudspeaker (Walnut) \_\_\_\_\_ MI-11401A/11411A
- Line Transformers, 250-600/250-600 ohms \_\_\_\_\_ MI-11713
- Pads, 6 db, 600/600 ohms \_\_\_\_\_ MI-4171-29
- 16 Pair Twisted Cable (per foot) \_\_\_\_\_ MI-61

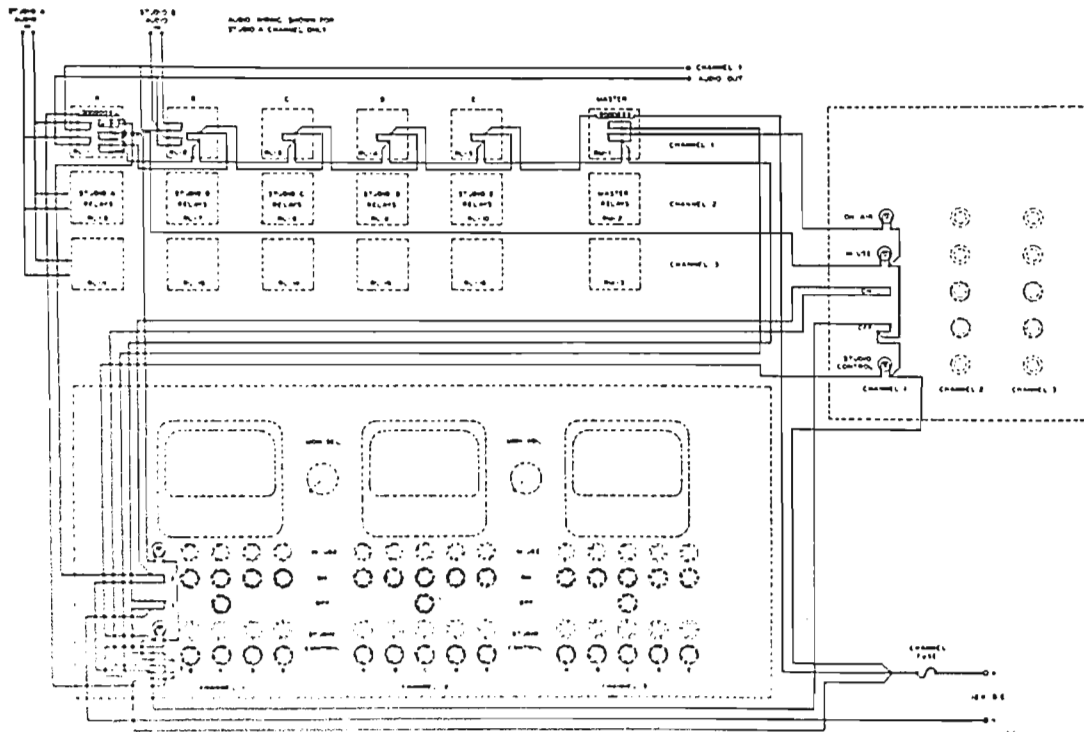
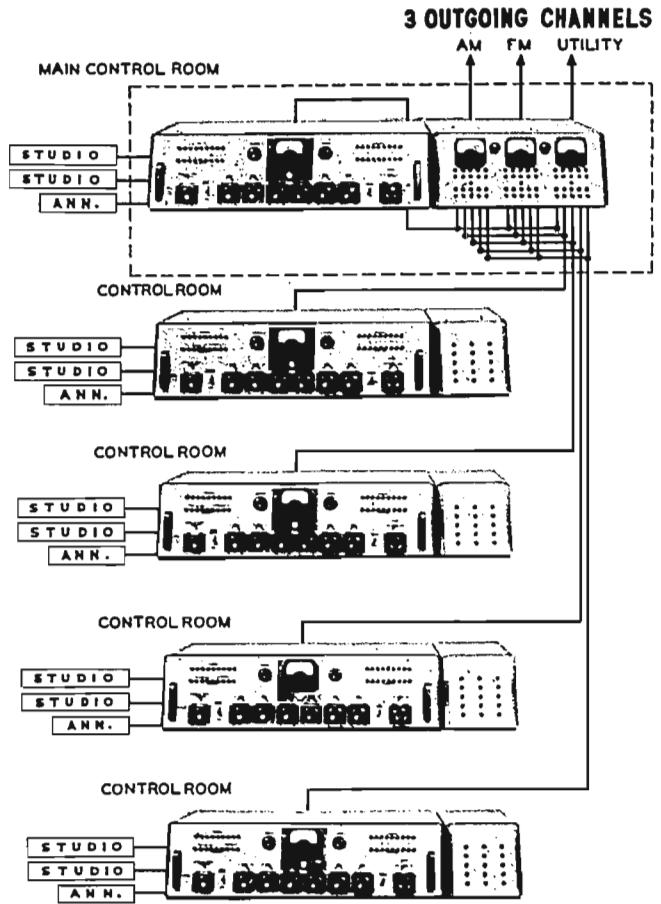

*Schematic diagram of BCS-1A Switching System*



# Simple switching for you

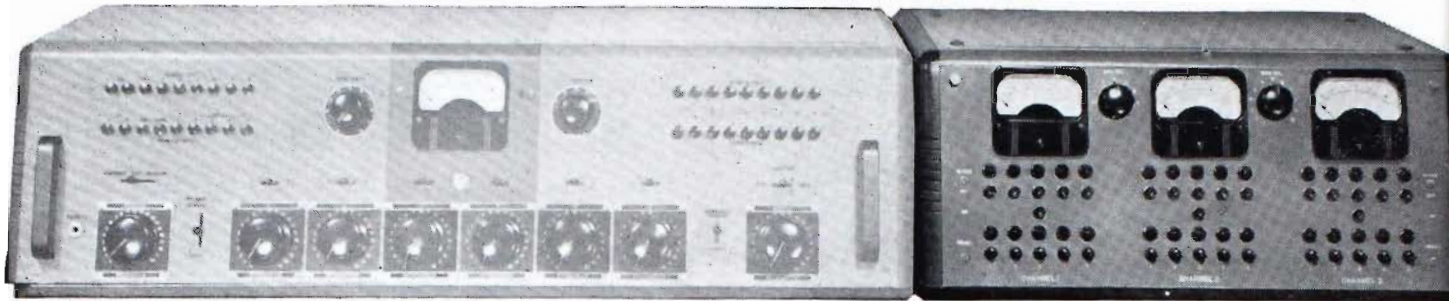

**RCA 76-B5 Consolette**

**Type BCS-1A  
Master Switching Unit**

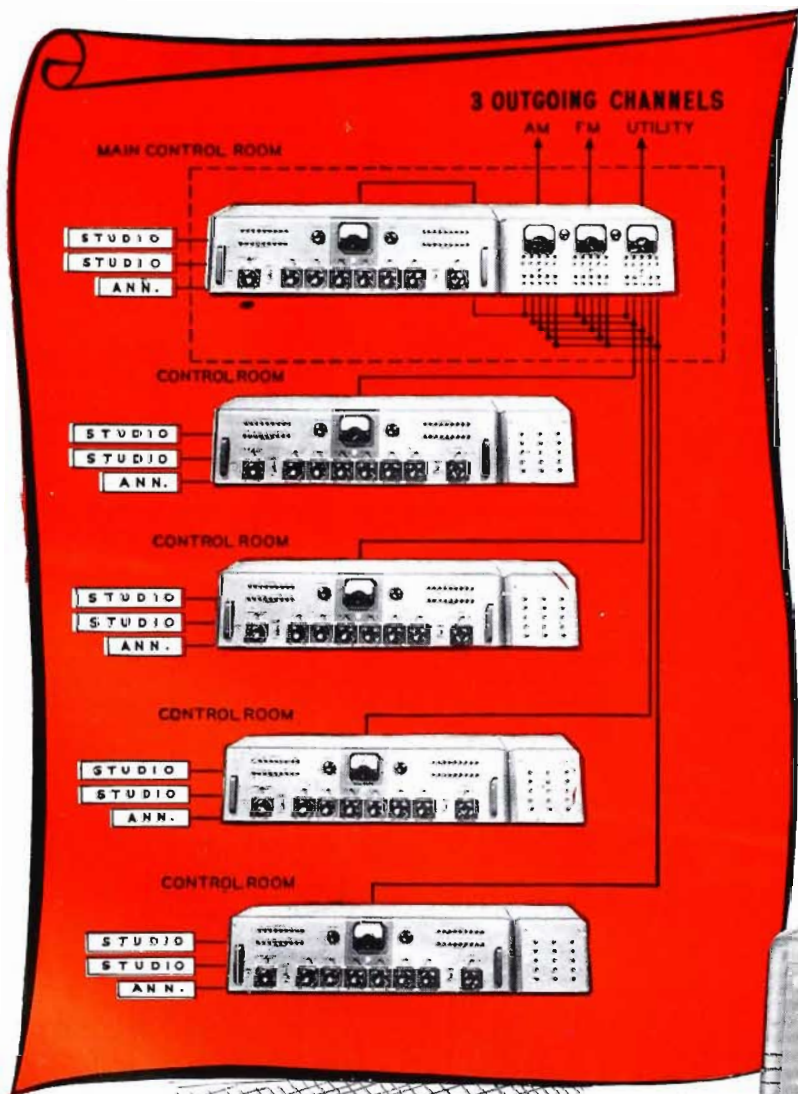

## Type BCS-1A Master Switching System

This system consists of one Master Switching Console (above, right—shown with an RCA 76-B5 Consolette), and one or more sub-control units (below). It contains all the relays needed for any combination of switching functions.

Up to five sub-control rooms can be used with the master console, each of which can handle from one to three studios.

Status lights give accurate picture of "On Air," "In Use," "Ready," and "On-Off" conditions in all control rooms for each outgoing line. Unique design features prevent feeding more than one program to any one line, although supporting program material can be handled as remotes from the originating studio. Sub-control units act as relay control stations between studios and master control unit.

**Type BCS-1A Studio  
Sub-Control**

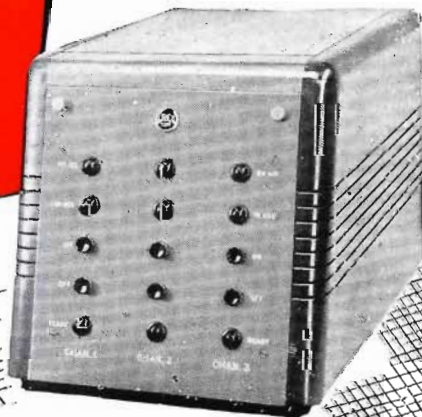



# AM-FM Programming

## RCA consolette switching systems co-ordinate all studio-station functions

Here's another example of RCA's program of providing "packaged" broadcast equipments having the flexibility and performance of custom-built jobs.

The two Switching Consoles shown, in connection with standard RCA Consolettes of identical styling, give you efficient latitude to perform intricate AM, FM and network programming operations—easily, precisely and quickly. Choice of model depends upon the complexity of your station's operating requirements.

The BCS-1A Console is designed for

the more elaborate station . . . switching the outputs of as many as five control consolettes to three outgoing lines. Many combinations are practicable. Inputs from studios, network, recording rooms or frequent remotes can be monitored and switched to transmitters or network lines. Electrically interlocking controls have reduced the possibility of switching error to the vanishing point.

Managers of stations requiring only two consolettes will find the RCA Type BCS-2A Console the ideal switching system. Used with two RCA 76-B5

Consolettes, program material from as many as four studios and two announce booths is routed to desired outgoing lines (AM and FM, or either transmitter and a network line).

• • •

Both types of RCA Switching Systems are designed for long-range station planning. They have sufficient flexibility to take care of future expansion. Complete details may be obtained from Engineering Products Dept., Section 19-EB, Radio Corporation of America, Camden, N. J.

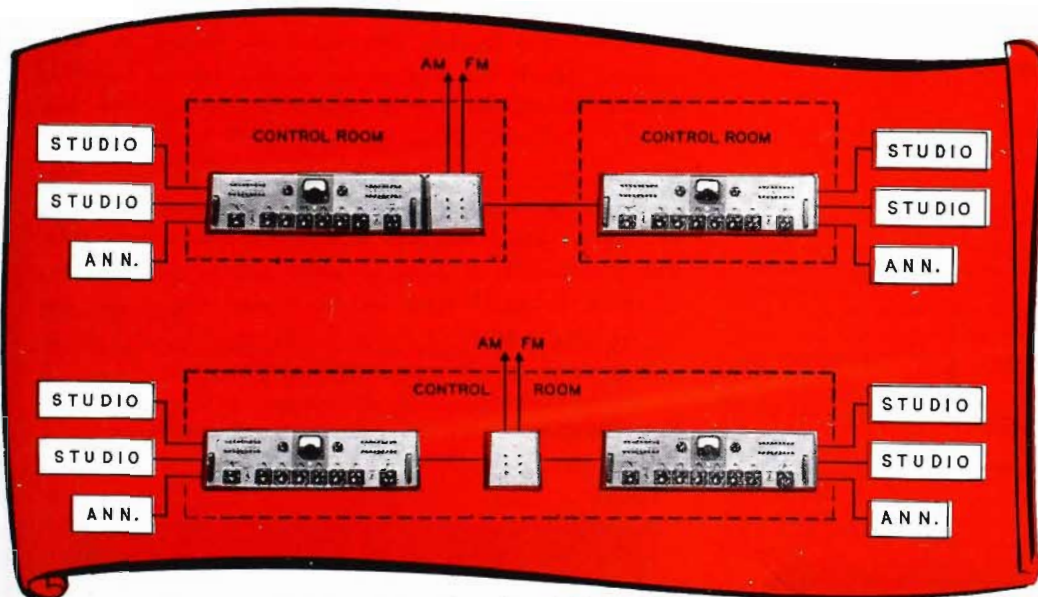

**Type BCS-2A Switching System**

Two studio inputs may be switched independently to either of two outgoing lines. Mechanical interlocking prevents feeding two inputs to the

same line. This system handles up to four studios and two announce booths. Two examples of the layouts possible are shown above.

**Studio Switching Console for Small Studios**



# Switching System, Type BCS-2A

## Features

- Economically priced.
- Control of two consolettes for two outgoing lines.
- Independent or simultaneous switching of inputs to outgoing channels.
- Attractive styling blends with all RCA consolettes and equipments.
- AM, FM, or other desired outgoing channel combinations.
- Nine possible combinations of switching.
- Mechanically interlocked.

## Uses

The BCS-2A switching console has been developed to meet the demands of many stations now operating both AM and FM transmitters, or one transmitter and a utility channel for feeding network, recording studio, etc. The addition of this extra channel adds many complications to programming, unless a switching system is evolved providing adequate flexibility and protection from erroneous switching. This is accomplished in the design of the BCS-2A.



## Description

The BCS-2A switching console is used in conjunction with the 76 series or any general consolette, and enables two console outputs to be switched independently to either of the two outgoing lines such as AM and FM or other combinations including recording, audition, and network feed. If desired, either of the two consolettes will feed both outgoing lines simultaneously, however, push button switches are mechanically interlocked and prevent both consolettes feeding the same outgoing line. If the program necessitates material from two different studios, this may be accomplished through the originating consolette's remote facilities. Switch contacts are provided to operate signal lights that may be located on or near the input consolettes to indicate if outgoing channel A or B or both are being fed. The 76 series consolettes have holes with plug buttons in place on either side of the VU meter in which the signal lights may be located. Signal light kits are available as MI-11714. Power for the signal lights is obtainable from 6.3 volt filament supply.

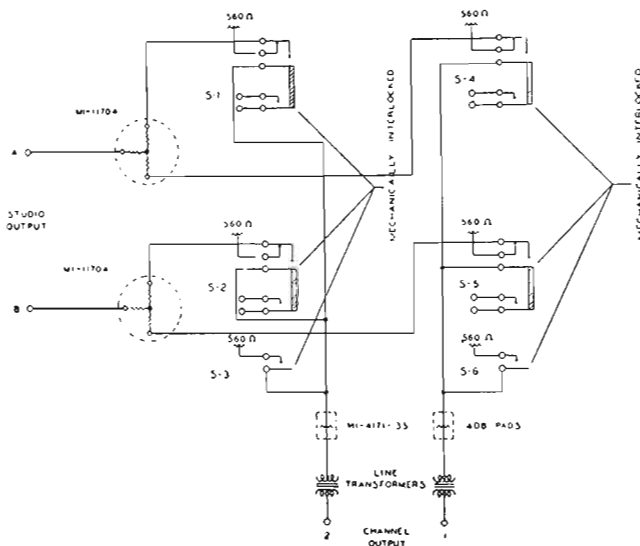

Simplified schematic diagram of BCS-2A

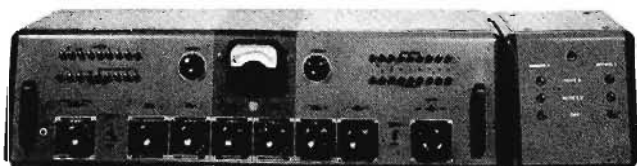

BCS-2A with 76-B5 Consolette

## Specifications

### Dimensions:

- Length \_\_\_\_\_ 10½"
- Height \_\_\_\_\_ 10½"
- Depth \_\_\_\_\_ 17"
- Weight \_\_\_\_\_ Approx. 30 lbs.
- Finish \_\_\_\_\_ Two tone umber gray
- Stock Identification \_\_\_\_\_ MI-11622

### Accessories

- Console Signal Light Kit \_\_\_\_\_ MI-11714

# Studio Warning Lights, MI-11706 Series



## Features

- Modern styling.
- Satin chrome finish.
- Available in five types.
- Uniform illumination.
- Easily mounted.

## Uses

The MI-11706 series of warning lights is another new product to supplement the RCA line of modernistically designed studio equipment. These lights have been developed after many requests from broadcasters to furnish a studio warning light that has bold and uniformly illuminated lettering with an external design that would enhance the appearance of any studio.

## Description

The lights are constructed of satin finish cast aluminum with trimmed etchings and tastefully styled for all studio turn-ins. The sign is an opaque black glass with frosted translucent 2" letters, using a 40 watt 12" lumiline lamp for a light source.

*Outer case removed showing Lumiline illuminating lamp*

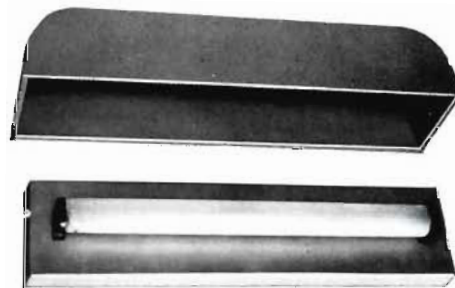

The interior or mounting base, containing the lamp, sockets and terminal strip for the a-c supply, is of separate metal construction and insures adequate protection from wires short-circuiting. The complete interior is a wall mounting fixture and allows a new lamp to be replaced quickly by simply removing the outer case by two screws. The warning light is available with five signs as indicated below.

## Specifications

Dimensions: (overall of case)

Length	14"
Width	3 1/2"
Depth	2 1/8"
(Glass Sign Aperture)	
Length	9 3/4"
Width	2 3/4"

Weight (unpacked) 3 1/2 lbs.

Stock Identification:

"ON-AIR"	MI-11706-1
"REHEARSAL"	MI-11706-2
"AUDITION"	MI-11706-3
"STANDBY"	MI-11706-4
"SILENCE"	MI-11706-5



*Back view showing simplicity of construction and outer case mounting screws*



# RCA Broadcast Amplifiers

The RCA line of high fidelity Speech Input Amplifiers has been designed to provide stations with studio, recording and portable remote amplifiers which will offer the maximum in fidelity, flexibility, convenience and reliability. All amplifiers are suitable for FM having a uniform response to 15,000 cycles. Distortion and noise levels have been reduced to a very low value through careful engineering design and construction.

While the apparatus is unexcelled in performance and appearance, it is very economical considering the many features which are offered. The amplifiers have been designed to give

unsurpassed service and nothing has been omitted which would contribute to their usefulness and reliability.

Attention is invited to gain and level references in this catalog. db—refers to gain.

dbm—sine wave power measurement referred to one milliwatt.

VU—refers to average program level as read on a standard VU meter. This value is subject to considerable variation from dbm but is generally considered 10 db below peaks.

Allowance must be made for program peaks to avoid amplifier overloading, for example, a pre-amplifier rated at +10 dbm should not be operated at more than 0 VU.

## Summary of RCA Broadcast Amplifier Characteristics

Type	Usage	Max. Gain db	Max. Input dbm*	Max. Output dbm*	Source Impedance Ohms	Load Impedance in Ohms	Type Mounting
BA-11A	Preamplifier	Matching 40	Matching -10	+18	30/150	150/600	Chassis or Rack
	Isolation Amp.	Bridging 4	Bridging +40	+18	10,000	150/600	Chassis or Rack
BA-2C	Mic. Preamp. or Turntable Preamplifier	50	-25	-2	30/250	250/600	Chassis or Rack
BA-13A	Program Amp. Line Amp. Isolation Amp. Monitor. Amp.	Matching 65 Bridging 28	Matching +10 Bridging +30	+33 2 Watts	600/150	600/150/15/7.5 and 5	Chassis or Rack
BA-14A	Monitoring or Recording Amplifier	105 73 with rem. v.c.	-27	+40.8 12 Watts	150/600 (10,000 ohms amp. input rem. v.c.)	600/150/15 7.5 and 5	Chassis or Rack
MI-12238	Monitoring Amplifier	85	-25	6 Watts	250	15	Chassis
86-B	Limiting Amplifier	60	At verge of Limiting +10	+30	600/250	600/250	Chassis or Rack
76-B5	Studio Console	110	-30	+26	30/50/250 300/600	600 Pgm. 15 Monitor	Console
76-D	Studio Console	112	-30	+26	30/50/150 250/300/600	600 Pgm. 15 Monitor	Console
BN-2A	Portable Remote Amplifier	92.5	-30	+18	30/150/250	150/600	Portable Carrying Case
OP-7	Portable Pre-amp. Mixer	8	-27	-24	30/250	30/250	Portable Carrying Case
OP-6	Portable Amplifier	90	-24	+19	30/250	600/150	Portable Carrying Case

\* Reference level one milliwatt.

# Two Stage Preamplifier and Isolation Amplifier, Type BA-11A

## Features

- Excellent frequency response  $\pm 1$  db 30 to 15,000 cycles.
- Two stages. Ample gain for any preamplifier application.
- May be used as an isolation amplifier providing 80 db isolation.
- Low distortion and hum level.
- High output capability makes it useful as a booster or line amplifier.
- Compact. Six units may be mounted in a single BR-2A Panel and Shelf Assembly.
- Hermetically sealed output transformer and oil-filled paper capacitor.
- Plug-in electrolytic capacitors.

## Uses

The BA-11A is a compact, two stage high fidelity preamplifier. Its high gain (40 db), extremely low noise level and low distortion make it an ideal unit for use as a microphone preamplifier, turntable preamplifier or booster amplifier. Its high output level makes it applicable as a line amplifier. It may also be used as an isolation amplifier operating from a zero to +40 vu feeder bus by the addition of an MI-11278-D bridging volume control. The BA-11A has a plug-in type chassis using multi-conductor plugs. The small size of the BA-11A gives it a great deal of mounting flexibility. It may be placed directly in a control console, control desk or transcription turntable cabinet. Where cabinet rack mounting is desired, one to six of these units may be installed in a single BR-2A Panel and Shelf Assembly.

## Description

The BA-11A has been designed to obtain high gain from two RCA 1620 tubes; one operated as a pentode, the other as a triode. The tubes are mounted vertically and the first stage

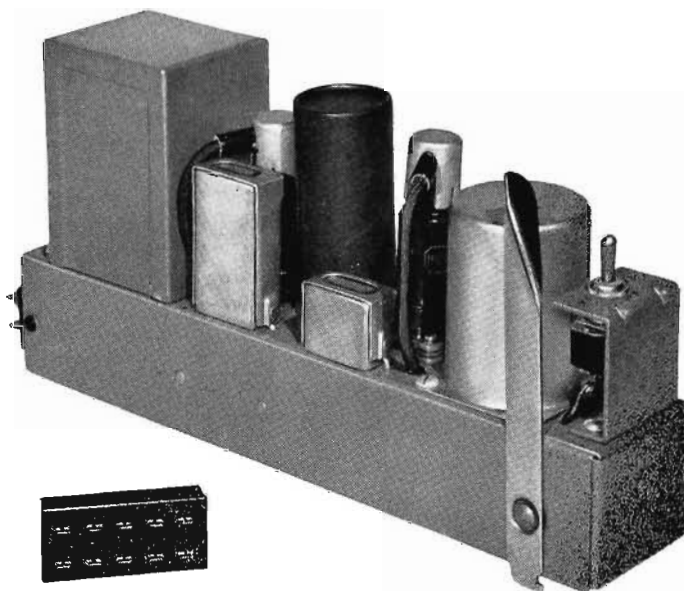

is shock mounted to prevent microphonics. The circuit is conventional with unloaded transformer input, resistance-capacitance coupling between stages and transformer output. The distortion and hum level has been reduced to a very low value through proper circuit design and through the use of stabilized feedback. Cross talk between units is  $-75$  dbm, 50 to 15,000 cycles when mounted side by side and operated from the BX-1D Power Supply.

With the addition of the MI-11278-D volume control kit to provide a 10,000 ohm input, the BA-11A may also be used as a bridging or isolation amplifier. The MI-11278-D kit can be mounted on the BA-1A chassis and be adjusted by screw driver through one of access holes in the front panel of BA-2A shelf. The MI-11278-C is intended for panel mounting remote from the amplifier. As a bridging amplifier, the BA-11A has a maximum of 4 db of gain with the volume control at minimum loss position and bridging a 600-ohm line. Approximately 80 db of isolation between output and input is obtained with the amplifier in this arrangement. A switch is provided for metering a portion of the cathode voltage of each tube when connected to a high resistance voltmeter such as the Type BI-1B. The switch is "off" in the center position. The unit is designed to operate from the BX-1D Power Supply or its equivalent. The power requirements are 6.3 volts a-c or d-c at 0.6 amperes and 250 volts d-c at 7 ma. Up to seven BA-11A preamplifiers can be operated from one BX-1E Power Supply.



Rear view of BA-11A showing multi-contact, plug-in connection

# Two Stage Preamplifier and Isolation Amplifier, BA-11A (Continued)

**Specifications**

BA-11A as Preamplifier:

- Source Impedance \_\_\_\_\_ 30/150 ohms
- Input Impedance (unloaded input transformer) \_\_\_\_\_  
Substantially above source impedance
- Load Impedance (balanced or unbalanced) \_\_\_\_\_ 150/600 ohms
- Maximum Input Level (less than 0.5 rms dist. 50-7500 cps) \_\_\_\_\_  
-22 dbm
- Maximum Output Level \_\_\_\_\_ +18 dbm
- Maximum Gain (150 ohm source to 150 ohm load) \_\_\_\_\_ 40 db

BA-11A as Isolation Amplifier (with MI-11278 Volume Control):

- Source Impedance \_\_\_\_\_ 30 to 600 ohms
- Input Impedance (through Volume Control) \_\_\_\_\_ 10,000 ohms
- Load Impedance (balanced or unbalanced) \_\_\_\_\_ 150/600 ohms
- Maximum Input Level, Volume Control at max.:  
Bridging 600 ohms \_\_\_\_\_ +14 dbm  
Bridging 150 ohms \_\_\_\_\_ +20 dbm
- Maximum Output Level \_\_\_\_\_ +18 dbm
- Maximum Gain \_\_\_\_\_ +4 db

BA-11A as either Preamplifier or Isolation Amplifier Frequency Response \_\_\_\_\_ ±1 db 30-15,000 cps

- Noise Level Output (input and output terminated) \_\_\_\_\_ -83 dbm
- Equivalent Input Noise \_\_\_\_\_ -123 dbm
- Plate Power Supply \_\_\_\_\_ 250 volts d-c at 7 ma
- Filament Supply \_\_\_\_\_ 6.3 volts a-c or d-c at 0.6 amps
- Dimensions, overall \_\_\_\_\_ Length 12 $\frac{3}{4}$ " , width 2 $\frac{3}{16}$ " , height 5 $\frac{1}{8}$ "
- Finish \_\_\_\_\_ Umber gray
- Weight (unpacked) \_\_\_\_\_ 5 $\frac{3}{4}$  lbs.
- Stock Identification (less tubes) \_\_\_\_\_ MI-11231

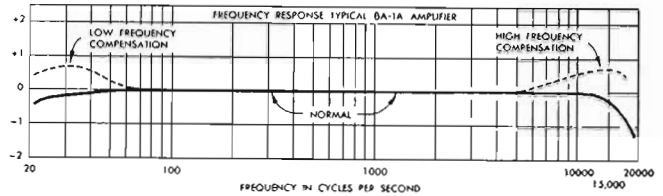

Frequency Response, BA-11A Amplifier

**Accessories**

- Tube Kit #1 (complete tube complement)  
Two RCA 1620 \_\_\_\_\_ MI-11288
- 1 Alternate Tube Complement  
Two RCA 6J7 \_\_\_\_\_ MI-11288-A
- Volume Control Kit  
(Bridging Chassis Mounting) \_\_\_\_\_ MI-11278-D  
(Bridging Remote Panel Mounting) \_\_\_\_\_ MI-11278-C
- Filament Transformer \_\_\_\_\_ MI-11606
- BX-1D Preamplifier Power Supply (furnishes filament and plate power for 1 to 7 BA-11A Preamplifiers) \_\_\_\_\_ MI-11305-D
- Type BI-1B Meter Panel (Umber gray) \_\_\_\_\_ MI-4388-C
- BR-2A Panel and Shelf Assembly  
(required when cabinet rack mounting is desired)  
Umber Gray \_\_\_\_\_ MI-11598/11599

## Remote Bridging Controls, MI-11278-B, MI-11278-C & 11278-D

**Description**

The MI-11278-B, -C and -D Bridging Volume Controls are designed to provide a high resistance bridging input circuit for connections between any low impedance source and the 250 ohm input terminals of an amplifier. The use of one of these units makes it possible to pick up program material conveniently from a program buss or any low impedance terminated line without disturbing the operation characteristics of the buss or the line. Any line of +40 dbm or below may be bridged. The MI-11278-D Volume Control is designed to be mounted on the chassis of an amplifier (i.e., BA-11A preamplifier). The MI-11278-B and -C Volume Controls are designed for rear panel mounting with shafts extending through the panel to accommodate dial knobs.



MI-11278-D

**Specifications**

- Input Impedance (approx.) (MI-11278-B, 20,000 ohms), (MI-11278-C, 10,000 ohms), (MI-11278-D, 10,000 ohms)
- Output Impedances, (MI-11278-B, 600 ohms), (MI-11278-C, 150 ohms), (MI-11278-D, 250 ohms)
- Insertion Loss, bridging a 600-ohm line and operating into a 250-ohm amplifier output (MI-11278-B, 31 db), (MI-11278-C, 36 db), (MI-11278-D, 36 db)
- Maximum Input Level \_\_\_\_\_ +40 dbm
- Overall Dimension (including shaft):

- Height \_\_\_\_\_ 2 $\frac{5}{8}$ "
- Width \_\_\_\_\_ 1 $\frac{1}{2}$ "
- Depth \_\_\_\_\_ 1 $\frac{1}{2}$ "
- Weight \_\_\_\_\_ 4 $\frac{1}{2}$  ozs.



MI-11278-B and C with dial knob



# Booster Amplifier, Type BA-2C



BA-2C Amplifier—Front View

**Features**

- High gain — Two stages — Self contained power supply.
- Excellent frequency response — Low distortion.
- Low noise level. Specially shielded transformers.
- Plug-in chassis—Simplified servicing.
- Compact—two BA-2C's may be mounted on one BR-2A Shelf.
- May be mounted inside turntable cabinet.
- Provision for tube plate current check.
- Economically priced.

**Uses**

The RCA BA-2C Amplifier is a high fidelity two stage unit for use as a microphone preamplifier, a booster amplifier for transcription turntables or as an isolation amplifier when used with suitable bridging resistors. It is also useful at transmitter installations where a high gain amplifier is required between the announce microphone and the limiting amplifier. When used as a transcription pickup amplifier, the BA-2C may be mounted inside the turntable cabinet. For rack mounting, two BA-2C Amplifiers may be mounted on one BR-2A Panel and Shelf Assembly.

**Description**

The BA-2C circuit is conventional and utilizes two RCA 1620 tubes operated as triodes. The first stage tube is shock mounted to reduce microphonic noises. An interstage gain control, which is a continuously variable potentiometer with a logarithmic taper, is provided for adjusting the output level. The amplifier is designed to work into a balanced load of 600/250 ohms.

The amplifier is complete with built in a-c power supply which eliminates the need for external rectifiers. The hum and noise level has been kept to a very low value through the use of

specially shielded power and audio transformers. Connections are provided from each cathode circuit to terminals on the male plug at the rear of the chassis. Corresponding terminals on the receptacle permit metering of tube condition when connected to a high resistance voltmeter such as the Type BI-1A. Input, output and a-c connections are also brought out to the male plug. The unit is equipped with a power switch and fuse and is provided with a base cover plate for shielding when used in turntable installations. A mating receptacle is supplied for the male chassis plug.

**Specifications**

Source Impedance	30/250 ohms	
Load Impedance (tapped transformer)	250/600 ohms	
Input Impedance	Substantially above source impedance	
Distortion (at normal output level of -15 dbm measured at any frequency between 40 and 15,000 cycles)	less than 0.75% rms	
Maximum Input Level (less than 1% distortion)	40-15,000 cycles) —25 dbm	
Maximum Output Level (less than 1% distortion)	40-15,000 cycles) —2 dbm	
Frequency Response (see curve)	±1.5 db 30 to 15,000 cycles	
Gain (250 or 30 ohm source to 600 or 250 ohm load)	50 db	
Noise Level (below -2 db* output, maximum gain)	-70 db	
A-c Power Input 105/125 volts, 50/60 cycles	13 watts	
Dimension	Overall	Chassis
Height	6½"	2½"
Width	8"	8"
Length	14"	11¾"
Weight (unpacked)		11 lbs.
Finish		Umber gray
Stock Identification (less tubes)		MI-11226-B

**Accessories**

- Tube Kit (complete tube complement)  
2 RCA 1620, 1 RCA 6X5GT/G — MI-11287
- Alternate Tube Kit (complete tube complement)  
2 RCA 6J7, 1 RCA 6X5GT/G — MI-11287-A
- Note: 6J7's may be used when maximum uniformity of characteristics and minimum of microphonics, hum and distortion are not required.
- BR-2A Shelf and Panel — MI-11598/11599

\* Reference level one milliwatt.

BA-2C Amplifier—Rear view. Plug-in chassis permits easy removal of amplifier for servicing

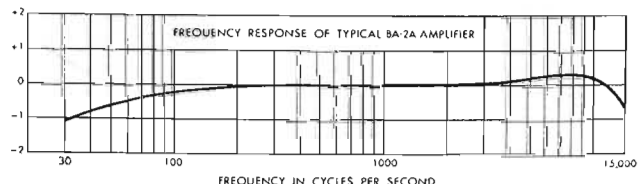
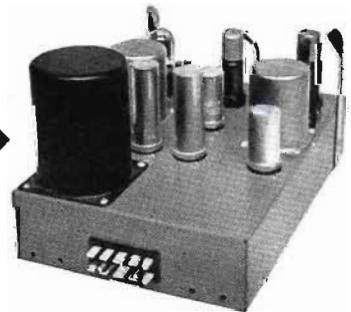

Frequency Response of a Typical BA-2C Amplifier



# RCA "PLUG-IN" amplifiers

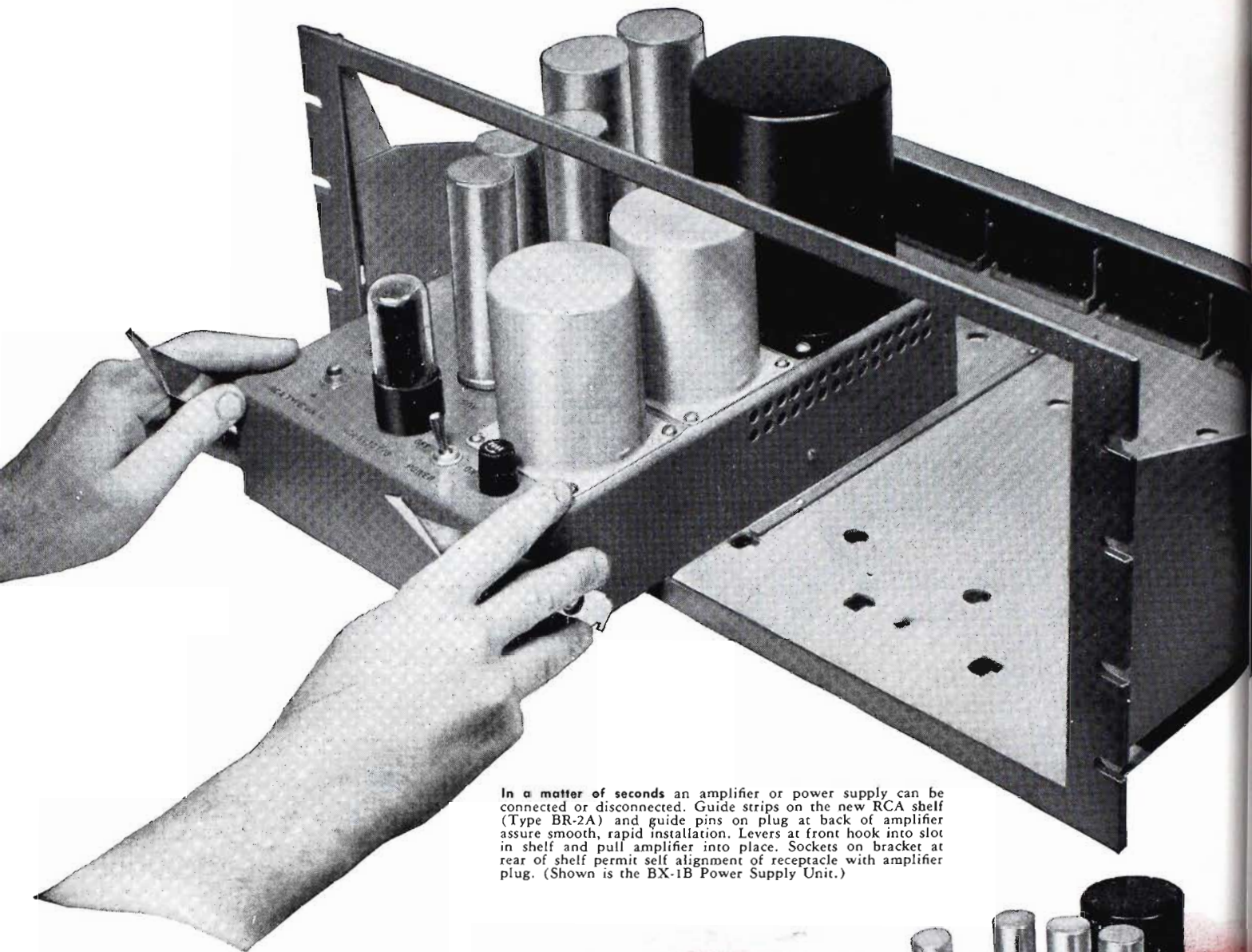

In a matter of seconds an amplifier or power supply can be connected or disconnected. Guide strips on the new RCA shelf (Type BR-2A) and guide pins on plug at back of amplifier assure smooth, rapid installation. Levers at front hook into slot in shelf and pull amplifier into place. Sockets on bracket at rear of shelf permit self alignment of receptacle with amplifier plug. (Shown is the BX-1B Power Supply Unit.)

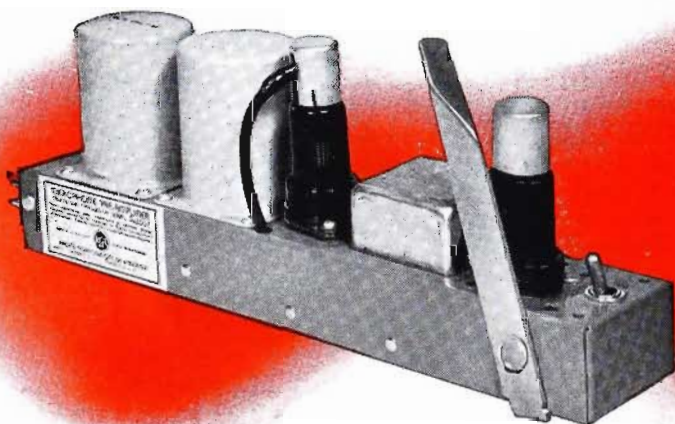

**Two-stage Preamplifier (Type BA-11A)**—Ideal for use as a microphone preamplifier, turntable preamplifier, booster amplifier, or low-level isolation amplifier. *High gain:* 40 db. *High output:* +10 db. *Low noise level:* -80 db. *Low distortion:* 0.5% rms, 50 to 7500 cycles. *Isolation factor:* approx. 90 db; over 100 db with special Volume Control Kit. *Frequency response:*  $\pm 1$  db, 30 to 15,000 cycles. *Small size:* six units will fit on a 36-B or new BR-2A shelf!



**Booster Amplifier (Type BA-2C)**—A two-stage unit having applications similar to those for the BA-1A; also valuable where a high-gain amplifier between announce microphone and limiting amplifier is required. *High gain:* 50 db. *Low noise level:* -68 db. *Low distortion:* 0.75% rms, 40 to 15,000 cycles. *Frequency response:*  $\pm 1.5$  db, 30 to 15,000 cycles. *Compact:* two units can be mounted on one 36-B or BR-2A shelf. Features plug-in capacitors and built-in power supply.



# for quick interchanges—and easy maintenance

## All units available for immediate delivery

AS easy to install or remove as an electronic tube! Pull a lever near the front of the amplifier and the plug on the rear of the unit is smoothly withdrawn from its socket—automatically disconnected from the supply voltage. No longer is it necessary to crawl around to the back of hard-to-get-at racks and unsolder or unscrew countless connections. System changes can be made quickly; minutes can be slashed from inspection, servicing, and testing time.

This new RCA line now includes the four amplifiers and one power-supply unit shown. Others will be added in the near future. New, carefully selected characteristics make these units ideal for a large number of studio jobs.

All units use the same standard plug. To assure maximum convenience, a new shelf (Type BR-2A) has been designed. With a few easy changes, however, the conventional RCA Type 36-B panel and shelf can be used, if desired. The necessary accessories are available for this purpose.

Here, we believe, is a real opportunity to modernize your amplifier system—a quick, convenient way to get better performance at low cost. Descriptive leaflets are yours for the asking. Write: Dept. 7L Audio Equipment Section, Radio Corporation of America, Camden, N. J.



The RCA Type BR-2A Shelf fits any standard rack; takes 8¾ inches of panel space. If desired, however, RCA Type 36-B panels and shelves now in use can be easily adapted for plug-in amplifier service.

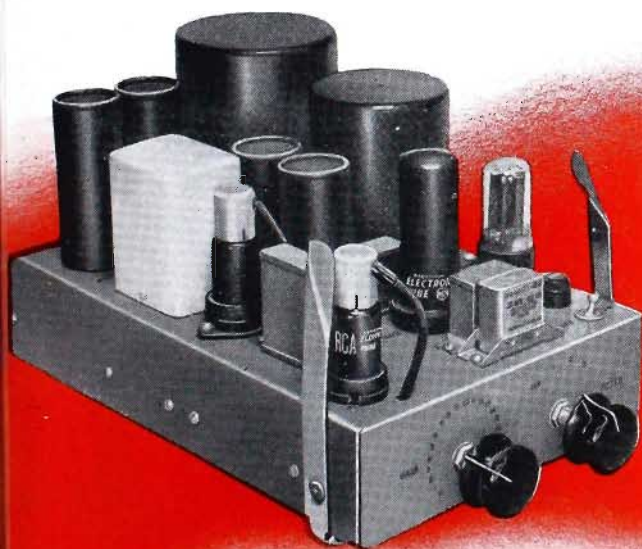

**New Program Amplifier (Type BA-13A)**—The most versatile high-fidelity amplifier ever designed for broadcasting. Ideal as a program or line amplifier, bridging amplifier, isolator amplifier, cueing or monitoring amplifier. Improved layout for greater accessibility; "plug-in" electrolytics for ease in servicing. Output: 2 watts (approx.). Higher gain: 65 db for matching input; 28 db for bridging input. Lower noise level: -82 db (with max. gain). Lower distortion: less than 0.5 to 1% rms, depending on output level. Frequency response: ±1 db, 30 to 15,000 cps.

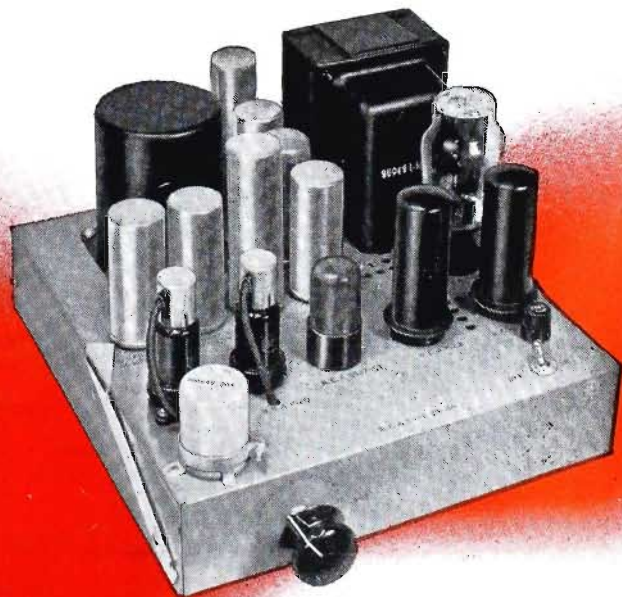

**Monitoring Amplifier (Type BA-14A)**—Designed for operation at microphone levels. High output of 12 watts is sufficient to drive several speakers or, in some applications, a recording head. Other uses include application as line amplifier for portable and mobile transmitters. High gain: 105 db. Low noise level: -20 db (with maximum gain); -40 db (with minimum gain). Low distortion: less than 3% at 12 watts. Frequency response: ±2 db, 30 to 15,000 cycles.



# Program Amplifier, Type BA-13A



◀  
*BA-13A Program Amplifier,  
front view*

## Features

- Excellent frequency response for FM and television.
- High gain, low distortion, low noise level.
- Provisions for cathode metering.
- Improved step type volume control which permits volume adjustment in 2 db steps.
- Uses oil filled paper capacitors and plug-in electrolytic capacitors.
- Economical in price.

## Uses

The BA-13A is one of the most versatile high fidelity broadcast amplifiers available. Its high gain and low distortion makes it ideal for use as:

1. Program or line amplifier.
2. Bridging amplifier.
3. Isolation amplifier.
4. Cueing or monitoring amplifier with approximately 2 watts output.

The BA-13A is a plug-in type amplifier which has been designed for use with the BR-2A panel and shelf. This shelf permits easy removal for servicing or interchanging units. Two BA-13A amplifiers can be mounted in a BR-2A panel and shelf.

## Description

The BA-13A is a three stage amplifier employing one RCA 1620 pentode first stage, one RCA 1620 pentode second stage, and one RCA 1622 beam power output tube.

Excellent frequency response, high gain and low distortion have been provided in the design of this amplifier by use of resistance-capacitance interstage coupling and stabilized feedback. The noise level has been kept extremely low by the use of a dual volume control which simultaneously controls the gain of the first and second stages. When a step type control is required an MI-11233 amplifier should be ordered; an MI-11233-A if a continuous control is required.



*Plug-in amplifier permits quick and easy removal or interchange of units*

A special design feature of the BA-13A permits a boost of the low, the high or the low and high frequencies as shown in the accompanying frequency response curve. This feature aids in obtaining an overall system flat response since compensation may be added to overcome high frequency losses in the interconnecting lines or in adequate low frequency response of associated equipment. High frequency compensation is easily made by changing the value of one capacitor. Low frequency compensation is effected by changing the value of one capacitor and adding one capacitor and one resistor.

All external connections to the BA-13A are made through the ten-prong male plugs, which engage with two mating sockets supplied with the amplifier. Connections are provided from each cathode circuit through a selector switch to terminals on the plug in the back of the amplifier. These connections permit metering of tube conditions by means of a high resistance voltmeter such as the RCA Type BI-1B and Type BI-2A.

The amplifier is complete with built-in a-c power supply. The rectifier used is 1 RCA 5Y3GT/G.

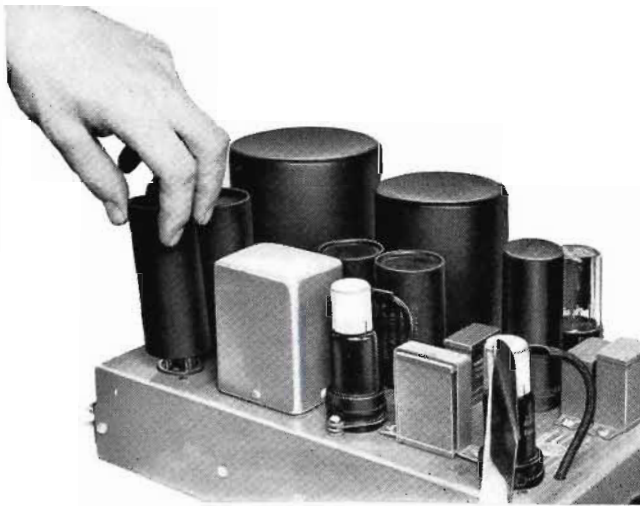

*"Plug-in" type electrolytics provide long-life operation and maximum accessibility*

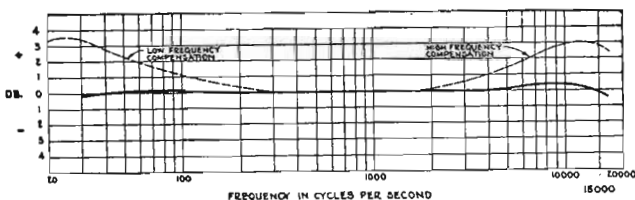

*Frequency response of a typical BA-13A amplifier*

## Specifications

Source Impedance \_\_\_\_\_ 150/600 ohms

Input Impedance (balanced—center tap grounded):

- a. Matching (50-15,000 cps) \_\_\_\_\_ 150/600 ohms
- b. Bridging (50-15,000 cps) \_\_\_\_\_ 20,000 ohms (approx.)

Maximum Input Level:

- a. Bridging (less than .1% rms distortion  
30 to 15,000 cycles) \_\_\_\_\_ +40 dbm\*
- b. Matching (with less than .1% rms distortion  
30 to 15,000 cycles) \_\_\_\_\_ +11 dbm

Load Impedance (tapped transformer) \_\_\_\_\_ 5/7.5/15/150/600 ohms

Output Level:

- Less than .5% rms Distortion 30-15,000 Cycles \_\_\_\_\_ +25 dbm
- Less than 1% rms Distortion 30-15,000 Cycles \_\_\_\_\_ +30 dbm
- Less than 1% rms Distortion 50-15,000 Cycles  
(2 watts) \_\_\_\_\_ +33 dbm

Gain Maximum:

- a. Matching Input (600 ohm line to 600 ohm load) \_\_\_\_\_ 65 db
- b. Bridging Input (600 ohm terminated line to  
600 ohm load) \_\_\_\_\_ 28 db

Frequency Response (30 to 15,000 cps) \_\_\_\_\_ ±1 db

Noise Level (with gain control in maximum position and input and output circuits terminated with 600 ohms):

- Output \_\_\_\_\_ Less than -52 dbm
- Referred to Input \_\_\_\_\_ Less than -117 dbm

A-c Power Input, 100 to 130 volts, 50/60 cycles \_\_\_\_\_ 55 watts

Dimensions, Overall \_\_\_\_\_ Length, 14"; Width, 8"; Height, 7¼"

Finish \_\_\_\_\_ Light umber gray

Weight (unpacked) \_\_\_\_\_ 17½ lbs.

Stock Identification:

- (with continuous type gain control) \_\_\_\_\_ MI-11233-A
- (with step type attenuator gain control) \_\_\_\_\_ MI-11233

## Accessories

Tube Kit (complete tube complement):

2 RCA-1620, 1 RCA-1622, 1 RCA-5Y3GT/G \_\_\_\_\_ MI-11266

1 Alternate Tube Kit:

2 RCA-6J7, 1 RCA-6L6, 1 RCA-5Y3GT \_\_\_\_\_ MI-11266-A

BR-2A Panel and Shelf Assembly:

(Black MI-11598A/11599A) U/G \_\_\_\_\_ MI-11598/11599

Type BI-1B Meter Panel (Umer gray) \_\_\_\_\_

MI-4338-C

\* dbm=db referred to one milliwatt when single frequency tone modulation is used.

# Monitoring Amplifier, Type BA-14A



## Features

- Excellent frequency response to 15,000 cycles.
- 12 watts output with low distortion—uses feedback.
- Suitable for emergency use as program amplifier.
- Ideal for recording and playback applications.
- Sufficient gain for direct operation of a speaker from turntable output.
- High gain—Used directly in talk-back circuits, without preamplifier.
- Heavy-duty components. Will operate continuous duty with ambients up to 120°F.
- Suitable for cabinet or panel mounting.
- Compensator Kit supplied for boosting response at 60 and 15,000 cycles.
- Use oil filled paper capacitors and plug-in electrolytic capacitors.
- Economical in price.

## Uses

The BA-14A is a high fidelity, high gain flexible 12 watt amplifier suitable for monitoring, audition, recording, and talk-back applications or it may be used in emergencies as a program or line amplifier. It is ideal for transcription playback booths since its 105 db gain is sufficient to operate an LC-1A Speaker directly from the output of a 70-D Turntable. The high gain feature also allows its use directly in studio talk-back circuits without an intervening preamplifier. The BA-14A is an excellent recording amplifier being suitable for both high quality recording and playback applications. It may be mounted in a type BR-2A Panel and Shelf Assembly. The BA-14A has a plug-in type chassis using multi-conductor plugs.

## Description

Employing metal tubes in the audio circuits, this amplifier has four stages consisting of: (1) RCA-1620 single stage, (2) RCA-1620 single stage, (3) single stage with RCA-6SN7-GT phase inverter, and (4) 2 RCA-1622's in push-pull. Feedback is used around the phase inverter and output tubes to reduce noise and distortion. Gain adjustment is provided through the use of an interstage control in the grid circuit of the second RCA-1620 tube and through an additional remote volume control. The remote volume control is a potentiometer and resistance network which is used when the BA-14A input is to be bridged across a low impedance line. This control provides for a bridging input impedance of 10,000 ohms and may be placed on

the side of a speaker cabinet, on a console panel, or at any other point within two or three hundred feet of the amplifier. Where the normal flat frequency response is not desired by the customer, a boost of the low and high frequencies may be made by connecting additional resistors and capacitors which are supplied with the amplifier. A +5.0 db boost at 60 cycles is accomplished by adding a resistance capacity network into the plate circuit of the second stage. A +6.0 db boost at 15,000 cycles is accomplished by adding a resistance capacity network into the cathode circuit of the third stage.

The amplifier is complete with a heavy-duty built-in power supply. The hum level has been kept to a low value through the use of a multiple-case shielded input transformer. The amplifier is designed to supply a nominal low-distortion output of 12 watts.

## Specifications

Source Impedance (unloaded transformer input) 150/600 ohms  
 Bridging Impedance (when used with remote volume control) 10,000 ohms  
 Load Impedance 600/150/15/7.5/5 ohms  
 Audio Power Output (rated output with less than 3% total rms distortion 50-7500 cycles) 12 watts  
 +40.8 dbm\*

### Maximum Input Level

(a) Matching (less than 1% rms distortion) -27 dbm  
 (b) Bridging (less than 1% rms distortion) +40 dbm

### Maximum Gain

(a) Overall from 150 or 600 ohm source to a 15 ohm load 105 ±2 db  
 (b) With bridging volume control 600 ohm terminated line to 15 ohm or 600 ohm load 73 db

Frequency Response (see curve) 150 or 600 ohm source to 15 ohm load ±2 db, 30-15,000 cycles

Noise Level (with gain control in maximum position and input and output with 600 ohms)  
 Less than -20 db at output  
 Less than -120 dbm referred to input

A-c Power Input (105-125 volts, 50-60 cycles) 105 watts

### Dimensions, overall

Width 10 3/4"  
 Depth 11 3/4"  
 Height 7 1/2"  
 Finish Light lumber gray  
 Weight (unpacked) 21 1/4 lbs.  
 Stock Identification MI-11234

## Accessories

### Stock Identification

BR-2A Panel and Shelf, U/G MI-11598/MI-11599  
 Tube Kit (complete tube complement) 2 RCA-1620, 1 RCA-6SN7-GT, 2 RCA-1622, 1 RCA-5U4G MI-11267  
 Alternate Tube Kit (complete tube complement) 2 RCA-6J7, 1 RCA-6SN7-GT, 2 RCA-6L6/G, 1 RCA-5U4G MI-11267-A

Note: 6J7's may be substituted for RCA-1620's and 6L6's for RCA-1622's when maximum uniformity of characteristics and minimum of microphonics, hum and distortion are not required.

\* Reference level one milliwatt.

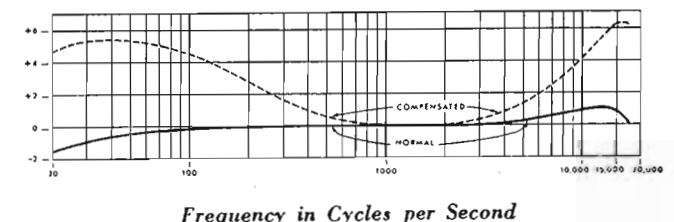



# Monitoring Amplifier, MI-12239



## Features

- Excellent frequency response.
- Provision for mixing microphone and turntable inputs.
- Microphone volume control, master control and tone control.
- Variable load impedance—4 to 30 ohms.
- 250 ohm input.

## Uses

The MI-12238 amplifier is an ideal medium output unit, admirably suited for use as a cueing amplifier with transcription turntables.

## Description

The amplifier is supplied with or without a cover and may be fitted within a 70-C or 70-D series turntable. The circuit employs two RCA 6J7's and one RCA 6L6 beam power tube in the output stage. The potentiometer is connected in the input with a master gain control in the second stage. 14 db of inverse feedback insures a flat response with a low distortion factor. The low impedance input allows a low impedance microphone or pick up to be used with excellent results.

## Specifications

Frequency Response \_\_\_\_\_  $\pm 3$  db 40-10,000 cps

### Inputs:

(General Microphones) \_\_\_\_\_ High Impedance Microphone  
 (Turntables) \_\_\_\_\_ Low Impedance Turntable  
 (Crystal Pickups) \_\_\_\_\_ High Impedance Pickup

### Gain—Low Impedance:

250 ohm Source to 15 ohm load \_\_\_\_\_ 85 db

Power Output (with 7½% distortion) \_\_\_\_\_ 6 watts

Output Impedance \_\_\_\_\_ 4, 7½ and 15 ohms

### Dimensions:

Length \_\_\_\_\_ 11½"

Width \_\_\_\_\_ 7"

Height \_\_\_\_\_ 7½"

Weight (unpacked) \_\_\_\_\_ 11½ lbs.

Power Supply \_\_\_\_\_ 115 volts, 50 to 60 cycles, 75 watts

### Stock Identification:

(With Cover) \_\_\_\_\_ MI-12239



MI-12239 with cover removed

## Limiting Amplifier - Type 86-B



86-B Mounted on 36-B Shelf

### Features

- Excellent frequency response—suitable for FM.
- High compression with low distortion.
- Low noise level.
- Prevents distortion and adjacent channel interference caused by overmodulation of transmitters.
- Provides for a more effective use of transmitter power by raising the average modulation percentage.
- Meter with rotary selector switch shows gain reduction, checks plate current of all tubes, and checks overall voltage supply.
- Economical in price.
- Improved tube balance.

### Uses

The 86-B Limiting Amplifier has been designed for use in the speech input channels of FM and AM broadcast transmitters. It serves to limit the audio signal peaks to a certain pre-determined level thereby preventing over modulation with its consequent distortion and adjacent channel interference. This amplifier also provides for a more effective use of transmitter power by raising the average percentage modulation level several db without appreciably increasing the harmonic distortion. The limiting characteristics of the 86-B also readily adapt it for use in recording applications. For this use, it prevents over-cutting of the recording disc on heavy passages of music or speech and permits a marked improvement in the signal to noise ratio.

### Description

The 86-B Limiting Amplifier uses push-pull vacuum tubes (RCA 6K7) in the variable-gain stage. The design is such that a uniform frequency response and a remarkably low distortion is maintained with large compression ratios as much as 18 db. Moreover, low distortion is maintained at all modulating frequencies in the normal audio band.

An improved tube balancing circuit has been included in this amplifier which allows any pair of standard RCA 6K7 tubes to be used in the limiter circuit. Balance can be easily maintained through the normal life of the tube.

There are no audible "thumps" even though a large compression is suddenly applied. Compression timing constants have been chosen which have proved most desirable in actual broadcast service. The fast pick-up time of one millisecond restricts over-modulation surges which might cause transmitter outages. The return time is slow enough to prevent distorting low frequency times, but fast enough to prevent noticeable level reduction after loud volume peaks.

The circuit of the 86-B is straight forward and push-pull stages are used throughout. The a-c power supply is self contained and utilizes one RCA 5T4 rectifier tube. New plug-in type electrolytic capacitors are used to simplify servicing the equipment. The hum and noise level is maintained to a low value through special transformer shielding. When used in conjunction with a two stage pre-amplifier, the 86-B has sufficient maximum gain (60 db) for making local announcements. The push-pull output stage and efficient circuit design provide a maximum power output of 1 watt (+30 VU) with less than 0.75% total rms distortion measured at 400 cycles with a compression of 18 db. The distortion is less than 1.8% rms when measured at any frequency between 50 and 7500 cycles.

All the components are mounted on a single metal chassis. A meter is provided for (1) indicating gain reduction directly in

db, (2) dynamic match indicator for input tubes, (3) measurement of all tube plate currents, and (4) measurement of plate voltage. A switch on the front of the chassis selects the desired meter function.

Step-by-step input and output volume controls are provided. These controls are equipped with "vu" scales to indicate input and output levels at the verge of compression. Auxiliary adjustable controls are (1) hum balance, (2) zero adjustment of gain reduction meter scale, (3) vernier control for close adjustment of level at which limiting action takes place, and (4) switch (on front) which makes limiter function inoperative. A power switch and fuse are provided. For rack mounting the Type 36-B Shelf should be used. A special umber-grey 36-B door panel with meter cut-out is supplied with the 86-B Amplifier.

### Specifications

Input Source Impedance \_\_\_\_\_ 600 or 250 ohms

Output Load Impedance \_\_\_\_\_ 600 or 250 ohms

Frequency Response \_\_\_\_\_  $\pm 2$ db 30-15,000 cycles  
(At any setting of gain controls—with or without compression)

#### Input Level

Maximum (at limiting verge) \_\_\_\_\_ +10 dbm  
Maximum (with 18 db gain reduction) \_\_\_\_\_ +30 dbm  
Minimum (at limiting verge) \_\_\_\_\_ -30 dbm

#### Output Level:

Less than 1.8% rms distortion with 18 db compression at any frequency between 50 and 7500 cycles \_\_\_\_\_ +30 dbm  
Less than 0.75% rms distortion at 400 cycles with 18 db gain reduction \_\_\_\_\_ +30 dbm  
Less than 0.4% rms distortion at 400 cycles with no gain reduction \_\_\_\_\_ +10 dbm

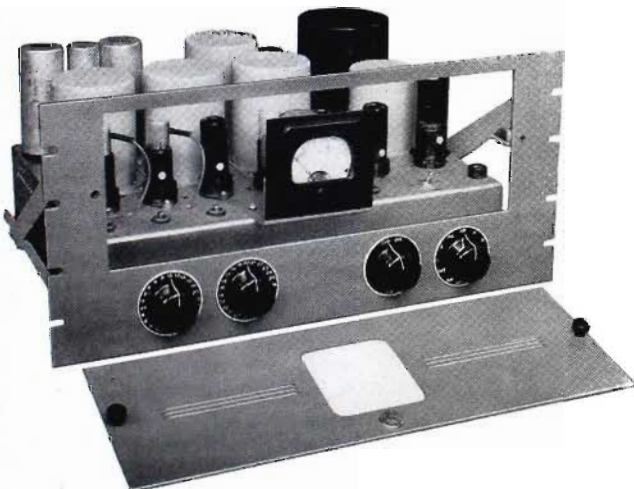

The 86-B, as shipped, includes the special door panel shown above

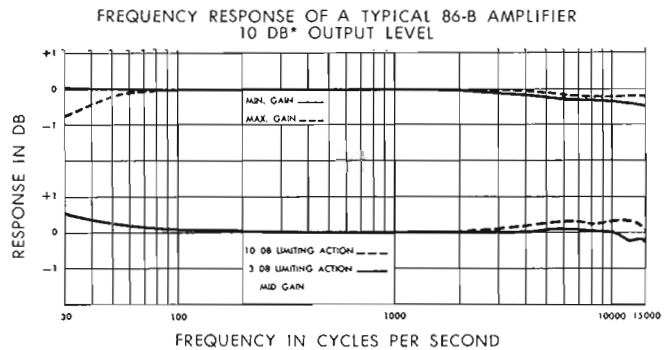
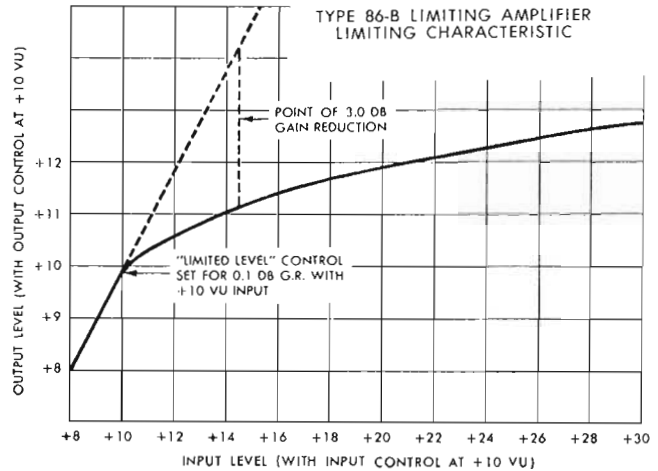

Gain (with maximum volume control setting and signal below limiting level) \_\_\_\_\_ 60 db

Noise Level: below +30 dbm output \_\_\_\_\_ -85 db  
below +10 dbm output \_\_\_\_\_ -77 db

Output Range (at verge of limiting) \_\_\_\_\_ +10 dbm to +30 dbm

#### Time Constants

Seconds for complete action of gain reduction \_\_\_\_\_ 0.001  
Seconds for 90% recovery of gain after signal drops below limiting level (when connected as furnished) \_\_\_\_\_ 2.0  
Note: may be varied from .26 sec. to 5.2 sec. by changing one resistor.

Power Input (105-125 volts, 50-60 cycles) \_\_\_\_\_ 70 watts

Dimensions \_\_\_\_\_ Width 16", depth 13", height 7½"

Weight (unpacked) \_\_\_\_\_ 30 lbs.

Stock Identification: UMBER GRAY \_\_\_\_\_ MI-11216-D  
Complete with one set of tubes and panel and shelf

#### Accessories

Tube Kit (complete tube complement) \_\_\_\_\_ MI-11286-B  
2 RCA-6K7, 1 RCA-6N7, 2 RCA-1621, 1 RCA-6R7,  
1 RCA-5R4GY

\* Reference level one milliwatt.



# 15-Watt Monitoring Amplifier, Type 15W-1

## Features

- Low distortion—less than 1%.
- Continuous single frequency rating of 15 watts RMS, 30 watts peak.
- Small size and weight.
- Low noise level.
- Low phase shift distortion.
- High-quality components and simplified servicing.



## Uses

The McIntosh 15-watt amplifier is designed for broadcast applications where frequencies of 20 to 20,000 cycles are useful, and where high efficiency and low distortion features are required. The type 15W-1 is useful as a broadcast monitoring or recording amplifier, or as a general purpose amplifier.

## Description

The Type 15W-1 McIntosh Amplifier is divided into logical, small, "plug-in" units which facilitate maintenance and circuit checking. The amplifier circuit operates "Class B" with relatively small current flowing in the final tubes (without input signal). Wide frequency range, low distortion and low generator impedance are features provided. The amplifier includes

output, driver, rectifier, inverter amplifier and preamplifier stages. Two type 15W-1 amplifiers containing power supplies will mount in a standard rack panel 7" x 19". Units may also be arranged as a single unit for portable use by means of an assembly kit available.

## Specifications

- Distortion\_\_\_\_\_1% or less 20-20,000 cycles
- Intermodulation Distortion\_\_\_1% RMS or less (if peak power does not exceed 30 watts)
- Efficiency\_\_\_\_\_50% @ 15 watts
- Gain\_\_\_\_\_40 db min.; 100 db max.; (with 1 preamp. and input transformer)
- Input Impedance\_\_\_\_\_200,000 ohms without input transformer  
With Universal Input Transformer 30 to 250 ohms  
600 ohms and bridging input with series resistors
- Output Impedance\_\_\_600 ohms balanced; 4, 8, 16, or 32 ohms, balanced or unbalanced
- Noise and Inverter Input\_\_\_90 db below rated output—80 db below rated output with preamp. input

## Tubes:

- 2 6V6-G Output
- 2 6J5 Driver
- 1 5Z4 Rectifier
- 1 12AX7 Inverter Amplifier
- 1 12AX7 Preamplifier

Size (Amplifier and Power Supply Unit)\_\_\_Each 8 $\frac{3}{16}$ " x 6 $\frac{3}{4}$ " x 4 $\frac{3}{4}$ " high (plug-in units extend 3" above amplifier)

Weight (approx.)\_\_\_\_\_25 lbs.

Finish \_\_\_\_\_Umber gray

Stock Identification \_\_\_\_\_MI-11235

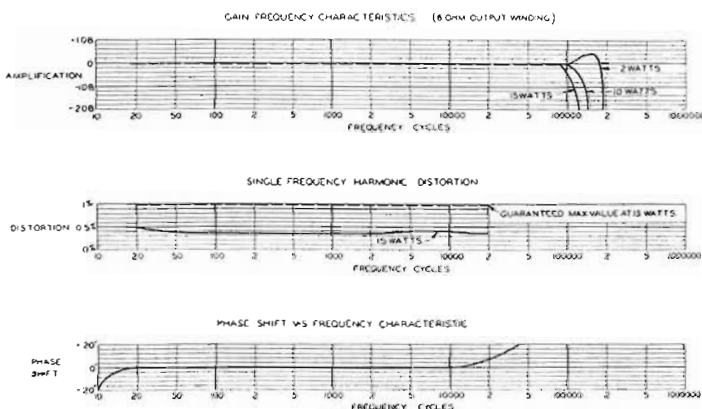

# 50-Watt Monitoring Amplifier, Type 50W-1

## Features

- Low distortion—less than 1%.
- Continuous single frequency rating of 50 watts RMS, 100 watts peak.
- Small size and weight.
- Low noise level.
- Low phase shift distortion.
- High-quality components and simplified servicing.

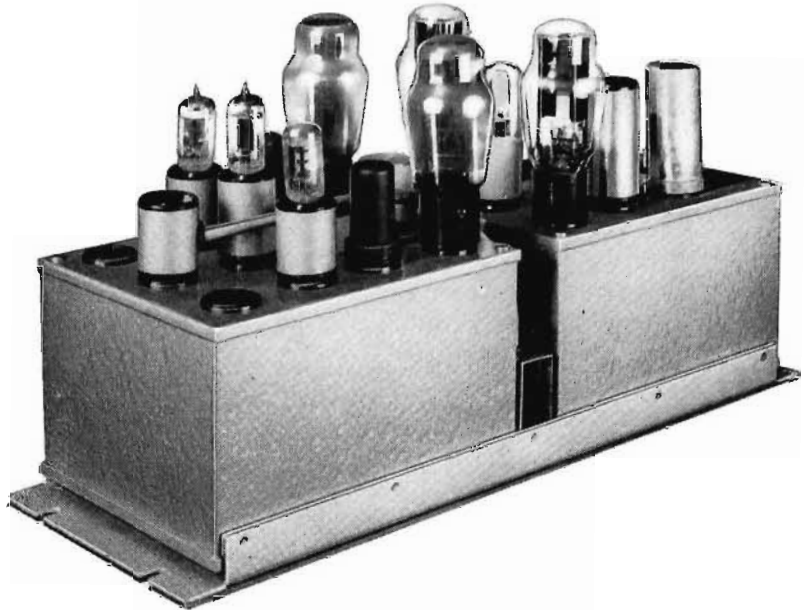

## Uses

The McIntosh 50-watt amplifier is designed for broadcast applications where frequencies of 20 to 20,000 cycles are useful, and where high efficiency and low distortion features are required. The type 50W-1 is useful as a broadcast monitoring or recording amplifier, or as a general purpose amplifier.

## Description

The Type 15W-1 McIntosh Amplifier is divided into logical, small, "plug-in" units which facilitate maintenance and circuit checking. The amplifier circuit operates "Class B" with relatively small current flowing in the final tubes (without input signal). Wide frequency range, low distortion and low generator impedance are features provided. The Type 50W-1 amplifier consists of one power supply unit and one amplifier unit plus power connector cord. The amplifier includes output, driver, rectifier, inverter amplifier and preamplifier stages. One

50W-1 amplifier and one power supply will mount in a standard rack panel 7" x 19". Units may also be arranged as a single unit for portable use by means of an assembly kit available.

## Specifications

Distortion \_\_\_\_\_ 1% or less 20-20,000 cycles

Intermodulation Distortion \_\_\_\_\_ 1% RMS or less (if peak power does not exceed 100 watts)

Efficiency \_\_\_\_\_ 60% @ 50 watts, 67% @ 60 watts

Gain \_\_\_\_\_ 40 db min.; 100 db max.; (with 1 preamp. and input transformer)

Input Impedance \_\_\_\_\_ 200,000 ohms without input transformer

With Universal Input Transformer 30 to 250 ohms  
600 ohms and bridging input with series resistors

Output Impedance \_\_\_\_\_ 600 ohms balanced; 4, 8, 16, or 32 ohms, balanced or unbalanced

Noise and Inverter Input \_\_\_\_\_ 90 db below rated output—80 db below rated output with preamp. input

### Tubes:

- |                 |                            |
|-----------------|----------------------------|
| 2 6L6-G Output  | 1 12AX7 Inverter Amplifier |
| 2 6J5 Driver    | 1 12AX7 Preamplifier       |
| 1 5U4 Rectifier |                            |

Size (Amplifier and Power Supply Unit) \_\_\_\_\_ Each 8 $\frac{3}{16}$ " x 6 $\frac{3}{4}$ " x 4 $\frac{3}{4}$ " high (plug-in units extend 3" above amplifier)

Weight (approx.) (each unit) \_\_\_\_\_ 25 lbs.

Finish \_\_\_\_\_ Umber gray

Stock Identification \_\_\_\_\_ MI-11236

GAIN-FREQUENCY CHARACTERISTICS (8 OHM OUTPUT WINDING)



PHASE SHIFT V/S FREQUENCY CHARACTERISTICS

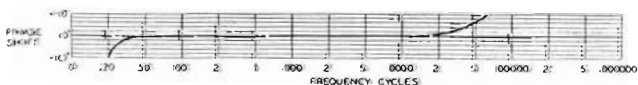

SINGLE FREQUENCY HARMONIC DISTORTION







**RCA**  
**Remote Amplifier**  
**Type BN2A**

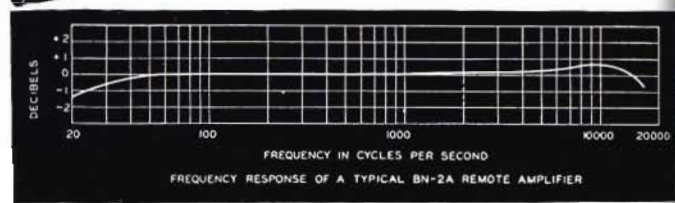

# High-Fidelity Remotes

**-30 to 15,000 cps!**



HERE IS ONE of the finest high-quality amplifiers yet designed for remote services. Distortion is less than 1 per cent over the complete frequency range of the instrument. High-level mixing reduces general noise level by at least 15 to 20 db. Stabilized feedback holds program quality steady over a wide range of operating conditions. Each of the three amplifier channels provides an over-all gain of 92.5 db—enough to help high-quality microphones through nearly any situation.

The BN2A is plenty flexible, too. You can feed the program to the output channel and the public address system *simultaneously*. You can isolate the remote amplifier and feed the cue circuit into the PA *direct*. You can monitor both circuits. You can switch in as many as four microphones—through the four microphone inputs provided

(inputs 3 and 4 are switchable to mixer 3). And you can run the BN2A from a battery simply by removing the power line connector—and plugging in the battery cord.

Weighing only 29 pounds, and completely self-contained for a-c operation, this sturdy remote amplifier carries as lightly as a brief case. More about the BN2A from your RCA Broadcast Sales Engineer. Or drop us a card. Dept. 19 HA.

SPECIFICATIONS	
Mixing Channels.....	Three
Microphone Input Combinations.....	Four
Freq. Response (±1.0 db).....	30-15000 cycles
Noise Level.....	-70 db below +18 dbm
Distortion.....	Less than 1% rms
Rated Output Level.....	+18 dbm
Power Source	105-125 v. a. c. (or battery)
Size.....	14½"L., 9½"D., 10"H.
Weight.....	29 lbs. (complete with a-c cable and spare tubes)
Cabine...	Deep umber-gray metalustre wrinkle. Removable aluminum front cover.



# Remote Amplifier, Type BN-2A

## Features

- High level mixing—15 to 20 db reduction in noise level.
- Portable, compact and completely self-contained for a-c operation.
- Excellent frequency response  $\pm 1$  db 30 to 15,000 cycles.
- Low distortion—less than 1% for complete range.
- Complete range facilities for feeding PA amplifier and program channel simultaneously.
- Battery Cover Pack MI-11279 available.
- Can also be operated with the MI-11214 battery box.

## Uses

The BN-2A is a lightweight, three channel amplifier designed especially for remote broadcast use. It has capacity for four microphone inputs, the third and fourth switchable to Channel 3. An OP-7 can be used with this unit to provide 6 channels. Program may be fed to the output channel and to a PA amplifier simultaneously. Also the cue circuit may be switched to isolate the remote amplifier and feed the PA direct. Monitoring facilities in both circuits are provided.

The input circuits are isolated in the same manner as a console, so that no special precautions are necessary in the grounding of microphones. Microphones with input impedances from 30 to 250 ohms can be accommodated by the same amplifier.

The unit is completely self-contained for a-c operations. By adding Battery Cover Kit, MI-11279, the unit can be operated on a-c or battery by the flip of a switch, the batteries being carried inside the unit. The amplifier can also be operated on external batteries by using the battery box MI-11214.

## Description

The BN-2A consists of a three stage, resistance-capacitance coupled amplifier combined with three individual input channels for each mixing stage. Each input channel uses a high quality balanced transformer with electrostatic shielding, operating into a non-microphonic RCA 1620 tube. These tubes are connected with each mixer in parallel to feed the first stage of the main amplifier. This stage employs another RCA 1620 pentode connected with feedback from the master gain control, which is a high grade step-by-step potentiometer. The unique design of this arrangement produces maximum feedback with minimum gain, a feature which reduces any inadvertent overloading of the first stage by announcers "blasting" the microphone or by excessive background noise. The second and third stages each utilize a 6J7 pentode connected to the output transformer. Further feedback is taken from the plate of the last stage to the second stage cathode, resulting in an excellent frequency response with exceptionally low distortion. Each channel offers an overall gain of 92.5 db; more than adequate for any application. The high level mixing reduces microphonics and general noise level by at least 15 to 20 db. High level mixing also means unloaded input circuits, so that microphone response is better.

A line switch allows the operator to turn off the feed from the amplifier to the program line. Another switch connects the PA feed to the amplifier, or to the cue line with a third position for "Off". The volume to the PA feed is on a separate control.

The front panel is attractively styled and arranged to give centralized control of all circuits. The standard size VU meter is provided for measuring tube voltages in the cathode circuit and output level. A switch position for feeding +8 VU to line when the meter is reading 0 is also provided.



The steel case is ruggedly constructed with the front cover easily removed for quick operation. Accommodation for carrying spare tubes and fuses is provided within the case.

External connections located in the rear of the chassis include four, Cannon 3-connector microphone receptacles and the 12-connector plug for either a-c or battery operation. The power supply is built into the amplifier and employs one RCA 6X5GT full-wave rectifier tube.

If an emergency battery supply is desired, the top of the case can be removed by loosening four quick-disconnect screws and the MI-11279 kit added in its place. The battery unit plugs into the amplifier in the usual place and a standard extension cord can be used for the a-c. A switch allows quick switching to batteries if the a-c fails. For long operation on batteries the battery box, MI-11214, can be used.

## Specifications

Source Impedance	30/150/250 ohms*
Load Impedance	150/600 ohms
Normal Output Level	+8 VU
Distortion (+18 db output 50 to 15,000 cycles)	Less than 1% rms
Maximum Output Level (less than 1% rms distortion)	+18 dbm
Maximum Gain (150 ohm source to 600 ohm load)	92.5 db
Frequency Response	$\pm 1$ db 30 to 15,000 cycles
Noise Level (for +18 dbm output max. gain)	-70 db
A-c Power Input	105-125 volts, 50/60 cycles, 25 watts
Battery Operation:	
"A" Supply	6.3 volts (nominal) 2.1 amps. (incl. VU lamp)
"B" Supply	270 volts (nominal) 10 MA
Dimensions:	
Length	15"
Depth (with cover)	9 1/2"
Height	10"
Weight	29 lbs. (complete with a-c cable and spare tubes)
Finish	Umber gray wrinkle
Stock Identification (less tubes)	MI-11230

## Remote Amplifier, Type BN-2A (continued)

### Accessories

Tube Kit (complete tube complement) \_\_\_\_\_ MI-11269  
 4 RCA-1620, 2 RCA-6J7, 1 RCA-6X5GT  
 Waterproof Cover for BN-2A \_\_\_\_\_ MI-11277  
 BN-2A Battery Cover \_\_\_\_\_ MI-11279

Kit of Batteries (for above) \_\_\_\_\_ MI-11281  
 Battery Box Complete with Cord Connectors \_\_\_\_\_ MI-11214  
 Kit of Batteries (for above) \_\_\_\_\_ MI-11255

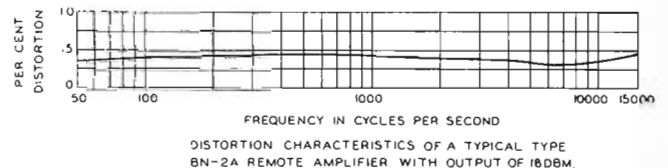
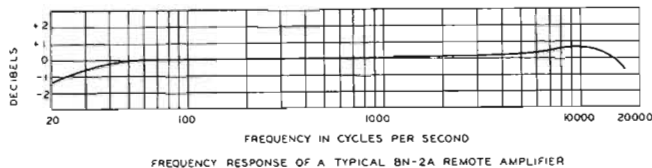

## Battery Container and Cover for BN-2A

### Features

- Provides complete battery operation for BN-2A Portable Amplifier (1½ to 2 hours).
- Easily attached to BN-2A without alterations.
- Employs standard "A" and "B" batteries.
- Built-in switch selects a-c or battery operation.



### Description

The Battery Cover, MI-11279, is designed for mounting on the BN-2A Portable Amplifier in place of the usual top cover supplied. The cover unit contains an a-c receptacle, a switch to select a-c or battery operation, and a clamp for holding two 6 volt "A" batteries (RCA #V5009, Eveready #A-509 or Burgess #F4P1 and four 67½ volt "B" batteries (RCA #VS016, Eveready #467 or Burgess #XX45). The battery

pack will supply power to the BN-2A Portable Amplifier (requiring 6 volts at 2.1 amp. and 270 volts at 10 ma) for 1½ to 2 hours of continuous operation. With interval operation of 15 min. on, 15 min. off, the batteries will provide approximately 2 to 2½ hours service.



Rear view of Battery Cover showing batteries mounted in place

### Specifications

Weight (Battery Cover) \_\_\_\_\_ 6½ lbs.

Weight (Batteries) \_\_\_\_\_ 5 lbs.

Size, overall (adds only 5/8" to overall height of BN-2A)  
 14¾" x 6½" x 3½"

### Stock Identification:

Battery Cover (less batteries, with twist-lock connector) \_\_\_\_\_ MI-11279

Kit of Batteries (two 6 v. "A" and four 67½ v. "B") \_\_\_\_\_ MI-11255



# Remote Pickup Amplifier, Type OP-6

## Features

- Excellent frequency response.
- High maximum output level with low distortion.
- Low noise and hum level.
- High overall gain permits use with high quality microphones under adverse conditions.
- Small size and light weight.
- A-c power supply built in. No external supply required.
- Two input positions and transfer key.
- Tapped input transformer accommodates any type of microphone.
- Ruggedly built with high quality components.

## Description

The OP-6 is a three stage resistance coupled amplifier using RCA 1620 low noise, non microphonic tubes. The three stages afford a gain of 88 db which is more than ample for any required application. One RCA 6X5GT/G is used in the rectifier. Since only two tube types are used, the stocking of spares is simplified. The amplifier circuit is unique in that it utilizes two feedback loops. One loop is around the first stage and is varied with the main gain control thus maintaining a maximum feedback consistent with required gain. This arrangement prevents overloading the first tube by high output microphones. The gain control is located between the first and second stage and is a high quality step by step device equipped with a large knob. The second feedback loop is fixed and is connected around the second and third stages. Two inputs are provided and either may be selected by means of a turn key switch. One input is brought to shielded screw terminals and the other to a standard Cannon microphone receptacle. The output terminates on insulated binding posts which are located on the front panel for greater accessibility. The power input receptacle has a number of contacts which are used for altering the circuit for a-c or battery operation. An a-c power cord is furnished with the amplifier and the d-c battery cord is supplied with the MI-11214 Battery Box. Located on the front panel are the power switch, fuse and monitoring headset jack.

The complete amplifier and power supply is enclosed in a steel case which has removable cover, rubber feet, and steel reinforced handle. The handle lies flat when not in use. A leather shoulder strap facilitates transporting the unit and leaves the hands free to carry microphones, etc. The chassis and front panel may be easily slipped from the case by removing four thumb-screws. The unit is furnished less meter, thereby avoiding additional expense for those applications where a meter is unnecessary.

## Specifications

Source Impedance	30/250 ohms
Load Impedance	150/600 ohms
Normal Output Level	+8 dbm
Distortion (+8 db* output, 50-7500 cycles)	Less than 0.5% rms
Maximum Output Level (less than 1% rms distortion between 50 and 7500 cycles)	+18 db
Frequency Response	+2 db 30 to 15,000 cycles +1 db 40 to 10,000 cycles
Overall Gain	88 db
Noise Level (+18 dbm output, 68 db gain)	-70 db
Dimensions, overall	
Height	9 1/2"
Width	12 3/8"
Depth	7 1/4"
Finish	Grey wrinkle
Weight (unpacked but including 8' power cord)	20 1/2 lbs.
A-c Power Input, 105-125 volts, 50 to 60 cycles	18 watts
Stock Identification (shipped less tubes)	MI-11202-A

## Accessories

Tube Kit (complete tube complement)	
Three RCA 1620 and one RCA 6X5GT/G	MI-11253
Emergency Tube Kit (complete tube complement)	
Three RCA 6J7 and one RCA 6X5GT/G	MI-11253-A

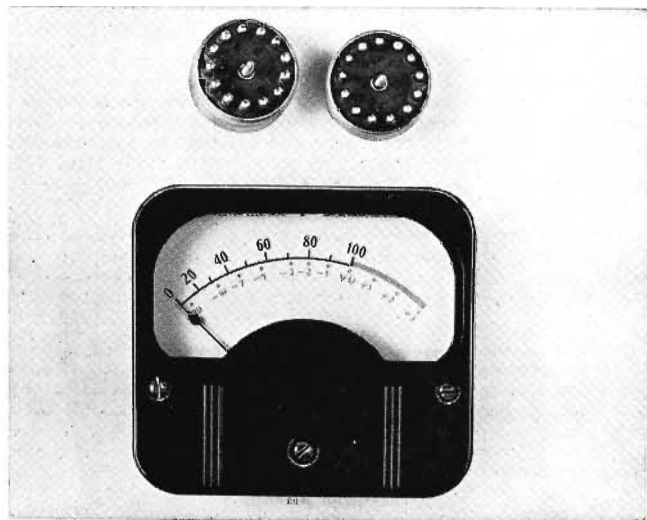
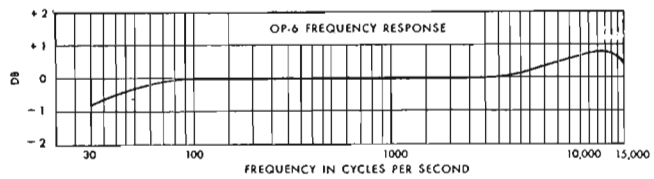
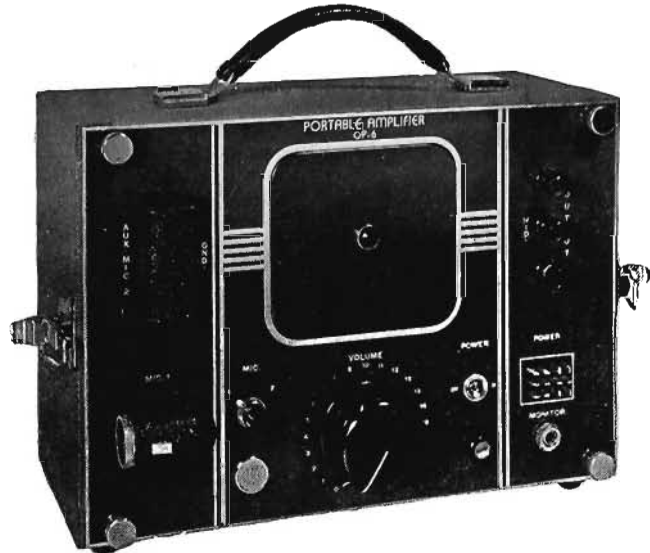

VU Meter and Attenuator Kit MI-11251

VU Meter and Attenuator Kit (MI-11251 above) is available as accessory equipment for indicating audio volume levels when installed in the OP-6 Portable Amplifier. VU meter scale reads in percent voltage and in "vu's."

VU Meter and Attenuator Kit	MI-11251
Weatherproof Fabric Cover	MI-11256
Battery Box	MI-11214
Kit of Batteries	MI-11255
Cannon Microphone Plug	MI-4630-B
Mixer Amplifier, Type OP-7	MI-11213



# Mixer Preamplifier, Type OP-7

## Features

- Excellent frequency response to 15,000 cycles.
- High level mixing reduces noise to a minimum.
- Provides unloaded transformer input and high level mixing for one to four microphones.
- Self contained a-c power supply or may be battery operated.
- May be used with any program amplifier having a gain of 80 db.

## Description

The OP-7 is a high fidelity, compact and lightweight portable unit. It provides unloaded transformer input and high level mixing for as many as four microphones. It may be used with the OP-6 Portable Amplifier or with any other program amplifier which has a gain of at least 80 db.

The front panel contains the power receptacle, "on-off" power switch, a-c fuse, four mixer knobs and shielded output terminals. A front panel cover held by two snap type clasps protects the equipment and provides space for carrying cables. Four Cannon Type "P" Microphone Receptacles are assembled on the rear of the amplifier chassis. A fifth receptacle, with male contacts, provides a cable output connection. This type of receptacle safeguards the battery from short-circuits that might occur using a male plug.

The OP-7 is equipped with long life carbon type mixing controls. In addition, the MI-11276 Modification Kit containing four Daven step-by-step attenuators with the necessary accessory equipment for modification, is available for modifying the MI-11213. The OP-7 is complete with built-in power supply or it may be operated from the MI-11214 Battery Box without circuit changes. A suitable OP-6 interconnection cable, equipped with Cannon Plugs, is furnished with the OP-7.

## Specifications

Source Impedance	30/250 ohms
Load Impedance	30/250 ohms
Normal Output Level	-55 dbm
Distortion (-55 dbm output, 50-7500 cycles)	less than 0.5% rms
Maximum Output Level (less than 1% rms distortion measured at any frequency between 50 and 7500 cycles)	-24 dbm
Gain (maximum, 250 ohm source to 250 ohm load)	8 db
Frequency Response	$\pm 2$ db 30 to 15,000 cycles $\pm 1$ db 40 to 10,000 cycles
Noise Level (-24 dbm output for 8 db gain)	-88 db
Dimensions	
Height	9 1/2"
Width	12 3/4"
Depth	9"
Finish	Gray wrinkle
Weight (unpacked but with cables)	23 lbs.
A-c Power Input, 105-125 volts, 50 to 60 cycles	20 watts
Stock Identification	MI-11213

## Accessories

Tube Kit (complete tube complement)	
4 RCA 1620, 1 RCA 6X5GT/G	MI-11254
Alternate Tube Kit (complete complement)	
4 RCA 6J7, 1 RCA 6X5GT/G	MI-11254-A
Weatherproof Fabric Cover"	MI-11257
Battery Box	MI-11214
Kit of Batteries	MI-11255
Cannon Microphone Plugs	MI-4630-B
OP-6 Amplifier (shipped less tubes)	MI-11202-A

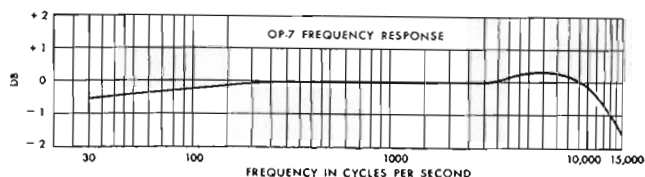

OP-7 with front panel cover removed. Covers of OP-7 and OP-6 provide space for carrying interconnecting cables.

MI-11257 Fabric Cover for OP-7. Similar covers, listed as accessories, are available for OP-6 and for the MI-11214 Battery Box.

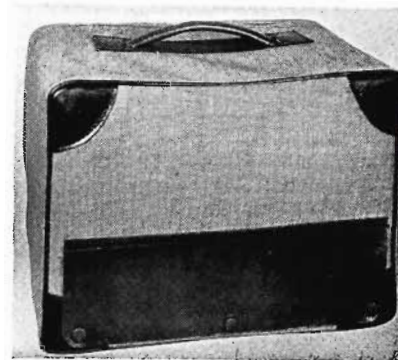

OP-7 chassis, rear view. Four microphone receptacles and output receptacle are provided.



# Remote Pickup Equipment, OP-6/OP-7



## Uses

The OP-6/OP-7 is a high quality, light weight portable pickup equipment providing four microphone inputs with high level mixing and separate preamplifiers, built in a-c power supply and full sized vu meter. Small sized cases furnished with shoulder straps provide a maximum of convenience in carrying these units. Battery operation may be used at any time by plugging in the cord of the MI-11214 Battery Box. No circuit changes are required. The mixer and amplifier units may be used side by side or the amplifier may be mounted on top of the mixer. An outstanding value at an economical price, the OP-6/OP-7 combination provides the broadcaster with a field pickup equipment having studio quality performance.

## Description

The OP-7 Mixer Preamplifier comprises four unloaded transformer input circuits each working into an RCA-1620 triode connected tube. Its source impedance is for 30 or 250 ohm microphones and the load impedance is 250 ohms. While primarily designed for use with the OP-6 Amplifier, the OP-7 may be operated with any amplifier having a 250 ohm source impedance and a gain of 30 db or more. A more complete de-

scription as well as features and specifications will be found on the OP-7 Mixer Preamplifier catalogue sheet.

The OP-6, companion unit to the OP-7, is a high quality, high gain, three stage resistance coupled amplifier using three RCA 1620 Pentode-Connected tubes. A more complete description as well as features and specifications will be found on the catalogue sheet for the OP-6 Amplifier.

Stock Identification OP-6 and OP-7:

With Carbon Controls: MI-11202-A / 11213

Complete as shown in photograph but less tubes, vu meter and microphone plug. Complete listing for accessories will be found under the catalogue listing for the individual OP-6/OP-7 units.

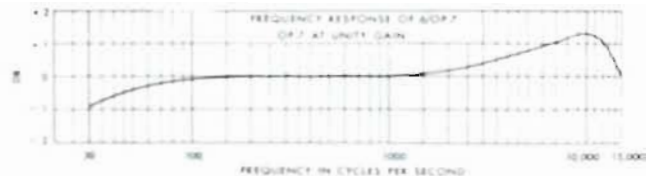

# Battery Box, MI-11214

The MI-11214 Battery Box has been designed especially for use with the OP-6 and OP-7 Remote Amplifiers. It is equipped with two interconnection cords so that it may be used with both amplifiers simultaneously. The box is constructed of steel with durable gray wrinkle finish and is equipped with a large steel reinforced handle and rubber feet. The cables are stored in the cover when not in use.

Approximate Battery Life in hours for average amplifier operation of six hours per day.

RCA Type No.	Quantity	Burgess Type No.	OP-6		OP-7 and OP-7	
			1 RCA 1620	2 RCA 6BF7G	1 RCA 1620	2 RCA 6BF7G
YS 004	(15)	4F "A"	34	50	26	7.5
YS 004	(10)	4F "A"	16	24	12	3.5
YS 012	(6)	B-30 "B"	270	270	240	95

## Specifications

- Finish (matches OP-6/OP-7) \_\_\_\_\_
- Dimensions:
  - Height \_\_\_\_\_ 12 1/2"
  - Width \_\_\_\_\_ 13 1/2"
  - Depth \_\_\_\_\_ 8 3/4"
- Weight (unpacked) \_\_\_\_\_ 15 1/2 lbs.
- Weight (including batteries) \_\_\_\_\_ 44 lbs.
- Stock Identification \_\_\_\_\_ MI-11214

## Accessories

- Weather Proof Cover, MI-11258

Grey wrinkle







RCA Radiomike  
Type BTP-1A

*At both National political conventions, the BTP-1A broke all records for getting first-news FIRST!*

# THE RCA RADIOMIKE . . .

## *ideal as a Roving Microphone*

### SPECIFICATIONS

Power output . . . . .	0.2 watt, approx.
Frequency range . . . . .	25 to 28 Mc
Frequency stability . . . . .	$\pm 0.01\%$
Modulation capability . . . . .	85%
A-F response (overall)	$\pm 4$ db 80-6000 cps
A-F distortion (90% mod) . . . . .	Less than 8%
Battery life . . . . .	8 hours, intermittent service
Weight (total) . . . . .	.6 lbs.
Overall size . . . . .	11" H x 4½" W x 3½" D

**NOTE:** License application for the BTP-1A can be made simply by informal letter to the FCC.

**T**HIS IS IT, the perfect portable microphone for remotes—fires, accidents, sporting events, conventions, trick broadcasts—any occasion and any place where microphone cable connections are difficult or impractical to install.

Combining a 0.2-watt AM transmitter (25-28 Mc), a crystal microphone, a 20" antenna, and batteries—all in one compact unit, here is a complete announcer's unit weighing only 6 pounds that can transmit up to several hundred yards under ideal conditions. Any communications receiver cover-

ing the 25-28 Mc band can be used for reception.

In the BTP-1A, the radio transmitter is crystal-controlled for high frequency stability. Automatic a-f gain control eliminates overloading and distortion. The crystal microphone . . . using three crystal units in series . . . provides extra gain with excellent quality.

Your BTP-1A is ready for delivery—complete with one set of tubes, one crystal, and a battery. Specify your frequency and order it from your RCA Broadcast Sales Engineer, or from Department 191A.



# Radio-Microphone, Type BTP-1A

## Features

- Light, compact and completely self contained.
- Excellent frequency response—low distortion.
- Crystal controlled transmitter for stability.
- Automatic gain control to prevent overloading and distortion.
- Permits broadcasting from locations otherwise inaccessible.

## Uses

The BTP-1A Radio-Microphone is a crystal controlled portable UHF transmitter and microphone. It is especially adapted to broadcasts by announcers mingling with crowds on the street, at conventions, large stores, golf matches or other locations, where wire connections are difficult or impractical.

The maximum satisfactory range of the BTP-1A is determined largely by the interference level at the receiver location. Under ideal conditions, several hundred yards may be covered; however, building structures or other media possessing a high signal attenuation will limit the working range. Overall transmitted quality is comparable to a network line.

## Description

The BTP-1A Radio-Microphone with its battery power pack is housed in an attractively styled aluminum case measuring 11 x 4½ x 3½ inches. Total weight of the unit with batteries is 6 pounds. A 20 inch removable whip antenna projects from the top of the case during operation.

The transmitter portion of the Radio-Microphone is crystal controlled and is designed to operate at any specified frequency between 25 and 28 mc. Maximum power output from the r-f amplifier is approximately 0.2 watt. The carrier is Amplitude Modulated by a Class A audio stage to ensure low distortion.

Automatic gain control is incorporated in the audio amplifier modulation and prevent overloading over a wide range of sound intensity.

The microphone consists of three crystal units operated in series to effect a high output with excellent quality.

Power for operating the transmitter is supplied by a battery pack which will provide 8 hours of service under normal operating conditions. A "high-low" battery switch is provided to insure uniform quality and power output throughout the life of the battery.

The BTP-1A is shipped complete with antenna, battery, crystal and one set of tubes.

Application for a channel allocation may be made by informal application to F.C.C.

## Specifications

Frequency Range \_\_\_\_\_ 25 to 28 mc.  
 Power Output \_\_\_\_\_ Approx. 0.2 watt  
 Carrier Frequency Stability \_\_\_\_\_ ±.01% deviation  
 Modulation Capability \_\_\_\_\_ 85%  
 Audio Frequency Response (including microphone)  
 \_\_\_\_\_ ±4 db 80 to 6000 cycles  
 Audio Distortion (90% modulation) \_\_\_\_\_ Less than 8%  
 Crystal Frequency (specify operating frequency  
 when ordering) \_\_\_\_\_ 1/3 transmitter output frequency



Battery life (approx.):  
 Continuous Service \_\_\_\_\_ 4 hours  
 Intermittent Service \_\_\_\_\_ 8 hours  
 Dimensions \_\_\_\_\_ Height 11"; Width 4½"; Depth 3½"  
 (Not including handles or antenna)

Tube Complement:  
 AF \_\_\_\_\_ 1 RCA-1L4 Voltage Amplifier  
 AF \_\_\_\_\_ 1 RCA-3A4 Modulator  
 RF \_\_\_\_\_ 1 RCA-3A5 Oscillator and Tripler  
 RF \_\_\_\_\_ 1 RCA-3A4 RF Amplifier  
 Weight (total) \_\_\_\_\_ 6 lbs.  
 Stock Identification \_\_\_\_\_ MI-28923

## Accessories

Spare Crystals Type RC-2A (specify ½ operating frequency) \_\_\_\_\_ MI-28293  
 Replacement Battery \_\_\_\_\_ MI-28291  
 Spare Set Tubes \_\_\_\_\_ MI-28292

## Standard Cabinet Racks, BR-84 Series



BR-84A



BR-84B



BR-84C

### Features

- Cabinets with same styling and height as RCA FM transmitters.
- Total panel space 77".
- Available in many combinations to suit all studio applications.
- Drilled and tapped for standard 19" panels.
- Attractively styled to blend with all control room installations.
- Suitable for fitting in a flush position to a side or rear wall.
- Accommodates the heaviest equipment encountered in studio use.
- Provides flexibility for future expansion.

### Uses

The BR-84 series cabinet rack program is another of the new feature lines of RCA. The cabinet program is presented after years of practical experience in finally developing a flexible scheme for accommodating broadcast equipment.

### Description

The five combinations of cabinets and accessories offer a versatile system for accommodating the user's immediate requirements with maximum accessibility for any future growth of the installation. Each rack may be mounted singly or, where desired, tandem together to facilitate the grouping of any number of cabinets. The cabinet is of sturdy metal construction, welded and bolted in one standard height and width. The ventilated top with slotted edges provides complete ventilation but protects the equipment from falling articles and dust. Vertical panel mounting angles have tapped holes at RMA standard locations to provide 77" of standard 19" panel mounting space. These angles may be installed to mount equipment within the cabinet, where doors are used, or flush with the front. When the latter method is desired, trim strips of neat design for panel mounting and clip fitting provide the finished appearance. The front and rear doors are of the universal type and may be hinged on the right or left side, to rotate in an arc of 180°. Electrical side shields are available in two sizes—21" for the center section, and 28" for the top and bottom sections. If found necessary after assembly, they may be fitted between racks of equipment. Terminal board mounting angles facilitate the mounting of power and audio blocks in a vertical or horizontal position. Additional terminal board mounting angles (MI-30527-G29) are available as accessories.

Units placed adjacently may be rigidly bolted together to produce a secure assembly. Locks may be fitted later by virtue of the "knock outs" provided. The cabinets are finished in a two-tone umber gray, with dimensional characteristics artistically blending with all RCA FM transmitters.

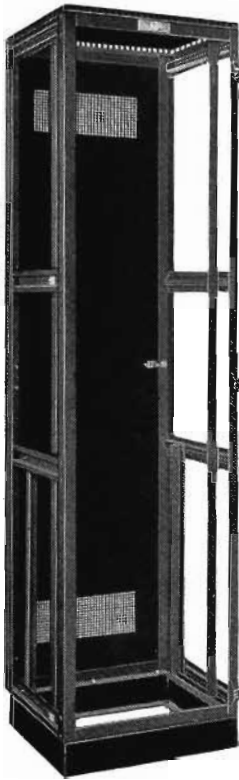

**BR-84D**

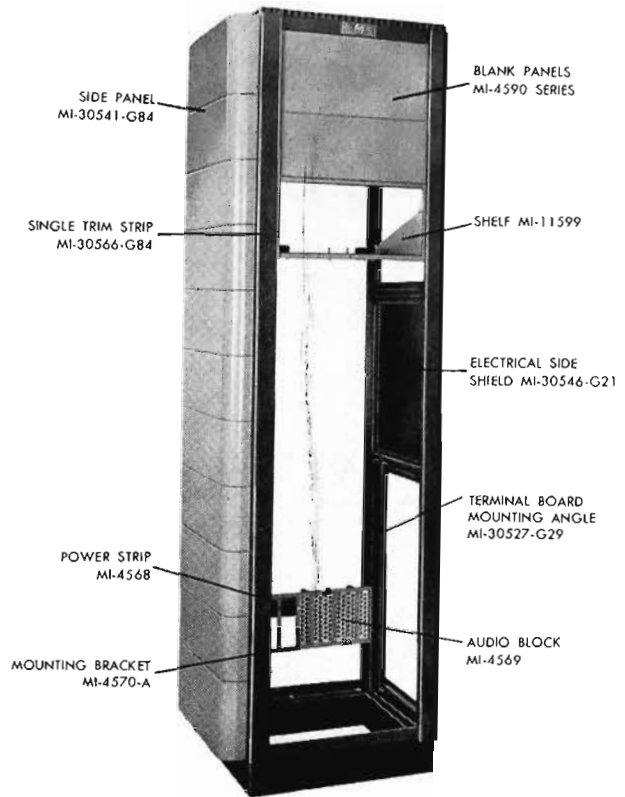

**BR-84E with Accessories**

**Specifications**

Panel Width \_\_\_\_\_ 19"  
 Panel Mounting Space (height) \_\_\_\_\_ 77"  
 Clearance for Door Swing \_\_\_\_\_ 23"  
 Weight (BR-84A) \_\_\_\_\_ 225 lbs.  
 Finish \_\_\_\_\_ Two-tone umber gray enamel except for the base which is black

**Dimensions:**

Height \_\_\_\_\_ 84"  
 Width—BR-84A, -B (with side panels) \_\_\_\_\_ 28"  
           BR-84C, -D, -E \_\_\_\_\_ 22"  
 Width of Frame \_\_\_\_\_ 22"  
 Depth of Frame \_\_\_\_\_ 18"  
 Depth (including doors and handles) \_\_\_\_\_ 24 1/4"

**Stock Identification:**

Type BR-84A consisting of one frame, one base, one top cover, one front door (non-ventilated), one rear door (ventilated), one pair of side panels, one set of terminal board mounting angles and one set of panel mounting angles and instruction book \_\_\_\_\_ MI-30951-A84  
 Type BR-84B, same as BR-84A, less front door only \_\_\_\_\_ MI-30951-B84  
 Type BR-84C, same as BR-84A, less side panels only \_\_\_\_\_ MI-30951-C84  
 Type BR-84D, same as BR-84A, less side panels and front door \_\_\_\_\_ MI-30951-D84  
 Type BR-84E, same as BR-84A, less side panels, front and rear doors \_\_\_\_\_ MI-30951-E84

**Accessories**

One front door (non-ventilated) \_\_\_\_\_ MI-30531-G84  
 One side panel \_\_\_\_\_ MI-30541-G84  
 One electrical shield (for top and bottom sections) two per side \_\_\_\_\_ MI-30546-G28

- One electrical shield (for mid-section of rack) one per side \_\_\_\_\_ MI-30546-G21
- One only single trim strip for one cabinet where panels are fitted without door \_\_\_\_\_ MI-30566-G84
- One only double trim strip used where two or more cabinets are placed together \_\_\_\_\_ MI-30568-G84
- One terminal board mounting bracket \_\_\_\_\_ MI-4570-A
- Blank panels \_\_\_\_\_ MI-4590 Series
- One audio terminal block \_\_\_\_\_ MI-4569
- One power terminal strip \_\_\_\_\_ MI-4568
- One panel and shelf assembly \_\_\_\_\_ MI-11598/11599\*

\* When ordering for cabinet with door, order MI-11599 shelf only.

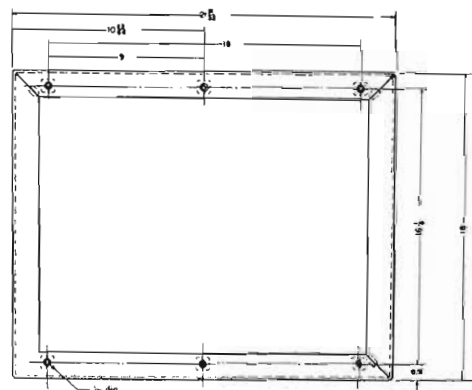

*Layout and dimensions of cabinet base.*





**Specifications**

<b>Dimensions, overall</b>	
Height	82 $\frac{7}{8}$ "
Width	20 $\frac{1}{8}$ "
Depth	14 $\frac{3}{8}$ "
Panel Size	19"
Mounting Space	77"
Weight (unpacked)	190 lbs.
<b>Stock Identification</b>	
Black	MI-4519-C
Light Umber Grey	MI-4519-E

**Accessories**

<b>"J" Strip</b>	
Black	MI-4537-A
Dark Umber Grey	MI-4537-D
<b>"U" Strip</b>	
Black	MI-4524-A
Dark Umber Grey	MI-4524-D
Terminal Block Mounting Bracket	MI-4570
Terminal Block (4 rows of 20 each)	MI-4569
A-C Terminal Strip (12 terminals)	MI-4568
Cable Support	MI-4571

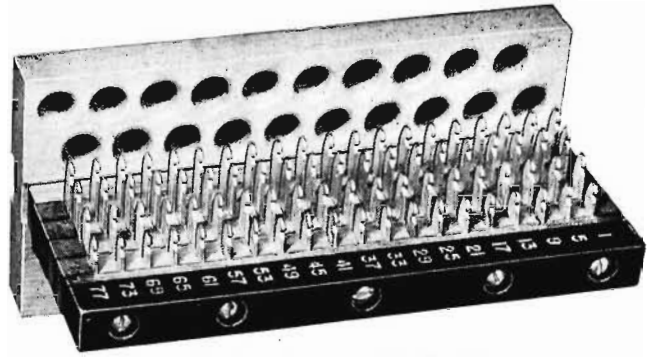

*Audio Terminal Block MI-4569*

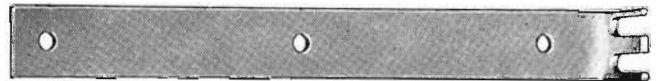

*Cable Support MI-4571*

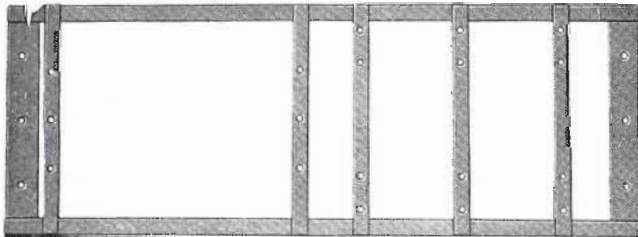

*Terminal Block Mounting Bracket MI-4570*

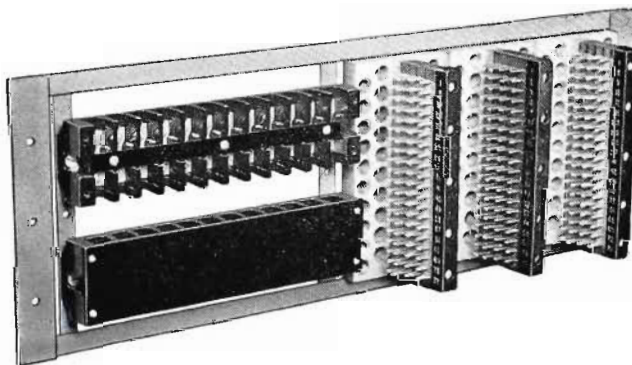

*Terminal Block Mounting Bracket with Terminal Blocks in Position*

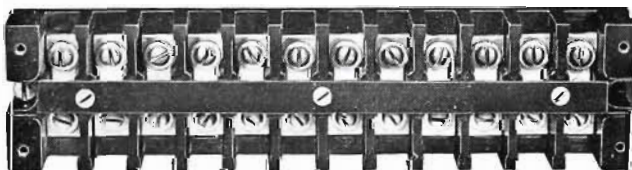

*Power Terminal Block MI-4568*

**Blank Panels**

A complete line of 19" blank panels are carried in stock for filling spaces on racks and cabinets not occupied by equipment panels. These blanks are also suitable for applications where equalizers, transformers, switches or other items must be panel mounted by the user. The stock of panels includes all standard widths from 1 $\frac{3}{4}$ " to 13  $\frac{31}{32}$ ". They are  $\frac{20}{100}$ " sheet steel and are finished and drilled to match the standard equipment panels. The 33-A and 33-B Jack Panel heights are not standard multiples of 1 $\frac{3}{4}$ ". Therefore when these jack panels are mounted in the Type BR-84 series Cabinet Racks or the Type 9-AX Rack it is often necessary to use either a 2 $\frac{1}{8}$ " or 2 $\frac{3}{8}$ " blank panel so that the summation of all panel heights will equal 77".

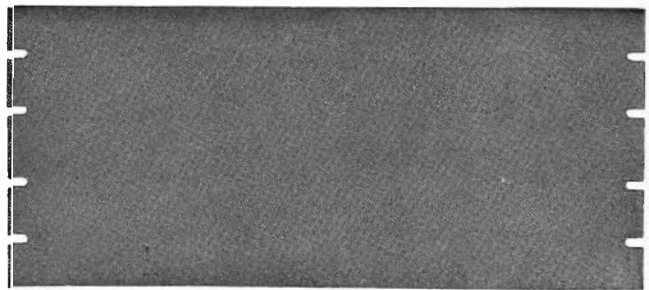

**Panel Width**

1 $\frac{23}{32}$ "	Blank Panel, Umber Grey	MI-4590-A
2 $\frac{1}{8}$ "	" " Umber Grey	MI-4598-A
2 $\frac{3}{8}$ "	" " Umber Grey	MI-4599-A
3 $\frac{3}{32}$ "	" " Umber Grey	MI-4589-A
3 $\frac{15}{32}$ "	" " Umber Grey	MI-4591-B
5 $\frac{7}{32}$ "	" " Umber Grey	MI-4592-B
6 $\frac{31}{32}$ "	" " Umber Grey	MI-4593-A
8 $\frac{23}{32}$ "	" " Umber Grey	MI-4594-B
10 $\frac{15}{32}$ "	" " Umber Grey	MI-4595-B
12 $\frac{7}{32}$ "	" " Umber Grey	MI-4596-A
13 $\frac{31}{32}$ "	" " Umber Grey	MI-4597-A



# Wall Mounting Cabinet, MI-11500

## Features

- Provides mounting space for equalizer and jack panels.
- May be mounted at any convenient wall location.
- Sturdy steel construction.
- Hinged door permits easy access for servicing.
- Drilled and tapped for standard 19" panels.
- Attractive appearance.

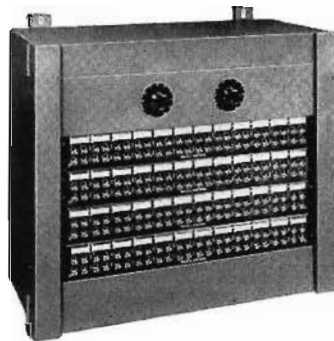

*Wall Mounting Cabinet, MI-11500, shown with equalizer and jack panels mounted in place*



## Uses

The MI-11500 Cabinet has been designed especially to mount a combination of line equalizers (Type 56-D or 56-E) and jack panels (Type 33-A or 33-B). It will be found particularly useful for terminating remote lines in installations using the 76 Series Consolettes. Sample combinations for this cabinet are given below:

- 1—56-E Equalizer and 4—33-A Jack Strips.
- 1—56-E Equalizer, 3—33-A Jack Strips, 1—MI-4590 (1 $\frac{3}{4}$ " blank panel and 1—MI-11503 (7" Jack Mat.
- 1—56-E Equalizer, 2—33-A Jack Strips, 1—MI-4591 (3 $\frac{1}{2}$ " blank panel and 1 MI-11502 (5 $\frac{1}{4}$ " Jack Mat.
- 1—56-E Equalizer, 1—33-A Jack Strips, 2—MI-4598 (2 $\frac{1}{8}$ " blank panels and 1—MI-4599 (2 $\frac{3}{8}$ " blank panel.
- 1—56-E Equalizer, 1—33-A Jack Strip, 1—MI-11501 (3 $\frac{1}{2}$ " Jack Mat and 1—MI-4592 (5 $\frac{1}{4}$ " blank panel.
- 2—56-E Equalizers, 2—33-A Jack Strips and 1—MI-11502 (5 $\frac{1}{4}$ " Jack Mat.
- 1—56-D Equalizer, 1—33-A Jack Strip and 1—MI-11501 (3 $\frac{1}{2}$ " Jack Mat.

## Description

The cabinet is constructed of steel and is equipped with a hinged door on which the panels may be mounted. Drilling and tapping has been provided for standard 19" panels which are attached by means of the machine screws supplied. A left-hand and a right-hand "J" strip are furnished to cover the mounting screws. Five knockouts are provided in the bottom of the cabinet, and five in the top, for conduit connections. Five terminal blocks may be mounted inside the cabinet on the brackets provided. Mats are available for improving the appearance of the jack strips.

## Specifications

Dimensions Overall \_\_\_\_\_ 21" wide, 19 $\frac{1}{4}$ " high, 10 $\frac{3}{8}$ " deep

Weight (unpacked, less panels) \_\_\_\_\_ 36 lbs.

Finish \_\_\_\_\_ Dark Umber-Grey

Panel Mounting Space \_\_\_\_\_ 19" wide, 12 $\frac{1}{4}$ " high

Terminal Mounting Space \_\_\_\_\_ Maximum-five Standard W.E. Cat. No. 100-B, 80 terminal (4 rows of 20 each) blocks which are 2 $\frac{1}{8}$ " wide by 6 $\frac{1}{8}$ " long

Stock Identification \_\_\_\_\_ MI-11500

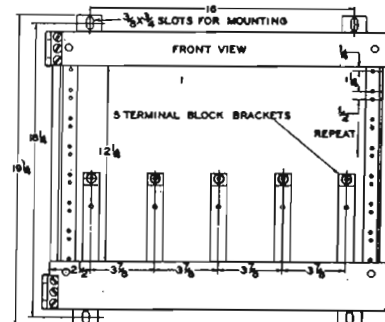
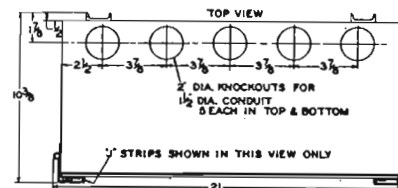



# Panel and Shelf, Type BR-2A

## Features

- High quality panel mounting for chassis type units.
- Quick access to tubes.
- Easy insertion and removal of units.
- Provision for control shafts on front panel.
- Units installed from front of rack.

## Uses

The BR-2A Panel and Shelf was designed for use in a broadcasting station audio system primarily to hold the new RCA plug-in units. It may also be used, however, for amplifiers with terminal board connections. The shelf is capable of mounting the following quantities of specific equipments.

- 6—BA-11 Series Pre-amplifiers.
- 2—BA-13 Series Program amplifiers.
- 2—BA-2 Series Booster amplifiers.
- 2—BX-1 Series Power supplies.
- 1—BA-14 Series Monitor amplifier plus  
2—BA-11A Pre-amplifiers.

## Description

This shelf will mount in either the 9AX or the BR-84 series of racks, or in any other standard nineteen-inch rack. It occupies eight and three-quarters inches of panel space. Since the RCA plug-in amplifiers have a standard dimension in depth, they all fit perfectly in this shelf. They are slid into the shelf from the front and the connection plugs pushed into the receptacles at the rear. Guide bars fitting between the amplifiers assist in guiding them into position. All the plug-in amplifiers are equipped with levers which serve either to force them into position or to eject the plugs when dismantling them. The receptacles are mounted on individual U-shaped brackets, secured to the chassis of the shelf. They fit in such a manner that a small amount of free movement is permitted in all directions. This eases the alignment of the plugs and receptacles when the amplifiers are pushed into position. The brackets are constructed with a small protruding stop on the lower, front edge, preventing the amplifier from being forced to the point where it would exert undue pressure on the receptacle. Provision is made for holding six of these receptacles. The holes in the chassis which are provided for fastening the brackets are slightly oversize to permit perfect alignment during initial installation. The wiring in back of the receptacles is protected by a steel cover which is fastened in place by two machine screws.

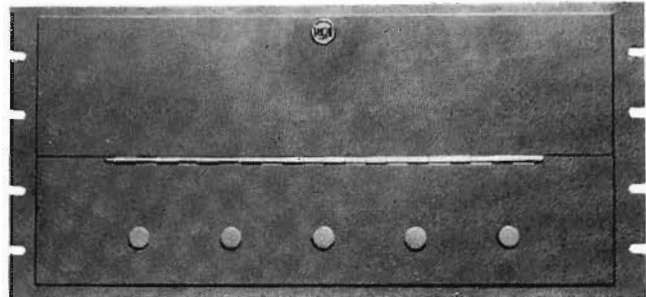

The opening in the front of the shelf is covered by a matching panel. This panel is hinged across the center so that the top half may be opened to gain access to the vacuum tubes of the amplifiers. The bottom half has five shaft holes to provide for any controls which the amplifiers may have. When not in use, these holes are covered by small removable buttons. The bottom of the shelf has several round holes for ventilation, and also a number of square holes into which fit the amplifier insertion levers.

The shelf may be obtained separately, if desired, or the shelf and panel together, as appropriate. It is supplied complete with mounting brackets, guide bars, and receptacle cover. The receptacles themselves are supplied with the amplifiers, and therefore need not accompany the shelf.

## Specifications

Dimensions, overall:

Width	19"
Height	8 <sup>3</sup> / <sub>4</sub> "
Depth	12 <sup>3</sup> / <sub>4</sub> "

Inside Width 16<sup>7</sup>/<sub>8</sub>"

Weight, unpacked:

Shelf	12 lbs.
Panel	3 lbs.

Stock Identification:

Shelf:	
Umber Gray	MI-11599
Panel:	
Umber Gray	MI-11598

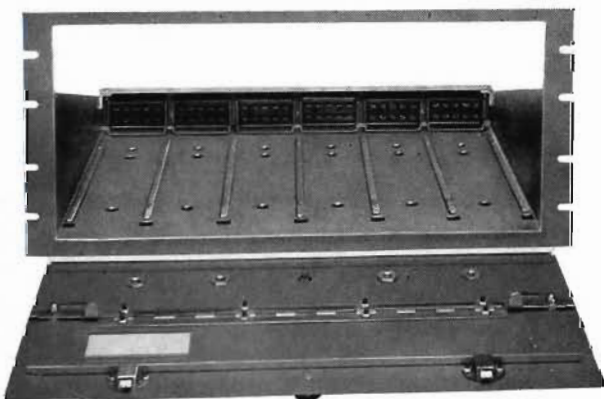

Panel removed showing guide bars and receptacles

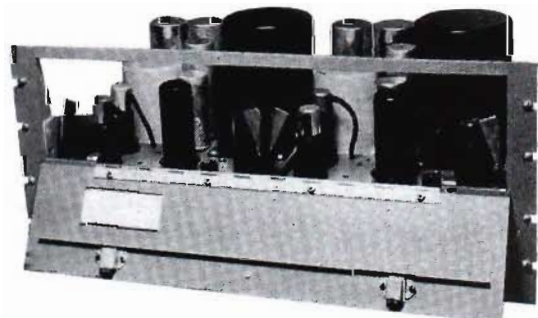

Panel open showing two BA-13A amplifiers

# Jack Panels, Types 33-A and 33-B



33-A Jack Panel

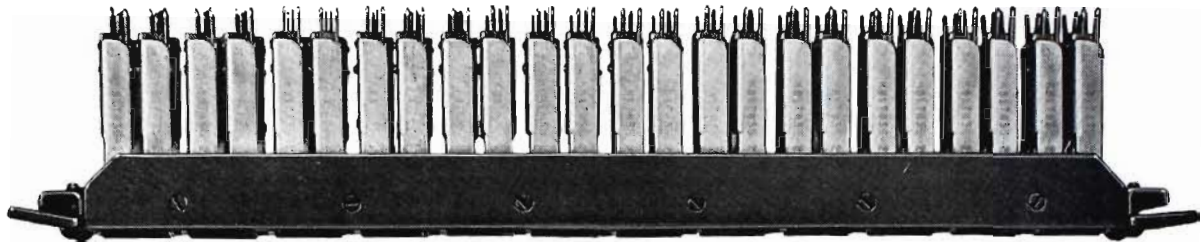

A Rear View of the 33-A Jack Panel

Jack Panels, with their associated patch cords, are used with broadcast speech input systems to improve the overall operating flexibility. In addition to providing a convenient termination for program and order wire telephone circuits, closed-circuit jacks may be connected to provide "patch cord" access to the input and output circuits of individual units of the speech assembly. When connected for this purpose, the regular circuits are continuous through the jacks until a patch cord is inserted to make an external connection. With properly connected jacks, patch cords may be freely used in emergencies or for test purposes to interchange or transfer telephone lines, amplifiers, mixers, microphones, or other equipment items.

The 33-A consists of two rows of twelve double jacks mounted on thick black bakelite and furnished with designation card holders. The 33-B is similar to the 33-A but has only one row of twelve double jacks. The jack sleeves of the 33-A and 33-B are chromium plated.

### Specifications

Number of Jack Pairs		
33-A	_____	24
33-B	_____	12
Type of Jacks	Double jacks of standard closed circuit type	
Dimensions		
33-A	2 1/8" x 19"	33-B 1 1/4" x 19"
Weight (unpacked)		
33-A	5 1/2 lbs.	33-B 3 lbs.
Stock Identification		
33-A (RCA Standard)	_____	MI-4645-A
33-B (RCA Standard)	_____	MI-4646-A



33-B Jack Panel

### Jack Mats

Jack Mats are available for covering 1, 2, 3, or 4 type 33-A Double Jack Strips.

### Specifications

Single 33-A Jack Strip Mat, overall size	19" x 3 15/32"	
Umber Gray		MI-11501-A
Double 33-A Jack Strip Mat, overall size	19" x 5 7/32"	
Umber Gray		MI-11502-A
Triple 33-A Jack Strip Mat, overall size	19" x 6 31/32"	
Umber Gray		MI-11503
Quadruple 33-A Jack Strip Mat, overall size	19" x 10 15/32"	
Umber Gray		MI-11504

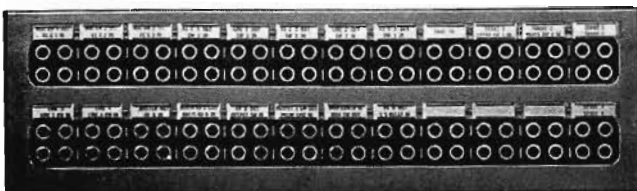

### Patch Cords

RCA maintains a stock of patch cords for the convenience of broadcasting stations. The W.E. Cord is the standard telephone type using two W.E. 241-A Double Plugs. The Audio Development Co. Cord is shielded and uses two of their Type PJ-1 Plugs which are interchangeable with the W.E. Type 241-A Plug. Three sizes of patch cords are available as listed below:

	Western Electric Co.	Audio Development Co.
Two Foot Cord Length	MI-4652-2A	MI-4652-2B
Four Foot Cord Length	MI-4652-4A	MI-4652-4B
Six Foot Cord Length	MI-4652-6A	MI-4652-6B

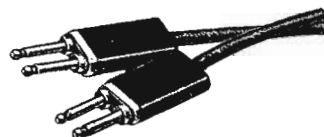

Western Electric Telephone Type Patch Cord



Audio Development Co. Shielded Type Patch Cord



# Meter Panel, Type BI-1B

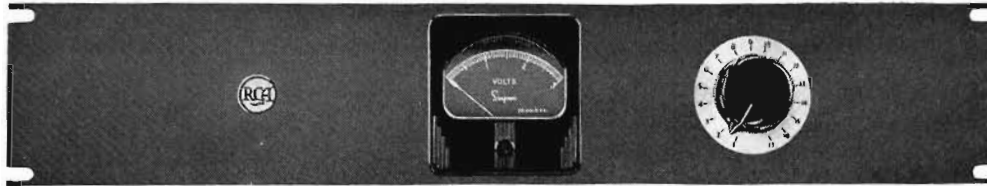

### Features

- Provides meter and switch for measuring cathode voltage of amplifier tubes.
- Gives plate current indication of operating condition of tubes and circuits.
- Up to 10 circuits may be metered by rotary selector switch.
- Designed for cabinet rack mounting.

### Uses

The BI-1A Meter Panel provides a convenient means for checking the cathode bias voltages of amplifier tubes and thereby furnishes an indication of the operating conditions of amplifier tubes and circuits. Metering terminals are provided on the BA-1, BA-2 and BA-3 Series Amplifiers for use with this panel. The mounting is for a BR84 Series Standard cabinet rack or a 9AX Rack.

### Description

The BI-1A consists essentially of a meter and switch mounted on a standard 3½", ⅜" thick steel panel. The meter is a 3.0 volt d-c voltmeter having a resistance of 20,000 ohms per volt. The double section switch has eleven positions including the "off" position with the switch arms connected to the meter terminals. All connections to the panel are made to the switch contacts.

### Specifications

D-c Voltmeter \_\_\_\_\_ 0-3.0 volts, 20,000 ohm per volt  
 Metering Switch \_\_\_\_\_ 10 position and "off," double pole  
 Dimensions (overall)  
 Height \_\_\_\_\_ 3 15/32"  
 Width \_\_\_\_\_ 19"  
 Depth \_\_\_\_\_ 2¼"  
 Weight (unpacked) \_\_\_\_\_ 4½ lbs.  
 Stock Identification  
 Light Umber Gray \_\_\_\_\_ MI-11388

# Meter Panel, Type BI-2A

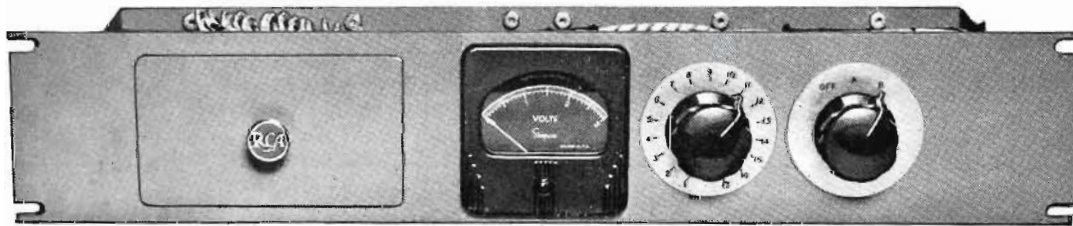

### Features

- Provides metering for 34 circuits by operation of rotary switches.
- Precision 0-3 volt voltmeter—20,000 ohms per volt.
- May be mounted in any standard 19" rack.
- Card index to log maintenance routine checks.
- High grade rotary switches.

### Uses

The BI-2A Meter Panel has been developed after numerous requests from broadcasters to supply a larger version of the BI-1A Meter Panel. The switching system provides for an instantaneous check of tubes and circuit conditions for 34 circuits and is ideal for use where a large number of circuits are required to be metered from a central point. The meter is suitable for use with all RCA standard equipment.

### Description

A high grade rotary switch with 17 positions and four banks of contacts is used in conjunction with a three position switch to effect the metering of 34 circuits. The precision built 0 to 3 volt meter possessing an internal resistance of 20,000 ohms per volt is mounted on a 3½" steel panel of standard 19" width. The hinged portion of the meter panel encloses a card index providing a convenient means of logging maintenance routine tests. The mounting is for a BR-84 Series Standard Cabinet Rack or a 9-AX Rack.

### Specifications

D-C Voltmeter \_\_\_\_\_ 0-3 volts, 20,000 ohms per volt  
 Metering Switches \_\_\_\_\_ One 17 position, one 3 position, giving a total of 34 positions  
 Dimensions (overall):  
 Height \_\_\_\_\_ 3½"  
 Width \_\_\_\_\_ 19"  
 Depth (behind panel) \_\_\_\_\_ 3⅝"  
 Weight (unpacked) \_\_\_\_\_ 6 lbs.  
 Stock Identification:  
 Umber Gray \_\_\_\_\_ MI-11275



## V. U. Meter Panel, Type BI-5A

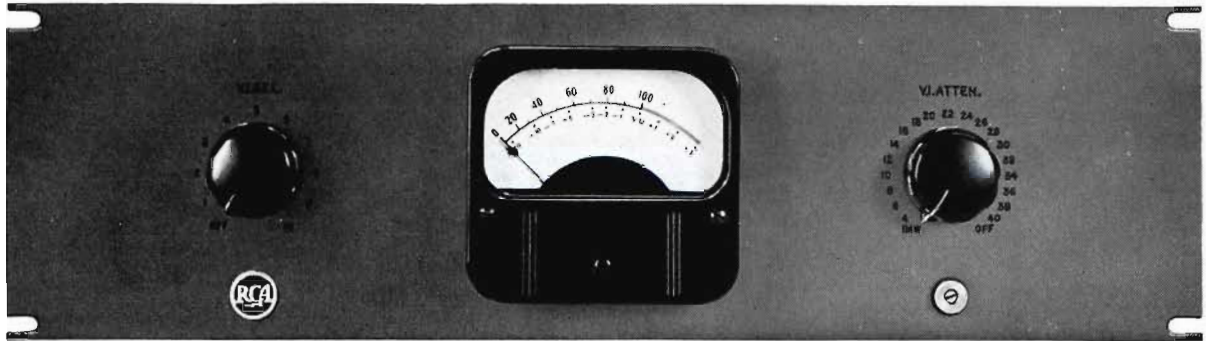

### Features

- Measures audio volume levels from +4 to +40 db.
- Ten point selector switch permits rapid connection to any number of circuits up to ten.
- Calibration curve supplied for loads other than 600 ohms.
- Large vu meter lessens eye strain and fatigue.

### Uses

The BI-5A employs the industry standardized Weston Type 30 VU Meter which embodies closely controlled electrical and dynamic characteristics combined with deliberate pointer action, moderate pointer speed, and small pointer overswing. It is intended as an audio level indicator for broadcasting, recording or wherever it is desired to read the level of one or more audio circuits with a rack mounting type of instrument.

### Description

The volume indicator panel assembly includes the vu meter, a two circuit ten point selector switch, a variable step-by-step attenuator (4 to 40 db attenuation), and a vernier control for making a fine adjustment of the level reading over a range of  $\pm 0.5$  db. The attenuator has a 1 milliwatt reference position which enables a level reading of zero vu.

The vu meter scale is arranged with percent volts in black figures from "0" to "100" as the principal scale above the arc, and "vu" levels from "-20" to "0" to "+3" as supplementary figures in red below the arc.

The meter and attenuator are calibrated for use with a 600 ohm line, however, a calibration correction curve furnished with the instrument permits its use with loads other than 600 ohms. The ten point selector switch may be connected to any ten lines (or circuits). If one or more switch positions are connected to a jack strip, the number of circuits that may be monitored is unlimited. The meter is provided with the 6.3 volt lamp for illuminating the meter scale. If the 6.3 volt source is not available, MI-11606 filament transformer will be necessary.

### Specifications

Input Impedance (except on 1 milliwatt step) \_\_\_\_\_ 7500 ohms  
 Attenuator steps \_\_\_\_\_ 1 milliwatt position, +4 to +40 db in 2db steps and off position  
 No. of lines that may be measured \_\_\_\_\_ 1 to 10 inclusive  
 Mounting \_\_\_\_\_ Standard Cabinet Rack  
 Dimensions  
   Height \_\_\_\_\_ 5 1/4"  
   Width \_\_\_\_\_ 19"  
   Depth \_\_\_\_\_ 3 3/4"  
 Finish \_\_\_\_\_ Light Umber Gray  
 Weight (unpacked) \_\_\_\_\_ 7 1/2 lbs.  
 Stock Identification  
   Umber Gray \_\_\_\_\_ MI-11265-B

## Switch and Fuse Panel, Type 57-D

### Features

- Provides master switch and fuses for rack-mounted equipment.
- Pilot lamp glows when equipment is on.
- Removable door permits front panel access to fuses and pilot lamp.

### Uses

The Type 57-C Switch and Fuse Panel is designed for use as a master input control of the a-c power supply. Ordinarily one such panel is used with each rack or channel of speech input units. The mounting is for a BR84 Series Standard cabinet rack or a 9AX Rack.

### Description

On this panel are mounted and wired an indicator lamp with red cap, two single fuse blocks of the screw-plug type and a double-pole single-throw power switch. A removable door permits front panel access to fuses and pilot lamp.

### Specifications

Switch \_\_\_\_\_ D.P.S.T., 250 volts, 30 amperes  
 Fuses \_\_\_\_\_ Screw-plug type (rating depends upon equipment to be protected)  
 Dimensions, overall (panel thickness  $\frac{3}{16}$ " )  
   Height \_\_\_\_\_ 5 7/32"  
   Width \_\_\_\_\_ 19"  
   Depth \_\_\_\_\_ 3 1/2"  
 Weight (unpacked) \_\_\_\_\_ 8 1/2 lbs.  
 Stock Identification  
   Light Umber Gray \_\_\_\_\_ MI-4395-E



Front View

# Variable Line Equalizer, Type BE-1B

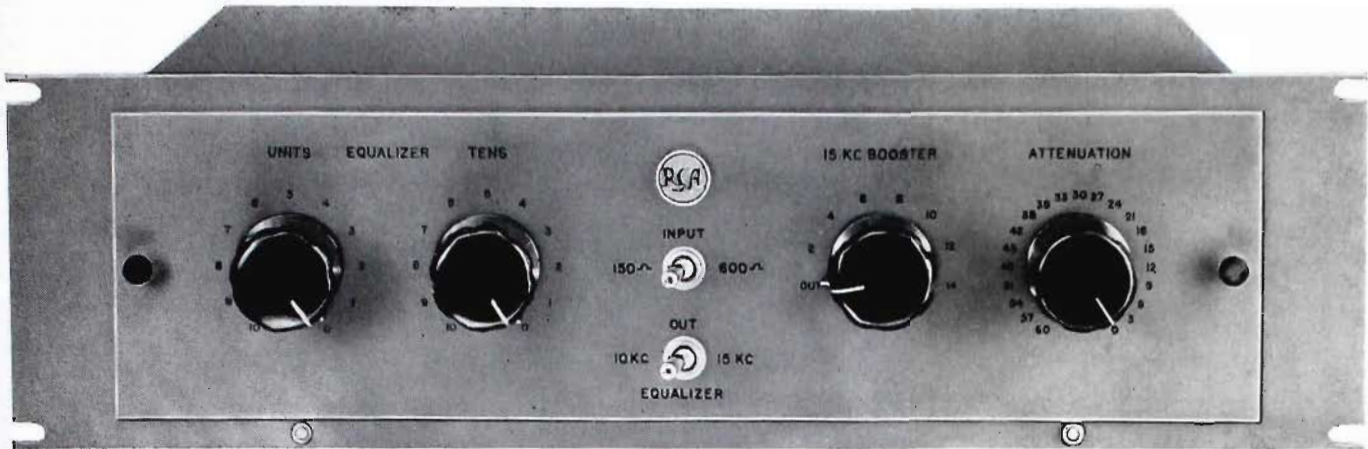

## Features

- Provides a line response  $\pm 1$  db 30 to 15,000 cycles for FM.
- Frequency boost circuit permits up to 14 db boost at 15,000 cycles.
- Toggle switch permits 10 kc or 15 kc cut-off.
- 20 step attenuator affords variable output control.
- Line and Isolation transformers built in.
- Rack mounting panel—easy installation.

## Uses

The BE-1B is an ideal unit for equalizing unloaded telephone lines up to ten miles in length to a frequency response within  $\pm 1$  db, 30 to 15,000 cycles. In addition to the conventional parallel resonant circuits this equalizer has additional tuned networks providing a variable frequency boost of 2 to 14 decibels (2 db steps) at 15,000 cycles. This feature aids materially in obtaining an overall flat frequency response to 15,000 cycles. More than 1,000 different attenuation vs frequency curves are available through adjustment of the front panel controls.

## Description

The BE-1B consists of a tuned equalizing circuit, isolating transformer, attenuating pad, 15,000 cycle booster circuit and another isolating transformer in the output. A two-position input switch selects an impedance of 150 or 600 ohms for terminating lines offering 150 or 600 ohms impedance. A three-position switch prepares the circuit for equalization up to 10,000 cycles or 15,000 cycles. The center position of the toggle switch removes the attenuator from the circuit, leaving lines connected with a loss of 1.5 db at 1,000 cycles. A 20 step (3 db per step, last step infinity) attenuator is inserted in the circuit to permit control of the output level. The 15,000 cycle booster circuit is controlled by an 8 position switch which will vary the boost from 0 to 14 db in 2 db steps. Attenuation vs Frequency curves are shown for extreme boost control settings of "Boost out" and "14 db boost." Intermediate attenuation values will be obtained for intermediate settings of the boost control. The output transformer has variable taps for a load impedance of 150, 250 and 600 ohms. The BE-1B is built on a standard 19" panel and is supplied with a dust cover. A hinged door on the front panel permits easy access for cleaning or servicing the equipment. A terminal strip, mounted on the rear of the unit, has five screw-type terminals for input, output and ground connections.

## Specifications

Source Impedance (balanced or unbalanced) 150/600 ohms  
 Load Impedance 150/250/600 ohms  
 Equalization Frequency Limit 15,000 cycles  
 Insertion Loss (attenuator at zero)  
 For 15 kc equalization Min. 6.5 db; Max. 59 db  
 For 10 kc equalization Min. 3.5 db; Max. 42.5 db  
 Note: With equalization and boost out the minimum loss at 1000 cycles is 1.5 db.

Equalization Range (See attenuation characteristic curves)  
 Mounting BR-84 series and 9AX racks  
 Dimensions  
 Height 5  $\frac{3}{16}$ "  
 Width 19"  
 Depth behind panel 8"  
 Overall including knobs 9  $\frac{1}{4}$ "  
 Weight (unpacked) 7 lbs.  
 Stock Identification MI-4196-B  
 Light Umber Grey

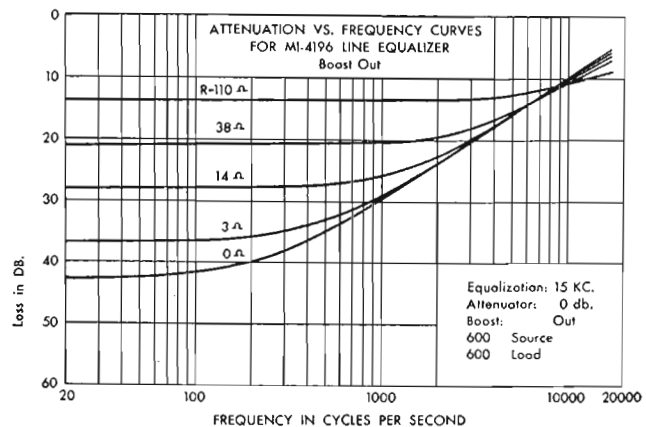
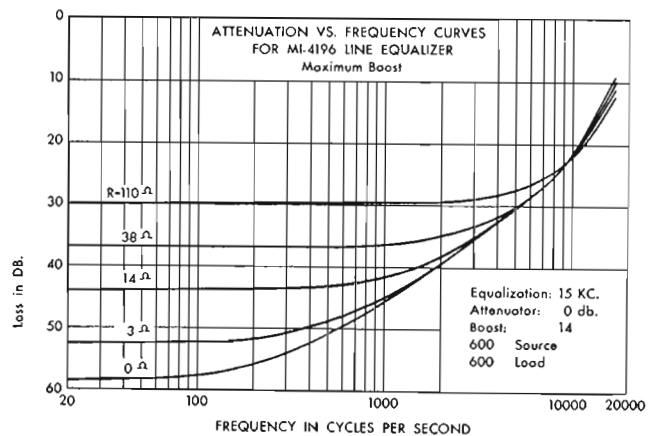



## Dual Line Equalizer, Type 56-E



### Features

- Provides line equalization to 10,000 cycles or to 15,000 cycles when used with MI-4925-A Compensator.
- Equalization variable in steps of 3 db.
- Facilities for equalizing two lines.
- Rack mounting panel—easy installation.

### Uses

The 56-E has been designed to equalize the non-linear frequency characteristics of either one or two non-loaded telephone lines up to ten miles in length. It consists of two separate and complete variable equalizers mounted on a single panel. The 56-E is suitable for 15,000 cycle FM applications when used with the RCA MI-4925-A High Frequency Compensator. Without this compensator the cut-off frequency is 10,000 cycles.

### Description

Parallel resonant circuits are used in the two equalizers. Each unit consists of a capacitor, a reactor, a series of resistors and a rotary selector switch for selecting different resistance values. Varying amounts of equalization may be obtained in steps of 3 db by rotation of the selector switch to the proper position. The 56-E does not include line transformers or master attenuators.

### Specifications

Source Impedance	600 ohms
Equalization Frequency Limit	10,000 cycles
with MI-4925-A Compensator	15,000 cycles
Insertion Loss (minimum at 1000 cycles)	7 db
Equalization Range (see attenuation characteristic curve)	1.5 to 40 db
Mounting	Standard 19" panel
Dimensions	
Width	19"
Height	3 1/2"
Depth	4 3/4"
Weight (unpacked)	7 lbs.
Stock Identification	
Black	MI-4162
Umber Gray	MI-4162-A
Accessory	

### Accessories

High Frequency Compensator (2 units required if 56-E is to be converted for 15,000 cycle use)	MI-4925-A
Line Transformer	MI-11713

## Equalizer, Type 56-C

The 56-C Equalizer is a semi-fixed unit which is particularly useful in connection with permanent lines. Its applications are similar to those of the Type 56-E described elsewhere on this page. It is a single unit with reactor, capacitor and all necessary resistors mounted in a metal case to reduce space requirements. The resistance terminals are brought out to soldering lugs on the top of the case where connections may be made for obtaining any resistance value between 1 and 111 ohms in 1 ohm steps.

### Specifications

Source Impedance	600 ohms
Equalization Frequency Limit	10,000 cycles
with MI-4925-A Compensator	15,000 cycles
Insertion Loss (minimum at 1000 cycles)	11.5 db

Equalization Range (see attenuation characteristic curves)  
1.5 to 40 db

Dimensions  
Width 3 5/8"  
Height 3 3/4"  
Depth 2 1/2"

Weight (unpacked) 7 lbs.

Stock Identification MI-4168

Accessory High Frequency Compensator

(one only required if 56-C is to be converted for 15,000 cycle use) MI-4925-A

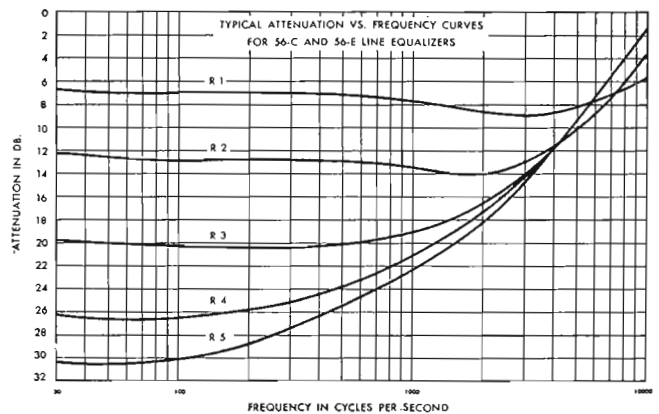
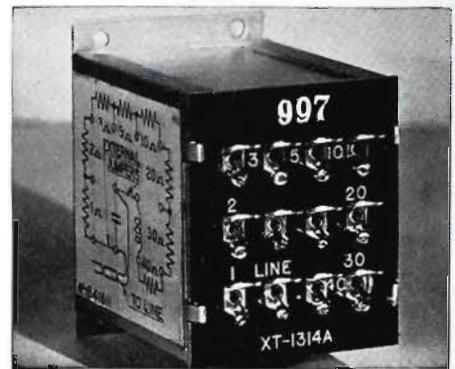

## High Frequency Compensator, MI-4925-A

The MI-4925-A is a constant impedance bridged "T" type compensator network to extend the range of the 56-C or 56-E Equalizers to 15,000 cycles. The necessary reactors and condensers are mounted inside a round metal can, on the side of which is mounted a terminal board and two groups of resistors. Compensation can be varied by shifting the resistor connections which are connected by means of solder type terminals.

### Specifications

Source Impedance	600 ohms
Equalization Frequency Limit	15,000 cycles
Insertion Loss (minimum at 1000 cycles)	4.8 db
Equalization Range (see curves)	1.7 to 17.4 db
Mounting	Four-hole flange mounting
Dimensions	
Width	4 3/8"
Height	4 3/4"
Depth	3 3/4"
Weight (unpacked)	2 3/4 lbs.
Stock Identification	MI-4925-A

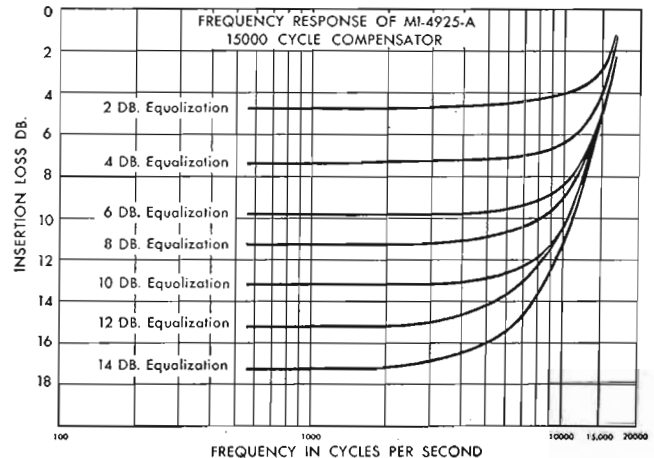



# Variable Sound Effects Filter, Type BE-21A

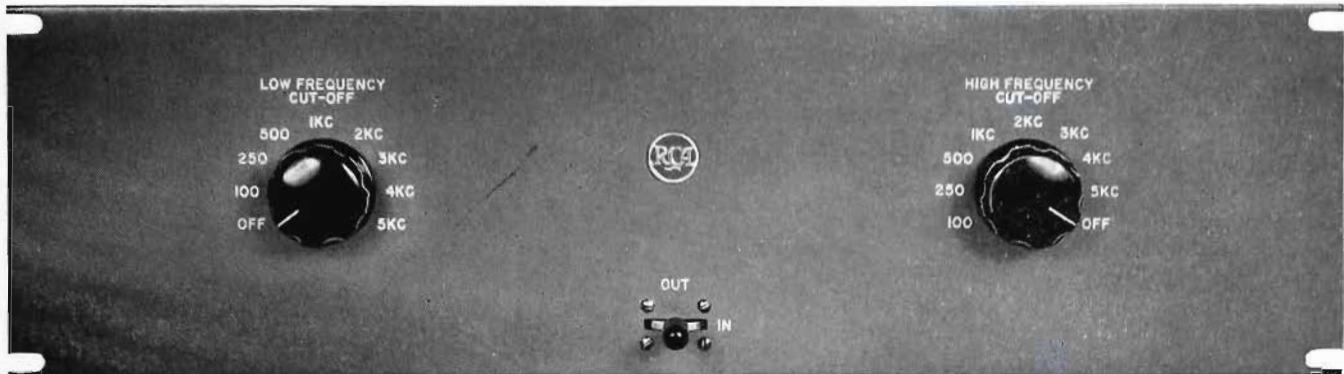

### Features

- Permits control of audio bandwidth to permit a variety of sound effects.
- Two front panel selector switches permit easy and quick change to desired sound effect.

### Uses

The BE-21A furnishes a desirable means for producing a variety of special or unusual sound effects through control of the audio bandwidth of the transmitted program. It is especially useful in the production of dramatic plays for making programs sound "bassy" or "tinny" or for simulating the sound of telephone conversations, short wave radio communications or midjet radios.

### Description

The BE-21A consists of high and low pass filters assembled on a panel with two selector panel switches. The switches have nine positions each and are calibrated for high and low cut-off frequencies of 100, 250, 500, 1,000, 2,000, 3,000, 4,000, and 5,000 cycles. There is also an "off" position on each switch. A key switch is provided for removing the filter from the circuit thus making it possible to preset the filter for the desired

characteristics and insert it in the circuit instantly when required.

The 600 ohm input and output impedances of the filter enables it to be connected in any 600 ohm circuit or it may be used in a 250 ohm circuit with only a slight change in response characteristics.

### Specifications

Source Impedance (unbalanced)	_____	600 ohms
Load Impedance	_____	600 ohms
Input Level	_____	-60 to +23 db*
Output Level (maximum)	_____	+23 db*
Frequency Response	_____	see curves
Insertion Loss	_____	1 db or less at frequencies remote from cut-off
Dimensions, overall	_____	
Height	_____	5 1/4"
Width	_____	19"
Depth	_____	5"
Weight (unpacked)	_____	15 lbs.
Stock Identification—Light Umber Gray	_____	MI-4917-A

\* Reference level one milliwatt.

**BE-21A VARIABLE SOUND EFFECTS FILTER (600 OHMS)**

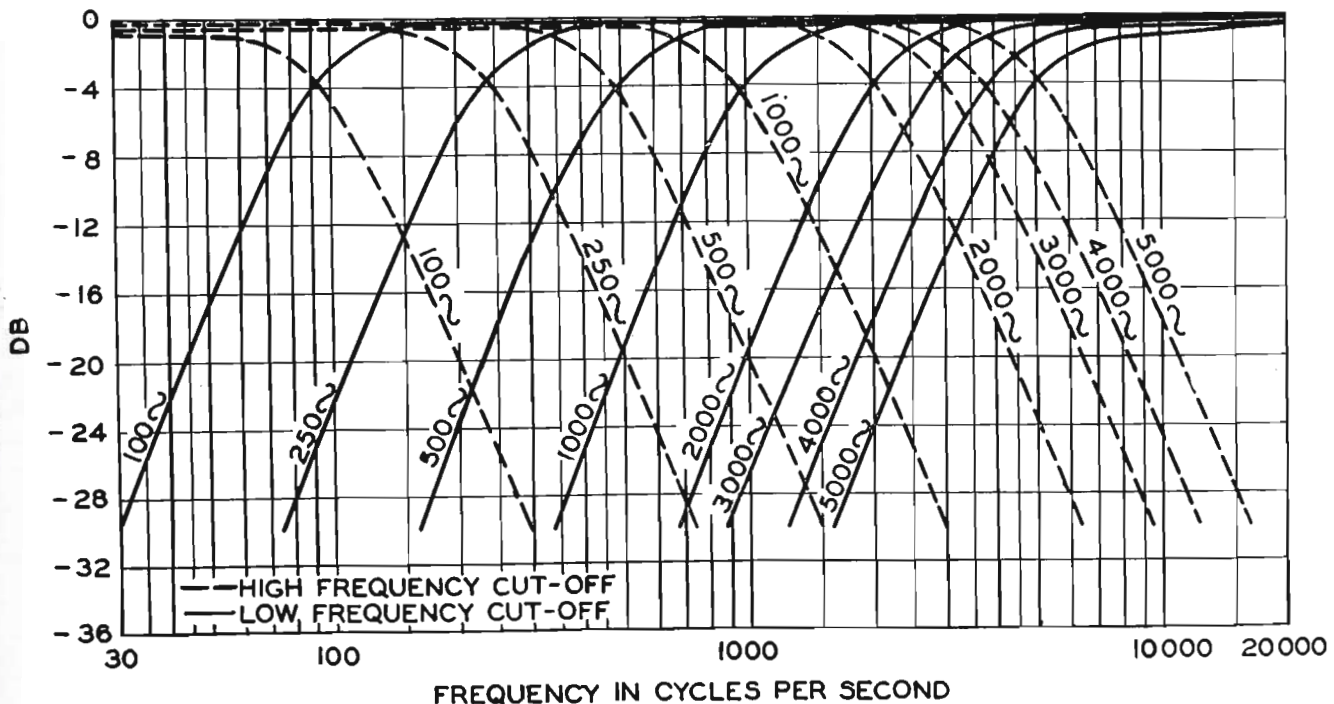

# Line, Mixing and Bridging Transformers

The following standard RCA transformers are stocked as a convenience to broadcasting stations. These transformers are of the highest quality design having excellent frequency response. They are provided with electrostatic shields between primary and secondary and are furnished with heavily shielded cases. Cores are of special high permeability steel. Terminals are at one end and diagrams of the connections are stenciled on the side of the case. Broadcasting stations may employ the RCA transformers between units with assurance that the overall fidelity of the system will be maintained.

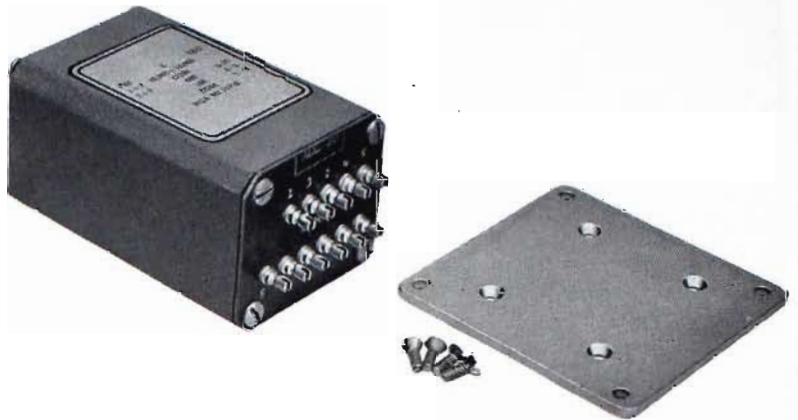

## Line Transformer, MI-11713

The core structure, frequency characteristics and shielding of this transformer makes it an ideal unit for isolating line circuits. Its taps provide several combinations of available impedances. One to two of these transformers are very useful items to have around any broadcast station. The impedance combinations are:

Frequency Response \_\_\_\_\_  $\pm 1/2$  db 20 to 20,000 cps.

Primary Impedances <i>ohms</i>
150
600

Secondary Impedances <i>ohms</i>
150
600

Stock Identification \_\_\_\_\_ MI-11713

## Bridging Transformer, MI-11712

This transformer may be used as an input transformer for a bridging line amplifier or a monitoring amplifier. It may also be satisfactorily used where it is desired to bridge a program line to feed programs to other mixing or outgoing circuits such as normally employed in a master control room line distribution system. The impedance combinations are:

Frequency Response \_\_\_\_\_  $\pm 1/2$  db 20 to 20,000 cps.

Primary Impedances <i>ohms</i>
20,000

Secondary Impedances <i>ohms</i>
150
600

Stock Identification \_\_\_\_\_ MI-11712

## Mixing Transformer, MI-4902

Those contemplating the design of their own, or special microphone mixing circuits, will find this transformer ideal for a large number of mixer combinations. The impedance combinations are:

Frequency Response \_\_\_\_\_  $\pm 1$  db 30 to 15,000 cps.

Primary Impedances <i>ohms</i>	
76.5	153
90	187
109	237
134	320

Secondary Impedances <i>ohms</i>
250
600

Stock Identification \_\_\_\_\_ MI-4902

## General Specifications for MI-11713, MI-11712 and MI-4902

Dimensions, overall for cases:

Height \_\_\_\_\_  $4\frac{3}{8}$ "  
 Diameter \_\_\_\_\_ 3"  
 Baseplate \_\_\_\_\_  $3\frac{1}{4}$ " x  $3\frac{1}{4}$ "

Mounting \_\_\_\_\_ Four holes with center lines  $2\frac{3}{4}$ " x  $2\frac{3}{4}$ "

Weight \_\_\_\_\_ 2 lbs. 14 ozs.

Finish \_\_\_\_\_ Aluminum gray

# Pads - Fixed, Bridging, Network

RCA offers a comprehensive selection of attenuator pads, bridging pads and dividing networks. The pads and networks are well constructed and insulated with precision wound resistors, assuring no internal reflection. The terminals are accessible and securely mounted with the connections stenciled in an appropriate place. The fixed balanced "H" type is available in two types, one introducing a loss of 6 db, the other 10 db. The dividing networks are also available in two types, unbalanced and balanced "H" type, as tabulated below.

**FIXED PADS—BALANCED "H" TYPE**

Input Impedance_____	600 ohms
Output Impedance_____	600 ohms
Insertion Loss_____	6 db
Stock Identification _____	MI-4171-29

**FIXED PADS—BALANCED "H" TYPE**

Input Impedance_____	600 ohms
Output Impedance_____	600 ohms
Insertion Loss_____	10 db
Stock Identification _____	MI-4171-30



MI-11704-A

## DIVIDING NETWORKS

Balanced Two-way, 600 ohms	
Insertion Loss_____	6 db
Stock Identification _____	MI-11704
Balanced Three-way, 600 ohms	
Insertion Loss_____	9.5 db
Stock Identification _____	MI-11704-A
Balanced Four-way, 600 ohms	
Insertion Loss_____	12 db
Stock Identification _____	MI-11704-B
Balanced Six-way, 600 ohms	
Insertion Loss_____	15.6 db
Stock Identification _____	MI-11704-D
Balanced Eight-way, 600 ohms	
Insertion Loss_____	18.1 db
Stock Identification _____	MI-11704-E
Unbalanced Two-way, 600 ohms	
Unbalanced Three-way, 600 ohms	
Unbalanced Four-way, 600 ohms	
Insertion Loss_____	12 db
Stock Identification _____	MI-11704-J
Unbalanced Six-way, 600 ohms	
Insertion Loss_____	15.6 db
Stock Identification _____	MI-11704-L
Unbalanced Eight-way, 600 ohms	
Insertion Loss_____	18.1 db
Stock Identification _____	MI-11704-M

## BRIDGING PAD

Input Impedance_____	600 ohms to two 600 ohm lines—	isolation between lines about 45 db
Insertion Loss_____		10 db
Stock Identification _____		MI-11705



MI-4171-29

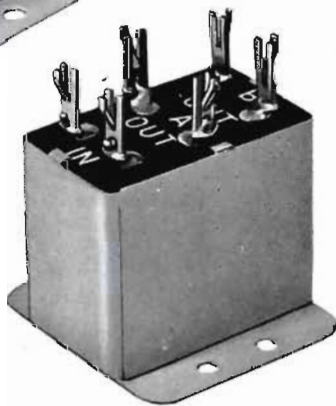

MI-4171-30

## Filament Transformer, MI-11606

The MI-11606 Filament Transformer furnishes filament voltage to a maximum of three BA-1A Pre-amplifiers. It has primary taps for 110 and 120 volts a-c 50/60 cycles. A variable potentiometer is connected across the secondary and is screw driver operated for obtaining minimum hum. This transformer is also used to provide voltage for the MI-11265 VU Meter Panel.

### Specifications

Output_____	6.3 volts, a-c, 1.8 amperes max.
Dimensions, overall	
Height_____	4"
Base_____	2 1/8" x 2 3/8"



Mounting_____	Four .199" mounting holes are located on 2 5/8" x 1 1/4" center line
Weight (unpacked)_____	2 lbs.
Stock Identification _____	MI-11606



# Preamplifier Power Supply, Type BX-1E

## Features

- Exceptionally low hum level.
- Plugs into BR-2A Shelf Assembly.
- High capacity filter.
- Filament supply hum balancing potentiometer.
- Voltage variable 180 to 250 volts.

## Uses

The Type BX-1E Preamplifier Power Supply is designed to provide d-c plate and a-c heater power for preamplifiers in which the hum level must be kept to a minimum. It is intended especially for use as a power supply for preamplifiers and isolation amplifiers such as the BA-11A.

## Description

The BX-1E is a plug-in unit designed primarily for mounting in the RCA Shelf Assembly Type BR-2A. Two of these power supplies can be installed as plug-in units in the BR-2A Shelf Assembly. Connection to the terminals is made through a quickly removable, multi-contact connector which fastens to the plug at the rear of the chassis.

The power supply circuit is a full-wave, high-vacuum tube rectifier with a choke-input filter. With a total of 260 microfarads of filter capacitance, the d-c output is exceptionally free from hum. The voltage is variable, by means of a screw driver adjustment, between 180 and 250 volts. The voltage output is very stable with any load up to fifty milliamperes. A hum balancing potentiometer, likewise a screw driver adjustment, is connected across the filament supply circuit.

The BX-1E is designed for operation on any a-c line voltage between 100 and 130 volts, 50 to 60 cycles. A one ampere, glass-enclosed, time-delay fuse is mounted on the front of the chassis. This fuse is unaffected by high transient currents.

## Specifications

Power Supply Required \_\_\_\_\_ 100 to 130 volts, 50 to 60 cycles,  
65 watts  
Fuse \_\_\_\_\_ 1 ampere, Type MDL



Power Output  
D-c \_\_\_\_\_ 180 to 285 volts, up to 50 ma  
A-c \_\_\_\_\_ 6.3 volts, up to 4.2 amperes  
Output Hum Level \_\_\_\_\_ Approximately —134 db (below 50 ma  
d-c load at 250 volts d-c)  
Dimensions and Weight:  
Length \_\_\_\_\_ 12 $\frac{5}{8}$ " ; Width \_\_\_\_\_ 8 $\frac{1}{16}$ " ; Height \_\_\_\_\_ 7"  
Weight \_\_\_\_\_ 15 $\frac{1}{2}$  lbs.  
Stock Identification (less tube) \_\_\_\_\_ MI-11305-D

## Accessories

Tube Complement, 1 RCA-5Y3GT/G \_\_\_\_\_ MI-11262  
Panel and Shelf Type BR-2A:  
Umber Gray \_\_\_\_\_ MI-11598/11599

# Relay Power Supply, Type BX-4A

## Features

- Supplies two amperes filtered d-c at 24 volts.
- Transformer tap for increasing output voltage.
- Full wave selenium rectifier.
- Rack mounting—easy installation.
- Plug-in capacitors.

## Uses

The MI-11309 Relay Power Supply is capable of supplying up to 2 amperes filtered d-c at 24 volts to relay and pilot light circuits.

## Description

The power supply is constructed on a panel suitable for mounting on the BR-84 series (19") cabinet racks. The electrical circuit consists of a power transformer, selenium rectifier, plug-in electrolytic capacitors, choke, bleeder resistor, fuse and power switch. The primary of the transformer is tapped for line voltage adjustments and the secondary is tapped for increasing the output voltage to compensate for changes in the internal resistance of the selenium rectifier. All electrical connections are made to a barrier type terminal board.

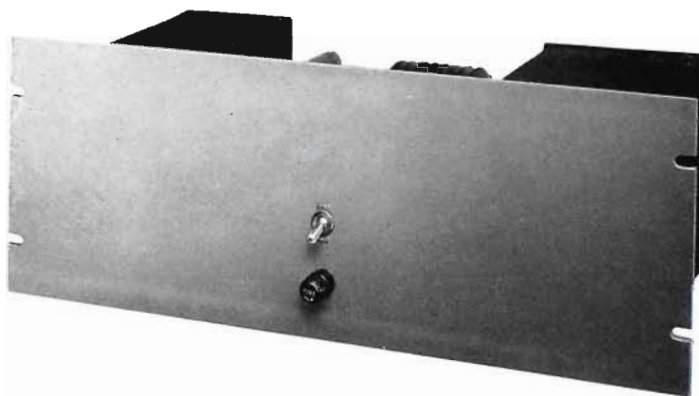

## Specifications

Output, Maximum \_\_\_\_\_ 2 amperes at 24 volts, d-c  
Ripple Voltage at Full Load \_\_\_\_\_ 0.35 volt  
A-c Power Input \_\_\_\_\_ 124 watts, 110-125 v., 50-60 cps.  
Transformer Tapped at \_\_\_\_\_ 110, 115, 120 and 125 volts  
Dimensions:  
Length \_\_\_\_\_ 19"  
Height \_\_\_\_\_ 6 31/32"  
Depth \_\_\_\_\_ 7 $\frac{1}{4}$ "  
Weight \_\_\_\_\_ 41 lbs. (unpacked)  
Mounting \_\_\_\_\_ BR-84 series (19") rack  
Finish \_\_\_\_\_ Light umber gray  
Stock Identification \_\_\_\_\_ MI-11309

# Relay Power Supply, MI-11303

## Features

- Supplies 12 volts filtered d-c at 1 ampere.
- Rotary switch permits varying output voltage in 1/2 volt steps.
- Long life full wave copper sulphide magnesium rectifier.
- Housed in an attractive wall mounting cabinet with hinged door

## Uses

The MI-11303 Relay Power Supply is a complete unit capable of supplying filtered d-c power to a number of relays and pilot lights if the total load current at 12 volts does not exceed one ampere.

## Description

The power supply is built in an attractive wall-mounting box. The electrical circuit consists of a power transformer, copper-sulfide magnesium full wave rectifier, and a resistance-capacity filter system with three 1000 mfd. electrolytic plug-in capacitors. The power transformer primary is tapped at 105, 115, and 125 volts to provide line voltage adjustment. The secondary of the power transformer is tapped and connected to a six position rotary switch which permits a variation in output voltage of approximately 1/2 volt per step.

The chassis is bolted in the enclosure with a snap-off cover. The chassis, inside of the mounting box and the terminal board cover are finished in silver grey. The outside of the box is finished in light umber grey with a 4 inch dark umber grey stripe through the middle of the cover.

## Specifications

Output (adjustable for loads from 0.2 to 1.0 ampere) \_\_\_\_\_ maximum 12 volts 1 amp.  
 Ripple Voltage (at maximum output of 1 amp.) \_\_\_\_\_ 0.4 volts rms  
 Ac Power Input, 105 to 125 volts, 60 cycles \_\_\_\_\_ (maximum at rated output) 34 watts  
 Rectifier \_\_\_\_\_ Copper-Sulphide magnesium full wave type

Dimensions  
 Height \_\_\_\_\_ 9"  
 Width \_\_\_\_\_ 9 1/8"  
 Depth \_\_\_\_\_ 6"

Mounting \_\_\_\_\_ Wall mounted by four mounting slots  
 Finish \_\_\_\_\_ Two tone umber grey  
 Weight (unpacked) \_\_\_\_\_ 14.5 lbs.  
 Stock Identification \_\_\_\_\_ MI-11303

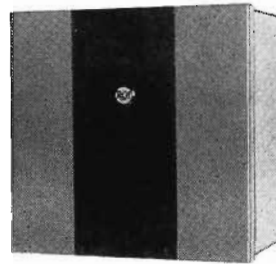

# Heavy Duty Relay Power Supply, MI-11304

## Features

- Supplies 12 volts filtered d-c at 5 amperes.
- Output voltage substantially constant from no-load to full-load output.
- Full wave Selenium Type Rectifier.
- Housed in an attractive wall-mounting box.

## Uses

The MI-11304 Relay Power Supply is a complete unit capable of supplying filtered d-c power to a number of relays and pilot lights if the total load current at 12 volts does not exceed 5 amperes.

## Description

The power supply is built into an attractive cabinet for wall mounting. The electrical circuit consists of a power transformer, line and load voltage regulating and shunt reactors, full wave selenium rectifier, filter reactors and capacitors, variable resistors, and terminal board and fuses. Regulation of the d-c output voltage is accomplished by use of a saturable reactor which maintains the output voltage substantially constant from no-load to full-load output.

## Specifications

Output (substantially constant from no-load to full-load output) \_\_\_\_\_ maximum, 12 volts 5 amps.  
 Ripple Voltage (at full load) \_\_\_\_\_ 0.1 volt rms  
 Ac Power Input, 105 to 125 volts, 60 cycles \_\_\_\_\_ (maximum at rated output) 165 watts  
 Rectifier \_\_\_\_\_ full wave Selenium type

Dimensions  
 Height \_\_\_\_\_ 16 3/8"  
 Width \_\_\_\_\_ 15 1/4"  
 Depth \_\_\_\_\_ 8 1/2"

Mounting \_\_\_\_\_ Wall mounted by four mounting slots  
 Finish \_\_\_\_\_ light umber grey  
 Weight (unpacked) \_\_\_\_\_ 80 lbs.  
 Stock Identification \_\_\_\_\_ MI-11304

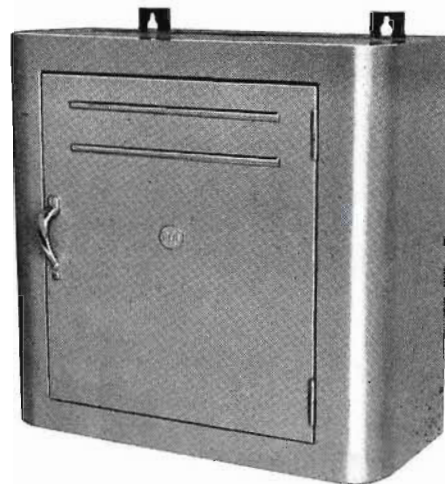



# Transcription Turntable, Type 70-D

## Features

- High fidelity reproduction of vertical and lateral recordings.
- Universal lightweight pickup with long wear diamond point stylus.
- Heavy duty constant speed synchronous motor with ample driving power for recording or reproducing.
- Provision for RCA Recording Attachment.
- Quiet operation. Cushion-mounted motor with silent on-off switch.
- Speed change lever in rim of turntable permits change without removing record.
- Ruggedly built to give years of satisfactory service.

## Uses

The Type 70-D Transcription Turntable has been developed to meet the continued demand for higher and higher quality in the reproduction of broadcast transcriptions. It is the latest edition to the popular 70 SERIES of transcription equipments, of which more than 3000 are now in use. The 70-D provides high fidelity reproduction of *all* vertical or lateral cut records.

## Description

The complete equipment is housed in a metal cabinet of modern design. The cabinet is finished in two tones of umber grey and trimmed in chromium. A large hinged door is located on the front of the cabinet so as to permit ready access to the motor and filter circuits. A heat resistant, "Micarta" top is used. All filters are securely mounted within the cabinet and arranged for minimum hum pickup. There is also sufficient space within the cabinet for a booster amplifier (such as the RCA BA-2 Series) where additional output level is required. If the user desires to raise the height of the cabinet from 28 to 30 inches, the MI-11803 mounting base complete with hardware is available for the purpose.

Terminal boards are provided for a-c and the audio connections and are accessible from the front of the cabinet. Mounted on top of the 70-D cabinet are the tone arm, tone arm rest and filter selector switch. The tone arm is of the counter weight balance type and provisions are made for accurately setting the stylus for one ounce weight on a record. The pickup head is unexcelled and designed to impart high fidelity characteristics for both vertical and lateral recordings. It is of a moving conductor type in which two ribbons are free to move in a vertical or lateral magnetic field.

The pickup and filter reproduce the various types of records, Orthacoustic, RCA-Victor, Columbia, World and others, with a response characteristic that produces an ideal playback response. The filter unit is designed so that this may be accomplished by merely turning a switch to one of the following six positions:

**LATERAL:** 1. Transcriptions—NAB Lateral. 2. Home records with 500 cycle crossover frequency (Victor). 3. Home records with 300 cycle crossover frequency. 4. Test records and special recordings (wide open at high frequencies).

**VERTICAL:** 1. Transcriptions—NAB Standard Vertical. 2. Transcriptions (worn).



Two vacant positions are available on the switch to permit additional filters or compensators to be added if required.

The motor is a high torque synchronous type, cushion-mounted on the bottom shelf of the equipment, thus isolating motor noise from the cabinet. In order to insure the faithful reproduction of high fidelity records, the turntable platter has associated with it a separate specially designed flywheel. This flywheel is approximately 12" in diameter and is located within the cabinet itself. The turntable platter and flywheel assembly is completely isolated from the motor through a series of mechanical filters and a spring clutch arrangement.

## Specifications

Pickup Impedance	_____	250 ohms
Load Impedance	_____	Output of compensator should be connected to the unloaded input transformer of an amplifier designed to operate from a 250 ohm source such as BA-11A or BA-2C.
Output Level	_____	-63 dbm L1 position at 1,000 cycles T-2485 test record
	_____	-68 dbm (.001 watt reference) VI position at 1,000 cycles—TRV-104 test record
Noise Level (below 1 milliwatt reference level)	_____	-120 dbm
Frequency Response (see curves)	_____	50-10,000 cycles
Transmission Loss of Filter	_____	24 db at 1,000 cycles at each of the 6 switch positions
Stylus	_____	Polished diamond
Turntable Diameter	_____	16"
		(Will handle records up to 18" in diameter)
Turntable Speed	_____	33 1/3-78 rpm
Speed Regulation (wows)	_____	0.2% rms at 33 1/3 rpm
		0.09% rms at 78 rpm



**Dimensions, overall**  
 Height (overall) \_\_\_\_\_ 28 3/8"  
 Height (overall with MI-11803) \_\_\_\_\_ 30 3/8"  
 Width \_\_\_\_\_ 25 1/4"  
 Depth \_\_\_\_\_ 24 1/4"  
**Finish** \_\_\_\_\_ Two tone umber grey with chromium trim  
**Weight (unpacked)** \_\_\_\_\_ 155 lbs.  
**Power Supply** \_\_\_\_\_ 105-125 volts, 50 or 60 cycles  
**Power Consumption** \_\_\_\_\_ 35 watts  
**Stock Identification**  
 UMBER GREY, 60 CYCLES \_\_\_\_\_ MI-11801

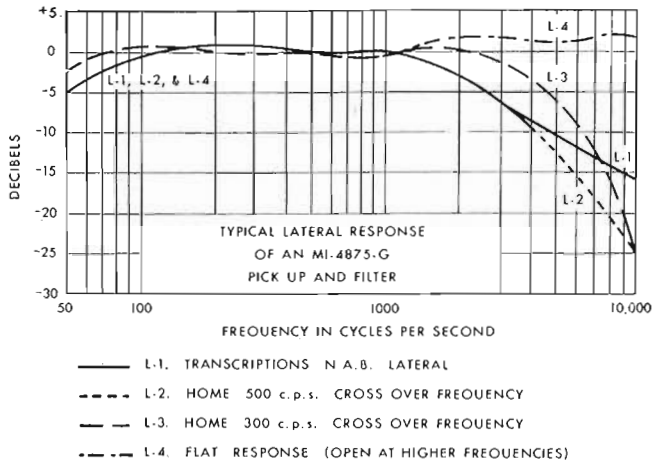
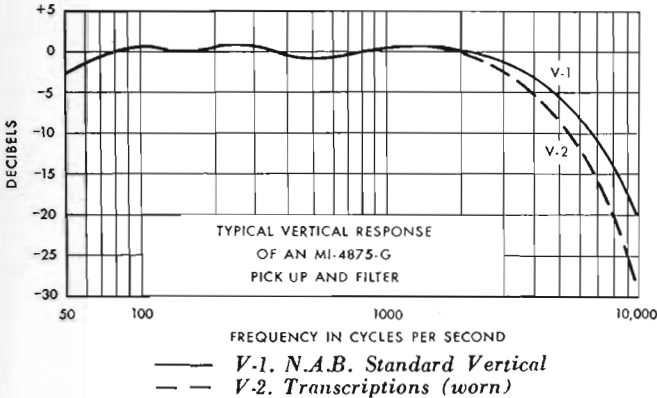

UMBER GREY, 50 CYCLES \_\_\_\_\_ MI-11802  
 BLACK, 60 CYCLES \_\_\_\_\_ MI-11802-A

**Accessories**

BA-2C Booster Amplifier \_\_\_\_\_ MI-11226-B  
 72-D/72-DX Recording Attachment \_\_\_\_\_ MI-11901 or MI-11900  
 Mounting Base \_\_\_\_\_ MI-11803  
 45 rpm Conversion Kit \_\_\_\_\_ MI-11883

**45 R.P.M. Conversion Kit, MI-11883**

**Features**

- Simple to add to present turntables.
- Quick speed changes.
- Rugged construction for long service.
- Quiet operation.
- Accessory fine groove pickup and tone arm available.

**Description**

The 45 R.P.M. Conversion Kit is made available to broadcasters for playing the new RCA 45 R.P.M. records on any type 70-C or 70-D Transcription Turntable. The modification kit is easy to add to existing turntable and requires minimum investment by eliminating the expense of additional turntables. The kit consists of a ball-type speed reducer which is installed between the two flexible couplings in the main drive shaft of the 70-D turntable. In one position, the ball reducer is inoperative and the shaft is driven straight through at 78 R.P.M. In the other position, the ball reducer drives the shaft and flywheel at 45 R.P.M. The over-riding spring clutch is built into the new mechanism and is operative in both positions. Speed change is accomplished by turning the motor control

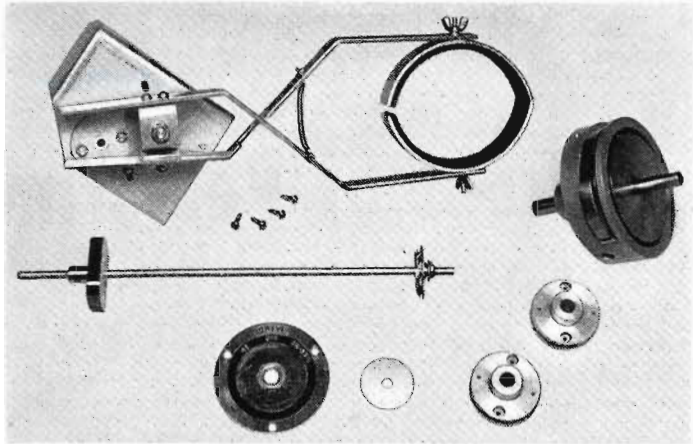

knob on the turntable deck. It may be shifted in either direction while the turntable is running. Three positions are provided: (1) an "OFF" position which completely shuts down turntable by turning off motor, (2) a "78-33 1/2" R.P.M. position which permits either speed by use of speed-change lever on turntable and (3) "45" R.P.M. position which permits this speed with speed-change lever set at "78".

Mechanical installation is simple and the only electrical work necessary is the transfer of motor switch leads to the micro-switch incorporated in the kit. Sturdy construction and careful mechanical alignment assures the same long, trouble-free operation that thousands of 70-series turntables are now giving in the field. Also required but not included in this kit, is a second tone arm for fine groove playback (MI-11884).

**Specifications**

Approximate Weight, Unpacked \_\_\_\_\_ 6 1/2 lbs.  
 Stock Identification \_\_\_\_\_ MI-11883  
 (Kit includes clutch assembly (speed changer), arm assembly (brake), switch and cam shaft assembly, dial plate, 2 couplings and adapter hub.)

**Accessory**

Fine Groove Pickup and Tone Arm \_\_\_\_\_ MI-11884



Interior view of the 70-D Turntable with 45 R.P.M. Kit installed



TYPE 70-D  
RCA HIGH-FIDELITY  
TRANSCRIPTION TURNTABLE

# The Proof of Performance—*is in its acceptance*

Over 4,500 RCA "70-type" Turntables shipped to date

THIS moderately priced transcription turntable has no superior—either in mechanical simplicity or in high-fidelity reproduction.

One heavy-duty synchronous motor provides the drive required for playback *and* recording. Mechanical filters and spring-clutch assembly completely isolate the platter and the fly-wheel from the motor—and assure even running and smooth starts and stops. A high-quality universal lightweight

pick-up, with a diamond-point stylus, provides true reproduction—for either vertical or lateral recordings.

A hinged door on the metal cabinet makes everything easy to get at. There is ample space inside to house booster amplifiers and record-cueing amplifiers. There is also accommodation on top for an RCA 72-D (or 72-DX) Recording Attachment.

*And you can handle the new records designed to play at 45 rpm—by means of a simple*

*modification kit now available.*

For the finest response from your recording . . . for dependable timing to the very last second . . . for even running and smooth starts and stops, this studio turntable has it! Available in two cabinet-top heights . . . 28 inches and 30 inches. Equipped with convenience-plug outlets for a-c and audio circuits.

Ask your RCA Broadcast Sales Engineer for complete data.

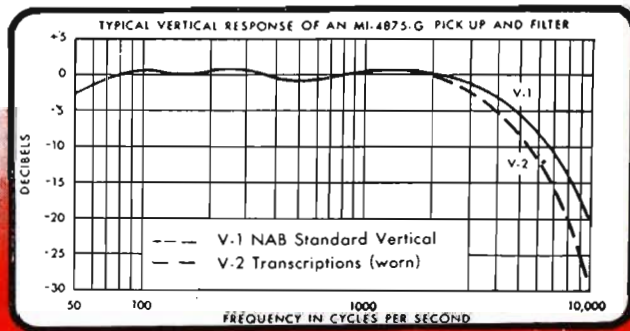
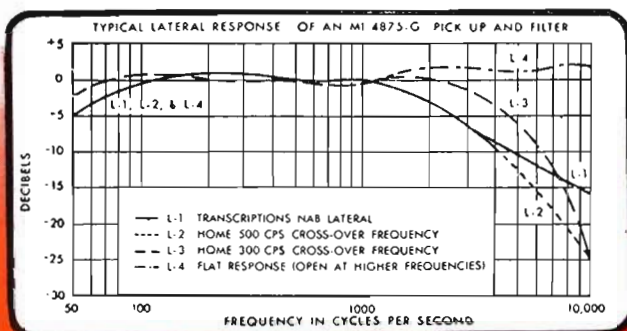



# Universal Pickup Kit, MI-4875-G

**Features**

- High fidelity reproduction of vertical and lateral recordings.
- Adjustable weight pickup head.
- Low moving mass.
- Adjustable vertical and lateral stops.
- No stylus breakages.

**Uses**

The Universal Pickup Kit has been designed to give an ideal playback response for all vertical and lateral recordings. This unit has a versatile mounting attachment and may be fitted to most turntables.

**Description**

The pickup head is a high quality moving conductor type, in which two ribbons are free to move in a vertical and lateral field. The head used in conjunction with a carefully designed compensator, produces ideal curves for all the various types of records. The compensator uses a series resonant circuit, variably tuned and shunted by merely turning a switch to one of six positions. Each kit consists of a Universal Pickup Head with an attractively styled tone-arm complete with finger lift, tone-arm rest position, six position compensator switch with

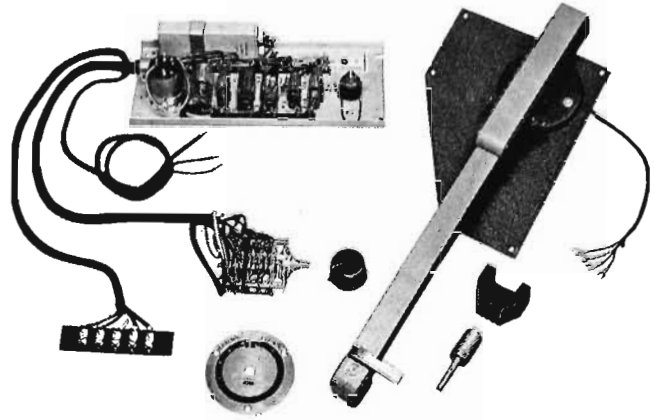

dial plate and filter kit with cable and terminal board. All the necessary accessories are provided for use on the 70-C series transcription turntables. For a more complete description and response curves, refer to the catalog page which features the 70-D turntable. The pickup compensator will operate satisfactorily into a BA-1A pre-amplifier, BA-3C program amplifier or any amplifier designed with an unloading input transformer for operation from a 250 ohm source impedance.

Weight (unpacked) \_\_\_\_\_ 12 lbs.  
 Stock Identification \_\_\_\_\_ MI-4875-G

# Reproducing Filter, MI-4975

The MI-4975 Filter is a newly designed unit and is an integral part of the 70-C2 and 70-D Turntables and the MI-4875-G Universal Pickup Kit. This kit is made available for the user who wishes to convert the superseded 70-C and 70-C1 Turntables and the MI-4875-C Pickup and take advantage of the considerable improvement in this filter design. The high frequency response for the Associated records is very much improved and the overall response characteristics for lateral records now conform to an ideal curve. The kit consists of compensator complete with cable, terminal board and a six-position compensator switch.

The changes are effected by merely transferring five wires on the terminal board. For the new response characteristics produced, reference is made to the 70-D Turntable catalog page, where these curves are shown.

Weight \_\_\_\_\_ 5 lbs.  
 Stock Identification \_\_\_\_\_ MI-4975

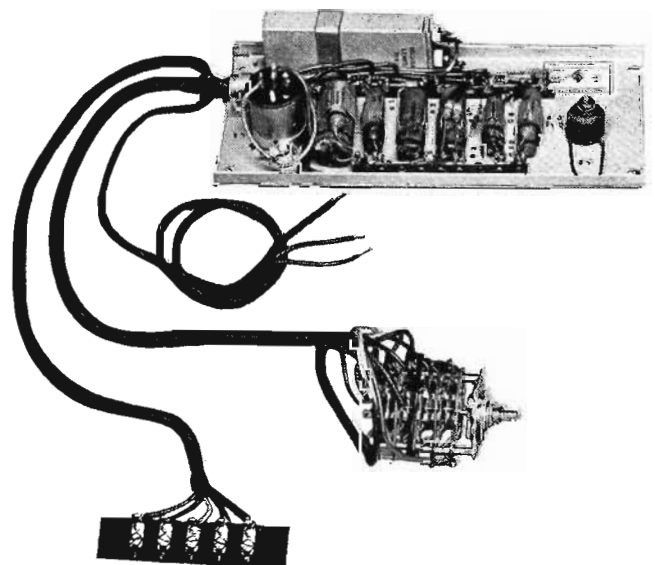



# RECORDING INSTALLATIONS



◀ Studio recording installation at KUTA, Salt Lake Cty, Utah, showing two bench-mounted RCA 73-B Professional Recorders.

An ideal recording installation at KECA, Los Angeles, Calif., showing two of the four RCA 73-B Professional Recorders. Note the conveniently located overhead lighting, the large size suction duct, and relatively short length of hose for chip removal.

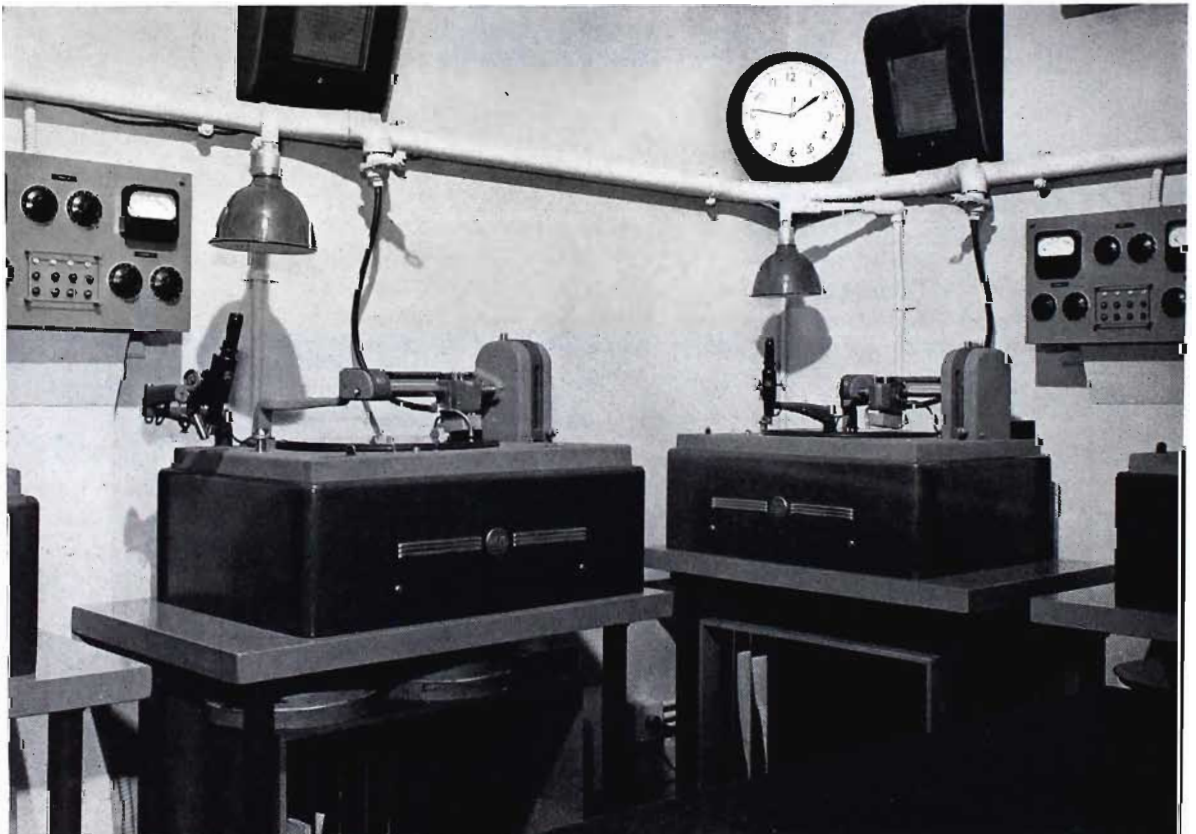

# Recording Equipment

RCA offers a complete line of high fidelity recording equipment featuring outstanding performance characteristics, simplicity of operation and many other exclusive features which are described on the following pages. For professional recording studios, broadcasting stations, educational institutions or wherever high quality discs are to be cut, these recorders are unexcelled.

Type	Usage	Recording Speed rpm	Recording Pitch Lines per Inch— Inside out or Outside in	Max. Dia. Blank	Frequency Response cps	Required Audio Power
73-B	Professional AM-FM Broadcast Studios Educational	33 1/3 or 78	Con. Var. 96 to 152	18 1/4"	±2 db 50-10,000	Approx. 10 Watt*
72-DX	AM-FM Broadcast Studios Educational	With 70 Ser. Turntables 33 1/3 or 78	96,112,136	18 1/4"	±2 db 50-10,000	Approx. 10 Watt*
72-D	AM-FM Broadcast Studios Educational	With 70 Ser. Turntables 33 1/3 or 78	96,112,136	18 1/4"	±3 db 50-7,500	Approx. 10 Watt**

\* For 6.3 cm/sec stylus velocity at 1000 cps.

\*\* For 6.1 cm/sec stylus velocity at 1000 cps.

The following diagrams have been designed to assist the user in determining the equipment required for a recording channel. Since there is considerable difference in recording technique, these illustrations must only be regarded as suggested installa-

tions. For example, some engineers prefer to introduce compensation prior to the limiting amplifier, while others prefer to record "flat" with automatic equalization to compensate for the changes in cutting diameter.

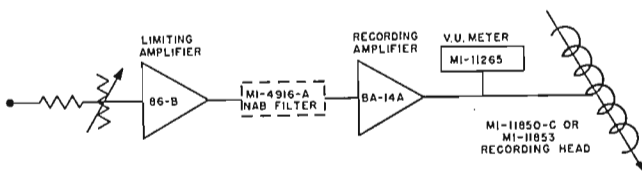

Fig. 1. This diagram illustrates a recording technique using the orthacoustic filter only.

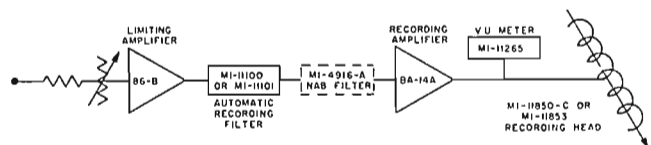

Fig. 3. This arrangement is included for recordists who choose to use both "automatic" and NAB orthacoustic compensation.

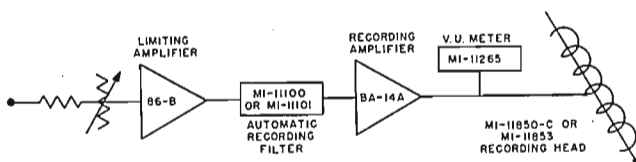
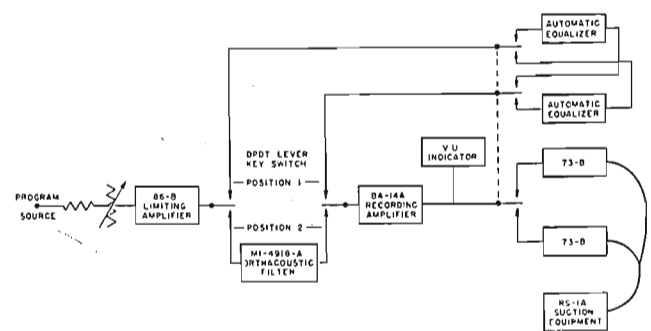

Fig. 2. This diagram illustrates a recording technique using the automatic recording filter only (or "flat").



This diagram illustrates a recording installation which will handle recording techniques shown in Figures 1 and 2.

# Recording Attachment, Type 72-D/72-DX

## Features

- Produces high quality recordings on any 70-Series Turntable.
- Records at 33 $\frac{1}{3}$  or 78 rpm at 96, 112 and 136 lines per inch. *Outside-in or inside-out* recording is accomplished without changing feedscrews or gears.
- Timing scales indicate remaining recording time.
- Improved lowering device avoids stylus or record damage.
- Convenient adjustment of stylus angle and depth of cut.
- Hand crank for spiralling grooves.
- Convenient adjustment for horizontal alignment.
- Lead screw protected by cylindrical tube housing.
- Provision made for installing automatic equalizer.

## Uses

The 72-D Recording Attachment may be easily and quickly installed on any of the RCA 70-Series Turntables to provide an unusually high quality instantaneous recording equipment at an economical price. It is a newly designed and much improved version of the widely used Type 72-C. Broadcast stations will find many uses for this item such as recording rehearsals and controversial broadcasts, making records for use by the time salesmen and recording programs for delayed broadcasts. It may also be satisfactorily used for making masters for processing.

## Description

The 72-D is equipped with a sturdy frame containing a screw mechanism for driving the cutter carriage across a record blank. Power coupling is made to the center of the turntable by means of a vertical shaft spiral gear and loosely coupled three pin driving flange which eliminates slippage and "knocks." Precision leveling adjustments are made by a swivel support with an accurate vertical adjustment. The mechanism is made so that it will swing clear when not in use or it may be easily removed from the transcription turntable if desired.

An improved lowering device permits the operator to gently lower the cutter on to the record, thus avoiding stylus breakage or deep cuts from sudden dropping. The angle of the stylus and the depth of cut may be conveniently adjusted even during operation. A spiralling hand crank permits spacing between musical selections without breaking the continuity of the groove. It is useful also for cutting starting and finishing spirals. The 72-D will record at either 33 $\frac{1}{3}$  or 78 rpm outside-in or inside-out at 96, 112 and 136 lines per inch. Selection of direction and pitch is made easily and quickly without changing lead screws or gears. Two interchangeable spring released hexagon timing scales are provided for giving an accurate indication of the remaining recording time. The scales are calibrated to cover all combinations of turntable speed and groove spacing. The cutter carriage does not ride on the feedscrew, but is supported on a metal tube in which the feedscrew is enclosed and is guided on another tube which is designed to house an automatic equalizer. This feature eliminates "grouping" of grooves, increases the life of the feedscrew and protects the feedscrew from dust. A lip has been turned on the driving spindle to catch the threads and prevent their climbing into the gears or bearings.



Type 72-D Recorder Mounted on a Type 70-D Turntable

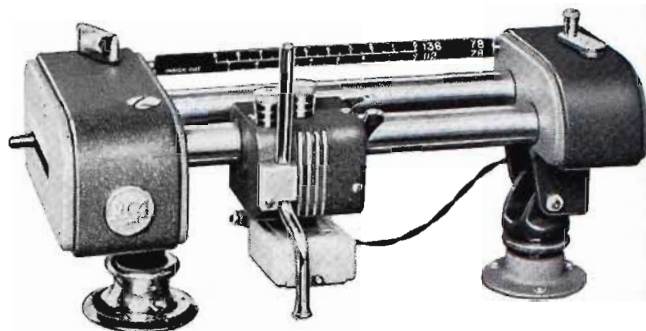

Type 72-D Recording Attachment

The 72-D is furnished complete with Standard recorder head, MI-11853-A mounting base and rest post. However, if a high fidelity response is required, the type 72-DX with the MI-11850-C recorder head is available. This high quality head is maintained at a constant temperature while operating by self-contained heater and thermostat. The power for the heater operation is obtained from an MI-11855-A heater and compensator kit as an accessory item. The MI-11854 base attachment is available for mounting the 72-D/72-DX on all 70 series turntables. Additional base attachment kits are available if the recorder is to be used on more than one turntable.

An MI-4910-A conversion kit, which consists of a replacement turntable felt, cement, support assembly and template, may be ordered when the 72-D attachment is to be used with a 70-A or 70-B turntable.

A suction nozzle is provided to facilitate the use of RCA suction equipment, MI-11857/MI-11858.

## Specifications

Input Impedance to Cutter	_____	15 ohms nominal
Frequency Response:		
Type 72-D	_____	$\pm 3$ db, 50-7500 cps
Type 72-DX	_____	$\pm 2$ db, 30-10,000 cps
Sensitivity:		
Type 72-D [groove velocity 6.1 cm/sec., .00079" (peak to peak) at 1000 cps]	_____	+ 28 dbm
Type 72-DX [groove velocity 6.3 cm/sec., .00079" (peak to peak) at 1000 cps]	_____	+ 30 dbm
Recording Direction (adjustable)	_____	Inside-out and outside-in
Recording Pitch (adjustable)	_____	96, 112, and 136 lines per inch
Drive	_____	Platter of an RCA 70-C series or OR-1A Turntable
Dimensions, overall		
Height	_____	5 $\frac{3}{4}$ "
Length	_____	15 $\frac{1}{2}$ "
Depth	_____	6 $\frac{1}{2}$ "
Weight (unpacked)	_____	8 $\frac{1}{2}$ lbs.
Finish	_____	Two tone umber-grey, wrinkle
Stock Identification (as normally shipped)	_____	MI-11901
		(Includes MI-11852 Attachment, MI-11853 Recorder Head, and MI-11854 Mounting Base)
Stock Identification (Type 72-DX)	_____	MI-11900
		(Includes MI-11852 Attachment, MI-11850-C High Fidelity Recorder Head, MI-11854 Mounting Base, and MI-11855-A Heater and Compensator Kit)

## Accessories

Automatic Equalizer	_____	MI-11101-A
Fixed Orthacoustic Equalizer	_____	MI-4916-A
Heater and Compensator Accessory Kit	_____	MI-11855-A
Recording Suction Equipment (less hose)	_____	MI-11857
Chip Remover and Hose Assembly (for suction equipment)	_____	MI-11858
BA-14A Recording Amplifier	_____	MI-11234
Sapphire Stylus	_____	90° MI-4878-BC
		70° MI-4842
Additional Mounting Base Kit	_____	MI-11854



# The HIGH-FIDELITY RECORDER...

...for  
The Studio  
Professionalist



## RCA Type 73-B

DESIGNED with almost every known device for cutting your high-fidelity reproductions, this professional recorder has everything you need for versatile control of cutting to meet any recording situation.

- For instance, a new improved cam-operated lowering device prevents stylus damage and overcutting . . . because it enables you to lower the flutter-proof cutting head gently with decreasing speed as the head approaches the spinning record.
- For instance, start and finish spiralling is controlled by a *separate* motor . . . push-button operated. Spiralling pitch: approximately 6 lines per inch at 78 rpm and 2.5 lines per inch at 33 1/3 rpm.
- For instance, you can change cutting from *inside out* to *outside in* by the simple turn of a dial . . . without adjusting the lead screw or driving gears. The pitch is continuously variable, while recording, from 96 to 152 lines per inch to handle program overruns. During actual running, too, you can adjust the

RCA 73-B RECORDER, with its optional cabinet type MI-11827

stylus cutting angle and cutting depth. Groove grouping is eliminated because the head rides smoothly along a tubular enclosure that protects the feed screw. An automatic equalizer . . . available on special order . . . compensates for recording-level variations due to changes in surface speeds.

For additional facts ask your RCA Broadcast Sales Engineer for Bulletin 2J4784 . . . or write Dept. 30-L.

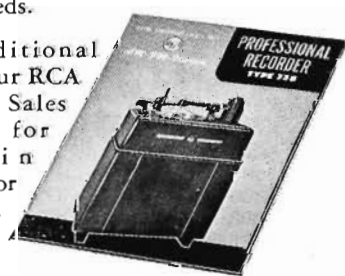

**CHECK THESE SPECIFICATIONS**

Frequency response . . . 30 to 10,000 cycles,  $\pm 2$  db

Head sensitivity (groove velocity 6.3 cm/sec., 0.00079" peak to peak at 1000 cps) . . . . .  $\pm 30$  dbm (1.0 watt)

Turntable accuracy . . . . .  $\pm 1/2\%$  33 1/3 or 78 rpm

Speed regulation (wows) . . . 0.14% rms at 33 1/3 rpm  
0.07% rms at 78 rpm

Turntable drive . . . . . 2 hysteresis type synchronous motors, using rim drive through rubber idler rollers

Type of stylus . . . . . Sapphire or Steel

Microscope . . . . . 36 power Spencer

# Professional Recorder, Type 73-B



## Features

- Complete shock mounting and special motors reduce vibration and rumble to a minimum.
- High fidelity recording head handles full power with low distortion.
- Two motor drive. Each motor has its own rubber idler wheel providing high torque and excellent regulation.
- Can be adjusted, while recording, for 96 to 152 lines per inch *inside-out* or *outside-in* cut without changing lead screw or gears.
- Large platter with rubber mat takes blanks up to 18¼ inches.
- One driving pin enables any type blank to be used. Pin is held up by spring and sinks into platter if record without driving holes is used.
- Cutter angle and depth of cut can be easily adjusted while recording.
- Dropping mechanism can be operated with one hand; lowers cutter on record slowly to prevent stylus damage.
- Lathe type construction ensures accurate alignment and permits rapid record changing.
- Equipped with high grade microscope and illuminating lamp for accurately checking grooves on any portion of record.

## Uses

The 73-B Recorder is an outstanding professional type unit which has been designed to include almost every known device for making high quality recordings. Recording studios will acclaim the 73-B as the ideal recorder for making masters from which any number of pressings may be made. Broadcasting stations will find it unsurpassed for recording programs for use on delayed broadcasts, commercial accounts, rehearsals, auditions or the reference file.

## Description

The 73-B Recording Equipment consists of a high fidelity MI-11850-C Recording Head with its associated carriage and lead screw mechanism, a turntable assembly which includes a dual motor with rim drive mechanism, a turntable platter with rubber mat, a microscope and microscope lamp and a suction nozzle (less the suction generating and hose connecting equipment) for removing acetate shavings from the record.

The MI-11850-C Recording Head is a high quality, precision built, magnetic type unit with a frequency response which does not depart from an ideal response curve by more than two decibels between 30 and 10,000 cycles per second. Any discrepancies created by temperature variation are eliminated by the self-contained heater and thermostat. A visual indicator controlled by a switch on the base indicates when the heater is in circuit. Its flat type mechanical construction eliminates flutter without the use of special damping mechanisms. The recorder head rides on a smooth metal tube which encloses the feed screw and is guided on another tube which is designed to house an MI-11100 automatic equalizer. This arrangement eliminates "grouping" of grooves, increases the life of the feed screw and protects the feed screw from dust and dirt particles.

An improved cam-operated lowering device permits the head to be lowered gently with decreasing acceleration as the head approaches the record. This feature prevents stylus breakage or deep cuts from sudden dropping of the recorder head. The angle of the stylus, the depth of the cut and the number of lines per inch may be conveniently adjusted even while recording.

The turntable is rim driven through rubber idler rollers from two hysteresis type synchronous motors. These motors were chosen because of their quiet operation and accurate speed. The two motors and turntable drive wheels are both controlled by one "on-off" switch and both mechanisms are controlled by one "speed-change" switch. When the motor switch



is turned "off", the driving rollers are disengaged and a brake is applied to the rim of the turntable, bringing it quickly to a stop. The motors are doubly rubber shock-mounted from the motor board to avoid motor rumble in the recordings.

The feed screw is driven by a planetary-drive mechanism using a rubber-tired roller on a vertical shaft and a flat driving-disc on the end of the horizontally mounted feed screw. The driving roller may be adjusted to various vertical positions across the driving disc, the speed and direction of rotation of the feed screw being determined by the roller's position with respect to the center of the drive disc. The roller is automatically disengaged from the driving disc whenever the cutter head carriage is raised to the rest position. The number of cutting lines per inch is indicated by an illuminated scale in the drive housing. Four spring-released interchangeable time scales are provided to cover all combinations of turntable speed and groove spacings.

A separate motor, controlled by a push button on the recorder base, is used for motor driven spiralling, overdriving the lead screw to provide start and finishing spirals. The spiralling pitch is 6 lines per inch when the recorder is set for 96 lines per inch and the turntable speed is 78 rpm. For a turntable speed of 33½ rpm, the spiralling pitch will be reduced in proportion to the speed change.

A high quality, 36 power, Spencer microscope is furnished for observing the grooves. The microscope has a calibrated eyepiece having 50 divisions of .001 inch and is mounted on an adjustable arm which permits it to be moved to any part of the record. On the same arm is mounted a small shielded lamp which is independently adjustable so as to illuminate the grooves under observation.

Playback provisions are made by a removable plate on the recorder base for mounting an MI-11871 Universal pickup and arm. A receptacle in the base is already connected to the terminal board. The entire recording mechanism is isolated from room vibration by rubber mounts. A removable plate, placed over the pulleys on the left side of the machine, permits ready access to the driver pulleys and driver motors for servicing. Terminal boards are provided on the front and on the rear of the recorder base for a-c and audio connections respectively. The entire mechanism is furnished with an attractive and substantial wooden apron.

The 73-B is supplied with adjustable suction nozzle attached to the carriage mechanism. The newly designed suction pump (MI-11857) and accompanying chip collector and hose (MI-11858) are available as accessories. For a complete and detailed description, refer to the catalog page for this equip-

ment. Also available is the advance ball kit (MI-11851) for use with the MI-11850-C Recording Head when making wax recordings.

Provision has been made for convenient installation of the MI-11100 Automatic Equalizer. This was designed to compensate for the variations in recording level, resulting from changes in the surface speed of the record.

The MI-11827 Recorder Base Cabinet has been specifically designed to offer an attractive and practical base cabinet to accommodate the 73-B Recorder. The recording cabinet is substantially constructed with a robust adjustable interior shelf for accommodating transcriptions, recordings, etc. The top is composed of 1" solid wood with no possibility of introducing rumble. The door and top are finished in dark umber gray with the sides in light umber gray to blend with all other RCA broadcast equipment.

## Specifications

Recorder Head Impedance (MI-11850-C High Fidelity Head)	15 ohms nominal	
Frequency Response	±2 db, 30-10,000 cps	
Sensitivity: (Groove velocity 6.3 cm/sec., .00079"		
(peak to peak) at 1000 cps)	+30 dbm (1.0 watt)	
Stylus	Sapphire or steel	
Turntable Diameter (handles blanks up to 18¼" dia. and up to ⅜" thick)	17½"	
Turntable Drive	Rim driven through rubber idler rollers from two hysteresis synchronous motors	
Turntable Speed (accuracy ± ½%)	33½ or 78 rpm	
Speed Regulation (wows)	0.14% rms at 33½ rpm 0.07% rms at 78 rpm	
Recording Direction (adjustable)	Inside-out and Outside-in	
Recording Pitch	Continuously variable 96 to 152 lines per inch with detents provided in steps of 8 lines per inch	
Dimensions, overall	<i>With Cabinet</i>	<i>Less Apron</i>
Height	20"	20"
Width	31¾"	30"
Depth	22¼"	20½"
Height to Top of Base	10½"	10½"
Weight (unpacked)	289 lbs.	
Finish	Light umber grey wrinkle with dark umber grey trim. Apron finished with smooth dark umber grey. All control knobs and levers are polished nickel.	
A-c Power Supply, 115 volts 50-60 cycles—		
Turntable drive motors	80 watts	
Pilot Light	5 watts	
Spiralling Motor (when operating)	145 watts	
Stock Identification	60 cycles, MI-11825/11850-C 50 cycles, MI-11826/11850-C	

## SPECIFICATIONS FOR MI-11827 BASE CABINET

Dimensions:	
Height (overall)	2' 8½"
Width	2' 9"
Depth	1' 11½"
Thickness of Top	1"
Weight	85 lbs.
Stock Identification	MI-11827

## Accessories

Automatic Equalizer	MI-11100-A
Othacoustic Equalizer	MI-4916-A
Suction Equipment	MI-11857
Spare Chip Collector and Hose Assembly	MI-11858
Sapphire Stylus	90° MI-4878-BC 70° MI-4842
Amplifier (BA-14A)	MI-11234
Additional High Fidelity Recording Head	MI-11850-C
Standard Cutter Head	MI-11853
Advance Ball Kit for MI-11850-C Recording Head	MI-11851



MI-11827 Recorder Base Cabinet with 73-B Recorder



# SMOOTH, VERSATILE CONTROL

73-B, DUAL-MOTOR RIM-DRIVE PROVIDES HIGH TORQUE, EXCELLENT REGULATION

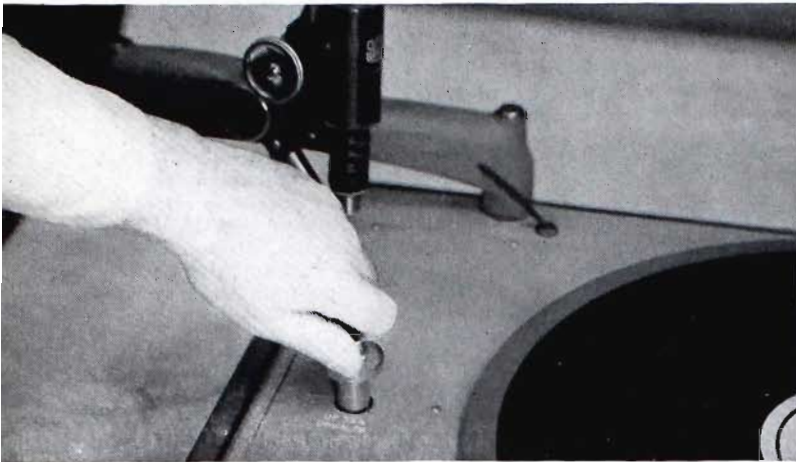

**SPEED-CHANGE** is simply accomplished by operating the control knob shown here. "UP" is  $33\frac{1}{3}$  RPM—"DOWN" is 78 RPM.

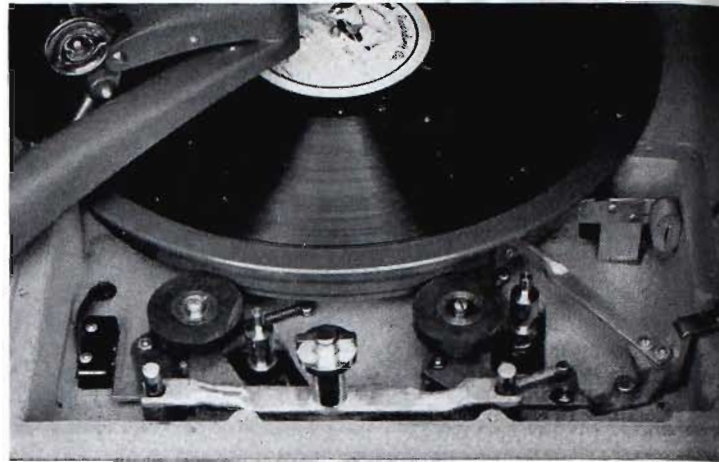

**OFF-78 RPM**—In the "OFF" position a brake shoe is applied to the turntable rim, and rubber idlers are moved away from both the drive wheel and turntable rim.



**A SINGLE "OFF-ON"** lever controls both synchronous turntable drive motors. In "OFF" position, a brake brings turntable to quick stop.

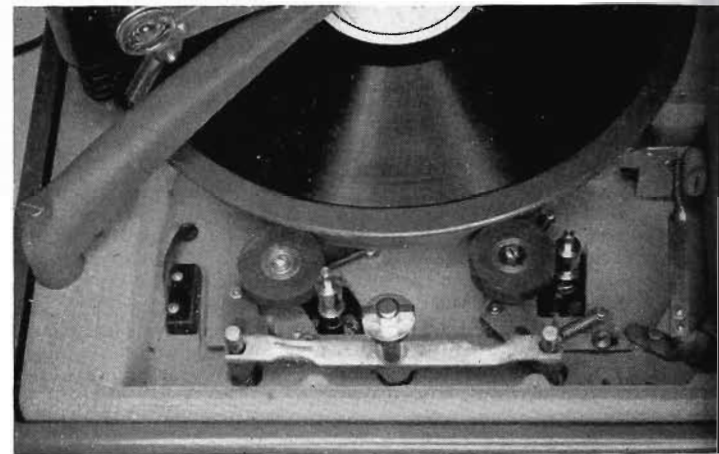

**ON-78 RPM**—In "ON" position, the brake shoe moves away from turntable rim and rubber idlers are now in active contact with drive wheel and turntable rim.

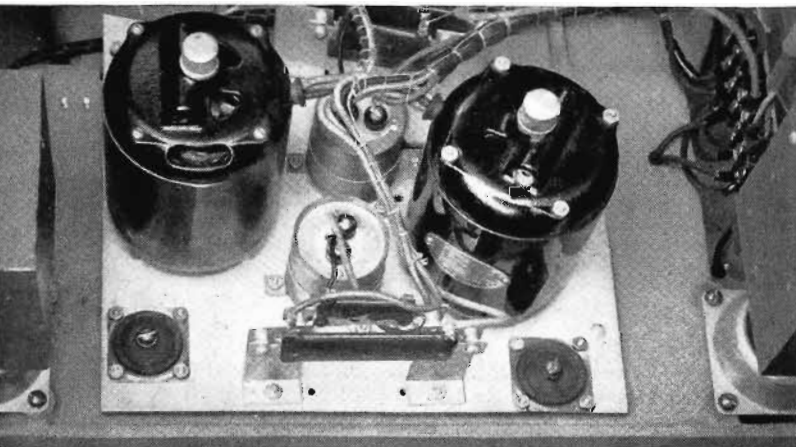

**TWO SYNCHRONOUS MOTORS** hysteresis type, are coupled to wheels which rim-drive the turntable through sturdy, rubber-idler rollers.

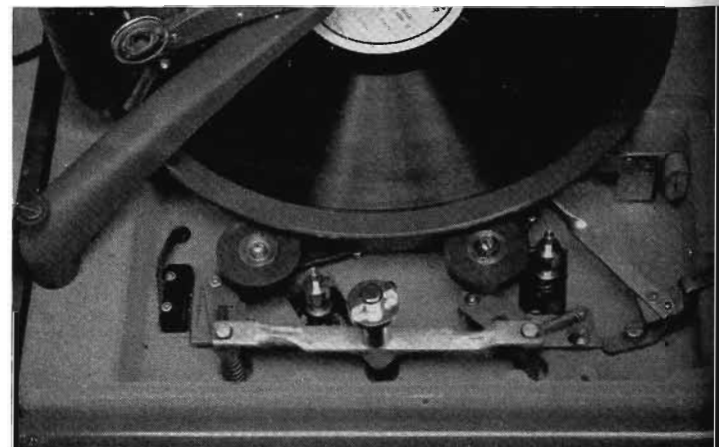

**AT- $33\frac{1}{3}$  RPM**—With speed change knob "UP," rubber idlers are moved vertically to low-speed position of drive wheel (note drive wheel has "lo- and hi-speed" shoulders of different diameters).



# HIGH-QUALITY RECORDINGS

RECORDING PROCEDURE IS SIMPLE AND EASY TO PERFORM

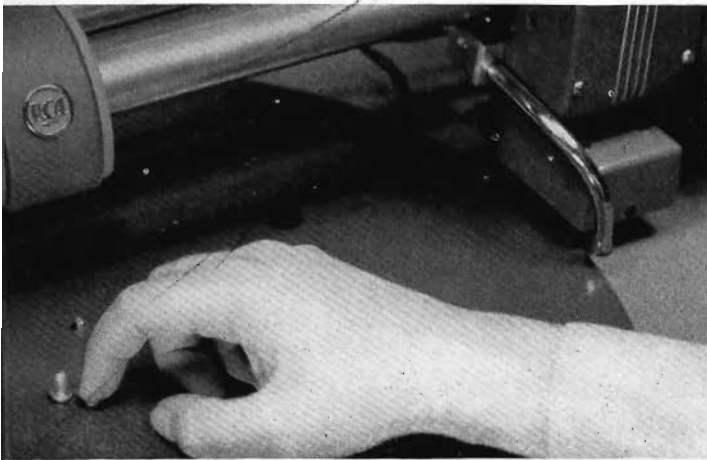

**RECORD-DRIVE PIN** comes up into position when this trigger-release button is pressed. Pin sinks into platter for records without driving holes.

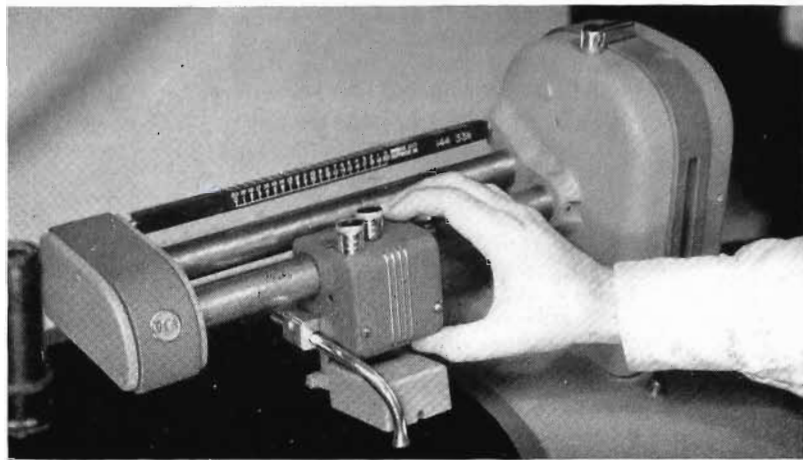

**CARRIAGE LEVER** is being pressed to allow movement of recorder-head horizontally over the record to desired "cutting" position.



**ANY TYPE BLANK** may be used with the single driving pin provided. Here, recording blank is placed in position.



**RAISING AND LOWERING** the cutter head is easily done by this lever which permits raising the "to rest" position or a gentle lowering to the recording position.

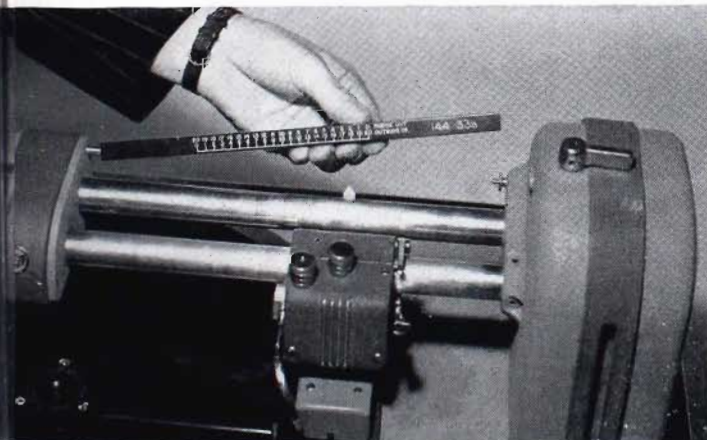

**CALIBRATED TIME SCALES** for 96, 104, 112, 120, 128, 136, 144 and 152 ("inside-out," "outside-in," at  $33\frac{1}{3}$  or 78 rpm are provided. Here, proper scale to agree with "pitch" setting is inserted.

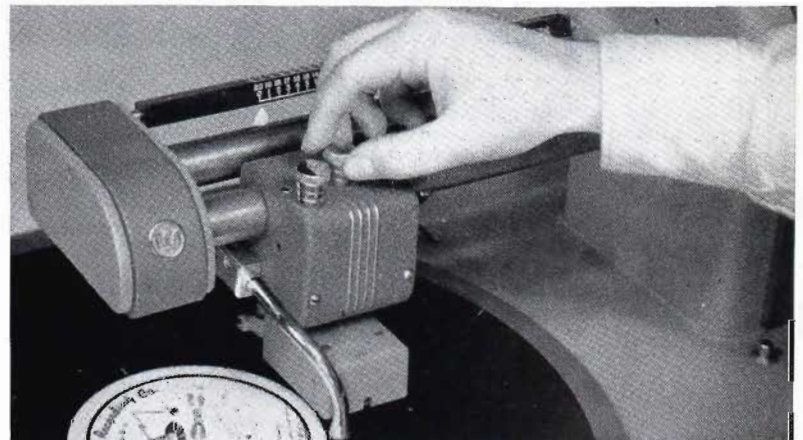

**ANGLE AND DEPTH OF CUT** are conveniently and precisely controlled by the two knobs atop the carriage. (In above, angle of cut is being adjusted.)

# RS-1A Recording Suction Equipment

## Features

- ¼ h.p. motor—insuring adequate suction for two recorders.
- Reduces fire risk to a minimum.
- Motor maintains constant temperature.
- Chip collector eliminating pump failure.
- Motor may be isolated from recording room.

## Description

This equipment is a new development by RCA and has been designed to use the most efficient method of removing acetate shavings from the record surface during the cutting of recordings. The suction apparatus is a high grade, rotary vane type pump, driven by a ¼ HP. Repulsion Start, Single Phase Motor. The unit is ruggedly constructed and mounted on shock dampening rubber cushions. A 10 foot length of tubing with a "Y" connector provides the suction outlet for one or two recorders. The chip filter and water jar insure that all chips removed are absorbed in the water and cannot foul the suction pump. This equipment is a combination of the following:

### MI-11857

- One Suction Equipment
- One 10' Length of Black Rubber Tubing 1" ID
- One "Y" Branch Connector
- Two Couplings and Caps
- One Reducer Bushing

### MI-11858

- One Chip Collector and Hose Assembly
- Two 6' Lengths of Black Rubber Tubing ¾" ID

If the user desires to place the suction apparatus remote from the recorder, 1" tubing which introduces a negligible loss of suction is recommended. As the majority of loss occurs in the ¾" diameter house, the length of this link should be kept to a minimum. When the apparatus is used with two recorders, an additional MI-11858 chip collector and hose assembly is necessary.

## Specifications

Power Supply \_\_\_\_\_ 115 volts, 50/60 cycles, approx. 450 watts

Dimensions (overall of suction equipment):

Length _____	15"
Width _____	16"
Height _____	10¾"
Weight _____	75 lbs.

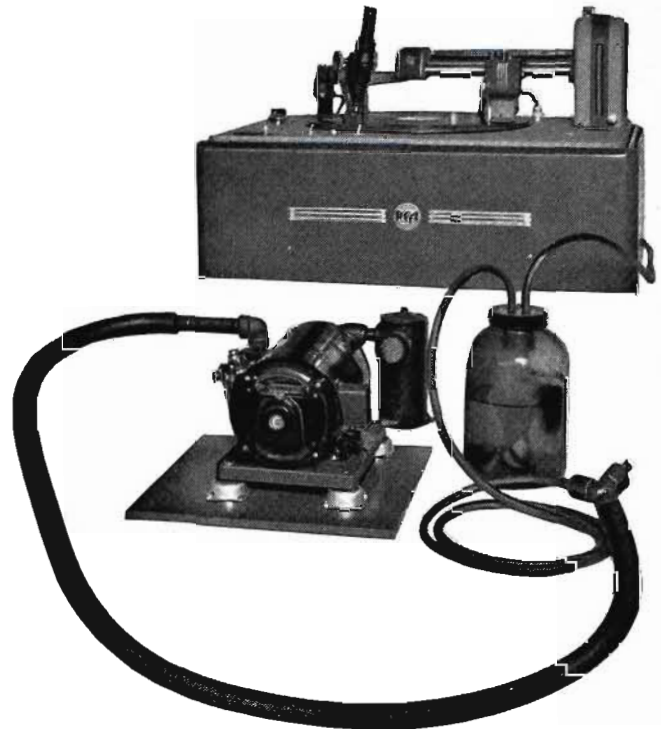

Normal operating temperature \_\_\_\_\_ 130-160°F.  
 Maximum vacuum for continuous operation \_\_\_\_\_ 8" mercury  
 Stock Identification:

RS-1A Equipment (complete for use with one recorder) \_\_\_\_\_  
 MI-11857/11858

## Accessory

Extra Chip Collector and Hose Assembly \_\_\_\_\_ MI-11858  
 (For use with two recorders)

# Microscope, Type MI-4928

The MI-4928 is a high quality, 36 power Spencer Microscope and Arm Attachment for recorders. It permits close examination of the cutting needle to determine its condition and allows inspection of individual recording grooves for determining the noise level, quality and depth of cut.

The microscope has a calibrated eyepiece having 50 divisions of .001 inch and is mounted on an adjustable arm which permits it to be moved to any part of the record. On the same arm is mounted a small shielded lamp which is independently adjustable so as to illuminate the grooves under observation. The microscope is shipped complete with lens tube assembly, transformer for the microscope lamp, necessary mounting screws and installation instructions.

## Specifications

Dimensions:

	Microscope Unmounted	Overall with Microscope Mounted on Arm	Microscope Light Transformer
Height _____	7¾"	9"	2 7/16"
Width _____	3"	3"	2 5/16"
Depth _____	2⅝"	2⅝"	2 7/32"

Finish:  
 Microscope \_\_\_\_\_ Finished instrument black  
 Arm \_\_\_\_\_ Light umber gray  
 Weight (unpacked less trans-  
 former) \_\_\_\_\_ 7½ lbs.  
 Transformer \_\_\_\_\_ 1 lb.  
 Stock Identification MI-4928

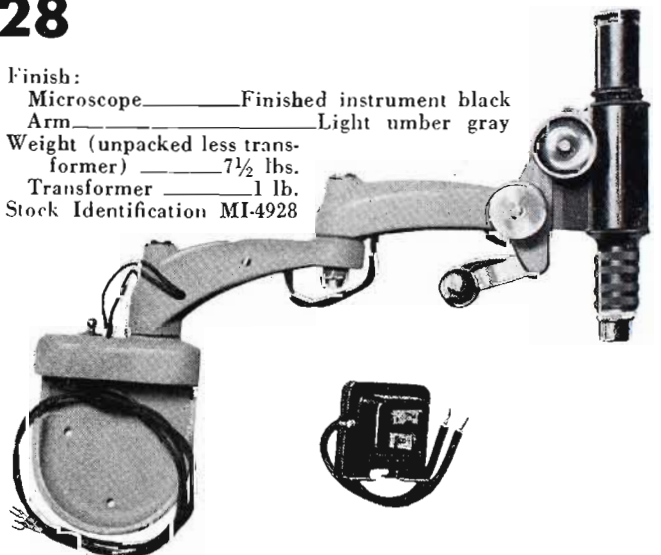



# High Fidelity Recording Head, MI-11850-C

## Features

- Meets all high fidelity requirements.
- Does not depart from an "ideal response" by more than  $\pm 2$  db 50-10,000 cps.
- Response independent of ambient temperatures.
- Precision built.
- Self-contained heater.

## Uses

The MI-11850-C High Fidelity Recording Head has been specially designed for the user who demands high fidelity recordings. It was primarily produced for use with the 72-DX Recording Attachment, 73-B Professional Recorder and the OR-1A Portable Recorder.

## Description

The High Fidelity Head is a high quality professionally built and accurately adjusted unit of the magnetic type. Physically, the head consists of a cobalt-alloy permanent magnetic, laminated pole pieces, a driving coil, an armature, and dampening material assembled in an attractive case. The armature is supported on knife-edge bearings and held in position by a steel centering spring. Its flat type construction allows the head to

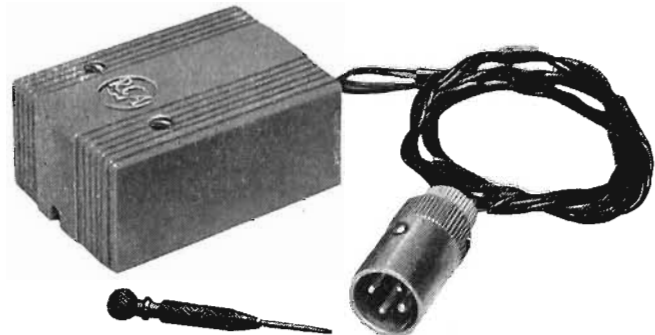

lie in a lateral plane, thus eliminating flutter without the need for special dampening mechanism. Connections are made through a four-pin plug. Any discrepancies that might be created by temperature variations are eliminated by a self-contained heater and thermostat. The power for the heater operation is obtained from an MI-11855-A Heater and Compensator Kit. A small screwdriver is provided to fit the stylus setscrew.

## Specifications

Input Impedance (with compensator)	15 ohms
Frequency Response	$\pm 2$ db 50 to 10,000 cps
Sensitivity (groove velocity 6.3 cm/sec., .00079" (peak to peak) at 1000 cps)	+30 dbm (1.0 watt)
Stylus	Sapphire or steel
Dimensions:	
Height	1 3/4"
Width	2"
Length	3 3/4"
Weight	10 1/2 oz.
Finish	Light amber gray
Stock Identification	MI-11850-C

## Accessories

Heater and Compensator Kit	MI-11855-A
Stylus Sapphire 90°	MI-4878-BC
Stylus Sapphire 70°	MI-4842

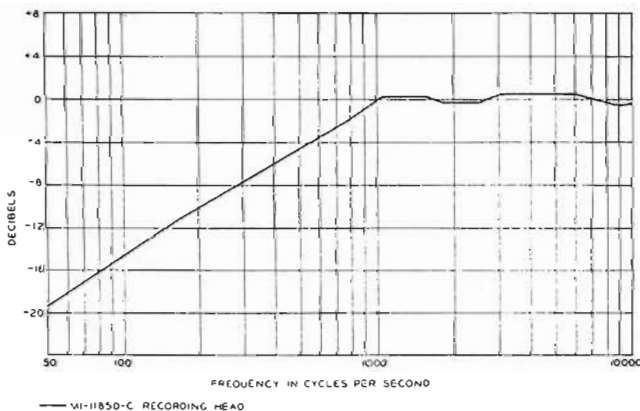

# Heater and Compensator Kit, MI-11855-A

This kit was specifically design for use with an MI-11850-C High Fidelity Recording Head. This maintains the operating temperature at a constant value, rendering the response of the recorder head independent of ambient temperature. The temperature is held at approximately 95° F. by means of a thermostatically controlled heater mounted in the recorder head. The kit consists of the following components: heater transformer, pilot light assembly complete with bulb, 3 position switch, a 7 ohm 5 watt resistor, a dial plate reading "High", "Low" and "Off", and a Cannon X-4-13 Receptacle. Connections are made through this receptacle.

Mounting facilities are provided for 70-C and 70-D series of turntables and OR-1A portable recording equipment.

This kit is an integral part of the MI-11850-C Recording Head and should be ordered as an accessory except when used with Type 73-B Recorders, where this kit is self-contained.

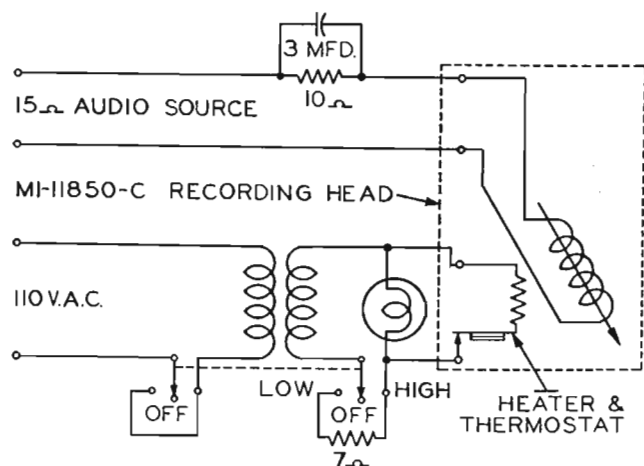

MI-11855-A HEATER & COMPENSATOR

# Recording Filter, MI-4916-A

## (Orthacoustic)

The MI-4916-A recording filter was designed to provide the most desirable reproduction characteristic for turntables as set forth by NAB standards for lateral transcriptions. This filter was primarily designed for use with an MI-11850-C and MI-4887 high fidelity recording head to give this orthacoustic response characteristic.

The filter may also be employed with the MI-11853 standard recording heads with an excellent frequency response. However, with the MI-11853 recording head, the frequency response about 7500 cps will be slightly lower due to the lower frequency response of this head. This unit may be mounted on a BR-2A or 36-B panel and shelf assembly.

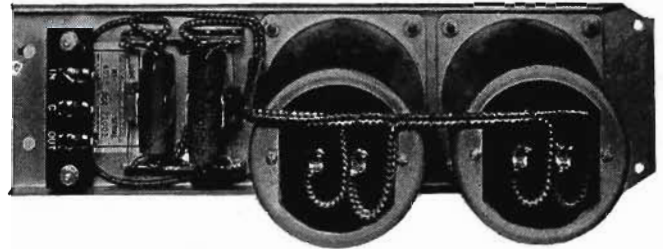
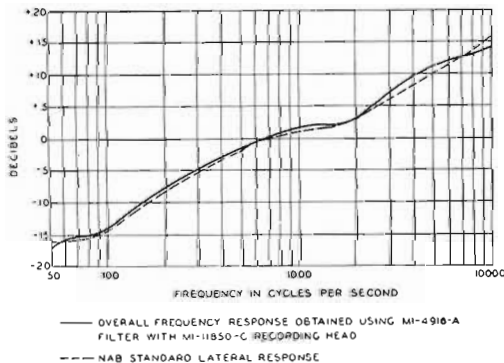

### Specifications

Input Impedance (unbalanced)	_____	250/600 ohms
Output Impedance (unbalanced)	_____	250/600 ohms
Insertion Loss		
(Operating from a 600 ohm source into a 250 ohm load at 400 cps)	_____	16 db
(Operating from a 600 ohm source into a 600 ohm load at 400 cps)	_____	10.5 db
Maximum Input Level	_____	+20 dbm
Hum Pickup Level (when placed 6" or more from a power transformer)	_____	Less than -120 dbm
Dimensions:		
Height	_____	4 $\frac{3}{4}$ "
Width	_____	3 $\frac{9}{16}$ "
Length	_____	12 $\frac{5}{8}$ "
Weight (unpacked)	_____	6 $\frac{1}{2}$ lbs.
Stock Identification	_____	MI-4916-A

# Automatic Recording Equalizer, MI-11100-A, MI-11101-A

### Description

The automatic recording equalizer is another addition to RCA equipment developed to contribute toward raising the standards of producing records and transcriptions. The equalizer is designed to compensate for the variation in recording level due to changes in surface speed of the recorder blank relative to the stylus. Without this compensation, the recording level due to the speed change would be of a lower level at the higher frequencies near the center of the record than they would near the periphery. The MI-11100-A is for use with type 73-B professional recorders and the MI-11101-A is for use with the 72D/72DX recording attachments. Fundamentally the two equalizers have the same equalization characteristics and differ only in the mounting facilities and the external connections. The equalizer consists of fixed capacitors, introduced by a switch, and a series of ten resistors, varied by a spring-tipped contact pin, riding with the recorder head carriage. The equalizers both contain a five-position switch to select the desired degree of equalization. Suitable hardware is included.

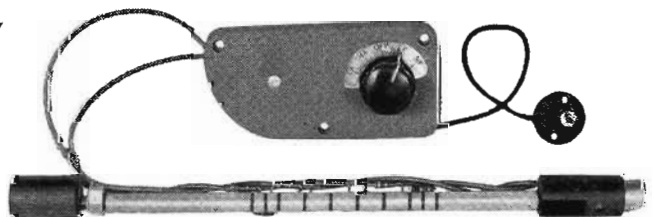

### Specifications

Impedances:		
Source	_____	600 ohms
Input	_____	Approx. 600 ohms
		(depending on compensation and frequency)
Load	_____	Unloaded transformer
Output	_____	Approx. 600 ohms
		(depending on compensation and frequency)
Insertion Loss (at low frequencies)	_____	22 db
Operating Level	_____	-40 db to +20 db
Weight (unpacked, less cords and plugs)	_____	12 ozs.



## Standard Recording Head, MI-11853-A

The MI-11853-A Recording Head is available to broadcasters who demand a good quality, low priced recording head for applications where the high fidelity response of the MI-11850-C is not required.

The physical construction of this head is similar to the MI-11850-C, possessing the feature of eliminating flutter without using special dampening material. The MI-11853-A is standard equipment with the 72-D Recording Attachment, the OR-1A Portable Recorder and may also be used with the 73-B professional recorder. The case is composed of durable, molded "Urea" with screws for mounting on all RCA type recording attachments. A 28" two wire, "Vinylite" insulated cable is provided for external connections.

### Specifications

Frequency Response \_\_\_\_\_  $\pm 3$  db, 50 to 7500 cycles  
 Input Impedance (recording head and compensating resistor) \_\_\_\_\_ 15 ohms nominal  
 Sensitivity [Groove velocity of 6.1 cm/sec. for a stylus excursion of .00077" (peak to peak) at 1000 cps] \_\_\_\_\_  $+ 28$  dbm



Stylus \_\_\_\_\_ Sapphire or steel  
 Method of External Connection \_\_\_\_\_  
 Two-wire "Vinylite" insulated 28" long

Dimensions  
 Height \_\_\_\_\_ 1 1/8"  
 Width \_\_\_\_\_ 2"  
 Length \_\_\_\_\_ 2 7/8"  
 Finish \_\_\_\_\_ Dark umber gray  
 Weight \_\_\_\_\_ 7 3/4 ozs.  
 Stock Identification \_\_\_\_\_ MI-11853-A

## Advance Ball Kit, MI-11851

The MI-11851 Advance Ball Kit has been designed for use in conjunction with the MI-11850-C Recorder Head. It serves to control accurately the depth of groove when the cutter head is used with soft recording materials. The Advance Ball Kit is essential when recording on wax and some operators find it convenient for use with lacquer recordings when mechanical vibration is present.

The Advance Ball is a sapphire cylinder with a tip that has been highly polished to a spherical shape and mounted in a Duralumin shank. The Ball rests on the unrecorded portion of the record surface, supporting the head at a constant height above the record, so that the depth and width of the groove will remain constant. An adjusting knob on top of the head adjusts the vertical position of the Advance Ball to regulate the depth of cut. Provision is made for moving the Advance Ball to either side of the stylus to accommodate outside-in or inside-out cuts as desired.

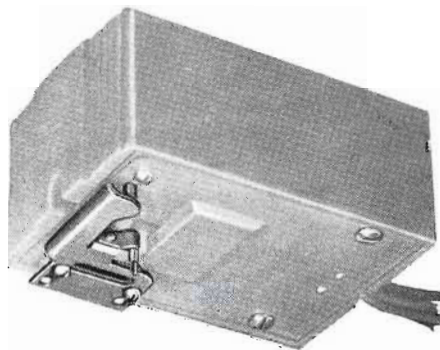

### Specifications

Dimensions, overall, approximate  
 Height \_\_\_\_\_ 1/4"  
 Width \_\_\_\_\_ 1 1/2"  
 Depth \_\_\_\_\_ 1"  
 Weight, approximate \_\_\_\_\_ 10 grams  
 Finish \_\_\_\_\_ White nickel  
 Stock Identification \_\_\_\_\_ MI-11851

## Cutting Styli

The MI-4842 Sapphire Stylus with 70° angle and short shank is recommended for use with RCA recorders when cutting lacquer blanks for immediate playback and cutting masters for processing. The 90° stylus is recommended only for use in cutting masters from which 10" and 12" commercial pressings are to be made. Long shank styli are no longer stocked by RCA since their use impairs the recorder frequency response beyond 8000 c.p.s. and a rather severe peak may develop in this region.

The use of a sapphire stylus is recommended for all recordings except unimportant tests. Initial cost is reasonable and the moderate charge for sharpening brings the cost per minute

of recording equal to or below that for steel cutting points. Steel cutting points may be used with RCA recorders for unimportant tests or for cuttings being made by inexperienced personnel. In general, steel cutters are not recommended for high fidelity work because they may produce a higher noise level, a reduced frequency range and their life is relatively short.

### Stock Identification

70° Sapphire Stylus (short shank) \_\_\_\_\_ MI-4842  
 90° Sapphire Stylus (short shank) \_\_\_\_\_ MI-4878-BC



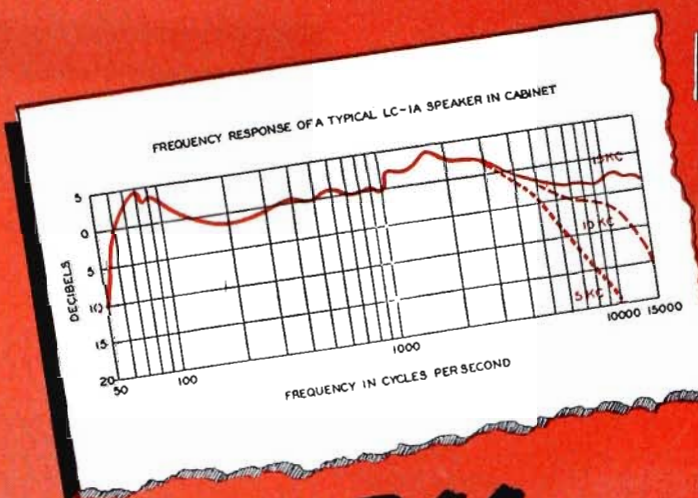

# True FM Response

FOR CONTROL ROOMS... OFFICES...  
AND HOME MONITORING

## ...with the new RCA LC-1A Duo-Cone Speaker



The RCA LC-1A speaker is expressly designed for monitoring FM programs and high-fidelity recordings in broadcast stations. Its response is exceptionally free from distortion—over the full FM range. Read these highlights:

**Uniform response, 50 to 15,000 cycles.** Audio measurements prove RCA's new speaker free from resonant peaks, harmonic and transient distortion... at all usable volume levels.

**120 degrees radiation at 15,000 cycles!** The LC-1A is unique in its ability to project a wide cone of radiation through a constant angle of 120 degrees. And frequency response is uniform throughout! Advantages: It eliminates the familiar sharp peak of high-frequency response usually present in other systems. And exact location of the LC-1A in control or listening rooms is not critical.

**Remarkably smooth crossover-response.** Both cones are mounted on the

same axis and have the same flare angle to place their surfaces in line. Thus the possibility of undesirable interference between H-F and L-F units over the crossover range is eliminated.

**Controlled "roll-off" at 5 and 10 kc.** Because of the LC-1A's exceptional high-frequency response, the surface noise and high-frequency distortion present in many recordings is accentuated. Therefore, a panel-mounted switch is provided to control and restrict the LC-1A's high-frequency range for this type of program material (see response curve).

Two fine LC-1A bass-reflex cabinets (optional) are designed to match the Duo-Cone speaker. One is finished in the familiar RCA two-tone gray. The other is finished in dark walnut.

For data and further details on Duo-Cone speakers... now in production... write Dept. 23-C.

**DETAILS OF RCA DUO-CONE DESIGN**

Two individually actuated cones are mounted on the same axis and flare angle, with a specially designed heavy Alnico magnet of high flux density. The high-frequency unit is a 2 3/8" cone with an exceptionally low-mass aluminum voice coil. This cone follows out the shallow angle of the larger cone to radiate a pattern at full power over an area of 120 degrees at 15,000 cycles! The low-frequency unit has a massive 15" diaphragm with a high-mass voice coil of large diameter. Its resonant frequency, only 35 cycles... with true bass response at all volume levels.

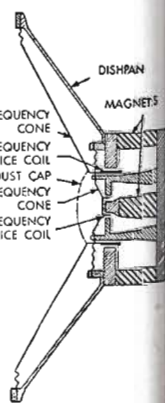



# RCA LOUDSPEAKERS

RCA offers to broadcasters a complete line of studio and station monitoring loudspeakers for use in monitoring and auditioning booths, hallway installations, talk-back applications, elevators and executives' offices. All RCA loudspeakers are designed to handle adequate power for the particular application for which they are designed. The LC-1A, representing the greatest advance in loudspeaker fidelity, is obtainable in a choice of cabinet styles and finishes, thereby making it possible to conform to any of several interior decorating schemes. In addition, the LC-1A speaker mechanism may be obtained by itself for those applications where it is desirable to use a special type, or custom-made, mounting.

In order to serve the vast multitude of miscellaneous needs for loudspeakers around broadcasting stations, there is also included in this line a choice of three permanent-magnet loudspeaker mechanisms. These mechanisms are intended to be mounted in one of the wall-mounting speaker housings, MI-13225 or MI-6106. The three loudspeaker impedance matching transformers, MI-12370, MI-12371, and MI-12373 are designed for these and many other types of loudspeakers. The quick-or for coupling any of a wide variety of outputs to these and many other types of loudspeakers. The quick-selection chart given below provides for design engineers a quick, convenient reference by means of which they can select the RCA loudspeakers best suited to their particular requirement.

## LOUDSPEAKER DATA

<i>Identification</i>	<i>Voice Coil Impedance (ohms)</i>	<i>Power Handling Capacity (watts)</i>	<i>Weight (lbs.)</i>	<i>Cone Dia. (inches)</i>	<i>Bolt Circle Dia. (inches)</i>	<i>Freq. Range (CPS)</i>
LC-1A	15	20	21 (mechanism only)	15 $\frac{1}{4}$	16 $\frac{1}{4}$	50-15000
MI-12421	2	10	4 $\frac{1}{2}$	11	11 $\frac{7}{8}$	50-8500
MI-6234-B	6	5	2 $\frac{1}{4}$	5 $\frac{3}{4}$	6 $\frac{1}{8}$	70-7000
MI-6333-C	6	25	6 $\frac{3}{4}$	10 $\frac{8}{32}$	9 $\frac{5}{8}$	60-7000

# Monitoring Speaker, Type LC-1A

## Features

- Excellent frequency response, uniform 50-15,000 cps.
- Wide angle sound radiation of all frequencies.
- Tastefully styled cabinet.
- Low non-linear distortion.
- Ideal for monitoring AM-FM television programs.
- High grade Alnico V magnets.

## Uses

The LC-1A is a high fidelity loudspeaker with a low distortion, wide angle distribution, of extended frequency range, and specifically designed for the broadcaster and recording studios.

The fundamental principles are based upon extensive loudspeaker research and development performed by Dr. Olson at RCA Laboratories (Princeton).

For applications where it is desired to mount the mechanism on a wall baffle, ceiling, etc., the speaker may be used with assurance that the entire frequency range will be realized. The speaker's outstanding performance makes it ideal for the full frequency range of FM. The LC-1A is also being used with RCA's new "Festival" series of high quality custom-built home receivers.

## Description

The LC-1A is a duo-cone speaker mechanism of the direct radiated type, consisting of high and low frequency units mounted co-axially together. The 2" high frequency cone and the aluminum wound voice coil has a low mass utilizing the wide angle of the shallow, low frequency cone, to effect its remarkable directional pattern (see curve). An equilibrium has been reached between the electrical and mechanical design to impart a high frequency radiation of 120° arc with a loss of approximately 6 db at 15,000 cps. This eliminates the conventional "beam effect" usually experienced at this frequency.

The low frequency cone employs a 15" diaphragm with a high mass voice coil and produces the most desirable directional pattern with a handling capacity of 20 watts. Low distortion has been accomplished by a carefully designed compromise of many contributing factors. Distortion usually experienced when handling large power in the 100-1,000 cycles range is eliminated by using a high mass coil and a massive rigid cone, coupled with a low fundamental frequency peak of 35 cycles. Above this frequency, the reluctance due to the suspension system of the cone does not appreciably affect the velocity and, therefore, minimizes distortion.

The cross-over network utilizes the physical disposition of the cones to mutually vibrate in unison over the cross-over frequency region and merely employs one capacitor in the high



frequency unit to limit the current flowing at the low frequencies. When program material containing a large distortion factor is prevalent, such as worn records, etc., an MI-11707 high frequency compensator producing curves with a "roll-off" at 5, 10 and 15 kc, is available to restrict the high frequency range. The LC-1A is supplied with or without cabinet and is ideally suited for mounting in the wall or ceiling of the control room, giving a uniform response of 50 to 15,000 cycles. The cabinet was specifically designed for this speaker and is attractively styled in two finishes—two-tone umber gray with a satin chrome trim to blend with all RCA studio equipment, and a rich walnut veneer for use in finely finished listening booths. This cabinet is particularly designed for high fidelity loudspeakers and is constructed with a fixed port to give maximum response in the low frequencies. Accommodation for the BA-4 series of monitoring amplifiers is provided. A brushed-chrome panel on the side of the cabinet will accommodate a volume control, 5/10/15 kc high frequency compensator, 10 channel selector switch, an "off-on" amplifier switch with a visual indicator.

With an MI-11708, 15 ohm attenuator, the speaker will operate from a speaker buss, or with an internal amplifier and selector switch, will function as an independent unit and will bridge any of ten speaker channels. The desired ordering arrangement is obtained by consulting the stock identification accessories.





*LC-1A Speaker Mechanism*

**Specifications**

**LC-1A SPEAKER MECHANISM**

Impedance (nominal) \_\_\_\_\_ 15 ohms  
 Frequency Response (see curve) \_\_\_\_\_ 50-15,000 cps  
 Directional Characteristic \_\_\_\_\_ See curve  
 Power Handling Capacity \_\_\_\_\_ 20 watts  
 Non-linear Distortion (for 10 watt output, 50-15,000 cycles)  
 Less than 4% at 60 cycles  
 Weight (unpacked) \_\_\_\_\_ 21 lbs.

**Dimensions:**

Diameter (cone) \_\_\_\_\_ 15 $\frac{5}{16}$ "  
 Diameter (bolt fixing circle) \_\_\_\_\_ 16 $\frac{1}{4}$ "  
 Diameter (overall frame) \_\_\_\_\_ 17"

**LC-1A CABINET**

**Dimensions:**

Height \_\_\_\_\_ 40 $\frac{5}{8}$ "  
 Width \_\_\_\_\_ 27 $\frac{1}{2}$ "  
 Depth \_\_\_\_\_ 15"  
 Weight \_\_\_\_\_ Approx. 50 lbs.

**Stock Identification:**

- LC-1A Speaker, cabinet complete with BA-4C monitor amplifier, volume control, high frequency filter unit 5 kc, 10 kc, and 15 kc, 10-position channel selector switch, and an on-off switch with a visual indicator (less tubes for amplifier) \_\_\_\_\_ MI-11411/11401/MI-11711/11223-B
- LC-1A Speaker and Cabinet \_\_\_\_\_ MI-11411/11401
- LC-1A Duo-cone Loudspeaker Mechanism only \_\_\_\_\_ MI-11411
- LC-1A Speaker Console Cabinet Only (Umber Gray) \_\_\_\_\_ MI-11401
- LC-1A Speaker Console Cabinet Only (Walnut) \_\_\_\_\_ MI-11401-A

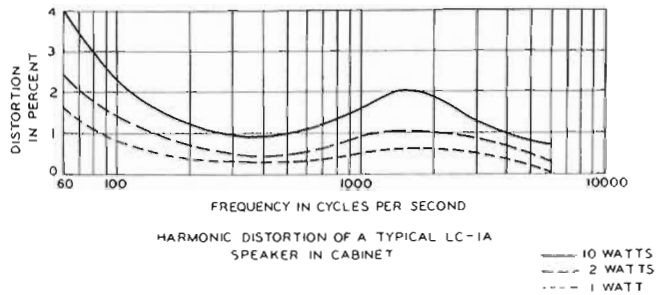
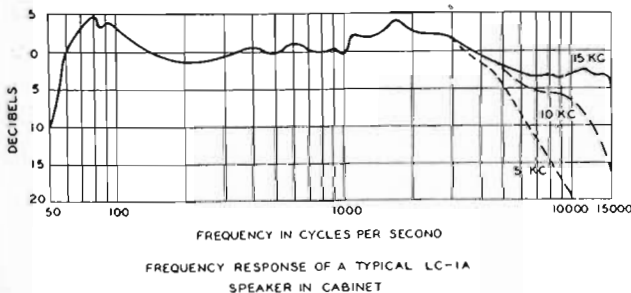

**Accessories**

- Speaker Filter Unit \_\_\_\_\_ MI-11707  
 (This item is included in both cabinets, MI-11401 and MI-11401-A, but is necessary if a high frequency filter is desired when the speaker only is ordered. This unit includes a filter switch and an escutcheon plate reading 5 kc, 10 kc, and 15 kc.)
- Speaker Power Attenuator, 15 ohms \_\_\_\_\_ MI-11708-A  
 (This is necessary when the audio source is fed externally through a buss bar, etc. This is mounted on the speaker cabinet escutcheon.)
- Speaker Accessory Kit \_\_\_\_\_ MI-11711  
 (This kit contains a 10 position channel selector switch, "on-off" switch with visual indicator and necessary hardware for mounting BA-4C amplifier.)

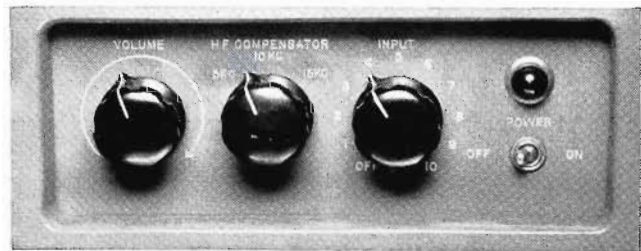

*Close-up of control panel of LC-1A showing controls for MI-11707, MI-11708, and MI-11711*

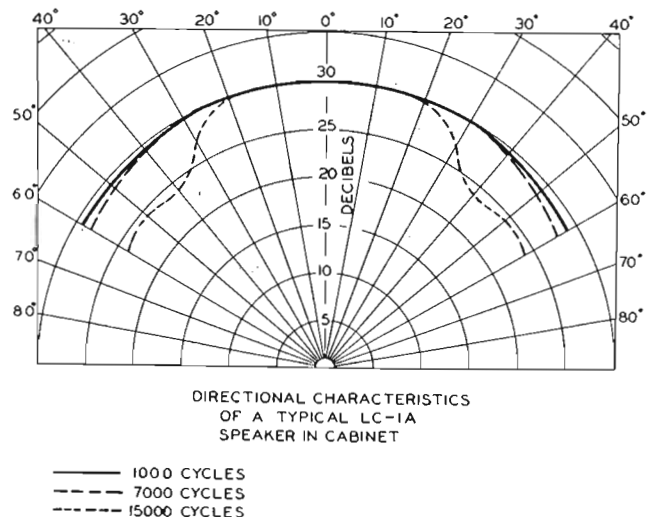

# Wall Speaker Housing, MI-13225

## Description

The MI-13225 wall speaker housing is constructed of special molded material, with excellent acoustical properties. The exterior has an attractive appearance of rich brown Morocco-grain leather. The sloping front provides for maximum radiation in all directions. Mounting bolts in the housing facilitate a secure and easy speaker installation. This speaker housing was specifically designed to accommodate the MI-6234-B accordion speaker with adequate space for the MI-12371 or MI-12373 transformer. Mounting hardware and terminal strip for the speaker leads are provided.



## Specifications

Dimensions (exterior):

Height \_\_\_\_\_ 17"  
 Width \_\_\_\_\_ 13"

Depth \_\_\_\_\_ 5½" maximum  
 Stock Identification \_\_\_\_\_ MI-13225

# Molded Speaker Housings, MI-6106, and Adaptor, MI-13245

## Description

These speaker housings are available for use with MI-12421 speakers. MI-6106 housings may also be used with MI-6333-C (10" speakers) when insert adaptor MI-13245 is employed. These molded fiber wall baffles are particularly suitable for all internal installations and are handsomely finished in "moulded-in" walnut-grained bakelite with a gray and silver grill cloth. The front of the housing has a 10° slope, giving good sound radiation characteristics. The baffle board attached to the housing permits the speaker to be securely installed and eliminates vibration. Speaker mounting bolts for either speaker render speaker installation an easy operation. Wall mounting brackets and associated hardware complement each housing.



## Specifications

MI-6106 plus Adaptor, MI-13245 for 10" PM Speaker MI-6333-C  
 MI-6106 \_\_\_\_\_ for 12" PM Speaker MI-12421

Dimensions:

Length \_\_\_\_\_ 23"  
 Width \_\_\_\_\_ 17¾"  
 Depth \_\_\_\_\_ .8" (top)



# Permanent Magnet Loudspeaker Mechanisms

## Speaker Mechanism, MI-12421

### Description

The MI-12421 is a 12" permanent magnet type speaker using an Alnico magnet and suitable for all general purpose applications. The cone is constructed in one piece, effecting a superior response to the lapped type of cone. The voice coil assembly is supported by an adjustable centering device. The speaker gives a good frequency response and has a power handling capacity of 10 watts. The MI-6106 speaker housing is recommended for use with this speaker.

### Specifications

Frequency Range \_\_\_\_\_ 50-8500 cycles  
 Power Handling Capacity \_\_\_\_\_ 10 watts  
 Voice Coil Impedance \_\_\_\_\_ 2 ohms  
 Transformer Primary Impedances  
 1000-2000-4000-8000-16,000 ohms



Overall Diameter \_\_\_\_\_ 12 19/64"  
 Weight (unpacked) \_\_\_\_\_ 4 1/2 lbs.  
 Stock Identification \_\_\_\_\_ MI-12421

## Accordion Edge Speaker Mechanism, MI-6234-B

The MI-6234-B is a 7" permanent magnet type loudspeaker with folded edge (accordion) cone. This type of cone is particularly suited for applications where an undistorted low frequency response is demanded. The cone is virtually freely suspended and allows the low frequencies to vibrate the maximum length and are not impeded by the reluctance of the conventional type suspension system. The permanent field is produced by Alnico magnet insuring a maximum and stable field. To derive maximum benefit from this type of speaker, an enclosed type of housing, such as the MI-13225 which was specifically designed for this speaker, is recommended. MI-12373 transformers are available for matching use.

### Specifications

Frequency Range \_\_\_\_\_ 70-7000 cycles  
 Power Handling Capacity \_\_\_\_\_ 5 watts

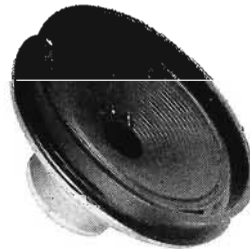

Voice Coil Impedance \_\_\_\_\_ 6 ohms nominal  
 Finish \_\_\_\_\_ Umber gray  
 Weight \_\_\_\_\_ 2 1/4 lbs.  
 Stock Identification \_\_\_\_\_ MI-6234-B

## Speaker Mechanism, MI-6333-C

The MI-6333-C is a high quality 10" general purpose, permanent magnet speaker suitable for wall baffle or ceiling mounting. The cone is of single piece construction and moisture resistant, giving it great ruggedness and a handling capacity of 25 watts of power.

The speaker uses Alnico II metal for the permanent magnets, insuring high efficiency and sensitivity with an unusually good frequency response. The MI-6381 molded speaker housing was designed and is recommended for use with this speaker. MI-12370 and MI-12371 transformers are recommended.

### Specifications

Frequency Range \_\_\_\_\_ 60-7000 cycles  
 Power Handling Capacity (maximum) \_\_\_\_\_ 25 watts  
 Voice Coil Impedance \_\_\_\_\_ 6 ohms nominal



Cone Diameter \_\_\_\_\_ 10 1/4"  
 Depth of Speaker \_\_\_\_\_ 6 3/8"  
 Weight (unpacked) \_\_\_\_\_ 6 3/4 lbs.  
 Stock Identification \_\_\_\_\_ MI-6333-C

## Speaker Transformer, MI-12370

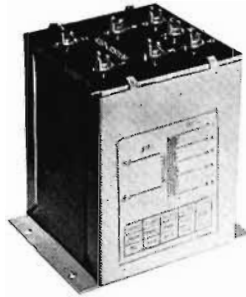
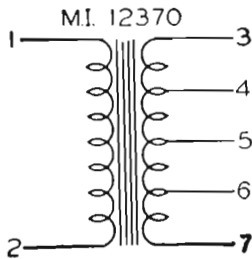

The MI-12370 is an ideal speaker matching transformer for use where a large power handling capacity is required. The secondary has three taps which, for a given source impedance provide ten different output impedances for matching to the load. All taps are connected to lugs on a bakelite terminal cover to which the load may be attached by either a screw or solder connection. The transformer is enclosed in a metal case which is finished in aluminum gray. The terminal arrangement, voltage ratios, and a schematic diagram of the windings are stenciled on the side of the case. Four holes through the two bottom flanges provide for mounting the unit.

### Specifications

Impedance: (primary connected to 500/600 ohm source)

Terminals	Impedance
1-2 (Primary)	500/600 ohms
3-4	33 "
3-5	66 "
3-6	132 "
3-7	264 "
4-5	6 "
4-6	32 "
4-7	106 "
5-6	10.6 "
5-7	63 "
6-7	22 "

Frequency Response \_\_\_\_\_  $\pm 1$  db, 30 to 10,000 cycles  
 Power Handling Capacity \_\_\_\_\_ 40 watts  
 Distortion \_\_\_\_\_ Less than 1% 100-8000 cycles  
 Maximum Primary Voltage \_\_\_\_\_ 125 volts rms  
 Dimensions \_\_\_\_\_  $4\frac{3}{8}'' \times 4\frac{1}{4}'' \times 5''$   
 Finish \_\_\_\_\_ Aluminum gray  
 Weight (unpacked) \_\_\_\_\_ 7 lbs.  
 Stock Identification \_\_\_\_\_ MI-12370

## Speaker Transformer, MI-12371

The MI-12371 speaker transformer is a good quality unit with several taps on the primary winding, giving a wide impedance range of 1000 to 16,000 ohms. The secondary winding has a variable tap for three speaker voice coil impedances. It is designed for bracket mounting with 8" connection leads. This transformer is suitable for use with the MI-6234-B, MI-6333-C and the MI-12422 RCA speakers.

The MI-12372 is identical to the MI-12371 except that it is hermetically sealed.

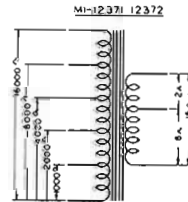

### Specifications

Frequency Response \_\_\_\_\_  $\pm 2$  db 100-6500 cycles  
 Distortion \_\_\_\_\_ Less than 1% 100-6500 cycles on 2000 ohm tap  
 Power Handling Capacity \_\_\_\_\_ 10 watts

Length \_\_\_\_\_  $2\frac{3}{8}''$   
 Width \_\_\_\_\_  $2''$   
 Height \_\_\_\_\_  $2\frac{5}{8}''$   
 Weight \_\_\_\_\_  $1\frac{1}{4}$  lbs.

## Speaker Transformer, MI-12373

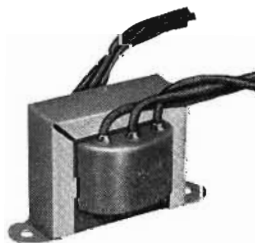
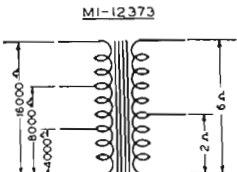

This transformer is ideal for operating a number of medium power speakers with a voice coil having 6 or 2 ohms impedance. The primary winding has three taps for 4000, 8000 and 16,000 ohms. It is designed for bracket mounting and has 10"

connection leads. The same transformer, hermetically sealed for tropical use, is available as MI-12374.

### Specifications

Frequency Response \_\_\_\_\_  $\pm 1$  db 100-12,000 cycles  
 Distortion \_\_\_\_\_ Less than 2% between 100 and 8000 cycles  
 Power Handling Capacity \_\_\_\_\_ 5 watts  
 Maximum Primary Voltage \_\_\_\_\_ 125 volts  
 Height \_\_\_\_\_  $2''$   
 Length \_\_\_\_\_  $2\frac{7}{8}''$   
 Width \_\_\_\_\_  $1\frac{1}{2}''$   
 Mounting Centers \_\_\_\_\_  $1\frac{1}{8}''$   
 Connections \_\_\_\_\_ 10" leads  
 Net Weight \_\_\_\_\_  $\frac{3}{4}$  lbs.



# **VIDEO EQUIPMENT**

	<b>Page</b>
<b>FIELD EQUIPMENT</b>	<b>112</b>
<b>RELAY EQUIPMENT</b>	<b>128</b>
<b>MOBILE UNIT</b>	<b>137</b>
<b>STUDIO CAMERAS</b>	<b>144</b>
<b>FILM EQUIPMENT</b>	<b>152</b>
<b>STUDIO CONTROL EQUIPMENT</b>	<b>165</b>
<b>MONOSCOPE</b>	<b>182</b>
<b>SYNC GENERATOR</b>	<b>184</b>
<b>AMPLIFIERS</b>	<b>188</b>
<b>POWER SUPPLIES</b>	<b>193</b>
<b>STUDIO LIGHTING</b>	<b>197</b>
<b>ACCESSORIES</b>	<b>201</b>

# Everything for TV

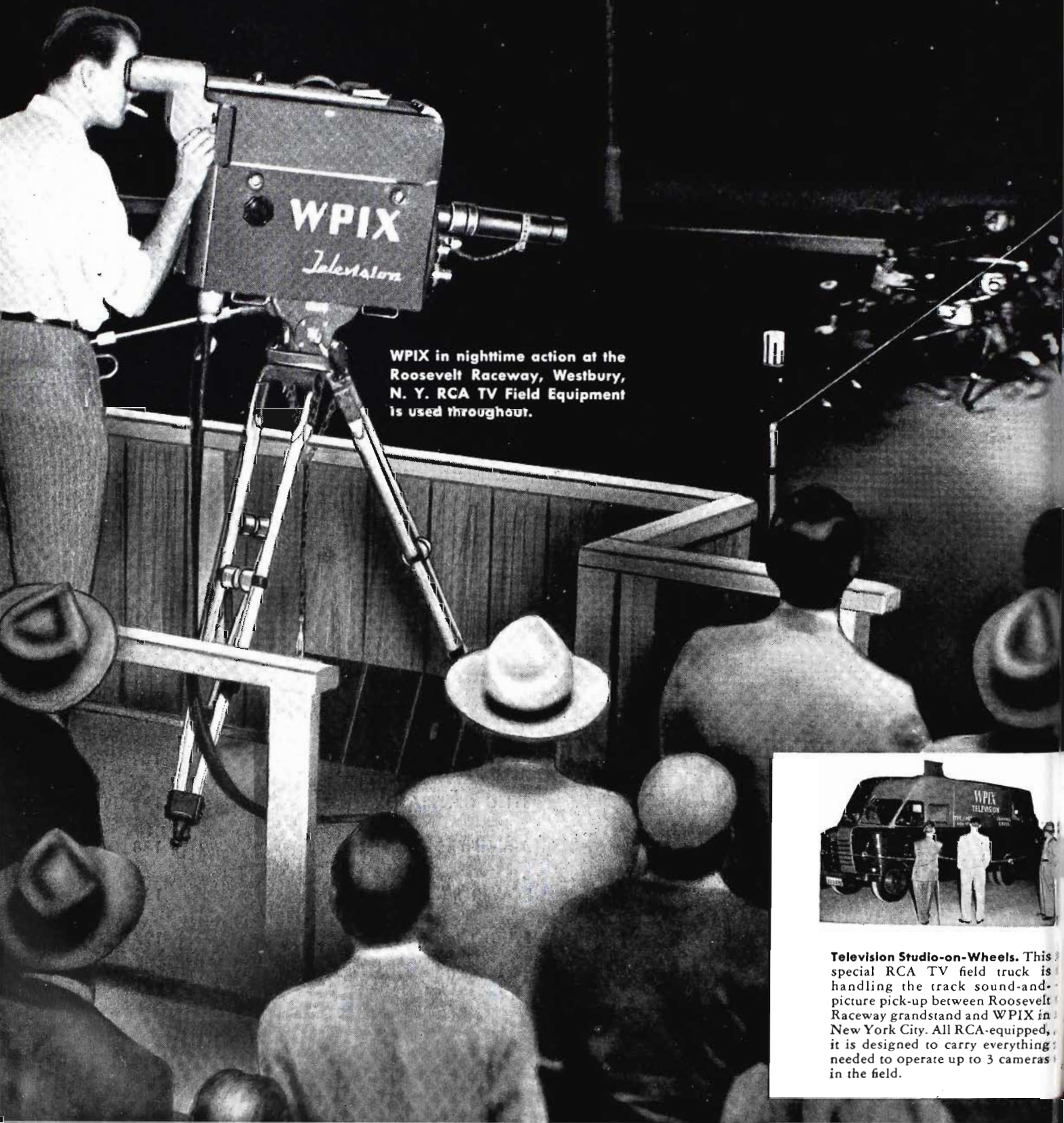

WPIX in nighttime action at the Roosevelt Raceway, Westbury, N. Y. RCA TV Field Equipment is used throughout.



**Television Studio-on-Wheels.** This special RCA TV field truck is handling the track sound-and-picture pick-up between Roosevelt Raceway grandstand and WPIX in New York City. All RCA-equipped, it is designed to carry everything needed to operate up to 3 cameras in the field.



# ... complete field equipment,

*for instance —*

● That exciting finish you see is being covered by television field equipment, all-RCA from camera to microwave relay antenna.

Thoroughly practical for quick, on-the-spot pick-ups, this highly compact and portable equipment is designed to handle outdoor telecasting under all sorts of conditions. Complete pick-up and relay equipment includes: two image orthicon cameras (with telephoto lens); camera tripods; camera control units; on-the-air master monitor; camera switching system; synchronizing generator; microwave relay equipment; associated power supplies; reels of cable—all carried in one special truck.

Why this preference for RCA field equipment among the majority of TV stations now in operation?

Because RCA TV Field Equipment has been worked out by television experts who know

the business. All gear, for example, is completely portable and subdivided into small units for easy handling. All field cameras are equipped with 4-position turret lens and electronic view finders. There are complete switching facilities that help the operators deliver faster-moving shows. And there is a special truck that carries the equipment to location... with all the facilities required to run most of the equipment *right from the vehicle itself*. No wires needed to get the picture signals back to the station. High-efficiency microwave radio relay does it—airline!

Overlook none of the technical and economical advantages of correct initial station planning. Your RCA Television Specialist can help. Call him. Or write Dept. 190-D RCA Engineering Products, Camden, New Jersey.



**RCA Microwave Relay Transmitter TR-1A.** Transmits the picture signals from field to studio (or from studio to transmitter). It includes a parabolic antenna with hook-shaped wave guide, built-in transmitter, and remote control unit. Matching receiver unit at the station picks up the microwave relay signal.



**RCA Field Camera Control TK-30A.** For monitoring the picture and controlling its quality. Unit No. 1 includes one 7" picture monitor tube and one 3" oscilloscope (to observe video signal waveform). Unit No. 2 is the power supply.



**RCA Field-Switching System TS-30A.** Nerve center of TV field pick-up operations. Switches intercom circuits and picture signals between cameras and monitor. Unit No. 1 provides for video switching, sync signal insertion, and master monitor switching. Unit No. 2 is the power supply.

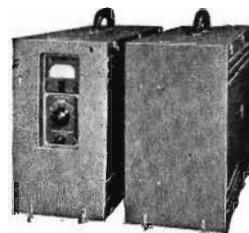

**RCA Field Synchronizing Generator TG-10A.** Produces timing pulses for TV field equipment. Unit No. 1 includes pulse-forming circuits, frequency-control circuits, and power supply. Unit No. 2 includes the pulse-shaping and output circuits.

## RCA Television Field Pick-up Equipment



The RCA Television Field Pickup Equipment is designed for portable or field use in picking up television programs such as sporting events, parades, outdoor or indoor shows, and other special events in places where permanent television installations are not available. The design of the equipment is centered around the RCA Image Orthicon camera tube which is so sensitive that it may be used with incident illumination on the scene as low as approximately one foot candle, and which is entirely free of any blocking or "charging-up" effect from flashes of excess light which paralyze other types of pick-up tubes.

The Field Equipment includes such important features as a four-position lens turret on each camera, an electronic view finder in each camera, a complete telephone intercommunication system, accessibility of tubes, components, and circuits for easy servicing, and many other features.

To facilitate portability, the equipment has been divided into relatively small units with emphasis placed on keeping the number of major pieces to a minimum, and at the same time maintaining high standards of reliability and flexibility in operation. Wherever possible the major units have the shape and approximate size of a medium sized suitcase. The camera and view finder, master monitor, and power distribution box are the only exceptions. Each unit is provided with one or more carrying handles, and covers and shock mounts to pro-

tect fragile parts during transportation. All interconnections are made with cables and plugs which may be connected or disconnected in a few minutes.

A general practice of making all electrical connections through receptacles mounted on the rear panels of the suitcase units has been followed. An exception exists in the case of intercommunication head-sets which are plugged into jacks on the front of the Field Switching System. Whenever possible, multiple conductor cables are used so that the number of cable connections is kept to a minimum consistent with flexibility of the equipment. With few exceptions, the connectors used have single-turn locking rings which prevent accidental disconnecting of the cables.

Careful consideration has been given to conservative design in the selection of high quality components and in allowing ample reserve in ratings. Also attention has been given to providing rugged construction and secure mountings so that the equipment will stand the wear and tear of daily use over long periods of time.

The Field Equipment is so designed that it may be set up for temporary operation on a table or desk. In such a case, the desk and control units comprise a simple operating console. The equipment may also be used in conjunction with a mobile television unit in which the suitcases may be installed to form a mobile television studio.



The units included with the standard Two-Camera Chain, Field Pick-Up Equipment are as follows:

- 2—Type TK-30A Field Camera Equipments
  - 1—Type TG-10A Field Synchronizing Generator
  - 1—Type TS 30A Field Switching Equipment
- (All equipments are supplied with tubes)

The Type TK-30A Field Camera Equipment includes:

- 1—High Sensitivity Image Orthicon Camera with newsreel-type tripod, plug-in electronic view finder employing a 5" Kinescope and three turret-mounted lenses (50 mm and 90 mm and 135 mm focal lengths).
- 1—Field Camera Control Unit. This unit provides the required control and operating voltages for the Field Camera and provides picture (on a 7" Kinescope) and wave form (on a 3" Cathode Ray Oscilloscope tube) monitoring of the camera signal.
- 1—Field type Power Supply. This unit contains the heater and plate supply transformer, rectifiers and plate-voltage regulating circuits.
- 1—Set of Camera-Camera Control Unit Cables; one 50' length, one 100' length and one 200' length.

The Type TG-10A Field Synchronizing Generator includes:

- 1—Field Pulse Former
- 1—Field Pulse Shaper
- 1—Power Distribution Box. This unit provides for power supply connections to a-c power systems of three types: 3 phase—4 wire; Single phase—3 wire; Single phase—2 wire. 9 Twist Lock power outlets and 2 convenience outlets are provided.

The Type TS-30A Field Switching Equipment includes:

- 1—Switching System. This unit provides all the video program, monitor and intercommunication switching required for field pick-up equipment using up to four cameras, plus two auxiliary video program lines. Camera, view finder, camera control and switching equipment tally lights indicate to performers, cameraman, control operators and program director which camera is supplying program.

The Field Type Master Monitor (listed below) can be switched to:

- a. The outgoing video signal.
- b. Relay equipment monitoring signal.
- c. Either of the two auxiliary video program lines.
- d. A separate Monitor input.

The audio intercommunication facilities provide a flexible set-up so that the program director can talk to any or all of the operating personnel and the home station, or various special and separate intercommunication circuits may be set up. All operating personnel normally hear program sound on one headphone, and intercommunication sound on the other.

- 1—Field Type Power Supply. This furnishes power to the switching system and Master Monitor.

**OPTIONAL**

- 1—Field Type Master Monitor. This unit provides for picture (on a 10" Kinescope) and wave form (on a 5" CRO Tube) monitoring of the Signal selected by the field switching system.

**RCA TELEVISION FIELD PICKUP EQUIPMENT**

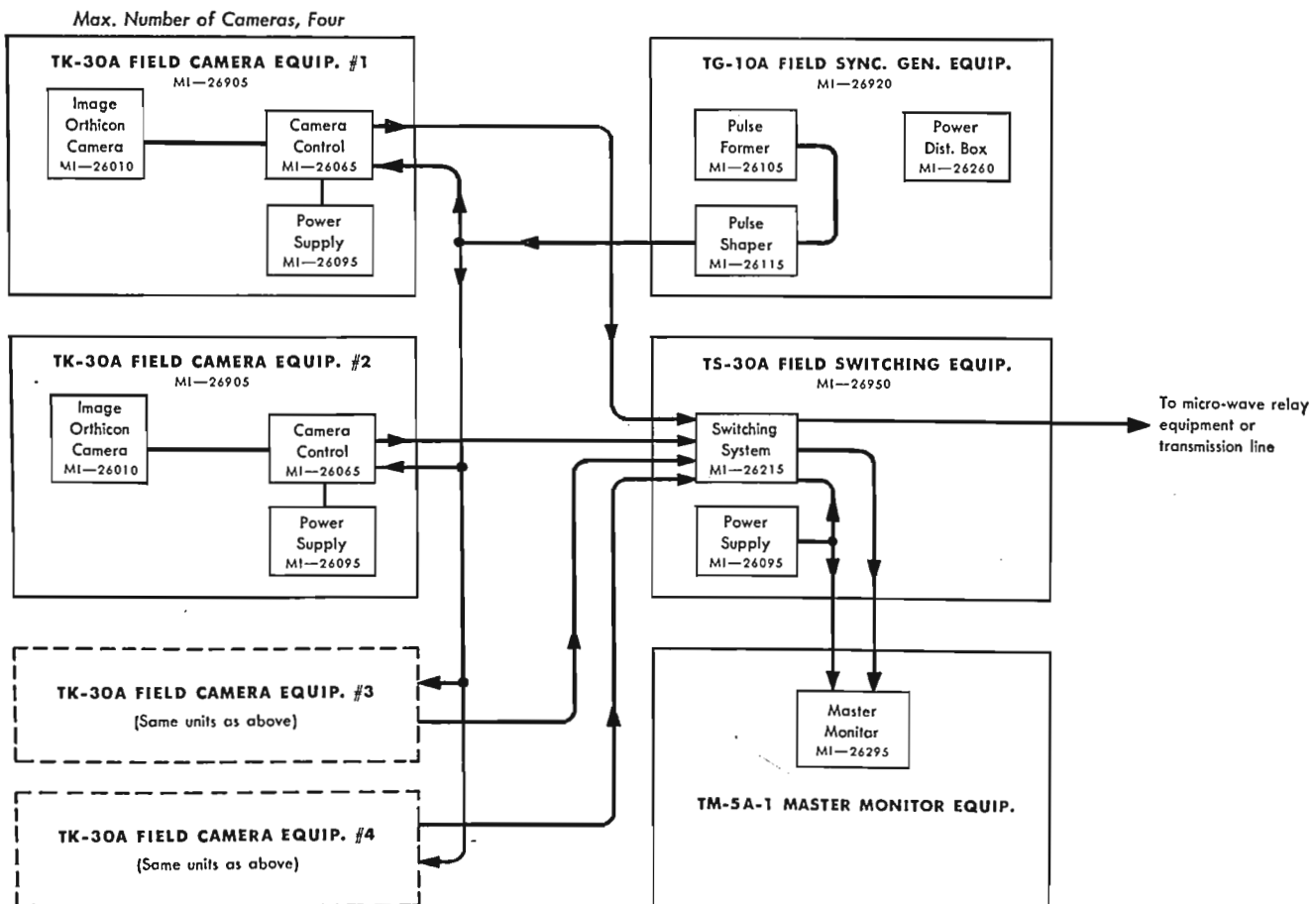

# Field Television Camera Equipment, Type TK-30A

## Features

- Highly sensitive at extremely low light levels.
- Able to handle enormous light ranges.
- No loss of picture after intense flashes of light.
- Simplified interconnections providing quick assembly on location.
- Electronic view finder.
- Rugged mechanical construction.
- A four position lens turret controlled from rear.
- Provision for two intercom telephone sets.
- Suitable for studio use.
- Easy access to all parts.

## Uses

The TK-30A television camera is intended to be used in field television pick-ups of all kinds. It is especially suitable for use where the lighting conditions are poor, as is frequently the case at sporting events, in night clubs, and at other remote pick-up points. While designed especially for field use, it is also satisfactory for most types of studio programs; and for many applications the TK-30A has special advantages.

## Description

The TK-30A is a portable, field television camera equipment consisting of camera, tripod, camera control, field power supply, and miscellaneous accessory items; such as: cables, etc. The camera makes use of the RCA-developed Image Orthicon. The remarkable sensitivity of the Image Orthicon is so great that operation is possible with light levels as low as one foot-candle with an f3.5 lens. The Image Orthicon is able to adapt itself automatically to enormous changes in scene brilliance without serious loss of contrast anywhere in the range. This characteristic makes it possible to shift instantly from a dark scene in heavy shadows to another in bright sunlight with only very slight readjustment. The Image Orthicon is able to withstand extreme peaks of intense illumination, such as photo flash lamps aimed directly at the lens, without any after effects requiring the resetting of controls.

The Field Camera Control is contained in a small easily-carried case. On the front, there are located two cathode ray tubes which serve as indicators of the picture quality. A seven inch kinescope is used as a picture monitor, and a three inch oscilloscope is used as a wave form monitor.

The picture signal amplifier performs the following several important functions:

1. It provides a gain control for the picture signal.
2. It mixes the picture blanking signal with the signal from the Camera.
3. It establishes black level at the beginning of each scanning line by means of a "clamp" circuit.
4. It provides for the addition of the Synchronizing signal whenever only a single camera chain is used.
5. Its output stage is a line amplifier capable of delivering two volts peak to peak composite picture and synchronizing signal to a 75 ohm coaxial transmission line (or 1.5 volts of picture only).
6. It includes a stage for introducing a fixed amount of gamma correction.
7. It includes high level driver stages for feeding the two monitor tubes.

The Field Power Supply is a portable unit designed to provide all the d-c required by the circuits in the Field Camera, Field View Finder, and Field Camera Control in one camera chain. It may, of course, be used for any other application where its voltage and current ratings meet the requirements. The output voltage of this power supply is electronically regulated within very close limits. It is capable of delivering 1 ampere at a maximum of 285 volts. The internal impedance of the power supply is less than 0.25 ohm. This low impedance



makes it an excellent power supply for amplifiers having variable current requirements and critical low frequency response such as television amplifiers.

The complete camera may be disassembled into several parts for easy carrying. The camera is built into an exceedingly compact case which mounts on top of the tripod. All controls are conveniently located on the back. The camera assembly includes a picture signal preamplifier and the deflection and camera blanking circuits. A feature of this camera is the provision of a lens turret in which four lenses of different focal lengths may be mounted. On the rear of the case is located a large handle which rotates the lens turret. A trigger switch incorporated in the handle cuts off the picture during the interval while the handle is turning. Changing from one lens to another requires only one and a half seconds.

The operator focuses the picture by observing the image in the electronic view finder, constituting the upper section of the camera assembly, and adjusting a knob on the right side of the cabinet. This knob slides the Orthicon back and forth inside the case. This saves having to adjust the lenses themselves for focusing. The use of the electronic view finder with this camera is a necessity; since at low light levels an optical view finder would not be satisfactory. It also has the advantage of eliminating the need for additional lenses which would be required for an optical system. The view finder employs a five inch kinescope with sufficient brilliance to produce a satisfactory picture under normal outdoor light conditions. Since the operator sees on the face of this kinescope the picture which is being transmitted, he is able to focus the picture, and also to monitor the quality and general operation. Two different viewing hoods are provided: one straight-on type, and the other a periscope type, which may be mounted in either of two positions. This gives the operator a choice of three different viewing heights. For ease in transporting and maintenance, the view finder and camera are separate units, each of which is an integral unit in itself. A streamlined cover with a carrying handle is placed on the camera unit when the view finder is removed. It is also possible to operate





*Field Camera Control Unit and Field Power Supply*

the camera without the view finder: as for instance where the camera is set up in a fixed position and operates unattended.

**Specifications**

**FIELD CAMERA AND POWER SUPPLY**

- Number of Scanning Lines.....525
- Interlacing.....2 to 1
- Field Repetition Rate.....60 per sec.
- Frame Repetition Rate.....30 per sec.
- Line Repetition Rate.....15750 per sec.
- Picture Signal Level.....2.0 volts, peak-to-peak, max. of which 75% is picture and blank, and 25% is sinc. (See RMA Standards).
- Picture Signal Polarity at Output.....Black negative
- Type of Transmission Line for Picture Signal.....Coaxial
- Impedance of Transmission Line.....75 ohms
- Maximum Length of Camera Cable.....1000 ft.
- Total Included Angle of Lenses (in horizontal plane):
  - a. 50 mm f1.9 Ektar.....34°
  - b. 90 mm f3.5 Ektar.....20°
  - c. 135 mm f3.8 Ektar.....13°
  - \*\*\*d. 8.5 in., f3.9.....8°
  - \*\*\*e. 13 in., f5.0.....5.3°
  - \*\*\*f. 15 in., f5.0.....4.5°
  - \*\*\*g. 17 in., f5.0.....4°
  - \*\*\*h. 25 in., f5.0.....2.75°

- Incident Illumination on Scene:
  - (a) Minimum (approx.).....0.5 ft. candle
  - (b) Required for First Grade Results.....10 to 20 ft. candles
  - (c) Maximum.....Bright sunlight
- Note: Figure for (a) above is based on the use of an f3.5 lens or faster.

Primary Volts.....98-129 volts, a-c, 50-60 cycles  
 Primary Voltage Taps:

	Nominal	Range
Tap No. 1.....	125 v.	121-129 v.
Tap No. 2.....	117 v.	113-121 v.
Tap No. 3.....	109 v.	105-113 v.
Tap No. 4.....	102 v.	98-106 v.

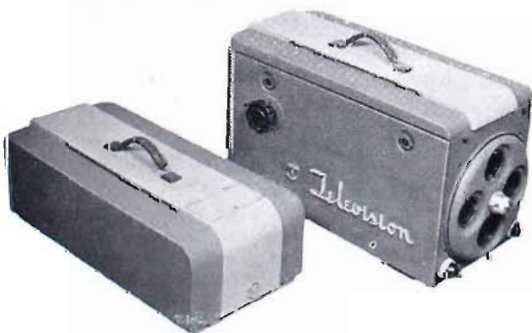

*TK-30A Electronic View Finder and Camera disassembled for easy carrying*

A-c Power Input for All Units.....Approx. 1200 watts  
 Power Output of Supply:  
 Regulated d-c Supply 270-285 volts.....1 amp.  
 Constant Current Supply intended to operate into 2000 ohm load (focusing coil).....50-80 ma.

**Dimensions (in inches):**

	CASE ONLY			OVERALL			Weight
	L.	W.	Ht.	L.	W.	Ht.	
Field Camera	28 1/8	10 3/8	11 1/8	26	11 3/4	13 3/8**	65 lbs.
View Finder	21 3/4	10 3/8	7	21 3/4#	11 3/4	13 3/8**	34 lbs.
Field Camera Control	24 1/2	8 1/8	15 1/8	27 1/4	8 1/2	18 1/2	65 lbs.
Field Power Supply	24 1/2	8 1/8	15 1/8	24 1/2	8 1/2	18 1/2	58 lbs.
Turret with 3 Ektar Lenses							4 3/4 lbs.
Camera Cable (200 ft. with plugs)							80 lbs.
Camera Cable Dimensions:							
Diameter						0.810 in.	
Standard Lengths						50 ft., 100 ft., 200 ft.	
Finish						Two tone umber gray wrinkle with chrome trim	

**Tube Complement**

- 1 RCA Image Orthicon (Field Type), 3 RCA 6AK5, 1 RCA 6AG5, 1 RCA 6J6, 3 RCA 6SN7GT, 2 RCA 6SL7GT, 1 RCA 6BG6G, 1 RCA 6AS7G, 1 RCA 1B3GT/8016, 1 RCA 6V6GT, 1 RCA 6L7
- Field Camera View Finder.....2 RCA 6AG7, 1 RCA 6J6, 1 RCA 6V6GT, 1 RCA 6H6, 2 RCA 6SN7GT, 1 RCA 6SL7GT, 1 RCA 6BG6G, 1 RCA 1B3GT/8016, 1 RCA 6AS7G, 1 RCA 5FP4A
- Field Camera Control.....1 RCA 6SK7, 4 RCA 6AC7, 2 RCA 6H6, 10 RCA 6SN7GT, 1 RCA 6AL5, 4 RCA 6AG7, 1 RCA 884, 1 RCA 6SL7GT, 1 RCA 6BG6G, 1 RCA 6AS7G, 1 RCA 2X2, 1 RCA 991, 1 RCA 3KP1, 1 RCA 7CP4
- Field Power Supply.....5 RCA 6AS7G, 6 RCA 5R4GY, 1 RCA 6Y6G, 1 RCA 6AC7, 1 RCA 6SL7GT, 2 RCA VR150
- Stock Identification.....MI-26905

**Equipment Supplied**

- (Includes equipment below plus miscellaneous cables, fittings, hardware and miscellaneous)
- 1 Camera.....MI-26010-A
  - 1 Camera Viewfinder.....MI-26015
  - 1 Metal Camera Tripod.....MI-26046
  - 1 Camera Control Unit.....MI-26065
  - 1 Power Supply.....MI-26095
  - 1 Set Interconnecting Cables.....MI-26730
  - 1 50 ft. Camera Cable.....MI-26725-1
  - 1 100 ft. Camera Cable.....MI-26725-2
  - 1 200 ft. Camera Cable.....MI-26725-3
  - 1 Camera Lens f1.9, 50mm.....MI-26550-1
  - 1 Camera Lens f3.5, 90mm.....MI-26550-2
  - 1 Camera Lens f3.8, 135mm.....MI-26550-3
  - 2 Shock Mounts.....MI-26510-1
  - 1 Shock Mount.....MI-26510-3
  - 1 Set of Tubes including (1) 3KP1, (1) 5FP4, (1) 7CP4, (1) Image Orthicon
  - 1 Ring Sight.....MI-26576
  - 1 Friction Head.....MI-26205-A

**Accessories**

- Camera Cable (length to be specified by customer) MI-94-C
- Video Coax Cable RG-11/u.....MI-83
- Video Coax Cable RG-59/u.....MI-75
- Camera Lens 8.5 in., f3.9.....MI-26550-4
- Camera Lens 13 in., f5.....MI-26550-5
- Camera Lens 15 in., f5.....MI-26550-6
- Camera Lens 17 in., f5.....MI-26550-7
- Camera Lens 25 in., f5.....MI-26550-8
- Plate Current Meter.....MI-21200-C1

‡ Less viewing hood.  
 \* Less lenses.  
 \*\* Including cover.  
 \*\*\* Not standard equipment. Available as accessory items.

# Field Synchronizing Generator, Type TG-10A

## Features

- Delivers standard RMA synchronizing and blanking.
- Also delivers separate horizontal and vertical driving signals.
- Complete in two suitcases, Pulse Former and Pulse Shaper.
- Frequency controlled either by 60 cycle power line or by quartz crystal.
- Built-in cathode ray tube indicator for counter circuits.
- Built-in regulated power supply.
- Single cable connection between the two suitcases.
- All output signals, except synchronizing, on single cable.
- Synchronizing on separate cable to provide for single or multiple camera operation.
- Operation over wide range of line voltage.
- Built-in line voltage meter and tap switch.
- Convenience outlet with fuse.

## Uses

The TG-10A synchronizing generator is the heart of the field television pickup equipment. Its function is to provide all the timing information, in the form of electrical pulse signals, required for controlling and synchronizing the scanning processes in both the field pickup equipment and the receiver.

## Description

In order to keep the weight and size of the TG-10A within reasonable limits, the equipment has been divided into two parts, the Field Pulse Former and the Field Pulse Shaper, each contained in a separate case. Also included with the TG-10A is a Power Distribution Box which is intended to be used for connecting the 117 volt power source to the various units of the RCA Field Television Equipment.

The equipment generates four separate signals which are required for a 525 line interlaced system as recommended by the RMA. The signals are designated as follows:

1. Synchronizing
2. Blanking
3. Vertical driving (at field frequency, 60 cycles)
4. Horizontal driving (at line frequency, 15,750 cycles)

The first two of these signals, Synchronizing and Blanking, are used directly in composing the final picture signal fed to the output of the system. In other words, they appear as parts of the composite picture signal. The last two signals, Horizontal and Vertical Driving, are used in the pickup equipment only. Their principal function is to trigger deflection generators in cameras and monitors. They are also used for keying signals in "clamp" circuits and for blanking signals in the camera.

### FIELD PULSE FORMER

The Field Pulse Former contains the timing circuits required in the system. Specifically, they include the master oscillator which operates at twice line frequency (31,500 cycles), a



series of counters for stepping this master frequency down to line frequency (15,750 cycles) and to field frequency (60 cycles), and an automatic frequency control circuit for locking the synchronizing generator to the power supply frequency. A crystal oscillator operating at 94.5 kc. is provided as an alternative means of controlling the frequency of the generator where the power supply system is not stable enough to serve as a reference.

Controls for the counter circuits, AFC circuit, and crystal oscillator are made accessible by removing the side cover on the tube side of the unit. A cathode ray tube indicator (RCA 2BP1) for the counter circuits is mounted within the case and is visible when the cover is removed to make adjustments of the controls.

A single cable containing 4 coaxial lines and several other conductors carries signals and power between the Field Pulse Former and the Field Pulse Shaper. The a-c power enters the Pulse Former through a special connector. A convenience outlet, separately fused for 10 amperes, is provided on the rear panel. No other connections are required.

The Field Pulse Former also includes a regulated power supply which provides all the plate current required by both the Former and the Shaper. The Transformer primary is tapped at several points to accommodate a wide range of line voltage (98 to 129 volts). A selector switch for these taps is mounted on the front panel directly under a line voltmeter which indicates when the proper tap has been selected.

### FIELD PULSE SHAPER

The Field Pulse Shaper contains all circuits necessary for shaping, mixing, and pulse width control to produce the four output signals. Pulse widths are adjustable by means of screw-driver-type controls which may be locked in position.





*Power Distribution Box*

The outputs are fed to 75 ohm coaxial lines from the plate circuits of the final amplifier tubes (RCA 6AG7). These outputs are coupled through blocking capacitors to prevent dc from flowing in the transmission lines. The normal signal level on these lines is 4 volts, peak to peak. All four signals are negative in polarity.

Two separate cables carry the signals to the equipment in the system. One multiple cable, consisting of four coaxials, carries the Picture Blanking and the Horizontal and Vertical Driving signals to the Field Camera Controls. The second cable is a single coaxial line which carries the Synchronizing signal.

Two filament transformers are mounted in the Pulse Shaper to supply the tube heaters. Plate current for the tubes is provided by the regulated power supply in the Field Pulse Former.

**POWER DISTRIBUTION BOX**

This distribution box has nine 2-prong twistlock receptacles which fit the power cables supplied with the equipment. This number of outlets is more than sufficient for a four camera setup, and thus allows extra outlets for operation of associated audio equipment. Two standard convenience outlets are also provided for soldering irons, trouble lights, etc.

The power-feed line to the box is a four-conductor water proof cable (each conductor #10 gauge, stranded) connected through 4-prong twistlock connectors. A total of 200 feet of this cable is supplied with each equipment.

Provision is made for connecting this box to any one of three types of power distribution lines which are normally encountered in the United States. These are:

1. Single phase, 2 wire (117 volts).
2. Single phase, 3 wire (117 volts from each outer line to neutral).
3. Three phase, 4 wire (117 volts from each outer line to neutral).

A link board under a trap door at one end of the box provides easy means for rearranging the circuits to fit any of these three systems. Outlets are color-coded to indicate phasing on the three phase system, and correspondingly colored pilot lamps indicate which phases are "hot" in case a main fuse burns out.

Provision is thus made to utilize all elements of any available power distribution system so as to minimize voltage drop.

**Specifications**

Field Repetition Rate \_\_\_\_\_ 60 per sec.  
 Frame Repetition Rate \_\_\_\_\_ 30 per sec.  
 Line Repetition Rate \_\_\_\_\_ 15,750 per sec.  
 Synchronizing Generator Master Oscillator Frequency  
 31,500 cycles/sec.

**Synchronizing Generator Counter Ratios:**

First \_\_\_\_\_ 7 : 1  
 Second \_\_\_\_\_ 5 : 1  
 Third \_\_\_\_\_ 5 : 1  
 Fourth \_\_\_\_\_ 3 : 1

Frequency Stability of Horizontal Sync.  
 (when stabilized by power supply) \_\_\_\_\_ ±0.15% /sec. max.

Frequency of Quartz Crystal \_\_\_\_\_ 94,500 cycles/sec. ±50 cycles

**Synchronizing Generator Output Signals:**

- (a) Signal Level (all signals)  
 4.0 (−0.5, +1.0 volts, peak-to-peak)
- (b) Signal Polarity (all signals) \_\_\_\_\_ Negative
- (c) Waveform-Sync \_\_\_\_\_ Defined by "Recommended Sync. Generator Waveforms", a drawing submitted January 22, 1946 (Revised October 9, 1946) by the RMA Sub-committee on Studio Facilities.
- (d) Waveform-Picture Blanking \_\_\_\_\_ Defined by "Recommended Sync. Generator Waveforms", a drawing submitted January 22, 1946 (Revised October 9, 1946) by the RMA Sub-committee on Studio Facilities.
- (e) Waveform-Horizontal Driving \_\_\_\_\_ Rectangular pulse,  
 15,750/sec. Width 6.3 microsec. (approx.)
- (f) Waveform-Vertical Driving \_\_\_\_\_ Rectangular pulse,  
 60/sec. Width 4% or .00067 sec.

A-c Power Input, Sync Gen. \_\_\_\_\_ 325 watts

**Dimensions (in inches):**

	CASE ONLY			OVERALL			
	L.	Wt.	Ht.	L.	W.	Ht.	Wt.
Field Pulse Form'r	24½	8⅞	15⅞	25¾	8½	18½	67½ lbs.
Field Pulse Shaper	24½	8⅞	15⅞	25¾	8½	18½	52 lbs.
Power Dist. Box	11⅞	8⅞	3¾	11⅞	8⅞	5	10 lbs.
Finish _____	Deep umber gray wrinkle with chrome trim						

**Tube Complement:**

- |                       |                       |
|-----------------------|-----------------------|
| Pulse Former MI-26105 | Pulse Shaper MI-26115 |
| 1 RCA 2BP1            | 6 RCA 6AC7            |
| 2 RCA 5V4G            | 4 RCA 6AG7            |
| 4 RCA 6AC7            | 4 RCA 6L7             |
| 1 RCA 6AS7G           | 12 RCA 6SL7GT         |
| 7 RCA 6H6             | 2 RCA 6SN7GT          |
| 3 RCA 6SL7GT          | 2 RCA 5691            |
| 7 RCA 6SN7GT          |                       |
| 2 RCA OD3/VR150       |                       |
| 1 RCA VC5K1           |                       |

Stock Identification \_\_\_\_\_ MI-26920

**Equipment Supplied:**

- |                                |             |
|--------------------------------|-------------|
| 1 Pulse Former _____           | MI-26105    |
| 1 Pulse Shaper _____           | MI-26115    |
| 1 Power Distribution Box _____ | MI-26260    |
| 1 Plate Current Meter _____    | MI-21200-C1 |
| 2 Shock Mounts _____           | MI-26510-1  |
| 1 Set of Cables _____          | MI-26735    |

**Accessories**

1 Crystal Unit \_\_\_\_\_ MI-26545



# Master Monitor, Type TM-5A

## Features

- Operates with composite picture signal input (synchronized operation) or with separate picture signal and pulse signal input voltages (driven operation).
- Special 10 inch diameter, kinescope with aluminum backing makes possible a very brilliant picture.
- Special low capacity input connection.
- Compact design permits location in operating consoles with minimum space requirements. Operator can easily look over the top of the console and can observe at least three adjacent monitors without difficulty.
- Synchronization of the oscilloscope sweep with the kinescope sweep at half-line or half-field frequency is completely automatic.
- Operating controls are extremely simple.
- Pulse high-voltage supply reduces shock hazard considerably.
- Tubes and circuits are readily accessible.
- Adapter is available for rack mounting and a suitcase type enclosure available for portable or field use.
- Calibration circuit permits quick reference to a fixed voltage level.
- Grid circuit of oscilloscope is available for pulse measuring techniques.

## Uses

The Type TM-5A Master Monitor provides in a compact chassis a complete monitoring unit adaptable to the supervision of composite picture signals at any stage of transmission, from camera pickup to radio transmitter input. It may be used for both picture and waveform monitoring of signals from the relay receiver, the output signal at the master control room, or any other picture signals it may be desirable to monitor at the radio transmitter location.

## Description

The Master Monitor is furnished in chassis form. It may, therefore, be placed in a housing and grouped with other master monitors or camera controls to form an operating console. A case for table top mounting is available so it can be used conveniently with field equipment for monitoring purposes, and in conjunction with the adaptor, MI-26526, it can be used as a rack mounted monitor.

The unit employs a 10 inch kinescope for direct picture monitoring and a 5 inch oscilloscope for signal component analysis. Input circuits are arranged to permit the same or different picture signals to appear on the kinescope and oscilloscope screens at the same time.

A calibration circuit is included to establish a definite voltage level on the oscilloscope screen for measuring purposes. The horizontal scanning frequency of the oscilloscope tube is automatically half that of the kinescope and results in two cycles of either horizontal or vertical pulses, as may be selected by the operator, appearing on the oscilloscope screen.



*TM-5A Master Monitor shown mounted in Field Carrying Case, MI-26521*

The vertical front panel of the monitor, finished in dark umber gray is arranged with an opening at the top center, fitted with a rectangular mask, for the 10 inch kinescope to present the picture screen. The screen of the 5 inch oscilloscope is arranged immediately below the kinescope screen in a 5 inch circular opening. The lower section of the panel carries the switches and controls, conveniently grouped.

With the ends of the kinescope and oscilloscope presented to the panel, the other components of the circuits are mounted on vertical chassis on both sides of the cathode-ray tubes with tube sockets and circuit components arranged on narrow shelf members so that all parts are readily accessible for servicing.

A twelve contact plug at the rear of the assembly provides for the connection of necessary input power and external synchronizing pulse wiring. A safety feature is included in the form of an interlock which is attached to the monitor, so that withdrawal of the chassis from the case opens the high voltage circuits in the unit to prevent accidental contact with dangerous potentials.

The Master Monitor may be operated as either a "synchronized" or as a "driven" monitor. In the synchronized case, the scanning circuits are operated by blocking oscillators which in turn are triggered by the sync. pulses contained in the incoming composite picture signal. In the driven case, the incoming signal will normally come from a camera chain without sync. pulses. The scanning circuits are therefore "driven" directly by separate signals from the synchronizing generator. Connections to the sync. generator are made through the multi-contact plug. The switching arrangement employed for selecting the type of operation cuts off the blocking oscillators by opening the cathode circuits when the unit is operated as a driven monitor. The unit includes three step down transformers to furnish current for the tube heaters and filaments but d-c currents for the tube plate circuits and centering circuits must be obtained from an external regulated power supply.

**Specifications**

**INPUT POWER WHEN USED AS LINE OR RELAY RECEIVER MONITOR**

From Line for Tube Heaters:  
 Line Voltage \_\_\_\_\_ 105-125 volts  
 Line Frequency \_\_\_\_\_ 50-60 cycles, single phase

From Power Supply:  
 Plate Voltage \_\_\_\_\_ 285 volts d-c  
 Plate Current \_\_\_\_\_ 510 ma.  
 Centering Voltage \_\_\_\_\_ -7 volts d-c

Tube Complement—3—6AC7, 6—6AG7, 2—6AL5, 1—6AS7-G,  
 2—6BC6-G, 11—6SN7-GT, 2—IB3-GT/8016, 1—5CP1A,  
 1—1816P4

**INPUT FROM CAMERA CHAIN WHEN USED AS CAMERA OR PROGRAM MONITOR**

	<u>Peak to Peak Voltage</u>	<u>Frequency in Cycles</u>	<u>Pulse Width</u>
Vertical Drive _____	2 min.	60	4%
Horizontal Drive _____	2 min.	15,750	10%
*Oscillator Drive _____	8	Mixed 30 and 7875	
** Bias _____	-18	d-c	
*** Tally Light _____	6.3 v.		

Frequency Response:  
 Kinescope Amplifier \_\_\_\_\_ Flat  $\pm 1$  db to 8 mc.  
 Oscilloscope Amplifier  
 (Vertical Deflection) \_\_\_\_\_ Flat  $\pm 1.5$  db to 4 mc.

Input Impedance:  
 CRO Input \_\_\_\_\_ High  
 Kinescope Input \_\_\_\_\_ High  
 CRO Drive Signal \_\_\_\_\_ High

Signal Input Range:  
 CRO Input \_\_\_\_\_ 0.5 to 3 volts  
 Kinescope Input \_\_\_\_\_ 0.5 to 3 volts

Chassis Dimensions \_\_\_\_\_ 17 $\frac{3}{4}$ " high; 13" wide; 20 $\frac{1}{4}$ " deep  
 Weight \_\_\_\_\_ 68 lbs.

Stock Identification (chassis only) \_\_\_\_\_ MI-26135-A  
 Accessory Field Carrying Case \_\_\_\_\_ MI-26521  
 Shock Mount \_\_\_\_\_ MI-26510-2  
 Rack Mounting Adaptor \_\_\_\_\_ MI-26526  
 Blower Kit (needed if TM-5A is used in Console Housing) \_\_\_\_\_ MI-26579

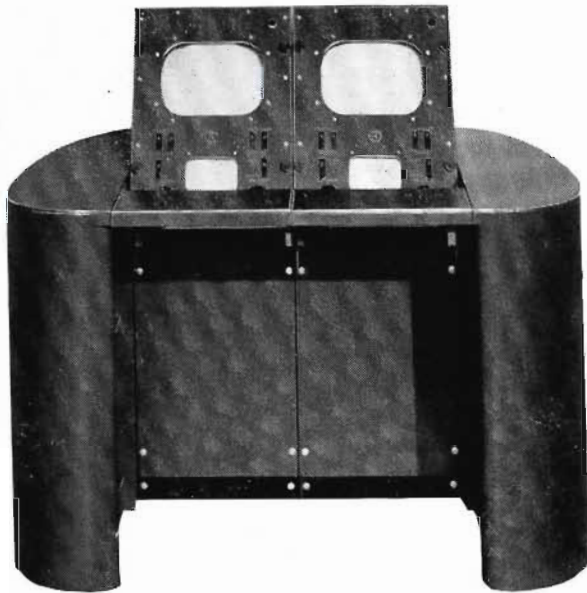

The TM-5A Master Monitor may be mounted in Video Console unit as shown above



Photo above shows how TM-5A may be mounted in a special housing for portable uses

\* Use of this signal is optional.  
 \*\* Used only with camera chain, under which condition following output voltages are available from monitor:  
 Pedestal Control \_\_\_\_\_ 0 to -18 volts d-c  
 Video Gain Control \_\_\_\_\_ 0 to -18 volts d-c  
 \*\*\* Connected to switching or monitor heater circuit.

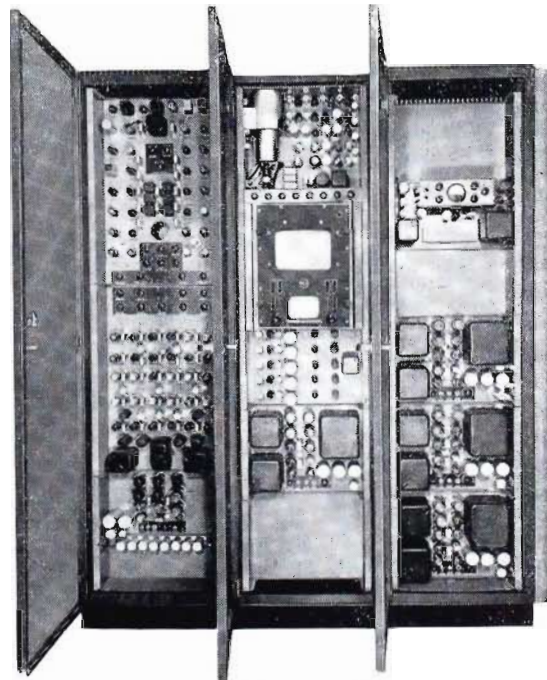

With Rack Mounting Adaptor, MI-26526, the TM-5A may be mounted as shown above



# Field Switching System, Type TS-30A

## Features

- Surgeless camera switching (clamp circuit) for four cameras and two auxiliary signals.
- Switching between cameras without interrupting sync, thus eliminating frame slipping at receivers.
- Individual level control on each auxiliary picture input.
- Switching of Master Monitor for checking the outgoing picture line, auxiliary lines, relay transmitter, etc.
- Push button switches for picture signals.
- Tally system to indicate "on-the-air" to the camera control operator, camera man, and performers.
- Clamp circuit holds black level constant.
- Sync. level adjustable over wide range.
- Incoming signal may be with or without sync.
- Operation in conjunction with a Master Monitor from a single external power supply.
- Built-in power supply with separate control switch for the intercom. system.
- Complete miniature "central office" for an inter-communication system between all operators in a four camera setup and the program director, technical director, and main studio.

## Uses

The Field Switching System, when used in combination with the Field Master Monitor, is the equivalent, in the Field Equipment, of the director's console in a studio. It provides two major services in a setup involving more than one camera. The first is, of course, a means of switching between cameras and of monitoring the outgoing signal. The second is the provision of an intercommunication center for the telephone system which enables all operating personnel to talk with each other.

## Description

The complete equipment consists of the Field Switching unit, contained in a compact, easily carried case; and the associated Field Power Supply, likewise contained in a portable case.

The picture signal circuits provide for switching between four cameras and two incoming auxiliary lines, or in unusual cases, between six cameras. Communication circuits are limited to a maximum of four cameras.

Two sets of push button switches are provided for picture switching. One set, located at the bottom of the front panel, and marked "CAMERA SWITCHING," switches signal from any of four cameras or two auxiliary inputs to the outgoing line. The second set marked "MONITOR SWITCHING" provides for switching the Field Master Monitor to any of the following five positions:

1. Outgoing picture line.
2. Monitor output of relay transmitter.
3. Incoming auxiliary line 5.
4. Incoming auxiliary line 6.
5. Spare input to monitor.



Each push button has an associated tally. Camera switching tallies operate in conjunction with tallies in the Cameras and Camera Controls.

The picture amplifier includes a "clamp" circuit to eliminate switching transients and other low frequency disturbances which may have been added to the signal earlier in the system, and thus provides that smooth switching which adds much to program technique.

The three 75-ohm coaxial outputs from the outgoing line amplifier are as follows:

1. Picture Output (for feeding a relay transmitter or studio line).
2. Master Monitor Output.
3. Auxiliary Monitor Output.

At output 1 appears the signal from the particular camera selected by the CAMERA SWITCHING push button. The second output is effectively in parallel with the first output when the monitor switch is in the picture line position.

The third output is provided to supply signal to any auxiliary equipment which it may be desired to operate such as an additional monitor, a standby link transmitter, or the switching system of an additional set of field equipment.

All three of these outputs deliver the same signal level and polarity, i.e., 2 volts, peak to peak, of picture and sync. with sync. negative. It is assumed that this level is based on the standard ratio of 75% picture and 25% sync. However, for signals from local Cameras, where sync. is mixed with the camera signal in the Field Switching System, the amount of synchronizing voltage may be increased above the 25% value by adjusting the Synchronizing Gain Control.

Pulse signals for operation of the clamp circuit are derived from the synchronizing signal. The clamp operates at black level so that the output stage always operates over the same portion of its characteristic.

Filament power for all tubes in the field switcher is supplied by a transformer in the Field Switching System. D-c





# Auxiliary Field Switching Control, MI-26238

## Features

- Provides means for a dissolve, fade, superimposed picture, or instantaneous switching.
- Switches up to six local signals.
- Tally light switching for four camera chains.
- Provides local tally light system to indicate camera or cameras "on-the-air".
- Separate adjustments of signal levels for superimposed picture.
- Use in conjunction with TS-30A Camera Control permits handling of various combinations of eleven signals.

## Uses

The Auxiliary Field Switching Control is designed for use with the TS-30A Field Switching System. It permits a varied number of switching and fading conditions depending on individual requirements. For example, actual operation allows the following to be accomplished with the output of the auxiliary switcher fed to "AUX" 5 input on the TS-30A:

Combination	Switching		Fading
	Local	Remote	Local
A	11	0	6
B	8	3	1
C	4	7	0

(Other combinations are also possible)

For example, in combination "B" above, actual operation permits the following: (1) Four local signals may be fed to Auxiliary Switcher which can be faded or switched instantaneously. (2) Four other local signals may be fed to TS-30A for instantaneous switching. (3) Two remote signals may be fed to Auxiliary Switcher on "Aux 5" and "Aux 6" and a third remote to "Aux 6" of TS-30A.

As used above in normal operation with the output of the Auxiliary Switcher fed to "Aux 5" input of TS-30A, the TS-30A "Sync" switch is used at "INT" position when switching remotes, and at "EXT" for switching or fading local signals.



Rear view of Field Switching Control showing coax connectors and Jones plug supplied



## Description

The Auxiliary Field Switching Control includes the necessary push-button switches, fader control, resistor networks, tally lights and coaxial connectors for accommodating six camera control circuits (or four cameras and two auxiliary). Fader lever arms provided are normally operated together but may be operated separately as the operator chooses. When fading from black, it is not necessary to punch a "release" button on the "off" channel. If no button is depressed in the "off" channel, operation is automatically set for black. The auxiliary unit is housed in an all-metal case finished in umber gray wrinkle. All switching circuit controls are clearly and legibly identified on the front panel. Coax terminals are brought out at the rear with suitable coax connectors provided for making the necessary connections. Output of the auxiliary control is fed into the TS-30A Field Switching Equipment on any input with its termination lifted. A Jones plug and connector are also provided at the rear to supply d-c to the camera tally light relays.

## Specifications

### ELECTRICAL

- (1) Input Impedance.....75 ohms
- (2) Input Signal.....15 volts, peak to peak, black negative
- (3) Frequency Response.....Flat to 7 mc  $\pm 10\%$  (fader arms locked and at one extreme position), sloping off to  $-20\%$  at 7 mc with arms locked and at mid-position
- (4) Tally Lights.....12 volt miniature bayonet #1815 or equivalent

### MECHANICAL

- Maximum Dimensions.....Width  $8\frac{1}{4}$ ", height  $3\frac{1}{2}$ ", depth 6"  
 Approximate Weight.....6 lbs.  
 Finish.....Body—Umer gray wrinkle; Pushbuttons—One row of six white, one row of six black; Lever Handles—One white, one black.

Stock Identification .....MI-26238

# Metal Tripod, Type TD-11A

## Features

- Three-point leg bracing with individual tie rods and sturdy center post insure rigidity and stability.
- Extremely light in weight—yet rugged in design.
- Provides mountings for relay receiver and transmitter and field or studio cameras (MI-26010-A and MI-26000-A respectively).
- May be readily used with Tripod Dolly TD-15A.
- Folds into small, compact, self-locking package for carrying.
- Individual leg calibrations aid in accurate positioning and adjusting.
- Attractively finished in deep umber gray wrinkle and hard chrome.



## Uses

The type TD-11A tripod is designed to accommodate tilt head MI-26206 which may be used in conjunction with microwave relay transmitter (TTR-1B) and microwave receiver unit (TRR-1B). The type TD-11A tripod may also be used in supporting RCA television studio and field cameras (with friction head MI-26205). When used with television tripod dolly type TD-15A, it provides a maximum of convenience and mobility for dolly operations.

## Description

The type TD-11A consists of an all-metal tripod structure of aluminum castings and tubular steel construction which provides a compact, lightweight, yet rugged design. It folds into a small-size unit which is easily portable. When collapsed for carrying, legs are latched to the center stabilizing post, thus preventing leg spread during transport.



TD-11A Tripod above with RCA Studio Camera. At right TD-11A is collapsed for carrying.

In operation the TD-11A provides a "working-height" range of approximately 25 to 42 inches. Outstanding in design are individual tie rods which connect to and brace all tripod legs (these same three tie rods also couple to the center stabilizing post and provide a stable, rigid support).

The lower tubular portion of each leg is easily adjusted and slides within a long-length bearing which is held to close tolerances. Thus, minimum play and maximum rigidity are assured throughout the working range. When tripod legs are adjusted for desired height, they may be locked in position by means of hand-operated, clamp screws. The lower end of each leg is provided with a self-aligning, universally-mounted casting, which in one plane has a flat surface for use on level flooring—and in another plane has a steel spike for use on rough surfaces. The flat-surface also provides a suitable mounting for use with Tripod Dolly, TD-15A.

## Specifications

Recommended Operating Heights:	
Minimum	25 $\frac{5}{8}$ "
Maximum	42 $\frac{1}{2}$ "
Maximum Diameter at Feet (legs extended)	70"
Dimensions (folded for transport):	
Overall Height (legs collapsed)	31 $\frac{3}{8}$ "
Overall Diameter	10"
Weight	25 lbs.
Stock Identification	MI-26046

## Accessories

Camera Friction Head	MI-26205
Tilt Head for Microwave Relay Transmitter and/or Receiver	MI-26206
Tripod Dolly, Type TD-15A	MI-26042



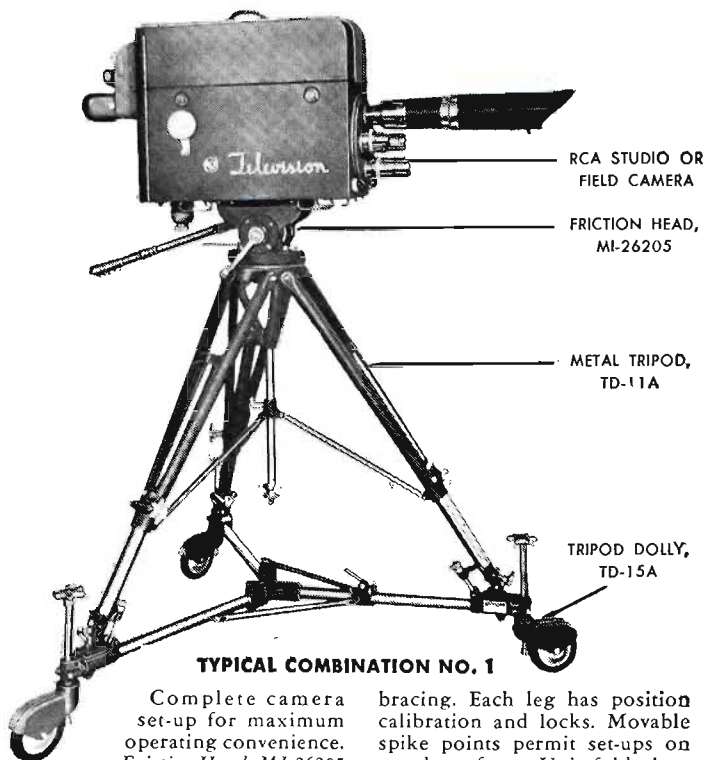

**TYPICAL COMBINATION NO. 1**

Complete camera set-up for maximum operating convenience. *Friction Head, MI-26205* gives camera 360-degree panning and full tilting action. Has "degree-indicator" scales and locking handles. *All-Metal Tripod, TD-11A* uses individual tie rods and center post for sturdy

bracing. Each leg has position calibration and locks. Movable spike points permit set-ups on rough surfaces. Unit folds into compact, self-locking package. *Tripod Dolly, TD-15A* takes up a circular area only 57" diameter. Wheel stops for fixed positions. Folds and carries in a compact package.

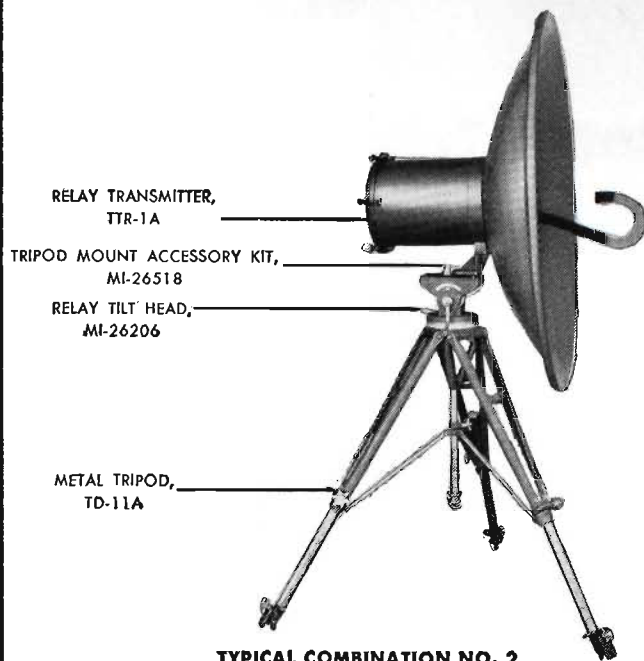

**TYPICAL COMBINATION NO. 2**

A complete vhf relay transmitter *Relay Tilt Head MI-26206* provides wide adjustment angles for difficult terrain and long distances, where radio relay is more practical than coaxial cable. *Tripod Mount Accessory Kit, MI-26518* provides means for mounting relay equipment to tripod. Includes mounting plate, saddle, and bolts.

*Relay Tilt Head MI-26206* provides wide adjustment angles for vertical tilt and horizontal rotation. Sealed bearings for all-weather service. Accurately calibrated. Individual locking devices. *Metal Tripod TD-11A* same as Combination No. 1.

# Dollies, booms, stands,

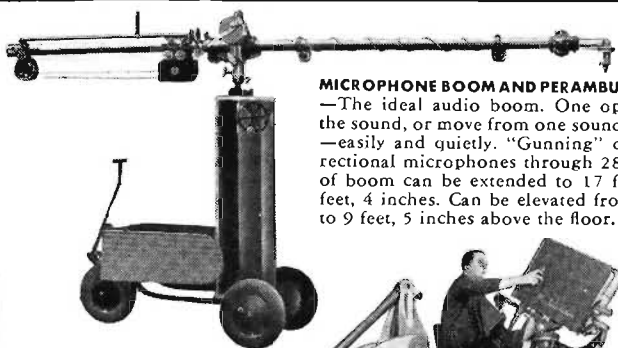

**MICROPHONE BOOM AND PERAMBULATOR, MI-26574**  
—The ideal audio boom. One operator can follow the sound, or move from one sound source to another—easily and quietly. "Gunning" device revolves directional microphones through 280 degrees. Radius of boom can be extended to 17 feet; retracted to 7 feet, 4 inches. Can be elevated from 6 feet, 5 inches to 9 feet, 5 inches above the floor.

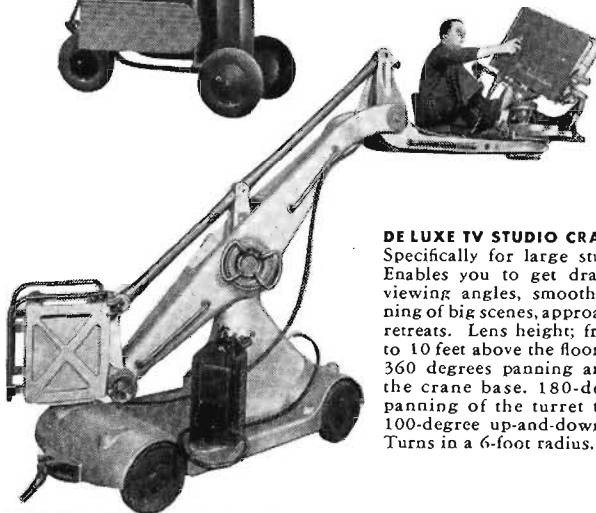

**DELUXE TV STUDIO CRANE—**Specifically for large studios. Enables you to get dramatic viewing angles, smooth panning of big scenes, approaches, retreats. Lens height; from 2 to 10 feet above the floor. Full 360 degrees panning around the crane base. 180-degree panning of the turret table. 100-degree up-and-down lift. Turns in a 6-foot radius.



**"MAGIC LOCK" BOOM STAND, KS-4A—**The handiest microphone boom ever designed for TV studios. Convenient locking devices enable operator to control it with one hand. No set screws. No release mechanisms. No slipping. Each adjustment locks into position. Moves in a 180-degree arc and a base radius of 26 inches. Silent in operation.

**STUDIO CAMERA DOLLY, TD-5A—**Similar to the dollies used in film studios—but both front and rear wheels turn to the side. Entire unit can be moved sideways. Stops lock the dolly in a fixed position. Camera crane boom can be elevated from 23 inches to 74 inches above the floor. -

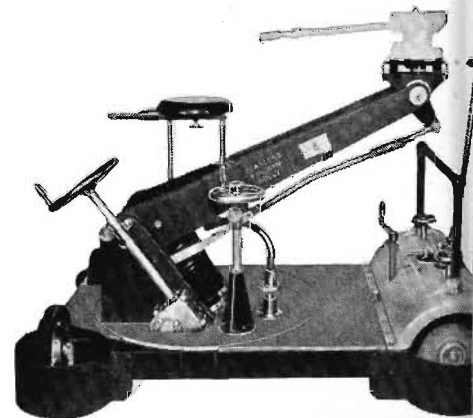

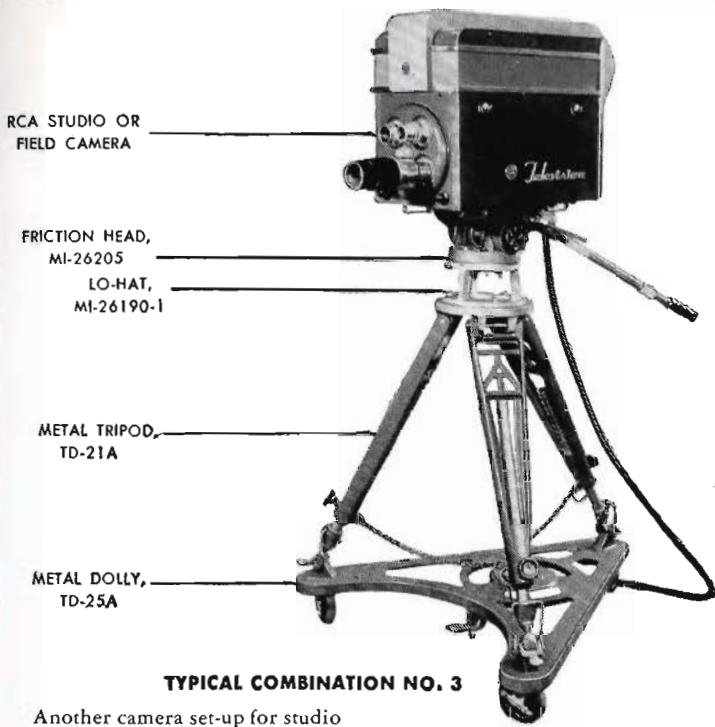

**TYPICAL COMBINATION NO. 3**

Another camera set-up for studio and mobile work. Handles RCA Studio Camera or Field Camera. *Friction Head, MI-26205* same as used in Combination No. 1. *Lo-Hat, MI-26190-1* provides greater freedom and height for camera action. *Metal Tripod TD-21A* for fixed or portable set-ups. Cast

aluminum and stainless steel construction. Legs adjustable up to 21 inches. Dual feet; pointed for field work and flanged for fixed service. *Metal Dolly TD-25A*. Non-swiveling. Foot-controls for parallel wheel alignment. Individual wheel and tripod locks.

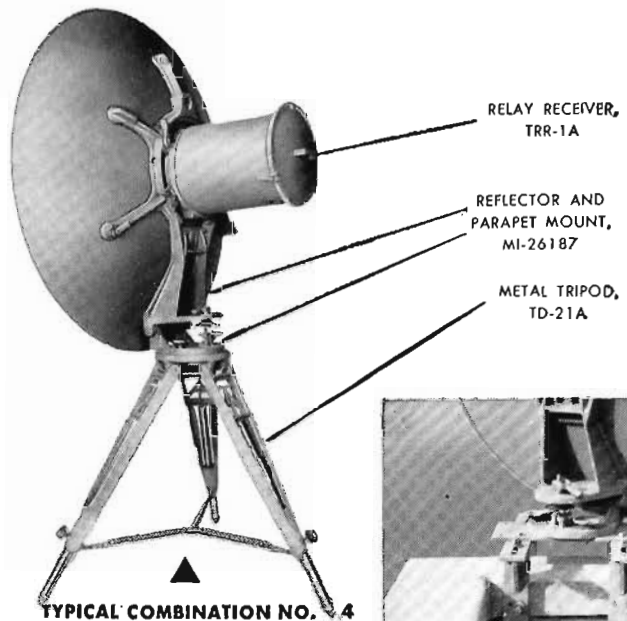

**TYPICAL COMBINATION NO. 4**

A complete relay pick-up receiving system. Relay receiver and parabola fasten to tripod through Reflector and Parapet Mount, MI-26187. *Metal Tripod, TD-21A* is set up for rough surfaces.

Field Camera and Friction Head, MI-26205, can be mounted on *High Hat MI-26190-2* for wall or parapet use. Complete assembly is attached to *Parapet Clamp Support MI-26189*.

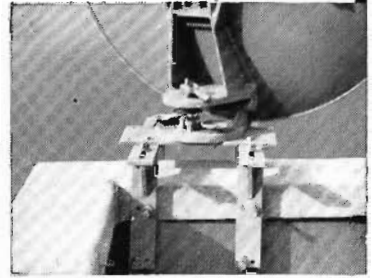

▲ Here, Reflector and Parapet Mount MI-26187 fasten to Clamp Support, MI-26189—which mounts on top of wall. Relay reflector may also be permanently mounted in wall openings by means of "Gimbal" Antenna Ring Mount, MI-26207 (not illustrated).

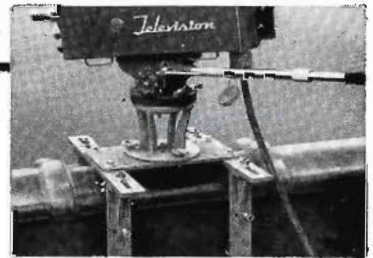

# mounts, accessories...

# for every TV set-up



**STUDIO CAMERA PEDESTAL, TD-1A**—Television's favorite pedestal for studio and other indoor operations. Moves freely, quietly. Crank handle raises and lowers camera to any height between 40 inches and five feet above the floor. Moves in any direction—or about a point. Panning and tilting provided by Friction Head MI-26205.

PICTURED on these pages are typical units and combinations from the most complete line of television accessories in the industry—application-engineered to meet every pick-up situation called for in your TV operations.

This line of mechanical accessories enables you to select just the right combination for your station operation. It includes every device needed for providing universal camera action in the studio and the field. It provides additional flexibility for maneuvering and covering shots from any angle.

RCA TV accessories are stoutly built to withstand the tough wear and tear encountered in field and studio operations. Yet each unit is a model of mechanical simplicity—easy to transport, easy to set up, easy to adjust, and easy to handle.

RCA TV accessories like these are used today in nearly every television station in the country. For complete information on the entire line, call your RCA Broadcast Sales Engineer. Or write Dept. 19JD, RCA Engineering Products, Camden, New Jersey.



# Camera Friction Head, MI-26205A



## Features

- Designed for use with RCA Field and Studio Cameras, MI-26010A and MI-26000A.
- Single screw mounting for cameras—detachable telescopic handle furnished.
- Separate positive locking handle for tilt and panning positions.
- Separate friction shoe permits adjustment of tilting friction to suit individual operator.
- Ball bearings in races on both ends of tilt shaft as well as large ball thrust bearing in races for panning assure smooth tilting and panning action.
- Ball thrust bearing and friction control adjustment assure smooth panning and tilting action.
- Carefully selected materials and weather sealed bearings.
- All exterior parts are of stainless steel or are hard chrome plated to completely eliminate possibility of corrosion.
- Counter-balancing springs are completely enclosed.

## Uses

The MI-26205A Friction Head was designed especially for use with the RCA Field and Studio Cameras, MI-26010A and MI-26000A, and may be mounted on any of the following units:

- RCA Type TD-11A Tripod, MI-26046
- RCA Type TD-1A Studio Pedestal, MI-26035
- RCA Type TD-5A Panoram Dolly, MI-26040
- RCA Series of High and Low Hat Adapters, MI-26190

The Friction Head is mounted on these units by means of a single hand-operated wing nut, which is furnished with the Friction Head.

## Description

The MI-26205A Friction Head is of rugged all-metal construction, in which all materials have been carefully selected for both field and studio use.

Since all castings used are aluminum, the friction head is light, yet sturdy, and lends itself to extreme portability. All visible surfaces of the castings are attractively finished in deep umber gray wrinkle and present a very neat appearance.

Rotation through 360 degrees in azimuth and ample tilt, up and down, are provided for operation with the RCA cameras. Extremely smooth in operation, RCA Field and Studio Cameras when mounted on this unit are well balanced in any position of tilt, by means of specially designed counterbalance springs. Thus, a minimum of effort is required by the camera operator.

## Specifications

### Dimensions:

Overall Height \_\_\_\_\_ 8¼"  
 Overall Length \_\_\_\_\_ 8½"  
 Overall Width \_\_\_\_\_ 13"

Weight (including panning handle) \_\_\_\_\_ 18 lbs. approx.

Finish \_\_\_\_\_ Dark umber gray wrinkle

Angle of Rotation \_\_\_\_\_ 360°

Stock Identification \_\_\_\_\_ MI-26205-A

# Tripod Dolly, Type TD-15A



## Features

- Provides mobility for tripod camera mounting.
- Folds into compact lightweight self-locking package for carrying.
- Large diameter 5" wheels permit easy movement.
- Wheel stops provide for locking tripod in position.
- Tripod firmly locked to dolly.
- Attractively finished in hard chrome.

## Use

The Tripod Dolly is designed for use on tripods fitted with television cameras. When tripods are used indoors, which is very often the case, use of the dolly precludes any possibility of marring the floor, and provides greater mobility for the tripod. Used in the field with reasonably flat terrain, the dolly makes it convenient and easy to change the position of the tripod.

## Description

The Tripod Dolly consists of a lightweight triangular-shaped steel structure supported on three swivel wheels, five inches in diameter. The finish is hard chrome. For convenience in transporting, the dolly folds into a package 8 x 14 x 29 inches. When extended and fastened to the tripod, it occupies a circular area 57 inches in diameter. The dolly is fastened firmly to the tripod by a clamp at each leg. Spring-loaded stop feet at each wheel serve to hold the tripod in a fixed position. Wheels may be removed readily if such should be required.

## Specifications

Dimensions (unfolded and extended):

Height \_\_\_\_\_ 6 in.  
Diameter \_\_\_\_\_ 57 in.

Folded for transport:

Height \_\_\_\_\_ 8 in.  
Width \_\_\_\_\_ 14 in.  
Length \_\_\_\_\_ 29 in.

Weight \_\_\_\_\_ 25 1/4 lbs.  
Stock Identification \_\_\_\_\_ MI-26042

*Dolly Fitted  
to Camera  
Tripod.  
TD-15A*



*Dolly Folded for Transportation*



# Television Relay Transmitter, Type TTR-1B



TTR-1B Relay Transmitter at right, and Transmitter Control Unit (MI-26305) below

## Features

- Used with TRR-1B Receiver provides complete Television Relay System.
- Microwave frequency operation permits simplified circuits and small size.
- Tripod mountings and accessories provide portability for field use.
- Effective automatic frequency control.
- Sturdily constructed to withstand continued outdoor use.
- Parapet mount and gimbal mount available for fixed installations.
- Wide band circuits provide excellent system response satisfactory for a 500 line picture without noticeable degradation.

## Uses

The Type TTR-1B Relay Transmitter, when used with a Type TRR-1B Relay Receiver, constitutes a highly directional wide-band relay link—capable of transmitting video signals without visible decrease in picture quality. Such a system has three important applications which are:

(a) FOR STUDIO-TO-TRANSMITTER CIRCUITS where conditions of terrain, distance, or right-of-way permit economical and reliable operation. For such use the transmitter and parabolic antenna units will be permanently mounted on the roof or other high location near the studio and the transmitter control unit will be mounted, ordinarily, on the equipment racks in the studio control room. The receiving equipment will be permanently located at the transmitter site.

(b) FOR FIELD PICKUPS as a means of transmitting video signal from field pickup cameras or similar sources to a television control room for broadcasting. In this case, the rotatable tripod mounting illustrated will ordinarily be used. The antenna will be located on some high point, such as the top of a stadium where a line-of-sight path with sufficient clearance is available. The transmitter control unit will be located with the camera control equipment as, for instance, in the radio booth or in the field truck or mobile unit.

(c) AS A REPEATER STATION, when distances or intervening obstacles necessitate an additional link to reach the picture signal destination. Picture degradation through two links is negligible. The intermediate transmitter and receiver will be situated on a building or other suitable support, (antenna locations and frequency assignments being made so that local transmitter signal does not interfere with local receiver reception). The RCA relay equipment utilizes microwave frequencies in the 6500 to 7050 megacycle band. Radiation is confined to a relatively narrow beam by the paraboloid reflectors. Either 4-foot or 6-foot diameter paraboloids are available. A maximum range of 25 miles with good signal-to-noise ratio can be expected using a 4-foot diameter paraboloid. The 6-foot parabola permits longer range, but it has a narrower radiating pattern and of course is heavier.

## Description

The TTR-1B Relay Transmitter is a complete, transportable transmitting system consisting of (1) a transmitter, (2) a narrow-beam antenna, (3) an antenna mounting capable of wide adjustment in the horizontal and vertical plane, and (4) a transmitter control unit.

The transmitter is contained in a cylindrical weatherproof housing attached to the rear of a parabolic reflector. It utilizes a klystron oscillator which is frequency-modulated by variations of the negative voltage on the repeller plate. It has a power output of approximately 100 milliwatts, operating at any selected frequency between 6500 and 7050 megacycles. The normal frequency deviation is 12 mc. with polarity such that a video signal in the white direction produces an increase in frequency. The output is fed to the parabolic reflector by means of a wave guide. Coupled into this wave guide system are an absorption type wavemeter, and a crystal detector monitor. The wavemeter is factory-set to any assigned frequency. The d-c from the crystal detector may be measured either at the transmitter or at the transmitter control unit as a rough indication of relative power output. The a-c component of the crystal detector output is amplified and fed over a coaxial line to the transmitter control unit where it serves during preliminary adjustment to indicate the correct frequency, and during operation, to indicate proper centering of the signal around the resonant frequency of the klystron cavity. Filament power for the tubes in the transmitter is supplied from a small filament transformer on the same chassis. All other voltage supplies are received on the transmitter chassis which are accessible by removing the protective cover over the cable input connection. By plugging in a suitable meter in the proper jack, it is possible to measure the current through modulator tube, and the oscillator tube. Another jack is provided so that a telephone handset can be plugged into the unit for communication with the transmitter control unit location.

The parabolic antenna provides a very high gain in the direction of transmission. The four foot size (illustrated) has a gain of approximately 5000, thereby giving an equivalent power output of 500 watts. The parabola is also available in the six foot size, with more than twice the gain, for use in communicating over greater distances. Transmission is limited to a line-of-sight path, and under normal conditions, a range of 10 to 25 miles may be expected with a satisfactory signal to noise ratio.

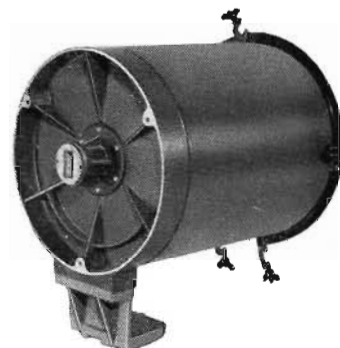

Transmitter, front end, showing Wave Guide Stub and Antenna Mounting Studs

The transmitter control unit is housed in a small, easily-carried, portable cabinet with a convenient handle on the top. The controls are accessibly located on a control panel on the side of the cabinet. This control unit may be located up to 200 feet from transmitter for camera cable and for greater lengths RG/8U coax to carry video from transmitter control to transmitter. It contains all the necessary operating and monitoring controls, and after initial adjustments of the transmitter and antenna have been made, all operations may be carried on from this unit. It also contains a regulated B+ supply for operation of the transmitter tubes, and a regulated negative supply for the klystron repeller plate. For greater operating convenience, provision is made for extending the operation of the controls necessary for routine adjustments of the transmitter to a monitoring console.

A tripod mounting and four foot parabolic reflector usually serve best for mobile service. A six foot reflector with corresponding antenna waveguide can be tripod mounted but is not recommended because of size and weight.

For fixed service two types of mount are available. The parapet mount is designed for installation on building parapets and similar structures. (Mount has a four foot dish attached.) The transmitter housing and antenna waveguide are easily installed or removed as an assembly at rear of the antenna support, thus permitting a permanent support and reflector installation without unnecessary encumbrance of a transmitter.

The additional fixed service mount is a gimbal ring which serves as a "wall" mount for four, and six-foot reflectors. It is particularly suitable for fixed installations using six-foot reflectors.

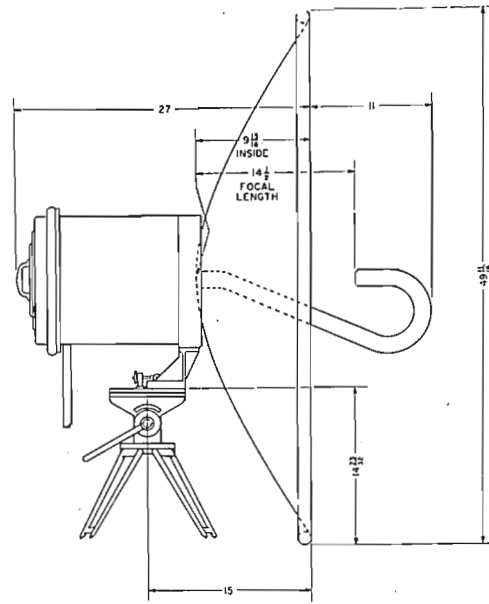

Simplified sketch showing tripod mounting of TTR-1B Transmitter

**Specifications**

- Frequency Range \_\_\_\_\_ 6500-7050 mc.
- Power Output, Nominal \_\_\_\_\_ 100 milliwatts
- Antenna Gain, approximate:
  - 4 ft. Reflector \_\_\_\_\_ 5,000
  - 6 ft. Reflector \_\_\_\_\_ 11,500
- Frequency Deviation, normal, each side of center \_\_\_\_\_ 5 to 6 mc.
- Video Input (at Transmitter Control)
  - Complete Modulation \_\_\_\_\_ 2 volts, peak-to-peak
  - Video Input Impedance \_\_\_\_\_ 75 ohms
- Video Frequency Range \_\_\_\_\_ 60 cycles to 7.5 mc.
- Power Supply Requirements (Transmitter and Control) 117 volt, 60 cycles a-c \_\_\_\_\_ 170 watts
- Tube Complement:
  - Transmitter Unit \_\_\_\_\_ RCA 6AG7 video amplifier and modulator; RCA 6SL7GT voltage regulator; RCA 6H6 d-c setter; RCA 6SL7GT monitor amplifier; and RCA 2K26 oscillator.
  - Transmitter Control Unit \_\_\_\_\_ RCA 6AG7 video amplifier; 2 RCA 6X5-GT rectifiers; 3 RCA VR150 voltage regulator; RCA VR105 voltage regulator; RCA 5V4G rectifier; RCA 6AS7G regulator; RCA 6SL7GT amplifier.

**Mechanical Specifications**

- Transmitter Control
  - (in carrying case) \_\_\_\_\_ 13" high, 20" wide, 9 1/2" deep
  - Weight \_\_\_\_\_ 38 lbs.
- Transmitter (in housing) \_\_\_\_\_ 14 1/2" high, 17" wide, 14" deep
- Weight \_\_\_\_\_ 40 lbs.
- Parabolic Reflector with Parapet:
  - Base Mounting \_\_\_\_\_ 48 1/2" high, 48" wide, 14 1/2" deep
  - Weight \_\_\_\_\_ 47 lbs.
- Parabolic Reflectors \_\_\_\_\_ Dia. 4ft., 14 1/2" deep, weight 30 lbs.
- \_\_\_\_\_ Dia. 6 ft., 15 1/2" deep, weight 75 lbs.
- Finish \_\_\_\_\_ Two-tone umber gray
- Stock Identification \_\_\_\_\_ MI-26935-A

**Equipment Supplied**

- Field television relay transmitter equipment is packed as Master Item 26935-A from the following units and components.
- 1 TTR-1B Relay Transmitter including set of tubes in place \_\_\_\_\_ MI-26166-A
  - 1 Field Relay Transmitter Control including set of tubes in place \_\_\_\_\_ MI-26305
  - 1 Wavemeter (with crystal in place) \_\_\_\_\_ MI-26565\*

\* Dash No. of MI-26565 as specified by Sales Order to correspond with frequency assigned to customer.

- 1 Antenna (select from list below)
  - a. Antenna, including 4 ft. Paraboloid and Feed System \_\_\_\_\_ MI-26185-A
  - b. Antenna, including 6 ft. Paraboloid and Feed System \_\_\_\_\_ MI-26185-B
  - \*c. Mounting and 4 ft. Reflector (for parapet antenna) \_\_\_\_\_ MI-26187
  - MI-26186 Antenna Feed System (for 4 ft. Parabola) required in addition.
- 1 Mounting Support for Transmitter and Antenna (select from list below)
  - \*a. Mounting and 4 ft. Reflector (for parapet antenna) \_\_\_\_\_ MI-26187
  - b. Television Tripod, TD-11A \_\_\_\_\_ MI-26046
  - c. Antenna Tilt Head \_\_\_\_\_ MI-26206
  - d. Tripod Accessories Kit \_\_\_\_\_ MI-26518
  - Required with (b), (c) combination and with (d).
  - e. Relay Antenna Ring Mount (Gimbal Ring) \_\_\_\_\_ MI-26207
- \* Do not duplicate.
- 2 Headset (single earphone) \_\_\_\_\_ MI-26570-3
- 1 Set of Interconnecting Cables \_\_\_\_\_ MI-26755
- 1 Cable, Camera, 20 ft. length with connectors \_\_\_\_\_ MI-26725-4
- 1 Camera, Cable, with connector (for installation between transmitter control and transmitter) 20/50/100/200 ft. lengths \_\_\_\_\_ MI-26725-4,1,2,3
- 1 Intercom, Cable, with connectors for use between transmitter control and picture control position 7/25/100 ft. lengths \_\_\_\_\_ MI-26756-1,2,3
- 1 Instruction Book \_\_\_\_\_ IB-36051-1

**Accessories**

- 1 Coaxial Cable with connectors for Video Input
- 1 Plug-in Meter MI-21200-C1 for making adjustments
- 1 Cable and components for remote monitoring; plug is supplied
- 1 16-22 volt, d-c source and retardation coil for telephone talking voltage when not available on public or private lines being used
- 1 Oscilloscope for frequency tuning and monitoring
- 1 Picture Monitor for checking video input to transmitter
- Pins for scope and ground pin jacks

**Spare Components**

- Crystal Detector \_\_\_\_\_ MI-26660



# Television Relay Receiver, Type TRR-1B

*Relay Receiver TRR-1B (at right), and TY-25A Regulated Power Supply and Receiver Control Unit (MI-26310-A) below*



## Features

- Used with TTR-1B Transmitter, provides complete receiving system.
- Suitable for permanent installation.
- Completely portable for field use.
- Lightweight.
- Effective automatic frequency control.
- Use of identical items (antennas, mounts and enclosures) increases flexibility and interchangeability.

## Uses

The Type TRR-1B Relay Receiver, when used with a Type TTR-1B Relay Transmitter, constitutes a highly-directional wide-band radio link especially suited to the transmission and reception of television video signals. Such a link circuit has three important applications which are:

(a) **FOR STUDIO-TO-TRANSMITTER CIRCUITS** where conditions of terrain, distance, or right-of-way make such a system more convenient or economical than a coaxial line. For such use the antenna of the TRR-1B is located on a tower or other high point near the transmitter building in a fixed position directed toward the TTR-1B Transmitter located at the studio. The receiver control unit and power supply unit are ordinarily mounted on equipment racks in the transmitter control room.

(b) **FOR FIELD PICKUPS** where a TTR-1B Transmitter, arranged for portable use, is employed to send the video signal back to the studio (instead of wire or coaxial lines). In this case a rotatable mounting such as that illustrated will ordinarily be used (since there will be pickups from various directions). For temporary use, the tripod mounting may be used. When the equipment is used frequently, a more permanent mounting is desirable. In any event it must be high enough to provide a line-of-sight path to the transmitting antenna location.

(c) **AS A REPEATER STATION**, when distances or intervening obstacles necessitate an additional link to reach the picture signal destination. Picture degradation through two links is negligible. The intermediate transmitter and receiver will be situated on a building or other suitable support, (antenna locations and frequency assignments being made so that local transmitter signal does not interfere with local receiver reception). The RCA relay equipment utilizes microwave frequencies in the 6500 to 7050 megacycle band. Radiation is confined to a relatively narrow beam by the paraboloid reflectors. Either 4-foot or 6-foot diameter paraboloids are available. A maximum range of 25 miles with good signal-to-noise ratio can be expected using a 4-foot diameter paraboloid. The 6-foot parabola permits longer range, but it has a narrower radiating pattern and of course is heavier.

## Description

The TRR-1B Relay Receiver is a complete (transportable, if desired) FM receiving system covering the frequency range of 6500-7050 megacycles. It consists of (1) a receiver, (2) a highly directional antenna, (3) an antenna mounting unit which may be either fixed or rotatable, (4) a receiver control unit, and (5) a regulated power supply unit. These units are easily set up and connected by means of convenient plug-in cables.

The signal is picked up on the highly directional, high gain (5000) parabolic (4-foot) antenna and fed into the receiver. The receiver is contained in a cylindrical, weatherproof housing attached to the back of the parabolic reflector. This housing contains a klystron tube heterodyne oscillator, a crystal mixer circuit, and five stages of the receiver i-f amplifier. This provides an output signal of about 50 millivolts at an i-f center frequency of 129 mc. This signal is fed to a coaxial line leading to the receiver control unit. The receiver has a built-in transformer which supplies filament power to all tubes. All other voltages are obtained from the power supply by way of the receiver control unit. The equipment is provided with an intercommunication system so that handsets may be plugged in and operators may communicate between the receiver and the receiver control unit.

The receiver control unit contains seven additional i-f stages, the limiter and discriminator stages, and the AFC system. There are two separate discriminator channels fed from the output of the i-f amplifier. One supplies signal to the main transmitter and monitoring circuits. The other is used to generate a control voltage for the AFC amplifier. The receiver control unit is connected to the receiver by means of a single cable with plug connectors at each end. In operation this cable may be as long as 200 feet. Longer lengths may be used where RG/8U coax is employed for the I-F signal. In addition, a cable connector at the rear of the receiver control unit permits the connection of an extension cable so that routine adjustments may be conducted from a nearby monitoring console. Both this unit and the power supply may be mounted in a standard equipment rack. The receiver control panel is located on the front. A convenient power supply carrying case for portable operation is available. This control unit has its own filament transformer, but the other voltages are received from the power supply. All tubes are accessible from the front of the unit, and all cable connections are made at the rear.

## Specifications

Frequency Range	6500-7050
Receiver I-F Centered About	129 mc
Receiver I-F and Discriminator Bandwidth, approx.	16 mc
Antenna Gain, Approx. 4-foot Reflector	5000
6-foot Reflector	11,500
Video Output of Receiver	2 volts, peak-to-peak
Power Supply Requirements (Receiver and Receiver Control)	117 volt, 60 cycles
	250 watts

## Mechanical Specifications

Receiver Control (in carrying case)	13" high, 20" wide, 9½" deep
Weight	26 lbs.
Receiver (in housing)	14¼" high, 17¼" wide, 14" deep
Weight	38 lbs.
Parabolic Reflector with Parapet Base Mounting	48½" high, 48" wide, 14½" deep
Weight	47 lbs.
Parabolic Reflectors	Dia. 4 ft., 14½" deep, weight 30 lbs.
	Dia. 6 ft., 15½" deep, weight 75 lbs.

## TUBE COMPLEMENT

Receiver Unit—RCA 6J6 IF amplifier; 4 64Kt IF amplifiers; RCA 2K26 heterodyne oscillator

Receiver Control Unit—7 RCA 6AK5 IF amplifiers; 2 RCA 6J6 limiters; 4 RCA 6AK5 balancing amplifiers; 2 RCA 6AL5 discriminators; RCA 6SL7-GT AFC oscillator; RCA 6SL7-GT balanced amplifier; RCA 6SN7-GT amplifier and rectifier; RCA 6AC7-1649 video amplifier; 2 RCA 6AG7 video amplifiers

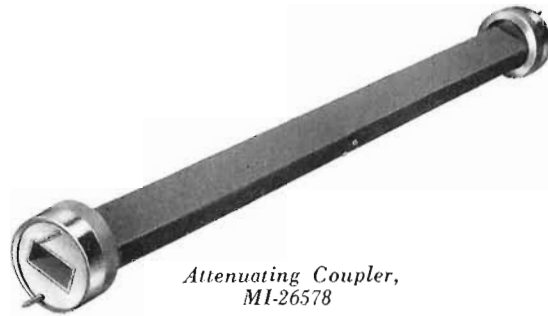

Attenuating Coupler,  
MI-26578

## Equipment Supplied

Field television relay receiving equipment is packed as Master Item 26940-A from the following units and components:

- 1 TRR-1B Relay Receiver including set of tubes in place \_\_\_\_\_ MI-26181-A
- 1 Relay Receiver Control including set of tubes in place \_\_\_\_\_ MI-26310-A
- 1 Regulated Power Supply
  - Type 580-C (for rack mounting) \_\_\_\_\_ MI-21523-B1
  - Type TY-25A (rack mounting) \_\_\_\_\_ MI-26086
 Field case to adapt Type TY-25A for portable service \_\_\_\_\_ MI-26527
- 1 Antenna (select from list below)
  - a. Antenna, including 4 ft. Paraboloid and Feed System \_\_\_\_\_ MI-26185-A
  - b. Antenna, including 6 ft. Paraboloid and Feed System \_\_\_\_\_ MI-26185-B
  - \*c. Mounting and 4 ft. Reflector (for parapet antenna) \_\_\_\_\_ MI-26187
  - MI-26186 Antenna Feed System (for 4 ft. Parabola) required in addition.
- 1 Mounting Support for Transmitter and Antenna (select from list below)
  - \*a. Mounting and 4 ft. Reflector (for parapet antenna) \_\_\_\_\_ MI-26187
  - b. Television Tripod, TD-11A \_\_\_\_\_ MI-26046
  - c. Antenna Tilt Head \_\_\_\_\_ MI-26206
  - d. Tripod Accessories Kit \_\_\_\_\_ MI-26518
  - Required with (b), (c) combination and with (d).
  - e. Relay Antenna Ring Mount (Gimbal Ring) \_\_\_\_\_ MI-26207
- 2 Headset (single earphone) \_\_\_\_\_ MI-26570-3
- 1 Attenuating Coupler (equivalent to approx. 10 miles of transmission) \_\_\_\_\_ MI-26578
- 1 Cable, Camera, 20 ft. length with connectors \_\_\_\_\_ MI-26725-4
- 1 Cable, Camera with connectors for installation between Receiver Control and Receiver 20/50/100/200 ft. lengths \_\_\_\_\_ MI-26725-4, 1, 2, 3
- 1 Instruction Book \_\_\_\_\_ IB-36051-1

## Accessories

- 1 Coaxial Cable with connectors for video output
- 1 Plug-in Meter MI-21200-C1 for making adjustments
- 1 Cable and components for remote monitoring; plug is supplied
- 1 16-22 volt d-c source and retardation coil for telephone talking voltage when not available on public or private lines being used
- 1 Oscilloscope for receiver frequency adjustments, tuning and balancing of discriminators
- 1 Picture Monitor for checking video output of receiver

## Spare Components

Crystal Detector \_\_\_\_\_ MI-26660

\* Do not duplicate.

# Metal Tripod, Type TD-21A

**Features**

- Designed for Microwave Relay use.
- Legs adjustable up to 21 inches.
- Feet pointed for field use—flanged for permanent use.
- Cast aluminum and stainless steel construction.

**Uses**

The type TD-21A metal tripod is designed primarily for use with Microwave Relay field equipment. The tripod may be used directly with the back loading parapet mount, MI-26187. It may also be used for supporting RCA Field or Studio Cameras.

**Description**

The type TD-21A tripod is made of cast aluminum and stainless steel to provide a rigid, yet lightweight, portable unit. The tripod legs are adjustable up to 21 inches and the unit may be employed in either permanent or temporary installations by means of two types of feet—pointed for field work, flanged for more permanent use. While intended primarily for relay transmitter and receiver applications, some stations may also employ the tripod for camera use. Friction heads, plus Hi and/or Lo-Hat adaptors are required for such applications.



*In addition to Microwave Relay uses, the TD-21A may be employed to support Television Cameras, as shown at left with Lo-Hat and TD-25A Dolly.*



**Specifications**

Finish	_____	Gray crackle
Weight	_____	42 lbs.
Stock Identification	_____	MI-26047

**Accessories**

TD-15A Dolly	_____	MI-26042
TD-25A Dolly	_____	MI-26043
Lo-hat	_____	MI-26190-1
Hi-hat	_____	MI-26190-2
Studio Friction Head	_____	MI-26205
Tilt Head	_____	MI-26206

# Camera Tripod Dolly, Type TD-25A

The type TD-25A dolly is designed for use in studio or portable TV applications. It is of all-metal design and incorporates a foot-actuated wheel alignment and release pedestal which fixes all wheels in a parallel plane. Thus, swivelling is prevented and straight line dollying is permitted. Individual wheel locks and positive tripod locks, without springs, are provided. The type TD-25A dolly may be used in conjunction with available tripods for a TV studio combination.

**Specifications**

Construction	_____	Cast aluminum
Finish	_____	Gray crackle
Weight	_____	30 lbs.
Stock Identification	_____	MI-26043





# Relay Tilt Head, MI-26206

## Features

- Simplified construction, with improved weather-sealed bearings.
- Interchangeable mounting with regular friction head of the panning handle type.
- Degree scales are provided for tilt and 360° rotation.
- Separate, positive lock handles are provided for tilt and azimuth rotation.
- All exterior parts are of stainless steel or are hard chrome plated to eliminate possibility of corrosion.
- Mounting design permits interchangeability on all mounts where regular friction head is used.

## Uses

The MI-26206 Tilt Head has been designed especially for use with the RCA Microwave Relay Equipment. It is easily transported and provides an ease of set-up adjustment. It is less expensive than the friction head of the panning handle type. It is suitable for mounting directly on the TD-11A all-metal tripod for field use.

## Description

The Tilt Head is of a sturdy, all-metal design in which materials have been carefully selected for outdoor or field use. Lightweight aluminum castings are employed and all surfaces are attractively finished in an umber gray wrinkle. The standard TTR-1A Microwave transmitter or TRR-1B Microwave receiver mounts on the MI-26206 head in conjunction with Tripod Mount Accessory Kit. A total rotational angle of 360 degrees and an ample tilt angle together with suitable "degree-indicator" scales are provided. Individual positive locking handles maintain proper settings of tilt and rotation.



## Specifications

Height	_____	8"
Length	_____	8"
Width	_____	7"
Width (Over Handle)	_____	10½"
Angle of Rotation	_____	360°
Stock Identification	_____	MI-26206
Companion Tripod (TD-11A)	_____	MI-26046

# Tripod Mount Accessory Kit

## Description

The Tripod Mount Accessory Kit is required and provides a convenient means for the Tripod Mounting of Relay Antenna Transmitters and Receivers for mobile service. The Accessory Kit consists of tripod mounting plate and saddle plus necessary mounting bolts. The front casting of the relay transmitter or receiver has a suitable rectangular surface for attaching the tripod accessory kit mounting. The tripod mounting plate fastens directly to Relay Tilt Head, MI-26206, which mounts on the TD-11A all-metal tripod. The tripod mounting saddle and plate form a dovetailed mounting assembly and easily slide together by means of a "V" cut groove and raised shoulder. A threaded rod equipped with a clamping wing screw securely locks the assembly in place to provide a rigid mounting. This same device enables the assembly to be easily and readily disassembled.

## Specifications

Finish	_____	Black crackle
Weight (approx.)	_____	2 lbs.
Stock Identification	_____	MI-26518

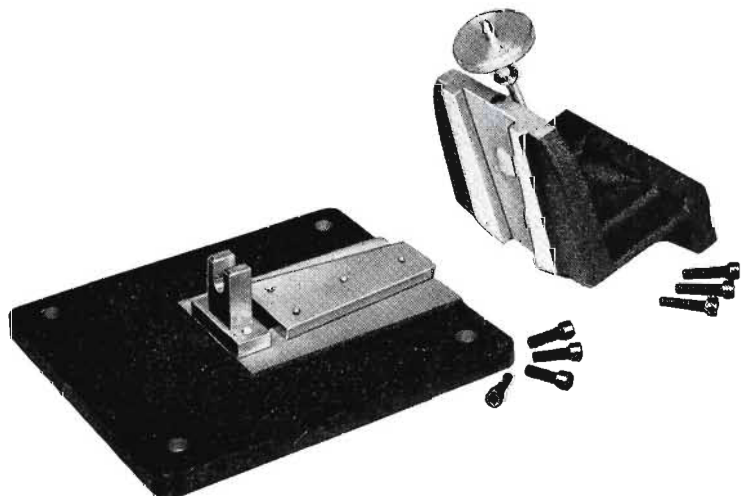

# Reflector and Parapet Mount, MI-26187

**Description**

Reflector and Parapet Mountings are available for use with RCA Portable Microwave Relay Equipment. The back-loading feature of the equipment permits quick installation of relay links by means of four fasteners. (Four equally spaced lugs on the rim of relay transmitter housing are utilized to clamp the unit in place for parapet mounting.) Telecasters may install reflectors on a permanent or semi-permanent basis at strategic locations by simply bolting directly to a flat surface. The reflector and mount is also suited for installing in conjunction with Parapet Clamp, MI-26189 as a fixed-service mounting. The Reflector and Parapet Mount unit may be used with Tripod MI-26047 for day-to-day, Relay use on a mobile unit, when desired.



*Reflector and Parapet Mount as used with TD-21A Tripod to support Relay Transmitter*

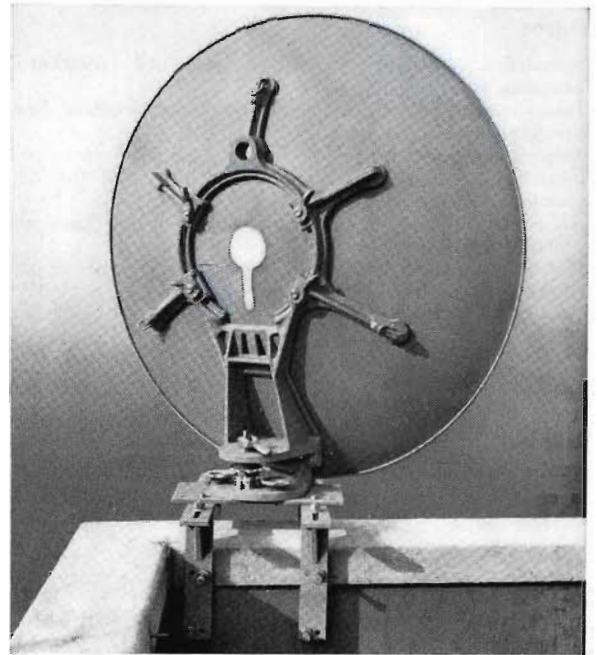

*Reflector and Parapet Mount shown as used with Parapet Clamp for wall type mounting*

**Specifications**

Finish \_\_\_\_\_ Gray crackle  
 Weight \_\_\_\_\_ 45 lbs.  
 Stock Identification (Reflector and Parapet Mount) \_\_\_\_\_ MI-26187  
 Accessory Parapet Clamp \_\_\_\_\_ MI-26189  
 Accessory Tripod \_\_\_\_\_ MI-26047

# Parapet Clamp Support Mount, MI-26189

**Description**

The Parapet Clamp is designed to mount on building parapets or walls for accommodating Microwave Relay Equipment—and in some cases television cameras. The clamp is made of rugged cold rolled steel and serves as an adjustable platform for either temporary or permanent installation, as desired.

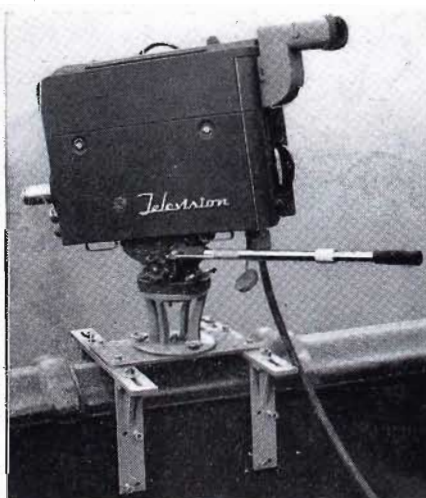

*Parapet Clamp Support, MI-26189, as used with Hi-Hat to support RCA Field Camera*

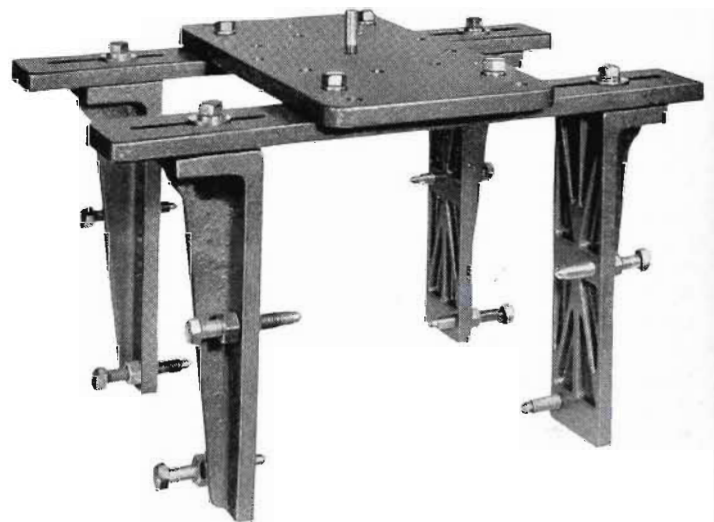

**Specifications**

Finish \_\_\_\_\_ Gray crackle  
 Weight \_\_\_\_\_ 53 lbs.  
 Stock Identification \_\_\_\_\_ MI-26189

# Camera Hi-Hat and Lo-Hat

## Description

The camera Hi- and Lo-hats are made available as camera mounts for use in restricted quarters where a tripod may not prove convenient. Installation of the hi-hat may save time on fixed locations from which frequent pickups are made. Either the hi-hat or lo-hat will accept friction head MI-26205A or tilt head MI-26206, for studio or field use, respectively. Both camera hat units may be used in combination with parapet clamp, MI-26189 and/or tripod, MI-26047.



*Lo-Hat, MI-26190-1*



*Hi-Hat, MI-26190-2*

## Specifications

Construction	_____	Cast aluminum, blue hammeroid finish
Height:	_____	
Lo-hat	_____	4"
Hi-hat	_____	6"
Weight:	_____	
Lo-hat	_____	14 lbs.
Hi-hat	_____	17 lbs.
Stock Identification:	_____	
Lo-hat	_____	MI-26190-1
Hi-hat	_____	MI-26190-2

# Relay Antenna Ring Mount

## Description

The RCA Relay Antenna Ring Mount consists of a gimbal ring assembly which serves as a convenient "wall-type" or fixed-service mount for four- and six-foot reflectors. It is particularly recommended for the six-foot reflector as a fixed-location assembly. The antenna ring fastens directly to antenna reflector bosses provided. (The transmitter or receiver housing with its wave guide receives support from the reflector.) With the rear ring of the assembly rigidly bolted to its support, the middle and front rings, which carry the relay equipment and

reflector, may be adjusted in both horizontal and vertical planes by means of hinged links and locking bolts. Adjustments provided on the gimbal ring permit a  $\pm 7\frac{1}{2}$  degree horizontal and vertical movement.

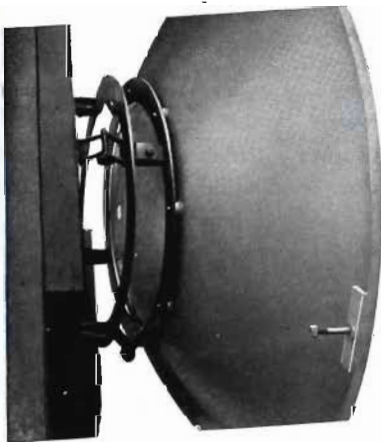

*Antenna Ring Mount as used to mount Relay Reflector*



*Sketch showing mounting details for Antenna Ring Mount*

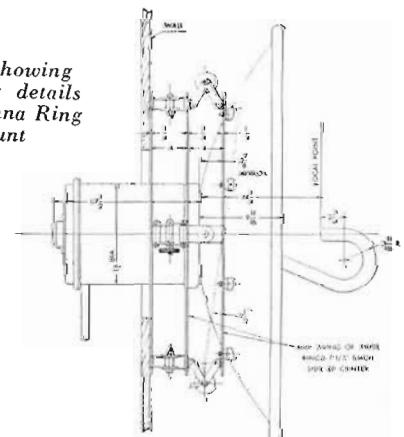

## Specifications

Dimensions:	_____	
Ring Diameter (outside)	_____	34"
Ring Adjustment, Vertical and Horizontal	_____	$\pm 7\frac{1}{2}$ degrees
Finish	_____	Umber gray crackle
Weight (approx.)	_____	80 lbs.
Stock Identification	_____	MI-26207



# Attenuating Coupler, MI-26578

(For Testing Microwave Relay Equipment)



## Features

- Convenient attenuation of transmitter signal for making receiver adjustments.
- Equipped for rapid attachment to both transmitter and receiver.
- Provides attenuation of approximately 52 db, equivalent to about 10 miles of free space transmission.

## Use

When used in conjunction with the TTR-1A/1B Transmitter and TRR-1A/1B Receiver, the Attenuating Coupler facilitates checking of the micro-wave receiver assembly for proper sensitivity, alignment, signal-to-noise ratio, tuning, and other similar adjustments. The attenuator may also be used to dissipate power when aligning the transmitter. Accurate results may be obtained because adjustments are made under conditions comparable to actual operation.

## Description

The Attenuating Coupler is a section of waveguide, Type RG50/U, modified to provide a small, easily handled piece of equipment for making receiver tests. The attenuating material used is laminated phenolic sheet, inserted in the waveguide with a tight fit. Two set screws hold the attenuator in position. Coupling nuts furnished for attaching to transmitter and re-

ceiver housings are the same as those supplied with standard antenna waveguides.

Receiver adjustments and sensitivity tests are made under simulated operating conditions. Dependable results are possible at a distance normally providing less than one db of free space attenuation.

With the attenuator as the path between the transmitter and the receiver under test, the strength of signal received is equivalent to the signal strength ten miles from a transmitter under normal operating conditions. No blocking of receiver stages due to excessive signal is present, because the transmitted signal undergoes 52 db of attenuation before being fed to the receiver.

## Specifications

Overall Length, excluding Pins	24"
Overall Length, with Pins	25½"
Waveguide	RG50/U ¾" x 1½" O.D.
Coupling Nuts	Same as supplied with standard antenna waveguide
Attenuation	Approximately 52 db, equivalent to about 10 miles of free space transmission
Weight	4½ lbs.

# Mobile Power Control Unit, MI-26293

## Features

- Provides line voltage control near operator's position.
- Voltmeter to check supply voltage before it is applied to Control Unit.
- Voltmeter to check voltage applied to equipment.
- Separate circuit breakers for equipment and utility loads.
- Watthour-demand meter to measure power consumption.
- Permits a-c operation of television mobile unit lighting system.
- Mounts conveniently on stand near wall of mobile unit.

## Use

The Power Control Unit is designed to provide a means for controlling, from a central point, the line voltage input to the equipment used in the television mobile unit. In addition, it is designed to record the power consumption of the equipment. The control is capable of operating from any two-wire system providing input voltages between 100 and 120 volts or between 200 and 220 volts, 60 cycles, at 5 KVA, which is sufficient to supply power to two camera chains, a master monitor, switching, audio and relay transmitter equipment.

## Description

The Power Control Unit consists of transformers, circuit breakers and other control apparatus for manually regulating the output voltage. The equipment is housed in a cabinet 18" x 24½" x 27", which is designed for mounting on the

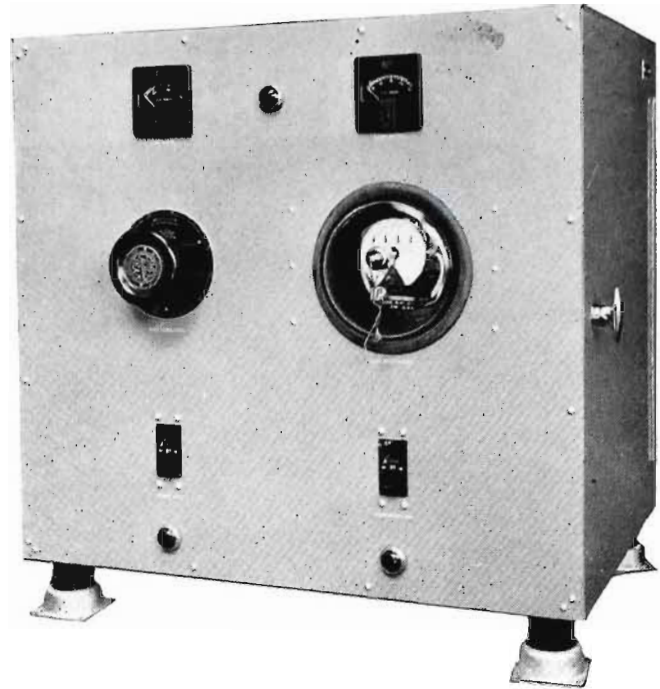

stand located near the wall of the mobile unit directly behind one of the operators' seats. Heavy shock mounts are provided with the cabinet.

Three meters are provided: a line input voltmeter, and output voltmeter and a half-hour demand watthour meter. A master line switch inside the cabinet is accessible through a side door. There are two circuit breakers on the front panel. One, rated at 40 amperes, is in the line to the television equipment. The other, a 10-ampere circuit breaker, is in the circuit to the utility outlets. The utility outlet is intended to supply the lighting system of the Television Mobile Unit when it is stationary during programs. Three pilot lights are located on the front panel. One is used as an indicator for the master switch. The other two are associated with the two circuit breakers. All connections to the power control unit are made through connectors mounted at the bottom.

## Specifications

Line Input Voltage \_\_\_\_\_ 100-220, or 200-220 volts, 60 cycles, single phase

Power Handling Capability (to television equipment) \_\_\_\_\_ 4 KVA

Power Handling Capability (to utility outlets) \_\_\_\_\_ 1 KVA

Output Voltages \_\_\_\_\_ 117 volts

Dimensions of Cabinet:

Height \_\_\_\_\_ 27"

Width \_\_\_\_\_ 24½"

Depth \_\_\_\_\_ 18"

Weight \_\_\_\_\_ 250 lbs. approx.

Stock Identification \_\_\_\_\_ MI-26293

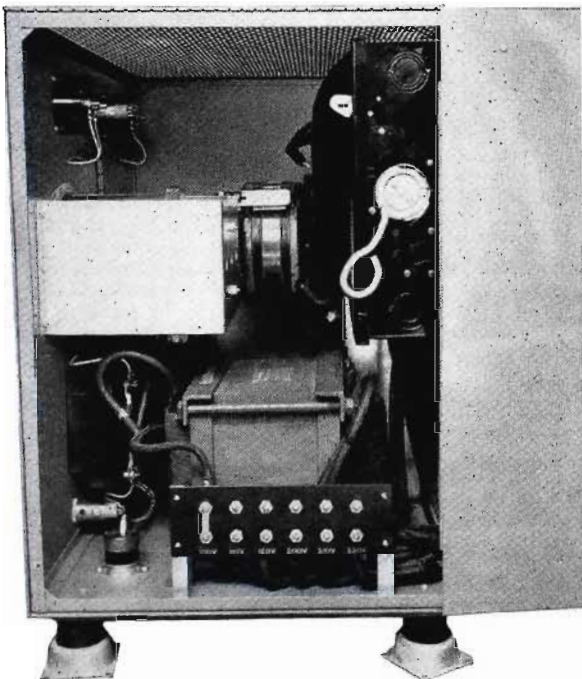

*Inside View of Power Control Unit*

# Television Mobile Unit, Type TJ-50A



## Features

- Provision made for mounting voltage control unit.
- Economical and convenient to maintain—standard chassis.
- Modern styling conforms with that of RCA Television Equipment.
- Six feet of head room in interior.
- Large windows in driving compartment.
- All glass is shatterproof.
- Complete and convenient stowage facilities.
- Provision made for six cable reels.
- Inside ladder and hatch provides access to roof.
- Roof covered with special non-skid tread material.
- Adequate heating facilities.
- Complete control room in rear of truck.

## Uses

The RCA Television Mobile Unit is a custom-built vehicle designed to carry the television equipment needed to pick up outdoor scenes and relay the pictures to a studio or transmitter room for broadcasting.

The interior arrangement provides adequate storage space for three cameras, their tripods and the relay transmitting parabola—units which must be set up outside the vehicle for telecasting. Equipment which need not be removed from the vehicle, such as the relay transmitter control unit, audio amplifier and mixer, monitors and the camera control unit, are shock-mounted on a metal frame. An attractively finished, linoleum covered operating table is provided adjacent to equipment.

Use of the Mobile Unit greatly simplifies the work of transporting the television equipment required for field pickups. It also saves considerable wear and tear on the television units as well as time in setting them up for operation.

## Description

The body of the vehicle, built on a standard 1½-ton chassis, is custom-built to provide an attractive, practical and compact unit. The standard finish is in two-tone umber gray which is both attractive and durable. (Optional colors can be furnished.) The roof is reinforced to support the weight of the field cameras as well as the relay antenna and the operators. Access to the roof is made easy through use of an inside ladder and a 24" x 36" rain-tight hatch.



A short wheelbase gets the vehicle around sharp turns in narrow streets; large, full-view shatterproof windows facilitate safe driving in heavy traffic; and a 90-horsepower engine provides speed on open roads as well as pulling power on the hills.

The four cable reels supplied are mounted on swinging arms housed in a rear compartment accessible through two doors in the back of the unit. When the rear doors are opened, the reels can be swung out into the clear to facilitate unreeling the cable. Each reel can accommodate 200 feet of camera cable. If additional cable is required, there is space in the compartment for the addition of two cable reels.

Shock mounts are available for use under the operator's table in mounting power supplies and portable sync generator. Also provided is a mounting plate for accommodating the microwave relay transmitter head end. Truck overhead lights and two 110 volt utility outlets in either wall at the side of the operating table are provided. A convenient shelf is incorporated for relay transmitter control and monitor equipment. Curtains are supplied for closing off control section to provide a darkened operating area.

Inside, the vehicle has adequate heating facilities for cold weather. A transformer provided under the hood allows the switching at the dashboard panel of truck lights to regular a-c outlets whenever available. The linoleum covered operating table at the rear runs the full width of the Mobile Unit, and provides convenient operating space for three operators seated side by side. Swivel chairs for the operators are permanently mounted to the floor. The storage lockers for the cameras, tripods and accessories are built along the inside walls of the vehicle.

**Specifications**

**Outside Dimensions (overall):**

Length (bumper to bumper) \_\_\_\_\_ 269"  
 Width \_\_\_\_\_ 89"  
 Height \_\_\_\_\_ 110"

**Inside Dimensions:**

Width \_\_\_\_\_ 84"  
 Height \_\_\_\_\_ 72"  
 Height (at operators' table) \_\_\_\_\_ 67"

Gross Weight \_\_\_\_\_ 13,500 lbs.

Tire Size \_\_\_\_\_ 7.50 x 20

Chassis \_\_\_\_\_ Standard 1½-ton 160" wheelbase

Finish \_\_\_\_\_ Two-tone umber gray (light umber gray inside)



*Interior view, looking aft, showing ladder to roof, and operators' positions*

**Equipment Supplied**

Stock Identification _____	MI-26981
1 TJ504 Field Truck _____	MI-26290
4 Cable Reels _____	MI-26573
1 Set of Shock Mounts (transmitter control) _____	MI-26758
1 Audio Amplifier Rack _____	MI-26569
1 Tripod Plate and Accessories _____	MI-26518-99

**Accessories**

Mobile Power Control Unit _____	MI-26293
---------------------------------	----------

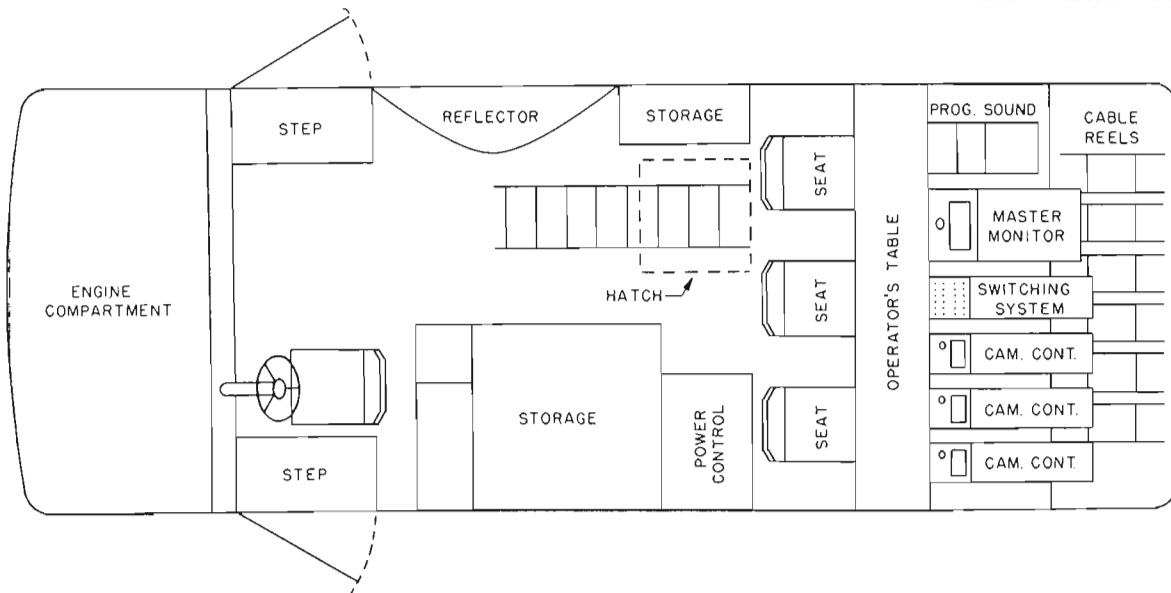

*Interior layout plan of TJ-50A*

# RCA Equipment



**WJZ-TV.** RCA field equipment in action atop a WJZ-TV field truck. WJZ-TV also uses RCA television camera controls, microwave relay equipment, sync generators, studio cameras, video and audio control-room console, complete film facilities, turntables, microphones, Superturnstile antenna, and the 5-kw transmitter Type TT-5A.

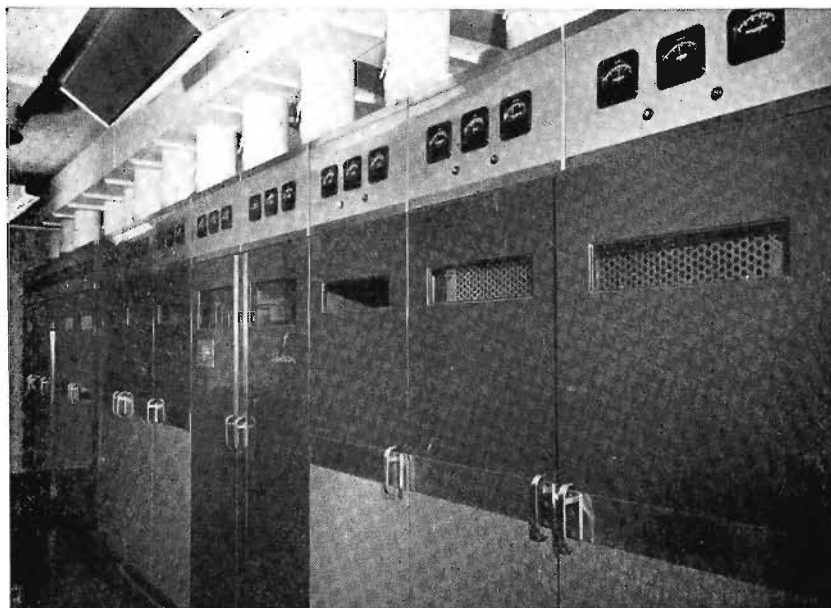

**WENR-TV.** The RCA 5-kw television transmitter Type TT-5A and RCA 10-kw FM transmitter Type BTF-10B at WENR-TV. This station also includes an RCA Superturnstile antenna, field truck and field camera equipment, studio cameras, video and audio control-room equipment, film projectors, film cameras, turntables, and microphones.



# ..The Choice of Television Stations

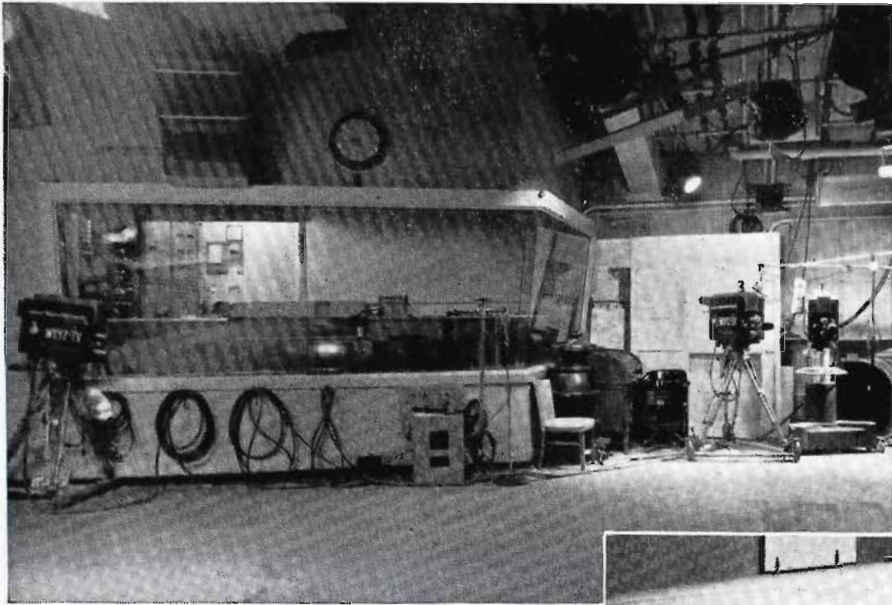

**WXYZ-TV.** One of the WXYZ-TV studios showing RCA studio cameras and the RCA-equipped control room. WXYZ-TV also uses RCA television field trucks, sync generator, microwave relay equipment, film projectors, slide projectors, film cameras, turntables, microphones, transmitter equipment—including the RCA TT-5A 5-kw transmitter and an RCA Superturnstile antenna.

**KECA-TV.** KECA-TV's television field truck—like many other TV stations—is an RCA "studio on wheels." It is complete with RCA image orthicon cameras, camera tripods, camera control units, on-the-air master monitor, camera switching system, sync generator, microwave relay equipment, power supplies. KECA-TV also uses RCA studio cameras, film equipment, turntables, microphones, and an RCA Superturnstile antenna.

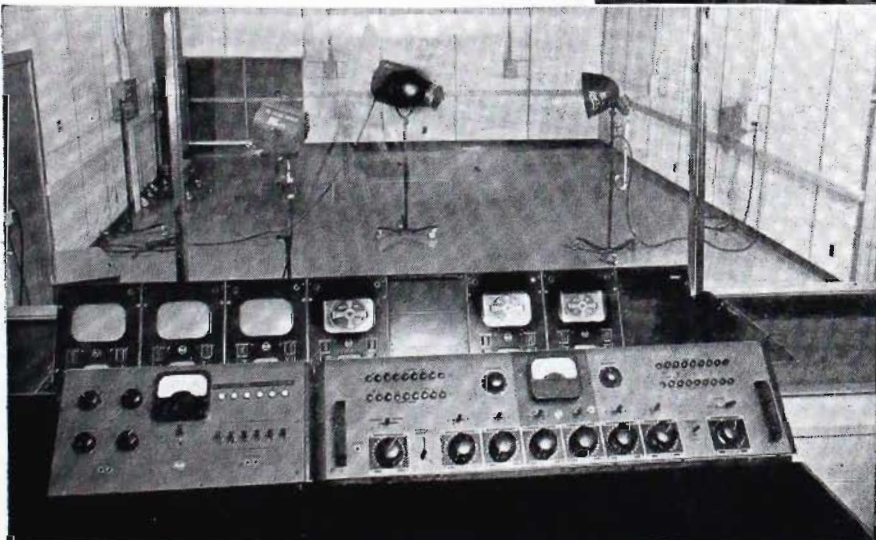

**KGO-TV.** Video control-room equipment at KGO-TV is completely RCA. KGO-TV also uses RCA field cameras, microwave relay equipment, field truck, sync generator, studio cameras, film projectors, slide projectors, film cameras, turntables, microphones and an RCA Superturnstile antenna.



# RCA Television Camera and Studio Control Room Equipment



*TK-10A Studio Camera*



*TS-10A Switching Section*



*TP-16A Television Projector*

*TK-20A Film Camera*

RCA Television Studio Cameras and associated control equipments are designed for all television installations, large or small. It is economical for stations starting out in a small way, because a minimum number of equipment units will handle their early requirements. As these stations grow, and new sources of program material become available, additional equipment units can be added without discarding previously installed equipment. In this way the small broadcaster can expect to have eventually a station which duplicates in appearance and facilities those stations which start on a larger scale.

RCA add-a-unit designs are also economical for larger television stations; first, because they eliminate costly duplication of apparatus, and second, because their manufacture in relatively larger quantities makes it possible to offer better quality at lower prices.

For all television broadcasters who plan to provide studio and film telecasts, there are five basic types of equipment required. These are, namely: (1) Pickup equipment, i.e., studio cameras, film and slide projectors; (2) a switching system for the cameras (or for the studios); (3) sync generating equipment; (4) program monitoring equipment; and (5) camera dollies and pedestals, line amplifiers, power supplies, etc. These items can be obtained separately, so that in each case, the broadcaster

can buy to suit his particular needs. All units have matching appearance and umber-gray finish. Moreover, they are electrically and mechanically designed to operate together. Additional units can be added at any time without fear of filling studios and control rooms with a number of dissimilar components.

A typical electrical arrangement of what we consider to be the basic camera equipment required for even the smallest station with studio control facilities is shown in the block diagram.

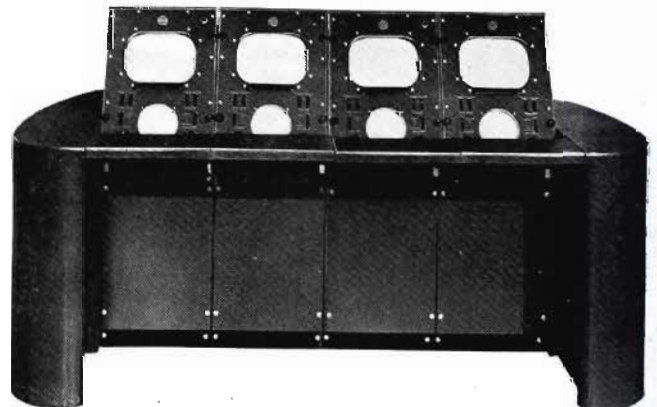

*4-Section Video Console*

Use is made of two Type TK-10A Studio Camera equipments, two TK-20A Film Camera equipments, a TG-1A Studio Sync Generator, and a TS-10A Switching System. The switching system can handle six input lines. As shown in the diagram, two of these six inputs are used for remote lines such as network or field pickups, and the other four are divided between two studio cameras and two film cameras. Sync is fed from the Sync Generator through a pulse distribution box to the TA-5B Stabilizing Amplifier which combines the sync with the camera video signals. Ordinarily, video signals fed to the remote inputs already contain sync which is supplied by the field equipment, or, in the case of the network input, is supplied at the station of origin. However, the Stabilizing Amplifier can also add sync automatically to remote input signals when necessary.

Program monitoring equipment required depends upon the number of studios employed by the broadcaster. For the smaller stations with perhaps one studio plus a projection

room, the video console formed by the camera control units and one switching unit will in most cases be adequate for satisfactory supervision and direction of programming. This video console is made up by bolting side by side one camera control section from each camera equipment plus a switching section. The addition of trim end-sections then forms an attractive desk-type console. Any number of these units can be fastened together.

Stations employing several studios and facilities for network programs will require a program director's console. This console is styled similarly to the video console, but the viewing monitors are built inside the housing and viewed through an opening in the top of the console. Thus, light cannot strike the screens. The director's console is provided with three monitors, two for preview and one for the program line. A switching panel allows the director to fade, lap-dissolve and switch the video signals.

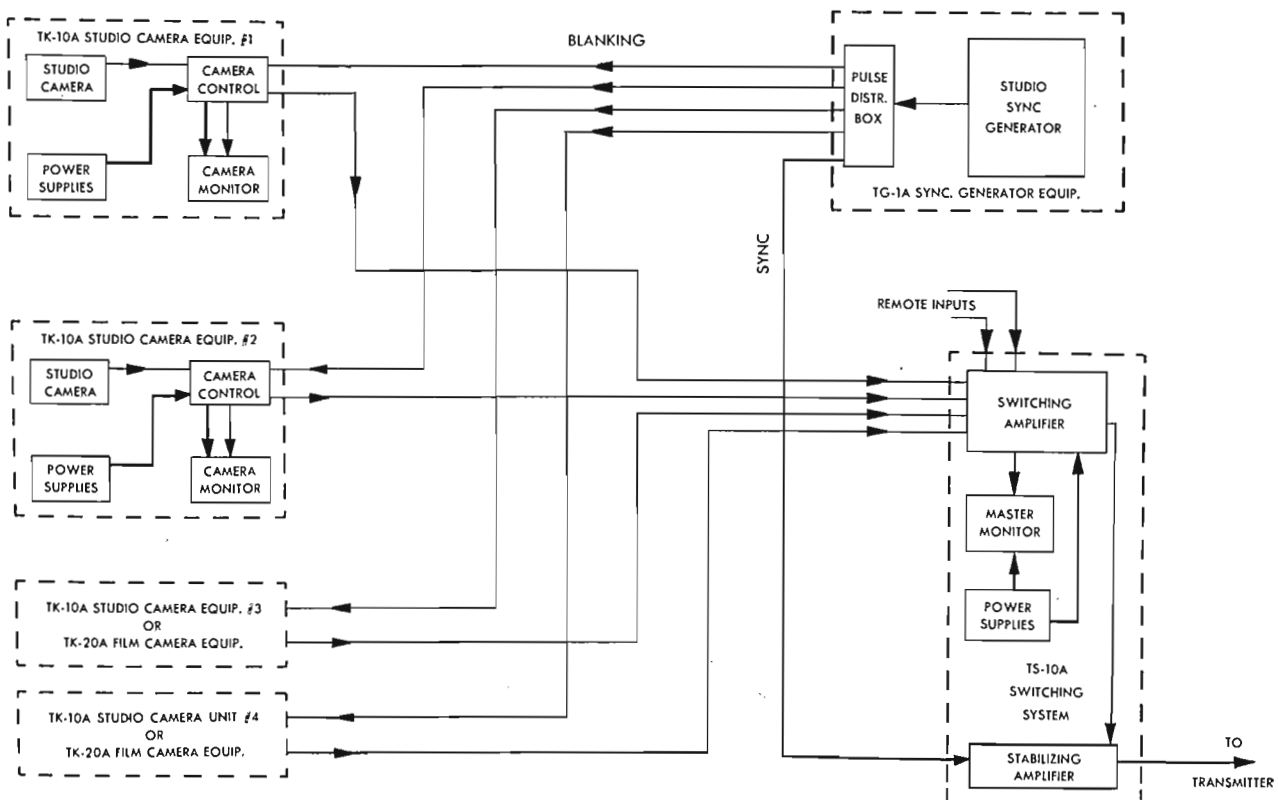

Block Diagram showing Schematic Arrangement of Studio Camera, Pickup, and Control Room Equipment



# Studio Camera Equipment, Type TK-10A

## Features

- Electronic Viewfinder included as standard equipment.
- Four lens positions provided on a rotatable turret.
- Optical focusing easily accomplished by a knob on the side of the camera.
- Studio Camera is supplied as single, complete, compact package.
- Hinged doors and covers permit easy access to camera circuits and controls.
- Four tally lights, two on the front of the camera, one on rear of camera and one beside the viewfinder kinescope, indicate to the cameraman and performers when the camera is on-the-air.
- A combination microphone and headset for each operator produces program sound in one earphone and order wire conversation in the microphone and other earphone.
- Two phone jacks on camera—one for cameraman, one for production man.
- Camera mounting designed for a standard tripod, a crane type dolly or studio pedestal.

## Uses

The TK-10A Studio Camera Equipment is designed to pick up scenes produced in television studios, and provide composite video signals that can be fed to a television transmitter.

The camera uses an Image Orthicon pickup tube which requires much less light than former studio cameras. Under normal lighting conditions (75-150 foot-candles) an excellent picture is obtained.

## Description

The TK-10A Studio Camera Equipment consists of the Camera itself, which can be mounted on a crane type dolly or studio pedestal, a Camera Control mounted in a desk-type console section, and power supplies designed for rack mounting. The size and general appearance of the console section is identical to that of the Film Camera Equipment and the Studio Switching System. Therefore, the studio camera control unit can be used in conjunction with other studio and film units. Any number of these console sections (one for each camera) can be bolted together to form a convenient desk-type console.

### STUDIO CAMERA

The general arrangement of the controls and components of the Studio Camera resembles that of the RCA Field Camera. Like the field camera, the studio camera employs image orthicon deflection circuits, a picture pre-amplifier, and an electronic viewfinder which is mounted directly on the camera. The viewfinder, which enables the camera man to view the scene he is picking up, uses a 5 inch picture tube (RCA-5FP4A) which operates with an image brightness satisfactory for viewing scenes even in brightly lighted studios. Sufficient gain is available to insure a sharp viewfinder image, even when handling dark scenes. Camera circuits are arranged on either side of the tube and coil assembly. On one side, the



*Studio Camera mounted on TD-1A Pedestal Dolly*

video preamplifier tubes are mounted on a shelf with the circuit components easily accessible on a terminal board below the shelf. The deflection and high voltage pulse supply circuits are mounted in a similar manner on the other side of the camera. Hinged doors on either side of the camera swing down to provide easy access to the camera circuits.

Four EKTAR type lenses are mounted on a lens turret which can be rotated by a handle at the rear of the camera. These lenses are relatively small due to the small size of the photocathode in the pickup tube. They are available in sizes from 35 mm f3.3 to 135 mm f3.8. Optical focusing is accomplished by adjustment of a knob on the side of the camera. This knob moves the pickup tube and its focus and deflection coil assembly with respect to the lens.

Controls for the studio camera circuits are located on the rear of the camera in two rows behind hinged covers. All these controls are normally preset and do not require adjustment during a program. Communication and tally light circuits are provided in the camera cable.

*Studio Camera Control Unit consisting of TM-5A Monitor and Camera Control Chassis (MI-26055) mounted in console housing (MI-26266B)*



**STUDIO CAMERA CONTROL**  
The Studio Camera Control enables the video operator to monitor and control the quality of the picture signal produced by the studio camera. It is a desk-type console section with a TM-5A camera monitor mounted in the upper part, and the control chassis mounted in the compartment below. The camera monitor has a 10-inch picture tube for displaying the picture, and a 5-inch oscillograph tube which reproduces the picture signal waveform. Controls for gain and black level setting are brought out on the monitor front panel.

The control chassis contains the necessary circuits for amplifying the video signal, establishing black level, mixing in a sawtooth correcting signal, adding picture blanking to the picture signal, adding the synchronizing signal, and providing 3 separate outputs. It is a vertically mounted chassis with a bracket projecting from the top part of the chassis supporting the operating controls. Four commonly used controls project through the desk top surface. These are:

1. Orthicon Focus
2. Beam Current
3. Target
4. Image Focus

Three less frequently used controls are recessed under a small panel in the top surface.

The control unit complete with its controls can be removed easily from the console by removing the lower front panel and sliding the unit out. All electrical connections are made with plug-in connectors.

**POWER SUPPLIES**

Four power supplies are required for each camera chain. These are as follows:

1. Type WP-33B to supply B+ to master monitor.
2. Type WP-33B to supply B+ to camera and viewfinder.
3. Type 580-C to supply B+ to camera control and to current regulator.
4. Current regulator to supply constant current to camera focus coil.

These four power supplies are designed for mounting in a standard rack in the studio control room.

**Specifications**

Number of Lines	525
Odd Line Interlacing	2 to 1
Frame Rate	30 per sec.
Field Rate	60 per sec.
Picture Signal Level	1.5 volts, peak-to-peak max. (conforms to RMA standards)
Picture Polarity at Output	Black negative
Impedance of Coaxial Transmission Line	75 ohms
Maximum Length Camera Cable	1000 ft.
<b>Total Included Angle of Lenses:</b>	
(a) 35 mm f3.3 Ektar	50°
(b) 50 mm f1.9 Ektar	34°
(c) 90 mm f3.5 Ektar	20°
(d) 135 mm f4.5	13°
(e) 8.5 in., f3.9 Ilex	8°
(f) 13 in., f3.5 Ilex	5°

Incident Illumination (min.) 25 foot-candles  
Incident Illumination for Best Results 100 to 200 foot-candles  
Power Source 117 volts, 60 cycles  
Power Consumption:

- (a) Heater Supply Camera Control 375 watts
- (b) Two WP-33B Power Supplies 800 watts
- (c) One 580-C Power Supply 370 watts
- (d) Current Regulator 15 watts

Total for One Camera Chain 1560 watts

**MECHANICAL SPECIFICATIONS**

Camera (including Viewfinder)	
Length	35"
Width	13"
Height	20"
Camera Control Console:	
Depth	36"
Width	13 1/4"
Height (overall)	41"
<b>Weights:</b>	
Camera (without lenses including Viewfinder)	105 lbs.
Camera Control Console Assembly (including Master Monitor)	140 lbs.
Camera Cable	0.4 lbs. per foot

**Tube Complements**

- TK-10A Studio Camera—1 RCA Image Orthicon (Studio type), 1 RCA 6AG5, 3 RCA 6AK5, 1 RCA 6J6, 3 RCA 6SN7GT, 2 RCA 6SL7GT, 1 RCA 6BG6G, 1 RCA 6AS7G, 1 RCA 1B3GT/8016, 1 RCA 6V6GT, 1 RCA 6L7.
  - Studio View Finder—2 RCA 6AG7, 1 RCA 6J6, 1 RCA 6V6GT, 1 RCA 6H6, 2 RCA 6SN7GT, 1 RCA 6SL7GT, 1 RCA 6BG6G, 1 RCA 1B3GT/8016, 1 RCA 6AS7G, 1 RCA 5FP4A.
  - Studio Camera Control—6 RCA 6SN7GT, 1 RCA 6SH7, 2 RCA 6AG7, 2 RCA 6AL5, 1 RCA 6Y6G, 4 RCA 6AC7.
- Tube Complement for Power Supply 580-C, WP-33A, and Current Regulator are listed elsewhere in this catalog.

**Equipment Furnished**

Stock Identification	MI-26900
(Equipment below plus miscellaneous cables, fittings and hardware is supplied)	
1 Studio Camera	MI-26000-A
1 Camera Viewfinder	MI-26005
1 Camera Control Chassis	MI-26055
1 Master Monitor TM-5A	MI-26135-A
1 Regulated Power Supply	MI-21523-B2
2 Regulated Power Supplies	MI-26985-B
1 Current Regulator	MI-26090
1 Console Housing	MI-26266-B
1 Blower	MI-26579-A
1 Lens 50mm f1.9	MI-26550-1
1 Lens 90mm f3.9	MI-26550-2
1 Lens 35mm f3.8	MI-26550-3
1 Set of Tubes for MI-26900 consisting of (1) 5CP1A, (1) 5FP4A, (1) 186P4 and (1) Image Orthicon	

**Accessories**

8.5 in. f3.9 Lens	MI-26550-4
35mm f3.3 Lens	MI-26550-9
13 in. f3.5 Lens	MI-26550-10
17 in. f5.0 Lens	MI-26550-7
Camera Cable (length to be specified by customer)	MI-94-C
Video Coax Cable RG 11/u	MI-83
Video Coax Cable RG 59/u	MI-75
Power Cable 12-cond., Shielded	MI-80
Inter Communication Cable 8-cond., Shielded	MI-82
Pulse Distribution Box	MI-26757
Studio Camera Dolly	MI-26040
Studio Camera Pedestal	MI-26035
Camera Friction Head	MI-26205-A
Metal Tripod TD-11A	MI-26046

# Studio Camera Pedestal, Type TD-1A

## Features

- Pedestal moves smoothly and silently.
- Ruggedly constructed for durability.
- Mechanically balanced for ease of operation.
- Easily maneuvered in small areas.
- Attractively finished in wrinkle enamel and stainless steel.

## Uses

The Studio Camera Pedestal, MI-26035 provides a convenient and useful mounting pedestal for the television camera. It is designed for use in the studio and in other indoor places where telecasts might be made. Mounted on the pedestal, the camera can be moved freely and quietly about the telecasting site. A crank handle on the pedestal raises or lowers the camera to any height between approximately 40 inches and five feet above the floor. Panning and tilting of the camera is provided by a Friction Head, which although shown in the photograph, is supplied separately, as MI-26205. The Friction Head, which can be used to mount either field or studio type RCA cameras to the pedestal, is described in detail on a separate sheet.

## Description

The illustrations show the Studio Camera Pedestal with and without camera mounted. As previously mentioned, the wheel with the crank handle is used for raising and lowering the camera. Because of fine mechanical balance in the gear mechanism, very little effort is required either to raise or lower the camera.



Studio type camera mounted on the pedestal.



Fully extended, the overall height of pedestal is 54". Friction head for mounting camera is supplied separately as MI-26205.

The large wheel steers the three rubber-tired wheels on which the pedestal rides. In steering, these three wheels turn in any direction simultaneously because of a chain which links them together. The small pedal shown lowers a caster which effectively raises a wheel and makes the pedestal maneuverable about a point. The pedestal is finished in umber gray and is styled to match other RCA television equipment.

## Specifications

Overall Dimensions (not including Friction Head):	
Height (Maximum)	54 inches
Height (Minimum)	32 inches
Width and Depth (maximum at base)	39 inches
Weight	450 lbs.
Stock Identification	MI-26035

## Accessory

Friction Head	MI-26205-A
---------------	------------



# Studio Camera Dolly, Type TD-5A



View showing rear wheels turned at right angles. Friction head for mounting camera is supplied separately as MI-26205.

## Features

- Rubber-tired wheels insure smooth, quiet movement.
- Provision for turning rear wheels 90°.
- System of counterbalanced weight makes controls easy to operate.
- Stops provided for holding dolly in fixed position.
- Finished in umber gray wrinkle and stainless steel.

## Uses

The Studio Camera Dolly is designed for use in television studios. One of the most important uses of the dolly is to dolly the camera in and out of scenes. The boom upon which the camera is mounted can be raised or lowered, or swung completely around. Shots can be made from unusual angles, and movement of the camera can be slow and steady. Thus, it provides the television station with facilities to produce more effective, more interesting programs. The dolly is usually manned by two operators, one who maneuvers the dolly and the other who trains and focuses the camera.

## Description

The Studio Camera Dolly is similar to the dolly used in film productions. An important difference is that the rear wheels of the television dolly can be turned at right angles as shown in the photo. This allows the rear end of the dolly to be

swung around, while the front end of the chassis pivots on a caster. The caster is lowered simultaneously with the turning of the rear wheels. The control for this operation is the "trolley-switch" handle near the front of the chassis. This feature of turning the wheels and lowering a fifth wheel permits the dolly to be moved sidewise, which is of course advantageous in small studios. The crane boom on which the camera is mounted can be raised to a height of 74 inches (above the floor) or lowered to a height of 23 inches. This boom is raised and lowered by the inclined control wheel at the rear. The control wheel in front of this turns the boom turret on the chassis. Mechanical design is such that very little effort is required to turn the control wheels.

## Specifications

Overall Dimensions (without Friction Head):	
Height (Maximum)	68 inches
Length (Including Boom)	81 inches
Length (Chassis)	65 inches
Width (Chassis)	35 inches
Weight	745 lbs.
Stock Identification	MI-26010

## Accessory

Friction Head	MI-26205-A
---------------	------------

# Everything for TV— entire studios, for instance...

• Action in this TV studio is being covered by picture-and-sound pick-up units—all RCA. Just one combination, this, among dozens of different studio equipment arrangements now being delivered to more than 50 of the nation's leading television stations.

As workable and versatile, we believe, as the pick-up equipment in any motion-picture studio, this set-up has the electrical and mechanical facilities required to handle any show in the station—and with the same professional results. It includes two studio cameras using the new studio-type RCA image orthicon pick-up tube—with one camera mounted on a new crane-type dolly, and one camera mounted on a pedestal-type dolly. It includes a high-fidelity microphone, and a special-type microphone boom to follow the action swiftly.

Good reason why RCA studio equip-

ment is tops with so many TV station men.

RCA TV studio equipment is integrated to work together like the mechanism in a watch. RCA TV studio equipment is uniquely versatile. It can be used in any combination by any station, large or small. It can be supplemented by additional units—without doing away with the initial equipment. RCA TV studio equipment produces sharper picture contrast with great depth of focus—and with less expensive lighting. RCA TV studio equipment is designed and built by a company well-known in the industry for its *continued* interest in the performance of the equipment—after it's in your station.

Why not let an RCA Television Specialist help you plan your TV station? Call him in. Or write Dept. 19KC, RCA Engineering Products, Camden, New Jersey. No charge. No obligation.



RCA Studio  
Microphone Boom,  
Type MI-26574



RCA Studio Dolly,  
Type MI-26040

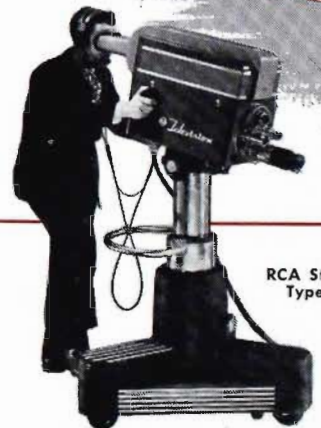

RCA Studio Pedestal,  
Type MI-26040





Hornung's "Beauty on Parade"

**A Typical TV Station Studio—RCA Throughout**

More than 50 television studios are being equipped by RCA in dozens of different combinations to fit individual station needs and budgets. Professional performance—with perfect picture-and-sound pick-ups every time.



## Television Studio Cranes, Types TD-30B, C, D

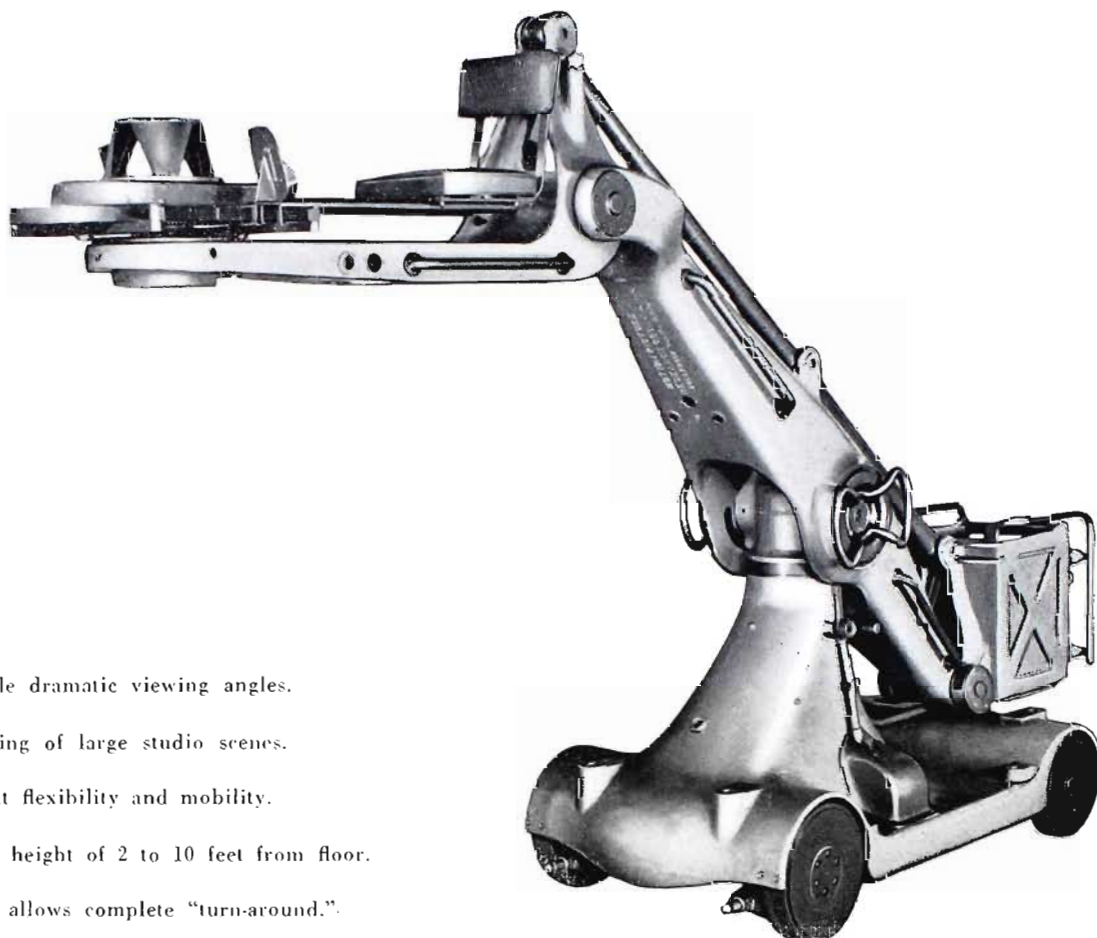

### Features

- Makes possible dramatic viewing angles.
- Smooth panning of large studio scenes.
- Provides great flexibility and mobility.
- Provides lens height of 2 to 10 feet from floor.
- Steering unit allows complete "turn-around."
- Operator's seat and foot-operated panning controls provided.

### Uses

The Houston Television Cranes are designed for use in large television studios and enable the operator to obtain dramatic viewing angles, smooth panning of large scenes, approaches and retreats that add life and interest to television programs.

### Description

The Model TD-30B DeLuxe Television Crane provides a lens height of from 2 to 10 feet from the floor, full 360-degree panning around the crane base, 180-degree panning of the turret table, and 100-degrees up and down lift. The crane will pass through a doorway 36 inches wide by 6 feet high, and weighs approximately 1,200 pounds. The Models TD-30C and TD-30D Cranes differ from the Model TD-30B only in the accessories included. The crane consists of the base, platform,

boom arm, and parallel arm made of cast aluminum alloy, the weight box, the center post with panning and tilt brake, the steering unit and the turret table. The optional equipment that determines the type of crane consists of the drive unit, jacks and hydraulic pump.

The turret table is an integral part of the crane and is permanently mounted on the platform. It is capable of 180-degree rotation, and contains the operator's seat, foot pedals for rotating the turret table and an adjustable friction type turret lock within the operator's reach.

The center post is a telescoping tube. It permits the boom to be panned a full 360-degrees and lifted up 55-degrees and down 45 degrees from the horizontal position. A hydraulic cylinder with 15-inch extension is mounted in the telescoping tube. It is manually operated by a hydraulic pump with the handle on the side of the base. A flow restrictor, located in the cylinder base, limits the down stroke speed in case of accidental dam-

age to the hydraulic lines. The panning brake is hand-operated by moving the small lever on the base. It can be adjusted to any degree of friction desired. An automatic locking pin prevents the use of the hydraulic pump when the panning brake is out of its neutral position. The tilt brake is operated by handles on both sides of the boom casting and can be set to any degree of friction.

The steering unit is of a special design that permits the crane to be completely turned around within a 6-foot radius and it allows it to be placed squarely against a wall with very little maneuvering. It incorporates a "lock-preventing arm" which allows a sharp turn without running the risk of jamming the steering mechanism.

The motor drive unit consists of a specially designed 2-hp 110-volt d-c series-wound motor, supported on rubber mounts. It is coupled to a 10 : 1 differential drive by a Morse-Morflex Coupling to provide smooth silent operation. A control unit that contains the motor control, reversing switch and brake control permits various degrees of acceleration and deceleration. The control unit (not shown) can be operated at the crane, or remotely, if desired. The brake is a solenoid-operated friction, air-cooled disk type, controlled by a carbon pile that gives the operator a braking power proportional to the pressure applied to the brake handle.

### Specifications

Main Boom Panning Angle \_\_\_\_\_ 360°  
 Turret Table Panning Angle \_\_\_\_\_ 180° or 90° each side of center  
 Overall Length (maximum) \_\_\_\_\_ 13 ft. approx.  
 Overall Height (maximum) \_\_\_\_\_ 8½ ft. approx.  
 Overall Width \_\_\_\_\_ 3 ft. approx.

#### TYPE TD-30B DELUXE TELEVISION CRANE

Complete with Power Drive, Remote Control Unit, Hydraulic Lift, Jack Assembly, Electrical Circuitry and Model TCT Turret Table.

Shipping Weight (crated) \_\_\_\_\_ 3,250 lbs. approx.  
 Stock Identification \_\_\_\_\_ MI-26037-1

#### TYPE TD-30C TELEVISION CRANE

Complete with Hydraulic Lift, Hand Brake and TCT Turret Table. (Power Drive, Remote Control Unit, Jack Assembly and Electrical Circuitry not included.)

Shipping Weight (crated) \_\_\_\_\_ 3,080 lbs. approx.  
 Stock Identification \_\_\_\_\_ MI-26037-2

#### TYPE TD-30D TELEVISION CRANE

Basic Crane Unit complete with TCT Turret Table and Hand Brake. (Does not include accessories listed with other models.)

Shipping Weight (crated) \_\_\_\_\_ 3,000 lbs. approx.  
 Stock Identification \_\_\_\_\_ MI-26037-3

### Accessory

Friction Head \_\_\_\_\_ MI-26205-A



*The Television Studio Crane shown at left is equipped with Studio Camera TK-10A. Lens heights up to 10 feet from floor make dramatic viewing angles possible.*



# Film Projector, Type TP-16B

## Features

- Simple, straightforward film path provides for quick and easy threading.
- Removable film gate makes aperture cleaning easy.
- Constant light source provides utmost simplicity in design.
- Film lengths up to 2000 feet can be used without replacing reels.
- Coated lenses minimize reflections and improve contrast.
- Resolving power of lens is 60 lines per millimeter at any point in the field.
- Projector can be operated on a current supply of 50 cycles as well as 60 cycles.

## Uses

The TP-16B Film Projector is used in television studios to provide regular program material using standard 16mm sound motion-picture film. To obtain the video signal, the projector is used in conjunction with the TK-20A Film Camera, and the two units are mounted in such a position that the TP-16B projects a picture directly onto the mosaic of the picture tube in the film camera.

The TK-20A Film Camera is similar to a studio camera except that it is not provided with any optical focusing system. Instead, the optical system of the projector is used to size and focus the picture which is projected on the pickup tube mosaic.

It is not necessary to have a separate camera for each projector. If the film projectors are arranged in pairs, a multiplexing arrangement may be employed to make one camera serve both projectors, and a slide projector in addition. Since projectors are ordinarily used in pairs (for showing alternate reels) this is a very practical arrangement.

## Description

The TP-16B Projector is entirely self-contained and, with the exception of the film feed arrangement, is entirely enclosed. The projector housing is provided with an attractive umber-gray crackle finish matching that of other RCA television equipment. The projector proper is mounted on a heavy cast base frame. This frame in turn is mounted by means of leveling screws on a pedestal of matching design and finish. This pedestal greatly improves the appearance and provides a convenient place for mounting the controls and field-supply for the special three-phase motor which is a feature of the TP-16B.

The optical projection system consists of a 1000-watt air-blast-cooled incandescent lamp, a silver-coated pyrex glass reflector, a large two-element aspheric condenser lens, and a 3.5 inch, F.2 "coated" projection lens. This system provides plenty of illumination on the mosaic of the camera iconoscope and is, of course, much simpler than systems using switched or pulsed light sources.

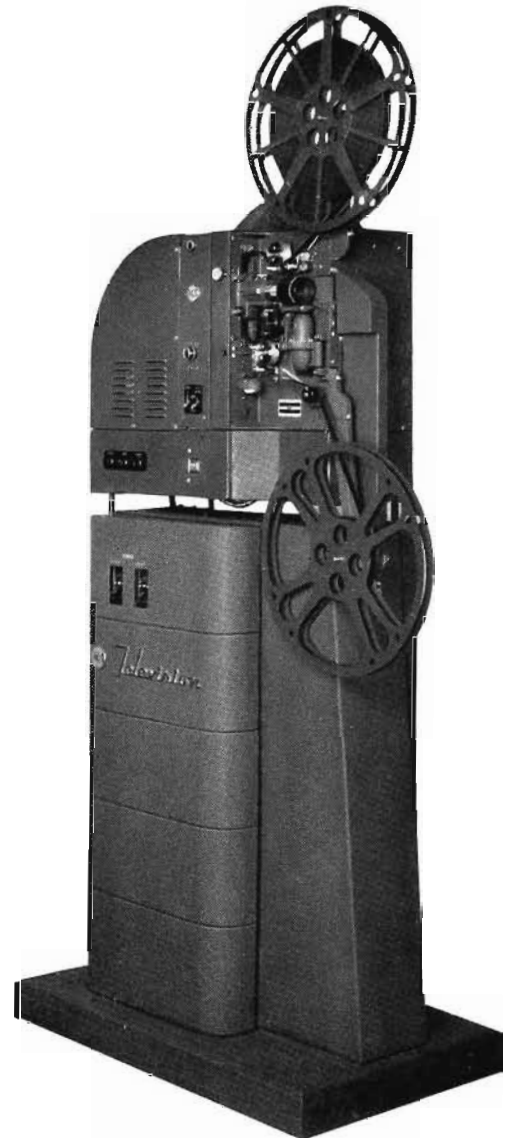

The film feed arrangement of the TP-16B is identical to that of the standard projector with the exception that the pull-down claw works at a greater speed. Film is fed from the upper reel under a large sixteen-tooth feed sprocket and through the precision made film gate. Light, controlled by a rotating shutter, is projected through the film at this point. The film is pulled down through the gate, a single frame at a time, by the pull-down claw just below the gate.

Since television standards (and proper synchronization) require transmission of 60 fields (30 frame, interlaced) per second, and motion picture film is made for projection at 24 frames per second, some means must be provided for conversion from the one rate to the other. In the TP-16B this is done by "scanning" the first frame twice, the second frame three times, the third twice, the fourth three times, and so on.

The average rate, then is  $2\frac{1}{2}$  scanings per frame—which, multiplied by the 24 frames per second, provides 60 scanned fields per second.

If the "pull-down" could be accomplished during the vertical blanking interval— $1/750$ th of a second, every  $1/60$ th of a second—no further modifications of the standard projector would be necessary. Unfortunately this is not mechanically possible. Therefore, a further stratagem is employed. This consists in the use of short light flashes so timed that the film picture is projected on the pickup tube mosaic for only  $1/1200$ th of a second, every  $1/60$ th of a second. These flashes occur during the vertical retrace time and are provided by a rotary shutter which consists of an 18-inch metal disc with a slot cut in its periphery. This disc is driven at a speed of exactly 3600 rpm by a special 3-phase synchronous motor. This arrangement is possible because the mosaic of the pickup tube "stores" the picture during the interval between flashes of illumination.

Synchronization of the TP-16B Projector with the television system is assured by virtue of the fact that both the television synchronizing generator (which drives the beam in the camera pickup tube) and the motor which drives the projector shutter have a common source of power. To insure that the shutter will be in step at all times a large-size motor with a separately excited d-c field is used. The d-c field, being polarized, makes the motor always "lock" in proper phase relationship with the sync generator. The power supply for the motor field is mounted in the pedestal.

**Sound System**

A number of unusual features are incorporated in this sound unit. One is the use of radio-frequency voltage (28 kc) on the exciter lamp filament. This prevents hum and noise from being introduced by the lamp itself. Another feature is the fact that the exciter lamp mounting and sound carriage are die-cast in one piece, thereby insuring permanent accurate alignment. Still another is the use of the famous RCA-developed rotary stabilizer on the sound drive.

An audio preamplifier is built into the base of the projector. This amplifier, which is of conventional design, employs an RCA-1620 as a photo-cell amplifier, an RCA-6J7 as a voltage amplifier and RCA 6V6FT/G as an output tube. A tapped output transformer provides output impedances of 250 or 500 ohms. Output level is +4VU at 1000 cycles with less than 1% total r-m-s harmonic distortion.

The audio amplifier is assembled on a small chassis which can be easily removed from the base housing. Also mounted on this panel is the 28 kc oscillator which supplies voltage for the filament of the exciter lamp and a power supply using a 5Y3-CT/E which supplies plate voltage for the amplifier and oscillator.

A sound equalizer panel is available as an accessory for the projector sound channel and is identified as MI-26313. The unit is constructed to be mounted convenient to the audio control position so that the film sound may be easily adjusted for proper response. The compensation in frequency response is necessary because of the wide variation in recording of and printing of 16mm films. A single control is used in a tilt circuit with a straight through center position; with three high boost and three low boost positions of 2.5 db steps each.

**Provision for Remote Control**

Controls mounted on the projector include "Standby," "Emergency Run," "Start," "Stop" and "Remote." When the remote switch is operated, "Start" and "Stop" controls at a remote location may be used to control operation. These circuits operate through relays and a master contactor mounted on the pedestal.

**Maintenance Features**

Easy and quick maintenance is one of the features of the TP-16B projector. The field power supply, control circuits and all external connectors in the pedestal are easily reached by removing the pedestal side covers. The preamplifier and exciter filament supply unit are available when the cover plate, held by two thumbscrews, is removed. The projector lamp is reached through a hinged door. The film gate assembly is easily removed for cleaning. All parts of the film feed system are in the open where they may be constantly observed.

**Specifications**

Film Type	Standard 16mm
Film Capacity	400' to 2000'
Film Speed	24 frames per second
Shutter Speed	60 frames per second
Projector Lens Line	48" above floor
Audio Output Power	+4 VU at 1000 cycles
Output Impedance	250/500 ohms
Frequency Response	$\pm 2$ db from 80 to 3000 cycles $\pm 3$ db from 80 to 4000 cycles
Hum and Noise Level	40 db below output level
Dimensions	Height 68"; Length 32"; Width $16\frac{3}{4}$ "
Weight	Projector 90 lbs.; Pedestal 135 lbs.; Total 225 lbs.
Tubes Required	1 RCA-927, 1 RCA-1620, 1 RCA-6J7, 2 RCA-6V6GT/G, 3 RCA-5U4G, 1 RCA-5Y3GT/G, Projector Lamp T-12
Power Required	209-220 volts, three-phase 250 watts 105-125 volts, single-phase 1200 watts
Stock Identification	MI-26930-A

**Equipment Furnished**

Projector Head	MI-26125-A
Pedestal	MI-26132
Projector Motor Field Power Supply	MI-26314

**Accessories**

16mm Film Projector Equalizer	MI-26313
Panel and Shelf (supports 2 MI-26313)	MI-26581
Rack Mounting Control Panel	MI-26321
TP-9A Multiplexer	MI-26318-A
TP-1A Slide Projector	MI-26130



# Television Film Projector, Type TP-35B

## Features

- Highly efficient pulsed light source, no shutter mechanism required.
- Quiet operation.
- Excellent picture definition.
- Completely enclosed unit—even to film magazines.
- Very little heat on film—stills of any frame of the film can be projected.
- RCA sound head used—response flat out to 6 kc.
- Light output of projector favorable for proper operation of film camera.

## Use

The TP-35B 35mm Television Projector is designed for use in television stations as a means for utilizing standard 35mm sound motion picture films as program material. The TP-35B can be used as the single source of program material for the television station, or it may be alternated with "live" programs and network shows to add variety to the station's program schedule.

The TP-35B Projector is designed for use with the TK-20A Film Camera. In the simplest arrangement, the projector is mounted in such a position that it projects motion pictures directly on the pickup tube in the TK-20A Film Camera. The video signal produced by the camera is then fed to the studio control room. A single TK-20A Film Camera can serve two motion picture projectors and a slide projector by using a Multiplexer. This device employs a slide projector and two mirrors mounted at the required angle to direct the pictures from either projector onto the pickup tube of the film camera.

## Description

The TP-35B Projector is entirely enclosed. The housing is finished in an attractive umber-gray crackle finish, matching that of other RCA equipment. Shatterproof glass windows permit viewing the operation of the mechanism without removing any door or cover.

Film is fed from the upper film magazine down through the film feed sprocket and through the film gate in the picture head. At this point, light produced by a pulsed-light lamp is projected through the film. The pulsed-light system eliminates the need for a shutter mechanism. It consists of an electrically operated gas-filled lamp which produces short pulses of light at the required rate of speed. The film then passes over the sound drum to the lower film magazine in the pedestal of the projector.

Also contained in the pedestal is a power supply which furnishes d-c voltage for the field of the driving motor, and a terminal board on which is mounted the relay for the pulsed-

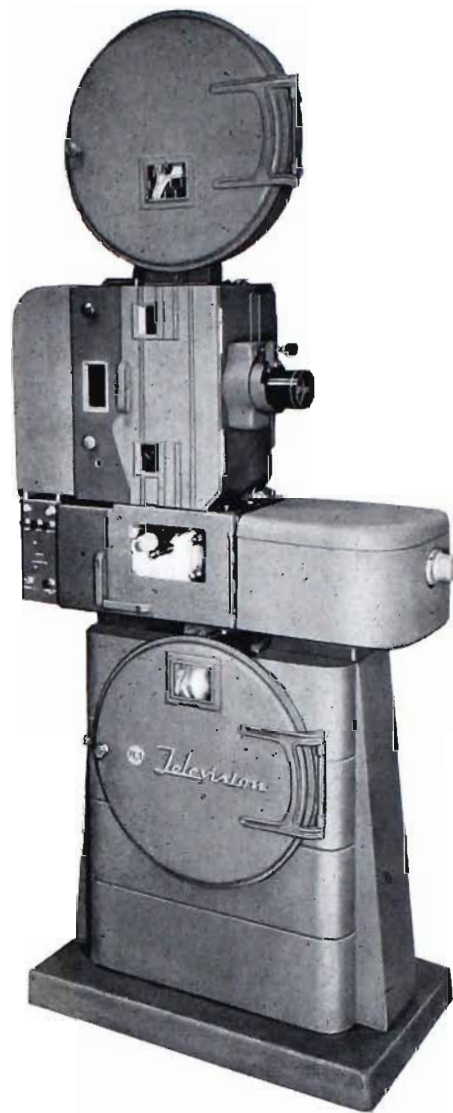

light lamp. Power for this lamp is furnished by a power supply which is mounted in the projection room control rack which contains the monitoring equipment and remote control panel. A control box on the rear of the projector contains the necessary switches for starting and stopping. For the use of two projectors, a changeover panel is provided. This panel, which is rack-mounted directly below the video monitor in the projection room, contains switches for starting and stopping either projector, and for changing over from one projector to the other. The changeover switches control relays which switch the optical systems (douse and undouse) as well as the sound circuits.

For the purpose of using standard motion picture film, which runs at an average speed of 24 frames per second, on a television system which has a basic rate of 30 frames per second, a new type intermittent has been designed. This intermittent is a 3-sided geneva movement driven at an average speed of 24 cycles per second. Pull down time is 120° (as compared to

90° on a standard theatre projector). Showing time is alternately 168° and 312° (as compared to 270° on a standard theatre projector). This arrangement permits a 5% 60-cycle light pulse to be phased so that three pulses occur during the 312° showing interval, and 2 pulses occur during the 168° showing interval. This results in 60 pictures or 30 television frames per second, while the average speed of the film remains at 24 frames per second.

The TP-35B designed for television by RCA, employs the most advanced features known to the field of film projection and its application to the production of television programs. One of the basic units of the equipment is the Brenkert BT90 Projector Head employing the special geneva movement and other features needed to meet the standards set up for the television system.

The sound head is the standard RCA high quality unit used in all Brenkert theatre projectors. For the TP-35B, it includes a special salient-pole synchronous motor. The projection lens combines the favorable features associated with high quality projection lenses, such as: flatness of field, freedom from color fringes, excellent contrast, and definition. Durable anti-reflection coatings increase light transmission and improve image contrast through elimination of internal reflections. The lens mount is hermetically sealed to prevent the entrance of dust or moisture.

Auxiliary equipment, not a part of the basic projector assembly, is normally housed in a standard cabinet rack located in the projection room. This rack-mounted equipment includes the pulsed light power supply, exciter lamp supply, remote control panels, and a 10-inch picture monitor. Controls are arranged so that either of two projectors can be started and



*View of Projection Room Control Rack, MI-26927-A, which contains monitoring and control equipment*

stopped and change-over relays operated either at the projector or from the control room.

Most moving parts of the projector are automatically and continuously lubricated. A pump inside the housing delivers a continuous flow of oil from the reservoir at the base of the main frame to the rotary lubricator which throws the oil over the gears and to every bearing. An oil sight gauge provides an indication of the amount of oil in the reservoir.

**Specifications**

- Film Type \_\_\_\_\_ Standard 35mm
- Film Capacity \_\_\_\_\_ 2000'
- Film Speed \_\_\_\_\_ 24 frames per second
- Light Pulse \_\_\_\_\_ 5% duration—60 times per second (synchronized with flyback time of camera pickup tube)
- Projector Lens Line \_\_\_\_\_ 48" above floor
- Projection Distance \_\_\_\_\_ (6½" focal length lens)—37"
- Audio Output Impedance \_\_\_\_\_ 500 ohms balanced
- Dimensions (overall):
  - Height \_\_\_\_\_ 6' 3"
  - Width \_\_\_\_\_ 16½"
  - Depth \_\_\_\_\_ 34"
- Weight \_\_\_\_\_ 400 lbs. (approx.)
- Power Requirements (Projector):
  - Projector Motor \_\_\_\_\_ 200 watts, 208 volts, three phase
  - Projector Motor Field Supply \_\_\_\_\_ 100 watts, 115 volts, single phase
  - Pulsed Light Supply \_\_\_\_\_ 450 watts, 208 volts, three phase  
200 watts, 115 volts, single phase
  - Exciter Lamp Supply \_\_\_\_\_ 45 watts, 115 volts, single phase
- Tube Complement (for Projector only):
  - 3—RCA 5U4G
  - 1—Exciter Lamp, 10 v., 5 a.
  - 1—Type 868 Photo Cell (for Sound Head)
- Stock Identification \_\_\_\_\_ MI-26925

**Equipment Furnished**

- Projector Head \_\_\_\_\_ MI-26120
- Projector Motor Field Supply \_\_\_\_\_ MI-26314
- Projector Pedestal \_\_\_\_\_ MI-26304-A
- Projector Control Box \_\_\_\_\_ MI-26210-A
- Sound Head \_\_\_\_\_ MI-26300-A
- Lamp House and Optical System \_\_\_\_\_ MI-26762
- Upper Film Magazine \_\_\_\_\_ MI-26301
- Lens \_\_\_\_\_ MI-26317
- Set of Interconnecting Cables \_\_\_\_\_ MI-26731-A
- Tubes and Spares (Sound Head) \_\_\_\_\_ MI-9625-B
- One Complete Cabinet Rack of Equipment \_\_\_\_\_ MI-26927-A  
(Consisting of the followings items):
  - Exciter Lamp Supply \_\_\_\_\_ MI-9607
  - Tubes and Spares (Lamp Supply) \_\_\_\_\_ MI-9636
  - Receiver Monitor and Panel \_\_\_\_\_ MI-26323
  - Projector Control Panel \_\_\_\_\_ MI-26321
  - Pulsed Light Unit \_\_\_\_\_ MI-26303-A
  - Fuse Panel \_\_\_\_\_ MI-4395-B
- BA-1A Preamplifier \_\_\_\_\_ MI-11218-A
- Preamplifier Power Supply \_\_\_\_\_ MI-26320
- BR-2A Panel (Preamp. and Power Supply) \_\_\_\_\_ MI-11598
- Shelf (Preamplifier and Power Supply) \_\_\_\_\_ MI-11599
- Set of Tubes (Preamplifier) \_\_\_\_\_ MI-11288
- Tube (Preamplifier and Power Supply) \_\_\_\_\_ MI-11262



# Film Camera Equipment, Type TK-20A

## Features

- Either positive or negative film can be used.
- Tubes and parts are easily accessible.
- Operation is simple—few controls are used.
- Camera can be operated 50 feet from control console.
- Oscilloscope in monitor can be used for measuring pulses.
- 10-inch aluminized tube for picture monitoring provides very bright picture.
- Clamp circuit eliminates low-frequency microphonics from video signal.

## Uses

The RCA Film Camera Equipment consists of a Film Camera, a Camera Control Unit, and associated power supplies and cables. This camera chain when properly set up with a motion picture film projector or a slide projector, and supplied with synchronizing signals, will produce standard video signals which can be fed to the television transmitter. By use of an RCA Multiplexer, which is a small, compact device having two mirrors mounted at the required angle, a single film camera can be arranged to serve two film projectors and a slide projector. The TK-20A can be used with either 16MM or 35MM projectors.

## Description

The Film Camera Equipment is designed to meet the requirements of any size television station. Ordinarily, the film camera is permanently mounted to the floor in the projection room, although it also can be mounted on a wall track so that it can be moved easily to any one of several film projectors installed in the room.

The Camera Control Unit consists of a chassis type unit containing circuits for control of the signal generated in the film camera, and a Type TM-5A Camera Monitor for analysis of the video signal and observation of its picture quality. These two units are mounted in a desk-type console section which is located in the transmitter room or studio control room. This console section can be grouped with other console housings (with end sections for trim) to form a neat convenient operating desk. The monitor unit contains a 10-inch picture tube and a 5-inch oscilloscope. D-c voltages for the TK-20A camera equipment are supplied by two Type WP-33B heavy duty regulated power supplies. These power supplies are rack-mounted in the control room or transmitter room. The TK-20A equipment is finished in umber gray to match other RCA television equipment.



## FILM CAMERA

In the illustration, the film camera is shown mounted on a pedestal, which provides for permanent mounting to the floor. If the camera is to be mounted on a wall track, the pedestal of course is not required. Contained in the film camera case are the RCA 1850A Iconoscope pickup tube, blanking and deflection amplifiers and a 6-stage video preamplifier. Since the picture from the projector is focused directly on the mosaic of the Iconoscope, no focusing lenses are required for the film camera.

## CAMERA CONTROL

The Camera Control consists of the control unit proper and the Type TM-5A Camera Monitor. The control unit contains a picture signal amplifier fed by the preamplifier in the camera, pulse line amplifiers to feed driving signals from the studio sync generator to the camera, and several controls directly associated with the operation of circuits in the camera. All components of the control unit are mounted on a chassis installed in the console desk directly below the camera monitor, the controls projecting through a sloping panel on the top of the console.

Electrically, the Camera Monitor is identical to the TM-5A Master Monitor used with the field camera equipment. It contains a 10-inch aluminum-backed Kinescope for observation

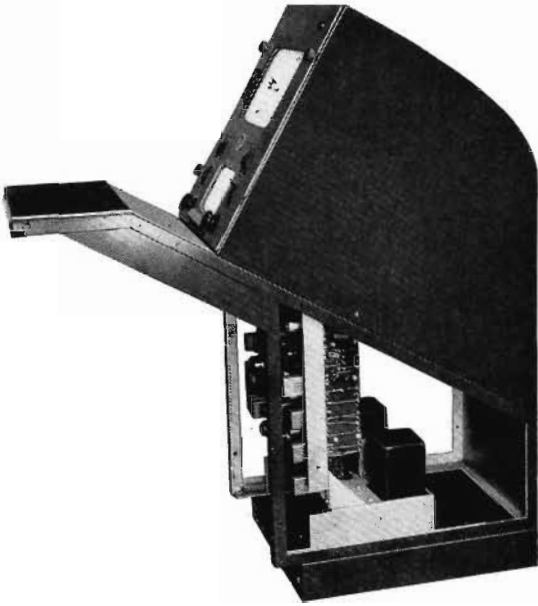

Camera Control Unit showing interior arrangement. This unit is normally housed in the master control console.

of the composite video signal fed to the transmitter, and a 5-inch oscilloscope for viewing the signal waveform and for quickly and accurately measuring signal levels. A calibration circuit in the monitor permits quick reference to a fixed voltage level. Circuits in the camera monitor include separate low-capacity inputs, video amplifiers and scanning generators for both the Kinescope and oscilloscope tubes. Transformers within the TM-5A provide filament voltages for all tubes in the monitor. Plate voltages are supplied by one of the WP-33-B power supplies.

**POWER SUPPLIES**

The Type WP-33B Heavy Duty power supplies each furnish extremely well-regulated d-c voltages at loads from 200 to 600 milliamperes. Output voltages are adjustable between 260 and 295 volts. The components are assembled on recessed type chassis for mounting in standard cabinets or open racks.

**Specifications**

**POWER REQUIREMENTS**

Line Rating \_\_\_\_\_ 105-125 volts, 60 cycle, single phase  
 Power \_\_\_\_\_ 1000 watts  
 Current \_\_\_\_\_ 10.1 amps.  
 Power Factor \_\_\_\_\_ 0.94

**INPUT SIGNALS**

Horiz. Drive \_\_\_\_\_ .4 volts, 15,750 cps, 10% pulse width  
 Vert. Drive \_\_\_\_\_ .4 volts, 60 cps, 4% pulse width  
 CRO Drive (optional) \_\_\_\_\_ 8 volts, mixed 30 cps and 7,875 cps  
 Mixed Sync (optional) \_\_\_\_\_ .4 volts, RMA signal  
 Mixed Blanking \_\_\_\_\_ .4 volts, RMA signal

**OUTPUT SIGNALS**

Picture Output \_\_\_\_\_ 1.5 v. peak-to-peak (picture signal)  
 Remote Monitor Output \_\_\_\_\_ 1.5 v. peak-to-peak (picture signal)  
 Frequency Response \_\_\_\_\_ Flat within 1 db to 6 megacycles  
 Input Impedance for Pulses \_\_\_\_\_ High

**Tube Complement**

<b>FILM CAMERA</b>	<b>FILM CAMERA CONTROL</b>
1 RCA 1850-A	3 RCA 6AC7
3 RCA 6SL7GT	2 RCA 6AL5
5 RCA 6SN7GT	8 RCA 6SN7-GT
1 RCA 6AC7	3 RCA 6AG7
1 RCA 6BG6G	1 RCA 6Y6-G
1 RCA 6Y6-G	2 RCA 6SH7
1 RCA 6V6-GT	
3 RCA 6AK5	
2 RCA 6AG5	
1 RCA 6J6	

(Tube complement for WP-33B Power Supply is listed on page B.4361)

Stock Identification \_\_\_\_\_ MI-26910

**Equipment Supplied**

(Equipment below plus Miscellaneous Cables, Fittings, Hardware, etc., is supplied)

1 Film Camera _____	MI-26020-A
Film Camera Pedestal _____	MI-26050
1 Camera Control Chassis _____	MI-26075
1 Master Monitor Chassis _____	MI-26135-A
2 Regulated Power Supplies _____	MI-26085-B
1 Console Housing _____	MI-26266-B
1 Set of Tubes for MI-26910 consisting of (1) 5CP1A, (1) 1816P4, (1) 1850-A	
1 Blower _____	MI-26579-A

**Accessories**

Intercom Cable 8 Cond. Shielded _____	MI-82
Video Coax Cables RG 11/u _____	MI-83
Video Coax Cables RG 59/u _____	MI-75
Pulse Distribution Box _____	MI-26757

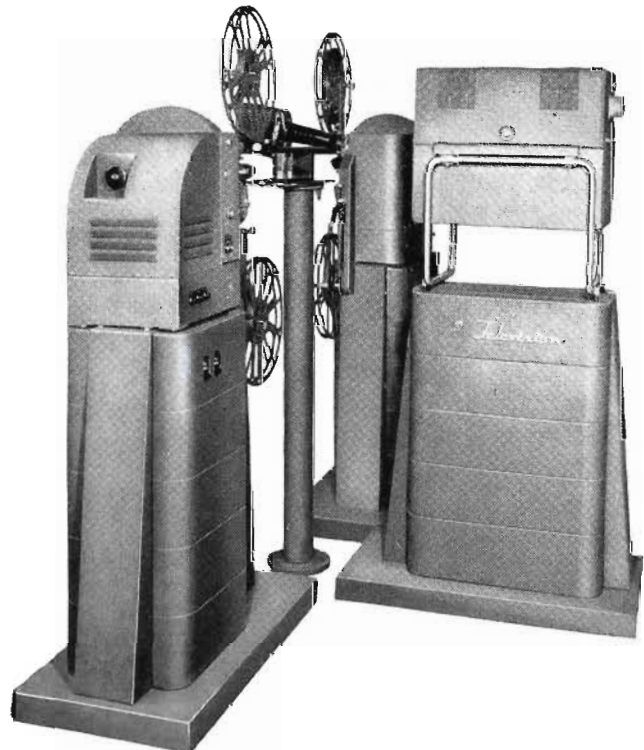

Typical arrangement of TK-20A Film Camera, TP-16A Film Projector and TP-9B Film Multiplexer



# Everything for TV...

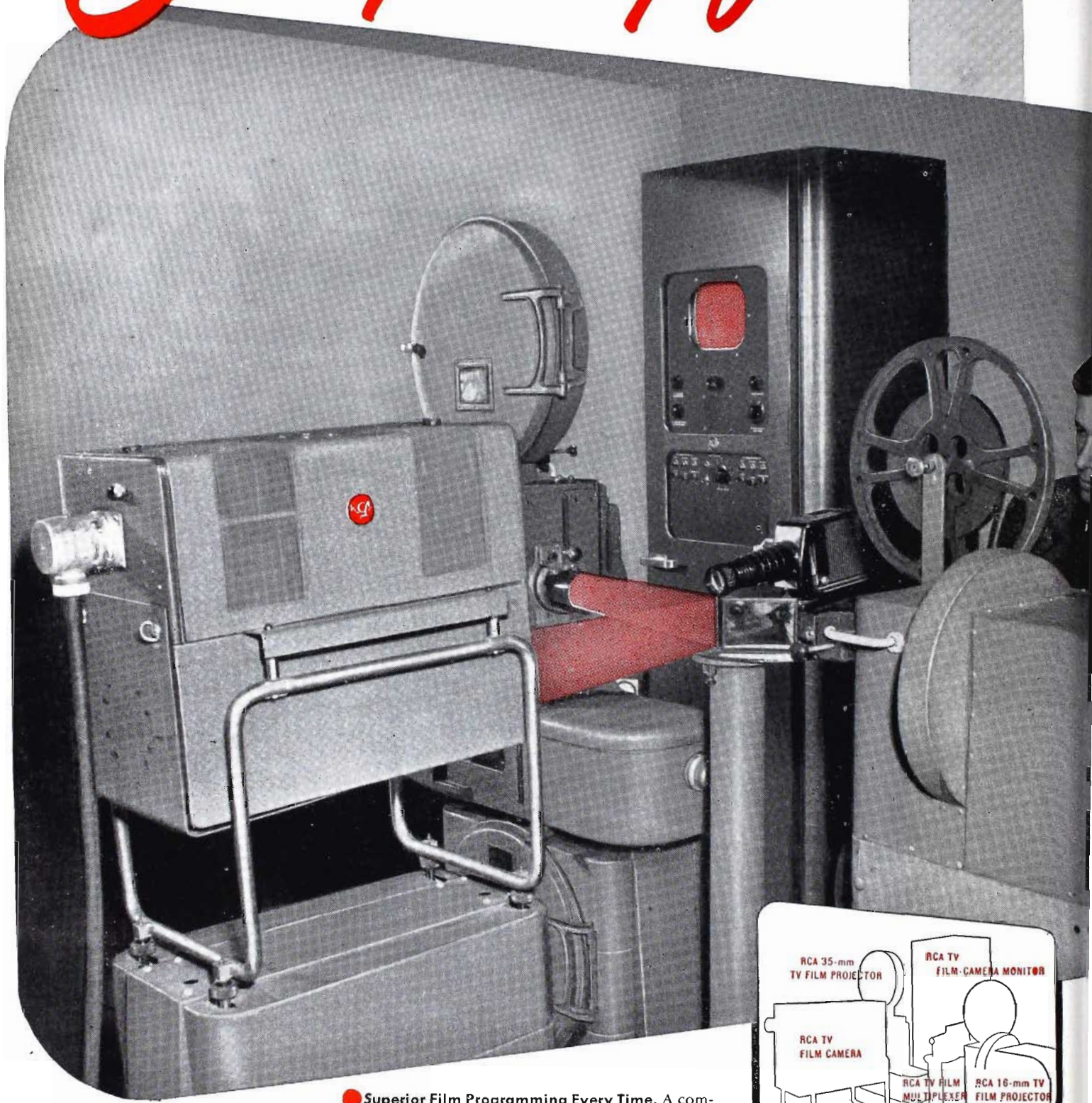

● **Superior Film Programming Every Time.** A completely equipped TV film-projection room by RCA —one of nearly 10 different combinations now being delivered to more than 50 television stations throughout the country.

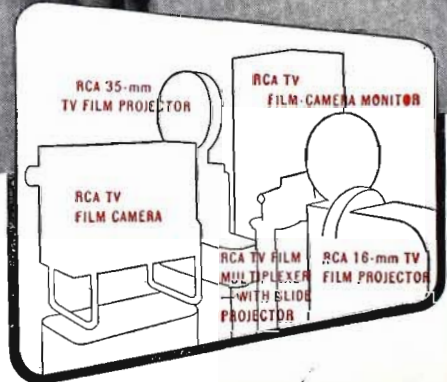



# entire film-projection rooms,

*for instance —*

**Y**OU are looking at a complete film projection room for a typical small television station—one of nearly ten different "all-RCA" combinations now being delivered to more than fifty stations throughout the country.

As reliable and practicable as the projection room of a modern theatre, this simple, integrated equipment is designed to handle film program material of every description—station identification slides, newsreels, commercial announcements, shorts, feature films, cue-ins for live-talent shows, etc. *And one operator can run it!*

All-RCA from floor to ceiling, the installation includes everything needed to produce bright, flickerless, dependable television pictures: A TV film camera; A new 35-mm film projector; A 16-mm film projector; A multiplexer for using two projectors with *one* film camera; and rack-mounting power supplies, amplifiers, and monitor. Projector switching for the entire room is under finger-tip control from the room itself—or from the studio control room.

Why the extraordinary acceptance of RCA film projection equipment by more than 50 television stations?

Because all RCA projection units are unified and designed to work together in any combination... enabling each station to select just the proper units for its special needs and budget. Because RCA makes it practical for a station to start small and add projection units as it grows—without discarding any of the original equipment. Because RCA makes everything required in a television film-projection room—and accepts complete responsibility for the over-all performance of the equipment. Because each station layout is planned *correctly from the start*, by television experts who understand the business thoroughly.

• • •

No need for expensive experiments with your own film-projection room... if you let an RCA Television Specialist help you with the planning. Call him. Or write Dept. 19 JA, RCA Engineering Products, Camden, New Jersey.

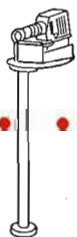

**RCA Multiplexer, Type TP-9B.** Produces uninterrupted projection of multi-reel films with only *one* film camera. Complets, with slide projector for station breaks, commercials, etc.

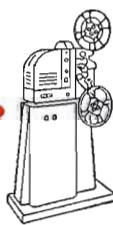

**RCA 16-mm Film Projector, Type 16B.** Popular low-cost projector. Self-contained. Simple. Low cost. Enables any station to use the film programming now available. Produces brilliant pictures and high-quality sound.

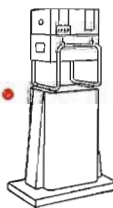

**RCA Film Camera, Type TK-20A.** A high-contrast film camera having unusual stability. It is used with either 16-mm or 35-mm film projectors, and slide projectors.

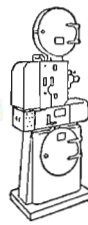

**RCA 35-mm Film Projector, Type TP-35B.** Projects sharp, flickerless pictures—and high-fidelity sound. Brilliant light output with negligible heating of film and film gate. Can project single frames as stills.



**RCA Film Camera Monitor Rack.** This is the control center of the projection room. It houses the amplifiers, all necessary rack-mounted power supplies, and the kinescope for viewing the film pictures.



# Film Multiplexer, Type TP-9B

## Features

- Permits use of a single film camera for two film projectors.
- Accommodates slide projector MI-26130 available extra.
- Employs long life front-surface optical type mirrors.
- Aids program continuity.
- Introduces negligible optical distortion.
- Designed for use with 16mm and 35mm projectors.
- Employs no moving parts.

## Uses

The Film Multiplexer is a device for use in the television projection room. It enables television station personnel to permanently arrange a single film camera and two film projectors so that either projector can be used with the film camera, without need for moving the units about the room.

The Multiplexer employs two mirrors mounted at the required angle to reflect the image from either projector onto the pickup tube in the film camera. In addition, a small slide projector mounted just above the two mirrors provides a means for station identification. The image from the slide projector is focused directly on the tube in the film camera.

## Description

The Film Multiplexer consists of a pedestal which is made up of pipe and suitable mounting flanges. Two front-surface mirrors are mounted and provision for incorporating a slide projector. The pedestal is fitted with a flange at the bottom for bolting to the floor. The recommended slide projector is an Eastman Type A-2 Kodaslide Projector with a 100-watt projection lamp. The Multiplexer (MI-26318) is finished in umber gray to match other RCA television equipment.

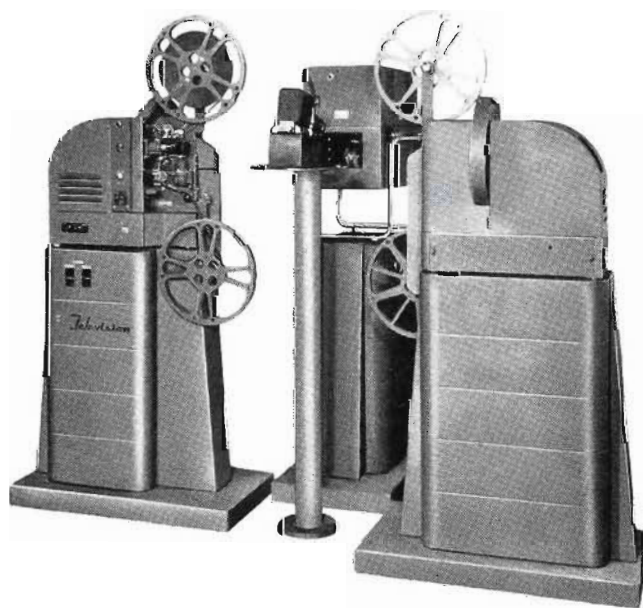

*Typical projection installation showing Multiplexer with two Film Projectors and Film Camera*

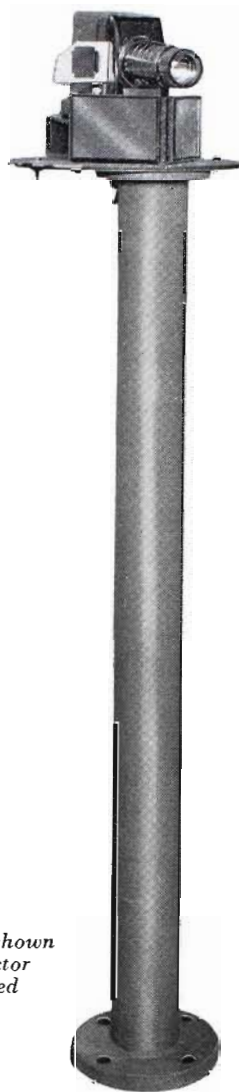

*Film Multiplexer shown with Slide Projector MI-26130 mounted atop*

## Specifications

Power Requirement (for projector lamp)  
110 volts a-c, 50/60 cycles

Dimensions (overall):

Height \_\_\_\_\_ 54"

Width \_\_\_\_\_ 13"

Weight \_\_\_\_\_ 40 lbs.

Stock Identification \_\_\_\_\_ MI-26318

## Accessory

Slide Projector (TP-1A) \_\_\_\_\_ MI-26130

# Projector Changeover Panel, MI-26321

## Features

- Mounts in standard 35mm equipment rack.
- Control panel provides start, stop and changeover of light and sound.
- Will control two projectors (16mm and 35mm in any combination).



## Uses

The Television Projector Changeover Panel is employed in TV projection rooms for the start, stop or simultaneous changeover of light and sound in 16mm and 35mm film programming.

## Description

The projector panel is a standard 19" rack equipment type and consists of two banks of switches, each having 3 momentary-contact push buttons (START, STOP and CHANGE-

OVER). Associated tally lights, slide projector on-off switch, slide projector fader control for controlling lamp brightness and tally light are also provided. All circuits and push-button contacts terminate in terminal strips mounted at the rear of the changeover panel.

Changeover push-button control provides for switching companion circuit relays associated with either 16mm or 35mm TV projectors. These circuits and relays are remote from the changeover panel and are located within the projectors and in TV equipment racks. The MI-26321 panel is provided as standard equipment with TV Projector Equipment Rack. Used in this manner or as a separately mounted panel, it provides extreme flexibility in the control and switching of two projectors (any combination of 16mm and/or 35mm) and one slide projector.

Rear view showing switches, relays and terminal strip.

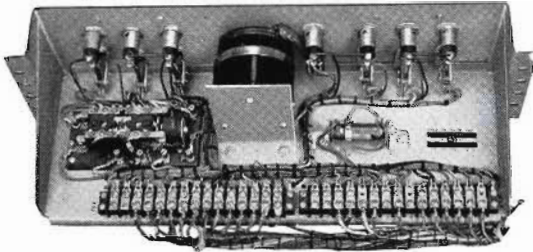

## Specifications

Projector Panel Width	_____	19"
Projector Panel Height	_____	4 <sup>7</sup> / <sub>8</sub> "
Stock Identification	_____	MI-26321

# Sound Equalizer and Panel

## Features

- Panel and shelf accommodates up to 3 equalizers.
- Equalizer provides frequency compensation for 16mm sound.
- Panel flush mounts in standard relay rack and may be located in TV studio control room.

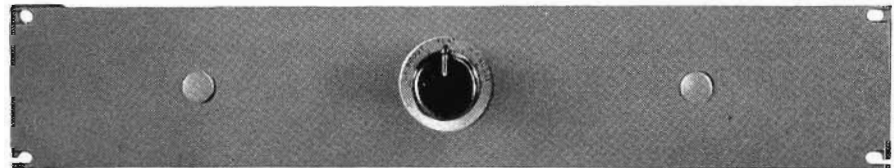

## Uses

Equalizer, MI-26313, is used in conjunction with 16mm sound for providing proper frequency compensation. Panel and shelf, MI-26581, is used as a convenient mounting and may be rack panel mounted.

## Description

Equalizer, MI-26313, consists of a compensator network which tilts frequencies about the 1000 cycle point in 2 db steps (see curve below). There is an insertion loss of 7.2 db in the "flat" position. Three, 2-db steps on either side of the "flat" position are provided: one is for high-frequency boost, the other for low-frequency boost. Input and output impedances are 250 ohms. Panel and Shelf, MI-26581, as described above is available separately for mounting up to three equalizer units.

## Specifications

For Equalizer	_____	(See curve)
Equalizer Dimension	8 <sup>1</sup> / <sub>16</sub> " long, 3 <sup>3</sup> / <sub>8</sub> " wide, 2 9/32" high	
Panel Width	_____	19"
Panel Height	_____	3 <sup>1</sup> / <sub>2</sub> "
Stock Identification:		
Equalizer	_____	MI-26313
Panel and Shelf	_____	MI-26581

## Accessories

Line Transformer	_____	MI-4000-B
H-Pad	_____	MI-4171-30



Rear view of Panel and Shelf with equalizer mounted

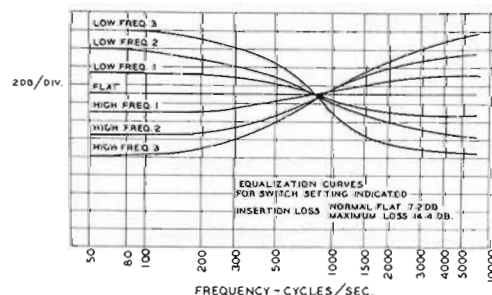



# Kinephoto Equipment, Type TMP-20B

## Features

- Provides permanent film record of television studio shows, field pickups, excerpts from special broadcasts.
- Utilizes standard 16mm motion picture film.
- Records positive or negative images.
- Accommodates 1200 feet of film.

## Uses

RCA Kinephoto Equipment, Type TMP-20B when used with a suitable camera,\* provides a method to record television images on motion picture film for subsequent use as television program material. Video signals fed to the TMP-20B appear on a kinescope, and in turn are recorded on film by the camera.

There are many uses for the TMP-20B: (1) Outdoor pickup or network programs can be recorded for later broadcasting. An example of this might be the broadcast, to a large evening audience, of political or sports events picked up and recorded in the afternoon; (2) the TMP-20B permits the recording of scenes which might be used in conjunction with studio scenes for plays, or for clients' advertising commercials; (3) the TMP-20B provides a means for syndication of television shows to other television stations; and (4) it allows program material to be checked and edited to suit the station, or perhaps the advertisers' needs.

## Description

The TMP-20B Kinephoto Equipment consists basically of a projection type kinescope with its associated control panel, video amplifier, deflection circuits and power supplies. As illustrated, the kinescope and camera\* are mounted on top a double cabinet rack which houses the rack-mounted sections.

The camera available for use with the TMP-20B is designed with a precision timing shutter which exposes exactly 525 picture lines per frame. The camera permits exposure of a complete television frame, after which the film is transported for exposure of the next film frame. The time for moving the film equals half of the television field, so that one field in every five provides the time for moving the film.

The built-in oscilloscope provides a monitoring waveform for maintaining the necessary adjustments on the kinescope circuits.

The TMP-20B has been designed to provide the best results in kinescope photography and the kinescope images have proper brightness and other qualities for optimum photographic results.

## Specifications

(Exclusive of Camera)

Power Source \_\_\_\_\_ 110-120 volts, 60 cycles, 750 watts

Video Input \_\_\_\_\_ Standard RMA 2 volt peak to peak combined video synchronizing and blanking signal

Input Impedance \_\_\_\_\_ 72 ohms

Overall Dimensions:

Length \_\_\_\_\_ 50"  
 Width \_\_\_\_\_ 26"  
 Height \_\_\_\_\_ 56"

Weight (not including camera) \_\_\_\_\_ 500 lbs. (approx.)

\*RCA 16mm Television Motion Picture Camera, Type TVK-75B.



TMP-20B Kinephoto Equipment with Type TVK-75B 16mm Motion Picture Camera

## Tube Complement:

3 RCA OD3/VR-150	4 RCA 6AS7-G
5 RCA 1B3-GT	2 RCA 6BG6-G
2 RCA 5V4-G	1 RCA 6SL7-GT
4 RCA 5R4-GY	1 RCA 6V6
2 RCA 6AG5	3 RCA 6Y6-G
3 RCA 6AH6	16 RCA 12AU7
3 RCA 6AL5	1 RCA 3KP1
4 RCA 6AQ5	1 RCA 5WP11

Stock Identification \_\_\_\_\_ MI-15005-B

## Equipment Supplied

(Includes Projection Kinescope, Video Amplifier, 30 kv Supply, Scope Power Supply, Deflection and Blanking Panel, Scope and Control Panel, Bias Supply, Blank Chassis, WP-33A Power Supply, Frames, Doors, Side Panels and Bases.)

## Accessories

16mm Television Motion Picture Camera, TVK-75B  
 (including two film magazines and lens) \_\_\_\_\_ MI-15006-B  
 Sound Recording Equipment \_\_\_\_\_ On application  
 Houston Developer \_\_\_\_\_ MI-26602

# Automatic Film Developers, Types TVF-2A and 4A

## Features

- Completely self contained.
- Easy to operate.
- Provides reversal processing of black and white 16mm films (Type TVF-2A).
- Provides for developing of negative or positive 16mm films of all types (Type TVF-4A).
- Combines with RCA Kinephoto equipment to facilitate TV programming possibilities.
- Three film magazines with 1200-foot capacity.

## Uses

Houston automatic film developers are available for use by TV stations in providing film processing facilities. They are suitable for use in conjunction with RCA Kinephoto equipment in expanding 16mm TV programming. The Type TVF-2A is designed for the reversal processing of black and white 16mm films, and the Type TVF-4A for developing negative or positive films of all types.

## Description

Both units are semi-portable, in that they are mounted on casters for ease in moving to suitable locations and are equipped with locks to hold them stationary during operation of the equipment. The machines are constructed almost entirely of stainless steel with the exception of castings, motors, film rollers and other detail parts. The solution and wash tanks, drying cabinet, two solution circulating pumps, a refrigeration system, a solution heater, thermometer, footage counter, three electric motors, and advanced design film transport mechanism with variable speed transmission, comprise the basic parts. Heat lamps for heating and a filter for cleaning the circulating air for the dry-box are also provided. Three film magazines of 1200-foot capacity are provided for loading the exposed film in a dark room and to allow operation of the machine in white light. Air squeegee outlets are provided after the first rinse and before the dry-box to be fed from an air pressure line. Where no such source of air is available, a supplementary auxiliary silenced and filtered air blower for remote mounting is available as MI-26606.

### TYPE TVF-2A FOR REVERSAL PROCESSING

Replenishers for the first and second developers, the bleach and the hypo are also furnished. The replenisher bottles are fitted with glass petcocks and the rate of replenishment is gauged by calibrations on the replenisher brackets. The fresh replenisher solution is added at the bottom of the tanks and



View of Auxiliary Photographic Air Unit, MI-26606

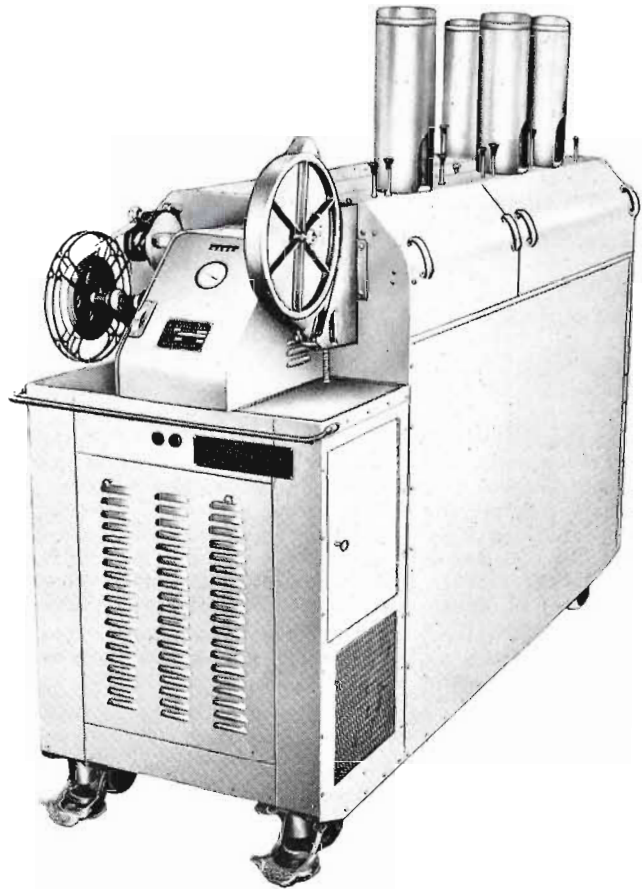

solution level maintained in the various tanks by overflow drains at the top. This overflow is piped to a single drain line at the rear of the machine. Processing speeds for reversal film are dependent upon the manufacturer's specifications and type used. Speeds of 18 to 35 feet per minute are possible, dependent on the film type.

### TYPE TVF-4A FOR NEGATIVE OR POSITIVE PROCESSING

The Houston Type TVF-4A, Negative or Positive, automatic film developer, is almost identical to the Type TVF-2A. It is designed for developing of positive or negative films. In size, it is the same. Replenishers in the Type TVF-4A are for both the developer solution and the hypo. Processing speeds for negative are 18 to 35 feet per minute, and for positive, 25 to 45 feet per minute, dependent on the film type.

## Specifications

Power Supply (Type TVF-2A and 4A)	220 volts a-c, 60 cycle, single phase, 32.06 amperes, 7 k.v.a.
Water Requirements	7½ gal. per min.
Length Overall	76"
Width	26¼"
Height	66"
Net Weight	1400 lbs.
Crated Gross Weight	2200 lbs.
Total Shipping Space	112 cu. ft.
Equipment Furnished	(See description)
Type TVF-2A 16mm Automatic Film Developer (for reversal processing)	MI-26602
Type TVF-4A 16mm Automatic Film Developer (for negative or positive processing)	MI-26604
Type TVF-6A Air Unit for Film Developer	MI-26606



# 16mm Double-head Contact Printers, Type TVF-8A

## Features

- Provides television stations with quick-printing method for 16mm picture and sound films.
- Continuous contact printer.
- Flexible in operation.
- Easy to use—controlled by one operator.
- Speeds of 60 or 120 ft./min. provided.
- Adjustable printing heads and enclosed drive mechanism.

## Uses

The Houston Continuous Contact Printer may be used by television stations to provide a quick method of printing 16mm sound and picture films. It is designed for continuous commercial use and four printing procedures are possible: (1) Composite Print—One roll of positive stock with picture negative threaded over one head and sound negative on the other; (2) Double Print—Two rolls of positive stock and one negative with apertures adjusted for picture or sound; (3) Single Print—Using either head independently, with other side of machine empty; and (4) Double Print—Using both heads independently with two rolls of negatives.

## Description

The double-head design, with selective apertures that may be individually adjusted, permits flexibility of operation. The printer is designed primarily for composite printing, although easily threaded for any of the four practical printing procedures mentioned above. For composite printing, the picture negative and the unexposed positive film pass through one gate and the sound negative and the positive through the second gate. This results in a synchronized positive print produced by a single operator. The printer operates in either direction, thus eliminating either extra handling, or rewinding of the film negative, additional prints being made simply by threading a new roll of positive stock.

The light intensities of two printing heads are independently adjustable and offer 22 logarithmically graduated exposure adjustments. These adjustments can be made while the film is running. The operator may set the light adjustment for the following scene while one scene is running. The light will remain at the proper exposure for the scene being printed and will not change until the scene change notch reaches the proper position. When this occurs, the light adjustment will change automatically to the value set for the new scene. Provision is made for a filter holder assembly for emulsion correction, if desired.

The printer is provided with selective speeds of either 60 or 120 feet per minute. The slower speed is usually employed for cut negatives and the faster speed for duplicate negatives.

The drive mechanism, lamp houses and electrical installation are enclosed in the upper cabinet and are easily accessible through a large rear door for inspection and maintenance. The reel clutches have been specially designed to provide a light hold-back tension on the film in the takeoff and a tight drive tension on the takeup. The change of tensions is automatic as the printer is reversed, and no manual adjustment is necessary.



## Specifications

A-c Power Requirements	110 volt, 8 amps., 60 cycle, single phase
D-c Power Requirements	115 volt, 4 amps. (200 watt lamps)
Film	16mm, single or double perforated
Apertures	(3) picture, full, sound
Printing Heads	2
Printing Lamps	200 watt, 110 volt d-c
Lamp Rheostats	10 ohm, 50 watt
Printing Direction	Heads or tails
Reel Capacity	2000 ft.
Motor	1/3 H.P., 110 volt, 60 cycles, a-c capacitor start
Fuses	15 amp. a-c, 10 amp. d-c
Dimensions	Height 79 3/8", Width 55 3/4", Depth 22"
Weight, Uncrated	635 lbs.
Weight, Crated	1025 lbs.
Stock Identification (Type TVF-8A 16mm Double-Head Contact Printer)	MI-26608

# Program Control Panel, MI-26221



## Features

- Designed for use in TS-20A Relay Switching System.
- 6 input channels.
- 2 output channels.
- Manual fading control.
- Tally lamps to indicate channels in use.
- Mounts in standard console section, MI-26266.

## Uses

The push button circuits are arranged for use with the Relay Switching Units in the TS-20A system. Remote switching may then be accomplished between 6 inputs and 2 outputs. In addition, a fader lever assembly consisting of two levers which may be operated independently or locked together is provided. Potentiometers geared to these levers are the proper value for use with the TA-10A Mixing Amplifier. Thus, both instantaneous switching and manually controlled fading and lap-dissolving effects may be obtained by use of this panel and its associated equipment. Interlock contacts operated by the levers are provided for tally lamp control.

## Description

The MI-26221 Program Control Panel is especially designed for mounting in an MI-26266 Console Section in which is also mounted a TM-5A Master Monitor. The panel hinges downward

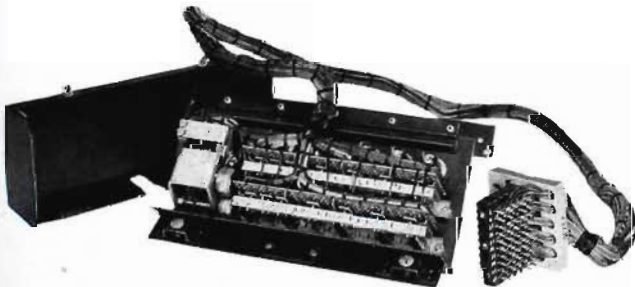

*Rear view of MI-26221 Control Panel showing protective back cover, panel wiring, switches and terminal block.*

to permit removal of the Master Monitor. A cover is provided on the back of the Program Control panel for protection of the switch assemblies. The push buttons are arranged in two rows of six with one additional release button in each row. Above these are six tally lamps for use as active channel indicators. Lamps are removable from the front of the panel. Connections are made to a telephone type terminal block which may be located in the lower portion of the console.

## Specifications

Lamp Voltage \_\_\_\_\_ 12 volts  
 Circuit \_\_\_\_\_ Three make contacts for each push button, wired to terminals on telephone block.  
 One side of lamps common wired to terminal block.  
 Fader potentiometer and interlock contacts wired to terminal block.  
 Dimensions \_\_\_\_\_ 13" wide, 5 $\frac{5}{8}$ " high, 3 $\frac{1}{2}$ " high  
 Length of Cable \_\_\_\_\_ 45"  
 Weight \_\_\_\_\_ Approximately 16 lbs.  
 Stock Identification \_\_\_\_\_ MI-26221

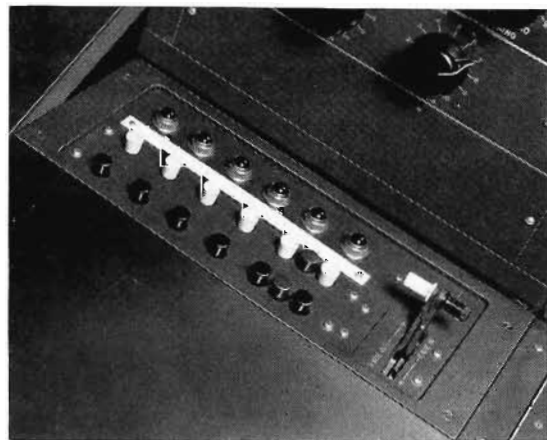

*The Program Control Panel may be mounted in Console Master Monitor Section. Adapter mounting panel is supplied.*



# Television Switching Panel, Type TS-1A

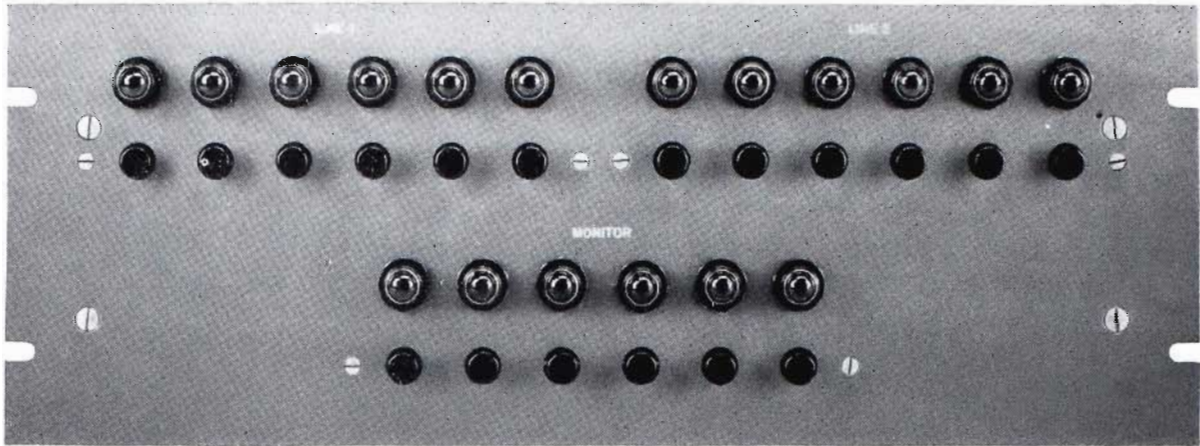

**Features**

- Accommodates six input lines—provides outputs for local monitor and 2 remote lines.
- Interlocked push button switches prevent accidental overlap.
- Indicator lights for each push button.
- Compensating networks in the input.
- Coaxial connectors, input and output.
- Standard rack-mounting assembly.

**Use**

The TS-1A Switching Panel provides an easy and convenient means for switching any one of six different input video signals to the television transmitter or to local and remote monitors. It is an inexpensive method which can be employed when the fading or lap-dissolving features of the more elaborate TS-10A Switching System are not required.

**Description**

As can be seen in the above photo, the Switching Panel employs three banks of six switches marked "Line 1," "Line 2," and "Monitor." Each bank handles six input signals and provides instant selection without disturbing the frequency characteristics of the incoming lines. The tally lights for the three banks are independent. Energized by the switches, they identify which input signals are being fed to the respective output lines.

The Switching Panel is designed to provide a constant matching termination to all the input lines, independent of the output load. Each incoming line passes through a 75 ohm constant resistance network, and is terminated in a 75-ohm resistor. The monitor push buttons switch a high impedance, low-capacity, line to the center point of any one of these networks. In this

way, a local monitor connection with a capacity up to 200 mmf can be used. In cases where the monitor capacity is less, fixed padding condensers can be paralleled with the output to bring the total up to 200 mmf. This is done to prevent disturbing the response of the monitoring network.

As can be seen in the circuit diagram, the "Line 1" and "Line 2" outputs are bridging the monitor line. Therefore, short, low-capacity output cables should be used. The usual method is to connect the output lines to a rack-mounted TA-1A Distribution Amplifier, which in turn feeds the transmitter and monitor lines.

A rear view of the TS-1A Switching Panel is shown below. The six coaxial jacks grouped on the right side are the input for the six video lines. The three at the left are the output connectors. A transformer mounted on the chassis supplies the tally light voltage. A-c power for this is brought in on a standard connector on the lower left corner.

**Specifications**

Overall Dimensions:

Height	7"
Width	19"
Depth	8"

Input Circuits \_\_\_\_\_ 6  
 Output Circuits \_\_\_\_\_ 3

Impedances:

Input	75 ohms (RG/59U or RG/11U)
Output	93 ohms (RG/62U)

Weight \_\_\_\_\_ 13 lbs.

Power Requirements  
 (for lamps) \_\_\_\_\_ 117 volts, 50-60 cycles, 0.2 amps.

Finish \_\_\_\_\_ Umber gray enamel (to match other RCA Television units)

Stock Identification \_\_\_\_\_ MI-26237

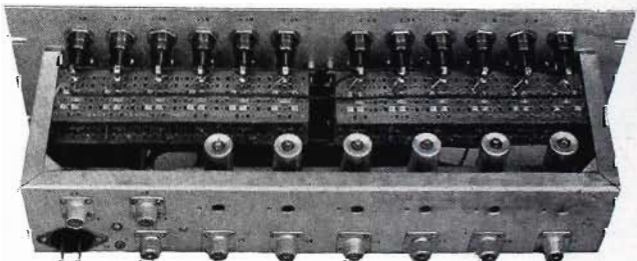
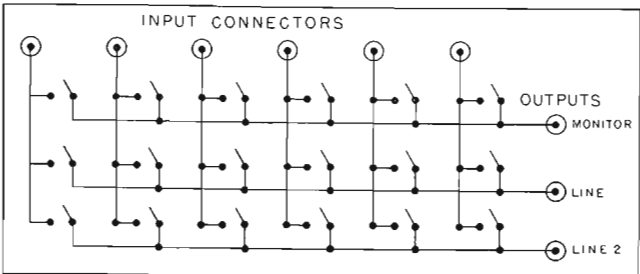

# Studio Camera Switching Equipment, Type TS-10A

## Features

- System will accommodate six signal inputs.
- Manual fading control allows choice of any fading speed.
- Remote signals can be previewed before being switched on-the-air.
- Full complement of tally lights.
- Tally lights at on-the-air cameras are activated by the switching system.
- Local sync automatically added when remote sync fails.
- Private or conference communication can be maintained between all stations.
- Intercommunication can be operated with other equipment off.
- All personnel have access to program sound.
- Stabilizing amplifier automatically corrects picture-sync ratio for transmitter.

## Uses

The TS-10A Studio Camera Switching System is designed for use by television stations obtaining video signals from more than one line. Briefly, the TS-10A will allow a single video operator to do these things: (1) Select any signal from six input lines; (2) switch the desired signal into the on-the-air line; (3) fade or dissolve two local signals simultaneously at any speed; (4) fade in or fade out any one signal; (5) switch instantaneously from one signal to another; and (6) superimpose two local signals with any desired degree of magnitude for each signal.

Intercommunication circuits in the TS-10A allow program personnel two-way conversation. In addition, volume-controlled program sound is supplied to all personnel through one ear-piece of their headset.

## Description

The TS-10A Studio Camera Switching Equipment consists of the switching amplifier chassis-type unit, a TM-5A Master Monitor, two WP-33B Power Supplies and a TA-5B Stabilizing Amplifier. The switching amplifier is mounted in the lower compartment of an RCA desk-type console section, and the TM-5A Master Monitor is mounted above it. The TA-5B Stabilizing Amplifier and WP-33B Power Supplies are also chassis-type units designed for mounting in a standard equipment rack. Equipment also included are intercom control box, 6 headsets, 1 blower kit.

The controls for the switching amplifier project through the inclined top panel of the desk. These controls consist of two banks of push buttons from which the on-the-air signal is selected, two toggle switches for controlling local and remote sync, gain controls for two remote input lines, a three-position switch for selecting either the on-the-air signal or one of the two remote signals for preview display on the monitor, fading and dissolving controls, and tally lights showing which inputs are being used.

The switching amplifier consists of two-stage picture amplifiers and two two-stage sync relay interlock amplifiers. Two of the picture amplifiers have their inputs

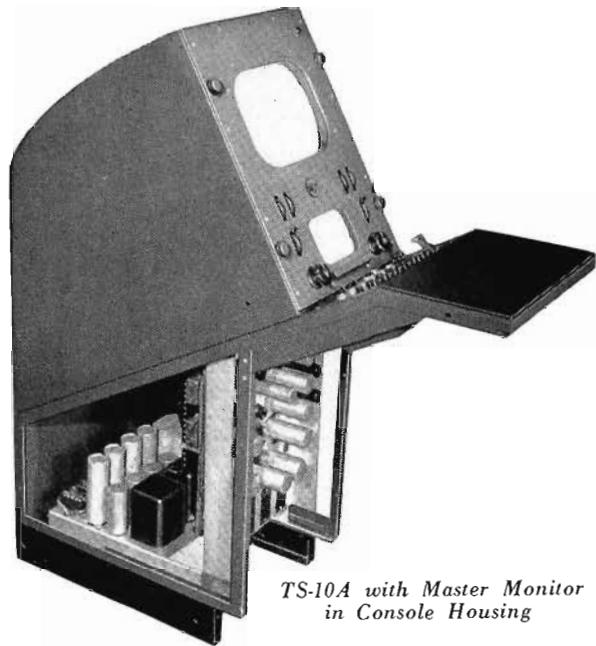

TS-10A with Master Monitor  
in Console Housing

connected to separate banks of camera selector switches. They have common outputs, however, so that they can serve one camera singly or two cameras together in a lap-dissolve or superimposition. The third picture amplifier feeds the monitor input. The two sync amplifiers automatically add local sync to the video signal when remote sync fails or when local sync is otherwise required.

## Specifications

### Power Line Requirements

100-120 volts, 50/60 cycles, 1060 (max.) watts  
(includes power required by the two WP-33A Power Supplies)

### Input Signal:

#### Local Input

(video from camera control) \_\_\_\_\_ 1.5 v. peak-to-peak

Auxiliary Input (as remote) \_\_\_\_\_ 1.5 v. min. peak-to-peak  
video, 18-33% sync

### Input Impedance:

Local Input \_\_\_\_\_ 75 ohms

#### Auxiliary Input

(as remote) \_\_\_\_\_ 75 ohms, variable line termination

Output Impedance \_\_\_\_\_ Approx. 2000 ohms

Load Impedance \_\_\_\_\_ 75 ohms

### Mechanical Specifications (Console Section):

Dimensions (overall) \_\_\_\_\_ 41" High, 13" Wide, 6" Deep

Weight \_\_\_\_\_ 46 lbs.

Finish \_\_\_\_\_ Dark umber gray

### Tube Complement:

4 RCA 6AG7

1 RCA 6SN7/GT

2 RCA 6AC7

1 RCA 6SL7/GT

Stock Identification \_\_\_\_\_ MI-26965

### Equipment Supplied:

(Equipment below plus miscellaneous cables, fittings, hardware, etc., are supplied)

1 Studio Camera Switching Control Chassis \_\_\_\_\_ MI-26235

1 TA-5B Stabilizing Amplifier \_\_\_\_\_ MI-26160-A

1 Master Monitor Chassis \_\_\_\_\_ MI-26135-A

1 Console Housing \_\_\_\_\_ MI-26266-B

1 Blower \_\_\_\_\_ MI-26579-A

2 Regulated Power Supplies \_\_\_\_\_ MI-26085-B

6 Headsets \_\_\_\_\_ MI-26570-6

1 Set of Tubes Including (1) 5CP1A, (1) 18I6P4

1 Studio Intercom Control Box \_\_\_\_\_ MI-26568

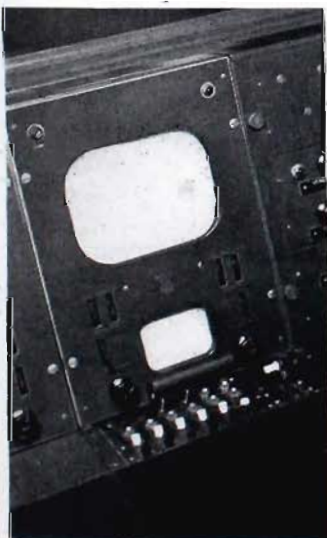

Closeup of TS-10A Control Panel



# Now...

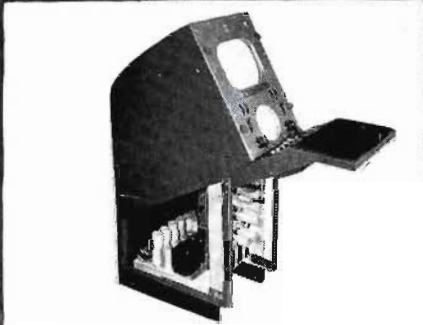

**This RCA Switching System** consists of a master "on-the-air" monitor and oscilloscope, a waist-high control panel (enlarged view, above) and mixing amplifier, below. This equipment becomes one of the standard-size sections of RCA's unit-built video console (top of page). Any combination of camera-controls and monitors is possible to fit your particular station.



# split-second selection of all television program material

## New RCA Camera Switching Unit provides convenient, push-button control at your video console

HERE, in one compact unit, is a control center for your television programs. Into it can be brought as many as six video inputs—from studio cameras, film cameras, relays, and network. *One* operator can handle the lot!

*Twelve* different types of switching are your assurance of a smooth, dramatic presentation, whatever the program. Look at the possibilities:

Your operator can *instantly* switch: (1) between two local camera signals; (2) between two remote signals; (3) from local to remote; (4) from remote to local; (5) from local to black screen (no signal); (6) from remote to black (screen); (7) from black to remote. With the special manual fader control he can, *at any desired speed*: (9) fade out local to black; (10) fade in local from black; (11) lap-dissolve between any two locals; (12) superimpose two locals and adjust the level of each. All sorts of trick effects are possible by moving the two levers that make up the fader control.

Tally lights provide an instant check on which input is being used and whether a remote signal is being received. If remote sync fails for any reason, local sync automatically takes over.

The monitor in the top of the console section allows the operator to either view the on-the-air signal or preview one of the two remote signals.

An unusually flexible intercom switching system (not shown) is included to permit private, special-group, or conference communication between practically all personnel. All have access to program sound through one earpiece of their headsets.

Here, we believe, is a switching system that represents the most advanced engineering in television station techniques. It will help you simplify television station routine—bring new possibilities to television programming. Be sure to get the complete story. Write Dept. 30-L, Radio Corporation of America, Engineering Products Department, Camden, N. J.

FADING CONTROL

MONITOR SWITCH

3-position: program line, either of two remotes

GAIN FOR REMOTE INPUT (#6)

REMOTE INPUTS

RELEASE BUTTONS

TALLY LIGHTS

and switches for remote sync

CAMERA SWITCHES

(2 rows) handle 4 inputs from studio and film cameras and 2 remotes to permit fading, instantaneous switching, special effects.

TALLY LIGHTS

for six inputs

GAIN FOR REMOTE INPUT (#5)

### PROGRAM SOURCES

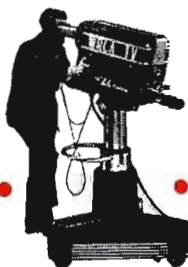

RCA Studio Camera (Switching Unit handles up to four)



RCA's Mobile Studio (Switching Unit can handle two remotes)



RCA Film Camera (Switching Unit handles two with 2 studio cameras)



# Studio Remote Control Equipment, Type TC-65A

## Features

- Provides remote control of various rack-mounted television units.
- Adapted to mounting in a desk section of control consoles, or in a standard rack.
- Provides central control position for units mounted in separate rooms.
- Often reduces cost in running video lines.
- Offers better efficiency in control room operations.



MI-26249



MI-26250



MI-26247



MI-26248



MI-26251



Blank Panel MI-26253



Remote Control Equipment  
Mounted in Console Housing Section, MI-26266-B

## Uses

The RCA Studio Remote Control Equipment, MI-26985 consists of five separate control panels, a console housing section which matches RCA video console housings, and a mounting adapter which permits the panels to be mounted in the console housing. Other adapters are also available which permit the panels to be individually rack-mounted.

The five different control panels, which can be obtained separately, provide for remote control of rack-mounted television units such as the monoscope camera, power relay panel, relay receiver, sync generator (phasing control), and stabilizing amplifier. Up to six such panels can be installed in the upper compartment of the housing. The power control panel will control up to five power supplies, and the sync generator panel will control the phasing of the two sync signals. If less than six control panels are used, blank panels can be obtained to fill empty space in the housing. The complement of control panels and blank panels mounted in the housing provides a very attractive desk section, and permits future expansion of remote control facilities.



*Panel Adapter MI-26254*

### Description

The five different remote control panels, as well as the various adapters, and blank panels are described in the following paragraphs:

#### MONOSCOPE CAMERA (MI-26248)

The Monoscope Camera Remote Control Panel consists of two potentiometers wired to a terminal board in the rear. These potentiometers provide remote control of video gain and focus of the monoscope camera. Engraved panel markings permit instant check for proper setting of controls.

#### POWER CONTROL (MI-26251)

The Power Remote Control Panel consists of five on-off toggle switches, five tally lights, and five small card holders for switch identifications. The five switches can operate as many as five different power supplies, by operating 120-volt relays in the power supply lines. Relays for this purpose are mounted in a relay power control panel which is available as MI-26271.

#### RELAY RECEIVER (MI-26247)

The Relay Receiver Remote Control Panel consists of two potentiometers, an AFC on-off switch, a tally light and a telephone jack for checking incoming sound on a wire line. The two potentiometers control video gain and receiver tuning; the tally light indicates when the receiver is turned on.

#### SYNC GENERATOR PHASING (MI-26249)

The Sync Generator Phasing Remote Control Panel consists of two potentiometers, two tally lights and a phasing indicator on-off switch. This panel will provide for phasing one of two local sync generators with a remote sync generator. The tally lights indicate which local generator is in use.

#### STABILIZING AMPLIFIER (MI-26250)

The Stabilizing Amplifier Remote Control Panel consists of three potentiometers for controlling picture gain, the picture clipper and sync level in the circuits of a stabilizing amplifier.

#### BASIC PANEL (MI-26252)

The Basic Panel provides for mounting up to six remote control panels (or blank panels) in the upper compartment of the console housing. The basic panel is provided with four fasteners which hold it securely to the flanges of the housing.

#### PANEL ADAPTER (MI-26254)

The Panel Adapter when used with any one of the remote control panels adapts them to mounting in any standard rack.

### Specifications

Power Requirements \_\_\_\_\_ 120 volts, 60 cycles, 10 watts  
for tally lights and relays

Panel Dimensions \_\_\_\_\_ 11" length, 2 $\frac{5}{8}$ " width

Rack Panel Adapter \_\_\_\_\_ 19" length, 3 $\frac{1}{2}$ " width

Stock Identification \_\_\_\_\_ MI-26985

#### Equipment Supplied:

1 Monoscope Camera Control Panel _____	MI-26248
1 Power Control Panel _____	MI-26251
1 Relay Receiver Panel _____	MI-26247
1 Sync Generator Phasing Panel _____	MI-26249
1 Stabilizing Amplifier Panel _____	MI-26250
1 Basic Mounting Panel _____	MI-26252
1 Console Housing Section _____	MI-26266-B
1 Blank Panel _____	MI-26253

### Accessories

Cabinet Rack Mounting Adapter \_\_\_\_\_ MI-26254

Television Cabinet Rack \_\_\_\_\_ MI-30951 series

Power Relay Panel \_\_\_\_\_ MI-26761

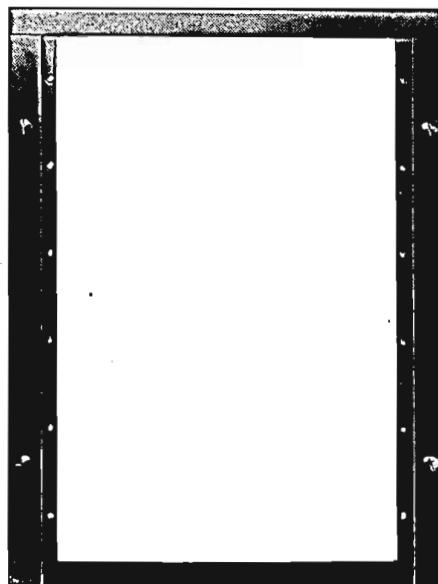

*Basic Panel MI-26252*



# Remote Control Switching System, Type TS-20A

## Features

- Employs relays for local and remote video switching.
- Can be used for studio or master control switching.
- Permits use of all programming techniques such as fading and lap-dissolving between local signals.
- Centralizes coaxial cable connections.
- Coaxial cable connections not required at operating positions.
- Provides circuits for tally light operation.
- Provides control circuits for sync interlocks.
- Design permits expansion of facilities without obsolescence of original equipment.

## Use

The RCA Type TS-20A Remote Control Switching System is designed for use in television studio control and master control rooms. It consists of different types and quantities of equipment depending upon the size and type of switching operation desired. The equipment may be used for switching a minimum of six inputs to two outputs or a maximum of twelve inputs to six outputs (five outputs if tally light relay panel is used).

For the studio control room the system can be set up to provide complete facilities for program monitoring, production talk back and video switching between television studio cameras, film cameras, remote pick-ups or network programs. Controls can be provided for fading and lap-dissolving between local studio video signals. The system can provide for program previewing and other monitoring functions since up to five program monitors can be furnished.

For the master control room the system can be set up to provide complete video switching and monitoring facilities within the limits noted above.

The push-button control panels designed for the system can be housed in consoles in convenient position for monitoring the video facilities. Actual switching is accomplished remotely by d-c relays which are housed in racks at any desired location in the control room. By installing a panel of jacks and video patch cords in adjacent rack equipment, switching of all sources of signals to this position and to the master control console, or directly to the transmitter, can be accomplished quickly and efficiently. Special high-speed transfer relays almost completely eliminate picture disturbance caused by switching.

The use of d-c relays in the TS-20A system adds to the overall flexibility of television stations layouts and simplifies the addition of studio facilities when expanded operating schedules require the use of more than one control room. The RCA Remote Control Switching System permits the broadcaster to eliminate the costly expense of installing intricate video lines to interconnect the television studios and control rooms.

## Description

The complete TS-20A Remote Control Switching System consists of several types of individual units which fall in the following categories. (For break-down see equipment listing under "Specifications".)

- The video relay switching chassis and panels used to extend functions of basic units.
- The push-button panels (for operating the video relays) which are available for several switching schemes and mounting arrangements.
- The program or master monitors, for use in conjunction with push-button panels.
- The various consoles for mounting the push-button panels and monitors.
- Standard components.

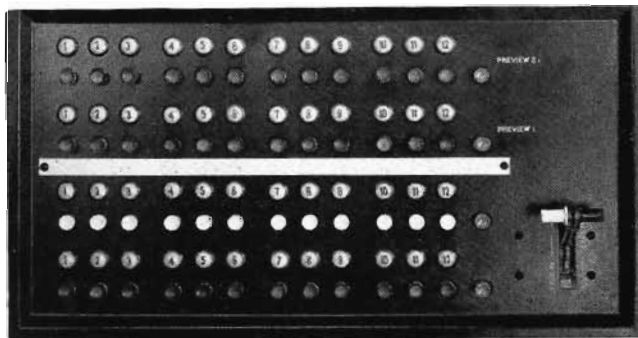

*Push Button Panel MI-26220-1. This is one of five different panels available for mounting in the TC-5A Program Director's Console.*



*Standard rack containing relay chassis, amplifiers and power supplies.*

**RELAY SWITCHING**

The basic relay switching chassis supplied with the TS-20A System provides for switching six video input channels to two output lines. All six inputs can be used for local signals. However, two channels may be used for remote signals since they are equipped with automatic circuits which remove the local sync addition. Following are the units included: (A) Basic Relay Chassis (MI-26231); (B) Two Basic Relay Panels (MI-26233). The number of outputs may be increased to a maximum of six (five if tally light relay panel is used) by the addition of Basic Relay Panels (MI-26233)—one panel for each output. The Basic Relay Chassis contains a cathode coupled output tube for each channel to isolate the source signal from any output line. The Auxiliary Relay Chassis (MI-26230) which is designed for installation directly below the Basic Relay Chassis, provides six additional inputs for two output channels. Here the number of outputs can be increased to six by mounting four Auxiliary Relay Panels (MI-26232) in the Auxiliary Chassis. The Tally Relay Panel (MI-26234) can be mounted in the Basic or in the Auxiliary Relay Chassis. This panel is designed for mounting where the sixth relay panel would be located. If Tally Relay Panels are used, the number of outputs is limited to a maximum of five. **PUSH-BUTTON PANELS**

RCA has designed five different push-button video control panels to handle all or only a few of the switching and fading functions. Three of the units include switching and fading and two of the units include only switching. MI-26220-1 handles twelve inputs and four outputs with fader; MI-26220-2, twelve inputs and three outputs with fader; MI-26221, six inputs and two outputs with fader; and MI-26222, and MI-26223, each handle six inputs and two outputs only. MI-26220-1 and 2 were designed primarily for program director's console type TC-5A installation. The MI-26221, 26222 and 26223 switch panels have been designed for use in console sections for master switching. All the buttons are of the push type and a tally light is associated with each one. A release button is located in each row of channel buttons.

**MONITORS**  
The TC-5A Program Director's Console with its Program Monitors (MI-26140) may form a part of the TS-20A system. The push-button switch panel (MI-26220-1 or 2) is mounted as a part of this console. The MI-26221 and MI-26222 switch panels are designed for mounting in a single console section (sloped portion) which is at right angles to the panel on which remote control panels are located (see data sheet on Studio Remote Control Equipment, MI-26985). The MI-26223 switch panel mounts in the upper section and space required is equal to that of two small remote control panels. With the MI-26221 and MI-26222 panels, a Master Monitor, TM-5A, may be mounted in the same console. With the MI-26223, other remote panels may be mounted in the same console and a master monitor in an adjacent console housing.

**AMPLIFIERS AND POWER SUPPLIES**  
The amplifiers associated with the system include Types TA-1A Distribution Amplifiers, TA-5B or 5C Stabilizing Amplifiers and Type TA-10A Mixing Amplifiers. The number required, of course, depends on the size of the installation. The Distribution Amplifier makes possible multiple distribution of video signals, while the Stabilizing Amplifier, which in addition to inserting local sync, also corrects relative sync and picture levels. These units are described in RCA sales literature (Form 1J-268 and Form 1J-2917, respectively). The Mixing Amplifier has two input channels and a common output channel. This is the unit which provides for lap-dissolving and fading of two input signals. Two levers mounted on the switching panel operate gain controls in the amplifier—one gain control for each channel. Thus, two signals fed into the amplifier can be superimposed with any relative degree of amplitude for each.

The TS-20A Switching System uses regulated power supplies and 24-volt supplies for the d-c relays. The equipment has been designed so that it is possible to employ the units in a great number of different combinations to meet the requirements of the individual stations. Station plans can be obtained from RCA upon request.

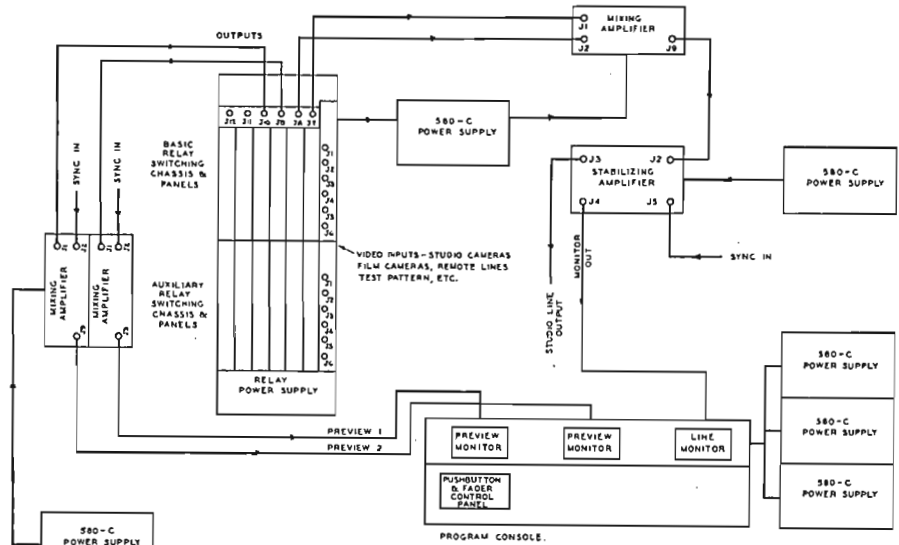

Layout diagram showing typical equipment employed in one version of TS-20A system using the Program Console, TC-5A

**Specifications**

**Power Requirements:**

Relays	24 volts d-c
Amplifiers	280 volts d-c
Filaments	115 volts a-c
Video Input Channels	6 min., 12 max.
Video Output Channels	2 min., 6 max.*
Input Impedance	75 ohms**
Output Impedance	High***
Video Transfer Relay Adjustments for	Overlap switching Gap switching

**Dimensions:**

Basic Relay Chassis	26 1/4" high, 19" wide, 9 1/2" deep
Auxiliary Relay Chassis	21" high, 19" wide, 8 3/4" deep

**Tube Complement:**

Basic Relay Chassis	6 RCA 6J6 output tubes
Tube Complement	(For complement tube listings refer to catalog pages on individual equipments)

**Stock Identification**

Schedule 26990  
Equipment Supplied—The TS-20A System includes the following equipment which may be used in many different combinations determined by individual station requirements.

**A. Relay Switching Units:**

Basic Relay Chassis	MI-26231
Basic Relay Panel	MI-26233
Auxiliary Relay Chassis	MI-26230
Auxiliary Relay Panel	MI-26232
Tally Light Relay Panel	MI-26234

**B. Push-Button Panels:**

Program Control Panel (with fader)	MI-26221
Master Control Panel	MI-26222
Master Control Panel	MI-26223
Program Control Panel (part of 26975)	MI-26220-1 or 2

**C. Monitors:**

Master Monitor	MI-26135-A
Program Monitor (part of 26975)	MI-26140

**D. Console Units:**

Program Director's Console	MI-26975-1 thru 8
Console Housing	MI-26266
Blower for Master Monitor	MI-26579

**E. Standard Components:**

Relay Power Supply	MI-11309
Cabinet Rack	MI-30951-C84
Type 580C Power Supply	MI-21523-B1
WP-33A Power Supply	MI-26085-A
Stabilizing Amplifier, TA-5B	MI-26160-A
Regulated Power Supply, Type TY-25A	MI-26086
Distribution Amplifier	MI-26155
Mixing Amplifier TA-10A	MI-26281

\* 5 max. when tally relay panel is used.

\*\* Adjustable between 60-87 ohms.

\*\*\* For capacity coupled inputs.



# Everything for TV.



**RCA De Luxe Video Console.** Everything you need to monitor, control, and switch camera pictures. "Add-a-unit" design enables you to expand these facilities as your station grows.



**RCA Camera Control Type TK-10A.** Makes it practical to watch and control the picture quality of station camera. Same size and appearance as RCA's switching units, film camera control, and preview- and line-monitoring units. These units can be grouped in any combination to form a video console (shown above).



**RCA Studio Consolelette Type 76-C4.** This flexible and easy-to-operate control unit performs all the audio amplifying, monitoring, and control functions of a TV station—large or small. Can be used for single- or two-studio operation, and for two transcription turntables.

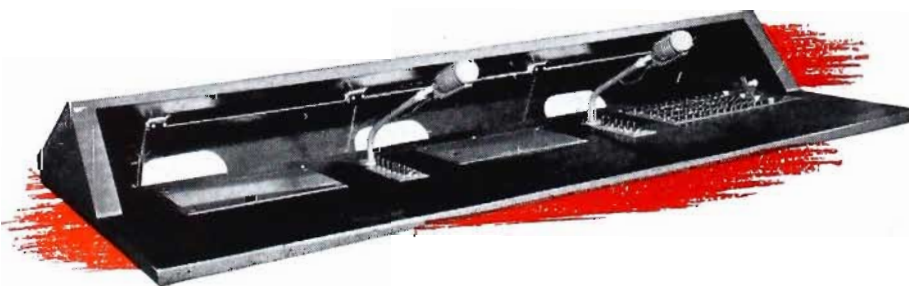

**RCA Program Directors Console Type TC-5A.** Television's most up-to-date directors' control. Includes large-size picture monitors for the studio outgoing line, for previewing, and for "on-the-air" monitoring. All switching under finger-tip control. Low height for full studio visibility. Recessed monitors for maximum image brightness in a fully-lighted control room.

**T**HAT PICTURE you see over there is a studio control room for a medium-size television station—complete by RCA, from sight to sound.

This room virtually puts entire programming under "push-button" supervision. From here you control and monitor studio programs . . . sound and picture . . . switch between *all* cameras, switch to network or remote programs, control and monitor recorded sound, monitor the programs on the air.

In this room are large picture monitors for previewing signals from remotes or networks and from the studio cameras. In this room also is an audio consolette that controls all program sound lines—from the studio microphones, network audio line, studio and announce microphones, and from the turntables shown in the foreground. A program console . . . with its picture monitor for viewing the studio line and the on-the-air picture . . . co-ordinates the programming. Nothing included in this room that should not be there. Nothing omitted that should be included.

Why do most TV stations go RCA all the way on studio control-room equipment?

Because RCA control-room equipment has design flexibility to meet every station's need and budget. Because RCA control-room equipment is *unit-built* . . . permits easy and economical addition of extra units without a worry about discarding the original equipment. Because a single company makes the entire line . . . *and backs it up!*

For professional assistance in planning your television station, call in an RCA Specialist. Or write Dept. 19 FLD, RCA Engineering Products, Camden, N. J.



entire studio control rooms,  
*for instance* —

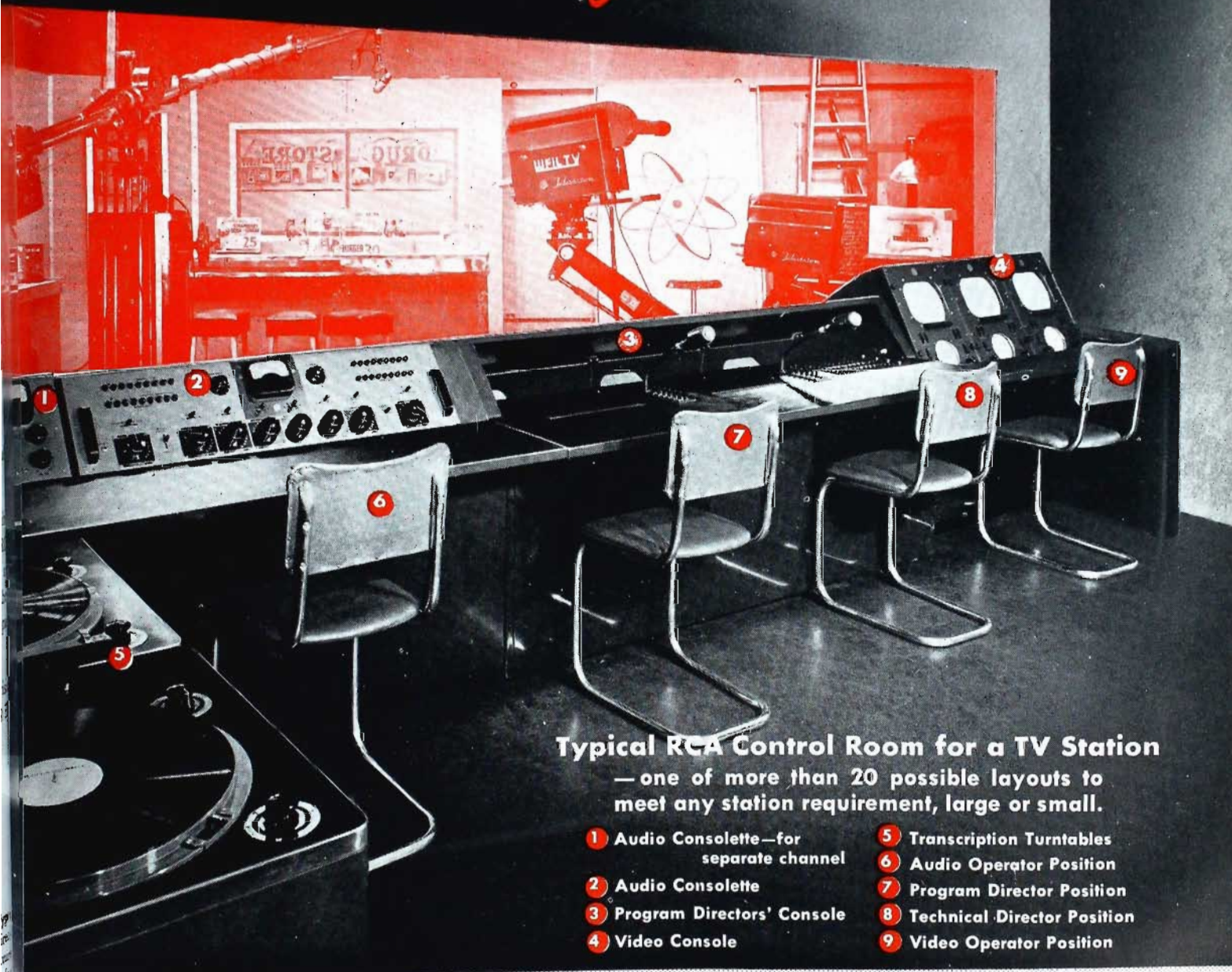

**Typical RCA Control Room for a TV Station**  
— one of more than 20 possible layouts to meet any station requirement, large or small.

- |                                      |                               |
|--------------------------------------|-------------------------------|
| 1 Audio Console—for separate channel | 5 Transcription Turntables    |
| 2 Audio Console                      | 6 Audio Operator Position     |
| 3 Program Directors' Console         | 7 Program Director Position   |
| 4 Video Console                      | 8 Technical Director Position |
|                                      | 9 Video Operator Position     |



# Program Director's Console, Type TC-5A



*Program Director's Console with video switching panel, talkback microphone and key switches visible at right*

## Features

- Provides complete program and technical directors' facilities for supervision of television programming.
- Picture monitors totally enclosed in console—shielded from stray light—permits better viewing.
- Up to five 10-inch monitors may be mounted in console.
- Low console construction provides unobstructed view into studio—minimum depth of console places directors close to control room window.
- Optimum viewing distance—wide angle viewing of monitor screens.
- Controls provided for switching, fading or previewing any of twelve input signals—tally lights for each push button.
- Two microphones for one-way communication to 6 different points for each microphone—equipped with tally lights.

## Use

The Type TC-5A, Program Director's Console is a compactly built supervisory console designed to provide complete control of television studio produced programs; however, it has facilities for switching in other sources of programs as desired. It is intended for use by the program and technical directors, and is constructed to permit a maximum unobstructed view of the studio. The monitors (MI-26140) are mounted in a vertical position in the bottom of the console, and are viewed on a mirror, resulting in minimum height and depth for the console, as well as an optimum viewing distance. The console is designed to be a part of the TS-20A Switching System.

The use of three or five monitors is a matter of preference. Uses for three monitors are: (1) a studio line monitor showing the picture going to the master control room; (2) a preview monitor showing the next picture to be used; and (3) an "on air" monitor showing the picture actually going to the transmitter. Connections can be provided in the TC-5A so that

this third monitor may be employed as a second preview monitor and can be controlled by push buttons with associated tally lights. To permit flexibility, the video inputs to all monitors can be brought out on a rack mounted patch panel so that any composite signal may be patched into them for different requirements.

The technical and program directors sit side by side, serving to coordinate large programs with a maximum of smoothness. The technical director has at his fingertips controls to switch, fade, lap-dissolve or preview any signal upon orders from the program director.

## Description

The technical director's control panel handles up to twelve input signals, of which up to four can be from remote lines and the remainder from local lines. The switching relays and mixing amplifier (used for fading) are rack-mounted, but the push-button controls for switching are located on the console. Two rows of push buttons are associated with the mixing amplifier, one row for each amplifier input channel. A third row of push buttons selects the desired input signal for the preview monitor in the console. A fourth row of push buttons may be added to accommodate the option of a second preview monitor. Electrical interlocking prevents putting more than one signal on the air at one time. Associated with each

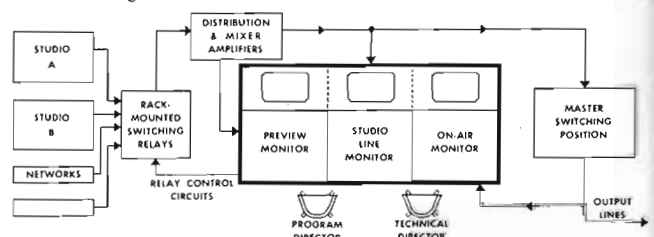

*Block diagram showing typical use of the Program Director's Console*

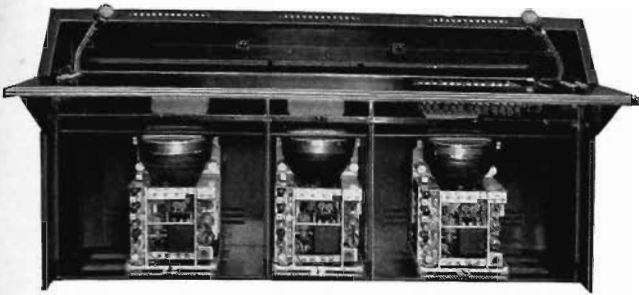

TC-5A front cover removed to show mounting of monitors

push button on the control panel is a tally light which shows when the circuit is in use. The glass jewels contain numbers from one to twelve, corresponding to the twelve inputs. In addition, three sets of tally lights are provided at the top front of the console cover, each set consisting of twelve lights with jewels numbered from one to twelve. The contrast, brightness, focus, vertical and horizontal hold controls for each program monitor mount at the back edge of the console desk directly in front of the respective monitor. The console is designed so that switching and fading controls may be installed at either end of the program console desk, leaving the seating arrangement up to individual customer requirements.

Ten different signal switching and fading operations are possible with the technical director's control panel when used in conjunction with the TS-20A System.

1. Black screen to any signal instantaneously
2. Any signal to black screen instantaneously
3. Fading from local signal to black screen
4. Fading from black screen to local signal
5. Local signal to remote signal instantaneously
6. Remote signal to local signal instantaneously
7. Fade out local signal to black screen and instantaneously switch in remote signal
8. Switch out remote signal instantaneously to black screen and fade in local signal
9. Lap dissolve between two local signals at any speed
10. Super-imposition of two local signals

Intercommunication facilities, consisting of two microphones with a bank of six selector keys for each, are provided on the console for one-way communication to a maximum of

**Stock Identification:** Note from the chart below that a choice of eight different TC-5A combinations is available to meet broadcasters' individual requirements. Combinations offer a selection of three or five monitors, 38 or 48 button switching panels, and a left or right hand location for switching panels. ORDER TC-5A BY SCHEDULE NOS. (i.e., MI-26975-1, MI-26975-2, or MI-26975-3, etc.) . . . except when ordering individual items for replacement or as spare equipment.

TC-5A Program Console Equipment Supplied	MI-26975-1	MI-26975-2	MI-26975-3	MI-26975-4	MI-26975-5	MI-26975-6	MI-26975-7	MI-26975-8
Basic Console	(1) MI-26562	(1) MI-26562	(1) MI-26562	(1) MI-26562	(1) MI-26562	(1) MI-26562	(1) MI-26562	(1) MI-26562
Desk Top	(1) MI-26563	(1) MI-26563	(1) MI-26563	(1) MI-26563	(1) MI-26563	(1) MI-26563	(1) MI-26563	(1) MI-26563
(4x12) 48 Button Panel	(1) MI-26220-1	(1) MI-26220-1	---	---	(1) MI-26220-1	(1) MI-26220-1	---	---
(3x12) 36 Button Panel	---	---	(1) MI-26220-2	(1) MI-26220-2	---	---	(1) MI-26220-2	(1) MI-26220-2
Intercom Panels	(1) MI-26224	(1) MI-26224	(1) MI-26224	(1) MI-26224	(1) MI-26224	(1) MI-26224	(1) MI-26224	(1) MI-26224
Console Assembly Kit	(1) MI-26553	(1) MI-26553	(1) MI-26553	(1) MI-26553	(1) MI-26553	(1) MI-26553	(1) MI-26553	(1) MI-26553
Tally Light Assembly	(1) MI-26554	(1) MI-26554	(1) MI-26554	(1) MI-26554	(1) MI-26554	(1) MI-26554	(1) MI-26554	(1) MI-26554
Console Cable (3 Mon.)	(1) MI-26555-1	---	(1) MI-26555-1	---	(1) MI-26555-1	---	(1) MI-26555-1	---
Console Cable (5 Mon.)	---	(1) MI-26555-2	---	(1) MI-26555-2	---	(1) MI-26555-2	---	(1) MI-26555-2
Items Above Are Shipped Assembled	MI-26324-1	MI-26324-2	MI-26324-3	MI-26324-4	MI-26324-5	MI-26324-6	MI-26324-7	MI-26324-8
Monitor	(3) MI-26140	(5) MI-26140	(3) MI-26140	(5) MI-26140	(3) MI-26140	(5) MI-26140	(3) MI-26140	(5) MI-26140
Mirror	(1) MI-26551	(1) MI-26551	(1) MI-26551	(1) MI-26551	(1) MI-26551	(1) MI-26551	(1) MI-26551	(1) MI-26551
Glass	(1) MI-26552	(1) MI-26552	(1) MI-26552	(1) MI-26552	(1) MI-26552	(1) MI-26552	(1) MI-26552	(1) MI-26552
Mask-Control Strip (3 Mon.)	(1) MI-26564-1	---	(1) MI-26564-1	---	(1) MI-26564-1	---	(1) MI-26564-1	---
Mask-Control Strip (5 Mon.)	---	(1) MI-26564-2	---	(1) MI-26564-2	---	(1) MI-26564-2	---	(1) MI-26564-2
Microphone	(2) MI-6206-E	(2) MI-6206-E	(2) MI-6206-E	(2) MI-6206-E	(2) MI-6206-E	(2) MI-6206-E	(2) MI-6206-E	(2) MI-6206-E
Monitor Mta. Kit	(3) MI-26523	(5) MI-26523	(3) MI-26523	(5) MI-26523	(3) MI-26523	(5) MI-26523	(3) MI-26523	(5) MI-26523
Instruction Book	IB-36043-1	IB-36043-1	IB-36043-1	IB-36043-1	IB-36043-1	IB-36043-1	IB-36043-1	IB-36043-1

Items Above Are Shipped Separately

**Accessories** (Order separately)  
 Type 580-C Power Supply MI-21523-B1  
 (One needed for each MI-26140 Program Monitor)  
 Mixer Amplifier (3 normally required) MI-26281

twelve different points. The selector keys are the lever type, non-locking on one side, and locking on the other. Tally lights indicate which circuit is in use, preventing interruption while orders are being given. The designation strips on the intercom and technical director's panel are designed for making penciled notations which can be rubbed off, a feature to accommodate changes in designations with each program.

The television Program Director's Console, TC-5A, can be called a custom-built standard unit since there are eight different standard assemblies than can be furnished on order. (See 26975-1 through 8.)

**Specifications**

**POWER REQUIREMENTS**

Line to Tube Heaters:

- 3 Monitors \_\_\_\_\_ 105-125 volts, 50/60 cycles, 225 watts
- 5 Monitors \_\_\_\_\_ 105-125 volts, 50/60 cycles, 375 watts

Line to Type 580-C Regulated Power Supplies (to supply monitor plate voltage)

- 3 Monitors \_\_\_\_\_ 105-125 volts, 50/60 cycles, 1110 watts
- 5 Monitors \_\_\_\_\_ 105-125 volts, 50/60 cycles, 1850 watts

**MECHANICAL SPECIFICATIONS**

Overall Dimensions \_\_\_\_\_ 36" High, 72" Wide, 36" Deep

Desk Top \_\_\_\_\_ 21" Deep

Weight:

- With 3 Monitors \_\_\_\_\_ 383 lbs.
- With 5 Monitors \_\_\_\_\_ 507 lbs.

Finish \_\_\_\_\_ Dark umber gray

**TUBE COMPLEMENT**

For One Program Monitor—1st Picture Amplifier, RCA 6AG7; 2nd Picture Amplifier, RCA 6AG7; D. C. Restorer, RCA 6SN7GT; Sync. Separator, RCA 6AC7; Sync. Output, RCA 6SN7GT; Vert. S.T. Generator, RCA 6SN7GT; Vert. S.T. Output, RCA 6SN7GT; Vert. Distortion Amplifier, RCA 6AC7; Focus Coil Current Reg., RCA 6AG7; Hor. S.T. Generator, RCA 6SN7GT; Hor. Driver, RCA 6SN7GT; 2-Hor. Output, 2-RCA 6BG6G; Hor. Damper, RCA 6AS7G; 2-H.V. Rectifier, 2-RCA 1B3-GT/8016; Kinescope, RCA 1816-P4.

Stabilizing Amplifier (additional 580-C power supply desirable) MI-26160-B  
 TS-20A Relay Switching Equipment Schedule 26990  
 (available to suit individual requirements)



# *This* director's console put



- 1** Preview of studio cameras
- 2** Control room outgoing line
- 3** Preview of network and remote
- 4** Inter-com microphone
- 5** Inter-com switching
- 6** Camera and remote signal switching



# the television pictures

# ...right before your eyes!

## At last program directors can watch monitoring pictures and studio operations—simultaneously

**N**OW it is possible to sit before your studio window—and see everything that's going on. No high-built equipment to obstruct your view of the studio. No need to play peek-a-boo with the video operators up front. You see large, bright pictures of what the cameras see . . . right before your eyes.

In this new director's console—only 37 inches high and 72 inches wide—the program monitors are mounted *below* the desk . . . and viewed indirectly from light-shielded mirrors. The advantages: A console of low height that enables the program director to see the entire studio from the director's position; daylight-bright monitor pictures that can be seen in a fully-lighted control room.

Using anywhere from two to five monitors—with a 10-inch kinescope of high brilliance in each—this console displays (1) preview pictures of the local cameras, (2) network or

other remote signals, (3) the picture going to the transmitter room. All fading, dissolving, and video signal switching is under "push-button" control through a switching panel right in the console. Tally lights indicate the camera that is on the air and the camera that has been selected for preview. Order-wire microphones and order-wire switching provide maximum operating efficiency.

Here, we believe, is a director's console that is years ahead in programming facilities and operating conveniences. It is styled to match all other RCA television and audio equipment and requires a minimum of room. Plenty of desk space, too, for scripts, schedules, and other programming material.

For more information on this new console . . . now in regular production . . . call your RCA Television Specialist. Or write Dept. 19KD, RCA Engineering Products Division, Camden, N. J.

**Cross-section Side View**—The 10" kinescopes are mounted below the desk and viewed indirectly from front-surface type mirrors. This unique design shields the tube screens from direct outside light and provides a complete view of the studio. Normally, two directors handle the console: one for the programming; one for the technical aspects of programming.

This modern and practical Director's Console brings all electronic aspects of programming under finger-tip control.

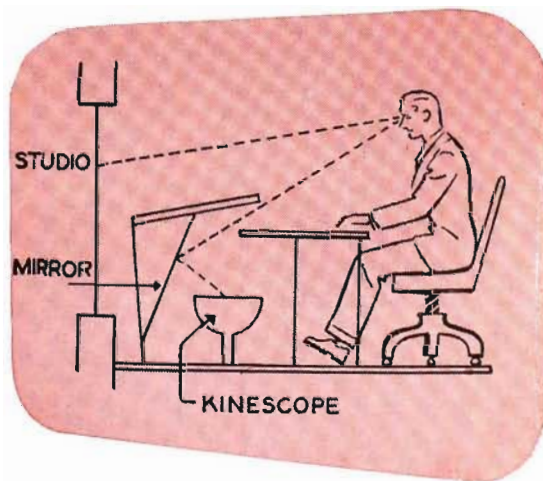



# Master Control Panels, MI-26222 & 26223

## Features

- Designed for use in TS-20A Relay Switching System.
- 6 input channels.
- 2 output channels.
- Tally lamps to indicate channels in use.
- Mounts in standard console section, MI-26266.



*Master Control Panel MI-26222 is supplied with back protective cover and adapter mounting plate, as shown.*

## Uses

The push button circuits of Master Control Panels MI-26222 and MI-26223 are arranged for use with the Relay Switching Units in the TS-20A Switching System. Remote switching may then be accomplished between 6 inputs and 2 outputs.

## Description

Both panels include two rows of 6 push buttons plus release buttons in each row. Also associated with each row of push buttons, is a row of lamps to indicate which circuits are in use. All connections are brought out to a telephone type terminal block which may be located in the lower part of the console section. The MI-26222 panel mounts in the sloping section of the desk area and is hinged to permit removal of a Master Monitor if one is mounted in the same console section. A removable back cover provides protection for the switch assemblies. The MI-26223 Panel, although similar in layout, is designed to mount in the MI-26252 Remote Control Basic Frame, which, in turn, mounts in the monitor face of the console section.

## Specifications

Lamp Voltage \_\_\_\_\_ 12 volts

### Circuit:

Three make contacts for each push button, wired to terminals on telephone block.  
One side of lamps common.

### Dimensions:

MI-26222 \_\_\_\_\_ 13" wide, 5 $\frac{5}{8}$ " high, 3 $\frac{1}{2}$ " deep  
MI-26223 \_\_\_\_\_ 11 $\frac{1}{16}$ " wide, 5 11/32" high, 5" deep

### Weight:

MI-26222 \_\_\_\_\_ Approximately 15 lbs.  
MI-26223 \_\_\_\_\_ Approximately 12 lbs.

### Stock Identification:

Push button Switch Panel  
(For Master Control, Desk Top Mtg.) \_\_\_\_\_ MI-26222  
(For Remote Control or Turret Top Mtg.) \_\_\_\_\_ MI-26223



*MI-26223 Panel as supplied for Remote Control Console mounting.*



*The MI-26223 Panel, when mounted in Remote Control Console MI-26252, provides convenient Master Control facilities.*



*MI-26222 Master Control Panel shown mounted in sloping desk portion of TV console section.*

# Program Monitor, Type TM-1A



## Features

- A high quality television picture monitor.
- Lends itself to application as program or announce monitor.
- Easily adapted to portable use.
- Minimum size construction with bright picture on 10-inch aluminum backed screen.
- Operates from either composite or separate synchronizing and picture signals—switch controlled.
- Contrast, brightness, focus and horizontal and vertical hold controls mounted on panel which can be removed for remote control.
- Adapter MI-26524 available for rack mounting of program monitor.

## Uses

The Type TM-1A Program Monitor is a high quality picture monitor designed for use in announcer's booths, offices, clients' viewing rooms and control rooms of television stations. It can be furnished in an attractive carrying case, or adapted for rack mounting. Supplied with front panel and carrying case, the monitor can be made portable for field applications. Basically, the Program Monitor is identical to the monitors supplied in the RCA Program Director's Console, Type TC-5A.

## Description

Features of the electrical circuits and components include a picture amplifier with a bandwidth of 6 mc, vertical deflection circuit with automatic linearity control, combined horizontal deflection and high voltage circuit, synchronizing pulse separating circuit, and shielded filament transformers. The monitor will operate from either a composite signal or from separate sync and picture signals. A switch provides rapid changeover for either type of operation. The 10 kv second anode voltage produces a sharp, bright picture.



TM-1A Program Monitor shown mounted in Field Carrying Case, MI-26522

The input stage of the picture signal amplifier has adjustable gain by means of d-c bias control. When installed in the Program Console, this contrast control along with brightness, focus, and horizontal and vertical hold controls, are wired to a receptacle which permits remote control. The operating controls can thus be made accessible at the operators' positions at the console. In portable operation, these five controls are wired on a removable panel, plug connected to the chassis, permitting use of an extension cable. All other controls, such as size and centering, are part of the internal chassis structure and are accessible for initial adjustment. Means are also provided for reversing both deflection circuits, simplifying the changes necessary to accommodate either direct or reflected view positions of operation.

D-c plate and a-c filament primary power, externally supplied, are introduced through a single 7-pin plug. The picture signal is fed through a standard coaxial fitting, with an additional fitting for connecting a termination plug or another monitor in parallel. The separate sync circuit is provided with the same type of coupling arrangement.

## Specifications

### INPUT POWER

From Line for Tube Heaters:

Line Voltage	105-125 volts
Line Frequency	60 cycles
Line Power	75 watts

From Regulated Power Supply:

Plate Voltage	280 volts d-c
Plate Current	300 ma.
Centering Bias Supply	4 volts, min.

Electrical Characteristics:

Frequency Response	±1 db to 6 mc.
Signal Input Range	0.75 to 4.0 volts peak to peak
Limiting Resolution (horizontal)	500 lines, minimum
Second Anode Voltage	10 kv. (approx.)

Controls:

Remote	Contrast, brightness, focus, horizontal and vertical hold
Internal	Width, height, horizontal and vertical centering, horizontal and vertical linearity

Tube Complement 2—IB3-GT/8016, 2—6AC7, 3—6AG7, 1—6AS7G, 2—6BG6-G, 6—6SN7-GT, 1—1816P4

Mechanical Specifications: (with carrying case)

Length	19½"	Width	12½"	Height	13¼"
Weight	45 lbs. (approx.)				
Finish	Dark amber gray wrinkle				

Stock Identification MI-26140

Stock Identification Announce Monitor

(with carrying case) MI-26297

## Accessories

Carrying Case	MI-26522
Rack Mounting Adapter	MI-26524
580-C Power Supply	MI-21523-B1



Program Monitors, TM-1A, shown installed in Program Director's Console



# Monoscope Camera, Type TK-1A

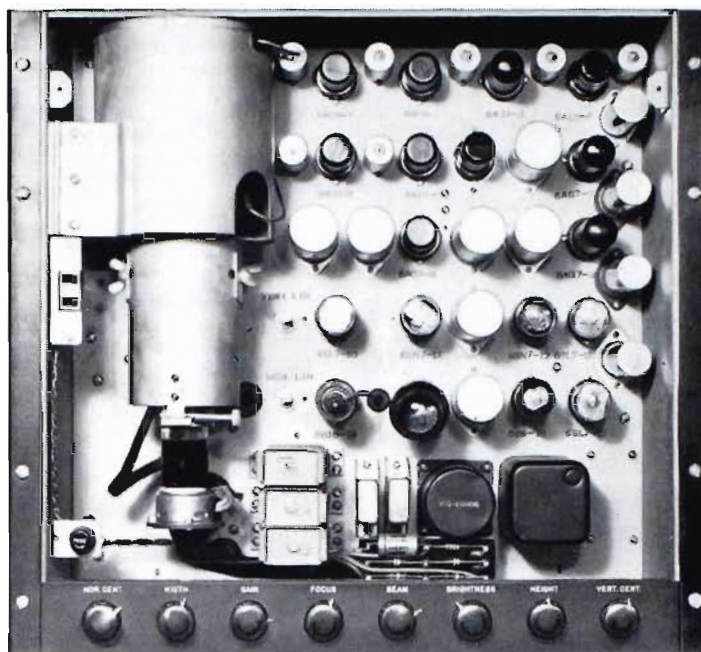

## Features

- Useful to television transmitting station, laboratory, factory, or service bench.
- Centralized operating controls.
- Compact construction; "bath tub" chassis for standard rack mounting.
- Auxiliary input for alignment purposes.
- Built-in high voltage power supply.
- Provision for remote control of gain and focus.
- Pattern shows scanning symmetry, vertical and horizontal resolution, shading, reproduction of isolated details, contrast and brightness.
- Accessible arrangement.
- RMA signal output.

## Uses

The Type TK-1A Monoscope Camera may be used as a convenient means of obtaining an image for video testing of television transmitting equipment, or a "test pattern" to be transmitted during warm-up and stand-by periods. In the latter case, the station call letters may be made a part of the pattern, thereby providing station identification. It may, likewise, be used in the television transmitting station as a readily available source of video signal, of known quality, to be used in place of the studio camera when making tests or adjustments on other units of the system. In the laboratory, factory, or service bench, the equipment may be used as a source of video signal to test or adjust television receivers, video amplifiers, and

picture tubes. With the addition of a source of blanking and driving signals, an IF sweep generator and an RF signal generator, it produces a complete television picture signal simulating that received off the air, and thus provides a means of testing receivers under conditions equivalent to actual use.

## Description

The TK-1A Monoscope Camera comprises the monoscope tube, the scanning generators, the video output amplifiers, and the high voltage power supply for the monoscope tube. This equipment is built on the familiar recessed "bath tub" type of chassis which fits into a standard nineteen-inch rack. All tubes and large components are located on the front of the chassis, while the wiring and smaller components are on the rear. The controls are grouped on a narrow control panel along the bottom of the chassis. When installed and in operation, the front is covered by a large cover plate which conceals everything but the control panel. This cover plate is interlocked to protect operating personnel from the high voltages present in the equipment.

The monoscope tube in the TK-1A is mounted in a vertical position at the left of the chassis. The upper part of the tube is enclosed in a mu-metal shield. The magnetic deflecting coils are mounted within the shield, and are attached to it. By disconnecting the tube socket, anode, and signal leads, the whole assembly—tube, coils, and shield—may be swung outward. This arrangement allows the tube to be changed very easily, and, at the same time, is very economical of rack space.

The monoscope tube ordinarily used in the TK-1A is an RCA-2F21. This tube provides a pattern which combines the

features of several previously used tubes. It shows the following details of the quality of reproduction in a given television system: scanning symmetry, resolution in both vertical and horizontal directions, shading and reproduction of isolated details. In addition it provides a pattern to facilitate proper adjustment of contrast and brightness.

The Vertical Deflection Generator consists of four tubes and associated circuits. The first of these tubes amplifies the driving signal received from the synchronizing generator and generates a saw-tooth voltage wave which is amplified in the second, third, and fourth tubes. The output is applied to the magnetic deflecting coils of the monoscope tube. Negative feedback is employed to improve scanning linearity.

The Horizontal Deflection Generator includes three tubes and associated circuits. The first tube is the driving signal input amplifier and sawtooth voltage generator; the second and third tubes amplify the output wave and feed it to the horizontal deflecting coils of the monoscope tube.

The Blanking Amplifier is used to provide the proper level and polarity of the blanking pulses received from the synchronizing generator before these pulses are fed into the Video Amplifier for mixing with the video signal.

The Video Amplifier includes six stages of video amplification—together with a clipper stage which is inserted between the fifth and sixth stages. The monoscope output signal is fed directly into the first stage of this amplifier, and the blanking

signal is introduced in the output of the fourth stage. The output of the fifth stage (which contains both video and blanking signals) is fed to a clipper stage which adjusts the height of the blanking "pedestals". The clipper feeds an output stage which consists of two tubes having their grids tied in parallel, but with the plate circuits separate. This provides two separate outputs—one for picture output and one for monitoring purposes.

**Specifications**

Output Voltage \_\_\_\_\_ 1.5 volts peak to peak

**Power Supply Required:**

Blanking, Horizontal Drive and Vertical Drive

Pulse Inputs (neg. polarity) \_\_\_\_\_ 3.5 to 5 volts

Resolution Capability \_\_\_\_\_ At least 450 lines

**Power Consumption:**

110-120 volts a-c 60 cycles \_\_\_\_\_ 100 watts

280 volts d-c (from Type 580-C Power Supply) \_\_\_\_\_ 200 ma.

Dimensions \_\_\_\_\_ 17½" high, 19" wide, 11" deep

Weight \_\_\_\_\_ 55 lbs.

**Tube Complement:**

6 RCA 6AC7	1 RCA 8016
1 RCA 6H6	1 RCA 6Y6
3 RCA 6AG7	1 RCA 6V6-GT
3 RCA 6SL7-GT	1 RCA 2F21
2 RCA 6SN7-GT	1 RCA 991

Stock Identification \_\_\_\_\_ MI-26960  
(includes monoscope tube RCA 2F21)

**Accessories**

Monoscope Camera Remote Control Panel \_\_\_\_\_ MI-26248

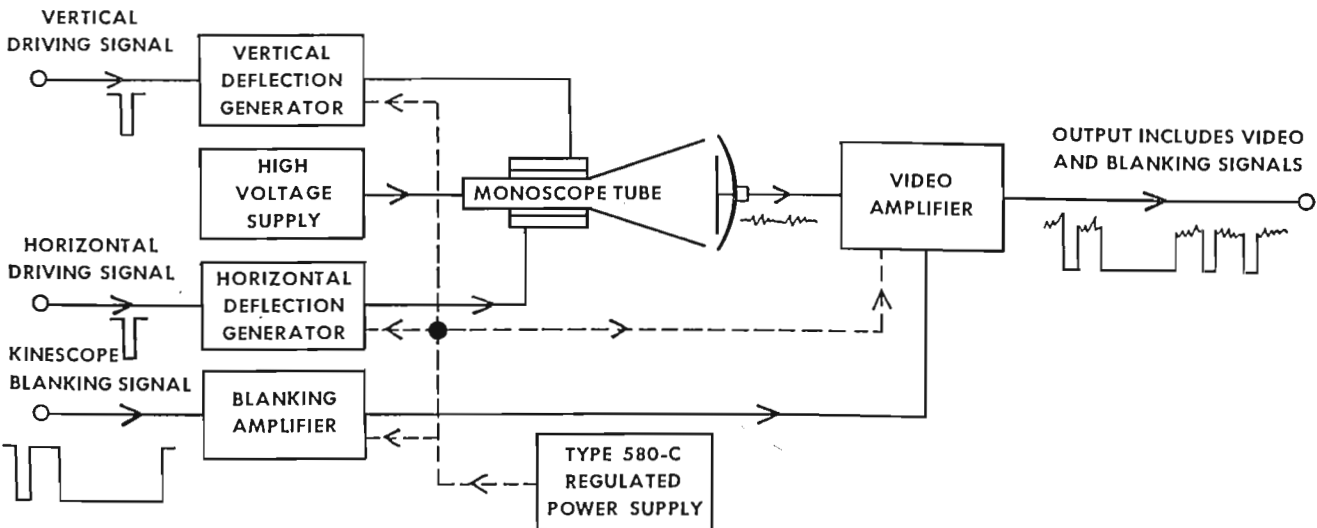

**BLOCK DIAGRAM OF THE TYPE TK-1A MONOSCOPE CAMERA**



# Synchronizing Generator, Type TG-1A

## Features

- Special circuits which maintain the timing of the leading edges of the equalizing pulses, the horizontal synchronizing pulses and the vertical synchronizing pulses, with extreme accuracy.
- An improved locking circuit for synchronizing the generator with the 60-cycle power supply—or with a remotely generated synchronizing wave form.
- A built-in crystal oscillator for frequency control.
- Use of circuits which are relatively insensitive to large changes in tube characteristics, so that ageing of tubes will not affect operation of the equipment.
- Operation of all tubes in extremely conservative manner, so that a very long, useful life may be expected.
- Wiring which has been greatly simplified by carefully grouping components so that all leads are very short.
- A built-in oscilloscope which, by means of a selector switch, can be used to check the step-down ratio of any of the frequency-dividing counter circuits.
- A regulated plate voltage power supply unit which, with the other panels, is mounted in place and wired at the factory. The unit is ready for operation immediately on installation.

## Uses

The TG-1A Synchronizing Generator is designed for use in television transmitting stations as a source of synchronizing pulses for the studio and film cameras, the monoscope camera, the monitoring oscilloscopes, and the mixing amplifier (which adds the synchronizing pulses to the transmitted video signal). In laboratories and factories it is used in conjunction with a monoscope camera to furnish a complete RMA standard video signal voltage which can be used in the development and production testing of television receivers.

## Description

The Type TG-1A Synchronizing Generator is an integral unit complete with power supply. It is assembled in a standard cabinet-type rack which is 84 inches high, 22 inches wide and 18 inches deep. The rack has front and rear doors which open the full length and width of the unit. This type of rack has been standardized for all RCA television, broadcast, and communications terminal equipment. Moreover, all RCA Television and FM transmitters are made up of racks which are similar in appearance, construction and height (although of greater width). Therefore, the TG-1A Generator, and other units mounted in similar racks, may be installed as needed, with assurance that they will match in appearance, other terminal and transmitting units which may be added later.

The 60 tubes and other components which make up the circuits of the TG-1A Generator are mounted on "bath-tub" type chassis which are placed in the cabinet vertically, as shown in the illustration. The 29 $\frac{3}{4}$  inch chassis at the top of the cabinet contains the pulse former. Immediately below is a similar chassis containing the "pulse shaping" circuits. The 10 $\frac{1}{2}$  inch chassis near the bottom is a standard Type 580-C Power Supply Unit, and just below is a 1 $\frac{3}{4}$  inch chassis containing electrolytic filter capacitors.

All of the controls, tubes and major components are mounted on the front of the vertical chassis. Thus, all ordinary adjustments, as well as routine checks, can be made by opening the front door. Since no high voltages are exposed on the front of the chassis, this door is not interlocked. Wiring and minor components, such as small capacitors and resistors, are on

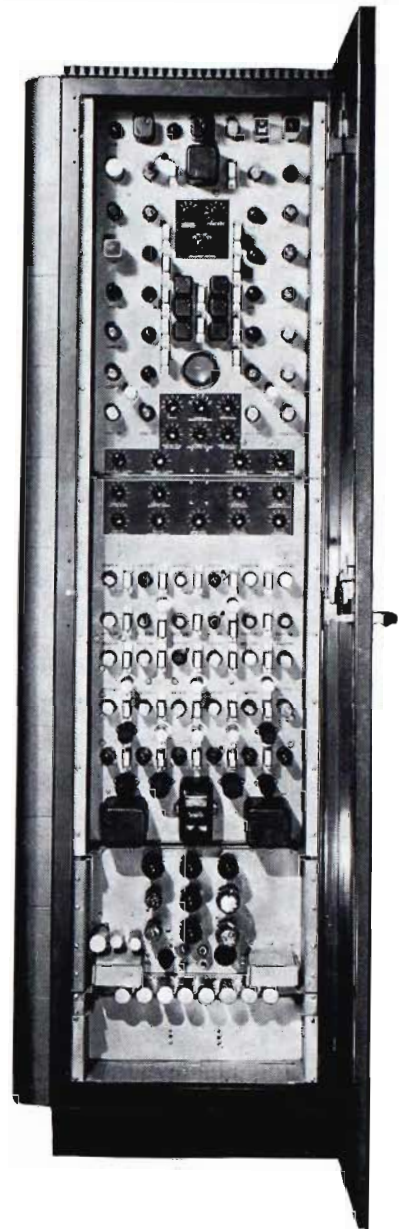

the back of the panels, and are accessible through the rear door. All terminals are in the clear, and components are identified so that circuit testing, when required, is relatively easy.

Electrically, as well as mechanically, the TG-1A Generator is divided into two main sections. The first section is the pulse former while the second section is the pulse shaper. The pulse former generates all of the different timing frequencies which are required by the system. It also provides a means whereby these frequencies (which are all derived from a single master oscillator) may be "locked in", either with the local 60-cycle power line frequency, with a crystal oscillator, or with some other external source, such as a remotely generated synchronizing wave form. The pulse shaper forms the pulses into the proper wave shapes and combines them as required to provide

the five different signals listed below. These signals are fed to ten output connectors located on a subpanel at the base of the pulse shaper.

It is intended that RG-11U or RG-59U concentric lines be used between these points and the studio cameras, mixing amplifiers, etc. Two coaxial output connections are provided for each signal so that output of either negative or positive polarity is available. When more than one equipment is fed from the generator, a distribution amplifier, such as the Type TA-1A, should be employed in order to isolate the circuits.

Regulated plate voltages for the pulse former and pulse shaper are furnished by the Type 580-C Power Supply. Filament voltages are provided by transformers mounted on the pulse shaper. All a-c power input to the cabinet is controlled by the circuit-breaker switch at the bottom of the pulse shaper.

The Type TG-1A Synchronizing Generator furnishes all of the timing pulses required in a complete television system. These pulses are accurately timed with relation to each other, and are carefully controlled as to wave form in accordance with the standards adopted by the RMA. The five different output signals which are generated will provide all of the timing and synchronizing requirements of a standard 525-line, 30-frame, interlaced television system. These five output signals are:

**(1) HORIZONTAL DRIVING SIGNAL**

This consists of short-duration, square-wave pulses at horizontal scanning frequency (15,750 cycles). These pulses are used to "trigger" the saw-tooth wave generator (in the camera) which supplies the horizontal scanning voltage for the pickup tube. The width of these pulses is sufficient to blank out the horizontal return trace of the camera tube.

**(2) VERTICAL DRIVING SIGNAL**

This consists of square-wave pulses of somewhat longer duration which occur at vertical scanning frequency (60 cycles). These pulses are used to "trigger" the saw-tooth wave generator (in the camera) which supplies the vertical scanning voltage for the pickup tube. The width of these pulses is sufficient to blank out the vertical return trace of the camera tube.

**(3) SYNCHRONIZING SIGNAL**

This is the signal which must be added to the camera picture signal before it is transmitted in order to synchronize the scanning action in the receiver. It is a composite signal consisting of (a) short-duration, horizontal synchronizing pulses at 15,750 cycles, (b) longer duration, vertical synchronizing pulses of the "serrated" type at 60 cycles, and (c) a series of six short-duration, equalizing pulses just preceding each vertical pulse interval and six more following it. All of these have the timing and wave shape prescribed by the RMA Standards.

**(4) BLANKING SIGNAL**

This signal is added to the transmitted video signal in order to blank out the return trace in the receiver picture tube (kinescope). It consists of square-wave pulses at horizontal scanning frequency (15,750 cycles) and vertical scanning frequency (60 cycles). These pulses are of longer duration than the synchronizing pulses and are transmitted at approximately "black" level. They form the "pedestals" on which the synchronizing signals are placed.

**(5) OSCILLOSCOPE SYNCHRONIZING SIGNAL**

This signal consists of pulses at half horizontal (7,875 cycles) and half vertical (30 cycles) frequencies. They are used to "trigger" the saw-tooth generator in the monitoring oscilloscope, thus providing (for "wave form" monitoring) oscilloscope patterns which are two lines or two fields in length.

**Specifications**

**Output Voltages**

- Synchronizing Signals—4 volts, peak-to-peak across 75 ohms
- Kinescope Blanking Signal—4 volts, peak-to-peak across 75 ohms
- Horizontal Driving Signal—4 volts, peak-to-peak across 75 ohms
- Vertical Driving Signal—4 volts, peak-to-peak across 75 ohms
- Oscilloscope Synchronizing Signal—8 volts, peak-to-peak across 75 ohms

**Power Supply Required**

From 109-125 volt, 60 cycle, single phase line—450 watts

**Dimensions**

- Mounted in Cabinet—84" High, 22" Wide, 18" Deep
- Unmounted Rack Units—77" High, 19" Wide, 12½" Deep
- Weight (in cabinet)—375 lbs.
- (unmounted)—160 lbs.

**Tube Complement**

- 1 RCA 1B3GT/8016      18 RCA 6SL7GT
- 10 RCA 6AC7            11 RCA 6SN7GT
- 5 RCA 6AG7            2 RCA 5691
- 8 RCA 6H6             1 RCA 3KP1
- 4 RCA 6L7

**Power Supply**

- 2 RCA 5U4G             5 RCA 6Y6G
- 1 RCA 6SL7GT         2 RCA OD3/VR150
- 1 RCA Stock No. 16864 Neon Lamp

Stock Identification—MI-26915

**Equipment Supplied**

Includes below plus hardware, fittings, misc. material

- 1 Synchronizing Generator Rack—MI-26815
- 1 Rear Door—MI-30536-G84
- 1 3KP1 Cathode Ray Tube—MI-26650
- 1 Instruction Book—1B-36008-1

**Accessories**

- Front Door—MI-30536-G84
- Side Panel (single)—MI-30541-G84
- Monogram—MI-30596
- Synchronizing Generator Phasing Remote Control—MI-26249
- Synchronizing Generator Switching Panel—MI-26285
- Pulse Distribution Box—MI-26757



# Sync Generator Switching Panel, MI-26285

## Features

- Used to switch outputs of either of two sync generators to television studio equipment in use.
- Permits quick changeover without loss of airtime in event of breakdown.
- Provides terminations for signals coming from standby sync generator.
- Contacts arranged so that proper termination is provided for both generators at all times.
- Supplied complete with cable connectors.

## Uses

The Synchronizing Generator Switching Panel MI-26285 may be used to switch all five signals (horizontal driving, vertical driving, blanking, synchronizing and CRO synchronizing) from a single front panel control knob.

The Sync Generator switching chassis can be conveniently mounted in standard 19" television equipment racks.

## Description

The Synchronizing Generator Switching Panel MI-26285 consists of necessary connectors, switches and terminating resistors. Contacts are arranged so that the proper termination is provided for both sync generators at all times. It is supplied in a

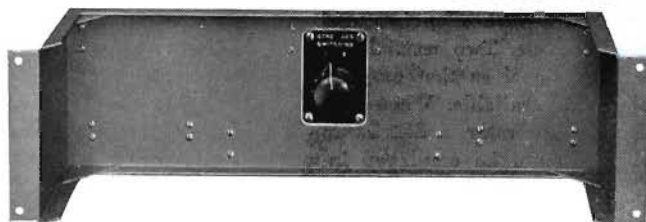

recessed type chassis for standard 19" rack panel mounting and is of proper size to fit in place of the blank panels included in studio sync generator equipment rack MI-26815.

## Specifications

Power Requirement	_____	None
Generator Switch	_____	12 pole, 2 position rotary
Input Signals Accommodated	_____	10
Output Signals Accommodated	_____	5
Dimensions:		
Panel Height	_____	5¼"
Panel Length	_____	19"
Panel Depth	_____	8¾"
Weight (approx.)	_____	14 lbs.

# Sync Generator Delay Panel, MI-26286

## Description

The Sync Generator Delay Panel is used to equalize the time delay in coaxial cables between the sync generator and studios located at different remote distances. The Delay Panel is to be used with a Distribution Amplifier, as follows. Horizontal driving and blanking pulses are fed into the two lines which are terminated internally in 75 ohms. Lines are tapped at points of desired delay, and fed through short lengths of unterminated coaxial line to the Distribution Amplifier, which feeds pulses to the studio.

The Panel consists of 2 delay lines and each line is equivalent (in time delay) to 2000 feet of RG-11/U coax cable. One is for horizontal driving pulses, the other for blanking. Since the total delay involved is to the studio and return, the maximum studio distance is 1000 feet. Each line consists of 40 sections, giving a total delay of 3.08 microseconds (equivalent to 2000 feet of RG-11/U coax). Each section has a delay of .077 microsecond (equivalent to 50 feet of RG-11/U). The Sync Generator Delay Panel is supplied in standard recessed "hathtub" chassis for regular 19" panel mounting.

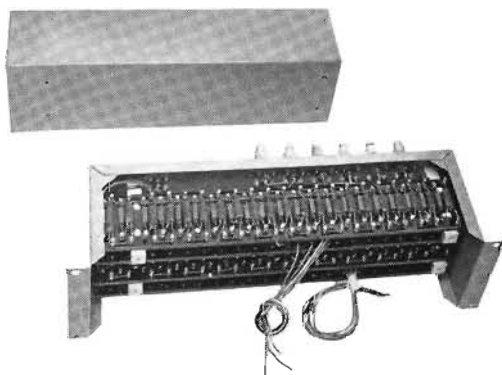

*View of Sync Generator Delay Panel shown with protective cover removed*

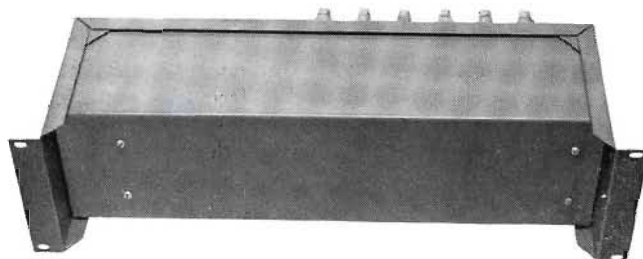

## Specifications

Provision for 6 Taps Per Line	_____	6 studios
Bandwidth	_____	50% response @ 3 mc.
Cutoff at End of Line (suitable for pulses only)	_____	@ 5 mc.
Impedance	_____	75 ohms (Delay of sync must be adjusted on delay line in sync gen.)
Panel Width	_____	19"
Panel Height	_____	5¼"
Approx. Weight	_____	12 lbs.
Stock Identification	_____	MI-26286

# The Pulse Distribution Box

## Features

- Convenient distribution of synchronizing generator pulses.
- Distributes blanking to as many as eight camera controls.
- Eliminates complicated patching system.
- Four 6-pin output connectors.

## Use

The Pulse Distribution Box is a compact junction box designed to provide a convenient distribution of the driving, and blanking pulses received from the Studio Synchronizing Generator and fed to the Camera Controls. It replaces distribution by means of complex patching systems, supplying a common feed point for as many as eight camera controls.

## Description

As can be seen on the circuit diagram of the Pulse Distribution Box, coaxial cables from the synchronizing generator bring blanking, and horizontal and vertical driving pulses to the center terminals of the box. The coaxial lines are normally terminated in this box, therefore, terminating resistors connected from the lines to ground are built into the box. Because the lines are terminated in the box, the output lines are necessarily high-impedance, low-capacity circuits. From the center terminals, connections are made to four 6-pin connectors, wired in parallel, and placed on the ends of the box, as seen in the picture below. Normal operation provides pulsing for four camera controls. By series connecting sets of two cameras, the four connectors can be expanded to handle as many as eight cameras simultaneously. An additional coaxial cable is brought into the box from the generator, carrying the Cathode Ray Oscilloscope driving pulse. This terminal provides an auxiliary method of drive, since the driving pulse is carried by other means in normal television station operation.



ing the Cathode Ray Oscilloscope driving pulse. This terminal provides an auxiliary method of drive, since the driving pulse is carried by other means in normal television station operation.

## Specifications

Overall Dimensions:

Height \_\_\_\_\_ 6"

Width \_\_\_\_\_ 6"

Depth \_\_\_\_\_ 2 3/4"

Input \_\_\_\_\_ Solder connections for four coaxial lines

Output \_\_\_\_\_ Four 6-pin connectors

Approximate Weight \_\_\_\_\_ 5 lbs.

Stock Identification \_\_\_\_\_ MI-26757

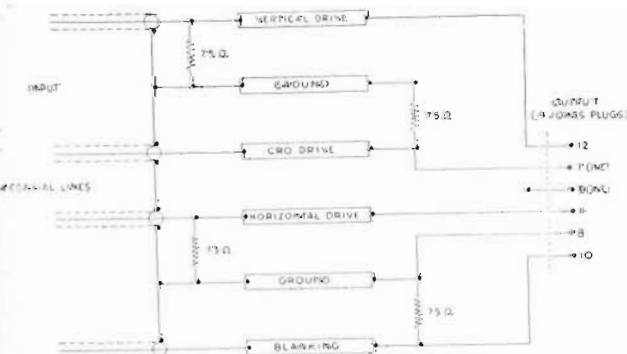

Sketch showing Distribution Box Connection

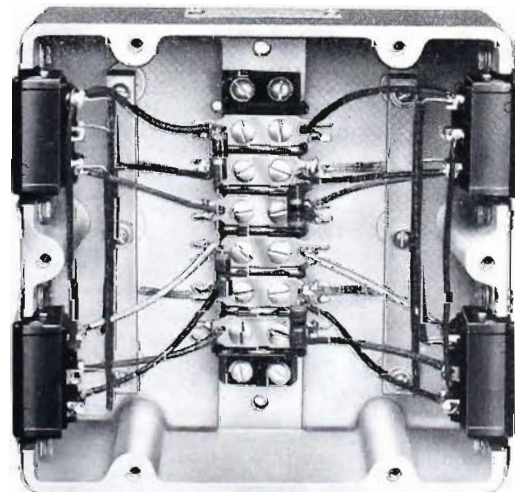

Pulse Distribution Box with cover removed



# Distribution Amplifier, Type TA-1A

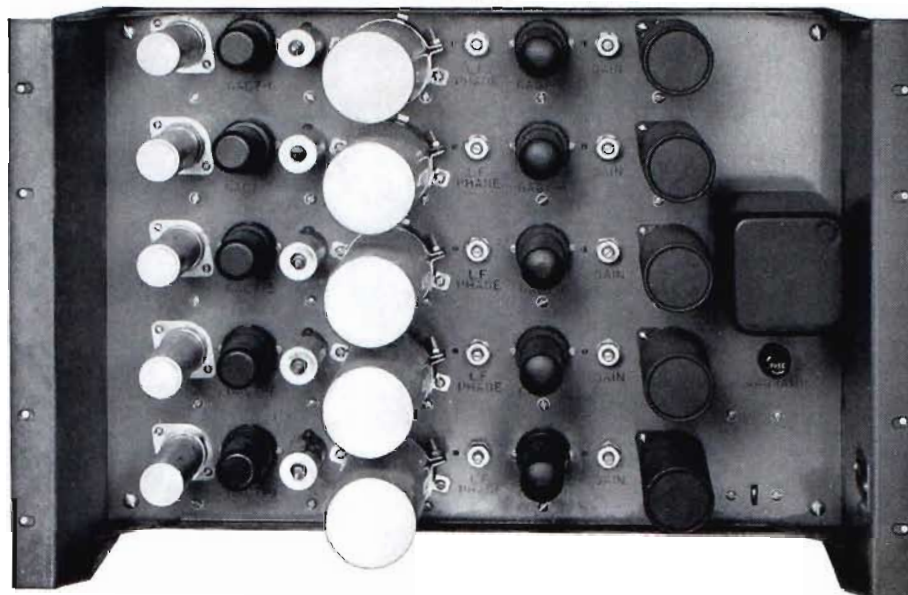

## Features

- Equally useful as distribution, mixing or isolation amplifier.
- Five amplifiers on one chassis.
- Bridging inputs.
- Excellent isolation between equipments.
- Positive or negative polarity.
- Standard "bath tub" type chassis.
- Accessible mounting arrangement.

## Uses

The Type TA-1A Distribution Amplifier may be used in any one of the three following applications: (a) to feed video or pulse signals from a single source to several separate outlets; (b) to mix video and synchronizing signals in order that they may be fed to a single output line; (c) as a straight-forward isolation amplifier, by paralleling all five channels. The wide variety of possible uses of this equipment makes it equally adaptable to test bench, laboratory, or television transmitting installations.

## Description

The equipment consists of five separate video isolation amplifiers mounted on a single chassis. These amplifiers are of the bridging type, and have relatively high input impedance, permitting a number of them to be paralleled across a video line with a minimum disturbance to the driving source. Each amplifier delivers, to a 75 ohm output line, a signal of the same level and polarity as it receives.

When the amplifiers are used to feed several output lines, the inputs being paralleled, there is a high degree of isolation between lines and between any individual line and the source. Thus, disturbances, short circuits, equipment failures, or the like on one line will not be reflected onto the other lines. This is of considerable value to good overall operation in any television installation.

The components of the TA-1A are assembled on a chassis of the recessed, or "bath tub" type. All tubes and other large components are mounted on the front of the chassis, with the resistors and other small components on the rear. This type of construction provides neat appearance, convenient operation and maximum accessibility. The chassis is standard rack width and is designed to mount in either an enclosed cabinet type rack or a standard open type rack. In the latter case a cover panel may be used, if desired.

Each of the five amplifiers consists of two stages. The two tubes and other components which make up each amplifier are arranged in a row across the chassis. Each amplifier is provided with a gain control so that the gain may be varied from approximately .9 to 1.1. This feature is especially convenient when it is desired to equalize accurately the levels on the several output lines.

The input and output connections on the rear of the amplifier are designed to accommodate standard fittings for either RG 11/U or RG 59/U coaxial lines. Two connectors are provided for each input and each output to facilitate interconnecting the sections. This amplifier may be used at any point in a television system regardless of whether the polarity at that point is positive or negative. An adjustment is provided for reducing the low frequency phase distortion to a negligible value.

A built in filament transformer provides filament voltages for all tubes. Plate voltages are obtained externally, preferably from a well regulated power supply such as the Type 580-C. Power connections are made by means of a standard cable receptacle at the lower left of the chassis.

## Specifications

Number of Amplifiers	Five
Voltage Gain, Each Amplifier	Adjustable .9 to 1.1
Frequency Char	+1 db to 10 mc, and adjustable to ideal 60 cycle square-wave response
Input Picture Signal Level (max.)	2 volts, peak-to-peak
Input Pulse Signal Level (max.)	4 volts, peak-to-peak
Output Signal Level (per section)	2 volts, peak-to-peak
Input Impedance	Bridging
Input Capacity (on two cable sockets)	40 mmf
Input Polarity	Positive or negative
Output Impedance	Approximately 2000 ohms
Output Polarity	Positive or negative
Power Supply Required:	
105-125 volts, 50-60 cycles	50 watts
d-c 280 volts (Type 580-C Supply)	260 ma
Tube Complement	5 RCA 6AC7, 5 RCA 6AG7
Dimensions	12 1/4" high, 19" wide, 8" deep
Weight	35 lbs.
Stock Identification	MI-26155

## Accessories

Type 580-C Regulated Power Supply MI-21523-B1

# Stabilizing Amplifier, Type TA-5C

## Features

- Reshapes sync portion of degraded composite signals.
- Amplifies sync portion of signal to desired value of from 0-1.5 volts.
- Removes low frequency distortion on signal.
- Has separate "sync output" in phase with incoming signal.
- "Picture Output" provides 2.0 volts across 37.5 ohms.
- Has "Monitor Output" for monitoring purposes.
- Can mix sync with camera signals.
- Cleans up blanking pulse.
- Gain and sync level can be controlled separately and remotely.
- Operates on signals as low as .15 volts peak-to-peak.
- Bathtub chassis for standard rack mounting.

## Uses

The TA-5C stabilizing amplifier, which replaces the TA-5B design, is a unit for: correcting many types of faulty television signals, mixing sync with video signals from the cameras, supplying a separate sync pulse for local sync generator "lock-in," and for removing sync from a remote signal so that it may be switched, faded or dissolved with local signals. Here are a few ways in which the TA-5C equipment is employed:

- (1) In a microwave relay system.
- (2) On the input of a remote or network incoming line.
- (3) On the output of a studio line.
- (4) With the RCA studio switching equipment in a master control room as individual studios.
- (5) On the input of the transmitter.

Some of the common sources of disturbance which the TA-5C will correct are as follows:

1. Hum or surges originating in power supplies and other random disturbances created by high-impedance grounding circuits, long cable sheaths, etc.
2. Circuit saturation, with resultant destruction of the proper sync-picture ratio.
3. Switching surges.
4. Low-frequency distortion introduced by coupling circuits with inadequate time constants.

## Description

The TA-5C stabilizing amplifier is a new improved circuit design which replaces its predecessor, the TA-5B. It clips a composite signal at blanking level. The video portion of the signal, with its cleaned up blanking reference, is fed to a mixing amplifier stage where sync (which was previously clipped and reshaped) is once again added.

Separate gain controls are used on both video and sync portions of the signal and permit a sync range setting of 0 to 50%. The recombined composite signal is fed to a two-stage picture amplifier which provides the proper output across 37½ ohms and to a monitor output circuit which feeds 75 ohms.

Sync is separated from the composite video signal and after two stages of clipping provides a standard RMA sync signal to a sync output jack. This signal may be used to phase a local sync generator with the incoming remote signal. Thus, it is possible to add the local sync signal to the remote video signal, making possible "fades and dissolves" between local and remote signals.



A two-position attenuator at the input accommodates a range of input signals from 0.25 volt to 15 volts, peak-to-peak. The output of the amplifier is designed to deliver the standard level of picture and blanking signal (1.5 volts, peak-to-peak) with a maximum sync of 1.5 volts peak-to-peak. The amount of sync can be adjusted independently to any value between 0 and 1.5 volts, peak-to-peak.

Filament power for all tubes is provided by a transformer mounted on the chassis. Plate voltage must be obtained from an external regulated power supply such as the RCA Type 580-C. All external power connections are made through an 8-pin plug and receptacle. One side of the primary line to the filament transformer is fused.

The TA-5C Stabilizing Amplifier is mounted on a recessed chassis for standard rack-mounting. Therefore, it can be mounted in the transmitter room or studio control room with other rack-mounted equipment.

## Specifications

### Power Requirements:

A-c \_\_\_\_\_ 109-125 volts, 55 watts, 50/60 cycles  
D-c \_\_\_\_\_ 280 volts, 320 ma.

### Input Signal Requirements:

Composite Signal Black Negative \_\_\_\_\_ .15 volts peak-to-peak  
Sync Amplitude (minimum) \_\_\_\_\_ .15% of composite signal  
Local Sync Signal \_\_\_\_\_ 3.5-5.0 volts

### Output Signal Values:

Picture Component \_\_\_\_\_ 1.5 volts peak-to-peak  
Sync Component of Composite Signal \_\_\_\_\_ 0-1.5 volts peak-to-peak  
Sync Output (negative) \_\_\_\_\_ 4.0 volts peak-to-peak  
Stable Operation Limits  
Composite Signal Level Change \_\_\_\_\_ ±6 db  
(Picture level will change; sync level will remain constant)

### Dimensions:

Height \_\_\_\_\_ 10½"  
Width \_\_\_\_\_ 19"  
Depth \_\_\_\_\_ 8¾"

Weight \_\_\_\_\_ 17 lbs.

Finish (front of chassis) \_\_\_\_\_ Light umber gray

Stock Identification \_\_\_\_\_ MI-26160-B

### Tube Complement:

9 RCA 6AC7	1 RCA 6SL7GT
4 RCA 6AG7	1 RCA 6H6
1 RCA 6SK7	1 RCA OD3/VR-150
2 RCA 6SN7GT	





**Regulated Power Supply (Heavy-Duty) WP-33B.** Provides well-regulated d-c voltage at loads of 200 to 600 ma. Adjustable output, 260 to 295 volts. Voltage variation, less than 0.2 volt between minimum and maximum load.

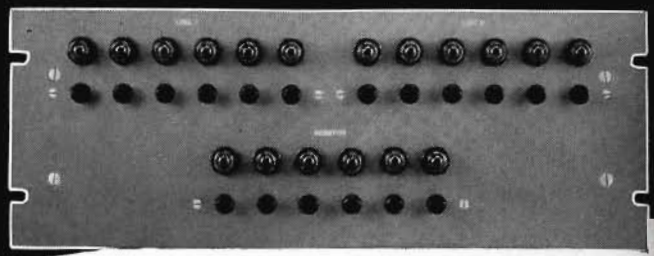

**Switching Panel, TS-1A.** A convenient way to switch any one of 6 different input video signals to TV transmitter, or to local and remote monitors.



**Regulated Power Supply, TY-25A.** Provides well-regulated d-c source at loads from 200 to 300 ma. Output is adjustable between 260 and 290 volts. Less than 0.5% variation between minimum and maximum load.

# Everything in



**Regulated Power Supply, 580-C.** Output adjustable between 260 and 295 volts—at 50 to 400 ma. Less than 0.25-volt variation between min. and max. load. Includes meter selector switch and meter jack.



**Current Regulator, MI-26090.** Maintains constant current in focus coil of Studio Camera TK-10A. Current can be adjusted over a range of 65 to 85 ma.

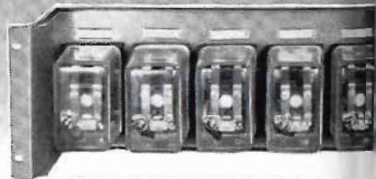

**Power Relays MI-26761.** Provides remote power switching in conjunction with Power Control Panel MI-26251. Includes 5 separate power relays.



**Stabilizing Amplifier Control, MI-26250.** Includes three potentiometers. Controls: (1) picture gain; (2) picture clipper; (3) sync level in stabilizing amplifier.



**Elapsed Time Indicator, MI-26760.** Provides constant record of "hours on" life of tubes, etc. Includes 5 individually-operated counter indicators driven by synchronous motors.



**Sync Generator Phasing Control, MI-26249.** Provides for phasing one of two local synchronizing generators with one remote synchronizing generator.

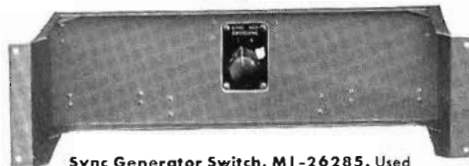

**Sync Generator Switch, MI-26285.** Used to switch outputs of either of two sync generators over to studio equipment. One selector for all 5 signals (horizontal, vertical, blanking, sync, and CRO sync).

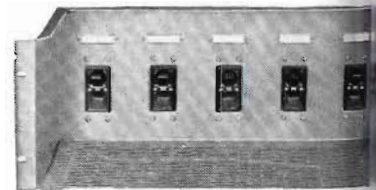

**Circuit Breaker, MI-26240.** Designed as a switch breaker between power line and TV studio equipment. Accommodates up to 5 breakers (choice of breakers available, extra).



**Relay Receiver Control, MI-26247.** Controls video gain and receiver tuning. Includes 2 potentiometers, AFC "on-off" switch, tally light, and telephone jack.



**Panel Adapter MI-26254.** Enables you to mount control panels (shown in left column and below) in any standard rack.



**Monoscope Camera Control, MI-26248.** Provides remote control of video gain, and focus of monoscope camera. Includes 2 potentiometers wired to terminal board.



**Power Remote Control, MI-26251.** Operates up to 5 power supplies through 120-volt relays. Has 5 "on-off" toggle switches and 5 tally lights.

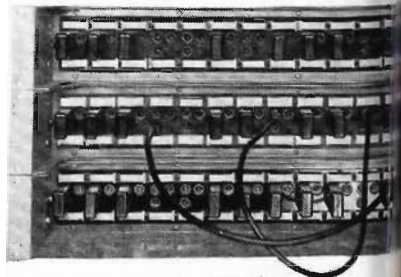

**Video Jack Panel, MI-26245.** For patching and/or sync signals. Includes 12 groups of contact assemblies (3 per group). Video jack plugs and cords.



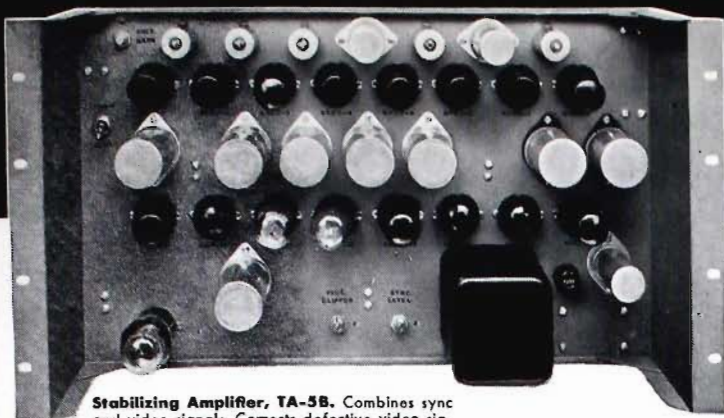

**Stabilizing Amplifier, TA-5B.** Combines sync and video signals. Corrects defective video signals. Eliminates hum. Corrects low-frequency response. Improves signal-to-noise ratio of sync signals.

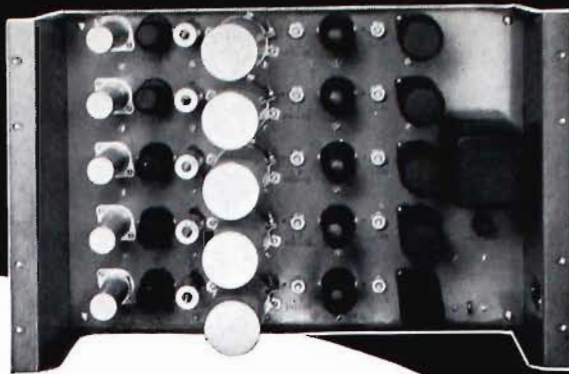

**Distribution Amplifier, TA-1A.** Well-suited for use as: (1) video and sync signal mixer, (2) isolation amplifier, or (3) for feeding video or pulse signals from a single source to separate outlets.

# Rack-mounted Units for TV stations



**Mixing Amplifier, TA-10A.** Useful as mixing, fading, remote control, or isolation amplifier. Two bridging-type inputs; one output. Positive or negative polarity.



**Projector Change-Over MI-26321.** Designed for starting, stopping or simultaneous changeover of light and sound for 16- and 35-mm film programming. Handles two projectors in any combination (16mm or 35mm).



**Sound Equalizer, MI-26313.** Provides proper frequency compensation of 16-mm sound reproduction. Compensator circuit tilts frequencies above 1000 cps in 2-db steps. See also Equalizer and Shelf (MI-26581), available extra.

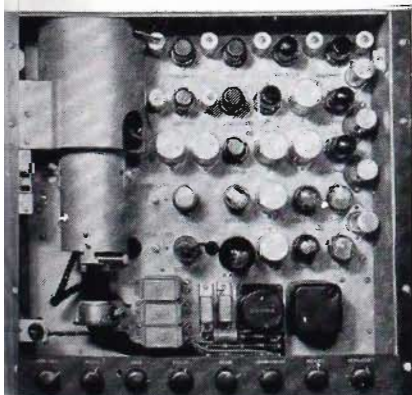

**Monoscope Camera, TK-1A.** Ideal as signal source of known quality for testing: station transmitters, video amplifiers, picture tubes, TV receivers. Pattern tests scanning symmetry, vertical and horizontal resolution, linearity, contrast, and brightness.

... control panels, amplifiers, projector changeover, switch panels, relay and indicator panels, power supplies, circuit breakers, jack panels

Here is your answer for ready-to-operate units that can be installed wherever you need them.

All units are identical in design and construction to those used in RCA's regular station-proved TV Broadcast Equipment—and are built with the same high-quality components. Units are built on recessed, or "bathtub" type chassis. Tubes and components are within handy reach. Controls are centralized and clearly marked.

Representing the most comprehensive line of rack-mounted TV equipment in the industry, these

carefully engineered units can readily be mounted in enclosed-type racks or in standard open-type racks. Many types can be mounted conveniently in RCA console-type housings.

• • •

RCA rack-mounted units are being used in practically every television station in the country. For information about any one of them ... or the entire line ... simply ask your RCA Broadcast Sales Engineer. Or write Department 19KB, RCA Engineering Products, Camden, New Jersey.



# Mixing Amplifier, Type TA-10A



### Features

- Useful as a mixing, fading, remote control or isolation amplifier.
- Accommodates two inputs—one output.
- Bridging type inputs provided.
- Positive or negative polarity.
- Standard “bath tub” type chassis.
- Accessible mounting arrangement.

### Uses

The type TA-10A, Mixing Amplifier may be used in several different television applications. As a mixing amplifier it may be employed for sync addition. For fader service, the TA-10A may be used to fade, lap dissolve, or mix two picture signals. Either in the above applications, or as an isolation amplifier, the TA-10A may be adjusted for fixed gain or may be operated from a remotely located control position.

### Description

The TA-10A equipment consists of two input amplifier stages feeding (through a common load network) a single output stage. These inputs are of the bridging type and have relatively high input impedance, thus permitting parallel operation with other units, and operation from a cathode follower source. The output stage is designed to feed a 75 ohm line, delivering a signal of the same level and polarity as that which is fed into either input channel (one channel on—the other off).

The components of the TA-10A are assembled on a chassis of the recessed, or “bath tub” type. All tubes and large components are mounted on the front of the chassis—with circuit wiring, small component terminal boards, video and power connections located at the rear. This type of construction provides neat appearance, convenient operation and maximum accessibility. The chassis is standard 19” rack width and is designed to mount in either an enclosed cabinet type rack or a standard open type rack. In the latter case, a cover panel may be used, if desired.

Two methods of gain control are provided. The remote control feature provides for remotely located potentiometers which vary the grid bias on the input stages (a bias supply is “built-in” the TA-10A for use with this external circuit if desired). In this way, the gain may be varied from cut-off to full output. Secondly, potentiometers on the chassis provide for adjustment of the full gain value from approximately .9 to 1.1. (This feature is essential in maintaining standard system levels.)

The input and output connections are designed to accommodate standard fittings for RG-11U (MI-83) or RG-59U (MI-75) coaxial cables. Two connectors are provided for each of the two inputs to allow for terminations or “loop-through” circuits.

An adjustment is provided for reducing the low frequency phase distortion to a negligible value. The bias supply is also provided with a voltage adjustment.

A built-in, filament transformer supplies filament voltages for all tubes. Plate voltages are obtained externally, preferably from a well-regulated power supply such as the type 580-C. Power connections are made by means of a multi-pin receptacle.

For fader service, a remote fader lever assembly is available as MI-26531-2. This assembly is also included in the MI-26220-1 and MI-26220-2 and MI-26221 push-button panels which are used in the TS-20A Relay Switching System.

### Specifications

Inputs	_____	2
Outputs	_____	1
Voltage Gain, Each Amplifier, Maximum	_____	.9 to 1.1 (adjustable)
Voltage Gain, Each Amplifier, Remote Control	_____	
Frequency Response	_____ ±1 db to 8 mc, and adjustable to ideal	Cut-off to maximum
		60 cycle square-wave response
Input Signal Level	_____	2 volts, peak-to-peak
(Channel 2, Composite sync)	_____	4 volts, peak-to-peak
Output Signal Level	_____	2 volts, peak-to-peak
Input Impedance	_____	Bridging
Input Polarity	_____	Positive or negative
Output Load Impedance	_____	75 ohms
Output Polarity	_____	Positive or Negative
Power Supply Required:		
A-c, 105-125 Volts (tap adjustment)	_____	60 Cycles _____ 20 watts
D-c, 280 Volts (type 580-C supply)	_____	_____ 120 ma
Tube Complement:		
	3 RCA 6AG7	1 RCA OD3NR150
	1 RCA 6SL7GT	
Dimensions	_____	3½” high, 19” wide, 10” deep
Weight	_____	_____ 12 lbs. approx.
Finish	_____	Dark umber gray
Stock Identification	_____	MI-26281

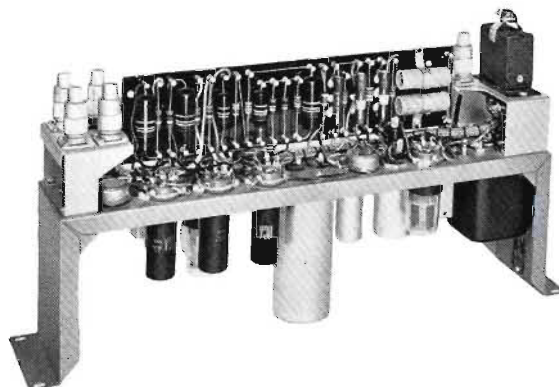

*Small components, video and power connection are at rear of chassis*

# Regulated Power Supply, Type 580-C

## (General Purpose)



### Features

- Extremely well-regulated output.
- Unusually low output ripple.
- Low internal d-c resistance.
- Components and connections easily accessible.
- Compact and neat in arrangement.

### Uses

The RCA Type 580-C Regulated Power Supply fills the need for a well-regulated source of d-c at loads of 50 to 400 milliamperes. The output is adjustable between 260 and 295 volts, with variations of less than 0.25 volts from minimum to maximum load. Thus it is suitable for laboratory, industrial, and communications applications in which an unusually well-regulated source of d-c is required. As a-c ripple in the output is less than 0.005 per cent, the output voltage may be used for most purposes without additional filtering.

The Type 580-C is especially suited for use with RCA television equipment, which it matches in appearance and construction.

### Description

The regulating circuit employed in the 580-C is of the series type. The d-c internal resistance is less than 0.7 ohms.

This Power Supply is assembled on a recessed chassis of the "bath-tub" type. Tubes and filter condensers project from the front of the chassis, while transformers, resistors, and wiring are at the rear. The chassis is standard rack width and may be mounted either in one of the new enclosed-type RCA cabinet racks, or on a standard "open-face" rack. In the latter event a blank panel may be mounted over the Power Supply if desired. Controls are centralized on a small, plainly-marked panel at the bottom of the unit. In addition to the power "on-off" switch there is provision for switching from a load range of 50-80 ma. to 80-400 ma., as well as a potentiometer for adjusting output voltage. A meter selector switch and a meter jack provide for plugging in a meter to read individual tube plate currents, output current, and output voltage. A special meter (MI-21200-C) is available for this purpose.

### Specifications

Output Voltage	Adjustable 260 to 295 volts
Output Current	50 to 400 ma.
D-C Regulation	Less than 0.25 volts, minimum to maximum load
A-C Ripple	Less than 0.005 per cent
Power Supply	110-120 volts, 50-60 cycles
Power Input	370 watts (maximum)
Tube Complement:	
2 RCA 0D3/VR150	1 RCA 6SL7GT
2 RCA 5U46	6 RCA 6Y6G
1 NE 32	
Dimensions	10½" high, 19" wide, 12" deep
Weight	58 lbs.
Stock Identification	MI-21523-B2

### Accessory

Plate Current Meter.....MI-21200-C1





# Regulated Power Supply, Type TY-25A



*The Regulated Power Supply, MI-26086, as furnished for mounting in a standard rack*

## Features

- Extremely well-regulated output.
- Unusually low output ripple, less than .01%.
- Can be rack-mounted, also available in attractive carrying case.
- Input and output plug connection easily accessible.

## Use

The RCA Type TY-25A is a special lightweight power supply which provides a well-regulated source of d-c at loads from 200 to 300 milliamperes. The output is adjustable between 260 and 290 volts, with variations of less than 0.5% from minimum to maximum load. Thus, the power supply is suitable for laboratory, broadcast, industrial and communications applications in which an unusually well-regulated, well-filtered source of d-c is required. The TY-25A is especially suited for use with RCA broadcast equipment, which it matches in appearance and construction.

## Description

The TY-25A Power Supply is assembled on a recessed type chassis, which is standard rack width and can be mounted in RCA cabinet-type or open racks. Transformer, tubes and filter condensers project from the front of the chassis, while resistors and plug connectors are at the rear. Controls consist of an a-c line voltmeter, a power on-off switch, meter selector switch, output voltage adjustment and a meter jack. The meter selector switch and meter jack provide for plugging in a separate meter to read individual tube plate currents, output current and output voltage. A special meter (MI-21200-C) is available for this purpose.

## Specifications

Output Voltage \_\_\_\_\_ Adjustable 260-290 volts  
 Output Current \_\_\_\_\_ 200-300 ma.  
 D-c Regulation \_\_\_\_\_ 0.5% variations, min. to max. load  
 A-c Ripple \_\_\_\_\_ Less than 0.01% (peak-to-peak)  
 Power Requirements \_\_\_\_\_ 120 volts, 60 cy., 300 w.  
 Dimensions \_\_\_\_\_ 10½" high, 19" wide, 9" deep  
 Weight \_\_\_\_\_ 50 lbs.

## Stock Identification:

Power Supply for Rack Mounting \_\_\_\_\_ MI-26086  
 Power Supply in Carrying Case \_\_\_\_\_ MI-26096  
 Carrying Case Only \_\_\_\_\_ MI-26527

## Tube Complement

1 RCA 6SL7-GT                      2 RCA 6AS7G  
 2 RCA OD3/VR150                1 NE-32  
 2 RCA 5R4GY



*Regulated Power Supply mounted in a carrying case for portable use (MI-26096). The case is available as MI-26527.*



# Current Regulator, MI-26090



## Features

- Counteracts current variations in camera focus coil circuit.
- Current can be manually adjusted over a range from 65 to 85 milliamperes.
- Common tube types are employed.
- All tubes easily replaced from front of unit.
- Designed for standard racks and cabinets.

## Use

The Current Regulator is an electronic device which maintains constant current in the focus coil of the TK-10A Studio Camera. Variations in the magnitude of current flowing through the coil are brought about by temperature changes, which would ordinarily impair the focus of the camera. The Current Regulator counteracts these variations and also provides a means for adjusting the focus coil current to the proper value.

## Description

All components of the Current Regulator are mounted on a recessed chassis designed for rack mounting. The unit employs an RCA 6SL7-GT twin triode as a d-c amplifier, and an RCA 6Y6-G current regulator tube. The cathodes of the d-c amplifier are kept at fixed levels by voltage regulator tubes.

The 6Y6-G current regulator tube is effectively in series with the camera focus coil and its 400-volt source of d-c so that the internal resistance of the 6Y6-G, which is controlled by the d-c amplifier, determines the magnitude of current flowing in the coil circuit. The input of the d-c amplifier is connected across a small resistor also connected in series with the focus coil. Thus variations in the voltage developed across the small resistor (as a result of current changes in the focus coil circuit) are fed to the d-c amplifier which in turn raises or lowers the conductance of the 6Y6-G to counteract the current change taking place. Regulation is, of course, instantaneous and the result is a constant flow of current through the focus coil of the camera. The Current Regulator will maintain constant current at a preset value over wide ranges of resistance change in the load and over wide ranges of input voltage.

## Specifications

### Power Requirements:

A-c \_\_\_\_\_ Single phase 117 volts, 60 cycles, 15 watts  
(for fil. transformer)

D-c \_\_\_\_\_ 400 volts from Type 580-C Power Supply

### Chassis Dimensions:

Depth \_\_\_\_\_ 5½"  
Width \_\_\_\_\_ 19"  
Height \_\_\_\_\_ 8"  
Weight \_\_\_\_\_ 9 lbs.

### Tube Complement:

1—RCA 0D3/VR150 Voltage Regulator  
1—RCA 991 Voltage Regulator  
1—RCA 6SL7-GT D-C Amplifier  
1—RCA 6Y6-G Current Regulator

Stock Identification \_\_\_\_\_ MI-26090

### Accessories

Plate Current Meter \_\_\_\_\_ MI-21200-C1

# TV Studio Lighting Equipment

## Features

- Efficient, economical lighting equipment for most any type of TV studio
- Complete line of equipment available—incandescents, fluorescents and hi-intensity spots.
- Fully controllable—maximum of rotation and tilt offers flexibility of use.
- Noiseless control through chrome fairleads provided by central control board.
- All types may be ceiling mounted in an inverted pyramid pattern.
- High-voltage wiring is eliminated.

## Uses

RCA's television studio lighting equipment enables controllable lighting of TV studios. In use, all units may be remotely and noiselessly controlled from a central control board. Lights are usually ceiling mounted in an inverted pyramid (see sketch below) for most efficient use of equipment.

## Description

A complete line of studio lighting equipment including hi-intensity controllable fluorescents, incandescent units, Fairlead control guides, spotlight hangers, control board and switching panels are available to the telecaster. All equipment is studio tested and may be supplied as a packaged system to match the lighting response curves of modern studio cameras. Lighting equipment systems for handling any studio setup can be furnished (see sketches for small and average studio). Hi-intensity fluorescents easily provide 200 foot candles of uniformly distributed light. All lights are rotatable, may be tilted, and are designed for inverted pyramid mounting on studio ceilings. Studio lights are conveniently controlled mechanically from a central control board.

Maximum flexibility is provided, since each light may be positioned for basic work, modeling, or back lighting. Each light may be directed to more than one acting area. Dimming by tilting, rotating, or cutting off half banks can be accomplished without disturbing the light distribution. All equipment is mounted "off-the-floor," thus leaving valuable studio space free from congestion. RCA will gladly assist in the planning of studio lighting arrangements to meet particular station requirements.

## Typical TV Studio-Proved Floor Plans and Ceiling Arrangement for RCA Lighting Systems

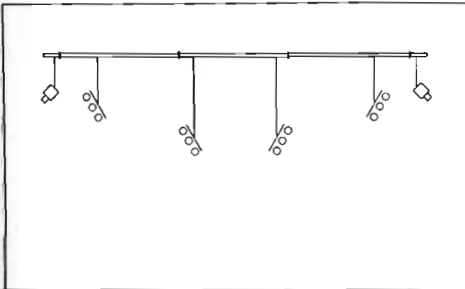

*Cross-sectional view of a TV studio, showing RCA's inverted pyramid-type of lighting. This system delivers unobstructed light to every point in the studio.*

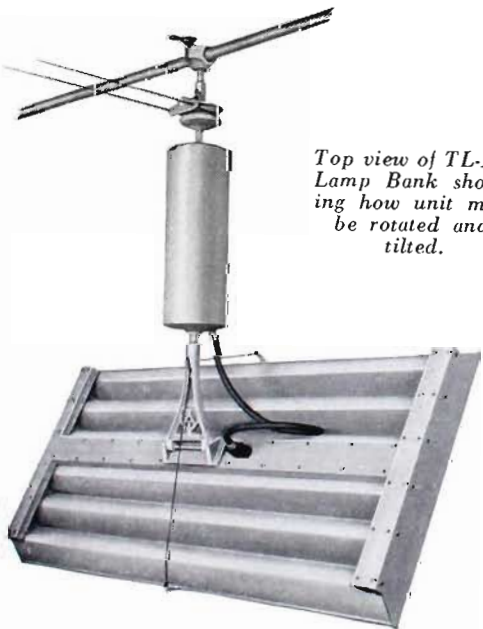

*Top view of TL-1A Lamp Bank showing how unit may be rotated and tilted.*

*For a small interim-type studio, 21 feet by 35 feet. This plan more than meets the minimum lighting requirements of 200 foot candles and a contrast range of 2-to-1.*

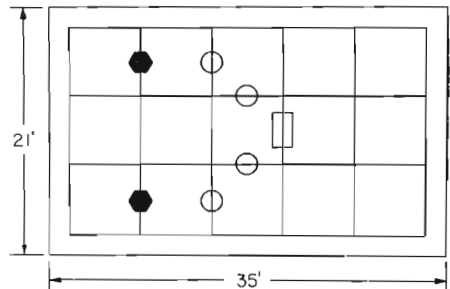

NO. REQD.	SYMBOL
1	HI-INTENSITY FLUORESCENT BANK
4	INCANDESCENT FLOOD-LITES
2	CONTROLLABLE SPOT-LITES

*For the average-size studio, 40 feet by 60 feet. This plan more than meets the minimum lighting requirements of 200 foot candles and a contrast range of 2-to-1.*

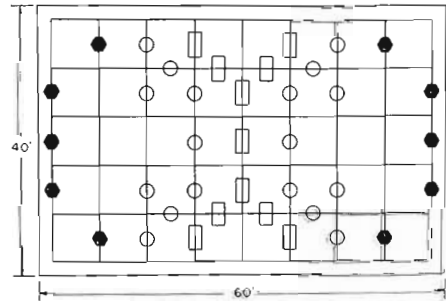

NO. REQD.	SYMBOL
11	HI-INTENSITY FLUORESCENT BANKS
18	INCANDESCENT FLOOD-LITES
10	CONTROLLABLE SPOT-LITES



**TV Studio Lighting Equipment (Continued)**



*High-Intensity Fluorescent Bank, Type TL-1A*

**HI-INTENSITY FLUORESCENT BANK, TYPE TL-1A**

The fluorescent bank is designed for general studio illumination where Image Orthicon cameras are employed. It is fully controllable in rotation and tilt (rotates 360 degrees; tilts 170 degrees). Built-in rubber-cushioned ballast units, heavy duty jumper cord connections, and instant start, hi-voltage striking circuit. Designed for use with 3500-4500 Kelvin slim-line tubes for producing proper color temperature illumination. Only 600 watts connected load. 2000-3000 hour life. Individual parabolic alzac reflectors for each tube pre-focused at 20 feet.

**Specifications**

Total Wattage	_____	600 watts
Lamps	_____6	3500° K slim-line 5 ft. tubes
Suspension	_____	Standard full control unit
Supply Voltage	_____	60 cycles, 115 volt, a-c
Stock Identification	_____	MI-26615

**INCANDESCENT LAMP BANK, TYPE TL-5A**

The 12-lamp standard light source for normal studio operation. Ideal for slow fades and provides equal light distribution on "douses." Circuits terminate in a recessed male twist lock receptacle with connecting jumpers furnished. Heavy duty asbestos covered interior wiring is used. Maximum load per circuit is 3 kw; per unit is 6 kw. Recommended lamping is 3 kw overall and 1½ kw per circuit. Utilizes heavy duty ball-bearing mounted control spindle, quick release head clamp, fixture clamp and ¾ inch pipe extension. Single cast aluminum grille construction. Rotates 360 degrees. Tilts 170 degrees. Noiseless control.

**Specifications**

Finish	_____	Dark umber gray wrinkle and chrome
Weight, Control Spindle	_____	7 lbs.
Weight, Unclamped Fixture	_____	28 lbs.
Total Weight	_____	35 lbs.
Stock Identification	_____	MI-26618



*Incandescent Lamp Bank, Type TL-5A*

**SPOTLIGHT HANGERS, TYPES TL-10A & TL-11A (2 KW MI-26621, and ¾ KW MI-26620)**

Convenient spotlight hangers are available for use with Mole-Richardson or Oleson 2-KW Solar Spot, or 750 watt Baby Spot. Rotation of 360 degrees and a tilt of 170 degrees about the point of support is provided.

**Specifications**

Finish	_____	Dark umber gray wrinkle and chrome
Weight (Spindle and Adaptor)	_____	10¾ lbs.
Weight, 2-KW Spot	_____	41 lbs.
Weight, ¾-KW Spot	_____	17½ lbs.
Total Weight, 2-KW Assembly	_____	51¾ lbs.
Total Weight, ¾-KW Assembly	_____	28¼ lbs.
Stock Identification:		
¾-KW Hanger	_____	MI-26620
2-KW Hanger	_____	MI-26621



*Spotlight Hanger, MI-26620*

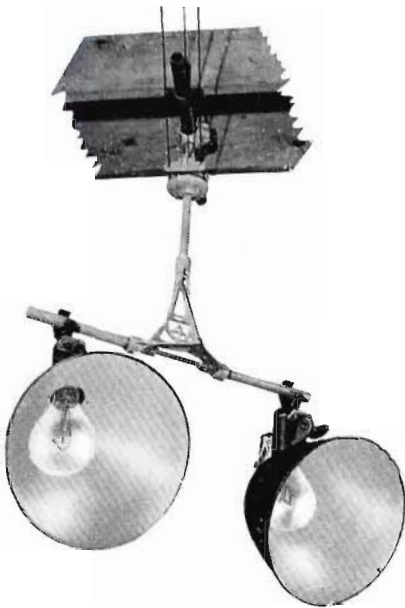

### ROTATABLE LAMP MOUNT, TYPE TL-15A

The rotatable lamp mount is furnished with or without extension bars for mounting individual or multiple flood lamps, as desired. Control spindle can rotate 360 degrees—tilt 170 degrees about the point of support.

#### Specifications

Finish \_\_\_\_\_ Dark umber gray wrinkle and chrome  
 Weight \_\_\_\_\_ 35 lbs. approx.  
 Stock Identification (scoops not included) \_\_\_\_\_ MI-26622



### FAIRLEADS, TYPE TL-32A

The Fairlead provides a practical way of guiding mechanical control lines to the control board without noise. It is fully adjustable and will rotate 360 degrees or tilt 170 degrees about the point of support. It is equipped with a quick-release grid-iron clamp. Nine chrome bushings reduce control line friction.

#### Specifications

Finish \_\_\_\_\_ Dark umber gray wrinkle and chrome  
 Weight \_\_\_\_\_ 4¼ lbs.  
 Stock Identification \_\_\_\_\_ MI-26632

### HIGH-INTENSITY DOLLY LIGHT, TL-26A

The TL-26A Dolly Light is designed to provide maneuverability in studio lighting at floor levels. It is ideal for front light reinforcement and low-angle side illumination in difficult program situations. It may also be used as a mobile floor unit where restricted heights make the usual ceiling installations difficult. The TL-26A uses six five-foot Slimline lamps mounted in Alzak reflectors. Entire reflector is rigidly supported by cast aluminum construction plus steel backing channels. Dolly wheels incorporate individual foot-operated wheel locks. Light banks may be rotated from horizontal to vertical and tilted through 90 degrees. Built-in rubber cushioned ballast is mounted over center support spindle. The TL-26A may be easily modified for ceiling mounting, when desired.

#### Specifications

Total Wattage \_\_\_\_\_ 600 watts  
 Lamps \_\_\_\_\_ 6, 3500 K slimline 5-foot tubes  
 Dolly \_\_\_\_\_ Similar to Type TD-25A  
 Power \_\_\_\_\_ 60 cycle, a-c  
 Finish \_\_\_\_\_ Umber gray  
 Stock Identification \_\_\_\_\_ MI-26617





## TV Studio Lighting Equipment (Continued)

### MERCURY SWITCH PANEL, TYPE TL-30A

The mercury switch panel is designed to provide instantaneous and noiseless switching of studio lighting equipment. It handles up to 20 separate circuits in the space normally occupied by one ordinary circuit breaker. The panels are bracket mounted and may be connected in series for multiple assemblies. Panel-board can be used to double as a wire trunk.

#### Specifications

Size \_\_\_\_\_ 33" x 14" x 5½"  
 Construction \_\_\_\_\_ Aluminum with dark umber gray wrinkle  
 Weight \_\_\_\_\_ 22 lbs.  
 Stock Identification \_\_\_\_\_ MI-26624



*Mercury Switch Panel, MI-26624*

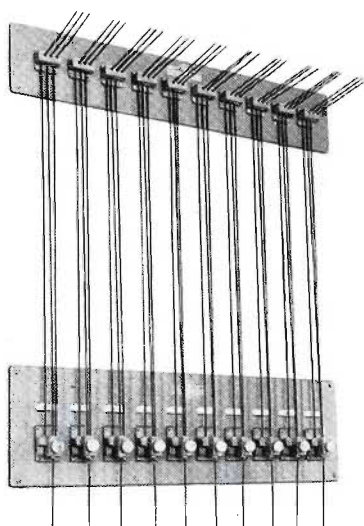

*Light  
Control  
Panel,  
MI-26627*

### LIGHT CONTROL PANEL, TYPE TL-31A

The light control panel is a completely assembled unit which consists of ten headblocks and ten rope locks for controlling ten light banks. The headblock which is equipped with three chromed grommets and a noiseless split roller—and the rope lock assembly which provides an automatic lock for any degree of tilt are available as single units.

#### Specifications

Finish \_\_\_\_\_ Dark umber gray wrinkle and chrome  
 Weight \_\_\_\_\_ 14½ lbs.  
 Stock Identification:  
 Ready-to-Operate Panel \_\_\_\_\_ MI-26627

# Console Housings and Wing Sections

## Features

- Convenient mounting for remote control panel equipment or master monitor.
- Sturdy steel frame construction.
- Two-tone umber gray to match companion studio equipment.
- Removable cover plates allow access to components.
- Allows "block-building" to suit individual needs.

## Use

RCA standard "add-a-unit" Console Housing and End Sections are available for mounting Master Monitors, or the Television series of Remote Control Panels. The bottom portions of console housings may be used for housing Studio Camera Controls, Film Camera Controls and the TS-10A Switching Control Chassis. Thus, the console housing may be used for TV studio applications and expanded as additional facilities are required. The trim "end" or "wing" sections are used to form an attractive studio console unit which gives a finished appearance.

## Description

The Standard Console Housing Section consists of a steel framework structure which forms a convenient mounting for Studio equipment. It is finished in a dark umber gray to match other units. The operating desk portion is at a 28 inch height and is covered in a durable, burn-proof, black linoleum surface. The desk turret top section has holes provided at the rear for the adjustment of circuits without the removal of chassis units. Removable front cover plates allow easy access to console monitor units and blower assembly which is located below desk surfaces. (When a Master Monitor is used, the suitable blower, MI-26579-A should also be employed.)



Console Housing Units and Wing Sections are easy to "Block Build"



Between the console desk portion and the Master Monitor is a sloping area which is used for operating controls such as: Film Camera Controls, Studio Camera Controls or Studio Switching Chassis.

The trim "end" or "wing" sections are available for completing the console desk setup. They are finished in matching umber gray with black linoleum tops and give an attractive appearance to the installation. End sections are equipped with shelves which may be used for storage of files, station logs, etc.

## Specifications

### Stock Identification:

Console Housing \_\_\_\_\_ MI-26266-B

### Dimensions (Console Housing):

Height \_\_\_\_\_ 41"  
 Width \_\_\_\_\_ 13 $\frac{1}{4}$ "  
 Depth \_\_\_\_\_ 36"  
 Weight \_\_\_\_\_ 50 lbs.

### Stock Identification:

Console End Section (left wing) \_\_\_\_\_ MI-26265-1  
 Console End Section (right wing) \_\_\_\_\_ MI-26265-2

### Dimensions (End Section):

Height \_\_\_\_\_ 28 $\frac{1}{4}$ "  
 Width \_\_\_\_\_ 9"  
 Depth \_\_\_\_\_ 36"  
 Weight \_\_\_\_\_ 43 lbs.



# Now... a deluxe

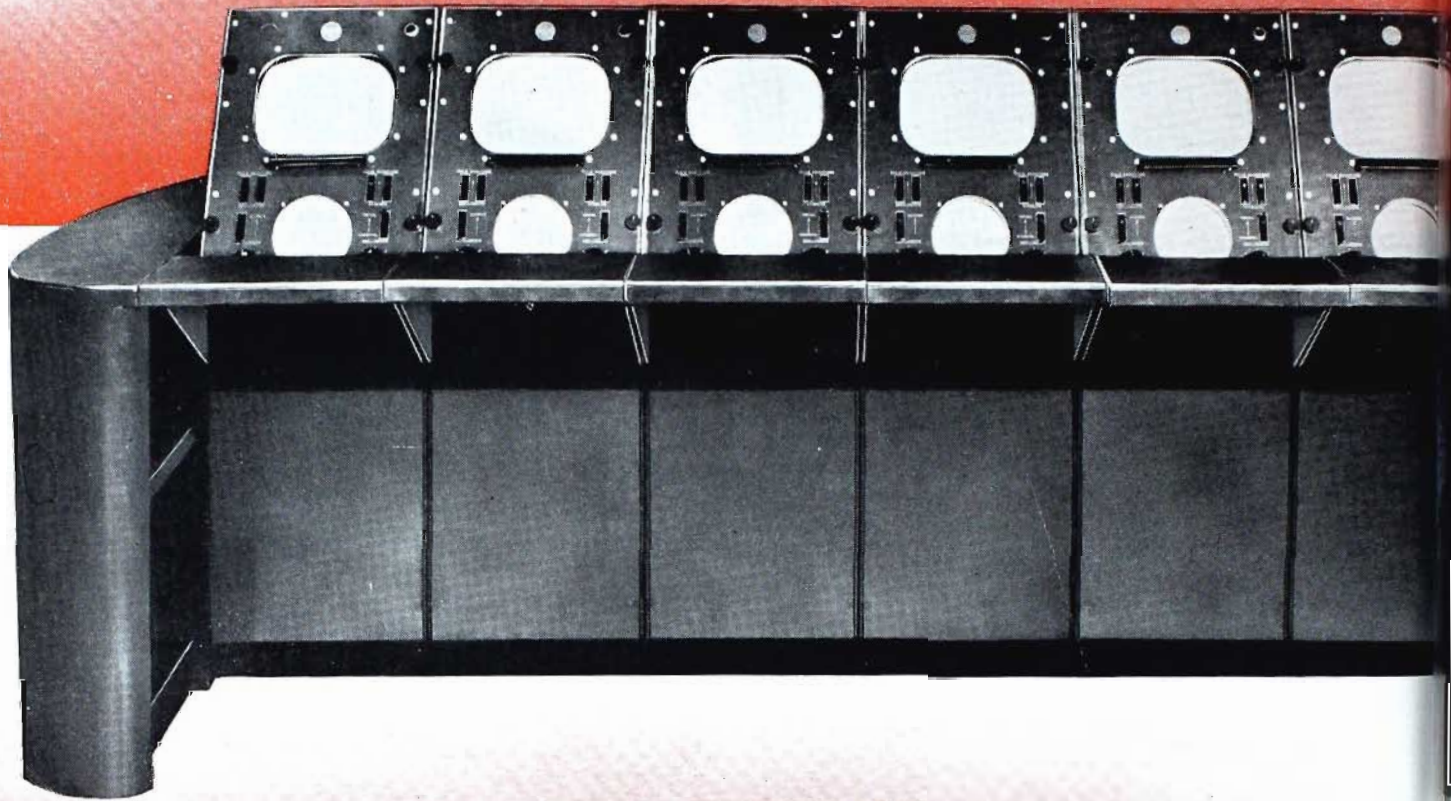

THE NUMBER OF UNITS DEPENDS UPON THE SIZE OF YOUR STATION

CAMERA MONITOR SECTION  
(ONE FOR EACH STUDIO  
AND FILM CAMERA)

PROGRAM MONITOR SECTION

PREVIEW MONITOR SECTION

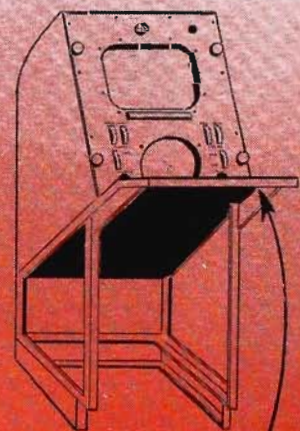
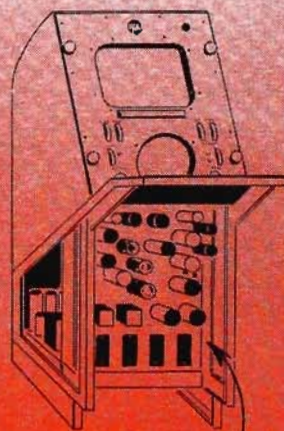
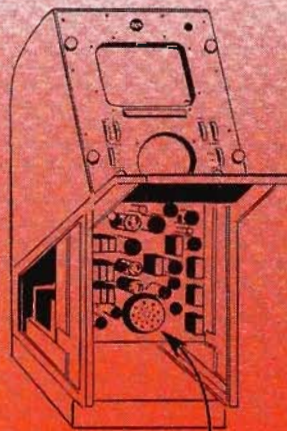
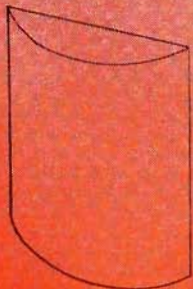

HOUSING END SECTION  
(LEFT END)

CAMERA CONTROL UNIT

CAMERA SWITCHING UNIT

ON-THE-AIR  
CAMERA SWITCH

HOUSING END  
(RIGHT END)



# Studio Console

## for smooth video programming

**Includes every practical facility and refinement for monitoring, dissolving, fading, and switching.**

**H**ERE'S THE CONSOLE that puts all electronic aspects of television programming "under control." It is already in production at RCA.

It contains everything needed to monitor, control, and switch the outputs of several studio cameras, film cameras, and network lines. Ten-inch Kinescopes provide for direct picture monitoring; five-inch oscilloscopes for checking video signal components. It's easy to increase picture brilliance, adjust contrast and focus, and provide proper shading.

Complete switching facilities centralize the selection of all video program material . . . permit push-button control of closeups, long shots, film commercials, station breaks, fadeouts, dissolves, wipes, special effects, and network programs.

### *Engineered with an eye to the future:*

The number of units in the video console depends upon the size of your station. RCA's "add-a-unit" design gives you a compact, unified console, whatever your requirements . . . permits easy and economical addition of extra units as your

station expands . . . without discard of any original equipment.

To co-ordinate all programming directions, provision has been made for telephone communication between key studio personnel and console operators.

This console, we believe, is a real contribution to convenient video control . . . another step by RCA to assure smoother studio programming . . . more interesting, more dramatic telecasting. We'll be glad to make specific recommendations for your station. Write Dept.

**Normally, two operators** handle a 5-monitor console . . . one selects the "on-the-air" signal at the request of the program director; the other has technical control of the individual cameras.





# Television Camera Lenses



## Features

- Varied lens speeds and focal lengths provide necessary flexibility for TV programming.
- Precision design and lightweight construction permit smooth convenient turret manipulation.
- Special long lenses ideal for sports pickups with dramatic closeups.
- Bayonet-type mountings permit quick and easy interchange of long lenses without unscrewing mounting rings.
- Ektar series of lenses (made exclusively for TV) provide high optical quality, precision interchangeability, barrel preset focusing and engraved depth of field scales.

## Uses

RCA lenses are especially designed for television camera use (all lenses mount directly in the four-position turrets of RCA TK-10A and TK-30A studio and field cameras). A wide choice of lens sizes, speeds and focal lengths permits versatility in television studio scenes, sporting events, dramatic closeups and fast action scenes . . . and makes possible the detailed pickup of objects varying in size, from a coin less than 3 inches from

the lens, to a ball player located over four hundred feet away. Larger objects such as an airplane may be clearly seen several thousand feet distant.

The increasing use of theatre stages with camera locations 20 to 50 feet from footlights is bringing the so-called "field" lenses indoors. The improved sensitivity of recent image orthicons has made it possible to stop down field lenses to f8 and f11 without resorting to additional illumination.

## Description

The RCA television camera lenses range in focal lengths from 1½ inches to 25 inches (35mm to 610mm). Some of the short focal length Kodak lenses are now called "Ektanon" rather than "Ektar." Optically, the lenses are identical and both types are made exclusively for TV use. For purposes of description, the group of lenses will be divided into two classes—(1) Special Long Lenses for Television Field Use and (2) Standard Lenses for Television Studio and Field Use.

**SPECIAL LONG LENSES (FIELD USE)**

The group of special long lenses (frequently called telephoto) includes the 25-inch, 17-inch, 15-inch and 13-inch lens sizes. All incorporate simplicity of design, lightweight construction and are ideally suited for television field uses, sports pickup, etc. (focal lengths from 13 to 25 inches enable interesting closeups, particularly when action is over 50 feet away). The design requirement of lightweight construction is met by use of a thin, lightweight barrel which is specially threaded to minimize internal reflections. Instead of the usual glass assembly, brass shell and adjustable iris, the long lenses employ a high quality doublet (or achromat lens) consisting of two kinds of glass cemented together and mounted between two threaded aluminum rings. The achromat, as the name implies, is corrected for color distortion (correction is excellent below f-11 and acceptable at full aperture). Very lightweight, removable "Waterhouse" fixed stops (f-8, f-11, f-16 and f-22) are provided. The maximum aperture is approximately f5.0. Ability of the image orthicon to accept wide fluctuations in light level made the use of fixed stops (instead of built-in iris) possible and facilitated design of a lightweight barrel. All lenses incorporate a quick-change, precision-machined bayonet mount which permits rapid interchange or removal of long lenses from camera turret as desired.

**STANDARD LENSES (STUDIO AND FIELD USE)**

This group of lenses includes the 13-inch, 8½-inch, 135mm, 90mm, 50mm and 35mm sizes. The 13-inch studio lens, although similar to other long lenses in barrel design, is quite different in optical design. It is a high-quality f3.5 Cook type anastigmat lens mounted in a fixed focus, lightweight barrel (interchangeable with other long lens adapters). The 13-inch lens has a built-in iris, adjustable from f3.5 to f42. While primarily intended for studio use, it may also be used for field pickups. Since it is faster than a 13-inch achromat lens, it is useful for night pickup of poorly lighted indoor or outdoor events. The



*Closeup of special 13" lens. MI-26550-10, suitable for either field or studio use.*

resolution of this lens is better than 55 lines per millimeter over the entire scanned area. The 8½-inch lens is similar in design to the 13-inch lens described above with lightweight barrel, built-in iris, and turret mounting bayonet adapter.

The smaller, standard sizes (135mm, 90mm, 50mm and 35mm focal lengths) employ Ektar lenses which offer features of high quality, speed, small size and lightweight construction. Focusing barrel adjustments, suited to RCA camera turret designs, permit the pre-setting of a given lens for closeups while other lenses remain at infinity focus. This avoids time-consuming re-adjustment of the focus knob for extreme closeups.

All Ektar and Ektanon lenses have focusing barrels except the 35mm lens. Fortunately, very short focal length lenses have great depth of field and require little adjustment for closeup scenes. Lenses are threaded to receive standard filters and sunshades available but not supplied.

All the smaller lenses employ an adjustable built-in iris and double-threaded mountings of stainless steel for long wear and safety. Lenses are specially treated by a coating process which increases efficiency of light transmission, thus improving the clarity, brilliance and black and white contrast of pictures obtained. Lens elements are accurately assembled and positioned in mounts. Inside the mounts are light baffles which give added contrast by reducing flare. All lens barrels carry diaphragm scales and depth of field scales. The entire group of lenses is made available to meet normal, wide angle, telephoto and ultra speed requirements for television use.

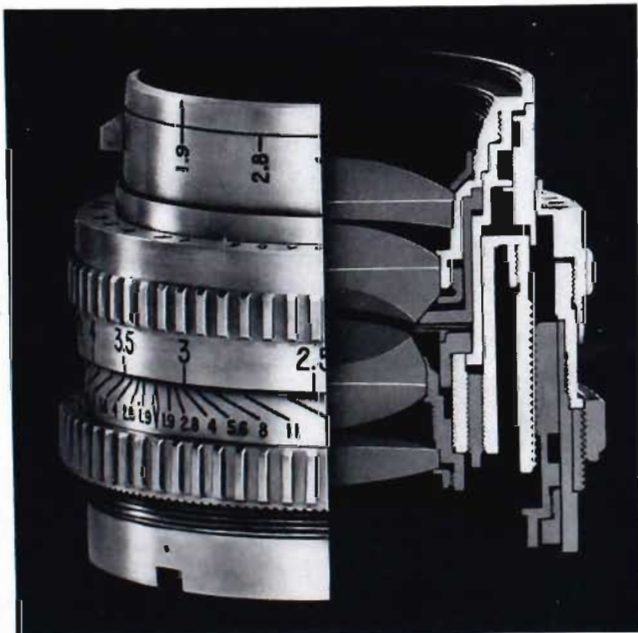

*Cataway view of smaller or "studio" type lens showing features of mechanical design.*

**Specifications**

Description	f Number	Total Horizontal		Stock No.
		f	Field Angle	
Studio Camera Lens, 35mm	f3.3	51.5°		MI-26550-9
Studio Camera Lens, 50mm	f1.9	34°		MI-26550-1
Studio Camera Lens, 90mm	f3.5	19°		MI-26550-2
Studio Camera Lens, 135mm	f3.8	13°		MI-26550-3
Studio and Field Camera Lens, 8½"	f3.9	8°		MI-26550-4
Studio and Field Camera Lens, 13"	f3.5	5°		MI-26550-10
Field Camera Lens, 13"	f5.0	5°		MI-26550-5
Field Camera Lens, 15"	f5.0	1.5°		MI-26550-6
Field Camera Lens, 17"	f5.0	1°		MI-26550-7
Field Camera Lens, 25"	f5.0	2.75°		MI-26550-8



# Television Zoomar Lens

## Features

- "Zoom" feature permits quick shifting from long shots or wide views to closeups—ideal for sports pickup.
- Continuous variation provided for focal length from 3 to 22 inches.
- A precision lens consisting of specially-coated multi-elements reduces loss of incident light.
- Lever arrangement provides wide-angle, intermediate and "telephoto" positions.

## Uses

The Television Zoomar lens is designed for use with the RCA image orthicon tube for TV pickups of sporting events and other outdoor functions such as large political meetings or gatherings. Two "Zoom" ranges provide variable focal lengths: (a) The first range for closer viewing; (b) The second for distant viewing.

With proper lighting, the "Zoomar" may be used as a vari-focal lens or as a single purpose lens set at a focal length desired for proper composition. The Zoomar lens is not designed to yield maximum picture definition under poor light conditions and should not be used with insufficient light when high definition is desired. However, when used with inadequate light the Zoomar will produce special effects or illusions, if desired.

## Description

The Television Zoomar consists of 28 lens elements which permit full compensation with linear displacements of optical components. The result is a vari-focal lens with a single barrel movement. The 28 lens elements are made up of two main groups; namely, the stationary lens elements and coupled movable lens elements. A lever attached to the lens barrel enables movement or a change in focal length. Movement of the barrel to any position in the housing yields an image of varying size and maximum sharpness. The front set of lenses in the movable barrel takes care of the change in focal length (the "Zoom") and the rear lenses compensate for focus.

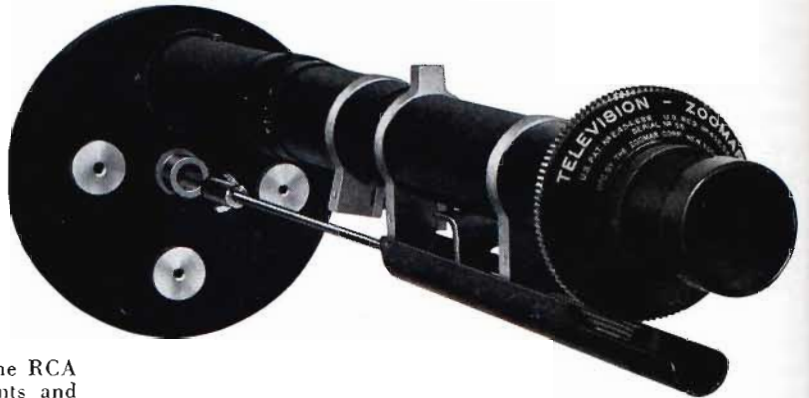

The maximum 'F' speed of the Television Zoomar when used up to 12 inches focal length is f/5.6. Above 12 inches focal length, full aperture should not be used. The highest recommended 'F' speed when using the Zoomar at over 12 inches focal length is f/8. Both variable focal length ranges can be stopped-down to f/22 if desired. Definition when using the Television Zoomar is dependent upon 'F' setting. When stopped down to f/16, maximum definition is obtained on the optical axis. At this point, there is no appreciable difference between the Television Zoomar and a good single purpose lens. At f/11 the definition is equal to about 90% that of a good single purpose lens; at f/8, definition is equal to about 80%. When used wide open at f/5.6, definition of the Zoomar is equivalent to approximately 75% that of a good single purpose lens.

## Specifications

Interchangeable Wide Angle Front Lens:

Zoom Range (for close viewing) \_\_\_\_\_ Focal lengths, 3" to 13"

Interchangeable Tele Front-lens:

Zoom Range (for distant viewing) \_\_\_\_\_ Focal lengths, 5" to 22"

Field Coverage (difference in field area) \_\_\_\_\_ Up to 15 times  
Speed \_\_\_\_\_ f/5.6 to f/22

Dimensions, overall \_\_\_\_\_ Length 30", width 3"

Approximate Weight \_\_\_\_\_ 14 lbs.

Stock Identification \_\_\_\_\_ MI-26549-3

# Video Analyzer



## Features

- Accurate means of checking orthicon tube characteristics.
- Enables quick alignment and adjustment of TV cameras.
- Convenient for matching and balancing two or more camera chains.
- Eliminates laborious methods of pattern comparison tests.

## Uses

The Video Analyzer is used as a convenient means for checking image orthicon tube characteristics and camera adjustments. With the Video Analyzer, the following checks can be made quickly, easily and accurately: (1) Lens turret alignment, (2) Mechanical alignment of Image Orthicon Assembly, (3) Old Mosaic (or previously scanned target area), (4) Vertical and horizontal image size, (5) Vertical and horizontal linearity, (6) Vertical and horizontal centering, (7) Vertical and horizontal shading, (8) Resolution (both horizontal and

vertical by rotating analyzer), (9) Color response, (10) Sensitivity, (11) Saturation point, (12) Contrast range, (13) Frequency distortion, (14) "S" distortion (image section electrical adjustment), and (15) Scanning tilt.

## Description

The Video Analyzer consists of an incandescent low Kelvin rating light source, a precision transparent test pattern, and a calibrated correction lens mounted in a compact, lightweight metal housing having a telescoping barrel that fits directly on the TV camera's 80 mm lens. A "bubble level" on the top of the analyzer's housing makes it easy to adjust the built-in test pattern for perfect horizontal alignment.

The Analyzer can be connected to any 110-volt source, including the utility outlet on the camera. The test pattern is illuminated by pressing a spring-tension hand switch. By checking the tones of the three color strips (red, green and blue) against the six-step, gray scale on the analyzer's target (as they appear on the monitor)—it is a simple matter to evolve a convenient code-number system for identifying color and light sensitivity characteristics of an image orthicon.

## Specifications

Length \_\_\_\_\_ 12"; Weight \_\_\_\_\_ 1 lb.; Shipping Weight \_\_\_\_\_ 6 lbs.

Overall Cable Length (plug and switch) \_\_\_\_\_ 5'

Stock Identification \_\_\_\_\_ MI-26548

# Television Balowstar Lens

## Features

- Extremely fast lens possessing high resolution.
- Produces image of unusual contrast and clarity.
- Ideal for remote pickup where lighting conditions may be unfavorable.
- Designed for use with RCA image orthicons.
- Sharp focus maintained under mixed-light conditions.

## Uses

The Balowstar Lens is intended for television remote pickups where lighting conditions and object distances are unfavorable, as in theatres, churches and other public gathering places. Church services, night street scenes, concerts, opera, night club performances and on-the-spot news events in hotel lobbies can be covered. The Balowstar lens is designed for use with the RCA image orthicon. If used with an image orthicon, which has practically no response to infra-red, the lens can be regarded for all practical purposes as an apochromat. The lens will also give good results when some infra-red component is present—since the Balowstar lens has its focal plane for infra-red close to its general focal plane.

## Description

The television Balowstar, designed by Dr. Frank G. Back, is a very fast, low-loss lens possessing a high degree of resolution and contrast, features which contribute to high quality TV images. The Balowstar consists of three groups of special lens elements which are precision ground to very close tolerances.

Rated at  $f/1.3$ , with a focal length of 7 inches, the TV Balowstar operates efficiently under all kinds of lighting conditions and is corrected for infra-red illumination (the invisible light given off by unfiltered incandescent lamps) as well as for



visible illumination. Under mixed light, some lenses produce one focus for the infra-red light and another for the visible light, resulting in an image which tends to be fuzzy and out of focus. This condition is avoided by special design of the lens elements which brings the two foci practically together to produce a sharp focus even when infra-red light and visible light are combined (as in TV pickups on the spot where the kind and quality of illumination cannot be controlled as it is in the studio). Not only is the Balowstar lens color corrected, but it is free of zonal spherical aberration, which means that its focus does not change when the aperture is closed down.

## Specifications

"F" Number	1.3
Focal Length	7"
Type Lens	Low-loss, high resolution, color corrected, and consisting of 3 groups of special lens elements.
Approximate Weight	6 lbs.
Overall Length, Approximate	15"
Stock Identification	MI-26549-2

# Television Reflectorar Lens



## Features

- 40-inch focal length with compact 16-inch unit.
- High resolution and picture quality.
- Light in weight and mounts directly on TV Camera Turret without interfering with other lenses.
- Provides close "closeups" without decrease in picture quality.

## Uses

The Television Reflectorar Lens is a long-focal length (40-inch) unit which is designed for "pickups" where extreme closeups are desirable—such as: football games, baseball games, boxing matches, horse races and news events.

## Description

The Television Reflectorar (invented by Dr. Back) is actually a "lenseless" lens, since four special reflectors are utilized to bounce light beams back and forth to obtain desired magnification. The long-focus, (40-inch equivalent focal length) lens consists of a correction plate (a mirror-reflector, shaped like a segment of a large sphere), and three aluminized flat mirrors. Light enters through correction plate, is picked up by the mirror-reflector, and is "zig-zagged" back and forth by the aluminized reflectors to the target of the image orthicon.

Lens control (F stop opening) is obtained by adjustment of a rotatable damper which is placed directly in front of the aspherical reflector. Depending on the damper's position, "F" stops of  $F/8$  to  $F/22$  are provided. Since there is only one refractive element of very low power, the lens is free of chromatic aberrations. It is also fully corrected for spherical aberration. Astigmatism and curvature of field are negligible.

## Specifications

Resolution	Approx. 3000 TV lines at center Approx. 1500 TV lines at edges
Focal Length (equivalent)	40"
"F" Speed (dependent on damper position)	$F/8$ to $F/22$
Overall Length (approx.)	16"
Weight (approx.)	6 lbs.
Stock Identification	MI-26549-1



# Elapsed Time Indicator, MI-26760

## Features

- Provides five meters for convenient hour-indication in comparing life of camera tubes, etc., with warranties.
- Card holders provided for circuit identification.
- High-quality, long-life synchronous motors.
- Jones terminal strips provided for ease in making connections.
- Supplied in standard recessed type chassis.

## Uses

The Elapsed Time Indicator Panel may be operated directly from any 110 volt a-c line. When used with suitable circuit breakers, it provides a constant record of "hours on", or elapsed time in measuring the life of television tubes such as camera tubes, etc.

## Description

The time indicator, MI-26760, consists of a system of five, individually-operated, counter indicators which are driven by synchronous motors. Gearing ratios are selected so that indicators may be read directly in elapsed-hours (up to a maximum of 10,000 hours). A tenths scale is provided for hour readings where greater accuracy is desired. The indicator chassis is operable from any 110 volt, 60 cycle line.

The complete assembly is supplied in a standard recessed or "bathtub" type chassis for 19" television rack panel mounting. It is reasonably compact and occupies only 3½" of vertical panel space. A Jones terminal strip is provided for greater ease in making connections.



## Specifications

Line Voltage	_____	110 volts, 60 cycles
Power Input	_____	Negligible
Calibration Markings	_____	Hours, tenths hours
Total Time Reading	_____	10,000 hours max.
Dimensions:		
Panel Vertical Height	_____	3½"
Panel Length	_____	19"
Panel Depth	_____	5¼"
Weight, approx.	_____	6 lbs.
Stock Identification	_____	MI-26760
(including 5 time indicators mounted in place)		

# Blank Recessed Chassis

## Use

A complete line of standard 19" recessed type chassis is available for filling out blank spaces in television cabinet racks. They are convenient for later use in mounting television components, meters, or special equipment.

## Description

A variety of eight chassis (all of the standard recessed or "bathtub" type) are carried in different panel heights of 1 23/32" to 13 31/32". All are supplied in a standard 19" panel length and 5¼" depth. All chassis are made of 16 gauge sheet steel with suitable mounting holes for standard 19" equipment racks. Units are finished in light umber gray to match companion rack equipment.

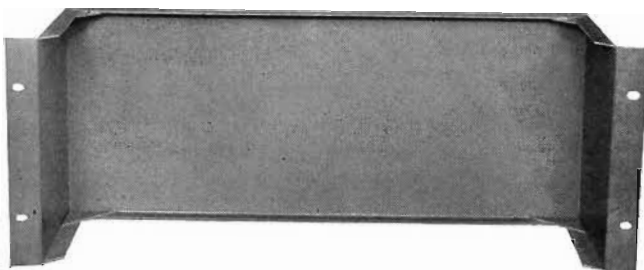

## Chassis Height

## Stock Identification

1 23/32"	_____	MI-26525-1
3 15/32"	_____	MI-26525-2
5 7/32"	_____	MI-26525-3
6 31/32"	_____	MI-26525-4
8 23/32"	_____	MI-26525-5
10 15/32"	_____	MI-26525-6
12 7/32"	_____	MI-26525-7
13 31/32"	_____	MI-26525-8

## Chassis Trim Cover, MI-21457-B

This cover is essentially a flat piece of perforated steel properly framed so that it will fit in over the ends of either blank or equipment chassis if mounted in the rack.

It effectively forms a separator lying in a horizontal plane between equipments in the rack. The Chassis Trim Cover (MI-21457-B) is particularly useful when it becomes necessary to install front mounted units in combination with standard bathtub chassis in the same rack. In this manner gaping holes in the rack are eliminated, small tools will not be dropped inside of the rack, and neat appearance is coupled with a convenient shelf arrangement.

# Circuit Breaker Chassis, MI-26240

## Features

- Supplied as standard recessed chassis with mounting accommodations for any combination of 5 breakers (MI-26764 series).
- Cover plates provided for unused breaker mounting holes.
- Mounts in 19" cabinet rack.
- Choice of breakers available (3 current ratings, available as MI-26764).

## Uses

Circuit Breaker Chassis, MI-26240, is employed as a main switch breaker panel between the power line and the television studio equipment to be controlled.

## Description

MI-26240 consists of a standard recessed type chassis suitable for regular 19" rack panel mounting. It includes individual cutouts for mounting five series MI-26764 circuit breakers. (Available ratings of 10 amps., 20 amps. and 40 amps., all at 115 volts.)

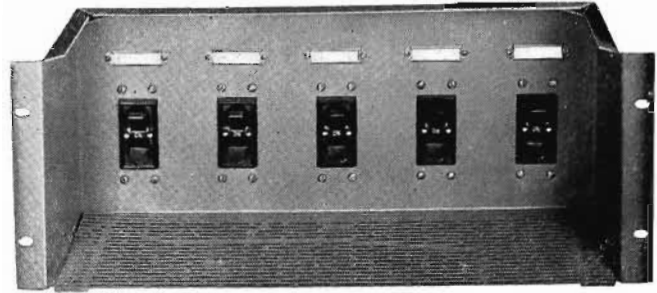

## Specifications

Panel Height	7"
Panel Length	19"
Panel Depth	5 1/4"
Weight (approx.)	10 lbs.
Stock Identification	MI-26240

## ACCESSORY CIRCUIT BREAKERS

10 amps., 115 volts	MI-26764-1
20 amps., 115 volts	MI-26764-2
40 amps., 115 volts	MI-26764-3

# Power Relay Panel, MI-26761

## Features

- Five individual relays provided in standard 19" recessed type chassis.
- Makes possible remote switching of power circuits in conjunction with studio power remote control panel (MI-26251).
- Glass dust covers avoid corrosion of contacts or intermittent operation.
- Convenient, standard 19" rack mounting.
- Card holders provided for circuit identification.

## Uses

Use of the Power Relay Control Chassis, MI-26761, facilitates the remote switching of television studio control circuits directly from a separate Studio Console Remote Control Panel (MI-26251), or from the studio control desk.

The energizing coils of all relays are operated from a regular 110 volt, 60 cycle line thus eliminating need for separate transformers.

## Description

The Power Relay Panel consists of five magnetically-operated relays which are supplied in a standard recessed type chassis suitable for 19" television equipment rack mounting. All relays are equipped with contacts rated at 30 amps., so that relatively high-power circuits may be easily handled. Glass dust covers prevent contact corrosion due to moisture and allow visual inspection of relay operation. Relay equipment is designed to operate from a 110 volt, 60 cycle source and employs low current coils, thus eliminating the use of heavy-duty wiring, switches, etc.

## Specifications

Line Voltage	110 volts, 60 cycles
Relay Contact Rating (two circuits)	60 amps.
Relay Contact Rating (single circuit)	30 amps., max.
Dimensions:	
Panel Vertical Height	7"
Panel Length	19"
Panel Depth	7 3/4"
Weight (approx.)	10 lbs.
Stock Identification (includes 5 relays mounted in place)	MI-26761

## Accessory

Studio Console Control Panel	MI-26251
------------------------------	----------





# Plate Current Meter, MI-21200-C1

### Features

- Two scales provided (0-150 ma., 0-15 ma.).
- Compact, small in size.
- Quick means of checking regulated power supplies.
- Furnished complete with 5' 9" cord and plug-in jack.

### Uses

Plate Current Meter, MI-21200-C1, is a two scale (0-15 ma. and 0-150 ma.) meter for checking the plate current of the regulator tubes of the 580-C and WP-33B regulated power supplies. It is also suitable for use in checking field power supply MI-26095. In addition it may be used to check total current drain and voltage output of the above-mentioned circuit, as well as alignment coil current of the studio camera supplied by the current regulator MI-26090.

### Description

The Plate Current Meter is furnished in a bakelite case of convenient size ( $3\frac{5}{8}$ " x  $5\frac{7}{16}$ " x  $2\frac{3}{8}$ ") and has a 5' 9" cord complete with plug-in jack for use in checking power supply panels. A momentary-contact meter push-button switch changes the 0-150 ma. scale to 0-15 ma., when desired.



### Specifications

Stock Identification	MI-21200-C1
Approximate Size	$3\frac{5}{8}$ " x $5\frac{7}{16}$ " x $2\frac{3}{8}$ "
Weight	
Range Scales	0-150 ma., 0-15 ma.

# Video Jack Panel, Plugs and Cords

### Features

- Provides convenient patching of video and synchronizing circuits.
- Accessory bridging plugs and cords available.
- Supplied in standard 19" recessed type chassis for rack mounting.
- 12 groups (arranged three per group) of coaxial jack assemblies provided.
- Removable mounting bracket allows recessed or flush mounting as desired.

### Uses

Video Jack Panel, MI-26245, and associated plugs and cords provide a convenient means for patching video and/or synchronizing signals as desired. Sufficient jack positions are provided to lend flexibility and enable patching of special lines when desired.

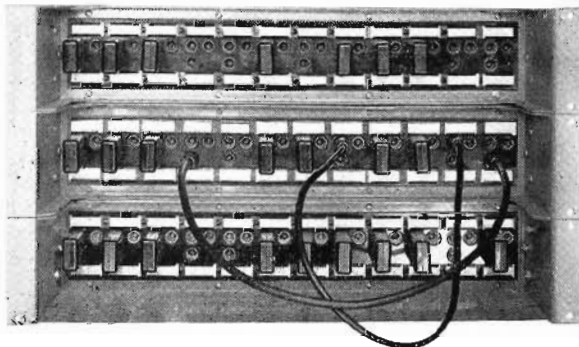

Three Video Jack Panels (MI-26245) are shown above. Each has 12 jack groups (3 jacks per group).

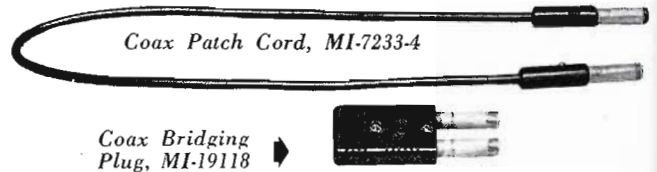

### Description

The Video Jack Panel is supplied in a recessed or "bathtub" type chassis for standard 19" cabinet rack panel mounting. It is finished in amber gray to match other equipment. Twenty-four (two rows of 12 each) coaxial connectors are provided at the rear of the chassis to facilitate making cable connections from desired sources.

Located on the front of the chassis panel are 12 groups of coaxial jack assemblies (arranged three jacks per group). The top two jacks of each group are paralleled and in turn connected to the input coaxial connector at the rear of the chassis. The bottom, or output coaxial jacks, are also connected to coaxial connectors on the rear of the chassis. Circuits may be simply bridged by use of special coaxial plugs (MI-19118) or patched to other lines or circuits by use of coaxial patch cords (MI-7233-4). The third coaxial jack of each group provides a convenient means for monitoring (without disturbing the program line) or paralleling of output circuits. RG-11/U cable is recommended for use in making external connections.

### Specifications

Stock Identification (Video Jack Panel)	MI-26245
Dimensions:	
Height	$3\frac{15}{32}$ "
Length	19"
Depth (overall)	$9\frac{1}{4}$ "
Depth (mounting flange to jack board)	$5\frac{1}{4}$ "
Stock Identification (Coaxial Bridging Plug)	MI-19118
Stock Identification (Coaxial Patch Cord $98\frac{1}{2}$ " long)	MI-7233-4

# Television Cables, Plugs, Connectors

## Uses

RCA television cables, plugs and connectors are made available for inter-connecting the various components of TV broadcast setups—studio, control room and remote. Camera, power, pulse, intercom, coax transmission line and inter-connecting cables with companion connectors can be obtained as individual items or in special groups as desired. The use of the specially designed cables and connectors described below will facilitate station installations and avoid expensive delays.

## Features

- Wide variety of cables and connectors provided.
- Specially designed for television applications.
- Facilitates TV installations—avoids delays.
- High-quality insulations with conservative voltage ratings and special shields employed.
- Various cable lengths and special cables available as kits.

## Camera Cables and Plugs

The 24-conductor, flexible cables listed here provide five convenient lengths. Cables are supplied complete with necessary male and female connectors and accommodate required inter-connections between cameras, camera control and monitoring positions. Communication and tally light circuits are also handled by the camera cables. Conductors are stranded and covered with "color-coded" silk and cotton braid insulation. An inner shield of tinned copper braid is provided. Outer coverings are of a durable rubber compound. Overall cable diameter is  $\frac{3}{4}$  inches.

Stock Identification	Type—Camera Cable	Length
MI-26759-1	24-conductor with 90 degree female and a straight male connector. Partial special braided outer shield.	50 feet
MI-26725-1	24-conductor, with straight male and female connectors. With dustcaps.	50 feet
MI-26725-2	24-conductor, with straight male and female connectors. With dustcaps.	100 feet
MI-26725-3	24-conductor, with straight male and female connectors. With dustcaps.	200 feet
MI-26725-4	24-conductor, with straight male and female connectors. Protective rubber grommet.	20 feet



Camera Cable MI-26759-1, showing connectors and partial outer shield.



Camera Cable MI-26725-4, shown with special protective grommet. Other Cables, MI-26725-1, -2 and -3 are similar.

## Intercom Cables

The cables listed below are available for TV intercom use in the three different lengths shown. All are flexible and are complete with phone-type jack plugs at each end.

Stock Identification	Length
MI-26756-1	7 feet
MI-26756-2	25 feet
MI-26756-3	100 feet



Intercom Cable MI-26756-1, -2 and -3 are identical except for cable lengths.



## Power Cables and Plugs

The power cable and plug assemblies described below provide a choice in number of conductors and various cable lengths for convenience in handling TV power circuits.

Stock Identification	Power Cable Description	Length
MI-26759-2	2-conductor, rubber covered, flexible with male connector and female connector with dustcap.	10 feet
MI-26759-3	4-conductor, rubber covered, flexible with male and female connectors.	50 feet
MI-26759-4	Same as MI-26759-3.	100 feet
MI-26759-5	4-conductor, rubber covered, flexible with female connector at one end—and terminals on 4 leads at other end.	24 feet
MI-26759-6	12-conductor, rubber covered, flexible with male and female connectors.	34 inches
MI-26759-7	12-conductor, rubber covered, flexible with male and female connectors with dustcaps.	6 feet
MI-26759-8	12-conductor, rubber covered, flexible with male and female connectors.	6 feet



*2-Conductor Power Cable, MI-26759-2.*



*12-Conductor Power Cable, MI-26759-7.*



*4-Conductor Power Cable and Plug, MI-26759-5 (at left) is supplied with terminals at one end. 4-Conductor Power Cables MI-26759-3 and -4 are supplied as shown, at right above.*



*12-Conductor Power Cables, MI-26759-6 and -8 are supplied, as above, with "Jones" type connectors.*

## Pulse and Intercom Cables

The cable assemblies described here are supplied complete with suitable multi-contact connectors and protective dustcaps.



*Pulse Cables MI-26759-9 and -10 are supplied with "straight" type connectors (shown above less dustcaps).*

Stock Identification	Description	Length
MI-26759-9	Pulse Cable—7-conductor, rubber covered, flexible with straight male and female connectors and dustcaps.	7 feet
MI-26759-10	Pulse Cable—Same as MI-26759-9.	4 feet
MI-26759-11	Intercom Cable—9-conductor, rubber covered, flexible, with male and female connectors and dustcaps.	7 feet

*9-Conductor Intercom Cable, MI-26759-11 is furnished as shown at right.*



## Coax Cable Assemblies

The coaxial transmission line cable assemblies are made available in several different convenient lengths as shown in the accompanying chart. Durable, rubber-covered, flexible cables with inner conductor and outer shield conductor.

Stock Identification	Description	Length
MI-26759-12	Coax Cable Assembly with male plugs and dustcaps. Impedance, 73 ohms.	7 feet
MI-26759-13	Same as MI-26759-12.	25 feet
MI-26759-14	Same as MI-26759-12 less dustcaps.	64 inches
MI-26759-15	Coax Cable Assembly with male plugs and dustcaps. Impedance, 75 ohms.	100 feet



The MI-26759 Coax Cables are similar (differences are noted in table at left).

## Cable Connectors

The connectors described below include both the 90 degree and straight type for use in making up TV interconnections and terminations, as needed. Connectors are suitable for use with bulk cables listed.

Stock Identification	Type	Description
MI-26759-17	Pulse Termination Plug.	7-pin male connector with 3 pins tied to ground at common pin thru three 75 ohm resistors.
MI-26759-18	Set of Coax Fittings.	Includes 5 junction fittings and 5 termination fittings for joining coax cable assemblies.
MI-26759-19	Male Chassis Camera Cable Connector.	24-contact with flange for mounting on chassis or panel.
MI-26759-20	Female Chassis Camera Cable Connector.	24-contact with flange for mounting on chassis or panel.
MI-26759-21	Straight Male Camera Cable Connector.	24-contact for use as a cable termination.
MI-26759-22	Straight Female Camera Cable Connector.	24-contact for use as cable termination with MI-26759-21.
MI-26759-23	90° Female Camera Cable Connector.	24-contact for use as cable termination. Designed so that cable enters connector at 90° to axis of contact pins.
MI-26759-24	90° Male Camera Cable Connector.	24-contact for use as cable termination. Designed so that cable enters connector at 90° to axis of contact pins.

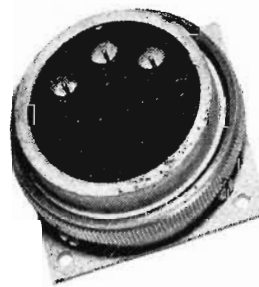

MI-26759-20

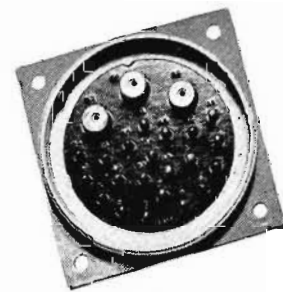

MI-26759-19



MI-26759-21



MI-26759-22



Above, Pulse Termination Plug, MI-26759-17.



At right, Coax fittings, MI-26759-18 includes 5 junction fittings and 5 terminations.



MI-26759-23



MI-26759-24



## Bulk Cable

The various cables described in the accompanying table are available to the broadcaster in bulk quantities for making TV interconnections in special or non-standard lengths as desired. Cables listed are suitable for use with individual connectors and plugs available.

Stock Identification	Type Cable	Approx. Diam.	Characteristics
MI-48	PULSE CABLE—8-conductor, rubber covered, flexible with individual color coding.	0.073"	4 coax conductors of 72 ohms impedance, and 4 conductors of #16 A.W.G. with insulation for 600 v. d-c.
MI-51	POWER CABLE—4-conductor, rubber covered, flexible, shielded, and individual color coding.	0.050"	4 conductors of #14 A.W.G. with insulation for 2500 v, rms, 60 cycles.
MI-54	POWER CABLE—4-conductor, rubber covered, flexible, shielded with color coding (untinned, 1 white, 1 black).	0.50"	4 conductors of 41 strands of .0063" copper wire.
MI-74A	COAXIAL CABLE—Type RG-8/U, flexible, rubber covered. Single inner conductor and outer shield conductor.	0.405"	Impedance, 52 $\pm$ 2 ohms.
MI-75	COAXIAL CABLE—Type RG-59/U, flexible, rubber covered. Single inner conductor and outer shield conductor.	0.242"	Impedance, 73 $\pm$ 3 ohms.
MI-78	POWER CABLE—2-conductor, rubber covered, flexible, shielded (wire untinned, 1 white, 1 black).	0.390"	2 conductors of 65 strands of .0063" wire.
MI-79	POWER CABLE—2-conductor, rubber covered, flexible, shielded (wire untinned, 1 white, 1 black).	0.484"	2 conductors of 65 strands of .010" wire.
MI-80	POWER CABLE—12-conductor, rubber covered, flexible, shielded and individually color coded.	0.590"	12 conductors of #18 A.W.G. with insulation for 2500 v, rms, 60 cycles.
MI-82	INTERCOM CABLE—8-conductor, rubber covered, flexible, shielded with individual color coding.	0.490"	7 conductors #18 A.W.G. 1 conductor #14 A.W.G. with insulation for 2500 v, rms, 60 cycles.
MI-83	COAXIAL CABLE—Type RG-11/U, flexible, rubber covered. Single inner conductor and outer shield conductor.	0.405"	Impedance, 73 $\pm$ 3 ohms.
MI-90	COAXIAL CABLE—Type RG-62/U, flexible, rubber covered. Single inner conductor and outer shield conductor.	0.242"	Impedance, 93 ohms approx.
MI-94C	CAMERA CABLE—24-conductor, rubber-covered, flexible, color coded, shielded cable consisting of: (A) 3 coaxial conductors, (B) 3 groups of (7 each) stranded, tinned copper conductors.	0.81"	Coax conductor impedance, 51 ohms $\pm$ 5%, 21 conductors of #22 A.W.G. with insulation for 1000 v, d-c.

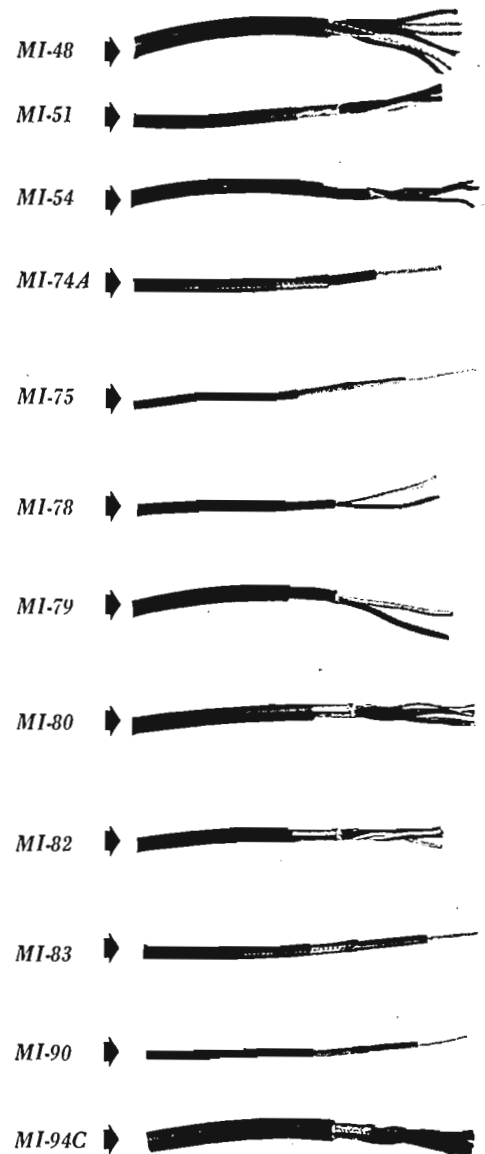

## Sets of Interconnection Cables

The special cable groups listed below are supplied as special selected sets which prove convenient in making interconnections of various classes of Television equipment.

### MI-26730, INTERCONNECTING CABLES FOR FIELD CAMERA EQUIPMENT

- Includes: 1—10 ft., 2-cond., Power Cable, MI-26759-2  
 1— 6 ft., 12-cond., Power Cable, MI-26759-7  
 1— 7 ft., 7-cond., Pulse Cable, MI-26759-9  
 1— 7 ft., 9-cond., Intercom Cable, MI-26759-11  
 1— 7 ft., Coaxial Transmission Cable, MI-26759-12

### MI-26735, INTERCONNECTING CABLES AND PLUG FOR FIELD SYNC GENERATOR

- Includes: 1—10 ft., 2-cond., Power Cable with Plugs and Dustcap, MI-26759-2  
 2—50 ft., 4-cond., Power Cable with Plugs, MI-26759-3  
 1—100 ft., 4-cond., Power Cable with Plugs, MI-26759-4  
 1—7 ft., Transmission Line Cable with Plugs and Dustcap, MI-26759-12  
 1—4 ft., 7-cond., Pulse Cable with Plugs and Dust Caps, MI-26759-10  
 1—2 ft., 4-cond., Power Cable with Female Plug, MI-26759-5  
 1—Pulse Termination Plug, MI-26759-17

### MI-26740, INTERCONNECTING CABLES AND FITTINGS FOR FIELD SWITCHING EQUIPMENT

- Includes: 1—10 ft., 2-cond., Power Cable, MI-26759-2  
 1— 6 ft., 12-cond., Power Cable, MI-26759-7  
 1— 6 ft., 12-cond., Power Cable, MI-26759-8  
 1— 7 ft., Coaxial Transmission Cable, MI-26759-12  
 1—25 ft., Coaxial Transmission Cable, MI-26759-13  
 1—100 ft., Coaxial Transmission Cable, MI-26759-15  
 1—Set of Coaxial Fittings, MI-26759-18

### MI-26746, INTERCONNECTING CABLES FOR STUDIO CAMERA CONTROL

- Includes: 1—34 inch, 8-cond., Power Cable, MI-26759-6  
 1—64 inch, Transmission Line Cable, MI-26759-14

### MI-26745, INTERCONNECTING CABLES FOR FILM CAMERA

- Includes: 1—50 ft., Camera Cable, MI-26759-1  
 1—34 inch, 8-cond., Power Cable, MI-26759-6  
 1—64 inch, Transmission Line Cable, MI-26759-14

### MI-26755, INTERCONNECTING CABLES FOR FIELD RELAY TRANSMITTER

- Includes: 1— 10 ft., 2-cond., Power Cable, MI-26759-2  
 1— 25 ft., Transmission Line Cable, MI-26759-13  
 1—100 ft., Transmission Line Cable, MI-26759-15

# **TRANSMITTERS AM - FM - TV**

	<b>Page</b>
<b>AM TRANSMITTERS</b>	<b>216</b>
<b>AM PHASING</b>	<b>237</b>
<b>FM TRANSMITTERS</b>	<b>244</b>
<b>AM, FM TUBES</b>	<b>267</b>
<b>TV TRANSMITTERS</b>	<b>270</b>
<b>TV TUBES</b>	<b>281</b>
<b>CRYSTALS</b>	<b>282</b>



# AM Broadcast Transmitter, Type BTA-250L

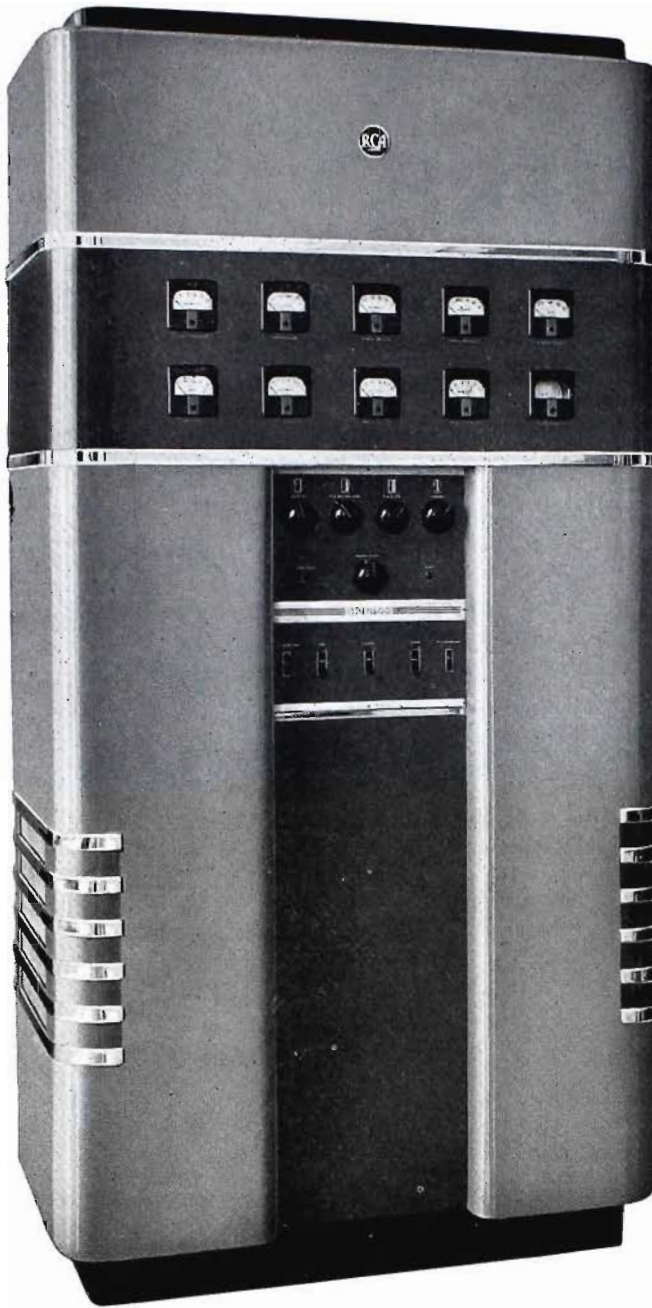

## Features

- Low installation cost.
- Low maintenance cost—only eleven tubes, six types.
- Completely self-contained.
- Simple and efficient in operation.
- Vertical chassis construction for accessibility and ventilation.

## Description

The Type BTA-250L Broadcast Transmitter is a complete self-contained unit that will provide reliable, high fidelity operation at any frequency within the range of 540 to 1600 kc. Encompassing the latest developments in broadcast transmitters, the RCA BTA-250L has been designed to fill every need of the 250 watt broadcasting station.

The BTA-250L is housed in a modern, attractive, steel cabinet finished in two tone umber gray and trimmed with strips of satin chrome. There are ten instruments conveniently located at eye level on the front panel. All controls are grouped together on a central control panel which is photo-etched and indirectly illuminated. The tuning controls are provided with indicators so that their positions may be accurately logged. The BTA-250L uses the RCA vertical chassis type of construction, whereby the equipment is mounted in such a manner that each item may be easily removed by one man in the shortest possible time. The variable elements are placed where they are functionally needed and where connection leads to other circuit components may be kept relatively short. This vertical type of construction provides a high degree of mechanical rigidity, adds considerably to the accessibility of the components, and greatly increases the normal circulation of air within the cabinet.

The BTA-250L employs a very simple basic circuit arrangement consisting of a crystal oscillator followed by a buffer amplifier and class "C" power amplifier.

Two RCA low temperature coefficient quartz crystals mounted in RCA Type TMV-129-B temperature controlled holders are provided. The oscillator stage has an extra crystal socket in which the spare crystal may be continuously maintained at the correct operating temperature. These crystals provide excellent frequency stability with no greater deviation than  $\pm 10$  cycles from the assigned frequency.

The BTA-250L uses no variable capacitors. Continuously variable inductors are employed as tuning elements throughout, thus eliminating the possibility of flashovers sometimes occurring in variable capacitors.

The modulation system is high-level with a class "B" modulator. High fidelity is materially aided by the use of approximately 20 decibels of audio feedback over the audio system.

In order to insure low maintenance cost, the BTA-250L uses a minimum number of tubes, all inexpensive. There are only eleven tubes, altogether, and only six tube types. A single high voltage power supply provides plate voltage for all tubes. This power supply makes use of two RCA 8008 mercury vapor rectifier tubes, which are known for their long life and unexcelled performance. Bias voltage for the modulators is provided by a separate power supply using a single RCA 5Y3-GT. The power control circuits of the BTA-250L were designed with an eye to simplicity while also providing adequate protection to the equipment and operating personnel. This transmitter features a relay which eliminates any necessity for re-

cycling of the time delay relay when momentary power failures or interruptions occur. Overall protection is provided by the use of magnetic circuit breakers, serving also as switches, and completely eliminating fuses from any power circuits.

A matching network is provided between the output tank circuit and the output terminals of the transmitter, which includes series inductive elements and shunt capacitances resulting in very complete radio frequency harmonic attenuation. Output terminals are provided at the top of the cabinet for connecting to an unbalanced open wire transmission line or an antenna lead-in. A concentric transmission line may be connected through either the base or the top of the transmitter.

**Specifications**

- Carrier Frequency Range \_\_\_\_\_ 540 to 1600 kcs
- Carrier Frequency Stability \_\_\_\_\_  $\pm 10$  cycles
- Carrier Power Output \_\_\_\_\_ 250 watts
- Carrier Frequency Harmonics \_\_\_\_\_ Below .05%
- A-c Power Input (105 to 115 volts, 50/60 cycles, single phase)
  - Average Program at 250 Watts Output \_\_\_\_\_ 1625 watts
  - Carrier Shift (zero to 100% modulation) \_\_\_\_\_ Less than 5%
  - Carrier Noise and Hum Level (unweighted below 100% modulation) \_\_\_\_\_ 60 db
  - Audio Frequency Response (30 to 10,000 cycles) \_\_\_\_\_  $\pm 1.5$  db

- Audio Input Level for 100% Modulation \_\_\_\_\_ +16 dbm\*
- Audio Frequency Harmonic Distortion (50 to 7500 cycles, 0 to 95% modulation) \_\_\_\_\_ Not to exceed 3% rms
- R-f Load Impedance (unbalanced transmission line or antenna) \_\_\_\_\_ 20 to 250 ohms
- Tube Complement \_\_\_\_\_ 1—807, 2—810, 2—6J7, 3—828, 2—800B, 1—5Y3GT

**Dimensions, overall**

- Width \_\_\_\_\_ 40 1/2"
- Depth \_\_\_\_\_ 20 1/4"
- Height \_\_\_\_\_ 84 7/8"
- Weight (unpacked) \_\_\_\_\_ 1360 lbs.
- (packed) \_\_\_\_\_ 1635 lbs.
- Stock Identification \_\_\_\_\_ MI-7242-C

**Equipment Supplied**

The following is a condensed list of equipment included as a complete BTA-250L transmitter.

Qty.	Description	Reference
1	Type BTA-250L Broadcast Transmitter Unit	MI-7243-C
1	Type UL-4392 Crystal Oscillator Unit	MI-19458
1	Touch-up Finish Kit	MI-7443
2	Instruction Books	IB-30116-1
2	Type TMV-129B Crystal Units	MI-7467
2	Sets of Tubes	MI-7245-B
1	RF Output Ammeter	MI-7157-B

**Available Accessories**

- 1 KW Amplifier and Conversion Kit \_\_\_\_\_ MI-7187-A
- Type BPA-1 Antenna Tuner \_\_\_\_\_ MI-28901-A
- Type BPM-1A Remote Metering Equipment \_\_\_\_\_ MI-28027/28037-A
- Antenna Towers and RF Transmission Line \_\_\_\_\_ On application

\* dbm = no. of db above one milliwatt when single frequency tone modulation is used.

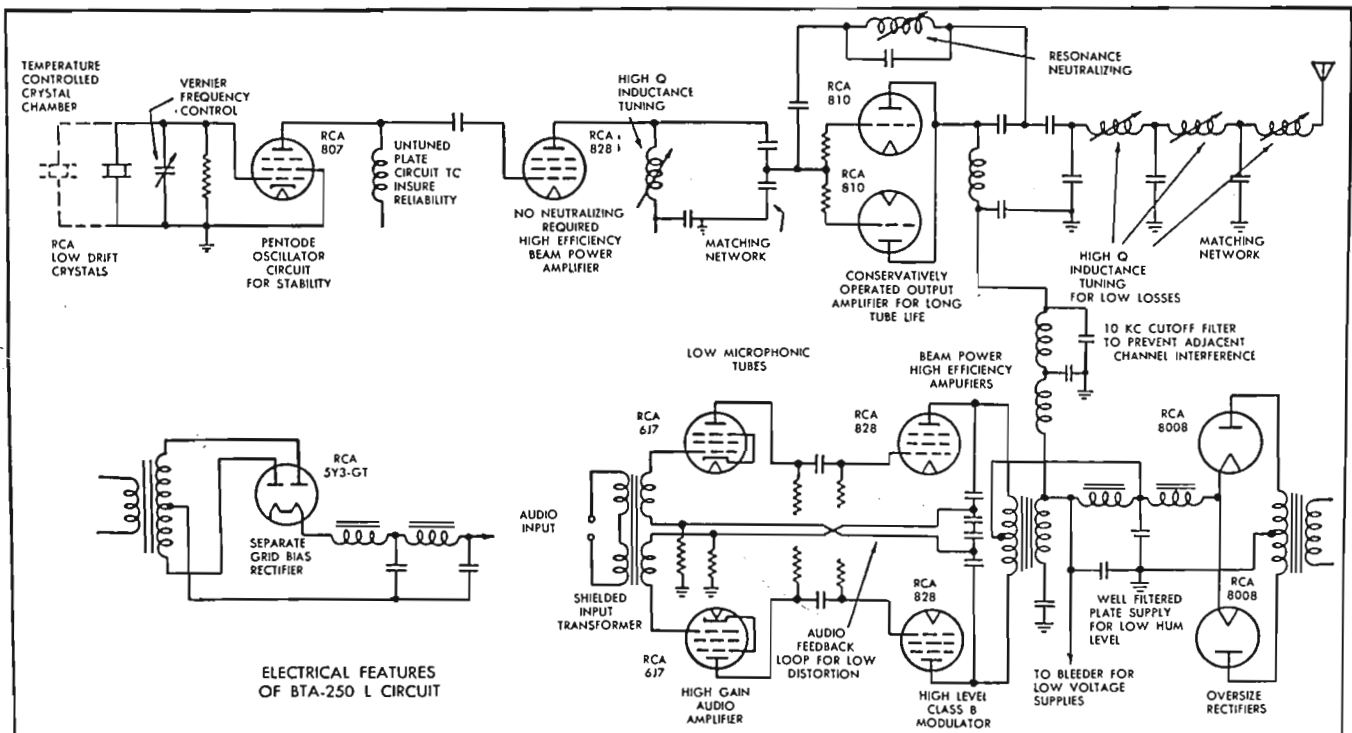



# This 250-watt

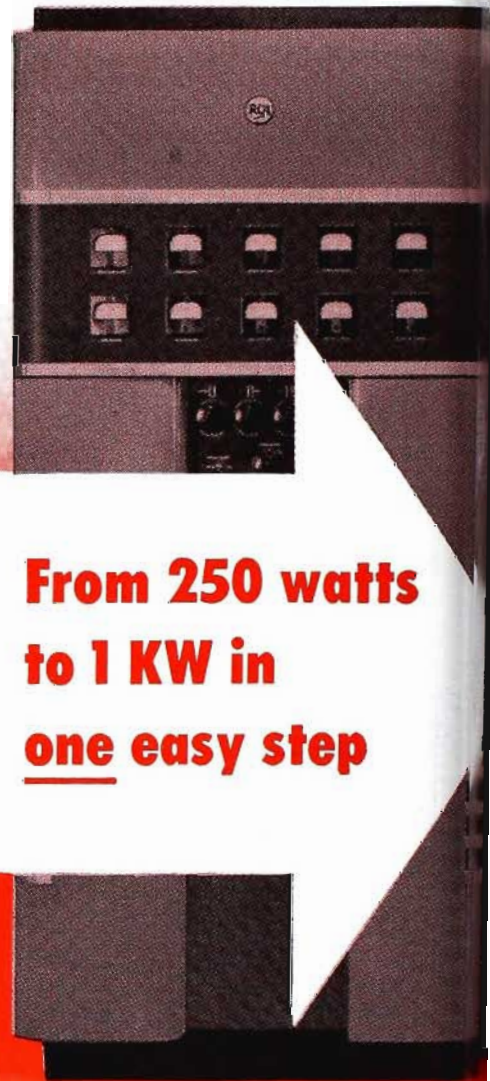

**From 250 watts  
to 1 KW in  
one easy step**

Use the BTA-250L as your  
250-watt Transmitter now

**READY TO SHIP** — America's favorite  
250-watt AM transmitter, type BTA-250L



# AM transmitter can be stepped up to 1 KW

... simply



WITH this 250-watt AM transmitter you can go to 500 or 1000 watts... simply by adding on an RCA 1-kw r-f power amplifier. Your BTA-250L then becomes your driver. Not a penny of your original transmitter investment is lost . . . because in this conversion there are no power tubes to discard or obsolete equipment left on your hands.

How quick and easy is it to convert? *You can make the change to higher power between "sign-off" and "sign-on"!*

This is one reason why the BTA-250L is a "natural" for stations planning a future power increase . . . or replacement of old equipment.

And there are many other reasons, too. Here is a transmitter that is *hushed* for quiet operation—uses no fans, blowers, or noisy a-c contact controls. It is designed with all controls and switches grouped on one central panel—and within handy reach. It provides an accurate means for logging . . . because it uses precision-type vernier tuning indicators. And all meters are located at eye-level for convenience of the operator.

For complete information about the BTA-250L . . . and how you can add an RCA 1-kw power amplifier to it *inexpensively* . . . call your RCA Broadcast Sales Engineer. Or write Dept. 19LA, RCA Engineering Products, Camden, New Jersey.

... add on this 1-kw Power amplifier type BTA-1L for high power later



# AM Broadcast Transmitter, Type BTA-1L



## Features

- Low installation and maintenance costs.
- Completely self-contained.
- Simple and efficient operation.
- Vertical chassis construction for accessibility and ventilation.
- 1000 watt, 500 watt, 500/1000 watt, 250/1000 watt and 250/500 watt operation.
- Adaptable to 500 or 250 watt operation.
- Low tube cost.

## Description

The BTA-1L is a one kilowatt AM transmitter designed to meet the most exacting demands of the modern broadcasting station. Essentially, the BTA-1L is composed of an RCA BTA-250L transmitter, serving as an exciter section, with the addition of an amplifier section. The complete transmitter is housed in an attractive cabinet assembly consisting of the BTA-250L cabinet, a matching amplifier cabinet, and a center section which contains the heavy power equipment. The completely accessible RCA open vertical chassis construction, which is used throughout, insures mechanical rigidity and good ventilation. The equipment is mounted in such a manner that every item can be easily removed by one man. Controls for each of the two units are grouped on indirectly illuminated panels conveniently placed on each of the two cabinets. There are no variable capacitors used in this transmitter. The tuning elements are continuously variable inductors which are connected to the control knobs by means of beveled gears and extension shafts. The tuning controls are provided with indicators so that their positions may be accurately logged. The cabinets and center section are finished in two-tone umber gray with trim strips of satin chrome.

The BTA-1L provides reliable, high-fidelity operation at any frequency between 540 and 1600 kc. Efficient high level modulation is employed. Only inexpensive tubes are used throughout and the number of tube types is kept to a minimum.

Two RCA low temperature coefficient quartz crystals mounted in RCA Type TMV-129-B temperature controlled holders are provided. The oscillator stage has an extra crystal socket in which the spare crystal may be continuously maintained at the correct temperature. These crystals provide excellent frequency stability with no greater deviation than  $\pm 10$  cycles from the assigned frequency. A control is provided in the oscillator circuit for precise adjustment of the crystal frequency.

The Type BTA-1L will deliver rated power into a 20 to 250 ohm transmission line or into any type of antenna normally used by broadcast stations. A matching network is provided between the output tank circuit and the output terminals of the transmitter which includes series inductors and shunt capacitors, resulting in excellent radio frequency harmonic attenuation. Output terminals are provided at the top of the cabinet for connections to an unbalanced open wire transmission line or antenna lead-in. A concentric transmission line may be connected through either the top or the base of the transmitter. Should the BTA-1L be coupled into either a concentric line or to a single ended line, the RCA Type BPA-1 (MI-28901) Antenna Tuner may be used. In such cases, a remote metering kit BPM-1A is available to replace the r-f ammeter in the transmitter.

Terminals are provided on the BTA-1L for modulation indication by means of a pickup coil coupled to the tank coil of the output stage. Excitation for r-f frequency monitoring is

taken off an r-f voltage divider across a capacitor in the ground side of the buffer stage. A-f monitoring is accomplished by means of a voltage developed across a resistor connected in series with the secondary of the modulation transformer, at which point a level of approximately +10 dbm is available at 100% modulation.

Control circuits are simplified and offer maximum protection to the transmitter and operating personnel. A distinctive feature is a relay which eliminates the necessity of recycling of the time delay when momentary power failures or interruptions occur. Overload protection is provided by using magnetic circuit breakers that also serve as switches.

The BTA-1L is normally supplied for operation at 1000 watts output. Where power change is required, a kit of power change equipment (MI-7188-A) is necessary and is easily installed on the chassis in the center section of the equipment. This equipment will reduce the power output from 1000 to 500 or 250 watts or from 500 to 250 watts as required. A variable transformer adjustable from the control panel provides a means of maintaining the proper voltages as required. A separate 110 volts, 50 to 60 cycle supply is required for the crystal heaters.

The BTA-1L is furnished with two sets of tubes and two crystals.

**Specifications**

- Carrier Frequency Range \_\_\_\_\_ 540 to 1600 kcs
- Carrier Frequency Stability \_\_\_\_\_ ±10 cycles
- Carrier Power Output
  - (a) 1,000 watts (c) 500/1,000 watts\*
  - (b) 500 watts (d) 250/1,000 watts\*
  - (e) 250/500 watts\*
- Carrier Frequency Harmonics \_\_\_\_\_ below .05%
- A-c Power Input (220 to 240 volt, 50/60 cycles, single phase (Line voltage regulation and variation not to exceed 5%))
  - Average Program Level at 1,000 watts \_\_\_\_\_ 4,500 watts
  - 500 watts \_\_\_\_\_ 3,700 watts
  - 250 watts \_\_\_\_\_ 3,350 watts
- 100% Modulation
  - 1,000 watts \_\_\_\_\_ 5,700 watts
  - 500 watts \_\_\_\_\_ 4,900 watts
  - 250 watts \_\_\_\_\_ 4,450 watts
- A-c Power Input (crystal heaters) \_\_\_\_\_ 110 volts, 28 watts
- Carrier Shift—from zero to 100% modulation \_\_\_\_\_ less than 5%
- Carrier Noise and Hum Level (unweighted below 100% modulation) \_\_\_\_\_ -60 db
- Audio Frequency Response (30 to 10,000 cycles) \_\_\_\_\_ ±1.5 db
- Audio Input for 100% Modulation \_\_\_\_\_ +11 dbm\*\*

- Audio Frequency Harmonic Distortion (50 to 7,500 cycles, 0 to 95% modulation) \_\_\_\_\_ not to exceed 3% rms
- R-f Load Impedance (unbalanced transmission line or antenna) \_\_\_\_\_ 20 to 250 ohms
- Dimensions, overall
  - Width \_\_\_\_\_ 108 3/4"
  - Depth (door swing 18 3/4") \_\_\_\_\_ 20 1/4"
  - Height \_\_\_\_\_ 84 7/8"
- Weight (unpacked) \_\_\_\_\_ 3,410 lbs.

**Tube Complement**

- For BTA-1L Transmitter Exciter Only \_\_\_\_\_ MI-7320
  - 1 RCA-807 1 RCA-810 2 RCA-6J7
  - 3 828 2 RCA-8008 1 RCA-5Y3GT
- For Type BTA-1L Amplifier Only \_\_\_\_\_ MI-7318
  - 4 RCA-833-A 4 RCA-8008 2 RCA-866/866A

**Stock Identification**

- BTA-1L Transmitter \_\_\_\_\_ MI-7186-B
- BTA-1L Amplifier (for 250K and BTA-250-L) \_\_\_\_\_ MI-7187-A (complete with conversion accessories)

**Equipment Supplied**

The following is a condensed list of equipment included as a complete BTA-1L transmitter:

- 1 Type BTA-1L Exciter Unit \_\_\_\_\_ MI-7281-B
- 1 Type BTA-1L Power Amplifier \_\_\_\_\_ MI-7185-A
- 1 Type BTA-1L Power Equipment Section \_\_\_\_\_ MI-7284-A
- 1 Type UL-4392 Crystal Oscillator Unit \_\_\_\_\_ MI-19458
- 1 Touchup Finish Kit \_\_\_\_\_ MI-7443
- 1 Miscellaneous Hardware Kit \_\_\_\_\_ MI-7474
- 2 Instruction Books \_\_\_\_\_ IB-30118-1
- 2 Type TMV-129B Crystal Units \_\_\_\_\_ MI-7467
- 1 RF Output Meter \_\_\_\_\_ MI-7157-B
- 2 Sets of Tubes \_\_\_\_\_ MI-7320/7318
- 1 Set of Station Call Letters \_\_\_\_\_ MI-26910

**Available Accessories**

- Type BPA-1 Antenna Tuner \_\_\_\_\_ MI-28901-A
- Power Change Equipment \_\_\_\_\_ MI-7188-A
- Type BPM-1A Remote Metering Kit \_\_\_\_\_ MI-28027/MI-28037-A
- Antenna Phasing Equipment \_\_\_\_\_ On application
- Antenna Towers and RF Transmission Line \_\_\_\_\_ On application

\* MI-7188-A Power Change equipment is required.  
 \*\* dbm = no. of db above one milliwatt when single frequency tone modulation is used.

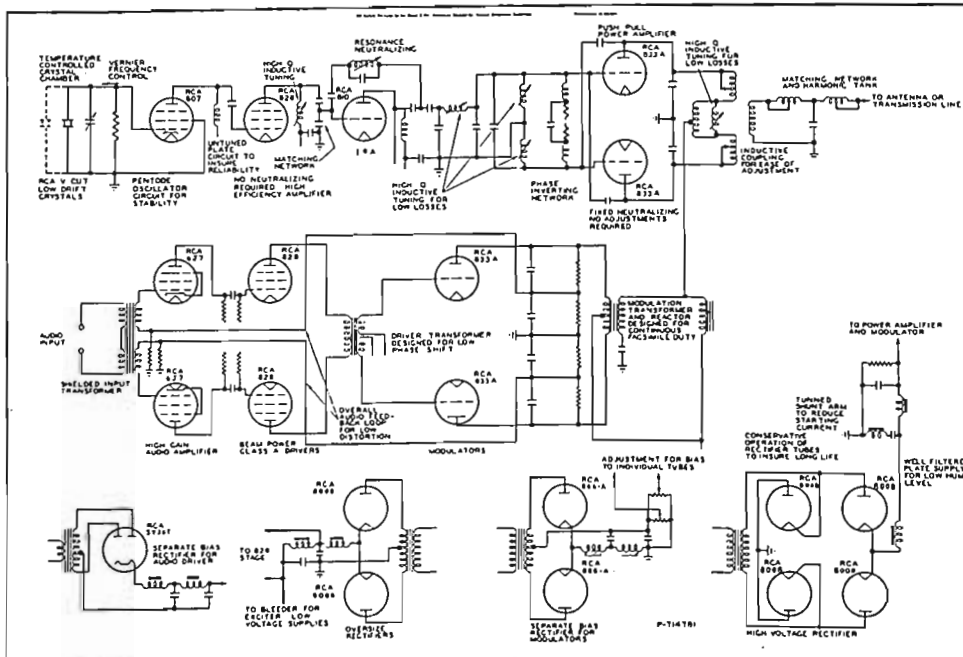

*Simplified Schematic Diagram of BTA-1L*



# AM Broadcast Transmitter, Type BTA-5F

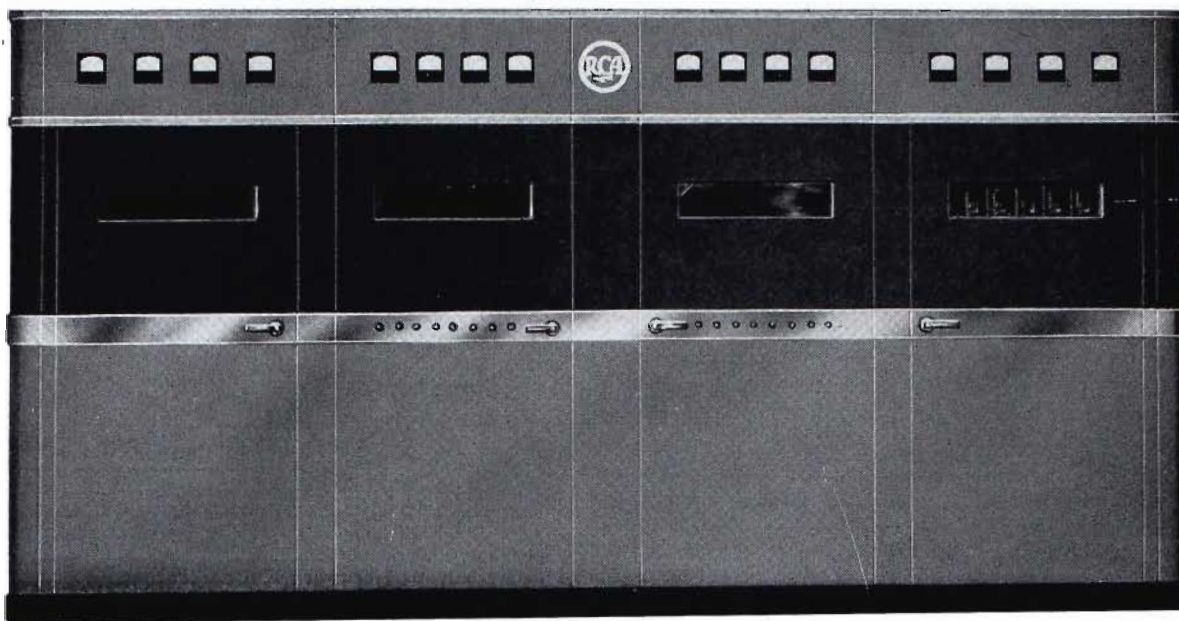

## Features

- Low operating cost—long life tubes—high efficiency circuits.
- Low installation cost—built-in wire channel—efficient layout.
- Vertical chassis construction—utmost accessibility.
- Push button electric tuning—complete circuit metering—panel viewing windows.
- Equipped with control console—centralized control system.
- Entirely air cooled—all cooling air filtered.
- Can be operated at 1 kw by the flick of a switch.
- Quickly and inexpensively converted for 10 kw operation.
- Extension wing cabinets available for housing phasing, monitoring, testing and audio equipments.

## Description

The BTA-5F 5 kw Broadcast Transmitter is considered one of the finest, most efficient equipments ever offered to broadcasters. Its excellent design includes refinements in circuits, carefully planned mechanical layout, long life components, and complete protection for personnel and equipment. The design of this transmitter is so conservative that it may be operated on 10 kw with only minor modifications. The front panel view of the new BTA-5F shows the attractive unified panel with two-tone amber gray finish and light trim.

The BTA-5F offers a new concept of accessibility. When the front doors are opened, components and tubes are immediately accessible. This feature provides ready access for servicing, and allows a quick change of tubes when failures occur. In addition it is possible to erect a smaller and less costly structure to house the transmitter.

Vertical chassis construction is employed throughout. This type of construction facilitates the removal or testing of components and insures better ventilation of the cabinet with resultant longer life for individual units.

No trick circuits are used in the BTA-5F. Basic circuits have been time-tested and proved in at least one hundred 5-D, 5-DX, 5-E and 5-F installations throughout the world. The use of straight-forward circuits which are easily adjusted and maintained, prevents loss of time, eliminates the necessity for buy-

ing extra test equipment and simplifies tuning and maintenance. Some of the time proven circuit design features are: Automatic reclosure without recycling on instantaneous power drop-outs.

Class C r-f Stages—easy tuning—no critical adjustments.

Class B Modulators—simple circuit design—high efficiency.

Equalized Feedback—low distortion operation—no adjustments.

Fixed Neutralization—stable performance.

The BTA-5F represents a distinct advance in tube economy. Fewer tubes are employed which reduces the number of spares required. Only 6 tube types are used as compared to 11 tube types in a previous design. Greater use is made of beam power tubes with consequently lower drive requirements and increased efficiencies. All tubes are air-cooled and each high power tube has its own blower, insuring an adequate supply of air and eliminating any possibility of overheating.

The control console for the BTA-5F has been designed to provide a maximum of ease and efficiency in station operation. Each major control function of the transmitter is at the engineer's fingertips, and important meters are placed within easy viewing distance.

For the purpose of housing phasing components and monitoring, test, and audio equipments, extension cabinets may be added to either or both ends of the BTA-5F.

## Increasing Power to 10 KW

The BTA-5F may be easily and inexpensively changed over to a standard RCA Type BTA-10F, 10 kw Transmitter by the installation of a 10 kw kit (MI-7267-A). The spare tube position of the BTA-5F provides a socket for the additional required Type 892-R Tube. Sockets, completely wired, are provided for two additional 828 modulator driver tubes. The MI-7267-A conversion kit includes a blower, filament transformers, 10 kw Modulation Transformer and Reactor, and all necessary accessories. Mounting facilities have been provided for new components so that conversion is rapid and easily made.

The BTA-5F is shipped with control console, 2 type TMV-129-B crystal units, 2 complete sets of tubes, 1 installation material kit, 1 touch-up kit and 2 instruction manuals.

**Specifications**

(All values under "Specifications" are based on RMA Load Impedances)

Type of Emission	A3
Normal Rated Power Output (into RMA normal load)	5 kw
Maximum Power Output	5.5 kw
Frequency Limits—Lower	540 kc
Upper	1600 kc
Frequency Stability	±10 cycles
<b>Power Supply Requirements:</b>	
Line Volts	230 volts
Phase	3
Frequency	50 or 60 cycle
Permissible Voltage Deviation	±5%
A-c Power Input	
Carrier Only	16.5 kw
*25% Modulation, Average Program Level	17.5 kw
100% Modulation (tone)	21.5 kw
<b>Crystal Oscillators</b>	
	115 volts, 50 or 60 cycle, single phase, 30 watts
<b>Modulation</b>	
	High level class B
<b>Audio Frequency Input—</b>	
Impedance	600 ohms
(Approx.)—100% Modulation Level	±12.5 dbm
<b>Audio Frequency Response 30-10,000 cy. uniform, within</b>	
	±1.5 db
<b>Audio Frequency Distortion 50-7,500 cy. not to exceed**</b>	
	3% rms
Residual Noise, Unweighted Below 100% Modulation	60 db
Maximum Ambient Operating Temperature	45° C.

**Tube Complement (MI-7083A)**

Crystal Oscillator 2—RCA 807; RF Buffer 1—RCA 828; RF Driver 2—RCA 810; Power Amplifier 1—RCA 892R; 1st AF Amplifier 2—RCA 1620; 2nd AF Amplifier 2—RCA 828; AF Driver 2—RCA 828; Modulator 2—RCA 892R; Bias Rectifier 2—RCA 8008; Low Power Rectifier 2—RCA 8008; Main Rectifier 6—RCA 8008.

**Mechanical Specifications**

Overall Length	171½"
Overall Height	85½"
Overall Depth (less modulation output unit and plate transformer)	38½"
Plate Transformer (air cooled)	33⅝" x 21" x 24⅝" high
Console	60" x 34½" x 41½" high
<b>Modulator Output Unit (BTA-5F)</b>	
Modulation Transformer	26" x 19½" x 23½" high
(Output Filter—Increases transformer height from 23½" to 27½")	
Building Entrance Requirements	38½" wide, 87" high

Weight in Pounds (unpacked):

Transmitters (Less Modulator Output Unit)	6000
Modulator Output Unit	
Modulation Transformer, Modulation Reactor, Blocking Capacitor	992
Plate Transformer (air cooled)	750
Console	393

**Equipment Furnished**

The BTA-5F Transmitter (MI-7260-C) consists of:

1 RF Unit	MI-7259-E
1 L.P. Rectifier	MI-7253-C
1 A.F. Unit	MI-7258-E
1 Modulator Output Unit	MI-7087-A
1 Power Control Unit	MI-7257-A
1 Base Assembly	MI-7255-A
1 Enclosure	MI-7256-A
1 Interconnection Jumper Kit	MI-7077
1 Plate Transformer (air cooled)	MI-7088-C
2 UL-4392 Crystal Oscillator Unit	MI-19458
1 Supervisory Control Console	MI-11616
2 TMV-129B Crystal Unit	MI-7467
1 Miscellaneous Hardware Kit	MI-7474
1 Tool Kit	MI-7086-B
1 Touch-up Kit	MI-7499-A
2 Sets of Tubes	MI-7083-A
1 Set of Frequency Determining Parts	MI-19465-A
1 Nameplate	MI-28180-A
1 Installation Wiring Kit	MI-7268-E
2 Instruction Books	IB-30140
2 Installation Prints	IB-300991-1

**Available Accessories**

(Consult nearest RCA office for particulars)

Antennas and RF Transmission Lines	On application
Antenna Tuner, BPA-10 (less or with monitor)	MI-28902A or B
Special Phasing Equipment	On application
Transmitter Amplifier and Monitor Rack	MI-11623
Test and Measuring Equipment	On application
<b>Modification Kit for converting BTA-5F to BTA-10F (with one set of tubes) 60 cycle</b>	
	MI-7267-A
Set of Tubes for BTA-5F	MI-7083-A
Left Wing Extension Cabinet (Phasing)	MI-7485-F
Right Wing Extension Cabinet (Audio)	MI-7485-E
50 Cycle Conversion Kit	MI-7085-A
Line Voltage Regulator	On application

\* For 5 kw output, power factor is 85%.

For 1 kw output, power factor is 78%.

\*\* At 95% Modulation and operating into a load within RMA limits.

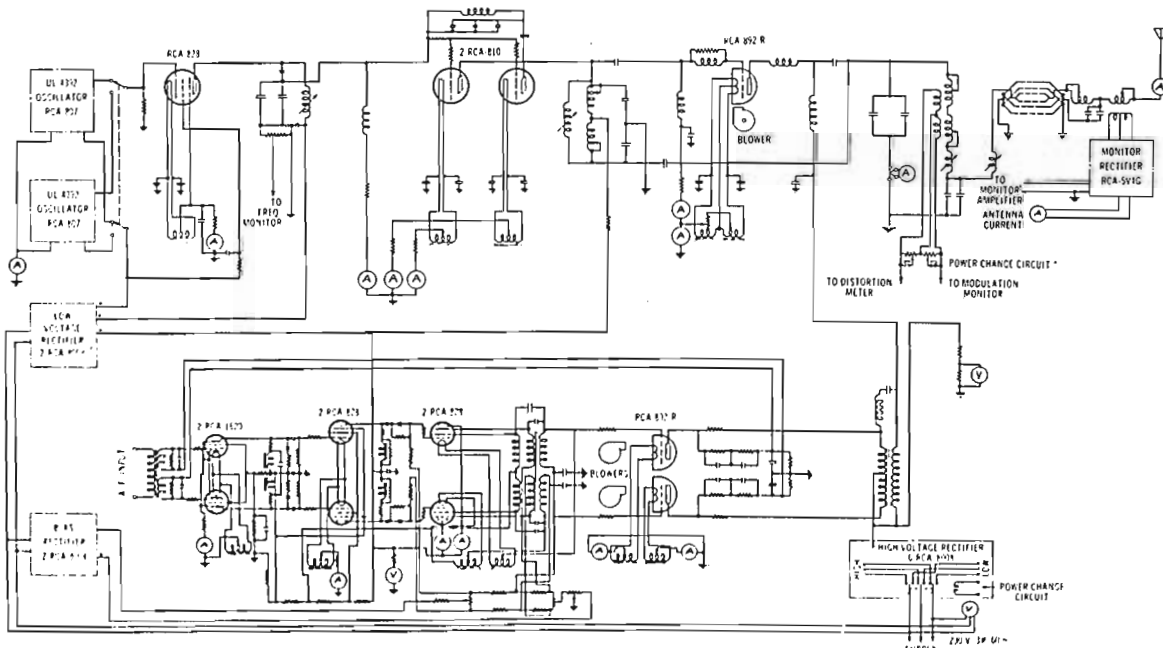



# The 5-KW AM TRANSMITTER.\*



\* The RCA 10-KW AM transmitter, Type BTA-10F, is identical in size and appearance to the BTA-5F you see here. Over 125 transmitters of this series now in operation.

*(Photo courtesy of Radio Station KOOL,  
Phoenix, Arizona)*



# with 10-kilowatt insurance

**BTA-5F.** The one 5-KW AM Transmitter that insures easy increase to 10 KW at any time! Power changeover is simple...inexpensive...quick. *Because it was planned that way.*

When you install the BTA-5F Transmitter for 5-KW operation there is just one tube in the power amplifier stage (left-hand cubicle in view below). But note the additional tube socket already mounted in place. To increase power to 10 KW, you need only buy the simple modification kit (described in box at right). With the parts contained in this kit...and the few simple circuit changes required, changeover can be made "overnight." It's easy...it's inexpensive. You need lose no air time.

Naturally, you can also buy this transmitter originally for 10-KW operation (specified as Type BTA-10F). Both models—the BTA-5F for 5-KW operation, and the BTA-10F for 10-KW operation—have the same sleek, well-finished, business-like appearance shown by COL's installation on the opposite page. Both models have the true unified front...an *exclusive feature* of RCA high-power AM transmitters. This front is an integral piece *separate from the compartment enclosures*. It greatly facilitates flush-mounting...and improves appear-

ance of the installation by several times.

And careful planning like this goes right on through. For instance, this transmitter is equipped with one of the most complete centralized control systems ever designed for *any* transmitter... with all the necessary controls, circuit breakers and relays needed for fully automatic operation or step-by-step manual operation. It has push-button motor-tuning for its high-power stages...and instantaneous power control reduction. It can be furnished with matching cabinet end-extensions for housing antenna phasing, monitoring, test and audio equipment. These extensions have front sections that become an integral part of the overall unified front—another exclusive RCA feature of great importance in station appearance. And note this too: the 5-KW BTA-5F uses only 24 tubes (6 different tube types); the 10-KW BTA-10F uses only 27 tubes (6 different types).

Here, we believe, is the finest streamlined station installation ever engineered for standard-band broadcasting... with all basic circuits proved in more than 125 transmitters of this series now operating throughout the world. Get the details from your RCA Broadcast Sales Engineer, or write Department 19AD

This simple kit (MI-7267-A) takes the BTA-5F to 10 KW... inexpensively and without one change in station layout.

- One blower
- Two filament transformers
- One 10-KW modulation transformer
- One reactor
- All necessary hardware



The Transmitter Control Console—standard equipment with every BTA-5F and BTA-10F.

THE 5-KW BTA-5F (open view). Sweet and simple... with everything up front where you can reach it.

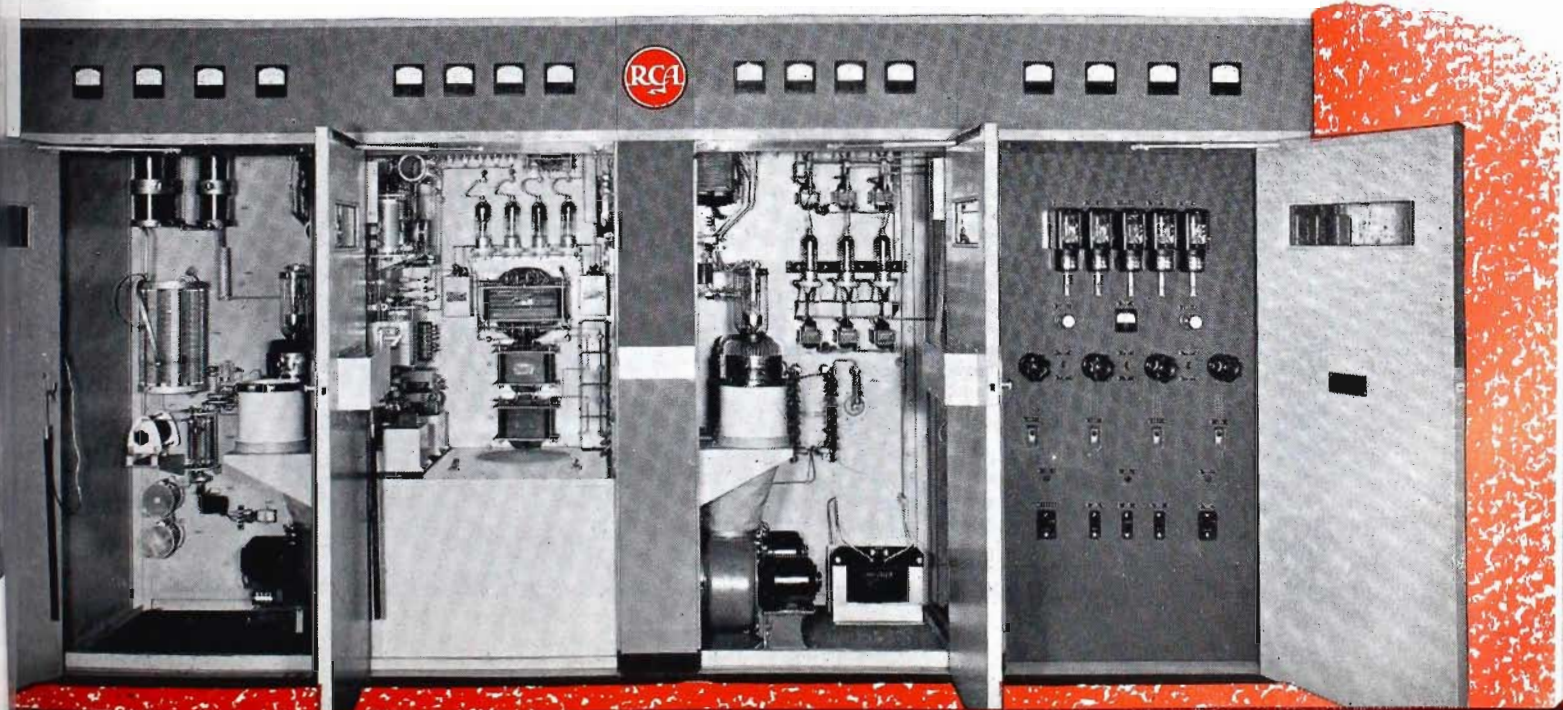



# AM Broadcast Transmitter, Type BTA-10F

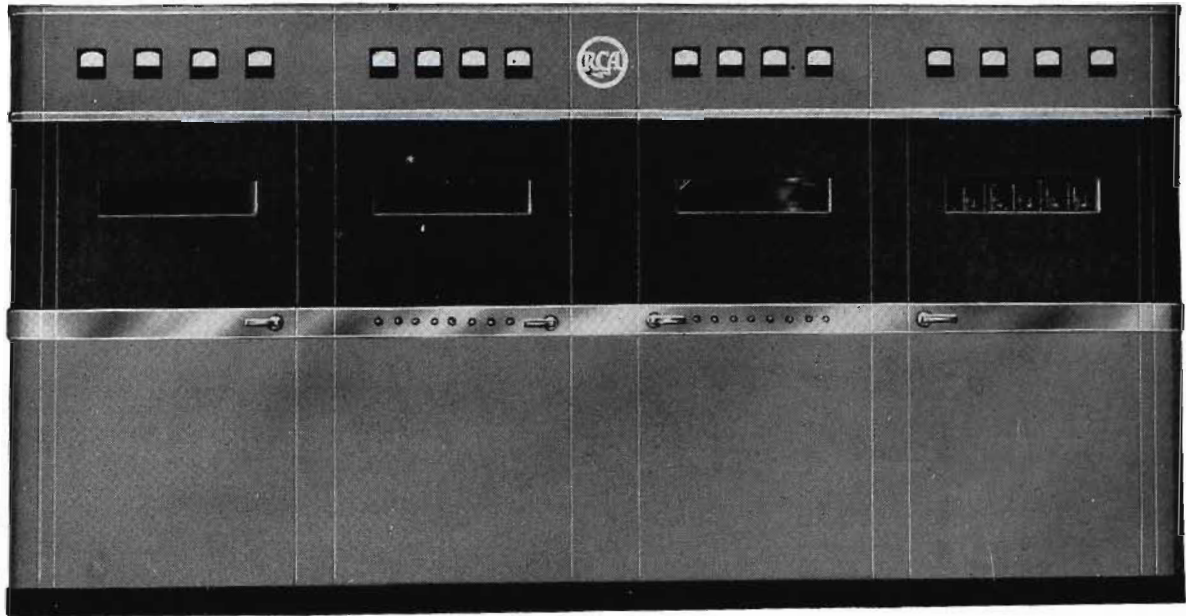

## Features

- Low operating cost—long life tubes—high efficiency circuit.
- Low installation cost—efficient layout—built-in wire channel.
- Vertical chassis construction—utmost accessibility—tubes easily removed.
- Entirely air-cooled. Push button electric tuning.
- Automatic reclosure without recycling on instantaneous power drop-out.
- Equipped with control console—centralized control system.
- Power output may be reduced to 2 kw in emergencies by operation of one switch.
- Extension wing cabinets available for housing phasing, monitoring, testing and audio equipments.
- Tube hour meter.
- Dry transformers.

## Description

The Type BTA-10F provides a 10 kw AM transmitter which is outstanding in appearance, performance, and reliability. Fidelity, distortion, and noise level are held to standards meeting the highest requirements. Economy is assured by the use of extremely long life tubes, and the highly efficient high level system of modulation. The cost of operation per hour of this 10 kw equipment has been shown to be considerably less than that of many 5 kw installations.

Basically this 10 kw Transmitter is similar to the Type BTA-5F 5 kw Transmitter. It differs in that it includes an additional 892-R tube with its associated filament transformers and blower motor, a larger modulation transformer, a reactor and two additional 828 modulator driver tubes. The conditions of operation of the tubes are the same, permitting similar performance and the same long tube life which experience has proved to be attained in the BTA-5F Transmitter. The fidelity of transmission and operating efficiency of the Type BTA-10F Transmitter is exceptional. Its high level modulation system is identical to that incorporated in the BTA-5F. The audio feedback circuit is extremely stable and unaffected by adjustments of the radio frequency circuits. Other exclusive circuit design features of the BTA-10F will be found under the description of the type BTA-5F Transmitter.

The BTA-10F Transmitter is equipped with an attractive, unified front panel finished in two-tone umber gray and light trim. Extension cabinets are available for both ends for phasing components and monitoring, test and audio equipment. This compact design not only represents the ideal installation but

also permits transmitter houses to be planned for a complete installation with minimum space requirements.

The BTA-10F is shipped with control console, 2 type TMV-129-B Crystal Units, 2 complete sets of tubes (except only seven 892-R tubes are supplied), interconnecting wire kit, 1 touch-up paint kit and 2 instruction manuals.

## Specifications

(All values under "Specifications" are based on RMA Load Impedances)

Type of Emission	A3
Normal Rated Power Output (into RMA normal load)	10 kw
Maximum Power Output	10.6 kw
Frequency Limits—Lower	540 kc
Upper	1600 kc
Frequency Stability	±10 cycles
Power Supply Requirements:	
Line Volts	230 volts
Phase	3
Frequency	50 or 60 cycle
Permissible Voltage Deviation	±5%
A-c Power Input	
Carrier Only	24.0 kw
*25% Modulation, Average Program Level	26 kw
100% Modulation (Tone)	33.5 kw
Crystal Oscillators	115 v., 50 or 60 cy., single phase, 30 watts
Modulation	High level class B
Audio Frequency Input—	
Impedance	600 ohms
(Approx.)—100% Modulation Level	±12.5 dbm
Audio Frequency Response 30-10,000 cy. uniform,	
within	±1.5 db
Audio Frequency Distortion 50-7,500 cy.	
not to exceed**	3% rms
Residual Noise, Unweighted Below 100% Modulation	60 db
Maximum Ambient Operating Temperature	45° C.

## Tube Complement (MI-7084A)

Crystal Oscillator, 2 RCA 807; RF Buffer, 1 RCA 828; RF Driver, 2 RCA 810; Power Amplifier, 2 RCA 892R; 1st AF Amplifier, 2 RCA 1620; 2nd AF Amplifier, 2 RCA 828; AF Driver, 4 RCA 828; Modulator, 2 RCA 892R; Bias Rectifier, 2 RCA 8008; Low Power Rectifier, 2 RCA 8008; Main Rectifier, 6 RCA 8008.

\*\* At 95% Modulation and operating into a load within RMA limits.

**Mechanical Specifications**

Dimensions in inches (Approx.)

Overall Length	171½"
Overall Height	85½"
Overall Depth (less modulation output unit and plate transformer)	38½"
Plate Transformer (air cooled)	33⅝" x 21" x 24⅝" high
Console	60" x 34½" x 41½" high
Modulator Output Unit (BTA-10F)	
Modulation Transformer	26" x 20" x 24⅞" high
Modulation Reactor	29½" x 27" x 22" high
Blocking Capacitor and Output Filter	26½" x 6¼" x 20" high
Building Entrance Requirements	38½" wide, 87" high
Weight in Pounds (unpacked):	
Transmitters (Less Modulator Output Unit)	6500
Modulator Output Unit	
Modulation Transformer	1115
Modulation Reactor	1340
Blocking Capacitor	58
Plate Transformer (air cooled)	750
Console	393

**Equipment Furnished**

The BTA-10F Transmitter (MI-7266-C) consists of:

1 RF Unit	MI-7259-G
1 L.P. Rectifier	MI-7253-D
1 A.F. Unit	MI-7258-G
1 Modulator Output Unit	MI-7087-B
1 Power Control Unit	MI-7257-C

1 Base Assembly	MI-7255-A
1 Enclosure	MI-7256-B
1 Interconnection Jumper Kit	MI-7077
1 Plate Transformer (air cooled)	MI-7088-C
2 UL-4392 Crystal Oscillator Unit	MI-19458
1 Supervisory Control Console	MI-11616
2 TMV-129B Crystal Unit	MI-7467
1 Miscellaneous Hardware Kit	MI-7474
1 Tool Kit	MI-7086-B
1 Touch-up Kit	MI-7499-A
2 Sets of Tubes	MI-7084-A
1 Set of Frequency Determining Parts	MI-19465-B
1 Nameplate	MI-28180-1
1 Installation Wiring Kit	MI-7268-E
2 Instruction Books	IB-30141
2 Installation Notes	IB-30099-1

**Available Accessories**

(Consult nearest RCA office for particulars)

Antennas and RF Transmission Lines	On application
Antenna Tuner, BPA-10 (less or with monitor)	MI-28902A or B
Special Phasing Equipment	On application
10 to 5 kw Antenna Cutback Kit	MI-28152
Transmitter Amplifier and Monitor Rack	MI-11623
Test and Measuring Equipment	On application
Modification Kit for converting BTA-5F to BTA-10F (with one set of tubes) 60 cycle	MI-7267-A
Set of Tubes for BTA-10F	MI-7084-A
Left Wing Extension Cabinet (Phasing)	MI-7485-F
Right Wing Extension Cabinet (Audio)	MI-7485-E

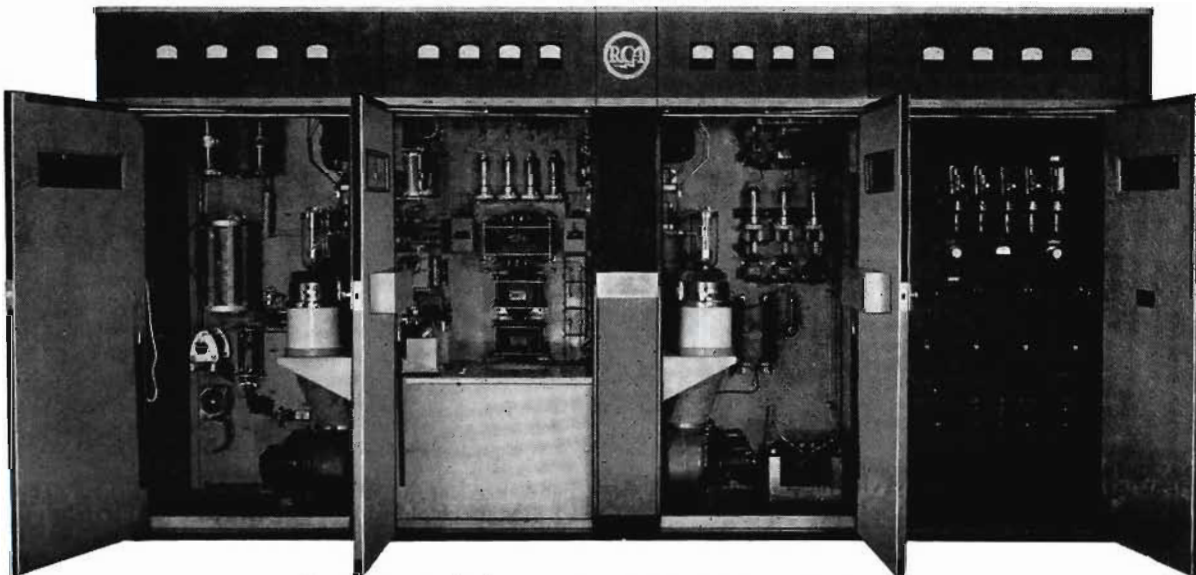

Front view with doors open showing interior construction.  
BTA-10F Transmitter with left and right wing extension cabinets.





# Transmitter Control Console, MI-11616



## Features

- Simplifies transmitter installation.
- Major control functions are at engineer's fingertips and important meters are within easy viewing distance.
- Contains all required mixing and switching facilities.
- Standardized vu meter plus extension modulation monitor and antenna current indication.
- All necessary controls for transmitter operations plus visual indicating lamps.

## Uses

The MI-11616 Transmitter Control Console is an attractive desk type console containing all the mixing and switching facilities required at the transmitter plant. It is equipped with a standardized vu meter, extension modulation monitor meter and antenna current meters. Designed primarily for use with the RCA BTA-5F and BTA-10F Broadcast Transmitter, it may be combined with the MI-11623 Transmitter Monitor and Amplifier Rack to provide a most flexible and complete system of control and monitors.

## Description

All controls, switches and meters are mounted on three panels which are assembled in the turret mounted on a metal desk. Each panel is hinged at the bottom so that it may be opened for easy servicing and the entire rear cover of the turret may be removed to facilitate installation or basic changes. Desk and turret are of metal construction throughout. The left hand pedestal contains a typewriter shelf and the right pedestal contains two convenient drawers. A third drawer is located in the center between the pedestals. A cylinder lock on this drawer also locks the drawers in the pedestal. Skirts have been provided below the pedestals to conceal the wiring conduits and all wiring is carried inside the desk. The desk top is covered with black linoleum with rounded corners and metal trim.

Mechanically interlocked push-keys permit instant selection of the circuit to be monitored by the vu meter or by the monitoring amplifier. By means of these keys, the monitoring speaker may be used to check (1) transmitter audio input, (2) transmitter audio output, (3 and 4) two incoming lines and (5) turntable output.

Balanced, high quality, step-by-step mixers are provided for the (1) incoming line, (2) announce microphone and (3) turntable. A master or transmitter input control and a monitor amplifier volume control are also furnished. Key switches in the outputs of the microphone and turntable mixers are equipped with indicating lamps. The microphone key is interlocked with the monitoring speaker through a relay and disconnects the speaker whenever the microphone is on. A line transfer key permits ready selection of two incoming lines and transfers the telephone set to the line not being used for the program. A three position key switch selects the studio line or the local microphone and turntable. Chromium plated guards prevent accidental operation of the important keys. A spare

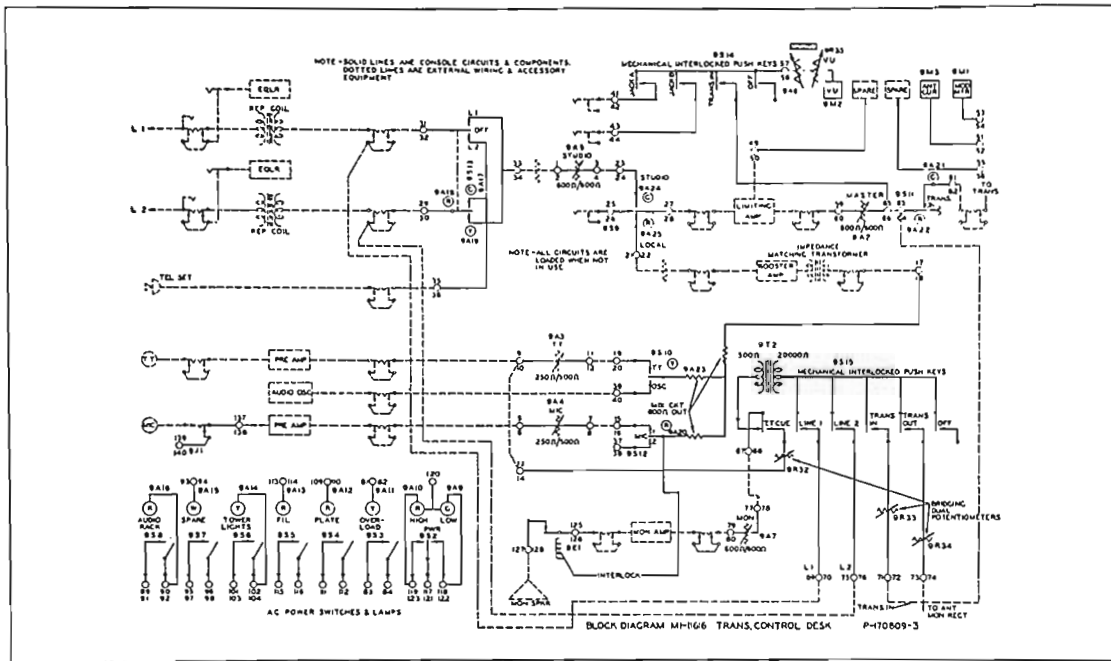

*Block Diagram MI-11616 Transmitter Control Desk*

D. P. D. T. lever key is furnished for the convenience of station personnel. The center panel contains a standardized vu meter, with a step-by-step control making it possible to read levels of +4 vu to +40 vu; a modulation meter intended to operate as an extension for a type 66A modulation monitor and an antenna current indicator consisting of a 0-50 ma, d-c movement with a scale of 50 divisions calibrated linearly from 0 to 10 amperes r-f (other scales are available) and intended to be connected into the rectified carrier circuit. Cutouts are provided for two additional meters such as an extension db compression meter for the limiting amplifier; an extension meter from a frequency monitor or additional antenna current indicators where required. The attenuator controls are located below the meters on the center panel.

A 12 volt, 1 ampere, d-c power supply furnishes power to the speaker interlocking relay and to the audio circuit indicating lamps. The power supply utilizes a copper sulphide dry rectifier and capacity filter.

The power control switches are mounted on the left hand panel and are designed for 230 volt operation. Associated lamps are furnished and may be arranged for operation on 115 volt for audio power and 230 volt for transmitter power. Switches and lamps are provided for (1) transmitter filaments, (2) transmitter plate, (3) overload reset, (4) transmitter high-low power transfer, (5) tower lights, (6) audio equipment and (7) spare.

**Specifications**

**Input Impedances**

- Lines 1 and 2, Studio, Master and Monitor Controls...600 ohms
- Telephone Set...600 ohms
- Microphone and Turntables...250 ohms
- Monitor—Transmitter in and out (Bridging)...20,000 ohms
- Monitor—Lines 1 and 2...20,000 ohms

**Output Impedances**

- Lines 1 and 2, Lever Key; Microphone and Turntable Mixer; Studio, Master and Monitor Control...600 ohms
- Microphone and Turntable Controls...250 ohms
- Frequency Response (30 to 15,000 cycles).....±0.1 db
- Insertion Losses (microphone and turntable mixer circuit).....7 db

Noise Level: Circuits are isolated so that residual noise level will not exceed the aggregate noise level of the associated amplifiers.

**A-c Power Input for Lamps and Relays**

- (105-125 volts, 50-60 cycles).....25 watts
- Dimensions, overall...Width 60", depth 34½", height 41½"
- Note—Turret extends approximately 11" above desk top
- Weight (unpacked).....393 lbs.
- Stock Identification...MI-11616

**Accessories**

- Transmitter Monitor and Amplifier Rack...MI-11623
- Extension Meter for 86-A1 Amplifier...Stock No. 43504

**5/10 KW Conversion Kits For RCA AM Transmitters**

Any RCA 5 KW broadcast transmitter from type 5D to type BTA-5F may be easily and inexpensively modified to a standard 10 KW RCA transmitter by installing a 5/10 KW conversion kit. The conversion kit includes a blower, filament transformers, modulation transformer, reactor and all other necessary accessories and instructions.

Conversion can be easily and rapidly accomplished without loss of air time since only minor changes in the existing installation are required. The converted transmitter is efficient and reliable and has quality equal to that of the original.

Moreover, this does not make the installation an orphan, for with this change the former 5 KW transmitter becomes a

standard RCA 10 KW unit which is registered with the FCC as such, and for which replacement parts can be readily obtained.

- 5D to 10D Conversion Kit...MI-7303
- 5DX to 10DX Conversion Kit...MI-7303-A
- 5F to BTA-10F...MI-7267-A
- or
- BTA-5F to BTA-10F
- (60 cycle).....MI-7267-A
- (50 cycle).....MI-7267-B



# AM Broadcast Transmitter, Type BTA-50F1

## Features

- Low power consumption—reduced operating costs.
- Unified front design—facilitates flush mounting—attractive appearance.
- Fewer tube types—only 9 types of tubes used in entire 50 KW transmitter—fewer spares needed.
- Simplified Power Supply Circuits—only 3 vacuum tube rectifiers used in entire transmitter.
- Small floor space requirements—built-in wiring duct for ease of installation and lower installation costs.
- Spare tube positions in Power Amplifier, Modulator, and Main Rectifier.
- Modern P. A. and modulator design—Type RCA 5671 (thoriated-tungsten filament design) is used in both.
- Walk-in access to every section.
- Simplified control with high-speed air circuit-breaker fault interruption and reclosure.
- Supervisory control console furnished.

## Description

Providing up to 53 kilowatts of r-f power, the new RCA BTA-50F1, all air-cooled AM transmitter operates in the range of 540 to 1600 kc. It not only incorporates the latest in modern, deluxe transmitter design—but includes features “proved in” through twenty years of actual service . . . many features as familiar to broadcasters as station call letters. Each RCA 50 kw design has improved on previous designs—new features added.

The BTA-50F1, latest of the “RCA 50” series, is designed to insure *minimum installation cost* plus economy and simplicity of operation. Heavy-duty components are used throughout. All are features that mean *less air time lost* and reduced maintenance costs. Moreover, the BTA-50F1 is outstanding among 50 kw designs in its *unusually low power consumption*—another factor contributing to reduced operating costs.

Electrically, the BTA-50F1 crystal oscillator is followed by three stages of r-f amplification and the final power amplifier. Simplified single-ended circuits are used with push-button motor tuning provided in IPA, R-F driver and Power Amplifier. The audio section of the BTA-50F1 employs push-pull circuits with fixed audio feedback. This design results in excellent fidelity characteristics with very low distortion and noise level. A minimum number of audio stages and high level, class B modulation provide further economy of equipment and operation. By using high gain tubes in stabilized circuits—a total of only four audio stages are needed (including the modulator) to provide excellent over-all audio performance.

Both modulator and power amplifier employ the same type tube, thus providing greater spare tube economy. Fewer tuned circuits (only 8 simple, single-ended circuits—4 motor-tuned and 4 fixed tuned)—and fewer tube types (only 9 in the entire 50 kw transmitter) are required than in ordinary transmitters of similar power.

Mechanically, the BTA-50F1 is made up of five main units: the exciter, modulator, power amplifier, main rectifier, and control-and-distribution section. All sections are mounted immediately behind a single unified-front panel enclosure, which is thirty-three feet long and eighty-four inches high. Full length doors are provided in each section, front and rear to provide maximum accessibility to tubes and components.

Modulation transformer, reactor and high-voltage plate transformers are oil-filled and require no attention other than occasional inspection of oil. The main filter reactor is air cooled



and may be located in the transformer vault or at the rear of the transmitter. A typical transmitter installation requires a space of only 33 x 17 feet for transmitter and associated control and power equipment. A control console finished in umber gray to blend with the transmitter styling is furnished.

## Performance Specifications

Operating Frequency—Any specific frequency in the band from 540 kc to 1600 kc  
 R. F. Power Output—53 kw at transmitter terminals  
 \*Output Load Impedance—40 to 250 ohms—zero reactance  
 Radio Frequency Stability—±10 cycles  
 Audio Frequency Response—±1 db from 30 to 10,000 cycles from a reference level of 1000 cycles at 60% modulation  
 Audio Input Impedance—600 ohms  
 Audio Input Level—Plus 10 dbm at 100% modulation (0 VU, Average Program level)  
 \*Audio Distortion—Less than 3% RMS from 50 to 7500 cycles at 90% modulation  
 Noise Level—RMS—60 db below 100% modulation  
 \*Carrier Shift—Less than 5%  
 R. F. Harmonics—70 db below carrier fundamental measured at one mile

	With 50 KW into Non-Directional Radiator	With 52.5 KW into A Directional System
Power Consumption:		
Without Modulation	96.5 kw	99.5 kw
(@ 87% P. F.)		
25% Modulation (@ 88% P. F.)	104.5 kw	108.0 kw
100% Modulation (@ 90% P. F.)	138.0 kw	143.0 kw

(A loss of 500 watts, approx., has been allowed between the transmitter terminals and the point of power measurement.)  
 Power Supply Requirements—460 volts, 60 cycles, 3 phase, 3 wire, with 5% maximum combined regulation and variation. The equipment can be adapted for 50 cycle operation by minor modification.

\* These values are based on RMA minimum standard normal load specifications.

**Console**—For Specifications on Console see Page 232.

**Tube Complement**

- For RF Exciter Unit: Crystal Oscillators (2) 2 RCA 807, Buffer Amplifier 1 RCA 828, Low Power R-F 2 RCA 810, 5 kw I. P. A. 1 RCA 892-R, Low Power Rectifier 2 RCA 8008.
- For Main Modulator: First A-F Input Amplifier 2 RCA 6C6, Second A-F Amplifier 2 RCA 828, Driver 4 RCA 828, Modulator 2 RCA 5671, Bias Rectifier 2 RCA 8008, Stabilizing Rectifier 2 RCA 5R4GY.
- For Power Amplifier \_\_\_\_\_ 2 RCA 5671
- For Main Rectifier \_\_\_\_\_ 6 RCA 857-B
- For Antenna Monitor Rectifier \_\_\_\_\_ 1 RCA 5V4G

**Mechanical Specifications**

- (Dimensions in inches—Weight, uncrated in pounds)
1. MI-7041 Enclosure \_\_\_\_\_ Approx. Weight 2800 lbs.  
Width 39 $\frac{1}{2}$ ; Height 84  
This enclosure is broken down into 6 sections to facilitate shipping and handling.
  2. MI-7042 RF Exciter \_\_\_\_\_ Approx. Weight 1800 lbs.  
Height 88 $\frac{1}{4}$ ; Width 42; Depth 42 $\frac{3}{4}$
  3. MI-7044 Main Modulator \_\_\_\_\_ Approx. Weight 1850 lbs.  
Overall Height including Insulators 87 $\frac{1}{4}$ ; Width 63 $\frac{3}{4}$ ; Depth 42 $\frac{1}{2}$
  4. MI-7043 50 kw Power Amplifier \_\_\_\_\_ Approx. Weight 3600 lbs.  
Overall Height including insulators 93 $\frac{3}{4}$ ; Width 96 $\frac{1}{4}$ ; Depth 66
  5. MI-7378 Main Rectifier \_\_\_\_\_ Approx. Weight 1250 lbs.  
Height 81; Width 29 $\frac{1}{2}$ ; Depth 75 $\frac{1}{4}$
  6. MI-7046 Control and Distribution \_\_\_\_\_ Approx. Weight 4300 lbs.  
Height 90; Width 46; Depth 74
  7. MI-7048 Rectifier Plate Transformer \_\_\_\_\_ 1400 lbs.  
Approx. Weight \_\_\_\_\_  
Height 53; Width 27; Depth 27
  8. MI-28040 A and B Filament Power Units \_\_\_\_\_ 300 lbs.  
Approx. Weight \_\_\_\_\_  
Height 38; Width 26; Depth 12 $\frac{1}{2}$
  9. MI-7344-1 Modulation Transformer \_\_\_\_\_ 6100 lbs.  
Approx. Weight \_\_\_\_\_  
Height 90 $\frac{3}{4}$ ; Width 56 $\frac{3}{8}$ ; Depth 48 $\frac{1}{8}$
  10. MI-7344-2 Modulation Reactor \_\_\_\_\_ Approx. Weight 4000 lbs.  
Height 90 $\frac{1}{2}$ ; Width 39 $\frac{1}{2}$ ; Depth 43
  11. MI-7383 Main Filter Reactor \_\_\_\_\_ Approx. Weight 2000 lbs.  
Height 56 $\frac{1}{8}$ ; Width 37 $\frac{7}{8}$ ; Depth 29 $\frac{3}{8}$
  12. MI-7047 Switchgear Unit \_\_\_\_\_ Approx. Weight 3500 lbs.  
Height 90; Width 44; Depth 48
  13. MI-7049 Blower \_\_\_\_\_ Approx. Weight 1200 lbs.  
Max. Height (each unit) 61 $\frac{7}{8}$ ; Overall Width 39 $\frac{1}{8}$ ; Depth including motor 86

14. MI-7389 Monitor Rectifier \_\_\_\_\_ Approx. Weight 50 lbs.  
Height 24 $\frac{3}{8}$ ; Width 15 $\frac{3}{8}$ ; Depth 6 $\frac{1}{8}$
15. MI-11621 Supervisory Console \_\_\_\_\_ Approx. Weight 500 lbs.  
Height 41 $\frac{1}{4}$ ; Width 60; Depth 34
16. MI-7380-A Tube Jack \_\_\_\_\_ Approx. Weight 800 lbs.

**Equipment Furnished**

Following is a condensed list of equipment included as a complete BTA-50F1 Transmitter (MI-7050-A):

- 1 Unified Front Panel \_\_\_\_\_ MI-7041
- 1 RF Exciter Unit \_\_\_\_\_ MI-7042
- 1 50 kw Power Amplifier Unit \_\_\_\_\_ MI-7043
- 1 Main Modulator Unit \_\_\_\_\_ MI-7044
- 1 Main Rectifier and Filter Capacitor \_\_\_\_\_ MI-7378
- 1 Control and Distribution Unit \_\_\_\_\_ MI-7046
- 1 Switchgear Unit \_\_\_\_\_ MI-7047
- 1 Filament Power Unit, Power Amplifier \_\_\_\_\_ MI-28040-A
- 3 Main Rectifier Plate Transformer \_\_\_\_\_ MI-7048
- 1 Blower and Filter Equipment \_\_\_\_\_ MI-7049
- 1 Filament Power Unit, Modulator \_\_\_\_\_ MI-28040-B
- 1 Main Modulation Transformer Reactor and Coupling Capacitor \_\_\_\_\_ MI-7344
- 1 Main Filter Reactor \_\_\_\_\_ MI-7383
- 1 Remote Antenna Meter \_\_\_\_\_ MI-7384-C
- 1 Protective Relay Panel \_\_\_\_\_ MI-7387
- 1 Monitor Rectifier Unit \_\_\_\_\_ MI-7389
- 1 Supervisory Console \_\_\_\_\_ MI-11621
- 1 Complete Set of Tubes \_\_\_\_\_ MI-28194-A1/A2
- 1 Spare Set of Tubes (complete set less one 5671) \_\_\_\_\_ MI-28194-A1/A3
- 2 Crystals in TMV-129B Holders \_\_\_\_\_ MI-7467
- 1 Tube Jack \_\_\_\_\_ MI-7380-A
- 2 Instruction Books \_\_\_\_\_ IB-30200
- 2 Crystal Oscillator Units \_\_\_\_\_ MI-19458

**Available Accessories**

(Consult nearest RCA Office for particulars)

- Antenna Tuner (230 ohms) \_\_\_\_\_ MI-28903-A
- Antenna Tuner (70 ohms) \_\_\_\_\_ MI-28903-B
- Modification Kit for operation on 50 cycle power supply \_\_\_\_\_ MI-7037
- Audio and Monitoring Rack, factory wired for use with MI-11621 Transmitter Control Desk \_\_\_\_\_ MI-11623
- Antenna Phasing Equipment \_\_\_\_\_ On application
- Antenna Towers and RF Transmission Line \_\_\_\_\_ On application
- Measuring and Test Equipment \_\_\_\_\_ See RCA Catalog
- Installation Material and Engineering Service \_\_\_\_\_ On application
- Water Cooled Dummy Antenna \_\_\_\_\_ On application
- Spare Parts \_\_\_\_\_ On application
- Power Reduction Kit, 50/10 KW \_\_\_\_\_ MI-28905

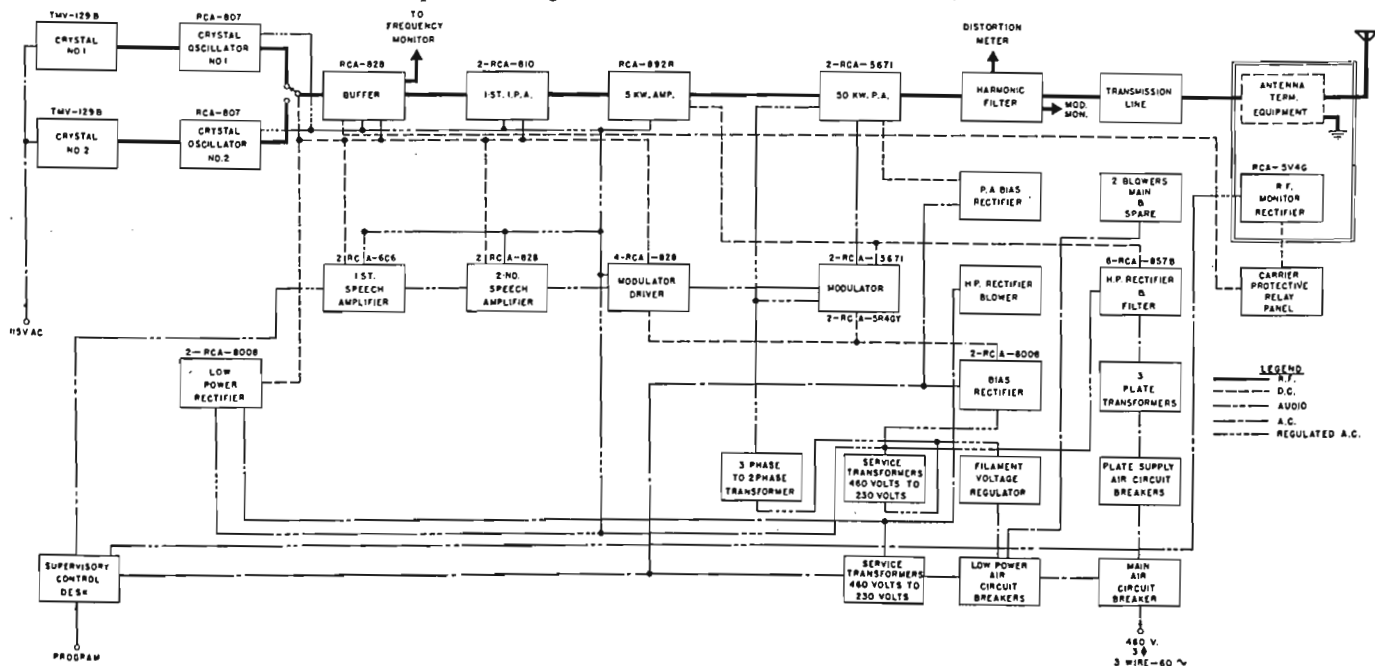



# 50 KW AM Supervisory Console, MI-11621



## Features

- Simplifies transmitter operation.
- Provides switching facilities for emergency announce microphone and turntable operation.
- Balanced high-quality mixers and selector keys provided for incoming line, announce and turntable operation.
- Monitor selector switch permits monitoring of transmitter audio input, transmitter output, turntable output and incoming lines.

## Description

Supervisory Console, Type MI-11621, is a control console especially designed for use with the 50 kw transmitter. It provides maximum ease and efficiency of station operation and includes all the switching, mixing and control-circuit metering facilities required in the station to insure a complete and flexible system. All controls, indicator lamps, switches and meters are grouped on three panels which are located in the turret mounted on the metal desk. Thus, all major control functions are centralized at the engineer's fingertips—and a constant visual circuit indication is afforded. The console is equipped with a standard VU meter, extension modulation monitor and antenna current meters. Also provided are "time of outage" and "duration of outage" clocks which are controlled by

relays located in the transmitter overload circuits. Thus, an accurate station record of outage is made available—in the event carrier is interrupted.

Mechanically interlocked push-keys permit instant selection of the circuit to be monitored. Program operation, special tests, and appropriate transmitter control switches—all are easily and quickly handled by the operator at the console. Important audio control circuit keys such as "transmitter on," and studio and local switches are protected from accidental tripping by chromium plated guards.

The desk and turret are of sturdy metal construction finished in two-tone umber gray to match transmitter styling. The left-hand section of the desk contains a typewriter shelf and the right-section—two convenient drawers. A third drawer is located in the center between the two pedestals. The panels of the turret top of the desk are hinged for ease of maintenance.

## Specifications

Input Impedance:

Lines 1 and 2, Studio, Master and Monitor Controls	600 ohms
Telephone Set	600 ohms
Microphone and Turntables	250 ohms
Monitor—Transmitter In and Out (Bridging)	20,000 ohms
Monitor—Lines 1 and 2	20,000 ohms

### Output Impedances:

Lines 1 and 2, Lever Key; Microphone and Turntable Mixer; Studio, Master and Monitor Control \_\_\_\_\_ 600 ohms  
 Microphone and Turntable Controls \_\_\_\_\_ 250 ohms  
 Frequency Response (30 to 15,000 cycles) \_\_\_\_\_ -1.0 db  
 Insertion Losses (microphone and turntable mixer circuit) \_\_\_\_\_ 7 db

Noise Level \_\_\_\_\_ Circuits are isolated so that residual noise level will not exceed the aggregate noise level of the associated amplifier.

A-c Power Input for Audio Lamps and Relays (105-125 volts, 50-60 cycles) \_\_\_\_\_ 25 watts

Dimensions, Overall \_\_\_\_\_ Width 60", depth 34½", height 41½"  
 Note—Turret extends approximately 11" above desk top.

Weight (unpacked) \_\_\_\_\_ 500 lbs.

Stock Identification \_\_\_\_\_ MI-11621

### Accessories

Transmitter Monitor and Amplifier Rack \_\_\_\_\_ MI-11623

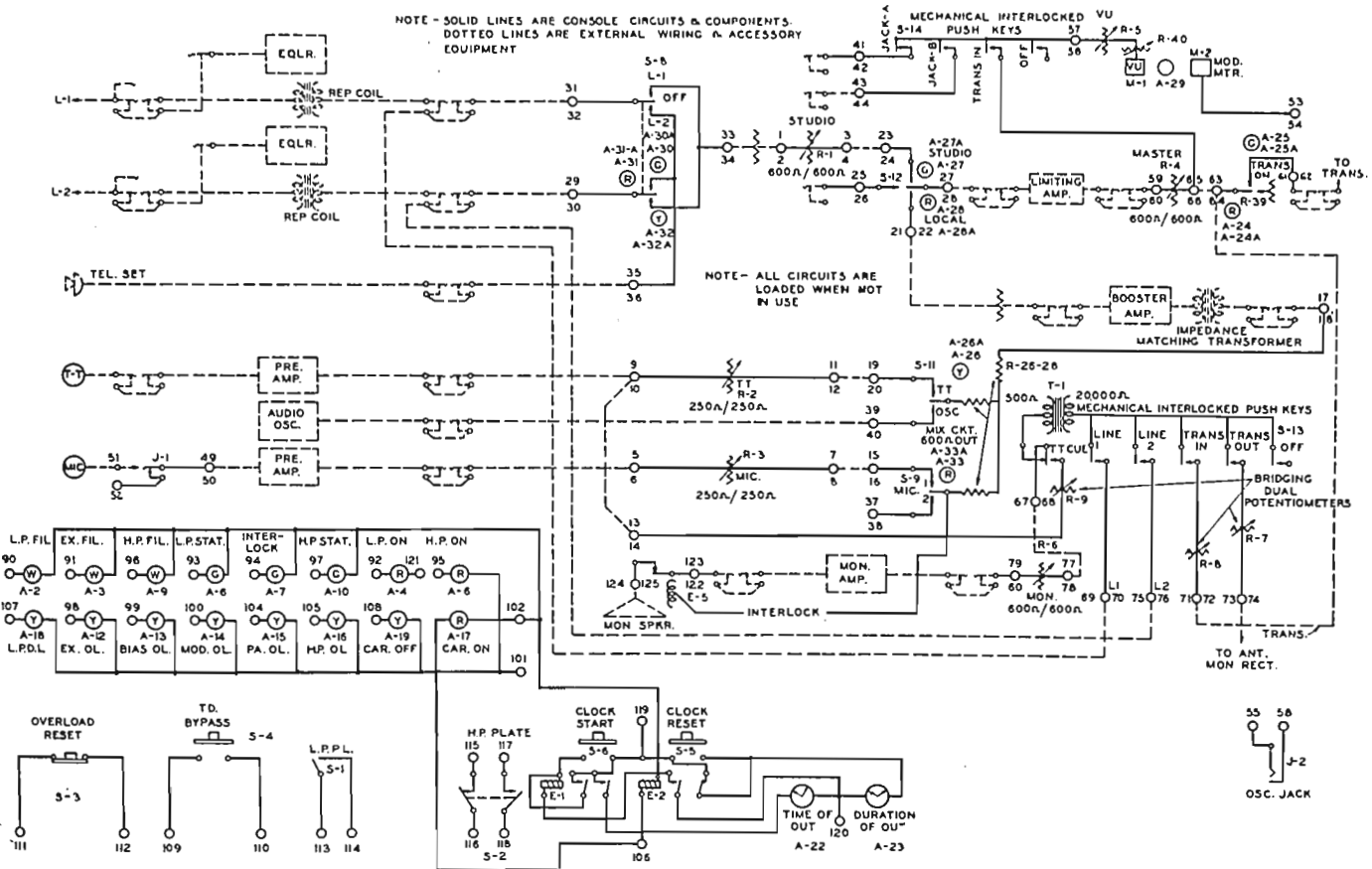

*Simplified Schematic Diagram of the MI-11621 Console*





(Courtesy of WGAR, Cleveland, Ohio)

# Replace your old AM transmitter *with RCA's new 50 kw.*



The revolutionary, new power  
RCA-5671. This tube takes about  
third the filament power of conven-  
triodes used in the older trans-  
It reduces hum modulation belt  
requirements—even without r-f fe-

The two 5671's in the r-f power  
fier and the two in the class B mo-  
of this 50-kw transmitter save  
\$1200 yearly in filament power al-



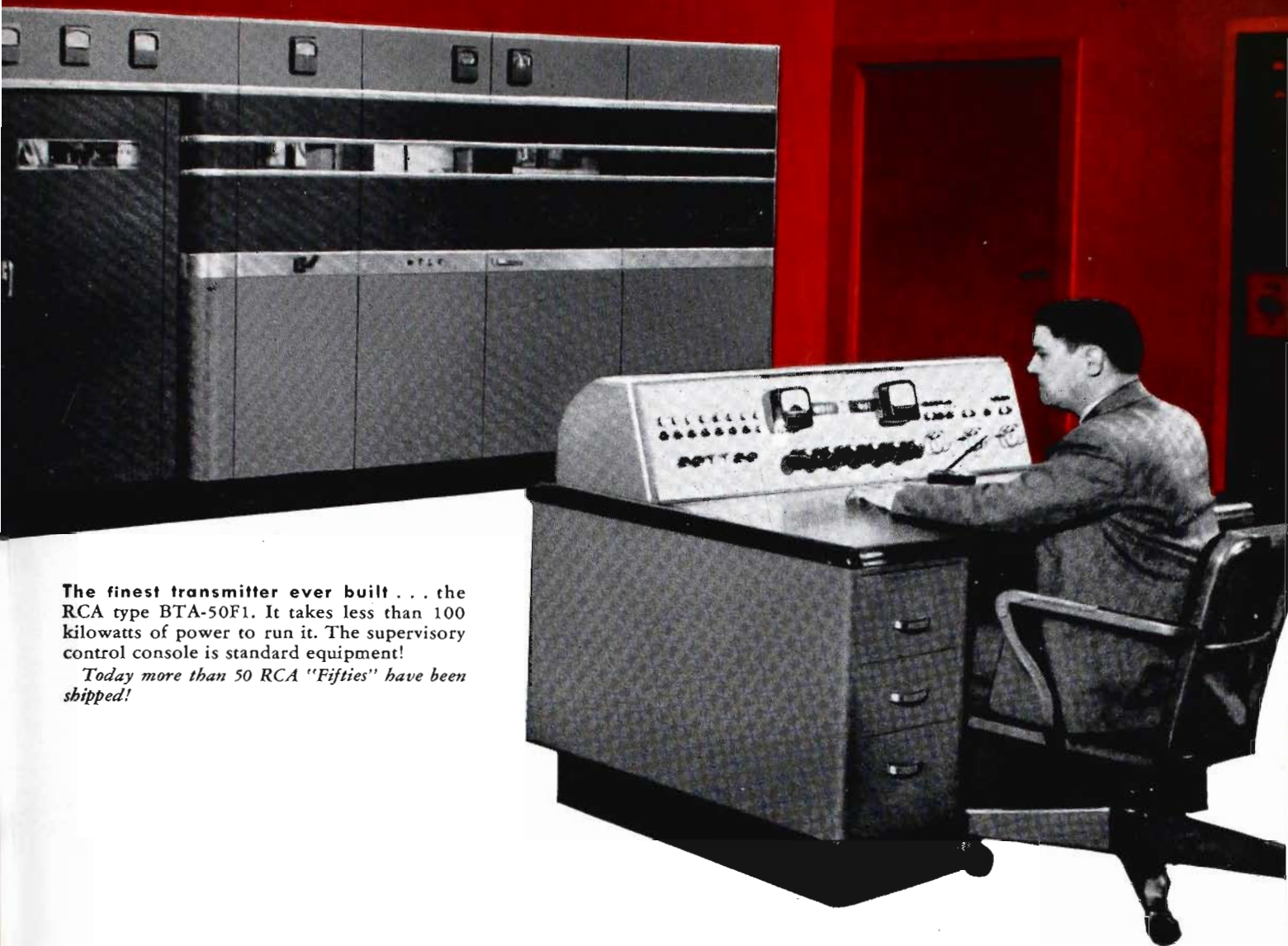

The finest transmitter ever built . . . the RCA type BTA-50F1. It takes less than 100 kilowatts of power to run it. The supervisory control console is standard equipment!

*Today more than 50 RCA "Fifties" have been shipped!*

## and write off its cost in power savings alone!

It is a fact — as one high-power broadcaster recently discovered to his complete satisfaction. Now, he has replaced his old transmitter with an RCA "fifty"—and it's paying its way.

### HERE'S WHY.

Using revolutionary new RCA-5671 power triodes that take about one-third the filament power of conventional types, this RCA "fifty" saves up to \$1.75 an hour in power savings over former transmitters—\$12,000 a year, based on daily operation at 9 hours a day!

Many other new design features, too, that add to this \$12,000 savings.

*For example, only 29 tubes and 11 different tube types—less than half the number used in many present 50 kw's. True walk-in accessibility that assures faster maintenance — and lowers maintenance costs. Ultra-conservative operation of tubes and components—with less chance for outages.*

Here is a 50-kw AM transmitter that does away entirely with oil circuit breakers—assures faster circuit protection. Because the BTA-50F1 operates from a 460-volt supply. Control and protection circuits are

the most complete of any transmitter designed to date. And its true unified front (an integral part separate from compartment enclosures) facilitates flush-mounting — gives your transmitter room a new, handsome appearance.

Write for the new 28-page brochure about the BTA-50F1. It gives you complete details—including circuits, specifications, floor plans, and full-page pictures showing the remarkable accessibility of this great transmitter.

Dept. 19HC, RCA Engineering Products, Camden, New Jersey.





◀  
*At the power control section of the five kilowatt transmitter, Type BTA-5F, at KOOL, Phoenix, Ariz.*

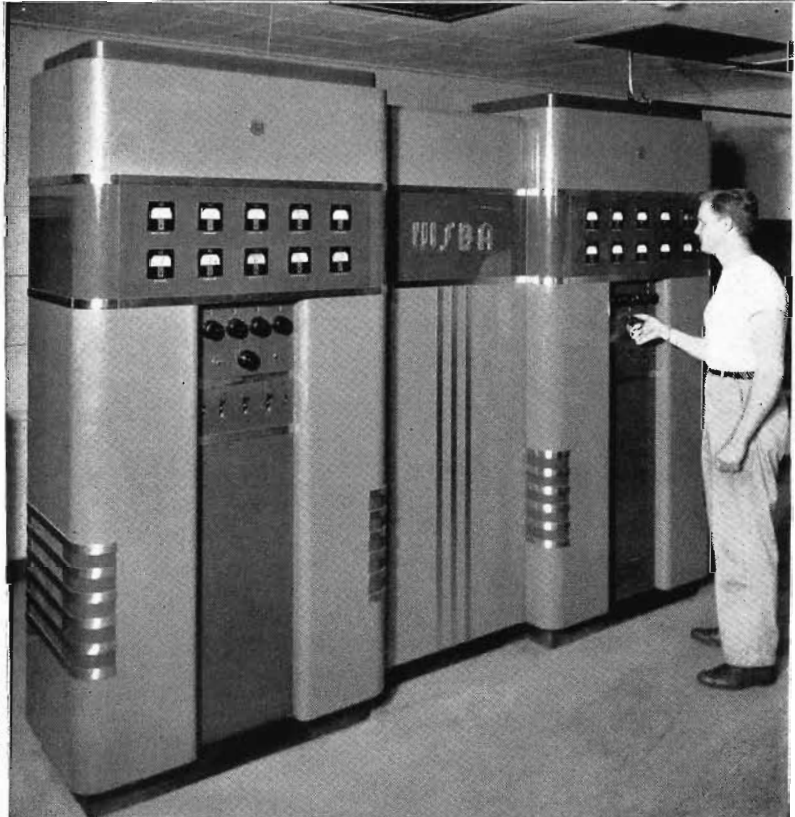

▲  
*Fifty kilowatt transmitter, Type BTA-50F, with control console and extension cabinets containing phasing equipment, at KMPC, Hollywood, Cal.*

◀  
*At the controls of the one kilowatt transmitter, Type BTA-1L, at WSBA, York, Pa.*

# RCA Custom Built Antenna Phasing Equipment

## Features

- Individual custom design provides optimum efficiency for feeding each array.
- Circuits chosen to give maximum stability and operating convenience.
- Lower cost—no excess equipment included.
- Coordination of phasing and transmitter design for best performance.
- Shipped wired and assembled.
- Monitoring rectifiers, lighting circuits, automatic switching and electric tuning furnished, if desired.
- Metering facilities may be expanded or minimized as required.
- Various enclosure cabinets and mounting methods available to meet individual requirements.

## Description

RCA has adopted the policy of custom-building antenna phasing equipment in accordance with individual design to meet the particular requirements of the user. Experience has shown this policy to be more economical and satisfactory than to attempt to standardize on one elaborate design with sufficient components to meet the requirements of a wide range of powers, various numbers of towers and an almost infinite combination of networks. Such designs will inevitably have excess equipment and must, therefore, be a compromise rather than the optimum design. Several types of enclosures and all circuit components are manufactured in quantities and are available from stock, thus making possible a quick delivery of an individual and economical design.

It will be noted from the simplified schematic of a typical directional array installation that, where possible, "T-Networks", having a lagging phase shift, are used in order to take full advantage of their harmonic suppressing qualities, relative ease of adjustment, economy and high efficiency.

The power dividing network usually consists of a parallel-resonant tank circuit having a KVA to KW ratio of approximately two. The inductor is a tapped unit shunted at various points along its length by front-panel controlled rotary coils. These give independent amplitude control for each antenna and allow for a maximum of flexibility in power division. When the network is adjusted to parallel resonance, the input line from the transmitter may be tapped in at the point of proper resistance.

The phasing networks consist of a "T-Network" with a 1:1 impedance transformation. The two inductive legs of the "T" network consist of rotary coils, ganged, with front-of-panel control. For a fixed shunt element, this allows phase variations from approximately  $60^\circ$  to  $120^\circ$  with no appreciable change of impedance transformation. The inductive leg of the series-

resonant network consists of a single rotary coil with front panel adjustment.

The line terminating unit consists of a "T-Network" with phase shift impedance-transformation minimum KVA losses, and maximum flexibility.

Faradon mica capacitors are generally utilized and are operated at approximately 50% of the nameplate rating. Polystyrene treated capacitors provide lower losses than the wax-treated type and are also more stable under high temperatures sometimes encountered in unventilated antenna tuner houses. Gas-filled or vacuum capacitors, operated well within their nameplate rating, are used where they become an economical choice or when requested by the customer. In general, RCA does not recommend the use of open, air-dielectric capacitors due to their vulnerability to the accumulation of dust and foreign matter, but in those cases where air capacitors are specifically desired, they will be supplied.

RCA phasing equipment embodies high Q coils which are supported on micalex and wound with copper strap or tubing. These coils are available in a large variety of inductance ranges and current handling capacity, and are all supplied with variable taps so that precise adjustments are possible. Special care is taken to insure that conservatively rated coils of sufficient inductance range are utilized to take care of normal variations in antenna array parameters. RCA phasing equipment is designed to insure minimum degradation of transmitter power output, sideband waveform and frequency response.

The r-f meters supplied employ expanded scales and have a full scale range between 1.3 and 2 times the RMS carrier value of the current being metered.

Facilities for remote control switching from directional to non-directional operation, or from night-time to day-time patterns, are supplied if required. Other optional items are: (1) Antenna monitoring rectifiers, (2) Circuit components for isolating the tower lighting system, (3) Phase sampling coils or tower mounted loops, (4) Remote metering, (5) Lightning protective systems.

*Schematic of a Typical Directional Arrangement*

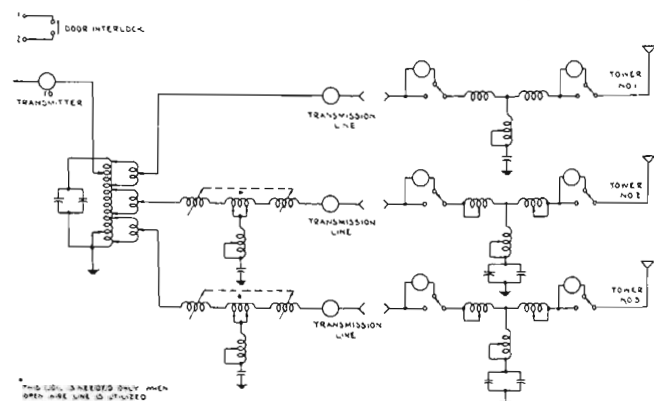



# 1 KW Phasing and Branching Equipment

One kilowatt phasing and branching equipment is usually supplied in an MI-7485-G cabinet, a BR-84 cabinet, or mounted on a wall-mounting steel panel. The MI-7485-G cabinet has both front and rear doors with the components mounted on a sub panel behind the front door. The panel controls are made accessible by opening the front door while the interlocked rear door provides access to all components and wiring. The BR-84 rack-type cabinet is suitable for two element non-direction day, and directional day-night arrays. It has front and rear doors and is similar to the MI-7485-G. It is the most economical phasing equipment cabinet in the RCA line. Wall Mounting steel panels are made to order to meet each purchaser's requirements. This type of construction is quite popular because of several inherent advantages—low cost, excellent accessibility—flexible component layout which allows shorter lead lengths and thereby better efficiency.

The line terminating units are supplied in a weatherproof metal housing, or wall-mounting steel panels. The interior view of a tuner housing shows a typical arrangement of components for an installation employing switching facilities for day-night pattern changes, and metering facilities for transmission line and antenna current. Provision can be made for either coaxial line or open wire termination insulators contingent upon the design specifications.

## Specifications

### MI-7485-G CABINET

Color—Two-tone umber gray enamel except for black base

#### Dimensions:

Height	84 $\frac{1}{16}$ "
Width (including end shields)	31"
Depth (including doors and handles)	30 $\frac{1}{8}$ "
Clearance of Door Swing	25 $\frac{5}{8}$ "

### BR-84 CABINET

Finish—Two-tone umber gray enamel except for the black base

#### Dimensions:

Height	84"
Width	28"
Depth (including door and handles)	24 $\frac{1}{4}$ "
Clearance of Door Swing	23"

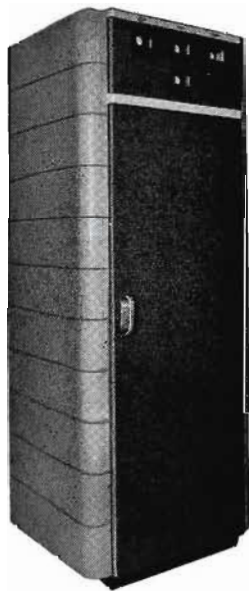

*Exterior view of a 1 KW phasing and branching equipment in MI-7485-G cabinet*



*Interior view of a 1 KW phasing and branching equipment*

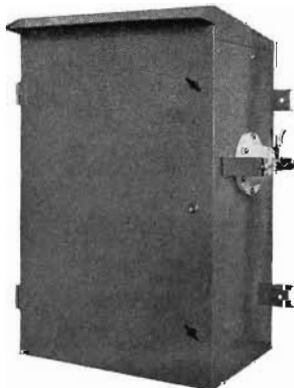

*Exterior view of a 1 KW line terminating unit in weatherproof cabinet*

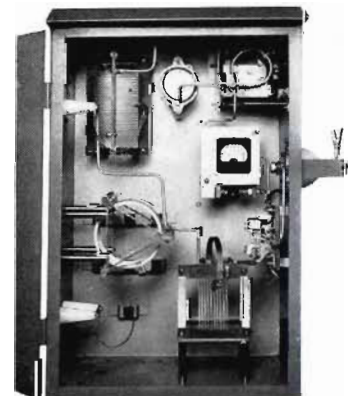

*Interior view of 1 KW line terminating unit with phase sampling coil, antenna base metering and pattern switching facilities mounted in BPA-1A Housing*

# 5/10 KW Phasing and Branching Equipment

The 5/10 KW phasing and branching equipment is available in two cabinet styles, as well as the wall-mounting panel construction. When supplied in the MI-7485-F cabinet, the equipment is intended to form a left-wing extension for the RCA BTA-5F or BTA-10F transmitter. This cabinet matches the transmitters both in appearance and quality of material and workmanship. The decorative front panel is finished with a two-tone umber gray, rubbed and waxed, with stainless steel trim and handles. An interlocked door in the left side of the cabinet allows operating personnel to walk inside the cabinet for inspection of phasing components. Meters for measuring transmission line and common point currents are mounted on a sub-panel behind the front door and may be read through the glass panel in the door. Controls for the phase and amplitude of the current in each tower are mounted on the same sub-panel.

The standard double rack type cabinet, MI-28935-B, is designed for those stations where it is desired or necessitated by space requirements that the phasing and branching equipment be set apart from the transmitter. The two typical floor plans illustrated below show, in one case, a typical transmitter room where the phasing equipment is housed in the left wing extension cabinet, and in the other case, an application of the self-contained, standard rack type phasing cabinet. This cabinet is finished in two-tone umber gray lacquer with stainless steel handles and trim. Necessary meters are mounted on the meter panel over the front doors. All controls are brought out through a sub-panel behind the front doors as described for the wing type cabinet. Interlocked, double doors in the rear of the cabinet provide access to all components for inspection. With installations involving unusual complexity, it may be necessary to supply phasing and branching equipment in a three section cabinet of the same design as the one illustrated.



Typical, double section, standard, rack type cabinet, MI-28935-B

### Specifications

#### MI-28935-B CABINET

#### Dimensions:

Height	_____	84"
Width	_____	56 3/32"
Depth	_____	31"
Clearance for Front Door Swing	_____	25 5/8"
Clearance for Rear Door Swing	_____	25 5/8"

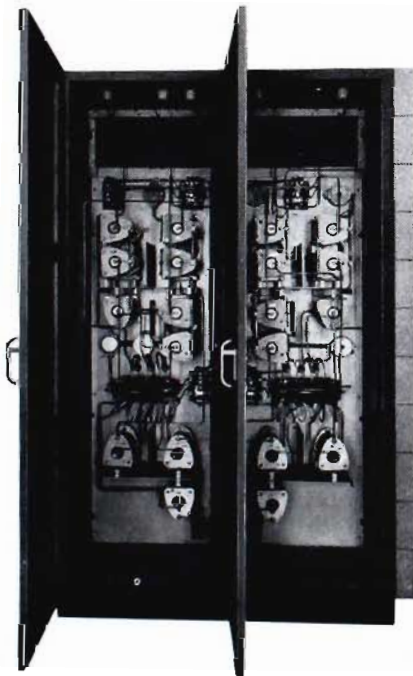

Open-door view of the equipment in an MI-28935-B Cabinet

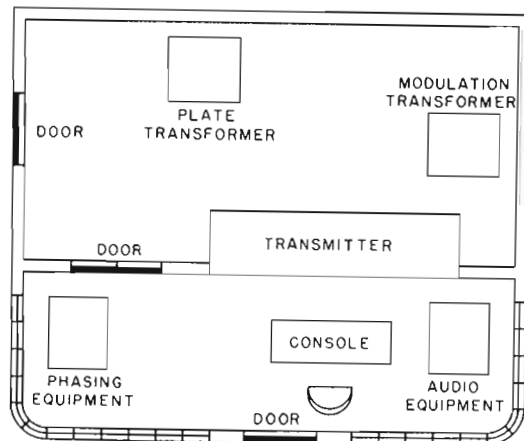

Typical floor plan where audio and phasing equipment is housed in the separate standard rack type cabinets



## 5/10 KW Phasing and Branching Equipment (Continued)

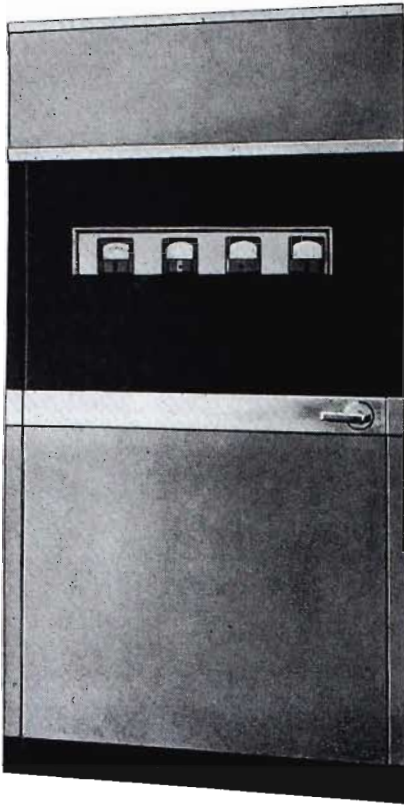

*Exterior front view of a 5 KW phasing and branching equipment housed in MI-7485-F left wing extension cabinet*

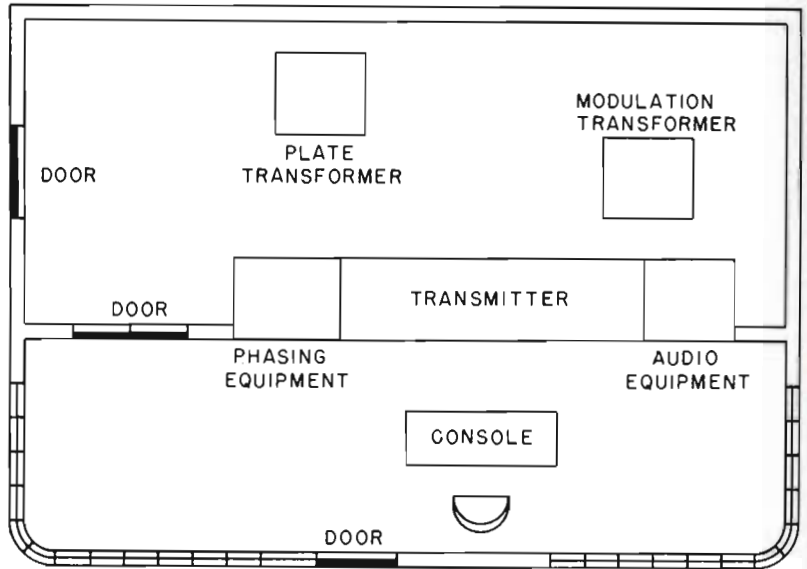

*Typical floor plan using left and right wing extension cabinets*

### Specifications

#### MI-7485-F CABINET

#### Dimensions:

Height	_____	85½"
Width	_____	42½"
Depth (including enclosure)	_____	38½"
Clearance for Side Door Swing	_____	24¼"
Clearance for Enclosure Door Swing	_____	39¾"

## 5/10 KW Line Terminating Unit

The 5/10 kilowatt terminating unit can be supplied in a weatherproof metal cabinet or on a wall mounting steel panel. The weatherproof cabinet is designed for mounting on a wooden platform or steel angle cradle by means of side flanges at the bottom of the housing. Rear mounting strips are also provided to permit wall mounting. The antenna and transmission line ammeters may be read through a circular window in the door and they are protected from lightning surges by a single pole double throw make-before-break switch, which is operated by means of a knob extending through the side of the tuning house.

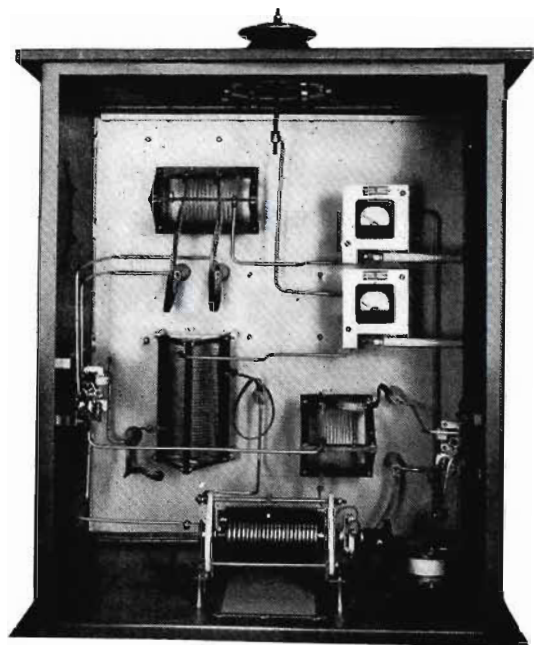

*Interior view of a 5 KW line terminating unit mounted in a BPA-1A Housing*

# 50 KW Phasing and Branching Equipment

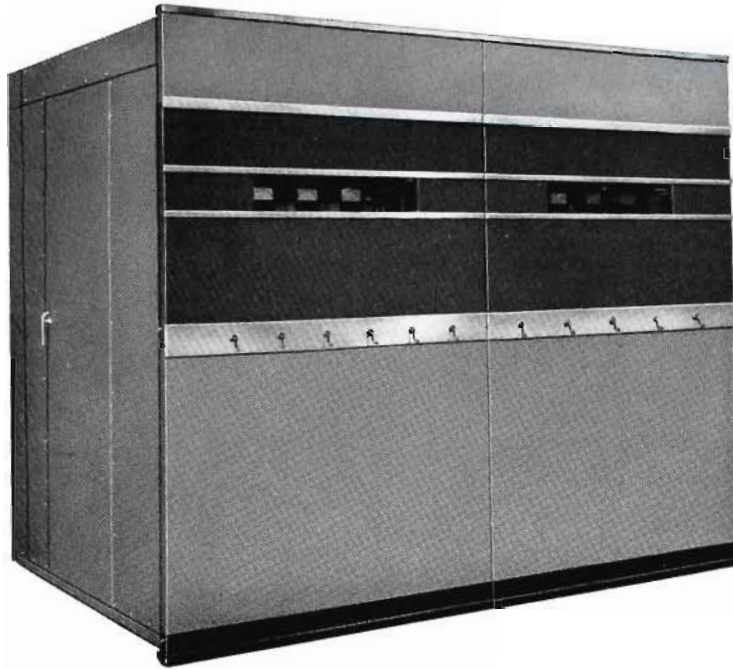

The fifty KW phasing and branching equipment is supplied in an MI-7485-J cabinet which may be used to provide a matching wing extension to give a unified appearance for an RCA BTA-50F1 transmitter.

## Specifications

### MI-7485-J CABINET

#### Dimensions:

Height	84 3/32"
Width	102 1/4"
Depth	78 7/16"
Clearance for Side Door	31"

Finish \_\_\_\_\_ Two tone umber gray

The line terminating unit for 50 KW equipment is designed to be mounted in a tuner house at the base of the tower. RCA does not supply the tuner house but does supply all inductors, capacitors (gas, vacuum, or mica), meters, meter panels, static drain choke, bowl insulators, lightning gap, surge suppressor, wiring material, brackets and hardware. Not included are the protective grill, interlocks, ground strap, and light and telephone auxiliaries. The line terminating unit will require approximately 70 square feet of floor space and an 8 foot ceiling.

## How to Order

RCA will be pleased to furnish a proposal on custom built phasing equipment upon receipt of general requirements such as:

- (1) Number, height and type and ground plot of towers.
- (2) Phase and relative amplitude of current in each tower.
- (3) Type of enclosures in which equipment is to be mounted.
- (4) Transmission line specifications together with length of run to each tower.
- (5) Any special requirements which should be incorporated in the design of the equipment such as: (a) interlocked pattern switching; (b) type and extent of metering facilities; (c) carrier off protective systems; and (d) monitoring facilities.

To facilitate the transmission of this information, copies of an "Engineering Specification for Broadcast Antenna Phasing Equipment Form" are available at all RCA Broadcast Sales Offices. Those interested in phasing equipment are invited to communicate with their nearest RCA Sales Office for additional information.

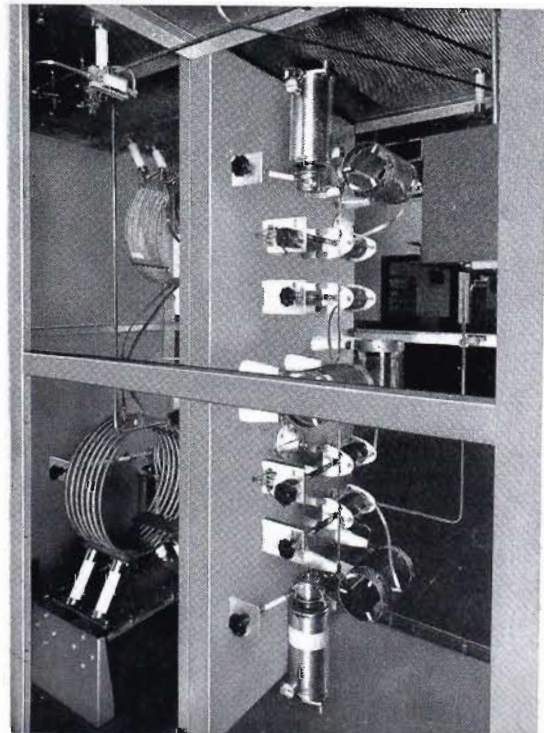

*Interior view of a 50 KW phasing and branching equipment*



# Typical Wall-Mounted Phasing Installations

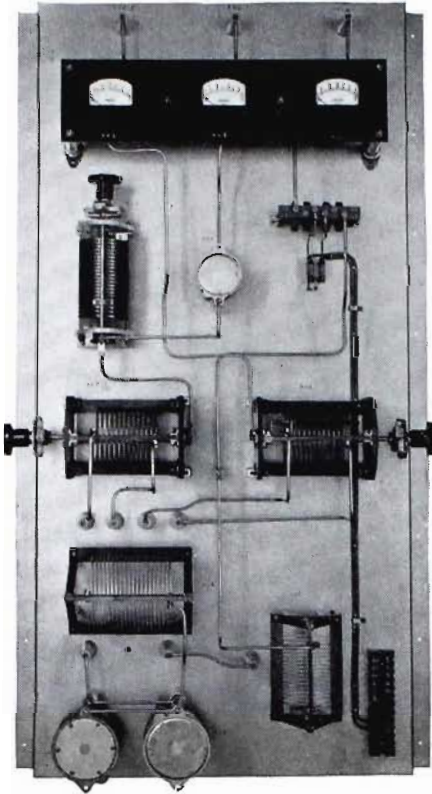

◀ 5 KW, 2 Tower Phasing and Branching Unit

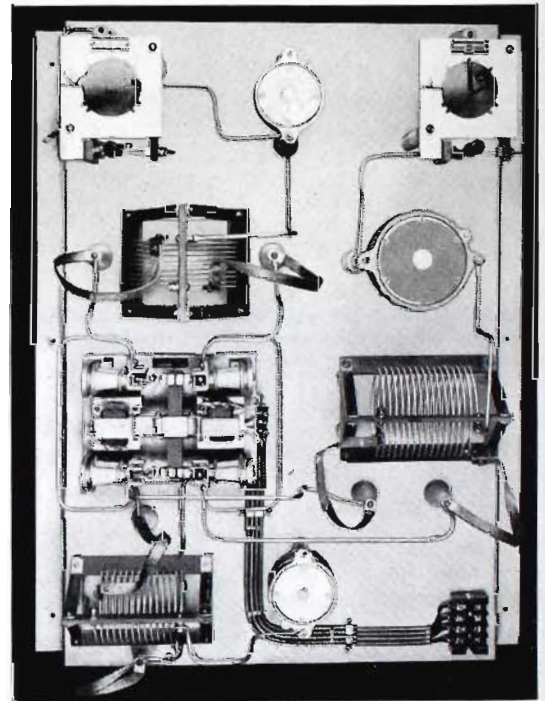

5 KW Line Terminating Unit on Wall Mounted Steel Panel

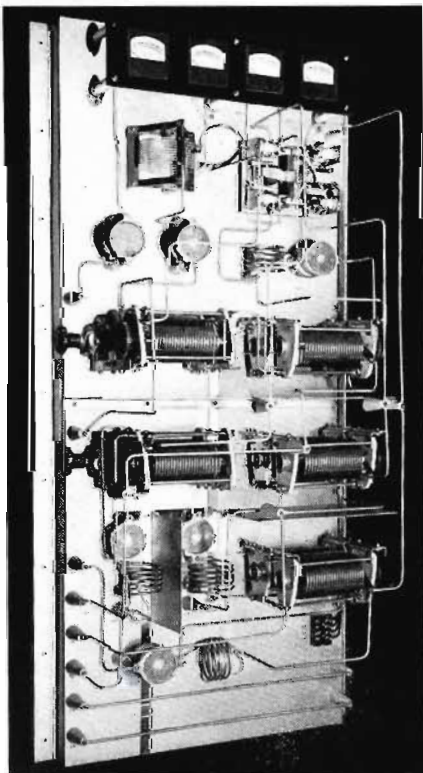

◀ Typical 5 KW, 5 Tower Phasing Unit on Steel Panel

# Antenna Current and Phase Sampling Equipment

Two general methods of obtaining samples of antenna current for phase and amplitude monitoring are commonly used.

The first method employs an electrostatically shielded, resonant, pickup coil mounted adjacent to the antenna feed line in the line terminating unit or tuner house. The tuned sampling coil can be coupled at virtually any point along the radiator or feed line in many installations and still pick up enough voltage to operate the current and phase indicators. Since the tuned circuit is more sensitive than a non-resonant loop, care must be taken to avoid pickup from adjacent towers or voltages induced by other inductors in the installation. Pickup from an extraneous field will cause error in phase indication and may also produce non-linearity in current indicators. Mounting the pickup coil inside a metal shield through which the feed line is run will generally produce satisfactory results. The RCA MI-8217-A remote metering and sampling kit supplies the pickup coil and also the thermo-milliammeter to be mounted on the panel of the WM-30A phase monitor.

The second method of sampling antenna currents employs a non-resonant loop mounted on the tower. This type installation has the advantage that indicators are not usually influenced by base currents if the loop is located up from the base of the tower. In the tower mounting loop type of installation, the sampling line, which may be clamped to the tower, must be brought across the tower base insulators. This may be accomplished by using the RCA MI-7327-4 isolation coil, which is a  $\frac{3}{8}$ " 72 ohm concentric line formed into a high impedance coil at broadcast frequencies. This coil, supplied with the necessary insulators for mounting, is usually located within the tuner house at the base of the tower. In some cases the sampling lines can be spaced from the tower by high voltage insulators, and brought across the base without an isolating network.

The RCA MI-8217-D/MI-7184-A-150 remote metering and sampling loop kit supplies the pickup loop, mounting insulators, and also the necessary thermo-milliammeter to be mounted on the panel of the WM-30A phase monitor.

## Type WM-30A Phase Monitor

The RCA Type WM-30A phase monitor provides a simple means of accurately measuring phase differences between currents in the various towers of an antenna array. It is particularly useful in checking the directional arrays to insure proper phasing and hence proper field pattern. All phase angles up to 360° at any frequency between 225 and 1800 KC can be measured. The Type WM-30A can be used to adjust the phase shifting networks, to measure impedances of arrays, and to facilitate calculation of mutual impedances of antennas.

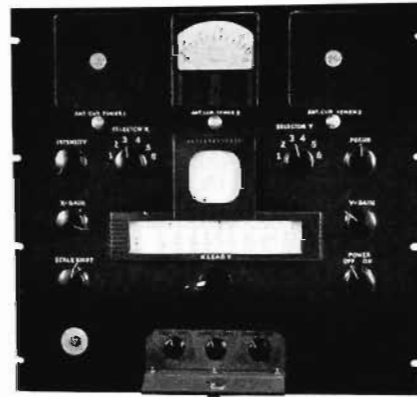

WM-30A Phase Monitor. Blanks in top of panel are to provide for additional meters

The RCA phase monitor can be used for remote indication of both relative amplitude and phase of antenna currents in arrays employing up to three elements. Used in conjunction with the MI-8216-C remote meter panel, correct relationships can be maintained between phase and magnitude of currents in directional arrays having as many as six elements.

## Specifications

### MI-8217-A SAMPLING COIL

Clearance Dimensions \_\_\_\_\_ 5" x 5" x 5"

Stock Identification \_\_\_\_\_ MI-8217-A

### MI-8217-D NON-RESONANT LOOP

Dimensions \_\_\_\_\_ 2' x 8'

Stock Identification \_\_\_\_\_ MI-8217-D

### MI-7327-4 ISOLATION COIL

Dimensions:

Base Plate \_\_\_\_\_ 14 $\frac{1}{4}$ " x 21 $\frac{3}{4}$ "

Coil \_\_\_\_\_ 19" I.D.

Winding Length \_\_\_\_\_ 10 $\frac{1}{2}$ "

Stock Identification \_\_\_\_\_ MI-7327-4

### MI-7184-A-150 REMOTE METER

Dimensions \_\_\_\_\_ 4" rectangular case

Scale \_\_\_\_\_ 0-150%

Type \_\_\_\_\_ Weston 743 expanded scale (150 ma movement)

Stock Identification \_\_\_\_\_ MI-7184-A-150

WM-30-A PHASE MONITOR \_\_\_\_\_ MI-30030-A

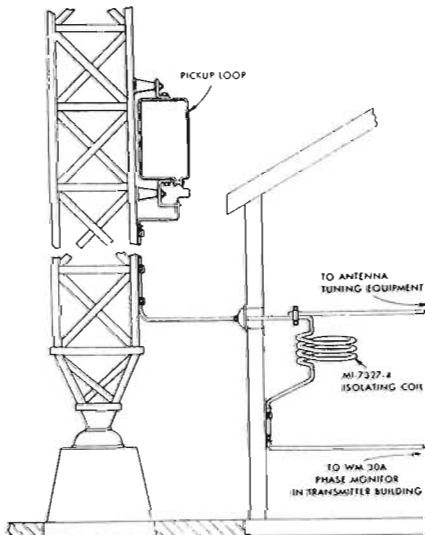

Typical installation of MI-8217-D Pickup Loop and MI-7327-4 Isolating Coil

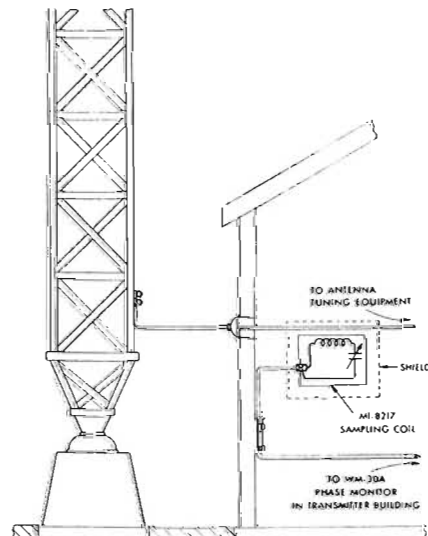

Typical installation of MI-8217-A Sampling Coil



# FM Broadcast Transmitter, Type BTF-250A

## Features

- Incorporates RCA's Direct FM system which requires fewer and less expensive tubes and parts.
- Automatic frequency control.
- Excellent frequency response  $\pm 1$  db 30 to 15,000 cps.
- Low distortion—less than 1%, 30 to 15,000 cps.
- Easy to tune, single ended r-f circuits throughout.
- Simplified controls with complete circuit protection.
- Multi-unit construction permits easy addition of higher powered units.
- Vertical chassis construction—front and rear door accessibility.
- Completely self-contained.

## Description

The new BTF-250A FM Transmitter incorporates all the latest engineering advances and many desirable basic features. Attractively housed in a single standardized cabinet, this compact unit will provide a maximum of 250 watts output at any specified frequency between 88 and 108 mc. Installation is simple and economical. Future power increases are easily made by adding one or more power amplifiers and power control units housed in matching cabinets. Accessibility is assured by vertical chassis construction plus surface mounting of components and exposed wiring for easy and speedy circuit tracing and servicing.

The exciter unit of the BTF-250A contains RCA's well known Direct FM modulator and frequency control circuits. Fewer tubes and fewer components are used in this exciter than in previous designs. All components are mounted on a single vertical panel and are easily accessible. The exciter power supply is on a separate chassis.

Frequency modulation is accomplished directly by push-pull reactance tubes connected across the frequency-determining circuit of the modulated oscillator. This "direct modulation" process eliminates numerous multiplier and converter stages with a resulting lower noise and distortion level.

Simplified single-ended amplifiers operating Class "C" and comprising a minimum of variable elements form the r-f section of the BTF-250A.

Tube costs have been kept low by using sturdy receiver type tubes in the FM exciter and high efficiency circuits plus inexpensive low power transmitting tubes in the r-f amplifiers. The same tube type is employed in several stages thus reducing spare tube requirements.

All power circuits are protected by magnetically-tripped circuit-breaker type switches. A transmission line monitor which acts as watchman over the antenna and transmission line system is provided. Any unwarranted increase in the standing wave ratio such as might result from an arc in the transmission line,

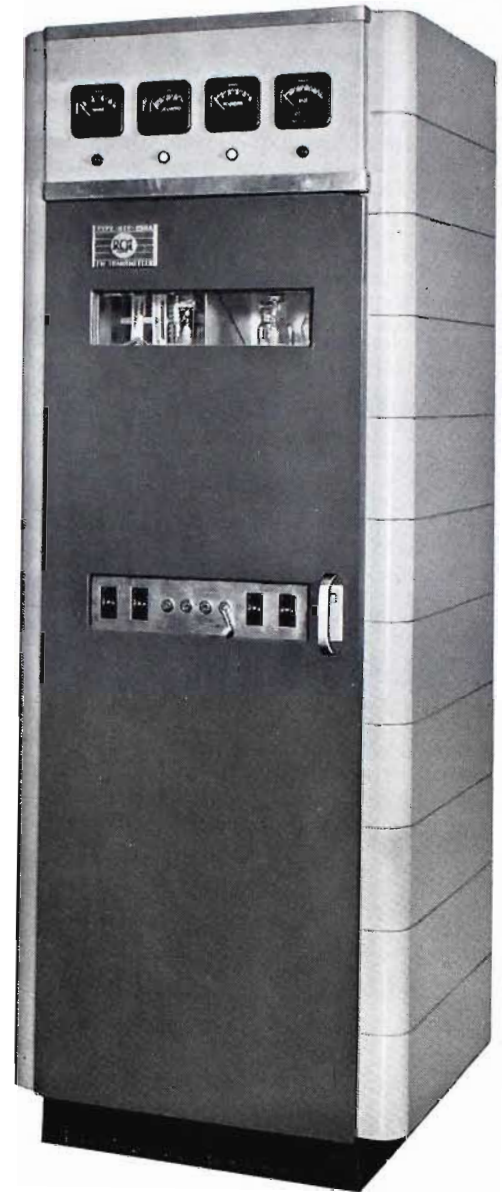

or a fault in the antenna itself, actuates this monitor and shuts down the transmitter. An interlocking control circuit prevents the application of plate power until the rectifier filaments have reached operating temperature. Filament voltage is controlled by tapped transformers and a common filament rheostat. Door interlocks are provided, where required, for the safety of operating personnel. In addition, high voltage compartments are equipped with mechanically operated grounding bars which are automatically released when the doors are opened.

The entire transmitter is housed in a single fabricated steel cabinet which is bolted to a base frame. This cabinet is equipped with both front and rear doors which are provided with observation windows. End shields and a meter panel complete the cabinet-type enclosure which has been styled func-

tionally and presents a pleasing appearance. A filtered air supply for the cabinet is supplied through the air inlet opening, and a removable filter is provided in the base frame. An exhaust fan in the roof expels the warm air.

The BTF-250A is shipped complete with two crystals, two sets of tubes and transmission line monitor.

## Specifications

- Frequency Range \_\_\_\_\_ Any specified frequency between 88 and 108 mc.
- Power Output (into transmission line) \_\_\_\_\_ 50 to 250 watts
- R-f Output Impedance (SWR 1.75 or less) \_\_\_\_\_ 51.5 ohms
- Carrier Frequency Stability, deviation less than \_\_\_\_\_  $\pm 1000$  cycles
- Modulation Capability \_\_\_\_\_  $\pm 100$  kc.
- Method of Modulation \_\_\_\_\_ Reactance-tubes
- Audio Input-Impedance \_\_\_\_\_ 150/600 ohms
- 100% Modulation Level \_\_\_\_\_  $+10 \pm 2$  dbm
- Audio Frequency Response<sup>1</sup>  
30 to 15,000 Cycles, 1000 Cycle Reference, within \_\_\_\_\_  $\pm 1$  db
- Audio Frequency Distortion<sup>2</sup>  
30-15,000 cycles \_\_\_\_\_ Less than 1% rms  
Including all harmonics up to 30 kc/s at 75 kc swing
- FM Noise Level, below 75 kc. swing \_\_\_\_\_ -65 db.
- AM Noise Level, below 100% amplitude modulation<sup>2</sup> \_\_\_\_\_ -50 db.
- Power Supply Requirements \_\_\_\_\_ 208/230 volts, 50 or 60 cycles single phase, capable of supplying approximately 1200 watts at 85% power factor, and 5% maximum regulation and variation. Also approximately 30 watts at 115 volts, 50/60 cycles single phase, is required for the crystal heaters.
- Tube Complement \_\_\_\_\_ 4 RCA 6V6, 4 RCA 1614, 1 RCA 6SH7, 4 RCA 5U4G, 2 RCA OD3/VR150, 1 RCA OC3/VR105, 1 RCA 6AL5, 2 RCA 2E26, 5 RCA 6AC7, 1 RCA 2BP1, 3 RCA 4-125A/4D21, 2 RCA 866A/866, 1 RCA 2D21.

## Dimensions in Inches

- Overall Width \_\_\_\_\_ 31"  
 Overall Height \_\_\_\_\_ 84"  
 Overall Depth \_\_\_\_\_ 31 1/4"  
 Maximum Crate Size \_\_\_\_\_ 28" x 30" x 84"  
 Weight in Pounds (unpacked—assembled) \_\_\_\_\_ 1025 (approx.)  
 Maximum Ambient Temperature \_\_\_\_\_ 45° C.  
 Finish \_\_\_\_\_ Two-tone umber gray with brushed chrome trim and fitting
- Stock Identification \_\_\_\_\_ MI-28911

## Equipment Supplied

Following is a condensed list of equipment included as a complete BTF-20A Transmitter:

Quantity	Stock Ident.
1 Transmitter _____	MI-28100
1 Pre-emphasis Network _____	MI-4926-A
1 Transmission Line Monitor _____	MI-28155-1
2 TMV-129C Crystal Units _____	MI-19450-A
2 Complete Set of Tubes _____	MI-28156
1 Installation Material Kit _____	MI-28166
1 Finish Touch-up Kit _____	MI-28153
2 Instruction Books _____	IB-30131
2 Installation Plans _____	K-8858996

## Available Accessories

- 250 Watt to 1 KW Conversion Kit \_\_\_\_\_ MI-28919
- Set of Tubes for Above Conversion Kit \_\_\_\_\_ MI-28160
- FM Transmitting Antennas \_\_\_\_\_ See antennas
- Towers for Supporting FM Antennas \_\_\_\_\_ On application
- Transmission Line \_\_\_\_\_ On application
- Transmitter Monitoring and Test Equipment \_\_\_\_\_ See Test and Meas. Equip.
- Spare Parts \_\_\_\_\_ On application

<sup>1</sup> For pre-emphasized response the pre-emphasis filter MI-4926A is provided to be inserted in the 600-ohm audio input line.  
<sup>2</sup> Distortion and noise are measured following a standard de-emphasis network.

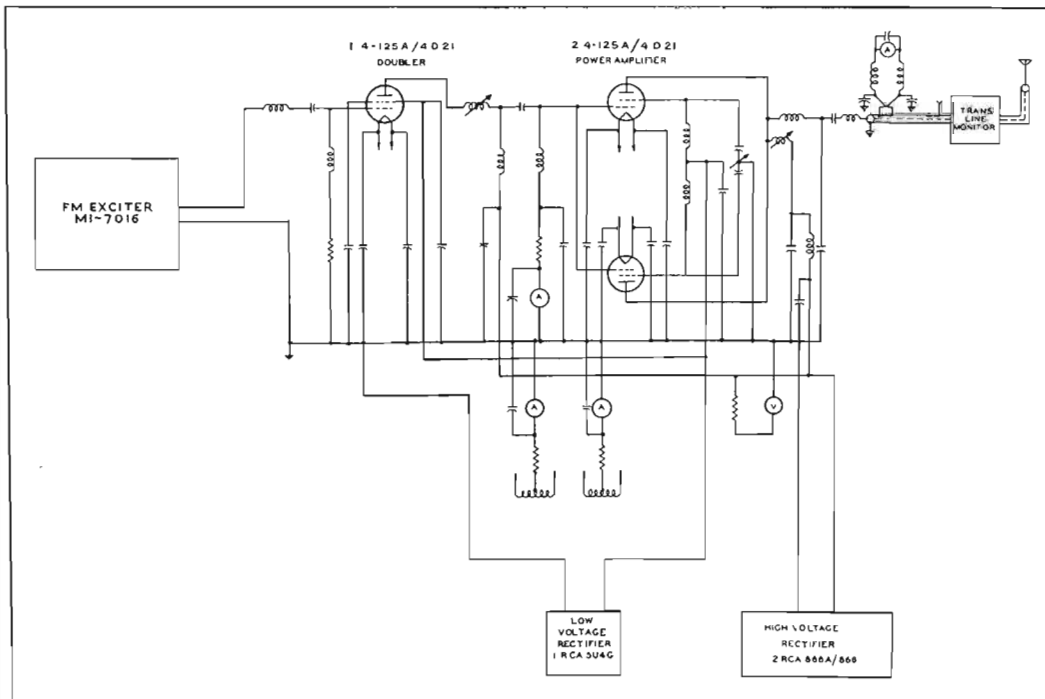

Simplified Schematic of BTF-250A



# FM Broadcast Transmitter, Type BTF-1C

## Features

- Incorporates RCA's Direct FM system which requires fewer and less expensive tubes and parts.
- Automatic frequency control.
- Excellent frequency response  $\pm 1$  db 30 to 15,000 cps.
- Grounded grid amplifiers reduce overall transmitter and tube costs, reduce installation and maintenance costs and insure stable operation.
- Single-ended r-f circuits throughout.
- Simplified controls with complete circuit protection.
- Minimum of different tube types.
- Equipment protected against transmission line or antenna failures.
- Multi-unit construction permits easy addition of higher powered units.
- Vertical chassis construction--front and rear door accessibility.
- Completely self-contained--no external units.

## Description

Attractively housed in two compact standardized cabinets, the new BTF-1C FM transmitter will provide 1000 watts output at any specified frequency between 88 and 108 mc. Initial installation is simple and economical. Conversion to 3 kw or 10 kw operation is quickly and inexpensively made by the addition of one grounded-grid amplifier unit and a power and control unit housed in matching cabinets.

Circuits of the BTF-1C are similar to those of the BTF-250A with the addition of a grounded-grid amplifier stage to give the increased power. Since all RCA FM broadcast transmitters employ the same basic exciter circuit, all the advantages of the Direct FM circuit used in the BTF-250A also accrue to the user of the BTF-1C, one kilowatt transmitter. Benefits obtained by the use of the Direct FM circuit plus those of the power-saving, grounded-grid amplifier greatly reduce (below that of other transmitters of similar rating) the number of tubes needed to provide required output. This reduction results in a lower, dollar-value, inventory of spares required.

Simplified single ended amplifiers, operating class "C" and comprising a minimum number of variable elements, form the r-f section of the BTF-1C. The same type tube is employed in several stages--an important item when considering spare tube needs. The final stage using a 7C24 tube is operated grounded-grid thus reducing tube, installation and maintenance costs and insuring stable operation. All tubes are air cooled.

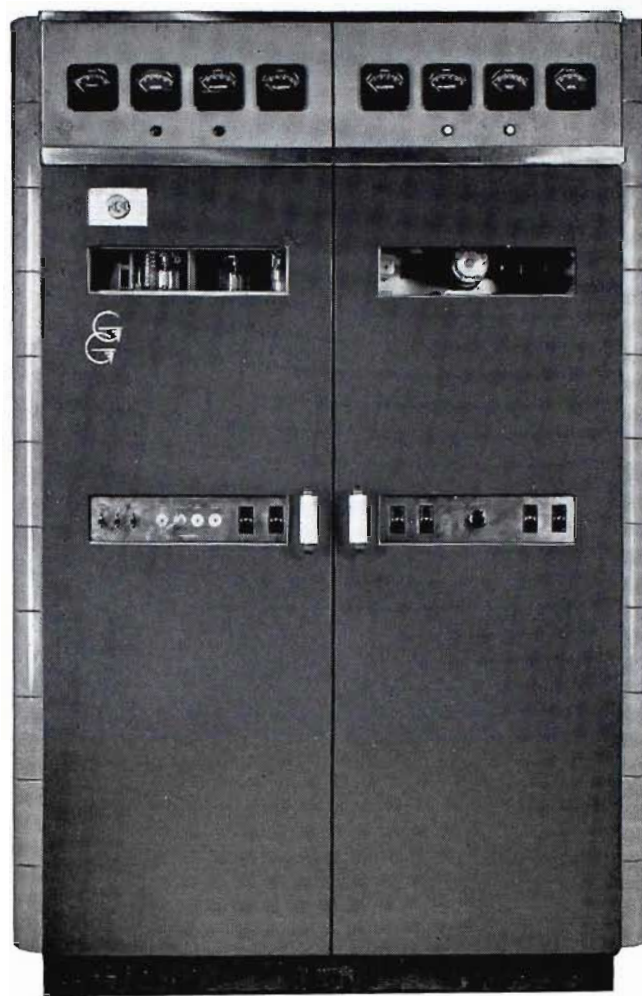

Variable output coupling, provided by front panel control, varies the output into the antenna transmission line from 250 to 1000 watts. Power circuits are protected by magnetically-tripped circuit-breaker type switches and overload relays. A transmission line monitor which acts as a watchman over the antenna and transmission line system is provided. Any change in transmission line characteristic which might result from an arc in the transmission line, or a fault in the antenna itself, actuates this monitor and shuts down the transmitter. An interlocking control circuit prevents the application of plate power until the rectifier filaments have reached operating temperature. Filament voltage is controlled by tapped transformers and a common filament rheostat. The 7C24 tube has a separate filament rheostat control. Means are provided for reducing the plate voltage for tuning purposes. Door interlocks are provided, where required, for the safety of operating personnel. High voltage compartments are equipped with mechanically operated grounding bars which are automatically released when a compartment door is opened.

Multi-unit construction is employed in the BTF-1C and the entire transmitter is housed in two fabricated steel frames which are bolted to a base frame. Each compartment is equipped with both a front and rear door. These doors are

provided with windows for observation of the interior of the transmitter while in operation. End shields and meter panels complete the cabinet-type enclosure which has been styled functionally, and presents a pleasing and dignified appearance. A filtered air supply for each compartment is supplied through individual air inlet openings and removable filter sections provided in the base frame. The warm air is exhausted through the roof. For ease in shipment and installation the equipment is partially disassembled. The transmitter is furnished with one FM exciter. A second exciter unit plus a transfer panel mounted in a separate cabinet are available as optional equipment. With dual exciters, instantaneous transfer of operation from one unit to the other is accomplished by the flick of a switch.

The BTF-1C is furnished with two crystals, two sets of tubes, interconnection wire kit, harmonic filter, and transmission line monitor.

### Specifications

Frequency Range \_\_\_\_\_ Any specified frequency between 88 and 108 mc  
 Power Output (into transmission line) \_\_\_\_\_ 250 to 1000 watts  
 R-f Output Impedance (SWR 1.75 or less) \_\_\_\_\_ 51.5 ohms  
 Carrier Frequency Stability, deviation less than \_\_\_\_\_  $\pm 1000$  cycles  
 Modulation Capability \_\_\_\_\_  $\pm 100$  kc  
 Method of Modulation \_\_\_\_\_ Reactance-tubes  
 Audio Input-Impedance \_\_\_\_\_ 150/600 ohms  
 100% Modulation Level \_\_\_\_\_  $+10 \pm 2$  dbm  
 (0 dbm = 1 milliwatt)

#### Audio Frequency Response<sup>1</sup>

30 to 15,000 Cycles, 1,000 Cycle Reference, within  $\pm 1$  db

#### Audio Frequency Distortion<sup>2</sup>

30-15,000 Cycles \_\_\_\_\_ Less than 1% rms  
 (Including all harmonics up to 30 kc/s at  $\pm 75$  kc swing.)

FM Noise Level, below  $\pm 75$  kc swing<sup>2</sup> \_\_\_\_\_ -65 db

AM Noise Level, below 100% amplitude modulation<sup>2</sup> \_\_\_\_\_ -50 db

Power Supply Requirements \_\_\_\_\_ 208/230 volts, 50 or 60 cycles single phase, capable of supplying approximately 3700 watts at 89% power factor, and 5% maximum regulation and variation. Also approximately 30 watts at 115 volts, 50 or 60 cycles single phase is required for the crystal heaters.

Tube Complement \_\_\_\_\_ 4 RCA 6V6, 4 RCA 1614, 1 RCA 6SH7, 4 RCA 5U4G, 2 RCA OD3/VR150, 1 RCA OC3/VR105, 1 RCA 6AL5, 2 RCA 2E26, 5 RCA 6AC7, 1 RCA 2BP1, 3 RCA 4-125A/4D21, 4 RCA 8008, 1 RCA 7C24, 1 RCA 2D21.

### Dimensions in Inches

Overall Width \_\_\_\_\_ 56 3/32"  
 Overall Depth (including door handles) \_\_\_\_\_ 31 1/4"  
 Overall Height \_\_\_\_\_ 84"  
 Maximum Crate Size \_\_\_\_\_ 28" x 30" x 84"  
 Weight in Pounds (unpacked-assembled) \_\_\_\_\_ 1900 (approx.)  
 Maximum Ambient Temperature \_\_\_\_\_ 45° C.  
 Finish \_\_\_\_\_ Two-tone umber gray with brushed chrome trim  
 Stock Identification \_\_\_\_\_ MI-28912

### Equipment Supplied

Following is a condensed list of equipment included as a complete BTF-1C Transmitter:

Quantity	Stock Ident.
1 Low Power RF and PA Unit _____	MI-28101
1 Exciter, Power and Control Unit _____	MI-28102
1 Harmonic Filter _____	MI-28151
1 Transmission Line Monitor _____	MI-28155-2
1 Pre-emphasis Network _____	MI-4926-A
2 TMV-129G Crystal Units _____	MI-19450-A
2 Complete Sets of Tubes _____	MI-28157
1 Installation Material Kit _____	MI-28167
1 Wiring Material Kit _____	MI-28145
1 Finish Touch-up Kit _____	MI-28153
2 Instruction Books _____	IB-30132
2 Installation Plans _____	K-8883058

### Available Accessories

1 KW to 3 KW Conversion Kit _____	MI-28920
Set of Tubes for Above Kit _____	MI-28161
1 KW to 10 KW Conversion Kit _____	MI-28921
Set of Tubes for Above Kit _____	MI-28162
FM Transmitting Antenna _____	See antennas
Towers for Supporting FM Antennas _____	On application
Transmission Line _____	On application
Transmitter Monitoring and Test Equipment _____	See Test and Meas. Equip.
Spare Parts _____	On application

<sup>1</sup> For pre-emphasized response the pre-emphasis filter (MI-4926A) is provided to be inserted in the 600 ohm audio input line.  
<sup>2</sup> Distortion and noise is measured following a standard de-emphasis network.

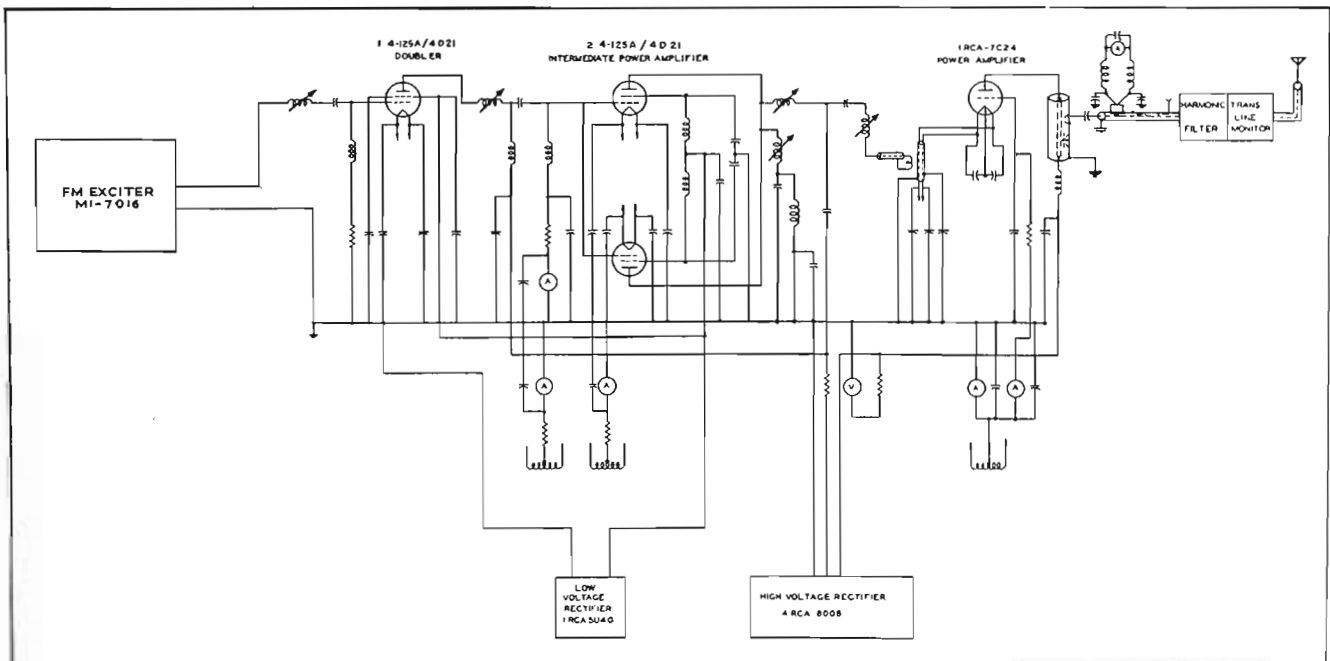

Simplified Schematic of BTF-1C



# FM Broadcast Transmitter, Type BTF-3B

## Features

- Low installation cost—requires minimum of floor space.
- Low operating cost—low power input.
- Direct FM Exciter—with space provided for dual units with instantaneous transfer panel.
- Low distortion—low noise level—frequency response 30 to 15,000 cycles ( $\pm 1$  db).
- Automatic frequency control.
- Motor driven tuning for power stages.
- Fixed-tuned harmonic attenuator.
- All controls conveniently located—utmost accessibility provided both front and rear. Vertical chassis construction throughout.
- All air-cooled.
- Power increase is accomplished by “block-building” with additional power amplifiers.

## Description

The BTF-3B FM transmitter will provide a maximum of 3000 watts output at any specified frequency between 88 and 108 mc. Attractively housed in three standardized cabinets, this compact unit is easily and economically installed. Power increases can be made by the addition of a grounded grid r-f amplifier, a power unit and a control unit housed in matching cabinets.

Accessibility is assured by vertical chassis construction plus surface mounting of components and exposed wiring for easy and speedy circuit tracing and servicing.

Electrically, circuits of the BTF-3B are the same as circuits of the BTF-1C plus an additional grounded-grid amplifier stage to furnish the increased power. All RCA FM transmitters use the same basic exciter unit. Therefore, all features of the RCA “Direct FM” circuit common to the other FM transmitters are also realized in the operation of BTF-3B, the 3 kilowatt transmitter. Benefits of RCA “Direct FM” plus the advantages of the power-saving, grounded-grid circuits serve to reduce (below that of other similarly rated transmitters) the number of tubes needed to provide the desired output.

Simplified single-ended amplifiers operating class “C” and comprising a minimum number of variable elements form the r-f section of the BTF-3B. The number of tubes has been reduced to a minimum. The same type tube is used in several stages thus greatly reducing spare tube requirements. High stability grounded grid circuits using RCA type 7C24 tubes are employed in the last two stages.

A variable output coupling provided by front panel control permits adjusting the power output to the antenna transmission line over a range from 1000 to 3000 watts. A fixed-tuned harmonic attenuator (externally mounted) designed to reduce all harmonics 30 db or better is located in the output circuit and is provided as standard equipment. Filament voltage, except for the 7C24 tube, is controlled by tapped transformers and a common filament rheostat. The 7C24 tubes have separate filament rheostat controls.



The entire transmitter is housed in three fabricated steel frames which are bolted to a base frame. Each compartment has both front and rear doors which are provided with observation windows. End shields and meter panels complete the cabinet type enclosure which has been styled functionally to present a pleasing and dignified appearance. Filtered air, supplied through individual air inlet openings and removable filters are provided in the base frame. Warm air is expelled through the roof.

A transmission line monitor externally mounted which acts as watchman over the antenna and transmission line system is provided. Any unwarranted increase in signal-to-noise ratio such as might result from an arc in the transmission line or a fault in the antenna itself, actuates this monitor which shuts down the transmitter. Both manual and automatic overload protection are provided. When in the automatic position, a three shot recycling sequence is provided by the control “brain center” which automatically returns the transmitter to the air up to two times in case of repeated overloads. If such overload condition persists the transmitter is automatically shut down on the third overload.

All high power circuits are doubly protected by high-speed overload relays backed up by magnetic-trip circuit-breaker type switches. Door interlocks are provided, where required, for the safety of the operating personnel. High voltage components are equipped with mechanically operated grounding bars which are automatically released when a door is opened.

The transmitter is furnished with one FM exciter. A second exciter plus a transfer panel are available as optional equipment. Instantaneous transfer of operation from one exciter to the other is accomplished by the flick of a switch.

The BTF-3B is furnished with one exciter, two sets of tubes, two crystals, interconnection wire kit, harmonic filter, and transmission line monitor. An interconnection wiring kit is furnished with each transmitter.

## Specifications

Frequency Range \_\_\_\_\_ Any specified frequency between 88 and 108 mc

Power Output (into transmission line) \_\_\_\_\_ 1000 to 3000 watts

R-f Output Impedance (SWR 1.75 or less) \_\_\_\_\_ 51.5 ohms

Carrier Frequency Stability \_\_\_\_\_ Deviation less than  $\pm 1000$  cycles

Modulation Capability \_\_\_\_\_  $\pm 100$  kc

Method of Modulation \_\_\_\_\_ Reactance-tubes

Audio Input-Impedance \_\_\_\_\_ 150/600 ohms

100% Modulation Level \_\_\_\_\_  $+10 \pm 2$  dbm

Audio Frequency Response<sup>1</sup>  
30 to 15,000 Cycles, 1000 Cycle Reference, within \_\_\_\_\_  $\pm 1$  db

Audio Frequency Distortion<sup>2</sup>  
30-15,000 Cycles \_\_\_\_\_ Less than 1% rms  
(Including all harmonics up to 30 kc/s at 75 kc swing.)

FM Noise Level, below 75 kc swing<sup>2</sup> \_\_\_\_\_ -65 db

AM Noise Level, below 100% amplitude modulation<sup>2</sup> \_\_\_\_\_ -50 db

Power Supply Requirements \_\_\_\_\_ 208/230 volts, 50 or 60 cycles three phase, capable of supplying approximately 7700 watts at 90% power factor, and 5% maximum regulation and variation. Also approximately 30 watts at 115 volts, 50/60 cycles single phase is required for the crystal heaters.

### Tube Complement

4 RCA 6V6	2 RCA 2E26
4 RCA 1614	5 RCA 6AC7
1 RCA 6SH7	1 RCA 2BP1
4 RCA 5U4G	3 RCA 4-125A/4D21
2 RCA 0D3/VR150	2 RCA 7C24
1 RCA 0C3/VR105	6 RCA 8008
1 RCA 6AL5	1 RCA 2D21

### Dimensions in Inches

Overall Width \_\_\_\_\_  $81\frac{3}{8}$ "

Overall Height \_\_\_\_\_ 84"

Overall Depth (including door handles) \_\_\_\_\_  $31\frac{1}{8}$ "

Maximum Crate Size \_\_\_\_\_ 28" x 30" x 84"

Weight in Pounds (unpacked—assembled) \_\_\_\_\_ 2900 (approx.)

Maximum Ambient Temperature \_\_\_\_\_ 45° C.

Finish \_\_\_\_\_ Two-tone umber gray with brushed chrome trim

Stock Identification \_\_\_\_\_ MI-28913

## Equipment Supplied

Following is a condensed list of equipment included as a complete BTF-3B Transmitter.

Quantity	Stock Identification
1 Low Power RF, IPA and PA Unit _____	MI-28103
1 Exciter Unit _____	MI-28104-1
1 Power and Control Unit _____	MI-28105
1 Harmonic Filter _____	MI-28151
1 Transmission Line Monitor _____	MI-28155-3
1 Pre-emphasis Network _____	MI-4926-A
2 TMV-129G Crystal Units _____	MI-19450-A
2 Complete Sets of Tubes _____	MI-28158
1 Installation Material Kit _____	MI-28168
1 Wiring Material Kit _____	MI-28146
1 Finish Touch-up Kit _____	MI-28153
2 Instruction Books _____	IB-32133-1
2 Installation Plans _____	IB-30214

## Available Accessories

3 KW to 10 KW Conversion Kit _____	MI-28922
Set of Tubes for Above Kit _____	MI-28163
Spare FM Exciter Kit _____	MI-7015
Set of Tubes for Spare Exciter _____	MI-7020
FM Transmitting Antennas _____	See Antennas
Towers for Supporting FM Antennas _____	On application
Transmission Line _____	On application
Transmitter Monitoring and Test Equipment _____	See Test and Meas. Equip.
Spare Parts _____	On application

## Accessories

Set of Tubes for BTF-3B _____	MI-28158
3 to 10 kw Conversion Kit _____	MI-28922
Set of Tubes for Above Kit _____	MI-28163
Spare FM Exciter Kit _____	MI-7015
Set of Tubes for Spare Exciter _____	MI-7020

<sup>1</sup> For pre-emphasized response the pre-emphasis filter (MI-4926A) is provided to be inserted in the 600 ohm audio input line.

<sup>2</sup> Distortion and noise is measured following a standard de-emphasis network.

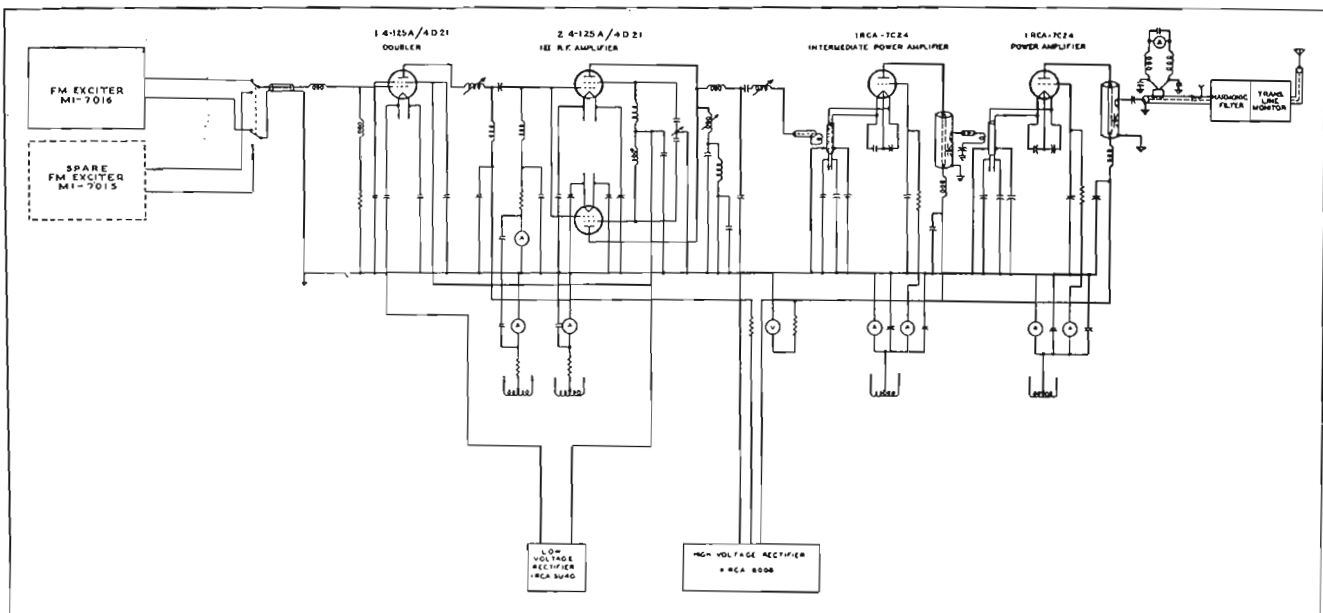

Simplified Schematic of BTF-3B



# "DIRECT FM"

Only 6 tubes in the audio and RF generating circuits of this exciter

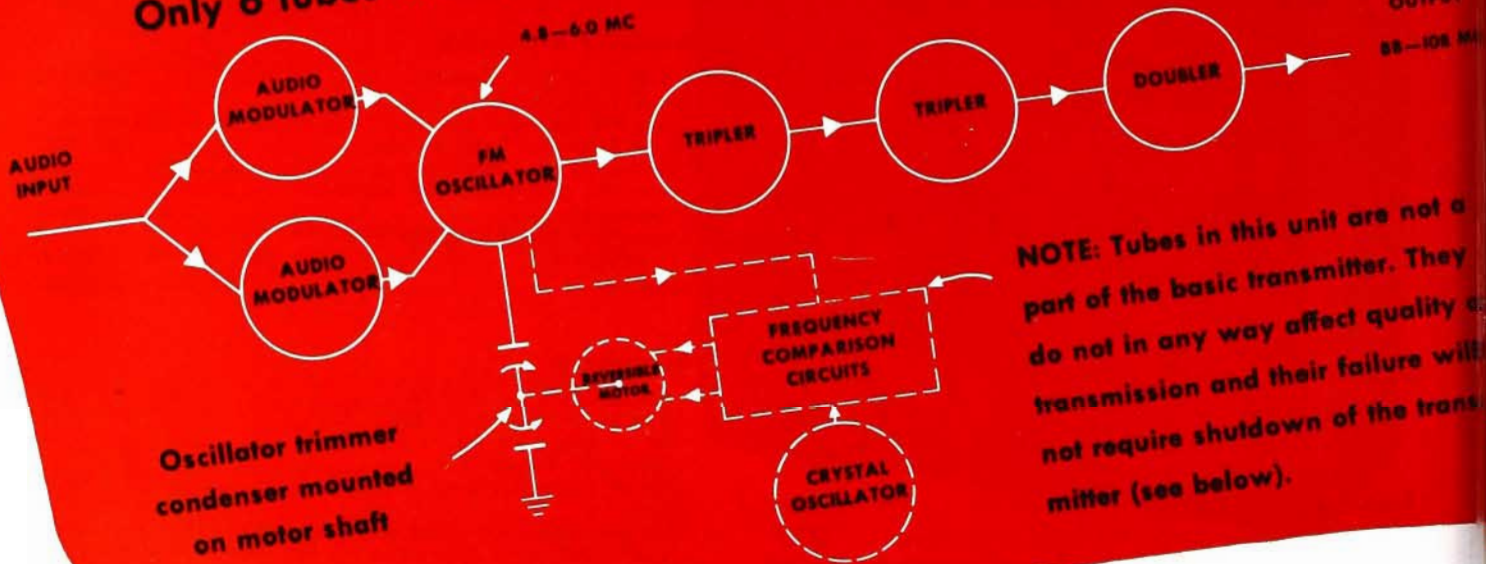

**NOTE:** Tubes in this unit are not a part of the basic transmitter. They do not in any way affect quality of transmission and their failure will not require shutdown of the transmitter (see below).

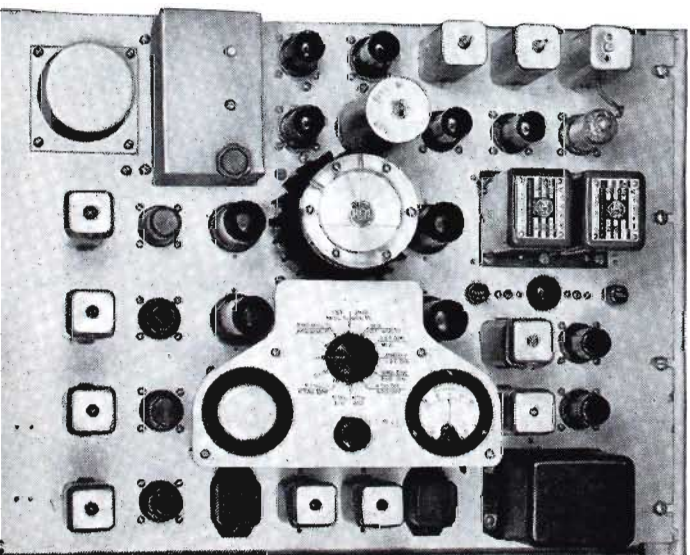

**BASIC CIRCUITS** are mounted on this part of the exciter panel. They include two audio modulators, an FM oscillator, and three frequency multiplying stages (see diagram above).

**AUTOMATIC FREQUENCY CONTROL** is provided by the circuits in this part of the exciter panel. Two temperature-controlled, precision ground crystals (one a spare) are provided. Sub-harmonics of the crystal oscillator and FM oscillator are compared. Any difference between these frequencies operates a reversible motor with a vernier condenser mounted on the motor shaft. The motor never turns more than 90 degrees either way. No gears, counter circuits, or compensating voltages are involved. Failure in this section does not take the transmitter off the air, since operation may be continued by making occasional manual frequency corrections.

# provides the lowest distortion!

**COMPARE** these laboratory performance measurements  
on one of the new RCA "DIRECT FM" EXCITERS

✓ **Distortion:**

Less than  $\frac{1}{2}\%$  from 30 to 15,000 cycles

✓ **Frequency Response:**

Within  $\pm\frac{1}{2}$  db from 30 to 15,000 cycles

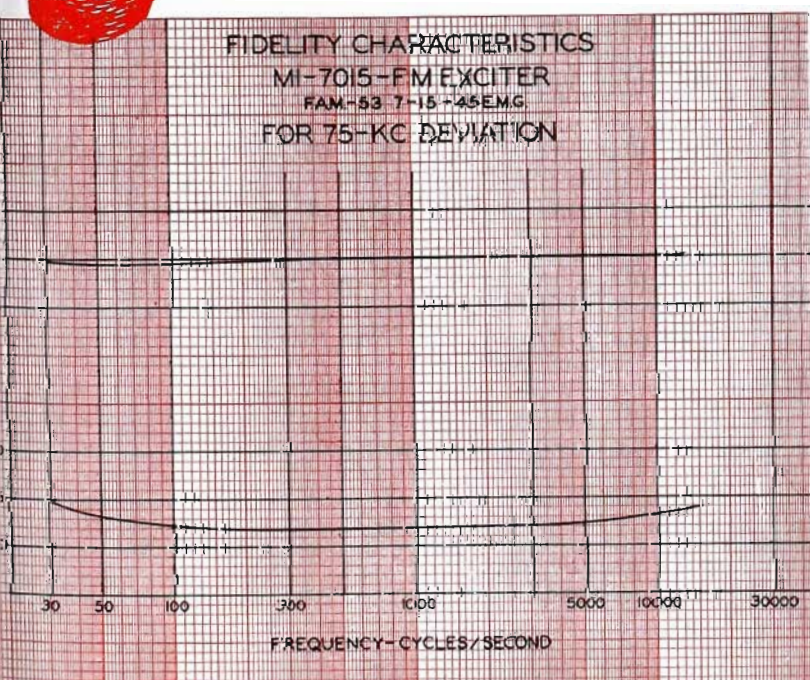

THE CURVES at the left show the distortion and response versus frequency as actually measured on one of the first of the new RCA "Direct FM" exciter units. Distortion has been measured at less than one-half of one per cent over the whole "FM range" of 30 to 15,000 cycles, with frequency response varying less than  $\frac{1}{2}$  db over the same range.

The fidelity which can be obtained in an FM transmitter is basically limited by the distortion and noise introduced in the FM generating circuits located in the exciter. The simple, straightforward circuits used in the RCA exciter are inherently capable of lower distortion and lower noise level than any other type yet developed. The curves at the left prove this!

The station which proposes to provide true "FM Quality" should start with the best exciter available. We believe that the RCA "Direct FM" exciter is just that!



# FM Broadcast Transmitter, BTF-5A

## Features

- Low installation cost—requires minimum of floor space.
- Direct FM Exciter—with space provided for dual units with instantaneous transfer panel.
- Automatic frequency control.
- Motor driven tuning for power stages.
- Simplified single-ended r-f circuits throughout.
- High-stability, power-saving, grounded-grid amplifier.
- All air-cooled.
- Power increase easily accomplished with additional power amplifiers.

## Description

The RCA BTF-5A FM Transmitter is designed to provide up to 5000 watts of power at any specified frequency in the 88 to 108 mc. band. The entire transmitter is housed in three standard cabinets bolted to a base frame. Each cabinet has front and rear doors for easy access to components.

Electrically, the BTF-5A is similar to the 3 kw transmitter (BTF-3B) except that increased power output is provided through the use of a new type power tube (RCA 5762) designed with higher plate voltage and current ratings.

All features of the RCA "Direct FM" circuit common to other RCA FM transmitters are realized in the operation of BTF-5A, the 5 kilowatt transmitter. Benefits of RCA "Direct FM" plus the advantages of the power-saving, grounded-grid circuits serve to reduce (below that of other similarly rated transmitters) the number of tubes needed to provide the desired output. The reduction in the number of tubes results in a lower dollar value of spare-tube inventory required for station operation.

The standard direct FM exciter is followed by a doubler stage using one Type 4-125A/4D21 and two r-f amplifier stages using, respectively, two Type 4-125/4D21 tubes and one RCA 5762 (the latter operating as a grounded-grid amplifier). This stage acts as the driver for a final output stage which consists of another RCA 5762, in a grounded-grid circuit. The use of the same size tube in both driver and output stages is made practical by the use of grounded-grid circuits in which the driver stage contributes a substantial share of the output power. Thus, it is possible to use a much smaller tube in the output stage than would be required with a conventional grounded-filament circuit. Rectifiers include a low-voltage unit using one RCA 5U4G and a high-voltage unit using six RCA 8008's. The control circuit includes automatic starting and recycling.

All high-power circuits are doubly protected by high-speed overload relays backed up by magnetic-trip circuit-breaker type switches. Similar circuit-breaker type switches are also used to connect blowers, filament and low power circuits to the power line. Interlock switches prevent the application of plate power until rectifier filaments have reached operating temperature, and blowers are supplying sufficient air to cool P. A. tubes.



The power control circuits include both manual and automatic overload protection. When in the automatic position, a 3 shot recycling sequence is provided by the control "brain center" which automatically returns the transmitter to the air up to two times in case of repeated overloads. If such an overload condition still persists the transmitter is automatically shut down on the third overload.

A transmission line monitor acts as a watchman over the antenna and transmission line system. This monitor automatically shuts down the transmitter in case of an unwarranted change in signal intensity such as might result from a transmission line arc or from a change.

Operation of circuits and tubes may be easily and quickly observed by means of a cathode ray tube checking device built in the exciter unit. Selector switches are provided so that frequency control circuits, frequency multipliers and reactance modulators can be rapidly checked.

## Performance Specifications

Type of Emission\_\_\_\_\_Frequency modulated  
 Frequency Range\_\_\_\_\_Any specified frequency between  
 88 and 108 mc.  
 Power Output (into transmission line)\_\_\_\_\_1000 to 5000 watts  
 Output Impedance\_\_\_\_\_51.5 ohms  
 (standing wave ratio 1.75 to 1 or less)  
 Carrier Frequency Stability\_\_\_\_\_Deviation less than 1000 cycles  
 Modulation Capability\_\_\_\_\_±100 kc

Method of Modulation	Reactance-tubes
Audio Input-Impedance	600/150 ohms
100% Modulation Level (at input of 600 ohms pre-emphasis network)	+10 ± 2 dbm
Audio Frequency Response (with pre-emphasis filter)	30 to 15,000 cycles (1000 cycle reference)
Audio Frequency Distortion*	Within ±1 db
30 to 15,000 cycles	Not more than 1.0% (including all harmonics up to 30 kc/s at 76 kc swing)
FM Noise Level (reference ±75 kc swing)	Not more than -65 db
AM Noise Level (reference 100% amplitude modulation)	Not more than -50 db
Power Line Requirement—Transmitter	
Line Voltage	208/230 volts
Phase	3
Frequency	50/60 cycles
Instantaneous Regulation (maximum)	5%
Power Consumption (approximate)	11,000 watts
Power Factor (approximate)	Better than 90%
Power Line Requirements—Crystal Heaters	
Line Voltage	100 to 130 volts a-c or d-c
Power Consumption	28 watts
Stock Identification	MI-28960

\* Measured with a standard de-emphasis network.

### Mechanical Specifications

Size and Weight, approximate	
Overall Length	81 <sup>3</sup> / <sub>16</sub> "
Overall Height	84"
Overall Depth (including door handles)	31 <sup>1</sup> / <sub>16</sub> "
Overall Weight (unpacked)	3000 lbs.
Overall Weight (packed)	4300 lbs.

### Tube Complement

For the FM Exciter:	
Modulators	2 RCA 6V6
Modulated Oscillator	1 RCA 6V6
1st Buffer-Multiplier	1 RCA 6V6
2nd Buffer-Multiplier	1 RCA 2E26
Amplifier	1 RCA 2E26
1st Frequency Divider	1 RCA 6AC7
2nd Frequency Divider	1 RCA 6AC7
3rd Frequency Divider	1 RCA 6AC7
4th Frequency Divider	1 RCA 6AC7
Motor Control Tubes	4 RCA 1614
Crystal Frequency Divider	1 RCA 6AC7
Crystal Oscillator	1 RCA 6SH7
Cathode Ray Indicator	1 RCA 2BP1

For the Exciter Power Supply:	
Low Voltage Rectifiers	2 RCA 5U4G
High Voltage Rectifier	1 RCA 5U4G
Voltage Regulator	1 RCA OC3/VR105
Voltage Regulators	2 RCA OD3/VR150
For the R-F Unit:	
Doubler	1 RCA 4-125A/4D21
First R-F Power Amplifier	2 RCA 4-125A/4D21
Intermediate Power Amplifier	1 RCA 5762
Power Amplifier	1 RCA 5762
For the Low Voltage Rectifier	1 RCA 5U4G
For the High Voltage Rectifier	6 RCA 8008
For the Transmission Line Monitor:	
R-F Rectifier	1 RCA 6AL5
Thyratron	1 RCA 2D21

### Equipment Supplied

1 Low Power RF, IPA and PA Unit	MI-28107-A
1 Exciter	MI-28104-1
1 Power and Control Unit	MI-28042
1 Harmonic Filter	MI-28151
1 Transmission Line Monitor	MI-28155-3
1 Pre-emphasis Filter	MI-4926-A
1 Wiring Material Kit	MI-28043
1 Installation Material Kit	MI-28044
1 Finish Touch-up Kit	MI-28153
1 Tool Kit	MI-28288
2 TMV-129G Crystal Units	MI-19450-A
2 Complete Sets of Tubes	MI-28158-A
2 Instruction Books	IB-30211
2 Installation Plans	IB-30213

### Available Accessories

Spare FM Exciter Kit	MI-7015
Set of Tubes for Above Kit	MI-7020
FM Transmitting Antennas	See Antennas
Towers for Supporting FM Antennas	On application
Transmission Line	On application
Transmitter Monitor and Test Equipment	See Test and Measuring Equipment
Spare Parts	On application

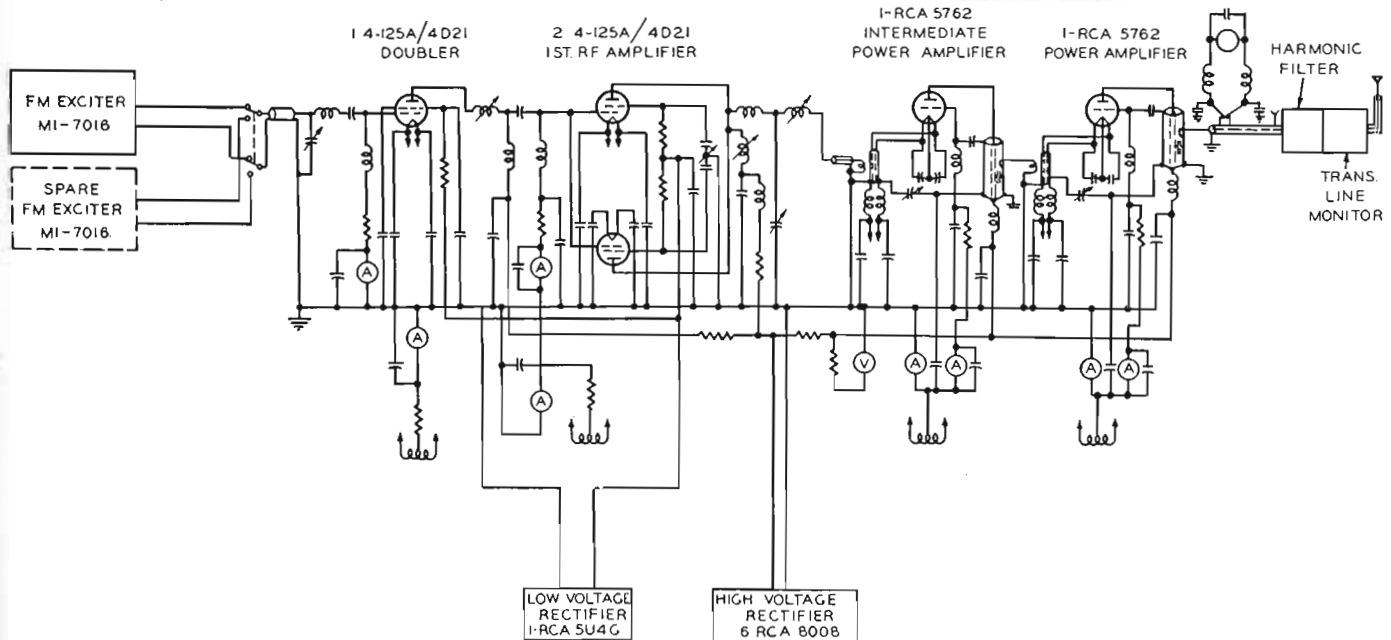



# FM Broadcast Transmitter, Type BTF-10B

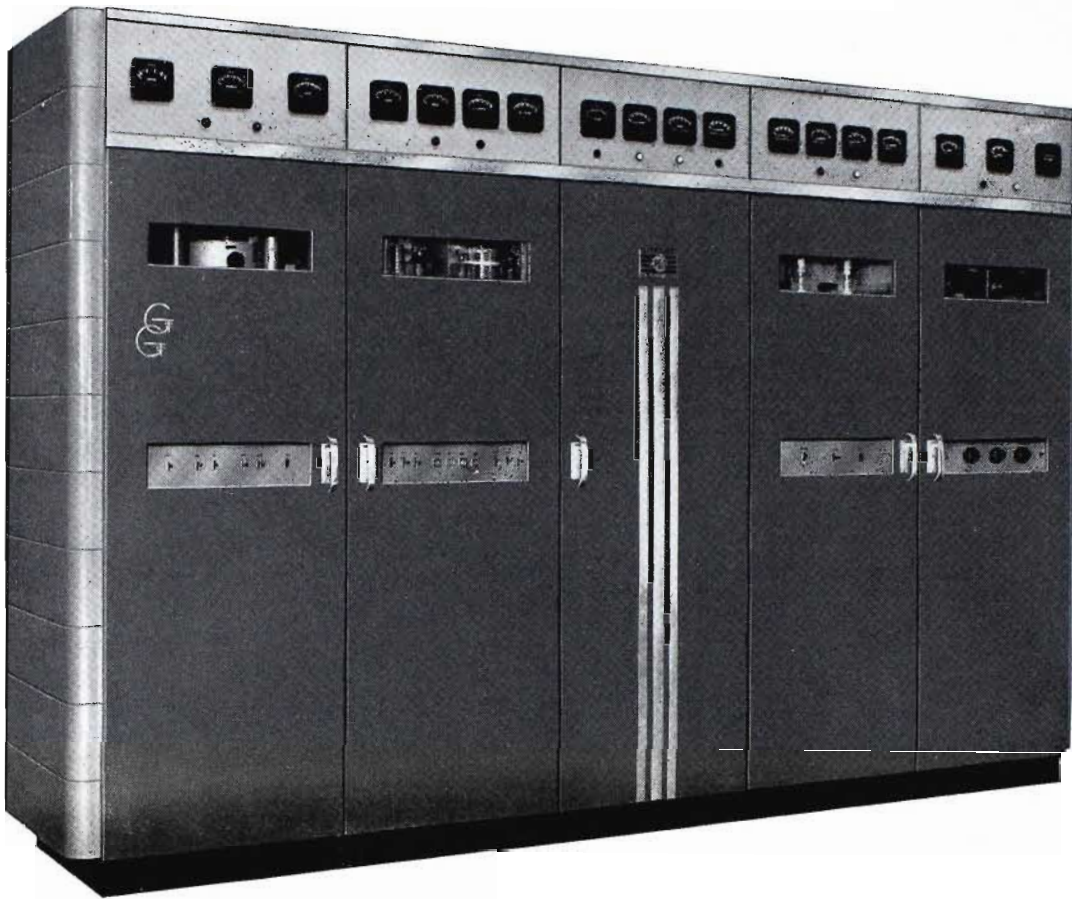

## Features

- Low installation cost—requires minimum of floor space area.
- Low operating cost—low power consumption.
- All tubes in the 1kw, 3 kw and 10 kw final amplifiers are the same types, low-cost 7C24's.
- High-stability, power-saving, grounded-grid amplifiers.
- Direct FM Exciter—with space provided for dual units with instantaneous transfer panel.
- Simplified single-ended r-f circuits throughout with motor driven tuning for high-power stages.
- All controls conveniently located—utmost accessibility provided both front and rear. Vertical chassis construction throughout.

## Description

The RCA BTF-10B is a new frequency modulated transmitter designed to supply up to 10,000 watts of power at any specified frequency in the 88 to 108 mc. band. Incorporating the latest developments in FM transmitter design, the BTF-10B is outstanding in performance and reliability. Compact and simplified mechanical construction plus attractive cabinet styling make for an economical installation with dignified appearance. The entire transmitter is housed in five fabricated steel frames which are bolted to a base frame. Each compartment has both front and rear doors with observation windows. Accessibility is assured by vertical chassis construction, surface mounting of components and exposed wiring for speedy circuit tracing.

Electrically, the r-f circuits of the BTF-10B, 10 kilowatt transmitter, are the same as those of the BTF-3B plus an additional grounded-grid amplifier stage to furnish the increased power.

Since all RCA FM transmitters use the same basic exciter unit, all the benefits of RCA Direct FM plus the advantages of grounded-grid amplifiers are made available to the user of the BTF-10B.

Simplified single-ended amplifiers operating class "C" and using a minimum number of variable elements form the RF section of the BTF-10B. High stability grounded-grid circuits are employed in the last three stages using RCA type 7C24 tubes. This use of the same type tube in several stages results in greatly reduced spare tube requirements.

A variable output coupling with front panel control permits adjusting the power output into the transmission line over a range from 3,000 to 10,000 watts. Harmonic radiation is held to a minimum by a fixed-tuned harmonic attenuator which is located in the output circuit and is provided as standard equipment.

An externally mounted transmission line monitor acts as a watchman over the antenna and transmission line system. Any unwarranted change in standing wave ratio, such as might result from an arc in the transmission line, or a fault in the antenna itself, actuates this monitor which removes plate voltage from the transmitter to prevent damage. The power control circuits include both manual and automatic overload protection. When in the automatic position, a three-shot recycling sequence is provided by the control "brain center" which automatically returns the transmitter to the air up to two times in the case of repeated overloads, and then, if such overload persists, shuts the transmitter down on the third overload. A reset switch is provided which may be used to restore the transmitter to normal after one, two or three overloads. This switch can be set to lock out the recycling circuit.

All high power circuits are doubly protected by high speed overload relays backed up by magnetic-trip circuit-breaker type switches. Door interlocks are provided, where required, for the safety of operating personnel. High voltage components are equipped with mechanically operated grounding bars which are automatically released when a door is opened.

To minimize lost "air time", an antenna cut-back kit is available as optional equipment. When it is incorporated in the BTF-10B, the antenna can be instantly switched to the 3 kw intermediate power amplifier output. At the same time, the power amplifier plate voltage is removed and the plate circuit grounded. P. A. tube changes or necessary servicing in the power amplifier compartment can then be carried out in complete safety while program continuity is maintained through the driver.

Filtered air is supplied by an external blower for the 1, 3 and 10 kw stages. Individual, internal blowers for these stages are available as optional equipment where the single external blower is not desired. Space is provided in the exciter cabinet for a spare exciter which can be supplied as additional equipment. Instantaneous transfer of operation from one exciter to the other can then be accomplished by the flick of a switch. The transmitter is furnished with one FM exciter, two sets of tubes, two crystals, interconnecting wire kit, harmonic filter and transmission line monitor.

### Specifications

Frequency Range \_\_\_\_\_ 88 to 108 mc  
 Power Output (into transmission line) \_\_\_\_\_ 3,000 to 10,000 watts  
 RF Output Impedance \_\_\_\_\_ 51.5 ohms (standing wave ratio 1.75 to 1 or less)  
 Carrier Frequency Stability \_\_\_\_\_ Deviation less than  $\pm 1,000$  cycles  
 Modulation Capability \_\_\_\_\_  $\pm 100$  kc  
 Method of Modulation \_\_\_\_\_ Reactance tubes  
 Audio Input Impedance \_\_\_\_\_ 600/150 ohms  
 100% Modulation Level\* \_\_\_\_\_  $\pm 10 \pm 2$  dbm  
 Audio Frequency Response\*\* 30 to 15,000 cycles \_\_\_\_\_  $\pm 1$  db  
 Audio Frequency Distortion\*\*\* 30 to 15,000 cycles (including all harmonics up to 30 kc/s at  $\pm 75$  kc swing) \_\_\_\_\_ Less than 1%  
 FM Noise Level, below 75 kc swing\*\*\* \_\_\_\_\_ Not more than -65 db  
 AM Noise Level, below 100% amplitude modulation\*\*\* \_\_\_\_\_ Not more than -50 db

### Power Line Requirements—Transmitter:

Line Voltage \_\_\_\_\_ 208/230 volts  
 Phase \_\_\_\_\_ 3  
 Frequency \_\_\_\_\_ 60 cycles  
 (50 cycles equipment available at slightly higher cost)  
 Instantaneous Regulation and Variation \_\_\_\_\_ 5%  
 Power Consumption (approx.) \_\_\_\_\_ 23 kw  
 Power Factor (approx.) \_\_\_\_\_ 90%  
 Tube Complement \_\_\_\_\_ 4 RCA 6V6, 4 RCA 1614, 1 RCA 6SH7,  
 4 RCA 5U4G, 2 RCA OD3/VR150, 1 RCA OC3/VR105,  
 1 RCA 6AL5, 2 RCA 2E26, 5 RCA 6AC7, 1 RCA 2BP1,  
 3 RCA 4-125A/4D21, 4 RCA 7C24, 6 RCA 673, 1 RCA 2D21

### Dimensions:

Overall Length \_\_\_\_\_ 131 3/8"  
 Overall Height \_\_\_\_\_ 84"  
 Overall Depth \_\_\_\_\_ 31 1/8"  
 Building Entrance Requirements \_\_\_\_\_ 25" x 80"  
 Weight in Pounds (unpacked—assembled) \_\_\_\_\_ 5000 (approx.)  
 Maximum Ambient Temperature \_\_\_\_\_ 45° C.  
 Finish \_\_\_\_\_ Two tone umber gray with brushed chrome trim and fittings

### Equipment Supplied

Following is a condensed list of equipment included as a complete BTF-10B Transmitter.

Quantity	Stock Identification
1	Power Amplifier _____ MI-28106-A
1	Low Power RF and IPA Unit _____ MI-28107
1	Exciter _____ MI-28104-1
1	Power Supply _____ MI-28109
1	Control Unit _____ MI-28110
1	Plate Transformer _____ MI-28150
1	Harmonic Filter _____ MI-28151
1	Transmission Line Monitor _____ MI-28155-3
1	Pre-emphasis Network _____ MI-4926-A
1	Wiring Material Kit _____ MI-28147
1	Installation Material Kit _____ MI-28169
1	Finish Touch-up Kit _____ MI-28153
1	Tool Kit _____ MI-28288
2	TMV-129G Crystal Units _____ MI-19450-A
2	Complete Set of Tubes _____ MI-28159
2	Instruction Books _____ IB-30134
2	Installation Plans _____ IB-30201
1	External or Internal Blower _____ Equipment _____ Specify when ordering

### Available Accessories

Spare FM Exciter Kit _____ MI-7015
Set of Tubes for Spare Exciter _____ MI-7020
Power Cut-back Equipment _____ MI-28154
Modification Kit for 50 Cycle Operation _____ MI-28178
FM Transmitting Antennas _____ See Antennas
Tower for Supporting FM Antennas _____ On application
Transmission Line _____ On application
Transmitter Monitoring and Test Equipment _____ See Test and Meas. Equip.
Spare Parts _____ On application

\* Level at input of 600 ohm pre-emphasis network. Insertion loss of this network is approximately 24 db.  
 \*\* For pre-emphasized response, the pre-emphasis filter (MI-4926A) is provided to be inserted in the 600 ohm audio input line at the most effective point.  
 \*\*\* Distortion and noise is measured following a standard 75 microsecond de-emphasis network.  
 Stock Identification \_\_\_\_\_ MI-28914

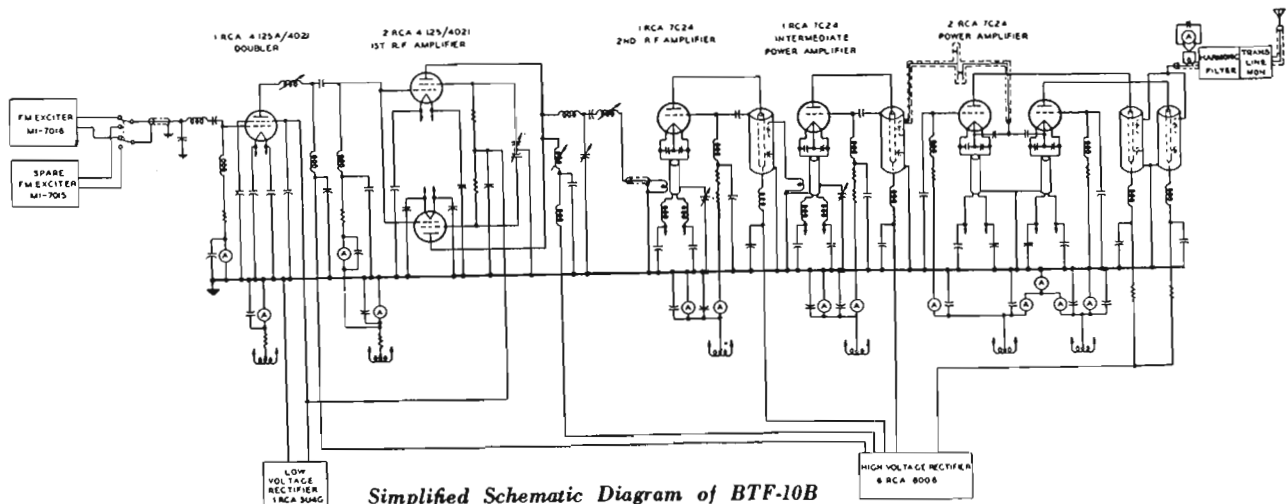





*Over*  
**2000**  
*FM Broadcasters*



# are going RCA

## Here's why...

- ✓ RCA FM transmitters are designed for transmitter engineers who *know* transmitters.  
RCA FM transmitters provide a professional performance that comes only through building more broadcast equipment than any other manufacturer.  
RCA FM transmitters are backed by a long-standing reputation for making reliable broadcast equipment . . . FM, AM, TV.
- ✓ RCA FM transmitters have Grounded-Grid circuits for true circuit stability at vhf.  
RCA FM transmitters use Direct-FM exciters that reduce distortion and noise . . . use fewer tubes.  
RCA FM transmitters enable you to go to higher power with only minor equipment modification.
- ✓ RCA FM transmitters are unit-built . . . are easy to move and inexpensive to install.  
RCA FM transmitters use RCA-pioneered vertical chassis design and are completely accessible.  
RCA FM transmitters can be tuned in minutes . . . even by inexperienced personnel.

*For complete information on RCA FM transmitters, write RCA, Broadcast Section, Dept. 19-F, Camden, N. J.*



# FM Broadcast Transmitter, Type BTF-50A

## Features

- Entirely air cooled.
- Low cost installation.
- Small space requirements.
- Simplified power supply—only one high-power rectifier.
- Reduced power feature assures uninterrupted program service.
- Protection against transmission line or antenna failure.
- New BTC-1A control console supplied as standard equipment.

## Description

The BTF-50A is an all-new 50 kw FM transmitter incorporating the latest developments in high power FM transmitter design. This RCA transmitter will supply 50,000 watts at any specified frequency in the 88 to 108 mc. band. Installation and operating costs have been held to a minimum through the use of compact mechanical construction and efficient, grounded-grid circuits using a minimum of different tube types. Reliability is assured by conservative operation of all components and dependable forced air cooling.

The general arrangement of the transmitter consists of a series of vertical chassis supported by steel frames which are in line with an attractively styled, sectionalized front. All units employ "dead front" construction with doors in the front panel allowing free access to the low power RF cabinets and to the transmitter area. The entire radio frequency portion of the transmitter can easily be installed in a space only 16½ feet wide by 9 feet deep. External blower and power equipment may be installed either in a basement or on the same floor, depending on individual choice.

A new RCA transmitter control console (BTC-1A) is supplied as standard equipment with the BTF-50A. This control console contains audio mixing and monitor controls, primary power switching for the transmitter and tower lights. "Block type" construction permits the addition of control sections if other transmitters are to be operated in the same building.

The exciter unit of the BTF-50A contains RCA's "Direct FM" system in which frequency modulation is accomplished directly by push-pull reactance tubes connected across the frequency determining circuit of the modulated oscillator.

Simplified single ended amplifiers operating class "C" and using a minimum of variable elements form the RF section of the BTF-50A. High stability grounded-grid amplifiers using the new RCA 7C24 and 5592 tubes are employed in all stages above the 250 watt level. This use of the same type tube in several stages results in greatly reduced spare tube requirements. Inherent advantages of grounded-grid amplifiers at FM frequencies include greater stability, higher efficiency, simpler circuits and elimination of the need for neutralization.

Variable output coupling with a front panel control permits adjusting the power output into the transmission line over a wide range. Harmonic radiation is held to a minimum by a fixed-tuned attenuator, which is located in the output circuit.

Full protection from antenna or transmission line failure is provided by a transmission line monitor which automatically shuts down the transmitter when any unwarranted change in standing wave ratio at the input of the transmission line is detected. An automatic "three spot" reclosing system will return full power up to three times when plate voltage is removed by operation of the transmission line monitor or other overload devices.

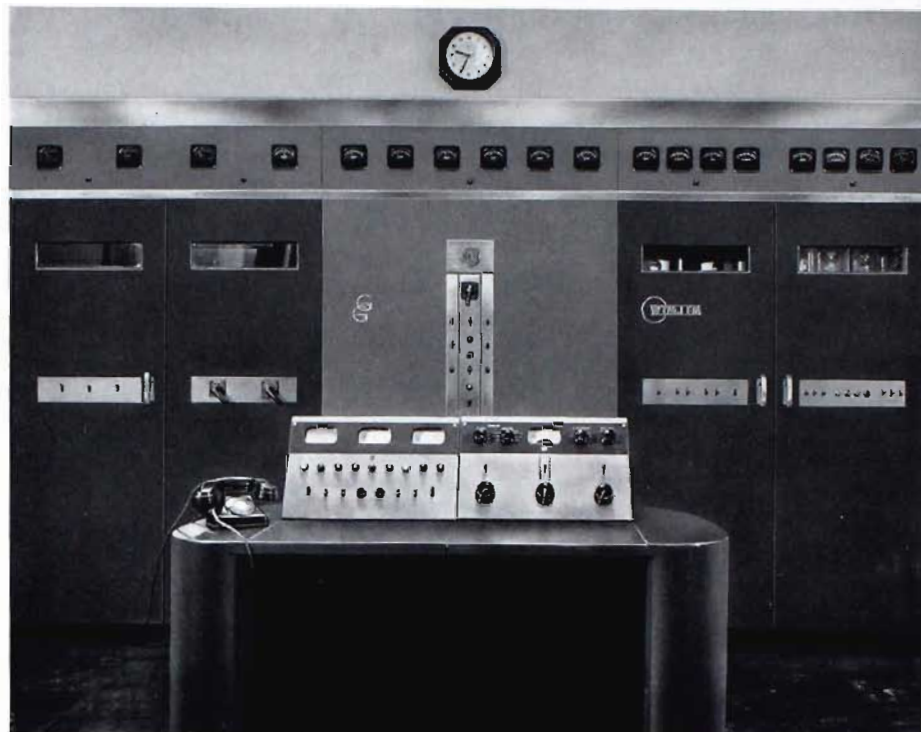

The power control system of the BTF-50A is carefully engineered to provide proper starting sequence. All high-powered circuits are doubly protected by high speed overload relays backed up by magnetic-trip circuit breaker type switches, and circuit indicator lamps provide a quick means for analyzing faults such as air failure, tube failure, etc. A single high-power rectifier supplies all anode voltages for the RF stages, and a heated spare tube is provided which may be quickly connected into the circuit, if necessary. Two small rectifiers are used for RF screen and exciter plate voltages. Door interlocks and high voltage grounding bars are provided, where required, for the safety of operating personnel.

To provide for continuous broadcast service with a minimum of interruption, the transmitter is equipped with an antenna cut-back arrangement. Operation of a single control switch transfers the antenna from the final amplifier to an intermediate amplifier which supplies approximately 7.5 kw. At the same time, the driver and power amplifier plate voltage is removed and the plate circuits grounded. Tube changes or necessary servicing in the driver, P.A. or high power blower compartments can then be carried out in complete safety, while program continuity is maintained through the intermediate power amplifier.

Air for all RF stages up to and including the intermediate power amplifier is supplied by a single blower. Air for the driver and final stages is supplied by a separate blower which draws filtered air from outside the transmitter area and may be exhausted into a manifold for outside delivery or for heating purposes, if desired.

## Specifications

Frequency Range—Any specified frequency between 88 to 108 mc  
 Power Output (into transmission line) \_\_\_\_\_ 10 to 50 kw  
 RF Output Impedance \_\_\_\_\_ 51.5 ohms  
 Carrier Frequency Stability—Deviation less than  $\pm 1000$  cycles  
 Modulation Capability \_\_\_\_\_  $\pm 100$  kc

Method of modulation \_\_\_\_\_ Reactance tubes  
 Audio Input Impedance \_\_\_\_\_ 600/150 ohms  
 Audio Input Level for 100% Modulation\* \_\_\_\_\_ +10 ±2 dbm  
 Audio Frequency Response\*\* 30 to 15,000 cycles \_\_\_\_\_ ±1 db  
 Audio Frequency Distortion\*\*\* 30 to 15,000 cycles (including all harmonics up to 30 kc/s at ±75 kc swing) \_\_\_\_\_ Less than 1.0%

FM Noise Level\*\*\* (below 75 kc swing) \_\_\_\_\_ Not more than -65 db  
 AM Noise Level (below 100% amplitude modulation) \_\_\_\_\_ Not more than -50 db

**Power Line Requirements:**  
 Line Voltage (nominal open circuit) \_\_\_\_\_ 440/480  
 Phase \_\_\_\_\_ 3  
 Frequency (can be adapted for 50 cycles) \_\_\_\_\_ 60 cycles  
 Total Variation from Nominal Including Regulation \_\_\_\_\_ 5%  
 Power Consumption (maximum) \_\_\_\_\_ 120 kw  
 Power Factor (approximate) \_\_\_\_\_ 87%  
 Crystal Heaters \_\_\_\_\_ 115 volts, 50/60 cycles, 28 watts

**Tube Complement:**

- |                 |            |                  |
|-----------------|------------|------------------|
| 4 RCA 6V6       | 1 RCA 6AL5 | 1 RCA 2BP1       |
| 4 RCA 1614      | 2 RCA 2E26 | 3 RCA 4-125/4D21 |
| 1 RCA 6SH7      | 1 RCA 2D21 | 4 RCA 7C24       |
| 4 RCA 5U4G      | 1 RCA 6X5  | 3 RCA 5592       |
| 2 RCA OD3/VR150 | 5 RCA 6AC7 | 6 RCA 857B       |
| 1 RCA OC3/VR105 |            |                  |

**Dimensions:**

Transmitter Panel and Equipment Enclosure  
 198" long x 84½" high (allow depth of 9' to rear wall)  
 Plate Transformer \_\_\_\_\_ Base 25" x 49"; height 50"  
 Filter Reactor \_\_\_\_\_ Base 32" x 40"; height 50"  
 Rectifier \_\_\_\_\_ 50" wide x 70" long x 84" high  
 Control and Distribution Unit \_\_\_\_\_ 48" wide x 82" long x 80" high  
 High-power Blower Enclosure \_\_\_\_\_ 8' x 8' x 6' (approx.)  
 Console \_\_\_\_\_ Base 46" x 36"; height (including turrets) 38½"  
 Minimum Entrance Requirements \_\_\_\_\_ 30" x 84"

Weight, total unpacked \_\_\_\_\_ Approx. 20,000 lbs.

Finish \_\_\_\_\_ Two tone umber gray

Stock Identification \_\_\_\_\_ MI-28926

**Equipment Furnished**

The BTF-50A Broadcast Transmitter equipment is identified as MI-28926 and consists of the condensed list of equipment shown below. Broadcast audio equipment, monitoring and test equipment, antennas and transmission feed line are not furnished as part of this equipment and should be specified and ordered separately if required.

- |   |                   |
|---|-------------------|
| 1 Power Amplifier Unit _____  | MI-28232          |
| 1 Rectifier _____   | MI-28233          |
| 1 Control and Distribution Unit _____                                 | MI-28234          |
| 1 Plate Transformer _____   | MI-28235          |
| 1 Filter Reactor _____  | MI-28236          |
| 1 Main Blower and Filter Equipment _____                              | MI-28237          |
| 1 Enclosure and Meter Panel _____                                     | MI-28238          |
| 1 Transmission Line Monitor _____                                     | MI-28155-A        |
| 1 Harmonic Attenuator _____   | MI-28239          |
| 1 Cut Back Equipment _____  | MI-28240          |
| 1 FM Exciter Unit _____   | MI-28104-1        |
| (See Note 1)  |                   |
| 1 Low Power R.F. Units _____  | MI-28106-A, and 7 |
| 1 Pre-emphasis Filter (600 ohms) _____                                | MI-4926-A         |
| 1 Touch-up Enamel Kit _____   | MI-28153          |
| 2 Set of Operating Tubes _____  | MI-28225-1, and 2 |
| 1 Blower and 2nd R.F., 3rd R.F. and I.P.A. Units (and air duct) _____ | MI-28165          |
| 1 Type BTC-1A Supervisory Control Console _____                       | MI-28950          |
| (See Note 2)  |                   |
| 2 TMV-129G Crystal Units _____  | MI-19450-A        |
| 2 Instruction Books _____   | IB-30175          |
| 2 Set Installation Instructions _____                                 | 8889029           |
| 1 Tube Hoist and Accessories _____                                    | MI-28246          |

Note 1: When dual FM exciters are to be specified, order in addition to item #12 above, the spare FM exciter kit MI-7015 listed under accessories.

Note 2: Specify the carrier frequency when ordering.

**Accessories**

- |   |          |
|---|----------|
| Spare FM Exciter _____                        | MI-7015  |
| Set of Tubes for Spare Exciter _____          | MI-7020  |
| Modification Kit for 50 Cycle Operation _____ | MI-28248 |

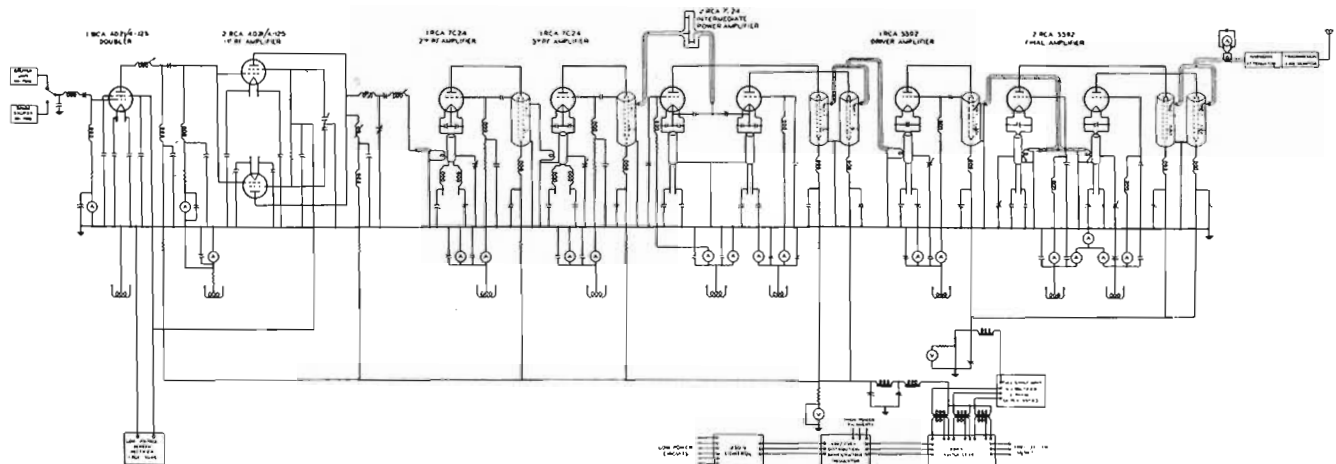

Simplified schematic diagram of BTF-50A



# Station man's dream come true... **ADD-A-**

RCA Transmitter Control Console, type BTC-1A—as versatile and handsome a control console as ever graced a transmitter room. With this BTC-1A you add control turrets and desk sections as your station grows. The left turret is the transmitter control section. The right turret is the audio control section. No equipment obsolescence here when you add on units.



A few of the many combinations

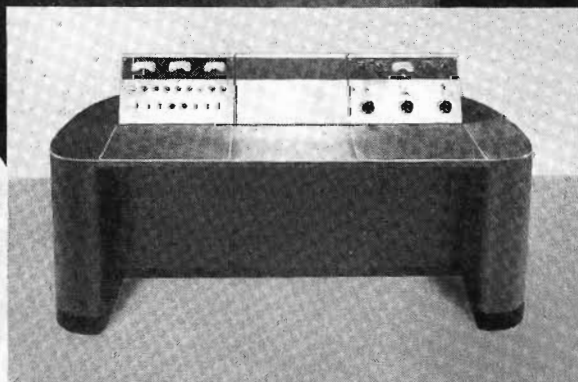

BTC-1A Control Console—with transmitter-control turret, audio control turret, and blank turret for additional facilities such as special meters, jack fields, ringdown, etc. Front panels are bottom-hinged. Rear covers are removable.

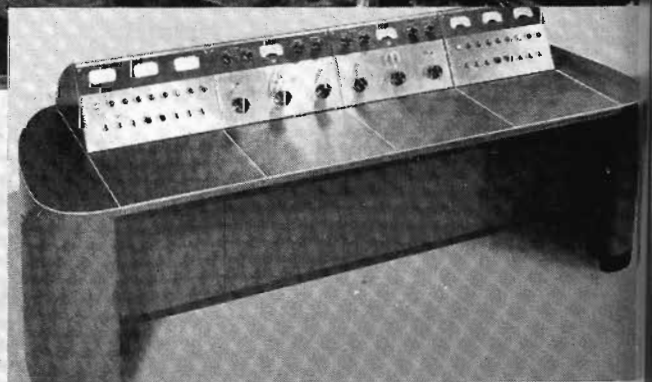

Typical console set-up for two transmitters, such as: two AM transmitters, two FM transmitters, or one AM and one FM transmitter. The turrets bolt to the desks. Desk sections bolt to each other. Knockouts for the wiring are provided in all desk and turret sections. All meters are recessed behind turret panels.



# BTC-1A Transmitter Control Console

**Fits every plant—AM, FM, TV,  
or any combination**

THIS IS THE MOST FLEXIBLE and versatile control console ever engineered for broadcast service. With you can handle audio mixing and transmitter switching operations in stations using RCA 3-, 5-, 10-, or 50-kw FM transmitters—or RCA 5-, 10-, or 50-kw AM transmitters. And by simply adding units to this basic console, you can also handle audio, video and transmitter switching for any combination of transmitter setups—starting with a single AM, FM, or TV transmitter and going to two or more AM and/or FM transmitters and a television transmitter.

The BTC-1A starts with the basic unit shown in the picture at the left. It includes one r-f transmitter control turret and one audio control turret—mounted on a two-section desk having removable end-sections.

The r-f control turret contains all power control switches and pilot lights for normal operation of the

transmitter; transmitter start; transmitter plate voltage; overload reset; time delay by-pass; manual-automatic control; day-night power switching; tower lights; and a spare switch and pilot lamp. And there is mounting space for three remote indicating meters.

The audio control turret includes: a standard VU meter and range switch; an 8-position selector switch that permits monitoring all important circuits, a monitor gain control; and individual bridging pads that enable you to equalize the level of the signal sources. Control of six inputs . . . one microphone, a remote circuit or oscillator, two lines, two turntables . . . is handled by three high quality mixers and associated transfer keys.

• • •

Call your RCA Broadcast Sales Engineer for *all* the details. Or write Dept. 19CD, RCA Engineering Products, Camden, N. J.

Possible with the BTC-1A console



Typical console set-up for an RCA 5-kw television transmitter, and one AM or FM transmitter. From left to right: (1) TV transmitter control; (2) picture monitor; (3) TV audio monitor; (4) blank turret; (5) AM or FM transmitter control; (6) blank turret; and (7) AM or FM transmitter control.

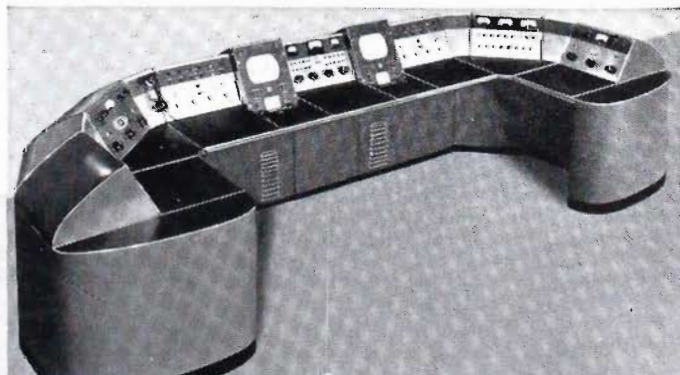

De luxe set-up for combined centralized control . . . AM-FM and TV. Extreme left and right sections are the AM (or FM) transmitter controls. Each includes a transmitter-control, audio-control, and blank wing turret. Center turret controls (for RCA 5-kw TV transmitter) are, left to right: TV power, picture monitor, TV audio, preview monitor, TV program switching.



# Universal Transmitter Console, Type BTC-1A

## Features

- Handles transmitter switching and audio mixing facilities required for complete supervisory transmitter control—AM or FM.
- Add-a-unit or “block-build” construction allows easy addition of control turrets and desk sections for one or more transmitters of any type—AM, FM and TV.
- Important transmitter power switches and indicating lamps on turret for transmitter-control.
- Provides a VU meter, and facilities for mounting three remote indicating meters.
- Eight position monitor selector switch and monitor gain control.
- Mixing and switching provided for six audio inputs: two lines—two turntables—one microphone—and one utility input for oscillator or remote.

## Description

The BTC-1A, Universal Transmitter Supervisory Console is one of the most flexible and versatile consoles ever engineered for broadcast transmitter service. It provides complete centralized control of primary switching and audio mixing operations required for AM and FM transmitters . . . and provides for easy addition of video control facilities. The basic console is specially designed for use with RCA 3-, 5-, 10- and 50 kw FM transmitters, as well as RCA 5-, 10- and 50 kw AM transmitters. Moreover, it is suitable for use with any transmitter which is contactor controlled.

Unique “add-a-unit” or “block-type” construction enables the simple addition of turrets and desk sections when expanding facilities to accommodate one or more AM, FM and TV transmitters. As many as nine or more combinations are possible, ranging from the basic BTC-1A for a single AM or FM transmitter . . . up to more elaborate “L,” “U” or “in-line” type arrangements which will accommodate AM, FM and TV transmitters at one location. Thus, immediate plans may be made for the future installation of any combination of AM, FM and/or television transmitters, without obsolescence of equipment.

The BTC-1A includes one transmitter control turret and one audio control turret—mounted on an attractive two-section desk having removable end sections. Control-turret front panels have a satin chrome finish and the desk proper is two-tone umber gray with a durable black linoleum top. All meters are recessed and each meter panel is hinged for easy adjustment. Rear turret covers may be removed to facilitate installation. End sections contain shelves for storing station logs, records, etc.

The transmitter-control turret contains all power control switches and pilot lights for normal operation of the transmitter; transmitter start, transmitter plate voltage, overload reset, time delay by-pass, manual-automatic control, day-night power switching, tower lights, and an extra switch and pilot lamp which may be connected as desired. And there is convenient space provided for mounting a choice of three remote indicating meters. The associated RCA transmitter monitor and amplifier rack, MI-11623, may be added to boost a-f gain from program line to transmitter, and facilitate overall station monitoring and control.

The audio-control turret includes: a standard VU meter and range switch, an 8-position selector switch that permits monitoring all important circuits, a master monitor gain control, and individual bridging pads for equalizing the level of the signal sources. With the BTC-1A, control is provided for six



*Basic BTC-1A Control Console*

different inputs—one microphone-oscillator or remote, two different lines, and two separate turntables—with three high-quality mixers and associated transfer keys. A microphone key cuts off the signal to the monitor amplifier—and prevents feedback when the microphone is in use. A line transfer key removes equalization and connects the telephone to the particular line not in use.

Accessory audio and monitoring equipment is available in a factory-wired assembly (MI-11623). It is supplied in a BR-84 series cabinet rack, finished to match companion equipment. It is suited for co-ordinated operation with the BTC-1A console and facilitates transmitter operation. It also provides extreme flexibility by the termination of all audio units in jack strips. (See FM Transmitter Monitor and Amplifier Cabinet.)

## Performance Specifications

### Power Required:

Indicator Lights \_\_\_\_\_ 220 volts a-c, 50-60 cycles  
 Meter Lights (6.3 volts from  
 transformer) \_\_\_\_\_ 110 volts a-c, 50-60 cycles

### Input Impedances:

Lines 1 and 2 \_\_\_\_\_ 600 ohms, balanced  
 Microphone and Turntable \_\_\_\_\_ 600 ohms, balanced  
 Audio Oscillator or Remote Line \_\_\_\_\_ 600 ohms, balanced  
 VU Meter \_\_\_\_\_ 7500 ohms  
 Monitor \_\_\_\_\_ Bridging

### Output Impedances:

Lines 1 and 2, Microphone and Turntable  
 Mixer Circuit \_\_\_\_\_ 600 ohms, balanced  
 Microphone and Turntable Controls \_\_\_\_\_ 600 ohms  
 Lines 1 and 2 Control \_\_\_\_\_ 600 ohms

Insertion Losses (lines, microphone, and turntable  
 mixer circuit) \_\_\_\_\_ 18 db

### Volume Controls:

Microphone and Osc./Remote Control \_\_\_\_\_ 600/600 ohms, 20  
 steps, 2 db per step, last step infinite, tapered; insertion  
 loss 6 db; balanced.

Lines 1 and 2 Control—600/600 ohms, 30 steps, 1 db per step, last step infinite, tapered; insertion loss 6 db; balanced.

Turntable Control—600/600 ohms, 20 steps, 2 db per step, last step infinite, tapered; insertion loss 6 db; balanced.

Monitor Control—600/600 ohms, 20 steps, 2 db per step, last step infinite, tapered; insertion loss 32 db; balanced.

VU Attenuator Rheostat—800 ohms, 10 steps, 0.1 db per step, linear.

Noise Level: Circuits are isolated so that residual noise will not exceed the aggregate noise level of the associated amplifiers.

**Mechanical Specifications**

Overall Dimensions:

- Width \_\_\_\_\_ 56½"
- Depth \_\_\_\_\_ 36"
- Height, including Turret (turret extends approx. 11" above desk top) \_\_\_\_\_ 39"
- Weight (approx.) \_\_\_\_\_ 300 lbs.
- 45° Wing Turrets—10¾" high, 19" deep, 4⅞" wide (front), 19" wide (rear)
- Control Turrets—10¾" high, 19" deep, 19" wide (front and rear)
- Straight Desk Sections—28⅜" high, 36" deep, 19" wide (front and rear)
- 90° Desk Sections—28⅜" high, 38 11/32" deep, 3⅝" wide (front), 54⅛" wide (rear)

**Equipment Furnished**

The RCA Type BTC-1A (MI-28950) Universal Transmitter Control Console is composed of the following:

- 1 Transmitter Control Turret \_\_\_\_\_ MI-28420
- 1 AM/FM Audio Control Turret \_\_\_\_\_ MI-28410
- 2 Console Desk Sections \_\_\_\_\_ MI-27401-1
- 1 Console End Section (left-hand) \_\_\_\_\_ MI-26265-1
- 1 Console End Section (right-hand) \_\_\_\_\_ MI-26265-2

Space is available on the MI-28420 turret for mounting three 4" square-case meters which may be purchased on separate order from the list under "Accessories" below.

**Available Accessories**

- AM/FM Audio Control Turret \_\_\_\_\_ MI-28410
- Universal Transmitter Control Turret \_\_\_\_\_ MI-28420
- Basic Desk Section \_\_\_\_\_ MI-28401-1
- 90° Desk Section \_\_\_\_\_ MI-28401-2
- Complete Turret with Blank Panel \_\_\_\_\_ MI-28403-1
- Wing Turret with Blank Panel \_\_\_\_\_ MI-28404-1
- Television Control Console \_\_\_\_\_ MI-19122-A



90° desk sections and 45° turret wings being used to "block-build" a "U" shaped arrangement to accommodate two transmitters (AM and/or FM). Sections simply bolt together.

**REMOTE METERS FOR AM EQUIPMENT:**

- 1 Remote Limiting Meter, for use with RCA Type 86-A1 Limiting Amplifier \_\_\_\_\_ MI-28425
- 1 Remote Meter, for use with RCA Type WM-43A AM Modulation Monitor \_\_\_\_\_ 44899

**REMOTE METERS FOR FM EQUIPMENT:**

- 1 Remote Meter (carrier deviation), for use with General Radio FM Monitor Type 1170-A \_\_\_\_\_ MI-19116-2
- 1 Remote Meter (percentage modulation), for use with General Radio FM Monitor Type 1170-A \_\_\_\_\_ MI-19116-3
- 1 Remote Meter (percentage modulation), for use with Hewlett-Packard FM Monitor Type 335-B \_\_\_\_\_ HP-112-13
- 1 Remote Meter (percentage output), for use with RCA FM Transmitters Types BTF-250A, BTF-1C, BTF-3B, BTF-5A, BTF-10B, BTF-50A \_\_\_\_\_ 56412

Space is also available and mounting holes are provided in the MI-28410 turret for one line transformer, MI-11713.

The following related equipment, which is recommended, may be obtained on separate order:



Deluxe "U" Setup of the BTC-1A for complete control of the RCA 5-KW TV transmitter plus any choice of two transmitters (AM and/or FM).



# FM Exciter Unit, MI-7016

## Power Supply MI-7017

### Features

- Crystal-controlled frequency stability.
- Distortion less than 1% through range of 30 to 15,000 cycles.
- Every component and connection is easily accessible.
- Built-in oscilloscope for checking performance.
- No auxiliary equipment necessary for setting up to desired frequency.

### Description

The RCA FM Exciter, MI-7016, and Power Supply, MI-7017, are vertical panel units designed to generate a high quality frequency modulated signal. These are the carrier generating units used in all RCA FM transmitters.

The RCA FM Exciter employs the principle of direct FM which uses fewer tubes and introduces less audio distortion, (especially at low frequencies). In this system, the mean, or "carrier" frequency is produced in a simple and straightforward manner by a master oscillator which is modulated directly by means of a reactance tube modulator. The oscillator is then followed by a relatively small number of multiplier stages. A new-type automatic frequency control system is employed in this exciter. Sub-harmonics of the FM master oscillator are compared with sub-harmonics of a low frequency crystal oscillator (100 to 125 kc). Any difference between these frequencies operates a two-phase, reversible, induction motor attached directly to the shaft of a variable capacitor. The motor never turns more than 45 degrees either way. No gears, counter circuits, or compensating voltages are involved. Its fast action and complete freedom from temperature variations provides a high degree of frequency stability. Failure of the automatic frequency control does not take the transmitter off the air, since operation may be continued by locking the motor shaft and making occasional manual frequency corrections.

The operation of the circuits may be checked easily and rapidly by means of a built-in cathode ray oscilloscope, milliammeter, and associated selector switches. All tubes and large components are mounted on the front of the panel. Wiring on the rear of the panel is "in the clear" with all terminals clearly marked and easily accessible.

### Specifications

- Frequency Range \_\_\_\_\_ 44 to 54 mc  
 Frequency doubled in amp. section to 88-108 mc  
 Carrier Frequency Stability, at FM output frequency \_\_\_\_\_  
 Deviation less than 1000 cycles  
 Modulation Capability \_\_\_\_\_  $\pm 100$  kc  
 Method of Modulation \_\_\_\_\_ Push-pull reactance-tubes  
 Audio Input Impedance \_\_\_\_\_ 600/150 ohms  
 Audio Frequency Response \_\_\_\_\_  
 30 to 15,000 cycles, 1000 cycle reference \_\_\_\_\_  $\pm 1$  db  
 Audio Frequency Distortion \_\_\_\_\_  
 30 to 100 cycles \_\_\_\_\_ 1.0%  
 100 to 7,500 cycles \_\_\_\_\_ 0.5%  
 7,500 to 15,000 cycles \_\_\_\_\_ 1.0%  
 (including all harmonics up to 30 kc at 75 kc swing)  
 FM Noise Level, below  $\pm 75$  kc swing \_\_\_\_\_ 70 db  
 AM Noise Level, below 100% amplitude modulation \_\_\_\_\_ 60 db  
 Power Line Requirements \_\_\_\_\_ 208/230 volts, 50/60 cycles,  
 370 watts (approx.)  
 Power Line Requirements—  
 (Crystal Heaters) \_\_\_\_\_ 100 to 125 volts a-c or d-c, 28 watts

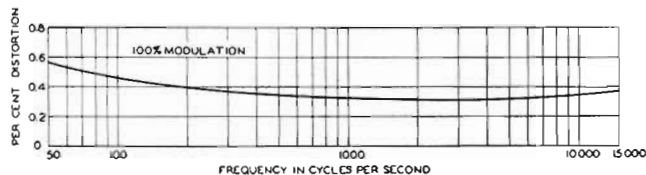

Percentage distortion at 100% modulation

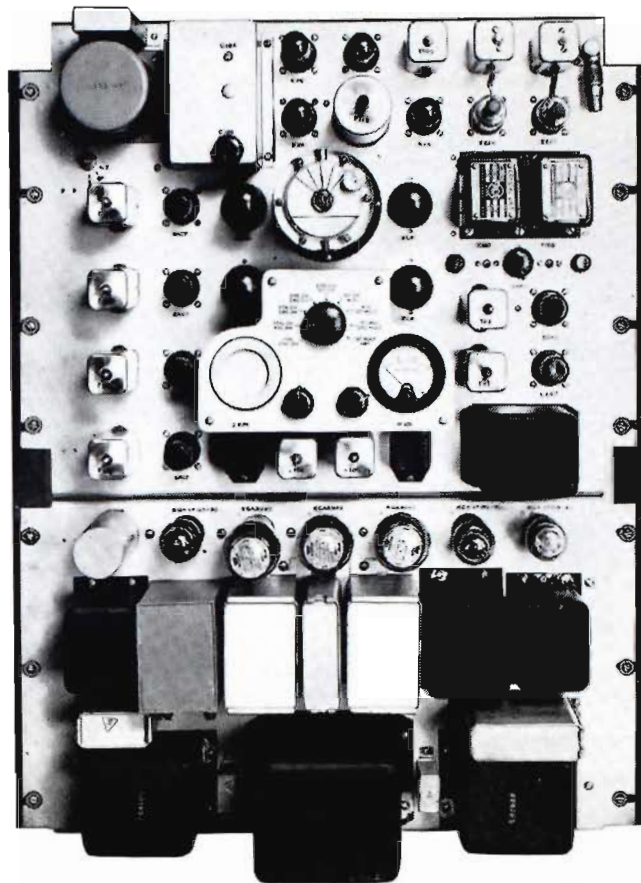

Overall Height—(RF and Power Supply)	29"
Overall Width	22 1/4"
Weight (RF Unit)	47 lbs.
Weight (Power Supply)	66 1/2 lbs.
Stock Identification:	
Exciter	MI-7016
Power Supply	MI-7017

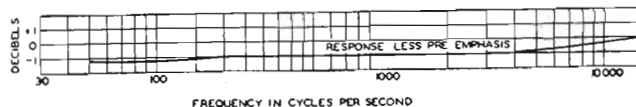
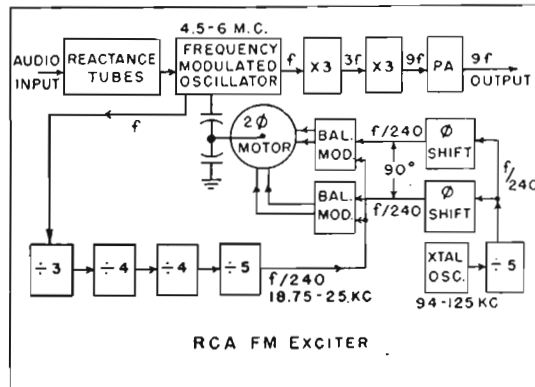

Audio frequency response less pre-emphasis

# Pre-emphasis Filter, MI-4926-A



## Features

- Accurate within 1.5 db from 30 to 15,000 cycles.
- Minimum insertion loss.
- Operation for levels up to +30 db.
- Compact design—completely shielded.

## Uses

The MI-4926-A filter is designed for use in such equipment as disc recorders and frequency modulated transmitters to produce the FCC standard 75-microsecond audio pre-emphasis characteristic. The MI-4926-A is supplied as a part of all RCA FM and Television transmitters, as well as the studio-transmitter link equipment. It is also used in conjunction with disc recorders to obtain recordings having the 75 micro-second pre-emphasis characteristic. In FM transmitter installations, if a spare FM exciter is ordered, and it is desired to switch ahead of the filter rather than after, an additional pre-emphasis filter will be required. The MI-4926-A may also be used with composite transmitters.

## Description

The MI-4926-A filter is of the constant impedance, balanced, "bridge T" type. The characteristic frequency curve of the filter follows a 75-microsecond curve in accordance with RMA and FCC recommendations.

Mechanically, the filter consists of two reactors, two capacitors and eight resistors sealed inside metal can. Connections are made to the filter by means of solder terminals on top of the can.

The filter may be inserted at any point in the audio system where the signal does not exceed +30 db, and may be mounted in any convenient place so long as the magnetic fields of transformers and similar equipment are avoided.

## Specifications

Input:  
 Source Impedance \_\_\_\_\_ 600 ohms  $\pm 5\%$   
 Input Impedance \_\_\_\_\_ 600 ohms  $\pm 5\%$   
 Maximum Input Level \_\_\_\_\_ +30 dbm<sup>0</sup>

## Output:

Load Impedance \_\_\_\_\_ 600 ohms  $\pm 5\%$   
 Output Impedance \_\_\_\_\_ 600 ohms  $\pm 5\%$

## Insertion Loss (from 600 ohm source to 600 ohm load):

Minimum Loss at 15,000 cps \_\_\_\_\_ Approx. 5 db.  
 Maximum Loss Below 500 cps \_\_\_\_\_ Approx. 22 db.

Frequency Response \_\_\_\_\_ Corresponds to FCC 75 microsecond pre-emphasis curve within  $\pm 1.5$  db from 30 to 15,000 cycles

Attenuation Characteristic \_\_\_\_\_ Fixed (See curve)

## Physical Specifications:

Diameter \_\_\_\_\_ 3"  
 Height \_\_\_\_\_  $4\frac{3}{8}$ "  
 Weight (unpacked) \_\_\_\_\_  $2\frac{1}{4}$  lbs.  
 Base Plate \_\_\_\_\_  $3\frac{1}{4}$ " x  $3\frac{1}{4}$ "  
 Mounting \_\_\_\_\_ Four holes with center lines  $2\frac{3}{4}$ " x  $2\frac{3}{4}$ "

\* 0 db = .001 watt.

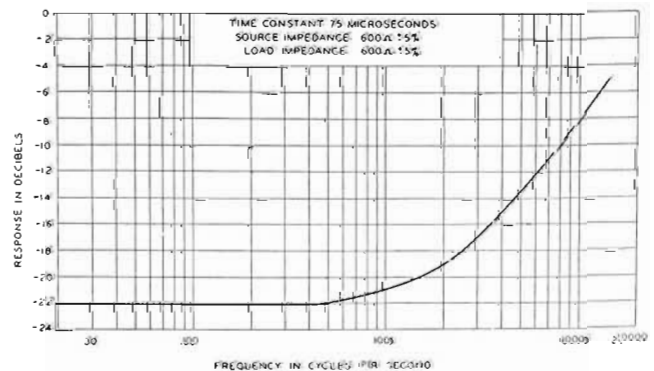

Frequency response of MI-4926-A



# Transmitter Monitor and Amplifier Cabinet Rack, MI-11623

## Features

- Simplifies transmitter installations.
- Provides complete monitor and amplifier facilities in one rack.
- Provides extreme flexibility through termination of all audio units in jack strips.
- Wiring and monitoring facilities furnished for addition of optional equipment.
- Attractive styling—matches all RCA transmitters and auxiliary equipment.

## Uses

The transmitter monitor and amplifier cabinet facilitates the grouping of all appropriate apparatus necessary to simplify the installation of any broadcast transmitter. This cabinet utilizes the new modernistically styled cabinet of the BR-84 series which blends with all RCA transmitters and equipment. The cabinet is factory wired to accommodate all the required items for transmitter, speech input equipment, modulation and frequency monitors, and power change switch, etc. The MI-11623 has been designed to operate with the control desks supplied with the BTA-5F/BTA-10F, BTA-50F and BTF-50A Transmitters to provide a complete and flexible system of controls and monitors.

## Description

The transmitter control cabinet embraces all the functional equipment, amplifiers, jack panels, etc., required for the operation of an RCA broadcast transmitter in conjunction with the transmitter control console. The MI-11623 consists of one Standard Cabinet Rack complete with a ventilated rear door, one BA-14A<sup>6</sup> monitoring amplifier, one type 86-A1 limiting amplifier, two type 33-A jack strips complete with mat, and one type 57-C switch and fuse panel. An additional BR-2A panel and shelf is supplied and wired to accommodate three type BA-1A pre-amplifiers, with one type BX-1B power supply for the pre-amplifiers. This arrangement allows microphones and transcription turntables to be used directly from the transmitter in the event of an emergency.

Mountings and all wiring are also provided for the following accessory equipment:

- Two type 56-C Fixed Line Equalizers
- Two MI-4925-A 15 KC High Frequency compensators
- One MI-4926-A FM pre-emphasis equalizer
- One MI-4309-B Power Reduction panel (BTA-5F/10F)
- One MI-7264-E Hum Equalizer (BTA-50F)

A blank panel is drilled and tapped for mounting three MI-10253 line transformers.

Measuring equipment space and wiring are available at the top of the rack for mounting the AM Frequency Monitor type WF-48A and the Modulation Monitor type WM-43A, or the combination FM Frequency and Modulation Monitor type WF-5A.

The two type 33-A jack panels provide flexibility for all the described audio circuits with spares for utility apparatus according to local requirements.

The photograph illustrates the MI-11623 complete with accessory side panels, MI-30541-G84 and MI-30566-G84 Trim Strips. These are not supplied, but are available for the user's individual requirements. Where fluctuating mains prevail, the Solar voltage regulator is available to regulate the a-c to the 86-A1 limiting amplifier.

## Specifications

Frequency Response (line in to transmitter in)  $\pm 2$  db 30-15,000 cycles  
 Noise Level (below +10 db output) \_\_\_\_\_ -75 db  
 Power Supply (115 to 125 volts, 50-60 cycles) \_\_\_\_\_ 450 watts  
 Dimensions:  
 Height \_\_\_\_\_ 84"  
 Width (less side panels and 28" side panels) \_\_\_\_\_ 22"  
 Overall Depth (including door handles) \_\_\_\_\_ 19"  
 Panel Width \_\_\_\_\_ 19"

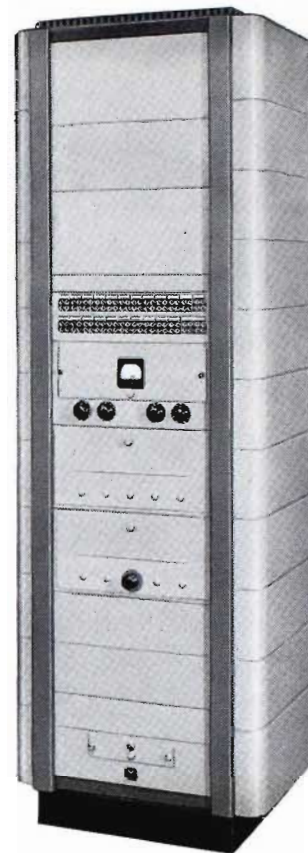

MI-11623 fitted with  
 MI-30541-G84 Side Panels  
 and MI-30566-G84  
 Trim Strips

Stock Identification (including tubes) \_\_\_\_\_ MI-11623  
 Weight (unpacked) \_\_\_\_\_ 400 lbs. (approx.)

## Equipment Supplied

- MI-11623 includes the following equipment:
- 1 Type BR-84 Cabinet Rack \_\_\_\_\_ MI-30951-84D
  - 1 Type BA-14A Monitoring Amplifier \_\_\_\_\_ MI-11234
  - 1 Type 86-A1 Limiting Amplifier including tubes plus 36-B Panel and Shelf \_\_\_\_\_ MI-11216-C/4682-B
  - 2 Type 33-A Jack Strips with Mat \_\_\_\_\_ MI-11501-A
  - 1 Type 57-C Switch and Fuse Panel
  - 1 Type BR-2A Panel and Shelf. This panel and shelf is wired to accommodate 3 Type BA-1A Pre-Amplifiers and 1 Type BX-1B power supply.

## Accessories

- Side Panels (each) \_\_\_\_\_ MI-30541-G84
- Single Trim Strip (each) \_\_\_\_\_ MI-30566-G84
- AM Frequency Monitor \_\_\_\_\_ Type WF-48A
- AM Modulation Monitor \_\_\_\_\_ Type BW-66E
- FM Frequency and Modulation Monitor (RCA) \_\_\_\_\_ Type WF-5A
- BA-11A Pre-Amplifier \_\_\_\_\_ MI-11231
- Tube Kit for BA-11A \_\_\_\_\_ MI-11288
- BX-1E Power Supply for Pre-Amplifier \_\_\_\_\_ MI-11305-D
- Tube Kit for BX-1E Power Supply \_\_\_\_\_ MI-11262
- Power Change Panel for BTA-5F and BTA-10F Transmitter \_\_\_\_\_ MI-4309-B
- Line Transformer \_\_\_\_\_ MI-10253
- 56-C Fixed Equalizer \_\_\_\_\_ MI-4168
- 15 KC High Frequency Compensator \_\_\_\_\_ MI-4925-A
- FM Pre-Emphasis Equalizer \_\_\_\_\_ MI-4926-A
- Solar Voltage Regulator  
 60 cycle \_\_\_\_\_ MI-11280  
 50 cycle \_\_\_\_\_ MI-11280-A
- Audio Terminal Block \_\_\_\_\_ MI-4569

\* Note: Limiting and monitoring amplifiers supplied with tubes.

# RCA Tubes for AM and FM

There's an RCA tube for practically every type of AM or FM broadcast requirement . . . tubes for low, medium, and high power needs . . . rectifier tubes . . . tubes for audio applications . . . special types. RCA pioneers the development of tubes designed specifically for broadcast needs. And you can buy RCA tubes with the assurance that you are getting the world's finest!

Listed below are only a few of the RCA tubes for AM and FM broadcasting.

## RCA 833-A

"King of the Kilowatters"—RCA-designed—universally used in the output stages of 1-kw AM broadcast transmitters. Offers exceptional watts-per-dollar value.

## RCA 892-R

The standard of the industry for use in 5-kw AM broadcast transmitters. Features rugged, efficient, RCA-designed radiator for simplified, forced-air-cooled operation.

## RCA 1620

A universally used triple-grid amplifier which offers unequalled performance in low-level audio applications where low noise level and low microphonics are important.

## RCA 7C24

Popular, forced-air-cooled, grounded-grid triode widely used in RCA 1-kw, 3-kw, and 10-kw FM broadcast transmitters. Features famous RCA "metal header" design.

## RCA 8008

Standard half-wave mercury-vapor rectifier tube featuring heavy-duty, industrial-type base. Used in most modern broadcast transmitters. RCA's oxide-coated cathode gives copious electron emission at increased efficiency.

## RCA 872-A

Similar to RCA 8008, but has standard radio-type base. Used in many broadcast transmitters of all powers.

## RCA 5671

RCA-designed power triode featuring a thoriated-tungsten filament which requires 60% less filament power than similar pure-tungsten-filament types. Used in output stages of modern 50-kw air-cooled AM broadcast transmitters.

## RCA 828

Beam power amplifier developed by RCA for relatively large power output at low distortion with low driving power requirements. Widely used in audio and radio service in AM broadcast transmitters.

## RCA 4-125A/4D21

High-frequency tetrode widely employed in FM and television broadcast transmitters.

## RCA 5592

Forced-air-cooled power triode featuring RCA "metal header" design. Used in output stages of grounded-grid, 50-kw FM broadcast transmitters.



For technical data, prices, or delivery on RCA Tubes for AM, FM, or Television—or any RCA Electron Tube phone your local RCA Tube Distributor, or write RCA Tube Department, Harrison, N. J.



# Everything for TV

**RCA EQUIPMENT CABINETS** for small rack-mounting units, such as monoscope camera, studio line amplifiers for sound and picture, microwave relay receiver, test equipment, power supplies, etc.



**RCA DUMMY LOAD.** For testing and measuring power output. This unit consists of a coaxial line, the inner conductor of which is a water-cooled resistor.

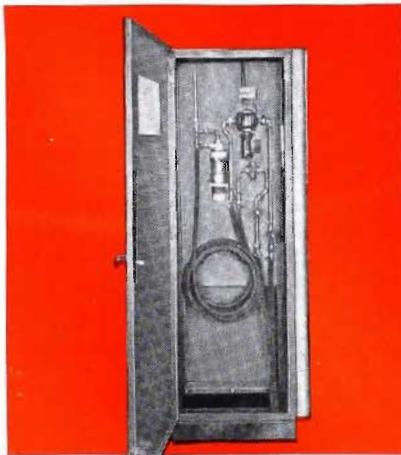

**L-F ANTENNA DIPLEXER** (left) **AND THE VESTIGIAL SIDE-BAND FILTER** (right). Diplexer makes it practical to use one antenna for picture-and-sound signals. Side-band filter partially suppresses one sideband. No adjustments required.

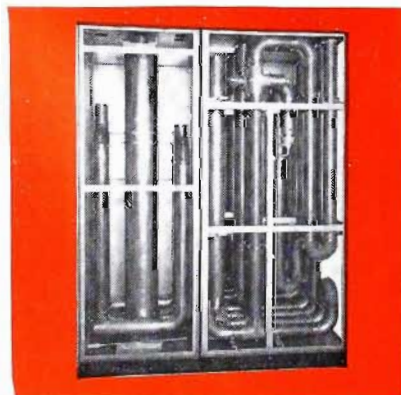

You see here the transmitter room that is *being delivered to more than thirty television stations . . .* complete, and RCA throughout.

As practical, we believe, as an AM station transmitter room, this layout has the proper equipment you need to put high-quality picture-and-sound signals on the air—reliably, and with surprisingly little supervision. It includes: a combined 5-kw picture and 2.5-kw FM sound transmitter; a complete transmitter control console; a vestigial side-band filter; a dummy load; an antenna coupling network; sound-and-picture input antenna coupling network; sound-and-picture input amplifiers; and frequency and modulation monitors.

Why the overwhelming acceptance for this transmitter room . . . and all other RCA television equipment?

It's the *thoroughness* with which RCA TV equipment is designed. It's the *practical engineering* experience behind it—more of it than any other television equipment manufacturer. It's the *completeness of the line . . .* with one equipment source for everything you need in your station. It's the undivided *responsibility* RCA assumes for all equipment you buy. It's the unbroken *record of past performance and service* to the industry.

Nothing to planning a television station—when you let an RCA Television Specialist help you. Call him in. Or write Dept. 19, RCA Engineering Products Division, Camden, N. J.

**RCA CONTROL CONSOLE** for "push-button" control of your transmitter room. Handles both picture and sound transmitters, a turntable, and an announce microphone. Includes power switches, picture and sound monitors, switching circuits, antenna current meters—and an oscilloscope.



**THE RCA 5-KW TV TRANSMITTER** (plus 2.5 kw for FM sound). Full picture-and-sound power on your channel. High-level modulation. Meter-tuned, narrow-band drivers. Only one class B stage to adjust. No neutralizing of PA. Built for "walk-in." Delivery being made to more than 30 stations.

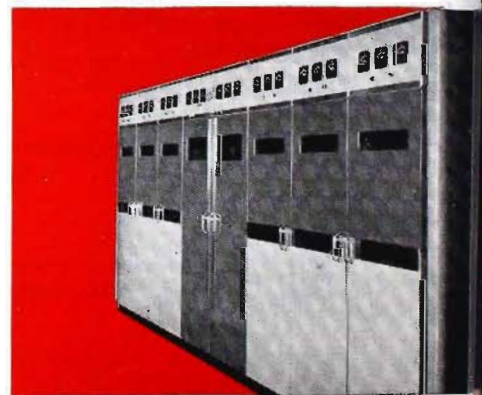



# ...entire transmitter rooms, *for instance —*



**COMPLETE TRANSMITTER ROOM — by RCA**

More than 30 rooms like this one are going to television stations. The entire layout is designed to be used adjacent to your TV studio control room...or at a remote control location.



# Television Transmitter, Type TT-5A

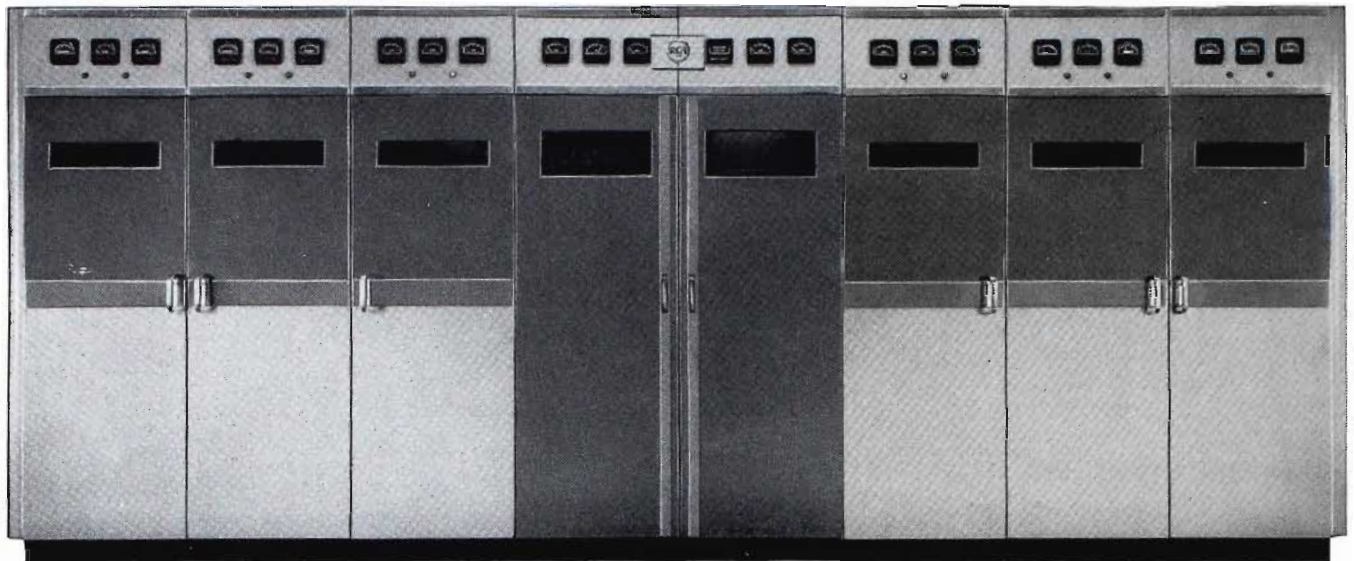

## Features

- Low installation costs.
- Low operating cost.
- Straight-forward "meter tuning" of all r-f driver stages.
- Uses highly efficient RCA FM exciter in aural section.
- Packaged for convenience in shipping and installation.
- Power amplifiers require no neutralization.

## Description

The TT-5A is a television broadcast transmitter with a nominal power output of five kilowatts peak visual power, and two and one-half kilowatts peak aural power, in conformance with FCC and RMA standards. The TT-5A is designed to operate in any specified channel between Channels 2 to 13.

The entire transmitter is housed in eight steel cabinets which are fastened to a base frame. This frame is divided in such a manner that the eight cabinets may be placed either in a straight line (overall width—208") or in a "U"-shaped arrangement (smallest possible overall width—150"). Each cabinet has both a front and rear door. The components and wiring are arranged to permit maximum accessibility. The visual section of the transmitter is located on the right side and the aural section is on the left, with the power supplies and control panel for both sections in the center.

The visual section of the transmitter consists of a crystal oscillator followed by r-f amplifiers and a grid-modulated power amplifier. The use of final-amplifier, grid-modulation makes possible the operation of all driver stages as high-efficiency, narrow-band, class "C" amplifiers, which can be tuned quickly and easily from front panel meter observations.

The final power stages of the aural and visual sections each use the RCA 8D21 dual tetrode operated as a push pull amplifier. Dual tetrode construction does away with the need for neutralization of these stages, assuring better picture quality and less likelihood of adjacent channel interference.

The aural section of the transmitter utilizes the highly efficient RCA Direct FM exciter, followed by amplifiers and the power amplifier.

All high power circuits are doubly protected by highspeed overload relays backed up by thermal type circuit breaker switches.

## Control Console

Certain controls on the control panel of the TT-5A transmitter such as "start-stop" and aural and visual input gain controls are duplicated on the control console supplied with the transmitter. In addition, the control console contains a picture monitor and oscilloscope, switches for operating tower lights, a VU meter for the aural channel, and meters which operate from the reflectometers in the transmission line. These meters give indications for determining power output as well as standing wave ratio on the transmission line.

In order to provide greater convenience in shipping and installation, the transmitter is partially disassembled when it leaves the factory. The largest unit, uncrated, is 25 x 38 x 80 inches, and no single unit weighs over 1000 pounds. This facilitates handling in confined spaces and elevators. All connections between units are made from conveniently located terminal boards on each unit.

## Specifications

	<i>Aural</i>	<i>Visual</i>
Type of emission.....	A3	A5
Frequency range.....	Chan. 2 to 13	Chan. 2 to 13
Power output (into transmission line).....	2 to 4 kw.	2.5 to 5 kw peak
RF output impedance.....	72 ohms	72 ohms
Carrier frequency stability.....	$\pm 0.002\%$	$\pm 0.002\%$
Modulation capability.....	$\pm 50$ kc.	90%
Method of modulation.....	Frequency mod.	Amplitude mod.
Input impedance.....	600 ohms	75 ohms
Input level.....	+12, $\pm 2$ db	1 volt peak to peak
Frequency response**.....	Uniform within $\pm 1$ db from 30 to 15,000 cycles	*0 db at 0.1 mc. 2 db at 0.5 mc. 2 db at 1.25 mc. 2 db at 2 mc. 2 db at 3 mc. 3 db at 4 mc.
Audio frequency distortion:***		
50 to 100 cycles.....		1.5%
100 to 7,500 cycles.....		1.0%
7,500 to 15,000 cycles.....		1.5%
Noise level:		
FM noise, below $\pm 25$ kc swing.....		60 db
Amplitude noise, rms below carrier.....		50 db

### Power Line Requirement:

<b>Transmitter</b>	
Line	208/230 volts, 3 phase, 50/60 cycles
Power consumption (approx.)	24.28 kw
Power factor	85%

### Console, crystal heaters, etc.

Line	115 volts, single phase, 50/60 cycles
Power consumption (approx.)	600 watts

### Dimensions:

Overall length****	208"
Overall height	84"
Overall depth (inc. door handles)	38"
Building entrance and elevator clearance requirements	25" x 80"

### Weight:

Transmitter**** (8 cabinets plus 2 PA cabinets)	8000 lbs. (approx.)
Console	600 lbs. (approx.)
Water circulating system	1300 lbs. (approx.)
Finish	Two-tone umber gray with satin chrome trim and fittings
Stock Identification	MI-19205-A, B

### Tube Complement

Visual Crystal Oscillator	1	1614
---------------------------	---	------

### Visual R-F Chain:

Doubler	1	8001
Tripler	1	8001
IPA or Tripler	2	4-125A/4D21
†First IPA	2	4-125A/4D21
†Second IPA	2	4X500A
Power Amplifier	1	8D21

### Visual Amplifier and Modulator:

First Visual Amplifier	3	6AG7
Second Visual Amplifier	2	807
Second Visual Amplifier (Synchronizing Pulse Expander)	1	6AG7
Modulator	6	4E27/8001
Synchronizing Separator	1	6J5
Synchronizing Amplifier	1	6AG7
D-c Insertion Diode	1	6H6
Visual Monitor	1	6AG7

### Visual Power Supplies:

Driver Power Supply	3	8008
Modulator Power Supply	6	8008
Power-Amplifier Plate Supply	6	8008
Bias Supply	1	5U4G
<b>PA Bias Supply</b>		
Rectifier	2	816
Electronic Regulator	3	6AS7G
Voltage Regulator	3	VR150
D-c Amplifier	1	6J5
D-c Amplifier	1	6SH7
<b>Amplifier Voltage Regulator</b>		
Electronic Regulator	3	6AS7G
Voltage Regulator	3	OC3/VR105
Voltage Regulator	1	OA3/VR75
Voltage Regulator	2	OD3/VR150
D-c Amplifier	1	6SH7

### PA Screen Supply

Rectifier	2	816
Electronic Regulator	2	6AS7G
Voltage Regulator	3	VR150
D-c Amplifier	1	6SH7
D-c Amplifier	1	6J5

### FM Exciter:

Modulator	2	6V6
Modulated Oscillator	1	6V6
First Multiplier	1	6V6
Second Multiplier	1	2E26
Third Multiplier	1	2E26
First Frequency Divider	1	6AC7
Second Frequency Divider	1	6AC7

Third Frequency Divider	1	6AC7
Fourth Frequency Divider	1	6AC7
Monitor Drivers	4	1614
Crystal Frequency Divider	1	6AC7
Crystal Oscillator	1	6SH7
Cathode-Ray Indicator	1	2BP1

### Aural R-F Chain:

First Amplifier/Doubler	1	4E27/8001
Tripler/Doubler	1	4E27/8001
Amplifier/Tripler	2	4-125A/4D21
†First IPA	2	4-125A/4D21
†Second IPA	2	4X500A
Power Amplifier	1	8D21
Bias Supply	1	5U4G

### Aural Power Supplies:

<b>FM Exciter Power Supply</b>		
Low Voltage Rectifier	2	5U4G
High Voltage Rectifier	1	5U4G
Voltage Regulator	1	OC3/VR105
Voltage Regulator	2	OD3/VR150
Driver Power Supply	3	8008
Power Amplifier Plate Supply	6	8008

### Reflectometers:

Diode	4	6AL5
R-F Over-voltage Cut-out	2	502-A
† Channels 7-13 only.		

### Equipment Supplied

1	Sound Exciter	MI-19031
1	Sound Driver	MI-19032
1	Sound Rectifier	MI-19033
1	Power Control Unit	MI-19034
1	Picture Modulator Rectifier	MI-19035
1	Picture Rectifier	MI-19036
1	Picture RF Rectifier	MI-19037
1	Picture Modulator	MI-19038
1	Sound Amplifier	MI-19039
1	Picture Amplifier	MI-19040
1	Set of Frequency Determining Coils	MI-19110
1	Set Installation Hardware and Accessories	MI-19108
1	Set Installation and Wiring Kit	MI-19109
3	TMV-129C Crystal Units	MI-19400
2	TMV-129G Crystal Units	MI-19450
1	Touchup Kit	MI-28153
1	Set of Tubes	MI-19030
1	Water Cooler	MI-19045
1	Control Console	MI-19202
1	Vestigial Side Band Filter	MI-19114
1	Inside Transmission Line	MI-19111
1	Monitoring Diode	MI-19051
2	Instruction Books	IB-36012

### Available Accessories

Spare Set of Tubes	MI-19030
FCC Spare Tubes	MI-19050
Input and Monitoring Equipment	MI-19203
Antenna Equipment	On application
Dummy Load	MI-19024-A

\* Maximum attenuation with respect to idealized rectified vestigial sideband response.

\*\* For pre-emphasized response the pre-emphasis filter (MI-4926A) is provided to be inserted in the 600 ohm audio input line at the most effective point.

\*\*\* Distortion and noise are measured following a standard de-emphasis network.

\*\*\*\* To facilitate packaging and handling, the equipment breaks down into its component cabinets (8 plus 2 PA cabinets) and is shipped accordingly. The larger power supply components are also removed and packed separately. Thus, the dimensions of the largest unit (unpacked) is 25 x 80 x 38 inches, and the weight approximately 600 lbs.



# Television Transmitter, Type TT-500A

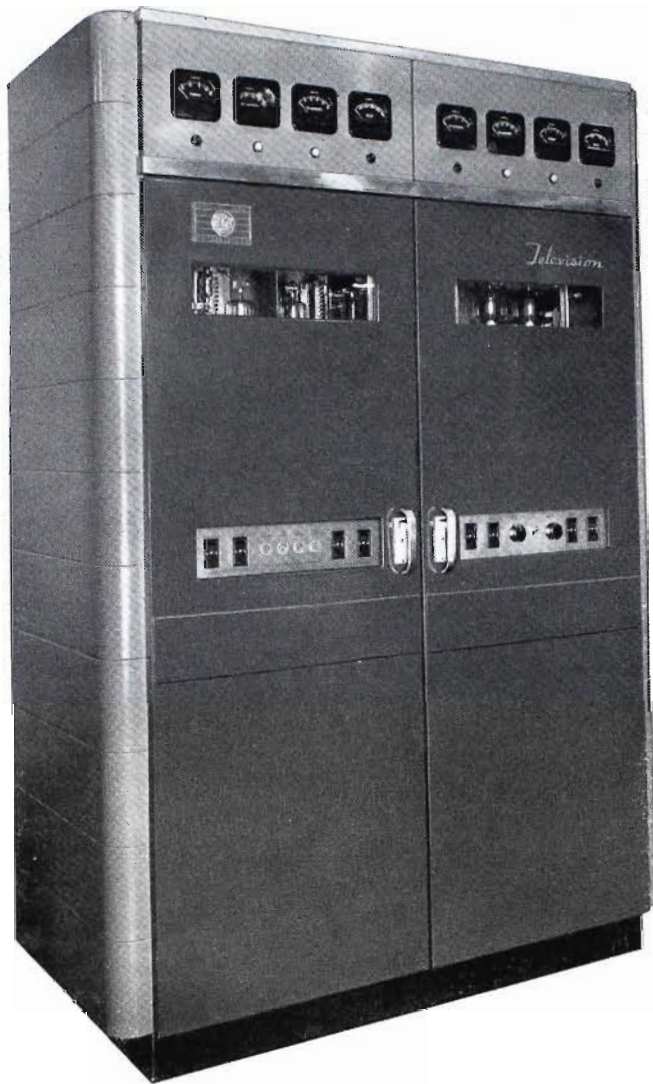

## Features

- Economical installation—low tube costs.
- Video system with excellent frequency and phase response.
- Easily tuned—straightforward meter-tuned stages.
- Independent control circuits for visual and aural sections of transmitter.
- Air-cooled tubes used throughout.
- Equipment incorporates picture and waveform monitors in console.

## Use

The RCA TT-500A is a television transmitter capable of providing a peak power output of 500 watts. It is designed for use in areas where a low-power transmitter will provide adequate signal strength for the desired coverage. The output of the TT-500A multiplied by the power gains of the Super Turnstile and Super-Gain antennas will provide a strong signal in many areas.

## Description

The TT-500A Television Transmitter will operate in any one of the low-frequency channels 2-6 (54 mc-88 mc). The transmitter, which employs air-cooled tubes throughout, is housed in two identical cabinets, which can be installed bolted together as one unit 56 inches wide, or arranged on individual cabinets each 31 inches wide. One of these cabinets contains all the components of the visual transmitter, and the other cabinet contains those of the aural transmitter. Controls for both aural and visual sections of the transmitter are accessible through openings in the door of each cabinet.

The visual section of the TT-500A transmitter consists of the carrier generating circuits, video amplifiers, modulator, power supplies, and the necessary control circuits. The video amplifiers, modulator and r-f circuits occupy the upper half of the cabinet. For the r-f channel, an RCA 6V6 Crystal Oscillator drives a 6V6 doubler. This is followed by an RCA 807 tripler, an RCA 4-125/4D21 doubler and two Type 4-250A/5D22's in parallel as the final amplifier. Modulation is applied to the grids of the two 4-250A/5D22 tubes in the power amplifier. Therefore all r-f stages can be simply meter tuned as straight-forward class C amplifiers. None of these stages except the power amplifier require neutralization.

The video system is a three-stage amplifier with excellent frequency and phase response. Video signals at RMA standard levels are fed into an RCA 6AG7 first video amplifier which is followed by another RCA 6AG7 video amplifier which drives three RCA 807's in parallel as the modulator.

The aural section of the transmitter is frequency modulated and has a power output of 250 watts in accordance with RMA requirements for television transmitters of this power. It consists of a Direct-FM exciter followed by a single 4-125A/4D21 doubler, which in turn drives a pair of 4-125A/4D21's in parallel as the power amplifier.

**TRANSMITTER CONSOLE**

The control console for the transmitter is constructed as a monitoring center where the operator has complete fingertip control over operation of the transmitter. In the console are the gain controls for both visual and aural inputs to the transmitter, plus complete monitoring facilities for both visual and aural signals.

Power output of the television transmitter can be measured by means of a dummy load and wattmeter, which can be obtained with the transmitter. A "reflectometer" built into the visual section of the transmitter, and coupled to the transmission line, provides a means for continuous observation of transmitter output during broadcasts.

**Specifications**

	<i>Aural</i>	<i>Visual</i>
Type of Emission_____	A3	A5
Frequency Range (TT-500A)_____	Channels 2-6	Channels 2-6
Power Output (into transmission line)_____	250 watts	500 watts peak
RF Output Impedance_____	51.5 ohms	51.5 ohms
Carrier Frequency Stability_____	±.002%	±.002%
Modulation Capability_____	±40 kc.	90%
Method of Modulation_____	Reactance tube	Grid amplitude
Input Impedance_____	600 ohms	75 ohms
Input Voltage_____	+10 ±2 dbm	1 v. peak to peak
Frequency Response_____	Uniform ±1 db 30 to 15,000 cycles	*2 db at 0.5 mc. 2 db at 1.25 mc. 2 db at 2. mc. 2 db at 3. mc. 3 db at 4. mc.
Maximum Audio Frequency		
Distortion_____	50 to 100 cycles 1.5%	
	100 to 7500 cycles 1.0%	
	7500 to 15000 cycles 1.5%	
Noise Level		
F-M Noise Below ±25 kc swing_____	60 db	
Amplitude Noise, r.m.s.		
Below Carrier_____	50 db	
Amplitude Variation Over One Frame of Picture_____		peak to peak less than 5% of the synchronizing peak level

**Tube Complement**

**VISUAL SECTION**

Crystal Oscillator, 1 RCA 6V6-GT; Doubler, 1 RCA 6V6-GT; Tripler, 1 RCA 807; Doubler, 1 RCA 4-125A/4D21; Power Amplifier, 2 4-250A/5D22; 1st Video Stage, 1 RCA 6AG7; 2nd Video Stage, 1 RCA 6AG7; Sync Expander, 1 RCA 6AC7; Sync Separator, 1 RCA 6C4; Pulse Amplifier, 1 RCA 6C4; D-C Insertion Diode, 1 RCA 6AL5; Monitor Amplifier, 1 RCA 6V6-GT; Modulator, 3 RCA 807; Modulator Screen Regulators, 2 RCA VR105; Modulator Power Rectifiers, 2 RCA 866A/866; Video Voltage Regulators, 2 RCA VR105; 500 Volt Rectifier, 2 RCA 866A/866; Low Voltage Supply Regulator, 1 RCA VR105; Low Voltage Rectifier, 1 RCA 6X5-GT; Power Amplifier Rectifier, 2 RCA 8008; Reflectometer Diode, 1 RCA 6AL5.

**AURAL SECTION**

**FM Exciter**

Crystal Oscillator, 1 RCA 6SH7; Crystal Frequency Divider, 1 RCA 6AC7; Modulated Oscillator, 1 RCA 6V6; Modulators, 2 RCA 6V6; 1st Buffer-Multiplier, 1 RCA 6V6; 2nd Buffer-Multiplier, 1 RCA 2E26; Amplifier, 1 RCA 2E26; 1st Frequency Divider, 1 RCA 6AC7; 2nd Frequency Divider, 1 RCA 6AC7; 3rd Frequency Divider, 1 RCA 6AC7; 4th Frequency Divider, 1 RCA 6AC7; Motor Drivers, 4 RCA 1614; Cathode Ray Indicator, 1 RCA 2BP1; Low Voltage Rectifier, 2 RCA 5U4G; High Voltage Rectifier, 1 RCA 5U4G; Voltage Regulator, 1 RCA VR105; Voltage Regulator, 2 RCA VR150.

**FM Amplifier**

Power Doubler, 1 RCA 4-125A/4D21; Power Amplifier, 2 RCA 4-125A/4D21; Low Voltage Rectifier, 1 RCA 5U4G; High Voltage Rectifier, 2 RCA 866A/866.

**Power Line Requirements**

Transmitter:  
Line\_\_\_\_\_208/230 v., 50-60 cycles, single phase  
Power Consumption (approx.)\_\_\_\_\_3000 watts  
Power Factor (approx.)\_\_\_\_\_0.85

**Crystal Heaters:**

Line\_\_\_\_\_115 v., 50/60 cycles, single phase  
Power Consumption\_\_\_\_\_56 watts

**MECHANICAL SPECIFICATIONS**

Transmitter:  
Dimensions—  
Overall Width \_\_\_\_\_56"  
Overall Height \_\_\_\_\_84"  
Overall Depth (including door handles)\_\_\_\_\_31<sup>1</sup>/<sub>16</sub>"  
Weight\_\_\_\_\_5150 lbs. (approx.)  
Finish\_\_\_\_\_Two-tone umber gray with brushed chrome trim and fittings  
Stock Identification \_\_\_\_\_MI-19206

**Equipment Supplied**

1 Aural Transmitter _____	MI-19005
1 Visual Transmitter _____	MI-19006
1 Control Console _____	MI-19266
1 Set of Inside Transmission Line_____	MI-19112
1 Set of Installation Accessories_____	MI-19129
1 Installation Wire Kit_____	MI-19132
1 Frequency Determining Kit_____	MI-19004
2 TMV-129C Crystal Units_____	MI-19400-1
2 TMV-129G Crystal Units_____	MI-19450-A
1 Monitoring Diode _____	MI-19051
1 Set of Tubes_____	MI-19003-A
1 Vestigial Side Band Filter_____	MI-19114
1 Touchup Kit _____	MI-28153
2 Instruction Books _____	IB-36053

**Available Accessories**

Input and Monitoring Equipment\_\_\_\_\_MI-19203  
Antenna Equipment \_\_\_\_\_On application  
RF Load and Wattmeter\_\_\_\_\_MI-19024-B

\* Maximum variation below idealized rectified vestigial side-band response.



# Television Transmitter, Type TT-500B

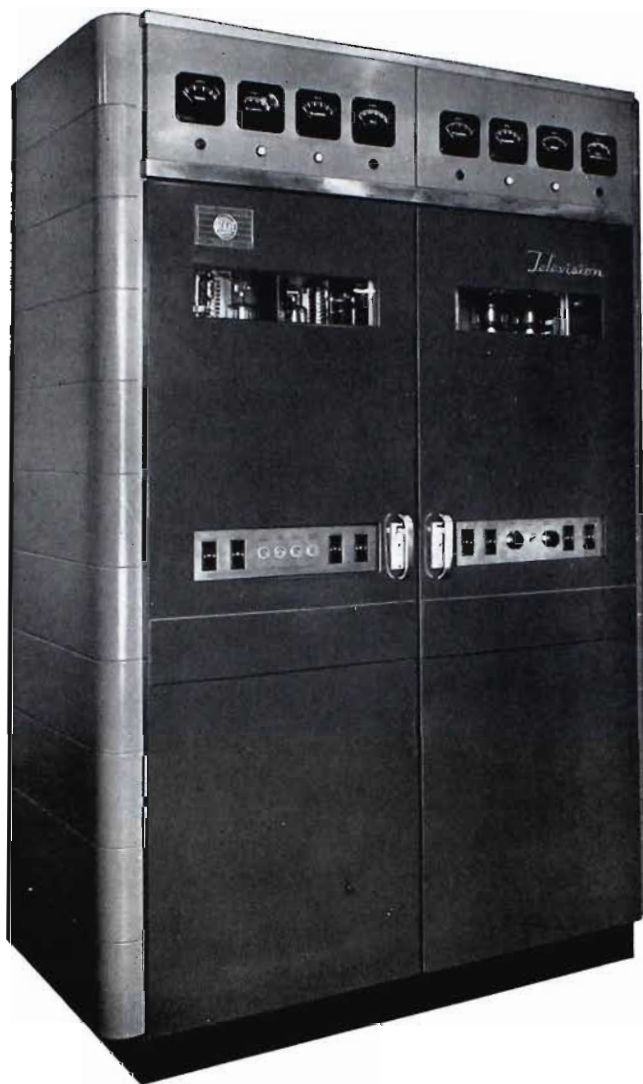

## Features

- Economical installation—low tube costs.
- Video system with excellent frequency and phase response.
- Easily tuned—straightforward meter-tuned stages.
- Independent control circuits for visual and aural sections of transmitter.
- Air-cooled tubes used throughout.
- Equipment incorporates picture and waveform monitors in console.

## Use

The RCA TT-500B is a television transmitter capable of providing a peak power output of 500 watts. It is designed for use in areas where a low-power transmitter will provide adequate signal strength for the desired coverage. The output of the TT-500B multiplied by the power gains of the Super Turnstile and Super-Gain antennas will provide a strong signal in many areas.

## Description

The Type TT-500B television transmitter will operate in any one of the channels 7-13 (174 mc-216 mc). The transmitter, which employs air-cooled tubes throughout, is housed in two identical cabinets, which can be installed bolted together as one unit 56 inches wide, or arranged on individual cabinets each 31 inches wide. One of these cabinets contains all the components of the visual transmitter, and the other cabinet contains those of the aural transmitter. Controls for both aural and visual sections of the transmitter are accessible through openings in the door of each cabinet.

Both the aural and visual sections of the Type TT-500B television transmitter employ four 4X150A tubes in parallel in the final stage. In the case of the visual section, these four tubes are grid-modulated by a pair of 807's. Relatively little power is required for complete modulation of these tubes. The transmitter provides a visual peak power of 500 watts.

In the visual section, a 6V6 crystal oscillator establishes the correct submultiple of the carrier frequency. This oscillator feeds a 6V6 tripler. The frequency is then doubled in the next stage which utilizes a Type 2E26, and tripled again by a 4-65A in the following stage. The 4-65A in turn feeds a 4X150A doubler which drives the four 4X150A's in parallel.

Modulation takes place in the final stage, and so all the preceding stages are narrow-band types providing optimum power amplification and ease of tuning. The frequency multiplying and driver stages are simply meter-tuned as straight class C amplifiers. The transmitter employs a sideband filter which suppresses the undesired sideband. This greatly simplifies the tuning of the transmitter, as compared to transmitters employing low-level modulation and internal sideband cutting. This is easily recognized, because in the latter type, each low-level modulated stage operates as a class B amplifier and each stage must be adjusted for proper band width to do its part of the sideband cutting.

In the FM aural channel, the carrier center frequency is provided by the direct FM exciter. This exciter is identical to that used in RCA FM transmitters. In order to provide the proper carrier frequency, the exciter output, which is in the range of 29-36 mc, is tripled in a 4-65A stage, then doubled in a 4X150A stage. This latter stage drives the four paralleled 4X150A's as the power amplifier.

## TRANSMITTER CONSOLE

The control console for the transmitter is constructed as a monitoring center where the operator has complete fingertip control over operation of the transmitter. In the console are the gain controls for both visual and aural inputs to the transmitter, plus complete monitoring facilities for both visual and aural signals.

Power output of the television transmitter can be measured by means of a dummy load and wattmeter, which can be obtained with the transmitter. A "reflectometer" built into the visual section of the transmitter, and coupled to the transmission line, provides a means for continuous observation of transmitter output during broadcasts.

### Specifications

	<i>Aural</i>	<i>Visual</i>
Type of Emission _____	A3	A5
Frequency Range (TT-500B) _____	Channels 7-13	Channels 7-13
Power Output (into transmission line) _____	250 watts	500 watts peak
RF Output Impedance _____	51.5 ohms	51.5 ohms
Carrier Frequency Stability _____	±.002%	±.002%
Modulation Capability _____	±40 kc.	90%
Method of Modulation _____	Reactance tube	Grid amplitude
Input Impedance _____	600 ohms	75 ohms
Input Voltage _____	+10 ±2 dbm	1 v. peak to peak
Frequency Response _____	Uniform ±1db 30 to 15,000 cycles	*2 db at 0.5 mc. 2 db at 1.25 mc. 2 db at 2. mc. 2 db at 3. mc. 3 db at 4. mc.
Maximum Audio Frequency Distortion _____	50 to 100 cycles 1.5% 100 to 7500 cycles 1.0% 7500 to 15000 cycles 1.5%	
Noise Level		
F-M Noise Below ±25 kc swing _____	60 db	
Amplitude Noise, r.m.s.		
Below Carrier _____	50 db	
Amplitude Variation Over One Frame of Picture _____		peak to peak less than 5% of the synchronizing peak level
Power Line Requirements		
Transmitter:		
Line _____	208/230 volts, 50/60 cycles, single phase	
Power Consumption (approx.) _____	3000 watts	
Power Factor (approx.) _____	0.85	
Crystal Heaters:		
Line _____	115 volts, 50/60 cycles, single phase	
Power Consumption _____	56 watts	

## MECHANICAL SPECIFICATIONS

### Transmitter:

Dimensions—	
Overall Width _____	56"
Overall Height _____	84"
Overall Depths (including door handles) _____	31 $\frac{1}{8}$ "
Weight _____	5150 lbs. (approx.)
Finish _____	Two-tone umber gray with brushed chrome trim and fittings
Stock Identification _____	MI-19206-B

## Tube Complement

### VISUAL SECTION

Crystal Oscillator, 1 RCA 6V6-GT; Tripler, 1 RCA 6V6-GT; Doubler, 1 RCA 2E26; Tripler, 1 4-65A; Doubler, 1 4X150-A; Power Amplifier, 4 4X150-A; 1st Video Stage, 1 RCA 6AG7; 2nd Video Stage, 1 RCA 6AG7; Sync Expander, 1 RCA 6AG7; Sync Separator, 1 RCA 6C4; Pulse Amplifier, 1 RCA 6CD; D-C Insertion Diode, 1 RCA 6AL5; Monitor Amplifier, 1 RCA 6AG7; Modulators, 2 RCA 807; Power Amplifier Rectifier, 2 RCA 8008; Reflectometer Diode, 1 RCA 6AL5; Low Voltage Rectifier, 2 RCA 5U4G; Voltage Regulator, 2 RCA 6AS7G.

### AURAL SECTION

#### FM Exciter

Voltage Regulator, 1 RCA 6SL7; Voltage Regulator, 1 RCA OA2; Bias Regulator, 2 RCA OA2; Crystal Oscillator, 1 RCA 6SH7; Crystal Frequency Divider, 1 RCA 6AC7; Modulated Oscillator, 1 RCA 6V6; Modulators, 2 RCA 6V6; 1st Buffer-Multiplier, 1 RCA 6V6; 2nd Buffer-Multiplier, 1 RCA 2E26; Amplifier, 1 RCA 2E26; 1st Frequency Divider, 1 RCA 6AC7; 2nd Frequency Divider, 1 RCA 6AC7; 3rd Frequency Divider, 1 RCA 6AC7; 4th Frequency Divider, 1 RCA 6AC7; Motor Drivers, 4 RCA 1614; Cathode Ray Indicator, 1 RCA 2BP1; Low Voltage Rectifier, 2 RCA 5U4G; High Voltage Rectifier, 1 RCA 5U4G; Voltage Regulator, 1 RCA VR105; Voltage Regulator, 2 RCA VR150.

#### FM AMPLIFIER

Tripler, 1 4-65A; Doubler, 1 4X150A; Power Amplifier, 4 4X150A; High Voltage Rectifier, 2 RCA 8008.

## Equipment Supplied

1 Aural Transmitter _____	MI-19005-B
1 Visual Transmitter _____	MI-19006-B
1 Control Console _____	MI-19266
1 Set of Installation Accessories _____	MI-19129
1 Installation Kit _____	MI-19132
2 TMV-129C Crystal Units _____	MI-19400-1
2 TMV-129G Crystal Units _____	MI-19450-A
1 Set of Tubes _____	MI-19003-B
1 Vestigial Side Band Filter _____	MI-19114
1 Monitoring Diode _____	MI-19051
1 Touchup Kit _____	MI-28153
2 Instruction Books _____	IB-36054

## Available Accessories

Input and Monitoring Equipment _____	MI-19203
Antenna Equipment _____	On application
Dummy Load _____	MI-19024-B

\* Maximum variation below idealized rectified vestigial side-band response.



# Audio/Video Switching Console, Type TTC-3A

## Features

- Provides central position for TV program control at transmitter location.
- Provides for remote control of film projectors and automatic slide projectors.
- Accommodates 5 video and 5 audio inputs.
- Video preview and audio monitoring.
- Remote control for one stabilizing amplifier.
- A matching item in RCA's Universal transmitter control console series.

## Uses

Audio/Video Switching Console, Type TTC-3A consists of a switching turret, desk section and relay/lamp power supply. When used with master monitor and film camera control, the unit provides centralized program-control and transmitter-control positions.

The TTC-3A contains switches and controls which permit the following major functions:

- (1) "Start", "stop", "changeover" and "standby" of two 16mm TV film projectors.
- (2) Operate an electrical slide-changing device and control the light intensity of a slide projector.
- (3) Select and control volume of any one of four sources of sound.
- (4) Switch and mix a separate announce circuit with any one of the four sources of sound.
- (5) Select and control volume of seven audio monitoring circuits.
- (6) Select any one of five video program circuits for feeding the transmitter.
- (7) Select any one of six video monitoring circuits.
- (8) Operate "chopper" to indicate percentage of picture modulation.
- (9) Picture gain control of transmitter input.

## Description

The TTC-3A is an all metal unit with flush sides that permit adjacent installation of a Type TM-5B Master Monitor and TK-20A Film Camera Control. The control panel is hinged providing easy access to components mounted on the rear of the panel. Front and rear panels of the desk section are removable providing access to all terminal blocks and the relay power supply.

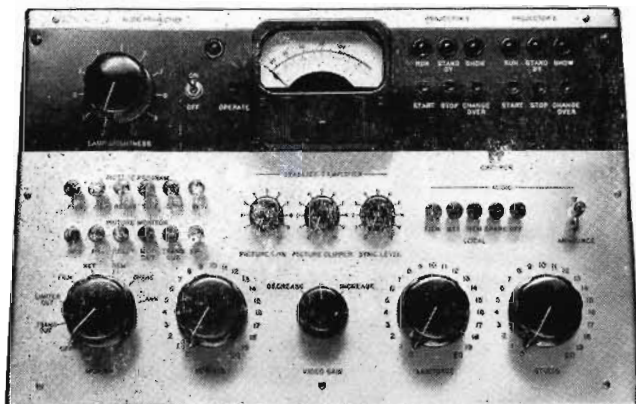

Picture gain, picture clipper and sync level controls are extension controls for remote operation of the RCA TA-5C Stabilizing Amplifier. The video gain control remotely controls the video gain fader in the transmitter.

The design of the system is based upon use of a standard RMA signal level being delivered to it at all times. The minimum usable signal level at the program switches is the RMA recommended minimum of 1.5 volts.

## Specifications

### POWER REQUIREMENTS

Relay and Lamp Power Supply—105/125 volts, 50/60 cycle,  
34 watts  
Slide Projector Lamp Supply—105/125 volts, 50/60 cycle,  
100 watts (for TP-9A Multiplexer Unit)

### IMPEDANCE

4 Sound Program Input Circuits—600 ohms (+14 dbm)  
1 Announce Input Circuit—600 ohms (+14 dbm)  
Sound Output Circuit—600 ohms (-20 dbm, L.B.)  
with 86B Amplifier in circuit (-30 dbm, H.B.)  
Modulation Monitor Output—600 ohms 0 dbm @ 100% mod.  
@ 100% mod.  
Picture Program Input (5)—75 ohms unbalanced  
(1.5 to 2.0 volts)  
Picture Monitor Input (6)—75 ohms unbalanced. Three  
provided with level equalizer controls

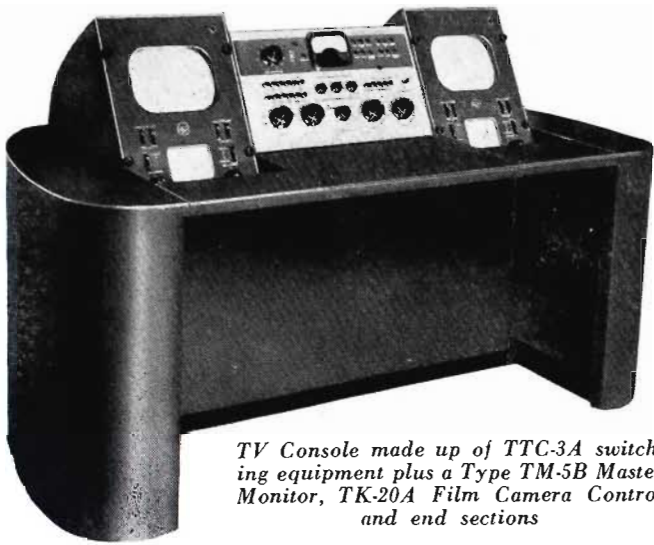

TV Console made up of TTC-3A switching equipment plus a Type TM-5B Master Monitor, TK-20A Film Camera Control and end sections

## VOLUME CONTROLS

- Picture Gain \_\_\_\_\_ Switch rotary type SPDT momentary contact
- Sound Gain \_\_\_\_\_ 600/600 ohms 20 steps, 2 db per step, 6 db insertion loss balanced ladder
- VU Attenuator \_\_\_\_\_ Semi-adjustable; +4 to +40 VU
- Sound Monitor Gain \_\_\_\_\_ 10,000/600 ohms continuously variable

## MECHANICAL SPECIFICATIONS

- Width Overall \_\_\_\_\_ 19"
- Depth \_\_\_\_\_ 36"
- Height Overall \_\_\_\_\_ 39"
- Weight \_\_\_\_\_ 290 lbs.
- Stock Identification \_\_\_\_\_ MI-19316-A

Block Diagram of TTC-3A Switching System (auxiliary equipment in dotted lines)

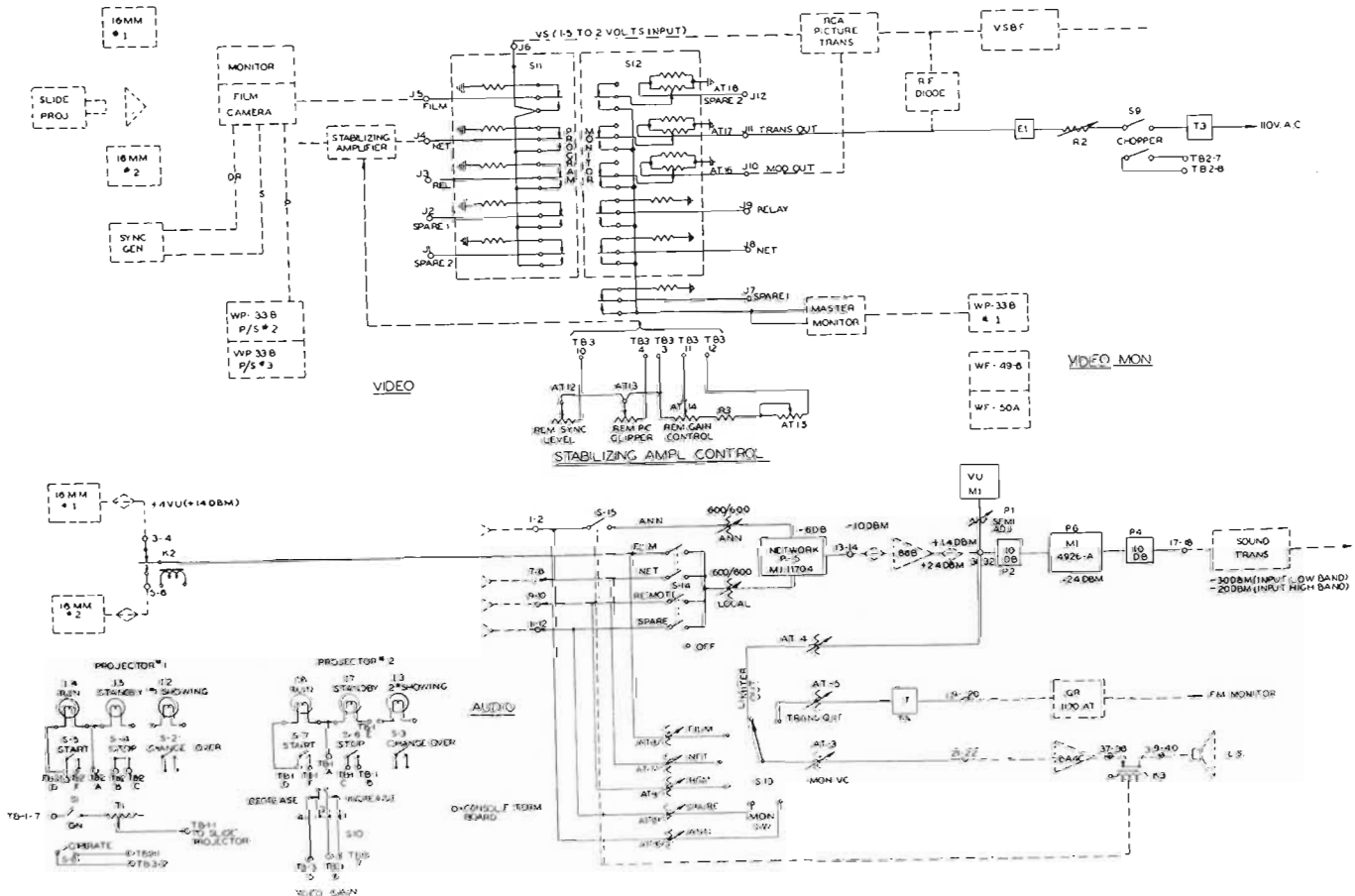



# Audio / Video Switching Turret, Type MI-19063

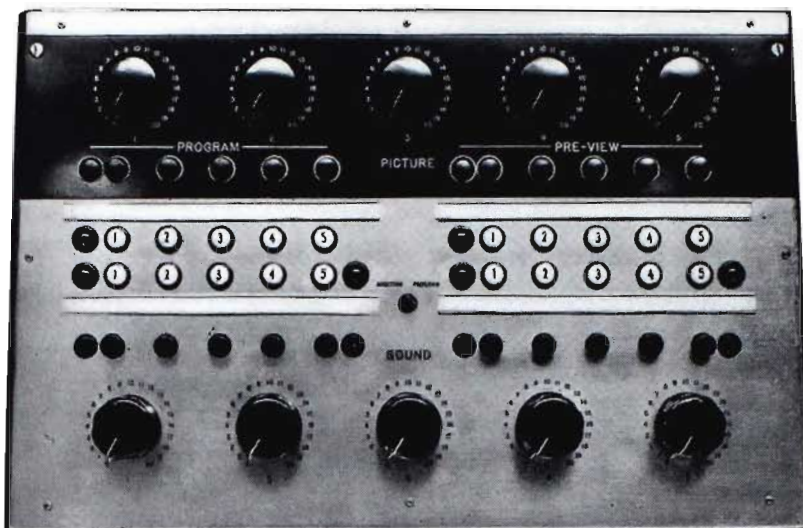

## Features

- Attractively styled turret matches TV transmitter control consoles.
- Provides a program control position at the transmitter location.
- Centralizes program controls at the transmitter control position.
- 5 video and 5 audio inputs with preview and audition provisions.

## Uses

Switching Turret, Type MI-19063, is an attractively styled audio and video switching turret designed for use in conjunction with RCA television transmitter consoles. The turret is particularly useful in installations where the transmitter location is remote from the studio. Transmitter input switching required during certain hours can be performed at this position, thus freeing studio control facilities for shut down or rehearsals. The turret is also useful for installations where program sources such as relay, network, and film are available at the transmitter location, and can be more conveniently previewed and switched to the transmitter at this location.

The Switching Turret will permit instantaneous switching of any of five sources of picture signal and five sources of sound signal to the input of the TV transmitter. The level of these signals as well as the ratio of picture and sync components are always under control of the operator. The turret utilizes the sound monitor amplifier and VU meter installed in RCA TV transmitter consoles. Video preview is provided by either the transmitter control monitor, which is also a part of the standard transmitter console, or a separate master monitor mounted in a similar desk section.

## Description

The identification MI-19063 consists of the turret only. It is designed for mounting on a desk section (MI-28401-1) and to work into a TA-1A Distribution Amplifier which can be mounted in the desk. Angles for mounting the amplifier are furnished with the turret. The available desk section matches RCA TV transmitter consoles and can be permanently installed adjacent to the transmitter control section.

All switching is accomplished by push-button switches arranged so that the normally associated picture and sound push buttons are one above the other and can be operated simultaneously with one hand. However, the switches are independent, thus sound and picture can be switched separately if desired.

## AUDIO CIRCUITS

Five audio push buttons are arranged so that any one of them can be operated to feed its signal to the output. The #5 position, intended for a microphone, can be mixed with the signal from #1, #2, #3 and #4, or used alone as desired. Each audio channel includes a 20-step gain control with 2 db steps tapered to infinity. OFF push buttons remove all signals from the output. Audio circuits are electrically interlocked giving the program circuit priority over audition circuits. Audio monitoring is normally performed through the associated transmitter control console.

## VIDEO CIRCUITS

Five video circuits are arranged to receive signals from external preamplifiers (one for each program source), and select signals desired for preview and program uses. Video channels #1, #2 and #3 are designed for use with Stabilizing Amplifiers, Type TA-5B.

These channels are normally used for remotely generated composite signals, but they can be used to mix sync with local signals if necessary. Channels #4 and #5 are designed for use with mixer amplifiers, Type TA-10A, and can be used for local signals where sync and video are available separately. The preview and program video circuits are completely isolated. Two identical outputs are obtained from each pre-amplifier and connected to the turret through 75-ohm coaxial cable. In the turret, each cable is terminated by a special isolating network. This network permits switching of any of

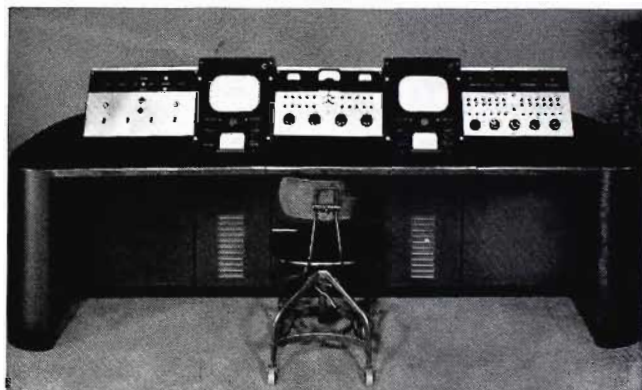

Transmitter Console, Preview Monitor and Switching Turret  
(right sections)

# TV TRANSMITTER

the five video inputs to a Distribution Amplifier mounted in the desk, without the loss of high frequency response. One channel of the five-channel Distribution Amplifier supplies the preview monitor, two channels provide signals for the transmitter and transmitter input monitor, and the remaining two channels provide signals for the preview channels #4 and #5. Mixing of video signals is not possible, but locally generated signals can be faded to black. Five controls are mounted on the front panel to remotely control the gain of five external amplifiers. Eight additional controls, accessible by tilting the panel forward, control sync in the five channels as well as the "picture clipper" controls of stabilizing amplifiers used in channels #1, #2 and #3. Three remaining controls, accessible by removing the turret cover, provide for initial gain adjustment for the three stabilizing amplifiers.

### Specifications

- Number of Audio Channels \_\_\_\_\_ 5
- Audio Input and Output Impedances \_\_\_\_\_ 600 ohm
- Required Audio Input and Output Impedances \_\_\_\_\_ 600 ohm
- Required Audio Input Levels \_\_\_\_\_ -20 dbm at input terminals of turret
- Number of Video Channels \_\_\_\_\_ 5
- Video Input and Output Impedance \_\_\_\_\_ 75-ohm
- Overall Dimensions:
  - Turret \_\_\_\_\_ 19" wide, 10 $\frac{3}{4}$ " high, 19" deep (approx.)
  - Turret Panel \_\_\_\_\_ 19" wide, 12 $\frac{1}{2}$ " high (approx.)
  - Turret with Accessory Desk Section \_\_\_\_\_ 19" wide, 39" high, 36" deep (approx.)
- Stock Identification \_\_\_\_\_ MI-19063

### Available Accessories\*

- Basic Desk Section, Type MI-28401-1
- Distribution Amplifier, Type TA-1A
- Audio Amplifier, Types BA-13A, BA-1A and BA-2C
- Equalizer, MI-26313
- Stabilizing Amplifiers, Type TA-5B
- Mixer Amplifiers, Type TA-10A
- Power Supplies, Types WP-33B, 580-C
- Signal Light Relays for External Use, Type MI-11702
- Speaker Interlock Relays, Type MI-11703-A
- Relay Power Supply (12 v. 1 A.) Type MI-11303
- Cables of Specified Length: (allow 4 feet for connections inside turret)
  - Video and Sync, 75-ohm Coax RG11/U, Type MI-83
  - Power to Master Monitor, 8 cond. (5 required), Type MI-82
  - Power to Distribution Amplifier, 4 cond., Type MI-51
  - Audio and Signal Circuits, #20 or #22 stranded, twisted pair, shielded, Types MI-33, MI-34, MI-49 or MI-63A

\* Accessory requirements depend upon circuit arrangement and layout. See block diagram for a typical layout utilizing the five audio and five video channels of the turret.

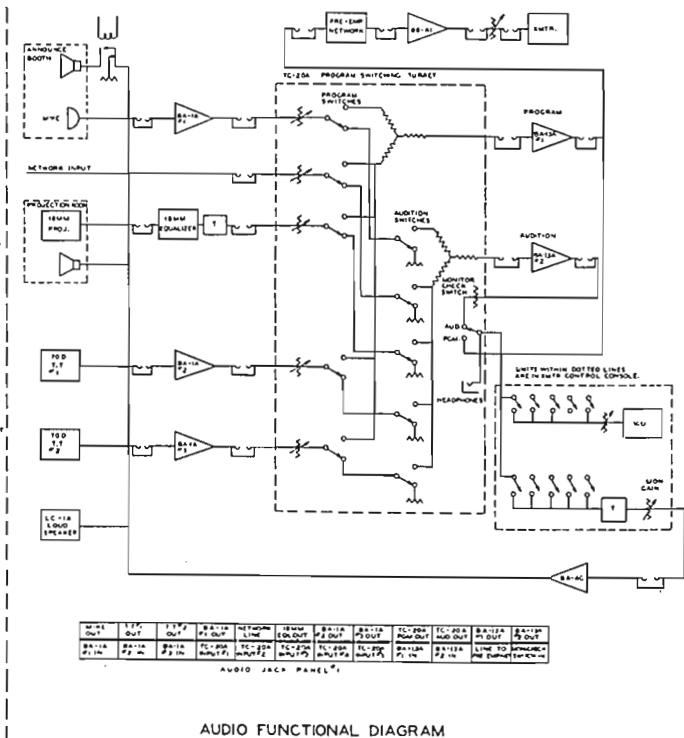
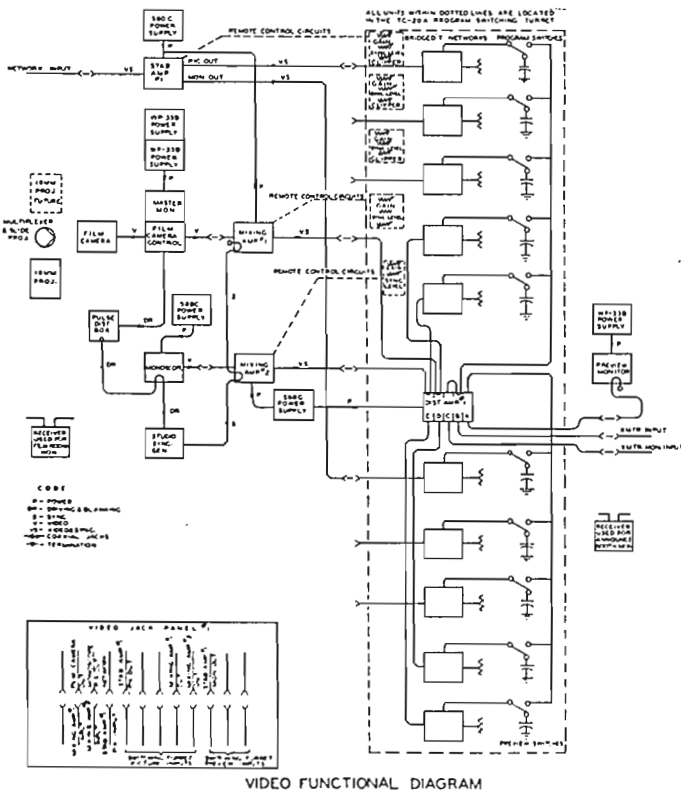

Block diagram of typical installation using five program sources. Amplifying equipment is shown with power supplies indicated where needed.



# Vestigial Side Band Filter, MI-19104

## Features

- No adjustments.
- Low insertion loss.
- Constant impedance input over entire double sideband.
- Completely enclosed to prevent tampering and admission of dust.
- Insurance against adjacent channel interference.

## Description

The sideband filter is a device which is connected directly to the output of the television visual transmitter to absorb the relatively small amount of lower sideband energy falling outside of the assigned television channel. Use of a sideband filter has several advantages: first, the tedious adjustment of tuned radio frequency amplifiers needed for the rejection of the sideband when low level modulation is employed is eliminated; second, the sideband filter has a constant impedance input so that the process of sideband elimination is accomplished without a detrimental effect on the picture quality; and third, the high level modulation system used in the transmitter gives the visual transmitter a better overall linearity.

Electrically, the sideband filter is a combination of two M-derived filters. Since filter components of the common coil and condenser construction would be difficult to manufacture and uneconomical to use because of the currents, voltages and reactances involved, the sideband filter has been designed, using low loss coaxial transmission line elements. The undesired sidebands are passed through one of the filter units into a properly terminated transmission line that effectively eliminates reflections of the lower sidebands. The desired signals are passed through the other filter unit and a notch filter. The notch filter is incorporated in the design to give positive insurance against interference with the sound channel of the next lower television channel. This notch filter is a system of resonant coaxial transmission line elements that allows the absorption of a single frequency in a second terminated coaxial transmission line while the desired television signals are not effected.

Since the filter is completely assembled at the factory, all tuning adjustments are factory made. It is contained in a completely enclosed metal cabinet finished in umber-gray and styled to match the associated television transmitter. The sideband filter is designed to stand in a vertical position near the visual transmitter, with a connecting transmission line preferably not more than 10 feet in length. The transmission line connecting the filter to the visual transmitter may leave the filter through the top or bottom or on one side. The output line passes through the top of the unit. The only other connections are with the station water-cooling supply and the visual transmitter interlock circuit.

Vestigial sideband filter, MI-19104-A, covers channels 2 to 6 inclusive; and vestigial sideband filter, MI-19104-B covers channels 7 to 13 inclusive. Each unit is tuned for the desired specific channel at the factory.

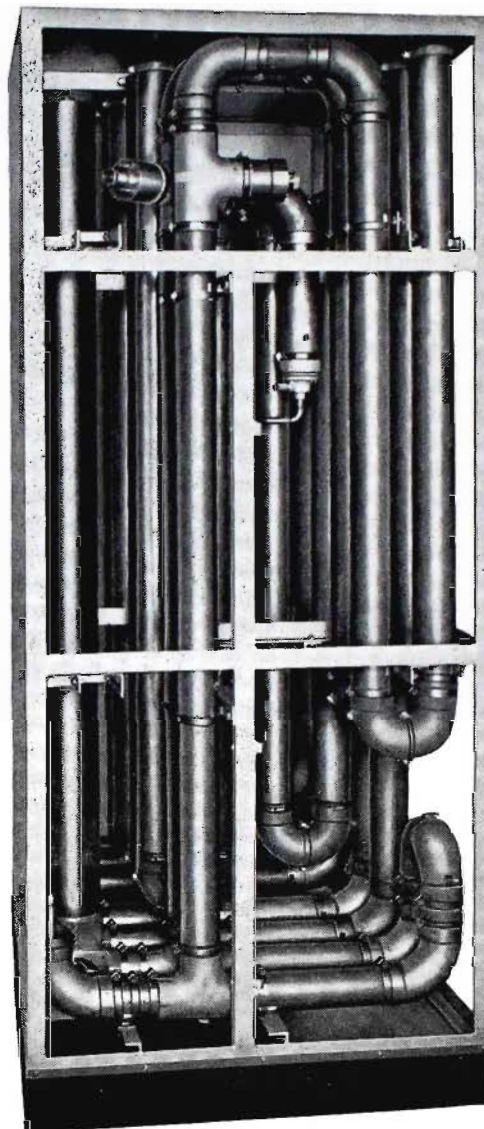

## Specifications

### Dimensions

Height*	84"
Width	36"
Depth	42"

Weight 1400 lbs.

Finish Two-tone umber gray

Water connections (connected to transmitter water cooling system)

"In" union for 1/2 nominal dia. copper water tubing

"Out" union for 1/2 nominal dia. copper water tubing

Electrical Connections Transmitter interlock of circuit

### Radio Frequency Connections

Input Impedance	72 ohms, 3 1/8" coaxial line
Output Impedance	72 ohms, 3 1/8" coaxial line

\* Height of sideband filter with base taken off for shipment is 80".

# RCA Tubes for Television

There's an RCA tube for practically every type of television requirement . . . power tubes . . . camera tubes . . . monitor tubes . . . flying-spot scanner . . . tubes for film recording. And you can buy RCA tubes with the assurance that you are getting the world's finest!

Listed below are only a few of the RCA Tubes designed specifically for television broadcasting.

## RCA 5820

Image Orthicon. RCA-designed for outside pickup, also suitable for studio use. Has high sensitivity, spectral response close to that of the human eye, stability of performance, 500-line resolution.

## RCA 8D21

The RCA push-pull power tetrode used in RCA TT-5A 5-kw television transmitters. Offers important operating benefits by utilizing advanced principles of screening, cooling, and electron optics.

## RCA 1850-A

RCA Iconoscope universally used for television film and slide pickup.

## RCA 5WP11

Projection-type Kinescope used for photographic transcribing of television broadcasts on motion picture film. Screen incorporates special spectral characteristics required for film recording.

## RCA 5WP15

Five inch projection-type Kinescope specially designed for Flying-Spot Scanner television service.

## RCA 1816-P4

Kinescope with metal-backed screen used exclusively for television station picture monitoring.

## RCA 1699

Custom-Built Monoscope similar to RCA-2F21 except that its test pattern is individually styled to the customer's requirements. Provides TV station identification.

## RCA 2F21

Standard "Indian-Head" test pattern Monoscope for routine check of television transmitters and receivers.

## RCA 715-C

Pulse amplifier tetrode for use in TV pulsed-light projectors to eliminate the need for mechanical shutters.

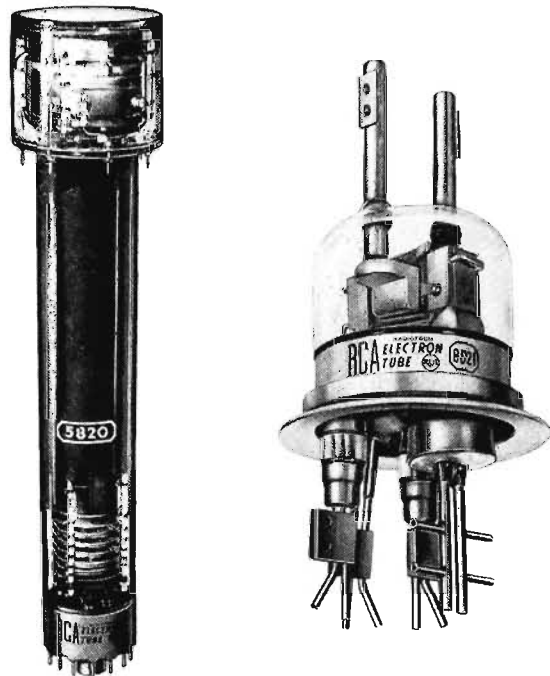

For technical data, prices, or delivery on RCA Tubes for Television—or any RCA Electron Tube—phone your local RCA Tube Distributor, or write RCA Tube Department, Harrison, N. J.



# Crystal Unit, Type TMV-129B

**Uses**

The RCA type TMV-129B crystal unit was designed especially for stable frequency control of transmitters operating in the AM broadcast band. However, in addition to covering the band from 550 to 1600 kc, these precision units are also available for frequencies as low as 325 kc and as high as 3000 kc. The units may be employed in any type of equipment, within the applicable frequency range, where maximum frequency precision and high crystal activity are essential. The TMV-129B holder has six external contact pins in a polarized arrangement.

**Specifications**

Frequency Range\_\_\_\_\_325 to 3000 kc  
 Operating Oven Temperature +60° C. (temperature controlled)  
 Ambient Temperature Range\_\_\_\_\_ -20° C. to +55° C.  
 Frequency deviation\_\_\_\_\_ ±10 cycles maximum  
 (normally within ±2 cycles)  
 Heater Power\_\_\_\_\_14 watts from a 110 volt a-c or d-c source  
 Stock Identification:  
 Type TMV-129B \_\_\_\_\_MI-7467  
 Quartz Plate Size\_\_\_\_\_1.000" x .938", predimensioned

# Crystal Unit, Type TMV-129C

**Uses**

The RCA type TMV-129C crystal unit was designed for precise frequency control at frequencies above the AM broadcast band. By use of carefully processed AT cut quartz plates designed to operate at the third harmonic mode, the TMV-129C may be used at frequencies as high as 20 mc. The unit was designed primarily for high frequency transmitters where maximum frequency stability is required. These crystals may also be employed in certain types of receivers for precision fixed frequency reception.

The TMV-129C holder resembles the TMV-129B type. It has six external contact pins in a polarized arrangement.

**Specifications**

Frequency Range\_\_\_\_\_2,000-20,000 kc  
 Ambient Temperature Range\_\_\_\_\_ -20° C. to +55° C.  
 Operating Oven Temperature\_\_\_\_\_ +60° C. (other temperatures  
 on special order)  
 Frequency Stability\_\_\_\_\_ ±.005% or better  
 Heater Power\_\_\_\_\_14 watts from 110 volt source, a-c or d-c  
 Stock Identification:  
 Type TMV-129C \_\_\_\_\_MI-19400

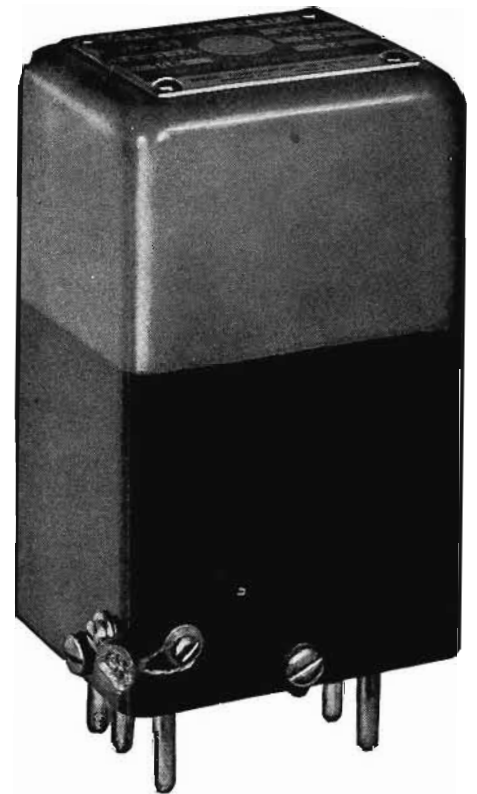

# Crystal Unit, Type TMV-129G

**Uses**

The RCA type TMV-129G crystal unit was designed to provide the optimum of frequency stability in the low frequency range at approximately 100 kc. This unit is widely employed in frequency modulation and television transmitters in which the oscillators normally operate at these low frequencies. Although optimum performance is realized at frequencies between 85 and 125 kc, this unit may be employed with very satisfactory performance as high as 350 kc. The frequency stability approaches that of a primary frequency standard and under normal operating conditions the maximum frequency variation will not exceed one or two cycles.

The TMV-129G holder resembles the TMV-129B type. It has six external contact pins in a polarized arrangement.

**Specifications**

Frequency Range\_\_\_\_\_70 kc to 350 kc using either DT or CT  
 cut quartz plates  
 Ambient Temperature Range\_\_\_\_\_ -10° C. to +65° C.  
 Operating Temperature \_\_\_\_\_ +70° C.  
 Frequency Stability\_\_\_\_\_ ±2 cycles  
 Frequency Calibration\_\_\_\_\_ Zero beat in customer's circuit with  
 trimmer capacitor  
 Heater Power\_\_\_\_\_14 watts from 110 volt source, a-c or d-c  
 Stock Identification:  
 Type TMV-129G \_\_\_\_\_MI-19450-A





Tower and two-section Pylon at WSBA-FM, York, Pa.

Raising the four-section Pylon in one completely assembled unit at WJPG-FM, Green Bay, Wisc.

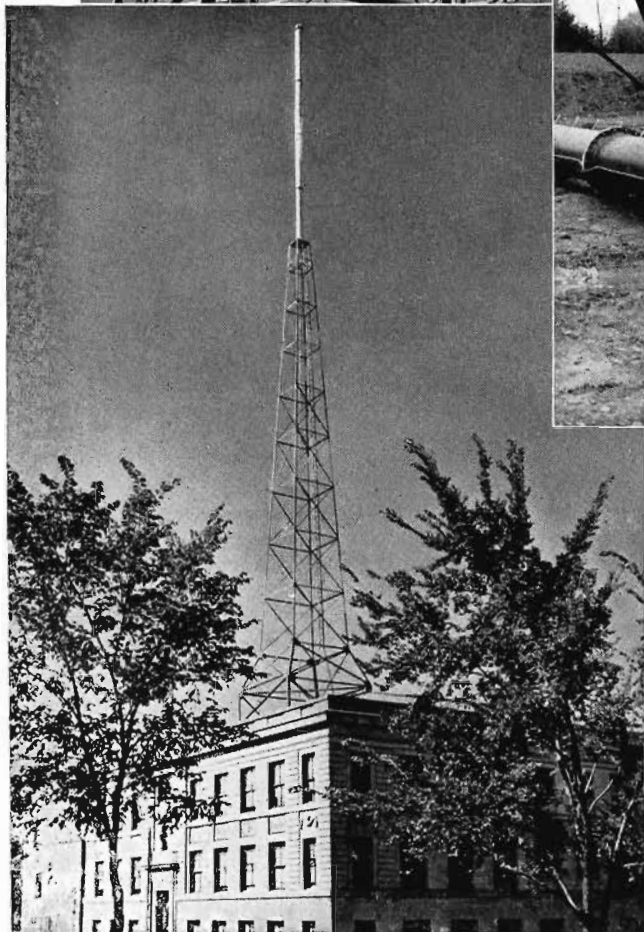
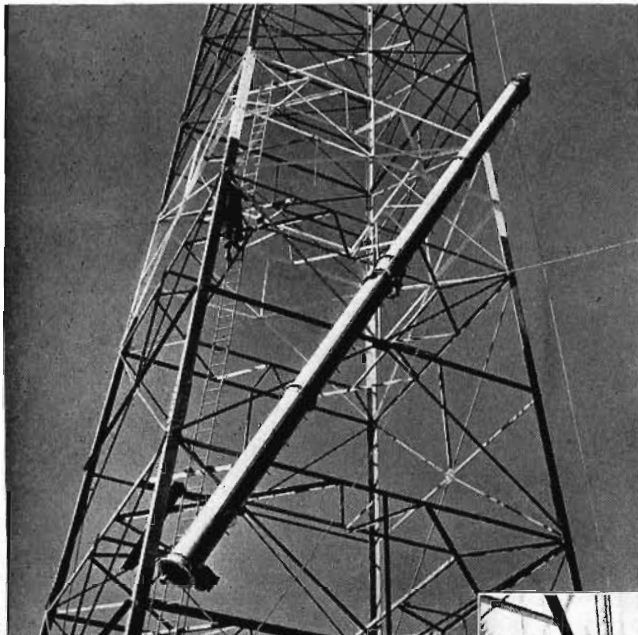

Inserting the transmission line harness into the two-section Pylon at WSBA-FM, York, Pa.

Four-section Pylon installation with supporting tower atop building at WSUI, Iowa City, Iowa.

# **ANTENNAS AM - FM - TV**

	<b>Page</b>
<b>FM ANTENNAS</b>	<b>286</b>
<b>TV ANTENNAS</b>	<b>293</b>
<b>TRANSMISSION LINE EQUIPMENT</b>	<b>304</b>
<b>AM ANTENNA TUNERS</b>	<b>330</b>
<b>ANTENNA TOWERS &amp; EQUIPMENT</b>	<b>333</b>



# Pylon FM Antenna

## Features

- Single element, self-supporting structure.
- Easy to install.
- High gain. Broadband.
- High power handling capacity.
- Sectionalized to facilitate erection.
- Mechanically strong and needs no guying.
- Heavy duty types will support RCA Super Turnstile
- One feed point per section.
- Icing problem negligible.
- Easy to maintain.

## Description

The new RCA Pylon Antenna is a radically new design of antenna for the FM broadcast band. This antenna is simpler in design, poses fewer installation problems, and provides higher gain (height for height) than any other type of FM antenna.

The Pylon is essentially a cylinder of sheet metal, mounted in a vertical position, with a narrow slot running from top to bottom. This cylindrical structure itself is the radiator. The operation may be best understood by considering the edges of the slot as an open wire transmission line, and the cylinder as an infinite number of horizontal loops. The cylinder is approximately a wave length long and a half wave length in circumference. When properly excited, at the midpoint, there is a voltage distribution along the slot similar to that along any full wave transmission line shorted at both ends. This voltage excites the cylindrical portion, and results in horizontally polarized radiation. The Pylon has an essentially circular radiation pattern. Its gain depends upon the number of stacked sections. The basic cylindrical section is approximately thirteen and one-half feet high and twenty inches in diameter. The sections may be stacked, one on top of the other, with the gain increasing in a direct linear proportion. For example, at 98 megacycles, a single section will have a gain of one and a half, two sections will have a gain of three, four sections a gain of six, and eight sections a gain of twelve. For a given number of sections, there is a model of the Pylon designed to operate in either the lower or upper half of the FM broadcast band.

The Pylon can be safely mounted almost anywhere. Its low weight places a minimum of load and stress on any building or tower on which it might be mounted, and it is entirely self-supporting in its mounting. There are no appendages or protruding elements which high winds would cause to loosen or fall, or which would require bracing against the possibility of ice loading. Icing is a negligible problem with the Pylon because the transmission lines are inside the cylinder where ice formation is unlikely. The formation of ice on the outside will add only a negligible amount to the total weight and loading. De-icing equipment is not considered necessary.

The Pylon presents extremely simple installation problems. One feed point per section is all that is required. One-, two- and four-section Pylons can be completely assembled on the ground and raised to position as a unit. Therefore, only one transmission line connection need be made "in the air." For the four section antenna, only two connections "in the air" are required. Maintenance problems for this antenna are reduced by the extreme simplicity of the feed line arrangements, the small number of end seals, and the fact that the lines are enclosed within the cylinder. Provision is made for mounting a standard 300 mm. code beacon on the top of the antenna. Wiring to this lamp may run outside the cylinder. Steps on the cylinder provide a means of servicing the lamp or inspect-

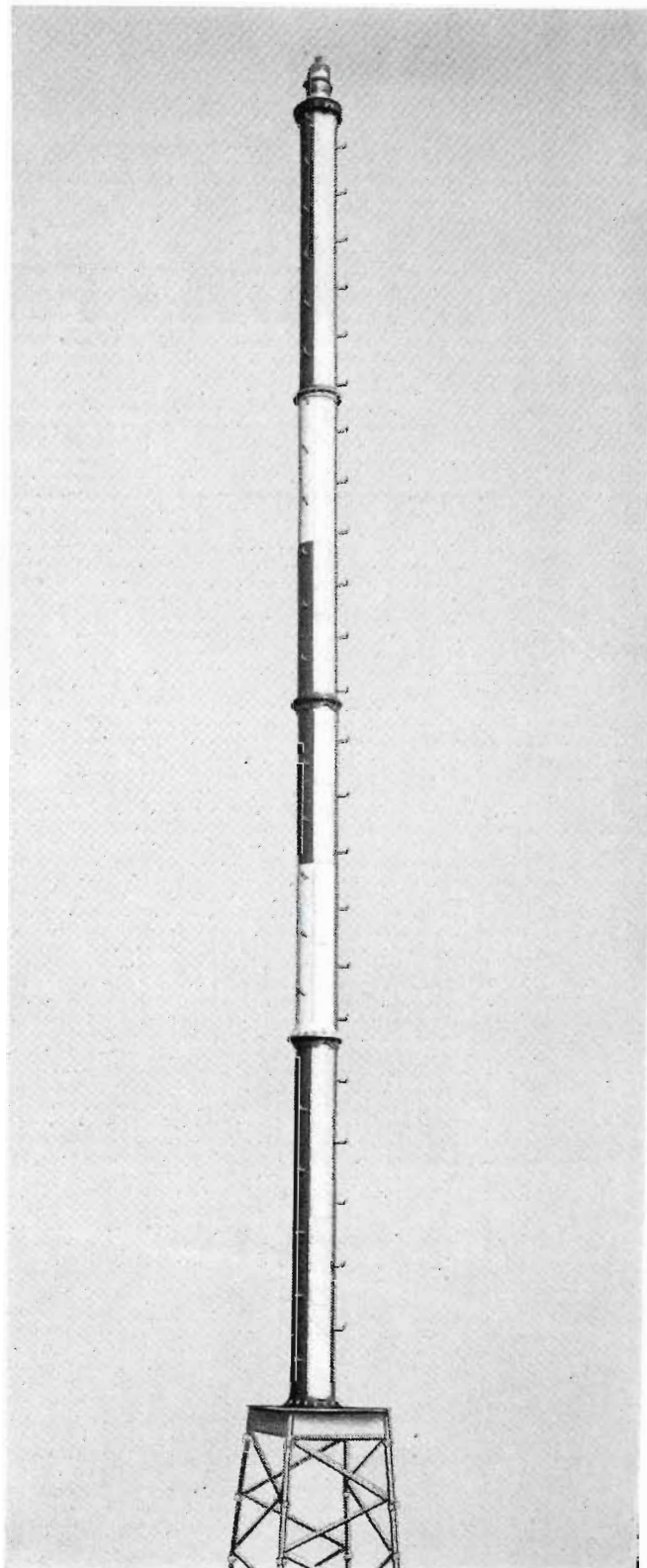

ing the slot. The slot is normally covered with a strip of polyethylene for the purpose of excluding water, ice and other foreign matter. If it should ever become necessary to service the transmission line harness within the Pylon, the securing bolts, which are accessible at the slot, may be removed, and the harness lowered to the ground. Shackles are provided at the top of the Pylon, both inside and out, to permit the rigging of a boatswain's chair and for the purpose of facilitating the lowering and raising of the harness.

## There Is A Pylon For Every Application

In order to meet the requirements of the many different sets of circumstances under which an FM antenna may be installed, the Pylon has been made available under several different classifications, each of which serves the needs of a particular application. The three basic types of Pylons are designated as: The Standard Pylon, the Heavy Duty Pylon, and the Low Power Pylon. The 8-section Pylon is a combination of the Standard and the Heavy Duty types.

### Standard Pylon

The Standard Pylon is designed to meet the requirements of the average FM installation. It meets all of the RMA specifications, and will safely handle the output of any FM transmitter —up to 50 kw. This Pylon is constructed of aluminum and is designed to combine the maximum of strength and rigidity with the minimum of weight. It meets the RMA recommended wind loading capability equivalent to a wind velocity of 87 mph, assuming the structure to be covered with a half inch layer of ice.

### Heavy Duty Pylon

The Heavy Duty Pylon is designed primarily to support the RCA Super Turnstile Television Antenna and to form the lower half of the 8-section Pylon. Used either way the combination meets the RMA recommended wind loading capacity of at least 87 miles per hour. Like the Standard Pylons, these units are capable of handling any power up to 50 kw. The Heavy Duty Pylons used alone are especially applicable where high winds of hurricane intensity can be expected. When not supporting TV antennas, they will withstand wind velocities in excess of 160 miles per hour.

### Low Power Pylon

The Low Power Pylon is an ideal FM antenna for low power FM stations not requiring exceptionally high gain. It also can be used as a standby antenna for stations normally operating at higher power. Made of sheet steel, hot-dip galvanized, it will handle a power of 3 kw, and will withstand a wind velocity of 87 mph. The Low Power Pylon provides a low cost installation, and has the same gain as the other single section Pylons.

### Eight-Section Pylon

The Eight-Section Pylon combines features which cannot be found in any other type of FM Antenna. To the broadcaster desiring high power handling capability at high gain, it gives a gain of 12 with power input up to 100 kw. Particularly advantageous use can be made of this power rating where dual operation by separate stations operating with a combined output of over 50 kw is contemplated. (The whole gain of 12 is, of course, applied to both stations in such a case.) The easily adjusted deflectable beam directs maximum signal at or below the horizon, as desired. Optimum beyond-the-horizon

coverage is thus assured for any set of terrain conditions, or increased local signal made possible where necessary. Application of Sectionalizing equipment makes possible the operation of either the top or bottom four sections by themselves or of all eight together.

The Eight-Section Pylon is a combination of a Standard four-section and a Heavy Duty four-section unit with suitable phasing equipment. It is designed to meet RMA recommendations of wind loading capacity of at least 87 mph with 1/2" of ice loading.

### Dual Operation

All Pylons lend themselves to common use by two separate broadcasting stations, thus affecting great economy in tower and antenna equipment. Employment of one of the line of RCA Notch Filter Units assures freedom from objectionable cross-modulation with a maximum power transfer to the antenna.

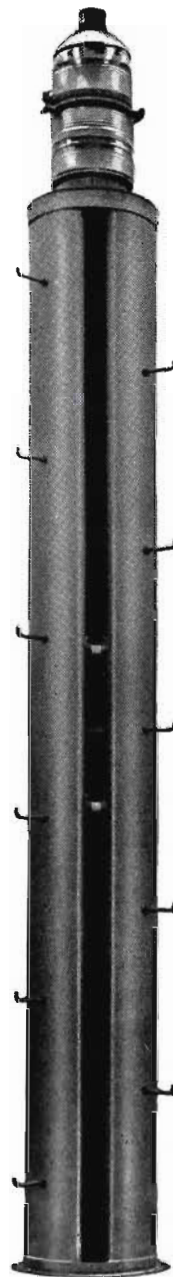

*Low Power Pylon*



# Engineering Data For Pylon Antennas

## STANDARD PYLONS

Type No.	Sec-tions	Fre-quency Range (Mcs.)	Nom-inal Power Gain	R (lbs.)	h <sub>1</sub> (ft.)	h <sub>2</sub> (ft.)	D <sub>1</sub> (in.)	D <sub>2</sub> (in.)	W (lbs.)	Stock Identifi-cation
BF-11A	1	88-97.4	1.5	501	7.5	13.5	19.5	22 <sup>5</sup> / <sub>8</sub>	350	MI-28221-A
BF-11B	1	96.4-108	1.5	501	7.5	13.5	19.5	22 <sup>5</sup> / <sub>8</sub>	350	MI-28221-B
BF-12A	2	88-96.5	3.0	950	14	27	19.5	22 <sup>5</sup> / <sub>8</sub>	700	MI-28222-A
BF-12B	2	94.5-108	3.0	950	14	27	19.5	22 <sup>5</sup> / <sub>8</sub>	700	MI-28222-B
BF-14A1	4	88-98	6.0	1868	27.5	54	19.5	22 <sup>5</sup> / <sub>8</sub>	2000	MI-28224-XY
BF-14B1	4	97.6-108	6.0	1868	27.5	54	19.5	22 <sup>5</sup> / <sub>8</sub>	2000	MI-28224-XY
BF-18A	8	88-97	12.0	3746	55.4	109.7	20.0	27	13434	MI-28228-A
BF-18B	8	97-108	12.0	3746	55.4	109.7	20.0	27	13434	MI-28228-B

## HEAVY DUTY PYLONS

BF-12E	2	88-96	3.0	1028	14.7	27.8	20.0	25	4802	MI-28222-E
BF-12F	2	94-108	3.0	1028	14.7	27.8	20.0	25	4802	MI-28222-F
BF-14J	4	88-96	6.0	1974	28.6	55.7	20.0	27	11500	MI-28224-J
BF-14K	4	96-108	6.0	1974	28.6	55.7	20.0	27	11500	MI-28224-K

## LOW POWER PYLONS

BF-21A	1	92-95	1.5	515	7.75	13.5	19.8	22	376	MI-28231-A
BF-21D	1	94-108	1.5	419	5.9	11.8	17.8	20	312	MI-28231-D

### LEGEND—

- R Wind force. Equivalent to 87 mph wind, RMA Standard.
- h<sub>1</sub> Height of center of wind force.
- h<sub>2</sub> Height of antenna. Does not include beacon (3 feet).
- D<sub>1</sub> Diameter of cylinder.
- D<sub>2</sub> Diameter of flange bolt circle.
- W Total weight including beacon lamp.

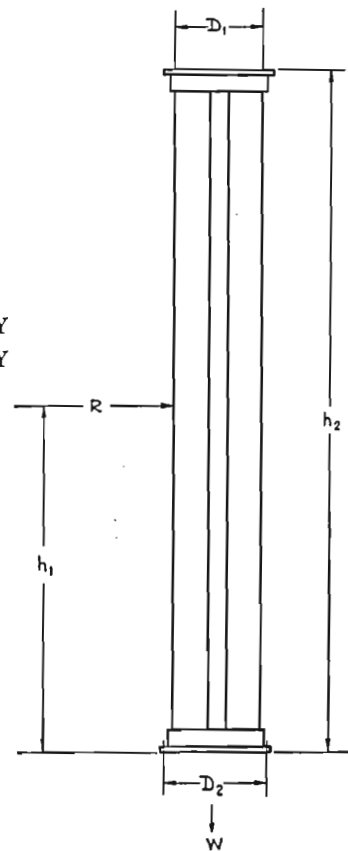

The Pylon is furnished complete with transmission line harness, fittings, mounting flanges, and all hardware. The harnesses of all Pylons except low power types terminate in 51.5 ohm, 3<sup>1</sup>/<sub>8</sub>" flanged line at the base of the antenna. Low power harnesses terminate in 51.5 ohm <sup>7</sup>/<sub>8</sub>" flange. The standing wave ratio is, in all cases, less than 1.5. Connectors are available to couple the antenna to a <sup>7</sup>/<sub>8</sub>", 1<sup>5</sup>/<sub>8</sub>", 3<sup>1</sup>/<sub>8</sub>", or 6<sup>1</sup>/<sub>8</sub>" plain or flanged transmission line. Where requested, RCA will also be glad to quote on tower and installation.

### Accessory Equipment

- Supporting Structures and Fittings \_\_\_\_\_ On application
- Coaxial Transmission Line for use from Antenna to Transmitter \_\_\_\_\_ On application
- FM-AM Isolation Unit Type BAF-14A \_\_\_\_\_ MI-28227A/B
- Sectionalizing Kit for Eight-Section Pylon \_\_\_\_\_ On application
- Notch Filter \_\_\_\_\_ On application

# Engineering Data For Pylon Super Turnstile Combination

The combined antenna structures are designed to withstand a maximum wind velocity of 85 mph when coated with 1/2" radial ice. Maximum unit stress = 20,000 lbs. per square inch. Reaction "R" shown is for estimating purposes only and is calculated on the basis of 20 lbs. per square foot (equivalent to 30 P.S.I. for flats) of projected area without ice. All sections are rounds. "W" = total dead weight, including pole, 300 mm code beacon, pole steps, special connection between FM pylon and TV pole, transmission lines, Pylon, and miscellaneous hardware.

TABLE OF ORDERING INFORMATION\*

Item	TV Channels	TV Freq. Band	TV Sections	TV MI-	FM Sections	FM Freq. Band	FM MI- Separate Sections	FM MI- Combined Sections	FM Pylon Type No.	TV Sales Type No.
1	7-13	174-216 mc	6	19013-A	2	88-96 mc 94-108 mc	28222J 28222K	28222E 28222F	BF-12E BF-12F	TF-6B
2	7-13	174-216 mc	6	19013-A	4	88-96 mc 95-108 mc	28224G 28224H	28224J 28224K	BF-14J BF-14K	TF-6B
3	4,5,6	66-88 mc	3	19012-D	2	88-96 mc 94-108 mc	28222J 28222K	28222E 28222F	BF-12E BF-12F	TF-3B
4	4,5,6	66-88 mc	3	19012-D	4	88-96 mc 96-108 mc	28224G 28224H	28224J 28224K	BF-14J BF-14K	TF-3B
5	2,3	54-66 mc	3	19012-C	2	88-96 mc 94-108 mc	28222J 28222K	28222E 28222F	BF-12E BF-12F	TF-3B
6	2,3	54-66 mc	3	19012-C	4	88-96 mc 96-108 mc	28224G 28224H	28224J 28224K	BF-14J BF-14K	TF-3B
7	4,5,6	66-88 mc	4	19017-D	2	88-96 mc 94-108 mc	28222J 28222K	28222E 28222F	BF-12E BF-12F	TF-4A
8	4,5,6	66-88 mc	4	19017-D	4	88-96 mc 94-108 mc	28224G 28224H	28224J 28224K	BF-14J BF-14K	TF-4A

\* PLUS 300 MM CODE BEACON.

TABLE OF SPECIFICATIONS

ITEM	1	2	3	4	5	6	7	8
FREQ MC	74-216	74-216	66-88	66-88	54-66	54-66	66-88	66-88
TV NO OF SECTIONS	6	6	3	3	3	3	4	4
APPROX. PWR GAIN	6.9	6.9	3.8	3.8	3.6	3.6	5.0	5.0
FM NO OF SECTIONS	2	4	2	4	2	4	2	4
FM APPROX. PWR GAIN	3	6	3	6	3	6	3	6
A	13' 11"	27' 10"	13' 11"	27' 10"	13' 11"	27' 10"	13' 11"	27' 10"
B	27' 10"	55' 8"	27' 10"	55' 8"	27' 10"	55' 8"	27' 10"	55' 8"
C	33' 2"	46' 2"	35' 8"	4' 9"	40' 3"	54' 2"	41' 5"	55'
D	54' 6 7/16"	82' 4 7/16"	56' 3 1/2"	84' 1 1/2"	60' 1 1/2"	87' 11 1/2"	61' 5 1/2"	89' 3 1/2"
E	3' 2"	3' 2"	6' 11"	6' 11"	8' 11"	8' 11"	6' 11"	6' 11"
F FT	72' 6 1/2"	100' 4 1/2"	75' 11 1/2"	103' 9 1/2"	84' 1"	111' 11"	88' 2"	116' 0"
R LBS	2100	3050	2300	3250	2730	3670	2780	3720
W LBS WITH COMBINED SECTIONS	6982	13,660	8487	15,185	9893	16,591	10,620	17,318
W LBS WITH SEPARATE SECTIONS	7282	13,980	8787	15,485	10,193	16,891	10,920	17,618
AREA SQUARE FT WITHOUT ICE	105	157	119	171	141	193	141	193
AREA SQUARE FT WITH 1/2" RADIAL ICE	135	190	150	204	181	235	183	237
MOMENT IN FOOT POUNDS NO ICE AT TOWER TOP	69,720	140,910	82,340	159,250	110,020	198,920	115,370	204,600
C' WITH 1/2" RADIAL ICE	34.7'	48'	38.5'	50.4'	44'	58.8'	45'	59.8'
R LBS WITH 1/2" RADIAL ICE	2310	3300	2600	3590	3550	4550	3590	4580
MOMENT IN FOOT POUNDS WITH 1/2" RADIAL ICE AT TOWER TOP	80,160	158,400	100,100	180,930	156,200	269,600	161,550	273,880

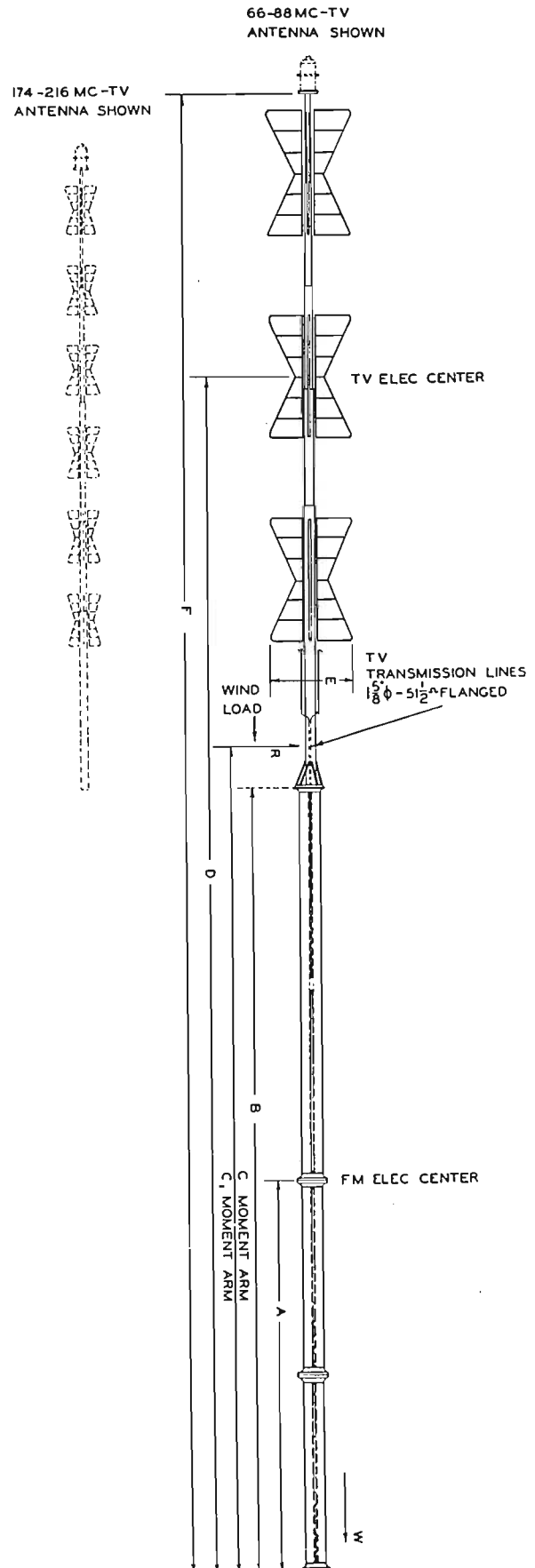



# AM-FM Isolation Unit, Type BAF-14A



## Features

- Accommodates up to 5 kw FM power.
- Isolates for AM power up to 50 kw.
- No tuning adjustments required.
- FM power transfer approximately 99% efficient.
- Maintains low standing wave ratio on any FM channel (SWR less than 1.15 any channel).
- Equipped with swivel transmission line flanges.
- Lightweight, compact—easy to install.
- Inserts directly in FM transmission line—no additional support required.
- Rugged design includes heavily reinforced lid and bottom channel . . . and oversize ceramic insulators.

## Uses

The RCA Type BAF-14A FM-AM Isolation Unit is a device for transferring FM power across the insulating zone of an AM antenna tower to feed an FM antenna mounted atop the tower. It is designed to provide complete isolation of FM and AM signals and efficient operation over the entire FM frequency range.

## Description

The circuit of the FM-AM Isolation Unit consists of two series resonant circuits coupled together to such a degree as to provide excellent band-pass characteristics over a range of frequencies from 88 to 108 megacycles. The inductors consist of solid copper loops, and the capacitors consist of built-in concentric line reactances which are concentric with the input and output inner conductors. The input assembly is insulated from the output assembly and there remains a stray capacitance of approximately 65 mmfd. across the insulator. The effect of this capacitance in shunt with the AM input impedance is negligible.

Equipped with *Swivel flanges* at both the input and output, the BAF-14A may be easily, and economically installed without any special expensive coaxial fittings. Suggested mountings of the isolation unit for towers with and without guys are shown in sketches below. The flanges connect to standard 1 $\frac{5}{8}$ " 51.5 ohm flanged line which extends from top and bottom of the BAF-14A unit. The swivel feature permits perfect line-up of *flange mounting holes* of the BAF-14A with those of the line entering the top of the unit from the antenna and those of the line entering the bottom of the unit from the transmitter.

The isolation unit is housed in a sturdy, yet compact and lightweight metal box and is self-supporting, when mounted directly in the transmission line. The finish of the BAF-14A housing consists of a heavy electro-galvanized plating plus a weatherproof, baked enamel coating capable of withstanding long periods of exposure. All FM and AM insulation material is fully protected. Access to the interior of the housing for inspection or maintenance is made by means of a removable screen panel on the bottom. Provision is made for carrying the gas pressure across the unit with a high-pressure composition hose.

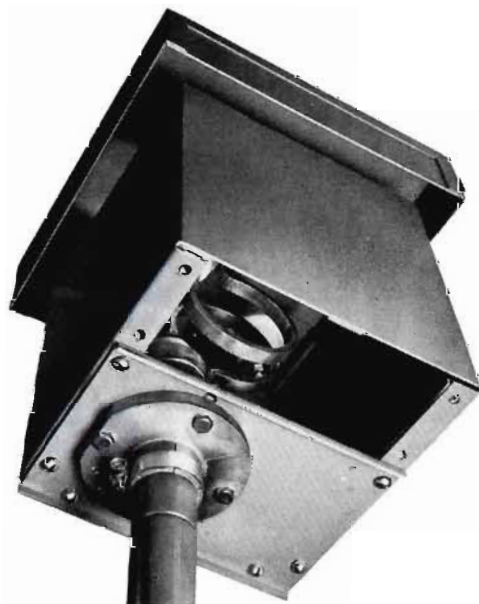

Closeup of BAF-14A with bottom shield removed

**Specifications**

Frequency Range \_\_\_\_\_ 88-108 mcs  
 Transmission Line Impedance \_\_\_\_\_ 51.5 ohms  
 Input Impedance \_\_\_\_\_ 51.5 ohms with less than 1.15 VSWR  
 Maximum FM Power \_\_\_\_\_ 5 kw  
 Maximum AM Base Voltages \_\_\_\_\_ Base insulator voltage should not exceed 14,000 volts peak at 100% modulation  
 FM Efficiency \_\_\_\_\_ Approximately 99%

Weight (net) \_\_\_\_\_ 29.5 lbs.  
 Stock Identification:  
 88 to 92 mc \_\_\_\_\_ MI-28227-1  
 92 to 108 mc \_\_\_\_\_ MI-28227-2

**Dimensions:**

Height (Housing) \_\_\_\_\_ 12 1/4"  
 Height (Overall, including line extensions) \_\_\_\_\_ 30"  
 Width \_\_\_\_\_ 9"  
 Depth \_\_\_\_\_ 11 1/4"

**Accessories**

3/8" to 1/8" Flange-to-flange Reducer \_\_\_\_\_ MI-19112-6  
 1 5/8" to 7/8" Flange-to-flange Reducer \_\_\_\_\_ MI-19309-6  
 These adapters are necessary only if an FM feed line other than 1 5/8" diameter is used.

**OUTLINE DRAWINGS**

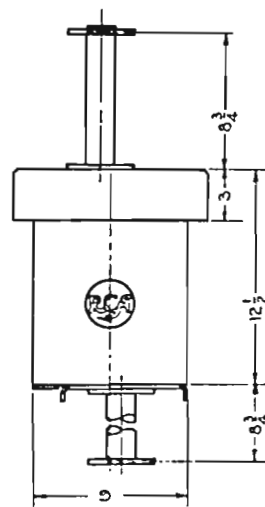
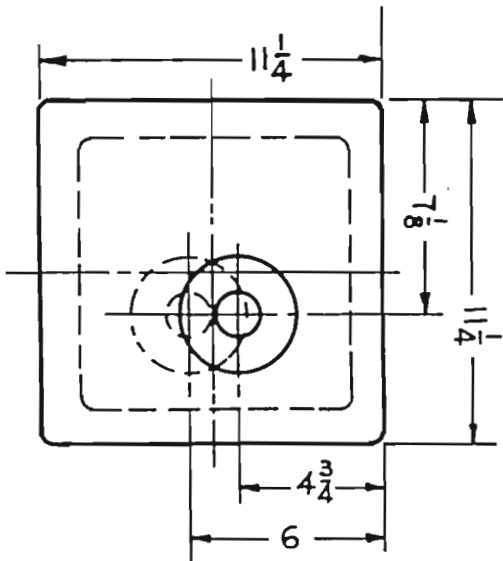

**SUGGESTED BAF-14A MOUNTINGS**

FOR GUINED TYPE TOWER

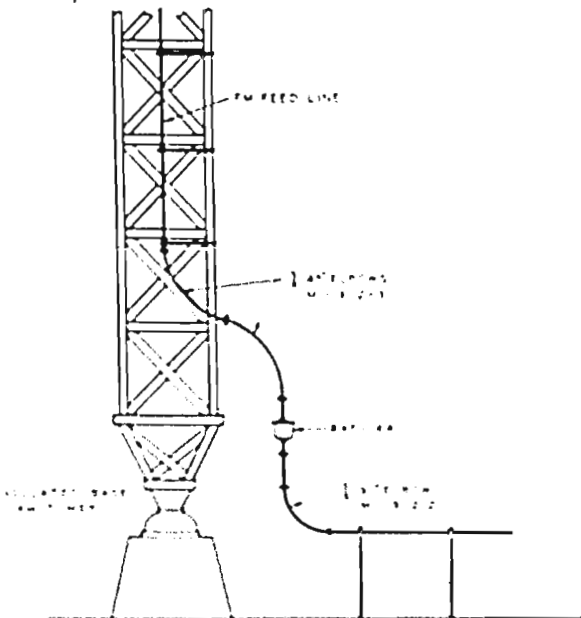

FOR SELF-SUPPORTING TYPE TOWER

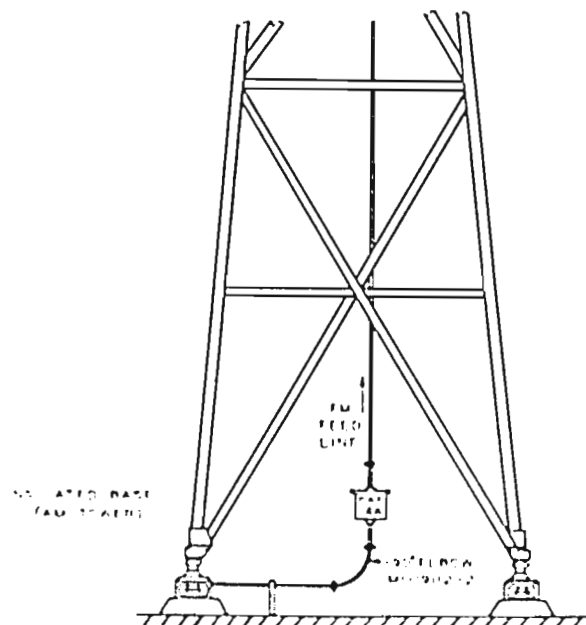



# FM Notch Filters, Types MI-28051, MI-28052

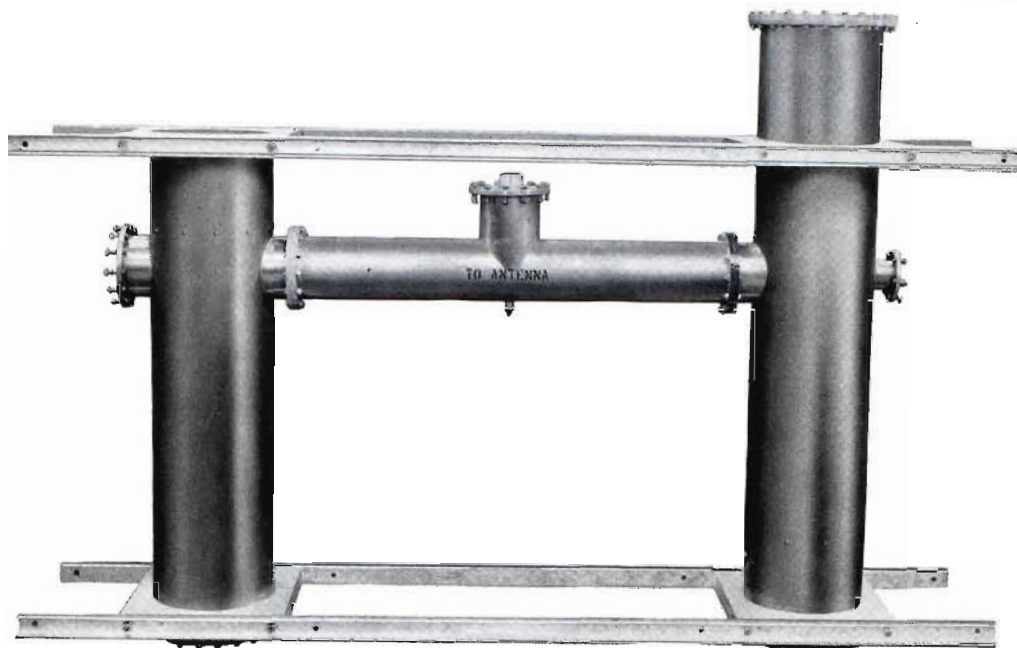

## Features

- Permits dual FM operation with single antenna.
- Economical of space.
- Pretuned at factory.

## Use

The RCA FM Notch Filter is a coaxial-type filter designed to permit the feeding of two separate FM signals into a single transmission line and thence to a single FM antenna. The filters are applicable where two FM stations desire to use the same antenna, thus effecting savings in transmission line, antennas, towers and perhaps transmitter buildings. Two units are available with power ratings of 50 kw (Type MI-28051) and 10 kw (Type MI-28052). These power ratings are ap-

plicable to one input of the dual input filter. Thus a 10 kw filter can accommodate a maximum power of 20 kw, 10 kw on each input, and a 50 kw can handle a total input of 100 kw. Any power up to the rating can be used on either input of the filter.

## Description

Sturdily built, compact, weatherproof and gas tight, the FM Notch Filters can be mounted indoors at either one of the stations, or at some outdoor location convenient to both stations. FM notch filters can be obtained for any frequency spacing, within the FM band, down to a minimum of two megacycles. The exact efficiency of the filter depends upon the spacing used, but even at two megacycles the efficiency is practically 100%.

Accessories required, such as gas stops, pressure interlocks and appropriate connectors to standard 51.5 ohm line depend on the size line in use. These items are described in full under "Transmission Line Equipment" pages.

## Specifications

Frequency Range \_\_\_\_\_ (Specified) between 88-108 mc  
 Input and Output Impedance \_\_\_\_\_ 51.5 ohms  
 Minimum Carrier Separation \_\_\_\_\_ 2 mc

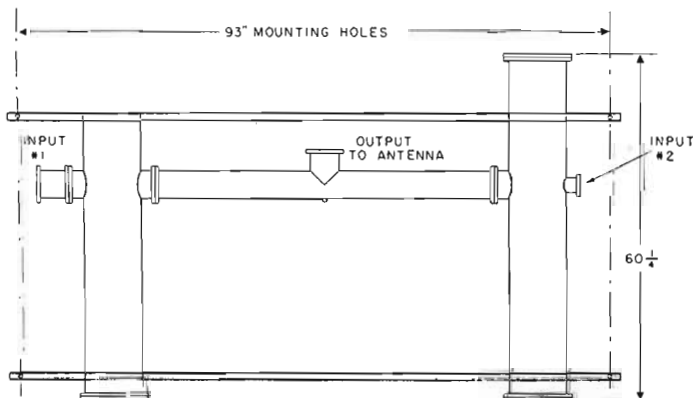

# TV Super Turnstile Antennas

## Features

- Radiates over wide band with good efficiency and high gain.
- Rugged mechanical construction assures long life.
- Radiators attached directly to steel pole at top and bottom—no weight supported by insulators.
- Grounded for lightning protection.
- No coupling networks required at tower top.
- Low wind resistance.

## Description

The RCA Super Turnstile is a television transmitting antenna designed for television channels 2-13. The Super Turnstile radiates equally well in all directions and also provides a substantial power gain. Because of its high gain, circular coverage, and rugged construction, the Super Turnstile has become the standard antenna of the television broadcast industry.

Increased gain is accomplished by concentrating the radiation at a low vertical angle. This gain increases with the number of sections or layers used in the antenna. Single-section, two-section, three-section, four-section, five-section, and six-section Super Turnstiles are available. An antenna with six layers provides a power gain of approximately 7. (For television antennas with greater gain, see "Super Gain" antenna on another page of this catalog.)

Each section of the Super Turnstile antenna consists of four radiators, mounted at 90 degrees around the pole. Sections are mounted approximately a wavelength above each other, center to center. Electrical feed is by means of coaxial transmission lines. The line feeds the center of the radiator, so that only the central part is subject to impedance change due to ice formation. Such ice formation can be alleviated by the use of sleet melting resistors which are available as accessories.

## Specifications

Super Turnstile antennas are designed to withstand a maximum wind velocity of 85 miles per hour when coated with  $\frac{1}{2}$ " radial ice and a maximum wind velocity of 95 miles per hour when there is no ice. The antennas are designed for total transmitter power of 20 kw.

### SINGLE-SECTION ANTENNA

(Dimensions shown on diagram)

Type Number	TF-1A	TF-1C
Stock Identification	MI-19015-3	MI-19015-2
Number of Sections	1	1
Channels	4, 5, & 6	2 & 3
Frequency Band	66-88 Mc.	54-66 Mc.
W** Llbs.	625	937
H <sub>2</sub> Feet	13' 0"	15' 0"
H <sub>3</sub> Feet	8' 4"	9' 3½"

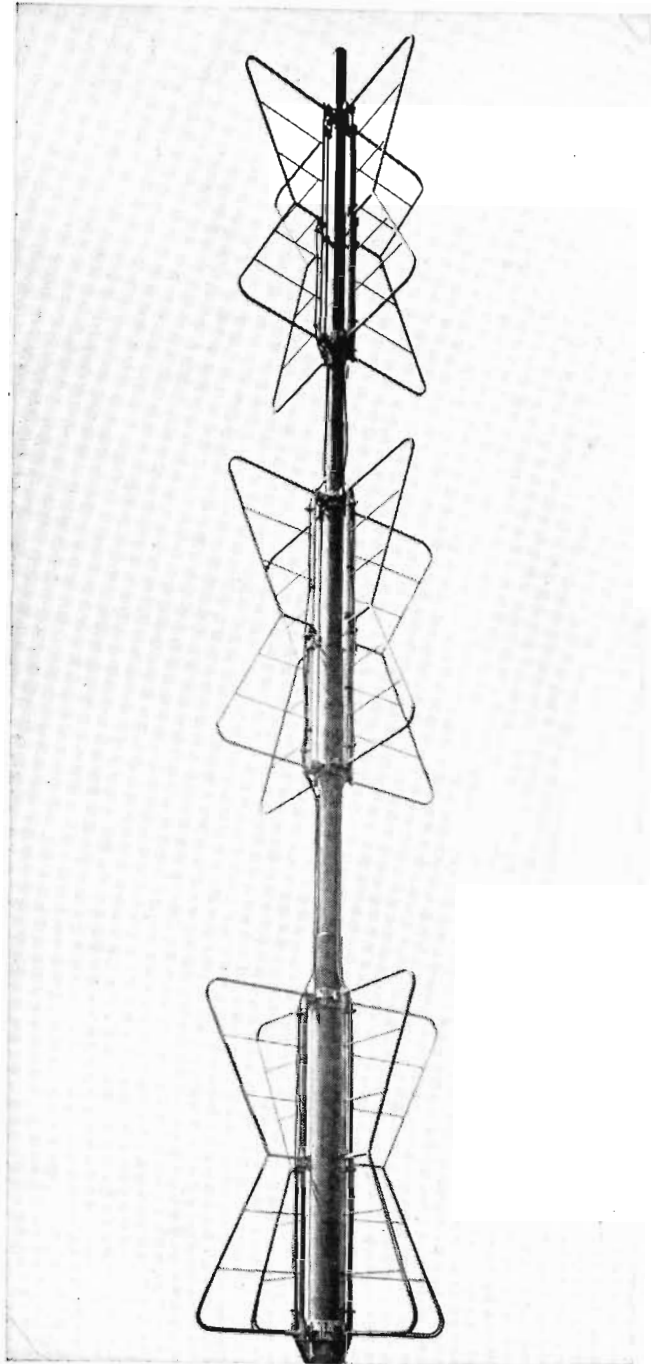

*Three Section Super Turnstile. The pole is self-supporting and may be mounted on top of a suitable building, mountain or tower.*



# Super Turnstile Antennas (Continued)

## TWO-SECTION ANTENNA

Type Number _____	TF-2A
Stock Identification _____	MI-19002
No. of Sections _____	2
Channels _____	7 to 13
Frequency Bands _____	174-216 Mc.
W** Lbs. _____	1960
H <sub>2</sub> Feet _____	37' 3"
H <sub>3</sub> Feet (Elec. Center) _____	31' 2 $\frac{1}{8}$ "

## THREE-SECTION ANTENNAS

Type Number _____	TF-3A/B*	TF-3A/B*
Stock Identification _____	MI-19012-A & MI-19012-C	MI-19012-B & MI-19012-D
No. of Sections _____	3	3
Channels _____	2 & 3	4, 5, & 6
Frequency Bands _____	54-66 Mc.	66-88 Mc.
W** Lbs. _____	5121	3527
H <sub>2</sub> Feet _____	49' 0"	40' 0"
H <sub>3</sub> Feet (Electric Center) _____	25' 0"	20' 4"

## FOUR-SECTION AND FIVE-SECTION ANTENNAS

Type Number _____	TF-4A	TF-5A	TF-5B
Stock Identification _____	MI-19017-A	MI-19018-A	MI-19029
No. of Sections _____	4	5	5
Channels _____	4, 5, & 6	4, 5, & 6	2 & 3
Frequency Bands _____	66-88 Mc.	66-88 Mc.	54-66 Mc.
W** Lbs. _____	4423	5963	11709
H <sub>2</sub> Feet _____	54' 8"	68' 9"	83'
H <sub>3</sub> Feet (Elec. Center) _____	27' 11 $\frac{1}{2}$ "	35' 0"	42'

## SIX-SECTION ANTENNAS

Type Number _____	TF-6A/B*
Stock Identification _____	MI-19013 & MI-19013-A
No. of Sections _____	6
Channels _____	7 to 13
Frequency Bands _____	174-216 Mc.
W** Lbs. _____	2108
H <sub>2</sub> Feet _____	37' 3"
H <sub>3</sub> Feet (Elec. Center) _____	19' 2 $\frac{1}{8}$ "

Chart Showing Mid-Channel Gain of Various Super Turnstile Antennas

Channel	2	3	4	5	6	7	8	9	10	11	12	13
TF-1A			1.2	1.2	1.2							
TF-1C	1.2	1.2										
TF-2A						2.4	2.4	2.4	2.4	2.4	2.4	2.4
TF-3A/B*	3.4	3.7										
TF-3A/B*			3.3	3.6	4.2							
TF-4A			4.5	5.1	5.5							
TF-5A			5.5	6.2	6.8							
TF-5B	5.8	6.2										
TF-6A/B*						6.4	6.5	6.7	6.8	6.9	7.0	7.2

\* A indicates tower mounting type; B, Pylon mounting.

## Accessories Available

### SLEET-MELTING EQUIPMENT, MI-19009

MI Number	Description	Rating of One Heater Element
MI-19009-B	54-66 Mc., TV Antenna	115 v., 6.5 amps., 750 watts
MI-19009-C	66-88 Mc., TV Antenna	115 v., 4.4 amps., 500 watts
MI-19009-D	174-216 Mc., TV Antenna	115 v., 2.2 amps., 250 watts

The MI-19009 kit contains four enclosed heater elements, together with the necessary connector material, for a single section of a Super Turnstile antenna. (Thus, three MI kits are required for a 3-section antenna.)

For information not included on these pages, write for Specifications AS5979-C.

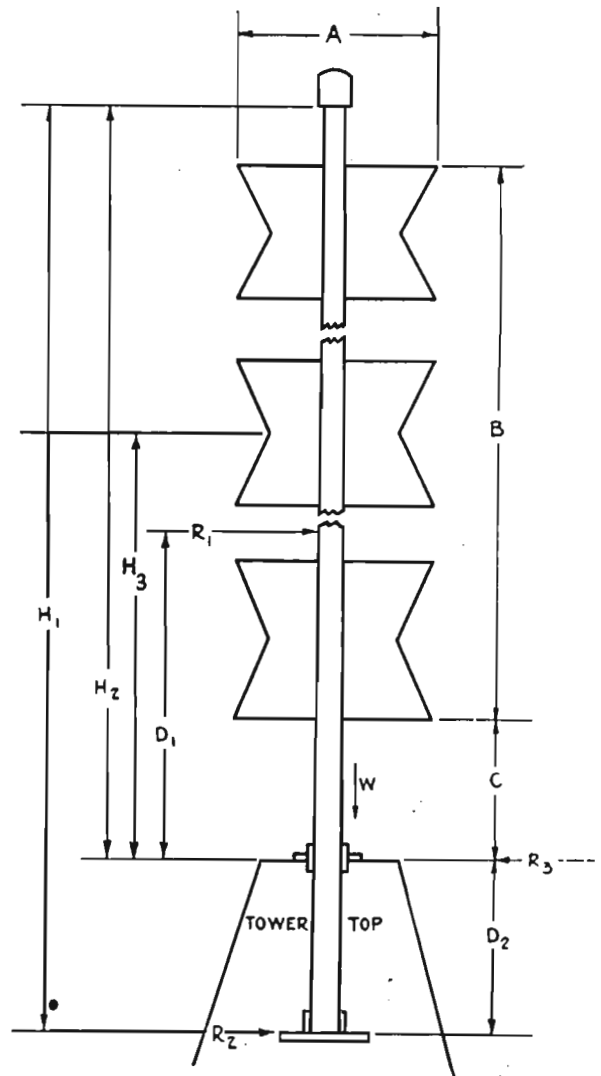

\* Type number followed by A indicates tower mountings, and followed by B indicates Pylon mounting.  
 \*\* W = total weight, including pole, guide flange, pole socket, 300 mm beacon, pole steps and miscellaneous hardware.

# Television Diplexer, Type TX-2A

## (Bridge Type)



### Features

- Permits feeding both aural and visual signals to one transmitting antenna.
- Compact, saves floor space—can be mounted overhead with transmission line.
- Easy to install.
- Enclosure keeps out dust.
- Furnished precut to channel—no adjustment required.

### Uses

The Diplexer is a device constructed of transmission line sections which permit feeding both the aural and visual counterparts of the television signal to the same Super Turnstile antenna without detrimental crosstalk. This makes it possible to use one antenna for radiating both the aural and visual signals.

### Description

The Diplexer is of the split-balun type, in which a single coaxial line-section constitutes two arms of a Wheatstone

bridge and also serves as the inner conductor of the aural input. The schematic diagram shows the elements of the bridge circuit. As can be seen, the antenna has two inputs: one to the E-W radiators and the other to the N-S radiators. Thus, these two loads are the two resistance loads in the Wheatstone bridge. The two arms of the split-balun provide the reactance arms on the left side of the bridge circuit, and also constitute the aural input circuit.

### Specifications

Frequency	_____54-216 mc (cut to specified channel)
Power Rating	_____5 kw
R F Efficiency	_____99%
Input and Output Impedance	_____51½ ohms
Dimensions	_____(See drawing and accompanying table below)
Weight	_____12-30 lbs. (depending on channel)
Stock Identification	_____MI-19028

# Television Notch Diplexer

### Use

The Television Notch Diplexer is a custom made filter of the type used to combine the aural and visual transmitter output into a single transmission line. The diplexer is designed particularly for use in transmission lines for Super-Gain and directional antennas; however, it can be used with any TV antenna which utilizes a single transmission line.

### Description

The Notch Diplexer consists of coaxial line sections arranged to "notch-in" the sound transmitter without detrimental feedback into the visual transmitter. The design provides the broadband required for the visual output without crosstalk into the aural transmitter.

The diplexer is designed for mounting to the ceiling at the rear of the television transmitter. Dimensions of the diplexer depend upon the frequency band used.



**Now—** *Tailored* **—with RCA's**

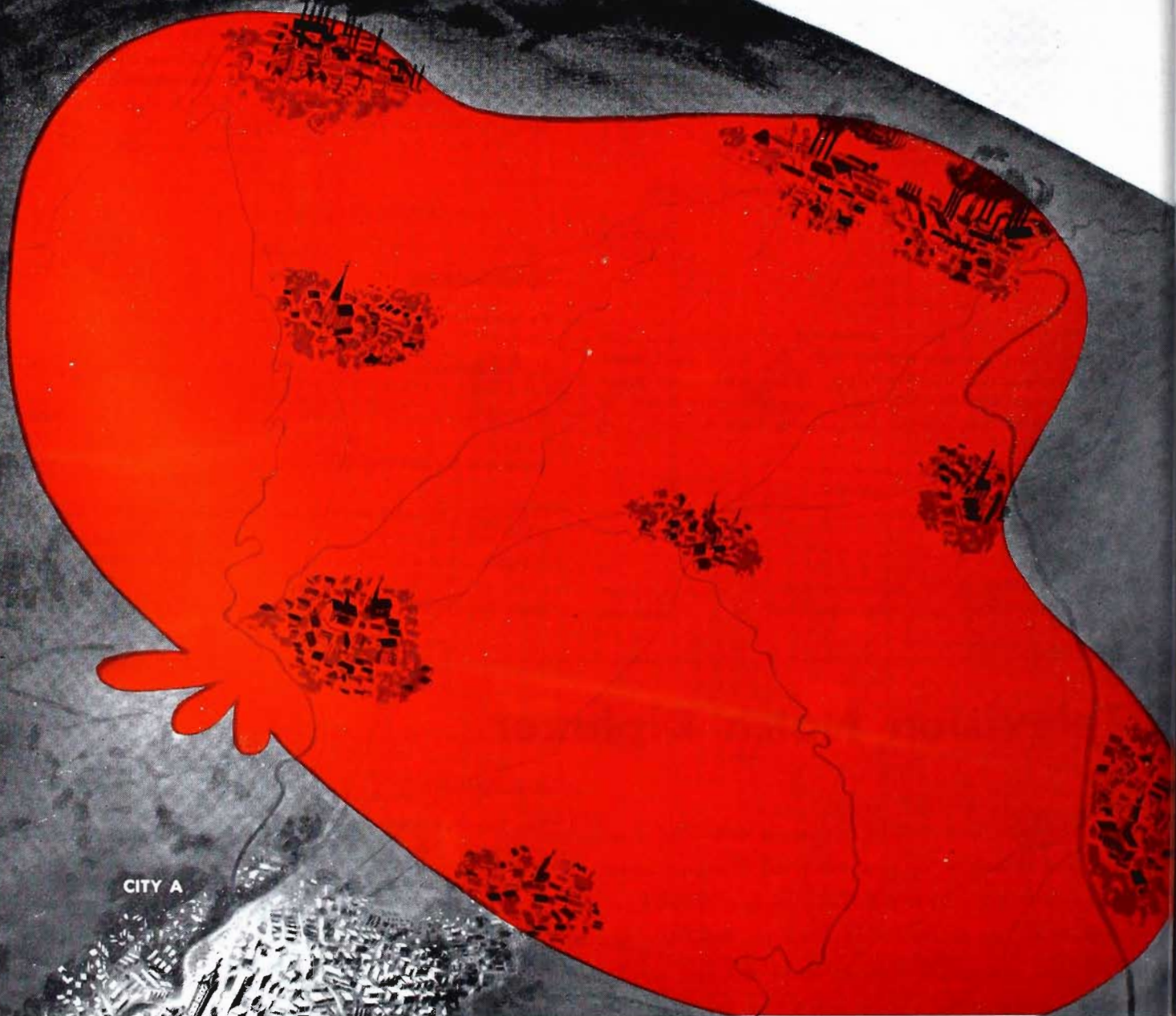



# TV Coverage Patterns

## New Super-Gain TV Antenna

● To give your radiated TV signals the right pattern for the area you want to cover, RCA's custom-built Super-Gain antenna is the answer.

This antenna can be set up to radiate in one or more directions—or in all directions. It can be arranged to lay down a stronger signal in the service area most vital to you. And, if you wish, it can be arranged in such a way as to reduce your signal in other areas.

RCA's Super-Gain TV antenna is made up of pre-tuned dipoles—each backed by a reflecting screen. The units are stacked one above the other—on one or more sides of a rectangular or triangular tower. A stack of four dipoles can deliver gains of 4 to 5—and the bigger the stack the higher

the gain. (For example, a stack of twelve dipoles and screens on four sides of a tower *will deliver a power gain of 12 in all directions.*) In many cases, existing towers which have uniform cross-section can be used for mounting the antenna.

The new RCA Super-Gain TV antenna will find application for TV stations having specific coverage or interference problems. It does not, of course, *take the place of the general-coverage Super-Turnstile.*

• • •

It will pay you to consider the new Super-Gain antenna when you review the coverage possibilities of your new TV station. Ask your RCA Broadcast Sales Engineer for complete data. Or write Dept. 19FA, RCA Engineering Products, Camden, N. J.

### THE NEW RCA SUPER-GAIN TV ANTENNA

A stacked array of 6 dipoles (per side) delivers a power gain of 6 to 8. The tower for the Super-Gain Antenna might be used to support an FM Pylon or a Super-Turnstile—or both!

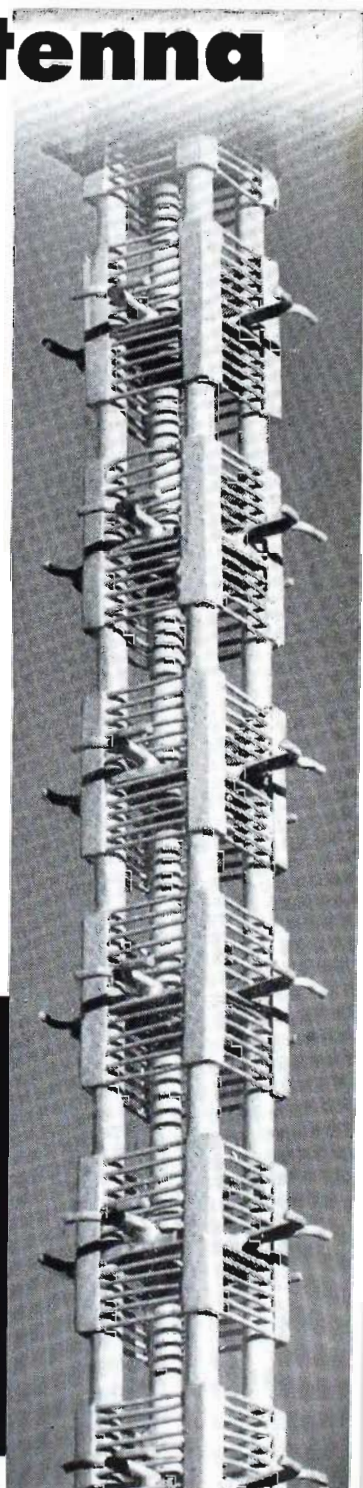

### Typical tailored coverage patterns possible with the RCA TV Super-Gain Antenna

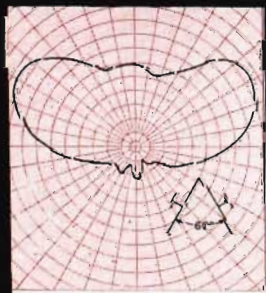

60° angle between dipoles  
0° phasing between dipoles

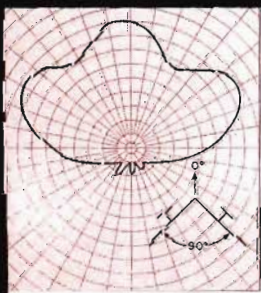

90° angle between dipoles  
0° phasing between dipoles

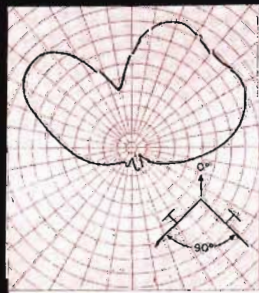

90° angle between dipoles  
90° phasing between dipoles

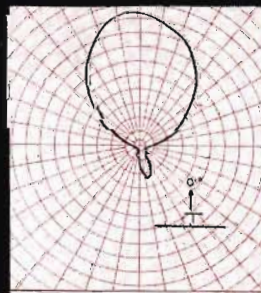

Single dipole radiator



# TV Super-Gain Antenna

## Features

- Adaptable to most rectangular or triangular straight-sided towers.
- Provides omnidirectional power gains up to 22.
- Radiates omnidirectionally, unidirectionally or polydirectionally, as required.
- Can support other antennas such as FM Pylons and TV Super Turnstiles.
- Handles high input power and delivers output power with enormous ERP.
- Economical where unusual gain or a directional radiation pattern is required.

## Uses

The Super-Gain TV Antenna is a special television transmitting antenna designed for TV stations which require an antenna system either with unusually high gain, or one with a directional radiation pattern. The Super Gain Antenna provides power gains as high as 22 for the type TFS-22A. Power is normally radiated omnidirectionally, thus providing essentially circular coverage; however, the Super-Gain can be constructed to radiate in one or more desired directions to obtain maximum useful coverage. This may be an important consideration for stations located in coastal regions.

## Description

The Super Gain consists fundamentally of a vertically-stacked array of horizontal dipoles each backed by a reflecting screen. Four dipoles, backed by reflecting screens and oriented at 90-degree intervals around the tower, provide an essentially non-directional pattern. Due to the backing screens, the per-

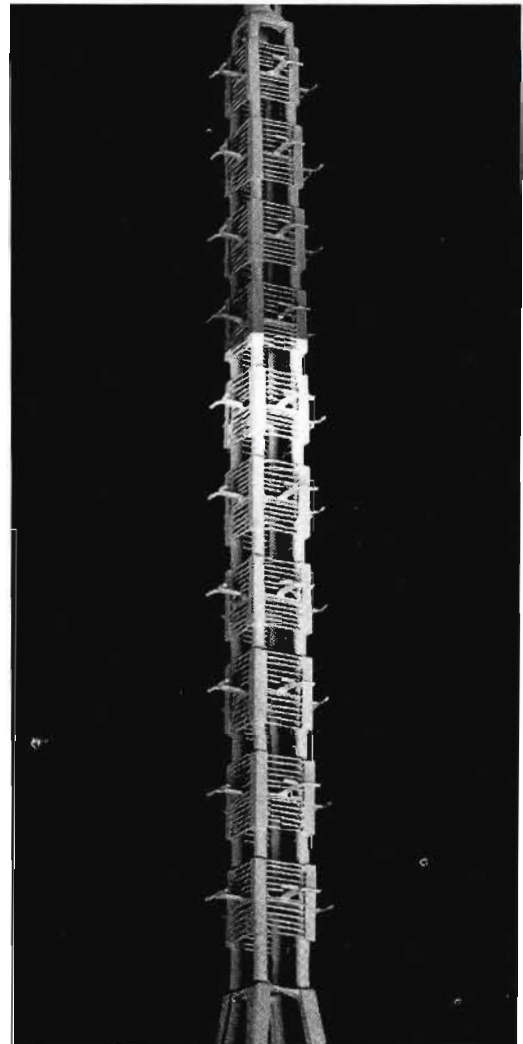

## Special Radiation Patterns Produced by the Super-Gain Antenna

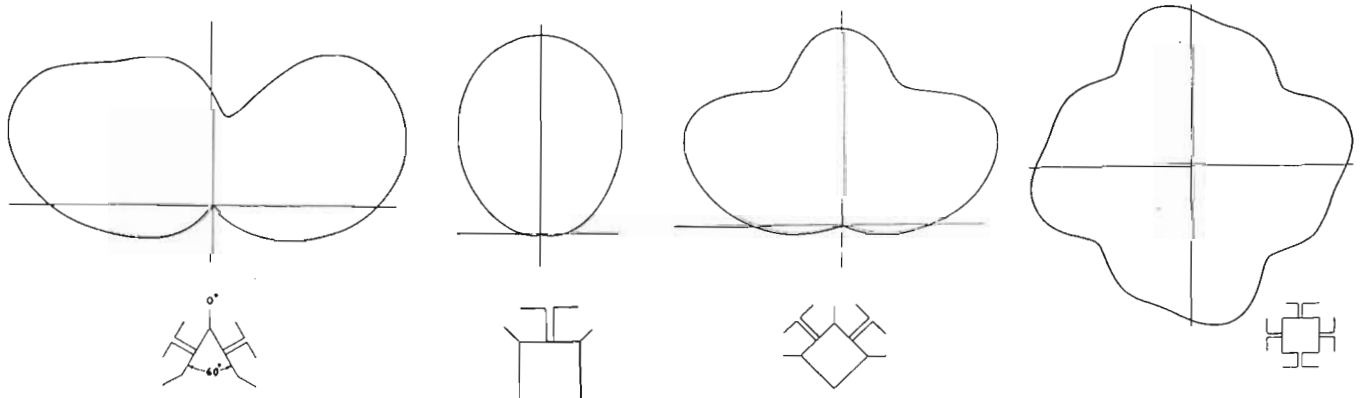

formance of the Super-Gain antenna is independent of the supporting tower construction. The cross-section of the tower is determined by the operating frequency; however, the tower can be either rectangular or triangular in shape.

Gain is determined by the number of stacked layers. The type TFS-11A consists of 12 layers and provides a power gain of 11.5. The type TFS-22A consists of 24 layers and provides a power gain of 22. Directional patterns, providing much higher values of gain in the favored directions, can be obtained by placing the elements in various respective locations in the horizontal plane. A few of the many radiation patterns obtainable with the Super-Gain antenna are shown by the diagrams.

The radiators are vertically spaced a nominal 0.9 wavelength apart, providing, as close as possible, uniform current distribution throughout the height of the antenna. The Super Gain is fed by a single transmission line running up the inside of the tower. A notch-type diplexer to put both aural and visual signals on the one line is used at the transmitter. A power equalizer incorporated in the antenna tends to make all dipoles take equal power. A diagram of the feed system is shown. The feed line used is standard 51.5-ohm coaxial line, the size depending on the power to be handled.

**Specifications**

Power Rating \_\_\_\_\_ 20 kw

Wind Load \_\_\_\_\_ Composite calculation by tower manufacture of RCA screens and dipoles, plus tower structure

Power Gain \_\_\_\_\_ 11.5 (12-section); 22 (24-section)

Channel	H. for Gain of 11.5	H. for Gain of 22	A
2	174 ft.	348	8.8 ft.
3	159 ft.	318	8.0 ft.
4	145 ft.	290	7.3 ft.
5	127 ft.	254	6.4 ft.
6	118 ft.	236	5.9 ft.
7 to 9	58 ft.	116	2.7 ft.
10 to 13	53 ft.	106	2.5 ft.

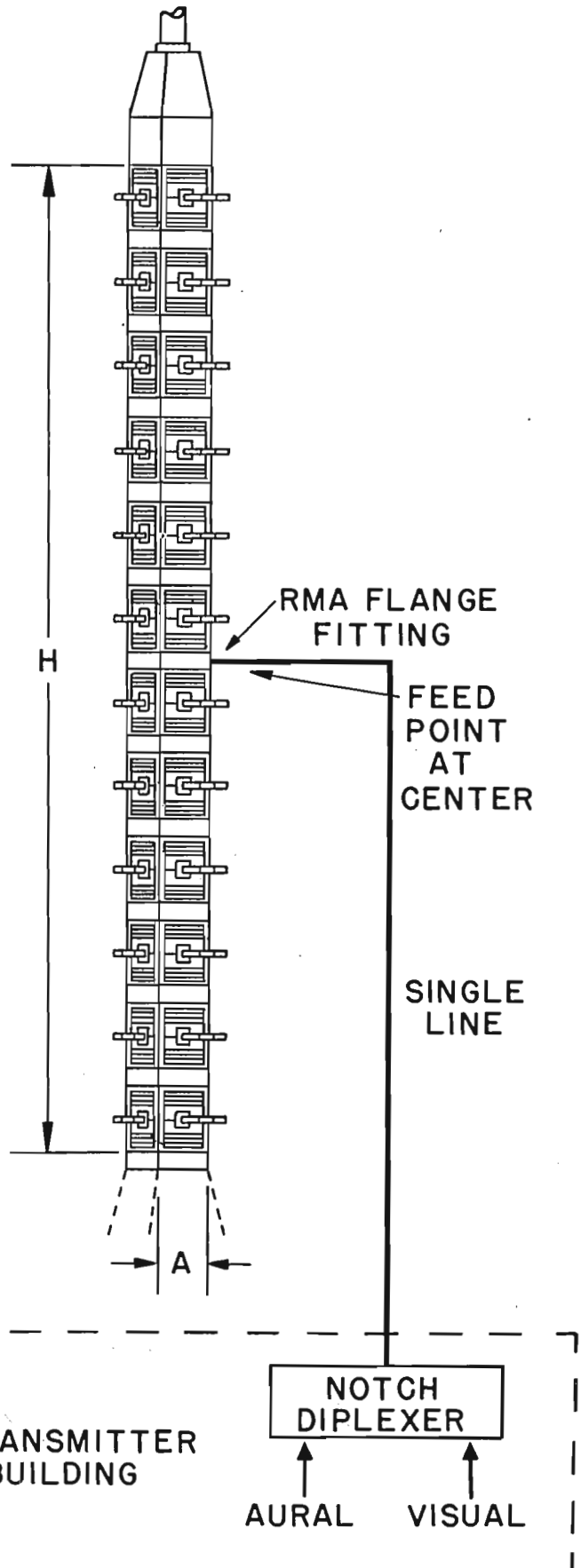



# Television Triplexer, MI-19023

## Features

- Permits use of one Super Turnstile antenna for both FM and TV services.
- Styled to match other transmitting equipment.
- Simple, compact design.
- Requires no elaborate accessory items.
- Small floor space requirement.

## Uses

The RCA Triplexer is designed to permit feeding three independent signals to the proper Super Turnstile Antenna from where they can be radiated with good efficiency. The need for such a system might be found by the broadcaster planning television plus FM service. In this case all three, FM signals in the 88-108 mc band, the TV picture signal and the TV sound signal can be fed through the Triplexer to one Super Turnstile Antenna, saving the broadcaster the expense of separate antennas. The broadband characteristics of the Super Turnstile make such a system very practicable.

## Description

The Triplexer consists of a number of rigid coaxial line segments tuned to the frequencies of the three signals fed into it. These tuned segments act as wave traps to prevent any one of the three signals from feeding back into the feed lines of the other two.

The usual arrangement is to have the TV picture and sound transmitters feed through a Diplexer to the Triplexer. The FM signal is fed directly to the Triplexer as shown in the diagram.

The FM power that can be handled by this system is limited by the standing wave ratios appearing on the lines. This is, of course, determined by the operating frequencies used. Channels 4-6 can be used with an FM input up to 10 kw.

The coaxial line assembly of the Triplexer is contained in a completely enclosed steel cabinet the same size as the standard low-frequency Diplexer unit. The Triplexer, which is installed adjacent to the Diplexer, is finished in umber-gray to match the other television units.

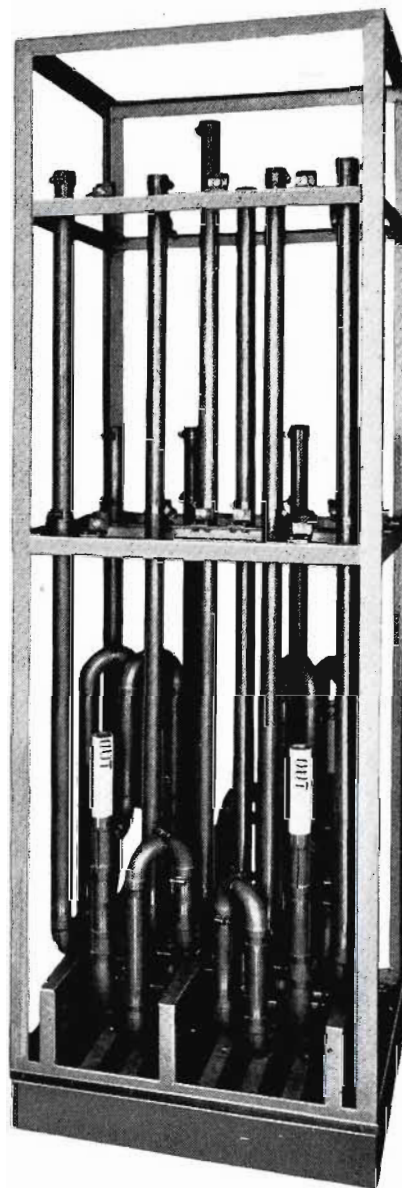

*Triplexer with all covers removed to show system of tunable coaxial lines. Two output connections are made near the bottom, as shown. The two input lines are at the rear and are not visible.*

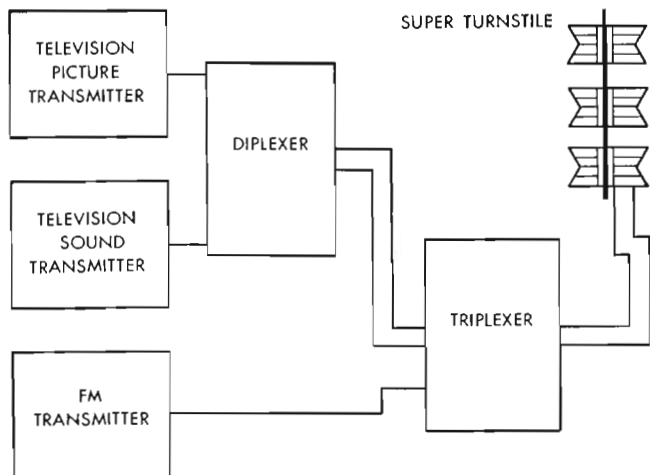

## Specifications

Input and Output Impedances	51½ ohms
Height	84"
Width	22 <sup>5</sup> / <sub>8</sub> "
Depth	28 <sup>1</sup> / <sub>8</sub> "
Weight	475 lbs.

# RF Load and Wattmeter, MI-19024A

## Features

- Combines dummy TV antenna and RF power-measurement functions.
- Easily installed—occupies little space.
- Power indications given directly in watts.
- Meets FCC standards.

## Uses

The RF Load and Wattmeter, MI-19024A, is designed for use in measuring the power output of the aural and visual sections of 5 kw television transmitters. The load, which is designed for frequencies between 44 mc and 216 mc, properly terminates the output of either the visual or aural transmitter and gives a measurement of the average RF power as required by FCC standards. It is also used as a dummy antenna for transmitter tuning.

## Description

The RF Load and Wattmeter consists of a water-cooled resistor element and a current indicating meter. A small RF voltage fed from a pickup probe within the load is fed to an internal crystal rectifier. Output from the rectifier is in turn coupled through a time-constant filter network to the external meter which is calibrated to indicate average power directly in watts. The time constant of the filter is such that meter indications are accurate within  $\pm 5\%$ .

The instrument is designed for direct connection to  $1\frac{1}{8}$ " diameter 51.5-ohm coaxial transmission line. For connection to  $3\frac{1}{8}$ " 51.5-ohm, an MI-19112-6 (MI-19113-6) adapter should be ordered. An MI-19111-10 matching transformer ( $1\frac{1}{8}$ " ) is supplied if the transmitter output is 72 ohms. Channel number must be specified when ordering. The power indicating meter and ten feet of connecting cable are also supplied with the unit. An ordinary tap water supply and drain can be connected to input and output water connections on the RF Load and Wattmeter.



## Specifications

Frequency Range	_____	44-216 mc
Power Rating	_____	5 kw
RF Input Line	_____	$1\frac{1}{8}$ " dia., 51.5-ohm
Water Connection	_____	$\frac{1}{2}$ " I.P.S. union
Dimensions:		
Length	_____	33"
Diameter	_____	5" (approx.)
Weight	_____	46 lbs.
Type Mounting	_____	Vertical surface
Stock Identification	_____	MI-19024A

## Available Accessories

$1\frac{1}{8}$ " to  $3\frac{1}{8}$ ", 51.5 to 51.5 Adapter \_\_\_\_\_ MI-19112-6 (MI-19113-6)



# Everything for TV-

## complete antenna systems



● Up there, 737 feet above the sidewalks, is a 6-section Super Turnstile—RCA complete from transmission line to beacon light. More than sixty RCA TV antennas of this bat-wing type have been shipped to television's top stations. Many are now in use.

Each RCA Super Turnstile is complete—with everything needed to transmit high-quality sound-and-picture signals. A complete system includes a Diplexer for handling sound and picture signals simultaneously, transmission lines, de-icing equipment, 300-mm beacon, and all miscellaneous hardware. The system can also include a Triplexer (optional) for operating your present FM transmitter and your new television sound-and-picture transmitter . . . *simultaneously on the one antenna.*

Why are RCA Super Turnstiles the choice of nearly 90 per cent of the TV stations?

Because RCA Super Turnstiles produce a horizontal radiation pattern that is virtually circular. They provide power gains of 3.5 to 7.1, depending on the TV channel used. (For example, Type TF-3A antenna delivers an effective radiated power of over 20 kilowatts with a 5-kw transmitter on channel 6.) RCA Super Turnstiles are lightweight, have low wind resistance, are effectively grounded for lightning protection, and are easy to erect.

Get the proper start in planning your antenna system . . . and your station . . . by calling in your RCA Television Specialist. Or write Department 19LE, RCA Engineering Products, Camden, New Jersey.

**Six-section RCA TV Super Turnstile Antenna, Type TF-6.** This single unit can be mounted on building or tower. Total weight, only 2,300 lbs. Height, 46 feet, 3 inches. Power gain, 6.4-7.1 on channels 7 to 13.

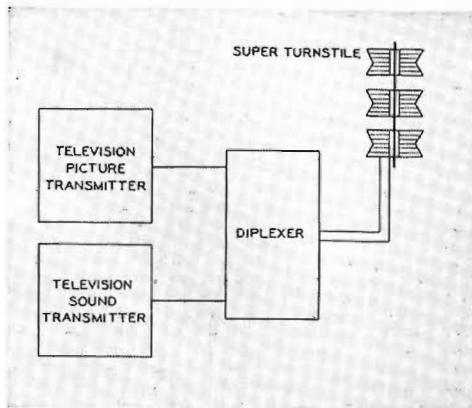

**For the Separate TV Station**

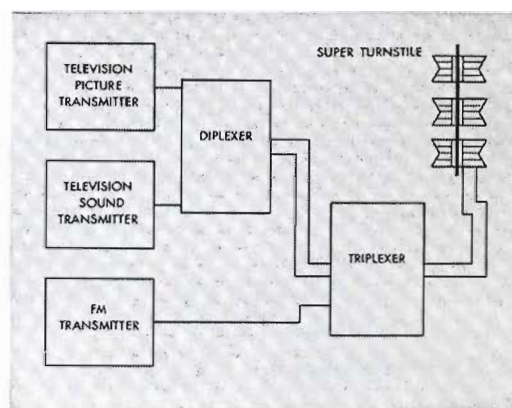

**For the Combination TV-FM Station  
(Certain powers and channels only)**

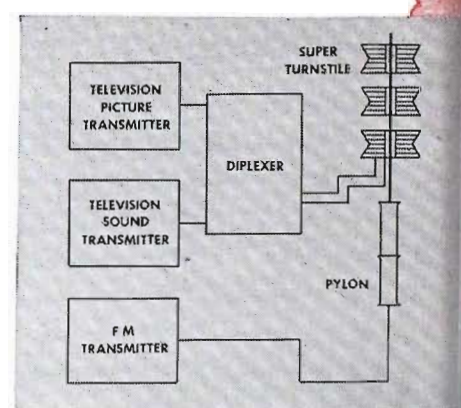

**For the Combination TV-FM Station  
(All powers and channels not covered by 2)**

**for instance**

WCAU-TV Philadelphia, on channel ten, uses an RCA 6-section TV Super Turnstile atop an RCA FM Heavy-Duty Pylon antenna. Here you see two antennas on a single self-supporting tower.



# RCA Transmission Line Equipment

## General

RCA coaxial transmission line provides an efficient means for transferring RF power to AM, FM and TV antennas. It is manufactured in various sizes and types to accommodate many different power and installation requirements.

RCA transmission line equipment features the high efficiency with which it transmits RF energy, plus the time that can be saved in its installation. Ease of installation is due to the RCA-developed flanged line which is now used in all types of radio and television installations. This line is supplied in convenient lengths with flanges silver soldered to the ends. Thus, line sections can be quickly and easily bolted together. A specially designed connector which compensates for line expansion and contraction is used for joining the inner conductors. No special tools, no torches or soldering are necessary. Mating flanges are automatically sealed for pressure by insertion of a neoprene O-ring gasket before assembly. With the gasket in place, the line will withstand gas or air pressure without leaking at temperatures ranging from  $-40^{\circ}$  F. to  $155^{\circ}$  F. The gas fittings are specially designed to work as efficiently as the line.

## Choice of Transmission Line

Each of the several types of transmission line is designed for a particular application. The choice of line for an installation will depend principally upon the frequency in use and the power to be handled, as indicated in the data given below. Selection of the proper line will provide the most economical and efficient installation.

For broadcast installations, the line selected should have a power rating which equals or exceeds the power output of the transmitter. Except, if any power increases are contemplated, it will be economical to install larger line than required thus saving the cost of a new installation at a later time.

Choice between the use of soft line and hard line will be determined by the installation. Hard, flanged-type line is the preferred type for most cases because of its ease of installation and immunity to damage and consequent failure. It is also easier to replace in sections than is soft line. On the other



hand, soft, solder-type line readily lends itself to bending around obstructions thus eliminating the need for elbows.

All RCA Transmission Line items are packaged at the factory and are identified by the RCA label and stock number. The following pages describe in detail the various lines and their fittings.

## MECHANICAL AND ELECTRICAL PROPERTIES OF RCA TRANSMISSION LINES

Power ratings for 51.5 ohm lines are based on RMA ratings at unity SWR

Size	Stock Ident.	Type	Impedance	Power	Dia. of Inner Cond. (in.)	Flashover Insulator Spacing (in.)	Voltage RMS 60 cy.	Use
3/8"	MI-19306	Solder fittings pressurized or unpressurized	72 ohm	250 w. nominal 1 kw max.	.081	1 3/4	2,500	Mobile, aircraft, phase sampling and frequency checking in AM broadcast systems
7/8"	MI-19307	Solder fittings pressurized	72 ohm	1 kw nominal 5 kw max.	.250	4	7,000	AM Broadcast lines, phase sampling
7/8"	MI-19308	Flanged fittings no solder—pressurized	72 ohm	1 kw nominal 5 kw max.	.250	6	7,000	AM Broadcast lines, phase sampling
7/8"	MI-19309	Flanged fittings no solder—pressurized	51.5 ohm	4.5 kw max. 3 kw max. 2 kw max.	50 mc .312 100 mc 200 mc	6	5,000	AM and FM Broadcast lines, phase sampling
1 1/8"	MI-19310	Flanged fittings no solder—pressurized	72 ohm	10 kw max.	.375	12	12,000	AM Broadcast lines
1 3/8"	MI-19112	Flanged fittings pressurized, no solder	51.5 ohm	16 kw max. 10 kw max. 7 kw max.	50 mc .625 100 mc 200 mc	12	11,000	Designed for FM and TV lines (up to 220 mc), AM lines
3 1/8"	MI-19113	Flanged fittings no solder—pressurized	51.5 ohm	64 kw max. 42 kw max. 27 kw max.	50 mc 1.200 100 mc 200 mc	12	18,000	Designed for FM and TV lines (up to 220 mc), AM lines
6 1/8"	MI-19314	Flanged fittings no solder—pressurized	51.5 ohm	235 kw max. 166 kw max. 118 kw max.	50 mc 2 500 100 mc 200 mc	18	30,000	Designed for AM, FM and TV lines. For high power, high efficiency and exceptionally long runs

# Performance Data on RCA Transmission Lines

## COAXIAL LINE EFFICIENCY

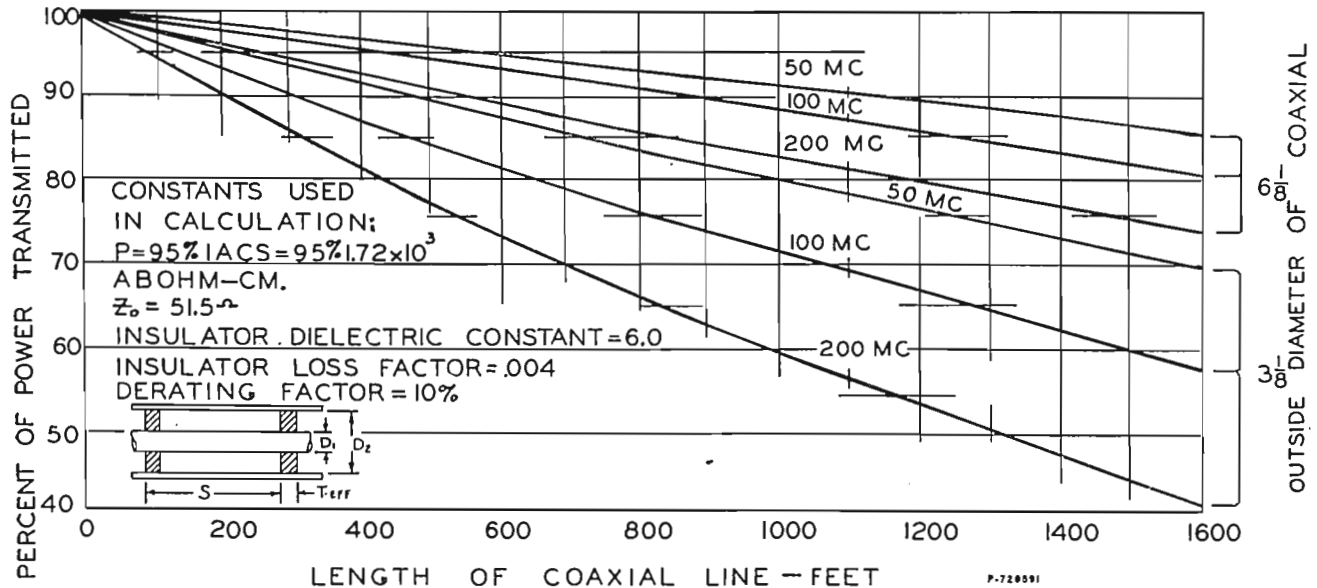
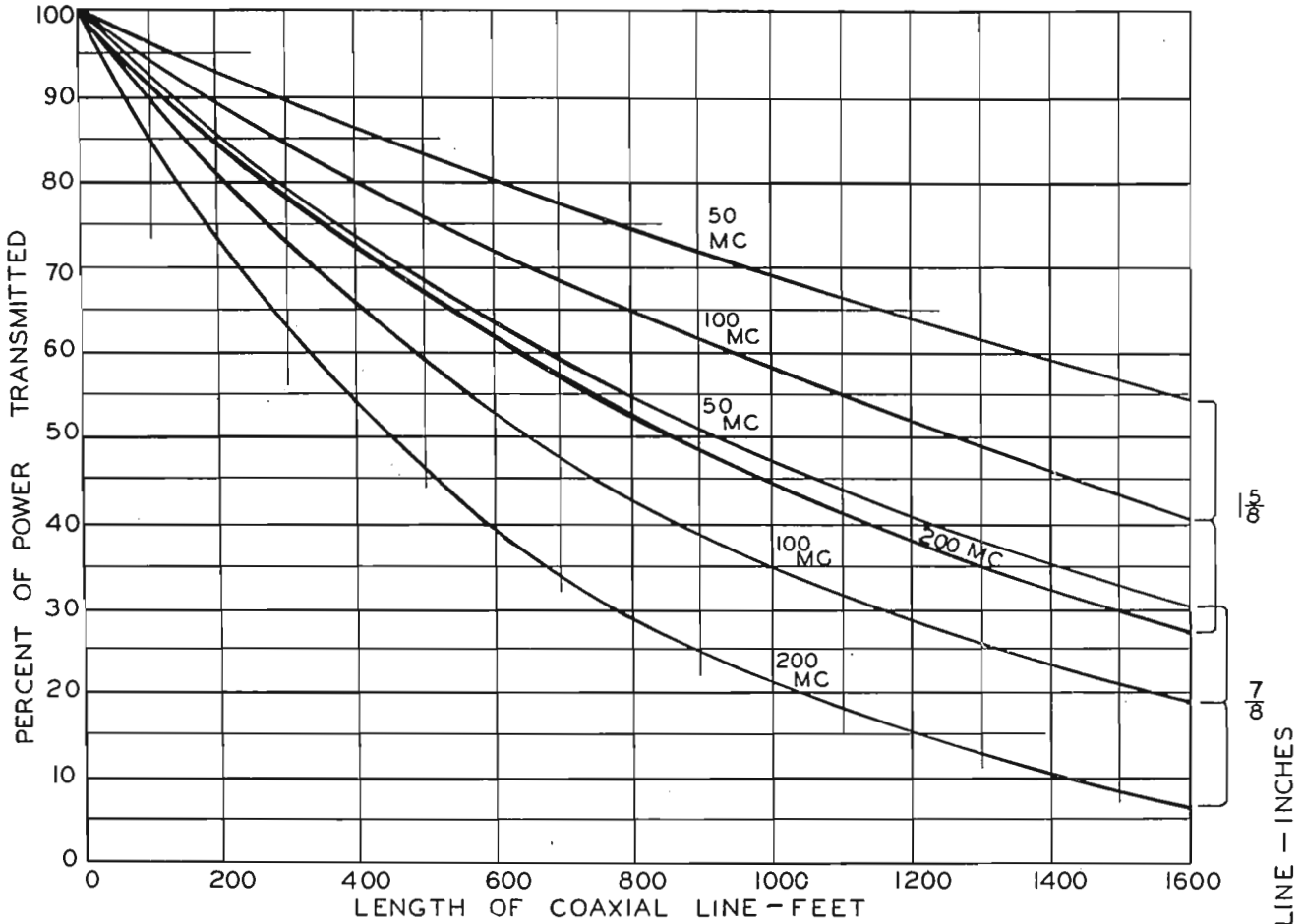

SIZE	$D_1$	$D_2$	S	$T_{err}$	50MC	100MC	200MC
$\frac{1}{8}$	.3125	.785	6	.187	.318	.460	.673
$\frac{1}{4}$	.625	1.527	12	.193	.161	.234	.346
$\frac{3}{8}$	1.200	3.027	12	.375	.096	.145	.230
$\frac{6}{8}$	2.500	5.981			.039	.056	.081
IN.	IN.	IN.	IN.	IN.			

Above charts show relative efficiency of  $\frac{1}{8}$ ",  $\frac{1}{4}$ ",  $\frac{3}{8}$ " and  $\frac{6}{8}$ " line at VHF frequencies



# 3/8" 72-Ohm Soft Copper Line and Fittings, MI-19306

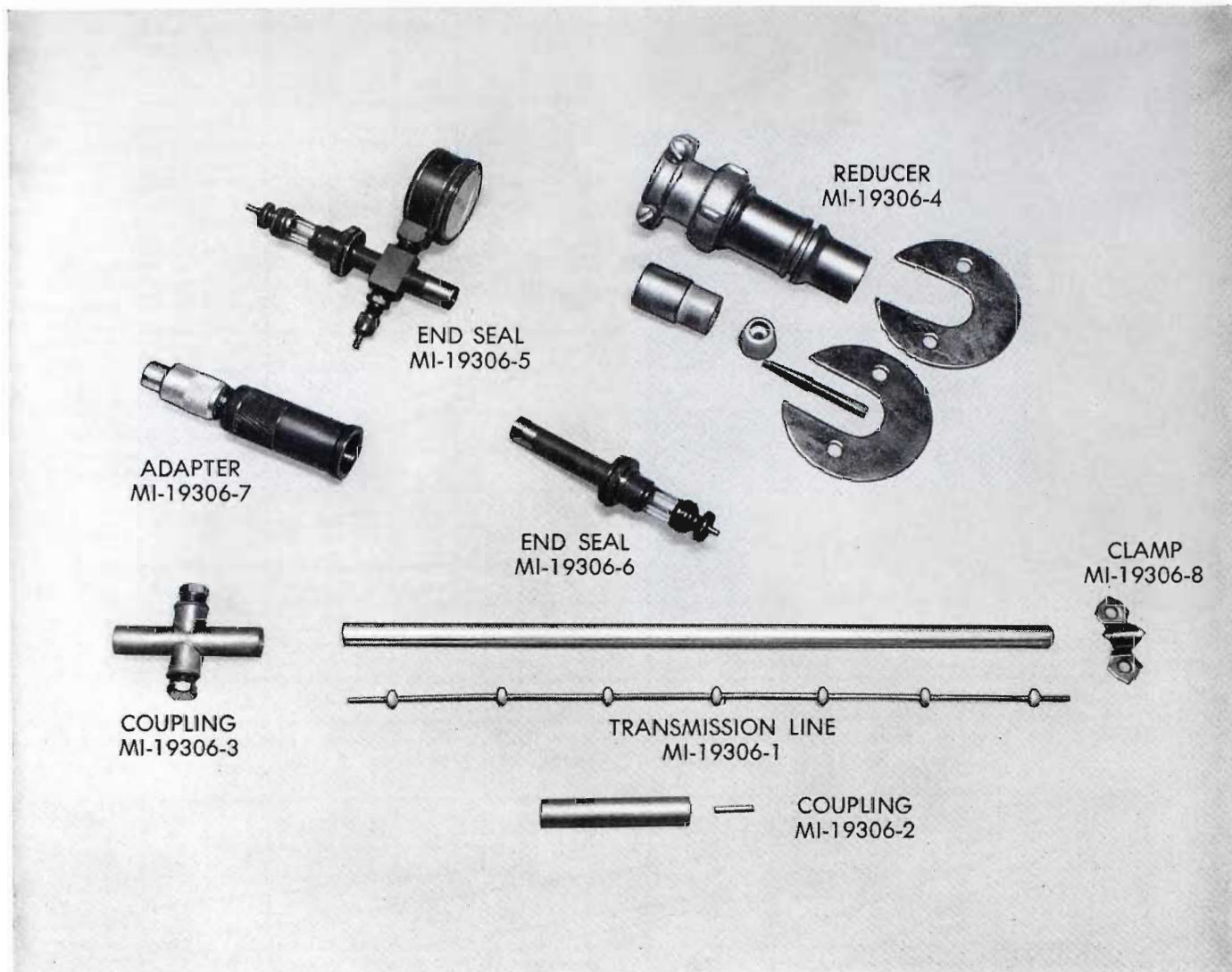

**Description**

RCA 3/8" Transmission Line, Type MI-19306, is a soft copper 72-ohm coaxial line designed for uses where the power and frequency to be handled are relatively low, and where line efficiency is not too important a factor. This type line is widely used to carry phase sampling voltages for directional AM arrays, to feed frequency measuring equipment, etc. It is also used in mobile and aircraft communication installations.

This solder-type, soft line is available with a complete complement of couplings, adapters, end seals, clamps, and reducers. The line lends itself readily to bending around obstructions and therefore requires no elbows.

**MI-19306-1 Transmission Line**

This line is furnished to specified length on 36"-diameter reels which contain up to 250 feet, or on larger returnable reels which contain up to 5000 feet. The coils are hermetically sealed. Orders should specify which is desired. Insulators are spaced 1 3/4" apart allowing a bending radius of 8" without shorting or loss of concentricity. Capable of handling 250 w. nominal and 1 kw maximum power.

**MI-19306-2 Straight Coupling**

This item includes solder type inner and outer conductors.

**MI-19306-3 Coupling (Straight Gas Servicing)**

Outer conductor has two 1/8" IPS ports for gas admission with pipe plugs. Item includes solder type inner conductor.

**MI-19306-4 Reducer Coupling**

Used for reducing 7/8" diameter MI-19309 hard drawn transmission line to 3/8" diameter soft line for soldering. Includes 2 steel locking plates for mounting to flat surface.

**MI-19306-5 End Seal**

Solder type including two 1/8" IPS ports for gas admission with pipe plugs. Furnished with nut for clamping to mounting surface.

**MI-19306-7 Adapter**

Used for coupling RG 11/U Cable to End Seals MI-19306-5 or MI-19306-6.

**MI-19306-8 Clamp**

Used for clamping 3/8" diameter line. Has 2 holes for number 10 screws. Mount one clamp approximately every 4 feet.

# 7/8" Soft Copper Line and Fittings MI-19307 (72-ohm), MI-19305 (51.5-ohm)

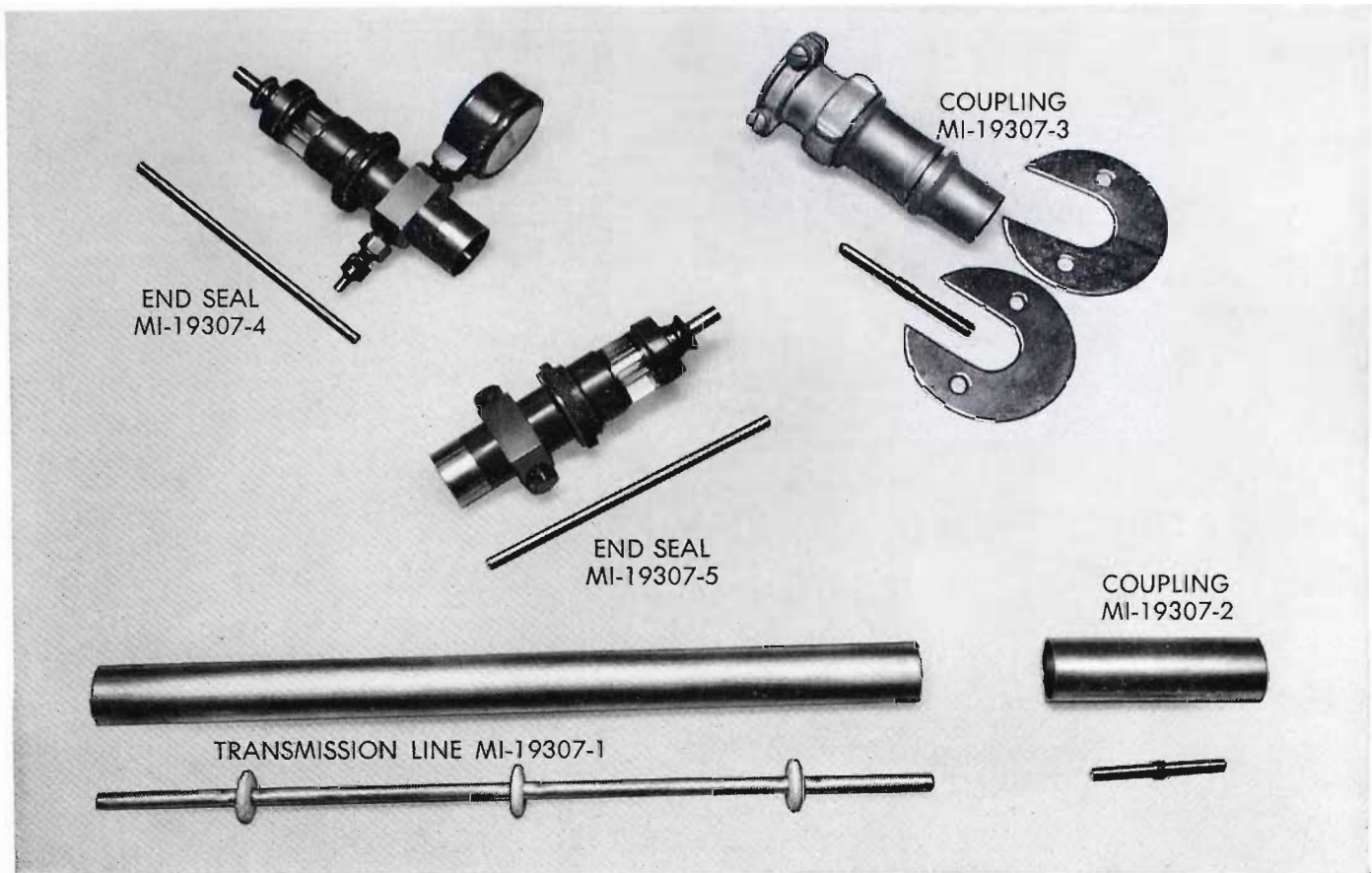

**Description**

RCA 7/8" Transmission Line, MI-19307, is a soft-tempered copper coaxial line with a nominal impedance of 72 ohms. This line is also supplied with an impedance of 51.5 ohms. The 51.5-ohm soft line is identified by MI-19305. List of accessory items and dimensions for MI-19305 are identical to MI-19307 except O.D. of the inner conductor.

**MI-19307-1 (MI-19305-1) Transmission Line**

Furnished in 48" diameter coils hermetically sealed. Insulators are spaced 4" apart allowing a bending radius of 30" without shorting or loss of concentricity. The 51.5 ohm line is rated at 45 kw input at 50 mc with a 92% efficiency for 100 feet. Weight is 60 pounds per 100 feet.

**MI-19307-2 (MI-19305-2) Straight Coupling**

Includes solder type inner and outer conductors.

**MI-19307-3 (MI-19305-3) Straight Coupling**

Used for connecting 7/8" diameter (MI-19309) hard drawn transmission line to 7/8" diameter soft solder-type line. Includes two steel locking plates for mounting to flat surface. Inner connector is solderless type.

**MI-19307-4 (MI-19305-4) End Seal**

Solder-type fitting with two ports. Includes 30-pound pressure gauge and gas admission valve. End Seal is furnished with nut for clamping to mounting surface.

**MI-19307-5 (MI-19305-5) End Seal**

Solder-type fitting with two 1/8" IPS gas admission ports and pipe plugs. Furnished with nut for clamping to mounting surface.

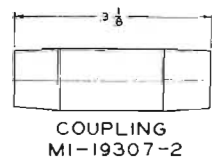
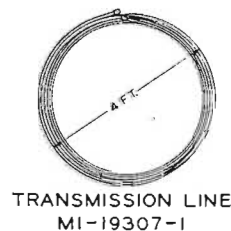
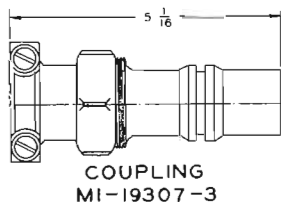
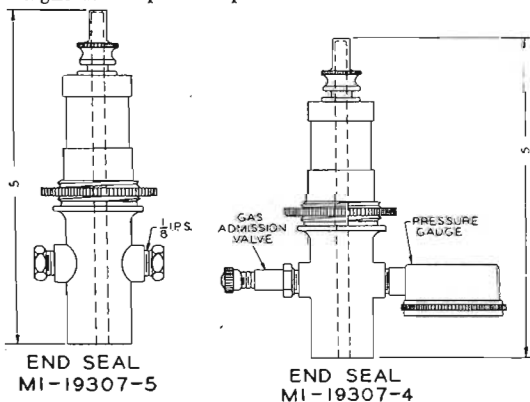

*Dimensions for 7/8" Soft Line and Fittings*



# 7/8" 72-Ohm Hard Copper Line and Fittings, MI-19308

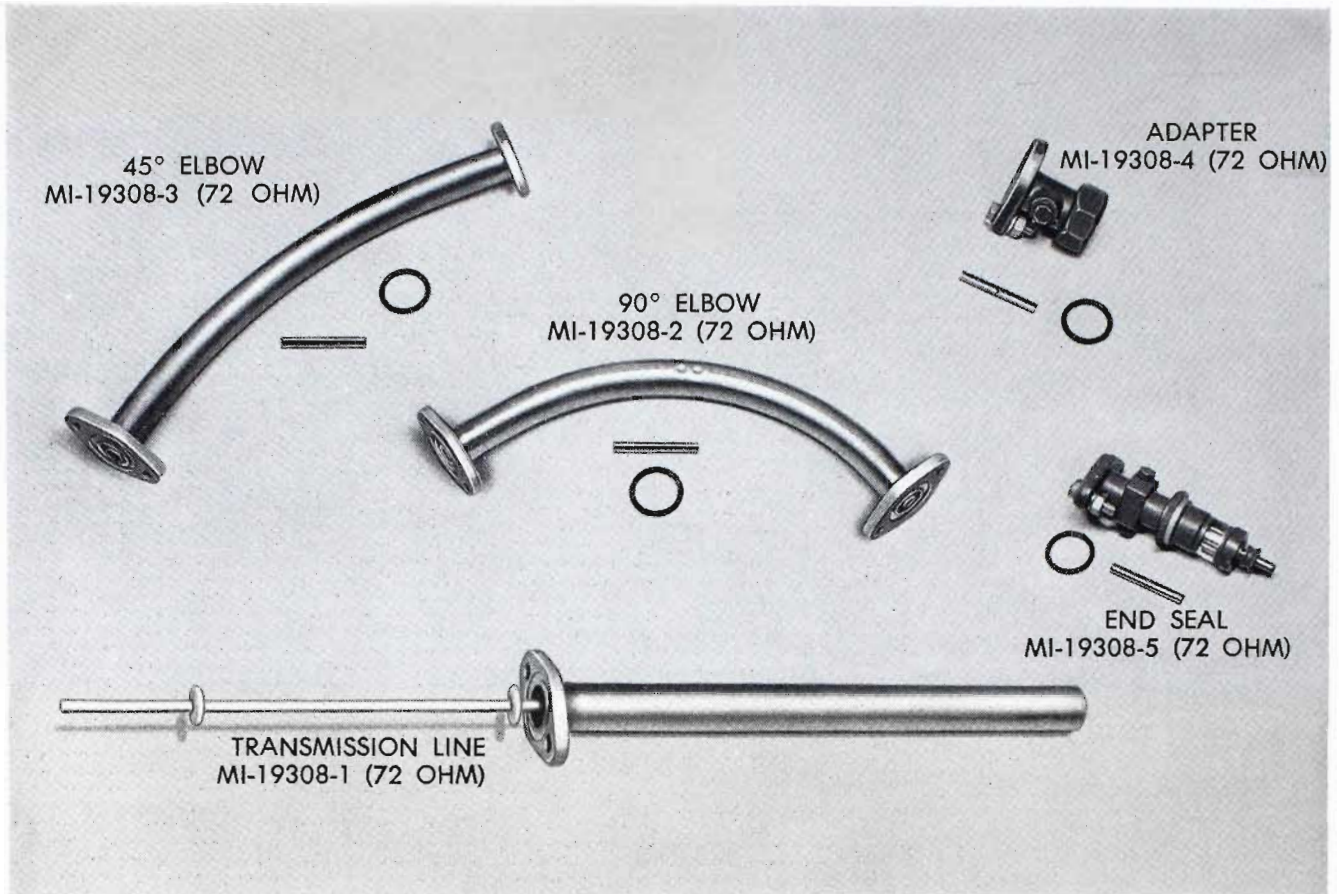

**Description**

RCA 7/8" Transmission Line, Type MI-19308, is a hard-tempered coaxial line with a nominal impedance of 72 ohms. This line operates with good efficiency on the low, medium and high frequencies, and is widely used for AM installations of 5 kw and less. Hangers for this line are shown on another page of this catalog.

**MI-19308-1 Transmission Line**

This line is supplied in 20-foot length with a flange silver soldered to each end. The inner conductor is 1/4" diameter with steatite insulators spaced 6" apart. The outer conductor is designed to allow for removing inner conductor for inspection. Power rating is 1 kw nominal with 90% efficiency for 100 feet. Line includes solderless inner connector, O-ring gasket and silicon copper hardware.

**MI-19308-1-F Transmission Line**

Same as MI-19308-1 except one flange is omitted.

**MI-19308-1-NF Transmission Line**

Same as MI-19308-1 except both flanges are omitted.

**MI-19308-2 Coupling (90° Elbow)**

This elbow has one flange silver soldered. Opposite flange swivels to take care of any angle. Inner conductor is supported by 3 steatite insulators held in place. The elbow is furnished with solderless inner conductor, O-ring gasket and hardware.

**MI-19308-2-F Coupling (90° Elbow)**

Same as MI-19308-2 except the fixed flange is omitted.

**MI-19308-2-NF Coupling (90° Elbow)**

Same as MI-19308-2 except both flanges are omitted.

**MI-19308-3 Coupling (45° Elbow)**

Same as MI-19308-2 except 45°.

**MI-19308-3-F Coupling (45° Elbow)**

Same as MI-19308-3 except the fixed flange is omitted.

**MI-19308-3-NF Coupling (45° Elbow)**

Same as MI-19308-3 except both flanges are omitted.

**MI-19308-4 Adapter Coupling**

Used for coupling a 7/8" 72-ohm flanged line to a 7/8" 72-ohm unflanged line. A 1 1/2" wrench is required for clamping the special gland nut on the unflanged line. Furnished with solderless inner connector, O-ring gasket and hardware.

**MI-19308-5 End Seal**

This sturdy end seal uses Pyrex as an insulator. It is fitted with two 1/8" IPS ports and brass plugs for gas admission or bleeding the line. A clamp nut is supplied for mounting. A screw terminal with locking nut is used for the termination of inner conductor. No soldering is necessary for installing. Furnished with O-ring gasket and solderless inner connector.

**MI-19308-6 Adapter**

Adapts a flange using two bolts on 1 3/4"-bolt circle to a flange using three bolts on same bolt circle. Furnished complete with solderless inner conductor and O-ring gaskets.

**Dimensions For 7/8" 72-Ohm Hard Copper Line and Fittings**

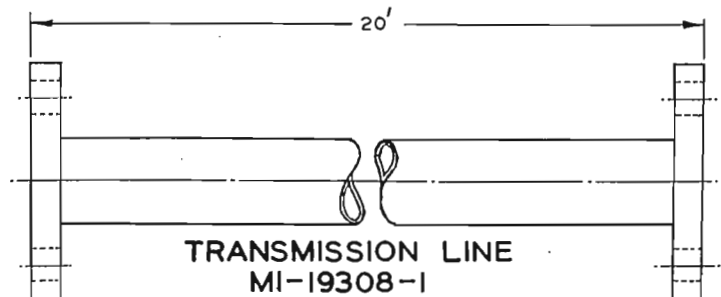
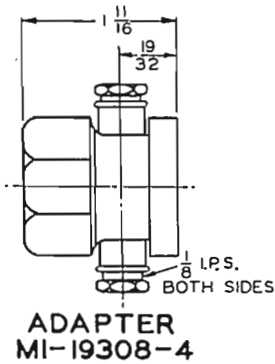
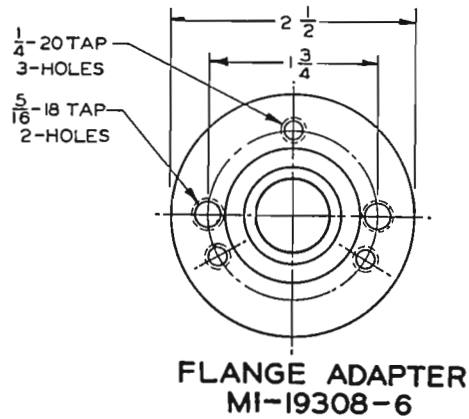
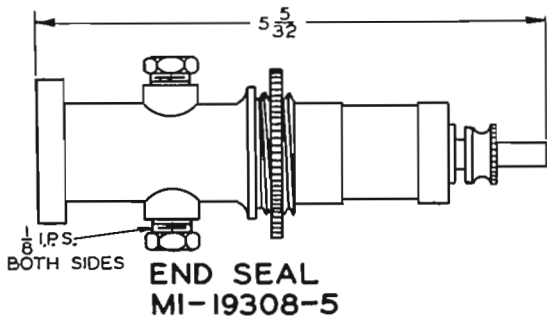
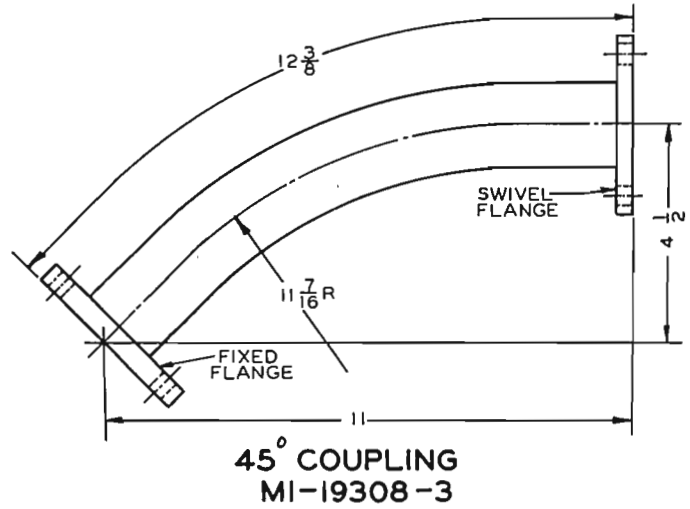
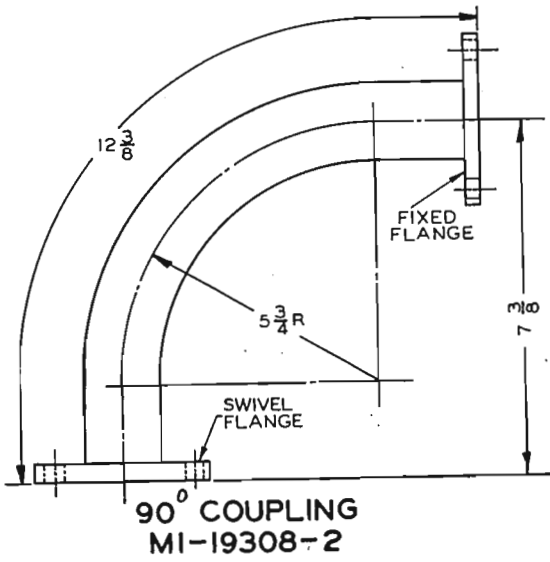



# 7/8" 51.5-Ohm Hard Copper Line and Fittings, MI-19309

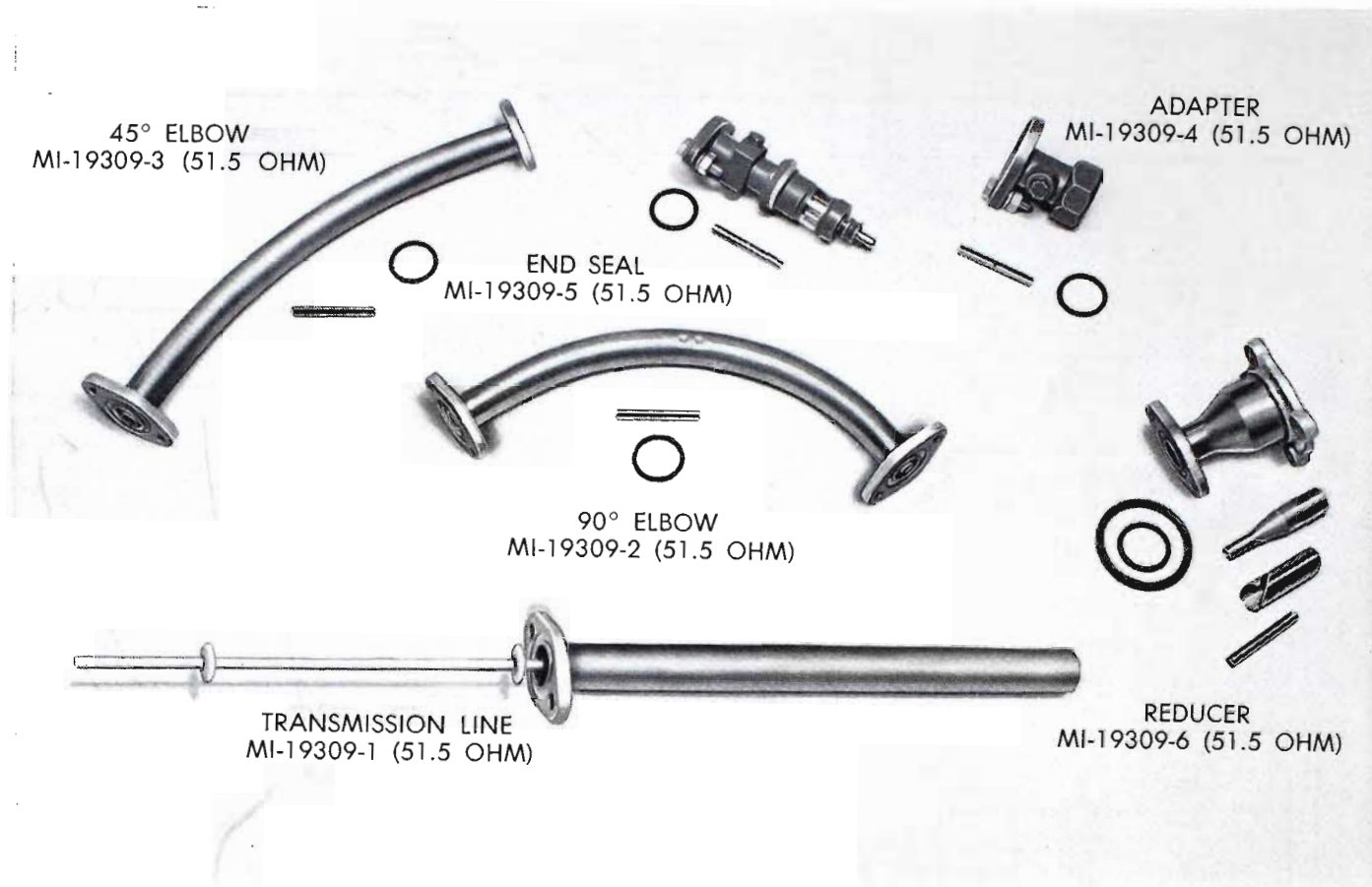

**Description**

RCA 7/8" Transmission Line, Type MI-19309, is a hard tempered coaxial line with a nominal impedance of 51.5 ohms. This line operates with good efficiency on low, medium and high frequencies.

**MI-19309-1 Transmission Line**

This line is supplied in 20-foot lengths with a flange silver soldered to each end. The inner conductor is 5/16" diameter with steatite insulators spaced 6" apart. The outer conductor is designed to allow for removing inner conductor for inspection. Power rating is 3 kw at 100 mc with 90% efficiency for 100 feet. Line includes solderless inner connector, O-ring gasket and silicon copper hardware. Hangers for this line are shown on another page of this catalog.

**MI-19309-1-F Transmission Line**

Same as MI-19309-1 except one flange is omitted.

**MI-19309-1-NF Transmission Line**

Same as MI-19309-1 except both flanges are omitted.

**MI-19309-2 Coupling (90° Elbow)**

This elbow has one flange silver soldered to outer conductor. Opposite flange swivels to take care of any angle. Inner conductor is supported by 3 steatite insulators held in place. The elbow is furnished with solderless inner conductor, O-ring gasket and hardware.

**MI-19309-2-F Coupling (90° Elbow)**

Same as MI-19309-2 except the fixed flange is omitted.

**MI-19309-2-NF Coupling (90° Elbow)**

Same as MI-19309-2 except both flanges are omitted.

**MI-19309-3 Coupling (45° Elbow)**

Same as MI-19309-2, except 45°.

**MI-19309-3-F Coupling (45° Elbow)**

Same as MI-19309-3 except the fixed flange is omitted.

**MI-19309-3-NF Coupling (45° Elbow)**

Same as MI-19309-3 except both flanges are omitted.

**MI-19309-4 Adapter Coupling**

Used for coupling a 7/8" 51.5-ohm flanged line to a 7/8" 51.5-ohm unflanged line. A 1 1/2" wrench is required for clamping the special gland nut on the unflanged line. Furnished with solderless inner connector, O-ring gasket and hardware.

**MI-19309-5 End Seal**

This sturdy end seal uses Pyrex as an insulator. It is fitted with two 1/8" IPS ports and brass plugs for gas admission or bleeding the line. A clamp nut is supplied for mounting. A screw terminal with locking nut is used for the termination of inner conductor. No soldering is necessary for installing. Furnished with O-ring gasket and solderless inner connector.

**MI-19309-6 Reducer Coupling**

Used for reducing from 1 5/8" 51.5-ohm to 7/8" 51.5-ohm gassed line. Complete with outer and inner conductor, inner connectors, O-ring gaskets and hardware.

**Dimensions for 7/8" 51.5-Ohm Hard Line and Fittings**

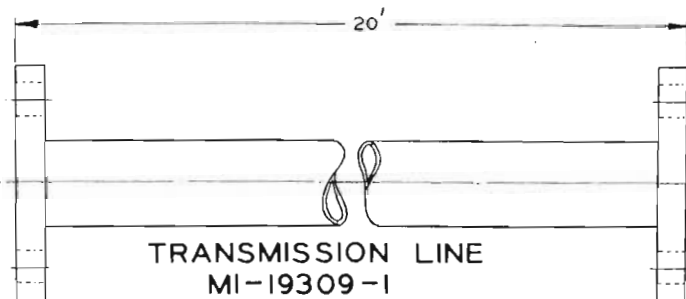
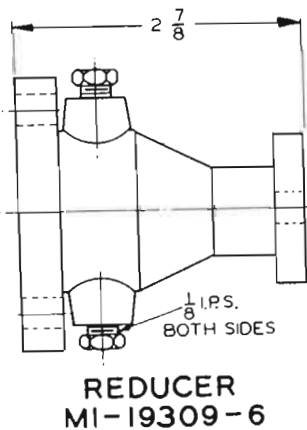
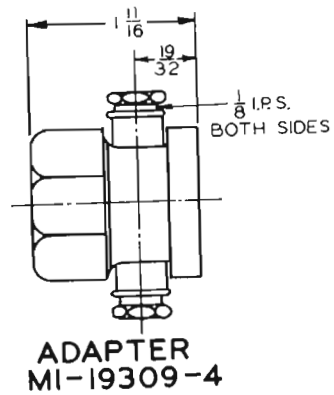
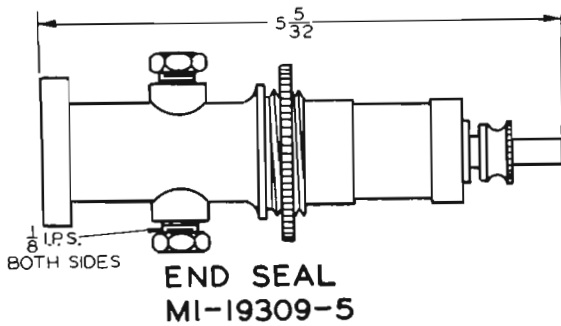
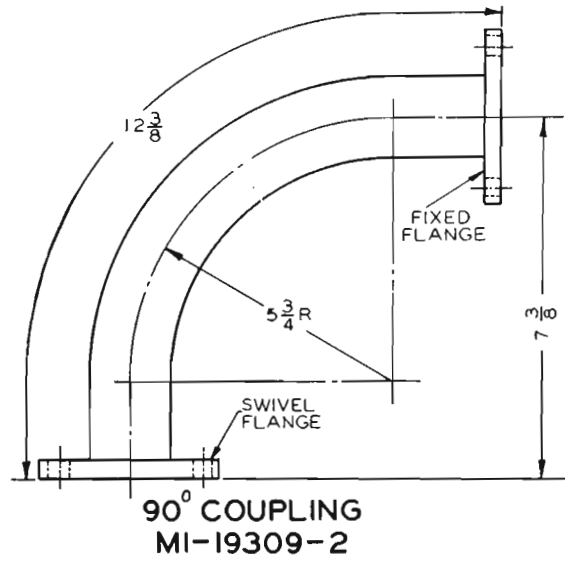
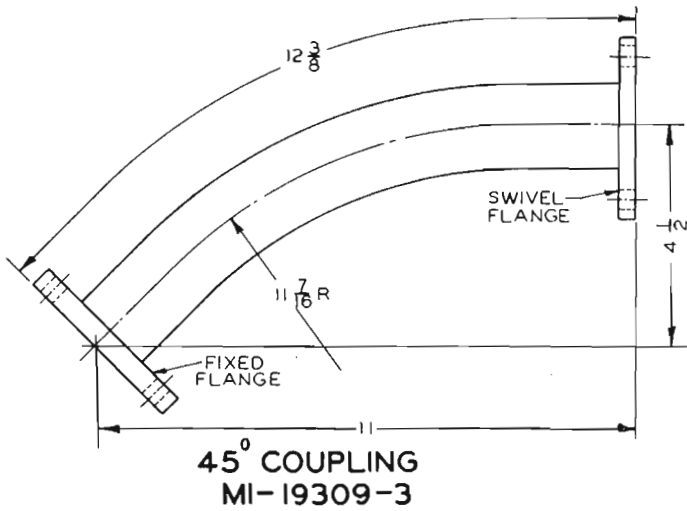



# 1 5/8" 51.5-Ohm Hard Copper Line and Fittings, MI-19112

**Description**

RCA 1 5/8" Transmission Line, Type MI-19112, is a hard-tempered copper line with a nominal impedance of 51.5 ohms. Because of its low impedance and good efficiency at VHF frequencies, this type line is widely used in FM and TV installations. Hangers for this size line are shown on another page of this catalog.

**MI-19112-1 Transmission Line**

This line is supplied in 20-foot length\* with flanges silver-soldered to ends. The outer conductor is 1 5/8" diameter with an inner conductor of 3/8" diameter using special low loss insulators spaced 12" apart. The outer conductor is designed to allow for removing inner conductor for inspection. Maximum power rating is 10 kw at 100 mc with standing wave ratio of 1. Line includes solderless inner connector, O-ring gasket, and silicon copper hardware.

**MI-19112-1-F Transmission Line**

Same as MI-19112-1 except one flange is omitted.

**MI-19112-1-NF Transmission Line**

Same as MI-19112-1 except both flanges are omitted.

**MI-19112-2 Coupling (90° Elbow)**

Elbow with one fixed flange and opposite flange that swivels to take care of any angle. Inner conductor is supported by insulators spaced 12" apart. There is also a support for the inner conductor in the center of the elbow. Furnished with inner connector, O-ring gasket and silicon copper hardware.

**MI-19112-2-F Coupling (90° Elbow)**

Same as MI-19112-2 except the fixed flange is omitted.

**MI-19112-2-NF Coupling (90° Elbow)**

Same as MI-19112-2 except both flanges are omitted.

**MI-19112-3 Coupling (45° Elbow)**

Same as MI-19112-2 except 45°.

**MI-19112-3-F Coupling (45° Elbow)**

Same as MI-19112-3 except the fixed flange is omitted.

**MI-19112-3-NF Coupling (45° Elbow)**

Same as MI-19112-3 except both flanges are omitted.

**MI-19112-4 Adapter**

Used for adapting a flange type line to an unflanged line. The only tools necessary are wrenches for the flange hardware and screwdriver for tightening clamp. Furnished with inner connector, O-ring gasket and hardware.

**MI-19112-5 Gas Stop**

To be inserted between two flanged sections of line to seal a gassed section from an ungassed section of line. (Usually located before input to antenna.)

\* May be ordered in lengths less than 20 feet. When line is to be used for television, it should be in multiples of feet. If length is not in multiples of feet, it is necessary to make up the difference by using .647 diameter conductor MI-19112-9. When ordering specify the MI-number and length required.

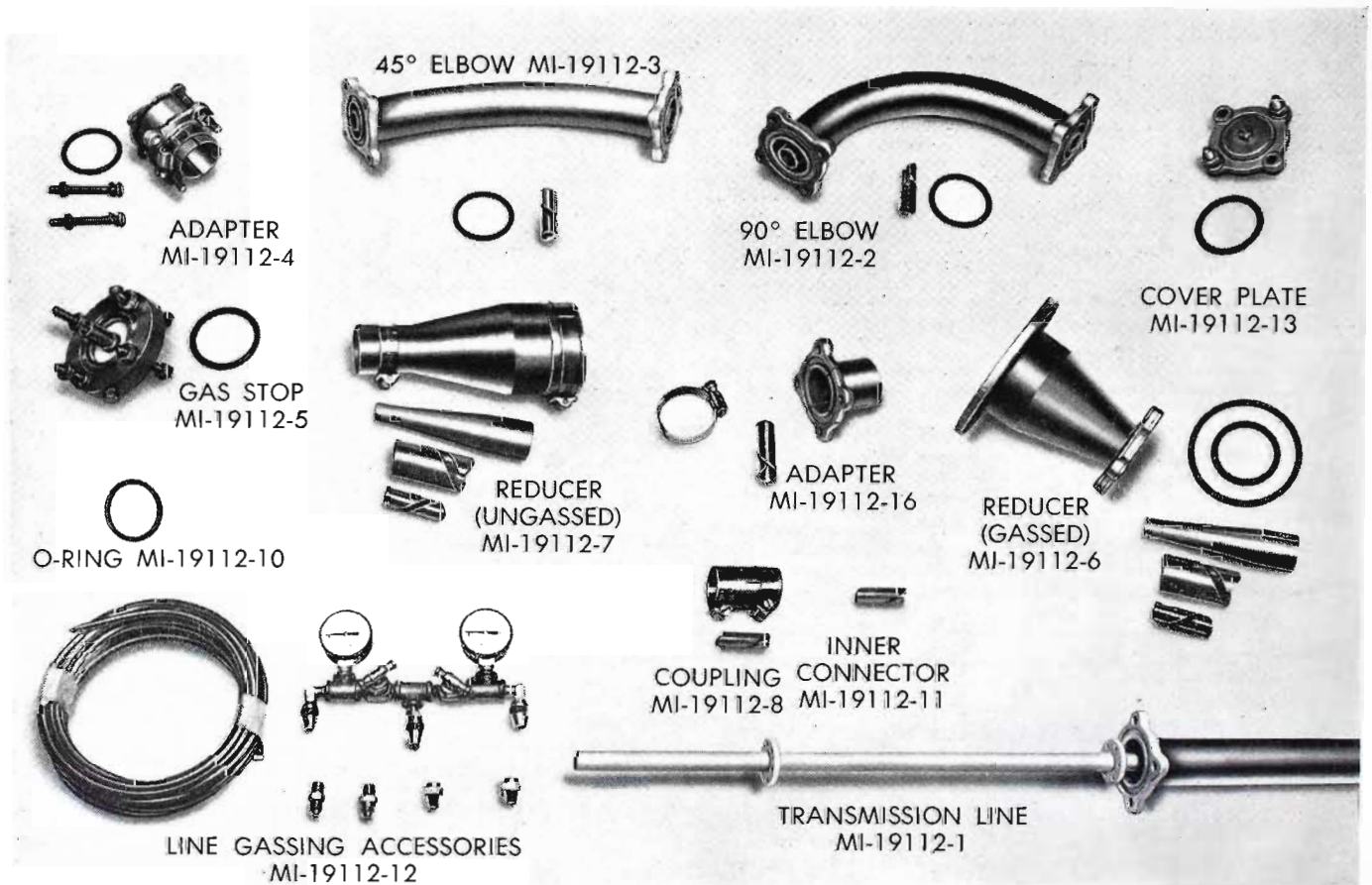

# Dimensions for 1 5/8" 51.5-Ohm Hard Line & Fittings

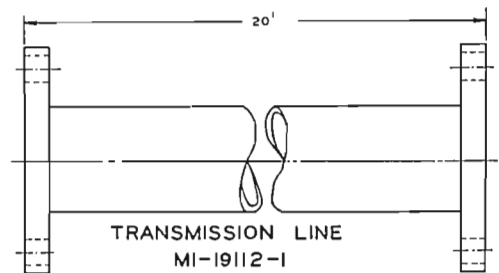
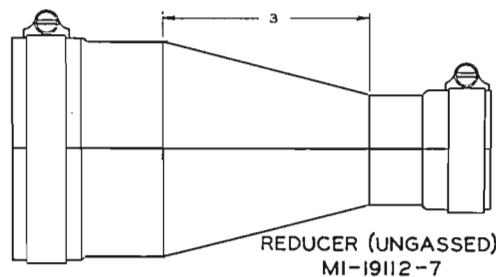
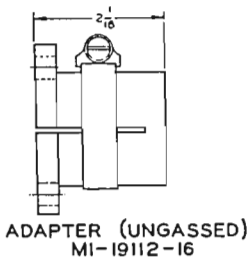
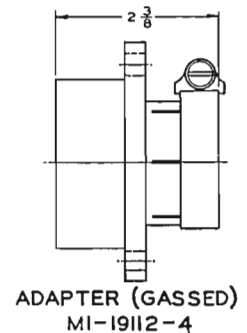
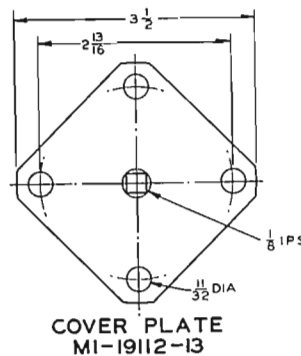
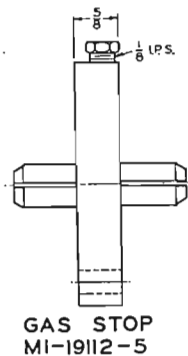
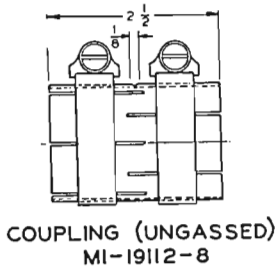
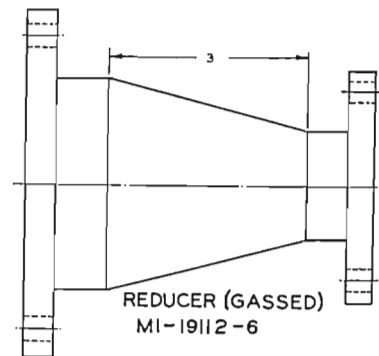
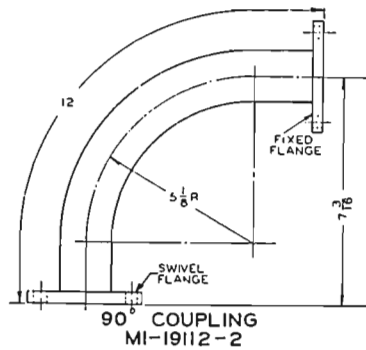
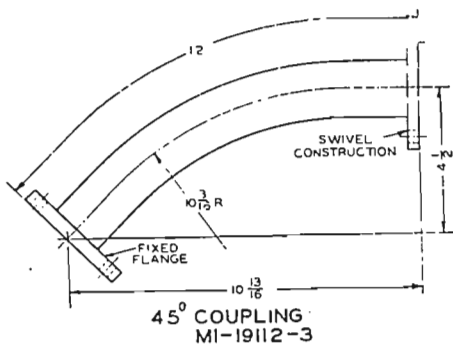

## MI-19112-6 Reducer Coupling

Flanged coupling used for reducing from 3 1/8" 51.5-ohm to 1 5/8" 51.5-ohm gassed line. Complete with outer and inner conductor and connectors, O-ring gaskets and hardware.

## MI-19112-7 Reducer Coupling

Used for reducing from 3 1/8" 51.5-ohm to 1 5/8" 51.5-ohm un-gassed line. Outer conductor is split in two pieces, providing a very convenient assembly. Complete with outer and inner conductor and connectors and stainless steel clamps.

## MI-19112-8 Straight Coupling

Used for coupling two sections of 1 5/8" 51.5-ohm unflanged lines. (Not to be used for gassed line.) Consists of outer and inner connectors with stainless steel clamps.

## MI-19112-9 Special Inner Conductor

Used for splicing lengths of line which are cut at points between the supporting insulators (these are spaced 12"). Inner conductor as supplied is .645 O.D. x .569 I.D. x 12 feet long. The special inner conductor will fit inner conductor MI-19112-11.

## MI-19112-10 O-Ring Gasket

A long-life synthetic rubber gasket for use between the flanges to make flanged joints pressure tight.

## MI-19112-11 Inner Connector

A specially designed solderless inner connector for joining inner conductors of 1 5/8" 51.5-ohm line.

## MI-19112-12 Line Gassing Accessories

Consists of indicators, couplings, 25 feet of 1/4" O.D. copper tubing and fittings. Used for indicating line pressure.

## MI-19112-13 Emergency Cover Plate

Used to cap the end of 1 5/8" line to keep moisture out during installation, or for other temporary capping of the line.

## MI-19112-16 Adapter

An adapter (ungassed) to couple a flanged to an unflanged line. Furnished complete with inner connector, hardware and clamp.



# 1 5/8" 72-Ohm Hard Copper Line and Fittings, MI-19310

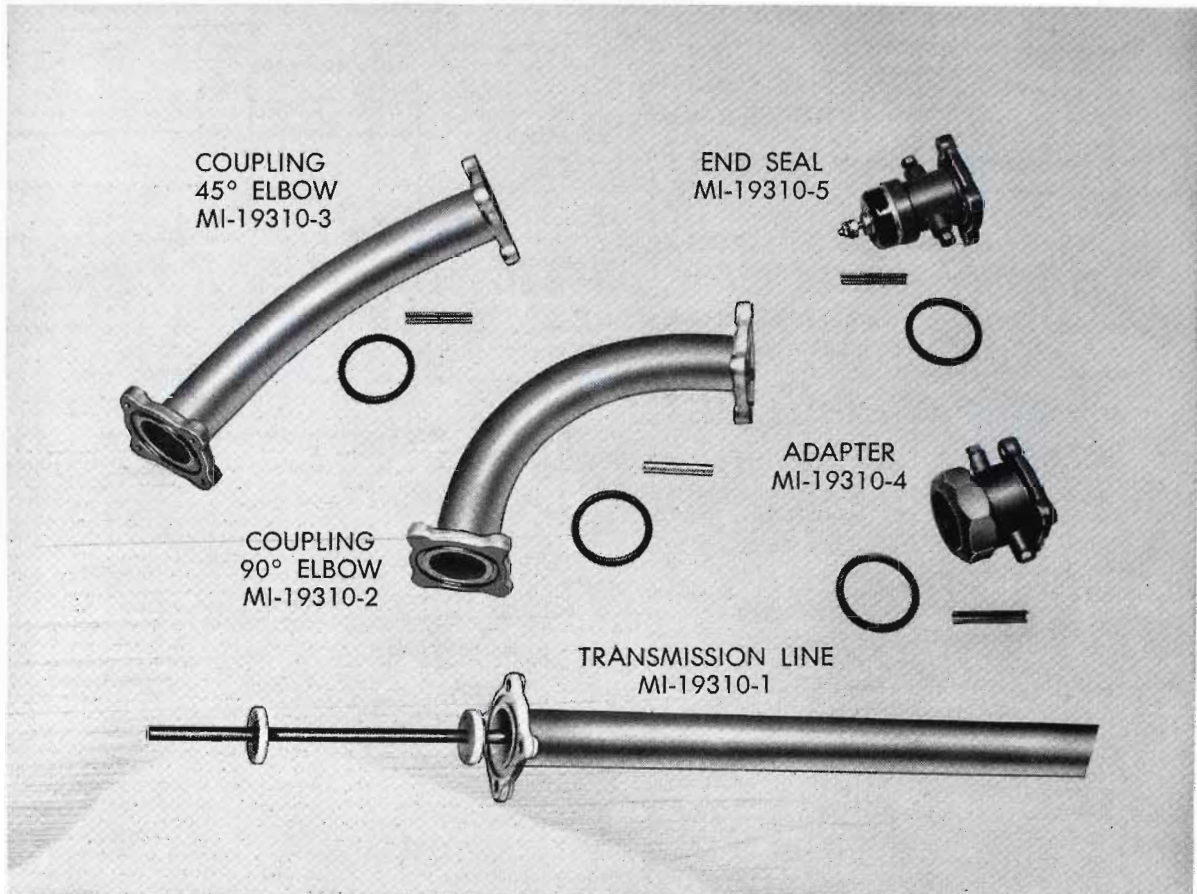

**Description**

RCA 1 5/8" Transmission Line, Type MI-19310, is a hard-tempered coaxial line designed for installation where medium power is to be handled, and where the frequency to be used dictates use of a line with good efficiency. This line operates with good efficiency in the VHF bands, and is used in FM and TV installations where the runs to be made are not exceptionally long. Hangers for this line are shown on another page of this catalog.

**MI-19310-1 Transmission Line**

This line is supplied in 20-foot lengths with flanges silver soldered to ends. The outer conductor is 1 5/8" diameter with an inner conductor of 3/8" diameter using steatite insulators spaced 12" apart. The outer conductor is designed to allow for removing inner conductor for inspection. Power rating is 10 kw maximum with 95% efficiency for 100 feet. Line includes solderless inner connector, O-ring gasket and silicon copper hardware.

**MI-19310-1-F Transmission Line**

Same as MI-19310-1 except one flange is omitted.

**MI-19310-1-NF Transmission Line**

Same as MI-19310-1 except both flanges are omitted.

**MI-19310-2 Coupling (90° Elbow)**

This elbow has one flange silver soldered. Opposite flange swivels to take care of any angle. Inner conductor is supported by 3 steatite insulators held in place. The elbow is furnished with solderless inner conductor, O-ring gasket and hardware.

**MI-19310-2-F Coupling (90° Elbow)**

Same as MI-19310-2 except the solid flange is omitted.

**MI-19310-2-NF Coupling (90° Elbow)**

Same as MI-19310-2 except both flanges are omitted.

**MI-19310-3 Coupling (45° Elbow)**

Same as MI-19310-2 except 45°.

**MI-19310-3-F Coupling (45° Elbow)**

Same as MI-19310-3 except the solid flange is omitted.

**MI-19310-3-NF Coupling (45° Elbow)**

Same as MI-19310-3 except both flanges are omitted.

**MI-19310-4 Adapter Coupling**

Used for coupling a 1 5/8" 72-ohm flanged line to a 1 5/8" 72-ohm unflanged line. A 2" wrench is required for clamping the special gland nut for the unflanged line. Furnished with solderless inner connector, O-ring gasket and hardware.

**MI-19310-5 End Seal**

This end seal uses steatite as an insulator. Constructed with two 1/8" IPS parts and brass plugs for gas admission or bleeding the line. A screw terminal with lockwasher and nut is used for termination of center conductor. Furnished with solderless inner conductor, O-ring gasket and hardware.

**Dimensions for 1 5/8" 72-Ohm Hard Line and Fittings**

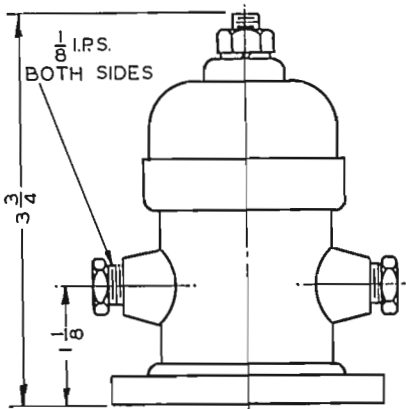

**END SEAL  
MI-19310-5**

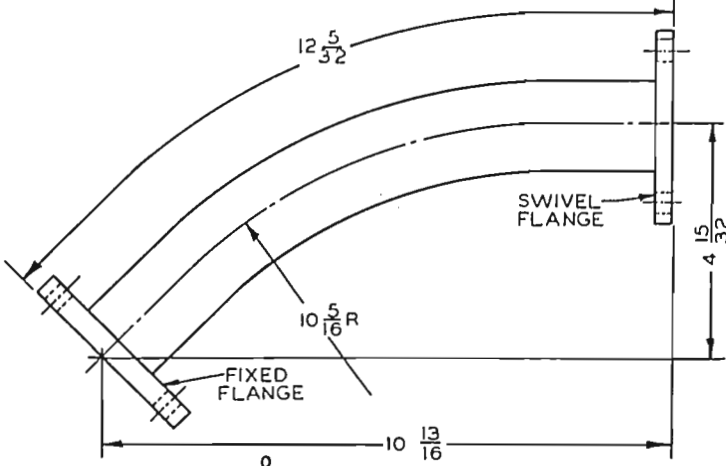

**45° COUPLING  
MI-19310-3**

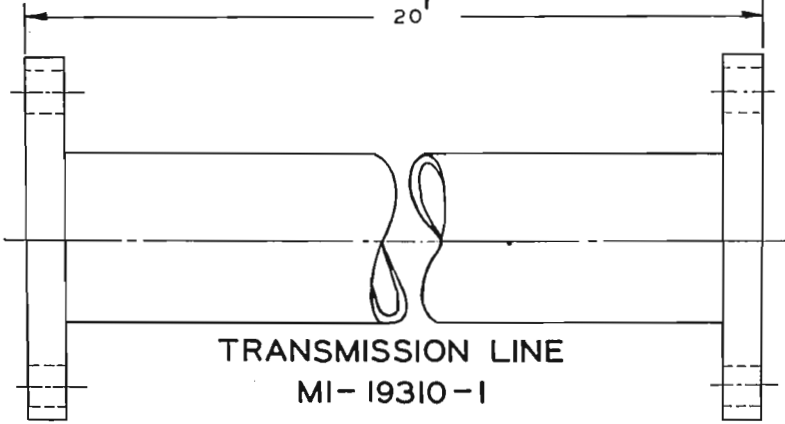

**TRANSMISSION LINE  
MI-19310-1**

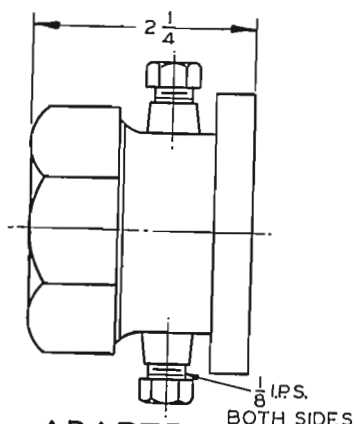

**ADAPTER  
MI-19310-4**

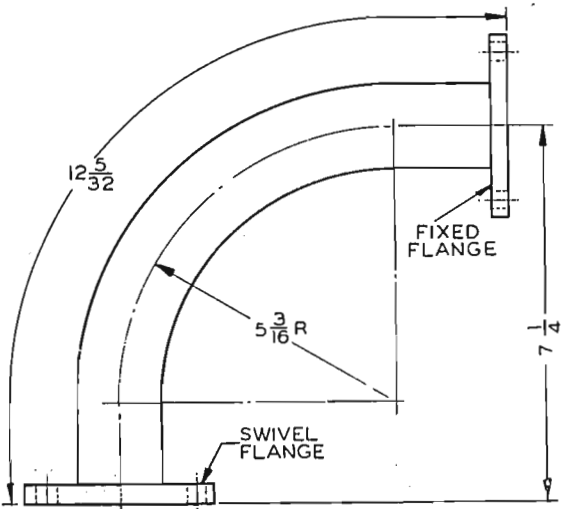

**90° COUPLING  
MI-19310-2**



# 3 1/8" 51.5-Ohm Hard Copper Line and Fittings, MI-19113

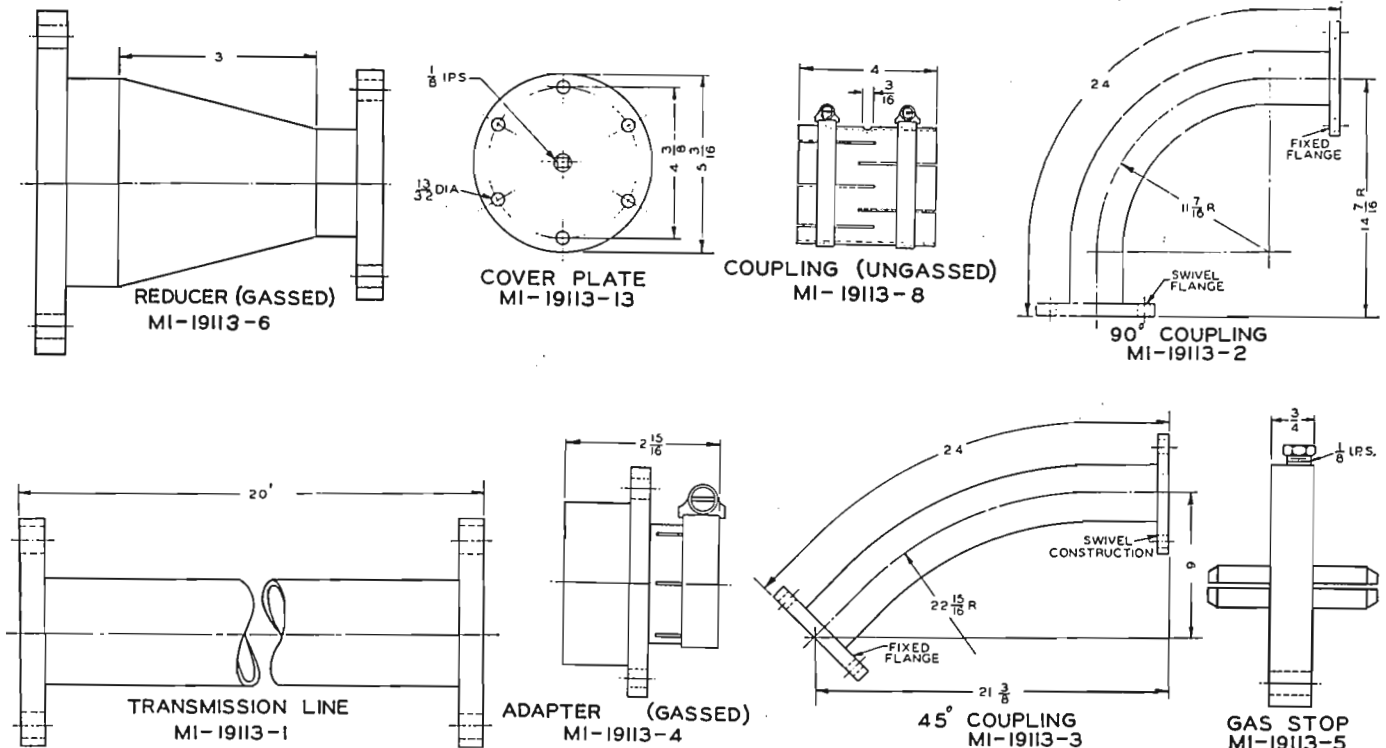

**Description**

RCA 3 1/8" Transmission Line, Type MI-19113, is a hard-tempered copper line designed for use in AM, FM and TV installations where high power is to be handled or long transmission line runs are required. This type line operates very efficiently at VHF frequencies. Hangers for this line are shown on another page of this catalog.

**MI-19113-1 Transmission Line**

This line is supplied in 20-foot lengths\* with flanges silver-soldered to ends. The outer conductor is 3 1/8" O.D. with an inner conductor of 1.200 diameter using special low loss insulators spaced 12" apart. The outer conductor is designed to allow for removing inner conductor for inspection. Maximum power rating is 42 kw at 100 mc with standing wave ratio of 1. Line includes solderless inner connector, O-ring gasket, and silicon copper hardware.

**MI-19113-1-F Transmission Line**

Same as MI-19113-1 except one flange is omitted.

**MI-19113-1-NF Transmission Line**

Same as MI-19113-1 except both flanges are omitted.

**MI-19113-2 Coupling (90° Elbow)**

Elbow with one fixed flange and opposite flange that swivels to take care of any angle. Inner conductor is supported by insulators spaced 12" apart. There is also a teflon insulator for support in the center of the elbow. Furnished with inner connector, O-ring gasket and silicon copper hardware.

**MI-19113-2-F Coupling (90° Elbow)**

Same as MI-19113-2 except the solid flange is omitted.

**MI-19113-2-NF Coupling (90° Elbow)**

Same as MI-19113-2 except both flanges are omitted.

**MI-19113-3 Coupling (45° Elbow)**

Same as MI-19113-2 except 45°.

**MI-19113-3-F Coupling (45° Elbow)**

Same as MI-19113-3 except the solid flange is omitted.

**MI-19113-3-NF Coupling (45° Elbow)**

Same as MI-19113-3 except both flanges are omitted.

**MI-19113-4 Adapter**

Used for adapting a flange type line to an unflanged line. The only tools necessary are wrenches for the flange hardware and screwdriver for tightening clamp. Furnished with inner connector, O-ring gasket and hardware.

**MI-19113-5 Gas Stop**

To be inserted between two flanged sections of line to seal a gassed section from an un-gassed section of line. (Usually located before input to antenna.)

**MI-19113-6 Reducer Coupling**

Flanged coupling used for reducing from 3 1/8" 51.5-ohm to conductor and connectors, O-ring gaskets and hardware. Dimensions same as MI-19112-6.

**MI-19113-7 Reducer Coupling**

Used for reducing from 3 1/8" 51.5-ohm to 1 5/8" 51.5-ohm un-gassed line. Outer conductor is split in two pieces, providing a very convenient assembly. Complete with outer and inner conductor and connectors and stainless steel clamps. Dimensions same as MI-19112-7.

**MI-19113-8 Straight Coupling**

Used for coupling two sections of 3 1/8" 51.5-ohm unflanged lines. (Not to be used for gassed line.) Consists of outer and inner connectors with stainless steel clamps.

\* May be ordered less than 20 feet. For television installations line sections should be in multiples of 1 foot whenever possible. Otherwise, the Special Conductor MI-19113-9 should be used to join these sections. When ordering transmission line, specify the MI-number and the length required.

**MI-19113-9 Special Inner Conductor**

Used for splicing lengths of line which are cut at points between the supporting insulators (these are spaced 12"). Inner conductor as supplied is 1.282 O.D. x 1.136 I.D. x 12 feet long. The special inner conductor will fit inner conductor MI-19113-11.

**MI-19113-10 O-Ring Gasket**

A long-life synthetic rubber gasket for use between the flanges to make flanged joints pressure tight.

**MI-19113-11 Inner Connector**

A specially designed solderless inner connector for joining inner conductors of 3 1/8" 51.5-ohm line.

**MI-19113-13 Emergency Cover Plate**

Used to cap the end of 3 1/8" line to keep moisture out during installation, or for other temporary capping of the line.





# 6 1/8" 51.5-Ohm Hard Copper Line and Fittings, MI-19314

**Description**

RCA 6 1/8" Transmission Line, Type MI-19314, is a hard-tempered copper line with an impedance of 51.5 ohms. (See photo on opposite page.) The large size and low impedance of this type line adapts it to very high power AM, FM and TV installations or for use with medium power FM installations where the transmission line runs are exceptionally long. Hangers for this line are shown on another page of this catalog.

**MI-19314-1 Transmission Line**

This line is supplied in 20-foot lengths with 2 1/2" diameter inner conductor and special pin insulators spaced every 12". Maximum power 166 kw at 100 mc with 90% efficiency. Attenuation 0.056 db maximum per 100 feet at 100 mc. Due to the size and weight, the outer conductor is shipped in a separate container than the inner conductor with the pin insulators packaged separately to avoid breakage. MI-19314-1 includes one solderless inner connector, O-ring gasket, hardware with instruction sheet.

**MI-19314-2 Coupling (90° Elbow)**

A specially designed long sweep elbow with fixed flange on one end and swivel flange on the other end. Uses special pin insulators spaced every 12". Furnished with inner conductor, O-ring gasket and hardware.

**MI-19314-3 Coupling (45° Elbow)**

Same as MI-19314-2 except 45°.

**MI-19314-4 Reducer**

For connecting 6 1/8" diameter line to 3 1/8" diameter line. Flange type complete with inner conductor, O-ring gasket and hardware.

**MI-19314-5 Inner Connector**

A connector to couple the 2 1/2" diameter inner conductors of 6 1/8" line.

**Dimensions For 6 1/8" 51.5-Ohm Line and Fittings**

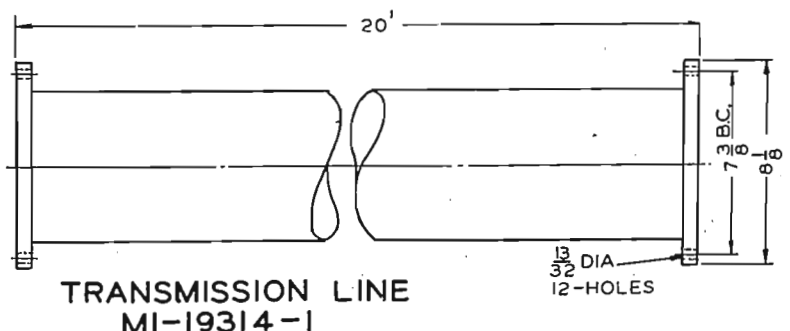
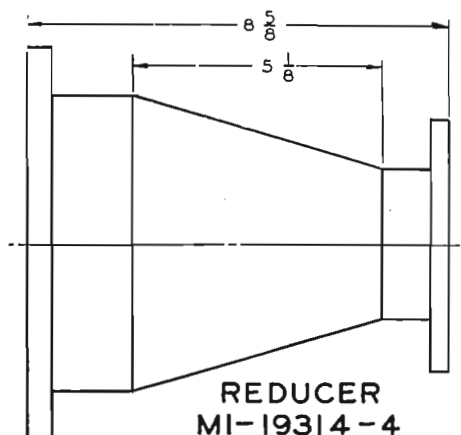
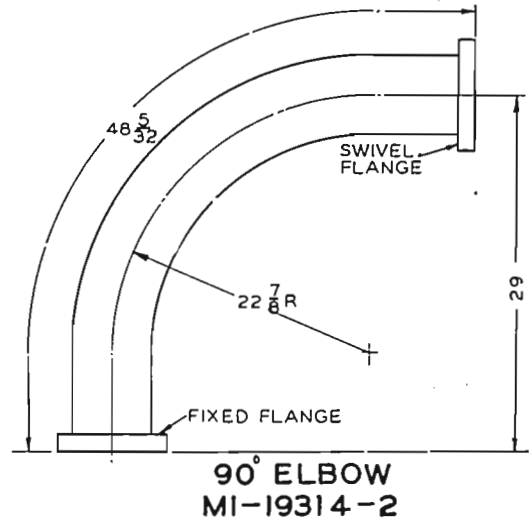
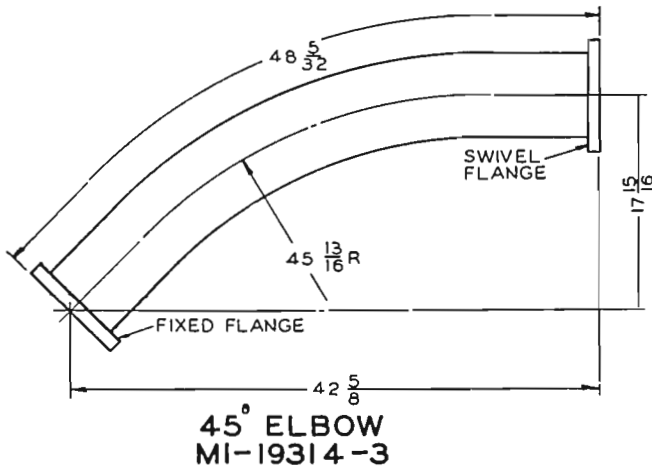

# 6 1/8" 51.5 Ohm Hard Copper Line and Fittings



45° ELBOW  
MI-19314-3



90° ELBOW  
MI-19314-2



REDUCER  
MI-19314-4



TRANSMISSION LINE  
MI-19314-1



# RCA Transmission Line Hangers and Accessories

## Types and Uses

RCA has a complete line of hangers designed for  $\frac{7}{8}$ "-,  $1\frac{1}{8}$ "- and  $3\frac{1}{8}$ " diameter transmission lines. There are hangers for mounting both single and dual lines either vertically or horizontally to flat members, pipes, or angular members. These hangers consist of several general types, i.e., spring suspended expansion hangers (which permit differential thermal expansion of the line and tower), swivel hangers which provide for either horizontal or vertical mounting of the line, and lateral braces and direct mounting anchors. Of these there are short hangers for close mounting, long hangers to provide additional

clearance, and insulated as well as noninsulated types. The direct mounting type of hanger requires drilling of a hole in the mounting surface, but no drilling is required for the other types.

The instructions supplied with each spring-suspension hanger should be closely followed for proper installation. The practice is to space the hangers at approximate 10-foot intervals. The line section at the tower top is firmly secured by two fixed hangers, and the lower sections are suspended by spring hangers to allow for differential thermal expansion.

*Spring-Suspended Hangers for Supporting Single Lines to Flat Members*



MI-19309-20 ( $\frac{7}{8}$  LINE)  
MI-19312-20 ( $1\frac{1}{8}$  LINE)  
MI-19313-20 ( $3\frac{1}{8}$  LINE)



MI-19309-21 ( $\frac{7}{8}$  LINE)  
MI-19312-21 ( $1\frac{1}{8}$  LINE)  
MI-19313-21 ( $3\frac{1}{8}$  LINE)



MI-19309-22 ( $\frac{7}{8}$  LINE)  
MI-19312-22 ( $1\frac{1}{8}$  LINE)  
MI-19313-22 ( $3\frac{1}{8}$  LINE)

## Expansion Hangers for Supporting Single Lines

### Description

	Hanger Stock No.	
$\frac{7}{8}$ " Line	$1\frac{1}{8}$ " Line	$3\frac{1}{8}$ " Line
MI-19309-20	MI-19312-20	MI-19313-20
MI-19309-21	MI-19312-21	MI-19313-21
MI-19309-22	MI-19312-22	MI-19313-22

### Description of Hanger

An expansion hanger of the spring-suspended type for supporting a single line to any flat member. By use of a wrench, the hanger can be clamped to a tower member. An adjustable arm allows the line support to swing in an arc of  $135^\circ$  for alignment of line. After the spring is pulled to a length given in a chart with the instruction sheet, and the adjustable clamp is tightened, the hanger will automatically adjust itself for any expansion of the line.

Same as above except support arm is longer. This hanger provides additional clearance of line from tower.

A spring-suspended hanger with an insulated support arm. This hanger provides isolation of tower from transmission line.

# Dimensions for Single Line Expansion Hangers

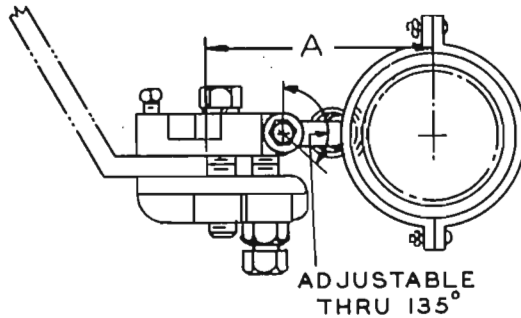
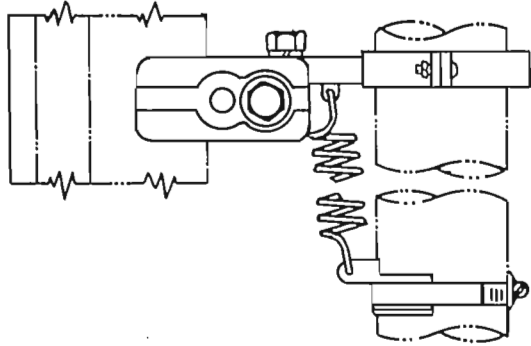

HANGER  
GROUNDED  
FLAT MEMBER

LINE	MI NO	"A"
$\frac{7}{8}$	19309-20	$3 \frac{15}{16}$
$\frac{7}{8}$	19309-21	$7 \frac{11}{16}$
$1 \frac{5}{8}$	19312-20	$4 \frac{9}{16}$
$1 \frac{5}{8}$	19312-21	$8 \frac{1}{16}$
$3 \frac{1}{8}$	19313-20	$5 \frac{5}{16}$
$3 \frac{1}{8}$	19313-21	$8 \frac{7}{8}$

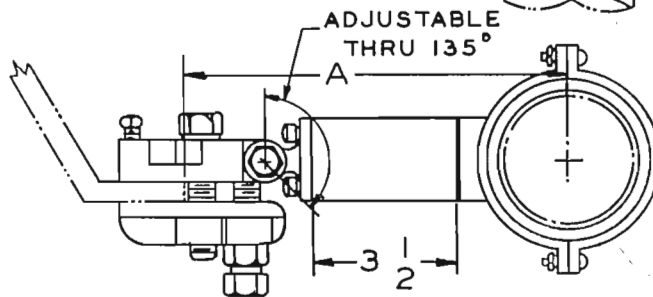
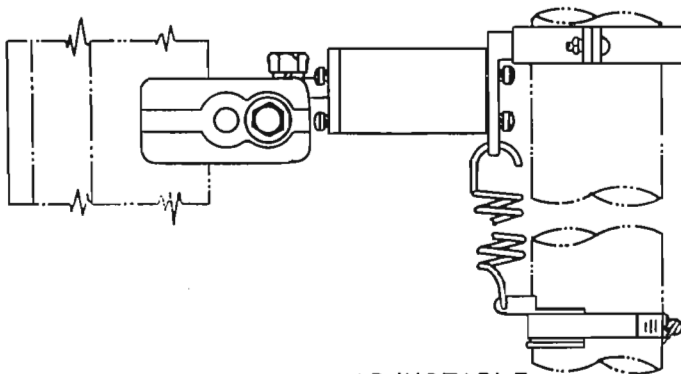

HANGER  
INSULATED  
FLAT MEMBER

LINE	MI NO	"A"
$\frac{7}{8}$	19309-22	$7 \frac{11}{16}$
$1 \frac{5}{8}$	19312-22	$8 \frac{1}{16}$
$3 \frac{1}{8}$	19313-22	$8 \frac{7}{8}$



## Expansion Hangers for Supporting Single Lines

### HANGERS FOR MOUNTING TO ROUND MEMBERS



MI-19309-23 (7/8 LINE)  
MI-19312-23 (1 5/8 LINE)  
MI-19313-23 (3 1/8 LINE)



MI-19309-24 (7/8 LINE)  
MI-19312-24 (1 5/8 LINE)  
MI-19313-24 (3 1/8 LINE)



MI-19309-25 (7/8 LINE)  
MI-19312-25 (1 5/8 LINE)  
MI-19313-25 (3 1/8 LINE)



MI-19309-26 (7/8 LINE)  
MI-19312-26 (1 5/8 LINE)  
MI-19313-26 (3 1/8 LINE)



MI-19309-27 (7/8 LINE)  
MI-19312-27 (1 5/8 LINE)  
MI-19313-27 (3 1/8 LINE)



MI-19309-28 (7/8 LINE)  
MI-19312-28 (1 5/8 LINE)  
MI-19313-28 (1 5/8 LINE)

### HANGERS FOR DIRECT MOUNTING



MI-19312-32 (1 5/8 LINE)  
MI-19313-32 (3 1/8 LINE)



MI-19312-33 (1 5/8 LINE)  
MI-19313-33 (3 1/8 LINE)



MI-19312-34 (1 5/8 LINE)  
MI-19313-34 (3 1/8 LINE)

The expansion hangers shown above are of the spring-suspended type designed for supporting single 7/8", 1 5/8", and 3 1/8" transmission lines. The direct-mounting type of hanger requires the

drilling of a hole in the tower member. The hangers for mounting to round members are provided with a clamp which can be fastened to pipe-like structures or other rounded members.

7/8" Line	1 5/8" Line	3 1/8" Line
MI-19309-23	MI-19312-23	MI-19313-23
MI-19309-24	MI-19312-24	MI-19313-24
MI-19309-25	MI-19312-25	MI-19313-25
MI-19309-26	MI-19312-26	MI-19313-26

#### Description of Hanger

A spring-suspended hanger for supporting a single line to a round member having a diameter from 1" to 2 1/4". An adjustable clamp supports the hanger to tower member. An adjustable arm allows the line to swing in an arc of 180° for alignment of line. Refer to chart given with instruction sheet for proper stretch of spring at assembly.

Same as above except support arm is longer. This hanger provides additional clearance of line from tower.

Spring-suspended hanger same as -24 except with an insulated support arm. This hanger provides isolation of tower from transmission line.

Spring-suspended hanger designed for mounting to round members with diameters from 2 1/4" to 5".

$\frac{7}{8}$ " Line	$1\frac{1}{8}$ " Line	$3\frac{1}{8}$ " Line
MI-19309-27	MI-19312-27	MI-19313-27
MI-19309-28	MI-19312-28	MI-19313-28
MI-19309-29	MI-19312-29	MI-19313-29
MI-19309-30	MI-19312-30	MI-19313-30
MI-19309-31	MI-19312-31	MI-19313-31
MI-19309-32	MI-19312-32	MI-19313-32
MI-19309-33	MI-19312-33	MI-19313-33
MI-19309-34	MI-19312-34	MI-19313-34

*Description of Hanger*

Same as -26 type except has a longer support arm to provide additional clearance of line from tower.

Same as -27 type except the support arm is insulated.

Spring suspended hanger designed for supporting a single line to an angular member. The hanger support has a vice like mechanism that clamps to the member. An adjustable arm allows the line to swing in an arc of 135°.

Same as -29 except it has a longer support arm.

Same as -29 except insulated from tower.

Direct-mounting hanger for supporting a single line. Requires drilling a hole in the support member for hanging bracket. An adjustable arm allows the line support to swing in an arc of 90° for alignment of line.

Same as -32 type except has a longer support arm to provide additional clearance of line from tower.

Direct-mounting hanger, insulated to provide isolation of tower from transmission line.

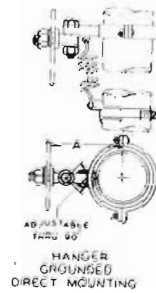

LINE	MI NO.	A'
$\frac{7}{8}$	19309-32	$3\frac{1}{16}$
$\frac{7}{8}$	19309-33	$6\frac{1}{16}$
$1\frac{1}{8}$	19312-32	$3\frac{1}{16}$
$1\frac{1}{8}$	19312-33	$7\frac{1}{16}$
$3\frac{1}{8}$	19313-32	$4\frac{1}{16}$
$3\frac{1}{8}$	19313-33	$8\frac{1}{16}$

**Dimensions for Single Line Expansion Hangers**

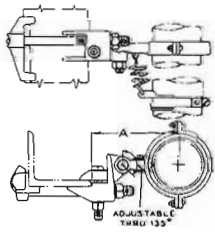

LINE	MI NO.	A'
$\frac{7}{8}$	19309-29	$4\frac{1}{16}$
$\frac{7}{8}$	19309-30	$7\frac{1}{16}$
$1\frac{1}{8}$	19312-29	$4\frac{1}{16}$
$1\frac{1}{8}$	19312-30	$8\frac{1}{16}$
$3\frac{1}{8}$	19313-29	$5\frac{1}{16}$
$3\frac{1}{8}$	19313-30	$9\frac{1}{16}$

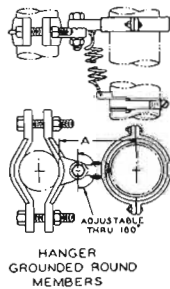

LINE	MI NO.	DIA. MEMBER	A'
$\frac{7}{8}$	19309-23	1 TO 2 $\frac{1}{2}$	$3\frac{1}{4}$
$\frac{7}{8}$	19309-24		7
$1\frac{1}{8}$	19312-23		$3\frac{7}{8}$
$1\frac{1}{8}$	19312-24		$7\frac{3}{8}$
$3\frac{1}{8}$	19313-23		$4\frac{5}{8}$
$3\frac{1}{8}$	19313-24	1 TO 2 $\frac{1}{2}$	$8\frac{1}{16}$
$3\frac{1}{8}$	19309-26	2 $\frac{1}{2}$ TO 5	$3\frac{5}{16}$
$7$	19309-27		7 $\frac{1}{16}$
$1\frac{1}{8}$	19312-26		$3\frac{15}{16}$
$1\frac{1}{8}$	19312-27		7 $\frac{1}{16}$
$3\frac{1}{8}$	19313-28		$4\frac{11}{16}$
$3\frac{1}{8}$	19313-27	2 $\frac{1}{2}$ TO 5	$8\frac{1}{2}$

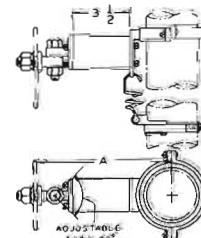

LINE	MI NO.	A'
$\frac{7}{8}$	19309-34	$6\frac{11}{16}$
$1\frac{1}{8}$	19312-34	$7\frac{1}{16}$
$3\frac{1}{8}$	19313-34	$8\frac{1}{16}$

*Hangers for Supporting Single Lines to Angular Members*

MI-19312-29 ( $1\frac{1}{8}$  LINE)  
MI-19313-29 ( $3\frac{1}{8}$  LINE)



MI-19312-30 ( $1\frac{1}{8}$  LINE)  
MI-19313-30 ( $3\frac{1}{8}$  LINE)

MI-19312-31 ( $1\frac{1}{8}$  LINE)  
MI-19313-31 ( $3\frac{1}{8}$  LINE)

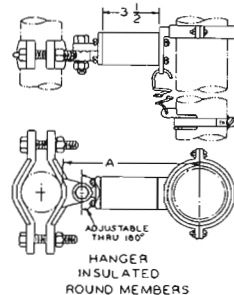

LINE	MI NO.	DIA. MEMBER	A'
$\frac{7}{8}$	19309-25	1 TO 2 $\frac{1}{2}$	7
$1\frac{1}{8}$	19312-25	1 TO 2 $\frac{1}{4}$	$7\frac{3}{8}$
$3\frac{1}{8}$	19313-25	1 TO 2 $\frac{1}{4}$	$8\frac{3}{8}$
$7$	19309-28	2 $\frac{1}{2}$ TO 5	$7\frac{1}{16}$
$1\frac{1}{8}$	19312-28	2 $\frac{1}{2}$ TO 5	$7\frac{1}{16}$
$3\frac{1}{8}$	19313-28	2 $\frac{1}{2}$ TO 5	$8\frac{1}{16}$

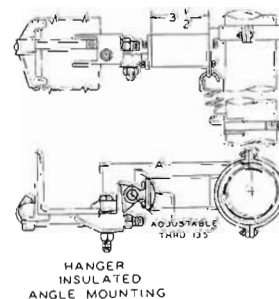

LINE	MI NO.	A'
$\frac{7}{8}$	19309-31	$7\frac{1}{16}$
$1\frac{1}{8}$	19312-31	$8\frac{1}{16}$
$3\frac{1}{8}$	19313-31	$9\frac{1}{16}$



## Expansion Hanger for Supporting Dual Lines

Hanger Stock No.

1 5/8" Line  
MI-19112-14

3 1/8" Line  
MI-19113-14

Description of Hanger

Spring-suspended type expansion hanger designed for supporting dual transmission lines. The spring is stainless steel suspended between two bronze castings, one of which fastens to the tower. The hanger will compensate for thermal differential expansion between a steel tower and copper lines up to 1000 feet in length at temperatures between -20°F and 140°F.



DUAL HANGER  
MI-19112-14 (1 5/8")  
MI-19113-14 (3 1/8")

LINE SIZE	A	B APPROX.
5/8	3 3/4	2 1/4
3/8	5 1/2	3 1/8

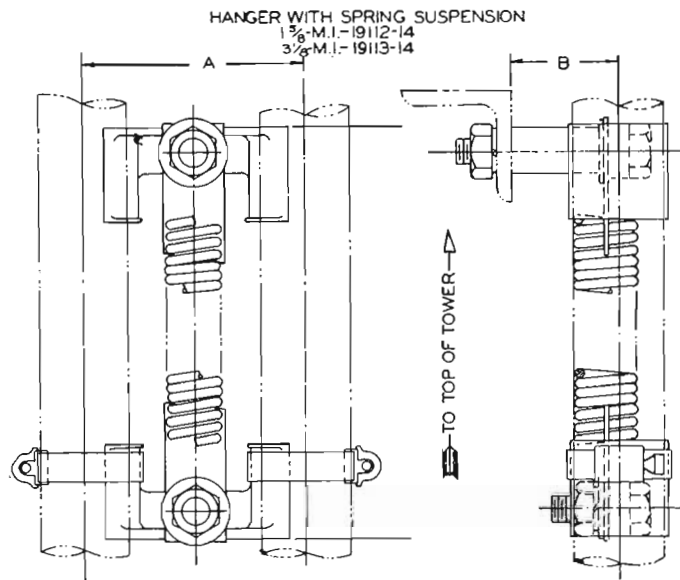

## Roller Assembly for Horizontal Runs

Hanger Stock No.

1 5/8" Line  
MI-19312-35

3 1/8" Line  
MI-19313-35

Description

Roller assembly used for a horizontal run of single line. The roller revolves in a slotted bracket which supports a hood for protection. Mounting holes are provided in base of assembly. Dual lines require installation of two adjacent assemblies.

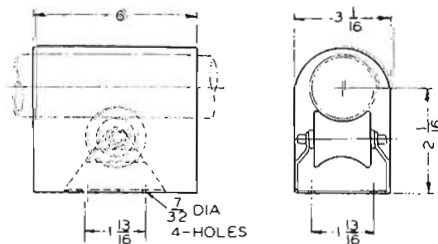

ROLLER  
MI-19312-35

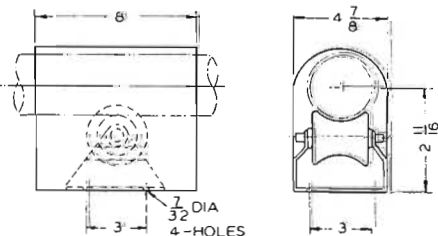

ROLLER  
MI-19313-35

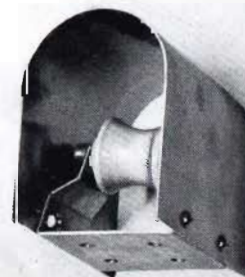

ROLLER ASSEMBLY  
MI-19312-35 (1 5/8" LINE)  
MI-19313-35 (3 1/8" LINE)

## Fixed Hanger for Supporting Dual Lines



**DUAL HANGER**  
MI-19112-15 (1 5/8")  
MI-19113-15 (3 1/8")

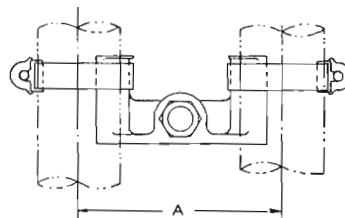

HANGER WITHOUT SPRING SUSPENSION  
1 5/8" --- MI-19112-15  
3 1/8" --- MI-19113-15

Line Size	"A"
1 5/8"	3 3/4"
3 1/8"	5 1/2"

*Hanger Stock No.*  
1 5/8" Line      3 1/8" Line  
MI-19112-15    MI-19113-15

*Description of Hanger*  
A fixed hanger for supporting two parallel transmission lines. Designed for use in clamping lines securely to top of tower, or for other places where an expansion hanger is not required.

## Horizontal Anchors for Supporting Single and Dual Lines

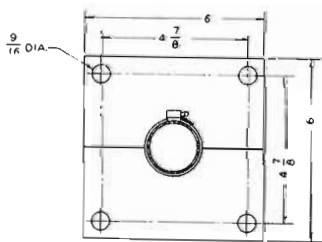

HORIZONTAL ANCHOR  
MI-19312-17

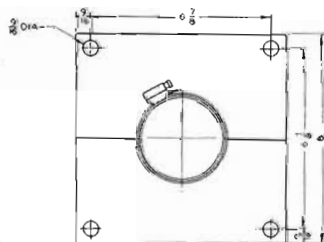

HORIZONTAL ANCHOR  
MI-19313-17

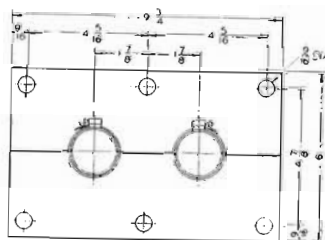

HORIZONTAL ANCHOR  
MI-19312-18

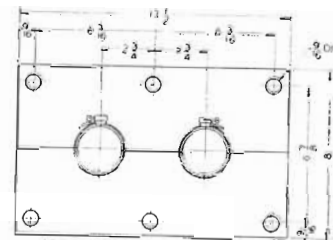

HORIZONTAL ANCHOR  
MI-19313-18

*Anchor Stock No.*

1 5/8" Line      3 1/8" Line  
MI-19312-17    MI-19313-17

*Description of Anchor*

Anchor designed to support a single transmission line at point of entry through a wall. Requires 3 1/2" diameter hole. Anchor plate is furnished in two halves which can be centrally located over hole and bolted in place.

MI-19312-18      MI-19313-18  
Same as above anchor except has two openings for dual lines.

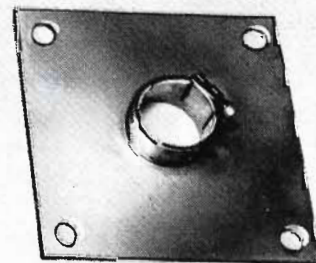

HORIZONTAL ANCHOR  
MI-19312-17 (1 5/8" LINE)  
MI-19313-17 (3 1/8" LINE)

## Lateral Brace for Supporting a Single Line

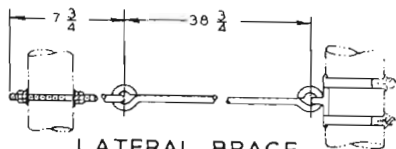

LATERAL BRACE  
MI-19312-36

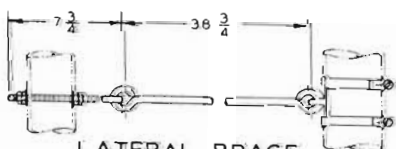

LATERAL BRACE  
MI-19313-36

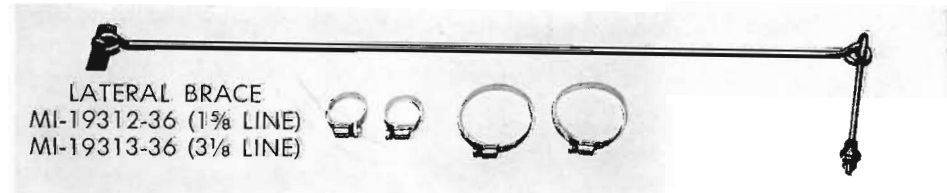

LATERAL BRACE  
MI-19312-36 (1 5/8" LINE)  
MI-19313-36 (3 1/8" LINE)

*Stock No.*  
1 5/8" Line      3 1/8" Line  
MI-19312-36    MI-19313-36

*Description*  
Lateral Brace designed for supporting a single line in any position from tower or building.



# Fixed Hangers for Supporting Single Lines

LINE	MI NO	A
1 $\frac{5}{8}$	19312-40	4 $\frac{9}{16}$
3 $\frac{1}{8}$	19313-40	5 $\frac{5}{16}$

FIXED HANGER  
FLAT MEMBERS

LINE	MI NO	DIA MEMBER	A
1 $\frac{5}{8}$	19312-41	1 TO 2 $\frac{1}{4}$	3 $\frac{7}{8}$
3 $\frac{1}{8}$	19313-41	1 TO 2 $\frac{1}{4}$	4 $\frac{5}{8}$
1 $\frac{5}{8}$	19312-42	2 $\frac{1}{4}$ TO 5	3 $\frac{15}{16}$
3 $\frac{1}{8}$	19313-42	2 $\frac{1}{4}$ TO 5	4 $\frac{11}{16}$

FIXED HANGER  
ROUND MEMBERS

LINE	MI NO	A
1 $\frac{5}{8}$	19312-43	4 $\frac{3}{4}$
3 $\frac{1}{8}$	19313-43	5 $\frac{1}{2}$

FIXED HANGER  
ANGLE MOUNTING

LINE	MI NO	A
1 $\frac{5}{8}$	19312-44	3 $\frac{13}{16}$
3 $\frac{1}{8}$	19313-44	4 $\frac{9}{16}$

FIXED HANGER  
DIRECT MOUNTING

*Dimensions for Fixed Single Line Hangers*

**Description**

The above hangers are designed for supporting single 1 $\frac{5}{8}$ " and 3 $\frac{1}{8}$ " transmission lines in fixed positions. These hangers

differ principally in the hanger mounting assemblies, which are designed for direct mounting, mounting to angular members, round members and flat members.

<i>Hanger Stock No.</i>	
<i>1<math>\frac{5}{8}</math>" Line</i>	<i>3<math>\frac{1}{8}</math>" Line</i>
MI-19312-40	MI-19313-40

*Description*

Fixed hanger (less suspension spring) commonly used to support the upper end of a vertical transmission line. Visc-like clamp secures hanger to any flat member. An adjustable clamp secures the line to the support arm casting. Pivot bolt allows compensation for misalignment of transmission line up to 135°.

MI-19312-41	MI-19313-41	Same as -40 except is designed for mounting to round members 1"—2 $\frac{1}{4}$ " diameter.
MI-19312-42	MI-19313-42	Same as -41 except designed for round members 2 $\frac{1}{4}$ "—5" diameter.
MI-19312-43	MI-19313-43	Same as -40 except designed for mounting to angular members.
MI-19312-44	MI-19313-44	Same as -40 except designed for direct mounting by drilling hole in members.

## Swivel Hangers for Supporting Single and Dual Lines

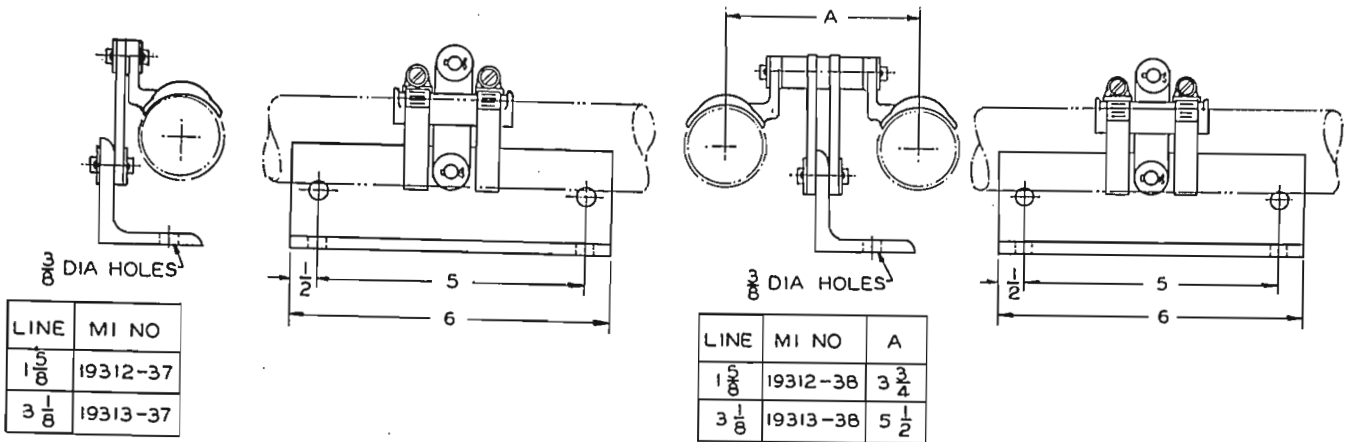

<i>Hanger Stock No.</i>	
<i>1 5/8" Line</i>	<i>3 1/8" Line</i>
MI-19312-37	MI-19313-37

*Description*

Hanger with angle support which can be mounted either vertically or horizontally by means of bolts. A link pivots on the support angle by means of a pin. On the other end of the link is a casting which also pivots on a pin. The casting holds line which is fastened with an adjustable stainless steel clamp. The hanger is designed to take care of uneven terrain, also will take care of expansion on a horizontal run of line.

MI-19312-38	MI-19313-38
-------------	-------------

Same as above except designed for two parallel lines.

## Spreader for Supporting Dual Lines

**Description**

The dual line spreader is a special type of fixed hanger designed to maintain spacing between two parallel transmission lines. The spreader, which consists of a casting with asbestos-lined surfaces, holds the lines firmly in place without scoring

them. Two adjustable stainless steel clamps are furnished to clamp the lines to the casting. Spreader MI-19312-19 is available for dual 1 5/8" lines, and spreader MI-19313-19 for dual 3 1/8" lines.

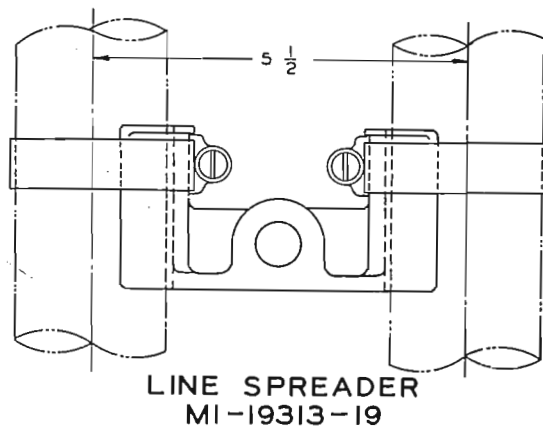
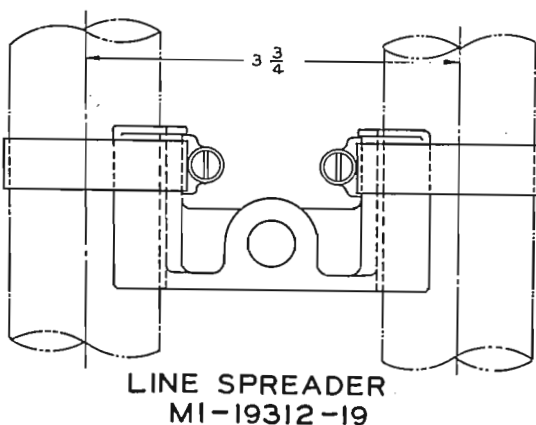



# Coaxial RF Transfer Panel

## Uses

The Coaxial RF Transfer Panel is a custom made item designed to provide a means for manual transfer of TV or FM transmission lines. It provides for transfer of single or dual transmitter lines to an emergency antenna or dummy load. Alternatively, the panel can be connected to provide transfer of the antenna from the main transmitter to an emergency transmitter.

## Description

The panel is designed for overhead mounting in the transmitter room 6½ feet above the floor, preferably behind the transmitter. The location can be selected so that the coaxial lines from the transmitter, diplexers or dummy load can be conveniently routed to the panel.

Switching operations are accomplished by loosening the clamps holding the double elbow assemblies so that the assemblies can be removed and inserted for the desired connection.

The panel is supplied to order, and can be made available for multiple transfer of either single or dual 1½" lines. It is supplied with the necessary elbows, connectors, clamps and hardware for assembly to the underside of the panel.



## Specifications

Line Size and Impedance \_\_\_\_\_ 1½", 51.5 ohms  
 Number of Lines Accommodated \_\_\_\_\_ Custom built for multiple transfer of either single or dual lines  
 Panel Size \_\_\_\_\_ 24" x 24"

# Six Wire Open Transmission Line and Accessories

## Features

- Simplicity.
- Low maintenance cost.
- Open for constant inspection.
- Requires no auxiliary apparatus (dehydrators, gas, etc.).
- High power handling capacity at low cost.

## Uses

The six wire open line is intended for transmission of RF power from the transmitter to the antenna. The six wire line may be used for either phased arrays or non-directional antennas. It is suitable for use at any standard broadcast frequency and is designed for use in all weather conditions.

## Description

Open wire transmission lines when properly designed and constructed, provide high power handling capabilities at low cost. The open wire line is reliable and may be serviced easily. The various RCA transmission line kits simplify the installation of an efficient line suitable for RF powers up to 50 KW. Radiation is made negligible by using a six wire line consisting of two central power conductors surrounded by four grounded conductors. By use of this line configuration, with appropriate spacing between conductors, a characteristic impedance of 230 ohms is obtained which results in an economy of phasing and terminating equipment.

## Specifications

### TRANSMISSION LINE BAYONET INSULATOR

This kit consists of a bracket designed for mounting station post insulator and also supporting the four ground wires of the 6 wire transmission line. It is designed to be mounted on an MI-28013 or other suitable pole. Included are 1 bayonet bracket, 1 insulator, 4 ground wire connectors.

Stock Identification \_\_\_\_\_ MI-19421

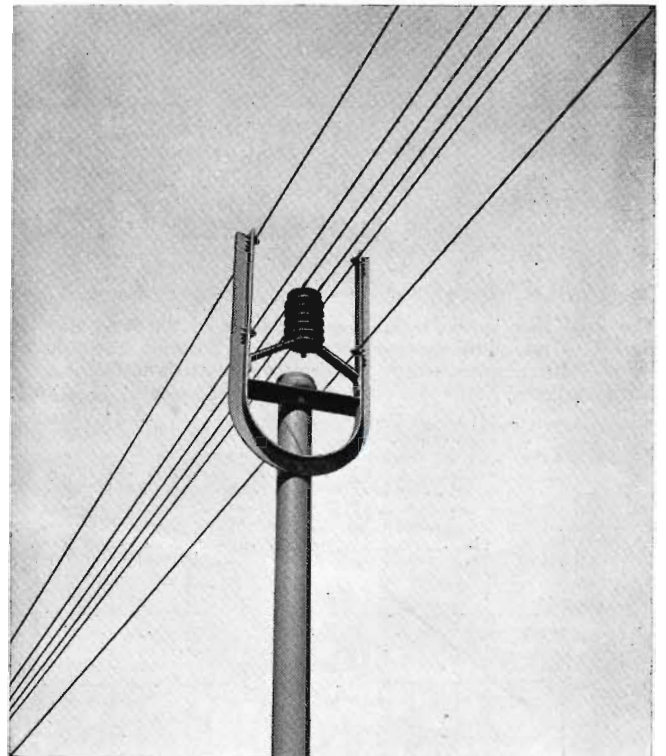

### TRANSMISSION LINE WIRE

Transmission line wire consisting of hard-drawn, stranded, number 6 AWG copper wire may be ordered by the foot in any convenient length.

Stock Identification \_\_\_\_\_ MI-28010

**TRANSMISSION LINE LEAD-IN KIT**

This kit provides lightning protection to transmitter or tuner at the point where the transmission line enters the transmitter or tuner house. Included are horn gap, station post insulator, bracket for mounting insulator, anti-surge inductor, necessary copper tubing for ground and lead-in connections, all necessary hardware.

Stock Identification \_\_\_\_\_MI-28011-A

**TRANSMISSION LINE DEAD-END KIT (USING POLE)**

This kit includes all parts necessary to terminate a 6 wire open line on a 4" steel pole. Wing type ground anchor and guy wire for supporting the pole are also supplied. The pole is not part of this MI. Included are two cross channels, 1 conductor plate, 4 turnbuckles for ground wires, 1 turnbuckle for center conductors, 1 Clevis for eye bolts, 1 insulator, 1 guy wire, 1 wing anchor, necessary clamps, hardware, etc.

Stock Identification \_\_\_\_\_MI-28012-A

**TRANSMISSION LINE DEAD-END KIT (USING BUILDING)**

This kit consists of all parts required to terminating open wire line on the wall of the transmitter or tuner house. Included are one connector plate, 4 turnbuckles for ground wires, 1 turnbuckle for center conductors, 1 Clevis, 1 line connector, 6 dead-end clamps, 1 line insulator, 4 servisleaves  $\frac{3}{16}$ " x  $1\frac{1}{4}$ ", 5 shoulder eye bolts.

Stock Identification \_\_\_\_\_MI-28012-B

**TRANSMISSION LINE POLE AND CAP**

The transmission line pole is a 4 inch diameter steel pole 20 feet long. It is supplied complete with cap to close the upper end and is suitably treated to render it corrosion resistant. It may be drilled at installation for use with either the MI-28012-A pole dead-end kit or MI-19421 bayonet and insulator.

Stock Identification \_\_\_\_\_MI-28013

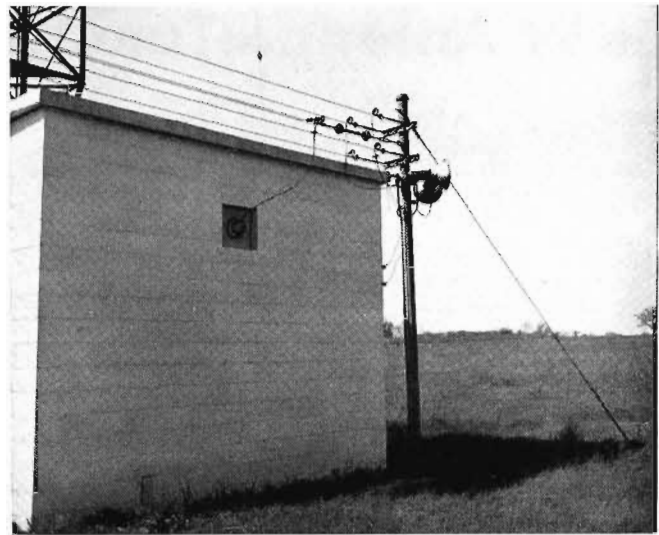

*Typical installation of MI-28012-A Dead-end Kit (using pole)*

**TRANSMISSION LINE BAYONET ACCESSORIES**

This kit consists of rack saddles and bolts necessary to mounting an MI-19421 bayonet and insulator on an MI-28013 pole. Five feet of 080 diameter copper wire for use in wiring transmission line center conductors to the station post insulator is also supplied.

Stock Identification \_\_\_\_\_MI-28014

**LEAD-IN AND GROUND ACCESSORY KIT**

This kit includes 1 plate drilled for mounting an MI-19413-1 entering insulator, 4 line termination clamps, 1 ground strap, (sheet copper  $25\frac{1}{2}$ ' x 4' x .032" thick), 2 terminal lugs  $\frac{1}{2}$ " x  $2\frac{1}{8}$ " .

Stock Identification \_\_\_\_\_MI-28015

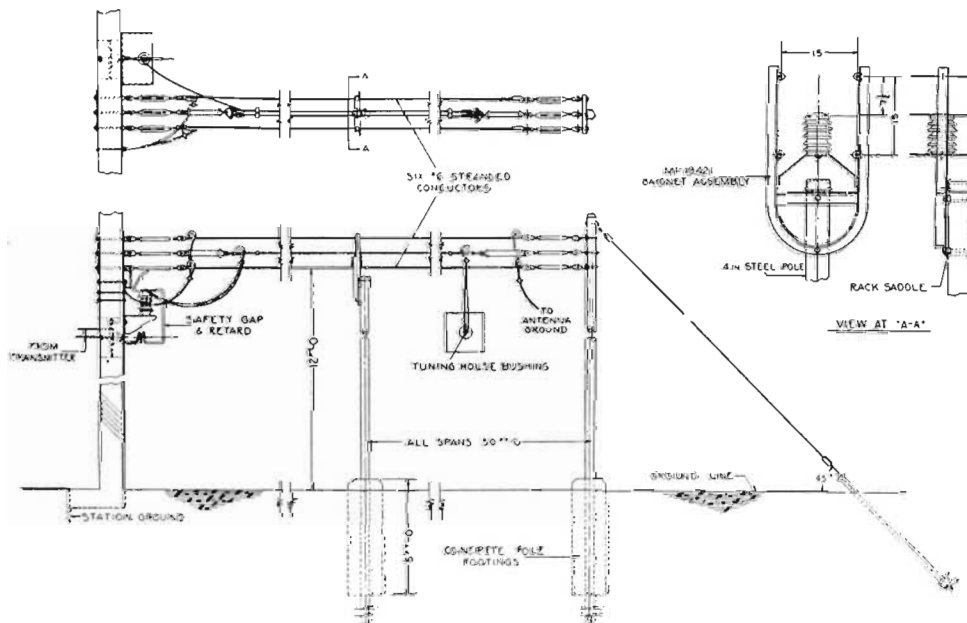



# 1 KW Antenna Tuning Unit, Type BPA-1A

## Features

- Designed for carrier powers up to 1 kw.
- Make-before-break switch reduces damage to antenna ammeter from static discharges.
- Self extinguishing horn type gap protects equipment from lightning.
- Reliable operation—conservatively rated capacitors and inductors.
- Equipment housed in weatherproof metal box with hinged door and lock.
- Designed for quick installation of remote metering kit.

## Uses

The Type BPA-1A Antenna Tuning Unit serves to match broadcast antennas to either concentric or open wire transmission lines and also aids in suppressing carrier harmonics.

## Description

The BPA-1 consists essentially of line terminating and antenna-tuning elements housed in a weatherproof metal box. Access to the interior and component parts of the tuning unit may be had through the front door which is provided with a lock, keys and two pivoting clamps. An opening is provided in the bottom of the housing for entrance

of a concentric tube transmission line, but the unit may also be used with an open wire type of line by addition of a bowl insulator, MI-19406. Provision has been made for ready installation of Remote Metering Kit (MI-28027/MI-28037-A) which will provide for remote indication of antenna current. Electrically, the unit consists of a low-pass impedance-matching filter using a "T" type network.

When ordering, specify: (1) Transmitter carrier power. (2) Transmitter frequency. (3) Antenna resistance and reactance or type and height. (4) Transmission line impedance.

## Specifications

Input Impedance (unbalanced open wire or concentric line) 20-350 ohms  
 Output Matching—Will match any antenna having a reactance of +j500 to -j500 and a resistance of from 25 to 1000 ohms  
 Lightning Protection—Horn type gap and meter protective switch  
 Dimensions 30" x 22" x 16"  
 Weight (unpacked) 67 lbs.  
 Finish Durable gray  
 Stock Identification MI-28901-A

## Accessories

Open Wire Line Bowl Insulator MI-19406  
 Remote Metering Kit MI-28027/MI-28037-A

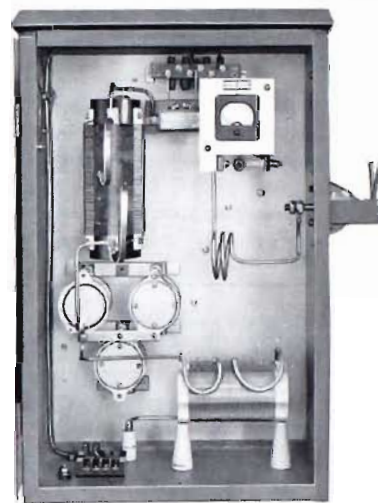

# Remote Metering Kit, BPM-1A

## Description

The BPM-1A Remote Metering Kit provides a means of observing the antenna current at a remote location (transmitter house). Basically the unit is an electrostatically shielded current transformer with an adjustable loop primary coil and a tapped secondary coil in series with a germanium crystal and loading resistor. The taps provided on the secondary coil and the adjustable coupling between that coil and the primary loop provide coarse and vernier control of the remote meter indication. A wide range of antenna currents can be metered from approximately 1 ampere to 30 amperes depending on the operating frequency. The unit has been designed for installation in antenna tuner housings employed with transmitters of 50 kw or less, depending on the voltage and displacement between the primary circuit and grounded faraday shield.

The kit is intended to be used with MI-28037-A or MI-28037 Remote Ammeter; the "A" series meter is a 3" rectangular cased meter while the latter series is a 4" rectangular cased meter. These meters have a 1 ma d-c movement, and are available in various scale ranges to match the scale of the antenna ammeter. When ordering, specify desired meter scale.

## Specifications

### REMOTE METERING KIT

Dimensions 7" high, 7 3/8" wide, 5 3/8" deep

## Sensitivity:

1-30 Amperes at 1600 kc  
 3-30 Amperes at 540 kc  
 Stock Identification MI-28027

## METER

Dimensions 3" and 4" rectangular case  
 Scale Ranges 0-2, 0-3, 0-5, 0-8, 0-10, 0-15, 0-20, 0-30 amps.  
 Sensitivity 1 mc. d-c movement  
 Stock Identification 3" MI-28037-A  
 4" MI-28037

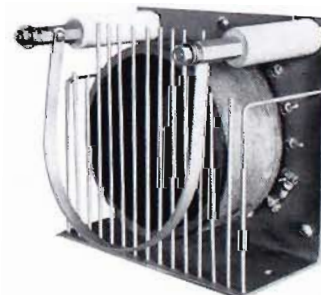

Remote Ammeter MI-7157-D, and Current Transformer

# 5-10 KW Antenna Tuning Unit, BPA-10

## Features

- Designed for carrier powers of 5 and 10 kw.
- Matches open wire or concentric transmission lines to antennas of widely divergent characteristics.
- Built-in monitoring rectifier supplies rectified current for remote antenna meter and furnishes audio voltage for program monitoring and carrier off protection.

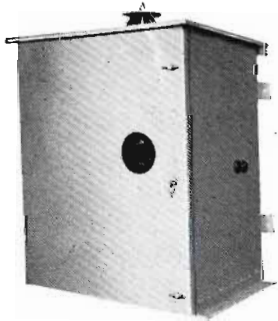

## Uses

The Type BPA-10 Antenna Tuning Unit serves the double purpose of matching broadcast antennas of widely divergent characteristics to either concentric or open-wire transmission lines and of suppressing carrier harmonics.

## Description

All parts of this equipment are enclosed in a weatherproof

metal housing equipped at the front with a door affording ready access to the interior. This door is provided with a lock. The unit is designed for mounting on a wooden platform or a steel angle cradle by means of side flanges at the bottom of the housing. Rear mounting strips also are provided to permit mounting the unit on two upright posts. The Antenna ammeter may be read through a circular window in the door. This meter is protected from lightning surges by a double-throw switch, which is operated by means of a knob extending through the side of the housing. Electrically, the unit consists of a low-pass impedance matching filter using a "T" type network.

A monitoring rectifier unit (MI-7488-A) is contained within the housing to furnish, if desired, audio frequency voltage for program monitoring and rectified carrier current for remote antenna current indication and protective relay operation. Signal energy for operation of this rectifier is obtained from a tuned pickup coil which is coupled to the antenna loading inductor. This energy is rectified in a full wave circuit using an RCA 5V4G tube and the output is balanced to ground for excitation of a monitoring amplifier. For applications where the MI-7488-A Monitoring Rectifier unit is not required the Type BPA-10 Antenna Tuner may be purchased less the rectifier by specifying MI-28902-A. Terminals are also provided for connection to a remote antenna ammeter and interlock relay located in the transmitter house.

The antenna lead-in insulator is located on the top of the unit, and provision is made for mounting a similar insulator (MI-19413-1 bowl insulator) on the left hand side of the housing in case an open-wire line is used. A hole is provided in the bottom of the cabinet for bringing in a concentric line. When ordering specify:

1. Transmitter carrier power
2. Frequency
3. Antenna resistance and reactance
4. Transmission line impedance

## Specifications

Operating Limits  
 Carrier Frequency \_\_\_\_\_ 540 to 1700 kc  
 Transmitting Power (maximum) \_\_\_\_\_ .10 kw  
 Input Impedance  
 (unbalanced open wire or concentric line) \_\_\_\_\_ 40-350 ohms  
 Antenna Resistance (approximately) \_\_\_\_\_ 20 to 1100 ohms

Antenna Reactance \_\_\_\_\_ +J500 to -J500  
 (can be extended in a positive direction by the addition of a series capacitor; and in a negative direction if operating from a line of lower impedance than the antenna resistance.)

## Monitoring Rectifier

Output Impedance  
 (Balanced) \_\_\_\_\_ designed to operate into a 500 ohm line  
 Note: Load should be bridging with not less than 20,000 ohms d-c resistance.

Output Level to 500 ohm line

At 5-10 kw Output \_\_\_\_\_ +17 dbm\*

At 1 kw Output \_\_\_\_\_ +11 dbm\*

## Rectified Current

75 ma d-c maximum into a maximum of 1000 ohms

Audio Frequency Characteristic (50 to 10,000 cycles) \_\_\_\_\_ ±2 db

Power Supply (230 volts, 60 cycles) \_\_\_\_\_ approx. 12 watts

Tube Complement (monitoring rectifier) \_\_\_\_\_ 1 RCA 5V4G

Type Antenna Meter (scale range determined at time of installation) \_\_\_\_\_ Weston Model 425

## Dimensions

Height \_\_\_\_\_ 44"

Width \_\_\_\_\_ 34"

Depth \_\_\_\_\_ 23"

Weight (unpacked) \_\_\_\_\_ 330 lbs.

Finish \_\_\_\_\_ Durable grey

## Stock Identification

(with MI-7488-A monitoring rectifier) \_\_\_\_\_ MI-28902-B

(less MI-7488-A monitoring rectifier) \_\_\_\_\_ MI-28902-A

## Accessories

Tube Kit (1 Type 5V4G) \_\_\_\_\_ MI-7321

1 Bowl Insulator (required for open wire lines) \_\_\_\_\_ MI-19413-1

1 Remote Antenna Meter for Console (MI-11616)

Mounting \_\_\_\_\_ MI-19889

\* dbm = db level above one milliwatt reference when single frequency tone modulation is used.

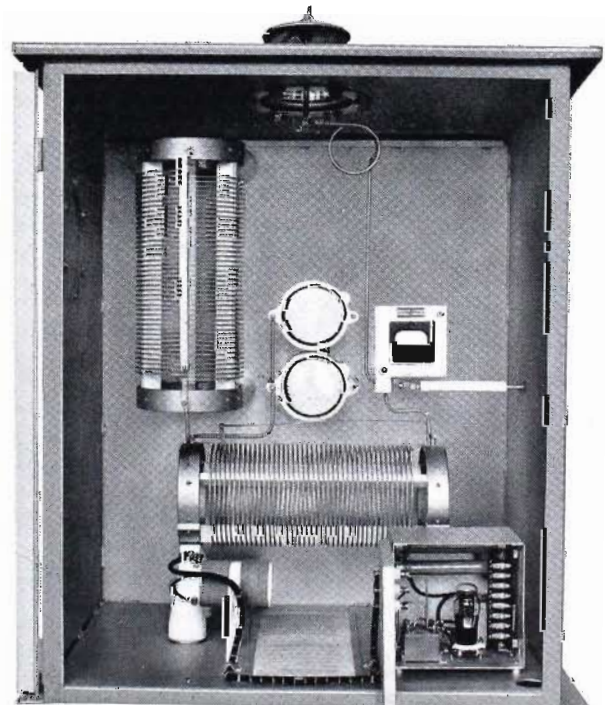

Interior view of BPA-10 with MI-7488A Monitor Rectifier



# 50 KW Antenna Tuning Equipment, Type BPA-50

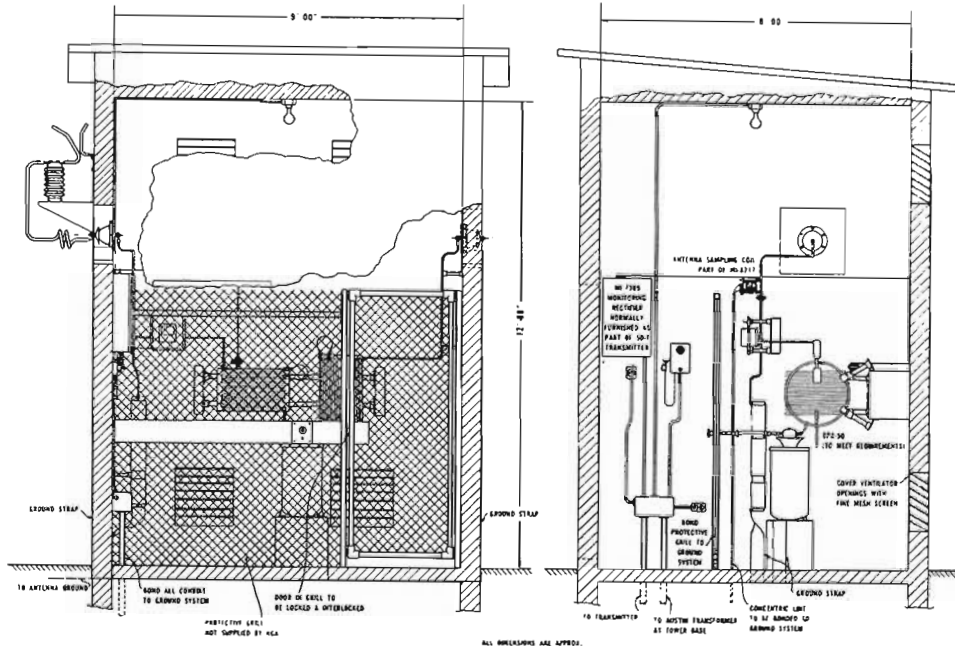

**Features**

- Matches open wire or concentric transmission lines to antennas of widely divergent characteristics.
- Self extinguishing horn gap helps protect equipment from lightning surges.
- Oversize capacitors and inductors for reliable operation.
- Static drain choke supplied.

**Uses**

The type BPA-50 antenna tuning equipment serves to match broadcast antennas of widely divergent characteristics to either concentric or open-wire transmission lines at powers up to 50 kw.

**Description**

The type BPA-50 antenna tuning equipment is designed to be mounted in a tuner house at the base of the antenna tower. The tuning equipment does not include the tuner house, but all the necessary electrical components, brackets, wiring material and hardware are supplied. Complete blueprints, diagrams and instructions for assembly of the tuner are also included.

Electrically, the BPA-50 consists of a low-pass impedance-matching filter using a "T" type network. The large series arm coils are made of heavy silver-plated copper tubing, and are conservatively rated. The shunt leg capacitors are normally of the gas or vacuum variety, although mica capacitors are used when very large capacitance values are required.

A monitoring rectifier unit, MI-7488-A, may be purchased separately to furnish audio frequency voltage for program monitoring and rectified carrier current for remote antenna current indication and protective relay operation. A similar monitoring rectifier, MI-7389, is supplied as standard equipment with the RCA type BTA-50F1 transmitter.

The antenna ammeter is protected from lightning surges by a double-throw switch which cuts the meter out of the circuit.

**Specifications  
TUNER**

Operating Limits:

Carrier Frequency	_____	550-1700 kc
Transmitter Power (maximum)	_____	50 kw
Input Impedance (unbalanced open wire or concentric line)	_____	40 to 350 ohms
Antenna Resistance (approximately)	_____	20 to 1100 ohms
Antenna Reactance	_____	+j500 to -j500
(Can be extended in a positive direction by the addition of a series capacitor; and in a negative direction if operating from a line of lower impedance than the antenna resistance.)		
Space Requirements	_____	Approximately 70 sq. ft. floor area with 10 ft. ceiling
Net Weight (approx.)	_____	500 lbs.
Stock Identification:		
For 230 Ohm Line	_____	MI-28903-A
For 70/51.5 Ohm Line	_____	MI-28903-B

**Accessories**

Extra Bowl Insulator	_____	MI-19413-1
Monitoring Rectifier	_____	MI-7488-A
Tube Kit (1 RCA 5V4G)	_____	MI-7321

# Antenna Towers

RCA is a representative of antenna towers for all prominent manufacturers. A wide selection of towers is available for all applications. These include standard self-supporting and guyed designs as well as custom made designs. Towers are available for use as radiators in directional arrays, and for supporting combinations of FM Pylons and TV Super Turnstiles.

RCA can also furnish tower lighting equipment and tower erections, if desired. This may include erection and installation of FM or TV antennas and associated transmission lines. Complete ground systems can be furnished if required.

Price and delivery quotations for towers and services may be obtained by forwarding essential information to RCA. The following questionnaire is provided as an aid to the station in determining specific requirements.

## Antenna Tower Questionnaire

### LOCATION

City \_\_\_\_\_ State \_\_\_\_\_

### QUOTATIONS TO BE FURNISHED

Tower Guyed \_\_\_\_\_ ( )  
 Self-Supporting \_\_\_\_\_ ( )

#### Tower Erection:

Antenna and Harness Installation: FM \_\_\_\_\_ ( )  
 TV \_\_\_\_\_ ( )

Transmission Line Installation \_\_\_\_\_ ( )

Lighting Equipment \_\_\_\_\_ ( )

### SPECIFICATIONS

Tower Height: Ground to top of tower \_\_\_\_\_  
 Ground to top of base insulator \_\_\_\_\_

Tower Use: Antenna support \_\_\_\_\_  
 AM Radiator \_\_\_\_\_

AM Power \_\_\_\_\_ KW

Frequency \_\_\_\_\_ kcs.

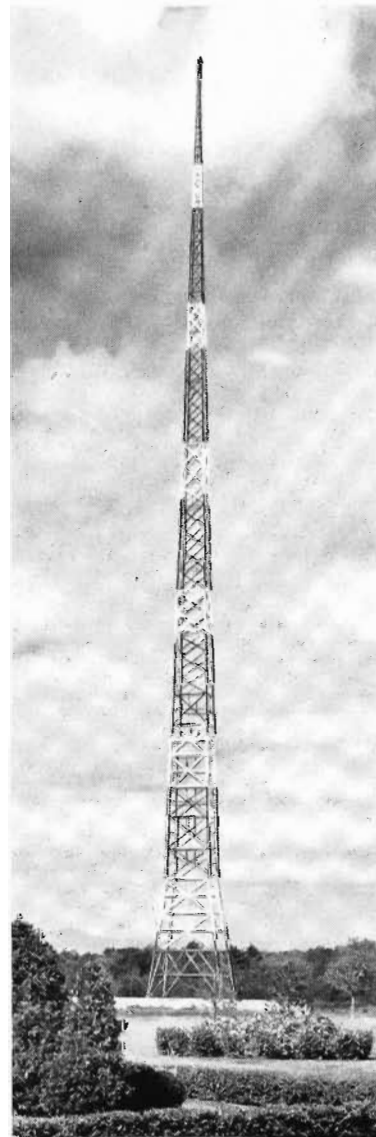

FM Antenna: Type \_\_\_\_\_  
 Description \_\_\_\_\_

TV Antenna: Type \_\_\_\_\_  
 Description \_\_\_\_\_

Transmission Lines:  
 Size \_\_\_\_\_ Nr. \_\_\_\_\_

Design Load: B-1 Open Country \_\_\_\_\_  
 B-2 Congested Area \_\_\_\_\_

Remarks:  
 (Special requirements, site accessibility, etc.)



# Austin Tower Lighting Transformers

## Features

- Independent of frequency. No tuning adjustments.
- No housing required—eliminates leakage losses.
- Trouble-free operation under all conditions.
- Excellent regulation and efficiency.
- Cost is comparable to other types of tower lighting units.

## Uses

The Austin insulating transformer is a device for supplying a-c power to the lighting circuits of an insulated or section-alized radio tower. Being independent of frequency, the same transformer may be used for any radio frequency and for a wide range of transmitting power.

## Description

The Austin insulating transformer provides the radio engineer with a means of supplying current to tower lighting circuits which is more efficient, reliable and easier to install than other types of tower lighting filters. The transformer consists of ring type windings with a clear air gap between primary and secondary rings. This type of construction makes the Austin transformer independent of radio frequency and therefore it requires no tuning or adjustment. Since the windings are fully enclosed, no transformer housing is required, and the air gap between primary and secondary rings eliminates the possibility of surface leakage which may be appreciable in the housing covering other types of tower lighting filters. The total capacity added at the tower insulating zone is of the order of a very few micro-microfarads which produces only a slight effect upon the radio frequency circuit, and is constant under all weather conditions.

Installation is simplified since the Austin transformer requires no housing, chokes or filters. The primary of the transformer is usually attached to the base of the tower insulator or pier supporting the insulator. The secondary is supported by a conduit attached to the top of the insulator or to the tower above the insulator.

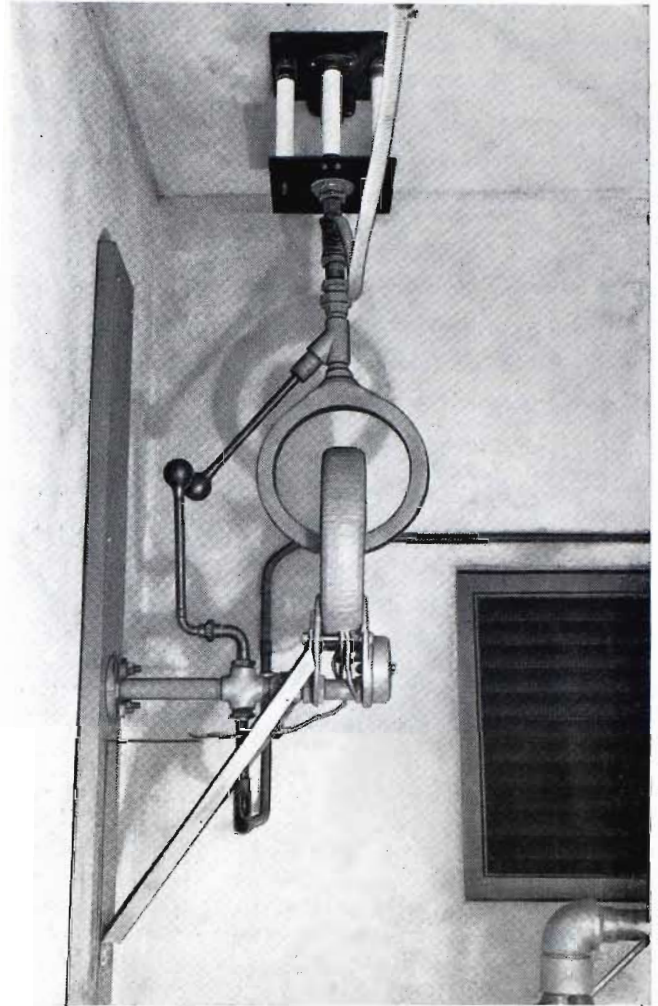

*Typical Installation of an Austin Tower Lighting Transformer*

Austin tower lighting transformers are available in sizes ranging from 700 watts to 7 kw. The larger sizes may be used to furnish extra energy for lighting neon or other signs on the tower, or for de-icing.

## Specifications

Type	Primary Voltage	Secondary Voltage	Capacity	Secondary Taps	Net Weight
A-2101	115/230	115	1 to 1.75 kv.	None	85 lbs.
A-1971	115/230	115	2 to 3 kv.	10% over volt.	201 lbs.
A-2815	115/230	115/230	3 to 7 kv.	None	300 lbs.

## Stock Identification:

A-2101	_____	MI-28215-1
A-1971	_____	MI-28215-2
A-2815	_____	MI-28215-3

# Bowl Insulator, MI-19413-1/3



For transmitter carrier powers up to and including 50 kw, this insulator assembly is ideal for taking r-f leads into or out of antenna tuner or phasing equipment.

The insulator comes complete with corona ring, lead in stud, and all mounting hardware.

The same bowl insulator is available with a hollow stud, for

use where it is necessary to carry power lighting wires out of the tuner house on the same insulator which carries the r-f conductor.

### Specifications for Solid Stud Insulator

Dimension:

Flange Diameter	8 3/4"
Bolt Circle Diameter	7 3/4"
No. of Mounting Studs	6 spaced equidistantly
Lead in Stud Size	3/8" diameter, 8 1/2" long
Height (approx.)	6"
Unpacked Weight	11 3/4 lbs.
Stock Identification	MI-19413-1

### Specifications for Hollow Stud Insulator

Dimension:

Same as MI-19413-1 except the stud is made from 3/4" 14 NPSL—4 pipe nipple. This stud is 3" long with a 1" O.D. and .8" I.D.

Stock Identification	MI-19413-3
----------------------	------------

# Bowl Insulator, MI-19406

This insulator is recommended for antenna tuner or phasing equipment r-f lead-ins for carrier powers up to and including 1 kw. The insulator comes complete with all mounting hardware and lead-in stud.

### Specifications

Flange Diameter	5 1/4"
Bolt Circle Diameter	4 5/8"
No. of Mounting Studs	6 equally spaced
Lead-in Stud Size	1/2" diameter, 6" long
Unpacked Weight	2 1/8 lbs.
Stock Identification	MI-19406

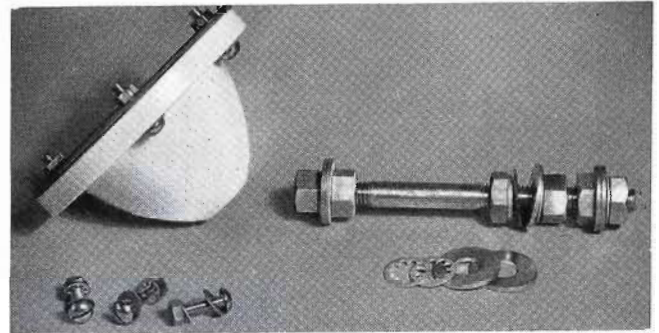

# Antenna Lighting Choke Coil, Type BPC-1A

### Uses

In broadcast transmitter installations where the tower itself forms the antenna, special transformers or radio frequency choke coils must be employed to feed power to the lighting circuits on the tower. Type BPC-1A antenna lighting choke coil has been designed for this purpose. Its electrical characteristics are such that it presents a low impedance to commercial lighting frequency and a high impedance to the radio frequency in the broadcast range. It, therefore, provides a means for supplying energy to the tower lighting circuits and at the same time prevents any appreciable loss of r-f energy supplied to the tower by the radio transmitter.

Diameter \_\_\_\_\_ 4"

Stock Identification \_\_\_\_\_ MI-7112-A

Accessories:  
Capacitors .01 MFD \_\_\_\_\_ UC3004

### Description

The coil consists of a double winding on a bakelite form. The windings are coated with an insulating varnish which binds the turns together and prevents moisture absorption. This coil, however, must be protected from the weather by installing it within some weatherproof enclosure. Such an enclosure or housing is not provided with the unit. The natural resonant frequency of the coil is well removed from any frequency within the broadcast band. Its characteristics, therefore, are such that it presents a relatively high impedance in the order of several hundred ohms to all broadcast frequencies. All windings that are not directly connected to the tower or ground should be properly bypassed by suitable capacitors as illustrated.



### Specifications

Maximum Continuous Current (50/60 cycles)	15 amperes
D-c Resistance (total both windings)	Approx. .314 ohms
Inductance at 1 mc.	360 microhenries
Length	11 5/8"

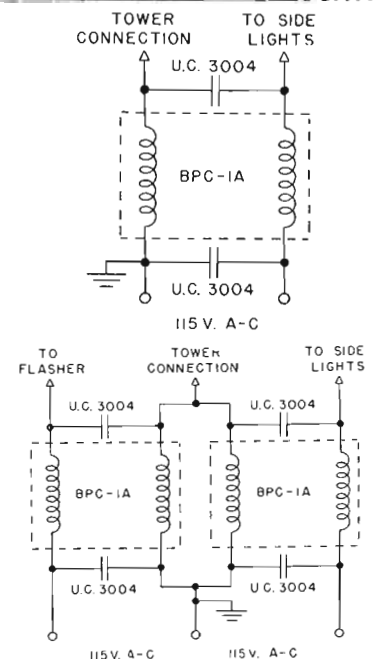



**RCA Field-Intensity Meter**  
**Type WX-1A**  
**50 to 220 Mc**



**NEW** *field-intensity meter*

**—for the television and FM bands**

**SPECIFICATIONS**

- Freq. Range . . . . . 50 to 220 Mc
- Sensitivity . . . . . 5 microvolts to 20 microvolts/meter, depending on frequency
- I-F Bandwidth . . . . . 150 kc
- FM Adjacent Channel Selectivity . . . . . 65 to 1
- FM Band Image Ratio . . 130 to 1
- Power Supply . . . . . Built-in 6-v, voltage-regulated (a-c power supply also available)
- Weight
  - Meter . . . . . 43½ lbs.
  - Antenna (including tripod) . . . . 15 lbs.
- Size . . . . . 19" L x 14½" H x 13" D

THE WX-1A meets the strict requirements of FM and TV engineers for a field-intensity meter of laboratory accuracy covering television, FM, and AM services between 50 and 220 Mc. Its high sensitivity permits minimum readings ranging from as low as 5 microvolts per meter at 50 Mc, to 20 microvolts per meter at 200 Mc.

Completely self-contained, the WX-1A includes a very stable superheterodyne receiver. Selectivity characteristic is down 65 to 1 on adjacent FM channels. Image ratio is 130 to 1 at 100 Mc. A 2-stage audio amplifier drives a built-in loudspeaker for continuous audio monitoring of the signals being measured.

Separate output terminals provide for convenient use with the standard Easterline-Angus recorder. The built-in vibrator power supply includes its own voltage regulator. The antenna . . . furnished with each WX-1A...is adjustable for horizontal or vertical polarization.

For accurate data on the service area of any TV, FM, or AM station in the uhf —and for authoritative coverage information for FCC proof-of-performance—the WX-1A is second to none. Complete details are available from your RCA Broadcast Sales Engineer. Or from Dept. 191B, RCA Engineering Products, Camden, N. J.

# **TEST AND MEASURING EQUIPMENT**

	<b>Page</b>
<b>MEASURING EQUIPMENT</b>	<b>338</b>
<b>MONITORING EQUIPMENT</b>	<b>353</b>
<b>SERVICE TEST EQUIPMENT</b>	<b>362</b>



# Field Intensity Meter, Type WX-1A



## Features

- High sensitivity—varies from 10 uv per meter at 100 mc to 100 uv per meter at 200 mc—for full scale reading. Better than 10 uv per meter below 100 mc.
- High selectivity—adjacent FM channel down 65 to 1.
- Stable meter reading—unaffected by modulation.
- Image ratio at least 130 to 1 at 100 mc.
- Suitable for AM, FM and TV measurements—frequencies up to 220 mc.
- Built-in vibrator power supply with voltage regulator—provision made for a-c power supply.
- Output for standard Esterline-Angus recorder.
- Built-in speaker eliminates need for headphones.
- Simultaneous measuring and speaker monitoring of all frequencies, including FM.

## Uses

The model WX-1A Field Intensity Meter is especially designed to provide an accurate, self-contained, easy-to-operate instrument for the measurement of radio-frequency field intensities in the range of 50 to 220 megacycles. It is suitable for AM, FM and Television measurement use. The frequency range covers those frequencies assigned to black and white television and FM broadcasting—as well as frequencies, lying within the limits of 50 to 220 mc, that are assigned to aeronautical and other public services.

## Description

The WX-1A is a very sensitive, stable and selective super-heterodyne receiver equipped with an accurate attenuator and output indication system. Receiver gain is standardized by means of a calibrating oscillator and associated voltmeter. A dipole antenna, furnished as part of the standard equipment, picks up the signal to be measured. The receiver compares the antenna voltage with a standard signal calibrating voltage. Attenuators in both R-F and I-F circuits vary the receiver sensitivity in decade steps and serve as a multiplier for the meter.

Signal levels as low as 5 mv/m at 50 mcs and 20 mv/m at 200 mc can be satisfactorily measured. At intermediate frequencies, minimum measureable signal levels are proportional.

The WX-1A provides an extremely stable meter reading which is unaffected by modulation—a condition often present in instruments of ordinary design where limiters cannot be used and round nosed IF response characteristics result. Consequently, in some systems wide frequency excursions extending beyond the flat portion of the response characteristic result in amplitude modulation of the output. In the design of the WX-1A, precautions have been taken to *eliminate the occurrence of this condition.*

A separate, built-in, thoroughly-shielded calibrating oscillator is provided and a voltmeter is used to indicate its output. Calibration is convenient and reliable throughout the range of frequencies covered by the WX-1A. In this instrument, it is not necessary to adjust the output of the calibrating oscillator to find any fixed value. It is necessary only to adjust receiver gain to a point where the output meter indication remains unchanged when a front-panel push-button switch is actuated, thus providing an easier more rapid procedure than with other methods. During calibration the antenna is automatically disconnected from the receiver and it is possible to calibrate in the presence of strong signals without detuning the receiver or moving antenna to its null.

One stage of amplification at the signal frequency is provided which functions on all ranges of the receiver. This, together with the use of a high intermediate frequency, combines to reduce interference troubles. Without these features, FM measurements would prove increasingly difficult as the band becomes more congested.

The WX-1A is designed for use with a 6-volt storage battery. In mobile use the car battery may be used; in portable use a small motorcycle-type, 6-volt battery (not furnished) provides a convenient source of power. The battery actuates a shielded built-in vibrator power supply which is equipped with a voltage regulator.

The power supply is easily removable to allow the substitution of a 110-volt 60-cycle, a-c supply which is available as extra equipment. This feature facilitates the use of the WX-1A at a fixed location where a-c power is available.

Provision is made for both AM and FM reception. A two-stage audio amplifier feeds a built-in miniature dynamic speaker. This permits continuous audio monitoring of the received signal without the use of headphones. Thus, FM signals may be measured and monitored at the same time.

Provision is made in the WX-1A for convenient use with the Esterline-Angus Model AW instrument for mobile recording without the need for external multipliers or shunts. The Clarke Instrument Corp. Model 110 Mobile Recording assembly is available for driving this recorder from the speedometer shaft of an automobile. Everything needed is provided in the assembly except the recorder which may be obtained from Esterline-Angus. AVC is employed in the receiver for recorder use. As a result, recording is possible over a signal range of 100 to 1 without changing attenuator steps.

The antenna system furnished consists of a mounting tripod which supports a dipole antenna. Antenna elements are adjustable and may be locked at any desired length. Antenna elements are permanently fastened to the top of the antenna structure and may be folded parallel to the supporting structure while being transported. A calibrated frequency scale for 30 mcs and above is engraved on the support member to facilitate rapid adjustment of elements to the proper length without the use of auxiliary measuring devices. Elements snap into a horizontal position without the aid of fastening devices of any kind. For measurement of vertically polarized signals, an additional support member is furnished. This enables the feed cable to be run at right angles to the axis of the antenna before it is run vertically down to the field strength meter.

**Specifications**

Frequency Range \_\_\_\_\_ 50 to 220 megacycles  
 Sensitivity \_\_\_\_\_ 5 uv to 20 uv/meter depending on frequency  
 I-F Bandwidth \_\_\_\_\_ 150 kc  
 FM Adjacent Channel Selectivity \_\_\_\_\_ 65 to 1  
 FM Band Image Ratio \_\_\_\_\_ 130 to 1  
 Power Supply \_\_\_\_\_ Built-in 6 volt, voltage regulated  
 (a-c power supply also available)  
 Antenna \_\_\_\_\_ Dipole mounted on tripod for vertically or  
 horizontally polarized signals  
 Weight:  
 Meter \_\_\_\_\_ 43½ lbs.  
 Antenna \_\_\_\_\_ 15 lbs.  
 Size, overall:  
 Length \_\_\_\_\_ 19"  
 Height \_\_\_\_\_ 14½"  
 Depth \_\_\_\_\_ 13"  
 Stock Identification \_\_\_\_\_ MI-30001-A

**Accessories Available**

- (a) Clarke Instrument Corp. Mobile Recording Assembly \_\_\_\_\_ Model 110
- (b) A-c Power Supply \_\_\_\_\_ MI-8293

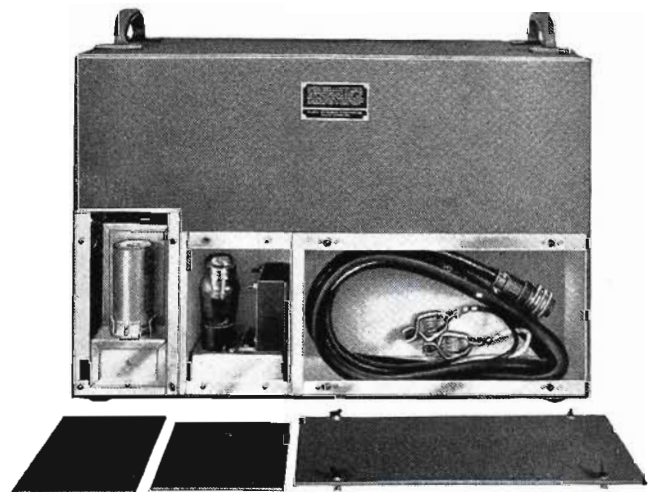

*Rear view of WX-1A with cover plates removed. Compartments left to right are: Removable Vibrator Power Supply, Voltage Regulator and Filter, and cable and storage compartment.*



**RCA Type WX-2C**  
**540-1600 kc.**



The new Portable Field-Intensity Meter, RCA Type WX-2C shown one-third actual size. A loop antenna is built right into the lid!

## a truly portable Field-Intensity Meter

● Weighing only 12½ pounds—including batteries, here's a small, compact field-intensity meter of high accuracy that carries around like a portable radio . . . and operates almost as simply. You tune in a signal, adjust a *built-in* calibrating oscillator and receiver gain . . . and *read signal intensity directly in microvolts-per-meter*. No charts, curves, or correction factors to worry about. No computations to make.

Designed with a wide sensitivity range of 10 microvolts/meter to 10 volts/meter, Type WX-2C enables you to make field-strength readings anywhere—from the very shadow of your transmitter, to the toughest location "down-in-the-

noise." Plenty of front-end selectivity, too. Loop antenna Q is approximately 100 at one megacycle; An r-f amplifier stage provides a very high order of image rejection.

Power supply; Ordinary flashlight dry cells for the quick-heating tube filaments—and a 67-volt battery of the size used in camera-type radios for the B supply.

A lot easier now to get the facts on your coverage, service area, and antenna efficiency . . . with RCA's new portable WX-2C. Ask your RCA Broadcast Sales Engineer for the facts. Or write Department 19-HB, RCA Engineering Products, Camden, New Jersey.



# Field Intensity Meter, Type WX-2C

## Features

- Truly portable—Weight, approximately 12½ lbs. including batteries—Size approximately 12" x 8½" x 5½".
- Reads directly in microvolts per meter—No correction factor charts are needed.
- Stable in operation—Calibrates readily in presence of strong fields.
- Wide sensitivity range—10 uv/meter to 10 volts/meter.
- Accurate—Built-in calibrating oscillator.

## Uses

The type WX-2C Intensity Meter is a small, accurate and truly portable instrument, especially adapted for field use by Broadcast Station Engineers and Consultants. Designed for battery operation, it provides for a wide range of measurement (10 v/meter to 10 uv/meter) in conducting broadcast band (540 to 1600 kc) field intensity surveys. It makes possible close-in measurements on high-powered directional arrays, as well as interference studies where very low signal strengths are encountered.

## Description

Type WX-2C Field Intensity Meter is direct reading in microvolts per meter without the aid or necessity of charts, curves, correction factors, or computations of any kind. In the WX-2C, a statically shielded, unbalanced loop is used as an integral part of the instrument cover. The loop has only a few turns, thus the natural resonant frequency is very much higher than the highest frequency in the operating range. The high side of the loop is loaded with a high "Q" coil to provide the total inductance required for the operating range. Injection of the calibrating voltage into the loop circuit is by means of a small toroidal-wound inductance. The "Q" of the loop circuit is approximately 100 at one megacycle. This high "Q", plus the use of a stage of radio frequency amplification, results in a very high order of image rejection. This feature is desirable since the large increase in the number of stations in some localities has made the use of field intensity meters having insufficient front-end selectivity impractical. By careful design, other spurious responses, such as IF harmonics, have been greatly reduced. The use of crystal diodes for metering purposes eliminates the meter errors due to varying cathode voltages on thermionic rectifiers. The crystals are used in special circuits which swamp out variations due to temperature, etc. The meter will indicate accurately with filament voltages as low as one volt and plate voltages as low as 45 volts.

Ordinary flashlight cells, obtainable everywhere, are used for the filament. A 67-volt battery of the size in common use in small camera-type radios is used for plate supply. The total plate drain of the receiver is 8 ma. The filament drain is 300 ma. Separate batteries are used for the calibrating oscillator. All batteries are carried in a compartment accessible through a door in the rear of the instrument. Provision is made for checking battery voltages with the same meter as used for field intensity indication.

All tubes are quick-heating filamentary types so that the WX-2C stabilizes within a few seconds, thus it is not necessary to keep the instrument operating between readings.

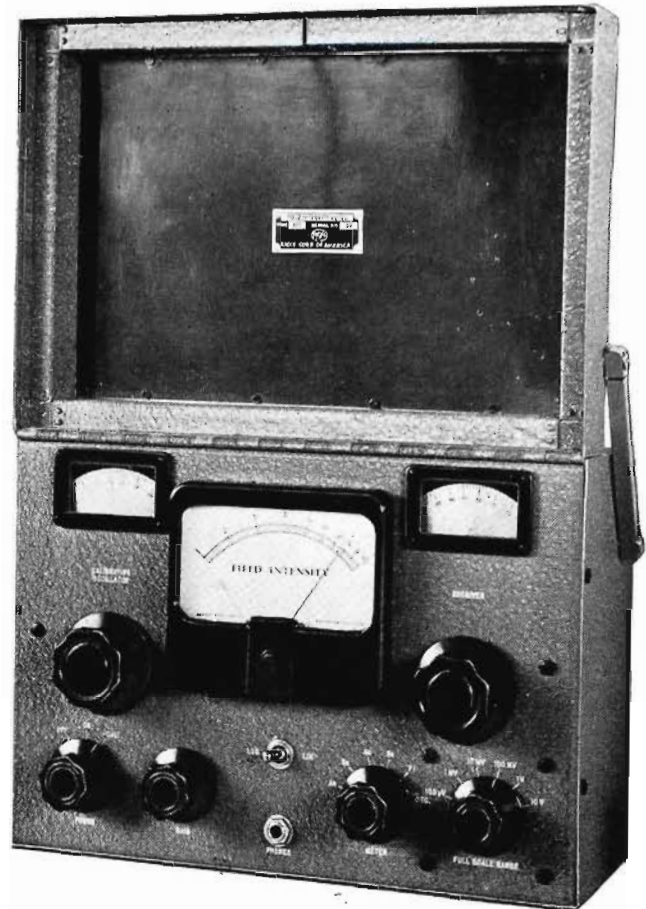

The direct reading feature of the WX-2C simplifies field intensity measurements and eliminates the needs of the usual attenuator readings, meter readings and multiplication factors. A wide sensitivity range, 10 volts per meter to 10 microvolts per meter, permits maximum flexibility of operation within the range of 540 to 1600 kc.

Despite its small size and compactness, nothing has been sacrificed in the way of quality or workmanship. Components of the highest quality are used throughout. The design is such that all components are accessible. Broadcast Station Engineers and Consultants will find that it offers extreme flexibility in use and fills a long-felt need for a light-weight, portable instrument.

## Specifications

Frequency Range	_____	550-1600 kc
Sensitivity	_____	10 uv/m to 10 v/m (all frequencies)
Power Supply	_____	(not supplied with equipment) 2 67½ VB—5 1½ unit cells (RCA VS016)—(RCA VS001)
Antenna	_____	Built in loop with electro-static shield
Weight	_____	12.6 lbs.
Size	_____	9" high, 13" wide, 5¼" deep
Stock Identification	_____	MI-30002-C



# Field Intensity Meter, Type 301-B (High Frequency)



### Features

- Measures AM and FM carrier strength.
- Range — 18-125 Mc.
- Sensitivity — 10 microvolts per meter at 18 Mc.
- Complete with power supply and antenna.

### Uses

The Type 301-B Field Intensity Meter has been designed for measuring field intensities of FM or AM stations operating in the frequency band of 18 to 125 megacycles. It is ideal for checking antenna efficiency, directivity and service range and for research and propagation studies. It provides either linear or logarithmic output and may be used in conjunction with a standard recording meter for making records of variation in signal intensity. It is intended particularly for field use and is arranged for convenient operation and for carrying from one location to another.

### Description

The RCA High-frequency Field Intensity Meter consists of three units—the field intensity meter unit—the power supply—and an accessory case.

It contains a local oscillator providing a source of calibrating voltage. Calibration curves on the line and doublet antenna are supplied so that readings may be converted into field intensity values. The frequency range of 18 to 125 megacycles is covered in three bands. The minimum readable field strength varies from 10 microvolts per meter at 18 megacycles to 50 microvolts per meter at 125 megacycles. The output indicating meter is a four-inch instrument and will provide indications which are either linear or logarithmic.

A separate FM detector is provided for identification of FM stations without detuning the instrument.

A recording milliammeter having a sensitivity of 5 milliamperes and a resistance up to 560 ohms maximum may be operated directly from the instrument. A jack is provided for headphones. Noise meter readings may be taken of the noise level to indicate interference which may be encountered from various industrial sources.

The power supply unit contains a storage battery and regulated vibrator system designed to operate continuously for 8 hours.

The accessory case contains an insulated tripod on the top of which is mounted a dipole adjustable in length for the frequency being measured.

### Specifications

Field Intensity Meter—Height 13"; width 20 $\frac{3}{8}$ "; depth 9 $\frac{1}{4}$ "; weight 38 lbs.

Accessory Case—Length 39"; height 12"; depth 7 $\frac{3}{8}$ "; weight 24 lbs.

Battery Unit—Height 14 $\frac{1}{4}$ "; width 13 $\frac{1}{4}$ " depth 7 $\frac{1}{4}$ "; total weight 36 lbs.

Frequency Range—18 to 125 megacycles

Field Intensity Range at 18 Mc—10 to 500,000 u.v. per meter

Field Intensity Range at 125 Mc—50 to 2,500,000 u.v. per meter

### Output Scales

Linear—10 to 1 or 20 db

Logarithmic—100 to 1 or 40 db

### Output

Audio—Phones or noise meter

Recorder—Operates any recorder of 5 ma and 560 ohm maximum resistance

Antenna—Doublet in 6 sections

R-f Transmission Line—Length 30'

Vibrator Power Supply—6 volts at 4 ampere load

### TUBE COMPLEMENT

2 RCA 955

1 RCA 954

3 RCA 6SG7

1 RCA 6H6

1 RCA 6R7

# Field Intensity Meter, Type 308-B

## Features

- Direct readings in microvolts-per-meter.
- An accuracy independent of non-linear detectors and panel-meter scales.
- Wide frequency and amplitude ranges.
- Shielded loops for magnetic pickup.
- Simplified tuning by ganged controls.

## Uses

The 308-B, an entirely portable instrument, measures field strengths from 20 microvolts-per-meter up to 20 volts-per-meter. This wide range enables field surveys to be made practically anywhere, from the very shadow of the transmitting antenna to the most "down-in-the-noise" location—a welcome advantage in adjusting directive arrays and exploring radiation patterns.

## Description

The 308-B is a sensitive superheterodyne receiver with a built-in calibrating oscillator for standardizing the receiver sensitivity. A shielded, unbalanced loop picks up the signal to be measured.

Due to the design of critical components such as the r-f and i-f attenuators and the mutual-inductance coupler, which couples the calibrating signal to the input circuit of the receiver, measurements can be obtained with an accuracy that is considerably better than has been obtained in the past. For example, it is not necessary to know the exact frequency of the incoming signal in order to measure it accurately; moreover, the instrument can be calibrated on a frequency somewhat removed from that of a very strong, incoming signal, to prevent the strong signal from interfering with the low-level calibrating signal.

A series of readings can be obtained conveniently, with field strength indicated in microvolts-per-meter on the scales of the built-in attenuators; no involved calculations are necessary.

Special precautions have been taken in the RCA 308-B to obtain maximum oscillator stability and effective shielding. In addition, the i-f stages are selective enough to prevent interference from signals on adjacent channels.

The wide frequency range of this instrument is covered in six bands; no plug-in coils are used. Three loop antennas cover the entire frequency range.

Shielded loops are used to minimize distributed capacitance and eliminate "antenna effect", thus further reducing error. The loops require no balancing adjustments.

## Specifications

- Frequency Range  
(3 loops) \_\_\_\_\_ 120 kc.-18,000 kc.
- Field Intensity Range—20 microvolts to  
20 volts per meter
- Accuracy \_\_\_\_\_  $\pm 5\%$  at 180 kc.-7,000 kc.  
\_\_\_\_\_  $\pm 10\%$  at any frequency
- Loop Antennas  
Loop #1 (Furnished) \_\_\_\_\_ 120 kc.-350 kc.  
Loop #2 (Furnished) \_\_\_\_\_ 350 kc.-3,000 kc.  
Loop #3 (Furnished) \_\_\_\_\_ 3,000 kc.-18,000 kc.
- Output Indication  
Linear and logarithmic scales  
(Provision made for standard 5 ma.  
recording meter and headphones.)

## POWER REQUIREMENTS

"A" Battery Circuit \_\_\_\_\_ 6 volts, 1.5 amperes  
"B" Battery Circuit \_\_\_\_\_ 135 volts, 45 ma.  
"C" Battery Circuits (two) \_\_\_\_\_ 7.5 volts each

## TUBE COMPLEMENT

1 RCA 6L5-G      1 RCA 6J5      1 RCA 6R7  
1 RCA 6L7      3 RCA 6S7

Dimensions (loop unmounted) \_\_\_\_\_  $13\frac{1}{2}'' \times 13\frac{1}{4}'' \times 20\frac{1}{4}''$

Weight (unpacked) \_\_\_\_\_ 48 lbs.

Finish \_\_\_\_\_ Gray wrinkle

Stock Identification \_\_\_\_\_ MI-8225-E

(Includes Field Meter and 3 Loops less 93-A Power  
Supply and storage batteries.)

## ACCESSORIES

Type 93-A Power Supply \_\_\_\_\_ MI-7519-A  
(Mounted in case but less storage battery.)

Note: 93-A Power Supply Dimensions are  $13\frac{1}{2}'' \times 13\frac{1}{2}'' \times 8''$   
and its weight with storage battery is 29 lbs.

Storage Battery for 93-A \_\_\_\_\_ MI-8204-A





# Beat Frequency Oscillator, Type 68-B



## Features

- Very low distortion—0.2 to 0.3 per cent total arithmetic sum
- Low background level—70 db below maximum output.
- Wide frequency range.
- Electron-coupled oscillators.
- Push-pull detector and amplifier stages.
- Large direct-reading hand-calibrated frequency scale.
- Balanced outputs of 250, 500, 5000 ohms.
- Magic-eye tube for checking calibration.
- Standard double-jack output connections.
- High output level—125 milliwatts (max.).
- Frequency stability.

## Uses

The Type 68-B Beat Frequency Oscillator is designed for easy and fast fidelity measurements with laboratory accuracy. This instrument is required for frequency response, audio distortion, noise level, and other measurements which must constantly be made on broadcast station equipment in order to maintain high fidelity transmission.

The Type 68-B plus the 69-C Distortion Meter forms the combination necessary for making all types of fidelity observations. This equipment can be used to advantage by broadcasting stations and laboratories, and serves well in experimental work. Additional applications of these two units are: equalization of lines, receiver measurements, a source of sine waves for oscilloscope work or modulated oscillators.

## Description

The Type 68-B BFO employs the usual two r-f oscillators, one fixed and the other adjustable to produce a beat note of the desired frequency. In the 68-B, however, the oscillators are

electronically coupled to obtain the maximum of stability. Push-pull detector and amplifier stages are employed, thereby eliminating the second harmonic distortion frequently found in these stages, and providing linearity.

The instrument has sufficiently good waveshape to supply tone for distortion measurements at all frequencies. It has a range of 20 to 17,000 cycles throughout which optimum performance is obtained, and has useable output of good waveshape down to 5 cycles. The output is flat over the whole audio range, while the distortion content in the output is of the order of 0.2 to 0.3 per cent, total arithmetic sum. Precautions taken in design insure the low background level of -50 vu or 70 db below maximum output.

Output impedances of 250, 500, and 5000 ohms are obtainable from taps on the output transformer, which has a center tap to provide for balanced outputs at all impedances.

## Specifications

Frequency Range \_\_\_\_\_ 20 to 17,000 cycles  
(good waveform down to 5 cps)  
Output Power \_\_\_\_\_ 125 mw. (max.)  
Output Impedances \_\_\_\_\_ 250, 500, 5000 ohms

Frequency Characteristics:  
5000 ohm tap \_\_\_\_\_ ±0.5 db  
500 ohm tap \_\_\_\_\_ ±1 db  
250 ohm tap \_\_\_\_\_ ±1 db

Distortion (total arithmetic sum):  
Below 100 cycles \_\_\_\_\_ 0.3%  
Above 100 cycles \_\_\_\_\_ 0.2%  
Hum (max. output) \_\_\_\_\_ -70 db  
Power Input \_\_\_\_\_ 110/120 volts, 25/60 cycles, 70 watts

## Tube Complement:

6 RCA-6C5G	3 RCA-6J7
1 RCA-45	1 RCA-874
1 RCA-5Z4	1 RCA-6E5

Dimensions \_\_\_\_\_ 8¾" high, 19" wide, 10" deep  
Weight \_\_\_\_\_ 50 lbs.

# Distortion and Noise Meter, Type 69-C



## Features

- Wide frequency range for f-m applications.
- Electronic output meter improves stability.
- Wide range distortion measurements.
- New bridging transformer for wider frequency band.
- Noise level measurements from -75 db.
- Direct reading, large-size meter.
- Gain standardized on 1 milliwatt, 600-ohm level.
- Self-contained power supply.

## Uses

The Type 69-C Distortion and Noise Meter has wide application in the broadcast field for measuring harmonic distortion, obtaining frequency response characteristics, and measuring background noise levels. It is designed for the accurate measurement of distortion over the entire audio range of 30 to 15,000 cycles, thus enabling the broadcaster to obtain a true picture of the fidelity of his station.

The RCA 69-C is capable of accurately measuring very low level distortions. It gives a precise indication of distortion from 0.3 to 100 per cent, rms.

Modern transmitters have noise levels 60 db below 100 per cent modulation. The Type 69-C can accurately indicate noise levels as low as 85 db below 100 per cent modulation. In addition, background noise levels down to -75 vu can be measured.

## Description

The Type 69-C employs a simplified switching arrangement for making distortion measurements over the entire audio range. The input and output fundamental signals from the equipment under test are balanced against one another by means of the amplitude and phase controls on the front panel, leaving the harmonics to be measured by a vacuum tube voltmeter. Noise voltages are measured directly by the voltmeter.

The Type 69-C has three alternative inputs so that measurements can conveniently be made at either the output of the transmitter, any 500 ohm termination in the speech input system, or at any point where no appreciable load may be drawn.

The meter can be connected by means of a patch cord to any point in the speech input system. A linear r-f rectifier stage in the 69-C provides for measurements of overall transmitter distortion. The r-f input terminals may be connected through a twisted pair from a pick-up coil in the transmitter.

Noise levels and distortion percentages can be read directly from the large-size meter.

## Specifications

R-F Range \_\_\_\_\_ 500 to 2000 kc

Frequency Range for

Distortion Measurements \_\_\_\_\_ 30 to 15,000 cycles  
(harmonics to 30,000 cycles using bridging input)  
(harmonics to 45,000 cycles using unbalanced high impedance input)

Frequency Response:

30 to 45,000 cycles  $\pm 1$  db unbalanced input  
30 to 30,000 cycles  $\pm 1$  db bridging input

Distortion Measurement Range \_\_\_\_\_ 0.3 to 100%

Noise Level Measurement Range:

Any level down to 85 db below 100% modulation  
Any level down to -75 vu

Input Levels:

Modulated r-f \_\_\_\_\_ 10 to 80 volts

A-F Level from Oscillator \_\_\_\_\_ 2 to 4 volts

A-F from System under Test

Bridging Input \_\_\_\_\_ -15 to +22 vu

Unbalanced Input \_\_\_\_\_ 0.12 to 8 volts and 1.2 to 80 volts  
by means of high-low taps

Audio Input Impedance:

Bridging Input \_\_\_\_\_ 20,000 ohms

Unbalanced Input \_\_\_\_\_ 200,000 and 20,000 ohms

Power Input \_\_\_\_\_ 50 watts, 105/125 volts, 50/60 cycles

Tube Complement:

2 RCA-6C5G

1 RCA-6F8G

1 Amperite

2 RCA-6SJ7

1 RCA-VR150

Ballast Tube 6-8

2 RCA-6X5G

1 RCA-VR105

Dimensions \_\_\_\_\_ 8 3/4" high, 19" wide, 10" deep

Weight \_\_\_\_\_ 44 lbs. (net)



# Distortion and Noise Meter, Type WM-71A



## Features

- Continuous coverage of audio range for distortion, noise and hum measurements.
- Distortion measurements, as low as .1%, quickly and easily made by one tuning adjustment.
- Distortion measurements independent of phase shift.
- Requires no direct connection to audio oscillator.
- Audio oscillator distortion can be measured.
- Can be used as a wide range highly sensitive voltmeter or VU meter.
- Tapped power transformer permits operation on either 105-125 volts or 210-250 volts.

## Uses

Distortion and Noise Meter RCA Type WM-71A is a compact precision instrument of new design. It permits continuous coverage of the audio frequency range, indicating directly the percentage of a-f distortion in modulators, speech amplifiers, a-f generators, receivers and other equipment employing audio frequencies. The instrument will give full-scale readings for distortion percentages as low as 0.3%, and is capable of measuring noise components at frequencies from 50 to 45,000 cycles.

Innovations in circuit design permit distortion measurements to be made easily and rapidly. Direct connection to the audio oscillator is not required, making it easy to measure at places remote from the oscillator. Moreover, the flat response and wide frequency range of the internal amplifier make the instrument useful for accurately measuring noise and VU levels.

## Description

Essentially, the WM-71A consists of a high-gain amplifier, an r-c interstage coupling unit, a calibrated attenuator for adjusting the sensitivity, and a panel meter to indicate amplifier output.

The r-c interstage coupling unit balances to a sharp null at the frequency to which it is tuned, the null frequency being controlled from the panel. Degeneration is employed to maintain high stability in the amplifier and to provide flat transmission characteristics (except within an octave of the null point).

In measuring distortion, the a-f signal is applied to the instrument and the null point is obtained to balance out its fundamental frequency, leaving only its harmonics and other distortion components which are indicated in percentage directly on the panel meter. When the modulated output of a radio transmitter is to be measured, a linear rectifier is required to produce the audio envelope. Any linear detector system having an undistorted output of 1.5 volts can be used.

A switch on the front panel provides for switching out the null circuit so that the instrument can be used as an extremely sensitive voltmeter for measuring noise and hum levels.

Since the WM-71A has only one tuning control plus a small trimmer, it can be quickly set to any frequency over its range. This is a time-saving feature in making a series of measurements.

## Specifications

**Audio Frequency Range**—50-15,000 cycles (fundamental) for distortion measurements; 50-45,000 cycles for VU and noise measurements.

**Distortion Range**—100% to 0.1% in six ranges. Full-scale meter deflection for values of 100%, 30%, 10%, 3%, 1%, and 0.3%.

**Noise Range**—Extends from 0 to -80 db below a reference level of one milliwatt in 600 ohms, in seven ranges; and to -80 db below 100% modulation when at least one volt is available from the modulation monitor at 100% modulation level.

**Accuracy**—For distortion measurements, accurate to within  $\pm 5\%$  of full-scale  $\pm$  residual distortion level which will not exceed .05% to .1%. Noise measurements accurate to within  $\pm 5\%$  of full-scale (residual noise level is less than -80 db). Effect of line-voltage variations from 105 to 125 volts, negligible.

**Input Voltage Range**—For distortion and noise, 1.2-30 volts at 100,000 ohms input; 0.8-30 volts at 10,000 ohms (bridging) input.

**Input Impedance**—100,000 ohms unbalanced; 600 ohms bridging input (10,000 ohms) balanced or unbalanced to ground

**Audio Frequency Response**—Flat within 1 db from 30-45,000 cycles

**Tube Complement**—5 Type 6J5, 1 Type 6H6, 1 Type 6X5, 1 Type 6SN7-GT, 1 Type 6K6-GT, 2 Type VR-150-30

**Power Requirements**—A tapped primary provides for operation on a-c line voltages of 105-125 volts 50/60 cycles, or 210-250 volts 50/60 cycles. Approximately 60 watts is required.

**Dimensions**—Rack mounting type—height 7", width 19", and depth 12" (approx.)

**Weight**—35½ lbs.

**Finish**—Umber gray lacquer

**Stock Identification**—MI-30071-A

# Video Sweep Generator, Type WA-21A

## Features

- Sweep or CW signals up to 10 mc.
- Uniform sweep rate—no crowding at either end.
- Entire CW and Marker signal range covered in one continuous band.
- Unusually flat response.
- Built-in output metering circuit.
- Continuous control of output.
- Built-in mixer system eliminates spurious marker signals.

## Uses

The RCA Video Sweep Generator, Type WA-21A, is designed to facilitate rapid testing of video frequency networks by permitting visual observation of the frequency response characteristic. It permits direct viewing of the envelope of the output wave of a video circuit while the input signal sweeps through a range from 100 kc to 10 mc, at the rate of 60 complete sweeps per second. It is generally used in conjunction with a suitable detector and oscilloscope to observe the output voltage vs frequency curve. In this use the deflection voltage source provided in the instrument furnishes a convenient system for synchronizing the horizontal deflection of the oscilloscope with the frequency excursion of the video input signal.

The WA-21A also embodies a CW generating section that produces sine wave signals tunable from 100 kc to 10 mc for point-by-point or steady-state tests. The beat-frequency principle is employed, and the entire range is covered in one continuous band. The CW section is also valuable for detailed analysis of a narrow portion of the video frequency spectrum, for example, in adjusting infinite rejection traps in television circuits.

The section of the circuit which produces the CW signal is separate from that which generates the sweep signal, thereby allowing the CW signal to serve as a calibrating marker on the sweep trace. When the marker is employed, a clearly visible "pip" appears on the trace and the frequency at which this pip occurs may be read directly from the dial.

In testing video amplifiers this instrument is useful for adjusting peaking circuits and for checking overall performance. In setting up transmitters, it can be used for adjusting the r-f networks to insure proper frequency response, and can also be used in conjunction with a field intensity meter for checking sideband energy distribution. For special applications, the sweep width may be reduced and the center frequency adjusted (by means of screw-driver adjustments) to permit detailed observation of the response of narrow band-width circuits within the range of 100 kc to 10 mc.

## Description

The output of an FM sweep oscillator and a heterodyne oscillator are combined in a mixer to produce a sweep signal covering the range from 100 kc to 10 mc at a rate of 60 complete sweeps per second—when using a 60 cycle power supply. Output is uniform within 1 db of the midrange response over this range. A blanking circuit is provided to eliminate the signal during the return portion of the trace (from 10 mc to 100 kc) if desired, and this feature also furnishes a zero-output base line on an oscilloscope screen.

The CW circuit utilizes two oscillators, the outputs of which are combined in a mixer tube to produce a beat output that can be continuously adjusted from zero to 10 mc.

The CW generator and the sweep generator may be operated simultaneously to produce a fluctuation or pip on the output of the sweep, where it crosses the frequency at which the CW generator is set. In order to produce this marker without any spurious by-products, a special built-in mixer system has been



incorporated. The marker is visible on an oscilloscope screen either when using a video detector or when viewing the video waves directly. The pip is uniform in size over the entire range of adjustment, and the full range from 100 kc to 10 mc is covered by a single dial scale.

The CW output is supplied through the same coaxial line as the sweep signal, while a panel switch permits selection of sweep, sweep plus marker, or CW. The output feeds into a 75-ohm terminated coaxial cable. An output metering circuit is provided to indicate the RMS value of the signal voltage. This circuit consists of a diode VTVM with a step attenuator. Continuous control of the output from 1 millivolt to 1 volt is achieved through the use of a fine control in connection with the step attenuator. Distortion and spurious outputs are less than 5% of the fundamental signal voltages.

A built-in source of supply-frequency voltage is provided for connection to the horizontal deflection circuit of an oscilloscope. This voltage is adjustable in phase. It is useful for synchronizing the oscilloscope sweep rate and phase with the frequency sweep rate of the WA-21A. Stability of the WA-21A sweep signal is insured by use of an electro-mechanical sweep capacitor.

The instrument is designed for either table top or rack mounting. It is normally furnished in a table model cabinet. For rack mounting, suitable protective enclosures are provided, the panel space required is 8¾ by 19 inches, and standard relay-rack mounting slots are provided in the panel.

## Specifications

Sweep Frequency Range	100 kc to 10 mc	
CW Range	100 kc to 10 mc	
Calibration Accuracy	2%	
Sweep Frequency Rate	Line frequency	
Marker Accuracy	2%	
Output Voltage	1 millivolt to 1 volt	
Output Impedance	75-ohm terminated coaxial line	
Output Characteristic	Flat within 1 db of mid-range response from 100 kc to 10 mc	
Power Supply	105/120 volts, 50/60 cycles, 180 watts	
Tube Complement:		
	5—6AG5	1—6C4
	2—955	1—6BA6
	1—6SQ7	1—6AS6
	1—VR150	1—6SJ7
	1—5U4-G	

## Dimensions:

Cabinet	22" wide, 10½" high, 15" deep
Relay Rack	8¾" high, 19" wide, 13½" deep
Finish	Umber gray
Weight	80 lbs.



# Grating Generator, Type WA-3A



## Features

- For precise adjustment of scanning linearity in television cameras, monitors, and receivers
- Assures uniform distribution of picture detail
- Mixes standard TV blanking signal with bar signals to produce composite "grating" pattern
- Pattern is adjustable for screen size
- Output voltage may be either positive or negative
- Useful for any video testing system

## Uses

The RCA Grating Generator, Type WA-3A, is designed for checking linearity of television deflection circuits in cameras, monitors, and receivers to assure faithful reproduction. This instrument provides a means of determining the linearity of scanning velocity in both the receiver kinescope and the camera pickup tube. Should the scanning beam in either of these devices deviate from the standard rates of speed, the picture on the kinescope will be compressed over some areas and expanded over others. Through use of the Grating Generator, even small degrees of non-linearity may be detected, and adjustment for faithful reproduction of fine detail may easily be made.

For adjusting the linearity of a monoscope camera with monitor equipment, the output of the Grating Generator may be fed into one channel of a distribution amplifier, the monoscope camera fed into another channel, then the output of the two channels together fed into the master monitor. Field equipment can be aligned by this method prior to use for remote pickup. Television camera deflection linearity can be similarly checked and adjusted, by focusing the camera on a test chart. Television receivers may also be tested, either by injecting the composite timing-test pattern signal into the receiver video circuit or by remote pickup of a transmitter modulated with the composite signal. The WA-3A may be employed in any video signal test system for speeding accurate alignment of deflection circuits

## Description

The RCA Grating Generator, Type WA-3A, produces a timing signal, which is synchronized by standard television sync pulses, for precise adjustment of scanning linearity. The resultant pattern on the kinescope consists of horizontal and vertical bars, which give the appearance of a grating. The horizontal bars serve for vertical alignment, while the vertical bars serve for horizontal alignment. Equal spacing between bars means perfect linearity. Packing or spreading of the bars indicates non-linearity. Curvature of the bars reveals the effect of stray magnetic fields. Thus the scanning velocity may be conveniently adjusted to produce uniform distribution of picture detail.

The WA-3A generates the test signal as follows: A negative driving pulse of 15,750 cycles is amplified, clipped, and differentiated to synchronize a multivibrator. The pulse output of the multivibrator constitutes the vertical bar signal. It is amplified, then fed to a mixer stage. A negative driving pulse of 60 cycles is amplified, clipped, and differentiated to synchronize another multivibrator. The output is a multiple of 60 cycles. It is fed to a width control circuit, by means of which the pulse width may be adjusted to 10 per cent of the cycle over the entire frequency range. This pulse constitutes the horizontal bar signal, which is mixed with the vertical bar signal. The mixed signals are held to approximately equal levels by a limiter stage. Output is adjustable to provide for control of contrast.

Standard 60 cycle and 15,750 cycle signals from a video sync generator are employed for synchronizing the WA-3A. The standard blanking signal from the sync generator is connected to a polarity control stage, with output taken from either cathode or plate circuit, depending upon desired polarity. Separate tubes having a common load combine the bar and blanking signals. A limiter stage prevents the bar signal from exceeding the blanking signal level.

Separate switches are provided for independent operation of the horizontal, vertical, and blanking signal circuits. The number of bars is adjustable for convenient spacing on different screens. Horizontal bars are adjustable from 12 to 36 bars; vertical bars are adjustable from 10 to 64. Bar width is adjustable to 10 per cent of space between bars. Bar pulse level can be controlled independent of blanking level to give desired degree of contrast. Polarity of blanking signal can be changed to permit use of the WA-3A in any video system.

**Specifications**

**Output:**

Horizontal and Vertical Bar Pulses (combined with blanking pulses if desired) \_\_\_\_\_ 0 to 2 volts peak-to-peak  
 Horizontal Bars \_\_\_\_\_ 12 to 36  
 Vertical Bars \_\_\_\_\_ 10 to 64  
 Bar Width \_\_\_\_\_ Adjustable to 10% of space between bars  
 Blanking \_\_\_\_\_ Polarity changing and mixing  
 Impedance \_\_\_\_\_ 75 ohms (approx.)

**Input:**

Vertical Sync Signal \_\_\_\_\_ 60 cycle standard (2 volts min.)  
 Horizontal Sync Signal \_\_\_\_\_ 15,750 cycle standard (2 volts min.)  
 Blanking Signal \_\_\_\_\_ RMA standard (2 volts min.)  
 Power Supply \_\_\_\_\_ 105/125 volts, 60 cycles, 175 watts

**Tube Complement:**

5 RCA 6SN7	1 RCA 6AG7
2 RCA 6AG5	2 RCA 6Y6G
2 RCA 6AC7	1 RCA VR-105-30
5 RCA 6SJ7	1 RCA 5R4GY
1 RCA 6J5	

Dimensions \_\_\_\_\_ 8 3/4" High, 19" Wide, 14" Deep  
 (Standard relay rack mounting)

Weight \_\_\_\_\_ 42 lbs.

Finish \_\_\_\_\_ Umber gray

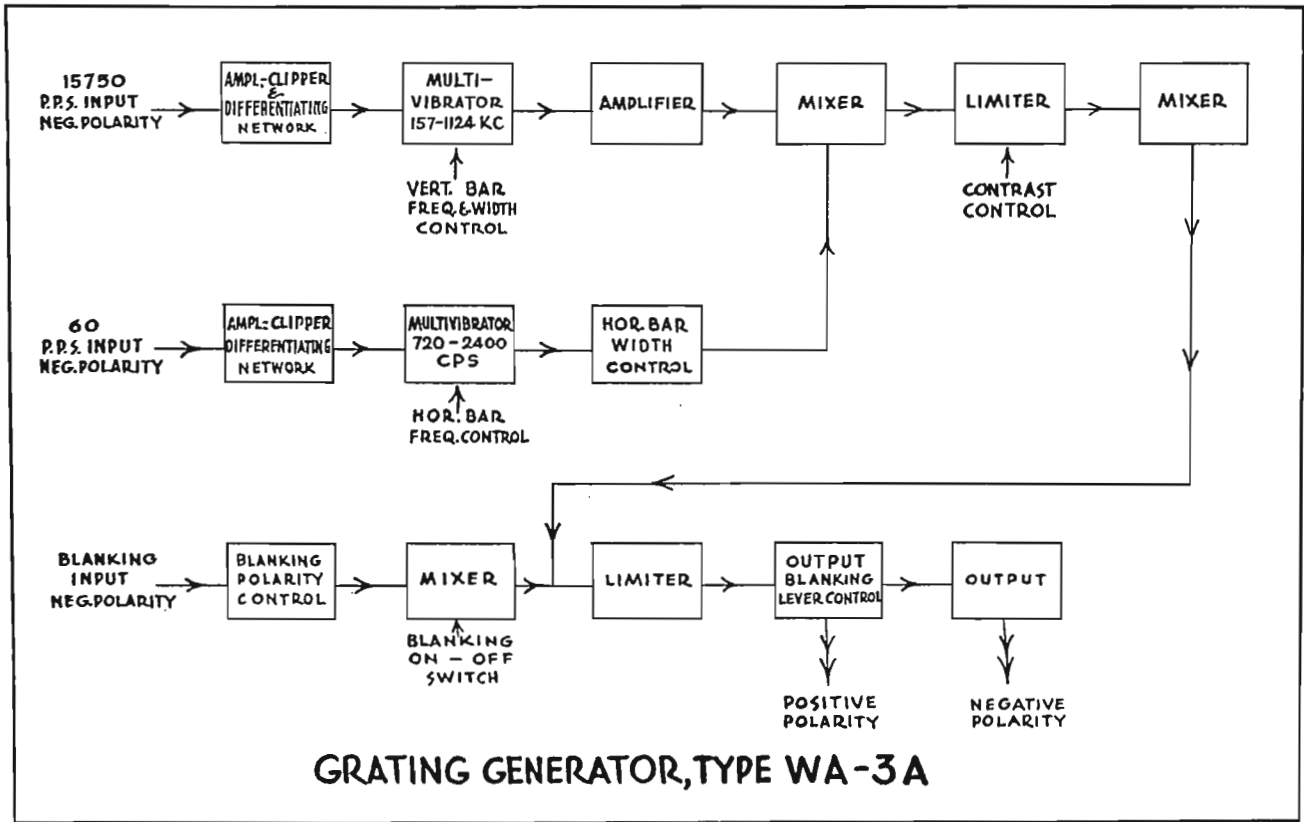



# Transmission Measuring Set, BI-11A

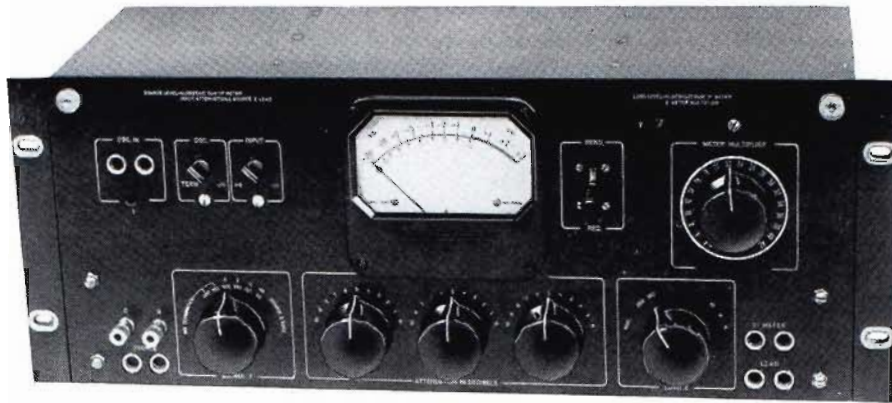

## Features

- Simplifies fidelity measurements.
- Eliminates lengthy calculations—direct reading.
- $\pm 0.1$  db accuracy (20 cycles to 20 kilocycles).
- Automatic correction for changes in load impedance.
- Output impedance switch for matching.
- Wide range of load levels handled.

## Uses

The Type BI-11A transmission measuring set is a simplified, accurate and direct-reading instrument designed for use in the following applications: (1) audio gain measurements; (2) audio loss measurements; (3) measurements of matching and bridging devices; (4) complex circuit measurements; (5) measuring mismatch loss and frequency response measurements.

It facilitates overall system measurements and may be used with the 68-B Beat Frequency Oscillator and the Type 69-C Distortion and Noise Meter. By use of the Type BI-11A Measuring Set, suitable attenuation can be introduced to feed the equipment being measured from the 68-B, Beat Frequency Oscillator. The Type BI-11A eliminates lengthy calculations and intricate setups. It is designed to provide accuracies conforming to FCC regulations and is particularly useful for broadcast stations in the master control room or at the transmitter.

## Description

The Type BI-11A consists of a volume indicator meter, input and output attenuators, an impedance matching system and jacks for convenient connections. A meter multiplier, which is geared to the load impedance shaft, provides an automatic correction for changes in load impedance. Convenient switches allow the volume indicator to be connected to the input of

the attenuator system or to jacks for external connection. An output impedance switch allows matching to 600-250-150-16-8-4 ohm circuits.

Level controls, switches, jacks and VI meter are located on the front of a standard 19" rack-type panel. The panel hinges forward to provide ready access to attenuators, jacks, switches and other components. Unit type assemblies (individual sections, such as source, attenuation and load) are readily removable for servicing, if necessary. Each section is a complete assembly with its own jacks and terminal block.

## Specifications

Range of Instrument \_\_\_\_\_ 20 cycles to 20 kilocycles

Accuracy (independent of level from +4 to -110 dbm):

Overall \_\_\_\_\_  $\pm 0.1$  db, 20 cycles to 20 kilocycles.

Source and Load Impedances for Dial Indicators

Over Entire Range (20 cy. to 20 kc.) \_\_\_\_\_ Within  $\pm 2\%$

Network Resistors \_\_\_\_\_  $\pm 1.0\%$

Source Characteristics:

Shielded output can be used equally well on either balanced or unbalanced equipment.

Ranges (in steps of 0.1 db) \_\_\_\_\_ +4 to -110 db  
 \_\_\_\_\_ -10 to -124 db

Range of Impedance:

Internally Terminated \_\_\_\_\_ 600-150 ohms

Unterminated \_\_\_\_\_ 600-250-150-30 ohms

Internal isolation network for operating into non-linear devices.

Load Characteristics (resistive load, ungrounded):

Range of Load Levels \_\_\_\_\_ +4 to +42 VU @ 600 ohms

Range of Impedance \_\_\_\_\_ 600-250-150-16-8-4 ohms

Dimensions \_\_\_\_\_ 7" high x 19" wide

Approximate Weight \_\_\_\_\_ 19 lbs.

Stock Identification \_\_\_\_\_ MI-11350

# Tone Generator, Type WA-26A

## Features

- Extremely light in weight—small in size.
- Easily portable—completely self-contained—attractive leatherette carrying case provided.
- Supplies suitable tone (ten frequencies from 30 to 15,000 cycles) for equalizing remote telephone lines.
- Easy-to-read output meter—calibrated in dbm.
- Choice of two outputs 150/600 ohms selected by front panel switch.
- Simple and easy to operate—minimum of maintenance required.

## Uses

The new WA-26A Tone Generator is specially designed to meet the broadcaster's needs for a truly versatile and portable instrument. It provides suitable tone for equalizing remote telephone lines, and provides for selection of ten discreet frequencies between the range of 50 to 15,000 cycles. The output meter, which is calibrated in dbm, indicates the true level applied to any load which matches the impedance designated.

## Description

The WA-26A Tone Generator is a completely self-contained instrument supplied complete with batteries and an attractive leatherette carrying case. Because of its extremely small size and weight, it offers extreme portability.

The circuit design is essentially an RC type which provides for 10 frequencies between the range of 50 to 15,000 cycles. Oscillator tubes operate in a resistance-capacitance bridge circuit to provide high stability and very low harmonic content. Frequency determining capacitors are selected by a ten-position rotary switch which is operated by the "Frequency" control knob on the front panel. All adjustments are preset at the factory except oscillator feedback which is quickly and easily adjusted by the "Calibrate" control on the front panel.

Output voltages are conveniently brought out to front panel terminals and may be varied directly by the front-panel "Output" control. Associated with the output circuit is a companion "150/600" ohm front panel selector switch. It connects either a 150-ohm or a 600-ohm impedance into the output circuit, and at the same time connects the output meter. A neon lamp is provided on the front panel to indicate operation. The WA-26A is designed for maximum convenience and ease of operation—requires practically no maintenance except for the usual battery renewal.

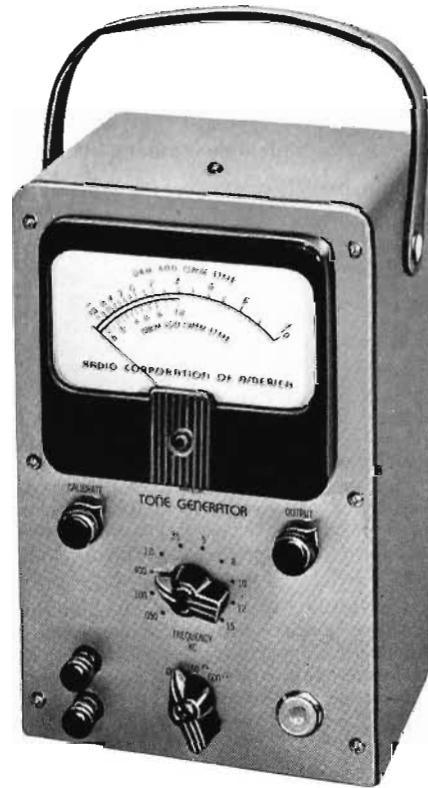

## Specifications

Frequencies (cycles per second)	50, 100, 400, 1000, 3500, 5000, 8,000, 10,000, 12,000, 15,000
Frequency Accuracy	±5%
Output Impedance (ohms)	150 and 600
Output Level into 150 Ohms	-6 to +10 dbm
Into 600 Ohms	-10 to +10 dbm
Distortion at Zero dbm Output	Less than 8% at 50 and 100 cycles; 5% above 100 cycles
Dimensions (Approximate), Inches	9½ x 6¼ x 5¾
Weight (Approximate), With Batteries	9 lbs. 4 oz.
Carrying Case	3 lbs., 10 oz.
Stock Identification	MI-30026-A

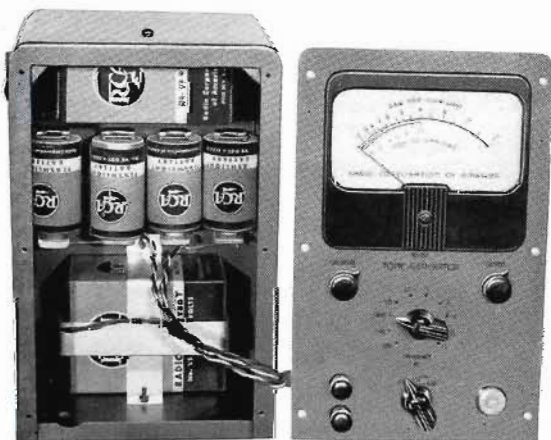

Removable panel provides easy access to batteries

An attractive leatherette carrying case is provided





# Cathode Ray Oscilloscope, Type 715-B

## (Laboratory Type)

### Features

- Extended frequency range—flat to 11 mc.
- High vertical deflection sensitivity.
- Low input capacity and high input resistance.
- Precisely compensated attenuator for vertical amplifier.
- Calibration meter.
- Triggered sweep.
- Adjustable phase.
- Time base marker.

### Uses

The RCA Cathode Ray Oscilloscope Type 715-B fills the need for a laboratory instrument that will permit detailed study of extremely short, sharp-fronted pulses, and other unusual waveforms. Recurring and transient phenomena can both be observed and measured with the Type 715-B; the waveform need not be repeated at regular intervals because even a random recurrence produces a clear, steady trace. It is ideal for trouble-shooting sync generators.

The wide-band amplifier, triggered sweep, blanking, and high accelerating voltage features make this instrument particularly well-suited to the photographic study of transients. Heavy-duty, ball-bearing swivel casters, and a conveniently located front handle make it easy to move the unit.

### Description

The 715-B Oscilloscope is a console type instrument especially designed for close examination of high-speed transients as well as regularly occurring phenomena. The cathode ray tube is operated with a high accelerating voltage in order to produce the intense spot necessary for many applications. A removable metal shield prevents direct external light from striking the surface of the cathode ray tube. A peak-to-peak a-c voltmeter is included. It may be used to check signal amplitude by pressing a convenient switch at the probe end of the input cable. The sweep can be triggered either from the signal causing vertical deflection or from an external signal. The speed with which the spot moves is completely independent of the repetition rate, being continuously adjustable by panel controls to give time calibrations from less than 2 microseconds per inch to over 100,000. Thus, pulses almost invisible on a standard oscilloscope can be expanded to reveal their true waveform on the 715-B. The aperiodic circuit will work satisfactorily when triggered by a single isolated impulse, or by pulses having any repetition rate up to 10,000 cps. When desired, a special built-in oscillator will superimpose clear, steady, microsecond peaks on the curve to facilitate the determination of time intervals.

With the control in the PERIODIC position a sawtooth deflection is produced, having the exceptional frequency range of 5 cps. to 100 kc. This can be synchronized with very high frequency signals or with pulses of extremely short duration.

### Specifications

#### VERTICAL AMPLIFIER

Frequency Range—Flat within  $\pm 1$  db from 5 cycles to 11 mc  
Deflection Sensitivity:

With 2600 volts on Second Anode—0.17 rms volts per inch  
With 1500 volts on Second Anode—0.10 rms volts per inch

#### INPUT IMPEDANCE

Vertical Amplifier:

With Attenuating Cable—1.1 megohm + 15 mmf  
With Direct Cable—1.0 megohm + 150 mmf

Horizontal Amplifier—1.0 megohm + 50 mmf

Sawtooth Frequency Range—5 cps to 100 kc



Triggered Sweep Speed—2 to 100,000 microseconds per inch  
(continuously adjustable)

Time Interval Markers—1.0 microsecond

Blanking—Return line blanked on aperiodic deflection only

Power Requirements—105/125 or 210/250 volts,  
50/60 cycles, 500 watts

Dimensions—50" High, 21" Wide, 27" Deep

Finish:

Cabinet—Two-tone gray enamel  
Panel—Brush chrome

#### Tube Complement:

9—6AC7	4—6AC7	2—6U6
2—6H6	1—6SJ7	2—6SL7-GT
1—6SH7	1—2X2/879	4—6L6-G
2—VR150-30	2—807	2—866/866A
1—5VP1		

Weight—350 lbs.





# Phase Monitor, Type WM-30A

**Features**

- Phase angles can be read to better than  $\pm 0.5$  degree.
- No complicated preliminary adjustments.
- Oversize components insure long life.
- Accurate and quick field pattern checking.
- Direct reading phase angle scale.
- Plug-in resistors to match sampling line impedance.
- Instantaneous quadrant indicator.

**Uses**

The RCA Type WM-30A Phase Monitor provides a simple means of accurately measuring phase differences between currents in the various towers of an antenna array. It is particularly useful in checking directional arrays to insure proper phasing and hence proper field pattern. All phase angles up to 360 degrees at any frequency between 225 and 1800 kc can be measured.

The WM-30A can be used to adjust phase-shifting networks, to measure impedances of arrays, and to facilitate calculation of mutual impedances of antennas. Another important application is the measuring of phase characteristics of television i-f circuits (this requires the use of an i-f signal generator, two mixer stages and a variable frequency oscillator).

The RCA Phase Monitor can be used for remote indication of both relative amplitude and phase of antenna currents in arrays employing up to three elements. Used in conjunction with the MI-8216-C Remote Meter Panel correct relationships can be maintained between phase and magnitude of currents in directive arrays having as many as six elements.

**Description**

Two identical amplifiers are used to drive the two pairs of plates of the 3-inch Cathode ray tube. One of the amplifiers incorporates a network which permits a manual phase shift of 90 degrees by means of a potentiometer. Thus, if two out-of-phase voltages are impressed on the two amplifier units, it is only necessary to adjust the potentiometer until the ellipse on the tube screen becomes a straight line. Then the two voltages are in phase and their original angular differences can be read directly on the scale.

A unique circuit is incorporated for producing a keying impulse for correct quadrant indication. By means of a push button the proper impulse is selected and modulates the Cathode ray tube so that a spot appears in that quadrant on the screen in which phase balance occurs.

The RCA Phase Monitor can accommodate three self-contained meters for remote indication of antenna currents. The unit is complete with power cord and tubes but does not include sampling coils or meters. It is designed for rack mounting and is finished in RCA umber gray.

The WM 30-A is supplied with three 79-ohm plug-in resistors for each of the three input circuits, to provide termination impedance for the commonly used type of sampling line which has a characteristic impedance of between 70 and 80 ohms. MI-8279 Plug-in Resistors can be ordered separately to match 52-ohm sampling lines.



Remote Meter Panel MI-8216-C



WM-30A Phase Monitor

**REMOTE ANTENNA METER PANEL**

This unit is designed to give relative indications of the currents in antenna arrays employing up to three elements, thus insuring correct current relationships and proper field patterns. The unit is complete with power cord and tubes but does not include sampling coils or meters. It is furnished with a standard rack mounting panel. (This is the same unit that forms an integral part of the WM-30A Phase Monitor.) Dimensions: 7" high, 19" wide, 5½" deep.

**ANTENNA SAMPLING KITS**

A single element Sampling Kit is recommended for each tower to be monitored. Two Kits are available, one of which employs a tuned sampling coil, while the other employs an untuned sampling loop. The Antenna Sampling Kit, MI-8217, comprises one Antenna Sampling Coil (MI-8217-A) and one Antenna Current Meter (MI-7184-A-150). The Antenna Sampling Kit, MI-8217-D/MI-7184-A-150, comprises one Antenna Sampling Loop (MI-8217-D) and one Antenna Current Meter (MI-7184-A-150).

**Specifications**

Frequency Range	_____	225 to 1800 kc
Phase Angle Range	_____	0 to 360 degrees
Monitoring Accuracy—		
For small angles (up to 30 degrees)	_____	$\pm 1$ degree
All other angles	_____	$\pm 2$ degrees
R-F Input Impedances	_____	79 ohms
R-F Input Voltage Range	_____	3.8 to 12 volts
Power Supply	_____	105/125 volts, 50/60 cycles
Power Consumption	_____	115 watts
Tube Complement:		
4 RCA-6AC7	2 RCA-6AG7	1 RCA-6AB7
1 RCA-2X2A	1 RCA-5R4GY	1 RCA-3AP1A
Dimensions	_____	17½" high, 19" wide, 15" deep*
Weight	_____	.80 lbs.
Stock Identification	_____	WM-30A

\* Will not fit 9AX rack but can be used in Type BR-1A rack.

# Accessories for Phase Monitor, WM-30A



**REMOTE ANTENNA AMMETER, MI-7184-A-150**

The Remote Antenna Ammeter is a special high-frequency thermo-milliammeter with a 150 ma. movement designed for use with the WM-30A Phase Monitor. The expanded scale of this meter is calibrated from 0-150 per cent of reference antenna current.

Dimension \_\_\_\_\_ 4" rectangular case  
 Stock Identification \_\_\_\_\_ MI-7184-A-150



**SAMPLING COIL, MI-8217-A**

The antenna current and phase Sampling Coil comprises a tuned circuit constructed with an internal double electrostatic shield, so that the user need provide magnetic shielding only. It is normally mounted in the antenna tuner housing or in a separate housing between the tuner and the antenna. This unit feeds a sampling current to the WM-30A Phase Monitor.

Dimension (clearance) \_\_\_\_\_ 5" x 5" x 5"  
 Stock Identification \_\_\_\_\_ MI-8217-A

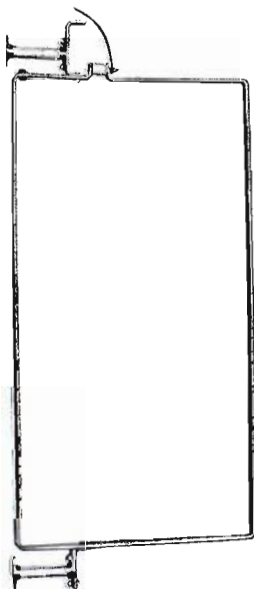

**PHASE SAMPLING LOOP, MI-8217-D**

The antenna current and phase Sampling Loop is a rectangular copper plated steel loop which is shipped complete with associated mounting hardware. The construction is such that the loop can be rotated so as to provide adjustments in coupling with the antenna tower. This unit is designed to feed a sample of antenna current to a WM-30A Phase Monitor.

Dimensions \_\_\_\_\_ 2" x 8" x 1/4"  
 Stock Identification \_\_\_\_\_ MI-8217-D

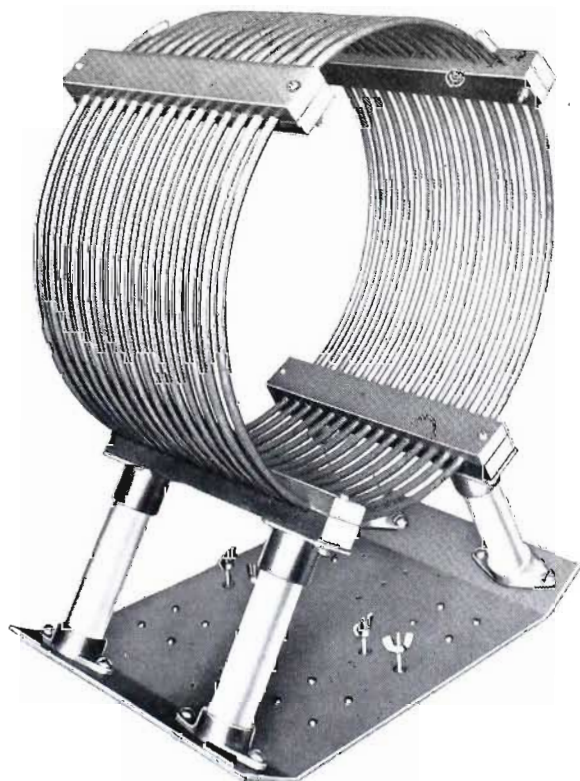

**ISOLATION COIL, MI-7327-4**

The Isolation Coil is a 110 microhenry coil wound with  $\frac{3}{16}$ " 72 ohm copper concentric line. It is designed to carry the sampling line across the base insulator of the tower, when employing the MI-8217-D Sampling Loop.

Dimensions:  
 Base Plate \_\_\_\_\_ 14 1/4" x 21 1/4"  
 Inside Diameter \_\_\_\_\_ 19 1/2"  
 Winding Length \_\_\_\_\_ 10 1/2"  
 Stock Identification \_\_\_\_\_ MI-7123-t



# AM Frequency Monitor, Type WF-48A



## Features

- Continuous Reading Deviation Meter.
- Modulation of transmitter does not affect frequency indication.
- Direct connection to transmitter not required.
- Simple pickup antenna supplies r-f excitation.
- Warning Lamp System indicates failure of either transmitter carrier or monitor crystal oscillator.
- Reliable—minimum of attention required from operating staff.

## Uses

The RCA Type WF-48A Frequency Deviation Monitor is FCC approved for use in standard broadcast stations. It indicates continuously, and directly in cycles-per-second, the magnitude and direction of any departure of the carrier from its assigned channel frequency.

## Description

The elements of the monitor are shown in the accompanying schematic block diagram. Voltages from a temperature controlled piezo-electric oscillator (frequency  $f \pm 1000$  cycles) and the transmitter to be monitored (frequency  $f \pm \Delta f$ ) are amplified and fed to a mixer from which their difference frequency ( $1000 \pm \Delta f$ ) is obtained. This audio frequency is

amplified, its peaks are clipped to produce an essentially square waveform, and the square waves are applied to an audio frequency meter.

The indicating element of the frequency meter is calibrated to read zero when the audio beat is exactly 1000 cycles per second. Deviations from 1000 cycles ( $\Delta f$ ) are indicated directly as frequency deviation of the transmitter in cycles per second.

The monitor is a-c operated and is mounted on a single relay rack panel. Coupling to the transmitter is obtained from a short length of wire attached to the input terminals to act as an antenna.

## Specifications

Frequency Deviation Range (readable to 1 cycle)  $\pm 30$  cycles  
 Carrier Frequency Range \_\_\_\_\_ 500 to 2000 kc  
 Accuracy \_\_\_\_\_  $\pm 10$  parts per million  
 Stability (under normal operating conditions)

Better than one part per million  
 R-f Input Voltage \_\_\_\_\_ Approx. 100 millivolts to 1 volt  
 Power Requirements \_\_\_\_\_ 60 cycles, 105-120 volts or 210-240 volts  
 Power Input \_\_\_\_\_ Heater 25 watts; monitor circuits 100 watts  
 Coupling to Transmitter \_\_\_\_\_ Short antenna

Tube Complement (supplied with instrument):

3 Type 6SJ7	1 Type 5V4-G
2 Type 6AC7	1 Type 6B4-G
2 Type 6H6	1 Type VR-105 (0C3)
2 Type 6SQ7	1 Type 2050
1 Type 6V6-GT	

Dimensions \_\_\_\_\_ 19" wide x 15 $\frac{3}{4}$ " high x 12 $\frac{1}{2}$ " deep  
 Finish \_\_\_\_\_ Umber gray  
 FCC Approval Number \_\_\_\_\_ 1468  
 Stock Identification \_\_\_\_\_ MI-30048-A

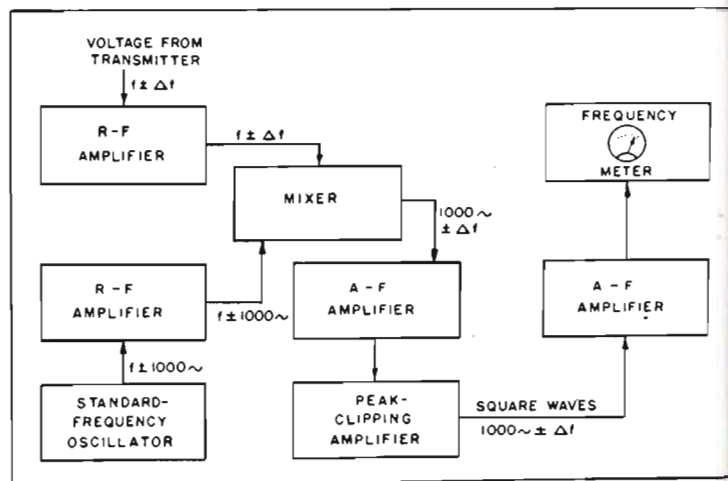

Schematic Block Diagram of Type WF-48A  
 Frequency Deviation Monitor

# Television Frequency Monitor, Type WF-49B/50A

## Features

- Direct indication of frequency drift from assigned channel.
- High sensitivity—requires negligible power from transmitter.
- High stability—temperature controlled crystal oscillator.
- Provision for remote frequency deviation meter.
- Requires no critical adjustments.

## Uses

Television Frequency Monitor, Type WF-49B/50A is a complete TV frequency monitor consisting of an RCA Type WF-49B Frequency Deviation Meter and an RCA Type WF-50A Frequency Monitor. Used together, these units, both designed for standard rack mounting, provide a direct indication of the visual transmitter frequency deviation from the assigned channel frequency for TV channels 2-13. Monitoring requirements for the aural channel are met by the Type GR-1170AT described on another page.

Used singly, the Type WF-50A Frequency Monitor has other applications such as frequency monitoring of high frequency AM broadcast, police or aircraft transmitters. Other uses for the Type WF-49B might be in the laboratory where it is useful for measuring audio and supersonic frequencies with any waveform up to 60 kc.

## Description

The RCA Type WF-50A Frequency Monitor consists of a temperature controlled crystal oscillator, a harmonic generator, a mixer, and an AF output amplifier. This unit develops a beat frequency with the transmitter carrier frequency which, for TV monitoring purposes, is fed to the Deviation Meter for deviation indications. The Type WF-49B Frequency Deviation Meter consists of AF amplifiers, a clipper, limiting amplifiers and a pulse counter circuit. The beat frequency from the monitor is fed through the amplifiers and clippers to develop a square wave which is then applied to the pulse counter circuit. Unidirectional pulses are applied to a d-c microammeter whose deflection is proportional to the number of pulses per unit time, and hence to frequency. The meter scale for the deviation meter is calibrated in plus and minus deviations about a zero center. In accordance with FCC proposals, two alternative scale ranges are available: 3-0-3 kc for TV channels 2-6 inclusive, and 6-0-6 kc for TV channels 7-13 inclusive. Scale ranges can easily be changed by reversing the meter scales which have alternate calibrations on either side. Spare crystals can be mounted in the rear of the Frequency Monitor and selected by means of a panel switch.

## Specifications

### TV FREQUENCY MONITOR, TYPE WF-49B/50A

Transmitter Frequency Range \_\_\_\_\_ 1.6 to 220 mc.

Deviation Range \_\_\_\_\_ 3-0-3 kc for television channels 2 to 6 inclusive; 6-0-6 kc for channels 7 to 13 inclusive

Accuracy \_\_\_\_\_ Crystal frequency, when monitor is received, is within  $\pm 10$  parts per million (0.001%) of specified channel frequency. Center-frequency reading can be adjusted to bring monitor into agreement with frequency measuring service.



Stability \_\_\_\_\_  $\pm 0.001\%$

Input Impedance—High-impedance circuits for channels 2 to 6, coaxial line for channels 7 to 13. Complete coupling directions are included in the operating instructions.

### Tube Complement:

1—6AC7	1—6BE6
1—6AG7	1—OD3/VR150
1—6E5	1—6SQ7
1—6SN7GT	1—6J5
1—6H6	1—OA3/VR75
2—6SJ7	1—6V6
2—6X5	1—Amperite 3-4

Accessories Supplied—All tubes, connecting cable, and power cords; plug-in filter; one quartz plate

Mounting—19 inch relay rack panel. Walnut end frames are available for table mounting

Dimensions \_\_\_\_\_ Panel 19" x 12 $\frac{1}{4}$ ", overall; depth behind panel, 11 $\frac{1}{4}$ ", overall

Net Weight \_\_\_\_\_ 42 lbs.

### FREQUENCY MONITOR, TYPE WF-50A

Carrier Frequency Range \_\_\_\_\_ 1.6 to 220 mc

Power Supply \_\_\_\_\_ 105/125 or 215/250 volts, 50/60 cycles

Power Input \_\_\_\_\_ 75 watts (including temperature control)

Mounting \_\_\_\_\_ Standard 19" relay-rack panel

Finish \_\_\_\_\_ RCA umber gray

Accuracy \_\_\_\_\_ (With Type 376-M Quartz Plate) 0.002% (Crystals are supplied separately)

Dimensions \_\_\_\_\_ Length 19"; depth 11 $\frac{1}{4}$ "; height 7"

Net Weight \_\_\_\_\_ 22 lbs.

### FREQUENCY DEVIATION METER, TYPE WF-49B

Range \_\_\_\_\_ 25 to 60,000 cycles per second in 6 ranges

Accuracy \_\_\_\_\_  $\pm 2$  cycles,  $\pm 2\%$  of full scale, for all ranges ( $\pm 3\%$  of full scale for 60,000 cycles when input becomes less than 0.5 volts)

Input Voltages \_\_\_\_\_ 0.25 to 150 volts

Power Supply \_\_\_\_\_ 105/125 or 215/250 volts, 50/60 cycles

Power Input \_\_\_\_\_ Approximately 50 watts

Mounting \_\_\_\_\_ Standard 19" relay-rack panel

Finish \_\_\_\_\_ RCA umber gray

Dimensions \_\_\_\_\_ Length 19"; depth 11 $\frac{1}{4}$ "; height 5 $\frac{1}{4}$ "

Net Weight \_\_\_\_\_ 19 $\frac{1}{2}$  lbs.



# FM Frequency Monitor, Type GR-1170AT

## Uses

The Type GR-1170AT is an FM Frequency Monitor designed to give (1) a continuous indication of center frequency without the necessity for frequency calibration checks; (2) an indication of percentage modulation (positive, negative and full wave) and a flashing lamp indication of over-modulation; (3) a high fidelity output with less than 0.2% distortion for distortion measurements; and (4) a 600-ohm output for audio monitoring. The instrument is designed for TV aural monitoring as well as for FM. (For TV use, specify Type GR-1170AT; for FM use, specify Type GR-1170A.)

## Description

The FM Frequency Monitor consists of the RF generator and multiplier stages, a mixer, an IF section, discriminator, and amplifier for high fidelity audio output. The RF generator is a temperature-controlled crystal oscillator. This is followed by an aperiodic buffer and three multipliers. A 150 kc beat between crystal harmonic and the transmitter frequency is produced in a pentagrid converter, fed through the IF section to the discriminator, the d-c output of which is fed to a vacuum tube voltmeter. The instrument meets all FCC specifications.

## Specifications

Transmitter Frequency Range—30 to 162 mc with Type 1170-P1 R-F Tuning Unit; 160 to 220 mc with Type 1170-P2 R-F Tuning Unit.

R-F Input Impedance—High impedance, with Type 774 Coaxial Connector. The monitor can be used with standard R.M.A. transmitter monitoring output.

Input Sensitivity—1 volt r-f, or better

Input Level Indicators—A meter for indicating r-f input level is provided at the rear of the chassis. Signal pilot lamp and center-frequency meter pilot are illuminated when input level is adequate and are extinguished when level drops below the usable minimum.

Intermediate Frequency—150 kc

Discriminator—Pulse-counter type linear to better than 0.05% over a range of  $\pm 100$  kc (133% modulation).

Center Frequency:

Indication—Meter is calibrated in 100-cycle divisions from -3000 to +3000 cycles per second. No zero set is necessary for each reading and no second crystal is provided.

Accuracy—Crystal frequency within  $\pm 10$  parts per million of specified channel frequency. Center frequency indication is accurate to  $\pm 200$  cycles per second.

Percentage Modulation:

Indication—Meter is calibrated from 0 to 133%. Additional db scale is provided. Switch selects positive or negative peaks, or full-wave (peak-to-peak) indication. 100% modulation corresponds to 75 kc deviation for f-m bands. Single internal adjustment of meter circuit changes calibration to read 100% at 25 kc deviation, for television audio monitoring. Meter ballistics meet FCC requirements.

Accuracy— $\pm 5\%$  modulation

Overmodulation Indicator—Lamp flashes when predetermined modulation level, as set on a dial, is exceeded. Range of dial is 0 to 120% modulation.

Output Circuits:

1. Distortion and Noise Measurements:

Terminals are provided for connecting a Type 1932-A Distortion and Noise Meter, and a gain control is provided.

Residual Distortion—Less than 0.2% at 100 kc swing ( $\pm 133\%$  modulation).

Response—50 to 30,000 cycles per second  $\pm 1/2$  db.

Standard 75 microsecond de-emphasis circuit is included.

Maximum Output—1.5 volts into 100,000 ohms.

Residual Noise Level—-75 db or better referred to 75 kc deviation; -65 db or better for 25 kc deviation.

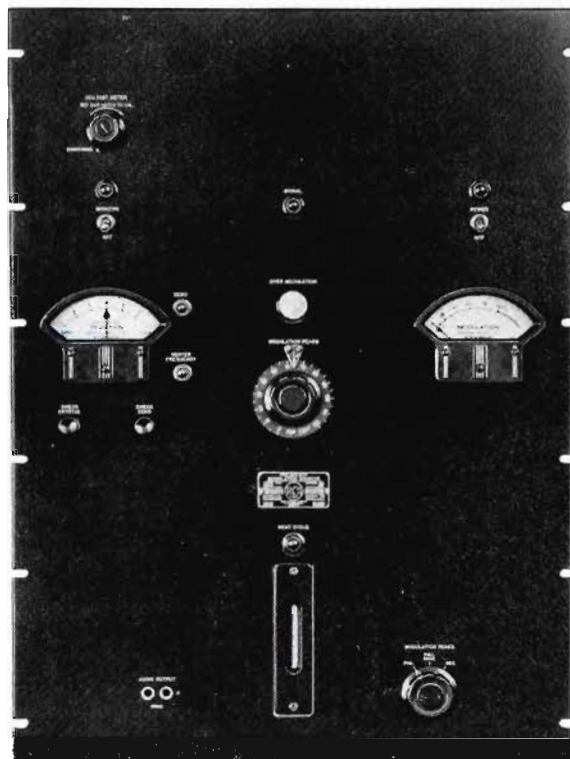

2. Audio Monitoring Output:  
Impedance—600 ohms, unbalanced  
Output—Zero dbm at 75 kc deviation (100% modulation)  
Response—50 to 15,000 cycles per second  $\pm 1/4$  db

## Tube Complement

The following tubes are used and are supplied with the monitor:

1—6AK6	1—6SJ7
1—6AB7	4—6SL7-GT
1—6BE6	1—6AS7-C
2—2050	2—6C4
6—6AL5	1—815
1—6SK7	2—OD3/VR150
2—3-4	1—6J6
2—6AG7	1—991
2—6SN7-GT	1—OC3/VR105
1—6AG5	

## Accessories Supplied

All tubes, coaxial connector for r-f input, power line connection cord, power supply plug.

Power Supply—105 to 125 volts, 50 to 60 cycles. Power-transformer-primary-connections can be changed to permit operation on 210 to 250 volts.

Power Input—300 watts

Mounting—19" relay-rack panel with dust cover

Dimensions—Panel, 19" x 26 1/4"; depth behind panel, 13 1/4" overall.

Net Weight—88 lbs.

# AM Modulation Monitor, Type BW-66E



## Features

- Operates at low r-f input power (0.85 watt in 75 ohms).
- Indicates either positive or negative peaks in percentage modulation and in decibels.
- Meets all FCC specifications for modulation monitors.
- Carrier amplitude shift with modulation can be measured.
- High impedance, low distortion output circuit permits use of RCA WM-71A or 69-C Distortion and Noise Meter.
- Low impedance, low distortion output circuit for aural monitoring.
- Terminals for connecting remote percentage-modulation indicator.

## Uses

The RCA Type BW-66E Modulation Monitor is designed to give continuous direct reading indications of percentage modulation in the carriers of broadcast or other transmitters operating in the range of 500 to 2500 kc. This modulation monitor performs the following specific functions:

1. Measurement of percentage of modulation on either positive or negative peaks.
2. Overmodulation indication.
3. Program level monitoring.
4. Measurement of carrier shift when modulation is applied.
5. Measurement of transmitter audio-frequency response.

## Description

The RCA BW-66E Modulation Monitor consists of three essential elements: (1) A linear diode rectifier which gives an instantaneous output voltage proportional to the carrier envelope, (2) a peak voltmeter which gives a continuous indication of the peak modulation, and (3) a trigger circuit which flashes a light whenever the modulation momentarily exceeds any previously set value.

The linear rectifier is designed for operation at a low power level, which greatly simplifies the coupling to the transmitter. In the output of the linear rectifier is a d-c meter, which indicates the carrier level at which the instrument is operating and also shows any carrier shift during modulation.

In addition, two auxiliary audio output circuits operating from a separate diode rectifier are provided. One of these at 600 ohms, is intended for audible monitoring; the other, a high-impedance circuit, gives a faithful reproduction of the carrier envelope with less than 0.1% distortion. The high impedance output circuit can be connected directly to the RCA WM-71A or 69-C Distortion and Noise Meter, enabling overall fidelity and noise measurements to be made on the transmitter.

## Specifications

Carrier Frequency Range \_\_\_\_\_ 500 to 2500 kc

### MODULATION PERCENTAGE RANGE

Negative Peaks \_\_\_\_\_ 0 to 100%  
Positive Peaks \_\_\_\_\_ 0 to 120%

### ACCURACY

At 100% Modulation \_\_\_\_\_  $\pm 2\%$   
At any other percentage \_\_\_\_\_  $\pm 1\%$

### AUDIO FREQUENCY RESPONSE

Meter Indication, 30 to 15,000 cps \_\_\_\_\_  $\pm 0.5$  db  
Meter Circuit, 50 to 15,000 cps \_\_\_\_\_  $\pm 0.1$  db  
Audio Monitoring Output, 30 to 45,000 cps \_\_\_\_\_  $\pm 1.0$  db  
Measuring Output, when used with RCA Type WM-71A Distortion—Noise Meter and Coupling Cable, 30 to 15,000 cps \_\_\_\_\_  $\pm 1.0$  db

R-f Input Power (over entire frequency range)  
(approximately 8 volts across 75 ohms) \_\_\_\_\_ 0.85 watts

R-f Input Impedance, broadcast band, approximately \_\_\_\_\_ 75 ohms

NOTE: Input impedance increases at higher frequencies. Actual impedance varies with coil position and input tuning.

Power Requirement \_\_\_\_\_ 110-120 volts, 50-60 cycles, 110 watts

### WARNING LAMP CIRCUIT

The overmodulation lamp will flash whenever the negative modulation peaks exceed the setting of the MODULATION PEAKS dial by approximately 2% modulation, for audio frequencies between 30 and 7500 cps. For higher audio frequencies, the percentage overmodulation required to flash the lamp increases slightly.

### AUXILIARY OUTPUT

Connections at the rear of the instrument provides a means of connecting:

1. Two remote percentage modulation meters.
2. Line for 600 ohm monitoring (1 volt at 100% modulation).
3. The RCA WM-71A or 69-C Distortion and Noise Meter.

### TUBE COMPLEMENT (shipped with instrument)

2 RCA-6AL5	2 RCA-884
1 RCA-6C4	1 RCA-OD3
1 RCA-6AQ5	1 RCA-5V4G
1 RCA-12AU7	

Dimensions \_\_\_\_\_ Width 19", height 8 $\frac{3}{4}$ ", depth 11"  
Weight (unpacked) \_\_\_\_\_ 37 lbs.  
Finish \_\_\_\_\_ Umber gray  
Stock Identification \_\_\_\_\_ MI-30066-A



# Frequency Monitor and Modulation Meter, Type 335-BR

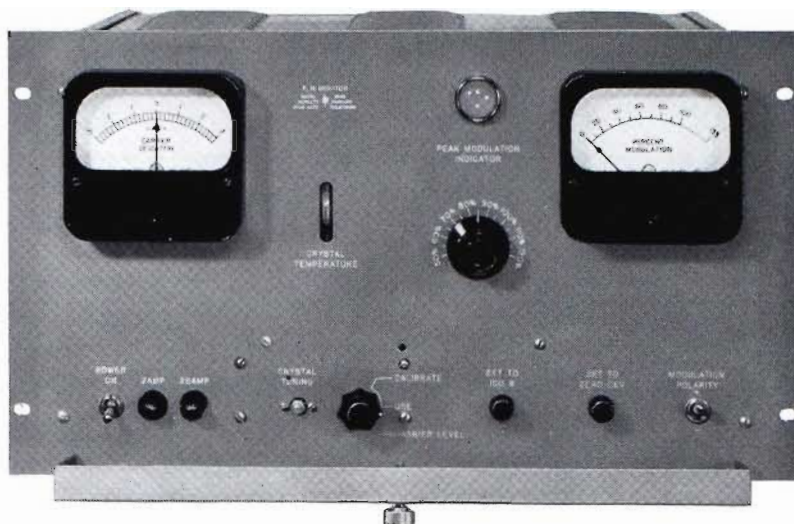

## Use

The Type 335-BR Frequency and Modulation Meter monitors FM transmitters reliably, accurately, over long periods of time. No adjustments are necessary during operation, and because the instrument does not depend on a tuned circuit, it is not necessary to re-set the carrier level or re-align circuits. The instrument is specifically designed to operate without adjustment week after week. It gives continuous indication of broadcast frequency and of modulation level at all times, and has F.C.C. type approval.

## Description

A low-temperature coefficient crystal, oscillating inside a temperature-controlled oven, provides a reference standard of approximately 5 mc. The output of this crystal oscillator is multiplied 20 times, and mixed with the transmitter frequency to form a 200 kc intermediate frequency. This frequency is fed into electronic counter circuits, which measure the intermediate frequency and thereby indicate the carrier deviation. The linear counter circuits also provide a measurement of percentage modulation as well as an audio output signal for measurement and monitoring purposes. See block diagram.

The electronic counter circuits are unusually stable, are independent of signal level, tube characteristics and tube voltages, and require no adjustment except at long intervals. To check the accuracy of the counter circuits, a crystal-controlled oscillator at 200 kc is provided. This check is operated by a front-panel switch, and is usually only required at one-week intervals.

The 335BR includes provision for operation of a remote modulation meter, as well as remote peak modulation indicator

lamp. The percentage modulation at which the lamp flashes a warning is adjusted on the front panel.

An audio output signal, provided for measurement purposes, has residual distortion of less than 0.25%, and the noise level is at least 75 db below 100% modulation at low frequencies. Frequency response is flat within 0.5 db of standard de-emphasis curve, 20 cps to 20 kc. A demodulated signal for remote or local aural monitoring is also provided at 1 VU level.

Simple to install, compact in size, this new FM monitor can be supplied in a cabinet, or for relay rack mounting. Construction throughout is in accordance with engineering practices proven satisfactory for broadcast equipment. Components are rigidly mounted on bakelite cards; bathtub, mica and oil-filled condensers are used where voltages exceed 50 volts. Instrument is furnished in standard RCA umber gray finish.

## Specifications

### FREQUENCY MONITOR

Frequency Range\_\_\_\_\_Any frequency, 88 mc to 108 mc.  
Supplied with crystal of frequency matching customer's transmitter.

Deviation Range\_\_\_\_+3 kc to -3 kc mean frequency deviation

Accuracy\_\_\_\_\_Deviation indicator accuracy better than  $\pm 1000$  cps ( $\pm .001\%$ ).

Power Required\_\_\_\_\_Approximately 2 watts. Operates satisfactorily at levels above and below 2 watts.

## MODULATION METER

**Modulation Range**\_\_\_\_\_Meter reads full scale on modulation swing of 100 kc. Scale calibrated to 100% at 75 kc; 133% at 100 kc.

**Accuracy**\_\_\_\_\_Within 5% modulation percentage over entire scale.

**Meter Characteristics**\_\_\_\_\_Meter damped in accordance with F.C.C. requirements. Reads peak value of modulation peak of duration between 40 and 90 milliseconds. Meter returns from full reading to 10% of full value within 500 to 800 milliseconds.

**Frequency Response**\_\_\_\_\_Flat within  $\pm\frac{1}{2}$  db from 50 to 15,000 cps.

**External Meters**\_\_\_\_\_Provision is made for installation of remote meter having full scale sensitivity of 400 microamperes. Scale should indicate 100% modulation at 300 microamperes. Extra meters can be supplied with unit.

## PEAK LIMIT INDICATOR

**Peak Limit Range**\_\_\_\_\_From 50% to 120% modulation (75 kc = 100%). Provision for external peak limit indicators.

## AUDIO OUTPUT

**Frequency Range**\_\_\_\_\_20 cps to 20 kc. Response flat within  $\pm\frac{1}{2}$  db. Equipped with standard 75 microsecond de-emphasis circuit.

**Distortion**\_\_\_\_\_Less than 0.25% at 100% modulation.

**Output Voltage**\_\_\_\_\_10 volts into 20,000 ohms, at low frequencies. (At 100% modulation.)

**Noise**\_\_\_\_\_At least 75 db below audio output level resulting from 100% modulation at low frequencies.

**Monitoring Output**\_\_\_\_\_1.0 mw into 600 ohms, balanced, at 100% modulation (at low frequencies).

**Size**\_\_\_\_\_Front panel 10½" x 19". 13" deep.

**Power**\_\_\_\_\_115 volts 50/60 cps primary power. Requires approximately 150 watts.

**Stock Identification** \_\_\_\_\_ 335-BR

## Tube Complement

2-6AC7	1-5R4GY
1-7F8	2-VR-75
6-6V6	1-6Y6G
1-6SL7-GT	1-6SJ7
1-2050	

## Available Accessories

Remote Modulation Meter \_\_\_\_\_ HP-112-13

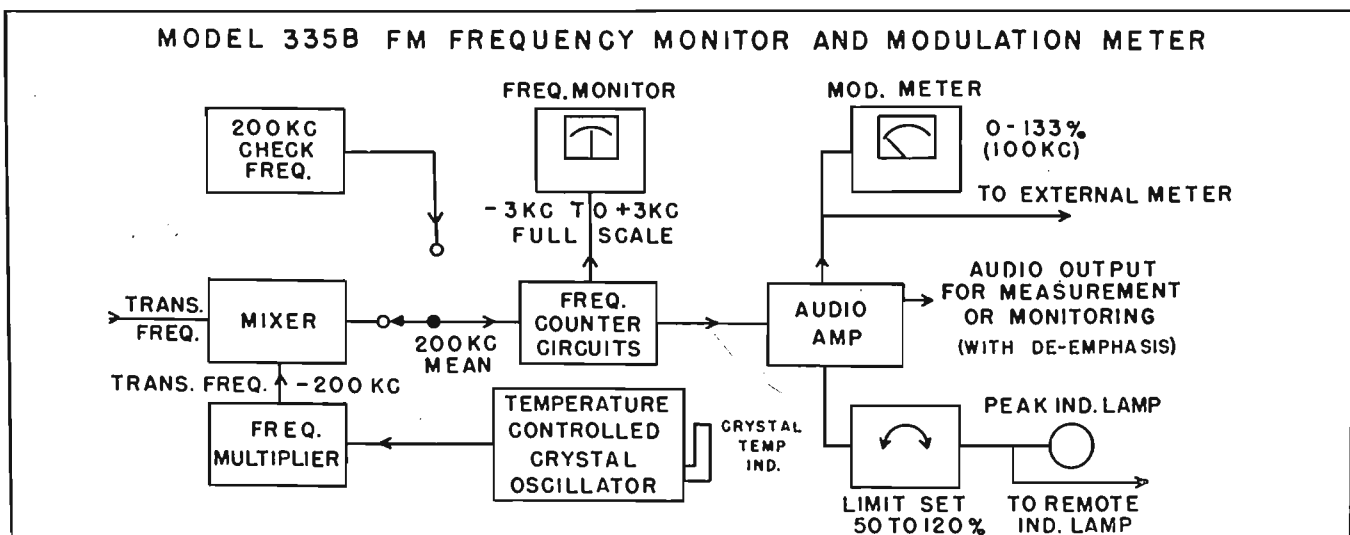



## TV Sweep Generator, WR-59A

WR-59A is a frequency-modulated TV sweep-alignment generator. It generates signals of fundamental frequency on all ranges, which are preset for speed and accuracy. The signals provided include all 13 TV rf channels, picture and sound i-f, video, pre-war picture i-f, the standard FM intermediate, and a spare 25-40-Mc channel. Sweep width is continuously variable, and output level is exceptionally flat in all positions. The output cable termination will match balanced or unbalanced lines; the output level is variable over wide limits by means of a coaxial-type piston attenuator. The unit develops a sweep frequency signal for a scope; a phasing control is provided. An additional feature is return-trace blanking which produces a zero-reference line on the cathode-ray tube for measurement of instantaneous voltages. The unit is complete with rf and i-f/vf output cables. Shipping weight, 35 lbs.



### Specifications

Frequency Ranges:  
 Pre-war Picture Intermediate, First Band \_\_\_\_\_ 5-15 Mc  
 TV Sound Intermediate \_\_\_\_\_ 20.25-22.25 Mc  
 Picture Intermediate, Second Band \_\_\_\_\_ 20-30 Mc  
 Video Band \_\_\_\_\_ 100 kc to 10 Mc  
 Picture Intermediate, Spare \_\_\_\_\_ 25-40 Mc (adjustable)  
 FM Radio Intermediate \_\_\_\_\_ 10-11.5 Mc  
 Television RF Channels 1-13 \_\_\_\_\_ 44-50, 54-60, 60-66, 66-72, 76-82, 82-88, 174-180, 180-186, 186-192, 192-198, 198-204, 204-210, 210-216 Mc

### Output Impedance:

RF Ranges \_\_\_\_\_ 150-0-150 ohms (normal load)  
 IF and Video Ranges \_\_\_\_\_ 100-ohm cable termination  
 Maximum Attenuator Ratio:  
 RF Ranges \_\_\_\_\_ 20,000/1  
 Maximum Amplitude Variation of Sweep  
 Envelope \_\_\_\_\_ All ranges, better than  $\pm 1.5$  db  
 Horizontal Sweep:  
 Phase Range \_\_\_\_\_ 0-160°  
 Frequency \_\_\_\_\_ 60 cps  
 Amplitude \_\_\_\_\_ 5.6 peak-to-peak (2 RMS) volts

## FM Sweep Generator, WR-53A

Speeds up FM receiver alignment . . . regardless of bandwidth requirements. Brings the recognized advantages of the sweep method of alignment to every FM job. Packed with



features which mean speed, accuracy and reliability . . . i-f center frequency 8.3 to 10.8-Mc . . . adjustable i-f sweep width . . . facilities for external frequency modulation . . . rf range continuously variable from 85 to 110-Mc . . . includes step and fine attenuators . . . a scope phase control permits centering of sweep patterns. Provides the signals you need for fast, accurate FM alignment Shipping weight, 17 lbs.

### Specifications

Intermediate-Frequency Oscillator:  
 Center-Frequency Range \_\_\_\_\_ 8.3-10.8 Mc  
 Scale Accuracy \_\_\_\_\_  $\pm 2\%$   
 Output \_\_\_\_\_ Adjustable from 1 uv to 0.1 RMS volt  
 Sweep Width \_\_\_\_\_ 0 to  $\pm 200$ -kc at 8.3 Mc  
 \_\_\_\_\_ 0 to  $\pm 400$ -kc at 10.7 Mc  
 Internal Modulation \_\_\_\_\_ Line frequency  
 (External modulation can be applied)  
 Radio-Frequency Oscillator:  
 Frequency Range \_\_\_\_\_ 85-110 Mc  
 Scale Accuracy \_\_\_\_\_  $\pm 2\%$   
 Output \_\_\_\_\_ Adjustable from uv to 0.1 RMS volt  
 Amplitude Modulation \_\_\_\_\_ Twice line frequency

## D-C Microammeter, WV-84A

Readings \_\_\_\_\_ 0.001 ua to 1 ma full scale  
 Six Ranges \_\_\_\_\_ 0.01; 0.1; 1.0; 10; 100; 1000 ua  
 Voltage Drop at Full Scale (all ranges) \_\_\_\_\_ 0.5 volts  
 Power Supply (batteries) \_\_\_\_\_ 2-1½ volts "A" RCA VS106)  
 \_\_\_\_\_ 2-2½ volts "B" (RCA VS102)  
 Dimensions \_\_\_\_\_ 6¼" wide; 9½" high; 5¾" deep  
 Weight (including batteries) \_\_\_\_\_ 9½ lbs.

Reads from 0.001 to 1000 microamperes in six separate ranges. Useful for measuring high values of resistance; may be used as high resistance voltmeter. Approaches galvanometer sensitivity. Electronic protected non-burn-out meter. Accuracy, 0.01 range,  $\pm 5\%$  of full scale reading; other ranges  $\pm 4\%$ . Ideal for weak-current measurements in phototubes, multiplier phototubes, etc.



## Television Calibrator, WR-39A

The WR-39A is a marker signal generator, a dual crystal standard, and a heterodyne frequency meter with built-in audio amplifier and speaker. The marker VFO operates on fundamentals, and produces strong marker pips on scope traces anywhere within its specified frequency ranges. For regular signal-generator and calibrator applications, the VFO also can be used on harmonic frequencies, thus giving increased coverage. For stagger-tuned alignment work, the VFO can be amplitude-modulated by an audio oscillator. The frequency standard uses a 2.5-Mc primary crystal and a 250-kc modulating crystal. This crystal combination will calibrate any signal source over the range of 250-kc to 250-Mc. The heterodyne frequency meter provides audible beats to identify the 2.5-Mc and 0.25-Mc check points. Unit is complete with signal injection cable. Shipping weight, 22 lbs.

### Specifications

Variable-Frequency Oscillator Frequency Ranges  
(continuous coverage) \_\_\_\_\_ 19-110 Mc; 170-240 Mc

Output Voltage \_\_\_\_\_ Better than 0.28 peak-to-peak volt.  
0.1 RMS volt at any frequency

Output Impedance \_\_\_\_\_ 100 ohms

Attenuator Range \_\_\_\_\_ 100/1

Impedance at "Mod In" Jack \_\_\_\_\_ 5000 ohms



### Crystal Oscillators:

Primary Standard Frequency \_\_\_\_\_ 2.5-Mc; accuracy  $\pm 0.01\%$   
Modulating Standard Frequency \_\_\_\_\_ 0.25-Mc; adjustable for exact zero-beat with 2.5-Mc crystal

### Heterodyne Detector Input Requirements:

External Signal Beating Against VFO \_\_\_\_\_ 1 millivolt  
External Signal Beating Against Crystals \_\_\_\_\_ 10 millivolts

### Audio Amplifier:

Gain (approx.) \_\_\_\_\_ 1000; output 0.3 watts max.

Loudspeaker \_\_\_\_\_ 3-inch cone, Alnico magnet type

Dimensions \_\_\_\_\_ 10" x 13 1/2" x 7 1/2"

## Audio Voltmeter, WV-73A

A sensitive high-impedance a-c VTVM capable of measurements from 0.001 RMS volt to 1000 RMS volts a-c over a range of 20 to 20,000 cycles. Logarithmic scale and overlapping attenuator assure accuracy even when pointer is at either end of scale. In combination with a modulated high-frequency generator and rectifying probe, the WV-73A is especially useful in determining characteristics of coaxial cables and slotted lines. Standing-wave ratios can be read in terms of voltage or db ratios, since the meter is equipped with both scales. The high-fidelity amplifier is externally accessible. Shipping weight, 17 lbs.

### Specifications

A-c Voltmeter Ranges (1 millivolt to 1000 RMS volts in 11 ranges) \_\_\_\_\_ 0.001-0.01, 0.004-0.025, 0.01-0.1, 0.04-0.25, 0.1-1, 0.4-2.5, 1-10, 4-25, 10-100, 40-250, 100-1000 RMS volts.

DB Ranges (0-120 db in 11 ranges) \_\_\_\_\_ 0 to 20, 30, 40, 50, 60, 70, 80, 90, 100, 110, 120 db

Frequency Response \_\_\_\_\_ Flat within  $\pm 0.5$  db from 20 cps to 20 kc



Input Resistance and Capacitance \_\_\_\_\_ 1 megohm shunted by less than 25 puf

Scale Accuracy \_\_\_\_\_ Better than  $\pm 50\%$

Amplifier Gain \_\_\_\_\_ 2500 (with 25,000-ohm load)



## Audio Oscillator, WA-54A

The WA-54A Audio Oscillator is a portable, a-c operated instrument for generating sinusoidal voltages within the frequency range of 20 to 17,000 cycles. It is used to measure the fidelity of radio receivers, frequency response of audio amplifiers, and modulation characteristics of small transmitters. It is useful to determine frequencies and mechanical speeds and to troubleshoot TV deflection, sync and video amplifier circuits. Tapped output transformer makes it possible to match the oscillator output to load impedances most frequently encountered . . . electronic "eye" serves as calibration indicator, output level indicator, and pilot lamp. Frequency settings are read from a large, easy-to-read drum dial. Shipping weight, 19 lbs.

### Specifications

Frequency Range (continuous) \_\_\_\_\_ 20 cps to 17 kc  
 Output Impedance:  
 High-Level Balanced \_\_\_\_\_ 250, 500, 5000 ohms  
 High-Level Unbalanced \_\_\_\_\_ 62.5, 125, 1250 ohms  
 Low-Level Unbalanced \_\_\_\_\_ 10,000 min. ohms  
 Output Voltage (approx.):  
 No Load (high level) \_\_\_\_\_ 40 RMS volts  
 With 5000-Ohm Load \_\_\_\_\_ 25 RMS volts



With 500-Ohm Load \_\_\_\_\_ 7.9 RMS volts  
 With 250-Ohm Load \_\_\_\_\_ 5.5 RMS volts  
 No Load (low level) \_\_\_\_\_ 2.5 RMS volts  
 Output Voltage Variation (loaded) \_\_\_\_\_ Less than  $\pm 2$  db  
 Distortion \_\_\_\_\_ Less than 5% RMS  
 Dimensions \_\_\_\_\_ 10" x 13½" x 7½"

## Test Oscillator, WR-67A

The WR-67A provides speed, accuracy, convenience, and overall dependability in signal injection and alignment work. A range switch allows the quick selection of three fixed frequencies of 1500, 600, and 455 kc . . . band-spread dial provides



continuously variable fundamental frequencies from 100 kc to 30 Mc, plus useful harmonics out to 90 Mc. Add to this—a temperature compensated oscillator . . . special signal-injection probe . . . both step and vernier attenuators . . . double shielding . . . six-band drum dial with easy-to-read, four-foot scale spread . . . scale accuracy of  $\pm 2\%$ , adjustable modulation level on internal and external modulation positions . . . power-line filter to minimize rf leakage . . . and 400-cycle signal source—more features than can be found in most signal generators. Shipping weight, 20 lbs.

### Specifications

Frequency Range \_\_\_\_\_ Continuous from 100 kc to 30 Mc  
 Band A: 100-260 kc; Band B: 260-650 kc; Band C: 635-1600 kc;  
 Band D: 1.6-4.7 Mc; Band E: 4.4-12.8 Mc; Band F: 10.5-30 Mc.  
 Scale Accuracy \_\_\_\_\_  $\pm 2\%$   
 Fixed Frequencies \_\_\_\_\_ 455, 600, 1500 kc  
 Output Voltage (RMS) \_\_\_\_\_ Continuously variable, 5 uv to 1 volt  
 Internal Modulation \_\_\_\_\_ 400 cps; adjustable from 0% to 50%  
 External Modulation \_\_\_\_\_ 2 RMS volts req. for 30% mod.  
 Audio Output \_\_\_\_\_ 25 max. RMS volts across 100,000 ohms  
 RF Output Impedance \_\_\_\_\_ 10-1000 ohms  
 (Varies with attenuator setting)  
 Dimensions \_\_\_\_\_ 10" x 13½" x 7½"

## Rack-Adaptor Panel, WS-18A

WS-18A Rack Adapter Panel for mounting any of the matched RCA Test Instruments in standard 19-inch relay racks . . . adds convenience and standardization to industrial test setups.

Dimensions \_\_\_\_\_ 10½" high, 19" wide, ½" thick

Finish \_\_\_\_\_ Umber gray

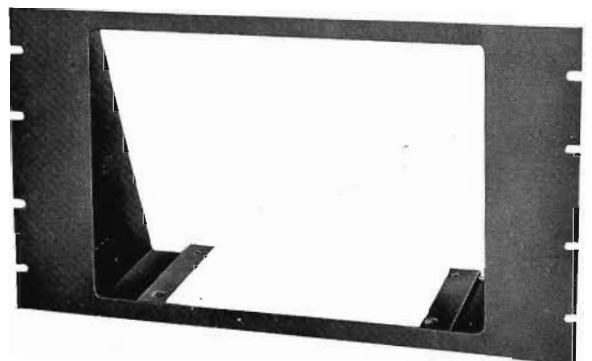

## VoltOhmyst, 195-A

The ideal instrument for radio servicing. In one instrument, at one price, you get 6 testing devices; D-c Voltmeter; Ohmmeter; A-c Voltmeter; A-F Voltmeter; Outputmeter; FM Indicator. New features include diode for a-c measurements, linear a-c scale for all ranges; RCA crystal probe WG-263 (available on request).

### Specifications

Electronic D-c Voltmeter Range \_\_\_\_\_ 0-3; 10; 50; 100; 500; 1000 volts  
 Input Impedance \_\_\_\_\_ 10 megohms constant  
 Electronic Ohmmeter Range \_\_\_\_\_ 0-1,000; 10,000; 100,000 ohms; 0-1; 10; 1000 megohms  
 Internal Source \_\_\_\_\_ 3 volts  
 Electronic A-c Voltmeter Range \_\_\_\_\_ 0-5; 10; 50; 100; 500; 1000 volts  
 Power Supply \_\_\_\_\_ 105/125 volts; 50-60 cycles  
 Dimensions \_\_\_\_\_ 6 $\frac{3}{8}$ " wide, 9 $\frac{5}{8}$ " high, 6 $\frac{3}{4}$ " deep  
 Weight \_\_\_\_\_ 14 lbs.  
 Finish \_\_\_\_\_ Gray wrinkle, brush chrome panel

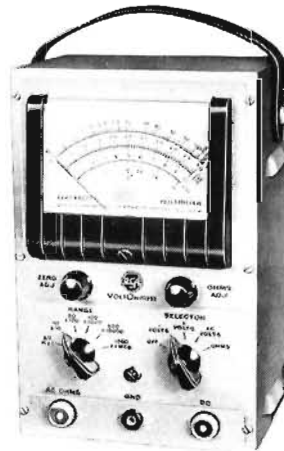

## Battery VoltOhmyst, WV-65A

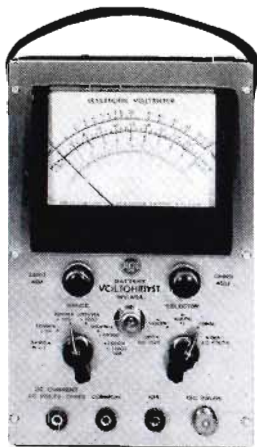

Portable electronic voltmeter-ohmmeter and ammeter combination for mobile, industrial or rural use. Works anywhere without a-c power source, thereby extending famous VoltOhmyst features to places remote from power lines. Neon panel lamp lights when battery is used. Unusually long battery life with normal use.

D-c Ranges \_\_\_\_\_ 0-3; 10; 30; 100; 300; 1000 volts  
 Input Resistance \_\_\_\_\_ 11 megohms constant  
 A-c Ranges \_\_\_\_\_ 0-10; 30; 100; 300; 1000 volts  
 Sensitivity \_\_\_\_\_ 1000 ohms per volt  
 Ohmmeter Ranges \_\_\_\_\_ 0-1000; 10,000; 100,000 ohms; 0-1; 10; 1000 megohms  
 D-c Ammeter Ranges \_\_\_\_\_ 0-3; 10; 30; 100; 300 milliamp; 0-10 amp  
 Batteries \_\_\_\_\_ Four 1 $\frac{1}{2}$  volt "A"; two 45 volt "B"  
 Dimensions \_\_\_\_\_ 6 $\frac{1}{4}$ " wide, 9 $\frac{1}{2}$ " high, 5 $\frac{1}{2}$ " deep  
 Weight (including batteries) \_\_\_\_\_ 9 lbs.

## Advanced VoltOhmyst, WV-75A

For High-Frequency, FM, TV, UHF and pulse work. Newly-developed diode probe permits peak-to-peak a-c voltage readings to 250 Mc. WV-75A is really 6 instruments: VHF Voltmeter, Audio Voltmeter, A-c Voltmeter, D-c Voltmeter, Ohmmeter, FM Indicator. Meter is burn-out proof. The WV-75A employs a push-pull D-c Vacuum Tube Voltmeter circuit, characterized by excellent linearity and stability.

D-c (6 ranges) \_\_\_\_\_ 0 to 1000 volts  
 A-c (6 ranges):  
 Using probe directly \_\_\_\_\_ 0 to 100 volts  
 Using probe and multipliers \_\_\_\_\_ 0 to 1000 volts  
 Frequency Response:  
 Using probe directly \_\_\_\_\_ 30 cycles to 250 Mc  
 Using probe and multipliers \_\_\_\_\_ 30 cycles to 15 kc  
 Input Impedance (using probe directly):  
 At 1 Mc \_\_\_\_\_ 625 Kilohms; 15.6  $\mu$ f  
 Resistance (6 ranges) \_\_\_\_\_ 0 ohms to 1000 megohms  
 Power Supply (a-c) \_\_\_\_\_ 105/125 volts, 50/60 cycles  
 Dimensions \_\_\_\_\_ 6 $\frac{3}{8}$ " wide, 9 $\frac{5}{8}$ " high, 6 $\frac{3}{4}$ " deep





## Master VoltOhmyst, WV-95A

The WV-95A is truly the "master" electronic multimeter. It combines in one case an a-c voltmeter, d-c voltmeter, ohmmeter, d-c microammeter, d-c milliammeter, capacitance meter, and a d-c ammeter. The instrument is a-c line operated. The carefully balanced meter is virtually burn-out proof; it has a full-scale accuracy of  $\pm 2\%$ , and can be zero-centered for discriminator alignment work. The capacitance measuring circuit includes a polarizing voltage for measurement of electrolytic capacitors. The entire electrical system is insulated from the metal case which may be grounded separately. Accessories available on separate order include a 100-Mc crystal probe, WG-263, and a 250-Mc peak-to-peak diode probe, WG-275. Unit is complete with three test leads and two test cables with plugs and clips. Shipping weight, 17 lbs.

### Specifications

D-c Voltmeter Ranges \_\_\_\_\_ 0 to 5-10-50-100-500-1000 d-c volts  
 Input Resistance \_\_\_\_\_ 11 megohms on all ranges  
 A-c Voltmeter Ranges \_\_\_\_\_ 0 to 1.5-10-50-100-500-1000 RMS volts  
 Frequency Response \_\_\_\_\_ 30 cps to 20 kc  
 Input Resistance and Capacitance \_\_\_\_\_ 0.5 megohms shunted  
 by 125 uuf  
 D-c Ammeter Ranges \_\_\_\_\_ 0-10, 0-100 ua, 0 to 1-10-100 ma,  
 0-1, 0-10 amps  
 Ohmmeter Ranges \_\_\_\_\_ 0.1 ohm to 1000 megohms in six ranges  
 Center-Scale Indications \_\_\_\_\_ 10, 100, 1000, 10,000 ohms;  
 0.1, 10 megohms  
 Capacitance Meter Ranges (4 uuf to 1000 uf in six ranges)  
 Center-Scale Indications \_\_\_\_\_ 100,000 uuf; 0.01, 0.1, 1, 10 uf  
 (Note): The following data apply to the WV-95A when used with RCA Diode Probe WG-275 which is supplied on separate order.)



RF Voltmeter Ranges:  
 0 to 5-10-50-100 RMS volts from 30 cps to 17.5 Mc  
 0 to 5-10-30 RMS volts from 17.5 to 75 Mc  
 0-5, 0-10 RMS volts from 75 to 250 Mc  
 Input Resistance and Capacitance:  
 625,000 ohms shunted by 15.6 uuf at 1 Mc  
 32,000 ohms shunted by 14.5 uuf at 10 Mc  
 100 ohms shunted by 13 uuf at 250 Mc  
 Meter Indications \_\_\_\_\_ RMS value of sine-wave voltage, 0.354  
 peak-to-peak value of recurrent complex-wave voltage  
 Dimensions \_\_\_\_\_ 10" x 13½" x 7½"

## Crystal Probe, WG-263

Converts VoltOhmyst Meters 163, 165, 165-A 195, 195-A, WV-65A, WV-75A, and WV-95A into VHF voltmeters for use up to 100 Mc; also used with Chanalysts Types 162, 162-A, 162-B, 162-C and 170-A. Can be used for relative readings to 175 Mc.

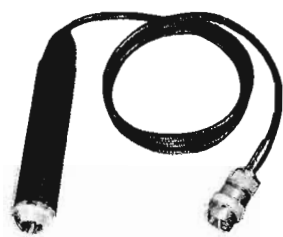
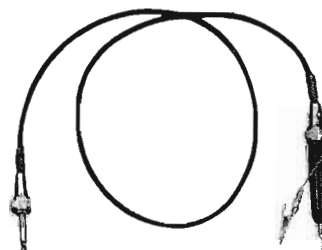

## Diode Probe, WG-275

The RCA Diode Probe WG-275 is designed to operate in combination with RCA VoltOhmyst Electronic Meter WV-95A; it enables this instrument to read RMS or peak-to-peak voltages at frequencies from 30 cycles to 250 Mc. The probe fits coaxial "T" connectors, and permits direct measurement of voltages in coaxial lines.

## High-Voltage Probe, WG-284 (288)

Extends the d-c voltage range of RCA VoltOhmyst and Chanalyst Vacuum-Tube Voltmeters to 30,000 volts. Measures d-c voltages in television sets, X-ray machines, and other high-voltage devices . . . useful in measuring the output voltages of pulse-operated and rf power supplies and other high-resistance voltage sources that require high-resistance measuring instruments. Both probes are identical except for the resistance values of the multiplier resistor. VoltOhmysts 195 and 195-A, and Chanalyst 170-A use probe WG-288. Others use probe WG-284.



## 3" WO-79B Oscilloscope

Truly a laboratory instrument, the WO-79B 3-inch oscilloscope is outstanding for a wide range of research and industrial applications. It is particularly useful for the observation and measurement of phenomena such as TV synchronizing and deflecting voltages, ignition waveforms, pulses, and radar signals. The WO-79B will accurately display 1- $\mu$ s pulses and other waveforms which have extremely steep leading edges, such as are encountered in photo-flash devices and electro-mechanical relays.

The WO-79B features a triggered sawtooth sweep with a delay network, two-to-one trace expansion, flat frequency response from 10 cps to 5 Mc, calibrating meter for voltage measurements, intensifying and blanking amplifier, high voltage for photography of transients, wide-range centering controls, and retractable light shield. It is shipped complete with compensated attenuating cable, and with a direct probe cable.



### Specifications

#### Frequency Range:

Vertical Amplifier \_\_\_\_\_  $\pm 20\%$ , 10 cps to 5 Mc  
 Horizontal Amplifier \_\_\_\_\_  $\pm 10\%$ , 10 cps to 500 kc

#### Deflection Factor: (for 1000 volts at second anode)

Vertical Amplifier \_\_\_\_\_ 0.18 RMS volt/inch\*  
 \_\_\_\_\_ 0.5 peak-to-peak volt/inch  
 Horizontal Amplifier \_\_\_\_\_ 0.46 RMS volt/inch\*  
 \_\_\_\_\_ 1.3 peak-to-peak volts/inch

Sweep Frequency Range \_\_\_\_\_ 20 cps to 250 kc  
 Triggered-sweep Repetition Rate \_\_\_\_\_ up to 50 kc  
 Blanking \_\_\_\_\_ Return trace blanked on triggered deflection  
 Power Supply \_\_\_\_\_ 105/125 volts, 50/60 cycles  
 Power Consumption \_\_\_\_\_ 200 watts  
 Dimensions \_\_\_\_\_ 14 $\frac{1}{2}$ " high, 8 $\frac{1}{4}$ " wide, 18 $\frac{1}{4}$ " deep  
 Weight \_\_\_\_\_ 42 lbs.  
 \_\_\_\_\_ \* For Sine Waves.

## WO-27A D-C Oscilloscope

Specifically designed for the accurate analysis of extremely low-frequency phenomena in mechanical, hydraulic, pneumatic, electrical, and electronic systems, the RCA WO-27A D-c Oscilloscope has a wide range of applications in the laboratory and industrial plant.



It features triggered sweep and blanking circuits that permit the observation and photographic recording of one-time, high-speed transients. This oscilloscope also shows a-c and d-c simultaneously, providing more information than can be obtained from a simple stroboscope. The 5-inch C-R tube can be readily interchanged from the front with a tube of other persistence characteristics.

### Specifications

#### Frequency Range:

Vertical and Horizontal Amplifiers \_\_\_\_\_ 0 cycles to 100 kc  
 Timing Axis Oscillator \_\_\_\_\_ 1 cycle to 30 kc  
 Blanking Amplifier \_\_\_\_\_ 30 cycles to 100 kc

#### Deflection Sensitivity (volts per inch):

	<i>D-c or Peak-to-Peak</i>	<i>RMS Sine Wave</i>
Vertical Amplifier _____	0.084	0.030
Horizontal Amplifier _____	0.105	0.037
<i>(Direct to Deflection Plates)</i>		
Vertical _____	54	19
Horizontal _____	67.5	24

Power Supply \_\_\_\_\_ 105/125 volts, 50/60 cycles  
 Power Consumption \_\_\_\_\_ 130 watts  
 Dimensions \_\_\_\_\_ 13" wide, 20" high, 25" deep  
 Weight \_\_\_\_\_ 80 lbs.



## 5" Cathode-Ray Oscilloscope, WO-58A

The WO-58A is a portable wide-band 5 inch oscilloscope especially suited for television receiver servicing. It performs all regular oscilloscope services, and in addition it displays sync pulses, blanking pedestals, and deflection waveforms accurately. Because provision is made for intensity modulation, the scope will substitute for the kinescope, video amplifier and the vertical and horizontal oscillators and amplifiers in television receivers. A calibrating voltage and 3-1 range switch make the instrument a direct-reading VTVM. Sweep circuits include a vacuum tube sawtooth multivibrator and an auxiliary 60-cycle sine-wave source with phasing control. Supplied complete with r-f crystal probe, direct probe, and high-impedance frequency compensating probe.

**Vertical Amplifier:**

Deflection Factor (direct probe) \_\_\_\_\_ 0.18 RMS volt/inch  
 Deflection Factor (attenuating probe) \_\_\_\_\_ 1.8 RMS volt/inch  
 Input Impedance (direct probe) \_\_\_\_\_ 1 megohm, shunted by  
 62 $\mu$ f (approx.)

Input Impedance (attenuating probe) \_\_\_\_\_ 2 megohms, shunted  
 by 9.5  $\mu$ f (approx.)

Input Capacitance (crystal probe) \_\_\_\_\_ 5.5  $\mu$ f

**Sine-Wave Frequency Response:**

Flat within  $\pm 20\%$  from 5 cps to 2 Mc  
 Flat within  $\pm 50\%$  from 1 cps to 4 Mc

**Square-Wave Response:**

Tilt and overshoot less than 2% from 30-50,000 cps  
 Rise time less than 0.15  $\mu$ s from 10% to 90% of total rise



**Horizontal Amplifier:**

Sine-Wave Frequency Response:

Flat within  $\pm 10\%$  from 6 cps to 100 kc

**Horizontal Sweep:**

Frequency Range \_\_\_\_\_ 10 cps to 100 kc

**Z-Axis Sensitivity:**

Beam Blanking Voltage (max.) \_\_\_\_\_ 50 peak volts

Size \_\_\_\_\_ 13 $\frac{3}{4}$ " x 9 $\frac{1}{2}$ " x 19  $\frac{13}{32}$ "

Shipping Weight \_\_\_\_\_ Approx. 40 lbs.

## Regulated Power Supply, WP-23A

A high-quality unit designed for dependable, continuous service in shop, laboratory, and factory. Output voltage is virtually independent of line-voltage variations as well as load-current variations. Maximum load-current capability increases with the output voltage level. Insulated output terminals permit grounding of either the positive or negative terminal. Primarily intended as an extremely stable "B" supply, the WP-23A also can be used as a low-impedance "C" bias supply. Shipping weight, 25 lbs.

**Specifications**

**Regulated d-c Output:**

Voltage Range (continuously adjustable) \_\_\_\_\_ 0-300 volts

Current Range for 120-300 Volts \_\_\_\_\_ 0-120 ma

60-120 Volts \_\_\_\_\_ 0-80 ma

0-60 Volts \_\_\_\_\_ 0-60 ma

**Regulation for Line-voltage Variation of**

105 to 125 Volts \_\_\_\_\_ Less than 1 $\frac{1}{2}\%$

**Regulation Above 30 Volts from Zero Load**

to Full Load \_\_\_\_\_ Less than 1%

Ripple Voltage (RMS) \_\_\_\_\_ Less than 8 millivolts



**Auxiliary Unregulated d-c Output:**

Voltage (approx.) \_\_\_\_\_ 600 volts

Current Capability \_\_\_\_\_ 120 ma

Ripple Voltage (RMS) \_\_\_\_\_ 0.1 volts

**Auxiliary Unregulated a-c Output:**

Voltage (RMS) \_\_\_\_\_ 6.3 volts

Current Capability (RMS) \_\_\_\_\_ 5 amperes

# OTHER RCA PRODUCTS

In addition to products designed primarily for Broadcast applications, RCA also handles many other products which are frequently used in the Broadcast field. Some of these products are described in the following pages.

"Other RCA" Equipment items included in this section of the catalog carry different warranties from those applying to "Broadcast Equipment" items. For information regarding warranty, price or delivery on items in this section, contact your nearest RCA Distributor or write direct to Engineering Products Department, Camden, New Jersey.

	Page
SOUND EQUIPMENT	370
16MM PROJECTORS	391
THEATRE EQUIPMENT	395
MOBILE COMMUNICATION EQUIPMENT	396



# It's Easy to Install a Sound System...

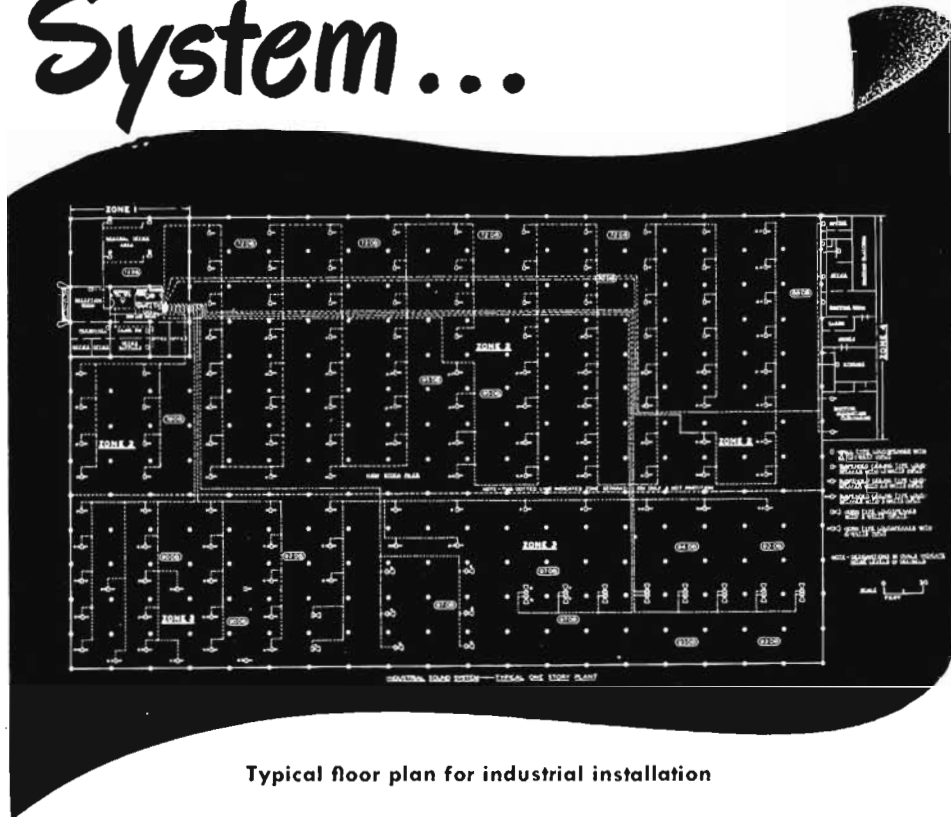
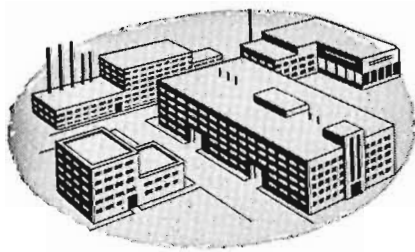

Typical floor plan for industrial installation

## —with time-saving RCA Engineering Service

YOU'LL FIND SOUND SYSTEMS easy to install when they are engineered by RCA. All units of an RCA Sound System are designed for easiest possible mounting. You'll save time because RCA Sound System layouts and specifications are easy to follow.

You gain a good reputation when your clients are enthusiastic with the results of your installations. You generate this kind of enthusiasm when you recommend or install an

RCA Sound System. That's because these sound systems are engineered to the requirements of your client's organization.

There is no ready-made "package" sound system that perfectly suits the noise level, type of buildings, needs of various types of plant and office layouts. Working with your nearest RCA Sound Products Distributor, you provide your clients with sound systems that give them the most for

their money.

No matter what size or type of sound system you are asked to bid on, RCA can help you plan and engineer a system that will best fit your customer's requirements.

Contact your nearest RCA Sound Products Distributor or write: Sound Products (Dept. 118-D), Radio Corporation of America, Camden, New Jersey.

----- Let RCA Help You Plan and Engineer Sound Systems For -----

OFFICE BUILDINGS  
SCHOOLS  
CHURCHES  
HOSPITALS  
INDUSTRIAL BUILDINGS

HOTELS  
INSTITUTIONS  
DEPARTMENT STORES  
TRANSPORTATION TERMINALS  
RECREATIONAL CENTERS

WAREHOUSES AND GARAGES

### DO YOU HAVE A COPY?

*The Architect's Manual of Engineered Sound Systems.* The most authoritative work book and reference manual published on sound systems. Typical plans, and specifications for all types of buildings. 288 pages. Price \$5.00 (\$5.50 foreign).



**MICROPHONES**

- Pressure
- Velocity
- Cardioid
- Varacoustic
- Hand Sets
- Sound Power Telephones
- Stands, Plugs, Cables and Connectors



**AMPLIFIERS**

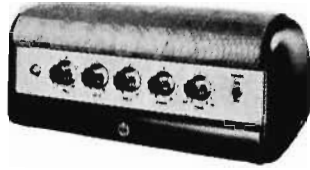

- Pre-Amplifiers
- Line Amplifiers
- Voltage Amplifiers
- Power Amplifiers
- Remote Amplifiers

**SPEAKERS**



- Cone Type
- Horns and Drivers
- High-Fidelity Speakers
- Speaker Accessories

**SPEAKER HOUSINGS**



- Baffles, All Types
- Console Cabinets

**INTERCOM SYSTEMS**

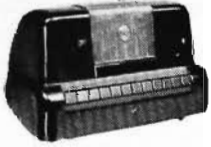

- All Master Systems
- Master-Remote Systems
- Combination Systems

**PORTABLE SOUND SYSTEMS**



**CUSTOM-BUILT EQUIPMENT**



- Consoles
- Desks
- Turrets
- Cabinets



**CONSOLETTES**

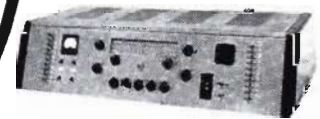

- Single Channel
- Dual Channel
- Custom-Built

*Why shop around?*

**It's easy to get the right equipment from RCA's full line of matched sound products**

Buy your sound products the easy way. The wide variety of RCA Sound Products simplifies your problem of finding the right equipment for your sound jobs.

Every item in RCA's extensive sound line is electronically engineered with its own special characteristics to give top performance, dependable long-life service with quality appearance. Not only is the RCA Sound Products line built right, it is

also priced right to enable you to build a steady volume of profitable business.

You cash in on the popular acceptance of the RCA trade mark when you buy RCA. You save time, save money and save the trouble of shopping around, when you purchase your sound products from *one* source—RCA. No other manufacturer offers so extensive a line of "matched" sound products from the smallest "ballyhoo" system to the largest systems for industrial, educational, institutional, church, hotel, hospital or commercial users.



# There Is An RCA Sound System That Meets The Needs Of Your School

## Standard Single Channel System

Here's a handsome low-cost Single Channel Program Console that distributes selected programs or administrative announcements to any or all locations equipped with loudspeakers in the school or grounds. Superb value, an exceptional buy for the medium-size elementary or junior high school working on a limited budget.



- 20 room or zone distribution switches with provision for installation of up to 20 more.
- 5 input circuits permit program pickup from any location.
- Built-in de luxe RCA radio with AM, FM and short-wave reception.
- Volume indicator meter.
- Provision for attaching separate record player or transcription turntable.
- Talk-back or two-way communication feature (optional equipment).
- Master emergency switch.

## Standard Dual Channel System

Administrators, supervisors, teachers and the student body use this Dual Channel Program Console for a variety of instructive purposes and for administrative control. Provides for the distribution of teaching programs or announcements to selected classrooms over one channel while the second channel simultaneously permits intercommunication or distribution of an additional program to other classrooms or areas in the school or grounds. Priced within the budget of high, junior high or the larger elementary schools.

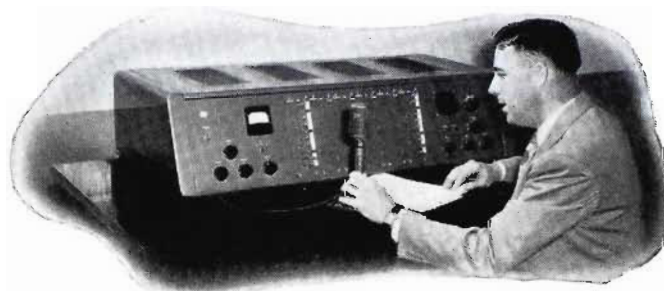

- 9 input circuits provide numerous possibilities for program pickups from radio, phonograph and microphones in auditorium and elsewhere.
- Volume indicator meter.
- Switches control loudspeakers for 20 to 60 classrooms or areas.
- Provision for attaching separate record player, transcription turntable and radio tuner.
- 2 high-quality 25-watt amplifiers.
- Two-way communication between classrooms and console.
- Master emergency switch.

## De Luxe Dual Channel Equipment

Provides complete audio facilities for the larger high schools and colleges. Dual channel services for administrative broadcasts . . . teaching programs . . . radio listening . . . in-school program originations . . . record and transcription reproduction . . . independent two-way intercommunication (optional), unit-built from standardized frames and panels to allow numerous combinations of basic units. Gives you the advantage of a "custom-made" sound system within the price range of regular production equipment.



- De luxe studio-type control console.
- Individual loudspeaker selection for up to 120 rooms or areas.
- Provision for at least 10 program input circuits if desired.
- AM, FM and short-wave tuner (optional).
- Transcription or record player (optional).
- Master emergency switch.
- Provision for expansion or other features as required.
- Intercommunication (optional).

# Portable Sound System

## Model SP-15A



Exceptional tone quality and ease of operation are two of the features that make the new RCA Model SP-15A the outstanding portable sound system available. Matched microphone, amplifier, and loudspeaker insure faithful reproduction of voice and music, while the large, heavy duty, highly efficient Alnico Magnet speaker is capable of handling the maximum output of the 15 watt amplifier without distortion. The high efficiency of the speaker gives acoustical output equivalent to a conventional 30 watt portable sound system incorporating two average permanent magnet speakers.

The equipment is assembled in a handsome inlaid steel-band reinforced heavy plywood carrying case, finished in gray and black (two-tone) durable Du Pont Fabrikoid, and measuring 8" deep, 17" wide, and 21" high. Weight 45 lbs.

Phonograph jack permits playing of recorded music for musical programs or to furnish background for voice announcements.

The RCA SP-15A is truly the outstanding portable sound system, and is admirably suited for use in moderate size auditoriums, as well as such diversified places as bus terminals, night clubs, taverns, fairs, restaurants, auction rooms, bowling alleys, and numerous other places.

## FEATURES

### MICROPHONE

- Dynamic—Pressure type
- Rugged, light weight, small in size
- Shock absorbing mounting
- Built-in cable connector
- Detachable cable

### AMPLIFIER

- Modernly styled
- Inverse feedback circuit—low distortions, high output
- Individual volume control for each input
- Power output—15 watts
- Frequency response—50 to 10,000 cycles
- Two lock-in type microphone plugs and receptacles
- Two standard shorting type phonograph jacks
- Balanced output

### SPEAKER

- Large heavy duty, highly efficient Alnico permanent magnet
- High power handling capacity—25 watts
- Moisture resistant
- 50 feet of speaker cable with polarized plug

### CARRYING CASE

- Heavy plywood construction
- Durable Du Pont Fabrikoid two-tone covering—gray and black
- Cabinet by Belber\*
- Inlaid steel band edge construction
- Conventional luggage size—easy to handle and carry
- Provision for mounting all components
- Handle will not rattle at full power reproduction

\* One of the country's leading luggage manufacturers



# Remote Pre-Amplifier MI-12242

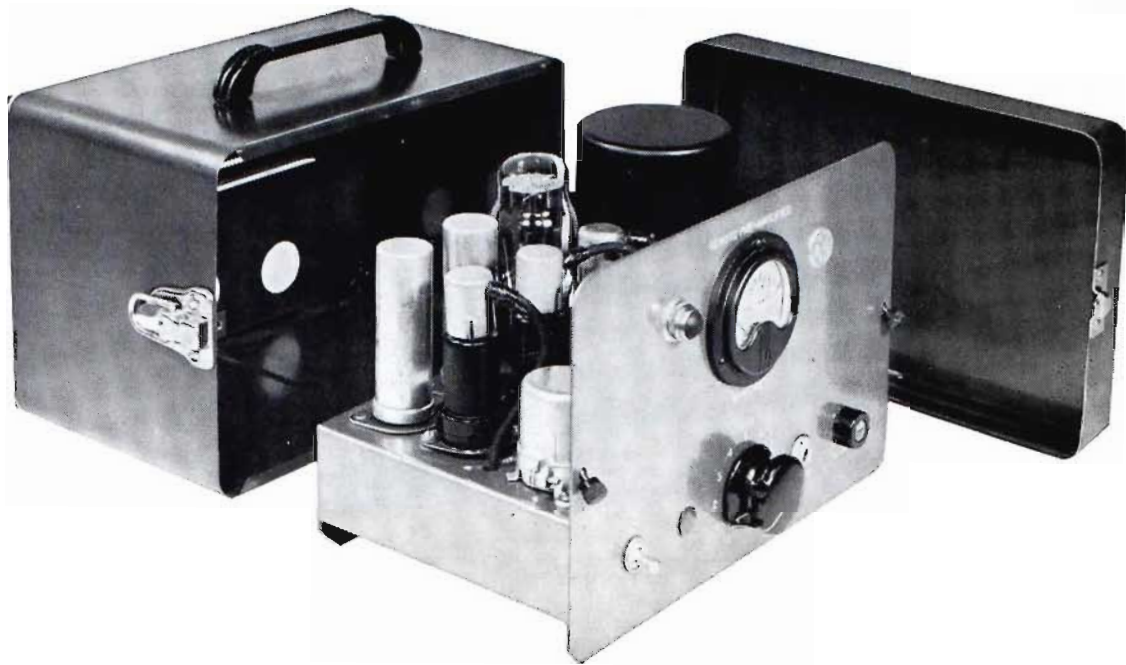

## Description

The MI-12242 pre-amplifier has been designed for portable use or for shelf mounting. The problem of remote pick-up has existed for a long time in sound work and this pre-amplifier fills the gap.

Microphones may be used at considerable distance from the equipment located in a fixed position. For instance, a large assembly of people may be in an auditorium, park, church, school, railroad or airline waiting room, mill, factory, etc., and a program or message of interest is taking place in another building or remote location. With the aid of the remote pre-amplifier the program may be fed back to any of the above places that have a sound system, by means of telephone lines or by running a line from the pre-amplifier to the fixed equipment. The remote pick-up can be fed at zero level over telephone lines into pre-amplifiers or at short distances from the power amplifiers, it will drive them directly.

Balance frequency control is a unique feature of this model. This control compensates for both high and low frequencies simultaneously. A screwdriver adjusted control in the front panel shifts the response about a pivotal frequency of 800 CPS, which permits a rising or falling characteristic with a maximum variation of 15 db between lows and highs without any apparent change of volume, thus eliminating the disadvantages of the conventional separate high and low tone controls previously used for frequency compensation. This gives a flat response curve.

Two of these pre-amplifiers can be connected in parallel to feed a 250 ohm line while four can be connected into a series parallel arrangement to feed a 500 ohm line, by so doing from one to four microphones can be used at the remote pick-up point.

The pre-amplifier is designed to fit an attractively styled compact cabinet with a handle for easy carrying. It is mounted into a metal case which provides new style connections for the input and output, a phone jack for aural monitoring, a VI meter for visual monitoring and an a-c male receptacle. A gain control for riding gain, a pilot light and a-c switch are

also mounted in the front panel. An accessible one ampere fuse is provided for protection of the equipment. A removable cover clips over the front panel to prevent damage when not in use.

The entire unit may be removed from the case by removing the two thumb screws on the front panel. This facilitates quick service or the replacing of a tube.

## Features

- Compact design.
- Light weight.
- Excellent frequency response  $\pm 2$  db 30 to 10,000 cycles.
- Balanced frequency response control.
- A portable shelf mounted.
- Light weight, easily handled.
- Built-in handle for easy carrying.
- Low impedance input and output.
- Good regulation between no load and full load.
- 77 db gain.
- Feedback for better frequency response.
- Low distortion and noise level.
- Two or more amplifiers can be used giving additional microphone locations.
- Low hum level.

**Specification**

Frequency Response \_\_\_\_\_  $\pm 2$  db 30 to 10,000 cycles

Input \_\_\_\_\_ 3-prong female plug

Source Impedance \_\_\_\_\_ 250/500 ohms

Minimum Input Level \_\_\_\_\_ -67 dbm

Maximum Input Level \_\_\_\_\_ -35 dbm

Gain \_\_\_\_\_ 77 db

Output Load Impedance \_\_\_\_\_ 250/500 ohms

Rated Power Output  
 $+18$  dbm with 1.5% distortion at 1000 cycles

Feedback \_\_\_\_\_ -12 db

Tubes \_\_\_\_\_ 3—RCA 6J7, 1—RCA 5Y3GT

Finish \_\_\_\_\_ Light umber gray hammeroid

Power Consumption \_\_\_\_\_ .109 amp. on 117 v. line  
 (maximum) 12 watts

Fuse \_\_\_\_\_ 1 ampere

Height \_\_\_\_\_  $6\frac{3}{4}$ "

Width \_\_\_\_\_ 10"

Depth \_\_\_\_\_ 6"

Weight \_\_\_\_\_ 12 lbs.

Shipping Weight \_\_\_\_\_ 16 lbs.

Stock Identification:

105/125/210/250 volts, 50/60 cycles \_\_\_\_\_ MI-12242

105/125/210/250 volts, 25/60 cycles \_\_\_\_\_ MI-12247

directly from a short distance. Balanced control shall be provided to control the response about a pivotal frequency of 800 CPS to permit a rising or falling characteristic with a maximum variation of 15 db between lows and highs without apparent change of volume, thus eliminating the disadvantages of the conventional separate high and low tone controls previously used for frequency compensation.

The pre-amplifier shall be compact and easy to handle. It shall be mounted in a metal case, which provides plugs for the input and output connections, one jack and an a-c male receptacle. The front panel of the equipment shall mount a db meter, a gain control and a monitor jack. A pilot light and a-c switch shall be provided in addition to an accessible one ampere fuse. A removable cover shall clip over the front panel to prevent damage when not in use. A handle shall be built into the side to allow easy carrying.

The unit shall be so constructed that it may be removed from the case by removing two thumb screws on the front of the panel.

The pre-amplifier shall be light in weight, have smart design and low hum level. It shall have a frequency response  $\pm 2$  db 30 to 10,000 cycles. It shall have a source impedance of 250/500 ohms with a maximum input -35 dbm and a minimum input of -67 dbm and a gain of 77 db. The output load impedance shall be 250/500 ohms and the rated output power shall be 18 dbm with 1.5% distortion at 1000 cycles. It shall have a feedback of -12 db. The power supply shall be 105/125 v. a-c, 50/60 cycles with power consumption of 0.109 amp. on 117 v. (maximum 12 watts).

The finish shall be light umber gray hammeroid. The height shall be  $6\frac{3}{4}$  inches, width 10 inches, and depth 6 inches. It shall weigh 12 pounds.

**Architects and Engineers Specifications**

The pre-amplifier shall be designed for portable use or for shelf mounting. It shall be capable of operating with a microphone at a considerable distance from the pre-amplifiers. Its output shall be great enough to feed the power amplifiers

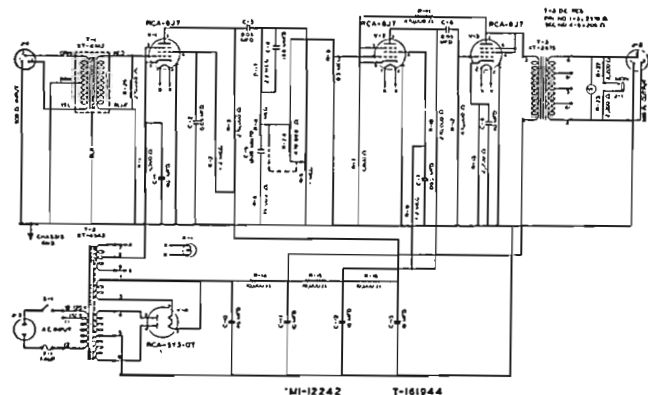
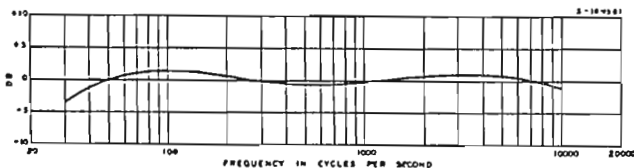



# Intercom System



MI-12596-3 Master Station provides two-way communications with as many as twelve other Masters, twelve Remote Stations, or a wide combination of Masters and Remotes. Earphone for privacy optional.



MI-12592 2 Master Station permits connection with up to six other Masters, six Remote Stations, or a combination of Masters and Remotes in one system. Earphone for privacy optional.

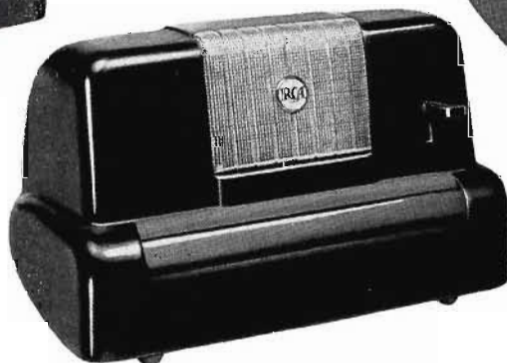

MI-12595 Remote Stations. Can be used in connection with any of the Master Stations.

The RCA Intercom System offers wide application in offices, factories, retail stores, and many other enterprises where flexible, intelligible, two-way intercommunication is desired. It provides the same practical use and convenience for the two-office suite or the large manufacturing plant which covers many acres. In fact, it can be of service in any location of more than a single room.

The primary function of the RCA Intercom is to furnish amplified, two-way conversation between two or more points. Contact is direct, instantaneous, automatic and private. The voice is amplified so that it can be heard across a large room or the volume may be reduced to a whisper. Quality of reproduction is so true that the speaker's voice can be recognized instantly.

Use of the RCA Intercom System results in a more completely coordinated organization, fuller utilization of man-power through the elimination of delays, less office walking, fewer interruptions and more efficient service to customers.

Complete flexibility of the RCA Intercom System makes future expansion practical without affecting the original installation. All of the Master Stations have been designed to permit connection with other Master Stations, Remote Stations, or any combination of Masters and Remotes up to the selector key capacity

of the Master Station. Contact between a central location and a number of outlying points is accomplished through a Master Station connected with the necessary number of Remotes. Complete intercommunication, in which every Station can call and receive calls from all others, is attained through a requisite number of connected Master Stations. For a System requiring complete intercommunication among a number of locations and, at the same time, contacts from these locations to outlying points, a combination of Masters and Remotes can be connected in the one System to provide the service required at each location.

## SPECIFICATIONS

- Cabinet—Matte black with satin chrome grille.
- Dimensions—10 $\frac{3}{8}$ " x 7 $\frac{1}{8}$ " x 5 $\frac{7}{8}$ ".
- Power Required— 105/125V. A.C.  
50/60 cycles, 25 Watts
- Output Impedance—15 ohms.
- PM Speaker Impedance—15 ohms.
- Tubes—1 RCA-6SL7GT, 1 RCA-6V6GT,  
1 RCA-6X5GT.
- Pilot Light—6.3 volt, bayonet socket, 250 M.A.
- Power Cord—8 ft.
- Inter-Station Wire Size—No. 22 or larger.
- Wiring Connections—Cable and Junction Box.
- Shipping Weight—10 $\frac{1}{2}$  lbs.

# RCA'S UNIT-BUILT CONSTRUCTION SIMPLIFIES SOUND SYSTEM PLANNING



**MANY  
COMBINATIONS  
BY  
FUNCTIONS**

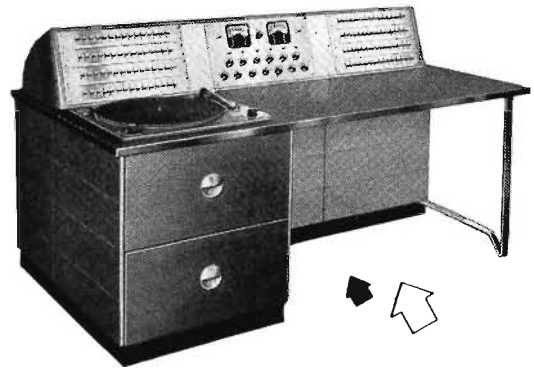

JUST ONE SERIES OF MODELS . . . standardized in dimension, styling and function . . . RCA has included every sound service required in modern institutional and industrial buildings.

Flexibility is the keynote of the new RCA Master Sound control equipment. The completed control unit may contain only paging facilities in a single pedestal . . . or paging may be combined with record transcription turntables, microphone inputs, recorders, and radio unit. All included functions are assembled in basic units . . . occupying minimum building space . . . and arranged for easy, efficient operation.

Because of the standardized units and uniform modern styling, RCA's Unit-Built Sound Systems are high in favor with the designers who have already included them in new and modern buildings. They provide custom-built consoles within the price range of regular production equipment.

Three of the many possible combinations of RCA Unit-Built Master Sound Control Consoles are illustrated on this page. They range from a simple pedestal with paging facilities to loudspeakers in 16 zones, to a console capable of distributing announcements, music, radio, and interdepartmental communication to loudspeakers in 128 zones.

For additional information; contact your nearest RCA Sound Products Distributor.



# Unit-built Master Sound Dual Channel Console, MI-14901



## Features

- Attractively styled and finished in high quality contrasting light and dark umber gray, with the base in black.
- Compact and sturdy, welded all steel construction.
- Easily removable snap-on console panels.
- Frames accommodate standard rack mounted equipment in a 22" height.
- Console top is conventional desk height.
- Front of the two large corner sections supplied with bin type panels.
- Turret has a sloping front.
- Turret cover fastened with cowl fasteners and is easily removed.
- Top can accommodate two transcription turntables.
- Complete unit is easily assembled.

## Uses

This console provides for three sections of panel space, two transcription turntables and four bin panels for a radio or other equipment. RCA plug-in type pre-amplifiers and RCA plug-in line amplifiers or similar equipment may be mounted inside the console.

## Description

The console consists of a triple section turret mounted on a one-piece steel top which is supported by three small and two large welded steel angle frames with individual bases. The top has a black linoleum covering and a polished stainless steel trim around its edges. The console panels are made of light gauge sheet steel and are held to the frames with

snap spring catches which permit easy access to equipment mounted inside the console. The six side, one front and three rear panels are ribbed for styling, and are finished in light umber gray. The outer front panels are comprised of four bin type panels finished in dark umber gray. They open downward and are adapted to hold a radio or similar piece of equipment. A transcription turntable can be located on both sections of the top above the two large corner pieces. The turret is made up of aluminum end bells and center sections, steel tie parts and cover, with the outer surfaces finished in light umber gray. It has a sloping front and accommodates three 19" x 10½" panels or submultiples of 10½" in steps of 2⅝". Each one of the center sections has space for a 4" x 10½" panel.

The panel mounting angles in the bottom sections of the console are tapped for universal mounting of standard panels and shelves, and can be shifted on the frames to accommodate equipment of different depths.

The complete unit is shipped "knocked-down" and includes all of the necessary hardware for assembly.

## Specifications

Overall Height	39"
Height of Console Top	28"
Top Dimensions	71" x 40" x 1" thick
Blank Space on Top	71" x 22"
Console Dimensions (less top)	27" high, 70" wide, 39" deep
Open Space Under Top	22" wide, 23" deep
Turret Dimensions	11" high, 68" wide, 16" deep
Turret Panel Space:	
Main Panels	19" x 31½"
Center Panels	4" x 21"
Panel Space Inside Console	110"
Clear Inside Width per Frame	21"
Clear Inside Depth of Large Frame	22½"
Clear Inside Depth of Small Frame	14¼"
Shipping Weight	552¾ lbs.

MI-14901 UNIT-BUILT MASTER SOUND - DUAL CHANNEL CONSOLE

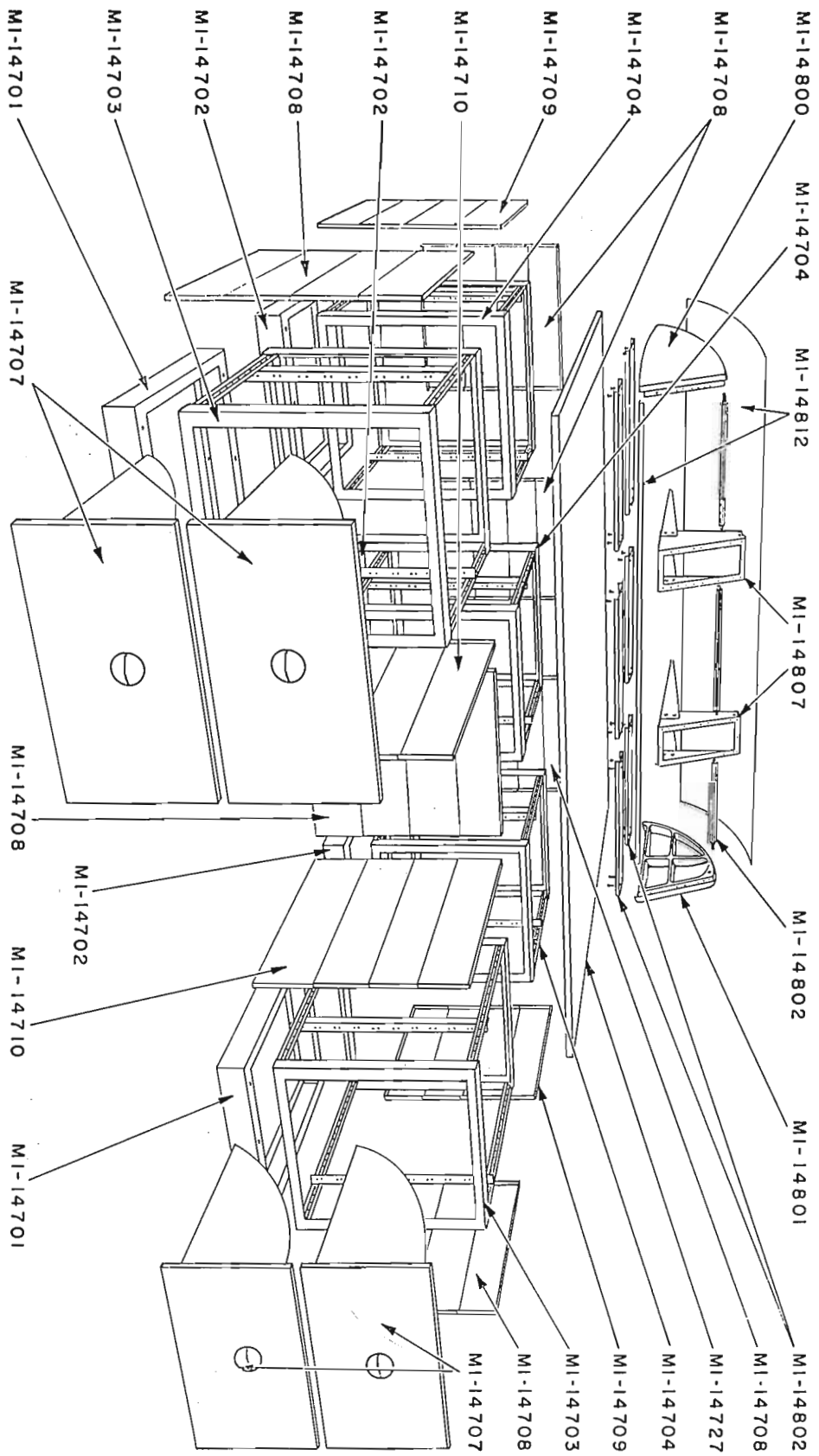



# Unit-built Master Sound Single Channel Console, MI-14902



## Features

- Attractively styled and finished in high quality contrasting light and dark umber gray, with the base in black.
- Compact and sturdy, welded all steel construction.
- Easily removable snap-on console panels.
- Frames accommodate standard rack mounted equipment in a 22" height.
- Base drilled for leveling devices or casters.
- Console top is conventional desk height.
- Front of the large corner section supplied with two bin type panels.
- Turret has a sloping front.
- Turret cover fastened with cowl fasteners and is easily removed.
- Top can accommodate a transcription turntable.
- Complete unit is easily assembled.

## Uses

This console provides for three sections of panel space, a transcription turntable and two bin panels for a radio or other equipment. RCA plug-in type pre-amplifiers and RCA plug-in line amplifiers or similar equipment may be mounted inside the console.

## Description

The console consists of a triple section turret mounted on a one-piece steel top which is supported by three small and one large welded steel angle frame with individual bases. The top has a black linoleum covering and a polished stainless steel trim around its edges. The console panels are made of light gauge sheet steel and are held to the frames with snap spring catches which permit easy access to equipment mounted inside the console. The four side, three rear and two of the front panels are ribbed for styling, and are finished

in light umber gray. The front of the larger frame structure has two bin type panels finished in dark umber gray. They open downward and are adapted to hold a radio or similar piece of equipment. The top above the larger frame structure can accommodate a transcription turntable.

The turret is made up of aluminum end bells and center sections, steel tie parts and cover, with the outer surfaces finished in light umber gray. It has a sloping front and accommodates three 19" x 10½" panels or sub-multiples of 10½" in steps of 2⅝". Each one of the center sections has space for a 4" x 10½" panel. A desk leg of highly polished chromium plated finish supports one end of the console top.

The panel mounting angles in the bottom sections of the console are tapped for universal mounting of standard panels and shelves, and can be shifted on the frames to accommodate equipment of different depths.

The complete unit is shipped "knocked-down" and includes all of the necessary hardware for assembly.

## Specifications

Overall Height	39"
Height of Console	28"
Top Dimensions	71" x 40" x 1" thick
Blank Space on Top	71" x 22"
Console Dimensions (less top)	27" high, 70" wide, 39" deep
Open Space Under Top	41" wide, 23" deep
Turret Dimensions	11" high, 68" wide, 16" deep
Turret Panel Space:	
Main Panels	19" x 31½"
Center Panels	4" x 21"
Panel Space Inside Console	88"
Clear Inside Width per Frame	21"
Clear Inside Depth of Large Frame	22½"
Clear Inside Depth of Small Frame	14¼"
Shipping Weight	484¼ lbs.

**SOUND EQUIP.**

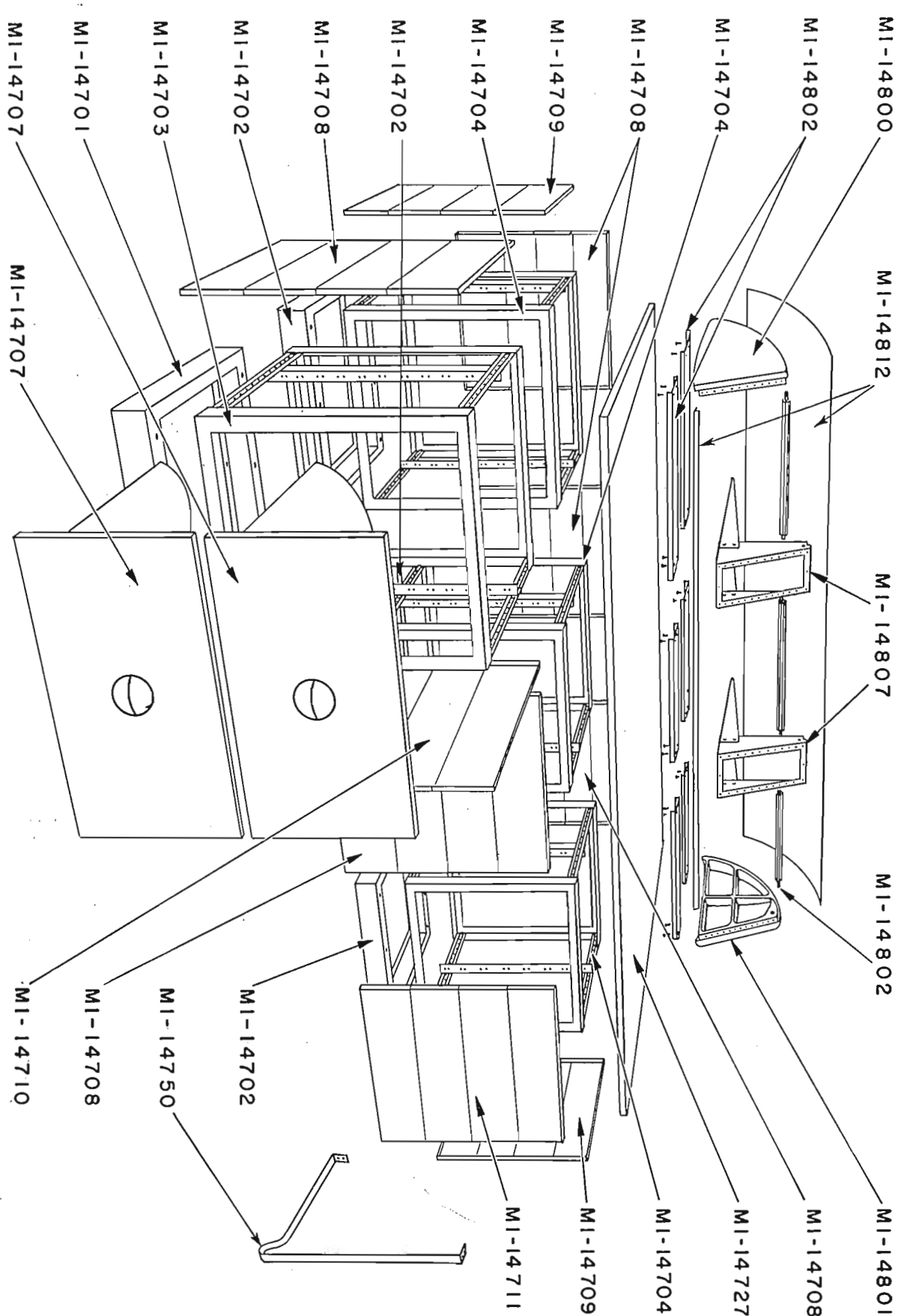

**MI-14902 UNIT-BUILT MASTER SOUND-SINGLE CHANNEL CONSOLE**



# Unit-built Master Sound Dual Control Pedestal, MI-14904



## Features

- Attractively styled and finished in high quality contrasting light and dark umber gray, with the base in black.
- Compact and light in weight.
- All steel, welded construction.
- Snap-on pedestal panels.
- Base drilled for leveling devices or casters.
- Pedestal accommodates standard rack mounted panels and shelves in a 22" height.
- Turret has a sloping front.
- Turret cover fastened with cowl fasteners and is easily removed.
- Complete unit is quickly assembled.

## Uses

This control pedestal finds its usefulness in a system that requires two control or switching panels, thus making a double section turret necessary. RCA plug-in type pre-amplifiers and RCA plug-in line amplifiers or similar equipment may be mounted inside the pedestal.

## Description

The pedestal consists of a double section turret mounted on a one-piece steel top which is supported by two welded steel angle frames with individual bases. The top has a black linoleum covering and a polished stainless steel trim around its edges. The pedestal panels are made of light gauge sheet steel and are held to the frames with snap spring catches

which permit easy access to equipment mounted within the enclosure. The side and two rear panels are ribbed for styling, and are finished in light umber gray, whereas the two front panels are plain and finished in dark umber gray. The extended 8" x 48" portion of the top provides a convenient support when operating the controls. The panel mounting angles in the pedestals are tapped for universal mounting of standard panels and shelves, and can be shifted on the frames to accommodate equipment of different depths.

The turret is made up of aluminum end bells and a center section, steel tie parts and cover, with the outer surfaces finished in light umber gray. It has a sloping front and accommodates two 19" x 10½" panels or submultiples of 10½" in steps of 2⅝". The center section allows for a 4" x 10½" panel.

The complete unit is shipped "knocked-down" and includes all of the necessary hardware for assembly.

## Specifications

Overall Height	39"
Top Dimensions	48" x 25" x 1" thick
Pedestal Dimensions (less top)	27" high, 47" wide, 16" deep
Turret Dimensions	11" high, 45" wide, 16" deep
Turret Panel Space:	
Main Panels	19" x 21"
Center Panel	4" x 10½"
Panel Space Inside Pedestal	44"
Clear Inside Width per Pedestal	21"
Clear Inside Depth per Pedestal	14¼"
Shipping Weight	249¾ lbs.

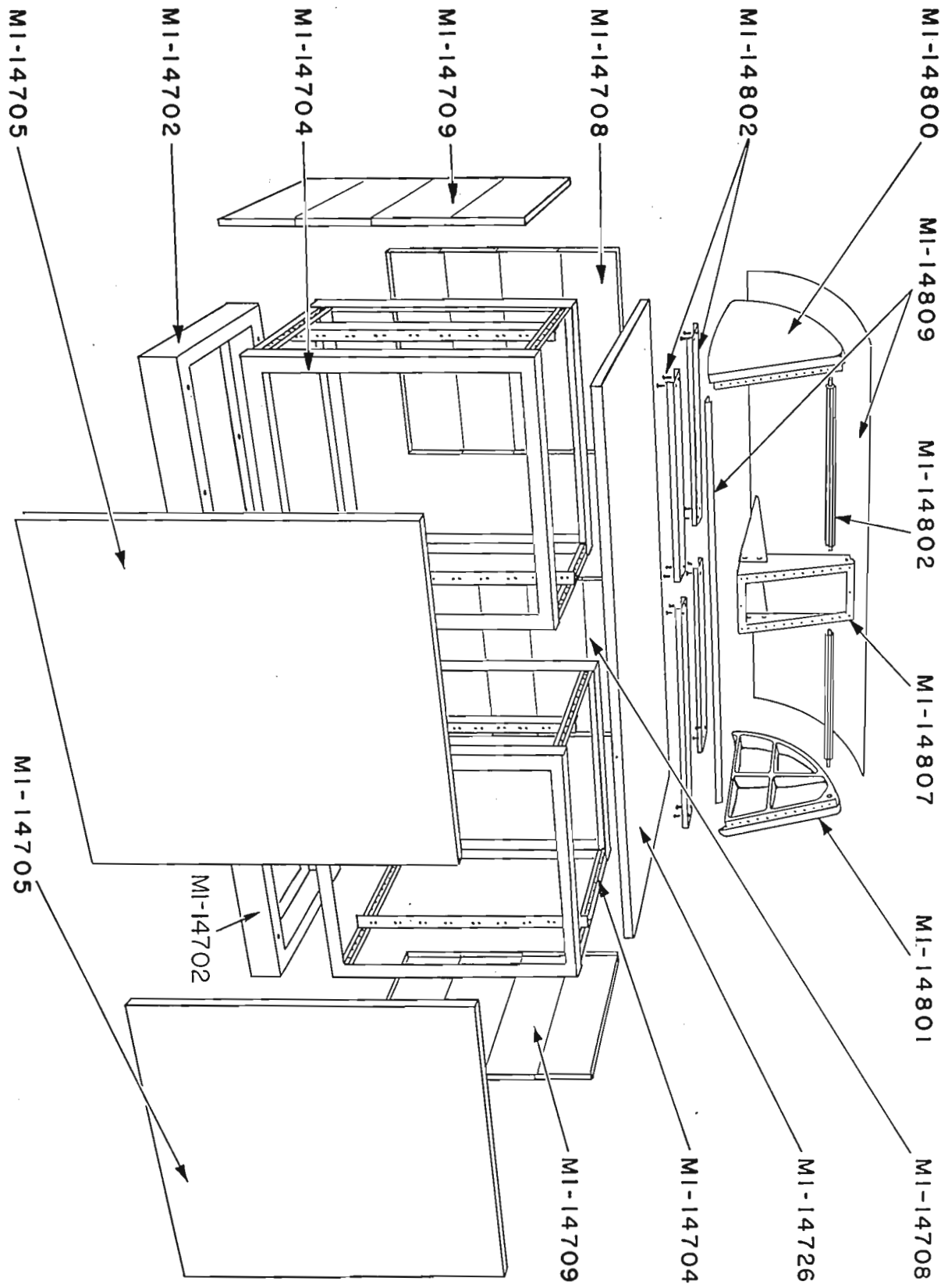

**MI-14904 UNIT-BUILT MASTER SOUND - DUAL CONTROL PEDESTAL**

# Unit-built Master Sound Control Pedestal, MI-14905



## Features

- Attractively styled to harmonize with any decorative scheme.
- Turret and panels finished in high quality contrasting light and dark umber gray, with the base in black.
- Compact, light weight and sturdy welded steel construction.
- Snap-on pedestal panels provide easy access to interior.
- Pedestal accommodates standard rack mounted panels and shelves in a 22" height.
- Base drilled for leveling devices or casters.
- Turret has a sloping front.
- Turret cover fastened with cowl fasteners and is easily removed.
- Complete unit is quickly assembled.

## Uses

The pedestal is designed for use where a small control or switching system is desired. RCA plug-in type pre-amplifiers and RCA plug-in line amplifiers or similar equipment may be mounted inside the pedestal.

## Description

This pedestal consists of a single section turret mounted on a one-piece steel top which is supported on a welded steel angle frame with separate base. The top has a black linoleum covering and a polished stainless steel trim around its edges.

The pedestal panels are made of light gauge sheet steel and are held to the frame with snap spring catches which permit

easy access to equipment mounted within the enclosure. The side and rear panels are ribbed for styling and are finished in light umber gray, whereas the front panel is plain and finished in dark umber gray. The extended 8" x 25" portion of the top provides a convenient support when operating the controls. The panel mounting angles in the pedestal are tapped for universal mounting of standard panels and shelves, and can be shifted on the frame to accommodate equipment of different depths.

The turret is made up of aluminum end bells and steel tie parts and cover, with the outer surfaces finished in light umber gray. It has a sloping front and accommodates a 19" x 10½" panel or submultiples of 10½" in steps of 2⅝".

The complete unit is shipped "knocked-down" and includes all of the necessary hardware for assembly.

## Specifications

Overall Height	39"
Top Dimensions	25" x 25" x 1" thick
Pedestal Dimensions (less top)	27" high, 24" wide, 16" deep
Turret Dimensions	11" high, 22" wide, 16" deep
Turret Panel Space	19" x 10½"
Panel Space Inside Pedestal	22"
Clear Inside Width	21"
Clear Inside Depth	14¼"
Shipping Weight	121½ lbs.



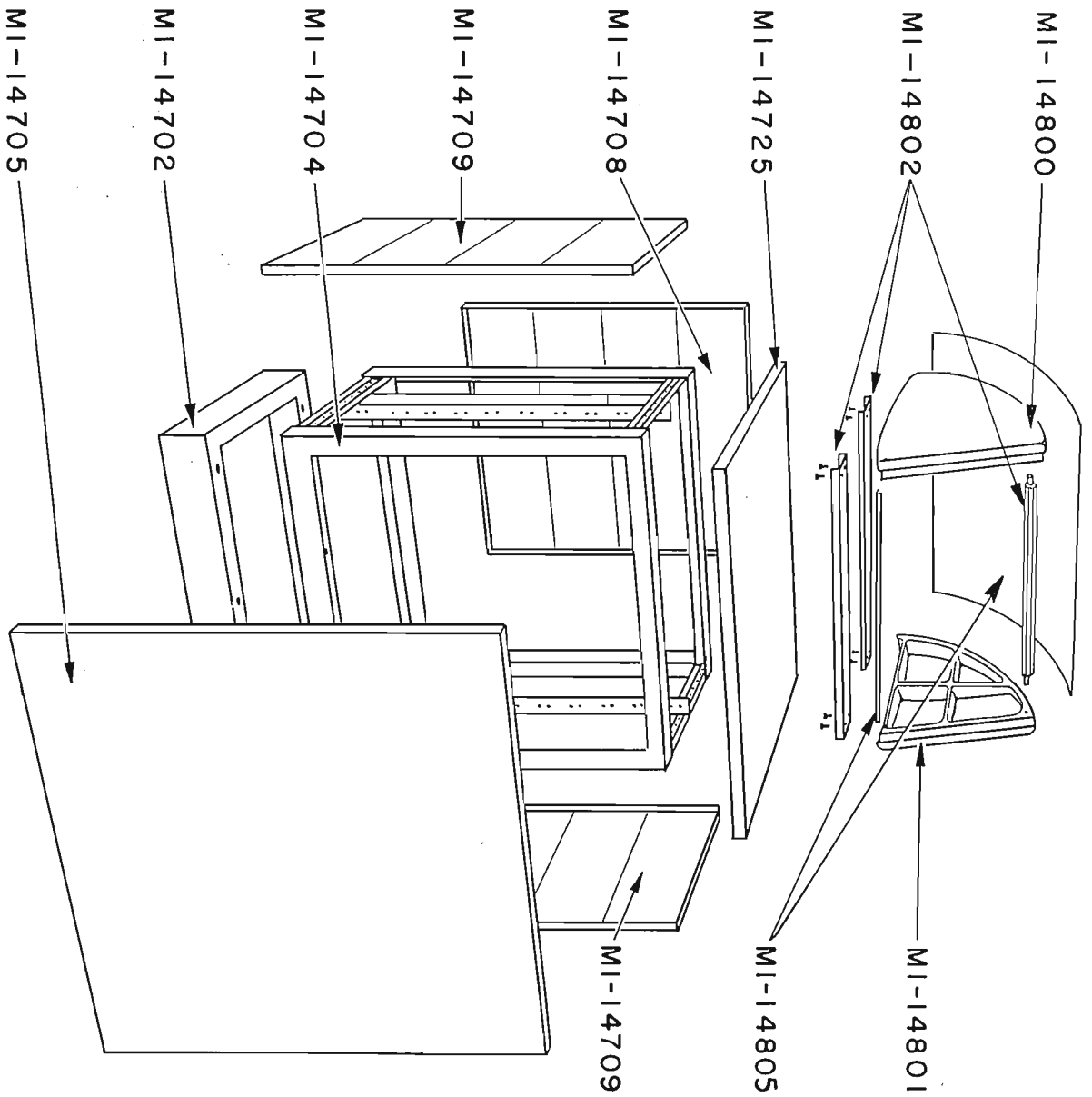

**MI-14905 UNIT-BUILT MASTER SOUND - CONTROL PEDESTAL**

# Unit-built Master Sound Transcription Pedestal, MI-14906



## Features

- Styled to harmonize with any decorative scheme.
- Compact, light weight, sturdy, welded steel construction.
- Top can accommodate a 16" transcription turntable.
- Easily removable snap-on panels.
- Space of 22" available for standard rack mounted panels and shelves.
- Pedestal panels have high quality finish in two-tone light and dark umber gray.
- Front panels are bin type with adjustable opening.
- Base drilled for leveling devices or casters.
- Top, frame and base fastened together to form a complete unit.
- Overall height of unit is 28".
- Convertible to larger units at a minimum cost.

## Uses

This pedestal is designed for transcription purposes. A transcription turntable can be mounted on the top. RCA plug-in type pre-amplifiers and small general purpose amplifiers may be mounted inside the pedestal.

## Description

The pedestal consists of a welded steel angle frame finished in dark umber gray, mounted on a steel channel base finished in black and a steel top which has a black linoleum covering and a polished stainless steel trim around the edges. These three parts when fastened together, form a sturdy and light weight unit. The side and rear panels are formed of light gauge sheet steel and are held to the frame with snap spring catches, which permit easy access to the interior for installing or servicing equipment. These panels are finished in light umber gray. The front panels are two bin type panels which open downward and are adapted to hold a radio or similar piece of equipment. These two panels are finished in dark umber gray.

The panel mounting angles are  $\frac{1}{8}$ " steel, accurately drilled and tapped for universal mounting of standard 19" panels and shelves, and are finished in dark umber gray. These angles can be shifted on the frame to accommodate equipment of different depths.

The unit is shipped "knocked down" with all necessary hardware for assembly.

## Specifications

Overall Dimensions	28" high, 25" wide, 25" deep
Panel Space Inside Pedestal	22"
Clear Inside Width	21"
Clear Inside Depth	22 $\frac{1}{2}$ "
Shipping Weight	117 $\frac{3}{8}$ lbs.

MI-14906 UNIT-BUILT MASTER SOUND - TRANSCRIPTION PEDESTAL

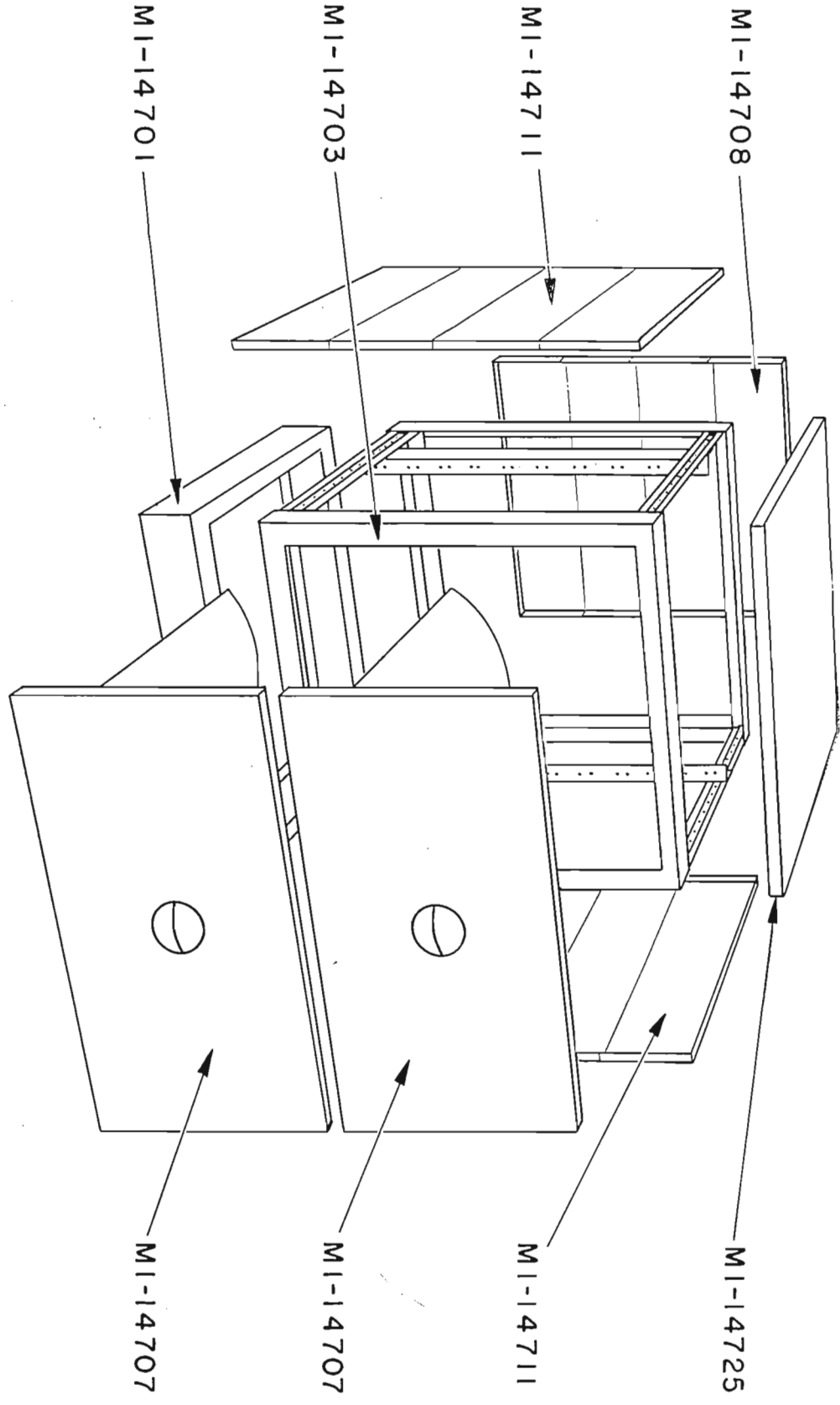



# AM-FM Radio Tuner, MI-6787

## Features

- Broadcast and frequency modulation reception.
- Good selectivity.
- Compact and light in weight.
- Excellent sensitivity.

## Description

The AM-FM Radio Tuner MI-6787 is intended for use in schools, hotels or other applications where a central radio receiver is to be used with a sound distribution system. The unit is designed for rack mounting with the MI-12388 Panel and Shelf Assembly which provides three suitable control knobs and a panel with the switch positions stenciled on the panel. A four-prong socket and associated plug are provided at the rear of the chassis to furnish power to a preamplifier for variable-reluctance phonograph pickups, or for any additional pilot lights which might be desirable.

The MI-6787 receiver is designed to operate on AM signals in the 535 to 1620 kilocycle band and FM signals in the 88 to 108 megacycle band. This unit also operates between a standard AM antenna or a 300-ohm FM dipole and a 500/600 ohm line.

As an AM receiver, the tube complement consists of a 6BA6 in a tuned RF stage, a 6BE6 mixer, 6J6 oscillator, 6BA6 1st IF amplifier, 6BA6 2nd detector, 6AU6 audio amplifier.

As an FM receiver, the tube complement consists of a 6BA6 RF amplifier, 6BE6 mixer, 6J6 oscillator and reactance modulator, 6BA6 1st IF amplifier, 6BA6 2nd IF amplifier, 6AU6 1st limiter, 6AU6 2nd limiter, 6AL5 discriminator and 6AU6 audio amplifier.

As an FM receiver, the oscillator reactance modulator 6J6 is under the control of the discriminator which corrects the oscillator frequency to maintain a 10.7 megacycle beat between the oscillator frequency and the incoming signal effectively eliminating the drift encountered in many FM receivers.

The automatic frequency control circuit is effective over a range of approximately 500 kilocycles at 98 megacycles.

A four-prong plug, PRE-AMP, has been provided on which 6.3 volts a-c and 150 volts d-c are available for operation of a preamplifier and/or additional pilot lights. Between pins #1 and #2, 6.3 volts a-c are available; pin #1 is grounded. Between pins #1 and #3, 150 volts d-c are available; pin #4 is open.

The input receptacles A and B, the third and fourth positions for the selector switch as marked on the panel are high impedance inputs, 500,000 ohms each, into the one-stage audio amplifier. The response is flat from 50-15,000 cycles  $\pm 2$ db. The voltage gain in each input, measured from the 500,000-ohm input to the 500/600-ohm output, is four. A phonograph, television audio or any signal source providing approximately 1 volt of signal may be plugged into either of these two inputs. The output of preamplifiers such as, MI-4117, MI-4118 or MI-4263 may be plugged into these inputs, and power for the operation of these preamplifiers may be obtained from the four-prong socket provided on the tuner.



MI-6787

## Technical Data

Power Supply \_\_\_\_\_ 105-125 volts, 60 cycles a-c

Power Consumption \_\_\_\_\_ 100 watts

Intermediate Frequency:

AM \_\_\_\_\_ 455 kc

FM \_\_\_\_\_ 10.7 mc

Audio Frequency Response \_\_\_\_\_ Within 2 db from 50 to 15,000 cycles

Output Impedance \_\_\_\_\_ 500/600 ohms ungrounded

Sensitivity:

AM \_\_\_\_\_ 5 microvolts

FM \_\_\_\_\_ 10 microvolts

Output:

1.73 volts \_\_\_\_\_ Less than 1.5% distortion

7.5 volts \_\_\_\_\_ Less than 5% distortion

Audio Noise Level \_\_\_\_\_ 60 db below 0 level (1.73 volts) minimum with output ungrounded

Tuning Range:

AM \_\_\_\_\_ 535 kc to 1620 kc

FM \_\_\_\_\_ 88 mc to 108 mc

Limiter Action \_\_\_\_\_ 20 db of quieting with output signal of 12 microvolts

Pilot Lamps \_\_\_\_\_ #44 Mazda lamp (2) 6-8 volts, 0.15 amp., bayonet

Antenna:

AM \_\_\_\_\_ RMA standard input

FM \_\_\_\_\_ 300-ohm folded dipole

Tube Complement:

3 6BA6 1 6AL5

1 6BE6 3 6AU6

1 6J6 1 5Y3-GT

Dimensions and Weight:

Length \_\_\_\_\_ 15 $\frac{3}{8}$ "

Height \_\_\_\_\_ 7"

Depth \_\_\_\_\_ 9" (rear chassis to dial)

Weight \_\_\_\_\_ 13 $\frac{1}{2}$  lbs.

# Two Way Loudspeaker, MI-12499

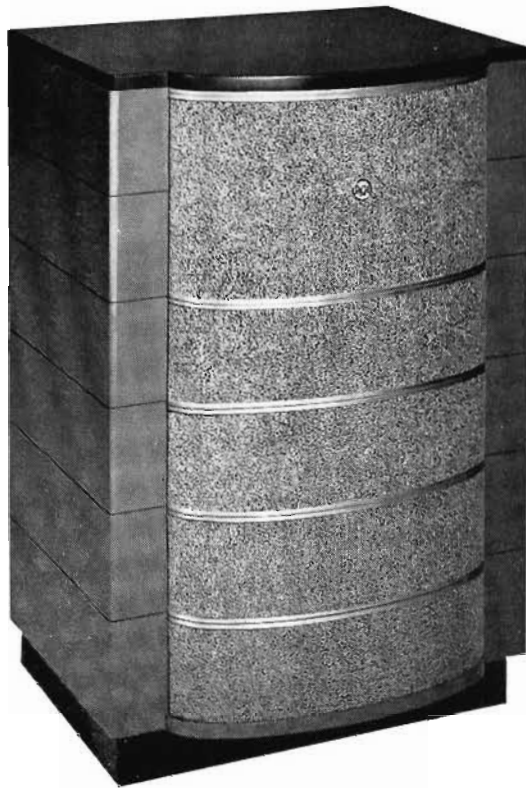

## Features

- Unusually fine frequency response.
- Low distortion.
- High efficiency.
- Large power handling capacity.
- Wide angle distribution.
- Alnico magnets in separate low frequency and high frequency units.
- Attractive styling and modern appearance.

## Uses

The RCA MI-12499 Two Way Loudspeaker has been designed to meet the long felt need of the particularly discriminating listener for unusually faithful and distortionless reproduction. It is suitable for studio monitoring, transcription and phonograph playback, and reproduction of AM-FM radio programs in hotel lobbies, broadcast studios, finely-appointed offices, and other locations where a reproducing unit of unusual fidelity, low distortion, high power-handling capacity, and truly fine appearance is desired.

## Description

The MI-12499 Two Way Loudspeaker is made up of the following units:  
 MI-12424 Cabinet, Cross-over Network, High Frequency Horn  
 MI-12431 High Frequency Horn Driver  
 MI-12432 Low Frequency Speaker

This assembly is a console type loudspeaker of unusually wide frequency range, low distortion and with great power handling ability. It has wide angle distribution. The input impedance characteristic is essentially flat throughout the operating range, rising somewhat at frequencies below 100 cycles. The cabinet is of wood, attractively styled, with a two-tone gray finish, giving it a distinctively modern appearance.

## Specifications

Frequency Response	50 to 13,000 cycles
Power Capacity	20 watts
Impedance	15 ohms
Axial Sensitivity	95 db at 4 ft. with 1 watt input
Distribution	100° at 1000 cycles
Height	37 $\frac{1}{8}$ "
Width	24 $\frac{1}{2}$ "
Depth	20 19/32"
Cabinet	Wood
Finish	Two-tone gray
Cross-over Frequency	800 cycles

## ARCHITECTS' AND ENGINEERS' SPECIFICATIONS

The Two Way Speaker shall be a console type assembly housing separate low frequency and high frequency units, together with a crossover network. The frequency response of the assembly shall be from 50 to 13,000 cycles. The input impedance shall be 15 ohms, and the axial sensitivity at 4 feet with 1 watt input shall be 95 db. The distribution angle shall be 100° at 1000 cycles. The power handling capacity shall be 20 watts. The crossover frequency shall be 800 cycles. The cabinet shall be 37 $\frac{1}{8}$ " high, 24 $\frac{1}{2}$ " wide, and 20 19/32" deep, made of wood; and shall be finished in two-tone gray. The cabinet styling shall be modern and attractive.



# Extended Range Loudspeaker Type LC-4A

## Features

- Natural life-like reproduction of music and speech—employs two high quality loudspeaker mechanisms. (Low frequency and high frequency.)
- High power handling capacity—20 watts peak. (Music and speech.)
- High efficiency (twice that of an average PM loudspeaker)—high grade Alnico permanent magnets.
- Conservatively styled cabinet in natural wood or walnut finish.
- Floor or wall mounting—base feet are removable.

## Uses

The LC-4A loudspeaker fulfills the need for an inexpensive, wide range loudspeaker of small compact size for Commercial Sound applications. It will be a welcomed addition to any club, bar, restaurant, hotel, school or other places where superior reproduction of live or transcribed music is demanded. Because of its well balanced overall response, obtained by extending the high frequency range in correct proportion to the low frequency cut off, reproduced music will take on a new color heretofore lost in the conventional single diaphragm loudspeaker.

## Description

This loudspeaker assembly consists of an MI-6333-C low frequency mechanism, an MI-12459 high frequency horn driver, an MI-12448 loudspeaker cabinet, MI-12449 cabinet feet and an MI-12451 high frequency kit. The kit is used in conjunction with the high frequency horn driver and includes a 2 microfarad capacitor and the necessary wiring and hardware for installing these components.

The cabinet which is 22" wide, 25" high (excluding mounting feet) and 12" deep has an inside volume of approximately 5000 cubic inches. The low frequency mechanism is mounted near the center of the front face with the high frequency unit mounted above it at the top of the cabinet. Bass boost reflex principle is used to enhance the low frequencies below 150 cycles/sec. Special acoustically tested grille cloth covers the openings and provides a pleasing front to this modernly styled cabinet.

The frequency range from 75 to 6500 cycles/sec. is handled superbly by the MI-6333-C loudspeaker mechanism. At the point where the high end of this mechanism begins to fall off, the MI-12459 high frequency driver takes over with the result that the entire range of 75 to 12,000 cycles/sec. is beautifully reproduced. The voice coils of the 2 units are isolated by a capacitor in order to keep the low frequencies out of the high frequency unit. The two voice coils are combined to provide a nominal impedance of 7½ ohms.



## Specifications

Frequency Range	_____	75 to 12,000 cycles/sec.
Power Handling Capacity	_____	20 watts peak (complex wave)
Voice Coil Impedance (nominal):		
Low Frequency Unit (MI-6333-C)	_____	6 ohms
High Frequency Unit (MI-12459)	_____	15 ohms
		(Voice coils are combined for 7½ ohms impedance)
Axial Sensitivity	_____	95 db at 4 feet with 1 watt
Gap Flux Density:		
Low Frequency Unit (MI-6333-C)	_____	9500 gauss
High Frequency Unit (MI-12459)	_____	9500 gauss
Magnet Material	_____	Alnico II
Magnet Weight:		
Low Frequency Unit (MI-6333-C)	_____	2½ lbs.
High Frequency Unit (MI-12459)	_____	1 lb. 9 oz.
Weight (fully assembled but unpacked)	_____	43¼ lbs.
LC-4A Loudspeaker complete with cabinet, base mounting feet, low frequency mechanism, high frequency horn driver and high frequency kit	_____	MI-12448, MI-12449, MI-6333-C, MI-12459, MI-12451
LC-4A Cabinet (natural wood finish)	_____	MI-12448
LC-4A Cabinet (walnut finish)	_____	MI-12448-A
LC-4A Cabinet Mounting Feet	_____	MI-12449
LC-4A Low Frequency Mechanism	_____	MI-6333-C
LC-4A High Frequency Horn Driver	_____	MI-12459
LC-4A High Frequency Kit	_____	MI-12451



# RCA 400 "Senior" 16mm Projector

## A Two Case Projector



### Features

- Sixteen tooth, double size sprockets.
- Cushion action sprocket shoes.
- Hinged film gate—opens wide.
- Theatrical framing.
- Precision sound speed stabilizer and scanning system.
- Four stage, ten watt amplifier with public address facilities.
- Vernier tilt control.
- Efficient cooling system for 1000 watt lamp.
- Easy portability.
- Sound and silent film speeds.

### Uses

The RCA 400 "Senior" is designed with greatly diversified applications in industry for institutional and sales presentations, indoctrination programs, conferences, and for shop training programs. It may be used to advantage in school lecture halls, classrooms, or by churches, lodges, clubs, community centers and private homes.

### Description

The RCA 400 16mm projector is a portable equipment contained in two matching carrying cases. One case contains the projector-amplifier unit. The other contains the speaker, and is also used for carrying the reels, reel arms, speaker cable, power cable and spares. Both of these cases are made of durable plywood, covered with tough, heavy, elephant-gray, coated fabric. This fabric is moisture and scuff resistant, and

will withstand hard usage. The cases are further reinforced by external hardware finished in highly polished nickel.

The projector is beautifully styled and finished in a blue-green Hammertone with polished chrome and aluminum metal parts. The reflector is made of heavily silver plated, heat resistant glass. It is factory aligned and readily accessible. The projection lamp is contained in a scientifically designed lamp shield, affording maximum ventilation of the heat source with a minimum of heat-conducting stray light hitting any area of the lamphouse walls. The shield opening permits only usable light to pass. A newly designed cooling system provides a high rate of ventilation for a 1000 watt lamp at either silent or sound speeds. The blower speed is constant, and independent of the mechanism speed. This exclusive RCA feature, together with the lamp shield, results in a cool running projector regardless of the length of the show.

The condensing lens system has an aspheric element and is instantly removable for cleaning. The projection lens is the RCA deluxe series "A", two inch, F1.6 "coated" lens which provides brilliant illumination, excellent contrast and a sharp picture. Lenses of other focal lengths are readily interchangeable. Both vernier and rapid lens focusing are provided with a positive lens lock.

The picture gate is the wide opening type which permits easy threading and cleaning of the aperture plate and film shoe. The film shoe is made of solid stainless steel. The sprockets of the RCA 400 "Senior" are sixteen-tooth, double size, slow speed sprockets with steel teeth and contoured polished hubs

## RCA 400 "Senior" 16mm Projector (Continued)

These exclusively RCA sprockets have twice the life of the standard eight-tooth sprockets, and reduce film wear to a minimum. Threading is amazingly easy. The cushion action, finger-tip control, sprocket shoes permit poor splices or badly warped film to pass freely over the sprockets without additional damage. The RCA 400 "Senior" permits instant finger-tip adjustment of either film loop while the machine is in operation. This exclusive feature permits an uninterrupted show even if both upper and lower loops are lost due to damaged film. Corrections to loop threading to synchronize the sound properly with the picture can also be made instantly. Film rewind of the RCA 400 "Senior" is rapid, automatic and convenient, and may be done without removing or interchanging reels. An improved automatic, even-tension film take-up assures proper film tension regardless of film reel size.

The RCA 400 "Senior" is designed for two-speed operation for use with either sound or silent films. A finger-tip selector knob permits instant selection of one or the other speed (16 frames or 24 frames), without change of motor speed. An automatic motor governor controls both the sound and silent speeds. A newly designed sound roller assembly assures smooth and constant film speed at the point of sound take-off, maintaining reproduction at recording pitch. At no point of the projector film path does the sound track or picture area of the film come in contact with a stationary surface. The RCA 400 "Senior" is provided with a tilting mechanism permitting rapid or vernier action, and which is amazingly easy to operate.

A powerful four stage high gain amplifier is incorporated into the RCA 400 "Senior." This amplifier utilizes the "inverse feedback" principle to assure natural tone amplification. The amplifier provides means for connection of a microphone or phonograph pickup. This permits announcer comment or the use of recorded music when running silent films. Likewise, the RCA 400 "Senior" may be used as a complete public address system.

The exciter lamp is lighted with an a-c voltage of supersonic frequency so as to assure high fidelity and freedom from hum. The tone control is "equalized" thereby preventing variation in volume when the tone control is changed. RCA "preferred type" tubes are used throughout, assuring low cost, and immediate availability for replacement.

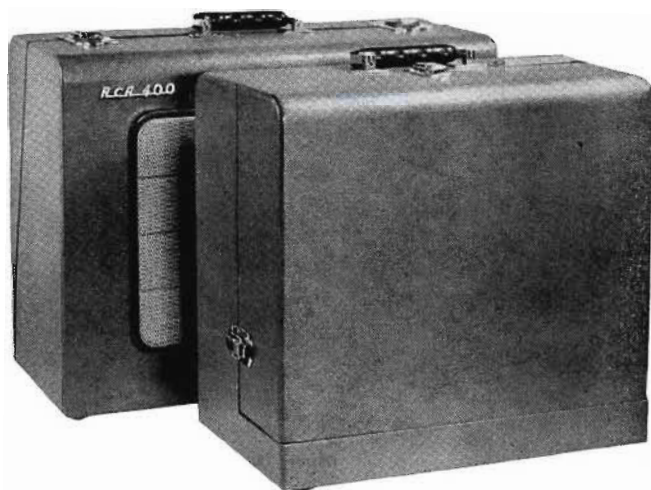

RCA 400 "Senior" is contained in two matching carrying cases

### Specifications

#### PROJECTOR

Projection Lamp—Up to 1000-watt, standard medium prefocused  
 Projection Lens\_\_\_\_\_RCA, 2-inch F1.6, coated  
 Film Capacity\_\_\_\_\_2000 ft., 16mm film  
 Operating Speed\_\_\_\_\_24 frames (sound), 16 frames (silent)  
 per second  
 Motor Speed\_\_\_\_\_Constant, within 2% from 105 to 125 volts

#### AMPLIFIER

Gain:  
 Phototube Input\_\_\_\_\_115 db  
 Microphone Input (40,000 ohms)\_\_\_\_\_112 db  
 Power Output\_\_\_\_\_10 watts at less than 5% distortion

#### Tubes:

1 RCA-6J7	3 RCA-6V6GT
1 RCA-921	1 RCA-6SN7GT
1 RCA-6J5	1 RCA-5Y3GT

#### SPEAKER

Voice Coil Impedance\_\_\_\_\_6.0 ohms  
 Field\_\_\_\_\_Alnico, permanent magnet  
 Sensitivity\_\_\_\_\_97 db at 4 ft. with 1 watt input  
 (ref. level 10<sup>-16</sup> watts/sq. cm.)  
 A-c Power Requirements (with 1000-watt lamp)  
 1275 watts (105-125 v., 50/60 cycles)  
 (D-c operation possible with amplifier on inverter)

#### Cables:

Speaker\_\_\_\_\_50 ft., two cond. #18 rubber covered cable,  
 with a 2 contact connector  
 Power\_\_\_\_\_15 ft., cable, moulded plugs, 2-cond. #16

#### Net Weight:

Projector-Amplifier Case\_\_\_\_\_38 lbs.  
 Speaker Case\_\_\_\_\_26 lbs.

#### Shipping Weight:

Projector-Amplifier Case\_\_\_\_\_50 lbs.  
 Speaker Case\_\_\_\_\_32 lbs.

#### Dimensions:

Projector-Amplifier Case\_\_\_\_\_15<sup>9</sup>/<sub>16</sub>" long, 14<sup>1</sup>/<sub>8</sub>" high, 9<sup>1</sup>/<sub>8</sub>" deep  
 Speaker Case\_\_\_\_\_19<sup>5</sup>/<sub>8</sub>" long, 15<sup>1</sup>/<sub>8</sub>" high, 9" deep

Finish\_\_\_\_\_Heavy grained, elephant-gray coated fabric

#### Stock Identification:

Projector-Amplifier in Carrying Case  
 (Sound and Silent Speeds)\_\_\_\_\_MI-1305-1  
 Speaker and Accessories in Carrying Case\_\_\_\_\_MI-1306-1

# RCA 400 "Junior" 16mm Projector

## A Single Case Projector



### Features

- Sixteen tooth, double size sprockets.
- Cushion action sprocket shoes.
- Hinged film gate—opens wide.
- Theatrical framing.
- Precision sound speed stabilizer and scanning system.
- Four stage, ten watt amplifier with public address facilities.
- Vernier tilt control.
- Efficient cooling system for 1000 watt lamp.
- Easy portability—single case.
- Sound and silent film speeds.

### Uses

The RCA 400 "Junior" is designed with greatly diversified applications in industry for institutional and sales presentations, indoctrination programs, conferences, and for shop training programs. It may be used to advantage in school lecture halls, classrooms, or by churches, lodges, clubs, community centers and private homes.

### Description

The RCA 400 "Junior" 16mm projector is a portable equipment contained in a single case. The cover of the case houses the speaker, and is used as carrying space for the reels, reel arms, speaker cable, power cable and spares. The case is made of durable plywood, covered with tough, heavy, elephant-gray, coated fabric. This fabric is moisture and scuff resistant, and will withstand hard usage. The case is further reinforced by external hardware finished in highly polished nickel.

The projector is beautifully styled and finished in a blue-green Hammertone with polished chrome and aluminum metal parts. The reflector is made of heavily silver plated, heat resistant glass. It is factory aligned and readily accessible. The projection lamp is contained in a scientifically designed lamp shield, affording maximum ventilation of the heat source with a minimum of heat-conducting stray light hitting any area of the lamphouse walls. The shield opening permits only usable light to pass. A newly designed cooling system provides a high rate of ventilation for a 1000 watt lamp at either silent or sound speeds. The blower speed is constant, and independent of the mechanism speed. This exclusive RCA feature, together with the lamp shield, results in a cool running projector regardless of the length of the show.

The condensing lens system has an aspheric element and is instantly removable for cleaning. The projection lens is the RCA deluxe series "A", two inch, F1.6 "coated" lens which provides brilliant illumination, excellent contrast and a sharp picture. Lenses of other focal lengths are readily interchangeable. Both vernier and rapid lens focusing are provided with a positive lens lock.

The picture gate is the wide opening type which permits easy threading and cleaning of the aperture plate and film shoe. The film shoe is made of solid stainless steel. The sprockets of the RCA 400 "Junior" are sixteen-tooth, double size, slow speed sprockets with steel teeth and contoured polished hubs. These exclusively RCA sprockets have twice the life of the standard eight-tooth sprockets, and reduce film wear to a minimum. Threading is amazingly easy. The cushion action, finger-tip control, sprocket shoes permit poor splices or



## RCA 400 "Junior" 16mm Projector (Continued)

badly warped film to pass freely over the sprockets without additional damage. The RCA 400 "Junior" permits instant finger-tip adjustment of either film loop while the machine is in operation. This exclusive feature permits an uninterrupted show even if both upper and lower loops are lost due to damaged film. Corrections to loop threading to synchronize the sound properly with the picture can also be made instantly. Film rewind of the RCA 400 "Junior" is rapid, automatic, and convenient, and may be done without removing or interchanging reels. An improved, automatic, even-tension film take-up assures proper film tension regardless of film reel size.

The RCA 400 "Junior" is designed for two-speed operation for use with either sound or silent films. A finger-tip selector knob permits instant selection of one or the other speed (16 frames or 24 frames), without change of motor speed. An automatic motor governor controls both the sound and silent speeds. A newly designed sound roller assembly assures smooth and constant film speed at the point of sound take-off, maintaining reproduction at recording pitch. At no point of the projector film path does the sound track or picture area of the film come in contact with a stationary surface. The RCA 400 "Junior" is provided with a tilting mechanism permitting rapid or vernier action, and which is amazingly easy to operate.

A powerful four stage high gain amplifier is incorporated into the RCA 400 "Junior." This amplifier utilizes the "inverse feedback" principle to assure natural tone amplification. The amplifier provides a connection for a microphone or phonograph pickup. This permits announcer comment or the use of recorded music when running silent films. Likewise, the RCA 400 "Junior" may be used as a complete public address system.

The exciter lamp is lighted with an a-c voltage of supersonic frequency so as to assure high fidelity and freedom from hum. The tone control is "equalized" thereby preventing variation in volume when the tone control is changed. RCA "preferred type" tubes are used throughout, assuring low cost, and immediate availability for replacement.



*RCA 400 "Junior" is portable and contained in a single case*

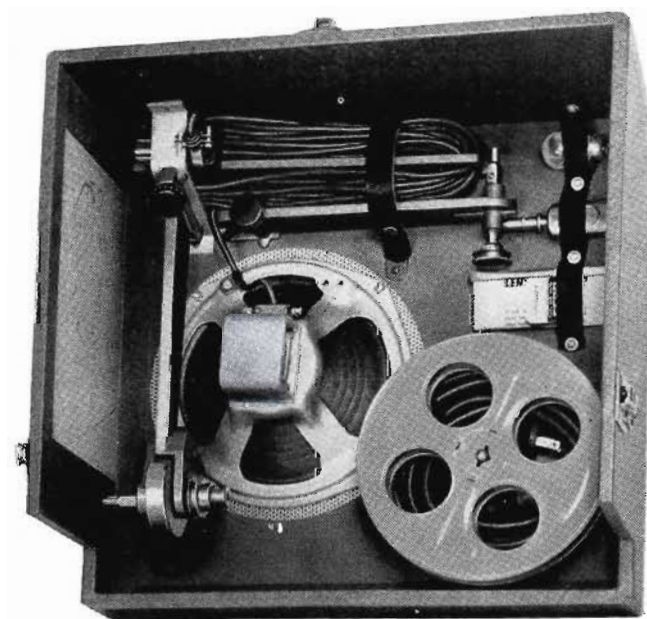

*This sturdily built speaker case houses the 8" PM speaker and accessories*

### Specifications

#### PROJECTOR

Projection Lamp—Up to 1000-watt, standard medium prefocused  
 Projection Lens—RCA, 2-inch F1.6, coated  
 Film Capacity—2000 ft., 16mm film  
 Operating Speed—24 frames (sound), 16 frames (silent)  
 per second  
 Motor Speed—Constant, within 2% from 105 to 125 volts

#### AMPLIFIER

##### Gain:

Phototube Input—115 db  
 Microphone Input (40,000 ohms)—112 db  
 Power Output—10 watts at less than 5% distortion

##### Tubes:

1 RCA-6J7	3 RCA-6V6GT
1 RCA-921	1 RCA-6SN7GT
1 RCA-6J5	1 RCA-5Y3GT

#### SPEAKER

Voice Coil Impedance—3.2 ohms  
 Field—Alnico, permanent magnet  
 Sensitivity—93 db at 4 ft. with 1 watt input  
 (ref. level 10<sup>-10</sup> watts/sq. cm.)  
 A-c Power Requirements (with 1000-watt lamp)  
 1275 watts (105-125 v., 50/60 cycles)  
 (D-c operation possible with amplifier on inverter)

##### Cables:

Speaker—50 ft., two cond. #18 rubber covered cable,  
 with a 2 contact connector  
 Power—15 ft., cable, moulded plugs, 2-cond. #16  
 Net Weight—45 lbs.  
 Shipping Weight—57 lbs.  
 Dimensions—15<sup>2</sup>/<sub>16</sub>" long, 14<sup>11</sup>/<sub>16</sub>" high, 11<sup>1</sup>/<sub>2</sub>" deep  
 Finish—Heavy grained, elephant-gray, coated fabric  
 Stock Identification—MI-1313

# *You'll Attract and Hold Patrons*

with the seating comfort of

## **INTERNATIONAL CHAIRS**

Patrons will enjoy your shows more . . . come back more often—when your theatre seating induces them to relax, to see the screen with the utmost comfort. INTERNATIONAL CHAIRS are designed to assure luxurious comfort, rest and relaxation.

Patron-appeal is only one of many reasons why INTERNATIONAL is your best buy in theatre seating. You will find INTERNATIONAL'S superior construction and mechanical features mean longer lasting, trouble-free service with minimum maintenance.

Your Independent RCA Theatre Supply Dealer will gladly demonstrate the complete line of smart looking INTERNATIONAL CHAIRS.

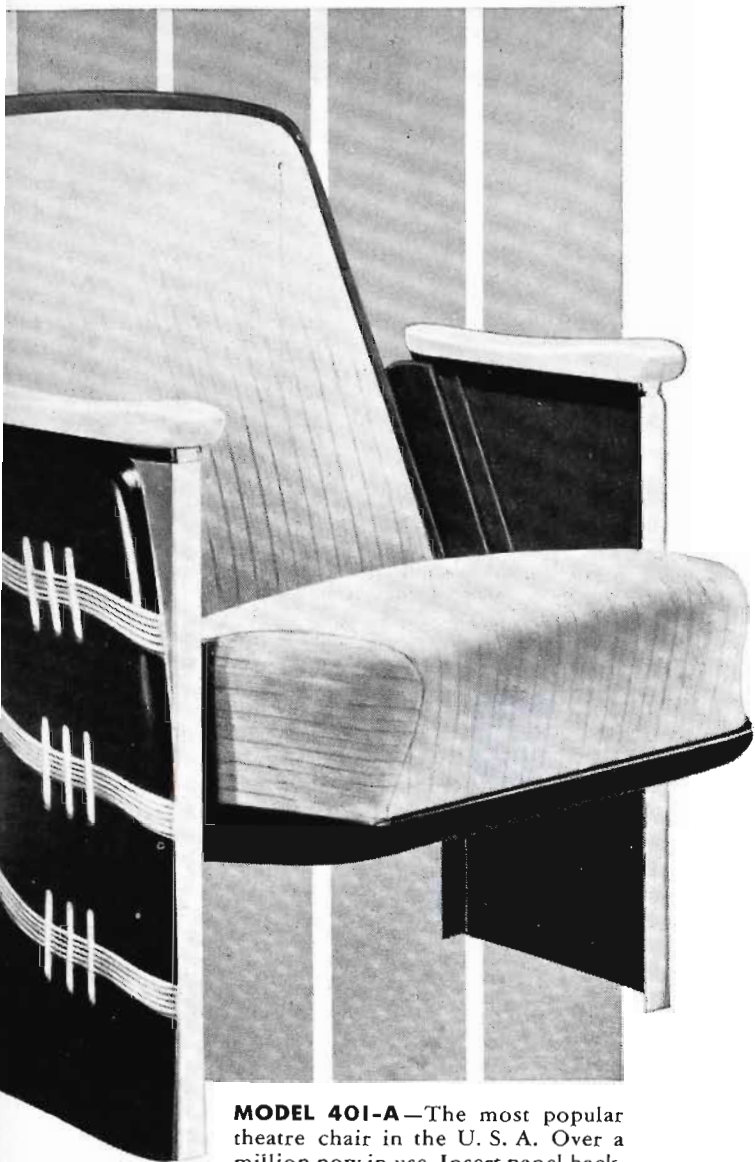

**MODEL 401-A**—The most popular theatre chair in the U. S. A. Over a million now in use. Insert panel back.

Upholstery fully protected at top by metal rim. Full-coil, spring-edge seat cushions. Hingeless seat suspension. Built of steel. No exposed bolts, nuts or screws.

**MODEL 1000**—Wider and deeper seats with the exclusive, new "Comfort Cushion." Form fitting, padded steel insert panel back. "Wire-on" back and seat covers.



**MODEL 350-AH**—An excellent investment for patron comfort. Padded, welted back. "Wire-on" back cover. Full spring-edge cushion. All steel.

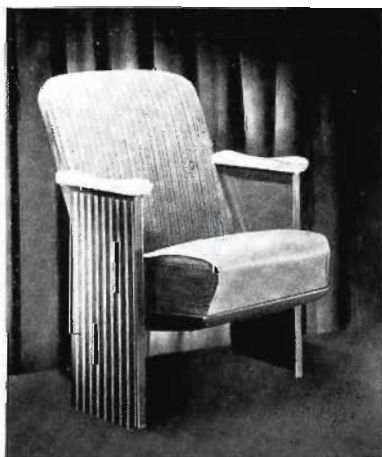

**MODEL 301-A**—Famous for comfort and durability. "Wire-on" back cover. Hingeless seat suspension. Full upholstered back. Full spring-edge cushion of coil type. Unit construction.





# The RCA Carfone

152-174 Mc. Mobile Communication Equipment Type CMV-1A



## Features

- Wide choice of mounting locations.
- "31 Circuit" selectivity.
- Grounded-Grid input for higher sensitivity.
- Small size.
- Low spurious emission.
- Low spurious response.
- Extended frequency range.
- Transducer modulation control.
- Single cable from Transmitter Receiver.
- Simplified control unit.

## Uses

The CARFONE is a two-way mobile communication equipment designed for practically every mobile application in the 152-174 mc band. This includes police, fire, taxis, trucks, forestry vehicles, public utilities or any other services licensed to operate in this part of the spectrum. It also includes the frequencies of 162-174 mc which have been allocated for the use of departments of the federal government. The CARFONE is especially suitable for limited space installations or locations where the equipment must be mounted on a vertical surface.

## Description

The design of the CARFONE was directed toward combining the best possible solutions to the most important problems of the mobile communications service. Outstanding features of the CARFONE are its great mounting versatility, its "31 Circuit" Selectivity, and the revolutionary Transducer Modulation Control.

## MOUNTING VERSATILITY

The CARFONE transmitter/receiver is housed in a single compact case approximately 5½" x 9" x 16". The chassis and cover are constructed in such a way as to permit installation in practically any position on the floor, sides or back of the automobile trunk,—thus leaving the maximum amount of space for luggage, tools, packages, or other material. In addition, the CARFONE may be installed on the floor between the front seat passengers, or the fire wall, or (in many vehicles) on the shelf behind the back seat. For use in trucks, the CARFONE lends itself well to mounting on the wall of the driver's compartment, in the freight section or in many cases (as in public utility vehicles and fire engines) inside the side-mounted lockers. Many other possibilities will present themselves where some other space is most appropriate for the installation.

## "31 CIRCUIT" SELECTIVITY

One of the objectives of the CARFONE design was to make adjacent channel operation a practical possibility. This required that the receiver be capable of a new high degree of selectivity. The CARFONE has 31 tuned circuits, which contribute to the receiver selectivity. Of these, 18 are in the important low frequency i-f section. This greater number of tuned circuits has resulted in the required greater selectivity necessary for adjacent channel operation.

## TRANSDUCER MODULATION CONTROL

The Transducer Modulation Control is the perfect companion (on the transmitter side) to "31 Circuit" Selectivity for assuring maximum channel conservation. Loud shouting into the microphone cannot cause deviation into adjacent channels—nor will the signal become distorted or lose intelligibility. Likewise, a weak voice or a message spoken at some distance



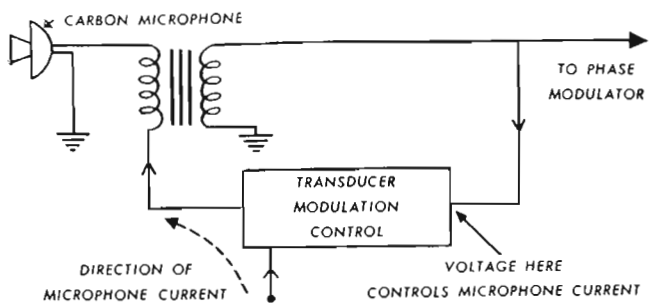

*Simplified diagram of the Transducer Modulation Control. Note that the signal does not pass THROUGH the Transducer Modulation Control. It merely acts as a valve on the microphone current.*

from the microphone is boosted up to come through loud and clear. The operation of the **TRANSducer MODULATION CONTROL** is the essence of simplicity. The signal itself does not pass through the **TRANSducer MODULATION CONTROL**, therefore, no microphonic noise or distortion is introduced. Instead, the circuit automatically reduces the microphone output when it approaches the level of 100% modulation. Actually, it is the microphone itself which is the source of the control. For **CARFONE** users this basic simplicity assures greater dependability in use.

**LOW SPURIOUS EMISSION AND RESPONSE**

Spurious emission is not only annoying to other mobile stations but also may require expensive modification to existing equipment in order to correct it. In the **CARFONE**, all spurious emissions are attenuated at least 60 db. This includes the especially bothersome 2nd and 3rd harmonics of the carrier. Spurious responses in the receiver are attenuated more than

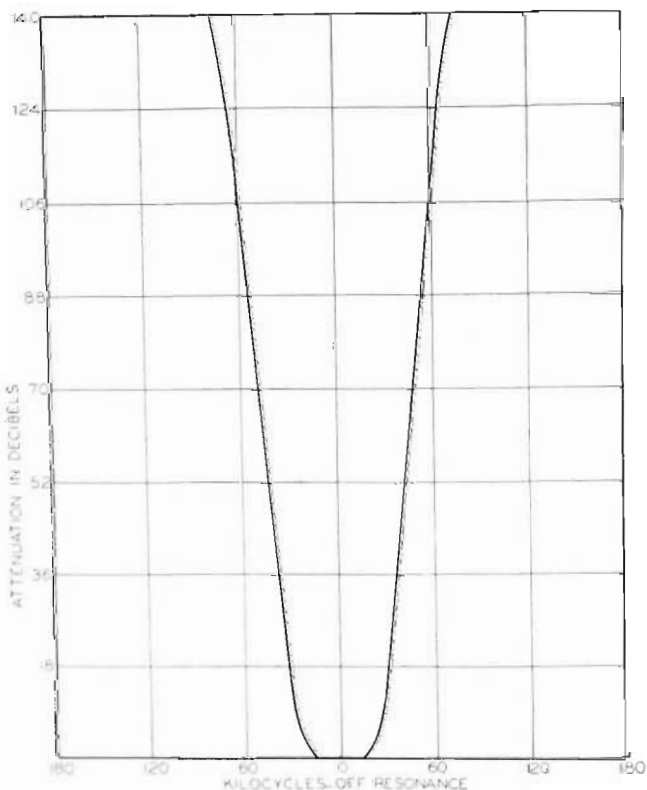

*Selectivity curve of the CARFONE. "31 Circuit" Selectivity attenuates adjacent channel signals ( $\pm 60$ kc) by more than 100 db.*

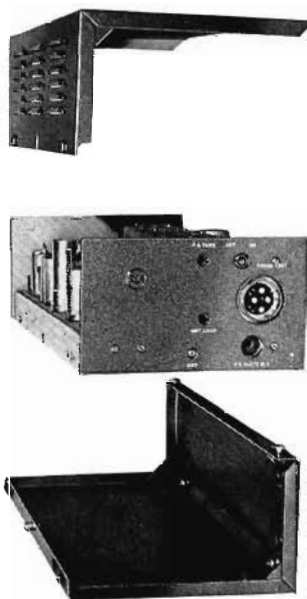

*Accordion view showing construction of chassis and covers. Unique construction permits mounting on either right or left side.*

85 db. In addition, the **CARFONE** has a much lower susceptibility to intermodulation interference.

**NO DETAILS OVERLOOKED**

In every detail, the emphasis of the **CARFONE** is on performance. At no point is there a compromise with quality. Yet seemingly minor items have been given the same careful consideration. For example: the A line fuses are installed at the battery end of the cable to insure against the possibility of fire in case of a cable shorted to the car frame. In addition, there is but a single cable from the Transmitter/Receiver to the control unit and battery. The antenna may be installed from outside the car, without disturbing the headlining.

**Specifications**

- Frequency Range \_\_\_\_\_ 152-174 megacycles
- Dimensions:
  - Transmitter/Receiver \_\_\_\_\_ 5½" x 9" x 16"
  - Control Unit \_\_\_\_\_ 7½" x 4" x 5¾"
  - Cable Length \_\_\_\_\_ 16' 8"
- Weight:
  - Transmitter/Receiver \_\_\_\_\_ 28 lbs.
  - Control Unit \_\_\_\_\_ 1¾ lbs.
- Battery Drain \_\_\_\_\_ (At 6.3 volts) 8.4 amperes, standby  
20.6 amperes, transmitting
- Power Output \_\_\_\_\_ 11-13 watts, 152-162 mc  
8-11 watts, 162-174 mc
- Sensitivity \_\_\_\_\_ Better than 0.8 mv with 20 db of quieting
- Selectivity \_\_\_\_\_ 100 db,  $\pm 60$  kc
- Spurious Emission \_\_\_\_\_ All attenuated more than - 60 db
- Spurious Response \_\_\_\_\_ All attenuated more than - 85 db
- Temperature Limits \_\_\_\_\_ 25° to 140° Fahrenheit
- Transmitter Frequency Deviation \_\_\_\_\_  $\pm 15$  kc for 100% modulation

Frequency Stability (either transmitter or receiver) \_\_\_\_\_ Within .003% over entire temperature range

- Audio Distortion:
  - Transmitter \_\_\_\_\_ Less than 5%
  - Receiver \_\_\_\_\_ Less than 10%

# The RCA Fleetfone

30-50 mc. Mobile Communication Equipment, Type CMV-2A



## Features

- Mounting flexibility.
- 30 or 60 watts output.
- 6 or 12 volt operation.
- "Canyon-Curve" selectivity.
- Transducer modulation control.
- High receiver sensitivity.
- Provision for two-frequency operation.
- Low spurious emission and response.

## Uses

The FLEETFONE is a two-way mobile communication equipment designed for practically every mobile application in the 30-50 mc. band. This includes such important services as police, fire, trucks, forestry, public utilities, transportation, the petroleum industry, and departments of the federal government.

## Description

In the FLEETFONE, RCA has incorporated advanced features of special value to users of mobile communication equipment who operate in the 30-50 mc. band. The FLEETFONE represents a radical departure from earlier equipment design and introduces a new high standard of performance, economy and operating convenience.

### MOUNTING FLEXIBILITY

The FLEETFONE transmitter/receiver is housed in a single, compact case approximately  $7\frac{3}{8}$ " x  $11\frac{1}{4}$ " x  $16\frac{1}{4}$ ". The chassis, with front and back panels, is constructed so as to be inserted into the bottom half of the cover from either the right or left side. The top cover is then slid into place and secured by means of four quarter-turn locking screws. This ingenious construction makes possible installation under the widest variety of circumstances. It mounts easily on either the bottom, side, or on a vertical surface. In automobile trunks, it may be installed in just about any desired location. It fits in out-of-the-way places, and may be so located as to leave the maximum amount of space for luggage, tools, packages or other material. In trucks it may be mounted in the drivers' cab, in the freight compartment, in a side-mounted locker, or any of a number of other locations.

### "CANYON-CURVE" SELECTIVITY

One of the greatest problems of users of mobile communication equipment is the matter of interference between channels. The best protection against interference is high receiver selectivity. The FLEETFONE provides that protection with "Canyon-Curve" Selectivity. The steep-sided curve of the FLEETFONE effectively discriminates against interference from adjacent or alternate channels. The flat bottom of the curve assures clear, understandable reception of the desired signal.

### CHOICE OF 30 OR 60 WATTS OUTPUT

Frequency assignments in the 30-50 megacycle band are generally made to services which operate over relatively large areas. The power output requirements of the mobile transmitters are based upon the distance to be covered and the character of the surrounding terrain. For many installations, entirely satisfactory performance can be obtained with a 30 watt mobile transmitter. In other cases, circumstances will demand 60 watts. The RCA FLEETFONE is available for either type of installation. In both cases, it's the same size single-package unit.

### 6 OR 12 VOLT OPERATION

This added convenience is just another of the advantages of the FLEETFONE. Many mobile vehicles such as trucks, fire-engines, etc., use a 12 volt battery. In these vehicles, the 12 volt FLEETFONE eliminates the need for power-wasting, voltage-dropping resistors, or the necessity to impose too heavy a drain on half of the battery. The 6 volt FLEETFONE is the standard equipment for general-purpose application.

### THE TRANSDUCER MODULATION CONTROL

The Transducer Modulation Control is the perfect companion (on the transmitter side) to "Canyon-Curve" Selectivity, for assuring maximum channel conservation:

Loud shouting into the microphone cannot cause deviation into adjacent channels—nor will the signal become distorted or lose intelligibility. Likewise, a weak voice or a message spoken at some distance from the microphone is boosted up to come through loud and clear.

The operation of the Transducer Modulation Control is the essence of simplicity. The signal itself does not pass through the Transducer Modulation Control, therefore no microphonic

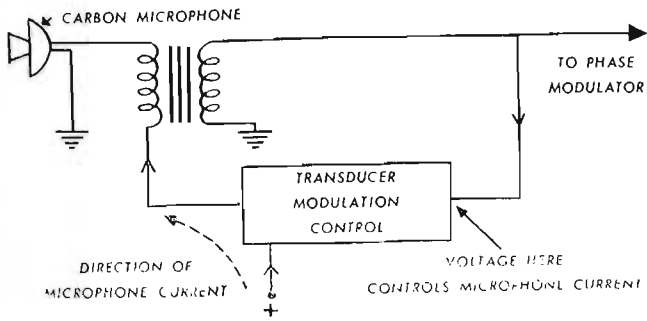

Simplified diagram of the Transducer Modulation Control. Note that the signal does not pass THROUGH the Transducer Modulation Control. It merely acts as a valve on the microphone current

noise or distortion is introduced. Instead, the circuit automatically reduces the microphone output when it approaches the level of 100% modulation. Actually, it is the microphone itself which is the source of the control. For CARFONE users this basic simplicity assures greater dependability in use.

**EXTRA FEATURES**

The FLEETFONE has provision for either single-frequency or two-frequency operation. Where two-frequency operation is provided, there is a switch on the control unit to permit instant change of the mobile transmitter frequency. Under this arrangement, the mobile vehicle may communicate with either the control station or the other mobile units in a two frequency system. An adjustable squelch control permits accurate adjustment of the degree of noise quieting necessary for varying conditions. For the highest reliability and the greatest efficiency the FLEETFONE is equipped with a dynamotor power supply for the mobile transmitter. The dynamotor is self-contained within the single-unit FLEETFONE case. No external wiring is required. There is but a single cable from the transmitter/receiver to the control unit and the battery. The antenna is of the universal mounting type with spring mount and stainless steel rod. It may be mounted on the outside of the vehicle in any desired position.

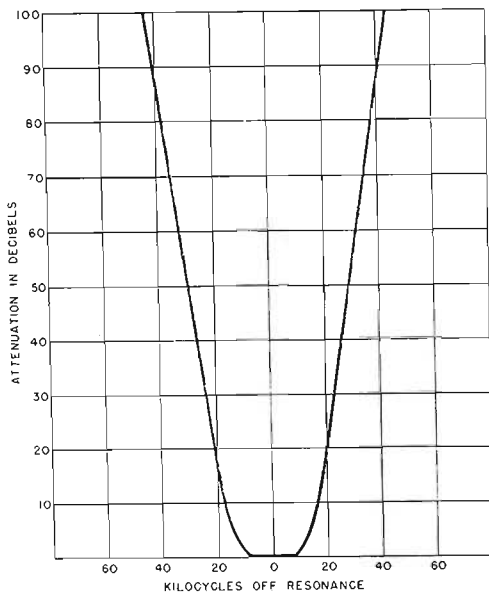

"Canyon-Curve" Selectivity provides best assurance against interference from other channels

**The FLEETFONE Mounts Easily:**



On the bottom

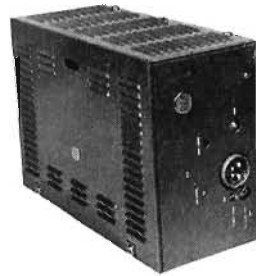

On the side, or on a vertical surface

**Specifications**

Frequency Range \_\_\_\_\_ 30-50 mc.

**Dimensions:**

Transmitter/Receiver \_\_\_\_\_ 7<sup>3</sup>/<sub>8</sub>" x 11<sup>1</sup>/<sub>4</sub>" x 16<sup>1</sup>/<sub>4</sub>"  
 Control Unit \_\_\_\_\_ 7<sup>1</sup>/<sub>4</sub>" x 4" x 5<sup>3</sup>/<sub>4</sub>"  
 Cable Length \_\_\_\_\_ 16' 8"

**Weight:**

Transmitter/Receiver \_\_\_\_\_ 45 lbs.  
 Control Unit \_\_\_\_\_ 1<sup>3</sup>/<sub>4</sub> lbs.

**Standby Battery Drain:**

	6 Volt	12 Volt
30 watt	8.2 amps.	4.4 amps.
60 watt	9.1 amps.	

**Transmitting Battery Drain:**

30 watt	40 amps.	20 amps.
60 watt	60 amps.	

Power Output \_\_\_\_\_ 30 watts, 60 watts

Sensitivity \_\_\_\_\_ Better than 0.3 microvolt with 20 db quieting

Selectivity \_\_\_\_\_ At least 85 db down at ±40 kc (adjacent channel)

Spurious Radiation \_\_\_\_\_ Down 60 db everywhere.  
 80 db 30-50 mc band

Spurious Response \_\_\_\_\_ All attenuated more than 85 db.  
 Image 100 db

Temperature Limits \_\_\_\_\_ -22° to 140° Fahrenheit

Two Frequency Separation \_\_\_\_\_ 120 kc max.

Frequency Stability (either transmitter or receiver)  
 Within .003% over entire temperature range

Transmitter Frequency Deviation \_\_\_\_\_ ±15 kc for 100% modulation

Audio Distortion \_\_\_\_\_ Less than 10% at ±15 kc

Audio Output \_\_\_\_\_ 1 watt

Transmitter Power Supply \_\_\_\_\_ Dynamotor

Receiver Power Supply \_\_\_\_\_ Vibrator

Rating \_\_\_\_\_ Intermittent 5 minutes on, 15 minutes off or  
 10 seconds on, 20 seconds off

**Stock Identification:**

6 Volt, 30 Watt _____	CMV-2A
12 Volt, 30 Watt _____	CMV-2C
6 Volt, 60 Watt _____	CMV-3A



# 250 Watt Station Transmitter

## Type CT-4c, 30-50mc, Fleetfone Station Equipment

### Features

- Superior audio quality establishes new standard.
- Positive threshold modulation limiter.
- Low spurious emission.
- Improved phase modulator requires no tuning.
- Excellent stability over wide temperature range.
- Adjustable to exact specified frequency.
- All tuning adjustments from front of transmitter.
- Exciter is standard unit.
- Provision for local or remote control.
- Provides space to mount additional receivers.

### Uses

This transmitter is designed for Emergency Communication Service where coverage of large area is involved. The transmitter design incorporates the latest circuit refinements. It can be used either at a remote location to obtain the benefit of a good site or installed near the operator.

### Description

The Type CT-4c Transmitter is housed in an attractively styled, new type cabinet rack which is 84 inches high. It has adequate space for receivers. The cabinet has locks on the front and rear doors. All tuning can be accomplished from the front of the transmitter. The front door is not electrically interlocked as no high voltage is exposed when this door is open. The r-f circuit of the Type CT-4c Transmitter consists of a 6SJ7 crystal oscillator, a 6SJ7 as a new type phase modulator, a 6SJ7 as first tripler, a 6SJ7 as second tripler, a 6V6 doubler, two 807's as an intermediate amplifier and two 8005's as a final power amplifier. The audio circuit consists of a 6SG7 audio amplifier and a 6SL7 threshold modulation limiter.

Two power supplies are provided, one for the exciter and one for the final amplifier. These are conventional rectifier and filter units using two 5R4-GY and two 866A's. All units are designed to fit a cabinet rack and consist of two 12¼ inch panels, one 10½ inch panel and one 7 inch panel. A special panel of four meters is provided so that the operation may be observed with the cabinet door closed. For remote operation, a control unit is provided to give transmitter and receiver operation over a single pair of telephone lines. The equipment is of rugged construction and conservatively rated to give maximum performance over a wide range of ambient temperatures.



**Specifications**

**Panel Space and Weights:**  
 Power Amplifier \_\_\_\_\_ 12¼", 30 lbs.  
 Exciter \_\_\_\_\_ 10½", 16 lbs.  
 Amplifier Power Supply \_\_\_\_\_ 12¼", 97 lbs.  
 Exciter Power Supply \_\_\_\_\_ 7", 51 lbs.

**Accessories Included** \_\_\_\_\_ Handset and stand, meter panel

**Frequency Range** \_\_\_\_\_ 30 to 44 megacycles

**Audio Characteristic** \_\_\_\_\_ 15 db. rise from 300 to 3000 cycles with rapid cut off after 3000 cycles

**Modulation** \_\_\_\_\_ ±15 kc for 100% modulation

**Rating** \_\_\_\_\_ Continuous at +50° C.

**Power Output** \_\_\_\_\_ 250 watts

**Frequency Stability** \_\_\_\_\_ Within .003% from -30° to +50° C.

**Distortion** \_\_\_\_\_ Less than 10% at 500 cycles with ±15 kc. swing

**Threshold Modulation Limiter** \_\_\_\_\_ 20 db. control

**Spurious Emission** \_\_\_\_\_ At least 70 db. down everywhere, including harmonics of carrier

**Standby Power Input** \_\_\_\_\_ 140 watts at 115 volts a-c

**Total Power Input** \_\_\_\_\_ 880 watts at 115 volts a-c

**Meters** \_\_\_\_\_ Final amplifier cathode current  
 \_\_\_\_\_ Final amplifier grid current  
 \_\_\_\_\_ Final amplifier plate voltage  
 \_\_\_\_\_ Final amplifier r-f current

**Metering Jacks** \_\_\_\_\_ Provided to measure:  
 \_\_\_\_\_ Second tripler grid current  
 \_\_\_\_\_ Doubler grid current  
 \_\_\_\_\_ Intermediate amplifier grid current  
 \_\_\_\_\_ Intermediate amplifier cathode current

**Antenna Relay** \_\_\_\_\_ Built in for send-receive operation

**TUBE COMPLEMENT**

Oscillator \_\_\_\_\_ 1 RCA 6SJ7  
 Phase Modulator \_\_\_\_\_ 1 RCA 6SJ7  
 1st Tripler \_\_\_\_\_ 1 RCA 6SJ7  
 2nd Tripler \_\_\_\_\_ 1 RCA 6SJ7  
 Doubler \_\_\_\_\_ 1 RCA 6V6  
 Intermediate Amplifier \_\_\_\_\_ 2 RCA 807  
 Limiter \_\_\_\_\_ 1 RCA 6SL7-GT  
 Audio Amplifier \_\_\_\_\_ 1 RCA 6SG7

Power Amplifier \_\_\_\_\_ 2 RCA 8005  
 Rectifier \_\_\_\_\_ 2 RCA 5R4-GY  
 Rectifier \_\_\_\_\_ 2 RCA 866A

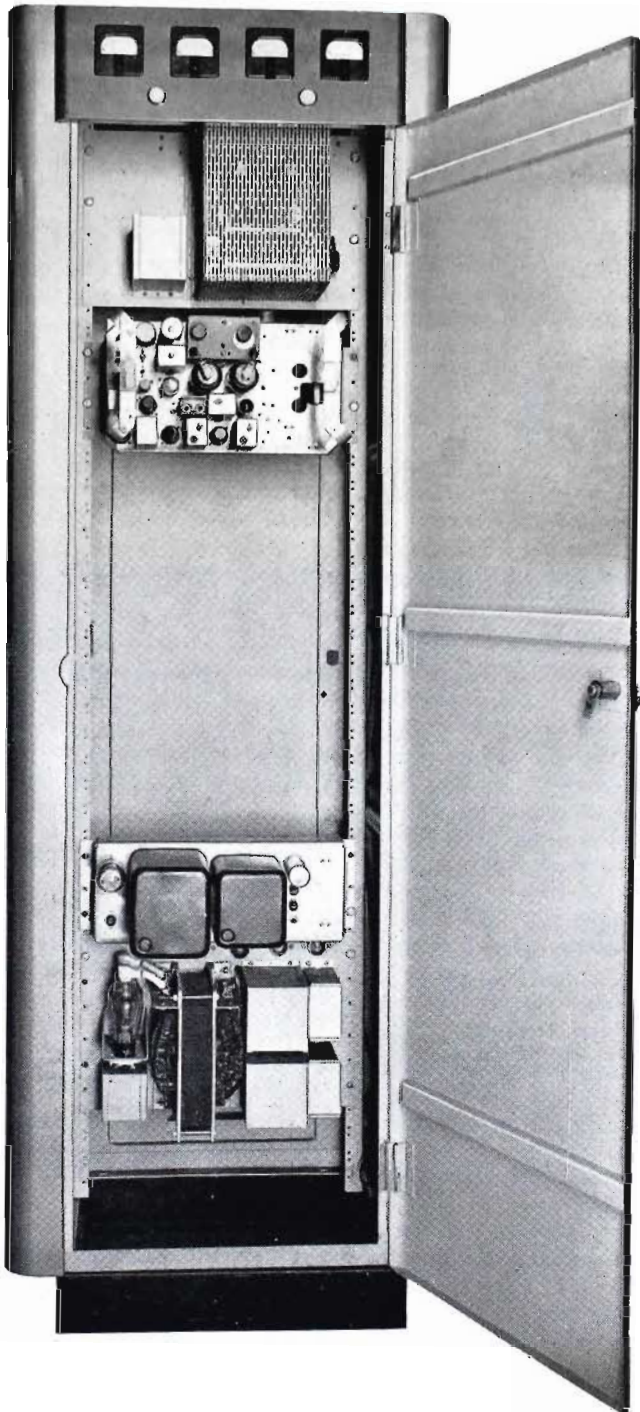



# 250 Watt Station Transmitter Type CT-6C

## 152-174 Mc, Carfone Station Equipment

### Features

- Excellent frequency stability.
- Attractive 84 inch cabinet rack.
- Interlock switch insures safety.
- Thermostatically controlled exhaust fan.
- Space provided for receivers.
- Remote control equipment available.
- Rack mounted—simplifies periodic inspections.

### Uses

RCA's Type CT-6C 250 Watt FM Transmitter is designed to meet the demands of those stations authorized to operate in the 152-162 mc. frequency range. This high power transmitter is ideally suited to areas needing a full 250 watt output.

### Description

The Type CT-6C Frequency-Modulated Transmitter consists of a 45-watt exciter unit, and its associated power supply plus a 250-watt power amplifier and its power supply. The 45-watt exciter unit is employed as a driver for the power amplifier unit. The combined equipment is capable of a power output of 250 watts at frequencies between the limits of 152 and 162 megacycles.

All units of the transmitter are installed in an attractive, rugged cabinet rack 84 inches in height, which allows adequate space for mounting receivers. Access to the units is afforded by front and rear doors, which are provided with locks to prevent unauthorized personnel from tampering with the equipment. An interlock switch is provided which removes high voltage from the equipment when the rear door is opened. All tuning is accomplished from the front of the transmitter, but there is no interlock here since no high voltage is exposed when this door is opened. A thermostatically controlled exhaust fan is mounted in the top of the cabinet to expell any excessive heat which may be created by the operation of the transmitter. A special panel of four meters is provided so the operation of the transmitter may be readily observed even though the cabinet door is closed.

The power amplifier incorporates a pair of 4-125A/4D21 tubes in a push-pull, class "C" circuit. Link coupling is employed at both input and output. The grid tank circuit consists of an open-ended line tuned by sliding a fixed capacitor along the line. The plate tank circuit has a shorted line tuned by a variable capacitor. Grid bias is obtained by a fixed voltage from the power supply and grid leak bias arrangement. The 4-125A/4D21 tubes are neutralized by series-resonating their screen grid lead inductance. Voltage is applied to the screens through the shunt r-f chokes in the circuit. The power supply incorporates a pair of RCA 866-A mercury vapor rectifier tubes connected in a single phase, full wave circuit.

RCA's remote control unit CC-1A is available for remote control operation of the type CT-6C FM transmitter. Through the use of this unit it is possible to transmit and receive from a remote operating point up to ten miles away.



### Specifications

#### Dimensions:

Power Amplifier	_____19" Rack Panel 12 7/32" wide
Exciter	_____19" Rack Panel 10 15/32" wide
Amplifier Power Supply	_____19" Rack Panel 12 7/32" wide
Exciter Power Supply	_____19" Rack Panel 10 15/32" wide
Standard Cabinet	_____Length, 84 1/4", Width 28", Depth 20 1/2"

#### Weight:

Power Amplifier	_____31 lbs.
Exciter (MI-31515)	_____29 lbs.
Amplifier Power Supply	_____126 lbs.
Exciter Power Supply (MI-31524)	_____40 lbs.
Cabinet (complete with above listed units)	_____507 lbs.



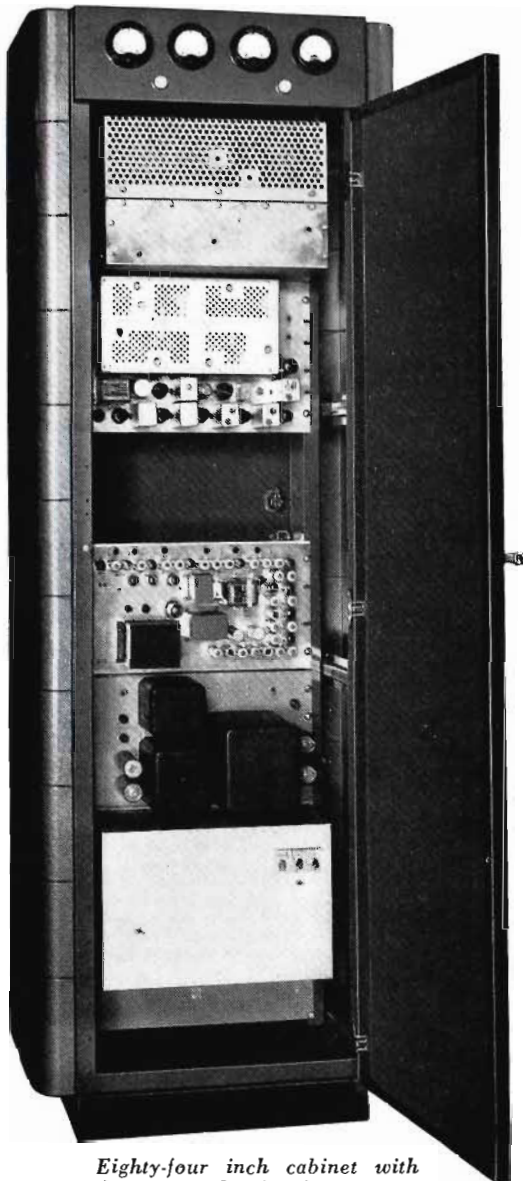

*Eighty-four inch cabinet with door open showing from top to bottom: CT-6C Power Amplifier, Exciter, CR-9A Receiver, and Transmitter Power Supply.*

Frequency Range	152-174 mc
Crystal Frequency Range	2111-2250 kc
Crystal Frequency Multiplication	72 times
Frequency Stability	$\pm 0.002\%$
Spurious Emission	At least 70 db down everywhere including carrier harmonics
Modulation (phase)	$\pm 15$ kc for 100% modulation
Distortion	Less than 5% at 500 cycles with 15 kc swing
Audio Characteristic	15 db rise from 500 to 3000 cycles
Modulation Threshold Limiter	20 db control
Input Volts	115 volts, 50-60 cycles
Temperature Range of Operation	30° C to 55° C
Duty	Continuous in maximum ambient temperature of 55° C
<b>Power Consumption:</b>	
R.F. Power Output	250 watts
Standby Power Input	200 watts
Total Power Input	1000 watts
Plate Power Supply	Full wave rectifier
<b>Meters</b>	
	PA Grid Current
	PA Plate Current
	PA Plate Voltage
	Line Voltage
<b>Metering Jacks—Provided to measure</b>	
	Power Amplifier Cathode Current
	Power Amplifier Grid Current
	Tripler Cathode Current
	Tripler Grid Current
	Doubler Cathode Current
<b>Tube Complement:</b>	
45 Watt Driver	
Audio Amplifier	1 RCA-6SG7
Limiter	1 RCA-6SL7
Oscillator	1 RCA-6SJ7
Phase Modulator	1 RCA-6SJ7
1st Tripler	1 RCA-6SJ7
1st Doubler	1 RCA-6SJ7
2nd Doubler	1 RCA-6V6
3rd Doubler	1 RCA-1614
2nd Tripler	1 RCA-829-B
Amplifier	1 RCA-829-B
250 Watt Power Amplifier	
Power Amplifier	2 RCA-4-125-A/4D21
Low Voltage Supply	
Rectifier	2 RCA-5R5-GY
High Voltage Supply	
Rectifier	2 RCA-866-A

# INDEX

<i>Type or MI Number</i>	<i>Description</i>	<i>Page</i>
A-1971	Austin Tower Lighting Transformer.....	334
A-2101	Austin Tower Lighting Transformer.....	334
A-2815	Austin Tower Lighting Transformer.....	334
BA-2C	Booster Amplifier .....	51
BA-5A	Recording Amplifier .....	43
BA-11A	Preamplifier .....	49
BA-13A	Program Amplifier .....	54
BA-14A	Monitoring Amplifier .....	56, 290
BCS-1A	Switching System .....	42
BCS-2A	Switching System .....	46
BE-1B	Line Equalizer .....	79
BE-21A	Sound Effects Filter.....	81
BF-Series	Pylon Antenna .....	288
BI-1B	Meter Panel .....	77
BI-2A	Meter Panel .....	77
BI-5A	Meter Panel .....	77
BI-11A	Transmission Meas. Set .....	350
BN-2A	Remote Amplifier .....	63
BPA-1A	1 KW Antenna Tuner.....	217, 221, 330
BPA-10	5-10 KW Antenna Tuner.....	223, 227, 331
BPA-50	50 KW Antenna Tuner.....	231, 332
BPC-1A	Antenna Lighting Choke Coil.....	335
BPM-1A	Remote Metering Kit.....	330
BR-2A	Panel and Shelf.....	75
BR-84	Standard Cabinet Racks.....	70
BTA-1L	1 KW AM Transmitter.....	220
BTA-5F	5 KW AM Transmitter.....	222
BTA-10F	10 KW AM Transmitter.....	226
BTA-50F1	50 KW AM Transmitter.....	231
BTA-250L	250 W AM Transmitter.....	216
BTC-1A	Transmitter Console .....	262
BTF-1C	1 KW FM Transmitter.....	246
BTF-3B	3 KW FM Transmitter.....	248
BTF-5A	5 KW FM Transmitter.....	252
BTF-10B	10 KW FM Transmitter.....	254
BTF-50A	50 KW FM Transmitter.....	258
BTF-250A	250 W FM Transmitter.....	244
BTP-1A	Radio Microphone .....	69
BX-1E	Power Supply .....	84
BX-4A	Relay Power Supply .....	84
BW-66E	AM Modulation Monitor.....	266, 359
CMV-1A	Carfone .....	396
CMV-2A	Flectfone .....	398
CT-4C	Flectfone Transmitter .....	400
CT-6C	Carfone Transmitter .....	402
GR-1170AT	FM Freq. and Mod. Monitor.....	358
HP-112-13	Remote Mod. Meter .....	361
KB-2C	Microphone .....	16
KN-1A	Microphone .....	19
KS-1A	Microphone Stand .....	22

<i>Type or MI Number</i>	<i>Description</i>	<i>Page</i>
KS-3B	Microphone Stand .....	23
KS-4A	Microphone Stand .....	24
KS-5A	Microphone Stand .....	20
LC-1A	Monitoring Speaker .....	104
LC-4A	Extended Range Loudspeaker.....	390
OP-6	Remote Amplifier .....	65
OP-7	Remote Mixer .....	66
OR-1A	Recorder .....	78
RC-2A	Crystals for BTP-1A.....	69, 283
RC-2B	Crystal Units .....	283
RC-2C	Crystal Units .....	283
RS-1A	Recording Suction Equipment.....	98
SP-15A	Portable Sound System.....	373
TA-1A	Distribution Amplifier .....	188
TA-5C	Stabilizing Amplifier .....	189
TA-10A	Mixing Amplifier .....	192
TC-5A	Director's Console .....	176
TC-65A	Remote Control .....	170
TD-1A	Camera Pedestal .....	146
TD-5A	Camera Dolly .....	147
TD-11A	Camera Tripod .....	123, 129
TD-15A	Tripod Dolly .....	127
TD-21A	Metal Tripod .....	132
TD-25A	Tripod Dolly .....	132
TD-30B/C/D	TV Studio Crane .....	150
TF-Series	Super Turnstile Antennas.....	293, 294
TFS-11A/22A	Super Gain Antenna .....	298
TG-1A	Synchronizing Generator .....	184
TG-10A	Field Sync Generator.....	116
TJ-50A	Mobile Unit .....	138
TK-1A	Monoscope .....	183
TK-10A	Studio Camera .....	144
TK-20A	Film Camera .....	156
TK-30A	Field Camera .....	114
TL-1A	Flourescent Bank .....	198
TL-5A	Lamp Bank .....	198
TL-10A	Spotlight Hanger .....	198
TL-11A	Spotlight Hanger .....	198
TL-15A	Lamp Mount .....	199
TL-26A	Dolly Light .....	199
TL-30A/31A	Light Panels .....	200
TL-32A	Fairleads .....	199
TM-1A	Program Monitor .....	181
TM-5A	Master Monitor .....	118, 154
TMP-20B	Kinphoto Video Equipment.....	162
TMV-129B	C/G/F Crystal Unit .....	217, 282, 283
TP-1A	Slide Projector .....	160
TP-9B	Multiplexer .....	160
TP-16B	Film Projector .....	152



<i>Type or MI Number</i>	<i>Description</i>	<i>Page</i>	<i>Type or MI Number</i>	<i>Description</i>	<i>Page</i>
TP-35B	Film Projector .....	154	15W-1	Monitoring Amplifier .....	61
TRR-1B	Relay Receiver .....	130	33-A/B	Jack Panels .....	76
TS-1A	Switching Panel .....	166	44-BX	Microphone .....	15
TS-10A	Switching System .....	167	50W-1	Monitoring Amplifier .....	60
TS-20A	Relay Switching System.....	172	56-C	Line Equalizer .....	80, 266
TS-30A	Field Switching System.....	120	56-E	Line Equalizer .....	80
TT-5A	5 KW TV Transmitter.....	270	57-D	Switch and Fuse Panel.....	78
TT-500A	500 W TV Transmitter, L.F.....	272	68-B	B.F. Oscillator .....	344
TT-500B	500 W TV Transmitter, H.F.....	274	69-C	Distortion and Noise Meter.....	345
TTC-3A	Switching Console .....	276	70-D	Turntable .....	86
TTR-1B	Relay Transmitter .....	128	72-D/72-DX	Recording Attachment .....	92
TVF-2A/4A	Houston Developer .....	163	73-B	Recorder .....	95
TVF-6A	Houston Air Unit.....	163	76-B5	Consolette .....	34
TVF-8A	Houston Printer .....	164	76-D	Consolette .....	38
TVK-75B	Kinephoto Camera .....	162	77-D	Microphone .....	12
TX-2A	Diplexer .....	295	86-B	Limiting Amplifier .....	58
TX-3A	Triplexer .....	300	88-A	Microphone .....	18
TY-25A	Power Supply .....	195	90-A	Program Stand .....	22
UC-3004	Capacitors .....	335	91-A	Microphone Stand .....	20
WA-3A	Grating Generator .....	348	91-B	Microphone Stand .....	20
WA-21A	Video Sweep Generator.....	347	93-A	Power Supply .....	343
WA-26A	Tone Generator .....	351	110 (Model)	Mobile Rec. Assembly (Clarke).....	339
WA-54A	Audio Oscillator .....	364	195-A	VoltOhmyst .....	365
WF-48A	AM Frequency Monitor.....	356	301-A		
WF-49A	Frequency Meter .....	357	(Model)	International Chairs .....	395
WF-50A	TV Frequency Monitor .....	357	301-B	Field Intensity Meter .....	342
WG-263	Crystal Probe .....	366	308-B	Field Intensity Meter .....	343
WG-275	Diode Probe .....	366	335-BR	Monitor and Meter .....	360
WG-284 (288)	High Voltage Probe.....	366	350-AH		
WM-20A	TV Signal Demodulator.....	353	(Model)	International Chairs .....	395
WM-30A	Phase Monitor .....	243, 354	"400" Series	16mm Projector .....	391-394
WM-71A	Distortion and Noise Meter.....	346	401-A		
WO-27A	D.C. Oscilloscope .....	367	(Model)	International Chairs .....	395
WO-58A	Cathode Ray Oscilloscope.....	368	580-C	Power Supply .....	193
WO-79A	Cathode Ray Oscilloscope .....	367	715-B	C.R. Oscilloscope .....	352
WP-23A	Reg. Power Supply .....	368	34	Cable .....	28
WP-33B	Power Supply .....	194	35	Cable .....	28
WR-39A	TV Calibrator .....	363	43-A	Cable .....	27
WR-53A	FM Sweep Generator .....	362	48	Pulse Cable .....	214
WR-59A	TV Sweep Generator .....	362	49	Cable .....	28
WR-67A	Test Oscillator .....	364	51	Power Cable .....	214
WS-18A	Rack-Adaptor Panel .....	364	54	Power Cable .....	214
WV-65A	Battery VoltOhmyst .....	365	62	Cable .....	27
WV-73A	Audio Voltmeter .....	363	63-A	Cable .....	28
WV-75A	Advanced VoltOhmyst .....	365	64	Cable .....	26
WV-84A	D-C Microammeter .....	362	65	Cable .....	26
WV-95A	Master VoltOhmyst .....	366	74-A	Coax Cable .....	214
WX-1A	F.I. Meter .....	338	75	Coax Cable .....	214
WX-2C	F.I. Meter .....	341	78/79/80	Power Cable .....	214
9-AX	Cabinet Rack .....	72	82	Intercom Cable .....	214

<i>Type or MI Number</i>	<i>Description</i>	<i>Page</i>
83	Coax Cable .....	214
83-506	Reducer for BAF-14A.....	291
90	Coax Cable .....	214
94-C	Camera Cable .....	214
98-505	Reducer for BAF-14A.....	291
1000 (Model)	International Chairs .....	395
4027-G	Microphone .....	15
4045-B	Microphone .....	12
4048-E	Microphone .....	18
4058-C	Microphone Stand .....	20
4087	Protective Cloth Bag.....	12
4092-C	Microphone Stand .....	20
4093-B	Microphone Stand .....	23
4095-A	Microphone Stand .....	20
4096	Microphone Stand .....	21
4162/A	Equalizer .....	80
4168	Equalizer .....	80
4171-29/30	Pads .....	83, 161
4196	Equalizer .....	79
4309-B	Audio Power Change Panel.....	266
4395-E	Switch Panel .....	78
4519-C/E	Cabinet Rack .....	72
4524-A/D	"U" Strip .....	73
4537-A/D	"J" Strip .....	73
4568	Power Block .....	73
4569	Audio Block .....	73, 266
4570/A	Terminal Bracket .....	71, 73
4571	Cable Support .....	73
4589/99	Blank Panels .....	73
4620-B	Extension Cord .....	27
4624-A	Receptacle .....	27
4630-B	Plug .....	27
4645-A	Jack Panel .....	76
4646-A	Jack Panel .....	76
4652 (Series)	Patch Cords .....	76
4842	Stylus .....	101
4875-G	Pickup Kit .....	89
4878-BC	Stylus .....	101
4879-A	Stylus .....	81
4901-A	Transformer .....	65
4902	Transformer .....	82
4916-A	Recording Filter .....	100
4917-A	Sound Effects Filter.....	81
4925-A	H.F. Compensator .....	80, 266
4926-A	Pre-Emphasis Filter .....	266, 267
4928	Microscope .....	98
4975	Filter .....	89
6106	Molded Speaker Housing.....	106
6206-E	Microphone .....	19
6208	Microphone Stand .....	23

<i>Type or MI Number</i>	<i>Description</i>	<i>Page</i>
6229	Microphone Adaptor .....	21
6234-B	Accordion Edge Speaker Mechanism.....	107
6333-C	Speaker Mechanism .....	107
6425	Pushmike Adaptor .....	21
6427	Microphone Stand .....	21
6787	AM-FM Radio Tuner .....	388
7015	Spare FM Exciter Equipment.....	249, 255, 259
7016	FM Exciter Unit .....	264
7017	Power Supply .....	264
7020	Tube Kit for MI-7016/7017.....	249, 255, 259
7037	60/50 Cycle Conv. Kit for BTA-50F.....	231
7050-A	50 KW AM Transmitter.....	231
7083-A	Tube Kit for BTA-5F.....	223
7084-A	Tube Kit for BTA-10F.....	227
7085-A	60/50 Cycle Conv. Kit for BTA-5F.....	223
7112-A	Lighting Choke .....	335
7147	Ant. Ammeter with Int. Thermocouple.....	330
7157-B	Remote Ammeter .....	217, 221
7184-A-150	Remote Antenna Current Meter.....	243, 355
7186-B	1 KW AM Transmitter.....	220
7187-A	1 KW AM Amplifier.....	217
7188-A	Power Change Kit, 1 KW Transmitter.....	221
7233-4	Patch Cord .....	210
7242-C	250 W AM Transmitter.....	216
7245-B	Tube Kit for BTA-250L Transmitter.....	217
7260-C	5 KW AM Transmitter.....	222
7266-C	10 KW AM Transmitter.....	226
7267-A	5/10 KW Conversion Kit.....	223, 227, 229
7303/-A	5/10 KW Conversion Kit.....	229
7318	Tube Kit for BTA-1L Amplifier.....	221
7320	Tube Kit for BTA-1L Exciter.....	221
7321	Tube Kit for MI-7488-A.....	331, 332
7327-4	Isolation Coil .....	243, 355
7467	Crystal Unit .....	217, 282
7485-E	Right Wing Audio Cab. for BTA-5F/10F .....	223, 227
7485-F	Left Wing Phasing Cab. for BTA-5F/10F .....	223, 227
7488-A	Monitoring Rectifier .....	331, 332
7511-D	Beat Freq. Oscillator.....	344
7512-H	Distortion and Noise Meter.....	345
7519-A	Power Supply .....	343
7549-C	F.I. Meter, H.F. ....	342
8204-A	Storage Battery for 93-A.....	343
8217	Sampling Kit .....	243
8217-A	Sampling Coil .....	243, 355
8217-B	Loop and Meter.....	243
8217-C	Meter Panel .....	243
8217-D	Loop .....	243, 355
8223-A2	Loop No. 1 .....	343

<i>Type or MI Number</i>	<i>Description</i>	<i>Page</i>	<i>Type or MI Number</i>	<i>Description</i>	<i>Page</i>
8223-A3	Loop No. 3 .....	343	11309	Relay Power Supply.....	84
8225-E	F.I. Meter .....	343	11350	Transmission Meas. Set.....	350
8263	Crystal Probe .....	366	11388	Meter Panel .....	77
8293	Power Supply .....	339	11401/A	Monitoring Loudspeaker .....	104
9625-B	Tubes (Sound Head).....	155	11411	Monitoring Loudspeaker .....	104
10253	Transformer .....	266	11500	Cabinet .....	74
11001	Microphone .....	16	11501-4	Jack Mats .....	76
11050	Program Stand .....	22	11598/9	Panel and Shelf.....	75
11052	Microphone Stand .....	24	11606	Filament Transformer .....	83
11056	Boom Stand .....	23	11613-D	Consolette .....	34
11099	Cable Hook .....	22	11616	Transmitter Control Console.....	227, 228
11100-A/ 11101-A	Automatic Rec. Equalizer.....	100	11621	Supervisory Console .....	232
11202-A	Remote Amplifier .....	65	11622	Switching System .....	46
11213	Mixer Amplifier .....	66	11623	Monitor and Amplifier Rack .....	223, 227, 229, 233, 266
11214	Battery Box .....	64, 67	11625	Master Switching Console.....	42
11226-B	Booster Amplifier .....	51	11625-A	Studio Switching Console.....	42
11230	Remote Amplifier .....	63	11631	Consolette .....	38
11231	Pre-Amplifier .....	49	11702	On-Air Light Relay.....	35, 279
11233/A	Program Amplifier .....	54	11703-A	Speaker Relay .....	35, 39, 279
11235	Monitoring Amplifier .....	61	11704/A-M	Dividing Networks .....	83
11236	Monitoring Amplifier .....	60	11705	Bridging Pad .....	83
11251	V.U. Meter and Kit.....	65	11706/1-5	Studio Warning Lights.....	47
11252/D	Tube Kit for 76-B5 and 76-D.....	35, 38	11707	Speaker Filter .....	105
11253/A	Tube Kit for OP-6.....	65	11708-A	Speaker Attenuator .....	105
11254/A	Tube Kit for OP-7.....	66	11711	Speaker Accessory Kit.....	105
11255	Kit of Batteries for MI-11255.....	64	11712	Bridging Transformer .....	82
11256	Fabric Cover .....	65	11713	Line Transformer .....	82, 161
11257/8	Fabric Cover .....	66, 67	11714	Signal Light .....	46
11262	Tube Kit for BX-1E.....	84, 266	11719-A/B	Cord .....	28
11265	V.U. Meter Panel.....	78	11801/2/A	Turntable .....	86
11266/A	Tube Kit for MI-11233.....	55	11803	Mounting Base for 70-D.....	87
11267/A	Tube Kit for BA-14A.....	56	11825/6	Recorder .....	95
11268/A	Tube Kit for 76-D.....	39	11827	Recorder Base Cabinet.....	95
11269	Tube Kit for BN-2A.....	64	11850-C	Recording Head .....	95, 99
11270-A/B	Grounding Sheath Connectors.....	28	11851	Advance Ball Kit.....	101
11271	Wedge-On Tool .....	28	11853-A	Recording Head .....	101
11275	Meter Panel .....	77	11854	Mounting Base Kit.....	92
11277	Waterproof Cover for BN-2A.....	64	11855-A	Heater and Compensator Kit.....	99
11278/B/C/D	Volume Control Kit.....	50	11857/8	Recording Suction Equipment.....	98
11279	BN-2A Battery Cover.....	64	11858	Chip Collector .....	98
11280/A	Voltage Regulator Transf.....	266	11883	45 RPM Conversion Kit.....	87
11281	Kit of Batteries for Cover.....	64	11884	Fine Groove Pickup and Tone Arm.....	87
11286-B	Tube Kit for 86-B.....	59	11900/1	Recording Attachment .....	92
11287/A	Tube Kit for BA-2C.....	51	12051	Microphone Adaptor .....	21
11288/A	Tube Kit for BA-11A.....	50, 266	12053	Microphone Adaptor .....	21
11301-B	Power Supply .....	34	12055	Microphone Adaptor .....	21
11303	Power Supply .....	85, 279	12057/A	Microphone Adaptor .....	21
11304	Power Supply .....	85	12058	Female Connectors .....	27
11305-D	Power Supply .....	84, 266	12059	Male Plug for Microphone.....	27



<i>Type or MI Number</i>	<i>Description</i>	<i>Page</i>
12065	Microphone Stand .....	22
12066	Microphone Stand .....	20
12081-C	Microphone .....	19
12239	Monitoring Amplifier .....	57
12242	Remote Pre-Amplifier .....	374
12370	Speaker Transformer .....	108
12371	Speaker Transformer .....	108
12373	Speaker Transformer .....	108
12421	Speaker Mechanism .....	107
12499	Two-Way Loudspeaker .....	389
12592	Intercom System .....	376
12595	Intercom System .....	376
12596-3	Intercom System .....	376
13225	Wall Speaker Housing .....	106
13240	Desk Stand .....	21
13245	Adaptor for Speakers .....	106
14901/2/4/5	Sound Consoles.....	378, 380, 382, 384
14906	Sound Transcription Pedestal.....	386
15005-B	Kinephoto Video Equip. ....	162
15006-B	Kinephoto Camera .....	162
18715-B	C.R. Oscilloscope .....	352
19002	Super Turnstile, Two-Section.....	294
19009-B/C/D	Sleet Melting Equipment.....	294
19012-A		
B/C/D	Super Turnstile, Three-Section.....	294
19013/A	Super Turnstile, Six-Section.....	294
19015-2/3	Super Turnstile, Single-Section.....	293
19017-A	Super Turnstile, Four-Section.....	294
19018-A	Super Turnstile, Five-Section.....	294
19023	Triplexer .....	300
19024-A/B	Dummy Load.....	271, 273, 301
19028	Diplexer .....	295
19029	Super Turnstile, Five-Section.....	294
19030-A/B	Spare Tubes (TT-5A).....	271
19050-A/B	Set Tubes (FCC) TT-5A.....	271
19051	TV Monitoring Diode .....	353
19058	Coax RF Transfer Panel.....	328
19063	Switching Turret .....	278
19104	Side-Band Filter .....	280
19112-		
1 thru 16	1 $\frac{5}{8}$ " 51.5-Ohm Line and Fittings.....	312, 313
19112-6	Reducer for BAF-14A.....	291
19112-14	Expansion Hangers—1 $\frac{5}{8}$ " .....	324
19112-15	Fixed Hanger—1 $\frac{5}{8}$ " .....	325
19113-		
1 thru 13	3 $\frac{1}{8}$ " 51.5-Ohm Line and Fittings.....	316, 317
19113-14	Expansion Hangers—3 $\frac{1}{8}$ " .....	324
19113-15	Fixed Hanger—3 $\frac{1}{8}$ " .....	325
19114-1 thru 5	6 $\frac{1}{8}$ " 51.5-Ohm Line and Fittings.....	318
19118	Bridging Plug .....	210

<i>Type or MI Number</i>	<i>Description</i>	<i>Page</i>
19122-A	TV Control Console .....	263
19203	Monitoring Equipment .....	273
19205-A/B	TV Transmitter .....	270
19206	TV Transmitter .....	272
19305-1 thru 5	$\frac{7}{8}$ " 51.5-Ohm Line and Fittings.....	307
19306-1 thru 8	$\frac{3}{4}$ " 72-Ohm Line and Fittings.....	306
19307-1 thru 5	$\frac{7}{8}$ " 72-Ohm Line and Fittings.....	307
19308-1 thru 6	$\frac{7}{8}$ " 72-Ohm Line and Fittings.....	308
19309-1 thru 6	$\frac{7}{8}$ " 51.5-Ohm Line and Fittings.....	310
19309-6	Reducer for BAF-14A.....	291
19309-20		
21/22	Hangers ( $\frac{7}{8}$ "—Flat Members).....	320
19309-		
23 thru 28	Hangers ( $\frac{7}{8}$ "—Round Members).....	322, 323
19309-29		
30/31	Hangers ( $\frac{7}{8}$ "—Angular Members).....	323
19309-32		
33/34	Hangers ( $\frac{7}{8}$ "—Direct Mounting).....	323
19310-1 thru 5	1 $\frac{5}{8}$ " 72-Ohm Line and Fittings.....	314
19312-17/18	Hor. Anchors—1 $\frac{5}{8}$ " .....	325
19312-19	Spreader—1 $\frac{5}{8}$ " .....	327
19312-20		
21/22	Hangers (1 $\frac{5}{8}$ "—Flat Members).....	320
19312-		
23 thru 28	Hangers (1 $\frac{5}{8}$ "—Round Members).....	322, 323
19312-29		
30/31	Hangers (1 $\frac{5}{8}$ "—Angular Members).....	323
19312-32		
33/34	Hangers (1 $\frac{5}{8}$ "—Direct Mounting).....	323
19312-35	Roller Assembly—1 $\frac{5}{8}$ " Line.....	324
19312-36	Lateral Brace .....	325
19312-37/38	Swivel Hangers—1 $\frac{5}{8}$ " .....	327
19312-		
40 thru 44	Fixed Hangers—1 $\frac{5}{8}$ " .....	326
19313-17/18	Hor. Anchors—3 $\frac{1}{8}$ " .....	325
19313-19	Spreaders—3 $\frac{1}{8}$ " .....	327
19313-20		
21/22	Hangers (3 $\frac{1}{8}$ "—Flat Members).....	320
19313-		
23 thru 28	Hangers (3 $\frac{1}{8}$ "—Round Members).....	322, 323
19313-29		
30/31	Hangers (3 $\frac{1}{8}$ "—Angular Members).....	323
19313-32		
33/34	Hangers (3 $\frac{1}{8}$ "—Direct Mounting).....	323
19313-35	Roller Assembly—3 $\frac{1}{8}$ " Line.....	324
19313-36	Lateral Brace .....	325
19313-37/38	Swivel Hangers—3 $\frac{1}{8}$ " .....	327
19313-		
40 thru 44	Fixed Hangers—3 $\frac{1}{8}$ " .....	326
19400/A	Crystal Unit .....	282, 283

<i>Type or MI Number</i>	<i>Description</i>	<i>Page</i>	<i>Type or MI Number</i>	<i>Description</i>	<i>Page</i>
19406	Lead-In Bowl Insulator.....	330, 335	26223	Master Con. Panel (Remote Console).....	180
19413-1	Bowl Insulator .....	331, 332, 335	26230	Auxiliary Relay Chassis.....	173
19413-3	Entering Insulator .....	335	26231	Basic Relay Chassis.....	173
19421	Bayonet Insulator .....	328	26232	Auxiliary Relay Panel .....	173
19450-A	TMV-129G Crystal Units.....	249, 282	26233	Basic Relay Panel .....	173
19463-3	Crystal Units .....	283	26234	Tally Light Panel .....	173
19464-4/7	Crystal Units .....	283	26237	Switching Panel .....	166
19889	Remote Antenna Meter .....	331	26238	Aux. Field Switching Control.....	122
21200-C1	Plate Current Meter .....	210	26240	Circuit Breaker Panel .....	209
21523-B2	Power Supply .....	193	26245	Video Jack Panel.....	210
26000-A	Studio Camera Less I.O.....	145	26247	Remote Con. Panel for Relay Rec. ....	170
26005	Camera Viewfinder .....	145	26248	Remote Control Panel .....	170, 183
26020-A	Film Camera .....	157	26249	Sync. Gen. Control .....	170, 185
26035	Camera Pedestal .....	146	26250	Stabilizing Amp. Control .....	170
26037-1/2/3	Studio Crane .....	150	26251	Console Power Relay Control Panel...170,	209
26040	Camera Dolly .....	147	26252	Panel (Basic) .....	170
26042	Tripod Dolly .....	127	26253	Panel (Blank) .....	170
26043	Tripod Dolly .....	132	26254	Remote Con. Panel (Adapter).....	171
26046	Camera Tripod .....	123, 129	26265-1/2	Desk End Sections.....	201, 263
26047	Metal Tripod .....	132	26266-B	Console Housing .....	145, 157, 201
26050	Pedestal .....	157	26281	Mixing Amplifier .....	192
26055	Camera Control Chassis .....	145	26285	Sync. Gen. Switching Panel.....	186
26075	Camera Control Chassis.....	157	26286	Sync. Gen. Delay Panel.....	186
085-B	Power Supply .....	194	26293	Power Control .....	137
26086	Power Supply .....	195	26297	Announce Monitor .....	181
26090	Current Regulator .....	196	26300-A	Sound Head .....	155
26095	Power Supply .....	115	26301	Film Magazine .....	155
26096	Power Supply .....	195	26304-A	Pedestal .....	155
26120	Projector Head .....	155	26305	Relay Transmitter Control.....	129
26125-A	Projector Head .....	153	26310-A	Relay Receiver Control.....	130
26130	Slide Projector .....	160	26313	Sound Equalizer .....	153
26132	Pedestal .....	153	26314	Power Supply (Proj. Motor).....	153
26135-A	Master Monitor .....	118, 154, 157	26317	Lens .....	155
26140	Program Monitor .....	181	26318	Multiplexer .....	160
26155	Distribution Amplifier .....	188	26321	Changeover Panel .....	161
26160-A	Stabilizing Amplifier .....	189	26510-1/2/3	Shock Mounts .....	115, 119
26166-A	Relay Transmitter Only.....	129	26518	Tripod Access. Kit .....	133
26181-A	Relay Receiver Only.....	130	26518-99	Tripod Plate for Relay Transmitter.....	139
26185-A/B	Parabolic Reflector .....	129	26521	Field Carrying Case.....	119
26186	Antenna Feed System .....	129	26522	Carrying Case .....	181
26187	Parapet Mount and Reflector.....	134	26525-1 thru 8	Blank Chassis .....	208
26189	Parapet Clamp Support Mount.....	134	26526	Rack Mounting Adaptor.....	119
26190-1	Lo-Hat .....	135	26527	Carrying Case .....	195
26190-2	Hi-Hat .....	135	26548	Video Analyzer .....	206
26205	Friction Head .....	126, 146	26549-1/2/3	Camera Lenses .....	206, 207
26206	Antenna Tilt Head.....	129, 133	26550-		
26207	Antenna Ring Mount.....	135	1 thru 10	Camera Lenses .....	205
26210-A	Control Box .....	155	26565	Wavemeter .....	129
26221	Program Control Panel .....	165	26569	Rack—Audio Equipment .....	139
26222	Master Con. Panel (Master Console).....	180	26570-3	Headset .....	129

<i>Type or MI Number</i>	<i>Description</i>	<i>Page</i>	<i>Type or MI Number</i>	<i>Description</i>	<i>Page</i>
26570-6	Headset .....	121	26925	35mm Projector .....	154
26573	Cable Reel .....	139	26927-A	Projector Room Con. Rack.....	155
26574	Boom Stand and Perambulator.....	26	26930-A	16mm Projector .....	152
26576	Ring Sight .....	115	26935-A	Relay Transmitter .....	128
26578	Attenuating Coupler .....	136	26940-A	Relay Receiver .....	130
26579-A	Blower Kit .....	119, 145, 157	26950	Field Switching System.....	120
26581	Panel and Shelf.....	153	26960	Monoscope Camera .....	183
26602	Houston Developer .....	163	26965	Switching System .....	167
26604	Houston Developer .....	163	26970	Relay Switching System .....	172
26606	Houston Air Unit .....	163	26975-1 thru 8	Director's Console .....	176
26608	Houston Printer .....	164	26981	Mobile TV Unit .....	138
26615	Flourescent Bank .....	198	26985	Remote Control .....	170
26617	Dolly Light .....	199	28010	Transmission Line Wire.....	328
26618	Lamp Bank .....	198	28011-A	Lead-In Kit .....	329
26620/21	Spotlight Hangers .....	198	28012-A/B	Dead-End Kits .....	329
26622	Lamp Mount .....	199	28013	Pole and Cap .....	329
26624	Mercury Switch Panel.....	200	28014	Bayonet Accessories .....	329
26627	Light Control Panel .....	200	28015	Lead-In and Ground Access. Kit.....	329
26632	Fairleads .....	199	28027	Metering Kit .....	217, 221, 330
26660	Crystal Detector .....	129	28037-A	Meter and Thermocouple.....	217, 221, 330
26725-1 thru 4	Camera Cable .....	211	28051	FM Notch Filter, 50 KW.....	292
26730	Interconnecting Cables—Field Camera.....	214	28052	FM Notch Filter, 10 KW.....	292
26735	Interconnecting Cables—Sync. Gen. ....	214	28152	Power Change Kit for BTA-10F.....	227
26740	Interconnecting Cables—Field Switch.....	214	28154	BTF-10B Power Cut Back Equipment.....	25
26745	Interconnecting Cables—Film Camera.....	214	28156	Tube Kit for BTF-250A Transmitter.....	2
26746	Interconnecting Cables—Camera Con. ....	214	28157	Tube Kit for BTF-1C Transmitter.....	2
26755	Interconnecting Cables—Field .....	214	28158	Tube Kit for BTF-3B Transmitter.....	249, 2
26756-1/2/3	Interconnecting Cables .....	211	28159	Tubes for BTF-10B.....	255
26757	Pulse Distr. Box .....	187	28160	Tubes for MI-28919.....	245
26758	Shock Mounts .....	139	28161	Tube Kit for MI-28920.....	247
26759-1	Camera Cables and Plugs.....	211	28162	Tube Kit for MI-28921.....	247
26759-2 thru 8	Power Cable .....	212	28163	Tube Kit for MI-28922.....	249
26759-9/10	Pulse Cable .....	212	28178	Modification Kit .....	255
26759-11	Intercom Cable .....	212	28194-A1/A3	Tube Set .....	231
26759-12 thru 15	Coax Cable .....	213	28215-1/2/3	Austin Tower Lighting Transf. ....	334
26759-17	Pulse Term. Plug .....	213	28221-A/B	Pylon, One-Section .....	286-289
26759-18	Coax Fittings .....	213	28222-		
26759-19 thru 24	Cable Connectors .....	213	A/B/E/F	Pylon, Two-Section .....	288
26760	Elapsed Time Indicator.....	208	28224-		
26761	Power Relay Panel.....	171, 209	J/K/X/Y	Pylon, Four-Section .....	288
26762	Lamp House .....	155	28227-A/B	Isolation Unit .....	290
26764-1/2/3	Circuit Breaker Panel.....	209	28228-A/B	Pylon, Eight-Section .....	288
26815	Sync Generator .....	185	28231-A/D	Pylon, One-Section .....	288
26900	Studio Camera Chain .....	144	28248	Modification Kit .....	259
26905	Field Camera Chain .....	114	28291	Battery for BTP-1A.....	69
26910	Film Camera Equip. ....	156	28292	Tubes for BTP-1A.....	69
26915	Sync Generator .....	184	28293	Crystals for BTP-1A.....	69
26920	Field Sync Generator .....	116	28401-1	Basic Desk Section.....	263, 279
			28401-2	90° Desk Section.....	263
			28403-1	Blank Turret .....	263



Type or MI Number	Description	Page
28404-1	Blank Turret for 90° Section.....	263
28410	Audio Control Turret.....	263
28420	Transmitter Control Turret.....	263
28425	Limiting Amp. Ext. Meter 4".....	263
28901-A	1 KW Antenna Tuner.....	217, 330
28902-A/B	5-10 KW Antenna Tuner.....	223, 227, 331
28903-A/B	50 KW Antenna Tuner.....	231, 331, 332
28905	Power Change Kit for BTA-50F.....	231
28911	250 W FM Transmitter.....	244
28914	10 KW FM Transmitter.....	254
28919	Conv. Kit for BTF-250A.....	245
28920	1 KW to 3 KW FM Conv. Equip.....	247
28921	1 KW to 10 KW FM Conv. Equip.....	247
28922	3 KW to 10 KW FM Conv. Equip.....	219
28926	50 W FM Transmitter.....	258
28950	Universal Transmitter Console.....	262
28960	5 KW FM Transmitter.....	252
30001-A	F.I. Meter .....	338
30002-C	F.I. Meter .....	341
30003-A	Grating Generator .....	318
30021-A	Video Sweep Generator .....	347
30026-A	Tone Generator .....	351

Type or MI Number	Description	Page
30030-A	Phase Monitor .....	243, 354
30048-A	Frequency Monitor .....	266, 356
30050-A	TV Frequency Monitor .....	357
30053-A	FM Sweep Generator .....	362
30054-A	Audio Oscillator .....	364
30065-A	Battery VoltOhmyst .....	365
30066-A	AM Modulation Monitor.....	266, 359
30071-A	Distortion and Noise Meter.....	346
30073-A	Audio Voltmeter .....	363
30179	Oscilloscope .....	367
30195-A	VoltOhmyst .....	365
30531-G81	Door .....	71
30541-G84	Panels .....	71, 266
30546-G21	Shield .....	71
30516-G28	Shield .....	71
30566-G81	Cabinet Rack Trim Strip.....	71, 266
30568-C81	Cabinet Rack Trim Strip.....	71
30951/ A81-E81	Racks .....	70
43501	Extension Meter .....	229
44899	Remote Meter .....	263